

United States of America

United States Patent and Trademark Office

EMERSON PROCESS MANAGEMENT

Reg. No. 4,064,996

Registered Dec. 6, 2011

**Int. Cls.: 7, 9, 11, 35, 37
and 42**

TRADEMARK

SERVICE MARK

PRINCIPAL REGISTER

EMERSON ELECTRIC CO. (MISSOURI CORPORATION)
8000 W. FLORISSANT AVE.
ST. LOUIS, MO 63136

FOR: REGULATORS BEING PARTS OF MACHINES, AND NOT PART OF PLUMBING, HEATING OR COOLING INSTALLATIONS, NAMELY, GAS FLOW REGULATORS, GAS PRESSURE REGULATORS, GAS PRESSURE REGULATORS FOR CONTROLLING GAS, AIR OR WATER, AIR PRESSURE REGULATORS, PRESSURE REGULATORS, FUEL PRESSURE REGULATORS AND AIR AND FUEL REGULATORS, IN CLASS 7 (U.S. CLS. 13, 19, 21, 23, 31, 34 AND 35).

FIRST USE 10-0-2001; IN COMMERCE 10-0-2001.

FOR: CONTROL PLATES, NAMELY ELECTRICAL CONTROL PANELS; CONDENSER REGULATOR CONTROL VALVES FOR REGULATING THE FLOW OF LIQUIDS AND GASES; FLOW SELECTORS, NAMELY, FLUID AND GAS FLOW REGULATORS THAT SELECT THE APPROPRIATE FLUID OR GAS FLOW FOR COMMERCIAL AND INDUSTRIAL USE; PRESSURE, TEMPERATURE, LEVEL AND FLOW MEASUREMENT DEVICES, NAMELY, PRESSURE, DENSITY AND FLOW RATE DETERMINING UNITS FOR PROCESS MONITORING AND WATER TREATMENT CONTROL IN THE NATURE OF COMMERCIAL FLOW REGULATORS; AUTOMATIC TEMPERATURE REGULATORS; TEMPERATURE CONTROL VALVES FOR REGULATING THE TEMPERATURE OF WATER IN WATER TREATMENT PLANTS; TEMPERATURE RESPONSIVE, FLAME RESPONSIVE, AND PRESSURE RESPONSIVE SWITCHING DEVICES IN THE NATURE OF ELECTRIC SWITCHES THAT ARE TEMPERATURE RESPONSIVE, FLAME RESPONSIVE, PRESSURE RESPONSIVE; ELECTRIC TEMPERATURE CONTROLS; TEMPERATURE CONTROL DEVICES FOR ELECTRIC HOT WATER HEATERS IN THE NATURE OF TEMPERATURE SENSORS; TEMPERATURE INDICATORS, TEMPERATURE RECORDERS AND ELECTRONIC FLUID TEMPERATURE CONTROL UNITS FOR INDUSTRIAL WASTE PROCESSING PLANTS; TEMPERATURE DETECTORS AND ASSOCIATED ELECTRICAL CONTROLLERS; SOLID STATE TEMPERATURE ELECTRIC CONTROLLERS; ELECTRONIC SPEED CONTROLLERS; SOLID STATE TEMPERATURE ELECTRICAL CONTROLLERS; OVERHEAT CONTROLS, NAMELY, ELECTRICAL CONTROLLERS TO PREVENT OVERHEATING IN REFRIGERATION SYSTEMS; ELECTRONIC TEMPERATURE CONTROL APPARATUS FOR CONTROL OF HEATING/COOLING UNITS USED IN INDUSTRIAL PROCESSING AND COMMERCIAL APPLICATIONS, NAMELY TEMPERATURE SENSORS, AND TEMPERATURE CONTROL DEVICES FOR ELECTRIC HOT WATER HEATERS, NAMELY, TEMPERATURE SENSORS;



David J. Kybas

Director of the United States Patent and Trademark Office

Reg. No. 4,064,996 ELECTRICAL OIL BURNER CONTROLS; GAS BURNER ELECTRICAL CONTROLS; FLOW METERS FOR MEASURING, INDICATING, RECORDING AND CONTROLLING THE FLOW OF FLUIDS; SIGHT FLOW INDICATORS; SIGNALING OR ALARM DEVICES AND SYSTEMS FOR SENSING AND REGULATING OR CONTROLLING FLUID LEVEL OR FLUID FLOW IN THE NATURE OF EMERGENCY SIGNAL TRANSMITTERS; ELECTRONIC MOTION AND POSITION TRANSMITTERS FOR USE IN CONNECTION WITH FLOW METERS AND FLUID LEVEL INDICATORS; FLOW-INDICATING, FLOW-RECORDING, FLOW-CONTROLLING, FLOW-PROPORTIONING AND FLOW-INTERPRETING EQUIPMENT FOR USE WITH FLOW METERS TO SENSE THE POSITION OF A FLOW-RESPONSIVE ELEMENT AND TO TRANSMIT, SIGNAL, INDICATE OR RECORD THE SAME AT A PLACE REMOTE FROM THE FLOW METER, OR TO RECORD, CONTROL, PROPORTION OR INTERPRET THE FLUID FLOW TO OR FROM THE FLOW METER IN THE NATURE OF COMPUTERS AND COMPUTER PROCESSING UNITS; DIAPHRAGM-TYPE PRESSURE TRANSMITTING SEALS FOR USE WITH PRESSURE RESPONSIVE FLOW METERS CONSISTING OF A RADIO TRANSMITTER AND A METAL SEAL SOLD AS A UNIT; POSITIVE DISPLACEMENT BI-ROTOR FLUID METERS; LIQUID LEVEL GAUGES; LIQUID AND FLOWABLE SOLIDS LEVEL INDICATORS; BIN AND TANK LEVEL INDICATORS; DISPLAY AND RECORDING UNITS CONSISTING OF COMPUTERS AND COMPUTER HARDWARE FOR MEASURING LEVEL, DENSITY, WEIGHT, MASS FLOW AND MOISTURE CONTENT OF INDUSTRIAL PROCESS MATERIALS; FLOW CONTROL VALVES FOR REGULATING THE FLOW OF LIQUIDS AND GASES FOR REFRIGERATING UNITS; VARIABLE AREA FLOW METERS FOR MEASURING, INDICATING, RECORDING, AND CONTROLLING THE FLOW OF FLUIDS; MOTION OR POSITION DIGITAL TRANSMITTERS FOR USE IN CONNECTION WITH FLOW METERS AND FLUID LEVEL INDICATORS; GAS FLOW REGULATORS IN THE NATURE OF FLOW METERS; FLOW METERS FOR MEASURING, INDICATING, RECORDING, AND CONTROLLING THE FLOW OF FLUIDS; FLOW RATE INDICATING METERS; GAS FLOW REVOLUTION COUNTERS, TEMPERATURE, PRESSURE, DENSITY, FLOW RATE, AND PH DETERMINING UNITS IN THE NATURE OF ELECTRONIC SENSORS FOR PROCESS MONITORING AND WATER TREATMENT CONTROL; MASS FLOW ELECTRICAL CONTROLLER; GAS AND LIQUID FLOW ELECTRICAL CONTROLLERS FOR INDUSTRIAL USE, PRIMARILY IN THE PHARMACEUTICAL, SEMICONDUCTOR, BIOTECH AND PETROCHEMICAL INDUSTRIES; LIQUID ANALYSIS INSTRUMENTS AND EQUIPMENT, NAMELY, LIQUID LEVEL SENSORS; AUTOMATIC LIQUID SAMPLING DEVICES FOR USE WITH LIQUID ANALYSIS INSTRUMENTS, NAMELY, SENSORS, TRANSMITTERS AND ANALYZERS FOR MEASURING PH, ORP, CONDUCTIVITY, DISSOLVED OXYGEN CHLORINE, OZONE SUSPENDED SOLIDS AND TURBIDITY; INDICATING AND MEASURING INSTRUMENTS, NAMELY, INDUSTRIAL PROCESS PRESSURE RECORDERS AND ELECTRICAL CONTROLLERS, FLOW MEASUREMENT ELECTRIC RECORDERS AND ELECTRICAL CONTROLLERS, GAS AND LIQUID ANALYSIS ELECTRIC RECORDERS AND ELECTRICAL CONTROLLERS; LIQUID LEVEL ANALYSIS METERS; RESIDUAL GAS ANALYZERS; COMBUSTION ANALYZERS; ELECTRONIC SIGNALING AND CONTROL DEVICES RESPONSIVE TO LIQUID OR GAS FLOW IN INDUSTRIAL FLOW-MEASURING EQUIPMENT, NAMELY, SIGNAL CONDITIONING AND COMMUNICATION DEVICE FOR INDUSTRIAL PROCESS CONTROL; GAS FLOW REGULATORS FOR CONTROLLING AND REGULATING THE FLOW OF GASES OR LIQUIDS NOT BEING PARTS OF PLUMBING, HEATING, COOLING INSTALLATIONS OR MACHINES; GAS PRESSURE REGULATORS FOR CONTROLLING AND REGULATING THE FLOW OF GASES OR LIQUIDS NOT BEING PARTS OF PLUMBING, HEATING, COOLING INSTALLATIONS OR MACHINES; GAS PRESSURE REGULATORS FOR CONTROLLING GAS, AIR OR WATER FOR CONTROLLING AND REGULATING THE FLOW OF GASES OR LIQUIDS NOT BEING PARTS OF PLUMBING, HEATING, COOLING INSTALLATIONS OR MACHINES; LABORATORY ANALYZERS, NAMELY LABORATORY RESIDUAL GAS ANALYZERS; CONTROL VALVES FOR REGULATING THE FLOW OF GASES; ELECTRO-MECHANICAL INSTRUMENTS FOR USE IN MEASURING THE PRESSURE AND FLOW OF A VALVE OR REGULATOR; AUTOMATIC VALVES, NAMELY, AUTOMATIC CHECK VALVES, AUTOMATIC BALL CHECK VALVES; AUTOMATIC PIEZOELECTRICALLY OPERATED VALVES; ANALOG AND DIGITAL ELECTRIC AND ELECTRONIC CONTROL, OPERATING, DIAGNOSTIC AND CONNECTING ELEMENTS AND UNITS, NAMELY, COMPUTERS FOR

Reg. No. 4,064,996 CONTROLLING, OPERATING, DIAGNOSING AND CONNECTING DATA IN PLANTS; EXPLOSION PROOF AUTOMATIC VALVES; PRESSURE EQUALIZING AUTOMATIC VALVES; PRESSURE RELIEF VALVES FOR USE IN FARM TAP APPLICATIONS; AUTOMATIC REGULATING VALVES; CONTROL DEVICES IN THE NATURE OF ELECTRONIC CONTROLLERS FOR THE FORCIBLE OPENING OF AUTOMATIC COMPRESSOR VALVES; VALVE POSITION ELECTRONIC SENSORS FOR DETERMINING VALVE POSITION; ELECTRIC VALVE ACTUATORS; AUTOMATIC CONDENSER REGULATION CONTROL VALVES; AUTOMATIC BALL VALVES; AUTOMATIC SEAL VALVES; AUTOMATIC BUTTERFLY VALVES; COMBINATION VALVES CONSISTING OF CONTROL VALVES FOR REGULATING THE FLOW OF GASES AND LIQUIDS AND AUTOMATIC VALVES; AUTOMATIC GLOBE CONTROL VALVES; AUTOMATIC JACKETED VALVES; AUTOMATIC LINE BLOCK VALVES; AUTOMATIC NEEDLE CONTROL VALVES; AUTOMATIC PLUG VALVES; SOLENOID VALVES IN THE NATURE OF ELECTROMAGNETIC SWITCHES; DIGITAL ELECTRICAL VALVE CONTROLLERS; AUTOMATIC STEAM CONDITIONING VALVES; AUTOMATIC ROTARY VALVES; AUTOMATIC SEGMENTED BALL VALVES; ELECTRIC PLUG VALVES; AUTOMATIC FULL BORE PIPE LINE BALL VALVES; AUTOMATIC HIGH PERFORMANCE BUTTERFLY VALVES; UNIVERSAL AUTOMATIC GLOBE VALVES; GENERAL SERVICE AUTOMATIC GLOBE VALVES; CHEMICAL SERVICE AUTOMATIC GLOBE VALVES; HIGH PRESSURE AUTOMATIC GLOBE VALVES; DIGITAL LEVEL ELECTRICAL CONTROLLERS; DIGITAL FLUID LEVEL TRANSMITTERS; PNEUMATIC PRESSURE CONTROLLERS; PNEUMATIC TEMPERATURE CONTROLLERS; AUTOMATIC LOW FLOW VALVES; AUTOMATIC ROTARY ECCENTRIC PLUG VALVES; AUTOMATIC SANITARY VALVES; VALVE INSTRUMENTATION, NAMELY, ELECTRO-PNEUMATIC TRANSDUCERS, POSITION DIGITAL TRANSMITTERS, AUTOMATIC TRIP VALVES FEATURING VOLUME BOOSTERS THAT ARE USED IN CONJUNCTION WITH A POSITIONER ON A THROTTLING CONTROL VALVE TO INCREASE STROKING SPEED; AIR PRESSURE REGULATORS FOR CONTROLLING AND REGULATING THE FLOW OF GASES OR LIQUIDS NOT BEING PARTS OF PLUMBING, HEATING, COOLING INSTALLATIONS OR MACHINES; ELECTRO-MECHANICAL INSTRUMENTS FOR USE IN MEASURING THE PRESSURE AND FLOW OF A VALVE OR REGULATOR, NAMELY PRESSURE GAUGES AND AIR FLOW GAUGES; PRESSURE REGULATORS FOR CONTROLLING THE FLOW OF GASES NOT BEING PARTS OF PLUMBING, HEATING, COOLING INSTALLATIONS OR MACHINES; FUEL PRESSURE REGULATORS FOR CONTROLLING THE FLOW OF GASES NOT BEING PARTS OF PLUMBING, HEATING, COOLING INSTALLATIONS OR MACHINES; ELECTRICAL DEVICES FOR MEASURING PHYSICAL PROPERTIES OF FLOWABLE MATERIALS AND CONTROLLING PROCESS EQUIPMENT AND ACCESSORIES THEREFOR NAMELY, ELECTRICAL POWER SUPPLIES AND AIR FLOW REGULATORS, CONVERTERS, AIR FLOW METERS, AND ELECTRICAL CONTROLLERS; AIR AND FUEL REGULATORS FOR CONTROLLING THE FLOW OF GASES NOT BEING PARTS OF PLUMBING, HEATING, COOLING INSTALLATIONS OR MACHINES; PLANT, FACILITY AND FIELD PROCESS MANAGEMENT DEVICES, NAMELY, RESIDUAL GAS ANALYZERS, ELECTRICAL VALVE CONTROLLERS, DIGITAL CONDUCTIVITY TRANSMITTERS, DIGITAL VALVE CONTROLLERS, FAN/DAMPER ELECTRIC VALVE ACTUATORS, FLUID FLOW AND FLUID DENSITY METERS, GAS CHROMATOGRAPH, MAGNETIC FLOW METERS, OXYGEN ANALYZERS, OXYGEN DIGITAL TRANSMITTERS, PH DIGITAL TRANSMITTERS, PRESSURE DIGITAL TRANSMITTERS, TEMPERATURE DIGITAL TRANSMITTERS, ELECTRIC VALVE ACTUATORS, VORTEX WATER FLOW METERS; COMPUTER SOFTWARE FOR PROCESS AND FACILITY AUTOMATION, MANAGEMENT AND OPTIMIZATION, NAMELY, DATABASE MANAGEMENT SOFTWARE FOR PROCESS VARIABILITY REDUCTION, INCREASED PLANT AVAILABILITY, REDUCED CAPITAL AND ENGINEERING COSTS, REDUCED OPERATIONS AND MAINTENANCE COSTS, ENHANCED SAFETY AND ENVIRONMENTAL COMPLIANCE; AUTOMATIC VALVES; GAS FLOW METERS FOR DOMESTIC, INDUSTRIAL, COMMERCIAL OR AGRICULTURAL USE; FLUID FLOW INDICATORS; SIGNAL AND ALARM DEVICES FOR THE DETECTION OF EQUIPMENT FAILURE AND MALFUNCTION; VALVE POSITION INDICATORS; PROCESS CALIBRATORS; CALIBRATORS TO IDENTIFY CALIBRATION ERRORS; MOTION OR POSITION DIGITAL TRANSMITTERS FOR USE IN CONNECTION WITH FLOW METERS AND FLUID LEVEL INDICATORS; DIGITAL TRANSMITTERS FOR USE WITH MOISTURE,

Reg. No. 4,064,996 HUMIDITY AND/OR TEMPERATURE SENSORS, AND WITH MOISTURE, HUMIDITY AND/OR TEMPERATURE INDICATORS, RECORDERS AND CONTROL UNITS; ELECTRONIC MOTION OR POSITION TRANSMITTERS, PARTICULARLY ADAPTED FOR USE IN CONNECTION WITH FLOW METERS AND LIQUID LEVEL INDICATORS; LIQUID LEVEL DIGITAL TRANSMITTERS; PURGE METERS FUNCTIONING AS VARIABLE AREA FLOW METERS FOR BOTH LIQUID AND GAS; ELECTRICAL CONDUCTIVITY METERS; FLOW RATE INDICATING METERS FOR LIQUIDS AND GAS; PETROL METERS; REGULATORY, RECORDING AND INTERPRETATIVE FLUID METERS AND DEVICES USED IN CONNECTION THEREWITH FOR COMMERCIAL AND INDUSTRIAL USE, NAMELY, FLOW METERS FOR MEASURING, INDICATING, RECORDING AND CONTROLLING THE FLOW OF FLUIDS, OIL GAUGES, LIQUID LEVEL GAUGES, POSITIVE DISPLACEMENT FLUID FLOW METERS; FLOW COMPUTERS; OIL GAUGES; LIQUID LEVEL GAUGES; APPARATUS AND INSTRUMENTS FOR MEASURING, CONTROLLING, SUPPLYING AND DISTRIBUTING GASES AND MIXTURES THEREOF, NAMELY, GAS FLOW METERS, MASS FLOW METERS AND ELECTRICAL CONTROLLERS; ELECTRONIC FLUID ANALYSIS METERS; ELECTRIC VALVE ACTUATORS; SWITCH BOXES; SPEED CONTROL PLATES CONSISTING OF ELECTRONIC SPEED CONTROLLERS INSIDE OF A METAL PLATE; ELECTRICAL POWER SUPPLIES; COMPUTER DATABASE MANAGEMENT SOFTWARE FOR ASSET, EQUIPMENT AND FACILITY MANAGEMENT; COMPUTER SOFTWARE FOR INDUSTRIAL PROCESS CONTROL; COMPUTER SOFTWARE FOR DATABASE MANAGEMENT THAT STORES DATA PROCESS CONTROL INFORMATION; REMOTE REPAIR AND DIAGNOSIS EQUIPMENT IN THE NATURE OF COMPUTERS FOR THE REMOTE REPAIR AND DIAGNOSIS OF EQUIPMENT; ELECTRICAL CONTROLS FOR INCREASING STROKING SPEED ON THROTTLING CONTROL VALVES; COMPUTER INDUSTRIAL PROCESS CONTROL SOFTWARE FOR REDUCING PROCESS VARIABILITY AND FACILITATING REGULATORY COMPLIANCE; COMPUTER INDUSTRIAL PROCESS CONTROL SOFTWARE FOR LOWERING FACILITY INSTALLATION, OPERATING AND MAINTENANCE COSTS; COMPUTER INDUSTRIAL CONTROL SOFTWARE FOR IMPROVING PROCESS UP TIME; COMPUTER INDUSTRIAL PROCESS CONTROL SOFTWARE FOR INCREASING MACHINERY ASSET UTILIZATION, MONITORING AND COMMUNICATING PROCESS AND EQUIPMENT INFORMATION; COMPUTER INDUSTRIAL PROCESS MANAGEMENT SOFTWARE FOR REDUCING UNPLANNED ENERGY OUTAGES AND OPTIMIZING THE DISTRIBUTION OF MACHINERY LOAD DEMANDS ACROSS MULTIPLE UNITS OR UNIT COMPONENTS; ULTRASONIC SENSING SYSTEMS, NAMELY, LIQUID LEVEL SENSORS; TEMPERATURE SENSORS; NON-CONTACTING PRESSURE SENSORS; PRODUCTION OPTIMIZATION INDUSTRIAL PROCESS MANAGEMENT SOFTWARE; PERFORMANCE MONITORING INDUSTRIAL PROCESS MANAGEMENT SOFTWARE; ANALYTICAL INSTRUMENTS, NAMELY, INSTRUMENTS FOR MEASURING PRESSURE, TEMPERATURE, LEVEL AND FLOW OF LIQUIDS AND GASSES; REMOTE OPERATIONS ELECTRICAL CONTROLLERS; DIGITAL PRESSURE TRANSMITTERS; DIGITAL MASS FLOW TRANSMITTERS; DIGITAL MULTIVARIABLE TRANSMITTERS; DIGITAL ABSOLUTE PRESSURE TRANSMITTERS; DIGITAL GAUGE PRESSURE TRANSMITTERS; DIGITAL PRESSURE TRANSMITTERS FOR THE PULP AND PAPER INDUSTRY; DIGITAL PRESSURE TRANSMITTERS FOR THE FOOD AND PHARMACEUTICAL INDUSTRIES; DIGITAL TEMPERATURE TRANSMITTERS; PROGRAMMABLE DIGITAL TEMPERATURE TRANSMITTERS; TEMPERATURE SENSORS; RADAR LEVEL GAUGES; LIQUID LEVEL TRANSMITTERS; VORTEX FLUID AND GAS FLOW METERS; MASS FLUID AND GAS FLOW TRANSMITTERS; PROCESS AND ENVIRONMENTAL ANALYZERS IN THE NATURE OF COMPUTERS FOR GATHERING AND LOGGING DATA AND MONITORING PROCESSES RUNNING ON A GIVEN SYSTEM AND ALERTING AS TO WHEN SHUT DOWNS ARE APPROPRIATE AND/OR NECESSARY; PROCESS CHROMATOGRAPHS; GAS BTU CHROMATOGRAPHS; PORTABLE PROCESS CHROMATOGRAPHS; PORTABLE GAS BTU CHROMATOGRAPHS; DEVICES IN THE NATURE OF COMPUTERS FOR RECORDING PROCESS VARIABLES, NAMELY, FLOW RATE, DENSITY, LEVEL, PRESSURE AND TEMPERATURE; SOLID STATE TEMPERATURE ELECTRICAL CONTROLLERS; ELECTRONIC PROGRAMMABLE SERVO CONTROL UNITS FOR INDUSTRIAL USE, CONSISTING OF ELECTRONIC SERVO MOTOR CONTROLLERS, BRUSHLESS SERVO MOTORS AND DIGITAL SERVO MOTOR DRIVES; ELECTRONIC TEMPERATURE CONTROL APPARATUS FOR CONTROL OF

Reg. No. 4,064,996 HEATING/COOLING UNITS USED IN INDUSTRIAL PROCESSING AND COMMERCIAL APPLICATIONS CONSISTING OF TEMPERATURE SENSORS AND ELECTRICAL CONTROLLERS; DYNAMOELECTRIC CONTROLS USED IN INDUSTRIAL PROCESSING AND COMMERCIAL APPLICATIONS; ELECTRICAL CONTROLLERS; TEMPERATURE CONTROL DEVICES FOR ELECTRIC HOT WATER HEATERS; OIL BURNER CONTROLS; GAS BURNER CONTROLS; REMOTE CONTROLS FOR OPERATING MACHINES; ELECTRONIC SPEED CONTROLLERS FOR MACHINERY; ELECTRIC VALVE ACTUATORS; FLUID FLOW CONTROL VALVES, IN CLASS 9 (U.S. CLS. 21, 23, 26, 36 AND 38).

FIRST USE 10-0-2001; IN COMMERCE 10-0-2001.

FOR: GAS REGULATORS; GAS FLOW REGULATORS IN THE NATURE OF PRESSURE REGULATORS FOR GAS INSTALLATIONS; GAS FLOW REGULATORS IN THE NATURE OF PRESSURE REGULATORS FOR GAS, AIR AND WATER INSTALLATIONS; AUTOMATIC VALVE IN THE NATURE OF A COMBINATION GAS PRESSURE REGULATOR AND REDUNDANT SOLENOID GAS VALVE FOR USE IN FORCED AIR FURNACES, BOILERS, CLOTHES DRYERS AND GAS WATER HEATERS; GAS FLOW REGULATORS BEING PARTS OF GAS, WATER, AND SANITARY INSTALLATIONS; AIR PRESSURE REGULATORS BEING PARTS OF GAS, WATER, AND SANITARY INSTALLATIONS; PRESSURE REGULATORS BEING PARTS OF GAS, WATER, AND SANITARY INSTALLATIONS; FUEL PRESSURE REGULATORS BEING PARTS OF GAS, WATER, AND SANITARY INSTALLATIONS; AIR AND FUEL PRESSURE REGULATORS BEING PARTS OF GAS, WATER, AND SANITARY INSTALLATIONS, IN CLASS 11 (U.S. CLS. 13, 21, 23, 31 AND 34).

FIRST USE 10-0-2001; IN COMMERCE 10-0-2001.

FOR: TECHNICAL CONSULTATION IN THE FIELD OF OPERATIONS EFFICIENCY, NAMELY, BUSINESS EFFICIENCY ADVICE, IN CLASS 35 (U.S. CLS. 100, 101 AND 102).

FIRST USE 10-0-2001; IN COMMERCE 10-0-2001.

FOR: INDUSTRIAL AND COMMERCIAL MACHINE AND EQUIPMENT REPAIR AND PREDICTIVE MAINTENANCE SERVICES IN THE CHEMICAL, FOOD AND BEVERAGE, HYDROCARBON AND ENERGY, LIFE SCIENCE, PHARMACEUTICAL, POWER, PULP AND PAPER, REFINING AND WATER AND WASTE WATER INDUSTRIES; INSTALLATION AND REPAIR OF PROCESS CONTROL AND AUTOMATION SYSTEMS CONSISTING OF COMPUTERS, AUTOMATION SOFTWARE, MEASUREMENT DEVICES, ANALYTICAL INSTRUMENTS AND VALVES; MACHINERY REPAIR AND REPLACEMENT, IN CLASS 37 (U.S. CLS. 100, 103 AND 106).

FIRST USE 10-0-2001; IN COMMERCE 10-0-2001.

FOR: TECHNICAL CONSULTING SERVICES IN THE FIELDS OF DESIGN, ENGINEERING, TESTING, ANALYSIS AND EVALUATION OF PLANT MACHINERY AND FACILITY MACHINERY; TECHNICAL CONSULTING SERVICES REGARDING DESIGNING PLANT AND FACILITY MACHINERY TO REDUCE OPERATIONAL COSTS; TECHNICAL CONSULTING IN THE FIELD OF PLANT AND FACILITY ENGINEERING, NAMELY, TESTING AND EVALUATION OF MACHINERY TO IMPROVE PERFORMANCE AND EFFICIENCY OF SUCH MACHINERY; ENGINEERING SERVICES; DIAGNOSTIC SERVICES IN THE FIELD OF MACHINERY, PLANT MACHINERY AND FACILITY MACHINERY, FEATURING REMOTE ANALYSIS OF MACHINERY; PLANT, FACILITY AND MACHINERY TROUBLESHOOTING IN THE NATURE OF DIAGNOSIS SERVICES OF MACHINERY; PRODUCT SAFETY PERFORMANCE TESTING OF PLANT AND FACILITY MACHINERY AND EQUIPMENT TO ENSURE SATISFACTORY PERFORMANCE; MACHINERY CALIBRATION; REMOTE PERFORMANCE MONITORING OF PROCESS AND MECHANICAL PLANT AND FACILITY EQUIPMENT, NAMELY, REMOTE PERFORMANCE MONITORING OF FACILITY MACHINERY AND HEATING, VENTILATING AND AIR CONDITIONING

Reg. No. 4,064,996 APPARATUS FOR PROCESS AND MECHANICAL PLANTS, IN CLASS 42 (U.S. CLS. 100 AND 101).

FIRST USE 10-0-2001; IN COMMERCE 10-0-2001.

THE MARK CONSISTS OF STANDARD CHARACTERS WITHOUT CLAIM TO ANY PARTICULAR FONT, STYLE, SIZE, OR COLOR.

OWNER OF U.S. REG. NOS. 111,931, 1,626,293 AND OTHERS.

SEC. 2(F).

SER. NO. 76-294,524, FILED 8-6-2001.

APRIL HESIK, EXAMINING ATTORNEY

United States of America

United States Patent and Trademark Office

FOREVER GREEN DIAMONDS

Reg. No. 4,064,997

Registered Dec. 6, 2011

Int. Cl.: 14

TRADEMARK

PRINCIPAL REGISTER

ESSLINGER & CO. (MINNESOTA CORPORATION)
1165 MEDALLION DRIVE
SAINT PAUL, MN 55120

FOR: DIAMOND JEWELRY, IN CLASS 14 (U.S. CLS. 2, 27, 28 AND 50).

FIRST USE 3-9-2009; IN COMMERCE 3-9-2009.

THE MARK CONSISTS OF STANDARD CHARACTERS WITHOUT CLAIM TO ANY PARTICULAR FONT, STYLE, SIZE, OR COLOR.

NO CLAIM IS MADE TO THE EXCLUSIVE RIGHT TO USE "GREEN DIAMONDS", APART FROM THE MARK AS SHOWN.

SER. NO. 76-696,374, FILED 3-18-2009.

MARK PILARO, EXAMINING ATTORNEY



David J. Kyffers

Director of the United States Patent and Trademark Office

United States of America

United States Patent and Trademark Office

ENERGY INTELLIGENCE PLATFORM

Reg. No. 4,064,998

POWER ADVOCATE, INC. (DELAWARE CORPORATION)
179.LINCOLN STREET
BOSTON, MA 02111

Registered Dec. 6, 2011

Int. Cl.: 35

FOR: BUSINESS RESOURCE MANAGEMENT AND BUSINESS CONSULTATION SERVICES FOR THE ENERGY INDUSTRY, IN CLASS 35 (U.S. CLS. 100, 101 AND 102).

SERVICE MARK

FIRST USE 9-18-2008; IN COMMERCE 10-27-2008.

PRINCIPAL REGISTER

THE MARK CONSISTS OF STANDARD CHARACTERS WITHOUT CLAIM TO ANY PARTICULAR FONT, STYLE, SIZE, OR COLOR.

OWNER OF U.S. REG. NOS. 3,730,358, 3,759,661 AND OTHERS.

NO CLAIM IS MADE TO THE EXCLUSIVE RIGHT TO USE "ENERGY" AND "PLATFORM", APART FROM THE MARK AS SHOWN.

SER. NO. 76-697,720, FILED 6-2-2009.

WILLIAM ROSSMAN, EXAMINING ATTORNEY



David J. Kybas

Director of the United States Patent and Trademark Office

United States of America

United States Patent and Trademark Office

CAT WINDOWOR

Reg. No. 4,064,999

Registered Dec. 6, 2011

Int. Cl.: 6

TRADEMARK

PRINCIPAL REGISTER

DAWES, CHARLES, J. (UNITED STATES INDIVIDUAL)
84 RAMBLING LANE, APT. 28B
BATTLE CREEK, MI 49015

FOR: METAL PET DOORS, IN CLASS 6 (U.S. CLS. 2, 12, 13, 14, 23, 25 AND 50).

FIRST USE 0-0-2006; IN COMMERCE 0-0-2006.

THE MARK CONSISTS OF STANDARD CHARACTERS WITHOUT CLAIM TO ANY PARTICULAR FONT, STYLE, SIZE, OR COLOR.

NO CLAIM IS MADE TO THE EXCLUSIVE RIGHT TO USE "CAT", APART FROM THE MARK AS SHOWN.

SER. NO. 76-702,035, FILED 3-12-2010.

DAVID YONTEF, EXAMINING ATTORNEY



David J. Kyffers

Director of the United States Patent and Trademark Office

United States of America

United States Patent and Trademark Office

MOYO CRAFTS AND MORE

Reg. No. 4,065,000

Registered Dec. 6, 2011

Int. Cl.: 25

TRADEMARK

PRINCIPAL REGISTER

NOLTEN, YOLANDE (UNITED STATES INDIVIDUAL)
21515 SE ALDER STREET
GRESHAM, OR 97030

FOR: CLOTHING, NAMELY, APRONS, BANDANAS, HEADWEAR, AND SHIRTS, IN CLASS 25 (U.S. CLS. 22 AND 39).

FIRST USE 4-17-2010; IN COMMERCE 5-24-2010.

THE MARK CONSISTS OF STANDARD CHARACTERS WITHOUT CLAIM TO ANY PARTICULAR FONT, STYLE, SIZE, OR COLOR.

NO CLAIM IS MADE TO THE EXCLUSIVE RIGHT TO USE "CRAFTS", APART FROM THE MARK AS SHOWN.

SER. NO. 76-704,032, FILED 8-6-2010.

JERI J. FICKES, EXAMINING ATTORNEY



David J. Kyffers

Director of the United States Patent and Trademark Office

United States of America

United States Patent and Trademark Office

EROS GUIA

Reg. No. 4,065,001

Registered Dec. 6, 2011

Int. Cl.: 35

SERVICE MARK

PRINCIPAL REGISTER

GROUP KAITU, LLC (DELAWARE CORPORATION)
9702 GAYTON ROAD, SUITE 167
RICHMOND, VA 23233

FOR: PROVIDING DISSEMINATION OF ADVERTISING FOR THE GOODS AND SERVICES OF OTHERS VIA A GLOBAL COMPUTER NETWORK; PROMOTING THE GOODS AND SERVICES OF OTHERS BY PROVIDING A WEBSITE FEATURING ADVERTISEMENTS, BANNERS AND LINKS TO THE WEBSITES OF OTHERS IN THE FIELD OF ADULT-THEMED PRODUCTS, SERVICES AND ENTERTAINMENT; PROVIDING ON-LINE DIRECTORY INFORMATION SERVICES ALSO FEATURING HYPERLINKS TO OTHER WEBSITES; PROVIDING A WEBSITE WHERE USERS CAN POST RATINGS, REVIEWS AND RECOMMENDATIONS ON PRODUCTS AND SERVICES; PROVIDING DIRECTORY INFORMATION SERVICES IN THE AREA OF ADULT-THEMED PRODUCTS, SERVICES AND ENTERTAINMENT VIA A GLOBAL COMPUTER NETWORK; PROVIDING AN ONLINE COMPUTER DATABASE IN THE AREA OF ADULT-THEMED PRODUCTS AND SERVICES VIA A GLOBAL COMPUTER NETWORK; PROVIDING AN ONLINE RETAIL STORE FEATURING ADULT-THEMED PRODUCTS VIA A GLOBAL COMPUTER NETWORK, IN CLASS 35 (U.S. CLS. 100, 101 AND 102).

FIRST USE 7-7-2011; IN COMMERCE 7-7-2011.

THE MARK CONSISTS OF STANDARD CHARACTERS WITHOUT CLAIM TO ANY PARTICULAR FONT, STYLE, SIZE, OR COLOR.

OWNER OF U.S. REG. NOS. 2,549,369, 3,717,173 AND OTHERS.

NO CLAIM IS MADE TO THE EXCLUSIVE RIGHT TO USE "GUIA", APART FROM THE MARK AS SHOWN.

"GUIA" IS A SPANISH WORD. THE ENGLISH TRANSLATION OF "GUIA" IN THE MARK IS "GUIDE".

SER. NO. 76-704,640, FILED 9-24-2010.

NATALIE POLZER, EXAMINING ATTORNEY



David J. Kyppas

Director of the United States Patent and Trademark Office

United States of America

United States Patent and Trademark Office

PENNSYLVANIA

Reg. No. 4,065,002

ADVANTAGE WHOLESALE SUPPLY LLC (NEW YORK LIMITED LIABILITY COMPANY)
172 EMPIRE BLVD.
BROOKLYN, NY 11225

Registered Dec. 6, 2011

Int. Cl.: 2

FOR: PAINTS, IN CLASS 2 (U.S. CLS. 6, 11 AND 16).

TRADEMARK

FIRST USE 2-0-1999; IN COMMERCE 2-0-1999.

PRINCIPAL REGISTER

THE MARK CONSISTS OF STANDARD CHARACTERS WITHOUT CLAIM TO ANY PARTICULAR FONT, STYLE, SIZE, OR COLOR.

SEC. 2(F).

SER. NO. 76-704,715, FILED 9-28-2010.

SEAN CROWLEY, EXAMINING ATTORNEY



David J. Kyffers

Director of the United States Patent and Trademark Office

United States of America

United States Patent and Trademark Office

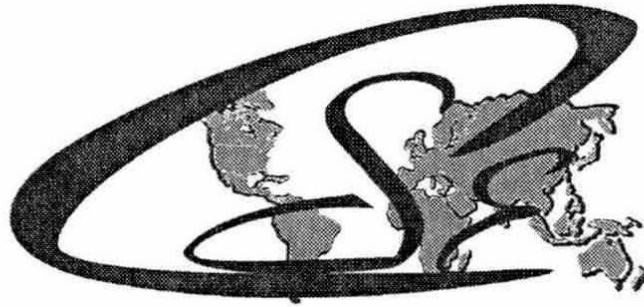

Reg. No. 4,065,003

Registered Dec. 6, 2011

Int. Cl.: 31

TRADEMARK

PRINCIPAL REGISTER

CENTRAL STATES ENTERPRISES, LLC. (FLORIDA LIMITED LIABILITY COMPANY)
668 NW WALDO STREET
LAKE CITY, FL 32056

FOR: ANIMAL FEED, IN CLASS 31 (U.S. CLS. 1 AND 46).

FIRST USE 10-1-2002; IN COMMERCE 10-1-2002.

THE MARK CONSISTS OF THE STYLIZED WORDING "CSE" APPEARING ON A DESIGN OF A WORLD MAP.

SER. NO. 76-704,783, FILED 10-5-2010.

ANDREA HACK, EXAMINING ATTORNEY



David J. Kybas

Director of the United States Patent and Trademark Office

United States of America

United States Patent and Trademark Office



Reg. No. 4,065,004

Registered Dec. 6, 2011

Int. Cls.: 37 and 42

SERVICE MARK

PRINCIPAL REGISTER

ONE SUN, INC. (CALIFORNIA CORPORATION)
P.O. BOX 532
GRATON, CA 95444

FOR: INSTALLATION AND CONSTRUCTION OF PHOTOVOLTAIC BASED SOLAR SYSTEMS, IN CLASS 37 (U.S. CLS. 100, 103 AND 106).

FIRST USE 10-1-2009; IN COMMERCE 10-1-2009.

FOR: DESIGN OF PHOTOVOLTAIC BASED SOLAR POWER SYSTEMS, IN CLASS 42 (U.S. CLS. 100 AND 101).

FIRST USE 10-1-2009; IN COMMERCE 10-1-2009.

NO CLAIM IS MADE TO THE EXCLUSIVE RIGHT TO USE "SOLAR", APART FROM THE MARK AS SHOWN.

THE COLOR(S) GREEN AND YELLOW IS/ARE CLAIMED AS A FEATURE OF THE MARK.

THE MARK CONSISTS OF THE WORDING "ONE SUN" IN GREEN ABOVE THE PHRASE "SOLAR DONE RIGHT" IN YELLOW AND A YELLOW CURVED BAND ABOVE THE WORDING.

SER. NO. 76-704,989, FILED 10-20-2010.

PRISCILLA MILTON, EXAMINING ATTORNEY



David J. Kybas

Director of the United States Patent and Trademark Office

United States of America
United States Patent and Trademark Office

Square²

Reg. No. 4,065,005

STUDIO 180 DESIGN, LTD. (PENNSYLVANIA LIMITED LIABILITY COMPANY)
180 WILBUR WAY
COGAN STATION, PA 17728

Registered Dec. 6, 2011

Int. Cl.: 20

FOR: PLASTIC TEMPLATE FOR CUTTING FABRICS, IN CLASS 20 (U.S. CLS. 2, 13, 22, 25, 32 AND 50).

TRADEMARK

FIRST USE 5-15-2010; IN COMMERCE 5-15-2010.

PRINCIPAL REGISTER

SER. NO. 76-705,100, FILED 10-27-2010.

DANIEL CAPSHAW, EXAMINING ATTORNEY

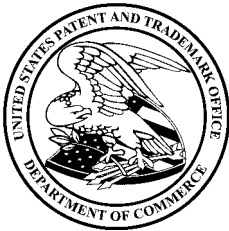

David J. Kyffers

Director of the United States Patent and Trademark Office

United States of America

United States Patent and Trademark Office

RAPID FIRE HUNTER'S STAR

Reg. No. 4,065,006

STUDIO 180 DESIGN (PENNSYLVANIA LIMITED LIABILITY COMPANY)
180 WILBUR WAY
COGAN STATION, PA 17728

Registered Dec. 6, 2011

Int. Cl.: 20

FOR: PLASTIC TEMPLATE FOR CUTTING FABRICS, IN CLASS 20 (U.S. CLS. 2, 13, 22, 25, 32 AND 50).

TRADEMARK

FIRST USE 9-0-2005; IN COMMERCE 9-0-2005.

PRINCIPAL REGISTER

THE MARK CONSISTS OF STANDARD CHARACTERS WITHOUT CLAIM TO ANY PARTICULAR FONT, STYLE, SIZE, OR COLOR.

NO CLAIM IS MADE TO THE EXCLUSIVE RIGHT TO USE "HUNTER'S STAR", APART FROM THE MARK AS SHOWN.

SER. NO. 76-705,103, FILED 10-27-2010.

DANIEL CAPSHAW, EXAMINING ATTORNEY



David J. Kyffers

Director of the United States Patent and Trademark Office

United States of America

United States Patent and Trademark Office

DURACON

Reg. No. 4,065,007

Registered Dec. 6, 2011

Int. Cl.: 6

TRADEMARK

PRINCIPAL REGISTER

MUDGE FASTENERS, INC. (CALIFORNIA CORPORATION)
3050 PALISADES DRIVE
CORONA, CA 92880

FOR: STEEL FASTENERS, NAMELY, BOLTS, NUTS AND WASHERS COATED WITH AN ORGANIC TYPE MATERIAL THAT PROVIDES PROTECTION AGAINST CORROSION OF THE FASTENERS USED IN SUPPORT STRUCTURES FOR PHOTOVOLTAIC PANELS IN SOLAR POWER PROJECTS, IN CLASS 6 (U.S. CLS. 2, 12, 13, 14, 23, 25 AND 50).

FIRST USE 9-1-2010; IN COMMERCE 9-1-2010.

THE MARK COMPRISES THE WORD PORTIONS "DURA" AND "CON" (IN RED) JOINED BY AN INTERMEDIATE HEXAGONAL SHAPE (IN BLACK) WHICH HEXAGONAL SHAPE INCLUDES THE WORD PORTIONS "DURA" AND "CON" (IN RED) WITH A ZIGZAG LINE (IN YELLOW) THERE BETWEEN.

THE COLOR(S) BLACK, RED AND YELLOW IS/ARE CLAIMED AS A FEATURE OF THE MARK.

SER. NO. 76-705,573, FILED 12-6-2010.

DORITT L. CARROLL, EXAMINING ATTORNEY



David J. Kypos

Director of the United States Patent and Trademark Office

United States of America

United States Patent and Trademark Office

Off-site information at your fingertips

Reg. No. 4,065,008

Registered Dec. 6, 2011

Int. Cls.: 35, 39 and 40

SERVICE MARK

PRINCIPAL REGISTER

CORODATA (CALIFORNIA CORPORATION)
12375 KERRAN STREET
POWAY, CA 92064

FOR: BUSINESS RECORDS MANAGEMENT, IN CLASS 35 (U.S. CLS. 100, 101 AND 102).

FIRST USE 8-31-2010; IN COMMERCE 8-31-2010.

FOR: ELECTRONIC STORAGE OF RECORDS AND DOCUMENTS, IN CLASS 39 (U.S. CLS. 100 AND 105).

FIRST USE 8-31-2010; IN COMMERCE 8-31-2010.

FOR: DESTRUCTION OF RECORDS AND DOCUMENTS, IN CLASS 40 (U.S. CLS. 100, 103 AND 106).

FIRST USE 8-31-2010; IN COMMERCE 8-31-2010.

THE MARK CONSISTS OF STANDARD CHARACTERS WITHOUT CLAIM TO ANY PARTICULAR FONT, STYLE, SIZE, OR COLOR.

NO CLAIM IS MADE TO THE EXCLUSIVE RIGHT TO USE "OFF-SITE INFORMATION", APART FROM THE MARK AS SHOWN.

SER. NO. 76-705,781, FILED 12-23-2010.

CHRISTINE MARTIN, EXAMINING ATTORNEY



David J. Kyffers

Director of the United States Patent and Trademark Office

United States of America

United States Patent and Trademark Office

Corodata

Reg. No. 4,065,009

Registered Dec. 6, 2011

Int. Cls.: 35, 39 and 40

SERVICE MARK

PRINCIPAL REGISTER

CORODATA (CALIFORNIA CORPORATION)
12375 KERRAN STREET
POWAY, CA 92064

FOR: BUSINESS RECORDS MANAGEMENT, IN CLASS 35 (U.S. CLS. 100, 101 AND 102).

FIRST USE 8-31-2010; IN COMMERCE 8-31-2010.

FOR: ELECTRONIC STORAGE OF RECORDS AND DOCUMENTS, IN CLASS 39 (U.S. CLS. 100 AND 105).

FIRST USE 8-31-2010; IN COMMERCE 8-31-2010.

FOR: DESTRUCTION OF RECORDS AND DOCUMENTS, IN CLASS 40 (U.S. CLS. 100, 103 AND 106).

FIRST USE 8-31-2010; IN COMMERCE 8-31-2010.

THE MARK CONSISTS OF STANDARD CHARACTERS WITHOUT CLAIM TO ANY PARTICULAR FONT, STYLE, SIZE, OR COLOR.

SER. NO. 76-705,785, FILED 12-23-2010.

CHRISTINE MARTIN, EXAMINING ATTORNEY



David J. Kybas

Director of the United States Patent and Trademark Office

United States of America

United States Patent and Trademark Office



D I V I N E
Perfection is an obsession

Reg. No. 4,065,010

Registered Dec. 6, 2011

Int. Cl.: 14

TRADEMARK

PRINCIPAL REGISTER

DIVINE, LLC (NEW YORK LIMITED LIABILITY COMPANY)
580 FIFTH AVENUE, SUITE 810
NEW YORK, NY 10036

FOR: JEWELRY, IN CLASS 14 (U.S. CLS. 2, 27, 28 AND 50).

FIRST USE 1-10-2001; IN COMMERCE 5-15-2001.

THE MARK CONSISTS OF THE WORDING "DIVINE PERFECTION IS AN OBSESSION" WITH THE WORD "DIVINE" APPEARING, IN LARGER LETTERS, ABOVE THE WORDS "PERFECTION IS AN OBSESSION". ABOVE THE WORDING IS A STYLIZED FLOWER DESIGN.

SER. NO. 76-706,111, FILED 1-24-2011.

DAWN FELDMAN, EXAMINING ATTORNEY



David J. Kybas

Director of the United States Patent and Trademark Office

United States of America

United States Patent and Trademark Office

CALLA

Reg. No. 4,065,011

Registered Dec. 6, 2011

Int. Cl.: 3

TRADEMARK

PRINCIPAL REGISTER

ANDPAK, INC. (CALIFORNIA CORPORATION), DBA ZIP-CHEM PRODUCTS
400 JARVIS DRIVE
MORGAN HILL, CA 95037

FOR: HEAVY DUTY DEGREASING PREPARATIONS, DEGREASING PREPARATIONS IN LIQUID FORM AND AEROSOL FORM, ALL FOR CLEANING AIRCRAFT INTERIORS AND EXTERIORS, IN CLASS 3 (U.S. CLS. 1, 4, 6, 50, 51 AND 52).

FIRST USE 11-23-1999; IN COMMERCE 11-23-1999.

THE MARK CONSISTS OF STANDARD CHARACTERS WITHOUT CLAIM TO ANY PARTICULAR FONT, STYLE, SIZE, OR COLOR.

SER. NO. 76-706,408, FILED 2-14-2011.

FRED CARL, EXAMINING ATTORNEY



David J. Kypos

Director of the United States Patent and Trademark Office

United States of America

United States Patent and Trademark Office

NO DRAWING-SENSORY MARK

Reg. No. 4,065,012

Registered Dec. 6, 2011

Int. Cls.: 9 and 41

TRADEMARK

SERVICE MARK

PRINCIPAL REGISTER

DANJAQ, LLC (DELAWARE CORPORATION)
2400 BROADWAY ST.
SUITE 310
SANTA MONICA, CA 90404

FOR: PRE-RECORDED COMPACT DISCS, CASSETTES, DVDS, AND MOTION PICTURE FILMS FEATURING ENTERTAINMENT, NAMELY, ACTION ADVENTURE, DRAMA, COMEDY, AND ROMANCE; MOTION PICTURE FILMS AND FILMS FOR TELEVISION FEATURING ENTERTAINMENT, NAMELY, ACTION ADVENTURE, DRAMA, COMEDY, AND ROMANCE; GRAPHICS AND MUSIC VIA A GLOBAL COMPUTER NETWORK AND WIRELESS DEVICES, IN CLASS 9 (U.S. CLS. 21, 23, 26, 36 AND 38).

FIRST USE 3-26-1997; IN COMMERCE 3-26-1997.

FOR: ENTERTAINMENT SERVICES, NAMELY, PRODUCTION AND DISTRIBUTION OF MOTION PICTURES; INTERNET SERVICES, NAMELY, PROVIDING INFORMATION VIA AN ELECTRONIC GLOBAL COMPUTER NETWORK IN THE FIELD OF ENTERTAINMENT RELATING TO MOTION PICTURES; PROVIDING ELECTRONIC GAMES, NOT DOWNLOADABLE, VIA THE INTERNET; ENTERTAINMENT SERVICES, VIDEO AND GRAPHICS PRESENTED TO MOBILE COMMUNICATIONS DEVICES VIA A GLOBAL COMPUTER NETWORK AND WIRELESS NETWORKS, IN CLASS 41 (U.S. CLS. 100, 101 AND 107).

FIRST USE 5-8-1963; IN COMMERCE 5-8-1963.

THE MARK CONSISTS OF THE MARK IS A SOUND. THE SOUND CONSISTS OF AN INSTRUMENTAL MUSICAL THEME PLAYED BY A BRASS INSTRUMENT AND STRING INSTRUMENT. THE MELODY OF THE THEME IS AS FOLLOWS: E#4 EIGHTH NOTE; F#4 SIXTEENTH NOTE; F#4 SIXTEENTH NOTE; F#4 EIGHTH NOTE; F#4 EIGHTH NOTE HELD OVER AN EIGHTH NOTE; E4 EIGHTH NOTE; E4 EIGHTH NOTE; E4 EIGHTH NOTE; G4 SIXTEENTH NOTE; G4 SIXTEENTH NOTE; G4 EIGHTH NOTE; G4 EIGHTH NOTE HELD OVER AN EIGHTH NOTE; F#4 EIGHTH NOTE; F#4 EIGHTH NOTE; F#4 EIGHTH NOTE; E4 EIGHTH NOTE; F#4 SIXTEENTH NOTE; F#4 SIXTEENTH NOTE; F#4 EIGHTH NOTE; F#4 EIGHTH NOTE HELD OVER AN EIGHTH NOTE; E4 EIGHTH NOTE ; E4 EIGHTH NOTE; E4 EIGHTH NOTE; E4 EIGHTH NOTE; G4 SIXTEENTH NOTE; G4 SIXTEENTH NOTE; G4 EIGHTH NOTE; E4 EIGHTH NOTE; F#4 SIXTEENTH NOTE; F#4 SIXTEENTH NOTE; F#4 EIGHTH NOTE; F#4 EIGHTH NOTE HELD OVER AN EIGHTH NOTE; E4 EIGHTH NOTE; E4 EIGHTH NOTE; E4 EIGHTH NOTE; G4 SIXTEENTH NOTE; G4 SIXTEENTH NOTE; G4 EIGHTH NOTE; G4 EIGHTH NOTE HELD OVER AN EIGHTH NOTE; F#4 EIGHTH NOTE; F#4 EIGHTH NOTE; F#4 EIGHTH NOTE; F#4 EIGHTH NOTE HELD OVER AN EIGHTH NOTE; D#5 EIGHTH NOTE; D5 AND B4 CHORD EIGHTH NOTE HELD OVER A HALF NOTE; B4 AND G4 CHORD EIGHTH NOTE; A4 AND F#4 CHORD EIGHTH NOTE; B4 AND G4 CHORD WHOLE NOTE. SIMULTANEOUSLY TO THE MELODY, THE BASS PLAYS A B2 HALF NOTE, C3 HALF NOTE, C#3 HALF NOTE, C3 HALF NOTE, B2 HALF NOTE, C3 HALF NOTE, C#3 HALF NOTE, C3 HALF NOTE, B2 HALF NOTE, C3 HALF NOTE, C#3 HALF NOTE, C3 HALF NOTE, B2 HALF NOTE, C3 HALF NOTE,



David J. Kyros

Director of the United States Patent and Trademark Office

Reg. No. 4,065,012 C#3 HALF NOTE, AND C3 HALF NOTE. AND SIMULTANEOUSLY TO BOTH, AN E2 NOTE IS PLAYED AT THE SECOND AND FOURTH BEAT OF EVERY MEASURE.

SEC. 2(F).

SER. NO. 76-706,452, FILED 2-18-2011.

JASON BLAIR, EXAMINING ATTORNEY

United States of America

United States Patent and Trademark Office

ARTSTEM

Reg. No. 4,065,013

Registered Dec. 6, 2011

Int. Cl.: 44

SERVICE MARK

PRINCIPAL REGISTER

ADVANCED REGENERATIVE THERAPIES (COLORADO CORPORATION)
320 EAST VINE DRIVE, SUITE 22
FORT COLLINS, CO 80524

FOR: AUTOLOGOUS CELL EXPANSION SERVICES FOR TREATMENT OF ANIMALS, NAMELY, THE EXTRACTION OR ACCEPTANCE OF CELLS FROM AN ANIMAL, SUBJECTING THE CELLS TO PROCESSES WHICH CAUSE THEM TO MULTIPLY SIGNIFICANTLY AND RETURNING THE MULTIPLIED CELLS TO THE ANIMAL'S CUSTODIAN FOR INJECTION INTO THE BODY OF THE ANIMAL, IN CLASS 44 (U.S. CLS. 100 AND 101).

FIRST USE 11-9-2010; IN COMMERCE 11-9-2010.

THE MARK CONSISTS OF STANDARD CHARACTERS WITHOUT CLAIM TO ANY PARTICULAR FONT, STYLE, SIZE, OR COLOR.

SER. NO. 76-706,624, FILED 2-28-2011.

LINDA ORNDORFF, EXAMINING ATTORNEY



David J. Kyffers

Director of the United States Patent and Trademark Office

United States of America

United States Patent and Trademark Office



Reg. No. 4,065,014

Registered Dec. 6, 2011

Int. Cl.: 43

SERVICE MARK

PRINCIPAL REGISTER

PETALAS, JOHN (UNITED STATES INDIVIDUAL)
11775 SEMINOLE BOULEVARD
SEMINOLE, FL 33778

FOR: RESTAURANT SERVICES, INCLUDING SIT-DOWN SERVICE OF FOOD AND TAKE-OUT RESTAURANT SERVICES, IN CLASS 43 (U.S. CLS. 100 AND 101).

FIRST USE 7-22-1992; IN COMMERCE 7-22-1992.

NO CLAIM IS MADE TO THE EXCLUSIVE RIGHT TO USE "SEMINOLE SUBS & GYROS", APART FROM THE MARK AS SHOWN.

THE COLOR(S) ORANGE, YELLOW, LIGHT BLUE, DARK BLUE, AND WHITE IS/ARE CLAIMED AS A FEATURE OF THE MARK.

THE MARK CONSISTS OF AN OVAL IN WHITE OUTLINED IN DARK BLUE CONTAINING THE WORDING "SEMINOLE SUBS & GYROS" AND A RISING SUN DESIGN WITH "SEMINOLE" IN DARK BLUE WITH A DARK BLUE LINE BENEATH, "SUBS & GYROS" IN YELLOW WITH AN ORANGE OUTLINE AGAINST A LIGHT BLUE BACKGROUND, AND THE RISING SUN IN ORANGE WITH A YELLOW CENTER WITH YELLOW RAYS.

SER. NO. 76-706,789, FILED 3-14-2011.

KATHY DE JONGE, EXAMINING ATTORNEY



David J. Kyros

Director of the United States Patent and Trademark Office

United States of America

United States Patent and Trademark Office

ORIGINAL SPUNKY SAUCE

Reg. No. 4,065,015

Registered Dec. 6, 2011

Int. Cl.: 30

TRADEMARK

PRINCIPAL REGISTER

CARNEY, ROBERT W. (UNITED STATES INDIVIDUAL)
9356 BRADLEY AVENUE
CUBA, NY 14727 AND

CARNEY, GEORGANNE J. (UNITED STATES INDIVIDUAL)
9356 BRADLEY AVENUE
CUBA, NY 14727

FOR: SAUCES, IN CLASS 30 (U.S. CL. 46).

FIRST USE 9-17-2005; IN COMMERCE 5-6-2009.

THE MARK CONSISTS OF STANDARD CHARACTERS WITHOUT CLAIM TO ANY PARTICULAR FONT, STYLE, SIZE, OR COLOR.

NO CLAIM IS MADE TO THE EXCLUSIVE RIGHT TO USE "ORIGINAL" AND "SAUCE", APART FROM THE MARK AS SHOWN.

SER. NO. 76-706,983, FILED 3-28-2011.

HOWARD B. LEVINE, EXAMINING ATTORNEY



David J. Kyros

Director of the United States Patent and Trademark Office

United States of America

United States Patent and Trademark Office

Reg. No. 4,065,016

Registered Dec. 6, 2011

Int. Cl.: 19

TRADEMARK

PRINCIPAL REGISTER

INNERFACE ARCHITECTURAL SIGNAGE, INC. (GEORGIA CORPORATION)
5849 PEACHTREE ROAD
ATLANTA, GA 30341

FOR: ARCHITECTURAL SIGNAGE CONSISTING OF NON-LUMINOUS AND NON-MECHANICAL PLASTIC SIGNS AND REPLACEMENT PARTS SOLD AS A UNIT, IN CLASS 19 (U.S. CLS. 1, 12, 33 AND 50).

FIRST USE 6-1-2010; IN COMMERCE 6-1-2010.

THE MARK CONSISTS OF THE WORD "WAVE" IN CAPITAL LETTERS, WITH A CONTINUOUS CHANGE OF COLOR ACROSS THE LOWER PORTIONS OF THE LETTERS THAT IMITATES A WAVE OF WATER. COLOR IS NOT PART OF THE MARK.

SER. NO. 76-707,060, FILED 4-1-2011.

CIMMERIAN COLEMAN, EXAMINING ATTORNEY



David J. Kyfos

Director of the United States Patent and Trademark Office

United States of America

United States Patent and Trademark Office

LIFE'S ENDLESS CIRCLE

Reg. No. 4,065,017

ESSLINGER & CO. INC. (MINNESOTA CORPORATION)
1165 MEDALLION DRIVE
MENDOTA HEIGHTS, MN 55120

Registered Dec. 6, 2011

Int. Cl.: 14

FOR: PENDANTS, LOCKETS, BRACELETS, EARRINGS, NECKLACES, KEY CHAINS OF
PRECIOUS METAL, IN CLASS 14 (U.S. CLS. 2, 27, 28 AND 50).

TRADEMARK

FIRST USE 3-13-2003; IN COMMERCE 3-13-2003.

PRINCIPAL REGISTER

THE MARK CONSISTS OF STANDARD CHARACTERS WITHOUT CLAIM TO ANY PAR-
TICULAR FONT, STYLE, SIZE, OR COLOR.

SER. NO. 76-707,088, FILED 4-4-2011.

DAWN FELDMAN, EXAMINING ATTORNEY



David J. Kybas

Director of the United States Patent and Trademark Office

United States of America

United States Patent and Trademark Office

KIDS WHO CARE COOK FOR THOSE IN NEED

Reg. No. 4,065,018

LARZIK, JO ANNE (UNITED STATES INDIVIDUAL)
5805 S. JAMAICA WAY
ENGLEWOOD, CO 80111

Registered Dec. 6, 2011

Int. Cl.: 41

FOR: EDUCATION SERVICES, NAMELY, CONDUCTING COOKING CLASSES FOR CHILDREN, IN CLASS 41 (U.S. CLS. 100, 101 AND 107).

SERVICE MARK

FIRST USE 10-1-2009; IN COMMERCE 10-1-2009.

PRINCIPAL REGISTER

THE MARK CONSISTS OF STANDARD CHARACTERS WITHOUT CLAIM TO ANY PARTICULAR FONT, STYLE, SIZE, OR COLOR.

SER. NO. 76-707,117, FILED 4-5-2011.

JOHN WILKE, EXAMINING ATTORNEY



David J. Kybas

Director of the United States Patent and Trademark Office

United States of America

United States Patent and Trademark Office

SWEET GEORGIA BELLE

Reg. No. 4,065,019

Registered Dec. 6, 2011

Int. Cl.: 33

TRADEMARK

PRINCIPAL REGISTER

PRICHARD'S DISTILLERY (TENNESSEE CORPORATION)
P.O. BOX 100
KELSO, TN 37348

FOR: DISTILLED SPIRITS, IN CLASS 33 (U.S. CLS. 47 AND 49).

FIRST USE 4-1-2004; IN COMMERCE 4-1-2004.

THE MARK CONSISTS OF STANDARD CHARACTERS WITHOUT CLAIM TO ANY PARTICULAR FONT, STYLE, SIZE, OR COLOR.

NO CLAIM IS MADE TO THE EXCLUSIVE RIGHT TO USE "SWEET", APART FROM THE MARK AS SHOWN.

SER. NO. 76-707,286, FILED 4-15-2011.

MARC LEIPZIG, EXAMINING ATTORNEY



David J. Kyffers

Director of the United States Patent and Trademark Office

United States of America

United States Patent and Trademark Office

SMARTZONE

Reg. No. 4,065,020

SIGNATURE CONTROL SYSTEMS, INC. (CALIFORNIA CORPORATION)
18 GOODYEAR, SUITE 110
IRVINE, CA 92618

Registered Dec. 6, 2011

Int. Cl.: 9

FOR: AUTOMATIC IRRIGATION AND WATERING CONTROLS, NAMELY, ELECTRONIC WATER TIMERS AND CONTROLLERS, IN CLASS 9 (U.S. CLS. 21, 23, 26, 36 AND 38).

TRADEMARK

FIRST USE 12-31-1995; IN COMMERCE 12-31-1995.

PRINCIPAL REGISTER

THE MARK CONSISTS OF STANDARD CHARACTERS WITHOUT CLAIM TO ANY PARTICULAR FONT, STYLE, SIZE, OR COLOR.

SER. NO. 76-707,457, FILED 5-2-2011.

CHRISIE B. KING, EXAMINING ATTORNEY



David J. Kybas

Director of the United States Patent and Trademark Office

United States of America

United States Patent and Trademark Office

FORMULART

Reg. No. 4,065,021

Registered Dec. 6, 2011

Int. Cl.: 16

TRADEMARK

PRINCIPAL REGISTER

BALTES, KENNETH (UNITED STATES INDIVIDUAL)
2238 FOXTAIL COURT
WHITE BEAR LAKE, MN 55110

FOR: ART PRINTS, ART PICTURES, GRAPHIC ART REPRODUCTIONS, PRINTED ART REPRODUCTIONS, CALENDARS, DECALS, GREETING CARDS, NOTE CARDS, PICTURE BOOKS, POSTERS, AND STATIONERY, IN CLASS 16 (U.S. CLS. 2, 5, 22, 23, 29, 37, 38 AND 50).

FIRST USE 1-15-1978; IN COMMERCE 12-10-2011.

THE MARK CONSISTS OF STANDARD CHARACTERS WITHOUT CLAIM TO ANY PARTICULAR FONT, STYLE, SIZE, OR COLOR.

SER. NO. 76-707,469, FILED 5-2-2011.

RENEE MCCRAY, EXAMINING ATTORNEY



David J. Kyffers

Director of the United States Patent and Trademark Office

United States of America

United States Patent and Trademark Office

EXPECTINGBABY

Reg. No. 4,065,022

Registered Dec. 6, 2011

Int. Cl.: 9

TRADEMARK

PRINCIPAL REGISTER

MEAD JOHNSON & COMPANY, LLC (DELAWARE LIMITED LIABILITY COMPANY)
2400 W. LLOYD EXPRESSWAY
EVANSVILLE, IN 477210001

FOR: DOWNLOADABLE COMPUTER APPLICATION SOFTWARE FOR MOBILE PHONES, NAMELY, SOFTWARE THAT PROVIDES A PORTABLE USER-FRIENDLY FEATURE TO TRACK AND SHARE A BABY'S DEVELOPMENT AND GROWTH DURING AND AFTER A BABY'S GESTATIONAL PERIOD AND BIRTH PERIOD BY PROVIDING FOR THE EASY INTERACTION AND INTEGRATION OF INFORMATION, INCLUDING TEXT, LINKS, PHOTO, TABLES, CHARTS, AND FILES INTO SOCIAL INTERNET NETWORKING SITES FROM AN INTERACTIVE INFORMATIONAL WEBSITE THAT NOT ONLY PROVIDES EDUCATIONAL INFORMATION ABOUT THE PREGNANCY, ABOUT THE BABY'S GESTATIONAL DEVELOPMENT, ABOUT THE CHILDBIRTH PROCESS AND ABOUT THE NEW-BORN BABY'S DEVELOPMENT, BUT ALSO PROVIDES TO THE MOM-TO-BE INTERACTIVE AND CUSTOMIZED WEEK-BIWEEKLY UPDATES ON THE CHILD'S DEVELOPMENT AND TOOLS THAT HELP IN THE MANAGEMENT OF PREPARATIONS IN ANTICIPATION OF BABY'S ARRIVAL, AND A TRACK AND SHARE FEATURE FOR PHOTOS, UPDATES AND MILESTONES DURING AND AFTER BABY'S GESTATION AND BIRTH, AND ALSO PROVIDES A FEATURE DIRECTED AT THE BIRTH LABOR TO HELP TRACK CONTRACTIONS, PROVIDE DIRECTIONS TO THE NEAREST HOSPITAL AND ALERT FAMILY AND FRIENDS USING A ONE-STEP NOTIFICATION SYSTEM, IN CLASS 9 (U.S. CLS. 21, 23, 26, 36 AND 38).

FIRST USE 5-18-2011; IN COMMERCE 5-18-2011.

THE MARK CONSISTS OF STANDARD CHARACTERS WITHOUT CLAIM TO ANY PARTICULAR FONT, STYLE, SIZE, OR COLOR.

SER. NO. 76-707,978, FILED 6-14-2011.

ANTHONY RINKER, EXAMINING ATTORNEY



David J. Kyros

Director of the United States Patent and Trademark Office

United States of America

United States Patent and Trademark Office



Reg. No. 4,065,023

Registered Dec. 6, 2011

Int. Cl.: 41

SERVICE MARK

PRINCIPAL REGISTER

US ROAD SPORTS & ENTERTAINMENT GROUP, L.P. (TEXAS LIMITED PARTNERSHIP)
5080 SPECTRUM DRIVE, SUITE 609 EAST
ADDISON, TX 75001

FOR: ORGANIZING SPORTING EVENTS, NAMELY, MARATHONS; SPECIAL EVENT
PLANNING FOR ENTERTAINMENT PURPOSES, IN CLASS 41 (U.S. CLS. 100, 101 AND
107).

FIRST USE 3-5-2008; IN COMMERCE 3-5-2008.

OWNER OF U.S. REG. NOS. 3,624,891, 3,624,898 AND OTHERS.

NO CLAIM IS MADE TO THE EXCLUSIVE RIGHT TO USE "13.1 MARATHON", APART
FROM THE MARK AS SHOWN.

THE MARK CONSISTS OF "13.1" WITH THE WORD "MARATHON" VERTICALLY POSI-
TIONED INSIDE THE NUMBER "1", WITH AN OVAL ENCOMPASSING THE ENTIRE MARK.

SER. NO. 76-708,287, FILED 7-11-2011.

KIMBERLY FRYE, EXAMINING ATTORNEY



David J. Kyjars

Director of the United States Patent and Trademark Office

United States of America

United States Patent and Trademark Office

Mother Nature's Vitamin D

Reg. No. 4,065,024

SHPUR, MAURICE (CANADA INDIVIDUAL)
44 CHARLES ST. WEST #2809
TORONTO, CANADA M4Y1R7

Registered Dec. 6, 2011

Int. Cl.: 44

FOR: TANNING SALONS, IN CLASS 44 (U.S. CLS. 100 AND 101).

SERVICE MARK

THE MARK CONSISTS OF STANDARD CHARACTERS WITHOUT CLAIM TO ANY PARTICULAR FONT, STYLE, SIZE, OR COLOR.

PRINCIPAL REGISTER

OWNER OF CANADA REG. NO. 708036, DATED 2-21-2008, EXPIRES 2-21-2023.

NO CLAIM IS MADE TO THE EXCLUSIVE RIGHT TO USE "VITAMIN D", APART FROM THE MARK AS SHOWN.

SER. NO. 77-011,580, FILED 10-2-2006.

HOWARD FRIEDMAN, EXAMINING ATTORNEY



David J. Kyffers

Director of the United States Patent and Trademark Office

United States of America
United States Patent and Trademark Office

SINGAMAS

Reg. No. 4,065,025

Registered Dec. 6, 2011

Int. Cl.: 39

SINGAMAS CONTAINER HOLDINGS LIMITED (HONG KONG LIMITED LIABILITY COMPANY)
108 GLOUCESTER ROAD
19/F, DAH SING FINANCIAL CENTRE
WANCHAI, HONG KONG

SERVICE MARK

PRINCIPAL REGISTER

FOR: TRANSPORTATION OF FREIGHT AND CARGO BY SHIP, BOAT, TRUCK, AND RAIL; TRANSPORT, WAREHOUSE AND DELIVERY SERVICES, NAMELY, THE PACKAGING, CRATING, STORING, SHIPPING AND DELIVERY OF FREIGHT, CARGO AND THE MERCHANDISE OF OTHERS; ROAD HAULAGE SERVICES VIA TRUCK; CARTING OF CARGO AND FREIGHT VIA SHIP, RAIL, TRUCK AND LIGHTERAGE SERVICES; FREIGHT BROKERAGE AND FREIGHT FORWARDING SERVICES; MARINE TRANSPORT SERVICES; RIVER CARGO TRANSPORTATION SERVICES VIA SHIP, BOAT AND BARGE; RENTAL OF WAREHOUSES; WAREHOUSE STORAGE AND CARGO HANDLING SERVICES; STORAGE OF CARGO, FREIGHT AND GOODS; RENTAL OF CARGO CONTAINERS; OPERATION OF SHIPPING CONTAINER DEPOTS AND TERMINALS; MID-STREAM AND LOGISTICS SERVICES, NAMELY, SHIPPING CARGO VIA RAILWAY, SHIP, AND TRUCK; MAKING RESERVATIONS AND BOOKING FOR TRANSPORTATION; PASSENGER TRANSPORT SERVICES; RESCUE SERVICES; RESCUE OF SHIPS IN DISTRESS; CARGO, FREIGHT, AND PASSENGER SHIP TRANSPORT SERVICES; TRANSPORT RESERVATION SERVICES; ARRANGING OF TRANSPORTATION, IN CLASS 39 (U.S. CLS. 100 AND 105).

PRIORITY CLAIMED UNDER SEC. 44(D) ON HONG KONG APPLICATION NO. 300753246, FILED 11-3-2006, REG. NO. 300753246, DATED 11-3-2006, EXPIRES 11-3-2016.

THE MARK CONSISTS OF THE WORD "SINGAMAS" WITH A LINE ABOVE AND BELOW.

SER. NO. 77-043,644, FILED 11-14-2006.

REBECCA EISINGER, EXAMINING ATTORNEY



David J. Kyros

Director of the United States Patent and Trademark Office

United States of America

United States Patent and Trademark Office

P2000

Reg. No. 4,065,026

Registered Dec. 6, 2011

Int. Cl.: 12

TRADEMARK

PRINCIPAL REGISTER

PIRELLI TYRE S.P.A. (ITALY SOCIETA PER AZIONI)
VIALE SARCA 222
MILAN, ITALY 20126

FOR: TIRES AND WHEELS FOR VEHICLES; INNER TUBES; RIMS; PARTS AND FITTING FOR TIRES, NAMELY, VALVES, RIM BANDS AND SPONGE RUBBER RINGS; WHEELS, TUBES AND RIMS, IN CLASS 12 (U.S. CLS. 19, 21, 23, 31, 35 AND 44).

THE MARK CONSISTS OF STANDARD CHARACTERS WITHOUT CLAIM TO ANY PARTICULAR FONT, STYLE, SIZE, OR COLOR.

OWNER OF ITALY REG. NO. 1416662, DATED 2-7-2011, EXPIRES 2-7-2021.

SER. NO. 77-119,997, FILED 3-1-2007.

FLORENTINA BLANDU, EXAMINING ATTORNEY



David J. Kybas

Director of the United States Patent and Trademark Office

United States of America

United States Patent and Trademark Office

PACIFIC

Reg. No. 4,065,027

Registered Dec. 6, 2011

Int. Cl.: 11

TRADEMARK

PRINCIPAL REGISTER

LEYANT INDUSTRY CO. (TAIWAN CORPORATION)
1F, NO. 20, LANE 929
SAN FENG RD., FENG YUAN CITY
TAICHUNG HSIEN, TAIWAN

FOR: GAS BURNERS FOR DOMESTIC USE; FIREPLACE INSERTS IN THE NATURE OF STOVES; GAS STOVES, NAMELY, SPACE HEATERS FOR HOUSEHOLD USE; ELECTRIC HOT-WATER BOTTLES; DISH DISINFECTANT APPARATUS FOR INDUSTRIAL PURPOSES; WATER PURIFYING APPARATUS; WATER FILTERING UNITS FOR DOMESTIC USE; WATER IONIZERS FOR HOUSEHOLD PURPOSES; OXYGEN GENERATOR FOR PROCESSING WATER BY INCREASING OXYGEN CONTENT IN THE WATER; WATER TREATMENT EQUIPMENT, NAMELY, REVERSE OSMOSIS FILTRATION UNITS; FILTERS MADE OF FIBER FOR WATER FILTRATION; HOT AIR BLOWERS; HUMIDIFIERS FOR HOUSEHOLD PURPOSES; EXHAUST HOODS FOR KITCHENS; HOODS FOR RANGES; VENTILATION HOODS FOR STOVES; OVEN VENTILATOR HOODS; EXTRACTOR HOODS FOR HOUSEHOLD PURPOSES; HOT WATER HEATERS; HOT WATER TANKS; SOLAR WATER HEATERS; ELECTRIC AIR DEODORIZERS; AIR FILTERS FOR AIR CONDITIONING UNITS; AIR CONDITIONING UNITS; ELECTRIC FANS FOR HOUSEHOLD PURPOSES; AND, VENTILATING EXHAUST FANS, IN CLASS 11 (U.S. CLS. 13, 21, 23, 31 AND 34).

FIRST USE 2-1-2007; IN COMMERCE 2-1-2007.

THE MARK CONSISTS OF THE HIGHLY STYLIZED WORD "PACIFIC".

SER. NO. 77-150,452, FILED 4-6-2007.

ANTHONY RINKER, EXAMINING ATTORNEY



David J. Kypos

Director of the United States Patent and Trademark Office

United States of America

United States Patent and Trademark Office

LIFE ON MARS

Reg. No. 4,065,028

Registered Dec. 6, 2011

**Int. Cls.: 9, 16, 25, 28, 38
and 41**

TRADEMARK

SERVICE MARK

PRINCIPAL REGISTER

KUDOS FILM & TELEVISION LIMITED (UNITED KINGDOM CORPORATION)
C/O LEE & THOMPSON, GREEN GARDEN HOUSE
15-22 ST CHRISTOPHER'S PLACE
LONDON, UNITED KINGDOM W1U1NL

FOR: IMAGE, DATA AND VIDEO RECORDINGS FEATURING TELEVISION PROGRAMS, RADIO PROGRAMS OR MOTION PICTURE FILMS CONTAINING DRAMA, ENTERTAINMENT OR FACTUAL CONTENT; MOTION PICTURE FILMS FEATURING DRAMA, COMEDY ACTION, ADVENTURE, ANIMATION AND/OR DOCUMENTARIES; TELEVISION FILMS AND PROGRAMS FEATURING DRAMA, COMEDY ACTION, ADVENTURE, ANIMATION AND/OR DOCUMENTARIES RECORDED ON CDS, CDRS, DVDS, DVDRS, DATS, DACS, MINI-DISCS, RECORDS, TAPES, CASSETTES AND DISCS; RADIO PROGRAMS FEATURING DRAMA, COMEDY ACTION, ADVENTURE, ANIMATION AND/OR DOCUMENTARIES RECORDED ON CDS, CDRS, DVDS, DVDRS, DATS, DACS, MINI-DISCS, RECORDS, TAPES, CASSETTES AND DISCS; PRE-RECORDED AUDIO AND/OR VIDEO MEDIA, NAMELY, CDS, CDRS, DVDS, DVDRS, DATS, DACS, MINI-DISCS, RECORDS, TAPES, CASSETTES AND DISCS FEATURING TELEVISION PROGRAMMES, RADIO PROGRAMMES OR MOTION PICTURE FILMS, AND SOUNDTRACKS THEREOF CONTAINING DRAMA, ENTERTAINMENT OR FACTUAL CONTENT; INTERACTIVE GAME PROGRAMS AND VIDEO GAME PROGRAMS FEATURING OR RELATING TO TELEVISION PROGRAMMES, RADIO PROGRAMMES OR MOTION PICTURE FILMS, SOUNDTRACKS THEREOF OR CHARACTERS THEREFROM; MOUSE MATS, NAMELY, MOUSE PADS; DOWNLOADABLE DIGITAL VIDEO, FILM AND TV PROGRAM RECORDINGS FROM THE INTERNET FEATURING DRAMA, COMEDY ACTION, ADVENTURE, ANIMATION AND/OR DOCUMENTARIES; DOWNLOADABLE DIGITAL VIDEO, FILM AND TV PROGRAM RECORDINGS PROVIDED FROM MP4 WEB SITES ON THE INTERNET FEATURING FILMS AND TV PROGRAMS IN THE FIELD OF DRAMA, COMEDY ACTION, ADVENTURE, ANIMATION AND/OR DOCUMENTARIES, IN CLASS 9 (U.S. CLS. 21, 23, 26, 36 AND 38).



David J. Kybas

Director of the United States Patent and Trademark Office

FOR: PAPER AND STATIONERY MATTER, NAMELY, MESSAGE CARDS, ENVELOPES, FOLDERS, LABELS, ORGANIZERS, PRINTING PAPER; PAPER AND ADVERTISING MATERIALS, NAMELY, POSTERS, BROCHURES, LEAFLETS, EVENT SOUVENIR PROGRAMS, POSTER BOOKS; BOOKS; PAMPHLETS; MAGAZINES; POSTCARDS; PICTURES; POSTERS; DIARIES; DRAWING INSTRUMENTS; GREETING CARDS; ADDRESS BOOKS; CATALOGUES; BROCHURES; EVENT PROGRAMS; PRINTED TICKETS; CALENDARS; PHOTOGRAPHS; SIGNED PHOTOGRAPHS; AUTOGRAPHED PRINTED ITEMS, NAMELY, BOOKS, POSTERS AND CALENDARS; PHOTOGRAPHIC ALBUMS; AUTOGRAPH ALBUMS;

Reg. No. 4,065,028 NEWSPAPERS; NEWSLETTERS; NOTELETS; NOTE PADS; NOTE BOOKS; STICKERS; DECALCOMANIAS; DOCUMENT FILES; PRINTED PERIODICALS; INSTRUCTION MANUALS; PRINTED INSTRUCTIONAL AND TEACHING MATERIALS; RECORD TOKEN CARDS; GIFT TOKEN CARDS; WRAPPING PAPER; WRITING IMPLEMENTS; PENS; BALLPOINT PENS; FOUNTAIN PENS; PENCILS; RULERS, NAMELY, DRAWING RULERS AND DRAFTING RULERS; ERASERS; PENCIL SHARPENERS; PEN AND PENCIL CASES; PICTURE CARDS, NAMELY, TRADING CARDS; PICTURE BOOKS; SONG BOOKS; SHEET MUSIC; CARDBOARD AND PAPER BADGES; PAPER FLAGS; ALL THE AFORESAID GOODS FEATURING OR RELATING TO TELEVISION PROGRAMS, RADIO PROGRAMS OR MOTION PICTURE FILMS, SOUNDTRACKS THEREOF OR CHARACTERS THEREFROM, IN CLASS 16 (U.S. CLS. 2, 5, 22, 23, 29, 37, 38 AND 50).

FOR: CLOTHING, NAMELY, T-SHIRTS, SHIRTS, JACKETS, SWEATSHIRTS, HOODED TOPS, PULLOVERS, JUMPERS, SHORTS, BOXER SHORTS, UNDERWEAR, SOCKS, SCARVES, DRESSING GOWNS, CHILDREN'S AND INFANTS' CLOTH AND PLASTIC BIBS, ROMPER SUITS, BABY SLEEPSUITS, DUNGAREES, BRACES, WRISTBANDS, TRACK-SUITS, TIES, LINGERIE, HOSIERY, BATHING COSTUMES, BATHING SUITS, BATHING TRUNKS, BATHROBES, BEACHWEAR, BIKINIS, BLOUSES, BRAS, BRIEFS, CAMISOLES, DRESSES, GLOVES, GOWNS, INFANTWEAR, JEANS, JUMPERS, KILTS, MINISKIRTS, NIGHTWEAR, PAJAMAS, SKIRT SUITS, SKIRTS, SLACKS, SLEEPING GARMENTS, SLEEPWEAR, SUITS, SWIM WEAR, SWIMSUITS, TANKINIS, TEDDIES, THONGS, TROUSERS, WAISTCOATS; FOOTWEAR; HEADGEAR, NAMELY, HEADWEAR; ALL THE AFORESAID GOODS FEATURING OR RELATING TO TELEVISION PROGRAMS, RADIO PROGRAMS OR MOTION PICTURE FILMS, SOUNDTRACKS THEREOF OR CHARACTERS THEREFROM, IN CLASS 25 (U.S. CLS. 22 AND 39).

FOR: TOYS, NAMELY, BATH TOYS, BENDABLE TOYS, CHILDREN'S ART ACTIVITY TOYS, COLLECTABLE TOY FIGURES, INFANT TOYS, MUSICAL TOYS AND WATER SQUIRTING TOYS; DOLLS; PLAYTHINGS, NAMELY, BOARD GAMES, JIGSAW PUZZLES, INTERACTIVE ELECTRONIC EDUCATIONAL GAMES FOR CHILDREN, TOY VEHICLES, RIDE-ON TOYS, ROCKING HORSES, TOY AIR PISTOLS, TOY MASKS, PLAY COSMETICS FOR CHILDREN, TOYS FOR PETS, BATHTUB TOYS, MOBILES, BUILDING GAMES, DOMINOES, CHESS AND CHECKERS GAMES, SKITTLES, BACKGAMMON GAMES, DICE, DICE GAMES, TABLES FOR INDOOR FOOTBALL, BALLS FOR GAMES; MODELED PLASTIC TOY FIGURES AND FIGURINES; TOY ACTION FIGURES AND ACCESSORIES THEREFOR; PLAY FIGURES; SCALE MODEL TOY FIGURES; SOFT SCULPTURE TOYS; RAG DOLLS; MINIATURES, NAMELY, MINIATURE TOY FIGURES AND VEHICLES; MODELS, NAMELY, MODEL FIGURES AND MODEL CARS; TOY MODEL HOBBYCRAFT KITS; ORDINARY PLAYING CARDS; CARD GAMES; TRADING CARD GAMES; CARD GAMES, NAMELY, PRINTED LOTTERY SCRATCH CARDS; BOARD GAMES; JIGSAW PUZZLES; ALL THE AFORESAID GOODS FEATURING OR RELATING TO TELEVISION PROGRAMS, RADIO PROGRAMS OR MOTION PICTURE FILMS, SOUNDTRACKS THEREOF OR CHARACTERS THEREFROM, IN CLASS 28 (U.S. CLS. 22, 23, 38 AND 50).

FOR: BROADCASTING SERVICES RELATING TO THE TRANSMISSION OF TELEVISION PROGRAMS, RADIO PROGRAMS OR MOTION PICTURE FILMS, OR SOUNDTRACKS THEREOF; INFORMATION, ADVISORY AND CONSULTANCY SERVICES IN RELATION TO THE FOREGOING, IN CLASS 38 (U.S. CLS. 100, 101 AND 104).

FOR: SCRIPTWRITING SERVICES; PREPARATION, PRESENTATION, SCRIPT WRITING, DIRECTION AND PRODUCTION OF RADIO, CABLE TELEVISION, SATELLITE, CINEMA AND TELEVISION PROGRAMMES; DISTRIBUTION OF RADIO, SATELLITE AND TELEVISION PROGRAMMES; FILM AND MOTION PICTURE PRODUCTION; PRODUCTION OF ANIMATED CARTOONS; PRODUCTION OF ENTERTAINMENT IN THE FORM OF A TELEVISION OR RADIO SERIES; PRODUCTION OF SPECIAL EFFECTS FOR FILMS, RADIO AND TELEVISION; PUBLICATION OF BOOKS FEATURING OR RELATING TO TELEVISION PROGRAMS, RADIO PROGRAMS OR MOTION PICTURE FILMS, SOUNDTRACKS THEREOF OR CHARACTERS THEREFROM; SYNDICATION OF RADIO AND TELEVISION

Reg. No. 4,065,028 PROGRAMMES; EDITING OF FILM, VIDEOS, TELEVISION, RADIO AND CINEMA FILM RECORDINGS; PROVIDING OF ONGOING RADIO AND TELEVISION PROGRAMS, FILMS, SHOWS, AND/OR RECORDINGS OF IMAGES IN THE FIELD OF DRAMA, COMEDY ACTION, ADVENTURE, ANIMATION AND/OR DOCUMENTARIES; PROVIDING DIGITAL VIDEO, RADIO AND TV PROGRAMS IN THE NATURE OF DRAMA, ENTERTAINMENT OR FACTUAL CONTENT, NOT DOWNLOADABLE, FROM THE INTERNET; PROVIDING DIGITAL VIDEO, RADIO AND TV PROGRAMS IN THE NATURE OF DRAMA, ENTERTAINMENT OR FACTUAL CONTENT, NOT DOWNLOADABLE, FROM MP4 INTERNET WEBSITES; INFORMATION, ADVISORY AND CONSULTANCY SERVICES IN RELATION TO THE FOREGOING, IN CLASS 41 (U.S. CLS. 100, 101 AND 107).

THE MARK CONSISTS OF STANDARD CHARACTERS WITHOUT CLAIM TO ANY PARTICULAR FONT, STYLE, SIZE, OR COLOR.

PRIORITY CLAIMED UNDER SEC. 44(D) ON ERPN CMNTY TM OFC APPLICATION NO. 005412796, FILED 10-24-2006, REG. NO. 005412796, DATED 5-22-2008, EXPIRES 10-24-2016.

SER. NO. 77-164,773, FILED 4-24-2007.

SANI KHOURI, EXAMINING ATTORNEY

United States of America

United States Patent and Trademark Office

GEEM

Reg. No. 4,065,029

Registered Dec. 6, 2011

Int. Cls.: 29 and 30

TRADEMARK

PRINCIPAL REGISTER

NISSHIN SEIFUN GROUP INC. (JAPAN CORPORATION)
1-25, KANDANISHIKICHO, CHIYODA-KU
TOKYO, JAPAN

FOR: MEAT; FISH; FOOD PRODUCTS MADE FROM FISH AND SHELLFISH, NAMELY, FISH CAKES, FISH CROQUETTES, FISH STICKS AND FISH DUMPLINGS; PROCESSED MEAT; PROCESSED BEANS; PRESERVED, DRIED AND COOKED FRUITS AND VEGETABLES; PROCESSED FROZEN FRUITS AND VEGETABLES; JELLIES; EGGS AND PROCESSED EGGS; EDIBLE OILS AND FATS; SOUPS; PREPARATIONS FOR MAKING SOUP; PREPARATIONS FOR MAKING STEW OR BOUILLON; FERMENTED BEAN; FRIED SOYBEAN CURD; FREEZE-DRIED SOYBEAN CURD; JELLY MADE FROM DEVIL'S TONGUE ROOT; SOYBEAN MILK; TOFU; PROTEIN BEING FOODSTUFFS FOR HUMAN CONSUMPTION; WHEY-BASED FOOD BEVERAGES; MILK AND MILK PRODUCTS EXCLUDING ICE CREAM, ICE MILK AND FROZEN YOGURT; SKIM MILK POWDER AND EGG POWDER, IN CLASS 29 (U.S. CL. 46).

FOR: CURRY; CURRY SPICE; PASTA SAUCES; COFFEE; COCOA; TEA; SEASONINGS; SUGAR; SALT; MUSTARD; VINEGAR; SAUCES FOR PASTA AND NOODLES; SAUCES; SPICES; HONEY; RICE; HUSKED OATS; HUSKED BARLEY; FLOUR FOR FOOD; GLUTEN FOR FOOD; PROCESSED CEREALS; CEREAL PREPARATIONS, NAMELY, PROCESSED CEREALS; NOODLES; PASTA; BOILED AND DRIED NOODLES; PRE-COOKED FROZEN FOODS, NAMELY, FROZEN BREADS, FROZEN PASTA, FROZEN MEALS CONSISTING PRIMARILY OF PASTA OR RICE; PREPARED ENTREES CONSISTING PRIMARILY OF RICE OR PASTA; DUMPLING; SANDWICHES; SUSHI; HAMBURGER SANDWICHES; PIZZAS; BOXED LUNCHES, NAMELY, HOT DOG SANDWICHES AND RICE-BASED BENTO; HOT DOG SANDWICHES; MEAT PIES; RAVIOLI; CANDY; BREAD; CRACKERS; BISCUITS; BUNS; CAKES; PIES; COOKIES; PREPARATIONS FOR MAKING INSTANT CAKES, COOKIES OR PUDDINGS; PREPARATIONS FOR MAKING ICE CREAMS OR SHERBETS; ICE CREAMS; SHERBETS; BATTER MIX, NAMELY, DRY BLEND OF FLOUR; ALMOND PASTE; YEAST POWDER; YEAST; BAKING POWDER; NATURAL OR ARTIFICIAL ICE; MEAT TENDERIZERS; SAKE CAKE; FOOD STARCH; BREADER MIX, NAMELY, FLOUR BASED BREAD CRUMB OR CRACKER MEAL; TEMPURA BATTER MIX, NAMELY, MIX FOR MAKING BATTER FOR TEMPURA; BREADCRUMBS; TAPIOCA; SAGO; ARTIFICIAL COFFEE; PASTRIES AND CONFECTIONERY, NAMELY, CANDY, IN CLASS 30 (U.S. CL. 46).



David J. Kyros

Director of the United States Patent and Trademark Office

Reg. No. 4,065,029 THE MARK CONSISTS OF STANDARD CHARACTERS WITHOUT CLAIM TO ANY PARTICULAR FONT, STYLE, SIZE, OR COLOR.

OWNER OF JAPAN REG. NO. 5382244, DATED 1-7-2011, EXPIRES 1-7-2021.

THE WORD "GEEM" HAS NO MEANING IN A FOREIGN LANGUAGE.

SER. NO. 77-212,073, FILED 6-21-2007.

TINA BROWN, EXAMINING ATTORNEY

United States of America

United States Patent and Trademark Office

EIKON

Reg. No. 4,065,030

Registered Dec. 6, 2011

Int. Cls.: 6, 8 and 9

TRADEMARK

PRINCIPAL REGISTER

EIKON DEVICE INC. (CANADA CORPORATION)
692 MCKAY STREET
KINGSTON, CANADA K7M7G2

FOR: METAL SCREWS AND METAL WASHERS FOR TATTOO MACHINES, IN CLASS 6 (U.S. CLS. 2, 12, 13, 14, 23, 25 AND 50).

FIRST USE 12-0-1995; IN COMMERCE 12-0-1995.

FOR: TATTOO NEEDLES; TATTOO MACHINE COMPONENTS, NAMELY, TATTOO NEEDLE BARS AND GROMMETS THEREFORE; TATTOO MACHINES; TATTOO MACHINE KITS COMPRISED OF COMPONENT ELEMENTS SPECIFICALLY DESIGNED FOR TATTOO MACHINES CONSISTING OF TATTOO MACHINE FRAMES, COILS, PRE-WIRED CAPACITORS, SPRINGS, ARMATURE BARS, SCREWS, WASHES AND BINDING POSTS SOLD TOGETHER AS A UNIT; SPRING AND ARMATURE KITS FOR TATTOO MACHINES CONSISTING OF SPRINGS, ARMATURE, SHIMS, WASHERS AND SCREWS SOLD TOGETHER AS A UNIT AND SPECIFICALLY DESIGNED FOR TATTOO MACHINES; BINDING POSTS FOR TATTOO MACHINES; TATTOO MACHINE REPLACEMENT PARTS KITS, CONSISTING OF SCREWS, WASHERS, SET SCREWS, SHIM WASHERS, INSULATING SHOULDER WASHERS, SOLID WIRE AND SOLDER, HEAT SHRINK TUBING, A COMPLETE BACK BINDING POST, A COMPLETE TOP BINDING POSTS AND CAPACITORS, ALL OF WHICH ARE SPECIFICALLY DESIGNED FOR TATTOO MACHINES AND SOLD TOGETHER AS A UNIT; TATTOO MACHINE ACCESSORIES, NAMELY, TUBES, TIPS AND GRIPS SPECIALLY DESIGNED FOR TATTOO NEEDLES; TATTOOING SUPPLIES, NAMELY, PLASTIC SLEEVES SPECIFICALLY DESIGNED FOR USE ON CLIP CORDS AS PART OF TATTOOING MACHINES; TATTOOING SUPPLIES, NAMELY, INK AND PIGMENT BOTTLE HOLDERS SPECIALLY ADAPTED FOR USE AS PART OF A TATTOOING MACHINE, IN CLASS 8 (U.S. CLS. 23, 28 AND 44).

FIRST USE 1-0-2000; IN COMMERCE 1-0-2000.

FOR: TATTOO MACHINE POWER SUPPLIES AND ACCESSORIES, NAMELY, DIAGNOSTIC METERS FOR ANALYZING VOLTAGE, TATTOO MACHINE SPEED AND PERFORMANCE, POWER ADAPTERS AND ELECTRIC CORD SETS; TATTOO MACHINE ACCESSORIES, NAMELY, ELECTRIC CLIP CORDS, CONNECTOR CORDS, AND ELECTRIC FOOT SWITCHES; ELECTRICAL PARTS FOR TATTOO MACHINES, NAMELY, CAPACITORS, SOLDER LUGS IN THE NATURE OF ELECTRIC CONDUCTORS, FOOT SWITCH WIRE,



David J. Kybas

Director of the United States Patent and Trademark Office

Reg. No. 4,065,030 CLIP CORD WIRE, PLUGS AND JACKS FOR ELECTRICAL COMPONENTS, ELECTRICAL WIRE AND PRE-WIRED CAPACITORS, ELECTRIC PLUG CONVERSION KITS CONSISTING OF ELECTRIC SWITCH HOUSINGS, ELECTRIC CONNECTORS, METAL BRACKET SPECIFICALLY DESIGNED AS COMPONENT ELEMENTS FOR ELECTRIC SWITCH HOUSINGS, ELECTRIC WIRE AND ELECTRIC CONTACTS IN THE NATURE OF SOLDER LUGS FOR ELECTRIC CONDUCTION, IN CLASS 9 (U.S. CLS. 21, 23, 26, 36 AND 38).

FIRST USE 1-0-2000; IN COMMERCE 1-0-2000.

THE MARK CONSISTS OF STANDARD CHARACTERS WITHOUT CLAIM TO ANY PARTICULAR FONT, STYLE, SIZE, OR COLOR.

PRIORITY CLAIMED UNDER SEC. 44(D) ON CANADA APPLICATION NO. 1350521, FILED 6-6-2007.

SER. NO. 77-223,074, FILED 7-5-2007.

COLLEEN KEARNEY, EXAMINING ATTORNEY

United States of America

United States Patent and Trademark Office

EXPOSÉ

Reg. No. 4,065,031

Registered Dec. 6, 2011

Int. Cl.: 41

SERVICE MARK

PRINCIPAL REGISTER

WALKING DISTANCE ENTERTAINMENT LLC (NEVADA LIMITED LIABILITY COMPANY)
4851 TORRENCE DRIVE
LAS VEGAS, NV 89103

FOR: LIVE MUSICAL PERFORMANCES, IN CLASS 41 (U.S. CLS. 100, 101 AND 107).

FIRST USE 8-1-2003; IN COMMERCE 8-1-2003.

THE MARK CONSISTS OF STANDARD CHARACTERS WITHOUT CLAIM TO ANY PARTICULAR FONT, STYLE, SIZE, OR COLOR.

SER. NO. 77-252,342, FILED 8-10-2007.

MARY CRAWFORD, EXAMINING ATTORNEY



David J. Kybas

Director of the United States Patent and Trademark Office

United States of America

United States Patent and Trademark Office

SHOPPERLOGIC

Reg. No. 4,065,032

Registered Dec. 6, 2011

Int. Cls.: 9, 35, 38 and 42

TRADEMARK

SERVICE MARK

PRINCIPAL REGISTER

MEDIAEDGE:CIA INTERNATIONAL LIMITED (UNITED KINGDOM PRIVATE LIMITED COMPANY)
1 PARIS GARDEN
LONDON SE1 8NU, UNITED KINGDOM

FOR: COMPUTER SOFTWARE FOR THE COLLECTION, MONITORING, TRACKING, ANALYSIS, COLLATION AND PRESENTATION OF DATA FOR USE IN THE FIELD OF MARKETING AND RETAIL POINT-OF-SALE MARKETING; APPARATUS FOR RECORDING, TRANSMISSION OR REPRODUCTION OF SOUND OR IMAGES; BLANK MAGNETIC DATA CARRIERS, BLANK RECORDING VIDEO DISCS, AUDIO DISCS, DVD DISCS; COMPUTERS, IN CLASS 9 (U.S. CLS. 21, 23, 26, 36 AND 38).

FOR: ADVERTISING SERVICES; ADVERTISING ANALYSIS FOR BUSINESS; ADVERTISING SERVICES PROVIDED OVER THE INTERNET; SALES PROMOTION; ADVISORY SERVICES RELATING TO BUSINESS ORGANIZATION, TO DATA PROCESSING AND TO PROMOTIONAL ACTIVITIES; BENCHMARKING, NAMELY, EVALUATION OF BUSINESS ORGANIZATION PRACTICES; BUSINESS ADVICE; BUSINESS ADVICE RELATING TO ADVERTISING AND MARKETING; BUSINESS EXPERTISE SERVICES, NAMELY, INFORMATION AND EXPERT OPINIONS RELATING TO COMPANIES, BUSINESS AND ANALYSIS OF CONSUMER BEHAVIOR; BUSINESS INFORMATION IN THE NATURE OF BUSINESS FEASIBILITY STUDIES; COMPILATION AND PROVISION OF BUSINESS INFORMATION AND INVESTIGATIONS; CONDUCTING BUSINESS MARKET SURVEYS; SURVEYS FOR BUSINESS PURPOSES; COMPILATION OF BUSINESS INFORMATION, WRITTEN COMMUNICATIONS, STATISTICAL DATA AND MARKETING SURVEYS FOR OTHERS; BUSINESS DATA MANAGEMENT CONSULTANCY AND ADVICE FOR OTHERS FOR USE IN RETAIL INDUSTRY AND MANUFACTURERS; BUSINESS DATA MANAGEMENT CONSULTANCY AND ADVICE FOR OTHERS FOR USE IN RETAIL INDUSTRY AND MANUFACTURERS; COLLECTION OF MARKET RESEARCH INFORMATION; COLLECTION OF STATISTICS FOR BUSINESS; COMPILATION OF BUSINESS INFORMATION INTO COMPUTER DATABASES; COMPILATION OF STATISTICS RELATING TO ADVERTISING; COMPILATION OF STATISTICAL MODELS FOR THE PROVISION OF MARKET DYNAMICS INFORMATION; ANALYSIS OF MARKET RESEARCH DATA; MARKET ANALYSIS; MARKET ANALYSIS REPORTS; MARKET ANALYSIS SERVICES RELATING TO THE AVAILABILITY AND THE SALE OF GOODS; BUSINESS MARKET INFORMATION SERVICES RELATING TO MARKET STATISTICS; BUSINESS MARKET INFORMATION SERVICES RELATING TO TRADE REPORTS; MARKET RESEARCH; MARKET RESEARCH BY MEANS OF A COMPUTER DATA BASE; MARKET RESEARCH FOR ADVERTISING;



David J. Kybas

Director of the United States Patent and Trademark Office

Reg. No. 4,065,032 MARKETING CONSULTING; CUSTOMER LOYALTY SERVICES FOR COMMERCIAL, PROMOTIONAL AND ADVERTISING PURPOSES; MARKETING PLAN DEVELOPMENT; MARKETING, PROJECT STUDIES FOR BUSINESSES, IN CLASS 35 (U.S. CLS. 100, 101 AND 102).

FOR: TELECOMMUNICATIONS, NAMELY, TRANSFER OF DATA BY TELECOMMUNICATIONS; ADVISORY AND COMMUNICATIONS CONSULTANCY IN THE NATURE OF TECHNICAL CONSULTING IN THE FIELD OF AUDIO, TEXT AND VISUAL DATA TRANSMISSION AND COMMUNICATION; PROVIDING PRIVATE AND SECURE ELECTRONIC COMMUNICATION SERVICES VIA COMPUTER NETWORK; DATA COMMUNICATION SERVICES; DATA TRANSMISSION VIA ELECTRONIC MEANS; PROVIDING INFORMATION RELATING TO ELECTRONIC COMMUNICATION TRANSMISSION STRATEGIES, IN CLASS 38 (U.S. CLS. 100, 101 AND 104).

FOR: SCIENTIFIC RESEARCH; TECHNOLOGY RESEARCH IN THE FIELD OF INFORMATION TECHNOLOGY, MARKETING AND COMPUTERS; DESIGN FOR OTHERS IN THE FIELD OF COMPUTERS AND ENGINEERING COMPUTER PROGRAMS; DESIGN AND DEVELOPMENT OF COMPUTER HARDWARE AND SOFTWARE; ADVISORY SERVICES RELATING TO COMPUTER SOFTWARE BASED INFORMATION SYSTEMS, TO COMPUTER PROGRAMMING, TO COMPUTER SOFTWARE, TO COMPUTER SOFTWARE DESIGN, TO COMPUTER SYSTEMS DESIGN AND TO THE USE OF COMPUTER SOFTWARE; COMPUTER NETWORK SERVICES, NAMELY, DESIGN AND IMPLEMENTATION OF COMPUTER NETWORKS; COMPUTER PROGRAM MAINTENANCE AND UPDATING SERVICES; COMPUTER PROGRAMMING; DUPLICATION OF COMPUTER PROGRAMS; COMPUTER SOFTWARE RESEARCH SERVICES; CREATION, DESIGN, DEVELOPMENT, INSTALLATION, UPDATING AND MAINTENANCE OF COMPUTER SOFTWARE; COMPUTER SOFTWARE ADVISORY SERVICES; COMPUTER SOFTWARE RENTAL SERVICES; COMPUTER SOFTWARE RESEARCH; COMPUTER SYSTEMS ANALYSIS; COMPUTER TIME SHARING; COMPUTER DATABASE DESIGN; DEVELOPMENT OF PROGRAMS FOR DATA PROCESSING; PROFESSIONAL CONSULTANCY RELATING TO COMPUTER SOFTWARE; SURVEYING AND QUANTITY SURVEYING, IN CLASS 42 (U.S. CLS. 100 AND 101).

THE MARK CONSISTS OF STANDARD CHARACTERS WITHOUT CLAIM TO ANY PARTICULAR FONT, STYLE, SIZE, OR COLOR.

OWNER OF ERPN CMNTY TM OFC REG. NO. 006177828, DATED 10-29-2010, EXPIRES 8-7-2017.

SER. NO. 77-261,789, FILED 8-22-2007.

ZACHARY BELLO, EXAMINING ATTORNEY

United States of America

United States Patent and Trademark Office



Reg. No. 4,065,033

Registered Dec. 6, 2011

**Int. Cls.: 1, 2, 3, 6, 7, 8,
9, 10, 11, 13, 14, 16, 17,
18, 19, 20, 21, 27 and 28**

TRADEMARK

PRINCIPAL REGISTER

MITSUBISHI SHOJI KAISHA, LTD. (JAPAN CORPORATION)
3-1, MARUNOUCHI 2-CHOME, CHIYODA-KU
TOKYO, JAPAN

FOR: CHEMICAL PREPARATIONS, NAMELY, INORGANIC ACIDS, ALKALIS, INORGANIC SALTS, HYDROGEN, HELIUM, BORON, CARBON, NITROGEN, OXYGEN, FLUORINE, NEON, PHOSPHORUS, SULFUR, CHLORINE, ARGON, ARSENIC, BROMINE, IODINE, SODIUM, POTASSIUM AND CALCIUM, OXIDES, SULFIDES, CARBIDES, ALDEHYDES AND KETONES, ORGANIC ACIDS AND THEIR SALTS, ESTERS, NITROGEN COMPOUNDS, HETEROCYCLIC COMPOUNDS, CARBOHYDRATES, TERPENES, PROTEINS AND ENZYMES, ORGANOPHOSPHATE COMPOUNDS AND ORGANOARSENIC COMPOUNDS, ORGANO-METALLIC COMPOUNDS, SURFACE-ACTIVE AGENTS, FOR USE IN THE MANUFACTURE OF PHARMACEUTICALS, DYESTUFFS, PAINTS, SOAPS, PERFUMERY, COSMETICS, MANURES AND PLASTICS; CHEMICAL PREPARATIONS, NAMELY, HEAVY WATER FOR USE IN NUCLEAR REACTORS, DISTILLED WATER, OXYGEN FOR INDUSTRIAL USE; CHEMICAL PREPARATIONS, NAMELY, ADHESIVES FOR USE IN THE AGRICULTURAL INDUSTRY, PETROCHEMICAL INDUSTRY, ELECTRONICS INDUSTRY, PRINTING INDUSTRY, PHARMACEUTICAL INDUSTRY, MANUFACTURING, MEDICAL SERVICES, CLOTHES MANUFACTURING INDUSTRY, AUTOMOTIVE INDUSTRY, FOOD PREPARATION INDUSTRY, CONSTRUCTION, AEROSPACE INDUSTRY, COMMUNICATIONS, PACKAGING INDUSTRY, CHEMICAL INDUSTRY; CHEMICAL PREPARATIONS, NAMELY, GLUE FOR ADHESIVES FOR USE WITH LUMBER, PAPER, CLOTH; CHEMICAL PREPARATIONS, NAMELY, ALCOHOL FOR USE IN THE MANUFACTURE OF PAINTS AND OTHER COATINGS, ALCOHOL FOR USE IN THE MANUFACTURE OF PERFUMES; CHEMICAL PREPARATIONS, NAMELY, SCOURING LIQUID AND POWDER, WETTING AGENTS FOR USE IN THE MANUFACTURE OF COSMETICS AND PAINTS; CHEMICAL PREPARATIONS, NAMELY, ANTISTATIC SPRAY FOR ELECTRONIC EQUIPMENT; CHEMICAL PREPARATIONS, NAMELY, WATERPROOFING CHEMICAL COMPOSITIONS FOR ARTICLES OF FABRIC, LEATHER, MASONRY, WOOD AND OTHER BUILDING CONSTRUCTION SURFACES; CHEMICAL PREPARATIONS, NAMELY, RADIATOR ADDITIVE TO PREVENT RUST; CHEMICAL PREPARATIONS, NAMELY, MOLD RELEASING COMPOUNDS FOR USE IN THE PLASTICS/FIBERGLASS INDUSTRY AND CONCRETE FABRICATION; CHEMICAL PREPARATIONS, NAMELY, CATALYSTS USED IN THE MANUFACTURE OF RUBBER; CHEMICAL PREPARATIONS, NAMELY, TEMPERING CHEMICALS USED IN METALWORKING AND SOLDERING, TEMPERING CHEMICALS FOR USE IN THE TEXTILE AND AUTOMOTIVE INDUSTRIES; CHEMICAL PREPARATIONS, NAMELY, SOLDERING FLUX; CHEMICAL PREPARATIONS, NAMELY, WATER PROOFING



David J. Kyjars

Director of the United States Patent and Trademark Office

Reg. No. 4,065,033 CHEMICALS FOR BUILDING AND CONSTRUCTION SURFACES; CHEMICAL PREPARATIONS, NAMELY, ANTI-SULPHURIZING CHEMICALS FOR USE IN THE MANUFACTURE OF BATTERIES; CHEMICAL PREPARATIONS, NAMELY, FOOD PRESERVATIVES; CHEMICAL PREPARATIONS, NAMELY, CHEMICAL ADDITIVES FOR FUEL TREATMENT, NAMELY, TO IMPROVE FUEL ECONOMY; CHEMICAL PREPARATIONS, NAMELY, AGRICULTURAL FERTILIZERS; CHEMICAL PREPARATIONS, NAMELY, CHEMICAL CATALYSTS USED IN THE OIL PROCESSING INDUSTRY; CHEMICAL PREPARATIONS, NAMELY, PETROLEUM CRACKING CATALYSTS; CHEMICAL PREPARATIONS, NAMELY, ADHESIVES USED IN THE PLASTICS INDUSTRY; CHEMICAL PREPARATIONS, NAMELY, SYNTHETIC FRAGRANCES USED IN THE MANUFACTURE OF COSMETICS; CHEMICAL PREPARATIONS, NAMELY, PLANT GROWTH REGULATORS AND SOIL CONDITIONERS FOR AGRICULTURAL USE; CHEMICAL PREPARATIONS, NAMELY, UNEXPOSED FILM AND CHEMICALS USED FOR PHOTOGRAPHIC DEVELOPMENT, NAMELY, SENSITIZING AGENTS, DEVELOPING AGENTS, AND FIXING AGENTS; PHOTOGRAPHIC SUPPLIES, NAMELY, PHOTOGRAPHIC CHEMICALS, PHOTOGRAPHIC DEVELOPERS, PHOTOGRAPHIC DRY PLATES, PHOTOGRAPHIC EMULSIONS, PHOTOGRAPHIC FIXERS, PHOTOGRAPHIC PAPER, PHOTOGRAPHIC SENSITIZERS, UNEXPOSED PHOTOGRAPHIC FILM; CHEMICAL TEST PAPER, BLUEPRINT PAPER, PHOTSENSITIVE PAPER; PLANT GROWTH REGULATING PREPARATIONS; ADHESIVES FOR INDUSTRIAL USE; HIGHER FATTY ACIDS FOR INDUSTRIAL USE; NON-METALLIC MINERALS, NAMELY, SULPHUR; UNPROCESSED PLASTICS, NAMELY, PLASTICS IN PRIMARY FORM; PULP, NAMELY, PAPER PULP AND SULPHITE PULP; FLOUR AND STARCH FOR INDUSTRIAL PURPOSES; FERTILIZERS; ARTIFICIAL SWEETENERS; CERAMIC GLAZINGS FOR INDUSTRIAL USE; GLAZIERS PUTTY; WALLPAPER REMOVING PREPARATIONS; PHOTSENSITIVE GLASS; PHOTOGRAPHIC MATERIALS, NAMELY, DRY PLATES, IN CLASS 1 (U.S. CLS. 1, 5, 6, 10, 26 AND 46).

FOR: PAINTS; DYESTUFFS; PIGMENTS; PRINTING INKS, OTHER THAN MIMEOGRAPHING INKS; NONFERROUS METALS IN FOIL AND POWDER FORM FOR PAINTERS, DECORATORS, PRINTERS AND ARTISTS; PRECIOUS METALS IN FOIL AND POWDER FORM FOR PAINTERS, DECORATORS, PRINTERS AND ARTISTS; ANTI-RUST GREASES; RAW NATURAL RESINS FOR USE IN THE MANUFACTURE OF ADHESIVES, PAINTS AND COSMETICS, NAMELY, CANADA BALSAM; COPAL; SANDARAC; SHELLAC; VARNISHES, NAMELY, PINE OIL; DAMMAR; MORDANTS FOR GENERAL INDUSTRIAL USE; RAW NATURAL RESINS FOR USE IN THE MANUFACTURE OF RESINS, MASTIC; PINE GUM, NAMELY, NATURAL RESINS IN THE NATURE OF GUM EXTRACTS FROM PINE BARK; WOOD PRESERVATIVES, IN CLASS 2 (U.S. CLS. 6, 11 AND 16).

FOR: BATH, DEODORANT AND DISINFECTANT SOAPS AND DETERGENTS; PERFUMERY; FRAGRANCES AND INCENSES; ADHESIVES FOR AFFIXING FALSE HAIR, FALSE NAILS, FALSE EYELASHES; DENTIFRICES; NON-MEDICATED DENTAL RINSE; ANTI-STATIC PREPARATIONS FOR HOUSEHOLD PURPOSES; DEGREASING PREPARATIONS FOR HOUSEHOLD PURPOSES; RUST REMOVING PREPARATIONS; STAIN REMOVING PREPARATIONS, NAMELY, BENZINE; FABRIC SOFTENERS FOR LAUNDRY USE; LAUNDRY STARCH; LAUNDRY BLEACH; SEAWEED GELATINE FOR LAUNDRY USE; POLISHING PREPARATIONS; ABRASIVE PAPER, NAMELY, SANDPAPER; ABRASIVE CLOTH; ABRASIVE SAND; ARTIFICIAL PUMICE STONE FOR PERSONAL USE; POLISHING PAPER; SHOE AND BOOT CREAM; SHOE BLACK, NAMELY, SHOE POLISH; PAINT STRIPPING PREPARATIONS, IN CLASS 3 (U.S. CLS. 1, 4, 6, 50, 51 AND 52).

FOR: IRONS AND STEELS; METAL ORES SOLD IN UNFINISHED FORM FOR FURTHER MANUFACTURE; METAL BUILDING MATERIALS, NAMELY, CEILINGS, WAINSCOTING, SIDING GRATINGS, PILLARS, BEAMS, WINDOWS, WINDOW SASH PULLEYS, DOORS, WINDOW SHUTTERS, RAILINGS, GUTTERS, FENCES, GATES, POLES, HINGES, LATHS; TILES MADE OF METAL USED FOR FLOORS, WALLS AND CEILINGS; BARBED WIRE; METAL VISES; METAL RINGS USED FOR BUILDING AND CONSTRUCTION SUCH AS FOR FASTENING PIPES; METAL JOINERY FITTINGS; METAL HARDWARE, METAL FASTENERS, NAMELY, NAILS, TACKS, SCREWS, BOLTS, NUTS, WASHERS, RIVETS;

Reg. No. 4,065,033 METAL SHIMS; METAL CHAINS AND LOCKS AND KEYS THEREFOR; PREFABRICATED BUILDING ASSEMBLY KITS OF METAL; RESERVOIRS OF METAL; METAL PULLEYS; METAL SPRINGS AND VALVES, NOT BEING MACHINE PARTS; INDUSTRIAL PACKAGING CONTAINERS OF METAL; LOADING AND UNLOADING PALLETS OF METAL; METAL TURN-TABLES FOR LOAD HANDLING; METAL TRAVERSERS FOR LOAD HANDLING; ARTIFICIAL FISH REEFS OF METAL; METAL MOULDS FOR FORMING CEMENT PRODUCTS; TRANSPORTABLE GREENHOUSES OF METAL FOR HOUSEHOLD USE; PAINT SPRAYING BOOTHS OF METAL; POULTRY CAGES OF METAL; NON-LUMINOUS BEACONS OF METAL; NON-LUMINOUS AND NON- MECHANICAL ROAD SIGNS OF METAL; RAILWAY POINTS; METAL KEYS MECHANICAL ELEMENT; METAL JUNCTIONS FOR PIPES; METAL FLANGES; COTTER PINS; ANCHORS; MOORING BITTS OF METAL; MOORING BOLLARDS OF METAL; ANVILS; SWAGE BLOCKS; WIRE NETS AND GAUZES; WIRE ROPES; METAL CHAINS FOR DOGS; WATER TANKS OF METAL FOR HOUSEHOLD PURPOSES; TOOL BOXES OF METAL; MONEY BOXES OF METAL; METAL STEPLADDERS AND LADDERS; METAL NAMEPLATES AND DOOR NAMEPLATES; TOWEL DISPENSERS OF METAL; HAT-HANGING HOOKS OF METAL; LETTER BOXES OF METAL; METAL SAFES; UPRIGHT SIGNBOARDS OF METAL; SCULPTURES OF METAL; BLINDS OF METAL; METAL TOMBS AND METAL TOMB PLAQUES; BUCKLES OF METAL; FERRULES OF METAL FOR CANES AND WALKING-STICKS; CRAMPONS AND CLIMBING IRONS; CARABINERS; DIVING PLATFORMS OF METAL; SPURS; ROCK PITONS OF METAL; APPARATUS OF METAL FOR BICYCLE PARKING, IN CLASS 6 (U.S. CLS. 2, 12, 13, 14, 23, 25 AND 50).

FOR: DRYING MACHINES FOR CHEMICAL PROCESSING, IN CLASS 7 (U.S. CLS. 13, 19, 21, 23, 31, 34 AND 35).

FOR: HAND TOOLS, NAMELY, BUSH HAMMERS, STONE HAMMERS, MALLETS, SPANNERS, ADJUSTABLE SPANNERS, WRENCHES, NON-ELECTRIC SOLDERING IRONS, VICES, CARPENTERS' PINNERS, NIPPERS, PLIERS, CUTTING PLIERS, TONGS TAMPING PICKS, SHOVELS, SNOW SHOVELS, CARVING PICKS; HAND-HELD HOES; DIGGING FORKS, NAMELY, SPADING FORKS; HAND-HELD LAWN RAKES; HAND-HELD BRAIDERS; RAZORS; MANUAL HAIR CLIPPERS; TABLEWARE OF PRECIOUS METALS; CUTLERY, NAMELY, THIN BLADED KITCHEN KNIVES, HEAVY KITCHEN KNIVES, NON-ELECTRIC VEGETABLE CHOPPERS, BUTCHER KNIVES, TABLE KNIVES, FRUIT KNIVES, FOLDING KNIVES; GRINDING TOOLS, NAMELY, WHETSTONES, AND MANUALLY-OPERATED GRINDING WHEELS; HAND-HELD LASTS FOR SHOE-MAKING; CASES FOR RAZORS AND SHAVING BLADES; PEDICURE SETS; MANICURE SETS; NON-ELECTRIC PLANES FOR FLAKING DRIED BONITO BLOCKS; SUGAR TONGS; NON-ELECTRIC CAN OPENERS; NUTCRACKERS NOT OF PRECIOUS METALS; CUTLERY, NAMELY, SPOONS; FORKS; NON-ELECTRIC FLAT IRONS; DRESSMAKERS CHALK SHARPENERS; DIVING KNIVES; DIVING KNIFE HOLDERS; MOUNTAINEERING PICKELS, NAMELY, ICE AXES; HAND-HELD INSECTICIDE SPRAYERS; JAPANESE CHARCOAL EXTINGUISHERS IN THE NATURE OF CERAMIC JAR USED TO PUT OUT CHARCOAL EMBERS; FIRE TONGS; TWEEZERS; TABLEWARE NOT OF PRECIOUS METALS, NAMELY, FORKS, KNIVES, AND SPOONS; KITCHEN UTENSILS MADE OF PRECIOUS METALS, NAMELY, NUTCRACKERS, IN CLASS 8 (U.S. CLS. 23, 28 AND 44).

FOR: PHYSICAL AND CHEMICAL APPARATUS AND INSTRUMENTS USED FOR EXPERIMENTAL PURPOSES, NAMELY, THERMOSTATS, AND HYGROSTATS, DESIGNED TO INCREASE THE BULK DENSITY OF POWDERS AND TO REDUCE THE VOLUME OF POWDERS; LABORATORY APPARATUS AND INSTRUMENTS, NAMELY, AIR-GAS PRODUCERS, CONSTANT TEMPERATURE INCUBATORS, CONSTANT HUMIDITY INCUBATORS, GLASSWARE FOR SCIENTIFIC EXPERIMENT LABORATORIES, PORCELAIN FOR SCIENTIFIC EXPERIMENT LABORATORIES, SCIENTIFIC MODELS AND SPECIMENS; OPTICAL APPARATUS AND INSTRUMENTS, NAMELY, TELESCOPES AND MICROSCOPES; EYEGLASSES, SUNGLASSES AND FRAMES THEREFOR; PROCESSED GLASS FOR LABORATORY PURPOSES; LABORATORY GLASS; ELECTRIC CONDUCTION GLASS; MEASURING INSTRUMENTS WITH GRADUATIONS IN STANDARD MEASURING UNITS,

Reg. No. 4,065,033 NAMELY, BALANCES AND SCALES; TESTING MACHINES AND INSTRUMENTS, NAMELY, METAL STRENGTH TESTING MACHINES AND TESTING EQUIPMENT FOR MEASURING THE TEMPERATURE, PRESSURE, POSITION OR FORM OF WORKPIECES IN A MACHINE TOOL; THERMOMETERS, GAS METERS, AND WATER METERS; MEASURING INSTRUMENTS WITH GRADUATIONS IN DERIVED MEASURING UNITS, NAMELY, SPEED METERS, PRESSURE METERS, PHOTOMETERS, LUMINOFLUX METERS, HYGROMETERS, CALORIMETERS, FLOWMETERS, LEVEL GAUGES, GRAVIMETERS, VISCOMETERS; PRECISION MEASURING MACHINES AND INSTRUMENTS, NAMELY, CLINOMETERS, SURFACE ROUGHNESS TESTERS, FLATNESS TESTING MACHINES AND INSTRUMENTS; STRAIGHTNESS TESTING MACHINES AND INSTRUMENTS; SURVEYING INSTRUMENTS, NAMELY, LEVELING INSTRUMENTS, DISTANCE MEASURING INSTRUMENTS, PHOTOGRAMMETRIC INSTRUMENTS, GYRO COMPASSES, GYROMAGNETIC COMPASSES, MAGNETIC COMPASSES, TRIPODS; ASTRONOMICAL MEASURING INSTRUMENTS, NAMELY, ZENITH TELESCOPES, TRANSIT INSTRUMENTS, AND ASTRONOMICAL SPECTROGRAPHS; PHOTOGRAPHIC MACHINES AND APPARATUS; CINEMATOGRAPHIC MACHINES AND APPARATUS; PHOTOGRAPHIC MATERIALS, NAMELY, EXPOSED FILMS; EXPOSED CINEMATOGRAPHIC FILMS; EXPOSED SLIDE FILMS; SLIDE FILM MOUNTS; RECORDED VIDEO DISCS AND VIDEO TAPES FEATURING AUTO REPAIRS, SPORTS EVENTS, MUSICS, HISTORIES AND MOVIES; PHONOGRAPH RECORDS FEATURING MUSIC; CONSUMER VIDEO GAMES, NAMELY, AMUSEMENT APPARATUS AND GAMES ADAPTED FOR USE WITH TELEVISION RECEIVERS OR WITH VIDEO OR COMPUTER MONITORS, AND COMPUTER PROGRAMS FOR VIDEO AND COMPUTER GAMES; LIFE SAVING APPARATUS AND EQUIPMENT, NAMELY, LIFE-SAVING JACKETS, RAFTS AND LIFE-SAVING INNER TUBES; OZONISERS, NAMELY, OZONATORS; ELECTROLYSERS AND ELECTROLYTIC CELLS FOR USE IN ELECTROPLATING PURPOSES; AMUSEMENT MACHINES AND APPARATUS ADAPTED FOR USE WITH AN EXTERNAL DISPLAY SCREEN OR MONITOR; SLOT MACHINES; VEHICLE DRIVE TRAINING SIMULATORS; RAILWAY SIGNALS; VEHICLE BREAKDOWN WARNING TRIANGLES; LUMINOUS AND MECHANICAL ROAD SIGNS; FIRE ALARMS; GAS ALARMS; GLOVES FOR PROTECTION AGAINST ACCIDENTS; FIRE EXTINGUISHERS; FIRE HYDRANTS; FIRE HOSE NOZZLES; FIRE ENGINES; FIRE BOATS; SPRINKLER SYSTEMS FOR FIRE PROTECTION; ANTI-THEFT WARNING APPARATUS; PROTECTIVE HELMETS; FIREPROOF GARMENTS; DUST MASKS; GAS MASKS; CIGAR LIGHTERS FOR AUTOMOBILES; WELDING MASKS; GASOLINE STATION EQUIPMENT, NAMELY, GASOLINE PUMPS; VENDING MACHINES; COIN-OPERATED GATES FOR CAR PARKING FACILITIES; CASH REGISTERS; COIN COUNTING AND SORTING MACHINES; ELECTRIC SIGN BOARDS FOR DISPLAYING TARGET FIGURES, CURRENT OUTPUTS; PHOTO-COPYING MACHINES; MANUALLY OPERATED COMPUTING APPARATUS, NAMELY, CALCULATING SCALE; DRAWING AND DRAFTING MACHINES AND APPARATUS, NAMELY, MECHANICAL CALCULATORS, SLIDE RULES, AND SCALES; TIME AND DATE STAMPING MACHINES; TIME CLOCKS, NAMELY, TIME RECORDING DEVICES; PUNCHED CARD OFFICE MACHINES; VOTING MACHINES; BILLING MACHINES; POSTAGE STAMP CHECKING APPARATUS; WEIGHT BELTS FOR SCUBA DIVING; WETSUITS, NAMELY, INSULATED OVERALL WET SUITS AND DRY SUITS FOR SCUBA DIVING; INFLATABLE SWIMMING FLOATS FOR SAFETY PURPOSES; AIR TANKS FOR SCUBA DIVING; DIVING MACHINES AND APPARATUS NOT FOR SPORTS, NAMELY, HELMETS, AIR TANKS, SUITS; REGULATORS FOR SCUBA DIVING; EGG-CANDLERS; ELECTRIC DOOR OPENERS; METRONOMES; BLUEPRINTING MACHINES, IN CLASS 9 (U.S. CLS. 21, 23, 26, 36 AND 38).

FOR: MEDICAL MACHINES AND APPARATUS, NAMELY, MEDICAL DIAGNOSTIC SYSTEMS USED TO MEASURE AND TEST BLOOD AND OTHER BIOLOGICAL SAMPLES AND GENERATE DIAGNOSTIC TEST RESULTS, COMPRISED OF ANALYZERS, COMPUTER HARDWARE, SOFTWARE AND DOCUMENTATION, ALL SOLD AS A UNIT FOR COAGULATION ANALYSIS, TESTING FOR BIOLOGICAL MARKERS, PROTEINS, INFECTIOUS DISEASE, DIABETES, HORMONES, ELECTROLYTES, AND FOR BIOCHEMISTRY AND IMMUNOLOGY TESTING, THERAPEUTIC DRUG MONITORING, AND TESTING FOR HEALTH RELATED CONDITIONS; EMPTY CONTAINERS FOR CLINICAL AND MEDICAL USE TO CONTAIN DIAGNOSTIC REAGENTS AND TEST SAMPLES; MEDICAL MACHINES,

Reg. No. 4,065,033 APPARATUS AND INSTRUMENTS AND THEIR PARTS AND ACCESSORIES, NAMELY, MAGNETIC RESONANCE CT MACHINES, BLOOD TESTING MACHINES, EYE TESTING MACHINES, BODY-FAT MONITORS, AUDIOMETERS, HIGH FREQUENCY ELECTROMAGNETIC THERAPY MACHINES, LOW FREQUENCY ELECTROMAGNETIC THERAPY MACHINES, HEART PACEMAKERS, INJECTION NEEDLES, STATIC ELECTRIC THERAPY MACHINES, MASSAGE MACHINES FOR MEDICAL PURPOSE, BLOOD TRANSFUSION MACHINES; MEDICAL X-RAY APPARATUS; DIAGNOSTIC INSTRUMENTS, NAMELY, STETHOSCOPIES, SPHYGMOMANOMETERS, ELECTROCARDIOGRAPHS, ELECTROENCEPHALOGRAPHS, OPHTHALMIC TESTING INSTRUMENTS, OPHTHALMOTONOMETERS AND OPHTHALMOSCOPES; OPHTHALMOTONOMETERS; CLINICAL THERMOMETERS; SURGICAL OPERATING INSTRUMENTS, NAMELY, ANESTHETIC INHALERS SOLD EMPTY, KNIVES, SCISSORS, ELECTRIC KNIVES, SHARP CURETTES, BLUNT CURETTES, SEPARATORS, FORCEPS, RETRACTORS; THERAPEUTIC INSTRUMENTS, NAMELY, OXYGEN INHALERS SOLD EMPTY, INFRARED HEAT LAMPS, ULTRA VIOLET HEAT LAMPS; SYRINGES AND HYPODERMIC SYRINGE NEEDLES; ULTRA SONIC DIAGNOSTIC APPARATUS FOR MEDICAL USE; RADIOLOGICAL APPARATUS FOR MEDICAL PURPOSES; MEDICAL EXAMINING AND OPERATING TABLES; STERILIZATION UNITS FOR MEDICAL INSTRUMENTS; SURGICAL LAMPS; MEDICAL STRETCHERS; DENTAL EXAMINATION CHAIRS; DENTAL INSTRUMENTS, NAMELY, DRILLS; ORTHODONTIC APPLIANCES; VETERINARY INSTRUMENTS, NAMELY, CASTRATING PINNERS; PROSTHESES, NAMELY, ARTIFICIAL LIMBS, ARTIFICIAL EYES; HEARING AIDS; ORTHOPEDIC DEVICES, NAMELY, ABDOMINAL BELTS, TRUSSES, CRUTCHES, SPLINTS; MEDICAL ICE BAGS, MEDICAL ICE BAG HOLDERS; ICE BAG PILLOWS FOR MEDICAL PURPOSES; TRIANGULAR BANDAGES; SUPPORTIVE BANDAGES; SURGICAL CATGUTS; FEEDING CUPS FOR MEDICAL PURPOSES; DROPPING PIPETTES FOR MEDICAL PURPOSES; BABY BOTTLES; TEATS; VACUUM BOTTLES FOR NURSING; FINGER GUARDS FOR MEDICAL PURPOSES; CONTRACEPTIVES APPARATUS; ARTIFICIAL TYMPANIC MEMBRANES; PROSTHETIC AND FILLING MATERIALS FOR REPLACEMENT OF BONES, NOT FOR DENTAL USE; EAR PLUGS FOR MEDICAL USE; GLOVES FOR MEDICAL USE; URINALS FOR MEDICAL PURPOSES; BED PANS; EAR PICKS, IN CLASS 10 (U.S. CLS. 26, 39 AND 44).

FOR: STANDING PAPER LANTERNS; PORTABLE PAPER LANTERNS; GAS LAMPS; OIL LAMPS; LAMP CHIMNEYS; INDUSTRIAL FURNACES; NUCLEAR REACTORS, NAMELY, ATOMIC PILES; NON-ELECTRIC HEATING APPARATUS FOR HOUSEHOLD PURPOSES; INDUSTRIAL BOILERS; GAS WATER HEATERS FOR HOUSEHOLD USE; PORTABLE ELECTRIC HEATERS FOR DOMESTIC USE; DOMESTIC COOKING OVENS; GAS RANGES; SINKS; BATHTUBS, WHIRLPOOL BATHS AND BATH INSTALLATIONS; HOT WATER HEATERS FOR USE IN BATHTUBS; KITCHEN SINKS; NON-ELECTRIC COOKING HEATERS FOR HOUSEHOLD PURPOSE, NAMELY, KEROSENE HEATERS, SOLAR HEATERS, GAS HEATERS; COOKING EQUIPMENT FOR INDUSTRIAL USE, NAMELY, COOKING OVENS, MICROWAVE OVENS, AND BROILERS; INDUSTRIAL DISHDRYING MACHINES; FREEZING MACHINES AND APPARATUS, NAMELY, ICE MACHINES, FREEZERS, COOLING DOMES, REFRIGERATING AND FREEZING SHOW CASES, INDUSTRIAL REFRIGERATION MACHINES; NON-PORTABLE ICE CHESTS FOR HOUSEHOLD PURPOSES; ICE-COOLING REFRIGERATORS FOR HOUSEHOLD PURPOSES; REFRIGERATED ICE BOXES; FORAGE DRYING APPARATUS; MILK STERILIZERS; RECUPERATORS FOR CHEMICAL PROCESSING; ELECTRIC STEAMERS FOR CHEMICAL PROCESSING; EVAPORATORS FOR CHEMICAL PROCESSING; DISTILLERS FOR CHEMICAL PROCESSING; HEAT EXCHANGERS FOR CHEMICAL PROCESSING; AIR-CONDITIONING APPARATUS FOR INDUSTRIAL PURPOSES; SET UNITS OF TOILET BOWL AND SEAT; SET UNITS OF BATHROOM EXHAUST FANS; JAPANESE-STYLE STIRRERS FOR HOT BATHTUB WATER; MACHINES AND APPARATUS FOR USE IN BEAUTY SALONS AND BARBER SHOPS NOT INCLUDING HAIRDRESSING CHAIRS, NAMELY, HAIR DRYERS, TOWEL STEAMERS, SHAMPOO BASINS; LAVATORY STOOLS; SOLAR WATER HEATERS; WATER PURIFYING APPARATUS; BATHTUBS; HOUSEHOLD TAP-WATER FILTERS; WASHERS FOR WATER TAPS; WASHERS FOR WATER TAPS; TAP WATER FAUCETS; PLUMBING FITTINGS, NAMELY, LEVEL CONTROLLING VALVES FOR TANKS, PIPE

Reg. No. 4,065,033 LINE COCKS; WATER POLLUTION CONTROL EQUIPMENT, NAMELY, ULTRAVIOLET STERILIZATION; WASTE WATER TREATMENT TANKS FOR HOUSEHOLD PURPOSES; SEPTIC TANKS FOR HOUSEHOLD PURPOSES; GARBAGE INCINERATORS; TOILET STOOL UNITS WITH A WASHING WATER SQUIRTER; DISINFECTANT DISPENSERS FOR TOILETS; TOILET BOWLS; SEATING FOR USE WITH JAPANESE STYLE TOILET BOWLS; NON-ELECTRIC WARMING PANS; NON-ELECTRIC POCKET WARMERS, NAMELY, CHEMICALLY-ACTIVATED HEATING PACKETS FOR WARMING HANDS; STICK FUEL FOR JAPANESE POCKET WARMERS; HEATING AND COOLING PACKS FILLED WITH CHEMICAL SUBSTANCES READY TO REACT WHEN REQUIRED; HOT WATER BOTTLES FOR WARMING ONE'S FEET IN BED, IN CLASS 11 (U.S. CLS. 13, 21, 23, 31 AND 34).

FOR: ROCKETS, IN CLASS 13 (U.S. CLS. 2 AND 9).

FOR: HOROLOGICAL INSTRUMENTS, NAMELY, WATCHES AND CLOCKS, AND THEIR PARTS AND ACCESSORIES, NAMELY, DIALS, SPRINGS, WATCH CASES, WATCH GLASSES, WATCH BANDS, WATCH CHAINS; PRECIOUS METALS SOLD IN UNFINISHED FORM FOR FURTHER MANUFACTURE; BOXES OF PRECIOUS METALS FOR NEEDLES; JEWEL CASES OF PRECIOUS METALS; SHOE ORNAMENTS OF PRECIOUS METALS; PERSONAL ORNAMENTS OF PRECIOUS METAL; UNWROUGHT AND SEMI-WROUGHT PRECIOUS STONES AND THEIR IMITATIONS; TROPHIES AND PRIZE CUPS OF PRECIOUS METALS; COMMEMORATIVE SHIELDS OF PRECIOUS METALS; KEY RINGS, TRINKETS AND FOBS OF PRECIOUS METALS, IN CLASS 14 (U.S. CLS. 2, 27, 28 AND 50).

FOR: PAPER GOODS, NAMELY, PRINTING PAPER, CARBON PAPER, PAPER FOR BOOKS AND LOOSE-LEAF NOTEBOOKS, PRESSURE SENSITIVE PAPER, PRINTING PAPER, CONVERTED PAPER, DUPLICATING PAPER, MIMEOGRAPH PAPER, ENVELOPES, WRITING PAPER, PACKING PAPER, NOTE CARDS, GREETING CARDS, NAPKINS, TOWELS, MAILING BAGS, PAPER WALLETS, FILES, SPRING FOLDERS, BEER MATS OF PAPER, AND CARDBOARD; INDUSTRIAL PACKING CONTAINERS OF PAPER; FOOD WRAPPING PLASTIC FILM FOR HOUSEHOLD USE; GARBAGE BAGS OF PAPER FOR HOUSEHOLD USE; GARBAGE BAGS OF PLASTICS FOR HOUSEHOLD USE; HYGIENIC PAPER; PAPER PATTERNS; PAPER PATTERNS FOR MAKING CLOTHES; TABLE CLOTHS OF PAPER; TABLE NAPKINS OF PAPER; TOWELS OF PAPER; HAND TOWELS OF PAPER; BANNERS OF PAPER; FLAGS OF PAPER; HANDKERCHIEFS OF PAPER; BABIES DIAPERS OF PAPER; TAILORS CHALK; PRINTED MATTER, NAMELY, PRESS RELEASES AND ADVERTISEMENTS FEATURING AUTOMOBILES, ELECTRIC APPLIANCES, PHARMACEUTICAL PRODUCTS AND OTHER GENERAL CONSUMER GOODS; PAINTINGS AND CALLIGRAPHIC WORKS; PHOTOGRAPHS; PHOTOGRAPH STANDS; PASTES AND OTHER ADHESIVES FOR STATIONERY AND HOUSEHOLD PURPOSES; BLUE PRINTS; ADDRESSING MACHINES; PRINTERS REGLETS, NAMELY, INTERLINE LEADS; INKING RIBBONS; PRINTING PAPERS; PRINTING TYPES; AUTOMATIC STAMP PUTTING-ON MACHINES; ELECTRIC STAPLERS FOR OFFICES; ENVELOPE SEALING MACHINES FOR OFFICES; STAMP OBLITERATING MACHINES; DRAWING INSTRUMENTS; DECORATORS PAINTBRUSHES; PAINT BRUSHES; TYPEWRITERS; CHECKWRITERS; MIMEOGRAPHS; ROTARY DUPLICATORS; PAPER SHREDDERS FOR OFFICE USE; SEALING WAX; MARKING TEMPLATES; FRANKING MACHINES, NAMELY, STAMPING MACHINES; DRAWING PENS; DRAWING AND DRAFTING MACHINES AND APPARATUS, NAMELY, COMPASSES, PROTRACTORS, AND RULERS, IN CLASS 16 (U.S. CLS. 2, 5, 22, 23, 29, 37, 38 AND 50).

FOR: PLASTIC, SYNTHETIC, AND RUBBER BUILDING MATERIAL, NAMELY, VULCANIZED FIBERS FOR USE IN THE MANUFACTURE OF BUILDING INSULATION, AND POLYURETHANE FOAM SHEETING FOR USE AS BUILDING INSULATION; RAW AND SEMI-WORKED RUBBER; RUBBER THREAD AND COVERED RUBBER YARN, NOT FOR TEXTILE USE; WASHERS OF RUBBER AND VULCANIZED FIBER FOR USE IN THE MANUFACTURE OF BUILDING INSULATION; VALVES OF RUBBER AND VULCANIZED FIBER, NOT INCLUDING MACHINE ELEMENTS FOR USE IN THE MANUFACTURE OF BUILDING INSULATION; RUBBER CORDS AND LACES; ASBESTOS CORDS AND

Reg. No. 4,065,033 STRINGS; RUBBER STOPPERS FOR INDUSTRIAL PACKAGING CONTAINERS; RUBBER LIDS AND CAPS FOR INDUSTRIAL PACKAGING CONTAINERS; INDUSTRIAL PACKAGING CONTAINERS OF RUBBER; SILICONE RUBBER SEALANT USED FOR ROOFING, WINDOW FRAMES AND FLOOR COVERINGS; PLASTIC SEMI-WORKED PRODUCTS FOR USE AS MATERIAL IN FORM OF PELLETS, RODS, FOILS, FOAMS, FIBERS, FILMS AND SHEETS; CHEMICAL FIBER YARN AND THREAD, NOT FOR TEXTILE USE; RAW AND PARTLY-PROCESSED MICA; ROCK WOOL; SLAG WOOL FOR USE AS A BUILDING INSULATOR; ASBESTOS; ASBESTOS NETS; ASBESTOS YARN; ASBESTOS FELT; ASBESTOS BOARDS; ASBESTOS POWDER; CONDENSER PAPER, NAMELY, FLAME RETARDANT PAPER USED TO INSULATE BUILDINGS; ASBESTOS PAPER; VULCANIZED FIBER; FLOATING ANTI-POLLUTION BARRIERS; GASKETS FOR PIPE USE; NON-METAL JUNCTIONS FOR FLEXIBLE GASKET AND FLEXIBLE PLASTIC PIPES; FIRE HOSES; ASBESTOS FIRE CURTAINS; INSULATING GLOVES; PLASTIC SHEETING FOR AGRICULTURAL PURPOSES; PACKING AND INSULATING MATERIALS; SOUNDPROOFING MATERIALS OF ROCK WOOL NOT FOR BUILDING PURPOSES, IN CLASS 17 (U.S. CLS. 1, 5, 12, 13, 35 AND 50).

FOR: COMPOSITE HORSESHOES MADE OF PLASTIC, IN CLASS 18 (U.S. CLS. 1, 2, 3, 22 AND 41).

FOR: MATERIALS USED EXCLUSIVELY FOR BUILDING AND CONSTRUCTION, NAMELY, ASPHALT, GYPSUM TILES, NON-AGRICULTURAL LIME, BRICKS, CERAMIC AND SYNTHETIC BUILDING MATERIALS USED FOR FLOORS, WALLS AND CEILINGS, PREFABRICATED NON-METAL BUILDING SETS, CEMENT MIXES, LUMBER, STONE, GLASS WINDOWS, TILES MADE OF GLASS AND CERAMIC USED FOR FLOORS, WALL AND CEILING SPACKLING COMPOUNDS; NON-METALIC MINERALS FOR BUILDING AND CONSTRUCTION; TAR AND PITCH; NON-METALIC MINERALS FOR BUILDING AND CONSTRUCTION; CERAMIC BUILDING MATERIALS; BRICKS AND REFRACTORY PRODUCTS FOR BUILDING FURNACES, NAMELY, STOVES, CERAMICS; PLASTIC BUILDING MATERIALS, NAMELY, PANELS AND PIPE SUPPORTS; PLASTIC BUILDING MATERIAL USED FOR FLOOR COVERINGS AND WAINSCOTS; TILES MADE OF PLASTIC AND VINYL USED FOR FLOORS; SYNTHETIC BUILDING MATERIALS, NAMELY, FIBERS; ASPHALT, AND ASPHALT BUILDING AND CONSTRUCTION MATERIALS, NAMELY, ASPHALT FELT, ASPHALT PAVING COMPOSITIONS AND ROOF COATINGS; BUILDING AND CONSTRUCTION MATERIALS, NAMELY, HARD WOODS, SEMI WORKED WOODS, CONCRETE, LOGS, PANELS, AND MARBLE; RUBBER BUILDING AND CONSTRUCTION MATERIALS, NAMELY, HARD WOODS, SEMI WORKED WOODS, CONCRETE, LOGS, PANELS, AND MARBLE; PLASTER FOR BUILDING PURPOSES; LIME BUILDING AND CONSTRUCTION MATERIALS, NAMELY, NON-AGRICULTURAL LIME, SLAG-LIME, HYDRATED LIME, HARD WOODS, SEMI WORKED WOODS, CONCRETE, LOGS, PANELS, AND MARBLE; BUILDING AND CONSTRUCTION MATERIALS OF PLASTER; NON-METAL PREFABRICATED BUILDING KITS; BUILDING MATERIAL, NAMELY, PLASTIC VEGETATION SEED-CARRIER SHEETS FOR PREVENTION OF EARTH COLLAPSE AND LANDSLIDE; PLASTIC SECURITY WINDOWS ALLOWING COMMUNICATION; CEMENT AND ITS PRODUCTS, NAMELY, ROOFING, POSTS; BUILDING TIMBER; BUILDING STONE; BUILDING GLASS; NON-METAL ARTIFICIAL FISH REEF; NON-METAL HEN-HOUSES AND POULTRY CAGES; NON-METAL PAINT SPRAYING BOOTHS; NON-METAL MOULDS FOR FORMING CEMENT PRODUCTS; NON-METAL, NON-LUMINOUS, NON-MECHANICAL ROAD SIGNS; NON-METAL, NON-LUMINOUS BEACONS; STORAGE TANKS OF MASONRY FOR INDUSTRIAL PURPOSES NOT OF METAL OR PLASTICS; MOORING BITTS AND BOLLARDS NOT OF METAL BUT OF CONCRETE; LETTER BOXES OF MASONRY; NON-METAL JOINERY FITTINGS; STONE LANTERNS; NON-METAL TRANSPORTABLE GREENHOUSES FOR HOUSEHOLD USE; NON-METAL GRAVESTONES AND TOMB PLAQUES; NON-METAL DIVING PLATFORMS; STONE SCULPTURES; CONCRETE SCULPTURES; MARBLE SCULPTURES; NONMETALLIC MINERAL MATERIALS UNWORKED AND PARTLY WORKED FOR BUILDING AND CONSTRUCTION, IN CLASS 19 (U.S. CLS. 1, 12, 33 AND 50).

FOR: BLINDS OF PAPER, IN CLASS 20 (U.S. CLS. 2, 13, 22, 25, 32 AND 50).

Reg. No. 4,065,033 FOR: DENTAL FLOSS; UNWORKED AND SEMI-WORKED GLASS, NOT FOR BUILDING; PLATE AND SHEET GLASS NOT FOR BUILDING; GLASS RODS AND GLASS TUBES NOT FOR SCIENTIFIC PURPOSES; GLASS BULBS; MANGERS AND TROUGHS FOR LIVESTOCK ANIMALS; POULTRY RINGS; COOKING UTENSILS, NAMELY, GRILLS; CHOPPING BOARDS; ROASTING NETS, NAMELY, NON-ELECTRIC GRILLS; NON-ELECTRIC EGG BEATERS; SHAKERS; CAN OPENERS; BOTTLE OPENERS; COOKING SKEWERS; BRUSHES MADE OF STEEL WIRE, PLASTIC FIBER AND ANIMAL HAIR; NAMELY, SCRUBBING BRUSHES, BRUSHES FOR PIPES AND INDUSTRIAL BRUSHES; TUB BRUSHES, METAL BRUSHES, BRUSHES FOR PIPES, INDUSTRIAL BRUSHES, SHIP-SCRUBBING BRUSHES; GLOVES FOR HOUSEHOLD PURPOSES; SHOPPING BASKETS; CONTAINERS FOR HOUSEHOLD USE; FOOD AND DRINK STORAGE CONTAINERS, NAMELY, VACUUM BOTTLES, CANTEENS, BREAD CONTAINERS, CROCKS, BARRELS; INDUSTRIAL PACKAGING CONTAINERS OF GLASS; INDUSTRIAL PACKAGING CONTAINERS OF CERAMICS; KITCHEN UTENSILS, NAMELY, PANS, POTS, STEAMERS, STEAMER BASKETS, KETTLES; NON-ELECTRIC AND NON-METAL COFFEE POTS; NON-ELECTRIC COOKING POTS AND PANS; NON-ELECTRIC COFFEE-POTS, NOT OF PRECIOUS METALS; NON-ELECTRIC JAPANESE CAST IRON KETTLES; NON-ELECTRIC KETTLES; TABLEWARE, NAMELY, BOWLS, DISHES, TEA CUPS, BEVERAGE GLASSWARE, TEA POTS, TIERED FOOD BOXES; NON-ELECTRIC PORTABLE COLDBOXES; RICE CHESTS; FOOD PRESERVING JARS OF GLASS; DRINKING FLASKS FOR TRAVELERS; VACUUM BOTTLES, NAMELY, INSULATED FLASKS; ICE PAILS; NON-ELECTRIC WHISKS; COOKING STRAINERS; PEPPER POTS; SUGAR BOWLS AND SALT SHAKERS, NOT OF PRECIOUS METALS; EGG CUPS, NOT OF PRECIOUS METALS; NAPKIN HOLDERS AND NAPKIN RINGS, NOT OF PRECIOUS METALS; TRAYS, NOT OF PRECIOUS METALS; TOOTHPICK HOLDERS, NOT OF PRECIOUS METALS; TOOTHPICK HOLDERS OF PRECIOUS METALS; COLANDERS; SALT AND PEPPER SHAKERS; JAPANESE-STYLE COOKED RICE SCOOPS; HAND-OPERATED COFFEE GRINDERS AND PEPPER MILLS; COOKING FUNNELS; JAPANESE STYLE WOODEN PESTLES; JAPANESE STYLE PERSONAL DINING TRAYS AND STANDS; BOTTLE OPENERS; COOKING GRATERS; TART SCOOPS; PAN-MATS; CHOPSTICKS; CHOPSTICK CASES; LADLES AND DIPPERS; COOKING SIEVES AND SIFTERS; CHOPPING BOARDS FOR KITCHEN USE; ROLLING PINS FOR COOKING PURPOSES; COOKING GRILLS; TOOTH PICKS; LEMON SQUEEZERS AND CITRUS JUICERS; NON-ELECTRIC WAFFLE IRONS; CLEANING AND WASHING EQUIPMENT, NAMELY, BROOMS, DUSTERS, DUST-PANS, WASTE BASKETS, BUCKETS, RINSING TUBS, WASH BASINS, CLOTHES PINS; IRONING BOARDS; TAILORS SPRAYERS SOLD EMPTY; SPRAY BOTTLES SOLD EMPTY; IRONING BOARDS; WOOD CHOPPING BOARDS; CANDLE EXTINGUISHERS AND CANDLESTICKS, NOT OF PRECIOUS METALS; CANDLE EXTINGUISHERS AND CANDLESTICKS OF PRECIOUS METALS; CINDER SIFTERS FOR HOUSEHOLD PURPOSES; COAL SCUTTLES; FLY SWATTERS; MOUSE TRAPS; FLOWER POTS; WATERING CANS; FEEDING VESSELS FOR PETS; BRUSHES FOR PETS; BIRD CAGES; BIRD BATHS; INDOOR AQUARIA AND THEIR FITTINGS; CLOTHES BRUSHES; CHAMBER POTS; TOILET PAPER HOLDERS; NON-METAL PIGGY BANKS; BOXES OF METAL FOR DISPENSING PAPER TOWELS; BOOT JACKS; SOAP DISPENSERS; FLOWER VASES AND BOWLS, NOT OF PRECIOUS METALS; FLOWER VASES AND BOWLS OF PRECIOUS METALS; UPRIGHT SIGNBOARDS OF GLASS AND CERAMICS; PERFUME BURNERS; COSMETIC AND TOILET UTENSILS, NAMELY, BRUSHES, SPONGES, TOOTHBRUSHES; SHOE BRUSHES; SHOE HORNS; SHOE SHINE CLOTHS; HANDY SHOE SHINERS; SHOE-TREES AND SHOE STRETCHERS; PORTABLE COOKING KITS FOR OUTDOOR USE; PIG BRISTLES FOR BRUSHES; POLISHING CLOTHS; POT STANDS; FIRE PANS FOR CARRYING LIVE CHARCOAL; KITCHEN UTENSILS MADE OF PRECIOUS METALS, NAMELY, COFFEE POTS, BASKETS, BREAD BOXES, SAUCERS, DISHES, TABLES, PLATES, TRAYS, CUPS, BOWLS, SUGAR BOWLS, GOBLETS, TANKARDS, TEA CADDIES AND INFUSERS, URNS, FLASKS, JUGS, STRAINERS, CRUET STANDS, PEPPER POTS, SALT SHAKERS AND CELLARS, EGG CUPS, NAPKIN HOLDERS AND RINGS, TOOTHPICK HOLDERS; BATHROOM PAILS; POWDER COMPACTS OF PRECIOUS METALS SOLD EMPTY; HYDROPONICS APPARATUS FOR DOMESTIC HORTICULTURAL USE COMPRISING GROWING CONTAINERS, HYDROPONICS FERTILIZERS, SEEDS, SUBSTRATE, DRAIN COMPONENTS,

Reg. No. 4,065,033 A BOOK AND DVD AND CD INSTRUCTIONAL MATERIALS, IN CLASS 21 (U.S. CLS. 2, 13, 23, 29, 30, 33, 40 AND 50).

FOR: FLOOR COVERINGS; TATAMI MATS; BATH MATS; ARTIFICIAL TURF; GYMNASTIC MATS; WALL HANGINGS NOT OF TEXTILE; WALLPAPER; LINOLEUM; LINOLEUM FOR USE ON FLOORS AND WAINSCOTS; CARPET TILES MADE OF PLASTIC AND VINYL USED FOR FLOORS, WALLS AND CEILINGS; DOOR MATS OF METAL, IN CLASS 27 (U.S. CLS. 19, 20, 37, 42 AND 50).

FOR: ELECTRONIC SPORTS TRAINING SIMULATORS; PLAYING CARDS, IN CLASS 28 (U.S. CLS. 22, 23, 38 AND 50).

OWNER OF JAPAN REG. NO. 4319476, DATED 10-1-1999, EXPIRES 10-1-2019.

THE COLOR(S) RED IS/ARE CLAIMED AS A FEATURE OF THE MARK.

THE MARK CONSISTS OF A DESIGN OF THREE DIAMONDS COLORED RED.

SER. NO. 77-296,936, FILED 10-5-2007.

ZACHARY BELLO, EXAMINING ATTORNEY

United States of America

United States Patent and Trademark Office

WEDGEHEAD

Reg. No. 4,065,034

Registered Dec. 6, 2011

Int. Cl.: 28

TRADEMARK

PRINCIPAL REGISTER

PRETTY UGLY LLC (DELAWARE LIMITED LIABILITY COMPANY)
45 FERNWOOD AVENUE
EDISON, NJ 08837 AND

HORVATH, DAVID (UNITED STATES INDIVIDUAL)
45 FERNWOOD AVENUE
EDISON, NJ 08837 AND

KIM, SUN-MIN (REPUBLIC OF KOREA INDIVIDUAL)
45 FERNWOOD AVENUE
EDISON, NJ 08837

FOR: STUFFED TOYS, IN CLASS 28 (U.S. CLS. 22, 23, 38 AND 50).

FIRST USE 1-1-2003; IN COMMERCE 1-1-2003.

THE MARK CONSISTS OF STANDARD CHARACTERS WITHOUT CLAIM TO ANY PARTICULAR FONT, STYLE, SIZE, OR COLOR.

SER. NO. 77-308,423, FILED 10-19-2007.

ELLEN B. AWRICH, EXAMINING ATTORNEY



David J. Kyros

Director of the United States Patent and Trademark Office

United States of America

United States Patent and Trademark Office

PHYTORELAXER

Reg. No. 4,065,035

Registered Dec. 6, 2011

Int. Cl.: 3

TRADEMARK

PRINCIPAL REGISTER

CASTER (FRANCE CORPORATION)
99 RUE DU FAUBOURG SAINT HONORÉ
75008 PARIS, FRANCE

FOR: NON MEDICAL HAIR CARE PREPARATIONS, NAMELY, CREAMS, SHAMPOO,
FLUID AND BALM, IN CLASS 3 (U.S. CLS. 1, 4, 6, 50, 51 AND 52).

FIRST USE 0-0-1998; IN COMMERCE 4-1-1999.

THE MARK CONSISTS OF STANDARD CHARACTERS WITHOUT CLAIM TO ANY PAR-
TICULAR FONT, STYLE, SIZE, OR COLOR.

OWNER OF U.S. REG. NOS. 2,755,594, 3,243,524 AND OTHERS.

SEC. 2(F).

SER. NO. 77-323,327, FILED 11-7-2007.

MAUREEN DALL, EXAMINING ATTORNEY



David J. Kybas

Director of the United States Patent and Trademark Office

United States of America

United States Patent and Trademark Office

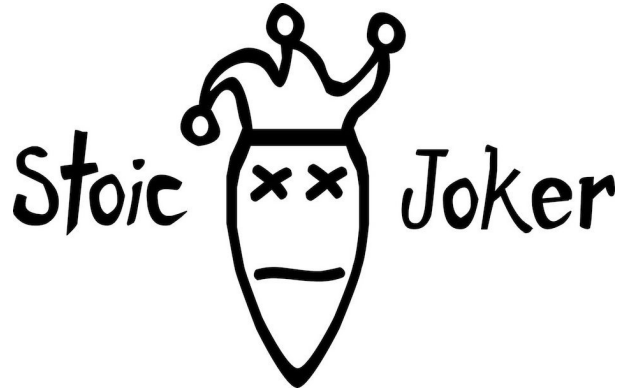

Reg. No. 4,065,036

Registered Dec. 6, 2011

Int. Cl.: 25

TRADEMARK

PRINCIPAL REGISTER

EPLER, JEREMY (UNITED STATES INDIVIDUAL)
20517 CALORA ST.
COVINA, CA 917241240

FOR: T-SHIRTS, LONG SLEEVE T-SHIRTS, SWEATERS, SWEATSHIRTS, HOODED SWEATSHIRTS, ZIPPER HOODED SWEATSHIRTS, JACKETS, COATS, TANK TOPS, HATS, VISORS, BEANIES, UNDERWEAR; SOCKS, SWIMWEAR, SHORTS, PANTS, CAPRI PANTS, BOXER SHORTS, ARM BANDS, AND HEAD BANDS, IN CLASS 25 (U.S. CLS. 22 AND 39).

FIRST USE 10-27-2007; IN COMMERCE 12-17-2007.

THE MARK CONSISTS OF THE STYLIZED WORD "STOIC" ON LEFT SIDE OF A CLOWN TYPE FACE WITH X SYMBOLS FOR EYES AND A BARELY CURVED LINE FOR A MOUTH. THERE IS A JESTER TYPE HAT ON HEAD. THE STYLIZED WORD "JOKER" IS ON THE RIGHT SIDE OF THE FACE. THE FACE IS OBLONG WITH A POINTY CHIN.

SER. NO. 77-371,763, FILED 1-15-2008.

ANGELA DUONG, EXAMINING ATTORNEY



David J. Kybas

Director of the United States Patent and Trademark Office

United States of America

United States Patent and Trademark Office

RUBYGUARD

Reg. No. 4,065,037

Registered Dec. 6, 2011

Int. Cl.: 1

TRADEMARK

PRINCIPAL REGISTER

KOLON INDUSTRIES, INC. (REPUBLIC OF KOREA CORPORATION)
KYUNGGI-DO
1-23, BYULYANG-DONG
KWACHON-CITY, REPUBLIC OF KOREA 427-040

FOR: DRY FILM PHOTORESISTS FOR USE IN THE MANUFACTURE OF ELECTRONIC COMPONENTS; LIQUID PHOTORESISTS, IN CLASS 1 (U.S. CLS. 1, 5, 6, 10, 26 AND 46).

FIRST USE 2-27-2008; IN COMMERCE 2-27-2008.

THE MARK CONSISTS OF STANDARD CHARACTERS WITHOUT CLAIM TO ANY PARTICULAR FONT, STYLE, SIZE, OR COLOR.

OWNER OF REPUBLIC OF KOREA REG. NO. 40-0831543, DATED 8-2-2010, EXPIRES 8-2-2020.

SER. NO. 77-407,159, FILED 2-27-2008.

WENDY GOODMAN, EXAMINING ATTORNEY



David J. Kyffers

Director of the United States Patent and Trademark Office

United States of America

United States Patent and Trademark Office



Reg. No. 4,065,038

Registered Dec. 6, 2011

Int. Cl.: 44

SERVICE MARK

PRINCIPAL REGISTER

DR ROLAND HOFMEISTER (UNITED STATES INDIVIDUAL), DBA THE PET VET
4915 CAMDEN AVE NE
MINNEAPOLIS, MN 55430

FOR: VETERINARY SERVICES, IN CLASS 44 (U.S. CLS. 100 AND 101).

FIRST USE 2-1-1987; IN COMMERCE 2-1-1987.

NO CLAIM IS MADE TO THE EXCLUSIVE RIGHT TO USE "PET VET", APART FROM THE MARK AS SHOWN.

THE MARK CONSISTS OF A RECTANGLE WITH A CURVED CENTER PORTION, REPEATED INSIDE IN SAME SHAPE, THE CENTER HAS A CIRCLE WITH A DOG FOOT PRINT. THE WORD "PET" APPEARS IN LEFT PORTION OF RECTANGLE AND "VET" APPEARS IN RIGHT PORTION OF RECTANGLE.

SER. NO. 77-415,633, FILED 3-6-2008.

JERI J. FICKES, EXAMINING ATTORNEY



David J. Kybas

Director of the United States Patent and Trademark Office

United States of America

United States Patent and Trademark Office

REAL FCA. DE TAPICES

Reg. No. 4,065,039

Registered Dec. 6, 2011

Int. Cl.: 27

TRADEMARK

PRINCIPAL REGISTER

FUNDACIÓN REAL FÁBRICA DE TAPICES (SPAIN FOUNDATION)
FUENTERRABÍA, 2
28014 MADRID, SPAIN

FOR: CARPETS, RUGS, NON-TEXTILE WALL HANGINGS, IN CLASS 27 (U.S. CLS. 19, 20, 37, 42 AND 50).

FIRST USE 0-0-1721; IN COMMERCE 0-0-1924.

THE MARK CONSISTS OF STANDARD CHARACTERS WITHOUT CLAIM TO ANY PARTICULAR FONT, STYLE, SIZE, OR COLOR.

PRIORITY CLAIMED UNDER SEC. 44(D) ON ERPN CMNTY TM OFC APPLICATION NO. 6708853, FILED 2-28-2008, REG. NO. 006708853, DATED 6-26-2010, EXPIRES 2-28-2018.

NO CLAIM IS MADE TO THE EXCLUSIVE RIGHT TO USE "TAPICES", APART FROM THE MARK AS SHOWN.

THE FOREIGN WORDING IN THE MARK TRANSLATES INTO ENGLISH AS ROYAL FABRICATOR OF WALL HANGINGS.

SER. NO. 77-461,732, FILED 4-30-2008.

SALLY SHIH, EXAMINING ATTORNEY



David J. Kyros

Director of the United States Patent and Trademark Office

United States of America

United States Patent and Trademark Office



Reg. No. 4,065,040

Registered Dec. 6, 2011

Int. Cl.: 39

SERVICE MARK

PRINCIPAL REGISTER

BRITISH AIRWAYS PLC (UNITED KINGDOM COMPANY)
WATERSIDE HB A3 HARMONDSWORTH
WEST DRAYTON, UNITED KINGDOM UB70GB

FOR: AIRLINE TRANSPORTATION SERVICES; AIRLINE TRAVEL SERVICES, NAMELY, BOOKING OF SEATS FOR AIRLINE TRAVEL; AIR TRANSPORT SERVICES; TRAVEL AGENCY SERVICES, NAMELY, MAKING AIRLINE RESERVATIONS AND BOOKINGS FOR AIRLINE TRANSPORTATION; AIRLINE TRAVEL BOOKING AGENCIES; PROVIDING AIRLINE TRAVEL INFORMATION; COURIER SERVICES; CARGO STORAGE AND HANDLING SERVICES; AIRCRAFT CHARTERING SERVICES; ORGANIZATION OF AIRLINE TRAVEL IN THE NATURE OF PACKAGE HOLIDAYS; INFORMATION SERVICES RELATING TO ALL THE AFOREMENTIONED SERVICES, IN CLASS 39 (U.S. CLS. 100 AND 105).

PRIORITY CLAIMED UNDER SEC. 44(D) ON UNITED KINGDOM APPLICATION NO. 2486596, FILED 5-2-2008, REG. NO. 2486596, DATED 5-2-2008, EXPIRES 5-2-2018.

THE COLOR(S) BLUE, RED AND WHITE IS/ARE CLAIMED AS A FEATURE OF THE MARK.

OWNER OF U.S. REG. NOS. 2,315,313, 3,246,561 AND OTHERS.

NO CLAIM IS MADE TO THE EXCLUSIVE RIGHT TO USE "BED", APART FROM THE MARK AS SHOWN.

THE MARK CONSISTS OF THE WORDS "Z BED CLUB WORLD" IN BLUE WITH A RIBBON DESIGN TO THE LEFT OF THE LETTER "Z". THE TOP HORIZONTAL PORTION OF THE RIBBON IS RED IN COLOR, AND THE CURVED PORTION OF THE RIBBON CONTAINS A SMALL AREA OF HIGHLIGHTING IN WHITE, FOLLOWED BY THE BOTTOM SECTION IN BLUE.

SER. NO. 77-470,761, FILED 5-9-2008.

ELIZABETH HUGHITT, EXAMINING ATTORNEY



David J. Kyffers

Director of the United States Patent and Trademark Office

United States of America

United States Patent and Trademark Office

SPOTTY WOT

Reg. No. 4,065,041

Registered Dec. 6, 2011

Int. Cls.: 9, 16, 28 and 41

TRADEMARK

SERVICE MARK

PRINCIPAL REGISTER

WOT WOTS LIMITED (NEW ZEALAND CORPORATION)
CAMPERDOWN STUDIOS
CORNER CAMPERDOWN AND PARK ROADS
MIRAMAR, WELLINGTON, NEW ZEALAND

FOR: AUDIO RECORDINGS FEATURING CHILDREN'S ENTERTAINMENT; VIDEO RECORDINGS FEATURING CHILDREN'S ENTERTAINMENT; COMPACT DISCS FEATURING CHILDREN'S ENTERTAINMENT; COMPUTER GAME PROGRAMS; DVDS FEATURING CHILDREN'S ENTERTAINMENT, IN CLASS 9 (U.S. CLS. 21, 23, 26, 36 AND 38).

FOR: CHILDREN'S ACTIVITY BOOKS; CHILDREN'S STORYBOOKS; COLOR PENCILS; COLORING BOOKS; MODELING CLAY FOR CHILDREN; PRINTED INVITATIONS; POSTERS; STATIONERY, IN CLASS 16 (U.S. CLS. 2, 5, 22, 23, 29, 37, 38 AND 50).

FOR: TOY VEHICLES; TOY ACTION FIGURES AND ACCESSORIES THEREFOR; CHILDREN'S MULTIPLE ACTIVITY TOYS; DOLLS AND ACCESSORIES THEREFOR; DOLLS' CLOTHES; PLUSH TOYS; STUFFED TOYS; RIDE-ON-TOYS; PUSH TOYS; PULL TOYS; BUILDING GAMES; WATER SQUIRTING TOYS; MUSICAL TOYS; INFLATABLE TOYS; JIGSAW PUZZLES; BOARD GAMES; CARD GAMES; HAND HELD UNIT FOR PLAYING ELECTRONIC GAMES; TRADING CARD GAMES; BALL FOR GAMES; BALLOONS; BATH TOYS; BEAN BAGS; HAND PUPPETS; TOY BUILDING BLOCKS, IN CLASS 28 (U.S. CLS. 22, 23, 38 AND 50).

FOR: ENTERTAINMENT SERVICES, NAMELY, PRODUCTION OF A CHILDREN'S TELEVISION SERIES; FILM AND VIDEO PRODUCTION; INFORMATION RELATING TO ENTERTAINMENT PROVIDED ON-LINE FROM A COMPUTER DATABASE OR THE INTERNET; PRODUCTION OF VIDEO DISCS AND TAPES, IN CLASS 41 (U.S. CLS. 100, 101 AND 107).

THE MARK CONSISTS OF STANDARD CHARACTERS WITHOUT CLAIM TO ANY PARTICULAR FONT, STYLE, SIZE, OR COLOR.

PRIORITY CLAIMED UNDER SEC. 44(D) ON NEW ZEALAND APPLICATION NO. 790825, FILED 6-9-2008, REG. NO. 790825, DATED 6-9-2008, EXPIRES 6-9-2018.

OWNER OF NEW ZEALAND REG. NO. 776793, DATED 10-1-2007, EXPIRES 10-1-2017.

OWNER OF U.S. REG. NO. 3,866,270.



David J. Kyros

Director of the United States Patent and Trademark Office

Reg. No. 4,065,041 SER. NO. 77-495,114, FILED 6-10-2008.

CORY BOONE, EXAMINING ATTORNEY

United States of America

United States Patent and Trademark Office

Think2Play

Reg. No. 4,065,042

Registered Dec. 6, 2011

Int. Cls.: 28 and 41

TRADEMARK

SERVICE MARK

PRINCIPAL REGISTER

NEWBOY FZCO (UNITED ARAB EMIR. CORPORATION)
P.O. BOX 61177
JEBEL ALI, DUBAI, UNITED ARAB EMIR.

FOR: GAMES, NAMELY, BOARD GAMES, HAND-HELD UNITS FOR PLAYING VIDEO GAMES; PLAYTHINGS, NAMELY, DOLLS AND ACCESSORIES THEREFOR, TOY VEHICLES, CONSTRUCTION TOYS, PLUSH TOYS, TOY FIGURES, ELECTRONIC ACTION TOYS, IN CLASS 28 (U.S. CLS. 22, 23, 38 AND 50).

FOR: ENTERTAINMENT, NAMELY, PRODUCTION AND DISTRIBUTION OF MOVIES, IN CLASS 41 (U.S. CLS. 100, 101 AND 107).

THE MARK CONSISTS OF STANDARD CHARACTERS WITHOUT CLAIM TO ANY PARTICULAR FONT, STYLE, SIZE, OR COLOR.

PRIORITY CLAIMED UNDER SEC. 44(D) ON UNITED ARAB EMIR. APPLICATION NO. 112448, FILED 5-5-2008, REG. NO. 147171, DATED 6-1-2011, EXPIRES 5-5-2018.

PRIORITY CLAIMED UNDER SEC. 44(D) ON UNITED ARAB EMIR. APPLICATION NO. 112192, FILED 5-5-2008, REG. NO. 147170, DATED 6-1-2011, EXPIRES 5-5-2018.

SER. NO. 77-518,598, FILED 7-10-2008.

MELISSA VALLILLO, EXAMINING ATTORNEY



David J. Kyros

Director of the United States Patent and Trademark Office

United States of America

United States Patent and Trademark Office

Amber
BAKERY

Reg. No. 4,065,043

Registered Dec. 6, 2011

Int. Cl.: 35

SERVICE MARK

PRINCIPAL REGISTER

AMBER BAKERY, INC (NEW YORK CORPORATION)
30 WEST WATER ST
PO BOX 1145
SAG HARBOR, NY 11963

FOR: RETAIL BAKERY SHOPS; TAKE-OUT BAKERY SERVICES, IN CLASS 35 (U.S. CLS. 100, 101 AND 102).

FIRST USE 7-1-2008; IN COMMERCE 7-1-2008.

NO CLAIM IS MADE TO THE EXCLUSIVE RIGHT TO USE "BAKERY", APART FROM THE MARK AS SHOWN.

THE COLOR(S) AMBER IS/ARE CLAIMED AS A FEATURE OF THE MARK.

THE MARK CONSISTS OF THE AMBER COLORED WORDING "AMBER BAKERY"; "AMBER" IS IN LARGE STYLIZED CURSIVE WRITING AND "BAKERY" IS SMALLER IN UPPERCASE LETTERS UNDERNEATH AND TO THE RIGHT OF THE WORD "AMBER".

SER. NO. 77-531,623, FILED 7-25-2008.

MICHAEL LITZAU, EXAMINING ATTORNEY



David J. Kyros

Director of the United States Patent and Trademark Office

United States of America

United States Patent and Trademark Office

REDWOOD TECHNOLOGIES

Reg. No. 4,065,044

Registered Dec. 6, 2011

Int. Cls.: 9, 35, 38 and 42

TRADEMARK

SERVICE MARK

PRINCIPAL REGISTER

REDWOOD TECHNOLOGIES LIMITED (UNITED KINGDOM CORPORATION)
THE REDWOOD BUILDING, BROAD LANE
BRACKNELL, BERKSHIRE, UNITED KINGDOM RG129GU

FOR: TELECOMMUNICATIONS AND COMMUNICATIONS HARDWARE, MIDDLEWARE AND SOFTWARE FOR THE DEVELOPMENT, CREATION, PROVISION, HOSTING, OPERATION AND MANAGEMENT OF TELECOMMUNICATIONS SERVICES; TELECOMMUNICATIONS AND COMMUNICATIONS HARDWARE, MIDDLEWARE AND SOFTWARE FOR THE PROVISION, OPERATION AND MANAGEMENT OF VOICE OVER IP TELEPHONY, THE PROVISION AND MANAGEMENT OF MESSAGE DELIVERY, MESSAGE DISSEMINATION AND MESSAGE BROADCASTING, THE PROVISION, OPERATION AND MANAGEMENT OF AUDIO AND VIDEO CONFERENCING, AND THE PROVISION OF CALL RECORDING; TELECOMMUNICATIONS AND COMMUNICATIONS SOFTWARE FOR UPDATING AND MANAGEMENT OF WEBSITES AND THEIR CONTENT; COMPUTER SOFTWARE FOR THE PROVISION, OPERATION AND MANAGEMENT OF INTERACTIVE VOICE RESPONSE, MASS CALLING AND TELEVOTING SERVICES; COMPUTER SOFTWARE FOR THE PROVISION, OPERATION AND MANAGEMENT OF UNIFIED MESSAGING SERVICES; COMPUTER HARDWARE AND SOFTWARE FOR THE PROVISION OF TELECOMMUNICATIONS BILLING; COMPUTER HARDWARE AND SOFTWARE FOR FINANCIAL TRANSACTIONS, TRANSFERRING FUNDS, ACCOUNTING AND BILLING; TELECOMMUNICATIONS SOFTWARE FOR THE PROVISION OF PREPAID, LEAST-COST AND CONTROLLED-COST TELECOMMUNICATIONS; TELECOMMUNICATIONS HARDWARE AND SOFTWARE FOR THE PROVISION OF TELECOMMUNICATIONS SWITCHING; TELECOMMUNICATIONS HARDWARE AND SOFTWARE FOR THE PROVISION OF CALL SWITCHING AND ROUTING; TELECOMMUNICATIONS HARDWARE AND SOFTWARE FOR THE PROVISION, OPERATION AND MANAGEMENT OF TELECOMMUNICATIONS EXCHANGE SERVICES; COMPUTER SOFTWARE FOR THE CONVERSION OF TEXT INTO SPEECH FOR TELECOMMUNICATIONS PURPOSES; TELECOMMUNICATIONS SOFTWARE FOR THE STORAGE, EXTRACTION, COMPILATION AND ANALYSIS OF TELECOMMUNICATIONS DATA; COMPUTER SOFTWARE FOR USE IN THE DEVELOPMENT, DESIGN, CREATION, CUSTOMIZATION AND UPDATING OF TELECOMMUNICATIONS AND COMMUNICATIONS SYSTEMS AND SERVICES; COMPUTER SOFTWARE FOR THE DEVELOPMENT, DESIGN, CREATION, CUSTOMIZATION AND UPDATING OF COMMUNICATIONS AND TELECOMMUNICATIONS SYSTEMS AND SERVICES; COMMUNICATIONS APPARATUS AND INSTRUMENTS, NAMELY, COMPUTER SOFTWARE AND HARDWARE FOR THE COMPUTER-AIDED DESIGN AND DEVELOPMENT OF HIGH PERFORMANCE ELECTRONIC COMMUNICATIONS SYSTEMS AND SERVICES USING GRAPHICAL REP-



David J. Kyjars

Director of the United States Patent and Trademark Office

Reg. No. 4,065,044 REPRESENTATIONS OF SYSTEM STRUCTURES, COMPONENTS, PROCESSES AND FUNCTIONS; COMPUTER SOFTWARE AND FIRMWARE FOR THE DEVELOPMENT, DESIGN, CREATION, CUSTOMIZATION AND UPDATING OF HIGH PERFORMANCE COMMUNICATIONS SYSTEMS AND SERVICES FOR USE WITH COMPUTER NETWORKS; COMPUTER SOFTWARE AND HARDWARE FOR THE DEVELOPMENT, DESIGN, CREATION, CUSTOMIZATION AND UPDATING OF HIGH PERFORMANCE COMMUNICATIONS SYSTEMS AND SERVICES FOR USE WITH COMPUTER NETWORKS; COMPUTER SOFTWARE FOR THE CONTROL AND MANAGEMENT OF TELECOMMUNICATIONS HARDWARE RESOURCES; COMPUTER SOFTWARE FOR MONITORING AND MANAGING THE PERFORMANCE OF TELECOMMUNICATIONS SYSTEMS; COMPUTER SOFTWARE FOR THE ADMINISTRATION AND MANAGEMENT OF COMMUNICATIONS AND TELECOMMUNICATIONS SYSTEMS AND SERVICES; MULTIPLE CALLER PROCESSING AND MANAGEMENT SOFTWARE AND SYSTEMS, NAMELY, COMPUTER SOFTWARE AND HARDWARE FOR MANAGING AND CONTROLLING CALL CENTRE OPERATIONS; CUSTOMER RELATIONS MANAGEMENT SOFTWARE AND SYSTEMS, NAMELY, COMPUTER SOFTWARE AND HARDWARE FOR MANAGING AND CONTROLLING CALL CENTRE OPERATIONS; COMPUTER SYSTEMS, NAMELY, COMPUTER SERVERS AND NETWORK ACCESS OPERATING SOFTWARE FOR TELECOMMUNICATIONS USE; COMPUTER SOFTWARE FOR THE PURPOSE OF ENABLING THE TRANSMISSION OF DATA AND MESSAGES AND VOICE TELECOMMUNICATIONS; TELECOMMUNICATIONS HARDWARE, MIDDLEWARE AND SOFTWARE ENABLING THE MANAGEMENT, RUNNING AND OPERATION OF TELECOMMUNICATIONS AND COMMUNICATIONS NETWORKS, APPLICATIONS AND SYSTEMS; COMPUTERIZED TELEPHONY SYSTEMS, NAMELY, DIGITAL TELEPHONE PLATFORMS AND SOFTWARE; COMPUTERIZED TELEPHONY HARDWARE AND SOFTWARE, NAMELY, TELEPHONE ADAPTORS FOR TRANSPORTING AND AGGREGATING VOICE, DATA, AND VIDEO COMMUNICATIONS ACROSS MULTIPLE NETWORK INFRASTRUCTURES AND COMMUNICATIONS PROTOCOLS, AND COMPUTER SOFTWARE THAT ENABLES TELEPHONE ACTIVITIES TO BE PERFORMED THROUGH A COMPUTER; COMPUTER SOFTWARE TO ENABLE CONNECTION TO DATABASES, COMMUNICATIONS NETWORKS AND THE INTERNET; COMPUTER SOFTWARE, NAMELY, COMMUNICATION SOFTWARE FOR PROVIDING SECURE ACCESS TO THE INTERNET, IN CLASS 9 (U.S. CLS. 21, 23, 26, 36 AND 38).

FOR: BUSINESS MANAGEMENT SERVICES IN THE FIELD OF TELECOMMUNICATIONS AND COMMUNICATIONS NETWORKS, APPLICATIONS AND SERVICES; COMPILATION OF INFORMATION PROVIDED ON-LINE FROM A COMPUTER DATABASE OR THE INTERNET; BUSINESS MANAGEMENT OF TELECOMMUNICATIONS, COMMUNICATIONS AND INTERNET SERVICES FOR OTHERS; TELEVOTING SERVICES, NAMELY, SERVICES ALLOWING USERS TO CAST VOTES IN CONTESTS USING TELEPHONES; BUSINESS MANAGEMENT SERVICES IN THE FIELD OF TELECOMMUNICATIONS AND COMMUNICATIONS, NAMELY, ADMINISTRATION AND MANAGEMENT OF COMMUNICATIONS AND TELECOMMUNICATIONS SYSTEMS FOR OTHERS, ADMINISTRATION AND MANAGEMENT OF COMMUNICATIONS AND TELECOMMUNICATIONS SERVICES FOR OTHER CARRIERS, AND MANAGING AND CONTROLLING CALL CENTERS FOR OTHERS; FACILITATING ELECTRONIC COMMERCIAL TRANSACTIONS, NAMELY, PROVIDING INFORMATION ABOUT PRODUCTS VIA TELECOMMUNICATION NETWORKS FOR ADVERTISING AND SALES PURPOSES; FACILITATING ELECTRONIC COMMERCIAL TRANSACTIONS BY PROVIDING A SECURED ACCESS DATABASE VIA THE INTERNET THROUGH WHICH DOCUMENTS, NAMELY, CONTRACTUAL AGREEMENTS, TERMS OF USE AGREEMENTS, AND ELECTRONIC FORMS, CAN BE VIEWED, COPIED, AND PRINTED FOR PURPOSES OF CONDUCTING CORPORATE TRANSACTIONS, IN CLASS 35 (U.S. CLS. 100, 101 AND 102).

FOR: TELECOMMUNICATIONS AND COMMUNICATIONS SERVICES, NAMELY, TRANSMISSION OF VOICE, AUDIO, VISUAL IMAGES AND DATA BY TELECOMMUNICATIONS NETWORKS, WIRELESS COMMUNICATION NETWORKS, THE INTERNET, INFORMATION SERVICES NETWORKS, AND DATA NETWORKS; TELECOMMUNICATIONS AND COMMUNICATIONS SERVICES, NAMELY, PROVISION OF SERVICES IN THE FIELDS

Reg. No. 4,065,044 OF VOICE OVER IP TELEPHONY, AUDIO AND VIDEO CONFERENCING, MESSAGE DELIVERY BY ELECTRONIC TRANSMISSION, ELECTRONIC MESSAGE TRANSMISSION, CALL RECORDING, INTERACTIVE VOICE RESPONSE, ELECTRONIC VOICE MESSAGING, NAMELY, THE RECORDING AND SUBSEQUENT TRANSMISSION OF VOICE MESSAGES BY TELEPHONE, TEXT AND NUMERIC WIRELESS DIGITAL MESSAGING SERVICES, LOCAL AND LONG DISTANCE TELEPHONE SERVICES, MOBILE TELEPHONE SERVICES, AND CO-LOCATION SERVICES FOR VOICE, VIDEO AND DATA COMMUNICATIONS APPLICATIONS; CALL SWITCHING AND ROUTING SERVICES FOR MOBILE, LOCAL, LONG-DISTANCE AND INTERNATIONAL TELEPHONE CALLS, TELECOMMUNICATIONS GATEWAY SERVICES, NAMELY, PROVISION OF TELECOMMUNICATIONS AND COMMUNICATIONS LINKS FOR TV AND MEDIA ENTERTAINMENT BROADCASTS AND INTERNET BROADCASTS; TRANSMISSION OF INFORMATION VIA COMPUTERS CONNECTED TO THE SAME TELEMATIC NETWORK; COMMUNICATION SERVICES, NAMELY, ELECTRONIC TRANSMISSION OF DATA AND DOCUMENTS AMONG USERS OF COMPUTERS; PROVISION OF TELECOMMUNICATIONS AND COMMUNICATIONS ACCESS AND CONNECTIONS TO A GLOBAL COMPUTER NETWORK AND THE INTERNET; COMPUTERIZED DATA COMMUNICATIONS; COMPUTERIZED MOBILE AND WIRELESS TELEPHONY SERVICES; INTERNET TELEPHONY SERVICES; COMMUNICATION BY COMPUTER TERMINALS; PROVISION OF ACCESS TO ELECTRONIC COMMERCIAL COMMUNICATIONS SYSTEMS, DATA TRANSMISSION SYSTEMS, AND COMMERCIAL COMMUNICATIONS NETWORKS; ELECTRONIC TRANSMISSION OF DATA; ELECTRONIC TRANSMISSION OF CONTRACTUAL AGREEMENTS AND OTHER DOCUMENTATION; PROVIDING ELECTRONIC TELECOMMUNICATIONS CONNECTIONS AND SIGNAL AND ELECTRONIC DATA TRANSMISSION FOR ELECTRONIC COMMERCE VIA TELECOMMUNICATIONS SYSTEMS AND DATA COMMUNICATIONS SYSTEMS; FACILITATING ELECTRONIC COMMERCIAL TRANSACTIONS, NAMELY, PROVIDING ELECTRONIC TRANSMISSION OF CREDIT CARD TRANSACTION DATA AND ELECTRONIC PAYMENT DATA VIA A GLOBAL COMPUTER NETWORK TO ALLOW USERS TO PERFORM ELECTRONIC BUSINESS TRANSACTIONS; TELECOMMUNICATIONS SERVICES, NAMELY, TRANSMISSION OF COMMERCIAL TRANSACTION DOCUMENTS, NAMELY, CONTRACTUAL AGREEMENTS, TERMS OF USE AGREEMENTS, INVESTMENT INSTRUMENTS, AND BUSINESS FORMS; TELECOMMUNICATIONS SERVICES, NAMELY, PROVIDING ACCESS TO THE INTERNET, INTRANETS AND EXTRANETS; TRANSMISSION AND RECEPTION OF DATA AND OF INFORMATION VIA TELECOMMUNICATIONS MEANS; TELEPHONE, FACSIMILE, TELETEXT, MESSAGE COLLECTION AND TRANSMISSION, RADIO-PAGING AND ELECTRONIC MAIL SERVICES; ON-LINE INFORMATION SERVICES RELATING TO TELECOMMUNICATIONS; NETWORK CONFERENCING SERVICES; PROVIDING COMPUTER ACCESS TO ELECTRONIC COMMUNICATION NETWORKS; ELECTRONIC DATA INTERCHANGE SERVICES; TRANSFER OF DATA BY TELECOMMUNICATIONS; LEASING AND RENTAL OF TELECOMMUNICATION EQUIPMENT; TRANSMISSION OF INFORMATION BY ELECTRONIC COMMUNICATIONS NETWORKS , IN CLASS 38 (U.S. CLS. 100, 101 AND 104).

FOR: RESEARCH, DEVELOPMENT AND DESIGN SERVICES IN CONNECTION WITH COMMUNICATIONS AND TELECOMMUNICATIONS NETWORKS, EQUIPMENT, SYSTEMS, SOFTWARE AND COMPONENTS; UPDATING OF COMPUTER SOFTWARE RELATING TO COMPUTER SECURITY AND PREVENTION OF COMPUTER RISKS; RENTAL AND LEASING OF COMPUTER AND DATA PROCESSING EQUIPMENT; COMPUTER NETWORK SERVICES, NAMELY, COMPUTER NETWORK DESIGN FOR OTHERS, PROVIDING SEARCH ENGINES FOR OBTAINING DATA ON A GLOBAL COMPUTER NETWORK, AND REMOTE COMPUTER NETWORK MONITORING AND SOFTWARE MAINTENANCE SERVICES; PLANNING AND DESIGN SERVICES FOR TELECOMMUNICATIONS AND COMMUNICATIONS NETWORKS, THE INTERNET, AND COMPUTER HARDWARE; DESIGNING AND DEVELOPING WEB PAGES ON THE INTERNET; CREATING AND MAINTAINING WEB SITES FOR OTHERS; COMPUTER SERVICES, NAMELY, UPDATING AND MANAGEMENT OF WEB SITES AND THEIR CONTENT FOR OTHERS; HOSTING THE WEB SITES OF OTHERS; SOFTWARE AS A SERVICE FOR FACILITATING ELECTRONIC COMMERCIAL TRANSACTIONS, NAMELY, HOSTING E-COMMERCE SOFTWARE FOR USE BY OTHERS

Reg. No. 4,065,044 IN PERFORMING ELECTRONIC BUSINESS TRANSACTIONS VIA A GLOBAL COMPUTER NETWORK; SOFTWARE AS A SERVICE SERVICES FOR FACILITATING ELECTRONIC COMMERCIAL TRANSACTIONS, NAMELY, HOSTING E-COMMERCE SOFTWARE FOR USE BY OTHERS IN PERFORMING ELECTRONIC BUSINESS TRANSACTIONS, NAMELY, EXECUTING AND EXCHANGING CONTRACTUAL AGREEMENTS, REVIEWING, ACCEPTING AND REJECTING TERMS OF USE AGREEMENTS, EXCHANGING STOCKS, BONDS, COMMODITIES AND OTHER INVESTMENT INSTRUMENTS, AND COMPLETING ELECTRONIC FORMS, IN CLASS 42 (U.S. CLS. 100 AND 101).

THE MARK CONSISTS OF STANDARD CHARACTERS WITHOUT CLAIM TO ANY PARTICULAR FONT, STYLE, SIZE, OR COLOR.

OWNER OF ERPN CMNTY TM OFC REG. NO. 005217815, DATED 7-7-2006, EXPIRES 7-7-2016.

NO CLAIM IS MADE TO THE EXCLUSIVE RIGHT TO USE "TECHNOLOGIES", APART FROM THE MARK AS SHOWN.

SER. NO. 77-544,833, FILED 8-12-2008.

KIM MONINGHOFF, EXAMINING ATTORNEY

United States of America

United States Patent and Trademark Office

CELEBRATIONS

Reg. No. 4,065,045

Registered Dec. 6, 2011

Int. Cl.: 9

TRADEMARK

PRINCIPAL REGISTER

SOMERSET ENTERTAINMENT LTD. (CANADA CORPORATION)
20 YORK MILLS ROAD, SUITE 600
TORONTO, ONTARIO, CANADA M2P2C2

FOR: ENTERTAINMENT PRODUCTS, NAMELY, PRE-RECORDED CDS AND DVDS FEATURING MUSIC AND LIVE MUSICAL PERFORMANCES BY ARTISTS; DIGITAL MUSIC DOWNLOADABLE FROM THE INTERNET; AND DOWNLOADABLE VIDEO AND SOUND RECORDINGS FEATURING LIVE MUSICAL PERFORMANCES, IN CLASS 9 (U.S. CLS. 21, 23, 26, 36 AND 38).

FIRST USE 10-31-2008; IN COMMERCE 10-31-2008.

THE MARK CONSISTS OF STANDARD CHARACTERS WITHOUT CLAIM TO ANY PARTICULAR FONT, STYLE, SIZE, OR COLOR.

PRIORITY CLAIMED UNDER SEC. 44(D) ON CANADA APPLICATION NO. 1,405,378, FILED 7-30-2008.

SER. NO. 77-547,207, FILED 8-14-2008.

SKYE YOUNG, EXAMINING ATTORNEY



David J. Kybas

Director of the United States Patent and Trademark Office

United States of America

United States Patent and Trademark Office

TOPPER

Reg. No. 4,065,046

Registered Dec. 6, 2011

Int. Cls.: 25 and 28

TRADEMARK

PRINCIPAL REGISTER

SAO PAULO ALPARGATAS S.A. (BRAZIL CORPORATION)
160 VILA OLIMPIA, 04551-903
SAO PAULO, BRAZIL

FOR: GARMENTS, NAMELY, SHORTS, JACKETS, BERMUDA SHORTS, KNICKERS, T-SHIRTS, JOGGING SUITS, DRESSES, SWEAT PANTS, SWEAT SHIRTS, STOCKINGS, CAPS, SOCKS, UNDERPANTS, UNIFORMS, POLO SHIRTS, SOCIAL SHIRTS, SOCIAL PANTS, SPORTS PANTS, BIKINIS, BODY LINEN, BODY SHAPERS, BODY STOCKINGS, BODY SUITS, LONG SKIRTS, SHORT SKIRTS, SUN VISORS, HATS, OVERCOATS, COATS, SUITS, BLAZERS, PARKAS, GLOVES; FOOTWEAR, NAMELY, TENNIS SHOES, SPORTS SHOES, SHOES FOR PRACTICING SPORTS, SOCCER SHOES, BOOTS FOR PRACTICING SPORTS, BOOTS, ANKLE BOOTS, GYMNASTICS SHOES, BATHING SANDALS, BATHING THONGS, SANDALS AND SOCIAL SHOES, IN CLASS 25 (U.S. CLS. 22 AND 39).

FOR: ELBOW GUARDS FOR ATHLETIC USE, KNEE GUARDS FOR ATHLETIC USE; GLOVES, NAMELY, BASEBALL GLOVES, BATTING GLOVES, BOXING GLOVES, FENCING GLOVES, AND GOLF GLOVES; PLAY BALLS; SHINBONE GUARDS FOR ATHLETIC USE; BALLS FOR SPORTS, IN CLASS 28 (U.S. CLS. 22, 23, 38 AND 50).

THE MARK CONSISTS OF STANDARD CHARACTERS WITHOUT CLAIM TO ANY PARTICULAR FONT, STYLE, SIZE, OR COLOR.

OWNER OF BRAZIL REG. NO. 006648371, DATED 2-25-2008, EXPIRES 2-25-2018.

OWNER OF BRAZIL REG. NO. 007112483, DATED 4-25-1980, EXPIRES 4-25-2020.

OWNER OF BRAZIL REG. NO. 006648371, DATED 2-25-1978, EXPIRES 2-25-2018.

SER. NO. 77-564,562, FILED 9-8-2008.

KIMBERLY PERRY, EXAMINING ATTORNEY



David J. Kyros

Director of the United States Patent and Trademark Office

United States of America

United States Patent and Trademark Office



Reg. No. 4,065,047

Registered Dec. 6, 2011

Int. Cl.: 35

SERVICE MARK

PRINCIPAL REGISTER

TRANS.L SYSTEMS PTY. LTD. (AUSTRALIA CORPORATION)
9-100 CLAREMONT STREET, SUITE 105
SOUTH YARRA, VICTORIA, AUSTRALIA VIC3141

FOR: BUSINESS SERVICES, NAMELY, BUSINESS EFFICIENCY AUDITS AND STUDIES, BUSINESS SUPPLY CHAIN EFFICIENCY AUDITS AND STUDIES, BUSINESS PROCESS AUDITING SERVICES, BUSINESS EFFICIENCY EXPERT SERVICES, BUSINESS FEASIBILITY STUDIES, BUSINESS PLANNING SERVICES, MANAGEMENT OF BUSINESS PLAN IMPLEMENTATION, BUSINESS CONSULTANCY AND ADVISORY SERVICES RELATING TO SUPPLY CHAINS, BUSINESS CONSULTANCY AND ADVISORY SERVICES RELATING TO MANUFACTURING, BUSINESS CONSULTANCY AND ADVISORY SERVICES RELATING TO PRODUCT DEVELOPMENT, OUTSOURCING SERVICES, BUSINESS ADVISORY SERVICES FOR MANAGEMENT OF OUTSOURCING; BUSINESS RESEARCH, PROVIDING BUSINESS DATA ANALYSIS AND BUSINESS INFORMATION SERVICES; COMPILATION OF BUSINESS STATISTICS, NAMELY, PROVIDING STATISTICAL INFORMATION RELATING TO SUPPLY CHAINS, MANUFACTURERS, PROCESSORS AND THE PACKAGING INDUSTRY AND PROVIDING STATISTICAL INFORMATION RELATING TO LOGISTICS IN THE FIELD OF MANUFACTURING, PRIMARY PRODUCTION, PACKAGING, SUPERMARKETS AND FOOD SERVICE; BUSINESS CONSULTANCY AND ADVISORY SERVICES, NAMELY, PROVIDING LOGISTICS CONSULTANCY IN THE FIELD OF SUPPLY CHAINS, PACKAGING, STORAGE, TRANSPORTATION, MANUFACTURING, AUTOMATION, PRIMARY INDUSTRY, NAMELY, FRUIT AND VEGETABLE PRODUCTION, MEAT, POULTRY AND FISH PRODUCTION, SECONDARY INDUSTRY, NAMELY, GOODS MANUFACTURING, SUPERMARKETS AND FOOD SERVICE AND PROVIDING LOGISTICS ADVICE IN THE FIELD OF SUPPLY CHAINS, PACKAGING, STORAGE, TRANSPORTATION, MANUFACTURING, AUTOMATION, PRIMARY INDUSTRY, NAMELY, FRUIT AND VEGETABLE PRODUCTION, MEAT, POULTRY AND FISH PRODUCTION, SECONDARY INDUSTRY, NAMELY, GOODS MANUFACTURING SUPERMARKETS AND FOOD SERVICE; BUSINESS MANAGEMENT SERVICES, NAMELY, CHANGE MANAGEMENT, PROJECT MANAGEMENT SERVICES FOR OTHERS IN THE FIELD OF MANUFACTURING, PRIMARY PRODUCTION, PACKAGING, STORAGE, TRANSPORTATION, AUTOMATION, SUPERMARKETS AND FOOD SERVICE; BUSINESS LOGISTICS MANAGEMENT IN THE FIELD OF SUPPLY CHAINS, PACKAGING, STORAGE, TRANSPORTATION, MANUFACTURING, AUTOMATION, PRIMARY INDUSTRY, NAMELY, FRUIT AND VEGETABLE PRODUCTION, MEAT, POULTRY AND FISH PRODUCTION, SECONDARY INDUSTRY, NAMELY, GOODS MANUFACTURING, SUPERMARKETS AND FOOD SERVICE, COMPUTERIZED INVENTORY CONTROL MANAGEMENT, COMPUTERIZED FILE MANAGEMENT, BUSINESS



David J. Kybas

Director of the United States Patent and Trademark Office

Reg. No. 4,065,047 MANAGEMENT OF OUTSOURCING IN THE FIELDS OF PACKAGING, STORAGE, AUTOMATION AND TRANSPORTATION OF PRODUCE, GOODS AND MATERIALS; BUSINESS MANAGEMENT ADVISORY SERVICES, BUSINESS MANAGEMENT AND BUSINESS MANAGEMENT ASSISTANCE TO INDUSTRIAL, AGRICULTURAL OR COMMERCIAL COMPANIES; BUSINESS OPERATION FOR OTHERS; PROCUREMENT SERVICES FOR OTHERS, NAMELY, PROCURING, ON BEHALF OF OTHER BUSINESSES, PACKAGING, REUSABLE PACKAGING, PACKAGING SYSTEMS, CRATES, BINS, MACHINES FOR PACKAGING, MACHINES FOR CLEANING PACKAGING, MACHINES FOR RECYCLING PACKAGING, PACKAGING HANDLING EQUIPMENT, CRATE ERECTORS, CRATE PALLETIZERS, PACKAGING EQUIPMENT, PACKAGING SYSTEMS, LOGISTICS AUTOMATION TECHNOLOGY AND LOGISTICS SOFTWARE; WHOLESALE DISTRIBUTORSHIPS FEATURING PACKAGING, REUSABLE PACKAGING, PACKAGING SYSTEMS, CRATES, BINS, MACHINES FOR PACKAGING, MACHINES FOR CLEANING PACKAGING, MACHINES FOR RECYCLING PACKAGING, PACKAGING HANDLING EQUIPMENT, CRATE ERECTORS, CRATE PALLETIZERS, PACKAGING EQUIPMENT, PACKAGING SYSTEMS, LOGISTICS AUTOMATION TECHNOLOGY AND LOGISTICS SOFTWARE; WHOLESALE ORDERING SERVICES IN THE FIELD OF PACKAGING, REUSABLE PACKAGING, PACKAGING SYSTEMS, CRATES, BINS, MACHINES FOR PACKAGING, MACHINES FOR CLEANING PACKAGING, MACHINES FOR RECYCLING PACKAGING, PACKAGING HANDLING EQUIPMENT, CRATE ERECTORS, CRATE PALLETIZERS, PACKAGING EQUIPMENT, PACKAGING SYSTEMS, LOGISTICS AUTOMATION TECHNOLOGY AND LOGISTICS SOFTWARE; WHOLESALE STORES FEATURING PACKAGING, REUSABLE PACKAGING, PACKAGING SYSTEMS, CRATES, MACHINES FOR PACKAGING, MACHINES FOR CLEANING PACKAGING, MACHINES FOR RECYCLING PACKAGING, PACKAGING HANDLING EQUIPMENT, CRATE ERECTORS, CRATE PALLETIZERS, PACKAGING EQUIPMENT, PACKAGING SYSTEMS, LOGISTICS AUTOMATION TECHNOLOGY AND LOGISTICS SOFTWARE; RETAIL SERVICES, NAMELY, RETAIL STORE SERVICES, RETAIL STORE SERVICES PROVIDED ONLINE OVER A COMPUTER NETWORK, RETAIL MAIL ORDER SERVICES, ALL IN RESPECT OF PACKAGING, REUSABLE PACKAGING, PACKAGING SYSTEMS, CRATES, BINS, MACHINES FOR PACKAGING, MACHINES FOR CLEANING PACKAGING, MACHINES FOR RECYCLING PACKAGING, PACKAGING HANDLING EQUIPMENT, CRATE ERECTORS, CRATE PALLETIZERS, PACKAGING EQUIPMENT, PACKAGING SYSTEMS, LOGISTICS AUTOMATION TECHNOLOGY AND LOGISTICS SOFTWARE; DISTRIBUTORSHIP SERVICES IN THE FIELD OF PACKAGING, REUSABLE PACKAGING, PACKAGING SYSTEMS, CRATES, BINS, MACHINES FOR PACKAGING, MACHINES FOR CLEANING PACKAGING, MACHINES FOR RECYCLING PACKAGING, PACKAGING HANDLING EQUIPMENT, CRATE ERECTORS, CRATE PALLETIZERS, PACKAGING EQUIPMENT, PACKAGING SYSTEMS, LOGISTICS AUTOMATION TECHNOLOGY AND LOGISTICS SOFTWARE; ARRANGING OF BUSINESS EXHIBITIONS FOR ADVERTISING PURPOSES, AND FOR BUSINESS, COMMERCIAL OR TRADE PURPOSES, NAMELY, EXHIBITIONS FEATURING PACKAGING, REUSABLE PACKAGING, PACKAGING SYSTEMS, CRATES, MACHINES FOR PACKAGING, MACHINES FOR CLEANING PACKAGING, MACHINES FOR RECYCLING PACKAGING, PACKAGING HANDLING EQUIPMENT, PACKAGING TECHNOLOGY, CRATE ERECTORS, CRATE PALLETIZERS, PACKAGING EQUIPMENT, PACKAGING SYSTEMS, LOGISTICS TECHNOLOGY, RECYCLING TECHNOLOGY, AUTOMATION TECHNOLOGY AND LOGISTICS SOFTWARE; AND EXHIBITIONS RELATING TO LOGISTICS, SUPPLY CHAIN AND PACKAGING PRODUCTS AND SERVICES; ORGANIZATION, OPERATION AND SUPERVISION OF INCENTIVE SCHEMES, NAMELY, CUSTOMER LOYALTY SERVICES FOR COMMERCIAL, PROMOTIONAL AND/OR ADVERTISING PURPOSES; AND PROVIDING BUSINESS INFORMATION AND INFORMATION IN THE FIELD OF LOGISTICS, NAMELY, MANAGING LOGISTICS, REVERSE LOGISTICS, SUPPLY CHAIN SERVICES, SUPPLY CHAIN VISIBILITY AND SYNCHRONIZATION, SUPPLY AND DEMAND FORECASTING AND PRODUCT DISTRIBUTION PROCESSES FOR OTHERS; BUSINESS MANAGEMENT SERVICES, NAMELY, SUPPLY CHAIN LOGISTICS, REVERSE LOGISTICS AND LIQUIDATION OF GOODS OF OTHERS; FREIGHT LOGISTICS MANAGEMENT; TRANSPORTATION LOGISTICS SERVICES, NAMELY, ARRANGING THE TRANSPORTATION OF GOODS FOR OTHERS; TRANSPORTATION LOGISTICS SERVICES, NAMELY, PLANNING AND

Reg. No. 4,065,047 SCHEDULING SHIPMENTS FOR USERS OF TRANSPORTATION SERVICES; PROVIDING BUSINESS INFORMATION AND INFORMATION IN THE FIELD OF BUSINESS MANAGEMENT, BUSINESS INFORMATION IN THE FIELD OF BUSINESS ORGANIZATION OF FACILITIES AND IMPLEMENTATION OF STRATEGIC BUSINESS PLANS, IN CLASS 35 (U.S. CLS. 100, 101 AND 102).

OWNER OF AUSTRALIA REG. NO. 7233078, DATED 4-3-2008, EXPIRES 4-3-2018.

NO CLAIM IS MADE TO THE EXCLUSIVE RIGHT TO USE "SYSTEMS", APART FROM THE MARK AS SHOWN.

THE MARK CONSISTS OF THE WORDS "TRANS.L SYSTEMS" AND ENDLESS-BELTS IN FORM OF ELLIPSE AROUND WORDS.

SER. NO. 77-587,131, FILED 10-7-2008.

LOURDES AYALA, EXAMINING ATTORNEY

United States of America

United States Patent and Trademark Office

LIBRESTREAM

Reg. No. 4,065,048

Registered Dec. 6, 2011

Int. Cl.: 9

TRADEMARK

PRINCIPAL REGISTER

LIBRESTREAM TECHNOLOGIES INC. (CANADA CORPORATION)
SUITE 110
895 WAVERLY STREET
WINNIPEG, MANITOBA, CANADA R3T5P4

FOR: MOBILE VIDEO COLLABORATION SYSTEM COMPRISED OF A VIDEO CAMERA WITH AUDIO CAPABILITY, AND COMPUTER SOFTWARE, TO ALLOW REAL-TIME VOICE AND VIDEO COLLABORATION BETWEEN A REMOTE LOCATION AND A COMPUTER RELATED TO SUBJECT MATTER BEING FILMED BY THE VIDEO CAMERA, IN CLASS 9 (U.S. CLS. 21, 23, 26, 36 AND 38).

FIRST USE 4-3-2007; IN COMMERCE 4-3-2007.

THE MARK CONSISTS OF STANDARD CHARACTERS WITHOUT CLAIM TO ANY PARTICULAR FONT, STYLE, SIZE, OR COLOR.

PRIORITY CLAIMED UNDER SEC. 44(D) ON CANADA APPLICATION NO. 1413230, FILED 10-3-2008, REG. NO. TMA802,355, DATED 7-18-2011, EXPIRES 7-18-2026.

OWNER OF U.S. REG. NO. 3,571,062.

SER. NO. 77-591,235, FILED 10-13-2008.

BARBARA RUTLAND, EXAMINING ATTORNEY



David J. Kybas

Director of the United States Patent and Trademark Office

United States of America

United States Patent and Trademark Office

Fabulous

Reg. No. 4,065,049

Registered Dec. 6, 2011

Int. Cl.: 39

SERVICE MARK

PRINCIPAL REGISTER

A RAY LAND PRODUCTIONS COMPANY (FLORIDA CORPORATION)
304 SW SUWANNEE AVE
BRANFORD, FL 32008

FOR: CHARTERING OF BUSES, MOTOR COACHES, LUGGAGE TRUCKS, VANS, MINI COACHES, AND MID-SIZE COACHES; TRANSPORTATION OF PASSENGERS BY BUS, MOTOR COACH, VANS, MINI COACHES, AND MID-SIZE COACHES; ARRANGING TRAVEL TOURS; CONDUCTING SIGHTSEEING TOURS FOR OTHERS; ORGANIZATION OF SIGHTSEEING TOURS; TOUR GUIDE SERVICES; ORGANIZATION OF EXCURSIONS, SIGHTSEEING TOURS, AND TRAVEL; ORGANIZATION, BOOKING AND ARRANGEMENT OF EXCURSIONS, DAY TRIPS AND SIGHTSEEING TOURS; TOUR CONDUCTING OR ESCORTING; TRAVEL AND TOUR INFORMATION SERVICE; TRAVEL AND TOUR TICKET RESERVATION SERVICES; VEHICLE DRIVING SERVICES; BUS TRANSPORT AND CHARTERING SERVICES FOR TOUR OPERATORS, SPORTS TEAMS, ENTERTAINERS, SCHOOLS, UNIVERSITIES, RELIGIOUS GROUPS, POLITICIANS, AND CONVENTION AND MEETING PLANNERS; TRANSPORTATION OF GOODS AND PASSENGERS BY BUS, IN CLASS 39 (U.S. CLS. 100 AND 105).

FIRST USE 10-1-2004; IN COMMERCE 10-1-2004.

THE MARK CONSISTS OF STANDARD CHARACTERS WITHOUT CLAIM TO ANY PARTICULAR FONT, STYLE, SIZE, OR COLOR.

SER. NO. 77-592,707, FILED 10-14-2008.

JAMES MACFARLANE, EXAMINING ATTORNEY



David J. Kyffers

Director of the United States Patent and Trademark Office

United States of America

United States Patent and Trademark Office

LIMELIGHT

Reg. No. 4,065,050

TYLER CANDLE COMPANY, L.L.C. (TEXAS LIMITED LIABILITY COMPANY)
11733 HIGHWAY 155 NORTH
TYLER, TX 75708

Registered Dec. 6, 2011

Int. Cls.: 3 and 4

FOR: FRAGRANCE EMITTING WICKS FOR ROOM FRAGRANCE, IN CLASS 3 (U.S. CLS. 1, 4, 6, 50, 51 AND 52).

TRADEMARK

FIRST USE 6-1-2007; IN COMMERCE 6-1-2007.

PRINCIPAL REGISTER

FOR: LAMP FUEL, IN CLASS 4 (U.S. CLS. 1, 6 AND 15).

FIRST USE 6-1-2006; IN COMMERCE 6-1-2006.

THE MARK CONSISTS OF STANDARD CHARACTERS WITHOUT CLAIM TO ANY PARTICULAR FONT, STYLE, SIZE, OR COLOR.

OWNER OF U.S. REG. NO. 2,995,231.

SER. NO. 77-596,030, FILED 10-20-2008.

ROBERT C. CLARK JR., EXAMINING ATTORNEY



David J. Kyfos

Director of the United States Patent and Trademark Office

United States of America

United States Patent and Trademark Office



Reg. No. 4,065,051

Registered Dec. 6, 2011

Int. Cl.: 29

TRADEMARK

PRINCIPAL REGISTER

JSK FOODS INC. (CANADA CORPORATION)
8680 CAMBIE ROAD, SUITE 111
RICHMOND, BRITISH COLUMBIA, CANADA V6X 4K1

FOR: FRUIT-BASED SNACK FOODS; SEED-BASED AND NUT-BASED SNACK BARS, IN CLASS 29 (U.S. CL. 46).

PRIORITY CLAIMED UNDER SEC. 44(D) ON CANADA APPLICATION NO. 1,399,157, FILED 6-11-2008, REG. NO. TMA801,491, DATED 7-6-2011, EXPIRES 7-6-2026.

NO CLAIM IS MADE TO THE EXCLUSIVE RIGHT TO USE "KITCHEN", APART FROM THE MARK AS SHOWN.

THE MARK CONSISTS OF A DESIGN ELEMENT FEATURING AN OVAL SURROUNDING THE WORDS "JESSICA'S KITCHEN" AND A SMALL BRANCH WITH TWO LARGE LEAVES. THE BRANCH AND LEAVES ARE SITUATED ATOP OF THE "I" IN THE WORD "JESSICA'S". THEY ARE PARTLY IN THE OVAL AND PARTLY EXTENDING BEYOND IT.

SER. NO. 77-605,388, FILED 10-31-2008.

WILLIAM VERHOSEK, EXAMINING ATTORNEY



David J. Kybas

Director of the United States Patent and Trademark Office

United States of America

United States Patent and Trademark Office

Business Innovation By Design

Reg. No. 4,065,052

Registered Dec. 6, 2011

Int. Cl.: 42

SERVICE MARK

PRINCIPAL REGISTER

3D IDEATION INC. (CANADA CORPORATION)
8 RACCOON STREET
BRAMPTON, CANADA L6S6L8

FOR: COMMERCIAL ART DESIGN; CONSULTATION IN THE FIELD OF ERGONOMICS, NAMELY, DESIGNING WORKPLACE FACILITIES AND EQUIPMENT TO OPTIMIZE EFFICIENCY AND SAFETY; CONSULTING SERVICES IN THE FIELD OF DESIGN OF NEWSLETTERS; DESIGN SKETCHING OF PACKAGING, CONTAINERS, DINNERWARE AND TABLE UTENSILS; DESIGN, ENGINEERING, RESEARCH, DEVELOPMENT AND TESTING SERVICES IN THE FIELD OF POLYMERIC MATERIALS, POLYMER SYNTHESIS, AND MATERIALS CUSTOMIZATION FOR MEDICAL, SCIENTIFIC, AND TECHNOLOGICAL APPLICATIONS; DESIGNING THEME GRAPHICS AND MULTIMEDIA SHOWS FOR CONVENTIONS, PRODUCT LAUNCHES, TRADE SHOWS, KEY NOTE ADDRESSES AND AWARD CEREMONIES FOR OTHERS; FURNITURE DESIGN SERVICES; GRAPHIC DESIGN; GRAPHIC DESIGN SERVICES; INDUSTRIAL DESIGN; INDUSTRIAL DESIGN SERVICES; PACKAGING DESIGN; PROVIDING DESIGN SERVICES FOR OTHERS IN THE FIELD OF THEME PARKS, MUSEUMS, AND MINIATURE GOLF COURSES; SET DESIGN FOR THEATRICAL ENTERPRISES, IN CLASS 42 (U.S. CLS. 100 AND 101).

FIRST USE 1-1-2004; IN COMMERCE 1-1-2005.

THE MARK CONSISTS OF STANDARD CHARACTERS WITHOUT CLAIM TO ANY PARTICULAR FONT, STYLE, SIZE, OR COLOR.

SER. NO. 77-635,542, FILED 12-18-2008.

TRACY FLETCHER, EXAMINING ATTORNEY



David J. Kyjars

Director of the United States Patent and Trademark Office

United States of America

United States Patent and Trademark Office

RIDERSAVER

Reg. No. 4,065,053

Registered Dec. 6, 2011

Int. Cls.: 9, 12 and 35

TRADEMARK

SERVICE MARK

PRINCIPAL REGISTER

CHIPKAR HEALTH CONCEPTS LIMITED (CANADA CORPORATION)
5302 FOREST RIDGE DRIVE
MISSISSAUGA, CANADA L5M5B4

FOR: METALLIC AND METALLIZED PLASTIC ELECTROMAGNETIC RADIATION SHIELDING, IN THE FORM OF SHEETS, WEAVES AND MESH FOR THE PROTECTION OF OPERATORS OF MOTORIZED VEHICLES FROM ELECTROMAGNETIC RADIATION, IN CLASS 9 (U.S. CLS. 21, 23, 26, 36 AND 38).

FOR: SEATS FOR MOTORCYCLES, IN CLASS 12 (U.S. CLS. 19, 21, 23, 31, 35 AND 44).

FOR: RETAIL AND ONLINE RETAIL STORE SERVICES FEATURING SEATS, SEAT COVERS AND SEAT PADS FOR MOTORCYCLES, SNOWMOBILES, BICYCLES, ELECTRIC BICYCLES, MOPEDS, SCOOTERS, ALL-TERRAIN VEHICLES, PERSONAL WATERCRAFT, LAWN MOWERS, TRACTORS AND GARDEN TRACTORS; RETAIL AND ONLINE RETAIL STORE SERVICES FEATURING METALLIC AND METALLIZED PLASTIC MATERIAL FOR SHIELDING AGAINST ELECTROMAGNETIC FIELDS, SAID MATERIAL BEING IN THE FORM OF SHEET, TAPE, WEAVES AND MESH, IN CLASS 35 (U.S. CLS. 100, 101 AND 102).

THE MARK CONSISTS OF STANDARD CHARACTERS WITHOUT CLAIM TO ANY PARTICULAR FONT, STYLE, SIZE, OR COLOR.

PRIORITY CLAIMED UNDER SEC. 44(D) ON CANADA APPLICATION NO. 1422603, FILED 12-22-2008, REG. NO. TMA802698, DATED 7-21-2011, EXPIRES 7-21-2026.

SER. NO. 77-643,776, FILED 1-6-2009.

ANGELA DUONG, EXAMINING ATTORNEY



David J. Kyffers

Director of the United States Patent and Trademark Office

United States of America

United States Patent and Trademark Office

PRIMOWARE

Reg. No. 4,065,054

Registered Dec. 6, 2011

Int. Cls.: 35, 37 and 40

SERVICE MARK

PRINCIPAL REGISTER

PRIMO ARCHITECTURAL SUPPLIES INC. (CANADA CORPORATION)
122 FIRST AVENUE NORTH
MAPLE CREEK, CANADA S0N1N0

FOR: RETAIL STORE AND ON-LINE RETAIL STORE SERVICES FEATURING, ARCHITECTURAL PRODUCTS AND SUPPLIES, NAMELY, HARDWARE, MOLDINGS, SPECIALTY TURNING KNOBS, HANDLES, SCREWS AND FASTENERS, KITCHEN CABINET HARDWARE, CLOSET HARDWARE, CORBELS, HINGES, OPENING SYSTEMS AND SLIDES, KNOBS, HANDLES, APPLIANCE PULLS, APPLIANCE HANDLES, DECORATIVE CABINET AND CLOSET HARDWARE AND FIXTURES, WOOD AND COMPOSITE MOLDINGS, ORNAMENTS, APPLIQUES, ACCENTS AND ONLAYS, IN CLASS 35 (U.S. CLS. 100, 101 AND 102).

FOR: INSTALLATION SERVICES, NAMELY, INSTALLATION OF ARCHITECTURAL PRODUCTS AND SUPPLIES, NAMELY, HARDWARE, MOLDINGS, SPECIALTY TURNING KNOBS, HANDLES, SCREWS AND FASTENERS, KITCHEN CABINET HARDWARE, CLOSET HARDWARE, CORBELS, HINGES, OPENING SYSTEMS AND SLIDES, KNOBS, HANDLES, APPLIANCE PULLS, APPLIANCE HANDLES, DECORATIVE CABINET AND CLOSET HARDWARE AND FIXTURES, WOOD AND COMPOSITE MOLDINGS, ORNAMENTS, APPLIQUES, ACCENTS AND ONLAYS, IN CLASS 37 (U.S. CLS. 100, 103 AND 106).

FOR: CUSTOM FABRICATION AND FABRICATION TO THE ORDER AND SPECIFICATION OF OTHERS OF ARCHITECTURAL PRODUCTS AND SUPPLIES, NAMELY, HARDWARE, MOLDINGS, SPECIALTY TURNING KNOBS, HANDLES, KITCHEN CABINET HARDWARE, CLOSET HARDWARE, CORBELS, HINGES, OPENING SYSTEMS AND SLIDES, KNOBS, HANDLES, APPLIANCE PULLS, APPLIANCE HANDLES, DECORATIVE CABINET, KITCHEN AND CLOSET HARDWARE AND FIXTURES, IN CLASS 40 (U.S. CLS. 100, 103 AND 106).



THE MARK CONSISTS OF STANDARD CHARACTERS WITHOUT CLAIM TO ANY PARTICULAR FONT, STYLE, SIZE, OR COLOR.

OWNER OF CANADA REG. NO. TMA775,093, DATED 8-20-2010, EXPIRES 8-20-2025.

SER. NO. 77-653,932, FILED 1-21-2009.

KATHLEEN LORENZO, EXAMINING ATTORNEY

David J. Kyffers

Director of the United States Patent and Trademark Office

United States of America

United States Patent and Trademark Office

CAREERSEARCH.COM RESEARCH YOUR FUTURE

Reg. No. 4,065,055

NETWORLD SYSTEMS INC. (NEW YORK CORPORATION)
10780 EAST ACOMA DRIVE
SCOTTSDALE, AZ 85255

Registered Dec. 6, 2011

Int. Cl.: 35

FOR: PROVIDING AN ON-LINE INFORMATION SERVICE FEATURING INFORMATION REGARDING CAREERS, IN CLASS 35 (U.S. CLS. 100, 101 AND 102).

SERVICE MARK

FIRST USE 1-13-2011; IN COMMERCE 1-13-2011.

PRINCIPAL REGISTER

THE MARK CONSISTS OF STANDARD CHARACTERS WITHOUT CLAIM TO ANY PARTICULAR FONT, STYLE, SIZE, OR COLOR.

SEC. 2(F) AS TO "CAREERSEARCH.COM".

SER. NO. 77-654,872, FILED 1-22-2009.

MICHAEL SOUDERS, EXAMINING ATTORNEY



David J. Kybas

Director of the United States Patent and Trademark Office

United States of America

United States Patent and Trademark Office



ARIZONA HUMANE SOCIETY

Reg. No. 4,065,056

Registered Dec. 6, 2011

Int. Cl.: 45

SERVICE MARK

PRINCIPAL REGISTER

THE ARIZONA HUMANE SOCIETY (ARIZONA NON-PROFIT CORPORATION)
1521 W. DOBBINS ROAD
PHOENIX, AZ 85041

FOR: ANIMAL PROTECTION SERVICES IN THE NATURE OF A HUMANE SOCIETY, NAMELY, PROVIDING ADOPTION SERVICES FOR ANIMALS; PLACEMENT SERVICES FOR A PET WHEN THE OWNER DIES AND A NEW OWNER IS NEEDED AND SUBSEQUENT MONITORING OF THE CARE PROVIDED FOR THE PET; AND INVESTIGATING ANIMAL ABUSE AND ANIMAL CRUELTY, IN CLASS 45 (U.S. CLS. 100 AND 101).

FIRST USE 12-31-1999; IN COMMERCE 12-31-1999.

NO CLAIM IS MADE TO THE EXCLUSIVE RIGHT TO USE "HUMANE SOCIETY", APART FROM THE MARK AS SHOWN.

THE MARK CONSISTS OF THE WORDS "ARIZONA HUMANE SOCIETY" CENTERED BENEATH A ROW OF THREE HORIZONTALLY ALIGNED BOXES CONTAINING THE DESIGNS OF A DOG FACE, A HEART, AND A CAT FACE, RESPECTIVELY.

SEC. 2(F) AS TO "ARIZONA".

SER. NO. 77-671,811, FILED 2-17-2009.

SEAN CROWLEY, EXAMINING ATTORNEY



David J. Kyffers

Director of the United States Patent and Trademark Office

United States of America

United States Patent and Trademark Office

PULSAR

Reg. No. 4,065,057

Registered Dec. 6, 2011

Int. Cl.: 9

TRADEMARK

PRINCIPAL REGISTER

YUKON ADVANCED OPTICS WORLDWIDE, UAB (LITHUANIA CORPORATION)
ZIETELOS 4
VILNIUS, LITHUANIA LT-03202

FOR: DAY AND NIGHT VISION BINOCULARS, MONOCULARS AND GOGGLES, RIFLE SCOPES, SPOTTING SCOPES, LASER RANGE FINDERS, IN CLASS 9 (U.S. CLS. 21, 23, 26, 36 AND 38).

THE MARK CONSISTS OF STANDARD CHARACTERS WITHOUT CLAIM TO ANY PARTICULAR FONT, STYLE, SIZE, OR COLOR.

PRIORITY CLAIMED UNDER SEC. 44(D) ON ERPN CMNTY TM OFC APPLICATION NO. 259717, FILED 3-3-2009, REG. NO. 008132284, DATED 3-3-2011, EXPIRES 3-3-2019.

SER. NO. 77-682,797, FILED 3-3-2009.

SANJEEV VOHRA, EXAMINING ATTORNEY



David J. Kybas

Director of the United States Patent and Trademark Office

United States of America

United States Patent and Trademark Office

PRONTO

Reg. No. 4,065,058

Registered Dec. 6, 2011

Int. Cls.: 35, 42 and 45

SERVICE MARK

PRINCIPAL REGISTER

PRONTO, INC. (DELAWARE CORPORATION)
555 WEST 18TH STREET
NEW YORK, NY 10011

FOR: COMPARISON SHOPPING SERVICES; PROMOTING THE GOODS AND SERVICES OF OTHERS BY PROVIDING LINKS TO WEB SITES OF ONLINE RETAILERS, IN CLASS 35 (U.S. CLS. 100, 101 AND 102).

FIRST USE 1-12-2006; IN COMMERCE 1-12-2006.

FOR: COMPUTER SERVICES, NAMELY, PROVIDING A SEARCH ENGINE FOR LOCATING INFORMATION ABOUT PRODUCTS OR SERVICES OR PRODUCTS OR SERVICES PRICES, EXCLUDING INFORMATION RELATING TO LAND VALUATIONS OR THE COST OF REAL ESTATE, IN CLASS 42 (U.S. CLS. 100 AND 101).

FIRST USE 1-12-2006; IN COMMERCE 1-12-2006.

FOR: ONLINE SOCIAL NETWORKING SERVICES, IN CLASS 45 (U.S. CLS. 100 AND 101).

FIRST USE 9-26-2007; IN COMMERCE 9-26-2007.

THE MARK CONSISTS OF STANDARD CHARACTERS WITHOUT CLAIM TO ANY PARTICULAR FONT, STYLE, SIZE, OR COLOR.

SER. NO. 77-684,235, FILED 3-5-2009.

TIMOTHY FINNEGAN, EXAMINING ATTORNEY



David J. Kybas

Director of the United States Patent and Trademark Office

United States of America

United States Patent and Trademark Office

RBC GLOBAL ASSET MANAGEMENT

Reg. No. 4,065,059

Registered Dec. 6, 2011

Int. Cl.: 36

SERVICE MARK

PRINCIPAL REGISTER

ROYAL BANK OF CANADA (CANADA CHARTERED BANK)
A/S RBC LAW GROUP
1 PLACE VILLE MARIE, 4TH FLOOR-EAST WING
MONTREAL, CANADA H3C3A9

FOR: FINANCIAL ASSET MANAGEMENT SERVICES FOR A WIDE RANGE OF DOMESTIC AND INTERNATIONAL CLIENTS, NAMELY, INSTITUTIONS AND PENSION PLANS, FOUNDATIONS AND TRUSTS AS WELL AS PRIVATE CLIENTS, PROVIDER AND MANAGER OF RETAIL MUTUAL FUNDS AND PUBLICLY AND PRIVATELY OFFERED INVESTMENT FUNDS UTILIZING TRADITIONAL AND ALTERNATIVE INVESTMENT STRATEGIES, IN CLASS 36 (U.S. CLS. 100, 101 AND 102).

THE MARK CONSISTS OF STANDARD CHARACTERS WITHOUT CLAIM TO ANY PARTICULAR FONT, STYLE, SIZE, OR COLOR.

OWNER OF CANADA REG. NO. TMA780753, DATED 10-26-2010, EXPIRES 10-26-2020.

OWNER OF U.S. REG. NOS. 2,463,205, 3,565,553 AND OTHERS.

NO CLAIM IS MADE TO THE EXCLUSIVE RIGHT TO USE "GLOBAL ASSET MANAGEMENT", APART FROM THE MARK AS SHOWN.

SER. NO. 77-684,621, FILED 3-5-2009.

JEFF DEFORD, EXAMINING ATTORNEY



David J. Kybas

Director of the United States Patent and Trademark Office

United States of America

United States Patent and Trademark Office

JOINTHEALTH CHANGING ARTHRITIS

Reg. No. 4,065,060

Registered Dec. 6, 2011

Int. Cls.: 16 and 41

TRADEMARK

SERVICE MARK

PRINCIPAL REGISTER

ACE PLANNING & CONSULTING INC. (CANADA CORPORATION)
1228 HAMILTON STREET
SUITE 200 B
VANCOUVER, BC, CANADA V6B6L2

FOR: (BASED ON SECTION 44(E)) MAGAZINES, JOURNALS, NEWSLETTERS, AND BOOKS IN PRINTED FORM ON THE SUBJECT MATTER OF ARTHRITIS RESEARCH, TREATMENT, HEALTH CARE POLICY, AND RELATED HEALTH CARE TOPICS, IN CLASS 16 (U.S. CLS. 2, 5, 22, 23, 29, 37, 38 AND 50).

FOR: (BASED ON USE AND SECTION 44(E)) EDUCATIONAL SERVICES IN THE NATURE OF IN-PERSON WORKSHOPS, SEMINARS, CLASSES, LECTURES AND WEB-BASED WORKSHOPS IN THE FIELD OF ARTHRITIS RESEARCH, TREATMENT, HEALTH CARE POLICY, AND RELATED HEALTH CARE TOPICS, IN CLASS 41 (U.S. CLS. 100, 101 AND 107).

FIRST USE 6-30-2008; IN COMMERCE 6-30-2008.

THE MARK CONSISTS OF STANDARD CHARACTERS WITHOUT CLAIM TO ANY PARTICULAR FONT, STYLE, SIZE, OR COLOR.

OWNER OF CANADA REG. NO. TMA764,617, DATED 4-20-2010, EXPIRES 4-20-2025.

NO CLAIM IS MADE TO THE EXCLUSIVE RIGHT TO USE "JOINTHEALTH" AND "ARTHRITIS", APART FROM THE MARK AS SHOWN.

SER. NO. 77-701,096, FILED 3-27-2009.

LINDSEY RUBIN, EXAMINING ATTORNEY



David J. Kyjars

Director of the United States Patent and Trademark Office

United States of America

United States Patent and Trademark Office

LA TERRE

Reg. No. 4,065,061

Registered Dec. 6, 2011

Int. Cl.: 33

TRADEMARK

PRINCIPAL REGISTER

CONSTELLATION WINES U.S., INC. (NEW YORK CORPORATION)
235 NORTH BLOOMFIELD RD
CANANDAIGUA, NY 144241059

FOR: WINE, IN CLASS 33 (U.S. CLS. 47 AND 49).

FIRST USE 3-10-1998; IN COMMERCE 3-10-1998.

THE MARK CONSISTS OF STANDARD CHARACTERS WITHOUT CLAIM TO ANY PARTICULAR FONT, STYLE, SIZE, OR COLOR.

THE ENGLISH TRANSLATION OF "LA TERRE" IN THE MARK IS "THE EARTH".

SER. NO. 77-706,612, FILED 4-3-2009.

BARBARA GAYNOR, EXAMINING ATTORNEY



David J. Kybas

Director of the United States Patent and Trademark Office

United States of America

United States Patent and Trademark Office

AXIOM EPM

Reg. No. 4,065,062

Registered Dec. 6, 2011

Int. Cls.: 9, 41 and 42

TRADEMARK

SERVICE MARK

PRINCIPAL REGISTER

AXIOM GROUP, LLC (OREGON LIMITED LIABILITY COMPANY)
10260 SW GREENBURG RD.
PORTLAND, OR 97223

FOR: ENTERPRISE PERFORMANCE MANAGEMENT COMPUTER SOFTWARE FOR USE IN BUDGETING, FORECASTING, STRATEGIC PLANNING, CAPITAL PLANNING AND REPORTING EXCLUDING COMPUTER SOFTWARE FOR USE IN ELECTRONIC ENTRY AND MANAGEMENT OF TIMEKEEPING AND EXPENSES FOR PROFESSIONAL SERVICES, IN CLASS 9 (U.S. CLS. 21, 23, 26, 36 AND 38).

FIRST USE 1-6-2009; IN COMMERCE 1-9-2009.

FOR: EDUCATIONAL SERVICES, NAMELY, CONDUCTING WEBINARS, ON-SITE TRAINING, AND SEMINARS IN THE USE OF CUSTOMIZED SOFTWARE APPLICATIONS EXCLUDING COMPUTER SOFTWARE FOR USE IN ELECTRONIC ENTRY AND MANAGEMENT OF TIMEKEEPING AND EXPENSES FOR PROFESSIONAL SERVICES, IN CLASS 41 (U.S. CLS. 100, 101 AND 107).

FIRST USE 1-6-2009; IN COMMERCE 1-19-2009.

FOR: CUSTOMIZATION OF COMPUTER SOFTWARE EXCLUDING COMPUTER SOFTWARE FOR USE IN ELECTRONIC ENTRY AND MANAGEMENT OF TIMEKEEPING AND EXPENSES FOR PROFESSIONAL SERVICES, IN CLASS 42 (U.S. CLS. 100 AND 101).

FIRST USE 1-6-2009; IN COMMERCE 1-6-2009.

THE MARK CONSISTS OF STANDARD CHARACTERS WITHOUT CLAIM TO ANY PARTICULAR FONT, STYLE, SIZE, OR COLOR.

NO CLAIM IS MADE TO THE EXCLUSIVE RIGHT TO USE "EPM", APART FROM THE MARK AS SHOWN.

SER. NO. 77-724,841, FILED 4-29-2009.

CURTIS FRENCH, EXAMINING ATTORNEY



David J. Kypos

Director of the United States Patent and Trademark Office

United States of America

United States Patent and Trademark Office

EDEN

Reg. No. 4,065,063

Registered Dec. 6, 2011

Int. Cls.: 43 and 44

SERVICE MARK

PRINCIPAL REGISTER

EDEN FOODS, INC. (MICHIGAN CORPORATION)
701 TECUMSEH ROAD
CLINTON, MI 49236

FOR: PROVIDING RECIPES AND INFORMATION IN THE FIELD OF COOKING AND FOOD PREPARATION, IN CLASS 43 (U.S. CLS. 100 AND 101).

FIRST USE 12-0-2004; IN COMMERCE 12-0-2004.

FOR: PROVIDING INFORMATION IN THE FIELD OF HEALTH, NUTRITION, DIET, BEAUTY AND ORGANIC FARMING TECHNIQUES, IN CLASS 44 (U.S. CLS. 100 AND 101).

FIRST USE 12-0-2004; IN COMMERCE 12-0-2004.

THE MARK CONSISTS OF STANDARD CHARACTERS WITHOUT CLAIM TO ANY PARTICULAR FONT, STYLE, SIZE, OR COLOR.

OWNER OF U.S. REG. NOS. 1,233,768, 1,452,337 AND OTHERS.

SER. NO. 77-732,286, FILED 5-8-2009.

DAVID C. REIHNER, EXAMINING ATTORNEY



David J. Kyros

Director of the United States Patent and Trademark Office

United States of America

United States Patent and Trademark Office



AFFINITY
FEDERAL CREDIT UNION

Reg. No. 4,065,064

Registered Dec. 6, 2011

Int. Cl.: 36

SERVICE MARK

PRINCIPAL REGISTER

AFFINITY FEDERAL CREDIT UNION (UNITED STATES FEDERALLY CHARTERED CREDIT UNION)
73 MOUNTAIN VIEW BOULEVARD
BASKING RIDGE, NJ 07920

FOR: CREDIT UNION SERVICES, IN CLASS 36 (U.S. CLS. 100, 101 AND 102).

FIRST USE 4-1-1996; IN COMMERCE 4-1-1996.

NO CLAIM IS MADE TO THE EXCLUSIVE RIGHT TO USE "FEDERAL CREDIT UNION", APART FROM THE MARK AS SHOWN.

THE MARK CONSISTS OF A HALF CIRCLE DESIGN AND THE WORDING "AFFINITY FEDERAL CREDIT UNION". THE HALF CIRCLE DESIGN IS DIVIDED INTO THREE PORTIONS -- ONE LOWER AND TWO UPPER -- BY CURVED LINES AND FEATURES HORIZONTAL LINES IN THE UPPER TWO PORTIONS. THE TEXT PORTION OF THE MARK IS DISPLAYED TO THE RIGHT OF THE HALF CIRCLE DESIGN AND FEATURES THE WORD "AFFINITY" IN LARGE TEXT ABOVE THE WORDS "FEDERAL CREDIT UNION" IN SMALLER TEXT. THE TWO LINES OF TEXT ARE SEPARATED BY A SINGLE HORIZONTAL LINE.

SER. NO. 77-770,469, FILED 6-29-2009.

KATHERINE CHANG, EXAMINING ATTORNEY



David J. Kyros

Director of the United States Patent and Trademark Office

United States of America

United States Patent and Trademark Office

MARSHMALLOW TREATS

Reg. No. 4,065,065

Registered Dec. 6, 2011

Int. Cl.: 30

TRADEMARK

PRINCIPAL REGISTER

KELLOGG NORTH AMERICA COMPANY (DELAWARE CORPORATION)
ONE KELLOGG SQUARE
BATTLE CREEK, MI 49016

FOR: CEREAL-BASED SNACK FOOD BARS CONTAINING MARSHMALLOW, IN CLASS 30 (U.S. CL. 46).

FIRST USE 2-22-2005; IN COMMERCE 2-22-2005.

THE MARK CONSISTS OF STANDARD CHARACTERS WITHOUT CLAIM TO ANY PARTICULAR FONT, STYLE, SIZE, OR COLOR.

OWNER OF U.S. REG. NOS. 2,223,484, 3,612,469 AND OTHERS.

NO CLAIM IS MADE TO THE EXCLUSIVE RIGHT TO USE "MARSHMALLOW", APART FROM THE MARK AS SHOWN.

SEC. 2(F).

SER. NO. 77-770,855, FILED 6-30-2009.

JOHN KELLY, EXAMINING ATTORNEY



David J. Kyros

Director of the United States Patent and Trademark Office

United States of America

United States Patent and Trademark Office



Reg. No. 4,065,066

Registered Dec. 6, 2011

Int. Cl.: 41

SERVICE MARK

PRINCIPAL REGISTER

YOUNG DRIVERS OF CANADA CORPORATION (CANADA CORPORATION)
1 JAMES STREET SOUTH, SUITE 300
HAMILTON, CANADA L8P4R5

FOR: EDUCATIONAL SERVICES, NAMELY, CONDUCTING DRIVER TRAINING CLASSES AND ONE-ON-ONE IN-CAR DRIVING TRAINING COURSES; CONDUCTING DRIVER EDUCATION COURSES TO IMPROVE AND MAINTAIN DRIVING SKILLS; PROVIDING ONLINE COGNITIVE ASSESSMENTS AND TRAINING PROGRAMS THAT HELP IDENTIFY COGNITIVE STRENGTHS AND WEAKNESSES OF AN INDIVIDUAL; ONLINE COURSES FEATURING SAFE DRIVING SKILLS, IN CLASS 41 (U.S. CLS. 100, 101 AND 107).

PRIORITY CLAIMED UNDER SEC. 44(D) ON CANADA APPLICATION NO. 1442563, FILED 6-23-2009, REG. NO. TMA786228, DATED 12-31-2010, EXPIRES 12-31-2025.

OWNER OF U.S. REG. NO. 1,542,970.

THE MARK CONSISTS OF THE STYLIZED LETTERS "Y" AND "D" CONTAINED WITHIN ROAD TRAFFIC SIGNS.

SER. NO. 77-775,589, FILED 7-7-2009.

JOHN DALIER, EXAMINING ATTORNEY



David J. Kybas

Director of the United States Patent and Trademark Office

United States of America

United States Patent and Trademark Office

ACCULOGIC

Reg. No. 4,065,067

Registered Dec. 6, 2011

Int. Cls.: 9 and 42

TRADEMARK

SERVICE MARK

PRINCIPAL REGISTER

ACCULOGIC CORPORATION (CANADA CORPORATION)
175 RIVIERA DRIVE
MARKHAM, ONTARIO, CANADA L3R5J6

FOR: COMPUTER HARDWARE, SOFTWARE AND INSTRUMENTATION FOR TESTING AND VALIDATING ELECTRONIC CIRCUIT BOARD ASSEMBLIES FOR USE IN FACTORIES THAT ASSEMBLE ELECTRONIC CIRCUIT BOARDS; THE PRECEDING EXPRESSLY EXCLUDING COMPUTER HARDWARE, SOFTWARE AND INSTRUMENTATION IN THE FIELDS OF MEDICAL BILLING, ACCOUNTING, AND COLLECTIONS OF ACCOUNTS RECEIVABLE, IN CLASS 9 (U.S. CLS. 21, 23, 26, 36 AND 38).

FIRST USE 12-31-1993; IN COMMERCE 12-31-1993.

FOR: CONSULTING SERVICES IN THE FIELD OF TESTING, ANALYSIS AND EVALUATION OF THE ELECTRONIC CIRCUIT BOARD ASSEMBLIES OF OTHERS FOR PURPOSES OF CERTIFICATION; DESIGN AND DEVELOPMENT OF COMPUTER HARDWARE AND SOFTWARE FOR TESTING AND VALIDATING ELECTRONIC CIRCUIT BOARD ASSEMBLIES; TESTING SERVICES IN THE FIELD OF ELECTRONIC CIRCUIT BOARD ASSEMBLIES, IN CLASS 42 (U.S. CLS. 100 AND 101).

FIRST USE 12-31-1993; IN COMMERCE 12-31-1993.

THE MARK CONSISTS OF STANDARD CHARACTERS WITHOUT CLAIM TO ANY PARTICULAR FONT, STYLE, SIZE, OR COLOR.

PRIORITY CLAIMED UNDER SEC. 44(D) ON CANADA APPLICATION NO. 1430624, FILED 3-11-2009, REG. NO. TMA771692, DATED 7-12-2010, EXPIRES 7-12-2025.

SER. NO. 77-779,941, FILED 7-13-2009.

JOHN GARTNER, EXAMINING ATTORNEY



David J. Kypos

Director of the United States Patent and Trademark Office

United States of America

United States Patent and Trademark Office



Reg. No. 4,065,068

Registered Dec. 6, 2011

Int. Cl.: 9

TRADEMARK

PRINCIPAL REGISTER

PIONEER KABUSHIKI KAISHA (JAPAN CORPORATION), TA PIONEER CORPORATION
1-1, SHIN-OGURA, SAIWAI-KU, KAWASAKI-SHI
KANAGAWA-KEN 212-0031, JAPAN

FOR: LOUDSPEAKERS; CONSUMER ELECTRONIC PRODUCTS, NAMELY, AUDIO AMPLIFIERS, AUDIO SPEAKERS, AUDIO RECEIVERS, ELECTRICAL AUDIO AND SPEAKER CABLES AND CONNECTORS, HOME THEATER SYSTEMS, AUDIO DECODERS, VIDEO DECODERS, SPEAKERS, POWER CONVERSION DEVICES, POWER CONVERTERS, AND POWER INVERTERS; HEADPHONES; EARPHONES; AUDIO RACKS FOR BUILT-IN LOUDSPEAKERS; AUDIO EQUIPMENT FOR VEHICLES, NAMELY, STEREOS, SPEAKERS, AMPLIFIERS, EQUALIZERS, CROSSOVERS AND SPEAKER HOUSINGS; REMOTE CONTROLS FOR EACH OF AFORESAID GOODS, IN CLASS 9 (U.S. CLS. 21, 23, 26, 36 AND 38).

OWNER OF JAPAN REG. NO. 5288678, DATED 12-18-2009, EXPIRES 12-18-2019.

THE MARK CONSISTS OF THE LETTERS "HVT", WITH THE "HV" CONTAINED WITHIN A DARK RECTANGLE AND THE "T" CONTAINED WITHIN A LIGHT SQUARE.

SER. NO. 77-780,814, FILED 7-14-2009.

FRED CARL, EXAMINING ATTORNEY



David J. Kyros

Director of the United States Patent and Trademark Office

United States of America

United States Patent and Trademark Office

SAFE RETURNS

Reg. No. 4,065,069

Registered Dec. 6, 2011

Int. Cl.: 35

SERVICE MARK

PRINCIPAL REGISTER

JOHNSON & JOHNSON (NEW JERSEY CORPORATION)
ONE JOHNSON & JOHNSON PLAZA
NEW BRUNSWICK, NJ 089337001

FOR: PROMOTING PUBLIC AWARENESS TO CONSUMERS ON THE NEED TO PROPERLY DISPOSE OF EMPTY PHARMACEUTICAL INJECTORS AND SYRINGES, IN CLASS 35 (U.S. CLS. 100, 101 AND 102).

FIRST USE 12-0-2009; IN COMMERCE 12-0-2009.

THE MARK CONSISTS OF STANDARD CHARACTERS WITHOUT CLAIM TO ANY PARTICULAR FONT, STYLE, SIZE, OR COLOR.

SER. NO. 77-784,907, FILED 7-20-2009.

WON TEAK OH, EXAMINING ATTORNEY



David J. Kyffers

Director of the United States Patent and Trademark Office

United States of America

United States Patent and Trademark Office



Reg. No. 4,065,070

Registered Dec. 6, 2011

Int. Cl.: 42

SERVICE MARK

PRINCIPAL REGISTER

VIP HOSTING, LLC (OKLAHOMA LIMITED LIABILITY COMPANY)
SUITE 105
2525 N.W. EXPRESSWAY
OKLAHOMA CITY, OK 73112

FOR: DESIGN OF HOME PAGES AND WEB SITES; HOSTING OF WEB SITES, IN CLASS 42 (U.S. CLS. 100 AND 101).

FIRST USE 3-9-2009; IN COMMERCE 3-9-2009.

NO CLAIM IS MADE TO THE EXCLUSIVE RIGHT TO USE "HOSTING, LLC", APART FROM THE MARK AS SHOWN.

THE MARK CONSISTS OF A DESIGN COMPRISED OF AN ABSTRACT REPRESENTATION OF THE WORD "VIP." TO THE RIGHT OF THE DESIGN APPEARS THE WORD "VIP" AND BELOW THAT IS THE WORDING "HOSTING, LLC".

SER. NO. 77-787,463, FILED 7-22-2009.

KATHERINE CHANG, EXAMINING ATTORNEY



David J. Kybas

Director of the United States Patent and Trademark Office

United States of America

United States Patent and Trademark Office

COMEDY REPUBLIC

Reg. No. 4,065,071

Registered Dec. 6, 2011

**Int. Cls.: 9, 16, 35, 38
and 41**

TRADEMARK

SERVICE MARK

PRINCIPAL REGISTER

COMEDY REPUBLIC LTD. (UNITED KINGDOM CORPORATION)
33 FOLEY STREET
LONDON, UNITED KINGDOM W1W7TL

FOR: MOTION PICTURE FILMS, VIDEO, AUDIO AND DATA RECORDINGS ALL FEATURING COMEDY; RECORDS, DISCS, TAPES, CASSETTES, CDS, CD-ROMS, CARTRIDGES AND DVDS ALL FEATURING COMEDY; VIDEO AND COMPUTER GAME PROGRAMS; VIDEO GAME CARTRIDGES AND CASSETTES; ELECTRONIC GAME PROGRAMS; DOWNLOADABLE TELEPHONE RING TONES; DOWNLOADABLE ONLINE PUBLICATIONS, NAMELY, NEWSLETTERS AND MAGAZINES IN THE FIELD OF COMEDY; DOWNLOADABLE ONLINE TEXT, DATA AND IMAGES IN THE FIELD OF COMEDY; DOWNLOADABLE ONLINE DISCUSSION BOARDS, WEBCASTS AND PODCASTS FEATURING MOTION PICTURE FILMS, FILM CLIPS AND MUSIC; SOFTWARE TO ENABLE UPLOADING, DOWNLOADING, CAPTURING, POSTING, SHOWING, EDITING, PLAYING, STREAMING, VIEWING, PREVIEWING, DISPLAYING, TAGGING, BLOGGING, SHARING, MANIPULATING, DISTRIBUTING, PUBLISHING AND REPRODUCING OF ELECTRONIC MEDIA, MULTIMEDIA CONTENT, VIDEOS, MOVIES, PICTURES, IMAGES, TEXT, PHOTOS, GAMES, USER-GENERATED CONTENT, AUDIO CONTENT AND INFORMATION VIA THE INTERNET OR OTHER COMPUTER AND COMMUNICATION NETWORKS, IN CLASS 9 (U.S. CLS. 21, 23, 26, 36 AND 38).

FOR: BOOKS, MAGAZINES, PERIODICALS, BOOKLETS, COMICS, CATALOGUES AND GUIDES ALL IN THE FIELD OF COMEDY; STICKERS, POSTERS AND PHOTOGRAPHS, IN CLASS 16 (U.S. CLS. 2, 5, 22, 23, 29, 37, 38 AND 50).

FOR: PRODUCTION OF TELEVISION AND RADIO ADVERTISEMENTS; RETAIL SERVICES, NAMELY, RETAIL STORE SERVICES PROVIDED ONLINE, FEATURING PRINTED PUBLICATIONS, DVDS, CDS, GAMES AND PLAYTHINGS; PORTAL SERVICES, NAMELY, PROVIDING AN INTERNET WEBSITE PORTAL FEATURING LINKS TO COMEDY-RELATED MERCHANDISE FOR RETAIL PURPOSES, IN CLASS 35 (U.S. CLS. 100, 101 AND 102).

FOR: CHAT ROOM SERVICES, NAMELY, PROVIDING ONLINE CHAT ROOMS FOR TRANSMISSION OF MESSAGES AMONG COMPUTER USERS IN THE FIELD OF ENTERTAINMENT AND COMEDY; PROVIDING USER ACCESS TO THE INTERNET; BROADCAST AND TRANSMISSION OF TELEVISION PROGRAMS AND RADIO PROGRAMS; ONLINE DISCUSSION BOARDS FOR TRANSMISSION OF MESSAGES AMONG USERS IN THE FIELD OF MOTION PICTURE FILMS, FILM CLIPS AND MUSIC; TRANSMISSION OF



David J. Kybas

Director of the United States Patent and Trademark Office

Reg. No. 4,065,071 WEBCASTS AND PODCASTS FEATURING MOTION PICTURE FILMS, FILM CLIPS AND MUSIC, IN CLASS 38 (U.S. CLS. 100, 101 AND 104).

FOR: PRODUCTION, RECORDING, SYNDICATION, PRESENTATION AND RENTAL OF TELEVISION AND RADIO PROGRAMS, MOTION PICTURE FILMS, VIDEO TAPE FILMS AND VIDEO DISC FILMS, AND SOUND RECORDINGS; DISTRIBUTION OF TELEVISION AND RADIO PROGRAMS AND MOTION PICTURE FILMS; ANIMATION PRODUCTION SERVICES; MULTIMEDIA PRODUCTION SERVICES; NON-DOWNLOADABLE ELECTRONIC PUBLICATIONS AVAILABLE ONLINE FROM A DATABASE OR THE INTERNET, NAMELY, NEWSLETTERS AND MAGAZINES IN THE FIELD OF COMEDY; PRODUCTION AND PRESENTATION OF TELEVISION PROGRAMS AND MOTION PICTURE FILMS FOR TRANSMISSION AND ACCESS VIA COMMUNICATION AND COMPUTER NETWORKS INCLUDING THE INTERNET; ORGANIZATION, PRESENTATION AND PRODUCTION OF COMEDY SHOWS, CONCERTS AND LIVE PERFORMANCES; RECORDING STUDIO SERVICES; PROVIDING TEMPORARY USE OF NON-DOWNLOADABLE INTERACTIVE GAMES; MUSIC PUBLISHING SERVICES; PROVISION OF INFORMATION IN THE FIELD OF ENTERTAINMENT AND COMEDY; PROVIDING WEBCASTS AND PODCASTS FEATURING MOTION PICTURE FILMS, FILM CLIPS AND MUSIC; PORTAL SERVICES, NAMELY, PROVIDING AN INTERNET WEBSITE PORTAL IN THE FIELD OF ENTERTAINMENT AND COMEDY, IN CLASS 41 (U.S. CLS. 100, 101 AND 107).

THE MARK CONSISTS OF STANDARD CHARACTERS WITHOUT CLAIM TO ANY PARTICULAR FONT, STYLE, SIZE, OR COLOR.

PRIORITY CLAIMED UNDER SEC. 44(D) ON ERPN CMNTY TM OFC APPLICATION NO. 8436917, FILED 7-20-2009, REG. NO. 008436917, DATED 3-16-2010, EXPIRES 7-20-2019.

NO CLAIM IS MADE TO THE EXCLUSIVE RIGHT TO USE "COMEDY", APART FROM THE MARK AS SHOWN.

SER. NO. 77-787,932, FILED 7-23-2009.

TEJBIR SINGH, EXAMINING ATTORNEY

United States of America

United States Patent and Trademark Office



Reg. No. 4,065,072

Registered Dec. 6, 2011

Int. Cls.: 41 and 45

SERVICE MARK

PRINCIPAL REGISTER

EQUAL RIGHTS CENTER (D.C. NON-PROFIT CORPORATION)
11 DUPONT CIRCLE, SUITE 450
WASHINGTON, DC 20036

FOR: EDUCATIONAL WORKSHOPS AND TRAINING PROGRAMS IN THE FIELD OF CIVIL RIGHTS, FAIR HOUSING, FAIR EMPLOYMENT, DISABILITY RIGHTS, AND IMMIGRANT RIGHTS, IN CLASS 41 (U.S. CLS. 100, 101 AND 107).

FIRST USE 1-13-2009; IN COMMERCE 1-13-2009.

FOR: PROVIDING INFORMATION IN THE FIELDS OF CIVIL RIGHTS LAW, FAIR HOUSING LAW, FAIR EMPLOYMENT LAW, DISABILITY RIGHTS LAW, AND IMMIGRANT RIGHTS LAW; PROVIDING REGULATORY COMPLIANCE CONSULTING IN THE FIELDS OF CIVIL RIGHTS, FAIR HOUSING, FAIR EMPLOYMENT, DISABILITY RIGHTS, AND IMMIGRANT RIGHTS; INVESTIGATION SERVICES RELATED TO COMPLIANCE WITH CIVIL RIGHTS LAWS, FAIR HOUSING LAWS, FAIR EMPLOYMENT LAWS, DISABILITY RIGHTS, AND IMMIGRANT RIGHTS, IN CLASS 45 (U.S. CLS. 100 AND 101).

FIRST USE 1-13-2009; IN COMMERCE 1-13-2009.

NO CLAIM IS MADE TO THE EXCLUSIVE RIGHT TO USE "HOUSING, EMPLOYMENT, PUBLIC ACCOMMODATIONS & GOVERNMENT SERVICES", "CENTER", "EST. 1983", AND "CIVIL RIGHTS", APART FROM THE MARK AS SHOWN.

THE COLOR(S) RED, BLUE, BLACK, AND WHITE IS/ARE CLAIMED AS A FEATURE OF THE MARK.

THE MARK CONSISTS OF THE WORDING "EQUAL RIGHTS CENTER" IN WHITE IN A RED CIRCLE. A HORIZONTAL WHITE LINE APPEARS BELOW THE WORDS "EQUAL" AND "RIGHTS". THE WORDING "FAIRNESS & EQUALITY IN HOUSING, EMPLOYMENT, PUBLIC ACCOMMODATIONS & GOVERNMENT SERVICES" IN BLACK APPEARS WITHIN A WHITE CIRCLE AROUND THE RED CIRCLE. THE WORDING "EST. 1983" IN WHITE APPEARS WITHIN A RED AND BLUE RIBBON. THE WORDING "ADVANCING CIVIL RIGHTS FOR OVER A QUARTER CENTURY" APPEARS IN BLACK UNDER THE DESIGN PORTION OF THE MARK.

SEC. 2(F) AS TO "EQUAL RIGHTS CENTER".



David J. Kyjars

Director of the United States Patent and Trademark Office

Reg. No. 4,065,072 SER. NO. 77-788,303, FILED 7-23-2009.

JESSICA FATHY, EXAMINING ATTORNEY

United States of America

United States Patent and Trademark Office

WATERSAVER

Reg. No. 4,065,073

Registered Dec. 6, 2011

Int. Cls.: 6 and 11

TRADEMARK

PRINCIPAL REGISTER

WATERSAVER FAUCET CO. (ILLINOIS CORPORATION)
701 WEST ERIE STREET
CHICAGO, IL 60610

FOR: PRE-RINSE UNITS, NAMELY, METAL PRE-RINSE WASH DOWN SPRAY NOZZLES FOR COMMERCIAL AND INDUSTRIAL USE; METAL ESCUTCHEONS USED TO PROVIDE A CLEAN FINISHED LOOK TO SHOWER AND/OR FAUCET CONTROL FITTINGS; MANUALLY OPERATED METAL VALVES, IN CLASS 6 (U.S. CLS. 2, 12, 13, 14, 23, 25 AND 50).

FIRST USE 8-1-1925; IN COMMERCE 8-1-1925.

FOR: FAUCETS, WATER FAUCETS, MIXING FAUCETS, MULTIPLE OUTLET WATER FIXTURES, DISTILLED WATER FAUCETS, TIN-LINED BRASS FAUCETS, STAINLESS STEEL FAUCETS; COMBINATION COLD WATER AND GAS FIXTURES, NAMELY, PLUMBING FITTINGS IN THE NATURE OF FIXTURES THAT CONTROL COLD WATER AND GAS COMPRESSION; COMBINATION HOT AND COLD WATER AND GAS FIXTURES, NAMELY, PLUMBING FITTINGS IN THE NATURE OF FIXTURES THAT CONTROL HOT AND COLD WATER AND GAS COMPRESSION; FAUCET AERATORS; FAUCET SPRAYERS; MIXER FAUCET FOR WATER PIPES; WATER FAUCET SPOUT; PLUMBING FITTINGS, NAMELY, FAUCET FILTERS, BIBBS, DRAINS, SPOUTS; SHOWER CONTROL FITTINGS, NAMELY, ESCUTCHEONS; MANUALLY OPERATED PLUMBING VALVES; REGULATING ACCESSORIES FOR WATER SUPPLY, NAMELY, METERED VALVES; STEAM VALVES, IN CLASS 11 (U.S. CLS. 13, 21, 23, 31 AND 34).

FIRST USE 8-1-1925; IN COMMERCE 8-1-1925.

THE MARK CONSISTS OF STANDARD CHARACTERS WITHOUT CLAIM TO ANY PARTICULAR FONT, STYLE, SIZE, OR COLOR.

OWNER OF U.S. REG. NOS. 3,960,370 AND 3,968,336.

SEC. 2(F).

SER. NO. 77-790,006, FILED 7-27-2009.

JOHN DWYER, EXAMINING ATTORNEY



David J. Kyffers

Director of the United States Patent and Trademark Office

United States of America

United States Patent and Trademark Office



Reg. No. 4,065,074

FETTERMAN & ASSOCIATES, P.A. (FLORIDA CORPORATION)
648 US HIGHWAY ONE
NORTH PALM BEACH, FL 33408

Registered Dec. 6, 2011

Int. Cl.: 45

FOR: LITIGATION SERVICES, IN CLASS 45 (U.S. CLS. 100 AND 101).

SERVICE MARK

FIRST USE 1-1-2006; IN COMMERCE 1-1-2006.

PRINCIPAL REGISTER

NO CLAIM IS MADE TO THE EXCLUSIVE RIGHT TO USE "ASSOCIATES THE LAW TEAM", APART FROM THE MARK AS SHOWN.

THE COLOR(S) BLUE AND GOLD IS/ARE CLAIMED AS A FEATURE OF THE MARK.

THE MARK CONSISTS OF NAVY BLUE "FETTERMAN & ASSOCIATES THE LAW TEAM" WITH A BLUE LINE ORIGINATING AS PART OF THE "A" IN "ASSOCIATES" AND EXTENDING UNDER THE REMAINING LETTERS OF THE TERM AND WITH THREE GOLD GAVELS BEHIND THE "F" IN "FETTERMAN".

SER. NO. 77-794,519, FILED 7-31-2009.

DEIRDRE ROBERTSON, EXAMINING ATTORNEY



David J. Kyjars

Director of the United States Patent and Trademark Office

United States of America

United States Patent and Trademark Office



THE HAPPY BODY

Reg. No. 4,065,075

Registered Dec. 6, 2011

Int. Cl.: 41

SERVICE MARK

PRINCIPAL REGISTER

GREGOREK, JERZY (UNITED STATES INDIVIDUAL), DBA THE HAPPY BODY
104 ALTA MESA RD
WOODSIDE, CA 94062

FOR: COUNSELING SERVICES IN THE FIELD OF PHYSICAL FITNESS; EDUCATION SERVICES, NAMELY, PROVIDING MENTORING, TUTORING, CLASSES, SEMINARS AND WORKSHOPS IN THE FIELD OF FITNESS, IN CLASS 41 (U.S. CLS. 100, 101 AND 107).

FIRST USE 6-0-2002; IN COMMERCE 6-0-2002.

THE MARK CONSISTS OF A STYLIZED GRAPHIC OF A SUN IN RED, APPEARING BEHIND A BLACK LINE DRAWING OF A MAN SQUATTING. BELOW THE GRAPHIC IS THE WORDING "THE HAPPY BODY" IN BLACK.

THE COLOR(S) RED AND BLACK IS/ARE CLAIMED AS A FEATURE OF THE MARK.

SER. NO. 77-794,689, FILED 7-31-2009.

ALYSSA STEEL, EXAMINING ATTORNEY



David J. Kybas

Director of the United States Patent and Trademark Office

United States of America

United States Patent and Trademark Office

H₂ouse

Reg. No. 4,065,076

Registered Dec. 6, 2011

Int. Cls.: 6, 7, 9 and 11

TRADEMARK

PRINCIPAL REGISTER

ITM FUEL CELLS LIMITED (UNITED KINGDOM COMPANY)
UNIT H, SHEFFIELD BUSINESS PARK
EUROPA LINK, SHEFFIELD, UNITED KINGDOM S91XU

FOR: TANKS, CYLINDERS AND RECEPTACLES OF METAL FOR USE IN THE STORAGE OF GASES, LIQUEFIED GASES AND COMPRESSED GASES; STRUCTURAL PARTS AND FITTINGS FOR ALL THE AFORESAID GOODS, IN CLASS 6 (U.S. CLS. 2, 12, 13, 14, 23, 25 AND 50).

FOR: ELECTRIC CIRCULATING PUMPS FOR CENTRAL HEATING INSTALLATIONS; ELECTRICITY GENERATORS; GENERATORS UTILIZING HYDROGEN FOR THE PRODUCTION OF ELECTRICITY; STRUCTURAL PARTS AND FITTINGS FOR ALL THE AFORESAID GOODS, IN CLASS 7 (U.S. CLS. 13, 19, 21, 23, 31, 34 AND 35).

FOR: SCIENTIFIC APPARATUS, NAMELY, GAS STORAGE MODULES COMPRISING OF ELECTRONIC POWER CONVERTERS, POWER SUPPLY, ELECTRIC SWITCHES, POWER LINE CONDITIONERS, STEP-UP AND STEP-DOWN TRANSFORMERS, ELECTRIC GENERATORS, VOLTAGE STABILIZING POWER SUPPLY, POWER LINE CONDITIONING MODULES, ELECTRIC POWER DISTRIBUTION CONVERSION MODULES, POWER SUPPLY MODULES, ELECTRIC SWITCH MODULES, STEP-UP POWER BOOST ELECTRONIC MODULES, STEP-DOWN POWER BOOST ELECTRONIC MODULES, SWITCH MODE POWER SUPPLY MODULES, POWER SUPPLY MATCHING MODULES, AND CONTAINERS FOR GAS AND WATER AND ELECTRIC GENERATORS; APPARATUS FOR CONDUCTING, STORING, SWITCHING, TRANSFORMING, ACCUMULATING, REGULATING AND/OR CONTROLLING ELECTRICITY, NAMELY, DC/DC CONVERTERS, AC/DC CONVERTERS, AC/AC CONVERTERS, DC/AC CONVERTERS, ELECTRODES, ELECTRICAL CONNECTORS; ELECTRONIC INSTRUMENTS WHICH MONITOR AND CONTROL THE PERFORMANCE OF DC/DC CONVERTERS, AC/DC CONVERTERS, AC/AC CONVERTERS, DC/AC CONVERTERS; FUEL CELLS; ELECTROLYSERS; PHOTOELECTROLYSERS; APPARATUS FOR THE CONTROL AND MONITORING OF FUEL CELLS, ELECTROLYSERS AND PHOTOELECTROLYSERS, NAMELY, ELECTRONIC MODULES FOR DETECTING GAS FLOW RATE, ELECTRONIC MODULES FOR DETECTING WATER FLOW RATE, AND ELECTRONIC MODULES FOR DETECTING LIQUID FLOW RATE; PHOTOVOLTAIC SOLAR MODULES AND PANELS FOR PRODUCTION OF ELECTRICITY, PHOTOVOLTAIC CELLS; SOLAR PANELS AND SOLAR CELLS FOR THE PRODUCTION OF ELECTRICITY; SCIENTIFIC TESTING APPARATUS AND INSTRUMENTS FOR THE PURPOSES OF MEASURING THE AMOUNT OF HYDROGEN AND OXYGEN PRODUCED BY THE PROCESS OF PHOTOELEC-



David J. Kyros

Director of the United States Patent and Trademark Office

Reg. No. 4,065,076 TROLYSIS FOR USE IN CONNECTION WITH APPARATUS FOR PHOTOELECTROLYSIS; SCIENTIFIC TESTING APPARATUS AND INSTRUMENTS FOR THE PURPOSES OF MEASURING THE AMOUNT OF FUEL PRODUCED FOR USE IN CONNECTION WITH APPARATUS FOR CONVERTING HYDROGEN INTO ELECTRICITY; SOLAR CELLS; THERMOSTATS, OTHER THAN VALVES, FOR CENTRAL HEATING INSTALLATIONS; COMPUTER SOFTWARE FOR MONITORING, REGULATING AND CONTROLLING DC/DC CONVERTERS, AC/DC CONVERTERS, DC/AC CONVERTERS, AC/AC CONVERTERS, FUEL CELLS, ELECTROLYSERS, PHOTOELECTROALYSERS, CENTRAL HEATING SYSTEMS, HOT WATER SYSTEMS; THERMOSTATS; RHEOSTATS; INSTRUMENTS AND APPARATUS FOR TEMPERATURE CONTROL IN CENTRAL HEATING INSTALLATIONS AND HOT WATER INSTALLATIONS, NAMELY, THERMOSTATS; STRUCTURAL PARTS AND FITTINGS FOR ALL THE AFORESAID GOODS, IN CLASS 9 (U.S. CLS. 21, 23, 26, 36 AND 38).

FOR: HYDROGEN GENERATORS; HYDROGEN BURNING GENERATORS; HYDROGEN AND OXYGEN GENERATORS FOR THE PURPOSES OF GENERATING HYDROGEN AND OXYGEN FROM WATER AND/OR RENEWABLE ELECTRICITY; REFRIGERATORS; REFRIGERATORS POWERED BY HYDROGEN; ELECTRICAL BOILERS; HEAT EXCHANGERS; STEAM GENERATORS; BOILERS POWERED BY HYDROGEN; STEAM GENERATORS POWERED BY HYDROGEN; INSTALLATIONS COMBINING BOILERS AND STEAM GENERATORS FOR HEATING; INSTALLATIONS COMBINING BOILERS AND STEAM GENERATORS FOR PRODUCING HOT WATER; HEAT EXCHANGERS; INDUCTION, CONVECTION, AND GAS BURNING OVENS, AND INDUCTION, CONVECTION, AND GAS BURNING OVENS UTILIZING HYDROGEN; HYDROGEN HOBBS, NAMELY, COOKING RANGES; SOLAR PANELS FOR USE IN HEAT COLLECTION; THERMOSTATIC VALVES; THERMOSTATIC VALVES FOR CONTROLLING TEMPERATURE IN CENTRAL HEATING RADIATORS; EXPANSION HOT WATER TANKS FOR CENTRAL HEATING INSTALLATIONS AND HOT WATER INSTALLATIONS; STRUCTURAL PARTS AND FITTINGS FOR ALL THE AFORESAID GOODS, IN CLASS 11 (U.S. CLS. 13, 21, 23, 31 AND 34).

OWNER OF ERPN CMNTY TM OFC REG. NO. 008465817, DATED 8-24-2010, EXPIRES 7-31-2019.

THE MARK CONSISTS OF THE STYLIZED WORDING "H2OUSE" WITH THE NUMBER "2" SHOWN AS A SUBSCRIPT.

SER. NO. 77-795,616, FILED 8-3-2009.

KAPIL BHANOT, EXAMINING ATTORNEY

United States of America

United States Patent and Trademark Office

FITT MEALS TO GO

Reg. No. 4,065,077

Registered Dec. 6, 2011

Int. Cls.: 30 and 43

TRADEMARK

SERVICE MARK

PRINCIPAL REGISTER

FITT ENTERPRISES, INC. (CALIFORNIA CORPORATION)
30251 GOLDEN LANTERN
SUITE C
LAGUNA NIGUEL, CA 92677

FOR: PIZZA, MADE FROM WHOLE GRAIN, MULTI GRAIN, HIGH FIBER AND LOW FAT INGREDIENTS; PREPARED MEALS CONSISTING PRIMARILY OF PASTA OR RICE, MADE FROM WHOLE GRAIN, MULTI GRAIN, HIGH FIBER AND LOW FAT INGREDIENTS; BAKERY DESSERTS MADE FROM WHOLE GRAIN, HIGH FIBER AND LOW FAT INGREDIENTS, IN CLASS 30 (U.S. CL. 46).

FIRST USE 8-0-2007; IN COMMERCE 11-27-2008.

FOR: FOOD PREPARATION SERVICES FEATURING WHOLE GRAIN, MULTI GRAIN, HIGH FIBER, AND LOW FAT BASED PREPARED MEALS MADE TO ORDER FOR DELIVERY OR PICK UP, IN CLASS 43 (U.S. CLS. 100 AND 101).

FIRST USE 8-0-2007; IN COMMERCE 11-27-2008.

THE MARK CONSISTS OF STANDARD CHARACTERS WITHOUT CLAIM TO ANY PARTICULAR FONT, STYLE, SIZE, OR COLOR.

NO CLAIM IS MADE TO THE EXCLUSIVE RIGHT TO USE "MEALS TO GO", APART FROM THE MARK AS SHOWN.

SER. NO. 77-807,500, FILED 8-18-2009.

TRACY CROSS, EXAMINING ATTORNEY



David J. Kyros

Director of the United States Patent and Trademark Office

United States of America

United States Patent and Trademark Office

SIERRA PACIFIC WINDOWS

Reg. No. 4,065,078

Registered Dec. 6, 2011

Int. Cl.: 19

TRADEMARK

PRINCIPAL REGISTER

SIERRA PACIFIC INDUSTRIES (CALIFORNIA CORPORATION)
PO BOX 496028
ANDERSON, CA 96007

FOR: DOORS OF WOOD CLAD IN ALUMINUM; WINDOW FRAMES, SASHES AND CASEMENTS MADE OF WOOD; WINDOW FRAMES, SASHES AND CASEMENTS OF WOOD CLAD IN ALUMINUM; WOODEN DOORS, IN CLASS 19 (U.S. CLS. 1, 12, 33 AND 50).

FIRST USE 8-1-1990; IN COMMERCE 8-1-1990.

THE MARK CONSISTS OF STANDARD CHARACTERS WITHOUT CLAIM TO ANY PARTICULAR FONT, STYLE, SIZE, OR COLOR.

OWNER OF U.S. REG. NO. 2,195,422.

NO CLAIM IS MADE TO THE EXCLUSIVE RIGHT TO USE "WINDOWS", APART FROM THE MARK AS SHOWN.

SER. NO. 77-810,038, FILED 8-21-2009.

LAURIE MAYES, EXAMINING ATTORNEY



David J. Kyffers

Director of the United States Patent and Trademark Office

United States of America

United States Patent and Trademark Office

Green-Dri

Reg. No. 4,065,079

Registered Dec. 6, 2011

Int. Cl.: 11

TRADEMARK

PRINCIPAL REGISTER

GREENSTONE INC. OF DELAWARE (DELAWARE CORPORATION)
SUITE 481
35 JOURNAL SQUARE
JERSEY CITY, NJ 07306

FOR: ENERGY EFFICIENT DRY KILNS, IN CLASS 11 (U.S. CLS. 13, 21, 23, 31 AND 34).

FIRST USE 12-18-2007; IN COMMERCE 12-18-2007.

THE MARK CONSISTS OF STANDARD CHARACTERS WITHOUT CLAIM TO ANY PARTICULAR FONT, STYLE, SIZE, OR COLOR.

SER. NO. 77-811,806, FILED 8-25-2009.

JAMES LOVELACE, EXAMINING ATTORNEY



David J. Kybas

Director of the United States Patent and Trademark Office

United States of America

United States Patent and Trademark Office

THE MICHAEL BAISDEN SHOW

Reg. No. 4,065,080

Registered Dec. 6, 2011

Int. Cl.: 41

SERVICE MARK

PRINCIPAL REGISTER

BAISDEN COMMUNICATIONS, LLC (TEXAS LIMITED LIABILITY COMPANY)
325 NORTH SAINT PAUL STREET
SUITE 1975
DALLAS, TX 75201

FOR: (BASED ON USE IN COMMERCE) ENTERTAINMENT SERVICES, NAMELY, PERSONAL APPEARANCES BY A NATIONALLY SYNDICATED RADIO PERSONALITY, BEST-SELLING AUTHOR, AND MOTIVATIONAL SPEAKER; ENTERTAINMENT SERVICES, NAMELY, PROVIDING A RADIO PROGRAM IN THE FIELDS OF RELATIONSHIPS, BUSINESS, HEALTH, BOOKS, MUSIC, NEWS, SOCIAL COMMENTARY, AND POLITICS; PRODUCTION OF RADIO PROGRAMS; PROVIDING INFORMATION, NEWS AND COMMENTARY IN THE FIELDS OF ENTERTAINMENT, POLITICS, AND LIFE; RADIO ENTERTAINMENT SERVICES, NAMELY, RADIO PROGRAMS FEATURING PERFORMANCES BY A NATIONALLY SYNDICATED RADIO PERSONALITY, BEST-SELLING AUTHOR, AND MOTIVATIONAL SPEAKER; SPECIAL EVENT PLANNING; RADIO ENTERTAINMENT SERVICES, NAMELY, RADIO PROGRAMS FEATURING PERFORMANCES BY A RADIO PERSONALITY; ENTERTAINMENT SERVICES, NAMELY, PROVIDING PODCASTS IN THE FIELDS OF NEWS, MUSIC, RELATIONSHIPS, INTERVIEWS, POLITICS, SOCIAL COMMENTARY, AND POP CULTURE, IN CLASS 41 (U.S. CLS. 100, 101 AND 107).

FIRST USE 2-1-2003; IN COMMERCE 2-1-2003.

THE MARK CONSISTS OF STANDARD CHARACTERS WITHOUT CLAIM TO ANY PARTICULAR FONT, STYLE, SIZE, OR COLOR.

NO CLAIM IS MADE TO THE EXCLUSIVE RIGHT TO USE "SHOW", APART FROM THE MARK AS SHOWN.

THE NAME(S), PORTRAIT(S), AND/OR SIGNATURE(S) SHOWN IN THE MARK IDENTIFIES "MICHAEL BAISDEN", WHOSE CONSENT(S) TO REGISTER IS MADE OF RECORD.

SER. NO. 77-815,718, FILED 8-28-2009.

GRETTA YAO, EXAMINING ATTORNEY



David J. Kyros

Director of the United States Patent and Trademark Office

United States of America

United States Patent and Trademark Office



by DEMPTOS

Reg. No. 4,065,081

TONNELLERIE DEMPTOS (FRANCE SIMPLIFIED COMPANY WITH SHARES)
18 AVENUE LUZANNE

Registered Dec. 6, 2011

ST CAPRAIS DE BORDEAUX, FRANCE 33880

Int. Cls.: 1, 30, 31 and 42

FOR: ADJUVANTS FOR USE IN THE MANUFACTURE OF WINE; CHEMICALS FOR FOOD DEVELOPMENT, FOOD PRESERVATION, AND WINE PRODUCTION, BREWING AND FERMENTATION; ENZYMES FOR USE IN THE WINE INDUSTRY; ADJUVANTS FOR USE IN THE MANUFACTURE AND PRESERVATION OF FARM PRODUCE; CHEMICAL PREPARATIONS IN THE NATURE OF FILTERING MATERIALS IN THE WINE AND FARM PRODUCE INDUSTRIES, IN CLASS 1 (U.S. CLS. 1, 5, 6, 10, 26 AND 46).

TRADEMARK

SERVICE MARK

PRINCIPAL REGISTER

FOR: YEAST FOR USE IN MAKING WINE, IN CLASS 30 (U.S. CL. 46).

FOR: WOOD SHAVINGS AND SAWDUST FOR USE IN THE MANUFACTURE OF WINE; WOOD SHAVINGS, SAWDUST AND POWDER FOR USE IN THE PRODUCTION OF WINE, IN CLASS 31 (U.S. CLS. 1 AND 46).

FOR: DESIGN AND DEVELOPMENT OF COMPUTER SOFTWARE FOR THE MANAGEMENT OF CASK, DRUM AND WOOD BARREL FABRICATION AND THE DESIGN OF WINE STOREHOUSES; RESEARCH IN THE FIELD OF WINE STOREHOUSE DESIGN; DEVELOPMENT AND DESIGN OF CASKS, DRUMS AND BARRELS OF WOOD; QUALITY CONTROL FOR OTHERS AND INDUSTRIAL RESEARCH IN THE FIELD OF WOOD; INDUSTRIAL RESEARCH IN THE FIELD OF WOOD; CONSULTING IN THE FIELD OF OENOLOGY, IN CLASS 42 (U.S. CLS. 100 AND 101).



PRIORITY CLAIMED UNDER SEC. 44(D) ON FRANCE APPLICATION NO. 093635939, FILED 3-12-2009, REG. NO. 093635939, DATED 3-12-2009, EXPIRES 3-11-2019.

THE COLOR(S) ORANGE, BURGUNDY AND WHITE IS/ARE CLAIMED AS A FEATURE OF THE MARK.

PRIORITY CLAIMED UNDER SEC. 44(D) ON ERPN CMNTY TM OFC APPLICATION NO. 008433435, FILED 7-17-2009, REG. NO. 008433435, DATED 2-17-2010, EXPIRES 7-17-2019.

David J. Kyffers

OWNER OF FRANCE REG. NO. 093635939, DATED 3-12-2009, EXPIRES 3-11-2019.

OWNER OF U.S. REG. NO. 2,710,311.

Reg. No. 4,065,081 NO CLAIM IS MADE TO THE EXCLUSIVE RIGHT TO USE "OAK IN WINE", APART FROM THE MARK AS SHOWN.

THE MARK CONSISTS OF THE FOLLOWING: AN ORANGE RECTANGLE CONTAINING THE WORDING "OAKINWINE" WITH THE "OAKIN" IN WHITE, AND THE WORD "WINE" IN BURGUNDY. THE WORDS "OAK" AND "WINE" ARE UNDERLINED IN WHITE. THE WORDING "BY DEMPTOS" APPEARS IN BURGUNDY OUTSIDE OF THE RECTANGLE, BENEATH TO THE RIGHT.

SER. NO. 77-824,692, FILED 9-11-2009.

RON FAIRBANKS, EXAMINING ATTORNEY

United States of America

United States Patent and Trademark Office

Marcy Place

Reg. No. 4,065,082

WILLIAM LANDRON (UNITED STATES INDIVIDUAL), AKA DON OMAR
45 ANN ARBOR PLACE
CLOSTER, NJ 07624

Registered Dec. 6, 2011

Int. Cl.: 41

FOR: PRESENTATION OF MUSICAL PERFORMANCE, IN CLASS 41 (U.S. CLS. 100, 101 AND 107).

SERVICE MARK

FIRST USE 2-4-2008; IN COMMERCE 2-11-2008.

PRINCIPAL REGISTER

THE MARK CONSISTS OF STANDARD CHARACTERS WITHOUT CLAIM TO ANY PARTICULAR FONT, STYLE, SIZE, OR COLOR.

THE NAME(S), PORTRAIT(S), AND/OR SIGNATURE(S) SHOWN IN THE MARK DOES NOT IDENTIFY A PARTICULAR LIVING INDIVIDUAL.

SER. NO. 77-825,926, FILED 9-14-2009.

JOHN KELLY, EXAMINING ATTORNEY



David J. Kybas

Director of the United States Patent and Trademark Office

United States of America

United States Patent and Trademark Office



Reg. No. 4,065,083

Registered Dec. 6, 2011

Int. Cl.: 11

TRADEMARK

PRINCIPAL REGISTER

KIM, DANIEL KYONG C. (UNITED STATES INDIVIDUAL)
530 W. 27TH STREET
LOS ANGELES, CA 90007

FOR: WATER SYSTEMS, NAMELY, WATER PURIFYING UNITS FOR DOMESTIC AND COMMERCIAL USE, WATER CONDITIONING UNITS FOR DOMESTIC AND COMMERCIAL USE, WATER FILTERING UNITS FOR DOMESTIC AND COMMERCIAL USE, AND WATER COOLERS, IN CLASS 11 (U.S. CLS. 13, 21, 23, 31 AND 34).

FIRST USE 3-1-2009; IN COMMERCE 3-1-2009.

THE MARK CONSISTS OF THE CHARACTERS "PURI" AND "5" WITH A STYLIZED LEAF SERVING AS THE DOT FOR THE "I".

SER. NO. 77-826,312, FILED 9-14-2009.

JEFFERY COWARD, EXAMINING ATTORNEY



David J. Kyffers

Director of the United States Patent and Trademark Office

United States of America

United States Patent and Trademark Office



Reg. No. 4,065,084

Registered Dec. 6, 2011

Int. Cl.: 25

TRADEMARK

PRINCIPAL REGISTER

MAGGIE SMILES, LLC (NEW JERSEY LIMITED LIABILITY COMPANY)
4935 COVERED BRIDGE RD
MILLVILLE, NJ 08332

FOR: CLOTHING, NAMELY, SHIRTS, SWEATSHIRTS, HOODED SWEATSHIRTS, FLEECE PULL-OVERS, HATS, TOTE BAGS, CHILDREN'S ONE-PIECE UNDERWEAR, IN CLASS 25 (U.S. CLS. 22 AND 39).

FIRST USE 12-15-2009; IN COMMERCE 12-15-2009.

THE MARK CONSISTS OF THE STYLIZED TERM "SMILE" WITH THE DESIGN OF A DRAGONFLY AND A BUTTERFLY.

SER. NO. 77-828,522, FILED 9-17-2009.

HOWARD B. LEVINE, EXAMINING ATTORNEY



David J. Kyros

Director of the United States Patent and Trademark Office

United States of America

United States Patent and Trademark Office

INTERNATIONAL VACATION RESORTS

Reg. No. 4,065,085

Registered Dec. 6, 2011

Int. Cl.: 36

SERVICE MARK

PRINCIPAL REGISTER

INTERNATIONAL VACATION RESORTS, INC. (CALIFORNIA CORPORATION)
4887 E. LA PALMA AVE #708
ANAHEIM, CA 92807

FOR: REAL ESTATE SERVICES, NAMELY, BROKERAGE SERVICES, AND PROPERTY
MANAGEMENT SERVICES, IN CLASS 36 (U.S. CLS. 100, 101 AND 102).

FIRST USE 9-3-2004; IN COMMERCE 9-3-2004.

THE MARK CONSISTS OF STANDARD CHARACTERS WITHOUT CLAIM TO ANY PAR-
TICULAR FONT, STYLE, SIZE, OR COLOR.

OWNER OF U.S. REG. NO. 3,826,592.

NO CLAIM IS MADE TO THE EXCLUSIVE RIGHT TO USE "RESORTS", APART FROM
THE MARK AS SHOWN.

SEC. 2(F).

SER. NO. 77-831,999, FILED 9-22-2009.

ANDREA BUTLER, EXAMINING ATTORNEY



David J. Kyros

Director of the United States Patent and Trademark Office

United States of America

United States Patent and Trademark Office

UtiliWorks

Reg. No. 4,065,086

Registered Dec. 6, 2011

Int. Cl.: 35

SERVICE MARK

PRINCIPAL REGISTER

UTILIWORKS, L.L.C. (LOUISIANA LIMITED LIABILITY COMPANY)
8000 GSRI AVE., LBTC BUILDING, SUITE 245
BATON ROUGE, LA 70820

FOR: BUSINESS CONSULTING SERVICES FOR THE UTILITY INDUSTRY, IN CLASS 35
(U.S. CLS. 100, 101 AND 102).

FIRST USE 6-30-2005; IN COMMERCE 6-30-2005.

THE MARK CONSISTS OF STANDARD CHARACTERS WITHOUT CLAIM TO ANY PARTICULAR FONT, STYLE, SIZE, OR COLOR.

SER. NO. 77-834,801, FILED 9-25-2009.

TAMARA FRAZIER, EXAMINING ATTORNEY



David J. Kybas

Director of the United States Patent and Trademark Office

United States of America

United States Patent and Trademark Office



Reg. No. 4,065,087

Registered Dec. 6, 2011

Int. Cl.: 40

SERVICE MARK

PRINCIPAL REGISTER

AEROSION LTD. (CANADA CORPORATION)
11012 MACLEOD TRAIL, SUITE 300
CALGARY, AB T2J 6A5, CANADA

FOR: GRINDING SERVICES, NAMELY, REDUCING FRIABLE MATERIALS INTO FINE POWDERS AND/OR SMALL PARTICLES, IN CLASS 40 (U.S. CLS. 100, 103 AND 106).

PRIORITY CLAIMED UNDER SEC. 44(D) ON CANADA APPLICATION NO. 1453250, FILED 9-28-2009, REG. NO. TMA794,915, DATED 4-6-2011, EXPIRES 4-6-2026.

THE MARK CONSISTS OF THE WORD "AEROSION" WITH THE WORDS "SMALLER PARTICLES BIGGER POSSIBILITIES" BELOW IT. TO THE LEFT OF "AEROSION" IS A DESIGN ELEMENT CONSISTING OF A HALF-CIRCULAR ELEMENT CUT BY A DIAGONAL BAR WITH AN EXPLOSION OF SMALLER SHAPES TO THE RIGHT OF THE BAR.

SER. NO. 77-841,265, FILED 10-5-2009.

LINDSEY RUBIN, EXAMINING ATTORNEY



David J. Kybas

Director of the United States Patent and Trademark Office

United States of America

United States Patent and Trademark Office

ON FOR HOURS

Reg. No. 4,065,088

Registered Dec. 6, 2011

Int. Cl.: 9

TRADEMARK

PRINCIPAL REGISTER

LG ELECTRONICS INC. (REPUBLIC OF KOREA CORPORATION)
20, YOIDO-DONG, YONGDUNGPO-GU
SEOUL, REPUBLIC OF KOREA

FOR: TELEVISION SETS; WIRELESS TELEPHONE SETS; PORTABLE COMMUNICATIONS APPARATUS, NAMELY, HANDSETS, WALKIE-TALKIES, SATELLITE TELEPHONES AND PERSONAL DIGITAL ASSISTANTS; MOBILE PHONES; MPEG AUDIO LAYER-3 PLAYERS; TELEVISION RECEIVERS; TELEVISION REMOTE CONTROLLERS; UNIVERSAL SERIAL BUS DRIVES; DIGITAL MEDIA BROADCASTING PLAYERS; HEADSETS FOR MOBILE PHONES; PORTABLE CHARGERS FOR BATTERIES; ELECTRONIC ALBUMS, NAMELY, ELECTRONIC PHOTO ALBUMS; DIGITAL PICTURE FRAMES FOR DISPLAYING DIGITAL PICTURES; MONITORS FOR COMPUTER; LAPTOP COMPUTERS; COMPUTERS; DIGITAL VERSATILE DISC PLAYERS; PORTABLE HARD DISK DRIVES; APPARATUS FOR RECORDING, TRANSMISSION OR REPRODUCTION OF SOUND OR IMAGES FOR USE IN TELECOMMUNICATION; APPARATUS FOR RECORDING, TRANSMISSION OR REPRODUCTION OF SOUND OR IMAGES; COMPUTER APPLICATION SOFTWARE FOR IMPROVEMENT OF MOBILE PHONES IMAGE QUALITY; DIGITAL VERSATILE DISC PLAYERS FOR HOME THEATERS; SPEAKERS FOR HOME THEATERS; AUDIO-VIDEO RECEIVERS FOR HOME THEATERS; PROJECTORS FOR HOME THEATERS; INTEGRATED CIRCUITS; AUDIO RECEIVERS; ON BOARD UNITS AND ELECTRONIC TOLL SMART CARDS FOR EXPEDITED PASS THROUGH HIGHWAY TOLL FACILITIES; TRANSPONDERS, NAMELY, ELECTRONIC TERMINALS EQUIPPED IN VEHICLES FOR TOLL PAYMENT TRANSACTIONS; CLOSED-CIRCUIT TELEVISION CAMERAS; NETWORK MONITORING CAMERAS, NAMELY, FOR SURVEILLANCE, IN CLASS 9 (U.S. CLS. 21, 23, 26, 36 AND 38).



THE MARK CONSISTS OF STANDARD CHARACTERS WITHOUT CLAIM TO ANY PARTICULAR FONT, STYLE, SIZE, OR COLOR.

PRIORITY CLAIMED UNDER SEC. 44(D) ON REPUBLIC OF KOREA APPLICATION NO. 2009-0046759, FILED 9-23-2009, REG. NO. 0856893, DATED 3-14-2011, EXPIRES 3-14-2021.

SER. NO. 77-842,353, FILED 10-6-2009.

ADA HAN, EXAMINING ATTORNEY

David J. Kyros

Director of the United States Patent and Trademark Office

United States of America

United States Patent and Trademark Office

AGRITHERM

Reg. No. 4,065,089

Registered Dec. 6, 2011

Int. Cl.: 37

SERVICE MARK

PRINCIPAL REGISTER

AGRI-THERM INC. (CANADA CORPORATION)
100 COLLIP CIRCLE
SUITE 105
LONDON, ONTARIO, CANADA N6G4X8

FOR: BIO-MASS DISPOSAL SERVICES; MAINTENANCE AND REPAIR OF MACHINES THAT PRODUCE BIO-OIL, BIO-CHAR AND RENEWABLE FUELS FROM BIO-WASTE AND BIO-MASS , IN CLASS 37 (U.S. CLS. 100, 103 AND 106).

PRIORITY CLAIMED UNDER SEC. 44(D) ON CANADA APPLICATION NO. 1453979, FILED 10-2-2009, REG. NO. TMA776244, DATED 9-3-2010, EXPIRES 9-3-2025.

THE MARK CONSISTS OF THE WORDS "AGRI" AND "THERM" DISPLAYED WITH A TEARDROP SHAPE CENTERED BETWEEN THE WORDS.

SER. NO. 77-844,446, FILED 10-8-2009.

DAVID TOOLEY, EXAMINING ATTORNEY



David J. Kyffers

Director of the United States Patent and Trademark Office

United States of America

United States Patent and Trademark Office



Babies 411
Babies Are Our Business

Reg. No. 4,065,090

Registered Dec. 6, 2011

Int. Cl.: 35

SERVICE MARK

PRINCIPAL REGISTER

BABIES 411, LLC (DELAWARE LIMITED LIABILITY COMPANY)
172 FREDERICK ST.
GARFIELD, NJ 07026

FOR: ADVERTISING OF THE PUBLISHED TEXTS OF OTHERS; ELECTRONIC COMMERCE SERVICES, NAMELY, PROVIDING INFORMATION ABOUT PRODUCTS VIA TELECOMMUNICATION NETWORKS FOR ADVERTISING AND SALES PURPOSES; PUBLISHING OF ADVERTISING TEXTS, IN CLASS 35 (U.S. CLS. 100, 101 AND 102).

FIRST USE 6-1-2009; IN COMMERCE 6-1-2009.

NO CLAIM IS MADE TO THE EXCLUSIVE RIGHT TO USE "BABIES", APART FROM THE MARK AS SHOWN.

THE COLOR(S) YELLOW, WHITE, BEIGE, PINK, BROWN, BLACK, RED, AND GRAY IS/ARE CLAIMED AS A FEATURE OF THE MARK.

THE MARK CONSISTS OF A PINK BABY BENT OVER WITH A WHITE DIAPER. IT HAS ITS HEAD BETWEEN ITS LEGS, MOUTH OPEN AND HANDS TO THE SIDE OUTWARD. THE BABY IS INSIDE A YELLOW CIRCLE. THE COLOR BLACK APPEARS IN THE BABY'S FEATURES, AND AS OUTLINING FOR THE BABY, DIAPER AND CIRCLE. THE COLOR RED APPEARS IN THE BABY'S TONGUE. THE COLOR BROWN APPEARS IN THE BABY'S HAIR. THE COLOR DARK PINK APPEARS IN THE SHADING ON THE BABY'S LEG. THE COLOR GRAY APPEARS AS SHADING INSIDE THE DIAPER. BELOW THE DESIGN IS THE TEXT "BABIES 411 BABIES ARE OUR BUSINESS" IN BEIGE. THE MARK APPEARS ON A WHITE BACKGROUND.

SER. NO. 77-845,998, FILED 10-9-2009.

KIM MONINGHOFF, EXAMINING ATTORNEY



David J. Kybas

Director of the United States Patent and Trademark Office

United States of America

United States Patent and Trademark Office



Reg. No. 4,065,091

Registered Dec. 6, 2011

Int. Cl.: 9

TRADEMARK

PRINCIPAL REGISTER

FAMILY EMERGENCY RESPONSE INC. (NEW YORK CORPORATION)
C/O HARRY SCHOCHAT, 8 LUNAR DRIVE
WOODBIDGE, CT 06525

FOR: CENTRAL DISPATCH SECURITY SYSTEM COMPOSED OF ELECTRONIC TRANSMITTERS AND RECEIVERS FOR SENDING AND RECEIVING EMERGENCY SIGNALS , IN CLASS 9 (U.S. CLS. 21, 23, 26, 36 AND 38).

FIRST USE 9-9-2009; IN COMMERCE 10-22-2009.

THE MARK CONSISTS OF THE LETTERS "LIFEC" IN BLUE, FOLLOWED BY A RED HEART WITH A WHITE CROSS IN THE MIDDLE OF IT REPRESENTING AN 'O', FOLLOWED BY THE LETTERS "NNECT" IN BLUE. THE LETTERS AND HEART ARE UNDERNEATH A BLUE LINE IN THE STYLE OF AN ECHOCARDIOGRAM.

THE COLOR(S) RED, WHITE, AND BLUE IS/ARE CLAIMED AS A FEATURE OF THE MARK.

SER. NO. 77-848,711, FILED 10-14-2009.

ROBERT STRUCK, EXAMINING ATTORNEY



David J. Kybas

Director of the United States Patent and Trademark Office

United States of America

United States Patent and Trademark Office



Reg. No. 4,065,092

Registered Dec. 6, 2011

Int. Cl.: 9

TRADEMARK

PRINCIPAL REGISTER

LG ELECTRONICS INC. (REPUBLIC OF KOREA CORPORATION)
20, YOIDO-DONG, YONGDUNGPO-GU
SEOUL, REPUBLIC OF KOREA

FOR: COMPUTER MONITORS; NOTEBOOK COMPUTERS; TELEVISION RECEIVERS, IN CLASS 9 (U.S. CLS. 21, 23, 26, 36 AND 38).

PRIORITY CLAIMED UNDER SEC. 44(D) ON REPUBLIC OF KOREA APPLICATION NO. 40-2009-0040, FILED 8-21-2009, REG. NO. 0842847, DATED 11-12-2010, EXPIRES 11-12-2020.

NO CLAIM IS MADE TO THE EXCLUSIVE RIGHT TO USE "SCREEN OFF", APART FROM THE MARK AS SHOWN.

THE MARK CONSISTS OF THE WORDS "SCREEN OFF" UNDERNEATH AN ELECTRONIC DEVICE EMITTING SOUND WAVES.

SER. NO. 77-856,287, FILED 10-23-2009.

ANDREA HACK, EXAMINING ATTORNEY



David J. Kybas

Director of the United States Patent and Trademark Office

United States of America

United States Patent and Trademark Office



5.1CH Surround

Reg. No. 4,065,093

Registered Dec. 6, 2011

Int. Cl.: 9

TRADEMARK

PRINCIPAL REGISTER

LG ELECTRONICS INC. (REPUBLIC OF KOREA CORPORATION)
20, YOIDO-DONG, YONGDUNGPO-GU
SEOUL, REPUBLIC OF KOREA

FOR: COMPUTER MONITORS; NOTEBOOK COMPUTERS; TELEVISION RECEIVERS, IN CLASS 9 (U.S. CLS. 21, 23, 26, 36 AND 38).

PRIORITY CLAIMED UNDER SEC. 44(D) ON REPUBLIC OF KOREA APPLICATION NO. 40-2009-0040, FILED 8-21-2009, REG. NO. 008635906, DATED 4-26-2010, EXPIRES 8-21-2019.

NO CLAIM IS MADE TO THE EXCLUSIVE RIGHT TO USE "70W POWER SOUND" OR "5.1CH SURROUND", APART FROM THE MARK AS SHOWN.

THE MARK CONSISTS OF THE WORDS "70W POWER SOUND" SHOWN BETWEEN A SOUND SYSTEM. WRITTEN UNDERNEATH THE WORDING IS "5.1 CH SURROUND".

SER. NO. 77-856,295, FILED 10-23-2009.

ANDREA HACK, EXAMINING ATTORNEY



David J. Kybas

Director of the United States Patent and Trademark Office

United States of America
United States Patent and Trademark Office

GOGOGEAR

Reg. No. 4,065,094

GOGOGEAR, INC. (CALIFORNIA CORPORATION)
PO BOX 6356
MALIBU, CA 90264

Registered Dec. 6, 2011

Int. Cl.: 18

FOR: LUGGAGE; MESSENGER BAGS; TOTE BAGS; TRAVEL BAGS, IN CLASS 18 (U.S. CLS. 1, 2, 3, 22 AND 41).

TRADEMARK

FIRST USE 6-1-2005; IN COMMERCE 6-1-2005.

PRINCIPAL REGISTER

THE MARK CONSISTS OF STANDARD CHARACTERS WITHOUT CLAIM TO ANY PARTICULAR FONT, STYLE, SIZE, OR COLOR.

SER. NO. 77-856,568, FILED 10-23-2009.

EDWARD FENNESSY, EXAMINING ATTORNEY



David J. Kyros

Director of the United States Patent and Trademark Office

United States of America

United States Patent and Trademark Office

BURLESQUERCISE

Reg. No. 4,065,095

Registered Dec. 6, 2011

Int. Cl.: 41

SERVICE MARK

PRINCIPAL REGISTER

FIELD, SARA ANN (UNITED STATES INDIVIDUAL)
UNIT 102
715 BRYANT STREET
SAN FRANCISCO, CA 94107

FOR: DANCE PERFORMANCE AND DANCE INSTRUCTION; PHYSICAL FITNESS INSTRUCTION, IN CLASS 41 (U.S. CLS. 100, 101 AND 107).

FIRST USE 3-3-2004; IN COMMERCE 7-14-2004.

THE MARK CONSISTS OF STANDARD CHARACTERS WITHOUT CLAIM TO ANY PARTICULAR FONT, STYLE, SIZE, OR COLOR.

SER. NO. 77-859,464, FILED 10-28-2009.

JAMES STEIN, EXAMINING ATTORNEY



David J. Kybas

Director of the United States Patent and Trademark Office

United States of America

United States Patent and Trademark Office

Premier Vault Online Backup and Sharing

Reg. No. 4,065,096

Registered Dec. 6, 2011

Int. Cl.: 9

TRADEMARK

PRINCIPAL REGISTER

PREMIER VAULT, INC. (COLORADO CORPORATION)
5477 LONE EAGLE COURT
BOULDER, CO 80301

FOR: COMPUTER SOFTWARE FOR THE COLLECTION, EDITING, ORGANIZING, MODIFYING, BOOK MARKING, TRANSMISSION, STORAGE AND SHARING OF DATA AND INFORMATION, IN CLASS 9 (U.S. CLS. 21, 23, 26, 36 AND 38).

FIRST USE 3-26-2009; IN COMMERCE 8-24-2009.

THE MARK CONSISTS OF STANDARD CHARACTERS WITHOUT CLAIM TO ANY PARTICULAR FONT, STYLE, SIZE, OR COLOR.

NO CLAIM IS MADE TO THE EXCLUSIVE RIGHT TO USE "PREMIER" AND "ONLINE BACKUP AND SHARING", APART FROM THE MARK AS SHOWN.

SER. NO. 77-862,498, FILED 11-2-2009.

SAIMA MAKHDOOM, EXAMINING ATTORNEY



David J. Kyffers

Director of the United States Patent and Trademark Office

United States of America

United States Patent and Trademark Office

PATHOCEPT

Reg. No. 4,065,097

Registered Dec. 6, 2011

Int. Cl.: 5

TRADEMARK

PRINCIPAL REGISTER

PATHOCEPT CORPORATION (CANADA CORPORATION)
4711 YONGE STREET, SUITE 1103
TORONTO, ON, CANADA M2N6K8

FOR: ALL PURPOSE DISINFECTANT PREPARATIONS; ALL PURPOSE DISINFECTANT SPRAY; PREPARATIONS FOR NEUTRALIZING ODORS FOR GENERAL USE , IN CLASS 5 (U.S. CLS. 6, 18, 44, 46, 51 AND 52).

THE MARK CONSISTS OF STANDARD CHARACTERS WITHOUT CLAIM TO ANY PARTICULAR FONT, STYLE, SIZE, OR COLOR.

PRIORITY CLAIMED UNDER SEC. 44(D) ON CANADA APPLICATION NO. 1,459,758, FILED 11-19-2009, REG. NO. TMA798,403, DATED 5-25-2011, EXPIRES 5-25-2026.

SER. NO. 77-877,215, FILED 11-20-2009.

AMY C. KEAN, EXAMINING ATTORNEY



David J. Kappas

Director of the United States Patent and Trademark Office

United States of America

United States Patent and Trademark Office

darci
BY DICAPRIO

Reg. No. 4,065,098

Registered Dec. 6, 2011

Int. Cl.: 3

TRADEMARK

PRINCIPAL REGISTER

LISA BIERNACKI, LLC (PENNSYLVANIA LIMITED LIABILITY COMPANY), DBA LISA BIERNACKI, LLC
6 CALLERY WAY
MALVERN, PA 19355

FOR: COSMETICS AND MAKE-UP, IN CLASS 3 (U.S. CLS. 1, 4, 6, 50, 51 AND 52).

FIRST USE 11-17-2009; IN COMMERCE 11-17-2009.

THE MARK CONSISTS OF LOWER CASE LETTERS "D", "A", "R", "C", "I" IN THE FONT ARNO PRO. "BY DI CAPRIO" IN ALL CAPS, BENEATH "DARCI" WITH VINE WRAPPED AROUND "D". THE DOT ON THE LETTER "I" IS A FREE-FORM LEAF SHAPE.

SER. NO. 77-879,471, FILED 11-24-2009.

SHAUNIA CARLYLE, EXAMINING ATTORNEY



David J. Kybas

Director of the United States Patent and Trademark Office

United States of America

United States Patent and Trademark Office

The "Towel Spinner"

Reg. No. 4,065,099

Registered Dec. 6, 2011

Int. Cl.: 28

TRADEMARK

PRINCIPAL REGISTER

JQR ENTERPRISES, LLC (PENNSYLVANIA LIMITED LIABILITY COMPANY)
10476 OLDE VILLA DRIVE
GIBSONIA, PA 15044

FOR: NOVELTY HANDHELD MECHANICAL TOY THAT ALLOWS THE USER TO ATTACH A SPORTS TOWEL SO THAT AS THE TOP OF THE ITEM ROTATES THE TOWEL, IT ACTIVATES THE NOISEMAKER, IN CLASS 28 (U.S. CLS. 22, 23, 38 AND 50).

FIRST USE 10-16-2009; IN COMMERCE 10-16-2009.

NO CLAIM IS MADE TO THE EXCLUSIVE RIGHT TO USE "THE "TOWEL SPINNER"", APART FROM THE MARK AS SHOWN.

THE MARK CONSISTS OF THE WORDS "THE TOWEL SPINNER" WITH 3 BLADES FROM A FAN OR PROPELLER CONTAINED IN THE LETTER "O" OF THE WORD "TOWEL". QUOTES ENCLOSE THE WORD "TOWEL" AND "SPINNER" AND THE INITIAL WORD "THE" HAS NO QUOTES AROUND IT.

SER. NO. 77-880,362, FILED 11-24-2009.

LINDSEY RUBIN, EXAMINING ATTORNEY



David J. Kyros

Director of the United States Patent and Trademark Office

United States of America

United States Patent and Trademark Office

QUE

Reg. No. 4,065,100

Registered Dec. 6, 2011

Int. Cl.: 16

TRADEMARK

PRINCIPAL REGISTER

PEARSON EDUCATION, INC. (DELAWARE CORPORATION)
ONE LAKE STREET
UPPER SADDLE RIVER, NJ 07458

FOR: PUBLICATIONS, NAMELY, BOOKS IN THE FIELDS OF COMPUTERS, COMPUTER SOFTWARE, TECHNOLOGY, THE INTERNET, SOCIAL NETWORKING, CONSUMER ELECTRONICS, HANDHELD PERSONAL COMPUTING DEVICES, MOBILE COMPUTING, BUSINESS AND MANAGEMENT, INFORMATION TECHNOLOGY CERTIFICATION, COMPUTER DATABASES, ENGINEERING, GRAPHICS AND WEB DESIGN, COMPUTER HARDWARE AND PERIPHERALS, HOME AND OFFICE COMPUTING, INFORMATION TECHNOLOGY, COMPUTER OPERATING SYSTEMS, COMPUTER PROGRAMMING AND WEB DEVELOPMENT, IN CLASS 16 (U.S. CLS. 2, 5, 22, 23, 29, 37, 38 AND 50).

FIRST USE 7-31-1981; IN COMMERCE 7-31-1981.

THE MARK CONSISTS OF STANDARD CHARACTERS WITHOUT CLAIM TO ANY PARTICULAR FONT, STYLE, SIZE, OR COLOR.

SER. NO. 77-880,378, FILED 11-24-2009.

HEATHER THOMPSON, EXAMINING ATTORNEY



David J. Kyjars

Director of the United States Patent and Trademark Office

United States of America

United States Patent and Trademark Office

QUE

Reg. No. 4,065,101

Registered Dec. 6, 2011

Int. Cl.: 35

SERVICE MARK

PRINCIPAL REGISTER

PEARSON EDUCATION, INC. (DELAWARE CORPORATION)
ONE LAKE STREET
UPPER SADDLE RIVER, NJ 07458

FOR: ONLINE RETAIL STORE SERVICES FEATURING BOOKS, ELECTRONIC BOOKS AND PUBLICATIONS, NON-DOWNLOADABLE BOOKS AND PUBLICATIONS, IN CLASS 35 (U.S. CLS. 100, 101 AND 102).

FIRST USE 10-12-1999; IN COMMERCE 10-12-1999.

THE MARK CONSISTS OF STANDARD CHARACTERS WITHOUT CLAIM TO ANY PARTICULAR FONT, STYLE, SIZE, OR COLOR.

SER. NO. 77-880,380, FILED 11-24-2009.

HEATHER THOMPSON, EXAMINING ATTORNEY



David J. Kyros

Director of the United States Patent and Trademark Office

United States of America

United States Patent and Trademark Office

QUE

Reg. No. 4,065,102

Registered Dec. 6, 2011

Int. Cl.: 38

SERVICE MARK

PRINCIPAL REGISTER

PEARSON EDUCATION, INC. (DELAWARE CORPORATION)
ONE LAKE STREET
UPPER SADDLE RIVER, NJ 07458

FOR: TRANSMISSION OF AUDIO, VIDEO AND TEXT INFORMATION IN THE FIELDS OF COMPUTERS, COMPUTER SOFTWARE, TECHNOLOGY, THE INTERNET, SOCIAL NETWORKING, CONSUMER ELECTRONICS, HANDHELD PERSONAL COMPUTING DEVICES, MOBILE COMPUTING, BUSINESS AND MANAGEMENT, INFORMATION TECHNOLOGY CERTIFICATION, COMPUTER DATABASES, ENGINEERING, GRAPHICS AND WEB DESIGN, COMPUTER HARDWARE AND PERIPHERALS, HOME AND OFFICE COMPUTING, INFORMATION TECHNOLOGY, COMPUTER OPERATING SYSTEMS, COMPUTER PROGRAMMING AND WEB DEVELOPMENT; TRANSMISSION OF ELECTRONIC BOOKS IN THE FIELDS OF COMPUTERS, COMPUTER SOFTWARE, TECHNOLOGY, THE INTERNET, SOCIAL NETWORKING, CONSUMER ELECTRONICS, HANDHELD PERSONAL COMPUTING DEVICES, MOBILE COMPUTING, BUSINESS AND MANAGEMENT, INFORMATION TECHNOLOGY CERTIFICATION, COMPUTER DATABASES, ENGINEERING, GRAPHICS AND WEB DESIGN, COMPUTER HARDWARE AND PERIPHERALS, HOME AND OFFICE COMPUTING, INFORMATION TECHNOLOGY, COMPUTER OPERATING SYSTEMS, COMPUTER PROGRAMMING AND WEB DEVELOPMENT, IN CLASS 38 (U.S. CLS. 100, 101 AND 104).

FIRST USE 7-31-2006; IN COMMERCE 7-31-2006.

THE MARK CONSISTS OF STANDARD CHARACTERS WITHOUT CLAIM TO ANY PARTICULAR FONT, STYLE, SIZE, OR COLOR.

SER. NO. 77-880,382, FILED 11-24-2009.

HEATHER THOMPSON, EXAMINING ATTORNEY



David J. Kyros

Director of the United States Patent and Trademark Office

United States of America

United States Patent and Trademark Office

QUE

Reg. No. 4,065,103

Registered Dec. 6, 2011

Int. Cl.: 41

SERVICE MARK

PRINCIPAL REGISTER

PEARSON EDUCATION, INC. (DELAWARE CORPORATION)
ONE LAKE STREET
UPPER SADDLE RIVER, DE 07458

FOR: PROVIDING ON-LINE PUBLICATIONS IN THE NATURE OF ELECTRONIC BOOKS IN THE FIELDS OF COMPUTERS, COMPUTER SOFTWARE, TECHNOLOGY, THE INTERNET, SOCIAL NETWORKING, CONSUMER ELECTRONICS, HANDHELD PERSONAL COMPUTING DEVICES, MOBILE COMPUTING, BUSINESS AND MANAGEMENT, INFORMATION TECHNOLOGY CERTIFICATION, COMPUTER DATABASES, ENGINEERING, GRAPHICS AND WEB DESIGN, COMPUTER HARDWARE AND PERIPHERALS, HOME AND OFFICE COMPUTING, INFORMATION TECHNOLOGY, COMPUTER OPERATING SYSTEMS, COMPUTER PROGRAMMING AND WEB DEVELOPMENT; ELECTRONIC PUBLISHING SERVICES, NAMELY, PUBLICATION OF TEXT AND GRAPHICAL WORKS IN THE FIELDS OF COMPUTERS, COMPUTER SOFTWARE, TECHNOLOGY, THE INTERNET, SOCIAL NETWORKING, CONSUMER ELECTRONICS, HANDHELD PERSONAL COMPUTING DEVICES, MOBILE COMPUTING, BUSINESS AND MANAGEMENT, INFORMATION TECHNOLOGY CERTIFICATION, COMPUTER DATABASES, ENGINEERING, GRAPHICS AND WEB DESIGN, COMPUTER HARDWARE AND PERIPHERALS, HOME AND OFFICE COMPUTING, INFORMATION TECHNOLOGY, COMPUTER OPERATING SYSTEMS, COMPUTER PROGRAMMING AND WEB DEVELOPMENT; PROVIDING A WEBSITE FEATURING ONLINE PUBLICATIONS IN THE FIELDS OF COMPUTERS, COMPUTER SOFTWARE, TECHNOLOGY, THE INTERNET, SOCIAL NETWORKING, CONSUMER ELECTRONICS, HANDHELD PERSONAL COMPUTING DEVICES, MOBILE COMPUTING, BUSINESS AND MANAGEMENT, INFORMATION TECHNOLOGY CERTIFICATION, COMPUTER DATABASES, ENGINEERING, GRAPHICS AND WEB DESIGN, COMPUTER HARDWARE AND PERIPHERALS, HOME AND OFFICE COMPUTING, INFORMATION TECHNOLOGY, COMPUTER OPERATING SYSTEMS, COMPUTER PROGRAMMING AND WEB DEVELOPMENT; ENTERTAINMENT SERVICES, NAMELY, PROVIDING NON-DOWNLOADABLE AUDIO, VIDEO AND TEXT VIA A GLOBAL COMPUTER NETWORK AND WIRELESS NETWORKS; PROVIDING NON-DOWNLOADABLE ELECTRONIC PUBLICATIONS IN THE FIELDS OF COMPUTERS, COMPUTER SOFTWARE, TECHNOLOGY, THE INTERNET, SOCIAL NETWORKING, CONSUMER ELECTRONICS, HANDHELD PERSONAL COMPUTING DEVICES, MOBILE COMPUTING, BUSINESS AND MANAGEMENT, INFORMATION TECHNOLOGY CERTIFICATION, COMPUTER DATABASES, ENGINEERING, GRAPHICS AND WEB DESIGN, COMPUTER HARDWARE AND PERIPHERALS, HOME AND OFFICE COMPUTING, INFORMATION TECHNOLOGY, COMPUTER OPERAT-



David J. Kyjars

Director of the United States Patent and Trademark Office

Reg. No. 4,065,103 ING SYSTEMS, COMPUTER PROGRAMMING AND WEB DEVELOPMENT , IN CLASS 41
(U.S. CLS. 100, 101 AND 107).

FIRST USE 7-31-2006; IN COMMERCE 7-31-2006.

THE MARK CONSISTS OF STANDARD CHARACTERS WITHOUT CLAIM TO ANY PARTICULAR FONT, STYLE, SIZE, OR COLOR.

SER. NO. 77-880,385, FILED 11-24-2009.

HEATHER THOMPSON, EXAMINING ATTORNEY

United States of America

United States Patent and Trademark Office

QUE

Reg. No. 4,065,104

Registered Dec. 6, 2011

Int. Cl.: 42

SERVICE MARK

PRINCIPAL REGISTER

PEARSON EDUCATION, INC. (DELAWARE CORPORATION)
ONE LAKE STREET
UPPER SADDLE RIVER, NJ 07458

FOR: APPLICATION SERVICE PROVIDER (ASP) FEATURING SOFTWARE FOR ACCESSING NON-DOWNLOADABLE PUBLICATIONS, AUDIO, VIDEO, TEXT AND GRAPHICS; APPLICATION SERVICE PROVIDER (ASP) FEATURING SOFTWARE FOR DOWNLOADING ELECTRONIC BOOKS, ELECTRONIC PUBLICATIONS, ELECTRONIC STUDY AIDS, AUDIO, VIDEO AND TEXT, IN CLASS 42 (U.S. CLS. 100 AND 101).

FIRST USE 7-31-2006; IN COMMERCE 7-31-2006.

THE MARK CONSISTS OF STANDARD CHARACTERS WITHOUT CLAIM TO ANY PARTICULAR FONT, STYLE, SIZE, OR COLOR.

SER. NO. 77-880,387, FILED 11-24-2009.

HEATHER THOMPSON, EXAMINING ATTORNEY



David J. Kybas

Director of the United States Patent and Trademark Office

United States of America

United States Patent and Trademark Office

MOI

BOUTIQUE

Reg. No. 4,065,105

Registered Dec. 6, 2011

Int. Cl.: 35

SERVICE MARK

PRINCIPAL REGISTER

MOI BOUTIQUE, LLC (ILLINOIS LIMITED LIABILITY COMPANY)
2050 N. HALSTED ST.
CHICAGO, IL 60614

FOR: RETAIL CLOTHING BOUTIQUES, IN CLASS 35 (U.S. CLS. 100, 101 AND 102).

FIRST USE 9-9-2009; IN COMMERCE 9-9-2009.

NO CLAIM IS MADE TO THE EXCLUSIVE RIGHT TO USE "BOUTIQUE", APART FROM THE MARK AS SHOWN.

THE MARK CONSISTS OF THE STYLIZED WORDING "MOI BOUTIQUE", WHEREIN "MOI" APPEARS ABOVE "BOUTIQUE", AND WHEREIN A LINE APPEARS BETWEEN "MOI" AND "BOUTIQUE".

THE ENGLISH TRANSLATION OF "MOI" IN THE MARK IS "MY".

SER. NO. 77-881,845, FILED 11-30-2009.

B. PARADEWELAI, EXAMINING ATTORNEY



David J. Kyffers

Director of the United States Patent and Trademark Office

United States of America

United States Patent and Trademark Office

ANYROLL

Reg. No. 4,065,106

Registered Dec. 6, 2011

Int. Cls.: 2, 6 and 17

TRADEMARK

PRINCIPAL REGISTER

G. TECHNOLOGY CO., LTD. (REPUBLIC OF KOREA CORPORATION)
273, SINYANG-RI, DUNPO-MYEON, ASAN-SI
CHUNGCHEONGNAM-DO, REPUBLIC OF KOREA

FOR: COLOR PIGMENTS USED IN FOILS, RIBBONS AND FILM FOR PRINTERS; NON-METALLIC PRINTERS INK; LIQUID COATING FOR USE AS A TRANSFERABLE SUBSTRATE FOR PRINTING FOR USE IN THE GRAPHIC ARTS INDUSTRY; METALS IN FOILS AND POWDER FORM FOR USE IN PRINTING, TYPOGRAPHY, LABELING, CODING AND DECORATING; PRINTING INK; METALLIC INKS; TRANSFERABLE LIQUID COATINGS CARRIED BY A SUBSTRATE FOR USE FOR PRINTING FOR USE IN THE GRAPHIC ARTS INDUSTRY; LIQUID LIGHT SENSITIVE COATINGS FOR USE IN THE MANUFACTURE OF PHOTOGRAPHIC RECORDINGS, IN CLASS 2 (U.S. CLS. 6, 11 AND 16).

FIRST USE 3-1-2007; IN COMMERCE 3-1-2007.

FOR: STAMPING FOILS OF NON-PRECIOUS METAL FOR USE IN PRINTING, TYPOGRAPHY, LABELING, CODING AND DECORATIONS; METALLIC PAPER, BOARD, AND FOILS; MATERIALS WHOLLY OR PRINCIPALLY OF COMMON METAL IN THE FORM OF FILM FOR USE IN MAKING STICKERS, LABELS AND PACKAGES; RIBBONS MADE OF METAL FOIL COMBINED WITH PLASTICS OR OF PAPER, THE METAL FOIL PREDOMINATING, FOR USE WITH HOT STAMPING MACHINES, IN CLASS 6 (U.S. CLS. 2, 12, 13, 14, 23, 25 AND 50).

FIRST USE 3-1-2007; IN COMMERCE 3-1-2007.

FOR: LAMINATE FOIL CONSISTING PRIMARILY OF PLASTIC WITH A METAL LAYER, WITH OR WITHOUT AN ADHESIVE BACKING FOR APPLICATION TO A SUBSTRATE FOR INDUSTRIAL OR COMMERCIAL USE; SELF-ADHESIVE TRANSPARENT PROTECTING FILM USED AS PACKAGING FOR FOOD; SELF-ADHESIVE TRANSPARENT PROTECTING FILM FOR USE IN LAMINATING PAPER; POLY-OLEFIN FILM WITH A RUBBER ADHESIVE USED TO PROTECT SURFACES; PLASTIC FILM AND TAPE FOR STAMPING AND EMBOSsing, IN CLASS 17 (U.S. CLS. 1, 5, 12, 13, 35 AND 50).

FIRST USE 3-1-2007; IN COMMERCE 3-1-2007.

THE MARK CONSISTS OF STANDARD CHARACTERS WITHOUT CLAIM TO ANY PARTICULAR FONT, STYLE, SIZE, OR COLOR.



David J. Kyjars

Director of the United States Patent and Trademark Office

Reg. No. 4,065,106 SER. NO. 77-884,255, FILED 12-2-2009.

JERI J. FICKES, EXAMINING ATTORNEY

United States of America

United States Patent and Trademark Office



Reg. No. 4,065,107

GESTAMP ASETYM SOLAR, S.L. (SPAIN CORPORATION)

Registered Dec. 6, 2011

TITÁN, 15 7A PLANTA
28045 MADRID, SPAIN

**Int. Cls.: 9, 11, 37, 39, 40
and 42**

FOR: APPARATUS AND INSTRUMENTS FOR TRANSFORMING, SWITCHING AND ACCUMULATING ELECTRICITY AND ENERGY, NAMELY, ELECTRICAL SWITCHGEAR, NAMELY, GAS INSULATED CUBICLES, AIR-INSULATED CUBICLES, WITHDRAWABLE CIRCUIT BREAKERS, GAS-INSULATED COMPACT MODULAR CUBICLES, DISTRIBUTION TRANSFORMERS, LOW, MEDIUM AND HIGH VOLTAGE SWITCHBOARDS, TRANSFORMER SUBSTATIONS, ELECTRICAL SWITCHGEAR, NAMELY, VOLTAGE BOOSTING DEVICES FOR ELECTRIC POWER LINES, ELECTRICAL SWITCHES, PATCH PANELS FOR HOUSING ELECTRICAL COMPONENTS, ELECTRICAL CONNECTORS, AND ELECTRICAL SWITCHES, ELECTRICAL CONNECTORS, ELECTRICAL CABLES, ELECTRICAL WIRES, ELECTRICAL TRANSFORMERS, ELECTRICAL TRANSDUCERS, ELECTRICAL TERMINAL BLOCKS, ELECTRICAL RESOLVERS, ELECTRICAL SHIELDING SPACERS FOR CABLES AND CABLE ASSEMBLIES, ELECTRICAL SENSOR APPARATUS, ELECTRICAL RELAYS, ELECTRICAL RECEPTACLES, ELECTRICAL POWER CONNECTORS, ELECTRICAL FUSES, ELECTRICAL INDUCTORS, ELECTRICAL DISTRIBUTION BOXES, ELECTRICAL DISTRIBUTION SYSTEMS, NAMELY, POWER DISTRIBUTION PANELS, ELECTRICAL CONTROLLERS, ELECTRICAL CIRCUIT BOARDS, HIGH, MEDIUM AND LOW-VOLTAGE SWITCHGEAR, ELECTRIC SWITCHGEAR AND CONTROL CABINETS, DATA PROCESSING DEVICES, NAMELY, DATA PROCESSORS, COMPUTERS, COMPUTER PERIPHERALS, THE ABOVE-MENTIONED GOODS ALSO FOR DATA COMMUNICATION VIA WIRED OR WIRELESS TELECOMMUNICATION NETWORKS FOR REMOTE DATA TRANSMISSION AND FOR DATA TRANSMISSION IN LOCAL NETWORKS IN THE NATURE OF TELECONTROL, SUBSTATION AND POWER SYSTEM CONTROL, ELECTRICAL SIGNALLING, MEASURING, CHECKING, COUNTING, RECORDING, MONITORING, REGULATING, CONTROLLING AND SWITCHING DEVICES, NAMELY, LASER MEASURING SYSTEMS, CALCULATORS, ELECTRIC SWITCHES, VACUUM TUBES FOR SWITCHGEAR, SPECIALLY DESIGNED CABINETS FOR HOLDING SWITCHGEAR, METERING DEVICES FOR USE IN CONJUNCTION WITH ELECTRICITY, GAS, LIQUIDS AND HEAT, ELECTRICAL CONTROLS FOR SWITCHGEAR AND POWER SYSTEM CONTROL NAMELY, ELECTRICAL CONTROLLERS, ELECTRONIC DEVICES, NAMELY, REMOTE CONTROLS FOR OPERATING SWITCHGEARS AND ELECTRICAL POWER SUPPLY EQUIPMENT, PHOTOVOLTAIC INSTALLATION APPARATUS, NAMELY, SOLAR MODULES FOR PRODUCTION OF ELECTRICITY, SOLAR THERMAL AND ELECTRIC RECEIVERS, TRACKING MECHANISMS AND CONCENTRATING OPTICS, AND CONTROL ALGORITHMS, PHOTOVOLTAIC

TRADEMARK

SERVICE MARK

PRINCIPAL REGISTER



David J. Kyros

Director of the United States Patent and Trademark Office

Reg. No. 4,065,107 SOLAR MODULES FOR PRODUCTION OF ELECTRICITY, IN CLASS 9 (U.S. CLS. 21, 23, 26, 36 AND 38).

FOR: SOLAR PANELS; SOLAR APPARATUS, NAMELY, PHOTOVOLTAIC SOLAR HYBRID MODULES, IN CLASS 11 (U.S. CLS. 13, 21, 23, 31 AND 34).

FOR: BUILDING CONSTRUCTION, REPAIR AND MAINTENANCE SERVICES IN THE FIELD OF SOLAR PANELS AND PARKS, IN CLASS 37 (U.S. CLS. 100, 103 AND 106).

FOR: DISTRIBUTION OF ENERGY SERVICES, IN CLASS 39 (U.S. CLS. 100 AND 105).

FOR: PRODUCTION OF ENERGY SERVICES, IN CLASS 40 (U.S. CLS. 100, 103 AND 106).

FOR: ENGINEERING SERVICES, IN CLASS 42 (U.S. CLS. 100 AND 101).

PRIORITY CLAIMED UNDER SEC. 44(D) ON ERPN CMNTY TM OFC APPLICATION NO. 8735029, FILED 12-4-2009, REG. NO. 008735029, DATED 6-2-2010, EXPIRES 12-4-2019.

THE COLOR(S) BLUE, GRAY AND WHITE IS/ARE CLAIMED AS A FEATURE OF THE MARK.

THE MARK CONSISTS OF THE WORDING "GA-SOLAR" IN BLUE STYLIZED TYPEFACE AND DESIGN ELEMENTS WHICH CONSIST OF A BLUE HORIZONTAL LINE UNDER THE WORDING "GA", A BLUE RHOMBOID SHAPED ELEMENT LOCATED AFTER THE WORDING "SOLAR" AND A GRAY DEPICTION OF A TOWER WITH SOLAR PANELS AGAINST A BLUE RECTANGULAR BACKGROUND LOCATED BEFORE THE WORDING "GA".

SER. NO. 77-887,507, FILED 12-7-2009.

HENRY S. ZAK, EXAMINING ATTORNEY

United States of America

United States Patent and Trademark Office

OXOLIN

Reg. No. 4,065,108

Registered Dec. 6, 2011

Int. Cls.: 16 and 17

TRADEMARK

PRINCIPAL REGISTER

LINPAC PACKAGING LIMITED (UNITED KINGDOM COMPANY)
AL BUSINESS PARK, KNOTTINGLEY
WEST YORKSHIRE, UNITED KINGDOM WF110BL

FOR: PLASTIC FILMS FOR DOMESTIC PACKAGING, IN CLASS 16 (U.S. CLS. 2, 5, 22, 23, 29, 37, 38 AND 50).

FOR: PLASTIC FILMS FOR COMMERCIAL OR INDUSTRIAL USE, NAMELY, FOR USE IN THE MANUFACTURE OF PACKAGING; PLASTIC FILM FOR INDUSTRIAL AND COMMERCIAL PACKING USE, IN CLASS 17 (U.S. CLS. 1, 5, 12, 13, 35 AND 50).

THE MARK CONSISTS OF STANDARD CHARACTERS WITHOUT CLAIM TO ANY PARTICULAR FONT, STYLE, SIZE, OR COLOR.

OWNER OF ERPN CMNTY TM OFC REG. NO. 008740111, DATED 7-20-2010, EXPIRES 7-20-2020.

SER. NO. 77-890,017, FILED 12-9-2009.

PAM WILLIS, EXAMINING ATTORNEY



David J. Kybas

Director of the United States Patent and Trademark Office

United States of America

United States Patent and Trademark Office



Reg. No. 4,065,109

Registered Dec. 6, 2011

Int. Cl.: 35

SERVICE MARK

PRINCIPAL REGISTER

STAFFING TECHNOLOGIES, INC. (GEORGIA CORPORATION)
221 ROSWELL ROAD, SUITE 200
ALPHARETTA, GA 30009

FOR: PERSONNEL SERVICES, NAMELY, PROVIDING CONTRACT/TEMPORARY AND PERMANENT COMPUTER PERSONNEL FOR COMPUTER PROGRAMMING, SYSTEMS ADMINISTRATION, SOFTWARE ENGINEERING AND NETWORK ADMINISTRATION, IN CLASS 35 (U.S. CLS. 100, 101 AND 102).

FIRST USE 3-1-2006; IN COMMERCE 3-1-2006.

OWNER OF U.S. REG. NO. 2,174,137.

THE COLOR(S) RED AND GRAY IS/ARE CLAIMED AS A FEATURE OF THE MARK.

NO CLAIM IS MADE TO THE EXCLUSIVE RIGHT TO USE "STAFFING TECHNOLOGIES", APART FROM THE MARK AS SHOWN.

THE MARK CONSISTS OF THE WORD "STAFFING TECHNOLOGIES" IN STYLIZED LETTERING AND DESIGN. THE MARK CONSISTS OF THE COLOR RED WHICH IS USED IN THE FIRST WORD "STAFFING" FOR THE LETTERS "S", "T", "F", "F", "I", "N", "G" AND FOR THE HEAD OF THE MAN DESIGNED AS THE LETTER "A". THE MARK CONSISTS OF THE COLOR GRAY WHICH IS USED FOR THE LETTER "A" DESIGN AS A MAN HOLDING UP HIS ARMS IN THE WORD "STAFFING" AND ALL LETTERS IN THE WORD "TECHNOLOGIES".

SER. NO. 77-891,464, FILED 12-11-2009.

CIMMERIAN COLEMAN, EXAMINING ATTORNEY



David J. Kybas

Director of the United States Patent and Trademark Office

United States of America

United States Patent and Trademark Office



Reg. No. 4,065,110

Registered Dec. 6, 2011

Int. Cl.: 35

SERVICE MARK

PRINCIPAL REGISTER

INTEGRATED MARKETING SERVICES, INC. (NEW JERSEY CORPORATION)
279 WALL STREET
PRINCETON, NJ 08540

FOR: ADVERTISING SERVICES, PUBLIC RELATIONS AND MARKETING SERVICES, NAMELY, PROMOTING AND MARKETING THE GOODS AND SERVICES OF OTHERS THROUGH ALL PUBLIC COMMUNICATION MEANS, IN CLASS 35 (U.S. CLS. 100, 101 AND 102).

FIRST USE 6-29-1998; IN COMMERCE 6-29-1998.

NO CLAIM IS MADE TO THE EXCLUSIVE RIGHT TO USE "INTEGRATED MARKETING SERVICES INC", APART FROM THE MARK AS SHOWN.

THE MARK CONSISTS OF THE WORDING "INTEGRATED MARKETING SERVICES INC" PRESENTED IN STYLIZED FONT. "INTEGRATED" IS STACKED ABOVE "MARKETING" WHICH IS STACKED ABOVE "SERVICES" AND "INC" IS SITUATED VERTICALLY AGAINST "SERVICES". TO THE LEFT OF THE WORDING IS A DESIGN COMPRISED OF THREE INTERLOCKING GEARS ARRANGED IN A TRIANGLE FORMATION. THE TOP GEAR CONTAINS THE OUTLINE OF A SQUARE WHICH CONTAINS A BALL IN ITS CENTER. A VERTICAL LINE BISECTS THE GEAR AND THE SQUARE AND OUTLINES THE BALL. ANOTHER GEAR IS SITUATED BELOW THE TOP GEAR. IT CONTAINS THE OUTLINE OF A TRIANGLE AND CONTAINS AN OUTLINED BALL WITHIN IT. A VERTICAL LINE WHICH BEGINS AT THE BOTTOM OF THE SPHERE CUTS THROUGH THE TRIANGLE AND TERMINATES AT THE BOTTOM OF THE GEAR. ANOTHER GEAR IS SITUATED TO THE UPPER RIGHT OF THE BOTTOM GEAR AND THE LOWER RIGHT OF THE TOP GEAR. THE GEAR CONTAINS AN OUTLINED BALL IN ITS CENTER. A VERTICAL LINE BISECTS THE GEAR AND OUTLINES THE SPHERE. TWO SMALL HORIZONTAL LINES RUN FROM THE BALL AND CONNECT TO THE OUTLINE OF THE SPHERE. A LINE EXTENDS VERTICALLY FROM THE GEAR AND EXTENDS HORIZONTALLY FROM THE RIGHT OF THE GEAR AND DIRECTLY ABOVE THE WORD "INTEGRATED". AT THE END OF THE LINE IS A SMALL CIRCLE.



David J. Kyros

SER. NO. 77-893,709, FILED 12-15-2009.

GRETCHEN ULRICH, EXAMINING ATTORNEY

United States of America

United States Patent and Trademark Office

ESCAPEE
JAYS

Reg. No. 4,065,111

Registered Dec. 6, 2011

Int. Cl.: 25

TRADEMARK

PRINCIPAL REGISTER

ESCAPEEJAYS SLEEPWEAR, LLC (TEXAS LIMITED LIABILITY COMPANY)
4502 TREE LANE
FORT WORTH, TX 761143822

FOR: CLOTHING, NAMELY, CHILDREN'S SLEEPWEAR, SOCKS, ARM WARMERS AND LEG WARMERS, IN CLASS 25 (U.S. CLS. 22 AND 39).

FIRST USE 10-1-2009; IN COMMERCE 12-1-2009.

THE MARK CONSISTS OF THE WORDS "ESCAPEE JAYS". THE WORD "ESCAPEE" APPEARS ABOVE THE WORD "JAYS". THE MARK IS PRESENTED IN ALL CAPITALIZED LETTERS WITH THE FIRST LETTER "E" AND THE LETTERS "P" AND "J" IN A LARGER SIZE THAN THE REST OF THE LETTERS.

SER. NO. 77-894,164, FILED 12-15-2009.

JIM RINGLE, EXAMINING ATTORNEY



David J. Kyffers

Director of the United States Patent and Trademark Office

United States of America

United States Patent and Trademark Office

BRAIDING FRIENDS

Reg. No. 4,065,112

Registered Dec. 6, 2011

Int. Cl.: 28

TRADEMARK

PRINCIPAL REGISTER

MATTEL, INC. (DELAWARE CORPORATION)
M1-1518
333 CONTINENTAL BOULEVARD
EL SEGUNDO, CA 90245

FOR: TOYS, GAMES AND PLAYTHINGS, NAMELY, DOLLS, DOLL CLOTHING AND DOLL ACCESSORIES; TOY ANIMAL FIGURES AND ACCESSORIES THEREFOR, IN CLASS 28 (U.S. CLS. 22, 23, 38 AND 50).

FIRST USE 8-2-2010; IN COMMERCE 8-2-2010.

THE MARK CONSISTS OF STANDARD CHARACTERS WITHOUT CLAIM TO ANY PARTICULAR FONT, STYLE, SIZE, OR COLOR.

NO CLAIM IS MADE TO THE EXCLUSIVE RIGHT TO USE "BRAIDING", APART FROM THE MARK AS SHOWN.

SER. NO. 77-894,691, FILED 12-16-2009.

AMY C. KEAN, EXAMINING ATTORNEY



David J. Kappas

Director of the United States Patent and Trademark Office

United States of America

United States Patent and Trademark Office



Reg. No. 4,065,113

Registered Dec. 6, 2011

Int. Cl.: 10

TRADEMARK

PRINCIPAL REGISTER

MEDICINA LIMITED (UNITED KINGDOM COMPANY)
STATION ROAD, BLACKROD
UNIT 2 RIVINGTON VIEW BUSINESS PARK
BOLTON, UNITED KINGDOM BL65BN

FOR: ORAL AND ENTERAL SYRINGES; MEDICAL SYRINGE ACCESSORIES TO ACCESS MEDICINE CONTAINERS, NAMELY, ADAPTERS, EXTENSION LINES AND SYRINGE CAPS; MEDICINE BOTTLE ADAPTERS FOR USE WITH ORAL AND ENTERAL SYRINGES; NEEDLES OF ALL TYPES FOR MEDICAL PURPOSES; MEDICAL ACCESSORY KITS COMPRISED OF A NEEDLE, A TUBE AND A SYRINGE, ALL SOLD AS A UNIT; MEDICAL SYRINGE ACCESSORY EXTENSION LINES, CAPS, ADAPTERS, 3-WAY TAPS AND DRAINAGE BAGS; NASOGASTRIC AND GASTROSTOMY FEEDING CATHETERS AND FEEDING DEVICES; ENTERAL CATHETER EXTENSION SETS; ENTERAL SYRINGE DRIVER PUMPS, IN CLASS 10 (U.S. CLS. 26, 39 AND 44).

FIRST USE 1-18-2010; IN COMMERCE 8-26-2010.

PRIORITY CLAIMED UNDER SEC. 44(D) ON ERPN CMNTY TM OFC APPLICATION NO. 8781171, FILED 12-8-2009.

THE MARK CONSISTS OF "M" IN A CIRCLE.

SER. NO. 77-896,625, FILED 12-18-2009.

MARY ROSSMAN, EXAMINING ATTORNEY



David J. Kybas

Director of the United States Patent and Trademark Office

United States of America

United States Patent and Trademark Office



Reg. No. 4,065,114

Registered Dec. 6, 2011

Int. Cls.: 9 and 11

TRADEMARK

PRINCIPAL REGISTER

UNIX AMERICA CORP. (NEW JERSEY CORPORATION)
120 SYLVAN AVE
#301
ENGLEWOOD CLIFFS, NJ 07632

FOR: ELECTRIC FLAT IRONS; ELECTRIC HAIR CURLING IRONS, IN CLASS 9 (U.S. CLS. 21, 23, 26, 36 AND 38).

FIRST USE 7-15-2009; IN COMMERCE 11-25-2009.

FOR: HAIR DRYERS, IN CLASS 11 (U.S. CLS. 13, 21, 23, 31 AND 34).

FIRST USE 7-15-2009; IN COMMERCE 11-25-2009.

THE MARK CONSISTS OF THE STYLIZED TEXT "XENOCH" INSIDE AN OVAL.

SER. NO. 77-897,486, FILED 12-18-2009.

Laurie Kaufman, Examining Attorney



David J. Kybas

Director of the United States Patent and Trademark Office

United States of America

United States Patent and Trademark Office



Reg. No. 4,065,115

Registered Dec. 6, 2011

Int. Cl.: 30

TRADEMARK

PRINCIPAL REGISTER

FLAVORCRAFT, LLC (KENTUCKY LIMITED LIABILITY COMPANY)
2123 WATTERSON TRAIL
LOUISVILLE, KY 40299

FOR: SAUCES, SALSA, SALAD DRESSINGS, BARBEQUE SAUCES, PASTA SAUCES, STEAK SAUCES, MARINADES, KETCHUP, MUSTARDS, ETHNIC SAUCES, FOOD GLAZES, VINEGARS, FLAVORING SYRUPS, IN CLASS 30 (U.S. CL. 46).

FIRST USE 8-27-2009; IN COMMERCE 8-27-2009.

THE NAME JACOMINA DOES NOT IDENTIFY A LIVING INDIVIDUAL.

THE MARK CONSISTS OF AN ARCHED BANNER WITH THE WORD "JACOMINA'S" INSIDE OF IT OVERLAPPING A RECTANGLE ORIENTED VERTICALLY. INSIDE OF THE RECTANGLE IS ANOTHER SMALLER RECTANGLE ORIENTED VERTICALLY THAT SHARES ITS RIGHT EDGE WITH THE OUTER RECTANGLE. A PORTION OF A CIRCLE EXTENDS ABOVE THE INNER RECTANGLE WITH A SCROLL DESIGN INSIDE OF IT AND A PORTION OF A CIRCLE EXTENDS FROM THE RIGHT SIDE OF THE INNER RECTANGLE. A VINE WITH LEAVES IS EXTENDING FROM BEHIND THE LOWER LEFT SIDE OF THE INNER RECTANGLE. INSIDE OF THE INNER RECTANGLE IS A DINING ROOM SCENE WITH SHELVES HOLDING DRINKING GLASSES, A PLATE, AND A PITCHER ON THEM, A TABLE SET WITH A PLATE, A KNIFE AND DRINKING GLASSES, A TWO-TIER FRUIT BOWL WITH ORANGES AND GRAPES AND SMALL ROUND FRUIT ON THE TABLE, A CHAIR, AND A WOMAN IN A COLONIAL DRESS WITH A FLOWER IN HER HAIR HOLDING A PLATE ON WHICH THERE IS A SLICE AND A LOAF OF BREAD IN FRONT OF THE TABLE. INSIDE OF THE OUTER RECTANGLE AND OVERLAPPING THE INNER RECTANGLE IS THE WORDING "FAVORITE".

SER. NO. 77-904,901, FILED 1-5-2010.

SARA BENJAMIN, EXAMINING ATTORNEY



David J. Kyjars

Director of the United States Patent and Trademark Office

United States of America

United States Patent and Trademark Office

BLACKBOOK 27

Reg. No. 4,065,116

Registered Dec. 6, 2011

Int. Cl.: 45

SERVICE MARK

PRINCIPAL REGISTER

BLACK27, INC. (CALIFORNIA CORPORATION)
F-487
28241 CROWNVALLEY PKWY.
LAGUNA NIGUEL, CA 92677

FOR: INTERNET BASED INTRODUCTION AND SOCIAL NETWORKING SERVICES, IN CLASS 45 (U.S. CLS. 100 AND 101).

FIRST USE 7-4-2009; IN COMMERCE 7-4-2009.

THE MARK CONSISTS OF THE WORDS "BLACKBOOK" IN BLACK STENCIL FORM ALONGSIDE THE NUMBERS "2" AND "7" FORMED BY STENCIL OUTLINES.

SER. NO. 77-907,456, FILED 1-7-2010.

CHRISTOPHER BUONGIORNO, EXAMINING ATTORNEY



David J. Kybas

Director of the United States Patent and Trademark Office

United States of America

United States Patent and Trademark Office



Reg. No. 4,065,117

Registered Dec. 6, 2011

Int. Cls.: 35, 38 and 45

SERVICE MARK

PRINCIPAL REGISTER

QUICKVOX LIMITED (ENGLAND LIMITED COMPANY REGISTERED UNDER THE LAWS OF ENGLAND AND WALES)
SUITE 1, INVICTA BUSINESS CENTRE
MONUMENT WAY, ORBITAL PARK
ASHFORD, KENT, UNITED KINGDOM TN24OHB

FOR: CONDUCTING OPINION POLLS; ADVERTISING SERVICES; ONLINE ADVERTISING ON COMPUTER NETWORKS; DISSEMINATION OF ADVERTISING MATTER; BUSINESS NETWORKING; DATA PROCESSING, IN CLASS 35 (U.S. CLS. 100, 101 AND 102).

FOR: COMMUNICATION SERVICES, NAMELY, ELECTRONIC TRANSMISSION OF DATA, SOUND FILES, IMAGES AND DOCUMENTS AMONG USERS OF COMPUTERS; PROVIDING ACCESS TO ELECTRONIC DATABASES; ELECTRONIC EXCHANGE OF DATA STORED IN DATABASES ACCESSIBLE VIA TELECOMMUNICATION NETWORKS; CHAT ROOM SERVICES FOR BUSINESS NETWORKING; PROVIDING ON-LINE FORUMS FOR TRANSMISSION OF MESSAGES AMONG COMPUTER USERS, IN CLASS 38 (U.S. CLS. 100, 101 AND 104).

FOR: ON-LINE SOCIAL NETWORKING SERVICES, IN CLASS 45 (U.S. CLS. 100 AND 101).

PRIORITY CLAIMED UNDER SEC. 44(D) ON UNITED KINGDOM APPLICATION NO. 2521633, FILED 7-22-2009, REG. NO. 2521633, DATED 7-22-2009, EXPIRES 7-22-2019.

THE MARK CONSISTS OF THE WORD "QUICKVOX" APPEARING BELOW TWO QUOTE BUBBLES.

SER. NO. 77-916,937, FILED 1-21-2010.

IRA J. GOODSID, EXAMINING ATTORNEY



David J. Kyros

Director of the United States Patent and Trademark Office

United States of America

United States Patent and Trademark Office

planio

Reg. No. 4,065,118

Registered Dec. 6, 2011

Int. Cl.: 42

SERVICE MARK

PRINCIPAL REGISTER

ROCKET RENTALS GMBH (FED REP GERMANY CORPORATION)
BOXHAGENER STR. 119
BERLIN, FED REP GERMANY 10245

FOR: COMPUTER PROJECT MANAGEMENT SERVICES, NAMELY, COMPUTER PROJECT PLANNING FOR OTHERS; COMPUTER SERVICES, NAMELY, REMOTE AND ON-SITE MAINTENANCE OF ELECTRONIC MESSAGING SYSTEMS SOFTWARE AND APPLICATIONS FOR OTHERS, IN CLASS 42 (U.S. CLS. 100 AND 101).

FIRST USE 8-13-2009; IN COMMERCE 8-13-2009.

THE MARK CONSISTS OF STANDARD CHARACTERS WITHOUT CLAIM TO ANY PARTICULAR FONT, STYLE, SIZE, OR COLOR.

OWNER OF FED REP GERMANY REG. NO. 302009048755, DATED 10-16-2009, EXPIRES 8-31-2019.

SER. NO. 77-918,967, FILED 1-25-2010.

STEVEN PEREZ, EXAMINING ATTORNEY



David J. Kybas

Director of the United States Patent and Trademark Office

United States of America

United States Patent and Trademark Office

THE WAY CAT CARE SHOULD BE

Reg. No. 4,065,119

Registered Dec. 6, 2011

Int. Cl.: 43

SERVICE MARK

PRINCIPAL REGISTER

THE CAT'S INN OF NEW YORK (NEW YORK LIMITED LIABILITY COMPANY)
95 SOUTH WINDSOR AVENUE
BRIGHTWATERS, NY 117181516

FOR: ANIMAL BOARDING SERVICES, IN CLASS 43 (U.S. CLS. 100 AND 101).

FIRST USE 9-15-1998; IN COMMERCE 9-15-1998.

THE MARK CONSISTS OF STANDARD CHARACTERS WITHOUT CLAIM TO ANY PARTICULAR FONT, STYLE, SIZE, OR COLOR.

SER. NO. 77-920,115, FILED 1-26-2010.

KHANH LE, EXAMINING ATTORNEY



David J. Kybas

Director of the United States Patent and Trademark Office

United States of America

United States Patent and Trademark Office

*Patient***WEB**
ADVANCING THE STANDARD OF CARE

Reg. No. 4,065,120

Registered Dec. 6, 2011

Int. Cl.: 9

TRADEMARK

PRINCIPAL REGISTER

COMLINK SOLUTIONS, LLC (PENNSYLVANIA LIMITED LIABILITY COMPANY)
207 SOUTH 32ND STREET
CAMP HILL, PA 17011

FOR: COMPUTER SOFTWARE FOR USE IN THE HEALTHCARE FIELD, NAMELY, PROVIDING REMOTE ACCESS TO HEALTHCARE SYSTEMS, MEDICAL RECORDS, PATIENT ACCOUNTING, SCHEDULING, MANAGED CARE, LABORATORY ORDERS AND REPORTS AND ACCESS TO A MEDICAL DATA REPOSITORY, IN CLASS 9 (U.S. CLS. 21, 23, 26, 36 AND 38).

FIRST USE 11-5-2007; IN COMMERCE 11-5-2007.

THE MARK CONSISTS OF THE ITALICIZED WORDING "PATIENTWEB ADVANCING THE STANDARD OF CARE". THE LETTERS "P", "A", "T", "I", "E", "N", "T" ARE GREEN. THE LETTERS "W", "E", "B" ARE BLUE. "ADVANCING THE STANDARD OF CARE" IS BLACK. THE MARK APPEARS ON A TRANSPARENT BACKGROUND.

THE COLOR(S) GREEN, BLUE, BLACK IS/ARE CLAIMED AS A FEATURE OF THE MARK.

SER. NO. 77-921,073, FILED 1-27-2010.

DAVID MILLER, EXAMINING ATTORNEY



David J. Kyffers

Director of the United States Patent and Trademark Office

United States of America

United States Patent and Trademark Office

CONNECTSHARE

Reg. No. 4,065,121

Registered Dec. 6, 2011

Int. Cl.: 9

TRADEMARK

PRINCIPAL REGISTER

SAMSUNG ELECTRONICS CO., LTD. (REPUBLIC OF KOREA CORPORATION)
416, MAETAN-DONG, YEONGTONG-GU
SUWON-SI, GYEONGGI-DO, REPUBLIC OF KOREA

FOR: TELEVISION RECEIVERS; DVD PLAYERS; OPTICAL DISK DRIVES; AUDIO AMPLIFIERS AND AUDIO SPEAKERS; MP3 PLAYERS; PORTABLE MULTIMEDIA PLAYERS; COMPUTERS; MOBILE TELEPHONES; DIGITAL CAMERAS; PERSONAL DIGITAL ASSISTANTS; CAMCORDERS, IN CLASS 9 (U.S. CLS. 21, 23, 26, 36 AND 38).

THE MARK CONSISTS OF STANDARD CHARACTERS WITHOUT CLAIM TO ANY PARTICULAR FONT, STYLE, SIZE, OR COLOR.

PRIORITY CLAIMED UNDER SEC. 44(D) ON REPUBLIC OF KOREA APPLICATION NO. 2010-0004150, FILED 1-25-2010, REG. NO. 0859628, DATED 4-5-2011, EXPIRES 4-5-2021.

SER. NO. 77-922,399, FILED 1-28-2010.

STEPHANIE ALI, EXAMINING ATTORNEY



David J. Kybas

Director of the United States Patent and Trademark Office

United States of America

United States Patent and Trademark Office

THE COMMON APPLICATION

Reg. No. 4,065,122

Registered Dec. 6, 2011

Int. Cl.: 42

SERVICE MARK

PRINCIPAL REGISTER

THE COMMON APPLICATION, INC. (VIRGINIA CORPORATION)
SUITE 200, 620 HERNDON PARKWAY
HERNDON, VA 20170

FOR: PROVIDING AN ON-LINE WEBSITE FEATURING TECHNOLOGY THAT ENABLES USERS TO APPLY FOR ADMISSION TO THE MEMBER EDUCATIONAL INSTITUTIONS OF THEIR CHOICE, IN CLASS 42 (U.S. CLS. 100 AND 101).

FIRST USE 6-0-1998; IN COMMERCE 6-0-1998.

THE MARK CONSISTS OF STANDARD CHARACTERS WITHOUT CLAIM TO ANY PARTICULAR FONT, STYLE, SIZE, OR COLOR.

OWNER OF U.S. REG. NOS. 2,955,878, 3,722,412 AND OTHERS.

SEC. 2(F).

SER. NO. 77-922,732, FILED 1-28-2010.

SHAILA SETTLES, EXAMINING ATTORNEY



David J. Kyjars

Director of the United States Patent and Trademark Office

United States of America

United States Patent and Trademark Office

s5i

Reg. No. 4,065,123

Registered Dec. 6, 2011

Int. Cl.: 10

TRADEMARK

PRINCIPAL REGISTER

VOLCANO CORPORATION (DELAWARE CORPORATION)
2870 KILGORE ROAD
RANCHO CORDOVA, CA 95670

FOR: INTRAVASCULAR ULTRASOUND SYSTEMS, NAMELY, MEDICAL INTRAVASCULAR ULTRASOUND APPARATUS WITH A PHYSIOLOGICAL DATA DISPLAY FEATURE, IN CLASS 10 (U.S. CLS. 26, 39 AND 44).

FIRST USE 10-11-2006; IN COMMERCE 10-11-2006.

THE MARK CONSISTS OF STANDARD CHARACTERS WITHOUT CLAIM TO ANY PARTICULAR FONT, STYLE, SIZE, OR COLOR.

SER. NO. 77-922,869, FILED 1-28-2010.

SARA BENJAMIN, EXAMINING ATTORNEY



David J. Kybas

Director of the United States Patent and Trademark Office

United States of America

United States Patent and Trademark Office

INDOCHINO

Reg. No. 4,065,124

Registered Dec. 6, 2011

Int. Cls.: 25, 35 and 40

TRADEMARK

SERVICE MARK

PRINCIPAL REGISTER

INDOCHINO APPAREL INC. (CANADA CORPORATION)
112-1118 HOMER STREET
VANCOUVER, BC, CANADA V6B6L5

FOR: (BASED ON USE IN COMMERCE) CLOTHING, NAMELY, SUITS, TUXEDOS, SHIRTS, COATS, BLAZERS, VESTS, PANTS, NECK TIES; CLOTHING, NAMELY, BLUE JEANS, IN CLASS 25 (U.S. CLS. 22 AND 39).

FIRST USE 9-13-2007; IN COMMERCE 9-13-2007.

FOR: ONLINE RETAIL CLOTHING STORE SERVICES, IN CLASS 35 (U.S. CLS. 100, 101 AND 102).

FOR: CLOTHING ALTERATION AND TAILORING SERVICES; MONOGRAMMING SERVICES, IN CLASS 40 (U.S. CLS. 100, 103 AND 106).

THE MARK CONSISTS OF STANDARD CHARACTERS WITHOUT CLAIM TO ANY PARTICULAR FONT, STYLE, SIZE, OR COLOR.

OWNER OF CANADA REG. NO. TMA789101, DATED 1-31-2011, EXPIRES 1-31-2026.

SER. NO. 77-922,986, FILED 1-28-2010.

ELIZABETH HUGHITT, EXAMINING ATTORNEY



David J. Kyros

Director of the United States Patent and Trademark Office

United States of America

United States Patent and Trademark Office

E-TRON

Reg. No. 4,065,125

Registered Dec. 6, 2011

Int. Cl.: 9

TRADEMARK

PRINCIPAL REGISTER

AUDI AG (FED REP GERMANY CORPORATION)
85045
INGOLSTADT, FED REP GERMANY

FOR: ELECTRIC MOTOR VEHICLE BATTERIES, ELECTRONIC POWER SUPPLIES FOR DRIVING ELECTRIC MOTORS, BATTERY MONITORING DEVICES THAT MAY BE ATTACHED TO A BATTERY TO MONITOR ITS PERFORMANCE, SOLD AS A UNIT WITH OPERATING SOFTWARE THEREFOR, ELECTRONIC CONTROLS FOR ELECTRIC ENGINES FOR LAND VEHICLES, ELECTRICAL CHARGE CONTACT CONNECTORS AND ELECTRIC CHARGING CABLES, IN CLASS 9 (U.S. CLS. 21, 23, 26, 36 AND 38).

THE MARK CONSISTS OF STANDARD CHARACTERS WITHOUT CLAIM TO ANY PARTICULAR FONT, STYLE, SIZE, OR COLOR.

PRIORITY CLAIMED UNDER SEC. 44(D) ON FED REP GERMANY APPLICATION NO. 302009046417, FILED 8-4-2009, REG. NO. 302009046417, DATED 12-18-2009, EXPIRES 8-4-2019.

SER. NO. 77-923,333, FILED 1-29-2010.

REBECCA EISINGER, EXAMINING ATTORNEY



David J. Kyros

Director of the United States Patent and Trademark Office

United States of America

United States Patent and Trademark Office

ONE FOR ALL

Reg. No. 4,065,126

Registered Dec. 6, 2011

Int. Cl.: 42

SERVICE MARK

PRINCIPAL REGISTER

THE COMMON APPLICATION, INC. (VIRGINIA CORPORATION)
620 HERNDON PARKWAY, SUITE 200
HERNDON, VA 20170

FOR: PROVIDING AN ON-LINE WEBSITE FEATURING TECHNOLOGY THAT ENABLES USERS TO APPLY TO MEMBER EDUCATIONAL INSTITUTIONS OF THEIR CHOICE, IN CLASS 42 (U.S. CLS. 100 AND 101).

FIRST USE 6-0-2006; IN COMMERCE 6-0-2006.

THE MARK CONSISTS OF STANDARD CHARACTERS WITHOUT CLAIM TO ANY PARTICULAR FONT, STYLE, SIZE, OR COLOR.

SER. NO. 77-925,659, FILED 2-2-2010.

SHAILA SETTLES, EXAMINING ATTORNEY



David J. Kyffers

Director of the United States Patent and Trademark Office

United States of America

United States Patent and Trademark Office

Lizard Tongue

Reg. No. 4,065,127

Registered Dec. 6, 2011

Int. Cl.: 5

TRADEMARK

PRINCIPAL REGISTER

KUUS, RON H (CANADA INDIVIDUAL)
450 TAPSCOTT ROAD UNIT 5/6A
TORONTO, ONTARIO, CANADA M1B1Y4

FOR: FLY CATCHING PAPER; FLY PAPER, IN CLASS 5 (U.S. CLS. 6, 18, 44, 46, 51 AND 52).

THE MARK CONSISTS OF STANDARD CHARACTERS WITHOUT CLAIM TO ANY PARTICULAR FONT, STYLE, SIZE, OR COLOR.

PRIORITY CLAIMED UNDER SEC. 44(D) ON CANADA APPLICATION NO. 1468190, FILED 2-3-2010, REG. NO. TMA786914, DATED 1-11-2011, EXPIRES 1-11-2026.

NO CLAIM IS MADE TO THE EXCLUSIVE RIGHT TO USE "LIZARD", APART FROM THE MARK AS SHOWN.

SER. NO. 77-927,023, FILED 2-3-2010.

CYNTHIA TRIPI, EXAMINING ATTORNEY



David J. Kyros

Director of the United States Patent and Trademark Office

United States of America

United States Patent and Trademark Office

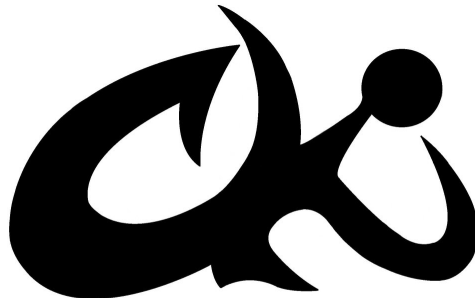

Reg. No. 4,065,128

Registered Dec. 6, 2011

Int. Cl.: 25

TRADEMARK

PRINCIPAL REGISTER

BASEBALLCHI.COM, LLC (CALIFORNIA LIMITED LIABILITY COMPANY)
657 LILJA COURT
ROSEVILLE, TX 95678

FOR: ATHLETIC APPAREL, NAMELY, SHIRTS, PANTS, JACKETS, FOOTWEAR, HATS
AND CAPS, ATHLETIC UNIFORMS, IN CLASS 25 (U.S. CLS. 22 AND 39).

FIRST USE 11-7-2009; IN COMMERCE 2-1-2010.

THE MARK CONSISTS OF A HIGHLY STYLIZED DEPICTION OF THE TERM "CHI" REPRESENTED BY STYLIZED DEPICTION OF A MAN IN A THROWING POSITION WHEREBY, FROM LEFT TO RIGHT THE LETTER "C" REPRESENTS A LEG AND ARM THAT OVERLAP WITH THE LETTER "H", WHICH FORMS THE ARMS AND RIGHT PARTIAL LEG FOLLOWED BY THE LETTER "I", WHICH REPRESENTS THE NECK AND HEAD.

SER. NO. 77-931,529, FILED 2-9-2010.

MYRIAH HABEEB, EXAMINING ATTORNEY



David J. Kybas

Director of the United States Patent and Trademark Office

United States of America

United States Patent and Trademark Office

PerformaLink

Reg. No. 4,065,129

Registered Dec. 6, 2011

Int. Cl.: 36

SERVICE MARK

PRINCIPAL REGISTER

SUPERIOR ESSEX COMMUNICATIONS, LP (DELAWARE LIMITED PARTNERSHIP)
SUITE 150
6120 POWERS FERRY ROAD
ATLANTA, GA 30339

FOR: PROVIDING WARRANTIES FOR OTHERS ON TELECOMMUNICATIONS EQUIPMENT,
NAMELY, HIGH BAND-WITH CABLES AND PASSIVE CONNECTORS, IN CLASS 36 (U.S.
CLS. 100, 101 AND 102).

FIRST USE 1-17-2000; IN COMMERCE 1-17-2000.

THE MARK CONSISTS OF STANDARD CHARACTERS WITHOUT CLAIM TO ANY PAR-
TICULAR FONT, STYLE, SIZE, OR COLOR.

SER. NO. 77-932,360, FILED 2-10-2010.

BERYL GARDNER, EXAMINING ATTORNEY



David J. Kybas

Director of the United States Patent and Trademark Office

United States of America

United States Patent and Trademark Office

TREELINK

Reg. No. 4,065,130

Registered Dec. 6, 2011

Int. Cl.: 38

SERVICE MARK

PRINCIPAL REGISTER

TREELINK (UTAH CORPORATION)
352 SOUTH DENVER STREET, SUITE 315
SALT LAKE CITY, UT 84111

FOR: PROVIDING INFORMATION POSTING SERVICES, NAMELY, ON-LINE CHAT ROOMS AND ELECTRONIC BULLETIN BOARDS FOR TRANSMISSION OF MESSAGES, INFORMATION, DATA, ARTICLES AND POSTINGS AMONG USERS IN THE FIELDS OF COMMUNITY FORESTRY, COMMUNITY FORESTRY RESOURCES, COMMUNITY FORESTRY TECHNOLOGY, COMMUNITY FORESTRY INFORMATION, COMMUNITY FORESTRY PROMOTION, COMMUNITY FORESTRY MAINTENANCE AND PLANTING, COMMUNITY FORESTRY JOB OPPORTUNITIES, AND METHODS TO ORGANIZE AND INCREASE COMMUNITY FORESTRY EFFORTS AND COMMUNITY FORESTRY MAINTENANCE AND PLANTING, IN CLASS 38 (U.S. CLS. 100, 101 AND 104).

FIRST USE 9-3-1997; IN COMMERCE 9-3-1997.

THE MARK CONSISTS OF STANDARD CHARACTERS WITHOUT CLAIM TO ANY PARTICULAR FONT, STYLE, SIZE, OR COLOR.

OWNER OF U.S. REG. NO. 3,014,612.

SER. NO. 77-933,866, FILED 2-11-2010.

MAYUR VAGHANI, EXAMINING ATTORNEY



David J. Kybas

Director of the United States Patent and Trademark Office

United States of America

United States Patent and Trademark Office

BREAKING NEW GROUND, FINDING INNOVATIVE THERAPEUTIC SOLUTIONS

Reg. No. 4,065,131

Registered Dec. 6, 2011

**Int. Cls.: 5, 38, 41, 42
and 44**

TRADEMARK

SERVICE MARK

PRINCIPAL REGISTER

IPSEN PHARMA S.A.S. (FRANCE CORPORATION)
65, QUAI GEORGES GORSE
BOULOGNE BILLANCOURT, FRANCE 92650

FOR: PHARMACEUTICAL PREPARATIONS, NAMELY, PHARMACEUTICAL PREPARATIONS FOR USE IN THE TREATMENT OF GASTROINTESTINAL DISEASES, LAXATIVES AND PURGATIVE AGENTS; PHARMACEUTICAL PREPARATIONS FOR IN USE IN THE TREATMENT OF CARDIOVASCULAR DISEASES, CIRCULATORY DISORDERS, CANCER, NEUROLOGICAL DISEASES, UROLOGICAL DISEASES AND HORMONAL DISORDERS; PHARMACEUTICAL PREPARATIONS COMPRISING PEPTIDES FOR HORMONAL TREATMENT AND TUMOR TREATMENT; PHARMACEUTICAL PREPARATIONS FOR USE IN THE TREATMENT OF BLOOD DISEASES, MUSCLE DISORDERS, AGE-RELATED DISORDERS, DIABETES, DIABETES-RELATED DISORDERS, RESPIRATORY DISORDERS, OPHTHAMOLOGICAL DISORDERS, ENDOCRINE DISORDERS, ACROMEGALIA AND CARCINOID TUMORS, GASTROINTESTINAL BLEEDING DISORDERS, COUGH, VERTIGO, NAUSEA, VOMITING AND MIGRAINE, DISORDERS AND DISEASES OF THE REPRODUCTIVE SYSTEM, GLABELLAR LINES, FACIAL WRINKLES, ASYMMETRIES AND DEFECTS AND CONDITIONS OF THE HUMAN SKIN, AND GOUT, IN CLASS 5 (U.S. CLS. 6, 18, 44, 46, 51 AND 52).

FOR: PROVIDING ON-LINE FORUMS FOR TRANSMISSION OF MESSAGES AMONG COMPUTER USERS CONCERNING THE FIELDS OF SCIENCE, HEALTH, MEDICINE AND BEAUTY, IN CLASS 38 (U.S. CLS. 100, 101 AND 104).

FOR: TRAINING SERVICES IN THE FIELDS OF SCIENCE, HEALTH, MEDICINE AND BEAUTY; EDUCATION SERVICES, NAMELY, ARRANGING AND CONDUCTING COLLOQUIUMS, CONFERENCES, CONVENTIONS, SEMINARS, SYMPOSIUMS IN THE FIELDS OF SCIENCE, HEALTH, MEDICINE AND BEAUTY, IN CLASS 41 (U.S. CLS. 100, 101 AND 107).

FOR: SCIENTIFIC RESEARCH AND DEVELOPMENT, SCIENTIFIC, MEDICAL AND INDUSTRIAL RESEARCH SERVICES IN THE FIELD OF BIOLOGY, BACTERIOLOGY, CHEMISTRY AND COSMETOLOGY; AND RESEARCH AND DEVELOPMENT SERVICES FOR NEW PRODUCTS IN THE FIELDS OF SCIENCE, HEALTH, MEDICINE AND BEAUTY; PRODUCT DESIGN SERVICES FOR CHEMICAL PRODUCTS, PHARMACEUTICAL PREPARATIONS, PHARMACEUTICAL PLANTS AND ENGINEERING PROCESSES IN THE PRODUCTION OF ACTIVE SUBSTANCES AND PREPARATIONS IN THE PHARMACEUTICAL AND



David J. Kyjars

Director of the United States Patent and Trademark Office

Reg. No. 4,065,131 COSMETIC FIELD; SCIENTIFIC TESTING OF CHEMICAL PRODUCTS, PHARMACEUTICAL PRODUCTS, COSMETIC PRODUCTS, IN CLASS 42 (U.S. CLS. 100 AND 101).

FOR: MEDICAL SERVICES; PROVIDING HYGIENIC AND BEAUTY CARE SERVICES; INFORMATION SERVICES, NAMELY, PROVIDING ADVICE AND CONSULTING IN CONNECTION WITH THE MEDICAL AND PHARMACEUTICAL AND COSMETIC FIELDS, NAMELY, PROVIDING ADVICE AND CONSULTING IN CONNECTION WITH MEDICAL IMAGING, PHARMACEUTICAL ADVICE, AND BEAUTY CONSULTATION SERVICES IN THE SELECTION AND USE OF COSMETICS, PERSONAL CARE PRODUCTS; PROVIDING A WEB SITE FEATURING MEDICAL INFORMATION; MEDICAL TESTING FOR DIAGNOSTIC OR TREATMENT PURPOSES, AND MEDICAL DIAGNOSTIC TESTING SERVICES, IN CLASS 44 (U.S. CLS. 100 AND 101).

THE MARK CONSISTS OF STANDARD CHARACTERS WITHOUT CLAIM TO ANY PARTICULAR FONT, STYLE, SIZE, OR COLOR.

OWNER OF FRANCE REG. NO. 3702708, DATED 1-5-2010, EXPIRES 1-5-2020.

SER. NO. 77-934,415, FILED 2-12-2010.

ANDREA K. NADELMAN, EXAMINING ATTORNEY

United States of America

United States Patent and Trademark Office

TRUE PATIENT MEASURES

Reg. No. 4,065,132

Registered Dec. 6, 2011

Int. Cls.: 35, 42 and 44

SERVICE MARK

PRINCIPAL REGISTER

SDI HEALTH LLC (DELAWARE LIMITED LIABILITY COMPANY)
1 SDI DRIVE
PLYMOUTH MEETING, PA 19462

FOR: COMPUTERIZED DATABASE MANAGEMENT, DATA PROCESSING SERVICES AND PROVIDING BUSINESS INFORMATION ALL IN THE FIELDS OF HEALTH CARE, PUBLIC HEALTH, PHARMACEUTICAL AND MEDICAL PRODUCTS AND DEVICES; CUSTOMIZED MARKET ANALYSIS OF DATA FOR OTHERS IN THE FIELDS OF HEALTH CARE, PUBLIC HEALTH, PHARMACEUTICAL, PHARMACOGENOMIC AND MEDICAL PRODUCTS AND DEVICES; BUSINESS MARKETING RESEARCH, AUDIT AND CONSULTING SERVICES IN THE FIELDS OF HEALTH CARE, PHARMACEUTICALS, PHARMACOGENOMIC, AND MEDICAL PRODUCTS AND DEVICES PROVIDED BY NON-ELECTRONIC OR ELECTRONIC MEANS, INCLUDING BY MEANS OF WIDE AREA NETWORKS OR A GLOBAL COMPUTER NETWORK, IN CLASS 35 (U.S. CLS. 100, 101 AND 102).

FIRST USE 4-0-2004; IN COMMERCE 4-0-2004.

FOR: PROVIDING TEMPORARY USE OF ONLINE NON-DOWNLOADABLE SOFTWARE FOR USE IN INTEGRATION OF INSTITUTIONAL AND RELATED DATA IN THE FIELDS OF HEALTHCARE, PUBLIC HEALTH, PHARMACEUTICAL, PHARMACOGENOMIC AND MEDICAL PRODUCTS AND DEVICES AND RELATED FIELDS INTO DETAILED ANALYTICAL MARKETING, SALES, NATIONAL ACCOUNTS AND MARKET RESEARCH REPORTS, IN CLASS 42 (U.S. CLS. 100 AND 101).

FIRST USE 4-0-2004; IN COMMERCE 4-0-2004.

FOR: PROVIDING INFORMATION IN THE FIELDS OF HEALTH CARE, PUBLIC HEALTH, PHARMACEUTICALS, PHARMACOGENOMIC, AND MEDICAL PRODUCTS AND DEVICES BY ELECTRONIC OR NON-ELECTRONIC MEANS, INCLUDING BY MEANS OF WIDE AREA NETWORKS OR A GLOBAL COMPUTER NETWORK; CONSULTING SERVICES IN THE FIELDS OF HEALTH CARE, PUBLIC HEALTH, PHARMACEUTICALS, PHARMACOGENOMIC, AND MEDICAL PRODUCTS AND DEVICES PROVIDED BY NON-ELECTRONIC OR ELECTRONIC MEANS, INCLUDING BY MEANS OF WIDE AREA NETWORKS OR A GLOBAL COMPUTER NETWORK, IN CLASS 44 (U.S. CLS. 100 AND 101).

FIRST USE 4-0-2004; IN COMMERCE 4-0-2004.



David J. Kyjars

Director of the United States Patent and Trademark Office

Reg. No. 4,065,132 THE MARK CONSISTS OF STANDARD CHARACTERS WITHOUT CLAIM TO ANY PARTICULAR FONT, STYLE, SIZE, OR COLOR.

OWNER OF U.S. REG. NO. 2,811,391.

NO CLAIM IS MADE TO THE EXCLUSIVE RIGHT TO USE "PATIENT", APART FROM THE MARK AS SHOWN.

SER. NO. 77-936,584, FILED 2-16-2010.

KAREN SEVERSON, EXAMINING ATTORNEY

United States of America

United States Patent and Trademark Office

La Bestia Norteña

Reg. No. 4,065,133

Registered Dec. 6, 2011

Int. Cl.: 41

SERVICE MARK

PRINCIPAL REGISTER

HERNANDEZ, ELOY (CALIFORNIA JOINT VENTURE)
2370 BERKLEY
LA HABRA, CA 90631 AND

GONZALES, PAZ (CALIFORNIA JOINT VENTURE)
APT. B
2810 GLENWOOD PLACE
SOUTH GATE, CA 90280

FOR: ENTERTAINMENT IN THE NATURE OF VISUAL AND AUDIO PERFORMANCES, NAMELY, MUSICAL BAND, ROCK GROUP, GYMNASTIC, DANCE, AND BALLET PERFORMANCES, IN CLASS 41 (U.S. CLS. 100, 101 AND 107).

FIRST USE 4-13-2009; IN COMMERCE 4-13-2009.

THE MARK CONSISTS OF STANDARD CHARACTERS WITHOUT CLAIM TO ANY PARTICULAR FONT, STYLE, SIZE, OR COLOR.

THE ENGLISH TRANSLATION OF "LA BESTIA NORTEÑA" IN THE MARK IS "THE NORTHERN BEAST".

SER. NO. 77-940,627, FILED 2-19-2010.

NORA BUCHANAN WILL, EXAMINING ATTORNEY



David J. Kyros

Director of the United States Patent and Trademark Office

United States of America

United States Patent and Trademark Office

MEDICAL NEWS *for you*

Your roadmap to healthcare

Reg. No. 4,065,134

Registered Dec. 6, 2011

Int. Cls.: 16 and 44

TRADEMARK

SERVICE MARK

PRINCIPAL REGISTER

MEDICAL NEWS, LLC (KENTUCKY LIMITED LIABILITY COMPANY)
207 WEST MARKET STREET 3RD FLOOR
LOUISVILLE, KY 40202

FOR: MAGAZINES FEATURING HEALTHCARE NEWS AND INFORMATION, IN CLASS 16 (U.S. CLS. 2, 5, 22, 23, 29, 37, 38 AND 50).

FIRST USE 2-17-2010; IN COMMERCE 2-17-2010.

FOR: PROVIDING NEWS AND INFORMATION RELATING TO HEALTHCARE VIA THE INTERNET, IN CLASS 44 (U.S. CLS. 100 AND 101).

FIRST USE 2-17-2010; IN COMMERCE 2-17-2010.

NO CLAIM IS MADE TO THE EXCLUSIVE RIGHT TO USE "MEDICAL NEWS", APART FROM THE MARK AS SHOWN.

THE STIPPLING IS FOR SHADING PURPOSES.

THE MARK CONSISTS OF THE WORDS "MEDICAL NEWS FOR YOU YOUR ROADMAP TO HEALTHCARE" IN STYLIZED FONTS.

SER. NO. 77-942,409, FILED 2-23-2010.

CURTIS FRENCH, EXAMINING ATTORNEY



David J. Kypos

Director of the United States Patent and Trademark Office

United States of America

United States Patent and Trademark Office

Mr. Tankless

Reg. No. 4,065,135

Registered Dec. 6, 2011

Int. Cl.: 11

TRADEMARK

PRINCIPAL REGISTER

BILUK MEDIA LLC (NEW JERSEY LIMITED LIABILITY COMPANY)
PO BOX 1802
UNION, NJ 07083

FOR: TANKLESS WATER HEATERS, IN CLASS 11 (U.S. CLS. 13, 21, 23, 31 AND 34).

FIRST USE 1-1-2006; IN COMMERCE 1-1-2006.

THE MARK CONSISTS OF STANDARD CHARACTERS WITHOUT CLAIM TO ANY PARTICULAR FONT, STYLE, SIZE, OR COLOR.

SER. NO. 77-944,479, FILED 2-25-2010.

TRACY CROSS, EXAMINING ATTORNEY



David J. Kyffers

Director of the United States Patent and Trademark Office

United States of America

United States Patent and Trademark Office

CEFCO

Reg. No. 4,065,136

Registered Dec. 6, 2011

**Int. Cls.: 1, 7, 8, 9, 11
and 17**

TRADEMARK

PRINCIPAL REGISTER

CITY ELECTRICAL FACTORS LIMITED (UNITED KINGDOM LIMITED COMPANY (LTD.))
141 FARMER WARD ROAD, KENILWORTH
WARWICKSHIRE, UNITED KINGDOM CV82SU

FOR: ADHESIVES FOR ELECTRICAL USE, IN CLASS 1 (U.S. CLS. 1, 5, 6, 10, 26 AND 46).

FOR: ELECTRIC MOTORS FOR MACHINES AND ELECTRIC MOTORS FOR ELECTRICAL CIRCUITS NOT FOR LAND VEHICLES; CONTROL GEAR, CONTACTORS AND STARTERS, ALL FOR ELECTRIC MOTORS FOR USE IN ELECTRIC CIRCUITS AND IN RELATION TO THE CONTROL, SUPPLY AND DISTRIBUTION OF ELECTRIC CURRENT NOT FOR LAND VEHICLES; POWER TOOLS, NAMELY, JIGSAWS, POWER OPERATED DRILLS, CIRCULAR SAWS, ELECTRIC HOLE SAWS, ELECTRIC SAWS, MOTOR DRIVEN SAWS, POWER OPERATED SAWS, CORDLESS ELECTRIC DRILLS, POWER OPERATED MITRE SAWS, POWER OPERATED ANGLE GRINDERS, ROUTERS, ELECTRIC SANDERS AND LAWN-MOWERS; COMPONENT PARTS FOR ALL THE AFORESAID GOODS, IN CLASS 7 (U.S. CLS. 13, 19, 21, 23, 31, 34 AND 35).

FOR: HAND TOOLS NAMELY, HAND SAWS, SCREWDRIVERS, HAND-OPERATED CIRCULAR SAWS, HAND-OPERATED ANGLE GRINDERS, HAND-OPERATED JIGSAWS, TRIMMING KNIVES FOR ELECTRICAL USE, HACKSAW BLADES, HAND OPERATED DRILLS AND DRILL BITS THEREFOR, HAND OPERATED CABLE CUTTERS, WIRE STRIPPERS, PLIERS, CABLE PULLERS, FISH TAPE FOR PULLING CABLES, TERMINAL CRIMPERS AND PIPE CUTTERS, IN CLASS 8 (U.S. CLS. 23, 28 AND 44).

FOR: ELECTRIC WIRES AND ELECTRIC CABLES; CONDUITS AND TRUNKING, BEING ELECTRIC CABLING, ALL BEING ELECTRIC; TIMERS, ELECTRIC SWITCHES, SWITCH FUSES, FUSE SWITCHES, ELECTRICAL FUSE BOARDS, BUSBAR CHAMBERS FOR ELECTRIC POWER DISTRIBUTION, ELECTRICAL POWER DISTRIBUTION UNITS, ELECTRICAL POWER DISTRIBUTION UNITS FOR CONSUMER USE, EARTH LEAKAGE CURRENT BREAKER APPARATUS NAMELY EARTH LEAKAGE CIRCUIT BREAKERS, GROUNDING EQUIPMENT NAMELY LIGHTNING RODS, GROUNDING CLAMPS, GROUNDING ELECTRODES, SWITCHING RODS AND HIGH VOLTAGE LIVE LINE TESTERS; VOLTAGE STABILIZERS; THERMOSTATS; TRANSFORMERS; ELECTRIC PLUGS AND ELECTRIC SOCKET OUTLETS; STRIP CONNECTORS, NAMELY APPARATUS FOR CONNECTING ELECTRICAL OUTLET STRIPS AND WIRES; ELECTRICAL TERMINALS IN THE NATURE OF ELECTRIC CONNECTORS AND EARTH TERMINALS, JUNCTION BOXES; DOOR CHIMES AND DOOR BELLS, ALL BEING ELECTRIC; INTRUDER ALARMS



David J. Kybas

Director of the United States Patent and Trademark Office

Reg. No. 4,065,136 AND FIRE ALARMS; INTERCOMMUNICATION APPARATUS AND INSTALLATIONS NAMELY INTERCOMS; GATE OPENING AUTOMATION, NAMELY AUTOMATED GATE OPENERS; ELECTRICAL TESTING APPARATUS AND INSTALLATIONS, NAMELY, CIRCUIT TESTERS, ELECTRICAL OUTLET TESTER, ELECTRIC METER, VOLTMETERS; ELECTRICAL APPARATUS INCORPORATING ULTRAVIOLET LIGHT TUBES FOR THE CONTROL AND EXTERMINATION OF INSECTS; BATTERIES; SECURITY LIGHTING NAMELY MOTION SENSITIVE SECURITY LIGHTING; COMPONENT PARTS FOR ALL THE AFORESAID GOODS, IN CLASS 9 (U.S. CLS. 21, 23, 26, 36 AND 38).

FOR: LIGHTING APPARATUS AND INSTALLATIONS, NAMELY, ELECTRIC LIGHT FIXTURES, WALL LIGHTS, SPOT LIGHTS, DOWN LIGHTS, AMENITY LIGHTS, SHAVER LIGHTS, TRACK LIGHTS, DECORATIVE LIGHTING FIXTURES, STREET LIGHTING, PERIMETER LIGHTS, CEILING LIGHTS; LIGHTING FIXTURES, HEATING APPARATUS, NAMELY, HEATING INSTALLATIONS, HEATING ELEMENTS, HEATING FURNACES; VENTILATING APPARATUS AND INSTALLATIONS, NAMELY, VENTILATION HOODS AND VENTILATING EXHAUST FANS; LAMP HOLDERS BEING SCONCE LIGHTING FIXTURES, LAMPSHADE AND FLASH LIGHT HOLDERS; PENDANTS NAMELY CEILING AND WALL LIGHT FIXTURES AND LIGHT SHADES; ELECTRIC SURFACE HEATING TAPES; ELECTRIC COOLING AND VENTILATING FANS; COMPONENT PARTS FOR ALL THE AFORESAID GOODS, IN CLASS 11 (U.S. CLS. 13, 21, 23, 31 AND 34).

FOR: ELECTRICAL INSULATION TAPE; PVC ELECTRICAL TAPE; ADHESIVES, NAMELY, SILICONE BASED ADHESIVES FOR ELECTRICAL USE; ADHESIVE TAPES FOR INDUSTRIAL AND COMMERCIAL USE; SEALANTS, NAMELY, ADHESIVE SEALANTS FOR ELECTRICAL USE; ADHESIVE SEALANTS FOR GENERAL ELECTRICAL USE, IN CLASS 17 (U.S. CLS. 1, 5, 12, 13, 35 AND 50).

THE MARK CONSISTS OF STANDARD CHARACTERS WITHOUT CLAIM TO ANY PARTICULAR FONT, STYLE, SIZE, OR COLOR.

OWNER OF UNITED KINGDOM REG. NO. 2418131, DATED 10-20-2006, EXPIRES 3-30-2016.

SER. NO. 77-944,818, FILED 2-25-2010.

CHARLOTTE CORWIN, EXAMINING ATTORNEY

United States of America

United States Patent and Trademark Office

TM4

Reg. No. 4,065,137

Registered Dec. 6, 2011

**Int. Cls.: 7, 9, 12, 35, 37
and 40**

TRADEMARK

SERVICE MARK

PRINCIPAL REGISTER

TM4 INC. (CANADA CORPORATION)
SUITE 25, 135, J-A BOMBARDIER
BOUCHERVILLE, QUEBEC, CANADA J4B8P1

FOR: STARTERS FOR MOTORS FOR VEHICLES; ALTERNATORS FOR LAND VEHICLES; ELECTRODYNAMIC MOTORS FOR NON-LAND VEHICLES, NAMELY, WATERCRAFTS AND AIRCRAFTS; ON BOARD STARTER ALTERNATORS FOR USE IN THE TRANSPORTATION FIELD; ENERGY ALTERNATORS IN THE NATURE OF AC GENERATORS FOR USE IN THE FIELD OF POWER GENERATION; STARTERS FOR MOTORS AND ENGINES FOR USE IN THE TRANSPORTATION FIELD; STARTER ALTERNATORS FOR USE IN THE TRANSPORTATION FIELD; ELECTRODYNAMIC MACHINES IN THE NATURE OF GENERATORS OF ELECTRICITY FOR ENERGY GENERATION AND STRUCTURAL PARTS THEREFOR; LOW-VOLTAGE GENERATORS; HIGH-VOLTAGE GENERATORS; ENERGY GENERATORS FOR USE IN THE FIELD OF POWER GENERATION; DC/DC ELECTRIC VOLTAGE CONVERSION; MAGNET ROTOR FOR USE AS PARTS OF ELECTRIC MOTORS; ELECTRODYNAMIC MOTORS NOT FOR LAND VEHICLES, POWER ELECTRONICS IN THE NATURE OF ELECTRONIC POWER SUPPLIES FOR DRIVING ELECTRIC MOTORS, ELECTRICITY GENERATORS AND STRUCTURAL PARTS THEREFOR; AC GENERATORS; ELECTRIC GENERATORS; ONBOARD ELECTRICITY GENERATORS FOR USE IN THE TRANSPORTATION FIELD; DC GENERATORS; PORTABLE ELECTRIC POWER GENERATORS; CONTROL UNITS FOR REGULATING ELECTRONIC GENERATORS USED IN LAND VEHICLES, WATERCRAFT, PERSONAL BOATS, AIRCRAFT AND STRUCTURAL PARTS THEREFOR; GENERATOR SYSTEM CONTROL HARDWARE, NAMELY, HARDWARE USED TO MONITOR AND CONTROL THE STATUS OF GENERATORS USED IN LAND VEHICLES, PERSONAL WATERCRAFT, BOATS AND AIRCRAFT; MACHINE PARTS, NAMELY, STATOR ASSEMBLIES; AUXILIARY POWER UNITS, NAMELY, GENERATORS FOR SUPPLYING ELECTRICAL POWER FOR HEATING, CHARGING THE BATTERY OR ENERGIZING OTHER COMPONENTS; HYBRID MOTORS, NOT FOR LAND VEHICLES; COIL WINDING MACHINES, COIL WINDING WIRES, INTERNAL COMBUSTION ENGINES LAND VEHICLE PARTS, NAMELY, COILS, IN CLASS 7 (U.S. CLS. 13, 19, 21, 23, 31, 34 AND 35).

FOR: INVERTERS; POWER ELECTRONIC INVERTERS; ELECTRONIC MODULES IN THE NATURE OF ELECTRICAL POWER DISTRIBUTION UNITS USED TO RECHARGE BATTERIES; POWER ELECTRONIC CONVERTERS; DIAGNOSTIC COMPUTER SOFTWARE FOR USE IN TESTING AND DIAGNOSING PROBLEMS WITH VEHICLES, MOTORS, ELECTRODYNAMIC MOTORS, POWER ELECTRONICS, GENERATORS AND PARTS AND



David J. Kybas

Director of the United States Patent and Trademark Office

Reg. No. 4,065,137 COMPONENTS THEREFOR; DIAGNOSTIC SYSTEM COMPRISED OF COMPUTER HARDWARE AND COMPUTER SOFTWARE THAT IS CONNECTED TO A PC FOR READING, COMMANDING AND WRITING INFORMATION TO VEHICLE ELECTRONIC CONTROL UNITS FOR THE PURPOSE OF VEHICLE AND MOTOR REPAIR DIAGNOSTICS; BATTERY RANGE EXTENDERS IN THE NATURE OF CHARGERS FOR USE IN THE TRANSPORTATION FIELD; ELECTRONIC CONTROL UNITS FOR USE IN LAND AND NON-LAND VEHICLES TO CONTROL ELECTRONIC DEVICES OF A VEHICLE; MOTOR SYSTEM CONTROL HARDWARE, NAMELY, ELECTRONIC CONTROLS FOR MOTORS; MOTOR SYSTEM CONTROL SOFTWARE, NAMELY, SOFTWARE THAT MONITORS ENGINE PERFORMANCE AND DELIVERS RECALCULATED SENSOR VALUES TO THE ORIGINAL ENGINE CONTROL UNIT TO CONTROL ENGINE PERFORMANCE; ELECTRONIC MOTOR VEHICLE IGNITION TUNING KITS COMPRISED OF AN ELECTRONIC CONTROL UNIT THAT MONITORS MOTOR PERFORMANCES AND DELIVERS RE-CALCULATED SENSOR VALUES TO THE ORIGINAL MOTOR CONTROL UNIT TO INCREASE MOTOR PERFORMANCE; COMPUTER SOFTWARE FOR USE IN ALTERNATOR SYSTEM CONTROL IN LAND VEHICLES; ELECTRICAL CONTROLLERS FOR USE AS ELECTRONIC ALTERNATOR SYSTEM CONTROL UNITS AND STRUCTURAL PARTS THEREFOR; ALTERNATOR SYSTEM CONTROL HARDWARE, NAMELY, ELECTRONIC CONTROLS FOR ALTERNATORS; CONTROL UNITS FOR REGULATING START-UP ELECTRICAL MOTORS, NAMELY, ELECTRONIC CONTROLS FOR MOTORS; COMPUTER SOFTWARE FOR USE IN CONTROLLING AND REGULATING THE OUTPUT OF AN ELECTRIC GENERATOR SYSTEM; ELECTRONIC CONTROLS FOR MOTORS, IN CLASS 9 (U.S. CLS. 21, 23, 26, 36 AND 38).

FOR: MOTORS FOR VEHICLES AND STRUCTURAL PARTS THEREFOR; WHEEL MOTORS FOR LAND VEHICLES; HUB MOTORS FOR LAND VEHICLES; HYBRID MOTORS FOR LAND VEHICLES; ELECTRODYNAMIC MOTORS FOR LAND VEHICLES AND STRUCTURAL PARTS THEREFOR; HYBRID MOTORS, NAMELY, COMBINED MOTOR AND GENERATOR FOR LAND VEHICLES; ELECTROMAGNETIC CLUTCHES FOR LAND VEHICLES; ELECTRODYNAMIC POWER TRAIN SYSTEMS FOR VEHICLES COMPRISED OF CLUTCH, TRANSMISSION, DRIVE SHAFT AND DIFFERENTIAL , IN CLASS 12 (U.S. CLS. 19, 21, 23, 31, 35 AND 44).

FOR: ADVERTISING AND MARKETING; ARRANGING AND CONDUCTING TRADE SHOWS AND EXHIBITIONS IN THE FIELDS OF VEHICLES, ELECTRODYNAMIC MOTORS, POWER ELECTRONICS, GENERATORS; PROVIDING TRADE INFORMATION VIA A GLOBAL COMPUTER NETWORK IN THE FIELDS OF VEHICLES, ELECTRODYNAMIC MOTORS, POWER ELECTRONICS AND GENERATORS; BUSINESS CONSULTING SERVICES, NAMELY, PROVIDING ASSISTANCE IN DEVELOPMENT OF GENERATORS AND MOTORS; SPONSORING TRADE SHOWS AND DEMONSTRATION VEHICLES, ELECTRIC MOTORS, ELECTRONIC POWER CONVERSION DEVICES AND ELECTRIC GENERATORS AND SPONSORING VEHICLES RACES, IN CLASS 35 (U.S. CLS. 100, 101 AND 102).

FOR: PROVIDING TECHNICAL SUPPORT, NAMELY, TECHNICAL ADVICE CONCERNING VEHICLE AND MOTOR INTEGRATION; PROVIDING TECHNICAL SUPPORT, NAMELY, TECHNICAL ADVICE CONCERNING POWER GENERATION INTEGRATION; REPAIRING, SERVICING AND RESTORING OF ELECTRODYNAMIC MOTORS, POWER ELECTRONICS, GENERATORS, MOTORS; REPAIRING VEHICLES ELECTRODYNAMIC MOTORS, POWER ELECTRONICS AND GENERATORS, IN CLASS 37 (U.S. CLS. 100, 103 AND 106).

FOR: MANUFACTURING TO THE ORDER AND SPECIFICATION OF OTHERS AND CUSTOM MANUFACTURING SERVICES, ALL IN THE FIELDS OF VEHICLES, ELECTRODYNAMIC MOTORS, POWER ELECTRONICS AND GENERATORS, IN CLASS 40 (U.S. CLS. 100, 103 AND 106).

THE MARK CONSISTS OF STANDARD CHARACTERS WITHOUT CLAIM TO ANY PARTICULAR FONT, STYLE, SIZE, OR COLOR.

Reg. No. 4,065,137 PRIORITY CLAIMED UNDER SEC. 44(D) ON CANADA APPLICATION NO. 1450167, FILED 9-1-2009, REG. NO. TMA789126, DATED 1-31-2011, EXPIRES 1-31-2026.

SER. NO. 77-945,428, FILED 2-25-2010.

ERNEST SHOSHO, EXAMINING ATTORNEY

United States of America

United States Patent and Trademark Office



Reg. No. 4,065,138

Registered Dec. 6, 2011

Int. Cl.: 25

TRADEMARK

PRINCIPAL REGISTER

TIRUMS, LEON A (UNITED STATES INDIVIDUAL), DBA MONTANA HOMEGROWN
2 CENTRAL AVE. EAST
CASCADE, MT 59421

FOR: ATHLETIC APPAREL, NAMELY, SHIRTS, PANTS, JACKETS, FOOTWEAR, HATS
AND CAPS, ATHLETIC UNIFORMS, IN CLASS 25 (U.S. CLS. 22 AND 39).

FIRST USE 1-1-2010; IN COMMERCE 1-1-2010.

NO CLAIM IS MADE TO THE EXCLUSIVE RIGHT TO USE "AMERICAN", APART FROM
THE MARK AS SHOWN.

THE COLOR(S) RED, WHITE, BLUE AND BLACK IS/ARE CLAIMED AS A FEATURE OF
THE MARK.

THE MARK CONSISTS OF RED, WHITE AND BLUE MARIJUANA LEAF OUTLINED IN
BLACK WITH THE WORDING "AMERICAN HOME GROWN" IN BLACK LETTERING IN
THE WHITE AREA.

SER. NO. 77-946,566, FILED 2-27-2010.

HEATHER SAPP, EXAMINING ATTORNEY



David J. Kyros

Director of the United States Patent and Trademark Office

United States of America

United States Patent and Trademark Office



Reg. No. 4,065,139

Registered Dec. 6, 2011

Int. Cls.: 6 and 12

TRADEMARK

PRINCIPAL REGISTER

RHINO RACK AUSTRALIA PTY LIMITED (AUSTRALIA LIMITED LIABILITY COMPANY)
3 PIKE STREET
RYDALMERE NSW, AUSTRALIA 2116

FOR: CONSTRUCTION ELEMENTS MADE OF METAL, NAMELY, CABLE STRAPS OF METAL; CONSTRUCTION ELEMENTS MADE OF METAL, NAMELY, STRAPS, BANDS, BRACES, CABLES AND HARNESSES IMPREGNATED WITH METAL AND STRAPS LINED WITH METAL; CONSTRUCTION ELEMENTS MADE OF METAL, NAMELY, METALLIC WEBBING STRAPS; METALLIC WEBBING BELTS FOR HANDLING LOADS; PROTECTIVE METAL EDGING FOR STRAPS, NAMELY, METAL BINDING STRIPS USED ON PACKAGING; BRACES, BELTS, BANDS, CABLES AND HARNESSES OF METAL IN THE NATURE OF METAL SLINGS FOR HANDLING LOADS; CAM BUCKLE TIGHTENERS OF METAL FOR SECURING LOADS PLACED ON LAND VEHICLES; PIPE CLAMPS OF METAL; WINCH TENSIONERS OF METAL FOR SECURING LOADS PLACED ON LAND VEHICLES; CONSTRUCTION ELEMENTS MADE OF METAL, NAMELY, STRAPS, BANDS, BRACES, CABLES AND HARNESSES REINFORCED WITH METAL, IN CLASS 6 (U.S. CLS. 2, 12, 13, 14, 23, 25 AND 50).

FIRST USE 5-16-2001; IN COMMERCE 5-16-2001.

FOR: AUTOMOTIVE STRUCTURAL PARTS AND ACCESSORIES, NAMELY, NON-ELECTRICAL AUTOMOTIVE ACCESSORIES, NAMELY, ROOF RACKS, SKI CARRIERS, WATER CRAFT CARRIERS, SPORTING GOODS CARRIERS, LADDER CARRIERS, BIKE CARRIERS, LUGGAGE CARRIERS, ROOF TOP BOXES AND MOUNTINGS FOR ROOF RACKS AND ROOF BARS; VEHICLE AND TRAILER HITCHES; TRAILER HITCH RECEIVERS, NAMELY, METAL LOCKING DEVICE FOR TRAILER HITCH COUPLERS; CARGO CARRIERS FOR VEHICLES AND TRAILERS; TRUCK BED EXTENDERS; TRAILERS FOR VEHICLES; AUTOMOTIVE STRUCTURAL PARTS, NAMELY, TRAILER HITCH MOUNTS AND BALLS, SWAY CONTROLS, HITCH BALLS, HITCH BALL COVERS, COUPLERS, SAFETY CHAINS, CLIPS, TOW HOOKS, PINTLE HOOKS, POLE TONGUE ADAPTERS, AND TOWING BARS; BICYCLE CARRIERS; BICYCLE CARRIER ADAPTERS; VEHICULAR TORSION HITCH KITS COMPRISED OF RECEIVER TUBING, RECEIVER TUBE COVERS, HOOK-UP BRACKETS AS STRUCTURAL PARTS OF HITCHES; AUTOMOTIVE STRUCTURAL PARTS, NAMELY, HITCH BOXES, BOLTS AND ANGLES; LICENSE PLATE BRACKETS, HOOD SHIELDS AS STRUCTURAL PARTS OF VEHICLES, AUTOMOTIVE STRUCTURAL PARTS, NAMELY, VEHICLE SIDE WINDOW VENT SHADES, TUBE STEPS, BRUSH BARS, TONNEAU COVERS, TRUCK BED COVERS, TAIL-LIGHT COVERS, VEHICLE SIDE WINDOW



David J. Kyros

Director of the United States Patent and Trademark Office

Reg. No. 4,065,139 LOUVRES, CARGO CARRIER NETS, CARGO BARRIERS, DOG GUARDS, ROOF RAILS, SIDE VIEW MIRRORS, RETRACTABLE AND FOLDABLE AWNINGS FOR VEHICLES, AND AWNINGS AND CANOPIES FOR VEHICLES; HUB CAPS; AUTOMOTIVE STRUCTURAL PARTS, NAMELY, VEHICULAR TRANSMISSION COOLERS AND MOUNTING BRACKETS THEREFOR, IN CLASS 12 (U.S. CLS. 19, 21, 23, 31, 35 AND 44).

FIRST USE 5-16-2001; IN COMMERCE 5-16-2001.

PRIORITY CLAIMED UNDER SEC. 44(D) ON ERPN CMNTY TM OFC APPLICATION NO. 008516163, FILED 8-28-2009, REG. NO. 008516163, DATED 9-16-2010, EXPIRES 8-28-2019.

THE COLOR(S) BLACK, WHITE AND BLUE IS/ARE CLAIMED AS A FEATURE OF THE MARK.

OWNER OF U.S. REG. NOS. 3,640,238 AND 3,640,239.

THE MARK CONSISTS OF THE IMAGE OF A BLACK AND WHITE RHINOCEROS IN A CIRCLE POSITIONED TO THE LEFT OF THE WORDING "RHINO-RACK", WHEREIN THE COLOR BLUE APPEARS IN VARIOUS SHADES IN THE WORDING AND IN THE BACKGROUND OF THE RHINOCEROS.

SER. NO. 77-947,036, FILED 3-1-2010.

TASNEEM HUSSAIN, EXAMINING ATTORNEY

United States of America

United States Patent and Trademark Office

THE ORGANIZER

Reg. No. 4,065,140

Registered Dec. 6, 2011

Int. Cl.: 35

SERVICE MARK

PRINCIPAL REGISTER

GAYLE HOLT BECKER (UNITED STATES INDIVIDUAL)
1310 JONES STREET, APT. 206
SAN FRANCISCO, CA 94109

FOR: BUSINESS MANAGEMENT CONSULTATION; BUSINESS AND PERSONAL ACCOUNTING; BOOKKEEPING; AND TAX PREPARATION SERVICES, IN CLASS 35 (U.S. CLS. 100, 101 AND 102).

FIRST USE 1-14-1984; IN COMMERCE 2-1-1984.

THE MARK CONSISTS OF STANDARD CHARACTERS WITHOUT CLAIM TO ANY PARTICULAR FONT, STYLE, SIZE, OR COLOR.

SEC. 2(F).

SER. NO. 77-949,982, FILED 3-3-2010.

TRACY FLETCHER, EXAMINING ATTORNEY



David J. Kyffers

Director of the United States Patent and Trademark Office

United States of America

United States Patent and Trademark Office



Reg. No. 4,065,141

Registered Dec. 6, 2011

Int. Cl.: 7

TRADEMARK

PRINCIPAL REGISTER

RLFSHOP, LLC (OHIO LIMITED LIABILITY COMPANY), DBA SHOPSMITH
6530 POE AVE.
DAYTON, OH 45414

FOR: DIGITAL VARIABLE RELUCTANCE MOTOR USED EXCLUSIVELY WITH THE SHOPSMITH MARK V/7 MULTI-PURPOSE WOODWORKING POWER TOOL PRIMARILY AS AN UPGRADE TO THE EXISTING MOTOR CONTAINED THEREIN, IN CLASS 7 (U.S. CLS. 13, 19, 21, 23, 31, 34 AND 35).

FIRST USE 7-14-2010; IN COMMERCE 7-14-2010.

OWNER OF U.S. REG. NOS. 530,111, 1,316,617, AND 1,354,841.

THE COLOR(S) RED, BLUE, BLACK, GREY AND WHITE IS/ARE CLAIMED AS A FEATURE OF THE MARK.

NO CLAIM IS MADE TO THE EXCLUSIVE RIGHT TO USE "POWER PRO", APART FROM THE MARK AS SHOWN.

THE MARK CONSISTS OF A SEMICIRCLE OUTLINED IN RED ENCLOSING AN IMAGE OF A BLUE AND BLACK SKY WITH WHITE LIGHTNING. ON THE BACKGROUND IS A CIRCULAR DESIGN WITH THE WORDS "SHOP SMITH" SHARING THE LETTER "S" WHERE THE WORDING IS IN WHITE AND OUTLINED IN GRAY AND THE CIRCULAR DESIGN IS OUTLINED IN GRAY ON THE OUTSIDE, THEN WHITE WITH A SEMI-CIRCULAR NOTCH AT THE TOP IN WHITE, AND THE CENTER OF THE CIRCULAR DESIGN IS IN THE COLOR RED. THE WORDS "POWERPRO" IN THE COLOR WHITE AND OUTLINED IN BLUE THEN GRAY SHADOW APPEAR BELOW THIS SLIGHTLY OBSTRUCTING THE BOTTOM OF THE CIRCULAR DESIGN." THE PICTURED MARK ILLUSTRATES A WHITE RECTANGLE SURROUNDING THE ABOVE DESCRIBED MARK. THE RECTANGLE IS FOR BACKGROUND PURPOSES ONLY AND IS EXCLUDED FROM THE MARK.

SER. NO. 77-950,219, FILED 3-4-2010.

CHARLOTTE CORWIN, EXAMINING ATTORNEY



David J. Kyjars

Director of the United States Patent and Trademark Office

United States of America

United States Patent and Trademark Office

GREEN CROP

Reg. No. 4,065,142

Registered Dec. 6, 2011

Int. Cl.: 1

TRADEMARK

PRINCIPAL REGISTER

PAN AMERICAN GRAIN CO., INC. (PUERTO RICO CORPORATION)
9 CLAUDIA ST., AMELIA INDUSTRIAL PARK
GUAYNABO, PUERTO RICO 00968

FOR: LIQUID, GRANULATED AND/OR PELLETIZED FERTILIZER AND FERTILIZERS IN GENERAL, IN CLASS 1 (U.S. CLS. 1, 5, 6, 10, 26 AND 46).

FIRST USE 8-29-1968; IN COMMERCE 8-29-1968.

THE MARK CONSISTS OF STANDARD CHARACTERS WITHOUT CLAIM TO ANY PARTICULAR FONT, STYLE, SIZE, OR COLOR.

SEC. 2(F).

SER. NO. 77-951,724, FILED 3-5-2010.

JOHN SCHUYLER YARD, EXAMINING ATTORNEY



David J. Kybas

Director of the United States Patent and Trademark Office

United States of America

United States Patent and Trademark Office

Alert, Review and Manage (ARM)

Reg. No. 4,065,143

Registered Dec. 6, 2011

Int. Cls.: 35 and 45

SERVICE MARK

PRINCIPAL REGISTER

MATRIX HEALTHCARE SERVICES, INC. (FLORIDA CORPORATION)
5706 BENJAMIN DRIVE, SUITE 103
TAMPA, FL 33634

FOR: BUSINESS MANAGEMENT AND CONSULTATION IN THE FIELD OF HEALTH CARE, PAIN MANAGEMENT, AND INJURY STATE MANAGEMENT CASES, IN CLASS 35 (U.S. CLS. 100, 101 AND 102).

FIRST USE 9-1-2005; IN COMMERCE 9-1-2005.

FOR: PROVIDING PATIENT ADVOCATE AND CASE MANAGEMENT SERVICES, NAMELY, COORDINATING THE PROCUREMENT AND ADMINISTRATION OF MEDICATION AND SERVICES VIA DIRECT INTERVENTION WITH THE PRESCRIBING PHYSICIAN, IN CLASS 45 (U.S. CLS. 100 AND 101).

FIRST USE 9-1-2005; IN COMMERCE 9-1-2005.

THE MARK CONSISTS OF STANDARD CHARACTERS WITHOUT CLAIM TO ANY PARTICULAR FONT, STYLE, SIZE, OR COLOR.

NO CLAIM IS MADE TO THE EXCLUSIVE RIGHT TO USE "ALERT, REVIEW AND MANAGE", APART FROM THE MARK AS SHOWN.

SER. NO. 77-953,905, FILED 3-9-2010.

ASMAT KHAN, EXAMINING ATTORNEY



David J. Kypos

Director of the United States Patent and Trademark Office

United States of America

United States Patent and Trademark Office



Reg. No. 4,065,144

Registered Dec. 6, 2011

Int. Cl.: 1

TRADEMARK

PRINCIPAL REGISTER

PAN AMERICAN GRAIN CO., INC. (PUERTO RICO CORPORATION)
9 CLAUDIA ST., AMELIA INDUSTRIAL PARK
GUAYNABO, PUERTO RICO 00968

FOR: LIQUID, GRANULATED AND/OR PELLETIZED FERTILIZER AND FERTILIZERS IN GENERAL, IN CLASS 1 (U.S. CLS. 1, 5, 6, 10, 26 AND 46).

FIRST USE 8-29-1968; IN COMMERCE 8-29-1968.

THE MARK CONSISTS OF THE WORD PHRASE "GREEN CROP" WRITTEN IN WHITE LETTERS. THE LETTER "G" IS SIMULATED BY A LEAF SHAPE. ALL AGAINST A GREEN BACKGROUND.

THE COLOR(S) GREEN AND WHITE IS/ARE CLAIMED AS A FEATURE OF THE MARK.

SEC. 2(F).

SER. NO. 77-954,303, FILED 3-9-2010.

JOHN SCHUYLER YARD, EXAMINING ATTORNEY



David J. Kyffers

Director of the United States Patent and Trademark Office

United States of America

United States Patent and Trademark Office

FPSuite

Reg. No. 4,065,145

Registered Dec. 6, 2011

Int. Cl.: 9

TRADEMARK

PRINCIPAL REGISTER

FPINNOVATIONS (CANADA CORPORATION)
580, BOULEVARD SAINT-JEAN
POINTE-CLAIRE, QUEBEC, CANADA H9R3J9

FOR: INTEGRATED PROCESS CONTROL PLATFORM FOR OPTIMIZATION OF FORESTRY OPERATIONS, NAMELY, COMPUTER HARDWARE AND SOFTWARE FOR HARVESTING, LOGISTICS AND TRANSPORTATION PLANNING, COMPUTER HARDWARE AND SOFTWARE FOR PLANNING, SCHEDULING, MONITORING OF SUPPLY CHAIN OPERATIONS IN REAL-TIME AND GENERATING KEY PERFORMANCE INDICATORS FOR CONTINUOUS IMPROVEMENT, IN CLASS 9 (U.S. CLS. 21, 23, 26, 36 AND 38).

THE MARK CONSISTS OF STANDARD CHARACTERS WITHOUT CLAIM TO ANY PARTICULAR FONT, STYLE, SIZE, OR COLOR.

PRIORITY CLAIMED UNDER SEC. 44(D) ON CANADA APPLICATION NO. 1451343, FILED 9-10-2009, REG. NO. TMA800451, DATED 6-21-2011, EXPIRES 6-21-2026.

OWNER OF U.S. REG. NOS. 3,738,576 AND 3,738,577.

NO CLAIM IS MADE TO THE EXCLUSIVE RIGHT TO USE "SUITE", APART FROM THE MARK AS SHOWN.

SER. NO. 77-955,159, FILED 3-10-2010.

LINDA ESTRADA, EXAMINING ATTORNEY



David J. Kybas

Director of the United States Patent and Trademark Office

United States of America

United States Patent and Trademark Office

LIPOCEUTICAL

Reg. No. 4,065,146

Registered Dec. 6, 2011

Int. Cls.: 1 and 5

TRADEMARK

PRINCIPAL REGISTER

YOUR ENERGY SYSTEMS, LLC (CALIFORNIA LIMITED LIABILITY COMPANY)
SUITE 303
555 BRYANT ST.
PALO ALTO, CA 94301

FOR: ANTIOXIDANTS AND PROTEINS USED IN THE MANUFACTURE OF COSMETICS, BEVERAGES, FOOD PRODUCTS AND FOOD SUPPLEMENTS, IN CLASS 1 (U.S. CLS. 1, 5, 6, 10, 26 AND 46).

FIRST USE 7-29-2004; IN COMMERCE 7-29-2004.

FOR: DIETARY AND NUTRITIONAL SUPPLEMENTS, IN CLASS 5 (U.S. CLS. 6, 18, 44, 46, 51 AND 52).

FIRST USE 7-29-2004; IN COMMERCE 7-29-2004.

THE MARK CONSISTS OF STANDARD CHARACTERS WITHOUT CLAIM TO ANY PARTICULAR FONT, STYLE, SIZE, OR COLOR.

SER. NO. 77-959,738, FILED 3-16-2010.

RUDY R. SINGLETON, EXAMINING ATTORNEY



David J. Kyros

Director of the United States Patent and Trademark Office

United States of America

United States Patent and Trademark Office

CLEAR BLUE

Reg. No. 4,065,147

Registered Dec. 6, 2011

Int. Cl.: 3

TRADEMARK

PRINCIPAL REGISTER

ZEP IP HOLDING LLC (GEORGIA LIMITED LIABILITY COMPANY)
1310 SEABOARD INDUSTRIAL BOULEVARD
ATLANTA, GA 30318

FOR: DETERGENT FOR COOKWARE, NAMELY, POTS AND PANS, IN CLASS 3 (U.S. CLS. 1, 4, 6, 50, 51 AND 52).

FIRST USE 11-0-2008; IN COMMERCE 11-0-2008.

THE MARK CONSISTS OF STANDARD CHARACTERS WITHOUT CLAIM TO ANY PARTICULAR FONT, STYLE, SIZE, OR COLOR.

NO CLAIM IS MADE TO THE EXCLUSIVE RIGHT TO USE "BLUE", APART FROM THE MARK AS SHOWN.

SER. NO. 77-960,873, FILED 3-17-2010.

STEPHANIE ALI, EXAMINING ATTORNEY



David J. Kybas

Director of the United States Patent and Trademark Office

United States of America

United States Patent and Trademark Office

VV SUPREMO

Reg. No. 4,065,148

Registered Dec. 6, 2011

Int. Cls.: 29 and 30

TRADEMARK

PRINCIPAL REGISTER

V&V SUPREMO FOODS, INC. (ILLINOIS CORPORATION)
2141 S. THROOP ST.
CHICAGO, IL 60608

FOR: CHEESE, SOUR CREAM, CHORIZO, IN CLASS 29 (U.S. CL. 46).

FIRST USE 1-31-1984; IN COMMERCE 1-31-1984.

FOR: SOPES, FLAN, FLAVORED AND SWEETENED GELATINS , IN CLASS 30 (U.S. CL. 46).

FIRST USE 11-10-2009; IN COMMERCE 11-10-2009.

THE MARK CONSISTS OF STANDARD CHARACTERS WITHOUT CLAIM TO ANY PARTICULAR FONT, STYLE, SIZE, OR COLOR.

OWNER OF U.S. REG. NOS. 1,928,829, 2,072,917, AND 2,547,216.

THE ENGLISH TRANSLATION OF "SUPREMO" IN THE MARK IS SUPREME.

SEC. 2(F) AS TO "SUPREMO".

SER. NO. 77-961,264, FILED 3-17-2010.

MARGARET POWER, EXAMINING ATTORNEY



David J. Kybas

Director of the United States Patent and Trademark Office

United States of America

United States Patent and Trademark Office



Reg. No. 4,065,149

Registered Dec. 6, 2011

Int. Cls.: 9, 16, 28 and 41

TRADEMARK

SERVICE MARK

PRINCIPAL REGISTER

V&S ENTERTAINMENT LTD (UNITED KINGDOM COMPANY)
LEE COMMON
VGI HOUSE, BALLINGER ROAD
GT MISSENDEN, BUCKS HP16 9LA, UNITED KINGDOM

FOR: AUDIO VISUAL RECORDINGS FEATURING CHILDREN'S TELEVISION PROGRAMS, CHILDREN'S ENTERTAINMENT, ANIMATION, MOTION PICTURES FILMS AND FILMS FOR TELEVISION FEATURING CHILDREN'S ENTERTAINMENT; MOTION PICTURE FILMS FEATURING CHILDREN'S ENTERTAINMENT; SOUND RECORDINGS FEATURING MUSIC, SPOKEN WORD IN THE FIELD OF CHILDREN ENTERTAINMENT, CHILDREN'S SONGS, CHILDREN'S STORIES, SOUNDTRACKS FROM TELEVISION PROGRAMS AND MOTION PICTURE FILMS, AND CHILDREN'S ENTERTAINMENT CONTENT; DOWNLOADABLE AUDIO VISUAL RECORDINGS, FEATURING CHILDREN'S TELEVISION PROGRAMS, CHILDREN'S ENTERTAINMENT, ANIMATION, MOTION PICTURES FILMS AND FILMS FOR TELEVISION FEATURING CHILDREN'S ENTERTAINMENT; DOWNLOADABLE SOUND RECORDINGS FEATURING MUSIC, SPOKEN WORD IN THE FIELD OF CHILDREN ENTERTAINMENT, CHILDREN'S SONGS, CHILDREN'S STORIES, SOUNDTRACKS FROM TELEVISION PROGRAMS AND MOTION PICTURES, AND CHILDREN'S ENTERTAINMENT CONTENT; DOWNLOADABLE ELECTRONIC GAME PROGRAMS, MOTION PICTURE FILMS FEATURING ANIMATION AND CHILDREN'S ENTERTAINMENT, MOTION PICTURE FILMS IN THE FIELD OF CHILDREN'S ENTERTAINMENT, DOWNLOADABLE TELEVISION SHOWS IN THE FIELD OF CHILDREN'S ENTERTAINMENT, ELECTRONIC PUBLICATIONS IN THE NATURE OF BOOKS, MAGAZINES, AND STORIES IN THE FIELD OF CHILDREN'S ENTERTAINMENT RECORDED ON COMPUTER MEDIA; DOWNLOADABLE ELECTRONIC PUBLICATIONS IN THE NATURE OF BOOKS, MAGAZINES, AND STORIES IN THE FIELD OF CHILDREN'S ENTERTAINMENT; DOWNLOADABLE ELECTRONIC SHEET MUSIC; DOWNLOADABLE ELECTRONIC POSTERS; PROTECTIVE COVERS AND CASES SPECIFICALLY ADAPTED FOR CELL PHONES, AND PERSONAL ELECTRONIC DEVICES AND LAPTOPS, IN CLASS 9 (U.S. CLS. 21, 23, 26, 36 AND 38).



David J. Kybas

Director of the United States Patent and Trademark Office

FOR: PRINTED PUBLICATIONS, NAMELY, CHILDREN'S BOOKS, CHILDREN'S ACTIVITIES BOOKS, COLORING BOOKS, A SERIES OF FICTION BOOKS FEATURING CHILDREN'S STORIES, SONGBOOKS, STORYBOOKS, TALKING CHILDREN'S BOOKS, DIARIES, BLANK JOURNALS, PERSONALIZED WRITING JOURNALS, CARTOON STRIPS, BOOKS WITH CARTOONS, MAGAZINES FEATURING CHILDREN'S STORIES, MAGAZINES FOR CHILDREN; PAPER PARTY SUPPLIES, NAMELY, PAPER PARTY BAGS, PAPER PARTY DECORATIONS, PAPER PARTY FAVORS, PAPER NAPKINS, PAPER TABLECLOTHS, WRAP-

Reg. No. 4,065,149 PING AND PACKING PAPER; SCHOOL SUPPLIES, NAMELY, STATIONERY, NOTE PADS, LOOSE LEAF BINDERS, NOTEBOOKS; POSTERS; GREETING CARDS; STICKERS; PHOTOGRAPHS; ARTWORK, NAMELY, PRINTED GRAPHIC WORKS OF ART, PRINTED HOLOGRAMS, AND GRAPHIC PRINTS AND REPRESENTATIONS; STENCILS, IN CLASS 16 (U.S. CLS. 2, 5, 22, 23, 29, 37, 38 AND 50).

FOR: TOYS AND GAMES, NAMELY, DOLLS, PLUSH DOLLS, PLUSH TOYS, RAG DOLLS, PORCELAIN DOLLS, BOARD GAMES, PARTY GAMES, PLAYING CARDS, AND CARD GAMES, IN CLASS 28 (U.S. CLS. 22, 23, 38 AND 50).

FOR: ENTERTAINMENT SERVICES, NAMELY, AN ON-GOING SERIES OF TELEVISION PROGRAMS FEATURING CHILDREN'S ENTERTAINMENT AND ANIMATION, AN ON-GOING SERIES OF MOTION PICTURES FEATURING CHILDREN'S ENTERTAINMENT AND ANIMATION, AN ON-GOING SERIES OF RADIO PROGRAMS FEATURING CHILDREN'S ENTERTAINMENT, PROVIDING A WEBSITE FEATURING ENTERTAINMENT INFORMATION ON A CHILDREN'S TELEVISION PROGRAM AND ITS CHARACTERS, VIDEO CLIPS WITH CHILDREN'S ENTERTAINMENT, NON-DOWNLOADABLE AUDIO VISUAL RECORDINGS AND SOUND RECORDINGS FEATURING CHILDREN'S ENTERTAINMENT, AND EPISODES AND PORTIONS OF EPISODES FROM A CHILDREN'S TELEVISION PROGRAM; MOTION PICTURE FILM PRODUCTION, PRODUCTION OF TELEVISION PROGRAMS, IN CLASS 41 (U.S. CLS. 100, 101 AND 107).

PRIORITY CLAIMED UNDER SEC. 44(D) ON ERPN CMNTY TM OFC APPLICATION NO. 008925604, FILED 3-3-2010, REG. NO. 008925604, DATED 10-13-2010, EXPIRES 3-3-2020.

THE COLOR(S) PURPLE, BLUE, BROWN, LIGHT BROWN, GREEN, PINK, WHITE, RED, YELLOW, TURQUOISE, PEACH, ORANGE, AND BLACK IS/ARE CLAIMED AS A FEATURE OF THE MARK.

THE MARK CONSISTS OF A PURPLE CIRCLE OUTLINING A BLUE BEAR WEARING A BROWN SWEATER WITH A TOUCAN ON ITS SHOULDER IN THE COLORS BLUE, YELLOW, PINK WITH ORANGE FEET AND BLACK EYES, THREE ACORNS (ONE LIGHT BROWN, ONE GREEN AND BROWN, AND ONE GREEN) ON THE GROUND, A GIRL IN A PINK OUTFIT AND SHOES, A PURPLE BOW IN HER HAIR AND PURPLE EYES, ANOTHER GIRL CHARACTER WITH A WHITE AND RED OUTFIT WITH RED SHOES AND YELLOW LACES, MULTI-COLORED HAIR IN THE COLORS RED, ORANGE, GREEN, YELLOW, BLUE, PURPLE, PINK, TURQUOISE WITH A GREEN BUTTON IN IT, AND BLUE EYES, A TURQUOISE RABBIT WITH BLACK EYES, A RED AND PEACH BUTTON AND YELLOW ZIPPER, A BOY CHARACTER WEARING A RED AND BLUE SHIRT, BLUE JEANS AND RED AND WHITE SHOES, WITH RED STRIPS OF HAIR, BROWN EYES, AND HOLDING A RED AND GREEN SOCCER BALL, AND AN OAK TREE WITH FACIAL CHARACTERISTICS WITH A BROWN TRUNK AND GREEN FOLIAGE. ALL OF THESE CHARACTERS ARE ON A PURPLE BACKGROUND WITH A HORIZONTAL STRIP OF YELLOW CUTTING THROUGH THE LOWER THIRD OF THE SCENE. IN THE UPPER THIRD OF THE SCENE IS THE STYLIZED WORDING EVERYTHING'S IN THE COLOR PURPLE ABOVE THE MULTI-COLORED STYLIZED WORD "ROSIE " IN THE COLORS RED, YELLOW, BLUE, PURPLE, PINK, GREEN, AND TURQUOISE. THE DOT ABOVE THE "I" IN THE WORD "ROSIE" IS A DESIGN OF A BUTTON.

SER. NO. 77-962,681, FILED 3-18-2010.

DARRYL SPRUILL, EXAMINING ATTORNEY

United States of America

United States Patent and Trademark Office



Reg. No. 4,065,150

Registered Dec. 6, 2011

Int. Cls.: 9, 16, 28 and 41

TRADEMARK

SERVICE MARK

PRINCIPAL REGISTER

V&S ENTERTAINMENT LTD (UNITED KINGDOM COMPANY)
LEE COMMON
VGI HOUSE, BALLINGER ROAD
GT MISSENDEN, BUCKS HP16 9LA, UNITED KINGDOM

FOR: AUDIO VISUAL RECORDINGS FEATURING CHILDREN'S TELEVISION PROGRAMS, CHILDREN'S ENTERTAINMENT, ANIMATION, MOTION PICTURES FILMS AND FILMS FOR TELEVISION FEATURING CHILDREN'S ENTERTAINMENT; MOTION PICTURE FILMS FEATURING CHILDREN'S ENTERTAINMENT; SOUND RECORDINGS FEATURING MUSIC, SPOKEN WORD IN THE FIELD OF CHILDREN ENTERTAINMENT, CHILDREN'S SONGS, CHILDREN'S STORIES, SOUNDTRACKS FROM TELEVISION PROGRAMS AND MOTION PICTURE FILMS, AND CHILDREN'S ENTERTAINMENT CONTENT; DOWNLOADABLE AUDIO VISUAL RECORDINGS, FEATURING CHILDREN'S TELEVISION PROGRAMS, CHILDREN'S ENTERTAINMENT, ANIMATION, MOTION PICTURES FILMS AND FILMS FOR TELEVISION FEATURING CHILDREN'S ENTERTAINMENT; DOWNLOADABLE SOUND RECORDINGS FEATURING MUSIC, SPOKEN WORD IN THE FIELD OF CHILDREN ENTERTAINMENT, CHILDREN'S SONGS, CHILDREN'S STORIES, SOUNDTRACKS FROM TELEVISION PROGRAMS AND MOTION PICTURES, AND CHILDREN'S ENTERTAINMENT CONTENT; DOWNLOADABLE ELECTRONIC GAME PROGRAMS, MOTION PICTURE FILMS FEATURING ANIMATION AND CHILDREN'S ENTERTAINMENT, MOTION PICTURE FILMS IN THE FIELD OF CHILDREN'S ENTERTAINMENT, DOWNLOADABLE TELEVISION SHOWS IN THE FIELD OF CHILDREN'S ENTERTAINMENT, ELECTRONIC PUBLICATIONS IN THE NATURE OF BOOKS, MAGAZINES, AND STORIES IN THE FIELD OF CHILDREN'S ENTERTAINMENT RECORDED ON COMPUTER MEDIA; DOWNLOADABLE ELECTRONIC PUBLICATIONS IN THE NATURE OF BOOKS, MAGAZINES, AND STORIES IN THE FIELD OF CHILDREN'S ENTERTAINMENT; DOWNLOADABLE ELECTRONIC SHEET MUSIC; DOWNLOADABLE ELECTRONIC POSTERS; PROTECTIVE COVERS AND CASES SPECIFICALLY ADAPTED FOR CELL PHONES, AND PERSONAL ELECTRONIC DEVICES AND LAPTOPS, IN CLASS 9 (U.S. CLS. 21, 23, 26, 36 AND 38).



David J. Kappas

Director of the United States Patent and Trademark Office

FOR: PRINTED PUBLICATIONS, NAMELY, CHILDREN'S BOOKS, CHILDREN'S ACTIVITIES BOOKS, COLORING BOOKS, A SERIES OF FICTION BOOKS FEATURING CHILDREN'S STORIES, SONGBOOKS, STORYBOOKS, TALKING CHILDREN'S BOOKS, DIARIES, BLANK JOURNALS, PERSONALIZED WRITING JOURNALS, CARTOON STRIPS, BOOKS WITH CARTOONS, MAGAZINES FEATURING CHILDREN'S STORIES, MAGAZINES FOR CHILDREN; PAPER PARTY SUPPLIES, NAMELY, PAPER PARTY BAGS, PAPER PARTY DECORATIONS, PAPER PARTY FAVORS, PAPER NAPKINS, PAPER TABLECLOTHS, WRAP-

Reg. No. 4,065,150 PING AND PACKING PAPER; SCHOOL SUPPLIES, NAMELY, STATIONERY, NOTE PADS, LOOSE LEAF BINDERS, NOTEBOOKS; POSTERS; GREETING CARDS; STICKERS; PHOTOGRAPHS; ARTWORK, NAMELY, PRINTED GRAPHIC WORKS OF ART, PRINTED HOLOGRAMS, AND GRAPHIC PRINTS AND REPRESENTATIONS; STENCILS, IN CLASS 16 (U.S. CLS. 2, 5, 22, 23, 29, 37, 38 AND 50).

FOR: TOYS AND GAMES, NAMELY, DOLLS, PLUSH DOLLS, PLUSH TOYS, RAG DOLLS, PORCELAIN DOLLS, BOARD GAMES, PARTY GAMES, PLAYING CARDS, AND CARD GAMES, IN CLASS 28 (U.S. CLS. 22, 23, 38 AND 50).

FOR: ENTERTAINMENT SERVICES, NAMELY, AN ON-GOING SERIES OF TELEVISION PROGRAMS FEATURING CHILDREN'S ENTERTAINMENT AND ANIMATION, AN ON-GOING SERIES OF MOTION PICTURES FEATURING CHILDREN'S ENTERTAINMENT AND ANIMATION, AN ON-GOING SERIES OF RADIO PROGRAMS FEATURING CHILDREN'S ENTERTAINMENT, PROVIDING A WEBSITE FEATURING ENTERTAINMENT INFORMATION ON A CHILDREN'S TELEVISION PROGRAM AND ITS CHARACTERS, VIDEO CLIPS WITH CHILDREN'S ENTERTAINMENT, NON-DOWNLOADABLE AUDIO VISUAL RECORDINGS AND SOUND RECORDINGS FEATURING CHILDREN'S ENTERTAINMENT, AND EPISODES AND PORTIONS OF EPISODES FROM A CHILDREN'S TELEVISION PROGRAM; MOTION PICTURE FILM PRODUCTION, PRODUCTION OF TELEVISION PROGRAMS, IN CLASS 41 (U.S. CLS. 100, 101 AND 107).

PRIORITY CLAIMED UNDER SEC. 44(D) ON ERPN CMNTY TM OFC APPLICATION NO. 008925646, FILED 3-3-2010, REG. NO. 008925646, DATED 9-20-2010, EXPIRES 3-3-2020.

THE COLOR(S) PURPLE, BLUE, BROWN, LIGHT BROWN, GREEN, PINK, WHITE, RED, YELLOW, TURQUOISE, PEACH, ORANGE, AND BLACK IS/ARE CLAIMED AS A FEATURE OF THE MARK.

THE MARK CONSISTS OF A PURPLE CIRCLE OUTLINING A BLUE BEAR WEARING A BROWN SWEATER WITH A TOUCAN ON ITS SHOULDER IN THE COLORS BLUE, YELLOW, PINK WITH ORANGE FEET AND BLACK EYES, THREE ACORNS (ONE LIGHT BROWN, ONE GREEN AND BROWN, AND ONE GREEN) ON THE GROUND, A GIRL IN A PINK OUTFIT AND SHOES, A PURPLE BOW IN HER HAIR AND PURPLE EYES, ANOTHER GIRL CHARACTER WITH A WHITE AND RED OUTFIT WITH RED SHOES AND YELLOW LACES, MULTI-COLORED HAIR IN THE COLORS RED, ORANGE, GREEN, YELLOW, BLUE, PURPLE, PINK, TURQUOISE WITH A GREEN BUTTON IN IT, AND BLUE EYES, A TURQUOISE RABBIT WITH BLACK EYES, A RED AND PEACH BUTTON AND YELLOW ZIPPER, A BOY CHARACTER WEARING A RED AND BLUE SHIRT, BLUE JEANS AND RED AND WHITE SHOES, WITH RED STRIPS OF HAIR, BROWN EYES, AND HOLDING A RED AND GREEN SOCCER BALL, AND AN OAK TREE WITH FACIAL CHARACTERISTICS WITH A BROWN TRUNK AND GREEN FOLIAGE. ALL OF THESE CHARACTERS ARE ON A PURPLE BACKGROUND WITH A HORIZONTAL STRIP OF YELLOW CUTTING THROUGH THE LOWER THIRD OF THE SCENE. IN THE UPPER THIRD OF THE SCENE ARE THE MULTI-COLORED, STYLIZED WORDS "ROSIE AND RAGGLES" IN THE COLORS RED, YELLOW, BLUE, PURPLE, PINK, GREEN, AND TURQUOISE. THE DOT ABOVE THE "I" IN THE WORD "ROSIE" IS A DESIGN OF A BUTTON.

SER. NO. 77-962,698, FILED 3-18-2010.

DARRYL SPRUILL, EXAMINING ATTORNEY

United States of America

United States Patent and Trademark Office



Reg. No. 4,065,151

Registered Dec. 6, 2011

Int. Cls.: 7, 9 and 11

TRADEMARK

PRINCIPAL REGISTER

EBM-PAPST MULFINGEN GMBH & CO. KG (FED REP GERMANY CORPORATION)
BACHMUHLE 2
MULFINGEN, FED REP GERMANY 74673

FOR: ELECTRIC DRIVE MOTORS, OTHER THAN FOR LAND VEHICLES; ELECTRIC FANS, VENTILATORS AND BLOWERS FOR MOTORS AND ENGINES; ELECTRIC MOTOR-OPERATED PUMPS, IN CLASS 7 (U.S. CLS. 13, 19, 21, 23, 31, 34 AND 35).

FOR: REGULATING APPARATUS AND CONTROL APPARATUS, NAMELY, APPARATUS AND INSTRUMENTS FOR CONVEYING, DISTRIBUTING, TRANSFORMING, STORING OR CONTROLLING ELECTRIC CURRENT; ELECTRONIC COMMUTATION CIRCUITS FOR MOTORS, IN CLASS 9 (U.S. CLS. 21, 23, 26, 36 AND 38).

FOR: HEATING APPARATUS, NAMELY, ELECTRIC HEATING FANS, ELECTRIC SPACE HEATERS, CENTRAL HEATING RADIATORS, ELECTRIC HEATING AIR BLOWERS; AIR COOLING APPARATUS; DRYING APPARATUS FOR USE IN HEATING, VENTILATION SYSTEMS, AIR CONDITIONING SYSTEMS AND REFRIGERATING SYSTEMS; ELECTRIC HOT AIR HAND DRYERS; HAIR DRYERS FOR HOUSEHOLD PURPOSES; INDUSTRIAL DISH DRYING MACHINES; INDUSTRIAL DRYERS FOR HEATING AND DEHUMIDIFYING; CLOTHES DRYING MACHINES; INDUSTRIAL APPARATUS USING AIR FOR DRYING COMPONENTS IN THE ELECTRONICS, SEMICONDUCTOR, CIRCUIT BOARD, PHARMACEUTICAL, MEDICAL, AND FOOD BEVERAGES INDUSTRIES; VENTILATING APPARATUS, NAMELY, VENTILATING FANS FOR COMMERCIAL AND INDUSTRIAL USE, VENTILATING EXHAUST FANS, HOT AIR BLOWERS, ELECTRIC FANS; AIR CONDITIONING APPARATUS; COOLING UNITS FOR INDUSTRIAL PURPOSES, HEATING UNITS FOR INDUSTRIAL PURPOSES; EXTRACTOR HOODS FOR KITCHEN, VENTILATION HOODS; CHEST FREEZERS, REFRIGERATORS, REFRIGERATING CABINETS, REFRIGERATING DISPLAY CABINETS, IN CLASS 11 (U.S. CLS. 13, 21, 23, 31 AND 34).



PRIORITY CLAIMED UNDER SEC. 44(D) ON FED REP GERMANY APPLICATION NO. 302009056692, FILED 9-22-2009, REG. NO. 302009056692, DATED 12-18-2009, EXPIRES 9-30-2019.

David J. Kyros

Director of the United States Patent and Trademark Office

THE COLOR(S) GREEN AND WHITE IS/ARE CLAIMED AS A FEATURE OF THE MARK.

NO CLAIM IS MADE TO THE EXCLUSIVE RIGHT TO USE "GREEN TECH", APART FROM THE MARK AS SHOWN.

Reg. No. 4,065,151 THE MARK CONSISTS OF A GREEN CIRCULAR DEVICE HAVING THE WORDS "GREEN
TECH" IN WHITE AND A CHECK MARK IN WHITE.

SER. NO. 77-963,515, FILED 3-19-2010.

JESSICA A. POWERS, EXAMINING ATTORNEY

United States of America

United States Patent and Trademark Office

Balázs

Reg. No. 4,065,152

Registered Dec. 6, 2011

Int. Cl.: 20

TRADEMARK

PRINCIPAL REGISTER

STAVE WORLDWIDE, LLC (NORTH CAROLINA LIMITED LIABILITY COMPANY)
1959 N PEACE HAVEN RD #173
WINSTON-SALEM, NC 27106

FOR: WOOD BARRELS, IN CLASS 20 (U.S. CLS. 2, 13, 22, 25, 32 AND 50).

FIRST USE 1-10-2006; IN COMMERCE 1-10-2006.

THE MARK CONSISTS OF A STYLIZED REPRESENTATION OF THE WORD "BALÁZS"
USING MODIFIED RAPIER FONT.

SEC. 2(F).

SER. NO. 77-964,228, FILED 3-21-2010.

MARY ROSSMAN, EXAMINING ATTORNEY



David J. Kyros

Director of the United States Patent and Trademark Office

United States of America

United States Patent and Trademark Office



Reg. No. 4,065,153

Registered Dec. 6, 2011

Int. Cl.: 4

TRADEMARK

PRINCIPAL REGISTER

SWEETWAXATIONS (MARYLAND LIMITED LIABILITY COMPANY)
2622 COOL SPRING ROAD
BEL AIR, MD 21015

FOR: CANDLES, IN CLASS 4 (U.S. CLS. 1, 6 AND 15).

FIRST USE 9-1-2009; IN COMMERCE 10-2-2009.

THE MARK CONSISTS OF THE WORDS "SWEET WAXATIONS," WITH THE WORD "SWEET" IN BROWN CURSIVE AND THE WORDS "WAXATIONS" IN THE COLORS FUCHSIA, LIGHT BLUE, GREEN AND PINK. THE DESIGN APPEARING TO THE RIGHT OF THESE WORDS CONSISTS OF FOUR CIRCLES APPEARING IN PINK, LIGHT BLUE, LIGHT GREEN AND FUCHSIA. THE WORDS "NAME YOUR FLAME" APPEAR IN BROWN, EACH WORD PLACED IN THE FIRST THREE CIRCLES, WITH A DESIGN OF A BROWN FLAME APPEARING INSIDE THE FOURTH CIRCLE.

THE COLOR(S) PINK, GREEN, BROWN, FUCHSIA, LIGHT GREEN, AND LIGHT BLUE IS/ARE CLAIMED AS A FEATURE OF THE MARK.

SER. NO. 77-964,926, FILED 3-22-2010.

GISELLE AGOSTO, EXAMINING ATTORNEY



David J. Kyffers

Director of the United States Patent and Trademark Office

United States of America

United States Patent and Trademark Office



Reg. No. 4,065,154

Registered Dec. 6, 2011

Int. Cls.: 7, 9 and 11

TRADEMARK

PRINCIPAL REGISTER

EBM-PAPST MULFINGEN GMBH & CO. KG (FED REP GERMANY CORPORATION)
BACHMÜHLE 2
MULFINGEN, FED REP GERMANY 74673

FOR: ELECTRIC DRIVE MOTORS, OTHER THAN FOR LAND VEHICLES; ELECTRIC FANS, VENTILATORS AND BLOWERS FOR MOTORS AND ENGINES; ELECTRIC MOTOR-OPERATED PUMPS, IN CLASS 7 (U.S. CLS. 13, 19, 21, 23, 31, 34 AND 35).

FOR: REGULATING APPARATUS AND CONTROL APPARATUS, NAMELY, APPARATUS AND INSTRUMENTS FOR CONVEYING, DISTRIBUTING, TRANSFORMING, STORING OR CONTROLLING ELECTRIC CURRENT; ELECTRONIC COMMUTATION CIRCUITS FOR MOTORS, IN CLASS 9 (U.S. CLS. 21, 23, 26, 36 AND 38).

FOR: HEATING APPARATUS, NAMELY, ELECTRIC HEATING FANS, ELECTRIC SPACE HEATERS, CENTRAL HEATING RADIATORS, ELECTRIC HEATING BLOWERS; AIR COOLING APPARATUS; DRYING APPARATUS FOR USE IN HEATING, VENTILATION SYSTEMS, AIR CONDITIONING SYSTEMS AND REFRIGERATING SYSTEMS; DRYING APPARATUS FOR USE IN HEATING, VENTILATION SYSTEMS, AIR CONDITIONING SYSTEMS AND REFRIGERATING SYSTEMS; ELECTRIC HOT AIR HAND DRYERS; HAIR DRYERS FOR HOUSEHOLD PURPOSES; INDUSTRIAL DISH DRYING MACHINES; INDUSTRIAL DRYERS FOR HEATING AND DEHUMIDIFYING; CLOTHES DRYING MACHINES; INDUSTRIAL APPARATUS USING AIR FOR DRYING COMPONENTS IN THE ELECTRONICS, SEMICONDUCTOR, CIRCUIT BOARD, PHARMACEUTICAL, MEDICAL, AND FOOD BEVERAGES INDUSTRIES; VENTILATING APPARATUS, NAMELY, VENTILATING FANS FOR COMMERCIAL AND INDUSTRIAL USE, VENTILATING EXHAUST FANS, HOT AIR BLOWERS, ELECTRIC FANS; AIR CONDITIONING APPARATUS; COOLING UNITS FOR INDUSTRIAL PURPOSES, HEATING UNITS FOR INDUSTRIAL PURPOSES; EXTRACTOR HOODS FOR KITCHEN, VENTILATION HOODS; CHEST FREEZERS, REFRIGERATORS, REFRIGERATING CABINETS, REFRIGERATING DISPLAY CABINETS, IN CLASS 11 (U.S. CLS. 13, 21, 23, 31 AND 34).

OWNER OF FED REP GERMANY REG. NO. 302009057203, DATED 1-21-2010, EXPIRES 9-30-2019.

THE COLOR(S) GREEN, WHITE, BLACK, BLUE AND GREY IS/ARE CLAIMED AS A FEATURE OF THE MARK.



David J. Kybas

Director of the United States Patent and Trademark Office

Reg. No. 4,065,154 OWNER OF U.S. REG. NOS. 1,363,205, 3,041,998 AND OTHERS.

NO CLAIM IS MADE TO THE EXCLUSIVE RIGHT TO USE "GREEN TECH", APART FROM THE MARK AS SHOWN.

THE MARK CONSISTS OF A GREEN CIRCULAR DEVICE HAVING THE WORDS "GREEN TECH" IN WHITE AND A CHECK MARK IN WHITE, LOCATED ABOVE THE WORDS "BY EBMPAPST" ON A GREY BACKGROUND, THE TERMS "BY" AND "EBM" IN BLACK AND THE TERM "PAPST" IN BLUE.

SER. NO. 77-965,121, FILED 3-22-2010.

JESSICA A. POWERS, EXAMINING ATTORNEY

United States of America

United States Patent and Trademark Office

XZONTI

Reg. No. 4,065,155

Registered Dec. 6, 2011

Int. Cl.: 25

TRADEMARK

PRINCIPAL REGISTER

COLLING, DARREN MARK (UNITED KINGDOM INDIVIDUAL)
48 ABBEY ROAD
NEWPORT, UNITED KINGDOM NP199DY

FOR: AMERICAN FOOTBALL BIBS; ATHLETIC APPAREL, NAMELY, SHIRTS, PANTS, JACKETS, FOOTWEAR, HATS AND CAPS, ATHLETIC UNIFORMS; ATHLETIC FOOTWEAR; ATHLETIC SHOES; BELTS; BODY SUITS; BOOTS; BOOTS FOR SPORT; CAPS; CHILDREN'S AND INFANT'S APPAREL, NAMELY, JUMPERS, OVERALL SLEEPWEAR, PAJAMAS, ROMPERS AND ONE-PIECE GARMENTS; CLOTHING FOR ATHLETIC USE, NAMELY, PADDED ELBOW COMPRESSION SLEEVES BEING PART OF AN ATHLETIC GARMENT; CLOTHING FOR ATHLETIC USE, NAMELY, PADDED PANTS; CLOTHING FOR ATHLETIC USE, NAMELY, PADDED SHIRTS; CLOTHING FOR ATHLETIC USE, NAMELY, PADDED SHORTS; CLOTHING FOR WEAR IN JUDO PRACTICES; CLOTHING FOR WEAR IN WRESTLING GAMES; CLOTHING, NAMELY, BASE LAYERS; CLOTHING, NAMELY, HAND-WARMERS; CLOTHING, NAMELY, KHAKIS; COATS; DRESSES THAT MAY ALSO BE USED AS TOWELS; EAR BANDS; EUROPEAN FOOTBALL BIBS; FOOTBALL BOOTS AND STUDS THEREFOR; FOOTBALL SHOES; FOOTWEAR; FOOTWEAR FOR TRACK AND FIELD ATHLETICS; FOOTWEAR NOT FOR SPORTS; GLOVES AS CLOTHING; GOLF PANTS, SHIRTS AND SKIRTS; GYM PANTS; GYM SUITS; HAT BANDS; HATS; HEAD WEAR; HEADBANDS FOR CLOTHING; HEADWEAR; HOODS; INFANT WEAR; JACKETS; JEANS; JERSEYS; JOGGING PANTS; JOGGING SUITS; JUDO SUITS; KARATE SUITS; LADIES' SUITS; LEISURE SUITS; LOUNGE PANTS; MEN'S AND WOMEN'S JACKETS, COATS, TROUSERS, VESTS; MEN'S SUITS, WOMEN'S SUITS; MIXED MARTIAL ARTS SUITS; MUSCLE TOPS; NECK BANDS; OUTDOOR GLOVES; OUTER JACKETS; OVER COATS; OVER SHIRTS; PANTS; PERSPIRATION ABSORBENT UNDERWEAR CLOTHING; POLO SHIRTS; RAIN COATS; RAIN SUITS; RIDING COATS; RUGBY SHIRTS; RUGBY TOPS; SASH BANDS FOR KIMONO (OBI); SHIRTS; SHOES; SHORT SETS; SHORT TROUSERS; SHORTS; SKI BOOT BAGS; SKI PANTS; SKI SUITS; SKI WEAR; SKIRTS AND DRESSES; SNOWBOARD PANTS; SOCKS; SOCKS AND STOCKINGS; SPORT COATS; SPORT SHIRTS; SPORT STOCKINGS; SPORTS BRAS; SPORTS CAPS AND HATS; SPORTS JACKETS; SPORTS JERSEYS; SPORTS PANTS; SPORTS SHIRTS; SPORTS SHIRTS WITH SHORT SLEEVES; SPORTS VESTS; SUITS; SURF WEAR; SWEAT BANDS; SWEAT PANTS; SWEAT SHIRTS; SWIM WEAR; SWIM WEAR FOR GENTLEMEN AND LADIES; SWIMMING CAPS; SWIMMING COSTUMES; T-SHIRTS; TENNIS WEAR; TIES; TOBOGGAN HATS, PANTS AND CAPS; TOP COATS; TOPS; TRACK AND FIELD SHOES; TRACK JACKETS; TRACK PANTS; TRACK SUITS; TRAINING SUITS; TRAVEL CLOTHING CONTAINED IN A PACKAGE COMPRISING REVERSIBLE JACKETS, PANTS, SKIRTS, TOPS AND A BELT



David J. Kyros

Director of the United States Patent and Trademark Office

Reg. No. 4,065,155 OR SCARF; TRIATHLON CLOTHING, NAMELY, TRIATHLON TIGHTS, TRIATHLON SHORTS, TRIATHLON SINGLET, TRIATHLON SHIRTS, TRIATHLON SUITS; UNDERARM CLOTHING SHIELDS; UNDERGARMENTS; VESTS; WAIST BANDS; WATERPROOF JACKETS AND PANTS; WEARABLE GARMENTS AND CLOTHING, NAMELY, SHIRTS; WET SUITS; WIND COATS; WRIST BANDS, IN CLASS 25 (U.S. CLS. 22 AND 39).

THE MARK CONSISTS OF STANDARD CHARACTERS WITHOUT CLAIM TO ANY PARTICULAR FONT, STYLE, SIZE, OR COLOR.

PRIORITY CLAIMED UNDER SEC. 44(D) ON ERPN CMNTY TM OFC APPLICATION NO. 008586621, FILED 1-27-2010, REG. NO. 008586621, DATED 1-27-2010, EXPIRES 1-27-2020.

SER. NO. 77-965,661, FILED 3-23-2010.

SUZANNE BLANE, EXAMINING ATTORNEY

United States of America

United States Patent and Trademark Office

PATHWAVES

Reg. No. 4,065,156

Registered Dec. 6, 2011

Int. Cl.: 9

TRADEMARK

PRINCIPAL REGISTER

LARCAN INC. (CANADA CORPORATION)
228 AMBASSADOR DRIVE
MISSISSAUGA, ON, CANADA L5T2J2

FOR: DIGITAL BROADCAST MICROWAVE RELAY TRANSMITTERS AND TRANSLATORS FOR USE BY TELEVISION BROADCASTERS TO RELAY, REFLECT, OR REPEAT THE BROADCAST SIGNAL TO A GEOGRAPHIC AREA NOT COVERED BY REGULAR BROADCAST, IN CLASS 9 (U.S. CLS. 21, 23, 26, 36 AND 38).

FIRST USE 6-12-2009; IN COMMERCE 6-12-2009.

THE MARK CONSISTS OF STANDARD CHARACTERS WITHOUT CLAIM TO ANY PARTICULAR FONT, STYLE, SIZE, OR COLOR.

SER. NO. 77-966,017, FILED 3-23-2010.

LINDA MICKLEBURGH, EXAMINING ATTORNEY



David J. Kybas

Director of the United States Patent and Trademark Office

United States of America

United States Patent and Trademark Office

imop

Reg. No. 4,065,157

Registered Dec. 6, 2011

Int. Cl.: 9

TRADEMARK

PRINCIPAL REGISTER

ADVANCED POWER COMPONENTS PLC (UNITED KINGDOM PUBLIC LIMITED COMPANY (PLC))
47 RIVERSIDE, MEDWAY CITY ESTATE
ROCHESTER, KENT, UNITED KINGDOM ME24DP

FOR: APPARATUS AND DEVICES USING REACTIVE POWER COMPENSATION FOR INDUCTIVE LOADS FOR THE PURPOSES OF MANAGING AND OPTIMIZING ELECTRICAL ENERGY CONSUMPTION, NAMELY, CAPACITORS; POWER FACTOR CORRECTION UNITS IN THE NATURE OF CORRECTING ELECTRIC CAPACITORS, IN CLASS 9 (U.S. CLS. 21, 23, 26, 36 AND 38).

THE MARK CONSISTS OF STANDARD CHARACTERS WITHOUT CLAIM TO ANY PARTICULAR FONT, STYLE, SIZE, OR COLOR.

OWNER OF UNITED KINGDOM REG. NO. 2527986, DATED 1-29-2010, EXPIRES 1-29-2020.

SER. NO. 77-969,178, FILED 3-26-2010.

COLLEEN KEARNEY, EXAMINING ATTORNEY



David J. Kybas

Director of the United States Patent and Trademark Office

United States of America

United States Patent and Trademark Office



Reg. No. 4,065,158

Registered Dec. 6, 2011

**COLLECTIVE
MEMBERSHIP**

PRINCIPAL REGISTER

PHI KAPPA PSI (INDIANA UNINCORPORATED ASSOCIATION)
5395 EMERSON WAY
INDIANAPOLIS, IN 46226

FOR: INDICATING MEMBERSHIP IN A NATIONAL COLLEGIATE SOCIAL FRATERNAL ORGANIZATION, IN CLASS 200 (U.S. CL. 200).

FIRST USE 7-31-2008; IN COMMERCE 7-31-2008.

OWNER OF U.S. REG. NOS. 753,082, 758,228 AND OTHERS.

THE NON-LATIN CHARACTERS IN THE MARK TRANSLITERATE TO "PHI KAPPA PSI" AND THIS HAS NO MEANING IN A FOREIGN LANGUAGE.

NO CLAIM IS MADE TO THE EXCLUSIVE RIGHT TO USE "EST. 1852", APART FROM THE MARK AS SHOWN.

THE MARK CONSISTS OF GREEK SYMBOLS AND THE WORDING "PHI KAPPA PSI" AND "EST. 1852", ALL AGAINST A BACKGROUND OF A RECTANGLE, A BANNER WITH TWO ROUNDED SIDES, LIGHT RAYS, AND A HORIZONTAL LINE WITH A CIRCLE IN THE MIDDLE.

SER. NO. 77-969,629, FILED 3-26-2010.

TINA MAI, EXAMINING ATTORNEY



David J. Kybas

Director of the United States Patent and Trademark Office

United States of America

United States Patent and Trademark Office

BLUE MENU

Reg. No. 4,065,159

Registered Dec. 6, 2011

Int. Cls.: 29, 30 and 32

TRADEMARK

PRINCIPAL REGISTER

LOBLAWS, INC. (CANADA CORPORATION)
SUITE 1901
22 ST. CLAIR AVENUE EAST
TORONTO, CANADA M4T 2S7

FOR: FRESH AND FROZEN MEATS; JAMS; SPREADS, NAMELY, PEANUT BUTTER; COOKING OIL; OLIVE OIL, SUNFLOWER OIL FOR FOOD; MARGARINE; CANNED VEGETABLES; SOUPS; SAUSAGE, FROZEN AND CANNED FISH AND SEAFOOD; PREPARED MEATS; FROZEN TURKEY, BEEF, CHICKEN, PORK AND DUCK; FROZEN PACKAGED ENTREES CONSISTING PRIMARILY OF MEAT, FISH, POULTRY OR VEGETABLES; FROZEN CASSEROLE DISHES CONSISTING PRIMARILY OF MEAT, FISH, POULTRY OR VEGETABLES, IN CLASS 29 (U.S. CL. 46).

FOR: SAUCES, NAMELY, BARBECUE, SPAGHETTI, SZECHWAN PEANUT; COOKIES; CRACKERS; SALAD DRESSINGS; WHIPPED DRESSING IN THE NATURE OF A WHIPPED SAUCE; DESSERTS, NAMELY, CAKES, PIES, BAKED FRUIT CRISP DESSERTS; SPICES; FROZEN CONFECTIONS; POPCORN; KETCHUP; BREAKFAST CEREALS; RICE; PIZZA; PASTA; MUFFINS; ICE CREAM; MAYONNAISE; BREAD; FROZEN PACKAGED ENTREES CONSISTING PRIMARILY OF PASTA OR RICE; FROZEN PREPARED MEALS, NAMELY, LASAGNA, CASSEROLE DISHES CONSISTING PRIMARILY OF PASTA OR RICE; BOXED MACARONI AND CHEESE; GRANOLA-BASED SNACK BARS; TORTILLA CHIPS, IN CLASS 30 (U.S. CL. 46).

FOR: BEVERAGES, NAMELY, FRUIT JUICES AND VEGETABLE JUICES, IN CLASS 32 (U.S. CLS. 45, 46 AND 48).

THE MARK CONSISTS OF STANDARD CHARACTERS WITHOUT CLAIM TO ANY PARTICULAR FONT, STYLE, SIZE, OR COLOR.

PRIORITY CLAIMED UNDER SEC. 44(D) ON CANADA APPLICATION NO. 1241273, FILED 12-15-2004, REG. NO. TMA697,287, DATED 9-26-2007, EXPIRES 9-26-2022.

SER. NO. 78-604,694, FILED 4-8-2005.

KATHLEEN M. VANSTON, EXAMINING ATTORNEY



David J. Kyros

Director of the United States Patent and Trademark Office

United States of America

United States Patent and Trademark Office

IMI

Reg. No. 4,065,160

Registered Dec. 6, 2011

**Int. Cls.: 10, 35, 38, 39,
42 and 44**

TRADEMARK

SERVICE MARK

PRINCIPAL REGISTER

IMI INTELLIGENT MEDICAL IMPLANTS AG (SWITZERLAND CORPORATION)
INDUSTRIESTRASSE 24
ZUG, SWITZERLAND CH-6302

FOR: ELECTRIC AND ELECTRONIC APPARATUS AND INSTRUMENTS SOLD AS COMPONENTS OF ARTIFICIAL IMPLANTS CONSISTING OF ARTIFICIAL MATERIALS FOR MEASURING, INPUTTING, STORING, DISPLAYING, ANALYZING, PROCESSING AND TRANSMITTING DATA IN SIGNALS; ID READERS SOLD AS COMPONENTS OF IMPLANTS CONSISTING OF ARTIFICIAL MATERIALS, MEDICAL APPARATUS FOR RE-ESTABLISHING NEUROLOGICAL DEFICITS FOR THERAPEUTIC PURPOSES; ELECTROMEDICAL APPARATUS AND PARTS THEREFOR, IN PARTICULAR ELECTRONIC APPARATUS FOR THE ELECTRICAL STIMULATION OF TISSUE AND NERVES, INCLUDING EXTERNAL OR IMPLANTABLE MEDICAL DEVICES, IN PARTICULAR CRANIAL IMPLANT DEVICES, IN PARTICULAR FOR ENHANCING SENSORY PERCEPTION FOR CLINICAL MEDICAL USE; HEART PACEMAKERS; PROGRAMMING AND TESTING APPARATUS FOR HEART PACEMAKERS FOR CLINICAL MEDICAL PURPOSES; DEFIBRILLATORS; CARDIOVERTERS; CARDIAC ELECTRODES, BALLOON DILATION APPARATUS FOR MEDICAL USE; MEDICAL PATIENT ORGAN AND INTERNAL SYSTEMS MONITORING, MEASURING AND REGULATING APPARATUS; RESUSCITATION APPARATUS; IMPLANTS CONSISTING OF ARTIFICIAL MATERIALS, IN CLASS 10 (U.S. CLS. 26, 39 AND 44).

FOR: ELECTRONIC REMOTE PROCESSING OF MEDICAL DATA FROM OR TO APPARATUS, NAMELY, ELECTRONIC REMOTE PROCESSING OF DATA TO AN ELECTRONIC IMPLANT AND ELECTRONIC REMOTE PROCESSING OF DATA FROM THE ELECTRONIC IMPLANT TO AN EXTERNAL UNIT; PROCESSING OF DATA RELATING TO PATIENTS AND/OR IMPLANTS FOR CLINICAL MEDICAL PURPOSES, IN CLASS 35 (U.S. CLS. 100, 101 AND 102).

FOR: ELECTRONIC REMOTE DATA FORWARDING FROM OR TO MEDICAL APPARATUS, IN CLASS 38 (U.S. CLS. 100, 101 AND 104).

FOR: ELECTRONIC REMOTE STORAGE OF DATA FROM OR TO MEDICAL APPARATUS, IN CLASS 39 (U.S. CLS. 100 AND 105).

FOR: MEDICAL RESEARCH IN THE FIELD OF TECHNOLOGY, IN CLASS 42 (U.S. CLS. 100 AND 101).



David J. Kybas

Director of the United States Patent and Trademark Office

Reg. No. 4,065,160 FOR: MEDICAL SERVICES; RENTAL OF MEDICAL EQUIPMENT; MEDICAL SERVICES, NAMELY, MEDICAL AND CLINICAL EXAMINATIONS; MEDICAL CARE BY MEANS OF TELEMETRY, INCLUDING LOCALIZATION, FOR PATIENTS AND IMPLANTS; PROVIDING MEDICAL DATA RELATING TO PATIENTS AND/OR IMPLANTS; PROVIDING TECHNICAL MEDICAL DATA RELATING TO PATIENTS AND/OR IMPLANTS, IN CLASS 44 (U.S. CLS. 100 AND 101).

THE MARK CONSISTS OF STANDARD CHARACTERS WITHOUT CLAIM TO ANY PARTICULAR FONT, STYLE, SIZE, OR COLOR.

PRIORITY CLAIMED UNDER SEC. 44(D) ON ERPN CMNTY TM OFC APPLICATION NO. 004330502, FILED 3-9-2005, REG. NO. 004330502, DATED 5-30-2009, EXPIRES 3-9-2015.

SER. NO. 78-708,994, FILED 9-8-2005.

BARNEY CHARLON, EXAMINING ATTORNEY

United States of America

United States Patent and Trademark Office

MOTORGIRL

Reg. No. 4,065,161

ULRICH, KIM (UNITED STATES INDIVIDUAL)
7323 EL CAJON BOULEVARD
LA MESA, CA 91941

Registered Dec. 6, 2011

Int. Cl.: 25

FOR: CLOTHING, NAMELY, SHIRTS, T-SHIRTS, TANK TOPS, SWEATSHIRTS, SWEAT-PANTS, PANTS, SHORTS, SKIRTS, JERSEYS, JACKETS, HATS, CAPS, VISORS, AND UN-
DERWEAR, IN CLASS 25 (U.S. CLS. 22 AND 39).

TRADEMARK

FIRST USE 1-20-2003; IN COMMERCE 1-20-2003.

PRINCIPAL REGISTER

THE MARK CONSISTS OF STANDARD CHARACTERS WITHOUT CLAIM TO ANY PAR-
TICULAR FONT, STYLE, SIZE, OR COLOR.

SER. NO. 78-857,678, FILED 4-10-2006.

GIANCARLO CASTRO, EXAMINING ATTORNEY



David J. Kybas

Director of the United States Patent and Trademark Office

United States of America

United States Patent and Trademark Office

MK5

Reg. No. 4,065,162

KHU, ANDREW D. (UNITED STATES INDIVIDUAL)
9026 SW 36TH AVE
PORTLAND, OR 97219

Registered Dec. 6, 2011

Int. Cl.: 13

FOR: FIREARMS, IN CLASS 13 (U.S. CLS. 2 AND 9).

TRADEMARK

FIRST USE 6-1-2006; IN COMMERCE 6-13-2006.

PRINCIPAL REGISTER

THE MARK CONSISTS OF STANDARD CHARACTERS WITHOUT CLAIM TO ANY PARTICULAR FONT, STYLE, SIZE, OR COLOR.

SER. NO. 78-907,267, FILED 6-13-2006.

ELISSA GARBER KON, EXAMINING ATTORNEY



David J. Kybas

Director of the United States Patent and Trademark Office

United States of America

United States Patent and Trademark Office



Reg. No. 4,065,163

Registered Dec. 6, 2011

Int. Cl.: 36

SERVICE MARK

PRINCIPAL REGISTER

WHITEWELD FOUNDATION (NEW JERSEY TRUST)
300 TICE BOULEVARD
WOODCLIFF LAKE, NJ 071025496

FOR: CHARITABLE FUNDRAISING SERVICES, IN CLASS 36 (U.S. CLS. 100, 101 AND 102).

FIRST USE 2-28-2006; IN COMMERCE 2-28-2006.

THE MARK CONSISTS OF THE LITERAL ELEMENT INSIDE OF A LEAVED CREST.

SER. NO. 78-932,591, FILED 7-19-2006.

KYLE PEETE, EXAMINING ATTORNEY



David J. Kybas

Director of the United States Patent and Trademark Office

United States of America

United States Patent and Trademark Office

SHEER VISIONS

Reg. No. 4,065,164

Registered Dec. 6, 2011

Int. Cls.: 20 and 24

TRADEMARK

PRINCIPAL REGISTER

LAFAYETTE VENETIAN BLIND, INC. (INDIANA CORPORATION)
3000 KLONDIKE RD., P.O. BOX 2838
WEST LAFAYETTE, IN 479962838

FOR: WINDOW BLINDS, WINDOW SHADES AND VENETIAN BLINDS, IN CLASS 20 (U.S. CLS. 2, 13, 22, 25, 32 AND 50).

FIRST USE 9-1-2001; IN COMMERCE 9-1-2001.

FOR: FABRIC FOR THE MANUFACTURE OF WINDOW COVERINGS AND TREATMENTS; FABRIC WINDOW COVERINGS AND TREATMENTS, NAMELY, CORNICES, CURTAINS, DRAPERIES, SHADES, SHEERS, SWAGS, AND VALANCES, IN CLASS 24 (U.S. CLS. 42 AND 50).

FIRST USE 9-1-2001; IN COMMERCE 9-1-2001.

THE MARK CONSISTS OF STANDARD CHARACTERS WITHOUT CLAIM TO ANY PARTICULAR FONT, STYLE, SIZE, OR COLOR.

NO CLAIM IS MADE TO THE EXCLUSIVE RIGHT TO USE "SHEER", APART FROM THE MARK AS SHOWN.

SER. NO. 78-949,973, FILED 8-11-2006.

MATTHEW MCDOWELL, EXAMINING ATTORNEY



David J. Kybas

Director of the United States Patent and Trademark Office

United States of America

United States Patent and Trademark Office



Reg. No. 4,065,165

Registered Dec. 6, 2011

Int. Cl.: 30

TRADEMARK

PRINCIPAL REGISTER

CUBICAFE S.A. (COLOMBIA SOCIEDAD ANONIMA)
BIS NO. 89A-73
CALLE 65
BOGOTA D.C., COLOMBIA

FOR: COFFEE, TEA, COCOA, ARTIFICIAL COFFEE, AROMATIC PREPARATIONS FOR FOOD, NAMELY, PROCESSED HERBS AND FRUIT FLAVORINGS, IN CLASS 30 (U.S. CL. 46).

FIRST USE 9-0-2004; IN COMMERCE 12-0-2004.

NO CLAIM IS MADE TO THE EXCLUSIVE RIGHT TO USE "COFFEE", APART FROM THE MARK AS SHOWN.

THE COLOR(S) RED, BROWN, PURPLE, YELLOW, BLACK AND WHITE IS/ARE CLAIMED AS A FEATURE OF THE MARK.

THE COLOR RED APPEARS IN THE LETTERS "OK". THE COLOR BROWN APPEARS IN THE OUTLINE OF THE OVAL, AND THE OUTLINE OF "OK". THE COLOR PURPLE APPEARS IN THE RIGHT STEAM LINE. THE COLOR YELLOW APPEARS IN THE LEFT STEAM LINE. THE COLOR BLACK APPEARS IN THE OVAL. THE COLOR WHITE APPEARS IN THE WORD "COFFEE".

SER. NO. 78-961,015, FILED 8-25-2006.

JASON BLAIR, EXAMINING ATTORNEY



David J. Kybas

Director of the United States Patent and Trademark Office

United States of America

United States Patent and Trademark Office

CARAT*
GIOIELLERIA

Reg. No. 4,065,166

Registered Dec. 6, 2011

Int. Cl.: 14

TRADEMARK

PRINCIPAL REGISTER

SECRETS INTERNATIONAL LIMITED (HONG KONG CORPORATION)
23 D'AGUILAR STREET
CENTRAL, HONG KONG

FOR: PRECIOUS METALS AND THEIR ALLOYS; GOODS IN PRECIOUS METALS OR COATED THEREWITH, NOT INCLUDED IN OTHER CLASSES, NAMELY, RINGS, BRACELETS, EARRINGS, PENDANTS AND TIARAS; JEWELRY, PRECIOUS STONES, DIAMONDS, SYNTHETIC DIAMONDS; HOROLOGICAL AND CHRONOMETRIC INSTRUMENTS, IN CLASS 14 (U.S. CLS. 2, 27, 28 AND 50).

OWNER OF HONG KONG REG. NO. 300089839, DATED 10-7-2003, EXPIRES 10-7-2013.

NO CLAIM IS MADE TO THE EXCLUSIVE RIGHT TO USE "CARAT OR GIOIELLERIA", APART FROM THE MARK AS SHOWN.

THE FOREIGN WORDING IN THE MARK TRANSLATES INTO ENGLISH AS "JEWELRY SHOP".

SER. NO. 78-963,740, FILED 8-30-2006.

KYLE PEETE, EXAMINING ATTORNEY



David J. Kybas

Director of the United States Patent and Trademark Office

United States of America

United States Patent and Trademark Office

BIRDIE

Reg. No. 4,065,167

Registered Dec. 6, 2011

Int. Cls.: 6 and 25

TRADEMARK

PRINCIPAL REGISTER

RICHARD A. LESLIE CO., INC. (NEW YORK CORPORATION)
SUITE 208
560 ROUT 303
ORANGEBURG, NY 10962

FOR: METAL KEY CHAINS, IN CLASS 6 (U.S. CLS. 2, 12, 13, 14, 23, 25 AND 50).

FIRST USE 9-0-2005; IN COMMERCE 1-0-2006.

FOR: WOMEN'S GOLF CLOTHING, NAMELY, GOLF SHIRTS, WIND SHIRTS, GOLF SWEATERS, GOLF JACKETS, GOLF PANTS, GOLF SHORTS, GOLF SKIRTS, SKORTS, GOLF CAPS, GOLF VISORS, GOLF GLOVES; WOMEN'S CLOTHING, NAMELY, SHIRTS, T-SHIRTS, TANK TOPS, POLO SHIRTS, SWEATERS, BLOUSES, JACKETS, BLAZERS, SKIRTS, DRESSES, PANTS, SHORTS, HATS, CAPS, VISORS, AND SWEATSHIRTS, IN CLASS 25 (U.S. CLS. 22 AND 39).

FIRST USE 6-0-2005; IN COMMERCE 10-0-2005.

THE MARK CONSISTS OF STANDARD CHARACTERS WITHOUT CLAIM TO ANY PARTICULAR FONT, STYLE, SIZE, OR COLOR.

OWNER OF U.S. REG. NOS. 2,286,401, 3,164,395 AND OTHERS.

SER. NO. 78-981,504, FILED 7-5-2006.

SUE LAWRENCE, EXAMINING ATTORNEY



David J. Kyros

Director of the United States Patent and Trademark Office

United States of America

United States Patent and Trademark Office

Kingdomlinen

Reg. No. 4,065,168

Registered Dec. 6, 2011

Int. Cls.: 23 and 24

TRADEMARK

PRINCIPAL REGISTER

ZHEJIANG JINYUAN FLAX CO., LTD. (CHINA CORPORATION)
JINDA INDUSTRY PARK
BAIBU TOWN,; HAIYAN;
ZHEJIANG 314313, CHINA

FOR: THREAD, LINEN THREAD AND YARN, RAYON THREAD, LONG THREAD, YARN, DARNING THREAD AND YARN, NYLON THREAD, SPUN WOOL, WOOL THREAD, CASHMERE YARN, IN CLASS 23 (U.S. CL. 43).

FOR: COTTON FABRIC, NON-WOVEN TEXTILE FABRICS, SILK-KNIT HANDICRAFTS IN THE NATURE OF HAND SPUN SILK FABRICS AND BED LINEN, FELTS, TOWELS OF TEXTILE, BED LINEN, CARPETS, UNFITTED FURNITURE COVERINGS OF TEXTILE, HADA BEING LINEN FABRIC, CLOTH BANNERS, IN CLASS 24 (U.S. CLS. 42 AND 50).

OWNER OF U.S. REG. NO. 3,245,226.

OWNER OF INTERNATIONAL REGISTRATION 0929562 DATED 6-12-2007, EXPIRES 6-12-2017.

SER. NO. 79-040,550, FILED 6-12-2007.

DEBRA LEE, EXAMINING ATTORNEY



David J. Kyros

Director of the United States Patent and Trademark Office

United States of America

United States Patent and Trademark Office



Reg. No. 4,065,169

Registered Dec. 6, 2011

Int. Cl.: 9

TRADEMARK

PRINCIPAL REGISTER

INTERCAST EUROPE S.R.L. (ITALY LIMITED LIABILITY COMPANY)
VIA G. NATTA, 10/A
I-43100 PARMA
ITALY

FOR: LENSES, NAMELY, EYEGLOSS LENSES, MAGNIFYING LENSES, OPTICAL LENSES, OPHTHALMIC LENSES; LENSES FOR SPECTACLES AND FOR SUNGLASSES; CONTACT LENSES; AND SPECTACLES, IN CLASS 9 (U.S. CLS. 21, 23, 26, 36 AND 38).

OWNER OF U.S. REG. NOS. 2,289,387, 2,303,377 AND OTHERS.

PRIORITY DATE OF 4-27-2007 IS CLAIMED.

OWNER OF INTERNATIONAL REGISTRATION 0940943 DATED 8-27-2007, EXPIRES 8-27-2017.

THE MARK CONSISTS OF A COMPLEX STRUCTURE SINCE IT COMPRISES GRAPHIC AND VERBAL ELEMENTS; THERE IS IN PARTICULAR THE LETTERS "APX" WRITTEN IN SPECIAL CHARACTERS WITH THE "X" PARTICULARLY STYLISED; THESE LETTERS ARE PLACED BETWEEN TWO HALF-MOON SHAPES; UNDERNEATH IS THE TEXT "BY INTERCAST".

SER. NO. 79-045,237, FILED 8-27-2007.

KATHERINE E. HALMEN, EXAMINING ATTORNEY



David J. Kyjars

Director of the United States Patent and Trademark Office

United States of America

United States Patent and Trademark Office



Reg. No. 4,065,170

Registered Dec. 6, 2011

**Int. Cls.: 6, 7, 9, 37, 38,
40 and 42**

TRADEMARK

SERVICE MARK

PRINCIPAL REGISTER

ELEKTROBIT OYJ (FINLAND PUBLIC JOINT-STOCK COMPANY)
AUTOMAATIOTIE 1
OULUNSALO, FINLAND FI90460

FOR: METAL PALLET AND METAL TRANSFER PLATFORMS , IN CLASS 6 (U.S. CLS. 2, 12, 13, 14, 23, 25 AND 50).

FOR: MACHINES FOR USE IN ASSEMBLY AUTOMATION, NAMELY, CONVEYORS, MAGAZINE HANDLERS IN THE NATURE OF MACHINES FOR LOADING AND UNLOADING STORAGE COMPARTMENTS, NAMELY, STACKING TRAYS THAT ACT AS A SHIELD BETWEEN MANUFACTURING WORKSTATIONS THAT ARE USED TO AUTOMATE MATERIAL FLOW IN PRINTED CIRCUIT BOARD PRODUCTION, PALLET HANDLING EQUIPMENT FOR ASSEMBLY AUTOMATION, NAMELY, CONVEYORS, ASSEMBLY MACHINES AND TRAVERSE MACHINES USED TO AUTOMATE MATERIAL FLOW IN PRODUCTION, AND BELT CONVEYOR SYSTEMS FOR ASSEMBLY AUTOMATION COMPRISED OF BELT CONVEYORS TO TRANSPORT PRODUCTS BETWEEN DIFFERENT PRODUCTIONS STAGES, IN CLASS 7 (U.S. CLS. 13, 19, 21, 23, 31, 34 AND 35).

FOR: WIRELESS DATA TRANSFER EQUIPMENT, NAMELY, ELECTRONIC INFORMATION RECEIVERS FOR TELEPHONE, AUDIO AND VIDEO, RADIO, SATELLITE AND TELEPHONE TRANSMITTERS, RADIO FREQUENCY IDENTIFICATION TAG READERS, RADIO FREQUENCY IDENTIFICATION TAGS; ELECTRONICS HARDWARE, NAMELY, NETWORK BASE STATIONS COMPRISED OF A RADIO UNIT, BASEBAND UNIT, POWER SUPPLY, ANTENNAS, FILTERS, RADIO CHANNEL EMULATORS AND SIMULATION SOFTWARE FOR MODELING RADIO CHANNELS, ELECTRICAL CONTROL DEVICES, NAMELY, ELECTRONIC CONTROL UNITS (ECUS) FOR AUTOMOTIVE ENGINE CONTROLLING; ANTENNAS FOR WIRELESS COMMUNICATIONS APPARATUS, APPARATUS FOR WIRELESS TRANSMISSION OF ACOUSTIC AND DIGITAL INFORMATION; COMPUTER SOFTWARE FOR MANAGEMENT OF WIRELESS DATA IN WIRELESS CONTENT DELIVERY FOR USE IN AUTOMOTIVE ELECTRONIC CONTROL UNITS (ECUS) AND READERS, NETWORK BASE STATIONS, EMULATORS, SIMULATORS, MOBILE COMPUTERS, NAVIGATION APPARATUS, AND VEHICLES; COMPUTER SOFTWARE FOR OPERATION OF AUTOMATION AND CONTROLLING MACHINERY; TESTING APPARATUS FOR TESTING OPERATIONS AND FUNCTIONS OF WIRELESS SYSTEMS, RADIO CHANNELS, NETWORK BASE STATIONS, ELECTRONIC CONTROL UNITS, MOBILE RADIO SYSTEMS, AND WIRELESS COMMUNICATIONS DEVICES; NETWORK TESTING EQUIPMENT, NAMELY, PROTOCOL ANALYZERS, NETWORK LOAD ANALYZERS; COMPUTER OPER-



David J. Kyjars

Director of the United States Patent and Trademark Office

Reg. No. 4,065,170 ATING SOFTWARE FOR SERVERS USED FOR WIRELESS DATA TRANSFER; CONTROL SOFTWARE FOR TESTING PRODUCTION SYSTEMS IN THE ELECTRONICS INDUSTRY, NAMELY, CONTROL SOFTWARE FOR PROGRAMMING, TESTING AND MEASURING MOBILE COMMUNICATION DEVICES, ELECTRONIC CONTROL UNITS, APPLICATION SIGNAL PROCESSORS; COMPUTER SOFTWARE FOR TESTING AND PROGRAMMING ELECTRONIC CONTROL UNITS, TESTING MANUFACTURING MACHINE VISION CONTROL OPERATIONS AND MEASURING PRODUCTION OUTPUT STATISTICS FOR PRODUCTION SYSTEMS IN THE ELECTRONICS INDUSTRY; ELECTRICAL, ELECTRONIC AND ELECTRO-MECHANICAL MEASURING AND TESTING DEVICES, NAMELY, ELECTRONIC SENSORS FOR SENSING ACOUSTIC, DIGITAL OR ANALOG VIDEO OR AUDIO SIGNALS, RADIO FREQUENCY WAVES, LUMINANCE, CAPACITANCE, POWER, TEMPERATURE, POSITION, AMPERE, HERTZ, VOLT, WATT; MOBILE TERMINAL PRODUCTION TESTING EQUIPMENT, NAMELY, USER INTERFACE FOR ELECTRONIC DEVICES, COMPUTER SOFTWARE FOR TESTING FUNCTIONALITY, QUALITY, STABILITY AND PERFORMANCE OF WIRELESS NETWORK DEVICES; ALL OF THE FOREGOING SOLD IN A BUSINESS-TO-BUSINESS ENVIRONMENT, IN CLASS 9 (U.S. CLS. 21, 23, 26, 36 AND 38).

FOR: MAINTENANCE, REPAIR AND INSTALLATION OF COMPUTER NETWORK SYSTEMS, COMPUTER HARDWARE SYSTEMS, WIRELESS NETWORK SYSTEMS, NAVIGATION AND SPEECH RECOGNITION SYSTEMS, TESTING SYSTEMS FOR WIRELESS NETWORK SYSTEMS, IN CLASS 37 (U.S. CLS. 100, 103 AND 106).

FOR: TELECOMMUNICATIONS SERVICES, NAMELY, PERSONAL COMMUNICATION SERVICES, ISDN SERVICES, WIRELESS TELEPHONE SERVICES, WIRELESS BROADBAND COMMUNICATION SERVICES, TELEMATIC SENDING OF INFORMATION, TELECOMMUNICATIONS ACCESS SERVICES, DATA TRANSMISSION AND RECEPTION SERVICES VIA TELECOMMUNICATIONS MEANS, TELECOMMUNICATIONS GATEWAY SERVICES, IN CLASS 38 (U.S. CLS. 100, 101 AND 104).

FOR: TREATMENT OF MATERIALS AND GOODS FOR OTHERS USED IN CONNECTION WITH PRODUCTION AND ASSEMBLY AUTOMATION EQUIPMENT, NAMELY, TELECOMMUNICATIONS EQUIPMENT, RADIO IDENTIFICATION APPARATUS, AND CIRCUIT BOARDS; MATERIAL PROCESSING SERVICES FOR THE ORDER AND SPECIFICATIONS FOR OTHERS, IN CLASS 40 (U.S. CLS. 100, 103 AND 106).

FOR: COMPUTER PROJECT MANAGEMENT SERVICES FOR AUTOMATIC PRODUCTION SYSTEMS; SCIENTIFIC CONSULTING SERVICES IN THE FIELD OF WIRELESS COMMUNICATIONS AND MOTOR VEHICLES; DESIGN AND DEVELOPMENT OF COMPUTER HARDWARE AND SOFTWARE; DESIGN AND TESTING FOR NEW PRODUCT DEVELOPMENT; AND QUALITY ASSURANCE SERVICES IN THE FIELD OF WIRELESS COMMUNICATIONS AND MOTOR VEHICLES; PRODUCT TESTING FOR OTHERS; DESIGN, DEVELOPMENT, AND TESTING OF NEW PRODUCTS FOR OTHERS, PRODUCT RESEARCH AND QUALITY ASSURANCE SERVICES ALL IN THE FIELD OF WIRELESS COMMUNICATIONS, DATA TRANSFER AND TELECOMMUNICATIONS, IN CLASS 42 (U.S. CLS. 100 AND 101).

THE MARK CONSISTS OF THE GREEN, STYLIZED LETTERS "EB" AGAINST A WHITE BACKGROUND.

OWNER OF INTERNATIONAL REGISTRATION 0941904 DATED 5-15-2007, EXPIRES 5-15-2017.

THE COLOR(S) GREEN AND WHITE IS/ARE CLAIMED AS A FEATURE OF THE MARK.

SER. NO. 79-045,526, FILED 5-15-2007.

CHRISTOPHER BUONGIORNO, EXAMINING ATTORNEY

United States of America

United States Patent and Trademark Office

ecoMeter
energy monitor

Reg. No. 4,065,171

Registered Dec. 6, 2011

Int. Cls.: 9 and 42

TRADEMARK

SERVICE MARK

PRINCIPAL REGISTER

LANDIS+GYR (EUROPE) AG (SWITZERLAND SOCIÉTÉ ANONYME)
THEILERSTRASSE 1
CH-6301 ZUG
SWITZERLAND

FOR: ELECTRICITY METERS; GAS METERS; WATER METERS; DISPLAYS AND DISPLAY UNITS, NAMELY, ELECTRONIC DISPLAY INTERFACES, LIQUID CRYSTAL DISPLAYS; REMOTE OPTICAL READERS CONNECTED TO THE ENERGY METERS; DEVICES IN THE NATURE OF ELECTRONIC DISPLAY INTERFACES AND FLAT PANEL DISPLAY SCREENS FOR DISPLAYING ENERGY CONSUMPTION; ALL THE AFORESAID GOODS NOT FOR OUTDOOR USE, NOT FOR USE IN SERVICE STATIONS BY PROFESSIONALS OR FOR USE IN THE RETAIL TRADE, NOT FOR USE IN CARS AND TRUCKS AND NOT FOR USE WITH STANDARD GASOLINE, DIESEL AND ALTERNATIVE FUELS, IN CLASS 9 (U.S. CLS. 21, 23, 26, 36 AND 38).

FOR: MEASUREMENT EVALUATIONS IN THE FIELD OF ENERGY CONSERVATION WITH ENERGY CONSUMPTION IN BUILDINGS, IN CLASS 42 (U.S. CLS. 100 AND 101).

NO CLAIM IS MADE TO THE EXCLUSIVE RIGHT TO USE "ENERGY MONITOR", APART FROM THE MARK AS SHOWN.

PRIORITY DATE OF 5-9-2007 IS CLAIMED.

OWNER OF INTERNATIONAL REGISTRATION 0956668 DATED 11-9-2007, EXPIRES 11-9-2017.

SER. NO. 79-051,091, FILED 11-9-2007.

ERNEST SHOSHO, EXAMINING ATTORNEY



David J. Kybas

Director of the United States Patent and Trademark Office

United States of America

United States Patent and Trademark Office

ECOMETER

Reg. No. 4,065,172

Registered Dec. 6, 2011

Int. Cls.: 9 and 42

TRADEMARK

SERVICE MARK

PRINCIPAL REGISTER

LANDIS+GYR (EUROPE) AG (SWITZERLAND SOCIÉTÉ ANONYME)
THEILERSTRASSE 1
CH-6301 ZUG
SWITZERLAND

FOR: ELECTRICITY METERS; GAS METERS; WATER METERS; DISPLAYS AND DISPLAY UNITS, NAMELY, ELECTRONIC DISPLAY INTERFACES, LIQUID CRYSTAL DISPLAYS; REMOTE OPTICAL READERS CONNECTED TO THE ENERGY METERS; DEVICES IN THE NATURE OF ELECTRONIC DISPLAY INTERFACES AND FLAT PANEL DISPLAY SCREENS FOR DISPLAYING ENERGY CONSUMPTION; ALL THE AFORESAID GOODS NOT FOR OUTDOOR USE, NOT FOR USE IN SERVICE STATIONS BY PROFESSIONALS OR FOR USE IN THE RETAIL TRADE, NOT FOR USE IN CARS AND TRUCKS AND NOT FOR USE WITH STANDARD GASOLINE, DIESEL AND ALTERNATIVE FUELS, IN CLASS 9 (U.S. CLS. 21, 23, 26, 36 AND 38).

FOR: MEASUREMENT EVALUATIONS IN THE FIELD OF ENERGY CONSERVATION WITH ENERGY CONSUMPTION IN BUILDINGS, IN CLASS 42 (U.S. CLS. 100 AND 101).

THE MARK CONSISTS OF STANDARD CHARACTERS WITHOUT CLAIM TO ANY PARTICULAR FONT, STYLE, SIZE, OR COLOR.

PRIORITY DATE OF 5-9-2007 IS CLAIMED.

OWNER OF INTERNATIONAL REGISTRATION 0956669 DATED 11-9-2007, EXPIRES 11-9-2017.

SER. NO. 79-051,092, FILED 11-9-2007.

ERNEST SHOSHO, EXAMINING ATTORNEY



David J. Kypos

Director of the United States Patent and Trademark Office

United States of America

United States Patent and Trademark Office



IFA

HOTELS & RESORTS

Reg. No. 4,065,173

Registered Dec. 6, 2011

Int. Cls.: 41 and 43

SERVICE MARK

PRINCIPAL REGISTER

IFA HOTEL & TOURISTIK AKTIENGESELLSCHAFT (FED REP GERMANY CORPORATION)
DÜSSELDORFER STRASSE 50
47051 DUISBURG
FED REP GERMANY

FOR: AMUSEMENT ARCADES AND CASINOS; PROVIDING SPORTS FACILITIES, SPORTS CAMP SERVICES; HOLIDAY CAMP SERVICES; GAMING SERVICES, NAMELY, PROVIDING CASINOS, PROVIDING GAMBLING SERVICES, IN CLASS 41 (U.S. CLS. 100, 101 AND 107).

FOR: PROVISION OF FOOD AND DRINK; PROVIDING TEMPORARY ACCOMMODATION; BAR SERVICES; PROVIDING CAMPGROUND FACILITIES; HOLIDAY CAMP SERVICES; MOTEL SERVICES; OUTSIDE CATERING; HOTEL RESERVATION SERVICES; RENTAL OF FURNITURE AND HOUSEHOLD FURNISHINGS IN THE NATURE OF RENTAL OF CHAIRS, TABLES, TABLE LINEN, GLASSES, TABLEWARE, AND CUTLERY; RENTAL OF PORTABLE BUILDINGS; RENTAL OF MEETING ROOMS; RENTAL OF TENTS; CAFES, CAFETERIAS, CANTEENS, RESTAURANTS, FAST-FOOD RESTAURANTS, SNACK BARS AND SELF SERVICE RESTAURANTS; MAKING RESERVATIONS AND BOOKINGS FOR OTHERS FOR ACCOMMODATIONS; PROVIDING HOTEL AND GUEST HOUSE ACCOMMODATION, IN CLASS 43 (U.S. CLS. 100 AND 101).

NO CLAIM IS MADE TO THE EXCLUSIVE RIGHT TO USE "HOTELS & RESORTS", APART FROM THE MARK AS SHOWN.

PRIORITY DATE OF 9-14-2007 IS CLAIMED.

OWNER OF INTERNATIONAL REGISTRATION 0972911 DATED 2-21-2008, EXPIRES 2-21-2018.

THE COLOR(S) BLUE IS/ARE CLAIMED AS A FEATURE OF THE MARK.

THE MARK CONSISTS OF THE DESIGN OF A FISH, WHICH APPEARS ABOVE THE WORDING "IFA HOTELS & RESORTS"; THE COLOR BLUE APPEARS IN THE FISH DESIGN, AND IN THE WORDING "IFA HOTELS & RESORTS".

SER. NO. 79-057,191, FILED 2-21-2008.



David J. Kybas

Director of the United States Patent and Trademark Office

Reg. No. 4,065,173 NAPOLEON SHARMA, EXAMINING ATTORNEY

United States of America

United States Patent and Trademark Office

BIKE RADAR

Reg. No. 4,065,174

Registered Dec. 6, 2011

**Int. Cls.: 9, 16, 35, 38
and 41**

TRADEMARK

SERVICE MARK

PRINCIPAL REGISTER

FUTURE PUBLISHING LIMITED (UNITED KINGDOM LIMITED LIABILITY COMPANY)
30 MONMOUTH STREET
BATH, AVON BA1 2BW
UNITED KINGDOM

FOR: DOWNLOADABLE VIDEO AND AUDIO FILES FEATURING MUSICAL PERFORMANCES, AND MOTION PICTURES FOR ENTERTAINMENT; COMPUTER MEMORY CARDS CONTAINING PRE-RECORDED ELECTRONIC PUBLICATIONS, NAMELY, MAGAZINES FEATURING INFORMATION IN THE FIELD OF TECHNOLOGY; ELECTRONIC PUBLICATIONS, NAMELY, MAGAZINES FEATURING INFORMATION RELATING TO BICYCLES AND BICYCLE ACCESSORIES, CYCLING, MOUNTAIN BIKING, BICYCLE RACING, CYCLING HOLIDAYS, CYCLING PATHS AND TRACKS; COMPUTER SOFTWARE FOR USE ON MOBILE TELEPHONES, PERSONAL DIGITAL ASSISTANTS (PDAS), MOBILE COMPUTING DEVICES AND OTHER COMMUNICATIONS DEVICES FOR PROVIDING NEWS AND INFORMATION IN THE FIELD OF BICYCLES AND BICYCLE ACCESSORIES, CYCLING, MOUNTAIN BIKING, BICYCLE RACING, CYCLING HOLIDAYS, CYCLING PATHS AND TRACKS; DOWNLOADABLE ELECTRONIC PUBLICATIONS IN THE NATURE OF MAGAZINES IN THE FIELD OF BICYCLES AND BICYCLE ACCESSORIES, CYCLING, MOUNTAIN BIKING, BICYCLE RACING, CYCLING HOLIDAYS, CYCLING PATHS AND TRACKS, IN CLASS 9 (U.S. CLS. 21, 23, 26, 36 AND 38).

FOR: PRINTED MATTER AND PUBLICATIONS, NAMELY, MAGAZINES, NEWSPAPERS, JOURNALS, AND COLUMNS AND SECTIONS WITHIN SUCH MAGAZINES, NEWSPAPERS, AND JOURNALS, AND PAMPHLETS AND BOOKLETS, ALL IN THE FIELDS OF BUSINESS, ENTERTAINMENT, INFORMATION AND EDUCATION, RELATING TO BICYCLES AND BICYCLE ACCESSORIES, CYCLING, MOUNTAIN BIKING, BICYCLE RACING, CYCLING HOLIDAYS, CYCLING PATHS AND TRACKS; POSTERS; EXTERIOR PACKAGING FOR SOFTWARE, NAMELY, CARDBOARD CARTONS; PRINTED PAPERBOARD INSERTS FOR PLASTIC PACKAGING OF SOFTWARE; PAPER BAGS; PLASTIC BUBBLE PACKS FOR PACKAGING; ENVELOPES; AND PAPER POUCHES FOR PACKAGING, IN CLASS 16 (U.S. CLS. 2, 5, 22, 23, 29, 37, 38 AND 50).

FOR: ADVERTISING, PROMOTIONAL AND MARKETING SERVICES FOR OTHERS; PROVIDING BUSINESS AND MARKETING INFORMATION; COMPUTERIZED ELECTRONIC ON-LINE RETAIL STORE SERVICES FEATURING COMPUTER AND VIDEO GAME SOFTWARE, COMPUTER HARDWARE AND SOFTWARE, CONSUMER ELECTRONICS, AND COMPUTER GAMES SOFTWARE AND HARDWARE, GENERAL MERCHANDISE



David J. Kyros

Director of the United States Patent and Trademark Office

Reg. No. 4,065,174 FOR BICYCLES AND CLOTHING ADAPTED FOR USE IN CYCLING, SAFETY CLOTHES, PROTECTIVE PADS GLOVES AND HELMETS FOR USE IN CYCLING, STATIONERY, CALENDARS, AND PRE-RECORDED AUDIO TAPES, VIDEO TAPES, AUDIO CASSETTES, VIDEO CASSETTES, CD-ROMS, DVDS, COMPACT DISCS, AND VIDEO DISCS FEATURING INFORMATION RELATING TO BICYCLES AND BICYCLE ACCESSORIES, CYCLING, MOUNTAIN BIKING, BICYCLE RACING, CYCLING HOLIDAYS, CYCLING PATHS AND TRACKS; BUSINESS ADVICE AND INFORMATION RELATING TO ON-LINE RETAIL STORE SERVICES, IN CLASS 35 (U.S. CLS. 100, 101 AND 102).

FOR: NETWORK TRANSMISSION, OF SOUND, DATA OR IMAGES, BROADCAST, NAMELY, AUDIO AND VIDEO BROADCASTING SERVICES OVER THE INTERNET, AND BY ELECTRONIC COMMUNICATIONS NETWORKS RELATING TO BICYCLES AND BICYCLE ACCESSORIES, CYCLING, MOUNTAIN BIKING, BICYCLE RACING, CYCLING HOLIDAYS, CYCLING PATHS AND TRACKS; PODCASTING SERVICES, NAMELY, ENHANCED TRANSMISSION OF AUDIO AND/OR VISUAL CONTENT AND TRANSMISSION OF REALLY SIMPLE SYNDICATION (RSS) FEEDS VIA A GLOBAL COMPUTER NETWORK OR OTHER ELECTRONIC OR DIGITAL COMMUNICATIONS NETWORK OR DEVICE CONCERNING TOPICS OF BICYCLES AND BICYCLE ACCESSORIES, CYCLING, MOUNTAIN BIKING, BICYCLE RACING, CYCLING HOLIDAYS, CYCLING PATHS AND TRACKS; PROVIDING ON-LINE CHAT ROOM FOR TRANSMISSION OF MESSAGES AMONG COMPUTER USERS CONCERNING TOPICS OF BICYCLES AND BICYCLE ACCESSORIES, CYCLING, MOUNTAIN BIKING, BICYCLE RACING, CYCLING HOLIDAYS, CYCLING PATHS AND TRACKS; TELECOMMUNICATIONS SERVICES, NAMELY, PROVIDING ACCESS TO ON-LINE ELECTRONIC BULLETIN BOARDS FOR TRANSMISSION OF MESSAGES AMONG COMPUTER USERS CONCERNING THE TOPICS OF BICYCLES AND BICYCLE ACCESSORIES, CYCLING, MOUNTAIN BIKING, BICYCLE RACING, CYCLING HOLIDAYS, CYCLING PATHS AND TRACKS; TELECOMMUNICATIONS SERVICES, NAMELY, PROVIDING INTERNET ACCESS TO ONLINE BLOGS, DISCUSSION GROUPS, CHAT ROOMS AND ELECTRONIC BULLETIN BOARDS; PROVIDING ACCESS TO AN INTERNET DISCUSSION WEBSITE; TRANSMISSION OF NEWS AND INFORMATION VIA THE INTERNET RELATING TO BICYCLES AND BICYCLE ACCESSORIES, CYCLING, MOUNTAIN BIKING, BICYCLE RACING, CYCLING HOLIDAYS, CYCLING PATHS AND TRACKS, IN CLASS 38 (U.S. CLS. 100, 101 AND 104).

FOR: PUBLISHING OF PRINTED MATTER RELATING TO BICYCLES AND BICYCLE ACCESSORIES, CYCLING, MOUNTAIN BIKING, BICYCLE RACING, CYCLING HOLIDAYS, CYCLING PATHS AND TRACKS; ENTERTAINMENT SERVICES IN THE FIELD OF FILM AND TELEVISION, NAMELY, THE PRODUCTION AND DISTRIBUTION OF FILMS, AND PRODUCTION OF VIDEO DISCS FOR OTHERS; ENTERTAINMENT, NAMELY, A CONTINUING NEWS SHOW FEATURING CYCLING NEWS AND REVIEWS DISTRIBUTED OVER ELECTRONIC MEDIA, NAMELY, GLOBAL AND LOCAL AREA COMPUTER NETWORKS; ORGANIZING, ARRANGING AND CONDUCTING EDUCATIONAL CONFERENCES AND SEMINARS IN THE FIELD OF BICYCLES AND BICYCLE ACCESSORIES, CYCLING, MOUNTAIN BIKING, BICYCLE RACING, CYCLING HOLIDAYS, CYCLING PATHS AND TRACKS, IN CLASS 41 (U.S. CLS. 100, 101 AND 107).

THE MARK CONSISTS OF STANDARD CHARACTERS WITHOUT CLAIM TO ANY PARTICULAR FONT, STYLE, SIZE, OR COLOR.

OWNER OF INTERNATIONAL REGISTRATION 0977329 DATED 10-24-2007, EXPIRES 10-24-2017.

NO CLAIM IS MADE TO THE EXCLUSIVE RIGHT TO USE "BIKE", APART FROM THE MARK AS SHOWN.

SER. NO. 79-058,884, FILED 10-24-2007.

VERNA BETH RIRIE, EXAMINING ATTORNEY

United States of America

United States Patent and Trademark Office

GERMAN MAESTRO

Reg. No. 4,065,175

Registered Dec. 6, 2011

Int. Cl.: 9

TRADEMARK

PRINCIPAL REGISTER

MAESTRO BADENIA AKUSTIK & ELEKTRONIC GMBH (FED REP GERMANY
GESELLSCHAFT MIT BESCHRÄNKTER HAFTUNG (GMBH))
NECKARSTRASSE 20
OBRIGHEIM, FED REP GERMANY 74847

FOR: LOUDSPEAKERS; LOUDSPEAKER SYSTEMS; LOUDSPEAKER CABINETS; HEAD-
PHONES; RECORD PLAYERS; ELECTRIC DISTRIBUTION CONSOLES; SOUND AND AUDIO
MIXERS; STANDS SPECIALLY ADAPTED FOR AUDIO COMPONENTS, NAMELY, STEREOS
AND AUDIO SPEAKERS; ELECTRIC CABLES; ELECTRIC CONDUCTORS; ELECTRIC
SWITCHES; ELECTRICAL DISTRIBUTION BOXES; REMOTE CONTROLS FOR RADIOS,
TELEVISION AND STEREOS, IN CLASS 9 (U.S. CLS. 21, 23, 26, 36 AND 38).

THE MARK CONSISTS OF STANDARD CHARACTERS WITHOUT CLAIM TO ANY PAR-
TICULAR FONT, STYLE, SIZE, OR COLOR.

PRIORITY DATE OF 1-31-2008 IS CLAIMED.

OWNER OF INTERNATIONAL REGISTRATION 0980286 DATED 7-25-2008, EXPIRES 7-25-
2018.

NO CLAIM IS MADE TO THE EXCLUSIVE RIGHT TO USE "GERMAN", APART FROM
THE MARK AS SHOWN.

SER. NO. 79-060,141, FILED 7-25-2008.

WENDY GOODMAN, EXAMINING ATTORNEY



David J. Kyffers

Director of the United States Patent and Trademark Office

United States of America

United States Patent and Trademark Office

CARRERA Y CARRERA

Reg. No. 4,065,176

Registered Dec. 6, 2011

Int. Cl.: 14

TRADEMARK

PRINCIPAL REGISTER

CARRERA Y CARRERA, S.A. (SPAIN S.A.)
CARRETERA NACIONAL I,
KM. 31,600; E-28750 SAN AGUSTIN DE GUADALIX (MADRID)
SPAIN

FOR: PRECIOUS METALS AND THEIR ALLOYS AND GOODS IN PRECIOUS METALS OR COATED THEREWITH, NAMELY, JEWELLERY, PRECIOUS STONES, IN CLASS 14 (U.S. CLS. 2, 27, 28 AND 50).

OWNER OF U.S. REG. NOS. 1,247,018 AND 3,520,866.

OWNER OF INTERNATIONAL REGISTRATION 0943315 DATED 9-3-2007, EXPIRES 9-3-2017.

THE ENGLISH TRANSLATION OF "CARRERA Y CARRERA" IN THE MARK IS "RACE & RACE".

SER. NO. 79-068,938, FILED 2-27-2009.

CHRISIE B. KING, EXAMINING ATTORNEY



David J. Kybas

Director of the United States Patent and Trademark Office

United States of America

United States Patent and Trademark Office

KISS KISS BABY

Reg. No. 4,065,177

Registered Dec. 6, 2011

Int. Cl.: 3

TRADEMARK

PRINCIPAL REGISTER

GUERLAIN SOCIETE ANONYME (FRANCE SOCIÉTÉ ANONYME (SA))
68 AVENUE DES CHAMPS ELYSÉES
F-75008 PARIS
FRANCE

FOR: MAKE-UP FOR THE FACE AND BODY, IN CLASS 3 (U.S. CLS. 1, 4, 6, 50, 51 AND 52).

PRIORITY DATE OF 11-4-2008 IS CLAIMED.

OWNER OF INTERNATIONAL REGISTRATION 1003102 DATED 4-28-2009, EXPIRES 4-28-2019.

SER. NO. 79-068,979, FILED 4-28-2009.

B. PARADEWELAI, EXAMINING ATTORNEY



David J. Kyffers

Director of the United States Patent and Trademark Office

United States of America

United States Patent and Trademark Office



Reg. No. 4,065,178

Registered Dec. 6, 2011

Int. Cls.: 7, 12 and 17

TRADEMARK

PRINCIPAL REGISTER

CONTITECH AKTIENGESELLSCHAFT (FED REP GERMANY JOINT STOCK COMPANY)
VAHRENWALDER STR. 9
30165 HANNOVER
FED REP GERMANY

FOR: ENGINE COMPONENTS, NAMELY, BEARINGS, CAMSHAFTS, CYLINDERS, INJECTORS; FAN BELTS; BELTS FOR ENGINES, BELTS FOR MACHINES; CONVEYORS AND CONVEYOR BELTS; MACHINE PARTS, NAMELY, SPRINGS, PNEUMATIC SPRINGS, SHOCK ABSORBER PISTONS, VIBRATION DAMPERS, ENGINE BEARINGS, HYDRAULIC BEARINGS, ROTATIONAL VIBRATION ATTENUATORS, IN CLASS 7 (U.S. CLS. 13, 19, 21, 23, 31, 34 AND 35).

FOR: SUSPENSION SPRINGS FOR MOTOR VEHICLES AND PARTS THEREFOR, AIR SPRINGS FOR VEHICLE SUSPENSION COMPONENTS FOR CUSHIONING DRIVER'S SEATS AND CABS, LAND VEHICLE SUSPENSION PARTS, NAMELY, COIL SPRINGS AND LEAF SPRINGS, SHOCK ABSORBERS AND SUSPENSION STRUTS FOR VEHICLES; SHOCK ABSORBING SPRINGS FOR VEHICLES; VEHICLE SUSPENSION SPRINGS FOR MOTOR VEHICLES; AXLE BEARINGS FOR LAND VEHICLES; SHAPED RUBBER AND RUBBER-METAL PARTS FOR OSCILLATION DAMPERS AND POWER TRANSMISSIONS INCLUDED IN THIS CLASS, NAMELY, AUTOMOTIVE ENGINE MOUNTS; DRIVE CHAINS FOR LAND VEHICLES, DRIVE BELTS, BRAKE HOSES, IN CLASS 12 (U.S. CLS. 19, 21, 23, 31, 35 AND 44).



David J. Kyjars

Director of the United States Patent and Trademark Office

FOR: NATURAL RUBBER, GUTTA-PERCHA; RAW RUBBER, SEMI-WORKED RUBBER, RUBBER SHEETS, SYNTHETIC RUBBER; SEMI-PROCESSED PLASTICS; SEALING, PACKING AND INSULATING MATERIALS; NON-METALLIC HOSES, AIR CONDITIONER HOSES MADE OF RUBBER AND PLASTIC, AIR HOSES, CONNECTING HOSES FOR VEHICLE RADIATORS, FIRE HOSES, GARDEN HOSES, HOSES FOR PNEUMATIC TOOLS, HYDRAULIC HOSES MADE OF RUBBER AND PLASTIC, IRRIGATION HOSES, NON-METAL HOSES FOR COMMERCIAL MARINE USE, NON-METAL HOSES FOR USE IN THE AUTOMOTIVE AND OIL INDUSTRIES, NON-METAL, PLASTIC AND RUBBER HOSES FOR INDUSTRIAL APPLICATIONS; NON-METAL HOSE FITTINGS; NON-METAL CABLE-REINFORCING MATERIALS; RUBBER SOLUTIONS, RUBBER DERIVATIVES; RUBBER COMPENSATORS SEMI-FINISHED; PIPE GASKETS; NON-METAL SEALING RINGS FOR USE AS CONNECTION SEALS, INSULATING WATERPROOFING MEMBRANES; SHOCK ABSORBING BUFFERS OF RUBBER FOR INDUSTRIAL MACHINERY, VALVES OF RUBBER; RUBBER SHEETING AND RUBBER SLEEVES FOR PROTECTING MACHINE PARTS;

Reg. No. 4,065,178 PADDING MATERIALS OF RUBBER, NAMELY, MATTING OF RUBBER FOR VIBRATION AND SHOCK ABSORPTION IN TRACK LAYING; OIL ABSORPTION MATS IN RUBBER; CONVERTIBLE HOOD, DOOR, WINDOW AND ENGINE COMPARTMENT NON-METAL GASKETS; UPHOLSTERY MATERIAL OF RUBBER AND PLASTIC; PLASTIC FILMS FOR PACKING AND INSULATING; ELASTOMERIC EXPANSION AND CONTRACTION JOINT SEALS FOR USE IN BUILDING, BRIDGES, ROADWAYS, PARKING STRUCTURES AND OPEN-AIR STRUCTURES, IN CLASS 17 (U.S. CLS. 1, 5, 12, 13, 35 AND 50).

OWNER OF U.S. REG. NO. 1,785,216.

PRIORITY DATE OF 4-21-2009 IS CLAIMED.

OWNER OF INTERNATIONAL REGISTRATION 1016445 DATED 8-5-2009, EXPIRES 8-5-2019.

THE MARK CONSISTS OF A DIAMOND DESIGN WITH TWO SQUARE SHAPES ON EITHER SIDE NEXT TO THE WORD "PHOENIX" IN BLOCK LETTERS.

SER. NO. 79-074,045, FILED 8-5-2009.

LINDA ORNDORFF, EXAMINING ATTORNEY

United States of America

United States Patent and Trademark Office

SIGMA

Reg. No. 4,065,179

Registered Dec. 6, 2011

Int. Cls.: 7 and 9

TRADEMARK

PRINCIPAL REGISTER

KAESER KOMPRESSOREN GMBH (FED REP GERMANY GESELLSCHAFT MIT
BESCHRÄNKTER HAFTUNG (GMBH))
CARL-KAESER-STRASSE 26
COBURG, FED REP GERMANY 96450

FOR: MACHINES, NAMELY, AIR COMPRESSORS; COMPRESSED AIR MACHINES;
COMPRESSED AIR PUMPS, IN CLASS 7 (U.S. CLS. 13, 19, 21, 23, 31, 34 AND 35).

FOR: APPARATUS FOR DATA TRANSMISSION USED IN THE CONTROL OF AIR COM-
PRESSORS AND OF OTHER COMPRESSED AIR APPLICATIONS, NAMELY, COMPRESSED
AIR MACHINES AND COMPRESSED AIR PUMPS; MASTER ELECTRONIC CONTROLLERS
FOR CONTROLLING CONTROLLERS FOR PERIPHERAL AIR COMPRESSORS, COM-
PRESSED AIR MACHINES AND COMPRESSED AIR PUMPS, ALL OF THE FOREGOING
SOLD SEPARATELY FROM THE MACHINES THEMSELVES BUT INTENDED FOR USE
EXCLUSIVELY IN CONNECTION WITH AIR COMPRESSORS, COMPRESSED AIR MA-
CHINES AND COMPRESSED AIR PUMPS, IN CLASS 9 (U.S. CLS. 21, 23, 26, 36 AND 38).

THE MARK CONSISTS OF STANDARD CHARACTERS WITHOUT CLAIM TO ANY PAR-
TICULAR FONT, STYLE, SIZE, OR COLOR.

OWNER OF INTERNATIONAL REGISTRATION 1017804 DATED 7-14-2009, EXPIRES 7-14-
2019.

OWNER OF U.S. REG. NO. 3,148,051.

SER. NO. 79-074,545, FILED 7-14-2009.

NANCY CLARKE, EXAMINING ATTORNEY



David J. Kyros

Director of the United States Patent and Trademark Office

United States of America

United States Patent and Trademark Office



Ace Camp

Reg. No. 4,065,180

Registered Dec. 6, 2011

**Int. Cls.: 6, 8, 9, 11, 18,
20, 21, 22, 24, 25 and 28**

ACECAMP GMBH (FED REP GERMANY LIMITED LIABILITY COMPANY)
SONTRAER STRASSE 6
60386 FRANKFURT AM MAIN
FED REP GERMANY

FOR: GOODS OF COMMON METAL NOT INCLUDED IN OTHER CLASSES, NAMELY, BOXES, BUCKLES, FIGURES, IDENTITY PLATES, KEY FOBS, KEY RINGS, IN CLASS 6 (U.S. CLS. 2, 12, 13, 14, 23, 25 AND 50).

TRADEMARK

PRINCIPAL REGISTER

FOR: HAND TOOLS, NAMELY, AXES, CROW BARS, DRILLS, FILES, FIREPLACE BELLOWS, HAMMERS, HARPOONS FOR FISHING IN THE NATURE OF SPEARS, ICE AXES, INSTRUMENTS AND TOOLS FOR SKINNING ANIMALS IN THE NATURE OF HAND-OPERATED SCRAPER, MACHETES, MATTOCKS, PLANES, PLIERS, RESCUE HAMMERS FOR SMASHING GLASS, SAWS, SCALING KNIVES, SCREWDRIVERS, SHARPENING INSTRUMENTS IN THE NATURE OF SHARPENING STEELS, SHARPENING STONES, SHARPENING RODS, SPADES, WEED CUTTERS, WRENCHES; KNIVES, CUTLERY, TABLE CUTLERY, NAMELY, FORKS AND SPOONS; SIDE ARMS, NAMELY, HUNTING KNIVES; RAZORS, IN CLASS 8 (U.S. CLS. 23, 28 AND 44).

FOR: LIFE-SAVING APPARATUS AND INSTRUMENTS, NAMELY, LIFE-SAVING RAFTS; APPARATUS FOR RECORDING, TRANSMISSION OR REPRODUCTION OF SOUND OR IMAGES; BLANK MAGNETIC DATA CARRIERS; BLANK COMPACT DISCS FOR USE IN RECORDING MUSIC; AUTOMATIC VENDING MACHINES AND MECHANISMS FOR COIN-OPERATED APPARATUS; CASH REGISTERS, CALCULATING MACHINES, DATA PROCESSING EQUIPMENT AND COMPUTERS; FIRE-EXTINGUISHING APPARATUS, IN CLASS 9 (U.S. CLS. 21, 23, 26, 36 AND 38).

FOR: APPARATUS FOR LIGHTING, HEATING, STEAM GENERATING, COOKING, REFRIGERATING, DRYING, VENTILATING, WATER SUPPLY AND SANITARY PURPOSES, NAMELY, BICYCLE LIGHTS, ELECTRIC COOKTOPS, ELECTRIC KETTLES, FILTERS FOR DRINKING WATER, GAS BURNERS, GAS LAMPS, IMMERSION HEATERS, KILNS, LANTERNS FOR LIGHTING, LIGHT BULBS, POCKET TORCHES IN THE NATURE OF ELECTRIC TORCHES FOR LIGHTING, REFRIGERATING CONTAINERS, NAMELY, REFRIGERATORS, SOLAR WATER HEATERS, WATER STERILIZERS, HOT WATER TANKS, IN CLASS 11 (U.S. CLS. 13, 21, 23, 31 AND 34).



David J. Kyjars

Director of the United States Patent and Trademark Office

Reg. No. 4,065,180 FOR: LEATHER AND IMITATIONS OF LEATHER; ANIMAL SKINS AND HIDES; WHIPS, HARNESS AND SADDLERY, IN CLASS 18 (U.S. CLS. 1, 2, 3, 22 AND 41).

FOR: FURNITURE, MIRRORS, PICTURE FRAMES, IN CLASS 20 (U.S. CLS. 2, 13, 22, 25, 32 AND 50).

FOR: CONTAINERS FOR HOUSEHOLD OR KITCHEN USE; HOUSEHOLD AND KITCHEN UTENSILS, NAMELY, GRATERS, POT AND PAN SCRAPERS, POURING AND STRAINING SPOUTS, SERVING TONGS, SIEVES, SKIMMERS, SPATULAS, SPLATTER SCREENS, STRAINERS, WHISKS; COMBS AND CLEANING SPONGES; BRUSHES, NAMELY, BATH BRUSHES; BRUSH-MAKING MATERIALS; ARTICLES FOR CLEANING PURPOSES, NAMELY, CLEANING SPONGES; STEEL WOOL; UNWORKED GLASS, SEMI-WORKED GLASS, AND GLASSWARE, ALL IN THE NATURE OF BEVERAGE GLASSWARE; PORCELAIN AND EARTHENWARE, NAMELY, PORCELAIN BOWLS, PORCELAIN CUPS, PORCELAIN MUGS, PORCELAIN PLATES, PORCELAIN POTS, PORCELAIN SAUCERS, EARTHENWARE BOWLS, EARTHENWARE CUPS, EARTHENWARE MUGS, EARTHENWARE PLATES, EARTHENWARE POTS, EARTHENWARE SAUCERS, IN CLASS 21 (U.S. CLS. 2, 13, 23, 29, 30, 33, 40 AND 50).

FOR: ROPES, STRING, FISHING NETS, TENTS, AWNINGS, TARPAULINS, SAILS; SACKS AND BAGS NOT INCLUDED IN OTHER CLASSES, NAMELY, BODY BAGS, MULTI-PURPOSE CLOTH BAGS, SHOE BAGS FOR STORAGE; PADDING AND STUFFING MATERIALS NOT OF RUBBER, PAPER OR PLASTIC; RAW FIBROUS TEXTILE MATERIALS, IN CLASS 22 (U.S. CLS. 1, 2, 7, 19, 22, 42 AND 50).

FOR: TEXTILES AND TEXTILE GOODS, NAMELY, BED AND TABLE LINEN, TOWELS; BED COVERS; TABLE COVERS, NAMELY, FABRIC TABLE RUNNERS AND FABRIC TABLE TOPPERS, IN CLASS 24 (U.S. CLS. 42 AND 50).

FOR: CLOTHING, NAMELY, BELTS, COATS, JACKETS, MANTLES, PANTS, PULLOVERS, SHIRTS, SHORTS, SKIRTS AND DRESSES, SOCKS, TOPS, T-SHIRTS, UNDERWEAR; FOOTWEAR; HEADGEAR, NAMELY, HATS, CAPS, BANDANAS , IN CLASS 25 (U.S. CLS. 22 AND 39).

FOR: GAMES AND PLAYTHINGS, NAMELY, BACKGAMMON GAME SETS, BADMINTON GAME PLAYING EQUIPMENT, BOARD GAMES, CARD GAMES, DART GAMES, DICE GAMES, NETS FOR BALL GAMES, PARLOUR GAMES, VOLLEYBALL GAME PLAYING EQUIPMENT; GYMNASTIC APPARATUSES; SPORTING ARTICLES, NAMELY, BASKETBALLS, FOOT BALLS, SOCCER BALLS; DECORATIONS FOR CHRISTMAS TREES, IN CLASS 28 (U.S. CLS. 22, 23, 38 AND 50).

NO CLAIM IS MADE TO THE EXCLUSIVE RIGHT TO USE "CAMP", APART FROM THE MARK AS SHOWN.

OWNER OF INTERNATIONAL REGISTRATION 1018264 DATED 9-16-2009, EXPIRES 9-16-2019.

THE MARK CONSISTS OF THE STYLIZED WORDING "ACE CAMP". ABOVE "CAMP" IN THE MARK IS A TRIANGULAR DESIGN WITH THE DESIGN OF THREE PERSONS WALKING AND CARRYING BACKPACKS ON TOP.

SER. NO. 79-074,733, FILED 9-16-2009.

MAUREEN DALL, EXAMINING ATTORNEY

United States of America

United States Patent and Trademark Office



InterSearch

Reg. No. 4,065,181

Registered Dec. 6, 2011

Int. Cls.: 35 and 45

SERVICE MARK

PRINCIPAL REGISTER

NOVAGRAAF NEDERLAND B.V. (NETHERLANDS BESLOTEN VENNOOTSCHAP)
HOGEHILWEG 3
NL-1101 CA AMSTERDAM ZUIDOOST
NETHERLANDS

FOR: PROVIDING OFFICE FUNCTIONS IN THE FIELD OF INTELLECTUAL AND INDUSTRIAL PROPERTY RIGHTS; PROVIDING DATABASES CONTAINING INFORMATION REGARDING INTELLECTUAL AND INDUSTRIAL PROPERTY, NAMELY, INTELLECTUAL AND INDUSTRIAL PROPERTY RIGHTS AVAILABLE FOR POSSIBLE ACQUISITIONS, IN CLASS 35 (U.S. CLS. 100, 101 AND 102).

FOR: LEGAL RESEARCH AND LEGAL MONITORING SERVICES IN THE FIELD OF INTELLECTUAL PROPERTY RIGHTS AND INDUSTRIAL PROPERTY RIGHTS, AND INTELLECTUAL PROPERTY CONSULTATION; CONSULTANCY AND LEGAL SERVICES IN THE FIELD OF INTELLECTUAL AND INDUSTRIAL PROPERTY RIGHTS; LEGAL RESEARCH REGARDING ISSUES OF THE PROTECTION OF INDUSTRIAL PROPERTY AND LEGAL MATTERS; LEGAL SERVICES AND CONSULTANCY CONCERNING INTELLECTUAL AND INDUSTRIAL PROPERTY RIGHTS; MANAGEMENT OF INTELLECTUAL AND INDUSTRIAL PROPERTY RIGHTS, NAMELY, INTELLECTUAL PROPERTY WATCH SERVICES, LEGAL CONSULTATION AND MEDIATION IN LEGAL DISPUTES; PROVIDING ON-LINE INTERACTIVE DATABASES FEATURING LEGAL INFORMATION REGARDING INTELLECTUAL AND INDUSTRIAL PROPERTY, IN CLASS 45 (U.S. CLS. 100 AND 101).



PRIORITY DATE OF 8-26-2009 IS CLAIMED.

OWNER OF INTERNATIONAL REGISTRATION 1020057 DATED 8-28-2009, EXPIRES 8-28-2019.

THE COLOR(S) GOLD AND BLACK IS/ARE CLAIMED AS A FEATURE OF THE MARK.

THE MARK CONSISTS OF A GUARDIAN ANGEL IN THE COLOUR GOLD AND THE WORD MARK "INTERSEARCH" IN THE COLOUR BLACK.

SER. NO. 79-075,575, FILED 8-28-2009.

APRIL ROACH, EXAMINING ATTORNEY

David J. Kyros

Director of the United States Patent and Trademark Office

United States of America

United States Patent and Trademark Office

Water For Life

Reg. No. 4,065,182

Registered Dec. 6, 2011

Int. Cls.: 9, 16, 35 and 41

SMITH, GREGORY (UNITED KINGDOM INDIVIDUAL)
FOCUS MEDIA COMMUNICATIONS LTD.
STANSTEAD HALL THE COTTAGE,; 15 HIGH STREET; STANSTEAD ABBOTTS,
HERTFORDSHIRE SG12 8AA
UNITED KINGDOM

TRADEMARK

SERVICE MARK

PRINCIPAL REGISTER

FOR: SCIENTIFIC, NAUTICAL, SURVEYING, PHOTOGRAPHIC, CINEMATOGRAPHIC, OPTICAL, WEIGHING, MEASURING, SIGNALING, CHECKING AND SUPERVISION, LIFE-SAVING AND TEACHING APPARATUS AND INSTRUMENTS, NAMELY, MICROSCOPES, COMPASSES, PROTRACTORS, CAMERAS, MAGNIFYING GLASSES, TELESCOPES, GRADUATED RULERS, EMERGENCY FLARES, OPTICAL LENSES, SCALES, SIGNALING BUOYS, LIFE-SAVING RAFTS; APPARATUS AND INSTRUMENTS FOR CONDUCTING, DISTRIBUTING, TRANSFORMING, ACCUMULATING, REGULATING OR CONTROLLING ELECTRICITY; APPARATUS FOR RECORDING, TRANSMISSION OR REPRODUCTION OF SOUND OR IMAGES; BLANK MAGNETIC DATA CARRIERS AND RECORDING DISCS; AUTOMATIC VENDING MACHINES AND MECHANISMS FOR COIN-OPERATED APPARATUS; CASH REGISTERS, CALCULATING MACHINES, DATA PROCESSING EQUIPMENT AND COMPUTERS; FIRE-EXTINGUISHING APPARATUS, IN CLASS 9 (U.S. CLS. 21, 23, 26, 36 AND 38).

FOR: PAPER, CARDBOARD AND GOODS MADE OF PAPER AND CARDBOARD, NAMELY, PAPER BAGS, CARDBOARD BOXES, FOLDERS, BINDERS; PRINTED MATTER, NAMELY, MAGAZINES, BROCHURES, NEWSPAPERS, NEWSLETTERS, PAMPHLETS, AND TICKETS IN THE FIELD OF CONCERTS, EVENTS, PUBLIC RELATIONS, ADVERTISING, MARKETING, AND CHARITY WORK, NON-FICTION BOOKS RELATING TO THE ENVIRONMENT OR ENVIRONMENTAL ISSUES, EVENT PROGRAMS AND BROCHURES RELATING TO THE ENVIRONMENT, ENVIRONMENTAL ISSUES OR MUSICAL PERFORMANCES; POSTERS; BOOKBINDING MATERIAL; PHOTOGRAPHS; STATIONERY; ADHESIVES FOR STATIONERY OR HOUSEHOLD PURPOSES; ARTISTS' MATERIALS, NAMELY, ARTISTS' PASTELS, ARTISTS' PENS; PAINT BRUSHES; TYPEWRITERS AND OFFICE REQUISITES NOT BEING FURNITURE, NAMELY, STAPLERS, PUNCHES, PAPER CLIPS; PRINTED INSTRUCTIONAL AND TEACHING MATERIAL NOT BEING APPARATUS IN THE SUBJECT MATTER OF CONCERTS, EVENTS, PUBLIC RELATIONS, ADVERTISING, MARKETING AND CHARITY WORK; PLASTIC MATERIALS FOR PACKAGING, NAMELY, PLASTIC POUCHES FOR MERCHANDISE PACKAGING, PLASTIC BAGS FOR PACKAGING AND GENERAL PURPOSE PLASTIC BAGS FOR CARRYING, PLASTIC BUBBLE PACKS FOR



David J. Kyjars

Director of the United States Patent and Trademark Office

Reg. No. 4,065,182 PACKAGING; PRINTERS' TYPE; PRINTING BLOCKS , IN CLASS 16 (U.S. CLS. 2, 5, 22, 23, 29, 37, 38 AND 50).

FOR: ADVERTISING; BUSINESS MANAGEMENT; BUSINESS ADMINISTRATION; OFFICE FUNCTIONS, IN CLASS 35 (U.S. CLS. 100, 101 AND 102).

FOR: EDUCATIONAL SERVICES, NAMELY, PROVIDING CLASSES, SEMINARS, WORKSHOPS, CONFERENCES AND SUMMITS, CONCERTS IN THE FIELD OF ENVIRONMENTAL AND CHARITY ACTIVITIES; PROVIDING TRAINING IN THE FIELD OF COMPUTER EDUCATION, PUBLIC AWARENESS OF ENVIRONMENT AND RECYCLING; ENTERTAINMENT SERVICES, NAMELY, LIVE MUSIC CONCERTS, DANCE EVENTS, SHOWS, LIVE SHOW PERFORMANCES, LIVE PERFORMANCES BY MUSICAL PERFORMERS; ORGANIZING COMMUNITY ENVIRONMENTAL, MUSICAL AND CULTURAL EVENTS, IN CLASS 41 (U.S. CLS. 100, 101 AND 107).

THE MARK CONSISTS OF STANDARD CHARACTERS WITHOUT CLAIM TO ANY PARTICULAR FONT, STYLE, SIZE, OR COLOR.

OWNER OF INTERNATIONAL REGISTRATION 1021769 DATED 7-10-2009, EXPIRES 7-10-2019.

SER. NO. 79-076,175, FILED 7-10-2009.

KRISTINA MORRIS, EXAMINING ATTORNEY

United States of America
United States Patent and Trademark Office

MeMod

Reg. No. 4,065,183

Registered Dec. 6, 2011

Int. Cls.: 6, 19 and 37

TRADEMARK

SERVICE MARK

PRINCIPAL REGISTER

STONELAKE PTY LTD (AUSTRALIA PROPRIETARY LIMITED COMPANY)
UNIT 4
9-11 KEONA CIRCUIT; COFFS HARBOUR NSW 2450
AUSTRALIA

FOR: PREFABRICATED ELEMENTS OF METAL FOR BUILDING, NAMELY, STRUCTURAL STEEL CHASSIS, JIGS, TEMPLATES IN THE NATURE OF FRAMEWORKS, STRAPS, RAILS, WINDOW REVEALS, WINDOW SILLS, FERULES IN THE NATURE OF JOINTS, COLUMNS, BEAMS, WALL AND CEILING PANELS, ROOF TRUSSES, ROOF LUGS BEING SUPPORTS, CRANE LUGS BEING SUPPORTS, RE-ALIGNMENT PACKERS BEING SUPPORTS, BRACING, BRACING LUGS BEING SUPPORTS, CEILING SUPPORT RAILS, WALL ALIGNMENT RAILS, STRUCTURAL WINDOW SURROUNDS; PRE-FABRICATED METAL BUILDINGS, IN CLASS 6 (U.S. CLS. 2, 12, 13, 14, 23, 25 AND 50).

FOR: PRE-FABRICATED NON-METALLIC BUILDINGS; NON-METALLIC PREFABRICATED ELEMENTS FOR BUILDING, NAMELY, WALL PANELS, SKIRTING BOARDS FOR WALLS AND FLOORS, PLASTERBOARD SHEETING, IN CLASS 19 (U.S. CLS. 1, 12, 33 AND 50).

FOR: BUILDING CONSTRUCTION, IN CLASS 37 (U.S. CLS. 100, 103 AND 106).

THE MARK CONSISTS OF STANDARD CHARACTERS WITHOUT CLAIM TO ANY PARTICULAR FONT, STYLE, SIZE, OR COLOR.

OWNER OF INTERNATIONAL REGISTRATION 1022456 DATED 11-20-2009, EXPIRES 11-20-2019.

SER. NO. 79-076,462, FILED 11-20-2009.

MARIAM MAHMOUDI, EXAMINING ATTORNEY



David J. Kybas

Director of the United States Patent and Trademark Office

United States of America

United States Patent and Trademark Office

bōndi

Reg. No. 4,065,184

Registered Dec. 6, 2011

Int. Cls.: 32 and 33

CAPRICORN BRANDS PTY LIMITED (AUSTRALIA PROPRIETARY COMPANY ORGANISED UNDER THE LAWS OF AUSTRALIA)
LEVEL 13
22 MARKET STREET; SYDNEY NSW 2000
AUSTRALIA

TRADEMARK

PRINCIPAL REGISTER

FOR: BEERS; MINERAL AND AERATED WATERS; NON-ALCOHOLIC BEVERAGES, NAMELY, CARBONATED BEVERAGES, FRUIT DRINKS, FRUIT BEVERAGES AND FRUIT JUICES; NON-ALCOHOLIC BEVERAGES CONTAINING FRUIT JUICES; NON-ALCOHOLIC MALT BEVERAGES; NON-ALCOHOLIC COCKTAIL MIXES; SYRUPS FOR MAKING BEVERAGES; PREPARATIONS FOR MAKING THE ABOVE-LISTED BEVERAGES, IN CLASS 32 (U.S. CLS. 45, 46 AND 48).

FOR: WINE; RED WINE; WHITE WINE; BLENDED WINES, FORTIFIED WINES; SPARKLING WINES; LIQUEURS; PORT WINES; APERITIF WINES; APERITIFS WITH A WINE BASE; COOKING WINE; WINE-BASED DRINKS, IN CLASS 33 (U.S. CLS. 47 AND 49).

THE MARK CONSISTS OF THE WORD "BONDI" WITH THE LETTER "O" APPEARING AS A STYLIZED DESIGN OF THE SUN.

PRIORITY DATE OF 6-11-2009 IS CLAIMED.

OWNER OF INTERNATIONAL REGISTRATION 1025692 DATED 12-9-2009, EXPIRES 12-9-2019.

SER. NO. 79-077,605, FILED 12-9-2009.

MARC LEIPZIG, EXAMINING ATTORNEY



David J. Kyros

Director of the United States Patent and Trademark Office

United States of America

United States Patent and Trademark Office

XTRASHARP

Reg. No. 4,065,185

Registered Dec. 6, 2011

Int. Cl.: 10

TRADEMARK

PRINCIPAL REGISTER

SUTUREX & RENODEX (FRANCE SOCIÉTÉ PAR ACTIONS SIMPLIFIÉE)
ZONE DE VIALARD
F-24200 CARSAC-AILLAC, FRANCE

FOR: SURGICAL NEEDLES FOR MEDICAL USE; SURGICAL NEEDLES FOR MEDICAL PURPOSES, IN CLASS 10 (U.S. CLS. 26, 39 AND 44).

NO CLAIM IS MADE TO THE EXCLUSIVE RIGHT TO USE "EXTRA SHARP", APART FROM THE MARK AS SHOWN.

PRIORITY DATE OF 7-15-2009 IS CLAIMED.

OWNER OF INTERNATIONAL REGISTRATION 1026906 DATED 12-7-2009, EXPIRES 12-7-2019.

SER. NO. 79-078,125, FILED 12-7-2009.

JANICE KIM, EXAMINING ATTORNEY



David J. Kybas

Director of the United States Patent and Trademark Office

United States of America

United States Patent and Trademark Office

Boster

Reg. No. 4,065,186

Registered Dec. 6, 2011

Int. Cls.: 1, 5 and 42

TRADEMARK

SERVICE MARK

PRINCIPAL REGISTER

WUHAN BOSTER; BIOLOGICAL TECHNOLOGY CO., LTD. (CHINA CORPORATION)
NO. 3-502, SPECIAL NO.1
INTERNATIONAL ENTERPRISE CENTER 2ND GUANSHAN ROAD DONGHU DEVELOPING
ZONE
430074 WUHAN, HUBEI, CHINA

FOR: ANTRANILIC ACID; ALKALIES; SALTS FOR ALKALINE METALS FOR INDUSTRIAL PURPOSES; INDUSTRIAL CHEMICALS; CULTURES OF MICROORGANISMS OTHER THAN FOR MEDICAL AND VETERINARY USE; BACTERIOLOGICAL PREPARATIONS OTHER THAN FOR MEDICAL AND VETERINARY USE; CHEMICAL REAGENTS OTHER THAN FOR MEDICAL AND VETERINARY USE; BIOLOGICAL PREPARATIONS OTHER THAN FOR MEDICAL AND VETERINARY USE, NAMELY, ENZYME SUBSTATES, IN CLASS 1 (U.S. CLS. 1, 5, 6, 10, 26 AND 46).

FOR: BACTERIOLOGICAL PREPARATIONS FOR MEDICAL AND VETERINARY USE; MICROBIAL PREPARATIONS FOR MEDICAL AND VETERINARY USE, NAMELY, PHARMACEUTICAL PREPARATIONS FOR USE IN CHEMOTHERAPY; BIOLOGICAL PREPARATIONS FOR MEDICAL PURPOSES, NAMELY, PHARMACEUTICAL PREPARATIONS FOR USE IN CHEMOTHERAPY; DIAGNOSTIC PREPARATIONS FOR MEDICAL PURPOSES; CULTURES OF MICROORGANISMS FOR MEDICAL AND VETERINARY USE; BODIES OF MICROORGANISMS FOR MEDICAL AND VETERINARY USE, NAMELY, BACTERIA FOR USE IN FOOD MANUFACTURE; DIETETIC FOODS ADAPTED FOR MICROORGANISMS FOR MEDICAL USE; DISINFECTANTS FOR MEDICAL INSTRUMENTS; NUTRITIVE SUBSTANCES FOR MICROORGANISM CULTURES; ASEPTIC PAPER, NAMELY, ASEPTIC COTTON, IN CLASS 5 (U.S. CLS. 6, 18, 44, 46, 51 AND 52).

FOR: SCIENTIFIC RESEARCH IN THE FIELD OF BIOLOGY, BACTERIOLOGY AND PHYSICS; CHEMICAL ANALYSIS; MATERIAL TESTING; INDUSTRIAL DESIGN; COMPUTER SOFTWARE DESIGN; ARCHITECTURAL RESEARCH, IN CLASS 42 (U.S. CLS. 100 AND 101).



PRIORITY DATE OF 7-10-2009 IS CLAIMED.

OWNER OF INTERNATIONAL REGISTRATION 1029848 DATED 7-31-2009, EXPIRES 7-31-2019.

SER. NO. 79-079,308, FILED 7-31-2009.

David J. Kyros

Director of the United States Patent and Trademark Office

Reg. No. 4,065,186 RENEE MCCRAY, EXAMINING ATTORNEY

United States of America

United States Patent and Trademark Office

NKE

Reg. No. 4,065,187

Registered Dec. 6, 2011

Int. Cls.: 7 and 12

TRADEMARK

PRINCIPAL REGISTER

NKE AUSTRIA GMBH (AUSTRIA GESELLSCHAFT MIT BESCHRÄNKTER HAFTUNG (GMBH))
IM STADTGUT C4
A-4407 STEYR-GLEINK
AUSTRIA

FOR: MACHINE PARTS, MACHINE TOOL PARTS, MACHINE MOTOR AND ENGINE PARTS, NAMELY, BEARINGS, ROLLER BEARINGS, BALL BEARINGS, CYLINDRICAL ROLLER BEARINGS, NEEDLE BEARINGS, TAPERED ROLLER BEARINGS, BARREL-SHAPED BEARINGS AND SPHERICAL ROLLER BEARINGS; BEARINGS FOR TRANSMISSION SHAFTS, BEING PART OF MACHINES, IN CLASS 7 (U.S. CLS. 13, 19, 21, 23, 31, 34 AND 35).

FOR: PARTS OF AUTOMOBILES, TRAINS AND BOATS OTHER THAN FOR MOTORS OR ENGINES, NAMELY, BEARINGS, ROLLER BEARINGS, BALL BEARINGS, CYLINDRICAL ROLLER BEARINGS, NEEDLE BEARINGS, TAPERED ROLLER BEARINGS, BARREL-SHAPED BEARINGS AND SPHERICAL ROLLER BEARINGS, ALL FOR USE FOR GEAR BOXES, SHIFT GEAR BOXES, CONNECTING RODS, TRANSMISSION SHAFTS, CLUTCHES, AXLES AND WHEELS, IN CLASS 12 (U.S. CLS. 19, 21, 23, 31, 35 AND 44).

THE MARK CONSISTS OF STANDARD CHARACTERS WITHOUT CLAIM TO ANY PARTICULAR FONT, STYLE, SIZE, OR COLOR.

OWNER OF INTERNATIONAL REGISTRATION 1032073 DATED 9-29-2009, EXPIRES 9-29-2019.

SER. NO. 79-080,132, FILED 9-29-2009.

CHRISTOPHER BUONGIORNO, EXAMINING ATTORNEY



David J. Kypos

Director of the United States Patent and Trademark Office

United States of America

United States Patent and Trademark Office

OXYMATIC

Reg. No. 4,065,188

Registered Dec. 6, 2011

Int. Cl.: 11

TRADEMARK

PRINCIPAL REGISTER

STARQUA WATER TREATMENT SYSTEMS, S.L. (SPAIN SOCIEDAD LIMITADA)
AVENIDA DE LA FUENTE NUEVA, 5
PLT 5 - NAVE 9 C; E-28703 SAN SEBASTIÁN DE LOS REYES, MADRID
SPAIN

FOR: WATER PURIFYING APPARATUS; EQUIPMENT FOR WATER DESCALING, NAMELY, WATER SOFTENING APPARATUS AND INSTALLATIONS, WATER SOFTENING UNITS; WATER FILTRATION EQUIPMENT, NAMELY, WATER PURIFICATION AND FILTRATION APPARATUS, CARTRIDGE FILTRATION UNITS, WATER FILTRATION APPARATUS FOR THE DEIONIZATION OF WATER; EQUIPMENT FOR WATER DISINFECTION, NAMELY, WATER PURIFICATION APPARATUS, WATER PURIFICATION UNITS, WATER DISTILLATION UNITS; WATER TREATMENT EQUIPMENT, NAMELY, CARTRIDGE FILTRATION UNITS AND REPLACEMENT CARTRIDGES THEREFOR, CHEMICAL STERILIZATION UNITS, REVERSE OSMOSIS FILTRATION UNITS, ULTRAVIOLET STERILIZATION UNITS, WATER FILTRATION UNITS, REVERSE OSMOSIS UNITS; WATER DESALINATION EQUIPMENT, NAMELY, WATER DESALINATION UNITS; CHLORINATORS FOR SALINE CHLORINATION, IN CLASS 11 (U.S. CLS. 13, 21, 23, 31 AND 34).

THE MARK CONSISTS OF STANDARD CHARACTERS WITHOUT CLAIM TO ANY PARTICULAR FONT, STYLE, SIZE, OR COLOR.

OWNER OF INTERNATIONAL REGISTRATION 1034257 DATED 2-18-2010, EXPIRES 2-18-2020.

SER. NO. 79-080,930, FILED 2-18-2010.

MICHAEL WIENER, EXAMINING ATTORNEY



David J. Kybas

Director of the United States Patent and Trademark Office

United States of America

United States Patent and Trademark Office

RPH Evo

Reg. No. 4,065,189

Registered Dec. 6, 2011

Int. Cls.: 7, 37 and 40

TRADEMARK

SERVICE MARK

PRINCIPAL REGISTER

BRONDOLIN S.P.A. (ITALY JOINT STOCK COMPANY)
VIA BONICALZA, 142
I-21012 CASSANO MAGNAGO (VA), ITALY

FOR: DIE-CASTING MACHINES; MACHINE TOOLS, NAMELY, TOOLS FOR DIE-CASTING TO FORM LIGHT METAL ALLOY PRODUCTS, IN CLASS 7 (U.S. CLS. 13, 19, 21, 23, 31, 34 AND 35).

FOR: REPAIR OF DIE-CASTING MACHINES; INSTALLATION OF DIE-CASTING MACHINES AND DIE-CASTING MACHINE TOOLS, IN CLASS 37 (U.S. CLS. 100, 103 AND 106).

FOR: THERMAL TREATMENT OF MATERIALS, NAMELY, METALS AND THEIR ALLOYS, FOR THE PURPOSE OF MANUFACTURING DIE-CASTING TOOLS, IN CLASS 40 (U.S. CLS. 100, 103 AND 106).

THE MARK CONSISTS OF STANDARD CHARACTERS WITHOUT CLAIM TO ANY PARTICULAR FONT, STYLE, SIZE, OR COLOR.

PRIORITY DATE OF 10-13-2009 IS CLAIMED.

OWNER OF INTERNATIONAL REGISTRATION 1034322 DATED 2-1-2010, EXPIRES 2-1-2020.

THE ENGLISH TRANSLATION OF "EVO" IN THE MARK IS "ERA", "TIMES", OR "AGE".

SER. NO. 79-080,945, FILED 2-1-2010.

MICHELLE DUBOIS, EXAMINING ATTORNEY



David J. Kyros

Director of the United States Patent and Trademark Office

United States of America

United States Patent and Trademark Office

mando

Reg. No. 4,065,190

Registered Dec. 6, 2011

**Int. Cls.: 9, 10, 16, 41, 42
and 44**

TRADEMARK

SERVICE MARK

PRINCIPAL REGISTER

MANDOMETER AB (SWEDEN AKTIEBOLAG)
SE-141 04 HUDDINGE
SWEDEN
SWEDEN

FOR: APPARATUS AND INSTRUMENTS FOR WEIGHT CONTROL, NAMELY, SCALES AND COMPUTERIZED SCALES AND SCALE PARTS THEREOF; COMPUTER SOFTWARE FOR OPERATING OF SCALES; AUTOMATIC TIMERS; DOSAGE DISPENSERS FOR DISPENSING FOOD PORTIONS, DOSIMETERS; COMPUTER STORAGE DEVICES IN THE NATURE OF MEMORY MEDIA FOR STORING INFORMATION COLLECTED FROM APPARATUS AND INSTRUMENTS FOR WEIGHT CONTROL; DOWNLOADABLE SOFTWARE FOR STORAGE OF ELECTRONICALLY STORED INFORMATION CONCERNING THE TREATMENT AND PREVENTION OF EATING DISORDERS AND FOR DISPLAY OF ILLUSTRATIVE MATERIAL CONCERNING THE TREATMENT AND PREVENTION OF EATING DISORDERS, IN CLASS 9 (U.S. CLS. 21, 23, 26, 36 AND 38).

FOR: APPARATUS FOR PHYSICAL TRAINING FOR MEDICAL USE; MEDICAL DIAGNOSTIC APPARATUS FOR DIAGNOSIS OF EATING DISORDERS, FOR WEIGHT AND OBESITY MEASUREMENT, AND FOR BLOOD PRESSURE MONITORING; ANALYTICAL APPARATUS FOR MEDICAL PURPOSES AND BLOOD PRESSURE MEASURING APPARATUS; MEDICAL APPARATUS, NAMELY, ELECTRIC HEATING DEVICES FOR CURATIVE TREATMENT FOR MEDICAL PURPOSES IN THE NATURE OF HEATING LAMPS, HEATING PADS, HEATING CUSHIONS AND HEATING BLANKETS, IN CLASS 10 (U.S. CLS. 26, 39 AND 44).

FOR: PRINTED PUBLICATIONS, NAMELY, MANUALS, PRINTED TEACHING AND WRITTEN INSTRUCTIONAL MATERIAL, WRITTEN ARTICLES, PAMPHLETS, MAGAZINES, BROCHURES, PERIODICALS, BOOKS, GUIDES, DIAGRAMS, TABLES AND FORMS, ALL THE AFOREMENTIONED PRINTED MATERIALS IN THE FIELD OF HEALTH CARE AND MEDICAL CARE, PARTICULARLY THE TREATMENT AND PREVENTION OF EATING DISORDERS, OVERWEIGHT AND OBESITY, IN CLASS 16 (U.S. CLS. 2, 5, 22, 23, 29, 37, 38 AND 50).

FOR: CONDUCTING WORKSHOPS, SEMINARS AND PROVIDING MENTORING AND TRAINING SERVICES IN THE TREATMENT AND PREVENTION OF EATING DISORDERS, OVERWEIGHT AND OBESITY; PROVIDING PERSONAL TRAINING TO INDIVIDUALS FOR THE PURPOSE OF HELPING THEM MAKE MEDICAL, HEALTH, AND PHYSICAL



David J. Kyros

Director of the United States Patent and Trademark Office

Reg. No. 4,065,190 FITNESS IMPROVEMENT IN THEIR DAILY LIVING; PRODUCTION OF AUDIO AND VIDEO RECORDINGS CONTAINING REHABILITATION INSTRUCTIONS FOR PERSONS SUFFERING FROM EATING DISORDERS, OVERWEIGHT OR OBESITY; RENTAL OF AUDIO AND VIDEO RECORDINGS CONTAINING REHABILITATION INSTRUCTIONS FOR PERSONS SUFFERING FROM EATING DISORDERS, OVERWEIGHT OR OBESITY, IN CLASS 41 (U.S. CLS. 100, 101 AND 107).

FOR: SCIENTIFIC RESEARCH SERVICES FOR MEDICAL PURPOSES; PROVIDING INFORMATION IN THE FIELD OF SCIENTIFIC RESEARCH FOR MEDICAL PURPOSES; MEDICAL LABORATORY SERVICES AND SCIENTIFIC LABORATORY SERVICES, ALL RELATING TO THE FIELD OF SCIENTIFIC RESEARCH FOR MEDICAL PURPOSES; DESIGN AND DEVELOPMENT OF COMPUTER HARDWARE AND SOFTWARE WITHIN THE DIETARY, MEDICAL AND MEDICO-TECHNICAL FIELDS, IN CLASS 42 (U.S. CLS. 100 AND 101).

FOR: MEDICAL SERVICES; X-RAY TECHNICIAN SERVICES; TAKING OF BLOOD SAMPLES AND MEASURING BLOOD PRESSURE; PHYSIOTHERAPY, PHARMACEUTICAL ADVICE, ADVICE CONCERNING NUTRITION, DIETARY AND NUTRITIONAL GUIDANCE; MEDICAL SERVICES RENDERED BY TELEPHONE OR THROUGH COMPUTER NETWORKS; PSYCHOLOGICAL CONSULTATION, IN CLASS 44 (U.S. CLS. 100 AND 101).

OWNER OF U.S. REG. NOS. 2,134,781, 3,663,791 AND OTHERS.

PRIORITY DATE OF 9-10-2009 IS CLAIMED.

OWNER OF INTERNATIONAL REGISTRATION 1034358 DATED 3-8-2010, EXPIRES 3-8-2020.

THE COLOR(S) BLACK AND RED IS/ARE CLAIMED AS A FEATURE OF THE MARK.

THE MARK CONSISTS OF THE TERM "MANDO" IN BLACK WITH A RED LINE DESIGN UNDERLINING THE TERM.

THE ENGLISH TRANSLATION OF "MANDO" IN THE MARK IS COMMAND.

SER. NO. 79-080,953, FILED 3-8-2010.

CHRISTOPHER BUONGIORNO, EXAMINING ATTORNEY

United States of America

United States Patent and Trademark Office

mtng

MUSIC TREND NIGHT GAME

Reg. No. 4,065,191

Registered Dec. 6, 2011

Int. Cls.: 18, 25 and 35

TRADEMARK

SERVICE MARK

PRINCIPAL REGISTER

AYMERICH INVER, S.L. (SPAIN SOCIEDAD LIMITADA)
CALLE SEVERO OCHOA, 36
ELCHE PARQUE INDUSTRIAL
E-03203 ELCHE (ALICANTE), SPAIN

FOR: LEATHER AND IMITATION LEATHER; GOODS MADE OF LEATHER AND IMITATION LEATHER, NAMELY, HANDBAGS, WALLETS, AND BAGS IN THE NATURE OF ALL-PURPOSE CARRYING BAGS, ALL-PURPOSE SPORT BAGS, BELT BAGS, BAGS FOR UMBRELLAS, CLUTCH BAGS, DUFFEL BAGS, AND OVERNIGHT BAGS; ANIMAL SKINS AND HIDES; TRUNKS AND TRAVELING BAGS; UMBRELLAS, PARASOLS AND WALKING STICKS; WHIPS, HARNESSES AND SADDLERY, IN CLASS 18 (U.S. CLS. 1, 2, 3, 22 AND 41).

FOR: CLOTHING, NAMELY, BELTS, GLOVES, JACKETS, SWEATERS, MITTENS, OVERCOATS, SHIRTS, T-SHIRTS, PANTS, AND UNDERGARMENTS; FOOTWEAR, NAMELY, BOOTS, SHOES, AND SANDALS; HEADGEAR, NAMELY, HATS AND CAPS, IN CLASS 25 (U.S. CLS. 22 AND 39).

FOR: ADVERTISING, BUSINESS MANAGEMENT, BUSINESS ADMINISTRATION, OFFICE FUNCTIONS, IN CLASS 35 (U.S. CLS. 100, 101 AND 102).

OWNER OF INTERNATIONAL REGISTRATION 1035383 DATED 2-3-2010, EXPIRES 2-3-2020.

SER. NO. 79-081,316, FILED 2-3-2010.

ANNE MADDEN, EXAMINING ATTORNEY



David J. Kyros

Director of the United States Patent and Trademark Office

United States of America

United States Patent and Trademark Office

Kyosan Electric Mfg. Co., Ltd.

Reg. No. 4,065,192

Registered Dec. 6, 2011

Int. Cls.: 7, 9 and 37

TRADEMARK

SERVICE MARK

PRINCIPAL REGISTER

KYOSAN ELECTRIC MANUFACTURING CO., LTD. (JAPAN CORPORATION)
29-1, HEIAN-CHO 2-CHOME, TSURUMI-KU
YOKOHAMA-SHI
KANAGAWA 230-0031, JAPAN

FOR: METALWORKING MACHINES; METALWORKING APPARATUS, NAMELY, MACHINES FOR GRINDING THE SURFACES OF WORKPIECES MADE OF STEEL, IN CLASS 7 (U.S. CLS. 13, 19, 21, 23, 31, 34 AND 35).

FOR: POWER DISTRIBUTION OR CONTROL MACHINES AND APPARATUS, NAMELY, ELECTRICAL POWER DISTRIBUTION UNITS; TELECOMMUNICATION DEVICES AND APPARATUS, NAMELY, COMPUTERS FOR CONTROLLING THE SPEEDS OF RAILROAD VEHICLES AND FOR CONTROLLING ROAD TRAFFIC SIGNALING EQUIPMENT; ELECTRONIC MACHINES, NAMELY, COMPUTERS FOR CONTROLLING THE SPEEDS OF RAILROAD TRAINS AND APPARATUSES IN THE NATURE OF COMPUTERS FOR CONTROLLING ROAD TRAFFIC SIGNALING EQUIPMENT; COMPUTER PROGRAMS FOR USE IN TRAFFIC SIGNALS AND RAILWAY SIGNALS, NAMELY, COMPUTER OPERATING PROGRAMS FOR USE IN TRAFFIC SIGNALS AND RAILWAY SIGNALS; COMPUTER HARDWARE; RAILWAY SIGNALING DEVICES, NAMELY, RAILWAY SIGNALS; POWER CONVERTERS; RADIO FREQUENCY POWER CONVERTERS; IMPEDANCE MATCHING DEVICES, NAMELY, ELECTRICITY ROUTER FOR MEASURING, MANAGING AND OPTIMIZING ENERGY LOADS FOR ESTABLISHING LOAD RESISTANCE MATCHING BETWEEN A POWER SUPPLY UNIT FOR SUPPLYING POWER TO A LOAD AND UNITS ON THE LOAD SIDE; TRAFFIC-LIGHT APPARATUS (SIGNALING DEVICES); RAILWAY SIGNALING SAFETY EQUIPMENT, NAMELY, RAILWAY SIGNALS; ELECTRIC SWITCHES; RAILWAY ELECTRIC POINT MACHINES, NAMELY, ROUTING SWITCHES FOR RAILWAY USE; RAILWAY LEVEL CROSSING BARRIERS, NAMELY, CROSSING BARS IN THE NATURE OF RAILWAY SIGNALS AFFIXED TO AUTOMATED SECURITY GATES FOR USE AT RAILROAD CROSSINGS; ELECTRONIC PLATFORM DOOR OPENING SYSTEMS; GAP FILLER DEVICES, NAMELY, AUTOMATED PLATFORM DOORS AND AUTOMATIC MOVABLE STEPS TO BRIDGE OVER A GAP FORMED BETWEEN THE PLATFORM AND TRAIN IN ORDER TO PREVENT PASSENGERS FROM FALLING; AUTOMATIC ELECTRICAL TRAIN CONTROLLERS; PASSENGER INFORMATION SYSTEMS PRIMARILY COMPRISED OF COMPUTERS AND COMPUTER SOFTWARE TO DISPLAY TRAIN SERVICE INFORMATION FOR TRAIN PASSENGERS; PASSENGER INFORMATION SYSTEMS PRIMARILY COMPRISED OF COMPUTERS AND COMPUTER SOFTWARE TO DISPLAY BUS SERVICE INFORMATION FOR BUS PASSENGERS; TRAIN TRAFFIC MANAGEMENT



David J. Kyros

Director of the United States Patent and Trademark Office

Reg. No. 4,065,192 DEVICES, NAMELY, COMPUTERS; BUS TRAFFIC MANAGEMENT DEVICES, NAMELY, COMPUTERS, IN CLASS 9 (U.S. CLS. 21, 23, 26, 36 AND 38).

FOR: MACHINERY INSTALLATION; ELECTRICAL WORKS, NAMELY, ELECTRICAL CONTRACTOR SERVICE; TELECOMMUNICATION WIRING, IN CLASS 37 (U.S. CLS. 100, 103 AND 106).

OWNER OF U.S. REG. NOS. 1,813,579 AND 3,988,000.

PRIORITY DATE OF 1-12-2010 IS CLAIMED.

OWNER OF INTERNATIONAL REGISTRATION 1035615 DATED 2-26-2010, EXPIRES 2-26-2020.

NO CLAIM IS MADE TO THE EXCLUSIVE RIGHT TO USE "ELECTRIC MFG. CO., LTD.", APART FROM THE MARK AS SHOWN.

THE MARK CONSISTS OF THE STYLIZED WORDING "KYOSAN ELECTRIC MFG. CO., LTD."

THE WORDING "KYOSAN" HAS NO MEANING IN A FOREIGN LANGUAGE.

SER. NO. 79-081,434, FILED 2-26-2010.

MAUREEN DALL, EXAMINING ATTORNEY

United States of America

United States Patent and Trademark Office

O'TIP

Reg. No. 4,065,193

Registered Dec. 6, 2011

Int. Cls.: 7 and 8

TRADEMARK

PRINCIPAL REGISTER

SAINT-GOBAIN ABRASIFS S.A. (FRANCE COMPANY)
RUE DE L'AMBASSADEUR, BP 8
F-78702 CONFLANS-SAINTE-HONORINE CEDEX
FRANCE

FOR: MACHINE TOOLS CONTAINING DIAMONDS, NAMELY, DRILLING MACHINES, GRINDING MACHINES AND POLISHING MACHINES; MACHINE TOOL SEGMENTS CONTAINING DIAMONDS, NAMELY, PISTON RINGS, BAND SAWS AND CORE DRILLING BITS; MACHINE TOOLS FOR USE IN DRILLING, CUTTING OR REMOVING SOLID MATERIAL, NAMELY, GRINDING TOOLS FOR GRINDING MACHINES, CEMENTED CARBIDE CUTTING TOOLS AND POWER DRILL BITS; MACHINE TOOL SEGMENTS, NAMELY, PISTON RINGS, BAND SAWS AND CORE DRILLING BITS, IN CLASS 7 (U.S. CLS. 13, 19, 21, 23, 31, 34 AND 35).

FOR: HAND TOOLS CONTAINING DIAMONDS, NAMELY, GRINDING TIPS FOR HAND OPERATED GRINDING WHEELS, GRINDING DISCS, SANDING DISCS; HAND TOOL SEGMENTS, NAMELY, PISTON RINGS, BAND SAWS AND CORE DRILLING BITS, IN CLASS 8 (U.S. CLS. 23, 28 AND 44).

THE MARK CONSISTS OF STANDARD CHARACTERS WITHOUT CLAIM TO ANY PARTICULAR FONT, STYLE, SIZE, OR COLOR.

PRIORITY DATE OF 9-8-2009 IS CLAIMED.

OWNER OF INTERNATIONAL REGISTRATION 1035940 DATED 3-3-2010, EXPIRES 3-3-2020.

SER. NO. 79-081,563, FILED 3-3-2010.

SIMON TENG, EXAMINING ATTORNEY



David J. Kyros

Director of the United States Patent and Trademark Office

United States of America

United States Patent and Trademark Office

PANMIND

Reg. No. 4,065,194

Registered Dec. 6, 2011

Int. Cls.: 38, 41 and 42

SERVICE MARK

PRINCIPAL REGISTER

MIND2MIND S.R.L. (ITALY SOCIÉTÉ À RESPONSABILITÉ LIMITÉE)
VIA OSTIA, 25
I-00192 ROME
ITALY

FOR: CALL HUNTING, TRANSMISSION OF PODCASTS, LOCAL AND LONG DISTANCE TRANSMISSION VOICE, DATA, GRAPHICS VIDEO BY MEANS OF BROADBAND, COPPER AND OPTICAL OR WIRELESS NETWORKS, AND TRANSMISSION OF VOICE, DATA, GRAPHICS, SOUND AND VIDEO BY MEANS OF BROADBAND POWER LINE OR WIRELESS NETWORKS, IN CLASS 38 (U.S. CLS. 100, 101 AND 104).

FOR: EDUCATION, NAMELY, PROVIDING SEMINARS, WORKSHOP IN THE FIELD OF INTERNET LAW AND INTELLECTUAL PROPERTY LAW, TRAINING IN THE USE AND OPERATION OF COMPUTER AND DATA PROCESSORS, TRAINING IN THE USE OF COMPUTERS, CONSTRUCTION MACHINERY, AND TRAINING SERVICES IN THE FIELDS OF COMPUTER'S USE; ENTERTAINMENT IN THE NATURE OF MUSICAL GROUP AND TELEVISION COMEDY SERIES, AND ENTERTAINMENT IN THE NATURE OF SOCCER AND FOOTBALL GAMES; SOCCER AND FOOTBALL COMPETITION, AND ORGANIZING EXHIBITIONS FOR CULTURAL PURPOSES, IN CLASS 41 (U.S. CLS. 100, 101 AND 107).

FOR: SCIENTIFIC INVESTIGATIONS FOR MEDICAL PURPOSES AND TECHNOLOGICAL CONSULTATION IN THE TECHNOLOGICAL FIELD OF COMPUTER HARDWARE SYSTEMS, AND RESEARCH SERVICES IN THE FIELD OF INTELLIGENCE AND SECURITY AND ENVIRONMENTAL PROTECTION, COMPUTER SOFTWARE DEVELOPMENT, IN CLASS 42 (U.S. CLS. 100 AND 101).



THE MARK CONSISTS OF STANDARD CHARACTERS WITHOUT CLAIM TO ANY PARTICULAR FONT, STYLE, SIZE, OR COLOR.

PRIORITY DATE OF 7-17-2009 IS CLAIMED.

OWNER OF INTERNATIONAL REGISTRATION 1036110 DATED 1-5-2010, EXPIRES 1-5-2020.

THE WORDING "PANMIND" HAS NO MEANING IN A FOREIGN LANGUAGE.

SER. NO. 79-081,625, FILED 1-5-2010.

David J. Kyros

Director of the United States Patent and Trademark Office

Reg. No. 4,065,194 WARREN L. OLANDRIA, EXAMINING ATTORNEY

United States of America

United States Patent and Trademark Office



Reg. No. 4,065,195

Registered Dec. 6, 2011

Int. Cl.: 12

TRADEMARK

PRINCIPAL REGISTER

HYUNDAI MOTOR COMPANY (REPUBLIC OF KOREA STOCK COMPANY)
231, YANGJAE-DONG
SEOCHO-GU; SEOUL
REPUBLIC OF KOREA

FOR: BEARINGS FOR LAND VEHICLES, NAMELY, AXLE BEARINGS, WHEEL BEARINGS; MUFFLERS FOR LAND VEHICLES; TRANSMISSIONS FOR LAND VEHICLES; REARVIEW MIRRORS FOR AUTOMOBILES; BUMPERS FOR AUTOMOBILES; WINDSCREEN WIPERS FOR AUTOMOBILES; SEAT COVERS FOR AUTOMOBILES; TIRE CHAINS FOR AUTOMOBILES; RADIATOR GRILLS FOR LAND VEHICLES; BODY PANELS FOR VEHICLES; AIR BAGS FOR VEHICLES; SWING DOORS FOR VEHICLE ENGINES; GLASSES FOR VEHICLES, NAMELY, GLASS WINDOWS FOR VEHICLES; CLUTCHES FOR LAND VEHICLES; FAN MOTORS FOR VEHICLES; AIR SENSORS FOR VEHICLES; BRAKE PADS FOR LAND VEHICLES; SUSPENSIONS FOR VEHICLES, NAMELY, WHEEL SUSPENSIONS, SUSPENSION STRUTS; SPRINGS FOR VEHICLES, NAMELY, COIL SPRINGS, LEAF SPRINGS; SPEED SENSORS FOR VEHICLES; SUN ROOFS FOR VEHICLES; FUEL GAUGES FOR VEHICLES; OIL SEALS FOR VEHICLES, NAMELY, TRANSMISSION SEALS; WIPER MOTORS FOR VEHICLES; CONTROL UNITS FOR VEHICLES, NAMELY, AIR SUSPENSION VALVES FOR CONTROLLING SUSPENSION HEIGHT FOR VEHICLES, ELECTRONIC STABILITY SYSTEM TO ALLOW BETTER CONTROL AND MANEUVERABILITY OF TRUCKS AND TRAILERS, SOLD AS AN INTEGRAL COMPONENT OF TRUCKS; PEDALS FOR VEHICLES, NAMELY, BRAKE PEDALS, GAS PEDALS, IN CLASS 12 (U.S. CLS. 19, 21, 23, 31, 35 AND 44).



OWNER OF INTERNATIONAL REGISTRATION 1036496 DATED 2-23-2010, EXPIRES 2-23-2020.

SER. NO. 79-081,778, FILED 2-23-2010.

ALLISON SCHRODY, EXAMINING ATTORNEY

David J. Kyros

Director of the United States Patent and Trademark Office

United States of America

United States Patent and Trademark Office

ATALIAN

Reg. No. 4,065,196

Registered Dec. 6, 2011

Int. Cls.: 37, 44 and 45

SERVICE MARK

PRINCIPAL REGISTER

LA FINANCIERE ATALIAN (FRANCE SOCIETE ANONYME A DIRECTOIRE ET CONSEIL DE SURVEILLANCE)
110 RUE DE L'OURCQ
F-75019 PARIS, FRANCE

FOR: MAINTENANCE AND REPAIR AND RENOVATION AND RESTORATION OF BUILDING AND PROPERTY SERVICES FOR INDUSTRIAL PREMISES, BUSINESS, PROFESSIONAL AND HOUSING PROJECTS; MAINTENANCE SERVICES, REPAIRS, FOR RENOVATION PURPOSES AND EQUIPPING OF ALL OR PARTS OF BUILDINGS FOR INDUSTRIAL USE, COMMERCIAL, PROFESSIONAL OR DWELLINGS; CONSTRUCTION SERVICES IN THE NATURE OF INSTALLATION OF AIR CONDITIONERS, HUMIDIFIERS, DEHUMIDIFIERS, HEATING SYSTEMS, HEAT PUMPS, SOLAR HEATING SYSTEMS, RENEWABLE ENERGY HEATING SYSTEMS, VENTILATION SYSTEMS, PLUMBING SYSTEMS, ELECTRICAL SYSTEMS, AND LIGHTING SYSTEMS; CONSTRUCTION SERVICES IN THE NATURE OF INSTALLATION AND REPAIR OF FIRE-DETECTION DEVICES SYSTEMS; CLEANING OF RESIDENTIAL HOUSES AND INDUSTRIAL PREMISES AND COMMERCIAL PREMISES SERVICES; INSECT ERADICATION, NAMELY, TERMITE AND PEST CONTROL OF ALL PREMISES; CLEANING SERVICES FOR EQUIPMENT, MACHINERY AND INSTALLATIONS; LAUNDERING OF LINEN, IN CLASS 37 (U.S. CLS. 100, 103 AND 106).

FOR: LANDSCAPE GARDENING; PLANNING AND PARK UPKEEP SERVICES, NAMELY, LAWN CARE SERVICES, IN CLASS 44 (U.S. CLS. 100 AND 101).

FOR: SECURITY SERVICES, NAMELY, PROVIDING PHYSICAL ACCESS TO PROPERTIES VIA A REMOTE CALL-IN LOCKING DEVICE AND FOR PROTECTING PROPERTY; PROTECTION AND SURVEILLANCE SERVICES, NAMELY, SECURITY GUARD SERVICES, MONITORING OF SECURITY SYSTEMS, AND PROVIDING EXECUTIVE PROTECTION; RENTAL OF FIRE ALARMS, RENTAL OF EXTINGUISHERS, IN CLASS 45 (U.S. CLS. 100 AND 101).

THE MARK CONSISTS OF STANDARD CHARACTERS WITHOUT CLAIM TO ANY PARTICULAR FONT, STYLE, SIZE, OR COLOR.

PRIORITY DATE OF 9-8-2009 IS CLAIMED.



David J. Kyros

Director of the United States Patent and Trademark Office

Reg. No. 4,065,196 OWNER OF INTERNATIONAL REGISTRATION 1037566 DATED 2-12-2010, EXPIRES 2-12-2020.

THE WORDING "ATALIAN" HAS NO MEANING IN A FOREIGN LANGUAGE.

SER. NO. 79-082,159, FILED 2-12-2010.

NAPOLEON SHARMA, EXAMINING ATTORNEY

United States of America

United States Patent and Trademark Office

D.A.D.

Reg. No. 4,065,197

Registered Dec. 6, 2011

**Int. Cls.: 7, 12, 14, 16, 25,
27, 34 and 35**

CACTUS CORPORATION (JAPAN CORPORATION)
37-1 NONOUE 3-CHOME
HABIKINO-CITY; OSAKA 583-0871
JAPAN

FOR: AUTOMOTIVE MUFFLERS , IN CLASS 7 (U.S. CLS. 13, 19, 21, 23, 31, 34 AND 35).

TRADEMARK

SERVICE MARK

PRINCIPAL REGISTER

FOR: BUMPERS FOR AUTOMOBILES; WHEELS FOR AUTOMOBILES; EXTERIOR PARTS FOR AUTOMOBILES, NAMELY, AUTOMOTIVE EXTERIOR METAL DECORATIVE AND PROTECTIVE TRIM; PLASTIC PARTS FOR VEHICLES, NAMELY, AUTOMOTIVE EXTERIOR AND INTERIOR PLASTIC EXTRUDED DECORATIVE AND PROTECTIVE TRIM; AUTO AFTERMARKET ACCESSORIES, NAMELY, VEHICLE GRILLS, FENDERS, LICENSE COVER FRAMES AND LAMPS; SPOILERS FOR VEHICLES; BUMPERS FOR AUTOMOBILES; VEHICLE SIDE VIEW MIRROR COVERS; INTERIOR PARTS FOR AUTOMOBILES, NAMELY, AUTOMOTIVE INTERIOR PANELING; AUTOMOTIVE INTERIOR TRIM, AUTOMOTIVE INTERIOR PANELING; CUSTOM LEATHER INTERIORS FOR VEHICLES; BRAKE PEDALS, ACCELERATOR PEDALS; REARVIEW MIRRORS; GEAR LEVER KNOBS FOR VEHICLES; DRINK HOLDERS FOR VEHICLES; STEERING WHEEL COVERS; FITTED FABRIC COVERS FOR VEHICLE SEAT BELTS; AUTOMOBILE SEAT CUSHIONS; VEHICLE PARTS, NAMELY, SUN VISORS; FRONT PASSENGER SEAT TABLES SPECIALLY ADAPTED FOR FITTING IN VEHICLES; CENTER CABINETS SPECIALLY ADAPTED FOR FITTING IN VEHICLES; HEAD RESTS FOR VEHICLES SEATS; NECK PADS SPECIALLY ADAPTED FOR FITTING VEHICLES; FITTED DASHBOARD COVERS FOR VEHICLES; CELL PHONE CASES ADAPTED FOR VEHICLES; ASSIST GRIP FOR USE IN VEHICLES, NAMELY, INTERIOR ROOF HANDLES; AUTOMOTIVE WINDSHIELD SHADE SCREENS; SHEET COVER FOR AUTOMOBILES, NAMELY, FITTED AUTOMOTIVE SEAT COVERS; PARTS AND FITTINGS FOR AUTOMOBILES, NAMELY, AUTOMOBILE STRUCTURAL PARTS; SHOCK ABSORBERS FOR AUTOMOBILES; SUSPENSION FOR AUTOMOBILES, IN CLASS 12 (U.S. CLS. 19, 21, 23, 31, 35 AND 44).

FOR: JEWEL CASES OF PRECIOUS METAL; PERSONAL ORNAMENTS OF PRECIOUS METAL, NAMELY, JEWELRY; SEMI-WROUGHT PRECIOUS STONES AND THEIR IMITATIONS; SHOE ORNAMENTS OF PRECIOUS METAL; WATCHES, IN CLASS 14 (U.S. CLS. 2, 27, 28 AND 50).

FOR: INDUSTRIAL PACKAGING CONTAINERS OF PAPER; STATIONERY; CARDS FOR STATIONERY USE; POCKET MEMORANDUM BOOKS; PAPER IDENTIFICATION TAGS;



David J. Kyffers

Director of the United States Patent and Trademark Office

Reg. No. 4,065,197 DESK PADS; STICKERS FOR STATIONERY USE; DECORATIVE STICKERS; STICKERS, NAMELY, DECORATIVE STICKERS FOR AUTOMOBILES, DECORATIVE DECALS FOR VEHICLE WINDOWS; PICTURE POSTCARDS; CATALOGUES IN THE FIELD OF AUTOMOBILES, CLOTHING, BAGS, BELTS AND PERSONAL ORNAMENTS; CALENDARS; MAGAZINES IN THE FIELD OF AUTOMOBILES; PAMPHLETS IN THE FIELD OF AUTOMOBILES, CLOTHING, BAGS, BELTS AND PERSONAL ORNAMENTS; PHOTOGRAPH STANDS, IN CLASS 16 (U.S. CLS. 2, 5, 22, 23, 29, 37, 38 AND 50).

FOR: NON-JAPANESE STYLE OUTER CLOTHING, NAMELY, JACKETS, SHIRTS AND TROUSERS; SWEATERS, VESTS, WAISTCOATS; HEADWEAR, NAMELY, CAPS; BELTS FOR CLOTHING, IN CLASS 25 (U.S. CLS. 22 AND 39).

FOR: AUTOMOBILE CARPETS, IN CLASS 27 (U.S. CLS. 19, 20, 37, 42 AND 50).

FOR: SMOKERS' ARTICLES, NAMELY, ASHTRAYS AND CIGARETTE CASES; CIGARETTE LIGHTER CASES, IN CLASS 34 (U.S. CLS. 2, 8, 9 AND 17).

FOR: RETAIL STORE SERVICES AND WHOLESALE STORE SERVICES FEATURING AUTOMOBILES, CLOTHING, BAGS AND POUCHES, PERSONAL ARTICLES, TOBACCOS AND SMOKERS' ARTICLES; ADVERTISING; PROVIDING INFORMATION ON COMMERCIAL SALES BY TELEPHONE FACSIMILE OR INTERNET, IN CLASS 35 (U.S. CLS. 100, 101 AND 102).

OWNER OF U.S. REG. NOS. 3,485,559 AND 3,518,446.

PRIORITY DATE OF 2-22-2010 IS CLAIMED.

OWNER OF INTERNATIONAL REGISTRATION 1037635 DATED 3-1-2010, EXPIRES 3-1-2020.

THE MARK CONSISTS OF THE STYLIZED WORD "D.A.D." WHERE THE FIRST LETTER IS REVERSED.

SER. NO. 79-082,189, FILED 3-1-2010.

TASNEEM HUSSAIN, EXAMINING ATTORNEY

United States of America

United States Patent and Trademark Office



Reg. No. 4,065,198

Registered Dec. 6, 2011

**Int. Cls.: 9, 35, 38, 42
and 45**

TRADEMARK

SERVICE MARK

PRINCIPAL REGISTER

OPERA SOFTWARE ASA (NORWAY CORPORATION)
WALDEMAR THRANES GATE 98
N-0175 OSLO
NORWAY

FOR: COMPUTERS; COMPUTER PROGRAMS FOR NETWORK SEARCHING AND COMMUNICATION, SOFTWARE FOR ENABLING ACCESS TO GLOBAL NETWORKS AND OTHER COMPUTER NETWORKS; WEB BROWSER SOFTWARE FOR LOCATING INTERNET CONTENT; SOFTWARE FOR ENABLING INTERNET BROWSER FUNCTIONALITY; ENCRYPTION SOFTWARE FOR USE WITH THE FOLLOWING, NAMELY, IN CONNECTION WITH NETWORK QUERIES AND SEARCHES AND NETWORK BROWSER SOFTWARE USED TO DISPLAY WEBSITES RETRIEVED FROM GLOBAL AND INTERNAL COMPUTER NETWORKS, AND INTERNET WEB BROWSER SOFTWARE AND BROWSER SOFTWARE FOR PROVIDING INTER-BROWSER COMMUNICATION PLATFORMS; SOFTWARE FOR ASSISTING IN ASSEMBLING PRESENTATIONS; MOBILE PHONES; MODEMS WITH USB CABLE CAPABILITIES, IN CLASS 9 (U.S. CLS. 21, 23, 26, 36 AND 38).

FOR: ADVERTISING, ADVERTISING AGENCIES, NAMELY, PROMOTING THE GOODS AND SERVICES OF OTHERS THROUGH THE DISTRIBUTION OF PROMOTIONAL MATERIALS AND BY RENDERING SALES PROMOTION ADVICE, DISTRIBUTION OF SAMPLES, PUBLICATION OF PUBLICITY TEXTS, RENTAL OF ADVERTISING SPACE, SYSTEMIZATION AND COMPILATION OF INFORMATION INTO COMPUTER DATABASES, COMPILATION OF ADVERTISING FOR USE ON WEBSITE, RETAIL STORE SERVICES FEATURING COMPUTER SOFTWARE FOR USE IN CONNECTION WITH COMPUTERS AND MOBILE TELEPHONES, IN CLASS 35 (U.S. CLS. 100, 101 AND 102).

FOR: TELECOMMUNICATION SERVICES, NAMELY, PROVIDING USER ACCESS TO INTERNET PORTALS; COMPUTER AIDED TRANSMISSION OF MESSAGES, IMAGES, INFORMATION VIA A GLOBAL COMPUTER NETWORK OR THE INTERNET AND PROVIDING ELECTRONIC TRANSMISSION OF ELECTRONIC PAYMENT DATA VIA GLOBAL COMPUTER NETWORK; ELECTRONIC MAIL, COMMUNICATIONS BY COMPUTER TERMINALS, COMMUNICATIONS VIA FIBER OPTIC NETWORKS, CELLULAR TELEPHONE COMMUNICATIONS, SATELLITE TRANSMISSION, COMMUNICATIONS BY TELEPHONE; NEWS AGENCY SERVICES FOR ELECTRONIC TRANSMISSION; TRANSMISSION OF NEWS ITEMS TO NEWS AGENCIES; CONSULTANCY SERVICES IN THE FIELD OF MOBILE TELEPHONIC TRANSMISSIONS, IN CLASS 38 (U.S. CLS. 100, 101 AND 104).



David J. Kappas

Director of the United States Patent and Trademark Office

Reg. No. 4,065,198 FOR: COMPUTER PROGRAMMING; PROFESSIONAL AND TECHNICAL SUPPORT, NAMELY, SUPPORT AND PROVISION OF TECHNICAL ASSISTANCE IN THE FIELD OF WEB BROWSERS, SOFTWARE, COMPONENTS AND ACCESSORIES; RENTAL OF SOFTWARE; COMPUTER SOFTWARE CONSULTANCY; INDIVIDUAL DESIGN AND DEVELOPMENT OF COMPUTER SOFTWARE, ONLINE COMPUTER SOFTWARE SYSTEMS, HOMEPAGES AND WEBSITES, WEB BROWSERS AND NETWORKS FOR OTHERS; WEB HOTEL SERVICES, NAMELY, PROVIDING AN ONLINE REPOSITORY FOR TEXT, IMAGES, SOUND, VIDEO, FILES, PERSONAL BOOKMARKS AND DATA; PROVIDING ACCESS TO DATABASES, IN CLASS 42 (U.S. CLS. 100 AND 101).

FOR: LICENSING OF SOFTWARE, IN CLASS 45 (U.S. CLS. 100 AND 101).

OWNER OF U.S. REG. NOS. 2,556,770, 2,718,373, AND 2,753,438.

PRIORITY DATE OF 10-23-2009 IS CLAIMED.

OWNER OF INTERNATIONAL REGISTRATION 1039390 DATED 12-22-2009, EXPIRES 12-22-2019.

THE COLOR(S) RED AND GRAY IS/ARE CLAIMED AS A FEATURE OF THE MARK.

NO CLAIM IS MADE TO THE EXCLUSIVE RIGHT TO USE "SOFTWARE", APART FROM THE MARK AS SHOWN.

THE MARK CONSISTS OF THE WORD "OPERA" IN RED POSITIONED ABOVE THE WORD "SOFTWARE" IN GRAY, WITH A STYLIZED LETTER "O" IN RED POSITIONED TO THE LEFT OF THE WORDS "OPERA" AND "SOFTWARE".

SER. NO. 79-082,780, FILED 12-22-2009.

NAPOLEON SHARMA, EXAMINING ATTORNEY

United States of America

United States Patent and Trademark Office

cDAQ

Reg. No. 4,065,199

Registered Dec. 6, 2011

Int. Cl.: 9

TRADEMARK

PRINCIPAL REGISTER

HOTTINGER BALDWIN MESSTECHNIK GMBH (FED REP GERMANY GMBH)
IM TIEFEN SEE 45
64293 DARMSTADT
FED REP GERMANY

FOR: INSTRUMENTS AND INSTRUMENTATION FOR MEASURING, VERIFYING, ACTUATING AND CONTROLLING, NAMELY, SCIENTIFIC AND ENGINEERING DATA ACQUISITION CONTROL AND ANALYSIS INSTRUMENTS FOR USE IN DATA ACQUISITION AND PROCESSING OF ENGINEERING, SCIENTIFIC AND INDUSTRIAL AUTOMATION DATA, BEING SIGNAL CONDITIONERS FOR USE IN ANALYZING INDUSTRIAL AUTOMATION DATA, BEING SENSORS FOR MEASURING AND MONITORING THE TEMPERATURES AND VOLTAGES OF SCIENTIFIC AND ENGINEERING INSTRUMENTS AND INSTRUMENT SYSTEMS, AND STRUCTURAL PARTS OF ALL AFOREMENTIONED GOODS, PARTICULARLY AMPLIFIERS, POWER AMPLIFIERS, COMMUNICATION SIGNAL PROCESSORS, DATA ACQUISITION OUTPUT MODULES, DATA ACQUISITION COMPENSATORS, NAMELY, THERMOCOUPLES, DATA ACQUISITION ELEMENTS FOR TARING, NAMELY, LOAD CELLS, DATA ACQUISITION ELEMENTS FOR PHASE COMPENSATION, NAMELY, PULSE PICKUPS AND HALL EFFECT DEVICES AND PROXIMITY DEVICES, MEMORY EXPANSION DEVICE MODULES, DATA ACQUISITION ARITHMETIC ELEMENTS, NAMELY, CHANNEL PROCESSORS AND OPERATIONAL ONBOARD CODE RUNNING POLYNOMIALS VIA PREDEFINED COEFFICIENTS FOR TRANSDUCER TYPE USED FOR DATA LINEARIZATION AND CORRECTION, DATA ACQUISITION FILTRATION MODULES BEING ENCAPSULATED ARRAY ANTI-ALIASING AND DIGITAL, PROCESSOR-BASED LOW PASS FILTERS, FREQUENCY COUNTERS, NAMELY, OSCILLATOR BASED SAMPLE COUNTERS, FREQUENCY METERS, DATA ACQUISITION CALIBRATION EQUIPMENT IN THE NATURE OF SIGNAL GENERATORS, ANALOG-DIGITAL CONVERTERS, DATA ACQUISITION LIMIT SWITCHES IN THE NATURE OF SIGNAL LEVEL LIMITERS PROGRAMMED ON FPGA, DIODE PROTECTION FOR POLARITY PROTECTION AND RC GROUND ISOLATION CIRCUITS, DATA ACQUISITION PEAK VALUE MEASURING DEVICES, NAMELY, ANALOG TO DIGITAL SIGNAL PROCESSORS (DSP), PROCESSORS USED TO ACQUIRE AND STORE DATA VIA A CONTROLLER AREA NETWORK (CAN) INTERFACE TO A HOST DEVICE MEMORY, DATA ACQUISITION LOW-PASS INDUCTOR FILTERS USED IN HIGH POWER ELECTRICAL APPLICATIONS, ELECTRICAL SWITCHING AND ATTENUATING EQUIPMENT FOR USE IN DATA ACQUISITION, NAMELY, BRIDGE-BASED TRANSDUCERS AND HIGH IMPEDANCE DEVICES INCORPORATING AN ELECTRICAL BRIDGE OR OTHER HIGH IMPEDANCE DEVICES, ELECTRICAL CABLES AND WIRES, PRINTED CIRCUIT BOARDS, POWER SUPPLIES, DATA ACQUISITION IN-



David J. Kyros

Director of the United States Patent and Trademark Office

Reg. No. 4,065,199 INTERFACE MODULES, AND DATA ACQUISITION INPUT AND OUTPUT DEVICES, NAMELY, THERMOCOUPLE AND ELECTRICAL SIGNAL GENERATORS; CASES SPECIFICALLY ADAPTED FOR DATA ACQUISITION INSTRUMENTS AND INSTRUMENTATION, IN CLASS 9 (U.S. CLS. 21, 23, 26, 36 AND 38).

THE MARK CONSISTS OF STANDARD CHARACTERS WITHOUT CLAIM TO ANY PARTICULAR FONT, STYLE, SIZE, OR COLOR.

PRIORITY DATE OF 2-12-2010 IS CLAIMED.

OWNER OF INTERNATIONAL REGISTRATION 1039986 DATED 3-11-2010, EXPIRES 3-11-2020.

SER. NO. 79-083,022, FILED 3-11-2010.

ANDREA HACK, EXAMINING ATTORNEY

United States of America

United States Patent and Trademark Office

MOVENO

Reg. No. 4,065,200

Registered Dec. 6, 2011

Int. Cls.: 6, 7 and 9

TRADEMARK

PRINCIPAL REGISTER

STOBAG DEUTSCHLAND GMBH (FED REP GERMANY LIMITED LIABILITY COMPANY)
BAHNHOFSTRASSE 12
79793 WUTÖSCHINGEN, FED REP GERMANY

FOR: METAL BRACKETS FOR MOUNTING AWNINGS; METAL JALOUSIES, IN CLASS 6 (U.S. CLS. 2, 12, 13, 14, 23, 25 AND 50).

FOR: ELECTRIC MOTORS FOR MACHINES WITH A DIGITAL SERVO DRIVE CONTROLLER; ELECTRIC MOTORS FOR AWNINGS AND JALOUSIES; HYDRAULIC AND PNEUMATIC CONTROLS FOR MACHINES, MOTORS AND ENGINES, IN CLASS 7 (U.S. CLS. 13, 19, 21, 23, 31, 34 AND 35).

FOR: ELECTRONIC CONTROL SYSTEMS FOR MACHINES, NAMELY, AWNINGS AND JALOUSIES; MEASURING APPARATUS, NAMELY, ELECTRONIC SENSORS FOR MEASURING TEMPERATURE, PRESSURE, HUMIDITY, AND VELOCITY; TEMPERATURE SENSORS, TIMING SENSORS, PRESSURE SENSORS, OPTICAL SENSORS, HUMIDITY SENSORS, ELECTRIC SENSORS AND ELECTRONIC SENSORS FOR OPENING AND CLOSING AWNINGS AND JALOUSIES, IN CLASS 9 (U.S. CLS. 21, 23, 26, 36 AND 38).

THE MARK CONSISTS OF STANDARD CHARACTERS WITHOUT CLAIM TO ANY PARTICULAR FONT, STYLE, SIZE, OR COLOR.

PRIORITY DATE OF 12-3-2009 IS CLAIMED.

OWNER OF INTERNATIONAL REGISTRATION 1040132 DATED 4-22-2010, EXPIRES 4-22-2020.

SER. NO. 79-083,073, FILED 4-22-2010.

TIMOTHY FINNEGAN, EXAMINING ATTORNEY



David J. Kyffers

Director of the United States Patent and Trademark Office

United States of America

United States Patent and Trademark Office

PBX SECURE

Reg. No. 4,065,201

Registered Dec. 6, 2011

Int. Cl.: 9

TRADEMARK

PRINCIPAL REGISTER

SCHNEIDER ELECTRIC INDUSTRIES SAS (FRANCE SOCIÉTÉ PAR ACTIONS SIMPLIFIÉE)
35 RUE JOSEPH MONIER
F-92500 RUEIL-MALMAISON
FRANCE

FOR: ELECTRICAL APPARATUS AND INSTRUMENTS, NAMELY, ELECTRICAL CUT-OFF OR COMMUTATION APPARATUS, ESPECIALLY CIRCUIT BREAKERS, ELECTRIC SWITCHES, MICRO-SWITCHES, CONTACTORS; ELECTRIC SENSORS, IN CLASS 9 (U.S. CLS. 21, 23, 26, 36 AND 38).

THE MARK CONSISTS OF STANDARD CHARACTERS WITHOUT CLAIM TO ANY PARTICULAR FONT, STYLE, SIZE, OR COLOR.

PRIORITY DATE OF 11-18-2009 IS CLAIMED.

OWNER OF INTERNATIONAL REGISTRATION 1040812 DATED 5-3-2010, EXPIRES 5-3-2020.

NO CLAIM IS MADE TO THE EXCLUSIVE RIGHT TO USE "PBX", APART FROM THE MARK AS SHOWN.

SER. NO. 79-083,321, FILED 5-3-2010.

LAURA HAMMEL, EXAMINING ATTORNEY



David J. Kybas

Director of the United States Patent and Trademark Office

United States of America

United States Patent and Trademark Office

STOBAG

Reg. No. 4,065,202

Registered Dec. 6, 2011

**Int. Cls.: 6, 7, 9, 20, 22
and 24**

TRADEMARK

PRINCIPAL REGISTER

STOBAG DEUTSCHLAND GMBH (FED REP GERMANY LIMITED LIABILITY COMPANY)
BAHNHOFSTRASSE 12
79793 WUTÖSCHINGEN, FED REP GERMANY

FOR: AWNINGS OF METAL; OUTDOOR ROLLER BLINDS OF METAL FOR GUIDING LIGHT; ROLLER BLIND CASINGS OF METAL FOR OUTDOOR ROLLER BLINDS; JALOUSIES OF METAL, IN CLASS 6 (U.S. CLS. 2, 12, 13, 14, 23, 25 AND 50).

FOR: ELECTRIC MOTORS FOR MACHINES WITH A DIGITAL SERVO DRIVE CONTROLLER; ELECTRIC MOTORS, NOT FOR LAND VEHICLES; HYDRAULIC AND PNEUMATIC CONTROLS FOR MACHINES, MOTORS AND ENGINES, IN CLASS 7 (U.S. CLS. 13, 19, 21, 23, 31, 34 AND 35).

FOR: ELECTRONIC CONTROLS FOR MOTORS; MEASURING APPARATUS, NAMELY, ELECTRONIC SENSORS FOR SENSING WIND, SUN, LIGHT, RAIN AND TEMPERATURE, IN CLASS 9 (U.S. CLS. 21, 23, 26, 36 AND 38).

FOR: SUN PROTECTION DEVICES AND BLINDS DEVICES FOR INDOOR USE, NAMELY, INDOOR NON-METAL JALOUSIES FOR WINDOWS AND DOORS OF TEXTILE MATERIALS; VERTICAL WINDOW BLINDS OF TEXTILE MATERIALS, IN CLASS 20 (U.S. CLS. 2, 13, 22, 25, 32 AND 50).

FOR: AWNINGS OF TEXTILE MATERIALS; AWNINGS OF PLASTIC, IN CLASS 22 (U.S. CLS. 1, 2, 7, 19, 22, 42 AND 50).

FOR: WINDOW BLINDS OF TEXTILE MATERIALS; TEXTILE FABRICS FOR USE IN THE MANUFACTURE OF SUN PROTECTION DEVICES, IN CLASS 24 (U.S. CLS. 42 AND 50).

THE MARK CONSISTS OF THE STYLIZED WORDING "STOBAG" WITH ALTERNATING LIGHT AND DARK RECTANGULAR BACKGROUNDS BEHIND EACH LETTER.

PRIORITY DATE OF 10-16-2009 IS CLAIMED.

OWNER OF INTERNATIONAL REGISTRATION 1040846 DATED 3-20-2010, EXPIRES 3-20-2020.

SER. NO. 79-083,332, FILED 3-20-2010.



David J. Kybas

Director of the United States Patent and Trademark Office

Reg. No. 4,065,202 TIMOTHY FINNEGAN, EXAMINING ATTORNEY

United States of America
United States Patent and Trademark Office

BluFlex

Reg. No. 4,065,203

Registered Dec. 6, 2011

Int. Cls.: 7 and 9

TRADEMARK

PRINCIPAL REGISTER

KOMET GROUP GMBH (FED REP GERMANY LIMITED LIABILITY COMPANY)
ZEPPELINSTRASSE 3
74354 BESIGHEIM
FED REP GERMANY

FOR: MECHANICALLY-OPERATED TOOLS, NAMELY, MACHINE TOOLS FOR THE TREATMENT OF METAL WORK PIECES; POWERED MECHANICAL CUTTING TOOLS FOR THE TREATMENT OF METAL WORK PIECES WITH INTEGRATED OR REMOVABLE CUTTERS OF HARD CUTTING MATERIALS, NAMELY, DRILLING TOOLS, BORING AND REBORING TOOLS, SUPERFINISH TURNING TOOLS, FRICTION TOOLS, SINK AND COUNTERSINK TOOLS, TURNING TOOLS, PLUG-IN TOOLS, THREAD CUTTING TOOLS, MILLING TOOLS; MANUALLY AND MECHANICALLY-ADJUSTABLE METAL WORKING MACHINE TOOLS, NAMELY, MECHANICALLY-OPERATED TOOLS FOR THE TREATMENT OF METAL WORK PIECES; MECHANICALLY-OPERATED TOOLS, NAMELY, FACING HEADS; COUPLINGS FOR MACHINE TOOLS IN THE NATURE OF TOOL HOLDING FIXTURES AND ADAPTERS, NAMELY, SPINDLE FLANGE ATTACHMENTS AND MODULAR MOUNTED TOOLS WITH COUPLINGS, BEING POINTS OF INTERSECTION AND SEPARATION FOR THE MECHANICAL COUPLING OF TOOLS WITH MACHINE TOOL SPINDLES, TOOLS AND PARTS OF TOOLS; TOOLS FOR MACHINE TOOLS, NAMELY, CLAMPS, HOLLOW CLAMPS AND MACHINE TOOL HOLDERS FOR USE WITH MACHINE TOOLS FOR THE TREATMENT OF METALWORK PIECES; MACHINE TOOL SPINDLES; ADJUSTING GAUGES AND ADJUSTING MACHINES FOR ADJUSTING AND ALIGNING MECHANICALLY-OPERATED TOOLS; DRIVE MECHANISMS, NAMELY, COUPLINGS FOR MACHINE TOOLS AND LINEAR ACTUATORS FOR MACHINE TOOLS; ALL THE AFORESAID GOODS WITH ELECTRIC/ELECTRONIC COMPONENTS, IN CLASS 7 (U.S. CLS. 13, 19, 21, 23, 31, 34 AND 35).

FOR: ELECTRONIC CONTROLS FOR MECHANICALLY-OPERATED TOOLS, NAMELY, ADJUSTING GAUGES WITH AND WITHOUT ELECTRIC/ELECTRONIC COMPONENTS FOR ADJUSTING AND ALIGNING MECHANICALLY-OPERATED TOOLS; ELECTRONIC RECEIVERS AND ELECTRONIC RECORDERS FOR MACHINE TOOL CONTROL SIGNALS; ELECTRIC SENSORS AND ELECTRIC/ELECTRONIC TOOL MEASURING INSTRUMENTS FOR USE IN AND FOR MECHANICALLY-OPERATED TOOLS FOR THE MEASUREMENT DATA FOR ADJUSTING, ALIGNING, CONTROLLING, HANDLING AND OPERATING MACHINE TOOLS FOR THE TREATMENT OF METAL WORK PIECES; FIXED OR MOBILE, CABLE AND/OR WIRELESS APPARATUS FOR THE TRANSMISSION OF DATA OF MECHANICALLY-OPERATED TOOLS, NAMELY, ROTATORS AND CONTROLLERS;



David J. Kybas

Director of the United States Patent and Trademark Office

Reg. No. 4,065,203 COMPUTER PROGRAMS RECORDED ON DATA CARRIERS, NAMELY, COMPUTER PROGRAMS FOR THE HANDLING, OPERATING AND ADJUSTMENT OF MECHANICALLY-OPERATED TOOLS; COMPUTER HARDWARE AND COMPUTER DISPLAY SCREENS FOR READING DATA CARRIERS FOR USE IN AND FOR MECHANICALLY-OPERATED TOOLS, IN CLASS 9 (U.S. CLS. 21, 23, 26, 36 AND 38).

THE MARK CONSISTS OF STANDARD CHARACTERS WITHOUT CLAIM TO ANY PARTICULAR FONT, STYLE, SIZE, OR COLOR.

PRIORITY DATE OF 7-29-2009 IS CLAIMED.

OWNER OF INTERNATIONAL REGISTRATION 1041165 DATED 1-8-2010, EXPIRES 1-8-2020.

SER. NO. 79-083,455, FILED 1-8-2010.

MARK SPARACINO, EXAMINING ATTORNEY

United States of America

United States Patent and Trademark Office

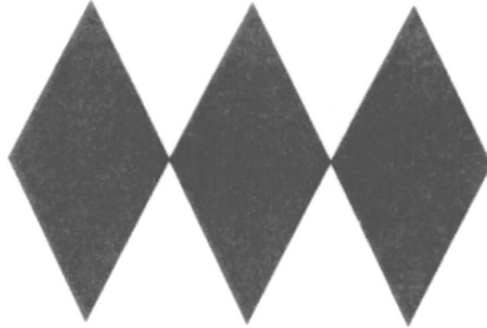

Reg. No. 4,065,204

Registered Dec. 6, 2011

Int. Cl.: 43

SERVICE MARK

PRINCIPAL REGISTER

EARL OF SANDWICH (FAMILYCO) AG (SWITZERLAND SOCIÉTÉ ANONYME)
BAHNHOFSTRASSE 8
CH-7250 KLOSTERS
SWITZERLAND

FOR: RESTAURANT, CANTEEN, CAFETERIA, SANDWICH BAR, SNACK BAR AND COFFEE SHOP SERVICES, IN CLASS 43 (U.S. CLS. 100 AND 101).

PRIORITY DATE OF 1-11-2010 IS CLAIMED.

OWNER OF INTERNATIONAL REGISTRATION 1041914 DATED 5-11-2010, EXPIRES 5-11-2020.

SER. NO. 79-083,717, FILED 5-11-2010.

JAMES STEIN, EXAMINING ATTORNEY



David J. Kybas

Director of the United States Patent and Trademark Office

United States of America
United States Patent and Trademark Office

Tetra 

Reg. No. 4,065,205

Registered Dec. 6, 2011

Int. Cls.: 5, 9 and 11

TRADEMARK

PRINCIPAL REGISTER

TETRA GMBH (FED REP GERMANY LIMITED LIABILITY COMPANY)
HERRENTEICH 78
49324 MELLE
FED REP GERMANY

FOR: VETERINARY PREPARATIONS FOR THE TREATMENT OF DISEASES IN REPTILES
FOR USE IN TERRARIUMS , IN CLASS 5 (U.S. CLS. 6, 18, 44, 46, 51 AND 52).

FOR: THERMOSTATS FOR USE IN TERRARIUMS, IN CLASS 9 (U.S. CLS. 21, 23, 26, 36
AND 38).

FOR: LIGHTS, HEATERS, AUTOMATIC TEMPERATURE REGULATORS, AIR FILTERS,
WATER FILTERS, ALL FOR USE IN TERRARIUMS, IN CLASS 11 (U.S. CLS. 13, 21, 23, 31
AND 34).

THE MARK CONSISTS OF THE WORDING "TETRA" BESIDE A STYLIZED REPRESENTA-
TION OF A WATERFLEA INSIDE A CIRCLE.

OWNER OF INTERNATIONAL REGISTRATION 0920680 DATED 10-31-2006, EXPIRES 10-
31-2016.

SER. NO. 79-084,033, FILED 3-12-2010.

TRACY FLETCHER, EXAMINING ATTORNEY



David J. Kyffers

Director of the United States Patent and Trademark Office

United States of America

United States Patent and Trademark Office



Reg. No. 4,065,206
Registered Dec. 6, 2011
Int. Cls.: 7, 12 and 42

VULKAN; KUPPLUNGS- UND GETRIEBEBAU; BERNHARD HACKFORTH GMBH & CO.
KG (FED REP GERMANY LIMITED (COMMERCIAL) PARTNERSHIP WITH A GMBH
AS GENERAL PARTNER)
HEERSTRABE 66
44653 HERNE
FED REP GERMANY

TRADEMARK

FOR: DRIVE TRAINS FOR WIND GENERATOR PLANTS; MACHINE COUPLINGS, BEING MACHINE PARTS FOR WIND GENERATOR PLANTS; TORSIONAL VIBRATION DAMPERS, BEING MACHINE PARTS FOR WIND GENERATOR PLANTS; TRANSMISSION COMPONENTS IN THE NATURE OF TRANSMISSION SHAFTS AND ENGINE MOUNTS, ALL BEING MACHINE PARTS FOR WIND GENERATOR PLANTS; MACHINE PARTS IN THE NATURE OF TRANSMISSION COMPONENTS BEING TORSIONAL VIBRATION DAMPERS, MACHINE COUPLINGS, TRANSMISSION SHAFTS, NOT FOR LAND VEHICLES, IN CLASS 7 (U.S. CLS. 13, 19, 21, 23, 31, 34 AND 35).

SERVICE MARK

FOR: LAND VEHICLE PARTS, NAMELY, DRIVE TRAINS, TORSIONAL VIBRATION DAMPERS, TRANSMISSION, FLEXIBLE AND TORSIONAL COUPLINGS FOR DRIVE SHAFTS, AND TRANSMISSION COMPONENTS BEING TRANSMISSION SHAFTS AND ENGINE MOUNTS, ALL FOR VEHICLES, IN CLASS 12 (U.S. CLS. 19, 21, 23, 31, 35 AND 44).

PRINCIPAL REGISTER

FOR: TECHNICAL MEASUREMENT EVALUATIONS IN THE FIELD OF WIND-ENERGY ENGINEERING, NAMELY, TESTING AND ANALYZING OF MEASURED DATA RELATING TO THE FUNCTIONALITY OF TRANSMISSION LINES USED FOR WIND POWER PLANTS; TECHNICAL MEASUREMENT EVALUATIONS IN THE FIELD OF THE OPERABILITY OF LAND VEHICLE AND DIESEL OBJECTS, NAMELY, THE TESTING AND ANALYZING OF MEASURED DATA RELATING TO THE EFFICIENCY OF LAND VEHICLE AND DIESEL ENGINES, IN CLASS 42 (U.S. CLS. 100 AND 101).



THE MARK CONSISTS OF THE TERM "ACOTEC" WITH "ACO" SURROUNDED BY AN OVAL FORMED BY BROKEN CURVED LINES AND PASSING THROUGH THE LETTER "O". THE LETTER "A" FORMS, IN PART, THE BROKEN LINE OVAL. "ACO" APPEARS IN THE COLOR BLUE AND "TEC" APPEARS IN THE COLOR BLACK.

David J. Kyjars

PRIORITY DATE OF 11-25-2009 IS CLAIMED.

Reg. No. 4,065,206 OWNER OF INTERNATIONAL REGISTRATION 1042957 DATED 4-16-2010, EXPIRES 4-16-2020.

THE COLOR(S) BLUE AND BLACK IS/ARE CLAIMED AS A FEATURE OF THE MARK.

SER. NO. 79-084,128, FILED 4-16-2010.

ZHALEH DELANEY, EXAMINING ATTORNEY

United States of America
United States Patent and Trademark Office

PURE
HERBS

Reg. No. 4,065,207

Registered Dec. 6, 2011

Int. Cls.: 8 and 25

TRADEMARK

PRINCIPAL REGISTER

ADA COSMETIC GMBH (FED REP GERMANY LIMITED LIABILITY COMPANY)
IM FUCHSECK
77694 KEHL/BADEN
FED REP GERMANY

FOR: HAND-OPERATED TOOLS AND DEVICES FOR BODY AND BEAUTY CARE, IN PARTICULAR FILES, NAIL FILES AND POLISHING FILES; CUTLERY; RAZORS, IN CLASS 8 (U.S. CLS. 23, 28 AND 44).

FOR: CLOTHING, IN PARTICULAR BATH ROBES; FOOTWEAR, IN PARTICULAR BATH SLIPPERS; HEADGEAR FOR WEAR, IN PARTICULAR SHOWER CAPS, IN CLASS 25 (U.S. CLS. 22 AND 39).

NO CLAIM IS MADE TO THE EXCLUSIVE RIGHT TO USE "PURE HERBS", APART FROM THE MARK AS SHOWN.

OWNER OF INTERNATIONAL REGISTRATION 0934489 DATED 5-30-2007, EXPIRES 5-30-2017.

THE MARK CONSISTS OF THE WORDING "PURE HERBS" WITH A SINGLE LEAF USED AS A HORIZONTAL BAR IN THE LETTER "H".

SER. NO. 79-084,654, FILED 5-17-2010.

SHAILA SETTLES, EXAMINING ATTORNEY



David J. Kyros

Director of the United States Patent and Trademark Office

United States of America

United States Patent and Trademark Office



Reg. No. 4,065,208

Registered Dec. 6, 2011

**Int. Cls.: 3, 8, 9, 14, 18,
20, 21, 24, 25 and 28**

TRADEMARK

PRINCIPAL REGISTER

CONSORZIO VINO CHIANTI CLASSICO (ITALY CONSORTIUM)
VIA PIANIGIANI, 9
I-53017 RADDA IN CHIANTI (SI)
ITALY

FOR: CLEANING, POLISHING, SCOURING AND ABRASIVE PREPARATIONS; SOAPS; PERFUMERY, ESSENTIAL OILS, COSMETICS, HAIR LOTIONS; DENTIFRICES, IN CLASS 3 (U.S. CLS. 1, 4, 6, 50, 51 AND 52).

FOR: CUTLERY; RAZORS, IN CLASS 8 (U.S. CLS. 23, 28 AND 44).

FOR: EYEGLASSES, SPECTACLES, SPECTACLES CASES; WEIGHING EQUIPMENT, NAMELY, BALANCES; FLASH MEMORYCARDS, COMPACT DISCS, DIGITAL VIDEO DISCS AND USB FLASH DRIVES FEATURING CULTURAL, HISTORICAL AND GEOGRAPHICAL CONTENTS; AUTOMATIC VENDING MACHINES AND MECHANISMS FOR COIN-OPERATED APPARATUS; CASH REGISTERS, CALCULATING MACHINES, DATA PROCESSING EQUIPMENT AND COMPUTERS; FIRE-EXTINGUISHING APPARATUS, IN CLASS 9 (U.S. CLS. 21, 23, 26, 36 AND 38).

FOR: JEWELRY, PRECIOUS STONES; HOROLOGICAL AND CHRONOMETRIC INSTRUMENTS, IN CLASS 14 (U.S. CLS. 2, 27, 28 AND 50).

FOR: LEATHER GOODS AND PLASTIC OR SYNTHETIC IMITATIONS OF LEATHER GOODS, NAMELY, HANDBAGS, SHOULDER BAGS, BRIEFCASES, KNAPSACKS, TRAVELING BAGS, PURSES, KEY-RINGS, WALLETS, BEAUTY CASES IN THE NATURE OF COSMETIC CARRYING CASES SOLD EMPTY, SUITCASES OF LEATHER; ANIMAL SKINS, ANIMAL HIDES; TRUNKS AND TRAVELING BAGS; UMBRELLAS, PARASOLS AND WALKING STICKS; WHIPS, HARNESS AND SADDLERY, IN CLASS 18 (U.S. CLS. 1, 2, 3, 22 AND 41).

FOR: FURNITURE, MIRRORS, PICTURE FRAMES; STATUES AND BUSTS OF WOOD, CORK, REED, CANE, WICKER, HORN, BONE, IVORY, WHALEBONE, SHELL, AMBER, MOTHER-OF-PEARL, MEERSCHAUM AND SUBSTITUTES FOR ALL THESE MATERIALS, OR OF PLASTICS, IN CLASS 20 (U.S. CLS. 2, 13, 22, 25, 32 AND 50).

FOR: HOUSEHOLD OR KITCHEN UTENSILS, NAMELY, PLATES, BOWLS, COOKING GRILL, TONGS, BOTTLE OPENERS AND TOPS AND CONTAINERS FOR HOUSEHOLD



David J. Kappas

Director of the United States Patent and Trademark Office

Reg. No. 4,065,208 AND KITCHEN USE; COMBS AND BATH SPONGES; BATH BRUSHES EXCLUDING PAINT BRUSHES; GLASSWARE, PORCELAIN AND EARTHENWARE NOT INCLUDED IN OTHER CLASSES, NAMELY, GLASSES, CUPS, TABLEWARE IN THE NATURE OF BOWLS, EARTHENWARE IN THE NATURE OF BOWLS, DECANTERS, IN CLASS 21 (U.S. CLS. 2, 13, 23, 29, 30, 33, 40 AND 50).

FOR: TEXTILES AND TEXTILE GOODS, NOT INCLUDED IN OTHER CLASSES, NAMELY, TEXTILE FABRICS FOR HOME AND COMMERCIAL INTERIORS; BED AND TABLE COVERS MADE OF LINEN, COTTON, PLASTIC, SYNTHETIC, IN CLASS 24 (U.S. CLS. 42 AND 50).

FOR: CLOTHING ARTICLES, NAMELY, TROUSERS, SKIRTS, SUITS, DRESSES, COATS, TEE-SHIRTS, SHIRTS, BLOUSES, SWEATSHIRTS, JACKETS, RAINCOATS, BELTS, FOOTWEAR, CAPS, HATS, CYCLING SHORTS, CYCLING SHOES, BICYCLE GLOVES, CYCLING SHIRTS, AND JOGGING OUTFITS, JOGGING PANTS, IN CLASS 25 (U.S. CLS. 22 AND 39).

FOR: BOARD GAMES AND ARCADE TYPE ELECTRONIC VIDEO GAMES, PLAYING CARDS, BOARD GAMES; SPORTING ARTICLES FOR CYCLING AND JOGGING NOT INCLUDED IN OTHER CLASSES; NAMELY, BICYCLES, STATIONARY EXERCISE BICYCLES, MANUALLY AND ELECTRONICALLY OPERATED JOGGING MACHINES; DECORATIONS FOR CHRISTMAS TREES, IN CLASS 28 (U.S. CLS. 22, 23, 38 AND 50).

NO CLAIM IS MADE TO THE EXCLUSIVE RIGHT TO USE "CHIANTI CLASSICO DAL 1716", APART FROM THE MARK AS SHOWN.

OWNER OF INTERNATIONAL REGISTRATION 1045132 DATED 5-31-2010, EXPIRES 5-31-2020.

THE COLOR(S) RED, BLACK, YELLOW, GOLD, WHITE AND BROWN IS/ARE CLAIMED AS A FEATURE OF THE MARK.

THE MARK CONSISTS OF THE WORDING "CHIANTI CLASSICO DAL 1716" IN WHITE, AND THE DESIGN OF A BLACK ROOSTER, ALL SET WITHIN A RED, BROWN, YELLOW, AND GOLD SEAL WITH YELLOW, WHITE AND BLACK CONCENTRIC CIRCLES.

THE ENGLISH TRANSLATION OF "CLASSICO DAL" IN THE MARK IS CLASSIC SINCE.

SER. NO. 79-085,039, FILED 5-31-2010.

SEAN CROWLEY, EXAMINING ATTORNEY

United States of America

United States Patent and Trademark Office

EasyWrapper

Reg. No. 4,065,209

Registered Dec. 6, 2011

Int. Cl.: 21

TRADEMARK

PRINCIPAL REGISTER

DAVID ANDREW PYNT (AUSTRALIA INDIVIDUAL)
36 WATERLOO CRESCENT
EAST PERTH, AUSTRALIA WA 6004

FOR: HOUSEHOLD CONTAINERS FOR FOODS, NAMELY, CONTAINERS FOR DISPENSING PLASTIC WRAP, CLING WRAP, PAPER WRAP, METALLIC WRAP FOR USE IN THE PRESERVATION OF FOODS, HOUSEHOLD UTENSILS, NAMELY, DISPENSERS FOR PLASTIC WRAP, CLING WRAP, PAPER WRAP, METALLIC WRAP FOR USE IN THE PRESERVATION OF FOODS; PLASTIC STORAGE CONTAINERS FOR HOUSEHOLD OR DOMESTIC USE, PORTABLE PLASTIC CONTAINERS FOR STORING HOUSEHOLD AND KITCHEN GOODS, THERMAL INSULATED CONTAINERS FOR FOOD OR BEVERAGES, INSULATED CONTAINERS FOR FOOD OR BEVERAGE FOR DOMESTIC USE, CONTAINERS FOR ICE, INSULATED BAGS FOR FOOD OR BEVERAGE FOR DOMESTIC USE, INSULATED CONTAINERS FOR BEVERAGE CANS FOR DOMESTIC USE, HEAT-INSULATED VESSELS, DISPENSERS FOR CELLULOSE WIPES FOR HOUSEHOLD USE, DISPENSERS FOR FACIAL TISSUES, DISPENSERS FOR PAPER TOWELS, PORTABLE COOLERS, CROCKERY, NAMELY POTS, DISHES, DRINKING CUPS AND SAUCERS, BOWLS, SERVING BOWLS AND TRAYS, IN CLASS 21 (U.S. CLS. 2, 13, 23, 29, 30, 33, 40 AND 50).

THE MARK CONSISTS OF STANDARD CHARACTERS WITHOUT CLAIM TO ANY PARTICULAR FONT, STYLE, SIZE, OR COLOR.

OWNER OF INTERNATIONAL REGISTRATION 1045268 DATED 2-15-2010, EXPIRES 2-15-2020.

SER. NO. 79-085,085, FILED 2-15-2010.

KELLEY WELLS, EXAMINING ATTORNEY



David J. Kypos

Director of the United States Patent and Trademark Office

United States of America

United States Patent and Trademark Office

IPSISSIMA

Reg. No. 4,065,210

Registered Dec. 6, 2011

Int. Cls.: 14, 18 and 25

TRADEMARK

PRINCIPAL REGISTER

IPSISSIMA AG (SWITZERLAND AKTIENGESELLSCHAFT)
C/O LOTTE SCHILDER BÄR
WINKELWIESE 6
ZÜRICH, SWITZERLAND CH8001

FOR: JEWELRY, SHOE ORNAMENTS OF PRECIOUS METAL, CUFF LINKS, KEY RINGS OF PRECIOUS METALS, IN CLASS 14 (U.S. CLS. 2, 27, 28 AND 50).

FOR: LEATHER AND IMITATIONS OF LEATHER; GOODS MADE OF LEATHER AND IMITATION OF LEATHER, NAMELY, BOXES AND BAGS; LEATHER OR LEATHER-BOARD BOXES, IN PARTICULAR FOR SHOES; BAGS, NAMELY, TRAVELLING BAGS, HAND BAGS, FASHION HAND BAGS, SHOULDER BAGS, BRIEF CASES; WHEELED BAGS; HAND AND TRAVELLING TRUNKS; LEATHER TRAVELLING SETS COMPRISED OF COSMETIC CASES SOLD EMPTY, TRAIN CASES, SUIT CARRIERS, CARRY-ON BAGS; LEATHER KEY CASES; LEATHER CASES, NOT ADAPTED TO THEIR INTENDED PRODUCTS; POCKET WALLETS, PURSES; TEXTILE CASES FOR JEWELLERY, IN CLASS 18 (U.S. CLS. 1, 2, 3, 22 AND 41).

FOR: CLOTHING, NAMELY, TROUSERS, SHIRTS, SWEATERS, DRESSES, SKIRTS, BLOUSES, JACKETS, COATS, BLAZERS, KNIT DRESSES, KNIT JACKETS, KNIT SHIRTS, KNIT SWEATERS, KNIT BLAZERS, KNIT SKIRTS, KNIT TOPS, KNITTED CAPS, KNITTED GLOVES, KNITTED UNDERWEAR, SPORT COATS, SPORT JACKETS, TIES, SASHES, SCARFS, FOOTWEAR, NAMELY, SHOES, BOOTS, SLIPPERS, SPORT SHOES, ESPARTO SHOES AND SANDALS; HEELS FOR SHOES, NON-SLIPPING DEVICES FOR FOOTWEAR, NAMELY, CLEATS FOR ATTACHMENTS TO SHOES, SLIP-RESISTANT FOOTWEAR AND NON-SLIP SOLES AND STRAPS FOR FOOTWEAR; HEADWEAR, GLOVES, BELTS, INNER SOLES FOR FOOTWEAR, SOLES FOR FOOTWEAR, SANDALS, STOCKINGS, IN CLASS 25 (U.S. CLS. 22 AND 39).

THE MARK CONSISTS OF STANDARD CHARACTERS WITHOUT CLAIM TO ANY PARTICULAR FONT, STYLE, SIZE, OR COLOR.

PRIORITY DATE OF 12-28-2009 IS CLAIMED.

OWNER OF INTERNATIONAL REGISTRATION 1045876 DATED 6-28-2010, EXPIRES 6-28-2020.



David J. Kyjars

Director of the United States Patent and Trademark Office

Reg. No. 4,065,210 SER. NO. 79-085,375, FILED 6-28-2010.

MARTHA FROMM, EXAMINING ATTORNEY

United States of America

United States Patent and Trademark Office

C.PETULA

Reg. No. 4,065,211

Registered Dec. 6, 2011

Int. Cls.: 14, 18 and 25

TRADEMARK

PRINCIPAL REGISTER

C.PETULA (FRANCE SOCIÉTÉ PAR ACTIONS SIMPLIFIÉE)
76 RUE SAINT LAZARE
F-75009 PARIS
FRANCE

FOR: JEWELRY; PRECIOUS STONES; HOROLOGICAL AND CHRONOMETRIC INSTRUMENTS; PRECIOUS METALS AND THEIR ALLOYS; NON-MONETARY, COLLECTIBLE AND COMMEMORATIVE COINS; WORKS OF ART OF PRECIOUS METAL; JEWELRY CASES; BOXES OF PRECIOUS METAL; WATCH CASES, BANDS, CHAINS, SPRINGS AND GLASSES; KEY RINGS OF PRECIOUS METALS; STATUES, STATUETTES AND FIGURINES OF PRECIOUS METAL; CASES FOR WATCHES AND CLOCKS; MEDALS, IN CLASS 14 (U.S. CLS. 2, 27, 28 AND 50).

FOR: LEATHER AND IMITATION LEATHER; ANIMAL SKINS; TRUNKS AND TRAVELING BAGS; UMBRELLAS, PARASOLS AND WALKING STICKS; WHIPS, HARNESSSES AND SADDLERY; POCKET WALLETS; PURSES; HANDBAGS, RUCKSACKS, WHEELED BAGS; BAGS FOR CLIMBERS IN THE NATURE OF ALL-PURPOSE CARRYING BAGS; BAGS FOR CAMPERS IN THE NATURE OF ALL-PURPOSE CARRYING BAGS; TRAVELING BAGS, BEACH BAGS, SCHOOL BAGS; UNFITTED VANITY CASES; COLLARS FOR ANIMALS; ANIMAL WRAPS AND COVERS; SHOPPING BAGS, NAMELY, LEATHER, MESH, RE-USABLE AND TEXTILE; BAGS FOR PACKAGING OF LEATHER, IN CLASS 18 (U.S. CLS. 1, 2, 3, 22 AND 41).

FOR: MEN'S, WOMEN'S AND CHILDREN'S CLOTHING, NAMELY, UNDERWEAR, LINGERIE, SUITS, SHIRTS, BLOUSES, PANTS, TROUSERS, SKIRTS, VESTS, DRESSES, BELTS, PAJAMAS, COATS, SCARVES, GLOVES, TIES, SWIMSUITS, BEACH ROBES, SOCKS, STOCKINGS AND GARTERS; FOOTWEAR, NAMELY, SLIPPERS, SHOES, BOOTS, HALF-BOOTS AND SANDALS; HEADGEAR, NAMELY, HATS AND CAPS, IN CLASS 25 (U.S. CLS. 22 AND 39).



THE NAME(S), PORTRAIT(S), AND/OR SIGNATURE(S) SHOWN IN THE MARK DOES NOT IDENTIFY A PARTICULAR LIVING INDIVIDUAL.

PRIORITY DATE OF 4-19-2010 IS CLAIMED.

OWNER OF INTERNATIONAL REGISTRATION 1045887 DATED 7-1-2010, EXPIRES 7-1-2020.

David J. Kappas

Director of the United States Patent and Trademark Office

Reg. No. 4,065,211 THE COLOR(S) BLUE AND RED IS/ARE CLAIMED AS A FEATURE OF THE MARK.

THE MARK CONSISTS OF THE WORDING "C. PETULA" IN BLUE, WHERE THE MIDDLE PORTION OF THE LETTER "E" IS REPRESENTED BY A RED STAR.

SER. NO. 79-085,377, FILED 7-1-2010.

MARC LEIPZIG, EXAMINING ATTORNEY

United States of America

United States Patent and Trademark Office

EKALIN

Reg. No. 4,065,212

Registered Dec. 6, 2011

Int. Cls.: 1 and 2

TRADEMARK

PRINCIPAL REGISTER

CLARIANT AG (SWITZERLAND SOCIÉTÉ ANONYME)
ROTHAUSSTRASSE 61
CH-4132 MUTTENZ
SWITZERLAND

FOR: CHEMICAL PRODUCTS FOR USE IN FURTHER MANUFACTURING IN THE TEXTILE, LEATHER AND PAPER INDUSTRIES, NAMELY, SURFACTANTS, DISPERSING AGENTS AND DYEING AUXILIARIES, IN CLASS 1 (U.S. CLS. 1, 5, 6, 10, 26 AND 46).

FOR: CHEMICAL PRODUCTS FOR THE TEXTILE, LEATHER AND PAPER INDUSTRY, NAMELY, ANILINE, ALIZARINE AND OTHER COLORANTS AND DYESTUFFS, IN CLASS 2 (U.S. CLS. 6, 11 AND 16).

OWNER OF U.S. REG. NO. 562,407.

OWNER OF INTERNATIONAL REGISTRATION 0315858 DATED 6-27-1966, EXPIRES 6-27-2016.

SER. NO. 79-085,413, FILED 3-22-2010.

HEATHER THOMPSON, EXAMINING ATTORNEY



David J. Kypos

Director of the United States Patent and Trademark Office

United States of America

United States Patent and Trademark Office



Reg. No. 4,065,213

Registered Dec. 6, 2011

Int. Cls.: 24 and 25

KUFNER TEXTIL GMBH (FED REP GERMANY GESELLSCHAFT MIT BESCHRÄNKTER HAFTUNG (GMBH))
BAIERBRUNNER STRASSE 39
81379 MUNICH
FED REP GERMANY

TRADEMARK

PRINCIPAL REGISTER

FOR: WOVEN AND KNITTED FABRICS, FLEECE AND NON-WOVEN FABRICS; TEXTILE LININGS FOR ARTICLES OF CLOTHING; WOVEN AND KNITTED INTERLINING FABRICS AS WELL AS FLEECE AND NON-WOVEN INTERLINING FABRICS; UNFINISHED STIFFENING INTERLININGS FOR ARTICLES OF CLOTHING AS YARD GOODS; TEXTILE LININGS, WOVEN AND KNITTED INTERLINING FABRICS AS WELL AS FLEECE AND NON-WOVEN INTERLINING FABRICS, ALL CUT TO SIZE AS LININGS FOR ARTICLES OF CLOTHING; TWISTED HORSEHAIR CLOTH AND HAIR INTERLINING CLOTH AS INTERLININGS FOR ARTICLES OF CLOTHING; ALL THE AFORESAID GOODS WITH OR WITHOUT RADIATION PROTECTION PROPERTIES, IN CLASS 24 (U.S. CLS. 42 AND 50).

FOR: TEXTILE LININGS, WOVEN AND KNITTED INTERLINING FABRICS AS WELL AS FLEECE AND NON-WOVEN INTERLINING FABRICS, ALL AS MADE-UP FINISHED TEXTILE INTERLININGS FOR CLOTHING; STIFFENING INTERLININGS OF TEXTILE FOR ARTICLES OF CLOTHING AS FINISHED PRODUCTS; TWISTED HORSEHAIR CLOTH AND HAIR INTERLINING CLOTH AS PREFABRICATED TEXTILE INTERLININGS FOR ARTICLES OF CLOTHING; ALL AFOREMENTIONED GOODS WITH OR WITHOUT RADIATION PROTECTION PROPERTIES; ARTICLES OF CLOTHING, NAMELY, DRESSES, PANTS, SHORTS, SHIRTS, SUITS, SWEATERS, BLOUSES, BLAZERS, JACKETS, COATS, AND POCKETS, BEING FINISHED PARTS FOR CLOTHING, WITH OR WITHOUT RADIATION PROTECTION PROPERTIES, IN CLASS 25 (U.S. CLS. 22 AND 39).

OWNER OF U.S. REG. NOS. 1,115,673 AND 3,561,293.

OWNER OF INTERNATIONAL REGISTRATION 0968017 DATED 3-13-2008, EXPIRES 3-13-2018.

THE COLOR(S) WHITE AND MAGENTA IS/ARE CLAIMED AS A FEATURE OF THE MARK.

THE MARK CONSISTS OF THE HEAD OF A HORSE IN WHITE AND MAGENTA WITH THE TERM "KUFNER" IN WHITE UNDERNEATH, ALL OF WHICH APPEARS ON A MAGENTA SQUARE BACKGROUND.



David J. Kybas

Director of the United States Patent and Trademark Office

Reg. No. 4,065,213 SER. NO. 79-085,429, FILED 5-17-2010.

SHAILA SETTLES, EXAMINING ATTORNEY

United States of America
United States Patent and Trademark Office

CLIFTON

Reg. No. 4,065,214

Registered Dec. 6, 2011

Int. Cl.: 14

TRADEMARK

PRINCIPAL REGISTER

RICHEMONT INTERNATIONAL SA (SWITZERLAND SOCIÉTÉ ANONYME (SA))
ROUTE DES BICHES 10
CH-1752 VILLARS-SUR-GLÂNE - FRIBOURG
SWITZERLAND

FOR: CUFF LINKS, TIE CLIPS, RINGS, BRACELETS, EARRINGS, NECKLACES, BROOCHES, KEY RINGS OF PRECIOUS METAL, WATCHES, CHRONOMETERS, CLOCKS; WATCH BANDS, BOXES OF PRECIOUS METAL FOR WATCHES AND JEWELRY, IN CLASS 14 (U.S. CLS. 2, 27, 28 AND 50).

THE MARK CONSISTS OF STANDARD CHARACTERS WITHOUT CLAIM TO ANY PARTICULAR FONT, STYLE, SIZE, OR COLOR.

PRIORITY DATE OF 2-26-2010 IS CLAIMED.

OWNER OF INTERNATIONAL REGISTRATION 1046997 DATED 7-29-2010, EXPIRES 7-29-2020.

SER. NO. 79-085,806, FILED 7-29-2010.

DAWN FELDMAN, EXAMINING ATTORNEY



David J. Kybas

Director of the United States Patent and Trademark Office

United States of America

United States Patent and Trademark Office

OKIO

Reg. No. 4,065,215

Registered Dec. 6, 2011

Int. Cl.: 9

TRADEMARK

PRINCIPAL REGISTER

CALEARO S.R.L. (ITALY S.R.L.)
VIA BACCHIGLIONE, 49
I-36030 ISOLA VICENTINA (VICENZA)
ITALY

FOR: VEHICLE TRACKING DEVICES COMPRISED OF CELLULAR RADIO MODULES, COMPUTER SOFTWARE AND COMPUTER HARDWARE, SENSORS, TRANSMITTERS, RECEIVERS AND GLOBAL POSITIONING SATELLITE RECEIVERS, ALL FOR USE IN CONNECTION WITH VEHICLE TRACKING, VEHICLE MONITORING AND ANTI-THEFT VEHICLE ALARMS; GPS NAVIGATION DEVICE; GPS DATA LOGGER FOR RECORDING TRIPS, IN CLASS 9 (U.S. CLS. 21, 23, 26, 36 AND 38).

THE MARK CONSISTS OF THE STYLIZED WORD "OKIO" WITH A STYLIZED EYE DESIGN WITHIN THE FIRST LETTER "O".

OWNER OF INTERNATIONAL REGISTRATION 1047593 DATED 7-26-2010, EXPIRES 7-26-2020.

SER. NO. 79-086,053, FILED 7-26-2010.

REBECCA POVARCHUK, EXAMINING ATTORNEY



David J. Kybas

Director of the United States Patent and Trademark Office

United States of America

United States Patent and Trademark Office



Reg. No. 4,065,216

Registered Dec. 6, 2011

Int. Cls.: 3, 9, 14 and 18

TRADEMARK

PRINCIPAL REGISTER

CLERC GÉRALD (FRANCE INDIVIDUAL)
35 AVENUE FERDINAND BUISSON
F-75016 PARIS
FRANCE

FOR: SOAP; PERFUMERY, ESSENTIAL OILS, COSMETICS, HAIR LOTIONS; ANTI-WRINKLE COSMETICS; DENTIFRICES, IN CLASS 3 (U.S. CLS. 1, 4, 6, 50, 51 AND 52).

FOR: OPTICAL GOODS, NAMELY, EYEGLASSES AND SUNGLASSES; EYEGLASS FRAMES; SPECTACLE CASES; GOGGLES FOR SPORTS; OPTICS, NAMELY, SPECTACLES; SPECTACLE FRAMES, IN CLASS 9 (U.S. CLS. 21, 23, 26, 36 AND 38).

FOR: PRECIOUS METALS AND THEIR ALLOYS; AND GOODS IN PRECIOUS METALS OR COATED THEREWITH, NOT INCLUDED IN OTHER CLASSES, NAMELY, CHARMS IN PRECIOUS METALS OR COATED THEREWITH, JEWELRY BOXES, WATCH BANDS AND TIE CLIPS; JEWELRY, PRECIOUS STONES; HOROLOGICAL AND CHRONOMETRIC INSTRUMENTS; PARTS OF CLOCKS AND WATCHES AND THEIR COMPONENTS; WATCHES AND THEIR COMPONENTS; MOVEMENTS FOR CLOCKS AND WATCHES AND THEIR COMPONENTS; MECHANICAL HAND-WINDING AND SELF-WINDING WATCHES; ELECTRIC AND ELECTRONIC WATCHES; WATCH AND CLOCK PARTS, NAMELY, CASES AND DIALS; WATCH BANDS; CHRONOMETERS; CHRONOGRAPHS; WALL CLOCKS; SMALL CLOCKS; WATCH AND CLOCK PARTS, NAMELY, CHAINS AND SPRINGS; WATCH CRYSTALS; ELECTRIC, ELECTRONIC OR HAND-WINDING ALARM CLOCKS, IN CLASS 14 (U.S. CLS. 2, 27, 28 AND 50).

FOR: LEATHER AND IMITATIONS OF LEATHER; AND GOODS MADE OF THESE MATERIALS AND NOT INCLUDED IN OTHER CLASSES, NAMELY, LEATHER AND IMITATION LEATHER SPORT BAGS AND GENERAL PURPOSE TROLLEY BAGS, LEATHER CASES FOR KEYS; LEATHER PURSES; LEATHER STRAPS; LEATHER BOXES FOR STORING GREETING CARDS; BRIEFCASE-TYPE LEATHER BUSINESS FOLDERS; LEATHER BAGS FOR MERCHANDISE PACKAGING; LEATHER SHOULDER BELTS; LUGGAGE, WALLETS, AND DAY PACKS OF LEATHER AND IMITATIONS OF LEATHER; ANIMAL SKINS; TRUNKS AND TRAVELING BAGS; HANDBAGS; BAGS FOR SPORTS; TRAVELING BAGS; UMBRELLAS, PARASOLS, IN CLASS 18 (U.S. CLS. 1, 2, 3, 22 AND 41).



David J. Kybas

Director of the United States Patent and Trademark Office

Reg. No. 4,065,216 THE MARK CONSISTS OF A CROWN, A BACKWARDS LETTER "F", A FORWARD LETTER "F", A SPIRAL, TWO GEARS, AND TWO CIRCLES WITH POINTED SPEARS UNDER THE LETTERS.

PRIORITY DATE OF 2-19-2010 IS CLAIMED.

OWNER OF INTERNATIONAL REGISTRATION 1048163 DATED 8-18-2010, EXPIRES 8-18-2020.

SER. NO. 79-086,259, FILED 8-18-2010.

APRIL ROACH, EXAMINING ATTORNEY

United States of America
United States Patent and Trademark Office

HS AMICA

Reg. No. 4,065,217

Registered Dec. 6, 2011

Int. Cl.: 10

TRADEMARK

PRINCIPAL REGISTER

H.S. - HOSPITAL SERVICE S.P.A. (ITALY CORPORATION)
VIA ZOSIMO, 13
I-00178 ROMA
ITALY

FOR: SURGICAL INSTRUMENTS AND APPARATUS FOR MEDICAL USE; MEDICAL DEVICES, NAMELY, SURGICAL DEVICES THAT FACILITATE THE IDENTIFICATION, SEPARATION, AND ABLATION OF BIOLOGIC TISSUES; PROBES FOR MEDICAL USE; DRAPES FOR MEDICAL AND SURGICAL USE, MEDICAL APPARATUS IN THE FIELDS OF SURGERY, CANCER DIAGNOSIS, AND THERAPY, NAMELY, TUBES FOR MEDICAL USE, SYRINGES, FORCEPS, NEEDLES, CANNULAS, TUBING FOR USE WITH CANNULAS, PUNCHES FOR MEDICAL AND SURGICAL USE, TIPS FOR MEDICAL AND SURGICAL USE, SPONGES FOR MEDICAL USE, SCALPELS FOR MEDICAL USE, SLIDERS FOR MEDICAL USE, CATHETERS, DILATATORS, SILICONE STABILIZERS, INFUSION PUMPS, INFUSION SETS, VESSELS FOR MEDICAL USE, DRAINAGE TUBES FOR MEDICAL PURPOSES, ENDOTRACHEAL TUBES, INTRAVENOUS FEEDING TUBES; ARTIFICIAL LIMBS, EYES AND TEETH; SUTURE MATERIALS; NEEDLES FOR USE IN CANCER DIAGNOSTICS AND THERAPY; CUTTING DEVICES FOR BIOPSY; SUTURE MATERIALS; MEDICAL APPARATUS AND INSTRUMENTS FOR USE IN CANCER DIAGNOSTICS AND THERAPY, IN CLASS 10 (U.S. CLS. 26, 39 AND 44).

THE MARK CONSISTS OF STANDARD CHARACTERS WITHOUT CLAIM TO ANY PARTICULAR FONT, STYLE, SIZE, OR COLOR.

PRIORITY DATE OF 2-16-2010 IS CLAIMED.

OWNER OF INTERNATIONAL REGISTRATION 1048364 DATED 3-25-2010, EXPIRES 3-25-2020.

OWNER OF U.S. REG. NO. 2,765,220.

THE ENGLISH TRANSLATION OF THE WORD "AMICA" IN THE MARK IS "FRIEND".

SER. NO. 79-086,328, FILED 3-25-2010.

KRISTINA MORRIS, EXAMINING ATTORNEY



David J. Kyros

Director of the United States Patent and Trademark Office

United States of America

United States Patent and Trademark Office

CAPTUREX

Reg. No. 4,065,218

Registered Dec. 6, 2011

Int. Cls.: 9 and 10

TRADEMARK

PRINCIPAL REGISTER

STRAUB MEDICAL AG (SWITZERLAND SOCIÉTÉ ANONYME (SA))
STRAUBSTRASSE 12
CH-7323 WANGS
SWITZERLAND

FOR: ELECTRONIC CONTROLLING APPARATUS AND CONTROLLING INSTRUMENTS FOR CATHETERS, FOR PROTECTION FROM EMBOLISMS AND FOR PERCUTANEOUS VASCULAR ACCESS PORTS, NAMELY, ELECTRONIC CONTROLLERS FOR PERI-INTERVENTIONAL, TEMPORARY AND PERMANENT EMBOLIC PROTECTION FILTER SYSTEMS FOR ARTERIAL AND VENOUS USE, IN CLASS 9 (U.S. CLS. 21, 23, 26, 36 AND 38).

FOR: SURGICAL APPARATUS AND INSTRUMENTS; MEDICAL AND VETERINARY APPARATUS AND INSTRUMENTS, NAMELY, CATHETERS; FILTERS FOR MEDICAL PURPOSES, NAMELY, FILTERS FOR BLOOD AND BLOOD COMPONENTS, AIR FILTERS FOR MEDICAL VENTILATORS; MEDICAL GUIDEWIRES; TROCARS; PERCUTANEOUS VASCULAR ACCESS PORTS; CATHETER EXTENSIONS FOR MEDICAL PURPOSES, NAMELY, MEDICAL GUIDEWIRES; TROCARS; PERCUTANEOUS VASCULAR ACCESS PORTS; CATHETER EXTENSIONS FOR MEDICAL PURPOSES; INSTRUMENTS FOR PROTECTION FROM EMBOLISMS, NAMELY, PERI-INTERVENTIONAL, TEMPORARY AND PERMANENT EMBOLIC PROTECTION FILTER SYSTEMS FOR ARTERIAL AND VENOUS USE; PARTS OF THE AFORESAID ARTICLES FOR THE INSERTION AND CONTROL THEREOF, NAMELY, INTRODUCER SHEATHS, DILATORS, FILTER DELIVERY CATHETERS AND GUIDEWIRES, IN CLASS 10 (U.S. CLS. 26, 39 AND 44).

THE MARK CONSISTS OF STANDARD CHARACTERS WITHOUT CLAIM TO ANY PARTICULAR FONT, STYLE, SIZE, OR COLOR.

PRIORITY DATE OF 2-24-2010 IS CLAIMED.

OWNER OF INTERNATIONAL REGISTRATION 1048940 DATED 8-20-2010, EXPIRES 8-20-2020.

SER. NO. 79-086,552, FILED 8-20-2010.

DEBRA LEE, EXAMINING ATTORNEY



David J. Kyros

Director of the United States Patent and Trademark Office

United States of America

United States Patent and Trademark Office

MIRÓ

Reg. No. 4,065,219

Registered Dec. 6, 2011

Int. Cl.: 34

TRADEMARK

PRINCIPAL REGISTER

TABACOS DE CENTRO AMERICA EXPORT, S.L. (SPAIN LIMITED LIABILITY COMPANY)
VIA DE LAS DOS CASTILLAS, 9-CP2
E-28224 POZUELO DE ALARCON
SPAIN

FOR: TOBACCO, IN CLASS 34 (U.S. CLS. 2, 8, 9 AND 17).

THE MARK CONSISTS OF STANDARD CHARACTERS WITHOUT CLAIM TO ANY PARTICULAR FONT, STYLE, SIZE, OR COLOR.

PRIORITY DATE OF 8-4-2010 IS CLAIMED.

OWNER OF INTERNATIONAL REGISTRATION 1050155 DATED 9-9-2010, EXPIRES 9-9-2020.

THE ENGLISH TRANSLATION OF "MIRO" IS "HE/SHE WATCHED".

SER. NO. 79-087,002, FILED 9-9-2010.

SUSAN RICHARDS, EXAMINING ATTORNEY



David J. Kybas

Director of the United States Patent and Trademark Office

United States of America

United States Patent and Trademark Office

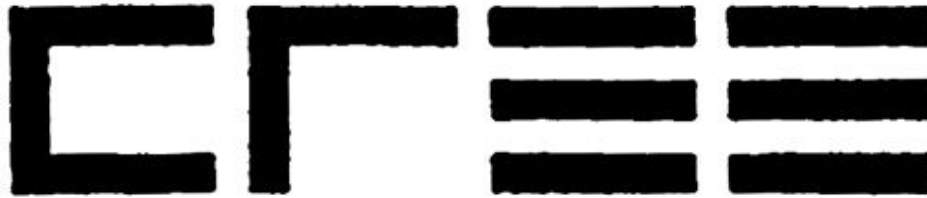

The Natural Change in Urban Architecture

INVENTED BY RHOMBERG

Reg. No. 4,065,220

Registered Dec. 6, 2011

Int. Cls.: 19, 36 and 37

RHOMBERG BAU GMBH (AUSTRIA GESELLSCHAFT MIT BESCHRÄNKTER HAFTUNG (GMBH))
MARIAHILFSTRASSE 29
A-6900 BREGENZ
AUSTRIA

TRADEMARK

FOR: BUILDING MATERIALS, NAMELY, SEMI-WORKED WOOD, WOOD BOARDS, BUILDING GLASS, CONCRETE, AND DRYWALL, IN CLASS 19 (U.S. CLS. 1, 12, 33 AND 50).

SERVICE MARK

FOR: FINANCIAL INVESTMENT IN THE FIELD OF REAL ESTATE, FINANCIAL VALUATION OF REAL ESTATE; FINANCIAL AFFAIRS AND MONETARY AFFAIRS, NAMELY, FINANCIAL INFORMATION, MANAGEMENT AND ANALYSIS SERVICES, IN CLASS 36 (U.S. CLS. 100, 101 AND 102).

PRINCIPAL REGISTER

FOR: BUILDING CONSTRUCTION AND REPAIR, BUILDING CONSTRUCTION SUPERVISION, CONSTRUCTION OF ENERGY EFFICIENT AND ENVIRONMENTALLY CONSCIOUS BUILDINGS, REAL ESTATE DEVELOPMENT AND CONSTRUCTION OF COMMERCIAL AND RESIDENTIAL PROPERTY, IN CLASS 37 (U.S. CLS. 100, 103 AND 106).

NO CLAIM IS MADE TO THE EXCLUSIVE RIGHT TO USE "URBAN ARCHITECTURE", APART FROM THE MARK AS SHOWN.

PRIORITY DATE OF 7-19-2010 IS CLAIMED.

OWNER OF INTERNATIONAL REGISTRATION 1050281 DATED 7-19-2010, EXPIRES 7-19-2020.

THE MARK CONSISTS OF THE TERM "CREE" IN STYLIZED LETTERING WRITTEN ABOVE THE TERM "THE NATURAL CHANGE IN URBAN ARCHITECTURE" WHICH IS WRITTEN ABOVE THE TERM "INVENTED BY RHOMBERG".

SER. NO. 79-087,041, FILED 7-19-2010.

JIM RINGLE, EXAMINING ATTORNEY



David J. Kyros

Director of the United States Patent and Trademark Office

United States of America

United States Patent and Trademark Office



Reg. No. 4,065,221

Registered Dec. 6, 2011

Int. Cls.: 36 and 41

SERVICE MARK

PRINCIPAL REGISTER

JOACHIM HERZ STIFTUNG - RECHTSFÄHIGE STIFTUNG DES BÜRGERLICHEN RECHTS
(FED REP GERMANY RECHTSFÄHIGE STIFTUNG DES BÜRGERLICHEN RECHTS)
LANGENHORNER CHAUSSEE 384
22419 HAMBURG
FED REP GERMANY

FOR: FINANCIAL SPONSORSHIP OF WORKSHOPS, SEMINARS, TUTORIAL SESSIONS, AND SUMMER CLASSES AND COURSES IN THE FIELD OF TRAINING, ADVANCE TRAINING AND RESEARCH FOR THE BENEFIT OF INDIVIDUALS, DESIGNATED PROJECTS AND LEARNING INSTITUTIONS; PROVIDING EDUCATIONAL SCHOLARSHIPS, IN CLASS 36 (U.S. CLS. 100, 101 AND 102).

FOR: EDUCATIONAL SERVICES, NAMELY, SEMINARS, WORKSHOPS, SUMMER CLASSES AND COURSES IN THE FIELD OF ECONOMIC AND BUSINESS, LAW, MEDICINE, CHEMISTRY, PHYSICS, AND BIOLOGY; ORGANIZING CULTURAL EVENTS; PROVIDING INFORMATION REGARDING EDUCATIONAL SERVICES; CAREER COUNSELING; DEVELOPMENT OF EDUCATIONAL RESEARCH PROGRAMS, IN CLASS 41 (U.S. CLS. 100, 101 AND 107).

NO CLAIM IS MADE TO THE EXCLUSIVE RIGHT TO USE "STIFTUNG", APART FROM THE MARK AS SHOWN.

OWNER OF INTERNATIONAL REGISTRATION 1050626 DATED 4-13-2010, EXPIRES 4-13-2020.

THE NAME "JOACHIM HERZ" DOES NOT IDENTIFY A PARTICULAR LIVING INDIVIDUAL.

THE MARK CONSISTS OF THE SHADED IMAGE OF A MAN RIDING A HORSE, ABOVE A HORIZONTAL SHADED RECTANGLE, APPEARING TO THE LEFT OF A SHADED VERTICAL RECTANGLE CONTAINING THE WORDING "JOACHIM HERZ STIFTUNG" SUPERIMPOSED THEREIN.

THE ENGLISH TRANSLATION OF "STIFTUNG" IN THE MARK IS "FOUNDATION".

SER. NO. 79-087,179, FILED 4-13-2010.

JERI J. FICKES, EXAMINING ATTORNEY



David J. Kappas

Director of the United States Patent and Trademark Office

United States of America

United States Patent and Trademark Office

DESERTEC

Reg. No. 4,065,222

Registered Dec. 6, 2011

**Int. Cls.: 35, 36, 37, 39,
40, 41 and 42**

SERVICE MARK

PRINCIPAL REGISTER

DESERTEC FOUNDATION (FED REP GERMANY RECHTSFÄHIGE STIFTUNG
BÜRGERLICHEN RECHTS)
VEITSTRASSE 42
13507 BERLIN
FED REP GERMANY

FOR: BUSINESS MANAGEMENT CONSULTANCY; PROFESSIONAL BUSINESS ADMINISTRATION CONSULTANCY; BUSINESS ADMINISTRATION ASSISTANCE; BUSINESS MANAGEMENT FOR OTHERS IN THE FIELD OF ENERGY, ENERGY SECURITY, CLIMATE PROTECTION AND CLEAN TECHNOLOGIES; SPONSORSHIP SEARCH; ARRANGING OF TRADING TRANSACTIONS AND COMMERCIAL CONTRACTS WITH ENERGY SUPPLIERS; PROVISION OF INFORMATION IN COMMERCIAL AND BUSINESS AFFAIRS; MARKET RESEARCH; PUBLIC RELATIONS; PREPARATION OF ECONOMIC FORECASTS; CONDUCTING, ARRANGING AND ORGANIZING TRADE SHOWS, CONFERENCES AND TRADE FAIRS FOR COMMERCIAL AND ADVERTISING PURPOSES, IN CLASS 35 (U.S. CLS. 100, 101 AND 102).

FOR: FINANCIAL AFFAIRS, NAMELY, FINANCIAL INFORMATION, MANAGEMENT AND ANALYSIS SERVICES; FINANCIAL ANALYSIS; BANKING; FINANCIAL CONSULTANCY; FINANCIAL SPONSORSHIP OF TRADE SHOWS, CONFERENCES AND TRADE FAIRS IN THE FIELD OF ENERGY, CLIMATE AND CLEAN TECHNOLOGIES; FINANCING; MUTUAL FUND BROKERAGE; FINANCIAL SERVICES, NAMELY, INVESTMENT FUND TRANSFER AND TRANSACTION SERVICES; CREDIT BUREAUX; INSURANCE AGENCIES; INSURANCE BROKERAGE SERVICES; INSURANCE AND RE-INSURANCE UNDERWRITING SERVICES; INSURANCE SERVICES, NAMELY, WRITING COMMERCIAL PROPERTY AND CASUALTY POLICIES, IN CLASS 36 (U.S. CLS. 100, 101 AND 102).

FOR: BUILDING CONSTRUCTION; INSTALLATION SERVICES, NAMELY, FOR SOLAR THERMAL, ENERGY BASED AND ALTERNATIVE ENERGY POWER AND DESALINATION PLANTS AND POWER LINES; INSTALLATION, MAINTENANCE AND REPAIR OF SOLAR THERMAL, ENERGY BASED, ALTERNATIVE ENERGY POWER AND DESALINATION PLANTS AND POWER LINES; INSTALLATION, MAINTENANCE AND REPAIR OF ELECTRICITY CONDUITS AND IRRIGATION DEVICES; DRILLING OF WELLS; UNDERWATER CONSTRUCTION AND UNDERWATER REPAIR; TECHNICAL CONSULTANCY, IN THE FIELD OF INSTALLATION, MAINTENANCE AND REPAIR OF FACILITIES FOR THE GENERATION, DISTRIBUTION AND STORAGE OF ELECTRICITY AND WATER, AND



David J. Kyffers

Director of the United States Patent and Trademark Office

Reg. No. 4,065,222 INSTALLATION AND MAINTENANCE OF FACILITIES FOR DESALINATION AND UNDERWATER CONSTRUCTION, IN CLASS 37 (U.S. CLS. 100, 103 AND 106).

FOR: TRANSPORT AND TRANSMISSION BY FERRY, BOAT, RAIL, AIR AND TRUCK OF WATER, FUELS AND OTHER TYPES OF ENERGY; TRANSMISSION AND DISTRIBUTION OF ELECTRICITY BY POWER LINES; TRANSMISSION AND DISTRIBUTION OF WATER, FUELS AND OTHER TYPES OF ENERGY BY PIPELINES; PACKAGING AND STORAGE OF GOODS, NAMELY, WATER AND FUELS, IN CLASS 39 (U.S. CLS. 100 AND 105).

FOR: TREATMENT OF MATERIALS, BY CHEMICAL AND ELECTROCHEMICAL PROCESSES, NAMELY, OIL, FUEL, WASTE, WATER, WASTE WATER FOR THE PRODUCTION OF ELECTRICITY; PRODUCTION OF ENERGY, NAMELY, ELECTRICITY; WATER TREATMENT SERVICES, NAMELY, DESALINATION AND HYDROLYSIS, IN CLASS 40 (U.S. CLS. 100, 103 AND 106).

FOR: TRAINING SERVICES IN THE FIELD OF ENERGY, ENERGY SECURITY AND EFFICIENCY, CLIMATE PROTECTION AND CLEAN TECHNOLOGIES; ENTERTAINMENT, SPORTING AND CULTURAL ACTIVITIES, NAMELY, ORGANIZING ENTERTAINMENT, COMMUNITY SPORTING AND CULTURAL EVENTS; PUBLISHING OF ELECTRONIC PUBLICATIONS; PUBLICATION OF TEXTS OTHER THAN PUBLICITY TEXTS; ARRANGING AND CONDUCTING OF EDUCATIONAL CONGRESSES, CONFERENCES AND COLLOQUIUMS; TEACHING AND EDUCATION, NAMELY, PROVIDING CONFERENCES, CLASSES, SEMINARS, WORKSHOPS IN THE FIELD OF ENERGY, ENERGY SECURITY AND EFFICIENCY, CLIMATE PROTECTION AND CLEAN TECHNOLOGIES, IN CLASS 41 (U.S. CLS. 100, 101 AND 107).

FOR: INDUSTRIAL ANALYSIS AND RESEARCH SERVICES IN THE FIELD OF ENERGY, RENEWABLE ENERGY, WATER, CLIMATE PROTECTION AND CLEAN TECHNOLOGIES; SCIENTIFIC AND TECHNOLOGICAL SERVICES, NAMELY, SCIENTIFIC RESEARCH, ANALYSIS AND TESTING IN THE FIELD OF GENERATION, TRANSMISSION, AND STORAGE OF RENEWABLE ENERGIES, WATER SUPPLY AND DESALINATION; CONSULTING SERVICES IN THE FIELD OF ENGINEERING, NAMELY, ENGINEERING PROJECT AND ENERGY MANAGEMENT; TECHNICAL CONSULTANCY SERVICES IN THE DEVELOPMENT OF ENERGY GENERATION AND UTILISATION PLANS AND IN CLIMATE PROTECTION; CONSULTANCY IN THE FIELD OF ENERGY EFFICIENCY; SCIENTIFIC AND TECHNOLOGICAL SERVICES, NAMELY, ANALYSIS REGARDING THE GENERATION OF POWER BY MEANS OF SOLAR THERMAL PLANTS AND OTHER FACILITIES MAKING USE OF RENEWABLE ENERGIES, AND SITE PLANNING; RESEARCH IN THE FIELD OF ENVIRONMENTAL PROTECTION; TECHNICAL RESEARCH IN THE FIELD OF ENERGY, ALTERNATIVE AND RENEWABLE ENERGIES, WATER SUPPLY, POWER PLANTS, DESALINATION, CLEAN TECHNOLOGIES; MECHANICAL RESEARCH; SURVEYING; CONSTRUCTION DRAFTING; CONDUCTING OF FEASIBILITY STUDIES; QUALITY CONTROL FOR OTHERS, IN CLASS 42 (U.S. CLS. 100 AND 101).

THE MARK CONSISTS OF STANDARD CHARACTERS WITHOUT CLAIM TO ANY PARTICULAR FONT, STYLE, SIZE, OR COLOR.

PRIORITY DATE OF 12-29-2009 IS CLAIMED.

OWNER OF INTERNATIONAL REGISTRATION 1050754 DATED 6-24-2010, EXPIRES 6-24-2020.

OWNER OF U.S. REG. NO. 3,784,998.

THE WORD "DESERTEC" HAS NO MEANING IN A FOREIGN LANGUAGE.

SER. NO. 79-087,217, FILED 6-24-2010.

Reg. No. 4,065,222 PAUL MORENO, EXAMINING ATTORNEY

United States of America
United States Patent and Trademark Office

Sinovel

Reg. No. 4,065,223

Registered Dec. 6, 2011

Int. Cl.: 7

TRADEMARK

PRINCIPAL REGISTER

SINOVEL WIND GROUP CO., LTD. (CHINA CORPORATION)
ROOM 1-3, FLOOR 19, CULTURE BUILDING
59 ZHONGGUANCUN STREET, HAIDAN DISTRICT
BEIJING, CHINA

FOR: WIND POWER EQUIPMENT, NAMELY, ALTERNATING CURRENT SERVO MOTORS, DRIVES FOR MOTORS, ELECTRIC MOTORS FOR WIND POWER EQUIPMENT, GEAR BOXES FOR WIND POWER EQUIPMENT, TRANSMISSION GEARS FOR WIND POWER EQUIPMENT; WIND TURBINES AND ACCESSORIES THEREFOR, NAMELY, AUXILIARY POWER UNITS FOR SUPPLYING ELECTRICAL POWER, BALL BEARINGS FOR USE IN WIND TURBINES, NAMELY, ROTOR HUBS, MAIN FRAMES, NAMELY, WIND TURBINE BODIES AND STRUCTURAL SHELLS, BEARINGS FOR TRANSMISSION SHAFTS, BEING PARTS OF WIND TURBINES, BEARINGS, AS PARTS OF WIND TURBINES, BRAKES FOR WIND TURBINES, COUPLINGS FOR WIND TURBINES, HEAT EXCHANGERS BEING PARTS OF WIND TURBINES, HEAT SINKS FOR USE IN WIND TURBINES, MACHINE COUPLINGS AND TRANSMISSION COMPONENTS FOR USE IN WIND TURBINES, PARTS OF WIND TURBINE MOTORS, NAMELY, COMPACT DRIVE SYSTEMS, POWER TRANSMISSIONS AND GEARING FOR WIND TURBINE MOTORS, SERVO MOTORS, SHOCK ABSORBERS FOR WIND TURBINE MOTORS; ELECTRIC PUMPS, VARIABLE FREQUENCY DRIVES FOR WIND TURBINE MOTORS; WIND POWER GENERATION EQUIPMENT, NAMELY, AC GENERATORS, ALTERNATORS, ELECTRIC GENERATORS, WIND TURBINES, WIND-POWERED ELECTRICITY GENERATORS, HYDRAULIC POWER EQUIPMENT, NAMELY, HOISTS, HYDRAULIC CONTROLS FOR MACHINES, MOTORS AND ENGINES, HYDRAULIC POWER PACKS, HYDRAULIC POWER UNITS, HYDRAULIC PUMPS, HYDRAULIC PUMPS AND MOTORS FOR HYDROSTATIC SYSTEMS, COMPRISED OF PUMPS, MOTORS, VALVES, SWITCHES, SENSORS AND ELECTRONIC CONTROLS, FOR HYDRAULIC DRIVES AND FORCE TRANSMISSION IN MACHINES AND MACHINE TOOLS, IN CLASS 7 (U.S. CLS. 13, 19, 21, 23, 31, 34 AND 35).



THE MARK CONSISTS OF STANDARD CHARACTERS WITHOUT CLAIM TO ANY PARTICULAR FONT, STYLE, SIZE, OR COLOR.

OWNER OF INTERNATIONAL REGISTRATION 1051173 DATED 8-17-2010, EXPIRES 8-17-2020.

THE WORDING "SINOVEL" HAS NO MEANING IN A FOREIGN LANGUAGE.

David J. Kyffers

Director of the United States Patent and Trademark Office

Reg. No. 4,065,223 SER. NO. 79-087,377, FILED 8-17-2010.

JEFFERY COWARD, EXAMINING ATTORNEY

United States of America

United States Patent and Trademark Office

Snipe

Reg. No. 4,065,224

GABOR FOOTWEAR GMBH (FED REP GERMANY LIMITED LIABILITY COMPANY)
MARIENBERGER STR. 31
83024 ROSENHEIM, FED REP GERMANY

Registered Dec. 6, 2011

**Int. Cls.: 2, 3, 4, 9, 18, 20,
24, 25, 28, 32 and 35**

FOR: COLORING MATTER FOR SHOES, NAMELY, COLORANTS AND DYE FOR SHOES,
IN CLASS 2 (U.S. CLS. 6, 11 AND 16).

FOR: SHOE CREAMS, IN CLASS 3 (U.S. CLS. 1, 4, 6, 50, 51 AND 52).

TRADEMARK

FOR: SHOES GREASE, IN CLASS 4 (U.S. CLS. 1, 6 AND 15).

SERVICE MARK

PRINCIPAL REGISTER

FOR: SPECTACLES; SPECTACLE FRAMES, SPECTACLE GLASSES, PINCE-NEZ EYE-
GLASSES, SUNGLASSES, SPECTACLE CASES, IN CLASS 9 (U.S. CLS. 21, 23, 26, 36 AND
38).

FOR: LEATHER AND IMITATION OF LEATHER, AND GOODS MADE OF THESE MATER-
IALS AND NOT INCLUDED IN OTHER CLASSES, NAMELY, ATTACHÉ CASES, BAGS,
ATTACHÉ CASES, BRIEFCASES, BRIEFCASE-TYPE BUSINESS FOLDERS, CASES, BANDS,
GARMENT BAGS FOR TRAVEL, SPORTS BAGS, GENERAL PURPOSE TROLLEY BAGS,
KEY CASES, KEY CHAINS, WALLETS, CREDIT CARD CASES, CREDIT CARD HOLDERS,
HANDBAGS, POUCHES, PURSES, SHOPPING BAGS; SKINS AND HIDES; SUITCASES
AND SMALL CARRYING CASES, ESPECIALLY ALL-PURPOSE CARRYING BAGS AND
WOMEN'S HANDBAGS IF NOT INCLUDED IN OTHER CLASSES, WALLETS, PURSES,
KEY POUCHES OF LEATHER, UMBRELLAS, SUNSHADES AS PARASOLS, WALKING
STICKS, WHIPS, HARNESS AND SADDLERY; LUGGAGE TAGS OF LEATHER, LUGGAGE
NAME TAGS OF LEATHER, IN CLASS 18 (U.S. CLS. 1, 2, 3, 22 AND 41).

FOR: FURNITURE, MIRRORS, PICTURE FRAMES; GOODS NOT INCLUDED IN OTHER
CLASSES MADE OF WOOD, CORK, CANE, RUSH, WILLOW, HORN, BONE, IVORY,
WHALEBONE, TORTOISESHELL, AMBER, MOTHER-OF-PEARL, NACRE, MEERSCHAUM
AND THEIR SUBSTITUTES, AND OF PLASTICS MATERIALS, NAMELY, DECORATIVE
BOXES, FIGURINES, FURNITURE PARTS, PICTURE FRAME MOLDINGS, ORNAMENTS,
PLAQUES, NON-METAL KEY HOLDERS, PLASTIC KEY CHAINS, PLASTIC KEY RINGS,
PLASTIC KEY TAGS, SCULPTURES, SHOE CABINETS, SHOE RACKS, UMBRELLA STANDS,
WALL PLAQUES AND WORKS OF ART, IN CLASS 20 (U.S. CLS. 2, 13, 22, 25, 32 AND 50).



David J. Kappas

Director of the United States Patent and Trademark Office

Reg. No. 4,065,224 FOR: TEXTILE AND TEXTILE GOODS, NOT INCLUDED IN OTHER CASES, NAMELY, TRAVELLING RUGS, QUILTS, BED COVERS, TABLE CLOTHS, BATH LINEN, BED LINEN, TABLE LINEN AND THROWS, IN CLASS 24 (U.S. CLS. 42 AND 50).

FOR: ARTICLES OF CLOTHING, NAMELY, SHIRTS, T-SHIRTS, PANTS, CAPRIS, SHORTS, SKIRTS, DRESSES, SWEATERS, TOPS, JACKETS, COATS, SOCKS, SLEEPWEAR, UNDERWEAR AND WRISTBANDS; FOOTWEAR; HEADGEAR, NAMELY, HATS, CAPS, CAP VISORS, IN CLASS 25 (U.S. CLS. 22 AND 39).

FOR: GAMES, NAMELY, BOARD GAMES, BUILDING GAMES, CARD GAMES, PARTY GAMES, TABLETOP GAMES; TOYS, NAMELY, ACTION FIGURES, BATH TOYS, CASES FOR TOY VEHICLES AND FOR TOY STRUCTURES, CONSTRUCTION SETS, CRIB TOYS, DOLLS, DRAWING TOYS, INFANT TOYS, STUFFED TOYS, TOY VEHICLES AND ACCESSORIES THEREFOR, WATER TOYS; ARTICLES FOR GYMNASTICS AND SPORTS, NOT INCLUDED IN OTHER CLASSES, NAMELY, GYMNASTIC APPARATUS, BALLS FOR SPORTS, BAGS AND CASE SPECIALLY ADAPTED FOR SPORTS EQUIPMENT; SPORTS FITNESS RESTRAINT STRAPS FOR RUNNING IN TANDEM OR PAIRS, KIDNEY BELTS FOR SPORTS, WEIGHT LIFTING BELTS, IN CLASS 28 (U.S. CLS. 22, 23, 38 AND 50).

FOR: BEERS, MINERAL WATERS AND OTHER ALCOHOL FREE BEVERAGES, NAMELY, NON-ALCOHOLIC BEER, NON-ALCOHOLIC WINE, FRUIT-FLAVORED BEVERAGES, FRUIT BEVERAGES, FRUIT JUICES, ENERGY DRINKS, FLAVORED WATERS, SPRING WATER, SOFT DRINKS; SYRUPS FOR BEVERAGES AND PREPARATIONS FOR BEVERAGES, NAMELY, SYRUP SUBSTITUTES, CONCENTRATES AND POWDERS USED IN THE PREPARATION OF ENERGY DRINKS, FRUIT FLAVORED BEVERAGES, FRUIT DRINKS AND SOFT DRINKS; ESSENCES FOR MAKING FLAVORED MINERAL WATER, NON-ALCOHOLIC BEVERAGES, SOFT DRINKS AND LIQUEURS NOT IN THE NATURE OF ESSENTIAL OILS, IN CLASS 32 (U.S. CLS. 45, 46 AND 48).

FOR: RETAIL AND WHOLESALE STORE SERVICES, NAMELY, RETAIL AND WHOLESALE SERVICES THROUGH MAIL ORDER CATALOGUES AND BY MEANS OF ELECTRONIC MEDIA, NAMELY, THROUGH WEBSITES AND TELEVISION SHOPPING PROGRAMMES IN THE FIELD OF POLISHES, ETC., IN CLASS 35 (U.S. CLS. 100, 101 AND 102).

THE MARK CONSISTS OF STANDARD CHARACTERS WITHOUT CLAIM TO ANY PARTICULAR FONT, STYLE, SIZE, OR COLOR.

PRIORITY DATE OF 11-26-2009 IS CLAIMED.

OWNER OF INTERNATIONAL REGISTRATION 1051189 DATED 4-29-2010, EXPIRES 4-29-2020.

SER. NO. 79-087,383, FILED 4-29-2010.

WILLIAM ROSSMAN, EXAMINING ATTORNEY

United States of America

United States Patent and Trademark Office



Reg. No. 4,065,225

Registered Dec. 6, 2011

**Int. Cls.: 3, 9, 14, 18, 28
and 35**

TRADEMARK

SERVICE MARK

PRINCIPAL REGISTER

HERBERT NEUMANN (AUSTRIA INDIVIDUAL)
C/ BATALLA DEL SALADO, 42
TARIFA; E-11380 CADIZ
SPAIN AND

ANDONI GALDEANO DEL SEL (SPAIN INDIVIDUAL)
C/ TRAFALGAR, 8 - 3C
TARIFA; E-11380 CADIZ
SPAIN

FOR: PERFUMERY, COSMETIC OILS, ESSENTIAL OILS, SCENTED OILS, COSMETICS,
IN CLASS 3 (U.S. CLS. 1, 4, 6, 50, 51 AND 52).

FOR: OPTICAL GLASSES, IN CLASS 9 (U.S. CLS. 21, 23, 26, 36 AND 38).

FOR: JEWELRY AND TIMEPIECES, IN CLASS 14 (U.S. CLS. 2, 27, 28 AND 50).

FOR: LEATHER AND IMITATION LEATHER; TRUNKS AND TRAVELING BAGS; UMBRELLAS,
PARASOLS AND WALKING STICKS, IN CLASS 18 (U.S. CLS. 1, 2, 3, 22 AND 41).

FOR: BOARD GAMES; GYMNASTIC AND SPORTING ARTICLES, NAMELY, HORIZONTAL
BARS, IN CLASS 28 (U.S. CLS. 22, 23, 38 AND 50).

FOR: ADVERTISING; BUSINESS MANAGEMENT; BUSINESS ADMINISTRATION; OFFICE
FUNCTIONS, IN CLASS 35 (U.S. CLS. 100, 101 AND 102).

NO CLAIM IS MADE TO THE EXCLUSIVE RIGHT TO USE "EL NIÑO" AND "WEAR" IN
INTERNATIONAL CLASS 003, 009, 014, 018, AND 028, APART FROM THE MARK AS
SHOWN.

PRIORITY DATE OF 3-5-2010 IS CLAIMED.

OWNER OF INTERNATIONAL REGISTRATION 1051832 DATED 9-2-2010, EXPIRES 9-2-
2020.



David J. Kybas

Director of the United States Patent and Trademark Office

Reg. No. 4,065,225 THE MARK CONSISTS OF A DESIGN OF A SEATED AND FROWNING FIGURE ABOVE THE STYLIZED WORDING "EL NIÑO" WITHIN A RECTANGULAR CARRIER ALL OF WHICH IS ABOVE THE STYLIZED WORDING "SWEET WEAR".

THE ENGLISH TRANSLATION OF "EL NIÑO" IN THE MARK IS "THE BOY" OR "THE CHILD".

SER. NO. 79-087,599, FILED 9-2-2010.

TASNEEM HUSSAIN, EXAMINING ATTORNEY

United States of America

United States Patent and Trademark Office



Reg. No. 4,065,226

Registered Dec. 6, 2011

Int. Cls.: 29, 30 and 32

TRADEMARK

PRINCIPAL REGISTER

RAUCH FRUCHTSÄFTE GMBH (AUSTRIA PRIVATE LIMITED COMPANY)
LANGGASSE 1
A-6830 RANKWEIL
AUSTRIA

FOR: MEAT, FISH, POULTRY AND GAME; MEAT EXTRACTS; PRESERVED, FROZEN, DRIED AND COOKED FRUITS AND VEGETABLES; JELLIES, JAMS, COMPOTES; EGGS, MILK AND MILK PRODUCTS EXCLUDING ICE CREAM, ICE MILK, AND FROZEN YOGURT; EDIBLE OILS AND FATS, IN CLASS 29 (U.S. CL. 46).

FOR: COFFEE, TEA, COCOA, SUGAR, RICE, TAPIOCA, SAGO, ARTIFICIAL COFFEE; FLOUR AND PREPARATIONS MADE FROM CEREALS, NAMELY, BREAKFAST CEREALS, PROCESSED CEREALS, CEREAL-BASED SNACK FOODS, AND READY TO EAT CEREAL DERIVED FOOD BARS; BREAD; PASTRY AND CONFECTIONERY MADE OF SUGAR; ICES; HONEY, TREACLE; YEAST, BAKING-POWDER; SALT, MUSTARD; VINEGAR, CONDIMENTS, NAMELY, SAUCES; SPICES; ICE, IN CLASS 30 (U.S. CL. 46).

FOR: BEERS; MINERAL AND AERATED WATERS AND OTHER NON-ALCOHOLIC DRINKS, NAMELY, ISOTONIC DRINKS, SWEET MUSTS, WATER OR MINERAL WATER MIXED WITH FRUITS, VEGETABLES, OR VITAMINS; FRUIT DRINKS AND FRUIT JUICES; SYRUPS AND OTHER PREPARATIONS FOR MAKING BEVERAGES, NAMELY, FRUIT ESSENCES FOR PREPARING CONCENTRATED SYRUPS USED IN THE PREPARATION OF NON-ALCOHOLIC BEVERAGES AND POWDERS USED IN THE PREPARATION OF FRUIT-BASED BEVERAGES; ENERGY DRINKS; LEMONADES, IN CLASS 32 (U.S. CLS. 45, 46 AND 48).

OWNER OF U.S. REG. NOS. 3,132,165, 3,576,357 AND OTHERS.

PRIORITY DATE OF 3-11-2010 IS CLAIMED.

OWNER OF INTERNATIONAL REGISTRATION 1052369 DATED 8-11-2010, EXPIRES 8-11-2020.

THE COLOR(S) GREEN, BROWN, ORANGE, YELLOW, RED AND VIOLET IS/ARE CLAIMED AS A FEATURE OF THE MARK.

THE MARK CONSISTS OF A TREE WITH GREEN LEAVES AND ORANGE, YELLOW, RED AND VIOLET FRUIT, AND A BROWN TRUNK ON GREEN GRASS. IN THE CENTER OF



David J. Kybas

Director of the United States Patent and Trademark Office

Reg. No. 4,065,226 THE TREE IS THE WORDING "RAUCH" IN GREEN ON A YELLOW OVAL SHAPED BACKGROUND. TO THE LEFT OF THE WORDING "RAUCH" IS A RED ORANGE. THE WORDING "RAUCH" IS SURROUNDED BY A RED OVAL.

THE ENGLISH TRANSLATION OF "RAUCH" IN THE MARK IS "SMOKE" OR "DUST".

SER. NO. 79-087,807, FILED 8-11-2010.

COLLEEN DOMBROW, EXAMINING ATTORNEY

United States of America

United States Patent and Trademark Office



Reg. No. 4,065,227

Registered Dec. 6, 2011

Int. Cls.: 9 and 42

TRADEMARK

SERVICE MARK

PRINCIPAL REGISTER

PROCAD GMBH & CO. KG
VINCENZ-PRIEBNITZ-STRASSE 3
76131 KARLSRUHE
FED REP GERMANY

FOR: SOFTWARE FOR THE EXCHANGE OF FILES WITHIN PROTECTED PROJECT ROOMS; SOFTWARE FOR WEB APPLICATIONS, NAMELY, SOFTWARE FOR USE IN ONLINE FILESHARING, IN CLASS 9 (U.S. CLS. 21, 23, 26, 36 AND 38).

FOR: CREATION OF SOFTWARE FOR THE EXCHANGE OF FILES WITHIN PROTECTED PROJECT ROOMS; CREATION OF SOFTWARE FOR WEB APPLICATIONS, IN CLASS 42 (U.S. CLS. 100 AND 101).

THE MARK CONSISTS OF THE WORD "PROOM" WITH A PARTIAL REFLECTION UNDERNEATH AND THE "O"'S RESEMBLING THE INFINITY SYMBOL. THE COLOR DARK BLUE APPEARS IN THE WORD "PROOM" AND THE COLOR LIGHT BLUE APPEARS IN THE PARTIAL REFLECTION.

OWNER OF INTERNATIONAL REGISTRATION 1052813 DATED 6-23-2010, EXPIRES 6-23-2020.

THE COLOR(S) DARK BLUE AND LIGHT BLUE IS/ARE CLAIMED AS A FEATURE OF THE MARK.

SER. NO. 79-087,976, FILED 6-23-2010.

CARYN GLASSER, EXAMINING ATTORNEY



David J. Kyjars

Director of the United States Patent and Trademark Office

United States of America

United States Patent and Trademark Office

ACM

THE ACADEMY OF CONTEMPORARY MUSIC

Reg. No. 4,065,228

Registered Dec. 6, 2011

Int. Cls.: 16 and 41

ACADEMY MUSIC SERVICES LIMITED (UNITED KINGDOM PRIVATE LIMITED COMPANY)
RODBORO BUILDINGS,
BRIDGE STREET; GUILDFORD, SURREY GU1 4SB
UNITED KINGDOM

TRADEMARK

FOR: PRINTED PUBLICATIONS, NAMELY, NEWSPAPERS, MAGAZINES, PAMPHLETS AND BROCHURES, ALL CONCERNING THE TOPIC OF MUSICAL EDUCATION; PRINTED INSTRUCTIONAL AND TEACHING MATERIALS IN THE FIELD OF MUSICAL EDUCATION; SHEET MUSIC, IN CLASS 16 (U.S. CLS. 2, 5, 22, 23, 29, 37, 38 AND 50).

SERVICE MARK

PRINCIPAL REGISTER

FOR: EDUCATIONAL, TEACHING AND TRAINING SERVICES, NAMELY, CONDUCTING CLASS, SEMINARS, CONFERENCES AND WORKSHOPS IN THE FIELD OF MUSICAL EDUCATION, IN CLASS 41 (U.S. CLS. 100, 101 AND 107).

NO CLAIM IS MADE TO THE EXCLUSIVE RIGHT TO USE "THE ACADEMY OF CONTEMPORARY MUSIC", APART FROM THE MARK AS SHOWN.

OWNER OF INTERNATIONAL REGISTRATION 1053064 DATED 6-4-2010, EXPIRES 6-4-2020.

SER. NO. 79-088,067, FILED 6-4-2010.

SUSAN STIGLITZ, EXAMINING ATTORNEY



David J. Kyffers

Director of the United States Patent and Trademark Office

United States of America

United States Patent and Trademark Office



PramPack

Reg. No. 4,065,229

Registered Dec. 6, 2011

Int. Cl.: 18

TRADEMARK

PRINCIPAL REGISTER

MYNORSE AS (NORWAY LIMITED COMPANY)
VERFTSGATA 4
N-7014 TRONDHEIM
NORWAY

FOR: LEATHER AND IMITATION LEATHER AND GOODS MADE FROM THESE MATERIALS, NAMELY, LEATHER POUCHES FOR TRAVELERS, CASES OF IMITATION LEATHER, LEATHER GARMENT BAGS FOR TRAVEL; SUITCASES AND TRAVELING BAGS, IN CLASS 18 (U.S. CLS. 1, 2, 3, 22 AND 41).

THE MARK CONSISTS OF THE WORD "PRAMPACK" BELOW THE DESIGN OF A PRAM WHICH IS LOCATED WITHIN A SHIELD.

OWNER OF INTERNATIONAL REGISTRATION 1054152 DATED 4-30-2010, EXPIRES 4-30-2020.

SER. NO. 79-088,414, FILED 4-30-2010.

AISHA SALEM, EXAMINING ATTORNEY



David J. Kyffers

Director of the United States Patent and Trademark Office

United States of America

United States Patent and Trademark Office



Reg. No. 4,065,230
Registered Dec. 6, 2011
Int. Cl.: 12

TRADEMARK
PRINCIPAL REGISTER

MUTSY B.V. (NETHERLANDS BESLOTEN VENNOOTSCHAP)
14, NIEUWKERKSEDIJK
NL-5051 HT GOIRLE
NETHERLANDS

FOR: STROLLERS, PUSHCHAIRS, BABY BUGGIES, BICYCLE TRAILERS; BICYCLE SEATS FOR CHILDREN, CAR SEATS FOR CHILDREN, STROLLER AND BABY BUGGY ACCESSORIES, NAMELY, BEAN-BAG FOOTMUFFS SPECIALLY ADAPTED FOR USE WITH STROLLERS AND BABY BUGGIES, IN CLASS 12 (U.S. CLS. 19, 21, 23, 31, 35 AND 44).

THE MARK CONSISTS OF AN ANGLE ABOVE TWO CIRCLES ALL WITHIN A SHADED CIRCLE.

PRIORITY DATE OF 12-1-2009 IS CLAIMED.

OWNER OF INTERNATIONAL REGISTRATION 1054450 DATED 5-20-2010, EXPIRES 5-20-2020.

SER. NO. 79-088,527, FILED 5-20-2010.

HOWARD B. LEVINE, EXAMINING ATTORNEY



David J. Kybas

Director of the United States Patent and Trademark Office

United States of America

United States Patent and Trademark Office

ART Accelerator

Reg. No. 4,065,231

Registered Dec. 6, 2011

Int. Cl.: 9

TRADEMARK

PRINCIPAL REGISTER

STMICROELECTRONICS NV (NETHERLANDS CORPORATION)
WTC SCHIPHOL AIRPORT, SCHIPHOL BLVD. 265
1118 BH SCHIPHOL AIRPORT, AMSTERDAM, NETHERLANDS

FOR: CENTRAL PROCESSING UNITS, MICROPROCESSORS, COMPUTER MEMORIES, MICROCONTROLLERS, INTEGRATED CIRCUITS, SEMICONDUCTORS, DEVICES IN THE NATURE OF ELECTRONIC COMPONENTS FOR COMPUTERS ENABLING THE PROCESSOR TO ACCESS COMPUTER MEMORY MORE QUICKLY, DEVICES IN THE NATURE OF ELECTRONIC COMPONENTS FOR COMPUTERS TO ENHANCE THE PERFORMANCE OF A MICROCONTROLLER AND/OR PROCESSOR, DEVICES IN THE NATURE OF ELECTRONIC COMPONENTS FOR COMPUTERS ENABLING REDUCTION OF THE AMOUNT OF ELECTRICITY USED BY A MICROCONTROLLER AND/OR PROCESSOR, IN CLASS 9 (U.S. CLS. 21, 23, 26, 36 AND 38).

NO CLAIM IS MADE TO THE EXCLUSIVE RIGHT TO USE "ACCELERATOR", APART FROM THE MARK AS SHOWN.

PRIORITY DATE OF 3-11-2010 IS CLAIMED.

OWNER OF INTERNATIONAL REGISTRATION 1054638 DATED 9-6-2010, EXPIRES 9-6-2020.

THE MARK CONSISTS OF THE WORDING "ART ACCELERATOR" IN A STYLIZED FORMAT.

SER. NO. 79-088,618, FILED 9-6-2010.

JAMES MACFARLANE, EXAMINING ATTORNEY



David J. Kyjars

Director of the United States Patent and Trademark Office

United States of America

United States Patent and Trademark Office

3D OXIMETER

Reg. No. 4,065,232

Registered Dec. 6, 2011

Int. Cls.: 9 and 10

TRADEMARK

PRINCIPAL REGISTER

MIR SRL MEDICAL INTERNATIONAL RESEARCH (ITALY LIMITED LIABILITY COMPANY)
VIA DEL MAGGIOLINO, 125
I-00155 ROMA
ITALY

FOR: SCIENTIFIC, MEASURING AND CHECKING AND SUPERVISION APPARATUS AND INSTRUMENTS, NAMELY, AIR FLOW METER, IN CLASS 9 (U.S. CLS. 21, 23, 26, 36 AND 38).

FOR: MEDICAL APPARATUS AND INSTRUMENTS, NAMELY, DISPOSABLE TURBINE FLOW METER FOR MEASURING OXYGEN SATURATION, IN CLASS 10 (U.S. CLS. 26, 39 AND 44).

THE MARK CONSISTS OF STANDARD CHARACTERS WITHOUT CLAIM TO ANY PARTICULAR FONT, STYLE, SIZE, OR COLOR.

PRIORITY DATE OF 7-20-2010 IS CLAIMED.

OWNER OF INTERNATIONAL REGISTRATION 1055281 DATED 9-6-2010, EXPIRES 9-6-2020.

NO CLAIM IS MADE TO THE EXCLUSIVE RIGHT TO USE "OXIMETER" , APART FROM THE MARK AS SHOWN.

SER. NO. 79-088,846, FILED 9-6-2010.

MARK PILARO, EXAMINING ATTORNEY



David J. Kyffers

Director of the United States Patent and Trademark Office

United States of America

United States Patent and Trademark Office



Reg. No. 4,065,233

Registered Dec. 6, 2011

Int. Cl.: 9

TRADEMARK

PRINCIPAL REGISTER

KONINKLIJKE PHILIPS ELECTRONICS N.V. (NETHERLANDS LIMITED LIABILITY COMPANY)
GROENEWOUDSEWEG 1
NL-5621 BA EINDHOVEN, NETHERLANDS

FOR: APPARATUS AND INSTRUMENTS FOR RECEIVING, AMPLIFYING, PROCESSING, RECORDING AND REPRODUCING SOUND, NAMELY, LOUDSPEAKERS AND LOUD-SPEAKER SYSTEMS, MULTI-CHANNEL SURROUND SOUND PROCESSORS, SOUND AMPLIFIERS; SOUND PROCESSING SOFTWARE FOR PROVIDING MULTICHANNEL SURROUND SOUND AND COMPUTER SOFTWARE FOR OPERATING LOUDSPEAKERS, IN CLASS 9 (U.S. CLS. 21, 23, 26, 36 AND 38).

THE MARK CONSISTS OF THE WORD "AMBISOUND" APPEARING UNDER A CIRCLE AND SEMI-CIRCULAR DESIGN.

PRIORITY DATE OF 2-4-2010 IS CLAIMED.

OWNER OF INTERNATIONAL REGISTRATION 1055609 DATED 7-29-2010, EXPIRES 7-29-2020.

SER. NO. 79-088,971, FILED 7-29-2010.

SAIMA MAKHDOOM, EXAMINING ATTORNEY



David J. Kybas

Director of the United States Patent and Trademark Office

United States of America

United States Patent and Trademark Office

Radio Santec Sophia TV

Reg. No. 4,065,234

Registered Dec. 6, 2011

Int. Cls.: 9, 38, 41 and 45

TRADEMARK

SERVICE MARK

PRINCIPAL REGISTER

RADIO SANTEC GMBH (FED REP GERMANY GMBH)
MAX-BRAUN-STR. 2/4
97828 MARKTHEIDENFELD
FED REP GERMANY

FOR: RECORDED DATA CARRIERS OF ALL KINDS, NAMELY, PRE-RECORDED CDS, VIDEOS TAPES, LASER DISKS AND DVDS FEATURING NATURE AND RELIGION; DOWNLOADABLE ELECTRONIC PUBLICATIONS IN THE NATURE OF PRE-RECORDED CDS, VIDEO TAPES, LASER DISKS AND DVDS IN THE FIELD OF ETHICAL TOPICS, IN CLASS 9 (U.S. CLS. 21, 23, 26, 36 AND 38).

FOR: RADIO BROADCASTING, TELEVISION BROADCASTING; RADIO AND TELEVISION BROADCASTING SERVICES VIA CABLE AND SATELLITE; TRANSMISSION OF RADIO AND TELEVISION SIGNALS VIA WIRED AND/OR WIRELESS ANALOGUE AND DIGITAL NETWORKS; TELECOMMUNICATION SERVICES, NAMELY, TRANSMISSION OF VOICE, DATA, GRAPHICS, IMAGES, AUDIO AND VIDEO BY MEANS OF THE INTERNET; PROVIDING ACCESS TO COMPUTER DATABASES; PROVIDING ACCESS TO DATABASES FOR RETRIEVAL BY MOBILE PHONES; TRANSMITTING DATA TO MOBILE PHONES BY TELECOMMUNICATION, IN CLASS 38 (U.S. CLS. 100, 101 AND 104).

FOR: BROADCAST ENTERTAINMENT SERVICES, NAMELY, THE PROVISION OF CONTINUING PROGRAMS, SEGMENTS, MOVIES, SHOWS, MEDITATIONS FEATURING ETHICAL TOPICS, BOOK READINGS DELIVERED BY TELEVISION, PTV, CABLE, RADIO, SATELLITE, THE INTERNET OR LIVE; COMPILATION OF RADIO AND TELEVISION PROGRAMMES; PRODUCTION OF FILM, AUDIO, RECORDINGS, VIDEO RECORDINGS; PRODUCTION OF TELEVISION PROGRAMS; PUBLISHING OF ELECTRONIC PUBLICATIONS VIA DVD, INTERNET OR SATELLITE; PUBLICATION OF PRINTED MATTER VIA INTERNET OR NEWSPAPER; ARRANGING AND CONDUCTING CONCERTS; ORGANIZING ENTERTAINMENT IN THE NATURE OF THEATRE PRODUCTIONS; ORGANIZATION OF CULTURAL EVENTS, NAMELY, CONFERENCES, MEETINGS, SEMINARS, COURSES AND EXHIBITIONS FOR CULTURAL ETHICAL OR EDUCATIONAL PURPOSES; PRESENTATION OF LIVE SHOW PERFORMANCES; ENTERTAINMENT SERVICES, NAMELY, THE PRESENTATION OF SEMINARS, LECTURES, WORKSHOPS AND PANEL DISCUSSIONS, IN THE FIELD OF PUBLIC INTEREST CONCERNING ETHICAL TOPICS; PROVIDING INFORMATION ON CULTURAL AND ETHICAL EVENTS; PROVIDING INFORMATION ON RELIGIOUS EDUCATION, IN CLASS 41 (U.S. CLS. 100, 101 AND 107).



David J. Kyros

Director of the United States Patent and Trademark Office

Reg. No. 4,065,234 FOR: LICENSING OF FILM, TELEVISION, MUSIC AND VIDEO; LICENSING OF INTELLECTUAL PROPERTY; COPYRIGHT MANAGEMENT; LEGAL SERVICES RELATING TO THE MANAGEMENT OF INTELLECTUAL PROPERTY; RELIGIOUS AND SPIRITUAL SERVICES, NAMELY, ORGANIZING GATHERINGS AND RETREATS TO DEVELOP AND ENHANCE THE SPIRITUAL LIVES OF INDIVIDUALS, IN CLASS 45 (U.S. CLS. 100 AND 101).

THE MARK CONSISTS OF STANDARD CHARACTERS WITHOUT CLAIM TO ANY PARTICULAR FONT, STYLE, SIZE, OR COLOR.

PRIORITY DATE OF 12-30-2009 IS CLAIMED.

OWNER OF INTERNATIONAL REGISTRATION 1055636 DATED 6-9-2010, EXPIRES 6-9-2020.

NO CLAIM IS MADE TO THE EXCLUSIVE RIGHT TO USE "RADIO" AND "TV", APART FROM THE MARK AS SHOWN.

SER. NO. 79-088,976, FILED 6-9-2010.

WILLIAM ROSSMAN, EXAMINING ATTORNEY

United States of America

United States Patent and Trademark Office



Reg. No. 4,065,235

Registered Dec. 6, 2011

Int. Cls.: 14 and 18

TRADEMARK

PRINCIPAL REGISTER

SZLEPER ALAIN (BELGIUM INDIVIDUAL)
AVENUE FOND ROY, 72
B-1180 BRUXELLES
BELGIUM AND

SZLEPER EMMANUEL (BELGIUM INDIVIDUAL)
DREVE DE DIELEGHEM 79
B-1090 BRUXELLES
BELGIUM

FOR: JEWELRY, WATCHES, IN CLASS 14 (U.S. CLS. 2, 27, 28 AND 50).

FOR: LUGGAGE, WEEKEND BAGS, PURSES, HANDBAGS, WALLETS, RUCKSACKS, TROLLEY BAGS, JEWELRY POUCHES, LEATHER POUCHES, TEXTILE POUCHES, COSMETICS BAGS SOLD EMPTY, IN CLASS 18 (U.S. CLS. 1, 2, 3, 22 AND 41).

NO CLAIM IS MADE TO THE EXCLUSIVE RIGHT TO USE "HEART" FOR THE GOODS IN INTERNATIONAL CLASS 014, APART FROM THE MARK AS SHOWN.

OWNER OF INTERNATIONAL REGISTRATION 1055818 DATED 9-28-2010, EXPIRES 9-28-2020.

THE MARK CONSISTS OF THE WORDING "HEART ETERNITY" AND THE DESIGN OF A BOW PARTIALLY FORMING THE SHAPE OF A HEART.

SER. NO. 79-089,035, FILED 9-28-2010.

SEAN CROWLEY, EXAMINING ATTORNEY



David J. Kybas

Director of the United States Patent and Trademark Office

United States of America

United States Patent and Trademark Office

Shan Rahimkhan True

Reg. No. 4,065,236

Registered Dec. 6, 2011

Int. Cls.: 3, 21, 25 and 35

TRADEMARK

SERVICE MARK

PRINCIPAL REGISTER

SHAN RAHIMKHAN (AUSTRIA INDIVIDUAL)
MARKGRAFENSTRASSE 36
10117 BERLIN
FED REP GERMANY

FOR: COSMETICS; PERFUMERY, ESSENTIAL OILS; SCENTED LINEN WATER, SOAPS; HAIR LOTIONS, IN CLASS 3 (U.S. CLS. 1, 4, 6, 50, 51 AND 52).

FOR: BRUSHES FOR COSMETIC PURPOSES, IN CLASS 21 (U.S. CLS. 2, 13, 23, 29, 30, 33, 40 AND 50).

FOR: BELTS, IN CLASS 25 (U.S. CLS. 22 AND 39).

FOR: RETAIL SERVICES, NAMELY, PROVIDING RETAIL STORES AND COMPUTERIZED ONLINE RETAIL STORE SERVICES IN THE FIELD OF COSMETICS, PERFUMERY, ESSENTIAL OILS, SCENTED WATER, SOAPS, HAIR LOTIONS, GOODS OF PRECIOUS METALS AND THEIR ALLOYS OR COATED THEREWITH, HOODS OF LEATHER AND IMITATIONS OF LEATHER, BRUSHES FOR COSMETIC PURPOSES, CLOTHING, BELTS, MINERAL AND AERATED WATERS AND OTHER NON-ALCOHOLIC BEVERAGES, IN CLASS 35 (U.S. CLS. 100, 101 AND 102).

THE MARK CONSISTS OF STANDARD CHARACTERS WITHOUT CLAIM TO ANY PARTICULAR FONT, STYLE, SIZE, OR COLOR.

PRIORITY DATE OF 8-7-2009 IS CLAIMED.

OWNER OF INTERNATIONAL REGISTRATION 1055914 DATED 2-3-2010, EXPIRES 2-3-2020.

OWNER OF U.S. REG. NO. 3,876,539.

THE NAME "SHAN RAHIMKHAN" IDENTIFIES A LIVING INDIVIDUAL WHOSE CONSENT IS OF RECORD.

SER. NO. 79-089,054, FILED 2-3-2010.

SAIMA MAKHDOOM, EXAMINING ATTORNEY



David J. Kyros

Director of the United States Patent and Trademark Office

United States of America
United States Patent and Trademark Office

IXIL

Reg. No. 4,065,237

ENRIC LLEVADOT PORTA (SPAIN INDIVIDUAL)
50, C/ CIUDAD ASUNCIÓN
E-08030 BARCELONE, SPAIN AND

Registered Dec. 6, 2011

Int. Cl.: 12

LAUREANO PUJADAS AZARA (SPAIN INDIVIDUAL)
50, C/ CIUDAD ASUNCIÓN
E-08030 BARCELONE, SPAIN

TRADEMARK

PRINCIPAL REGISTER

FOR: SILENCERS FOR MOTORCYCLES AND MOTOR CARS, IN CLASS 12 (U.S. CLS. 19, 21, 23, 31, 35 AND 44).

THE MARK CONSISTS OF STANDARD CHARACTERS WITHOUT CLAIM TO ANY PARTICULAR FONT, STYLE, SIZE, OR COLOR.

OWNER OF INTERNATIONAL REGISTRATION 0753227 DATED 2-9-2001, EXPIRES 2-9-2021.

SER. NO. 79-089,114, FILED 10-8-2010.

MYRIAH HABEEB, EXAMINING ATTORNEY



David J. Kyffers

Director of the United States Patent and Trademark Office

United States of America

United States Patent and Trademark Office

GS-ProStrip

Reg. No. 4,065,238

Registered Dec. 6, 2011

Int. Cl.: 10

TRADEMARK

PRINCIPAL REGISTER

SDC SWITZERLAND SA (SWITZERLAND JOINT STOCK COMPANY)
VIA ALLA ROGGIA
CH-6916 LUGANO-GRANCIA
SWITZERLAND

FOR: DENTAL SURGICAL INSTRUMENTS WITH DIAMONDS FOR ORTHODONTIC USES,
RESTORATIVE WORK AND PROPHYLAXIS, IN CLASS 10 (U.S. CLS. 26, 39 AND 44).

PRIORITY DATE OF 4-26-2010 IS CLAIMED.

OWNER OF INTERNATIONAL REGISTRATION 1056123 DATED 10-25-2010, EXPIRES 10-25-2020.

SER. NO. 79-089,146, FILED 10-25-2010.

CARYN GLASSER, EXAMINING ATTORNEY



David J. Kybas

Director of the United States Patent and Trademark Office

United States of America
United States Patent and Trademark Office

Mobget

Reg. No. 4,065,239

Registered Dec. 6, 2011

Int. Cl.: 9

TRADEMARK

PRINCIPAL REGISTER

MOBGETS LTD (UNITED KINGDOM LIMITED LIABILITY COMPANY)
33 PARKGATE RD
LONDON, UNITED KINGDOM 3W11 4NP

FOR: DOWNLOADABLE COMPUTER SOFTWARE FOR RUNNING APPLICATIONS ON
MOBILE AND CELLULAR DEVICES, IN CLASS 9 (U.S. CLS. 21, 23, 26, 36 AND 38).

THE MARK CONSISTS OF STANDARD CHARACTERS WITHOUT CLAIM TO ANY PAR-
TICULAR FONT, STYLE, SIZE, OR COLOR.

OWNER OF INTERNATIONAL REGISTRATION 1056612 DATED 7-23-2010, EXPIRES 7-23-
2020.

SER. NO. 79-089,322, FILED 7-23-2010.

KRISTIN CARLSON, EXAMINING ATTORNEY



David J. Kyffers

Director of the United States Patent and Trademark Office

United States of America

United States Patent and Trademark Office



Reg. No. 4,065,240

Registered Dec. 6, 2011

Int. Cls.: 30, 32 and 43

CUP & CINO KAFFEESYSTEM VERTRIEB GMBH & CO. KG (FED REP GERMANY GMBH & CO. KG (HAFTUNGSBESCHRÄNKTE PERSONENGESELLSCHAFT))
PADERBORNER STRAÙE 33
33161 HÖVELHOF
FED REP GERMANY

TRADEMARK

SERVICE MARK

PRINCIPAL REGISTER

FOR: COFFEE, COFFEE-BASED BEVERAGES, UNROASTED COFFEE, TEA, COCOA, SUGAR, RICE, TAPIOCA, SAGO, ARTIFICIAL COFFEE; FLOUR; PREPARATIONS MADE FROM CEREALS, NAMELY, BREAD AND PASTRY; CONFECTIONERY MADE FROM CEREALS, NAMELY, PASTILLES; ICE CREAM, ICED TEA, EDIBLE ICES, NAMELY, FRUIT ICES, FLAVORED ICES, ICE CREAM DRINKS, ICE CREAM CAKES; HONEY, GOLDEN SYRUP, NAMELY, TABLE SYRUP, CORN SYRUP, CHOCOLATE SYRUP, COFFEE FLAVORED SYRUP USED IN MAKING FOOD BEVERAGES, FLAVORING SYRUP, MAPLE SYRUP, PANCAKE SYRUP; YEAST, BAKING-POWDER, SALT MUSTARD, VINEGAR, SALAD DRESSINGS; CONDIMENT SAUCES; SPICES; ICE FOR REFRESHMENT; ICE; PASTA; PIZZAS, IN CLASS 30 (U.S. CL. 46).

FOR: BEERS, MINERAL AND AERATED WATERS; NON-ALCOHOLIC DRINKS, NAMELY, COFFEE FLAVORED SOFT DRINKS, ENERGY DRINKS, SOFT DRINKS FLAVORED WITH TEA, APPLE JUICE BEVERAGES, FROZEN FRUIT BEVERAGES, ICED FRUIT BEVERAGES, ORANGE JUICE BEVERAGES, PINE APPLE JUICE BEVERAGES, TOMATO JUICE, VEGETABLE JUICE; FRUIT DRINKS AND FRUIT JUICES; SYRUPS FOR MAKING BEVERAGES; PREPARATIONS FOR MAKING FRUIT DRINKS, AND SOFT DRINKS, IN CLASS 32 (U.S. CLS. 45, 46 AND 48).

FOR: SERVICES FOR PROVIDING FOOD AND DRINK, NAMELY, RESTAURANT SERVICES; PROVIDING TEMPORARY ACCOMMODATION, IN CLASS 43 (U.S. CLS. 100 AND 101).

THE MARK CONSISTS OF THE STYLIZED WORDING "PANTIAMO", WITH "PAN" AND THE DOT OVER THE "I" IN ORANGE AND "TIAMO" IN WHITE. THE WORDING IS CENTERED ON A BLACK RECTANGLE.

PRIORITY DATE OF 9-10-2010 IS CLAIMED.

OWNER OF INTERNATIONAL REGISTRATION 1056630 DATED 9-20-2010, EXPIRES 9-20-2020.



David J. Kybas

Director of the United States Patent and Trademark Office

Reg. No. 4,065,240 THE COLOR(S) WHITE, ORANGE, AND BLACK IS/ARE CLAIMED AS A FEATURE OF THE MARK.

SER. NO. 79-089,329, FILED 9-20-2010.

SIMON TENG, EXAMINING ATTORNEY

United States of America
United States Patent and Trademark Office

VYDRO

Reg. No. 4,065,241

Registered Dec. 6, 2011

Int. Cls.: 1, 17 and 19

TRADEMARK

PRINCIPAL REGISTER

HUNTSMAN INTERNATIONAL LLC, A DELAWARE CORPORATION (DELAWARE LIMITED LIABILITY COMPANY)
500, HUNTSMAN WAY
SALT LAKE CITY, UT 84108

FOR: CHEMICAL PRODUCTS FOR USE IN THE AGRICULTURE, HORTICULTURE AND FORESTRY, NAMELY, MANURES AND FERTILIZERS; POLYMER-BASED SUBSTRATES FOR SOIL-FREE GROWING; POLYMERBASED SUBSTRATES FOR GROWING AND CULTIVATING PLANTS, CROPS AND OTHER VEGETABLE LIFE, IN CLASS 1 (U.S. CLS. 1, 5, 6, 10, 26 AND 46).

FOR: SEMI-FINISHED HYDROPHILIC POLYURETHANE FOAM IN THE FORM OF SLABS, BLOCKS, STRIPS, RODS, PIPES AND FLAKES FOR USE AS MEDIA FOR GROWING AND CULTIVATING PLANTS, CROPS AND OTHER VEGETABLE LIFE, IN CLASS 17 (U.S. CLS. 1, 5, 12, 13, 35 AND 50).

FOR: NON-METALLIC BUILDING MATERIALS FOR BUILDING GREEN ROOFS, GREEN WALLS, VERTICAL GARDENS, GRASSING ROOFS AND CULTIVATING ROOF GARDENS, NAMELY, POLYMER-BASED FOAM; NON-METALLIC BUILDING MATERIALS FOR USE IN CONTROLLING, MANAGING AND DRAINING MOISTURE AND WATER ON ROOFS, NAMELY, POLYMER-FOAM SLABS, BLOCKS, STRIPS, FLAKES AND PIPES FOR DRAINAGE, PLASTIC CONDUIT FOR DRAINAGE, DRAIN BASES AND GRATES, IN CLASS 19 (U.S. CLS. 1, 12, 33 AND 50).



THE MARK CONSISTS OF STANDARD CHARACTERS WITHOUT CLAIM TO ANY PARTICULAR FONT, STYLE, SIZE, OR COLOR.

PRIORITY DATE OF 5-4-2010 IS CLAIMED.

OWNER OF INTERNATIONAL REGISTRATION 1056638 DATED 9-10-2010, EXPIRES 9-10-2020.

THE WORD(S) "VYDRO" HAS NO MEANING IN A FOREIGN LANGUAGE.

SER. NO. 79-089,332, FILED 9-10-2010.

WENDY JUN, EXAMINING ATTORNEY

David J. Kyros

Director of the United States Patent and Trademark Office

United States of America

United States Patent and Trademark Office

TAGHLEEF

Reg. No. 4,065,242

Registered Dec. 6, 2011

Int. Cls.: 16, 17 and 36

TAGHLEEF INDUSTRIES SPA CON SOCIO UNICO (ITALY JOINT-STOCK COMPANY
WITH SOLE SHAREHOLDER)
VIA ENRICO FERMI, 46
I-33058 SAN GIORGIO DI NOGARO (UD)
ITALY

TRADEMARK

FOR: PLASTIC MATERIALS FOR PACKAGING, NAMELY, BAGS, BUBBLE PACKS, AND POUCHES; PLASTIC SHEETS FOR FOOD STUFF PACKAGING PURPOSES; PLASTIC FILM FOR PACKAGING PURPOSES NOT FOR INDUSTRIAL OR COMMERCIAL USE, IN CLASS 16 (U.S. CLS. 2, 5, 22, 23, 29, 37, 38 AND 50).

SERVICE MARK

PRINCIPAL REGISTER

FOR: PLASTICS IN EXTRUDED FORM FOR USE IN MANUFACTURE OF PLASTIC PRODUCTS; PLASTIC SHEETS FOR USE AS RAW MATERIALS IN THE MANUFACTURE OF PLASTIC PRODUCTS; SEMI-FINISHED PLASTIC SHEETS FOR USE IN THE MANUFACTURE OF PLASTIC PRODUCTS; PLASTIC SHEETS FOR USE IN THE PRINTING INDUSTRY; SEMI-PROCESSED PLASTIC FILM FOR USE IN THE MANUFACTURE OF PLASTIC PRODUCTS; PLASTIC FILMS, NOT FOR PACKAGING PURPOSES FOR USE IN THE MANUFACTURE OF PLASTIC PRODUCTS; PLASTIC FILM ADAPTED FOR COMMERCIAL USE, NAMELY, FOR PRINTING; PLASTIC FILM FOR INDUSTRIAL AND COMMERCIAL PACKING USE; PLASTIC FILMS USED AS PACKAGING FOR FOOD, IN CLASS 17 (U.S. CLS. 1, 5, 12, 13, 35 AND 50).



FOR: FINANCIAL SERVICES, NAMELY, BANKING, INVESTMENT BROKERAGE, MORTGAGES; FINANCIAL BUSINESS LIQUIDATION SERVICES; FINANCING SERVICES IN THE FIELD OF MUTUAL FUNDS; REAL ESTATE MANAGEMENT, IN CLASS 36 (U.S. CLS. 100, 101 AND 102).

THE MARK CONSISTS OF STANDARD CHARACTERS WITHOUT CLAIM TO ANY PARTICULAR FONT, STYLE, SIZE, OR COLOR.

PRIORITY DATE OF 9-1-2010 IS CLAIMED.

OWNER OF INTERNATIONAL REGISTRATION 1056653 DATED 10-12-2010, EXPIRES 10-12-2020.

SER. NO. 79-089,338, FILED 10-12-2010.

David J. Kypos

Director of the United States Patent and Trademark Office

Reg. No. 4,065,242 ZACHARY BELLO, EXAMINING ATTORNEY

United States of America

United States Patent and Trademark Office

Reg. No. 4,065,243

Registered Dec. 6, 2011

Int. Cls.: 6 and 9

TRADEMARK

PRINCIPAL REGISTER

ALBAN GIACOMO S.P.A. (ITALY JOINT STOCK COMPANY)
VIA DE GASPERI, 75
ROMANO D'EZZELINO (VI), ITALY

FOR: METAL KEYS FOR LOCKS; NON-ELECTRIC METAL LOCKS; METAL SPRING LOCKS; METAL LOCK CYLINDERS; METAL CAMS FOR LOCKS; METAL STRIKES FOR LOCKS; METAL BOLTS; METAL LATCHES; METAL LATCH BARS; HINGES OF METALS; NON-ELECTRIC METAL LOCKING MECHANISMS FOR OPENING AND CLOSING DOORS AND GATES; NON-ELECTRIC, NON-PNEUMATIC, AND NON-HYDRAULIC DOOR CLOSERS OF METAL; METAL SASH FASTENERS FOR WINDOWS; METAL SASH LOCKS; HARDWARE, NAMELY, METAL BRACKETS, PINS AND HANDLES FOR WINDOW SHUTTERS; DOOR AND WINDOW HANDLES OF METALS; METAL ESCUTCHEON PLATES FOR DOOR HANDLES; WINDOW AND DOOR FITTINGS OF METAL; METAL RUNNERS FOR SLIDING DOORS AND FOR SLIDING WINDOWS; ANTI-BURGLAR METALLIC ACCESSORIES FOR SLIDING WINDOWS, NAMELY, LOCKING PINS, SASH PINS, GLIDER PLATES, CENTRAL LOCKS; SLIDING RAILS AND SLIDING GUIDES OF METAL FOR WINDOWS; METAL WINDOW PROFILES; WINDOW CASEMENT BOLTS OF METAL, IN CLASS 6 (U.S. CLS. 2, 12, 13, 14, 23, 25 AND 50).

FOR: ELECTRIC LOCKS; ELECTRIC LOCKING MECHANISMS FOR OPENING AND CLOSING DOORS, GRIDS AND SAFES CONSISTING OF ELECTRONIC MAGNETIC CYLINDRICAL PIN LOCK SETS AND KEYPADS; MAGNETIC KEY READERS; ELECTRONIC CARD READERS; ELECTRONIC READERS AND CONTROLLERS FOR CONTROLLING ACCESS TO PREMISES OR RESERVED AREAS; ELECTRONIC MEMORY CARD READERS; MAGNETICALLY ENCODED KEY CARDS; ELECTRONICALLY OPERATED HIGH SECURITY LOCK CYLINDERS, IN CLASS 9 (U.S. CLS. 21, 23, 26, 36 AND 38).

THE MARK CONSISTS OF A SIGN DEPICTING THREE CIRCLES PLACED HORIZONTALLY AND TANGENT ONE WITH ANOTHER, THE LETTER "A" IN FANCY CHARACTERS BEING PLACED INSIDE THE LEFT-HAND CIRCLE, THE LETTER "G" IN FANCY CHARACTERS INSIDE THE MIDDLE CIRCLE AND THE LETTER "B" IN FANCY CHARACTERS INSIDE THE RIGHT-HAND CIRCLE.

PRIORITY DATE OF 7-22-2010 IS CLAIMED.

OWNER OF INTERNATIONAL REGISTRATION 1057150 DATED 10-4-2010, EXPIRES 10-4-2020.



David J. Kappas

Director of the United States Patent and Trademark Office

Reg. No. 4,065,243 SER. NO. 79-089,562, FILED 10-4-2010.

JASON BLAIR, EXAMINING ATTORNEY

United States of America

United States Patent and Trademark Office

DRAINING GUARD

Reg. No. 4,065,244

Registered Dec. 6, 2011

**Int. Cls.: 6, 7, 9, 11, 12
and 40**

TRADEMARK

SERVICE MARK

PRINCIPAL REGISTER

FAUDI AVIATION GMBH (FED REP GERMANY GMBH)
SCHARNHORSTSTRASSE 7B
35260 STADTALLENDORF
FED REP GERMANY

FOR: GOODS OF COMMON METAL, NAMELY, CONTAINERS AND TANKS OF METAL FOR LIQUID FUELS, IN CLASS 6 (U.S. CLS. 2, 12, 13, 14, 23, 25 AND 50).

FOR: MACHINES AND APPARATUS FOR CONVEYING AND PUMPING PURPOSES, AND INSTALLATIONS AND EQUIPMENT CONSISTING THEREOF, NAMELY, CONVEYORS, PUMPS FOR MACHINES; PUMPS AS PARTS OF MACHINES, ENGINES OR MOTORS; FILTERS, SEPARATORS, MAGNETIC FILTERS, FILTER BODIES, FILTER FUNNELS, STRAINERS, EXTRACTORS, CONDENSERS, DROPLET SEPARATORS, ABSORBERS, FLUID SEPARATORS, PHASE SEPARATORS AND DE-OILERS BEING PARTS FOR MACHINES, MOTORS AND ENGINES; FUEL FILTERS AND SEPARATORS FOR FUELING VEHICLES AND AEROPLANES; FILTER PRESSES, NAMELY, INDUSTRIAL MACHINE PRESSES; MACHINES, NAMELY, CENTRIFUGES; FUEL FILTERS FOR FUELING VEHICLES AND AEROPLANES, COMBINED WITH A PRESSURE MEASURING AND/OR INDICATING DEVICE CONNECTED TO THE FILTER; HEAT EXCHANGERS BEING PARTS OF MACHINES, IN CLASS 7 (U.S. CLS. 13, 19, 21, 23, 31, 34 AND 35).

FOR: FUEL PUMPS FOR SERVICE STATIONS AND INSTALLATIONS CONSISTING THEREOF; FUELING INSTALLATIONS, INCLUDED IN THIS CLASS, MAINLY CONSISTING OF FUEL PUMPS FOR SERVICE STATIONS, AS WELL AS INSTRUMENTS AND APPARATUS FOR CHECKING FUEL LEVELS IN FUEL TANKS, NAMELY, FUEL GAUGES, FOR FUEL VAPOR RECOVERY AND FOR LEAK DIAGNOSIS IN FUEL TANKS; SELF-REGULATING FUEL PUMPS FOR SERVICE STATIONS; ELECTRIC AND ELECTRONIC MEASURING, SIGNALING, CONTROL AND REGULATING APPARATUS FOR FUEL PUMPS AND INSTALLATIONS, AS WELL AS FUELING INSTALLATIONS, NAMELY, FUEL CELLS, REMOTE FUEL OIL LEVEL SENSING SYSTEM; ELECTRIC AND ELECTRONIC FUEL FILTER MONITORING APPARATUS AND EQUIPMENT, NAMELY, FUEL GAUGES; LASERS, NOT FOR MEDICAL PURPOSES; REGULATING AND SAFETY ACCESSORIES, INCLUDED IN THIS CLASS, FOR FUEL PUMPS AND INSTALLATIONS, AS WELL AS FUELING INSTALLATIONS, NAMELY, SAFETY GOGGLES, SAFETY MARKERS, IN CLASS 9 (U.S. CLS. 21, 23, 26, 36 AND 38).



David J. Kyjars

Director of the United States Patent and Trademark Office

Reg. No. 4,065,244 FOR: DRYING AND VENTILATING APPARATUS, NAMELY, AIR CONDITIONERS, HEAT EXCHANGERS, REFRIGERATING APPARATUS AND INSTALLATIONS, NAMELY, REFRIGERATORS, REFRIGERATING INSTALLATIONS FOR LIQUIDS, NAMELY, REFRIGERATORS, IN CLASS 11 (U.S. CLS. 13, 21, 23, 31 AND 34).

FOR: AERONAUTICAL APPARATUS, MACHINES AND APPLIANCES, NAMELY, AEROPLANES; VEHICLES, NAMELY, LAND VEHICLES AND AIRCRAFTS, AND STRUCTURAL PARTS THEREFOR, IN CLASS 12 (U.S. CLS. 19, 21, 23, 31, 35 AND 44).

FOR: SERVICES IN THE FIELD OF FILTERING, IN PARTICULAR IN THE FIELD OF FILTERING OF FUELS, INCLUDING AVIATION FUEL, NAMELY, FUEL FILTRATION AND CONDITIONING SERVICES; FUEL TREATMENT SERVICES IN THE FIELD OF SEPARATION, STRAINING, SPLITTING, ADSORBING, PRECIPITATION, SEDIMENTATION, MEDIA AND MATERIAL CONVEYING, CENTRIFUGING, MATERIAL PROCESSING, DOSING, DEPOSITING, AGITATING, LIQUID AND GAS TREATMENT, VENTILATION AND CONDENSING, IN CLASS 40 (U.S. CLS. 100, 103 AND 106).

THE MARK CONSISTS OF STANDARD CHARACTERS WITHOUT CLAIM TO ANY PARTICULAR FONT, STYLE, SIZE, OR COLOR.

PRIORITY DATE OF 4-13-2010 IS CLAIMED.

OWNER OF INTERNATIONAL REGISTRATION 1057192 DATED 10-5-2010, EXPIRES 10-5-2020.

SER. NO. 79-089,584, FILED 10-5-2010.

SANI KHOURI, EXAMINING ATTORNEY

United States of America

United States Patent and Trademark Office

EXPERTtorque

Reg. No. 4,065,245

Registered Dec. 6, 2011

Int. Cl.: 10

TRADEMARK

PRINCIPAL REGISTER

KALTENBACH & VOIGT GMBH (FED REP GERMANY LIMITED LIABILITY COMPANY)
BISMARCKRING 39
88400 BIBERACH A. D. RISS
FED REP GERMANY

FOR: DENTAL INSTRUMENTS, NAMELY, HAND AND ANGLE PIECES, ELECTRIC AND PNEUMATIC DRIVES FOR THESE INSTRUMENTS, IN CLASS 10 (U.S. CLS. 26, 39 AND 44).

THE MARK CONSISTS OF STANDARD CHARACTERS WITHOUT CLAIM TO ANY PARTICULAR FONT, STYLE, SIZE, OR COLOR.

PRIORITY DATE OF 4-13-2010 IS CLAIMED.

OWNER OF INTERNATIONAL REGISTRATION 1057400 DATED 10-12-2010, EXPIRES 10-12-2020.

SER. NO. 79-089,662, FILED 10-12-2010.

COURTNEY ALVAREZ, EXAMINING ATTORNEY



David J. Kyros

Director of the United States Patent and Trademark Office

United States of America

United States Patent and Trademark Office



mister**step**

Reg. No. 4,065,246

Registered Dec. 6, 2011

Int. Cls.: 6, 19 and 39

TRADEMARK

SERVICE MARK

PRINCIPAL REGISTER

MISTERSTEP S.R.L. (ITALY LIMITED LIABILITY COMPANY)
VIA TRAIANO IMPERATORE, 6
I-47100 FORLÌ (FC)
ITALY

FOR: METAL FOLDING LADDERS, IN CLASS 6 (U.S. CLS. 2, 12, 13, 14, 23, 25 AND 50).

FOR: NON-METALLIC PREFABRICATED LADDERS, HELICAL STAIRCASES OF WOOD OR PLASTICS, RUNG LADDERS OF WOOD OR PLASTICS, EXTENSION LADDERS AND STEPLADDERS OF WOOD OR PLASTICS, IN CLASS 19 (U.S. CLS. 1, 12, 33 AND 50).

FOR: DELIVERY, TRANSPORT, PACKAGING AND WAREHOUSING OF STAIRCASES, FLOORS AND COVERINGS, PARQUET AND WOOD STRIPS, IN CLASS 39 (U.S. CLS. 100 AND 105).

THE MARK CONSISTS OF THE WORD "MISTERSTEP" BESIDE THE IMAGE OF THREE STEPS SKETCHED WITHIN A FRAME.

OWNER OF INTERNATIONAL REGISTRATION 1057485 DATED 6-18-2010, EXPIRES 6-18-2020.

SER. NO. 79-089,696, FILED 6-18-2010.

CHRISIE B. KING, EXAMINING ATTORNEY



David J. Kyffers

Director of the United States Patent and Trademark Office

United States of America

United States Patent and Trademark Office



SINCEHOME

Reg. No. 4,065,247

Registered Dec. 6, 2011

Int. Cl.: 21

TRADEMARK

PRINCIPAL REGISTER

SINCE HARDWARE (GUANGZHOU) CO.,LTD (CHINA CORPORATION)
XIANG SHAN CUN
HUADONG TOWN.; HUADU DISTRICT; 510890 GUANGDONG PROV
CHINA

FOR: IRONING BOARD COVERS, SHAPED; IRONING BOARDS; CLOTHES RACKS, FOR DRYING, CLOTHING STRETCHERS; STRETCHERS FOR CLOTHING; NON-METALLIC PEGS FOR CLOTHES FOR HANGING CLOTHES, IN CLASS 21 (U.S. CLS. 2, 13, 23, 29, 30, 33, 40 AND 50).

THE MARK CONSISTS OF THE WORDING "SINCEHOME" WRITTEN UNDERNEATH THE STYLIZED DESIGN OF AN IRONING BOARD.

OWNER OF INTERNATIONAL REGISTRATION 1057685 DATED 7-8-2010, EXPIRES 7-8-2020.

SER. NO. 79-089,755, FILED 7-8-2010.

JOHN DALIER, EXAMINING ATTORNEY



David J. Kybas

Director of the United States Patent and Trademark Office

United States of America

United States Patent and Trademark Office

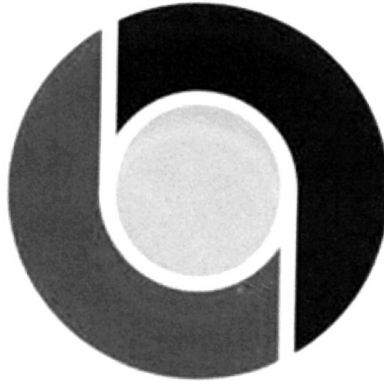

Reg. No. 4,065,248

Registered Dec. 6, 2011

Int. Cls.: 5, 9, 11 and 37

TRADEMARK

SERVICE MARK

PRINCIPAL REGISTER

BIOQUELL UK LIMITED (UNITED KINGDOM LIMITED COMPANY)
52 ROYCE CLOSE
WEST PORTWAY; ANDOVER, HAMPSHIRE SP10 3TS
UNITED KINGDOM

FOR: STERILISING PREPARATIONS AND SUBSTANCES; DISINFECTANTS FOR SANITARY PURPOSES AND STERILANTS FOR BIO-DECONTAMINATION, NAMELY, HYDROGEN PEROXIDE, BIOCIDES, GERMICIDES, VIRUCIDES, IN CLASS 5 (U.S. CLS. 6, 18, 44, 46, 51 AND 52).

FOR: FUME CUPBOARDS FOR LABORATORY USE; BIOLOGICAL SAFETY CABINETS; ANAEROBIC CHAMBERS FOR CELL CULTURE OR THE INCUBATION OF CELLS FOR LABORATORY OR SCIENTIFIC USE; LAMINAR FLOW CABINETS AND APPARATUS AND INSTRUMENTS, NAMELY, LAMINAR FLOW WORKBENCHES AND BIOLOGICAL SAFETY CABINETS; ISOLATION CABINETS AND APPARATUS AND INSTRUMENTS, NAMELY, FUME HOODS AND BIOLOGICAL SAFETY CABINETS FOR LABORATORY PURPOSES; LABORATORY EQUIPMENT IN THE NATURE OF FUME CUPBOARDS AND SAFETY CABINETS FOR USE IN PHARMACEUTICAL RESEARCH; CONTROL AND MONITORING APPARATUS AND INSTRUMENTS, NAMELY, STERILE TRANSFER CHAMBERS FOR BIO-DECONTAMINATION AND PORTABLE BIO-DECONTAMINATION UNITS, IN CLASS 9 (U.S. CLS. 21, 23, 26, 36 AND 38).



David J. Kybas

Director of the United States Patent and Trademark Office

FOR: INSTALLATIONS AND APPARATUS FOR FILTERING AIR, NAMELY, FORMALIN EVACUATION UNITS IN THE NATURE OF FILTRATION UNITS FOR REMOVING VAPOURS FROM SAFETY CABINETS AND ENCLOSURES; AIR FILTRATION AND VENTILATION INSTALLATIONS AND APPARATUS; INSTALLATIONS AND APPARATUS FOR PURIFYING OR STERILISING AIR; AIR CONDITIONING UNITS, SYSTEMS AND INSTALLATIONS; AIR STERILIZATION UNITS, SYSTEMS AND INSTALLATIONS; STERILE CABINETS AND APPARATUS FOR MAINTAINING STERILE CONDITIONS INSIDE SUCH CABINETS, NOT FOR MEDICAL PURPOSES, NAMELY, CLEAN AIR BOOTHS; HYDROGEN PEROXIDE VAPOUR GENERATORS; CONTAMINATION CONTROL EQUIPMENT, NAMELY, HEPA FILTERS FOR USE IN LAMINAR AND NON-LAMINAR FILTRATION UNITS FOR STERILISATION, DECONTAMINATION AND MICROBIOLOGICAL CONTROL IN HOSPITALS AND MEDICAL LABORATORIES; STERILIZATION APPARATUS AND INSTRUMENTS FOR CLINICAL USE AND NOT FOR MEDICAL PURPOSES, NAMELY, STERILIZERS FOR BIOLOGICAL AND CHEMICAL DECONTAMINATION FOR USE IN HEALTH CARE AND FOR MAINTAINING A SEPTIC ROOM ENVIRONMENT AND STERILE EQUIPMENT;

Reg. No. 4,065,248 CONTAMINATION CONTROL EQUIPMENT, NAMELY, HYDROGEN PEROXIDE VAPOUR GENERATORS, AIR FILTRATION UNITS AND BIO DECONTAMINATION VAPOUR GENERATORS FOR MAINTAINING A SEPTIC ROOM ENVIRONMENT AND STERILE EQUIPMENT, IN CLASS 11 (U.S. CLS. 13, 21, 23, 31 AND 34).

FOR: INSTALLATION, REPAIR, MAINTENANCE AND SERVICE OF FUME CUPBOARDS, BIOLOGICAL SAFETY CABINETS, LAMINAR FLOW CABINETS AND SYSTEMS, AIR FILTRATION AND VENTILATION SYSTEMS, AIR CONDITIONING UNITS AND SYSTEMS, PATIENT ISOLATION SYSTEMS, CLEAN ROOMS, STERILE ROOMS, ANAEROBIC CHAMBERS, ISOLATION CABINETS AND UNITS, CONTAMINATION CONTROL EQUIPMENT; ADVISORY, PLANNING, CONSULTANCY AND INFORMATION SERVICES RELATING TO ALL THE AFORESAID SERVICES, IN CLASS 37 (U.S. CLS. 100, 103 AND 106).

THE MARK CONSISTS OF A CIRCLE SURROUNDED BY A RING THAT IS DIVIDED NEAR THE TOP AND THE BOTTOM. THE INNER CIRCLE AND THE LINES CREATING THE DIVISIONS IN THE OUTER RING FORM THE STYLIZED LETTER COMBINATION "BQ".

PRIORITY DATE OF 4-8-2010 IS CLAIMED.

OWNER OF INTERNATIONAL REGISTRATION 1058121 DATED 10-6-2010, EXPIRES 10-6-2020.

SER. NO. 79-089,924, FILED 10-6-2010.

JAMES LOVELACE, EXAMINING ATTORNEY

United States of America

United States Patent and Trademark Office

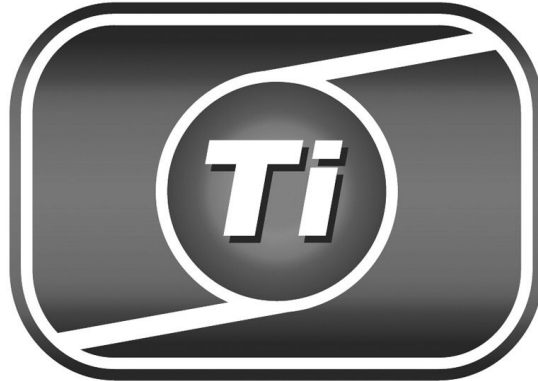

Reg. No. 4,065,249
Registered Dec. 6, 2011
Int. Cls.: 16, 17 and 36

TAGHLEEF INDUSTRIES SPA CON SOCIO UNICO (ITALY JOINT STOCK COMPANY
WITH SOLE SHAREHOLDER)
VIA ENRICO FERMI, 46
I-33058 SAN GIORGIO DI NOGARO (UD)
ITALY

TRADEMARK

FOR: PLASTIC MATERIALS FOR PACKAGING, NAMELY, BAGS, BUBBLE PACKS, AND POUCHES; PLASTIC SHEETS FOR FOOD STUFF PACKAGING PURPOSES; PLASTIC FILM FOR PACKAGING PURPOSES NOT FOR INDUSTRIAL OR COMMERCIAL USE, IN CLASS 16 (U.S. CLS. 2, 5, 22, 23, 29, 37, 38 AND 50).

SERVICE MARK

PRINCIPAL REGISTER

FOR: PLASTICS IN EXTRUDED FORM FOR USE IN MANUFACTURE OF PLASTIC PRODUCTS; PLASTIC SHEETS FOR USE AS RAW MATERIALS IN THE MANUFACTURE OF PLASTIC PRODUCTS; SEMI-FINISHED PLASTIC SHEETS FOR USE IN THE MANUFACTURE OF PLASTIC PRODUCTS; PLASTIC SHEETS FOR USE IN THE PRINTING INDUSTRY; SEMI-PROCESSED PLASTIC FILM FOR USE IN THE MANUFACTURE OF PLASTIC PRODUCTS; PLASTIC FILMS, NOT FOR PACKAGING PURPOSES FOR USE IN THE MANUFACTURE OF PLASTIC PRODUCTS; PLASTIC FILM ADAPTED FOR COMMERCIAL USE, NAMELY, FOR PRINTING; PLASTIC FILM FOR INDUSTRIAL AND COMMERCIAL PACKING USE; PLASTIC FILMS USED AS PACKAGING FOR FOOD, IN CLASS 17 (U.S. CLS. 1, 5, 12, 13, 35 AND 50).



FOR: FINANCIAL SERVICES, NAMELY, BANKING, INVESTMENT BROKERAGE, MORTGAGES; FINANCIAL BUSINESS LIQUIDATION SERVICES; FINANCING SERVICES IN THE FIELD OF MUTUAL FUNDS; REAL ESTATE MANAGEMENT, IN CLASS 36 (U.S. CLS. 100, 101 AND 102).

PRIORITY DATE OF 9-1-2010 IS CLAIMED.

OWNER OF INTERNATIONAL REGISTRATION 1058237 DATED 10-12-2010, EXPIRES 10-12-2020.

SER. NO. 79-089,967, FILED 10-12-2010.

ZACHARY BELLO, EXAMINING ATTORNEY

David J. Kyffers

Director of the United States Patent and Trademark Office

United States of America

United States Patent and Trademark Office

Sergio  *Amaranti*

Reg. No. 4,065,250

Registered Dec. 6, 2011

Int. Cls.: 18 and 25

TRADEMARK

PRINCIPAL REGISTER

AMARANTI, SERGIO (ITALY INDIVIDUAL)
VIA VILLAFRANCA, 3
CIVITANOVA MARCHE (MC), ITALY I62012

FOR: LEATHER AND IMITATION LEATHER, TRUNKS AND SUITCASES, UMBRELLAS, PARASOLS, WALKING STICKS, RUCKSACKS, ALL PURPOSE SPORTS BAGS, TRAVELING BAGS, GARMENT BAGS FOR TRAVEL, DUFFEL BAGS, BRIEFCASES, PURSES, WALLETS, BAGS, NAMELY, ALL-PURPOSE CARRYING BAGS, HANDBAGS, BARREL BAGS, BOSTON BAGS, TEXTILE SHOPPING BAGS, REUSABLE SHOPPING BAGS, CANVAS SHOPPING BAGS, LEATHER SHOPPING BAGS, SACKS IN THE NATURE OF A SOFT HANDBAG, BACKPACKS, AND CLUTCH BAGS, CARRY-ALL BAGS MADE OF FABRIC, WHEELED CARRIER BAGS, TOTE BAGS, LEATHER LEASHES FOR ANIMAL, BOOK BAGS, SACHEL CASES, SPORTS BAGS, BEACH BAGS, SHOULDER BAGS, WAIST BAGS, COSMETIC BAGS SOLD EMPTY, IN CLASS 18 (U.S. CLS. 1, 2, 3, 22 AND 41).

FOR: CLOTHING ITEMS, NAMELY, SWEATERS, CARDIGANS, WAISTCOATS, SUITS, TROUSERS, SHORTS, JUMPERS, RAINCOATS; CLOTHING MADE OF LEATHER, NAMELY, LEATHER COATS, LEATHER JACKETS, LEATHER VESTS, PANT SUITS OF LEATHER, TROUSERS OF LEATHER; STOCKINGS AND SOCKS, STOCKING SUSPENDERS, SOCK SUSPENDERS, WIND JACKETS, SKI TROUSERS, FUR COATS, OVERCOATS, SKIRTS, DRESSES, JACKETS, UNDERSHIRTS, T-SHIRTS; SPORTS CLOTHING, NAMELY, SPORT JERSEYS AND BREECHES FOR SPORTS, SPORT OVER UNIFORMS; BLOUSES, SHIRT COLLARS, SHIRTS, FOULARDS, BEACHWEAR, SWIMSUITS, BIKINI, TRACKSUITS; WEDDING DRESSES; UNDERWEAR, BRAS, BRASSIERE, CORSETS, UNDERPANTS, BRIEFS, VESTS, NIGHTGOWNS, NEGLIGEEES, PYJAMAS, GLOVES, SHAWLS, SCARVES, NECKTIES, BOW TIES, BELTS AS CLOTHING, SUSPENDERS, HATS, CAPS, SHOES, BOOTS, HALF-BOOTS, LEATHER SHOES, GALOSHES, RAIN BOOTS, SPORTS FOOTWEAR, SANDALS, SLIPPERS, SHOE SOLES, SHOE HEELS, FOOTWEAR UPPERS, IN CLASS 25 (U.S. CLS. 22 AND 39).



THE NAME(S), PORTRAIT(S), AND/OR SIGNATURE(S) SHOWN IN THE MARK IDENTIFIES "SERGIO AMARANTI", WHOSE CONSENT(S) TO REGISTER IS MADE OF RECORD.

David J. Kyros

OWNER OF INTERNATIONAL REGISTRATION 1058261 DATED 8-4-2010, EXPIRES 8-4-2020.

Reg. No. 4,065,250 THE TRADEMARK CONSISTS OF THE WORDS "SERGIO AMARANTI", BEING PART OF THE OWNER'S COMPANY NAME, WRITTEN IN ITALICS, SPECIAL THICK CHARACTERS, WHERE THE INITIALS "S" AND "A" ARE IN CAPITAL LETTERS, WHILE THE OTHERS ARE SMALL LETTERS. BETWEEN THE TWO WORDS THERE IS THE STYLIZED DRAWING OF AN EYE.

THE WORDING "AMARANTI" HAS NO MEANING IN A FOREIGN LANGUAGE.

SER. NO. 79-089,978, FILED 8-4-2010.

MICHAEL WIENER, EXAMINING ATTORNEY

United States of America

United States Patent and Trademark Office

SMARTtorque

Reg. No. 4,065,251

Registered Dec. 6, 2011

Int. Cl.: 10

TRADEMARK

PRINCIPAL REGISTER

KALTENBACH & VOIGT GMBH (FED REP GERMANY GMBH (LIMITED LIABILITY COMPANY))
BISMARCKRING 39
88400 BIBERACH A. D. RISS
FED REP GERMANY

FOR: DENTAL INSTRUMENTS, NAMELY, HAND AND ANGLE PIECES, ELECTRIC AND PNEUMATIC DRIVES FOR THESE INSTRUMENTS, IN CLASS 10 (U.S. CLS. 26, 39 AND 44).

THE MARK CONSISTS OF STANDARD CHARACTERS WITHOUT CLAIM TO ANY PARTICULAR FONT, STYLE, SIZE, OR COLOR.

PRIORITY DATE OF 4-20-2010 IS CLAIMED.

OWNER OF INTERNATIONAL REGISTRATION 1058446 DATED 10-12-2010, EXPIRES 10-12-2020.

SER. NO. 79-090,039, FILED 10-12-2010.

COURTNEY ALVAREZ, EXAMINING ATTORNEY



David J. Kyffers

Director of the United States Patent and Trademark Office

United States of America

United States Patent and Trademark Office

DIATHONITE

Reg. No. 4,065,252

Registered Dec. 6, 2011

Int. Cl.: 19

TRADEMARK

PRINCIPAL REGISTER

DIASEN S.R.L. (ITALY LIMITED LIABILITY COMPANY)
ZONA INDUSTRIALE BERBENTINA, 5
I-60047 SASSOFERRATO (AN)
ITALY

FOR: NON-METAL BUILDING MATERIALS, NAMELY, PLASTER, SLABS OF CEMENT, OF CONCRETE, OF CLAY, OF CORK AND OF NON-AGRICULTURAL LIME FOR USE IN CONSTRUCTION, COMPOSITE PANELS COMPOSED PRIMARILY OF NON-METAL MATERIALS; NON-METALLIC RIGID PIPES FOR BUILDING; ASPHALT, PITCH AND BITUMEN; NON-METALLIC TRANSPORTABLE BUILDINGS; MONUMENTS, NOT OF METAL, IN CLASS 19 (U.S. CLS. 1, 12, 33 AND 50).

THE MARK CONSISTS OF STANDARD CHARACTERS WITHOUT CLAIM TO ANY PARTICULAR FONT, STYLE, SIZE, OR COLOR.

OWNER OF INTERNATIONAL REGISTRATION 1058449 DATED 10-20-2010, EXPIRES 10-20-2020.

SER. NO. 79-090,040, FILED 10-20-2010.

DAVID H. STINE, EXAMINING ATTORNEY



David J. Kyros

Director of the United States Patent and Trademark Office

United States of America

United States Patent and Trademark Office

HUCAIS 虎彩

Reg. No. 4,065,253

Registered Dec. 6, 2011

Int. Cls.: 2, 16 and 40

DONGGUAN HUCAIS PRINTING CO., LTD. (CHINA LIMITED COMPANY)
SHIGU GANG,
CHENHUANGCUN INDUSTRIAL ZONE,; HUMEN, DONGGUAN CITY; 523925 GUANGDONG
PROV.
CHINA

TRADEMARK

FOR: MORDANT DYES; MORDANTS FOR USE IN PRINTING; PIGMENTS; COLORANTS;
METALS IN POWDER FORM FOR PAINTERS, DECORATORS, PRINTERS AND ARTISTS;
COLORANTS FOR BEER; PRINTING INK; FILLED TONER CARTRIDGES FOR PRINTERS
AND PHOTOCOPIERS; PAINTS; VARNISHES, IN CLASS 2 (U.S. CLS. 6, 11 AND 16).

SERVICE MARK

PRINCIPAL REGISTER

FOR: PAPER; COTTON PAPERS, TYPING PAPERS, COPYING PAPERS; PAINTING PAPERS;
HANDKERCHIEFS OF PAPER; COLOUR FURROW PAPERS; CARDBOARD ARTICLES,
NAMELY, BOXES AND BAGS; SIGNBOARDS OF PAPER OR CARDBOARD; WRITING OR
DRAWING BOOKS; ALBUMS; PRINTED MATTER, NAMELY, BILLBOOKS, WORKBOOKS,
PAPER DIE CUT SHAPES, VOUCHERS, DESK CALENDAR, CATALOG OF ELECTRONIC
PRODUCTS, CATALOG OF CIGARETTES; WRITING PADS; POSTERS; PICTURES; APPAR-
ATUS FOR MOUNTING PHOTOGRAPHS, NAMELY, ADHESIVE PLASTIC FILM, ADHESIVE
CORNERS; PACKING PAPER; BOOKBINDINGS; BAGS, ENVELOPES AND POUCHES OF
PAPER OR PLASTICS, FOR PACKAGING; BOOKBINDING APPARATUS, NAMELY, TAPE,
WIRE, CORDS AND STRIPS; ELECTRICAL AND MECHANICAL PENCIL SHARPENERS;
STATIONERY; OFFICE REQUISITES, NAMELY, BLANK PAPER NOTEBOOKS, NOTEPADS,
ADHESIVES, ADHESIVE NOTE PAPER, FILE POCKETS, FILE FOLDERS, DRAFTING
RULERS, DRAWING RULERS, DRAFTING COMPASSES, RUBBER ERASERS, RUBBER
STAMPS, STAPLERS, PUNCHES, RUBBER BANDS, BOOK COVERS, PEN AND PENCIL
CASES AND BOXES, CORRECTING FLUID FOR TYPE, CORRECTING FILM FOR TYPE;
INK FOR WRITING INSTRUMENTS; HAND-HELD LABELING DEVICE; WRITING INSTRU-
MENTS; ADHESIVE BANDS FOR STATIONERY OR HOUSEHOLD PURPOSES; DRAWING
INSTRUMENTS; DRAWING MATERIALS FOR BLACKBOARDS; MIMEOGRAPH APPAR-
ATUS AND MACHINES; PRINTED TEACHING MATERIALS IN THE FIELD OF CHILDREN'S
EDUCATION, HISTOLOGICAL SECTIONS FOR TEACHING PURPOSES ; PRINTED
TEACHING MATERIALS, NAMELY, MANUAL DESCRIBING THE STRUCTURE, FUNCTION,
OPERATION AND INSTRUCTION OF HOUSEHOLD APPLIANCES; MODELING MATERI-
ALS, NAMELY, MODELING CLAY, MODELING COMPOUNDS, IN CLASS 16 (U.S. CLS.
2, 5, 22, 23, 29, 37, 38 AND 50).



David J. Kyros

Director of the United States Patent and Trademark Office

Reg. No. 4,065,253 FOR: PROVIDING MATERIAL TREATMENT INFORMATION; METAL TREATING; TEXTILE TREATING IN THE NATURE OF BLEACHING AND DYEING; PAPER FINISHING; BOOK-BINDING; GLASS-BLOWING; PATTERN PRINTING; PHOTOGRAPHIC PRINTING; PRINTING; FRAMING OF WORKS OF ART, IN CLASS 40 (U.S. CLS. 100, 103 AND 106).

THE MARK CONSISTS OF THE WORDING "HUCAIS" WITH A STYLIZED "H" AND CHINESE CHARACTERS TRANSLITERATING INTO "HUCAIS".

PRIORITY DATE OF 1-8-2010 IS CLAIMED.

OWNER OF INTERNATIONAL REGISTRATION 1058472 DATED 6-3-2010, EXPIRES 6-3-2020.

THE TRANSLITERATION OF THE NON-LATIN CHARACTERS IN THE MARK IS: HUCAI.

THE ENGLISH TRANSLATION OF THE FOREIGN WORD(S) IN THE MARK IS: TIGER COLOR.

SER. NO. 79-090,047, FILED 6-3-2010.

TRACY CROSS, EXAMINING ATTORNEY

United States of America

United States Patent and Trademark Office

SCANDIT

Reg. No. 4,065,254

Registered Dec. 6, 2011

Int. Cls.: 9, 35 and 42

TRADEMARK

SERVICE MARK

PRINCIPAL REGISTER

MIRASENSE AG (SWITZERLAND SOCIÉTÉ ANONYME (SA))
REBBERGSTRASSE 1
CH-8037 ZÜRICH
SWITZERLAND

FOR: TELEPHONES; PORTABLE TELEPHONES; PORTABLE COMMUNICATION DEVICES, NAMELY, SMARTPHONES; CINEMATOGRAPHIC CAMERAS; CAMERAS FOR MOBILE TELEPHONES; COMPUTERS, LAPTOP COMPUTERS; DATA PROCESSING EQUIPMENT, NAMELY, OPTICAL READERS; OPTICAL CHARACTER READERS; BAR CODE READERS; COMPUTER SOFTWARE FOR READING BARCODES; COMPUTER SOFTWARE FOR READING BARCODES WITH A PORTABLE COMMUNICATION DEVICE; COMPUTER SOFTWARE USED TO OBTAIN, ORGANIZE AND SHARE INFORMATION ABOUT GOODS; COMPUTER SOFTWARE USED TO OBTAIN, ORGANIZE AND SHARE INFORMATION ABOUT GOODS WITH A PORTABLE COMMUNICATION DEVICE; COMPUTER SOFTWARE FOR COMPARING AND EVALUATING GOODS; COMPUTER SOFTWARE FOR COMPARING AND EVALUATING GOODS WITH A PORTABLE COMMUNICATION DEVICE; COMPUTER SOFTWARE THAT PROVIDES AN INTERACTION BETWEEN GOODS AND COMPUTERS OR PORTABLE COMMUNICATION DEVICES; COMPUTER SOFTWARE USED FOR SEARCHES ON THE INTERNET; COMPUTER PROGRAMS FOR THE IDENTIFICATION OF GOODS OR PHYSICAL OBJECTS; COMPUTER PROGRAMS FOR THE IDENTIFICATION OF GOODS OR PHYSICAL OBJECTS THROUGH BARCODES, IMAGES, VOICE COMMAND, KEYWORDS, GESTURES OR RADIO-FREQUENCY IDENTIFICATION; COMPUTER PROGRAMS FOR RETRIEVING INFORMATION ABOUT GOODS OR PHYSICAL OBJECTS; COMPUTER PROGRAMS FOR RETRIEVING INFORMATION ABOUT GOODS OR PHYSICAL OBJECTS THROUGH BARCODES, IMAGES, VOICE COMMAND, KEYWORDS, GESTURES OR RADIO-FREQUENCY IDENTIFICATION; COMPUTER PROGRAMS FOR INTERACTING WITH GOODS OR PHYSICAL OBJECTS; COMPUTER PROGRAMS FOR INTERACTING WITH GOODS OR PHYSICAL OBJECTS THROUGH BARCODES, IMAGES, VOICE COMMAND, KEYWORDS, GESTURES OR RADIO-FREQUENCY IDENTIFICATION; COMPUTER PROGRAMS FOR THE ELECTRONIC PAYMENT OF FUNDS FOR THE PURCHASE OF VIRTUAL OR PHYSICAL GOODS; COMPUTER PROGRAMS FOR THE ELECTRONIC PAYMENT OF FUNDS FOR THE PURCHASE OF VIRTUAL OR PHYSICAL GOODS WITH A PORTABLE COMMUNICATION DEVICE; COMPUTER PROGRAMS FOR THE MANAGEMENT, INVENTORY AND PROCUREMENT OF GOODS, CONSUMER PRODUCTS AND PHYSICAL OBJECTS; COMPUTER PROGRAMS FOR STORING, MANAGING, OFFERING OR SELLING INFORMATION ABOUT PRODUCTS, GOODS OR PHYSICAL OBJECTS; COMPUTER PROGRAMS FOR CREATING STATISTICS ABOUT INTERACTIONS WITH



David J. Kyjars

Director of the United States Patent and Trademark Office

Reg. No. 4,065,254 PHYSICAL GOODS AND OBJECTS; COMPUTER PROGRAMS FOR DEFINING, MANAGING, DISPLAYING AND THE ACCOUNTING OF ADVERTISING CAMPAIGNS, COUPONS AND OTHER MONETIZATION MECHANISMS, IN CLASS 9 (U.S. CLS. 21, 23, 26, 36 AND 38).

FOR: ADVERTISING; ONLINE ADVERTISING ON A COMPUTER NETWORK; ADVERTISING ON MOBILE TELEPHONES AND PORTABLE COMMUNICATIONS DEVICES; MARKETING, NAMELY, PROMOTING THE GOODS AND SERVICES OF OTHERS; ONLINE MARKETING ON A COMPUTER NETWORK, NAMELY, PROMOTING THE GOODS AND SERVICES OF OTHERS VIA A COMPUTER NETWORK; MARKETING ON MOBILE TELEPHONES AND PORTABLE COMMUNICATIONS DEVICES, NAMELY, PROMOTING THE GOODS AND SERVICES OF OTHERS VIA MOBILE TELEPHONES AND PORTABLE COMMUNICATIONS DEVICES; ADVERTISING AND MARKETING SERVICES PROVIDED BY MEANS OF INDIRECT METHODS OF MARKETING COMMUNICATIONS, NAMELY, SOCIAL MEDIA, SEARCH ENGINE MARKETING, INQUIRY MARKETING, INTERNET MARKETING, MOBILE MARKETING, BLOGGING AND OTHER FORMS OF PASSIVE, SHARABLE OR VIRAL COMMUNICATIONS CHANNELS; PRESENTATION OF GOODS ON COMMUNICATION MEDIA, FOR RETAIL PURPOSES; E-COMMERCE SERVICES, NAMELY, MAKING PRODUCT INFORMATION AVAILABLE VIA TELECOMMUNICATION NETWORKS FOR ADVERTISING AND SALES PURPOSES; PRODUCT INFORMATION SERVICES, NAMELY, PROVIDING INFORMATION ABOUT THE GOODS AND SERVICES OF OTHERS VIA THE GLOBAL COMPUTER NETWORK, MOBILE TELEPHONES AND PORTABLE COMMUNICATIONS DEVICES; COMMERCIAL INFORMATION AND ADVICE FOR CONSUMERS; PRICE COMPARISON SERVICES; SERVICES FOR THE MANAGEMENT, INVENTORY, PROCUREMENT, ORDERING, AND PURCHASING FOR VIRTUAL AND PHYSICAL GOODS AND OBJECTS, NAMELY, PROVIDING INFORMATION PERTAINING TO THE PROCUREMENT, BUYING, SELLING AND TENDERING INFORMATION AND OPPORTUNITIES RELATING TO GOODS AND SERVICES VIA COMPUTER, COMPUTER NETWORKS, THE INTERNET, MOBILE TELEPHONES AND PORTABLE COMMUNICATIONS DEVICES; MARKETING STUDIES; BUSINESS MANAGEMENT CONSULTING WITH RELATION TO STRATEGY, MARKETING, SALES, OPERATION, PRODUCT DESIGN PARTICULARLY SPECIALIZING IN THE USE OF ANALYTIC AND STATISTIC MODELS FOR THE UNDERSTANDING AND PREDICTING OF CONSUMERS, BUSINESSES, AND MARKET TRENDS AND ACTIONS; COMPILATION OF STATISTICS; ANALYTICS SERVICES, NAMELY, MARKETING ANALYSIS SERVICES AND ANALYSIS OF ADVERTISING RESPONSE; COMPILATION OF STATISTICS, NAMELY, FOR ANALYZING INTERACTIONS WITH PHYSICAL GOODS AND OBJECTS; DATA COMPILATION AND SYSTEMIZATION IN A DATABASE; INFORMATION RESEARCH IN COMPUTER FILES, NAMELY, PROVIDING RATINGS VIA A GLOBAL COMPUTER NETWORK FOR HOME PRODUCTS AND SERVICES RECOMMENDED BY CONSUMERS; DATA PROCESSING SERVICES FOR MANAGING PRODUCT DATA AND COMPILATION AND SYSTEMIZATION OF PRODUCT DATA INTO COMPUTER DATABASES; DATA PROCESSING SERVICES FOR MANAGING PRODUCT INTERACTION DATA AND COMPILATION AND SYSTEMIZATION OF PRODUCT INTERACTION DATA INTO COMPUTER DATABASES; ADVERTISING SERVICES FOR DEFINING, MANAGING, DISPLAYING AND THE ACCOUNTING OF ADVERTISING CAMPAIGNS, COUPONS AND MONETIZATION MECHANISMS IN THE NATURE OF DISCOUNTS, REBATES, VOUCHERS AND SPECIAL OFFERS; COMPUTERIZED FILE MANAGEMENT, IN CLASS 35 (U.S. CLS. 100, 101 AND 102).

FOR: DESIGN AND DEVELOPMENT OF COMPUTERS AND SOFTWARE; UPDATING OF COMPUTER SOFTWARE; RENTAL OF COMPUTER SOFTWARE; COMPUTER SOFTWARE DESIGN; DESIGN OF COMPUTER DATABASES; RENTAL AND MAINTENANCE, FOR OTHERS, OF STORAGE SPACE FOR USE AS WEBSITES, NAMELY, HOSTING WEBSITES FOR OTHERS; MAINTENANCE OF WEBSITES FOR OTHERS; PROVIDING OF AN INTERNET PLATFORM, NAMELY, PROVIDING AN ONLINE, NON-DOWNLOADABLE, INTERNET-BASED SOFTWARE APPLICATION USED FOR THE IDENTIFICATION OF AND INTERACTION WITH GOODS AND OBJECTS BY READING BARCODES, ANALYZING AN IMAGE OF THE PRODUCT, A VOICE COMMAND, A TEXT-BASED SEARCH OR A RADIO FREQUENCY SIGNAL, TO OBTAIN, ORGANIZE AND SHARE INFORMATION ABOUT GOODS

Reg. No. 4,065,254 AND FOR COMPARING AND EVALUATING GOODS; PROVIDING SEARCH ENGINES FOR THE INTERNET; PROVIDING HYPERLINKS FOR CONSULTING DATA AND OBTAINING INFORMATION THROUGH GLOBAL NETWORKS, NAMELY, PROVIDING CUSTOMIZED ON-LINE WEB PAGES FEATURING USER-DEFINED INFORMATION, WHICH INCLUDES SEARCH ENGINES AND ON-LINE WEB LINKS TO OTHER WEB SITES; RENTAL OF WEB SERVERS; SERVICES PROVIDED BY DESIGNERS, IN PARTICULAR BY WEB SITE DESIGNERS, NAMELY, WEBSITE DESIGN AND DEVELOPMENT FOR OTHERS, IN CLASS 42 (U.S. CLS. 100 AND 101).

THE MARK CONSISTS OF STANDARD CHARACTERS WITHOUT CLAIM TO ANY PARTICULAR FONT, STYLE, SIZE, OR COLOR.

PRIORITY DATE OF 4-19-2010 IS CLAIMED.

OWNER OF INTERNATIONAL REGISTRATION 1058532 DATED 10-13-2010, EXPIRES 10-13-2020.

THE WORDING "SCANDIT" HAS NO MEANING IN A FOREIGN LANGUAGE.

SER. NO. 79-090,064, FILED 10-13-2010.

TINA BROWN, EXAMINING ATTORNEY

United States of America

United States Patent and Trademark Office



drivania

Reg. No. 4,065,255

Registered Dec. 6, 2011

Int. Cl.: 39

DRIVANIA INTERNATIONAL, S.L. (SPAIN SOCIEDAD DE RESPONSABILIDAD LIMITADA (SL))
C/ FRANCESC VIÑAS, 3-B
E-08174 SANT CUGAT DEL VALLES
BARCELONA, SPAIN

SERVICE MARK

PRINCIPAL REGISTER

FOR: TRANSPORT SERVICES, NAMELY, TAXI TRANSPORT SERVICES; CHAUFFEUR DRIVEN CAR HIRE SERVICES; PARCEL DELIVERY AND SHIPPING SERVICES; CONFIDENTIAL PARCEL DELIVERY AND SHIPPING SERVICES; TRAVEL GUIDE SERVICES; TOUR GUIDE SERVICES; ORGANIZATION OF CULTURAL TRIPS; ORGANIZATION OF EXCURSIONS; PACKAGING FOR TRANSPORT AND STORAGE OF GOODS; TRAVEL ARRANGEMENT, IN CLASS 39 (U.S. CLS. 100 AND 105).

THE MARK CONSISTS OF FIVE GREEN TRIANGULAR SHAPES ARRANGED IN A CIRCLE ABOVE THE WORD "DRIVANIA" IN BLACK LETTERS. THE ENTIRE MARK IS SET AGAINST A WHITE BACKGROUND.

OWNER OF INTERNATIONAL REGISTRATION 0974875 DATED 2-11-2008, EXPIRES 2-11-2018.

THE COLOR(S) GREEN, WHITE AND BLACK IS/ARE CLAIMED AS A FEATURE OF THE MARK.

THE WORDING "DRIVANIA" HAS NO MEANING IN A FOREIGN LANGUAGE.

SER. NO. 79-090,123, FILED 10-1-2010.

RENEE SERVANCE, EXAMINING ATTORNEY



David J. Kyros

Director of the United States Patent and Trademark Office

United States of America

United States Patent and Trademark Office



LYONESS
Your Cashback Company

Reg. No. 4,065,256

Registered Dec. 6, 2011

Int. Cls.: 9, 35, 36 and 41

TRADEMARK

SERVICE MARK

PRINCIPAL REGISTER

LYONESS AUSTRIA GMBH (AUSTRIA LIMITED LIABILITY COMPANY)
GEWERBEPARK 2
A-8565 ST. JOHANN OB HOHENBURG, AUSTRIA

FOR: MAGNETIC DATA CARRIERS, NAMELY, ENCODED MAGNETIC CARDS, MAGNETIC ENCODED CARDS AND CARDS FOR PERSONAL IDENTIFICATION OF INDIVIDUAL LYONESS CUSTOMERS; AUTOMATIC VENDING MACHINES AND MECHANISMS FOR COIN OPERATED APPARATUS, IN CLASS 9 (U.S. CLS. 21, 23, 26, 36 AND 38).

FOR: ADVERTISING, IN PARTICULAR ADVERTISING FOR ALL KINDS OF GOODS AND FOR CREDIT NOTES AND CASHLESS MEANS OF PAYMENT; PROCUREMENT OF COMMERCIAL TRANSACTIONS AND SERVICES OF PARTICIPATING LYONESS PARTNER BUSINESSES BY GRANTING PARTIAL MONETARY REIMBURSEMENT TO THOSE CUSTOMERS' ACCOUNTS, WHO SHOP AT THESE PARTICIPATING LYONESS PARTNER BUSINESSES; BUSINESS MANAGEMENT; PROVIDING OFFICE FUNCTIONS; CONSULTANCY IN BUSINESS ORGANIZATION; CONSULTANCY FOR BUSINESS MANAGEMENT; PUBLIC RELATIONS; PUBLICATION OF ADVERTISING TEXTS; PROMOTION OF THE SALES OF GOODS AND SERVICES OF THIRD PARTIES INCLUDING BY MEANS OF ADVERTISEMENT, SALE PROMOTING COMPETITIONS, DISCOUNTS AND OTHER INCENTIVES SUCH AS DRAWINGS, DISCOUNTS, BONUS POINTS AND SURPLUS VALUE OFFERS, IN CLASS 35 (U.S. CLS. 100, 101 AND 102).

FOR: FINANCIAL AFFAIRS, NAMELY, PROVIDING CASH AND OTHER REBATES AS PART OF A CUSTOMER LOYALTY PROGRAM AND GRANTING OF MONETARY REIMBURSEMENT TO THE ACCOUNT OF LYONESS CUSTOMERS WHEN SHOPPING AT PARTICIPATING LYONESS PARTNER BUSINESSES; MONETARY AFFAIRS IN THE NATURE OF PROVIDING CASH AND OTHER REBATES AS PART OF A CUSTOMER LOYALTY PROGRAM, NAMELY, GRANTING OF MONETARY REIMBURSEMENT TO THE ACCOUNT OF LYONESS CUSTOMERS WHEN SHOPPING AT PARTICIPATING LYONESS PARTNER BUSINESSES; PROVIDING REBATES AS PART OF A CUSTOMER LOYALTY PROGRAM AND LOYALTY COUPON PAYMENT PROCESSING SERVICES, NAMELY, PROVIDING, ISSUING AND PROCESSING OF CREDIT NOTES AND CASHLESS MEANS OF PAYMENT, NAMELY, COUPON PAYMENTS THROUGH SALES AGENCIES AND COUPON PAYMENTS OF LYONESS AND LYONESS PARTNER BUSINESSES THROUGH ADVERTISING; ALL THE ABOVE SERVICES DO NOT INCLUDE LOAN PROCUREMENT, PRIVATE EQUITY FINANCING, VENTURE CAPITAL INVESTMENT AND UNDERWRITING



David J. Kyros

Director of the United States Patent and Trademark Office

Reg. No. 4,065,256 LIFE, ANNUITY, ACCIDENT AND DISABILITY INSURANCE, IN CLASS 36 (U.S. CLS. 100, 101 AND 102).

FOR: EDUCATION SERVICES, NAMELY, PROVIDING CLASSES AND TRAINING IN THE FIELDS OF CONSUMER PROMOTION AND ADVERTISING, IN CLASS 41 (U.S. CLS. 100, 101 AND 107).

OWNER OF U.S. REG. NO. 3,832,196.

PRIORITY DATE OF 4-21-2010 IS CLAIMED.

OWNER OF INTERNATIONAL REGISTRATION 1058753 DATED 7-8-2010, EXPIRES 7-8-2020.

THE COLOR(S) BLUE AND GOLD IS/ARE CLAIMED AS A FEATURE OF THE MARK.

NO CLAIM IS MADE TO THE EXCLUSIVE RIGHT TO USE "YOUR CASHBACK COMPANY", APART FROM THE MARK AS SHOWN.

THE MARK CONSISTS OF THREE GOLD INTERLOCKING INCOMPLETE TRIANGLES FORMING AN OVERALL TRIANGULAR SHAPE, WITH THE BLUE STYLIZED WORDING "LYONESS" ABOVE THE BLUE STYLIZED WORDING "YOUR CASHBACK COMPANY".

SER. NO. 79-090,144, FILED 7-8-2010.

SCOTT BIBB, EXAMINING ATTORNEY

United States of America

United States Patent and Trademark Office



LYONESS

Reg. No. 4,065,257

Registered Dec. 6, 2011

Int. Cls.: 9, 35, 36 and 41

TRADEMARK

SERVICE MARK

PRINCIPAL REGISTER

LYONESS AUSTRIA GMBH (AUSTRIA LIMITED LIABILITY COMPANY)
GEWERBEPARK 2
A-8565 ST. JOHANN OB HOHENBURG, AUSTRIA

FOR: MAGNETIC DATA CARRIERS, NAMELY, ENCODED MAGNETIC CARDS, MAGNETIC ENCODED CARDS AND CARDS FOR PERSONAL IDENTIFICATION OF INDIVIDUAL LYONESS CUSTOMERS; AUTOMATIC VENDING MACHINES AND MECHANISMS FOR COIN OPERATED APPARATUS, IN CLASS 9 (U.S. CLS. 21, 23, 26, 36 AND 38).

FOR: ADVERTISING, IN PARTICULAR ADVERTISING FOR ALL KINDS OF GOODS AND FOR CREDIT NOTES AND CASHLESS MEANS OF PAYMENT; PROCUREMENT OF COMMERCIAL TRANSACTIONS AND SERVICES OF PARTICIPATING LYONESS PARTNER BUSINESSES BY GRANTING PARTIAL MONETARY REIMBURSEMENT TO THOSE CUSTOMERS' ACCOUNTS, WHO SHOP AT THESE PARTICIPATING LYONESS PARTNER BUSINESSES; BUSINESS MANAGEMENT; PROVIDING OFFICE FUNCTIONS; CONSULTANCY IN BUSINESS ORGANIZATION; CONSULTANCY FOR BUSINESS MANAGEMENT; PUBLIC RELATIONS; PUBLICATION OF ADVERTISING TEXTS; PROMOTION OF THE SALES OF GOODS AND SERVICES OF THIRD PARTIES INCLUDING BY MEANS OF ADVERTISEMENT, SALE PROMOTING COMPETITIONS, DISCOUNTS AND OTHER INCENTIVES SUCH AS DRAWINGS, DISCOUNTS, BONUS POINTS AND SURPLUS VALUE OFFERS, IN CLASS 35 (U.S. CLS. 100, 101 AND 102).



FOR: FINANCIAL AFFAIRS, NAMELY, PROVIDING CASH AND OTHER REBATES AS PART OF A CUSTOMER LOYALTY PROGRAM AND GRANTING OF MONETARY REIMBURSEMENT TO THE ACCOUNT OF LYONESS CUSTOMERS WHEN SHOPPING AT PARTICIPATING LYONESS PARTNER BUSINESSES; MONETARY AFFAIRS IN THE NATURE OF PROVIDING CASH AND OTHER REBATES AS PART OF A CUSTOMER LOYALTY PROGRAM, NAMELY, GRANTING OF MONETARY REIMBURSEMENT TO THE ACCOUNT OF LYONESS CUSTOMERS WHEN SHOPPING AT PARTICIPATING LYONESS PARTNER BUSINESSES; PROVIDING REBATES AS PART OF A CUSTOMER LOYALTY PROGRAM AND LOYALTY COUPON PAYMENT PROCESSING SERVICES, NAMELY, PROVIDING, ISSUING AND PROCESSING OF CREDIT NOTES AND CASHLESS MEANS OF PAYMENT, NAMELY, COUPON PAYMENTS THROUGH SALES AGENCIES AND COUPON PAYMENTS OF LYONESS AND LYONESS PARTNER BUSINESSES THROUGH ADVERTISING; ALL THE ABOVE SERVICES DO NOT INCLUDE LOAN PROCUREMENT, PRIVATE EQUITY FINANCING, VENTURE CAPITAL INVESTMENT AND UNDERWRITING

David J. Kyros

Director of the United States Patent and Trademark Office

Reg. No. 4,065,257 LIFE, ANNUITY, ACCIDENT AND DISABILITY INSURANCE, IN CLASS 36 (U.S. CLS. 100, 101 AND 102).

FOR: EDUCATION SERVICES, NAMELY, PROVIDING CLASSES AND TRAINING IN THE FIELDS OF CONSUMER PROMOTION AND ADVERTISING, IN CLASS 41 (U.S. CLS. 100, 101 AND 107).

OWNER OF U.S. REG. NO. 3,832,196.

PRIORITY DATE OF 4-22-2010 IS CLAIMED.

OWNER OF INTERNATIONAL REGISTRATION 1058896 DATED 7-8-2010, EXPIRES 7-8-2020.

THE COLOR(S) BLUE AND GOLD IS/ARE CLAIMED AS A FEATURE OF THE MARK.

THE MARK CONSISTS OF THREE GOLD INTERLOCKING INCOMPLETE TRIANGLES FORMING AN OVERALL TRIANGULAR SHAPE, WITH THE BLUE STYLIZED WORDING "LYONESS" TO THE RIGHT OF THE DESIGN.

SER. NO. 79-090,190, FILED 7-8-2010.

SCOTT BIBB, EXAMINING ATTORNEY

United States of America

United States Patent and Trademark Office

Glass-Alliance

Reg. No. 4,065,258

Registered Dec. 6, 2011

Int. Cls.: 7, 11, 37 and 42

MSK-VERPACKUNGS-SYSTEME GESELLSCHAFT MIT BESCHRÄNKTER HAFTUNG (FED
REP GERMANY GESELLSCHAFT MIT BESCHRÄNKTER HAFTUNG)
BENZSTRASSE
47533 KLEVE
FED REP GERMANY

TRADEMARK

SERVICE MARK

PRINCIPAL REGISTER

FOR: INSTALLATIONS FOR GLASS MANUFACTURING, GLASS PROCESSING AND GLASS PACKAGING, NAMELY, MACHINES FOR HANDLING RAW MATERIALS FOR USE IN GLASS MANUFACTURING, GLASS FORMING MACHINES, GLASS INTERNAL TREATMENT MACHINES, GLASS PRODUCT INSPECTION EQUIPMENT, GLASS PACKAGING EQUIPMENT, GLASS LABELING MACHINES, GLASS COATING MACHINES, COMPRESSORS USED IN GLASS MANUFACTURING AND PROCESSING, COOLING TOWERS USED IN GLASS MANUFACTURING AND PROCESSING; MACHINE TOOLS, NAMELY, GLASS MANUFACTURING MACHINE TOOLS, GLASS PROCESSING MACHINE TOOLS AND GLASS PACKAGING MACHINE TOOLS; MOTORS AND ENGINES EXCEPT FOR LAND VEHICLES; MACHINE COUPLING AND TRANSMISSION COMPONENTS EXCEPT FOR LAND VEHICLES; INSTALLATIONS FOR THE PACKAGING INDUSTRY, IN PARTICULAR FOR PROCESSING FILMS FOR PACKAGING, MAINLY CONSISTING OF PACKING MACHINES AND CONVEYORS, IN PARTICULAR BELT CONVEYORS AND ROLLER CONVEYORS; PACKAGING MACHINES, IN PARTICULAR FOR PROCESSING FILMS FOR PACKAGING AND MANUFACTURING CARDBOARD ARTICLES; CONVEYORS, IN PARTICULAR BELT CONVEYORS AND ROLLER CONVEYORS, IN CLASS 7 (U.S. CLS. 13, 19, 21, 23, 31, 34 AND 35).



FOR: APPARATUS FOR LIGHTING, HEATING, STEAM GENERATING, COOKING, REFRIGERATING, DRYING, VENTILATING, WATER SUPPLY AND SANITARY PURPOSES, NAMELY, ANNEALING OVENS AND ANNEALING FURNACES; FURNACES, IN PARTICULAR FOR GLASS MANUFACTURING AND GLASS PROCESSING, IN CLASS 11 (U.S. CLS. 13, 21, 23, 31 AND 34).

FOR: BUILDING CONSTRUCTION; INSTALLATION AND REPAIR OF COMPONENTS OR OF COMPLETE EQUIPMENT FOR GLASS MANUFACTURING AND GLASS PROCESSING, INCLUDING IN THE SUB-FIELDS OF THE MIXING OF RAW MATERIALS AND SMELTING, AND OF PACKAGING MACHINES; REPAIR AND MAINTENANCE OF GLASS MANUFACTURING, GLASS PROCESSING AND GLASS PACKAGING EQUIPMENT, INCLUDING FOR THE PURPOSE OF MODERNIZATION AND OPTIMIZATION; INSTALLATION OF SEMI-ASSEMBLED GLASS-MELTING FURNACES, GLASS FORMING MACHINES, INTERNAL

David J. Kybas

Director of the United States Patent and Trademark Office

Reg. No. 4,065,258 TREATMENT MACHINES, GLASS INSPECTION EQUIPMENT, SECONDARY GLASS PROCESSING EQUIPMENT, NAMELY, LABELING MACHINES AND APPLIED CERAMIC LABELING MACHINES, PACKAGING MACHINES, COATING MACHINES, COOLING TOWERS, COMPRESSORS, NAMELY, COMPRESSORS UTILIZED IN GLASS MANUFACTURING PROCESSING, IN CLASS 37 (U.S. CLS. 100, 103 AND 106).

FOR: TECHNICAL CONSULTATION IN THE FIELD OF GLASS MANUFACTURING, GLASS PROCESSING AND GLASS PACKAGING; RESEARCH AND DEVELOPMENT OF TECHNOLOGY IN THE FIELD OF GLASS MANUFACTURING, GLASS PROCESSING AND GLASS PACKAGING; INDUSTRIAL RESEARCH IN THE FIELD OF GLASS MANUFACTURING GLASS PROCESSING AND GLASS PACKAGING; INDUSTRIAL DESIGN IN THE FIELD OF GLASS MANUFACTURING, GLASS PROCESSING AND GLASS PACKAGING; DESIGN AND DEVELOPMENT OF COMPUTER HARDWARE AND SOFTWARE, IN CLASS 42 (U.S. CLS. 100 AND 101).

THE MARK CONSISTS OF STANDARD CHARACTERS WITHOUT CLAIM TO ANY PARTICULAR FONT, STYLE, SIZE, OR COLOR.

PRIORITY DATE OF 12-22-2009 IS CLAIMED.

OWNER OF INTERNATIONAL REGISTRATION 1058915 DATED 6-21-2010, EXPIRES 6-21-2020.

SER. NO. 79-090,200, FILED 6-21-2010.

LINDA M. KING, EXAMINING ATTORNEY

United States of America

United States Patent and Trademark Office

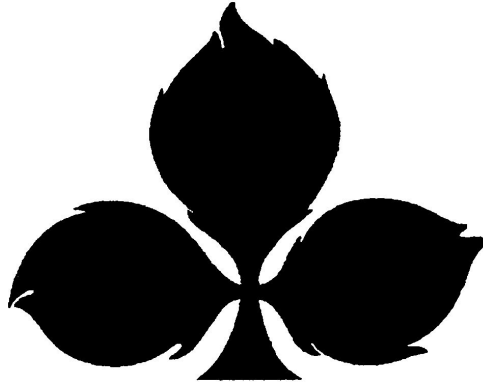

Reg. No. 4,065,259
Registered Dec. 6, 2011
Int. Cls.: 14, 18 and 25

TRADEMARK

PRINCIPAL REGISTER

YUGEN KAISHA MANDOLIN GOGO DESIGN WORKS (JAPAN CORPORATION)
1-17-8 KAMIMEGURO,
MEGURO-KU; TOKYO 153-0051
JAPAN

FOR: PRECIOUS METALS; KEY RINGS OF PRECIOUS METAL; JEWEL CASES OF PRECIOUS METAL; PERSONAL ORNAMENTS OF PRECIOUS METAL OTHER THAN CUFF LINKS; EARRINGS; INSIGNIAS OF PRECIOUS METAL; BADGES OF PRECIOUS METAL; BONNET PINS OF PRECIOUS METAL; TIE CLIPS; TIE PINS; NECKLACES; BRACELETS; PENDANTS; GEM BROOCHES; MEDALS; RINGS; MEDALLIONS; UNWROUGHT AND SEMI-WROUGHT PRECIOUS STONES AND THEIR IMITATIONS; CLOCKS AND WATCHES; PARTS OF CLOCKS AND WATCHES, IN CLASS 14 (U.S. CLS. 2, 27, 28 AND 50).

FOR: HANDBAG FRAMES; PURSE FRAMES; HORSESHOES; INDUSTRIAL PACKAGING CONTAINERS OF LEATHER; ALL-PURPOSE CARRYING BAGS; FOLDING BRIEFCASES; SHOULDER BAGS; GLADSTONE BAGS; KORI WICKERTRUNKS; BRIEFCASES; SUITCASES; CARRY-ON BAGS; TRUNKS; HANDBAGS; BOSTON BAGS; SCHOOLCHILDREN'S BACKPACKS; BACKPACKS; RUCKSACKS; LEATHER POUCHES; CHARM BAGS (OMAMORI-IRE); BANKNOTE HOLDERS; REUSABLE SHOPPING BAGS; WHEELED SHOPPING BAGS; PURSES; KEY CASES; WALLETS; JAPANESE UTILITY POUCHES (SHINGEN-BUKURO); WALLET FOR USE AS COMMUTATION-TICKET HOLDERS; BUSINESS CARD CASES; VANITY CASES SOLD EMPTY; UMBRELLAS AND THEIR PARTS; RAWHIDES; RAW SKINS; TANNED LEATHER; FUR SOLD IN BULK, IN CLASS 18 (U.S. CLS. 1, 2, 3, 22 AND 41).



David J. Kybas

Director of the United States Patent and Trademark Office

FOR: NON-JAPANESE STYLE OUTERWEAR, NAMELY, TOPS, DRESSES, BEACHWEAR, REMOVABLE COLLARS, PANTS, GYM SHORTS, GYM SUITS, SPORTS JERSEYS, UNIFORMS, BREECHES, JUMPERS, LEGGINGS, OVERALLS, SARIS, STUFF JACKETS; OUTER CLOTHING, NAMELY, COATS, JACKETS AND PARKAS; EVENING DRESSES; SCHOOL UNIFORMS; CHILDREN'S WEAR, NAMELY, JUMPERS, OVERALL SLEEPWEAR, PAJAMAS, ROMPERS, ONE-PIECE GARMENTS, CLOTH BIBS, HEADWEAR, HATS, HOODED SWEATSHIRTS, LEOTARDS, TIGHTS, SHIRTS, SWEATSHIRTS, T-SHIRTS, BABY BODYSUITS, BABY BOTTOMS, BABY DOLL PAJAMAS, BABY LAYETTES FOR CLOTHING, BABY TOPS, COATS, TOPCOATS, OVERCOATS, FROCKS, JACKETS, STUFF JACKETS, OUTER JACKETS, PANTS, TROUSERS, BREECHES FOR WEAR, LEGGINGS, OVERALLS, PARKAS, SARIS, SKIRTS, SMOCKS, SUITS, APRONS, COLLAR PROTECTORS, INFANT DIAPER COVERS, SHAWLS, SINGLETs, SCARFS, SWEATERS, SOCKS, TIGHTS, PAJAMAS,

Reg. No. 4,065,259 PULLOVERS, VESTS, WAISTCOATS, BOAS, MITTENS, HOSIERY, BIBS NOT OF PAPER, BODY LINEN, UNDERWEAR, PERSPIRATION ABSORBENT UNDERWEAR CLOTHING, SHOULDER WRAPS, EARMUFFS, GLOVES, BATHING UNDERWEAR, BATHING SUITS, BATHING CAPS, BATHING TRUNKS, MUFFS, FUR STOLES, BEACH CLOTHES, COLLARS, REMOVABLE COLLARS, ADHESIVE POCKETS THAT MAY BE AFFIXED DIRECTLY TO THE BODY AS A DECORATIVE PIECE OF CLOTHING WITH UTILITY, ADHESIVE POCKETS THAT MAY BE AFFIXED DIRECTLY TO THE INSIDE OF CLOTHING FOR STORAGE AND SAFEKEEPING OF PERSONAL ITEMS, GYM SHORTS, GYM SUITS, SPORTS JERSEYS, UNIFORMS; WORKING CLOTHING, NAMELY, LIVERIES, OVERALLS; JACKETS; JOGGING PANTS; SWEAT PANTS; SUITS; SKIRTS; SKI JACKETS; SKI PANTS; TROUSERS; SMOCKS; FORMAL WEAR, NAMELY, TAILCOATS, MORNING COATS, TUXEDOS, DIRECTOR'S SUITS, BLACK LOUNGE SUITS, DINNER SUITS, DRESS SUITS, WOMEN'S CEREMONIAL DRESSES, AFTERNOON DRESSES, EVENING DRESSES, SEMI-FORMAL DRESSES, GOWNS, EVENING GOWNS, COCKTAIL DRESSES, DINNER DRESSES, FROCKS; COATS; OVERCOATS; TOPCOATS; MANTLES; RAINCOATS; SWEATERS; CARDIGANS; VESTS AND WAISTCOATS; SHIRTS; OPEN-NECKED SHIRTS; CUFFS; COLLARS FOR CLOTHING; SPORT SHIRTS; BLOUSES; POLO SHIRTS; SHIRTS FOR SUITS; NIGHTWEAR; UNDERWEAR; SWIMWEAR; BATHING SUITS; SWIMMING CAPS; BATHING CAPS; STEEP MASKS; APRONS FOR CLOTHING; COLLAR PROTECTORS FOR WEAR; SOCKS AND STOCKINGS; PUTTEES AND GAITERS; FUR STOLES; SHAWLS; SCARVES; JAPANESE STYLE SOCKS (TABI); JAPANESE STYLE SOCKS COVERS (TABI COVERS); GLOVES AND MITTENS FOR CLOTHING; BABIES' DIAPERS OF TEXTILE; NECKTIES; BANDANAS; NECKERCHIEFS; WARMTH-KEEPING SUPPORTS, NAMELY, BOAS, LEG WARMERS, THERMAL SOCKS, MUFF, PELENERINES, SHOULDER WRAPS, FOOTMUFFS NOT ELECTRICALLY HEATED, SPATS; MUFFLERS; EAR MUFF FOR CLOTHING; HOODS; SEDGE HATS (SUGE-GASA); NIGHTCAPS; HATS; HEAT-PROTECTION HELMETS FOR CLOTHING, NAMELY, SKULL CAPS, CAPS, HATS, BANDANAS, CAP PEAKS, VISORS, SUN VISORS, HOODS; GARTERS; SOCK SUSPENDERS; BRACES FOR CLOTHING; SUSPENDERS; WAISTBANDS; BELTS FOR CLOTHING, SHOES AND BOOTS OTHER THAN SHOE DOWELS, SHOE PEGS, SHOE HANDLES, HOBNAI LS AND SHOE PROTECTIVE METAL MEMBERS; ANORAKS; KARATE SUITS; SPORTS OVERUNIFORMS; KENDO OUTFITS; JUDO SUITS; SKI SUITS FOR COMPETITION; HEADBANDS FOR CLOTHING; WIND-JACKETS; UNIFORMS AND STOCKINGS FOR SPECIAL SPORTSWEAR; WRIST-BANDS; BOOTS FOR SPORTS OTHER THAN HORSE-RIDING BOOTS; GOLF SHOES, SOCCER SHOES; SKI BOOTS; GYMNASTIC SHOES, TENNIS SHOES; CLIMBING BOOTS; MOUNTAINEERING BOOTS; BASKETBALL SNEAKERS; VOLLEYBALL SHOES; HANDBALL SHOES; BOWLING SHOES; BOXING SHOES; HOCKEY SHOES; BASEBALL SHOES; RUGBY SHOES; FOOTWEAR FOR TRACK AND FIELD ATHLETICS, IN CLASS 25 (U.S. CLS. 22 AND 39).

THE MARK CONSISTS OF A STYLIZED CLOVER.

PRIORITY DATE OF 1-12-2010 IS CLAIMED.

OWNER OF INTERNATIONAL REGISTRATION 1058923 DATED 7-9-2010, EXPIRES 7-9-2020.

SER. NO. 79-090,203, FILED 7-9-2010.

LINDA M. KING, EXAMINING ATTORNEY

United States of America
United States Patent and Trademark Office

SILCO

Reg. No. 4,065,260

Registered Dec. 6, 2011

Int. Cl.: 9

TRADEMARK

PRINCIPAL REGISTER

ANSALDO SISTEMI INDUSTRIALI S.P.A. (ITALY JOINT-STOCK COMPANY)
VIALE SARCA, 336
I-20126 MILANO MI
ITALY

FOR: STATIC ALTERNATING CURRENT THYRISTORS FOR DIRECT CURRENT FOR REGULATING ELECTRICAL ENGINES AT VARIABLE VELOCITY, IN CLASS 9 (U.S. CLS. 21, 23, 26, 36 AND 38).

THE MARK CONSISTS OF STANDARD CHARACTERS WITHOUT CLAIM TO ANY PARTICULAR FONT, STYLE, SIZE, OR COLOR.

PRIORITY DATE OF 10-14-2010 IS CLAIMED.

OWNER OF INTERNATIONAL REGISTRATION 1059198 DATED 10-29-2010, EXPIRES 10-29-2020.

THE WORDING "SILCO" HAS NO MEANING IN A FOREIGN LANGUAGE.

SER. NO. 79-090,275, FILED 10-29-2010.

MICHAEL SOUDERS, EXAMINING ATTORNEY



David J. Kyffers

Director of the United States Patent and Trademark Office

United States of America

United States Patent and Trademark Office

A.Y. CROWN

Reg. No. 4,065,261

Registered Dec. 6, 2011

**Int. Cls.: 9, 14, 18, 24, 25
and 26**

TRADEMARK

PRINCIPAL REGISTER

SHANGHAI A.Y.CROWN SPORTS GOODS CO., LTD. (CHINA LIMITED COMPANY)
1ST FLOOR, NO. 369
WEST ZHIJIANG ROAD; SHANGHAI
CHINA

FOR: EYEGLASSES; SWIMMING FLOAT BELTS FOR SAFETY PURPOSES; COMPUTER PERIPHERAL DEVICES; TIME RECORDING APPARATUS; VENDING MACHINES; GALVANIC BATTERY CELLS; FLAT IRONS, ELECTRIC; CONNECTIONS FOR ELECTRIC LINES; SURVEYING MACHINES AND INSTRUMENTS; BLANK COMPACT DISCS; SATELLITE NAVIGATIONAL APPARATUS, NAMELY, GLOBAL POSITIONING SYSTEM, ELECTRIC NAVIGATIONAL INSTRUMENTS, CAR NAVIGATION COMPUTERS, SATELLITE DISHES, IN CLASS 9 (U.S. CLS. 21, 23, 26, 36 AND 38).

FOR: PRECIOUS METALS, UNWROUGHT OR SEMI-WROUGHT; JEWELRY CASKETS, NAMELY, JEWELRY CASES; SILVER ORNAMENTS; JEWELRY, NAMELY, BRACELETS AND NECKLACES; JEWELLERY; JEWELRY, NAMELY, JADE; JEWELRY, NAMELY, RINGS MADE FROM HORN, BONE AND TEETH; CLOCKS; WATCHES, IN CLASS 14 (U.S. CLS. 2, 27, 28 AND 50).

FOR: PURSES; SCHOOL SACHELS; BACKPACKS; POCKET WALLETS; HANDBAGS; VALISES; BRIEFCASES; LEATHERWARE, NAMELY, KEY CASES AND TRUNKS; CLOTHING FOR PETS; UMBRELLAS; MOUNTAINEERING STICKS; ANIMAL SKINS; RE-USABLE SHOPPING BAGS; IMITATION LEATHER, IN CLASS 18 (U.S. CLS. 1, 2, 3, 22 AND 41).

FOR: CLOTH, NAMELY, COTTON CLOTH, LINEN CLOTH, SILK CLOTH, WASH CLOTHS, DISH CLOTHS; FABRIC FOR TEXTILE USE; TEXTILE SUBSTITUTE MATERIAL MADE FROM PLASTIC MATERIAL; WALL HANGINGS OF TEXTILE; TOWELS OF TEXTILE; TOWEL QUILTS; BED CLOTHES, NAMELY, BED BLANKETS, BED SHEETS, BED SPREADS; BED LINEN; CURTAINS OF TEXTILE OR PLASTIC; UNFITTED LOOSE FABRIC COVERS FOR FURNITURE; WASHING MITTS, IN CLASS 24 (U.S. CLS. 42 AND 50).

FOR: CLOTHING, NAMELY, SHIRTS, PANTS, DRESSES; OVERALLS; SPORTS JERSEYS; CLOTHING, NAMELY, LAYETTES; SHOES; HATS; HOSIERY; CLOTHING, NAMELY, GLOVES; SCARFS; CLOTHING, NAMELY, BELTS; NECKTIES; WEDDING GOWNS; SWIMSUITS; WATERPROOF CLOTHING, NAMELY, WATERPROOF JACKETS, WATER-PROOF PANTS, WATERPROOF FOOTWEAR; MASQUERADE COSTUMES; CHILDREN'S



David J. Kybas

Director of the United States Patent and Trademark Office

Reg. No. 4,065,261 CLOTHING, NAMELY, JUMPERS, OVERALL SLEEPWEAR, PAJAMAS, ROMPERS AND ONE-PIECE GARMENTS; GIRDLES, IN CLASS 25 (U.S. CLS. 22 AND 39).

FOR: HAIR ORNAMENTS; BELT CLASPS; ZIP FASTENERS; BUTTONS; FALSE HAIR; NEEDLES; ARTIFICIAL FLOWERS; SHOULDER PADS FOR CLOTHING; HEAT ADHESIVE PATCHES FOR REPAIRING TEXTILE ARTICLES; NON-TEXTILE NUMERALS FOR MARKING LINEN; TEA COSIES; EMBROIDERY, IN CLASS 26 (U.S. CLS. 37, 39, 40, 42 AND 50).

THE MARK CONSISTS OF THE STYLIZED WORD "A.Y.CROWN"; THE FIVE LETTER "O" OF THE WORD "A.Y.CROWN" APPEARS AS A CROWN DESIGN.

PRIORITY DATE OF 2-20-2010 IS CLAIMED.

OWNER OF INTERNATIONAL REGISTRATION 1059276 DATED 7-20-2010, EXPIRES 7-20-2020.

THE WORDING "A.Y". HAS NO MEANING IN A FOREIGN LANGUAGE.

SER. NO. 79-090,296, FILED 7-20-2010.

KRISTIN CARLSON, EXAMINING ATTORNEY

United States of America
United States Patent and Trademark Office

Solivia

Reg. No. 4,065,262

Registered Dec. 6, 2011

Int. Cl.: 9

DELTA ENERGY SYSTEMS GMBH (FED REP GERMANY GMBH (GESELLSCHAFT MIT
BESCHRÄNKTER HAFTUNG))
TSCHEULINSTR. 21
79331 TENINGEN
FED REP GERMANY

TRADEMARK

PRINCIPAL REGISTER

FOR: INVERTERS, IN PARTICULAR FOR SOLAR ENERGY; ENERGY SUPPLY UNITS WORKING ON THE BASIS OF REGENERATIVE ENERGIES, NAMELY, SOLAR CELLS, PHOTOVOLTAIC SOLAR MODULES FOR PRODUCTION OF ELECTRICITY, PHOTOVOLTAIC CELLS ALSO INCLUDING A SOLAR THERMAL COLLECTOR SOLD AS A UNIT, AND PHOTOVOLTAIC INSTALLATION APPARATUS, NAMELY, SOLAR MODULES FOR PRODUCTION OF ELECTRICITY, SOLAR THERMAL AND ELECTRIC RECEIVERS, TRACKING MECHANISMS AND CONCENTRATING OPTICS, AND CONTROL ALGORITHMS, ELECTRICAL SWITCHES, ELECTRICAL TRANSFORMERS, ELECTRIC ACCUMULATORS, VOLTAGE REGULATORS, AND ELECTRICAL CONTROLLERS, IN CLASS 9 (U.S. CLS. 21, 23, 26, 36 AND 38).

THE MARK CONSISTS OF STANDARD CHARACTERS WITHOUT CLAIM TO ANY PARTICULAR FONT, STYLE, SIZE, OR COLOR.

OWNER OF INTERNATIONAL REGISTRATION 1059425 DATED 10-6-2010, EXPIRES 10-6-2020.

SER. NO. 79-090,336, FILED 10-6-2010.

JOHN DWYER, EXAMINING ATTORNEY



David J. Kyros

Director of the United States Patent and Trademark Office

United States of America

United States Patent and Trademark Office

SILCO VERT

Reg. No. 4,065,263

Registered Dec. 6, 2011

Int. Cl.: 9

ANSALDO SISTEMI INDUSTRIALI S.P.A. (ITALY JOINT-STOCK COMPANY)
VIALE SARCA, 336
I-20126 MILANO MI
ITALY

FOR: INVERTERS, IN CLASS 9 (U.S. CLS. 21, 23, 26, 36 AND 38).

TRADEMARK

THE MARK CONSISTS OF STANDARD CHARACTERS WITHOUT CLAIM TO ANY PARTICULAR FONT, STYLE, SIZE, OR COLOR.

PRINCIPAL REGISTER

PRIORITY DATE OF 10-14-2010 IS CLAIMED.

OWNER OF INTERNATIONAL REGISTRATION 1059495 DATED 10-29-2010, EXPIRES 10-29-2020.

THE WORDING "SILCO VERT" HAS NO MEANING IN A FOREIGN LANGUAGE.

SER. NO. 79-090,348, FILED 10-29-2010.

MICHAEL SOUDERS, EXAMINING ATTORNEY



David J. Kybas

Director of the United States Patent and Trademark Office

United States of America

United States Patent and Trademark Office

MASTERLUX

Reg. No. 4,065,264

Registered Dec. 6, 2011

Int. Cl.: 9

TRADEMARK

PRINCIPAL REGISTER

STMICROELECTRONICS N.V (NETHERLANDS NV)
WTC SCHIPHOL AIRPORT
SCHIPHOL BOULEVARD, 265NL-1118 BH AMSTERDAM (LUCHTHAVEN SCHIPHOL
NETHERLANDS

FOR: INTEGRATED CIRCUITS; SEMICONDUCTOR DEVICES; INTEGRATED CIRCUIT
CARDS; PRINTED ELECTRONIC CIRCUITS FOR APPARATUS AND CARDS CONTAINING
INTEGRATED CIRCUITS; INTEGRATED CIRCUIT MICROPROCESSORS; CARDS FOR
INTEGRATED CIRCUITS OR MICROPROCESSORS, IN CLASS 9 (U.S. CLS. 21, 23, 26, 36
AND 38).

THE MARK CONSISTS OF STANDARD CHARACTERS WITHOUT CLAIM TO ANY PAR-
TICULAR FONT, STYLE, SIZE, OR COLOR.

PRIORITY DATE OF 10-14-2010 IS CLAIMED.

OWNER OF INTERNATIONAL REGISTRATION 1059559 DATED 10-19-2010, EXPIRES 10-
19-2020.

SER. NO. 79-090,374, FILED 10-19-2010.

KRISTINA MORRIS, EXAMINING ATTORNEY



David J. Kyffers

Director of the United States Patent and Trademark Office

United States of America

United States Patent and Trademark Office



Reg. No. 4,065,265

Registered Dec. 6, 2011

Int. Cls.: 18 and 25

TRADEMARK

PRINCIPAL REGISTER

AL BAZAR S.R.L. (ITALY LIMITED LIABILITY COMPANY)
VIA SCARPA, 9
I-20145 MILANO
ITALY

FOR: LEATHER, ANIMAL SKINS, HIDES AND IMITATIONS THEREOF; GOODS MADE OF LEATHER, ANIMAL SKINS, HIDES AND IMITATIONS THEREOF, NAMELY, LEATHER CASES; BOXES OF LEATHER OR IMITATIONS OF LEATHER; BAGS, NAMELY, BEACH BAGS, HANDBAGS, SHOULDER BAGS, BAGS FOR SPORTS, SHOPPING BAGS MADE OF SKIN, CANVAS SHOPPING BAGS, TRAVELLING BAGS, BRIEFCASES, SUITCASES, HAND LUGGAGE, TRAVELLING TRUNKS, WHEELED SHOPPING BAGS, GARMENTS BAGS FOR TRAVEL, OVERNIGHT BAGS, ATTACHE CASES, POCKET WALLETS, PURSES; CARD CASES, NAMELY, BUSINESS CARD CASES, CREDIT CARD CASES, KEY CASES, VANITY CASES NOT FITTED, BACKPACKS; UMBRELLAS, IN CLASS 18 (U.S. CLS. 1, 2, 3, 22 AND 41).

FOR: UNDERWEAR, T-SHIRTS, SPORTS JERSEYS, SPORTS SHIRTS, TROUSERS, SPORTS TROUSERS, JEANS, SHORTS, COATS, PARKAS, OVERCOATS, RAIN COATS, WATER-PROOF CLOTHING, NAMELY, PANTS AND JACKETS; WAISTCOATS, JACKETS, HEAVY JACKETS, HOSIERY, JUMPERS, PULLOVERS, SWEAT SHIRTS, SHIRTS, BLOUSES, OVERALLS, MEN'S SUITS, DRESSES, TRACKSUITS, SOCKS, TIGHTS, SUSPENDERS, NECKTIES, GLOVES, SHAWLS, VEILS, SCARVES, NECKERCHIEFS AND POCKET HANDKERCHIEFS; HEADGEAR, IN PARTICULAR HATS, BERETS, BELTS; FOOTWEAR, BOOTS, IN CLASS 25 (U.S. CLS. 22 AND 39).

NO CLAIM IS MADE TO THE EXCLUSIVE RIGHT TO USE "SARTORIA MILANESE", APART FROM THE MARK AS SHOWN.

PRIORITY DATE OF 9-28-2010 IS CLAIMED.

OWNER OF INTERNATIONAL REGISTRATION 1059643 DATED 10-6-2010, EXPIRES 10-6-2020.

THE MARK CONSISTS OF THE LETTERS "AB" IN STYLIZED, INTERSECTING LETTERING FORMING A MONOGRAM DESIGN WITH A CROWN RESTING ON TOP OF THE LETTERS. THE WORDING "SARTORIA MILANESE" IN A SCRIPT FONT RESTS ON A THICK STRAIGHT LINE NEXT TO THE DESIGN.



David J. Kyros

Director of the United States Patent and Trademark Office

Reg. No. 4,065,265 THE ENGLISH TRANSLATION OF "SARTORIA MILANESE" IN THE MARK IS "TAILORING FROM MILAN".

SER. NO. 79-090,398, FILED 10-6-2010.

ELLEN BURNS, EXAMINING ATTORNEY

United States of America

United States Patent and Trademark Office



Reg. No. 4,065,266
Registered Dec. 6, 2011
Int. Cl.: 25

TRADEMARK

PRINCIPAL REGISTER

DA LIAN YA TU TOU ZI ZI XUN YOU XIAN GONG SI (CHINA LIMITED COMPANY (LTD.))
NO. 439 HUANGPU ROAD, FLOOR 13,
02-2 ROOM.,; GANJINGZI DISTRICT.,; DALIANCITY; LIAONING PROVINCE
CHINA

FOR: CLOTHING, NAMELY, SHIRTS, JACKETS, SWEATERS, PANTS, SPORT COATS;
LAYETTES; MOUNTAIN CLIMBING SHOES; FOOTWEAR; HEADGEAR FOR WEAR,
NAMELY, HATS, CAPS; HOSIERY; GLOVES; NECKTIES; SCARVES; GIRDLES, IN CLASS
25 (U.S. CLS. 22 AND 39).

THE MARK CONSISTS OF A SHIELD WITH 5 STARS, ON THE RIGHT AND LEFT SIDES
ARE TWO PAIRS OF STARS AND THERE IS A SINGLE STAR ON TOP. THERE IS A MALE
SYMBOL IN THE BOTTOM BORDER. WITHIN THE SHIELD IS A SINGLE LINE CIRCLE
WITHIN THE SINGLE LINE OF THE CIRCLE THERE IS AN ARROW AT THE TOP THAT
IS WITHIN A SHADED CIRCLE. ON TOP OF THE CIRCLE DESIGN APPEARS A CURVED
DESIGN THAT LOOKS LIKE THE LETTER, "H".

OWNER OF INTERNATIONAL REGISTRATION 1059701 DATED 11-25-2010, EXPIRES 11-
25-2020.

SER. NO. 79-090,416, FILED 11-25-2010.

C. DIONNE CLYBURN, EXAMINING ATTORNEY



David J. Kyros

Director of the United States Patent and Trademark Office

United States of America

United States Patent and Trademark Office



Reg. No. 4,065,267

Registered Dec. 6, 2011

Int. Cl.: 9

TRADEMARK

PRINCIPAL REGISTER

OVIZIO IMAGING SYSTEMS SA, EN ABRÉGÉ, OVIZIO SA (BELGIUM SOCIÉTÉ ANONYME)
RUE ENGELAND 555
B-1180 UCCLE
BELGIUM

FOR: SCIENTIFIC AND OPTICAL APPARATUS AND INSTRUMENTS, NAMELY, FOUR DIMENSION (4D) HOLOGRAPHIC MICROSCOPES; APPARATUS AND INSTRUMENTS FOR EXAMINING THE EYE, NAMELY, NON MEDICAL FOUR DIMENSIONAL (4D) HOLOGRAPHIC MICROSCOPES; MICROSCOPES, IN CLASS 9 (U.S. CLS. 21, 23, 26, 36 AND 38).

THE MARK CONSISTS OF THE WORD "OVIZIO" IN BLACK, WITH THREE CIRCLES TO THE RIGHT OF THE WORD. THE UPPER LEFT CIRCLE RESEMBLES A HUMAN EYE, AND IS GRAY ON THE OUTSIDE AND BLUE IN THE MIDDLE, WITH A BLACK PUPIL IN THE VERY CENTER. THE UPPER RIGHT CIRCLE IS GRAY ON THE OUTSIDE AND RED IN THE CENTER. THE LOWER CIRCLE IS GRAY ON THE OUTSIDE AND GREEN IN THE CENTER.

PRIORITY DATE OF 4-7-2010 IS CLAIMED.

OWNER OF INTERNATIONAL REGISTRATION 1059765 DATED 10-4-2010, EXPIRES 10-4-2020.

THE COLOR(S) BLACK, BLUE, RED, GREEN, AND GRAY IS/ARE CLAIMED AS A FEATURE OF THE MARK.

THE WORD "OVIZIO" HAS NO FOREIGN LANGUAGE MEANING.

SER. NO. 79-090,474, FILED 10-4-2010.

JASON BLAIR, EXAMINING ATTORNEY



David J. Kybas

Director of the United States Patent and Trademark Office

United States of America

United States Patent and Trademark Office

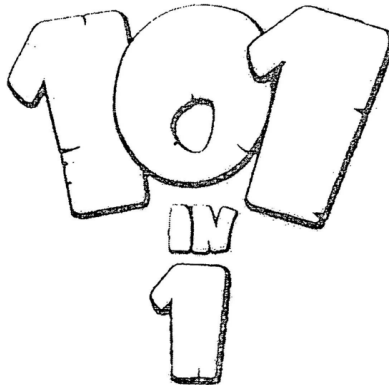

Reg. No. 4,065,268

Registered Dec. 6, 2011

Int. Cls.: 9, 16 and 28

TRADEMARK

PRINCIPAL REGISTER

UAB "NORDCURRENT" (LITHUANIA CLOSED JOINT-STOCK COMPANY)
SAVANORIU PR. 61
LT-03149 VILNIUS, LITHUANIA

FOR: EXPOSED CINEMATOGRAPHIC FILMS; VIDEO DISCS AND VIDEO TAPES WITH RECORDED ANIMATED CARTOONS; RECORDED COMPUTER OPERATING PROGRAMS, COMPUTER GAME PROGRAMS; DOWNLOADABLE COMPUTER GAME PROGRAMS; AMUSEMENT APPARATUS AND GAMES ADAPTED FOR USE WITH TELEVISION RECEIVERS OR WITH EXTERNAL VIDEO OR COMPUTER MONITORS, IN CLASS 9 (U.S. CLS. 21, 23, 26, 36 AND 38).

FOR: EDUCATIONAL PUBLICATIONS, NAMELY, EDUCATIONAL LEARNING CARDS, FLASH CARDS, ACTIVITY CARDS, WORKBOOKS, TEXTBOOKS, ACTIVITY BOOKS, STORY BOOKS, PUZZLE BOOKS, PRINTED PUZZLES, TEACHER GUIDES, MANUALS, POSTERS AND EDUCATIONAL BOOKLETS IN THE FIELD OF MEMORY AND ATTENTION TRAINING ACTIVITIES; BOOKS IN THE FIELD OF ENTERTAINMENT, INCLUDING STORY BOOKS AND PICTURE BOOKS; MAGAZINES IN THE FIELD OF ENTERTAINMENT AND MEMORY AND ATTENTION TRAINING ACTIVITIES; COMIC BOOKS, IN CLASS 16 (U.S. CLS. 2, 5, 22, 23, 29, 37, 38 AND 50).

FOR: GAMES, NAMELY, ACTION SKILL GAMES AND ACTION TARGET GAMES; BOARD GAMES; TOYS, NAMELY, CHILDREN'S MULTIPLE ACTIVITY TOYS, ELECTRONIC ACTION TOYS AND ELECTRONIC LEARNING TOYS, IN CLASS 28 (U.S. CLS. 22, 23, 38 AND 50).

SUBJECT TRADEMARK IN GRAPHICAL ASPECT IS COMPOSED OF STYLIZED RECORD OF DIGITAL FRAGMENTS "101" (ON THE TOP) AND "1" (BELOW) INTERRUPTED BY WORD "IN" STYLISED LETTERS, THE WHOLE RECORD BEING ARRANGED IN THE FORM OF FAN.

OWNER OF INTERNATIONAL REGISTRATION 1059811 DATED 6-10-2010, EXPIRES 6-10-2020.

SER. NO. 79-090,490, FILED 6-10-2010.

MATTHEW KLINE, EXAMINING ATTORNEY



David J. Kypas

Director of the United States Patent and Trademark Office

United States of America

United States Patent and Trademark Office

KOREX

Reg. No. 4,065,269

Registered Dec. 6, 2011

Int. Cl.: 39

SERVICE MARK

PRINCIPAL REGISTER

KOREA EXPRESS CO., LTD. (REPUBLIC OF KOREA CORPORATION)
58-12, SEOSOMUN-DONG, CHUNG-KU
SEOUL
REPUBLIC OF KOREA

FOR: COURIER SERVICES FOR DELIVERY OF MESSAGES AND MERCHANDISE; STORAGE OF GOODS; GOODS WAREHOUSING FOR MARINE PRODUCTS; STORAGE OF LUGGAGE; STORAGE OF STOCK FARM PRODUCTS; RENTAL OF STORAGE CONTAINERS; EMERGENCY AUTO OR TRUCK TOWING; BOAT TOWING SERVICES; TRUCKING SERVICES, NAMELY, HAULING OF FREIGHT, MERCHANDISE AND VALUABLES; RENTAL OF MOTOR RACING CARS; TRANSPORTATION OF PASSENGERS BY AIR, BOAT, RAIL AND BUS; INTERNATIONAL TRANSPORTATION RESERVATION SERVICES; TRANSPORT OF MONEY AND VALUABLES; RIVER TRANSPORT BY BOAT; PILOTING; ARMORED-CAR TRANSPORT; TRANSPORTATION OF GOODS IN THE NATURE OF DOCUMENTS AND PACKAGES; BARGE TRANSPORT; BUS TRANSPORT; BOAT TRANSPORT; SALVAGE OF SHIPS; CARGO SHIP TRANSPORT; RENTAL OF VESSELS, VEHICLES AND TRUCKS; PARCEL DELIVERY; TRAVEL GUIDE SERVICES FOR WATERWAYS; PASSENGER TRANSPORT; STREETCAR TRANSPORT; AMBULANCE TRANSPORT; FERRY-BOAT TRANSPORT; TRANSPORTATION RESERVATION SERVICES; TRANSPORTATION INFORMATION; TRANSPORT BROKERAGE; PLEASURE BOAT CRUISES; TRANSPORTATION OF OIL; ANIMAL REMOVAL SERVICES; TRANSPORTATION OF HOUSEHOLD GOODS OF OTHERS; CAR TRANSPORT; TRANSPORT BY HEARSE; CAR PARKING; RENTAL OF PARKING SPACES; GARAGE RENTAL; VEHICLE RENTAL; RAILWAY TRANSPORT; REFLOATING OF SHIPS; CABLE CAR TRANSPORT; TAXI TRANSPORT; TRUCK RENTAL; TRANSPORT BY PIPELINE; TRANSPORTATION OF MEDICAL WASTE AND SPECIAL WASTE; RIVER TRANSPORT BY SHIP; AIRCRAFT LEASING; AIR TRANSPORTATION RESERVATION SERVICES; AIR TRANSPORT; MARINE TRANSPORT; FREIGHT FORWARDING; FREIGHT AND TRANSPORT BROKERAGE; FREIGHT SHIPPING OF GOODS; FREIGHT TRANSPORTATION BY TRUCK, TRAIN AND AIR; FREIGHT BROKERAGE; AMBULANCE TRANSPORT; STEVEDORING SERVICES; GENERAL WAREHOUSING SERVICES; DELIVERY OF GOODS; HARBOR SERVICES, NAMELY, TRANSPORTATION OF PASSENGERS AND GOODS BY BOAT; LEASING OF RAILROAD FLATCARS; AIR FREIGHT BROKERAGE; AIR TRANSPORT BROKERAGE; CAR TRANSPORT BROKERAGE; MARINE FREIGHT BROKERAGE; TRANSPORT OF GOODS BY RAIL; TRANSPORT BROKERAGE; FARM PRODUCT WAREHOUSING SERVICES; FLOWER DELIVERY SERVICES; EXPRESS DELIVERY OF GOODS BY TRUCK AND AIR; DELIVERY OF GIFT BASKETS WITH SELECTED ITEMS REGARDING A PAR-



David J. Kyjars

Director of the United States Patent and Trademark Office

Reg. No. 4,065,269 PARTICULAR OCCASION OR THEME; FROZEN-FOOD LOCKER RENTAL; REFRIGERATOR RENTAL; REFRIGERATED WAREHOUSING SERVICES; TEMPORARY ELECTRONIC STORAGE OF INFORMATION AND DATA; DANGEROUS GOODS WAREHOUSING; RENTAL OF WAREHOUSES; STORAGE OF WASTE; PHYSICAL STORAGE OF ELECTRONICALLY-STORED DATA OR DOCUMENTS; DISTRIBUTION OF ENERGY; CHAUFFEUR SERVICES, IN CLASS 39 (U.S. CLS. 100 AND 105).

THE MARK CONSISTS OF STANDARD CHARACTERS WITHOUT CLAIM TO ANY PARTICULAR FONT, STYLE, SIZE, OR COLOR.

OWNER OF INTERNATIONAL REGISTRATION 1059851 DATED 6-24-2010, EXPIRES 6-24-2020.

OWNER OF U.S. REG. NO. 3,500,861.

SER. NO. 79-090,504, FILED 6-24-2010.

MICHAEL SOUDERS, EXAMINING ATTORNEY

United States of America

United States Patent and Trademark Office

Mirammer

Reg. No. 4,065,270

Registered Dec. 6, 2011

Int. Cl.: 1

TRADEMARK

PRINCIPAL REGISTER

MIWON SPECIALTY CHEMICAL CO., LTD (REPUBLIC OF KOREA CORPORATION)
834, YONGAM-RI, BONGDONG-EUP
WANJU-GUN, JEONBUK
REPUBLIC OF KOREA

FOR: CHEMICALS FOR USE IN THE MANUFACTURE OF ADHESIVES, COATINGS, ELECTRONICS, AND INKS, NAMELY, METHACRYLATE MONOMER; METHACRYLATE OLIGOMER; ACRYLATE MONOMER; ACRYLATE OLIGOMER, IN CLASS 1 (U.S. CLS. 1, 5, 6, 10, 26 AND 46).

OWNER OF INTERNATIONAL REGISTRATION 1060025 DATED 9-6-2010, EXPIRES 9-6-2020.

SER. NO. 79-090,571, FILED 9-6-2010.

BERYL GARDNER, EXAMINING ATTORNEY



David J. Kyffers

Director of the United States Patent and Trademark Office

United States of America

United States Patent and Trademark Office

A SAFER DAY, A CLICK AWAY

Reg. No. 4,065,271

Registered Dec. 6, 2011

Int. Cls.: 9, 38, 42 and 44

TRADEMARK

SERVICE MARK

PRINCIPAL REGISTER

WORLD MEDICAL CENTER NORDIC AS (NORWAY CORPORATION)
GAMLEHAUGVEGEN 20
N-5231 PARADIS
NORWAY

FOR: BLANK DIGITAL DATA STORAGE MEDIA; ENCODED ELECTRONIC CHIP CARDS CONTAINING PERSONAL INFORMATION, MEDICAL INFORMATION AND MEDICAL RECORDS; ELECTRONIC CARD READERS, IN CLASS 9 (U.S. CLS. 21, 23, 26, 36 AND 38).

FOR: PROVIDING MULTIPLE USER ACCESS TO THE INTERNET IN THE FIELD OF PERSONAL MEDICAL INFORMATION, IN CLASS 38 (U.S. CLS. 100, 101 AND 104).

FOR: DESIGN AND DEVELOPMENT OF COMPUTER HARDWARE AND SOFTWARE; PROVIDING AN ONLINE SEARCHABLE DATABASE IN THE FIELD OF PERSONAL MEDICAL INFORMATION ALL FOR SCIENTIFIC RESEARCH PURPOSES, IN CLASS 42 (U.S. CLS. 100 AND 101).

FOR: MEDICAL SERVICES; PROVIDING MEDICAL INFORMATION, IN CLASS 44 (U.S. CLS. 100 AND 101).

THE MARK CONSISTS OF STANDARD CHARACTERS WITHOUT CLAIM TO ANY PARTICULAR FONT, STYLE, SIZE, OR COLOR.

PRIORITY DATE OF 3-16-2010 IS CLAIMED.

OWNER OF INTERNATIONAL REGISTRATION 1060201 DATED 9-14-2010, EXPIRES 9-14-2020.

SER. NO. 79-090,641, FILED 9-14-2010.

BERYL GARDNER, EXAMINING ATTORNEY



David J. Kyffers

Director of the United States Patent and Trademark Office

United States of America

United States Patent and Trademark Office

ReFa

Reg. No. 4,065,272

Registered Dec. 6, 2011

Int. Cls.: 10 and 21

TRADEMARK

PRINCIPAL REGISTER

MTG CO., LTD. (JAPAN CORPORATION)
MTG HIKARI BLDG. 32
HONJIN-DORI 2-CHOME, NAKAMURA-KU, NAGOYA-SHI
AICHI-KEN, JAPAN 4530041

FOR: ESTHETIC MASSAGE APPARATUS; ESTHETIC MASSAGE APPARATUS FOR INDUSTRIAL PURPOSES; MASSAGE APPARATUS FOR MEDICAL PURPOSES; ELECTRIC ESTHETIC MASSAGE APPARATUS FOR HOUSEHOLD USE; ELECTRIC MASSAGE APPARATUS FOR THE FACE FOR HOUSEHOLD USE; HAND-OPERATED COSMETIC MASSAGE ROLLER FOR HOUSEHOLD USE, IN CLASS 10 (U.S. CLS. 26, 39 AND 44).

FOR: COSMETIC AND TOILET UTENSILS, NAMELY, COSMETIC BRUSHES, HAND-OPERATED COSMETIC ROLLERS, IN CLASS 21 (U.S. CLS. 2, 13, 23, 29, 30, 33, 40 AND 50).

PRIORITY DATE OF 8-24-2010 IS CLAIMED.

OWNER OF INTERNATIONAL REGISTRATION 1060243 DATED 10-18-2010, EXPIRES 10-18-2020.

SER. NO. 79-090,667, FILED 10-18-2010.

CURTIS FRENCH, EXAMINING ATTORNEY



David J. Kyros

Director of the United States Patent and Trademark Office

United States of America

United States Patent and Trademark Office

SORGEM

Reg. No. 4,065,273

Registered Dec. 6, 2011

Int. Cls.: 35, 41 and 42

SERVICE MARK

PRINCIPAL REGISTER

SORGEM (FRANCE SOCIETE ANONYME)
11, RUE LEROUX
F-75116 PARIS
FRANCE

FOR: BUSINESS MANAGEMENT ASSISTANCE TO INDUSTRIAL OR COMMERCIAL COMPANIES; BUSINESS APPRAISALS; BUSINESS ORGANIZATION AND MANAGEMENT CONSULTING, BUSINESS MANAGEMENT CONSULTING; PROFESSIONAL BUSINESS CONSULTING; BUSINESS RESEARCH; CONDUCTING MARKETING STUDIES; CONSUMER MARKETING RESEARCH AND CONSULTING RELATED THERETO; STATISTICAL ANALYSIS AND REPORTING SERVICES FOR BUSINESS PURPOSES; COMPUTERIZED FILE MANAGEMENT; DATA COMPILING AND ANALYZING IN THE FIELDS OF BUSINESS AND MARKETING; COMPILATION AND SYSTEMIZATION OF DATA INTO COMPUTER DATABASES; CONDUCTING OPINION POLLS AND SURVEYS; PUBLIC RELATIONS; ADVERTISING AND MARKETING CONSULTANCY; MARKET RESEARCH AND MARKET INTELLIGENCE SERVICES; BUSINESS CONSULTATION AND MANAGEMENT REGARDING MARKETING ACTIVITIES AND LAUNCHING OF NEW PRODUCTS; BUSINESS AUDITING CONCERNING NEW GOODS AND SERVICES DEVELOPED BY COMPANIES; ADVICE ON THE ANALYSIS OF CONSUMER BUYING HABITS AND NEEDS PROVIDED WITH THE HELP OF SENSORY, QUALITY AND QUANTITY-RELATED DATA; ADVERTISING CONSULTATION; ORGANIZATION OF EXHIBITIONS FOR COMMERCIAL OR ADVERTISING PURPOSES; CONDUCTING, ARRANGING AND ORGANIZING TRADE SHOWS AND TRADE FAIRS FOR COMMERCIAL AND ADVERTISING PURPOSES; LONG-TERM BUSINESS PLANNING CONCERNED WITH SOCIAL/CULTURAL ASPECTS; INDUSTRIAL MANAGEMENT ASSISTANCE, IN CLASS 35 (U.S. CLS. 100, 101 AND 102).



FOR: TRAINING SERVICES IN THE FIELD OF MARKET RESEARCH AND MARKET INTELLIGENCE; PUBLICATION OF BOOKS AND TEXTS; ONLINE ELECTRONIC PUBLISHING OF ELECTRONIC BOOKS AND JOURNALS; PUBLISHING OF ELECTRONIC PUBLICATIONS; ELECTRONIC DESKTOP PUBLISHING; ARRANGING AND CONDUCTING OF EDUCATIONAL CONFERENCES; VIDEOTAPING, IN CLASS 41 (U.S. CLS. 100, 101 AND 107).

David J. Kyjars

Director of the United States Patent and Trademark Office

FOR: RECOVERY OF COMPUTER DATA; QUALITY CONTROL FOR OTHERS; DESIGN ON THE INTERNET OF INTERACTIVE APPLICATIONS ON MULTIMEDIA DISCS; CONDUCTING OF TECHNICAL FEASIBILITY STUDIES; TECHNICAL CONSULTANCY IN RELATION TO RESEARCH IN THE FIELD OF TOOLS AND METHODS FOR QUALITATIVE

Reg. No. 4,065,273 STUDIES; SCIENTIFIC RESEARCH BY ENGINEERS; DESIGN OF ARCHITECTURAL MODELS, PROTOTYPES AND LOGOTYPES; RESEARCH AND DEVELOPMENT OF NEW PRODUCT DESIGNS FOR OTHERS; DESIGN AND DEVELOPMENT OF COMPUTER DATABASES, IN CLASS 42 (U.S. CLS. 100 AND 101).

THE MARK CONSISTS OF STANDARD CHARACTERS WITHOUT CLAIM TO ANY PARTICULAR FONT, STYLE, SIZE, OR COLOR.

PRIORITY DATE OF 7-7-2010 IS CLAIMED.

OWNER OF INTERNATIONAL REGISTRATION 1060318 DATED 10-25-2010, EXPIRES 10-25-2020.

SER. NO. 79-090,698, FILED 10-25-2010.

IRA J. GOODSID, EXAMINING ATTORNEY

United States of America

United States Patent and Trademark Office



Reg. No. 4,065,274

Registered Dec. 6, 2011

Int. Cl.: 20

TRADEMARK

PRINCIPAL REGISTER

ZHEJIANG WUYI ZHONGMAO ARTS AND CRAFTS MANUFACTURE CO., LTD. (CHINA CORPORATION)
CULTURAL & TOURISM PRODUCTS
INDUSTRIAL ZONE., WUYI; 321200 ZHEJIANG
CHINA

FOR: BENCHES; PLAYPENS FOR BABIES; BASSINETTES; FURNITURE; CHAIRS; ARM-CHAIRS; DIVANS; FURNITURE OF METAL; SEATS OF METAL; SETTEES; DECK CHAIRS, IN CLASS 20 (U.S. CLS. 2, 13, 22, 25, 32 AND 50).

NO CLAIM IS MADE TO THE EXCLUSIVE RIGHT TO USE "OUTDOOR ARTICLES" AND THE NON-LATIN CHARACTERS THAT TRANSLITERATE TO GONG YI, APART FROM THE MARK AS SHOWN.

PRIORITY DATE OF 8-4-2010 IS CLAIMED.

OWNER OF INTERNATIONAL REGISTRATION 1060338 DATED 11-24-2010, EXPIRES 11-24-2020.

THE NON-LATIN CHARACTERS IN THE MARK TRANSLITERATE TO "ZHONG MAO" GONG YI AND THIS MEANS CENTRE, LUXURIANT, PROJECT AND ART IN ENGLISH. THE WHOLE OF LAST TWO CHINESE CHARACTERS MEANS CRAFT. THE WHOLE OF THESE FOUR CHINESE CHARACTERS HAVE NO MEANING WHEN PLACE TOGETHER AND CANNOT BE TRANSLATED AS A PHRASE.

THE MARK CONSISTS OF A STYLIZED DESIGN OF A PALM TREE WITH THE LETTERS "ZM" UNDERNEATH ON THE LEFT AND THE WORDING "ZHONGMAO OUTDOOR ARTICLES" WITH FOUR ASIAN CHARACTERS UNDERNEATH ON THE RIGHT.

THE WORDING "ZHONGMAO" HAS NO MEANING IN A FOREIGN LANGUAGE.

SER. NO. 79-090,701, FILED 11-24-2010.

GINA FINK, EXAMINING ATTORNEY



David J. Kybas

Director of the United States Patent and Trademark Office

United States of America

United States Patent and Trademark Office

SECU4

Reg. No. 4,065,275

SECU4 SA (SWITZERLAND SOCIÉTÉ ANONYME (SA))
TECHNO ARK 3
CH-3960 SIERRE, SWITZERLAND

Registered Dec. 6, 2011

Int. Cls.: 9, 38, 42 and 45

FOR: SCIENTIFIC, PHOTOGRAPHIC, OPTICAL, MEASURING, SIGNALING, CHECKING, SUPERVISION, LIFE-SAVING AND TEACHING APPARATUS AND INSTRUMENTS, NAMELY, DIGITAL SIGNAL PROCESSORS; APPARATUS AND INSTRUMENTS FOR CONDUCTING, SWITCHING, TRANSFORMING, ACCUMULATING, REGULATING OR CONTROLLING ELECTRICITY, NAMELY, WARNING DEVICES, NAMELY, THEFT ALARMS; APPARATUS FOR RECORDING, TRANSMISSION OR REPRODUCTION OF SOUND OR IMAGES; DATA PROCESSING EQUIPMENT AND COMPUTERS; DOWNLOADABLE COMPUTER PROGRAMS FOR MOBILE PHONES TO ENSURE INTEROPERABILITY WITH SECURITY SYSTEMS, DOMOTICS, NAMELY, HOME AND OFFICE AUTOMATION SYSTEMS, AND ELECTRONIC DEVICES; COMPUTER APPLICATION PROGRAMS FOR MOBILE PHONES TO ENSURE INTEROPERABILITY WITH SECURITY SYSTEMS, DOMOTICS, NAMELY, HOME AND OFFICE AUTOMATION SYSTEMS, AND ELECTRONIC DEVICES; COMPUTER HARDWARE DEVICES FOR ENABLING WIRELESS CONNECTION AND INTEROPERABILITY BETWEEN PORTABLE ELECTRONIC APPARATUS; MOBILE ELECTRONIC SECURITY DEVICES, NAMELY, PERSONAL SECURITY ALARMS, SECURITY ALARM CONTROLLERS, ALARM MONITORING SYSTEMS; ALARMS, NAMELY, PERSONAL SECURITY ALARMS, THEFT ALARMS, SOUND ALARMS, SMOKE ALARMS, ELECTRICAL DOOR ALARMS; THEFT ALARM DEVICES, NAMELY, THEFT ALARMS, PERSONAL SECURITY ALARMS, SOUND ALARMS, IN CLASS 9 (U.S. CLS. 21, 23, 26, 36 AND 38).

TRADEMARK

SERVICE MARK

PRINCIPAL REGISTER

FOR: DATA TRANSMISSION AND TRANSFER SERVICES VIA CLOSE-RANGE WIRELESS COMMUNICATION, IN CLASS 38 (U.S. CLS. 100, 101 AND 104).

FOR: SCIENTIFIC AND TECHNOLOGICAL SERVICES AND RESEARCH AND DESIGN RELATING THERETO, NAMELY, DESIGN AND DEVELOPMENT OF SECURITY SYSTEMS, TESTING OF SECURITY SYSTEMS, ENGINEERING AND SYSTEM ANALYSIS IN THE FIELD OF SECURITY SYSTEMS, AND DOMOTICS, NAMELY, HOME AND OFFICE AUTOMATION SYSTEMS AND ELECTRONIC DEVICES; INDUSTRIAL ANALYSIS AND RESEARCH SERVICES IN THE FIELD OF DESIGN AND DEVELOPMENT OF SECURITY SYSTEMS, TESTING OF SECURITY SYSTEMS, ENGINEERING AND SYSTEM ANALYSIS IN THE FIELD OF SECURITY SYSTEMS, DOMOTICS, NAMELY, HOME AND OFFICE AUTOMATION SYSTEMS AND ELECTRONIC DEVICES; CREATION, DESIGN AND DE-



David J. Kyjars

Director of the United States Patent and Trademark Office

Reg. No. 4,065,275 DEVELOPMENT OF COMPUTER HARDWARE AND SOFTWARE; MAINTENANCE AND UPDATING OF COMPUTER SOFTWARE , IN CLASS 42 (U.S. CLS. 100 AND 101).

FOR: SECURITY SERVICES FOR THE PROTECTION OF PROPERTY AND INDIVIDUALS, NAMELY, SECURITY CONSULTANCY, MONITORING OF SECURITY SYSTEMS; LICENSING OF COMPUTER SOFTWARE, IN CLASS 45 (U.S. CLS. 100 AND 101).

THE MARK CONSISTS OF STANDARD CHARACTERS WITHOUT CLAIM TO ANY PARTICULAR FONT, STYLE, SIZE, OR COLOR.

PRIORITY DATE OF 5-26-2010 IS CLAIMED.

OWNER OF INTERNATIONAL REGISTRATION 1060467 DATED 11-25-2010, EXPIRES 11-25-2020.

SER. NO. 79-090,740, FILED 11-25-2010.

KRISTIN CARLSON, EXAMINING ATTORNEY

United States of America
United States Patent and Trademark Office

NoCry

Reg. No. 4,065,276

Registered Dec. 6, 2011

Int. Cl.: 5

A. MENARINI INDUSTRIE FARMACEUTICHE RIUNITE S.R.L. (ITALY LIMITED LIABILITY COMPANY)
VIA SETTE SANTI, 1-3
I-50131 FIRENZE
ITALY

TRADEMARK

PRINCIPAL REGISTER

FOR: PHARMACEUTICAL PREPARATIONS, NAMELY, DRUGS FOR THE TREATMENT OF FUNCTIONAL GASTROINTESTINAL DISORDERS, IN CLASS 5 (U.S. CLS. 6, 18, 44, 46, 51 AND 52).

EXPRESSION "NOCRY" WRITTEN IN A SINGLE WORD WITH THE CAPITAL LETTERS "N" AND "C".

OWNER OF INTERNATIONAL REGISTRATION 1060487 DATED 11-17-2010, EXPIRES 11-17-2020.

SER. NO. 79-090,749, FILED 11-17-2010.

MICHELE SWAIN, EXAMINING ATTORNEY



David J. Kyffers

Director of the United States Patent and Trademark Office

United States of America
United States Patent and Trademark Office

LACTOPAL

Reg. No. 4,065,277

Registered Dec. 6, 2011

Int. Cl.: 17

TRADEMARK

PRINCIPAL REGISTER

CONTITECH SCHLAUCH GMBH (FED REP GERMANY LIMITED LIABILITY COMPANY)
VAHRENWALDER STR. 9
30165 HANNOVER
FED REP GERMANY

FOR: PIPES, IN CLASS 17 (U.S. CLS. 1, 5, 12, 13, 35 AND 50).

THE WORDING "LACTOPAL" HAS NO MEANING IN A FOREIGN LANGUAGE.

OWNER OF INTERNATIONAL REGISTRATION 0481984 DATED 1-3-1984, EXPIRES 1-3-2014.

SER. NO. 79-090,781, FILED 10-7-2010.

NAKIA HENRY, EXAMINING ATTORNEY



David J. Kybas

Director of the United States Patent and Trademark Office

United States of America

United States Patent and Trademark Office

INVEST IN CONFIDENCE

Reg. No. 4,065,278

Registered Dec. 6, 2011

Int. Cls.: 7, 9, 37 and 41

TRADEMARK

SERVICE MARK

PRINCIPAL REGISTER

BERNARD CONTROLS (FRANCE SOCIÉTÉ ANONYME (SA))
ZONE INDUSTRIELLE
4 RUE D'ARSONVAL
GONESSE, FRANCE F95500

FOR: ELECTRIC ACTUATORS; PNEUMATIC VALVE ACTUATORS; HYDRAULIC VALVE ACTUATORS; PNEUMATIC AND HYDRAULIC POSITIONERS FOR CONTROLLING VALVES; PRESSURE REDUCERS FOR VALVES AND SLUICE GATES, IN CLASS 7 (U.S. CLS. 13, 19, 21, 23, 31, 34 AND 35).

FOR: ELECTRICAL AND ELECTRONIC APPARATUS FOR THE CONTROLLING AND REMOTE CONTROLLING OF INDUSTRIAL PLANTS AND EQUIPMENT COMPRISING MOTORIZED VALVES AND SLUICE GATES; DIGITAL ELECTRONIC CONTROLS FOR INDUSTRIAL PLANTS AND EQUIPMENT COMPRISING MOTORIZED VALVES AND SLUICE GATES; ELECTRONIC DEVICES FOR CONTROLLING ACTUATORS FOR MOTORIZED VALVES AND SLUICE GATES; ELECTRONIC NETWORK CONTROLLERS FOR MOTORIZED VALVES AND SLUICE GATES, IN CLASS 9 (U.S. CLS. 21, 23, 26, 36 AND 38).

FOR: INSTALLATION, COMMISSIONING, MAINTENANCE AND REPAIR OF EQUIPMENT AND DEVICES COMPRISING VALVES AND SLUICE GATES, IN CLASS 37 (U.S. CLS. 100, 103 AND 106).

FOR: ORGANIZING AND CONDUCTING OF TRAINING WORKSHOPS, COLLOQUIA, CONFERENCES AND SEMINARS, ALL IN THE FIELDS OF ELECTRIC ACTUATORS, PNEUMATIC VALVE ACTUATORS, HYDRAULIC VALVE ACTUATORS, POSITIONERS FOR CONTROLLING VALVES, PRESSURE REDUCERS FOR VALVES, LOUVERS AND DAMPERS AND APPARATUS FOR THE CONTROLLING AND REMOTE CONTROLLING OF INDUSTRIAL PLANTS AND EQUIPMENT COMPRISING MOTORIZED VALVES, LOUVERS AND DAMPERS, IN CLASS 41 (U.S. CLS. 100, 101 AND 107).

THE MARK CONSISTS OF STANDARD CHARACTERS WITHOUT CLAIM TO ANY PARTICULAR FONT, STYLE, SIZE, OR COLOR.

PRIORITY DATE OF 5-11-2010 IS CLAIMED.

OWNER OF INTERNATIONAL REGISTRATION 1060620 DATED 11-3-2010, EXPIRES 11-3-2020.



David J. Kyros

Director of the United States Patent and Trademark Office

Reg. No. 4,065,278 SER. NO. 79-090,821, FILED 11-3-2010.

DAVID H. STINE, EXAMINING ATTORNEY

United States of America
United States Patent and Trademark Office

MAXOFLEX

Reg. No. 4,065,279

Registered Dec. 6, 2011

Int. Cl.: 7

CONTITECH TRANSPORTBANDSYSTEME GMBH (FED REP GERMANY LIMITED
LIABILITY COMPANY)
BRESLAUER STR. 14
31764 NORTHEIM
FED REP GERMANY

TRADEMARK

PRINCIPAL REGISTER

FOR: BELTS FOR CONVEYORS AND MACHINES; CONVEYOR BELT PARTS, NAMELY, CONVEYOR BELT CLEATS AND SIDEWALLS FOR CONVEYOR BELTS, SOLD AS A COMPONENT PART OF CONVEYOR BELTS; POWER TRANSMISSION BELTS FOR MACHINES, FOR INDUSTRIAL PURPOSES; TRANSMISSION BELTS, NOT FOR LAND VEHICLES, FOR INDUSTRIAL PURPOSES, IN CLASS 7 (U.S. CLS. 13, 19, 21, 23, 31, 34 AND 35).

THE MARK CONSISTS OF STANDARD CHARACTERS WITHOUT CLAIM TO ANY PARTICULAR FONT, STYLE, SIZE, OR COLOR.

OWNER OF INTERNATIONAL REGISTRATION 1060729 DATED 11-3-2010, EXPIRES 11-3-2020.

THE WORDING "MAXOFLEX" HAS NO MEANING IN A FOREIGN LANGUAGE.

SER. NO. 79-090,870, FILED 11-3-2010.

MICHAEL GAAFAR, EXAMINING ATTORNEY



David J. Kyffers

Director of the United States Patent and Trademark Office

United States of America

United States Patent and Trademark Office

VICTORIA SOLENNE

Reg. No. 4,065,280

Registered Dec. 6, 2011

Int. Cls.: 16, 35 and 38

TRADEMARK

SERVICE MARK

PRINCIPAL REGISTER

VICTORIA CARRASCOSA PEÑALVER (SPAIN INDIVIDUAL)
GRAN VÍA MARQUÉS DEL TURIA, 7
PISO 8º, PTA. 15ª; E-46005 VALENCIA
SPAIN

FOR: PAPER, CARDBOARD AND GOODS MADE FROM THESE MATERIALS NOT INCLUDED IN OTHER CLASSES, NAMELY, PHOTOGRAPHS AND POSTERS; PRINTED MATTER, NAMELY, BOOKS AND MAGAZINES IN THE FIELD OF TELECOMMUNICATIONS; BOOKBINDING MATERIAL; PHOTOGRAPHS; STATIONERY; ADHESIVES FOR STATIONERY OR HOUSEHOLD PURPOSES; ARTISTS' MATERIALS, NAMELY, PAINTBRUSHES; OFFICE REQUISITES, NAMELY, TYPEWRITERS; INSTRUCTIONAL AND TEACHING MATERIALS, NAMELY, BOOKS AND WORKBOOKS IN THE FIELD OF MATH AND HISTORY; PLASTIC MATERIALS FOR PACKAGING IN THE NATURE OF PLASTIC BAGS FOR PACKAGING; PRINTING TYPE; PRINTING BLOCKS, IN CLASS 16 (U.S. CLS. 2, 5, 22, 23, 29, 37, 38 AND 50).

FOR: ADVERTISING; BUSINESS MANAGEMENT; BUSINESS ADMINISTRATION; OFFICE FUNCTIONS, IN CLASS 35 (U.S. CLS. 100, 101 AND 102).

FOR: TELECOMMUNICATIONS ACCESS SERVICES, IN CLASS 38 (U.S. CLS. 100, 101 AND 104).

THE MARK CONSISTS OF STANDARD CHARACTERS WITHOUT CLAIM TO ANY PARTICULAR FONT, STYLE, SIZE, OR COLOR.

PRIORITY DATE OF 9-3-2010 IS CLAIMED.

OWNER OF INTERNATIONAL REGISTRATION 1060846 DATED 10-21-2010, EXPIRES 10-21-2020.

THE NAME "VICTORIA SOLENNE" DOES NOT IDENTIFY A LIVING INDIVIDUAL.

SER. NO. 79-090,916, FILED 10-21-2010.

SEAN CROWLEY, EXAMINING ATTORNEY



David J. Kyros

Director of the United States Patent and Trademark Office

United States of America

United States Patent and Trademark Office

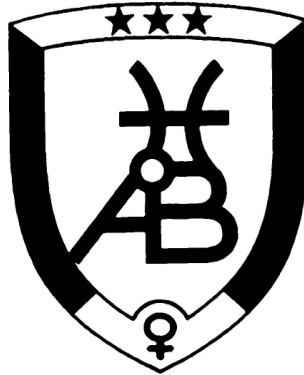

Reg. No. 4,065,281

Registered Dec. 6, 2011

Int. Cl.: 14

TRADEMARK

PRINCIPAL REGISTER

DA LIAN YA TU TOU ZI ZI XUN YOU XIAN GONG SI (CHINA CO, LTD)
NO. 439 HUANGPU ROAD, FLOOR 13
02-2 ROOM, GANJINGZI DISTRICT, DALIAN CITY
LIAONING PROVINCE, CHINA

FOR: BOXES OF PRECIOUS METAL; SILVER ORNAMENTS; COINS, NAMELY, COLLECTIBLE COINS, COMMEMORATIVE COINS, MONETARY COINS FOR COLLECTING PURPOSES, NON-MONETARY COINS; JEWELLERY; WORKS OF ART OF PRECIOUS METAL; BADGES OF PRECIOUS METAL; JEWELLERY MADE OF JADE CARVINGS; CLOISSONNÉ JEWELRY; JEWELLERY OF HORN, BONE, TOOTH AND SHELL; WRISTWATCHES, IN CLASS 14 (U.S. CLS. 2, 27, 28 AND 50).

THE MARK CONSISTS OF A DRAWING OF A SHIELD WITH STARS AND A BIOLOGICAL SYMBOL WITHIN THE BORDER OF THE SHIELD, AND THE LETTER "AB", A CIRCLE, AND A ZODIAC SIGN IN THE MIDDLE OF THE SHIELD.

OWNER OF INTERNATIONAL REGISTRATION 1061023 DATED 12-1-2010, EXPIRES 12-1-2020.

SER. NO. 79-090,980, FILED 12-1-2010.

CARYN GLASSER, EXAMINING ATTORNEY



David J. Kybas

Director of the United States Patent and Trademark Office

United States of America

United States Patent and Trademark Office

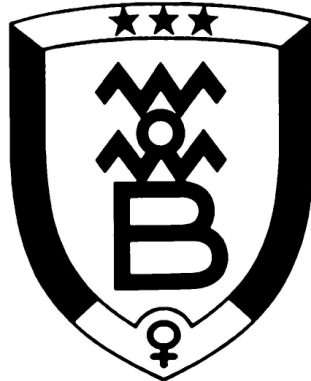

Reg. No. 4,065,282

Registered Dec. 6, 2011

Int. Cl.: 14

TRADEMARK

PRINCIPAL REGISTER

DA LIAN YA TU TOU ZI ZI XUN YOU XIAN GONG SI (CHINA CO, LTD)
NO. 439 HUANGPU ROAD, FLOOR 13
02-2 ROOM, GANJINGZI DISTRICT, DALIAN CITY
LIAONING PROVINCE, CHINA

FOR: BOXES OF PRECIOUS METAL; SILVER ORNAMENTS; COINS, NAMELY, COLLECTIBLE COINS, COMMEMORATIVE COINS, MONETARY COINS FOR COLLECTING PURPOSES, NON-MONETARY COINS; JEWELLERY; WORKS OF ART OF PRECIOUS METAL; BADGES OF PRECIOUS METAL; JEWELLERY MADE OF JADE CARVINGS; CLOISSONNÉ JEWELRY; JEWELLERY OF HORN, BONE, TOOTH AND SHELL; WRISTWATCHES, IN CLASS 14 (U.S. CLS. 2, 27, 28 AND 50).

THE MARK CONSISTS OF DRAWING OF A SHIELD WITH STARS AND A BIOLOGICAL SYMBOL WITHIN THE BORDER OF THE SHIELD, AND THE LETTER "B", A CIRCLE, AND A ZODIAC SIGN IN THE MIDDLE OF THE SHIELD.

OWNER OF INTERNATIONAL REGISTRATION 1061024 DATED 12-1-2010, EXPIRES 12-1-2020.

SER. NO. 79-090,981, FILED 12-1-2010.

CARYN GLASSER, EXAMINING ATTORNEY



David J. Kyffers

Director of the United States Patent and Trademark Office

United States of America

United States Patent and Trademark Office

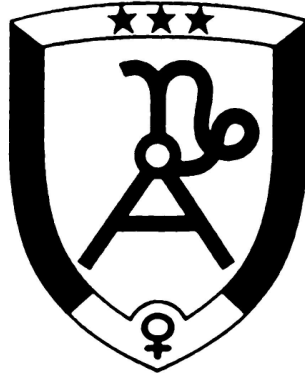

Reg. No. 4,065,283

Registered Dec. 6, 2011

Int. Cl.: 14

TRADEMARK

PRINCIPAL REGISTER

DA LIAN YA TU TOU ZI ZI XUN YOU XIAN GONG SI (CHINA CO, LTD)
NO. 439 HUANGPU ROAD, FLOOR 13
02-2 ROOM, GANJINGZI DISTRICT, DALIAN CITY
LIAONING PROVINCE, CHINA

FOR: BOXES OF PRECIOUS METAL; SILVER ORNAMENTS; COINS, NAMELY, COLLECTIBLE COINS, COMMEMORATIVE COINS, MONETARY COINS FOR COLLECTING PURPOSES, NON-MONETARY COINS; JEWELLERY; WORKS OF ART OF PRECIOUS METAL; BADGES OF PRECIOUS METAL; JEWELLERY MADE OF JADE CARVINGS; CLOISSONNÉ JEWELRY; JEWELLERY OF HORN, BONE, TOOTH AND SHELL; WRISTWATCHES, IN CLASS 14 (U.S. CLS. 2, 27, 28 AND 50).

THE MARK CONSISTS OF A DRAWING OF A SHIELD WITH STARS AND A BIOLOGICAL SYMBOL WITHIN THE BORDER OF THE SHIELD, AND THE LETTER "A", A CIRCLE, AND A ZODIAC SIGN IN THE MIDDLE OF THE SHIELD.

OWNER OF INTERNATIONAL REGISTRATION 1061025 DATED 12-1-2010, EXPIRES 12-1-2020.

SER. NO. 79-090,982, FILED 12-1-2010.

CARYN GLASSER, EXAMINING ATTORNEY



David J. Kybas

Director of the United States Patent and Trademark Office

United States of America

United States Patent and Trademark Office

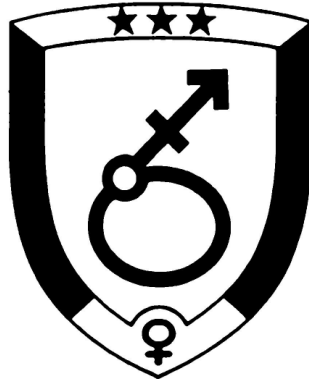

Reg. No. 4,065,284

Registered Dec. 6, 2011

Int. Cl.: 14

TRADEMARK

PRINCIPAL REGISTER

DA LIAN YA TU TOU ZI ZI XUN YOU XIAN GONG SI (CHINA CO, LTD)
NO. 439 HUANGPU ROAD, FLOOR 13
02-2 ROOM, GANJINGZI DISTRICT, DALIAN CITY
LIAONING PROVINCE, CHINA

FOR: BOXES OF PRECIOUS METAL; SILVER ORNAMENTS; COINS, NAMELY, COLLECTIBLE COINS, COMMEMORATIVE COINS, MONETARY COINS FOR COLLECTING PURPOSES, NON-MONETARY COINS; JEWELLERY; WORKS OF ART OF PRECIOUS METAL; BADGES OF PRECIOUS METAL; JEWELLERY MADE OF JADE CARVINGS; CLOISSONNÉ JEWELRY; JEWELLERY OF HORN, BONE, TOOTH AND SHELL; WRISTWATCHES, IN CLASS 14 (U.S. CLS. 2, 27, 28 AND 50).

THE MARK CONSISTS OF A DRAWING OF A SHIELD WITH STARS AND A BIOLOGICAL SYMBOL WITHIN THE BORDER OF THE SHIELD, AND THE LETTER "O" AND A ZODIAC SIGN IN THE MIDDLE OF THE SHIELD.

OWNER OF INTERNATIONAL REGISTRATION 1061026 DATED 12-1-2010, EXPIRES 12-1-2020.

SER. NO. 79-090,983, FILED 12-1-2010.

CARYN GLASSER, EXAMINING ATTORNEY



David J. Kybas

Director of the United States Patent and Trademark Office

United States of America

United States Patent and Trademark Office

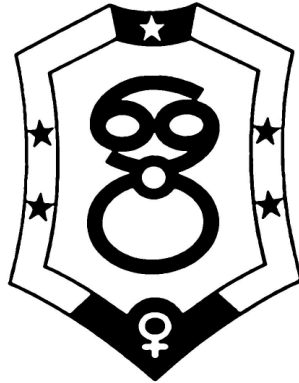

Reg. No. 4,065,285

Registered Dec. 6, 2011

Int. Cl.: 25

TRADEMARK

PRINCIPAL REGISTER

DA LIAN YA TU TOU ZI ZI XUN YOU XIAN GONG SI (CHINA CO, LTD)
NO. 439 HUANGPU ROAD, FLOOR 13,
02-2 ROOM,; GANJINGZI DISTRICT,; DALIANCITY; LIAONING PROVINCE
CHINA

FOR: CLOTHING, NAMELY, SHIRTS, JACKETS, SWEATERS, PANTS AND SPORT COATS;
LAYETTES FOR CLOTHING; MOUNTAIN CLIMBING SHOES; FOOTWEAR; HEADGEAR
FOR WEAR, NAMELY, HATS, CAPS; HOSIERY; GLOVES AS CLOTHING; NECKTIES;
SCARVES; GIRDLES, IN CLASS 25 (U.S. CLS. 22 AND 39).

THE MARK CONSISTS OF A DRAWING OF A SHIELD WITH STARS AND A BIOLOGICAL
SYMBOL WITHIN THE BORDER OF THE SHIELD, AND THE LETTER "O" AND A ZODIAC
SIGN IN THE MIDDLE OF THE SHIELD.

OWNER OF INTERNATIONAL REGISTRATION 1061160 DATED 12-1-2010, EXPIRES 12-
1-2020.

SER. NO. 79-091,019, FILED 12-1-2010.

CARYN GLASSER, EXAMINING ATTORNEY



David J. Kybas

Director of the United States Patent and Trademark Office

United States of America

United States Patent and Trademark Office



Reg. No. 4,065,286

Registered Dec. 6, 2011

Int. Cl.: 25

TRADEMARK

PRINCIPAL REGISTER

DA LIAN YA TU TOU ZI ZI XUN YOU XIAN GONG SI (CHINA CO, LTD)
NO. 439 HUANGPU ROAD, FLOOR 13,
02-2 ROOM,; GANJINGZI DISTRICT,; DALIANCITY; LIAONING PROVINCE
CHINA

FOR: CLOTHING, NAMELY, SHIRTS, JACKETS, SWEATERS, PANTS AND SPORT COATS;
LAYETTES FOR CLOTHING; MOUNTAIN CLIMBING SHOES; FOOTWEAR; HEADGEAR
FOR WEAR, NAMELY, HATS, CAPS; HOSIERY; GLOVES FOR CLOTHING; NECKTIES;
SCARVES; GIRDLES, IN CLASS 25 (U.S. CLS. 22 AND 39).

THE MARK CONSISTS OF A DRAWING OF A SHIELD WITH STARS AND A BIOLOGICAL
SYMBOL WITHIN THE BORDER OF THE SHIELD, AND THE LETTER "AB" AND A ZODIAC
SIGN IN THE MIDDLE OF THE SHIELD.

OWNER OF INTERNATIONAL REGISTRATION 1061161 DATED 12-1-2010, EXPIRES 12-
1-2020.

SER. NO. 79-091,020, FILED 12-1-2010.

CARYN GLASSER, EXAMINING ATTORNEY



David J. Kybas

Director of the United States Patent and Trademark Office

United States of America

United States Patent and Trademark Office

me time is tea time

Reg. No. 4,065,287

Registered Dec. 6, 2011

Int. Cls.: 16 and 30

TRADEMARK

PRINCIPAL REGISTER

TEEGSCHWENDNER GMBH (FED REP GERMANY GMBH)
HEIDESTR. 26
53340 MECKENHEIM
FED REP GERMANY

FOR: PRINTED MATTER, NAMELY, PRINTED CALENDARS, ART PRINTS, GREETING CARDS, BOOKS IN THE FIELD OF FOOD AND BEVERAGES, IN CLASS 16 (U.S. CLS. 2, 5, 22, 23, 29, 37, 38 AND 50).

FOR: TEA; TEA MIXTURES, NAMELY, BEVERAGES MADE OF TEA; FRUIT TEAS, IN CLASS 30 (U.S. CL. 46).

THE MARK CONSISTS OF STANDARD CHARACTERS WITHOUT CLAIM TO ANY PARTICULAR FONT, STYLE, SIZE, OR COLOR.

OWNER OF INTERNATIONAL REGISTRATION 1061170 DATED 11-29-2010, EXPIRES 11-29-2020.

SER. NO. 79-091,027, FILED 11-29-2010.

JAMES MACFARLANE, EXAMINING ATTORNEY



David J. Kybas

Director of the United States Patent and Trademark Office

United States of America
United States Patent and Trademark Office

SILCOPAC

Reg. No. 4,065,288

Registered Dec. 6, 2011

Int. Cl.: 9

TRADEMARK

PRINCIPAL REGISTER

ANSALDO SISTEMI INDUSTRIALI S.P.A. (ITALY JOINT STOCK COMPANY)
VIALE SARCA, 336
I-20126 MILANO MI
ITALY

FOR: STATIC ALTERNATING CURRENT THYRISTORS FOR DIRECT CURRENT FOR REGULATING ELECTRICAL ENGINES AT VARIABLE VELOCITY, IN CLASS 9 (U.S. CLS. 21, 23, 26, 36 AND 38).

THE WORD(S) "SILCOPAC" HAS NO MEANING IN A FOREIGN LANGUAGE.

OWNER OF INTERNATIONAL REGISTRATION 0433425 DATED 11-7-1977, EXPIRES 11-7-2017.

SER. NO. 79-091,053, FILED 10-29-2010.

MICHAEL SOUDERS, EXAMINING ATTORNEY



David J. Kybas

Director of the United States Patent and Trademark Office

United States of America
United States Patent and Trademark Office

KAHORI

Reg. No. 4,065,289

Registered Dec. 6, 2011

Int. Cl.: 31

MICHAËL JOANNES PETRUS HENRICUS DE KOK, T.H.O.D.N. JAPAN HOLLAND WEB
(NETHERLANDS SOLE PROPRIETORSHIP)
J.P. THIJSELAAN 5
NL-1431 JH AALSMEER
NETHERLANDS

TRADEMARK

PRINCIPAL REGISTER

FOR: HORTICULTURAL PRODUCTS, NAMELY, LIVE AND DRIED PLANTS; SEEDS, NAMELY, SEEDS TO PROPAGATE AND PRODUCE PLANTS; PLANT CUTTINGS, NAMELY, PLANT CUTTINGS TO PROPAGATE AND PRODUCE PLANTS; AND PLANT PARTS, NAMELY, PLANT PARTS TO PROPAGATE AND PRODUCE PLANTS AND OTHER ELEMENTS FOR PLANT REPRODUCTION, NAMELY, TISSUE CULTURE AND MERISTEEM-CULTURE TO PROPAGATE AND PRODUCE PLANTS, IN CLASS 31 (U.S. CLS. 1 AND 46).

THE MARK CONSISTS OF STANDARD CHARACTERS WITHOUT CLAIM TO ANY PARTICULAR FONT, STYLE, SIZE, OR COLOR.

OWNER OF INTERNATIONAL REGISTRATION 0911768 DATED 1-9-2007, EXPIRES 1-9-2017.

SER. NO. 79-091,091, FILED 7-30-2010.

APRIL ROACH, EXAMINING ATTORNEY



David J. Kyros

Director of the United States Patent and Trademark Office

United States of America
United States Patent and Trademark Office

HOLLANDIA

Reg. No. 4,065,290

Registered Dec. 6, 2011

Int. Cl.: 12

TRADEMARK

PRINCIPAL REGISTER

TRADECARE BRANDS BV (NETHERLANDS BESLOTEN VENNOOTSCHAP)
SOLINGENSTRAAT 49
DEVENTER, NETHERLANDS NL7421 ZR

FOR: BICYCLES, IN CLASS 12 (U.S. CLS. 19, 21, 23, 31, 35 AND 44).

THE MARK CONSISTS OF STANDARD CHARACTERS WITHOUT CLAIM TO ANY PARTICULAR FONT, STYLE, SIZE, OR COLOR.

OWNER OF INTERNATIONAL REGISTRATION 1020216 DATED 9-8-2009, EXPIRES 9-8-2019.

SER. NO. 79-091,111, FILED 5-17-2010.

RAUL CORDOVA, EXAMINING ATTORNEY



David J. Kyffers

Director of the United States Patent and Trademark Office

United States of America

United States Patent and Trademark Office

JENNIPIE

Reg. No. 4,065,291

Registered Dec. 6, 2011

**Int. Cls.: 16, 18, 25 and
30**

TRADEMARK

PRINCIPAL REGISTER

JENNY DALLA ZORZA (ITALY INDIVIDUAL)
VIALE ISONZO, 22
I-20100 MILANO
ITALY

FOR: PAPER, CARDBOARD AND GOODS MADE THEREOF, NAMELY, ADDRESS BOOKS, AGENDAS, PHOTOGRAPHS, PHOTOGRAPH ALBUMS, ANNIVERSARY BOOKS, ANNOUNCEMENT CARDS, APPOINTMENT BOOKS, BLANK CARDS, BLANK NOTE CARDS, BLANK OR PARTIALLY PRINTED LABELS NOT OF TEXTILE, BLANK OR PARTIALLY PRINTED POSTCARDS, BOOK COVERS, BOOK HOLDERS, BOOKENDS, BOOKMARKS, BUSINESS CARDS, CALENDARS, POCKET MEMORANDUM BOOKS, STATIONERY, WRITING PAPER, NOTEBOOKS, MEMO PAPER, POSTERS, GREETING CARDS, NOTE CARDS, CATALOGUES IN THE FIELD OF FASHION, FASHION DESIGN AND CONFECTIONERY; ENVELOPES, PAPER BOXES, CARDBOARD OR PAPER ADVERTISING SIGNS, PRINTED PAPER OR CARDBOARD SIGNS, PRICE TAGS, PRODUCT COMPOSITION TAGS AND CARE INSTRUCTION TAGS; PRINTED MATTER, NAMELY, BOOKS, MAGAZINES AND BROCHURES IN THE FIELDS OF FASHION, FASHION DESIGN AND CONFECTIONERY; PRINTED INSTRUCTIONAL AND TEACHING MATERIAL IN THE FIELD OF FASHION, FASHION DESIGN AND CONFECTIONERY; PACKAGING, NAMELY, CARDBOARD PACKAGING, PACKAGING CONTAINERS OF PAPER, PAPER BAGS FOR PACKAGING, PACKAGING MATERIALS MADE OF RECYCLED PAPER; PLASTIC MATERIALS, NAMELY, PLASTIC BAGS AND PLASTIC BUBBLE PACKS FOR WRAPPING AND FOR PACKAGING; PRINTERS' TYPE, PRINTING BLOCKS, IN CLASS 16 (U.S. CLS. 2, 5, 22, 23, 29, 37, 38 AND 50).



FOR: LEATHER AND IMITATION LEATHER; GOODS MADE OF LEATHER AND IMITATION LEATHER, NAMELY, CASES, HANDBAGS, LUGGAGE, SHOULDER BAGS, BEACH BAGS, CLUTCH BAGS, ALL PURPOSE SPORT BAGS, ATTACH CASES, SCHOOL BAGS, TOTE BAGS, TRAVELLING BAGS, CREDIT CARD CASES, DOCUMENT CASES, PASSPORT CASES, COSMETIC CASES SOLD EMPTY, KEY CASES, KNAPSACKS, RUCKSACKS, BRIEFCASES, PURSES, WALLETS, LUGGAGE TRUNKS, SUITCASES; ANIMAL SKINS AND HIDES; TRUNKS AND SUITCASES; UMBRELLAS, PARASOLS AND WALKING STICKS; WHIPS AND SADDLERY, IN CLASS 18 (U.S. CLS. 1, 2, 3, 22 AND 41).

David J. Kyffers

Director of the United States Patent and Trademark Office

FOR: NIGHTGOWNS, PYJAMAS, DRESSING GOWNS, HOME GOWNS, BED JACKETS, BOXER SHORTS, BODY SUITS, SINGLETs, VESTS, CAMISOLES, T-SHIRTS, TOPS, CORSETS, CORSELETTES, SLIPS, UNDERSHIRTS, UNDERPANTS, SWIMWEAR, UNDERWEAR,

Reg. No. 4,065,291 PANTIES, MINI BRIEFS, BRAS, STOCKINGS, TIGHTS, SUSPENDERS, BELTS, FOULARDS, SCARVES, SHAWLS; BATHING SUITS, SUN SUITS; HATS, CAPS; FOOTWEAR, NAMELY, BOOTS, SHOES AND SLIPPERS; CLOTHING FOR MEN, WOMEN AND CHILDREN, NAMELY, SOCKS, STOCKINGS, TROUSERS, SKIRTS, SLACKS, BLOUSES, SHIRTS, SWEATERS, WAISTCOATS, SHAWLS, PULLOVERS, CARDIGANS, JERSEYS, JACKETS, SUITS, TIES, OVERCOATS, COATS, TRACK SUITS, RAINCOATS, GLOVES, IN CLASS 25 (U.S. CLS. 22 AND 39).

FOR: CHOCOLATES; CHOCOLATE BARS; CHOCOLATE CANDIES; CHOCOLATE COVERED NUTS; CHOCOLATE TRUFFLES; ICE CREAM; BAKED GOODS, NAMELY, COOKIES, MUFFINS, SCONES, BISCUITS, PASTRIES, CAKES, AND BREADS; CANDY AND CARAMELS; MOUSSES, NAMELY, DESSERT MOUSSE, CHOCOLATE MOUSSE; BAKERY PRODUCTS, NAMELY, BREAD ROLLS AND SANDWICHES, BISCUITS, PIES, IN CLASS 30 (U.S. CL. 46).

THE MARK CONSISTS OF STANDARD CHARACTERS WITHOUT CLAIM TO ANY PARTICULAR FONT, STYLE, SIZE, OR COLOR.

PRIORITY DATE OF 1-27-2010 IS CLAIMED.

OWNER OF INTERNATIONAL REGISTRATION 1061278 DATED 6-8-2010, EXPIRES 6-8-2020.

SER. NO. 79-091,124, FILED 6-8-2010.

KEVIN CORWIN, EXAMINING ATTORNEY

United States of America

United States Patent and Trademark Office



Reg. No. 4,065,292

Registered Dec. 6, 2011

Int. Cls.: 9, 25 and 28

TRADEMARK

PRINCIPAL REGISTER

SCHOLLER, JOSEF (AUSTRIA INDIVIDUAL)
ALSERSTR. 65/27
A-1080 WIEN
AUSTRIA

FOR: SUNGLASSES; SAFETY GOGGLES; PROTECTIVE MASKS NOT FOR MEDICAL PURPOSES; SPORTS SPECTACLES; PROTECTIVE HELMETS, IN CLASS 9 (U.S. CLS. 21, 23, 26, 36 AND 38).

FOR: CLOTHING, NAMELY, SHIRTS, KNIT SHIRTS, JERSEYS AND TANK TOPS, T-SHIRTS, DRESSES, SKIRTS, UNDERWEAR, SHORTS, PANTS, SWEATERS, CAPS, HATS, BEANIES, BANDANAS, SCARVES, VISORS, WARM-UP SUITS, SWEATSHIRTS, JACKETS, UNIFORMS, WRISTBANDS AND HEADBANDS, GLOVES, SOCKS AND HOSIERY, BELTS, SUSPENDERS; FOOTWEAR; HEADWEAR, IN CLASS 25 (U.S. CLS. 22 AND 39).

FOR: GYMNAS TIC AND SPORTING ARTICLES NOT INCLUDED IN OTHER CLASSES, NAMELY, BASEBALLS, BASKETBALLS, SOCCER BALLS, FOOTBALLS, RUGBY BALLS, VOLLEYBALLS, HANDBALL BALLS, GYMNAS TIC BALLS, WATER POLO BALLS, SPORT BALLS, SKATING BOOTS WITH SKATES ATTACHED, ROLLER SKATES, IN-LINE SKATES, COVERS FOR ROLLER SKATES AND IN-LINE SKATES, ICE SKATES, BOXING GLOVES, HANG GLIDERS, ARCHERY IMPLEMENTS, ARCHERY BOW CASES, ARCHERY BOWS, BOB-SLEIGHS, KITES, TRACTION KITES, KITE REELS, STRINGS FOR RACKETS, GUTS FOR TENNIS RACKETS, GUTS FOR BADMINTON RACKETS, TENNIS RACKETS, TENNIS RACKET COVERS, TABLE TENNIS RACKETS, COVERS FOR TABLE TENNIS RACKETS, BADMINTON RACKETS, COVERS FOR BADMINTON RACKETS, BADMINTON SHUTTLECOCKS, BALLS FOR GAMES, FISHING TACKLE, WINDSURFING BOARDS, COVERS FOR WINDSURFING BOARDS, SURFBOARDS, NOT MOTORIZED, BODY BOARDS, BAGS ESPECIALLY DESIGNED FOR SURFBOARDS, SWIM FLOATS FOR RECREATIONAL USE, ARM FLOATS FOR RECREATIONAL USE, FLOATS FOR FISHING, SNOWBOARDS, SWIMMING BOARDS, NETS FOR SPORTS, GOLF CLUBS, GOLF TEES, GOLF PRACTICE NETS, GOLF ACCESSORIES AND EQUIPMENT, NAMELY, GOLF CLUB COVERS AND GOLF BAGS WITH OR WITHOUT WHEELS, SKIS, SKI POLES, WATER SKIS, SKI EDGES, SKI BINDINGS, SKI COVERS, SNOWSHOES, COVERS FOR SNOWSHOES, FISHING RODS AND FISHING AND ANGLING ACCESSORIES, NAMELY, WINGING MATERIAL FOR FISHING JIGS AND STREAMERS, FISHING LURE RETRIEVER, FISHING POOLS, FISHING ROD HOLDERS, FISHING ROD CASES, FISHING REELS, FISHING LINES, FISHING PLUGS, FISHING HOOKS, ARTIFICIAL FISHING BAIT, PACKAGED FREEZE-



David J. Kybas

Director of the United States Patent and Trademark Office

Reg. No. 4,065,292 DRIED FISHING BAIT, FISHING FLIES, FISHING WEIGHTS AND FISHING SINKERS, CROSS-BOWS AND ARROWS, SCUBA EQUIPMENT, NAMELY, SPEARFISHING HARPOON GUNS, FLIPPERS FOR SWIMMING, WATER GAMES, NAMELY, POLO, SWIMMING, DIVING, SURFING, SAILING, WATER SKIING, BASKETBALL, BASEBALL, VOLLEYBALL, POOL GOLF, AND WATER TOYS, INFLATABLE POOLS FOR RECREATIONAL USE, INFLATABLE SWIMMING POOLS, PLAY SWIMMING POOLS, SLEDGES, NAMELY, SNOW SLEDGES FOR RECREATIONAL USE, SWINGS, BILLIARD TABLES AND BILLIARD BALLS, BILLIARD CUES, STATIONARY EXERCISE BICYCLES, EXERCISE EQUIPMENT, NAMELY, CHEST EXPANDERS, FENCING WEAPONS, HOCKEY STICKS, SKITTLES AND BOWLS FOR SKITTLE GAME, PETANQUE BALLS, COVERS FOR PETANQUE BALLS, EXERCISE MACHINES, GYMNASTICS APPARATUS, NAMELY, ABDOMINAL BOARDS, WALL CLIMBING EQUIPMENT AND ACCESSORIES, NAMELY, CLIMBING HARNESES, CLIMBING GRIPS, KARABINERS FOR CLIMBING, TABLES FOR TABLE TENNIS, ELBOW GUARDS FOR ATHLETIC USE, KNEE GUARDS FOR ATHLETIC USE, SKIN GUARDS FOR ATHLETIC USE, GOLF GLOVES, FENCING GLOVES, BASEBALL GLOVES, BOB-SLEIGHS IN THE NATURE OF SPORTS ARTICLES, SNOW SLEDGES FOR RECREATIONAL USE, SKI MASKS, GOLF BAGS, TENNIS BAGS AND BAGS FOR RACKET SPORTS; SKATEBOARDS; SURFBOARDS; SURF SKIS, IN CLASS 28 (U.S. CLS. 22, 23, 38 AND 50).

THE MARK CONSISTS OF TWO HANDS FORMING A HEART SHAPE WITHIN A SHADED CIRCLE.

OWNER OF INTERNATIONAL REGISTRATION 1061307 DATED 10-18-2010, EXPIRES 10-18-2020.

SER. NO. 79-091,134, FILED 10-18-2010.

MELISSA VALLILLO, EXAMINING ATTORNEY

United States of America
United States Patent and Trademark Office

ePLAN
pro panel

Reg. No. 4,065,293

Registered Dec. 6, 2011

Int. Cls.: 9, 41 and 42

EPLAN SOFTWARE & SERVICE GMBH & CO. KG (FED REP GERMANY LIMITED
PARTNERSHIP WITH A LIMITED LIABILITY COMPANY)
AN DER ALTEN ZIEGELEI 2
40789 MONHEIM
FED REP GERMANY

TRADEMARK

FOR: DATA CARRIERS PRE-RECORDED WITH COMPUTER SOFTWARE FOR USE IN
DESIGNING ELECTRICAL AND FLUID-ENGINEERING MOUNTING LAYOUTS AND EN-
CLOSURES IN 3-DIMENSIONS, IN CLASS 9 (U.S. CLS. 21, 23, 26, 36 AND 38).

SERVICE MARK

FOR: PROVIDING COMPUTER EDUCATION TRAINING FOR COMPUTER USERS, IN
CLASS 41 (U.S. CLS. 100, 101 AND 107).

PRINCIPAL REGISTER

FOR: DESIGN OF COMPUTER PROGRAMS FOR COMPUTER AIDED CONSTRUCTION
PROJECTS, AND CUSTOMIZATION OF COMPUTER PROGRAMS FOR SPECIAL USER
REQUIREMENTS, IN CLASS 42 (U.S. CLS. 100 AND 101).

OWNER OF U.S. REG. NOS. 1,485,111, 3,302,169 AND OTHERS.

PRIORITY DATE OF 5-21-2010 IS CLAIMED.

OWNER OF INTERNATIONAL REGISTRATION 1061377 DATED 10-30-2010, EXPIRES 10-
30-2020.

NO CLAIM IS MADE TO THE EXCLUSIVE RIGHT TO USE "PANEL", APART FROM THE
MARK AS SHOWN.

THE MARK CONSISTS OF THE WORDING "EPLAN PRO PANEL" IN STYLIZED FONT.

SER. NO. 79-091,154, FILED 10-30-2010.

AMY C. KEAN, EXAMINING ATTORNEY



David J. Kappas

Director of the United States Patent and Trademark Office

United States of America

United States Patent and Trademark Office



Reg. No. 4,065,294

Registered Dec. 6, 2011

**Int. Cls.: 35, 38, 39, 42
and 43**

SERVICE MARK

PRINCIPAL REGISTER

HOTEL RESERVATION SERVICE ROBERT RAGGE GMBH (FED REP GERMANY LIMITED LIABILITY COMPANY)
50676 KÖLN
FED REP GERMANY

FOR: ARRANGING OF CONTRACTS FOR OTHERS FOR THE PROVIDING OF SERVICES, IN PARTICULAR REGARDING THE LODGING OF GUESTS; PRICE COMPARISON SERVICES; COMPUTERIZED ON-LINE ORDERING SERVICES, FEATURING GENERAL MERCHANDISE AND GENERAL CONSUMER GOODS; SYSTEMATIZATION OF DATA IN COMPUTER DATABASES; ADVERTISING AGENCIES, IN CLASS 35 (U.S. CLS. 100, 101 AND 102).

FOR: PROVISION OF ACCESS TO INFORMATION REGARDING WORLDWIDE HOTEL RESERVATIONS VIA THE INTERNET; PROVISION OF ACCESS TO DATABASES REGARDING WORLDWIDE HOTEL ACCOMMODATION IN COMPUTER NETWORKS; TELECOMMUNICATION SERVICES, NAMELY, PROVIDING ACCESS VIA INTERNET PLATFORMS AND PORTALS, FOR RESERVATION OF HOTEL AND GUESTHOUSE ACCOMMODATION AS WELL AS ACCOMMODATION FOR THIRD PARTIES, IN CLASS 38 (U.S. CLS. 100, 101 AND 104).

FOR: TRAVEL RESERVATION SERVICES, NAMELY, BOOKING OF SEATS FOR TRAVEL, IN PARTICULAR VIA A WORLDWIDE HOTEL RESERVATION SYSTEM; TRAVEL RESERVATION SERVICES, NAMELY, TRAVEL AND TOUR TICKET RESERVATION SERVICE; ARRANGEMENT AND ORGANIZATION OF TOURS, IN CLASS 39 (U.S. CLS. 100 AND 105).

FOR: PROVIDING SEARCH ENGINES ON THE INTERNET, IN PARTICULAR FOR WORLDWIDE HOTEL RESERVATIONS, IN CLASS 42 (U.S. CLS. 100 AND 101).

FOR: ACCOMMODATION BUREAU SERVICES, NAMELY, MAKING RESERVATIONS FOR TEMPORARY ACCOMMODATION, HOTELS AND GUEST HOUSES FOR OTHERS; SERVICES FOR THE RESERVATION OF MEETING ROOMS, IN CLASS 43 (U.S. CLS. 100 AND 101).



David J. Kyjars

Director of the United States Patent and Trademark Office

OWNER OF U.S. REG. NOS. 2,159,938 AND 3,112,205.

PRIORITY DATE OF 3-24-2010 IS CLAIMED.

Reg. No. 4,065,294 OWNER OF INTERNATIONAL REGISTRATION 1061439 DATED 9-24-2010, EXPIRES 9-24-2020.

THE COLOR(S) LIGHT BLUE, WHITE, RED AND DARK BLUE IS/ARE CLAIMED AS A FEATURE OF THE MARK.

NO CLAIM IS MADE TO THE EXCLUSIVE RIGHT TO USE "HOTELPORTAL" IN CLASS 38, APART FROM THE MARK AS SHOWN.

THE MARK CONSISTS OF THE LETTERS "HRS", SHOWN FADING FROM DARK BLUE AT THE BOTTOM TO LIGHT BLUE AT THE TOP, WITH A WHITE BACKGROUND; TO THE LEFT, IS SHOWN A CIRCLE WITH A WHITE BORDER WITH A RED BACKGROUND, CONTAINING A WHITE BED IN THE CENTER LINED IN RED, WITH THE WORDING, "DAS HOTELPORTAL", IN WHITE, BELOW WITH ALL THE PRECEDING ON A RED BACKGROUND.

THE ENGLISH TRANSLATION OF "DAS" IN THE MARK IS THAT.

SER. NO. 79-091,178, FILED 9-24-2010.

ODESSA BIBBINS, EXAMINING ATTORNEY

United States of America

United States Patent and Trademark Office

SLICK FLICK

Reg. No. 4,065,295

Registered Dec. 6, 2011

Int. Cls.: 9 and 41

TRADEMARK

SERVICE MARK

PRINCIPAL REGISTER

CURIOUS QUESTS (UNITED KINGDOM LIMITED COMPANY)
40 PALACE GARDENS TERRACE
LONDON W8 4RP
UNITED KINGDOM

FOR: DOWNLOADABLE SOFTWARE APPLICATION FOR ELECTRONIC DEVICES SUCH AS MOBILE PHONES, COMPUTERS AND OTHER SIMILAR DEVICES, NAMELY, SOFTWARE FOR TOUCH SCREEN DEVICES THAT ENABLES THE VIEWING OF PHOTOGRAPHY AND TEXT; DOWNLOADABLE ELECTRONIC PUBLICATIONS IN THE NATURE OF PICTURE STORIES, WHETHER FICTIONAL OR FACTUAL, IN A VARIETY OF ENTERTAINMENT GENRES FEATURING ACTION, ADVENTURE, DRAMA, ROMANCE, COMEDY, SPORTS, MYSTERIES, DOCUMENTARY, REPORTAGE, COOKING, SCIENCE FICTION, MUSIC, CHILDREN'S ENTERTAINMENT, AND ART, IN CLASS 9 (U.S. CLS. 21, 23, 26, 36 AND 38).

FOR: ENTERTAINMENT IN THE NATURE OF PHOTO STORIES, NAMELY, IMAGES AND TEXT, WHETHER FICTIONAL OR FACTUAL, IN A VARIETY OF ENTERTAINMENT GENRES FEATURING ACTION, ADVENTURE, DRAMA, ROMANCE, COMEDY, SPORTS, MYSTERIES, DOCUMENTARY, REPORTAGE, COOKING, SCIENCE FICTION, MUSIC, CHILDREN'S ENTERTAINMENT, AND ART; CULTURAL ACTIVITIES, NAMELY, FILM FESTIVALS; AND EDUCATIONAL SERVICES, NAMELY, CONDUCTING TRANSLATION EXERCISES OR EXERCISES FOR DYSLLEXIC CHILDREN USING PHOTO STORIES; CREATION AND DISTRIBUTION OF AUDIO AND VISUAL CREATIVE CONTENT ON THE PHOTO STORY PLATFORM FOR ENTERTAINMENT, CULTURAL ACTIVITIES AND EDUCATION PURPOSES AND ALSO, TO PROMOTE, SUPPORT AND COMPLEMENT THE PLATFORM ON THE INTERNET OR ON TV, IN CLASS 41 (U.S. CLS. 100, 101 AND 107).

THE MARK CONSISTS OF STANDARD CHARACTERS WITHOUT CLAIM TO ANY PARTICULAR FONT, STYLE, SIZE, OR COLOR.

PRIORITY DATE OF 9-22-2010 IS CLAIMED.

OWNER OF INTERNATIONAL REGISTRATION 1061551 DATED 11-11-2010, EXPIRES 11-11-2020.

NO CLAIM IS MADE TO THE EXCLUSIVE RIGHT TO USE "FLICK" , APART FROM THE MARK AS SHOWN.



David J. Kybas

Director of the United States Patent and Trademark Office

Reg. No. 4,065,295 SER. NO. 79-091,205, FILED 11-11-2010.

PRISCILLA MILTON, EXAMINING ATTORNEY

United States of America

United States Patent and Trademark Office



Reg. No. 4,065,296

Registered Dec. 6, 2011

Int. Cls.: 1, 9 and 11

TRADEMARK

PRINCIPAL REGISTER

AES CHEMUNEX (FRANCE SOCIÉTÉ ANONYME)
ZAC DE KER LAN -
RUE MARYSE BASTIÉ; F-35170 BRUZ
FRANCE

FOR: CHEMICALS USED IN INDUSTRY, SCIENCE AND PHOTOGRAPHY, AS WELL AS IN AGRICULTURE, HORTICULTURE AND FORESTRY EXCEPT FUNGICIDES, HERBICIDES, INSECTICIDES AND PARASITICIDES; ARTIFICIAL RESINS, UNPROCESSED; FERTILIZERS; FIRE EXTINGUISHING COMPOSITIONS; CHEMICAL SUBSTANCES FOR PRESERVING FOODSTUFFS; ADHESIVES FOR INDUSTRIAL PURPOSES; CHEMICAL REAGENTS, OTHER THAN FOR MEDICAL OR VETERINARY PURPOSES, IN CLASS 1 (U.S. CLS. 1, 5, 6, 10, 26 AND 46).

FOR: SCIENTIFIC RESEARCH APPARATUS AND INSTRUMENTS FOR THE FOOD, CHEMICAL AND PLASTICS INDUSTRIES, AND PARTICULARLY FOR USE IN LABORATORIES, NAMELY, FLOW CYTOMETER, AIR BIO COLLECTOR IN THE NATURE OF APPARATUS USED FOR COLLECTING AIR SAMPLES, GRAVIMETRIC DILUTOR, HOMOGENIZING BLENDER, CULTURE MEDIA DISPENSING SYSTEM IN THE NATURE OF AN AUTOMATED POURER STACKER FOR PETRI DISH FILLING, CULTURE MEDIA DISPENSING SYSTEM CONSISTING OF A PIPING SYSTEM USED TO PREPARE AND DISPENSE CULTURE MEDIA INTO TUBES AND BOTTLES, THERMOCYCLER BEING LABORATORY APPARATUS USED TO AMPLIFY DNA SEGMENTS, COLONY COUNTER BEING LABORATORY APPARATUS USED TO COUNT BACTERIA COLONIES, DEVICES FOR THE MANAGEMENT OF ANALYSIS IN THE NATURE OF AN IDENTIFICATION SYSTEM UTILIZING BARCODE SCANNERS WHICH IDENTIFY SAMPLES AND PRODUCTS TO BE ANALYZED, DEVICES FOR THE TRACKING AND MEASURING OF TEMPERATURES, PIPETTE, CENTRIFUGAL MACHINE, MICROSCOPE, SPIRAL INOCULATOR BEING AUTOMATED SPIRAL PLATER USED TO TEST AND INOCULATE MICROBIAL LIQUID SAMPLES, IN CLASS 9 (U.S. CLS. 21, 23, 26, 36 AND 38).

FOR: APPARATUS FOR LIGHTING, HEATING, STEAM GENERATING, COOKING, REFRIGERATING, DRYING, VENTILATING, APPLIED TO LABORATORY ANALYSES AND MEASUREMENTS, NAMELY, ELECTRIC AUTOCLAVE, REFRIGERATORS FOR LABORATORIES, FREEZERS FOR LABORATORIES, BUNSEN BURNER, LAMINAR AIR FLOW HOODS, DEVICES FOR USE IN THE PREPARATION OF CULTURE MEDIA NAMELY, A HEATER AND A MIXER VAT USED FOR THE AUTOMATIC PREPARATION OF CULTURE



David J. Kybas

Director of the United States Patent and Trademark Office

Reg. No. 4,065,296 MEDIA, WATER BATH IN THE NATURE OF HOT WATER HEATERS, IN CLASS 11 (U.S. CLS. 13, 21, 23, 31 AND 34).

OWNER OF U.S. REG. NO. 3,488,792.

PRIORITY DATE OF 4-19-2010 IS CLAIMED.

OWNER OF INTERNATIONAL REGISTRATION 1061672 DATED 10-18-2010, EXPIRES 10-18-2020.

THE COLOR(S) BLUE AND RED IS/ARE CLAIMED AS A FEATURE OF THE MARK.

NO CLAIM IS MADE TO THE EXCLUSIVE RIGHT TO USE "LABORATOIRE", APART FROM THE MARK AS SHOWN.

THE MARK CONSISTS OF THE WORDING "AES LABORATOIRE" IN BLUE, WHEREIN THE BOTTOM RIGHT PORTION OF THE LETTER "A" IN "AES" IS DEPICTED AS A RED SQUARE.

THE ENGLISH TRANSLATION OF "LABORATOIRE" IS "LABORATORY".

SER. NO. 79-091,249, FILED 10-18-2010.

MELISSA VALLILLO, EXAMINING ATTORNEY

United States of America

United States Patent and Trademark Office



Reg. No. 4,065,297

Registered Dec. 6, 2011

Int. Cls.: 6 and 20

TRADEMARK

PRINCIPAL REGISTER

L.M. DEI F.LLI MONTICELLI - S.R.L. (ITALY LIMITED LIABILITY COMPANY)
VIA DEI GIUGGIOLI
I-60027 OSIMO (AN)
ITALY

FOR: HANDLES, LOCKS, HINGES, BRACKETS, CORNER JOINTS, ALL MADE OF METAL AND LIGHT METAL ALLOYS, FOR METAL AND NON-METAL WINDOW AND DOOR FRAMES, IN CLASS 6 (U.S. CLS. 2, 12, 13, 14, 23, 25 AND 50).

FOR: HANDLES OF PLASTIC, LOCKS, HINGES, BRACKETS, CORNER JOINTS, ALL MADE OF NON-METAL MATERIAL, FOR METAL AND NON-METAL WINDOW AND DOOR FRAMES, IN CLASS 20 (U.S. CLS. 2, 13, 22, 25, 32 AND 50).

THE TRADEMARK CONSISTS OF THE WORDING "MONTICELLI" WRITTEN IN SPECIAL PRINTED CHARACTERS ENCLOSED IN A FILIFORM FRAME.

PRIORITY DATE OF 9-22-2010 IS CLAIMED.

OWNER OF INTERNATIONAL REGISTRATION 1061677 DATED 10-15-2010, EXPIRES 10-15-2020.

SEC. 2(F).

SER. NO. 79-091,251, FILED 10-15-2010.

JULIE VEPPUMTHARA, EXAMINING ATTORNEY



David J. Kybas

Director of the United States Patent and Trademark Office

United States of America

United States Patent and Trademark Office



Reg. No. 4,065,298

Registered Dec. 6, 2011

Int. Cls.: 18, 24 and 25

TRADEMARK

PRINCIPAL REGISTER

LEISURE SHOES SARL (FRANCE SOCIÉTÉ À RESPONSABILITÉ LIMITÉE (SARL))
4 RUE DU MARCHÉ SAINT-HONORÉ
F-75001 PARIS
FRANCE

FOR: LEATHER AND IMITATIONS OF LEATHER; ANIMAL SKINS; TRUNKS AND SUIT-CASES; UMBRELLAS, PARASOLS AND WALKING STICKS; WHIPS, HARNESS AND SADDLERY; WALLETS; PURSES; HANDBAGS, BACKPACKS, WHEELED BAGS; BAGS FOR CLIMBERS IN THE NATURE OF ALL-PURPOSE CARRYING BAGS, BAGS FOR CAMPERS IN THE NATURE OF ALL-PURPOSE CARRYING BAGS, TRAVELING BAGS, BEACH BAGS, SCHOOL BAGS; UNFITTED VANITY CASES; COLLARS OR COVERS FOR ANIMALS; SHOPPING BAGS AND MESH SHOPPING BAGS; BAGS OR SMALL BAGS OF LEATHER FOR PACKAGING, IN CLASS 18 (U.S. CLS. 1, 2, 3, 22 AND 41).

FOR: FABRIC FOR THE MANUFACTURE OF CLOTHING AND UPHOLSTERY; BED AND TABLE COVERS; FABRICS FOR TEXTILE USE; ELASTIC WOVEN MATERIAL, NAMELY, WOVEN FABRICS, ELASTIC WOVEN FABRICS FOR CLOTHING, WOVEN FABRIC FOR UPHOLSTERY; VELVET; BED LINEN; HOUSEHOLD LINEN; TABLE LINEN, NOT OF PAPER; BATH LINEN (EXCEPT CLOTHING), IN CLASS 24 (U.S. CLS. 42 AND 50).

FOR: CLOTHING, NAMELY, SHIRTS, PANTS, DRESSES, COATS, SKIRTS, JACKETS, TEE-SHIRTS, SWEATERS, SWIMSUIT; FOOTWEAR; HEADGEAR, NAMELY, HATS, CAPS; SHIRTS; LEATHER OR IMITATION OF LEATHER CLOTHING, NAMELY, LEATHER PANTS, LEATHER VESTS, LEATHER JACKETS, LEATHER BELTS, LEATHER DRESSES, LEATHER SKIRTS; BELTS (CLOTHING); FURS, NAMELY, COATS, FUR MUFFS, FUR TRIMMINGS, FUR HATS; GLOVES; SCARVES; NECKTIES; HOSIERY; SOCKS; SLIPPERS; BEACH, SKI OR SPORTS FOOTWEAR; BABIES' DIAPERS OF TEXTILE; UNDERWEAR, IN CLASS 25 (U.S. CLS. 22 AND 39).

NO CLAIM IS MADE TO THE EXCLUSIVE RIGHT TO USE "LEISURE SHOES" FOR INTERNATIONAL CLASS 25, APART FROM THE MARK AS SHOWN.

PRIORITY DATE OF 7-7-2010 IS CLAIMED.

OWNER OF INTERNATIONAL REGISTRATION 1061697 DATED 10-26-2010, EXPIRES 10-26-2020.



David J. Kyros

Director of the United States Patent and Trademark Office

Reg. No. 4,065,298 THE MARK CONSISTS OF THE WORDING "RIVIERAS LEISURE SHOES" WRITTEN IN A STYLIZED SCRIPT WITH THE TERM "RIVIERAS" APPEARING IN A LARGER FONT AND OVER THE TERMS "LEISURE SHOES".

SER. NO. 79-091,261, FILED 10-26-2010.

RICHARD WHITE, EXAMINING ATTORNEY

United States of America

United States Patent and Trademark Office

OPEN-PLUG

Reg. No. 4,065,299

Registered Dec. 6, 2011

Int. Cls.: 9, 38 and 42

TRADEMARK

SERVICE MARK

PRINCIPAL REGISTER

ALCATEL-LUCENT FRANCE
3 AVENUE OCTAVE GRÉARD
F-75007 PARIS
FRANCE

FOR: COMPUTER SOFTWARE FOR PROCESSING, TRANSMITTING AND REPRODUCING SOUND AND IMAGES; COMPUTER SOFTWARE FOR CREATING APPLICATIONS AND FEATURES OF MOBILE PHONES, SMARTPHONES, TABLET COMPUTERS OR ANY EMBEDDED DEVICES; ELECTRONIC APPARATUS, NAMELY, COMPUTERS DESIGNED TO ACQUIRE, PROCESS, TRANSMIT OR REPRODUCE SOUNDS, IMAGES OR ANY OTHER KIND OF DATA; ELECTRONIC PAYMENT OR PREPAYMENT APPARATUS IN THE NATURE OF ELECTRONIC PAYMENT TERMINALS, IN CLASS 9 (U.S. CLS. 21, 23, 26, 36 AND 38).

FOR: CONNECTION TO A GLOBAL COMPUTER NETWORK BY MEANS OF TELECOMMUNICATION; COMMUNICATION VIA COMPUTER TERMINALS; PROFESSIONAL ADVICE AND CONSULTING IN THE FIELD OF TELECOMMUNICATION, IN CLASS 38 (U.S. CLS. 100, 101 AND 104).

FOR: PRODUCT AND SCIENTIFIC RESEARCH AND DEVELOPMENT FOR OTHERS; COMPUTER SOFTWARE DESIGN; COMPUTER PROGRAMMING, IN CLASS 42 (U.S. CLS. 100 AND 101).

THE MARK CONSISTS OF STANDARD CHARACTERS WITHOUT CLAIM TO ANY PARTICULAR FONT, STYLE, SIZE, OR COLOR.

OWNER OF INTERNATIONAL REGISTRATION 1061822 DATED 10-21-2010, EXPIRES 10-21-2020.

SER. NO. 79-091,300, FILED 10-21-2010.

SEAN CROWLEY, EXAMINING ATTORNEY



David J. Kyros

Director of the United States Patent and Trademark Office

United States of America

United States Patent and Trademark Office

SONANGOL

Reg. No. 4,065,300

Registered Dec. 6, 2011

**Int. Cls.: 35, 39, 40 and
42**

SERVICE MARK

PRINCIPAL REGISTER

SOCIEDADE NACIONAL DE COMBUSTIVEIS DE ANGOLA (ANGOLA CORPORATION)
RUA RAINHA GINGA, N° 29/31
LUANDA
ANGOLA

FOR: MARKETING SERVICES, NAMELY, MARKETING CONSULTANCY SERVICES, BUSINESS MARKETING SERVICES, PROVIDING MARKETING ADVICE AND SOLUTIONS FOR OIL, GAS, FUEL AND AVIATION INDUSTRIES AND RETAILERS OF OIL, GAS AND FUEL, IN CLASS 35 (U.S. CLS. 100, 101 AND 102).

FOR: INFORMATION SERVICES RELATING TO THE TRANSPORTATION OF CRUDE OIL, GAS AND FUEL; OIL AND FUEL BUNKERING SERVICES; OIL, GAS AND FUEL DISTRIBUTION SERVICES; STORAGE OF OIL, GAS AND FUEL; TRANSPORTATION OF OIL, GAS AND FUEL; TRANSPORTATION OF OIL, GAS AND FUEL BY PIPELINE; CONSULTANCY, INFORMATION AND ADVISORY SERVICES RELATING TO THE AFORESAID , IN CLASS 39 (U.S. CLS. 100 AND 105).

FOR: CONSULTANCY RELATING TO THE CLEARANCE OF OIL POLLUTION; OIL-SPILL TREATMENT; PROCESSING OF OIL; REFINING OF CRUDE OIL; TREATMENT OF CRUDE MINERAL OIL; TREATMENT OF OILS BY THE REMOVAL OF POLYCHLORINATED BI-PHENOLS; FUEL REFINING; FUEL TREATMENT SERVICES; FILTRATION OF GASES; GAS PROCESSING SERVICES; PURIFICATION OF GASES; RECOVERY OF HYDROCARBONS FOR GAS; REFINING OF GAS; CONSULTANCY, INFORMATION AND ADVISORY SERVICES RELATING TO THE AFORESAID , IN CLASS 40 (U.S. CLS. 100, 103 AND 106).

FOR: ANALYSIS FOR OIL AND GAS FIELD EXPLOITATION; ANALYSIS FOR OIL AND GAS FIELD EXPLORATION; ANALYTICAL AND TESTING SERVICES FOR OIL WORKINGS; ANALYTICAL SERVICES RELATING TO THE DEVELOPMENT OF OIL AND GAS FIELDS; ANALYTICAL SERVICES RELATING TO THE EXPLORATION OF OIL AND GAS FIELDS; CONDUCTING FEASIBILITY STUDIES RELATIVE TO OIL AND GAS FIELD EXPLOITATION; CONDUCTING FEASIBILITY STUDIES RELATIVE TO OIL AND GAS FIELD EXPLORATION; EXPLORATION SERVICES TO LOCATE OIL AND GAS; GEOPHYSICAL EXPLORATION FOR THE OIL AND GAS INDUSTRIES; OIL AND GAS EXPLORATION; OIL AND GAS PROSPECTING; OIL SPILL CONTINGENCY PLANNING SERVICES; OIL-WELL TESTING; PROVISION OF TECHNICAL CONSULTANCY TO THE OIL REFINING INDUSTRY; OIL AND GAS FIELD SURVEY SERVICES; CONSULTANCY, INFORMATION



David J. Kyffers

Director of the United States Patent and Trademark Office

Reg. No. 4,065,300 AND ADVISORY SERVICES RELATING TO THE AFORESAID, IN CLASS 42 (U.S. CLS. 100 AND 101).

THE MARK CONSISTS OF STANDARD CHARACTERS WITHOUT CLAIM TO ANY PARTICULAR FONT, STYLE, SIZE, OR COLOR.

PRIORITY DATE OF 4-13-2010 IS CLAIMED.

OWNER OF INTERNATIONAL REGISTRATION 1061926 DATED 6-30-2010, EXPIRES 6-30-2020.

OWNER OF U.S. REG. NOS. 2,341,236, 2,442,485 AND OTHERS.

SER. NO. 79-091,352, FILED 6-30-2010.

MARILYN IZZI, EXAMINING ATTORNEY

United States of America

United States Patent and Trademark Office

U-MAN

Reg. No. 4,065,301

Registered Dec. 6, 2011

Int. Cl.: 32

TRADEMARK

PRINCIPAL REGISTER

U-MAN (FRANCE SOCIÉTÉ PAR ACTIONS SIMPLIFIÉE)
1 RUE SAINT-JUDICAËL
F-56490 LA TRINITE PORHOET
FRANCE

FOR: BEER; MINERAL AND AERATED WATERS; FRUIT DRINKS AND FRUIT JUICES;
SYRUPS FOR MAKING BEVERAGES; LEMONADES; FRUIT NECTARS; SODA WATER;
NON-ALCOHOLIC APERITIFS, IN CLASS 32 (U.S. CLS. 45, 46 AND 48).

THE MARK CONSISTS OF STANDARD CHARACTERS WITHOUT CLAIM TO ANY PAR-
TICULAR FONT, STYLE, SIZE, OR COLOR.

PRIORITY DATE OF 5-6-2010 IS CLAIMED.

OWNER OF INTERNATIONAL REGISTRATION 1061970 DATED 11-3-2010, EXPIRES 11-
3-2020.

SER. NO. 79-091,370, FILED 11-3-2010.

LINDSEY RUBIN, EXAMINING ATTORNEY



David J. Kyffers

Director of the United States Patent and Trademark Office

United States of America
United States Patent and Trademark Office

DESIKOTE

Reg. No. 4,065,302

Registered Dec. 6, 2011

Int. Cl.: 1

TRADEMARK

PRINCIPAL REGISTER

TAMINCO, NAAMLOZE VENNOOTSCHAP (BELGIUM JOINT STOCK COMPANY)
PANTSERSCHIPSTRAAT 207
B-9000 GENT
BELGIUM

FOR: CHEMICAL PREPARATIONS FOR USE IN AGRICULTURE, NAMELY, PRE-HARVEST MANAGEMENT CHEMICALS TO CONTROL POD SHATTER AND TO CONTROL TRANSPIRATION IN CEREAL AND GRASS SEED CROPS, IN CLASS 1 (U.S. CLS. 1, 5, 6, 10, 26 AND 46).

THE MARK CONSISTS OF STANDARD CHARACTERS WITHOUT CLAIM TO ANY PARTICULAR FONT, STYLE, SIZE, OR COLOR.

PRIORITY DATE OF 10-19-2010 IS CLAIMED.

OWNER OF INTERNATIONAL REGISTRATION 1061973 DATED 10-20-2010, EXPIRES 10-20-2020.

THE WORDING "DESIKOTE" HAS NO MEANING IN A FOREIGN LANGUAGE.

SER. NO. 79-091,371, FILED 10-20-2010.

COLLEEN DOMBROW, EXAMINING ATTORNEY



David J. Kybas

Director of the United States Patent and Trademark Office

United States of America

United States Patent and Trademark Office



Reg. No. 4,065,303

Registered Dec. 6, 2011

Int. Cls.: 14 and 35

TRADEMARK

SERVICE MARK

PRINCIPAL REGISTER

MELANO B.V. (NETHERLANDS B.V. (COMPANY WITH LIMITED LIABILITY))
KRUISSTRAAT 16
NL-6171 GG STEIN (LB)
NETHERLANDS

FOR: PRECIOUS METALS AND THEIR ALLOYS AND GOODS IN PRECIOUS METALS OR COATED THEREWITH, NOT INCLUDED IN OTHER CLASSES, NAMELY, BRACELETS; JEWELLERY, PRECIOUS STONES; HOROLOGICAL AND CHRONOMETRIC INSTRUMENTS, IN CLASS 14 (U.S. CLS. 2, 27, 28 AND 50).

FOR: ADVERTISING; BUSINESS MANAGEMENT; BUSINESS ADMINISTRATION; PROVIDING OFFICE FUNCTIONS; MANAGEMENT OF DATABASES FOR VIRTUAL MARKET AND SALES PLACES OR SHOPS FOR THE COMMERCIALIZATION OF GOODS, INCLUDING GIFTS AND JEWELLERY; MEDIATION OF TRADE BUSINESS FOR THIRD PARTIES WITH REGARD TO THE COMMERCIALIZATION OF GOODS, INCLUDING GIFTS AND JEWELLERY, INCLUDING VIA VIRTUAL MARKET PLACES AND SALES LOCATIONS OR SHOPS OR VIA WHOLESALE COMPANIES, IN CLASS 35 (U.S. CLS. 100, 101 AND 102).

THE MARK CONSISTS OF THE WORDING "MELANO" IN A STYLIZED FONT ON A SHADED RECTANGLE.

PRIORITY DATE OF 7-14-2010 IS CLAIMED.

OWNER OF INTERNATIONAL REGISTRATION 1062208 DATED 10-20-2010, EXPIRES 10-20-2020.

SER. NO. 79-091,445, FILED 10-20-2010.

COLLEEN DOMBROW, EXAMINING ATTORNEY



David J. Kybas

Director of the United States Patent and Trademark Office

United States of America
United States Patent and Trademark Office

MELANO

Reg. No. 4,065,304

Registered Dec. 6, 2011

Int. Cls.: 14 and 35

TRADEMARK

SERVICE MARK

PRINCIPAL REGISTER

MELANO B.V. (NETHERLANDS B.V. (COMPANY WITH LIMITED LIABILITY))
KRUISSTRAAT 16
NL-6171 GG STEIN (LB)
NETHERLANDS

FOR: PRECIOUS METALS AND THEIR ALLOYS AND GOODS IN PRECIOUS METALS OR COATED THEREWITH, NOT INCLUDED IN OTHER CLASSES, NAMELY, BRACELETS; JEWELLERY, PRECIOUS STONES; HOROLOGICAL AND CHRONOMETRIC INSTRUMENTS, IN CLASS 14 (U.S. CLS. 2, 27, 28 AND 50).

FOR: ADVERTISING; BUSINESS MANAGEMENT; BUSINESS ADMINISTRATION; PROVIDING OFFICE FUNCTIONS; MANAGEMENT OF DATABASES FOR VIRTUAL MARKET AND SALES PLACES OR SHOPS FOR THE COMMERCIALISATION OF GOODS, INCLUDING GIFTS AND JEWELLERY; MEDIATION OF TRADE BUSINESS FOR THIRD PARTIES WITH REGARD TO THE COMMERCIALISATION OF GOODS, INCLUDING GIFTS AND JEWELLERY, INCLUDING VIA VIRTUAL MARKET PLACES AND SALES LOCATIONS OR SHOPS OR VIA WHOLESALE COMPANIES, IN CLASS 35 (U.S. CLS. 100, 101 AND 102).

THE MARK CONSISTS OF STANDARD CHARACTERS WITHOUT CLAIM TO ANY PARTICULAR FONT, STYLE, SIZE, OR COLOR.

OWNER OF INTERNATIONAL REGISTRATION 1062213 DATED 10-20-2010, EXPIRES 10-20-2020.

SER. NO. 79-091,448, FILED 10-20-2010.

COLLEEN DOMBROW, EXAMINING ATTORNEY



David J. Kyros

Director of the United States Patent and Trademark Office

United States of America

United States Patent and Trademark Office

KONE EcoMod

Reg. No. 4,065,305

Registered Dec. 6, 2011

Int. Cl.: 37

SERVICE MARK

PRINCIPAL REGISTER

KONE CORPORATION (FINLAND LIMITED COMPANY)
KARTANONTIE 1
FI-00330 HELSINKI, FINLAND

FOR: INSTALLATION, MAINTENANCE, REPAIR AND MODERNIZATION OF ALL KINDS OF LIFTING AND TRANSPORTATION EQUIPMENT, NAMELY, ELEVATORS, ELEVATING APPARATUS, ESCALATORS AND MOVING WALKWAYS, AND ASSOCIATED COMPONENTS FOR SUCH EQUIPMENT, IN CLASS 37 (U.S. CLS. 100, 103 AND 106).

OWNER OF U.S. REG. NOS. 1,572,871, 3,692,710 AND OTHERS.

PRIORITY DATE OF 11-19-2010 IS CLAIMED.

OWNER OF INTERNATIONAL REGISTRATION 1062260 DATED 11-23-2010, EXPIRES 11-23-2020.

THE ENGLISH TRANSLATION OF "KONE" IS "HARDWARE" OR "MACHINE" OR "ENGINE".

SEC. 2(F) AS TO "KONE".

SER. NO. 79-091,474, FILED 11-23-2010.

ANDREA K. NADELMAN, EXAMINING ATTORNEY



David J. Kyros

Director of the United States Patent and Trademark Office

United States of America

United States Patent and Trademark Office

LE PETIT MOUZILLON

Reg. No. 4,065,306

Registered Dec. 6, 2011

Int. Cls.: 29, 30 and 43

TRADEMARK

SERVICE MARK

PRINCIPAL REGISTER

BIOFOURNIL (FRANCE SOCIÉTÉ ANONYME)
ZA DE LA CAMUSIÈRE
F-49600 LE PUISET DORE
FRANCE

FOR: PRESERVED, DRIED AND COOKED FRUIT AND VEGETABLES; JELLIES, JAMS, COMPOTES; EGGS, MILK AND DAIRY PRODUCTS, NAMELY, CREAM; EDIBLE OILS AND FATS; FRUIT-BASED SNACK FOOD; BEVERAGES CONSISTING PRINCIPALLY OF MILK; BEVERAGES HAVING A MILK BASE, IN CLASS 29 (U.S. CL. 46).

FOR: COFFEE, TEA, COCOA, SUGAR, RICE, TAPIOCA, SAGO, ARTIFICIAL COFFEE; FLOUR, BREAD, PASTRY AND CONFECTIONERY, NAMELY, PASTILLES AND FRUIT JELLIES, ICES; HONEY, TREACLE; YEAST, BAKING-POWDER; SALT; SPICES; ICE FOR REFRESHMENT; FRENCH BREAD IN THE NATURE OF BAGUETTES; VIENNESE PASTRIES; COOKIES; DOUGH; DOUGH FOR CAKES; LEAVEN, YEAST FOR BAKERY PURPOSES; BREAD-MAKING MIXES; TARTS, SWEET AND SAVORY TARTS, PIES; BRIOCHES, MINI-BRIOCHES; BRIOCHE BREAD, TOASTED BREAD, BREAD DOUGH; COCOA, COFFEE, CHOCOLATE OR TEA-BASED BEVERAGES; CEREAL-BASED SNACK FOOD; PUFF PASTRIES; CRACKERS; RUSKS; APPLE, CORN, STRAWBERRY, FRUIT AND CHOCOLATE FRITTERS; CAKES; PANCAKES; WAFFLES; SANDWICHES; FOCACCIA BREAD AND PASTRY; GENOESE CAKE; BISCUITS, IN CLASS 30 (U.S. CL. 46).

FOR: SERVICES FOR PROVIDING FOOD AND DRINK; FOOD AND DRINK CATERING, IN CLASS 43 (U.S. CLS. 100 AND 101).

THE MARK CONSISTS OF STANDARD CHARACTERS WITHOUT CLAIM TO ANY PARTICULAR FONT, STYLE, SIZE, OR COLOR.

PRIORITY DATE OF 3-12-2010 IS CLAIMED.

OWNER OF INTERNATIONAL REGISTRATION 1062449 DATED 9-9-2010, EXPIRES 9-9-2020.

OWNER OF U.S. REG. NO. 3,892,800.

NO CLAIM IS MADE TO THE EXCLUSIVE RIGHT TO USE "MOUZILLON", APART FROM THE MARK AS SHOWN.



David J. Kybas

Director of the United States Patent and Trademark Office

Reg. No. 4,065,306 THE ENGLISH TRANSLATION OF "LE PETIT MOUZILLON" IS "THE LITTLE MOUZILLON".

SER. NO. 79-091,600, FILED 9-9-2010.

APRIL HESIK, EXAMINING ATTORNEY

United States of America

United States Patent and Trademark Office



Reg. No. 4,065,307
Registered Dec. 6, 2011
Int. Cls.: 9, 41 and 42

EPLAN SOFTWARE & SERVICE GMBH & CO. KG (FED REP GERMANY LIMITED PARTNERSHIP)
AN DER ALTEN ZIEGELEI 2
MONHEIM, FED REP GERMANY 40789

FOR: PRERECORDED MAGNETIC DATA CARRIERS FEATURING COMPUTER PROGRAMS FOR USE IN COMPUTER-AIDED ENGINEERING AND DESIGN AUTOMATION, IN CLASS 9 (U.S. CLS. 21, 23, 26, 36 AND 38).

TRADEMARK

FOR: PROVIDING OF TRAINING FOR COMPUTER USERS IN THE AREA OF COMPUTER-AIDED ENGINEERING AND DESIGN AUTOMATION, IN CLASS 41 (U.S. CLS. 100, 101 AND 107).

SERVICE MARK

FOR: DESIGN OF COMPUTER PROGRAMS FOR COMPUTER AIDED CONSTRUCTION PROJECTS, AND CUSTOMIZATION OF THE COMPUTER PROGRAMS FOR SPECIAL USER REQUIREMENTS, IN CLASS 42 (U.S. CLS. 100 AND 101).

PRINCIPAL REGISTER

OWNER OF U.S. REG. NOS. 1,485,111, 3,302,169 AND OTHERS.

PRIORITY DATE OF 4-17-2010 IS CLAIMED.

OWNER OF INTERNATIONAL REGISTRATION 1062493 DATED 9-10-2010, EXPIRES 9-10-2020.

THE COLOR(S) RED, BLACK AND WHITE IS/ARE CLAIMED AS A FEATURE OF THE MARK.

THE STIPPLING IS A FEATURE OF THE MARK AND DOES NOT INDICATE COLOR.

THE MARK CONSISTS OF THE WORDING "EPLAN" IN STYLIZED FONT WHEREIN THE LETTER "E" APPEARS IN RED, AND "PLAN" APPEARS IN BLACK UNDERLINED IN BLACK, DEPICTED INSIDE A WHITE RECTANGLE, AND ABOVE APPEARS THREE DIAGONAL WHITE BANDS WITH BLACK LINES, ALL FEATURED INSIDE A RED RECTANGLE CARRIER.



David J. Kybas

SER. NO. 79-091,621, FILED 9-10-2010.

Reg. No. 4,065,307 AMY C. KEAN, EXAMINING ATTORNEY

United States of America

United States Patent and Trademark Office

JOINT RESPONSE

Reg. No. 4,065,308

Registered Dec. 6, 2011

Int. Cls.: 10, 39 and 44

TRADEMARK

SERVICE MARK

PRINCIPAL REGISTER

CORIN LTD (UNITED KINGDOM LIMITED COMPANY)
THE CORINIUM CENTRE
CIRENCESTER GLOUCESTERSHIRE, UNITED KINGDOM GL7 1YJ

FOR: ORTHOPAEDIC ARTICLES, NAMELY, ORTHOPAEDIC IMPLANTS MADE OF ARTIFICIAL MATERIALS AND MEDICAL INSTRUMENTS FOR INSTALLING SHOULDER, ANKLE, HIP AND KNEE IMPLANTS AND THEIR PARTS; ORTHOPAEDIC DEVICES, NAMELY, SHOULDER, ANKLE, HIP AND KNEE IMPLANTS OF ARTIFICIAL MATERIALS AND THEIR PARTS; ORTHOPAEDIC JOINT IMPLANTS AND THEIR PARTS; PROSTHESES FOR HIP AND KNEE REPLACEMENTS AND THEIR PARTS; TOTAL JOINT PROSTHESES FOR THE TREATMENT OF DEGENERATIVE ARTHRITIS AND THEIR PARTS; MEDICAL INSTRUMENTS AND APPARATUS FOR USE IN ORTHOPAEDIC SURGERY AND THEIR PARTS; CARRY CASES SPECIALLY ADAPTED FOR SURGICAL AND MEDICAL APPARATUS, NAMELY, PROSTHESES, ORTHOPAEDIC DEVICES, AND APPARATUS FOR USE IN ORTHOPAEDIC SURGERY AND ORTHOPAEDIC IMPLANTS AND INSTRUMENTS FOR USE IN ORTHOPAEDIC SURGERY, IN CLASS 10 (U.S. CLS. 26, 39 AND 44).

FOR: DISTRIBUTION SERVICES, NAMELY, DELIVERY OF MEDICAL APPARATUS, IMPLANTS, DEVICES AND EQUIPMENT; TRANSPORT AND DELIVERY OF MEDICAL APPARATUS, IMPLANTS, DEVICES AND EQUIPMENT; SHIPPING OF GOODS IN THE NATURE OF MEDICAL APPARATUS, IMPLANTS, DEVICES AND EQUIPMENT, IN CLASS 39 (U.S. CLS. 100 AND 105).

FOR: RENTAL OF MEDICAL APPARATUS, IMPLANTS, DEVICES AND EQUIPMENT; LEASING OF MEDICAL APPARATUS, IMPLANTS, DEVICES AND EQUIPMENT, IN CLASS 44 (U.S. CLS. 100 AND 101).

THE MARK CONSISTS OF STANDARD CHARACTERS WITHOUT CLAIM TO ANY PARTICULAR FONT, STYLE, SIZE, OR COLOR.

PRIORITY DATE OF 5-24-2010 IS CLAIMED.

OWNER OF INTERNATIONAL REGISTRATION 1062569 DATED 11-24-2010, EXPIRES 11-24-2020.

NO CLAIM IS MADE TO THE EXCLUSIVE RIGHT TO USE "JOINT" , APART FROM THE MARK AS SHOWN.



David J. Kyffers

Director of the United States Patent and Trademark Office

Reg. No. 4,065,308 SER. NO. 79-091,649, FILED 11-24-2010.

MICHAEL SOUDERS, EXAMINING ATTORNEY

United States of America

United States Patent and Trademark Office

DECELERINE

Reg. No. 4,065,309

Registered Dec. 6, 2011

Int. Cls.: 1 and 3

TRADEMARK

PRINCIPAL REGISTER

LIPOTEC, S.A. (SPAIN S.A.)
ISAAC PERAL, 17 -
POL. IND. CAMÍ RAL; E-08850 GAVA (BARCELONA)
SPAIN

FOR: CHEMICAL PREPARATIONS FOR USE IN THE MANUFACTURING OF COSMETICS, SOAPS, PERFUMERY, ESSENTIAL OILS, HAIR LOTIONS, DENTIFRICES AND PHARMACEUTICAL PREPARATIONS, IN CLASS 1 (U.S. CLS. 1, 5, 6, 10, 26 AND 46).

FOR: ESSENTIAL OILS, IN CLASS 3 (U.S. CLS. 1, 4, 6, 50, 51 AND 52).

THE MARK CONSISTS OF STANDARD CHARACTERS WITHOUT CLAIM TO ANY PARTICULAR FONT, STYLE, SIZE, OR COLOR.

OWNER OF INTERNATIONAL REGISTRATION 0964275 DATED 3-13-2008, EXPIRES 3-13-2018.

THE WORDING "DECELERINE" HAS NO MEANING IN A FOREIGN LANGUAGE.

SER. NO. 79-091,721, FILED 9-24-2010.

WILLIAM ROSSMAN, EXAMINING ATTORNEY



David J. Kyffers

Director of the United States Patent and Trademark Office

United States of America
United States Patent and Trademark Office

Grand'O

Reg. No. 4,065,310

Registered Dec. 6, 2011

Int. Cl.: 33

TRADEMARK

PRINCIPAL REGISTER

SOCIETE DES PRODUITS MARNIER-LAPOSTOLLE (FRANCE SOCIÉTÉ ANONYME)
91, BOULEVARD HAUSSMANN
F-75008 PARIS, FRANCE

FOR: PREPARED ALCOHOLIC COCKTAILS, SPIRITS AND LIQUEURS, IN CLASS 33 (U.S. CLS. 47 AND 49).

THE MARK CONSISTS OF STANDARD CHARACTERS WITHOUT CLAIM TO ANY PARTICULAR FONT, STYLE, SIZE, OR COLOR.

PRIORITY DATE OF 2-15-2010 IS CLAIMED.

OWNER OF INTERNATIONAL REGISTRATION 1040403 DATED 2-23-2010, EXPIRES 2-23-2020.

THE WORDING "GRAND'O" HAS NO MEANING IN A FOREIGN LANGUAGE.

SER. NO. 79-091,724, FILED 6-25-2010.

WILLIAM ROSSMAN, EXAMINING ATTORNEY



David J. Kyffers

Director of the United States Patent and Trademark Office

United States of America

United States Patent and Trademark Office

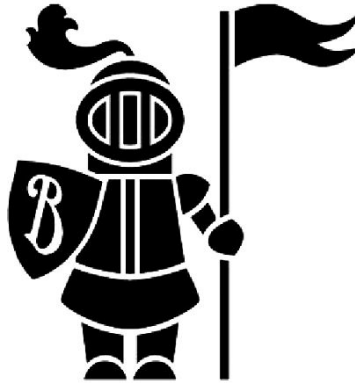

Reg. No. 4,065,311

Registered Dec. 6, 2011

**Int. Cls.: 3, 8, 10, 12, 14,
18, 21, 24, 25, 28 and 35**

TRADEMARK

SERVICE MARK

PRINCIPAL REGISTER

BURBERRY LIMITED (UNITED KINGDOM LIMITED COMPANY)
HORSEFERRY HOUSE,
HORSEFERRY ROAD; LONDON SW1P 2AW
UNITED KINGDOM

FOR: NON-MEDICATED TOILET PREPARATIONS FOR THE BATH AND SHOWER, PERFUMES, TALCUM POWDER, COSMETICS, PREPARATIONS FOR TEETH AND FOR HAIR, NAMELY, TOOTHPASTE AND SHAMPOOS AND HAIR CONDITIONERS, SOAPS, ALL OVER BODY WASH; SHAMPOOS, ANTI-PERSPIRANTS, EAU DE COLOGNE; EAU DE TOILETTE WITH OR WITHOUT ALCOHOL; AND TOILET WATER, ESSENTIAL OILS, BABY BODY BALM, MASSAGE OIL, POTPOURRI, IN CLASS 3 (U.S. CLS. 1, 4, 6, 50, 51 AND 52).

FOR: CUTLERY, CHRISTENING SPOONS FOR HOUSEHOLD PURPOSES, IN CLASS 8 (U.S. CLS. 23, 28 AND 44).

FOR: INFANT FEEDING BOTTLES AND TEATS; CUPS ADAPTED FOR FEEDING BABIES, INFANTS AND CHILDREN; PACIFIERS FOR BABIES, TEETHING RINGS AND TEETHING RINGS INCORPORATING BABY RATTLES, IN CLASS 10 (U.S. CLS. 26, 39 AND 44).

FOR: BABY CARRIAGES, STROLLERS, PRAMS; BABY CARRIAGE, STROLLER AND PRAM HOODS, COVERS AND ACCESSORIES FOR THE AFORESAID GOODS, NAMELY, STROLLER BAGS, HEAD SUPPORTS, SHADES, PILLOWS, WEATHER SHIELDS, RAIN COVERS, UMBRELLAS, FOOT MUFFS, CUP HOLDERS, WHEELED BOARDS; SAFETY SEATS FOR INFANTS AND CHILDREN FOR VEHICLES, IN CLASS 12 (U.S. CLS. 19, 21, 23, 31, 35 AND 44).

FOR: JEWELLERY, IMITATION JEWELLERY, FIGURINES OF PRECIOUS METAL, IN CLASS 14 (U.S. CLS. 2, 27, 28 AND 50).

FOR: BAGS, NAMELY, ATHLETIC AND SPORTS BAGS, BEACH BAGS, CARRY-ON BAGS, CLUTCH BAGS, DUFFEL AND GYM BAGS, OVERNIGHT BAGS, SCHOOL BOOK BAGS, TOTE BAGS; TRUNKS, VALISES, SUITCASES, TRAVEL BAGS, GARMENT BAGS FOR TRAVEL, BABY BAGS FOR CARRYING BABIES' ACCESSORIES, BABY CARRIERS WORN ON THE BODY, BABY HARNESSSES, RUCKSACKS, SACHELS, HOLD ALLS, HANDBAGS, SHOULDER BAGS, SHOPPING BAGS AND PURSES, POUCHES, WALLETS, KEY HOLDERS MADE OF LEATHER, CREDIT CARD AND BUSINESS CARD HOLDERS, LABELS; COS-



David J. Kybas

Director of the United States Patent and Trademark Office

Reg. No. 4,065,311 METIC CASES AND BAGS SOLD EMPTY; UMBRELLAS, PARASOLS, GENERAL PURPOSE AND SPORT TROLLEY BAGS, IN CLASS 18 (U.S. CLS. 1, 2, 3, 22 AND 41).

FOR: HOUSEHOLD, KITCHEN OR TABLE UTENSILS AND CONTAINERS, NAMELY, BOWLS, VASES, BOTTLES, POTS, FORKS, KNIVES, SPOONS AND TONGS; TABLEWARE, CERAMICS, PORCELAIN, GLASSWARE, EARTHENWARE AND CROCKERY, NAMELY DISHWARE, POTS, BOTTLES, BUTTER DISHES, GRAVY BOATS, JUGS, PITCHERS, SERVING PLATTERS AND TRAYS, SUGAR BOWLS, DINNERWARE, PLATES, BOWLS, CUPS, SAUCERS, MUGS, DRINKING GLASSES, TEAPOTS, COFFEE POTS, TEA SETS, GLASSES AND STEMWARE, CAKE STANDS, EGG CUPS, SALT AND PEPPER SHAKERS; BEAKERS, NAMELY, WIDE-MOUTHED DRINKING CUPS FOR HOUSEHOLD USE, DRINKING GLASSES, NAMELY, TUMBLERS; COMBS, HAIR BRUSHES; BABY BATH TUBS; POTTIES FOR CHILDREN; PORTABLE BATH TUBS FOR BABIES AND INFANTS, IN CLASS 21 (U.S. CLS. 2, 13, 23, 29, 30, 33, 40 AND 50).

FOR: TEXTILE AND TEXTILE ITEMS, NAMELY, BED BLANKETS; BED COVERS; BED LINEN; COT LINEN; DUVETS; CURTAINS; TOWELS; FACE CLOTHS; MATTRESS COVERS; PILLOW CASES; QUILTS AND EIDERDOWNS; BED SHEETS; TEXTILE AND PLASTIC TABLE COVERS; PLACE MATS OF TEXTILE; HANDKERCHIEFS; TRAVELLING RUGS; MUSLIN FABRIC, IN CLASS 24 (U.S. CLS. 42 AND 50).

FOR: CLOTHING, NAMELY, BABY LAYETTES FOR CLOTHING, SHIRTS, POLO SHIRTS, BLOUSES, DRESSES, SHORTS, TROUSERS, SKIRTS, JERSEYS, JUMPERS, SWEATERS, VESTS, T-SHIRTS, TANK TOPS, JEANS, PAJAMAS, COATS, OVERCOATS, JACKETS, RAINCOATS, PONCHOS, UNDERWEAR, SLEEPWEAR, LOUNGEWEAR, SKI WEAR, SWIMWEAR, TIES, SCARVES, SHAWLS, GLOVES, MITTENS, TIGHTS, SOCKS, STOCKINGS, HOSIERY, FOOTWEAR, HEADWEAR; DIAPERS OF TEXTILE, IN CLASS 25 (U.S. CLS. 22 AND 39).

FOR: TOYS, NAMELY, MECHANICAL TOYS, INFANT TOYS, STUFFED TOYS, DOLLS, TEDDY BEARS, CLOTHING FOR TOYS, BATH TOYS; GAMES, NAMELY, BOARD GAMES, CARD GAMES, TABLETOP GAMES; BABY RATTLES; BALLS FOR GAMES; EXERCISE EQUIPMENT, NAMELY, BABY GYM MATS; SWIMMING FLOATS FOR CHILDREN AND BABIES FOR RECREATIONAL USE, IN CLASS 28 (U.S. CLS. 22, 23, 38 AND 50).

FOR: RETAIL AND WHOLESALE STORE SERVICES FEATURING CLOTHING, FOOTWEAR, HEADWEAR, BAGS, SMALL LEATHER GOODS, ACCESSORIES, HOMEWARE, PERFUMES AND TOILETRIES, JEWELLERY, CHILDREN AND INFANTS' PRODUCTS, LUXURY ITEMS , IN CLASS 35 (U.S. CLS. 100, 101 AND 102).

THE MARK CONSISTS OF A STANDING KNIGHT IN ARMOR HOLDING A POLE WITH A BANNER IN ONE HAND AND A SHIELD WITH THE LETTER "B".

PRIORITY DATE OF 5-21-2010 IS CLAIMED.

OWNER OF INTERNATIONAL REGISTRATION 1062785 DATED 6-3-2010, EXPIRES 6-3-2020.

SER. NO. 79-091,733, FILED 6-3-2010.

STEVEN JACKSON, EXAMINING ATTORNEY

United States of America

United States Patent and Trademark Office

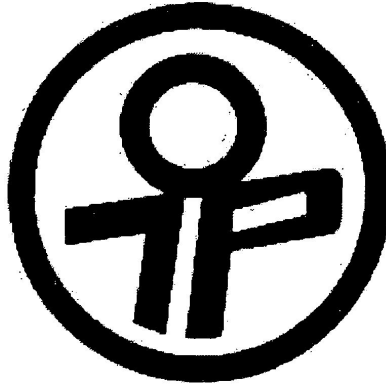

Reg. No. 4,065,312

Registered Dec. 6, 2011

Int. Cl.: 7

TRADEMARK

PRINCIPAL REGISTER

FUZHOU TEVICK AUTOMOBILE FITTING CO., LTD. (CHINA CORPORATION)
QINGKOU VILLAGE,
QINGKOU TOWN,; MINHOU COUNTY; FUJIAN
CHINA

FOR: PISTON RINGS; PISTONS FOR CYLINDERS; PISTONS FOR ENGINES; PISTONS BEING PARTS OF MACHINES OR ENGINES; AUTOMOBILE MOTOR PISTON; CYLINDERS FOR MOTORS; INJECTORS FOR ENGINES; CYLINDER HEADS FOR ENGINES; CYLINDERS FOR MACHINES; STARTERS FOR MOTORS AND ENGINES, IN CLASS 7 (U.S. CLS. 13, 19, 21, 23, 31, 34 AND 35).

THE MARK CONSISTS OF A STYLIZED HUMAN FIGURE SURROUNDED BY A CIRCLE.

OWNER OF INTERNATIONAL REGISTRATION 1062789 DATED 12-21-2010, EXPIRES 12-21-2020.

SER. NO. 79-091,734, FILED 12-21-2010.

MELISSA VALLILLO, EXAMINING ATTORNEY



David J. Kyffers

Director of the United States Patent and Trademark Office

United States of America
United States Patent and Trademark Office

yadilo

Reg. No. 4,065,313

Registered Dec. 6, 2011

Int. Cls.: 6 and 19

TRADEMARK

PRINCIPAL REGISTER

ZHEJIANG BAIJIA WAN'AN DOOR INDUSTRY CO., LTD. (CHINA CORPORATION)
NO.2, XINGGONG NORTH ROAD
JIANGDONG ZONE; JIANGSHAN ECONOMIC DEVELOPING AREA
ZHEJIANG PROVINCE, CHINA

FOR: DOORS OF METAL; DOOR PANELS OF METAL; METAL WINDOWS; CAST IRON FOR USE IN HYDRAULICS, SANITATION, ROAD SYSTEMS AND BUILDINGS; DOOR FITTINGS OF METAL; LETTER BOXES OF METAL; METAL CEILING PANELS; METAL DOOR FRAMES; METAL STAIRCASES; PRE-FABRICATED METAL ARCHITECTURAL COLUMNS, IN CLASS 6 (U.S. CLS. 2, 12, 13, 14, 23, 25 AND 50).

FOR: NON-METAL DOORS; NON-METAL DOOR PANELS; NON-METAL STAIRS; STAINED GLASS WINDOWS AND DOORS; DOOR CASINGS, NOT OF METAL; PLASTIC-STEEL, NAMELY, DOOR AND WINDOW FRAMES OF PLASTIC CLAD IN ALUMINUM; NON-METAL JALOUSIES; PARQUET FLOORING; NON-METAL GREENHOUSE FRAMES; BUILDING MATERIALS, NAMELY, COMPOSITE PANELS COMPOSED PRIMARILY OF NONMETAL MATERIALS, IN CLASS 19 (U.S. CLS. 1, 12, 33 AND 50).

THE MARK CONSISTS OF THE LITERAL ELEMENT "YADILO" REPRESENTED IN STYLIZED FONT.

OWNER OF INTERNATIONAL REGISTRATION 1062830 DATED 11-9-2010, EXPIRES 11-9-2020.

THE WORDING "YADILO" HAS NO MEANING IN A FOREIGN LANGUAGE.

SER. NO. 79-091,749, FILED 11-9-2010.

RONALD DELGIZZI, EXAMINING ATTORNEY



David J. Kypos

Director of the United States Patent and Trademark Office

United States of America

United States Patent and Trademark Office

COOLFUSION

Reg. No. 4,065,314

Registered Dec. 6, 2011

Int. Cls.: 23, 24 and 25

TRADEMARK

PRINCIPAL REGISTER

BRIDGEDALE OUTDOOR LIMITED (UNITED KINGDOM COMPANY)
KILTONGA INDUSTRIAL ESTATE BELFAST ROAD
NEWTONARDS, CO. DOWN, IRELAND BT23 4TJ

FOR: YARNS; THREADS; TEXTILE YARNS; POLYPROPYLENE YARNS, IN CLASS 23 (U.S. CL. 43).

FOR: TEXTILES AND TEXTILE GOODS, NAMELY, TEXTILES FOR MAKING ARTICLES OF CLOTHING, IN CLASS 24 (U.S. CLS. 42 AND 50).

FOR: CLOTHING, NAMELY, SOCKS, GLOVES, HATS, GAITERS, AND BASE LAYERS, IN CLASS 25 (U.S. CLS. 22 AND 39).

THE MARK CONSISTS OF STANDARD CHARACTERS WITHOUT CLAIM TO ANY PARTICULAR FONT, STYLE, SIZE, OR COLOR.

OWNER OF INTERNATIONAL REGISTRATION 1063040 DATED 10-25-2010, EXPIRES 10-25-2020.

SER. NO. 79-091,812, FILED 10-25-2010.

DEIRDRE ROBERTSON, EXAMINING ATTORNEY



David J. Kyffers

Director of the United States Patent and Trademark Office

United States of America

United States Patent and Trademark Office

Edo Popken

Reg. No. 4,065,315

Registered Dec. 6, 2011

Int. Cls.: 18 and 25

TRADEMARK

PRINCIPAL REGISTER

EDO POPKEN (SWITZERLAND INDIVIDUAL)
ROUTE DE LA CROIX 174
CH-1633 MARSENS
SWITZERLAND

FOR: LEATHER AND IMITATIONS OF LEATHER, AS WELL AS GOODS MADE OF THESE MATERIALS AND NOT INCLUDED IN OTHER CLASSES, NAMELY, PURSES, HANDBAGS, SPORTS BAGS, TRUNKS AND TRAVELLING BAGS; UMBRELLAS, PARASOLS AND WALKING STICKS; SADDLERY, IN CLASS 18 (U.S. CLS. 1, 2, 3, 22 AND 41).

FOR: CLOTHING, NAMELY, SHIRTS, JACKETS, PANTS, SHORTS, SUITS, SOCKS, UNDER- TROUSERS, UNDERSHIRTS, TIES, BOW TIES; FOOTWEAR; HEADGEAR, NAMELY, HATS AND CAPS; BELTS, IN CLASS 25 (U.S. CLS. 22 AND 39).

THE MARK CONSISTS OF STANDARD CHARACTERS WITHOUT CLAIM TO ANY PARTICULAR FONT, STYLE, SIZE, OR COLOR.

PRIORITY DATE OF 8-25-2010 IS CLAIMED.

OWNER OF INTERNATIONAL REGISTRATION 1063223 DATED 8-25-2010, EXPIRES 8-25-2020.

THE NAME(S), PORTRAIT(S), AND/OR SIGNATURE(S) SHOWN IN THE MARK IDENTIFIES "EDO POPKEN", WHOSE CONSENT(S) TO REGISTER IS MADE OF RECORD.

SER. NO. 79-091,870, FILED 8-25-2010.

JACLYN KIDWELL WALKER, EXAMINING ATTORNEY



David J. Kybas

Director of the United States Patent and Trademark Office

United States of America

United States Patent and Trademark Office

EQUINAVET

Reg. No. 4,065,316

Registered Dec. 6, 2011

Int. Cl.: 31

TRADEMARK

PRINCIPAL REGISTER

EQUINAVET GMBH (FED REP GERMANY LIMITED LIABILITY COMPANY)
SENTRUPER STRASSE 217
48149 MÜNSTER
FED REP GERMANY

FOR: ADDITIVES TO ANIMAL FOOD NOT FOR MEDICAL PURPOSES; PROTEINS FOR ANIMAL CONSUMPTION; NON-MEDICAL ADDITIVES TO ANIMAL FOOD AND NON-MEDICAL NUTRITIONAL ADDITIVES FOR ANIMAL FOODSTUFFS; ALL THE AFOREMENTIONED GOODS ESPECIALLY FOR LARGE ANIMALS SUCH AS HORSES, CAMELS, CATTLE, SWINE, SHEEP AND OTHER FARM ANIMALS AS WELL AS FOR SMALL ANIMALS SUCH AS DOGS AND CATS, IN CLASS 31 (U.S. CLS. 1 AND 46).

THE MARK CONSISTS OF STANDARD CHARACTERS WITHOUT CLAIM TO ANY PARTICULAR FONT, STYLE, SIZE, OR COLOR.

OWNER OF INTERNATIONAL REGISTRATION 1063353 DATED 7-29-2010, EXPIRES 7-29-2020.

SER. NO. 79-091,920, FILED 7-29-2010.

KAREN SEVERSON, EXAMINING ATTORNEY



David J. Kyfos

Director of the United States Patent and Trademark Office

United States of America

United States Patent and Trademark Office



Reg. No. 4,065,317

Registered Dec. 6, 2011

Int. Cls.: 7 and 11

TRADEMARK

PRINCIPAL REGISTER

ADBE CARTERA, S.A. (SPAIN SOCIEDAD ANÓNIMA)
FILADORES, 35/41, 4ª PLANTA
E-08208 SABADELL (BARCELONA)
SPAIN

FOR: WATER PUMPS FOR USE IN MOTOR AND ENGINES AND STRUCTURAL PARTS THEREFOR; SPRAYING MACHINES; MACHINE PARTS, NAMELY, CARTRIDGES FOR FILTERING MACHINES, FILTERING MACHINES, MOTORS NOT FOR LAND VEHICLES, TURBINES NOT FOR LAND VEHICLES, IN CLASS 7 (U.S. CLS. 13, 19, 21, 23, 31, 34 AND 35).

FOR: APPARATUS FOR FILTERING WATER, MACHINES FOR STERILIZING WATER, APPARATUS AND MACHINES FOR PURIFYING WATER, APPARATUS AND INSTALLATIONS FOR SOFTENING WATER, INSTALLATIONS FOR CONDUCTING AND SUPPLYING WATER, NAMELY, HYDRANTS AND IRRIGATION SPRINKLERS, IN CLASS 11 (U.S. CLS. 13, 21, 23, 31 AND 34).

THE MARK CONSISTS OF THE WORDING "BLAUFISH" AND OUTLINE DESIGN OF A FISH HAVING THE "BLAU" PORTION AND THE DOT TO THE LETTER "I" IN THE COLOR BLUE AND THE "FISH" PORTION ON FISH DESIGN IN THE COLOR YELLOW.

PRIORITY DATE OF 9-28-2010 IS CLAIMED.

OWNER OF INTERNATIONAL REGISTRATION 1063365 DATED 10-8-2010, EXPIRES 10-8-2020.

THE COLOR(S) BLUE AND YELLOW IS/ARE CLAIMED AS A FEATURE OF THE MARK.

THE WORDING "BLAUFISH" HAS NO MEANING IN A FOREIGN LANGUAGE.

SER. NO. 79-091,926, FILED 10-8-2010.

DOMINIC FATHY, EXAMINING ATTORNEY



David J. Kypos

Director of the United States Patent and Trademark Office

United States of America

United States Patent and Trademark Office

POETRY OF TIME

Reg. No. 4,065,318

Registered Dec. 6, 2011

Int. Cl.: 14

TRADEMARK

PRINCIPAL REGISTER

VAN CLEEF & ARPELS SA (SWITZERLAND CORPORATION)
8 ROUTE DES BICHES
CH-1752 VILLARS-SUR-GLÂNE, SWITZERLAND

FOR: CUFF LINKS, TIE CLIPS, RINGS, BRACELETS, EARRINGS, NECKLACES, BROOCHES, KEY RINGS OF PRECIOUS METAL, WATCHES, CHRONOMETERS, CLOCKS, WATCH BANDS, BOXES OF PRECIOUS METAL FOR WATCHES AND JEWELRY, IN CLASS 14 (U.S. CLS. 2, 27, 28 AND 50).

THE MARK CONSISTS OF STANDARD CHARACTERS WITHOUT CLAIM TO ANY PARTICULAR FONT, STYLE, SIZE, OR COLOR.

PRIORITY DATE OF 7-2-2010 IS CLAIMED.

OWNER OF INTERNATIONAL REGISTRATION 1063667 DATED 12-6-2010, EXPIRES 12-6-2020.

SER. NO. 79-092,042, FILED 12-6-2010.

DAVID HOFFMAN, EXAMINING ATTORNEY



David J. Kyfos

Director of the United States Patent and Trademark Office

United States of America

United States Patent and Trademark Office

TREASURY WINE ESTATES

Reg. No. 4,065,319

Registered Dec. 6, 2011

Int. Cl.: 35

SERVICE MARK

PRINCIPAL REGISTER

SOUTHCORP BRANDS PTY LIMITED (AUSTRALIA COMPANY, LIMITED BY SHARES)
77 SOUTHBANK BOULEVARD
SOUTHBANK VIC 3006
AUSTRALIA

FOR: RETAIL AND WHOLESALE STORE SERVICES AND ON-LINE RETAIL AND WHOLESALE STORE SERVICES FEATURING WINE, IN CLASS 35 (U.S. CLS. 100, 101 AND 102).

THE MARK CONSISTS OF STANDARD CHARACTERS WITHOUT CLAIM TO ANY PARTICULAR FONT, STYLE, SIZE, OR COLOR.

PRIORITY DATE OF 6-30-2010 IS CLAIMED.

OWNER OF INTERNATIONAL REGISTRATION 1063775 DATED 12-21-2010, EXPIRES 12-21-2020.

NO CLAIM IS MADE TO THE EXCLUSIVE RIGHT TO USE "WINE ESTATES", APART FROM THE MARK AS SHOWN.

SER. NO. 79-092,078, FILED 12-21-2010.

KRISTINA MORRIS, EXAMINING ATTORNEY



David J. Kybas

Director of the United States Patent and Trademark Office

United States of America

United States Patent and Trademark Office

NUIT PRECIEUSE

Reg. No. 4,065,320

Registered Dec. 6, 2011

Int. Cl.: 3

TRADEMARK

PRINCIPAL REGISTER

L'OCCITANE (FRANCE SOCIÉTÉ ANONYME)
ZONE INDUSTRIELLE SAINT MAURICE
F-04100 MANOSQUE
FRANCE

FOR: SOAP; PERFUMES; TOILET WATER; COSMETICS; HAIR LOTIONS; COSMETIC PREPARATIONS FOR BATHS; SHAMPOOS, SHOWER GELS, BEAUTY MASKS; COSMETIC PREPARATIONS FOR SKIN CARE; COSMETIC CREAMS; COSMETIC PENCILS; MAKE-UP AND MAKE-UP REMOVING PREPARATIONS; CLEANSING MILK FOR TOILET PURPOSES; LOTIONS FOR COSMETIC PURPOSES; DEODORANTS FOR PERSONAL USE; NON-MEDICATED TOILETRIES, IN CLASS 3 (U.S. CLS. 1, 4, 6, 50, 51 AND 52).

THE ENGLISH TRANSLATION OF "NUIT PRECIEUSE" IN THE MARK IS "PRECIOUS NIGHT".

PRIORITY DATE OF 6-24-2010 IS CLAIMED.

OWNER OF INTERNATIONAL REGISTRATION 1063952 DATED 12-13-2010, EXPIRES 12-13-2020.

SER. NO. 79-092,141, FILED 12-13-2010.

LEIGH LOWRY, EXAMINING ATTORNEY



David J. Kyros

Director of the United States Patent and Trademark Office

United States of America

United States Patent and Trademark Office

HAGALON

Reg. No. 4,065,321

Registered Dec. 6, 2011

Int. Cls.: 9, 25 and 35

TRADEMARK

SERVICE MARK

PRINCIPAL REGISTER

HAGALON AS (NORWAY AS)
P.O. BOX 25,
GREVERUD; N-1416 OPPEGARD
NORWAY

FOR: PROTECTIVE CLOTHING AGAINST ACCIDENTS, RADIATION, AND FIRE; PROTECTIVE CLOTHING AGAINST EXCESSIVE HEAT AND COLD, IN CLASS 9 (U.S. CLS. 21, 23, 26, 36 AND 38).

FOR: CLOTHING, NAMELY, PANTS, SHIRTS, JACKETS, AND CLOTHING FOR EXERCISE, SPORT, AND LEISURE, NAMELY, SHORTS, T-SHIRTS, PANTS, JACKETS, VESTS AND UNDERWEAR; FOOTWEAR; HEADGEAR, NAMELY, HATS AND CAPS, IN CLASS 25 (U.S. CLS. 22 AND 39).

FOR: ONLINE RETAIL STORE SERVICES FEATURING PROTECTIVE CLOTHING AGAINST ACCIDENTS, RADIATION, AND FIRE, PROTECTIVE CLOTHING AGAINST EXCESSIVE HEAT AND COLD, CLOTHING, NAMELY, PANTS, SHIRTS, JACKETS, AND CLOTHING FOR EXERCISE, SPORT, AND LEISURE, NAMELY, SHORTS, T-SHIRTS, PANTS, JACKETS, VESTS AND UNDERWEAR, FOOTWEAR, HEADGEAR, NAMELY, HATS AND CAPS, IN CLASS 35 (U.S. CLS. 100, 101 AND 102).

THE MARK CONSISTS OF STANDARD CHARACTERS WITHOUT CLAIM TO ANY PARTICULAR FONT, STYLE, SIZE, OR COLOR.

PRIORITY DATE OF 4-16-2010 IS CLAIMED.

OWNER OF INTERNATIONAL REGISTRATION 1064140 DATED 10-15-2010, EXPIRES 10-15-2020.

THE WORDING "HAGALON" HAS NO MEANING IN A FOREIGN LANGUAGE.

SER. NO. 79-092,227, FILED 10-15-2010.

KAREN SEVERSON, EXAMINING ATTORNEY



David J. Kyffers

Director of the United States Patent and Trademark Office

United States of America

United States Patent and Trademark Office

LES VOYAGES EXTRAORDINAIRES

Reg. No. 4,065,322

Registered Dec. 6, 2011

Int. Cl.: 14

TRADEMARK

PRINCIPAL REGISTER

VAN CLEEF & ARPELS SA (SWITZERLAND CORPORATION)
8 ROUTE DES BICHES
CH-1752 VILLARS-SUR-GLÂNE, SWITZERLAND

FOR: CUFF LINKS OF PRECIOUS OR SEMI-PRECIOUS METAL, TIE CLIPS OF PRECIOUS OR SEMI-PRECIOUS METAL, RINGS, BRACELETS, EARRINGS, NECKLACES, BROOCHES, KEY RINGS OF PRECIOUS METAL, WATCHES, CHRONOMETERS, CLOCKS; WATCH BANDS, BOXES OF PRECIOUS METAL FOR WATCHES AND JEWELRY, IN CLASS 14 (U.S. CLS. 2, 27, 28 AND 50).

THE MARK CONSISTS OF STANDARD CHARACTERS WITHOUT CLAIM TO ANY PARTICULAR FONT, STYLE, SIZE, OR COLOR.

PRIORITY DATE OF 6-4-2010 IS CLAIMED.

OWNER OF INTERNATIONAL REGISTRATION 1064170 DATED 11-30-2010, EXPIRES 11-30-2020.

THE ENGLISH TRANSLATION OF THE FOREIGN WORD(S) IN THE MARK IS: "THE EXTRAORDINARY VOYAGES".

SER. NO. 79-092,244, FILED 11-30-2010.

DAVID HOFFMAN, EXAMINING ATTORNEY



David J. Kybas

Director of the United States Patent and Trademark Office

United States of America
United States Patent and Trademark Office

TRUSTICO

Reg. No. 4,065,323

Registered Dec. 6, 2011

Int. Cl.: 35

SERVICE MARK

PRINCIPAL REGISTER

TRUSTICO LIMITED (UNITED KINGDOM COMPANY)
106 LOWER ADDISCOMBE ROAD
CROYDON SURREY CR0 6AD
UNITED KINGDOM

FOR: ON-LINE RETAIL, WHOLESALE AND RESALE STORE SERVICES FEATURING DIGITAL CERTIFICATES FOR SECURITY, AUTHENTICATION OR VERIFICATION PURPOSES IN ELECTRONIC TRANSACTIONS OR COMMUNICATIONS, OVER THE INTERNET AND OTHER COMPUTER NETWORKS, IN CLASS 35 (U.S. CLS. 100, 101 AND 102).

THE MARK CONSISTS OF STANDARD CHARACTERS WITHOUT CLAIM TO ANY PARTICULAR FONT, STYLE, SIZE, OR COLOR.

PRIORITY DATE OF 5-14-2010 IS CLAIMED.

OWNER OF INTERNATIONAL REGISTRATION 1064226 DATED 6-4-2010, EXPIRES 6-4-2020.

OWNER OF U.S. REG. NO. 3,529,780.

SER. NO. 79-092,263, FILED 6-4-2010.

PAM WILLIS, EXAMINING ATTORNEY



David J. Kyros

Director of the United States Patent and Trademark Office

United States of America
United States Patent and Trademark Office

PROAQT

Reg. No. 4,065,324

Registered Dec. 6, 2011

Int. Cl.: 10

TRADEMARK

PRINCIPAL REGISTER

PULSION MEDICAL SYSTEMS AG (FED REP GERMANY AG)
JOSEPH-WILD-STRASSE 20
81829 MÜNCHEN
FED REP GERMANY

FOR: MEDICAL APPARATUS AND INSTRUMENTS, NAMELY, PATIENT MONITORS FOR CRITICAL CARE AND SURGERY, MODULAR PATIENT MONITORING SENSORS, APPARATUS FOR DETERMINING AND DISPLAYING PHYSIOLOGICAL PARAMETERS, NAMELY, MEDICAL APPARATUS FOR MONITORING BLOOD PRESSURE, HEART RATE, CARDIAC OUTPUT, EXTRAVASCULAR LUNG WATER, PATIENT FILLING STATUS, BLOOD OXYGEN SATURATION, GLUCOSE LEVEL OR RESPIRATION; TECHNICAL MEDICAL SINGLE-USE ARTICLES WITH ELECTRONIC COMPONENTS, NAMELY, SINGLE-USE PRESSURE, TEMPERATURE, OR CHEMICAL CONCENTRATION SENSOR DEVICES FOR USE WITH ANY OF THE AFORESAID; BLOOD PRESSURE MEASURING DEVICES, IN PARTICULAR DISPOSABLE BLOOD PRESSURE MEASURING DEVICES; REPLACEMENT PARTS FOR THE AFORESAID GOODS IN THE NATURE OF CABLES AND CABLE CONNECTORS, ACCESSORIES FOR ANY OF THE AFORESAID GOODS IN THE NATURE OF CATHETERS, IN CLASS 10 (U.S. CLS. 26, 39 AND 44).

THE MARK CONSISTS OF STANDARD CHARACTERS WITHOUT CLAIM TO ANY PARTICULAR FONT, STYLE, SIZE, OR COLOR.

PRIORITY DATE OF 2-16-2010 IS CLAIMED.

OWNER OF INTERNATIONAL REGISTRATION 1064389 DATED 8-13-2010, EXPIRES 8-13-2020.

THE WORDING "PROAQT" HAS NO MEANING IN A FOREIGN LANGUAGE.

SER. NO. 79-092,328, FILED 8-13-2010.

KELLY TRUSILO, EXAMINING ATTORNEY



David J. Kybas

Director of the United States Patent and Trademark Office

United States of America
United States Patent and Trademark Office

frankly.

Reg. No. 4,065,325

Registered Dec. 6, 2011

Int. Cls.: 9, 24 and 25

FRANKLY INDUSTRIES PTY LTD (AUSTRALIA AUSTRALIAN PROPRIETARY LIMITED COMPANY)
164 MONBULK ROAD
MONBULK VICTORIA 3793
AUSTRALIA

TRADEMARK

PRINCIPAL REGISTER

FOR: PROTECTIVE CLOTHING, NAMELY, CLOTHING FOR PROTECTION AGAINST CHEMICALS AND RADIATION, CLOTHING FOR PROTECTION AGAINST ACCIDENTS, IRRADIATION AND FIRE, IN CLASS 9 (U.S. CLS. 21, 23, 26, 36 AND 38).

FOR: TEXTILES AND TEXTILE GOODS AND FABRICS INCLUDED IN THIS CLASS, NAMELY, KNITTED FABRICS, NON-WOVEN FABRICS, WOVEN FABRICS, FABRICS FOR TEXTILE USE; LAMINATES INCLUDED IN THIS CLASS, NAMELY, LAMINATED TEXTILES TO BE AFFIXED TO THE SURFACE OF CLOTHING, FOOTWEAR, BAGS, SPORTS BAGS AND ACCESSORIES; BED BLANKETS; BED SHEETS, IN CLASS 24 (U.S. CLS. 42 AND 50).

FOR: CLOTHING, NAMELY, SHIRTS, DRESSES, SKIRTS, BLOUSES, PANTS, JACKETS, SOCKS, SHORTS, SPORTS COATS, SPORTS SHIRTS, SPORTS VESTS, SPORTS SHIRTS WITH SHORT SLEEVES, UNDERGARMENTS, SWEATERS, FOOTWEAR, GLOVES; HEADGEAR, NAMELY, HATS, CAPS, BONNETS; JERSEYS, IN CLASS 25 (U.S. CLS. 22 AND 39).

THE MARK CONSISTS OF THE WORD "FRANKLY" IN LOWERCASE LETTERS WITH A DOT TO THE RIGHT.

OWNER OF INTERNATIONAL REGISTRATION 1064720 DATED 12-24-2010, EXPIRES 12-24-2020.

SER. NO. 79-092,429, FILED 12-24-2010.

CARYN GLASSER, EXAMINING ATTORNEY



David J. Kypos

Director of the United States Patent and Trademark Office

United States of America

United States Patent and Trademark Office

MENOTTE

Reg. No. 4,065,326

Registered Dec. 6, 2011

Int. Cl.: 14

TRADEMARK

PRINCIPAL REGISTER

CARTIER INTERNATIONAL AG (SWITZERLAND AKTIENGESELLSCHAFT)
HINTERBERGSTRASSE 22 -
POSTFACH 61; CH-6312 STEINHAUSEN
SWITZERLAND

FOR: CUFF LINKS, RINGS, BRACELETS, JEWELRY, EARRINGS, NECKLACES, BROOCHES,
IN CLASS 14 (U.S. CLS. 2, 27, 28 AND 50).

THE MARK CONSISTS OF STANDARD CHARACTERS WITHOUT CLAIM TO ANY PAR-
TICULAR FONT, STYLE, SIZE, OR COLOR.

OWNER OF INTERNATIONAL REGISTRATION 0811270 DATED 9-23-2003, EXPIRES 9-23-
2013.

THE ENGLISH TRANSLATION OF "MENOTTE" IN THE MARK IS "HANDCUFFS".

SER. NO. 79-092,481, FILED 6-7-2010.

MICHAEL SOUDERS, EXAMINING ATTORNEY



David J. Kybas

Director of the United States Patent and Trademark Office

United States of America

United States Patent and Trademark Office

KUUG

Reg. No. 4,065,327

Registered Dec. 6, 2011

Int. Cls.: 11 and 21

TRADEMARK

PRINCIPAL REGISTER

EURO SUISSE CORPORATION LIMITED (UNITED KINGDOM PRIVATE LIMITED COMPANY)
9-11 STORTFORD ROAD
GREAT DUNMOW, ESSEX, UNITED KINGDOM CM6 1DA

FOR: ELECTRIC APPARATUS FOR FILTERING AND BREWING COFFEE; AUTOMATIC MACHINES FOR MAKING COFFEE; BEVERAGE COOLING APPARATUS; ELECTRIC COFFEE MAKING APPARATUS; ELECTRIC COFFEE BEVERAGE MAKING APPARATUS; ELECTRIC COFFEE BREWERS; COFFEE FILTERS NOT OF PAPER BEING PART OF COFFEE MAKERS; ELECTRIC COFFEE MACHINES; ELECTRIC COFFEE MAKING MACHINES; ELECTRIC COFFEE POTS; ELECTRIC KETTLES; ELECTRIC TEA KETTLES; ELECTRICALLY-OPERATED APPARATUS FOR MAKING COFFEE; ELECTRIC MACHINES FOR MAKING COFFEE; WATER HEATERS; ELECTRIC HEATING FILAMENTS; OVENS FOR COOKING; APPARATUS FOR HEATING, NAMELY, ELECTRIC BEVERAGE BOTTLE WARMERS, HOT PLATES, IN CLASS 11 (U.S. CLS. 13, 21, 23, 31 AND 34).

FOR: BEER MUGS; BEVERAGE BOTTLES, SOLD EMPTY; PORTABLE BEVERAGE COOLERS; COFFEE CUPS; COFFEE MUGS; COFFEE SERVICES; CUPS; DRINKING FLASKS; DRINKING FLASKS FOR TRAVELERS; DRINKING VESSELS; HAND-OPERATED COFFEE GRINDERS; HEAT-INSULATED CONTAINERS FOR BEVERAGES; HEAT-INSULATED CONTAINERS; INSULATED VACUUM BOTTLES; INSULATING FLASKS; KITCHEN UTENSILS, NAMELY, TEA INFUSERS, TEA STRAINERS; MUGS; MUGS MADE OF PLASTIC; NON-ELECTRIC COFFEE MAKERS; NON-ELECTRIC COFFEE BREWERS; NON-ELECTRIC COFFEE POTS; COFFEE FILTERS NOT OF PAPER BEING PART OF NON-ELECTRIC COFFEE MAKERS; NON-ELECTRIC KETTLES; NON-ELECTRIC TEA KETTLES; PORTABLE COOLERS; POTS; TEA POTS; THERMALLY INSULATED CONTAINERS FOR BEVERAGES; THERMALLY INSULATED FLASKS FOR BEVERAGES; VACUUM FLASKS FOR HOLDING DRINKS; BEVERAGE GLASSWARE; HOUSEHOLD OR KITCHEN UTENSILS, NAMELY, SPOONS AND ICE TONGS; ICE PAIL COOLERS, IN CLASS 21 (U.S. CLS. 2, 13, 23, 29, 30, 33, 40 AND 50).



David J. Kappas

Director of the United States Patent and Trademark Office

THE MARK CONSISTS OF STANDARD CHARACTERS WITHOUT CLAIM TO ANY PARTICULAR FONT, STYLE, SIZE, OR COLOR.

OWNER OF INTERNATIONAL REGISTRATION 1064988 DATED 11-9-2010, EXPIRES 11-9-2020.

Reg. No. 4,065,327 SER. NO. 79-092,523, FILED 11-9-2010.

VIVIAN MICZNIK FIRST, EXAMINING ATTORNEY

United States of America

United States Patent and Trademark Office

PRECIOUS NIGHT

Reg. No. 4,065,328

Registered Dec. 6, 2011

Int. Cl.: 3

TRADEMARK

PRINCIPAL REGISTER

L'OCCITANE (FRANCE SOCIÉTÉ ANONYME)
ZONE INDUSTRIELLE SAINT-MAURICE
F-04100 MANOSQUE
FRANCE

FOR: SOAP; PERFUMES; TOILET WATER; COSMETICS; HAIR LOTIONS; COSMETIC PREPARATIONS FOR BATHS; SHAMPOOS, SHOWER GELS, BEAUTY MASKS; COSMETIC PREPARATIONS FOR SKIN CARE; COSMETIC CREAMS; COSMETIC PENCILS; MAKE-UP AND MAKE-UP REMOVING PREPARATIONS; CLEANSING MILK FOR TOILET PURPOSES; LOTIONS FOR COSMETIC PURPOSES; DEODORANTS FOR PERSONAL USE; NON-MEDICATED TOILETRIES, IN CLASS 3 (U.S. CLS. 1, 4, 6, 50, 51 AND 52).

PRIORITY DATE OF 6-24-2010 IS CLAIMED.

OWNER OF INTERNATIONAL REGISTRATION 1065035 DATED 12-13-2010, EXPIRES 12-13-2020.

SER. NO. 79-092,538, FILED 12-13-2010.

LEIGH LOWRY, EXAMINING ATTORNEY



David J. Kyros

Director of the United States Patent and Trademark Office

United States of America

United States Patent and Trademark Office

NOCOLYSE

Reg. No. 4,065,329

Registered Dec. 6, 2011

Int. Cl.: 5

TRADEMARK

PRINCIPAL REGISTER

OXY'PHARM (FRANCE LIMITED LIABILITY COMPANY)
917 RUE MARCEL PAUL
F-94500 CHAMPIGNY-SUR-MARNE
FRANCE

FOR: LIQUID PRODUCT FOR AIRBORNE DISINFECTION OF SURFACES AND USED FOR DISINFECTING FOR SANITARY PURPOSES ALL ENVIRONMENTS FREQUENTED BY HUMANS AND ANIMALS IN THE NATURE OF DOCTORS' OFFICES, DAY NURSERIES, TRANSPORTATION SYSTEMS, HOTELS, VETERINARY PREMISES, UNDERTAKERS' PREMISES, PLACES WHERE FOODSTUFFS ARE MANUFACTURED, PREPARED, SERVED OR EATEN, IN CLASS 5 (U.S. CLS. 6, 18, 44, 46, 51 AND 52).

THE MARK CONSISTS OF STANDARD CHARACTERS WITHOUT CLAIM TO ANY PARTICULAR FONT, STYLE, SIZE, OR COLOR.

OWNER OF INTERNATIONAL REGISTRATION 1065151 DATED 12-22-2010, EXPIRES 12-22-2020.

THE WORD(S) "NOCOLYSE" HAS NO MEANING IN A FOREIGN LANGUAGE.

SER. NO. 79-092,584, FILED 12-22-2010.

SUZANNE BLANE, EXAMINING ATTORNEY



David J. Kyros

Director of the United States Patent and Trademark Office

United States of America

United States Patent and Trademark Office

HARMONY

Reg. No. 4,065,330

AB LUDVIG SVENSSON (SWEDEN LIMITED LIABILITY COMPANY)
SE-511 82 KINNA
SWEDEN

Registered Dec. 6, 2011

Int. Cl.: 22

FOR: AWNINGS, NAMELY, SHADING AND ENERGY SAVING FABRIC SCREENS FOR USE IN GREENHOUSES, IN CLASS 22 (U.S. CLS. 1, 2, 7, 19, 22, 42 AND 50).

TRADEMARK

THE MARK CONSISTS OF STANDARD CHARACTERS WITHOUT CLAIM TO ANY PARTICULAR FONT, STYLE, SIZE, OR COLOR.

PRINCIPAL REGISTER

PRIORITY DATE OF 5-11-2010 IS CLAIMED.

OWNER OF INTERNATIONAL REGISTRATION 1065248 DATED 11-10-2010, EXPIRES 11-10-2020.

SER. NO. 79-092,612, FILED 11-10-2010.

SETH A. RAPPAPORT, EXAMINING ATTORNEY



David J. Kyffers

Director of the United States Patent and Trademark Office

United States of America

United States Patent and Trademark Office



Reg. No. 4,065,331
Registered Dec. 6, 2011
Int. Cls.: 7 and 9

BFT S.P.A. (ITALY JOINT STOCK COMPANY)
VIA LAGO DI VICO, 44
I-36015 SCHIO (VICENZA)
ITALY

TRADEMARK
PRINCIPAL REGISTER

FOR: MOTORS EXCEPT THOSE FOR LAND VEHICLES; MECHANICAL PARTS, NAMELY, JOINTS AND GEAR DRIVES EXCEPT THOSE FOR LAND VEHICLES; GEAR MOTORS EXCEPT FOR LAND VEHICLES; ELECTRIC MOTORS NOT FOR LAND VEHICLES, ELECTROMECHANICAL, HYDRAULIC AND PNEUMATIC ACTUATORS FOR OPENING, CLOSING, AND RELEASING DOORS, GATES, ROLLING SHUTTERS, WINDOWS, ROLLER BLINDS, AWNINGS, BLINDS, PARKING BARRIERS, VEHICLE AND PEDESTRIAN BARRIERS, AND SPEED BUMPS, IN CLASS 7 (U.S. CLS. 13, 19, 21, 23, 31, 34 AND 35).

FOR: ELECTRIC AND ELECTRONIC APPARATUS AND INSTRUMENTS FOR CONTROLLING, PROGRAMMING, SIGNALLING, COMMANDING, SECURING, MONITORING, MANAGING THE OPENING, CLOSING, AND RELEASING OF DOORS, GATES, ROLLING SHUTTERS, WINDOWS, ROLLER BLINDS, AWNINGS, BLINDS, PARKING BARRIERS, VEHICLE AND PEDESTRIAN BARRIERS, AND SPEED BUMPS, NAMELY, ELECTRIC AND ELECTRONIC CIRCUITS, RADIO RECEIVERS AND TRANSMITTERS, PHOTOELECTRIC SENSORS, RADARS, SAFETY SENSORS, SIGNALLING LAMPS, BATTERY PACKS, PHOTOVOLTAIC CELLS, BATTERY CHARGER, BAR CODE READERS, TRANSPONDERS; ELECTRIC AND ELECTRONIC APPARATUS AND INSTRUMENTS FOR CONTROLLING, SIGNALLING AND MEASURING FOR ELECTRIC AND ELECTRONIC DATA PROCESSING SYSTEMS AND DATA SUPPORT, FOR CASH TILLS, FOR AUTOMATIC BANKNOTE AND CASH MACHINES, AND FOR CONTROLLING THE ACCESS TO LIMITED AREAS AND CAR PARKS, NAMELY, ELECTRIC AND ELECTRONIC CIRCUITS, RADIO RECEIVERS AND TRANSMITTERS, PHOTOELECTRIC SENSORS, RADARS, SAFETY SENSORS, SIGNALLING LAMPS, BATTERY PACKS, PHOTOVOLTAIC CELLS, BATTERY CHARGER, BAR CODE READERS, TRANSPONDERS; ACCESS CONTROL AND ANTI-INTRUSION ALARMS; INTERCOM AND VIDEO-INTERCOM CONTROL UNITS; ELECTRONIC CONTROL UNITS AND COMPUTER SOFTWARE FOR PROGRAMMING, CONTROLLING AND MONITORING AFORESAID APPARATUS AND INSTRUMENTS, IN CLASS 9 (U.S. CLS. 21, 23, 26, 36 AND 38).



David J. Kyjars

Director of the United States Patent and Trademark Office

OWNER OF U.S. REG. NO. 1,921,508.

PRIORITY DATE OF 10-1-2010 IS CLAIMED.

Reg. No. 4,065,331 OWNER OF INTERNATIONAL REGISTRATION 1065518 DATED 11-29-2010, EXPIRES 11-29-2020.

THE COLOR(S) WHITE AND RED IS/ARE CLAIMED AS A FEATURE OF THE MARK.

THE MARK CONSISTS OF THE WORDING "BFT", WITH THE LETTER "B" BEING A BLOCK LETTER UPPER CASE, AND LETTERS "F" AND "T" BEING IN BLOCK LETTERS LOWER CASE, ALL THE LETTERS ARE WHITE INSIDE A RED RECTANGLE.

SER. NO. 79-092,696, FILED 11-29-2010.

MICHAEL KEATING, EXAMINING ATTORNEY

United States of America

United States Patent and Trademark Office

32 VIA DEI BIRRAI

Reg. No. 4,065,332

Registered Dec. 6, 2011

Int. Cl.: 32

TRADEMARK

PRINCIPAL REGISTER

32 VIA DEI BIRRAI S.R.L. (ITALY LIMITED LIABILITY COMPANY)
VIA CAL LUSENT, 41
I-31040 ONIGO DI PEDEROBBA (TREVISO)
ITALY

FOR: BEERS, IN CLASS 32 (U.S. CLS. 45, 46 AND 48).

THE MARK CONSISTS OF STANDARD CHARACTERS WITHOUT CLAIM TO ANY PARTICULAR FONT, STYLE, SIZE, OR COLOR.

OWNER OF INTERNATIONAL REGISTRATION 1065648 DATED 12-2-2010, EXPIRES 12-2-2020.

THE ENGLISH TRANSLATION OF THE WORDS "32 VIA DEI BIRRAI" IN THE MARK IS "32 BREWER'S STREET".

SER. NO. 79-092,748, FILED 12-2-2010.

SUSAN LESLIE DUBOIS, EXAMINING ATTORNEY



David J. Kybas

Director of the United States Patent and Trademark Office

United States of America

United States Patent and Trademark Office

ALFAPEEL

Reg. No. 4,065,333

Registered Dec. 6, 2011

Int. Cl.: 1

TRADEMARK

PRINCIPAL REGISTER

ALFA-KLEBSTOFFE AG (SWITZERLAND SOCIÉTÉ ANONYME (SA))
VOR EICHE 10
CH-8197 RAFZ
SWITZERLAND

FOR: CHEMICALS USED IN INDUSTRY, RAW DISPERSION IN RELATION TO PLASTICS FOR SPRAYING ON OR APPLYING TO AN OBJECT OR A SUBSTRATE TO FORM A PROTECTIVE COATING, NAMELY, VINYL ACETAL POLYMERS, BUTYRALS (PVB), ACRYLIC ACID ESTER COPOLYMERS, ETHYL-VINYL-ACETATE POLYMERS, AND MIXTURES THEREOF, IN CLASS 1 (U.S. CLS. 1, 5, 6, 10, 26 AND 46).

THE MARK CONSISTS OF STANDARD CHARACTERS WITHOUT CLAIM TO ANY PARTICULAR FONT, STYLE, SIZE, OR COLOR.

PRIORITY DATE OF 9-2-2010 IS CLAIMED.

OWNER OF INTERNATIONAL REGISTRATION 1065916 DATED 1-12-2011, EXPIRES 1-12-2021.

SER. NO. 79-092,866, FILED 1-12-2011.

MICHAEL WIENER, EXAMINING ATTORNEY



David J. Kyfos

Director of the United States Patent and Trademark Office

United States of America

United States Patent and Trademark Office

BRAMSHOTT

Reg. No. 4,065,334

Registered Dec. 6, 2011

Int. Cl.: 36

SERVICE MARK

PRINCIPAL REGISTER

BRAMSHOTT CAPITAL LLP (UNITED KINGDOM LIMITED LIABILITY PARTNERSHIP)
FLAT 7, CLARENDON LODGE
56 CLARENDON ROAD
LONDON, UNITED KINGDOM W11 2HL

FOR: TRUST SERVICES, NAMELY, INVESTMENT AND TRUST COMPANY SERVICES, INVESTMENT MANAGEMENT AND/OR ADVISORY SERVICES; TRUSTEESHIP REPRESENTATIVES; PROVIDING FINANCIAL SERVICES WITH RESPECT TO SECURITIES AND OTHER FINANCIAL INSTRUMENTS AND PRODUCTS, NAMELY, TRADING OF AND INVESTMENTS IN SECURITIES AND FINANCIAL INSTRUMENTS AND PRODUCTS FOR OTHERS; VENTURE CAPITAL AND PROJECT CAPITAL INVESTMENT SERVICES, NAMELY, PROVIDING VENTURE CAPITAL, DEVELOPMENT CAPITAL, PRIVATE EQUITY AND INVESTMENT FUNDING; SECURITIES BROKERAGE SERVICES; FINANCING SERVICES FOR THE SECURING OF FUNDS FOR OTHERS FOR THE PROVISION OF LOANS OR FOR THE PURCHASE OF EQUITIES, NAMELY, FINANCIAL SERVICES, NAMELY, RAISING DEBT AND EQUITY CAPITAL FOR OTHERS; FUND INVESTMENT SERVICES; UNIT TRUST SERVICES, NAMELY, TRUSTEE SERVICES; FINANCIAL, INVESTMENT AND FINANCIAL VALUATION SERVICES; BROKERS, PRINCIPALS AND AGENTS FOR BONDS AND OTHER ASSETS, INSTRUMENTS AND SECURITIES, NAMELY, FINANCIAL INVESTMENT SERVICES; FINANCIAL ADVICE AND MANAGEMENT, IN CLASS 36 (U.S. CLS. 100, 101 AND 102).



THE MARK CONSISTS OF STANDARD CHARACTERS WITHOUT CLAIM TO ANY PARTICULAR FONT, STYLE, SIZE, OR COLOR.

PRIORITY DATE OF 11-2-2010 IS CLAIMED.

OWNER OF INTERNATIONAL REGISTRATION 1065946 DATED 12-10-2010, EXPIRES 12-10-2020.

SER. NO. 79-092,879, FILED 12-10-2010.

SCOTT BIBB, EXAMINING ATTORNEY

David J. Kyffers

Director of the United States Patent and Trademark Office

United States of America

United States Patent and Trademark Office

medino

Reg. No. 4,065,335

Registered Dec. 6, 2011

Int. Cl.: 19

RINN BETON- UND NATURSTEIN GMBH & CO. KG (FED REP GERMANY LIMITED
PARTNERSHIP WITH A LIMITED LIABILITY COMPANY AS GENERAL PARTNER)
83, RODHEIMER STRASSE,
35452 HEUCHELHEIM
FED REP GERMANY

TRADEMARK

FOR: CONCRETE GOODS, NAMELY, SHAPED BRICKS, INTERLOCKING PAVERS, PAVING
STONES, FLAGSTONES, PREFABRICATED WALL AND SLAB PARTS, IN CLASS 19 (U.S.
CLS. 1, 12, 33 AND 50).

PRINCIPAL REGISTER

THE MARK CONSISTS OF STANDARD CHARACTERS WITHOUT CLAIM TO ANY PAR-
TICULAR FONT, STYLE, SIZE, OR COLOR.

OWNER OF INTERNATIONAL REGISTRATION 1066002 DATED 12-23-2010, EXPIRES 12-
23-2020.

SER. NO. 79-092,901, FILED 12-23-2010.

LINDA ESTRADA, EXAMINING ATTORNEY



David J. Kybas

Director of the United States Patent and Trademark Office

United States of America

United States Patent and Trademark Office

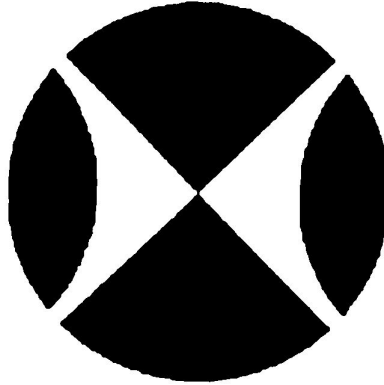

Reg. No. 4,065,336

Registered Dec. 6, 2011

Int. Cls.: 23 and 25

TRADEMARK

PRINCIPAL REGISTER

HAKRO GMBH (FED REP GERMANY GMBH (LIMITED LIABILITY COMPANY))
OBERSTETTENER STR. 41
74575 SCHROZBERG
FED REP GERMANY

FOR: THREAD AND YARN FOR TEXTILE USE, IN CLASS 23 (U.S. CL. 43).

FOR: CLOTHING, NAMELY, POLO SHIRTS, TEE-SHIRTS, SHIRTS, BLOUSES, SWEATERS, PULLOVERS, WAISTCOATS, JACKETS, TROUSERS, SKIRTS; FOOTWEAR; HEADGEAR, NAMELY, CAPS; HEADWEAR; SCARVES; GLOVES, IN CLASS 25 (U.S. CLS. 22 AND 39).

THE MARK CONSISTS OF A SHADED CIRCLE WITH TWO TOUCHING TRIANGLES, EACH HAVING A CURVED BASE SIDE CUT OUT IN THE CENTER.

PRIORITY DATE OF 6-17-2010 IS CLAIMED.

OWNER OF INTERNATIONAL REGISTRATION 1066004 DATED 12-13-2010, EXPIRES 12-13-2020.

SER. NO. 79-092,902, FILED 12-13-2010.

KELLY TRUSILO, EXAMINING ATTORNEY



David J. Kybas

Director of the United States Patent and Trademark Office

United States of America
United States Patent and Trademark Office

Dastit

Reg. No. 4,065,337

Registered Dec. 6, 2011

Int. Cl.: 19

DASTIT MANAGEMENT, SPOL. S R.O. (CZECH REPUBLIC LIMITED LIABILITY COMPANY)
RADIOVÁ 1285/7
CZ-102 00 PRAHA 10
CZECH REPUBLIC

TRADEMARK

PRINCIPAL REGISTER

FOR: NON METALLIC BUILDING MATERIALS, NAMELY, ANORGANIC MORTAR BASE HYDRAULIC BINDERS; ANORGANIC MORTAR BASE HYDRAULIC MIXTURES FOR MANUFACTURING OF PLASTERS, CEMENT AND OTHER BUILDING MATERIALS, NAMELY, CEMENT MIX, MORTAR MIX AND PLASTER MIX, IN CLASS 19 (U.S. CLS. 1, 12, 33 AND 50).

THE MARK CONSISTS OF STANDARD CHARACTERS WITHOUT CLAIM TO ANY PARTICULAR FONT, STYLE, SIZE, OR COLOR.

OWNER OF INTERNATIONAL REGISTRATION 1066072 DATED 10-27-2010, EXPIRES 10-27-2020.

SER. NO. 79-092,919, FILED 10-27-2010.

DANIEL CAPSHAW, EXAMINING ATTORNEY



David J. Kyros

Director of the United States Patent and Trademark Office

United States of America

United States Patent and Trademark Office

INOSTICS

Reg. No. 4,065,338

Registered Dec. 6, 2011

Int. Cls.: 1, 42 and 44

TRADEMARK

SERVICE MARK

PRINCIPAL REGISTER

INOSTICS GMBH (FED REP GERMANY GMBH)
FALKENRIED 88
20251 HAMBURG
FED REP GERMANY

FOR: CHEMICALS USED IN INDUSTRY, SCIENCE AND PHOTOGRAPHY, AS WELL AS IN AGRICULTURE, HORTICULTURE AND FORESTRY, EXCEPT FUNGICIDES, HERBICIDES, INSECTICIDES AND PARASITICIDES; UNPROCESSED ARTIFICIAL RESINS, UNPROCESSED PLASTICS; MANURES; FIRE EXTINGUISHING COMPOSITIONS; TEMPERING AND SOLDERING PREPARATIONS; CHEMICAL SUBSTANCES FOR PRESERVING FOODSTUFFS; TANNING SUBSTANCES, NAMELY, TANNING AGENTS FOR USE IN THE MANUFACTURE OF LEATHER; ADHESIVES USED IN INDUSTRY; REAGENTS FOR THE ANALYSIS, MANIPULATION, LABELING, SEPARATION, ISOLATION, PURIFICATION AND AMPLIFICATION OF BIOPOLYMERS, IN PARTICULAR FOR DETERMINING THE NUCLEOTIDE SEQUENCE OF NUCLEIC ACIDS FOR RESEARCH PURPOSES, INDUSTRIAL USE OTHER THAN MEDICAL AND VETERINARY PURPOSES; KITS CONTAINING PRIMARILY REAGENTS FOR THE ANALYSIS, MANIPULATION, LABELING, SEPARATION, ISOLATION, PURIFICATION AND AMPLIFICATION OF BIOPOLYMERS, IN PARTICULAR FOR DETERMINING THE NUCLEOTIDE SEQUENCE OF NUCLEIC ACIDS FOR RESEARCH PURPOSES, INDUSTRIAL USE OTHER THAN MEDICAL AND VETERINARY PURPOSES, IN CLASS 1 (U.S. CLS. 1, 5, 6, 10, 26 AND 46).



David J. Kyros

Director of the United States Patent and Trademark Office

FOR: SCIENTIFIC AND TECHNOLOGICAL SERVICES, NAMELY, SCIENTIFIC RESEARCH, SCIENTIFIC ANALYSIS IN THE FIELD OF ONCOLOGY AND INFECTIOUS DISEASES, AND RESEARCH AND DESIGN RELATING THERETO, NAMELY DESIGN AND DEVELOPMENT OF DIAGNOSTIC PRODUCTS AND SERVICES; INDUSTRIAL ANALYSIS AND RESEARCH SERVICES; DESIGN AND DEVELOPMENT OF COMPUTER HARDWARE AND SOFTWARE; RESEARCH AND DEVELOPMENT, NAMELY, SCIENTIFIC RESEARCH AND DEVELOPMENT AS WELL AS PRODUCT RESEARCH AND DEVELOPMENT, AND DIAGNOSTICS SERVICES AND DESIGN RELATING THERETO, NAMELY IN THE FIELD OF ONCOLOGY AND INFECTIOUS DISEASES; RESEARCH, FOR OTHERS, IN THE FIELD OF NATURAL SCIENCES, IN PARTICULAR MEDICINE OR VETERINARY MEDICINE, PHARMACY, BIOLOGY, MOLECULAR BIOLOGY, BIOCHEMISTRY, BIOTECHNOLOGY AND CHEMISTRY, INCLUDING FOOD CHEMISTRY; SERVICES IN THE FIELD OF BIOLOGY, MOLECULAR BIOLOGY, BIOCHEMISTRY, BIOTECHNOLOGY AND CHEMISTRY, INCLUDING FOOD CHEMISTRY, IN PARTICULAR CONDUCTING MOLECULAR BIOLOGICAL ASSAYS, DEVELOPMENT OF CHEMICALS USED IN INDUSTRY AND SCIENCE,

Reg. No. 4,065,338 INCLUDING PREPARATIONS AND REAGENTS, IN PARTICULAR NUCLEIC ACID REAGENTS, INCLUDING IN MEDICINE OR VETERINARY MEDICINE, PHARMACY, BIOLOGY, MOLECULAR BIOLOGY, BIOCHEMISTRY, BIOTECHNOLOGY AND CHEMISTRY, INCLUDING FOOD CHEMISTRY, FOR OTHERS; DEVELOPMENT OF PREPARATIONS AND REAGENTS FOR CLINICAL AND MEDICAL PURPOSES, INCLUDING DIAGNOSTIC AGENTS AND COMBINATIONS IN THE NATURE OF SETS AND KITS, IN PARTICULAR FOR DETERMINING THE NUCLEOTIDE SEQUENCE OF NUCLEIC ACIDS, IN CLASS 42 (U.S. CLS. 100 AND 101).

FOR: HYGIENIC AND BEAUTY CARE FOR HUMAN BEINGS OR ANIMALS; AGRICULTURE, HORTICULTURE AND FORESTRY SERVICES, NAMELY, HORTICULTURAL SERVICES; SERVICES IN THE FIELD OF MEDICINE, VETERINARY MEDICINE AND PHARMACY, IN PARTICULAR CONDUCTING MEDICAL AND VETERINARY DIAGNOSES, IN PARTICULAR ON THE BASIS OF MOLECULAR BIOLOGICAL TESTS, IN CLASS 44 (U.S. CLS. 100 AND 101).

THE MARK CONSISTS OF STANDARD CHARACTERS WITHOUT CLAIM TO ANY PARTICULAR FONT, STYLE, SIZE, OR COLOR.

PRIORITY DATE OF 8-4-2010 IS CLAIMED.

OWNER OF INTERNATIONAL REGISTRATION 1066723 DATED 12-14-2010, EXPIRES 12-14-2020.

SER. NO. 79-093,165, FILED 12-14-2010.

APRIL HESIK, EXAMINING ATTORNEY

United States of America

United States Patent and Trademark Office



TREASURY WINE ESTATES

Reg. No. 4,065,339

Registered Dec. 6, 2011

Int. Cl.: 35

SERVICE MARK

PRINCIPAL REGISTER

SOUTHCORP BRANDS PTY LIMITED (AUSTRALIA AUSTRALIAN COMPANY, LIMITED BY SHARES)
77 SOUTHBANK BOULEVARD
SOUTHBANK VIC 3006
AUSTRALIA

FOR: RETAIL AND WHOLESALE STORE SERVICES AND ON-LINE RETAIL AND WHOLESALE STORE SERVICES FEATURING WINE, IN CLASS 35 (U.S. CLS. 100, 101 AND 102).

NO CLAIM IS MADE TO THE EXCLUSIVE RIGHT TO USE "WINE ESTATES", APART FROM THE MARK AS SHOWN.

PRIORITY DATE OF 7-21-2010 IS CLAIMED.

OWNER OF INTERNATIONAL REGISTRATION 1067070 DATED 1-20-2011, EXPIRES 1-20-2021.

THE MARK CONSISTS OF A SHIELD WITH HORIZONTAL LINES ON THE BACKGROUND. THE TOP LEFT PORTION CONTAINS THE STAR ANISE, THE TOP RIGHT PORTION CONTAINS A BARREL, AND A SHIP ON WAVES WITH FIVE STARS ON THE BOTTOM PORTION. UNDERNEATH THE SHIELD ARE VINES WITH TWO BUNCHES OF GRAPES. BELOW THE SHIELD DESIGN IS THE STYLIZED WORDING "TREASURY WINE ESTATES".

SER. NO. 79-093,350, FILED 1-20-2011.

KRISTINA MORRIS, EXAMINING ATTORNEY



David J. Kyffers

Director of the United States Patent and Trademark Office

United States of America

United States Patent and Trademark Office

S P V

Reg. No. 4,065,340

Registered Dec. 6, 2011

Int. Cl.: 17

TRADEMARK

PRINCIPAL REGISTER

NITTO DENKO CORPORATION (JAPAN CORPORATION)
1-2, SHIMOHOZUMI 1-CHOME
IBARAKI-SHI; OSAKA 567-8680
JAPAN

FOR: FILMS FOR SURFACE PROTECTION, NAMELY, PLASTIC FILM WITH A RUBBER ADHESIVE USED TO PROTECT SURFACES; PLASTIC FILMS USED AS PACKAGING FOR MATERIALS; PLASTIC SHEETS, NOT FOR WRAPPING, FOR CONSTRUCTION AND GENERAL USE; PLASTIC FILMS WITH ADHESIVE TAPE IN THE NATURE OF ADHESIVE PLASTIC FILM FOR INDUSTRIAL AND COMMERCIAL USE; PLASTIC SHEETS WITH ADHESIVE TAPE FOR USE IN MANUFACTURING; PLASTIC FILMS WITH ADHESIVE FOR USE IN MANUFACTURING; PLASTIC SHEETS WITH ADHESIVE FOR USE IN MANUFACTURING; ADHESIVE TAPES FOR SURFACE PROTECTION FOR INDUSTRIAL AND COMMERCIAL USE; ADHESIVE TAPES FOR REPAIR AND REINFORCEMENT FOR INDUSTRIAL AND COMMERCIAL USE, IN CLASS 17 (U.S. CLS. 1, 5, 12, 13, 35 AND 50).

THE MARK CONSISTS OF STANDARD CHARACTERS WITHOUT CLAIM TO ANY PARTICULAR FONT, STYLE, SIZE, OR COLOR.

OWNER OF INTERNATIONAL REGISTRATION 1067701 DATED 5-25-2010, EXPIRES 5-25-2020.

OWNER OF U.S. REG. NO. 878,948.

SER. NO. 79-093,776, FILED 5-25-2010.

MELISSA VALLILLO, EXAMINING ATTORNEY



David J. Kybas

Director of the United States Patent and Trademark Office

United States of America

United States Patent and Trademark Office



Reg. No. 4,065,341

Registered Dec. 6, 2011

Int. Cl.: 9

TRADEMARK

PRINCIPAL REGISTER

TOSHIBA TEC KABUSHIKI KAISHA (JAPAN CORPORATION)
2-17-2, HIGASHIGOTANDA
SHINAGAWA-KU; TOKYO 141-8664
JAPAN

FOR: COMPUTER SOFTWARE USED FOR VIEWING, EDITING, AND MERGING DOCUMENTS IN MULTI-FUNCTION MACHINES WITH PHOTOCOPYING, SCANNING, PRINTING, AND FACSIMILE FUNCTIONS, IN CLASS 9 (U.S. CLS. 21, 23, 26, 36 AND 38).

OWNER OF U.S. REG. NOS. 3,223,282, 3,268,840, AND 3,885,554.

OWNER OF INTERNATIONAL REGISTRATION 1068103 DATED 1-14-2011, EXPIRES 1-14-2021.

NO CLAIM IS MADE TO THE EXCLUSIVE RIGHT TO USE "PRINT", APART FROM THE MARK AS SHOWN.

THE MARK CONSISTS OF THE STYLIZED WORDING "E-BRIDGE FLEXIBLE AREA PRINT" AND A DESIGN OF AN INCOMPLETE OVAL ENCIRCLING THE "E-BRIDGE" PORTION OF THE MARK.

SER. NO. 79-093,926, FILED 1-14-2011.

REBECCA SMITH, EXAMINING ATTORNEY



David J. Kybas

Director of the United States Patent and Trademark Office

United States of America

United States Patent and Trademark Office

Antale



Reg. No. 4,065,342

Registered Dec. 6, 2011

Int. Cl.: 33

TRADEMARK

PRINCIPAL REGISTER

CASA VINICOLA NATALE VERGA S.P.A. (ITALY JOINT STOCK COMPANY)
VIA MATTEOTTI, 51-53
I-22072 CERMENATE (COMO)
ITALY

FOR: ALCOHOLIC BEVERAGES EXCEPT BEERS, IN CLASS 33 (U.S. CLS. 47 AND 49).

THE MARK CONSISTS OF THE TERM "ANTALE" AND BELOW IT, THE DESIGN OF STYLISED GRAPEVINES.

PRIORITY DATE OF 12-28-2010 IS CLAIMED.

OWNER OF INTERNATIONAL REGISTRATION 1068135 DATED 1-12-2011, EXPIRES 1-12-2021.

SER. NO. 79-093,941, FILED 1-12-2011.

MICHAEL WIENER, EXAMINING ATTORNEY



David J. Kybas

Director of the United States Patent and Trademark Office

United States of America
United States Patent and Trademark Office

ANTALE

Reg. No. 4,065,343

Registered Dec. 6, 2011

Int. Cl.: 33

TRADEMARK

PRINCIPAL REGISTER

CASA VINICOLA NATALE VERGA S.P.A. (ITALY JOINT STOCK COMPANY)
VIA MATTEOTTI, 51-53
I-22072 CERMENATE (COMO)
ITALY

FOR: ALCOHOLIC BEVERAGES EXCEPT BEERS, IN CLASS 33 (U.S. CLS. 47 AND 49).

THE MARK CONSISTS OF STANDARD CHARACTERS WITHOUT CLAIM TO ANY PARTICULAR FONT, STYLE, SIZE, OR COLOR.

PRIORITY DATE OF 8-3-2010 IS CLAIMED.

OWNER OF INTERNATIONAL REGISTRATION 1068136 DATED 1-12-2011, EXPIRES 1-12-2021.

SER. NO. 79-093,942, FILED 1-12-2011.

MICHAEL WIENER, EXAMINING ATTORNEY



David J. Kyros

Director of the United States Patent and Trademark Office

United States of America

United States Patent and Trademark Office

STAR FLY

Reg. No. 4,065,344

Registered Dec. 6, 2011

Int. Cl.: 25

TRADEMARK

PRINCIPAL REGISTER

BEE FLY SARL (FRANCE SOCIETE A RESPONSABILITE LIMITEE)
118/130, AVENUE JEAN JAURÈS
PARIS, FRANCE F75019

FOR: CLOTHING, NAMELY, TOPS, DRESSES, SHIRTS, T-SHIRTS, JEANS, TROUSERS,
SHORTS, SKIRTS, SWEATERS, JACKETS; SHOES; HEADGEAR, NAMELY, HATS, CAPS,
IN CLASS 25 (U.S. CLS. 22 AND 39).

"STAR FLY" DOES NOT REPRESENT A PARTICULAR LIVING INDIVIDUAL.

OWNER OF INTERNATIONAL REGISTRATION 0769529 DATED 11-12-2001, EXPIRES 11-12-2011.

SER. NO. 79-093,948, FILED 12-22-2010.

SUZANNE BLANE, EXAMINING ATTORNEY



David J. Kyfos

Director of the United States Patent and Trademark Office

United States of America

United States Patent and Trademark Office

SYKEE 赛克

Reg. No. 4,065,345

Registered Dec. 6, 2011

Int. Cl.: 12

TIANJIN KELIN BICYCLE CO., LTD. (CHINA CORPORATION)
JINGJI JISHU KAIFANG
DAGANG DISTRICT; TIANJIN
CHINA

FOR: BICYCLES, IN CLASS 12 (U.S. CLS. 19, 21, 23, 31, 35 AND 44).

TRADEMARK

THE MARK CONSISTS OF THE WORDING "SKYEE" IN A STYLIZED FONT AND THE DESIGN OF TWO CHINESE CHARACTERS.

PRINCIPAL REGISTER

OWNER OF INTERNATIONAL REGISTRATION 1068174 DATED 2-11-2011, EXPIRES 2-11-2021.

THE TRANSLITERATION OF THE NON-LATIN CHARACTERS IN THE MARK IS: "SAI KE".

THE ENGLISH TRANSLATION OF THE FOREIGN WORD(S) IN THE MARK IS: THE FIRST CHINESE CHARACTER WHOSE TRANSLITERATION IS "SAI" MEANS "MATCH", THE SECOND CHINESE CHARACTER WHOSE TRANSLITERATION IS "KE" MEANS "GRAM", THE COMBINATION OF THE TWO CHINESE CHARACTERS AND THE WORD "SYKEE" HAVE NO MEANING IN A FOREIGN LANGUAGE.

SER. NO. 79-093,972, FILED 2-11-2011.

SEAN CROWLEY, EXAMINING ATTORNEY



David J. Kyros

Director of the United States Patent and Trademark Office

United States of America
United States Patent and Trademark Office

TACTYS

Reg. No. 4,065,346

Registered Dec. 6, 2011

Int. Cl.: 10

TRADEMARK

PRINCIPAL REGISTER

MEMOMETAL TECHNOLOGIES (FRANCE SOCIÉTÉ ANONYME)
2 RUE BLAISE PASCAL
CAMPUS DE KER LANN
BRUZ, FRANCE F35170

FOR: PROSTHESES FOR HANDS AND WRISTS FOR USE IN HAND SURGERY AND WRIST SURGERY; DIGITAL PROSTHESES FOR THE HANDS; TOTAL PROSTHESIS FOR PROXIMAL INTERPHALANGEAL JOINT, TOTAL PROSTHESIS FOR DISTAL INTERPHALANGEAL JOINT, TOTAL PROSTHESIS FOR METACARPOPHALANGEAL JOINT; RESURFACING PROSTHESES FOR HANDS AND WRISTS; INTERPOSITION IMPLANTS IN THE NATURE OF ORTHOPEDIC JOINT IMPLANTS; ARTIFICIAL SURGICAL IMPLANTS; GOODS OF METAL FOR MEDICAL USE, NAMELY, SURGICAL PINS; ALL THE AFOREMENTIONED GOODS INTENDED FOR HAND AND WRIST SURGERY, IN CLASS 10 (U.S. CLS. 26, 39 AND 44).

THE MARK CONSISTS OF STANDARD CHARACTERS WITHOUT CLAIM TO ANY PARTICULAR FONT, STYLE, SIZE, OR COLOR.

PRIORITY DATE OF 6-14-2010 IS CLAIMED.

OWNER OF INTERNATIONAL REGISTRATION 1068320 DATED 12-13-2010, EXPIRES 12-13-2020.

THE WORD(S) "TACTYS" HAS NO MEANING IN A FOREIGN LANGUAGE.

SER. NO. 79-094,043, FILED 12-13-2010.

KATHERINE E. HALMEN, EXAMINING ATTORNEY



David J. Kypos

Director of the United States Patent and Trademark Office

United States of America

United States Patent and Trademark Office

*Attic
and
Barn*

Reg. No. 4,065,347

Registered Dec. 6, 2011

Int. Cls.: 18 and 25

TRADEMARK

PRINCIPAL REGISTER

NYKY S.R.L. (ITALY LIMITED LIABILITY COMPANY)
PIAZZA TRENTO, 8
TREVISO
ITALY

FOR: HANDBAGS; SHOULDER BAGS; SUITCASES; RUCKSACKS; TRUNKS, BEING LUGGAGE; TRAVELLING BAGS, BEING LEATHER WARE, IN CLASS 18 (U.S. CLS. 1, 2, 3, 22 AND 41).

FOR: BRASSIERES; CORSELETS; PETTICOATS; BODICES; BODY SUITS; TANK TOPS; UNDERSHIRTS; VESTS; PANTIES; UNDERPANTS; BRIEFS; G-STRINGS; THONGS; CULLOTTES; GARTERS; UNDERWEAR; NIGHTGOWNS; PAJAMAS; DRESSING GOWNS; PULLOVERS; BATHING SUITS; GLOVES AND MUFFS, BEING CLOTHING; CARDIGANS; JERSEYS, BEING CLOTHING; NECKERCHIEFS; SCARVES; SWEATERS; STOCKINGS; TROUSERS; LEGGINGS; SKIRTS; JACKETS; JERKINS; SHIRTS; POLO SHIRTS; WAISTCOATS; JUMPERS; BLOUSES; JEANS; PANTS; BERMUDA SHORTS; SHORTS; T-SHIRTS; SWEAT-SHIRTS; DRESSES; OVERCOATS; COATS; RAINCOATS; SHAWLS; WINDCHEATERS; FOULARDS, BEING CLOTHING; PANTY HOSES; SASHES FOR WEAR; BELTS, BEING CLOTHING; WAISTBANDS; BRACES; LOUNGEWEAR; BEACHWEAR; SLEEPWEAR, IN CLASS 25 (U.S. CLS. 22 AND 39).

THE MARK CONSISTS OF A SIGN DEPICTING THE WORDING "ATTIC" AND "BARN", IN FANCY CHARACTERS, THE WORD "AND" BEING OF A SMALLER SIZE AND PLACED BELOW THE WORD "ATTIC", BUT ABOVE THE WORD "BARN".

PRIORITY DATE OF 8-2-2010 IS CLAIMED.

OWNER OF INTERNATIONAL REGISTRATION 1068450 DATED 11-26-2010, EXPIRES 11-26-2020.

SER. NO. 79-094,082, FILED 11-26-2010.

WARREN L. OLANDRIA, EXAMINING ATTORNEY



David J. Kyffers

Director of the United States Patent and Trademark Office

United States of America
United States Patent and Trademark Office

MIGNON

Reg. No. 4,065,348

Registered Dec. 6, 2011

Int. Cls.: 16 and 18

TRADEMARK

PRINCIPAL REGISTER

AGENDAS BONTEMPS LIMOGES - ABL SOCIÉTÉ PAR ACTIONS SIMPLIFIÉE (FRANCE
SOCIÉTÉ PAR ACTIONS SIMPLIFIÉE)
132, QUAI DE JEMMAPES
PARIS, FRANCE F75010

FOR: PAPER; GOODS OF PAPER AND STATIONERY, NAMELY, AGENDAS, POCKET NOTEBOOKS, TELEPHONE AND ADDRESS BOOKS, CALENDARS, ALMANACS, WRITING PADS, LETTERHEAD PAPER, BOXES AND HOLDERS FOR WRITING PAPER; OFFICE ACCESSORIES, NAMELY, DESK PADS, FILE FOLDERS, BLOTTERS, PAPERWEIGHTS, BOOKENDS; PLAYING CARDS AND GEOGRAPHICAL MAPS AND ROAD MAPS, PENCIL CASES, PHOTOGRAPH ALBUMS; CARDBOARD AND GOODS OF CARDBOARD, NAMELY, CARDBOARD BOXES; PARTIALLY PRINTED FORMS; BINDERS; MAGAZINES, BOOKS AND HANDBOOKS, ALL IN THE FIELD OF FASHION; PLAYING CARD CASES AND CASES FOR ROAD MAPS, OF LEATHER OR IMITATION LEATHER, IN CLASS 16 (U.S. CLS. 2, 5, 22, 23, 29, 37, 38 AND 50).

FOR: GOODS OF LEATHER AND IMITATION LEATHER, NAMELY, KEY CASES, PURSES, BILLFOLDS, POCKET WALLETS, IDENTITY CARD HOLDERS AND CHECK BOOK HOLDERS, ATTACHÉ CASES AND BRIEFCASES, TRUNKS AND VALISES, TRAVELING BAGS, LADIES' BAGS, TRAVELING SETS COMPRISED OF TWO OR MORE TRAVELING BAGS, IN CLASS 18 (U.S. CLS. 1, 2, 3, 22 AND 41).

THE MARK CONSISTS OF THE STYLIZED WORD "MIGNON".

OWNER OF INTERNATIONAL REGISTRATION 0560484 DATED 9-28-1990, EXPIRES 9-28-2020.

SER. NO. 79-094,207, FILED 9-29-2010.

KELLEY WELLS, EXAMINING ATTORNEY



David J. Kypos

Director of the United States Patent and Trademark Office

United States of America

United States Patent and Trademark Office

Lycopodium

Reg. No. 4,065,349

Registered Dec. 6, 2011

Int. Cls.: 37 and 42

LYCOPODIUM LIMITED (AUSTRALIA PUBLIC COMPANY LIMITED BY SHARES (PC LTD.))
1 ADELAIDE TERRACE
EAST PERTH WA 6004
AUSTRALIA

SERVICE MARK

PRINCIPAL REGISTER

FOR: ADVISORY SERVICES, NAMELY, CONSULTATION RELATING TO THE CONSTRUCTION OF CIVIL ENGINEERING STRUCTURES; ADVISORY SERVICES, NAMELY, CONSULTATION RELATING TO THE CONSTRUCTION OF MECHANICAL ENGINEERING STRUCTURES; ADVISORY SERVICES, NAMELY, CONSULTATION RELATING TO THE REPAIR OF CIVIL ENGINEERING STRUCTURES; ADVISORY SERVICES, NAMELY, CONSULTATION RELATING TO THE REPAIR OF MECHANICAL ENGINEERING STRUCTURES; CONSTRUCTION OF CIVIL ENGINEERING STRUCTURES; CONSTRUCTION OF ELECTRICAL ENGINEERING STRUCTURES; CONSTRUCTION OF MECHANICAL ENGINEERING STRUCTURES; CONSTRUCTION OF STRUCTURAL ENGINEERING STRUCTURES, IN CLASS 37 (U.S. CLS. 100, 103 AND 106).

FOR: ADVISORY SERVICES, NAMELY, CONSULTATION RELATING TO INDUSTRIAL ENGINEERING; BUILDING AND STRUCTURAL INSPECTION SERVICES, NAMELY, ENGINEERING SERVICES FOR ASSESSING BUILDING AND PROPERTY CONDITION, CONSULTING IN RELATION TO BUILDING AND STRUCTURAL QUALITY ASSESSMENT, AND SURVEYING SERVICES; CIVIL ENGINEERING; CIVIL ENGINEERING DESIGN SERVICES; CIVIL ENGINEERING DRAWING SERVICES, NAMELY, DRAFTING OF PLANS AND ENGINEERING DRAWINGS FOR OTHERS; DESIGN ENGINEERING, NAMELY, CIVIL, MINING, ENVIRONMENTAL, MECHANICAL, STRUCTURAL, ELECTRICAL, ELECTRONIC, CHEMICAL, PROCESS, OIL AND GAS, INDUSTRIAL AND SAFETY ENGINEERING DESIGN SERVICES; ELECTRICAL ENGINEERING SERVICES; ENGINEERING; ENGINEERING CONSULTANCY; ENGINEERING DESIGN; ENGINEERING DRAWING, NAMELY, DRAFTING OF PLANS AND ENGINEERING DRAWINGS FOR OTHERS; CONDUCTING OF ENGINEERING FEASIBILITY STUDIES; ENGINEERING PROJECT MANAGEMENT SERVICES; ENGINEERING PROJECT TECHNICAL STUDIES; ENGINEERING RESEARCH, NAMELY, IN THE FIELDS OF CIVIL, MINING, ENVIRONMENTAL, MECHANICAL, STRUCTURAL, ELECTRICAL, ELECTRONIC, CHEMICAL, PROCESS, OIL AND GAS, INDUSTRIAL AND SAFETY ENGINEERING; INDUSTRIAL ENGINEERING DESIGN SERVICES; MECHANICAL ENGINEERING SERVICES; PREPARATION OF ENGINEERING DRAWINGS; PREPARATION OF ENGINEERING REPORTS; PROVISION OF ENGINEERING REPORTS; PROVISION OF INFORMATION RELATING TO INDUSTRIAL ENGINEERING; RESEARCH,



David J. Kyffers

Director of the United States Patent and Trademark Office

Reg. No. 4,065,349 ENGINEERING AND TECHNOLOGICAL CONSULTANCY FOR INDUSTRY IN THE FIELDS OF CIVIL, MINING, ENVIRONMENTAL, MECHANICAL, STRUCTURAL, ELECTRICAL, ELECTRONIC, CHEMICAL, PROCESS, OIL AND GAS, INDUSTRIAL AND SAFETY ENGINEERING; STRUCTURAL ENGINEERING SERVICES; TECHNICAL ENGINEERING; CIVIL ENGINEERING CONSULTANCY; CONSTRUCTION ENGINEERING; TECHNICAL PROJECT PLANNING RELATING TO CIVIL ENGINEERING; TECHNICAL PROJECT PLANNING RELATING TO CONSTRUCTION ENGINEERING, IN CLASS 42 (U.S. CLS. 100 AND 101).

THE MARK CONSISTS OF THE CHARACTERS "LYCO" IN DARK GREEN AND THE CHARACTERS "PODIUM" IN LIGHT GREEN.

OWNER OF INTERNATIONAL REGISTRATION 1068881 DATED 9-23-2010, EXPIRES 9-23-2020.

THE COLOR(S) DARK GREEN AND LIGHT GREEN IS/ARE CLAIMED AS A FEATURE OF THE MARK.

SER. NO. 79-094,251, FILED 9-23-2010.

KRISTIN CARLSON, EXAMINING ATTORNEY

United States of America

United States Patent and Trademark Office

POWEROCKS

Reg. No. 4,065,350

Registered Dec. 6, 2011

Int. Cl.: 9

TRADEMARK

PRINCIPAL REGISTER

CHAM BATTERY TECHNOLOGY CO., LTD (CHINA CORPORATION)
ROOM 803, FANGDA BUILDING
SOUTH, HIGH-TECH ZONE;
NANSHAN DISTRICT; SHENZHEN, CHINA

FOR: BATTERIES FOR FLASHLIGHT; HIGH TENSION BATTERIES; BATTERIES FOR LIGHTING; GALVANIC CELLS FOR BATTERIES; SOLAR BATTERIES; GALVANIC BATTERIES; ELECTRIC BATTERIES; ELECTRIC ACCUMULATORS; COMPUTER PERIPHERALS; BATTERY CHARGERS, IN CLASS 9 (U.S. CLS. 21, 23, 26, 36 AND 38).

THE MARK CONSISTS OF THE WORD "POWEROCKS" IN HIGHLY STYLIZED CAPITAL LETTERS SEEMINGLY MADE OF FABRIC OR MESH WITH THE FIRST "O" IN "POWEROCKS" MADE TO RESEMBLE A COMPUTER DEVICE SYMBOL; THE "O" IS A DARKER SHADE THAN THE REST OF THE WORD, CONTAINS A STRAIGHT VERTICAL AT THE TOP THAT BREAKS AND BREAKING THROUGH THE CIRCLE ABOVE THE "O".

PRIORITY DATE OF 9-26-2010 IS CLAIMED.

OWNER OF INTERNATIONAL REGISTRATION 1068972 DATED 12-27-2010, EXPIRES 12-27-2020.

SER. NO. 79-094,296, FILED 12-27-2010.

JILL C. ALT, EXAMINING ATTORNEY



David J. Kyros

Director of the United States Patent and Trademark Office

United States of America

United States Patent and Trademark Office



BAG 'n' NOUN

NECESSARY or UNNECESSARY

Reg. No. 4,065,351

Registered Dec. 6, 2011

Int. Cls.: 18 and 25

TRADEMARK

PRINCIPAL REGISTER

MAMBORAMA, INC. (JAPAN CORPORATION)
4-4, MOMOYAMADAI 4-CHO
MINAMI-KU, SAKAI-SHI
OSAKA, JAPAN 5900141

FOR: FOLDING BRIEFCASES; SHOULDER BAGS; GLADSTONE BAGS; BRIEFCASES; SUITCASES; CARRY-ON BAGS; TRUNKS; HANDBAGS; BOSTON BAGS; SCHOOL CHILDREN'S BACKPACKS; BACKPACKS; RUCKSACKS; CHARM BAGS; CREDIT CARD CASES OF LEATHER; WHEELED SHOPPING BAGS; TEXTILE SHOPPING BAGS; PURSES; KEY CASES; WALLETS; JAPANESE UTILITY POUCHES (SHINGEN-BUKURO); BUSINESS CARD CASES, IN CLASS 18 (U.S. CLS. 1, 2, 3, 22 AND 41).

FOR: SCHOOL UNIFORMS; JACKETS; JOGGING PANTS; SWEAT PANTS; SUITS; SKIRTS; SKI JACKETS; SKI PANTS; TROUSERS; SMOCKS; COATS; OVERCOATS; TOPCOATS; MANTLES; RAINCOATS; CARDIGANS; SWEATERS; VESTS; WAISTCOATS; OPEN-NECKED SHIRTS; CUFFS; COLLARS; SPORT SHIRTS; BLOUSES; POLO SHIRTS; SHIRTS FOR SUITS; NIGHTWEAR; JAPANESE SLEEPING ROBES (NEMAKI); PAJAMAS; BATHROBES; UNDERWEAR; CAMISOLES; COMBINATIONS; UNDERSHIRTS; CHEMISES; SLIPS; PANTIES; SHORTS AND BRIEFS; PETTICOATS; SWIMWEAR; SWIMMING CAPS; SLEEP MASKS; APRONS; COLLAR PROTECTORS; SOCKS AND STOCKINGS; SHAWLS; SCARVES; GLOVES; MITTENS; NECKTIES; NECKERCHIEVES; BANDANAS; MUFFLERS; EAR MUFFS; HOODS; NIGHTCAPS; HEADGEAR FOR WEAR, NAMELY, HATS, CAPS; RAIN BOOTS; LACE BOOTS; TRAINING SHOES; OVERSHOES; WORK SHOES AND BOOTS; SANDALS; SHOES NOT FOR SPORTS; ANGLERS' SHOES; BOOTS; WINTER BOOTS; CANVAS SHOES; INFANTS' SHOES AND BOOTS; INNER SOLES; INSOLES; WELTS FOR SHOES AND BOOTS; TONGUE OR PULLSTRAP FOR SHOES AND BOOTS; PROTECTIVE METAL MEMBERS FOR SHOES AND BOOTS, IN CLASS 25 (U.S. CLS. 22 AND 39).



NO CLAIM IS MADE TO THE EXCLUSIVE RIGHT TO USE "BAG" FOR INTERNATIONAL CLASS 18, APART FROM THE MARK AS SHOWN.

OWNER OF INTERNATIONAL REGISTRATION 1069292 DATED 1-27-2011, EXPIRES 1-27-2021.

David J. Kybas

Director of the United States Patent and Trademark Office

THE MARK CONSISTS OF THE WORD "NOUN" WITHIN A HEXAGON ABOVE THE WORDING "BAG 'N' NOUN" ABOVE THE SMALLER WORDING "NECESSARY OR UNNECESSARY".

Reg. No. 4,065,351 SER. NO. 79-094,406, FILED 1-27-2011.

MICHAEL ENGEL, EXAMINING ATTORNEY

United States of America

United States Patent and Trademark Office



Reg. No. 4,065,352

Registered Dec. 6, 2011

Int. Cl.: 24

TRADEMARK

PRINCIPAL REGISTER

ALTINBASAK TEKSTIL SANAYI VE TICARET ANONIM SIRKETI (TURKEY JOINT STOCK COMPANY)
ORGANIZE SANAYI BÖLGESİ
TURAN BAHADIR CADDESİ NO. 116/2; DENİZLİ
TURKEY

FOR: BED COVER, BED LINEN, COVER FOR CUSHIONS, QUILTS, IN CLASS 24 (U.S. CLS. 42 AND 50).

NO CLAIM IS MADE TO THE EXCLUSIVE RIGHT TO USE "TURK MALI", APART FROM THE MARK AS SHOWN.

OWNER OF INTERNATIONAL REGISTRATION 0785984 DATED 7-16-2002, EXPIRES 7-16-2012.

THE COLOR(S) BLACK, GOLD, GREEN, AND RED IS/ARE CLAIMED AS A FEATURE OF THE MARK.

THE MARK CONSISTS OF THE FOLLOWING: A STYLIZED STALK OF GRAIN IN GOLD AND BLACK ABOVE THE WORDING "ALTIN BASAK" IN GOLD ON A BLACK CURVED BANNER, WHICH IS ABOVE A RED ROSE WITH GREEN LEAVES AND STEM, ALL SHADED IN BLACK. AT THE BOTTOM RIGHT THERE IS THE WORDING "TURK MALI" IN AN OVAL SHAPE, IN BLACK.

THE ENGLISH TRANSLATION OF "ALTIN BASAK" AND "TURK MALI" IN THE MARK IS "GOLDEN SPIKE" AND "TURKISH PRODUCT", RESPECTIVELY.

SER. NO. 79-094,486, FILED 1-24-2011.

KEVIN DINALLO, EXAMINING ATTORNEY



David J. Kybas

Director of the United States Patent and Trademark Office

United States of America

United States Patent and Trademark Office

birrecco

Reg. No. 4,065,353

Registered Dec. 6, 2011

Int. Cls.: 32 and 33

TRADEMARK

PRINCIPAL REGISTER

TREPOSÉ GMBH (FED REP GERMANY GMBH)
HAUPTSTRASSE 197
NEUKIRCHEN, FED REP GERMANY 09221

FOR: BEERS; MINERAL AND AERATED WATERS AND OTHER NON-ALCOHOLIC SOFT DRINKS; FRUIT DRINKS AND FRUIT JUICES; CONCENTRATES, SYRUPS OR POWDERS USED IN THE PREPARATION OF SOFT DRINKS, IN CLASS 32 (U.S. CLS. 45, 46 AND 48).

FOR: ALCOHOLIC BEVERAGES EXCEPT BEERS, IN CLASS 33 (U.S. CLS. 47 AND 49).

THE MARK CONSISTS OF STANDARD CHARACTERS WITHOUT CLAIM TO ANY PARTICULAR FONT, STYLE, SIZE, OR COLOR.

OWNER OF INTERNATIONAL REGISTRATION 1044741 DATED 5-18-2010, EXPIRES 5-18-2020.

THE WORDING "BIRRECCO" HAS NO MEANING IN A FOREIGN LANGUAGE.

SER. NO. 79-094,500, FILED 12-17-2010.

STEVEN PEREZ, EXAMINING ATTORNEY



David J. Kyros

Director of the United States Patent and Trademark Office

United States of America

United States Patent and Trademark Office



Reg. No. 4,065,354

Registered Dec. 6, 2011

Int. Cl.: 12

TRADEMARK

PRINCIPAL REGISTER

TIANJIN KELIN BICYCLE CO., LTD. (CHINA CORPORATION)
JINGJI JISHU KAIFANG
DAGANG DISTRICT; TIANJIN
CHINA

FOR: BICYCLES; MINI-MOTORCYCLES; ELECTRO-TRICYCLES; BICYCLES FOR CHILDREN; FOLDABLE BICYCLES; MOPEDS; FRONT FORKS FOR BICYCLES; BICYCLE FRAMES; ELECTRIC BICYCLES; MOTOR TRICYCLES, IN CLASS 12 (U.S. CLS. 19, 21, 23, 31, 35 AND 44).

THE MARK CONSISTS OF THE WORDING "SKYEE", TWO CHINESE CHARACTERS AND STYLIZED DESIGN ELEMENT IN THE SHAPE OF THE LETTER "K".

OWNER OF INTERNATIONAL REGISTRATION 1069607 DATED 2-11-2011, EXPIRES 2-11-2021.

THE TRANSLITERATION OF THE NON-LATIN CHARACTERS IN THE MARK IS "SAI KE".

THE ENGLISH TRANSLATION OF THE FOREIGN WORD(S) IN THE MARK IS: THE FIRST CHINESE CHARACTER WHOSE TRANSLITERATION IS "SAI" MEANS "MATCH", THE SECOND CHINESE CHARACTER WHOSE TRANSLITERATION IS "KE" MEANS "GRAM", THE COMBINATION OF THE TWO CHINESE CHARACTERS AND THE ENGLISH WORDING "SYKEE" HAVE NO MEANING IN A FOREIGN LANGUAGE.

SER. NO. 79-094,535, FILED 2-11-2011.

SEAN CROWLEY, EXAMINING ATTORNEY



David J. Kybas

Director of the United States Patent and Trademark Office

United States of America

United States Patent and Trademark Office



Reg. No. 4,065,355

Registered Dec. 6, 2011

Int. Cl.: 33

TRADEMARK

PRINCIPAL REGISTER

OENOFOROS AB (SWEDEN AKTIEBOLAG (AB))
P.O. BOX 24005
SE-104 50 STOCKHOLM
SWEDEN

FOR: ALCOHOLIC BEVERAGES EXCEPT BEERS, IN CLASS 33 (U.S. CLS. 47 AND 49).

THE MARK CONSISTS OF THE WORDING "IL NOSTRO" AND A CIRCULAR DESIGN ELEMENT ALL ON A RECTANGULAR BACKGROUND.

PRIORITY DATE OF 10-18-2010 IS CLAIMED.

OWNER OF INTERNATIONAL REGISTRATION 1069612 DATED 2-8-2011, EXPIRES 2-8-2021.

THE ENGLISH TRANSLATION OF "NOSTRO" IN THE MARK IS "OURS".

SER. NO. 79-094,538, FILED 2-8-2011.

PAUL MORENO, EXAMINING ATTORNEY



David J. Kyffers

Director of the United States Patent and Trademark Office

United States of America

United States Patent and Trademark Office

myClubem@il

Reg. No. 4,065,356

Registered Dec. 6, 2011

Int. Cl.: 38

SERVICE MARK

PRINCIPAL REGISTER

ONE PIXEL PTY LTD (AUSTRALIA AUSTRALIAN PROPRIETARY LIMITED COMPANY)
7 MARJORY STREET
YARRAVILLE VIC 3013
AUSTRALIA

FOR: ELECTRONIC MAIL SERVICES, IN CLASS 38 (U.S. CLS. 100, 101 AND 104).

THE MARK CONSISTS OF THE STYLIZED WORDING "MYCLUBEM@IL" AND A STYLIZED DESIGN OF THE BACK OF AN ENVELOPE LOCATED BEHIND THE TERM "EM@IL".

PRIORITY DATE OF 9-2-2010 IS CLAIMED.

OWNER OF INTERNATIONAL REGISTRATION 1069833 DATED 2-25-2011, EXPIRES 2-25-2021.

SER. NO. 79-094,616, FILED 2-25-2011.

DEIRDRE ROBERTSON, EXAMINING ATTORNEY



David J. Kybas

Director of the United States Patent and Trademark Office

United States of America
United States Patent and Trademark Office

BORUN

Reg. No. 4,065,357

Registered Dec. 6, 2011

Int. Cls.: 6 and 7

SHANDONG BORUN PROCESS INDUSTRIAL TECHNOLOGY CO., LTD. (CHINA CORPORATION)
169 YUMIN ROAD
HIGH & NEW TECHNOLOGY DISTRICT,; ZIBO CITY; SHANDONG PROVINCE
CHINA

TRADEMARK

PRINCIPAL REGISTER

FOR: STEEL ALLOYS, CLAD STEEL PLATES AND SHEETS, ELBOWS OF METAL FOR PIPES INCLUDING THOSE FROM ALLOY STEEL AND TITANIUM; JUNCTIONS OF METAL FOR PIPES INCLUDING THOSE FROM ALLOY STEEL AND TITANIUM; PIPEWORK OF METAL INCLUDING THOSE FROM ALLOY STEEL AND TITANIUM; REINFORCING MATERIALS OF METAL FOR BUILDING PURPOSE, NAMELY, FOR PIPES; METAL PIPE COUPLINGS AND JOINTS; METAL GUTTERS; METAL PIPE CONNECTORS; ANTI-FRICTION METAL, NAMELY, STEEL, IN CLASS 6 (U.S. CLS. 2, 12, 13, 14, 23, 25 AND 50).

FOR: EARTH MOVING MACHINES; EARTH COMPACTING MACHINES; EARTH MOVING MACHINES, NAMELY, CINDER SIFTERS; EARTH MOVING MACHINES, NAMELY, EXCAVATORS, IN CLASS 7 (U.S. CLS. 13, 19, 21, 23, 31, 34 AND 35).

THE MARK CONSISTS OF THE STYLIZED WORDING "BORUN".

PRIORITY DATE OF 10-28-2010 IS CLAIMED.

OWNER OF INTERNATIONAL REGISTRATION 1069841 DATED 3-1-2011, EXPIRES 3-1-2021.

THE WORDING "BORUN" HAS NO MEANING IN A FOREIGN LANGUAGE.

SER. NO. 79-094,618, FILED 3-1-2011.

PAUL MORENO, EXAMINING ATTORNEY



David J. Kyros

Director of the United States Patent and Trademark Office

United States of America

United States Patent and Trademark Office

Schneider Kreuznach UltraLED

Reg. No. 4,065,358

Registered Dec. 6, 2011

Int. Cls.: 9, 11 and 42

TRADEMARK

SERVICE MARK

PRINCIPAL REGISTER

JOS. SCHNEIDER OPTISCHE WERKE GMBH (FED REP GERMANY GMBH)
RINGSTRASSE 132
55543 BAD KREUZNACH
FED REP GERMANY

FOR: SCIENTIFIC, NAUTICAL, SURVEYING, PHOTOGRAPHIC, CINEMATOGRAPHIC, OPTICAL, WEIGHING, MEASURING, SIGNALING, CHECKING AND SUPERVISING, LIFE-SAVING AND TEACHING APPARATUS AND INSTRUMENTS, NAMELY, OPTICAL DETECTORS IN THE NATURE OF OPTICAL CHARACTER READERS AND OPTICAL SCANNERS, OPTICAL LENSES FOR SCANNING OR READING CHARACTERS IN A TELEFAXING OR COPYING APPARATUS; PHOTOGRAPHIC, CINEMATOGRAPHIC, AND PROJECTION OBJECTIVES, NAMELY, COMBINATIONS OF PHOTOGRAPHIC LENSES FOR USE WITH CAMERAS, ENLARGERS, AND PROJECTORS; LIGHT METERS, OPTICAL REFLECTORS, CONDENSERS, DIAPHRAGMS FOR CAMERAS, OPTICAL POWER SPLITTERS, DIGITAL SIGNAL PROCESSORS; PROJECTOR LAMPS AND FLASH LAMPS FOR CAMERAS; APPARATUS FOR RECORDING, TRANSMISSION OR REPRODUCTION OF IMAGES; BLANK MAGNETIC DATA CARRIERS; DATA PROCESSING EQUIPMENT, NAMELY, COMPUTERS, COMPUTER INTERFACE BOARDS, OPTICAL COMPUTER INPUTS, NAMELY, INTERFACES; COMPUTERS; PHOTOGRAPHIC AND CINEMATOGRAPHIC LENSES; PHOTOGRAPHIC AND CINEMATOGRAPHIC FILM AND DIGITAL PROJECTOR LENSES; OPTICAL GLASSES; OPTICAL FIBERS; FILTERS, NAMELY, OPTICAL FILTERS, IN CLASS 9 (U.S. CLS. 21, 23, 26, 36 AND 38).

FOR: LIGHTING APPARATUS, NAMELY, LIGHTING INSTALLATIONS, IN CLASS 11 (U.S. CLS. 13, 21, 23, 31 AND 34).

FOR: DESIGN OF CALCULATING LENSES FOR OBJECTIVES AND OF OPTICAL RECORDING, TRANSMISSION, AND REPRODUCTION SYSTEMS FOR USERS, NAMELY, CALCULATING LENSES OF OPTICAL OBJECTIVES, OPTICAL MODULES, AND OPTICAL INTERFACES, IN CLASS 42 (U.S. CLS. 100 AND 101).

THE MARK CONSISTS OF STANDARD CHARACTERS WITHOUT CLAIM TO ANY PARTICULAR FONT, STYLE, SIZE, OR COLOR.

OWNER OF INTERNATIONAL REGISTRATION 1069938 DATED 10-11-2010, EXPIRES 10-11-2020.



David J. Kybas

Director of the United States Patent and Trademark Office

Reg. No. 4,065,358 OWNER OF U.S. REG. NOS. 1,485,078, 2,826,929, AND 3,619,861.

NO CLAIM IS MADE TO THE EXCLUSIVE RIGHT TO USE "KREUZNACH", APART FROM
THE MARK AS SHOWN.

SER. NO. 79-094,663, FILED 10-11-2010.

RONALD DELGIZZI, EXAMINING ATTORNEY

United States of America

United States Patent and Trademark Office

AVHASH by Anne Valérie Hash

Reg. No. 4,065,359

Registered Dec. 6, 2011

Int. Cls.: 18 and 25

TRADEMARK

PRINCIPAL REGISTER

AVH (FRANCE SOCIÉTÉ PAR ACTIONS SIMPLIFIÉE)
36 BOULEVARD BONNE NOUVELLE
F-75010 PARIS
FRANCE

FOR: LEATHER AND IMITATIONS OF LEATHER, HANDBAGS, EVENING BAGS, AUMÔNIÈRES, NAMELY, PURSES THAT CAN BE WORN ATTACHED TO A BELT, PURSES, BEACH BAGS, SADDLE BAGS, TRAVELING BAGS, GARMENT BAGS FOR TRAVEL, ATTACHÉ CASES, BRIEFCASES, TRUNKS, SUITCASES, VALISES, UNFITTED VANITY CASES; LEATHER TRAVEL SETS IN THE NATURE OF LUGGAGE; POCKET WALLETS; LEATHER KEY CASES; PURSES, NAMELY, CLUTCH BAGS, TOTE BAGS, SACHELS, SHOULDER BAGS, EVENING BAGS, IN CLASS 18 (U.S. CLS. 1, 2, 3, 22 AND 41).

FOR: CLOTHING, NAMELY, DRESSES, PANTS, T-SHIRTS, BLOUSES, SKIRTS, JUMPSUITS, JACKETS, COATS, TRENCH COATS, SHIRTS, SHORTS, JEANS, KNITWEAR, NAMELY, CARDIGANS, PULL-OVERS; FOOTWEAR; HEADWEAR, IN CLASS 25 (U.S. CLS. 22 AND 39).

THE MARK CONSISTS OF STANDARD CHARACTERS WITHOUT CLAIM TO ANY PARTICULAR FONT, STYLE, SIZE, OR COLOR.

PRIORITY DATE OF 7-30-2010 IS CLAIMED.

OWNER OF INTERNATIONAL REGISTRATION 1069977 DATED 1-27-2011, EXPIRES 1-27-2021.

OWNER OF U.S. REG. NO. 2,965,368.

THE NAME(S), PORTRAIT(S), AND/OR SIGNATURE(S) SHOWN IN THE MARK IDENTIFIES "ANNE VALERIE HASH", WHOSE CONSENT(S) TO REGISTER IS MADE OF RECORD.

SER. NO. 79-094,681, FILED 1-27-2011.

COLLEEN DOMBROW, EXAMINING ATTORNEY



David J. Kyffers

Director of the United States Patent and Trademark Office

United States of America

United States Patent and Trademark Office



Reg. No. 4,065,360

Registered Dec. 6, 2011

Int. Cls.: 5, 16 and 21

ÇİFTÇİLER BİRLİK KAGITÇILIK HIJYENİK ÜRÜNLER VE YAG SANAYİ ANONİM ŞİRKETİ
(TURKEY JOINT STOCK COMPANY)
ORTA MAHALLE, YANYOL ÜZERİ
ORHANGAZI SOKAK, NO:19/2; ISTANBUL
TURKEY

TRADEMARK

FOR: DISPOSABLE DIAPERS FOR INCONTINENCE, DISPOSABLE ADULT DIAPERS, IN CLASS 5 (U.S. CLS. 6, 18, 44, 46, 51 AND 52).

PRINCIPAL REGISTER

FOR: PAPER; CARDBOARD; GOODS MADE FROM PAPER AND CARDBOARD, NOT INCLUDED IN OTHER CLASSES, NAMELY, COASTERS MADE OF PAPER OR OF CARDBOARD, HAND-TOWELS OF PAPER, PAPER TABLECLOTHS, PAPER TABLE LINEN, PAPER KITCHEN CLOTHS IN THE NATURE OF PAPER TOWELS, FACE TOWELS OF PAPER, PAPER HANDKERCHIEFS, BABIES' NAPKINS OF PAPER, BABIES' DIAPERS OF PAPER AND CELLULOSE, PAPER FACIAL TISSUES FOR REMOVING MAKE-UP, TOILET PAPER, PAPER GARBAGE BAG; PACKAGING MATERIALS, NAMELY, CARDBOARD PACKAGING, PAPER ENVELOPES FOR PACKAGING, PAPER POUCHES FOR PACKAGING, PACKAGING IN THE NATURE OF BLISTER CARDS, CARRY BAGS OF PAPER, NAMELY, PAPER SHOPPING BAGS, PAPER BAGS, GROCERY BAGS, PAPER LUNCH BAGS; FILTER PAPER, BOBBINS AND SPOOLS OF PAPER OR CARDBOARD, FOR PACKAGING PURPOSES; PLASTIC BUBBLE PACKS FOR WRAPPING OR PACKAGING; CARRY BAGS OF PLASTICS, NAMELY, PLASTIC SHOPPING BAGS, PLASTIC TRASH BAGS, PLASTIC LUNCH BAGS; BOOKBINDING MATERIAL, NAMELY, BOOKBINDING TAPE, BOOKBINDING WIRE, BOOKBINDINGS, CLOTH FOR BOOKBINDING, PRINTING TYPE, PRINTING BLOCKS; PRINTED MATTER AND PERIODICAL PUBLICATIONS, NAMELY, BOOKS, MAGAZINES, NEWSPAPERS, JOURNALS, REVIEWS, PAMPHLETS, CATALOGUES AND LEAFLETS IN THE FIELD OF PACKAGING; PRINTED VOUCHERS AND COUPONS; PRINTED TICKETS, AND POSTERS, WRITING PAPER, COPY PAPER, PARCHMENT PAPER; WRITING INSTRUMENTS, NAMELY, PENCILS, BALLPOINT PENS, PEN NIBS, STYLOGRAPHS BEING FOUNTAIN PENS, COLOR PENCILS, PEN HOLDERS; MATERIALS FOR ARTISTS, NAMELY, PASTELS FOR ARTISTS, BRUSHES FOR ARTISTS, PENCILS FOR ARTISTS; PAINT BRUSHES, PAPER KNIVES BEING LETTER OPENERS, PAPER CLIPS, TYPEWRITER RIBBONS, SEALS FOR OFFICES, STAMP PADS, STAMP INKS, WRITING INK, RUBBER ERASERS, PENCIL SHARPENERS, PRINTED INSTRUCTIONAL, EDUCATIONAL, AND TEACHING MATERIALS IN THE FIELD OF ELECTRONIC ENTERTAINMENT, MUSIC AND COOKING, CELESTIAL GLOBES, THREE DIMENSIONAL MODELS FOR EDUCATIONAL PURPOSES, SLATE BOARDS FOR WRITING, LAP BOARDS FOR READING AND



David J. Kyros

Director of the United States Patent and Trademark Office

Reg. No. 4,065,360 WRITING, DRAWING RULERS, DRAWING SHIELDS, DRAWING SQUARES, DRAWING TABLETS, TRAYS FOR HOLDING DRAWING INSTRUMENTS, DRAWING TRIANGLES, WRITING CHALK; TYPEWRITERS AND OFFICE REQUISITES, NAMELY, STAPLERS, RUBBER BANDS, PUNCHES, PAPER EMBOSSERS, ENVELOPE SEALING MACHINES, FRANKING MACHINES, FINGER-STALLS, CORRECTING FLUID FOR TYPE, CORRECTING FLUID FOR TYPE, PAINT BRUSHES, PAINT APPLICATOR ROLLERS, IN CLASS 16 (U.S. CLS. 2, 5, 22, 23, 29, 37, 38 AND 50).

FOR: CLEANING TOOLS AND EQUIPMENTS, NON-ELECTRIC, NAMELY, MOPS; BRUSHES OTHER THAN PAINTING BRUSHES, NAMELY, BATH BRUSHES, BRUSHES FOR CLEANING PURPOSES FOR HOUSEHOLD USE, MATERIALS USED IN BRUSH-MAKING, NAMELY, STEEL FILINGS, BATH SPONGES, STEEL WOOLS AND WOOL WASTES BEING STEEL WOOL; DUSTING AND CLEANING CLOTHS, GLOVES FOR HOUSEHOLD PURPOSES, NAMELY, GLOVES FOR WASHING DISHES, NON-ELECTRIC POLISHING MACHINES, CARPET BEATERS, CARPET SWEEPERS, PADS FOR CLEANING; TOOTHBRUSHES, ELECTRIC TOOTHBRUSHES, DENTAL FLOSS, SHAVING BRUSHES, HAIRBRUSHES, COMBS; NON-ELECTRICAL SMALL HAND TOOLS FOR HOME AND KITCHEN USE, NAMELY, FOOD MIXERS, FOOD BLENDERS, COFFEE AND SPICE MILLS, FRUIT AND VEGETABLE PRESSES, FOOD GRINDERS, ICE BREAKERS FOR KITCHEN USE, GRATERS; HOUSEHOLD AND KITCHEN GOODS MADE OF GLASS, PORCELAIN, CERAMICS, ORDINARY METAL, PLASTIC AND SYNTHETIC AND OTHER MATERIALS, NAMELY, MUGS; BUCKETS, WASTE BASKETS, SAUCE POTS, PLATES, PAPER PLATES AND DRINKING GLASSES, SERVING TRAYS, COFFEE POTS, NON-ELECTRIC, COOKING STRAINERS, LADLES FOR KITCHEN USE, MIXING SPOONS BEING KITCHEN UTENSILS, SPATULAS BEING HOUSEHOLD UTENSILS, WASHTUBS, BOWLS, EGG CUPS, CAKE MOLDS, PITCHERS, FOOD KEEPING BOXES, NAMELY, BREAD BOXES, COASTERS, NOT OF PAPER AND OTHER THAN TABLE LINEN, TOILET PAPER HOLDERS, BABY BATH TUBS, ICE CUBE MOLDS AND ICE BUCKETS; HEAT INSULATED CONTAINERS FOR BEVERAGES, FLASKS, FITTED PICNIC BASKETS INCLUDING DISHES, BREAD BOXES, BREAD BASKETS FOR DOMESTIC USE, BREAD CUTTING BOARDS; ALL AFOREMENTIONED GOODS ARE NOT OF PRECIOUS METAL OR COATED THEREWITH BUT MAY FEATURE SYNTHETIC MATERIALS; CLOTHES PEGS, VASES; NON-ELECTRIC HEATING AND COOKING TOOLS, NAMELY, PRESSURE COOKERS, AND HEATERS FOR FEEDING BOTTLES, GRILLS BEING COOKING UTENSILS, GRATERS BEING COOKING GRATERS, BRAZIER BEING A METAL CONTAINER FOR HOT COALS FOR USE IN COOKING, METAL COOKING SKEWERS; BOTTLES SOLD EMPTY, GLASS STORAGE JARS, DEMIJOHNS BEING GLASS BOTTLES USED FOR STORING WINE; CORKSCREWS, SHOE HORNS; TOOTHPICKS, PIPETTES BEING A TYPE OF CONTAINER FOR LIQUIDS FOR HOUSEHOLD PURPOSES; IRONING BOARDS, IRONING BOARD COVERS, LAUNDRY DRYING RACKS; ORNAMENTS MADE OF GLASS, PORCELAIN, CERAMICS OR TERRA-COTTA, SCULPTURES OF TERRA COTTA, GLASS, PORCELAIN, WORKS OF ART OF PORCELAIN, TERRA-COTTA OR GLASS; CUPS GIVEN AT THE SPORT CONTESTS; MOUSETRAPS, INSECT TRAPS, FLY CATCHERS, FLY SWATTERS, TOILET UTENSILS, NAMELY, PLUNGERS FOR CLEARING BLOCKED DRAINS; PERFUME BURNERS, PERFUME CENSERS BEING INCENSE BURNERS, PERFUME SPRAYERS AND VAPORIZERS SOLD EMPTY; COSMETIC UTENSILS, NON-ELECTRIC, NAMELY, COSMETIC BRUSHES, APPLIANCES FOR REMOVING MAKE-UP, NON-ELECTRIC, NAMELY, NON-WOVEN FABRIC COSMETIC WIPES, POWDER PUFFS, TOILET CASES, NAMELY, TOOTHBRUSH CASES, FITTED VANITY CASES, IN CLASS 21 (U.S. CLS. 2, 13, 23, 29, 30, 33, 40 AND 50).

THE MARK CONSISTS OF THE WORDING "FLEXI" IN WHITE WITHIN A RED QUADRILATERAL.

PRIORITY DATE OF 9-22-2010 IS CLAIMED.

OWNER OF INTERNATIONAL REGISTRATION 1070045 DATED 10-11-2010, EXPIRES 10-11-2020.

Reg. No. 4,065,360 THE COLOR(S) RED AND WHITE IS/ARE CLAIMED AS A FEATURE OF THE MARK.

SER. NO. 79-094,695, FILED 10-11-2010.

MELISSA VALLILLO, EXAMINING ATTORNEY

United States of America
United States Patent and Trademark Office

Heusch

Reg. No. 4,065,361

Registered Dec. 6, 2011

Int. Cls.: 7, 8 and 37

TRADEMARK

SERVICE MARK

PRINCIPAL REGISTER

HEUSCH GMBH & CO. KG (FED REP GERMANY KOMMANDITGESELLSCHAFT)
KELLERSHAUSSTR. 11-15
52078 AACHEN
FED REP GERMANY

FOR: KNIFE MACHINE PARTS, NAMELY, SHEARING SPIRAL BLADES, LEDGER BLADES, WOOL-SHEARING KNIVES, SHAVING KNIVES, FLESHING KNIVES AND SETTING KNIVES; PARTS FOR ELECTRIC SHEARING MACHINE, NAMELY, SHEARING CYLINDERS, FOLDING CYLINDERS AND FLESHING CYLINDERS; MACHINE PARTS, NAMELY, GRINDSTONES AND GRINDING WHEELS, IN CLASS 7 (U.S. CLS. 13, 19, 21, 23, 31, 34 AND 35).

FOR: HAND TOOLS, NAMELY, PARTS FOR A MANUALLY-OPERATED GRINDSTONE, NAMELY, GRINDSTONE HOLDER FOR A GRINDING APPARATUS FOR KNIVES AND BLADES, IN CLASS 8 (U.S. CLS. 23, 28 AND 44).

FOR: KNIFE SHARPENING , IN CLASS 37 (U.S. CLS. 100, 103 AND 106).

THE MARK CONSISTS OF STANDARD CHARACTERS WITHOUT CLAIM TO ANY PARTICULAR FONT, STYLE, SIZE, OR COLOR.

OWNER OF INTERNATIONAL REGISTRATION 1070049 DATED 1-26-2011, EXPIRES 1-26-2021.

THE WORDING "HEUSCH" HAS NO MEANING IN A FOREIGN LANGUAGE.

SER. NO. 79-094,697, FILED 1-26-2011.

CHRISTINA SOBRAL, EXAMINING ATTORNEY



David J. Kyros

Director of the United States Patent and Trademark Office

United States of America

United States Patent and Trademark Office



Reg. No. 4,065,362

Registered Dec. 6, 2011

Int. Cl.: 7

TRADEMARK

PRINCIPAL REGISTER

CHANGZHOU HAN-SUN MACHINERY CO.,LTD (CHINA CORPORATION)
NO.89 HUANBAO 4TH ROAD
XINBEI DISTRICT.; CHANGZHOU CITY; JIANGSU PROVINCE
CHINA

FOR: HARVESTORS; HARVEST DRYING MACHINES; WEEDING MACHINES; SOWERS IN THE NATURE OF AGRICULTURAL SEED PLANTING MACHINES; TRACTOR TOWED AGRICULTURAL IMPLEMENTS, NAMELY, HAY BALERS; SEEDLING PLANTING MACHINES; PLANING MACHINES FOR METALWORKING; EARTH MOVING MACHINES, NAMELY, LOADERS; DIESEL ENGINES FOR MACHINES, IN CLASS 7 (U.S. CLS. 13, 19, 21, 23, 31, 34 AND 35).

THE MARK CONSISTS OF THE LITERAL ELEMENT "HANMEY HANMEY" AND A DESIGN CONSISTING OF A GRAPHIC CARTOON REPRESENTATION OF A COW SITTING IN THE CANOPY OF A FARM TRACTOR WHICH IS SHOWING ONE SIDE AND TWO OF ITS TIRES, WHEREIN THE TRACTOR AND COW ARE SUPERIMPOSED UPON A FOUR-POINTED COMPASS STAR WITH FOUR ARROWS WHICH IN TURN IS SUPERIMPOSED UPON A BACKGROUND CONSISTING OF TWO PAIRS OF CONCENTRIC CIRCLES SEPARATED BY A BUFFER WITH LINES RADIATING OUTWARD FROM BEHIND THE COMPASS ARROWS TO THE FIRST SET OF CONCENTRIC CIRCLES, AND WHEREIN FURTHER ONE OF THE "HANMEY" TERMS, REPRESENTED IN TIMES NEW ROMAN FONT, IS LOCATED IN AN ARC FORM SITUATED BETWEEN THE OUTER OF THE TWO SETS OF CONCENTRIC CIRCLES WITH THE TERM "HAN" LOCATED TO THE LEFT AND THE TERM "MEY" LOCATED ON THE RIGHT OF THE UPPERMOST POINT IN THE COMPASS, AND WHEREIN THE SECOND TERM "HANMEY" IS LOCATED UNDER THE DESIGN ELEMENT AND IS REPRESENTED IN STYLIZED FONT IN WHICH THE LETTER "Y" COMPRISES A LONG TAIL WHICH EXTENDS UNDER THE TERM UP TO THE UNDERSIDE OF THE LETTER "A".



PRIORITY DATE OF 5-27-2010 IS CLAIMED.

OWNER OF INTERNATIONAL REGISTRATION 1070064 DATED 10-28-2010, EXPIRES 10-28-2020.

David J. Kybas

THE WORDING "HANMEY" HAS NO MEANING IN A FOREIGN LANGUAGE.

SER. NO. 79-094,708, FILED 10-28-2010.

Reg. No. 4,065,362 RONALD DELGIZZI, EXAMINING ATTORNEY

United States of America

United States Patent and Trademark Office

PIGMACARE Widmer

Reg. No. 4,065,363

Registered Dec. 6, 2011

Int. Cl.: 3

TRADEMARK

PRINCIPAL REGISTER

LOUIS WIDMER AG (SWITZERLAND SOCIÉTÉ ANONYME)
RIETBACHSTRASSE 5
CH-8952 SCHLIEREN
SWITZERLAND

FOR: COSMETICS, IN CLASS 3 (U.S. CLS. 1, 4, 6, 50, 51 AND 52).

THE MARK CONSISTS OF STANDARD CHARACTERS WITHOUT CLAIM TO ANY PARTICULAR FONT, STYLE, SIZE, OR COLOR.

OWNER OF INTERNATIONAL REGISTRATION 0771082 DATED 11-22-2001, EXPIRES 11-22-2011.

OWNER OF U.S. REG. NOS. 1,144,667, 2,623,315 AND OTHERS.

SER. NO. 79-094,780, FILED 8-19-2010.

MATTHEW EINSTEIN, EXAMINING ATTORNEY



David J. Kybas

Director of the United States Patent and Trademark Office

United States of America

United States Patent and Trademark Office

Y ZONE

Reg. No. 4,065,364

Registered Dec. 6, 2011

Int. Cl.: 25

TRADEMARK

PRINCIPAL REGISTER

GUANGZHOU PANYU CHONG SHUN SHOES CO., LTD. (CHINA LIMITED COMPANY
(LTD.))
JIULAN HIGHWAY,
JIUBI VILLAGE,; LANHE TOWN; PANYU DISTRICT; GUANGZHOU, GUANGDONG
CHINA

FOR: SHOES; TRACK SHOES, IN CLASS 25 (U.S. CLS. 22 AND 39).

THE ENGLISH TRANSLATION OF THE FOREIGN WORD(S) IN THE MARK IS "Y ZONE".

OWNER OF INTERNATIONAL REGISTRATION 1070598 DATED 3-4-2011, EXPIRES 3-4-2021.

THE TRANSLITERATION OF THE NON-LATIN CHARACTERS IN THE MARK IS "Y ZONE".

SER. NO. 79-094,913, FILED 3-4-2011.

ELI HELLMAN, EXAMINING ATTORNEY



David J. Kyffers

Director of the United States Patent and Trademark Office

United States of America
United States Patent and Trademark Office

Air frame

Reg. No. 4,065,365

Registered Dec. 6, 2011

Int. Cl.: 9

TRADEMARK

PRINCIPAL REGISTER

JIN CO., LTD. (JAPAN CORPORATION)
777-2, KAWAHARA-MACHI
MAEBASHI-SHI
GUNMA 371-0046, JAPAN

FOR: EYEGLASSES EXCLUDING THOSE HAVING AIR; SUNGLASSES EXCLUDING THOSE HAVING AIR; PARTS AND ACCESSORIES FOR SUNGLASSES AND EYEGLASSES, NAMELY, EYEGLASS FRAMES EXCLUDING THOSE HAVING AIR, SUNGLASS FRAMES EXCLUDING THOSE HAVING AIR, EYEGLASS LENSES, EYEGLASS CHAINS, SUNGLASS CHAINS, CASES FOR SUNGLASSES AND EYEGLASSES, IN CLASS 9 (U.S. CLS. 21, 23, 26, 36 AND 38).

NO CLAIM IS MADE TO THE EXCLUSIVE RIGHT TO USE "FRAME", APART FROM THE MARK AS SHOWN.

PRIORITY DATE OF 12-15-2010 IS CLAIMED.

OWNER OF INTERNATIONAL REGISTRATION 1070599 DATED 2-24-2011, EXPIRES 2-24-2021.

THE MARK CONSISTS OF THE STYLIZED WORDING "AIR FRAME".

SER. NO. 79-094,914, FILED 2-24-2011.

MAUREEN DALL, EXAMINING ATTORNEY



David J. Kyros

Director of the United States Patent and Trademark Office

United States of America

United States Patent and Trademark Office



ЧАЙ чай

Reg. No. 4,065,366

Registered Dec. 6, 2011

Int. Cl.: 30

TRADEMARK

PRINCIPAL REGISTER

SHAOXING TIANXIANG TEA CO., LTD. (CHINA CORPORATION)
WUJIALOU VILLAGE LIANGHU TOWN
SHANGYU CITY
ZHEJIANG PROVINCE, CHINA

FOR: TEA; TEA SUBSTITUTES; TEA-BASED BEVERAGES, IN CLASS 30 (U.S. CL. 46).

NO CLAIM IS MADE TO THE EXCLUSIVE RIGHT TO USE "TEA", APART FROM THE MARK AS SHOWN.

OWNER OF INTERNATIONAL REGISTRATION 1070628 DATED 1-4-2011, EXPIRES 1-4-2021.

THE MARK CONSISTS OF A DESIGN OF SCATTERED LEAVES ABOVE THE WORD "TEA" AND A COINED WORD BELOW, WHICH HAS NO MEANING AND CONTAINS LATIN CHARACTERS AND RUSSIAN CHARACTERS.

SER. NO. 79-094,922, FILED 1-4-2011.

REBECCA SMITH, EXAMINING ATTORNEY



David J. Kyros

Director of the United States Patent and Trademark Office

United States of America

United States Patent and Trademark Office

Demax Medical

Reg. No. 4,065,367

Registered Dec. 6, 2011

Int. Cl.: 10

TRADEMARK

PRINCIPAL REGISTER

BEIJING DEMAX MEDICAL TECHNOLOGY CO., LTD. (CHINA CORPORATION)
1ST FLOOR, BUILDING NO.1
NO.8 HONGDABEILU, BDA; 100176 BEIJING
CHINA

FOR: CATHETERS; SURGICAL APPARATUS AND INSTRUMENTS FOR MEDICAL, DENTAL OR VETERINARY USE; SYRINGES FOR INJECTIONS; DRAINAGE TUBES FOR MEDICAL PURPOSES; PROBES FOR MEDICAL PURPOSES; VACUUM PUMPS FOR MEDICAL PURPOSES; MEDICAL FLUID INJECTORS; MEDICAL APPARATUS AND INSTRUMENTS FOR USE IN SURGERY, IN CLASS 10 (U.S. CLS. 26, 39 AND 44).

NO CLAIM IS MADE TO THE EXCLUSIVE RIGHT TO USE "MEDICAL", APART FROM THE MARK AS SHOWN.

OWNER OF INTERNATIONAL REGISTRATION 1071013 DATED 3-1-2011, EXPIRES 3-1-2021.

THE MARK CONSISTS OF THE WORDING "DEMAX D MEDICAL". A STYLIZED LETTER "D" STANDS BETWEEN "DEMAX" AND "MEDICAL".

SER. NO. 79-095,083, FILED 3-1-2011.

PAUL MORENO, EXAMINING ATTORNEY



David J. Kyros

Director of the United States Patent and Trademark Office

United States of America

United States Patent and Trademark Office

GeoRacing

Reg. No. 4,065,368

TRIMARAN S.A. (FRANCE S.A.)

Registered Dec. 6, 2011

97 RUE JEAN JAURÈS

F-92300 LEVALLOIS PERRET, FRANCE

Int. Cls.: 9, 38, 41 and 42

FOR: COMPUTER BASED GPS TRACKING DEVICE WITH GRAPHIC AND VIDEO PROCESSING HARDWARE, AND GEOGRAPHIC DATA POSITION TREATMENT SOFTWARE, AND REAL-TIME RENDERING SOFTWARE FOR THE PRODUCTION OF A RECONSTRUCTION OF A 3D SCENE ASSOCIATED WITH TRACKED MOBILE OBJECTS, IN CLASS 9 (U.S. CLS. 21, 23, 26, 36 AND 38).

TRADEMARK

SERVICE MARK

PRINCIPAL REGISTER

FOR: TELECOMMUNICATION SERVICES, NAMELY, TRANSMISSION OF WEBCASTS AND BROADCAST OF AUDIOVISUAL TELEVISION PROGRAMS, GENERATED IN REAL-TIME WITH A GEOGRAPHIC DATABASE, IN CLASS 38 (U.S. CLS. 100, 101 AND 104).

FOR: PRODUCTION OF LIVE AND PRERECORDED AUDIOVISUAL TELEVISION PROGRAMS FEATURING OUTDOOR SPORTING EVENTS, IN CLASS 41 (U.S. CLS. 100, 101 AND 107).

FOR: SCIENTIFIC STUDY, RESEARCH AND DEVELOPMENT OF COMPUTER HARDWARE AND SOFTWARE FOR VIEWING LIVE AND IN 3D COMPUTER GRAPHICS BASED ON GEOGRAPHICAL DATA BY ADDING MOBILE TRACKS IN REAL TIME VIA THEIR GEOGRAPHICAL POSITIONS, IN CLASS 42 (U.S. CLS. 100 AND 101).

THE MARK CONSISTS OF THE WORDING "GEORACING" WITH THE WORD "RACING" IN A RECTANGULAR CARRIER.

OWNER OF INTERNATIONAL REGISTRATION 1071221 DATED 2-23-2011, EXPIRES 2-23-2021.

SER. NO. 79-095,138, FILED 2-23-2011.

DAVID HOFFMAN, EXAMINING ATTORNEY



David J. Kyfos

Director of the United States Patent and Trademark Office

United States of America
United States Patent and Trademark Office

Conchia

Reg. No. 4,065,369

Registered Dec. 6, 2011

Int. Cl.: 14

TRADEMARK

PRINCIPAL REGISTER

ARÉVALO MARTÍN MARÍA CONCEPCIÓN (SPAIN INDIVIDUAL)
VIA PALAZZINA, 29
ROVOLON (PD)
ITALY

FOR: SILVER AND GOLD UNWROUGHT; IMITATION JEWELRY; JEWELRY, NAMELY, THREADS AND WIRES OF PRECIOUS METALS; DECORATIVE BOXES OF PRECIOUS METAL; JEWEL CASES; WATCH CASES; PRECIOUS METAL TROPHIES; ORNAMENTAL JEWELRY CHAINS AND PINS; PERSONAL JEWELRY, NAMELY, EARRINGS, BRACELETS, NECKLACES, RINGS, BROOCHES, MEDALLIONS, DIADEMS, CUFFLINKS, TIE CLIPS, PENDANTS AND CHARMS, DECORATIVE CHARMS FOR MOBILE TELEPHONES; KEY RINGS OF PRECIOUS METAL; KEY RINGS BEING TRINKETS OR FOBS OF PRECIOUS METAL; JEWELRY; WORKS OF ART OF PRECIOUS METAL; WATCH BANDS; WRIST WATCHES, CLOCKS, CHRONOMETERS, IN CLASS 14 (U.S. CLS. 2, 27, 28 AND 50).

THE MARK CONSISTS OF THE WORDING "CONCHIA" IN FANCY CHARACTERS, WITH A HORIZONTAL LINE UNDERNEATH.

PRIORITY DATE OF 12-14-2010 IS CLAIMED.

OWNER OF INTERNATIONAL REGISTRATION 1071580 DATED 2-7-2011, EXPIRES 2-7-2021.

THE WORDING "CONCHIA" HAS NO MEANING IN A FOREIGN LANGUAGE.

SER. NO. 79-095,247, FILED 2-7-2011.

DAVID ELTON, EXAMINING ATTORNEY



David J. Kyros

Director of the United States Patent and Trademark Office

United States of America

United States Patent and Trademark Office

Mister Spex

Reg. No. 4,065,370

Registered Dec. 6, 2011

**Int. Cls.: 5, 35, 38, 40
and 44**

MISTER SPEX GMBH (FED REP GERMANY GESELLSCHAFT MIT BESCHRÄNKTER
HAFTUNG (GMBH))
GREIFSWALDER STRABE 156
10409 BERLIN
FED REP GERMANY

FOR: CLEANING PREPARATIONS FOR CONTACT LENSES AND SOLUTIONS FOR CON-
TACT LENSES, IN CLASS 5 (U.S. CLS. 6, 18, 44, 46, 51 AND 52).

TRADEMARK

FOR: ONLINE RETAIL STORE SERVICES FEATURING OPTICAL VISION AIDS, NAMELY,
SPECTACLES, FRAMES FOR SPECTACLES AND CONTACT LENSES; PROFESSIONAL
BUSINESS CONSULTANCY AND MARKETING FOR OTHERS; BUSINESS MANAGEMENT
AND ORGANIZATION CONSULTANCY, IN PARTICULAR FOR FRANCHISEES, IN CLASS
35 (U.S. CLS. 100, 101 AND 102).

SERVICE MARK

PRINCIPAL REGISTER

FOR: TELECOMMUNICATIONS BY MEANS OF PLATFORMS AND PORTALS ON THE
INTERNET, NAMELY, COMMUNICATIONS BY COMPUTER TERMINALS; COMMUNICA-
TIONS BY COMPUTER TERMINALS OR BY FIBRE OPTIC NETWORKS; PROVIDING AC-
CESS TO A GLOBAL COMPUTER NETWORK; PROVIDING ACCESS TO INFORMATION
ON THE INTERNET; PROVIDING ACCESS TO A DIGITALIZED MEDIA PLATFORM FOR
THE EXCHANGE OF MESSAGES AND INFORMATION OF ALL KINDS, NAMELY,
PROVIDING ON-LINE FORUMS FOR TRANSMISSION OF MESSAGES AMONG COMPUTER
USERS, IN CLASS 38 (U.S. CLS. 100, 101 AND 104).

FOR: THE GRINDING OF SPECTACLE LENSES, IN CLASS 40 (U.S. CLS. 100, 103 AND 106).

FOR: OPTICIANS' SERVICES, NAMELY, THE INSERTION OF SPECTACLE LENSES IN
SPECTACLE FRAMES, IN CLASS 44 (U.S. CLS. 100 AND 101).

THE MARK CONSISTS OF STANDARD CHARACTERS WITHOUT CLAIM TO ANY PAR-
TICULAR FONT, STYLE, SIZE, OR COLOR.

OWNER OF INTERNATIONAL REGISTRATION 1071768 DATED 11-5-2010, EXPIRES 11-
5-2020.

THE NAME(S), PORTRAIT(S), AND/OR SIGNATURE(S) SHOWN IN THE MARK DOES NOT
IDENTIFY A PARTICULAR LIVING INDIVIDUAL.



David J. Kyjars

Director of the United States Patent and Trademark Office

Reg. No. 4,065,370 SER. NO. 79-095,304, FILED 11-5-2010.

SEAN CROWLEY, EXAMINING ATTORNEY

United States of America

United States Patent and Trademark Office



Reg. No. 4,065,371

Registered Dec. 6, 2011

Int. Cl.: 32

TRADEMARK

PRINCIPAL REGISTER

G. SCHNEIDER & SOHN GMBH (FED REP GERMANY LIMITED LIABILITY COMPANY)
TAL 7
80331 MÜNCHEN
FED REP GERMANY

FOR: BEERS AND NON-ALCOHOLIC BEERS; NON-ALCOHOLIC BEVERAGES, NAMELY, CARBONATED BEVERAGES; FRUIT DRINKS AND FRUIT JUICES; SYRUPS AND SCENTED WATER FOR MAKING BEVERAGES, IN CLASS 32 (U.S. CLS. 45, 46 AND 48).

OWNER OF U.S. REG. NOS. 2,007,340, 2,656,860 AND OTHERS.

PRIORITY DATE OF 11-3-2010 IS CLAIMED.

OWNER OF INTERNATIONAL REGISTRATION 1071832 DATED 2-4-2011, EXPIRES 2-4-2021.

THE COLOR(S) GOLD, BLACK AND WHITE IS/ARE CLAIMED AS A FEATURE OF THE MARK.

THE NAME(S), PORTRAIT(S), AND/OR SIGNATURE(S) SHOWN IN THE MARK DOES NOT IDENTIFY A PARTICULAR LIVING INDIVIDUAL.



THE MARK CONSISTS OF THE STYLIZED WORDING "G. SCHNEIDER & SOHN" APPEARING IN WHITE LETTERING WITH THE COLOR BLACK APPEARING AS A SHADOW BEHIND THE WHITE LETTERS. THE WORDING APPEARS OVER A GOLD BANNER OUTLINED IN BLACK WITH BLACK ACCENT LINES. A STYLIZED GOLD AND BLACK DESIGN CONTAINING A PORTRAIT OF GEORG SCHNEIDER I WITH SIX STYLIZED BLACK AND WHITE CRESTS APPEARING INSIDE GOLD CIRCLES WITH A BLACK AND WHITE CROWN AND BLACK AND WHITE ORNAMENTAL FEATURES APPEARS ABOVE THE LEFT PORTION OF THE BANNER. A STYLIZED BLACK, GOLD AND WHITE DESIGN OF A BREWERY APPEARS TO THE BOTTOM RIGHT OF THE BANNER DESIGN WITH A WHITE CLOUD OUTLINED IN BLACK APPEARING OVER THE BREWERY.

THE ENGLISH TRANSLATION OF "SOHN" IN THE MARK IS SON.

SER. NO. 79-095,325, FILED 2-4-2011.

David J. Kybas

Director of the United States Patent and Trademark Office

Reg. No. 4,065,371 NATALIE POLZER, EXAMINING ATTORNEY

United States of America

United States Patent and Trademark Office



Reg. No. 4,065,372

Registered Dec. 6, 2011

Int. Cl.: 36

SERVICE MARK

PRINCIPAL REGISTER

CAIXA D'ESTALVIS I PENSIONS DE BARCELONA (SPAIN CORPORATION)
AVENUE DIAGONAL, 621-629
E-08028 BARCELONA
SPAIN

FOR: INSURANCE UNDERWRITING IN THE FIELDS OF LIFE, HEALTH, ACCIDENT, HOME, FIRE AND DISASTER INSURANCE; INSURANCE CONSULTANCY SERVICES; FINANCIAL CONSULTANCY SERVICES; MONETARY EXCHANGE SERVICES; CHECKING ACCOUNT AND SAVINGS ACCOUNT SERVICES; SAFETY DEPOSIT BOX SERVICES; CREDIT AND LOAN SERVICES; AND REAL ESTATE CONSULTANCY SERVICES, IN CLASS 36 (U.S. CLS. 100, 101 AND 102).

OWNER OF U.S. REG. NOS. 1,513,896, 3,731,500 AND OTHERS.

OWNER OF INTERNATIONAL REGISTRATION 0824090 DATED 3-10-2004, EXPIRES 3-10-2014.

THE COLOR(S) BLUE, YELLOW, RED, WHITE AND BLACK IS/ARE CLAIMED AS A FEATURE OF THE MARK.

NO CLAIM IS MADE TO THE EXCLUSIVE RIGHT TO USE "CAIXA BANK", APART FROM THE MARK AS SHOWN.

THE MARK CONSIST OF THE WORD "CAIXA" IN WHITE WITH A BLACK OUTLINE, AND THE WORD "BANK" IN BLACK APPEARING BENEATH THE DESIGN OF A BLUE STAR HAVING YELLOW AND RED CIRCLES APPEARING TO THE LEFT. THE CIRCLES AND STAR ARE OUTLINED IN BLACK.

THE ENGLISH LANGUAGE TRANSLATION OF "CAIXA" IN THE MARK IS "SAVINGS".

SER. NO. 79-095,403, FILED 2-3-2011.

DEBRA LEE, EXAMINING ATTORNEY



David J. Kybas

Director of the United States Patent and Trademark Office

United States of America

United States Patent and Trademark Office

KingCamp

Reg. No. 4,065,373

Registered Dec. 6, 2011

Int. Cls.: 18, 20, 22 and 25

TRADEMARK

PRINCIPAL REGISTER

KING CAMP & OUTDOOR PRODUCTS CO., LTD. (CHINA CORPORATION)
NO. 2-3 TAI, WORKERS' STADIUM
CHAOYANG DISTRICT
BEIJING, CHINA

FOR: PURSES; SCHOOL BAGS; TRAVELLING TRUNKS; BACKPACKS; BAGS FOR CLIMBERS IN THE NATURE OF ALL-PURPOSE CARRYING BAGS; TRAVELLING BAGS; BRIEFCASES; TRAVELLING SETS; VALISES; HAVERSACKS; GARMENT BAGS FOR TRAVEL; SPORT BAGS; CANVAS WOOD CARRIERS; UMBRELLAS; MOUNTAINEERING STICKS; CANES, IN CLASS 18 (U.S. CLS. 1, 2, 3, 22 AND 41).

FOR: FURNITURE, NAMELY, BENCHES; COTS; CRADLES; EASY CHAIRS; FURNITURE; SETTEES; TABLES; ARMCHAIRS; MATTRESSES; FURNITURE OF METAL; DECK CHAIRS; STOOLS; PACKAGING CONTAINERS OF PLASTIC; PILLOWS; AIR PILLOWS, NOT FOR MEDICAL PURPOSES; BOLSTERS; AIR CUSHIONS, NOT FOR MEDICAL PURPOSES; SLEEPING BAGS FOR CAMPING; NONMETAL AND NON-PAPER CONTAINERS FOR STORAGE OR TRANSPORT; TENT PEGS, NOT OF METAL, IN CLASS 20 (U.S. CLS. 2, 13, 22, 25, 32 AND 50).

FOR: ROPES; UNFITTED VEHICLE COVERS; HAMMOCKS; AWNINGS; TENTS; MONGOLIAN TENT; PACKAGING BAGS OF TEXTILE MATERIALS, IN CLASS 22 (U.S. CLS. 1, 2, 7, 19, 22, 42 AND 50).



FOR: SWEATERS; SHIRTS; KNIT DRESSES; SINGLETs; T-SHIRTS; FISHING VESTS; ANTI-SWEAT UNDERWEAR; SPORTS JERSEYS; NIGHT WEAR; CHILDREN CLOTHES, NAMELY, SHIRTS; PHOTOGRAPHY VEST; CYCLISTS' JACKETS; WATERPROOF JACKETS AND PANTS; RAINCOAT; PONCHO; SKI BOOTS; SHOE FOR MOUNTAIN CLIMBING; SHOE FOR MOUNTAIN CLIMBING WITH METAL NAILS; GALOSHES; ATHLETIC SHOES; NON-SLIP SOLES FOR FOOTWEAR, NAMELY, FOR BOOTS; BOOTS; CAPS; EAR MUFFS; MITTENS; WET SUITS FOR WATER-SKIING; FOOTWEAR; TROUSERS; GLOVES; CLOTHING, NAMELY, SHIRTS, SHORTS AND PANTS; SCARFS; HATS; HOSEIERY; PARKAS; DOWN SUITS, IN CLASS 25 (U.S. CLS. 22 AND 39).

David J. Kappas

Director of the United States Patent and Trademark Office

THE MARK CONSISTS OF THE WORD "KINGCAMP".

OWNER OF INTERNATIONAL REGISTRATION 1050424 DATED 5-27-2010, EXPIRES 5-27-2020.

Reg. No. 4,065,373 SER. NO. 79-095,414, FILED 2-8-2011.

TEJBIR SINGH, EXAMINING ATTORNEY

United States of America
United States Patent and Trademark Office

Gecko

Reg. No. 4,065,374

Registered Dec. 6, 2011

Int. Cls.: 7 and 8

TRADEMARK

PRINCIPAL REGISTER

TTS TOOLTECHNIC SYSTEMS AG & CO. KG (FED REP GERMANY LIMITED
PARTNERSHIP)
WERTSTRASSE 20
73240 WENDLINGEN
FED REP GERMANY

FOR: MECHANICALLY OPERATED VACUUM LIFTING MACHINE FOR STATIONARY APPLICATION TO WORKPIECES; MECHANICALLY OPERATED VACUUM HOLDING FIXTURES FOR STATIONARY APPLICATION TO WORKPIECES, IN CLASS 7 (U.S. CLS. 13, 19, 21, 23, 31, 34 AND 35).

FOR: MANUALLY OPERATED VACUUM LIFTING AND HOLDING TOOLS AND HANDLES TO BE FASTENED TO SURFACES OF WORKPIECES BY VACUUM FORCE; MANUALLY OPERATED VACUUM LIFTING IMPLEMENTS AND VACUUM HOLDING IMPLEMENTS, NAMELY, SUCTION CUP HOLDERS, IN CLASS 8 (U.S. CLS. 23, 28 AND 44).

THE MARK CONSISTS OF STANDARD CHARACTERS WITHOUT CLAIM TO ANY PARTICULAR FONT, STYLE, SIZE, OR COLOR.

OWNER OF INTERNATIONAL REGISTRATION 1072110 DATED 1-31-2011, EXPIRES 1-31-2021.

SER. NO. 79-095,438, FILED 1-31-2011.

RENEE MCCRAY, EXAMINING ATTORNEY



David J. Kybas

Director of the United States Patent and Trademark Office

United States of America

United States Patent and Trademark Office

ITALIAN FOR FLAVOUR IFF

Reg. No. 4,065,375

Registered Dec. 6, 2011

Int. Cl.: 29

TRADEMARK

PRINCIPAL REGISTER

GIA S.P.A. (ITALY CORPORATION)
VIA DELL'ARTIGIANATO, 15
I-44047 SANT'AGOSTINO (FE)
ITALY

FOR: MEAT, FISH, POULTRY AND GAME; MEAT EXTRACTS; MEAT PRESERVES, FRUIT PRESERVES, FISH PRESERVES, VEGETABLES PRESERVES; MEAT PASTA, TOMATO PASTA, VEGETABLE PASTA, CHEESE PASTA, FISH PASTA; PRESERVED, FROZEN, DRIED AND COOKED FRUITS AND VEGETABLES; JELLIES, JAMS, COMPOTES; EGGS, MILK AND MILK PRODUCTS EXCLUDING ICE CREAM, ICE MILK, AND FROZEN YOGURT; EDIBLE OILS AND FATS, IN CLASS 29 (U.S. CL. 46).

THE MARK CONSISTS OF STANDARD CHARACTERS WITHOUT CLAIM TO ANY PARTICULAR FONT, STYLE, SIZE, OR COLOR.

PRIORITY DATE OF 12-9-2010 IS CLAIMED.

OWNER OF INTERNATIONAL REGISTRATION 1072116 DATED 12-24-2010, EXPIRES 12-24-2020.

NO CLAIM IS MADE TO THE EXCLUSIVE RIGHT TO USE "ITALIAN FOR FLAVOUR", APART FROM THE MARK AS SHOWN.

SER. NO. 79-095,440, FILED 12-24-2010.

MELISSA VALLILLO, EXAMINING ATTORNEY



David J. Kyffers

Director of the United States Patent and Trademark Office

United States of America

United States Patent and Trademark Office

HAKUOKI

Reg. No. 4,065,376

Registered Dec. 6, 2011

Int. Cls.: 9 and 41

TRADEMARK

SERVICE MARK

PRINCIPAL REGISTER

IDEA FACTORY CO., LTD. (JAPAN CORPORATION)
2-23-2, HIGASHI-IKEBUKURO
TOSHIMA-KU; TOKYO 170-0013
JAPAN

FOR: PRE-RECORDED DIGITAL AND ELECTRONIC STORAGE MEDIA RECORDED WITH GAME PROGRAMS FOR APPARATUS FOR ARCADE GAMES ADAPTED FOR USE WITH AN EXTERNAL DISPLAY SCREEN OR MONITOR; PRE-RECORDED DIGITAL AND ELECTRONIC STORAGE MEDIA RECORDED WITH PROGRAMS FOR APPARATUS FOR CONSUMER GAMES ADAPTED FOR USE WITH AN EXTERNAL DISPLAY SCREEN OR MONITOR; DOWNLOADABLE GAME PROGRAMS FOR APPARATUS FOR CONSUMER GAMES ADAPTED FOR USE WITH AN EXTERNAL DISPLAY SCREEN OR MONITOR VIA COMPUTER NETWORKS; ELECTRONIC CIRCUITS AND CD-ROMS RECORDED WITH PROGRAMS FOR HAND-HELD GAMES WITH LIQUID CRYSTAL DISPLAYS; PRE-RECORDED DIGITAL AND ELECTRONIC STORAGE MEDIA RECORDED WITH PROGRAMS FOR GAMES WITH LIQUID CRYSTAL DISPLAYS; COMPUTER SOFTWARE, NAMELY, VIDEO GAME SOFTWARE, COMPUTER GAME PROGRAMS; DOWNLOADABLE COMPUTER SOFTWARE, NAMELY, DOWNLOADABLE VIDEO GAME SOFTWARE, DOWNLOADABLE COMPUTER GAME SOFTWARE; PRE-RECORDED DIGITAL AND ELECTRONIC STORAGE MEDIA RECORDED WITH COMPUTER GAME PROGRAMS; DOWNLOADABLE MUSIC VIA THE INTERNET AND WIRELESS DEVICES; PRE-RECORDED COMPACT DISCS, DVDS AND HIGH-CAPACITY OPTICAL DISCS USING A BLUE-VIOLET LASER FEATURING IMAGES AND VIDEO FROM COMPUTER GAMES, ANIMATED FILMS AND CARTOONS; VIDEO DISCS AND VIDEO TAPES FEATURING IMAGES AND VIDEO FROM COMPUTER GAMES, ANIMATED FILMS AND CARTOONS; ELECTRONIC CIRCUITS AND CD-ROMS RECORDED WITH AUTOMATIC PERFORMANCE PROGRAMS FOR ELECTRONIC MUSICAL INSTRUMENTS FEATURING IMAGES FROM COMPUTER GAMES, ANIMATED FILMS AND CARTOONS (MANGA); EXPOSED CINEMATOGRAPHIC FILMS; DOWNLOADABLE IMAGES, NAMELY, PHOTOGRAPHIC IMAGES, IMAGES GENERATED FROM COMPUTER GAMES, ANIMATED FILMS AND CARTOONS; PRE-RECORDED DIGITAL AND ELECTRONIC STORAGE MEDIA RECORDED WITH IMAGES AND TEXTS OF PROCESSED DATA, NAMELY, NEWSPAPERS, MAGAZINES, BOOKS, GEOGRAPHICAL MAPS, DRAWINGS AND PHOTOGRAPH; DOWNLOADABLE ELECTRONIC PUBLICATIONS, NAMELY, ELECTRONIC MAGAZINES RECORDED WITH GRAPHIC INFORMATION IN THE FIELD OF COMPUTER GAMES, ANIMATED FILMS AND CARTOONS (MANGA); MOUSE PADS; STRAPS FOR MOBILE PHONES, IN CLASS 9 (U.S. CLS. 21, 23, 26, 36 AND 38).



David J. Kybas

Director of the United States Patent and Trademark Office

Reg. No. 4,065,376 FOR: PROVIDING INFORMATION RELATING TO COMPUTER GAMES, MUSICAL PERFORMANCES AND MOVIE SHOWING VIA COMPUTER NETWORKS; PROVIDING GAMES VIA COMPUTER NETWORKS; PRESENTATION OF MUSICAL PERFORMANCES, IMAGES FOR MOVIES AND SOUND VIA COMPUTER NETWORKS; PROVIDING GAMES ON MOBILE PHONES VIA TELECOMMUNICATION MEANS; ENTERTAINMENT SERVICES, NAMELY, PROVIDING IMAGES, MUSIC OR SOUND ON MOBILE PHONES VIA TELECOMMUNICATION MEANS; ENTERTAINMENT SERVICES IN THE NATURE OF ARRANGING, CONDUCTING AND ORGANIZATION OF THE GAME-SHOW; ENTERTAINMENT SERVICES, NAMELY, ARRANGING, CONDUCTING AND ORGANIZATION OF VIDEO GAME EVENTS; PROVIDING OF ELECTRONIC PUBLICATIONS, NAMELY, ELECTRONIC MAGAZINES RECORDED WITH GRAPHIC INFORMATION IN THE FIELD OF COMPUTER GAMES, ANIMATED FILMS AND CARTOONS (MANGA); PROVIDING LIBRARY SERVICES FOR LITERATURE AND DOCUMENTARY RECORDS; PUBLICATION OF ELECTRONIC BOOKS; PRESENTATION OF MOVIES, SHOWS, PLAYS OR MUSICAL PERFORMANCES, IN CLASS 41 (U.S. CLS. 100, 101 AND 107).

THE MARK CONSISTS OF STANDARD CHARACTERS WITHOUT CLAIM TO ANY PARTICULAR FONT, STYLE, SIZE, OR COLOR.

PRIORITY DATE OF 8-27-2010 IS CLAIMED.

OWNER OF INTERNATIONAL REGISTRATION 1072500 DATED 10-19-2010, EXPIRES 10-19-2020.

THE WORDING "HAKUOKI" HAS NO MEANING IN A FOREIGN LANGUAGE.

SER. NO. 79-095,551, FILED 10-19-2010.

ZACHARY BELLO, EXAMINING ATTORNEY

United States of America

United States Patent and Trademark Office



Reg. No. 4,065,377

Registered Dec. 6, 2011

Int. Cls.: 6, 7 and 9

TRADEMARK

PRINCIPAL REGISTER

ATIKER METAL İTHALAT İHRACAT VE İMALAT SANAYİ TİCARET ANONİM ŞİRKETİ
(TURKEY JOINT STOCK COMPANY)

1. ORGANİZE SANAYİ BÖLGESİ
ATABEY SOKAK 5/A
KONYA, TURKEY

FOR: CONTAINERS OF METAL FOR COMPRESSED GAS OR LIQUID AIR, EMPTY METAL CONTAINERS FOR LIQUEFIED PETROLEUM GAS (LPG), METAL CONTAINERS FOR GAS, IN CLASS 6 (U.S. CLS. 2, 12, 13, 14, 23, 25 AND 50).

FOR: FUEL ECONOMIZERS FOR ENGINES, LIQUEFIED PETROLEUM GAS (LPG) FUEL CONVERSION APPARATUS FOR INTERNAL COMBUSTION ENGINES, IN CLASS 7 (U.S. CLS. 13, 19, 21, 23, 31, 34 AND 35).

FOR: ELECTRONIC DEVICES USED IN MACHINES AND DEVICES, NAMELY, ENERGY METERS FOR TRACKING AND MONITORING ENERGY USAGE; SEMI-CONDUCTORS, ELECTRONIC CIRCUITS, INTEGRATED CIRCUIT CHIPS FOR COMPUTERS, PHOTOCELLS, DIODES, TRANSISTORS, CIRCUIT BOARDS, CRYSTAL OSCILLATORS, CAPACITORS, INTERFACE CIRCUITS FOR VIDEO CAMERAS, OPTICAL DELAY LINES, ELECTRONIC HYBRID CIRCUITS, ELECTRONIC HEAT SENSORS, ELECTRONIC CONVERTERS, MAGNETIC HEADS IN THE NATURE OF STRUCTURAL PARTS OF MAGNETIC TAPE DRIVES, ELECTRONIC MAGNETIC DEFLECTION DEVICES IN THE NATURE OF MAGNETIC AND ELECTROMAGNETIC COILS, ELECTRONIC INDICATORS FOR VEHICLES, NAMELY, AUTOMATIC INDICATORS OF LOW PRESSURE IN TIRES; SPEED INDICATORS, OIL LEVEL INDICATORS AND TEMPERATURE INDICATORS, TACHOMETERS, TAXIMETERS, NAMELY, ELECTRIC METERS USED IN TAXICABS FOR CALCULATING THE PASSENGER FARES BASED ON A COMBINATION OF DISTANCE TRAVELED AND WAITING TIME, IN CLASS 9 (U.S. CLS. 21, 23, 26, 36 AND 38).



THE MARK CONSISTS OF THE WORDING "GASUA" WRITTEN IN STYLIZED CHARACTERS IN BLACK COLOR; A FLAME SHAPE IS AT THE LEFT OF WORDING "GASUA".

OWNER OF INTERNATIONAL REGISTRATION 1072537 DATED 12-24-2010, EXPIRES 12-24-2020.

SER. NO. 79-095,566, FILED 12-24-2010.

David J. Kyros

Director of the United States Patent and Trademark Office

Reg. No. 4,065,377 KALIE KUNG, EXAMINING ATTORNEY

United States of America

United States Patent and Trademark Office



ESPACIO DE LAS LENGUAS
IBERICAS Y PREHISPANICAS

Reg. No. 4,065,378

Registered Dec. 6, 2011

Int. Cls.: 16, 35 and 41

TRADEMARK

SERVICE MARK

PRINCIPAL REGISTER

INSTITUTO CERVANTES (SPAIN CORPORATION)
C/ ALCALÁ, N° 49
E-28014 MADRID, SPAIN

FOR: PRINTED MATTER, NAMELY, EDUCATIONAL MATERIALS IN THE FIELD OF THE SPANISH LANGUAGE; PRINTED INSTRUCTIONAL AND TEACHING MATERIALS IN THE FIELD OF THE SPANISH LANGUAGE, IN CLASS 16 (U.S. CLS. 2, 5, 22, 23, 29, 37, 38 AND 50).

FOR: ORGANIZATION OF EXHIBITIONS AND TRADE FAIRS FOR COMMERCIAL OR ADVERTISING PURPOSES; PROMOTING THE GOODS AND SERVICES OF OTHERS BY DISTRIBUTING ADVERTISING MATERIALS VIA TELECOMMUNICATIONS AND DATA NETWORKS, IN CLASS 35 (U.S. CLS. 100, 101 AND 102).

FOR: TEACHING SPANISH AS A FOREIGN LANGUAGE, TEACHER TRAINING IN THE FIELD INSTRUCTIONAL METHODS FOR TEACHING FOREIGN LANGUAGES; PROVIDING EDUCATIONAL TESTS IN THE FIELD OF SPANISH; PUBLICATION OF EDUCATIONAL TEXTS AND VIDEOS, IN CLASS 41 (U.S. CLS. 100, 101 AND 107).

NO CLAIM IS MADE TO THE EXCLUSIVE RIGHT TO USE "ESPACIO DE LAS LENGUAS IBERICAS Y PREHISPANICAS" IN CLASSES 16 AND 41, APART FROM THE MARK AS SHOWN.

PRIORITY DATE OF 11-2-2010 IS CLAIMED.

OWNER OF INTERNATIONAL REGISTRATION 1072653 DATED 11-4-2010, EXPIRES 11-4-2020.

THE MARK CONSISTS OF THE WORDING "ESPACIO DE LAS LENGUAS" ABOVE THE WORDING "IBERICAS Y PREHISPANICAS", ALL BELOW A LARGE, STYLIZED LETTER "I" WITH FIVE VERTICAL LINES APPEARING IN AN ARCH ABOVE THE LETTER "I".

THE ENGLISH TRANSLATION OF "ESPACIO DE LAS LENGUAS IBERICAS Y PREHISPANICAS" IN THE MARK IS "AREA OF THE IBERIAN AND PREHISPANIC LANGUAGES".

SER. NO. 79-095,601, FILED 11-4-2010.



David J. Kyffers

Director of the United States Patent and Trademark Office

Reg. No. 4,065,378 KAREN SEVERSON, EXAMINING ATTORNEY

United States of America

United States Patent and Trademark Office



Reg. No. 4,065,379

Registered Dec. 6, 2011

Int. Cl.: 35

SERVICE MARK

PRINCIPAL REGISTER

VIKINGSUN AB (SWEDEN AKTIEBOLAG)
KARDUANSMAKARGATAN 2 C
SE-111 52 STOCKHOLM, SWEDEN

FOR: ONLINE RETAIL STORE SERVICES FEATURING KNIVES AND KNIFE ACCESSORIES;
PRESENTATION OF GOODS ON COMMERCIAL MEDIA FOR RETAIL PURPOSES, IN
CLASS 35 (U.S. CLS. 100, 101 AND 102).

NO CLAIM IS MADE TO THE EXCLUSIVE RIGHT TO USE "KNIFE", APART FROM THE
MARK AS SHOWN.

PRIORITY DATE OF 9-20-2010 IS CLAIMED.

OWNER OF INTERNATIONAL REGISTRATION 1072681 DATED 3-18-2011, EXPIRES 3-18-
2021.

THE COLOR(S) RED, GREY, BLACK AND WHITE IS/ARE CLAIMED AS A FEATURE OF
THE MARK.

THE MARK CONSISTS OF THE DESIGN OF A SEMI-CIRCLE FORMED BY EIGHT TRI-
ANGLES IN THE COLOR GREY AND THE DESIGN OF A KNIFE FEATURED IN THE
CENTER OF THE SEMI-CIRCLE. THE KNIFE APPEARS IN THE COLOR WHITE WITH A
BLACK OUTLINE, AND THREE CIRCLES ON THE HANDLE OF THE KNIFE APPEAR IN
THE COLORS BLACK AND RED. THE WORDING "THE KNIFE ACADEMY.COM" IS FEAT-
TURED ABOVE THE SEMI-CIRCLE IN THE COLOR RED.

SER. NO. 79-095,609, FILED 3-18-2011.

CHARISMA HAMPTON, EXAMINING ATTORNEY



David J. Kybas

Director of the United States Patent and Trademark Office

United States of America

United States Patent and Trademark Office



Reg. No. 4,065,380

Registered Dec. 6, 2011

Int. Cls.: 27, 31, 37 and 44

TRADEMARK

SERVICE MARK

PRINCIPAL REGISTER

NUSCA, ROBERTO (ITALY INDIVIDUAL)
VIA DELLE MURELLE, 46
ARENA METATO; I-56010 S. GIULIANO TERME(PISA)
ITALY

FOR: ARTIFICIAL TURFS, IN PARTICULAR COMPRISING LAYERS OF MAN-MADE SYNTHETIC FIBERS, FILAMENTS AND PARTICULATE INFILL, IN PARTICULAR FOR THE PLAYING OF SOCCER, AMERICAN FOOTBALL, LACROSSE, FIELD HOCKEY, CRICKET, GOLF AND OTHER OUTDOOR ATHLETIC ACTIVITIES, IN CLASS 27 (U.S. CLS. 19, 20, 37, 42 AND 50).

FOR: NATURAL TURF FOR SPORTS GROUNDS; NATURAL TURF FOR OUTDOOR SPORTS ACTIVITIES, IN CLASS 31 (U.S. CLS. 1 AND 46).

FOR: INSTALLATION OF SYNTHETIC GRASS SYSTEMS FOR THE PLAYING OF SOCCER, AMERICAN FOOTBALL, LACROSSE, FIELD HOCKEY, CRICKET, GOLF AND OTHER OUTDOOR ATHLETIC ACTIVITIES, IN CLASS 37 (U.S. CLS. 100, 103 AND 106).

FOR: ADVISORY SERVICES RELATING TO THE USE OF GARDEN AND HORTICULTURAL PRODUCTS AND THE SELECTION, PROPAGATION AND GROWTH OF LAWNS, TURF, PLANTS, SHRUBS, TREES, VEGETABLES, SOFT FRUIT AND FRUIT TREES, IN CLASS 44 (U.S. CLS. 100 AND 101).

NO CLAIM IS MADE TO THE EXCLUSIVE RIGHT TO USE "FOOTBALL GREEN", APART FROM THE MARK AS SHOWN.

OWNER OF INTERNATIONAL REGISTRATION 1003935 DATED 4-22-2009, EXPIRES 4-22-2019.

THE COLOR(S) WHITE, GREY, BRIGHT GREEN, DARK GREEN IS/ARE CLAIMED AS A FEATURE OF THE MARK.

"LIVE" IN BRIGHT GREEN; "FOOTBALL" IN WHITE; "GREEN" IN DARK GREEN; SMALL PARALLELOGRAM IN DARK GREEN; BIG PARALLELOGRAM WITH GREY BACKGROUND; HALF FOOTBALL BALL IN WHITE AND DARK GREEN.



David J. Kyros

Director of the United States Patent and Trademark Office

Reg. No. 4,065,380 THE MARK CONSISTS OF THE WORDS "FOOTBALL GREEN LIVE" IN FANCY CHARACTERS, WHERE THE WORDS "FOOTBALL GREEN" ARE CONTAINED INTO A DARK GREEN PARALLELOGRAM WHERE AN HALF FOOTBALL BALL IS DEPICTED IN THE COLORS GREEN AND WHITE, THE WORD "FOOTBALL" IS IN THE COLOUR WHITE, AND THE WORD "GREEN" WITH A BRIGHT GREEN EDGE, THE WORD "LIVE" OBLIQUE, UNDERLINED, IN BRIGHT GREEN COLOUR WITH A DARK GREEN EDGE ON DARK BACKGROUND, THE WHOLE APPEARING INTO A PARALLELOGRAM WITH A GREY BACKGROUND.

SER. NO. 79-095,631, FILED 12-29-2010.

STEVEN JACKSON, EXAMINING ATTORNEY

United States of America

United States Patent and Trademark Office

KIKO

Reg. No. 4,065,381

Registered Dec. 6, 2011

Int. Cls.: 9 and 14

TRADEMARK

PRINCIPAL REGISTER

KIKO S.R.L. (ITALY LIMITED LIABILITY COMPANY)
VIA GIORGIO PAGLIA, 1/D
I-24122 BERGAMO
ITALY

FOR: SPECTACLES, CASES AND CHAINS FOR SPECTACLES, FRAMES FOR SPECTACLES, OPTICAL LENSES, IN CLASS 9 (U.S. CLS. 21, 23, 26, 36 AND 38).

FOR: JEWELLERY AND COSTUME JEWELLERY, NAMELY RINGS, BRACELETS, NECKLACES, TIE-BARS, SCARF RINGS, PENDANTS, EAR CLIPS, TIE CLIPS, CUFFINKS, EARRINGS, KEY HOLDERS MADE OF PRECIOUS METALS, BROOCHES, PINS BEING JEWELRY; CLOCKS, WATCHES, CHRONOGRAPHS FOR USE AS WATCHES, CHRONOMETERS, IN CLASS 14 (U.S. CLS. 2, 27, 28 AND 50).

THE MARK CONSISTS OF STANDARD CHARACTERS WITHOUT CLAIM TO ANY PARTICULAR FONT, STYLE, SIZE, OR COLOR.

PRIORITY DATE OF 11-16-2009 IS CLAIMED.

OWNER OF INTERNATIONAL REGISTRATION 1030124 DATED 12-11-2009, EXPIRES 12-11-2019.

OWNER OF U.S. REG. NOS. 1,837,925, 3,689,438 AND OTHERS.

THE NAME(S), PORTRAIT(S), AND/OR SIGNATURE(S) SHOWN IN THE MARK DOES NOT IDENTIFY A PARTICULAR LIVING INDIVIDUAL.

THE WORDING "KIKO" HAS NO MEANING IN A FOREIGN LANGUAGE.

SER. NO. 79-095,635, FILED 4-27-2010.

STEVEN JACKSON, EXAMINING ATTORNEY



David J. Kypos

Director of the United States Patent and Trademark Office

United States of America

United States Patent and Trademark Office

HOLLOH

Reg. No. 4,065,382

Registered Dec. 6, 2011

Int. Cls.: 3, 14, 18 and 25

TRADEMARK

PRINCIPAL REGISTER

ARENA GERARDA (ITALY INDIVIDUAL)
71 RUE DUNKERQUE
F-75009 PARIS
FRANCE

FOR: (PRIORITY CLAIM) PERFUMES, COSMETICS, SOAPS, ESSENTIAL OILS, MAKE-UP REMOVING PREPARATIONS, BEAUTY MASKS, SHAVING PRODUCTS, NAMELY, SHAVING GEL, SHAVING LOTIONS, SHAVING PREPARATIONS; HAIR LOTIONS, MAKE-UP PRODUCTS, NAMELY, MAKE UP, MAKE UP POWDER, MAKE UP REMOVER, IN CLASS 3 (U.S. CLS. 1, 4, 6, 50, 51 AND 52).

FOR: JEWELRY, WATCHES, BRACELETS AND JEWELRY CHAINS, IN CLASS 14 (U.S. CLS. 2, 27, 28 AND 50).

FOR: LEATHERS AND IMITATION LEATHERS, ANIMAL SKINS; TRUNKS AND TRAVELING BAGS; UMBRELLAS, PARASOLS AND WALKING STICKS; WHIPS, HARNESSES AND SADDLERY; BAGS FOR CLIMBERS AND CAMPERS IN THE NATURE OF ALL PURPOSE CARRYING BAGS, AND BEACH BAGS; HANDBAG FRAMES; FRAMES FOR UMBRELLAS OR PARASOLS; PURSES; HANDBAGS; TRAVELLING BAGS; TRAVEL CASES AND KEY BAGS; ATTACHÉ CASES; COIN PURSES, NOT OF PRECIOUS METAL; SCHOOL BAGS; GARMENT BAGS FOR TRAVEL; HAT BOXES OF LEATHER; LEATHER OR LEATHER-BOARD BOXES AND CASES; BOXES OF VULCANISED FIBRE; SACHEL BAGS; WALLETS; BRIEFCASES; TOILETRY BAGS SOLD EMPTY; COLLARS FOR ANIMALS; LEATHER LEASHES; LEATHER LEADS; UMBRELLA COVERS; BACKPACKS; CARRYING CASES FOR MUSIC; HORSE HALTERS; SMALL BAGS FOR PACKING PURPOSES MADE OF LEATHER, NAMELY, WALLETS AND POUCHES, IN CLASS 18 (U.S. CLS. 1, 2, 3, 22 AND 41).

FOR: CLOTHING, NAMELY, SHORTS, SHIRTS, PANTS, DRESSES, TROUSERS, JEANS, BERMUDA SHORTS, BOXER SHORTS, T-SHIRTS, POLO SHIRTS, SPORT SHIRTS, TOPS, CHASUBLES, BLOUSES, OVERALLS, SUITS, WAISTCOATS, PULL-OVERS, CARDIGANS, RAINCOATS, JACKETS, VESTS, COATS, OVERCOATS, TOPCOATS, BLOUSONS, BLAZERS, PARKAS; FOOTWEAR, HEADGEAR, NAMELY, HATS, CAPS, BONNETS; LEATHER OR IMITATION LEATHER CLOTHING, NAMELY, SHORTS, SHIRTS, PANTS, DRESSES, TROUSERS, JEANS, BERMUDA SHORTS, BOXER SHORTS, T-SHIRTS, POLO SHIRTS, SPORT SHIRTS, TOPS, CHASUBLES, BLOUSES, OVERALLS, SUITS, WAISTCOATS, PULL-OVERS, CARDIGANS, RAINCOATS, JACKETS, VESTS, COATS, OVERCOATS, TOPCOATS,



David J. Kappas

Director of the United States Patent and Trademark Office

Reg. No. 4,065,382 BLOUSONS, BLAZERS, PARKAS; BELTS; FURS, NAMELY, FUR COATS, FUR HATS, FUR JACKETS; GLOVES; SCARVES; HOSIERY; SOCKS; SLIPPERS; BEACH, SKI OR SPORTS FOOTWEAR; UNDERWEAR, IN CLASS 25 (U.S. CLS. 22 AND 39).

PRIORITY DATE OF 6-14-2010 IS CLAIMED.

OWNER OF INTERNATIONAL REGISTRATION 1072699 DATED 12-14-2010, EXPIRES 12-14-2020.

SER. NO. 79-095,649, FILED 12-14-2010.

LINDA ORNDORFF, EXAMINING ATTORNEY

United States of America

United States Patent and Trademark Office



Reg. No. 4,065,383

Registered Dec. 6, 2011

Int. Cls.: 5, 30 and 32

SAT NAM RASAYAN FOUNDATION STICHTING (NETHERLANDS FOUNDATION (STICHTING))
DEN TEXTSTRAAT 46
NL-1017 ZC AMSTERDAM
NETHERLANDS

TRADEMARK

PRINCIPAL REGISTER

FOR: TEA AND HERBAL TEA AND DRINKS BASED ON TEA AND HERBAL TEA, FOR MEDICINAL AND DIETETIC USE; NUTRITIONAL SUPPLEMENTS; DIETARY AND NUTRITIONAL SUPPLEMENTS; VITAMIN AND MINERAL SUPPLEMENTS; DIETETIC BEVERAGES ADAPTED FOR MEDICAL PURPOSES; DIETETIC SUBSTANCES, NAMELY, FOOD AND BEVERAGES ADAPTED FOR MEDICINAL PURPOSES; PREPARATIONS FOR MAKING BEVERAGES FOR MEDICAL USE; VITAMIN DRINKS, IN CLASS 5 (U.S. CLS. 6, 18, 44, 46, 51 AND 52).

FOR: TEA AND HERBAL TEA; DRINKS BASED ON TEA AND HERBAL TEA; FRUIT TEAS; TEA ESSENCES; TEA MIXTURES; ARTIFICIAL TEA; BEVERAGES MADE OF TEA; GREEN TEA; ICED TEA; HERBAL PREPARATIONS IN THE NATURE OF FLAVORINGS FOR MAKING BEVERAGES, IN CLASS 30 (U.S. CL. 46).

FOR: NON-ALCOHOLIC DRINKS, NAMELY, NON-ALCOHOLIC BEVERAGES WITH TEA, FRUIT JUICE, VEGETABLE JUICE AND HERBAL FLAVOR; MINERAL WATER; FRUIT DRINKS AND FRUIT JUICES; ESSENCES FOR MAKING NONALCOHOLIC BEVERAGES AND SOFT DRINKS; PREPARATIONS FOR MAKING BEVERAGES, NAMELY, FRUIT DRINKS AND NON-ALCOHOLIC BEVERAGES WITH TEA, FRUIT JUICE, VEGETABLE JUICE AND HERBAL FLAVOR; SYRUPS FOR MAKING BEVERAGES, IN CLASS 32 (U.S. CLS. 45, 46 AND 48).



THE MARK CONSISTS OF THE WORDING "SHOTI MAA" IN A STYLIZED FONT IN BETWEEN TWO SMALL DIAMONDS, INSIDE A MISCELLANEOUS DESIGN WITH A CONVEX CURVE SMOKE-SHAPED DESIGN BELOW AND BETWEEN THE WORDS "SHOTI" AND "MAA" GOING UPWARDS TOWARDS A DESIGN OF A FLOWER, WHICH REPLACES THE DOT OVER THE LETTER "I", IN "SHOTTI"; A STYLIZED TEA CUP AND A SAUCER DESIGN IS BELOW THE WORDING.

David J. Kyros

PRIORITY DATE OF 6-10-2010 IS CLAIMED.

Reg. No. 4,065,383 OWNER OF INTERNATIONAL REGISTRATION 1072730 DATED 12-10-2010, EXPIRES 12-10-2020.

THE ENGLISH TRANSLATION OF "SHOTI MAA" IN THE MARK IS LITTLE MOTHER.

SER. NO. 79-095,659, FILED 12-10-2010.

JULIE VEPPUMTHARA, EXAMINING ATTORNEY

United States of America

United States Patent and Trademark Office

Medical
Excellence
JAPAN



Reg. No. 4,065,384

Registered Dec. 6, 2011

Int. Cls.: 35, 41 and 44

SERVICE MARK

PRINCIPAL REGISTER

THE GOVERNMENT OF JAPAN REPRESENTED BY MINISTER OF ECONOMY, TRADE AND INDUSTRY (JAPAN GOVERNMENT OF JAPAN)
1-3-1 KASUMIGASEKI, CHIYODA-KU
TOKYO, JAPAN 1008901

FOR: ADVERTISING; SALES PROMOTION FOR OTHERS; ORGANIZATION OF EXHIBITIONS AND TRADE FAIRS FOR BUSINESS AND PROMOTIONAL PURPOSES, IN CLASS 35 (U.S. CLS. 100, 101 AND 102).

FOR: ORGANIZATION OF EVENTS OR EXHIBITIONS FOR EDUCATIONAL PURPOSES IN RELATION TO MEDICAL CARE; EDUCATIONAL SERVICES, NAMELY, ARRANGING AND CONDUCTING OF SEMINARS AND SYMPOSIUMS IN THE FIELD OF MEDICAL CARE; EDUCATIONAL SERVICES, NAMELY, WORKSHOPS, SEMINARS, CLASSES, CONFERENCES AND PANEL DISCUSSIONS IN THE FIELD OF MEDICAL CARE; PROVIDING ON-LINE ELECTRONIC PUBLICATIONS, NOT DOWNLOADABLE, NAMELY, BOOKS, PERIODICALS, NEWSLETTERS, MAGAZINES AND BROCHURES IN THE FIELD OF MEDICINE AND MEDICAL CARE, IN CLASS 41 (U.S. CLS. 100, 101 AND 107).

FOR: PROVIDING MEDICAL INFORMATION; MEDICAL SERVICES, IN CLASS 44 (U.S. CLS. 100 AND 101).

NO CLAIM IS MADE TO THE EXCLUSIVE RIGHT TO USE "MEDICAL" AND "JAPAN", APART FROM THE MARK AS SHOWN.

PRIORITY DATE OF 2-24-2011 IS CLAIMED.

OWNER OF INTERNATIONAL REGISTRATION 1072865 DATED 3-1-2011, EXPIRES 3-1-2021.

THE COLOR(S) GRAY AND RED IS/ARE CLAIMED AS A FEATURE OF THE MARK.

THE COLOR GRAY APPEARS IN THE LETTERS "MEDICAL EXCELLENCE JAPAN", AND THE COLOR RED APPEARS IN THE SPHERE SHOWN BEHIND THE LETTERS.

THE MARK CONSISTS OF THE STACKED TEXT "MEDICAL EXCELLENCE JAPAN" WITH A SPHERE IN THE BACKGROUND. THE COLOR GREY APPEARS IN THE TEXT "MEDICAL



David J. Kyjars

Director of the United States Patent and Trademark Office

Reg. No. 4,065,384 EXCELLENCE JAPAN" AND THE COLOR RED APPEARS IN THE SPHERE BEHIND THE
TEXT.

SER. NO. 79-095,707, FILED 3-1-2011.

CARYN GLASSER, EXAMINING ATTORNEY

United States of America

United States Patent and Trademark Office

GOTTA ROLL

ガッタロール

Reg. No. 4,065,385

Registered Dec. 6, 2011

Int. Cl.: 25

TRADEMARK

PRINCIPAL REGISTER

FLAT HEAD CO., LTD. (JAPAN CORPORATION)
3-1, OAZA KAMITOKUMA
CHIKUMA-SHI
NAGANO, JAPAN 3890805

FOR: CLOTHING, NAMELY, SHIRTS, JEANS, SWEATSHIRTS, T-SHIRTS, AND BASEBALL JACKETS; GARTERS; SOCK SUSPENDERS; SUSPENDERS, NAMELY, BRACES; WAIST-BANDS; BELTS FOR CLOTHING; FOOTWEAR; MASQUERADE COSTUMES; CLOTHES FOR SPORTS, NAMELY, TOPS, BOTTOMS, PANTS, SHIRTS, SHORTS AND HATS; BOOTS FOR SPORTS, IN CLASS 25 (U.S. CLS. 22 AND 39).

THE MARK CONSISTS OF THE STYLIZED WORDING "GOTTA ROLL" ABOVE ASIAN CHARACTERS WITH THE SAME MEANING.

OWNER OF INTERNATIONAL REGISTRATION 1072876 DATED 3-10-2011, EXPIRES 3-10-2021.

THE TRANSLITERATION OF THE NON-LATIN CHARACTERS IN THE MARK IS: "GATTARORU".

THE ENGLISH TRANSLATION OF THE FOREIGN WORD(S) IN THE MARK IS: "GOTTA ROLL".

SER. NO. 79-095,711, FILED 3-10-2011.

DAVID HOFFMAN, EXAMINING ATTORNEY



David J. Kyffers

Director of the United States Patent and Trademark Office

United States of America

United States Patent and Trademark Office



Reg. No. 4,065,386

Registered Dec. 6, 2011

Int. Cl.: 28

TRADEMARK

PRINCIPAL REGISTER

BI AIMIN (CHINA INDIVIDUAL)
ROOM 204
100 SHI TING ROAD,; SIMING DISTRICT,; XIAMEN; 361004 FUJIAN
CHINA

FOR: TOY GAME BALLS; EXERCISE BALLS, NAMELY, BASKETBALLS, FOOTBALLS, VOLLEYBALLS, BASEBALLS; MACHINES FOR PHYSICAL EXERCISES, EXERCISE MACHINES, IN CLASS 28 (U.S. CLS. 22, 23, 38 AND 50).

THE MARK CONSISTS OF THE STYLIZED UNDERSCORED WORDING "STEBELL".

OWNER OF INTERNATIONAL REGISTRATION 1073064 DATED 11-24-2010, EXPIRES 11-24-2020.

THE WORDING "STEBELL" HAS NO MEANING IN A FOREIGN LANGUAGE.

SER. NO. 79-095,791, FILED 11-24-2010.

JOHN HWANG, EXAMINING ATTORNEY



David J. Kybas

Director of the United States Patent and Trademark Office

United States of America

United States Patent and Trademark Office

DIAMANT SOLAR STAR

Reg. No. 4,065,387

Registered Dec. 6, 2011

Int. Cls.: 19 and 21

TRADEMARK

PRINCIPAL REGISTER

SAINT-GOBAIN GLASS FRANCE (FRANCE SOCIÉTÉ ANONYME)
"LES MIROIRS"
18 AVENUE D'ALSACE
F-92400 COURBEVOIE, FRANCE

FOR: TEMPERED AND SEMI-TEMPERED BUILDING GLASS; DOUBLE-GLAZING, NAMELY, WINDOW GLASS; LAMINATED BUILDING GLASS; ANNEALED BUILDING GLASS; WINDOW GLASS, NAMELY, CLEAR OR TINTED PLATE GLASS AND EXTRA-CLEAR PLATE GLASS; GLASS WALL COVERINGS, NAMELY, GLASS BLOCKS FOR BUILDING; GLASS PARTITIONS, NAMELY, PERMANENT NON-MOVEABLE GLASS PARTITIONS FOR BUILDING PURPOSES; PANELS OF GLASS FOR BUILDING, DRAWN GLASS FOR BUILDING, BLOWN GLASS FOR BUILDING, DOORS OF GLASS, NON-METAL DOORS MADE PARTIALLY OF GLASS; UNWORKED AND SEMI-WORKED PLATE GLASS FOR BUILDING PURPOSES, NAMELY, PANES OF GLASS READY TO BE CUT AND INSTALLED AS WINDOWS; GLASS FOR BUILDING; GLASS, TEMPERED AND NOT, FOR BUILDING, IN CLASS 19 (U.S. CLS. 1, 12, 33 AND 50).

FOR: DRAWN AND BLOWN GLASS FOR DECORATIVE PURPOSES, STAINED GLASS, THERMOFORMED GLASS FOR DECORATIVE PURPOSES; UNWORKED AND SEMI-WORKED GLASS FOR DECORATIVE PURPOSES, IN CLASS 21 (U.S. CLS. 2, 13, 23, 29, 30, 33, 40 AND 50).

OWNER OF U.S. REG. NO. 3,871,852.

PRIORITY DATE OF 8-31-2010 IS CLAIMED.

OWNER OF INTERNATIONAL REGISTRATION 1073288 DATED 1-25-2011, EXPIRES 1-25-2021.

THE ENGLISH TRANSLATION OF "DIAMANT" IN THE MARK IS "DIAMOND".

SER. NO. 79-095,860, FILED 1-25-2011.

LIEF MARTIN, EXAMINING ATTORNEY



David J. Kyffers

Director of the United States Patent and Trademark Office

United States of America

United States Patent and Trademark Office

CELMOLLIS

Reg. No. 4,065,388

Registered Dec. 6, 2011

Int. Cl.: 1

TRADEMARK

PRINCIPAL REGISTER

DAICEL CHEMICAL INDUSTRIES, LTD. (JAPAN CORPORATION)
MAINICHI INTECIO
4-5, UMEDA 3-CHOME, KITA-KU, OSAKA-SHI
OSAKA, JAPAN 5300001

FOR: CHEMICALS FOR USE IN INDUSTRY, COSMETIC AND TOILETRIES, NAMELY, POLYGLYCEROL, POLYGLYCEROL ALKYL ETHER, POLYGLYCEROL FATTY ACID ESTER, POLYGLYCEROL DERIVATIVES, FORMULATED MATERIALS OF POLYGLYCEROL, FORMULATED MATERIALS OF POLYGLYCEROL ALKYL ETHER, FORMULATED MATERIALS OF POLYGLYCEROL FATTY ACID ESTER, FORMULATED MATERIALS OF POLYGLYCEROL DERIVATIVES, IN CLASS 1 (U.S. CLS. 1, 5, 6, 10, 26 AND 46).

THE MARK CONSISTS OF STANDARD CHARACTERS WITHOUT CLAIM TO ANY PARTICULAR FONT, STYLE, SIZE, OR COLOR.

PRIORITY DATE OF 12-20-2010 IS CLAIMED.

OWNER OF INTERNATIONAL REGISTRATION 1073511 DATED 1-17-2011, EXPIRES 1-17-2021.

THE WORD(S) "CELMOLLIS" HAS NO MEANING IN A FOREIGN LANGUAGE.

SER. NO. 79-095,980, FILED 1-17-2011.

TASNEEM HUSSAIN, EXAMINING ATTORNEY



David J. Kybas

Director of the United States Patent and Trademark Office

United States of America

United States Patent and Trademark Office

DULCOACTIF

Reg. No. 4,065,389

Registered Dec. 6, 2011

Int. Cls.: 5, 29 and 30

TRADEMARK

PRINCIPAL REGISTER

BOEHRINGER INGELHEIM INTERNATIONAL GMBH (FED REP GERMANY CORPORATION)
55218 INGELHEIM
FED REP GERMANY

FOR: PHARMACEUTICAL PREPARATIONS, NAMELY, PHARMACEUTICAL PREPARATIONS FOR THE TREATMENT OF DISEASES AND DISORDERS OF THE ALIMENTARY TRACT AND METABOLISM; FOOD SUPPLEMENTS AND DIETARY PREPARATIONS FOR MEDICAL USE, NAMELY, DIETARY FIBER AS AN ADDITIVE FOR FOOD PRODUCTS AND DIETARY FOOD NUTRITIONAL SUPPLEMENTS IN THE FORM OF CAPSULES, IN CLASS 5 (U.S. CLS. 6, 18, 44, 46, 51 AND 52).

FOR: NUTRITIONAL ADDITIVES AND DIETETIC FOODS ADAPTED FOR NON-MEDICAL PURPOSES ON A FAT, FATTY ACIDS AND/OR PROTEIN BASIS, NAMELY, EDIBLE OILS AND EDIBLE FATS IN CAPSULES, MILK PROTEIN IN CAPSULES, AND EDIBLE SEEDS, IN CLASS 29 (U.S. CL. 46).

FOR: NUTRITIONAL ADDITIVES AND DIETETIC FOODS ADAPTED FOR NON-MEDICAL PURPOSES ON A DIETARY FIBER AND/OR CARBOHYDRATE BASIS, NAMELY, PROCESSED GRAINS AND PROCESSED WHEAT, IN CLASS 30 (U.S. CL. 46).

THE MARK CONSISTS OF STANDARD CHARACTERS WITHOUT CLAIM TO ANY PARTICULAR FONT, STYLE, SIZE, OR COLOR.

PRIORITY DATE OF 8-23-2010 IS CLAIMED.

OWNER OF INTERNATIONAL REGISTRATION 1073751 DATED 2-15-2011, EXPIRES 2-15-2021.

OWNER OF U.S. REG. NOS. 671,422, 3,505,530 AND OTHERS.

THE WORDING "DULCOACTIF" HAS NO MEANING IN A FOREIGN LANGUAGE.

SER. NO. 79-096,095, FILED 2-15-2011.

JAMES MACFARLANE, EXAMINING ATTORNEY



David J. Kyffers

Director of the United States Patent and Trademark Office

United States of America
United States Patent and Trademark Office

ODEN'S

Reg. No. 4,065,390

GAJANE GROSS KB (SWEDEN LIMITED PARTNERSHIP)
BRUTTOVÄGEN 18ASE-175 43 JÄRFÄLLA
SWEDEN

Registered Dec. 6, 2011

Int. Cl.: 34

FOR: SNUFF AND SNUFF BOXES, IN CLASS 34 (U.S. CLS. 2, 8, 9 AND 17).

TRADEMARK

THE MARK CONSISTS OF STANDARD CHARACTERS WITHOUT CLAIM TO ANY PARTICULAR FONT, STYLE, SIZE, OR COLOR.

PRINCIPAL REGISTER

OWNER OF INTERNATIONAL REGISTRATION 1073872 DATED 10-1-2010, EXPIRES 10-1-2020.

SER. NO. 79-096,144, FILED 10-1-2010.

JOHN WILKE, EXAMINING ATTORNEY



David J. Kyffers

Director of the United States Patent and Trademark Office

United States of America

United States Patent and Trademark Office



Reg. No. 4,065,391
Registered Dec. 6, 2011
Int. Cls.: 36, 40 and 42

SERVICE MARK

PRINCIPAL REGISTER

SCM SERVICES PTY LIMITED (AUSTRALIA PRIVATE COMPANY)
84-86 LAMBECK DRIVE
TULLAMARINE VIC 3043
AUSTRALIA

FOR: CARBON CREDIT BROKERAGE SERVICES; CARBON CREDIT TRADING SERVICES; TRADING OF EMISSION REDUCTION CREDITS; PREPARATION OF CREDIT REPORTS; CONSULTATION SERVICES RELATING TO FINANCIAL MATTERS; ECONOMIC FINANCIAL RESEARCH SERVICES; FINANCIAL INFORMATION; PROVISION OF ONLINE FINANCIAL CALCULATORS; PROVIDING BANKING INFORMATION, NAMELY, ISSUING STATEMENTS OF CARBON CREDIT AND CARBON TRADING ACCOUNTS; ISSUING OF TOKENS OF VALUE; ENVIRONMENTAL BROKERAGE SERVICES, NAMELY, ENERGY BROKERAGE AND CARBON CREDIT BROKERAGE, IN CLASS 36 (U.S. CLS. 100, 101 AND 102).

FOR: RECYCLING SERVICES FOR THE PURPOSE OF CARBON OFFSETTING; DECONTAMINATION OF WASTE; WASTE PROCESSING INFORMATION; WASTE PROCESSING; INFORMATION RELATING TO MATERIAL TREATMENT; PROVIDING INFORMATION, INCLUDING ONLINE, ABOUT TREATMENT OF MATERIALS; TREATMENT OF ENVIRONMENTAL WASTE MATERIALS; RECYCLING, IN CLASS 40 (U.S. CLS. 100, 103 AND 106).

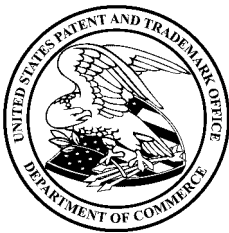

David J. Kybas

Director of the United States Patent and Trademark Office

FOR: PREPARATION OF TECHNICAL PROJECT STUDIES, TECHNICAL RESEARCH AND CONSULTANCY IN THE FIELD OF CARBON OFFSETTING AND CARBON TRADING; TECHNICAL ADVISORY SERVICES RELATING TO ENVIRONMENTAL POLLUTION, CARBON OFFSETTING AND CARBON TRADING; TECHNICAL ADVISORY SERVICES RELATING TO ENVIRONMENTAL PROTECTION, CARBON TRADING AND CARBON OFFSETTING; COMPILATION OF ENVIRONMENTAL INFORMATION FOR RESEARCH PURPOSES; ENVIRONMENTAL CONSULTANCY SERVICES IN THE FIELD OF ENVIRONMENTAL REGULATORY MATTERS, CARBON TRADING MATTERS AND CARBON OFFSETTING MATTERS; ENVIRONMENTAL SUSTAINABILITY TECHNICAL CONSULTANCY SERVICES; ENVIRONMENTAL TESTING; PROVISION OF INFORMATION RELATING TO ENVIRONMENTAL SUSTAINABILITY IN THE FIELD OF CARBON TRADING, CARBON OFFSETTING AND CLIMATE CHANGE; RESEARCH IN THE FIELD OF ENVIRONMENTAL PROTECTION, CLIMATE CHANGE, CARBON TRADING AND CARBON OFFSETTING; MANAGEMENT OF SCIENTIFIC RESEARCH PROJECTS; PREPARATION OF SCIENTIFIC REPORTS IN THE FIELD OF ENVIRONMENTAL POLLUTION,

Reg. No. 4,065,391 CARBON OFFSETTING AND CARBON TRADING; PREPARATION OF TECHNICAL REPORTS IN THE FIELD OF ENVIRONMENTAL POLLUTION, CARBON OFFSETTING AND CARBON TRADING; POLLUTION EMISSIONS TESTING, IN CLASS 42 (U.S. CLS. 100 AND 101).

NO CLAIM IS MADE TO THE EXCLUSIVE RIGHT TO USE "SHIPPED CARBON NEUTRAL", APART FROM THE MARK AS SHOWN.

OWNER OF INTERNATIONAL REGISTRATION 1074001 DATED 3-2-2011, EXPIRES 3-2-2021.

THE MARK CONSISTS OF A CIRCLE WITH 3 PARALLEL LINES RUNNING THROUGH IT AND 1 HORIZONTAL LINE RUNNING ACROSS THE MIDDLE. THERE ARE 2 CURVED LINES RUNNING THROUGH THE CIRCLE, ONE AT THE TOP AND ONE AT THE BOTTOM. INSIDE OF THE CIRCLE IS THE WORDING "SHIPPED CARBON NEUTRAL". THE WORD "SHIPPED" IS PLACED ON THE TOP CURVED LINE; THE WORD "CARBON" IS PLACED ON THE CENTER HORIZONTAL LINE; THE WORD "NEUTRAL" IS PLACED ON THE BOTTOM CURVED LINE.

SER. NO. 79-096,194, FILED 3-2-2011.

JENNIFER VASQUEZ, EXAMINING ATTORNEY

United States of America

United States Patent and Trademark Office



Reg. No. 4,065,392

Registered Dec. 6, 2011

Int. Cl.: 18

TRADEMARK

PRINCIPAL REGISTER

U DAN-LING, GUANGZHOU GARMENT CO., LTD (CHINA CORPORATION)
BLOCK 25
NO. 112-113-115 (INTERNATIONAL JEANS TOWN), NO. 82, XINNAN RD. (E), XINTANG
TOWN, ZENGCHENG
GUANGZHOU CITY, CHINA

FOR: PURSES; HANDBAGS; IMITATION LEATHER; VALISES; ATTACHE CASES;
LEATHEROID BOX; LEATHER STRAPS; FUR-SKINS; UMBRELLAS, IN CLASS 18 (U.S.
CLS. 1, 2, 3, 22 AND 41).

THE MARK CONSISTS OF THE ENGLISH LETTERS "U", "D", "L" WITH A DOT BETWEEN
LETTERS "U" AND "D", AND "D" AND "L". A HOOK SHAPED DESIGN APPEARS ABOVE
THE LETTERS.

PRIORITY DATE OF 8-19-2010 IS CLAIMED.

OWNER OF INTERNATIONAL REGISTRATION 1074128 DATED 11-9-2010, EXPIRES 11-
9-2020.

SER. NO. 79-096,251, FILED 11-9-2010.

ZACHARY BELLO, EXAMINING ATTORNEY



David J. Kyffers

Director of the United States Patent and Trademark Office

United States of America

United States Patent and Trademark Office



Reg. No. 4,065,393

Registered Dec. 6, 2011

Int. Cls.: 35 and 41

SERVICE MARK

PRINCIPAL REGISTER

KOVSHHEY HASHMAMA LTD (ISRAEL COMPANY)
20 HATCHYIA STREET (7TH FLOOR)
58403 HOLON
ISRAEL

FOR: ADVERTISING; BUSINESS MANAGEMENT; BUSINESS ADMINISTRATION; BUSINESS SERVICES, NAMELY, OFFICE FUNCTIONS; ON-LINE RETAIL STORE SERVICES FEATURING APPLIANCES, GADGETS, PHONES, SPORTING GOODS AND SOUVENIRS, IN CLASS 35 (U.S. CLS. 100, 101 AND 102).

FOR: CONDUCTING AND ORGANIZING MARATHON RACE COMPETITIONS, IN CLASS 41 (U.S. CLS. 100, 101 AND 107).

NO CLAIM IS MADE TO THE EXCLUSIVE RIGHT TO USE "42.2", APART FROM THE MARK AS SHOWN.

OWNER OF INTERNATIONAL REGISTRATION 1074149 DATED 11-25-2010, EXPIRES 11-25-2020.

THE MARK CONSISTS OF THE NUMBERS "42.2" AND THE WORDING "MEMBER OF THE CLUB" BELOW; ALL ENCLOSED BY AN EGG-SHAPED CIRCLE.

SER. NO. 79-096,265, FILED 11-25-2010.

ZACHARY BELLO, EXAMINING ATTORNEY



David J. Kyffers

Director of the United States Patent and Trademark Office

United States of America

United States Patent and Trademark Office

BAGLLERINA

Reg. No. 4,065,394

Registered Dec. 6, 2011

Int. Cls.: 18, 24 and 25

NATKIN PARIS SOCIÉTÉ À RESPONSABILITÉ LIMITÉE (FRANCE SOCIÉTÉ À
RESPONSABILITÉ LIMITÉE)
4 RUE BOULARD
F-75014 PARIS
FRANCE

TRADEMARK

FOR: LEATHER AND IMITATIONS OF LEATHER; ANIMAL SKINS; WALLETS; PURSES;
HANDBAGS, BACKPACKS, WHEELED BAGS , IN CLASS 18 (U.S. CLS. 1, 2, 3, 22 AND 41).

PRINCIPAL REGISTER

FOR: FABRICS FOR TEXTILE USE; ELASTIC WOVEN FABRICS FOR CLOTHING; VELVET,
IN CLASS 24 (U.S. CLS. 42 AND 50).

FOR: CLOTHING, NAMELY, SHIRTS, PANTS, COATS, AND DRESSES; HEADWEAR, HATS
AND CAPS; FOOTWEAR; BEACH, SKI OR SPORTS FOOTWEAR; SLIPPERS, IN CLASS 25
(U.S. CLS. 22 AND 39).

THE WORDING "BAGLLERINA" HAS NO MEANING IN A FOREIGN LANGUAGE.

PRIORITY DATE OF 9-22-2010 IS CLAIMED.

OWNER OF INTERNATIONAL REGISTRATION 1074415 DATED 3-14-2011, EXPIRES 3-14-
2021.

SER. NO. 79-096,387, FILED 3-14-2011.

NATALIE POLZER, EXAMINING ATTORNEY



David J. Kybas

Director of the United States Patent and Trademark Office

United States of America

United States Patent and Trademark Office

DARMAGI

Reg. No. 4,065,395

Registered Dec. 6, 2011

Int. Cl.: 33

TRADEMARK

PRINCIPAL REGISTER

GAJA SOCIETÀ SEMPLICE (ITALY PARTNERSHIP)
VIA TORINO, 18
I-12050 BARBARESCO (CN)
ITALY

FOR: ALCOHOLIC BEVERAGES, NAMELY, WINE AND EAU-DE-VIE (BRANDY), IN CLASS 33 (U.S. CLS. 47 AND 49).

THE MARK CONSISTS OF STANDARD CHARACTERS WITHOUT CLAIM TO ANY PARTICULAR FONT, STYLE, SIZE, OR COLOR.

OWNER OF INTERNATIONAL REGISTRATION 1074427 DATED 2-25-2011, EXPIRES 2-25-2021.

THE ENGLISH TRANSLATION OF THE WORD "DARMAGI" IN THE MARK IS "WHAT A PITY".

SER. NO. 79-096,389, FILED 2-25-2011.

ALYSSA STEEL, EXAMINING ATTORNEY



David J. Kyffers

Director of the United States Patent and Trademark Office

United States of America

United States Patent and Trademark Office

GAIA & REY

Reg. No. 4,065,396

Registered Dec. 6, 2011

Int. Cl.: 33

TRADEMARK

PRINCIPAL REGISTER

GAJA SOCIETÀ SEMPLICE (ITALY PARTNERSHIP)
VIA TORINO, 18
BARBARESCO (CN), ITALY I12020

FOR: ALCOHOLIC BEVERAGES, NAMELY, WINE AND EAU-DE-VIE (BRANDY), IN CLASS 33 (U.S. CLS. 47 AND 49).

THE MARK CONSISTS OF STANDARD CHARACTERS WITHOUT CLAIM TO ANY PARTICULAR FONT, STYLE, SIZE, OR COLOR.

OWNER OF INTERNATIONAL REGISTRATION 1074428 DATED 2-25-2011, EXPIRES 2-25-2021.

THE ENGLISH TRANSLATION OF THE ITALIAN WORD "GAIA" IS "CHEERFUL". THE ENGLISH TRANSLATION OF THE SPANISH WORD "REY" IS "KING".

SER. NO. 79-096,390, FILED 2-25-2011.

ALYSSA STEEL, EXAMINING ATTORNEY



David J. Kybas

Director of the United States Patent and Trademark Office

United States of America

United States Patent and Trademark Office

LG Nova

Reg. No. 4,065,397

Registered Dec. 6, 2011

Int. Cl.: 9

TRADEMARK

PRINCIPAL REGISTER

LG CORP. (REPUBLIC OF KOREA INCORPORATED COMPANY)
20, YEUIDO-DONG
YEONGDEUNGPO-GU; SEOUL, 150-721
REPUBLIC OF KOREA

FOR: LIQUID CRYSTAL DISPLAY FOR MOBILE PHONES, IN CLASS 9 (U.S. CLS. 21, 23, 26, 36 AND 38).

OWNER OF U.S. REG. NOS. 3,250,591, 3,701,805 AND OTHERS.

PRIORITY DATE OF 12-15-2010 IS CLAIMED.

OWNER OF INTERNATIONAL REGISTRATION 1074665 DATED 3-15-2011, EXPIRES 3-15-2021.

SER. NO. 79-096,474, FILED 3-15-2011.

EVELYN BRADLEY, EXAMINING ATTORNEY



David J. Kybas

Director of the United States Patent and Trademark Office

United States of America

United States Patent and Trademark Office

Meridaextrema

Reg. No. 4,065,398

Registered Dec. 6, 2011

Int. Cl.: 15

TRADEMARK

PRINCIPAL REGISTER

CONCERT MUSICAL INSTRUMENT FACTORY (CHINA CORPORATION)
PINGSHAN MINYING INDUSTRIAL ZONE
HUASHAN TOWN,; HUADU DISTRICT,; GUANGZHOU; GUANGDONG
CHINA

FOR: GUITARS; STRINGED MUSICAL INSTRUMENTS; MUSICAL INSTRUMENTS; VIOLINS; ELECTRONIC MUSICAL INSTRUMENTS; SHEET MUSIC STANDS; MUSICAL INSTRUMENTS, NAMELY, HORNS; REEDS FOR USE IN WOODWIND MOUTHPIECES; PIANOS; CASES FOR MUSICAL INSTRUMENTS, IN CLASS 15 (U.S. CLS. 2, 21 AND 36).

THE MARK CONSISTS OF THE WORDING "MERIDAEXTREMA" REPRESENTED IN STYLIZED FONT.

OWNER OF INTERNATIONAL REGISTRATION 1074848 DATED 4-11-2011, EXPIRES 4-11-2021.

THE WORDING "MÉRIDAEXTREMA" HAS NO MEANING IN A FOREIGN LANGUAGE.

SER. NO. 79-096,550, FILED 4-11-2011.

WARREN L. OLANDRIA, EXAMINING ATTORNEY



David J. Kyros

Director of the United States Patent and Trademark Office

United States of America

United States Patent and Trademark Office

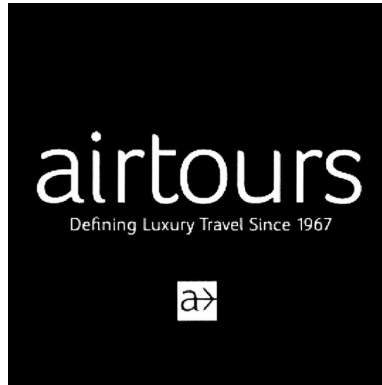

Reg. No. 4,065,399
Registered Dec. 6, 2011
Int. Cls.: 39, 41 and 43

SERVICE MARK

PRINCIPAL REGISTER

TUI AG (FED REP GERMANY AKTIENGESELLSCHAFT)
KARL-WIECHERT-ALLEE 4
30625 HANNOVER
FED REP GERMANY

FOR: TRANSPORT BY ROAD, RAIL, SEA AND AIR; PACKAGING OF GOODS FOR OTHERS AND STORAGE OF GOODS; TRANSPORT OF PERSONS AND GOODS, IN PARTICULAR BY ROAD, RAIL, SEA AND AIR; PORTER SERVICES; TRANSPORT OF MONEY AND VALUABLES; TRAVEL ORGANIZATION, BOOKING AND ARRANGEMENT OF TRAVEL, EXCURSIONS AND CRUISES; ARRANGEMENT OF TRANSPORT OF VEHICLES, PASSENGERS AND VALUABLES FOR OTHERS; RENTAL OF DEEP WATER DIVING SUITS; ORGANIZATION, BOOKING AND ARRANGEMENT OF EXCURSIONS, DAY TRIPS AND SIGHTSEEING TOURS; TRAVEL CONSULTANCY AND ESCORTING OF TRAVELERS; RENTAL OF AIRCRAFT; BOOKING OF SEATS FOR TRAVEL ON AIRCRAFT; RENTAL OF SHIPS, IN PARTICULAR ROWING AND MOTOR BOATS, SAILING VESSELS AND CANOES; BOOKING OF SEATS FOR TRAVEL ON SHIPS, IN PARTICULAR ROWING AND MOTOR BOATS, SAILING VESSELS AND CANOES; RENTAL OF MOTOR VEHICLES, BICYCLES AND HORSES; BOOKING OF SEATS FOR TRAVEL ON MOTOR VEHICLES, BICYCLES AND HORSES; PARCEL DELIVERY; ORGANIZATION OF TRIPS, HOLIDAYS AND SIGHTSEEING TOURS; TRAVEL AGENCY SERVICES, NAMELY, TRAVEL CONSULTANCY AND BOOKING SERVICES FOR TRANSPORTATION, PROVIDING INFORMATION ABOUT TRAVEL, AND ARRANGEMENT OF TRAVEL; RESERVATION OF SEATS FOR TRAVEL; PROVIDING INFORMATION ABOUT TRAVEL ON THE INTERNET RELATING TO TRAVEL RESERVATION AND TRANSPORTATION BOOKING IN THE TOURISM AND BUSINESS TRAVEL SECTOR; DELIVERY OF NEWSPAPERS AND MAGAZINES; TRAVEL CONSULTATION PROVIDED BY TELEPHONE CALL CENTERS AND TELEPHONE HOTLINES REGARDING BUSINESS TRAVEL AND THE FIELD OF LOGISTICS, TRANSPORT AND STORAGE; TRANSPORT SERVICES, NAMELY, TRACKING OF PASSENGER AND FREIGHT VEHICLES USING COMPUTERS OR GLOBAL POSITIONING SYSTEM (GPS); TRAFFIC INFORMATION, IN CLASS 39 (U.S. CLS. 100 AND 105).

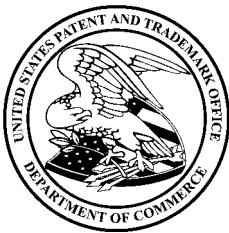

David J. Kybas

Director of the United States Patent and Trademark Office

FOR: EDUCATION AND CONTINUOUS TRAINING, NAMELY, CLASSES, SEMINARS, WORKSHOPS, PROGRAMS, AND CONFERENCES IN THE FIELD OF HOTEL MANAGEMENT, TRAVEL AND FOREIGN LANGUAGES; EDUCATIONAL CONSULTATION SERVICES RELATING TO FOREIGN LANGUAGE TRAINING AND HIGHER EDUCATION ADMINISTRATION; DISTANCE LEARNING INSTRUCTION AT THE SECONDARY, COLLEGE AND GRADUATE LEVELS AND DISTANCE LEARNING INSTRUCTION IN THE

Reg. No. 4,065,399 FIELD OF LANGUAGE INSTRUCTION; ENTERTAINMENT, NAMELY, ETHNIC FESTIVALS, TOURIST AND CULTURE SHOWS, FOOTBALL AND BASKETBALL GAMES, BASEBALL GAMES, PUPPET SHOWS, LIVE MUSICAL PERFORMANCES, WINE FESTIVALS; FILM AND VIDEO FILM PRODUCTION; DVD- AND CD-ROM-FILM PRODUCTION; PRODUCTION OF RADIO AND TELEVISION PROGRAMS; FILM AND VIDEO RENTAL; FILM AND VIDEO PERFORMANCES, NAMELY, MOVIE THEATERS, PROVISION OF NON-DOWNLOADABLE FILMS AND MOVIES VIA A VIDEO-ON-DEMAND SERVICE; ORGANIZATION OF SHOWS AND IMPRESARIO SERVICES, NAMELY, ARRANGING AND CONDUCTING CONCERTS; MODELLING FOR ARTISTS; PRESENTATION OF MUSICAL PERFORMANCES; CIRCUS PERFORMANCES; PUBLIC ENTERTAINMENT, NAMELY, BASEBALL GAMES, PUPPET SHOWS, LIVE MUSICAL PERFORMANCES, WINE FESTIVALS; THEATRICAL PERFORMANCES; ARRANGING AND CONDUCTING OF CONCERTS; TICKET AGENCY SERVICES FOR ENTERTAINMENT EVENTS; PROVIDING OF AN AFTER SCHOOL CHILDREN'S AMUSEMENT CENTRE FEATURING EDUCATIONAL ENTERTAINMENT; ENTERTAINMENT SERVICES, NAMELY, HOLIDAY CAMP SERVICES; TEACHING IN THE FIELD OF SPORTS AND LANGUAGES; HEALTH CLUB SERVICES, NAMELY, PROVIDING EQUIPMENT AND INSTRUCTION IN THE FIELD OF PHYSICAL FITNESS; PROVIDING TRAINING CLUBS AND FITNESS CLUBS, NAMELY, PROVIDING INSTRUCTION AND EQUIPMENT IN THE FIELD OF PHYSICAL EXERCISE; GOLF COURSES; PROVIDING TENNIS COURTS; PROVIDING HORSEBACK RIDING FACILITIES FOR RECREATIONAL PURPOSES; NURSERY SCHOOLS; CINEMA THEATRE FACILITIES; DISCOTHEQUES; MUSEUMS; AMUSEMENT ARCADES; SPORTS CAMPS AND PROVIDING SPORTS FACILITIES; AMUSEMENT PARKS; RENTAL OF SKIN DIVING EQUIPMENT; ORGANIZATION OF SPORTS COMPETITIONS; ORGANIZATION AND ARRANGEMENT OF CULTURAL AND SPORTING EVENTS; TICKET RESERVATION SERVICES FOR SPORTING, SCIENCE ORIENTED ENTERTAINMENT AND CULTURAL EVENTS; PROVIDED ON-LINE COMPUTER GAME SERVICES VIA A COMPUTER NETWORK; RENTAL OF PRE-RECORDED DATA CARRIERS FEATURING FILMS, MUSIC AND GAMES; RENTAL OF AUDIOVISUAL EQUIPMENT IN THE NATURE OF PROJECTORS AND THE ACCESSORIES THEREFOR; WRITING OF TEXTS, OTHER THAN PUBLICITY TEXTS; PUBLICATION OF PRINTED MATTER OTHER THAN PUBLICITY TEXTS, IN PARTICULAR OF BOOKS, MAGAZINES, NEWSPAPERS, PUBLICATION OF MATTER OTHER THAN PUBLICITY TEXTS, NAMELY, ELECTRONIC BOOKS, MAGAZINES AND NEWSPAPERS; ORGANIZATION OF EXHIBITIONS FOR CULTURAL AND TEACHING PURPOSES; SERVICES OF AN INTERPRETER AND OF A TRANSLATOR; PHOTOGRAPHY; RADIO AND TELEVISION ENTERTAINMENT PRODUCTION; CONSULTATION PROVIDED BY TELEPHONE CALL CENTERS AND HOTLINES IN THE FIELDS OF CHILD EDUCATION AND SPORTS ENTERTAINMENT; CONSULTATION PROVIDED BY TELEPHONE CALL CENTERS AND HOTLINES IN THE FIELD OF TICKET RESERVATION SERVICES FOR SPORTING, SCIENCE ORIENTED ENTERTAINMENT AND CULTURAL EVENTS; INFORMATION ABOUT ENTERTAINMENT AND ENTERTAINMENT EVENTS PROVIDED VIA ONLINE NETWORKS AND INTERNET, IN CLASS 41 (U.S. CLS. 100, 101 AND 107).

FOR: PROVIDING TEMPORARY ACCOMMODATION, PROVIDING OF FOOD AND DRINKS FOR GUESTS; ACCOMMODATION BUREAU SERVICES, NAMELY, AGENCY SERVICES FOR THE RESERVATION OF TEMPORARY ACCOMMODATION; RENTAL OF HOMES FOR TEMPORARY LIVING ACCOMMODATIONS FOR HOLIDAY VACATION STAYS; PROVIDING TEMPORARY ROOM ACCOMMODATION RESERVATION AND HOTEL RESERVATION SERVICES, PROVIDING HOTEL AND MOTEL SERVICES; CATERING; SERVICES OF BOARDING HOUSES; RENTAL OF MEETING ROOMS, NAMELY, PROVIDING SOCIAL MEETING, BANQUET AND SOCIAL FUNCTION FACILITIES AND PROVIDING OF CONFERENCE, EXHIBITION AND MEETING FACILITIES; BAR SERVICES; PROVIDING OF FOOD AND DRINKS FOR GUESTS IN RESTAURANTS; PROVIDING FOOD AND DRINKS IN INTERNET CAFES; CONSULTATION PROVIDED BY TELEPHONE CALL CENTERS AND HOTLINES IN THE FIELD OF TEMPORARY ROOM AND BOARD ACCOMMODATION SERVICES, RENTAL OF HOMES FOR TEMPORARY LIVING ACCOMMODATIONS FOR HOLIDAY VACATION STAYS, HOTEL RESERVATIONS AND CATERING FOR GUESTS, IN CLASS 43 (U.S. CLS. 100 AND 101).

Reg. No. 4,065,399 NO CLAIM IS MADE TO THE EXCLUSIVE RIGHT TO USE "AIRTOURS" AND "LUXURY TRAVEL SINCE 1967" , APART FROM THE MARK AS SHOWN.

PRIORITY DATE OF 9-9-2010 IS CLAIMED.

OWNER OF INTERNATIONAL REGISTRATION 1075129 DATED 10-9-2010, EXPIRES 10-9-2020.

THE MARK CONSISTS OF THE WORDING "AIRTOURS" ABOVE THE WORDING "DEFINING LUXURY TRAVEL SINCE 1967" ABOVE A STYLIZED REPRESENTATION OF THE LETTER "A" AND AN ARROW, ALL WITHIN A SHADED SQUARE.

SER. NO. 79-096,668, FILED 10-9-2010.

TRACY FLETCHER, EXAMINING ATTORNEY

United States of America
United States Patent and Trademark Office

TINI

Reg. No. 4,065,400

Registered Dec. 6, 2011

Int. Cl.: 33

TRADEMARK

PRINCIPAL REGISTER

COOPERATIVE AGRICOLE VITI - FRUTTICOLTORI ITALIANI RIUNITI ORGANIZZATI
S.C.A. (ITALY COOPERATIVE COMPANY)
VIA DELLE CONVERTITE, 12
I-48018 FAENZA, ITALY

FOR: WINE AND SPARKLING WINE, IN CLASS 33 (U.S. CLS. 47 AND 49).

THE MARK CONSISTS OF THE WORD "TINI" IN STYLIZED FORM.

OWNER OF INTERNATIONAL REGISTRATION 0785388 DATED 5-24-2002, EXPIRES 5-24-2012.

SER. NO. 79-096,729, FILED 3-3-2011.

ALLISON HOLTZ, EXAMINING ATTORNEY



David J. Kybas

Director of the United States Patent and Trademark Office

United States of America

United States Patent and Trademark Office

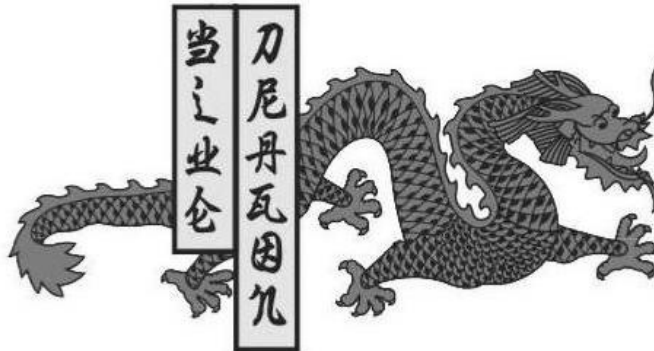

Reg. No. 4,065,401

Registered Dec. 6, 2011

Int. Cls.: 29 and 30

TRADEMARK

PRINCIPAL REGISTER

AB WORLD FOODS LIMITED (ENGLAND LIMITED LIABILITY COMPANY)
WESTON CENTRE
10 GROSVENOR STREET; LONDON W1K 4QY
UNITED KINGDOM

FOR: PRESERVED, DRIED, COOKED, FROZEN OR PROCESSED FRUITS AND VEGETABLES; PROCESSED, EDIBLE SEAWEED; SOUP PASTES; SOUP AND PREPARATIONS FOR MAKING SOUP; COCONUT MILK FOR COOKING, DESICCATED COCONUT; COCONUT POWDER; COCONUT BUTTER; PICKLES; EDIBLE OILS; SNACK FOODS CONSISTING PRIMARILY OF MEAT, FRUITS AND VEGETABLES; PREPARED MEALS CONSISTING PRIMARILY OF MEAT, FRUITS AND VEGETABLES, IN CLASS 29 (U.S. CL. 46).

FOR: AROMATIC PREPARATIONS FOR FOOD, NAMELY, SEASONINGS AND SPICES; CHUTNEYS; SAUCES; SOUP FLAVOURINGS AND SOUP PASTE IN THE NATURE OF SEASONING MIXES; VINEGAR, SPICES, CONDIMENTS, NAMELY, SAUCES AND SPICES; NOODLES, VERMICELLI NOODLES; RICE; CURRY PASTE; PREPARED MEALS CONSISTING PRIMARILY OF NOODLES AND RICE; CEREAL BASED SNACK FOODS; FROZEN FOODS, NAMELY, FROZEN PREPARED MEALS CONSISTING PRIMARILY OF NOODLES, RICE; PRESERVED GARDEN HERBS, DRIED CULINARY HERBS; STEM GINGER, IN CLASS 30 (U.S. CL. 46).

THE MARK CONSISTS OF A DRAGON BEHIND TWO RECTANGULAR BANNERS CONTAINING HIGHLY STYLIZED LATIN CHARACTERS FOR THE WORDS BLUE DRAGON.

PRIORITY DATE OF 10-26-2010 IS CLAIMED.

OWNER OF INTERNATIONAL REGISTRATION 1075562 DATED 2-28-2011, EXPIRES 2-28-2021.

SER. NO. 79-096,831, FILED 2-28-2011.

NICHOLAS COLEMAN, EXAMINING ATTORNEY



David J. Kyros

Director of the United States Patent and Trademark Office

United States of America

United States Patent and Trademark Office

SocialSalesMap

Reg. No. 4,065,402

Registered Dec. 6, 2011

Int. Cls.: 9, 35, 41 and 42

TRADEMARK

SERVICE MARK

PRINCIPAL REGISTER

ANDREAS UTHMANN (FED REP GERMANY INDIVIDUAL)
BITZIBERG 34
CH-8184 BACHENBÜLACH
SWITZERLAND

FOR: CALCULATING MACHINES, DATA PROCESSING EQUIPMENT AND COMPUTERS, IN CLASS 9 (U.S. CLS. 21, 23, 26, 36 AND 38).

FOR: ADVERTISING; BUSINESS MANAGEMENT; BUSINESS ADMINISTRATION CONSULTANCY; PROVIDING OFFICE FUNCTIONS, IN CLASS 35 (U.S. CLS. 100, 101 AND 102).

FOR: EDUCATION, NAMELY, SOFTWARE, INFORMATION TECHNOLOGY, CUSTOMER RELATIONSHIP MANAGEMENT (CRM), SALES AND MARKETING COURSES, CONFERENCES AND EVENTS; PROVIDING OF TRAINING IN THE FIELDS OF SOFTWARE, INFORMATION TECHNOLOGY, CUSTOMER RELATIONSHIP MANAGEMENT (CRM), SALES AND MARKETING, IN CLASS 41 (U.S. CLS. 100, 101 AND 107).

FOR: INDUSTRIAL ANALYSIS AND RESEARCH SERVICES IN THE FIELD OF SOFTWARE, INFORMATION TECHNOLOGY, CUSTOMER RELATIONSHIP MANAGEMENT (CRM), SALES AND MARKETING; DESIGN AND DEVELOPMENT OF COMPUTERS AND SOFTWARE, IN CLASS 42 (U.S. CLS. 100 AND 101).

THE MARK CONSISTS OF STANDARD CHARACTERS WITHOUT CLAIM TO ANY PARTICULAR FONT, STYLE, SIZE, OR COLOR.

PRIORITY DATE OF 2-18-2011 IS CLAIMED.

OWNER OF INTERNATIONAL REGISTRATION 1075597 DATED 4-1-2011, EXPIRES 4-1-2021.

SER. NO. 79-096,841, FILED 4-1-2011.

RON FAIRBANKS, EXAMINING ATTORNEY



David J. Kyros

Director of the United States Patent and Trademark Office

United States of America

United States Patent and Trademark Office

ASTRONAUTA

Reg. No. 4,065,403

ANÍBAL JOSÉ SIMÕES COUTINHO (PORTUGAL INDIVIDUAL)
AZINHAGA DAS GALHARDAS, N° 183, 3° B
P-1600-471 LISBOA, PORTUGAL

Registered Dec. 6, 2011

Int. Cl.: 33

FOR: WINES, IN CLASS 33 (U.S. CLS. 47 AND 49).

TRADEMARK

THE MARK CONSISTS OF STANDARD CHARACTERS WITHOUT CLAIM TO ANY PARTICULAR FONT, STYLE, SIZE, OR COLOR.

PRINCIPAL REGISTER

OWNER OF INTERNATIONAL REGISTRATION 1075933 DATED 3-23-2011, EXPIRES 3-23-2021.

THE ENGLISH TRANSLATION OF "ASTRONAUTA" IN THE MARK IS "ASTRONAUT".

SER. NO. 79-096,939, FILED 3-23-2011.

GENE MACIOL, EXAMINING ATTORNEY



David J. Kybas

Director of the United States Patent and Trademark Office

United States of America
United States Patent and Trademark Office

Frebini

Reg. No. 4,065,404

Registered Dec. 6, 2011

Int. Cl.: 5

TRADEMARK

PRINCIPAL REGISTER

FRESENIUS SE & CO. KGAA (FED REP GERMANY SOCIETAS EUROPÆ (SE))
ELSE-KRÖNER-STRASSE 1
61352 BAD HOMBURG
FED REP GERMANY

FOR: DIETETIC PRODUCTS, NAMELY, NUTRITIONAL SUPPLEMENTS FOR ENTERAL FEEDING FOR INDIVIDUALS WITH SPECIAL DIETARY REQUIREMENTS NECESSITATED BY MEDICAL TREATMENT; DIETETIC PRODUCTS, NAMELY, TUBE FEEDINGS FOR ENTERAL NUTRITION FOR INDIVIDUALS WITH SPECIAL DIETARY REQUIREMENTS NECESSITATED BY MEDICAL TREATMENT, IN CLASS 5 (U.S. CLS. 6, 18, 44, 46, 51 AND 52).

OWNER OF INTERNATIONAL REGISTRATION 0640953 DATED 6-30-1995, EXPIRES 6-30-2015.

SER. NO. 79-096,965, FILED 12-22-2010.

MATTHEW EINSTEIN, EXAMINING ATTORNEY



David J. Kybas

Director of the United States Patent and Trademark Office

United States of America

United States Patent and Trademark Office

STELLAR

PIPE&TUBE Group

Reg. No. 4,065,405

Registered Dec. 6, 2011

Int. Cl.: 6

TRADEMARK

PRINCIPAL REGISTER

STELLAR TUBE & PIPE GROUP CO., LTD. (CHINA CORPORATION)

QINGSHAN VILLAGE

YONGZHONG STREET;; LONGWAN DISTRICT;; WENZHOU; ZHEJIANG PROVINCE
CHINA

FOR: ELBOWS OF METAL FOR PIPES; JUNCTIONS OF METAL FOR PIPES; STEEL TUBES;
DUCTS AND PIPES OF METAL FOR CENTRAL HEATING INSTALLATIONS; BRANCHING
PIPES OF METAL; DRAIN PIPES MADE OF METAL; TUBES OF METAL; CASINGS OF
METAL FOR OILWELLS; METAL GUTTER PIPES; PIPEWORK OF METAL, IN CLASS 6
(U.S. CLS. 2, 12, 13, 14, 23, 25 AND 50).

NO CLAIM IS MADE TO THE EXCLUSIVE RIGHT TO USE "PIPE & TUBE GROUP", APART
FROM THE MARK AS SHOWN.

OWNER OF INTERNATIONAL REGISTRATION 1076326 DATED 3-28-2011, EXPIRES 3-28-
2021.

THE MARK CONSISTS OF THE STYLIZED WORDING "STELLAR PIPE&TUBE GROUP".

SER. NO. 79-097,086, FILED 3-28-2011.

SEAN CROWLEY, EXAMINING ATTORNEY



David J. Kybas

Director of the United States Patent and Trademark Office

United States of America

United States Patent and Trademark Office



Reg. No. 4,065,406

Registered Dec. 6, 2011

Int. Cls.: 29, 30 and 32

TRADEMARK

PRINCIPAL REGISTER

FRATELLI LONGOBARDI S.R.L. (ITALY LIMITED COMPANY LTD)
VIA DELLE INDUSTRIE, 15
I-84018 SCAFATI (SA), ITALY

FOR: MEAT, FISH, POULTRY AND GAME; MEAT EXTRACTS; PRESERVED, FROZEN, DRIED AND COOKED FRUITS AND VEGETABLES; JELLIES, JAMS, COMPOTES; EGGS, MILK; EDIBLE OILS AND FATS, IN CLASS 29 (U.S. CL. 46).

FOR: COFFEE, TEA, COCOA, SUGAR, RICE, TAPIOCA, SAGO, ARTIFICIAL COFFEE; FLOUR; ICES; HONEY, TREACLE; YEAST, BAKING POWDER; SALT, MUSTARD; VINEGAR, SAUCES; SPICES; ICE, IN CLASS 30 (U.S. CL. 46).

FOR: BEERS; MINERAL AND AERATED WATERS; FRUIT DRINKS AND FRUIT JUICES, IN CLASS 32 (U.S. CLS. 45, 46 AND 48).

NO CLAIM IS MADE TO THE EXCLUSIVE RIGHT TO USE "FRATELLI", APART FROM THE MARK AS SHOWN.

PRIORITY DATE OF 3-4-2011 IS CLAIMED.

OWNER OF INTERNATIONAL REGISTRATION 1076341 DATED 3-15-2011, EXPIRES 3-15-2021.



THE MARK CONSISTS OF THE WORD "FRATELLI" WITHIN A QUADRILATERAL WITHIN ANOTHER QUADRILATERAL HAVING DOTS ALONG THE BORDER, A SCROLL-LIKE CURVE IN THE BOTTOM LEFT, A HALF-CIRCLE DESIGN AT THE CENTER-TOP CONSISTING OF FOUR TEAR DROP SHAPED DESIGNS WITH THREE LINES WITH DOTS ABOVE; AND A VINE WITH LEAVES AROUND THE ENTIRE QUADRILATERAL; BELOW AND TO THE RIGHT OF THE TOP QUADRILATERAL IS ANOTHER CONNECTED QUADRILATERAL WITH THE WORD "LONGOBARDI" IN THE CENTER WITH THE SAME DESIGN FEATURES AS THE TOP QUADRILATERAL EXCEPT HALF-CIRCLE DESIGN IS AT THE CENTER-BOTTOM.

David J. Kyros

THE ENGLISH TRANSLATION OF THE FOREIGN WORD(S) IN THE MARK IS: "LONGOBARDI BROTHERS".

SER. NO. 79-097,092, FILED 3-15-2011.

Director of the United States Patent and Trademark Office

Reg. No. 4,065,406 MAYUR VAGHANI, EXAMINING ATTORNEY

United States of America

United States Patent and Trademark Office

NCP

engineering

Reg. No. 4,065,407

Registered Dec. 6, 2011

Int. Cl.: 9

NCPE GMBH NETWORK COMMUNICATIONS PRODUCTS ENGINEERING (FED REP GERMANY LIMITED LIABILITY COMPANY)
DOMBÜHLER STR. 2
90449 NÜRNBERG
FED REP GERMANY

TRADEMARK

FOR: COMPUTER SOFTWARE FOR USE WITH VIRTUAL PRIVATE NETWORKS (VPN) AND TO PROVIDE REMOTE ACCESS AND TO ADMINISTER ALL RELATED PROCESSES, IN CLASS 9 (U.S. CLS. 21, 23, 26, 36 AND 38).

PRINCIPAL REGISTER

NO CLAIM IS MADE TO THE EXCLUSIVE RIGHT TO USE "ENGINEERING", APART FROM THE MARK AS SHOWN.

PRIORITY DATE OF 9-22-2010 IS CLAIMED.

OWNER OF INTERNATIONAL REGISTRATION 1076463 DATED 3-21-2011, EXPIRES 3-21-2021.

SER. NO. 79-097,130, FILED 3-21-2011.

SKYE YOUNG, EXAMINING ATTORNEY



David J. Kyffers

Director of the United States Patent and Trademark Office

United States of America
United States Patent and Trademark Office

96 HOURS

Reg. No. 4,065,408

Registered Dec. 6, 2011

Int. Cl.: 25

TRADEMARK

PRINCIPAL REGISTER

ZHUANG WAN ZHEN (CHINA INDIVIDUAL)
NO. 13 XIACHETOU ROAD
QINGYANG TOWN,; JINJIANG CITY; FUJIAN PROVINCE
CHINA

FOR: WATERPROOF CLOTHING, NAMELY, JACKETS,PANTS; BABY LAYETTES FOR CLOTHING; BATHING SUITS; SHOES; HATS; HOSIERY; NECKTIES; SOLES FOR FOOTWEAR; CLOTHING, NAMELY, SHIRTS, TROUSERS, JACKETS, COATS, LEATHER COATS, SKIRTS, SINGLET, T-SHIRTS, UNDERWEAR, IN CLASS 25 (U.S. CLS. 22 AND 39).

THE MARK CONSISTS OF THE STYLIZED WORDING "96 HOURS".

OWNER OF INTERNATIONAL REGISTRATION 1076598 DATED 4-14-2011, EXPIRES 4-14-2021.

SER. NO. 79-097,180, FILED 4-14-2011.

COURTNEY ALVAREZ, EXAMINING ATTORNEY



David J. Kyffers

Director of the United States Patent and Trademark Office

United States of America

United States Patent and Trademark Office

AVIDITY

Reg. No. 4,065,409

Registered Dec. 6, 2011

Int. Cls.: 9, 35, 36 and 45

TRADEMARK

SERVICE MARK

PRINCIPAL REGISTER

HLBBSHAW LIMITED (UNITED KINGDOM LIMITED COMPANY)
MERLIN HOUSE
FALCONRY COURT, BAKER'S LANE; EPPING, ESSEX CM16 5DQ
UNITED KINGDOM

FOR: DOWNLOADABLE ELECTRONIC PUBLICATIONS IN THE NATURE OF NEWSLETTERS, BOOKLETS AND EDUCATIONAL JOURNALS IN THE FIELD OF PATENTS, TRADE MARKS, REGISTERED AND UNREGISTERED DESIGN RIGHTS, COPYRIGHTS AND INTELLECTUAL PROPERTY; ELECTRONIC PUBLICATIONS, NAMELY, NEWSLETTERS, BOOKLETS AND EDUCATIONAL JOURNALS IN THE FIELD OF PATENTS, TRADE MARKS, REGISTERED AND UNREGISTERED DESIGN RIGHTS, COPYRIGHTS AND INTELLECTUAL PROPERTY RECORDED ON COMPUTER MEDIA; DOWNLOADABLE ELECTRONIC PUBLICATIONS IN THE NATURE OF NEWSLETTERS, BOOKLETS AND EDUCATIONAL JOURNALS IN THE FIELD OF PATENTS, TRADE MARKS, REGISTERED AND UNREGISTERED DESIGN RIGHTS, COPYRIGHTS AND INTELLECTUAL PROPERTY PROVIDED VIA ON-LINE DATABASES, INTERNET FACILITIES AND WEBSITES, IN CLASS 9 (U.S. CLS. 21, 23, 26, 36 AND 38).

FOR: BUSINESS RECORDS MANAGEMENT SERVICES IN THE FIELD OF INTELLECTUAL PROPERTY RIGHTS; BUSINESS MANAGEMENT OF CORPORATE INTELLECTUAL PROPERTY LAW DEPARTMENTS, IN CLASS 35 (U.S. CLS. 100, 101 AND 102).

FOR: BILL PAYMENT SERVICES, NAMELY, MANAGEMENT OF PAYMENTS MADE FOR RENEWALS RELATING TO INTELLECTUAL PROPERTY RIGHTS AND REGISTRATIONS; INTELLECTUAL PROPERTY VALUATION SERVICES, IN CLASS 36 (U.S. CLS. 100, 101 AND 102).

FOR: INTELLECTUAL PROPERTY CONSULTATION SERVICES; INTELLECTUAL PROPERTY WATCH SERVICES; INTELLECTUAL PROPERTY SERVICES, NAMELY, LICENSING OF INTELLECTUAL PROPERTY; LEGAL SERVICES IN THE FIELD OF INTELLECTUAL PROPERTY, NAMELY, SEARCHING INTELLECTUAL PROPERTY DATABASES, DRAFTING INTELLECTUAL PROPERTY REGISTRATION DOCUMENTS, FILING INTELLECTUAL PROPERTY REGISTRATION DOCUMENTS, PROSECUTION OF INTELLECTUAL PROPERTY APPLICATIONS, PREPARING AND FILING DOCUMENTS TO MAINTAIN INTELLECTUAL PROPERTY REGISTRATIONS, FILING LEGAL OPPOSITIONS TO POTENTIALLY INFRINGING INTELLECTUAL PROPERTY APPLICATIONS, AND PREPARING AND FILING LEGAL DOCUMENTS FOR CANCELLATION, REVOCATION, INVALIDATION, MAINTEN-



David J. Kyros

Director of the United States Patent and Trademark Office

Reg. No. 4,065,409 ANCE, RENEWAL AND ENFORCEMENT OF INTELLECTUAL PROPERTY REGISTRATIONS; INTELLECTUAL PROPERTY CONSULTATION SERVICES RELATING TO LICENSING, ASSIGNMENT AND OTHER TRANSACTIONS IN RELATION TO INTELLECTUAL PROPERTY RIGHTS; PROVIDING INFORMATION IN THE FIELD OF INTELLECTUAL PROPERTY IN THE NATURE OF A RECORD OF TRANSACTIONS RELATING TO INTELLECTUAL PROPERTY AND CHANGES OF NAME AND CHANGES OF ADDRESS OF PERSONS ASSOCIATED WITH INTELLECTUAL PROPERTY; PATENT AND TRADEMARK AGENCY INTELLECTUAL PROPERTY CONSULTATION SERVICES; PATENT AND TRADEMARK ATTORNEY SERVICES; LEGAL SERVICES, NAMELY, PROVIDING LEGAL ADVICE IN THE FIELD OF INTELLECTUAL PROPERTY RELATING TO PATENTS, TRADE MARKS, COPYRIGHT AND REGISTERED AND UNREGISTERED DESIGN RIGHTS AND OTHER INTELLECTUAL PROPERTY RIGHTS; LEGAL SERVICES IN THE FIELD OF REGISTRATIONS RELATING TO PATENTS, TRADE MARKS, COPYRIGHT AND REGISTERED AND UNREGISTERED DESIGN RIGHTS AND OTHER INTELLECTUAL PROPERTY RIGHTS; INTELLECTUAL PROPERTY CONSULTATION SERVICES IN THE FIELD OF REGISTRATIONS RELATING TO PATENTS, TRADE MARKS, COPYRIGHT AND REGISTERED AND UNREGISTERED DESIGN RIGHTS AND OTHER INTELLECTUAL PROPERTY RIGHTS; INTELLECTUAL PROPERTY PARALEGAL AND PUBLIC RECORDS INVESTIGATION SERVICES; INTELLECTUAL PROPERTY CONSULTATION SERVICES RELATING TO INTELLECTUAL PROPERTY PORTFOLIO MANAGEMENT AND AUDITING; INTELLECTUAL PROPERTY WATCH SERVICES, NAMELY, WATCHING AND MONITORING SERVICES IN RELATION TO TRADE MARK AND OTHER INTELLECTUAL PROPERTY RIGHTS; LEGAL SERVICES IN THE FIELD OF INTELLECTUAL PROPERTY, NAMELY, PROVIDING LEGAL CONSULTATION CONCERNING THE DRAFTING OF INTELLECTUAL PROPERTY RIGHTS PROGRESS DIARIES; LEGAL SERVICES, ALL RELATING TO INTELLECTUAL PROPERTY RIGHTS; LEGAL RESEARCH, ARBITRATION, MEDIATION, LEGAL SERVICES IN THE NATURE OF CONCILIATION AND ALTERNATIVE DISPUTE RESOLUTION SERVICES ALL RELATING TO INTELLECTUAL PROPERTY RIGHTS; LITIGATION AND LITIGATION SUPPORT SERVICES ALL RELATING TO INTELLECTUAL PROPERTY RIGHTS, IN CLASS 45 (U.S. CLS. 100 AND 101).

THE MARK CONSISTS OF STANDARD CHARACTERS WITHOUT CLAIM TO ANY PARTICULAR FONT, STYLE, SIZE, OR COLOR.

PRIORITY DATE OF 8-24-2010 IS CLAIMED.

OWNER OF INTERNATIONAL REGISTRATION 1076728 DATED 2-24-2011, EXPIRES 2-24-2021.

SER. NO. 79-097,223, FILED 2-24-2011.

MICHAEL GAAFAR, EXAMINING ATTORNEY

United States of America

United States Patent and Trademark Office



Reg. No. 4,065,410

Registered Dec. 6, 2011

Int. Cls.: 9, 38 and 42

TRADEMARK

SERVICE MARK

PRINCIPAL REGISTER

NVS TECHNOLOGIES AG (SWAZILAND SOCIÉTÉ ANONYME (SA))
LETZAUSTRASSE 2
CH-9462 MONTLINGEN
SWITZERLAND

FOR: ELECTRONIC AND SCIENTIFIC APPARATUS, NAMELY, COMPASSES, GPS RECEIVERS, ODOMETERS, SLOPE INDICATORS, SPEEDOMETERS AND VERTICAL GYROSCOPES USED FOR THE ELECTRONIC IDENTIFICATION OF A GEOGRAPHICAL POSITION, DIRECTION AND SPEED; DETECTORS AND BUILDING ELEMENTS, NAMELY, COMPASSES, GPS RECEIVERS, ODOMETERS, SLOPE INDICATORS, SPEEDOMETERS AND VERTICAL GYROSCOPES USED FOR THE ELECTRONIC IDENTIFICATION OF GEOGRAPHICAL POSITION, DIRECTION AND SPEED; SENSORS AND PROBES AND THE PARTS THEREOF FOR THE ELECTRONIC IDENTIFICATION OF GEOGRAPHICAL SITES; ELECTRONIC NAVIGATIONAL APPARATUS AND DEVICES, NAMELY, COMPASSES, NAVIGATION DEVICES, NAMELY, GNSS NAVIGATION DEVICES, DATA PROCESSING AND COMPUTER DEVICES, NAMELY, DATA PROCESSING EQUIPMENT AND COMPUTERS; ODOMETERS, SLOPE INDICATORS, SPEEDOMETERS AND VERTICAL GYROSCOPES FOR THE ELECTRONIC IDENTIFICATION OF GEOGRAPHIC POSITION, APPARATUS FOR DETERMINING THE GEOGRAPHIC LOCATION OF OBJECTS, AND GLOBAL POSITIONING APPARATUS, NAMELY, GLOBAL POSITIONING DEVICES (GPS) CONSISTING OF COMPUTERS, COMPUTER SOFTWARE, FIRMWARE, TRANSMITTERS, RECEIVERS AND NETWORK INTERFACE DEVICES, SATELLITE SUPPORTED NAVIGATION SYSTEMS, NAMELY, GPS EQUIPMENT FOR TRACKING AND LOCATING VEHICLES, PROGRAMMED FOR GPS AND CELLULAR TELECOMMUNICATIONS USE; GPS RECEIVERS; CHIPSETS FOR RECEIVERS, RECEIVER UNITS, SATELLITE RECEIVERS, BASEBAND RECEIVERS, CENTRAL PROCESSING UNITS FOR RECEIVERS, HIGH FREQUENCY RECEIVER CONVERTERS, SMART ANTENNAS, ACTIVE ANTENNA MODULES AND RECEIVER CARDS; APPARATUS FOR MEASURING ELECTROMAGNETIC FIELDS, NAMELY, ANTENNAS; ELECTRONIC COMPASSES INCLUDED IN EQUIPMENT AND COMPUTER SOFTWARE SOLD AS INTEGRAL WIRELESS COMMUNICATIONS APPLICATION COMPONENTS SUCH AS MOBILE TELEPHONES; PORTABLE COMMUNICATION APPLICATIONS, NAMELY, PERSONAL DIGITAL ASSISTANTS (PDAS), RADIO PAGING RECEIVERS, PAGING EQUIPMENT, LAPTOP COMPUTERS, AND WIRELESS FACSIMILE MACHINES WHICH SUPPLY TRACKING, NAVIGATION AND SIGNAL TRANSMISSION FOR THE ELECTRONIC POSITIONING OF GEOGRAPHICAL SITES; COMPUTER EQUIPMENT, NAMELY, MICRO-PROCESSORS AND SIGNAL PROCESSORS; DIRECTIONAL COMPASSES; BLANK MAGNETIC, ELECTRONIC AND OPTICAL DATA MEDIA; COMPUTERS, CABLES, NAMELY,



David J. Kybas

Director of the United States Patent and Trademark Office

Reg. No. 4,065,410 COMPUTER CABLES AND DATA CABLES, KEYBOARDS, MONITORS, COMPUTER MICE AND COMPUTER SOFTWARE, INCLUDING EMBEDDED SOFTWARE FOR NAVIGATION PURPOSES AND TRANSMISSION OF SATELLITE SIGNALS, SENSOR FUSION, COMBINATIONS WITH ADDITIONAL MEASURES AND VISUALIZATION OF RESULTS FOR USE IN ELECTRONIC GEOPOSITIONING, DETERMINATION OF DIRECTION AND SPEED; INTEGRATED CIRCUITS FOR USE IN ELECTRONIC GEOPOSITIONING, DETERMINATION OF DIRECTION AND SPEED; BLANK MAGNETIC, OPTICAL AND ELECTRONIC DATA MEDIA, IN CLASS 9 (U.S. CLS. 21, 23, 26, 36 AND 38).

FOR: TELECOMMUNICATIONS SERVICES, NAMELY PROVIDING ELECTRONIC TELECOMMUNICATIONS CONNECTIONS, ELECTRONIC EXCHANGE OF DATA RECORDED IN DATABASES ACCESSIBLE VIA TELECOMMUNICATIONS NETWORKS, TRANSMISSION OF SUPPORT DATA, TRANSMISSION OF POSITIONING DATA; PROVIDING ACCESS TO SATELLITE-SUPPORTED TELECOMMUNICATIONS NETWORKS; ELECTRONIC TRANSMISSION OF DATA AND MESSAGES; CONSULTING SERVICES IN THE FIELD OF TELECOMMUNICATIONS; PROVIDING A COMPUTER DATABASE ON-LINE IN THE FIELD OF TELECOMMUNICATIONS AND FOR THE USE OF TELECOMMUNICATION APPARATUS, NAMELY GLOBAL POSITIONING SYSTEMS FOR CHECKING, NAVIGATING, MONITORING TRAFFIC AND THE AUTOMATIC LOCATION OF VEHICLES, IN CLASS 38 (U.S. CLS. 100, 101 AND 104).

FOR: SCIENTIFIC AND INDUSTRIAL RESEARCH IN THE FIELD OF TELECOMMUNICATIONS, INSPECTIONS, NAVIGATION AND AUTOMATIC LOCATION OF VEHICLES; CONSULTING IN COMPUTER SOFTWARE, IN COMPUTERS AND TECHNOLOGY; DEVELOPMENT, CREATION, DESIGN, UPGRADING AND MAINTENANCE OF COMPUTER SOFTWARE RELATING TO TELECOMMUNICATIONS, CHECKING, NAVIGATING AND MONITORING OF TRAFFIC AND THE AUTOMATIC LOCATION OF VEHICLES; PROGRAMMING OF DATABASES RELATING TO TELECOMMUNICATIONS, CHECKING, NAVIGATING AND THE AUTOMATIC LOCATION OF VEHICLES; CONVERSION OF COMPUTER DATA AND PROGRAMS EXCEPT THE PHYSICAL CONVERSION; COMPUTING SERVICES EXCEPT COMPUTER DESIGN, NAMELY, THE DESIGN OF SUPPORT DATA AND THE DESIGN OF POSITIONING DATA, IN CLASS 42 (U.S. CLS. 100 AND 101).

THE MARK CONSISTS OF THE FOLLOWING: A STYLIZED LETTER "N" IN THE COLOR GREY WITH RED CIRCLE AT TOP OF THE LETTER "N" WITH WHITE OUTLINING AROUND THE CIRCLE AND WITHIN THE LETTER "N".

OWNER OF INTERNATIONAL REGISTRATION 1076779 DATED 2-23-2011, EXPIRES 2-23-2021.

THE COLOR(S) GREY, WHITE AND RED IS/ARE CLAIMED AS A FEATURE OF THE MARK.

SER. NO. 79-097,264, FILED 2-23-2011.

JOSETTE BEVERLY, EXAMINING ATTORNEY

United States of America

United States Patent and Trademark Office

MINI Driving Experience

Reg. No. 4,065,411

Registered Dec. 6, 2011

Int. Cl.: 41

SERVICE MARK

PRINCIPAL REGISTER

BAYERISCHE MOTOREN WERKE AKTIENGESELLSCHAFT (FED REP GERMANY
AKTIENGESELLSCHAFT (JOINT STOCK COMPANY))
PETUELRING 130
80809 MÜNCHEN, FED REP GERMANY

FOR: DRIVER SAFETY TRAINING, IN CLASS 41 (U.S. CLS. 100, 101 AND 107).

THE MARK CONSISTS OF STANDARD CHARACTERS WITHOUT CLAIM TO ANY PARTICULAR FONT, STYLE, SIZE, OR COLOR.

PRIORITY DATE OF 11-24-2010 IS CLAIMED.

OWNER OF INTERNATIONAL REGISTRATION 1076885 DATED 4-9-2011, EXPIRES 4-9-2021.

OWNER OF U.S. REG. NOS. 2,746,570 AND 2,757,755.

NO CLAIM IS MADE TO THE EXCLUSIVE RIGHT TO USE "DRIVING EXPERIENCE", APART FROM THE MARK AS SHOWN.

SER. NO. 79-097,302, FILED 4-9-2011.

SUSAN LESLIE DUBOIS, EXAMINING ATTORNEY



David J. Kyffers

Director of the United States Patent and Trademark Office

United States of America
United States Patent and Trademark Office

Provicol

Reg. No. 4,065,412

Registered Dec. 6, 2011

Int. Cls.: 5 and 10

TRADEMARK

PRINCIPAL REGISTER

VOCO GMBH (FED REP GERMANY GMBH ("COMPANY WITH LIMITED LIABILITY"))
ANTON-FLETTNER-STR. 1-3
27472 CUXHAVEN
FED REP GERMANY

FOR: PHARMACEUTICAL PRODUCTS AND DENTAL MATERIALS FOR DENTAL MEDICINE, NAMELY, DIRECT AND INDIRECT RESTORATION COMPOUNDS, DENTAL ANESTHETICS FOR DESENSITIZING TEETH AND GUMS, FISSURE SEALING DENTAL RESINS, MATERIAL FOR TEMPORARY DENTAL BRIDGES AND DENTAL CROWNS, DENTAL VENEERS, DENTAL REPAIRING COMPOSITES, DENTAL ABRASIVES, DENTAL MASTICS, ADHESIVES FOR DENTURES, MOULDING WAX FOR DENTISTS, PORCELAIN FOR DENTAL PROSTHESES, DENTAL IMPRESSION MATERIALS AND DENTAL VARNISHES, IN CLASS 5 (U.S. CLS. 6, 18, 44, 46, 51 AND 52).

FOR: DENTAL APPARATUS AND INSTRUMENTS, NAMELY, APPLICATION AIDS, NAMELY, MIXING TIPS, DISPENSER, SPATULAS, BRUSH HOLDER, DISPOSABLE BRUSHES, FORMWORKS, DENTAL MATRIXES, DENTAL BURS BEING DENTAL CUTTERS, REAMER, FINISHING BURS, DENTAL DRILLS, ARTIFICIAL TEETH, DENTURES, IN CLASS 10 (U.S. CLS. 26, 39 AND 44).

THE MARK CONSISTS OF STANDARD CHARACTERS WITHOUT CLAIM TO ANY PARTICULAR FONT, STYLE, SIZE, OR COLOR.

PRIORITY DATE OF 8-10-2010 IS CLAIMED.

OWNER OF INTERNATIONAL REGISTRATION 1077073 DATED 2-8-2011, EXPIRES 2-8-2021.

THE WORDING "PROVICOL" HAS NO MEANING IN A FOREIGN LANGUAGE.

SER. NO. 79-097,364, FILED 2-8-2011.

MELISSA VALLILLO, EXAMINING ATTORNEY



David J. Kyffers

Director of the United States Patent and Trademark Office

United States of America

United States Patent and Trademark Office

EliteBake

Reg. No. 4,065,413

Registered Dec. 6, 2011

Int. Cl.: 16

TRADEMARK

PRINCIPAL REGISTER

AHLSTROM CORPORATION (FINLAND PUBLIC LIMITED COMPANY)
SALMISAARENAUKIO 1,
FI-00180 HELSINKI
FINLAND

FOR: GENUINE PARCHMENT PAPERS FOR BAKING, COOKING AND FOOD PACKAGING APPLICATIONS, IN CLASS 16 (U.S. CLS. 2, 5, 22, 23, 29, 37, 38 AND 50).

PRIORITY DATE OF 11-9-2010 IS CLAIMED.

OWNER OF INTERNATIONAL REGISTRATION 1077976 DATED 4-26-2011, EXPIRES 4-26-2021.

SER. NO. 79-097,660, FILED 4-26-2011.

HAI-LY LAM, EXAMINING ATTORNEY



David J. Kyffers

Director of the United States Patent and Trademark Office

United States of America

United States Patent and Trademark Office

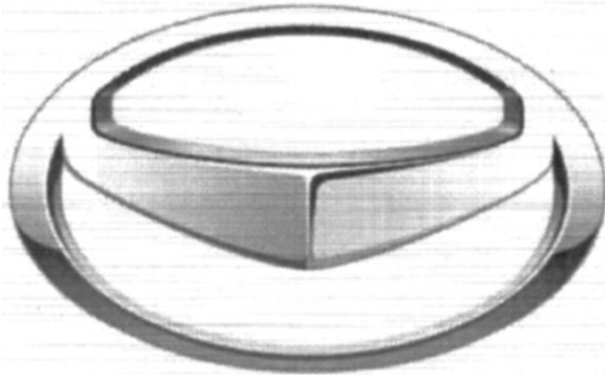

Reg. No. 4,065,414

Registered Dec. 6, 2011

Int. Cls.: 12 and 37

TRADEMARK

SERVICE MARK

PRINCIPAL REGISTER

GREAT WALL MOTOR COMPANY LIMITED (CHINA CORPORATION)
2266 CHAOYANG SOUTH STREET
BAODING; 071000 HEBEI
CHINA

FOR: AUTOMOBILES; TRUCKS; CARS; ELECTRIC VEHICLES, NAMELY, ELECTRIC CARS, ELECTRIC MOTORCYCLES AND ELECTRIC BICYCLES; VANS; SPORTS UTILITY VEHICLES; MOTORS FOR LAND VEHICLES; AMBULANCES; CAMPING TRAILERS; MOTOR HOMES, IN CLASS 12 (U.S. CLS. 19, 21, 23, 31, 35 AND 44).

FOR: MOTOR VEHICLE MAINTENANCE AND REPAIR; VEHICLE SERVICE STATIONS, FOR REFUELING AND MAINTENANCE; TIRE RETREADING; VEHICLE CLEANING; RE-FUELING AND LUBRICATION SERVICES FOR VEHICLES; ANTI-RUST TREATMENT FOR VEHICLES; VEHICLE POLISHING; VEHICLE REPAIR SERVICES; AUTOMOBILE CLEANING, IN CLASS 37 (U.S. CLS. 100, 103 AND 106).

THE MARK CONSISTS OF AN OVAL WITH A HORIZONTAL CURVED LINE IN THE MIDDLE.

PRIORITY DATE OF 12-13-2010 IS CLAIMED.

OWNER OF INTERNATIONAL REGISTRATION 1078122 DATED 3-24-2011, EXPIRES 3-24-2021.

SER. NO. 79-097,707, FILED 3-24-2011.

LESLIE RICHARDS, EXAMINING ATTORNEY



David J. Kypos

Director of the United States Patent and Trademark Office

United States of America

United States Patent and Trademark Office

BMW Group Driving Experience

Reg. No. 4,065,415

Registered Dec. 6, 2011

Int. Cl.: 41

SERVICE MARK

PRINCIPAL REGISTER

BAYERISCHE MOTOREN WERKE AKTIENGESELLSCHAFT (FED REP GERMANY JOINT STOCK COMPANY)
PETUELRING 130
80809 MÜNCHEN, FED REP GERMANY

FOR: DRIVER SAFETY TRAINING, IN CLASS 41 (U.S. CLS. 100, 101 AND 107).

THE MARK CONSISTS OF STANDARD CHARACTERS WITHOUT CLAIM TO ANY PARTICULAR FONT, STYLE, SIZE, OR COLOR.

PRIORITY DATE OF 11-24-2010 IS CLAIMED.

OWNER OF INTERNATIONAL REGISTRATION 1078583 DATED 4-9-2011, EXPIRES 4-9-2021.

OWNER OF U.S. REG. NOS. 3,527,844 AND 3,689,674.

NO CLAIM IS MADE TO THE EXCLUSIVE RIGHT TO USE "GROUP" OR "DRIVING EXPERIENCE", APART FROM THE MARK AS SHOWN.

SER. NO. 79-097,854, FILED 4-9-2011.

SUSAN LESLIE DUBOIS, EXAMINING ATTORNEY



David J. Kybas

Director of the United States Patent and Trademark Office

United States of America

United States Patent and Trademark Office

AXOS

Reg. No. 4,065,416

Registered Dec. 6, 2011

Int. Cl.: 28

HEINZ KETTLER GMBH & CO. KG (FED REP GERMANY GMBH & CO. KG (LIMITED PARTNERSHIP))
HAUPTSTRASSE 28
59469 ENSE-PARSIT
FED REP GERMANY

TRADEMARK

PRINCIPAL REGISTER

FOR: SPORTS EQUIPMENT, NAMELY, CROSS TRAINERS, NAMELY, EXERCISE MACHINES; SPORTS EQUIPMENT, NAMELY EXERCISE MACHINES, NAMELY, STAIR STEPPING MACHINES; SPORTS EQUIPMENT, NAMELY EXERCISE MACHINES, NAMELY, TREADMILLS; SPORTS EQUIPMENT, NAMELY EXERCISE MACHINES, NAMELY, ROWING MACHINES; SPORTS EQUIPMENT, NAMELY EXERCISE MACHINES, NAMELY, STATIONARY CYCLES; SPORTS EQUIPMENT, NAMELY, BODYBUILDING APPARATUS; SPORTS EQUIPMENT, NAMELY EXERCISE MACHINES, NAMELY, RESISTANCE MACHINES; SPORTS EQUIPMENT, NAMELY EXERCISE MACHINES, NAMELY, VIBRATING PLATFORMS FOR PHYSICAL TRAINING PURPOSES, IN CLASS 28 (U.S. CLS. 22, 23, 38 AND 50).

THE MARK CONSISTS OF STANDARD CHARACTERS WITHOUT CLAIM TO ANY PARTICULAR FONT, STYLE, SIZE, OR COLOR.

PRIORITY DATE OF 12-23-2010 IS CLAIMED.

OWNER OF INTERNATIONAL REGISTRATION 1079288 DATED 4-27-2011, EXPIRES 4-27-2021.

SER. NO. 79-098,112, FILED 4-27-2011.

DEBRA LEE, EXAMINING ATTORNEY



David J. Kypos

Director of the United States Patent and Trademark Office

United States of America

United States Patent and Trademark Office

TRIPLE BLEND

Reg. No. 4,065,417

Registered Dec. 6, 2011

Int. Cls.: 1 and 3

TRADEMARK

PRINCIPAL REGISTER

WELLA AG (FED REP GERMANY AKTIENGESELLSCHAFT)
BERLINER ALLEE 65
64274 DARMSTADT
FED REP GERMANY

FOR: CHEMICAL PREPARATIONS USED IN INDUSTRY FOR THE PRODUCTION OF COSMETIC PREPARATIONS, NAMELY, SHAMPOOS, CONDITIONERS, AND STYLING PRODUCTS, IN CLASS 1 (U.S. CLS. 1, 5, 6, 10, 26 AND 46).

FOR: HAIR CARE PREPARATIONS, NAMELY, SHAMPOOS AND HAIR CONDITIONERS; NON-MEDICATED HAIR SCALP TREATMENTS, NAMELY, RESTRUCTURIZERS AND SCALP CONDITIONERS, HAIR LOTIONS, IN CLASS 3 (U.S. CLS. 1, 4, 6, 50, 51 AND 52).

THE MARK CONSISTS OF STANDARD CHARACTERS WITHOUT CLAIM TO ANY PARTICULAR FONT, STYLE, SIZE, OR COLOR.

PRIORITY DATE OF 8-17-2010 IS CLAIMED.

OWNER OF INTERNATIONAL REGISTRATION 1079307 DATED 2-10-2011, EXPIRES 2-10-2021.

NO CLAIM IS MADE TO THE EXCLUSIVE RIGHT TO USE "BLEND", APART FROM THE MARK AS SHOWN.

SER. NO. 79-098,123, FILED 2-10-2011.

TEJBIR SINGH, EXAMINING ATTORNEY



David J. Kypos

Director of the United States Patent and Trademark Office

United States of America

United States Patent and Trademark Office

RENEGADE OPS

Reg. No. 4,065,418

Registered Dec. 6, 2011

Int. Cls.: 9 and 41

TRADEMARK

SERVICE MARK

PRINCIPAL REGISTER

KABUSHIKI KAISHA SEGA, D/B/A SEGA CORPORATION (JAPAN CORPORATION)
1-2-12, HANEDA
OHTA-KU; TOKYO 144-8531
JAPAN

FOR: COMPUTER GAME PROGRAMS; COMPUTER GAME SOFTWARE; VIDEO GAME SOFTWARE; VIDEO GAME PROGRAMS; VIDEO GAME DISCS AND CARTRIDGES, IN CLASS 9 (U.S. CLS. 21, 23, 26, 36 AND 38).

FOR: ENTERTAINMENT SERVICES, NAMELY, PROVIDING ON-LINE VIDEO GAMES, IN CLASS 41 (U.S. CLS. 100, 101 AND 107).

THE MARK CONSISTS OF STANDARD CHARACTERS WITHOUT CLAIM TO ANY PARTICULAR FONT, STYLE, SIZE, OR COLOR.

PRIORITY DATE OF 3-31-2011 IS CLAIMED.

OWNER OF INTERNATIONAL REGISTRATION 1079587 DATED 4-28-2011, EXPIRES 4-28-2021.

SER. NO. 79-098,227, FILED 4-28-2011.

BERYL GARDNER, EXAMINING ATTORNEY



David J. Kyros

Director of the United States Patent and Trademark Office

United States of America

United States Patent and Trademark Office

See what I'm Saying

Reg. No. 4,065,419

Registered Dec. 6, 2011

Int. Cl.: 38

SERVICE MARK

PRINCIPAL REGISTER

IRONROAD AB (PUBL) (SWEDEN PUBLIC LIABILITY COMPANY)
KARLAVÄGEN 65
SE-114 49 STOCKHOLM
SWEDEN

FOR: PROVIDING TELECOMMUNICATIONS CONNECTIVITY SERVICES FOR TRANSFER AND TRANSMISSION OF MESSAGES CONTAINING VIDEO SEQUENCES; PROVIDING ACCESS TO DATABASES CONTAINING VIDEO SEQUENCES, IN CLASS 38 (U.S. CLS. 100, 101 AND 104).

THE MARK CONSISTS OF STANDARD CHARACTERS WITHOUT CLAIM TO ANY PARTICULAR FONT, STYLE, SIZE, OR COLOR.

PRIORITY DATE OF 4-19-2011 IS CLAIMED.

OWNER OF INTERNATIONAL REGISTRATION 1079677 DATED 4-26-2011, EXPIRES 4-26-2021.

SER. NO. 79-098,266, FILED 4-26-2011.

HAI-LY LAM, EXAMINING ATTORNEY



David J. Kyffers

Director of the United States Patent and Trademark Office

United States of America

United States Patent and Trademark Office

ReSound Lex

Reg. No. 4,065,420

Registered Dec. 6, 2011

Int. Cl.: 10

TRADEMARK

PRINCIPAL REGISTER

GN RESOUND A/S (DENMARK LIMITED LIABILITY COMPANY)
LAUTRUPBJERG 7
DK-2750 BALLERUP
DENMARK

FOR: HEARING AIDS FOR MEDICAL PURPOSES, IN CLASS 10 (U.S. CLS. 26, 39 AND 44).

THE MARK CONSISTS OF STANDARD CHARACTERS WITHOUT CLAIM TO ANY PARTICULAR FONT, STYLE, SIZE, OR COLOR.

PRIORITY DATE OF 2-15-2011 IS CLAIMED.

OWNER OF INTERNATIONAL REGISTRATION 1079808 DATED 5-4-2011, EXPIRES 5-4-2021.

THE ENGLISH TRANSLATION OF THE FOREIGN WORD(S) IN THE MARK IS "RESOUND LEX".

SER. NO. 79-098,316, FILED 5-4-2011.

SAIMA MAKHDOOM, EXAMINING ATTORNEY



David J. Kyjars

Director of the United States Patent and Trademark Office

United States of America

United States Patent and Trademark Office

lamda

Reg. No. 4,065,421

Registered Dec. 6, 2011

Int. Cl.: 12

TRADEMARK

PRINCIPAL REGISTER

ZHEJIANG LAMDA BRAKE PADS CO., LTD. (CHINA CORPORATION)
HAIAN
XIALIN INDUSTRIAL ZONE,; RUIAN CITY; ZHEJIANG PROVINCE
CHINA

FOR: LOCOMOTIVES; BRAKES FOR MOTOR CARS; BICYCLES; TYRES FOR LAND
VEHICLE WHEELS, IN CLASS 12 (U.S. CLS. 19, 21, 23, 31, 35 AND 44).

OWNER OF INTERNATIONAL REGISTRATION 1079846 DATED 3-9-2011, EXPIRES 3-9-
2021.

SER. NO. 79-098,336, FILED 3-9-2011.

GEOFFREY FOSDICK, EXAMINING ATTORNEY



David J. Kyros

Director of the United States Patent and Trademark Office

United States of America

United States Patent and Trademark Office

DANAVOX

Reg. No. 4,065,422

Registered Dec. 6, 2011

Int. Cl.: 10

TRADEMARK

PRINCIPAL REGISTER

GN RESOUND A/S (DENMARK LIMITED LIABILITY COMPANY)
LAUTRUPBJERG 7
DK-2750 BALLERUP
DENMARK

FOR: HEARING DEVICES FOR PEOPLE HARD OF HEARING, NAMELY, HEARING AIDS AND HEADSETS, IN CLASS 10 (U.S. CLS. 26, 39 AND 44).

THE MARK CONSISTS OF STANDARD CHARACTERS WITHOUT CLAIM TO ANY PARTICULAR FONT, STYLE, SIZE, OR COLOR.

OWNER OF INTERNATIONAL REGISTRATION 1080357 DATED 5-4-2011, EXPIRES 5-4-2021.

SER. NO. 79-098,554, FILED 5-4-2011.

SAIMA MAKHDOOM, EXAMINING ATTORNEY



David J. Kybas

Director of the United States Patent and Trademark Office

United States of America

United States Patent and Trademark Office

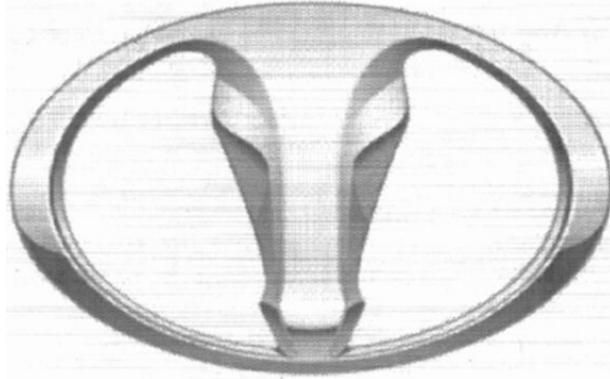

Reg. No. 4,065,423

Registered Dec. 6, 2011

Int. Cls.: 12 and 37

TRADEMARK

SERVICE MARK

PRINCIPAL REGISTER

GREAT WALL MOTOR COMPANY LIMITED (CHINA CORPORATION)
2266 CHAOYANG SOUTH STREET
BAODING
071000 HEBEI, CHINA

FOR: AUTOMOBILES; TRUCKS; CARS; ELECTRIC VEHICLES, NAMELY, ELECTRIC CARS, ELECTRIC MOTORCYCLES AND ELECTRIC BICYCLES; VANS; SPORTS UTILITY VEHICLES; MOTORS FOR LAND VEHICLES; AMBULANCES; CAMPING TRAILERS; MOTOR HOMES, IN CLASS 12 (U.S. CLS. 19, 21, 23, 31, 35 AND 44).

FOR: MOTOR VEHICLE MAINTENANCE AND REPAIR; VEHICLE SERVICE STATIONS (REFUELING AND MAINTENANCE); TIRE RETREADING; VEHICLE CLEANING; REFUELING AND LUBRICATION SERVICES FOR VEHICLES; ANTI-RUST TREATMENT FOR VEHICLES; VEHICLE POLISHING; VEHICLE REPAIR SERVICES; AUTOMOBILE CLEANING, IN CLASS 37 (U.S. CLS. 100, 103 AND 106).

THE MARK CONSISTS OF AN OVAL WITH A HORSE HEAD IN THE CENTER CONNECTED TO THE OVAL AT THE TOP AND BOTTOM; THE OVAL DESIGN HAS A CUTOUT TO THE LEFT AND RIGHT OF THE HORSE HEAD.

PRIORITY DATE OF 12-13-2010 IS CLAIMED.

OWNER OF INTERNATIONAL REGISTRATION 1080536 DATED 3-24-2011, EXPIRES 3-24-2021.

SER. NO. 79-098,610, FILED 3-24-2011.

MAYUR VAGHANI, EXAMINING ATTORNEY



David J. Kybas

Director of the United States Patent and Trademark Office

United States of America
United States Patent and Trademark Office

PoolTrack

Reg. No. 4,065,424

Registered Dec. 6, 2011

Int. Cl.: 9

TRADEMARK

PRINCIPAL REGISTER

BRANNSTROM SWEDEN AB (SWEDEN JOINT STOCK COMPANY)
UDDEVALLAGATAN 14
SE-416 70 GÖTEBORG
SWEDEN

FOR: OPTICAL FLUID ANALYZER; ELECTROCHEMICAL FLUID ANALYZERS; APPARATUS AND INSTRUMENTS FOR MEASURING AND REGULATING OF PH-VALUE, OXIDATION AND CHLORINE IN WATER; COMPUTER SYSTEMS CONSISTING OF COMPUTER HARDWARE, PERIPHERALS AND COMPUTER OPERATING PROGRAMS FOR MEASURING OF WATER IN SWIMMING POOLS, IN CLASS 9 (U.S. CLS. 21, 23, 26, 36 AND 38).

THE MARK CONSISTS OF STANDARD CHARACTERS WITHOUT CLAIM TO ANY PARTICULAR FONT, STYLE, SIZE, OR COLOR.

PRIORITY DATE OF 11-1-2010 IS CLAIMED.

OWNER OF INTERNATIONAL REGISTRATION 1080687 DATED 4-28-2011, EXPIRES 4-28-2021.

SER. NO. 79-098,653, FILED 4-28-2011.

SHAILA SETTLES, EXAMINING ATTORNEY



David J. Kyfos

Director of the United States Patent and Trademark Office

United States of America

United States Patent and Trademark Office

YOGU-MOGU

Reg. No. 4,065,425

Registered Dec. 6, 2011

Int. Cl.: 29

TRADEMARK

PRINCIPAL REGISTER

ASHTARAK-KAT CJSC (ARMENIA CLOSED JOINT-STOCK COMPANY)
VILLAGE AGARAK
ARAGATSOTN PROVINCE
ARMENIA

FOR: YOGURT, EXCLUDING FROZEN YOGURT; DRINKING YOGURT, IN CLASS 29 (U.S. CL. 46).

THE MARK CONSISTS OF STANDARD CHARACTERS WITHOUT CLAIM TO ANY PARTICULAR FONT, STYLE, SIZE, OR COLOR.

PRIORITY DATE OF 11-5-2010 IS CLAIMED.

OWNER OF INTERNATIONAL REGISTRATION 1080708 DATED 5-3-2011, EXPIRES 5-3-2021.

THE WORDING "YOGU-MOGU" HAS NO MEANING IN A FOREIGN LANGUAGE.

SER. NO. 79-098,656, FILED 5-3-2011.

CHRISTINE MARTIN, EXAMINING ATTORNEY



David J. Kybas

Director of the United States Patent and Trademark Office

United States of America
United States Patent and Trademark Office

Bombata

Reg. No. 4,065,426

Registered Dec. 6, 2011

Int. Cl.: 18

TRADEMARK

PRINCIPAL REGISTER

EXTREME DESIGN SRL (ITALY LIMITED LIABILITY COMPANY)
VIA BALDINUCCI, 4
I-59100 PRATO
ITALY

FOR: WALLET, CASES, PURSES AND BAGS MADE OF LEATHER OR ARTIFICIAL LEATHER, IN CLASS 18 (U.S. CLS. 1, 2, 3, 22 AND 41).

THE MARK CONSISTS IN THE WORD "BOMBATA" WRITTEN IN SEGOE SCRIPT BOLD FONT FIRST LETTER CAPITAL ALL OTHERS LOWER CASE LETTERS.

PRIORITY DATE OF 11-24-2010 IS CLAIMED.

OWNER OF INTERNATIONAL REGISTRATION 1081605 DATED 5-2-2011, EXPIRES 5-2-2021.

SER. NO. 79-098,986, FILED 5-2-2011.

ANNE E. GUSTASON, EXAMINING ATTORNEY



David J. Kyffers

Director of the United States Patent and Trademark Office

United States of America
United States Patent and Trademark Office

ANTARES

Reg. No. 4,065,427

Registered Dec. 6, 2011

Int. Cl.: 28

TRADEMARK

PRINCIPAL REGISTER

SHIMANO INC. (JAPAN CORPORATION)
3-77 OIMATSU-CHO
SAKAI-KU.; SAKAI CITY; OSAKA 590-8577
JAPAN

FOR: FISHING FLOATS; FISHING SINKERS; LANDING NETS FOR ANGLERS; FISHING LINES; FISHING REELS; FISHING RODS; FISHING ROD CASES; FISHING HOOKS; LURES FOR FISHING, IN CLASS 28 (U.S. CLS. 22, 23, 38 AND 50).

THE MARK CONSISTS OF STANDARD CHARACTERS WITHOUT CLAIM TO ANY PARTICULAR FONT, STYLE, SIZE, OR COLOR.

OWNER OF INTERNATIONAL REGISTRATION 1007758 DATED 6-8-2009, EXPIRES 6-8-2019.

SER. NO. 79-099,232, FILED 6-10-2011.

JOHN GARTNER, EXAMINING ATTORNEY



David J. Kybas

Director of the United States Patent and Trademark Office

United States of America

United States Patent and Trademark Office

FARMER'S STORY

Reg. No. 4,065,428

Registered Dec. 6, 2011

Int. Cl.: 33

TRADEMARK

PRINCIPAL REGISTER

WINEGRAPES AUSTRALIA PTY LTD (AUSTRALIA PROPRIETARY LIMITED COMPANY)
PO BOX 748
MCLAREN VALE SA 5171
AUSTRALIA

FOR: WINE, IN CLASS 33 (U.S. CLS. 47 AND 49).

THE MARK CONSISTS OF STANDARD CHARACTERS WITHOUT CLAIM TO ANY PARTICULAR FONT, STYLE, SIZE, OR COLOR.

PRIORITY DATE OF 3-23-2011 IS CLAIMED.

OWNER OF INTERNATIONAL REGISTRATION 1084195 DATED 4-21-2011, EXPIRES 4-21-2021.

SER. NO. 79-100,022, FILED 4-21-2011.

TRACY FLETCHER, EXAMINING ATTORNEY



David J. Kyffers

Director of the United States Patent and Trademark Office

United States of America

United States Patent and Trademark Office

DENIED

Reg. No. 4,065,429

Registered Dec. 6, 2011

Int. Cl.: 1

TAKASAGO KORYO KOGYO KABUSHIKI KAISHA (ALSO TRADING AS TAKASAGO INTERNATIONAL CORPORATION) (JAPAN CORPORATION)
37-1, KAMATA 5-CHOME
OHTA-KU; TOKYO 144-8721
JAPAN

TRADEMARK

FOR: CHEMICAL PRODUCTS, NAMELY, CHEMICAL CATALYSTS, IN CLASS 1 (U.S. CLS. 1, 5, 6, 10, 26 AND 46).

PRINCIPAL REGISTER

THE MARK CONSISTS OF STANDARD CHARACTERS WITHOUT CLAIM TO ANY PARTICULAR FONT, STYLE, SIZE, OR COLOR.

PRIORITY DATE OF 3-22-2011 IS CLAIMED.

OWNER OF INTERNATIONAL REGISTRATION 1084375 DATED 4-8-2011, EXPIRES 4-8-2021.

SER. NO. 79-100,094, FILED 4-8-2011.

SHANNON TWOHIG, EXAMINING ATTORNEY



David J. Kyffers

Director of the United States Patent and Trademark Office

United States of America
United States Patent and Trademark Office

PIETRAREGIA
DELL'
AMMIRAGLIA

Reg. No. 4,065,430

Registered Dec. 6, 2011

Int. Cl.: 33

TRADEMARK

PRINCIPAL REGISTER

MARCHESI DE' FRESCOBALDI SOCIETA' AGRICOLA S.R.L. (ITALY LIMITED LIABILITY COMPANY)
VIA S. SPIRITO, 11
I-50125 FIRENZE
ITALY

FOR: WINES, IN CLASS 33 (U.S. CLS. 47 AND 49).

PIETRAREGIA DELL' AMMIRAGLIA (FIGURATIVE).

PRIORITY DATE OF 1-26-2011 IS CLAIMED.

OWNER OF INTERNATIONAL REGISTRATION 1084440 DATED 4-22-2011, EXPIRES 4-22-2021.

THE ENGLISH TRANSLATION OF THE FOREIGN WORD(S) IN THE MARK IS: "ROYAL STONE OF THE FEMALE ADMIRAL".

SER. NO. 79-100,121, FILED 4-22-2011.

JANICE L. MCMORROW, EXAMINING ATTORNEY



David J. Kybas

Director of the United States Patent and Trademark Office

United States of America

United States Patent and Trademark Office

INTERTON COSMO

Reg. No. 4,065,431

Registered Dec. 6, 2011

Int. Cl.: 10

TRADEMARK

PRINCIPAL REGISTER

GN RESOUND A/S (DENMARK LIMITED LIABILITY COMPANY)
LAUTRUPBJERG 7
DK-2750 BALLERUP
DENMARK

FOR: HEARING AIDS FOR MEDICAL USE, IN CLASS 10 (U.S. CLS. 26, 39 AND 44).

THE MARK CONSISTS OF STANDARD CHARACTERS WITHOUT CLAIM TO ANY PARTICULAR FONT, STYLE, SIZE, OR COLOR.

PRIORITY DATE OF 12-17-2010 IS CLAIMED.

OWNER OF INTERNATIONAL REGISTRATION 1084786 DATED 5-16-2011, EXPIRES 5-16-2021.

SER. NO. 79-100,253, FILED 5-16-2011.

SAIMA MAKHDOOM, EXAMINING ATTORNEY



David J. Kyffers

Director of the United States Patent and Trademark Office

United States of America

United States Patent and Trademark Office

HYPERDECK

Reg. No. 4,065,432

Registered Dec. 6, 2011

Int. Cl.: 9

BLACKMAGIC DESIGN PTY LTD (AUSTRALIA A COMPANY INCORPORATED WITHIN THE COMMONWEALTH OF AUSTRALIA)
11 GATEWAY COURT
PORT MELBOURNE VIC 3205
AUSTRALIA

TRADEMARK

FOR: VIDEO DEVICE FOR RECORDING AND PLAYING BACK DIGITAL VIDEO, IN CLASS 9 (U.S. CLS. 21, 23, 26, 36 AND 38).

PRINCIPAL REGISTER

THE MARK CONSISTS OF STANDARD CHARACTERS WITHOUT CLAIM TO ANY PARTICULAR FONT, STYLE, SIZE, OR COLOR.

PRIORITY DATE OF 3-28-2011 IS CLAIMED.

OWNER OF INTERNATIONAL REGISTRATION 1084908 DATED 4-29-2011, EXPIRES 4-29-2021.

SER. NO. 79-100,339, FILED 4-29-2011.

KELLY TRUSILO, EXAMINING ATTORNEY



David J. Kyffers

Director of the United States Patent and Trademark Office

United States of America
United States Patent and Trademark Office

roamz

Reg. No. 4,065,433

Registered Dec. 6, 2011

Int. Cls.: 35, 38 and 42

SERVICE MARK

PRINCIPAL REGISTER

ONLINE MEDIA HOLDINGS PTY LTD (AUSTRALIA LIMITED LIABILITY COMPANY)
LEVEL 17
100 ARTHUR STREET; NORTH SYDNEY NSW 2060
AUSTRALIA

FOR: COMPILATION AND PROVISION OF ONLINE DIRECTORIES; ONLINE ADVERTISING ON A COMPUTER NETWORK; PROVIDING INFORMATION, INCLUDING ONLINE, ABOUT ADVERTISING, BUSINESS MANAGEMENT AND ADMINISTRATION AND OFFICE FUNCTIONS, IN CLASS 35 (U.S. CLS. 100, 101 AND 102).

FOR: PROVIDING ACCESS TO ONLINE COMPUTER DATABASES; PROVIDING USER ACCESS TO A GLOBAL COMPUTER NETWORK AND ONLINE SITES CONTAINING INFORMATION ON A WIDE RANGE OF TOPICS; TRANSMISSION OF INFORMATION ON A WIDE RANGE OF TOPICS, INCLUDING ONLINE AND OVER A GLOBAL COMPUTER NETWORK, IN CLASS 38 (U.S. CLS. 100, 101 AND 104).

FOR: COMPUTER SERVICES, NAMELY, HOSTING, MAINTAINING AND UPDATING WEBSITES AND WEB FACILITIES FOR OTHERS FOR ORGANISING AND CONDUCTING ON-LINE MEETINGS, GATHERINGS, DISCUSSIONS AND PROVIDING INFORMATION; COMPUTER SERVICES IN RELATION TO THE PROVISION AND HOSTING OF CUSTOMISED WEB PAGES CONTAINING USER DEFINED INFORMATION, PERSONAL PROFILES AND INFORMATION; PROVIDING USE OF SOFTWARE APPLICATIONS THROUGH A WEBSITE; COMPUTER SERVICES AND APPLICATION SERVICE PROVIDER (ASP) FEATURING SOFTWARE AND TOOLS TO ENABLE UPLOADING, POSTING, SHOWING, DISPLAYING, TAGGING, BLOGGING, SHARING OR OTHERWISE PROVIDING ELECTRONIC MEDIA OR INFORMATION OVER THE INTERNET OR OTHER COMMUNICATIONS NETWORKS; PROVIDING USE OF AND ACCESS TO NON-DOWNLOADABLE SOFTWARE APPLICATIONS FOR ADVERTISEMENTS, CLASSIFIEDS, PROMOTIONS, VIRTUAL COMMUNITY, SOCIAL NETWORKING, PHOTO SHARING, VIDEO SHARING AND TRANSMISSION OF INFORMATION AND IMAGES, IN CLASS 42 (U.S. CLS. 100 AND 101).

THE MARK CONSISTS OF STANDARD CHARACTERS WITHOUT CLAIM TO ANY PARTICULAR FONT, STYLE, SIZE, OR COLOR.

PRIORITY DATE OF 12-3-2010 IS CLAIMED.



David J. Kappas

Director of the United States Patent and Trademark Office

Reg. No. 4,065,433 OWNER OF INTERNATIONAL REGISTRATION 1085091 DATED 3-8-2011, EXPIRES 3-8-2021.

SER. NO. 79-100,415, FILED 3-8-2011.

JOHN WILKE, EXAMINING ATTORNEY

United States of America

United States Patent and Trademark Office

JJpackaging

Reg. No. 4,065,434

Registered Dec. 6, 2011

Int. Cls.: 35, 37 and 39

SERVICE MARK

PRINCIPAL REGISTER

D.LOGISTICS AG (FED REP GERMANY AG)
JOHANNES-GUTENBERG-STRABE 3-5
65719 HOFHEIM
FED REP GERMANY

FOR: PROFESSIONAL BUSINESS CONSULTING; MARKETING RESEARCH, MARKETING STUDIES AND MARKET ANALYSES; BUSINESS MANAGEMENT AND REPRESENTATION BY BUSINESS MANAGEMENT IN BUSINESS MATTERS OF OTHER LEGALLY INDEPENDENT COMPANIES; PROFESSIONAL BUSINESS CONSULTANCY AND PLANNING, ORGANIZING AND BUSINESS MANAGEMENT FOR AND IN OTHER LEGAL INDEPENDENT COMPANIES; ARRANGING AND CONCLUDING TRADING OPERATIONS FOR OTHERS; ARRANGING OF CONTRACTS FOR THIRD PARTIES BY PURCHASING AND SELLING OF GOODS; EMPLOYEE ASSIGNMENT FOR A TIME IN THE TRANSPORTING SECTOR; PROFESSIONAL BUSINESS CONSULTING, PLANNING AND ORGANIZING ON THE SECTORS OF MATERIALS LOGISTICS, WAREHOUSING AND TRANSPORTATION; RENTAL OF BINDING APPARATUS (OFFICE MACHINES), IN CLASS 35 (U.S. CLS. 100, 101 AND 102).

FOR: RENTAL OF CONSTRUCTION EQUIPMENT, DRIVING MOTORS FOR INDUSTRIAL MACHINES, OTHER THAN FOR LAND VEHICLES, IN CLASS 37 (U.S. CLS. 100, 103 AND 106).

FOR: TRANSPORT OF GOODS AND AUTOMOBILES, RAIL VEHICLE, SHIPS AND AERO PLANES (LOGISTICS); TRANSPORT, PACKAGING AND STORAGE OF GOODS; RENTAL OF VEHICLES FOR WAREHOUSING AND TRANSPORTING; RENTAL OF EQUIPMENT FOR WAREHOUSING AND TRANSPORTING; INCLUDED IN THIS CLASS; RENTAL OF PACKAGING MACHINES, LABELLERS, BOTTLE FILLING MACHINES, BELLOWS (FOR TRANSPORT PURPOSES) AND WRAPPING MACHINES, IN CLASS 39 (U.S. CLS. 100 AND 105).

THE MARK CONSISTS OF STANDARD CHARACTERS WITHOUT CLAIM TO ANY PARTICULAR FONT, STYLE, SIZE, OR COLOR.

PRIORITY DATE OF 6-28-2010 IS CLAIMED.

OWNER OF INTERNATIONAL REGISTRATION 1085119 DATED 10-13-2010, EXPIRES 10-13-2020.



David J. Kyffers

Director of the United States Patent and Trademark Office

Reg. No. 4,065,434 SER. NO. 79-100,424, FILED 10-13-2010.

JOHN WILKE, EXAMINING ATTORNEY

United States of America

United States Patent and Trademark Office



Reg. No. 4,065,435

Registered Dec. 6, 2011

Int. Cls.: 37, 39 and 40

SERVICE MARK

PRINCIPAL REGISTER

INTERSTATE WASTE SERVICES HOLDING CO., INC. (DELAWARE CORPORATION)
500 N. FRANKLIN TURNPIKE, SUITE 212
RAMSEY, NJ 07446

FOR: SOLID WASTE LANDFILL SERVICES, IN CLASS 37 (U.S. CLS. 100, 103 AND 106).

FIRST USE 12-7-1998; IN COMMERCE 12-7-1998.

FOR: TRANSPORTATION OF WASTE AND RECYCLED MATERIALS, IN CLASS 39 (U.S. CLS. 100 AND 105).

FIRST USE 12-7-1998; IN COMMERCE 12-7-1998.

FOR: WASTE TREATMENT; WASTE MANAGEMENT AND WASTE INCINERATION SERVICES; SORTING OF WASTE AND RECYCLABLE MATERIAL; CONVERSION UTILIZATION, NAMELY, CAPTURING AND CONVERTING LANDFILL GAS INTO ELECTRICITY AND USEFUL STEAM; GENERATION OF POWER; CONSULTANCY SERVICES IN THE FIELD OF WASTE TREATMENT, IN CLASS 40 (U.S. CLS. 100, 103 AND 106).

FIRST USE 12-7-1998; IN COMMERCE 12-7-1998.

NO CLAIM IS MADE TO THE EXCLUSIVE RIGHT TO USE "INTERSTATE", APART FROM THE MARK AS SHOWN.

THE COLOR(S) GREEN, WHITE AND YELLOW/GOLD IS/ARE CLAIMED AS A FEATURE OF THE MARK.

THE MARK CONSISTS OF A SHIELD OUTLINED IN GREEN AND WHITE, WITH THE UPPER PORTION IN GREEN WITH "INTERSTATE" IN WHITE, THE LOWER PORTION IN YELLOW/GOLD WITH LETTERS "IWS" IN WHITE AND OUTLINED IN GREEN, WITH A WHITE LINE SEPARATING THE UPPER FROM THE LOWER PORTION.

SER. NO. 85-000,502, FILED 3-29-2010.

RAUL CORDOVA, EXAMINING ATTORNEY



David J. Kyros

Director of the United States Patent and Trademark Office

United States of America

United States Patent and Trademark Office



Reg. No. 4,065,436

Registered Dec. 6, 2011

Int. Cls.: 37, 39 and 40

SERVICE MARK

PRINCIPAL REGISTER

INTERSTATE WASTE SERVICES HOLDING CO., INC. (DELAWARE CORPORATION)
500 N. FRANKLIN TURNPIKE, SUITE 212
RAMSEY, NJ 07446

FOR: SOLID WASTE LANDFILL SERVICES, IN CLASS 37 (U.S. CLS. 100, 103 AND 106).

FIRST USE 12-7-1998; IN COMMERCE 12-7-1998.

FOR: TRANSPORTATION OF WASTE AND RECYCLED MATERIALS, IN CLASS 39 (U.S. CLS. 100 AND 105).

FIRST USE 12-7-1998; IN COMMERCE 12-7-1998.

FOR: WASTE TREATMENT; WASTE MANAGEMENT AND WASTE INCINERATION SERVICES; SORTING OF WASTE AND RECYCLABLE MATERIAL; CONVERSION UTILIZATION, NAMELY, CAPTURING AND CONVERTING LANDFILL GAS INTO ELECTRICITY AND USEFUL STEAM; GENERATION OF POWER; CONSULTANCY SERVICES IN THE FIELD OF WASTE TREATMENT, IN CLASS 40 (U.S. CLS. 100, 103 AND 106).

FIRST USE 12-7-1998; IN COMMERCE 12-7-1998.

NO CLAIM IS MADE TO THE EXCLUSIVE RIGHT TO USE "INTERSTATE", APART FROM THE MARK AS SHOWN.

THE MARK CONSISTS OF A SHIELD WITH THE WORD "INTERSTATE" IN THE INSIDE UPPER PORTION OF THE SHIELD AND THE LETTERS "IWS" IN THE INSIDE LOWER PORTION OF THE SHIELD, WITH A LINE SEPARATING THE UPPER FROM THE LOWER PORTION.

SER. NO. 85-000,773, FILED 3-29-2010.

RAUL CORDOVA, EXAMINING ATTORNEY



David J. Kyffers

Director of the United States Patent and Trademark Office

United States of America

United States Patent and Trademark Office

HMWN

Reg. No. 4,065,437

ASSOCIAZIONE RADIO MARIA (ITALY CORPORATION)
VIA TURATI 7
22036 ERBA CO, ITALY

Registered Dec. 6, 2011

Int. Cls.: 9, 16, 38 and 41

FOR: RECORDING DISCS, NAMELY, BLANK MAGNETIC DISCS, BLANK OPTICAL DISCS; RECORDING DISCS, NAMELY, PRE-RECORDED DVDS, CDS, CD-ROMS, VIDEOCASSETTES, FEATURING RELIGIOUS CONTENTS; RADIO APPARATUS, NAMELY, TRANSMITTERS, RECEIVER AND ANTENNAS, IN CLASS 9 (U.S. CLS. 21, 23, 26, 36 AND 38).

TRADEMARK

SERVICE MARK

FOR: PAPER, CARDBOARD AND GOODS MADE FROM THESE MATERIALS, NOT INCLUDED IN OTHER CLASSES, NAMELY, BOXES, ADHESIVE LABELS, ADHESIVE NOTE PADS; POSTCARDS, BOOKMARKS, NOTEBOOKS, DIARY, CALENDAR, HOLY PICTURES; PRINTED MATTER, NAMELY, NEWSPAPERS, PHOTOGRAPHS, MAGAZINES, BOOKS, PRINTED PERIODICALS, NEWSLETTERS, AND BROCHURES, ALL IN THE FIELDS OF RELIGION, IN CLASS 16 (U.S. CLS. 2, 5, 22, 23, 29, 37, 38 AND 50).

PRINCIPAL REGISTER

FOR: TELECOMMUNICATIONS, NAMELY, BROADBAND RADIO COMMUNICATIONS SERVICES, AUDIO TELECONFERENCING, CABLE RADIO BROADCASTING, CALL FORWARDING SERVICES, CHAT ROOM SERVICES FOR SOCIAL NETWORKING; RADIO BROADCASTING STATIONS, IN CLASS 38 (U.S. CLS. 100, 101 AND 104).

FOR: EDUCATION SERVICES, NAMELY, PROVIDING CLASSES, SEMINARS, WORKSHOPS IN THE FIELD OF EDUCATIONAL ACTIVITY, RELIGION; ORGANIZING COMMUNITY SPORTING AND CULTURAL EVENTS, IN CLASS 41 (U.S. CLS. 100, 101 AND 107).



THE MARK CONSISTS OF STANDARD CHARACTERS WITHOUT CLAIM TO ANY PARTICULAR FONT, STYLE, SIZE, OR COLOR.

PRIORITY CLAIMED UNDER SEC. 44(D) ON ERPN CMNTY TM OFC APPLICATION NO. 008983025, FILED 3-25-2010, REG. NO. 008983025, DATED 8-24-2010, EXPIRES 3-25-2020.

THE ACRONYM "HMWN" STANDS FOR "HOLY MOTHER WORLD NETWORK".

David J. Kappas

SER. NO. 85-002,369, FILED 3-30-2010.

AMY C. KEAN, EXAMINING ATTORNEY

United States of America

United States Patent and Trademark Office

RAWLICIOUS

Reg. No. 4,065,438

Registered Dec. 6, 2011

Int. Cl.: 43

SERVICE MARK

PRINCIPAL REGISTER

ANGUS GRAHAM ALEXANDER CRAWFORD (CANADA INDIVIDUAL)
M6P 1Z8
3092 DUNDAS ST. W.
TORONTO, ONTARIO, CANADA

FOR: RESTAURANT SERVICES, CAFE SERVICES AND CATERING SERVICES, IN CLASS
43 (U.S. CLS. 100 AND 101).

THE MARK CONSISTS OF STANDARD CHARACTERS WITHOUT CLAIM TO ANY PAR-
TICULAR FONT, STYLE, SIZE, OR COLOR.

OWNER OF CANADA REG. NO. TMA734089, DATED 2-9-2009, EXPIRES 2-9-2024.

SER. NO. 85-002,774, FILED 3-31-2010.

MARTHA SANTOMARTINO, EXAMINING ATTORNEY



David J. Kybas

Director of the United States Patent and Trademark Office

United States of America

United States Patent and Trademark Office



Reg. No. 4,065,439

Registered Dec. 6, 2011

**Int. Cls.: 35, 39, 41, 42
and 45**

SERVICE MARK

PRINCIPAL REGISTER

TRAFFIC MANAGEMENT, INC. (CALIFORNIA CORPORATION)
2435 LEMON AVENUE
SIGNAL HILL, CA 90755

FOR: RETAIL STORE AND ONLINE RETAIL STORE SERVICES FEATURING CONSTRUCTION WORK ZONE SAFETY PRODUCTS, ROADWAY SIGNS, TEMPORARY WATER-FILLED K-RAILS, CUSTOMIZABLE DIRECTIONAL AND INFORMATIONAL SIGNS, TEMPORARY ROADWAY STRIPING, STRIPING TAPE, LIGHTED SIGNS, LIGHTED TRAILERS, LIGHTED MESSAGE BOARDS, VEHICULAR SIGNS, WARNING SIGNS, REGULATORY SIGNS, GUIDE SIGNS, SCHOOL SIGNS, RECREATIONAL AND CULTURE SIGNS, ROLL UP SIGNS, FLAGS FOR VEHICLE CONTROL, CONE MOUNTED SIGNS, SIGN STANDS, SIGN POSTS, STOP AND SLOW PADDLES, CONES FOR VEHICLE CONTROL, LANE DELINEATORS, CHANNELIZERS FOR VEHICLE CONTROL, VEHICLE CONTROL BARRELS AND DRUMS, RUBBER BASES FOR VEHICLE CONTROL SIGNS AND CHANNELIZERS, CROWD AND VEHICLE CONTROL BARRICADES, CROWD AND VEHICLE CONTROL BARRIERS, STROBE LIGHTS, WARNING BEACONS, CRASH ATTENUATORS AND BARRELS, ATTENUATOR TRAILERS, SAFETY FENCE, SAFETY TAPES AND RIBBONS, FIRST AID KITS, PERSONAL SAFETY EQUIPMENT, NAMELY, GLOVES, SAFETY GLASSES, HARD HATS, EAR PLUGS, REFLECTIVE SAFETY VESTS, SHIRTS, SWEATSHIRTS, JACKETS, COATS, WIND RESISTANT JACKETS, OVERALLS, IN CLASS 35 (U.S. CLS. 100, 101 AND 102).

FIRST USE 2-1-2000; IN COMMERCE 2-1-2000.



FOR: TRAFFIC MANAGEMENT SERVICES, NAMELY, VEHICLE TRAFFIC FLOW MANAGEMENT; TRAFFIC CONTROL SERVICES, NAMELY, VEHICLE, PEDESTRIAN, AND BICYCLE CONTROL SERVICES ACCOMPLISHED VIA LANE AND SIDEWALK CLOSURES OR ALTERATIONS; TRAFFIC MANAGEMENT SERVICES, NAMELY, CREATING SPECIAL EVENT TRAFFIC PLANS FOR VEHICLES, PEDESTRIANS AND BICYCLE TRAFFIC; PROVIDING INFORMATION REGARDING TRAFFIC CONGESTION VIA TEMPORARY ROAD SIGNS; FLAGGING SERVICES, NAMELY, DIRECTING VEHICULAR TRAFFIC FLOW; TRAFFIC MANAGEMENT SERVICES, NAMELY, PROVIDING LANE CLOSURE AND REMOVAL SERVICES AND FLAGGING AND ROADWAY DIVERSION SERVICES UTILIZING PORTABLE DEVICES, SUCH AS CONES, DELINEATORS, BARRICADES, SIGN STANDS, FLASHING BEACONS, FLASHING ARROW TRAILERS, AND CHANGEABLE MESSAGE SIGNS ON ROADWAYS, IN CLASS 39 (U.S. CLS. 100 AND 105).

David J. Kyjars

Director of the United States Patent and Trademark Office

Reg. No. 4,065,439 FIRST USE 2-1-2000; IN COMMERCE 2-1-2000.

FOR: EDUCATIONAL SERVICES, NAMELY, TRAINING AND EDUCATIONAL TESTING FOR CERTIFICATION OF HIGHWAY AND ROADWAY FLAGGERS, IN CLASS 41 (U.S. CLS. 100, 101 AND 107).

FIRST USE 2-1-2000; IN COMMERCE 2-1-2000.

FOR: TRAFFIC PLANNING SERVICES; TRAFFIC PLANNING SERVICES IN THE NATURE OF ROUTE AND FLOW CONTROL SERVICES; ROUTE AND FLOW TRAFFIC CONTROL ENGINEERING SERVICES, IN CLASS 42 (U.S. CLS. 100 AND 101).

FIRST USE 2-1-2000; IN COMMERCE 2-1-2000.

FOR: CROWD CONTROL SERVICES; SPECIAL EVENTS CROWD CONTROL SERVICES; CONSULTATION SERVICES IN CONNECTION WITH OBTAINING VEHICLE AND PEDESTRIAN CONTROL MUNICIPALITY PERMITS; PERMIT SERVICES, NAMELY, OBTAINING GOVERNMENTAL PERMITS FOR CONTROL OF VEHICLES, PEDESTRIANS, AND BICYCLES; RENTAL OF TRAFFIC SAFETY EQUIPMENT, NAMELY, CONES, DELINEATORS, BARRICADES, SIGN STANDS, FLASHING BEACONS, FLASHING ARROW TRAILERS, AND CHANGEABLE MESSAGE SIGNS ON ROADWAYS, IN CLASS 45 (U.S. CLS. 100 AND 101).

FIRST USE 2-1-2000; IN COMMERCE 2-1-2000.

THE MARK CONSISTS OF AN ORANGE DIAMOND SHAPED DESIGN WITH THE LETTERS "TMI" IN BLACK IN THE CENTER AND BLACK ARROWS FORMING AROUND THE PERIMETER OF THE DIAMOND SHAPED DESIGN.

THE COLOR(S) ORANGE AND BLACK IS/ARE CLAIMED AS A FEATURE OF THE MARK.

SER. NO. 85-003,343, FILED 3-31-2010.

KAREN K. BUSH, EXAMINING ATTORNEY

United States of America

United States Patent and Trademark Office



**TRAFFIC
MANAGEMENT**
I N C O R P O R A T E D

Reg. No. 4,065,440

Registered Dec. 6, 2011

**Int. Cls.: 35, 39, 41, 42
and 45**

SERVICE MARK

PRINCIPAL REGISTER

TRAFFIC MANAGEMENT, INC. (CALIFORNIA CORPORATION)
2435 LEMON AVENUE
SIGNAL HILL, CA 90755

FOR: RETAIL STORE AND ONLINE RETAIL STORE SERVICES FEATURING CONSTRUCTION WORK ZONE SAFETY PRODUCTS, ROADWAY SIGNS, TEMPORARY WATER-FILLED K-RAILS, CUSTOMIZABLE DIRECTIONAL AND INFORMATIONAL SIGNS, TEMPORARY ROADWAY STRIPING, STRIPING TAPE, LIGHTED SIGNS, LIGHTED TRAILERS, LIGHTED MESSAGE BOARDS, VEHICULAR SIGNS, WARNING SIGNS, REGULATORY SIGNS, GUIDE SIGNS, SCHOOL SIGNS, RECREATIONAL AND CULTURE SIGNS, ROLL UP SIGNS, FLAGS FOR VEHICLE CONTROL, CONE MOUNTED SIGNS, SIGN STANDS, SIGN POSTS, STOP AND SLOW PADDLES, CONES FOR VEHICLE CONTROL, LANE DELINEATORS, CHANNELIZERS FOR VEHICLE CONTROL, VEHICLE CONTROL BARRELS AND DRUMS, RUBBER BASES FOR VEHICLE CONTROL SIGNS AND CHANNELIZERS, CROWD AND VEHICLE CONTROL BARRICADES, CROWD AND VEHICLE CONTROL BARRIERS, STROBE LIGHTS, WARNING BEACONS, CRASH ATTENUATORS AND BARRELS, ATTENUATOR TRAILERS, SAFETY FENCE, SAFETY TAPES AND RIBBONS, FIRST AID KITS, PERSONAL SAFETY EQUIPMENT, NAMELY, GLOVES, SAFETY GLASSES, HARD HATS, EAR PLUGS, REFLECTIVE SAFETY VESTS, SHIRTS, SWEATSHIRTS, JACKETS, COATS, WIND RESISTANT JACKETS, OVERALLS, IN CLASS 35 (U.S. CLS. 100, 101 AND 102).

FIRST USE 1-1-2008; IN COMMERCE 1-1-2008.



FOR: TRAFFIC MANAGEMENT SERVICES, NAMELY, VEHICLE TRAFFIC FLOW MANAGEMENT; TRAFFIC CONTROL SERVICES, NAMELY, VEHICLE, PEDESTRIAN, AND BICYCLE CONTROL SERVICES ACCOMPLISHED VIA LANE AND SIDEWALK CLOSURES OR ALTERATIONS; TRAFFIC MANAGEMENT SERVICES, NAMELY, CREATING SPECIAL EVENT TRAFFIC PLANS FOR VEHICLES, PEDESTRIANS AND BICYCLE TRAFFIC; PROVIDING INFORMATION REGARDING TRAFFIC CONGESTION VIA TEMPORARY ROAD SIGNS; FLAGGING SERVICES, NAMELY, DIRECTING VEHICULAR TRAFFIC FLOW; TRAFFIC MANAGEMENT SERVICES, NAMELY, PROVIDING LANE CLOSURE AND REMOVAL SERVICES AND FLAGGING AND ROADWAY DIVERSION SERVICES UTILIZING PORTABLE DEVICES, SUCH AS CONES, DELINEATORS, BARRICADES, SIGN STANDS, FLASHING BEACONS, FLASHING ARROW TRAILERS, AND CHANGEABLE MESSAGE SIGNS ON ROADWAYS, IN CLASS 39 (U.S. CLS. 100 AND 105).

David J. Kyffers

Director of the United States Patent and Trademark Office

Reg. No. 4,065,440 FIRST USE 1-1-2008; IN COMMERCE 1-1-2008.

FOR: EDUCATIONAL SERVICES, NAMELY, TRAINING AND EDUCATIONAL TESTING FOR CERTIFICATION OF HIGHWAY AND ROADWAY FLAGGERS, IN CLASS 41 (U.S. CLS. 100, 101 AND 107).

FIRST USE 1-1-2008; IN COMMERCE 1-1-2008.

FOR: TRAFFIC PLANNING SERVICES; TRAFFIC PLANNING SERVICES IN THE NATURE OF ROUTE AND FLOW CONTROL SERVICES; ROUTE AND FLOW TRAFFIC CONTROL ENGINEERING SERVICES, IN CLASS 42 (U.S. CLS. 100 AND 101).

FIRST USE 1-1-2008; IN COMMERCE 1-1-2008.

FOR: CROWD CONTROL SERVICES; SPECIAL EVENTS CROWD CONTROL SERVICES; CONSULTATION SERVICES IN CONNECTION WITH OBTAINING VEHICLE AND PEDESTRIAN CONTROL MUNICIPALITY PERMITS; PERMIT SERVICES, NAMELY, OBTAINING GOVERNMENTAL PERMITS FOR CONTROL OF VEHICLES, PEDESTRIANS, AND BICYCLES; RENTAL OF TRAFFIC SAFETY EQUIPMENT, NAMELY, CONES, DELINEATORS, BARRICADES, SIGN STANDS, FLASHING BEACONS, FLASHING ARROW TRAILERS, AND CHANGEABLE MESSAGE SIGNS ON ROADWAYS, IN CLASS 45 (U.S. CLS. 100 AND 101).

FIRST USE 1-1-2008; IN COMMERCE 1-1-2008.

NO CLAIM IS MADE TO THE EXCLUSIVE RIGHT TO USE "TRAFFIC MANAGEMENT INCORPORATED", APART FROM THE MARK AS SHOWN.

THE COLOR(S) ORANGE AND BLACK IS/ARE CLAIMED AS A FEATURE OF THE MARK.

THE MARK CONSISTS OF AN ORANGE DIAMOND SHAPED DESIGN WITH THE LETTERS "TMI" IN BLACK IN THE CENTER AND BLACK ARROWS FORMING AROUND THE PERIMETER OF THE DIAMOND SHAPED DESIGN AND THE WORDS "TRAFFIC MANAGEMENT INCORPORATED" IN BLACK TO THE RIGHT OF THE DIAMOND SHAPED DESIGN.

SER. NO. 85-003,350, FILED 3-31-2010.

KAREN K. BUSH, EXAMINING ATTORNEY

United States of America

United States Patent and Trademark Office

PEGADESIGN

Reg. No. 4,065,441

Registered Dec. 6, 2011

Int. Cl.: 14

TRADEMARK

PRINCIPAL REGISTER

PEGATRON CORPORATION (TAIWAN CORPORATION)
5F., NO. 76, LIGONG ST., BEITOU DISTRICT
TAIPEI CITY 112, TAIWAN

FOR: KEY RINGS OF PRECIOUS METALS IN THE NATURE OF TRINKETS OR FOBS;
JEWELRY BROOCHES; NECKLACES IN THE NATURE OF JEWELRY; BANGLES;
BRACELETS; RINGS; EARRINGS; KEY CHAINS OF PRECIOUS METAL; CUFF LINKS; TIE
CLIPS; TIE PINS; TIMEPIECES; WATCHES; DIVING WATCHES; DIGITAL WATCHES;
DIGITAL CLOCKS, IN CLASS 14 (U.S. CLS. 2, 27, 28 AND 50).

PRIORITY CLAIMED UNDER SEC. 44(D) ON TAIWAN APPLICATION NO. 099012228,
FILED 3-19-2010, REG. NO. 01466158, DATED 8-1-2011, EXPIRES 7-31-2021.

THE MARK CONSISTS OF THE WORD "PEGADESIGN" WHERE THE LETTERS "PEGA"
ARE IN BOLD AND THE LETTER "A" DOES NOT HAVE A CROSS BAR.

SER. NO. 85-004,625, FILED 4-1-2010.

TINA MAI, EXAMINING ATTORNEY



David J. Kybas

Director of the United States Patent and Trademark Office

United States of America

United States Patent and Trademark Office

ADVOCATE DISTRIBUTION SOLUTIONS

Reg. No. 4,065,442

Registered Dec. 6, 2011

Int. Cl.: 39

SERVICE MARK

PRINCIPAL REGISTER

BIBLICA US, INC. (COLORADO CORPORATION), DBA STL DISTRIBUTION NORTH
AMERICA
100 BIBLICA WAY
ELIZABETHTON, TN 37643

FOR: WAREHOUSING SERVICES, NAMELY, STORAGE, DISTRIBUTION, PICK-UP,
PACKING, AND SHIPPING OF BOOKS, MUSIC, VIDEOS, OTHER MEDIA PRODUCTS AND
RELATED GIFT PRODUCTS FOR OTHERS; ORDER FULFILLMENT SERVICES FOR
OTHERS, IN CLASS 39 (U.S. CLS. 100 AND 105).

FIRST USE 1-13-2011; IN COMMERCE 1-13-2011.

THE MARK CONSISTS OF STANDARD CHARACTERS WITHOUT CLAIM TO ANY PAR-
TICULAR FONT, STYLE, SIZE, OR COLOR.

NO CLAIM IS MADE TO THE EXCLUSIVE RIGHT TO USE "DISTRIBUTION SOLUTIONS",
APART FROM THE MARK AS SHOWN.

SER. NO. 85-006,380, FILED 4-5-2010.

ESTHER A. BORSUK, EXAMINING ATTORNEY



David J. Kyffers

Director of the United States Patent and Trademark Office

United States of America

United States Patent and Trademark Office

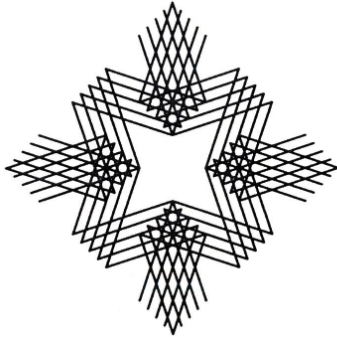

Wealth Enhancement Group

Reg. No. 4,065,443

Registered Dec. 6, 2011

Int. Cls.: 35 and 36

SERVICE MARK

PRINCIPAL REGISTER

WEALTH ENHANCEMENT GROUP, LLC (MINNESOTA LIMITED LIABILITY COMPANY)
505 NORTH HIGHWAY 169, SUITE 900
PLYMOUTH, MN 55441

FOR: TAX PLANNING SERVICES, IN CLASS 35 (U.S. CLS. 100, 101 AND 102).

FIRST USE 7-31-2010; IN COMMERCE 7-31-2010.

FOR: FINANCIAL PLANNING SERVICES, INVESTMENT MANAGEMENT, INSURANCE
COVERAGE ADVISORY SERVICES, ESTATE PLANNING; FINANCIAL SERVICES,
NAMELY, INDIVIDUAL RETIREMENT ACCOUNT PLANNING, IN CLASS 36 (U.S. CLS.
100, 101 AND 102).

FIRST USE 7-31-2010; IN COMMERCE 7-31-2010.

NO CLAIM IS MADE TO THE EXCLUSIVE RIGHT TO USE "WEALTH ENHANCEMENT
GROUP", APART FROM THE MARK AS SHOWN.

THE MARK CONSISTS OF A DIAMOND-SHAPED DESIGN CONTAINING STYLIZED
VERSIONS OF THE LETTER "W" TO THE LEFT OF THE WORDS "WEALTH ENHANCE-
MENT GROUP".

SER. NO. 85-008,387, FILED 4-7-2010.

JULIE VEPPUMTHARA, EXAMINING ATTORNEY



David J. Kybas

Director of the United States Patent and Trademark Office

United States of America

United States Patent and Trademark Office

VASECTOMY ON THE GO

Reg. No. 4,065,444

ROSENBLUM, JEFFREY LEE (UNITED STATES INDIVIDUAL)
P. O. BOX 1165
EXTON, PA 19341

Registered Dec. 6, 2011

Int. Cl.: 44

FOR: MEDICAL SERVICES, NAMELY, TREATMENT, TESTING AND SURGICAL SERVICES RELATED TO VASECTOMIES, IN CLASS 44 (U.S. CLS. 100 AND 101).

SERVICE MARK

FIRST USE 11-1-2009; IN COMMERCE 11-1-2009.

PRINCIPAL REGISTER

THE MARK CONSISTS OF STANDARD CHARACTERS WITHOUT CLAIM TO ANY PARTICULAR FONT, STYLE, SIZE, OR COLOR.

NO CLAIM IS MADE TO THE EXCLUSIVE RIGHT TO USE "VASECTOMY", APART FROM THE MARK AS SHOWN.

SER. NO. 85-008,479, FILED 4-7-2010.

JOHN KELLY, EXAMINING ATTORNEY



David J. Kybas

Director of the United States Patent and Trademark Office

United States of America

United States Patent and Trademark Office



Reg. No. 4,065,445

Registered Dec. 6, 2011

Int. Cls.: 8 and 37

TRADEMARK

SERVICE MARK

PRINCIPAL REGISTER

HATTORI HANZO SHEARS, LLC (OREGON LIMITED LIABILITY COMPANY)
3433 HONEYWOOD ST.
EUGENE, OR 97408

FOR: HAIR CUTTING SCISSORS, IN CLASS 8 (U.S. CLS. 23, 28 AND 44).

FIRST USE 1-1-2009; IN COMMERCE 4-1-2009.

FOR: SCISSORS SHARPENING, IN CLASS 37 (U.S. CLS. 100, 103 AND 106).

FIRST USE 1-1-2009; IN COMMERCE 4-1-2009.

THE MARK CONSISTS OF A STYLIZED DESIGN RESEMBLING THE LETTER "H".

SER. NO. 85-010,322, FILED 4-9-2010.

KATHERINE CONNOLLY, EXAMINING ATTORNEY



David J. Kybas

Director of the United States Patent and Trademark Office

United States of America

United States Patent and Trademark Office



Reg. No. 4,065,446

Registered Dec. 6, 2011

Int. Cls.: 9 and 28

TRADEMARK

PRINCIPAL REGISTER

VIRTUAL TOYS, S.L. (SPAIN CORPORATION)
C/ EN MEDIO, 21 1A PLANTA
TORREJON DE ARDOZ
MADRID, SPAIN 28850

FOR: VIDEO AND COMPUTER GAME PROGRAMS; VIDEO GAME CARTRIDGES, DISCS AND CASSETTES; VIDEO GAME CONSOLES FOR USE WITH AN EXTERNAL DISPLAY SCREEN OR MONITOR, IN CLASS 9 (U.S. CLS. 21, 23, 26, 36 AND 38).

FOR: GAMES AND PLAYTHINGS, NAMELY, HANDHELD UNITS FOR PLAYING ELECTRONIC GAMES AND VIDEO GAMES OTHER THAN THOSE ADAPTED FOR USE WITH AN EXTERNAL DISPLAY SCREEN OR MONITOR; ELECTRONIC GAMES OTHER THAN THOSE ADAPTED FOR USE WITH TELEVISION RECEIVERS ONLY, IN CLASS 28 (U.S. CLS. 22, 23, 38 AND 50).

PRIORITY CLAIMED UNDER SEC. 44(D) ON ERPN CMNTY TM OFC APPLICATION NO. 9012345, FILED 4-8-2010, REG. NO. 9012345, DATED 9-27-2010, EXPIRES 4-8-2020.

THE COLOR(S) ORANGE, YELLOW, BLUE, GREEN AND WHITE IS/ARE CLAIMED AS A FEATURE OF THE MARK.

THE MARK CONSISTS OF THE WORD ELEMENT "HELLO" IN ORANGE AND YELLOW STYLIZED TYPEFACE WHICH ARE OUTLINED IN THE COLORS BLUE AND WHITE WHICH ARE ACCOMPANIED BY A DESIGN ABOVE THE "O" WHICH DEPICT FLOWER PETALS IN THE COLOR ORANGE AS WELL AS THE WORD ELEMENT "FLOWERZ" IN THE COLOR GREEN WHICH ARE OUTLINED IN THE COLOR WHITE, ALL OF THE FOREGOING AGAINST A BLUE OVAL SHAPED BACKGROUND WHICH ALSO DEPICTS A BED OF DAISY FLOWERS IN THE COLORS GREEN, WHITE AND YELLOW.

SER. NO. 85-010,541, FILED 4-9-2010.

JAY FLOWERS, EXAMINING ATTORNEY



David J. Kyros

Director of the United States Patent and Trademark Office

United States of America

United States Patent and Trademark Office

BEAM IMPACT

Reg. No. 4,065,447

Registered Dec. 6, 2011

Int. Cl.: 9

TRADEMARK

PRINCIPAL REGISTER

SHIMADZU CORPORATION (JAPAN CORPORATION)
1, NISHINOKYO-KUWABARACHO, NAKAGYO-KU
KYOTO, JAPAN

FOR: LASER GENERATORS FOR NON-MEDICAL PURPOSES; MEASURING APPARATUS, NAMELY, LASER DISTANCE MEASURING INSTRUMENTS, LASER PHOTOMETERS, LASER ANEMOMETERS; LASER SPEED DETECTORS; LASER EQUIPMENT FOR NON-MEDICAL PURPOSES; LASER MEASURING SYSTEMS, IN CLASS 9 (U.S. CLS. 21, 23, 26, 36 AND 38).

THE MARK CONSISTS OF STANDARD CHARACTERS WITHOUT CLAIM TO ANY PARTICULAR FONT, STYLE, SIZE, OR COLOR.

PRIORITY CLAIMED UNDER SEC. 44(D) ON JAPAN APPLICATION NO. 2010-017592, FILED 3-9-2010, REG. NO. 5418638, DATED 6-17-2011, EXPIRES 6-17-2021.

OWNER OF U.S. REG. NO. 3,608,114.

NO CLAIM IS MADE TO THE EXCLUSIVE RIGHT TO USE "BEAM", APART FROM THE MARK AS SHOWN.

SER. NO. 85-011,415, FILED 4-12-2010.

WARREN L. OLANDRIA, EXAMINING ATTORNEY



David J. Kyros

Director of the United States Patent and Trademark Office

United States of America

United States Patent and Trademark Office

Auto Interiors

Reg. No. 4,065,448

Registered Dec. 6, 2011

Int. Cl.: 41

SERVICE MARK

PRINCIPAL REGISTER

PENTON BUSINESS MEDIA, INC. (DELAWARE CORPORATION)
4TH FLOOR
249 WEST 17TH STREET
NEW YORK, NY 10011

FOR: EDUCATIONAL SERVICES, NAMELY, CONDUCTING CONFERENCES, SEMINARS AND WORKSHOPS IN THE FIELD OF AUTOMOBILES AND VEHICLES AND DISTRIBUTION OF PRINTED MATERIALS IN CONNECTION THEREWITH IN HARD COPY OR ELECTRONIC FORMAT ON THE SAME TOPICS, IN CLASS 41 (U.S. CLS. 100, 101 AND 107).

FIRST USE 6-1-2002; IN COMMERCE 6-1-2002.

THE MARK CONSISTS OF STANDARD CHARACTERS WITHOUT CLAIM TO ANY PARTICULAR FONT, STYLE, SIZE, OR COLOR.

OWNER OF U.S. REG. NO. 2,801,641.

SEC. 2(F).

SER. NO. 85-012,988, FILED 4-13-2010.

MARK SPARACINO, EXAMINING ATTORNEY



David J. Kybas

Director of the United States Patent and Trademark Office

United States of America

United States Patent and Trademark Office

BABY 411

Reg. No. 4,065,449

Registered Dec. 6, 2011

Int. Cl.: 16

TRADEMARK

PRINCIPAL REGISTER

FIELDS, ALAN (UNITED STATES INDIVIDUAL), DBA WINDSOR PEAK PRESS
436 PINE STREET
BOULDER, CO 80302 AND

FIELDS, DENISE (UNITED STATES INDIVIDUAL), DBA WINDSOR PEAK PRESS
436 PINE STREET
BOULDER, CO 80302

FOR: SERIES OF NON-FICTION BOOKS ON VARIOUS TOPICS IN THE FIELDS OF INFANT MEDICAL CARE AND PARENTING ADVICE CONCERNING INFANTS, IN CLASS 16 (U.S. CLS. 2, 5, 22, 23, 29, 37, 38 AND 50).

FIRST USE 8-30-2003; IN COMMERCE 8-30-2003.

THE MARK CONSISTS OF STANDARD CHARACTERS WITHOUT CLAIM TO ANY PARTICULAR FONT, STYLE, SIZE, OR COLOR.

NO CLAIM IS MADE TO THE EXCLUSIVE RIGHT TO USE "BABY", APART FROM THE MARK AS SHOWN.

SER. NO. 85-013,140, FILED 4-13-2010.

JENNIFER DIXON, EXAMINING ATTORNEY



David J. Kyros

Director of the United States Patent and Trademark Office

United States of America

United States Patent and Trademark Office

BABY 411

Reg. No. 4,065,450

FIELDS, ALAN (UNITED STATES INDIVIDUAL), DBA WINDSOR PEAK PRESS
436 PINE STREET
BOULDER, CO 80302 AND

Registered Dec. 6, 2011

Int. Cl.: 44

FIELDS, DENISE (UNITED STATES INDIVIDUAL), DBA WINDSOR PEAK PRESS
436 PINE STREET
BOULDER, CO 80302

SERVICE MARK

PRINCIPAL REGISTER

FOR: PROVIDING AN ONLINE RESOURCE GUIDE AND INFORMATION IN THE FIELDS OF INFANT MEDICAL CARE, INFANT NUTRITION, AND PARENTING ADVICE CONCERNING THE HEALTH OF INFANTS, IN CLASS 44 (U.S. CLS. 100 AND 101).

FIRST USE 8-30-2003; IN COMMERCE 8-30-2003.

THE MARK CONSISTS OF STANDARD CHARACTERS WITHOUT CLAIM TO ANY PARTICULAR FONT, STYLE, SIZE, OR COLOR.

NO CLAIM IS MADE TO THE EXCLUSIVE RIGHT TO USE "BABY", APART FROM THE MARK AS SHOWN.

SER. NO. 85-013,198, FILED 4-13-2010.

JENNIFER DIXON, EXAMINING ATTORNEY



David J. Kybas

Director of the United States Patent and Trademark Office

United States of America

United States Patent and Trademark Office

SATIV

Reg. No. 4,065,451

Registered Dec. 6, 2011

Int. Cls.: 42 and 45

SERVICE MARK

PRINCIPAL REGISTER

ONCAM GLOBAL INC. (DELAWARE CORPORATION)
175 CABOT STREET, SUITE 400
LOWELL, MA 01854

FOR: DESIGN AND DEVELOPMENT OF HOME SECURITY SYSTEMS; ENGINEERING AND SYSTEM ANALYSIS IN THE FIELD OF HOME SECURITY SYSTEMS; ON-LINE SYSTEM MANAGEMENT SERVICES THAT ALLOW USERS TO REMOTELY VIEW, MONITOR, PROGRAM, OPERATE AND CONTROL LARGE AND SMALL APPLIANCES, ELECTRICAL SYSTEMS AND SECURITY SYSTEMS IN HOMES, OFFICES AND VEHICLES; PROVIDING TECHNOLOGY INFORMATION UPDATES FOR HOME SECURITY SYSTEMS VIA THE GLOBAL COMPUTER NETWORK; TESTING OF SECURITY SYSTEMS, IN CLASS 42 (U.S. CLS. 100 AND 101).

FIRST USE 4-6-2010; IN COMMERCE 4-6-2010.

FOR: ADVISORY SERVICES IN THE FIELD OF HOME SECURITY SYSTEMS; CONTROL OF BUILDING ENVIRONMENTAL ACCESS AND SECURITY SYSTEMS; MONITORING ALARMS; MONITORING OF SECURITY SYSTEMS; MONITORING OF SECURITY SYSTEMS USED IN ELECTRONIC TRACKING FOR USE IN CONNECTION WITH HOMELAND SECURITY; SECURITY CONSULTANCY; SECURITY SERVICES, NAMELY, PROVIDING SECURITY ASSESSMENTS OF PHYSICAL LOCATIONS, INFORMATION SYSTEMS, AND WORKING ENVIRONMENTS, IN CLASS 45 (U.S. CLS. 100 AND 101).

FIRST USE 4-1-2009; IN COMMERCE 4-1-2009.

THE MARK CONSISTS OF STANDARD CHARACTERS WITHOUT CLAIM TO ANY PARTICULAR FONT, STYLE, SIZE, OR COLOR.

SER. NO. 85-014,932, FILED 4-15-2010.

GIANCARLO CASTRO, EXAMINING ATTORNEY



David J. Kyros

Director of the United States Patent and Trademark Office

United States of America

United States Patent and Trademark Office



Reg. No. 4,065,452

Registered Dec. 6, 2011

Int. Cl.: 16

TRADEMARK

PRINCIPAL REGISTER

PAL BRANDS LIMITED (NEW ZEALAND COMPANY)
C/- DELOITTE, 8 NELSON STREET
AUCKLAND, NEW ZEALAND

FOR: PAINT BRUSHES, PAINT ROLLERS, PAINT PADDLES, PAINT STIRRERS, PAINT APPLICATORS AND PAINT TRAYS, IN CLASS 16 (U.S. CLS. 2, 5, 22, 23, 29, 37, 38 AND 50).

OWNER OF NEW ZEALAND REG. NO. 732064, DATED 1-5-2006, EXPIRES 7-1-2015.

NO CLAIM IS MADE TO THE EXCLUSIVE RIGHT TO USE "CONTRACT PROFESSIONAL", APART FROM THE MARK AS SHOWN.

THE MARK CONSISTS OF A "P" INSIDE A CIRCLE SURROUNDED BY THE WORDS "CONTRACT PROFESSIONAL".

SER. NO. 85-017,790, FILED 4-20-2010.

SHAILA SETTLES, EXAMINING ATTORNEY



David J. Kybas

Director of the United States Patent and Trademark Office

United States of America

United States Patent and Trademark Office

Cell-Phone-A-Thon

Reg. No. 4,065,453

Registered Dec. 6, 2011

Int. Cl.: 36

SERVICE MARK

PRINCIPAL REGISTER

EZSWIPE, LLC (MARYLAND LIMITED LIABILITY COMPANY)
2 INDUSTRIAL PARK DRIVE
SUITE B
WALDORF, MD 206022729

FOR: CHARITABLE FUNDRAISING SERVICES, IN CLASS 36 (U.S. CLS. 100, 101 AND 102).

FIRST USE 11-1-2009; IN COMMERCE 11-1-2009.

NO CLAIM IS MADE TO THE EXCLUSIVE RIGHT TO USE "CELL-PHONE-A-THON",
APART FROM THE MARK AS SHOWN.

THE MARK CONSISTS OF THE TEXT "CELL-PHONE-A-THON" WITH A STYLIZED "O"
IN THE WORD PHONE.

SER. NO. 85-018,611, FILED 4-20-2010.

BRENDAN MCCAULEY, EXAMINING ATTORNEY



David J. Kybas

Director of the United States Patent and Trademark Office

United States of America

United States Patent and Trademark Office



Reg. No. 4,065,454

Registered Dec. 6, 2011

Int. Cl.: 37

SERVICE MARK

PRINCIPAL REGISTER

CUSTOM TRANZ, INC. (CALIFORNIA CORPORATION), DBA V
SAME
16870 JOLEEN WAY SUITE #4
MORGAN HILL, CA 95037

FOR: REMANUFACTURE OF TRANSMISSION SOLENOIDS TO THE ORDER AND/OR SPECIFICATION OF OTHERS, IN CLASS 37 (U.S. CLS. 100, 103 AND 106).

FIRST USE 4-8-2010; IN COMMERCE 4-8-2010.

NO CLAIM IS MADE TO THE EXCLUSIVE RIGHT TO USE "PRO", APART FROM THE MARK AS SHOWN.

THE COLOR(S) BLUE, RED AND BLACK IS/ARE CLAIMED AS A FEATURE OF THE MARK.

THE MARK CONSISTS OF THE WORDING "SOL PRO" WRITTEN IN A LARGE, STYLIZED FONT, WHERE THE TERM "SOL" APPEARS IN BLUE AND THE TERM "PRO" APPEARS IN RED; THE WORDING "SOL PRO" APPEARS OVER THE WORDING "BUILT BY THE PROS FOR THE PROS" WRITTEN IN A SMALLER FONT AND APPEARING IN THE COLOR BLACK.

SER. NO. 85-020,672, FILED 4-22-2010.

RICHARD WHITE, EXAMINING ATTORNEY



David J. Kyros

Director of the United States Patent and Trademark Office

United States of America

United States Patent and Trademark Office

OTER

Reg. No. 4,065,455

Registered Dec. 6, 2011

Int. Cl.: 33

TRADEMARK

PRINCIPAL REGISTER

BAZ PONCELA, LORENZO (SPAIN INDIVIDUAL)
BARTOLOMÉ DE LAS CASAS, 59
URB. LA VEGA, ARROYO DE LA ENCOMIENDA
VALLADOLID, SPAIN 47195

FOR: WINES, IN CLASS 33 (U.S. CLS. 47 AND 49).

THE MARK CONSISTS OF STANDARD CHARACTERS WITHOUT CLAIM TO ANY PARTICULAR FONT, STYLE, SIZE, OR COLOR.

OWNER OF ERPN CMNTY TM OFC REG. NO. 009022971, DATED 9-2-2010, EXPIRES 4-13-2020.

THE WORDING "OTER" HAS NO MEANING IN A FOREIGN LANGUAGE.

SER. NO. 85-021,542, FILED 4-23-2010.

WILLIAM VERHOSEK, EXAMINING ATTORNEY



David J. Kybas

Director of the United States Patent and Trademark Office

United States of America

United States Patent and Trademark Office



Reg. No. 4,065,456

Registered Dec. 6, 2011

Int. Cl.: 9

TRADEMARK

PRINCIPAL REGISTER

TECH LOGIC CORPORATION (WISCONSIN CORPORATION)
1818 BUERKLE ROAD
WHITE BEAR LAKE, MN 55110

FOR: PORTABLE ELECTRONIC HAND-HELD RFID INVENTORY WAND, NAMELY, SCANNER FOR SCANNING BOOKS FOR MANAGEMENT OF LIBRARY BOOK INVENTORY, COMPUTER HARDWARE AND SOFTWARE FOR USE IN LIBRARY MANAGEMENT OF BOOKS, DESIGNED SPECIFICALLY FOR USE IN LIBRARIES WHICH COMMUNICATES VIA WIRELESS TELECOMMUNICATIONS PROTOCOL TO HAND-HELD MICRO PC, IN CLASS 9 (U.S. CLS. 21, 23, 26, 36 AND 38).

FIRST USE 1-1-2008; IN COMMERCE 1-1-2008.

NO CLAIM IS MADE TO THE EXCLUSIVE RIGHT TO USE "RF", APART FROM THE MARK AS SHOWN.

THE COLOR(S) RED AND BLUE IS/ARE CLAIMED AS A FEATURE OF THE MARK.

THE MARK CONSISTS OF THE WORDING "CIRC" IN RED, THE WORDING "TRAK" WITH AN ARROW APPEARING ON THE LETTER "A" IN BLUE, THE BLUE INCOMPLETE CONCENTRIC CIRCLES AND THE BLUE WORDING "RF" APPEARING TO THE RIGHT AND OUTSIDE OF THE CIRCLES. THE COLOR WHITE IN THE MARK REPRESENTS THE BACKGROUND AND IS NOT A FEATURE OF THE MARK.

SER. NO. 85-022,022, FILED 4-23-2010.

JENNY PARK, EXAMINING ATTORNEY



David J. Kyjars

Director of the United States Patent and Trademark Office

United States of America

United States Patent and Trademark Office



Reg. No. 4,065,457

Registered Dec. 6, 2011

Int. Cl.: 29

TRADEMARK

PRINCIPAL REGISTER

QUANTUM FOODS, LLC (DELAWARE LIMITED LIABILITY COMPANY)
750 SOUTH SCHMIDT ROAD
BOLINGBROOK, IL 60440

FOR: PROCESSED MEATS, BEEF, POULTRY AND PORK SOLD IN PORTIONS; FULLY COOKED ENTREES CONSISTING PRIMARILY OF BEEF, POULTRY AND PORK, IN CLASS 29 (U.S. CL. 46).

FIRST USE 8-1-2009; IN COMMERCE 8-1-2009.

OWNER OF U.S. REG. NOS. 3,013,149, 3,245,334, AND 3,889,904.

THE COLOR(S) BROWN, GREEN, BLUE, YELLOW, RED, WHITE, ORANGE, GOLD AND GRAY IS/ARE CLAIMED AS A FEATURE OF THE MARK.

NO CLAIM IS MADE TO THE EXCLUSIVE RIGHT TO USE "PREMIUM STEAKHOUSE MEATS" AND THE PHOTOGRAPH OF THE STEAK, APART FROM THE MARK AS SHOWN.

THE MARK CONSISTS OF RED BACKGROUND COLORS WHICH VARY FROM DARKER TO LIGHTER HUES. IN THE CENTER IS A RECTANGLE OUTLINED IN GRAY AND GOLD. WITHIN THE RECTANGLE IS A PICTURE OF COOKED STEAK IN BROWN AND RED WITH A GREEN PARSLEY LEAF AND THE WORDS "PREMIUM STEAKHOUSE" AND "MEATS" IN SHADES OF WHITE, YELLOW AND ORANGE LETTERS. ON THE LEFT SIDE OF THE RECTANGLE IS A STYLIZED DESIGN OF A GOLD GLOBE WITH POINTS AROUND THE CIRCUMFERENCE AND A RED BANNER WITH THE WORDS "COMMITTED TO QUALITY" IN WHITE LETTERS AND A BLUE RIBBON EXTENDING FROM THE BOTTOM OF THE GLOBE. ABOVE THE RECTANGLE ARE THE WORDS "GENUINE GOLD LABEL" IN WHITE LETTERS AND BELOW THE RECTANGLE ARE CIRCULAR DESIGNS IN WHITE AND THE WORDS "MIDWESTERN BRAND" IN WHITE LETTERS.

SEC. 2(F) AS TO "MIDWESTERN".

SER. NO. 85-023,223, FILED 4-26-2010.

JOHN HWANG, EXAMINING ATTORNEY



David J. Kybas

Director of the United States Patent and Trademark Office

United States of America

United States Patent and Trademark Office



Reg. No. 4,065,458

Registered Dec. 6, 2011

Int. Cls.: 37 and 42

SERVICE MARK

PRINCIPAL REGISTER

PRESSLINE SERVICES, INC. (MISSOURI CORPORATION)
9711 GREEN PARK INDUSTRIAL DRIVE
ST. LOUIS, MO 63123

FOR: MODIFICATION OF PRINTING PRESS UNITS AND THEIR PARTS, NAMELY, FOLDERS, DRIVE SYSTEMS, ELECTRONICS, CONTROLS AND THEIR ANCILLARY COMPONENTS; REPAIR, REBUILDING AND MAINTENANCE OF PRINTING PRESS UNITS AND THEIR PARTS, NAMELY, FOLDERS, DRIVE SYSTEMS, ELECTRONICS, CONTROLS AND THEIR ANCILLARY COMPONENTS; REPLACEMENT OF PRINTING PRESS UNITS AND THEIR PARTS, NAMELY, FOLDERS, DRIVE SYSTEMS, ELECTRONICS, CONTROLS AND THEIR ANCILLARY COMPONENTS; UPGRADE SERVICES, NAMELY, CONVERSION OF PRINTING PRESS UNITS AND FOLDERS FROM TWO AROUND PRINTING PROCESSES TO THREE AROUND PRINTING PROCESSES, CONVERTING ANALOG INKERS TO DIGITAL INKERS, CONVERTING MANUAL CIRCUMFERENTIAL AND SIDELAY ADJUSTMENTS TO MOTORIZED CIRCUMFERENTIAL AND SIDELAY ADJUSTMENTS AND CONVERTING OF INK AND WATER FEEDS FROM MANUAL SETTINGS TO AUTOMATIC SETTINGS IN THE PRINTING PRESS INDUSTRY, IN CLASS 37 (U.S. CLS. 100, 103 AND 106).

FIRST USE 6-0-1995; IN COMMERCE 6-0-1995.

FOR: CUSTOM DESIGN OF PRINTING PRESS UNITS AND THEIR PARTS, NAMELY, FOLDERS, DRIVE SYSTEMS, ELECTRONICS, CONTROLS AND THEIR ANCILLARY COMPONENTS BASED ON PERSONAL SELECTIONS MADE BY THE CUSTOMER IN THE COMMERCIAL PRESS INDUSTRY; AND ENGINEERING SERVICES IN THE PRINTING PRESS INDUSTRY, NAMELY, WEB REDUCTIONS, CUTOFF TECHNOLOGY, REMANUFACTURING, AND PARTS, IN CLASS 42 (U.S. CLS. 100 AND 101).

FIRST USE 6-0-1995; IN COMMERCE 6-0-1995.

NO CLAIM IS MADE TO THE EXCLUSIVE RIGHT TO USE "SERVICES" FOR BOTH CLASSES 37 AND 42 AND "PRESSLINE" FOR INTERNATIONAL CLASS 42, APART FROM THE MARK AS SHOWN.

THE MARK CONSISTS OF THREE HORIZONTAL LINES, WHICH ARE EQUALLY SPACED APART FROM EACH OTHER. THE THREE LINES ARE CONNECTED BY AN S-SHAPED CIRCULAR LINE, WHICH EXTENDS FROM THE TOP LINE TO BOTTOM LINE ON THE LEFT SIDE OF THE LOGO. A CIRCLE APPEARS BETWEEN THE TOP AND MIDDLE LINES



David J. Kyros

Director of the United States Patent and Trademark Office

Reg. No. 4,065,458 AND THE MIDDLE AND BOTTOM LINES NEXT TO THE S-SHAPED CIRCULAR LINE. THE WORD "PRESSLINE" APPEARS BETWEEN THE TOP AND MIDDLE LINES NEXT TO THE S-SHAPED LINE CIRCULAR LINE. THE WORD "SERVICES" APPEARS BETWEEN THE MIDDLE AND LOWER LINES, DIRECTLY UNDER THE WORD "PRESSLINE".

SER. NO. 85-024,629, FILED 4-27-2010.

CHRISTOPHER BUONGIORNO, EXAMINING ATTORNEY

United States of America

United States Patent and Trademark Office

SPA KIDZ

Reg. No. 4,065,459

Registered Dec. 6, 2011

Int. Cl.: 45

SERVICE MARK

PRINCIPAL REGISTER

SPA LADY INC. (CANADA CORPORATION)
7222 EDMONTON BLVD. N.W.
CALGARY, AB T3A 2X7, CANADA

FOR: CHILD MINDING SERVICES, NAMELY, PROVIDING BABY SITTING SERVICES, IN CLASS 45 (U.S. CLS. 100 AND 101).

THE MARK CONSISTS OF STANDARD CHARACTERS WITHOUT CLAIM TO ANY PARTICULAR FONT, STYLE, SIZE, OR COLOR.

OWNER OF CANADA REG. NO. TMA781,670, DATED 11-4-2010, EXPIRES 11-4-2025.

NO CLAIM IS MADE TO THE EXCLUSIVE RIGHT TO USE "KIDS", APART FROM THE MARK AS SHOWN.

SER. NO. 85-024,974, FILED 4-28-2010.

GRETCHEN ULRICH, EXAMINING ATTORNEY



David J. Kyros

Director of the United States Patent and Trademark Office

United States of America

United States Patent and Trademark Office



DocEpsilon

Reg. No. 4,065,460

Registered Dec. 6, 2011

Int. Cl.: 35

SERVICE MARK

PRINCIPAL REGISTER

DOCEPSILON LLC (TEXAS LIMITED LIABILITY COMPANY)
SUITE 136
8204 ELMBROOK, SUITE 136
DALLAS, TX 75247

FOR: ADVERTISING AND BUSINESS MANAGEMENT CONSULTANCY; BUSINESS MANAGEMENT AND CONSULTATION, IN CLASS 35 (U.S. CLS. 100, 101 AND 102).

FIRST USE 4-1-2010; IN COMMERCE 4-1-2010.

THE MARK CONSISTS OF THE MARK CONSISTS OF SIX DOTS ARRANGED IN 2 VERTICAL ROWS, WITH 3 DOTS IN EACH ROW. THE TOP LEFT DOT IS GREEN TOP RIGHT DOT IS RED; MIDDLE LEFT DOT IS GRAY, MIDDLE RIGHT DOT IS BLUE; BOTTOM LEFT DOT IS BLACK BOTTOM RIGHT DOT IS ORANGE.

THE COLOR(S) THE COLOR(S) GREEN, RED, GRAY, BLUE, BLACK, ORANGE, IS/ARE CLAIMED AS A FEATURE OF THE MARK. IS/ARE CLAIMED AS A FEATURE OF THE MARK.

SER. NO. 85-025,646, FILED 4-28-2010.

CURTIS FRENCH, EXAMINING ATTORNEY



David J. Kyros

Director of the United States Patent and Trademark Office

United States of America

United States Patent and Trademark Office

Lodge & Learn

Reg. No. 4,065,461

Registered Dec. 6, 2011

Int. Cl.: 41

SERVICE MARK

PRINCIPAL REGISTER

BLACKNOSE PET RESORTS, INC. (VIRGINIA CORPORATION)
P.O. BOX 111
GOOCHLAND, VA 23063

FOR: ANIMAL TRAINING; ARRANGEMENT OF TRAINING COURSES IN TEACHING INSTITUTES; ARRANGING PROFESSIONAL WORKSHOP AND TRAINING COURSES; DOG TRAINING; KENNEL SERVICES, NAMELY, DOG TRAINING SERVICES; OBEDIENCE SCHOOL TRAINING FOR ANIMALS; PET OBEDIENCE TRAINING SERVICES; PET TRAINING SERVICES; TRAINING ANIMALS FOR OTHERS, IN CLASS 41 (U.S. CLS. 100, 101 AND 107).

FIRST USE 2-19-2009; IN COMMERCE 2-19-2009.

THE MARK CONSISTS OF STANDARD CHARACTERS WITHOUT CLAIM TO ANY PARTICULAR FONT, STYLE, SIZE, OR COLOR.

SER. NO. 85-026,898, FILED 4-30-2010.

NELSON SNYDER, EXAMINING ATTORNEY



David J. Kyffers

Director of the United States Patent and Trademark Office

United States of America

United States Patent and Trademark Office

CCA

Reg. No. 4,065,462

Registered Dec. 6, 2011

**Int. Cls.: 19, 27, 35, 37
and 42**

TRADEMARK

SERVICE MARK

PRINCIPAL REGISTER

COMMERCIAL CARPETS OF AMERICA, INC. (VIRGINIA CORPORATION)
430 S. PICKETT STREET
ALEXANDRIA, VA 22304

FOR: CERAMIC TILES, CERAMIC TILES FOR FLOORING AND FACING, CERAMIC TILES FOR FLOORING AND LINING, CERAMIC TILES FOR TILE FLOORS AND COVERINGS, VINYL FLOORING, VINYL TILES, IN CLASS 19 (U.S. CLS. 1, 12, 33 AND 50).

FIRST USE 7-1-1980; IN COMMERCE 7-1-1980.

FOR: CARPET TILES, CARPET TILES FOR COVERING FLOORS, CARPETING, CARPETS, RUGS, MATS AND MATTING, FLOOR COVERINGS, FLOOR COVERINGS OF RUBBER AND SYNTHETIC RUBBER, RESILIENT HARD SURFACE COVERINGS FOR FLOORS, VINYL FLOOR COVERINGS, IN CLASS 27 (U.S. CLS. 19, 20, 37, 42 AND 50).

FIRST USE 7-1-1980; IN COMMERCE 7-1-1980.

FOR: RETAIL STORE SERVICES FEATURING CARPETS, LINOLEUM, VINYL AND CERAMIC TILES, AND HARDWOOD FLOORING; CUSTOMER SERVICE IN THE FIELD OF FLOORING, IN CLASS 35 (U.S. CLS. 100, 101 AND 102).

FIRST USE 7-1-1980; IN COMMERCE 7-1-1980.

FOR: INSTALLATION, CLEANING, MAINTENANCE, AND REPAIR OF CARPET, LINOLEUM, VINYL AND CERAMIC TILES, AND HARDWOOD FLOORING FOR COMMERCIAL AND RESIDENTIAL USE, IN CLASS 37 (U.S. CLS. 100, 103 AND 106).

FIRST USE 7-1-1980; IN COMMERCE 7-1-1980.

FOR: DESIGN AND DESIGN CONSULTING SERVICES, AND PRODUCT DEVELOPMENT, ALL IN THE FIELD OF FLOORING, IN CLASS 42 (U.S. CLS. 100 AND 101).

FIRST USE 7-1-1980; IN COMMERCE 7-1-1980.

THE MARK CONSISTS OF STANDARD CHARACTERS WITHOUT CLAIM TO ANY PARTICULAR FONT, STYLE, SIZE, OR COLOR.



David J. Kybas

Director of the United States Patent and Trademark Office

Reg. No. 4,065,462 SER. NO. 85-026,998, FILED 4-30-2010.

LINDA MICKLEBURGH, EXAMINING ATTORNEY

United States of America

United States Patent and Trademark Office



Reg. No. 4,065,463

Registered Dec. 6, 2011

Int. Cls.: 35 and 36

SERVICE MARK

PRINCIPAL REGISTER

CLENNAN, ROY J. (UNITED STATES INDIVIDUAL)
5455 N UNION BLVD.
COLORADO SPRINGS, CO 80918

FOR: MATCHING BORROWERS WITH POTENTIAL LENDERS IN THE FIELD OF MORTGAGE LENDING, IN CLASS 35 (U.S. CLS. 100, 101 AND 102).

FIRST USE 9-15-1997; IN COMMERCE 9-15-1997.

FOR: MORTGAGE BANKING; MORTGAGE BANKING SERVICES, NAMELY, ORIGATION, ACQUISITION, SERVICING, SECURITIZATION AND BROKERAGE OF MORTGAGE LOANS; MORTGAGE BROKERAGE; MORTGAGE LENDING, IN CLASS 36 (U.S. CLS. 100, 101 AND 102).

FIRST USE 9-15-1997; IN COMMERCE 9-15-1997.

NO CLAIM IS MADE TO THE EXCLUSIVE RIGHT TO USE "FINANCIAL SERVICES" AND "THE MORTGAGE EXPERTS", APART FROM THE MARK AS SHOWN.

THE COLOR(S) GREEN AND GOLD IS/ARE CLAIMED AS A FEATURE OF THE MARK.

THE MARK CONSISTS OF THE WORDING "FREEDOM FINANCIAL SERVICES THE MORTGAGE EXPERTS" AND A DESIGN ELEMENT COMPRISING TWO STYLIZED LETTER "F"'S INTERSECTING. TWO PARALLEL LINES APPEAR ABOVE AND BELOW THE WORDING "FINANCIAL SERVICES". THE COLOR GREEN APPEARS IN THE WORDING "FREEDOM FINANCIAL SERVICES THE MORTGAGE EXPERTS" AND IN THE "F" DESIGN ELEMENT. THE COLOR GOLD APPEARS IN THE "F" DESIGN ELEMENT AND IN THE PARALLEL LINES.

SER. NO. 85-027,281, FILED 4-30-2010.

LAURIE KAUFMAN, EXAMINING ATTORNEY



David J. Kyjars

Director of the United States Patent and Trademark Office

United States of America

United States Patent and Trademark Office

NEEL EFFECT

Reg. No. 4,065,464

Registered Dec. 6, 2011

Int. Cl.: 9

TRADEMARK

PRINCIPAL REGISTER

NEELOGY (FRANCE SOCIETE ANONYME)
191 AVENUE ARISTIDE BRIAND
CACHAN, FRANCE F-94230

FOR: ELECTROMAGNETIC SENSORS FOR CURRENT, VOLTAGE OR POWER, ELECTRIC POWER METERS, DIAGNOSTIC APPARATUS, NOT FOR MEDICAL USE, FOR TESTING ELECTRIC PARAMETERS, SAID APPARATUS CONSISTING OF ELECTRIC SENSORS AND PROBES FOR SCIENTIFIC PURPOSES, IN CLASS 9 (U.S. CLS. 21, 23, 26, 36 AND 38).

THE MARK CONSISTS OF STANDARD CHARACTERS WITHOUT CLAIM TO ANY PARTICULAR FONT, STYLE, SIZE, OR COLOR.

PRIORITY CLAIMED UNDER SEC. 44(D) ON ERPN CMNTY TM OFC APPLICATION NO. 008687907, FILED 11-16-2009, REG. NO. 008687907, DATED 8-10-2010, EXPIRES 11-16-2019.

SER. NO. 85-027,346, FILED 4-30-2010.

TRACY CROSS, EXAMINING ATTORNEY



David J. Kyffers

Director of the United States Patent and Trademark Office

United States of America

United States Patent and Trademark Office

One Pump. One Arm. Once a
Day.

Reg. No. 4,065,465

Registered Dec. 6, 2011

Int. Cl.: 5

TRADEMARK

PRINCIPAL REGISTER

LASALLE LABORATORIES, INC. (DELAWARE CORPORATION)
607 HERNDON PARKWAY
SUITE 110
HERNDON, VA 20170

FOR: PHARMACEUTICAL PREPARATIONS FOR TREATMENT OF MENOPAUSE AND POST-MENOPAUSE SYMPTOMS AND CONDITIONS; PHARMACEUTICAL PREPARATIONS FOR HORMONE THERAPY , IN CLASS 5 (U.S. CLS. 6, 18, 44, 46, 51 AND 52).

FIRST USE 11-0-2008; IN COMMERCE 11-0-2008.

THE MARK CONSISTS OF STANDARD CHARACTERS WITHOUT CLAIM TO ANY PARTICULAR FONT, STYLE, SIZE, OR COLOR.

SER. NO. 85-027,666, FILED 4-30-2010.

DORITT L. CARROLL, EXAMINING ATTORNEY



David J. Kybas

Director of the United States Patent and Trademark Office

United States of America

United States Patent and Trademark Office

THE ANTIQUES DIVA

Reg. No. 4,065,466

Registered Dec. 6, 2011

Int. Cl.: 35

SERVICE MARK

PRINCIPAL REGISTER

HAINES, TOMA I (UNITED STATES INDIVIDUAL), DBA THE ANTIQUES DIVA
MARIEN STRASSE 23
BERLIN, FED REP GERMANY 10117

FOR: PROVIDING AN ON-LINE DIRECTORY INFORMATION SERVICE FEATURING INFORMATION REGARDING ANTIQUES, SHOPPING AND TRAVEL, IN CLASS 35 (U.S. CLS. 100, 101 AND 102).

FIRST USE 12-31-2007; IN COMMERCE 12-31-2007.

THE MARK CONSISTS OF STANDARD CHARACTERS WITHOUT CLAIM TO ANY PARTICULAR FONT, STYLE, SIZE, OR COLOR.

NO CLAIM IS MADE TO THE EXCLUSIVE RIGHT TO USE "ANTIQUES", APART FROM THE MARK AS SHOWN.

SER. NO. 85-027,670, FILED 4-30-2010.

JOHN DWYER, EXAMINING ATTORNEY



David J. Kybas

Director of the United States Patent and Trademark Office

United States of America

United States Patent and Trademark Office



Reg. No. 4,065,467

Registered Dec. 6, 2011

Int. Cl.: 35

SERVICE MARK

PRINCIPAL REGISTER

EBID LIMITED (UNITED KINGDOM CORPORATION)
82 HIGH ROAD, BYFLEET, WEST BYFLEET
C/O TEMPLE WEST
SURREY, UNITED KINGDOM KT147QW

FOR: ON-LINE AUCTION SERVICES, IN CLASS 35 (U.S. CLS. 100, 101 AND 102).

FIRST USE 2-0-2008; IN COMMERCE 2-0-2008.

THE MARK CONSISTS OF A CIRCLE ENCLOSING THE PHRASE "EBID" CONNECTED TO ANOTHER CIRCLE ENCLOSING A HAMMER. THE COLOR GRAY IS FOR SHADING PURPOSES ONLY, AND COLOR IS NOT CLAIMED AS A FEATURE OF THE MARK.

SEC. 2(F).

SER. NO. 85-027,896, FILED 4-30-2010.

SEAN CROWLEY, EXAMINING ATTORNEY



David J. Kybas

Director of the United States Patent and Trademark Office

United States of America

United States Patent and Trademark Office

SPEND COMPASS

Reg. No. 4,065,468

Registered Dec. 6, 2011

Int. Cl.: 42

SERVICE MARK

PRINCIPAL REGISTER

THE ADVISORY BOARD COMPANY (DELAWARE CORPORATION)
2445 M STREET, NW
WASHINGTON, DC 20037

FOR: PROVIDING TEMPORARY USE OF ONLINE, NON-DOWNLOADABLE SOFTWARE FOR ANALYSIS OF DATA IN THE FIELD OF BUSINESS INTELLIGENCE, IN CLASS 42 (U.S. CLS. 100 AND 101).

FIRST USE 12-1-2005; IN COMMERCE 12-1-2005.

THE MARK CONSISTS OF STANDARD CHARACTERS WITHOUT CLAIM TO ANY PARTICULAR FONT, STYLE, SIZE, OR COLOR.

OWNER OF U.S. REG. NOS. 3,260,322, 3,743,938 AND OTHERS.

NO CLAIM IS MADE TO THE EXCLUSIVE RIGHT TO USE "SPEND", APART FROM THE MARK AS SHOWN.

SER. NO. 85-028,857, FILED 5-3-2010.

ERIN FALK, EXAMINING ATTORNEY



David J. Kybas

Director of the United States Patent and Trademark Office

United States of America

United States Patent and Trademark Office

SURGERY COMPASS

Reg. No. 4,065,469

Registered Dec. 6, 2011

Int. Cl.: 42

SERVICE MARK

PRINCIPAL REGISTER

THE ADVISORY BOARD COMPANY (DELAWARE CORPORATION)
2445 M STREET, NW
WASHINGTON, DC 20037

FOR: PROVIDING TEMPORARY USE OF ONLINE, NON-DOWNLOADABLE SOFTWARE FOR ANALYSIS OF DATA IN THE FIELD OF BUSINESS INTELLIGENCE, IN CLASS 42 (U.S. CLS. 100 AND 101).

FIRST USE 11-1-2005; IN COMMERCE 11-1-2005.

THE MARK CONSISTS OF STANDARD CHARACTERS WITHOUT CLAIM TO ANY PARTICULAR FONT, STYLE, SIZE, OR COLOR.

OWNER OF U.S. REG. NOS. 3,260,322, 3,743,938 AND OTHERS.

NO CLAIM IS MADE TO THE EXCLUSIVE RIGHT TO USE "SURGERY", APART FROM THE MARK AS SHOWN.

SER. NO. 85-028,861, FILED 5-3-2010.

ERIN FALK, EXAMINING ATTORNEY



David J. Kybas

Director of the United States Patent and Trademark Office

United States of America

United States Patent and Trademark Office

REVENUE INTEGRITY COMPASS

Reg. No. 4,065,470

Registered Dec. 6, 2011

Int. Cl.: 42

SERVICE MARK

PRINCIPAL REGISTER

THE ADVISORY BOARD COMPANY (DELAWARE CORPORATION)
2445 M STREET, NW
WASHINGTON, DC 20037

FOR: PROVIDING TEMPORARY USE OF ONLINE, NON-DOWNLOADABLE SOFTWARE FOR ANALYSIS OF DATA IN THE FIELD OF BUSINESS INTELLIGENCE, IN CLASS 42 (U.S. CLS. 100 AND 101).

FIRST USE 11-5-2008; IN COMMERCE 11-5-2008.

THE MARK CONSISTS OF STANDARD CHARACTERS WITHOUT CLAIM TO ANY PARTICULAR FONT, STYLE, SIZE, OR COLOR.

OWNER OF U.S. REG. NOS. 3,260,322, 3,743,938 AND OTHERS.

NO CLAIM IS MADE TO THE EXCLUSIVE RIGHT TO USE "REVENUE INTEGRITY", APART FROM THE MARK AS SHOWN.

SER. NO. 85-028,863, FILED 5-3-2010.

ERIN FALK, EXAMINING ATTORNEY



David J. Kybas

Director of the United States Patent and Trademark Office

United States of America

United States Patent and Trademark Office

REVENUE CYCLE COMPASS

Reg. No. 4,065,471

Registered Dec. 6, 2011

Int. Cl.: 42

SERVICE MARK

PRINCIPAL REGISTER

THE ADVISORY BOARD COMPANY (DELAWARE CORPORATION)
2445 M STREET, NW
WASHINGTON, DC 20037

FOR: PROVIDING TEMPORARY USE OF ONLINE, NON-DOWNLOADABLE SOFTWARE FOR ANALYSIS OF DATA IN THE FIELD OF BUSINESS INTELLIGENCE, IN CLASS 42 (U.S. CLS. 100 AND 101).

FIRST USE 12-1-2003; IN COMMERCE 12-1-2003.

THE MARK CONSISTS OF STANDARD CHARACTERS WITHOUT CLAIM TO ANY PARTICULAR FONT, STYLE, SIZE, OR COLOR.

OWNER OF U.S. REG. NOS. 3,448,041, 3,743,938 AND OTHERS.

NO CLAIM IS MADE TO THE EXCLUSIVE RIGHT TO USE "REVENUE CYCLE", APART FROM THE MARK AS SHOWN.

SER. NO. 85-028,871, FILED 5-3-2010.

ERIN FALK, EXAMINING ATTORNEY



David J. Kyros

Director of the United States Patent and Trademark Office

United States of America

United States Patent and Trademark Office

ED COMPASS

Reg. No. 4,065,472

Registered Dec. 6, 2011

Int. Cl.: 42

SERVICE MARK

PRINCIPAL REGISTER

THE ADVISORY BOARD COMPANY (DELAWARE CORPORATION)
2445 M STREET, NW
WASHINGTON, DC 20037

FOR: PROVIDING TEMPORARY USE OF ONLINE, NON-DOWNLOADABLE SOFTWARE FOR ANALYSIS OF DATA IN THE FIELD OF BUSINESS INTELLIGENCE, IN CLASS 42 (U.S. CLS. 100 AND 101).

FIRST USE 11-13-2007; IN COMMERCE 11-13-2007.

THE MARK CONSISTS OF STANDARD CHARACTERS WITHOUT CLAIM TO ANY PARTICULAR FONT, STYLE, SIZE, OR COLOR.

OWNER OF U.S. REG. NOS. 3,448,219, 3,743,938 AND OTHERS.

NO CLAIM IS MADE TO THE EXCLUSIVE RIGHT TO USE "ED", APART FROM THE MARK AS SHOWN.

SER. NO. 85-028,878, FILED 5-3-2010.

ERIN FALK, EXAMINING ATTORNEY



David J. Kyros

Director of the United States Patent and Trademark Office

United States of America

United States Patent and Trademark Office

NURSING COMPASS

Reg. No. 4,065,473

Registered Dec. 6, 2011

Int. Cl.: 42

SERVICE MARK

PRINCIPAL REGISTER

THE ADVISORY BOARD COMPANY (DELAWARE CORPORATION)
2445 M STREET, NW
WASHINGTON, DC 20037

FOR: PROVIDING TEMPORARY USE OF ONLINE, NON-DOWNLOADABLE SOFTWARE FOR ANALYSIS OF DATA IN THE FIELD OF BUSINESS INTELLIGENCE, IN CLASS 42 (U.S. CLS. 100 AND 101).

FIRST USE 6-27-2006; IN COMMERCE 6-27-2006.

THE MARK CONSISTS OF STANDARD CHARACTERS WITHOUT CLAIM TO ANY PARTICULAR FONT, STYLE, SIZE, OR COLOR.

OWNER OF U.S. REG. NOS. 3,448,042, 3,743,938 AND OTHERS.

NO CLAIM IS MADE TO THE EXCLUSIVE RIGHT TO USE "NURSING", APART FROM THE MARK AS SHOWN.

SER. NO. 85-028,879, FILED 5-3-2010.

ERIN FALK, EXAMINING ATTORNEY



David J. Kybas

Director of the United States Patent and Trademark Office

United States of America

United States Patent and Trademark Office



Reg. No. 4,065,474

Registered Dec. 6, 2011

Int. Cls.: 9 and 18

TRADEMARK

PRINCIPAL REGISTER

RANIPAK INC. (REPUBLIC OF KOREA CORPORATION)
ILSAN-GU, GOYANG-SI
I-SPACE #1019, JANGHANG-DONG 785
GYEONGGI-DO, REPUBLIC OF KOREA

FOR: MESSENGER BAGS ESPECIALLY ADAPTED FOR HOLDING LAPTOPS; WHEELED MESSENGER BAGS ESPECIALLY ADAPTED FOR HOLDING LAPTOPS; BAGS FOR CAMERAS AND PHOTOGRAPHIC EQUIPMENT, IN CLASS 9 (U.S. CLS. 21, 23, 26, 36 AND 38).

FOR: BAGS, NAMELY, ALL PURPOSE CARRYING BAGS, TOTE BAGS, BACKPACKS, DUFFLE BAGS, BEACH BAGS, LEATHER BANDOLEERS, HANDBAGS, TRAVELLING BAGS, SUITCASES, BRIEFCASES FOR DOCUMENTS, RUCKSACKS, PURSES, NOT OF PRECIOUS METAL, IN CLASS 18 (U.S. CLS. 1, 2, 3, 22 AND 41).

PRIORITY CLAIMED UNDER SEC. 44(D) ON REPUBLIC OF KOREA APPLICATION NO. 40201022994, FILED 4-29-2010, REG. NO. 0871591, DATED 7-5-2011, EXPIRES 7-5-2021.

THE COLOR(S) ORANGE AND OLIVE IS/ARE CLAIMED AS A FEATURE OF THE MARK.

THE MARK CONSISTS OF THE WORD "RANIPAK" IN ORANGE WITHIN AN OLIVE RECTANGLE.

SER. NO. 85-029,312, FILED 5-4-2010.

ANGELA M. MICHELI, EXAMINING ATTORNEY



David J. Kybas

Director of the United States Patent and Trademark Office

United States of America

United States Patent and Trademark Office

Used Cardboard Boxes

Reg. No. 4,065,475

Registered Dec. 6, 2011

Int. Cl.: 16

TRADEMARK

PRINCIPAL REGISTER

USED CARDBOARD BOXES, INC. (CALIFORNIA CORPORATION)
4032 WILSHIRE BOULEVARD, SUITE 402
LOS ANGELES, CA 90010

FOR: LOW-COST, EARTH-FRIENDLY CARDBOARD MOVING BOXES MADE FROM RECYCLED, USED BOXES WHICH ARE PACKED INTO STACKS AND KITS, IN CLASS 16 (U.S. CLS. 2, 5, 22, 23, 29, 37, 38 AND 50).

FIRST USE 6-29-2004; IN COMMERCE 6-29-2004.

THE MARK CONSISTS OF STANDARD CHARACTERS WITHOUT CLAIM TO ANY PARTICULAR FONT, STYLE, SIZE, OR COLOR.

NO CLAIM IS MADE TO THE EXCLUSIVE RIGHT TO USE "CARDBOARD BOXES", APART FROM THE MARK AS SHOWN.

SEC. 2(F).

SER. NO. 85-029,724, FILED 5-4-2010.

TRACY CROSS, EXAMINING ATTORNEY



David J. Kyffers

Director of the United States Patent and Trademark Office

United States of America

United States Patent and Trademark Office



Reg. No. 4,065,476

Registered Dec. 6, 2011

Int. Cl.: 11

TRADEMARK

PRINCIPAL REGISTER

KRUPS GMBH (FED REP GERMANY GESELLSCHAFT MIT BESCHRÄNKTER HAFTUNG (GMBH))
HERESBACHSTRASSE 29
SOLINGEN, FED REP GERMANY 42719

FOR: ELECTRIC COFFEE MAKERS AND PARTS THEREOF, IN CLASS 11 (U.S. CLS. 13, 21, 23, 31 AND 34).

PRIORITY CLAIMED UNDER SEC. 44(D) ON FED REP GERMANY APPLICATION NO. 302009061474, FILED 12-18-2009, REG. NO. 302009061474, DATED 12-18-2009, EXPIRES 12-31-2019.

OWNER OF U.S. REG. NOS. 1,241,799 AND 2,070,984.

NO CLAIM IS MADE TO THE EXCLUSIVE RIGHT TO USE "PRECISE WARMING TECHNOLOGY", APART FROM THE MARK AS SHOWN.

THE MARK CONSISTS OF A SOLID RECTANGLE CONTAINING THE WORDS "KRUPS PRECISE WARMING TECHNOLOGY" AND A DESIGN OF A COFFEE MAKER INSET WITH A THERMOMETER.

SER. NO. 85-030,271, FILED 5-4-2010.

WILLIAM P. SHANAHAN, EXAMINING ATTORNEY



David J. Kyros

Director of the United States Patent and Trademark Office

United States of America

United States Patent and Trademark Office



Reg. No. 4,065,477

Registered Dec. 6, 2011

Int. Cls.: 7 and 11

TRADEMARK

PRINCIPAL REGISTER

EBM-PAPST MULFINGEN GMBH & CO. KG (FED REP GERMANY CORPORATION)
BACHMUHLE2
MULFINGEN, FED REP GERMANY 74673

FOR: ELECTRIC FANS, VENTILATORS AND BLOWERS FOR MOTORS AND ENGINES;
ELECTRIC MOTORS, NOT FOR LAND VEHICLES, IN CLASS 7 (U.S. CLS. 13, 19, 21, 23,
31, 34 AND 35).

FOR: ELECTRIC MOTOR-OPERATED VENTILATORS FOR DOMESTIC, COMMERCIAL
AND INDUSTRIAL USE, ELECTRIC MOTOR OPERATED HOT AIR, COOL AIR AND
NEUTRAL AIR BLOWERS FOR DOMESTIC, COMMERCIAL AND INDUSTRIAL USE, IN
CLASS 11 (U.S. CLS. 13, 21, 23, 31 AND 34).

PRIORITY CLAIMED UNDER SEC. 44(D) ON FED REP GERMANY APPLICATION NO.
302009065674, FILED 11-9-2009, REG. NO. 302009065674, DATED 3-23-2010, EXPIRES 11-
30-2019.

THE MARK CONSISTS OF THE WORDING "RADICAL" WHICH IS UNDERLINED AND
SURROUNDED BY A LINED BORDER.

SER. NO. 85-032,945, FILED 5-7-2010.

JESSICA A. POWERS, EXAMINING ATTORNEY



David J. Kybas

Director of the United States Patent and Trademark Office

United States of America

United States Patent and Trademark Office

K TRACK

Reg. No. 4,065,478

Registered Dec. 6, 2011

Int. Cl.: 9

TRADEMARK

PRINCIPAL REGISTER

CARL ZEISS AG (FED REP GERMANY CORPORATION)
CARL-ZEISS-STRASSE 22
OBERKOCHEN, FED REP GERMANY 73447

FOR: SOFTWARE USED IN OPHTHALMOLOGY FOR THE VISUALIZATION OF CORNEAL CURVATURE, IN CLASS 9 (U.S. CLS. 21, 23, 26, 36 AND 38).

THE MARK CONSISTS OF STANDARD CHARACTERS WITHOUT CLAIM TO ANY PARTICULAR FONT, STYLE, SIZE, OR COLOR.

PRIORITY CLAIMED UNDER SEC. 44(D) ON FED REP GERMANY APPLICATION NO. 302010016054, FILED 3-17-2010, REG. NO. 302010016054, DATED 7-7-2010, EXPIRES 3-31-2020.

SER. NO. 85-034,530, FILED 5-10-2010.

FRANK LATTUCA, EXAMINING ATTORNEY



David J. Kybas

Director of the United States Patent and Trademark Office

United States of America

United States Patent and Trademark Office

TOOLSTREAM

Reg. No. 4,065,479

Registered Dec. 6, 2011

**Int. Cls.: 6, 7, 8, 9, 18, 20,
25 and 35**

TRADEMARK

SERVICE MARK

PRINCIPAL REGISTER

SILVERLINE TOOLS LIMITED (UNITED KINGDOM CORPORATION)
C/O BATT SANDERS & BENNETT, 17 HENDFORD
YEOVIL, SOMERSET, UNITED KINGDOM BA201UH

FOR: COMMON METALS AND THEIR ALLOYS; METAL BUILDING MATERIALS, NAMELY, TRANSPORTABLE BUILDINGS OF METAL; MATERIALS OF METAL FOR RAILWAY TRACKS; NON-ELECTRIC CABLES AND WIRES OF COMMON METAL; IRONMONGERY AND SMALL ITEMS OF METAL HARDWARE, NAMELY, BOLTS, NAILS, SCREWS, WALL ANCHORS, AND RIVETS; METAL DOOR HARDWARE, NAMELY, CYLINDER DEADLOCKS, DEADBOLTS, DEAD LATCHES; METAL DOOR HARDWARE, NAMELY, HANDLE SETS COMPRISING DOOR HANDLES AND KNOBS, LOCK CYLINDERS, DOOR STRIKES, DOOR KNOB ROSETTES, THUMB PIECES FOR DOOR HANDLES, KEYS AND TURN BUTTONS, KEY BLANKS, KNOBS, LATCHES, LEVERS, LOCKS; METAL DOOR HARDWARE, NAMELY, LOCK SETS COMPRISING LEVERS AND KNOBS, LOCK CYLINDERS, DOOR STRIKES, AND DOOR KNOB ROSETTES; PIPES AND TUBES OF METAL; METAL SAFES; COBALT, IRON, COPPER, NICKEL, TIN AND ZINC ORES; SOCKET HEAD CAP SCREWS MADE OF METAL; TOOL BOXES OF METAL; METAL SCREWS, NAMELY, SELFDRILLING, SELF-TAPPING, THREADED AND WOOD SCREWS; PARTS AND FITTINGS FOR THE AFOREMENTIONED GOODS, IN CLASS 6 (U.S. CLS. 2, 12, 13, 14, 23, 25 AND 50).

FOR: MACHINES AND POWER TOOLS, NAMELY, AC POWER OPERATED DRILLS, BATTERY OPERATED CORDLESS DRILLS, DRILL BITS, AC POWER OPERATED CIRCULAR SAWS, AC POWER OPERATED JIGSAWS, BATTERY OPERATED JIGSAWS, AC POWER OPERATED MITER SAWS, AC POWER OPERATED BENCH SAWS, ELECTRICALLY OPERATED HAND SAWS, AC POWER OPERATED SANDERS, AC POWER OPERATED POLISHERS, AC POWER OPERATED PLANERS, AC POWER OPERATED CHAINSAWS, GASOLINE OPERATED CHAINSAWS, AC POWER OPERATED GRINDERS, AC POWER OPERATED ROUTERS, BATTERY OPERATED SCREWDRIVERS, AC POWER OPERATED BRUSH CUTTERS, GASOLINE OPERATED BRUSH CUTTERS, AC POWER OPERATED GRASS CUTTERS, AC POWER OPERATED HEDGE TRIMMERS, BATTERY OPERATED HEDGE TRIMMERS, AC POWER OPERATED LINE TRIMMERS, AC POWER OPERATED VACUUMS AND BLOWERS, BATTERY OPERATED HAND VACUUMS, AND REPLACEMENT PARTS THEREFOR; POWER-DRIVEN WRENCHES, NAMELY, RATCHET, SOCKET, TAP AND TORQUE WRENCHES; AGRICULTURAL AND GARDEN IMPLEMENTS OTHER THAN HAND OPERATED, NAMELY, AC POWER, BATTERY POWER AND GASOLINE POWER CHIPPERS, SHREDDERS, CULTIVATORS, LAWN AND GARDEN EDGERS, LAWN MOWERS, GRASS SHEARS, AND PARTS FITTINGS FOR THE AFORESAID GOODS; MO-



David J. Kyros

Director of the United States Patent and Trademark Office

Reg. No. 4,065,479 TORS AND ENGINES EXCEPT FOR LAND VEHICLES; MACHINE COUPLING AND TRANSMISSION COMPONENTS EXCEPT FOR LAND VEHICLES; HYDRAULIC AND PNEUMATIC DOOR CLOSERS, IN CLASS 7 (U.S. CLS. 13, 19, 21, 23, 31, 34 AND 35).

FOR: HAND TOOLS AND HAND-OPERATED IMPLEMENTS, NAMELY, SCREWDRIVERS, HAMMERS, WRENCHES, POCKETKNIVES, RATCHET WRENCH SETS COMPRISED OF RATCHET WRENCHES OF VARYING SIZES, SOCKET SETS, HEX KEY WRENCHES, MALLETS, VICES, CHISELS, CLAMPS AND PLIERS AND PARTS AND FITTINGS THEREFOR; RAZORS; HAND-OPERATED WRENCHES, NAMELY, RATCHET, SOCKET, TAP AND TORQUE WRENCHES; SOCKET SETS; SOCKET SPANNERS; SOCKET WRENCHES; SOCKET HEAD CAP SCREW KEYS IN THE NATURE OF HEX KEY WRENCHES ON A KEY RING; PLIERS; SHOVELS; SPADES; AXES; KNIVES; SAWS; CLAMPS; VICES; SPANNERS; DRILL BITS FOR HAND DRILLS; PARTS AND FITTINGS FOR THE AFOREMENTIONED GOODS; BENCH VISES, VISES, BRACES, FIXED POSITION BENCH CLAMPS AND BOXES IN THE NATURE OF VISES FOR WORKBENCHES, IN CLASS 8 (U.S. CLS. 23, 28 AND 44).

FOR: SURVEYING, OPTICAL, WEIGHING, MEASURING, SIGNALING, CHECKING (SUPERVISION), LIFE-SAVING AND TEACHING APPARATUS AND INSTRUMENTS, NAMELY, SAFETY EYE GLASSES, PROTECTIVE INDUSTRIAL SHOES, PROTECTIVE WORK GLOVES AND PROTECTIVE EAR COVERINGS; CARPENTER'S LEVELS; SENSORS, NAMELY, ELECTRONIC SONIC TAPE MEASURER AND WALL STUD FINDERS; MEASURING APPARATUS, NAMELY, BEVELS, LASER DISTANCE METERS, DIGITAL TAPE MEASURER AND POWERED TAPE MEASURER; APPARATUS AND INSTRUMENTS FOR CONDUCTING, SWITCHING, TRANSFORMING, ACCUMULATING, CONTROLLING OR REGULATING ELECTRICITY, NAMELY, BATTERIES, BATTERY PACKS FOR CORDLESS POWER TOOLS, BATTERY CHARGERS AND ELECTRICAL WIRE; FIRE-EXTINGUISHING APPARATUS; ELECTRIC SOCKETS; ELECTRIC SOLDERING IRONS; SAFETY HARNESSES OTHER THAN FOR VEHICLE OR SPORTS PURPOSES; LEVEL INDICATORS AND GAUGES; SPIRIT LEVELS; ELECTRICAL SOCKETS; ELECTRIC SOLDERING IRONS; ELECTRIC DOOR CLOSERS; PARTS AND FITTINGS FOR THE AFOREMENTIONED GOODS, IN CLASS 9 (U.S. CLS. 21, 23, 26, 36 AND 38).

FOR: LEATHER AND IMITATIONS OF LEATHER, AND GOODS MADE OF THESE MATERIALS AND NOT INCLUDED IN OTHER CLASSES, NAMELY, WALLETS, KEY CHAINS AND CASES, BUSINESS CARD CASES, CREDIT CARD CASES, COIN PURSES, BRIEFCASES, GARMENT BAGS FOR TRAVEL, DUFFEL BAGS, FLIGHT BAGS, TOTE BAGS, PURSES, ATHLETIC BAGS, ALL PURPOSE SPORT BAGS, AND SCHOOL BOOK BAGS; TRUNKS AND TRAVELING BAGS; UMBRELLAS, PARASOLS AND WALKING STICKS; WHIPS, HARNESSES AND SADDLERY; TOOL BAGS OF LEATHER SOLD EMPTY; TOOL POUCHES SOLD EMPTY; PARTS AND FITTINGS FOR THE AFOREMENTIONED GOODS, IN CLASS 18 (U.S. CLS. 1, 2, 3, 22 AND 41).

FOR: FURNITURE; MIRRORS; PICTURE FRAMES; NON-METAL CLAMPS; BENCHES; WORK BENCHES FOR USE WITH SAWS; WORK BENCHES; NON-METALLIC SCREWS; SELF-TAPPING NON-METALLIC SCREWS; NON-METALLIC WOOD SCREWS; VICE BENCHES WHICH INCORPORATE VICES FOR CLAMPING WOOD PIECES; NON-METAL KEY HOLDERS; PARTS AND FITTINGS FOR THE AFOREMENTIONED GOODS, IN CLASS 20 (U.S. CLS. 2, 13, 22, 25, 32 AND 50).

FOR: CLOTHING, NAMELY, GLOVES, SHIRTS, PANTS, BELTS, T-SHIRTS, SHORTS, SWEAT PANTS, SWEAT SHIRTS, JACKETS, VESTS, RAIN WEAR, SOCKS, SUN VISORS, TIES, WRIST BANDS AND JEANS; FOOTWEAR; HEADGEAR, NAMELY, HATS AND CAPS, IN CLASS 25 (U.S. CLS. 22 AND 39).

FOR: ADVERTISING; BUSINESS MANAGEMENT; BUSINESS ADMINISTRATION; OFFICE FUNCTIONS; THE BRINGING TOGETHER, FOR THE BENEFIT OF OTHERS, OF A VARIETY OF GOODS, ENABLING CUSTOMERS TO CONVENIENTLY VIEW AND PURCHASE THESE

Reg. No. 4,065,479 GOODS IN THE FIELDS OF HARDWARE, TOOLS AND TRADESMAN'S TOOLS, DO-IT-YOURSELF APPARATUS, HOME FURNISHINGS AND GENERAL IRONMONGERY, IN CLASS 35 (U.S. CLS. 100, 101 AND 102).

THE MARK CONSISTS OF STANDARD CHARACTERS WITHOUT CLAIM TO ANY PARTICULAR FONT, STYLE, SIZE, OR COLOR.

OWNER OF ERPN CMNTY TM OFC REG. NO. 6843437, DATED 2-16-2009, EXPIRES 4-18-2018.

SER. NO. 85-034,592, FILED 5-10-2010.

JENNIFER DIXON, EXAMINING ATTORNEY

United States of America

United States Patent and Trademark Office



Reg. No. 4,065,480

Registered Dec. 6, 2011

Int. Cl.: 9

TRADEMARK

PRINCIPAL REGISTER

SEQCENTRAL, LLC (DELAWARE LIMITED LIABILITY COMPANY)
2309 CAPISTRANO STREET
BLACKSBURG, VA 24060

FOR: COMPUTER SOFTWARE FOR SEARCHING, INDEXING, SHARING, AND ORGANIZING INFORMATION ASSOCIATED WITH DIGITAL GENETIC SEQUENCES ON PERSONAL COMPUTERS, CLUSTERS OF COMPUTERS, AND COMPUTER NETWORKS IN THE CLOUD, IN CLASS 9 (U.S. CLS. 21, 23, 26, 36 AND 38).

FIRST USE 3-14-2009; IN COMMERCE 3-14-2009.

THE MARK CONSISTS OF THE WORD "SEQCENTRAL" IN WHITE WITH A STYLISTIC DNA HELIX STARTING BY THE "S" AND CURVING DOWN, BEHIND, AND AROUND THE "C". THE BASES ON THE DNA HELIX ARE INDIVIDUALLY IN RED, YELLOW AND BLUE POINTING DOWN ON THE FIRST HALF AND INDIVIDUALLY IN BLUE, GREEN AND YELLOW POINTING UP ON THE SECOND HALF. THE DNA HELIX ITSELF IS COLORED IN LIGHT BLUE, DARKENING TO DARK BLUE, THEN FADING BACK TO LIGHT BLUE, FROM LEFT TO RIGHT. THE ENTIRE MARK IS ON A DARK BLUE RECTANGULAR BACKGROUND.

THE COLOR(S) RED, YELLOW, LIGHT BLUE, DARK BLUE, GREEN AND WHITE IS/ARE CLAIMED AS A FEATURE OF THE MARK.

SER. NO. 85-035,526, FILED 5-11-2010.

LINDSEY RUBIN, EXAMINING ATTORNEY



David J. Kyjars

Director of the United States Patent and Trademark Office

United States of America

United States Patent and Trademark Office



Reg. No. 4,065,481

Registered Dec. 6, 2011

Int. Cl.: 25

TRADEMARK

PRINCIPAL REGISTER

TIJUANA 96, S.L. (SPAIN CORPORATION)
C/VIDRERIA, 15
BARCELONA, SPAIN 08003

FOR: SNEAKERS, IN CLASS 25 (U.S. CLS. 22 AND 39).

OWNER OF ERPN CMNTY TM OFC REG. NO. 005042452, DATED 4-20-2007, EXPIRES 4-26-2016.

THE MARK CONSISTS OF A CIRCULAR RING WITH BOTH THE INNER AND OUTER EDGES BEING TOOTHED. INSIDE THIS CIRCULAR RING, AT THE TOP, IS THE WORD "ARO".

THE ENGLISH TRANSLATION OF "ARO" IN THE MARK IS "RING".

SER. NO. 85-035,745, FILED 5-11-2010.

IRA J. GOODSaid, EXAMINING ATTORNEY



David J. Kyfos

Director of the United States Patent and Trademark Office

United States of America

United States Patent and Trademark Office

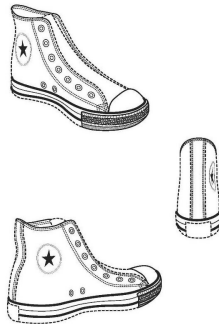

Reg. No. 4,065,482

Registered Dec. 6, 2011

Int. Cl.: 25

TRADEMARK

PRINCIPAL REGISTER

CONVERSE INC. (DELAWARE CORPORATION)
ONE HIGH STREET
NORTH ANDOVER, MA 018452501

FOR: ATHLETIC FOOTWEAR, IN CLASS 25 (U.S. CLS. 22 AND 39).

FIRST USE 0-0-1946; IN COMMERCE 0-0-1946.

OWNER OF U.S. REG. NOS. 741,662, 1,490,262, AND 1,789,476.

THE MARK CONSISTS OF THE THREE DIMENSIONAL TRADE DRESS DESIGN OF THE ICONIC AND CLASSIC CHUCK TAYLOR ALL STAR BASKETBALL SHOE FOR WHICH THE FOLLOWING PRIMARY FEATURES ARE CLAIMED: (A) MULTI-PATTERNED RUBBER TOE STRIP. THE RUBBER TOE STRIP HAS FOUR LAYERS OF BANDS FEATURING INTRICATE AND DISTINCT PATTERNS OF THREE-DIMENSIONAL DIAMONDS AND LINES. (B) ANKLE PATCH ON THE INSIDE ANKLE. THE ROUND PATCH DESIGN WITH DOUBLE DASHED LINE JUST INSIDE THE BOUNDARY OF THE CIRCULAR PATCH, WITH A STAR IN THE CENTER. (C) DOUBLE RAND STRIPES. TWO PARALLEL HORIZONTAL LINES RUN ALONG THE RUBBER OUTSOLE OF THE SHOE. THE UPPERMOST CONTRASTING STRIPE RUNS ALONG THE EDGE OF THE RUBBER OUTSOLE AROUND THE ENTIRE CIRCUMFERENCE OF THE SHOE, INCLUDING ON THE TOE CAP. THE SECOND CONTRASTING STRIPE APPEARS MIDWAY ALONG THE RUBBER OUTSOLE AND RUNS FROM THE FRONT EDGE OF THE LICENSE PLATE HEEL TAB TO THE BACK EDGE OF THE RUBBER TOE BUMPER. (D) BRUSHED METAL GROMMETS IN MEDIAL SIDE ARCH. TWO ROUND BRUSHED STEEL GROMMETS ARE PLACED IN A HORIZONTAL LINE ABOVE THE INSIDE MEDIAL ARCH OF THE SHOE. (E) BRUSHED METAL EYESTAY GROMMETS. A SERIES OF EQUALLY-SPACED WIDE, ROUND BRUSHED METAL EYESTAY GROMMETS ARE PART OF THE LACING SYSTEM INSTEAD OF HOOKS, LOOPS, D-RINGS, OR OTHER HOLDING AND LACING MECHANISMS. (F) CONVEX RUBBER TOE CAP. A RAISED, PROTRUDING RUBBER TOE CAP. (G) DOUBLE STITCHING AND BOX-LIKE STITCH ALONG THE UPPER. (H) TOP LINE COLLAR THROAT SHAPE. THE MATTER SHOWN IN BROKEN LINES, NAMELY, THE LICENSE PLATE HEEL TAB AS WELL AS THE OUTLINE OF THE SHOE ALONG THE UPPER, THE TONGUE, THE BACK EDGE, THE REAR PANEL, AND THE SOLE ARE NOT PART OF THE MARK. THE BROKEN LINES SERVE ONLY TO SHOW THE POSITION OR PLACEMENT OF THE PRIMARY FEATURES OF THE TRADE DRESS. THE DASHED LINES INDICATING THE DOUBLE STITCHING AND BOX-LIKE STITCH ALONG THE UPPER ARE PART OF THE MARK.



David J. Kyppos

Director of the United States Patent and Trademark Office

Reg. No. 4,065,482 SEC. 2(F).

SER. NO. 85-035,857, FILED 5-11-2010.

BARNEY CHARLON, EXAMINING ATTORNEY

United States of America

United States Patent and Trademark Office

THEISEN'S
HOME • FARM • AUTO

Reg. No. 4,065,483

THEISEN SUPPLY INC. (IOWA CORPORATION), DBA THEISEN'S HOME FARM AUTO
6201 CHAVENELLE ROAD
DUBUQUE, IA 52002 AND

Registered Dec. 6, 2011

Int. Cl.: 35

TONY THEISEN (UNITED STATES INDIVIDUAL)
DUBUQUE
6201 CHAVENELLE ROAD
DUBUQUE, IA 52002

SERVICE MARK

PRINCIPAL REGISTER

FOR: RETAIL APPAREL STORES; RETAIL AUTOMOBILE PARTS AND ACCESSORIES STORES; RETAIL CLOTHING STORES; RETAIL DEPARTMENT STORES; RETAIL LAWN, GARDEN AND NURSERY STORES; RETAIL PET STORES; RETAIL SPORTING GOODS STORES, IN CLASS 35 (U.S. CLS. 100, 101 AND 102).

FIRST USE 0-0-1994; IN COMMERCE 0-0-1994.

NO CLAIM IS MADE TO THE EXCLUSIVE RIGHT TO USE "HOME FARM AUTO", APART FROM THE MARK AS SHOWN.

THE COLOR(S) BLUE AND RED IS/ARE CLAIMED AS A FEATURE OF THE MARK.

THE MARK CONSISTS OF THE WORDING "THEISEN'S IN LARGE BLUE STYLIZED FONT. UNDERNEATH THIS APPEARS THE STYLIZED TERMS "HOME FARM AUTO" IN THE COLOR RED WITH TWO BLUE BULLETS SEPARATING THE TERMS.

SEC. 2(F) AS TO "THEISEN'S".

SER. NO. 85-036,360, FILED 5-12-2010.

COURTNEY ALVAREZ, EXAMINING ATTORNEY



David J. Kyffers

Director of the United States Patent and Trademark Office

United States of America

United States Patent and Trademark Office

TPF (Thermal Protection Factor)

Reg. No. 4,065,484

Registered Dec. 6, 2011

Int. Cl.: 3

TRADEMARK

PRINCIPAL REGISTER

AMOREPACIFIC CORPORATION (REPUBLIC OF KOREA CORPORATION)
181, 2GA, HANGANG-RO, YONGSAN-GU
SEOUL, REPUBLIC OF KOREA

FOR: COSMETICS; COSMETIC PREPARATIONS FOR ANTI-SUNBURN; SUN-BLOCK LOTIONS; SUNSCREEN CREAMS; COSMETIC CREAMS; LOTIONS FOR COSMETIC PURPOSES; COSMETIC PREPARATIONS FOR SKIN CARE; MAKE-UP BASE; MAKE-UP POWDER; MASCARA; CREAMY FOUNDATIONS; LIPSTICKS; SOAPS FOR PERSONAL USES; SHAMPOOS; OILS FOR COSMETIC PURPOSES; PERFUMERY; DENTIFRICES, IN CLASS 3 (U.S. CLS. 1, 4, 6, 50, 51 AND 52).

THE MARK CONSISTS OF STANDARD CHARACTERS WITHOUT CLAIM TO ANY PARTICULAR FONT, STYLE, SIZE, OR COLOR.

PRIORITY CLAIMED UNDER SEC. 44(D) ON REPUBLIC OF KOREA APPLICATION NO. 40-2010-0249, FILED 5-11-2010, REG. NO. 40-0873166, DATED 7-18-2011, EXPIRES 7-18-2021.

NO CLAIM IS MADE TO THE EXCLUSIVE RIGHT TO USE "THERMAL PROTECTION FACTOR", APART FROM THE MARK AS SHOWN.

SER. NO. 85-040,769, FILED 5-17-2010.

TRICIA SONNEBORN, EXAMINING ATTORNEY



David J. Kybas

Director of the United States Patent and Trademark Office

United States of America

United States Patent and Trademark Office

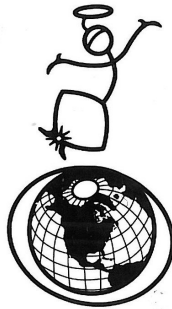

Reg. No. 4,065,485
Registered Dec. 6, 2011
Int. Cl.: 41

THE EXECUTOR OF THE FRANCISCO COLL MONGE ESTATE (PUERTO RICO ESTATE),
AKA DR. FRANCISCO COLL
ALLEY TM-IP
PO BOX 252
OSCEOLA, IA 502130252

SERVICE MARK
PRINCIPAL REGISTER

FOR: ARRANGING, ORGANIZING AND CONDUCTING SPECIAL EVENTS FOR SOCIAL ENTERTAINMENT PURPOSES; ARRANGING OF PRESENTATIONS FOR EDUCATIONAL AND TRAINING PURPOSES; ARRANGING AND CONDUCTING BUSINESS SEMINARS IN THE FIELD OF LEADERSHIP DEVELOPMENT AND PERSONAL GROWTH; MENTORING TRAINING; CHARITABLE SERVICES, NAMELY, PROVIDING TRAINING IN THE FIELD OF LEADERSHIP, SELF DISCIPLINE AND SELF RELIANCE; EDUCATIONAL SERVICES, NAMELY, CONDUCTING LECTURES, WORKSHOPS, MEDITATION TRAINING GROUPS, STUDY GROUPS, COURSES, CONFERENCES AND SEMINARS IN THE FIELD OF BALANCED LIVING, PERSONAL AND SPIRITUAL DEVELOPMENT, EFFECTIVE LEADERSHIP, EFFECTIVE LIVING, HOLISTIC HEALING, LEADERSHIP TOOLS AND TECHNIQUES, PRACTICAL METAPHYSICS, PSYCHOLOGY, PUBLIC RELATIONS, SPIRITUAL HEALTH, SPIRITUAL PRACTICES, SPIRITUAL LEADERSHIP, PUBLIC SPEAKING, MINISTERIAL TRAINING, CONSULTING TRAINING AND DISTRIBUTION OF PRINTED MATERIALS IN CONNECTION THEREWITH IN HARDCOPY OR ELECTRONIC FORMAT ON THE SAME TOPIC; EDUCATION IN THE FIELD OF EFFECTIVE LIVING, EFFECTIVE LEADERSHIP, SPIRITUAL AWARENESS AND SPIRITUAL PRACTICES RENDERED THROUGH CORRESPONDENCE COURSES; PROVIDING COURSES OF TRAINING FOR YOUNG PEOPLE IN THE FIELD OF SPIRITUAL AWARENESS, PERSONAL GROWTH, EFFECTIVE LIVING, PERSONAL DISCIPLINE, PERSONAL INITIATIVE AND EFFECTIVE LEADERSHIP; EDUCATIONAL AND ENTERTAINMENT SERVICES, NAMELY, PROVIDING MOTIVATIONAL AND EDUCATIONAL SPEAKERS; ENTERTAINMENT AND EDUCATIONAL SERVICES PROVIDED BY MEANS OF RADIO AND TELEVISION PROGRAMS RELATING TO SPIRITUAL, RELIGIOUS AND INSPIRATIONAL MESSAGES; INFORMATION RELATING TO ENTERTAINMENT AND EDUCATION, PROVIDED ONLINE FROM A COMPUTER DATABASE OR THE INTERNET; MULTIMEDIA PUBLISHING OF BOOKS, MAGAZINES, JOURNALS, SOFTWARE, MUSIC, CONSULTING CHARTS, LECTURE CHARTS AND ELECTRONIC PUBLICATIONS; PUBLICATION OF BOOKS, OF MAGAZINES, OF JOURNALS, OF NEWSPAPERS, OF PERIODICALS, OF CATALOGS, OF BROCHURES; DIGITAL VIDEO, AUDIO, AND MULTIMEDIA PUBLISHING SERVICES, IN CLASS 41 (U.S. CLS. 100, 101 AND 107).



David J. Kyros

Director of the United States Patent and Trademark Office

Reg. No. 4,065,485 FIRST USE 7-5-1969, THE MARK WAS FIRST USED ANYWHERE IN A DIFFERENT FORM OTHER THAN THAT SOUGHT TO BE REGISTERED AT LEAST AS EARLY AS 00/00/1967.; IN COMMERCE 7-5-1969, THE MARK WAS FIRST USED IN COMMERCE IN A DIFFERENT FORM OTHER THAN THAT SOUGHT TO BE REGISTERED AT LEAST AS EARLY AS 00/00/1969..

NO CLAIM IS MADE TO THE EXCLUSIVE RIGHT TO USE "THE GEOGRAPHIC REPRESENTATION OF THE EARTH", APART FROM THE MARK AS SHOWN.

THE MARK CONSIST OF A STICK FIGURE, WEARING A HALO ATTACHED TO ITS HEAD BY A CORD, LEAPING WITH OUTSTRETCHED ARMS AND CLICKING ITS HEELS, ALL ABOVE THE DESIGN OF PLANET EARTH ENCIRCLED BY AN OVAL.

SER. NO. 85-040,829, FILED 5-17-2010.

CHRISTINE COOPER, EXAMINING ATTORNEY

United States of America

United States Patent and Trademark Office

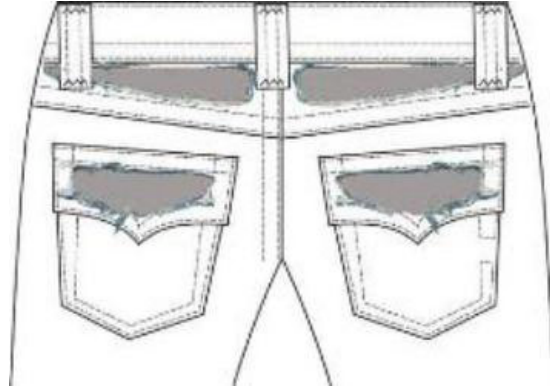

Reg. No. 4,065,486

Registered Dec. 6, 2011

Int. Cl.: 25

TRADEMARK

PRINCIPAL REGISTER

SWEET PEOPLE APPAREL, INC. (CALIFORNIA CORPORATION)
4715 S. ALAMEDA ST.
LOS ANGELES, CA 90058

FOR: APPAREL, NAMELY, JEANS AND PANTS, IN CLASS 25 (U.S. CLS. 22 AND 39).

FIRST USE 9-29-2005; IN COMMERCE 9-29-2005.

OWNER OF U.S. REG. NO. 3,494,338.

NO CLAIM IS MADE TO THE EXCLUSIVE RIGHT TO USE THE SHAPES OF THE POCKETS OR THE POCKET FLAPS, OR THE STITCHING APPEARING ON THE POCKETS OR THE POCKET FLAPS, WHICH ARE INCLUDED ONLY TO SHOW THE PLACEMENT OF THE MARK ON THE GOODS, APART FROM THE MARK AS SHOWN.

THE MARK CONSISTS OF A FABRIC CUT OUT DESIGN ON THE POCKET FLAP AND UNDER THE WAIST OF THE PANTS. THE AREA OF THE CUTOUT IS REPLACED WITH A FABRIC INSERT WHICH DIFFERS IN DESIGN FROM THE REMAINING PANTS FABRIC.

SEC. 2(F).

SER. NO. 85-041,242, FILED 5-18-2010.

SUZANNE BLANE, EXAMINING ATTORNEY



David J. Kyffers

Director of the United States Patent and Trademark Office

United States of America

United States Patent and Trademark Office



Reg. No. 4,065,487

Registered Dec. 6, 2011

Int. Cl.: 36

SERVICE MARK

PRINCIPAL REGISTER

WAYPOINT WEALTH MANAGEMENT, LLC (WASHINGTON LIMITED LIABILITY COMPANY), DBA WAYPOINT WEALTH MANAGEMENT
925 BASIN ST SW
EPHRATA, WA 98823

FOR: FINANCIAL SERVICES, NAMELY, WEALTH MANAGEMENT SERVICES, IN CLASS 36 (U.S. CLS. 100, 101 AND 102).

FIRST USE 5-1-2005; IN COMMERCE 5-1-2005.

NO CLAIM IS MADE TO THE EXCLUSIVE RIGHT TO USE "WEALTH MANAGEMENT", APART FROM THE MARK AS SHOWN.

THE MARK CONSISTS OF THE STYLIZED TEXT "WAYPOINT WEALTH MANAGEMENT" WITH A STYLIZED COMPASS-LIKE DESIGN ABOVE THE TEXT.

SER. NO. 85-041,696, FILED 5-18-2010.

SEAN CROWLEY, EXAMINING ATTORNEY



David J. Kybas

Director of the United States Patent and Trademark Office

United States of America

United States Patent and Trademark Office

ABIETA

Reg. No. 4,065,488

Registered Dec. 6, 2011

Int. Cl.: 1

TRADEMARK

PRINCIPAL REGISTER

ARIZONA CHEMICAL COMPANY, LLC (DELAWARE LIMITED LIABILITY COMPANY)
INTELLECTUAL PROPERTY DEPT. (LEGAL)
4600 TOUCHTON ROAD EAST, SUITE 1500
JACKSONVILLE, FL 32246

FOR: TALL OIL ROSIN FOR USE IN THE MANUFACTURE OF INDUSTRIAL CHEMICALS, MODIFIED TALL OIL ROSINS FOR USE IN THE MANUFACTURE OF INDUSTRIAL CHEMICALS, TALL OIL ROSIN SOAPS AND POLYMERIZED (DIMERIZED) ROSIN FOR USE IN THE MANUFACTURE OF INDUSTRIAL CHEMICALS, GUM ROSIN AND MODIFIED GUM ROSIN FOR USE IN THE MANUFACTURE OF INDUSTRIAL CHEMICALS, GUM ROSIN SOAPS AND MODIFIED GUM ROSIN SOAPS FOR USE IN THE MANUFACTURE OF INDUSTRIAL CHEMICALS, IN CLASS 1 (U.S. CLS. 1, 5, 6, 10, 26 AND 46).

THE MARK CONSISTS OF STANDARD CHARACTERS WITHOUT CLAIM TO ANY PARTICULAR FONT, STYLE, SIZE, OR COLOR.

OWNER OF ERPN CMNTY TM OFC REG. NO. 008775595, DATED 6-16-2010, EXPIRES 12-19-2019.

THE WORDING "ABIETA" HAS NO MEANING IN A FOREIGN LANGUAGE.

SER. NO. 85-042,395, FILED 5-19-2010.

KAREN SEVERSON, EXAMINING ATTORNEY



David J. Kybas

Director of the United States Patent and Trademark Office

United States of America

United States Patent and Trademark Office

SELFBRAZE

Reg. No. 4,065,489

Registered Dec. 6, 2011

Int. Cl.: 6

TRADEMARK

PRINCIPAL REGISTER

ALCAN RHENALU (FRANCE SOCIÉTÉ PAR ACTIONS SIMPLIFIÉE (SAS))
LA DÉFENSE 2
17 PLACE DES REFLETS
COURBEVOIE, FRANCE 92400

FOR: COMMON METALS AND THEIR ALLOYS; ALUMINUM ALLOYS; SHEETS OF COMMON METALS FOR USE IN THE MOTOR INDUSTRY; LAMINATES FOR USE IN THE MANUFACTURE OF PRINTED CIRCUIT BOARDS FOR THE MOTOR INDUSTRY, BRAZING SHEETS IN THE NATURE OF SHEETS OF ALUMINUM ALLOY FOR BRAZING; SHEETS OF ALUMINUM ALLOY FOR BRAZING, BRAZING ALLOYS CONTAINING ALUMINUM, ALUMINUM ALLOYS FOR HEAT EXCHANGERS FOR USE IN VEHICLE RADIATORS, IN CLASS 6 (U.S. CLS. 2, 12, 13, 14, 23, 25 AND 50).

THE MARK CONSISTS OF STANDARD CHARACTERS WITHOUT CLAIM TO ANY PARTICULAR FONT, STYLE, SIZE, OR COLOR.

OWNER OF ERPN CMNTY TM OFC REG. NO. 008795023, DATED 6-28-2010, EXPIRES 1-6-2020.

SER. NO. 85-042,653, FILED 5-19-2010.

SEAN CROWLEY, EXAMINING ATTORNEY



David J. Kybas

Director of the United States Patent and Trademark Office

United States of America

United States Patent and Trademark Office

cd2^{♂♀}

Reg. No. 4,065,490

Registered Dec. 6, 2011

Int. Cl.: 3

TRADEMARK

PRINCIPAL REGISTER

FILMAGIC INC. (CALIFORNIA CORPORATION)
120 N. FAIRWAY LANE
WEST COVINA, CA 91791

FOR: NON-MEDICATED SKIN CARE PREPARATIONS, NAMELY, FACE, HAND AND BODY CREAMS AND LOTIONS USED FOR THE PURPOSE OF TIGHTENING, SMOOTHING, BRIGHTENING, EXFOLIATION, PROTECTION, HYDRATION, CELL RESTORATION, AND ACCELERATION OF SKIN RENEWAL FOR FACE, HAND, AND BODY SKIN, IN CLASS 3 (U.S. CLS. 1, 4, 6, 50, 51 AND 52).

FIRST USE 1-1-2002; IN COMMERCE 1-1-2002.

NO CLAIM IS MADE TO THE EXCLUSIVE RIGHT TO USE THE BIOLOGICAL SYMBOLS FOR MALE AND FEMALE, APART FROM THE MARK AS SHOWN.

THE MARK CONSISTS OF "C", "D", "2" AND DESIGN.

SER. NO. 85-042,994, FILED 5-19-2010.

MICHELE SWAIN, EXAMINING ATTORNEY



David J. Kyros

Director of the United States Patent and Trademark Office

United States of America

United States Patent and Trademark Office

Smash!

Reg. No. 4,065,491

Registered Dec. 6, 2011

Int. Cl.: 30

TRADEMARK

PRINCIPAL REGISTER

NIDAR AS (NORWAY LIMITED CORPORATION)
BROMSTADVEIEN 2
TRONDHEIM, NORWAY 7005

FOR: CHOCOLATES; AND CHOCOLATE PRODUCTS, NAMELY, SWEET AND SALTY CHOCOLATE BARS AND SWEET AND SALTY CRISPY CHOCOLATE SNACKS, IN CLASS 30 (U.S. CL. 46).

THE MARK CONSISTS OF STANDARD CHARACTERS WITHOUT CLAIM TO ANY PARTICULAR FONT, STYLE, SIZE, OR COLOR.

PRIORITY CLAIMED UNDER SEC. 44(D) ON NORWAY APPLICATION NO. 201004956, FILED 5-11-2010, REG. NO. 256984, DATED 10-4-2010, EXPIRES 10-4-2020.

SER. NO. 85-043,660, FILED 5-20-2010.

DEZMONA MIZELLE, EXAMINING ATTORNEY



David J. Kybas

Director of the United States Patent and Trademark Office

United States of America

United States Patent and Trademark Office

DaDa Rocks

Reg. No. 4,065,492

Registered Dec. 6, 2011

Int. Cl.: 41

SERVICE MARK

PRINCIPAL REGISTER

DADA ROCKS, LTD. (NEW YORK CORPORATION)
SUITE 5-J
101 E 16TH STREET
NEW YORK, NY 10003

FOR: EDUCATIONAL AND ENTERTAINMENT SERVICES, NAMELY, THE PROVISION OF CONTINUING PROGRAMS FEATURING FATHERS, CHILDREN AND FAMILY RELATIONS DELIVERED LIVE AND BY BLOGGING, INTERNET, RADIO, TELEVISION, AND SATELLITE; ON-LINE JOURNALS, NAMELY, BLOGS FEATURING REVIEWS OF PRODUCTS AND SERVICES AVAILABLE TO FATHERS, CHILDREN AND FAMILIES AND INFORMATION OF NEW PRODUCTS, ENTERTAINMENT, CULTURAL AND RECREATIONAL ACTIVITIES THAT ARE COMING TO ASSIST FATHERS, CHILDREN AND FAMILIES IN MAKING CHOICES TO MAKE THEIR LIVES EASIER OR MORE FULFILLED; PROVIDING INFORMATION ADVICE AND INFORMATION ABOUT ENTERTAINMENT, CULTURAL AND RECREATIONAL ACTIVITIES THAT ARE COMING TO ASSIST FATHERS, CHILDREN AND FAMILIES IN MAKING CHOICES TO MAKE THEIR LIVES EASIER OR MORE FULFILLED, IN CLASS 41 (U.S. CLS. 100, 101 AND 107).

FIRST USE 8-17-2008; IN COMMERCE 8-17-2008.

THE MARK CONSISTS OF STANDARD CHARACTERS WITHOUT CLAIM TO ANY PARTICULAR FONT, STYLE, SIZE, OR COLOR.

NO CLAIM IS MADE TO THE EXCLUSIVE RIGHT TO USE "DADA", APART FROM THE MARK AS SHOWN.

SER. NO. 85-043,998, FILED 5-20-2010.

MARIA-VICTORIA SUAREZ, EXAMINING ATTORNEY



David J. Kyros

Director of the United States Patent and Trademark Office

United States of America

United States Patent and Trademark Office

Conscious Fashions

Reg. No. 4,065,493

Registered Dec. 6, 2011

Int. Cl.: 35

SERVICE MARK

PRINCIPAL REGISTER

RUBIN, ALLEN M (UNITED STATES INDIVIDUAL)
19615 REDBEAM AVE
TORRANCE, CA 90503

FOR: WHOLESALE AND RETAIL STORE SERVICES AND ON-LINE RETAIL AND WHOLESALE STORE SERVICES FEATURING CLOTHING, IN CLASS 35 (U.S. CLS. 100, 101 AND 102).

FIRST USE 1-1-2010; IN COMMERCE 1-1-2010.

THE MARK CONSISTS OF STANDARD CHARACTERS WITHOUT CLAIM TO ANY PARTICULAR FONT, STYLE, SIZE, OR COLOR.

NO CLAIM IS MADE TO THE EXCLUSIVE RIGHT TO USE "FASHIONS", APART FROM THE MARK AS SHOWN.

SER. NO. 85-044,698, FILED 5-21-2010.

NAPOLEON SHARMA, EXAMINING ATTORNEY



David J. Kyffers

Director of the United States Patent and Trademark Office

United States of America

United States Patent and Trademark Office

XKL

Reg. No. 4,065,494

Registered Dec. 6, 2011

Int. Cl.: 9

TRADEMARK

PRINCIPAL REGISTER

XKL, LLC (WASHINGTON LIMITED LIABILITY COMPANY)
12020 113TH AVENUE NE, SUITE 100
KIRKLAND, WA 98034

FOR: PASSIVE AND ACTIVE EQUIPMENT COMPONENTS FOR OPTICAL AND ELECTRICAL NETWORK TECHNOLOGY, NAMELY, WAVELENGTH DIVISION MULTIPLEXERS AND DEMULTIPLEXERS, OPTICAL FIBER AMPLIFIERS, OPTICAL COMMUNICATION LASERS FOR INDUSTRIAL USE, LASER DIODES AND LIGHT-EMITTING DIODES, OPTICAL RECEIVERS; COMPUTER SOFTWARE FOR CONTROLLING AND SURVEYING DATA TRANSMISSION NETWORKS, NAMELY, DATA TRANSMISSION NETWORK MANAGEMENT SOFTWARE; COMPUTER SOFTWARE FOR CONTROLLING, SURVEYING, REMOTE-CONTROLLING AND REMOTE-SURVEYING WAVELENGTH DIVISION MULTIPLEXERS AND DEMULTIPLEXERS, OPTICAL FIBER AMPLIFIERS, LASERS FOR INDUSTRIAL AND COMMERCIAL USE, LASER DIODES, LIGHT EMITTING DIODES, AND OPTICAL RECEIVERS; COMPUTER HARDWARE, NETWORK ROUTERS IN THE NATURE OF COMPUTER CONTROL HARDWARE, AND COMPUTER SOFTWARE FOR USE IN OPERATING, ANIMATING AND MANAGING THE AFOREMENTIONED OPTICAL TRANSMISSION SYSTEM HARDWARE, IN CLASS 9 (U.S. CLS. 21, 23, 26, 36 AND 38).

FIRST USE 12-1-2009; IN COMMERCE 12-1-2009.

THE MARK CONSISTS OF STANDARD CHARACTERS WITHOUT CLAIM TO ANY PARTICULAR FONT, STYLE, SIZE, OR COLOR.

SER. NO. 85-044,821, FILED 5-21-2010.

JASON TURNER, EXAMINING ATTORNEY



David J. Kyros

Director of the United States Patent and Trademark Office

United States of America

United States Patent and Trademark Office

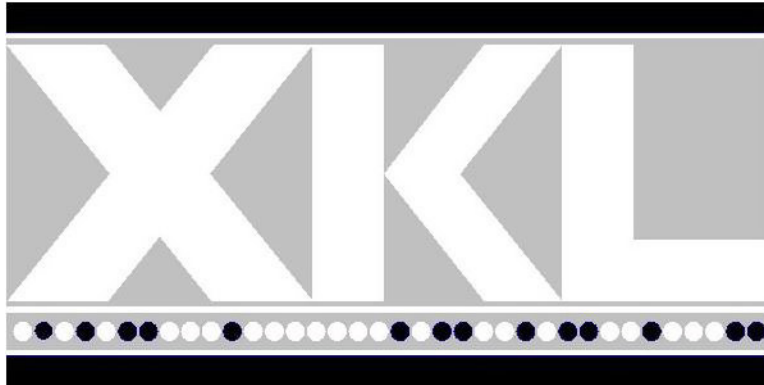

Reg. No. 4,065,495

Registered Dec. 6, 2011

Int. Cl.: 9

TRADEMARK

PRINCIPAL REGISTER

XKL, LLC (WASHINGTON LIMITED LIABILITY COMPANY)
12020 113TH AVENUE NE, SUITE 100
KIRKLAND, WA 98034

FOR: PASSIVE AND ACTIVE EQUIPMENT COMPONENTS FOR OPTICAL AND ELECTRICAL NETWORK TECHNOLOGY, NAMELY, WAVELENGTH DIVISION MULTIPLEXERS AND DEMULTIPLEXERS, OPTICAL FIBER AMPLIFIERS, OPTICAL COMMUNICATION LASERS FOR INDUSTRIAL USE, LASER DIODES AND LIGHT-EMITTING DIODES, OPTICAL RECEIVERS; COMPUTER SOFTWARE FOR CONTROLLING AND SURVEYING DATA TRANSMISSION NETWORKS, NAMELY, DATA TRANSMISSION NETWORK MANAGEMENT SOFTWARE; COMPUTER SOFTWARE FOR CONTROLLING, SURVEYING, REMOTE-CONTROLLING AND REMOTE-SURVEYING WAVELENGTH DIVISION MULTIPLEXERS AND DEMULTIPLEXERS, OPTICAL FIBER AMPLIFIERS, LASERS FOR INDUSTRIAL AND COMMERCIAL USE, LASER DIODES, LIGHT EMITTING DIODES, AND OPTICAL RECEIVERS; COMPUTER HARDWARE, NETWORK ROUTERS IN THE NATURE OF COMPUTER CONTROL HARDWARE, AND COMPUTER SOFTWARE FOR USE IN OPERATING, ANIMATING AND MANAGING THE AFOREMENTIONED OPTICAL TRANSMISSION SYSTEM HARDWARE, IN CLASS 9 (U.S. CLS. 21, 23, 26, 36 AND 38).

FIRST USE 12-1-2009; IN COMMERCE 12-1-2009.

THE MARK CONSISTS OF THE LETTERS "XKL" BETWEEN UPPER AND LOWER BANDS AND A SERIES OF DOTS OR CIRCLES BETWEEN THE LETTERS "XKL" AND THE LOWER BAND.

SER. NO. 85-044,853, FILED 5-21-2010.

JASON TURNER, EXAMINING ATTORNEY



David J. Kyffers

Director of the United States Patent and Trademark Office

United States of America

United States Patent and Trademark Office

BEST PICK REPORTS

Reg. No. 4,065,496

Registered Dec. 6, 2011

Int. Cls.: 16, 35 and 41

TRADEMARK

SERVICE MARK

PRINCIPAL REGISTER

EBSCO INDUSTRIES, INC. (DELAWARE CORPORATION)
FINANCE/LEGAL
5724 HIGHWAY 280 EAST
BIRMINGHAM, AL 35242

FOR: PRINTED GUIDES FOR PROVIDING HOMEOWNERS AND OTHER CONSUMERS WITH INFORMATION ABOUT SERVICES AND GOODS FOR THE HOME AND WITH INFORMATION ABOUT COMPANIES SELLING SERVICES AND GOODS FOR THE HOME, IN CLASS 16 (U.S. CLS. 2, 5, 22, 23, 29, 37, 38 AND 50).

FIRST USE 3-1-2010; IN COMMERCE 3-1-2010.

FOR: PROVIDING A WEBSITE FEATURING PRODUCTS AND SERVICES RATINGS OF OTHERS IN THE FIELD OF HOME CONTRACT SERVICES RECOMMENDED BY CONSUMERS; PROVIDING CONSUMER INFORMATION IN THE FIELD OF HOME CONTRACTOR PRODUCTS AND SERVICES, NAMELY, RATINGS FOR HOME CONTRACTOR PRODUCTS AND SERVICES RECOMMENDED BY CONSUMERS, CONSUMER REFERRALS IN THE FIELD OF HOME RENOVATION AND REPAIR CONTRACTORS, AND RECOMMENDATIONS OF HOME CONTRACTOR SERVICE PROVIDERS TO CONSUMERS FOR COMMERCIAL PURPOSES; PROVIDING RATINGS VIA A GLOBAL COMPUTER NETWORK FOR HOME PRODUCTS AND SERVICES RECOMMENDED BY CONSUMERS, IN CLASS 35 (U.S. CLS. 100, 101 AND 102).

FIRST USE 3-1-2010; IN COMMERCE 3-1-2010.

FOR: PROVIDING RECOGNITION AND INCENTIVES BY THE WAY OF AWARDS TO DEMONSTRATE EXCELLENCE IN THE FIELD OF HOME BUILDING, REPAIR AND MAINTENANCE PRODUCTS AND SERVICES FOR CONSUMERS, IN CLASS 41 (U.S. CLS. 100, 101 AND 107).

FIRST USE 3-1-2010; IN COMMERCE 3-1-2010.

THE MARK CONSISTS OF STANDARD CHARACTERS WITHOUT CLAIM TO ANY PARTICULAR FONT, STYLE, SIZE, OR COLOR.

NO CLAIM IS MADE TO THE EXCLUSIVE RIGHT TO USE "REPORTS", APART FROM THE MARK AS SHOWN.



David J. Kyros

Director of the United States Patent and Trademark Office

Reg. No. 4,065,496 SEC. 2(F) AS TO "BEST PICK".

SER. NO. 85-045,252, FILED 5-21-2010.

MICHAEL GAAFAR, EXAMINING ATTORNEY

United States of America

United States Patent and Trademark Office



Reg. No. 4,065,497

Registered Dec. 6, 2011

Int. Cl.: 33

TRADEMARK

PRINCIPAL REGISTER

PROXIMO SPIRITS, INC. (DELAWARE CORPORATION)
333 WASHINGTON STREET
JERSEY CITY, NJ 07302

FOR: VODKA, IN CLASS 33 (U.S. CLS. 47 AND 49).

FIRST USE 12-2-2002; IN COMMERCE 12-2-2002.

NO CLAIM IS MADE TO THE EXCLUSIVE RIGHT TO USE "VODKA", APART FROM THE MARK AS SHOWN.

THE MARK CONSISTS OF A THREE-DIMENSIONAL, CLEAR CYLINDRICAL BOTTLE UPON WHICH APPEARS A WIDE RECTANGULAR STRIP EMBOSSED ON THE BOTTLE ROUGHLY HALF-WAY UP AND COVERING ALMOST THE ENTIRE CIRCUMFERENCE OF THE BOTTLE. THE WORDING "HANGAR VODKA" APPEARS IN CLEAR LETTERS ON THE RECTANGLE AND CIRCLES THE BOTTLE. A CLEAR OVAL WITH THE EMBOSSED NUMBER "1" IN THE CENTER APPEARS IN THE MIDDLE OF THE RECTANGLE BETWEEN THE WORDS "HANGAR" AND "VODKA." THE LETTER "H" IN THE WORDING "HANGAR VODKA" MAY BE SEEN ON THE OPPOSITE SIDE OF THE BOTTLE THROUGH THIS OVAL AS A BACKGROUND TO THE NUMBER "1." THE MATTER SHOWN IN DOTTED LINES -- NAMEDLY, THE OVERALL SHAPE OF THE BOTTLE, THE FOIL AND BOTTLE CAP AT THE TOP OF THE BOTTLE, AND THE CONCAVE DEPRESSION THAT FORMS PART OF THE BOTTOM OF THE BOTTLE -- IS NOT CLAIMED AS PART OF THE MARK AND SERVES ONLY TO SHOW THE POSITION OR PLACEMENT OF THE MARK ON THE PACKAGING FOR THE GOODS.

SER. NO. 85-045,521, FILED 5-21-2010.

NICHOLAS ALTREE, EXAMINING ATTORNEY



David J. Kyros

Director of the United States Patent and Trademark Office

United States of America

United States Patent and Trademark Office



Reg. No. 4,065,498

Registered Dec. 6, 2011

Int. Cl.: 37

SERVICE MARK

PRINCIPAL REGISTER

MAACO FRANCHISING, INC. (DELAWARE CORPORATION)
128 S. TRYON STREET
SUITE 900
CHARLOTTE, NC 28202

FOR: SERVICES IN PAINTING, REPAIRING AND REFINISHING OF VEHICLE BODIES, IN CLASS 37 (U.S. CLS. 100, 103 AND 106).

FIRST USE 12-0-1998; IN COMMERCE 12-0-1998.

THE MARK CONSISTS OF THE IMAGE OF A MAN IN A LONG COAT WEARING A VENTILATOR WITH A PAINT SPRAYER IN HIS HAND.

SER. NO. 85-046,234, FILED 5-24-2010.

FRANK LATTUCA, EXAMINING ATTORNEY



David J. Kybas

Director of the United States Patent and Trademark Office

United States of America

United States Patent and Trademark Office

ANTON PAAR

Reg. No. 4,065,499

Registered Dec. 6, 2011

Int. Cl.: 9

TRADEMARK

PRINCIPAL REGISTER

ANTON PAAR USA, INC. (PENNSYLVANIA CORPORATION)
10215 TIMBER RIDGE DRIVE
ASHLAND, VA 23005

FOR: SCIENTIFIC INSTRUMENTS, NAMELY, ALCOHOL METERS, BEVERAGE METERS FOR MEASURING AND ANALYZING THE SUGAR, CO₂, ALCOHOL, AND EXTRACT CONTENT OF BEVERAGES, CO₂ METERS, DENSITY METERS, CONCENTRATION METERS, DYNAMIC-MECHANICAL THERMAL ANALYSIS (DMTA) INSTRUMENTS, HIGH-PRESSURE DIGESTION SYSTEMS COMPRISED OF VESSELS FOR THE HEATING AND MINERALIZATION OF SAMPLES, MICROWAVE DIGESTION SYSTEMS, NAMELY, MICROWAVE REACTORS FOR LABORATORY USE, INCLUDING FOR PERFORMING DRYING, EVAPORATION, EXTRACTION, UV DIGESTION, AND/OR OXYGEN COMBUSTION, MICROWAVE SYNTHESIS SYSTEMS, OXYGEN METERS, POLARIMETERS, REFRACTOMETERS, RHEOMETERS FOR INVESTIGATING THE DEFORMATION AND FLOW BEHAVIOR OF LIQUID AND/OR SOLID SAMPLES, SUGAR ANALYZERS, SURFACE ANALYZERS FOR PERFORMING SOLID SURFACE ANALYSIS AND ANALYZING SURFACE CHEMISTRY AND PROPERTIES OF MACROSCOPIC SOLIDS, THERMOMETERS, TRIBOMETERS, TURBIDITY METERS, VISCOMETERS FOR MEASURING FLOW RESISTANCE, X-RAY STRUCTURE ANALYZERS, SMALL-ANGLE X-RAY SCATTERING (SAXS) SYSTEMS, X-RAY DIFFRACTION (XRD) SYSTEMS, CO₂ SENSORS, DENSITY AND SOUND VELOCITY SENSORS, DENSITY SENSORS, EVALUATION UNITS FOR MEASURING THE DENSITY AND CONCENTRATION OF LIQUIDS AND GASES, AND SOUND VELOCITY SENSORS; AND ACCOMPANYING COMPUTER SOFTWARE, NAMELY, COMPUTER OPERATING SOFTWARE SOLD AS A UNIT WITH EACH OF THE INSTRUMENTS LISTED ABOVE FOR USE IN SCIENTIFIC LABORATORY OPERATIONS, IN CLASS 9 (U.S. CLS. 21, 23, 26, 36 AND 38).



FIRST USE 12-31-1986; IN COMMERCE 12-31-1986.

THE MARK CONSISTS OF STANDARD CHARACTERS WITHOUT CLAIM TO ANY PARTICULAR FONT, STYLE, SIZE, OR COLOR.

OWNER OF U.S. REG. NO. 2,814,702.

THE NAME "ANTON PAAR" DOES NOT IDENTIFY A LIVING INDIVIDUAL.

SER. NO. 85-046,680, FILED 5-24-2010.

David J. Kyffers

Director of the United States Patent and Trademark Office

Reg. No. 4,065,499 KATHERINE M. DUBRAY, EXAMINING ATTORNEY

United States of America

United States Patent and Trademark Office

Therapeutic Tour

Reg. No. 4,065,500

CE SYMMETRY, LLC (FLORIDA LIMITED LIABILITY COMPANY)
1488 BRIARGROVE WAY
OLDSMAR, FL 34677

Registered Dec. 6, 2011

Int. Cl.: 35

FOR: ADVERTISING OF MEDICAL EDUCATION SERVICES, NAMELY, PRODUCT DEMONSTRATION, IN CLASS 35 (U.S. CLS. 100, 101 AND 102).

SERVICE MARK

FIRST USE 8-28-2008; IN COMMERCE 8-28-2008.

PRINCIPAL REGISTER

THE MARK CONSISTS OF STANDARD CHARACTERS WITHOUT CLAIM TO ANY PARTICULAR FONT, STYLE, SIZE, OR COLOR.

NO CLAIM IS MADE TO THE EXCLUSIVE RIGHT TO USE "THERAPEUTIC", APART FROM THE MARK AS SHOWN.

SER. NO. 85-047,073, FILED 5-25-2010.

CURTIS FRENCH, EXAMINING ATTORNEY



David J. Kybas

Director of the United States Patent and Trademark Office

United States of America

United States Patent and Trademark Office



Reg. No. 4,065,501

Registered Dec. 6, 2011

Int. Cl.: 35

SERVICE MARK

PRINCIPAL REGISTER

ERIE INDEMNITY COMPANY (PENNSYLVANIA CORPORATION)
100 ERIE INSURANCE PLACE
ERIE, PA 16530

FOR: BUSINESS MARKETING SERVICES, NAMELY, PROVIDING INFORMATION IN THE NATURE OF ACHIEVEMENTS BY BUSINESSES USING BUSINESS PRACTICES TO PROMOTE ENVIRONMENTAL SUSTAINABILITY, ENERGY USE REDUCTIONS, ENERGY MANAGEMENT, CARBON EMISSION REDUCTIONS, WASTE REDUCTIONS, RECYCLING, ENVIRONMENTAL ADVOCACY, AND ENVIRONMENTAL EDUCATION, IN CLASS 35 (U.S. CLS. 100, 101 AND 102).

FIRST USE 4-22-2010; IN COMMERCE 4-22-2010.

THE MARK CONSISTS OF THE TERM "ECO" WRITTEN ABOVE THE TERM "ERIE" SUCH THAT THE BOTTOM PORTION OF THE TERM "ECO" IS INTERTWINED WITH THE TOP PORTION OF THE TERM "ERIE".

SER. NO. 85-047,183, FILED 5-25-2010.

JEAN IM, EXAMINING ATTORNEY



David J. Kybas

Director of the United States Patent and Trademark Office

United States of America

United States Patent and Trademark Office



Reg. No. 4,065,502

Registered Dec. 6, 2011

Int. Cls.: 25 and 28

TRADEMARK

PRINCIPAL REGISTER

BICYCLE LINE S.R.L. (ITALY LIMITED LIABILITY COMPANY)
VIA F. FERRARA 2 E 4 - CASIER
FRAZIONE DOSSON
TREVISO, ITALY

FOR: TIGHTS, BODYSUITS, UNDERWEAR, ALL THE AFORESAID GOODS EXCLUSIVELY FOR SPORT USE IN CYCLING ACTIVITY; TROUSERS, SHORTS, SINGLETS, JERSEYS BEING CLOTHING AND CYCLING CLOTHING, VESTS, T-SHIRTS, SUITS, BIB TIGHTS, JACKETS, GILETS, WINDCHEATERS, RAINCOATS, MANTLES, SOCKS, GLOVES BEING CLOTHING, KNEE WARMERS, LEG WARMERS, ARM WARMERS, ALL THE AFORESAID GOODS EXCLUSIVELY FOR SPORT USE IN CYCLING ACTIVITY; UNIFORMS FOR SPORTS, SWEAT SHIRTS, SWEAT PANTS, SPORTS SHIRTS, TRACK SUITS, ALL THE AFORESAID GOODS EXCLUSIVELY FOR SPORT USE IN CYCLING ACTIVITY; BANDANAS, HOODS, HEADBANDS, BALACLAVAS, ALL THE AFORESAID GOODS EXCLUSIVELY FOR SPORT USE IN CYCLING ACTIVITY; UNDERHELMETS AND HEAT-PROTECTION UNDERHELMETS, NAMELY, HEADWEAR IN THE NATURE OF TIGHT FITTING CAPS FOR WEARING UNDER HELMETS BEING CYCLING CLOTHING; CAPS, BERETS, SUN VISORS, ALL THE AFORESAID GOODS EXCLUSIVELY FOR SPORT USE IN CYCLING ACTIVITY; PROTECTIVE CYCLING HEADGEAR, NAMELY, PROTECTIVE FACE MASKS FOR PROTECTING AGAINST COLD; SWEAT-ABSORBENT STOCKINGS, ANORAKS, BELTS BEING CLOTHING, ALL THE AFORESAID GOODS EXCLUSIVELY FOR SPORT USE IN CYCLING ACTIVITY; OVERSHOES, CYCLING SHOES, GYMNASTIC SHOES, TRAINING SHOES, ALL THE AFORESAID GOODS EXCLUSIVELY FOR SPORT USE IN CYCLING ACTIVITY; SOLES FOR FOOTWEAR EXCLUSIVELY FOR SPORT USE IN CYCLING ACTIVITY; HEEL PIECES FOR SHOES AND BOOTS EXCLUSIVELY FOR SPORT USE IN CYCLING ACTIVITY, IN CLASS 25 (U.S. CLS. 22 AND 39).



David J. Kybas

Director of the United States Patent and Trademark Office

FOR: PROTECTIVE PADDINGS FOR FEET, ELBOWS, KNEES AND SHINS FOR CYCLING ACTIVITY AND CYCLING RACES INTENDED AS PARTS OF SPORTS CLOTHING; KNEE PADS AND KNEE GUARDS BEING SPORTS ARTICLES FOR CYCLING ACTIVITY AND CYCLING RACES; PROTECTIVE PADS FOR CYCLING GARMENTS AS PARTS OF SPORTS CLOTHING; SPORTING EQUIPMENT, NAMELY, FACE MASKS FOR CYCLING; PROTECTIVE SUPPORTS FOR FEET AND ELBOWS BEING SPORTS ARTICLES FOR CYCLING ACTIVITY AND CYCLING RACES; PROTECTIVE SUPPORTS FOR FEET AND ELBOWS EXCLUSIVELY FOR SPORT USE IN CYCLING ACTIVITY; PROTECTIVE PADDINGS FOR FEET, ELBOWS, KNEES AND SHINS FOR CYCLING; CYCLING GLOVES, IN CLASS 28 (U.S. CLS. 22, 23, 38 AND 50).

Reg. No. 4,065,502 OWNER OF ITALY REG. NO. 0001222100, DATED 10-16-2009, EXPIRES 10-16-2019.

NO CLAIM IS MADE TO THE EXCLUSIVE RIGHT TO USE "BICYCLE LINE", APART FROM THE MARK AS SHOWN.

THE MARK CONSISTS OF A DESIGN APPEARING AS TWO STYLIZED LETTER "U" ONE ON TOP OF ANOTHER, INSIDE AN OVAL WHICH IS SURROUNDED BY PARENTHESIS. THE WORDS "BICYCLE LINE" FOLLOW THE DESIGN AND 3 RECTANGULAR BARS UNDERNEATH THE WORD "LINE".

SER. NO. 85-048,656, FILED 5-26-2010.

BRIAN CALLAGHAN, EXAMINING ATTORNEY

United States of America

United States Patent and Trademark Office

REALITY CHECK

Reg. No. 4,065,503

Registered Dec. 6, 2011

Int. Cl.: 42

SERVICE MARK

PRINCIPAL REGISTER

REALITY CHECK SYSTEMS, INC. (CALIFORNIA CORPORATION)
726 S. FLOWER STREET
BURBANK, CA 91502

FOR: COMPUTER-AIDED GRAPHIC DESIGN, NAMELY, DESIGN AND PRODUCTION OF COMPUTER GENERATED VISUAL AND DIGITAL IMAGES, AND TEXT; DESIGN AND RENTAL OF CUSTOMIZED SOFTWARE AND CUSTOMIZED HARDWARE FOR LIVE EVENT AND REMOTE VIDEO PRODUCTION FOR TELEVISION, ON-LINE OR MOBILE; AND RENTAL OF GRAPHICS PRODUCTION SYSTEMS AND PRODUCTION AUTOMATION SOFTWARE FOR TELEVISION PRODUCTION, IN CLASS 42 (U.S. CLS. 100 AND 101).

FIRST USE 0-0-1997; IN COMMERCE 0-0-1997.

THE MARK CONSISTS OF STANDARD CHARACTERS WITHOUT CLAIM TO ANY PARTICULAR FONT, STYLE, SIZE, OR COLOR.

OWNER OF U.S. REG. NO. 2,320,359.

SER. NO. 85-050,934, FILED 5-29-2010.

SUNG IN, EXAMINING ATTORNEY



David J. Kyfos

Director of the United States Patent and Trademark Office

United States of America

United States Patent and Trademark Office

REALITY CHECK SYSTEMS

Reg. No. 4,065,504

Registered Dec. 6, 2011

Int. Cl.: 42

SERVICE MARK

PRINCIPAL REGISTER

REALITY CHECK SYSTEMS, INC. (CALIFORNIA CORPORATION)
726 S. FLOWER STREET
BURBANK, CA 91502

FOR: COMPUTER-AIDED GRAPHIC DESIGN, NAMELY, DESIGN AND PRODUCTION OF COMPUTER GENERATED VISUAL AND DIGITAL IMAGES, AND TEXT; DESIGN AND RENTAL OF CUSTOMIZED SOFTWARE AND CUSTOMIZED HARDWARE FOR LIVE EVENT AND REMOTE VIDEO PRODUCTION FOR TELEVISION, ON-LINE OR MOBILE; AND RENTAL OF GRAPHICS PRODUCTION SYSTEMS AND PRODUCTION AUTOMATION SOFTWARE FOR TELEVISION PRODUCTION, IN CLASS 42 (U.S. CLS. 100 AND 101).

FIRST USE 1-1-2010; IN COMMERCE 1-1-2010.

THE MARK CONSISTS OF STANDARD CHARACTERS WITHOUT CLAIM TO ANY PARTICULAR FONT, STYLE, SIZE, OR COLOR.

OWNER OF U.S. REG. NO. 2,320,359.

NO CLAIM IS MADE TO THE EXCLUSIVE RIGHT TO USE "SYSTEMS" , APART FROM THE MARK AS SHOWN.

SER. NO. 85-050,935, FILED 5-29-2010.

SUNG IN, EXAMINING ATTORNEY



David J. Kyffers

Director of the United States Patent and Trademark Office

United States of America

United States Patent and Trademark Office

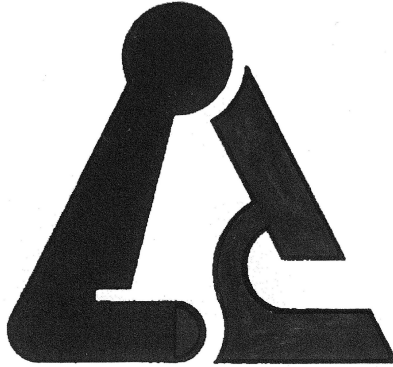

Reg. No. 4,065,505

Registered Dec. 6, 2011

Int. Cl.: 35

SERVICE MARK

PRINCIPAL REGISTER

CALIFORNIA ASSOCIATION FOR MEDICAL LABORATORY TECHNOLOGY (CALIFORNIA CORPORATION)
1895 MOWRY AVE. SUITE 112
FREMONT, CA 94538

FOR: ASSOCIATION SERVICES, NAMELY, PROMOTING THE INTERESTS OF MEDICAL LABORATORY PROFESSIONALS, IN CLASS 35 (U.S. CLS. 100, 101 AND 102).

FIRST USE 5-1-1975; IN COMMERCE 5-1-1975.

THE MARK CONSISTS OF A STYLIZED REPRESENTATION OF A STICK FIGURE USING A MICROSCOPE AND FALLS WITHIN THE GENERAL OUTLINE OF AN EQUILATERAL TRIANGLE.

SER. NO. 85-051,013, FILED 5-30-2010.

JOHN SCHUYLER YARD, EXAMINING ATTORNEY



David J. Kybas

Director of the United States Patent and Trademark Office

United States of America

United States Patent and Trademark Office

TOPAZ

Reg. No. 4,065,506

Registered Dec. 6, 2011

Int. Cls.: 6, 9 and 11

TRADEMARK

PRINCIPAL REGISTER

TOPAZ LIGHTING CORP. (NEW YORK CORPORATION)
225 PARKSIDE DRIVE
SAN FERNANDO, CA 91340

FOR: CABLE CLAMPS OF METAL; CEILING SUPPORTS OF METAL; ELBOWS OF METAL FOR PIPES; METAL CABLE CLIPS; METAL CLAMPS; METAL CONDUIT; METAL NIPPLE; METAL NUTS; METAL PIPE CLIPS; METAL PIPE COLLARS; METAL PIPE CONNECTORS; METAL PIPE COUPLINGS AND JOINTS; METAL PIPE FITTINGS; STEEL PIPES AND TUBES, IN CLASS 6 (U.S. CLS. 2, 12, 13, 14, 23, 25 AND 50).

FIRST USE 6-0-1985; IN COMMERCE 6-0-1985.

FOR: BALLASTS FOR GAS DISCHARGE LAMPS; CABLE CONNECTORS; ELECTRIC CABLES, WIRES, CONDUCTORS AND CONNECTION FITTINGS THEREFOR; ELECTRIC CONNECTIONS; ELECTRIC CONNECTIONS AND CONNECTORS; ELECTRIC CONNECTORS; ELECTRIC COUPLINGS; ELECTRICAL CONDUCTORS; ELECTRICAL CONNECTION BOXES; ELECTRICAL CONNECTIONS; ELECTRICAL CONNECTORS; ELECTRICAL CONNECTOR HOUSINGS; ELECTRICAL DISTRIBUTION BOXES; ELECTRICALLY INSULATED HOUSINGS FOR ELECTRICAL APPARATUS MADE FROM SYNTHETIC PLASTIC MATERIAL, IN CLASS 9 (U.S. CLS. 21, 23, 26, 36 AND 38).

FIRST USE 6-0-1985; IN COMMERCE 6-0-1985.

FOR: AQUARIUM LIGHTS; ARC LAMPS; CEILING LIGHTS; DISCHARGE LAMPS AND THEIR FITTINGS; DOWNLIGHTERS; ELECTRIC BULBS; ELECTRIC CANDELABRAS; ELECTRIC CANDLES; ELECTRIC HOLIDAY LIGHTS; ELECTRIC LAMPS; ELECTRIC LIGHT BULBS; ELECTRIC LIGHTING FIXTURES; ELECTRIC LIGHTS FOR CHRISTMAS TREES; ELECTRIC LUMINAIRES; FIXTURES FOR INCANDESCENT LIGHT BULBS; FLUORESCENT ELECTRIC LIGHT BULBS; FLUORESCENT LAMP TUBES; FLUORESCENT LAMPS; FLUORESCENT LIGHTING TUBES; HALOGEN LIGHT BULBS; INCANDESCENT LAMPS; INCANDESCENT LAMPS AND THEIR FITTINGS; INCANDESCENT LIGHT BULBS; INFRARED LAMPS; LAMP BASES; LAMP BULBS; LAMP REFLECTORS; LAMPS; LAMPS FOR OUTDOOR USE; LED AND HID LIGHT FIXTURES; LED LIGHT BULBS; LIGHT BULBS; LIGHT REFLECTORS; LIGHTBULBS; LIGHTING DEVICES FOR SHOWCASES; LIGHTING FIXTURES; LIGHTING TUBES; LIGHTS FOR USE IN ILLUMINATING SIGNS AND DISPLAYS; LUMINAIRES; MERCURY LAMPS; OVERHEAD LAMPS; ROADLIGHTS; SOCKETS FOR ELECTRIC LIGHTS; SPOT LIGHTS; SPOTLIGHTS; TOOLS, COMPONENTS AND



David J. Kyros

Director of the United States Patent and Trademark Office

Reg. No. 4,065,506 SUPPLIES FOR USE IN MAKING SIGNS, NAMELY, FLUORESCENT, HID, LED AND INCANDESCENT BULBS, LAMPS AND FIXTURES; UV HALOGEN METAL VAPOUR LAMPS, IN CLASS 11 (U.S. CLS. 13, 21, 23, 31 AND 34).

FIRST USE 6-0-1985; IN COMMERCE 6-0-1985.

THE MARK CONSISTS OF STANDARD CHARACTERS WITHOUT CLAIM TO ANY PARTICULAR FONT, STYLE, SIZE, OR COLOR.

SER. NO. 85-055,411, FILED 6-4-2010.

KAPIL BHANOT, EXAMINING ATTORNEY

United States of America

United States Patent and Trademark Office



Reg. No. 4,065,507

SAM GROUP HOLDING AG (SWITZERLAND CORPORATION)
JOSEFSTRASSE 218
CH - 8005 ZÜRICH, SWITZERLAND

Registered Dec. 6, 2011

Int. Cls.: 9, 16, 35 and 36

FOR: ELECTRONIC DATABASES IN THE FIELD OF SUSTAINABLE INVESTMENTS AND COMMERCIAL ENTERPRISES WITH SUSTAINABLE BUSINESS MODELS RECORDED ON COMPUTER MEDIA; DOWNLOADABLE ELECTRONIC PUBLICATIONS IN THE NATURE OF BROCHURES AND LEAFLETS IN THE FIELD OF SUSTAINABLE INVESTMENTS AND COMMERCIAL ENTERPRISES WITH SUSTAINABLE BUSINESS MODELS; COMPUTER SOFTWARE FOR USE IN DATABASE MANAGEMENT, USE AS A SPREADSHEET, AND FOR THE ANALYSIS OF BUSINESS MODELS IN RESPECT OF THE SUSTAINABILITY OF INVESTMENTS AND COMMERCIAL ENTERPRISES; COMPUTER APPLICATION SOFTWARE FOR USE IN DATABASE MANAGEMENT, USE AS A SPREADSHEET, AND FOR THE ANALYSIS OF BUSINESS MODELS IN RESPECT OF THE SUSTAINABILITY OF INVESTMENTS AND COMMERCIAL ENTERPRISES, IN CLASS 9 (U.S. CLS. 21, 23, 26, 36 AND 38).

TRADEMARK

SERVICE MARK

PRINCIPAL REGISTER

FOR: PRINTED MATTER OF ALL KIND, NAMELY, BOOKS, BROCHURES, MAGAZINES, LEAFLETS, LOOSE-LEAF-COLLECTIONS, ALL IN THE FIELD OF SUSTAINABLE INVESTMENTS AND COMMERCIAL ENTERPRISES WITH SUSTAINABLE BUSINESS MODELS; PRINTED INSTRUCTIONAL AND TEACHING MATERIALS IN THE FIELD OF SUSTAINABLE INVESTMENTS AND COMMERCIAL ENTERPRISES WITH SUSTAINABLE BUSINESS MODELS, IN CLASS 16 (U.S. CLS. 2, 5, 22, 23, 29, 37, 38 AND 50).



FOR: ECONOMIC FORECASTING; BUSINESS FAILURE ANALYSIS SERVICES; BUSINESS ORGANIZATION AND MANAGEMENT CONSULTANCY; EVALUATIONS RELATING TO COMMERCIAL MATTERS; BUSINESS APPRAISALS OF COMMERCIAL ENTERPRISES WITH QUALIFICATION AND CERTIFICATION SCHEMES IN THE FIELD OF SUSTAINABLE INVESTMENT POSSIBILITIES; COMPILATION AND SYSTEMIZATION OF INFORMATION INTO COMPUTER DATABASES; DATABASE MANAGEMENT, NAMELY, UPDATING CONTENT; CONSULTING SERVICES IN THE AREA OF SUSTAINABLE BUSINESS SOLUTIONS; ELECTRONIC COMMERCE SERVICES, NAMELY, PROVIDING INFORMATION ABOUT PRODUCTS VIA TELECOMMUNICATION NETWORKS FOR ADVERTISING AND SALES PURPOSES IN THE FIELD OF SUSTAINABLE INVESTMENTS, IN CLASS 35 (U.S. CLS. 100, 101 AND 102).

David J. Kappas

Director of the United States Patent and Trademark Office

Reg. No. 4,065,507 FOR: FINANCIAL ANALYSIS AND APPRAISALS OF COMMERCIAL ENTERPRISES; INSURANCE AGENCY SERVICES, NAMELY, INSURANCE BROKERAGE AND PROVIDING INSURANCE ADVICE; FINANCIAL AFFAIRS AND MONETARY AFFAIRS, NAMELY, FINANCIAL INFORMATION, MANAGEMENT AND ANALYSIS SERVICES; FINANCIAL CONSULTATION AND ADVICE; ASSET MANAGEMENT AND INVESTMENT ADVICE; FINANCIAL CONSULTING IN THE FIELD OF REAL ESTATE BROKERAGE; INSURANCE AND FINANCIAL INFORMATION AND CONSULTANCY SERVICES IN THE FIELD OF SUSTAINABLE INVESTMENTS AND COMMERCIAL ENTERPRISES WITH SUSTAINABLE BUSINESS MODELS, NONE OF THE AFORESAID SERVICES IN CONNECTION WITH CREDIT, DEBIT, CHARGE AND/OR PAYMENT CARDS, IN CLASS 36 (U.S. CLS. 100, 101 AND 102).

PRIORITY CLAIMED UNDER SEC. 44(D) ON SWITZERLAND APPLICATION NO. 63941/2009, FILED 12-9-2009, REG. NO. 604446, DATED 8-26-2010, EXPIRES 12-19-2019.

THE COLOR(S) DARK BLUE, TEAL, LIGHT GREEN AND WHITE IS/ARE CLAIMED AS A FEATURE OF THE MARK.

THE MARK CONSISTS OF THE WORD "SAM" TO THE LEFT OF OVERLAPPING CIRCLES, WITH PART OF THE SMALLER CIRCLE IN DARK BLUE AND WHITE AND PART OF THE LARGER CIRCLE IN LIGHT GREEN; THE OVERLAPPING AREA OF THE TWO CIRCLES IS IN THE COLOR TEAL.

SER. NO. 85-058,419, FILED 6-9-2010.

ALEXANDER L. POWERS, EXAMINING ATTORNEY

United States of America

United States Patent and Trademark Office

TRUTH 4 YOUTH

Reg. No. 4,065,508

Registered Dec. 6, 2011

Int. Cl.: 41

SERVICE MARK

PRINCIPAL REGISTER

NATIONAL ABSTINENCE CLEARINGHOUSE (SOUTH DAKOTA CORPORATION)
801 E 41ST STREET
SIOUX FALLS, SD 57105

FOR: EDUCATIONAL SERVICES, NAMELY, CONDUCTING CLASSES, SEMINARS, CONFERENCES AND WORKSHOPS IN THE FIELD OF SEXUAL HEALTH, ABSTINENCE UNTIL MARRIAGE EDUCATION, DRUG AND ALCOHOL PREVENTION FOR YOUTH, PARENTS, EDUCATORS AND COMMUNITY MEMBERS, IN CLASS 41 (U.S. CLS. 100, 101 AND 107).

FIRST USE 1-1-2002; IN COMMERCE 1-31-2002.

THE MARK CONSISTS OF STANDARD CHARACTERS WITHOUT CLAIM TO ANY PARTICULAR FONT, STYLE, SIZE, OR COLOR.

SER. NO. 85-058,726, FILED 6-9-2010.

DAWN FELDMAN, EXAMINING ATTORNEY



David J. Kyffers

Director of the United States Patent and Trademark Office

United States of America

United States Patent and Trademark Office

CITADELLE

Reg. No. 4,065,509

Registered Dec. 6, 2011

Int. Cl.: 30

CITADELLE, COOPERATIVE DE PRODUCTEURS DE SIROP D'ERABLE/CITADELLE,
MAPLE SYRUP PRODUCERS' COOPERATIVE (CANADA CORPORATION)
P.O. BOX 310
2100 ST-LAURENT
PLESSISVILLE, QUEBEC, CANADA G6L2Y8

TRADEMARK

PRINCIPAL REGISTER

FOR: MAPLE SUGAR, SYRUPS, NAMELY, CARAO FRUIT SYRUP FOR USE AS FOOD, CHOCOLATE SYRUP, COFFEE FLAVORED SYRUP USED IN MAKING FOOD BEVERAGES, CORN SYRUP, FLAVORING SYRUP, GLUTINOUS STARCH SYRUP (MIZU-AME), GOLDEN SYRUP, MIXES IN THE NATURE OF CONCENTRATES, SYRUPS OR POWDERS USED IN THE PREPARATION OF TEA BASED BEVERAGES, MOLASSES SYRUP, PANCAKE SYRUP, POWDERED STARCH SYRUP FOR FOOD, SNACK FOOD CHEWS MADE PRIMARILY FROM BROWN RICE SYRUP, STARCH SYRUP FOR FOOD, SYRUPS FOR MAKING TEA, TABLE SYRUP, TOPPING SYRUP, PURE MAPLE SYRUP, MAPLE SYRUP AND PRODUCTS DERIVED THEREFROM, NAMELY, MAPLE SPREAD, SNACKS, BEVERAGES, TREATS, CANDIES, PASTRIES, GELATOS AND SORBETS, VINAIGRETTES, VINEGAR, MUSTARD, IN CLASS 30 (U.S. CL. 46).

THE MARK CONSISTS OF STANDARD CHARACTERS WITHOUT CLAIM TO ANY PARTICULAR FONT, STYLE, SIZE, OR COLOR.

OWNER OF CANADA REG. NO. TMDA51426, DATED 1-30-1931, EXPIRES 1-30-2016.

OWNER OF U.S. REG. NO. 693,967.

THE ENGLISH TRANSLATION OF "CITADELLE" IN THE MARK IS "A STRONG FORTRESS" OR "A STRONG-HOLD".

SER. NO. 85-059,089, FILED 6-10-2010.

FRANK LATTUCA, EXAMINING ATTORNEY



David J. Kyros

Director of the United States Patent and Trademark Office

United States of America

United States Patent and Trademark Office

Portjak

Reg. No. 4,065,510

Registered Dec. 6, 2011

Int. Cl.: 9

TRADEMARK

PRINCIPAL REGISTER

IVB, INC. (D.C. CORPORATION), DBA INSIDER VIDEO CLUB
POST OFFICE BOX 93399
LOS ANGELES, CA 900930399

FOR: DIGITAL MEDIA, NAMELY, PRE-RECORDED VIDEO CASSETTES, DIGITAL VIDEO DISCS, DIGITAL VERSATILE DISCS, DOWNLOADABLE AUDIO AND VIDEO RECORDINGS, DVDS, AND HIGH DEFINITION DIGITAL DISCS FEATURING YOUTH DOCUMENTARIES WITH CULTURAL, SOCIAL, HISTORICAL, MILITARY, SPORT, EDUCATIONAL, ARTISTIC AND RELIGIOUS SUBJECTS, IN CLASS 9 (U.S. CLS. 21, 23, 26, 36 AND 38).

FIRST USE 5-15-2006; IN COMMERCE 5-15-2006.

THE MARK CONSISTS OF STANDARD CHARACTERS WITHOUT CLAIM TO ANY PARTICULAR FONT, STYLE, SIZE, OR COLOR.

SER. NO. 85-060,192, FILED 6-10-2010.

SAMUEL E. SHARPER JR., EXAMINING ATTORNEY



David J. Kybas

Director of the United States Patent and Trademark Office

United States of America

United States Patent and Trademark Office

We did not invent customer
service, we only perfected
it!

Reg. No. 4,065,511

Registered Dec. 6, 2011

Int. Cl.: 37

SERVICE MARK

PRINCIPAL REGISTER

WILLY MORA (UNITED STATES INDIVIDUAL)
UNIT 3D
120 SUSSEX STREET
HACKENSACK, NJ 07601

FOR: WINDOW REPAIR SERVICES; INSTALLATION SERVICES FOR WINDOWS AND
SHOWER ENCLOSURES, IN CLASS 37 (U.S. CLS. 100, 103 AND 106).

FIRST USE 10-1-2008; IN COMMERCE 10-1-2008.

THE MARK CONSISTS OF STANDARD CHARACTERS WITHOUT CLAIM TO ANY PAR-
TICULAR FONT, STYLE, SIZE, OR COLOR.

SER. NO. 85-060,691, FILED 6-11-2010.

TRACY WHITTAKER-BROWN, EXAMINING ATTORNEY



David J. Kyffers

Director of the United States Patent and Trademark Office

United States of America

United States Patent and Trademark Office

ORB

Reg. No. 4,065,512

Registered Dec. 6, 2011

Int. Cl.: 25

TRADEMARK

PRINCIPAL REGISTER

GLOBAL COLLECTIVE DESIGN INC. (CANADA CORPORATION)
130 - 11300 NO. 5 ROAD
RICHMOND, BC, CANADA V7A5J7

FOR: CLOTHING, NAMELY, T-SHIRTS, SHIRTS, SWEATSHIRTS, PULLOVERS, SWEAT-PANTS, PANTS, SHORTS, JACKETS, VESTS, BELTS; HEADWEAR, NAMELY, HATS, CAPS, TOQUES, HEADBANDS; FOOTWEAR, NAMELY, SHOES, SPORTS SHOES, BOOTS, SANDALS, IN CLASS 25 (U.S. CLS. 22 AND 39).

FIRST USE 10-0-2000; IN COMMERCE 10-0-2000.

THE MARK CONSISTS OF STANDARD CHARACTERS WITHOUT CLAIM TO ANY PARTICULAR FONT, STYLE, SIZE, OR COLOR.

SER. NO. 85-061,240, FILED 6-11-2010.

ODESSA BIBBINS, EXAMINING ATTORNEY



David J. Kyjars

Director of the United States Patent and Trademark Office

United States of America

United States Patent and Trademark Office

Rachel's Rags

Reg. No. 4,065,513

Registered Dec. 6, 2011

Int. Cl.: 25

TRADEMARK

PRINCIPAL REGISTER

DORAN, LISA I. (UNITED STATES INDIVIDUAL), DBA RACHEL'S RAGS
5 MAPLE LANE
WESTPORT, CT 06880

FOR: SLEEPING GARMENTS, IN CLASS 25 (U.S. CLS. 22 AND 39).

FIRST USE 9-1-2009; IN COMMERCE 1-1-2010.

THE MARK CONSISTS OF STANDARD CHARACTERS WITHOUT CLAIM TO ANY PARTICULAR FONT, STYLE, SIZE, OR COLOR.

NO CLAIM IS MADE TO THE EXCLUSIVE RIGHT TO USE "RAGS", APART FROM THE MARK AS SHOWN.

SER. NO. 85-061,792, FILED 6-14-2010.

BARNEY CHARLON, EXAMINING ATTORNEY



David J. Kyffers

Director of the United States Patent and Trademark Office

United States of America

United States Patent and Trademark Office

DONNAMAX

Reg. No. 4,065,514

DONNAMAX, INC. (NEW YORK CORPORATION)
765 MCDONALD AVENUE
BROOKLYN, NY 11218

Registered Dec. 6, 2011

Int. Cls.: 3, 8, 20, 21 and 25

FOR: BEAUTY PRODUCTS, NAMELY, CLEANSING PADS, COSMETIC COTTON PADS, COTTON SWABS FOR COSMETIC PURPOSES, COSMETIC PADS, COSMETIC OIL BLOT-
TING PAPERS, EMERY BOARDS, PUMICE STONES FOR PERSONAL USE, IN CLASS 3
(U.S. CLS. 1, 4, 6, 50, 51 AND 52).

TRADEMARK

FIRST USE 3-31-2003; IN COMMERCE 3-31-2003.

PRINCIPAL REGISTER

FOR: COSMETIC ACCESSORIES, NAMELY, EYELASH CURLERS; NAIL CARE PRODUCTS,
NAMELY, FINGER AND TOE NAIL CLIPPERS, NAIL FILES, FOOT SCRAPERS, SCISSORS,
PEDICURE SETS; PERSONAL CARE PRODUCTS, NAMELY, FOOT SCRAPERS, FOOT
FILES, RAZORS, TWEEZERS, IN CLASS 8 (U.S. CLS. 23, 28 AND 44).

FIRST USE 3-31-2003; IN COMMERCE 3-31-2003.

FOR: BEAUTY PRODUCTS, NAMELY, GEL TOE SEPARATORS, MAGNIFYING MIRRORS;
BATH ACCESSORIES, NAMELY, EMPTY SQUEEZE BOTTLES, EMPTY SPRAY BOTTLES,
EMPTY PUMP DISPENSER BOTTLES, AND EMPTY TRAVEL BOTTLES, IN CLASS 20 (U.S.
CLS. 2, 13, 22, 25, 32 AND 50).

FIRST USE 3-31-2003; IN COMMERCE 3-31-2003.

FOR: BEAUTY PRODUCTS, NAMELY, HAIR BRUSHES, FOOT AND HAND NAIL BRUSHES,
NAIL BRUSHES, COMBS, FACIAL CLEANSING SPONGES, EXFOLIATING FACIAL PADS,
COSMETIC BRUSHES, EXFOLIATING FACIAL BRUSHES; BATH ACCESSORIES, NAMELY,
BODY SCRUBBERS, TRAVEL SOAP DISHES; ORAL CARE PRODUCTS, NAMELY,
TOOTHBRUSH CASES, IN CLASS 21 (U.S. CLS. 2, 13, 23, 29, 30, 33, 40 AND 50).

FIRST USE 3-31-2003; IN COMMERCE 3-31-2003.

FOR: BEAUTY PRODUCTS, NAMELY, HAIR TURBANS, SHOWER CAPS, IN CLASS 25
(U.S. CLS. 22 AND 39).

FIRST USE 3-31-2003; IN COMMERCE 3-31-2003.



David J. Kyros

Director of the United States Patent and Trademark Office

Reg. No. 4,065,514 THE MARK CONSISTS OF STANDARD CHARACTERS WITHOUT CLAIM TO ANY PARTICULAR FONT, STYLE, SIZE, OR COLOR.

SER. NO. 85-062,066, FILED 6-14-2010.

CHRIS WELLS, EXAMINING ATTORNEY

United States of America

United States Patent and Trademark Office

ALUMA-FOAM

Reg. No. 4,065,515

Registered Dec. 6, 2011

Int. Cl.: 6

TRADEMARK

PRINCIPAL REGISTER

BLANTON CONSTRUCTION (CALIFORNIA SOLE PROPRIETORSHIP)
1070 HORIZON DR. SUITE I
FAIRFIELD, CA 94533

FOR: METAL ROOFING PANELS, IN CLASS 6 (U.S. CLS. 2, 12, 13, 14, 23, 25 AND 50).

FIRST USE 9-29-1983; IN COMMERCE 12-1-2009.

THE MARK CONSISTS OF STANDARD CHARACTERS WITHOUT CLAIM TO ANY PARTICULAR FONT, STYLE, SIZE, OR COLOR.

SER. NO. 85-062,208, FILED 6-14-2010.

JANET LEE, EXAMINING ATTORNEY



David J. Kyffers

Director of the United States Patent and Trademark Office

United States of America

United States Patent and Trademark Office

Global Beat

Reg. No. 4,065,516

RHYTHMS OF THE GLOBE (NEW YORK SOLE PROPRIETORSHIP)
46-60 156TH STREET
FLUSHING, NY 11355

Registered Dec. 6, 2011

Int. Cl.: 9

FOR: AUDIO AND VIDEO RECORDINGS FEATURING MUSIC AND ARTISTIC PERFORMANCES, IN CLASS 9 (U.S. CLS. 21, 23, 26, 36 AND 38).

TRADEMARK

FIRST USE 8-19-1996; IN COMMERCE 8-19-1996.

PRINCIPAL REGISTER

THE MARK CONSISTS OF STANDARD CHARACTERS WITHOUT CLAIM TO ANY PARTICULAR FONT, STYLE, SIZE, OR COLOR.

SER. NO. 85-062,693, FILED 6-14-2010.

SAMUEL E. SHARPER JR., EXAMINING ATTORNEY



David J. Kyros

Director of the United States Patent and Trademark Office

United States of America

United States Patent and Trademark Office

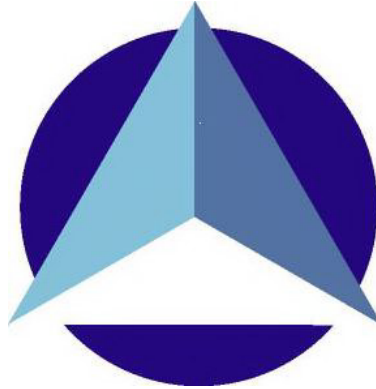

Reg. No. 4,065,517

Registered Dec. 6, 2011

Int. Cl.: 9

TRADEMARK

PRINCIPAL REGISTER

WINESTIMATOR, INC (WASHINGTON CORPORATION)
19450 68TH AVE. S.
KENT, WA 98032

FOR: COMPUTER PROGRAMS FOR COST ESTIMATING, IN CLASS 9 (U.S. CLS. 21, 23, 26, 36 AND 38).

FIRST USE 5-26-1997; IN COMMERCE 5-26-1997.

THE MARK CONSISTS OF A PRISM PLACED ON TOP OF A CIRCLE. THE PRISM HAS TWO BLUE SHADED SIDES AND ONE WHITE SIDE. THE CIRCLE IS A DARKER SHADE OF BLUE.

THE COLOR(S) BLUE AND WHITE IS/ARE CLAIMED AS A FEATURE OF THE MARK.

SER. NO. 85-062,699, FILED 6-14-2010.

KELLY BOULTON, EXAMINING ATTORNEY



David J. Kybas

Director of the United States Patent and Trademark Office

United States of America

United States Patent and Trademark Office

TERRASMART

Reg. No. 4,065,518

Registered Dec. 6, 2011

Int. Cl.: 6

TRADEMARK

PRINCIPAL REGISTER

TERRASMART LLC (FLORIDA LIMITED LIABILITY COMPANY)
17484 OLD HARMONY DRIVE, UNIT 202
FORT MYERS, FL 33908

FOR: METAL SCREWS; METAL STRUCTURES FOR MOUNTING SOLAR PANELS; SOLAR PANEL MOUNTS MADE OF METAL; SUBSTRATES PRIMARILY OF METAL FOR SUPPORTING SOLAR CELLS, PHOTOVOLTAIC CELLS AND SOLAR COLLECTORS, IN CLASS 6 (U.S. CLS. 2, 12, 13, 14, 23, 25 AND 50).

FIRST USE 4-13-2010; IN COMMERCE 4-13-2010.

THE MARK CONSISTS OF STANDARD CHARACTERS WITHOUT CLAIM TO ANY PARTICULAR FONT, STYLE, SIZE, OR COLOR.

SER. NO. 85-063,350, FILED 6-15-2010.

LINDA ESTRADA, EXAMINING ATTORNEY



David J. Kyjars

Director of the United States Patent and Trademark Office

United States of America

United States Patent and Trademark Office

NEA's Read Across America



Reg. No. 4,065,519
Registered Dec. 6, 2011
Int. Cls.: 16, 25 and 35

TRADEMARK

SERVICE MARK

PRINCIPAL REGISTER

DR. SEUSS ENTERPRISES, L.P. (CALIFORNIA LIMITED PARTNERSHIP)
C/O KARL ZOBELL, ESQ. DLA PIPER LLP (US)
1200 PROSPECT STREET, SUITE 575
LA JOLLA, CA 920373610 AND

NATIONAL EDUCATION ASSOCIATION (UNITED STATES A CONGRESSIONALLY
CHARTERED CORPORATION)
C/O CYNTHIA CHMIELEWSKI, ESQ. NEA OFFICE
OF GENERAL COUNSEL, 1201 16TH STREET, NW
WASHINGTON, DC 20036

FOR: STICKERS, BOOKMARKS, DECORATIVE PAPER BANNERS, IN CLASS 16 (U.S. CLS. 2, 5, 22, 23, 29, 37, 38 AND 50).

FIRST USE 3-2-2010; IN COMMERCE 3-2-2010.

FOR: HATS, IN CLASS 25 (U.S. CLS. 22 AND 39).

FIRST USE 7-3-2009; IN COMMERCE 7-3-2009.

FOR: PROMOTING PUBLIC AWARENESS ABOUT READING THROUGH A READING
MOTIVATION AND AWARENESS PROGRAM, IN CLASS 35 (U.S. CLS. 100, 101 AND 102).

FIRST USE 2-12-2010; IN COMMERCE 2-12-2010.

OWNER OF U.S. REG. NOS. 2,076,532, 2,941,623 AND OTHERS.

THE NAME(S), PORTRAIT(S), AND/OR SIGNATURE(S) SHOWN IN THE MARK DOES NOT
IDENTIFY A PARTICULAR LIVING INDIVIDUAL.

THE MARK CONSISTS OF THE WORDING "NEA'S READ ACROSS AMERICA" ABOVE
THE IMAGE OF A STRIPED STOVE-PIPE HAT, THE IMAGE OF A BOOK TITLED "THE
CAT IN THE HAT" AND DISPLAYS THE AUTHOR'S NAME "BY DR. SEUSS", AND THE
"CAT IN THE HAT" CHARACTER WEARING A STRIPED STOVE-PIPE HAT AND BOWTIE,
AND THERE IS A LABEL DEPICTING THE SAME "CAT IN THE HAT" CHARACTER

SEC. 2(F) AS TO "READ ACROSS AMERICA".



David J. Kyros

Director of the United States Patent and Trademark Office

Reg. No. 4,065,519 SER. NO. 85-063,780, FILED 6-15-2010.

DARRYL SPRUILL, EXAMINING ATTORNEY

United States of America

United States Patent and Trademark Office

LUNA AUSTRAL

Reg. No. 4,065,520

BUSNELLI, ROBERTO ORESTE ANTONIO (ARGENTINA INDIVIDUAL)
BESARES 1767
BUENOS AIRES, ARGENTINA

Registered Dec. 6, 2011

Int. Cl.: 33

FOR: WINES, IN CLASS 33 (U.S. CLS. 47 AND 49).

TRADEMARK

THE MARK CONSISTS OF STANDARD CHARACTERS WITHOUT CLAIM TO ANY PARTICULAR FONT, STYLE, SIZE, OR COLOR.

PRINCIPAL REGISTER

PRIORITY CLAIMED UNDER SEC. 44(D) ON ARGENTINA APPLICATION NO. 2988288, FILED 3-19-2010, REG. NO. 2416468, DATED 1-25-2011, EXPIRES 1-25-2021.

THE ENGLISH TRANSLATION OF THE WORDS "LUNA AUSTRAL" IN THE MARK IS SOUTHERN MOON.

SER. NO. 85-064,541, FILED 6-16-2010.

DORITT L. CARROLL, EXAMINING ATTORNEY



David J. Kybas

Director of the United States Patent and Trademark Office

United States of America

United States Patent and Trademark Office

SKYCOUCH

Reg. No. 4,065,521

Registered Dec. 6, 2011

Int. Cls.: 12 and 39

TRADEMARK

SERVICE MARK

PRINCIPAL REGISTER

AIR NEW ZEALAND LIMITED (NEW ZEALAND COMPANY)
185 FANSHAWE STREET
AUCKLAND, NEW ZEALAND

FOR: VEHICLES, NAMELY, LAND VEHICLES, AIR VEHICLES AND SEA VEHICLES; APPARATUS FOR LOCOMOTION BY LAND, AIR OR WATER, NAMELY, AUTOMOBILES, BOATS, AIRPLANES; AEROPLANES AND AIRCRAFT AND STRUCTURAL PARTS THEREFOR; AIRCRAFT STRUCTURAL PARTS AND ACCESSORIES, NAMELY, SEATS AND SEATING; SEATS FOR AIRCRAFTS, LAND VEHICLES, BOATS; MOTOR CAR SEATS; EJECTOR SEATS, BOOSTER SEATS FOR USE IN VEHICLES; ACCESSORIES AND COMPONENT PARTS OF ALL THE FOREGOING IN THIS CLASS SOLD AS A UNIT; SEAT BELTS AND SEAT COVERS FOR USE IN VEHICLES, IN CLASS 12 (U.S. CLS. 19, 21, 23, 31, 35 AND 44).

FOR: TRANSPORTATION SERVICES, NAMELY, TRANSPORTATION AND DELIVERY OF GOODS AND PEOPLE; STORAGE OF GOODS; LUGGAGE STORAGE SERVICES; SECURITY STORAGE SERVICES FOR DOCUMENTS AND GOODS OF OTHERS; TRANSPORT SECURITY SERVICES, NAMELY, THE GUARDED TRANSPORT OF GOODS OR PEOPLE; COURIER SERVICES; AIRLINE TRANSPORTATION SERVICES; AIRLINE PASSENGER SERVICES; PROVISION OF AIRPORT FACILITIES OR LOUNGE FACILITIES; PROVISION OF AIRLINE AND TRAVEL SERVICES BY INTERNET, ELECTRONIC MAIL, OR OTHER ELECTRONIC COMMUNICATION WITH CUSTOMERS; RESERVATION AND BOOKING OF SEATS FOR TRAVEL; RESERVATION AND BOOKING OF SEATS FOR TRAVEL FOR LAND, AIR OR WATER TRANSPORTATION; TRAVEL AGENCY SERVICES, NAMELY, THE MAKING OF TRAVEL RESERVATIONS; TOURIST OFFICE SERVICES; RESERVATION AND BOOKING SERVICES FOR FREQUENT FLYER PROGRAMS AND OTHER TRAVEL INCENTIVE PROGRAMS; BOOKING AND RESERVATION SERVICES FOR MEMBERSHIP PRIVILEGES AND LOYALTY RECOGNITION PROGRAMS IN CONNECTION WITH TRAVEL AND TRANSPORTATION; CHARTERING OF AIRCRAFT; PROVIDING INFORMATION AND DATA RELATING TO THE TRANSPORTATION OF GOODS AND PEOPLE, NAMELY, PROVIDING INFORMATION ABOUT TARIFFS, TIMETABLES AND METHODS OF TRANSPORTATION FOR GOODS AND PEOPLE; ARRANGING AND OPERATING TOURS AND TOURIST SERVICES; VEHICLE RENTAL AND RESERVATION SERVICES, NAMELY, RENTAL OF VEHICLES, BICYCLES, RAILWAY VEHICLES, MOTOR HOMES, TRAILERS AND TRAMS; VEHICLE PARKING SERVICES RELATING TO THE AVAILABILITY OF ON-STREET AND OFF-STREET PARKING SPACES; PROVISION OF CAR PARKING FACILITIES; VALET PARKING SERVICES; CONSULTANCY, ADVISORY AND INFORMATION



David J. Kyffers

Director of the United States Patent and Trademark Office

Reg. No. 4,065,521 SERVICES IN THIS CLASS RELATING TO THE FOREGOING SERVICES, IN CLASS 39
(U.S. CLS. 100 AND 105).

THE MARK CONSISTS OF STANDARD CHARACTERS WITHOUT CLAIM TO ANY PARTICULAR FONT, STYLE, SIZE, OR COLOR.

PRIORITY CLAIMED UNDER SEC. 44(D) ON NEW ZEALAND APPLICATION NO. 817419,
FILED 12-17-2009, REG. NO. 817419, DATED 8-12-2010, EXPIRES 12-17-2019.

SER. NO. 85-064,663, FILED 6-16-2010.

REGINA DRUMMOND, EXAMINING ATTORNEY

United States of America

United States Patent and Trademark Office

SPACESEAT

Reg. No. 4,065,522

Registered Dec. 6, 2011

Int. Cls.: 12 and 39

TRADEMARK

SERVICE MARK

PRINCIPAL REGISTER

AIR NEW ZEALAND LIMITED (NEW ZEALAND COMPANY)
185 FANSHAWE STREET
AUCKLAND, NEW ZEALAND

FOR: VEHICLES, NAMELY, LAND VEHICLES, AIR VEHICLES AND SEA VEHICLES; APPARATUS FOR LOCOMOTION BY LAND, AIR OR WATER, NAMELY, AUTOMOBILES, BOATS, AIRPLANES; AEROPLANES AND AIRCRAFT AND STRUCTURAL PARTS THEREFOR; AIRCRAFT STRUCTURAL PARTS AND ACCESSORIES, NAMELY, SEATS AND SEATING; SEATS FOR AIRCRAFTS, LAND VEHICLES, BOATS; MOTOR CAR SEATS; EJECTOR SEATS, BOOSTER SEATS FOR USE IN VEHICLES; ACCESSORIES AND COMPONENT PARTS OF ALL THE FOREGOING IN THIS CLASS SOLD AS A UNIT; SEAT BELTS AND SEAT COVERS FOR USE IN VEHICLES, IN CLASS 12 (U.S. CLS. 19, 21, 23, 31, 35 AND 44).

FOR: TRANSPORTATION SERVICES, NAMELY, TRANSPORTATION AND DELIVERY OF GOODS AND PEOPLE; STORAGE OF GOODS; LUGGAGE STORAGE SERVICES; SECURITY STORAGE SERVICES FOR DOCUMENTS AND GOODS OF OTHERS; TRANSPORT SECURITY SERVICES, NAMELY, THE GUARDED TRANSPORT OF GOODS OR PEOPLE; COURIER SERVICES; AIRLINE TRANSPORTATION SERVICES; AIRLINE PASSENGER SERVICES; PROVISION OF AIRPORT FACILITIES OR LOUNGE FACILITIES; PROVISION OF AIRLINE AND TRAVEL SERVICES BY INTERNET, ELECTRONIC MAIL, OR OTHER ELECTRONIC COMMUNICATION WITH CUSTOMERS; RESERVATION AND BOOKING OF SEATS FOR TRAVEL; RESERVATION AND BOOKING OF SEATS FOR TRAVEL FOR LAND, AIR OR WATER TRANSPORTATION; TRAVEL AGENCY SERVICES, NAMELY, THE MAKING OF TRAVEL RESERVATIONS; TOURIST OFFICE SERVICES; RESERVATION AND BOOKING SERVICES FOR FREQUENT FLYER PROGRAMS AND OTHER TRAVEL INCENTIVE PROGRAMS; BOOKING AND RESERVATION SERVICES FOR MEMBERSHIP PRIVILEGES AND LOYALTY RECOGNITION PROGRAMS IN CONNECTION WITH TRAVEL AND TRANSPORTATION; CHARTERING OF AIRCRAFT; PROVIDING INFORMATION AND DATA RELATING TO THE TRANSPORTATION OF GOODS AND PEOPLE, NAMELY, PROVIDING INFORMATION ABOUT TARIFFS, TIMETABLES AND METHODS OF TRANSPORTATION FOR GOODS AND PEOPLE; ARRANGING AND OPERATING TOURS AND TOURIST SERVICES; VEHICLE RENTAL AND RESERVATION SERVICES, NAMELY, RENTAL OF VEHICLES, BICYCLES, RAILWAY VEHICLES, MOTOR HOMES, TRAILERS AND TRAMS; VEHICLE PARKING SERVICES RELATING TO THE AVAILABILITY OF ON-STREET AND OFF-STREET PARKING SPACES; PROVISION OF CAR PARKING FACILITIES; VALET PARKING SERVICES; CONSULTANCY, ADVISORY AND INFORMATION



David J. Kyffers

Director of the United States Patent and Trademark Office

Reg. No. 4,065,522 SERVICES IN THIS CLASS RELATING TO THE FOREGOING SERVICES, IN CLASS 39
(U.S. CLS. 100 AND 105).

THE MARK CONSISTS OF STANDARD CHARACTERS WITHOUT CLAIM TO ANY PARTICULAR FONT, STYLE, SIZE, OR COLOR.

PRIORITY CLAIMED UNDER SEC. 44(D) ON NEW ZEALAND APPLICATION NO. 818302,
FILED 1-15-2010, REG. NO. 818302, DATED 7-22-2010, EXPIRES 1-15-2020.

SER. NO. 85-064,672, FILED 6-16-2010.

REGINA DRUMMOND, EXAMINING ATTORNEY

United States of America

United States Patent and Trademark Office

INNER SPACE

Reg. No. 4,065,523

Registered Dec. 6, 2011

Int. Cls.: 12 and 39

TRADEMARK

SERVICE MARK

PRINCIPAL REGISTER

AIR NEW ZEALAND LIMITED (NEW ZEALAND COMPANY)
185 FANSHAWE STREET
AUCKLAND, NEW ZEALAND

FOR: VEHICLES, NAMELY, LAND VEHICLES, AIR VEHICLES AND SEA VEHICLES; APPARATUS FOR LOCOMOTION BY LAND, AIR OR WATER, NAMELY, AUTOMOBILES, BOATS, AIRPLANES; AEROPLANES AND AIRCRAFT AND STRUCTURAL PARTS THEREFOR; AIRCRAFT STRUCTURAL PARTS AND ACCESSORIES, NAMELY, SEATS AND SEATING; SEATS FOR AIRCRAFTS, LAND VEHICLES, BOATS; MOTOR CAR SEATS; EJECTOR SEATS, BOOSTER SEATS FOR USE IN VEHICLES; ACCESSORIES AND COMPONENT PARTS OF ALL THE FOREGOING IN THIS CLASS SOLD AS A UNIT; SEAT BELTS AND SEAT COVERS FOR USE IN VEHICLES, IN CLASS 12 (U.S. CLS. 19, 21, 23, 31, 35 AND 44).

FOR: TRANSPORTATION SERVICES, NAMELY, TRANSPORTATION AND DELIVERY OF GOODS AND PEOPLE; STORAGE OF GOODS; LUGGAGE STORAGE SERVICES; SECURITY STORAGE SERVICES FOR DOCUMENTS AND GOODS OF OTHERS; TRANSPORT SECURITY SERVICES, NAMELY, THE GUARDED TRANSPORT OF GOODS OR PEOPLE; COURIER SERVICES; AIRLINE TRANSPORTATION SERVICES; AIRLINE PASSENGER SERVICES; PROVISION OF AIRPORT FACILITIES OR LOUNGE FACILITIES; PROVISION OF AIRLINE AND TRAVEL SERVICES BY INTERNET, ELECTRONIC MAIL, OR OTHER ELECTRONIC COMMUNICATION WITH CUSTOMERS; RESERVATION AND BOOKING OF SEATS FOR TRAVEL; RESERVATION AND BOOKING OF SEATS FOR TRAVEL FOR LAND, AIR OR WATER TRANSPORTATION; TRAVEL AGENCY SERVICES, NAMELY, THE MAKING OF TRAVEL RESERVATIONS; TOURIST OFFICE SERVICES; RESERVATION AND BOOKING SERVICES FOR FREQUENT FLYER PROGRAMS AND OTHER TRAVEL INCENTIVE PROGRAMS; BOOKING AND RESERVATION SERVICES FOR MEMBERSHIP PRIVILEGES AND LOYALTY RECOGNITION PROGRAMS IN CONNECTION WITH TRAVEL AND TRANSPORTATION; CHARTERING OF AIRCRAFT; PROVIDING INFORMATION AND DATA RELATING TO THE TRANSPORTATION OF GOODS AND PEOPLE, NAMELY, PROVIDING INFORMATION ABOUT TARIFFS, TIMETABLES AND METHODS OF TRANSPORTATION FOR GOODS AND PEOPLE; ARRANGING AND OPERATING TOURS AND TOURIST SERVICES; VEHICLE RENTAL AND RESERVATION SERVICES, NAMELY, RENTAL OF VEHICLES, BICYCLES, RAILWAY VEHICLES, MOTOR HOMES, TRAILERS AND TRAMS; VEHICLE PARKING SERVICES RELATING TO THE AVAILABILITY OF ON-STREET AND OFF-STREET PARKING SPACES; PROVISION OF CAR PARKING FACILITIES; VALET PARKING SERVICES; CONSULTANCY, ADVISORY AND INFORMATION



David J. Kyffers

Director of the United States Patent and Trademark Office

Reg. No. 4,065,523 SERVICES IN THIS CLASS RELATING TO THE FOREGOING SERVICES, IN CLASS 39
(U.S. CLS. 100 AND 105).

THE MARK CONSISTS OF STANDARD CHARACTERS WITHOUT CLAIM TO ANY PARTICULAR FONT, STYLE, SIZE, OR COLOR.

PRIORITY CLAIMED UNDER SEC. 44(D) ON NEW ZEALAND APPLICATION NO. 818686,
FILED 1-26-2010, REG. NO. 818686, DATED 9-9-2010, EXPIRES 1-26-2020.

SER. NO. 85-064,677, FILED 6-16-2010.

REGINA DRUMMOND, EXAMINING ATTORNEY

United States of America

United States Patent and Trademark Office

CUDDLE CLASS

Reg. No. 4,065,524

Registered Dec. 6, 2011

Int. Cls.: 12 and 39

TRADEMARK

SERVICE MARK

PRINCIPAL REGISTER

AIR NEW ZEALAND LIMITED (NEW ZEALAND COMPANY)
185 FANSHAWE STREET
AUCKLAND, NEW ZEALAND

FOR: VEHICLES, NAMELY, LAND VEHICLES, AIR VEHICLES AND SEA VEHICLES; APPARATUS FOR LOCOMOTION BY LAND, AIR OR WATER, NAMELY, AUTOMOBILES, BOATS, AIRPLANES; AEROPLANES AND AIRCRAFT AND STRUCTURAL PARTS THEREFOR; AIRCRAFT STRUCTURAL PARTS AND ACCESSORIES, NAMELY, SEATS AND SEATING; SEATS FOR AIRCRAFTS, LAND VEHICLES, BOATS; MOTOR CAR SEATS; EJECTOR SEATS, BOOSTER SEATS FOR USE IN VEHICLES; ACCESSORIES AND COMPONENT PARTS OF ALL THE FOREGOING IN THIS CLASS SOLD AS A UNIT; SEAT BELTS AND SEAT COVERS FOR USE IN VEHICLES, IN CLASS 12 (U.S. CLS. 19, 21, 23, 31, 35 AND 44).

FOR: TRANSPORTATION SERVICES, NAMELY, TRANSPORTATION AND DELIVERY OF GOODS AND PEOPLE; STORAGE OF GOODS; LUGGAGE STORAGE SERVICES; SECURITY STORAGE SERVICES FOR DOCUMENTS AND GOODS OF OTHERS; TRANSPORT SECURITY SERVICES, NAMELY, THE GUARDED TRANSPORT OF GOODS OR PEOPLE; COURIER SERVICES; AIRLINE TRANSPORTATION SERVICES; AIRLINE PASSENGER SERVICES; PROVISION OF AIRPORT FACILITIES OR LOUNGE FACILITIES; PROVISION OF AIRLINE AND TRAVEL SERVICES BY INTERNET, ELECTRONIC MAIL, OR OTHER ELECTRONIC COMMUNICATION WITH CUSTOMERS; RESERVATION AND BOOKING OF SEATS FOR TRAVEL; RESERVATION AND BOOKING OF SEATS FOR TRAVEL FOR LAND, AIR OR WATER TRANSPORTATION; TRAVEL AGENCY SERVICES, NAMELY, THE MAKING OF TRAVEL RESERVATIONS; TOURIST OFFICE SERVICES; RESERVATION AND BOOKING SERVICES FOR FREQUENT FLYER PROGRAMS AND OTHER TRAVEL INCENTIVE PROGRAMS; BOOKING AND RESERVATION SERVICES FOR MEMBERSHIP PRIVILEGES AND LOYALTY RECOGNITION PROGRAMS IN CONNECTION WITH TRAVEL AND TRANSPORTATION; CHARTERING OF AIRCRAFT; PROVIDING INFORMATION AND DATA RELATING TO THE TRANSPORTATION OF GOODS AND PEOPLE, NAMELY, PROVIDING INFORMATION ABOUT TARIFFS, TIMETABLES AND METHODS OF TRANSPORTATION FOR GOODS AND PEOPLE; ARRANGING AND OPERATING TOURS AND TOURIST SERVICES; VEHICLE RENTAL AND RESERVATION SERVICES, NAMELY, RENTAL OF VEHICLES, BICYCLES, RAILWAY VEHICLES, MOTOR HOMES, TRAILERS AND TRAMS; VEHICLE PARKING SERVICES RELATING TO THE AVAILABILITY OF ON-STREET AND OFF-STREET PARKING SPACES; PROVISION OF CAR PARKING FACILITIES; VALET PARKING SERVICES; CONSULTANCY, ADVISORY AND INFORMATION



David J. Kyffers

Director of the United States Patent and Trademark Office

Reg. No. 4,065,524 SERVICES IN THIS CLASS RELATING TO THE FOREGOING SERVICES, IN CLASS 39
(U.S. CLS. 100 AND 105).

THE MARK CONSISTS OF STANDARD CHARACTERS WITHOUT CLAIM TO ANY PARTICULAR FONT, STYLE, SIZE, OR COLOR.

PRIORITY CLAIMED UNDER SEC. 44(D) ON NEW ZEALAND APPLICATION NO. 818822,
FILED 1-28-2010, REG. NO. 818822, DATED 8-12-2010, EXPIRES 1-28-2020.

SER. NO. 85-064,694, FILED 6-16-2010.

REGINA DRUMMOND, EXAMINING ATTORNEY

United States of America

United States Patent and Trademark Office

AkerLatino

Reg. No. 4,065,525

ANDRE CARO (UNITED STATES INDIVIDUAL)
2224 HOMER AVENUE
BRONX, NY 10473 AND

Registered Dec. 6, 2011

Int. Cl.: 25

SHARLEEN CARO (UNITED STATES INDIVIDUAL)
2227 HOMER AVENUE
BRONX, NY 10473 AND

TRADEMARK

PRINCIPAL REGISTER

DWIGHT NORTON (UNITED STATES INDIVIDUAL)
2227 HOMER AVENUE
BRONX, NY 10473 AND

LUIS ARZU (UNITED STATES INDIVIDUAL)
2227 HOMER AVENUE
BRONX, NY 10473

FOR: HOODS; INFANT AND TODDLER ONE PIECE CLOTHING; JACKETS; TOPS; TRAVEL CLOTHING CONTAINED IN A PACKAGE COMPRISING REVERSIBLE JACKETS, PANTS, SKIRTS, TOPS AND A BELT OR SCARF; WEARABLE GARMENTS AND CLOTHING, NAMELY, SHIRTS, IN CLASS 25 (U.S. CLS. 22 AND 39).

FIRST USE 4-10-2010; IN COMMERCE 4-10-2010.

THE MARK CONSISTS OF STANDARD CHARACTERS WITHOUT CLAIM TO ANY PARTICULAR FONT, STYLE, SIZE, OR COLOR.

SER. NO. 85-065,266, FILED 6-17-2010.

TRACY CROSS, EXAMINING ATTORNEY



David J. Kypos

Director of the United States Patent and Trademark Office

United States of America

United States Patent and Trademark Office

SB SANGSIN BRAKE

Reg. No. 4,065,526

Registered Dec. 6, 2011

Int. Cl.: 12

TRADEMARK

PRINCIPAL REGISTER

SANGSIN BRAKE CO.,LTD. (REPUBLIC OF KOREA CORPORATION)
1-37, BUK-RI, NONGONG-EUP, DALSEONG-GUN
DAEGU, REPUBLIC OF KOREA

FOR: BRAKE LININGS FOR VEHICLES; BRAKE SHOES ASSEMBLY FOR VEHICLES;
HAND BRAKE SHOE ASSEMBLY FOR VEHICLES; BLOCK BRAKES FOR VEHICLES;
CONICAL BRAKES FOR VEHICLES; BRAKE FORKS FOR VEHICLES; DISC BRAKES FOR
LAND VEHICLES; BAND BRAKES FOR VEHICLES, IN CLASS 12 (U.S. CLS. 19, 21, 23, 31,
35 AND 44).

OWNER OF REPUBLIC OF KOREA REG. NO. 40-0619232, DATED 5-26-2005, EXPIRES 5-
26-2015.

NO CLAIM IS MADE TO THE EXCLUSIVE RIGHT TO USE "BRAKE", APART FROM THE
MARK AS SHOWN.

THE MARK CONSISTS OF THE WORDS "SB" AND "SANGSIN BRAKE".

SER. NO. 85-067,663, FILED 6-21-2010.

KHANH LE, EXAMINING ATTORNEY



David J. Kyros

Director of the United States Patent and Trademark Office

United States of America

United States Patent and Trademark Office

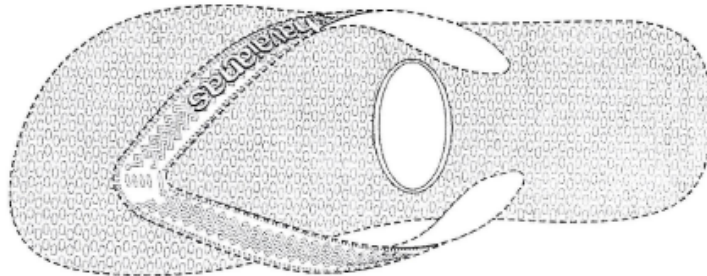

Reg. No. 4,065,527

Registered Dec. 6, 2011

Int. Cl.: 25

TRADEMARK

PRINCIPAL REGISTER

SAO PAULO ALPARGATAS S.A. (BRAZIL CORPORATION)
RUA FUNCHAL, 160, VILA OLIMPIA
SAO PAULO, SP, BRAZIL 04551-903

FOR: FOOTWEAR, IN CLASS 25 (U.S. CLS. 22 AND 39).

FIRST USE 4-30-1997; IN COMMERCE 4-30-1997.

OWNER OF U.S. REG. NOS. 1,858,280, 1,906,924, AND 3,069,819.

THE MARK CONSISTS OF A PATTERN OF INTERLOCKING, RAISED, "Z"-SHAPED LINES APPLIED TO THE STRAP OF A SANDAL, WITH THE WORD "HAVAIANAS" DISPLAYED ON THE STRAP, AN OVAL SHAPE APPEARING IN THE MIDDLE OF THE FOOT BED OF THE SANDAL, AND A PATTERN CONSISTING OF IMAGES OF GRAINS OF RICE APPLIED TO THE FOOT BED OF THE SANDAL. THE OUTLINE OF THE SANDAL AND THE OUTLINE OF THE STRAP ARE DISPLAYED IN BROKEN LINES, AND ARE NOT CLAIMED AS A FEATURE OF THE MARK.

THE ENGLISH TRANSLATION OF THE WORD "HAVAIANAS" IN THE MARK IS PORTUGUESE FOR HAWAIIAN.

SEC. 2(F).

SER. NO. 85-069,054, FILED 6-22-2010.

C. DIONNE CLYBURN, EXAMINING ATTORNEY



David J. Kyros

Director of the United States Patent and Trademark Office

United States of America
United States Patent and Trademark Office

PARATROOPERS
★ **AIR ASSAULT** ★

Reg. No. 4,065,528

SOFTWARE FACTORY LLC (TEXAS LIMITED LIABILITY COMPANY)
2303 BIG RIVER DR.
KINGWOOD, TX 77345

Registered Dec. 6, 2011

Int. Cl.: 9

FOR: COMPUTER GAME SOFTWARE; COMPUTER GAME SOFTWARE FOR USE ON MOBILE AND CELLULAR PHONES, IN CLASS 9 (U.S. CLS. 21, 23, 26, 36 AND 38).

TRADEMARK

FIRST USE 7-15-2009; IN COMMERCE 1-3-2010.

PRINCIPAL REGISTER

NO CLAIM IS MADE TO THE EXCLUSIVE RIGHT TO USE "PARATROOPERS AIR ASSAULT", APART FROM THE MARK AS SHOWN.

THE MARK CONSISTS OF THE STYLIZED TEXT "PARATROOPERS AIR ASSAULT" AND DESIGN. THE TERM "PARATROOPERS" APPEARS ABOVE THE WORDING "AIR ASSAULT". ONE STAR APPEARS BEFORE AND ANOTHER STAR APPEARS AFTER THE WORDING "AIR ASSAULT".

SER. NO. 85-069,099, FILED 6-22-2010.

MARLENE BELL, EXAMINING ATTORNEY



David J. Kybas

Director of the United States Patent and Trademark Office

United States of America

United States Patent and Trademark Office

FPInterface

Reg. No. 4,065,529

Registered Dec. 6, 2011

Int. Cl.: 9

TRADEMARK

PRINCIPAL REGISTER

FPINNOVATIONS (CANADA CORPORATION)
570, BOULEVARD SAINT-JEAN
POINTE-CLAIRE, QUEBEC, CANADA H9R3J9

FOR: SOFTWARE USED TO MODEL, STIMULATE AND PLAN FORESTRY OPERATIONS USING GEOREFERENCED BASE DATA IN CONJUNCTION WITH COST AND PRODUCTIVITY MODELS , IN CLASS 9 (U.S. CLS. 21, 23, 26, 36 AND 38).

THE MARK CONSISTS OF STANDARD CHARACTERS WITHOUT CLAIM TO ANY PARTICULAR FONT, STYLE, SIZE, OR COLOR.

OWNER OF CANADA REG. NO. TMA800491, DATED 6-21-2011, EXPIRES 6-21-2026.

OWNER OF U.S. REG. NOS. 3,738,576 AND 3,738,577.

SER. NO. 85-069,786, FILED 6-23-2010.

ANGELA DUONG, EXAMINING ATTORNEY



David J. Kybas

Director of the United States Patent and Trademark Office

United States of America

United States Patent and Trademark Office

TCX

Reg. No. 4,065,530

Registered Dec. 6, 2011

Int. Cl.: 25

TRADEMARK

PRINCIPAL REGISTER

TCX, LLC (NORTH CAROLINA LIMITED LIABILITY COMPANY)
115 EAST 3RD STREET
TA THE COTTON EXCHANGE
WENDELL, NC 275919791

FOR: CLOTHING, NAMELY, SHIRTS, T-SHIRTS, SWEATSHIRTS, PANTS AND SWEAT-PANTS, IN CLASS 25 (U.S. CLS. 22 AND 39).

FIRST USE 2-6-2003; IN COMMERCE 2-6-2003.

THE MARK CONSISTS OF STANDARD CHARACTERS WITHOUT CLAIM TO ANY PARTICULAR FONT, STYLE, SIZE, OR COLOR.

OWNER OF U.S. REG. NO. 3,164,387.

SER. NO. 85-069,979, FILED 6-23-2010.

HEATHER BIDDULPH, EXAMINING ATTORNEY



David J. Kybas

Director of the United States Patent and Trademark Office

United States of America

United States Patent and Trademark Office

InvisibleMemory

Reg. No. 4,065,531

Registered Dec. 6, 2011

Int. Cl.: 9

TRADEMARK

PRINCIPAL REGISTER

SHINING UNION LIMITED (HONG KONG LIMITED LIABILITY COMPANY)
SUITES 2601-2, 26/F, TOWER 2, NINA TOWER
TSUEN WAN, N.T., HK, HONG KONG

FOR: SILICON SLICE WAFERS; SEMI-CONDUCTORS; SILICON EPITAXIAL WAFERS;
INTEGRATED CIRCUITS; INTEGRATED CIRCUIT CHIPS; BLANK ELECTRONIC CHIP
CARDS AND ELECTRONIC CHIPS FOR THE MANUFACTURE OF INTEGRATED CIRCUITS;
SEMI-CONDUCTOR MEMORY UNITS; MEMORY EXPANSION MODULES IN THE FORM
OF ELECTRONIC CHIPS, IN CLASS 9 (U.S. CLS. 21, 23, 26, 36 AND 38).

THE MARK CONSISTS OF STANDARD CHARACTERS WITHOUT CLAIM TO ANY PAR-
TICULAR FONT, STYLE, SIZE, OR COLOR.

PRIORITY CLAIMED UNDER SEC. 44(D) ON HONG KONG APPLICATION NO. 301643111,
FILED 6-11-2010, REG. NO. 301643111, DATED 6-18-2010, EXPIRES 6-18-2020.

SER. NO. 85-070,306, FILED 6-24-2010.

NORA BUCHANAN WILL, EXAMINING ATTORNEY



David J. Kybas

Director of the United States Patent and Trademark Office

United States of America

United States Patent and Trademark Office



Reg. No. 4,065,532

Registered Dec. 6, 2011

Int. Cl.: 45

SERVICE MARK

PRINCIPAL REGISTER

IGLESIA HERMANOS UNIDOS EN CRISTO, INC. (PUERTO RICO CORPORATION)
P.O. BOX 1149
YABUCOA, PUERTO RICO 00767

FOR: RELIGIOUS MASS INTENTIONS SERVICES, NAMELY, PROVIDING FOR THE ARRANGEMENT OF MASS INTENTIONS FOR THE DECEASED AND OR LIVING, IN CLASS 45 (U.S. CLS. 100 AND 101).

FIRST USE 1-1-2000; IN COMMERCE 1-1-2000.

NO CLAIM IS MADE TO THE EXCLUSIVE RIGHT TO USE "IGLESIA" OR "CRISTO" OR "INC. 1939", APART FROM THE MARK AS SHOWN.

THE COLOR(S) RED, BLUE, YELLOW AND WHITE IS/ARE CLAIMED AS A FEATURE OF THE MARK.

THE MARK CONSISTS OF A BLUE SPHERE THAT CONTAINS WITHIN THE FOLLOWING PICTORIAL ELEMENTS: A CARTESIAN SKETCH OF PLANET EARTH, TWO HANDS ENGAGED IN A HANDSHAKE, AN OPEN BOOK AND THE YEAR "1939". THESE ELEMENTS ARE IN WHITE WITH BLUE OUTLINE, EXCEPT FOR THE HANDS THAT APPEAR TO HAVE YELLOW SHIRT SLEEVES AND ARE SUPERSEDING THE CARTESIAN SKETCH TOWARD THE UPPER PORTION OF THE SPHERE. THE OPEN BOOK AND THE DATE ARE PLACED TOWARD THE BOTTOM HALF OF THE SPHERE. THE PICTORIAL ELEMENTS ARE BOUND TOGETHER AND ENCLOSED BY A WHITE OUTLINE. OUTSIDE THE SPHERE AND IN A CURVED SLANT PARALLEL TO THE SPHERE'S CIRCUMFERENCE ARE THE WORDS IN RED "IGLESIA HERMANOS UNIDOS EN CRISTO, INC."

THE ENGLISH TRANSLATION OF "IGLESIA HERMANOS UNIDOS EN CRISTO, INC." IN THE MARK IS "CHURCH UNITED BROTHERS IN CHRIST, INC."

SER. NO. 85-070,459, FILED 6-24-2010.

RUDY R. SINGLETON, EXAMINING ATTORNEY



David J. Kyros

Director of the United States Patent and Trademark Office

United States of America

United States Patent and Trademark Office

DioxiCare

Reg. No. 4,065,533

Registered Dec. 6, 2011

Int. Cls.: 3 and 5

TRADEMARK

PRINCIPAL REGISTER

FRONTIER PHARMACEUTICAL, INC. (NEW YORK CORPORATION)
10 PONDEROSA DRIVE
MELVILLE, NY 11747

FOR: NON-MEDICATED MOUTHWASH, TOOTHPASTE, SOAP AND SKIN EMOLLIENTS FOR PERSONAL USE; AND CLEANING PREPARATIONS FOR HARD SURFACES FEATURING CHLORINE DIOXIDE, IN CLASS 3 (U.S. CLS. 1, 4, 6, 50, 51 AND 52).

FIRST USE 5-26-1999; IN COMMERCE 7-5-1999.

FOR: DISINFECTANTS FOR HOUSEHOLD AND COMMERCIAL USE; MEDICATED MOUTHWASH, TOOTHPASTE AND SOAPS FOR PERSONAL USE; MEDICATED SOAPS, ANTISEPTICS AND MEDICATED SKIN PREPARATIONS FOR VETERINARY USE; ANTI-SEPTICS AND MEDICATED SKIN AND WOUND HEALING PREPARATIONS FEATURING CHLORINE DIOXIDE, IN CLASS 5 (U.S. CLS. 6, 18, 44, 46, 51 AND 52).

FIRST USE 5-26-1999; IN COMMERCE 7-5-1999.

THE MARK CONSISTS OF STANDARD CHARACTERS WITHOUT CLAIM TO ANY PARTICULAR FONT, STYLE, SIZE, OR COLOR.

SER. NO. 85-070,601, FILED 6-24-2010.

REGINA DRUMMOND, EXAMINING ATTORNEY



David J. Kybas

Director of the United States Patent and Trademark Office

United States of America

United States Patent and Trademark Office

SOCIAL

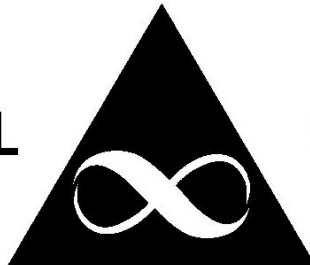

STATUS

Reg. No. 4,065,534

Registered Dec. 6, 2011

Int. Cl.: 25

TRADEMARK

PRINCIPAL REGISTER

JAIZAI INVESTMENTS INC (NORTH CAROLINA CORPORATION)
SUITE D
2041 SOUTH BLVD.
CHARLOTTE, NC 28203

FOR: A-SHIRTS; BUTTON-FRONT ALOHA SHIRTS; CAMP SHIRTS; DRESS SHIRTS; GOLF SHIRTS; HOODED SWEAT SHIRTS; KNIT SHIRTS; LONG-SLEEVED SHIRTS; NIGHT SHIRTS; OPEN-NECKED SHIRTS; PIQUE SHIRTS; POLO SHIRTS; RUGBY SHIRTS; SHIRT FRONTS; SHIRT YOKES; SHIRTS; SHIRTS FOR SUITS; SHORT-SLEEVED OR LONG-SLEEVED T-SHIRTS; SHORT-SLEEVED SHIRTS; SLEEP SHIRTS; SPORT SHIRTS; SPORTS SHIRTS; SPORTS SHIRTS WITH SHORT SLEEVES; SWEAT SHIRTS; T-SHIRTS; TEE SHIRTS; TRIATHLON CLOTHING, NAMELY, TRIATHLON TIGHTS, TRIATHLON SHORTS, TRIATHLON SINGLETS, TRIATHLON SHIRTS, TRIATHLON SUITS; WIND SHIRTS; YOGA SHIRTS; TRACK PANTS; WATERPROOF JACKETS AND PANTS; WIND PANTS; YOGA PANTS; BALLOON PANTS; CAPRI PANTS; CARGO PANTS; DENIMS; JOGGING PANTS; LEATHER PANTS; LOUNGE PANTS; NON-DISPOSABLE CLOTH TRAINING PANTS; NURSE PANTS; PANTS; PETTI-PANTS; SKI PANTS; SNOW PANTS; SNOWBOARD PANTS; STRETCH PANTS; SWEAT PANTS; TAP PANTS; TOBOGGAN HATS, PANTS AND CAPS; JEANS; BERMUDA SHORTS; BOARD SHORTS; BOXER SHORTS; FLEECE SHORTS; GYM SHORTS; PANTIES, SHORTS AND BRIEFS; RUGBY SHORTS; SHORT OVERCOAT FOR KIMONO (HAORI); SHORT PETTICOATS; SHORT SETS; SHORT TROUSERS; SHORTS; SLIDING SHORTS; SWEAT SHORTS; BED JACKETS; DENIM JACKETS; DOWN JACKETS; FISHERMEN'S JACKETS; FUR COATS AND JACKETS; FUR JACKETS; HEAVY JACKETS; JACKET LINERS; JACKETS; COATS; COATS FOR MEN AND WOMEN; COATS MADE OF COTTON; COATS OF DENIM; DUST COATS; FUR COATS; HEAVY COATS; LAB COATS; LEATHER COATS; LIGHT-REFLECTING COATS; MEN'S AND WOMEN'S JACKETS, COATS, TROUSERS, VESTS; MORNING COATS; OVER COATS; RAIN COATS; RIDING COATS; SPORT COATS; SUIT COATS; TOP COATS; TRENCH COATS; WIND COATS; ANGLERS' SHOES; APRES-SKI SHOES; ATHLETIC SHOES; BALLET SHOES; BALLROOM DANCING SHOES; BASEBALL SHOES; BEACH SHOES; BOWLING SHOES; BOXING SHOES; CANVAS SHOES; CYCLING SHOES; DANCE SHOES; DECK-SHOES; DRIVERS; FITTED SHOE OR BOOT COVERING TO PROTECT THE SHOES OR BOOT FROM WATER OR OTHER DAMAGE; FOOTBALL SHOES; GOLF SHOES; GYMNASTIC SHOES; HANDBALL SHOES; HOCKEY SHOES; INFANTS' SHOES AND BOOTS, IN CLASS 25 (U.S. CLS. 22 AND 39).



David J. Kyros

FIRST USE 11-15-2006; IN COMMERCE 2-15-2008.

Reg. No. 4,065,534 THE MARK CONSISTS OF A TRIANGLE WITH AN INFINITY SYMBOL AT THE CENTER OF IT.

SER. NO. 85-070,747, FILED 6-24-2010.

PAUL E. FAHRENKOPF, EXAMINING ATTORNEY

United States of America

United States Patent and Trademark Office

DIDWW

Reg. No. 4,065,535

Registered Dec. 6, 2011

Int. Cl.: 38

SERVICE MARK

PRINCIPAL REGISTER

DIDWW IRELAND LIMITED (IRELAND COMPANY)
WATERFORD INSTITUTE OF TECHNOLOGY
ARCLABS RESEARCH & INNOVATION CENTRE
CARRIGANORE, WATERFORD, IRELAND

FOR: TELECOMMUNICATION SERVICES, NAMELY, TRANSMISSION OF VOICE, GRAPHICS, IMAGES AND AUDIO BY MEANS OF COMPUTER NETWORKS, WIRELESS COMMUNICATION NETWORKS AND THE INTERNET, IN CLASS 38 (U.S. CLS. 100, 101 AND 104).

FIRST USE 9-1-2009; IN COMMERCE 9-1-2009.

THE MARK CONSISTS OF STANDARD CHARACTERS WITHOUT CLAIM TO ANY PARTICULAR FONT, STYLE, SIZE, OR COLOR.

SER. NO. 85-071,576, FILED 6-25-2010.

JOSETTE BEVERLY, EXAMINING ATTORNEY



David J. Kybas

Director of the United States Patent and Trademark Office

United States of America

United States Patent and Trademark Office

VIVANTY'S EXPRESS

Reg. No. 4,065,536

Registered Dec. 6, 2011

Int. Cl.: 43

SERVICE MARK

PRINCIPAL REGISTER

VIVANTY FOODS INC. (CANADA CORPORATION)
#1 - 1725 COOK STREET
VICTORIA, BC V9T 3P4, CANADA

FOR: RESTAURANT SERVICES, TAKE-OUT RESTAURANT SERVICES, IN CLASS 43 (U.S. CLS. 100 AND 101).

THE MARK CONSISTS OF STANDARD CHARACTERS WITHOUT CLAIM TO ANY PARTICULAR FONT, STYLE, SIZE, OR COLOR.

PRIORITY CLAIMED UNDER SEC. 44(D) ON CANADA APPLICATION NO. 1,484,351, FILED 6-9-2010, REG. NO. TMA797,825, DATED 5-17-2011, EXPIRES 5-17-2026.

OWNER OF U.S. REG. NOS. 3,566,704 AND 3,614,541.

NO CLAIM IS MADE TO THE EXCLUSIVE RIGHT TO USE "EXPRESS", APART FROM THE MARK AS SHOWN.

SER. NO. 85-073,496, FILED 6-29-2010.

TASNEEM HUSSAIN, EXAMINING ATTORNEY



David J. Kybas

Director of the United States Patent and Trademark Office

United States of America

United States Patent and Trademark Office

VALIDCARD

Reg. No. 4,065,537

Registered Dec. 6, 2011

Int. Cl.: 9

TRADEMARK

PRINCIPAL REGISTER

VALIDUS TECHNOLOGIES CORPORATION (DELAWARE CORPORATION)
SPEAR TOWER
ONE MARKET STREET, 36TH FLOOR
SAN FRANCISCO, CA 94105

FOR: CARDS WITH INTEGRATED CIRCUITS; CREDIT SCREENING SOFTWARE; ELECTRONIC AND MAGNETIC ID CARDS FOR USE IN CONNECTION WITH PAYMENT FOR SERVICES, IN CLASS 9 (U.S. CLS. 21, 23, 26, 36 AND 38).

FIRST USE 11-1-2008; IN COMMERCE 11-1-2008.

THE MARK CONSISTS OF STANDARD CHARACTERS WITHOUT CLAIM TO ANY PARTICULAR FONT, STYLE, SIZE, OR COLOR.

SER. NO. 85-074,054, FILED 6-29-2010.

INGRID C. EULIN, EXAMINING ATTORNEY



David J. Kybas

Director of the United States Patent and Trademark Office

United States of America

United States Patent and Trademark Office

TRAFFIC MAGNET

Reg. No. 4,065,538

Registered Dec. 6, 2011

Int. Cls.: 35 and 42

SERVICE MARK

PRINCIPAL REGISTER

PDHOST INC. (BR. VIRGIN ISLANDS CORPORATION)
2ND FLOOR
VANTERPOOL PLAZA WICKHAMS CAY 1
ROAD TOWN, TORTOLA, BR. VIRGIN ISLANDS

FOR: ADVERTISING AND MARKETING SERVICES FOR THIRD PARTIES; PROVIDING ON-LINE DIRECTORY INFORMATION SERVICES ALSO FEATURING HYPERLINKS TO OTHER WEB SITES; PROVIDING WEB SITE ANALYSIS CONSULTATION SERVICES IN THE FIELD OF MARKETING VIA A GLOBAL COMPUTER NETWORK, IN CLASS 35 (U.S. CLS. 100, 101 AND 102).

FIRST USE 10-31-2000; IN COMMERCE 10-31-2000.

FOR: SEARCH ENGINE AND INTERNET DIRECTORY MANAGEMENT SERVICES, NAMELY, TESTING IN THE FIELD OF MARKETING, ADVERTISING AND WEBSITE ANALYSIS, AND REPORTING SERVICES FOR OTHERS VIA A GLOBAL COMPUTER NETWORK, EXCLUDING VEHICULAR TRAFFIC INFORMATION SERVICES; PROVIDING INFORMATION FROM SEARCHABLE INDEXES AND DATABASES OF INFORMATION IN THE FIELD OF MARKETING, ADVERTISING AND WEBSITE ANALYSIS FEATURING TEXT, ELECTRONIC DOCUMENTS, GRAPHIC AND AUDIO VISUAL INFORMATION, AT THE SPECIFIC REQUEST OF END-USERS BY MEANS OF GLOBAL COMPUTER INFORMATION NETWORKS, EXCLUDING VEHICULAR TRAFFIC INFORMATION SERVICES; DISTRIBUTION OF CONTENT IN THE FIELD OF MARKETING, ADVERTISING AND WEBSITE ANALYSIS, NAMELY, ELECTRONIC TEXT, ELECTRONIC DOCUMENTS, DATABASES, GRAPHIC AND AUDIO VISUAL INFORMATION FOR THIRD PARTIES, EXCLUDING VEHICULAR TRAFFIC INFORMATION SERVICES; SEMINARS IN THE FIELD OF MARKETING AND ADVERTISING, IN CLASS 42 (U.S. CLS. 100 AND 101).

FIRST USE 10-31-2000; IN COMMERCE 10-31-2000.

THE MARK CONSISTS OF STANDARD CHARACTERS WITHOUT CLAIM TO ANY PARTICULAR FONT, STYLE, SIZE, OR COLOR.

NO CLAIM IS MADE TO THE EXCLUSIVE RIGHT TO USE "TRAFFIC", APART FROM THE MARK AS SHOWN.

SER. NO. 85-075,702, FILED 7-1-2010.



David J. Kyros

Director of the United States Patent and Trademark Office

Reg. No. 4,065,538 THOMAS MANOR, EXAMINING ATTORNEY

United States of America

United States Patent and Trademark Office

Seneca

Reg. No. 4,065,539

SENECA DATA DISTRIBUTORS, INC. (NEW YORK CORPORATION)
7401 ROUND POND ROAD
NORTH SYRACUSE, NY 13212

Registered Dec. 6, 2011

Int. Cl.: 40

FOR: CUSTOM MANUFACTURE OF COMPUTERS FOR OTHERS, IN CLASS 40 (U.S. CLS. 100, 103 AND 106).

SERVICE MARK

FIRST USE 4-21-2010; IN COMMERCE 4-21-2010.

PRINCIPAL REGISTER

THE MARK CONSISTS OF THREE PURPLE CIRCULAR DOTS ARRANGED IN A TRIANGULAR CONFIGURATION TO THE LEFT OF THE WORD "SENECA" WHICH APPEARS IN CHARCOAL STYLIZED LETTERING.

THE COLOR(S) PURPLE AND CHARCOAL IS/ARE CLAIMED AS A FEATURE OF THE MARK.

SER. NO. 85-076,788, FILED 7-2-2010.

KATHLEEN M. VANSTON, EXAMINING ATTORNEY



David J. Kyjars

Director of the United States Patent and Trademark Office

United States of America

United States Patent and Trademark Office

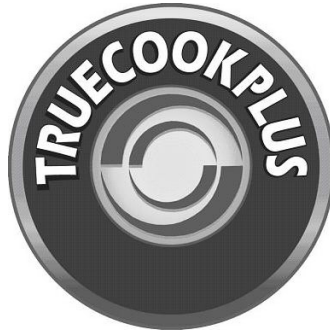

Reg. No. 4,065,540

Registered Dec. 6, 2011

Int. Cls.: 9 and 11

TRADEMARK

PRINCIPAL REGISTER

MICROWAVE SCIENCE JV, LLC (DELAWARE LIMITED LIABILITY COMPANY)
PENTHOUSE 3
140 PROSPECT AVENUE
HACKENSACK, NJ 07601

FOR: COMPUTER SOFTWARE AND COMPUTER HARDWARE AND INSTRUCTION
MANUALS SOLD AS A UNIT FOR CONTROL OF MICROWAVE OVENS , IN CLASS 9 (U.S.
CLS. 21, 23, 26, 36 AND 38).

FIRST USE 6-0-2008; IN COMMERCE 6-0-2008.

FOR: MICROWAVE OVENS, IN CLASS 11 (U.S. CLS. 13, 21, 23, 31 AND 34).

FIRST USE 6-0-2008; IN COMMERCE 6-0-2008.

OWNER OF U.S. REG. NO. 2,365,145.

THE MARK CONSISTS OF THE WORDS "TRUE COOK PLUS" IN A SEMI-CIRCULAR
LAYOUT AT THE TOP OF AND WITHIN A CIRCLE AND ABOVE A SMALL BULLSEYE.

SER. NO. 85-076,918, FILED 7-2-2010.

VIVIAN MICZNIK FIRST, EXAMINING ATTORNEY



David J. Kybas

Director of the United States Patent and Trademark Office

United States of America

United States Patent and Trademark Office

GREEN SCREEN ENVIRONMENTAL FILM FEST

Reg. No. 4,065,541

ELECTRIC LODGE (CALIFORNIA CORPORATION)
1416 ELECTRIC AVENUE
VENICE, CA 90291

Registered Dec. 6, 2011

Int. Cl.: 41

FOR: ENTERTAINMENT SERVICES, NAMELY, PLANNING AND CONDUCTING A SERIES OF FILM FESTIVALS, IN CLASS 41 (U.S. CLS. 100, 101 AND 107).

SERVICE MARK

FIRST USE 9-7-2007; IN COMMERCE 9-7-2007.

PRINCIPAL REGISTER

THE MARK CONSISTS OF STANDARD CHARACTERS WITHOUT CLAIM TO ANY PARTICULAR FONT, STYLE, SIZE, OR COLOR.

NO CLAIM IS MADE TO THE EXCLUSIVE RIGHT TO USE "ENVIRONMENTAL FILM FEST", APART FROM THE MARK AS SHOWN.

SER. NO. 85-080,848, FILED 7-8-2010.

EDWARD NELSON, EXAMINING ATTORNEY



David J. Kyffers

Director of the United States Patent and Trademark Office

United States of America

United States Patent and Trademark Office



Reg. No. 4,065,542

Registered Dec. 6, 2011

Int. Cl.: 3

TRADEMARK

PRINCIPAL REGISTER

JOHN GALLIANO S.A. (FRANCE SOCIÉTÉ ANONYME (SA))
60, RUE D'AVRON
PARIS, FRANCE 75020

FOR: PERFUMERY PRODUCTS, NAMELY, PERFUMES; TOILET WATERS; ESSENTIAL OILS FOR PERSONAL USE; BODY OILS; BODY LOTIONS AND CREAMS FOR THE BODY AND FACE; HAIR CREAMS; BATH SALTS; SHAVING CREAMS; SHAVING LOTIONS; DEODORANTS FOR PERSONAL USE FOR THE BODY; AND ANTI-PERSPIRANTS FOR THE BODY, IN CLASS 3 (U.S. CLS. 1, 4, 6, 50, 51 AND 52).

OWNER OF FRANCE REG. NO. 103752642, DATED 7-9-2010, EXPIRES 7-9-2020.

THE COLOR(S) PINK, RED, WHITE, BLACK AND GOLD IS/ARE CLAIMED AS A FEATURE OF THE MARK.

OWNER OF U.S. REG. NOS. 2,310,490 AND 3,946,093.

THE NAME(S), PORTRAIT(S), AND/OR SIGNATURE(S) SHOWN IN THE MARK IDENTIFIES A LIVING INDIVIDUAL, WHOSE CONSENT(S) TO REGISTER IS MADE OF RECORD.

THE MARK CONSISTS OF A STAMPED ENVELOPE APPLIED ONTO A CLEAR PINK BOTTLE WITH A GOLD TOP/CAP. THE IMAGE OF THE BACK OF THE ENVELOPE IS EMBOSSSED ON THE BACK FACE OF THE BOTTLE WHICH CAN BE VIEWED THROUGH THE FRONT FACE OF THE CLEAR PINK BOTTLE. THE BOTTLE ALSO CONTAINS A STAMP AND THE WORDING "YOU MY LOVE" AND "JOHN GALLIANO." THE WORDING "YOU MY LOVE" APPEARS ON THE TOP/CAP. THE STAMP APPEARS IN THE RIGHT UPPER CORNER OF THE FRONT OF THE BOTTLE. THE STAMP IS WHITE WITH PINK, RED AND BLACK FLOWERS. THE BLACK WORDING "JOHN GALLIANO" APPEARS ACROSS THE BOTTOM OF THE STAMP. THE SHAPE OF THE BOTTLE AND CAP PRESENTED IN BROKEN LINES ARE NOT CLAIMED AS FEATURES OF THE MARK.

SER. NO. 85-081,523, FILED 7-9-2010.

INGRID C. EULIN, EXAMINING ATTORNEY



David J. Kyros

Director of the United States Patent and Trademark Office

United States of America

United States Patent and Trademark Office

CARVERZ

Reg. No. 4,065,543

SHADE LLC (CALIFORNIA LIMITED LIABILITY COMPANY)

Registered Dec. 6, 2011

P.O. BOX 29503
LOS ANGELES, CA 900290503

Int. Cl.: 25

FOR: CLOTHING, NAMELY, FOOTWEAR, HEADWEAR, AND BEACHWEAR, IN CLASS 25 (U.S. CLS. 22 AND 39).

TRADEMARK

FIRST USE 3-15-2010; IN COMMERCE 7-1-2010.

PRINCIPAL REGISTER

THE MARK CONSISTS OF STANDARD CHARACTERS WITHOUT CLAIM TO ANY PARTICULAR FONT, STYLE, SIZE, OR COLOR.

SER. NO. 85-081,906, FILED 7-10-2010.

JULIE VEPPUMTHARA, EXAMINING ATTORNEY



David J. Kybas

Director of the United States Patent and Trademark Office

United States of America

United States Patent and Trademark Office



Reg. No. 4,065,544

Registered Dec. 6, 2011

Int. Cl.: 35

SERVICE MARK

PRINCIPAL REGISTER

THE GREENSOURCE CENTER, INC. (OHIO CORPORATION), DBA GREENSOURCE
CINCINNATI
19 EAST 8TH STREET
CINCINNATI, OH 45202

FOR: ORGANIZING COMMERCIAL AND ADVERTISING EXHIBITIONS FOR THE GREEN BUILDING COMMUNITY TO INSPIRE ENERGY EFFICIENT, SUSTAINABLE TECHNOLOGIES, IN CLASS 35 (U.S. CLS. 100, 101 AND 102).

FIRST USE 7-1-2009; IN COMMERCE 7-1-2009.

NO CLAIM IS MADE TO THE EXCLUSIVE RIGHT TO USE "GREENSOURCE", APART FROM THE MARK AS SHOWN.

THE COLOR(S) GREEN, WHITE, AND BLACK IS/ARE CLAIMED AS A FEATURE OF THE MARK.

THE MARK CONSISTS OF A PARTIAL GREEN CIRCLE IN THE MIDDLE OF THE MARK WITH BUILDINGS OUTLINED IN WHITE AND THE WORD, "GREENSOURCE", IN BLACK TEXT UNDERNEATH THE PARTIAL GREEN CIRCLE.

SER. NO. 85-082,080, FILED 7-11-2010.

APRIL ROACH, EXAMINING ATTORNEY



David J. Kybas

Director of the United States Patent and Trademark Office

United States of America

United States Patent and Trademark Office

THE RELEVANT UNIVERSITY

Reg. No. 4,065,545

Registered Dec. 6, 2011

Int. Cls.: 16 and 41

TRADEMARK

SERVICE MARK

PRINCIPAL REGISTER

THE UNIVERSITY OF TOLEDO (OHIO INSTRUMENTALITY)
2801 WEST BANCROFT
TOLEDO, OH 43606

FOR: PRINTED PUBLICATIONS IN THE NATURE OF BOOKS AND BOOKLETS RELATED TO HIGHER EDUCATION, IN CLASS 16 (U.S. CLS. 2, 5, 22, 23, 29, 37, 38 AND 50).

FIRST USE 4-14-2010; IN COMMERCE 4-14-2010.

FOR: EDUCATIONAL SERVICES, NAMELY, ORGANIZING AND CONDUCTING LECTURES AND SYMPOSIUMS IN THE FIELDS OF EMERGING MARKETS AND TECHNOLOGIES, THE LOCAL, REGIONAL AND GLOBAL ECONOMIES, AND ECONOMIC DEVELOPMENT, IN CLASS 41 (U.S. CLS. 100, 101 AND 107).

FIRST USE 4-14-2010; IN COMMERCE 4-14-2010.

THE MARK CONSISTS OF STANDARD CHARACTERS WITHOUT CLAIM TO ANY PARTICULAR FONT, STYLE, SIZE, OR COLOR.

SER. NO. 85-082,194, FILED 7-12-2010.

MARC LEIPZIG, EXAMINING ATTORNEY



David J. Kyfos

Director of the United States Patent and Trademark Office

United States of America

United States Patent and Trademark Office



Reg. No. 4,065,546

Registered Dec. 6, 2011

Int. Cl.: 29

TRADEMARK

PRINCIPAL REGISTER

U.S. FOODSERVICE, INC. (DELAWARE CORPORATION)
9399 W. HIGGINS ROAD
ROSEMONT, IL 60018

FOR: FRESH AND FROZEN BEEF, VEAL, LAMB, PORK AND POULTRY, IN CLASS 29
(U.S. CL. 46).

FIRST USE 0-0-1893; IN COMMERCE 0-0-1893.

OWNER OF U.S. REG. NOS. 1,482,550, 3,508,599 AND OTHERS.

NO CLAIM IS MADE TO THE EXCLUSIVE RIGHT TO USE "PACKING COMPANY", "SINCE 1893" AND "STEAKS & CHOPS", APART FROM THE MARK AS SHOWN.

THE MARK CONSISTS OF THE HEAD OF A STEER WITH THE WORDS "SINCE 1893" IN THE CENTER WITH THE WORDS "STOCK YARDS PACKING COMPANY" IN A BANNER DIRECTLY ABOVE THE STEER AND THE WORDS "THE WORLD'S FINEST STEAKS & CHOPS" DIRECTLY BELOW.

SEC. 2(F) AS TO "THE WORLD'S FINEST".

SER. NO. 85-082,231, FILED 7-12-2010.

BERYL GARDNER, EXAMINING ATTORNEY



David J. Kyffers

Director of the United States Patent and Trademark Office

United States of America

United States Patent and Trademark Office



Reg. No. 4,065,547

Registered Dec. 6, 2011

Int. Cl.: 9

TRADEMARK

PRINCIPAL REGISTER

AERO INSTRUMENTS (HAWAII SOLE PROPRIETORSHIP)
2798 KAUMANA DRIVE
HILO, HI 96720

FOR: ELECTRONIC SOUND PICKUPS, NAMELY, SENSORS TO CONVERT MECHANICAL VIBRATIONS INTO ELECTRICAL SIGNALS FOR THE PURPOSE OF CREATING MUSIC, IN CLASS 9 (U.S. CLS. 21, 23, 26, 36 AND 38).

FIRST USE 0-0-1994; IN COMMERCE 0-0-1995.

OWNER OF U.S. REG. NO. 3,498,833.

NO CLAIM IS MADE TO THE EXCLUSIVE RIGHT TO USE "INSTRUMENT", APART FROM THE MARK AS SHOWN.

THE MARK CONSISTS OF THE WORD "AERO" WITH THE TAIL OF THE "E" IN THE WORD EXTENDING DOWNWARDS AND FORMING A DESIGN IN THE SHAPE OF A GUITAR PICK; STACKED UNDERNEATH "AERO" IN A SMALLER FONT IS THE WORD "INSTRUMENT"; AT THE BOTTOM IS THE SAME GUITAR PICK DESIGN BUT POINTING UPWARDS.

SER. NO. 85-082,687, FILED 7-12-2010.

MICHELLE DUBOIS, EXAMINING ATTORNEY



David J. Kyffers

Director of the United States Patent and Trademark Office

United States of America

United States Patent and Trademark Office



Reg. No. 4,065,548

Registered Dec. 6, 2011

Int. Cl.: 43

SERVICE MARK

PRINCIPAL REGISTER

LAND OF KUSH, INC. (MARYLAND CORPORATION)
840 NORTH EUTAW STREET
BALTIMORE, MD 21201

FOR: CAFE AND RESTAURANT SERVICES; CAFE-RESTAURANTS; CAFETERIA AND RESTAURANT SERVICES; CARRY-OUT RESTAURANTS; RESTAURANT; RESTAURANT AND CAFE SERVICES; RESTAURANT AND CATERING SERVICES; RESTAURANT SERVICES; RESTAURANT SERVICES FEATURING SANDWICHES; RESTAURANT SERVICES FEATURING VEGETARIAN/VEGAN FOOD; RESTAURANT SERVICES, INCLUDING SIT-DOWN SERVICE OF FOOD AND TAKE-OUT RESTAURANT SERVICES; RESTAURANT SERVICES, NAMELY, PROVIDING OF FOOD AND BEVERAGES FOR CONSUMPTION ON AND OFF THE PREMISES; RESTAURANTS, IN CLASS 43 (U.S. CLS. 100 AND 101).

FIRST USE 6-28-2008; IN COMMERCE 6-28-2008.

NO CLAIM IS MADE TO THE EXCLUSIVE RIGHT TO USE "VEGETARIAN CUISINE" , APART FROM THE MARK AS SHOWN.

THE COLOR(S) SKY BLUE, GREEN, YELLOW, AND BLACK IS/ARE CLAIMED AS A FEATURE OF THE MARK.

THE MARK CONSISTS OF TWO GREEN LEAVES UNDERNEATH A PARTIAL PICTURE OF THE EARTH IN SKY BLUE AND GREEN WITH YELLOW OUTLINE. AROUND THE GLOBE AND LEAF DESIGN IS A BLACK CIRCLE INSCRIBED WITH THE WORDING "THE LAND OF KUSH" IN GREEN AND "VEGETARIAN CUISINE" IN YELLOW AND TWO GREEN CIRCLES BETWEEN "THE LAND OF KUSH" AND "VEGETARIAN CUISINE".

SER. NO. 85-083,914, FILED 7-13-2010.

ROBERT STRUCK, EXAMINING ATTORNEY



David J. Kypos

Director of the United States Patent and Trademark Office

United States of America

United States Patent and Trademark Office

50 ACTIVE YEARS AFTER 50

Reg. No. 4,065,549

Registered Dec. 6, 2011

Int. Cls.: 5, 10 and 42

TRADEMARK

SERVICE MARK

PRINCIPAL REGISTER

UNIVERSITY OF LEEDS (UNITED KINGDOM UNIVERSITY)
FACULTY OF ENGINEERING
LEEDS, UNITED KINGDOM LS29JT

FOR: PHARMACEUTICAL AND VETERINARY PREPARATIONS FOR THE TREATMENT OF CANCER, HEART DISEASE, LIVER DISEASE, KIDNEY DISEASE, DIABETES, ARTHRITIS, DEMENTIA, MUSCULOSKELETAL DISORDERS, INCLUDING OSTEOPOROSIS; SANITARY PREPARATIONS FOR MEDICAL PURPOSES; MATERIAL FOR STOPPING TEETH, DENTAL WAX; DISINFECTANTS; PREPARATIONS FOR DESTROYING VERMIN; FUNGICIDES, HERBICIDES; AIR DEODORISING PREPARATIONS; BIOLOGICAL IMPLANTS FOR HUMANS AND ANIMALS, NAMELY, IMPLANTS COMPRISING LIVING TISSUE, AUTOLOGOUS STEM CELLS, BIOLOGICAL REPLACEMENT BLOOD VESSELS, TENDONS AND LIGAMENTS, BIOLOGICAL SCAFFOLDS COMPRISING TISSUE WITH CELLS REMOVED FOR TISSUE REPAIR IN CARDIOVASCULAR, MUSCULOSKELETAL AND MAXILLA FACIAL SURGERY; BIOLOGICAL SCAFFOLDS COMPRISING TISSUE WITH CELLS REMOVED FOR REPAIR OF MAJOR ORGANS INCLUDING BLADDER, HEART, KIDNEY, LIVER, LUNGS, IN CLASS 5 (U.S. CLS. 6, 18, 44, 46, 51 AND 52).

FOR: ARTIFICIAL LIMBS, EYES AND TEETH; SUPPORTIVE BANDAGES; FURNITURE ADAPTED FOR MEDICAL USE; ARTIFICIAL IMPLANTS FOR HUMANS AND ANIMALS, NAMELY, NON-BIOLOGICAL IMPLANTS BEING REPLACEMENT JOINTS, BONES, ORGANS, SKIN, SOFT TISSUE, BLOOD VESSELS, MUSCLES AND TENDONS; HEART PACEMAKERS, IN CLASS 10 (U.S. CLS. 26, 39 AND 44).

FOR: SCIENTIFIC AND TECHNOLOGICAL SERVICES, NAMELY, SCIENTIFIC RESEARCH, ANALYSIS, AND TESTING, IN THE FIELDS OF MEDICINE, PHARMACEUTICAL AND VETERINARY PREPARATIONS, ARTIFICIAL AND BIOLOGICAL IMPLANTS; SCIENTIFIC RESEARCH; INDUSTRIAL ANALYSIS, NAMELY, BLOOD ANALYSIS SERVICES; NEW PRODUCT DESIGN AND DEVELOPMENT FOR OTHERS; DESIGN AND DEVELOPMENT OF COMPUTER HARDWARE AND SOFTWARE; RESEARCH DESIGN AND DEVELOPMENT SERVICES IN THE FIELD OF MEDICINE; RESEARCH DESIGN AND DEVELOPMENT OF SURGICAL, MEDICAL, DENTAL AND VETERINARY APPARATUS AND INSTRUMENTS, ARTIFICIAL LIMBS, EYES AND TEETH, IN CLASS 42 (U.S. CLS. 100 AND 101).



David J. Kyjars

THE MARK CONSISTS OF STANDARD CHARACTERS WITHOUT CLAIM TO ANY PARTICULAR FONT, STYLE, SIZE, OR COLOR.

Reg. No. 4,065,549 PRIORITY CLAIMED UNDER SEC. 44(D) ON UNITED KINGDOM APPLICATION NO. 2539684, FILED 2-18-2010, REG. NO. 2539684, DATED 2-18-2010, EXPIRES 2-18-2020.

SER. NO. 85-084,216, FILED 7-14-2010.

CHRISTINE MARTIN, EXAMINING ATTORNEY

United States of America

United States Patent and Trademark Office

Medens

Reg. No. 4,065,550

Registered Dec. 6, 2011

Int. Cl.: 9

TRADEMARK

PRINCIPAL REGISTER

MEDENS CORP. (PUERTO RICO CORPORATION)
447 DORADO BEACH EAST
DORADO, PUERTO RICO 00646

FOR: COMPUTER SOFTWARE FOR CONTROLLING AND MANAGING PATIENT MEDICAL INFORMATION, IN CLASS 9 (U.S. CLS. 21, 23, 26, 36 AND 38).

FIRST USE 11-15-2009; IN COMMERCE 5-27-2010.

THE MARK CONSISTS OF STANDARD CHARACTERS WITHOUT CLAIM TO ANY PARTICULAR FONT, STYLE, SIZE, OR COLOR.

SER. NO. 85-084,243, FILED 7-14-2010.

KEVIN DINALLO, EXAMINING ATTORNEY



David J. Kybas

Director of the United States Patent and Trademark Office

United States of America

United States Patent and Trademark Office

NetPod

Reg. No. 4,065,551

Registered Dec. 6, 2011

Int. Cl.: 38

SERVICE MARK

PRINCIPAL REGISTER

HARRIS, FREDERICK J. (UNITED STATES INDIVIDUAL)
P.O. BOX 799
NAALEHU, HI 96772

FOR: PROVIDING ACCESS BY ADVERTISERS AND END USER CONSUMERS, TO A UNIFORM NETWORK OF INTERNET MASTER CHANNELS BY MECHANICAL, BROADBAND, NARROWBAND, ELECTRONIC, WIRELESS, FIXED WIRELESS, WIRE LINE AND TELECOMMUNICATION SATELLITES FOR THE PURPOSE OF SENDING AND RECEIVING AUDIO, VIDEO, GRAPHICAL AND TEXTUAL INFORMATION ON A GLOBAL COMPUTER NETWORK, IN CLASS 38 (U.S. CLS. 100, 101 AND 104).

FIRST USE 7-15-2010; IN COMMERCE 7-15-2010.

THE MARK CONSISTS OF STANDARD CHARACTERS WITHOUT CLAIM TO ANY PARTICULAR FONT, STYLE, SIZE, OR COLOR.

SER. NO. 85-085,700, FILED 7-15-2010.

NATALIE POLZER, EXAMINING ATTORNEY



David J. Kyffers

Director of the United States Patent and Trademark Office

United States of America

United States Patent and Trademark Office

Sunburst

Reg. No. 4,065,552

Registered Dec. 6, 2011

Int. Cls.: 9 and 11

TRADEMARK

PRINCIPAL REGISTER

GROHE AG (FED REP GERMANY AKTIENGESELLSCHAFT)
HAUPTSTRASSE 137
58675 HEMER, FED REP GERMANY

FOR: THERMOSTATS FOR CONTROL OF HOT WATER OF WATER MIXERS AND WATER FAUCETS; THERMOSTATICALLY, ELECTRICALLY OR ULTRASONICALLY, INFRARED OR RADAR ELECTRONIC CONTROLLED WATER MIXING VALVES; PARTS AND COMPONENTS THEREFOR, IN CLASS 9 (U.S. CLS. 21, 23, 26, 36 AND 38).

FOR: WATER VALVES, WATER MIXING VALVES, WATER MIXERS, SELF CLOSING WATER VALVES AND WATER MIXERS AND WATER FAUCETS; SHOWERS, SHOWER SETS, HAND AND HEAD SHOWERS; LIGHTING FIXTURES AND COMPLETE LINES OF PLUMBING FITTINGS FOR SAID VALVES, MIXERS, FAUCETS AND SHOWERS FOR KITCHEN AND BATH; PARTS AND COMPONENTS THEREFOR, IN CLASS 11 (U.S. CLS. 13, 21, 23, 31 AND 34).

THE MARK CONSISTS OF STANDARD CHARACTERS WITHOUT CLAIM TO ANY PARTICULAR FONT, STYLE, SIZE, OR COLOR.

PRIORITY CLAIMED UNDER SEC. 44(D) ON ERPN CMNTY TM OFC APPLICATION NO. 009250846, FILED 7-15-2010, REG. NO. 009250846, DATED 12-27-2010, EXPIRES 7-15-2020.

SER. NO. 85-085,852, FILED 7-15-2010.

NAAKWAMA ANKRAH, EXAMINING ATTORNEY



David J. Kypos

Director of the United States Patent and Trademark Office

United States of America

United States Patent and Trademark Office

Sunglow

Reg. No. 4,065,553

Registered Dec. 6, 2011

Int. Cls.: 9 and 11

TRADEMARK

PRINCIPAL REGISTER

GROHE AG (FED REP GERMANY AKTIENGESELLSCHAFT)
HAUPTSTRASSE 137
58675 HEMER, FED REP GERMANY

FOR: THERMOSTATS FOR CONTROL OF HOT WATER OF WATER MIXERS AND WATER FAUCETS; THERMOSTATICALLY, ELECTRICALLY OR ULTRASONICALLY, INFRARED OR RADAR ELECTRONIC CONTROLLED WATER MIXING VALVES; PARTS AND COMPONENTS THEREFOR, IN CLASS 9 (U.S. CLS. 21, 23, 26, 36 AND 38).

FOR: WATER VALVES, WATER MIXING VALVES, WATER MIXERS, SELF CLOSING WATER VALVES AND WATER MIXERS AND WATER FAUCETS; SHOWERS, SHOWER SETS, HAND AND HEAD SHOWERS; LIGHTING FIXTURES AND COMPLETE LINES OF PLUMBING FITTINGS FOR SAID VALVES, MIXERS, FAUCETS AND SHOWERS FOR KITCHEN AND BATH; PARTS AND COMPONENTS THEREFOR, IN CLASS 11 (U.S. CLS. 13, 21, 23, 31 AND 34).

THE MARK CONSISTS OF STANDARD CHARACTERS WITHOUT CLAIM TO ANY PARTICULAR FONT, STYLE, SIZE, OR COLOR.

PRIORITY CLAIMED UNDER SEC. 44(D) ON ERPN CMNTY TM OFC APPLICATION NO. 009250804, FILED 7-15-2010, REG. NO. 009250804, DATED 12-27-2010, EXPIRES 7-15-2020.

SER. NO. 85-085,878, FILED 7-15-2010.

NAAKWAMA ANKRAH, EXAMINING ATTORNEY



David J. Kyros

Director of the United States Patent and Trademark Office

United States of America

United States Patent and Trademark Office

KNOW PAIN KNOW PROBLEM

Reg. No. 4,065,554

Registered Dec. 6, 2011

Int. Cl.: 44

WILLIAM J COLE, JR (UNITED STATES INDIVIDUAL), DBA ORTHOMED PAIN RELIEF CENTERS
SUITE #203
5922 CATTLEMEN LANE
SARASOTA, FL 34232

SERVICE MARK

PRINCIPAL REGISTER

FOR: CHARITABLE SERVICES, NAMELY, PROVIDING MEDICAL EQUIPMENT AND SERVICES TO UNDERSERVED COMMUNITIES; CHARITABLE SERVICES, NAMELY, PROVIDING MEDICAL SERVICES TO UNDERDEVELOPED COUNTRIES; CONSULTING SERVICES IN THE FIELD OF MEDICAL CARE; MEDICAL AND PHARMACEUTICAL CONSULTATION; MEDICAL CLINIC PROVIDING WEIGHT LOSS SOLUTIONS, SERVICES AND PROGRAMS, NUTRITION COUNSELING, HORMONE THERAPY, INCLUDING, BIOIDENTICAL HORMONE REPLACEMENT, ANTI AGING THERAPY, AND NATURAL HORMONE THERAPY, MEDICAL AESTHETIC PROCEDURES, INCLUDING, LASER HAIR REMOVAL, LASER PEELS, BOTULINUM TOXIN TREATMENTS, MICRODERMABRASION, LIPOSUCTION, VEIN TREATMENTS, VEIN THERAPY, CELLULITE TREATMENTS, BODY CONTOURING TREATMENTS, INJECTABLE FILLER TREATMENTS, FACIALS, AND SKIN CARE; MEDICAL CLINICS; MEDICAL CONSULTATIONS; MEDICAL SERVICES; MEDICAL TESTING FOR DIAGNOSTIC OR TREATMENT PURPOSES; MEDICAL, PHYSICAL REHABILITATION AND PHYSICAL THERAPY SERVICES; PROVIDING MEDICAL INFORMATION, CONSULTANCY AND ADVISORY SERVICES; URGENT MEDICAL CARE CENTERS, IN CLASS 44 (U.S. CLS. 100 AND 101).



FIRST USE 1-1-2001, THE MARK WAS FIRST USED ANYWHERE IN A DIFFERENT FORM OTHER THAN THAT SOUGHT TO BE REGISTERED AT LEAST AS EARLY AS 01/01/2001.; IN COMMERCE 1-1-2001, THE MARK WAS FIRST USED IN COMMERCE IN A DIFFERENT FORM OTHER THAN THAT SOUGHT TO BE REGISTERED AT LEAST AS EARLY AS 01/01/2001..

OWNER OF U.S. REG. NOS. 3,739,897 AND 3,739,972.

THE COLOR(S) BLACK AND RED IS/ARE CLAIMED AS A FEATURE OF THE MARK.

THE MARK CONSISTS OF THE WORDING "KNOW PAIN KNOW PROBLEM" WHERE THE WORDING IS IN BLACK EXCEPT FOR THE LETTERS "NO" IN THE WORDING "KNOW" WHICH ARE IN RED AND IN A LARGER FONT. THE LETTERS "K" AND "W" IN THE WORDING "KNOW" APPEAR IN A SMALLER FONT.

David J. Kyros

Director of the United States Patent and Trademark Office

Reg. No. 4,065,554 SER. NO. 85-086,307, FILED 7-16-2010.

MARIA-VICTORIA SUAREZ, EXAMINING ATTORNEY

United States of America

United States Patent and Trademark Office

ATLAS ENERGY

Reg. No. 4,065,555

Registered Dec. 6, 2011

Int. Cls.: 35, 37, 40 and 42

SERVICE MARK

PRINCIPAL REGISTER

ATLAS PIPELINE HOLDINGS, L.P. (DELAWARE LIMITED PARTNERSHIP)
1550 CORAOPOLIS HEIGHTS ROAD, SUITE 300
WESTPOINTE CORPORATE CENTER ONE
MOON TOWNSHIP, PA 15108

FOR: BUSINESS MANAGEMENT OF TAX-ADVANTAGED ENERGY INVESTMENT PARTNERSHIPS THAT FINANCE THE EXPLORATION AND DEVELOPMENT OF NATURAL GAS, IN CLASS 35 (U.S. CLS. 100, 101 AND 102).

FIRST USE 9-29-2009; IN COMMERCE 9-29-2009.

FOR: OIL AND GAS DRILLING, IN CLASS 37 (U.S. CLS. 100, 103 AND 106).

FIRST USE 9-29-2009; IN COMMERCE 9-29-2009.

FOR: PRODUCTION OF NATURAL GAS AND OIL, IN CLASS 40 (U.S. CLS. 100, 103 AND 106).

FIRST USE 9-29-2009; IN COMMERCE 9-29-2009.

FOR: OIL AND GAS PROSPECTING AND EXPLORATION, IN CLASS 42 (U.S. CLS. 100 AND 101).

FIRST USE 9-29-2009; IN COMMERCE 9-29-2009.

THE MARK CONSISTS OF STANDARD CHARACTERS WITHOUT CLAIM TO ANY PARTICULAR FONT, STYLE, SIZE, OR COLOR.

NO CLAIM IS MADE TO THE EXCLUSIVE RIGHT TO USE "ENERGY", APART FROM THE MARK AS SHOWN.

SER. NO. 85-086,710, FILED 7-16-2010.

CHRISIE B. KING, EXAMINING ATTORNEY



David J. Kyros

Director of the United States Patent and Trademark Office

United States of America

United States Patent and Trademark Office

ATLAS RESOURCES

Reg. No. 4,065,556

Registered Dec. 6, 2011

Int. Cls.: 35, 37 and 42

SERVICE MARK

PRINCIPAL REGISTER

ATLAS PIPELINE HOLDINGS, L.P. (DELAWARE LIMITED PARTNERSHIP)
1550 CORAOPOLIS HEIGHTS ROAD, SUITE 300
WESTPOINTE CORPORATE CENTER ONE
MOON TOWNSHIP, PA 15108

FOR: BUSINESS MANAGEMENT OF TAX-ADVANTAGED ENERGY INVESTMENT PARTNERSHIPS THAT FINANCE THE EXPLORATION AND DEVELOPMENT OF NATURAL GAS, IN CLASS 35 (U.S. CLS. 100, 101 AND 102).

FIRST USE 8-0-1990; IN COMMERCE 8-0-1990.

FOR: OIL AND GAS DRILLING, IN CLASS 37 (U.S. CLS. 100, 103 AND 106).

FIRST USE 8-0-1990; IN COMMERCE 8-0-1990.

FOR: OIL AND GAS PROSPECTING AND EXPLORATION, IN CLASS 42 (U.S. CLS. 100 AND 101).

FIRST USE 8-0-1990; IN COMMERCE 8-0-1990.

THE MARK CONSISTS OF STANDARD CHARACTERS WITHOUT CLAIM TO ANY PARTICULAR FONT, STYLE, SIZE, OR COLOR.

NO CLAIM IS MADE TO THE EXCLUSIVE RIGHT TO USE "RESOURCES", APART FROM THE MARK AS SHOWN.

SER. NO. 85-086,725, FILED 7-16-2010.

CHRISIE B. KING, EXAMINING ATTORNEY



David J. Kybas

Director of the United States Patent and Trademark Office

United States of America

United States Patent and Trademark Office



seedcreative

Reg. No. 4,065,557

SEED CREATIVE, LLC (GEORGIA LIMITED LIABILITY COMPANY)
P.O. BOX 523
MARIETTA, GA 30061

Registered Dec. 6, 2011

Int. Cl.: 35

FOR: ADVERTISING AND MARKETING SERVICES, NAMELY, PROMOTING THE GOODS AND SERVICES OF OTHERS, IN CLASS 35 (U.S. CLS. 100, 101 AND 102).

SERVICE MARK

FIRST USE 2-1-2003; IN COMMERCE 2-1-2003.

PRINCIPAL REGISTER

THE MARK CONSISTS OF THE TERM "SEEDCREATIVE" IN A LOWERCASE TYPEFACE WITH TWO LEAVES SPROUTING OUT OF THE ASCENDING BAR OF THE "D" IN "SEED".

THE WORDING "SEED CREATIVE" HAS NO MEANING IN A FOREIGN LANGUAGE.

SER. NO. 85-087,232, FILED 7-18-2010.

MICHELE SWAIN, EXAMINING ATTORNEY



David J. Kybas

Director of the United States Patent and Trademark Office

United States of America

United States Patent and Trademark Office

MEBS

Reg. No. 4,065,558

Registered Dec. 6, 2011

Int. Cls.: 35, 36 and 39

SERVICE MARK

PRINCIPAL REGISTER

MEBS GLOBAL REACH, LC (VIRGINIA LIMITED LIABILITY COMPANY)
14930 BOGLE DRIVE
CHANTILLY, VA 20151

FOR: CONTRACTOR SUPPORT SERVICES, NAMELY, EMPLOYMENT STAFFING IN THE FIELD OF MILITARY AND GOVERNMENT CONTRACTORS FOR ADMINISTRATION AND MANAGEMENT, IN CLASS 35 (U.S. CLS. 100, 101 AND 102).

FIRST USE 3-31-2006; IN COMMERCE 3-31-2006.

FOR: CONTRACTOR SUPPORT SERVICES, NAMELY, REAL ESTATE RENTAL SERVICES IN THE NATURE OF RESIDENTIAL HOUSING AND COMMERCIAL SPACE, IN CLASS 36 (U.S. CLS. 100, 101 AND 102).

FIRST USE 3-31-2006; IN COMMERCE 3-31-2006.

FOR: CONTRACTOR SUPPORT SERVICES, NAMELY, LEASING OF VEHICLES AND ARRANGING FOR TRAVEL AND RESIDENCY VISAS, PASSPORTS AND TRAVEL DOCUMENTS FOR PERSONS TRAVELING ABROAD, IN CLASS 39 (U.S. CLS. 100 AND 105).

FIRST USE 3-31-2006; IN COMMERCE 3-31-2006.

THE MARK CONSISTS OF STANDARD CHARACTERS WITHOUT CLAIM TO ANY PARTICULAR FONT, STYLE, SIZE, OR COLOR.

SER. NO. 85-087,408, FILED 7-19-2010.

KIM SAITO, EXAMINING ATTORNEY



David J. Kybas

Director of the United States Patent and Trademark Office

United States of America

United States Patent and Trademark Office

INTOPIC

Reg. No. 4,065,559

Registered Dec. 6, 2011

Int. Cl.: 35

SERVICE MARK

PRINCIPAL REGISTER

TRADEWIND MEDIA, LLC (GEORGIA LIMITED LIABILITY COMPANY), DBA INTOPIC
1739-B CHESHIRE BRIDGE ROAD
ATLANTA, GA 30324

FOR: ONLINE ADVERTISING AND MARKETING SERVICES; NAMELY, PLACING ADVERTISEMENTS FOR OTHERS LINKED TO THE APPEARANCE OF AN ADVERTISER NAME OR SELECTED KEYWORD IN THE TEXT OF WEBSITE PAGES, IN CLASS 35 (U.S. CLS. 100, 101 AND 102).

FIRST USE 6-25-2008; IN COMMERCE 1-1-2010.

THE MARK CONSISTS OF STANDARD CHARACTERS WITHOUT CLAIM TO ANY PARTICULAR FONT, STYLE, SIZE, OR COLOR.

SER. NO. 85-087,604, FILED 7-19-2010.

ANDREA HACK, EXAMINING ATTORNEY



David J. Kyffers

Director of the United States Patent and Trademark Office

United States of America

United States Patent and Trademark Office

SPEED STICK

Reg. No. 4,065,560

Registered Dec. 6, 2011

Int. Cl.: 28

TRADEMARK

PRINCIPAL REGISTER

DO OUTDOORS, INC. (MISSOURI CORPORATION)
2333 E. BENNETT
SPRINGFIELD, MO 65804

FOR: FISHING RODS, IN CLASS 28 (U.S. CLS. 22, 23, 38 AND 50).

FIRST USE 7-20-2010; IN COMMERCE 7-20-2010.

THE MARK CONSISTS OF STANDARD CHARACTERS WITHOUT CLAIM TO ANY PARTICULAR FONT, STYLE, SIZE, OR COLOR.

NO CLAIM IS MADE TO THE EXCLUSIVE RIGHT TO USE "STICK", APART FROM THE MARK AS SHOWN.

SER. NO. 85-088,565, FILED 7-20-2010.

NICHOLAS COLEMAN, EXAMINING ATTORNEY



David J. Kybas

Director of the United States Patent and Trademark Office

United States of America

United States Patent and Trademark Office

HABITAT HOTEL

Reg. No. 4,065,561

Registered Dec. 6, 2011

Int. Cl.: 35

SERVICE MARK

PRINCIPAL REGISTER

HABITAT DEVELOPMENT, LLC (FLORIDA LIMITED LIABILITY COMPANY)
1701 SW 2 AVENUE
MIAMI, FL 33129

FOR: PROVIDING AN INTERACTIVE REAL ESTATE WEBSITE WHICH PROMOTES RESERVATIONS AT BOUTIQUE HOTELS THROUGH OFFERING PROSPECTIVE TENANTS PROPERTY DESCRIPTIONS, TEXT, PRICE, LOCATION, AND OTHER INFORMATION THAT WOULD BE INFLUENTIAL TO A PROSPECTIVE TENANT IN MAKING A RENTAL DECISION, IN CLASS 35 (U.S. CLS. 100, 101 AND 102).

FIRST USE 1-2-2010; IN COMMERCE 1-2-2010.

THE MARK CONSISTS OF STANDARD CHARACTERS WITHOUT CLAIM TO ANY PARTICULAR FONT, STYLE, SIZE, OR COLOR.

NO CLAIM IS MADE TO THE EXCLUSIVE RIGHT TO USE "HOTEL", APART FROM THE MARK AS SHOWN.

SER. NO. 85-088,675, FILED 7-20-2010.

REBECCA EISINGER, EXAMINING ATTORNEY



David J. Kybas

Director of the United States Patent and Trademark Office

United States of America

United States Patent and Trademark Office

CIRCLE OF LIFE PARTNERS

Reg. No. 4,065,562

Registered Dec. 6, 2011

Int. Cl.: 16

TRADEMARK

PRINCIPAL REGISTER

CIRCLE OF LIFE PARTNERS LLC (MASSACHUSETTS LIMITED LIABILITY COMPANY)
200 BAKER AVENUE, SUITE 202
CONCORD, MA 01742

FOR: PRINTED MATERIALS, NAMELY, BOOKS IN THE FIELDS OF FAMILIES AND FRIENDS PROVIDING ELDER CARE AND GERIATRIC CARE FOR AGING RELATIVES, HEALTHY AGING, PERSONAL AND PROFESSIONAL DEVELOPMENT FOR FAMILY MEMBERS AND FRIENDS TAKING CARE OF AGING RELATIVES, PROFESSIONAL ADVISORY SERVICES FOR FAMILIES AND FRIENDS TAKING CARE OF AGING RELATIVES, AND COMMUNITY RESOURCES FOR FAMILIES AND FRIENDS TAKING CARE OF AGING RELATIVES, IN CLASS 16 (U.S. CLS. 2, 5, 22, 23, 29, 37, 38 AND 50).

FIRST USE 7-9-2010; IN COMMERCE 7-9-2010.

THE MARK CONSISTS OF STANDARD CHARACTERS WITHOUT CLAIM TO ANY PARTICULAR FONT, STYLE, SIZE, OR COLOR.

SER. NO. 85-089,415, FILED 7-21-2010.

LAURIE MAYES, EXAMINING ATTORNEY



David J. Kyros

Director of the United States Patent and Trademark Office

United States of America

United States Patent and Trademark Office

GOT-CHA

Reg. No. 4,065,563

Registered Dec. 6, 2011

Int. Cl.: 13

TRADEMARK

PRINCIPAL REGISTER

LEE BUSINESS FORMS, INC. (WISCONSIN CORPORATION)
S30W24720 SUNSET DRIVE
WAUKESHA, WI 53189

FOR: NON-METAL FIREARM STAND ADAPTED FOR HOLDING A FIREARM WITHIN HANDS REACH ADJACENT TO AN ITEM OF FURNITURE, IN CLASS 13 (U.S. CLS. 2 AND 9).

FIRST USE 7-12-2010; IN COMMERCE 7-12-2010.

THE MARK CONSISTS OF STANDARD CHARACTERS WITHOUT CLAIM TO ANY PARTICULAR FONT, STYLE, SIZE, OR COLOR.

SER. NO. 85-090,680, FILED 7-22-2010.

NELSON SNYDER, EXAMINING ATTORNEY



David J. Kybas

Director of the United States Patent and Trademark Office

United States of America

United States Patent and Trademark Office

Thairapeutics

Reg. No. 4,065,564

Registered Dec. 6, 2011

Int. Cl.: 44

BATTERMANN, MICHELLE LYNN (CALIFORNIA SOLE PROPRIETORSHIP), DBA
THAIRAPEUTICS

"A"

1396 A SOLANO AVE
ALBANY, CA 94706

SERVICE MARK

PRINCIPAL REGISTER

FOR: PROVIDING HOLISTIC HAIR AND BODY TREATMENTS FOR HEALTH AND WELLNESS OF THE BODY AND SPIRIT, NAMELY, FACIAL AND BODY TREATMENT SERVICES, COSMETIC BODY CARE SERVICES AND HAIR SALON SERVICES; AS WELL AS ALTERNATIVE HEALTH AND HEALING SERVICES IN THE NATURE OF WEIGHT LOSS PROGRAMS, ANTI-AGING THERAPY, RESTORATIVE HEALTH THERAPY, DETOXIFICATION THERAPY, HORMONE THERAPY, HYPERBARIC OXYGEN THERAPY, IN CLASS 44 (U.S. CLS. 100 AND 101).

FIRST USE 3-1-2003; IN COMMERCE 4-1-2003.

THE MARK CONSISTS OF STANDARD CHARACTERS WITHOUT CLAIM TO ANY PARTICULAR FONT, STYLE, SIZE, OR COLOR.

SEC. 2(F).

SER. NO. 85-091,197, FILED 7-23-2010.

KIMBERLY PERRY, EXAMINING ATTORNEY



David J. Kyffers

Director of the United States Patent and Trademark Office

United States of America

United States Patent and Trademark Office

CAJUN CANNON

Reg. No. 4,065,565

Registered Dec. 6, 2011

Int. Cl.: 41

SERVICE MARK

PRINCIPAL REGISTER

HEBERT, BOBBY (UNITED STATES INDIVIDUAL)
855 WALKER STREET
NEW ORLEANS, LA 70124

FOR: ENTERTAINMENT SERVICES, NAMELY, THE PROVISION OF CONTINUING SPORTS PROGRAMS FEATURING NEWS AND COMMENTARY DELIVERED BY TELEVISION, RADIO, SATELLITE, THE INTERNET OR LIVE, IN CLASS 41 (U.S. CLS. 100, 101 AND 107).

FIRST USE 9-1-1983; IN COMMERCE 9-1-2005.

THE MARK CONSISTS OF STANDARD CHARACTERS WITHOUT CLAIM TO ANY PARTICULAR FONT, STYLE, SIZE, OR COLOR.

SER. NO. 85-091,516, FILED 7-23-2010.

SANJEEV VOHRA, EXAMINING ATTORNEY



David J. Kybas

Director of the United States Patent and Trademark Office

United States of America

United States Patent and Trademark Office

N-TIMIDATOR

Reg. No. 4,065,566

Registered Dec. 6, 2011

Int. Cl.: 31

TRADEMARK

PRINCIPAL REGISTER

SUREFED, LTD (TEXAS PARTNERSHIP)
304 EAST CHURCH AVENUE
KILLEEN, TX 76541

FOR: LIVESTOCK FEED, IN CLASS 31 (U.S. CLS. 1 AND 46).

FIRST USE 3-1-1999; IN COMMERCE 3-1-1999.

THE MARK CONSISTS OF STANDARD CHARACTERS WITHOUT CLAIM TO ANY PARTICULAR FONT, STYLE, SIZE, OR COLOR.

SER. NO. 85-092,666, FILED 7-26-2010.

JOHN GARTNER, EXAMINING ATTORNEY



David J. Kybas

Director of the United States Patent and Trademark Office

United States of America

United States Patent and Trademark Office

THE WORLD'S BIGGEST HOTEL FAMILY

Reg. No. 4,065,567

Registered Dec. 6, 2011

Int. Cl.: 43

SERVICE MARK

PRINCIPAL REGISTER

BEST WESTERN INTERNATIONAL, INC. (ARIZONA CORPORATION)
6201 NORTH 24TH PARKWAY
PHOENIX, AZ 85016

FOR: HOTEL SERVICES, IN CLASS 43 (U.S. CLS. 100 AND 101).

FIRST USE 2-2-2011; IN COMMERCE 2-2-2011.

THE MARK CONSISTS OF STANDARD CHARACTERS WITHOUT CLAIM TO ANY PARTICULAR FONT, STYLE, SIZE, OR COLOR.

OWNER OF U.S. REG. NOS. 2,603,084, 2,719,374, AND 3,178,964.

SEC. 2(F).

SER. NO. 85-095,321, FILED 7-28-2010.

COURTNEY ALVAREZ, EXAMINING ATTORNEY



David J. Kyffers

Director of the United States Patent and Trademark Office

United States of America

United States Patent and Trademark Office



Reg. No. 4,065,568

Registered Dec. 6, 2011

Int. Cl.: 44

SERVICE MARK

PRINCIPAL REGISTER

GREEN RESOURCE, LLC (NORTH CAROLINA LIMITED LIABILITY COMPANY)
5204 HIGHGREEN COURT
COLFAX, NC 27235

FOR: AGRONOMIC CONSULTING SERVICES; FERTILIZER SPREADING, IN CLASS 44
(U.S. CLS. 100 AND 101).

FIRST USE 7-28-2004; IN COMMERCE 7-28-2004.

THE MARK CONSISTS OF THE WORD "GREEN" IN LIGHT GREEN TO THE LEFT OF A DESIGN OF LIGHT GREEN GRASS, ALL UNDERLINED BY A DARK GREEN HORIZONTAL LINE, BELOW WHICH APPEARS THE WORD "RESOURCE" IN DARK GREEN. THE COLOR WHITE REPRESENTS THE BACKGROUND AND/OR TRANSPARENT AREAS AND IS NOT PART OF THE MARK.

THE COLOR(S) LIGHT GREEN AND DARK GREEN IS/ARE CLAIMED AS A FEATURE OF THE MARK.

SER. NO. 85-095,994, FILED 7-29-2010.

LESLIE RICHARDS, EXAMINING ATTORNEY



David J. Kyros

Director of the United States Patent and Trademark Office

United States of America

United States Patent and Trademark Office

K 25

Reg. No. 4,065,569

Registered Dec. 6, 2011

Int. Cl.: 5

TRADEMARK

PRINCIPAL REGISTER

KVK-TECH, INC. (PENNSYLVANIA CORPORATION)
110 TERRY DRIVE, SUITE 200
NEWTOWN, PA 18940

FOR: PHARMACEUTICAL PREPARATIONS OF PHENTERMINE HYDROCHLORIDE FOR THE TREATMENT OF OBESITY AVAILABLE BY PRESCRIPTION ONLY, IN CLASS 5 (U.S. CLS. 6, 18, 44, 46, 51 AND 52).

FIRST USE 4-1-2008; IN COMMERCE 4-1-2008.

THE MARK CONSISTS OF STANDARD CHARACTERS WITHOUT CLAIM TO ANY PARTICULAR FONT, STYLE, SIZE, OR COLOR.

SER. NO. 85-096,192, FILED 7-29-2010.

NAKIA HENRY, EXAMINING ATTORNEY



David J. Kyffers

Director of the United States Patent and Trademark Office

United States of America

United States Patent and Trademark Office

OASIS

Reg. No. 4,065,570

Registered Dec. 6, 2011

Int. Cl.: 9

TRADEMARK

PRINCIPAL REGISTER

MEGAPHASE, LLC (PENNSYLVANIA LIMITED LIABILITY COMPANY)
BUILDING 3
2098 WEST MAIN STREET
STROUDSBURG, PA 18360

FOR: UNIVERSAL CABLE AND ADAPTOR KIT COMPRISED OF UNIVERSAL CABLE ASSEMBLIES, UNIVERSAL CABLE ADAPTERS, CABLE CONNECTORS, AND A RUGGED CASE WITH A LATCH FOR USE IN THE AREA OF FIELD TESTING AND MAINTENANCE, IN CLASS 9 (U.S. CLS. 21, 23, 26, 36 AND 38).

FIRST USE 10-31-2009; IN COMMERCE 10-31-2009.

THE MARK CONSISTS OF STANDARD CHARACTERS WITHOUT CLAIM TO ANY PARTICULAR FONT, STYLE, SIZE, OR COLOR.

SER. NO. 85-098,247, FILED 8-2-2010.

MEGHAN REINHART, EXAMINING ATTORNEY



David J. Kybas

Director of the United States Patent and Trademark Office

United States of America

United States Patent and Trademark Office



Reg. No. 4,065,571

Registered Dec. 6, 2011

Int. Cl.: 41

SERVICE MARK

PRINCIPAL REGISTER

ATLANTA HISTORICAL SOCIETY, INC. (GEORGIA CORPORATION), DBA ATLANTA HISTORY CENTER
130 WEST PACES FERRY ROAD
ATLANTA, GA 30305

FOR: MUSEUM SERVICES, FEATURING THE LIFE, HISTORICAL TIME PERIOD AND WRITING OF MARGARET MITCHELL, IN CLASS 41 (U.S. CLS. 100, 101 AND 107).

FIRST USE 0-0-2010; IN COMMERCE 0-0-2010.

OWNER OF U.S. REG. NOS. 2,361,681 AND 2,385,380.

NO CLAIM IS MADE TO THE EXCLUSIVE RIGHT TO USE "HOUSE", APART FROM THE MARK AS SHOWN.

THE NAME "MARGARET MITCHELL" DOES NOT IDENTIFY A LIVING INDIVIDUAL.

THE MARK CONSISTS OF THE LETTER "M" DISPLAYED INSIDE A CIRCLE WITH A BLACK OUTLINE. THE WORDS "MARGARET MITCHELL HOUSE" FORM THE OUTER CIRCLE.

SER. NO. 85-099,562, FILED 8-4-2010.

DAWN FELDMAN, EXAMINING ATTORNEY



David J. Kybas

Director of the United States Patent and Trademark Office

United States of America

United States Patent and Trademark Office



Reg. No. 4,065,572

Registered Dec. 6, 2011

Int. Cls.: 35 and 42

SERVICE MARK

PRINCIPAL REGISTER

MOTION INDUSTRIES, INC. (DELAWARE CORPORATION)
1605 ALTON ROAD
BIRMINGHAM, AL 35210

FOR: DISTRIBUTORSHIP SERVICES FEATURING MOTION CONTROL PRODUCTS, MECHANICAL AND ELECTRICAL DRIVES, PNEUMATIC CONTROLS, MACHINE SAFETY PRODUCTS, AND POWER TRANSMISSION PRODUCTS, IN CLASS 35 (U.S. CLS. 100, 101 AND 102).

FIRST USE 0-0-1948; IN COMMERCE 0-0-1948.

FOR: CONSULTING SERVICES IN THE FIELDS OF MANUFACTURING AND PROCESSING, NAMELY, PROVIDING PROCESS DESIGN SOLUTIONS IN THE AREAS OF MOTION CONTROL PRODUCTS, MECHANICAL AND ELECTRICAL DRIVES, PNEUMATIC CONTROLS, MACHINE SAFETY PRODUCTS, AND POWER TRANSMISSION PRODUCTS, IN CLASS 42 (U.S. CLS. 100 AND 101).

FIRST USE 0-0-1948; IN COMMERCE 0-0-1948.

NO CLAIM IS MADE TO THE EXCLUSIVE RIGHT TO USE "TRANSMISSION", APART FROM THE MARK AS SHOWN.

THE MARK CONSISTS OF A BAR CODE TO THE LEFT OF THE WORDS "MEIER" AND "TRANSMISSION", WITH "MEIER" WRITTEN IN LARGE BOLD CAPITAL LETTERS ABOVE THE WORD "TRANSMISSION".

SER. NO. 85-099,680, FILED 8-4-2010.

FRANK LATTUCA, EXAMINING ATTORNEY



David J. Kybas

Director of the United States Patent and Trademark Office

United States of America

United States Patent and Trademark Office

I'Me

Reg. No. 4,065,573

Registered Dec. 6, 2011

Int. Cl.: 25

TRADEMARK

PRINCIPAL REGISTER

JEANNETTA THOMAS (UNITED STATES INDIVIDUAL)
804 CHARLEY PATTERSON ROAD
NEW MARKET, AL 35761

FOR: BELTS; DRESSES; JACKETS; PANTS; SCARVES; SHIRTS; SHOES; SKIRTS;
SWEATERS, IN CLASS 25 (U.S. CLS. 22 AND 39).

FIRST USE 3-16-2010; IN COMMERCE 3-16-2010.

THE MARK CONSISTS OF STANDARD CHARACTERS WITHOUT CLAIM TO ANY PAR-
TICULAR FONT, STYLE, SIZE, OR COLOR.

SER. NO. 85-099,799, FILED 8-4-2010.

DOMINIC J. FERRAIUOLO, EXAMINING ATTORNEY



David J. Kybas

Director of the United States Patent and Trademark Office

United States of America

United States Patent and Trademark Office



Reg. No. 4,065,574
Registered Dec. 6, 2011

ROBINSON LASER, LLC (DELAWARE LIMITED LIABILITY COMPANY)
4303 KENNEDY AVENUE
EAST CHICAGO, IN 46312

Int. Cl.: 40

FOR: METAL TREATMENT, NAMELY, CUTTING AND SHAPING SEMI-FINISHED STEEL TO THE ORDER AND SPECIFICATION OF OTHERS; CUSTOM FABRICATION OF SEMI-FINISHED STEEL TO THE ORDER AND SPECIFICATION OF OTHERS; METAL FABRICATION, NAMELY, LASER CUTTING AND SHAPING TO THE ORDER AND SPECIFICATION OF OTHERS, IN CLASS 40 (U.S. CLS. 100, 103 AND 106).

SERVICE MARK

PRINCIPAL REGISTER

FIRST USE 7-1-2010; IN COMMERCE 7-1-2010.

NO CLAIM IS MADE TO THE EXCLUSIVE RIGHT TO USE "LASER", APART FROM THE MARK AS SHOWN.

THE MARK CONSISTS OF THE LETTER "R" SHOWN ON TOP OF THE LETTER "L", SHOWN NEXT TO THE WORD "ROBINSON" OVER THE WORD "LASER".

SER. NO. 85-100,289, FILED 8-4-2010.

ROBERT C. CLARK JR., EXAMINING ATTORNEY



David J. Kybas

Director of the United States Patent and Trademark Office

United States of America

United States Patent and Trademark Office

RL

Reg. No. 4,065,575

Registered Dec. 6, 2011

Int. Cl.: 40

SERVICE MARK

PRINCIPAL REGISTER

ROBINSON LASER, LLC (DELAWARE LIMITED LIABILITY COMPANY)
4303 KENNEDY AVENUE
EAST CHICAGO, IN 46312

FOR: METAL TREATMENT, NAMELY, CUTTING AND SHAPING SEMI-FINISHED STEEL TO THE ORDER AND SPECIFICATION OF OTHERS; CUSTOM FABRICATION OF SEMI-FINISHED STEEL TO THE ORDER AND SPECIFICATION OF OTHERS; METAL FABRICATION, NAMELY, LASER CUTTING AND SHAPING TO THE ORDER AND SPECIFICATION OF OTHERS, IN CLASS 40 (U.S. CLS. 100, 103 AND 106).

FIRST USE 7-1-2010; IN COMMERCE 7-1-2010.

THE MARK CONSISTS OF STANDARD CHARACTERS WITHOUT CLAIM TO ANY PARTICULAR FONT, STYLE, SIZE, OR COLOR.

SER. NO. 85-100,305, FILED 8-4-2010.

ROBERT C. CLARK JR., EXAMINING ATTORNEY



David J. Kybas

Director of the United States Patent and Trademark Office

United States of America
United States Patent and Trademark Office

ΑΣΣ

Reg. No. 4,065,576

NICKEL, NILE (UNITED STATES INDIVIDUAL)
8328 JENNIFER LANE
SEMINOLE, FL 33777

Registered Dec. 6, 2011

Int. Cl.: 25

FOR: HATS; JACKETS; PANTS; SHIRTS; SHOES, IN CLASS 25 (U.S. CLS. 22 AND 39).

TRADEMARK

FIRST USE 2-1-2010; IN COMMERCE 2-1-2010.

PRINCIPAL REGISTER

THE MARK CONSISTS OF THE GREEK LETTERS OR SYMBOLS "ALPHA", "SIGMA",
"SIGMA".

SER. NO. 85-101,408, FILED 8-5-2010.

KRISTIN DAHLING, EXAMINING ATTORNEY



David J. Kyffers

Director of the United States Patent and Trademark Office

United States of America

United States Patent and Trademark Office

Angel Chatter

Reg. No. 4,065,577

Registered Dec. 6, 2011

Int. Cls.: 14 and 41

TRADEMARK

SERVICE MARK

PRINCIPAL REGISTER

INNER BALANCE, LLC (MARYLAND LIMITED LIABILITY COMPANY)
3 BLENMONT COURT
PHOENIX, MD 21131

FOR: JEWELRY, IN CLASS 14 (U.S. CLS. 2, 27, 28 AND 50).

FIRST USE 12-1-2008; IN COMMERCE 12-1-2008.

FOR: ENTERTAINMENT AND EDUCATIONAL SERVICES, NAMELY, THE PRESENTATION OF SEMINARS, LECTURES, WORKSHOPS AND PANEL DISCUSSIONS, AND ONGOING TELEVISION AND RADIO TALK SHOWS ALL IN THE FIELD OF PUBLIC INTEREST CONCERNING PERSONAL GROWTH, MEDITATION AND SPIRITUAL HEALING, IN CLASS 41 (U.S. CLS. 100, 101 AND 107).

FIRST USE 12-1-2008; IN COMMERCE 12-1-2008.

THE MARK CONSISTS OF STANDARD CHARACTERS WITHOUT CLAIM TO ANY PARTICULAR FONT, STYLE, SIZE, OR COLOR.

SER. NO. 85-102,028, FILED 8-6-2010.

BERYL GARDNER, EXAMINING ATTORNEY



David J. Kypos

Director of the United States Patent and Trademark Office

United States of America

United States Patent and Trademark Office

HUMANOS

Reg. No. 4,065,578

Registered Dec. 6, 2011

Int. Cl.: 9

TRADEMARK

PRINCIPAL REGISTER

INSYDE SOFTWARE, INC. (DELAWARE CORPORATION)
1400 COMPUTER DRIVE
WESTBOROUGH, MA 01581

FOR: COMPUTER OPERATING PROGRAMS; COMPUTER OPERATING SYSTEMS; COMPUTER SOFTWARE FOR COMPUTER SYSTEM AND APPLICATION DEVELOPMENT, DEPLOYMENT AND MANAGEMENT, IN CLASS 9 (U.S. CLS. 21, 23, 26, 36 AND 38).

FIRST USE 1-8-2009; IN COMMERCE 1-8-2009.

THE MARK CONSISTS OF STANDARD CHARACTERS WITHOUT CLAIM TO ANY PARTICULAR FONT, STYLE, SIZE, OR COLOR.

OWNER OF U.S. REG. NO. 3,150,530.

THE ENGLISH TRANSLATION OF THE WORD "HUMANOS" IN THE MARK IS "HUMAN".

SER. NO. 85-104,918, FILED 8-11-2010.

SUSAN LESLIE DUBOIS, EXAMINING ATTORNEY



David J. Kybas

Director of the United States Patent and Trademark Office

United States of America

United States Patent and Trademark Office



Pursuing Global Justice
Through Grassroots Change

Reg. No. 4,065,579

Registered Dec. 6, 2011

Int. Cl.: 36

SERVICE MARK

PRINCIPAL REGISTER

AMERICAN JEWISH WORLD SERVICE, INC. (NEW YORK NON-PROFIT CORPORATION)
45 WEST 36TH STREET
NEW YORK, NY 10018

FOR: PROVIDING GRANTS TO GRASSROOTS ORGANIZATIONS AND VOLUNTEER SERVICES FOR PROVIDING HUMANITARIAN ASSISTANCE AND EMERGENCY RELIEF TO DISADVANTAGED PEOPLE WORLDWIDE, IN CLASS 36 (U.S. CLS. 100, 101 AND 102).

FIRST USE 11-0-2006; IN COMMERCE 11-0-2006.

NO CLAIM IS MADE TO THE EXCLUSIVE RIGHT TO USE "SERVICE", APART FROM THE MARK AS SHOWN.

THE COLOR(S) BLUE AND BROWN IS/ARE CLAIMED AS A FEATURE OF THE MARK.

THE MARK CONSISTS OF THE WORDS "AMERICAN JEWISH WORLD SERVICE" IN BROWN IN A CIRCLE COMPRISED OF THREE ARCS WHICH ARE BROWN AND BLUE AND THE WORDS "PURSUING GLOBAL JUSTICE THROUGH GRASSROOTS CHANGE" IN BROWN.

SEC. 2(F).

SER. NO. 85-105,837, FILED 8-12-2010.

ANGELA M. MICHELI, EXAMINING ATTORNEY



David J. Kyjars

Director of the United States Patent and Trademark Office

United States of America

United States Patent and Trademark Office



Reg. No. 4,065,580

Registered Dec. 6, 2011

Int. Cl.: 36

SERVICE MARK

PRINCIPAL REGISTER

AMERICAN JEWISH WORLD SERVICE, INC. (NEW YORK NON-PROFIT CORPORATION)
45 WEST 36TH STREET
NEW YORK, NY 10018

FOR: PROVIDING GRANTS TO GRASSROOTS ORGANIZATIONS AND VOLUNTEER SERVICES FOR PROVIDING HUMANITARIAN ASSISTANCE AND EMERGENCY RELIEF TO DISADVANTAGED PEOPLE WORLDWIDE, IN CLASS 36 (U.S. CLS. 100, 101 AND 102).

FIRST USE 1-0-2006; IN COMMERCE 1-0-2006.

NO CLAIM IS MADE TO THE EXCLUSIVE RIGHT TO USE "SERVICE", APART FROM THE MARK AS SHOWN.

THE COLOR(S) BLUE AND BROWN IS/ARE CLAIMED AS A FEATURE OF THE MARK.

THE MARK CONSISTS OF THE WORDS "AMERICAN JEWISH WORLD SERVICE" IN BROWN, ALL WITHIN A CIRCLE COMPRISED OF FOUR ARCS THAT APPEAR IN BLUE AND BROWN.

SEC. 2(F).

SER. NO. 85-105,860, FILED 8-12-2010.

ANGELA M. MICHELI, EXAMINING ATTORNEY



David J. Kybas

Director of the United States Patent and Trademark Office

United States of America

United States Patent and Trademark Office

LAROC

Reg. No. 4,065,581

Registered Dec. 6, 2011

Int. Cl.: 37

SERVICE MARK

PRINCIPAL REGISTER

LAROC REFRIGERATION-METAL DIVISION, INC. (NEW MEXICO CORPORATION)
516 W. WILSON
GALLUP, NM 87301

FOR: COMMERCIAL AND RESIDENTIAL CONTRACTOR SERVICES, NAMELY, ELECTRICAL, PLUMBING, AND HEATING CONTRACTOR SERVICES; REFRIGERATION SERVICES, NAMELY, INSTALLATION, REPAIR, AND MAINTENANCE OF FREEZING AND REFRIGERATING MACHINES AND APPARATUS; VENTILATION AND AIR CONDITIONING INSTALLATION, REPAIR, AND MAINTENANCE SERVICES; APPLIANCE REPAIR SERVICES, IN CLASS 37 (U.S. CLS. 100, 103 AND 106).

FIRST USE 1-1-1965; IN COMMERCE 1-1-1965.

THE MARK CONSISTS OF STANDARD CHARACTERS WITHOUT CLAIM TO ANY PARTICULAR FONT, STYLE, SIZE, OR COLOR.

SEC. 2(F).

SER. NO. 85-106,504, FILED 8-12-2010.

JAY BESCH, EXAMINING ATTORNEY



David J. Kyros

Director of the United States Patent and Trademark Office

United States of America

United States Patent and Trademark Office



Reg. No. 4,065,582

Registered Dec. 6, 2011

Int. Cl.: 9

TRADEMARK

PRINCIPAL REGISTER

LAW ENFORCEMENT ASSOCIATES, INC. (NEW JERSEY CORPORATION)
SUITE 125
2609 DISCOVERY DRIVE
RALEIGH, NC 27616

FOR: DIGITAL MEDIA, NAMELY, OPTICAL TRANSCEIVERS FEATURING SENSORS FOR THE COLLECTION OF DATA AND INFORMATION FOR LAW ENFORCEMENT AND PRIVATE INVESTIGATION PURPOSES, IN CLASS 9 (U.S. CLS. 21, 23, 26, 36 AND 38).

FIRST USE 5-0-2009; IN COMMERCE 5-0-2009.

NO CLAIM IS MADE TO THE EXCLUSIVE RIGHT TO USE "MICRO DV", APART FROM THE MARK AS SHOWN.

THE MARK CONSISTS OF TOP HALF IMAGE OF A SCORPION TO INCLUDE ITS TAIL STINGER AND CLAWS; THE BOTTOM HALF OF THE SCORPION IS REPLACED WITH THE WORDS "SCORPION MICRO DV".

SER. NO. 85-107,959, FILED 8-16-2010.

ARETHA SOMERVILLE, EXAMINING ATTORNEY



David J. Kybas

Director of the United States Patent and Trademark Office

United States of America

United States Patent and Trademark Office



Reg. No. 4,065,583

Registered Dec. 6, 2011

Int. Cl.: 9

TRADEMARK

PRINCIPAL REGISTER

LAW ENFORCEMENT ASSOCIATES, INC. (NEW JERSEY CORPORATION)
SUITE 125
2609 DISCOVERY DRIVE
RALEIGH, NC 27616

FOR: DIGITAL MEDIA, NAMELY, OPTICAL TRANSCIEVERS FEATURING SENSORS FOR THE COLLECTION OF DATA AND INFORMATION FOR LAW ENFORCEMENT AND PRIVATE INVESTIGATION PURPOSES, IN CLASS 9 (U.S. CLS. 21, 23, 26, 36 AND 38).

FIRST USE 5-0-2009; IN COMMERCE 5-0-2009.

NO CLAIM IS MADE TO THE EXCLUSIVE RIGHT TO USE "MINI DV", APART FROM THE MARK AS SHOWN.

THE MARK CONSISTS OF TOP HALF IMAGE OF A SCORPION TO INCLUDE IT TAIL STINGER AND FRONT CLAWS; BOTTOM IMAGE OF SCORPION IS REPLACED WITH THE WORDS "SCORPION MINI DV".

SER. NO. 85-107,967, FILED 8-16-2010.

ARETHA SOMERVILLE, EXAMINING ATTORNEY



David J. Kybas

Director of the United States Patent and Trademark Office

United States of America

United States Patent and Trademark Office

UNITED STATES HOLOCAUST MEMORIAL MUSEUM

Reg. No. 4,065,584

Registered Dec. 6, 2011

Int. Cl.: 41

SERVICE MARK

PRINCIPAL REGISTER

UNITED STATES HOLOCAUST MEMORIAL MUSEUM (UNITED STATES INDEPENDENT ESTABLISHMENT OF THE UNITED STATES, FOUNDED AND ORGANIZED UNDER 36 USC SECTIONS 2301-2310)
100 RAOUL WALLENBERG PLACE, SW
WASHINGTON, DC 200242126

FOR: MUSEUM SERVICES; EDUCATIONAL SERVICES, NAMELY, CONFERENCES, SEMINARS, WORKSHOPS, ROUNDTABLES, FORUMS, AND TEACHER TRAINING FELLOWSHIP PROGRAMS IN THE FIELDS OF HISTORY, WARFARE, CRIMES AGAINST HUMANITY, HOLOCAUST STUDIES, GENOCIDE STUDIES, AND GENOCIDE AWARENESS AND PREVENTION STUDIES; PRODUCTION OF EDUCATIONAL AUDIOVISUAL MULTI-MEDIA MATERIALS IN THE FIELDS OF HISTORY, WARFARE, CRIMES AGAINST HUMANITY, HOLOCAUST STUDIES, GENOCIDE STUDIES, AND GENOCIDE AWARENESS AND PREVENTION STUDIES; RESEARCH SERVICES ABOUT EDUCATION, NAMELY, IN THE FIELDS OF HOLOCAUST STUDIES, GENOCIDE STUDIES, AND GENOCIDE AWARENESS AND PREVENTION STUDIES; EDUCATIONAL SERVICES, NAMELY, PROVIDING MULTI-MEDIA DISPLAYS AND INTERACTIVE EXHIBITIONS IN MUSEUMS AND ONLINE VIA A WEBSITE IN THE FIELDS OF HISTORY, WARFARE, CRIMES AGAINST HUMANITY, HOLOCAUST STUDIES, GENOCIDE STUDIES, AND GENOCIDE AWARENESS AND PREVENTION STUDIES; NEWSLETTERS PROVIDED VIA EMAIL IN THE FIELDS OF HISTORY, WARFARE, CRIMES AGAINST HUMANITY, HOLOCAUST STUDIES, GENOCIDE STUDIES, AND GENOCIDE AWARENESS AND PREVENTION STUDIES, IN CLASS 41 (U.S. CLS. 100, 101 AND 107).



FIRST USE 12-31-1993; IN COMMERCE 12-31-1993.

THE MARK CONSISTS OF STANDARD CHARACTERS WITHOUT CLAIM TO ANY PARTICULAR FONT, STYLE, SIZE, OR COLOR.

OWNER OF U.S. REG. NOS. 2,381,460 AND 3,337,281.

NO CLAIM IS MADE TO THE EXCLUSIVE RIGHT TO USE "HOLOCAUST" AND "MUSEUM", APART FROM THE MARK AS SHOWN.

SEC. 2(F).

SER. NO. 85-109,182, FILED 8-17-2010.

David J. Kyffers

Director of the United States Patent and Trademark Office

Reg. No. 4,065,584 JEAN IM, EXAMINING ATTORNEY

United States of America

United States Patent and Trademark Office

MAXI SNEAKER

Reg. No. 4,065,585

Registered Dec. 6, 2011

Int. Cl.: 7

TRADEMARK

PRINCIPAL REGISTER

ASTEC INDUSTRIES, INC. (TENNESSEE CORPORATION)
1725 SHEPHERD ROAD
CHATTANOOGA, TN 37421

FOR: MACHINES FOR USE IN DIGGING TRENCHES AND LAYING UNDERGROUND CABLES AND REPLACEMENT PARTS THEREFOR, IN CLASS 7 (U.S. CLS. 13, 19, 21, 23, 31, 34 AND 35).

FIRST USE 0-0-2002; IN COMMERCE 0-0-2002.

THE MARK CONSISTS OF STANDARD CHARACTERS WITHOUT CLAIM TO ANY PARTICULAR FONT, STYLE, SIZE, OR COLOR.

SER. NO. 85-111,290, FILED 8-19-2010.

MARTHA FROMM, EXAMINING ATTORNEY



David J. Kyffers

Director of the United States Patent and Trademark Office

United States of America

United States Patent and Trademark Office

CREATING THE DONATION GENERATION

Reg. No. 4,065,586

Registered Dec. 6, 2011

Int. Cl.: 44

SERVICE MARK

PRINCIPAL REGISTER

LIFESOUTH COMMUNITY BLOOD CENTERS, INC. (FLORIDA CORPORATION)
ATTN: KIMBERLY KINSELL
4039 NEWBERRY ROAD
GAINESVILLE, FL 32607

FOR: BLOOD BANKS, IN CLASS 44 (U.S. CLS. 100 AND 101).

FIRST USE 7-1-2010; IN COMMERCE 8-16-2010.

THE MARK CONSISTS OF STANDARD CHARACTERS WITHOUT CLAIM TO ANY PARTICULAR FONT, STYLE, SIZE, OR COLOR.

SER. NO. 85-111,333, FILED 8-19-2010.

CURTIS FRENCH, EXAMINING ATTORNEY



David J. Kybas

Director of the United States Patent and Trademark Office

United States of America

United States Patent and Trademark Office

CLICK 4 COMPLIANCE

Reg. No. 4,065,587

Registered Dec. 6, 2011

Int. Cls.: 35, 42 and 45

SERVICE MARK

PRINCIPAL REGISTER

CLICK 4 COMPLIANCE LLC (VIRGINIA LIMITED LIABILITY COMPANY)
11710 PLAZA AMERICA DRIVE, SUITE 2000
RESTON, VA 20190

FOR: BUSINESS CONSULTING, IN CLASS 35 (U.S. CLS. 100, 101 AND 102).

FIRST USE 7-13-2006; IN COMMERCE 7-13-2006.

FOR: CONSULTING SERVICES RELATED TO DEVELOPMENT OF QUALITY CONTROL STANDARDS FOR BUSINESS ETHICS AND CONFORMING TO LEGAL AND REGULATORY STANDARDS AND REQUIREMENTS IN THE AREAS OF ANTI-CORRUPTION, EXPORT COMPLIANCE, PRIVACY AND PERSONAL DATA PROTECTION, PROTECTING CONFIDENTIAL INFORMATION, AVOIDING INSIDER TRADING, CONDUCTING INTERNAL BUSINESS COMPLIANCE INVESTIGATIONS, DUE DILIGENCE, AND DOING BUSINESS WITH THE FEDERAL AND FOREIGN GOVERNMENTS; CONSULTING RELATED TO DEVELOPMENT OF VOLUNTARY STANDARDS FOR BUSINESS ETHICS AND TESTING TO DETERMINE PROFESSIONAL COMPETENCY, IN CLASS 42 (U.S. CLS. 100 AND 101).

FIRST USE 7-13-2006; IN COMMERCE 7-13-2006.

FOR: LEGAL SERVICES, NAMELY, PROVIDING LEGAL COUNSELING AND ADVICE; CONSULTING RELATED TO REVIEWING STANDARDS AND PRACTICES TO ASSURE COMPLIANCE WITH ETHICS LAWS AND REGULATIONS; CONSULTING RELATED TO REVIEWING STANDARDS AND PRACTICES TO ASSURE COMPLIANCE WITH LAWS AND REGULATIONS RELATED TO BUSINESS ETHICS, ANTI-CORRUPTION, EXPORT COMPLIANCE, PRIVACY AND PERSONAL DATA PROTECTION, PROTECTING CONFIDENTIAL INFORMATION, AVOIDING INSIDER TRADING, CONDUCTING INTERNAL BUSINESS COMPLIANCE INVESTIGATIONS, DUE DILIGENCE, AND DOING BUSINESS WITH THE FEDERAL AND FOREIGN GOVERNMENTS, IN CLASS 45 (U.S. CLS. 100 AND 101).

FIRST USE 7-13-2006; IN COMMERCE 7-13-2006.

THE MARK CONSISTS OF STANDARD CHARACTERS WITHOUT CLAIM TO ANY PARTICULAR FONT, STYLE, SIZE, OR COLOR.

SER. NO. 85-112,012, FILED 8-20-2010.



David J. Kyffers

Director of the United States Patent and Trademark Office

Reg. No. 4,065,587 DAVID I, EXAMINING ATTORNEY

United States of America

United States Patent and Trademark Office



Reg. No. 4,065,588

Registered Dec. 6, 2011

Int. Cl.: 25

TRADEMARK

PRINCIPAL REGISTER

WASHINGTON, ANTWOINE D. (UNITED STATES INDIVIDUAL), DBA MOCHA SOUL
3051 EDGEFIELD DR.
WATERFORD, MI 48328 AND

CATLETT, WILLIAM H. (UNITED STATES INDIVIDUAL), DBA MOCHA SOUL
451 S. MAIN ST. # 520
LOS ANGELES, CA 90013 AND

MOSLEY, NORBERT L (UNITED STATES INDIVIDUAL), DBA MOCHA SOUL
830 SHORE GROVE CIRCLE #203
AUBURB HILLS, MI 48326

FOR: CLOTHING LINE, NAMELY, POLO SHIRTS, T-SHIRTS, HOODS, DENIM JEANS, BLAZERS, BEANIES, SANDALS, DRESSES, SKIRTS, PANTS, HATS, V-NECK SWEATERS, SWEATERS, BELTS, TANK TOPS, BIKINIS, BLOUSES, BRAS, BEACHWEAR, SNEAKERS, TOPS, VESTS, GLOVES, MINISKIRTS, SHOES, JOGGING OUTFITS, JOGGING PANTS, SCARVES, LEGGINGS, PANTIES, SHORTS AND BRIEFS, CAPRIS, JACKETS, SPORTS BRAS, SURF WEAR, ANKLE SOCKS, SOCKS, BATHING CAPS, BATHROBES, UNDERGARMENTS, UNDERSHIRTS, UNDERWEAR, ADHESIVE BRAS, WINTER BOOTS, WOOLLY HATS, CHILDREN AND INFANT BIBS MADE OF CLOTH AND PLASTIC, CHILDREN'S HEADWEAR, EAR MUFFS, FLEECE PULLOVERS, FOOTWEAR FOR MAN AND WOMAN, COATS, LADIES BOOTS, LACE BOOTS, AND LEATHER JACKETS, IN CLASS 25 (U.S. CLS. 22 AND 39).

FIRST USE 1-1-2009; IN COMMERCE 1-1-2009.

OWNER OF U.S. REG. NO. 3,424,341.

THE MARK CONSISTS OF A STYLIZED SKUNK ABOVE THE WORDING "MOCHA SOUL" IN A STYLIZED FONT. THE WORDING "LIVE YOUR DREAMS." APPEARS IN A STYLIZED FONT BELOW THE WORDING "MOCHA SOUL".

SER. NO. 85-112,461, FILED 8-20-2010.

COLLEEN DOMBROW, EXAMINING ATTORNEY



David J. Kyros

Director of the United States Patent and Trademark Office

United States of America

United States Patent and Trademark Office



Reg. No. 4,065,589

Registered Dec. 6, 2011

Int. Cls.: 20, 24 and 35

TRADEMARK

SERVICE MARK

PRINCIPAL REGISTER

HASTENS SANGAR AB (SWEDEN CORPORATION)
BOX 130
KOPING, SWEDEN 73123

FOR: FURNITURE, INCLUDING BEDS, BEDSTEADS AND BEDROOM FURNITURE; MIRRORS, INCLUDING TOILET MIRRORS; PICTURE FRAMES; MATTRESSES; SPRING MATTRESSES; PILLOWS AND DOWN PILLOWS, IN CLASS 20 (U.S. CLS. 2, 13, 22, 25, 32 AND 50).

FOR: WOVEN TEXTILES, NAMELY, SHEETS, TOWELS, BED BLANKETS; TEXTILE PRODUCTS, NOT INCLUDED IN OTHER CLASSES, NAMELY, BED SPREADS, CURTAINS OF TEXTILE OR PLASTIC; MATTRESS COVERS, BED BLANKETS, AND BEDDING PRODUCTS IN THE NATURE OF SHEETS, COMFORTERS AND PILLOW CASES; BED LINEN; DOWN QUILTS, IN CLASS 24 (U.S. CLS. 42 AND 50).

FOR: BUSINESS MANAGEMENT CONSULTANCY; BUSINESS MANAGEMENT ASSISTANCE; IMPORT-EXPORT AGENCIES; SALES PROMOTION FOR OTHERS; BUSINESS INFORMATION; BUSINESS RESEARCH; MARKET STUDIES; OPINION POLLING; PROCUREMENT SERVICES FOR OTHERS, NAMELY, PURCHASING FURNITURE, TEXTILE PRODUCTS AND INTERIOR DECORATION FOR OTHER ENTERPRISES; ADVERTISEMENT SERVICES FOR OTHERS; PRESENTATION OF GOODS ON COMMUNICATION MEDIA FOR RETAIL PURPOSE, IN CLASS 35 (U.S. CLS. 100, 101 AND 102).

OWNER OF SWEDEN REG. NO. 394820, DATED 3-20-2008, EXPIRES 3-20-2018.

THE MARK CONSISTS OF A STYLIZED RUNNING HORSE.

SER. NO. 85-113,167, FILED 8-23-2010.

ANNE MADDEN, EXAMINING ATTORNEY



David J. Kybas

Director of the United States Patent and Trademark Office

United States of America

United States Patent and Trademark Office

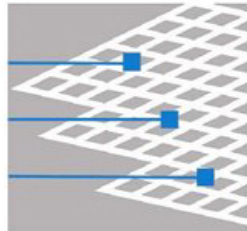

AirFlow
Catalyst Systems

Reg. No. 4,065,590

Registered Dec. 6, 2011

Int. Cls.: 2, 7 and 37

TRADEMARK

SERVICE MARK

PRINCIPAL REGISTER

AIRFLOW CATALYST SYSTEMS, INC. (DELAWARE CORPORATION)
SUITE 925
183 EAST MAIN STREET
ROCHESTER, NY 14604

FOR: CATALYTIC COATINGS FOR ENGINE EXHAUST EMISSION REDUCTION, NAMELY, METAL OXIDES FOR COATING SUBSTRATES FOR ABATING UNDESIRABLE DIESEL EXHAUST GASEOUS EMISSIONS, IN CLASS 2 (U.S. CLS. 6, 11 AND 16).

FIRST USE 3-1-2010; IN COMMERCE 3-1-2010.

FOR: ENGINE EXHAUST EMISSION REDUCTION UNITS FOR MOTORS AND ENGINES, NAMELY, CATALYTIC CONVERTERS, IN CLASS 7 (U.S. CLS. 13, 19, 21, 23, 31, 34 AND 35).

FIRST USE 3-1-2010; IN COMMERCE 3-1-2010.

FOR: APPLICATION OF COATINGS FOR OTHERS, IN CLASS 37 (U.S. CLS. 100, 103 AND 106).

FIRST USE 1-1-2009; IN COMMERCE 1-1-2009.

NO CLAIM IS MADE TO THE EXCLUSIVE RIGHT TO USE "CATALYST" AND "SYSTEMS", APART FROM THE MARK AS SHOWN.

THE COLOR(S) BLUE, GREY AND WHITE IS/ARE CLAIMED AS A FEATURE OF THE MARK.

THE MARK CONSISTS OF THE WORDS "AIRFLOW CATALYST SYSTEMS" IN BLUE WITH A SQUARE GREY BOX TO THE LEFT OF THE WORDS CONTAINING A WHITE GRID PATTERN IN A PORTION OF THE BOX WITH BLUE LINES TERMINATING IN SMALL SQUARES ON TOP OF THE GRID PATTERN.

SER. NO. 85-113,648, FILED 8-23-2010.

EUGENIA MARTIN, EXAMINING ATTORNEY

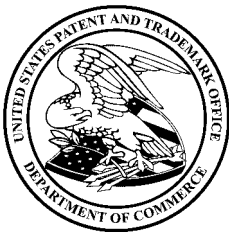

David J. Kyjars

Director of the United States Patent and Trademark Office

United States of America

United States Patent and Trademark Office

LONGWELL

Reg. No. 4,065,591

Registered Dec. 6, 2011

Int. Cl.: 9

TRADEMARK

PRINCIPAL REGISTER

LONGWELL COMPANY (TAIWAN CORPORATION)
10F., NO.36, CHANG AN EAST ROAD, SEC.1
TAIPEI, TAIWAN

FOR: ELECTRICAL WIRE; POWER SUPPLY CORDS; ELECTRICAL FLEXIBLE FLAT CABLES; ELECTRICAL COMPUTER INTERCONNECT CABLES; ELECTRICAL AC POWER CORDS; ELECTRICAL SIGNAL CONNECTORS, IN CLASS 9 (U.S. CLS. 21, 23, 26, 36 AND 38).

FIRST USE 9-23-1974; IN COMMERCE 9-23-1974.

THE MARK CONSISTS OF STANDARD CHARACTERS WITHOUT CLAIM TO ANY PARTICULAR FONT, STYLE, SIZE, OR COLOR.

SEC. 2(F).

SER. NO. 85-113,819, FILED 8-23-2010.

ZACHARY BELLO, EXAMINING ATTORNEY



David J. Kypos

Director of the United States Patent and Trademark Office

United States of America

United States Patent and Trademark Office

THE BIRTHDAY COMPANY

Reg. No. 4,065,592

Registered Dec. 6, 2011

Int. Cl.: 35

SERVICE MARK

PRINCIPAL REGISTER

THE BIRTHDAY COMPANY, INC. (IOWA CORPORATION)
531 HIGHLAND PARK AVE
CORALLVILLE, IA 52241

FOR: MANAGEMENT OF CUSTOMER APPRECIATION PROGRAMS OF OTHERS, IN CLASS
35 (U.S. CLS. 100, 101 AND 102).

FIRST USE 7-5-2006; IN COMMERCE 7-5-2006.

THE MARK CONSISTS OF STANDARD CHARACTERS WITHOUT CLAIM TO ANY PAR-
TICULAR FONT, STYLE, SIZE, OR COLOR.

NO CLAIM IS MADE TO THE EXCLUSIVE RIGHT TO USE "COMPANY", APART FROM
THE MARK AS SHOWN.

SEC. 2(F).

SER. NO. 85-116,913, FILED 8-26-2010.

KIMBERLY FRYE, EXAMINING ATTORNEY



David J. Kybas

Director of the United States Patent and Trademark Office

United States of America

United States Patent and Trademark Office

REFLECTIONS

Reg. No. 4,065,593

Registered Dec. 6, 2011

Int. Cl.: 20

TRADEMARK

PRINCIPAL REGISTER

MBC IP CO. (DELAWARE CORPORATION)
P.O. BOX 420
ONE MASTERBRAND CABINETS DRIVE
JASPER, IN 475470420

FOR: KITCHEN AND BATHROOM CABINETS COMPRISED PRIMARILY OF WOOD THAT WHEN INSTALLED ARE PERMANENTLY AFFIXED OR MOUNTED TO THE WALLS OR FLOORS OF A BUILDING , IN CLASS 20 (U.S. CLS. 2, 13, 22, 25, 32 AND 50).

FIRST USE 9-0-2002; IN COMMERCE 9-0-2002.

THE MARK CONSISTS OF STANDARD CHARACTERS WITHOUT CLAIM TO ANY PARTICULAR FONT, STYLE, SIZE, OR COLOR.

SER. NO. 85-117,668, FILED 8-27-2010.

WANDA KAY PRICE, EXAMINING ATTORNEY



David J. Kyros

Director of the United States Patent and Trademark Office

United States of America

United States Patent and Trademark Office

HALLE JOY

Reg. No. 4,065,594

Registered Dec. 6, 2011

Int. Cl.: 35

SERVICE MARK

PRINCIPAL REGISTER

HALLE JOY, LLC (TEXAS LIMITED LIABILITY COMPANY)
1201 W. MAGNOLIA AVE.
FORT WORTH, TX 76104

FOR: RETAIL STORE AND ONLINE RETAIL STORE SERVICES FEATURING JEWELRY,
THE PROFITS FROM WHICH ARE SHARED WITH VARIOUS CHARITIES, IN CLASS 35
(U.S. CLS. 100, 101 AND 102).

FIRST USE 6-30-2010; IN COMMERCE 7-8-2010.

THE MARK CONSISTS OF STANDARD CHARACTERS WITHOUT CLAIM TO ANY PAR-
TICULAR FONT, STYLE, SIZE, OR COLOR.

THE NAME "HALLE JOY" DOES NOT IDENTIFY A LIVING INDIVIDUAL.

SER. NO. 85-117,812, FILED 8-27-2010.

PAUL MORENO, EXAMINING ATTORNEY



David J. Kybas

Director of the United States Patent and Trademark Office

United States of America

United States Patent and Trademark Office

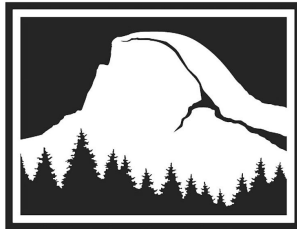

YOSEMITE
CONSERVANCY

Reg. No. 4,065,595

Registered Dec. 6, 2011

Int. Cl.: 41

SERVICE MARK

PRINCIPAL REGISTER

YOSEMITE FOUNDATION (CALIFORNIA NON-PROFIT CORPORATION)
101 MONTGOMERY STREET
SUITE 1700
SAN FRANCISCO, CA 941044129

FOR: PUBLICATION OF BOOKS, MAGAZINES AND JOURNALS; PROVIDING ONLINE PUBLICATIONS IN THE NATURE OF NEWSLETTERS AND MAGAZINES IN THE FIELDS OF CONSERVATION OF NATURAL RESOURCES, BIOLOGY, BOTANY, ART, PHOTOGRAPHY, AND HISTORY; EDUCATIONAL SERVICES, NAMELY, PROVIDING CLASSES, SEMINARS AND WORKSHOPS IN THE FIELDS OF CONSERVATION OF NATURAL RESOURCES, BIOLOGY, BOTANY, ART, PHOTOGRAPHY, AND HISTORY; ARRANGING ART EXHIBITIONS IN THE FIELDS OF CONSERVATION OF NATURAL RESOURCES, BIOLOGY, BOTANY, ART, PHOTOGRAPHY, AND HISTORY; PROVIDING A WEBSITE FEATURING INFORMATION IN THE FIELDS OF PHOTOGRAPHY AND HISTORY; ARRANGING AND CONDUCTING OF FAIRS AND EXHIBITIONS IN THE FIELDS OF CONSERVATION OF NATURAL RESOURCES, BIOLOGY, BOTANY, ART, PHOTOGRAPHY, AND HISTORY; RENTAL OF CAMPING AND HIKING EQUIPMENT, NAMELY, RENTAL OF BEAR-PROOF CAMPING STORAGE CONTAINERS, SNOWSHOES, IN CLASS 41 (U.S. CLS. 100, 101 AND 107).

FIRST USE 11-15-2010; IN COMMERCE 11-15-2010.

OWNER OF U.S. REG. NO. 3,190,567.

NO CLAIM IS MADE TO THE EXCLUSIVE RIGHT TO USE "YOSEMITE CONSERVANCY", APART FROM THE MARK AS SHOWN.

THE MARK CONSISTS OF A MOUNTAIN WITH TREES IN FRONT INSIDE A SQUARE BORDER WITH THE WORDS "YOSEMITE CONSERVANCY" BELOW THE DESIGN.

SER. NO. 85-117,999, FILED 8-27-2010.

JAMES STEIN, EXAMINING ATTORNEY



David J. Kybas

Director of the United States Patent and Trademark Office

United States of America

United States Patent and Trademark Office

Weeset Advisors

Reg. No. 4,065,596

Registered Dec. 6, 2011

Int. Cl.: 35

SERVICE MARK

PRINCIPAL REGISTER

HOWARD, ROBERT (MASSACHUSETTS LIMITED LIABILITY COMPANY), DBA WEESET
ADVISORS
ROBERT HOWARD
ORLEANS, MA 02653

FOR: BUSINESS MANAGEMENT CONSULTING AND ADVISORY SERVICES, IN CLASS
35 (U.S. CLS. 100, 101 AND 102).

FIRST USE 3-4-2010; IN COMMERCE 3-4-2010.

THE MARK CONSISTS OF STANDARD CHARACTERS WITHOUT CLAIM TO ANY PAR-
TICULAR FONT, STYLE, SIZE, OR COLOR.

NO CLAIM IS MADE TO THE EXCLUSIVE RIGHT TO USE "ADVISORS", APART FROM
THE MARK AS SHOWN.

SER. NO. 85-118,693, FILED 8-30-2010.

LAURA KOVALSKY, EXAMINING ATTORNEY



David J. Kybas

Director of the United States Patent and Trademark Office

United States of America

United States Patent and Trademark Office



Reg. No. 4,065,597

Registered Dec. 6, 2011

Int. Cl.: 28

TRADEMARK

PRINCIPAL REGISTER

MOOSE CREATIVE PTY LTD (AUSTRALIA LIMITED LIABILITY COMPANY)
7-13 ARDENA COURT
EAST BENTLEIGH, AUSTRALIA 3165

FOR: TOY RACING TRACKS; TOY RACING TRACK SETS COMPRISED OF PLASTIC AND VINYL TOY CHARACTERS, STICKERS, TOY RACE TRACK ENVIRONMENTS AND ACCESSORIES THEREFOR; POUCHES SPECIALLY DESIGNED FOR TOY CHARACTERS; STORAGE CASES SPECIALLY DESIGNED FOR TOY CHARACTERS; STORAGE CASES SPECIALLY DESIGNED FOR TOY RACING TRACKS; STORAGE CASES SPECIALLY DESIGNED FOR TOY RACING TRACK SETS, IN CLASS 28 (U.S. CLS. 22, 23, 38 AND 50).

PRIORITY CLAIMED UNDER SEC. 44(D) ON AUSTRALIA APPLICATION NO. 1351776, FILED 3-19-2010, REG. NO. 1351776, DATED 2-11-2011, EXPIRES 3-19-2020.

THE COLOR(S) BLUE, LIGHT BLUE, WHITE IS/ARE CLAIMED AS A FEATURE OF THE MARK.

NO CLAIM IS MADE TO THE EXCLUSIVE RIGHT TO USE "TRACK", APART FROM THE MARK AS SHOWN.

THE MARK CONSISTS OF THE STYLIZED WORDING "FLIP TRACK," WHERE THE LETTERS APPEAR IN WHITE OUTLINED IN BLUE. THE "K" EXTENDS INTO A TRACK THAT HOLDS A LIGHT BLUE FIGURE OUTLINED IN BLUE WITH WHITE EYES AND TEETH. THERE ARE BLUE WAVY LINES INDICATING MOVEMENT TO THE RIGHT OF THE DESIGN. THE BACKGROUND OF THE MARK IS TRANSPARENT.

SER. NO. 85-119,277, FILED 8-30-2010.

ANDREA HACK, EXAMINING ATTORNEY



David J. Kybas

Director of the United States Patent and Trademark Office

United States of America

United States Patent and Trademark Office



BY LEFT COAST SPORTS INNOVATIONS, LLC.

Reg. No. 4,065,598

Registered Dec. 6, 2011

Int. Cl.: 10

TRADEMARK

PRINCIPAL REGISTER

GRIP-N-RIDE, LLC (CALIFORNIA LIMITED LIABILITY COMPANY)
STE. 350
1258 N HIGHLAND AVE
LOS ANGELES, CA 90038

FOR: A ONE SIZE FITS ALL BELT FOR PATIENTS AND CAREGIVERS WORN AROUND THE WAIST THAT ALLOWS FOR MORE ASSISTED MOBILITY, MANEUVERABILITY, FLEXIBILITY AND SECURITY FOR MEDICAL USE, IN CLASS 10 (U.S. CLS. 26, 39 AND 44).

FIRST USE 5-31-2010; IN COMMERCE 5-31-2010.

NO CLAIM IS MADE TO THE EXCLUSIVE RIGHT TO USE "SPORTS" AND "LLC", APART FROM THE MARK AS SHOWN.

THE MARK CONSISTS OF THE STYLIZED TEST "GRIP N ASSIST" INSIDE OF A TRIANGLE LIKE SHIELD AND THE WORDS "BY LEFT COAST SPORTS INNOVATIONS, LLC." AT THE BOTTOM OF THE SHIELD.

SER. NO. 85-120,287, FILED 8-31-2010.

CHARLES L. JENKINS, EXAMINING ATTORNEY



David J. Kybas

Director of the United States Patent and Trademark Office

United States of America

United States Patent and Trademark Office

Draftmore

Reg. No. 4,065,599

Registered Dec. 6, 2011

Int. Cl.: 9

TRADEMARK

PRINCIPAL REGISTER

GRAM, JESPER (DENMARK INDIVIDUAL)
SLOTSGADE 35 E
AABENRAA, DENMARK

FOR: CONTROL VALVES FOR REGULATING THE FLOW OF GASES AND LIQUIDS; FLOW REGULATORS FOR DRAFT BEER SYSTEM USE; PRESSURE REGULATORS FOR DRAFT BEER SYSTEMS EXCEPT FOR REGULATORS FOR GAS, WATER OR OTHER SANITARY INSTALLATIONS; VALVES FOR CONTROLLING AND REGULATING THE FLOW OF GASES OR LIQUIDS NOT BEING PARTS OF PLUMBING, HEATING, COOLING INSTALLATIONS OR MACHINES, IN CLASS 9 (U.S. CLS. 21, 23, 26, 36 AND 38).

FIRST USE 4-16-2009; IN COMMERCE 4-16-2009.

THE MARK CONSISTS OF STANDARD CHARACTERS WITHOUT CLAIM TO ANY PARTICULAR FONT, STYLE, SIZE, OR COLOR.

SER. NO. 85-120,426, FILED 9-1-2010.

SEAN CROWLEY, EXAMINING ATTORNEY



David J. Kyros

Director of the United States Patent and Trademark Office

United States of America

United States Patent and Trademark Office

BELO HERITAGE SOCIETY

Reg. No. 4,065,600

Registered Dec. 6, 2011

Int. Cl.: 36

SERVICE MARK

PRINCIPAL REGISTER

DALLAS BAR FOUNDATION (TEXAS NON-PROFIT CORPORATION)
2101 ROSS AVENUE
DALLAS, TX 75201

FOR: CHARITABLE FUNDRAISING SERVICES; MANAGING ENDOWMENT FUNDS FOR CHARITABLE PURPOSES, NAMELY, ACCEPTING AND ADMINISTERING MONETARY CHARITABLE CONTRIBUTIONS, IN CLASS 36 (U.S. CLS. 100, 101 AND 102).

FIRST USE 11-30-2009; IN COMMERCE 11-30-2009.

THE MARK CONSISTS OF STANDARD CHARACTERS WITHOUT CLAIM TO ANY PARTICULAR FONT, STYLE, SIZE, OR COLOR.

NO CLAIM IS MADE TO THE EXCLUSIVE RIGHT TO USE "HERITAGE SOCIETY", APART FROM THE MARK AS SHOWN.

THE ENGLISH TRANSLATION OF THE WORD "BELO" IN THE MARK IS "BEAUTIFUL".

SER. NO. 85-120,898, FILED 9-1-2010.

KRISTIN DAHLING, EXAMINING ATTORNEY



David J. Kybas

Director of the United States Patent and Trademark Office

United States of America

United States Patent and Trademark Office

CHEER FOR A CURE

Reg. No. 4,065,601

Registered Dec. 6, 2011

Int. Cls.: 25 and 36

TRADEMARK

SERVICE MARK

PRINCIPAL REGISTER

STELLA BERTZ MEMORIAL CHEERLEADING ASSOCIATION (OHIO NON-PROFIT CORPORATION)
1607 DANIEL DRIVE
MILLBURY, OH 43447

FOR: CLOTHING ITEMS, NAMELY, T-SHIRTS, SWEATSHIRTS, HOODED SWEATSHIRTS, POLO SHIRTS, LONG-SLEEVE SHIRTS, BANDANAS, WRIST BANDS, SWEATPANTS, CAPRI SWEATPANTS, AND SHORTS, IN CLASS 25 (U.S. CLS. 22 AND 39).

FIRST USE 2-5-2005; IN COMMERCE 2-5-2005.

FOR: CHARITABLE FUNDRAISING SERVICES BY MEANS OF ORGANIZING AND CONDUCTING CHEERLEADING COMPETITIONS AND EVENTS TO RAISE AWARENESS OF AND MONEY FOR CANCER, EXCLUDING SERVICES RELATING TO BREAST CANCER, IN CLASS 36 (U.S. CLS. 100, 101 AND 102).

FIRST USE 2-5-2005; IN COMMERCE 2-5-2005.

THE MARK CONSISTS OF STANDARD CHARACTERS WITHOUT CLAIM TO ANY PARTICULAR FONT, STYLE, SIZE, OR COLOR.

NO CLAIM IS MADE TO THE EXCLUSIVE RIGHT TO USE "CHEER", APART FROM THE MARK AS SHOWN.

SER. NO. 85-121,075, FILED 9-1-2010.

KAPIL BHANOT, EXAMINING ATTORNEY



David J. Kyffers

Director of the United States Patent and Trademark Office

United States of America

United States Patent and Trademark Office

ATLAS

Reg. No. 4,065,602

Registered Dec. 6, 2011

Int. Cl.: 4

TRADEMARK

PRINCIPAL REGISTER

ATLAS MARKETING, LLC (IDAHO LIMITED LIABILITY COMPANY)
16620 W. PRAIRIE AVE.
HAUSER, ID 83854

FOR: FUEL PELLETS, IN CLASS 4 (U.S. CLS. 1, 6 AND 15).

FIRST USE 10-1-1996; IN COMMERCE 10-1-1996.

THE MARK CONSISTS OF STANDARD CHARACTERS WITHOUT CLAIM TO ANY PARTICULAR FONT, STYLE, SIZE, OR COLOR.

OWNER OF U.S. REG. NO. 2,112,375.

SER. NO. 85-121,262, FILED 9-1-2010.

GISELLE AGOSTO, EXAMINING ATTORNEY



David J. Kybas

Director of the United States Patent and Trademark Office

United States of America

United States Patent and Trademark Office

BEL-O Sales & Service

Reg. No. 4,065,603

Registered Dec. 6, 2011

Int. Cl.: 37

SERVICE MARK

PRINCIPAL REGISTER

BEL-O SALES & SERVICE, INC. (ILLINOIS CORPORATION)
5909 COOL SPORTS ROAD
BELLEVILLE, IL 62223

FOR: INSTALLATION, MAINTENANCE AND REPAIR OF HEATING AND COOLING SYSTEMS; PLUMBING SERVICES, IN CLASS 37 (U.S. CLS. 100, 103 AND 106).

FIRST USE 0-0-1961; IN COMMERCE 5-20-2008.

THE MARK CONSISTS OF STANDARD CHARACTERS WITHOUT CLAIM TO ANY PARTICULAR FONT, STYLE, SIZE, OR COLOR.

NO CLAIM IS MADE TO THE EXCLUSIVE RIGHT TO USE "SALES & SERVICE", APART FROM THE MARK AS SHOWN.

SER. NO. 85-121,697, FILED 9-2-2010.

KATHLEEN M. VANSTON, EXAMINING ATTORNEY



David J. Kybas

Director of the United States Patent and Trademark Office

United States of America

United States Patent and Trademark Office

If Comfort Is Your Plan Call the Bel-O Man

Reg. No. 4,065,604

BEL-O SALES & SERVICE, INC. (ILLINOIS CORPORATION)
5909 COOL SPORTS ROAD
BELLEVILLE, IL 62223

Registered Dec. 6, 2011

Int. Cl.: 37

FOR: INSTALLATION, MAINTENANCE AND REPAIR OF HEATING AND COOLING SYSTEMS; PLUMBING SERVICES, IN CLASS 37 (U.S. CLS. 100, 103 AND 106).

SERVICE MARK

FIRST USE 6-10-2005; IN COMMERCE 5-20-2008.

PRINCIPAL REGISTER

THE MARK CONSISTS OF STANDARD CHARACTERS WITHOUT CLAIM TO ANY PARTICULAR FONT, STYLE, SIZE, OR COLOR.

SER. NO. 85-121,882, FILED 9-2-2010.

KATHLEEN M. VANSTON, EXAMINING ATTORNEY



David J. Kybas

Director of the United States Patent and Trademark Office

United States of America

United States Patent and Trademark Office

VISION RESOURCES

Reg. No. 4,065,605

Registered Dec. 6, 2011

Int. Cl.: 4

TRADEMARK

PRINCIPAL REGISTER

VISION RESOURCES, INC. (TEXAS CORPORATION)
SUITE 300
1100 LOUISIANA
HOUSTON, TX 77002

FOR: CRUDE OIL AND CRUDE OIL CONDENSATES, IN CLASS 4 (U.S. CLS. 1, 6 AND 15).

FIRST USE 1-1-1991; IN COMMERCE 1-1-1991.

THE MARK CONSISTS OF STANDARD CHARACTERS WITHOUT CLAIM TO ANY PARTICULAR FONT, STYLE, SIZE, OR COLOR.

NO CLAIM IS MADE TO THE EXCLUSIVE RIGHT TO USE "RESOURCES", APART FROM THE MARK AS SHOWN.

SER. NO. 85-123,761, FILED 9-7-2010.

STEVEN PEREZ, EXAMINING ATTORNEY



David J. Kybas

Director of the United States Patent and Trademark Office

United States of America

United States Patent and Trademark Office

VICTORY JOURNAL

Reg. No. 4,065,606

Registered Dec. 6, 2011

Int. Cl.: 41

SERVICE MARK

PRINCIPAL REGISTER

OFFICE OF AIR LLC (NEW YORK LIMITED LIABILITY COMPANY)
902 BROADWAY, 20TH FLOOR
NEW YORK, NY 10010

FOR: PROVIDING A WEBSITE FEATURING NON-DOWNLOADABLE PUBLICATIONS IN THE NATURE OF MAGAZINES IN THE FIELD OF SPORTS AND CULTURE, ART, ILLUSTRATION, INTERVIEWS, FASHION EDITORIALS AND FICTION, IN CLASS 41 (U.S. CLS. 100, 101 AND 107).

FIRST USE 6-1-2010; IN COMMERCE 6-24-2010.

THE MARK CONSISTS OF STANDARD CHARACTERS WITHOUT CLAIM TO ANY PARTICULAR FONT, STYLE, SIZE, OR COLOR.

NO CLAIM IS MADE TO THE EXCLUSIVE RIGHT TO USE "JOURNAL", APART FROM THE MARK AS SHOWN.

SER. NO. 85-123,899, FILED 9-7-2010.

DAVID COLLIER, EXAMINING ATTORNEY



David J. Kyros

Director of the United States Patent and Trademark Office

United States of America

United States Patent and Trademark Office

SEEDER

Reg. No. 4,065,607

Registered Dec. 6, 2011

Int. Cls.: 35, 38, 42 and 45

SERVICE MARK

PRINCIPAL REGISTER

SEEDER CONNECT CORPORATION (CANADA CORPORATION)
5300 ADMIRAL WAY, SUITE 26,
DELTA, BRITISH COLUMBI, CANADA V4K5G6

FOR: OPERATION OF AN ONLINE NETWORKING WEBSITE TO FACILITATE BUSINESS NETWORKING BETWEEN INDIVIDUALS AND/OR BUSINESSES, IN CLASS 35 (U.S. CLS. 100, 101 AND 102).

FOR: PROVIDING ONLINE CHAT ROOMS AND ELECTRONIC BULLETIN BOARDS FOR TRANSMISSION OF MESSAGES AMONG COMPUTER USERS FOR PURPOSES OF SOCIAL AND BUSINESS NETWORKING, IN CLASS 38 (U.S. CLS. 100, 101 AND 104).

FOR: PROVIDING A WEB SITE ALLOWING USERS TO UPLOAD, POST AND DISPLAY ONLINE AUDIO AND VIDEO CONTENT FOR SOCIAL AND BUSINESS NETWORKING PURPOSES, IN CLASS 42 (U.S. CLS. 100 AND 101).

FOR: OPERATION OF AN ONLINE NETWORKING WEBSITE TO FACILITATE SOCIAL NETWORKING BETWEEN INDIVIDUALS AND/OR BUSINESSES, IN CLASS 45 (U.S. CLS. 100 AND 101).

THE MARK CONSISTS OF STANDARD CHARACTERS WITHOUT CLAIM TO ANY PARTICULAR FONT, STYLE, SIZE, OR COLOR.

PRIORITY CLAIMED UNDER SEC. 44(D) ON CANADA APPLICATION NO. 1494868, FILED 9-7-2010, REG. NO. 802538, DATED 7-20-2011, EXPIRES 7-20-2026.

SER. NO. 85-124,668, FILED 9-8-2010.

VIVIAN MICZNIK FIRST, EXAMINING ATTORNEY



David J. Kyros

Director of the United States Patent and Trademark Office

United States of America

United States Patent and Trademark Office

HUR HEALTH AND FITNESS EQUIPMENT

Reg. No. 4,065,608

Registered Dec. 6, 2011

Int. Cl.: 28

TRADEMARK

PRINCIPAL REGISTER

HUR USA INC (DELAWARE CORPORATION)
SUITE 108
1500 SHERMER ROAD,
NORTHBROOK, IL 60026

FOR: MANUALLY-OPERATED EXERCISE EQUIPMENT FOR PHYSICAL FITNESS PURPOSES; FITNESS EQUIPMENT, NAMELY, BALANCE BOARDS, IN CLASS 28 (U.S. CLS. 22, 23, 38 AND 50).

FIRST USE 1-1-2008; IN COMMERCE 1-1-2008.

THE MARK CONSISTS OF STANDARD CHARACTERS WITHOUT CLAIM TO ANY PARTICULAR FONT, STYLE, SIZE, OR COLOR.

NO CLAIM IS MADE TO THE EXCLUSIVE RIGHT TO USE "HEALTH AND FITNESS EQUIPMENT", APART FROM THE MARK AS SHOWN.

SER. NO. 85-124,685, FILED 9-8-2010.

ERNEST SHOSHO, EXAMINING ATTORNEY



David J. Kyros

Director of the United States Patent and Trademark Office

United States of America

United States Patent and Trademark Office

FURIA MUSICAL

Reg. No. 4,065,609

Registered Dec. 6, 2011

Int. Cl.: 41

SERVICE MARK

PRINCIPAL REGISTER

TELEVISA, S.A. DE C.V. (MEXICO CORPORATION)
EDIFICIO A PISO 4 COLONIA ZEDEC
AVENIDA VASCO DE QUIROGA 2000
SANTA FE, MEXICO 01210

FOR: ENTERTAINMENT SERVICES RENDERED THROUGH TELEVISION NAMELY, A VARIETY AND MUSICAL SHOW, IN CLASS 41 (U.S. CLS. 100, 101 AND 107).

FIRST USE 7-10-1993; IN COMMERCE 8-5-2006.

THE MARK CONSISTS OF STANDARD CHARACTERS WITHOUT CLAIM TO ANY PARTICULAR FONT, STYLE, SIZE, OR COLOR.

THE ENGLISH TRANSLATION OF "FURIA MUSICAL" IN THE MARK IS "MUSICAL FURY".

SER. NO. 85-125,212, FILED 9-8-2010.

RAMONA ORTIGA, EXAMINING ATTORNEY



David J. Kybas

Director of the United States Patent and Trademark Office

United States of America

United States Patent and Trademark Office

MOMoZoom

Reg. No. 4,065,610

YANG, SAN KUAN (UNITED STATES INDIVIDUAL)
1752 PINNACLE WAY
UPLAND, CA 91748

Registered Dec. 6, 2011

Int. Cl.: 9

FOR: CONSUMER ELECTRONIC PRODUCTS, NAMELY, POWER CONVERSION DEVICES, POWER CONVERTERS, AND POWER INVERTERS; REMOTE CONTROLS FOR AFTER-MARKET AUTOMOTIVE SPEED MONITOR; SPEEDOMETERS FOR VEHICLES, IN CLASS 9 (U.S. CLS. 21, 23, 26, 36 AND 38).

TRADEMARK

PRINCIPAL REGISTER

FIRST USE 9-3-2010; IN COMMERCE 9-3-2010.

THE MARK CONSISTS OF THE STYLIZED LETTERS "MOMOZOOM".

SER. NO. 85-126,100, FILED 9-9-2010.

MAUREEN DALL, EXAMINING ATTORNEY



David J. Kyffers

Director of the United States Patent and Trademark Office

United States of America

United States Patent and Trademark Office



Reg. No. 4,065,611

Registered Dec. 6, 2011

Int. Cl.: 38

SERVICE MARK

PRINCIPAL REGISTER

LINKLINE COMMUNICATIONS, INC. (CALIFORNIA CORPORATION)
360 S. MILLIKEN STE. G
302 SOUTH MILLIKEN AVENUE, STE. G-1
ONTARIO, CA 91761

FOR: INTERNET SERVICE PROVIDER (ISP), IN CLASS 38 (U.S. CLS. 100, 101 AND 104).

FIRST USE 6-9-1995; IN COMMERCE 7-17-1995.

THE MARK CONSISTS OF OPPOSING CURVED ARROWS NEXT TO THE WORD "LINK-LINE".

SEC. 2(F).

SER. NO. 85-126,459, FILED 9-9-2010.

CAROLYN CATALDO, EXAMINING ATTORNEY



David J. Kybas

Director of the United States Patent and Trademark Office

United States of America

United States Patent and Trademark Office

GET THE LED OUT

Reg. No. 4,065,612

Registered Dec. 6, 2011

Int. Cls.: 16 and 25

TRADEMARK

PRINCIPAL REGISTER

HAMMOND, PAUL (PENNSYLVANIA JOINT VENTURE)
112 E NINTH ST
BRIDGEPORT, PA 19405 AND

FARIELLO, PAUL (PENNSYLVANIA JOINT VENTURE)
903 VALLEY RD
BLUE BELL, PA 19422

FOR: PRINTED PUBLICATIONS, NAMELY, SOUVENIR POSTERS, IN CLASS 16 (U.S. CLS. 2, 5, 22, 23, 29, 37, 38 AND 50).

FIRST USE 12-26-2003; IN COMMERCE 12-26-2003.

FOR: CLOTHING, NAMELY, T-SHIRTS, JACKETS, SHIRTS, SWEATSHIRTS, HOODED SWEATSHIRTS, TANK TOPS, AND HEADGEAR, NAMELY, HATS, CAPS AND BEANIES, IN CLASS 25 (U.S. CLS. 22 AND 39).

FIRST USE 12-26-2003; IN COMMERCE 12-26-2003.

THE MARK CONSISTS OF STANDARD CHARACTERS WITHOUT CLAIM TO ANY PARTICULAR FONT, STYLE, SIZE, OR COLOR.

OWNER OF U.S. REG. NO. 3,153,660.

SER. NO. 85-126,502, FILED 9-9-2010.

GISELLE AGOSTO, EXAMINING ATTORNEY



David J. Kybas

Director of the United States Patent and Trademark Office

United States of America

United States Patent and Trademark Office

IHC-FIXATIVE

Reg. No. 4,065,613

Registered Dec. 6, 2011

Int. Cl.: 1

TRADEMARK

PRINCIPAL REGISTER

SCIGEN, INC (CALIFORNIA CORPORATION)
333 EAST GARDENA BLVD
GARDENA, CA 90248

FOR: TRANSPORT AND STORE REAGENTS USED FOR SCIENTIFIC OR MEDICAL RESEARCH USE, NAMELY, IN THE FIELD OF HISTOLOGY, PATHOLOGY, MOLECULAR PATHOLOGY AND CYTOGENETICS; PHARMACEUTICAL REAGENTS AND MEDICAL AND VETERINARY DIAGNOSTIC PREPARATIONS FOR MEDICAL LABORATORY USE; DIAGNOSTIC REAGENTS FOR CLINICAL OR MEDICAL LABORATORY USE; DIAGNOSTIC REAGENTS FOR IN VITRO USE IN BIOCHEMISTRY, CLINICAL CHEMISTRY AND MICROBIOLOGY; DIAGNOSTIC REAGENTS FOR SCIENTIFIC OR RESEARCH USE; HISTOLOGY FIXATIVES; PATHOLOGY FIXATIVES AND REAGENTS FOR RESEARCH PURPOSES, FOR DIAGNOSTIC PURPOSES FOR SCIENTIFIC OR RESEARCH USE, AND FOR CHEMICAL ANALYSES; REAGENTS FOR RESEARCH PURPOSES; REAGENTS FOR SCIENTIFIC OR MEDICAL RESEARCH USE; REAGENTS FOR USE IN SCIENTIFIC APPARATUS FOR CHEMICAL OR BIOLOGICAL ANALYSIS, IN CLASS 1 (U.S. CLS. 1, 5, 6, 10, 26 AND 46).

FIRST USE 3-15-2009; IN COMMERCE 9-1-2010.

THE MARK CONSISTS OF STANDARD CHARACTERS WITHOUT CLAIM TO ANY PARTICULAR FONT, STYLE, SIZE, OR COLOR.

OWNER OF U.S. REG. NO. 3,377,734.

SER. NO. 85-126,506, FILED 9-9-2010.

SANI KHOURI, EXAMINING ATTORNEY



David J. Kybas

Director of the United States Patent and Trademark Office

United States of America

United States Patent and Trademark Office

VidShield

Reg. No. 4,065,614

Registered Dec. 6, 2011

Int. Cl.: 9

TRADEMARK

PRINCIPAL REGISTER

VIDSYS, INC. (DELAWARE CORPORATION)
SUITE 310
293 BOSTON POST ROAD WEST
MARLBOROUGH, MA 01752

FOR: MULTI-VENDOR COMPUTER SOFTWARE FOR MANAGING INCOMING VIDEO SIGNALS FOR USE IN SECURITY SYSTEMS, IN CLASS 9 (U.S. CLS. 21, 23, 26, 36 AND 38).

FIRST USE 9-1-2005; IN COMMERCE 9-1-2005.

THE MARK CONSISTS OF STANDARD CHARACTERS WITHOUT CLAIM TO ANY PARTICULAR FONT, STYLE, SIZE, OR COLOR.

SER. NO. 85-126,657, FILED 9-10-2010.

CHRIS WELLS, EXAMINING ATTORNEY



David J. Kybas

Director of the United States Patent and Trademark Office

United States of America

United States Patent and Trademark Office



Reg. No. 4,065,615

Registered Dec. 6, 2011

Int. Cl.: 30

TRADEMARK

PRINCIPAL REGISTER

ALPI ALIMENTI PROTEICI ITALIA S.R.L. (ITALY SOCIEDAD DE RESPONSABILIDAD LIMITADA (SRL))
VIALE DELLE INDUSTRIE 1
FILAGO (BERGAMO), ITALY 24040

FOR: SEMI-FINISHED PRODUCTS FOR BREADMAKING AND CONFECTIONERY, NAMELY, ALIMENTARY PASTES, PASTAS, FLOURS AND CEREAL MIXES USED TO PREPARE BREADS, PASTRIES AND SWEETS; COFFEE, TEA, COCOA, SUGAR, RICE, TAPIOCA, SAGO, ARTIFICIAL COFFEE; FLOUR AND PROCESSED CEREALS, BREAD, PASTRY AND CONFECTIONERY CHIPS FOR BAKING; FLAVORED ICES; HONEY, TREACLE; YEAST, BAKING POWDER; SALT, MUSTARD; VINEGAR, SAUCES, CONDIMENTS, NAMELY, SALAD DRESSING, SPICES; AND ICE, IN CLASS 30 (U.S. CL. 46).

PRIORITY CLAIMED UNDER SEC. 44(D) ON ERPN CMNTY TM OFC APPLICATION NO. 009334889, FILED 8-26-2010.

THE COLOR(S) ORANGE, BROWN, YELLOW AND BLACK IS/ARE CLAIMED AS A FEATURE OF THE MARK.

OWNER OF ERPN CMNTY TM OFC REG. NO. 009334889, DATED 2-10-2011, EXPIRES 8-26-2020.

THE MARK CONSISTS OF THE WORDING "FARINELLO" IN ORANGE AND OUTLINED IN BROWN IMPOSED ON A DESIGN OF A YELLOW AND BLACK STALK OF WHEAT.

SER. NO. 85-126,726, FILED 9-10-2010.

KATHLEEN LORENZO, EXAMINING ATTORNEY



David J. Kybas

Director of the United States Patent and Trademark Office

United States of America

United States Patent and Trademark Office

SILVERADO SENIOR LIVING

Reg. No. 4,065,616

SILVERADO SENIOR LIVING, INC. (CALIFORNIA CORPORATION)
27123 CALLE ARROYO
SAN JUAN CAPISTRANO, CA 92675

Registered Dec. 6, 2011

Int. Cl.: 43

FOR: ASSISTED LIVING COMMUNITIES SERVICES, NAMELY, PROVIDING ASSISTED LIVING FACILITIES, IN CLASS 43 (U.S. CLS. 100 AND 101).

SERVICE MARK

FIRST USE 0-0-1997; IN COMMERCE 0-0-2001.

PRINCIPAL REGISTER

THE MARK CONSISTS OF STANDARD CHARACTERS WITHOUT CLAIM TO ANY PARTICULAR FONT, STYLE, SIZE, OR COLOR.

NO CLAIM IS MADE TO THE EXCLUSIVE RIGHT TO USE "SENIOR LIVING", APART FROM THE MARK AS SHOWN.

SER. NO. 85-126,969, FILED 9-10-2010.

RUDY R. SINGLETON, EXAMINING ATTORNEY



David J. Kybas

Director of the United States Patent and Trademark Office

United States of America

United States Patent and Trademark Office

SECRETO DE VIU MANENT

Reg. No. 4,065,617

Registered Dec. 6, 2011

Int. Cl.: 33

TRADEMARK

PRINCIPAL REGISTER

VIU MANENT & CIA LTDA. (CHILE CORPORATION)
ANTONIO VARAS 2740
NUNOA, SANTIAGO, CHILE

FOR: WINES, IN CLASS 33 (U.S. CLS. 47 AND 49).

FIRST USE 12-0-2009; IN COMMERCE 12-0-2009.

THE MARK CONSISTS OF STANDARD CHARACTERS WITHOUT CLAIM TO ANY PARTICULAR FONT, STYLE, SIZE, OR COLOR.

OWNER OF U.S. REG. NO. 2,188,427.

THE NAME "VIU MANET" DOES NOT IDENTIFY A LIVING INDIVIDUAL.

THE ENGLISH TRANSLATION OF "SECRETO DE VIU MANENT" IN THE MARK IS "THE SECRET OF VIU MANENT".

SER. NO. 85-127,376, FILED 9-10-2010.

REGINA DRUMMOND, EXAMINING ATTORNEY



David J. Kybas

Director of the United States Patent and Trademark Office

United States of America

United States Patent and Trademark Office



Reg. No. 4,065,618

Registered Dec. 6, 2011

Int. Cls.: 16 and 28

TRADEMARK

PRINCIPAL REGISTER

THAMES & KOSMOS LLC (RHODE ISLAND LIMITED LIABILITY COMPANY)
301 FRIENDSHIP STREET
PROVIDENCE, RI 02903

FOR: PRINTED INSTRUCTIONAL, EDUCATIONAL AND TEACHING MATERIALS IN THE AREA OF SCIENCE, TECHNOLOGY, ENGINEERING, CRAFT AND CREATION, IN CLASS 16 (U.S. CLS. 2, 5, 22, 23, 29, 37, 38 AND 50).

FIRST USE 4-28-2001; IN COMMERCE 4-28-2001.

FOR: TOYS AND PLAYTHINGS, NAMELY, TOY SCIENCE KITS, TOY CHEMISTRY SETS THAT INCLUDE CHEMICAL SUPPLIES AND INSTRUCTIONS, TOY PHYSICS KITS CONTAINING PHYSICAL SCIENCE EXPERIMENT SUPPLIES AND INSTRUCTIONS, TOY ELECTRONIC KITS CONTAINING SMALL ELECTRONIC DEVICES AND INSTRUCTIONS FOR CREATING ELECTRONIC TOYS, TOY MICROSCOPES, AND TOY CONSTRUCTION SETS, IN CLASS 28 (U.S. CLS. 22, 23, 38 AND 50).

FIRST USE 4-28-2001; IN COMMERCE 4-28-2001.

OWNER OF U.S. REG. NO. 2,888,262.

THE MARK CONSISTS OF FOUR OVERLAPPING CIRCLES AND THE STYLIZED TEXT, "THAMES & KOSMOS".

SEC. 2(F).

SER. NO. 85-127,384, FILED 9-10-2010.

ASMAT KHAN, EXAMINING ATTORNEY



David J. Kyros

Director of the United States Patent and Trademark Office

United States of America

United States Patent and Trademark Office

TALENT CAPITAL
singapore

Reg. No. 4,065,619

Registered Dec. 6, 2011

Int. Cls.: 16 and 38

TRADEMARK

SERVICE MARK

PRINCIPAL REGISTER

GOVERNMENT OF SINGAPORE (SINGAPORE SOVEREIGN REPUBLIC)
C/O MINISTRY OF MANPOWER
18 HAVELOCK RD #07-01
SINGAPORE, SINGAPORE 059764

FOR: ADVERTISEMENTS, NAMELY, PRINTED ADVERTISEMENTS AND ARTICLES IN THE FIELD OF TOURISM AND ECONOMIC DEVELOPMENT AND ABOUT INDIVIDUALS, ACTIVITIES AND PROJECTS THAT HAVE MADE SIGNIFICANT CONTRIBUTIONS TO THE DEVELOPMENT OF THE COUNTRY OF SINGAPORE; PRINTED NEWS REPORTS, NAMELY, PRINTED NEWS RELEASES IN THE FIELD OF TOURISM AND ECONOMIC DEVELOPMENT AND FEATURING INDIVIDUALS, ACTIVITIES, AND PROJECTS THAT HAVE MADE SIGNIFICANT CONTRIBUTIONS TO THE DEVELOPMENT OF THE COUNTRY OF SINGAPORE; PRINTED PERIODICALS IN THE FIELD OF TOURISM AND ECONOMIC DEVELOPMENT AND FEATURING INDIVIDUALS, ACTIVITIES AND PROJECTS THAT HAVE MADE SIGNIFICANT CONTRIBUTIONS TO THE DEVELOPMENT OF THE COUNTRY OF SINGAPORE; PRINTED LITERATURE, PRINTED MATTER AND PRINTED PUBLICATIONS, NAMELY, NEWSPAPERS, MAGAZINES, AND NEWSLETTERS IN THE FIELD OF TOURISM AND ECONOMIC DEVELOPMENT AND FEATURING INDIVIDUALS, ACTIVITIES AND PROJECTS THAT HAVE MADE SIGNIFICANT CONTRIBUTIONS TO THE DEVELOPMENT OF THE COUNTRY OF SINGAPORE, IN CLASS 16 (U.S. CLS. 2, 5, 22, 23, 29, 37, 38 AND 50).



FOR: TELECOMMUNICATIONS SERVICES, NAMELY, TRANSMISSION AND STREAMING OF VOICE, DATA, GRAPHICS, IMAGES, AUDIO AND VIDEO BY MEANS OF TELECOMMUNICATIONS NETWORKS, WIRELESS COMMUNICATION NETWORKS, AND THE INTERNET; ELECTRONIC DATA INTERCHANGE SERVICES; ELECTRONIC TRANSMISSION OF MESSAGES; ELECTRONIC TRANSMISSION OF DATA; BROADCASTING OF RADIO PROGRAMS; BROADCASTING OF RADIO AND TELEVISION PROGRAMS BY SATELLITE; BROADCASTING OF TELEVISION PROGRAMS; NETCASTING, NAMELY, BROADCASTING PROGRAMS OVER A GLOBAL COMPUTER NETWORK; AUDIO AND VIDEO BROADCASTING OF NEWS, IN CLASS 38 (U.S. CLS. 100, 101 AND 104).

PRIORITY CLAIMED UNDER SEC. 44(D) ON SINGAPORE APPLICATION NO. T1007356J, FILED 6-11-2010, REG. NO. T1007356J, DATED 6-11-2010, EXPIRES 6-11-2020.

David J. Kappas

Director of the United States Patent and Trademark Office

NO CLAIM IS MADE TO THE EXCLUSIVE RIGHT TO USE "SINGAPORE", APART FROM THE MARK AS SHOWN.

Reg. No. 4,065,619 THE MARK CONSISTS OF THE WORDS "TALENT CAPITAL" ABOVE THE WORD "SINGAPORE", ALL IN STYLIZED FONT, AND WITH THE "O" REPRESENTED BY A CIRCLE ON WHICH ARE THREE STYLIZED HUMAN FIGURES.

SER. NO. 85-127,422, FILED 9-10-2010.

REGINA DRUMMOND, EXAMINING ATTORNEY

United States of America

United States Patent and Trademark Office



Reg. No. 4,065,620

Registered Dec. 6, 2011

Int. Cls.: 16 and 38

TRADEMARK

SERVICE MARK

PRINCIPAL REGISTER

GOVERNMENT OF SINGAPORE (SINGAPORE SOVEREIGN REPUBLIC)
C/O MINISTRY OF MANPOWER
18 HAVELOCK RD #07-01
SINGAPORE, SINGAPORE 059764

FOR: ADVERTISEMENTS, NAMELY, PRINTED ADVERTISEMENTS AND ARTICLES IN THE FIELD OF TOURISM AND ECONOMIC DEVELOPMENT AND ABOUT INDIVIDUALS, ACTIVITIES AND PROJECTS THAT HAVE MADE SIGNIFICANT CONTRIBUTIONS TO THE DEVELOPMENT OF THE COUNTRY OF SINGAPORE; PRINTED NEWS REPORTS, NAMELY, PRINTED NEWS RELEASES IN THE FIELD OF TOURISM AND ECONOMIC DEVELOPMENT AND FEATURING INDIVIDUALS, ACTIVITIES, AND PROJECTS THAT HAVE MADE SIGNIFICANT CONTRIBUTIONS TO THE DEVELOPMENT OF THE COUNTRY OF SINGAPORE; PRINTED PERIODICALS IN THE FIELD OF TOURISM AND ECONOMIC DEVELOPMENT AND FEATURING INDIVIDUALS, ACTIVITIES AND PROJECTS THAT HAVE MADE SIGNIFICANT CONTRIBUTIONS TO THE DEVELOPMENT OF THE COUNTRY OF SINGAPORE; PRINTED LITERATURE, PRINTED MATTER AND PRINTED PUBLICATIONS, NAMELY, NEWSPAPERS, MAGAZINES, AND NEWSLETTERS IN THE FIELD OF TOURISM AND ECONOMIC DEVELOPMENT AND FEATURING INDIVIDUALS, ACTIVITIES AND PROJECTS THAT HAVE MADE SIGNIFICANT CONTRIBUTIONS TO THE DEVELOPMENT OF THE COUNTRY OF SINGAPORE, IN CLASS 16 (U.S. CLS. 2, 5, 22, 23, 29, 37, 38 AND 50).



FOR: TELECOMMUNICATIONS SERVICES, NAMELY, TRANSMISSION AND STREAMING OF VOICE, DATA, GRAPHICS, IMAGES, AUDIO AND VIDEO BY MEANS OF TELECOMMUNICATIONS NETWORKS, WIRELESS COMMUNICATION NETWORKS, AND THE INTERNET; ELECTRONIC DATA INTERCHANGE SERVICES; ELECTRONIC TRANSMISSION OF MESSAGES; ELECTRONIC TRANSMISSION OF DATA; BROADCASTING OF RADIO PROGRAMS; BROADCASTING OF RADIO AND TELEVISION PROGRAMS BY SATELLITE; BROADCASTING OF TELEVISION PROGRAMS; NETCASTING, NAMELY, BROADCASTING PROGRAMS OVER A GLOBAL COMPUTER NETWORK; AUDIO AND VIDEO BROADCASTING OF NEWS, IN CLASS 38 (U.S. CLS. 100, 101 AND 104).

PRIORITY CLAIMED UNDER SEC. 44(D) ON SINGAPORE APPLICATION NO. T1007356J, FILED 6-11-2010, REG. NO. T1007356J, DATED 6-11-2010, EXPIRES 6-11-2020.

David J. Kyros

Director of the United States Patent and Trademark Office

THE COLOR(S) BLACK, WHITE AND RED IS/ARE CLAIMED AS A FEATURE OF THE MARK.

Reg. No. 4,065,620 NO CLAIM IS MADE TO THE EXCLUSIVE RIGHT TO USE "SINGAPORE", APART FROM THE MARK AS SHOWN.

THE MARK CONSISTS OF THE WORDS "TALENT CAPITAL" ABOVE THE WORD "SINGAPORE", ALL IN STYLIZED FONT IN BLACK, AND WITH THE "O" REPRESENTED BY A RED CIRCLE ON WHICH ARE THREE STYLIZED HUMAN FIGURES IN WHITE.

SER. NO. 85-127,426, FILED 9-10-2010.

REGINA DRUMMOND, EXAMINING ATTORNEY

United States of America

United States Patent and Trademark Office

Race For Grace

Reg. No. 4,065,621

Registered Dec. 6, 2011

Int. Cls.: 35 and 36

SERVICE MARK

PRINCIPAL REGISTER

REFLECTIONS OF GRACE FOUNDATION, INC. (PENNSYLVANIA NON-PROFIT CORPORATION)
P. O. BOX 298
IRWIN, PA 15642

FOR: CHARITABLE SERVICES, NAMELY, ORGANIZING AND CONDUCTING AN EVENT TO RAISE PUBLIC AWARENESS OF ALL TYPES OF PEDIATRIC BRAIN CANCERS , IN CLASS 35 (U.S. CLS. 100, 101 AND 102).

FIRST USE 12-0-2007; IN COMMERCE 12-0-2007.

FOR: CHARITABLE SERVICES, NAMELY, PROVIDING FUNDRAISING ACTIVITIES IN THE NATURE OF ORGANIZING AND CONDUCTING AN EVENT TO PROVIDE FINANCIAL SUPPORT TO CHILDREN AND FAMILIES AFFECTED BY PEDIATRIC BRAIN CANCER; AND CHARITABLE SERVICES, NAMELY, PROVIDING FUNDRAISING ACTIVITIES IN THE NATURE OF ORGANIZING AND CONDUCTING AN EVENT TO SUPPORT MEDICAL RESEARCH TO FIND A CURE FOR PEDIATRIC BRAIN CANCERS , IN CLASS 36 (U.S. CLS. 100, 101 AND 102).

FIRST USE 12-0-2007; IN COMMERCE 12-0-2007.

THE MARK CONSISTS OF STANDARD CHARACTERS WITHOUT CLAIM TO ANY PARTICULAR FONT, STYLE, SIZE, OR COLOR.

NO CLAIM IS MADE TO THE EXCLUSIVE RIGHT TO USE "RACE", APART FROM THE MARK AS SHOWN.

SER. NO. 85-128,045, FILED 9-13-2010.

ANTHONY RINKER, EXAMINING ATTORNEY



David J. Kybas

Director of the United States Patent and Trademark Office

United States of America

United States Patent and Trademark Office



Reg. No. 4,065,622

DOI CHAANG COFFEE COMPANY INC. (CANADA CORPORATION)
311-837 WEST HASTINGS STREET
VANCOUVER, BC, CANADA V6C3N6

Registered Dec. 6, 2011

Int. Cls.: 9, 30, 35 and 43

FOR: COMPUTER SOFTWARE, NAMELY, EDUCATIONAL SOFTWARE CONTAINING INSTRUCTION IN THE HISTORY AND PRODUCTION OF COFFEE, IN CLASS 9 (U.S. CLS. 21, 23, 26, 36 AND 38).

TRADEMARK

FOR: GROUND AND WHOLE-BEAN COFFEE, HERBAL TEA, NON-HERBAL TEA, NON-ALCOHOLIC COFFEE AND ESPRESSO BEVERAGES AND NON-ALCOHOLIC COFFEE-BASED BEVERAGES, IN CLASS 30 (U.S. CL. 46).

SERVICE MARK

PRINCIPAL REGISTER

FOR: WHOLESALE, RETAIL AND ONLINE STORE SERVICES FEATURING GROUND AND WHOLE-BEAN COFFEE, HERBAL TEA, NON-HERBAL TEA, NON-ALCOHOLIC COFFEE AND ESPRESSO BEVERAGES, NON-ALCOHOLIC BEVERAGES WITH A BASE OF COFFEE, ACCESSORIES RELATED TO THE PREPARATION AND SERVING OF BEVERAGES, NAMELY, COFFEE BREWING EQUIPMENT, NAMELY, GRINDERS, MAKERS AND ROASTING OVENS, COFFEE AND TEA POTS, MUGS, CUPS AND SAUCERS, CLOTHING, NAMELY, T-SHIRTS, POLO SHIRTS, SWEATSHIRTS, CAPS, HATS, JACKETS, SHORTS AND APRONS, COMPUTER SOFTWARE, NAMELY, EDUCATIONAL SOFTWARE FEATURING INSTRUCTION IN THE HISTORY AND PRODUCTION OF COFFEE, BOOKS, IN CLASS 35 (U.S. CLS. 100, 101 AND 102).



FOR: SIT-DOWN AND TAKE OUT RESTAURANT SERVICES, IN CLASS 43 (U.S. CLS. 100 AND 101).

OWNER OF CANADA REG. NO. TMA783224, DATED 11-23-2010, EXPIRES 11-23-2025.

NO CLAIM IS MADE TO THE EXCLUSIVE RIGHT TO USE "FAIR TRADE.CA", APART FROM THE MARK AS SHOWN.

THE MARK CONSISTS OF TWO HANDS IN A CIRCLE OUTLINED WITH THE WORDING "BEYOND FAIR TRADE.CA".

David J. Kyros

SER. NO. 85-128,087, FILED 9-13-2010.

DEZMONA MIZELLE, EXAMINING ATTORNEY

United States of America

United States Patent and Trademark Office



Reg. No. 4,065,623

Registered Dec. 6, 2011

Int. Cl.: 41

SERVICE MARK

PRINCIPAL REGISTER

GUILFORD INTERNATIONAL GROUP LIMITED (BR. VIRGIN ISLANDS LIMITED COMPANY (LTD.))

P.O. BOX 4519
30 DE CASTRO STREET, WICKHAMS CAY
ROAD TOWN, TORTOLA, BR. VIRGIN ISLANDS

FOR: ENTERTAINMENT SERVICES, NAMELY, PROVIDING ON-LINE COMPUTER GAMES, IN CLASS 41 (U.S. CLS. 100, 101 AND 107).

FIRST USE 12-31-2005; IN COMMERCE 12-31-2005.

NO CLAIM IS MADE TO THE EXCLUSIVE RIGHT TO USE "BINGO", APART FROM THE MARK AS SHOWN.

THE COLOR(S) WHITE, BLACK, BLUE, RED, SILVER, GREEN, ORANGE, YELLOW AND PURPLE IS/ARE CLAIMED AS A FEATURE OF THE MARK.

THE MARK CONSISTS OF THE WORDING "B I N G O" IN BLACK LETTERS WITH THE LETTER "B" IN A BLUE AND WHITE BALL, THE LETTER "I" IN A RED AND WHITE BALL, THE LETTER "N" IN A SILVER AND WHITE BALL, THE LETTER "G" IN A GREEN AND WHITE BALL, AND THE LETTER "O" IN AN ORANGE AND WHITE BALL POSITIONED ABOVE THE WORDING "FOR" IN YELLOW LETTERS AND THE WORDING "MONEY" IN GREEN LETTERS, ALL OUTLINED IN BLACK AND ALL POSITIONED OVER A DESIGN CONSISTING OF THREE PURPLE BILLS HAVING FADED BLACK DOLLAR SIGNS.

SEC. 2(F) AS TO "BINGO FOR MONEY".

SER. NO. 85-128,110, FILED 9-13-2010.

MARY ROSSMAN, EXAMINING ATTORNEY



David J. Kyros

Director of the United States Patent and Trademark Office

United States of America

United States Patent and Trademark Office

SKED-EVAC

Reg. No. 4,065,624

Registered Dec. 6, 2011

Int. Cls.: 9 and 22

TRADEMARK

PRINCIPAL REGISTER

SKEDCO, INC. (OREGON CORPORATION)
P.O. BOX 3390
TUALATIN, OR 97062

FOR: RESCUE APPARATUS AND INSTRUMENTS, NAMELY, TRIPODS AND STANDS FOR USE IN EXTRICATION AND CHAINS AND CASES SOLD AS A UNIT THEREFOR; BAGS SPECIFICALLY DESIGNED FOR OXYGEN REGULATORS, SOLD EMPTY; METAL HARDWARE FOR USE IN RESCUE AND ESCAPE, NAMELY, CARABINERS, METAL PULLEYS, METAL WINDOW ANCHORS, SCREW LINKS, MOUNTING BRACKETS FOR LIFTS AND WINCHES, TRIPOD CHAINS AND BAGS THEREFOR; RESCUE KITS COMPRISED OF STRETCHERS, AND DEPLOYMENT AND EXTRICATION GEAR, FEATURING STRETCHERS, EXTRICATION COLLARS, WEIGHTS, TRIPODS, WINCHES, HELMETS, WINDOW ANCHORS, INSTRUCTIONAL VIDEOS, INSTRUCTION CARDS, CARABINERS, BLANKETS, HARNESSSES, SLINGS, TAG LINES, BELAY LINES, ASCENDERS, DESCENDERS, STIRRUPS, ROPE PADS, ROPE GUARDS, STRAPS, HANDLES, AND PACKS, BAGS AND CASES THEREFOR; EQUIPMENT FOR ASCENT AND DESCENT DURING RESCUE, NAMELY, ANCHORS, HARNESSSES, ANCHOR SLINGS, LANYARDS AND ANCHORAGE CONNECTORS; SIGNALING AND MARKING KITS FEATURING CHEMICAL LIGHTS, SIGNAL MIRRORS, FABRIC PANEL MARKERS, WHISTLES, ERASERS, BLANKETS, PACKING LISTS, INSTRUCTION CARDS, POUCHES, STRAPS, AND PENS, IN CLASS 9 (U.S. CLS. 21, 23, 26, 36 AND 38).

FIRST USE 3-15-1999; IN COMMERCE 3-15-1999.



FOR: RESCUE KITS FEATURING ROPES, CORDS AND STRAPS, HARNESSSES, DESCENDERS, BUCKLES, CARABINERS, PULLEYS, SCREW LINKS, BAGS AND POUCHES; STRAPS FOR HANDLING LOADS; ANCHOR STRAPS; TIE DOWN STRAPS; ALL PURPOSE STRAPS; ROPES AND HANDLES THEREFOR; ANCHORING ROPES; CARGO SLINGS OF ROPE OR FABRIC; RESCUE ACCESSORIES MADE OF WEBBING, NAMELY, HANDLES, STIRRUPS, LOOPS, BELTS, AND BELT SYSTEMS, FOR USE IN SAFETY, RESCUE, ESCAPE, AND FALL ARREST; ANCHOR SLINGS FOR USE IN SAFETY, RESCUE, ESCAPE, AND FALL ARREST, IN CLASS 22 (U.S. CLS. 1, 2, 7, 19, 22, 42 AND 50).

FIRST USE 3-15-1999; IN COMMERCE 3-15-1999.

THE MARK CONSISTS OF STANDARD CHARACTERS WITHOUT CLAIM TO ANY PARTICULAR FONT, STYLE, SIZE, OR COLOR.

David J. Kypos

Director of the United States Patent and Trademark Office

Reg. No. 4,065,624 OWNER OF U.S. REG. NO. 1,363,250.

SER. NO. 85-128,233, FILED 9-13-2010.

RAMONA ORTIGA, EXAMINING ATTORNEY

United States of America

United States Patent and Trademark Office

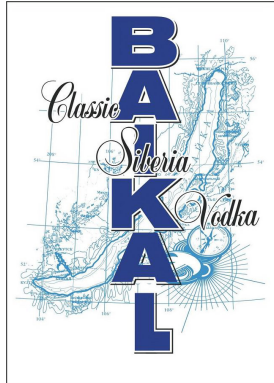

Reg. No. 4,065,625

Registered Dec. 6, 2011

Int. Cl.: 33

TRADEMARK

PRINCIPAL REGISTER

BAIKAL LLC (RUSSIAN FED. LIMITED LIABILITY COMPANY)
27, RABOCHEGO SHTABA STREET
IRKUTSK, RUSSIAN FED. 664001

FOR: VODKA, IN CLASS 33 (U.S. CLS. 47 AND 49).

FIRST USE 8-6-2010; IN COMMERCE 8-6-2010.

NO CLAIM IS MADE TO THE EXCLUSIVE RIGHT TO USE "CLASSIC SIBERIA VODKA",
APART FROM THE MARK AS SHOWN.

THE COLOR(S) BLACK, BLUE, WHITE AND LIGHT BLUE IS/ARE CLAIMED AS A FEAT-
TURE OF THE MARK.

THE MARK CONSISTS OF THE WORD "BAIKAL" IN BLUE LETTERING SUPERIMPOSED
IN A LIGHT BLUE MAP WITH THE WORDS "CLASSIC SIBERIA VODKA" IN BLACK AND
WHITE LETTERING ALL CONTAINED IN A BLACK AND WHITE RECTANGULAR BOX.

SER. NO. 85-128,801, FILED 9-14-2010.

CHARLES L. JENKINS, EXAMINING ATTORNEY



David J. Kyros

Director of the United States Patent and Trademark Office

United States of America

United States Patent and Trademark Office

The Sonic Universe

Reg. No. 4,065,626

Registered Dec. 6, 2011

Int. Cls.: 9, 25 and 41

TRADEMARK

SERVICE MARK

PRINCIPAL REGISTER

ARNDT, ALEX (CALIFORNIA SOLE PROPRIETORSHIP)
1620 VENICE BLVD. #209
VENICE, CA 90291

FOR: SERIES OF MUSICAL SOUND RECORDINGS, IN CLASS 9 (U.S. CLS. 21, 23, 26, 36 AND 38).

FIRST USE 2-15-2008; IN COMMERCE 2-15-2008.

FOR: WEARABLE GARMENTS AND CLOTHING, NAMELY, SHIRTS, IN CLASS 25 (U.S. CLS. 22 AND 39).

FIRST USE 5-2-2010; IN COMMERCE 5-2-2010.

FOR: ENTERTAINMENT SERVICES IN THE NATURE OF LIVE MUSICAL PERFORMANCES, IN CLASS 41 (U.S. CLS. 100, 101 AND 107).

FIRST USE 6-21-2009; IN COMMERCE 6-21-2009.

THE MARK CONSISTS OF STANDARD CHARACTERS WITHOUT CLAIM TO ANY PARTICULAR FONT, STYLE, SIZE, OR COLOR.

SER. NO. 85-129,702, FILED 9-14-2010.

SKYE YOUNG, EXAMINING ATTORNEY



David J. Kyros

Director of the United States Patent and Trademark Office

United States of America

United States Patent and Trademark Office

SOMBRERITO

Reg. No. 4,065,627

Registered Dec. 6, 2011

Int. Cls.: 32 and 33

TRADEMARK

PRINCIPAL REGISTER

TEQUILAS DEL SEÑOR, S.A. DE C.V. (MEXICO CORPORATION)
RIO TUITO NO. 1193, COLONIA ATLAS,
GUADALAJARA, JALISCO, MEXICO 44870

FOR: NON-ALCOHOLIC BEVERAGES, NAMELY, BEER, CARBONATED WATER, MINERAL WATER; NON-ALCOHOLIC FRUIT JUICE BEVERAGES, FRUIT JUICES, IN CLASS 32 (U.S. CLS. 45, 46 AND 48).

FOR: ALCOHOLIC BEVERAGES, NAMELY, TEQUILA AND LIQUOR, IN CLASS 33 (U.S. CLS. 47 AND 49).

THE MARK CONSISTS OF STANDARD CHARACTERS WITHOUT CLAIM TO ANY PARTICULAR FONT, STYLE, SIZE, OR COLOR.

PRIORITY CLAIMED UNDER SEC. 44(D) ON MEXICO APPLICATION NO. 1112176, FILED 8-16-2010, REG. NO. 1180431, DATED 9-23-2010, EXPIRES 8-16-2020.

PRIORITY CLAIMED UNDER SEC. 44(D) ON MEXICO APPLICATION NO. 1112175, FILED 8-16-2010, REG. NO. 1177555, DATED 9-2-2010, EXPIRES 8-16-2020.

OWNER OF U.S. REG. NOS. 2,874,896 AND 3,866,775.

THE ENGLISH TRANSLATION OF "SOMBRERITO" IN THE MARK IS "SMALL HAT".

SER. NO. 85-130,012, FILED 9-15-2010.

BARBARA BROWN, EXAMINING ATTORNEY



David J. Kyros

Director of the United States Patent and Trademark Office

United States of America

United States Patent and Trademark Office

COFFEE CUP FUEL STOP

Reg. No. 4,065,628

Registered Dec. 6, 2011

Int. Cls.: 35 and 37

SERVICE MARK

PRINCIPAL REGISTER

COFFEE CUP FUEL STOPS AND CONVENIENCE STORES, INC. (SOUTH DAKOTA CORPORATION)
706 S. MAIN STREET
ABERDEEN, SD 57401

FOR: RETAIL CONVENIENCE STORES, IN CLASS 35 (U.S. CLS. 100, 101 AND 102).

FIRST USE 9-1-1983; IN COMMERCE 9-1-1983.

FOR: VEHICLE FUELING SERVICES, IN CLASS 37 (U.S. CLS. 100, 103 AND 106).

FIRST USE 9-1-1983; IN COMMERCE 9-1-1983.

THE MARK CONSISTS OF STANDARD CHARACTERS WITHOUT CLAIM TO ANY PARTICULAR FONT, STYLE, SIZE, OR COLOR.

OWNER OF U.S. REG. NO. 1,949,033.

NO CLAIM IS MADE TO THE EXCLUSIVE RIGHT TO USE "FUEL STOP", APART FROM THE MARK AS SHOWN.

SEC. 2(F).

SER. NO. 85-130,512, FILED 9-15-2010.

VIVIAN MICZNIK FIRST, EXAMINING ATTORNEY



David J. Kybas

Director of the United States Patent and Trademark Office

United States of America

United States Patent and Trademark Office



Reg. No. 4,065,629

Registered Dec. 6, 2011

Int. Cl.: 30

TRADEMARK

PRINCIPAL REGISTER

FRISUN, INC. (NEW YORK CORPORATION)
27 DALE DRIVE
FARMINGDALE, NY 11735

FOR: NATURAL SWEETENERS, IN CLASS 30 (U.S. CL. 46).

FIRST USE 1-1-2009; IN COMMERCE 1-1-2009.

THE MARK CONSISTS OF THE WORD "FRISUN" IN STYLIZED FONT UNDERLINED WITH THE UNDERLINE BEGINNING WITH THREE DOTS UNDER THE "F" AND CONTINUING UNDER THE REST OF THE WORD IN A SOLID LINE. A CURVED LINE EXTENDS FROM UNDER THE "F" AROUND THE "F" AND ENDING IN THE DOT IN THE "I".

SER. NO. 85-131,388, FILED 9-16-2010.

MICHAEL WEBSTER, EXAMINING ATTORNEY



David J. Kybas

Director of the United States Patent and Trademark Office

United States of America

United States Patent and Trademark Office

Go eRx

Reg. No. 4,065,630

Registered Dec. 6, 2011

Int. Cl.: 35

SERVICE MARK

PRINCIPAL REGISTER

EPHARMACY HOLDINGS, LLC (MICHIGAN LIMITED LIABILITY COMPANY)
50349 KOSS DRIVE
MACOMB, MI 48044

FOR: BUSINESS DEVELOPMENT SERVICES, NAMELY, PROVIDING START UP AND ONGOING SUPPORT FOR BUSINESS OF OTHERS, IN CLASS 35 (U.S. CLS. 100, 101 AND 102).

FIRST USE 5-14-2002; IN COMMERCE 5-14-2002.

THE MARK CONSISTS OF STANDARD CHARACTERS WITHOUT CLAIM TO ANY PARTICULAR FONT, STYLE, SIZE, OR COLOR.

SER. NO. 85-131,579, FILED 9-16-2010.

DANNEAN HETZEL, EXAMINING ATTORNEY



David J. Kyffers

Director of the United States Patent and Trademark Office

United States of America

United States Patent and Trademark Office

FAMILY HYDROPONICS

Reg. No. 4,065,631

Registered Dec. 6, 2011

Int. Cl.: 35

SERVICE MARK

PRINCIPAL REGISTER

FAMILY HYDROPONICS & ORGANICS FRANCHISING INC. (CALIFORNIA CORPORATION)
7190 HIGHWAY 20
SMARTVILLE, CA 95977

FOR: RETAIL STORE SERVICES FEATURING EQUIPMENT AND SUPPLIES FOR HYDROPONIC AND ORGANIC FARMING AND GARDENING, IN CLASS 35 (U.S. CLS. 100, 101 AND 102).

FIRST USE 6-1-2003; IN COMMERCE 6-1-2003.

THE MARK CONSISTS OF STANDARD CHARACTERS WITHOUT CLAIM TO ANY PARTICULAR FONT, STYLE, SIZE, OR COLOR.

OWNER OF U.S. REG. NOS. 3,475,761 AND 3,475,774.

NO CLAIM IS MADE TO THE EXCLUSIVE RIGHT TO USE "HYDROPONICS", APART FROM THE MARK AS SHOWN.

SER. NO. 85-132,469, FILED 9-17-2010.

TIMOTHY FINNEGAN, EXAMINING ATTORNEY



David J. Kyfos

Director of the United States Patent and Trademark Office

United States of America

United States Patent and Trademark Office

Cedar Tree

Reg. No. 4,065,632

Registered Dec. 6, 2011

Int. Cl.: 25

TRADEMARK

PRINCIPAL REGISTER

LEE, WILL NAMHYUNG (UNITED STATES INDIVIDUAL)
#103
1016 TOWNE AVENUE
LOS ANGELES, CA 90021

FOR: CAPRI PANTS; CARGO PANTS; DENIM JACKETS; DENIMS; DRESS PANTS; DRESS SHIRTS; DRESS SUITS; FOOTWEAR FOR MEN AND WOMEN; JACKETS; LEOTARDS AND TIGHTS FOR WOMEN, MEN AND CHILDREN OF NYLON, COTTON OR OTHER TEXTILE FIBERS; MEN'S AND WOMEN'S JACKETS, COATS, TROUSERS, VESTS; PANTS; SHIRTS AND SHORT-SLEEVED SHIRTS; SHIRTS AND SLIPS; SHORT-SLEEVED OR LONG-SLEEVED T-SHIRTS; SKIRTS AND DRESSES; T-SHIRTS; VESTS; WOMEN'S HATS AND HOODS; WOMEN'S TOPS, NAMELY, CAMIS; WOVEN DRESSES, IN CLASS 25 (U.S. CLS. 22 AND 39).

FIRST USE 6-28-2010; IN COMMERCE 6-28-2010.

THE MARK CONSISTS OF STANDARD CHARACTERS WITHOUT CLAIM TO ANY PARTICULAR FONT, STYLE, SIZE, OR COLOR.

SER. NO. 85-132,523, FILED 9-17-2010.

SHAUNIA CARLYLE, EXAMINING ATTORNEY



David J. Kyros

Director of the United States Patent and Trademark Office

United States of America

United States Patent and Trademark Office



Reg. No. 4,065,633

Registered Dec. 6, 2011

Int. Cls.: 14 and 25

TRADEMARK

PRINCIPAL REGISTER

EQUINOX 7, LLC (ARIZONA LIMITED LIABILITY COMPANY)
9226 E. HORSESHOE BEND DR.
SCOTTSDALE, AZ 85255

FOR: KEY CHAINS AS JEWELRY, IN CLASS 14 (U.S. CLS. 2, 27, 28 AND 50).

FIRST USE 11-20-2009; IN COMMERCE 2-10-2010.

FOR: HATS , IN CLASS 25 (U.S. CLS. 22 AND 39).

FIRST USE 11-20-2009; IN COMMERCE 7-23-2010.

THE MARK CONSISTS OF THE DESIGN OF AN ELEPHANT WITH ITS TRUNK POINTED UP, BLOWING FLOWER PEDDLES OVER HIS HEAD. BENEATH THE DESIGN ELEMENT ARE THE WORDS "BE CUTIEFUL" IN A STYLIZED FONT WITH FLOWER DESIGNS AT THE BEGINNING OF THE LETTER "B" AND AS THE DOT OVER THE LETTER "I".

SER. NO. 85-132,823, FILED 9-18-2010.

ELLEN PERKINS, EXAMINING ATTORNEY



David J. Kybas

Director of the United States Patent and Trademark Office

United States of America

United States Patent and Trademark Office

T-14

Reg. No. 4,065,634

Registered Dec. 6, 2011

Int. Cl.: 13

TRADEMARK

PRINCIPAL REGISTER

SAFIR ARMS LLC (NEW JERSEY LIMITED LIABILITY COMPANY)
32 IRONSIDE COURT
WILLINGBORO, NJ 08046

FOR: FIREARMS, NAMELY, SHOTGUNS; STRUCTURAL PARTS AND REPLACEMENT PARTS FOR SHOTGUNS THEREFOR; STRUCTURAL PARTS FOR SHOTGUNS, NAMELY, UPPER AND LOWER RECEIVERS, IN CLASS 13 (U.S. CLS. 2 AND 9).

FIRST USE 1-1-2007; IN COMMERCE 1-1-2007.

THE MARK CONSISTS OF STANDARD CHARACTERS WITHOUT CLAIM TO ANY PARTICULAR FONT, STYLE, SIZE, OR COLOR.

SER. NO. 85-132,838, FILED 9-18-2010.

REGINA DRUMMOND, EXAMINING ATTORNEY



David J. Kybas

Director of the United States Patent and Trademark Office

United States of America

United States Patent and Trademark Office

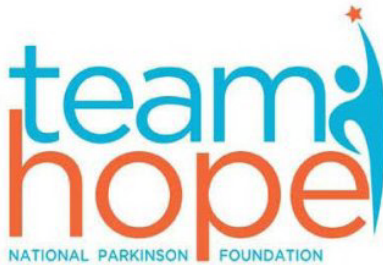

Reg. No. 4,065,635

Registered Dec. 6, 2011

Int. Cl.: 36

SERVICE MARK

PRINCIPAL REGISTER

NATIONAL PARKINSON FOUNDATION, INC. (FLORIDA NON-PROFIT CORPORATION)
1501 N.W. 9TH AVENUE
MIAMI, FL 331361494

FOR: CHARITABLE FUND RAISING AND CHARITABLE FUND-RAISING EVENTS FOR THE BENEFIT OF THE STUDY, CURE AND GENERAL AWARENESS OF PARKINSON'S DISEASE, IN CLASS 36 (U.S. CLS. 100, 101 AND 102).

FIRST USE 10-0-2009; IN COMMERCE 10-0-2009.

NO CLAIM IS MADE TO THE EXCLUSIVE RIGHT TO USE "PARKINSON FOUNDATION", APART FROM THE MARK AS SHOWN.

THE COLOR(S) BLUE AND ORANGE IS/ARE CLAIMED AS A FEATURE OF THE MARK.

THE MARK CONSISTS OF THE WORDING "TEAM HOPE" AND "NATIONAL PARKINSON FOUNDATION" WITHIN STYLIZED LETTERING. ALONGSIDE THE WORDING IS A STYLIZED DEPICTION OF A PERSON REACHING SKYWARD WITH A STAR AT THE END OF THE PERSON'S ARM. THE WORDING "TEAM", "NATIONAL PARKINSON FOUNDATION" AND THE STYLIZED PERSON ARE BLUE. THE WORDING "HOPE" AND THE DESIGN OF A STAR ARE ORANGE.

SEC. 2(F) AS TO "NATIONAL PARKINSON FOUNDATION".

SER. NO. 85-134,247, FILED 9-21-2010.

KEVON CHISOLM, EXAMINING ATTORNEY



David J. Kyros

Director of the United States Patent and Trademark Office

United States of America

United States Patent and Trademark Office



Reg. No. 4,065,636

Registered Dec. 6, 2011

Int. Cl.: 43

SERVICE MARK

PRINCIPAL REGISTER

129 WCS OC, LLC (FLORIDA LIMITED LIABILITY COMPANY), DBA MOJOS CAJUN BAR AND GRILL AND MOJO CAJUN BAR AND GRILL
SUITE 1070
260 WEKIVA SPRINGS ROAD
LONGWOOD, FL 32779

FOR: BAR AND RESTAURANT SERVICES, IN CLASS 43 (U.S. CLS. 100 AND 101).

FIRST USE 3-16-2010; IN COMMERCE 3-16-2010.

NO CLAIM IS MADE TO THE EXCLUSIVE RIGHT TO USE "CAJUN" AND "BAR & GRILL", APART FROM THE MARK AS SHOWN.

THE COLOR(S) YELLOW, GREEN, BLACK, PURPLE AND WHITE IS/ARE CLAIMED AS A FEATURE OF THE MARK.

THE MARK CONSISTS OF A YELLOW ELLIPSE OUTLINED IN GREEN WITH THE LITERAL ELEMENT "CAJUN MOJO BAR & GRILL" DISPLAYED WITHIN SAID YELLOW ELLIPSE; THE WORD "CAJUN" IS DISPLAYED IN A WHITE SANS-SERIF FONT WHICH IS OUTLINED IN PURPLE; THE WORD "MOJO" IS BELOW SAID WORD "CAJUN" IN A BLACK, STYLIZED FONT WHICH HAS A FIRST WHITE INNER OUTLINE AND A SECOND GREEN OUTER OUTLINE; THE WORDS "BAR & GRILL" ARE BELOW SAID WORD "MOJO" IN A WHITE SANS-SERIF FONT WHICH IS OUTLINED IN PURPLE.

SER. NO. 85-134,300, FILED 9-21-2010.

LAKEISHA LEWIS, EXAMINING ATTORNEY



David J. Kybas

Director of the United States Patent and Trademark Office

United States of America

United States Patent and Trademark Office

ButterLoads

Reg. No. 4,065,637

Registered Dec. 6, 2011

Int. Cl.: 41

SERVICE MARK

PRINCIPAL REGISTER

GRHK IP, LLC (FLORIDA LIMITED LIABILITY COMPANY)
10840 SW 113 PLACE
MIAMI, FL 33176

FOR: ENTERTAINMENT SERVICES, NAMELY, PROVIDING A WEB SITE FEATURING PHOTOGRAPHIC, AUDIO, VIDEO AND PROSE PRESENTATIONS FEATURING ADULT ORIENTED SUBJECT MATTER, IN CLASS 41 (U.S. CLS. 100, 101 AND 107).

FIRST USE 1-25-2010; IN COMMERCE 9-1-2010.

THE MARK CONSISTS OF STANDARD CHARACTERS WITHOUT CLAIM TO ANY PARTICULAR FONT, STYLE, SIZE, OR COLOR.

SER. NO. 85-134,454, FILED 9-21-2010.

GRETTA YAO, EXAMINING ATTORNEY



David J. Kyffers

Director of the United States Patent and Trademark Office

United States of America

United States Patent and Trademark Office

WE BELIEVE

Reg. No. 4,065,638

TREK BICYCLE CORPORATION (WISCONSIN CORPORATION)
801 WEST MADISON
WATERLOO, WI 53594

Registered Dec. 6, 2011

Int. Cl.: 35

FOR: PROMOTING THE INTERESTS OF PEOPLE AND ORGANIZATIONS INVOLVED AND CONCERNED WITH BICYCLING, IN CLASS 35 (U.S. CLS. 100, 101 AND 102).

SERVICE MARK

FIRST USE 6-27-2008; IN COMMERCE 6-27-2008.

PRINCIPAL REGISTER

THE MARK CONSISTS OF STANDARD CHARACTERS WITHOUT CLAIM TO ANY PARTICULAR FONT, STYLE, SIZE, OR COLOR.

SER. NO. 85-134,533, FILED 9-21-2010.

REGINA DRUMMOND, EXAMINING ATTORNEY



David J. Kybas

Director of the United States Patent and Trademark Office

United States of America

United States Patent and Trademark Office

T-16

Reg. No. 4,065,639

Registered Dec. 6, 2011

Int. Cl.: 13

TRADEMARK

PRINCIPAL REGISTER

SAFIR ARMS LLC (NEW JERSEY LIMITED LIABILITY COMPANY)
32 IRONSIDE COURT
WILLINGBORO, NJ 08046

FOR: FIREARMS, NAMELY, SHOTGUNS; STRUCTURAL PARTS AND REPLACEMENT PARTS FOR SHOTGUNS THEREFOR; STRUCTURAL PARTS FOR SHOTGUNS, NAMELY, UPPER AND LOWER RECEIVERS, IN CLASS 13 (U.S. CLS. 2 AND 9).

FIRST USE 2-1-2011; IN COMMERCE 2-1-2011.

THE MARK CONSISTS OF STANDARD CHARACTERS WITHOUT CLAIM TO ANY PARTICULAR FONT, STYLE, SIZE, OR COLOR.

SER. NO. 85-134,805, FILED 9-21-2010.

REGINA DRUMMOND, EXAMINING ATTORNEY



David J. Kybas

Director of the United States Patent and Trademark Office

United States of America

United States Patent and Trademark Office

DUNLOP

Reg. No. 4,065,640

Registered Dec. 6, 2011

Int. Cl.: 15

TRADEMARK

PRINCIPAL REGISTER

DUNLOP MANUFACTURING, INC. (CALIFORNIA CORPORATION)
P.O. BOX 846
170 INDUSTRIAL WAY
BENICIA, CA 94510

FOR: MUSICAL INSTRUMENTS AND MUSICAL INSTRUMENT ACCESSORIES, NAMELY, PLECTRA, STRINGS, STRINGWINDERS, KAZOOS, CAPOS, SLIDES, TONEBARDS, STRAP RETAINERS, PICKHOLDERS, HARMONICA HOLDERS, FRETWIRE, GUARD PLATES, IN CLASS 15 (U.S. CLS. 2, 21 AND 36).

FIRST USE 1-1-1988; IN COMMERCE 1-1-1988.

THE MARK CONSISTS OF STANDARD CHARACTERS WITHOUT CLAIM TO ANY PARTICULAR FONT, STYLE, SIZE, OR COLOR.

OWNER OF U.S. REG. NOS. 2,023,359 AND 3,377,754.

SEC. 2(F).

SER. NO. 85-134,897, FILED 9-21-2010.

BRIAN CALLAGHAN, EXAMINING ATTORNEY



David J. Kyros

Director of the United States Patent and Trademark Office

United States of America

United States Patent and Trademark Office

DUNLOP

Reg. No. 4,065,641

Registered Dec. 6, 2011

Int. Cls.: 3 and 4

TRADEMARK

PRINCIPAL REGISTER

DUNLOP MANUFACTURING, INC. (CALIFORNIA CORPORATION)
P.O. BOX 846
170 INDUSTRIAL WAY
BENICIA, CA 94510

FOR: POLISH CLEANING PREPARATIONS FOR MUSICAL INSTRUMENTS; OILS FOR CLEANING MUSICAL INSTRUMENTS, IN CLASS 3 (U.S. CLS. 1, 4, 6, 50, 51 AND 52).

FIRST USE 1-27-1999; IN COMMERCE 1-27-1999.

FOR: GREASE AND LUBRICATING OIL FOR USE ON MUSICAL INSTRUMENTS, IN CLASS 4 (U.S. CLS. 1, 6 AND 15).

FIRST USE 1-27-1999; IN COMMERCE 1-27-1999.

THE MARK CONSISTS OF STANDARD CHARACTERS WITHOUT CLAIM TO ANY PARTICULAR FONT, STYLE, SIZE, OR COLOR.

OWNER OF U.S. REG. NOS. 2,023,359 AND 3,377,754.

SEC. 2(F).

SER. NO. 85-135,362, FILED 9-22-2010.

BRIAN CALLAGHAN, EXAMINING ATTORNEY



David J. Kyros

Director of the United States Patent and Trademark Office

United States of America

United States Patent and Trademark Office

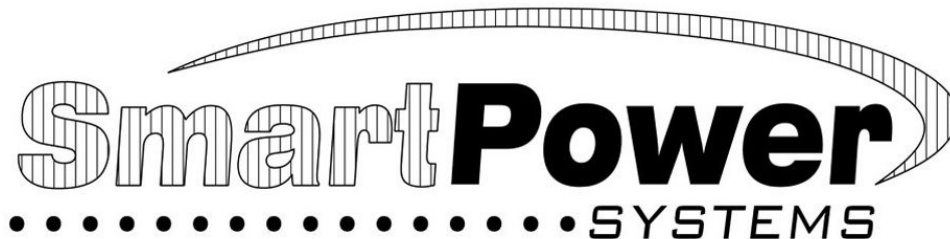

Reg. No. 4,065,642

Registered Dec. 6, 2011

Int. Cl.: 9

TRADEMARK

PRINCIPAL REGISTER

SMART POWER SYSTEMS, INC. (TEXAS CORPORATION)
1760 STEBBINS DRIVE
HOUSTON, TX 77043

FOR: CONSUMER AND OFFICE ELECTRONICS, NAMELY, ELECTRICAL POWER SURGE FILTERS, DIGITAL ELECTRICAL POWER CONDITIONERS, POWERLINE CONDITIONERS, UNINTERRUPTED POWER SURGE PROTECTORS, AND AUTOMATED ELECTRICAL VOLTAGE REGULATORS FOR COPIERS, FAX MACHINES, TELECOMMUNICATION EQUIPMENT, RETAIL TECHNOLOGY EQUIPMENT, AND COMPUTERS, NOT FOR INDUSTRIAL OR MANUFACTURING PURPOSES, IN CLASS 9 (U.S. CLS. 21, 23, 26, 36 AND 38).

FIRST USE 8-1-1999; IN COMMERCE 8-1-1999.

OWNER OF U.S. REG. NO. 2,932,001.

NO CLAIM IS MADE TO THE EXCLUSIVE RIGHT TO USE "SYSTEMS", APART FROM THE MARK AS SHOWN.

THE LINING IS FOR SHADING PURPOSES.

THE MARK CONSISTS OF THE STYLIZED WORDING "SMARTPOWER SYSTEMS" WITH THE WORDING "SYSTEMS" APPEARING BENEATH THE "POWER" PORTION OF THE WORDING, WITH SIXTEEN DOTS APPEARING BEFORE THE WORD "SYSTEMS" AND WITH A CURVED BAND BEGINNING ABOVE THE LETTER "M" IN THE "SMART" PORTION OF THE WORDING AND CURVING OVER THE WORDING AROUND TO THE SIDE OF THE LETTER "R" IN THE "POWER" PORTION OF THE WORDING.

SER. NO. 85-135,373, FILED 9-22-2010.

CYNTHIA TRIPI, EXAMINING ATTORNEY



David J. Kybas

Director of the United States Patent and Trademark Office

United States of America

United States Patent and Trademark Office

KOZY WORLD

Reg. No. 4,065,643

Registered Dec. 6, 2011

Int. Cl.: 11

TRADEMARK

PRINCIPAL REGISTER

WORLD MARKETING OF AMERICA, INC. (PENNSYLVANIA CORPORATION)
P.O. BOX 192
ROUTE 22 WEST
MILL CREEK, PA 17060

FOR: MOUNTED PROPANE HEATING UNITS FOR RESIDENTIAL AND COMMERCIAL USE; FREE STANDING PROPANE GAS HEATING UNITS FOR RESIDENTIAL AND COMMERCIAL USE; NATURAL GAS HEATING UNITS FOR RESIDENTIAL AND COMMERCIAL USE; GAS BURNING FIREPLACES; GAS BURNING STOVES; ELECTRIC FIREPLACES; ELECTRIC STOVES; BASE LEGS FOR GAS BURNING STOVES; BLOWERS FOR USE IN CONNECTION WITH FIREPLACES AND STOVES; HEARTH PRODUCTS, NAMELY, GAS BURNER ASSEMBLIES, ARTIFICIAL LOGS AND ARTIFICIAL EMBERS, IN CLASS 11 (U.S. CLS. 13, 21, 23, 31 AND 34).

FIRST USE 0-0-1995; IN COMMERCE 0-0-1995.

THE MARK CONSISTS OF STANDARD CHARACTERS WITHOUT CLAIM TO ANY PARTICULAR FONT, STYLE, SIZE, OR COLOR.

OWNER OF U.S. REG. NOS. 1,656,172 AND 1,722,938.

SER. NO. 85-135,819, FILED 9-22-2010.

BERYL GARDNER, EXAMINING ATTORNEY



David J. Kypos

Director of the United States Patent and Trademark Office

United States of America

United States Patent and Trademark Office

TRUE-GREEN BabySafe

Reg. No. 4,065,644

CLEAN CHOICE (MARYLAND LIMITED LIABILITY COMPANY)
6057 DUCKEYS RUN ROAD
ELKRIDGE, MD 21075

Registered Dec. 6, 2011

Int. Cl.: 37

FOR: GREEN RESIDENTIAL AND COMMERCIAL CARPET AND UPHOLSTERY CLEANING SERVICES, IN CLASS 37 (U.S. CLS. 100, 103 AND 106).

SERVICE MARK

FIRST USE 12-0-2009; IN COMMERCE 12-0-2009.

PRINCIPAL REGISTER

THE MARK CONSISTS OF STANDARD CHARACTERS WITHOUT CLAIM TO ANY PARTICULAR FONT, STYLE, SIZE, OR COLOR.

NO CLAIM IS MADE TO THE EXCLUSIVE RIGHT TO USE "BABYSAFE", APART FROM THE MARK AS SHOWN.

SER. NO. 85-135,832, FILED 9-22-2010.

JENNIFER MARTIN, EXAMINING ATTORNEY



David J. Kybas

Director of the United States Patent and Trademark Office

United States of America

United States Patent and Trademark Office

HUMBOLDT CLOTHING COMPANY

Reg. No. 4,065,645

YOUNG, ANGEL M (UNITED STATES INDIVIDUAL)
PO BOX 252
JUNCTION CITY, CA 96048

Registered Dec. 6, 2011

Int. Cl.: 25

FOR: BEANIES; BOTTOMS; HATS; HEADWEAR; HOODED SWEAT SHIRTS; JACKETS;
PANTS; SHIRTS; SHORTS; SWEAT SHIRTS; T-SHIRTS; TOPS, IN CLASS 25 (U.S. CLS. 22
AND 39).

TRADEMARK

FIRST USE 0-0-2004; IN COMMERCE 0-0-2004.

PRINCIPAL REGISTER

THE MARK CONSISTS OF STANDARD CHARACTERS WITHOUT CLAIM TO ANY PAR-
TICULAR FONT, STYLE, SIZE, OR COLOR.

NO CLAIM IS MADE TO THE EXCLUSIVE RIGHT TO USE "CLOTHING COMPANY",
APART FROM THE MARK AS SHOWN.

SEC. 2(F).

SER. NO. 85-135,990, FILED 9-22-2010.

H. M. FISHER, EXAMINING ATTORNEY



David J. Kyffers

Director of the United States Patent and Trademark Office

United States of America

United States Patent and Trademark Office



Reg. No. 4,065,646

YOUNG, ANGEL M (UNITED STATES INDIVIDUAL)
PO BOX 252
JUNCTION CITY, CA 96048

Registered Dec. 6, 2011

Int. Cl.: 25

FOR: BEANIES; BOTTOMS; HATS; HEADWEAR; HOODED SWEAT SHIRTS; JACKETS;
PANTS; SHIRTS; SHORTS; SWEAT SHIRTS; T-SHIRTS; TOPS, IN CLASS 25 (U.S. CLS. 22
AND 39).

TRADEMARK

FIRST USE 0-0-2005; IN COMMERCE 0-0-2005.

PRINCIPAL REGISTER

THE MARK CONSISTS OF THE STYLIZED WORDING "HUMBOLDT" IN WHITE WITH A
BLACK OUTLINE, WITH THE LETTER "L" BEING REPRESENTED BY A GREEN PINE
TREE WITH A BLACK OUTLINE.

THE COLOR(S) BLACK, WHITE AND GREEN IS/ARE CLAIMED AS A FEATURE OF THE
MARK.

SER. NO. 85-136,000, FILED 9-22-2010.

H. M. FISHER, EXAMINING ATTORNEY



David J. Kyffers

Director of the United States Patent and Trademark Office

United States of America

United States Patent and Trademark Office

JIM DUNLOP

Reg. No. 4,065,647

Registered Dec. 6, 2011

Int. Cl.: 15

TRADEMARK

PRINCIPAL REGISTER

DUNLOP MANUFACTURING, INC. (CALIFORNIA CORPORATION)
P.O. BOX 846
170 INDUSTRIAL WAY
BENICIA, CA 94510

FOR: MUSICAL INSTRUMENTS AND MUSICAL INSTRUMENT ACCESSORIES, NAMELY, PLECTRA, STRINGS, STRINGWINDERS, KAZOOS, CAPOS, SLIDES, TONEBARS, STRAP RETAINERS, PICKHOLDERS, HARMONICA HOLDERS, FRETWIRE, GUARD PLATES, IN CLASS 15 (U.S. CLS. 2, 21 AND 36).

FIRST USE 3-19-1965; IN COMMERCE 3-19-1965.

THE MARK CONSISTS OF STANDARD CHARACTERS WITHOUT CLAIM TO ANY PARTICULAR FONT, STYLE, SIZE, OR COLOR.

OWNER OF U.S. REG. NOS. 2,023,359 AND 3,377,754.

THE NAME(S), PORTRAIT(S), AND/OR SIGNATURE(S) SHOWN IN THE MARK IDENTIFIES "JIM DUNLOP", WHOSE CONSENT(S) TO REGISTER IS MADE OF RECORD.

SER. NO. 85-136,392, FILED 9-23-2010.

BRIAN CALLAGHAN, EXAMINING ATTORNEY



David J. Kyffers

Director of the United States Patent and Trademark Office

United States of America

United States Patent and Trademark Office

International Biomedical

Reg. No. 4,065,648

Registered Dec. 6, 2011

Int. Cl.: 10

TRADEMARK

PRINCIPAL REGISTER

INTERNATIONAL BIOMEDICAL CORPORATION (TEXAS CORPORATION)
8505 CROSS PARK DRIVE
AUSTIN, TX 787544578

FOR: RADIATION ATTENUATION SURGICAL GLOVES; INCUBATORS FOR BABIES, NAMELY, INFANT TRANSPORT INCUBATORS; WARMING DEVICE FOR STABILIZING INFANT BODY TEMPERATURE FOR MEDICAL PURPOSES; MEDICAL DEVICES FOR MONITORING BLOOD PROPERTIES, NAMELY, CONTINUOUS BLOOD, BLOOD GAS, GLUCOSE, AND BLOOD CHEMISTRY, IN CLASS 10 (U.S. CLS. 26, 39 AND 44).

FIRST USE 0-0-1975; IN COMMERCE 5-0-1981.

THE MARK CONSISTS OF STANDARD CHARACTERS WITHOUT CLAIM TO ANY PARTICULAR FONT, STYLE, SIZE, OR COLOR.

SEC. 2(F).

SER. NO. 85-136,771, FILED 9-23-2010.

ROSELLE HERRERA, EXAMINING ATTORNEY



David J. Kyros

Director of the United States Patent and Trademark Office

United States of America

United States Patent and Trademark Office

DUNLOP

Reg. No. 4,065,649

Registered Dec. 6, 2011

Int. Cl.: 9

TRADEMARK

PRINCIPAL REGISTER

DUNLOP MANUFACTURING, INC. (CALIFORNIA CORPORATION)
P.O. BOX 846
170 INDUSTRIAL WAY
BENICIA, CA 94510

FOR: ELECTRONIC EFFECT PEDALS FOR USE WITH SOUND AMPLIFIERS, IN CLASS 9
(U.S. CLS. 21, 23, 26, 36 AND 38).

FIRST USE 6-1-1982; IN COMMERCE 6-1-1982.

THE MARK CONSISTS OF STANDARD CHARACTERS WITHOUT CLAIM TO ANY PARTICULAR FONT, STYLE, SIZE, OR COLOR.

OWNER OF U.S. REG. NOS. 2,023,359 AND 3,377,754.

SEC. 2(F).

SER. NO. 85-137,005, FILED 9-23-2010.

BRIAN CALLAGHAN, EXAMINING ATTORNEY



David J. Kyros

Director of the United States Patent and Trademark Office

United States of America

United States Patent and Trademark Office

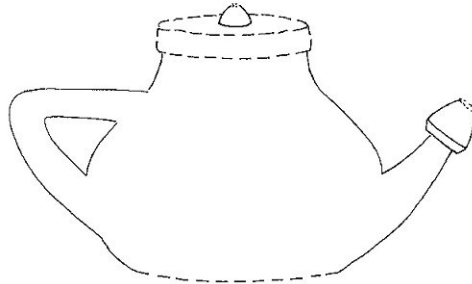

Reg. No. 4,065,650

Registered Dec. 6, 2011

Int. Cl.: 10

TRADEMARK

PRINCIPAL REGISTER

NEILMED PRODUCTS, INC. (CALIFORNIA CORPORATION)
601 AVIATION BOULEVARD
SANTA ROSA, CA 95403

FOR: APPARATUS FOR IRRIGATING NASAL PASSAGES, IN CLASS 10 (U.S. CLS. 26, 39 AND 44).

FIRST USE 6-30-2006; IN COMMERCE 6-30-2006.

THE MARK CONSISTS OF A SPHERICAL VESSEL WITH HANDLE, LID AND SPOUT. THE MATTER DEPICTED BY BLACK DASHED LINES ON THE BASE, LID AND SPOUT IS NOT CLAIMED AS A FEATURE OF THE MARK.

SEC. 2(F).

SER. NO. 85-137,051, FILED 9-23-2010.

TRACY CROSS, EXAMINING ATTORNEY



David J. Kybas

Director of the United States Patent and Trademark Office

United States of America

United States Patent and Trademark Office



Reg. No. 4,065,651

Registered Dec. 6, 2011

Int. Cl.: 35

SERVICE MARK

PRINCIPAL REGISTER

ROBINSON, TEANGELA T (UNITED STATES INDIVIDUAL)
1410-B DISTINCT CIRCLE
FAYETTEVILLE, NC 28314

FOR: WHOLESALE AND RETAIL STORE SERVICES FEATURING JEWELRY AND COSTUME JEWELRY, HANDBAGS, SHOES FOR MEN AND WOMEN, AND CUSTOM ICED HEELS FOR WOMEN'S SHOES, IN CLASS 35 (U.S. CLS. 100, 101 AND 102).

FIRST USE 10-0-2009; IN COMMERCE 10-0-2009.

NO CLAIM IS MADE TO THE EXCLUSIVE RIGHT TO USE "BOUTIQUE", APART FROM THE MARK AS SHOWN.

THE COLOR(S) FUSCHIA PINK, ORANGE, AND GOLD IS/ARE CLAIMED AS A FEATURE OF THE MARK.

THE MARK CONSISTS OF THE LETTERS "NKB" AND THE LADY WITH THE PURSE ARE THE MIXED COLORS OF FUSCHIA PINK AND ORANGE. THE WORDS, "NATURAL KLASS BOUTIQUE", IS COLORED GOLD. THE BACKGROUND IS BLACK AND NOT PART OF THE MARK.

SER. NO. 85-137,112, FILED 9-23-2010.

MARIA-VICTORIA SUAREZ, EXAMINING ATTORNEY



David J. Kyjars

Director of the United States Patent and Trademark Office

United States of America

United States Patent and Trademark Office



Reg. No. 4,065,652

Registered Dec. 6, 2011

Int. Cl.: 42

SERVICE MARK

PRINCIPAL REGISTER

NASTEL TECHNOLOGIES, INC. (DELAWARE CORPORATION)
SUITE 205
48 SOUTH SERVICE ROAD
MELVILLE, NY 11747

FOR: COMPUTER DIAGNOSTIC SERVICES; COMPUTER MONITORING SERVICE WHICH TRACKS APPLICATION SOFTWARE PERFORMANCE, PERFORMS PERIODIC MAINTENANCE AND PROVIDES REPORTS AND ALERTS CONCERNING SUCH PERFORMANCE; COMPUTER MONITORING SERVICE WHICH TRACKS HARDWARE PERFORMANCE AND PROCESSES AND SENDS OUT HISTORICAL REPORTS AND ALERTS; COMPUTER NETWORK CONFIGURATION SERVICES, IN CLASS 42 (U.S. CLS. 100 AND 101).

FIRST USE 4-8-2009; IN COMMERCE 4-8-2009.

OWNER OF U.S. REG. NOS. 3,368,730 AND 3,369,009.

THE COLOR(S) BLUE AND GRAY IS/ARE CLAIMED AS A FEATURE OF THE MARK.

THE MARK CONSISTS OF A TERM, "NASTEL", IN PANTONE COOL GRAY 11C, A TOP ARROW, LEFT OF THE TERM "NASTEL", IN A BLUE GRADIENT THAT SPANS SEVERAL SHADES OF BLUE ENDING IN PANTONE 7461C, A BOTTOM ARROW, LEFT OF THE TERM "NASTEL", IN A GRAY GRADIENT THAT SPANS SEVERAL SHADES OF GRAY ENDING IN COOL GRAY 11C AND A SWOOSH, BELOW THE TERM, "NASTEL", IN A BLUE PANTONE 7461C.

SER. NO. 85-137,158, FILED 9-24-2010.

KATHRYN COWARD, EXAMINING ATTORNEY



David J. Kyjars

Director of the United States Patent and Trademark Office

United States of America

United States Patent and Trademark Office

GCxP - ACCREDITED GREEN COMMISSIONING PROCESS PROVIDER

Reg. No. 4,065,653

Registered Dec. 6, 2011

Int. Cl.: 41

SERVICE MARK

PRINCIPAL REGISTER

BOARD OF REGENTS OF THE UNIVERSITY OF WISCONSIN (WISCONSIN CORPORATION)
361 BASCOM HALL 500 LINCOLN DRIVE
MADISON, WI 53706

FOR: EDUCATIONAL SERVICES, NAMELY, COURSES IN THE FIELD OF MANAGING BUILDING CONSTRUCTION COMMISSIONING PROCESS ACTIVITIES AS COMMISSIONING AUTHORITIES ON NEW OR EXISTING BUILDING PROJECTS THAT EMPHASIZE GREEN AND SUSTAINABLE BUILDING PRINCIPLES, WHILE DEMONSTRATING PROFESSIONAL EXPERIENCE AS WELL AS KNOWLEDGE IN THE COMMISSIONING PROCESS, IN CLASS 41 (U.S. CLS. 100, 101 AND 107).

FIRST USE 4-0-2010; IN COMMERCE 4-0-2010.

THE MARK CONSISTS OF STANDARD CHARACTERS WITHOUT CLAIM TO ANY PARTICULAR FONT, STYLE, SIZE, OR COLOR.

NO CLAIM IS MADE TO THE EXCLUSIVE RIGHT TO USE "ACCREDITED GREEN COMMISSIONING PROCESS PROVIDER", APART FROM THE MARK AS SHOWN.

SER. NO. 85-137,527, FILED 9-24-2010.

KATINA MISTER, EXAMINING ATTORNEY



David J. Kybas

Director of the United States Patent and Trademark Office

United States of America

United States Patent and Trademark Office

CxTS - ACCREDITED COMMISSIONING PROCESS TECHNICAL SERVICES PROVIDER

Reg. No. 4,065,654

Registered Dec. 6, 2011

Int. Cl.: 41

SERVICE MARK

PRINCIPAL REGISTER

BOARD OF REGENTS OF THE UNIVERSITY OF WISCONSIN (WISCONSIN CORPORATION)
361 BASCOM HALL 500 LINCOLN DRIVE
MADISON, WI 53706

FOR: EDUCATIONAL SERVICES, NAMELY, COURSES IN THE FIELD OF TECHNICAL SERVICES IN THE NATURE OF FUNCTIONAL PERFORMANCE TESTING, COMMISSIONING CONSTRUCTION MANAGEMENT, CHECKLIST CREATION AND/OR FIELD VERIFICATION, PROGRAMMING OR DESIGN VERIFICATION FOR PERSONS WHO CONTRIBUTE SIGNIFICANTLY TO THE SUCCESSFUL IMPLEMENTATION OF THE COMMISSIONING PROCESS IN A ROLE OTHER THAN LEAD COMMISSIONING AUTHORITY OR MANAGER OF A COMMISSIONING PROCESS PROGRAM, IN CLASS 41 (U.S. CLS. 100, 101 AND 107).

FIRST USE 5-0-2003; IN COMMERCE 5-0-2006.

THE MARK CONSISTS OF STANDARD CHARACTERS WITHOUT CLAIM TO ANY PARTICULAR FONT, STYLE, SIZE, OR COLOR.

NO CLAIM IS MADE TO THE EXCLUSIVE RIGHT TO USE "ACCREDITED COMMISSIONING PROCESS TECHNICAL SERVICES PROVIDER", APART FROM THE MARK AS SHOWN.

SER. NO. 85-137,541, FILED 9-24-2010.

KATINA MISTER, EXAMINING ATTORNEY



David J. Kybas

Director of the United States Patent and Trademark Office

United States of America

United States Patent and Trademark Office

PRECISION TROLLING

Reg. No. 4,065,655

Registered Dec. 6, 2011

Int. Cl.: 16

TRADEMARK

PRINCIPAL REGISTER

PRECISION ANGLING, LLC (MICHIGAN LIMITED LIABILITY COMPANY)
P.O. BOX 317
TUSTIN, MI 49688

FOR: PRINTED MATTER, NAMELY, BOOKS IN THE FIELD OF FISHING, IN CLASS 16
(U.S. CLS. 2, 5, 22, 23, 29, 37, 38 AND 50).

FIRST USE 3-1-1992; IN COMMERCE 3-1-1992.

THE MARK CONSISTS OF STANDARD CHARACTERS WITHOUT CLAIM TO ANY PARTICULAR FONT, STYLE, SIZE, OR COLOR.

NO CLAIM IS MADE TO THE EXCLUSIVE RIGHT TO USE "TROLLING", APART FROM THE MARK AS SHOWN.

SER. NO. 85-137,551, FILED 9-24-2010.

ESTHER A. BORSUK, EXAMINING ATTORNEY



David J. Kybas

Director of the United States Patent and Trademark Office

United States of America

United States Patent and Trademark Office

SCI-TRIV

Reg. No. 4,065,656

Registered Dec. 6, 2011

Int. Cl.: 16

TRADEMARK

PRINCIPAL REGISTER

WEEKLY READER CORPORATION (DELAWARE CORPORATION)
44 SOUTH BROADWAY
LEGAL DEPT
WHITE PLAINS, NY 10601

FOR: SECTION OF A MAGAZINE FEATURING A GAME OF KNOWLEDGE, IN CLASS 16
(U.S. CLS. 2, 5, 22, 23, 29, 37, 38 AND 50).

FIRST USE 3-3-1989; IN COMMERCE 3-3-1989.

THE MARK CONSISTS OF STANDARD CHARACTERS WITHOUT CLAIM TO ANY PARTICULAR FONT, STYLE, SIZE, OR COLOR.

SEC. 2(F).

SER. NO. 85-137,691, FILED 9-24-2010.

RICHARD WHITE, EXAMINING ATTORNEY



David J. Kybas

Director of the United States Patent and Trademark Office

United States of America

United States Patent and Trademark Office

JIM DUNLOP

Reg. No. 4,065,657

Registered Dec. 6, 2011

Int. Cl.: 9

TRADEMARK

PRINCIPAL REGISTER

DUNLOP MANUFACTURING, INC. (COLORADO CORPORATION)
P.O. BOX 846
170 INDUSTRIAL WAY
BENICIA, CA 94510

FOR: ELECTRONIC EFFECT PEDALS FOR USE WITH SOUND AMPLIFIERS, IN CLASS 9
(U.S. CLS. 21, 23, 26, 36 AND 38).

FIRST USE 6-1-1982; IN COMMERCE 6-1-1982.

THE MARK CONSISTS OF STANDARD CHARACTERS WITHOUT CLAIM TO ANY PARTICULAR FONT, STYLE, SIZE, OR COLOR.

OWNER OF U.S. REG. NOS. 2,023,359 AND 3,377,754.

THE NAME(S), PORTRAIT(S), AND/OR SIGNATURE(S) SHOWN IN THE MARK IDENTIFIES "JIM DUNLOP", WHOSE CONSENT(S) TO REGISTER IS MADE OF RECORD.

SER. NO. 85-137,890, FILED 9-24-2010.

BRIAN CALLAGHAN, EXAMINING ATTORNEY



David J. Kybas

Director of the United States Patent and Trademark Office

United States of America

United States Patent and Trademark Office

JIM DUNLOP

Reg. No. 4,065,658

Registered Dec. 6, 2011

Int. Cls.: 3 and 4

TRADEMARK

PRINCIPAL REGISTER

DUNLOP MANUFACTURING, INC. (CALIFORNIA CORPORATION)
P.O. BOX 846
170 INDUSTRIAL WAY
BENICIA, CA 94510

FOR: POLISH CLEANING PREPARATIONS FOR MUSICAL INSTRUMENTS; OILS FOR CLEANING MUSICAL INSTRUMENTS, IN CLASS 3 (U.S. CLS. 1, 4, 6, 50, 51 AND 52).

FIRST USE 1-27-1999; IN COMMERCE 1-27-1999.

FOR: GREASE AND LUBRICATING OIL FOR USE ON MUSICAL INSTRUMENTS, IN CLASS 4 (U.S. CLS. 1, 6 AND 15).

FIRST USE 1-27-1999; IN COMMERCE 1-27-1999.

THE MARK CONSISTS OF STANDARD CHARACTERS WITHOUT CLAIM TO ANY PARTICULAR FONT, STYLE, SIZE, OR COLOR.

OWNER OF U.S. REG. NOS. 2,023,359 AND 3,377,754.

THE NAME(S), PORTRAIT(S), AND/OR SIGNATURE(S) SHOWN IN THE MARK IDENTIFIES "JIM DUNLOP", WHOSE CONSENT(S) TO REGISTER IS MADE OF RECORD.

SER. NO. 85-137,985, FILED 9-24-2010.

BRIAN CALLAGHAN, EXAMINING ATTORNEY



David J. Kybas

Director of the United States Patent and Trademark Office

United States of America

United States Patent and Trademark Office

BARRISTER WINERY

Reg. No. 4,065,659

Registered Dec. 6, 2011

Int. Cl.: 33

TRADEMARK

PRINCIPAL REGISTER

GREG-MICHAEL CELLARS, LLC (WASHINGTON LIMITED LIABILITY COMPANY), AKA
BARRISTER WINERY
1213 W. RAILROAD AVENUE
SPOKANE, WA 99210

FOR: WINES, IN CLASS 33 (U.S. CLS. 47 AND 49).

FIRST USE 5-9-2001; IN COMMERCE 5-9-2001.

THE MARK CONSISTS OF STANDARD CHARACTERS WITHOUT CLAIM TO ANY PARTICULAR FONT, STYLE, SIZE, OR COLOR.

OWNER OF U.S. REG. NO. 2,792,091.

NO CLAIM IS MADE TO THE EXCLUSIVE RIGHT TO USE "WINERY", APART FROM THE MARK AS SHOWN.

SER. NO. 85-138,199, FILED 9-25-2010.

CHERYL CLAYTON, EXAMINING ATTORNEY



David J. Kyffers

Director of the United States Patent and Trademark Office

United States of America

United States Patent and Trademark Office



Reg. No. 4,065,660

Registered Dec. 6, 2011

Int. Cl.: 35

SERVICE MARK

PRINCIPAL REGISTER

LEE THOMAS (UNITED KINGDOM LIMITED LIABILITY COMPANY), TA MARSHMAN
PROJECTS LTD
20 MILLS BUILDING
PLUMPTRE STREET
NOTTINGHAM, UNITED KINGDOM NG11JL

FOR: MANAGEMENT AND BUSINESS CONSULTING SERVICES IN THE FIELD OF
TRAINING AND RECRUITMENT , IN CLASS 35 (U.S. CLS. 100, 101 AND 102).

PRIORITY CLAIMED UNDER SEC. 44(D) ON UNITED KINGDOM APPLICATION NO.
2556071, FILED 8-17-2010, REG. NO. 2556071, DATED 8-17-2010, EXPIRES 8-17-2020.

THE COLOR(S) PINK, WHITE AND GREY IS/ARE CLAIMED AS A FEATURE OF THE
MARK.

OWNER OF UNITED KINGDOM REG. NO. 2487272, DATED 5-12-2008, EXPIRES 5-12-2018.

NO CLAIM IS MADE TO THE EXCLUSIVE RIGHT TO USE "BUSINESSPRO", APART FROM
THE MARK AS SHOWN.

THE MARK CONSISTS OF A BUTTERFLY DESIGN IN PINK, WITHIN WHICH APPEARS
A NUMBER "4" IN WHITE APPEARING ABOVE THE LITERAL ELEMENT "BUSINESSPRO"
WITH "BUSINESS" IN GREY, AND "PRO" IN PINK.

SER. NO. 85-138,237, FILED 9-25-2010.

THOMAS MANOR, EXAMINING ATTORNEY



David J. Kyros

Director of the United States Patent and Trademark Office

United States of America

United States Patent and Trademark Office

FIVE STAR

Reg. No. 4,065,661

Registered Dec. 6, 2011

Int. Cl.: 29

TRADEMARK

PRINCIPAL REGISTER

LAMB WESTON BSW, LLC (DELAWARE LIMITED LIABILITY COMPANY)
8701 W. GAGE BOULEVARD
KENNEWICK, WA 993361034

FOR: FROZEN PROCESSED POTATOES, IN CLASS 29 (U.S. CL. 46).

FIRST USE 3-1-2004; IN COMMERCE 3-1-2004.

THE MARK CONSISTS OF STANDARD CHARACTERS WITHOUT CLAIM TO ANY PARTICULAR FONT, STYLE, SIZE, OR COLOR.

SER. NO. 85-138,562, FILED 9-27-2010.

LINDSEY RUBIN, EXAMINING ATTORNEY



David J. Kybas

Director of the United States Patent and Trademark Office

United States of America
United States Patent and Trademark Office

OPTIMÓ

Reg. No. 4,065,662

Registered Dec. 6, 2011

Int. Cl.: 29

TRADEMARK

PRINCIPAL REGISTER

LAMB WESTON BSW, LLC (DELAWARE LIMITED LIABILITY COMPANY)
8701 W. GAGE BOULEVARD
KENNEWICK, WA 993361034

FOR: FROZEN FRENCH FRIES, IN CLASS 29 (U.S. CL. 46).

FIRST USE 3-1-2004; IN COMMERCE 3-1-2004.

THE MARK CONSISTS OF STANDARD CHARACTERS WITHOUT CLAIM TO ANY PARTICULAR FONT, STYLE, SIZE, OR COLOR.

THE ENGLISH TRANSLATION OF "OPTIMÓ" IN THE MARK IS "OPTIMUM".

SER. NO. 85-138,566, FILED 9-27-2010.

LINDSEY RUBIN, EXAMINING ATTORNEY



David J. Kybas

Director of the United States Patent and Trademark Office

United States of America

United States Patent and Trademark Office



Reg. No. 4,065,663

Registered Dec. 6, 2011

Int. Cl.: 25

TRADEMARK

PRINCIPAL REGISTER

LECCA LECCA, LLC (FLORIDA LIMITED LIABILITY COMPANY)
1051 COLLINS AVE
MIAMI BEACH, FL 33139

FOR: BASEBALL CAPS AND HATS; T-SHIRTS, IN CLASS 25 (U.S. CLS. 22 AND 39).

FIRST USE 5-17-2010; IN COMMERCE 5-17-2010.

NO CLAIM IS MADE TO THE EXCLUSIVE RIGHT TO USE "LECCALECCA", APART FROM THE MARK AS SHOWN.

THE MARK CONSISTS OF A STYLIZED ICE-CREAM CONE TOPPED BY SEVEN ROUND ICE-CREAM SCOOPS AND THE WORD "LECCALECCA" UNDERNEATH THE CONE. THE FINAL LETTER "A" OF THE WORD "LECCALECCA" IS LINKED TO AN ADDITIONAL ICE-CREAM SCOOP OF IRREGULAR SHAPE ON THE RIGHT TOP END OF THE MARK.

THE ENGLISH TRANSLATION OF "LECCALECCA" IN THE MARK IS "LOLLIPOP".

SER. NO. 85-138,613, FILED 9-27-2010.

ANDREW RHIM, EXAMINING ATTORNEY



David J. Kybas

Director of the United States Patent and Trademark Office

United States of America

United States Patent and Trademark Office

BIODEFENSE

Reg. No. 4,065,664

WONDERCIDE LLC (TEXAS LIMITED LIABILITY COMPANY)
P.O. BOX 634
SEABROOK, TX 77586

Registered Dec. 6, 2011

Int. Cl.: 5

FOR: BIOCIDES; INSECT REPELLENTS; INSECTICIDES; PESTICIDES, IN CLASS 5 (U.S. CLS. 6, 18, 44, 46, 51 AND 52).

TRADEMARK

FIRST USE 9-24-2008; IN COMMERCE 9-24-2008.

PRINCIPAL REGISTER

THE MARK CONSISTS OF STANDARD CHARACTERS WITHOUT CLAIM TO ANY PARTICULAR FONT, STYLE, SIZE, OR COLOR.

SER. NO. 85-138,668, FILED 9-27-2010.

ANTHONY RINKER, EXAMINING ATTORNEY



David J. Kybas

Director of the United States Patent and Trademark Office

United States of America

United States Patent and Trademark Office

POWERDNA

Reg. No. 4,065,665

UNITED ELECTRONIC INDUSTRIES, INC. (MASSACHUSETTS CORPORATION)
27 RENMAR AVE
WALPOLE, MA 02081

Registered Dec. 6, 2011

Int. Cl.: 9

FOR: CIRCUIT BOARDS; COMPUTER HARDWARE; COMPUTER SOFTWARE FOR DATA ACQUISITION, IN CLASS 9 (U.S. CLS. 21, 23, 26, 36 AND 38).

TRADEMARK

FIRST USE 9-22-2000; IN COMMERCE 9-22-2000.

PRINCIPAL REGISTER

THE MARK CONSISTS OF STANDARD CHARACTERS WITHOUT CLAIM TO ANY PARTICULAR FONT, STYLE, SIZE, OR COLOR.

SER. NO. 85-138,932, FILED 9-27-2010.

ALLISON SCHRODY, EXAMINING ATTORNEY



David J. Kybas

Director of the United States Patent and Trademark Office

United States of America

United States Patent and Trademark Office

P O W E R

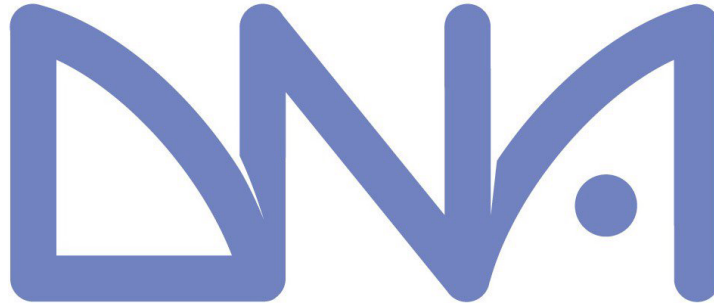

Reg. No. 4,065,666

Registered Dec. 6, 2011

Int. Cl.: 9

TRADEMARK

PRINCIPAL REGISTER

UNITED ELECTRONIC INDUSTRIES, INC. (MASSACHUSETTS CORPORATION)
27 RENMAR AVE
WALPOLE, MA 02081

FOR: CIRCUIT BOARDS; COMPUTER HARDWARE; COMPUTER SOFTWARE FOR DATA ACQUISITION, IN CLASS 9 (U.S. CLS. 21, 23, 26, 36 AND 38).

FIRST USE 9-22-2000; IN COMMERCE 9-22-2000.

THE MARK CONSISTS OF THE WORD "POWER" IN BLACK ABOVE THE WORD "DNA" STYLIZED IN BLUE WITH A BLUE DOT IN THE LETTER "A".

THE COLOR(S) BLACK AND BLUE IS/ARE CLAIMED AS A FEATURE OF THE MARK.

SER. NO. 85-138,934, FILED 9-27-2010.

ALLISON SCHRODY, EXAMINING ATTORNEY



David J. Kybas

Director of the United States Patent and Trademark Office

United States of America

United States Patent and Trademark Office

POWERDAQ

Reg. No. 4,065,667

Registered Dec. 6, 2011

Int. Cl.: 9

TRADEMARK

PRINCIPAL REGISTER

UNITED ELECTRONIC INDUSTRIES, INC. (MASSACHUSETTS CORPORATION)
27 RENMAR AVE
WALPOLE, MA 02081

FOR: CIRCUIT BOARDS; COMPUTER SOFTWARE FOR DATA ACQUISITION; COMPUTER HARDWARE USED FOR PERSONAL COMPUTER BASED DATA COLLECTION, IN CLASS 9 (U.S. CLS. 21, 23, 26, 36 AND 38).

FIRST USE 3-24-1997; IN COMMERCE 3-24-1997.

THE MARK CONSISTS OF STANDARD CHARACTERS WITHOUT CLAIM TO ANY PARTICULAR FONT, STYLE, SIZE, OR COLOR.

SER. NO. 85-138,936, FILED 9-27-2010.

ALLISON SCHRODY, EXAMINING ATTORNEY



David J. Kybas

Director of the United States Patent and Trademark Office

United States of America

United States Patent and Trademark Office

FIVE COLLEGE

Reg. No. 4,065,668

Registered Dec. 6, 2011

Int. Cl.: 35

SERVICE MARK

PRINCIPAL REGISTER

FIVE COLLEGES, INCORPORATED (MASSACHUSETTS CORPORATION)
97 SPRING STREET
AMHERST, MA 010022324

FOR: BUSINESS ADMINISTRATION AND OFFICE WORK FOR A COLLECTIVE OF COLLEGES AND UNIVERSITIES; ADMINISTRATION OF A PROGRAM FOR ENABLING PARTICIPANTS IN THE NATURE OF COLLEGES OR UNIVERSITIES TO OBTAIN DISCOUNTS ON THE COST OF SERVICES OR RECEIVE IMPROVED SERVICES; BUSINESS MANAGEMENT SERVICES, NAMELY, ADMINISTRATION OF BUSINESS ENGAGED IN PROVIDING EDUCATION AT UNDERGRADUATE AND POST-GRADUATE LEVELS; CONSULTING SERVICES IN THE FIELD OF HIGHER EDUCATION ADMINISTRATION, IN CLASS 35 (U.S. CLS. 100, 101 AND 102).

FIRST USE 9-20-1966; IN COMMERCE 9-20-1966.

THE MARK CONSISTS OF STANDARD CHARACTERS WITHOUT CLAIM TO ANY PARTICULAR FONT, STYLE, SIZE, OR COLOR.

NO CLAIM IS MADE TO THE EXCLUSIVE RIGHT TO USE "COLLEGE", APART FROM THE MARK AS SHOWN.

SEC. 2(F).

SER. NO. 85-139,002, FILED 9-27-2010.

IRA J. GOODSaid, EXAMINING ATTORNEY



David J. Kyros

Director of the United States Patent and Trademark Office

United States of America

United States Patent and Trademark Office



Reg. No. 4,065,669

Registered Dec. 6, 2011

Int. Cl.: 5

TRADEMARK

PRINCIPAL REGISTER

MERCK KGAA (FED REP GERMANY KOMMANDITGESELLSCHAFT AUF AKTIEN (KGAA))
FRANKFURTER STR. 250
64293 DARMSTADT, FED REP GERMANY

FOR: PHARMACEUTICAL PREPARATIONS CONSISTING OF VITAMINS, MINERALS AND PROBIOTIC CULTURES FOR THE TREATMENT OF DEFICIENCIES OF THE IMMUNE SYSTEM; DIETETIC SUBSTANCES AND FOOD SUPPLEMENTS ADAPTED FOR MEDICAL AND NON-MEDICAL USE, NAMELY, DIETARY SUPPLEMENTS CONSISTING OF VITAMINS, MINERALS AND PROBIOTIC CULTURES, IN CLASS 5 (U.S. CLS. 6, 18, 44, 46, 51 AND 52).

PRIORITY CLAIMED UNDER SEC. 44(D) ON FED REP GERMANY APPLICATION NO. 302010052500, FILED 9-4-2010, REG. NO. 302010052500, DATED 9-28-2010, EXPIRES 9-4-2020.

THE MARK CONSISTS OF "BION3" NEXT TO A FANCIFUL CIRCLE.

SER. NO. 85-139,528, FILED 9-28-2010.

CAROLYN CATALDO, EXAMINING ATTORNEY



David J. Kyjars

Director of the United States Patent and Trademark Office

United States of America

United States Patent and Trademark Office



Reg. No. 4,065,670

Registered Dec. 6, 2011

Int. Cl.: 5

TRADEMARK

PRINCIPAL REGISTER

MERCK KGAA (FED REP GERMANY KOMMANDITGESELLSCHAFT AUF AKTIEN (KGAA))
FRANKFURTER STR. 250
64293 DARMSTADT, FED REP GERMANY

FOR: PHARMACEUTICAL PREPARATIONS CONSISTING OF VITAMINS, MINERALS AND PROBIOTIC CULTURES FOR THE TREATMENT OF DEFICIENCIES OF THE IMMUNE SYSTEM; DIETETIC SUBSTANCES AND FOOD SUPPLEMENTS ADAPTED FOR MEDICAL AND NON-MEDICAL USE, NAMELY, DIETARY SUPPLEMENTS CONSISTING OF VITAMINS, MINERALS AND PROBIOTIC CULTURES, IN CLASS 5 (U.S. CLS. 6, 18, 44, 46, 51 AND 52).

PRIORITY CLAIMED UNDER SEC. 44(D) ON FED REP GERMANY APPLICATION NO. 302010052499, FILED 9-4-2010, REG. NO. 302010052499, DATED 9-28-2010, EXPIRES 9-4-2020.

THE MARK CONSISTS OF "BION" AND A FANCIFUL CIRCLE.

SER. NO. 85-139,534, FILED 9-28-2010.

CAROLYN CATALDO, EXAMINING ATTORNEY



David J. Kyjars

Director of the United States Patent and Trademark Office

United States of America

United States Patent and Trademark Office

ACTINVER

Reg. No. 4,065,671

Registered Dec. 6, 2011

Int. Cl.: 35

SERVICE MARK

PRINCIPAL REGISTER

GRUPO ACTINVER, S.A. DE C.V. (MEXICO CORPORATION)
PLAZA DEL PARQUE, COL. CENTRO DE CIUDAD
GUILLERMO GONZALEZ CAMARENA #1200
SANTA FE, MEXICO

FOR: PUBLICITY CONSULTATION; BUSINESS MANAGEMENT; BUSINESS ADMINISTRATION; PROVIDING OFFICE FUNCTIONS, IN CLASS 35 (U.S. CLS. 100, 101 AND 102).

THE MARK CONSISTS OF STANDARD CHARACTERS WITHOUT CLAIM TO ANY PARTICULAR FONT, STYLE, SIZE, OR COLOR.

OWNER OF MEXICO REG. NO. 1012045, DATED 11-20-2007, EXPIRES 10-9-2016.

SER. NO. 85-139,645, FILED 9-28-2010.

RONALD MCMORROW, EXAMINING ATTORNEY



David J. Kyros

Director of the United States Patent and Trademark Office

United States of America

United States Patent and Trademark Office

ACTINVER

Reg. No. 4,065,672

Registered Dec. 6, 2011

Int. Cl.: 36

SERVICE MARK

PRINCIPAL REGISTER

GRUPO ACTINVER, S.A. DE C.V. (MEXICO CORPORATION)
PLAZA DEL PARQUE, COL. CENTRO DE CIUDAD
GUILLERMO GONZALEZ CAMARENA #1200
SANTA FE, MEXICO

FOR: INSURANCE BROKERAGE; FINANCIAL MATTERS, NAMELY, FINANCIAL ADVICE, INSURANCE UNDERWRITING SERVICES FOR ALL TYPES OF INSURANCE, INVESTMENT MANAGEMENT AND ADVISORY SERVICES, MUTUAL FUND INVESTMENT SERVICES, PRIVATE EQUITY INVESTMENT SERVICES, VENTURE CAPITAL INVESTMENT SERVICES, FINANCIAL PLANNING SERVICES FOR OTHERS, INVESTMENT BANKING SERVICES, SECURITIES BROKERAGE SERVICES; MONETARY MATTERS, NAMELY, MONETARY EXCHANGE; REAL ESTATE MATTERS, NAMELY, REAL ESTATE VALUATIONS, REAL ESTATE INVESTMENT MANAGEMENT, REAL ESTATE APPRAISAL SERVICES, AND REAL ESTATE BROKERAGE SERVICES, IN CLASS 36 (U.S. CLS. 100, 101 AND 102).

THE MARK CONSISTS OF STANDARD CHARACTERS WITHOUT CLAIM TO ANY PARTICULAR FONT, STYLE, SIZE, OR COLOR.

OWNER OF MEXICO REG. NO. 1036111, DATED 4-23-2008, EXPIRES 10-9-2016.

SER. NO. 85-139,699, FILED 9-28-2010.

RONALD MCMORROW, EXAMINING ATTORNEY



David J. Kybas

Director of the United States Patent and Trademark Office

United States of America

United States Patent and Trademark Office

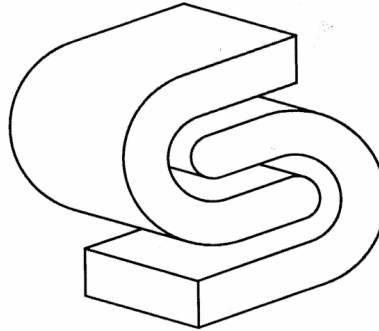

Reg. No. 4,065,673

Registered Dec. 6, 2011

Int. Cl.: 42

SERVICE MARK

PRINCIPAL REGISTER

CONCAT SYSTEMS, INC. (IOWA CORPORATION)
6711 CODY DRIVE
WEST DES MOINES, IA 50266

FOR: SOFTWARE DEVELOPMENT IN THE FIELD OF GLOBAL NETWORKS, MULTIMEDIA
AND MOBILE APPLICATIONS, IN CLASS 42 (U.S. CLS. 100 AND 101).

FIRST USE 3-1-2008; IN COMMERCE 3-1-2008.

THE MARK CONSISTS OF "CS" DESIGN.

SER. NO. 85-139,780, FILED 9-28-2010.

TIMOTHY FINNEGAN, EXAMINING ATTORNEY



David J. Kybas

Director of the United States Patent and Trademark Office

United States of America

United States Patent and Trademark Office

BEST OF ROCHESTER

Reg. No. 4,065,674

Registered Dec. 6, 2011

Int. Cls.: 16 and 35

TRADEMARK

SERVICE MARK

PRINCIPAL REGISTER

W.M.T. PUBLICATIONS, INC. (NEW YORK CORPORATION)
250 GOODMAN STREET
ROCHESTER, NY 14607

FOR: MAGAZINE SECTION FEATURING RESTAURANTS, SHOPPING, ENTERTAINMENT, OUTDOOR RECREATION, EVENTS, CULTURE, NEWS, PRODUCTS, AND SERVICES OF INTEREST IN ROCHESTER, IN CLASS 16 (U.S. CLS. 2, 5, 22, 23, 29, 37, 38 AND 50).

FIRST USE 0-0-1997; IN COMMERCE 0-0-1997.

FOR: CONDUCTING AWARD PROGRAMS TO PROMOTE THE BUSINESS OF RETAIL ESTABLISHMENTS THROUGH THE DEMONSTRATION OF EXCELLENCE IN CUSTOMER SERVICE, QUALITY OF PRODUCTS OR SERVICES, AND GENERALLY IN THEIR FIELD, IN CLASS 35 (U.S. CLS. 100, 101 AND 102).

FIRST USE 0-0-1997; IN COMMERCE 0-0-1997.

THE MARK CONSISTS OF STANDARD CHARACTERS WITHOUT CLAIM TO ANY PARTICULAR FONT, STYLE, SIZE, OR COLOR.

SEC. 2(F).

SER. NO. 85-139,814, FILED 9-28-2010.

ANTHONY RINKER, EXAMINING ATTORNEY



David J. Kybas

Director of the United States Patent and Trademark Office

United States of America

United States Patent and Trademark Office

Rabbit  Marketing

Reg. No. 4,065,675

Registered Dec. 6, 2011

Int. Cl.: 35

SERVICE MARK

PRINCIPAL REGISTER

RABBIT MARKETING SERVICES, LLC (DELAWARE LIMITED LIABILITY COMPANY)
COMPANY CORPORATION
2711 CENTERVILLE RD., SUITE 400
WILMINGTON, DE 19808

FOR: ADVERTISING, INCLUDING ONLINE ADVERTISING SERVICES ON A COMPUTER NETWORK, IN CLASS 35 (U.S. CLS. 100, 101 AND 102).

FIRST USE 4-1-2001; IN COMMERCE 3-1-2002.

NO CLAIM IS MADE TO THE EXCLUSIVE RIGHT TO USE "MARKETING", APART FROM THE MARK AS SHOWN.

THE COLOR(S) BLACK AND PURPLE IS/ARE CLAIMED AS A FEATURE OF THE MARK.

THE MARK CONSISTS OF THE WORDING "RABBIT MARKETING" IN BLACK WITH RABBIT EARS FORMING THE LETTER "M" IN PURPLE.

SER. NO. 85-139,965, FILED 9-28-2010.

AISHA SALEM, EXAMINING ATTORNEY



David J. Kybas

Director of the United States Patent and Trademark Office

United States of America

United States Patent and Trademark Office

SAURO

Reg. No. 4,065,676

Registered Dec. 6, 2011

Int. Cl.: 9

TRADEMARK

PRINCIPAL REGISTER

SAURO, INC. (TEXAS CORPORATION)
1604 BENCHMARK DR. STE. A
AUSTIN, TX 78728

FOR: ELECTRICAL CONNECTORS; ELECTRICAL TERMINAL BLOCKS; CONNECTION TERMINALS; CONNECTING ELECTRICAL CABLES; ELECTRICAL POWER CONNECTORS; ELECTRICAL POWER DISTRIBUTION BLOCKS; SUPPORTS FOR PRINTED CIRCUIT BOARDS; HOUSING FOR PRINTED CIRCUIT BOARDS; PINS FOR ELECTRICAL CIRCUITS; CLAMPS FOR ELECTRICAL CIRCUITS; SHORT-CIRCUIT JUMPERS FOR ELECTRIC CIRCUITS; MAGNETS; TEST PROBES; PROBES FOR TESTING INTEGRATED CIRCUITS; TEST ADAPTERS AND TEST PINS FOR TESTING CIRCUIT BOARDS, IN CLASS 9 (U.S. CLS. 21, 23, 26, 36 AND 38).

FIRST USE 6-15-1984; IN COMMERCE 6-30-1999.

THE MARK CONSISTS OF STANDARD CHARACTERS WITHOUT CLAIM TO ANY PARTICULAR FONT, STYLE, SIZE, OR COLOR.

OWNER OF U.S. REG. NO. 2,428,544.

THE ENGLISH TRANSLATION OF THE ITALIAN WORD "SAURO" IN THE MARK IS "SORREL".

SEC. 2(F).

SER. NO. 85-140,134, FILED 9-28-2010.

DAVID C. REIHNER, EXAMINING ATTORNEY



David J. Kypos

Director of the United States Patent and Trademark Office

United States of America

United States Patent and Trademark Office



Reg. No. 4,065,677

Registered Dec. 6, 2011

Int. Cls.: 3, 9 and 44

TRADEMARK

SERVICE MARK

PRINCIPAL REGISTER

THE SKIN ATELIER, INC. (NEW YORK CORPORATION)
1997 ROUTE 17M
GOSHEN, NY 10924

FOR: SOAPS, BODY SCRUBS, BODY MASSAGE OILS, BODY BUTTER, AND FRAGRANCE SPRAYS FOR THE BODY; FOOT SPRAYS; NON-MEDICATED PEDICURE SOAKS, AND PEDICURE SCRUBS; GEL EYE MASKS FOR COSMETIC PURPOSES; NON-MEDICATED SKIN CARE PRODUCTS, NAMELY, SKIN LOTIONS AND CREAMS, SKIN CLEANSERS, SKIN MOISTURIZERS, SKIN TONERS AND EXFOLIATES, FACE LOTION, BODY LOTION, FOOT LOTION, HAND LOTION, DÉCOLLETAGE LOTION, FACE CREAM, BODY CREAM, FOOT CREAM, HAND CREAM, DÉCOLLETAGE CREAM, FACE SERUM, HAND SERUM, FOOT SERUM, HAND CLEANSER, DÉCOLLETAGE CLEANSER, FACE CLEANSER, BODY CLEANSER, FOOT CLEANSER, AND SUNSCREEN PRODUCTS, NAMELY, SUNSCREEN CREAM AND COSMETIC SUN SCREEN PREPARATIONS; NON-MEDICATED SPA PROFESSIONAL PRODUCTS, NAMELY, FACE LOTION, BODY LOTION, FOOT LOTION, HAND LOTION, DÉCOLLETAGE LOTION, FACE CREAM, BODY CREAM, FOOT CREAM, HAND CREAM, DÉCOLLETAGE CREAM, FACE SERUM, HAND SERUM, FOOT SERUM, HAND CLEANSER, DÉCOLLETAGE CLEANSER, FACE CLEANSER, BODY CLEANSER, FOOT CLEANSER, SUNSCREEN CREAM AND COSMETIC SUN SCREEN PREPARATIONS; AND NON-MEDICATED BACK BAR PRODUCTS, NAMELY, MASSAGE CREAMS, MASSAGE OILS, FACIAL MASKS FOR COSMETIC PURPOSES, BODY MASKS, HAND MASKS, FOOT MASKS, DÉCOLLETAGE MASKS, FACIAL EXFOLIATORS, BODY EXFOLIATORS, FOOT EXFOLIATORS, HAND EXFOLIATORS AND DÉCOLLETAGE EXFOLIATORS; AND BODY DEODORANTS, IN CLASS 3 (U.S. CLS. 1, 4, 6, 50, 51 AND 52).

FIRST USE 11-15-2002; IN COMMERCE 11-15-2002.

FOR: DIAGNOSTIC EQUIPMENT FOR SKIN ANALYSIS, NAMELY, OPTICAL SENSORS FOR CAPTURING IMAGES, IN CLASS 9 (U.S. CLS. 21, 23, 26, 36 AND 38).

FIRST USE 7-1-2003; IN COMMERCE 7-1-2003.

FOR: COSMETIC ANALYSIS SERVICES, NAMELY, PROVIDING AN INDIVIDUALIZED EXTERIOR TISSUE DOSSIER RESULTING FROM BIOMETRIC TESTING OF THE SKIN, IN CLASS 44 (U.S. CLS. 100 AND 101).

FIRST USE 11-15-2002; IN COMMERCE 11-15-2002.



David J. Kyros

Director of the United States Patent and Trademark Office

Reg. No. 4,065,677 OWNER OF U.S. REG. NOS. 2,968,898 AND 2,993,443.

THE MARK CONSISTS OF THE LITERAL ELEMENT "SKINPRINT" TOGETHER WITH A STYLIZED RENDERING OF A FINGERPRINT AGAINST A HORIZONTAL RECTANGLE BACKGROUND.

SER. NO. 85-140,271, FILED 9-28-2010.

AISHA SALEM, EXAMINING ATTORNEY

United States of America

United States Patent and Trademark Office



Reg. No. 4,065,678

Registered Dec. 6, 2011

Int. Cls.: 35, 41 and 42

SERVICE MARK

PRINCIPAL REGISTER

AMERICAN GOLF CORPORATION (CALIFORNIA CORPORATION)
2951 28TH STREET
SANTA MONICA, CA 90405

FOR: PROVIDING A WEBSITE THAT ENABLES USERS TO LOCATE SERVICE PROVIDERS, NAMELY, PROVIDERS OF SERVICES OFFERED AT GOLF COURSES AND CLUBS, INCLUDING GOLF TEE TIME INFORMATION, COST AND FEE INFORMATION AND RATING/RANKING SUCH VENDORS AND PROVIDERS AS TO DATES, COST, AND OTHER DATA, TO ASCERTAIN THE AVAILABILITY OF THAT SERVICE PROVIDER OR RESOURCE BY ACCESSING CALENDAR INFORMATION FOR THAT SERVICE PROVIDER AND/OR BOOKING INFORMATION FOR THE TEE TIME OR OTHER SERVICE, ALL IN REAL-TIME; PROVIDING GOLF RELATED CONSUMER PRODUCT INFORMATION VIA INTERNET; PROMOTING ON-LINE GOODS AND SERVICES AT GOLF COURSES AND CLUB OF OTHERS, NAMELY GOLF TEE TIME RESERVATIONS AND/OR INTERCHANGES VIA A GLOBAL COMPUTER NETWORK; ON-LINE PUBLICITY AND SALES PROMOTION RELATING TO GOODS AND SERVICES AT GOLF COURSES AND CLUB AND IN THE GOLF INDUSTRY INCLUDING GOLF CLOTHING, GOLF EQUIPMENT AND ACCESSORIES, LESSONS, GOLF EVENTS, MEMBERSHIPS, FOOD AND BEVERAGE SPECIALS; PROVIDING AN ONLINE CLASSIFIEDS SERVICE TO USERS TO ADVERTISE ITS GOODS AND PRODUCTS, IN CLASS 35 (U.S. CLS. 100, 101 AND 102).

FIRST USE 9-22-2010; IN COMMERCE 9-22-2010.



FOR: PROVIDING AN ONLINE INTERACTIVE WEBSITE FOR USERS TO SIGN UP FOR FANTASY GOLF GAME, ACCESS TO MEMBER-ONLY GOLF TOURNAMENTS AND HANDICAP INDEX TRACKING SERVICES FOR GOLF COMPETITIONS AND MATCHES; PROVIDING GOLF INFORMATION, NAMELY COMPILATIONS, RANKINGS, RATINGS, REVIEWS, REFERRALS, ARTICLES, VIDEOS AND RECOMMENDATIONS RELATING TO BUSINESS ORGANIZATIONS, SERVICE PROVIDERS, AND OTHER RESOURCES RELATING TO GOLF AND GOLF INDUSTRY USING A GLOBAL COMPUTER NETWORK, IN CLASS 41 (U.S. CLS. 100, 101 AND 107).

FIRST USE 9-22-2010; IN COMMERCE 9-22-2010.

David J. Kybas

FOR: PROVIDING AN ONLINE INTERACTIVE WEBSITE OBTAINING USERS COMMENTS CONCERNING BUSINESS ORGANIZATIONS, SERVICE PROVIDERS, AND OTHER RE-

Reg. No. 4,065,678 SOURCES, ALL RELATED TO GOLF AND GOLF INDUSTRY, IN CLASS 42 (U.S. CLS. 100 AND 101).

FIRST USE 9-22-2010; IN COMMERCE 9-22-2010.

THE MARK CONSISTS OF A BLUE STREAK FADING TO WHITE WHICH HAS A WHITE GOLF BALL AT ONE END; THE GOLF BALL HAS A BLACK SMILE LINE, AND WEARS BLACK SUNGLASSES WITH BROWN LENSES, ALL ABOVE THE COINED WORD "GOLFZING" WITH THE WORD "GOLF" IN RED AND "ZING" IN BLUE. A PARTIAL REFLECTION OF THE STREAK, GOLFBALL AND WORD IS BELOW.

THE COLOR(S) RED, WHITE, BLUE, BLACK AND BROWN IS/ARE CLAIMED AS A FEATURE OF THE MARK.

SER. NO. 85-140,299, FILED 9-28-2010.

BRIDGETT SMITH, EXAMINING ATTORNEY

United States of America

United States Patent and Trademark Office

SCHOLARICH

Reg. No. 4,065,679

HARPER, KAMAU (UNITED STATES INDIVIDUAL)
48 LOTT AVE
BROOKLYN, NY 11212

Registered Dec. 6, 2011

Int. Cl.: 41

FOR: ENTERTAINMENT SERVICES IN THE NATURE OF RECORDING, PRODUCTION AND POST-PRODUCTION SERVICES IN THE FIELD OF MUSIC; PRODUCTION AND DISTRIBUTION OF VIDEOS IN THE FIELDS OF EDUCATION AND MUSIC, IN CLASS 41 (U.S. CLS. 100, 101 AND 107).

SERVICE MARK

PRINCIPAL REGISTER

FIRST USE 4-30-2009; IN COMMERCE 11-30-2009.

THE MARK CONSISTS OF STANDARD CHARACTERS WITHOUT CLAIM TO ANY PARTICULAR FONT, STYLE, SIZE, OR COLOR.

SER. NO. 85-140,516, FILED 9-29-2010.

ROBERT C. CLARK JR., EXAMINING ATTORNEY



David J. Kyffers

Director of the United States Patent and Trademark Office

United States of America

United States Patent and Trademark Office

BENEFIT

Reg. No. 4,065,680

Registered Dec. 6, 2011

Int. Cls.: 9 and 41

TRADEMARK

SERVICE MARK

PRINCIPAL REGISTER

UNLIMITED CONTINUES LLC (GEORGIA LIMITED LIABILITY COMPANY)
PO BOX 6383
MARIETTA, GA 300650383

FOR: DIGITAL AND PHYSICAL MEDIA, NAMELY, CDS, DVDS, DOWNLOADABLE RING TONES, AND DOWNLOADABLE AUDIO FILES FEATURING MUSIC AND PERFORMANCES BY A MUSICAL ARTIST; AUDIO RECORDINGS FEATURING MUSIC FROM A MUSICAL ARTIST, IN CLASS 9 (U.S. CLS. 21, 23, 26, 36 AND 38).

FIRST USE 1-1-1997; IN COMMERCE 6-1-1999.

FOR: ENTERTAINMENT IN THE NATURE OF VISUAL AND AUDIO PERFORMANCES BY A MUSICAL ARTIST; LIVE PERFORMANCES BY A MUSICAL ARTIST, IN CLASS 41 (U.S. CLS. 100, 101 AND 107).

FIRST USE 1-1-1997; IN COMMERCE 6-1-1999.

THE MARK CONSISTS OF STANDARD CHARACTERS WITHOUT CLAIM TO ANY PARTICULAR FONT, STYLE, SIZE, OR COLOR.

THE NAME(S), PORTRAIT(S), AND/OR SIGNATURE(S) SHOWN IN THE MARK IDENTIFIES THE INDIVIDUAL KNOWN PROFESSIONALLY AS "BENEFIT", WHOSE CONSENT(S) TO REGISTER IS MADE OF RECORD.

SER. NO. 85-140,545, FILED 9-29-2010.

BRIAN CALLAGHAN, EXAMINING ATTORNEY



David J. Kypos

Director of the United States Patent and Trademark Office

United States of America

United States Patent and Trademark Office

THE ABILITY UTILITY

Reg. No. 4,065,681

LEARN.COM, INC. (DELAWARE CORPORATION)
14001 NW 4TH STREET
SUNRISE, FL 33325

Registered Dec. 6, 2011

Int. Cl.: 42

FOR: COMPUTER SERVICES, NAMELY, APPLICATION SERVICE PROVIDER FEATURING SOFTWARE FOR USE IN MANAGING HUMAN RESOURCES AND FOR MANAGING AND TRACKING EMPLOYEE SKILLS, TRAINING AND PERFORMANCE , IN CLASS 42 (U.S. CLS. 100 AND 101).

SERVICE MARK

PRINCIPAL REGISTER

FIRST USE 12-31-2004; IN COMMERCE 12-31-2004.

THE MARK CONSISTS OF STANDARD CHARACTERS WITHOUT CLAIM TO ANY PARTICULAR FONT, STYLE, SIZE, OR COLOR.

OWNER OF U.S. REG. NO. 2,384,797.

NO CLAIM IS MADE TO THE EXCLUSIVE RIGHT TO USE "UTILITY", APART FROM THE MARK AS SHOWN.

SER. NO. 85-140,662, FILED 9-29-2010.

ALEXANDER L. POWERS, EXAMINING ATTORNEY



David J. Kyros

Director of the United States Patent and Trademark Office

United States of America

United States Patent and Trademark Office

Creative Stair Parts

Reg. No. 4,065,682

Registered Dec. 6, 2011

Int. Cls.: 6 and 19

TRADEMARK

PRINCIPAL REGISTER

THE EMPIRE COMPANY (MICHIGAN CORPORATION)
8181 LOGISTIC DRIVE
ZEELAND, MI 49464

FOR: COMPONENTS MADE OF METAL FOR USE WITH STAIRS, NAMELY, IRON BALUSTERS, BALUSTER COLLARS, AND NEWELS, IN CLASS 6 (U.S. CLS. 2, 12, 13, 14, 23, 25 AND 50).

FIRST USE 5-0-1989; IN COMMERCE 5-0-1989.

FOR: STAIRS NOT OF METAL AND COMPONENTS THEREFOR, NAMELY, BALUSTERS, NEWELS, TREADS, RISERS, SKIRT BOARDS, COVES, NOSINGS, HANDRAILS, AND RAIL FITTINGS, IN CLASS 19 (U.S. CLS. 1, 12, 33 AND 50).

FIRST USE 5-0-1989; IN COMMERCE 5-0-1989.

NO CLAIM IS MADE TO THE EXCLUSIVE RIGHT TO USE "STAIR PARTS", APART FROM THE MARK AS SHOWN.

THE MARK CONSISTS OF "CREATIVE STAIR PARTS" IN SCRIPT WRITING.

SER. NO. 85-141,170, FILED 9-29-2010.

SANI KHOURI, EXAMINING ATTORNEY



David J. Kybas

Director of the United States Patent and Trademark Office

United States of America

United States Patent and Trademark Office

XLERATOR

Reg. No. 4,065,683

Registered Dec. 6, 2011

Int. Cl.: 42

SERVICE MARK

PRINCIPAL REGISTER

MEDICAL PRIORITY CONSULTANTS, INC. (UTAH CORPORATION)
SUITE 500
139 E. SOUTH TEMPLE
SALT LAKE CITY, UT 84111

FOR: DEVELOPING AND HOSTING A SERVER ON A GLOBAL COMPUTER NETWORK FOR THE PURPOSE OF FACILITATING COMMUNICATION AMONG MULTIPLE RELATIONAL DATABASE SERVERS; APPLICATION SERVICE PROVIDER (ASP) FEATURING SOFTWARE FOR USE IN FACILITATING COMMUNICATION AMONG MULTIPLE RELATIONAL DATABASE SERVERS, IN CLASS 42 (U.S. CLS. 100 AND 101).

FIRST USE 7-29-2004; IN COMMERCE 7-29-2004.

THE MARK CONSISTS OF STANDARD CHARACTERS WITHOUT CLAIM TO ANY PARTICULAR FONT, STYLE, SIZE, OR COLOR.

SER. NO. 85-141,229, FILED 9-29-2010.

NELSON SNYDER, EXAMINING ATTORNEY



David J. Kybas

Director of the United States Patent and Trademark Office

United States of America

United States Patent and Trademark Office



Reg. No. 4,065,684

Registered Dec. 6, 2011

Int. Cl.: 41

SERVICE MARK

PRINCIPAL REGISTER

DALE, ERIC M (UNITED STATES INDIVIDUAL)
500 W. SILVER SPRING DRIVE, STE K200
GLENDALE, WI 53217

FOR: ENTERTAINMENT, NAMELY, A CONTINUING HOME IMPROVEMENT AND RE-MODELING SHOW BROADCAST OVER TELEVISION AND THE INTERNET, IN CLASS 41 (U.S. CLS. 100, 101 AND 107).

FIRST USE 4-6-2010; IN COMMERCE 4-6-2010.

THE MARK CONSISTS OF A BLUE CIRCLE WITH YELLOW OUTLINE AND DIFFERENTLY-SIZED AND REPEATING FAINT RECTANGLES APPEARING THROUGHOUT THE CIRCLE, BEHIND THE WORDING "HOMEWORK" IN WHITE WITH THE DESIGN OF A ROOF IN WHITE OVER THE WORD "HOME".

THE COLOR(S) BLUE, WHITE, AND YELLOW IS/ARE CLAIMED AS A FEATURE OF THE MARK.

SER. NO. 85-141,276, FILED 9-29-2010.

MICHAEL WIENER, EXAMINING ATTORNEY



David J. Kybas

Director of the United States Patent and Trademark Office

United States of America

United States Patent and Trademark Office

Dream Weavers

Reg. No. 4,065,685

Registered Dec. 6, 2011

Int. Cl.: 26

TRADEMARK

PRINCIPAL REGISTER

FUNCICH, SANDRA D (UNITED STATES INDIVIDUAL)
3638 YOUNG WOLF DRIVE
SIMI VALLEY, CA 93065 AND

FUNCICH, CHRISTOPHER N (UNITED STATES INDIVIDUAL)
3638 YOUNG WOLF DRIVE
SIMI VALLEY, CA 93065

FOR: CLEAR PLASTIC SHEETS FOR USE IN HAIR WEAVING AND HIGHLIGHTING, IN CLASS 26 (U.S. CLS. 37, 39, 40, 42 AND 50).

FIRST USE 7-19-1982; IN COMMERCE 7-19-1982.

THE MARK CONSISTS OF STANDARD CHARACTERS WITHOUT CLAIM TO ANY PARTICULAR FONT, STYLE, SIZE, OR COLOR.

NO CLAIM IS MADE TO THE EXCLUSIVE RIGHT TO USE "WEAVERS", APART FROM THE MARK AS SHOWN.

SER. NO. 85-141,362, FILED 9-29-2010.

SANI KHOURI, EXAMINING ATTORNEY



David J. Kybas

Director of the United States Patent and Trademark Office

United States of America

United States Patent and Trademark Office

Adoba Eco Hotel & Suites

Reg. No. 4,065,686

Registered Dec. 6, 2011

Int. Cl.: 43

SERVICE MARK

PRINCIPAL REGISTER

ATMOSPHERE HOSPITALITY MANAGEMENT LLC (DELAWARE LIMITED LIABILITY COMPANY)
300 QUAIL RIDGE CIRCLE
HIGHLANDS RANCH, CO 80126

FOR: HOTEL SERVICES; HOTELS, IN CLASS 43 (U.S. CLS. 100 AND 101).

FIRST USE 4-22-2010; IN COMMERCE 4-22-2010.

THE MARK CONSISTS OF STANDARD CHARACTERS WITHOUT CLAIM TO ANY PARTICULAR FONT, STYLE, SIZE, OR COLOR.

NO CLAIM IS MADE TO THE EXCLUSIVE RIGHT TO USE "ECO HOTEL & SUITES", APART FROM THE MARK AS SHOWN.

THE ENGLISH TRANSLATION OF "ADOBA" IS "CLAY".

SER. NO. 85-141,388, FILED 9-29-2010.

ROBERT C. CLARK JR., EXAMINING ATTORNEY



David J. Kybas

Director of the United States Patent and Trademark Office

United States of America

United States Patent and Trademark Office



Reg. No. 4,065,687

GOLD LEAF INTERNATIONAL (FLORIDA CORPORATION)
3000 S SR 7
MIRAMAR, FL 33023

Registered Dec. 6, 2011

Int. Cl.: 36

FOR: PROVIDING MONETARY EXCHANGE SERVICES, NAMELY, EXCHANGING GOLD AND SILVER OF OTHERS FOR CASH, IN CLASS 36 (U.S. CLS. 100, 101 AND 102).

SERVICE MARK

FIRST USE 7-18-2010; IN COMMERCE 7-18-2010.

PRINCIPAL REGISTER

NO CLAIM IS MADE TO THE EXCLUSIVE RIGHT TO USE "GOLD EXCHANGE"; "FINE GOLD GGG.G NET WT"; "1000 FINE SILVER .GG" AND A DEPICTION OF GOLD AND SILVER BARS, APART FROM THE MARK AS SHOWN.

THE MARK CONSISTS OF THE STYLIZED LETTERING, "GOLD EXCHANGE UNION", TO THE RIGHT OF THE LETTERING ARE, A BAR OF GOLD AND A BAR OF SILVER BEING CIRCLED BY A LINE AND A STYLIZED AIRPLANE, ON THE BAR OF GOLD IS THE LETTERING "FINE GOLD GGG.G", "NET WT, 1000", ON THE BAR OF SILVER UNDER THE GOLD, IT SAYS, "FINE SILVER.GG".

SER. NO. 85-141,436, FILED 9-29-2010.

ZACHARY BELLO, EXAMINING ATTORNEY



David J. Kyros

Director of the United States Patent and Trademark Office

United States of America

United States Patent and Trademark Office

DR. STENGLER'S NATURAL HEALING

Reg. No. 4,065,688

Registered Dec. 6, 2011

Int. Cls.: 41 and 44

SERVICE MARK

PRINCIPAL REGISTER

STENGLER VISION, INC. (CALIFORNIA CORPORATION)
894 ANTILLA WAY
SAN MARCOS, CA 92101

FOR: EDUCATIONAL SERVICES, NAMELY, A CONTINUING PROGRAM PROVIDING INFORMATION ABOUT HEALTH AND NUTRITIONAL AND HOLISTIC MEDICINE AND HOLISTIC MEDICAL INFORMATION ABOUT NUTRITIONAL PRODUCTS AND SUPPLEMENTS ACCESSIBLE BY RADIO, TELEVISION, SATELLITE, AUDIO, VIDEO AND COMPUTER NETWORKS, IN CLASS 41 (U.S. CLS. 100, 101 AND 107).

FIRST USE 6-30-2010; IN COMMERCE 7-14-2010.

FOR: PROVIDING INFORMATION ABOUT HEALTH AND NUTRITIONAL AND HOLISTIC MEDICINE; PROVIDING HOLISTIC MEDICAL INFORMATION ABOUT NUTRITIONAL PRODUCTS AND SUPPLEMENTS, IN CLASS 44 (U.S. CLS. 100 AND 101).

FIRST USE 6-30-2010; IN COMMERCE 7-14-2010.

THE MARK CONSISTS OF STANDARD CHARACTERS WITHOUT CLAIM TO ANY PARTICULAR FONT, STYLE, SIZE, OR COLOR.

NO CLAIM IS MADE TO THE EXCLUSIVE RIGHT TO USE "NATURAL HEALING", APART FROM THE MARK AS SHOWN.

THE NAME "DR. STENGLER" IDENTIFIES A LIVING INDIVIDUAL WHOSE CONSENT IS OF RECORD.

SER. NO. 85-141,758, FILED 9-30-2010.

WON TEAK OH, EXAMINING ATTORNEY



David J. Kyffers

Director of the United States Patent and Trademark Office

United States of America

United States Patent and Trademark Office



Reg. No. 4,065,689

Registered Dec. 6, 2011

Int. Cl.: 43

SERVICE MARK

PRINCIPAL REGISTER

129 WCS OC, LLC (FLORIDA LIMITED LIABILITY COMPANY), DBA MOJOS CAJUN BAR AND GRILL, MOJO CAJUN BAR AND GRILL
260 WEKIVA SPRINGS ROAD
LONGWOOD, FL 32779

FOR: BAR AND RESTAURANT SERVICES, IN CLASS 43 (U.S. CLS. 100 AND 101).

FIRST USE 3-16-2010; IN COMMERCE 3-16-2010.

THE MARK CONSISTS OF A GREEN CARTOON ALLIGATOR WITH A YELLOW UNDER-BELLY; SAID ALLIGATOR IS SMILING AND STANDING ON ITS HIND LEGS; THE HEAD OF SAID ALLIGATOR IS TURNED TO ITS RIGHT AND HAS TWO FRONT WHITE TEETH, TWO BLACK NOSTRILS, TWO WHITE EYES WITH BLACK PUPILS, AND TWO SETS OF BLACK EYELASHES; SAID ALLIGATOR'S RIGHT ARM IS BENT AND PLACED ON THE ALLIGATOR'S RIGHT HIP; SAID ALLIGATOR'S LEFT ARM IS OUTSTRETCHED AND CURLED UPWARDS; AND SAID ALLIGATOR'S TAIL CURLS UPWARDLY FROM BEHIND ITS RIGHT LEG ON THE ALLIGATOR'S RIGHT SIDE.

THE COLOR(S) GREEN, YELLOW, BLACK AND WHITE IS/ARE CLAIMED AS A FEATURE OF THE MARK.

SER. NO. 85-142,171, FILED 9-30-2010.

LAKEISHA LEWIS, EXAMINING ATTORNEY



David J. Kyros

Director of the United States Patent and Trademark Office

United States of America

United States Patent and Trademark Office

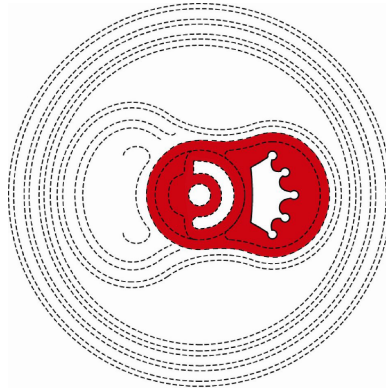

Reg. No. 4,065,690

Registered Dec. 6, 2011

Int. Cl.: 32

TRADEMARK

PRINCIPAL REGISTER

ANHEUSER-BUSCH, INCORPORATED (MISSOURI CORPORATION)
ONE BUSCH PLACE
ST. LOUIS, MO 63118

FOR: BEER, IN CLASS 32 (U.S. CLS. 45, 46 AND 48).

FIRST USE 2-7-2011; IN COMMERCE 2-7-2011.

OWNER OF U.S. REG. NOS. 2,926,426, 3,746,449 AND OTHERS.

THE COLOR(S) RED IS/ARE CLAIMED AS A FEATURE OF THE MARK.

THE MARK CONSISTS OF A DESIGN FEATURE OF PRODUCT PACKAGING, NAMELY, A RED COLORED TAB ON A CAN, WHICH FEATURES A CROWN DESIGN THAT IS TRANSPARENT. THE DOTTED LINES OUTLINING THE TOP OF THE CAN, OUTLINING THE TAB, AND ALL OTHER LINING ON THE TAB, INDICATE PLACEMENT OF THE MARK ON THE GOODS OR ARE FUNCTIONAL ATTRIBUTES OF THE CAN AND THE TAB AND ARE NOT CLAIMED AS PART OF THE MARK.

SER. NO. 85-142,261, FILED 9-30-2010.

MICHELLE DUBOIS, EXAMINING ATTORNEY



David J. Kyffers

Director of the United States Patent and Trademark Office

United States of America

United States Patent and Trademark Office

BIDEMATIC

Reg. No. 4,065,691

Registered Dec. 6, 2011

Int. Cl.: 11

TRADEMARK

PRINCIPAL REGISTER

BRACHETTA, DIEGO (ARGENTINA INDIVIDUAL)
CHACABUCO 92, 20 PISO 1069
CIUDAD DE BUENOS AIRES, ARGENTINA

FOR: SHOWERS, TOILETS, IN CLASS 11 (U.S. CLS. 13, 21, 23, 31 AND 34).

FIRST USE 12-3-1987; IN COMMERCE 12-3-1987.

THE MARK CONSISTS OF STANDARD CHARACTERS WITHOUT CLAIM TO ANY PARTICULAR FONT, STYLE, SIZE, OR COLOR.

SER. NO. 85-142,311, FILED 9-30-2010.

CHRISTINA SOBRAL, EXAMINING ATTORNEY



David J. Kybas

Director of the United States Patent and Trademark Office

United States of America

United States Patent and Trademark Office

DEL FONICS

Reg. No. 4,065,692

Registered Dec. 6, 2011

Int. Cls.: 16 and 18

TRADEMARK

PRINCIPAL REGISTER

DEL FONICS CO., LTD. (JAPAN CORPORATION)
3-23-20 YAKUMO MEGURO-KU
TOKYO, JAPAN 152-0023

FOR: STATIONERY AND PRINTED MATTER, NAMELY, PHOTOGRAPH ALBUMS, SCRAPBOOK ALBUMS, STAMP ALBUMS, AND SPIRAL BOUND ALBUMS FOR PHOTOGRAPHS, STICKERS OR DOCUMENTS WITH ENVELOPE-TYPE POCKETS AND ELASTIC CLOSURE STRAP; NOTE BOOKS; POCKET MEMORANDUM BOOKS; WRITING PADS; ENVELOPES; LETTER PAPER; RULERS FOR DRAWING AND DRAFTING; MECHANICAL PENCILS; BALL-POINT PENS; PEN AND PENCIL CASES AND BOXES; PEN HOLDERS; CLIPS FOR STATIONERY USE, NAMELY, BOOKMARK CLIPS, INDEX CLIPS, MARKING CLIPS, PEN CLIPS, RULER CLIPS, AND CALENDARS IN THE FORM OF CLIPS; RUBBER STAMPS AND IMPRESSION STAMPS; STICKERS; BOOKMARKERS; BOOK COVERS; CLIPBOARDS; DOCUMENT FILES; POSTCARDS; CALENDARS AND DIARIES; PASSPORT CASES AND PASSBOOK CASES, IN CLASS 16 (U.S. CLS. 2, 5, 22, 23, 29, 37, 38 AND 50).

FOR: BUSINESS CARD CASES, NAME CARD CASES, AND CREDIT CARD CASES; TICKET POUCHES; CARD FILES; WALLETS; BRIEFCASES; TOTE BAGS, CANVAS SHOPPING BAGS, SCHOOL BAGS, AND POUCHES MADE OF FELT, LEATHER OR CLOTH, IN CLASS 18 (U.S. CLS. 1, 2, 3, 22 AND 41).

OWNER OF JAPAN REG. NO. 5377297, DATED 12-17-2010, EXPIRES 12-17-2020.

OWNER OF JAPAN REG. NO. 5168155, DATED 9-19-2008, EXPIRES 9-19-2018.

THE MARK CONSISTS OF THE WORDING DEL FONICS IN STYLIZED LETTERS.

SER. NO. 85-142,406, FILED 9-30-2010.

REBECCA EISINGER, EXAMINING ATTORNEY



David J. Kybas

Director of the United States Patent and Trademark Office

United States of America

United States Patent and Trademark Office

GALAXY

Reg. No. 4,065,693

Registered Dec. 6, 2011

**Int. Cls.: 1, 6, 37, 39, 40
and 42**

TRADEMARK

SERVICE MARK

PRINCIPAL REGISTER

GALAXY RESOURCES LIMITED (AUSTRALIA CORPORATION)
LEVEL 2, 16 ORD STREET
WEST PERTH, AUSTRALIA 6005

FOR: ALKALI METALS, COMPOUNDS OF ALKALI METALS, LITHIUM, LITHIUM COMPOUNDS, NAMELY, LITHIUM CARBONATE, LITHIUM TANTALATE; MANGANESE DIOXIDE; ALUMINA AND ALUMINA SILICATE; SODIUM AND SODIUM SALTS FOR NON-MEDICAL PURPOSES, IN CLASS 1 (U.S. CLS. 1, 5, 6, 10, 26 AND 46).

FOR: TANTALITE AND TANTALUM CONTAINING COMPOUNDS, IN CLASS 6 (U.S. CLS. 2, 12, 13, 14, 23, 25 AND 50).

FOR: MINING EXTRACTION; QUARRYING SERVICES; COAL MINING EXTRACTION; MINING EXTRACTION OF ALKALI, PRECIOUS METALS, BASE METALS, MATERIALS CONTAINING THESE METALS AND COMPOUNDS OF THESE METALS, IN CLASS 37 (U.S. CLS. 100, 103 AND 106).

FOR: PACKAGING AND STORAGE OF CHEMICALS, METALS AND METAL CONTAINING COMPOUNDS, IN CLASS 39 (U.S. CLS. 100 AND 105).

FOR: BLENDING OF MINERALS, ORES; MINERAL PROCESSING SERVICES, NAMELY, CRUSHING, GRINDING, MILLING, BENEFICIATING, MIXING, REDUCTION, LEACHING, FILTRATION, DENSE MEDIA SEPARATION, DRYING, SOLVENT EXTRACTION, ELECTROWINNING, GRANULATING, DIGESTING, CONDENSING, CRYSTALLIZING AND PRECIPITATING AND DROSS TREATMENT; METAL CASTING; MINERAL REFINING SERVICES; TREATMENT OF METALS AND THEIR ALLOYS, NAMELY, ALKALI AND BASE METALS AND ARTICLES MADE WHOLLY OR PRINCIPALLY THEREFROM; TREATMENT OF METAL, NAMELY, REMOVAL OF DROSS; ELECTRICAL POWER GENERATION; PROCESSING ALKALI, PRECIOUS METALS, BASE METALS, MATERIALS CONTAINING THESE METALS AND COMPOUNDS OF THESE METALS, IN CLASS 40 (U.S. CLS. 100, 103 AND 106).

FOR: TECHNICAL RESEARCH IN THE FIELDS OF BATTERY TECHNOLOGY, MINING AND MINERAL PROCESSING TECHNOLOGIES; QUALITY CONTROL FOR OTHERS; GEOLOGICAL PROSPECTING; GEOLOGICAL SURVEYING; GEOLOGICAL RESEARCH; CHEMICAL ANALYSIS; MATERIALS TESTING; MINING AND MINERAL EXPLORATION SERVICES; ENGINEERING SERVICES RELATING TO MINING EXPLORATION; DEVEL-



David J. Kybas

Director of the United States Patent and Trademark Office

Reg. No. 4,065,693 OPMENT OF PRODUCTS CONTAINING ALKALI, PRECIOUS METALS, BASE METALS, MATERIALS CONTAINING THESE METALS AND COMPOUNDS OF THESE METALS, IN CLASS 42 (U.S. CLS. 100 AND 101).

THE MARK CONSISTS OF STANDARD CHARACTERS WITHOUT CLAIM TO ANY PARTICULAR FONT, STYLE, SIZE, OR COLOR.

PRIORITY CLAIMED UNDER SEC. 44(D) ON AUSTRALIA APPLICATION NO. 1383977, FILED 9-16-2010, REG. NO. 1383977, DATED 6-1-2011, EXPIRES 9-16-2020.

SER. NO. 85-142,447, FILED 9-30-2010.

JULIE VEPPUMTHARA, EXAMINING ATTORNEY

United States of America

United States Patent and Trademark Office

ORGANIC GEM

Reg. No. 4,065,694

Registered Dec. 6, 2011

Int. Cl.: 1

TRADEMARK

PRINCIPAL REGISTER

YOUNG, JEFFREY W (UNITED STATES INDIVIDUAL)
33 CAPE STREET
NEW BEDFORD, MA 02740

FOR: ORGANIC LIQUID FISH FERTILIZER FOR INDUSTRIAL, DOMESTIC AND AGRICULTURAL USE, IN CLASS 1 (U.S. CLS. 1, 5, 6, 10, 26 AND 46).

FIRST USE 3-1-1999; IN COMMERCE 3-1-1999.

THE MARK CONSISTS OF STANDARD CHARACTERS WITHOUT CLAIM TO ANY PARTICULAR FONT, STYLE, SIZE, OR COLOR.

NO CLAIM IS MADE TO THE EXCLUSIVE RIGHT TO USE "ORGANIC", APART FROM THE MARK AS SHOWN.

SER. NO. 85-142,707, FILED 10-1-2010.

MARLENE BELL, EXAMINING ATTORNEY



David J. Kybas

Director of the United States Patent and Trademark Office

United States of America

United States Patent and Trademark Office

PETS' SPARK

Reg. No. 4,065,695

Registered Dec. 6, 2011

Int. Cl.: 5

TRADEMARK

PRINCIPAL REGISTER

PETAWARE LLC (FLORIDA LIMITED LIABILITY COMPANY)
169 NE 44TH STREET
MIAMI, FL 331373415

FOR: MEDICATED GROOMING PREPARATION FOR DOMESTIC PETS, NAMELY, MEDICATED PREPARATION FOR TREATING AND ELIMINATING EPIPHORA TEARSTAINS, IN CLASS 5 (U.S. CLS. 6, 18, 44, 46, 51 AND 52).

FIRST USE 4-17-2008; IN COMMERCE 6-20-2008.

THE MARK CONSISTS OF STANDARD CHARACTERS WITHOUT CLAIM TO ANY PARTICULAR FONT, STYLE, SIZE, OR COLOR.

NO CLAIM IS MADE TO THE EXCLUSIVE RIGHT TO USE "PETS", APART FROM THE MARK AS SHOWN.

SER. NO. 85-142,724, FILED 10-1-2010.

MARLENE BELL, EXAMINING ATTORNEY



David J. Kyros

Director of the United States Patent and Trademark Office

United States of America

United States Patent and Trademark Office

WINTERGOLD

Reg. No. 4,065,696

Registered Dec. 6, 2011

Int. Cl.: 31

TRADEMARK

PRINCIPAL REGISTER

HEUGER, JOSEF (FED REP GERMANY INDIVIDUAL)
MÜNSTERSTR. 46
GLANDORF, FED REP GERMANY 49219

FOR: LIVE ORNAMENTAL PLANTS, LIVE CUTTINGS FROM YOUNG PLANTS, SEEDS AND LIVE PARTS OF ORNAMENTAL PLANTS USED FOR PROPAGATION PURPOSES, IN CLASS 31 (U.S. CLS. 1 AND 46).

THE MARK CONSISTS OF STANDARD CHARACTERS WITHOUT CLAIM TO ANY PARTICULAR FONT, STYLE, SIZE, OR COLOR.

OWNER OF ERPN CMNTY TM OFC REG. NO. 009406687, DATED 2-15-2011, EXPIRES 9-28-2020.

SER. NO. 85-142,919, FILED 10-1-2010.

BILL DAWE, EXAMINING ATTORNEY



David J. Kyffers

Director of the United States Patent and Trademark Office

United States of America

United States Patent and Trademark Office

CURIAN SERIES TRUST

Reg. No. 4,065,697

JACKSON NATIONAL LIFE INSURANCE COMPANY (MICHIGAN CORPORATION)
1 CORPORATE WAY
LANSING, MI 48951

Registered Dec. 6, 2011

Int. Cl.: 36

FOR: FINANCIAL SERVICES, NAMELY, OFFERING SHARES OF MUTUAL FUNDS, IN CLASS 36 (U.S. CLS. 100, 101 AND 102).

SERVICE MARK

FIRST USE 4-13-2011; IN COMMERCE 4-13-2011.

PRINCIPAL REGISTER

THE MARK CONSISTS OF STANDARD CHARACTERS WITHOUT CLAIM TO ANY PARTICULAR FONT, STYLE, SIZE, OR COLOR.

OWNER OF U.S. REG. NOS. 2,897,748, 2,952,505, AND 3,840,075.

NO CLAIM IS MADE TO THE EXCLUSIVE RIGHT TO USE "SERIES TRUST", APART FROM THE MARK AS SHOWN.

SER. NO. 85-142,950, FILED 10-1-2010.

MIDGE BUTLER, EXAMINING ATTORNEY



David J. Kybas

Director of the United States Patent and Trademark Office

United States of America

United States Patent and Trademark Office

BENCHMARK SENIOR LIVING

Reg. No. 4,065,698

Registered Dec. 6, 2011

Int. Cl.: 35

SERVICE MARK

PRINCIPAL REGISTER

BENCHMARK SENIOR LIVING (DELAWARE CORPORATION)
40 WILLIAM STREET, SUITE 350
WELLESLEY, MA 02481

FOR: MANAGEMENT OF THE BUSINESS OPERATIONS OF INDEPENDENT LIVING, ASSISTED LIVING AND DEMENTIA CARE FACILITIES, IN CLASS 35 (U.S. CLS. 100, 101 AND 102).

FIRST USE 10-1-2001; IN COMMERCE 10-1-2001.

THE MARK CONSISTS OF STANDARD CHARACTERS WITHOUT CLAIM TO ANY PARTICULAR FONT, STYLE, SIZE, OR COLOR.

NO CLAIM IS MADE TO THE EXCLUSIVE RIGHT TO USE "SENIOR LIVING", APART FROM THE MARK AS SHOWN.

SER. NO. 85-143,328, FILED 10-1-2010.

MICHELLE DUBOIS, EXAMINING ATTORNEY



David J. Kyros

Director of the United States Patent and Trademark Office

United States of America

United States Patent and Trademark Office

THE LOAN SOURCE

Reg. No. 4,065,699

THE LOAN SOURCE INC. (DELAWARE CORPORATION)
347 5TH AVENUE, SUITE 310
NEW YORK, NY 10016

Registered Dec. 6, 2011

Int. Cl.: 36

FOR: PROVIDING LOANS TO SMALL BUSINESSES, IN CLASS 36 (U.S. CLS. 100, 101 AND 102).

SERVICE MARK

FIRST USE 5-12-1995; IN COMMERCE 5-12-1995.

PRINCIPAL REGISTER

THE MARK CONSISTS OF STANDARD CHARACTERS WITHOUT CLAIM TO ANY PARTICULAR FONT, STYLE, SIZE, OR COLOR.

NO CLAIM IS MADE TO THE EXCLUSIVE RIGHT TO USE "LOAN", APART FROM THE MARK AS SHOWN.

SEC. 2(F).

SER. NO. 85-143,364, FILED 10-1-2010.

CHRISTOPHER BUONGIORNO, EXAMINING ATTORNEY



David J. Kybas

Director of the United States Patent and Trademark Office

United States of America

United States Patent and Trademark Office



Reg. No. 4,065,700

Registered Dec. 6, 2011

Int. Cl.: 35

SERVICE MARK

PRINCIPAL REGISTER

BENCHMARK SENIOR LIVING (DELAWARE CORPORATION)
40 WILLIAM STREET, SUITE 350
WELLESLEY, MA 02481

FOR: MANAGEMENT OF THE BUSINESS OPERATIONS OF INDEPENDENT LIVING, ASSISTED LIVING AND DEMENTIA CARE FACILITIES, IN CLASS 35 (U.S. CLS. 100, 101 AND 102).

FIRST USE 8-10-2010; IN COMMERCE 8-10-2010.

NO CLAIM IS MADE TO THE EXCLUSIVE RIGHT TO USE "SENIOR LIVING", APART FROM THE MARK AS SHOWN.

THE COLOR(S) BLUE (PANTONE 286) AND GREEN (PANTONE 335) IS/ARE CLAIMED AS A FEATURE OF THE MARK.

THE MARK CONSISTS OF THREE VERTICAL BLUE BARS TO THE IMMEDIATE LEFT OF A GREEN VERTICAL BAR ALL GRADUATING IN HEIGHT, A BLUE HORIZONTAL LINE ABOVE THE BLUE WORD "BENCHMARK" WITH A BLUE HORIZONTAL LINE ABOVE THE GREEN WORDS "SENIOR LIVING" WITH A BLUE HORIZONTAL LINE UNDERNEATH.

SER. NO. 85-143,379, FILED 10-1-2010.

MICHELLE DUBOIS, EXAMINING ATTORNEY



David J. Kyjars

Director of the United States Patent and Trademark Office

United States of America

United States Patent and Trademark Office



Reg. No. 4,065,701

Registered Dec. 6, 2011

Int. Cl.: 45

SERVICE MARK

PRINCIPAL REGISTER

BENCHMARK SENIOR LIVING (DELAWARE CORPORATION)
40 WILLIAM STREET, SUITE 350
WELLESLEY, MA 02481

FOR: PROVIDING PERSONAL CARE SERVICES TO ASSIST RESIDENTS OF ASSISTED LIVING AND DEMENTIA CARE FACILITIES IN THE ACTIVITIES OF DAILY LIVING, IN CLASS 45 (U.S. CLS. 100 AND 101).

FIRST USE 8-10-2010; IN COMMERCE 8-10-2010.

NO CLAIM IS MADE TO THE EXCLUSIVE RIGHT TO USE "SENIOR LIVING", APART FROM THE MARK AS SHOWN.

THE COLOR(S) BLUE (PANTONE 286) AND GREEN (PANTONE 335) IS/ARE CLAIMED AS A FEATURE OF THE MARK.

THE MARK CONSISTS OF THREE VERTICAL BLUE BARS TO THE IMMEDIATE LEFT OF A GREEN VERTICAL BAR ALL GRADUATING IN HEIGHT, A BLUE HORIZONTAL LINE ABOVE THE BLUE WORD "BENCHMARK" WITH A BLUE HORIZONTAL LINE ABOVE THE GREEN WORDS "SENIOR LIVING" WITH A BLUE HORIZONTAL LINE UNDERNEATH.

SER. NO. 85-143,426, FILED 10-1-2010.

MICHELLE DUBOIS, EXAMINING ATTORNEY



David J. Kybas

Director of the United States Patent and Trademark Office

United States of America

United States Patent and Trademark Office

TYTO CAPITAL PARTNERS LLC

Reg. No. 4,065,702

Registered Dec. 6, 2011

Int. Cl.: 36

SERVICE MARK

PRINCIPAL REGISTER

TYTO CAPITAL PARTNERS LLC (DELAWARE LIMITED LIABILITY COMPANY)
8 SHADBUSH LANE
WESTPORT, CT 06880

FOR: ASSUMING FINANCIAL RISK OF OTHERS BY ENTERING INTO OPTIONS AND SWAPS; ELECTRONIC FINANCIAL TRADING SERVICES; FINANCIAL ADMINISTRATION OF STOCK EXCHANGE TRADING OF SHARES AND OTHER FINANCIAL SECURITIES IN FINANCIAL MARKETS; FINANCIAL ADVICE AND CONSULTANCY SERVICES; FINANCIAL ADVISORY AND CONSULTANCY SERVICES; FINANCIAL ANALYSES; FINANCIAL ANALYSIS AND CONSULTATION; FINANCIAL ANALYSIS AND RESEARCH SERVICES; FINANCIAL AND INVESTMENT SERVICES, NAMELY, MANAGEMENT AND BROKERAGE IN THE FIELDS OF STOCKS, BONDS, OPTIONS, COMMODITIES, FUTURES AND OTHER SECURITIES, AND THE INVESTMENT OF FUNDS OF OTHERS; FINANCIAL ASSET MANAGEMENT; FINANCIAL CONSULTATION; FINANCIAL CONSULTING; FINANCIAL CONSULTING AND ADVISING IN THE FIELD OF MERGERS AND ACQUISITIONS; FINANCIAL DUE DILIGENCE; FINANCIAL EVALUATION, TRACKING, ANALYSIS, FORECASTING, CONSULTANCY, ADVISORY AND RESEARCH SERVICES RELATING TO SECURITIES AND OTHER FINANCIAL INSTRUMENTS; FINANCIAL FORECASTING; FINANCIAL INFORMATION AND ADVISORY SERVICES; FINANCIAL INFORMATION AND EVALUATIONS; FINANCIAL INVESTMENT ANALYSIS AND STOCK RESEARCH; FINANCIAL INVESTMENT BROKERAGE; FINANCIAL INVESTMENT BROKERAGE SERVICES; FINANCIAL MANAGEMENT; FINANCIAL PORTFOLIO MANAGEMENT; FINANCIAL RESEARCH; FINANCIAL RESEARCH AND INFORMATION SERVICES; FINANCIAL RISK MANAGEMENT; FINANCIAL SERVICES IN THE NATURE OF AN INVESTMENT SECURITY; FINANCIAL SERVICES, NAMELY, BROKER/DEALER SERVICES ON SECURITIES EXCHANGES AND OVER-THE-COUNTER MARKETS; FINANCIAL SERVICES, NAMELY, BUSINESS FUNDRAISING FOR OTHERS; FINANCIAL SERVICES, NAMELY, COMMODITY TRADING AND MANAGED FUTURES ADVISORY AND MANAGEMENT SERVICES; FINANCIAL SERVICES, NAMELY, CONDUCTING A SECURITIES AND DERIVATIVES EXCHANGE; FINANCIAL SERVICES, NAMELY, COORDINATION, WITHIN A SINGLE ACCOUNT, OF AN INVESTMENT PORTFOLIO'S MAINTENANCE, TRADING, REBALANCING, AND TAX MANAGEMENT NEEDS; FINANCIAL SERVICES, NAMELY, CREDIT AGENCIES FEATURING CREDIT PROCESSING, NAMELY, CREDIT CHECKING, CREDIT ANALYZING, AND FINANCIAL REPORTING SERVICES; FINANCIAL SERVICES, NAMELY, PROPRIETARY TRADING IN COMMODITIES, SECURITIES, OPTIONS, FUTURES, EQUITIES AND FIXED INCOME PRODUCTS IN THE U.S. AND OVERSEAS MARKET SECURITIES; FINANCIAL SERVICES, NAMELY, PROVIDING AN INVESTMENT OPTION



David J. Kyros

Director of the United States Patent and Trademark Office

Reg. No. 4,065,702 AVAILABLE FOR VARIABLE ANNUITY AND VARIABLE LIFE INSURANCE PRODUCTS; FINANCIAL SERVICES, NAMELY, THE TRADING OF FINANCIAL INSTRUMENTS, SECURITIES, SHARES, OPTIONS AND OTHER DERIVATIVE PRODUCTS; LEVERAGED BUY OUTS AND INVESTMENTS IN FINANCIALLY DISTRESSED OR UNDERPERFORMING COMPANIES, IN CLASS 36 (U.S. CLS. 100, 101 AND 102).

FIRST USE 4-1-2010; IN COMMERCE 4-1-2010.

THE MARK CONSISTS OF STANDARD CHARACTERS WITHOUT CLAIM TO ANY PARTICULAR FONT, STYLE, SIZE, OR COLOR.

NO CLAIM IS MADE TO THE EXCLUSIVE RIGHT TO USE "CAPITAL PARTNERS LLC", APART FROM THE MARK AS SHOWN.

SER. NO. 85-143,459, FILED 10-1-2010.

ROBERT C. CLARK JR., EXAMINING ATTORNEY

United States of America

United States Patent and Trademark Office

TYTO

Reg. No. 4,065,703

Registered Dec. 6, 2011

Int. Cl.: 36

SERVICE MARK

PRINCIPAL REGISTER

TYTO CAPITAL PARTNERS LLC (DELAWARE LIMITED LIABILITY COMPANY)
8 SHADBUSH LANE
WESTPORT, CT 06880

FOR: ASSUMING FINANCIAL RISK OF OTHERS BY ENTERING INTO OPTIONS AND SWAPS; ELECTRONIC FINANCIAL TRADING SERVICES; FINANCIAL ADVICE; FINANCIAL ADVICE AND CONSULTANCY SERVICES; FINANCIAL ADVISORY AND CONSULTANCY SERVICES; FINANCIAL ANALYSES; FINANCIAL ANALYSIS AND CONSULTATION; FINANCIAL ANALYSIS AND RESEARCH SERVICES; FINANCIAL AND INVESTMENT SERVICES, NAMELY, MANAGEMENT AND BROKERAGE IN THE FIELDS OF STOCKS, BONDS, OPTIONS, COMMODITIES, FUTURES AND OTHER SECURITIES, AND THE INVESTMENT OF FUNDS OF OTHERS; FINANCIAL ASSET MANAGEMENT; FINANCIAL CONSULTANCY; FINANCIAL CONSULTATION; FINANCIAL CONSULTING; FINANCIAL CONSULTING AND ADVISING IN THE FIELD OF MERGERS AND ACQUISITIONS; FINANCIAL DUE DILIGENCE; FINANCIAL DUE DILIGENCE SERVICES IN THE FIELD OF REAL ESTATE; FINANCIAL EVALUATION, TRACKING, ANALYSIS, FORECASTING, CONSULTANCY, ADVISORY AND RESEARCH SERVICES RELATING TO SECURITIES AND OTHER FINANCIAL INSTRUMENTS; FINANCIAL INFORMATION; FINANCIAL INFORMATION AND ADVISORY SERVICES; FINANCIAL INFORMATION AND EVALUATIONS; FINANCIAL INVESTMENT ANALYSIS AND STOCK RESEARCH; FINANCIAL INVESTMENT BROKERAGE; FINANCIAL INVESTMENT BROKERAGE SERVICES; FINANCIAL MANAGEMENT; FINANCIAL RESEARCH; FINANCIAL RESEARCH AND EQUITY RESEARCH BROKERAGE SERVICES; FINANCIAL RESEARCH AND INFORMATION SERVICES; FINANCIAL RESTRUCTURING SERVICES; FINANCIAL RISK MANAGEMENT; FINANCIAL SERVICES IN THE NATURE OF AN INVESTMENT SECURITY; FINANCIAL SERVICES, NAMELY, ASSISTING OTHERS WITH THE COMPLETION OF FINANCIAL TRANSACTIONS FOR STOCKS, BONDS, SECURITIES AND EQUITIES; FINANCIAL SERVICES, NAMELY, BROKER/DEALER SERVICES ON SECURITIES EXCHANGES AND OVER-THE-COUNTER MARKETS; FINANCIAL SERVICES, NAMELY, BUSINESS FUNDRAISING FOR OTHERS; FINANCIAL SERVICES, NAMELY, COMMODITY TRADING AND MANAGED FUTURES ADVISORY AND MANAGEMENT SERVICES; FINANCIAL SERVICES, NAMELY, CONDUCTING A SECURITIES AND DERIVATIVES EXCHANGE; FINANCIAL SERVICES, NAMELY, COORDINATION, WITHIN A SINGLE ACCOUNT, OF AN INVESTMENT PORTFOLIO'S MAINTENANCE, TRADING, REBALANCING, AND TAX MANAGEMENT NEEDS; FINANCIAL SERVICES, NAMELY, CREDIT AGENCIES FEATURING CREDIT PROCESSING, NAMELY, CREDIT CHECKING, CREDIT ANALYZING, AND FINANCIAL REPORTING SERVICES; FINANCIAL SERVICES, NAMELY, DEALING IN



David J. Kybas

Director of the United States Patent and Trademark Office

Reg. No. 4,065,703 SECURITIES AS A MARKET MAKER AND IN TRADING COMMODITIES, SECURITIES, OPTIONS, FUTURES, EQUITIES AND FIXED INCOME PRODUCTS IN THE U.S. AND OVERSEAS MARKET SECURITIES; FINANCIAL SERVICES, NAMELY, INVESTMENT ADVICE, INVESTMENT MANAGEMENT, INVESTMENT CONSULTATION AND INVESTMENT OF FUNDS FOR OTHERS, INCLUDING PRIVATE AND PUBLIC EQUITY AND DEBT INVESTMENT SERVICES; FINANCIAL SERVICES, NAMELY, INVESTMENT FUND TRANSFER AND TRANSACTION SERVICES; FINANCIAL SERVICES, NAMELY, ISSUANCE AND MANAGEMENT OF CERTIFICATES BACKED BY LOAN PORTFOLIOS WHICH ARE SUBSEQUENTLY MANAGED TO INSURE THE INTEGRITY OF THE CERTIFICATES; FINANCIAL SERVICES, NAMELY, PROPRIETARY TRADING IN COMMODITIES, SECURITIES, OPTIONS, FUTURES, EQUITIES AND FIXED INCOME PRODUCTS IN THE U.S. AND OVERSEAS MARKET SECURITIES; FINANCIAL SERVICES, NAMELY, PROVIDING AN INVESTMENT OPTION AVAILABLE FOR VARIABLE ANNUITY AND VARIABLE LIFE INSURANCE PRODUCTS; FINANCIAL SERVICES, NAMELY, RAISING DEBT AND EQUITY CAPITAL FOR OTHERS; FINANCIAL SERVICES, NAMELY, RAISING MONEY FOR THE HEDGE FUNDS OF OTHERS; FINANCIAL SERVICES, NAMELY, THE TRADING OF FINANCIAL INSTRUMENTS, SECURITIES, SHARES, OPTIONS AND OTHER DERIVATIVE PRODUCTS; FINANCIAL TRANSACTION SERVICES, NAMELY, PROVIDING SECURE COMMERCIAL TRANSACTIONS AND PAYMENT OPTIONS; FINANCIAL TRANSACTION SERVICES, NAMELY, PROVIDING SECURE COMMERCIAL TRANSACTIONS AND PAYMENT OPTIONS USING A MOBILE DEVICE AT A POINT OF SALE; FINANCIAL VALUATIONS; INSURANCE AND FINANCIAL INFORMATION AND CONSULTANCY SERVICES; LEVERAGED BUY OUTS AND INVESTMENTS IN FINANCIALLY DISTRESSED OR UNDERPERFORMING COMPANIES; PROVIDING FINANCIAL INFORMATION; PROVIDING INVESTORS WITH FINANCIAL INFORMATION; PROVISION OF FINANCIAL INFORMATION; STRATEGIC FINANCIAL ADVISORY SERVICES, IN CLASS 36 (U.S. CLS. 100, 101 AND 102).

FIRST USE 4-1-2010; IN COMMERCE 4-1-2010.

THE MARK CONSISTS OF STANDARD CHARACTERS WITHOUT CLAIM TO ANY PARTICULAR FONT, STYLE, SIZE, OR COLOR.

SER. NO. 85-143,511, FILED 10-1-2010.

ROBERT C. CLARK JR., EXAMINING ATTORNEY

United States of America

United States Patent and Trademark Office

HOT BUTTERED REVOLUTION

Reg. No. 4,065,704

Registered Dec. 6, 2011

Int. Cl.: 32

TRADEMARK

PRINCIPAL REGISTER

SHIELDS, JOHN R. (UNITED STATES INDIVIDUAL)
5431 N.E. 19TH AVENUE
PORTLAND, OR 97211

FOR: NON-ALCOHOLIC COCKTAIL MIXES, IN CLASS 32 (U.S. CLS. 45, 46 AND 48).

FIRST USE 9-24-2010; IN COMMERCE 9-24-2010.

THE MARK CONSISTS OF STANDARD CHARACTERS WITHOUT CLAIM TO ANY PARTICULAR FONT, STYLE, SIZE, OR COLOR.

NO CLAIM IS MADE TO THE EXCLUSIVE RIGHT TO USE "HOT BUTTERED", APART FROM THE MARK AS SHOWN.

SER. NO. 85-143,512, FILED 10-1-2010.

ROBERT C. CLARK JR., EXAMINING ATTORNEY



David J. Kyffers

Director of the United States Patent and Trademark Office

United States of America

United States Patent and Trademark Office



Reg. No. 4,065,705

Registered Dec. 6, 2011

Int. Cls.: 9 and 28

TRADEMARK

PRINCIPAL REGISTER

NEW BRIGHT INDUSTRIAL CO., LTD (HONG KONG COMPANY)
11 SHEUNG YUET ROAD
9TH FLOOR, LOWLOON BAY
HONG KONG, CHINA

FOR: BATTERY PACKS AND BATTERY CHARGERS, IN CLASS 9 (U.S. CLS. 21, 23, 26, 36 AND 38).

FIRST USE 12-0-2009; IN COMMERCE 12-0-2009.

FOR: TOY VEHICLES, BOATS, PLANES, TRAINS AND ACCESSORIES THEREFOR; RADIO-CONTROLLED TOY VEHICLES, BOATS, PLANES AND TRAINS; BATTERY-OPERATED TOYS, NAMELY, TOY VEHICLES, BOATS, MOTORCYCLES, PLANES, TRAINS AND ACCESSORIES, CONSTRUCTION EQUIPMENT, ROBOTS, DOLLS, CHRISTMAS TREES AND DECORATIONS, IN CLASS 28 (U.S. CLS. 22, 23, 38 AND 50).

FIRST USE 12-0-2009; IN COMMERCE 12-0-2009.

OWNER OF U.S. REG. NOS. 1,381,552 AND 2,310,502.

THE MARK CONSISTS OF A BACKGROUND RECTANGLE WITH A FLAME DESIGN ON THE RIGHT PORTION OF THE BACKGROUND DESIGN.

SER. NO. 85-144,292, FILED 10-4-2010.

ROBERT STRUCK, EXAMINING ATTORNEY



David J. Kybas

Director of the United States Patent and Trademark Office

United States of America

United States Patent and Trademark Office



Reg. No. 4,065,706

Registered Dec. 6, 2011

Int. Cls.: 9 and 28

TRADEMARK

PRINCIPAL REGISTER

NEW BRIGHT INDUSTRIAL CO., LTD (HONG KONG COMPANY)
11 SHEUNG YUET ROAD
9TH FLOOR KOWLOON BAY
HONG KONG, CHINA

FOR: BATTERY PACKS AND BATTERY CHARGERS, IN CLASS 9 (U.S. CLS. 21, 23, 26, 36 AND 38).

FIRST USE 12-0-2009; IN COMMERCE 12-0-2009.

FOR: TOY VEHICLES, BOATS, PLANES, TRAINS AND ACCESSORIES THEREFOR; RADIO-CONTROLLED TOY VEHICLES, BOATS, PLANES AND TRAINS; BATTERY-OPERATED TOYS, NAMELY, TOY VEHICLES, BOATS, MOTORCYCLES, PLANES, TRAINS AND ACCESSORIES, CONSTRUCTION EQUIPMENT, ROBOTS, DOLLS, CHRISTMAS TREES AND DECORATIONS, IN CLASS 28 (U.S. CLS. 22, 23, 38 AND 50).

FIRST USE 12-0-2009; IN COMMERCE 12-0-2009.

OWNER OF U.S. REG. NOS. 1,381,552 AND 2,310,502.

THE MARK CONSISTS OF A FLAME DESIGN.

SER. NO. 85-144,318, FILED 10-4-2010.

ROBERT STRUCK, EXAMINING ATTORNEY



David J. Kybas

Director of the United States Patent and Trademark Office

United States of America

United States Patent and Trademark Office

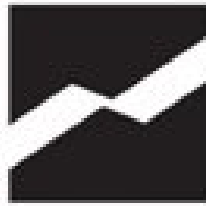

MOUNTAIN FORCE

Reg. No. 4,065,707

Registered Dec. 6, 2011

Int. Cl.: 25

TRADEMARK

PRINCIPAL REGISTER

MOUNTAIN FORCE AG (SWITZERLAND CORPORATION), DBA MOUNTAIN FORCE AG
ALLMEINDSTRASSE 15
EINSIEDELN, SWITZERLAND 8840

FOR: CLOTHING, NAMELY, SHIRTS, SWEATERS, JACKETS, PANTS, SKI WEAR, SWEAT
SUITS, UNDERWEAR; FOOTWEAR; HEADWEAR, IN CLASS 25 (U.S. CLS. 22 AND 39).

FIRST USE 1-2-2010; IN COMMERCE 1-2-2010.

OWNER OF U.S. REG. NO. 3,441,040.

THE MARK CONSISTS OF A STYLIZED OUTLINE OF A MOUNTAIN RANGE ON RECT-
ANGULAR BACKGROUND ON THE LEFT, AND THE WORDING "MOUNTAIN FORCE"
ON THE RIGHT.

SER. NO. 85-144,619, FILED 10-4-2010.

SOPHIA S. KIM, EXAMINING ATTORNEY



David J. Kybas

Director of the United States Patent and Trademark Office

United States of America

United States Patent and Trademark Office

Mediterranean Spirit

1877

E S S S S E
I E E E E I
G V V V V G
H E E E E H
T N N N N T
E T T E
E Y Y E
N N

Reg. No. 4,065,708

Registered Dec. 6, 2011

Int. Cls.: 18 and 25

TRADEMARK

PRINCIPAL REGISTER

SHOE, S.L. (SPAIN SOCIEDAD DE RESPONSABILIDAD LIMITADA (SL))
POLÍGONO INDUSTRIAL, S/N
INCA, BALEARES, SPAIN 07300

FOR: ANIMAL SKINS AND HIDES; BRIEFCASES; HANDBAGS; HARNESSES AND SADDLERY; LEATHER AND IMITATION LEATHER; PARASOLS; PURSES; RUCKSACKS; SUITCASES; TANNED LEATHER; TRUNKS; UMBRELLAS AND THEIR PARTS; WALKING STICKS; WALLETS; WHIPS, IN CLASS 18 (U.S. CLS. 1, 2, 3, 22 AND 41).

FOR: ANORAKS; BEACHWEAR; BELTS; BERMUDA SHORTS; BIKINIS; BLOUSES; BOXER SHORTS; CARDIGANS; COATS; FOOTWEAR; FUR JACKETS; GLOVES; GOLF SHIRTS; HEADWEAR; JACKETS; JEANS; JERSEYS; JUMPSUITS; NECKTIES; POLO SHIRTS; SCARVES; SKIRTS; SOCKS; SPORT COATS; SWEAT SHIRTS; SWIMWEAR; T-SHIRTS; TENNIS WEAR; TROUSERS; UNDERSHIRTS; UNDERWEAR, IN CLASS 25 (U.S. CLS. 22 AND 39).

PRIORITY CLAIMED UNDER SEC. 44(D) ON ERPN CMNTY TM OFC APPLICATION NO. 9241027, FILED 7-13-2010, REG. NO. 9241027, DATED 12-24-2010, EXPIRES 7-13-2020.

OWNER OF U.S. REG. NOS. 3,002,121 AND 3,767,600.

NO CLAIM IS MADE TO THE EXCLUSIVE RIGHT TO USE "1877", APART FROM THE MARK AS SHOWN.

THE MARK CONSISTS OF THE STYLIZED WORDS "MEDITERRANEAN SPIRIT" APPEARING HORIZONTALLY ABOVE THE STYLIZED NUMBER "1877", ALSO APPEARING HORIZONTALLY, AND, IMMEDIATELY UNDERNEATH IT, THE STYLIZED WORDS "EIGHTEEN SEVENTY SEVEN SEVEN SEVENTY EIGHTEEN" PLACED VERTICALLY NEXT TO EACH OTHER IN SAID ORDER.

SER. NO. 85-144,657, FILED 10-4-2010.

SUSAN STIGLITZ, EXAMINING ATTORNEY



David J. Kybas

Director of the United States Patent and Trademark Office

United States of America

United States Patent and Trademark Office

POOL SCHOOL

Reg. No. 4,065,709

Registered Dec. 6, 2011

Int. Cl.: 41

SERVICE MARK

PRINCIPAL REGISTER

FUEL TV, INC. (DELAWARE CORPORATION)
10201 WEST PICO BOULEVARD
LOS ANGELES, CA 90035

FOR: ENTERTAINMENT SERVICES IN THE NATURE OF A SERIES OF INTERSTITIAL TELEVISION PROGRAMS FEATURING SKATEBOARDING; PROVIDING ONLINE INFORMATION IN THE FIELD OF SKATEBOARDING AND ENTERTAINMENT VIA THE INTERNET; ENTERTAINMENT SERVICES IN THE NATURE OF NON-DOWNLOADABLE VIDEOS FEATURING INTERSTITIAL TELEVISION PROGRAMS ABOUT SKATEBOARDING TRANSMITTED VIA THE INTERNET, IN CLASS 41 (U.S. CLS. 100, 101 AND 107).

FIRST USE 4-26-2010; IN COMMERCE 4-26-2010.

THE MARK CONSISTS OF STANDARD CHARACTERS WITHOUT CLAIM TO ANY PARTICULAR FONT, STYLE, SIZE, OR COLOR.

SER. NO. 85-144,809, FILED 10-4-2010.

JOHN KELLY, EXAMINING ATTORNEY



David J. Kyffers

Director of the United States Patent and Trademark Office

United States of America

United States Patent and Trademark Office

MOPHIE JUICE PACK AIR

Reg. No. 4,065,710

Registered Dec. 6, 2011

Int. Cl.: 9

TRADEMARK

PRINCIPAL REGISTER

MOPHIE, INC. (CALIFORNIA CORPORATION)
2850 RED HILL AVENUE, SUITE 128
SANTA ANA, CA 92705

FOR: RECHARGEABLE BATTERIES INTEGRATED INTO A PROTECTIVE CASE OR HOUSING WITH AN ELECTRICAL CONNECTOR FOR USE WITH MOBILE ELECTRONIC DEVICES, NAMELY MOBILE PHONES, DIGITAL AUDIO AND VIDEO PLAYERS, HAND-HELD COMPUTERS, PERSONAL DIGITAL ASSISTANTS, ELECTRONIC ORGANIZERS, ELECTRONIC NOTEPADS, AND CAMERAS; BATTERY CHARGERS, IN CLASS 9 (U.S. CLS. 21, 23, 26, 36 AND 38).

FIRST USE 4-21-2009; IN COMMERCE 4-21-2009.

THE MARK CONSISTS OF STANDARD CHARACTERS WITHOUT CLAIM TO ANY PARTICULAR FONT, STYLE, SIZE, OR COLOR.

OWNER OF U.S. REG. NOS. 3,227,723 AND 3,227,725.

SER. NO. 85-144,833, FILED 10-4-2010.

MARY CRAWFORD, EXAMINING ATTORNEY



David J. Kyros

Director of the United States Patent and Trademark Office

United States of America

United States Patent and Trademark Office

MOPHIE JUICE PACK POWERSTATION

Reg. No. 4,065,711

Registered Dec. 6, 2011

Int. Cl.: 9

TRADEMARK

PRINCIPAL REGISTER

MOPHIE, INC. (CALIFORNIA CORPORATION)
2850 RED HILL AVENUE, SUITE 128
SANTA ANA, CA 92705

FOR: RECHARGEABLE BATTERIES FOR USE WITH MOBILE ELECTRONIC DEVICES, NAMELY MOBILE PHONES, DIGITAL AUDIO AND VIDEO PLAYERS, HANDHELD COMPUTERS, PERSONAL DIGITAL ASSISTANTS, ELECTRONIC ORGANIZERS, ELECTRONIC NOTEPADS, AND CAMERAS; BATTERY CHARGERS, IN CLASS 9 (U.S. CLS. 21, 23, 26, 36 AND 38).

FIRST USE 9-13-2010; IN COMMERCE 9-13-2010.

THE MARK CONSISTS OF STANDARD CHARACTERS WITHOUT CLAIM TO ANY PARTICULAR FONT, STYLE, SIZE, OR COLOR.

OWNER OF U.S. REG. NOS. 3,227,723 AND 3,227,725.

SER. NO. 85-144,834, FILED 10-4-2010.

MARY CRAWFORD, EXAMINING ATTORNEY



David J. Kyros

Director of the United States Patent and Trademark Office

United States of America

United States Patent and Trademark Office

MOPHIE JUICE PACK BOOST

Reg. No. 4,065,712

Registered Dec. 6, 2011

Int. Cl.: 9

TRADEMARK

PRINCIPAL REGISTER

MOPHIE, INC. (CALIFORNIA CORPORATION)
2850 RED HILL AVENUE, SUITE 128
SANTA ANA, CA 92705

FOR: RECHARGEABLE BATTERIES FOR USE WITH MOBILE ELECTRONIC DEVICES, NAMELY MOBILE PHONES, DIGITAL AUDIO AND VIDEO PLAYERS, HANDHELD COMPUTERS, PERSONAL DIGITAL ASSISTANTS, ELECTRONIC ORGANIZERS, ELECTRONIC NOTEPADS, AND CAMERAS; BATTERY CHARGERS, IN CLASS 9 (U.S. CLS. 21, 23, 26, 36 AND 38).

FIRST USE 8-4-2010; IN COMMERCE 8-4-2010.

THE MARK CONSISTS OF STANDARD CHARACTERS WITHOUT CLAIM TO ANY PARTICULAR FONT, STYLE, SIZE, OR COLOR.

OWNER OF U.S. REG. NOS. 3,227,723, 3,227,725, AND 3,949,983.

SER. NO. 85-144,835, FILED 10-4-2010.

MARY CRAWFORD, EXAMINING ATTORNEY



David J. Kyffers

Director of the United States Patent and Trademark Office

United States of America

United States Patent and Trademark Office

MOPHIE JUICE PACK RESERVE

Reg. No. 4,065,713

Registered Dec. 6, 2011

Int. Cl.: 9

TRADEMARK

PRINCIPAL REGISTER

MOPHIE, INC. (CALIFORNIA CORPORATION)
2850 RED HILL AVENUE, SUITE 128
SANTA ANA, CA 92705

FOR: RECHARGEABLE BATTERIES FOR USE WITH MOBILE ELECTRONIC DEVICES, NAMELY MOBILE PHONES, DIGITAL AUDIO AND VIDEO PLAYERS, HANDHELD COMPUTERS, PERSONAL DIGITAL ASSISTANTS, ELECTRONIC ORGANIZERS, ELECTRONIC NOTEPADS, AND CAMERAS; BATTERY CHARGERS, IN CLASS 9 (U.S. CLS. 21, 23, 26, 36 AND 38).

FIRST USE 6-23-2010; IN COMMERCE 6-23-2010.

THE MARK CONSISTS OF STANDARD CHARACTERS WITHOUT CLAIM TO ANY PARTICULAR FONT, STYLE, SIZE, OR COLOR.

OWNER OF U.S. REG. NOS. 3,227,723, 3,227,725, AND 3,949,983.

SER. NO. 85-144,836, FILED 10-4-2010.

MARY CRAWFORD, EXAMINING ATTORNEY



David J. Kyffers

Director of the United States Patent and Trademark Office

United States of America

United States Patent and Trademark Office

ROCKABYE BABY!

Reg. No. 4,065,714

Registered Dec. 6, 2011

Int. Cl.: 41

SERVICE MARK

PRINCIPAL REGISTER

CMH RECORDS, INC. (CALIFORNIA CORPORATION)
P.O. BOX 39439
LOS ANGELES, CA 90039

FOR: ENTERTAINMENT INFORMATION; ENTERTAINMENT SERVICES, NAMELY, PROVIDING A WEB PORTAL IN THE FIELDS OF MUSIC, MUSICAL ENTERTAINMENT, CHILDREN'S ENTERTAINMENT, AND ENTERTAINMENT DIRECTED TO CHILDREN, PARENTS AND FAMILIES; PROVIDING NEWS, ARTICLES AND OTHER INFORMATION IN THE FIELDS OF MUSIC, MUSICAL ENTERTAINMENT, CHILDREN'S ENTERTAINMENT, ENTERTAINMENT AND EDUCATIONAL ACTIVITIES DIRECTED TO CHILDREN, PARENTS AND FAMILIES, AND CHILDREN'S PRODUCTS; PROVIDING NON-DOWNLOADABLE PRE-RECORDED MUSICAL PERFORMANCES, AND NEWS, ARTICLES AND OTHER INFORMATION AND MULTI-MEDIA MATERIALS IN THE FIELDS OF MUSIC, MUSICAL ENTERTAINMENT, CHILDREN'S ENTERTAINMENT, ENTERTAINMENT AND EDUCATIONAL ACTIVITIES DIRECTED TO CHILDREN, PARENTS AND FAMILIES, AND CHILDREN'S PRODUCTS, THROUGH DIGITAL MEANS AND ELECTRONIC COMMUNICATIONS; ON-LINE JOURNALS, NAMELY, BLOGS FEATURING INFORMATION IN THE FIELDS OF MUSIC, MUSICAL ENTERTAINMENT, CHILDREN'S ENTERTAINMENT, ENTERTAINMENT AND EDUCATIONAL ACTIVITIES DIRECTED TO CHILDREN, PARENTS AND FAMILIES, AND CHILDREN'S PRODUCTS; ENTERTAINMENT SERVICES, NAMELY, PROVIDING TEMPORARY USE OF NON-DOWNLOADABLE ELECTRONIC GAMES; ENTERTAINMENT SERVICES, NAMELY, PROVIDING NON-DOWNLOADABLE EDUCATIONAL MATERIALS IN THE NATURE OF MULTI-MEDIA CONTENT CONTAINING IMAGES, GRAPHICS, ARTWORK, TEXT, HYPERTEXT, AUDIO AND VIDEO, IN THE FIELDS OF MUSIC, MUSICAL ENTERTAINMENT, CHILDREN'S ENTERTAINMENT, ENTERTAINMENT DIRECTED TO CHILDREN, PARENTS AND FAMILIES, AND TOPICS OF GENERAL INTEREST, IN CLASS 41 (U.S. CLS. 100, 101 AND 107).



FIRST USE 3-11-2009; IN COMMERCE 3-11-2009.

THE MARK CONSISTS OF A STYLIZED RENDITION OF "ROCKABYE BABY!" APPEARING IN THE COLORS PINK AND GREEN/GREEN-YELLOW.

THE COLOR(S) "PINK" AND "GREEN"/"GREEN-YELLOW" IS/ARE CLAIMED AS A FEATURE OF THE MARK.

SER. NO. 85-145,213, FILED 10-5-2010.

David J. Kyros

Director of the United States Patent and Trademark Office

Reg. No. 4,065,714 LINDA ESTRADA, EXAMINING ATTORNEY

United States of America

United States Patent and Trademark Office

Vidsys

Reg. No. 4,065,715

Registered Dec. 6, 2011

Int. Cl.: 9

TRADEMARK

PRINCIPAL REGISTER

VIDSYS, INC. (MASSACHUSETTS CORPORATION), DBA VIDSYS
SUITE 310
293 BOSTON POST RD
MARLBOROUGH, MA 01752

FOR: COMPUTER HARDWARE AND SOFTWARE PROVIDING A PLATFORM AND APPLICATIONS FOR COLLECTING INFORMATION AND CORRELATING EVENTS FROM A SECURITY DEVICE(S) , IN CLASS 9 (U.S. CLS. 21, 23, 26, 36 AND 38).

FIRST USE 9-1-2005; IN COMMERCE 9-1-2005.

THE MARK CONSISTS OF STANDARD CHARACTERS WITHOUT CLAIM TO ANY PARTICULAR FONT, STYLE, SIZE, OR COLOR.

SER. NO. 85-145,324, FILED 10-5-2010.

CHRIS WELLS, EXAMINING ATTORNEY



David J. Kybas

Director of the United States Patent and Trademark Office

United States of America

United States Patent and Trademark Office

A New Chapter

Reg. No. 4,065,716

WENDELL AUSTIN (UNITED STATES INDIVIDUAL), DBA A NEW CHAPTER
1635 FOLEY AVE
SAN JOSE, CA 95122

Registered Dec. 6, 2011

Int. Cl.: 35

FOR: PROFESSIONAL STAFFING AND RECRUITING SERVICES, IN CLASS 35 (U.S. CLS. 100, 101 AND 102).

SERVICE MARK

FIRST USE 10-1-2010; IN COMMERCE 10-1-2010.

PRINCIPAL REGISTER

THE MARK CONSISTS OF STANDARD CHARACTERS WITHOUT CLAIM TO ANY PARTICULAR FONT, STYLE, SIZE, OR COLOR.

SER. NO. 85-146,086, FILED 10-6-2010.

KATHERINE E. HALMEN, EXAMINING ATTORNEY



David J. Kyffers

Director of the United States Patent and Trademark Office

United States of America

United States Patent and Trademark Office

TWIGGY

Reg. No. 4,065,717

Registered Dec. 6, 2011

Int. Cl.: 35

SERVICE MARK

PRINCIPAL REGISTER

TWIGGY ORIGINALS, LLC (KENTUCKY LIMITED LIABILITY COMPANY)
7519 CLIPPING CROSS ROAD
LOUISVILLE, KY 40241

FOR: ART BROKERAGE, IN CLASS 35 (U.S. CLS. 100, 101 AND 102).

FIRST USE 12-31-2003; IN COMMERCE 12-31-2003.

THE MARK CONSISTS OF STANDARD CHARACTERS WITHOUT CLAIM TO ANY PARTICULAR FONT, STYLE, SIZE, OR COLOR.

"TWIGGY" IDENTIFIES THE NICKNAME OF CARLA TERWILLEGER, A LIVING INDIVIDUAL, WHOSE CONSENT IS OF RECORD.

SER. NO. 85-146,334, FILED 10-6-2010.

JOHN DWYER, EXAMINING ATTORNEY



David J. Kybas

Director of the United States Patent and Trademark Office

United States of America

United States Patent and Trademark Office

ALUMINUM PRECISION PRODUCTS

Reg. No. 4,065,718

Registered Dec. 6, 2011

Int. Cl.: 40

SERVICE MARK

PRINCIPAL REGISTER

ALUMINUM PRECISION PRODUCTS, INC. (CALIFORNIA CORPORATION)
3333 W. WARNER AVENUE
SANTA ANA, CA 92704

FOR: FORGING OF METAL GOODS TO THE ORDER AND SPECIFICATION OF OTHERS,
IN CLASS 40 (U.S. CLS. 100, 103 AND 106).

FIRST USE 12-31-1965; IN COMMERCE 12-31-1965.

THE MARK CONSISTS OF STANDARD CHARACTERS WITHOUT CLAIM TO ANY PAR-
TICULAR FONT, STYLE, SIZE, OR COLOR.

NO CLAIM IS MADE TO THE EXCLUSIVE RIGHT TO USE "PRODUCTS", APART FROM
THE MARK AS SHOWN.

SEC. 2(F).

SER. NO. 85-146,348, FILED 10-6-2010.

VIVIAN MICZNIK FIRST, EXAMINING ATTORNEY



David J. Kybas

Director of the United States Patent and Trademark Office

United States of America

United States Patent and Trademark Office

TEAM FREEDOM

Reg. No. 4,065,719

Registered Dec. 6, 2011

Int. Cl.: 41

SERVICE MARK

PRINCIPAL REGISTER

TEAM FREEDOM, LLC. (CALIFORNIA LIMITED LIABILITY COMPANY)
24822 SAUCO
MISSION VIEJO, CA 92692

FOR: EDUCATION SERVICES, NAMELY, PROVIDING TRAINING, MENTORING, COACHING, USING CONFERENCE CALLS, WEB BASED SEMINARS, VIDEO CONFERENCING, LIVE EVENTS, INDIVIDUAL, GROUP AND TELEPHONIC MEETINGS, ALL THE FIELD OF NETWORK MARKETING/MULTI-LEVEL MARKETING, SOCIAL MEDIA MARKETING, INTERNET MARKETING, PERSONAL FINANCE, LEADERSHIP DEVELOPMENT, TEAM BUILDING, TIME MANAGEMENT, AND OTHER ASPECTS OF PERSONAL DEVELOPMENT, AND DISTRIBUTING PRINTED COURSE MATERIALS THEREWITH; ONLINE JOURNALS, NAMELY, BLOGS IN THE FIELD OF NETWORK MARKETING/MULTI-LEVEL MARKETING, SOCIAL MEDIA MARKETING, INTERNET MARKETING, PERSONAL FINANCE, LEADERSHIP DEVELOPMENT, TEAM BUILDING, TIME MANAGEMENT, AND OTHER ASPECTS OF PERSONAL DEVELOPMENT, IN CLASS 41 (U.S. CLS. 100, 101 AND 107).

FIRST USE 0-0-2001; IN COMMERCE 0-0-2001.

THE MARK CONSISTS OF STANDARD CHARACTERS WITHOUT CLAIM TO ANY PARTICULAR FONT, STYLE, SIZE, OR COLOR.

SER. NO. 85-146,368, FILED 10-6-2010.

COLLEEN KEARNEY, EXAMINING ATTORNEY



David J. Kybas

Director of the United States Patent and Trademark Office

United States of America

United States Patent and Trademark Office



Reg. No. 4,065,720

Registered Dec. 6, 2011

Int. Cls.: 36, 37, 42 and 44

SERVICE MARK

PRINCIPAL REGISTER

DIAMOND B COMPANIES, INC. (MONTANA CORPORATION)
3529 GABEL ROAD
BILLINGS, MT 59102

FOR: REAL ESTATE MANAGEMENT OF COMMERCIAL AND RESIDENTIAL PROPERTIES; INVESTMENT MANAGEMENT; VENTURE CAPITAL FINANCING; REAL ESTATE SERVICES, NAMELY, LEASING AND MANAGEMENT OF COMMERCIAL PROPERTY, OFFICES AND OFFICE SPACE, IN CLASS 36 (U.S. CLS. 100, 101 AND 102).

FIRST USE 11-30-2005; IN COMMERCE 11-30-2005.

FOR: REAL ESTATE DEVELOPMENT; BUILDING CONSTRUCTION SERVICES; CONSTRUCTION OF UNDERGROUND UTILITIES; GENERAL CONSTRUCTION CONTRACTING, IN CLASS 37 (U.S. CLS. 100, 103 AND 106).

FIRST USE 11-30-2005; IN COMMERCE 11-30-2005.

FOR: PROFESSIONAL CONSULTING SERVICES IN THE FIELD OF LANDSCAPE ARCHITECTURE, IN CLASS 42 (U.S. CLS. 100 AND 101).

FIRST USE 11-30-2005; IN COMMERCE 11-30-2005.

FOR: LANDSCAPE DESIGN, IN CLASS 44 (U.S. CLS. 100 AND 101).

FIRST USE 11-30-2005; IN COMMERCE 11-30-2005.

NO CLAIM IS MADE TO THE EXCLUSIVE RIGHT TO USE "COMPANIES INC.", APART FROM THE MARK AS SHOWN.

THE MARK CONSISTS OF THE WORDS "DIAMOND B COMPANIES INC." IN A STYLIZED FONT OVER AN IMAGE OF A DIAMOND.

SER. NO. 85-147,342, FILED 10-7-2010.

BRIAN NEVILLE, EXAMINING ATTORNEY



David J. Kyffers

Director of the United States Patent and Trademark Office

United States of America

United States Patent and Trademark Office

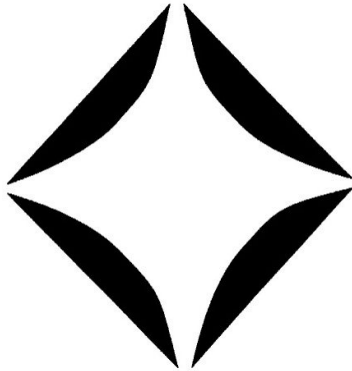

Reg. No. 4,065,721

Registered Dec. 6, 2011

Int. Cl.: 35

SERVICE MARK

PRINCIPAL REGISTER

DE BEERS CENTENARY AG (SWITZERLAND AKTIENGESELLSCHAFT)
ALPENSTRASSE 5
6000 LUZERN 6, SWITZERLAND

FOR: ADVERTISING SERVICES IN THE FIELD OF DIAMONDS, PRECIOUS STONES AND SEMI-PRECIOUS STONES, DIAMOND JEWELLERY, JEWELLERY AND IMITATION JEWELLERY, PRECIOUS METALS AND THEIR ALLOYS AND GOODS IN PRECIOUS METALS OR COATED THEREWITH, AND HOROLOGICAL AND CHRONOMETRIC INSTRUMENTS, IN CLASS 35 (U.S. CLS. 100, 101 AND 102).

OWNER OF AUSTRALIA REG. NO. 1246418, DATED 1-27-2009, EXPIRES 6-16-2018.

OWNER OF U.S. REG. NOS. 3,352,524 AND 3,676,672.

THE MARK CONSISTS OF A STYLIZED DIAMOND.

SER. NO. 85-147,676, FILED 10-7-2010.

JORDAN BAKER, EXAMINING ATTORNEY



David J. Kybas

Director of the United States Patent and Trademark Office

United States of America

United States Patent and Trademark Office



Reg. No. 4,065,722

Registered Dec. 6, 2011

Int. Cl.: 1

TRADEMARK

PRINCIPAL REGISTER

AQUA-MAXX, INC. (NEW YORK CORPORATION)
180 EAST PROSPECT AVENUE, PO BOX #159
MAMARONECK, NY 10543

FOR: CHEMICAL FERTILIZERS; CHEMICAL ADDITIVES AND BIOSTIMULANTS, AND APPLICATIONS, NAMELY, A CHEMICAL SUBSTANCE THAT IS ADDED TO WATER TO MAKE THE WATER MORE SOLUBLE THEREBY IMPROVING WATER ABSORPTION BY TURF-GRASS USED TO ENHANCE ROOT GROWTH AND TO STIMULATE AND IMPROVE OVERALL TURF HEALTH, IN CLASS 1 (U.S. CLS. 1, 5, 6, 10, 26 AND 46).

FIRST USE 11-1-2000; IN COMMERCE 11-1-2000.

THE MARK CONSISTS OF A STYLIZED WATER DROPLET FALLING ON A DARK BAND TO SYMBOLIZE THE GROUND, WITH 11 LINES EMANATING DIAGONALLY FROM BEHIND EACH SIDE OF THE DROPLET TO SYMBOLIZE RAYS OF LIGHT.

SER. NO. 85-148,143, FILED 10-8-2010.

JANICE L. MCMORROW, EXAMINING ATTORNEY



David J. Kybas

Director of the United States Patent and Trademark Office

United States of America

United States Patent and Trademark Office



Reg. No. 4,065,723

Registered Dec. 6, 2011

Int. Cls.: 37 and 42

SERVICE MARK

PRINCIPAL REGISTER

IT DOCTORS INC. (FLORIDA CORPORATION)
17021 WEST DIXIE HIGHWAY
AVENTURA, FL 33160

FOR: INSTALLATION, MAINTENANCE AND REPAIR OF COMPUTER HARDWARE, IN CLASS 37 (U.S. CLS. 100, 103 AND 106).

FIRST USE 9-0-2006; IN COMMERCE 9-0-2006.

FOR: INSTALLATION, MAINTENANCE, AND REPAIR OF COMPUTER SOFTWARE; COMPUTER NETWORK CONFIGURATION SERVICES; CONSULTING IN THE FIELD OF CONFIGURATION MANAGEMENT FOR COMPUTER HARDWARE AND SOFTWARE, IN CLASS 42 (U.S. CLS. 100 AND 101).

FIRST USE 9-0-2006; IN COMMERCE 9-0-2006.

NO CLAIM IS MADE TO THE EXCLUSIVE RIGHT TO USE "MANAGE YOUR TECHNOLOGY", APART FROM THE MARK AS SHOWN.

THE COLOR(S) BLUE, GREEN AND BLACK IS/ARE CLAIMED AS A FEATURE OF THE MARK.

THE MARK CONSISTS OF THE LETTERS "IT" IN BLUE, THE WORD "DOCTORS" IN GREEN WITH THE LETTER "R" IN BLUE WITH A LETTER "X" ATTACHED TO THE LETTER "R" ALSO IN BLUE AND THE PHRASE "MANAGE YOUR TECHNOLOGY" BELOW IN BLACK. A STYLIZED DEPICTION OF SPIRAL RINGS IN GREEN APPEARS BELOW THE LETTER "X". THE BACKGROUND OF THE ENTIRE MARK IS TRANSLUCENT.

SER. NO. 85-148,183, FILED 10-8-2010.

JIM RINGLE, EXAMINING ATTORNEY



David J. Kybas

Director of the United States Patent and Trademark Office

United States of America

United States Patent and Trademark Office

JOHNNIE BROWN'S

Reg. No. 4,065,724

Registered Dec. 6, 2011

Int. Cl.: 43

SERVICE MARK

PRINCIPAL REGISTER

DELRAY FOOD SERVICES INC. (FLORIDA CORPORATION)
79 SOUTH 23RD STREET
PITTSBURGH, PA 15203

FOR: RESTAURANT SERVICES, IN CLASS 43 (U.S. CLS. 100 AND 101).

FIRST USE 11-30-2009; IN COMMERCE 11-30-2009.

THE MARK CONSISTS OF STANDARD CHARACTERS WITHOUT CLAIM TO ANY PARTICULAR FONT, STYLE, SIZE, OR COLOR.

THE NAME "JOHNNIE BROWN" DOES NOT IDENTIFY A LIVING INDIVIDUAL.

SER. NO. 85-148,230, FILED 10-8-2010.

DAWN FELDMAN, EXAMINING ATTORNEY



David J. Kyffers

Director of the United States Patent and Trademark Office

United States of America

United States Patent and Trademark Office



Reg. No. 4,065,725

Registered Dec. 6, 2011

Int. Cl.: 43

SERVICE MARK

PRINCIPAL REGISTER

DELRAY FOOD SERVICES INC. (FLORIDA CORPORATION)
79 SOUTH 23RD STREET
PITTSBURGH, PA 15203

FOR: RESTAURANT SERVICES, IN CLASS 43 (U.S. CLS. 100 AND 101).

FIRST USE 11-30-2009; IN COMMERCE 11-30-2009.

THE NAME "JOHNNIE BROWN" DOES NOT IDENTIFY A LIVING INDIVIDUAL.

THE MARK CONSISTS OF A PARROT, A MONKEY AND THE WORDS "JOHNNIE BROWN'S" SUPERIMPOSED ON A CIRCULAR BACKGROUND.

SER. NO. 85-148,249, FILED 10-8-2010.

DAWN FELDMAN, EXAMINING ATTORNEY



David J. Kybas

Director of the United States Patent and Trademark Office

United States of America

United States Patent and Trademark Office

MOPHIE MARKETPLACE

Reg. No. 4,065,726

Registered Dec. 6, 2011

Int. Cls.: 9 and 36

TRADEMARK

SERVICE MARK

PRINCIPAL REGISTER

MOPHIE, INC. (CALIFORNIA CORPORATION)
2850 RED HILL AVENUE, SUITE 128
SANTA ANA, CA 92705

FOR: CARD READER TERMINAL FOR USE WITH MOBILE ELECTRONIC DEVICES, NAMELY, MOBILE PHONES, DIGITAL AUDIO AND VIDEO PLAYERS, HANDHELD COMPUTERS, PERSONAL DIGITAL ASSISTANTS, ELECTRONIC ORGANIZERS, AND ELECTRONIC NOTEPADS TO SCAN INFORMATION CONTAINED IN ELECTRONIC STRIPS OF VARIOUS CARDS, NAMELY, CREDIT CARDS, BANK CARDS, DEBIT CARDS, LICENSES, IDENTIFICATION CARDS AND FREQUENT BUYER CARDS; COMPUTER SOFTWARE FOR PROCESSING ELECTRONIC PAYMENTS VIA MOBILE DIGITAL ELECTRONIC DEVICES, NAMELY, MOBILE PHONES, HANDHELD COMPUTERS, PERSONAL DIGITAL ASSISTANTS, ELECTRONIC ORGANIZERS, AND ELECTRONIC NOTEPADS, IN CLASS 9 (U.S. CLS. 21, 23, 26, 36 AND 38).

FIRST USE 8-26-2010; IN COMMERCE 8-26-2010.

FOR: FINANCIAL TRANSACTION SERVICES, NAMELY, PROVIDING SECURE COMMERCIAL TRANSACTIONS AND PAYMENT OPTIONS USING MOBILE ELECTRONIC DEVICES AT A POINT OF SALE, NAMELY, MOBILE PHONES, HANDHELD COMPUTERS, PERSONAL DIGITAL ASSISTANTS, ELECTRONIC ORGANIZERS, AND ELECTRONIC NOTEPADS; PAYMENT PROCESSING SERVICES, NAMELY, CREDIT CARD AND DEBIT CARD TRANSACTION PROCESSING SERVICES, IN CLASS 36 (U.S. CLS. 100, 101 AND 102).

FIRST USE 8-26-2010; IN COMMERCE 8-26-2010.

THE MARK CONSISTS OF STANDARD CHARACTERS WITHOUT CLAIM TO ANY PARTICULAR FONT, STYLE, SIZE, OR COLOR.

OWNER OF U.S. REG. NOS. 3,227,723, 3,227,725, AND 3,949,983.

SER. NO. 85-148,369, FILED 10-8-2010.

MARY CRAWFORD, EXAMINING ATTORNEY



David J. Kyros

Director of the United States Patent and Trademark Office

United States of America

United States Patent and Trademark Office



Privacy Data Systems

Reg. No. 4,065,727

Registered Dec. 6, 2011

Int. Cl.: 9

TRADEMARK

PRINCIPAL REGISTER

PRIVACY DATA SYSTEMS, LLC (DELAWARE LIMITED LIABILITY COMPANY)
7810 BALLANTYNE COMMONS PKWY #300
CHARLOTTE, NC 28277

FOR: SOFTWARE TO SEND, RECEIVE AND COLLABORATE WITH TEXT, VIDEO, AUDIO, LARGE FILE ATTACHMENTS IN COMPLETE PRIVACY OVER ANY WEB-ENABLED COMPUTER, INCLUDING PATENT-PENDING BIOMETRIC AUTHENTICATION, IN CLASS 9 (U.S. CLS. 21, 23, 26, 36 AND 38).

FIRST USE 4-7-2010; IN COMMERCE 4-15-2010.

NO CLAIM IS MADE TO THE EXCLUSIVE RIGHT TO USE "PRIVACY DATA SYSTEMS", APART FROM THE MARK AS SHOWN.

THE MARK CONSISTS OF THE WORDS "PRIVACY DATA SYSTEMS" FEATURING A CIRCULAR DESIGN TO THE LEFT OF THE WORDING DEPICTING TWO FINGERTIPS BEING PLACED ON AN ABSTRACT SCANNER.

SER. NO. 85-148,392, FILED 10-8-2010.

KATHERINE M. DUBRAY, EXAMINING ATTORNEY



David J. Kyros

Director of the United States Patent and Trademark Office

United States of America

United States Patent and Trademark Office

LINK2

Reg. No. 4,065,728

Registered Dec. 6, 2011

Int. Cl.: 9

TRADEMARK

PRINCIPAL REGISTER

REACH ENGINEERING, LLC (FLORIDA LIMITED LIABILITY COMPANY)
6405 SW 38TH ST, BUILDING 200
OCALA, FL 34474

FOR: ON-BOARD MONITORING AND COMMUNICATIONS COMPUTER INTERFACE FOR SPECIALTY VEHICLES; DOWNLOADABLE SOFTWARE FOR CONFIGURING ON-BOARD MONITORING AND COMMUNICATIONS APPARATUS FOR SPECIALTY VEHICLES, IN CLASS 9 (U.S. CLS. 21, 23, 26, 36 AND 38).

FIRST USE 6-21-2010; IN COMMERCE 6-21-2010.

THE MARK CONSISTS OF STANDARD CHARACTERS WITHOUT CLAIM TO ANY PARTICULAR FONT, STYLE, SIZE, OR COLOR.

SER. NO. 85-148,515, FILED 10-8-2010.

ROBERT STRUCK, EXAMINING ATTORNEY



David J. Kybas

Director of the United States Patent and Trademark Office

United States of America

United States Patent and Trademark Office

LINK2

Reg. No. 4,065,729

Registered Dec. 6, 2011

Int. Cl.: 35

SERVICE MARK

PRINCIPAL REGISTER

REACH ENGINEERING, LLC (FLORIDA LIMITED LIABILITY COMPANY)
6405 SW 38TH ST, BUILDING 200
OCALA, FL 34474

FOR: THE SERVICE OF PROVIDING TEMPORARY USE OF ON-LINE NON-DOWNLOAD-ABLE SOFTWARE FOR MONITORING USAGE, SERVICE AND WARRANTY SPECIFIC DATA IN THE FIELD OF SPECIALTY VEHICLE FLEET MANAGEMENT, IN CLASS 35 (U.S. CLS. 100, 101 AND 102).

FIRST USE 6-23-2010; IN COMMERCE 6-23-2010.

THE MARK CONSISTS OF STANDARD CHARACTERS WITHOUT CLAIM TO ANY PARTICULAR FONT, STYLE, SIZE, OR COLOR.

SER. NO. 85-148,552, FILED 10-8-2010.

ROBERT STRUCK, EXAMINING ATTORNEY



David J. Kyffers

Director of the United States Patent and Trademark Office

United States of America

United States Patent and Trademark Office

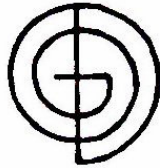

Reg. No. 4,065,730

Registered Dec. 6, 2011

Int. Cl.: 14

TRADEMARK

PRINCIPAL REGISTER

RUSS YUKIO HIRAKAWA (UNITED STATES INDIVIDUAL)
8 DONNER LANE
CHICO, CA 95928

FOR: EARRINGS; PENDANTS, IN CLASS 14 (U.S. CLS. 2, 27, 28 AND 50).

FIRST USE 6-10-2008; IN COMMERCE 12-17-2008.

THE MARK CONSISTS OF A HORIZONTAL LINE FROM LEFT TO RIGHT GOING THROUGH THE CENTER PORTION OF THE MARK AND THEN GOING STRAIGHT DOWN AND IMMEDIATELY TURNING IN A CIRCULAR CLOCKWISE DIRECTION TO FORM THE CAPITAL LETTER "G", IT THEN CONTINUES IN A GRADUALLY EXPANDING CLOCKWISE SPIRAL TO MAKE THE FORMATION OF AN "O", THEN CONTINUES FROM THE TOP OF THE MARK CLOCKWISE AROUND TO THE BOTTOM FROM WHERE IT GOES DIRECTLY UPWARD TO FORM THE LETTER "D".

SER. NO. 85-148,974, FILED 10-9-2010.

NANCY CLARKE, EXAMINING ATTORNEY



David J. Kybas

Director of the United States Patent and Trademark Office

United States of America

United States Patent and Trademark Office

FleetKnowSys

Reg. No. 4,065,731

Registered Dec. 6, 2011

Int. Cl.: 9

TRADEMARK

PRINCIPAL REGISTER

LIBAN, INC. (DELAWARE CORPORATION)
125 TECH PARK DRIVE
ROCHESTER, NY 14623

FOR: FLEET MANAGEMENT HARDWARE AND SOFTWARE SOLUTIONS, NAMELY, TELEMATICS HARDWARE AND SOFTWARE PROVIDING VEHICLE HEALTH ASSESSMENT, VEHICLE DIAGNOSTICS, MAINTENANCE RECOMMENDATIONS AND SUPPORT TOOLS, GPS FUNCTIONALITY AND COMMUNICATIONS FEATURES, ALL SOLD AS A UNIT, IN CLASS 9 (U.S. CLS. 21, 23, 26, 36 AND 38).

FIRST USE 4-13-2009; IN COMMERCE 4-13-2009.

THE MARK CONSISTS OF STANDARD CHARACTERS WITHOUT CLAIM TO ANY PARTICULAR FONT, STYLE, SIZE, OR COLOR.

SER. NO. 85-149,224, FILED 10-10-2010.

RONALD MCMORROW, EXAMINING ATTORNEY



David J. Kyffers

Director of the United States Patent and Trademark Office

United States of America

United States Patent and Trademark Office

Editors' Choice
ONLINE

Reg. No. 4,065,732

Registered Dec. 6, 2011

Int. Cl.: 35

SERVICE MARK

PRINCIPAL REGISTER

J.W. PEPPER & SON, INC. (PENNSYLVANIA CORPORATION)
P.O. BOX 1795
2480 INDUSTRIAL BOULEVARD
PAOLI, PA 19301

FOR: MAIL ORDER SERVICES FEATURING PRINTED SHEET MUSIC AND MUSICAL ACCESSORIES, IN CLASS 35 (U.S. CLS. 100, 101 AND 102).

FIRST USE 9-30-2010; IN COMMERCE 9-30-2010.

NO CLAIM IS MADE TO THE EXCLUSIVE RIGHT TO USE "ONLINE", APART FROM THE MARK AS SHOWN.

THE MARK CONSISTS OF THE WORDS "EDITOR'S CHOICE", IN SCRIPTED FONTS, ABOVE THE WORD "ONLINE", IN FRONT OF A STYLIZED ELLIPTICAL DESIGN.

SER. NO. 85-149,430, FILED 10-11-2010.

RAUL CORDOVA, EXAMINING ATTORNEY



David J. Kybas

Director of the United States Patent and Trademark Office

United States of America

United States Patent and Trademark Office



Reg. No. 4,065,733

Registered Dec. 6, 2011

Int. Cl.: 35

SERVICE MARK

PRINCIPAL REGISTER

J.W. PEPPER & SON, INC. (PENNSYLVANIA CORPORATION)
P.O. BOX 1795
2480 INDUSTRIAL BOULEVARD
PAOLI, PA 19301

FOR: MAIL ORDER SERVICES FEATURING PRINTED SHEET MUSIC AND MUSICAL ACCESSORIES, IN CLASS 35 (U.S. CLS. 100, 101 AND 102).

FIRST USE 9-30-2010; IN COMMERCE 9-30-2010.

NO CLAIM IS MADE TO THE EXCLUSIVE RIGHT TO USE "ONLINE", APART FROM THE MARK AS SHOWN.

THE MARK CONSISTS OF THE LETTERS "EC", IN SCRIPTED FONT, ABOVE THE WORD "ONLINE", ALL INSIDE A ROUNDED SQUARE.

SER. NO. 85-149,432, FILED 10-11-2010.

RAUL CORDOVA, EXAMINING ATTORNEY



David J. Kybas

Director of the United States Patent and Trademark Office

United States of America

United States Patent and Trademark Office



Reg. No. 4,065,734

Registered Dec. 6, 2011

Int. Cl.: 45

SERVICE MARK

PRINCIPAL REGISTER

CATHOLIC YOUTH EXPEDITIONS, INC. (WISCONSIN CORPORATION)
1000 WEST WISCONSIN AVENUE
APPLETON, WI 54914

FOR: EVANGELISTIC AND MINISTERIAL SERVICES, IN CLASS 45 (U.S. CLS. 100 AND 101).

FIRST USE 6-1-2002; IN COMMERCE 6-1-2002.

THE MARK CONSISTS OF HIKER ON MOUNTAIN WITH A CROSS ON TOP, WITH TREE, AND "C.Y.E." LOGO ON BOTTOM.

SER. NO. 85-149,434, FILED 10-11-2010.

GRETТА YAO, EXAMINING ATTORNEY



David J. Kybas

Director of the United States Patent and Trademark Office

United States of America

United States Patent and Trademark Office

very

Reg. No. 4,065,735

Registered Dec. 6, 2011

Int. Cls.: 35 and 36

SERVICE MARK

PRINCIPAL REGISTER

LITTLEWOODS LIMITED (UNITED KINGDOM COMPANY)
FIRST FLOOR
SKYWAYS HOUSE, SPEKE ROAD
LIVERPOOL, UNITED KINGDOM L701AB

FOR: RETAIL STORE SERVICES FEATURING CLOTHING, FOOTWEAR, HEADGEAR, LEATHER GOODS, BAGS, LUGGAGE, UMBRELLAS, JEWELRY, HOUSEHOLD ELECTRICAL APPARATUS AND APPLIANCES, AUDIO-VISUAL APPLIANCES AND APPARATUS, TELECOMMUNICATIONS EQUIPMENT, SATELLITE NAVIGATION APPARATUS AND EQUIPMENT, ELECTRONIC GAMING EQUIPMENT AND ELECTRICAL GARDEN AND DIY EQUIPMENT, TEXTILE GOODS, BED LINEN, TOWELS, FLOOR COVERINGS, RUGS, WALLPAPER AND WALL COVERINGS, HOUSEHOLD OR KITCHEN UTENSILS AND GLASSWARE, HOUSEHOLD OR KITCHEN GOODS MADE OF PORCELAIN AND EARTHENWARE, FURNITURE, MIRRORS, PHOTOGRAPHS AND PICTURE FRAMES, HOUSEHOLD CONTAINERS, TOYS, GAMES AND PLAYTHINGS, CHRISTMAS DECORATIONS, IN CLASS 35 (U.S. CLS. 100, 101 AND 102).

FOR: FINANCIAL SERVICES, NAMELY, CREDIT AND DEBIT CARD SERVICES; CREDIT AND LOAN SERVICES, IN CLASS 36 (U.S. CLS. 100, 101 AND 102).

OWNER OF UNITED KINGDOM REG. NO. 2529446, DATED 1-21-2011, EXPIRES 10-21-2019.

THE MARK CONSISTS OF THE WORD "VERY" IN STYLIZED FONT.

SER. NO. 85-149,928, FILED 10-11-2010.

WENDY JUN, EXAMINING ATTORNEY



David J. Kyros

Director of the United States Patent and Trademark Office

United States of America

United States Patent and Trademark Office

VERY

Reg. No. 4,065,736

Registered Dec. 6, 2011

Int. Cls.: 35 and 36

SERVICE MARK

PRINCIPAL REGISTER

LITTLEWOODS LIMITED (UNITED KINGDOM COMPANY)
FIRST FLOOR
SKYWAYS HOUSE, SPEKE ROAD
LIVERPOOL, UNITED KINGDOM L701AB

FOR: RETAIL STORE SERVICES FEATURING CLOTHING, FOOTWEAR, HEADGEAR, LEATHER GOODS, BAGS, LUGGAGE, UMBRELLAS, JEWELRY, HOUSEHOLD ELECTRICAL APPARATUS AND APPLIANCES, AUDIO-VISUAL APPLIANCES AND APPARATUS, TELECOMMUNICATIONS EQUIPMENT, SATELLITE NAVIGATION APPARATUS AND EQUIPMENT, ELECTRONIC GAMING EQUIPMENT AND ELECTRICAL GARDEN AND DIY EQUIPMENT, TEXTILE GOODS, BED LINEN, TOWELS, FLOOR COVERINGS, RUGS, WALLPAPER AND WALL COVERINGS, HOUSEHOLD OR KITCHEN UTENSILS AND GLASSWARE, HOUSEHOLD OR KITCHEN GOODS MADE OF PORCELAIN AND EARTHENWARE, FURNITURE, MIRRORS, PHOTOGRAPHS AND PICTURE FRAMES, HOUSEHOLD CONTAINERS, TOYS, GAMES AND PLAYTHINGS, CHRISTMAS DECORATIONS, IN CLASS 35 (U.S. CLS. 100, 101 AND 102).

FOR: FINANCIAL SERVICES, NAMELY, CREDIT AND DEBIT CARD SERVICES; CREDIT AND LOAN SERVICES, IN CLASS 36 (U.S. CLS. 100, 101 AND 102).

THE MARK CONSISTS OF STANDARD CHARACTERS WITHOUT CLAIM TO ANY PARTICULAR FONT, STYLE, SIZE, OR COLOR.

OWNER OF UNITED KINGDOM REG. NO. 2515302, DATED 5-8-2009, EXPIRES 5-8-2019.

SER. NO. 85-149,937, FILED 10-11-2010.

WENDY JUN, EXAMINING ATTORNEY



David J. Kybas

Director of the United States Patent and Trademark Office

United States of America

United States Patent and Trademark Office

YAY! LIFE!

Reg. No. 4,065,737

YAY! LIFE! LLC (COLORADO LIMITED LIABILITY COMPANY)
3215 OSAGE STREET
DENVER, CO 80211

Registered Dec. 6, 2011

Int. Cl.: 9

FOR: DECORATIVE MAGNETS; DECORATIVE REFRIGERATOR MAGNETS, IN CLASS 9
(U.S. CLS. 21, 23, 26, 36 AND 38).

TRADEMARK

FIRST USE 4-24-2010; IN COMMERCE 10-4-2010.

PRINCIPAL REGISTER

THE MARK CONSISTS OF STANDARD CHARACTERS WITHOUT CLAIM TO ANY PARTICULAR FONT, STYLE, SIZE, OR COLOR.

SER. NO. 85-149,974, FILED 10-11-2010.

SALLY SHIH, EXAMINING ATTORNEY



David J. Kybas

Director of the United States Patent and Trademark Office

United States of America

United States Patent and Trademark Office

BLUE
COMPETITION CYCLES

Reg. No. 4,065,738

Registered Dec. 6, 2011

Int. Cls.: 12 and 25

TRADEMARK

PRINCIPAL REGISTER

PETER SKOP INDUSTRIES (GEORGIA CORPORATION), DBA BLUE COMPETITION CYCLES
6161 ATLANTIC BOULEVARD
NORCROSS, GA 30071

FOR: BICYCLE FRAMES; BICYCLE PARTS, NAMELY, FORKS; BICYCLE SADDLES; BICYCLES, IN CLASS 12 (U.S. CLS. 19, 21, 23, 31, 35 AND 44).

FIRST USE 9-0-2007, THE MARK WAS FIRST USED ANYWHERE IN A DIFFERENT FORM OTHER THAN THAT SOUGHT TO BE REGISTERED AT LEAST AS EARLY AS 08/01/2003; IN COMMERCE 10-0-2007, THE MARK WAS FIRST USED IN COMMERCE IN A DIFFERENT FORM OTHER THAN THAT SOUGHT TO BE REGISTERED AT LEAST AS EARLY AS 05/01/2004.

FOR: BIB SHORTS; CLOTHING, NAMELY, ARM WARMERS; HATS; JACKETS; JERSEYS; SHIRTS; SHORTS; SOCKS; VESTS, IN CLASS 25 (U.S. CLS. 22 AND 39).

FIRST USE 9-0-2008, THE MARK WAS FIRST USED ANYWHERE IN A DIFFERENT FORM OTHER THAN THAT SOUGHT TO BE REGISTERED AT LEAST AS EARLY AS 08/01/2003; IN COMMERCE 10-0-2008, THE MARK WAS FIRST USED IN COMMERCE IN A DIFFERENT FORM OTHER THAN THAT SOUGHT TO BE REGISTERED AT LEAST AS EARLY AS 05/01/2004.

OWNER OF U.S. REG. NO. 3,124,319.

NO CLAIM IS MADE TO THE EXCLUSIVE RIGHT TO USE "COMPETITION CYCLES", APART FROM THE MARK AS SHOWN.

THE MARK CONSISTS OF THE WORDS "BLUE COMPETITION CYCLES" IN A SLANTED, BLOCK FONT.

SER. NO. 85-150,182, FILED 10-12-2010.

ALICIA COLLINS, EXAMINING ATTORNEY



David J. Kyffers

Director of the United States Patent and Trademark Office

United States of America

United States Patent and Trademark Office



Reg. No. 4,065,739

Registered Dec. 6, 2011

Int. Cl.: 45

SERVICE MARK

PRINCIPAL REGISTER

BUCKNER MANAGEMENT SERVICES, LLC (TENNESSEE LIMITED LIABILITY COMPANY)
2415 N. OCOEE STREET
CLEVELAND, TN 37311

FOR: FUNERAL HOMES; FUNERAL SERVICE UNDERTAKING; FUNERAL ARRANGEMENT SERVICES, NAMELY, ARRANGING AND COORDINATING VIEWINGS, TRANSPORTATION, RECEPTIONS, FLOWERS, CASKETS, VAULTS, URNS, CEREMONIAL ACCOUTERMENTS, AND INTERMENT; FUNERAL SERVICES ACCOMPANYING CREMATION; FUNERAL WORSHIP SERVICES; GRAVESIDE FUNERARY SERVICES AND BURIAL SERVICES FEATURING DOVE RELEASES AND BAGPIPE PERFORMANCES, IN CLASS 45 (U.S. CLS. 100 AND 101).

FIRST USE 12-31-1997; IN COMMERCE 12-31-1997.

THE MARK CONSISTS OF AN OUTLINED DRAWING OF A PROFILE OF A STANDING DOVE, FACING TO THE RIGHT WITH ONE WING VISIBLE, SPREAD OUT BEHIND IT TO THE LEFT.

SER. NO. 85-150,232, FILED 10-12-2010.

RONALD MCMORROW, EXAMINING ATTORNEY



David J. Kyffers

Director of the United States Patent and Trademark Office

United States of America

United States Patent and Trademark Office

ARCHETHOS

Reg. No. 4,065,740

Registered Dec. 6, 2011

Int. Cls.: 16 and 42

TRADEMARK

SERVICE MARK

PRINCIPAL REGISTER

EISENMANN & IMELAUER GBR (FED REP GERMANY CORPORATION)
KRAPFSTR. 35
STUTTGART, FED REP GERMANY 70180

FOR: ARCHITECT'S MODELS; ARCHITECTS' MODELS OF BUILDINGS; ARCHITECTS' MODELS OF INTERIOR FITTINGS FOR BUILDINGS, IN CLASS 16 (U.S. CLS. 2, 5, 22, 23, 29, 37, 38 AND 50).

FOR: TECHNICAL AND DESIGN SERVICES, NAMELY, DESIGNING BUILDINGS, INTERIOR AND EXTERIOR PARTS OF BUILDINGS, INTERIOR DECOR OF BUILDING, ARCHITECT'S MODELS, BUILDING MODELS, AND COMPONENT PARTS OF ARCHITECT'S MODELS AND BUILDING MODELS; ARCHITECTURAL CONSULTANCY, IN CLASS 42 (U.S. CLS. 100 AND 101).

THE MARK CONSISTS OF STANDARD CHARACTERS WITHOUT CLAIM TO ANY PARTICULAR FONT, STYLE, SIZE, OR COLOR.

PRIORITY CLAIMED UNDER SEC. 44(D) ON ERPN CMNTY TM OFC APPLICATION NO. 009144866, FILED 6-1-2010, REG. NO. 009144866, DATED 11-12-2010, EXPIRES 6-1-2020.

SER. NO. 85-150,494, FILED 10-12-2010.

GENE MACIOL, EXAMINING ATTORNEY



David J. Kyros

Director of the United States Patent and Trademark Office

United States of America

United States Patent and Trademark Office



Reg. No. 4,065,741

Registered Dec. 6, 2011

Int. Cl.: 43

SERVICE MARK

PRINCIPAL REGISTER

BOULEVARD INN LLC (OHIO LIMITED LIABILITY COMPANY)
55 E. NATIONWIDE BLVD
COLUMBUS, OH 43215

FOR: HOTEL SERVICES, IN CLASS 43 (U.S. CLS. 100 AND 101).

FIRST USE 11-1-1997; IN COMMERCE 11-1-1997.

OWNER OF U.S. REG. NO. 2,777,781.

THE MARK CONSISTS OF THREE STYLIZED RECTANGULAR BUILDINGS CONTAINED WITHIN A RECTANGLE. THE WORDS "THE LOFTS" APPEAR INSIDE THE RECTANGLE BENEATH THE BUILDINGS.

SEC. 2(F) "THE LOFTS".

SER. NO. 85-150,693, FILED 10-12-2010.

JIM RINGLE, EXAMINING ATTORNEY



David J. Kybas

Director of the United States Patent and Trademark Office

United States of America

United States Patent and Trademark Office

DON'T BE THAT GUY

Reg. No. 4,065,742

Registered Dec. 6, 2011

Int. Cl.: 36

SERVICE MARK

PRINCIPAL REGISTER

FIFTH THIRD BANCORP (OHIO CORPORATION), AKA FIFTH THIRD BANK
38 FOUNTAIN SQUARE PLAZA
CINCINNATI, OH 45263

FOR: BANKING SERVICES, IN CLASS 36 (U.S. CLS. 100, 101 AND 102).

FIRST USE 3-0-2009; IN COMMERCE 3-0-2009.

THE MARK CONSISTS OF STANDARD CHARACTERS WITHOUT CLAIM TO ANY PARTICULAR FONT, STYLE, SIZE, OR COLOR.

SER. NO. 85-150,816, FILED 10-12-2010.

JASON BLAIR, EXAMINING ATTORNEY



David J. Kybas

Director of the United States Patent and Trademark Office

United States of America

United States Patent and Trademark Office



Reg. No. 4,065,743

Registered Dec. 6, 2011

Int. Cls.: 36 and 42

SERVICE MARK

PRINCIPAL REGISTER

BOSTON SOFTWARE CORP. (MASSACHUSETTS CORPORATION)
189 RESERVOIR STREET
NEEDHAM, MA 02494

FOR: SERVICES IN THE FIELDS OF AUTOMOBILE AND HOMEOWNERS INSURANCE, NAMELY, SERVICES TO INSURANCE AGENCIES, AGENTS, AND HOMEOWNERS AND AUTOMOBILE INSURANCE CARRIERS, NAMELY, PROVIDING INFORMATION IN THE NATURE OF OBTAINING REAL TIME ESTIMATES OF POLICY PREMIUMS FROM, AND SUBMITTING NEW BUSINESS APPLICATIONS TO, MULTIPLE AUTOMOBILE AND HOMEOWNERS INSURANCE CARRIERS, IN CLASS 36 (U.S. CLS. 100, 101 AND 102).

FIRST USE 5-1-2007; IN COMMERCE 5-1-2007.

FOR: COMPUTER SERVICES, NAMELY, PROVIDING TEMPORARY USE OF NON-DOWNLOADABLE SOFTWARE, AND PLATFORM AS A SERVICES (PAAS) FEATURING COMPUTER SOFTWARE PLATFORMS FOR INSURANCE AGENCIES, AGENTS, AND HOMEOWNERS AND AUTOMOBILE INSURANCE CARRIERS THAT ENABLE AGENTS TO OBTAIN REAL TIME ESTIMATES OF POLICY PREMIUMS FROM, AND SUBMIT NEW BUSINESS APPLICATIONS TO, MULTIPLE AUTOMOBILE AND HOMEOWNERS INSURANCE CARRIERS, IN CLASS 42 (U.S. CLS. 100 AND 101).

FIRST USE 5-1-2007; IN COMMERCE 5-1-2007.

THE MARK CONSISTS OF THE WORD "SINGLEPOINT" WRITTEN WITH THE "S" AND "P" IN CAPS, WITH A BOOMERANG SYMBOL USED IN PLACE OF THE SECOND "I" IN THE WORD.

SER. NO. 85-150,948, FILED 10-12-2010.

GRETTA YAO, EXAMINING ATTORNEY



David J. Kybas

Director of the United States Patent and Trademark Office

United States of America

United States Patent and Trademark Office

WHITE CLIFF

Reg. No. 4,065,744

Registered Dec. 6, 2011

Int. Cl.: 1

TRADEMARK

PRINCIPAL REGISTER

KISKEYA MINERALS USA, LLC (FLORIDA LIMITED LIABILITY COMPANY)
P.O. BOX 2534
FORT LAUDERDALE, FL 33303

FOR: CALCIUM CARBONATE, IN CLASS 1 (U.S. CLS. 1, 5, 6, 10, 26 AND 46).

FIRST USE 6-1-2010; IN COMMERCE 6-1-2010.

THE MARK CONSISTS OF STANDARD CHARACTERS WITHOUT CLAIM TO ANY PARTICULAR FONT, STYLE, SIZE, OR COLOR.

SER. NO. 85-150,988, FILED 10-12-2010.

ELIZABETH KAJUBI, EXAMINING ATTORNEY



David J. Kybas

Director of the United States Patent and Trademark Office

United States of America

United States Patent and Trademark Office

BIO-NUTRITIONAL HARMONY

Reg. No. 4,065,745

Registered Dec. 6, 2011

Int. Cl.: 5

TRADEMARK

PRINCIPAL REGISTER

GENESIS LIFE FOODS CORPORATION (MINNESOTA CORPORATION)
#225
1161 WAYZATA BLVD. E
WAYZATA, MN 55391

FOR: DIETARY DRINK MIX FOR USE AS A MEAL REPLACEMENT; MEAL REPLACEMENT AND DIETARY SUPPLEMENT DRINK MIXES; NUTRITIONAL DRINK MIX FOR USE AS A MEAL REPLACEMENT; NUTRITIONAL SUPPLEMENT IN THE NATURE OF A NUTRIENT-DENSE, PROTEIN-BASED DRINK MIX; POWDERED FRUIT-FLAVORED DIETARY SUPPLEMENT DRINK MIX; POWDERED NUTRITIONAL SUPPLEMENT DRINK MIX, IN CLASS 5 (U.S. CLS. 6, 18, 44, 46, 51 AND 52).

FIRST USE 4-27-2010; IN COMMERCE 4-27-2010.

THE MARK CONSISTS OF STANDARD CHARACTERS WITHOUT CLAIM TO ANY PARTICULAR FONT, STYLE, SIZE, OR COLOR.

NO CLAIM IS MADE TO THE EXCLUSIVE RIGHT TO USE "BIO-NUTRITIONAL", APART FROM THE MARK AS SHOWN.

SER. NO. 85-151,780, FILED 10-13-2010.

ALICE BENMAMAN, EXAMINING ATTORNEY



David J. Kyros

Director of the United States Patent and Trademark Office

United States of America

United States Patent and Trademark Office

LIFE DR.

Reg. No. 4,065,746

Registered Dec. 6, 2011

Int. Cls.: 41, 44 and 45

SERVICE MARK

PRINCIPAL REGISTER

LIFE DR., INC. (CALIFORNIA CORPORATION)
2934 BEVERLY GLEN CIRCLE, SUITE 386
LOS ANGELES, CA 90077

FOR: LIFE COACHING SERVICES IN THE FIELDS OF PERSONAL DEVELOPMENT, HEALTH AND WELLNESS AND NUTRITION, PHYSICAL FITNESS, EXERCISE AND FITNESS, SPIRITUALITY, POSITIVE PSYCHOLOGY, HUMAN TRANSFORMATION, MANIFESTING ABUNDANCE, COPING STRATEGIES, HOLISTIC HEALTH AND ENVIRONMENT, AND CAREER DEVELOPMENT; YOGA INSTRUCTION, IN CLASS 41 (U.S. CLS. 100, 101 AND 107).

FIRST USE 1-1-2006; IN COMMERCE 6-1-2007.

FOR: PSYCHOTHERAPY SERVICES; PSYCHOTHERAPY SERVICES FOR THE PURPOSE OF IMPROVING SELF-IMAGE AND TO PROMOTE A HEALTHY LIFESTYLE; FOOD NUTRITION CONSULTATION IN THE FIELDS OF NATURAL AND GOURMET FOODS; PSYCHOTHERAPY SERVICES FOR THE PURPOSE OF IMPROVING WELLNESS OF THE MIND, BODY AND SPIRIT, IN CLASS 44 (U.S. CLS. 100 AND 101).

FIRST USE 1-1-2006; IN COMMERCE 6-1-2007.

FOR: PERSONAL IMAGE CONSULTING SERVICES; CONSULTING IN THE FIELD OF PERSONAL RELATIONSHIPS, IN CLASS 45 (U.S. CLS. 100 AND 101).

FIRST USE 1-1-2006; IN COMMERCE 6-1-2007.

THE MARK CONSISTS OF STANDARD CHARACTERS WITHOUT CLAIM TO ANY PARTICULAR FONT, STYLE, SIZE, OR COLOR.

OWNER OF U.S. REG. NO. 3,899,045.

NO CLAIM IS MADE TO THE EXCLUSIVE RIGHT TO USE "LIFE" IN CLASS 41 AND "DR." IN CLASS 44, APART FROM THE MARK AS SHOWN.

SER. NO. 85-152,029, FILED 10-13-2010.

KAREN SEVERSON, EXAMINING ATTORNEY



David J. Kyros

Director of the United States Patent and Trademark Office

United States of America

United States Patent and Trademark Office

SMART NET SYSTEMS

Reg. No. 4,065,747

Registered Dec. 6, 2011

Int. Cls.: 22 and 37

TRADEMARK

SERVICE MARK

PRINCIPAL REGISTER

SMART NET SYSTEMS LTD. (CANADA CORPORATION)
530 KINNIKINIK WAY
COMOX, BC, CANADA V9M3V8

FOR: COMMERCIAL NETS FOR AGRICULTURAL CROP PROTECTION, NAMELY, OVERHEAD BIRD BARRIER NETTING, HAIL NETTING, AND AGRICULTURAL PEST CONTROL NETTING USED TO PREVENT BIRDS AND OTHER PESTS FROM EATING CROPS, AND TO PREVENT HAIL FROM DAMAGING CROPS, IN CLASS 22 (U.S. CLS. 1, 2, 7, 19, 22, 42 AND 50).

FIRST USE 5-31-2001; IN COMMERCE 5-31-2001.

FOR: INSTALLATION OF AGRICULTURAL NETTING, NAMELY, INSTALLATION OF OVERHEAD BIRD BARRIER NETTING, HAIL NETTING, AND AGRICULTURAL PEST CONTROL NETTING FOR CROP PROTECTION, IN CLASS 37 (U.S. CLS. 100, 103 AND 106).

FIRST USE 5-31-2001; IN COMMERCE 5-31-2001.

THE MARK CONSISTS OF STANDARD CHARACTERS WITHOUT CLAIM TO ANY PARTICULAR FONT, STYLE, SIZE, OR COLOR.

NO CLAIM IS MADE TO THE EXCLUSIVE RIGHT TO USE "NET SYSTEMS", APART FROM THE MARK AS SHOWN.

SER. NO. 85-152,061, FILED 10-13-2010.

ZHALEH DELANEY, EXAMINING ATTORNEY



David J. Kybas

Director of the United States Patent and Trademark Office

United States of America

United States Patent and Trademark Office

RAISING STUDENT ACHIEVEMENT

Reg. No. 4,065,748

Registered Dec. 6, 2011

Int. Cl.: 35

SERVICE MARK

PRINCIPAL REGISTER

SCHOOL SPECIALTY, INC. (WISCONSIN CORPORATION)
P.O. BOX 1579
APPLETON, WI 549121579

FOR: ONLINE RETAIL STORE AND MAIL ORDER CATALOGUE SERVICES, ALL FEATURING PRINTED EDUCATIONAL AND TESTING MATERIALS DEALING WITH A VARIETY OF INSTRUCTIONAL AND EDUCATIONAL TOPICS, IN CLASS 35 (U.S. CLS. 100, 101 AND 102).

FIRST USE 1-0-2011; IN COMMERCE 1-0-2011.

THE MARK CONSISTS OF STANDARD CHARACTERS WITHOUT CLAIM TO ANY PARTICULAR FONT, STYLE, SIZE, OR COLOR.

SER. NO. 85-152,081, FILED 10-13-2010.

ELLEN BURNS, EXAMINING ATTORNEY



David J. Kyffers

Director of the United States Patent and Trademark Office

United States of America

United States Patent and Trademark Office



Reg. No. 4,065,749

Registered Dec. 6, 2011

Int. Cl.: 35

SERVICE MARK

PRINCIPAL REGISTER

SCHOOL SPECIALTY, INC. (WISCONSIN CORPORATION)
P.O. BOX 1579
APPLETON, WI 549121579

FOR: ONLINE RETAIL STORE AND MAIL ORDER CATALOGUE SERVICES, ALL FEATURING PRINTED EDUCATIONAL AND TESTING MATERIALS DEALING WITH A VARIETY OF INSTRUCTIONAL AND EDUCATIONAL TOPICS, IN CLASS 35 (U.S. CLS. 100, 101 AND 102).

FIRST USE 1-0-2011; IN COMMERCE 1-0-2011.

THE MARK CONSISTS OF THE WORDS "RAISING STUDENT ACHIEVEMENT" CURVED OVER THREE MOUNTAINS WITH TREES IN FRONT, THE TALLEST MOUNTAIN HAVING A FLAG ON TOP OF IT.

SER. NO. 85-152,082, FILED 10-13-2010.

ELLEN BURNS, EXAMINING ATTORNEY



David J. Kybas

Director of the United States Patent and Trademark Office

United States of America

United States Patent and Trademark Office

pxlwr

Reg. No. 4,065,750

Registered Dec. 6, 2011

Int. Cl.: 25

TRADEMARK

PRINCIPAL REGISTER

PIXELWEAR LLC (CONNECTICUT LIMITED LIABILITY COMPANY)
5 BENEDICT COURT
GREENWICH, CT 06830

FOR: SCIENTIFIC AND TECHNOLOGICAL APPAREL, NAMELY, SHIRTS, PANTS, JACKETS, FOOTWEAR, HATS AND CAPS, UNIFORMS, IN CLASS 25 (U.S. CLS. 22 AND 39).

FIRST USE 6-16-2010; IN COMMERCE 10-1-2010.

THE MARK CONSISTS OF STANDARD CHARACTERS WITHOUT CLAIM TO ANY PARTICULAR FONT, STYLE, SIZE, OR COLOR.

SER. NO. 85-152,102, FILED 10-13-2010.

ROSELLE HERRERA, EXAMINING ATTORNEY



David J. Kyffers

Director of the United States Patent and Trademark Office

United States of America

United States Patent and Trademark Office

GlobalMobile

Reg. No. 4,065,751

Registered Dec. 6, 2011

Int. Cl.: 9

TRADEMARK

PRINCIPAL REGISTER

KENNETH J. MAYER (UNITED STATES INDIVIDUAL)
318 S. COCHRAN AVENUE
LOS ANGELES, CA 90036

FOR: COMPUTER HARDWARE AND COMPUTER SOFTWARE PROGRAMS FOR THE INTEGRATION OF TEXT, AUDIO, GRAPHICS, STILL IMAGES AND MOVING PICTURES INTO AN INTERACTIVE DELIVERY FOR MULTIMEDIA APPLICATIONS; COMPUTER SOFTWARE THAT PROVIDES WEB-BASED ACCESS TO APPLICATIONS AND SERVICES THROUGH A WEB OPERATING SYSTEM OR PORTAL INTERFACE, IN CLASS 9 (U.S. CLS. 21, 23, 26, 36 AND 38).

FIRST USE 10-22-2006; IN COMMERCE 10-12-2010.

THE MARK CONSISTS OF STANDARD CHARACTERS WITHOUT CLAIM TO ANY PARTICULAR FONT, STYLE, SIZE, OR COLOR.

SER. NO. 85-152,114, FILED 10-13-2010.

JANICE L. MCMORROW, EXAMINING ATTORNEY



David J. Kybas

Director of the United States Patent and Trademark Office

United States of America
United States Patent and Trademark Office

WILRIDGE

Reg. No. 4,065,752

Registered Dec. 6, 2011

Int. Cl.: 33

TRADEMARK

PRINCIPAL REGISTER

TAPENADE, INC. (WASHINGTON CORPORATION), DBA WILRIDGE WINERY AND VINEYARD
1416 34TH AVENUE
SEATTLE, WA 981223334

FOR: GRAPE WINE; PORT WINES; RED WINE; RED WINES; STILL WINES; TABLE WINES; WHITE WINE; WINE; WINES; WINES AND FORTIFIED WINES , IN CLASS 33 (U.S. CLS. 47 AND 49).

FIRST USE 1-1-1988; IN COMMERCE 1-1-1990.

THE MARK CONSISTS OF STANDARD CHARACTERS WITHOUT CLAIM TO ANY PARTICULAR FONT, STYLE, SIZE, OR COLOR.

SEC. 2(F).

SER. NO. 85-152,193, FILED 10-13-2010.

DOUGLAS LEE, EXAMINING ATTORNEY



David J. Kyffers

Director of the United States Patent and Trademark Office

United States of America

United States Patent and Trademark Office

I-FAMILY

Reg. No. 4,065,753

Registered Dec. 6, 2011

Int. Cls.: 24, 25 and 35

TRADEMARK

SERVICE MARK

PRINCIPAL REGISTER

SHANGHAI SUNWIN INDUSTRY CO., LTD. (CHINA CORPORATION)
15/F,489 PUDIAN RD, PUDONG NEW DISTRICT
SHANGHAI, CHINA 200122

FOR: BED BLANKETS; CHILDREN'S BLANKETS; COTTON CLOTH; CURTAINS OF TEXTILE; FABRICS FOR TEXTILE USE; FURNITURE COVERINGS MADE OF PLASTIC MATERIALS; QUILTS; TOWELS; UPHOLSTERY FABRICS; WOOLLEN BLANKETS, IN CLASS 24 (U.S. CLS. 42 AND 50).

FIRST USE 3-3-2008; IN COMMERCE 3-3-2008.

FOR: BATHING SUITS; BELTS; CAPS; COATS; GLOVES AS CLOTHING; HATS; HOSIERY; LAYETTES; SCARVES; SHIRTS; SHOES; SKIRTS; SUITS; TROUSERS; UNDERPANTS; UNDERWEAR, IN CLASS 25 (U.S. CLS. 22 AND 39).

FIRST USE 3-3-2008; IN COMMERCE 3-3-2008.

FOR: IMPORT AND EXPORT AGENCIES; ORGANIZING EXHIBITIONS FOR COMMERCIAL OR ADVERTISING PURPOSES; PROCUREMENT SERVICES, NAMELY, PROCUREMENT OF CONTRACTS FOR OTHERS FOR THE PURCHASE OF ENERGY; SALES PROMOTION FOR THIRD PARTIES, IN CLASS 35 (U.S. CLS. 100, 101 AND 102).

FIRST USE 3-3-2008; IN COMMERCE 3-3-2008.

SER. NO. 85-152,272, FILED 10-14-2010.

KIM MONINGHOFF, EXAMINING ATTORNEY



David J. Kybas

Director of the United States Patent and Trademark Office

United States of America

United States Patent and Trademark Office

SOPHIE'S NEW

Reg. No. 4,065,754

SHANGHAI SUNWIN INDUSTRY CO., LTD. (CHINA CORPORATION)
15/F,489 PUDIAN RD, PUDONG NEW DISTRICT
SHANGHAI, CHINA 200122

Registered Dec. 6, 2011

Int. Cls.: 24, 25 and 35

FOR: BED BLANKETS; CHILDREN'S BLANKETS; COTTON CLOTH; CURTAINS OF TEXTILE; FABRICS FOR TEXTILE USE; FURNITURE COVERINGS MADE OF PLASTIC MATERIALS; QUILTS; TOWELS; UPHOLSTERY FABRICS; WOOLLEN BLANKETS, IN CLASS 24 (U.S. CLS. 42 AND 50).

TRADEMARK

SERVICE MARK

FIRST USE 3-3-2008; IN COMMERCE 3-3-2008.

PRINCIPAL REGISTER

FOR: BATHING SUITS; BELTS; CAPS; COATS; GLOVES AS CLOTHING; HATS; HOSIERY; LAYETTES; SCARVES; SHIRTS; SHOES; SKIRTS; SUITS; TROUSERS; UNDERPANTS; UNDERWEAR, IN CLASS 25 (U.S. CLS. 22 AND 39).

FIRST USE 3-3-2008; IN COMMERCE 3-3-2008.

FOR: IMPORT AND EXPORT AGENCIES; ORGANIZING EXHIBITIONS FOR COMMERCIAL OR ADVERTISING PURPOSES; PROCUREMENT SERVICES, NAMELY, PROCUREMENT OF CONTRACTS FOR OTHERS FOR THE PURCHASE OF ENERGY; SALES PROMOTION FOR THIRD PARTIES, IN CLASS 35 (U.S. CLS. 100, 101 AND 102).

FIRST USE 3-3-2008; IN COMMERCE 3-3-2008.

SER. NO. 85-152,277, FILED 10-14-2010.

KIM MONINGHOFF, EXAMINING ATTORNEY



David J. Kybas

Director of the United States Patent and Trademark Office

United States of America

United States Patent and Trademark Office

Document Driver

Reg. No. 4,065,755

Registered Dec. 6, 2011

Int. Cls.: 42 and 45

SERVICE MARK

PRINCIPAL REGISTER

GOODWIN PROCTER LLP (MASSACHUSETTS LIMITED LIABILITY PARTNERSHIP)
EXCHANGE PLACE, 53 STATE STREET
BOSTON, MA 02109

FOR: PROVIDING TEMPORARY USE OF ONLINE NON-DOWNLOADABLE SOFTWARE
FOR GENERATION OF CUSTOMIZED LEGAL DOCUMENTS FROM TEMPLATES AND
WIZARDS , IN CLASS 42 (U.S. CLS. 100 AND 101).

FIRST USE 10-1-2010; IN COMMERCE 10-1-2010.

FOR: LEGAL DOCUMENT PREPARATION SERVICES FOR OTHERS, NAMELY DRAFTING
LEGAL DOCUMENT TEMPLATES FOR CUSTOMIZATION BY OTHERS, IN CLASS 45 (U.S.
CLS. 100 AND 101).

FIRST USE 10-1-2010; IN COMMERCE 10-1-2010.

THE MARK CONSISTS OF STANDARD CHARACTERS WITHOUT CLAIM TO ANY PAR-
TICULAR FONT, STYLE, SIZE, OR COLOR.

NO CLAIM IS MADE TO THE EXCLUSIVE RIGHT TO USE "DOCUMENT", APART FROM
THE MARK AS SHOWN.

SER. NO. 85-152,597, FILED 10-14-2010.

JERI J. FICKES, EXAMINING ATTORNEY



David J. Kybas

Director of the United States Patent and Trademark Office

United States of America

United States Patent and Trademark Office

COMMUNITY BANK LENDING EXCHANGE

Reg. No. 4,065,756

Registered Dec. 6, 2011

Int. Cl.: 36

SERVICE MARK

PRINCIPAL REGISTER

FREMONT BANK (CALIFORNIA CORPORATION)
39150 FREMONT BOULEVARD
FREMONT, CA 94538

FOR: MORTGAGE BANKING, IN CLASS 36 (U.S. CLS. 100, 101 AND 102).

FIRST USE 9-0-2002; IN COMMERCE 12-0-2002.

THE MARK CONSISTS OF STANDARD CHARACTERS WITHOUT CLAIM TO ANY PARTICULAR FONT, STYLE, SIZE, OR COLOR.

OWNER OF U.S. REG. NO. 2,935,598.

NO CLAIM IS MADE TO THE EXCLUSIVE RIGHT TO USE "BANK LENDING EXCHANGE", APART FROM THE MARK AS SHOWN.

SEC. 2(F).

SER. NO. 85-152,693, FILED 10-14-2010.

LINDA ORNDORFF, EXAMINING ATTORNEY



David J. Kyffers

Director of the United States Patent and Trademark Office

United States of America

United States Patent and Trademark Office

Tranquillité

Reg. No. 4,065,757

Registered Dec. 6, 2011

Int. Cl.: 12

TRADEMARK

PRINCIPAL REGISTER

HEALTH CARE LOGISTICS, INC. (OHIO CORPORATION)
450 EAST TOWN STREET
CIRCLEVILLE, OH 43113

FOR: HOSPITAL CARTS, IN CLASS 12 (U.S. CLS. 19, 21, 23, 31, 35 AND 44).

FIRST USE 8-1-2008; IN COMMERCE 8-1-2008.

THE MARK CONSISTS OF STANDARD CHARACTERS WITHOUT CLAIM TO ANY PARTICULAR FONT, STYLE, SIZE, OR COLOR.

THE ENGLISH TRANSLATION OF "TRANQUILLITÉ" IN THE MARK IS "TRANQUILLITY".

SER. NO. 85-152,727, FILED 10-14-2010.

DEIRDRE ROBERTSON, EXAMINING ATTORNEY



David J. Kybas

Director of the United States Patent and Trademark Office

United States of America

United States Patent and Trademark Office



Reg. No. 4,065,758

Registered Dec. 6, 2011

Int. Cl.: 41

SERVICE MARK

PRINCIPAL REGISTER

THE RENEWABLES, LLC (ARIZONA LIMITED LIABILITY COMPANY)
#230
5013 WASHINGTON ST.
PHOENIX, AZ 85034

FOR: EDUCATIONAL SERVICES, NAMELY, PROVIDING CLASSES, SEMINARS, WORKSHOPS, IN THE FIELD OF ENERGY CONSERVATION AND RENEWABLE ENERGY; ENTERTAINMENT SERVICES, NAMELY, PROVISION OF NON-DOWNLOADABLE ANIMATED SHORT FILMS VIA THE INTERNET ON RENEWABLE ENERGY, AND LIVE THEATRICAL PERFORMANCES IN THE FIELD OF RENEWABLE ENERGY AND ENERGY CONSERVATION, IN CLASS 41 (U.S. CLS. 100, 101 AND 107).

FIRST USE 9-0-2008; IN COMMERCE 9-0-2008.

THE MARK CONSISTS OF A DARK GREEN CIRCLE - FILLED IN - WITH A LIGHTER GREEN OPEN CIRCLE BORDERING INSIDE THE DARK GREEN CIRCLE. A CAPITAL "R" IN LIGHT GREEN IS AGAINST THE DARK GREEN OF THE CIRCLE WITH THE TOP OF THE "R" GOING OUTSIDE OF THE CIRCLE SLIGHTLY. THE OPEN PORTION OF THE LIGHT GREEN CIRCLE ALLOWS THE END OF THE "R" TO COME OUT OF THE CIRCLE IN THE FORM OF A LIGHT GREEN LIGHTNING BOLT OUTLINED IN DARK GREEN.

THE COLOR(S) LIGHT GREEN AND DARK GREEN IS/ARE CLAIMED AS A FEATURE OF THE MARK.

SER. NO. 85-152,773, FILED 10-14-2010.

DEIRDRE ROBERTSON, EXAMINING ATTORNEY



David J. Kyjars

Director of the United States Patent and Trademark Office

United States of America

United States Patent and Trademark Office



Reg. No. 4,065,759

Registered Dec. 6, 2011

Int. Cl.: 3

TRADEMARK

PRINCIPAL REGISTER

GOLDINTUITIONS, LLC (ILLINOIS LIMITED LIABILITY COMPANY)
SUITE 503
711 W. GRAND AVENUE
CHICAGO, IL 60654

FOR: LOTIONS CONTAINING SUNSCREEN, NAMELY, BODY LOTIONS, COSMETIC SUNTAN LOTIONS, LOTIONS FOR FACE AND BODY CARE, SKIN LOTIONS, SUN CARE LOTIONS, SUN TAN LOTION, AND SUN-BLOCK LOTIONS, IN CLASS 3 (U.S. CLS. 1, 4, 6, 50, 51 AND 52).

FIRST USE 7-23-2010; IN COMMERCE 7-23-2010.

NO CLAIM IS MADE TO THE EXCLUSIVE RIGHT TO USE "SPF", APART FROM THE MARK AS SHOWN.

THE MARK CONSISTS OF THE WORD "GOLD" ABOVE A LARGE CAPITAL "N" WITH THE LETTERS "SPF" TO THE RIGHT OF THE "N".

SER. NO. 85-152,874, FILED 10-14-2010.

CHARLOTTE CORWIN, EXAMINING ATTORNEY



David J. Kybas

Director of the United States Patent and Trademark Office

United States of America

United States Patent and Trademark Office

gold N SPF

Reg. No. 4,065,760

Registered Dec. 6, 2011

Int. Cl.: 3

TRADEMARK

PRINCIPAL REGISTER

GOLDINTUITIONS, LLC (ILLINOIS LIMITED LIABILITY COMPANY)
SUITE 503
711 W. GRAND AVENUE
CHICAGO, IL 60654

FOR: LOTIONS CONTAINING SUNSCREEN, NAMELY, BODY LOTIONS, COSMETIC SUNTAN LOTIONS, LOTIONS FOR FACE AND BODY CARE, SKIN LOTIONS, SUN CARE LOTIONS, SUN TAN LOTION, AND SUN-BLOCK LOTIONS, IN CLASS 3 (U.S. CLS. 1, 4, 6, 50, 51 AND 52).

FIRST USE 7-23-2010; IN COMMERCE 7-23-2010.

THE MARK CONSISTS OF STANDARD CHARACTERS WITHOUT CLAIM TO ANY PARTICULAR FONT, STYLE, SIZE, OR COLOR.

NO CLAIM IS MADE TO THE EXCLUSIVE RIGHT TO USE "SPF", APART FROM THE MARK AS SHOWN.

SER. NO. 85-152,942, FILED 10-14-2010.

CHARLOTTE CORWIN, EXAMINING ATTORNEY



David J. Kyffers

Director of the United States Patent and Trademark Office

United States of America

United States Patent and Trademark Office

STEMPLE CREEK RANCH

Reg. No. 4,065,761

Registered Dec. 6, 2011

Int. Cls.: 29 and 31

TRADEMARK

PRINCIPAL REGISTER

LOREN PONCIA (UNITED STATES INDIVIDUAL), DBA STEMPLE CREEK RANCH
PO BOX 85
TOMALES, CA 94971 AND

LISA PONCIA (UNITED STATES INDIVIDUAL), DBA STEMPLE CREEK RANCH
PO BOX 85
TOMALES, CA 94971

FOR: BEEF AND LAMB MEAT, IN CLASS 29 (U.S. CL. 46).

FIRST USE 6-0-2010; IN COMMERCE 7-0-2010.

FOR: LIVE ANIMALS, NAMELY, COWS AND SHEEP, IN CLASS 31 (U.S. CLS. 1 AND 46).

FIRST USE 6-0-2009; IN COMMERCE 3-0-2010.

THE MARK CONSISTS OF STANDARD CHARACTERS WITHOUT CLAIM TO ANY PARTICULAR FONT, STYLE, SIZE, OR COLOR.

NO CLAIM IS MADE TO THE EXCLUSIVE RIGHT TO USE "RANCH", APART FROM THE MARK AS SHOWN.

SER. NO. 85-153,169, FILED 10-14-2010.

BILL DAWE, EXAMINING ATTORNEY



David J. Kybas

Director of the United States Patent and Trademark Office

United States of America

United States Patent and Trademark Office



Reg. No. 4,065,762

Registered Dec. 6, 2011

Int. Cl.: 36

SERVICE MARK

PRINCIPAL REGISTER

INTERNATIONAL GUJARATI CHARITIES (CALIFORNIA CORPORATION)
5011 ELTON STREET
BALDWIN PARK, CA 91706

FOR: CHARITABLE FUNDRAISING; CHARITABLE FUNDRAISING SERVICES BY MEANS OF A GOLF EVENT; CHARITABLE FUNDRAISING SERVICES BY MEANS OF AN ENTERTAINMENT EVENT; CHARITABLE FUNDRAISING SERVICES, NAMELY, RAISING FUNDS FOR COLLEGE EDUCATION COSTS, IN CLASS 36 (U.S. CLS. 100, 101 AND 102).

FIRST USE 12-31-1998; IN COMMERCE 12-31-1998.

NO CLAIM IS MADE TO THE EXCLUSIVE RIGHT TO USE "THE PICTORIAL REPRESENTATION OF INDIA", APART FROM THE MARK AS SHOWN.

THE COLOR(S) ORANGE, GREEN, BLACK, WHITE IS/ARE CLAIMED AS A FEATURE OF THE MARK.

THE MARK CONSISTS OF THE WHITE LETTERS "IGC" OUTLINED IN BLACK WITH BLACK LINES REPRESENTING SHADING OVER A MAP OF INDIA OUTLINED IN BLACK WITH ORANGE AT THE TOP FADING TO GREEN AT THE BOTTOM.

SER. NO. 85-153,211, FILED 10-14-2010.

TRACY FLETCHER, EXAMINING ATTORNEY



David J. Kyjars

Director of the United States Patent and Trademark Office

United States of America

United States Patent and Trademark Office

PUT A RING ON IT

Reg. No. 4,065,763

Registered Dec. 6, 2011

Int. Cl.: 44

SERVICE MARK

PRINCIPAL REGISTER

AIDS FOUNDATION OF CHICAGO (ILLINOIS FOUNDATION)
200 WEST JACKSON BLVD.
SUITE 2200
CHICAGO, IL 60602

FOR: PROVIDING INFORMATION REGARDING FEMALE CONTRACEPTIVES AND SEXUALLY TRANSMITTED INFECTIOUS DISEASE PREVENTION, IN CLASS 44 (U.S. CLS. 100 AND 101).

FIRST USE 7-1-2010; IN COMMERCE 7-1-2010.

THE MARK CONSISTS OF STANDARD CHARACTERS WITHOUT CLAIM TO ANY PARTICULAR FONT, STYLE, SIZE, OR COLOR.

SER. NO. 85-153,327, FILED 10-15-2010.

LINDA E. BLOHM, EXAMINING ATTORNEY



David J. Kybas

Director of the United States Patent and Trademark Office

United States of America

United States Patent and Trademark Office

emPRIMUS

Reg. No. 4,065,764

Registered Dec. 6, 2011

Int. Cl.: 9

TRADEMARK

PRINCIPAL REGISTER

EMPRIMUS, LLC (MINNESOTA LIMITED LIABILITY COMPANY)
1660 SOUTH HIGHWAY 100, SUITE 130
ST. LOUIS PARK, MN 55416

FOR: SHIELDED COMPUTER RACKS, DATA CENTER MODULES FOR USE IN THE STORAGE OF COMPUTER HARDWARE, MONITORING AND DETECTION SYSTEMS COMPRISED OF A LOOP ANTENNA, ELECTRONIC CIRCUITS, ELECTRONIC AND COMPUTER PROCESSORS, AND A COMMUNICATIONS BUS, AND SHIELDED TABLE TOP UNITS INTENDED TO HOLD PORTABLE ELECTRONIC AND COMPUTER EQUIPMENT, ALL OF THE AFOREMENTIONED INTENDED TO GUARD AGAINST ELECTROMAGNETIC INTERFERENCE, IN CLASS 9 (U.S. CLS. 21, 23, 26, 36 AND 38).

FIRST USE 1-0-2007; IN COMMERCE 1-0-2007.

THE MARK CONSISTS OF THE LETTERS "EMP" IN ORANGE AND THE LETTERS "RIMUS" IN BLUE.

THE COLOR(S) BLUE AND ORANGE IS/ARE CLAIMED AS A FEATURE OF THE MARK.

SER. NO. 85-153,469, FILED 10-15-2010.

ZACHARY BELLO, EXAMINING ATTORNEY



David J. Kyffers

Director of the United States Patent and Trademark Office

United States of America

United States Patent and Trademark Office

PCsmart

try the future

Reg. No. 4,065,765

Registered Dec. 6, 2011

Int. Cl.: 9

TRADEMARK

PRINCIPAL REGISTER

PC SMART, S.A. (COLOMBIA CORPORATION)
INTERIOR 2 BOD. 64
KM 3.5 VIA SIBERIA TERMINAL TER DE CARGA
COTA (CUNDINAMARCA), COLOMBIA

FOR: DATA PROCESSING EQUIPMENT AND COMPUTERS; APPARATUS FOR CONDUCTING, SWITCHING, TRANSFORMING, ACCUMULATING, REGULATING OR CONTROLLING ELECTRICITY; APPARATUS FOR THE REPRODUCTION OF SOUND OR IMAGES; CALCULATING MACHINES, IN CLASS 9 (U.S. CLS. 21, 23, 26, 36 AND 38).

OWNER OF COLOMBIA REG. NO. 355701, DATED 6-16-2008, EXPIRES 6-16-2018.

THE MARK CONSISTS OF "PCSMART TRY THE FUTURE" IN A STYLIZED FONT.

SER. NO. 85-153,556, FILED 10-15-2010.

LINDA E. BLOHM, EXAMINING ATTORNEY



David J. Kyros

Director of the United States Patent and Trademark Office

United States of America

United States Patent and Trademark Office

Keetown

Reg. No. 4,065,766

Registered Dec. 6, 2011

Int. Cl.: 35

SERVICE MARK

PRINCIPAL REGISTER

CHEN, AIDONG (UNITED STATES INDIVIDUAL)
20975 VALLEY GREEN DRIVE
#272
CUPERTINO, CA 95014

FOR: PROVIDING AN ON-LINE SEARCHABLE DATABASE FEATURING CLASSIFIED AD LISTINGS AND EMPLOYMENT OPPORTUNITIES FOR SERVICE PROVIDERS THAT DELIVER SERVICES THROUGH EMAILS, PHONE CALLS OR ONLINE MESSENGERS AND ALLOWING GENERAL USERS TO SCHEDULE AND MAKE APPOINTMENTS WITH THE SERVICE PROVIDERS, IN CLASS 35 (U.S. CLS. 100, 101 AND 102).

FIRST USE 6-27-2010; IN COMMERCE 6-27-2010.

THE MARK CONSISTS OF STANDARD CHARACTERS WITHOUT CLAIM TO ANY PARTICULAR FONT, STYLE, SIZE, OR COLOR.

SER. NO. 85-153,569, FILED 10-15-2010.

ALICE BENMAMAN, EXAMINING ATTORNEY



David J. Kybas

Director of the United States Patent and Trademark Office

United States of America

United States Patent and Trademark Office

White Space

Reg. No. 4,065,767

Registered Dec. 6, 2011

Int. Cl.: 41

SERVICE MARK

PRINCIPAL REGISTER

TALKING ON PURPOSE (CALIFORNIA CORPORATION)
1518 SOUTH GENESEE AVENUE
LOS ANGELES, CA 90019

FOR: BUSINESS EDUCATION AND TRAINING SERVICES, NAMELY, DEVELOPING, AND FACILITATING CUSTOMIZED IN-COMPANY LEADERSHIP AND EXECUTIVE DEVELOPMENT PROGRAMS, PROVIDING EXECUTIVE COACHING SERVICES, AND PROVIDING PUBLIC AND IN-COMPANY KEYNOTE PRESENTATIONS TO BUSINESS LEADERS; EDUCATION SERVICES, NAMELY, PROVIDING LIVE KEYNOTE SPEECHES, TRAININGS, SEMINARS, WEBINARS, WRITING ARTICLES IN THE FIELDS OF PERSONAL AND PROFESSIONAL DEVELOPMENT ARTICLES OTHER THAN FOR PUBLICITY; EDUCATIONAL AND ENTERTAINMENT SERVICES, NAMELY, PROVIDING MOTIVATIONAL AND EDUCATIONAL SPEAKERS; EDUCATIONAL AND ENTERTAINMENT SERVICES, NAMELY, PROVIDING MOTIVATIONAL AND EDUCATIONAL SPEAKERS IN THE FIELD OF SELF- AND PERSONAL IMPROVEMENT; EDUCATIONAL SERVICES, NAMELY, DEVELOPING, ARRANGING, AND CONDUCTING EDUCATIONAL CONFERENCES AND PROGRAMS AND PROVIDING COURSES OF INSTRUCTION IN THE FIELD OF PERSONAL AND PROFESSIONAL DEVELOPMENT; EDUCATIONAL SERVICES, NAMELY, PROVIDING CONTINUING PROFESSIONAL EDUCATION COURSES IN THE FIELD OF PERSONAL AND PROFESSIONAL DEVELOPMENT; EDUCATIONAL SERVICES, NAMELY, PROVIDING EDUCATIONAL SPEAKERS IN THE FIELD OF PERSONAL AND PROFESSIONAL DEVELOPMENT, IN CLASS 41 (U.S. CLS. 100, 101 AND 107).



FIRST USE 1-1-2006; IN COMMERCE 1-1-2006.

THE MARK CONSISTS OF STANDARD CHARACTERS WITHOUT CLAIM TO ANY PARTICULAR FONT, STYLE, SIZE, OR COLOR.

SER. NO. 85-153,791, FILED 10-15-2010.

MARK SPARACINO, EXAMINING ATTORNEY

David J. Kyros

Director of the United States Patent and Trademark Office

United States of America

United States Patent and Trademark Office

MYNEW.TV

Reg. No. 4,065,768

Registered Dec. 6, 2011

Int. Cl.: 42

SERVICE MARK

PRINCIPAL REGISTER

MYNEWTV, INC. (DELAWARE CORPORATION)
1080 RUBIO
ALTADENA, CA 91001

FOR: PROVIDING A WEB SITE FEATURING A MEDIA AGGREGATOR AND SEARCH ENGINE FOR INTERNET CONTENT BASED ON USER PREFERENCES; PROVIDING A WEB SITE THAT ENABLES USERS TO SHARE VIDEOS FROM ONLINE SOURCES BASED ON USER PREFERENCES; PROVIDING A WEBSITE THAT GIVES COMPUTER USERS THE ABILITY TO UPLOAD, SHARE, EXCHANGE, POST OR LISTEN TO AUDIO, COMMENTARY, AND SOUNDTRACKS TO EXISTING VIDEO CONTENT, IN CLASS 42 (U.S. CLS. 100 AND 101).

FIRST USE 6-0-2007; IN COMMERCE 6-0-2007.

THE MARK CONSISTS OF STANDARD CHARACTERS WITHOUT CLAIM TO ANY PARTICULAR FONT, STYLE, SIZE, OR COLOR.

SER. NO. 85-154,231, FILED 10-15-2010.

MICHAEL ENGEL, EXAMINING ATTORNEY



David J. Kybas

Director of the United States Patent and Trademark Office

United States of America

United States Patent and Trademark Office

ARCH ALLIES

Reg. No. 4,065,769

TODD, KEVIN (UNITED STATES INDIVIDUAL)
2040 17TH AVENUE EAST
NORTH ST. PAUL, MN 55109

Registered Dec. 6, 2011

Int. Cl.: 41

FOR: ENTERTAINMENT SERVICES, NAMELY, LIVE PERFORMANCES BY A MUSICAL BAND, IN CLASS 41 (U.S. CLS. 100, 101 AND 107).

SERVICE MARK

FIRST USE 4-1-2008; IN COMMERCE 4-1-2008.

PRINCIPAL REGISTER

THE MARK CONSISTS OF STANDARD CHARACTERS WITHOUT CLAIM TO ANY PARTICULAR FONT, STYLE, SIZE, OR COLOR.

SER. NO. 85-154,315, FILED 10-16-2010.

AMY C. KEAN, EXAMINING ATTORNEY



David J. Kybas

Director of the United States Patent and Trademark Office

United States of America

United States Patent and Trademark Office

gogosavings

Reg. No. 4,065,770

Registered Dec. 6, 2011

Int. Cl.: 35

SERVICE MARK

PRINCIPAL REGISTER

DIRECT MARKETING CONSULTANTS, LLC (MINNESOTA LIMITED LIABILITY COMPANY)
1149 RIVERWOOD DRIVE
BURNSVILLE, MN 55337

FOR: PROMOTING GOODS AND SERVICES OF COMPANIES BY PROVIDING DISCOUNTS FOR THE BENEFIT OF ALL WHO ACCESS WEBSITE, IN CLASS 35 (U.S. CLS. 100, 101 AND 102).

FIRST USE 9-15-2010; IN COMMERCE 9-15-2010.

THE MARK CONSISTS OF STANDARD CHARACTERS WITHOUT CLAIM TO ANY PARTICULAR FONT, STYLE, SIZE, OR COLOR.

SER. NO. 85-154,374, FILED 10-16-2010.

KELLY TRUSILO, EXAMINING ATTORNEY



David J. Kyffers

Director of the United States Patent and Trademark Office

United States of America

United States Patent and Trademark Office

Germ Bomb

Reg. No. 4,065,771

Registered Dec. 6, 2011

Int. Cl.: 5

TRADEMARK

PRINCIPAL REGISTER

JOHNSON II CHARLES T (UNITED STATES INDIVIDUAL), AKA TJ JOHNSON
135 NANTUCKETT DR
PORT DEPOSIT, MD 21904

FOR: AIR DEODORIZER; AIR FRESHENER SPRAYS; ALL PURPOSE DISINFECTANTS; ALL PURPOSE DISINFECTANTS FOR HARD AND SOFT SURFACES; ALL PURPOSE DISINFECTING AND DEODORIZING PREPARATIONS; ANTIBACTERIAL ALCOHOL SKIN SANITIZER GEL; DISINFECTANT BATHROOM CLEANERS; DISINFECTANT TOILET BOWL CLEANERS; DISINFECTANTS FOR CHEMICAL TOILETS; DISINFECTANTS FOR SANITARY PURPOSES; DISINFECTING HAND WASH; DISPOSABLE SANITIZING WIPES; DISPOSABLE WIPES IMPREGNATED WITH DISINFECTING CHEMICALS OR COMPOUNDS THEREFOR FOR USE IN HOMES, OFFICES, HOSPITALS, DAYCARES, AND SCHOOLS; DISPOSABLE WIPES IMPREGNATED WITH DISINFECTING CHEMICALS OR COMPOUNDS THEREFOR FOR USE ON HARD SURFACES AND HANDS; HAND-SANITIZING PREPARATIONS; KITS COMPRISING SANITIZER GEL, DISINFECTING WIPES, SANITARY MASKS, PLASTIC GLOVES AND HAND CREAM USED FOR GERM PREVENTION; LAUNDRY SANITIZER TABLETS; SANITIZING PREPARATIONS FOR HOSPITAL USE; SANITIZING PREPARATIONS FOR HOUSEHOLD USE; SANITIZING PREPARATIONS FOR USE IN INSTITUTIONAL AND INDUSTRIAL AREAS; SANITIZING WIPES; SPRAY SANITIZER FOR PERSONAL USE, IN CLASS 5 (U.S. CLS. 6, 18, 44, 46, 51 AND 52).

FIRST USE 2-0-2007; IN COMMERCE 1-0-2009.

THE MARK CONSISTS OF STANDARD CHARACTERS WITHOUT CLAIM TO ANY PARTICULAR FONT, STYLE, SIZE, OR COLOR.

NO CLAIM IS MADE TO THE EXCLUSIVE RIGHT TO USE "GERM", APART FROM THE MARK AS SHOWN.

SER. NO. 85-154,391, FILED 10-16-2010.

REBECCA EISINGER, EXAMINING ATTORNEY



David J. Kyros

Director of the United States Patent and Trademark Office

United States of America

United States Patent and Trademark Office

POWERTRAN

Reg. No. 4,065,772

Registered Dec. 6, 2011

Int. Cl.: 4

TRADEMARK

PRINCIPAL REGISTER

JAX, INC. (WISCONSIN CORPORATION), FORMERLY BEHNKE LUBRICANTS, INC.
W134 N5373 CAMPBELL DRIVE
MENOMONEE FALLS, WI 535017023

FOR: TRANSMISSION OILS, IN CLASS 4 (U.S. CLS. 1, 6 AND 15).

FIRST USE 1-1-1989; IN COMMERCE 1-1-1989.

THE MARK CONSISTS OF STANDARD CHARACTERS WITHOUT CLAIM TO ANY PARTICULAR FONT, STYLE, SIZE, OR COLOR.

SER. NO. 85-154,395, FILED 10-16-2010.

LESLEY LAMOTHE, EXAMINING ATTORNEY



David J. Kybas

Director of the United States Patent and Trademark Office

United States of America

United States Patent and Trademark Office

CRYOGUARD

Reg. No. 4,065,773

Registered Dec. 6, 2011

Int. Cl.: 4

TRADEMARK

PRINCIPAL REGISTER

JAX, INC. (WISCONSIN CORPORATION), FORMERLY BEHNKE LUBRICANTS, INC.
W134 N5373 CAMPBELL DRIVE
MENOMONEE FALLS, WI 535017023

FOR: LUBRICATING OILS, IN CLASS 4 (U.S. CLS. 1, 6 AND 15).

FIRST USE 1-1-1990; IN COMMERCE 1-1-1990.

THE MARK CONSISTS OF STANDARD CHARACTERS WITHOUT CLAIM TO ANY PARTICULAR FONT, STYLE, SIZE, OR COLOR.

SER. NO. 85-154,399, FILED 10-16-2010.

LESLEY LAMOTHE, EXAMINING ATTORNEY



David J. Kybas

Director of the United States Patent and Trademark Office

United States of America

United States Patent and Trademark Office

GOGO DAILY DEALS

Reg. No. 4,065,774

Registered Dec. 6, 2011

Int. Cl.: 35

SERVICE MARK

PRINCIPAL REGISTER

DIRECT MARKETING CONSULTANTS, LLC (MINNESOTA LIMITED LIABILITY COMPANY)
1149 RIVERWOOD DRIVE
BURNSVILLE, MN 55337

FOR: PROMOTING GOODS AND SERVICES OF OTHERS BY PROVIDING DAILY COUPONS OR VOUCHERS TO ALL WHO ACCESS WEBSITE, IN CLASS 35 (U.S. CLS. 100, 101 AND 102).

FIRST USE 9-15-2010; IN COMMERCE 9-15-2010.

THE MARK CONSISTS OF STANDARD CHARACTERS WITHOUT CLAIM TO ANY PARTICULAR FONT, STYLE, SIZE, OR COLOR.

NO CLAIM IS MADE TO THE EXCLUSIVE RIGHT TO USE "DAILY DEALS", APART FROM THE MARK AS SHOWN.

SER. NO. 85-154,405, FILED 10-16-2010.

KELLY TRUSILO, EXAMINING ATTORNEY



David J. Kybas

Director of the United States Patent and Trademark Office

United States of America

United States Patent and Trademark Office



Reg. No. 4,065,775

Registered Dec. 6, 2011

Int. Cl.: 30

TRADEMARK

PRINCIPAL REGISTER

PARAGALLO LUCINDA (UNITED STATES INDIVIDUAL)
172 FLOWER HILL ROAD
HUNTINGTON, NY 11743

FOR: CHOCOLATE CANDIES, IN CLASS 30 (U.S. CL. 46).

FIRST USE 3-2-2010; IN COMMERCE 3-2-2010.

NO CLAIM IS MADE TO THE EXCLUSIVE RIGHT TO USE "CANDY CAKE COMPANY",
APART FROM THE MARK AS SHOWN.

THE COLOR(S) PINK, BROWN IS/ARE CLAIMED AS A FEATURE OF THE MARK.

THE MARK CONSISTS OF BROWN SCROLLED BORDER AROUND THE BROWN WORDS
"THE LITTLE CANDY CAKE COMPANY" AND A BROWN CAKE ON A BROWN CAKE
STAND. ON THE CAKE IS A PINK BOW AND PINK BORDER AROUND THE TIERS OF
THE CAKE.

SER. NO. 85-154,464, FILED 10-17-2010.

MICHAEL KEATING, EXAMINING ATTORNEY



David J. Kybas

Director of the United States Patent and Trademark Office

United States of America

United States Patent and Trademark Office

RENTAR

Reg. No. 4,065,776

Registered Dec. 6, 2011

Int. Cl.: 7

TRADEMARK

PRINCIPAL REGISTER

RATNER, JOEL (UNITED STATES INDIVIDUAL)
2386 PLAYERS COURT
WELLINGTON, FL 33414

FOR: ENHANCEMENT PARTS FOR INTERNAL COMBUSTION ENGINES, NAMELY, FUEL CATALYSTS, IN CLASS 7 (U.S. CLS. 13, 19, 21, 23, 31, 34 AND 35).

FIRST USE 5-10-1961; IN COMMERCE 5-10-1961.

THE MARK CONSISTS OF STANDARD CHARACTERS WITHOUT CLAIM TO ANY PARTICULAR FONT, STYLE, SIZE, OR COLOR.

NO CLAIM IS MADE TO THE EXCLUSIVE RIGHT TO USE "RENTAR", APART FROM THE MARK AS SHOWN.

THE ENGLISH TRANSLATION OF "RENTAR" IN THE MARK IS HAS NO MEANING. THE WORDING "RENTAR" HAS NO MEANING IN A FOREIGN LANGUAGE.

SEC. 2(F) RENTAR HAS BECOME DISTINCTIVE OF THE GOODS/SERVICES THROUGH THE APPLICANT'S SUBSTANTIALLY EXCLUSIVE AND CONTINUOUS USE IN COMMERCE THAT THE U.S. CONGRESS MAY LAWFULLY REGULATE FOR AT LEAST THE FIVE YEARS IMMEDIATELY BEFORE THE DATE OF THIS STATEMENT..

SER. NO. 85-154,583, FILED 10-18-2010.

TRACY WHITTAKER-BROWN, EXAMINING ATTORNEY



David J. Kyros

Director of the United States Patent and Trademark Office

United States of America

United States Patent and Trademark Office

REGGAECITY.COM

Reg. No. 4,065,777

Registered Dec. 6, 2011

Int. Cl.: 35

SERVICE MARK

PRINCIPAL REGISTER

ISLAND MEDIA (NEW YORK CORPORATION)
858 E37TH STREET
BROOKLYN, NY 11210

FOR: ONLINE RETAIL ENTERTAINMENT STORE SERVICES FEATURING MUSIC CDS IN THE FIELDS OF REGGAE, DANCEHALL, SOCA OLDIES, CULTURE LOVER'S ROCK MUSIC, IN CLASS 35 (U.S. CLS. 100, 101 AND 102).

FIRST USE 1-1-2000; IN COMMERCE 1-1-2000.

THE MARK CONSISTS OF STANDARD CHARACTERS WITHOUT CLAIM TO ANY PARTICULAR FONT, STYLE, SIZE, OR COLOR.

SER. NO. 85-154,585, FILED 10-18-2010.

TRACY WHITTAKER-BROWN, EXAMINING ATTORNEY



David J. Kyros

Director of the United States Patent and Trademark Office

United States of America

United States Patent and Trademark Office



Reg. No. 4,065,778

Registered Dec. 6, 2011

Int. Cl.: 41

SERVICE MARK

PRINCIPAL REGISTER

BROTHERHOOD INSTRUCTOR'S LLC (ILLINOIS LIMITED LIABILITY COMPANY)
6 TOWER HILL DRIVE
WASHINGTONVILLE, NY 10992

FOR: EDUCATIONAL SERVICES, NAMELY, CONDUCTING LECTURES, DISCUSSIONS, FIELD TRAINING AND ON-LINE TUTORIALS IN THE FIELD OF FIREFIGHTING OPERATIONS, IN CLASS 41 (U.S. CLS. 100, 101 AND 107).

FIRST USE 2-28-2006; IN COMMERCE 2-28-2008.

NO CLAIM IS MADE TO THE EXCLUSIVE RIGHT TO USE "BROTHERHOOD INSTRUCTORS LLC", APART FROM THE MARK AS SHOWN.

THE COLOR(S) YELLOW, ORANGE, RED, LIGHT GREY, WHITE AND BLACK IS/ARE CLAIMED AS A FEATURE OF THE MARK.

THE MARK CONSISTS OF THE WORDS "BROTHERHOOD INSTRUCTORS LLC" WITH THE INSIDE OF THE LETTERS IN SHADES OF YELLOW, ORANGE, RED, WHITE, NAMELY, THE PART OF THE LETTER "S" AND BACKGROUND, AND BLACK OUTLINED IN BLACK, CREATING A FIRE OR BURNING EFFECT AND FRAMED IN A RECTANGLE DESIGN IN BLACK; A FIREFIGHTER BENDING OVER IN YELLOW AND BLACK TO THE RIGHT OF THE FRAME, USING A POWER SAW TOOL IN BLACK, LIGHT GREY AND RED.

SER. NO. 85-154,657, FILED 10-18-2010.

LOURDES AYALA, EXAMINING ATTORNEY



David J. Kyros

Director of the United States Patent and Trademark Office

United States of America

United States Patent and Trademark Office

GROVO

Reg. No. 4,065,779

Registered Dec. 6, 2011

Int. Cls.: 42 and 45

SERVICE MARK

PRINCIPAL REGISTER

GROVO LEARNING, INC. (DELAWARE CORPORATION)
223 10TH STREET, SUITE 1
NEW YORK, NY 10003

FOR: PROVIDING INFORMATION VIA A WEBSITE THAT FEATURES AUDIO, VIDEO, PHOTOGRAPHIC AND PROSE PRESENTATIONS ON HOW TO USE THE INTERNET, NAMELY, BROWSING WEBSITES, AND HOW TO USE MOBILE APPLICATIONS; AND EDUCATIONAL SERVICES, NAMELY, OFFERING WEB-BASED AND IN-PERSON CLASSES AND CERTIFICATION OF PROFICIENCY ON THE USE OF THE INTERNET, NAMELY, BROWSING WEBSITES, THE USE OF MOBILE APPLICATIONS AND THE USE OF WEB-BASED OR MOBILE SOCIAL NETWORKING APPLICATIONS AND WEBSITES, IN CLASS 42 (U.S. CLS. 100 AND 101).

FIRST USE 10-16-2007; IN COMMERCE 5-9-2010.

FOR: PROVIDING INFORMATION VIA A WEBSITE THAT FEATURES AUDIO, VIDEO, PHOTOGRAPHIC AND PROSE PRESENTATIONS ON HOW TO USE WEB-BASED OR MOBILE SOCIAL NETWORKING APPLICATIONS AND WEBSITES, IN CLASS 45 (U.S. CLS. 100 AND 101).

FIRST USE 10-16-2007; IN COMMERCE 5-9-2010.

THE MARK CONSISTS OF STANDARD CHARACTERS WITHOUT CLAIM TO ANY PARTICULAR FONT, STYLE, SIZE, OR COLOR.

SER. NO. 85-155,274, FILED 10-18-2010.

GIANCARLO CASTRO, EXAMINING ATTORNEY



David J. Kyjars

Director of the United States Patent and Trademark Office

United States of America

United States Patent and Trademark Office

BALÓN DE ORO

Reg. No. 4,065,780

Registered Dec. 6, 2011

Int. Cl.: 41

SERVICE MARK

PRINCIPAL REGISTER

FEDERACIÓN MEXICANA DE FÚTBOL ASOCIACIÓN, A.C. (MEXICO ASOCIACIÓN CIVIL (A.C.))
COLIMA #373, COLONIA ROMA NORTE
MEXICO CITY 06700, MEXICO

FOR: EDUCATIONAL SERVICES IN THE NATURE OF SOCCER SCHOOLS AND CAMPS; EDUCATION AND ENTERTAINMENT SERVICES IN THE NATURE OF SOCCER GAMES, MATCHES, AND EXHIBITIONS; PROVIDING SPORTS AND ENTERTAINMENT INFORMATION VIA THE INTERNET OR A COMMERCIAL ON-LINE SERVICE; FAN CLUB SERVICES; ARRANGING AND CONDUCTING ATHLETIC COMPETITIONS; PRODUCTION OF RADIO, TELEVISION AND CABLE PROGRAMS, ORGANIZING FESTIVALS FEATURING A VARIETY OF ACTIVITIES FOR FANS OF A SOCCER TEAM; AND ENTERTAINMENT SERVICES, NAMELY, ORGANIZING DRAWINGS AND SPORTS POOLS, ENTERTAINMENT SERVICES IN THE NATURE OF ON-GOING SPANISH LANGUAGE TELEVISION PROGRAMS IN THE FIELD OF SPORTS, IN CLASS 41 (U.S. CLS. 100, 101 AND 107).

THE MARK CONSISTS OF STANDARD CHARACTERS WITHOUT CLAIM TO ANY PARTICULAR FONT, STYLE, SIZE, OR COLOR.

OWNER OF MEXICO REG. NO. 815407, DATED 11-26-2003, EXPIRES 10-15-2013.

NO CLAIM IS MADE TO THE EXCLUSIVE RIGHT TO USE "BALÓN", APART FROM THE MARK AS SHOWN.

THE ENGLISH TRANSLATION OF "BALÓN DE ORO" IN THE MARK IS "GOLD SOCCER BALL".

SER. NO. 85-155,327, FILED 10-18-2010.

GIANCARLO CASTRO, EXAMINING ATTORNEY



David J. Kybas

Director of the United States Patent and Trademark Office

United States of America

United States Patent and Trademark Office

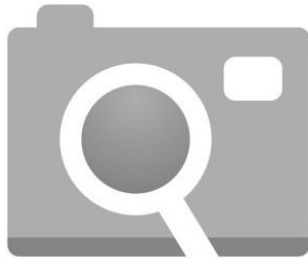

deviantART Stock Project

Reg. No. 4,065,781

Registered Dec. 6, 2011

**Int. Cls.: 35, 38, 41 and
45**

SERVICE MARK

PRINCIPAL REGISTER

DEVIANTART, INC. (DELAWARE CORPORATION)
SUITE 788
7095 HOLLYWOOD BOULEVARD
HOLLYWOOD, CA 90028

FOR: ONLINE ART GALLERIES, IN CLASS 35 (U.S. CLS. 100, 101 AND 102).

FIRST USE 10-13-2010; IN COMMERCE 10-13-2010.

FOR: PROVIDING ONLINE BULLETIN BOARDS AND CHAT ROOMS FOR TRANSMISSION OF MESSAGES AMONG COMPUTER USERS IN THE FIELD OF ART AND ARTISTS, IN CLASS 38 (U.S. CLS. 100, 101 AND 104).

FIRST USE 10-13-2010; IN COMMERCE 10-13-2010.

FOR: PROVIDING A WEBSITE FEATURING ARTWORK AND INFORMATION ABOUT ART AND ARTISTS; PROVIDING ONLINE INFORMATION IN THE FIELD OF ART, ARTWORK AND ARTISTS; PROVIDING ART EXHIBITIONS VIA THE INTERNET, IN CLASS 41 (U.S. CLS. 100, 101 AND 107).

FIRST USE 10-13-2010; IN COMMERCE 10-13-2010.

FOR: STOCK PHOTOGRAPHY SERVICES, NAMELY, LEASING REPRODUCTION RIGHTS OF PHOTOGRAPHS, TRANSPARENCIES AND DIGITAL CONTENT TO OTHERS, IN CLASS 45 (U.S. CLS. 100 AND 101).

FIRST USE 10-13-2010; IN COMMERCE 10-13-2010.

OWNER OF U.S. REG. NOS. 3,072,464, 3,457,203, AND 3,539,534.

NO CLAIM IS MADE TO THE EXCLUSIVE RIGHT TO USE "STOCK PROJECT", APART FROM THE MARK AS SHOWN.

THE MARK CONSISTS OF A DESIGN OF A CAMERA AND THE WORDS "DEVIANTART STOCK PROJECT".

SER. NO. 85-155,467, FILED 10-18-2010.

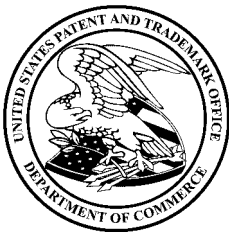

David J. Kyros

Director of the United States Patent and Trademark Office

Reg. No. 4,065,781 BRIAN CALLAGHAN, EXAMINING ATTORNEY

United States of America

United States Patent and Trademark Office



Reg. No. 4,065,782

Registered Dec. 6, 2011

Int. Cls.: 35, 38, 41 and 45

DEVIANTART, INC. (DELAWARE CORPORATION)
SUITE 788
7095 HOLLYWOOD BOULEVARD
HOLLYWOOD, CA 90028

FOR: ONLINE ART GALLERIES, IN CLASS 35 (U.S. CLS. 100, 101 AND 102).

FIRST USE 10-13-2010; IN COMMERCE 10-13-2010.

SERVICE MARK

PRINCIPAL REGISTER

FOR: PROVIDING ONLINE BULLETIN BOARDS AND CHAT ROOMS FOR TRANSMISSION OF MESSAGES AMONG COMPUTER USERS IN THE FIELD OF ART AND ARTISTS, IN CLASS 38 (U.S. CLS. 100, 101 AND 104).

FIRST USE 10-13-2010; IN COMMERCE 10-13-2010.

FOR: PROVIDING A WEBSITE FEATURING ARTWORK AND INFORMATION ABOUT ART AND ARTISTS; PROVIDING ONLINE INFORMATION IN THE FIELD OF ART, ARTWORK AND ARTISTS; PROVIDING ART EXHIBITIONS VIA THE INTERNET, IN CLASS 41 (U.S. CLS. 100, 101 AND 107).

FIRST USE 10-13-2010; IN COMMERCE 10-13-2010.

FOR: STOCK PHOTOGRAPHY SERVICES, NAMELY, LEASING REPRODUCTION RIGHTS OF PHOTOGRAPHS, TRANSPARENCIES AND DIGITAL CONTENT TO OTHERS, IN CLASS 45 (U.S. CLS. 100 AND 101).

FIRST USE 10-13-2010; IN COMMERCE 10-13-2010.

THE MARK CONSISTS OF A DESIGN OF A CAMERA.

SER. NO. 85-155,472, FILED 10-18-2010.

BRIAN CALLAGHAN, EXAMINING ATTORNEY



David J. Kybas

Director of the United States Patent and Trademark Office

United States of America

United States Patent and Trademark Office

NUVAR

Reg. No. 4,065,783

Registered Dec. 6, 2011

Int. Cls.: 31, 32 and 44

TRADEMARK

SERVICE MARK

PRINCIPAL REGISTER

BREACH, JOHN ROLAND (UNITED KINGDOM INDIVIDUAL)
CHITTENDEN ORCHARDS, STAPLEHURST
KENT TN12 0EX, UNITED KINGDOM

FOR: FRESH FRUITS AND VEGETABLES, FRESH FLOWERS, AND LIVE PLANTS, IN CLASS 31 (U.S. CLS. 1 AND 46).

FOR: FRUIT DRINKS, FRUIT JUICES, SOFT DRINKS FLAVORED WITH FRUIT JUICE, IN CLASS 32 (U.S. CLS. 45, 46 AND 48).

FOR: HORTICULTURAL SERVICES RELATING TO THE GROWING OF PLANTS AND TREES; AGRICULTURAL ADVICE; RENTAL OF AGRICULTURAL MACHINERY; PLANT CARE SERVICES, IN CLASS 44 (U.S. CLS. 100 AND 101).

THE MARK CONSISTS OF STANDARD CHARACTERS WITHOUT CLAIM TO ANY PARTICULAR FONT, STYLE, SIZE, OR COLOR.

OWNER OF ERPN CMNTY TM OFC REG. NO. 002578110, DATED 8-11-2003, EXPIRES 2-6-2012.

SER. NO. 85-155,697, FILED 10-19-2010.

DOMINIC J. FERRAIUOLO, EXAMINING ATTORNEY



David J. Kyros

Director of the United States Patent and Trademark Office

United States of America

United States Patent and Trademark Office

ETITLESEARCH

Reg. No. 4,065,784

Registered Dec. 6, 2011

Int. Cl.: 45

SERVICE MARK

PRINCIPAL REGISTER

PROPERTYINFO CORPORATION (TEXAS CORPORATION)
SUITE 900
1990 POST OAK BOULEVARD
HOUSTON, TX 77056

FOR: PROVIDING AN ON-LINE SEARCHABLE DATABASE FEATURING INFORMATION IN THE FIELD OF REAL PROPERTY TITLE FOR USE IN CONDUCTING REAL PROPERTY TITLE SEARCHES AND RETRIEVING RELATED DOCUMENTS IN THE FIELDS OF TITLE INSURANCE AND TITLE EXAMINATION, IN CLASS 45 (U.S. CLS. 100 AND 101).

FIRST USE 1-1-2000; IN COMMERCE 4-10-2000.

THE MARK CONSISTS OF STANDARD CHARACTERS WITHOUT CLAIM TO ANY PARTICULAR FONT, STYLE, SIZE, OR COLOR.

OWNER OF U.S. REG. NO. 1,818,612.

SEC. 2(F).

SER. NO. 85-155,788, FILED 10-19-2010.

TRACY FLETCHER, EXAMINING ATTORNEY



David J. Kyros

Director of the United States Patent and Trademark Office

United States of America

United States Patent and Trademark Office

Gen Waves

Reg. No. 4,065,785

Registered Dec. 6, 2011

Int. Cl.: 9

TRADEMARK

PRINCIPAL REGISTER

KOREA ELECTRIC TERMINAL CO., LTD. (REPUBLIC OF KOREA CORPORATION)
7-38, SONG-DONG, YEONSO-GU,
INCHEON-SI, REPUBLIC OF KOREA 406-130

FOR: ELECTRONIC COMPONENTS, FOR CELLULAR PHONES, PERSONAL DIGITAL ASSISTANTS (PDA), PERSONAL NAVIGATION DEVICES (PND), CAR BLACK-BOXES, E-BOOK READERS, DIGITAL CAMERAS, GLOBAL POSITIONING SYSTEMS (GPS), NAMELY, VOLTAGE CONTROL OSCILLATOR (VCO), TEMPERATURE COMPENSATED CRYSTAL OSCILLATOR, PHASE LOCKED LOOP MODULE, SURFACE ACOUSTIC WAVE (SAW) FILTER, CERAMIC FILTER, PORTABLE POWER AMPLIFIER MODULE, RADIO FREQUENCY (RF) ANTENNA, DUPLEXER, RADIO FREQUENCY (RF) MODULE, POWER AMPLIFIER, DIGITAL AUDIO BROADCASTING MODULE, DIGITAL MULTIMEDIA BROADCASTING MODULE, GLOBAL POSITIONING SYSTEM MODULE, FRONT-END MODULE, WIRELESS COMMUNICATION MODULE, IN CLASS 9 (U.S. CLS. 21, 23, 26, 36 AND 38).

THE MARK CONSISTS OF STANDARD CHARACTERS WITHOUT CLAIM TO ANY PARTICULAR FONT, STYLE, SIZE, OR COLOR.

OWNER OF REPUBLIC OF KOREA REG. NO. 504775, DATED 10-29-2001, RENEWED AS REG. NO. 0504775, DATED 10-29-2011, EXPIRES 10-29-2021.

SER. NO. 85-155,847, FILED 10-19-2010.

CHRISIE B. KING, EXAMINING ATTORNEY



David J. Kyros

Director of the United States Patent and Trademark Office

United States of America
United States Patent and Trademark Office

MEDKEY

Reg. No. 4,065,786

Registered Dec. 6, 2011

Int. Cl.: 9

TRADEMARK

PRINCIPAL REGISTER

MEDKEY CORPORATION (CALIFORNIA CORPORATION)
2923 VIA IPANEMA
CARLSBAD, CA 92009

FOR: UNIVERSAL SERIAL BUS (USB) FLASH MEMORY ELECTRONIC STORAGE DEVICE
FOR USE IN STORING MEDICAL INFORMATION, IN CLASS 9 (U.S. CLS. 21, 23, 26, 36
AND 38).

FIRST USE 6-17-2002; IN COMMERCE 6-17-2002.

THE MARK CONSISTS OF STANDARD CHARACTERS WITHOUT CLAIM TO ANY PAR-
TICULAR FONT, STYLE, SIZE, OR COLOR.

SER. NO. 85-155,862, FILED 10-19-2010.

TINA L. SNAPP, EXAMINING ATTORNEY



David J. Kybas

Director of the United States Patent and Trademark Office

United States of America

United States Patent and Trademark Office



Reg. No. 4,065,787

Registered Dec. 6, 2011

Int. Cls.: 35 and 39

SERVICE MARK

PRINCIPAL REGISTER

SHIPGOODER, INC. (CANADA CORPORATION)
21 PRINCESS MARGARET BOULEVARD
TORONTO, ONTARIO, CANADA M9A1Z5

FOR: SHOPPING FACILITATION SERVICES, NAMELY, PROVIDING AN ONLINE COMPARISON SHOPPING SEARCH ENGINE FOR OBTAINING PURCHASING INFORMATION IN THE NATURE OF COURIER AND MESSENGER SHIPPING RATES, IN CLASS 35 (U.S. CLS. 100, 101 AND 102).

FIRST USE 8-0-2006; IN COMMERCE 8-0-2006.

FOR: INFORMATION SERVICES IN THE FIELD OF SHIPPING, IN CLASS 39 (U.S. CLS. 100 AND 105).

FIRST USE 8-0-2006; IN COMMERCE 8-0-2006.

PRIORITY CLAIMED UNDER SEC. 44(D) ON CANADA APPLICATION NO. 1486484, FILED 6-25-2010, REG. NO. TMA798412, DATED 5-25-2011, EXPIRES 5-25-2026.

NO CLAIM IS MADE TO THE EXCLUSIVE RIGHT TO USE "SEARCH.SHIP" , APART FROM THE MARK AS SHOWN.

THE MARK CONSISTS OF "SEARCH. SHIP. SAVE." IN SMALLER TYPE AND ABOVE "SHIPG" OF "SHIPGOODER". THE "SHIP" PORTION OF "SHIPGOODER" IS BOLD WITH A LOWERCASE "I", AND "GOODER" HAS LOWERCASE "O"'S WITH A CONVEX LINE BELOW THE "O"'S.

SER. NO. 85-155,887, FILED 10-19-2010.

JAMES A. RAUEN, EXAMINING ATTORNEY



David J. Kybas

Director of the United States Patent and Trademark Office

United States of America

United States Patent and Trademark Office

SEARCH. SHIP. SAVE.

Reg. No. 4,065,788

Registered Dec. 6, 2011

Int. Cls.: 35 and 39

SERVICE MARK

PRINCIPAL REGISTER

SHIPGOODER, INC. (CANADA CORPORATION)
21 PRINCESS MARGARET BOULEVARD
TORONTO, ONTARIO, CANADA M9A1Z5

FOR: SHOPPING FACILITATION SERVICES, NAMELY, PROVIDING AN ONLINE COMPARISON SHOPPING SEARCH ENGINE FOR OBTAINING PURCHASING INFORMATION IN THE NATURE OF COURIER AND MESSENGER SHIPPING RATES, IN CLASS 35 (U.S. CLS. 100, 101 AND 102).

FIRST USE 8-0-2006; IN COMMERCE 8-0-2006.

FOR: INFORMATION SERVICES IN THE FIELD OF SHIPPING, IN CLASS 39 (U.S. CLS. 100 AND 105).

FIRST USE 8-0-2006; IN COMMERCE 8-0-2006.

THE MARK CONSISTS OF STANDARD CHARACTERS WITHOUT CLAIM TO ANY PARTICULAR FONT, STYLE, SIZE, OR COLOR.

PRIORITY CLAIMED UNDER SEC. 44(D) ON CANADA APPLICATION NO. 1486483, FILED 6-25-2010, REG. NO. TMA798413, DATED 5-25-2011, EXPIRES 5-25-2026.

NO CLAIM IS MADE TO THE EXCLUSIVE RIGHT TO USE "SEARCH.SHIP", APART FROM THE MARK AS SHOWN.

SER. NO. 85-155,924, FILED 10-19-2010.

JAMES A. RAUEN, EXAMINING ATTORNEY



David J. Kybas

Director of the United States Patent and Trademark Office

United States of America

United States Patent and Trademark Office



Reg. No. 4,065,789

Registered Dec. 6, 2011

Int. Cl.: 34

TRADEMARK

PRINCIPAL REGISTER

ZERO TOBACCO, LLC (MICHIGAN LIMITED LIABILITY COMPANY)
14262 BIRWOOD
DETROIT, MI 48238

FOR: NON-TOBACCO HERBS FOR USE WITH HOOKAH PIPE, IN CLASS 34 (U.S. CLS. 2, 8, 9 AND 17).

FIRST USE 6-26-2010; IN COMMERCE 6-26-2010.

NO CLAIM IS MADE TO THE EXCLUSIVE RIGHT TO USE "THE NATURAL CHOICE", APART FROM THE MARK AS SHOWN.

THE MARK CONSISTS OF THE WORD "ZERO" CENTERED IN CIRCLE WITH FLAME ABOVE THE LETTER "R" AND THE WORDS "THE NATURAL CHOICE" UNDERNEATH THE LETTERS "ZERO" WITH AN IMAGE OF A HOOKAH PIPE FOLLOWING THE WORDS.

SER. NO. 85-156,044, FILED 10-19-2010.

PAUL F. GAST, EXAMINING ATTORNEY



David J. Kybas

Director of the United States Patent and Trademark Office

United States of America

United States Patent and Trademark Office

BLEEPING COMPUTER

Reg. No. 4,065,790

BLEEPING COMPUTER LLC (NEW YORK LIMITED LIABILITY COMPANY)
P.O. BOX 1025
MELVILLE, NY 11747

Registered Dec. 6, 2011

Int. Cls.: 38, 41 and 42

FOR: PROVIDING ONLINE USER FORUMS IN THE FIELD OF PERSONAL COMPUTING ISSUES, IN CLASS 38 (U.S. CLS. 100, 101 AND 104).

SERVICE MARK

FIRST USE 2-0-2004; IN COMMERCE 2-0-2004.

PRINCIPAL REGISTER

FOR: PROVIDING ONLINE TUTORIALS AND INSTRUCTION IN THE FIELDS OF PERSONAL COMPUTING AND INFORMATION SECURITY, IN CLASS 41 (U.S. CLS. 100, 101 AND 107).

FIRST USE 2-0-2004; IN COMMERCE 2-0-2004.

FOR: PROVIDING WEBSITES FEATURING NEWS, INFORMATION, AND COMMENTARY IN THE FIELDS OF PERSONAL COMPUTING AND PERSONAL AND CONSUMER COMPUTER TECHNOLOGY; COMPUTER SERVICES, NAMELY, ONLINE DETECTION AND REMOVAL OF MALWARE AND SPYWARE; TECHNICAL SUPPORT SERVICES, NAMELY, ONLINE TROUBLESHOOTING, DIAGNOSTICS, AND REPAIR OF COMPUTER SOFTWARE PROBLEMS AND OPTIMIZATION OF COMPUTER PERFORMANCE; SOFTWARE AS A SERVICE (SAAS) SERVICES FEATURING THIRD-PARTY COMPUTER SOFTWARE USED FOR MALWARE AND SPYWARE REMOVAL, TROUBLESHOOTING, DIAGNOSTICS, AND REPAIR OF COMPUTER SOFTWARE PROBLEMS, AND OPTIMIZATION OF COMPUTER PERFORMANCE, IN CLASS 42 (U.S. CLS. 100 AND 101).

FIRST USE 2-0-2004; IN COMMERCE 2-0-2004.

THE MARK CONSISTS OF STANDARD CHARACTERS WITHOUT CLAIM TO ANY PARTICULAR FONT, STYLE, SIZE, OR COLOR.

NO CLAIM IS MADE TO THE EXCLUSIVE RIGHT TO USE "COMPUTER", APART FROM THE MARK AS SHOWN.

SER. NO. 85-156,083, FILED 10-19-2010.

ELISSA GARBER KON, EXAMINING ATTORNEY



David J. Kyros

Director of the United States Patent and Trademark Office

United States of America

United States Patent and Trademark Office

Magic Lace

Reg. No. 4,065,791

CHADE FASHIONS, INC. (ILLINOIS CORPORATION)
6400 W. GROSS POINT RD.
NILES, IL 60714

Registered Dec. 6, 2011

Int. Cl.: 26

FOR: HAIRWARE MADE IN WHOLE OR SUBSTANTIAL PART OF LACE, NAMELY, WIGS, HAIRPIECES, AND ADD-IN AND ADD-ON HAIR ACCESSORIES CONSTRUCTED PRIMARILY OF SYNTHETIC AND/OR HUMAN HAIR, WIG CAPS, TAPE FOR FIXING WIGS, IN CLASS 26 (U.S. CLS. 37, 39, 40, 42 AND 50).

TRADEMARK

PRINCIPAL REGISTER

FIRST USE 9-15-2008; IN COMMERCE 9-15-2008.

THE MARK CONSISTS OF STANDARD CHARACTERS WITHOUT CLAIM TO ANY PARTICULAR FONT, STYLE, SIZE, OR COLOR.

NO CLAIM IS MADE TO THE EXCLUSIVE RIGHT TO USE "LACE", APART FROM THE MARK AS SHOWN.

SER. NO. 85-156,100, FILED 10-19-2010.

JIM RINGLE, EXAMINING ATTORNEY



David J. Kyffers

Director of the United States Patent and Trademark Office

United States of America

United States Patent and Trademark Office

GRAYDON

Reg. No. 4,065,792

Registered Dec. 6, 2011

Int. Cls.: 9, 25 and 41

TRADEMARK

SERVICE MARK

PRINCIPAL REGISTER

MATTMILLERMUSIC, LLC (VIRGINIA LIMITED LIABILITY COMPANY)
1000 E CITY HALL AVENUE
NORFOLK, VA 23504

FOR: SERIES OF MUSICAL SOUND RECORDINGS, AUDIO-VISUAL RECORDINGS FEATURING MUSIC AND MUSICAL-BASED ENTERTAINMENT; DOWNLOADABLE MUSICAL SOUND RECORDINGS AND AUDIO-VISUAL RECORDINGS FEATURING MUSIC AND MUSICAL-BASED ENTERTAINMENT; MAGNETIC AUDIO TAPES FEATURING MUSIC; MAGNETIC SOUND TAPES FEATURING MUSIC; PHONOGRAPH RECORDS FEATURING MUSIC; DOWNLOADABLE ELECTRONIC DATA FILES FEATURING MUSIC AND INFORMATION ON MUSICAL BANDS; RECORDED COMPACT DISCS FEATURING MUSIC, IN CLASS 9 (U.S. CLS. 21, 23, 26, 36 AND 38).

FIRST USE 1-1-2010; IN COMMERCE 1-1-2010.

FOR: CLOTHING, NAMELY, T-SHIRTS, HATS, AND SWEATSHIRTS, IN CLASS 25 (U.S. CLS. 22 AND 39).

FIRST USE 10-31-2009; IN COMMERCE 10-31-2009.

FOR: ENTERTAINMENT SERVICES, NAMELY, LIVE PERFORMANCES BY A MUSICAL GROUP; PROVIDING A WEBSITE FOR INTERACTIVE DISCUSSION GROUPS FEATURING INFORMATION IN THE FIELD OF ENTERTAINMENT VIA THE INTERNET; INFORMATION SERVICES, NAMELY, PROVIDING A WEBSITE FEATURING INFORMATION IN THE FIELD OF ENTERTAINMENT; MUSIC COMPOSITION SERVICES FOR OTHERS, IN CLASS 41 (U.S. CLS. 100, 101 AND 107).

FIRST USE 10-21-2008; IN COMMERCE 10-21-2008.

THE MARK CONSISTS OF STANDARD CHARACTERS WITHOUT CLAIM TO ANY PARTICULAR FONT, STYLE, SIZE, OR COLOR.

SER. NO. 85-156,220, FILED 10-19-2010.

MARK SHINER, EXAMINING ATTORNEY



David J. Kyros

Director of the United States Patent and Trademark Office

United States of America

United States Patent and Trademark Office

YAKSONMYUNGGA

SINCE 1979 약손명가

Reg. No. 4,065,793

YAKSONMYUNGGA (REPUBLIC OF KOREA CORPORATION)
598-8, SHINSA-DONG, KANGNAM-GU
SEOUL, REPUBLIC OF KOREA

Registered Dec. 6, 2011

Int. Cl.: 44

FOR: COSMETIC BODY CARE SERVICES; COSMETIC SKIN CARE SERVICES, IN CLASS
44 (U.S. CLS. 100 AND 101).

SERVICE MARK

FIRST USE 6-10-1981; IN COMMERCE 6-10-1981.

PRINCIPAL REGISTER

NO CLAIM IS MADE TO THE EXCLUSIVE RIGHT TO USE "SINCE 1979", APART FROM
THE MARK AS SHOWN.

THE NON-LATIN CHARACTERS IN THE MARK TRANSLITERATE TO "YAKSONMY-
UNGGGA" AND THIS MEANS "MEDICINAL HANDS OF A DISTINGUISHED FAMILY" IN
ENGLISH.

THE MARK CONSISTS OF WORD "YAKSONMYUNGGA" ABOVE THE WORDING "SINCE
1979" AND FOUR KOREAN CHARACTERS.

THE ENGLISH TRANSLATION OF "YAKSONMUNGGA" IN THE MARK IS "MEDICINAL
HANDS OF A DISTINGUISHED FAMILY".

SER. NO. 85-156,280, FILED 10-19-2010.

STEVEN R. FINE, EXAMINING ATTORNEY



David J. Kybas

Director of the United States Patent and Trademark Office

United States of America

United States Patent and Trademark Office

RadAir Complete Car Care

Reg. No. 4,065,794

Registered Dec. 6, 2011

Int. Cls.: 35 and 37

SERVICE MARK

PRINCIPAL REGISTER

RAD AIR FRANCHISE SYSTEMS, INC. (OHIO CORPORATION), DBA RAD AIR SERVICE CENTERS
2124 WILLOW BROOK LANE
HINCKLEY, OH 44233

FOR: RETAIL STORE AND ON-LINE RETAIL STORE SERVICES FEATURING SPECIALIZED RADIATORS, AIR CONDITIONING PARTS, HARD TO FIND AUTOMOTIVE PARTS AND CUSTOM MADE AIR CONDITIONING LINES AND HOSES, IN CLASS 35 (U.S. CLS. 100, 101 AND 102).

FIRST USE 10-1-2001; IN COMMERCE 10-1-2001.

FOR: AUTOMOTIVE MAINTENANCE AND REPAIR, IN CLASS 37 (U.S. CLS. 100, 103 AND 106).

FIRST USE 10-1-2001; IN COMMERCE 10-1-2001.

THE MARK CONSISTS OF STANDARD CHARACTERS WITHOUT CLAIM TO ANY PARTICULAR FONT, STYLE, SIZE, OR COLOR.

NO CLAIM IS MADE TO THE EXCLUSIVE RIGHT TO USE "COMPLETE CAR CARE", APART FROM THE MARK AS SHOWN.

SER. NO. 85-156,372, FILED 10-19-2010.

BARNEY CHARLON, EXAMINING ATTORNEY



David J. Kybas

Director of the United States Patent and Trademark Office

United States of America

United States Patent and Trademark Office

AGENTLEGAL

Reg. No. 4,065,795

Registered Dec. 6, 2011

Int. Cls.: 9 and 42

TRADEMARK

SERVICE MARK

PRINCIPAL REGISTER

AGENTLEGAL, INC. (NEVADA CORPORATION)
3201 TEMPLE AVE., SUITE 100
POMONA, CA 917683279

FOR: SOFTWARE FOR DOCUMENT AND DATA MANAGEMENT AND FOR SEARCHING COMPUTER DATABASES, COMPUTER DATA REPOSITORIES, AND INTERNET WEB SITES, IN CLASS 9 (U.S. CLS. 21, 23, 26, 36 AND 38).

FIRST USE 2-26-2009; IN COMMERCE 3-20-2009.

FOR: NON-DOWNLOADABLE SOFTWARE FOR DOCUMENT AND DATA MANAGEMENT AND FOR SEARCHING COMPUTER DATABASES, COMPUTER DATA REPOSITORIES, AND INTERNET WEB SITES, IN CLASS 42 (U.S. CLS. 100 AND 101).

FIRST USE 2-26-2009; IN COMMERCE 3-20-2009.

THE MARK CONSISTS OF STANDARD CHARACTERS WITHOUT CLAIM TO ANY PARTICULAR FONT, STYLE, SIZE, OR COLOR.

SER. NO. 85-156,460, FILED 10-19-2010.

IRA J. GOODSaid, EXAMINING ATTORNEY



David J. Kyros

Director of the United States Patent and Trademark Office

United States of America

United States Patent and Trademark Office

Walk & Roll

Reg. No. 4,065,796

Registered Dec. 6, 2011

Int. Cl.: 10

TRADEMARK

PRINCIPAL REGISTER

NOBLE VENTURES OF VIRGINIA, LLC (VIRGINIA LIMITED LIABILITY COMPANY),
DBA WALK & ROLL
14900 Highberry Woods Terrace
Midlothian, VA 23112

FOR: WALKING AIDS, IN CLASS 10 (U.S. CLS. 26, 39 AND 44).

FIRST USE 9-15-2007; IN COMMERCE 11-15-2007.

THE MARK CONSISTS OF STANDARD CHARACTERS WITHOUT CLAIM TO ANY PARTICULAR FONT, STYLE, SIZE, OR COLOR.

SER. NO. 85-156,556, FILED 10-19-2010.

EMILY CHUO, EXAMINING ATTORNEY



David J. Kybas

Director of the United States Patent and Trademark Office

United States of America

United States Patent and Trademark Office



Reg. No. 4,065,797

Registered Dec. 6, 2011

Int. Cl.: 25

TRADEMARK

PRINCIPAL REGISTER

MACAW BAYZ (FLORIDA LIMITED LIABILITY COMPANY)
622 SW 7TH AVE APT#622
HALLANDALE BEACH, FL 33009

FOR: BUTTON DOWN SHIRTS; CARGO PANTS; COLLARED SHIRTS; DENIMS; GYM PANTS; HOODED SWEATSHIRTS; SHIRTS AND SHORT-SLEEVED SHIRTS; SWEATSHIRTS; T-SHIRTS, IN CLASS 25 (U.S. CLS. 22 AND 39).

FIRST USE 6-20-2009; IN COMMERCE 8-5-2009.

THE MARK CONSISTS OF A STYLIZED BIRD SITTING ON THE STYLIZED LETTERS "MB".

SER. NO. 85-156,581, FILED 10-19-2010.

STEVEN JACKSON, EXAMINING ATTORNEY



David J. Kyffers

Director of the United States Patent and Trademark Office

United States of America

United States Patent and Trademark Office



music^{1st}

Reg. No. 4,065,798

Registered Dec. 6, 2011

Int. Cl.: 44

SERVICE MARK

PRINCIPAL REGISTER

CORO HEALTH, LLC (TEXAS LIMITED LIABILITY COMPANY)
1409 W 10TH STREET
AUSTIN, TX 78703

FOR: MUSIC THERAPY SERVICES; MUSIC THERAPY FOR PHYSICAL, PSYCHOLOGICAL AND COGNITIVE PURPOSES; MUSIC THERAPY FOR SOCIAL ASSIMILATION PURPOSES, IN CLASS 44 (U.S. CLS. 100 AND 101).

FIRST USE 1-13-2010; IN COMMERCE 1-13-2010.

THE MARK CONSISTS OF THE WORD "MUSIC" IN WHICH THE LETTER "I" IS REPLACED BY "1ST" WHEREIN "ST" IS A SUPERSCRIPT TO "1" AND POSITIONED OVER THE "C" IN "MUSIC".

SER. NO. 85-156,651, FILED 10-20-2010.

KAREN BRACEY, EXAMINING ATTORNEY



David J. Kybas

Director of the United States Patent and Trademark Office

United States of America

United States Patent and Trademark Office

Blue Ocean Music Hall

Reg. No. 4,065,799

Registered Dec. 6, 2011

Int. Cl.: 41

SERVICE MARK

PRINCIPAL REGISTER

ATLANTIC HOSPITALITY GROUP, LLC FORMERLY OVC, LLC (MASSACHUSETTS LIMITED LIABILITY COMPANY), DBA BLUE OCEAN MUSIC HALL
98 ELM STREET
SALISBURY, MA 01952

FOR: ENTERTAINMENT IN THE NATURE OF LIVE PERFORMANCES BY MUSICAL BANDS, MUSICAL PERFORMERS, ROCK GROUPS, COMEDY SHOWS; ENTERTAINMENT SERVICES IN THE NATURE OF LIVE MUSICAL PERFORMANCES; ENTERTAINMENT SERVICES IN THE NATURE OF PRESENTING LIVE MUSICAL PERFORMANCES; ENTERTAINMENT, NAMELY, LIVE MUSIC CONCERTS; ENTERTAINMENT, NAMELY, LIVE PERFORMANCES BY MUSICAL BANDS; ENTERTAINMENT, NAMELY, LIVE PERFORMANCES BY ROCK GROUPS; PERFORMANCE HALL RENTAL SERVICES; PRESENTATION OF LIVE COMEDY SHOWS; PRESENTATION OF LIVE SHOW PERFORMANCES, IN CLASS 41 (U.S. CLS. 100, 101 AND 107).

FIRST USE 4-1-2010; IN COMMERCE 4-1-2010.

THE MARK CONSISTS OF STANDARD CHARACTERS WITHOUT CLAIM TO ANY PARTICULAR FONT, STYLE, SIZE, OR COLOR.

NO CLAIM IS MADE TO THE EXCLUSIVE RIGHT TO USE "MUSIC HALL", APART FROM THE MARK AS SHOWN.

SER. NO. 85-156,877, FILED 10-20-2010.

REBECCA GILBERT, EXAMINING ATTORNEY



David J. Kybas

Director of the United States Patent and Trademark Office

United States of America

United States Patent and Trademark Office

Comfort Key

Reg. No. 4,065,800

Registered Dec. 6, 2011

Int. Cl.: 10

TRADEMARK

PRINCIPAL REGISTER

VISOVATIONS, LLC (ILLINOIS LIMITED LIABILITY COMPANY)
539 WEST ALGONQUIN RD.
ARLINGTON HEIGHTS, IL 60005

FOR: MASSAGE TOOL COMPRISED OF A METAL OBJECT IN THE NATURE OF A SLIGHTLY DEPRESSED, SMOOTH ALUMINUM ELLIPTICAL SURFACE WITH SURROUNDING GENTLE FLOWING CURVES FOR RUBBING A THUMB ACROSS ITS SURFACE TO ALLEVIATE STRESS, IN CLASS 10 (U.S. CLS. 26, 39 AND 44).

FIRST USE 9-1-2010; IN COMMERCE 10-1-2010.

THE MARK CONSISTS OF STANDARD CHARACTERS WITHOUT CLAIM TO ANY PARTICULAR FONT, STYLE, SIZE, OR COLOR.

SER. NO. 85-157,006, FILED 7-13-2011.

DEZMONA MIZELLE, EXAMINING ATTORNEY



David J. Kyffers

Director of the United States Patent and Trademark Office

United States of America

United States Patent and Trademark Office

METHYLPLEX

Reg. No. 4,065,801

Registered Dec. 6, 2011

Int. Cls.: 1, 5 and 42

TRADEMARK

SERVICE MARK

PRINCIPAL REGISTER

RUBICON GENOMICS, INC. (MICHIGAN CORPORATION)
SUITE E
4355 VARSITY DRIVE
ANN ARBOR, MI 48108

FOR: REAGENTS FOR SCIENTIFIC OR RESEARCH USE IN CONNECTION WITH GENETIC MATERIALS, IN CLASS 1 (U.S. CLS. 1, 5, 6, 10, 26 AND 46).

FIRST USE 11-19-2004; IN COMMERCE 11-19-2004.

FOR: MEDICAL DIAGNOSTIC PREPARATIONS FOR USE IN DETECTING AND TREATING CANCER WHICH USE RESULTS OF GENETIC AND GENOMIC RESEARCH, IN CLASS 5 (U.S. CLS. 6, 18, 44, 46, 51 AND 52).

FIRST USE 11-19-2004; IN COMMERCE 11-19-2004.

FOR: PROVIDING RESEARCH AND ANALYTICAL SERVICES WITH RESPECT TO DNA OR OTHER GENETIC INFORMATION IN ANY FORM; RESEARCH AND DEVELOPMENT SERVICES FOR GENOMIC PRODUCTS AND APPLICATIONS THEREFOR, IN CLASS 42 (U.S. CLS. 100 AND 101).

FIRST USE 5-2-2006; IN COMMERCE 5-2-2006.

THE MARK CONSISTS OF STANDARD CHARACTERS WITHOUT CLAIM TO ANY PARTICULAR FONT, STYLE, SIZE, OR COLOR.

SER. NO. 85-157,062, FILED 10-20-2010.

LESLEY LAMOTHE, EXAMINING ATTORNEY



David J. Kybas

Director of the United States Patent and Trademark Office

United States of America

United States Patent and Trademark Office

SPACE FOR IDEAS

Reg. No. 4,065,802

Registered Dec. 6, 2011

Int. Cl.: 35

SERVICE MARK

PRINCIPAL REGISTER

STARCOM MEDIAVEST GROUP, INC. (DELAWARE CORPORATION)
35 W. WACKER DRIVE
CHICAGO, IL 60601

FOR: MARKETING RESEARCH AND ANALYSIS SERVICES; PREPARING AND PLACING ADVERTISEMENTS FOR OTHERS; PROVIDING ADVERTISING CONSULTING AND CONSULTING SERVICES IN THE FIELD OF FACILITATING THE PLANNING, BUYING AND SELLING OF MEDIA; MARKETING, ADVERTISING AND BRAND CONSULTING IN THE FIELD OF BRAND COMMUNICATION STRATEGY SERVICES; MARKETING AND ADVERTISING CONSULTING SERVICES FOR OTHERS, NAMELY, MEDIA PLANNING SERVICES AND MEDIA BUYING SERVICES; ADVERTISING AGENCY SERVICES, IN CLASS 35 (U.S. CLS. 100, 101 AND 102).

FIRST USE 9-0-2008; IN COMMERCE 12-0-2009.

THE MARK CONSISTS OF STANDARD CHARACTERS WITHOUT CLAIM TO ANY PARTICULAR FONT, STYLE, SIZE, OR COLOR.

SER. NO. 85-157,370, FILED 10-20-2010.

PRISCILLA MILTON, EXAMINING ATTORNEY



David J. Kybas

Director of the United States Patent and Trademark Office

United States of America

United States Patent and Trademark Office

HalfPerf

Reg. No. 4,065,803

Registered Dec. 6, 2011

Int. Cl.: 11

TRADEMARK

PRINCIPAL REGISTER

VODE LIGHTING LLC (CALIFORNIA LIMITED LIABILITY COMPANY)
1206 EAST MACARTHUR ST, #3
SONOMA, CA 95476

FOR: LIGHTING FIXTURES, IN CLASS 11 (U.S. CLS. 13, 21, 23, 31 AND 34).

FIRST USE 8-1-2009; IN COMMERCE 10-1-2009.

THE MARK CONSISTS OF STANDARD CHARACTERS WITHOUT CLAIM TO ANY PARTICULAR FONT, STYLE, SIZE, OR COLOR.

SER. NO. 85-157,466, FILED 10-20-2010.

GIANCARLO CASTRO, EXAMINING ATTORNEY



David J. Kybas

Director of the United States Patent and Trademark Office

United States of America

United States Patent and Trademark Office



Reg. No. 4,065,804

Registered Dec. 6, 2011

Int. Cl.: 35

CATARACT AND LASER CENTER PARTNERS, LLC (DELAWARE LIMITED LIABILITY COMPANY)
SUITE 2
195 HANOVER STREET
NORWELL, MA 02339

SERVICE MARK

FOR: AMBULATORY SURGERY CENTER BUSINESS DEVELOPMENT AND BUSINESS MANAGEMENT SERVICES, IN CLASS 35 (U.S. CLS. 100, 101 AND 102).

PRINCIPAL REGISTER

FIRST USE 11-0-2008; IN COMMERCE 11-0-2008.

OWNER OF U.S. REG. NO. 2,768,716.

THE COLOR(S) TEAL AND BLUE IS/ARE CLAIMED AS A FEATURE OF THE MARK.

NO CLAIM IS MADE TO THE EXCLUSIVE RIGHT TO USE "AMBULATORY SURGICAL CENTERS OF AMERICA", APART FROM THE MARK AS SHOWN.

THE MARK CONSISTS OF A BLUE, PARTIAL OVAL SHAPE IN THE UPPER LEFT HAND CORNER, WITH "ASCOA" TO THE RIGHT IN TEAL, WITH THE WORDS "AMBULATORY SURGICAL CENTERS OF AMERICA" BELOW IN BLUE.

SER. NO. 85-157,751, FILED 10-21-2010.

ALLISON SCHRODY, EXAMINING ATTORNEY



David J. Kybas

Director of the United States Patent and Trademark Office

United States of America

United States Patent and Trademark Office

Family Style / Our Style

Reg. No. 4,065,805

Registered Dec. 6, 2011

Int. Cl.: 43

SERVICE MARK

PRINCIPAL REGISTER

CAM'S NEW YORK PIZZERIA, INC. (NEW YORK CORPORATION)
P.O. BOX 369
WEBSTER, NY 14580

FOR: RESTAURANT SERVICES FEATURING PIZZA, WINGS, CALZONE, STROMBOLI, SAUSAGE ROLLS, PASTA, CHICKEN PARMESAN, EGGPLANT PARMESAN, CHEESE RAVIOLI, STUFFED SHELLS, CHICKEN, FRIED MUSHROOMS, FRENCH FRIES, SUBS, SALADS, WRAPS, COOKIES, DESSERTS, AND BEVERAGES, IN CLASS 43 (U.S. CLS. 100 AND 101).

FIRST USE 0-0-2006; IN COMMERCE 0-0-2006.

THE MARK CONSISTS OF STANDARD CHARACTERS WITHOUT CLAIM TO ANY PARTICULAR FONT, STYLE, SIZE, OR COLOR.

NO CLAIM IS MADE TO THE EXCLUSIVE RIGHT TO USE "FAMILY STYLE", APART FROM THE MARK AS SHOWN.

SER. NO. 85-157,811, FILED 10-21-2010.

TEJBIR SINGH, EXAMINING ATTORNEY



David J. Kyros

Director of the United States Patent and Trademark Office

United States of America

United States Patent and Trademark Office

EMSIBETH
C O S M E T I C S

THERMAL

Reg. No. 4,065,806

Registered Dec. 6, 2011

Int. Cl.: 3

TRADEMARK

PRINCIPAL REGISTER

EMSIBETH S.P.A. (ITALY CORPORATION)
VIA G. MURARI BRA 35/G
VERONA, ITALY I-37136

FOR: HAIR LOTIONS; HAIR CARE PREPARATIONS, IN CLASS 3 (U.S. CLS. 1, 4, 6, 50, 51 AND 52).

FIRST USE 3-31-2003; IN COMMERCE 5-5-2008.

OWNER OF U.S. REG. NO. 3,177,309.

NO CLAIM IS MADE TO THE EXCLUSIVE RIGHT TO USE "COSMETICS THERMAL", APART FROM THE MARK AS SHOWN.

THE MARK CONSISTS OF THE WORDS "EMSIBETH COSMETICS THERMAL", WITH "EMSIBETH" IN LARGER LETTERS THAN "COSMETICS" AND A HORIZONTAL LINE BETWEEN THE WORDS. THE AFOREMENTIONED WORDING APPEARS TO THE UPPER LEFT OF THE WORD "THERMAL", WITH THE LETTERS "TH" IN "THERMAL" IN BLOCK LETTERS, THE LETTERS "ERMAL" IN "THERMAL" IN THIN LETTERS, AND A WATER DROP DESIGN ON THE RIGHT LEG OF THE LETTER "H".

SER. NO. 85-157,879, FILED 10-21-2010.

NANCY CLARKE, EXAMINING ATTORNEY



David J. Kyros

Director of the United States Patent and Trademark Office

United States of America
United States Patent and Trademark Office

FIBERCO

Reg. No. 4,065,807

Registered Dec. 6, 2011

Int. Cl.: 35

SERVICE MARK

PRINCIPAL REGISTER

INTERNET2 (D.C. CORPORATION)
1150 18TH STREET, N.W. SUITE 1020
WASHINGTON, DC 20036

FOR: INDUSTRIAL ASSET MANAGEMENT SERVICES, NAMELY, ACQUIRING AND RE-MARKETING THE INDUSTRIAL ASSETS OF OTHERS, NAMELY, THE FIBER OPTIC NETWORK ASSETS OF OTHERS, IN CLASS 35 (U.S. CLS. 100, 101 AND 102).

FIRST USE 5-8-2003; IN COMMERCE 5-8-2003.

THE MARK CONSISTS OF STANDARD CHARACTERS WITHOUT CLAIM TO ANY PARTICULAR FONT, STYLE, SIZE, OR COLOR.

OWNER OF U.S. REG. NO. 2,907,412.

SEC. 2(F).

SER. NO. 85-157,951, FILED 10-21-2010.

MATTHEW KLINE, EXAMINING ATTORNEY



David J. Kybas

Director of the United States Patent and Trademark Office

United States of America

United States Patent and Trademark Office

HATCH MOTT MACDONALD DELIVERING SOLUTIONS

Reg. No. 4,065,808

Registered Dec. 6, 2011

Int. Cl.: 42

SERVICE MARK

PRINCIPAL REGISTER

HATCH MOTT MACDONALD GROUP (NEW JERSEY CORPORATION)
27 BLEEKER STREET
MILLBURN, NJ 07041

FOR: PROFESSIONAL SERVICES IN THE FIELDS OF ENGINEERING AND ARCHITECTURE, NAMELY, PLANNING, STUDIES, DESIGN, ENVIRONMENTAL COMPLIANCE, AND MANAGEMENT OF RAIL AND TRANSIT SYSTEMS, WATER, WASTEWATER, AND WASTE FACILITIES, TUNNELS, BRIDGES AND HIGHWAYS, AIRPORTS, PORTS AND HARBORS, BUILDINGS, LAND DEVELOPMENTS, AND PIPELINES, IN CLASS 42 (U.S. CLS. 100 AND 101).

FIRST USE 6-0-2005; IN COMMERCE 4-0-2008.

THE MARK CONSISTS OF STANDARD CHARACTERS WITHOUT CLAIM TO ANY PARTICULAR FONT, STYLE, SIZE, OR COLOR.

OWNER OF U.S. REG. NOS. 3,092,332, 3,164,603 AND OTHERS.

SER. NO. 85-157,996, FILED 10-21-2010.

GINA HAYES, EXAMINING ATTORNEY



David J. Kyros

Director of the United States Patent and Trademark Office

United States of America

United States Patent and Trademark Office

SPIKE

Reg. No. 4,065,809

Registered Dec. 6, 2011

Int. Cl.: 41

SERVICE MARK

PRINCIPAL REGISTER

NETWORK ENTERPRISES, INC. (TENNESSEE CORPORATION)
1515 BROADWAY
NEW YORK, NY 10036

FOR: ENTERTAINMENT SERVICES, NAMELY, PROVIDING CONTINUING TELEVISION AND RADIO PROGRAMS FEATURING LIVE ACTION, DRAMA, COMEDY, SCI-FI, ANIMATION, MUSIC, NEWS AND GENERAL ENTERTAINMENT; PROVIDING INFORMATION IN THE FIELD OF ENTERTAINMENT; PRODUCTION OF CABLE TELEVISION PROGRAMS AND RADIO PROGRAMS; ENTERTAINMENT SERVICES IN THE NATURE OF DEVELOPMENT, CREATION, PRODUCTION AND POST-PRODUCTION SERVICES OF MULTIMEDIA ENTERTAINMENT CONTENT, IN CLASS 41 (U.S. CLS. 100, 101 AND 107).

FIRST USE 5-1-2006; IN COMMERCE 5-1-2006.

THE MARK CONSISTS OF STANDARD CHARACTERS WITHOUT CLAIM TO ANY PARTICULAR FONT, STYLE, SIZE, OR COLOR.

OWNER OF U.S. REG. NOS. 2,891,969, 3,524,641 AND OTHERS.

SER. NO. 85-158,008, FILED 10-21-2010.

ANDREW LEASER, EXAMINING ATTORNEY



David J. Kybas

Director of the United States Patent and Trademark Office

United States of America

United States Patent and Trademark Office

DELIVERING SOLUTIONS

Reg. No. 4,065,810

Registered Dec. 6, 2011

Int. Cl.: 42

SERVICE MARK

PRINCIPAL REGISTER

HATCH MOTT MACDONALD GROUP (NEW JERSEY CORPORATION)
27 BLEEKER STREET
MILLBURN, NJ 07041

FOR: PROFESSIONAL SERVICES IN THE FIELDS OF ENGINEERING AND ARCHITECTURE, NAMELY, PLANNING, STUDIES, DESIGN, ENVIRONMENTAL COMPLIANCE, AND MANAGEMENT OF RAIL AND TRANSIT SYSTEMS, WATER, WASTEWATER, AND WASTE FACILITIES, TUNNELS, BRIDGES AND HIGHWAYS, AIRPORTS, PORTS AND HARBORS, BUILDINGS, LAND DEVELOPMENTS, AND PIPELINES, IN CLASS 42 (U.S. CLS. 100 AND 101).

FIRST USE 6-0-2005; IN COMMERCE 4-0-2008.

THE MARK CONSISTS OF STANDARD CHARACTERS WITHOUT CLAIM TO ANY PARTICULAR FONT, STYLE, SIZE, OR COLOR.

OWNER OF U.S. REG. NOS. 3,092,332, 3,164,603 AND OTHERS.

SER. NO. 85-158,139, FILED 10-21-2010.

GINA HAYES, EXAMINING ATTORNEY



David J. Kyros

Director of the United States Patent and Trademark Office

United States of America

United States Patent and Trademark Office

FILM SLUG

Reg. No. 4,065,811

Registered Dec. 6, 2011

Int. Cls.: 35 and 41

SERVICE MARK

PRINCIPAL REGISTER

FILM SLUG, LLC (UTAH LIMITED LIABILITY COMPANY)
3623 GLIMMER BAY DRIVE
MAGNA, UT 84044

FOR: PROMOTING SPONSORSHIP OF FILMS BY MEANS OF ADVERTISING FILM PROJECTS TO POTENTIAL SPONSORS; PROMOTING THE SERVICES OF OTHERS IN THE FIELD OF FILM BY MEANS OF ADVERTISING THE SERVICES OF OTHERS IN THE FIELD OF FILM TO POTENTIAL USERS OF THOSE SERVICES, IN CLASS 35 (U.S. CLS. 100, 101 AND 102).

FIRST USE 6-2-2009; IN COMMERCE 10-8-2010.

FOR: FILM PRODUCTION AND DISTRIBUTION, IN CLASS 41 (U.S. CLS. 100, 101 AND 107).

FIRST USE 6-2-2009; IN COMMERCE 10-8-2010.

THE MARK CONSISTS OF STANDARD CHARACTERS WITHOUT CLAIM TO ANY PARTICULAR FONT, STYLE, SIZE, OR COLOR.

NO CLAIM IS MADE TO THE EXCLUSIVE RIGHT TO USE "FILM" , APART FROM THE MARK AS SHOWN.

SER. NO. 85-158,209, FILED 10-21-2010.

ANTHONY RINKER, EXAMINING ATTORNEY



David J. Kybas

Director of the United States Patent and Trademark Office

United States of America

United States Patent and Trademark Office

SAPIENT AUTOMATION

Reg. No. 4,065,812

Registered Dec. 6, 2011

Int. Cl.: 7

TRADEMARK

PRINCIPAL REGISTER

SAPIENT AUTOMATION LLC (PENNSYLVANIA LIMITED LIABILITY COMPANY)
30 SOUTH PINE STREET
DOYLESTOWN, PA 18901

FOR: MATERIAL HANDLING EQUIPMENT, NAMELY, MACHINES FOR AUTOMATED STORAGE AND RETRIEVAL, IN CLASS 7 (U.S. CLS. 13, 19, 21, 23, 31, 34 AND 35).

FIRST USE 8-23-2010; IN COMMERCE 8-23-2010.

THE MARK CONSISTS OF STANDARD CHARACTERS WITHOUT CLAIM TO ANY PARTICULAR FONT, STYLE, SIZE, OR COLOR.

NO CLAIM IS MADE TO THE EXCLUSIVE RIGHT TO USE "AUTOMATION", APART FROM THE MARK AS SHOWN.

SER. NO. 85-158,516, FILED 10-21-2010.

SETH A. RAPPAPORT, EXAMINING ATTORNEY



David J. Kyffers

Director of the United States Patent and Trademark Office

United States of America

United States Patent and Trademark Office

GreenLite

Reg. No. 4,065,813

Registered Dec. 6, 2011

Int. Cl.: 6

TRADEMARK

PRINCIPAL REGISTER

UNIVERSAL STORAGE CONTAINERS LLC (CONNECTICUT LIMITED LIABILITY COMPANY)
146 OLD KINGS HIGHWAY
NEW CANAAN, CT 06840

FOR: CONTAINERS FOR STORAGE AND TRANSPORT MADE OF METAL OR PRIMARILY OF METAL; PREFABRICATED PORTABLE STRUCTURES FOR USE FOR SHELTER, OFFICE, CLINIC, EMERGENCY OPERATIONS, MOVING, STORAGE, OR COLD STORAGE, MADE OF METAL OR PRIMARILY OF METAL; WALL PANELS FOR CONTAINERS FOR STORAGE AND TRANSPORT MADE PRIMARILY OF METAL, IN CLASS 6 (U.S. CLS. 2, 12, 13, 14, 23, 25 AND 50).

FIRST USE 9-9-2009; IN COMMERCE 9-9-2009.

THE MARK CONSISTS OF STANDARD CHARACTERS WITHOUT CLAIM TO ANY PARTICULAR FONT, STYLE, SIZE, OR COLOR.

SER. NO. 85-158,624, FILED 10-21-2010.

JENNIFER MARTIN, EXAMINING ATTORNEY



David J. Kybas

Director of the United States Patent and Trademark Office

United States of America

United States Patent and Trademark Office



Reg. No. 4,065,814

HOWELL, GRAHAM T (UNITED STATES INDIVIDUAL)
1369 STATE ROUTE 9
SEDRO WOOLLEY, WA 98284

Registered Dec. 6, 2011

Int. Cl.: 25

FOR: WEARABLE GARMENTS AND CLOTHING, NAMELY, SHIRTS, IN CLASS 25 (U.S. CLS. 22 AND 39).

TRADEMARK

FIRST USE 9-28-2010; IN COMMERCE 10-21-2010.

PRINCIPAL REGISTER

THE MARK CONSISTS OF A WHITE HAND WITH BLACK FEATURES LYING FROM RIGHT TO LEFT OVER A DEPICTION OF A GRAY FACE OUTLINED IN BLACK AND FORMING AN EYE.

THE COLOR(S) BLACK, WHITE, GRAY IS/ARE CLAIMED AS A FEATURE OF THE MARK.

SER. NO. 85-158,696, FILED 10-22-2010.

JULIE GUTTADAURO, EXAMINING ATTORNEY



David J. Kyffers

Director of the United States Patent and Trademark Office

United States of America

United States Patent and Trademark Office

CARACO PHARMA, INC.

Reg. No. 4,065,815

Registered Dec. 6, 2011

Int. Cl.: 5

TRADEMARK

PRINCIPAL REGISTER

CARACO PHARMACEUTICAL LABORATORIES, LTD. (MICHIGAN CORPORATION)
1150 ELIJAH MCCOY DRIVE
DETROIT, MI 48202

FOR: ANALGESIC PREPARATIONS; HUMAN ANTIVIRAL PREPARATIONS; PHARMACEUTICAL PREPARATIONS FOR THE PREVENTION AND TREATMENT OF ASTHMA, CHRONIC BRONCHITIS, EMPHYSEMA, AND OTHER LUNG DISEASES; PHARMACEUTICAL PREPARATIONS FOR THE PREVENTION AND TREATMENT OF INFECTIONS CAUSED BY INFLUENZA A VIRUS; PHARMACEUTICAL PREPARATIONS FOR THE TREATMENT OF PAIN, FEVER, AND SWELLING, IN CLASS 5 (U.S. CLS. 6, 18, 44, 46, 51 AND 52).

FIRST USE 3-26-2010; IN COMMERCE 3-26-2010.

THE MARK CONSISTS OF STANDARD CHARACTERS WITHOUT CLAIM TO ANY PARTICULAR FONT, STYLE, SIZE, OR COLOR.

OWNER OF U.S. REG. NOS. 2,943,360, 2,943,361, AND 2,943,362.

NO CLAIM IS MADE TO THE EXCLUSIVE RIGHT TO USE "PHARMA, INC.", APART FROM THE MARK AS SHOWN.

SER. NO. 85-158,742, FILED 10-22-2010.

LOURDES AYALA, EXAMINING ATTORNEY



David J. Kyros

Director of the United States Patent and Trademark Office

United States of America

United States Patent and Trademark Office

VIXEN AESTHETICS

Reg. No. 4,065,816

Registered Dec. 6, 2011

Int. Cl.: 44

SERVICE MARK

PRINCIPAL REGISTER

VIXEN AESTHETICS, P.C. (MICHIGAN CORPORATION)
45569 VAN DYKE, SUITE 1 & 2
UTICA, MI 48317

FOR: MEDICAL CLINIC PROVIDING ANTI AGING THERAPY, AND NATURAL HORMONE THERAPY; MEDICAL CLINIC PROVIDING MEDICAL AESTHETIC PROCEDURES, NAMELY, LASER HAIR REMOVAL, LASER BOTULINUM TOXIN WRINKLE REDUCTION TREATMENTS AND CHEMICAL PEELS, MICRODERMABRASION, CARBON DIOXIDE COSMETIC BODY CARE TREATMENT IN THE NATURE OF CARBOXYTHERAPY, MESOTHERAPY, SCLEROTHERAPY VEIN TREATMENTS, VEIN THERAPY, CELLULITE TREATMENTS, BODY CONTOURING TREATMENTS, INJECTABLE FILLER TREATMENTS, COSMETIC FACE CARE SERVICES IN THE NATURE OF EYELASH GROWTH TREATMENTS, FACIALS, AND SKIN CARE, IN CLASS 44 (U.S. CLS. 100 AND 101).

FIRST USE 6-1-2007; IN COMMERCE 6-1-2007.

THE MARK CONSISTS OF STANDARD CHARACTERS WITHOUT CLAIM TO ANY PARTICULAR FONT, STYLE, SIZE, OR COLOR.

NO CLAIM IS MADE TO THE EXCLUSIVE RIGHT TO USE "AESTHETICS", APART FROM THE MARK AS SHOWN.

SER. NO. 85-158,747, FILED 10-22-2010.

JAY BESCH, EXAMINING ATTORNEY



David J. Kyros

Director of the United States Patent and Trademark Office

United States of America

United States Patent and Trademark Office



Reg. No. 4,065,817
Registered Dec. 6, 2011

CARACO PHARMACEUTICAL LABORATORIES, LTD. (MICHIGAN CORPORATION)
1150 ELIJAH MCCOY DRIVE
DETROIT, MI 48202

Int. Cl.: 5

FOR: ANALGESIC PREPARATIONS; HUMAN ANTIVIRAL PREPARATIONS; PHARMACEUTICAL PREPARATIONS FOR THE PREVENTION AND TREATMENT OF ASTHMA, CHRONIC BRONCHITIS, EMPHYSEMA, AND OTHER LUNG DISEASES; PHARMACEUTICAL PREPARATIONS FOR THE PREVENTION AND TREATMENT OF INFECTIONS CAUSED BY INFLUENZA A VIRUS; PHARMACEUTICAL PREPARATIONS FOR THE TREATMENT OF PAIN, FEVER, AND SWELLING, IN CLASS 5 (U.S. CLS. 6, 18, 44, 46, 51 AND 52).

TRADEMARK

PRINCIPAL REGISTER

FIRST USE 3-26-2010; IN COMMERCE 3-26-2010.

OWNER OF U.S. REG. NOS. 2,943,360, 2,943,361, AND 2,943,362.

NO CLAIM IS MADE TO THE EXCLUSIVE RIGHT TO USE "PHARMA, INC.", APART FROM THE MARK AS SHOWN.

THE MARK CONSISTS OF THE STYLIZED WORDING.

SER. NO. 85-158,753, FILED 10-22-2010.

LOURDES AYALA, EXAMINING ATTORNEY



David J. Kybas

Director of the United States Patent and Trademark Office

United States of America

United States Patent and Trademark Office



Reg. No. 4,065,818
Registered Dec. 6, 2011

CARACO PHARMACEUTICAL LABORATORIES, LTD. (MICHIGAN CORPORATION)
1150 ELIJAH MCCOY DRIVE
DETROIT, MI 48202

Int. Cl.: 5

FOR: ANALGESIC PREPARATIONS; HUMAN ANTIVIRAL PREPARATIONS; PHARMACEUTICAL PREPARATIONS FOR THE PREVENTION AND TREATMENT OF ASTHMA, CHRONIC BRONCHITIS, EMPHYSEMA, AND OTHER LUNG DISEASES; PHARMACEUTICAL PREPARATIONS FOR THE PREVENTION AND TREATMENT OF INFECTIONS CAUSED BY INFLUENZA A VIRUS; PHARMACEUTICAL PREPARATIONS FOR THE TREATMENT OF PAIN, FEVER, AND SWELLING, IN CLASS 5 (U.S. CLS. 6, 18, 44, 46, 51 AND 52).

TRADEMARK

PRINCIPAL REGISTER

FIRST USE 3-26-2010; IN COMMERCE 3-26-2010.

OWNER OF U.S. REG. NOS. 2,943,360, 2,943,361, AND 2,943,362.

THE COLOR(S) ORANGE AND GRAY IS/ARE CLAIMED AS A FEATURE OF THE MARK.

NO CLAIM IS MADE TO THE EXCLUSIVE RIGHT TO USE "PHARMA, INC.", APART FROM THE MARK AS SHOWN.

THE MARK CONSISTS OF THE STYLIZED WORDING.

SER. NO. 85-158,771, FILED 10-22-2010.

LOURDES AYALA, EXAMINING ATTORNEY



David J. Kyjars

Director of the United States Patent and Trademark Office

United States of America

United States Patent and Trademark Office

Ko-BQue

Reg. No. 4,065,819

Registered Dec. 6, 2011

Int. Cls.: 9 and 11

TRADEMARK

PRINCIPAL REGISTER

TYULUMAN, SAMUEL A (UNITED STATES INDIVIDUAL)
9301 N CENTRAL EXPRESSWAY #475
DALLAS, TX 75231

FOR: TEMPERATURE CONTROLLERS FOR FOOD PREPARATION APPLIANCES; WATER HEATER CONTROLS, IN CLASS 9 (U.S. CLS. 21, 23, 26, 36 AND 38).

FIRST USE 10-15-2010; IN COMMERCE 10-15-2010.

FOR: BAKING OVENS; BARBECUE APPARATUS, NAMELY, FUEL STARTER IN THE NATURE OF A METAL CONTAINER WITH A WOODEN HANDLE INTO WHICH FUEL BRIQUETTES MAY BE PLACED, LIT, AND THEN POURED INTO A BARBECUE GRILL FOR THE PURPOSE OF SPEEDING UP THE READY TO COOK TIME OF BARBECUE FUELS; BARBECUE GRILLS; BARBECUE SMOKER ACCESSORIES, NAMELY, CONVECTION PLATES; BARBECUE SMOKERS; BARBECUES; BARBECUES AND GRILLS; CERAMIC BRIQUETTES FOR USE IN BARBECUE GRILLS; CONVECTION OVENS; COOK- AND HOLD- OVENS; COOKING OVENS; COOKING PRODUCTS, NAMELY, LINERS FOR CONVENTIONAL OVENS IN THE NATURE OF HEAT- TRANSMITTING CONTAINERS FOR PROVIDING UNIFORM HEAT AND HUMIDITY DURING COOKING; DOMESTIC COOKING OVENS; ELECTRIC BATH-WATER PURIFYING APPARATUS FOR HOUSEHOLD PURPOSES; ELECTRIC COOKING OVENS; ELECTRIC DUTCH OVENS; ELECTRIC HOT-WATER BOTTLES; ELECTRIC TOASTER OVENS; FOLDING PORTABLE CHARCOAL, PROPANE AND GAS FIRED BARBECUES, STOVES, AND GRILLS; GAS COOKING OVENS; GAS WATER HEATER FOR BATHTUB CONSISTING OF CIRCULATION PUMP WITH THERMOSTAT TO FILL, RE-HEAT WATER AND KEEP WATER WARM; GAS WATER HEATERS; HOT WATER BOTTLE HOLDER WITH POUCH OF MICROWAVABLE MATERIAL FOR SUSTAINED WARMTH; HOT WATER BOTTLES; HOT WATER HEATERS; HOT WATER TANKS; INDUSTRIAL COOKING OVENS; LAVA ROCK FOR USE IN BARBECUE GRILLS; MULTI-PURPOSE, ELECTRIC COUNTERTOP FOOD PREPARATION APPARATUS FOR COOKING, BAKING, BROILING, ROASTING, TOASTING, SEARING, BROWNING, BARBECUING AND GRILLING FOOD; TEMPERATURE-CONTROLLED CONCESSION DISPENSING EQUIPMENT, NAMELY, CONDIMENT DISPENSING PUMPS, HOT TOPPING DISPENSERS AND CHILLED PRODUCT DISPENSERS; TEMPERATURE-CONTROLLED FOOD AND BEVERAGE DISPENSERS, AND COMPONENTS THEREOF; WATER HEATERS; WATER HEATERS USED IN THE PREPARATION OF FOOD, IN CLASS 11 (U.S. CLS. 13, 21, 23, 31 AND 34).



David J. Kybas

Director of the United States Patent and Trademark Office

Reg. No. 4,065,819 FIRST USE 10-15-2010; IN COMMERCE 10-15-2010.

THE MARK CONSISTS OF STANDARD CHARACTERS WITHOUT CLAIM TO ANY PARTICULAR FONT, STYLE, SIZE, OR COLOR.

SER. NO. 85-158,796, FILED 10-22-2010.

GENE MACIOL, EXAMINING ATTORNEY

United States of America

United States Patent and Trademark Office

NEWPORT BEAT

Reg. No. 4,065,820

RODENHUIS, FREDERIK (UNITED STATES INDIVIDUAL)
359 SAN MIGUEL DR., SUITE 208
NEWPORT BEACH, CA 92660

Registered Dec. 6, 2011

Int. Cl.: 41

FOR: LIVE PERFORMANCES BY A MUSICAL BAND, IN CLASS 41 (U.S. CLS. 100, 101 AND 107).

SERVICE MARK

FIRST USE 9-25-2010; IN COMMERCE 9-25-2010.

PRINCIPAL REGISTER

THE MARK CONSISTS OF STANDARD CHARACTERS WITHOUT CLAIM TO ANY PARTICULAR FONT, STYLE, SIZE, OR COLOR.

NO CLAIM IS MADE TO THE EXCLUSIVE RIGHT TO USE "NEWPORT", APART FROM THE MARK AS SHOWN.

SER. NO. 85-158,800, FILED 10-22-2010.

KATHLEEN M. VANSTON, EXAMINING ATTORNEY



David J. Kyffers

Director of the United States Patent and Trademark Office

United States of America

United States Patent and Trademark Office



Reg. No. 4,065,821

Registered Dec. 6, 2011

Int. Cl.: 44

SERVICE MARK

PRINCIPAL REGISTER

VIXEN AESTHETICS, P.C. (MICHIGAN CORPORATION)
45569 VAN DYKE, SUITE 1 & 2
UTICA, MI 48317

FOR: MEDICAL CLINIC PROVIDING ANTI AGING THERAPY, AND NATURAL HORMONE THERAPY; MEDICAL CLINIC PROVIDING MEDICAL AESTHETIC PROCEDURES, NAMELY, LASER HAIR REMOVAL, LASER BOTULINUM TOXIN WRINKLE REDUCTION TREATMENTS AND CHEMICAL PEELS, MICRODERMABRASION, CARBON DIOXIDE COSMETIC BODY CARE TREATMENT IN THE NATURE OF CARBOXYTHERAPY, MESOTHERAPY, SCLEROTHERAPY VEIN TREATMENTS, VEIN THERAPY, CELLULITE TREATMENTS, BODY CONTOURING TREATMENTS, INJECTABLE FILLER TREATMENTS, COSMETIC FACE CARE SERVICES IN THE NATURE OF EYELASH GROWTH TREATMENTS, FACIALS, AND SKIN CARE, IN CLASS 44 (U.S. CLS. 100 AND 101).

FIRST USE 11-4-2009; IN COMMERCE 11-4-2009.

NO CLAIM IS MADE TO THE EXCLUSIVE RIGHT TO USE "AESTHETICS", APART FROM THE MARK AS SHOWN.

THE MARK CONSISTS OF THE STYLIZED WORDING "VIXEN" ABOVE THE STYLIZED WORDING "AESTHETICS", AND THE DESIGN OF A SILHOUETTE OF A STANDING WOMAN IN HIGH HEELS TO THE RIGHT OF THE WORDING "VIXEN".

SER. NO. 85-158,822, FILED 10-22-2010.

JAY BESCH, EXAMINING ATTORNEY



David J. Kybas

Director of the United States Patent and Trademark Office

United States of America
United States Patent and Trademark Office

Blue Dot.

Reg. No. 4,065,822

Registered Dec. 6, 2011

Int. Cls.: 37 and 42

SERVICE MARK

PRINCIPAL REGISTER

FORT PITT GROUP (PENNSYLVANIA CORPORATION)
3000 MCKNIGHT EAST DR
PITTSBURGH, PA 15237

FOR: INSTALLATION, MAINTENANCE AND REPAIR OF AIR CONDITIONING, HEATING, COOLING AND VENTILATION SYSTEMS, EQUIPMENT, AND APPLIANCES, AND THE COMPONENTS AND PARTS OF SUCH SYSTEMS, EQUIPMENT AND APPLIANCES; PLUMBING SERVICES; AND ELECTRICAL CONTRACTING SERVICES, IN CLASS 37 (U.S. CLS. 100, 103 AND 106).

FIRST USE 9-1-1998; IN COMMERCE 9-1-1998.

FOR: CONSULTING SERVICES IN THE FIELD OF THE DESIGN OF ENERGY-EFFICIENT HEATING, COOLING, AND VENTILATION SYSTEMS FOR OTHERS, IN CLASS 42 (U.S. CLS. 100 AND 101).

FIRST USE 9-1-1998; IN COMMERCE 9-1-1998.

THE MARK CONSISTS OF THE WORDS "BLUE DOT." WITH THE "O" IN THE WORD "DOT" DEPICTED AS A GLOBE WITH MERIDIANS AND PARALLELS.

SER. NO. 85-158,918, FILED 10-22-2010.

LINDA E. BLOHM, EXAMINING ATTORNEY



David J. Kybas

Director of the United States Patent and Trademark Office

United States of America

United States Patent and Trademark Office



Reg. No. 4,065,823
Registered Dec. 6, 2011
Int. Cl.: 35

SERVICE MARK
PRINCIPAL REGISTER

NOT FOR SALE FUND (CALIFORNIA NON-PROFIT CORPORATION), AKA NOT FOR SALE CAMPAIGN
270 CAPISTRANO RD., SUITE 2
SAN FRANCISCO, CA 94019

FOR: ADVERTISING, PROMOTION AND MARKETING SERVICES BASED ON CONSUMER CREDIT REPORTS AND SCORES OF OTHERS; COMMERCIAL EVALUATION AND RATING OF CONSUMER GOODS FOR OTHERS PRIOR TO PURCHASE; COMMERCIAL INFORMATION AND ADVICE FOR CONSUMERS; CONSUMER RESEARCH; PROMOTING THE GOODS AND SERVICES OF OTHERS BY PROVIDING A WEBSITE FEATURING COUPONS, REBATES, PRICE-COMPARISON INFORMATION, PRODUCT REVIEWS, LINKS TO THE RETAIL WEBSITES OF OTHERS, AND DISCOUNT INFORMATION; PROVIDING A SEARCHABLE ONLINE ADVERTISING WEBSITE AND INFORMATIONAL GUIDE FEATURING THE GOODS AND SERVICES OF OTHER VENDORS VIA THE INTERNET IN THE FIELD OF LABOR ISSUES; PROVIDING A SEARCHABLE WEBSITE FEATURING THE GOODS AND SERVICES OF OTHER VENDORS; PROVIDING A WEBSITE FOR USERS WITH SPECIFIC INFORMED RECOMMENDATIONS OF SPECIFIC CONSUMER PRODUCTS AND SERVICES VALIDATED BY THE USERS' INPUTTED PREFERENCES AND SOCIAL NETWORK, IN CLASS 35 (U.S. CLS. 100, 101 AND 102).

FIRST USE 2-24-2009; IN COMMERCE 2-24-2009.

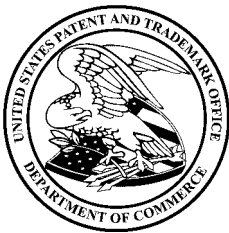

THE MARK CONSISTS OF THE TERM "FREE2WORK", WITH "FREE" AND "WORK" IN BLACK AND "2" IN ORANGE, BETWEEN TWO BLACK BAR CODES. THE COLOR WHITE REPRESENTS BACKGROUND AND/OR TRANSPARENT AREAS AND IS NOT PART OF THE MARK.

THE COLOR(S) ORANGE AND BLACK IS/ARE CLAIMED AS A FEATURE OF THE MARK.

SER. NO. 85-159,171, FILED 10-22-2010.

SALLY SHIH, EXAMINING ATTORNEY

David J. Kyros

Director of the United States Patent and Trademark Office

United States of America

United States Patent and Trademark Office



MASS SYNCHRONIZATION

Reg. No. 4,065,824

Registered Dec. 6, 2011

Int. Cl.: 16

TRADEMARK

PRINCIPAL REGISTER

LEO PAPER BAGS MANUFACTURING (1982) LIMITED (HONG KONG LIMITED LIABILITY COMPANY)
LEVEL 36, TOWER 1
ENTERPRISE SQ. (MEGABOX) 38 WANG CHIU RD
KOWLOON BAY, KOWLOON, HONG KONG 00000

FOR: PUBLICATIONS, NAMELY, BOOKS, HAND-OUTS, WORKBOOKS IN THE FIELD OF CHILDREN EDUCATION; EMBROIDERY DESIGN PATTERNS PRINTED ON PAPER; GREETING CARDS; ALMANACS ; MUSICAL GREETING CARDS; COMIC BOOKS, IN CLASS 16 (U.S. CLS. 2, 5, 22, 23, 29, 37, 38 AND 50).

FIRST USE 6-10-2010; IN COMMERCE 6-10-2010.

NO CLAIM IS MADE TO THE EXCLUSIVE RIGHT TO USE "MASS SYNCHRONIZATION", APART FROM THE MARK AS SHOWN.

THE MARK CONSISTS OF THE WORD "QUP" WITH A TRIANGLE UNDER THE LETTER "U" AND THE WORDS "MASS SYNCHRONIZATION" UNDERNEATH.

SER. NO. 85-159,175, FILED 10-22-2010.

RONALD MCMORROW, EXAMINING ATTORNEY



David J. Kyffers

Director of the United States Patent and Trademark Office

United States of America

United States Patent and Trademark Office

SEMEDICA

Reg. No. 4,065,825

Registered Dec. 6, 2011

Int. Cls.: 35 and 42

SERVICE MARK

PRINCIPAL REGISTER

SILVERCHAIR SCIENCE + COMMUNICATIONS INC. (VIRGINIA CORPORATION)
310 E. MAIN STREET
CHARLOTTESVILLE, VA 22902

FOR: BUSINESS CONSULTING SERVICES, NAMELY, PROVIDING KNOWLEDGE MANAGEMENT SERVICES INCORPORATING TAXONOMY AND ONTOLOGY DEVELOPMENT AND MAINTENANCE, AND CLASSIFICATION, CATEGORIZATION, AND TAGGING OF CONTENT, IN CLASS 35 (U.S. CLS. 100, 101 AND 102).

FIRST USE 12-2-2008; IN COMMERCE 12-2-2008.

FOR: COMPUTER CONSULTING SERVICES IN THE FIELD OF SEARCH ENGINE OPTIMIZATION; WEB SITE DESIGN AND SOFTWARE DEVELOPMENT AND CUSTOMIZATION, IN CLASS 42 (U.S. CLS. 100 AND 101).

FIRST USE 12-2-2008; IN COMMERCE 12-2-2008.

THE MARK CONSISTS OF STANDARD CHARACTERS WITHOUT CLAIM TO ANY PARTICULAR FONT, STYLE, SIZE, OR COLOR.

SER. NO. 85-159,328, FILED 10-22-2010.

REBECCA SMITH, EXAMINING ATTORNEY



David J. Kyros

Director of the United States Patent and Trademark Office

United States of America

United States Patent and Trademark Office

MOISTURE GUIDE

Reg. No. 4,065,826

Registered Dec. 6, 2011

Int. Cl.: 1

TRADEMARK

PRINCIPAL REGISTER

HEB GROCERY COMPANY, LP (TEXAS LIMITED PARTNERSHIP)
CORPORATE LAW DEPARTMENT
646 SOUTH MAIN
SAN ANTONIO, TX 78204

FOR: POTTING SOIL, IN CLASS 1 (U.S. CLS. 1, 5, 6, 10, 26 AND 46).

FIRST USE 3-0-2011; IN COMMERCE 3-0-2011.

THE MARK CONSISTS OF STANDARD CHARACTERS WITHOUT CLAIM TO ANY PARTICULAR FONT, STYLE, SIZE, OR COLOR.

NO CLAIM IS MADE TO THE EXCLUSIVE RIGHT TO USE "MOISTURE", APART FROM THE MARK AS SHOWN.

SER. NO. 85-159,350, FILED 10-22-2010.

WILLIAM VERHOSEK, EXAMINING ATTORNEY



David J. Kybas

Director of the United States Patent and Trademark Office

United States of America

United States Patent and Trademark Office

NOBODY BEATS

Reg. No. 4,065,827

INTERMEDIA AUTOMOTIVE ADVERTISING INC. (LOUISIANA CORPORATION)
9422 MYRTLE CREEK LN #812
ORLANDO, FL 32832

Registered Dec. 6, 2011

Int. Cl.: 35

FOR: PRODUCTION AND DISTRIBUTION OF RADIO AND TELEVISION COMMERCIALS,
IN CLASS 35 (U.S. CLS. 100, 101 AND 102).

SERVICE MARK

FIRST USE 1-11-2006; IN COMMERCE 1-11-2006.

PRINCIPAL REGISTER

THE MARK CONSISTS OF STANDARD CHARACTERS WITHOUT CLAIM TO ANY PAR-
TICULAR FONT, STYLE, SIZE, OR COLOR.

SER. NO. 85-159,507, FILED 10-22-2010.

ELLEN B. AWRICH, EXAMINING ATTORNEY



David J. Kyros

Director of the United States Patent and Trademark Office

United States of America

United States Patent and Trademark Office

MANOUSH

Reg. No. 4,065,828

Registered Dec. 6, 2011

Int. Cl.: 18

TRADEMARK

PRINCIPAL REGISTER

ASIA ADVERTISING LIMITED (HONG KONG CORPORATION)
2506 CHINA INSURANCE GROUP BUILDING
141 DES VOEUX ROAD
HONG KONG, HONG KONG

FOR: LEATHER AND IMITATIONS OF LEATHER, AND GOODS MADE OF THESE MATERIALS AND NOT INCLUDED IN OTHER CLASSES, NAMELY, BRIEFCASES, WALLETS, LEATHER LEASHES, LEATHER PET COLLARS, PURSES, LUGGAGE TAGS; HANDBAGS; SATCHELS; CARRY-ALL BAGS, CARRY-ON BAGS; SHOULDER BAGS; BELT BAGS, HIPSACKS; WRIST MOUNTED CARRYALL BAGS; CLUTCH PURSES; EVENING BAGS; RUCKSACKS, BACKPACKS; SHOPPING BAGS MADE OF LEATHER, CANVAS, TEXTILE, MESH AND CLOTH; WHEELED SHOPPING BAGS; GARMENT BAGS FOR TRAVEL; TRAVELLING SETS, NAMELY, SUITCASES, OVERNIGHT BAGS, AND LUGGAGE OF LEATHER; VANITY CASES SOLD EMPTY; SUIT BAGS; BEACH BAGS; GYM BAGS; SPORTS BAGS; BAGS FOR CLIMBERS IN THE NATURE OF ALL-PURPOSE CARRYING BAGS; BAGS FOR CAMPERS IN THE NATURE OF ALL-PURPOSE CARRYING BAGS; SCHOOL BAGS; BRIEFCASES; WALLETS; CREDIT-CARD HOLDERS; CHANGE PURSES; TRUNKS; TRAVEL BAGS; UMBRELLAS; PARASOLS; LEATHER LEADS; WHIPS, IN CLASS 18 (U.S. CLS. 1, 2, 3, 22 AND 41).

THE MARK CONSISTS OF STANDARD CHARACTERS WITHOUT CLAIM TO ANY PARTICULAR FONT, STYLE, SIZE, OR COLOR.

PRIORITY CLAIMED UNDER SEC. 44(D) ON ERPN CMNTY TM OFC APPLICATION NO. 9270026, FILED 7-23-2010.

OWNER OF HONG KONG REG. NO. 301690425, DATED 8-16-2010, EXPIRES 8-16-2020.

OWNER OF U.S. REG. NOS. 2,851,630 AND 3,747,791.

THE WORDING "MANOUSH" HAS NO MEANING IN A FOREIGN LANGUAGE.

SER. NO. 85-159,513, FILED 10-22-2010.

JAMES A. RAUEN, EXAMINING ATTORNEY



David J. Kyros

Director of the United States Patent and Trademark Office

United States of America
United States Patent and Trademark Office

ovenly

Reg. No. 4,065,829

Registered Dec. 6, 2011

Int. Cls.: 30 and 35

TRADEMARK

SERVICE MARK

PRINCIPAL REGISTER

OVENLY, LLC (NEW YORK LIMITED LIABILITY COMPANY)
#2R
114 NEWELL STREET
BROOKLYN, NY 11222

FOR: BAKERY GOODS; BREAD AND BUNS; BUTTER BISCUITS; CAKES; COOKIES;
DOUGHNUTS; MUFFINS; PASTRIES; PIES; SCONES; TARTS, IN CLASS 30 (U.S. CL. 46).

FIRST USE 10-15-2009; IN COMMERCE 10-15-2009.

FOR: RETAIL BAKERY SHOPS, IN CLASS 35 (U.S. CLS. 100, 101 AND 102).

FIRST USE 10-15-2009; IN COMMERCE 10-15-2009.

THE MARK CONSISTS OF THE WORD "OVEN", THE LETTER "L" REPRESENTED BY A
ROLLING PIN, AND THE LETTER "Y".

SER. NO. 85-159,570, FILED 10-22-2010.

WON TEAK OH, EXAMINING ATTORNEY



David J. Kybas

Director of the United States Patent and Trademark Office

United States of America

United States Patent and Trademark Office

Ovenly

Reg. No. 4,065,830

Registered Dec. 6, 2011

Int. Cls.: 30 and 35

TRADEMARK

SERVICE MARK

PRINCIPAL REGISTER

OVENLY, LLC (NEW YORK LIMITED LIABILITY COMPANY)
114 NEWELL STREET
BROOKLYN, NY 11222

FOR: BAKERY GOODS; BREAD AND BUNS; BUTTER BISCUITS; CAKES; COOKIES;
DOUGHNUTS; MUFFINS; PASTRIES; PIES; SCONES; TARTS, IN CLASS 30 (U.S. CL. 46).

FIRST USE 10-15-2009; IN COMMERCE 10-15-2009.

FOR: RETAIL BAKERY SHOPS, IN CLASS 35 (U.S. CLS. 100, 101 AND 102).

FIRST USE 10-15-2009; IN COMMERCE 10-15-2009.

THE MARK CONSISTS OF STANDARD CHARACTERS WITHOUT CLAIM TO ANY PARTICULAR FONT, STYLE, SIZE, OR COLOR.

SER. NO. 85-159,572, FILED 10-22-2010.

WON TEAK OH, EXAMINING ATTORNEY



David J. Kyros

Director of the United States Patent and Trademark Office

United States of America

United States Patent and Trademark Office



Reg. No. 4,065,831

Registered Dec. 6, 2011

Int. Cl.: 35

SERVICE MARK

PRINCIPAL REGISTER

CHECKWAITTIMES LLC (VIRGINIA LIMITED LIABILITY COMPANY)
5 DRUM CT.
STAFFORD, VA 22554

FOR: PROVIDING A WEB SITE FEATURING CONSUMER INFORMATION IN THE FIELD OF WAIT TIMES AT AUTO REPAIR SHOPS AND RESTAURANTS, IN CLASS 35 (U.S. CLS. 100, 101 AND 102).

FIRST USE 11-11-2009; IN COMMERCE 5-1-2010.

NO CLAIM IS MADE TO THE EXCLUSIVE RIGHT TO USE "CHECK WAIT TIMES.COM", APART FROM THE MARK AS SHOWN.

THE COLOR(S) GRAY, SILVER, WHITE, RED AND BLACK IS/ARE CLAIMED AS A FEATURE OF THE MARK.

THE MARK CONSISTS OF A GRAYISH/SILVER AND WHITE CLOCK FACE WITH BLACK HOUR AND MINUTE HANDS AND THE WORDS "CHECK WAIT TIMES" IN BLACK FOLLOWING THE CIRCUMFERENCE OF THE CLOCK AND THREE PEOPLE WAITING IN LINE OUTSIDE OF A WHITE DOOR TO THE LEFT OF THE CLOCK, WITH THE PERSON ON THE LEFT RED IN COLOR AND THE OTHER TWO PERSONS BLACK IN COLOR, AND THE WORDING ".COM" IN BLACK TO THE RIGHT OF THE CLOCK.

SER. NO. 85-159,630, FILED 10-22-2010.

MICHAEL ENGEL, EXAMINING ATTORNEY



David J. Kybas

Director of the United States Patent and Trademark Office

United States of America

United States Patent and Trademark Office

PIXIE PEARS

Reg. No. 4,065,832

Registered Dec. 6, 2011

Int. Cl.: 31

TRADEMARK

PRINCIPAL REGISTER

ALL STATE PACKERS, INC. (CALIFORNIA CORPORATION)
PO BOX 350
LODI, CA 95241

FOR: FRESH, RAW AND UNPROCESSED PEARS, IN CLASS 31 (U.S. CLS. 1 AND 46).

FIRST USE 9-0-2010; IN COMMERCE 9-0-2010.

THE MARK CONSISTS OF STANDARD CHARACTERS WITHOUT CLAIM TO ANY PARTICULAR FONT, STYLE, SIZE, OR COLOR.

NO CLAIM IS MADE TO THE EXCLUSIVE RIGHT TO USE "PEARS", APART FROM THE MARK AS SHOWN.

SER. NO. 85-160,404, FILED 10-25-2010.

APRIL ROACH, EXAMINING ATTORNEY



David J. Kyffers

Director of the United States Patent and Trademark Office

United States of America

United States Patent and Trademark Office

IMPERIAL GROUP

Reg. No. 4,065,833

Registered Dec. 6, 2011

Int. Cl.: 40

SERVICE MARK

PRINCIPAL REGISTER

IMPERIAL GROUP, L.P. (DELAWARE LIMITED PARTNERSHIP)
160 KIRBY ROAD
PORTLAND, TN 37148

FOR: METAL FABRICATING, STAMPING, CHROME PLATING AND ASSEMBLY SERVICES,
ALL IN THE HEAVY TRUCK AND BUS FIELD, IN CLASS 40 (U.S. CLS. 100, 103 AND 106).

FIRST USE 5-0-1997; IN COMMERCE 5-0-1997.

THE MARK CONSISTS OF STANDARD CHARACTERS WITHOUT CLAIM TO ANY PAR-
TICULAR FONT, STYLE, SIZE, OR COLOR.

NO CLAIM IS MADE TO THE EXCLUSIVE RIGHT TO USE "GROUP", APART FROM THE
MARK AS SHOWN.

SER. NO. 85-160,465, FILED 10-25-2010.

APRIL ROACH, EXAMINING ATTORNEY



David J. Kybas

Director of the United States Patent and Trademark Office

United States of America

United States Patent and Trademark Office



Reg. No. 4,065,834

Registered Dec. 6, 2011

Int. Cl.: 40

SERVICE MARK

PRINCIPAL REGISTER

IMPERIAL GROUP, L.P. (DELAWARE LIMITED PARTNERSHIP)
160 KIRBY ROAD
PORTLAND, TN 37148

FOR: METAL FABRICATING, STAMPING, CHROME PLATING AND ASSEMBLY SERVICES,
ALL IN THE HEAVY TRUCK AND BUS FIELD, IN CLASS 40 (U.S. CLS. 100, 103 AND 106).

FIRST USE 5-0-1997; IN COMMERCE 5-0-1997.

NO CLAIM IS MADE TO THE EXCLUSIVE RIGHT TO USE "GROUP", APART FROM THE
MARK AS SHOWN.

THE MARK CONSISTS OF A CIRCLE WITH DIAGONAL LINES DIVIDING THE CIRCLE
AND A STYLIZED DEPICTION OF THE WORDS "IMPERIAL GROUP".

SER. NO. 85-160,473, FILED 10-25-2010.

APRIL ROACH, EXAMINING ATTORNEY



David J. Kyfos

Director of the United States Patent and Trademark Office

United States of America

United States Patent and Trademark Office

Hair Essence

Reg. No. 4,065,835

Registered Dec. 6, 2011

Int. Cl.: 26

TRADEMARK

PRINCIPAL REGISTER

CHADE FASHIONS, INC. (ILLINOIS CORPORATION)
6400 W. GROSS POINT RD.
NILES, IL 60714

FOR: HAIRWARE, NAMELY, WIGS, HAIRPIECES, AND ADD-IN AND ADD-ON HAIR ACCESSORIES CONSTRUCTED PRIMARILY OF SYNTHETIC AND/OR HUMAN HAIR; WIG CAPS; TAPE FOR FIXING WIGS, IN CLASS 26 (U.S. CLS. 37, 39, 40, 42 AND 50).

FIRST USE 3-1-2000; IN COMMERCE 3-1-2000.

THE MARK CONSISTS OF STANDARD CHARACTERS WITHOUT CLAIM TO ANY PARTICULAR FONT, STYLE, SIZE, OR COLOR.

NO CLAIM IS MADE TO THE EXCLUSIVE RIGHT TO USE "HAIR", APART FROM THE MARK AS SHOWN.

SER. NO. 85-160,697, FILED 10-25-2010.

JIM RINGLE, EXAMINING ATTORNEY



David J. Kyffers

Director of the United States Patent and Trademark Office

United States of America

United States Patent and Trademark Office



Reg. No. 4,065,836

Registered Dec. 6, 2011

Int. Cl.: 43

SERVICE MARK

PRINCIPAL REGISTER

STICK IT TO ME LLC (COLORADO LIMITED LIABILITY COMPANY), DBA STICK IT TO ME
P.O. BOX 18685
DENVER, CO 80218

FOR: PROVIDING OF FOOD AND DRINK; PROVIDING OF FOOD AND DRINK VIA A MOBILE TRUCK; PROVISION OF FOOD AND DRINK IN RESTAURANTS, IN CLASS 43 (U.S. CLS. 100 AND 101).

FIRST USE 10-20-2010; IN COMMERCE 10-20-2010.

NO CLAIM IS MADE TO THE EXCLUSIVE RIGHT TO USE "FINE CUISINE ON A STICK", APART FROM THE MARK AS SHOWN.

THE COLOR(S) BLACK, RED ORANGE, AND TEAL GREY IS/ARE CLAIMED AS A FEATURE OF THE MARK.

THE MARK CONSISTS OF A BLACK STICK FIGURE HOLDING A STICK WITH STYLIZED FOOD ON IT BOTH BLACK AND RED ORANGE. THE CHARACTERS "STICK" AND "ME" ARE RED ORANGE AND CAPITALIZED. "FINE CUISINE ON A STICK" IS TEAL GREY BELOW "STICK IT TO ME". THE MARK CONSISTS OF BLACK FOR THE PHRASE "IT TO" AND BLACK BRUSH STROKES ABOVE AND BELOW THE WORDS "STICK IT TO ME".

SER. NO. 85-160,782, FILED 10-25-2010.

FLORENTINA BLANDU, EXAMINING ATTORNEY



David J. Kybas

Director of the United States Patent and Trademark Office

United States of America

United States Patent and Trademark Office

YLANTHIA

Reg. No. 4,065,837

Registered Dec. 6, 2011

Int. Cls.: 1, 5 and 42

TRADEMARK

SERVICE MARK

PRINCIPAL REGISTER

MORPHOSYS AG (FED REP GERMANY CORPORATION)
LENA-CHRIST-STRASSE 48
MARTINSRIED-PLANEGER, FED REP GERMANY 82152

FOR: CHEMICAL, BIOCHEMICAL, BIOLOGICAL, AND BIOTECHNOLOGICAL PREPARATIONS, NAMELY, ANTIBODIES AND FRAGMENTS OF ANTIBODIES FOR USE IN THE DEVELOPMENT OR MANUFACTURE OF IMMUNOLOGICAL REAGENTS FOR INDUSTRIAL AND SCIENTIFIC USE; BIOLOGICAL PREPARATIONS, NAMELY, ANTIBODIES AND FRAGMENTS OF ANTIBODIES FOR LABORATORIES, DIAGNOSTICS AND ANALYTICS FOR SCIENTIFIC OR RESEARCH USE, IN CLASS 1 (U.S. CLS. 1, 5, 6, 10, 26 AND 46).

FOR: DIAGNOSTIC PHARMACEUTICAL PREPARATIONS, NAMELY, ANTIBODIES AND FRAGMENTS OF ANTIBODIES FOR LABORATORIES, DIAGNOSTICS, AND ANALYTICS FOR HUMAN AND VETERINARY MEDICAL DIAGNOSTIC USE; PHARMACEUTICAL AND VETERINARY PREPARATIONS AND SUBSTANCES, NAMELY, ANTIBODIES AND FRAGMENTS OF ANTIBODIES FOR THE TREATMENT OF METABOLIC DISORDERS, INFECTIOUS DISEASES, CANCER, INFLAMMATORY DISEASES, ALZHEIMER, SEPSIS, AND RESTENOSIS, IN CLASS 5 (U.S. CLS. 6, 18, 44, 46, 51 AND 52).

FOR: SCIENTIFIC, BIOLOGICAL AND MEDICAL RESEARCH SERVICES, IN PARTICULAR IN THE FIELDS OF DEVELOPMENT AND MANUFACTURE OF IMMUNOLOGICAL REAGENTS, ANTIBODIES AND RESEARCH UNDER CONTRACT; LABORATORY RESEARCH IN THE FIELD OF ANALYTICAL CHEMISTRY, BIOCHEMISTRY, MEDICINAL CHEMISTRY, DRUG DEVELOPMENT, BIOTECHNOLOGY, MICROBIOLOGY AND MOLECULAR BIOLOGY; CHEMICAL, BIOCHEMICAL AND BIOTECHNOLOGICAL ANALYSIS AND RESEARCH SERVICES, IN CLASS 42 (U.S. CLS. 100 AND 101).

THE MARK CONSISTS OF STANDARD CHARACTERS WITHOUT CLAIM TO ANY PARTICULAR FONT, STYLE, SIZE, OR COLOR.

OWNER OF ERPN CMNTY TM OFC REG. NO. 009287327, DATED 1-17-2011, EXPIRES 8-2-2020.

SER. NO. 85-161,037, FILED 10-26-2010.

ANNE E. GUSTASON, EXAMINING ATTORNEY



David J. Kyjars

Director of the United States Patent and Trademark Office

United States of America

United States Patent and Trademark Office



Reg. No. 4,065,838

Registered Dec. 6, 2011

Int. Cl.: 44

SERVICE MARK

PRINCIPAL REGISTER

AMOREPACIFIC CORPORATION (REPUBLIC OF KOREA CORPORATION)
181, 2GA, HANGANG-RO, YONGSAN-GU
SEOUL, REPUBLIC OF KOREA 140-777

FOR: MASSAGE; TATTOOING; BEAUTY SALONS; BEAUTY CONSULTANCY; MANICURING; COSMETIC CONSULTANCY; SPA SERVICES, IN CLASS 44 (U.S. CLS. 100 AND 101).

OWNER OF REPUBLIC OF KOREA REG. NO. 41-0197011, DATED 5-14-2010, EXPIRES 5-14-2020.

THE COLOR(S) PINK AND BLACK IS/ARE CLAIMED AS A FEATURE OF THE MARK.

THE NON-LATIN CHARACTERS IN THE MARK TRANSLITERATE TO ARITAUM AND THIS MEANS "BEAUTY OR CHARM" IN ENGLISH.

OWNER OF U.S. REG. NOS. 3,371,381, 3,387,374, AND 3,518,804.

THE MARK CONSISTS OF A PINK-COLORED SQUARE DESIGN HAVING ROUNDED CORNERS AND A BLACK BORDER; AND THE WORD "ARITAUM" AND A KOREAN WORD WHICH TRANSLITERATES TO "ARITAUM" IN BLACK.

SER. NO. 85-161,283, FILED 10-26-2010.

MIDGE BUTLER, EXAMINING ATTORNEY



David J. Kybas

Director of the United States Patent and Trademark Office

United States of America

United States Patent and Trademark Office

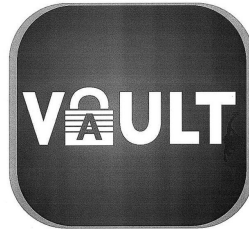

Reg. No. 4,065,839
Registered Dec. 6, 2011
Int. Cls.: 9 and 42

MASTER LOCK COMPANY LLC (DELAWARE LIMITED LIABILITY COMPANY)
P.O. BOX 927
137 W. FOREST HILL AVENUE
OAK CREEK, WI 53154

TRADEMARK

FOR: COMPUTER APPLICATION SOFTWARE FOR MOBILE PHONES, PERSONAL COMPUTERS, AND INTERNET WEBSITES, NAMELY, SOFTWARE FOR USE IN ELECTRONIC STORAGE AND SECURITY OF PERSONAL DATA, IN CLASS 9 (U.S. CLS. 21, 23, 26, 36 AND 38).

SERVICE MARK

FIRST USE 9-27-2010; IN COMMERCE 9-27-2010.

PRINCIPAL REGISTER

FOR: APPLICATION SERVICE PROVIDER FEATURING A SOFTWARE APPLICATION FOR USE IN ELECTRONIC STORAGE AND SECURITY OF PERSONAL DATA, IN CLASS 42 (U.S. CLS. 100 AND 101).

FIRST USE 9-16-2010; IN COMMERCE 9-16-2010.

THE MARK CONSISTS OF THE WORD "VAULT", WITH THE LETTER "A" APPEARING IN THE CENTER OF A PADLOCK, ALL SUPERIMPOSED ON A SQUARE WITH A SINGLE BORDER AND ROUNDED CORNERS.

SER. NO. 85-161,495, FILED 10-26-2010.

LIEF MARTIN, EXAMINING ATTORNEY



David J. Kybas

Director of the United States Patent and Trademark Office

United States of America

United States Patent and Trademark Office

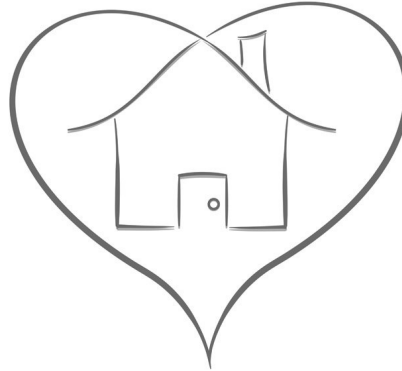

Reg. No. 4,065,840

Registered Dec. 6, 2011

Int. Cl.: 45

SERVICE MARK

PRINCIPAL REGISTER

1 LINK 4 SENIOR CARE, INC. (NEW JERSEY CORPORATION)
P.O. BOX 30
GLENDDORA, NJ 08029

FOR: CONSULTING SERVICES CONCERNING IDENTIFICATION OF FACILITIES, RESOURCES, AND SERVICE OPTIONS AVAILABLE TO INDIVIDUALS AND FAMILIES IN CONNECTION WITH THE CARE FOR THE ELDERLY AND FOR DISABLED ADULTS, NAMELY, CONSULTATION IN THE FIELD OF IN-HOME SUPPORT SERVICES TO SENIOR PERSONS AND MENTALLY OR PHYSICALLY CHALLENGED ADULT PERSONS, NAMELY, CARE MANAGEMENT SERVICES IN THE NATURE OF THE COORDINATION OF NECESSARY SERVICES AND PERSONAL CARE ASSISTANCE OF ACTIVITIES OF DAILY LIVING, SUCH AS BATHING, GROOMING AND PERSONAL MOBILITY FOR SENIOR PERSONS AND MENTALLY OR PHYSICALLY CHALLENGED ADULTS; AND THE COORDINATION OF SUCH CARE AND SERVICE OPTIONS, NAMELY, CASE MANAGEMENT SERVICES, NAMELY, COORDINATION OF LEGAL, SOCIAL AND PSYCHOLOGICAL SERVICES FOR ELDERLY PERSONS AND DISABLED PERSONS, IN CLASS 45 (U.S. CLS. 100 AND 101).

FIRST USE 10-1-2007; IN COMMERCE 10-1-2007.

THE MARK CONSISTS OF A STYLIZED REPRESENTATION OF A HEART BORDERING A STYLIZED REPRESENTATION OF A DWELLING, WITH THE TOP CENTER INTERSECTION OF THE HEART BEING EXTENDED TO FORM THE ROOF OF THE DWELLING.

SER. NO. 85-161,577, FILED 10-26-2010.

ROBERT STRUCK, EXAMINING ATTORNEY



David J. Kybas

Director of the United States Patent and Trademark Office

United States of America

United States Patent and Trademark Office

FOCUS2READ

Reg. No. 4,065,841

Registered Dec. 6, 2011

Int. Cl.: 41

SERVICE MARK

PRINCIPAL REGISTER

BRIGHT FUTURES LEARNING, INC. (SOUTH CAROLINA CORPORATION)
PO BOX 13929
FLORENCE, SC 29504

FOR: EDUCATIONAL SERVICES, NAMELY, ACADEMIC TUTORING SERVICES IN THE FIELD OF READING MATCHED TO CUSTOMER NEEDS AND DELIVERED BY TRAINED PROFESSIONAL TUTORS AT THE PRE-K THROUGH GRADE 12 LEVELS, AND THE DISTRIBUTION OF TRAINING COURSE MATERIALS PROVIDED IN CONNECTION THEREWITH, IN CLASS 41 (U.S. CLS. 100, 101 AND 107).

FIRST USE 11-1-2010; IN COMMERCE 11-1-2010.

THE MARK CONSISTS OF STANDARD CHARACTERS WITHOUT CLAIM TO ANY PARTICULAR FONT, STYLE, SIZE, OR COLOR.

OWNER OF U.S. REG. NO. 3,470,038.

SER. NO. 85-161,621, FILED 10-26-2010.

STEVEN R. FINE, EXAMINING ATTORNEY



David J. Kyffers

Director of the United States Patent and Trademark Office

United States of America

United States Patent and Trademark Office

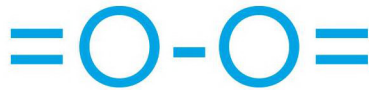

Reg. No. 4,065,842

Registered Dec. 6, 2011

Int. Cls.: 5, 9 and 10

TRADEMARK

PRINCIPAL REGISTER

ADLENS LIMITED (UNITED KINGDOM LIMITED COMPANY (LTD.))
OLD SCHOOL, FIRST TURN
OXFORD, OXFORDSHIRE, UNITED KINGDOM OX28AH

FOR: EYE DROPS, PHARMACEUTICAL COMPOUND EYE DROPS; EYE WASH; EYE LOTIONS FOR MEDICAL USE; EYE MOISTURISERS FOR MEDICAL USE; EYE OINTMENT FOR MEDICAL USE; MEDICATED PREPARATIONS FOR THE TREATMENT OF EYE DISEASES AND CONDITIONS; MEDICATED PREPARATIONS FOR THE TREATMENT OF DRY EYES; EYEGLOSS LENS CLEANING SOLUTION; PREPARATIONS FOR THE TREATMENT OF EYE DISEASES; SOLUTIONS OR PREPARATIONS FOR USE WITH OR IN EYEGASSES; TOPICAL ANTI-INFECTIVE SUBSTANCES FOR THE TREATMENT OF INFECTIONS OF THE EYE; VITAMIN PREPARATIONS FOR USE AS NUTRITIONAL AIDS FOR EYESIGHT, IN CLASS 5 (U.S. CLS. 6, 18, 44, 46, 51 AND 52).

FOR: OPTICAL GOODS, APPARATUS AND INSTRUMENTS, NAMELY, EYEWEAR, PRESCRIPTION EYEWEAR; EYEGASSES, PRESCRIPTION EYEGASSES, EYEGLOSS FRAMES, EYEGLOSS LENSES, CORRECTIVE LENSES; PROTECTIVE EYEWEAR, EYEGASSES ADAPTED TO PROTECT THE EYES, EYEGASSES HAVING FILTERING LENSES, EYEGASSES WITH PARTIAL VISION OCCLUSION, EYE PROTECTION WEAR FOR SPORTS, EYEGLOSS SHIELDS, INDUSTRIAL AND MILITARY SAFETY EYE PROTECTION ARTICLES, NAMELY, GOGGLES FOR THE PROTECTION OF THE EYES, PROTECTION MASKS FOR PROTECTION AGAINST TOXIC, NOXIOUS OR HARMFUL SUBSTANCES OR MATERIAL; EYEGLOSS CASES, CONTAINERS AND HOLDERS, EYEGLOSS CHAINS, CORDS AND RETAINING STRAPS; EYEPIECES AND INSTRUMENTS CONTAINING EYEPIECES; EYE SHADES AND PRESCRIPTION EYE SHADES, NAMELY, SUNGLASSES, PRESCRIPTION EYE SHADES, IN CLASS 9 (U.S. CLS. 21, 23, 26, 36 AND 38).

FOR: SURGICAL AND MEDICAL APPARATUS AND INSTRUMENTS, NAMELY, EYE PROTECTORS FOR POST-SURGERY EYE PROTECTION; EYE GLASSES FOR POST SURGERY VISION CORRECTION; ARTIFICIAL EYES; LENSES FOR SURGICAL IMPLANTATIONS; OPHTHALMOMETERS AND OPHTHALMOSCOPES, IN CLASS 10 (U.S. CLS. 26, 39 AND 44).

PRIORITY CLAIMED UNDER SEC. 44(D) ON ERPN CMNTY TM OFC APPLICATION NO. 009461451, FILED 10-20-2010, REG. NO. 009461451, DATED 4-12-2011, EXPIRES 10-20-2020.

THE COLOR(S) BLUE IS/ARE CLAIMED AS A FEATURE OF THE MARK.



David J. Kyjars

Director of the United States Patent and Trademark Office

Reg. No. 4,065,842 THE MARK CONSISTS OF THE SYMBOLS AND LETTERS ARRANGED AS "=O-O=" IN THE COLOR BLUE FORMING A STYLIZED PAIR OF EYEGLASSES.

SER. NO. 85-161,770, FILED 10-26-2010.

REBECCA SMITH, EXAMINING ATTORNEY

United States of America

United States Patent and Trademark Office



Instant Chai Premix

Reg. No. 4,065,843

Registered Dec. 6, 2011

Int. Cl.: 30

TRADEMARK

PRINCIPAL REGISTER

KHIANI, VEENA (UNITED STATES INDIVIDUAL)
3120 SPRING HILL LN.
PLANO, TX 75025

FOR: COFFEE AND TEA, IN CLASS 30 (U.S. CL. 46).

FIRST USE 6-1-2003; IN COMMERCE 6-1-2003.

NO CLAIM IS MADE TO THE EXCLUSIVE RIGHT TO USE "INSTANT CHAI PREMIX",
APART FROM THE MARK AS SHOWN.

THE MARK CONSISTS OF THE WORD "KOHINOOR" INSIDE OF CONCENTRIC OVALS
AND APPEARING OVER THE WORDING "INSTANT CHAI PREMIX".

THE ENGLISH TRANSLATION OF "KOHINOOR" IN THE MARK IS "MOUNTAIN OF LIGHT".

SER. NO. 85-161,881, FILED 10-26-2010.

RICHARD WHITE, EXAMINING ATTORNEY



David J. Kybas

Director of the United States Patent and Trademark Office

United States of America

United States Patent and Trademark Office

Cookies for all

Reg. No. 4,065,844

Registered Dec. 6, 2011

Int. Cl.: 35

SERVICE MARK

PRINCIPAL REGISTER

STRANGE MATTER VENTURES LLC (DELAWARE LIMITED LIABILITY COMPANY)
187 LAFAYETTE ST FL 5
NEW YORK, NY 10013

FOR: ADVERTISING AND MARKETING; ADVERTISING SERVICES, PUBLIC RELATIONS AND MARKETING SERVICES, NAMELY, PROMOTING AND MARKETING THE GOODS AND SERVICES OF OTHERS THROUGH ALL PUBLIC COMMUNICATION MEANS; CUSTOMER LOYALTY SERVICES AND CUSTOMER CLUB SERVICES, FOR COMMERCIAL, PROMOTIONAL AND/OR ADVERTISING PURPOSES; ON-LINE RETAIL STORE SERVICES FEATURING A WIDE VARIETY OF CONSUMER GOODS OF OTHERS, IN CLASS 35 (U.S. CLS. 100, 101 AND 102).

FIRST USE 9-15-2006; IN COMMERCE 3-15-2007.

THE MARK CONSISTS OF STANDARD CHARACTERS WITHOUT CLAIM TO ANY PARTICULAR FONT, STYLE, SIZE, OR COLOR.

SER. NO. 85-161,933, FILED 10-26-2010.

STEVEN JACKSON, EXAMINING ATTORNEY



David J. Kyros

Director of the United States Patent and Trademark Office

United States of America

United States Patent and Trademark Office

COPPA+ Guardian Watch

Reg. No. 4,065,845

Registered Dec. 6, 2011

Int. Cls.: 41, 42 and 45

SERVICE MARK

PRINCIPAL REGISTER

ALLPLAYERS.COM, INC (TEXAS CORPORATION)
SUITE 1525
600 E. LAS COLINAS BLVD
IRVING, TX 75039

FOR: ENTERTAINMENT SERVICES, NAMELY, PROVIDING RECREATIONAL ACTIVITIES DESIGNED FOR IMPROVING TALENT, SHOWING RELEVANT SKILLS, AND GAINING PEER FEEDBACK IN THE FORM OF PROVIDING SPORTS EVENTS AND ACTIVITIES, NAMELY, BASEBALL, SOFTBALL, T-BALL, VOLLEYBALL, FOOTBALL, FLAG FOOTBALL, BIKING, SOCCER, SWIMMING, TENNIS, PILATES, YOGA, GOLF, DANCE, BOXING, BADMINTON, AND BASKETBALL, DISCUSSION GROUPS, BOOK CLUBS, SHARED-INTEREST DISCUSSION GROUPS, AND PRIVATE TRAINING LESSONS IN THE FIELD OF TEAM SPORTS; PROVIDING A WEBSITE FEATURING INFORMATION ON SPORTS AND SHARED-INTEREST GROUPS IN THE NATURE OF FEEDBACK FROM PEERS AND OTHER MEMBERS OF A VIRTUAL COMMUNITY, NAMELY, PARENTS, ATHLETES, COACHES, AND TEACHERS, IN CLASS 41 (U.S. CLS. 100, 101 AND 107).

FIRST USE 11-3-2009; IN COMMERCE 11-3-2009.

FOR: COMPUTER SERVICES, NAMELY, CREATING A SAFE, ON-LINE COMMUNITY FOR REGISTERED USERS TO PARTICIPATE IN ACTIVITIES, EVENTS, AND COMPETITIONS, SHOWCASE THEIR SKILLS, GET FEEDBACK FROM THEIR PEERS, FORM VIRTUAL COMMUNITIES, ENGAGE IN SOCIAL NETWORKING, AND IMPROVE THEIR TALENT, IN CLASS 42 (U.S. CLS. 100 AND 101).

FIRST USE 11-3-2009; IN COMMERCE 11-3-2009.

FOR: ONLINE SOCIAL NETWORKING SERVICES PROVIDED THROUGH A COMMUNITY WEBSITE FOR REGISTERED USERS, IN CLASS 45 (U.S. CLS. 100 AND 101).

FIRST USE 11-3-2009; IN COMMERCE 11-3-2009.

THE MARK CONSISTS OF STANDARD CHARACTERS WITHOUT CLAIM TO ANY PARTICULAR FONT, STYLE, SIZE, OR COLOR.

SER. NO. 85-162,033, FILED 10-27-2010.



David J. Kyjars

Director of the United States Patent and Trademark Office

Reg. No. 4,065,845 ALYSSA STEEL, EXAMINING ATTORNEY

United States of America

United States Patent and Trademark Office

A SMARTER WAY TO COMMUNICATE

Reg. No. 4,065,846

Registered Dec. 6, 2011

Int. Cl.: 35

SERVICE MARK

PRINCIPAL REGISTER

PRESORT SERVICES, INC. (MICHIGAN CORPORATION)
4908 CONTEC DRIVE
LANSING, MI 48910

FOR: BUSINESS MANAGEMENT SERVICES, NAMELY, MANAGING MARKETING AND FINANCIAL COMMUNICATIONS CHANNELS BY PROCESSING THE MAIL OF OTHERS, MANAGEMENT AND PROCESSING OF DATA FOR OTHERS, MANAGING THE ELECTRONIC BUSINESS INVOICES AND STATEMENTS OF OTHERS, IN CLASS 35 (U.S. CLS. 100, 101 AND 102).

FIRST USE 4-20-2010; IN COMMERCE 4-20-2010.

THE MARK CONSISTS OF STANDARD CHARACTERS WITHOUT CLAIM TO ANY PARTICULAR FONT, STYLE, SIZE, OR COLOR.

SER. NO. 85-162,046, FILED 10-27-2010.

REGINA DRUMMOND, EXAMINING ATTORNEY



David J. Kybas

Director of the United States Patent and Trademark Office

United States of America
United States Patent and Trademark Office

buggyguard

Reg. No. 4,065,847

ANNETTE ATTERIDGE (UNITED STATES INDIVIDUAL)
1218 MERLOT DR
PALM BEACH GARDENS, FL 33410

Registered Dec. 6, 2011

Int. Cl.: 6

FOR: METAL LOCKS FOR SECURING WHEELED VEHICLES, NAMELY, STROLLERS, IN CLASS 6 (U.S. CLS. 2, 12, 13, 14, 23, 25 AND 50).

TRADEMARK

FIRST USE 7-10-2009; IN COMMERCE 10-10-2009.

PRINCIPAL REGISTER

THE MARK CONSISTS OF THE LOWERCASE LETTERS "BUGGYGUARD" WITH THE LETTER "A" REPLACED BY A PADLOCK WITH A KEYHOLE.

SER. NO. 85-162,288, FILED 10-27-2010.

ANDREW RHIM, EXAMINING ATTORNEY



David J. Kybas

Director of the United States Patent and Trademark Office

United States of America

United States Patent and Trademark Office



Reg. No. 4,065,848

Registered Dec. 6, 2011

Int. Cls.: 35 and 41

SERVICE MARK

PRINCIPAL REGISTER

BROADREACH INSTITUTE FOR TRAINING & EDUCATION (DELAWARE CORPORATION)
2500 WILSON BOULEVARD, SUITE 220
ARLINGTON, VA 22201

FOR: PROMOTING COLLABORATION WITHIN THE SCIENTIFIC, RESEARCH AND MEDICAL COMMUNITIES TO ACHIEVE ADVANCES IN THE FIELD OF HEALTHCARE AND HEALTHCARE MANAGEMENT, IN CLASS 35 (U.S. CLS. 100, 101 AND 102).

FIRST USE 2-5-2010; IN COMMERCE 2-5-2010.

FOR: EDUCATION AND TRAINING SERVICES, NAMELY, DEVELOPING, ARRANGING AND CONDUCTING CUSTOMIZED PROGRAMS FOR HEALTHCARE PROFESSIONALS IN THE FIELDS OF LEADERSHIP AND TECHNICAL AND CLINICAL DEVELOPMENT, PROVIDING TRAINING SERVICES, LECTURES AND MENTORING TO SUCH PROFESSIONALS IN THE FIELDS OF LEADERSHIP AND TECHNICAL AND CLINICAL DEVELOPMENT, IN CLASS 41 (U.S. CLS. 100, 101 AND 107).

FIRST USE 2-5-2010; IN COMMERCE 2-5-2010.

NO CLAIM IS MADE TO THE EXCLUSIVE RIGHT TO USE "INSTITUTE FOR TRAINING & EDUCATION", APART FROM THE MARK AS SHOWN.

THE MARK CONSISTS OF THE WORD "BRITE" WITH A CURVED LINE ABOVE THE LETTERS "RITE" ABOVE A HORIZONTAL LINE WITH THE WORDS "THE BROADREACH INSTITUTE FOR TRAINING & EDUCATION" BELOW THE HORIZONTAL LINE.

SER. NO. 85-162,834, FILED 10-27-2010.

RONALD MCMORROW, EXAMINING ATTORNEY



David J. Kybas

Director of the United States Patent and Trademark Office

United States of America

United States Patent and Trademark Office



Reg. No. 4,065,849

Registered Dec. 6, 2011

Int. Cl.: 38

SERVICE MARK

PRINCIPAL REGISTER

ROOT WIRELESS, INC. (WASHINGTON CORPORATION)
SUITE 300
11000 NE 33RD PLACE
BELLEVUE, WA 98004

FOR: TELECOMMUNICATIONS BENCHMARKING SERVICES, NAMELY, PROVIDING WIRELESS TELECOMMUNICATIONS INFORMATION RELATING TO NETWORK COVERAGE, IN CLASS 38 (U.S. CLS. 100, 101 AND 104).

FIRST USE 8-31-2010; IN COMMERCE 8-31-2010.

NO CLAIM IS MADE TO THE EXCLUSIVE RIGHT TO USE "METRICS", APART FROM THE MARK AS SHOWN.

THE MARK CONSISTS OF THE "ROOT METRICS" WORD DESIGN WITH "ROOT" DIRECTLY ABOVE "METRICS" AND AN 8-DOT DESIGN TO THE LEFT OF BOTH WORDS.

SER. NO. 85-163,086, FILED 10-27-2010.

MARK SPARACINO, EXAMINING ATTORNEY



David J. Kybas

Director of the United States Patent and Trademark Office

United States of America

United States Patent and Trademark Office



Reg. No. 4,065,850

Registered Dec. 6, 2011

Int. Cl.: 38

SERVICE MARK

PRINCIPAL REGISTER

ROOT WIRELESS, INC. (WASHINGTON CORPORATION)
11000 NE 33RD PLACE BELLEVUE SUITE 300
BELLEVUE, WA 98004

FOR: TELECOMMUNICATIONS BENCHMARKING SERVICES, NAMELY, PROVIDING WIRELESS TELECOMMUNICATIONS INFORMATION RELATING TO NETWORK COVERAGE, IN CLASS 38 (U.S. CLS. 100, 101 AND 104).

FIRST USE 7-30-2010; IN COMMERCE 7-30-2010.

NO CLAIM IS MADE TO THE EXCLUSIVE RIGHT TO USE "METRICS", APART FROM THE MARK AS SHOWN.

THE MARK CONSISTS OF "ROOT METRICS" HORIZONTAL DESIGN WITH DOTS DESIGN TO THE LEFT.

SER. NO. 85-163,099, FILED 10-27-2010.

MARK SPARACINO, EXAMINING ATTORNEY



David J. Kybas

Director of the United States Patent and Trademark Office

United States of America

United States Patent and Trademark Office

PANACHE DESAI

Reg. No. 4,065,851

DESAI, PANACHE (UNITED STATES INDIVIDUAL)
447 1ST AVE N
NAPLES, FL 34102

Registered Dec. 6, 2011

Int. Cl.: 41

FOR: EDUCATION AND ENTERTAINMENT SERVICES, NAMELY, CONDUCTING WORKSHOPS, RETREATS, SEMINARS, LECTURES, WEBINARS, TELECONFERENCES AND CONFERENCES IN THE FIELDS OF SPIRITUALITY, PERSONAL EMPOWERMENT, AND DIVINE ALCHEMY, IN CLASS 41 (U.S. CLS. 100, 101 AND 107).

SERVICE MARK

PRINCIPAL REGISTER

FIRST USE 9-1-2008; IN COMMERCE 9-1-2008.

THE MARK CONSISTS OF STANDARD CHARACTERS WITHOUT CLAIM TO ANY PARTICULAR FONT, STYLE, SIZE, OR COLOR.

THE NAME(S), PORTRAIT(S), AND/OR SIGNATURE(S) SHOWN IN THE MARK IDENTIFIES "PANACHE DESAI", WHOSE CONSENT(S) TO REGISTER IS MADE OF RECORD.

SER. NO. 85-163,218, FILED 10-28-2010.

REBECCA EISINGER, EXAMINING ATTORNEY



David J. Kybas

Director of the United States Patent and Trademark Office

United States of America

United States Patent and Trademark Office

STUDENTS SPEAK OUT

Reg. No. 4,065,852

Registered Dec. 6, 2011

Int. Cl.: 41

SERVICE MARK

PRINCIPAL REGISTER

CITIZENS LEAGUE (MINNESOTA NON-PROFIT CORPORATION)
555 NORTH WABASHA STREET
SUITE 240
ST. PAUL, MN 55102

FOR: EDUCATIONAL SERVICES, NAMELY, CONDUCTING PROGRAMS AND WORKSHOPS IN THE FIELDS OF EDUCATION, CITIZENSHIP, AND CIVIC ISSUES AND PROVIDING WRITTEN EDUCATIONAL MATERIALS IN CONNECTION THEREWITH; RESEARCH IN THE FIELDS OF EDUCATION, CITIZENSHIP, AND CIVIC ISSUES, IN CLASS 41 (U.S. CLS. 100, 101 AND 107).

FIRST USE 4-17-2007; IN COMMERCE 4-17-2007.

THE MARK CONSISTS OF STANDARD CHARACTERS WITHOUT CLAIM TO ANY PARTICULAR FONT, STYLE, SIZE, OR COLOR.

NO CLAIM IS MADE TO THE EXCLUSIVE RIGHT TO USE "STUDENTS", APART FROM THE MARK AS SHOWN.

SER. NO. 85-163,283, FILED 10-28-2010.

TOBY BULLOFF, EXAMINING ATTORNEY



David J. Kyffers

Director of the United States Patent and Trademark Office

United States of America

United States Patent and Trademark Office

STUDENTS SPEAK OUT

Reg. No. 4,065,853

Registered Dec. 6, 2011

Int. Cl.: 42

SERVICE MARK

PRINCIPAL REGISTER

CITIZENS LEAGUE (MINNESOTA NON-PROFIT CORPORATION)
555 NORTH WABASHA STREET
SUITE 240
ST. PAUL, MN 55102

FOR: PROVIDING ONLINE NON-DOWNLOADABLE SOFTWARE SERVICES, NAMELY, A PLATFORM FOR USERS TO COLLABORATE IN DISCUSSIONS AND PROBLEM-SOLVING OF ISSUES IN THE FIELDS OF EDUCATION, CITIZENSHIP, AND CIVICS; DEVELOPMENT OF A CUSTOMIZED SOFTWARE PLATFORM FOR OTHERS FOR USERS TO COLLABORATE IN DISCUSSIONS AND PROBLEM-SOLVING OF ISSUES IN THE FIELDS OF EDUCATION, CITIZENSHIP, AND CIVICS; COMPUTER SERVICES, NAMELY, CREATING AN ON-LINE COMMUNITY FOR REGISTERED USERS TO PARTICIPATE IN DISCUSSIONS, GET FEEDBACK FROM THEIR PEERS, FORM VIRTUAL COMMUNITIES, AND ENGAGE IN SOCIAL NETWORKING, IN CLASS 42 (U.S. CLS. 100 AND 101).

FIRST USE 4-17-2007; IN COMMERCE 4-17-2007.

THE MARK CONSISTS OF STANDARD CHARACTERS WITHOUT CLAIM TO ANY PARTICULAR FONT, STYLE, SIZE, OR COLOR.

NO CLAIM IS MADE TO THE EXCLUSIVE RIGHT TO USE "STUDENTS", APART FROM THE MARK AS SHOWN.

SER. NO. 85-163,284, FILED 10-28-2010.

TOBY BULLOFF, EXAMINING ATTORNEY



David J. Kybas

Director of the United States Patent and Trademark Office

United States of America

United States Patent and Trademark Office

NATIONAL HUMAN SERVICES ASSEMBLY

Reg. No. 4,065,854

Registered Dec. 6, 2011

Int. Cls.: 16 and 35

TRADEMARK

SERVICE MARK

PRINCIPAL REGISTER

NATIONAL HUMAN SERVICES ASSEMBLY (NEW YORK NON-PROFIT CORPORATION)
1319 F STREET, N.W., SUITE 601
WASHINGTON, DC 20004

FOR: PRINTED PUBLICATIONS, NAMELY, BROCHURES AND STUDIES IN THE NATURE OF RESEARCH REPORTS PERTAINING TO HEALTH, HUMAN SERVICES, FAMILY, YOUTH, COMMUNITY, AND SOCIAL ISSUES, IN CLASS 16 (U.S. CLS. 2, 5, 22, 23, 29, 37, 38 AND 50).

FIRST USE 0-0-2005; IN COMMERCE 0-0-2005.

FOR: ASSOCIATION SERVICES, NAMELY, PROMOTING THE INTERESTS OF ORGANIZATIONS IN THE HEALTH, HUMAN, FAMILY, YOUTH, AND COMMUNITY DEVELOPMENT FIELDS; PROVIDING INFORMATION AND RESEARCH IN THE FIELD OF GOVERNMENT AFFAIRS AND POLITICAL ISSUES AS THEY RELATE TO HEALTH, HUMAN AND COMMUNITY DEVELOPMENT, HUMAN SERVICES, FAMILIES AND YOUTH; PUBLIC POLICY RESEARCH SERVICES; GOVERNMENT RELATIONS CONSULTANCY SERVICES; LOBBYING SERVICES, NAMELY, PROMOTING THE INTERESTS OF FAMILIES AND YOUTH IN THE FIELDS OF LEGISLATION AND REGULATION; PROMOTING PUBLIC AWARENESS OF FAMILY, YOUTH AND SOCIAL ISSUES, INDIVIDUAL AND PROFESSIONAL DEVELOPMENT AND THE IMPORTANCE OF THE NONPROFIT HEALTH AND HUMAN SERVICES, IN CLASS 35 (U.S. CLS. 100, 101 AND 102).

FIRST USE 0-0-2005; IN COMMERCE 0-0-2005.

THE MARK CONSISTS OF STANDARD CHARACTERS WITHOUT CLAIM TO ANY PARTICULAR FONT, STYLE, SIZE, OR COLOR.

NO CLAIM IS MADE TO THE EXCLUSIVE RIGHT TO USE "HUMAN SERVICES", APART FROM THE MARK AS SHOWN.

SEC. 2(F).

SER. NO. 85-163,437, FILED 10-28-2010.

JOHN GARTNER, EXAMINING ATTORNEY



David J. Kyros

Director of the United States Patent and Trademark Office

United States of America

United States Patent and Trademark Office

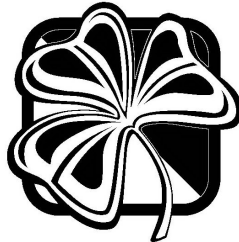

Irish
Bundles

Reg. No. 4,065,855

Registered Dec. 6, 2011

Int. Cl.: 25

TRADEMARK

PRINCIPAL REGISTER

TOLAND, MARY KATHRYN (UNITED STATES INDIVIDUAL)
39071 N. JACKSON DR
SPRING GROVE, IL 60081

FOR: BABY BIBS NOT OF PAPER; BABY BODYSUITS; JACKETS; PULLOVERS; ROMPERS;
SHIRTS, IN CLASS 25 (U.S. CLS. 22 AND 39).

FIRST USE 8-1-1993; IN COMMERCE 8-1-1993.

NO CLAIM IS MADE TO THE EXCLUSIVE RIGHT TO USE "IRISH", APART FROM THE
MARK AS SHOWN.

THE MARK CONSISTS OF A SHAMROCK ON TOP OF A SQUARE WITH THE STYLIZED
TEXT "IRISH BUNDLES".

SER. NO. 85-163,488, FILED 10-28-2010.

ROSELLE HERRERA, EXAMINING ATTORNEY



David J. Kybas

Director of the United States Patent and Trademark Office

United States of America

United States Patent and Trademark Office

surveyDIG

Reg. No. 4,065,856

RUNNER TECHNOLOGIES, INC. (FLORIDA CORPORATION)
6530 WEST ROGERS CIRCLE, STE. 31
BOCA RATON, FL 33487

Registered Dec. 6, 2011

Int. Cl.: 9

FOR: COMPUTER SOFTWARE FOR CONDUCTING WEB-ENABLED, PAPERLESS SURVEYS AND EVALUATIONS, IN CLASS 9 (U.S. CLS. 21, 23, 26, 36 AND 38).

TRADEMARK

FIRST USE 3-15-2006; IN COMMERCE 3-15-2006.

PRINCIPAL REGISTER

THE MARK CONSISTS OF STANDARD CHARACTERS WITHOUT CLAIM TO ANY PARTICULAR FONT, STYLE, SIZE, OR COLOR.

SER. NO. 85-163,549, FILED 10-28-2010.

LIEF MARTIN, EXAMINING ATTORNEY



David J. Kybas

Director of the United States Patent and Trademark Office

United States of America

United States Patent and Trademark Office

COVARIO

Reg. No. 4,065,857

Registered Dec. 6, 2011

Int. Cl.: 35

SERVICE MARK

PRINCIPAL REGISTER

COVARIO, INC. (DELAWARE CORPORATION)
3611 VALLEY CENTRE DRIVE, SUITE 500
SAN DIEGO, CA 92130

FOR: CONSULTING SERVICES FOR INTERNET MARKETING, ONLINE ADVERTISING AND MARKETING SERVICES, DISPLAY ADVERTISING, AND ADVERTISING VIA SOCIAL AND BROADCAST MEDIA, IN CLASS 35 (U.S. CLS. 100, 101 AND 102).

FIRST USE 5-17-2008; IN COMMERCE 5-17-2008.

THE MARK CONSISTS OF STANDARD CHARACTERS WITHOUT CLAIM TO ANY PARTICULAR FONT, STYLE, SIZE, OR COLOR.

THE WORD(S) "COVARIO" HAS NO MEANING IN A FOREIGN LANGUAGE.

SER. NO. 85-164,235, FILED 10-28-2010.

JULIE WATSON, EXAMINING ATTORNEY



David J. Kyffers

Director of the United States Patent and Trademark Office

United States of America

United States Patent and Trademark Office

COVARIO

Reg. No. 4,065,858

Registered Dec. 6, 2011

Int. Cl.: 42

SERVICE MARK

PRINCIPAL REGISTER

COVARIO, INC. (DELAWARE CORPORATION)
3611 VALLEY CENTRE DRIVE, SUITE 500
SAN DIEGO, CA 92130

FOR: CONSULTING SERVICES FOR INFORMATION TECHNOLOGY; PROVIDING AN APPLICATION SERVICES PROVIDER (ASP) FEATURING SOFTWARE FOR PROVIDING MARKETING AND ANALYSIS DATA AND INFORMATION; PROVIDING AN APPLICATION SERVICES PROVIDER (ASP) FEATURING SOFTWARE FOR PROVIDING ADVERTISING, SOCIAL AND BROADCAST MEDIA; APPLICATION SERVICE PROVIDER (ASP) FEATURING SOFTWARE FOR ANALYZING THE DATA GENERATED BY WEB LOGS, SEARCH ENGINES, AND THIRD PARTY PACKAGES TO DETERMINE EFFECTIVENESS OF INTERNET MARKETING PROGRAMS, DISPLAY ADVERTISING, AND SOCIAL AND BROADCAST MEDIA, ALL IN THE FIELD OF ONLINE AND DIGITAL MARKETING AUTOMATION ANALYTICS; COMPUTER SERVICES, NAMELY, MONITORING, TESTING, ANALYZING, AND REPORTING ON THE INTERNET TRAFFIC CONTROL AND CONTENT OF WEB SITES OF OTHERS, NAMELY, SEARCH ENGINE RESULTS OF OTHERS; EXPERT INTEGRATION OF COMPUTER SYSTEMS AND NETWORKS FOR USE IN CUSTOMER RELATIONSHIP MANAGEMENT AND DATA WAREHOUSE APPLICATIONS, IN CLASS 42 (U.S. CLS. 100 AND 101).

FIRST USE 5-17-2008; IN COMMERCE 5-17-2008.

THE MARK CONSISTS OF STANDARD CHARACTERS WITHOUT CLAIM TO ANY PARTICULAR FONT, STYLE, SIZE, OR COLOR.

THE WORD(S) "COVARIO" HAS NO MEANING IN A FOREIGN LANGUAGE.

SER. NO. 85-164,242, FILED 10-28-2010.

JULIE WATSON, EXAMINING ATTORNEY



David J. Kyros

Director of the United States Patent and Trademark Office

United States of America

United States Patent and Trademark Office

VALPARAISO UNIVERSITY

Reg. No. 4,065,859

Registered Dec. 6, 2011

**Int. Cls.: 12, 16, 18, 20,
21, 25, 35 and 41**

TRADEMARK

SERVICE MARK

PRINCIPAL REGISTER

THE LUTHERAN UNIVERSITY ASSOCIATION, INC. (INDIANA NON-PROFIT CORPORATION)
1700 CHAPEL DRIVE
VALPARAISO, IL 46383

FOR: LICENSE PLATE FRAMES, IN CLASS 12 (U.S. CLS. 19, 21, 23, 31, 35 AND 44).

FIRST USE 9-0-1994; IN COMMERCE 9-0-1994.

FOR: NEWSPAPERS, BOOKS, BROCHURES AND PAMPHLETS CONCERNING UNIVERSITY ADMISSIONS, ALUMNI ACTIVITIES AND GENERAL UNIVERSITY INFORMATION; STATIONERY; PRINTED INVITATIONS; POSTERS; NOTEBOOKS; NOTEPADS, IN CLASS 16 (U.S. CLS. 2, 5, 22, 23, 29, 37, 38 AND 50).

FIRST USE 0-0-1906; IN COMMERCE 0-0-1906.

FOR: TOTE BAGS; BACKPACKS; BRIEFCASE-TYPE LEATHER PORTFOLIOS; LEATHER KEY CHAINS; WALLETS; PURSES; UMBRELLAS, IN CLASS 18 (U.S. CLS. 1, 2, 3, 22 AND 41).

FIRST USE 9-0-1991; IN COMMERCE 9-0-1991.

FOR: PICTURE FRAMES, IN CLASS 20 (U.S. CLS. 2, 13, 22, 25, 32 AND 50).

FIRST USE 1-0-1996; IN COMMERCE 1-0-1996.

FOR: MUGS; CUPS; DRINKING GLASSWARE, IN CLASS 21 (U.S. CLS. 2, 13, 23, 29, 30, 33, 40 AND 50).

FIRST USE 1-0-1996; IN COMMERCE 1-0-1996.

FOR: CLOTHING AND ACCESSORIES, NAMELY, T-SHIRTS, HATS, SWEATSHIRTS, SHIRTS, SWEAT PANTS, SHORTS, TIES, FOOTWEAR AND BELTS, IN CLASS 25 (U.S. CLS. 22 AND 39).

FIRST USE 0-0-1961; IN COMMERCE 0-0-1961.



David J. Kyjars

Director of the United States Patent and Trademark Office

Reg. No. 4,065,859 FOR: ASSOCIATION SERVICES, NAMELY, PROMOTING THE INTERESTS OF UNIVERSITY ALUMNI, IN CLASS 35 (U.S. CLS. 100, 101 AND 102).

FIRST USE 8-0-1906; IN COMMERCE 8-0-1906.

FOR: EDUCATIONAL SERVICES, NAMELY, PROVIDING INSTRUCTION AT THE UNIVERSITY LEVEL; EDUCATIONAL RESEARCH; ARRANGING AND CONDUCTING EDUCATIONAL CONFERENCES; ENTERTAINMENT SERVICES IN THE NATURE OF CONDUCTING COLLEGIATE SPORTING EVENTS; PROVIDING FACILITIES FOR RECREATIONAL ACTIVITIES, NAMELY, ATHLETIC TRAINING, BASEBALL, BASKETBALL, BOWLING, CROSS COUNTRY, FOOTBALL, GOLF, RECREATIONAL SPORTS, SOCCER, SOFTBALL, STRENGTH AND CONDITIONING, SWIMMING AND DIVING, TENNIS, TRACK AND FIELD, AND VOLLEYBALL; ARRANGING AND CONDUCTING ARTISTIC PERFORMANCES AND CULTURAL EVENTS; PROVIDING ONLINE INFORMATION CONCERNING UNIVERSITY ADMISSIONS, ALUMNI ACTIVITIES AND GENERAL UNIVERSITY INFORMATION; BOOK AND JOURNAL PUBLISHING, IN CLASS 41 (U.S. CLS. 100, 101 AND 107).

FIRST USE 0-0-1906; IN COMMERCE 0-0-1906.

THE MARK CONSISTS OF STANDARD CHARACTERS WITHOUT CLAIM TO ANY PARTICULAR FONT, STYLE, SIZE, OR COLOR.

OWNER OF U.S. REG. NOS. 1,680,309 AND 1,682,897.

NO CLAIM IS MADE TO THE EXCLUSIVE RIGHT TO USE "UNIVERSITY", APART FROM THE MARK AS SHOWN.

SEC. 2(F).

SER. NO. 85-164,481, FILED 10-29-2010.

WON TEAK OH, EXAMINING ATTORNEY

United States of America

United States Patent and Trademark Office

I AM STEEL I AM STANDING I AM STEEL STANDING

Reg. No. 4,065,860

Registered Dec. 6, 2011

Int. Cl.: 25

TRADEMARK

PRINCIPAL REGISTER

KMT ENTERPRISES LLC (NEW YORK LIMITED LIABILITY COMPANY), DBA KMT
ENTERPRISES LLC
245 WEST 123RD ST.
NEW YORK, NY 10027

FOR: APPAREL FOR DANCERS, NAMELY, TEE SHIRTS, SWEATSHIRTS, PANTS, LEGGINGS, SHORTS AND JACKETS; ATHLETIC APPAREL, NAMELY, SHIRTS, PANTS, JACKETS, FOOTWEAR, HATS AND CAPS, ATHLETIC UNIFORMS; ATHLETIC SHOES; BASEBALL CAPS AND HATS; BATH SLIPPERS; BATHING SUITS; BATHING SUITS FOR MEN; BATHING TRUNKS; BLOUSES; BODY SUITS; BOOTS; BRIEFS; BUTTON DOWN SHIRTS; CARGO PANTS; CLOTHING FOR BABIES, TODDLERS AND CHILDREN, TREATED WITH FIRE AND HEAT RETARDANTS, NAMELY, PAJAMAS, JACKETS, SHIRTS, PANTS, JUMPERS; COATS FOR MEN AND WOMEN; COATS MADE OF COTTON; COATS OF DENIM; COLLARED SHIRTS; DENIM JACKETS; DRESS PANTS; DRESS SHIRTS; DRESS SUITS; DRESSES; DRESSES MADE FROM SKINS; DRESSES THAT MAY ALSO BE USED AS TOWELS; DRESSING GOWNS; EVENING DRESSES; FOOTWEAR, NAMELY, WORK BOOTS; FUR COATS AND JACKETS; GLOVES AS CLOTHING; GLOVES FOR APPAREL; GLOVES INCLUDING THOSE MADE OF SKIN, HIDE OR FUR; GOLF PANTS, SHIRTS AND SKIRTS; HAT BANDS; HATS; HATS FOR INFANTS, BABIES, TODDLERS AND CHILDREN; HEAD SCARVES; HEAVY COATS; HEAVY JACKETS; HIKING BOOTS; HOODED SWEAT SHIRTS; HUNTING JACKETS; HUNTING PANTS; HUNTING SHIRTS; INFANTS' SHOES AND BOOTS; JACKETS AND SOCKS; JOGGING PANTS; JOGGING SUITS; LEATHER JACKETS; LEATHER PANTS; LEATHER SHIRTS; LEATHER SHOES; LEISURE SHOES; LEISURE SUITS; LIGHT-REFLECTING COATS; LIGHT-REFLECTING JACKETS; LONG-SLEEVED SHIRTS; MEN'S AND WOMEN'S JACKETS, COATS, TROUSERS, VESTS; MEN'S SOCKS; MEN'S SUITS; MEN'S SUITS, WOMEN'S SUITS; MEN'S UNDERWEAR; MOCK TURTLE-NECK SWEATERS; MOTORCYCLE GLOVES; MOTORCYCLE JACKETS; MOTORCYCLE RAIN SUITS; MOTORCYCLIST BOOTS; MOUNTAINEERING BOOTS; OUTDOOR GLOVES; OUTER JACKETS; OVER COATS; OVER SHIRTS; PANTS; POLO SHIRTS; RAIN BOOTS; RAIN COATS; RAIN HATS; RAIN JACKETS; RAIN SUITS; RAINPROOF JACKETS; REVERSIBLE JACKETS; RIDING BOOTS; RIDING COATS; RIDING GLOVES; RIDING SHOES; ROBES; RUBBER SHOES; RUGBY SHIRTS; RUGBY SHOES; RUNNING SHOES; RUNNING SUITS; SHIRTS; SHIRTS AND SHORT-SLEEVED SHIRTS; SHOES; SHORT-SLEEVED SHIRTS; SILK SCARVES; SNEAKERS; SOCKS; SOCKS AND STOCKINGS; SPORTS SHIRTS; SUITS; SUITS OF LEATHER; SWEAT JACKETS; SWEAT PANTS; SWEAT SHIRTS; SWEAT SUITS; SWEATERS; SWIM SUITS; T-SHIRTS; TEE SHIRTS; THERMAL SOCKS; THERMAL UNDERWEAR; TURTLE NECK SHIRTS; TURTLENECK SWEATERS;



David J. Kybas

Director of the United States Patent and Trademark Office

Reg. No. 4,065,860 UNDERWEAR; UNDERWEAR, NAMELY, BOY SHORTS; V-NECK SWEATERS; WATER PROOF BOOTS; WATER REPELLING BOOTS; WATER REPELLING LEATHER BOOTS; WATER REPELLING LEATHER SHOES AND BOOTS; WATER SOCKS; WATERPROOF LEATHER BOOTS; WATERPROOF LEATHER SHOES; WATERPROOF LEATHER SHOES AND BOOTS; WEARABLE GARMENTS AND CLOTHING, NAMELY, SHIRTS; WIND COATS; WIND PANTS; WIND RESISTANT JACKETS; WIND SHIRTS; WIND-JACKETS; WINTER BOOTS; WOMEN'S HATS AND HOODS; WOMEN'S SHOES; WOMEN'S UNDERWEAR; WORK SHOES AND BOOTS, IN CLASS 25 (U.S. CLS. 22 AND 39).

FIRST USE 9-13-2001; IN COMMERCE 9-13-2001.

THE MARK CONSISTS OF STANDARD CHARACTERS WITHOUT CLAIM TO ANY PARTICULAR FONT, STYLE, SIZE, OR COLOR.

OWNER OF U.S. REG. NOS. 2,649,252 AND 3,893,175.

SER. NO. 85-164,627, FILED 10-29-2010.

BILL DAWE, EXAMINING ATTORNEY

United States of America

United States Patent and Trademark Office

HONORING THE SPIRIT OF COURAGE STRENGTH RESILIENCE AND REBIRTH

Reg. No. 4,065,861

Registered Dec. 6, 2011

Int. Cl.: 25

TRADEMARK

PRINCIPAL REGISTER

KMT ENTERPRISES LLC (NEW YORK LIMITED LIABILITY COMPANY), DBA KMT
ENTERPRISES LLC
245 WEST 123RD ST.
NEW YORK, NY 10027

FOR: ATHLETIC APPAREL, NAMELY, SHIRTS, PANTS, JACKETS, FOOTWEAR, HATS AND CAPS, ATHLETIC UNIFORMS; ATHLETIC SHOES; BASEBALL CAPS AND HATS; BASEBALL SHOES; BASKETBALL SNEAKERS; BATHING SUITS; BATHING SUITS FOR MEN; BATHING TRUNKS; BICYCLE GLOVES; BLOUSES; BOMBER JACKETS; BOOTS FOR MOTORCYCLING; BOOTS FOR SPORT; BOXING SHOES; BRIEFS; BUTTON DOWN SHIRTS; CAMOUFLAGE GLOVES; CAMOUFLAGE JACKETS; CAMOUFLAGE PANTS; CAMOUFLAGE SHIRTS; CAMP SHIRTS; CANVAS SHOES; CARGO PANTS; CLIMBING BOOTS; CLIMBING SHOES; CLOTHING FOR BABIES, TODDLERS AND CHILDREN, TREATED WITH FIRE AND HEAT RETARDANTS, NAMELY, PAJAMAS, JACKETS, SHIRTS, PANTS, JUMPERS; COATS; COATS FOR MEN AND WOMEN; COATS MADE OF COTTON; COATS OF DENIM; COLLARED SHIRTS; CREW NECK SWEATERS; DENIM JACKETS; DENIMS; DOWN JACKETS; DOWN SUITS; DRESS PANTS; DRESS SHIRTS; DRESSES; DRESSES MADE FROM SKINS; EVENING DRESSES; FISHERMEN'S JACKETS; FISHING SHIRTS; FITTED SHOE OR BOOT COVERING TO PROTECT THE SHOES OR BOOT FROM WATER OR OTHER DAMAGE; FOOTWEAR, NAMELY, WORK BOOTS; FUR COATS AND JACKETS; FUR JACKETS; GLOVES; GLOVES AS CLOTHING; GLOVES FOR APPAREL; GLOVES INCLUDING THOSE MADE OF SKIN, HIDE OR FUR; GOLF SHIRTS; GOLF SHOES; GYM BOOTS; GYM PANTS; GYM SUITS; HATS; HATS FOR INFANTS, BABIES, TODDLERS AND CHILDREN; HEAD SCARVES; HEAVY COATS; HEAVY JACKETS; HIKING BOOTS; HOODED SWEAT SHIRTS; HUNTING BOOT BAGS; HUNTING JACKETS; HUNTING PANTS; HUNTING SHIRTS; INFANTS' SHOES AND BOOTS; JACKET LINERS; JACKETS; JACKETS AND SOCKS; KNIT JACKETS; KNIT SHIRTS; KNITTED GLOVES; LACE BOOTS; LADIES' BOOTS; LADIES' UNDERWEAR; LEATHER COATS; LEATHER HATS; LEATHER JACKETS; LEATHER PANTS; LEATHER SHIRTS; LEATHER SHOES; LEISURE SHOES; LEISURE SUITS; LIGHT-REFLECTING COATS; LIGHT-REFLECTING JACKETS; LONG JACKETS; LONG UNDERWEAR; LONG-SLEEVED SHIRTS; MEN'S AND WOMEN'S JACKETS, COATS, TROUSERS, VESTS; MEN'S DRESS SOCKS; MEN'S SOCKS; MEN'S SUITS; MEN'S SUITS, WOMEN'S SUITS; MOTORCYCLE GLOVES; MOTORCYCLE JACKETS; MOTORCYCLE RAIN SUITS; MOUNTAINEERING BOOTS; MOUNTAINEERING SHOES; OUTDOOR GLOVES; OUTER JACKETS; OVER COATS; OVER SHIRTS; PANTS; POLO SHIRTS; RAIN BOOTS; RAIN COATS; RAIN HATS; RAIN JACKETS; RAIN SUITS; RAINPROOF JACKETS; REVERSIBLE JACKETS; RUBBER SHOES; RUGBY SHIRTS; RUNNING SHOES; RUNNING



David J. Kybas

Director of the United States Patent and Trademark Office

Reg. No. 4,065,861 SUITS; SANDALS; SCARVES; SHIRTS; SHIRTS AND SHORT-SLEEVED SHIRTS; SHOE COVERS FOR USE WHEN WEARING SHOES; SHOES; SHORT-SLEEVED OR LONG-SLEEVED T-SHIRTS; SHORT-SLEEVED SHIRTS; SHOULDER SCARVES; SILK SCARVES; SKI JACKETS; SKIRT SUITS; SKIRTS AND DRESSES; SOCKS; SOCKS AND STOCKINGS; SPORT COATS; SPORT SHIRTS; SPORTS CAPS AND HATS; SPORTS JACKETS; SPORTS PANTS; SPORTS SHIRTS; SPORTS SHIRTS WITH SHORT SLEEVES; SWEAT JACKETS; SWEAT PANTS; SWEAT SHIRTS; SWEAT SUITS; SWEATERS; SWIM SUITS; T-SHIRTS; TENNIS DRESSES; THERMAL SOCKS; THERMAL UNDERWEAR; TRACK AND FIELD SHOES; TRACK JACKETS; TRACK PANTS; TRACK SUITS; TRAINING SUITS; TRENCH COATS; TURTLE NECK SHIRTS; TURTLENECK SWEATERS; UNDERWEAR; UNDERWEAR, NAMELY, BOY SHORTS; V-NECK SWEATERS; WATER PROOF BOOTS; WATER REPELLING BOOTS; WATER REPELLING LEATHER BOOTS; WATER REPELLING LEATHER SHOES AND BOOTS; WATER SOCKS; WATERPROOF JACKETS AND PANTS; WATERPROOF LEATHER BOOTS; WATERPROOF LEATHER SHOES; WATERPROOF LEATHER SHOES AND BOOTS; WEARABLE GARMENTS AND CLOTHING, NAMELY, SHIRTS; WIND COATS; WIND PANTS; WIND RESISTANT JACKETS; WIND SHIRTS; WIND-JACKETS; WINTER BOOTS; WOMEN'S HATS AND HOODS; WOMEN'S SHOES; WOMEN'S UNDERWEAR; WORK SHOES AND BOOTS; WOVEN DRESSES; WOVEN OR KNITTED UNDERWEAR, IN CLASS 25 (U.S. CLS. 22 AND 39).

FIRST USE 11-22-2009; IN COMMERCE 11-22-2009.

THE MARK CONSISTS OF STANDARD CHARACTERS WITHOUT CLAIM TO ANY PARTICULAR FONT, STYLE, SIZE, OR COLOR.

SER. NO. 85-164,703, FILED 10-29-2010.

BILL DAWE, EXAMINING ATTORNEY

United States of America

United States Patent and Trademark Office

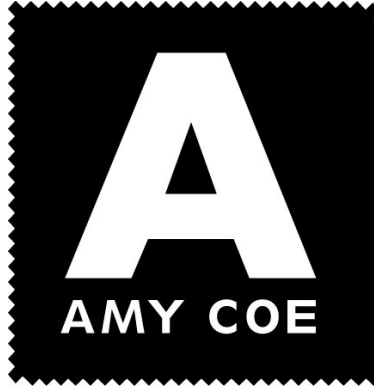

Reg. No. 4,065,862

Registered Dec. 6, 2011

Int. Cls.: 20, 24 and 35

TRADEMARK

SERVICE MARK

PRINCIPAL REGISTER

AMY COE, INC. (CONNECTICUT CORPORATION)
44 LONG LOTS ROAD
WESTPORT, CT 06880

FOR: BEDDING, NAMELY PILLOWS, IN CLASS 20 (U.S. CLS. 2, 13, 22, 25, 32 AND 50).

FIRST USE 1-21-1998; IN COMMERCE 1-21-1998.

FOR: BEDDING, NAMELY BED SHEETS, COMFORTERS, DUVETS AND CRIB BUMPERS;
HOODED TOWELS, IN CLASS 24 (U.S. CLS. 42 AND 50).

FIRST USE 1-21-1998; IN COMMERCE 1-21-1998.

FOR: RETAIL STORE AND ONLINE STORE SERVICES FEATURING A WIDE VARIETY
OF CONSUMER GOODS OF OTHERS, IN CLASS 35 (U.S. CLS. 100, 101 AND 102).

FIRST USE 2-3-2006; IN COMMERCE 2-3-2006.

THE NAME(S), PORTRAIT(S), AND/OR SIGNATURE(S) SHOWN IN THE MARK IDENTIFIES
"AMY COE", WHOSE CONSENT(S) TO REGISTER IS MADE OF RECORD.

THE MARK CONSISTS OF A LARGE CAPITAL LETTER "A" ABOVE THE WORDS "AMY
COE" IN CAPITAL LETTERS ALL WITHIN A SQUARE WITH SCALLOPED EDGES.

SER. NO. 85-164,709, FILED 10-29-2010.

MAYUR VAGHANI, EXAMINING ATTORNEY

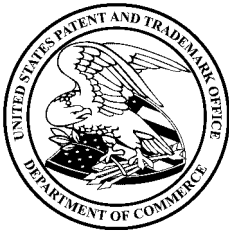

David J. Kybas

Director of the United States Patent and Trademark Office

United States of America

United States Patent and Trademark Office

DARCY

Reg. No. 4,065,863

Registered Dec. 6, 2011

Int. Cls.: 7, 37 and 42

TRADEMARK

SERVICE MARK

PRINCIPAL REGISTER

DARCY TECHNOLOGIES LIMITED (UNITED KINGDOM PRIVATE LIMITED COMPANY)
UNIT C1, SITE C SOUTH
KINTORE BUSINESS PARK
KINTORE, UNITED KINGDOM AB510YQ

FOR: TOOLS FOR USE IN OIL OR GAS WELLS, NAMELY, MACHINE TOOLS IN THE NATURE OF SAND CONTROL SCREENS, MACHINE TOOLS FOR CONTROLLING SAND INFLOW AND MACHINE TOOLS FOR WELL FORMATION STRESS CONTROL; MACHINES USED FOR THE DRILLING AND COMPLETION OF OIL AND GAS WELLS; APPARATUS AND EQUIPMENT USED FOR THE DRILLING AND COMPLETION OF OIL AND GAS WELLS, NAMELY, MACHINE TOOLS IN THE NATURE OF SAND CONTROL SCREENS, MACHINE TOOLS FOR CONTROLLING SAND INFLOW AND MACHINE TOOLS FOR WELL FORMATION STRESS CONTROL; DOWNHOLE TOOLS AND APPARATUS, NAMELY, MACHINE TOOLS IN THE NATURE OF SAND CONTROL SCREENS, MACHINE TOOLS FOR CONTROLLING SAND INFLOW AND MACHINE TOOLS FOR WELL FORMATION STRESS CONTROL, IN CLASS 7 (U.S. CLS. 13, 19, 21, 23, 31, 34 AND 35).

FOR: OIL AND GAS WELL DRILLING; WELL COMPLETION, NAMELY, SAND CONTROL AND INFLOW CONTROL COMPLETIONS TO CLEAR WELLS FOR DRILLING, WELL MAINTENANCE AND REMEDIAL SERVICES, NAMELY, SAND CONTROL AND INFLOW CONTROL COMPLETIONS TO CLEAR WELLS FOR DRILLING; RENTAL, REPAIR AND INSTALLATION OF TOOLS FOR USE IN THE CONSTRUCTION, OPERATION, REPAIR, MAINTENANCE AND INSPECTION OF OIL AND GAS WELLS, IN CLASS 37 (U.S. CLS. 100, 103 AND 106).

FOR: ENGINEERING RESEARCH AND DESIGN SERVICES FOR NEW PRODUCT DEVELOPMENT FOR USE WITH SAND CONTROL, INFLOW CONTROL AND FORMATION STRESS CONTROL, IN CLASS 42 (U.S. CLS. 100 AND 101).

THE MARK CONSISTS OF STANDARD CHARACTERS WITHOUT CLAIM TO ANY PARTICULAR FONT, STYLE, SIZE, OR COLOR.

PRIORITY CLAIMED UNDER SEC. 44(D) ON UNITED KINGDOM APPLICATION NO. 2551433, FILED 9-3-2010, REG. NO. 2551433, DATED 6-25-2010, EXPIRES 6-25-2020.

SER. NO. 85-164,781, FILED 10-29-2010.



David J. Kybas

Director of the United States Patent and Trademark Office

Reg. No. 4,065,863 DOMINIC FATHY, EXAMINING ATTORNEY

United States of America

United States Patent and Trademark Office

EQUALITY NOW

Reg. No. 4,065,864

Registered Dec. 6, 2011

Int. Cl.: 35

SERVICE MARK

PRINCIPAL REGISTER

EQUALITY NOW, INC. (NEW YORK NON-PROFIT CORPORATION)
PO BOX 20646, COLUMBUS CIRCLE STATION
NEW YORK, NY 10023

FOR: ASSOCIATION SERVICES, NAMELY, PROMOTING THE ECONOMIC, SOCIAL, CIVIL,
AND POLITICAL RIGHTS OF WOMEN AROUND THE WORLD, IN CLASS 35 (U.S. CLS.
100, 101 AND 102).

FIRST USE 4-8-1992; IN COMMERCE 4-8-1992.

THE MARK CONSISTS OF STANDARD CHARACTERS WITHOUT CLAIM TO ANY PAR-
TICULAR FONT, STYLE, SIZE, OR COLOR.

SER. NO. 85-165,066, FILED 10-29-2010.

ERIN FALK, EXAMINING ATTORNEY



David J. Kybas

Director of the United States Patent and Trademark Office

United States of America

United States Patent and Trademark Office

PINK AND BLUE FOR TWO

Reg. No. 4,065,865

FULL SPEED PRODUCTIONS, LLC (NORTH CAROLINA LIMITED LIABILITY COMPANY)
PO BOX 876
DAVIDSON, NC 28036

Registered Dec. 6, 2011

Int. Cl.: 35

FOR: ASSOCIATION SERVICES, NAMELY, PROMOTING THE PUBLIC INTEREST AND AWARENESS IN BREAST AND PROSTATE CANCER RESEARCH AND EDUCATION , IN CLASS 35 (U.S. CLS. 100, 101 AND 102).

SERVICE MARK

FIRST USE 11-15-2009; IN COMMERCE 11-15-2009.

PRINCIPAL REGISTER

THE MARK CONSISTS OF STANDARD CHARACTERS WITHOUT CLAIM TO ANY PARTICULAR FONT, STYLE, SIZE, OR COLOR.

SER. NO. 85-165,451, FILED 10-30-2010.

LOURDES AYALA, EXAMINING ATTORNEY



David J. Kybas

Director of the United States Patent and Trademark Office

United States of America

United States Patent and Trademark Office



Reg. No. 4,065,866

Registered Dec. 6, 2011

Int. Cls.: 2, 3, 4 and 28

TRADEMARK

PRINCIPAL REGISTER

KNAUF & ASSOCIATES, INC (GEORGIA CORPORATION)
SUITE 308
1590 N. ROBERTS RD.
KENNESAW, GA 30144

FOR: CORROSION INHIBITORS IN THE NATURE OF A COATING, IN CLASS 2 (U.S. CLS. 6, 11 AND 16).

FIRST USE 10-4-2010; IN COMMERCE 10-23-2010.

FOR: ALL-PURPOSE CLEANERS; CLEANER FOR USE ON METAL SURFACES; CLEANING, WASHING AND POLISHING PREPARATIONS; DEGREASING PREPARATIONS FOR METAL SURFACES; METAL POLISHING AND CLEANING PREPARATIONS, IN CLASS 3 (U.S. CLS. 1, 4, 6, 50, 51 AND 52).

FIRST USE 10-4-2010; IN COMMERCE 10-23-2010.

FOR: ALL PURPOSE LUBRICANTS; LUBRICATING OILS, IN CLASS 4 (U.S. CLS. 1, 6 AND 15).

FIRST USE 10-4-2010; IN COMMERCE 10-23-2010.

FOR: SKATEBOARDS, IN CLASS 28 (U.S. CLS. 22, 23, 38 AND 50).

FIRST USE 10-4-2010; IN COMMERCE 10-23-2010.

THE NAME(S), PORTRAIT(S), AND/OR SIGNATURE(S) SHOWN IN THE MARK IDENTIFIES JUSTIN ROBERT KNAUF, WHOSE CONSENT(S) TO REGISTER IS MADE OF RECORD.

THE COLOR(S) GRAY, WHITE, ORANGE, TAN AND YELLOW IS/ARE CLAIMED AS A FEATURE OF THE MARK.

THE MARK CONSISTS OF A HIGHLY STYLIZED ILLUSTRATION OF A CHERUB'S HEAD WITH HAIR STANDING ON END IN THE COLORS WHITE, ORANGE AND TAN, WINGS ARE PRESENT ON EITHER SIDE OF THE ILLUSTRATION IN THE COLORS GRAY AND WHITE, AND THE WORDING "SKANUNU" APPEARS BELOW THE ILLUSTRATION IN A YELLOWISH-TAN COMPLEMENTING TYPEFACE.



David J. Kybas

Director of the United States Patent and Trademark Office

Reg. No. 4,065,866 SER. NO. 85-165,544, FILED 10-30-2010.

GENE MACIOL, EXAMINING ATTORNEY

United States of America

United States Patent and Trademark Office



Reg. No. 4,065,867

Registered Dec. 6, 2011

Int. Cl.: 22

TRADEMARK

PRINCIPAL REGISTER

WILSON, ROBERT (TOBY) (UNITED STATES INDIVIDUAL), DBA COCOABSORB LLC
3974 SOUTH 900 WEST
RIVERDALE, UT 84405

FOR: COIR-BASED COMPOSITION FOR ABSORBING CARBON BASED SPILLS FROM FLOORS, IN CLASS 22 (U.S. CLS. 1, 2, 7, 19, 22, 42 AND 50).

FIRST USE 9-1-2010; IN COMMERCE 9-1-2010.

NO CLAIM IS MADE TO THE EXCLUSIVE RIGHT TO USE "THE GREEN FLOOR CLEAN", APART FROM THE MARK AS SHOWN.

THE COLOR(S) GREEN, GRAY, WHITE AND BLACK IS/ARE CLAIMED AS A FEATURE OF THE MARK.

THE MARK CONSISTS OF A GRAY AND WHITE COCONUT SURROUNDED BY GREEN CIRCLES CONTAINING ARROWS; BENEATH THE DESIGN ARE THE WORDS "COCOABSORB" IN GREEN FONT WITH BLACK OUTLINE, AND BELOW THAT IN SMALLER FONT ARE THE WORDS "THE GREEN FLOOR CLEAN" ALSO IN GREEN FONT WITH BLACK OUTLINE.

SER. NO. 85-165,725, FILED 10-31-2010.

LINDA MICKLEBURGH, EXAMINING ATTORNEY



David J. Kybas

Director of the United States Patent and Trademark Office

United States of America

United States Patent and Trademark Office



Reg. No. 4,065,868

Registered Dec. 6, 2011

Int. Cl.: 3

TRADEMARK

PRINCIPAL REGISTER

BIO JOUVANCE, INC. (CALIFORNIA CORPORATION)
5225 SAN FERNANDO ROAD WEST
LOS ANGELES, CA 90039

FOR: BODY AND HAND CREAMS, CREAM FOR USE BEFORE USING WAX FOR REMOVAL OF BODY HAIR, CREAM FOR USE AFTER USING WAX FOR REMOVAL OF BODY HAIR, EYE GEL, EYE CREAM, FACE AND BODY POLISH, FACE AND BODY SCRUB, FACIAL CREAM, FACIAL CLEANSERS, FOAM CLEANSERS FOR PERSONAL USE, GEL SKIN CLEANSER, NECK AND BUST CREAM, SKIN CLEANSERS, SKIN CONDITIONERS, SKIN CREAM, SKIN FRESHENING AND CLEANSING PREPARATIONS, SKIN HYDRATING MASKS, SKIN MOISTURIZERS, SKIN LOTIONS, SKIN TONERS, SKIN EXFOLIATING CREAM, SUNSCREEN CREAM, WAX FOR REMOVING BODY HAIR, IN CLASS 3 (U.S. CLS. 1, 4, 6, 50, 51 AND 52).

FIRST USE 1-31-2009; IN COMMERCE 1-31-2009.

NO CLAIM IS MADE TO THE EXCLUSIVE RIGHT TO USE "PARIS", APART FROM THE MARK AS SHOWN.

THE MARK CONSISTS OF THE WORD "BIO" FOLLOWED BY TWO INTERLOCKING RINGS AND THE WORD "JOUVANCE". THE WORD "PARIS" IS A SMALLER FONT AND IS BELOW THE WORD "JOUVANCE" AND IS RIGHT JUSTIFIED.

THE ENGLISH TRANSLATION OF "JOUVANCE" IN THE MARK IS "YOUTH".

SER. NO. 85-166,059, FILED 11-1-2010.

JANICE KIM, EXAMINING ATTORNEY



David J. Kybas

Director of the United States Patent and Trademark Office

United States of America

United States Patent and Trademark Office

EventeX

Reg. No. 4,065,869

NEWBOLD, RICHARD DEAN (UNITED STATES INDIVIDUAL)
208 NAOLA COURT
ARCHDALE, NC 27263

Registered Dec. 6, 2011

Int. Cl.: 35

FOR: ARRANGING AND CONDUCTING MARKETING PROMOTIONAL EVENTS FOR OTHERS, IN CLASS 35 (U.S. CLS. 100, 101 AND 102).

SERVICE MARK

FIRST USE 10-24-2010; IN COMMERCE 10-25-2010.

PRINCIPAL REGISTER

THE MARK CONSISTS OF STANDARD CHARACTERS WITHOUT CLAIM TO ANY PARTICULAR FONT, STYLE, SIZE, OR COLOR.

SER. NO. 85-166,089, FILED 11-1-2010.

SUNG IN, EXAMINING ATTORNEY



David J. Kyfos

Director of the United States Patent and Trademark Office

United States of America

United States Patent and Trademark Office



Reg. No. 4,065,870

Registered Dec. 6, 2011

Int. Cl.: 39

SERVICE MARK

PRINCIPAL REGISTER

A & H EXPEDITING SERVICE, INC. (NEW YORK CORPORATION), DBA KEY LOGISTICS
140 MUSHROOM BOULEVARD
ROCHESTER, NY 14623

FOR: TRANSPORTATION OF FREIGHT VIA TRUCKING; AND WAREHOUSING OR
STORING OF GOODS IN A WAREHOUSE, IN CLASS 39 (U.S. CLS. 100 AND 105).

FIRST USE 12-20-2002; IN COMMERCE 2-1-2003.

NO CLAIM IS MADE TO THE EXCLUSIVE RIGHT TO USE "LOGISTICS", APART FROM
THE MARK AS SHOWN.

THE COLOR(S) BLUE, BLACK AND WHITE IS/ARE CLAIMED AS A FEATURE OF THE
MARK.

THE MARK CONSISTS OF A BLUE KEY OUTLINED IN BLACK WITH THE WHITE
WORDING "KEY LOGISTICS" IN THE CIRCLE PORTION OF THE KEY AND THE WHITE
WORDING "YOUR KEY TO SERVICE" IN THE STEM PORTION OF THE KEY.

SER. NO. 85-166,411, FILED 11-1-2010.

KRISTIN CARLSON, EXAMINING ATTORNEY



David J. Kybas

Director of the United States Patent and Trademark Office

United States of America

United States Patent and Trademark Office

The logo for SYNCAPSE features the word "SYNCAPSE" in a bold, sans-serif font. The letter "Y" is stylized with two vertical lines extending downwards, each ending in a small circle. The letter "A" is a simple triangle. The background is a light gray grid.

Reg. No. 4,065,871

Registered Dec. 6, 2011

Int. Cls.: 35 and 42

SERVICE MARK

PRINCIPAL REGISTER

SYNCAPSE CORP. (CANADA CORPORATION)
SUITE 301
20 DUNCAN STREET
TORONTO, ONTARIO, CANADA M5H3G8

FOR: ADVERTISING; BUSINESS MANAGEMENT; BUSINESS ADMINISTRATION, NAMELY, BUSINESS ADMINISTRATION CONSULTING; OFFICE FUNCTIONS; MARKETING SERVICES, NAMELY, MARKETING DESIGN AND DEVELOPMENT OF ADVERTISING, MARKETING AND PROMOTIONAL CAMPAIGNS FOR OTHERS USING INTERACTIVE AND ONLINE MEDIA; BRAND EVALUATION SERVICES, NAMELY, EVALUATING INTERNET MEDIA AND MARKETING OF GOODS AND SERVICES OF OTHERS; CONSULTING SERVICES, NAMELY, PROVIDING MULTIPLE MEDIA INTERNET MARKETING STRATEGIES, AND ANALYZING AND COMPILING DATA TO MEASURE THE EFFECT OF ADVERTISING INITIATIVES THROUGH ONLINE MEDIA, INCLUDING SOCIAL MEDIA, IN CLASS 35 (U.S. CLS. 100, 101 AND 102).

FIRST USE 11-30-2007; IN COMMERCE 11-30-2007.

FOR: A SUITE OF SOFTWARE-AS-A-SERVICE APPLICATIONS THAT ENABLES LARGE COMPANIES TO BUILD, MANAGE, AND MEASURE THEIR SOCIAL MEDIA PRESENCE; A SUITE OF SOFTWARE-AS-A-SERVICE APPLICATIONS ENABLING COMPANIES TO BUILD AND CONNECT TO SOCIAL MEDIA PLATFORMS FROM A CENTRAL LOCATION; A SUITE OF SOFTWARE-AS-A-SERVICE APPLICATIONS USED BY COMPANIES TO MANAGE ALL SOCIAL MEDIA PROPERTIES, CONTENT AND CONVERSATIONS THROUGH SCALABLE TOOLS; A SUITE OF SOFTWARE-AS-A-SERVICE APPLICATIONS USED BY COMPANIES TO MEASURE THEIR MARKETING PERFORMANCE, TO COMPILE DATA USED TO UNDERSTAND MARKETING EFFECTIVENESS, AND TO ANALYZE MARKETING INFLUENCES, REACH AND EARNED MEDIA VALUE; CONSULTING IN THE FIELD OF DESIGN, DEVELOPMENT, INTEGRATION, IMPLEMENTATION OF SOCIAL MEDIA SOFTWARE TOOLS FOR ALLOWING GROUPS TO GENERATE CONTACT, ENGAGE IN PEER-TO-PEER CONVERSATIONS, AND EXCHANGE CONTENT; DESIGN, DEVELOPMENT, IMPLEMENTATION AND INTEGRATION OF SOCIAL MEDIA SOFTWARE TOOLS INTO MULTIPLE SYSTEMS AND NETWORKS USED FOR ALLOWING GROUPS TO GENERATE CONTACT, ENGAGE IN PEER-TO-PEER CONVERSATIONS, AND EXCHANGE CONTENT; COMPUTER MONITORING SERVICE WHICH TRACKS SOCIAL MEDIA SOFTWARE TOOL PERFORMANCE, IN CLASS 42 (U.S. CLS. 100 AND 101).



David J. Kappas

Director of the United States Patent and Trademark Office

Reg. No. 4,065,871 FIRST USE 11-30-2007; IN COMMERCE 11-30-2007.

THE MARK CONSISTS OF THE TERM "SYNCAPSE" WITH A STYLIZED "Y" HAVING A CIRCLE ADJACENT THE DISTAL END OF EACH LINE AND A STYLIZED "A" HAVING TWO VERTICAL LINES MEETING AT AN APEX BUT NO HORIZONTAL LINE.

SER. NO. 85-166,709, FILED 11-2-2010.

KELLY BOULTON, EXAMINING ATTORNEY

United States of America

United States Patent and Trademark Office



Corepoint
HEALTH

Reg. No. 4,065,872

Registered Dec. 6, 2011

Int. Cl.: 42

SERVICE MARK

PRINCIPAL REGISTER

COREPOINT HEALTH, LLC (TEXAS LIMITED LIABILITY COMPANY)
3010 GAYLORD PARKWAY, SUITE 320
FRISCO, TX 75034

FOR: COMPUTER SOFTWARE CONSULTANCY; COMPUTER SOFTWARE CONSULTING;
COMPUTER SOFTWARE DEVELOPMENT; COMPUTER SOFTWARE DEVELOPMENT
AND COMPUTER PROGRAMMING DEVELOPMENT FOR OTHERS; COMPUTER SOFT-
WARE DEVELOPMENT IN THE FIELD OF HEALTHCARE, IN CLASS 42 (U.S. CLS. 100
AND 101).

FIRST USE 2-16-2009; IN COMMERCE 2-16-2009.

OWNER OF U.S. REG. NOS. 3,400,000 AND 3,693,871.

THE COLOR(S) "GREEN", "YELLOW", "BLUE" AND "RED" IS/ARE CLAIMED AS A FEAT-
TURE OF THE MARK.

NO CLAIM IS MADE TO THE EXCLUSIVE RIGHT TO USE "HEALTH", APART FROM THE
MARK AS SHOWN.

THE MARK CONSISTS OF THE STYLIZED WORDS "COREPOINT HEALTH", THE BIGGER
WORD "COREPOINT" APPEARING ABOVE THE SMALLER WORD "HEALTH"; TO THE
LEFT OF THE WORDS APPEARS FOUR ARROWS POINTING TO A MIDDLE POINT
FORMING A SQUARE-LIKE FIGURE, THE ARROWS BEING THE COLORS, CLOCKWISE
FROM THE UPPER LEFT, GREEN, YELLOW, BLUE AND RED.

SER. NO. 85-166,860, FILED 11-2-2010.

ZHALEH DELANEY, EXAMINING ATTORNEY



David J. Kyjars

Director of the United States Patent and Trademark Office

United States of America

United States Patent and Trademark Office

REACT²

Reg. No. 4,065,873

Registered Dec. 6, 2011

Int. Cl.: 30

TRADEMARK

PRINCIPAL REGISTER

WM. WRIGLEY JR. COMPANY (DELAWARE CORPORATION)
410 NORTH MICHIGAN AVENUE
CHICAGO, IL 60611

FOR: CHEWING GUM, IN CLASS 30 (U.S. CL. 46).

FIRST USE 2-28-2011; IN COMMERCE 2-28-2011.

OWNER OF U.S. REG. NO. 3,874,217.

THE MARK CONSISTS OF THE WORD "REACT" WITH A SMALL NUMBER "2" NEAR THE LETTER "T".

SER. NO. 85-166,903, FILED 11-2-2010.

HENRY S. ZAK, EXAMINING ATTORNEY



David J. Kybas

Director of the United States Patent and Trademark Office

United States of America

United States Patent and Trademark Office

BIOTEMP

Reg. No. 4,065,874

Registered Dec. 6, 2011

Int. Cl.: 17

TRADEMARK

PRINCIPAL REGISTER

ABB INC. (DELAWARE CORPORATION)
SUITE 200
12040 REGENCY PARKWAY
CARY, NC 27518

FOR: BIODEGRADABLE ELECTRICAL INSULATION FLUID, NAMELY, A VEGETABLE OIL-BASED DIELECTRIC FLUID, FOR USE IN VARIOUS ELECTRICAL DEVICES, IN CLASS 17 (U.S. CLS. 1, 5, 12, 13, 35 AND 50).

FIRST USE 4-12-1999; IN COMMERCE 4-12-1999.

THE MARK CONSISTS OF STANDARD CHARACTERS WITHOUT CLAIM TO ANY PARTICULAR FONT, STYLE, SIZE, OR COLOR.

SER. NO. 85-167,091, FILED 11-2-2010.

BRIDGETT SMITH, EXAMINING ATTORNEY



David J. Kybas

Director of the United States Patent and Trademark Office

United States of America

United States Patent and Trademark Office



Reg. No. 4,065,875

Registered Dec. 6, 2011

Int. Cl.: 9

TRADEMARK

PRINCIPAL REGISTER

BUCKNER MANAGEMENT SERVICES, LLC (TENNESSEE LIMITED LIABILITY COMPANY)
2415 N. OCOEE STREET
CLEVELAND, TN 37311

FOR: PRE-RECORDED DVDS FEATURING MEMORIALS DEDICATED TO DECEASED PERSONS, IN CLASS 9 (U.S. CLS. 21, 23, 26, 36 AND 38).

FIRST USE 12-31-1997; IN COMMERCE 12-31-1997.

THE MARK CONSISTS OF AN OUTLINED DRAWING OF A PROFILE OF A STANDING DOVE, FACING TO THE RIGHT WITH ONE WING VISIBLE, SPREAD OUT BEHIND IT TO THE LEFT.

SER. NO. 85-167,192, FILED 11-2-2010.

RONALD MCMORROW, EXAMINING ATTORNEY



David J. Kybas

Director of the United States Patent and Trademark Office

United States of America

United States Patent and Trademark Office

COREPOINT OPERATIONS MONITOR

Reg. No. 4,065,876

Registered Dec. 6, 2011

Int. Cl.: 9

TRADEMARK

PRINCIPAL REGISTER

COREPOINT HEALTH, LLC (TEXAS LIMITED LIABILITY COMPANY)
3010 GAYLORD PARKWAY, SUITE 320
FRISCO, TX 75034

FOR: COMPUTER SOFTWARE FOR USE IN THE HEALTHCARE INDUSTRY FOR COLLECTING AND STORING PATIENT DATA, AND DELIVERING GRAPHICAL AND TABLE VIEWS OF SAID DATA THROUGH A WEB-BASED, DASHBOARD-LIKE USER INTERFACE, IN CLASS 9 (U.S. CLS. 21, 23, 26, 36 AND 38).

FIRST USE 3-31-2009; IN COMMERCE 3-31-2009.

THE MARK CONSISTS OF STANDARD CHARACTERS WITHOUT CLAIM TO ANY PARTICULAR FONT, STYLE, SIZE, OR COLOR.

OWNER OF U.S. REG. NO. 3,693,871.

NO CLAIM IS MADE TO THE EXCLUSIVE RIGHT TO USE "OPERATIONS MONITOR", APART FROM THE MARK AS SHOWN.

SER. NO. 85-167,198, FILED 11-2-2010.

ZHALEH DELANEY, EXAMINING ATTORNEY



David J. Kyffers

Director of the United States Patent and Trademark Office

United States of America

United States Patent and Trademark Office

COREPOINT ACTION POINTS

Reg. No. 4,065,877

Registered Dec. 6, 2011

Int. Cl.: 9

TRADEMARK

PRINCIPAL REGISTER

COREPOINT HEALTH, LLC (TEXAS LIMITED LIABILITY COMPANY)
3010 GAYLORD PARKWAY, SUITE 320
FRISCO, TX 75034

FOR: COMPUTER SOFTWARE FOR USE IN THE HEALTHCARE INDUSTRY WHICH TRANSMITS EVENT NOTIFICATIONS BASED ON SPECIFIC, DEFINED DATA ELEMENTS AND TRANSMITS REAL-TIME DATA ALERTS RELATED THERETO REGARDING WHEN THE EVENT OCCURS, FOR EXAMPLE, WHEN INCOMING STAT ORDERS FROM AN ORDERING PHYSICIAN ARE COMPLETE, WHEN DISEASE CODES FROM A DIAGNOSIS ARE RECEIVED, AND WHEN LAB RESULTS FOR A PATIENT IN THE ER ARE COMPLETE, IN CLASS 9 (U.S. CLS. 21, 23, 26, 36 AND 38).

FIRST USE 3-31-2009; IN COMMERCE 3-31-2009.

THE MARK CONSISTS OF STANDARD CHARACTERS WITHOUT CLAIM TO ANY PARTICULAR FONT, STYLE, SIZE, OR COLOR.

OWNER OF U.S. REG. NO. 3,693,871.

SER. NO. 85-167,321, FILED 11-2-2010.

ZHALEH DELANEY, EXAMINING ATTORNEY



David J. Kyros

Director of the United States Patent and Trademark Office

United States of America

United States Patent and Trademark Office

ARISTOCRAZY

Reg. No. 4,065,878

Registered Dec. 6, 2011

Int. Cls.: 14 and 25

TRADEMARK

PRINCIPAL REGISTER

ARISTOCRAZY, S.A. (SPAIN CORPORATION)
GRAN VÍA, 40, BIS. 3°
48009 BILBAO, VIZCAYA, SPAIN

FOR: JEWELRY, WATCHES, IN CLASS 14 (U.S. CLS. 2, 27, 28 AND 50).

FOR: CLOTHING, NAMELY, SHIRTS, PANTS, SKIRTS, SUITS, DRESSES, JACKETS, COATS, SWEATERS, VESTS, SCARVES, TIES; FOOTWEAR; HEADWEAR, IN CLASS 25 (U.S. CLS. 22 AND 39).

THE MARK CONSISTS OF STANDARD CHARACTERS WITHOUT CLAIM TO ANY PARTICULAR FONT, STYLE, SIZE, OR COLOR.

PRIORITY CLAIMED UNDER SEC. 44(D) ON ERPN CMNTY TM OFC APPLICATION NO. 9105768, FILED 5-14-2010, REG. NO. 009105768, DATED 1-27-2011, EXPIRES 5-14-2020.

SER. NO. 85-167,449, FILED 11-2-2010.

LOURDES AYALA, EXAMINING ATTORNEY



David J. Kybas

Director of the United States Patent and Trademark Office

United States of America

United States Patent and Trademark Office



Reg. No. 4,065,879

Registered Dec. 6, 2011

Int. Cls.: 29 and 32

TRADEMARK

PRINCIPAL REGISTER

TIM HORTONS USA INC. (DELAWARE CORPORATION)
SUITE 236
4150 TULLER ROAD
DUBLIN, OH 43017

FOR: SOUPS, CHILI, FRUIT SALADS, VEGETABLE SALADS, IN CLASS 29 (U.S. CL. 46).

FIRST USE 7-30-2009; IN COMMERCE 7-30-2009.

FOR: FRUIT JUICES, VEGETABLE JUICES, SOFT DRINKS AND BOTTLED WATER, IN CLASS 32 (U.S. CLS. 45, 46 AND 48).

FIRST USE 7-30-2009; IN COMMERCE 7-30-2009.

OWNER OF U.S. REG. NOS. 1,690,691, 2,433,796, AND 2,457,618.

NO CLAIM IS MADE TO THE EXCLUSIVE RIGHT TO USE "ALWAYS FRESH", "EST. 1964" AND "COFFEE & BAKE SHOP", APART FROM THE MARK AS SHOWN.

THE NAME(S), PORTRAIT(S), AND/OR SIGNATURE(S) SHOWN IN THE MARK DOES NOT IDENTIFY A PARTICULAR LIVING INDIVIDUAL.

THE MARK CONSISTS OF "TIM HORTONS EST. 1964" IN BLACK ON A WHITE QUADRILATERAL DESIGN WHICH IS BORDERED BY A BLACK BAND, "ALWAYS FRESH" IN BLACK ON A WHITE QUADRILATERAL DESIGN AND "COFFEE & BAKE SHOP" IN BLACK ON A WHITE QUADRILATERAL DESIGN.

SER. NO. 85-167,609, FILED 11-2-2010.

JENNIFER MARTIN, EXAMINING ATTORNEY



David J. Kybas

Director of the United States Patent and Trademark Office

United States of America

United States Patent and Trademark Office



Reg. No. 4,065,880

Registered Dec. 6, 2011

Int. Cl.: 25

TRADEMARK

PRINCIPAL REGISTER

LAWTON, KYRA C (UNITED STATES INDIVIDUAL), AKA KYRA LAWTON
9 WILLIAMS STREET
DARTMOUTH, MA 02748

FOR: ATHLETIC APPAREL, NAMELY, SHIRTS, PANTS, JACKETS, FOOTWEAR, HATS AND CAPS, ATHLETIC UNIFORMS; BASEBALL CAPS; BASEBALL CAPS AND HATS; CAP VISORS; CAPS; CAPS WITH VISORS; KNITTED CAPS; SKULL CAPS; SPORTS CAPS AND HATS, IN CLASS 25 (U.S. CLS. 22 AND 39).

FIRST USE 10-29-2010; IN COMMERCE 10-29-2010.

THE MARK CONSISTS OF THE WORDS "GIRLS RUN" IN A FIELD OF SHOES ARRANGED AS PETALS OF A FLOWER.

SER. NO. 85-167,676, FILED 11-3-2010.

BRIAN NEVILLE, EXAMINING ATTORNEY



David J. Kyffers

Director of the United States Patent and Trademark Office

United States of America

United States Patent and Trademark Office



Reg. No. 4,065,881

Registered Dec. 6, 2011

Int. Cl.: 35

SERVICE MARK

PRINCIPAL REGISTER

SPECIALTY SLEEP ASSOCIATION (D.C. NON-PROFIT CORPORATION)
46639 JONES RANCH RD.
FRIANT, CA 93626

FOR: ADMINISTERING CERTIFICATION PROGRAMS RELATING TO THE FIELD OF BEDDING, IN CLASS 35 (U.S. CLS. 100, 101 AND 102).

FIRST USE 10-1-2010; IN COMMERCE 10-1-2010.

NO CLAIM IS MADE TO THE EXCLUSIVE RIGHT TO USE "ENVIRONMENTAL & SAFETY PROGRAM PROMOTING MATTRESS ENVIRONMENTAL AND SAFETY INFORMATION TO CONSUMERS WWW.SLEEPINFORMATION.ORG", APART FROM THE MARK AS SHOWN.

THE COLOR(S) BLUE, GREEN, ORANGE, WHITE, AND YELLOW IS/ARE CLAIMED AS A FEATURE OF THE MARK.

THE MARK CONSISTS OF A CIRCLE CONTAINING THE WORDS "SSA ENVIRONMENTAL & SAFETY PROGRAM" ACROSS THE TOP WITHIN A BLUE BORDER AND WWW.SLEEPINFORMATION.ORG ACROSS THE BOTTOM ON TOP OF A CURVED GREEN AREA WHICH ALSO CONTAINS THE WORDS "PROMOTING MATTRESS ENVIRONMENTAL AND SAFETY INFORMATION TO CONSUMERS." ABOVE THE GREEN AREA ARE THREE GREEN LEAVES ON TOP OF A YELLOW BACKGROUND. THE GREEN, BLUE, AND YELLOW ARE BORDERED BY ORANGE. ALL OF THE WORDING IS WHITE.

SER. NO. 85-167,822, FILED 11-3-2010.

ZACHARY BELLO, EXAMINING ATTORNEY



David J. Kybas

Director of the United States Patent and Trademark Office

United States of America

United States Patent and Trademark Office



Reg. No. 4,065,882

Registered Dec. 6, 2011

Int. Cl.: 28

TRADEMARK

PRINCIPAL REGISTER

NORMAN ARCHERY (OKLAHOMA CORPORATION)
8317 GATEWAY TERRACE
OKLAHOMA CITY, OK 73149

FOR: BOWFISHING AND ARCHERY EQUIPMENT, NAMELY, FISHING LINES, ARROW POINTS, ARROW SHAFTS, ARROWS, BOWS, REELS, REEL SEATS, ARROW RESTS, STABILIZERS, AND BOW STRINGS, IN CLASS 28 (U.S. CLS. 22, 23, 38 AND 50).

FIRST USE 1-0-2003; IN COMMERCE 1-0-2003.

NO CLAIM IS MADE TO THE EXCLUSIVE RIGHT TO USE "BOWFISHING", APART FROM THE MARK AS SHOWN.

THE MARK CONSISTS OF THE WORD "SPLASH" ABOVE THE WORD "BOWFISHING", WITH AN ARROW GOING UP DIAGONALLY FROM LEFT TO RIGHT THROUGH THE LETTER "A" IN "SPLASH". THERE IS A WATER SPLASH DRAWN BEHIND THE WORDS "SPLASH BOWFISHING".

SER. NO. 85-167,932, FILED 11-3-2010.

JOHN SCHUYLER YARD, EXAMINING ATTORNEY



David J. Kyffers

Director of the United States Patent and Trademark Office

United States of America

United States Patent and Trademark Office

OSM

Reg. No. 4,065,883

Registered Dec. 6, 2011

Int. Cl.: 35

SERVICE MARK

PRINCIPAL REGISTER

DESKTOP ACQUISITION SUB, INC. (DELAWARE CORPORATION)
11 WEST 19TH STREET, 10TH FLOOR
NEW YORK, NY 10011

FOR: ADVERTISING, ADVERTISEMENT, MARKETING AND PROMOTION SERVICES; ON-LINE ADVERTISING, ADVERTISEMENT, MARKETING AND PROMOTION SERVICES; ADVERTISING, ADVERTISEMENT, MARKETING AND PROMOTION CONSULTATION SERVICES; DIGITAL-OUT-OF-HOME ADVERTISING, MARKETING, PROMOTION AND CONSULTATION SERVICES; PROMOTING THE GOODS AND SERVICES OF OTHERS VIA THE INTERNET THROUGH ADVERTISING, MARKETING AND PROMOTION SERVICES; MARKET RESEARCH, ANALYSIS, REPORTING AND MARKET INTELLIGENCE SERVICES; ADVERTISING SERVICES, NAMELY, ADVERTISING FOR OTHERS VIA THE INTERNET UTILIZING BANNERS AND BUTTONS, SKYSCRAPERS, POP-UPS, RICH MEDIA, DIRECT E-MAIL MARKETING, VIRAL MARKETING, AFFILIATE MARKETING, SEARCH ENGINE OPTIMIZATION, AND ON AND OFF-LINE INTEGRATION AND REPORTING THAT PROVIDES REAL TIME OPTIMIZATION OF MARKETING CAMPAIGNS; BUSINESS SERVICES, NAMELY, CONDUCTING MARKETING RESEARCH TO EVALUATE EFFECTIVENESS OF VARIOUS APPLIED ONLINE ADVERTISING MEDIUMS AND SUPPORTING AD-SERVING TECHNOLOGIES UTILIZING THE INTERNET; BUSINESS MARKETING AND MANAGEMENT CONSULTATION SERVICES, NAMELY, PROVIDING DATABASE LIST MANAGEMENT, TARGETED MARKETING, PERFORMANCE-BASED AND DIRECT RESPONSE MARKETING, MARKETING ANALYSIS AND REPORTING, INTERACTIVE AND CONTEXTUAL ADVERTISING AND MEDIA PLANNING FOR OTHERS; PROMOTING THE GOODS AND SERVICES OF OTHERS VIA THE INTERNET THROUGH THE DISTRIBUTION OF ONLINE MATERIALS, PROMOTIONAL CONTESTS AND SWEEPSTAKES; ADVERTISING, RICH-MEDIA ADVERTISING, MARKETING AND PROMOTION SERVICES; DISSEMINATION OF ADVERTISING FOR OTHERS VIA THE INTERNET; AD-SERVING, TRACKING AND REPORTING SERVICES FOR ADVERTISERS AND PUBLISHERS, IN CLASS 35 (U.S. CLS. 100, 101 AND 102).



FIRST USE 5-31-2010; IN COMMERCE 5-31-2010.

THE MARK CONSISTS OF STANDARD CHARACTERS WITHOUT CLAIM TO ANY PARTICULAR FONT, STYLE, SIZE, OR COLOR.

SER. NO. 85-168,158, FILED 11-3-2010.

David J. Kyros

Director of the United States Patent and Trademark Office

Reg. No. 4,065,883 JUDITH HELFMAN, EXAMINING ATTORNEY

United States of America

United States Patent and Trademark Office

OPEN SEGMENT MANAGER

Reg. No. 4,065,884

Registered Dec. 6, 2011

Int. Cl.: 35

SERVICE MARK

PRINCIPAL REGISTER

DESKTOP ACQUISITION SUB, INC. (DELAWARE CORPORATION)
11 WEST 19TH STREET, 10TH FLOOR
NEW YORK, NY 10011

FOR: ADVERTISING, ADVERTISEMENT, MARKETING AND PROMOTION SERVICES; ON-LINE ADVERTISING, ADVERTISEMENT, MARKETING AND PROMOTION SERVICES; ADVERTISING, ADVERTISEMENT, MARKETING AND PROMOTION CONSULTATION SERVICES; DIGITAL-OUT-OF-HOME ADVERTISING, MARKETING, PROMOTION AND CONSULTATION SERVICES; PROMOTING THE GOODS AND SERVICES OF OTHERS VIA THE INTERNET THROUGH ADVERTISING, MARKETING AND PROMOTION SERVICES; MARKET RESEARCH, ANALYSIS, REPORTING AND MARKET INTELLIGENCE SERVICES; ADVERTISING SERVICES, NAMELY, ADVERTISING FOR OTHERS VIA THE INTERNET UTILIZING BANNERS AND BUTTONS, SKYSCRAPERS, POP-UPS, RICH MEDIA, DIRECT E-MAIL MARKETING, VIRAL MARKETING, AFFILIATE MARKETING, SEARCH ENGINE OPTIMIZATION, AND ON AND OFF-LINE INTEGRATION AND REPORTING THAT PROVIDES REAL TIME OPTIMIZATION OF MARKETING CAMPAIGNS; BUSINESS SERVICES, NAMELY, CONDUCTING MARKETING RESEARCH TO EVALUATE EFFECTIVENESS OF VARIOUS APPLIED ONLINE ADVERTISING MEDIUMS AND SUPPORTING AD-SERVING TECHNOLOGIES UTILIZING THE INTERNET; BUSINESS MARKETING AND MANAGEMENT CONSULTATION SERVICES, NAMELY, PROVIDING DATABASE LIST MANAGEMENT, TARGETED MARKETING, PERFORMANCE-BASED AND DIRECT RESPONSE MARKETING, MARKETING ANALYSIS AND REPORTING, INTERACTIVE AND CONTEXTUAL ADVERTISING AND MEDIA PLANNING FOR OTHERS; PROMOTING THE GOODS AND SERVICES OF OTHERS VIA THE INTERNET THROUGH THE DISTRIBUTION OF ONLINE MATERIALS, PROMOTIONAL CONTESTS AND SWEEPSTAKES; ADVERTISING, RICH-MEDIA ADVERTISING, MARKETING AND PROMOTION SERVICES; DISSEMINATION OF ADVERTISING FOR OTHERS VIA THE INTERNET; AD-SERVING, TRACKING AND REPORTING SERVICES FOR ADVERTISERS AND PUBLISHERS, IN CLASS 35 (U.S. CLS. 100, 101 AND 102).



FIRST USE 5-31-2010; IN COMMERCE 5-31-2010.

THE MARK CONSISTS OF STANDARD CHARACTERS WITHOUT CLAIM TO ANY PARTICULAR FONT, STYLE, SIZE, OR COLOR.

SER. NO. 85-168,173, FILED 11-3-2010.

David J. Kyros

Director of the United States Patent and Trademark Office

Reg. No. 4,065,884 JUDITH HELFMAN, EXAMINING ATTORNEY

United States of America

United States Patent and Trademark Office

2FUNNYTSHIRTS

Reg. No. 4,065,885

Registered Dec. 6, 2011

Int. Cl.: 25

TRADEMARK

PRINCIPAL REGISTER

2FUNNYTSHIRTS, LLC (GEORGIA LIMITED LIABILITY COMPANY), DBA
2FUNNYTSHIRTS, LLC
5585 CLAIRE ROSE LANE
ATLANTA, GA 30327

FOR: BODY SHIRTS; COLLARED SHIRTS; LONG-SLEEVED SHIRTS; OPEN-NECKED SHIRTS; SHIRTS; SHIRTS AND SHORT-SLEEVED SHIRTS; SHORT-SLEEVED OR LONG-SLEEVED T-SHIRTS; SHORT-SLEEVED SHIRTS; SPORT SHIRTS; SPORTS SHIRTS; SPORTS SHIRTS WITH SHORT SLEEVES; SWEAT SHIRTS; T-SHIRTS; TEE SHIRTS, IN CLASS 25 (U.S. CLS. 22 AND 39).

FIRST USE 11-1-2010; IN COMMERCE 11-3-2010.

THE MARK CONSISTS OF STANDARD CHARACTERS WITHOUT CLAIM TO ANY PARTICULAR FONT, STYLE, SIZE, OR COLOR.

SER. NO. 85-168,352, FILED 11-3-2010.

TIMOTHY FINNEGAN, EXAMINING ATTORNEY



David J. Kybas

Director of the United States Patent and Trademark Office

United States of America

United States Patent and Trademark Office



Reg. No. 4,065,886

Registered Dec. 6, 2011

Int. Cls.: 35 and 44

SERVICE MARK

PRINCIPAL REGISTER

BEST FOR BABES FOUNDATION, INC. (NEW JERSEY CORPORATION)
380 LITTLE SILVER POINT ROAD
LITTLE SILVER, NJ 07739

FOR: PUBLIC ADVOCACY TO PROMOTE AWARENESS OF BREASTFEEDING, IN CLASS 35 (U.S. CLS. 100, 101 AND 102).

FIRST USE 3-1-2008; IN COMMERCE 3-1-2008.

FOR: PROVIDING BREASTFEEDING INFORMATION, IN CLASS 44 (U.S. CLS. 100 AND 101).

FIRST USE 3-1-2008; IN COMMERCE 3-1-2008.

THE MARK CONSISTS OF THE TERM "BFB" IN MAGENTA. THE FIRST "B" IN THE MARK IS INVERTED.

THE COLOR(S) MAGENTA IS/ARE CLAIMED AS A FEATURE OF THE MARK.

SER. NO. 85-168,371, FILED 11-3-2010.

GIANCARLO CASTRO, EXAMINING ATTORNEY



David J. Kybas

Director of the United States Patent and Trademark Office

United States of America

United States Patent and Trademark Office

We Help Families Find Solutions

Reg. No. 4,065,887

Registered Dec. 6, 2011

Int. Cl.: 45

SERVICE MARK

PRINCIPAL REGISTER

1 LINK 4 SENIOR CARE, INC. (NEW JERSEY CORPORATION)
P.O. BOX 30
GLENDDORA, NJ 08029

FOR: CONSULTING SERVICES CONCERNING IDENTIFICATION OF FACILITIES, RESOURCES, AND SERVICE OPTIONS AVAILABLE TO INDIVIDUALS AND FAMILIES IN CONNECTION WITH THE CARE FOR THE ELDERLY AND FOR DISABLED ADULTS, NAMELY, CONSULTATION IN THE FIELD OF IN-HOME SUPPORT SERVICES TO SENIOR PERSONS AND MENTALLY OR PHYSICALLY CHALLENGED ADULT PERSONS, NAMELY, CARE MANAGEMENT SERVICES IN THE NATURE OF THE COORDINATION OF NECESSARY SERVICES AND PERSONAL CARE ASSISTANCE OF ACTIVITIES OF DAILY LIVING, SUCH AS BATHING, GROOMING AND PERSONAL MOBILITY FOR SENIOR PERSONS AND MENTALLY OR PHYSICALLY CHALLENGED ADULTS; AND THE COORDINATION OF SUCH CARE AND SERVICE OPTIONS, NAMELY, CASE MANAGEMENT SERVICES, NAMELY, COORDINATION OF LEGAL, SOCIAL AND PSYCHOLOGICAL SERVICES FOR ELDERLY PERSONS AND DISABLED PERSONS, IN CLASS 45 (U.S. CLS. 100 AND 101).

FIRST USE 10-1-2007; IN COMMERCE 10-1-2007.

THE MARK CONSISTS OF STANDARD CHARACTERS WITHOUT CLAIM TO ANY PARTICULAR FONT, STYLE, SIZE, OR COLOR.

SER. NO. 85-168,584, FILED 11-3-2010.

ROBERT STRUCK, EXAMINING ATTORNEY



David J. Kyffers

Director of the United States Patent and Trademark Office

United States of America

United States Patent and Trademark Office



Reg. No. 4,065,888

Registered Dec. 6, 2011

Int. Cl.: 7

TRADEMARK

PRINCIPAL REGISTER

ROPO VALVE (YI XING) CO., LTD. (CHINA LIMITED LIABILITY COMPANY)
GAOYAO VILLAGE
GAOCHENG TOWN INDUSTRIAL ZONE
YIXING CITY, JIANGSU, CHINA

FOR: BALL VALVES BEING PARTS OF MACHINES; COMPRESSED AIR MACHINE COMPONENTS, NAMELY, CYLINDERS, VALVES AND AIR GRIPS; HYDRAULIC POWER UNITS; HYDRAULIC VALVE ACTUATORS; PARTS FOR COMPRESSED-AIR TOOLS, NAMELY, BRAKES, FILTERS, HOSES, PIPES, COUPLINGS VALVES, SWITCHES, COMPRESSORS, CLAMPING TOOLS AND INJECTORS; PARTS FOR PNEUMATIC BLOW GUNS, NAMELY, INFLATOR TIPS, INFLATOR VALVES, VALVE ADAPTERS, NOZZLES, NIPPLES, COUPLERS, CONNECTORS AND PIVOTS; PNEUMATIC VALVE ACTUATORS; PROPORTIONAL FLOW VALVES AS PARTS OF MACHINES; VALVES AS MACHINE COMPONENTS, IN CLASS 7 (U.S. CLS. 13, 19, 21, 23, 31, 34 AND 35).

FIRST USE 9-19-2006; IN COMMERCE 9-19-2006.

THE MARK CONSISTS OF A CIRCLE WITH A DESIGN INSIDE. THE INNER DESIGN CONSISTS OF A CIRCLE WITH THREE LINES EXTENDING DOWNWARD; TWO FROM THE SIDES OF THE CIRCLE AND ONE FROM THE MIDDLE.

SER. NO. 85-168,706, FILED 11-3-2010.

MICHAEL SOUDERS, EXAMINING ATTORNEY



David J. Kybas

Director of the United States Patent and Trademark Office

United States of America

United States Patent and Trademark Office



Reg. No. 4,065,889

Registered Dec. 6, 2011

Int. Cls.: 25 and 36

TRADEMARK

SERVICE MARK

PRINCIPAL REGISTER

LIBBY'S LEGACY BREAST CANCER FOUNDATION, INC. (FLORIDA CORPORATION)
1718 S. ORANGE AVE.
ORLANDO, FL 32806

FOR: CLOTHING, NAMELY, T-SHIRTS, HATS AND SWEATSHIRTS, IN CLASS 25 (U.S. CLS. 22 AND 39).

FIRST USE 2-28-2007; IN COMMERCE 2-28-2007.

FOR: CHARITABLE FUNDRAISING SERVICES, NAMELY, FUNDRAISING FOR BREAST CANCER AWARENESS, RESEARCH, EDUCATION AND SERVICES, IN CLASS 36 (U.S. CLS. 100, 101 AND 102).

FIRST USE 2-28-2007; IN COMMERCE 2-28-2007.

THE MARK CONSISTS OF A SCOOTER HANDLEBAR IN BLACK WITH A PINK RIBBON IN THE CENTER WHEREIN THE WORD "SCOOTERS" IN BLACK IS ABOVE THE HANDLEBAR, THE NUMBER "4" IS IN BLACK AND IS WITHIN THE TOP PART OF THE PINK RIBBON AND THE WORD "HOOTERS" IN BLACK IS BELOW THE HANDLEBAR AND ACROSS THE BOTTOM PORTION OF THE PINK RIBBON. THE COLOR WHITE APPEARS AS BACKGROUND IN THE MARK AND IS NOT CLAIMED AS A FEATURE OF THE MARK.

THE COLOR(S) BLACK AND PINK IS/ARE CLAIMED AS A FEATURE OF THE MARK.

SER. NO. 85-168,811, FILED 11-4-2010.

NATALIE POLZER, EXAMINING ATTORNEY



David J. Kybas

Director of the United States Patent and Trademark Office

United States of America

United States Patent and Trademark Office

ROTOLOG

Reg. No. 4,065,890

Registered Dec. 6, 2011

Int. Cl.: 9

TRADEMARK

PRINCIPAL REGISTER

FERRY INDUSTRIES, INC. (OHIO CORPORATION)
4445 ALLEN ROAD
STOW, OH 44224

FOR: CONTROL SYSTEM FOR ROTATIONAL MOLDING MACHINES, COMPRISED OF A TEMPERATURE SENSOR AND PROCESSOR, IN CLASS 9 (U.S. CLS. 21, 23, 26, 36 AND 38).

FIRST USE 6-1-2002; IN COMMERCE 6-1-2002.

THE MARK CONSISTS OF STANDARD CHARACTERS WITHOUT CLAIM TO ANY PARTICULAR FONT, STYLE, SIZE, OR COLOR.

SER. NO. 85-168,907, FILED 11-4-2010.

WON TEAK OH, EXAMINING ATTORNEY



David J. Kyffers

Director of the United States Patent and Trademark Office

United States of America

United States Patent and Trademark Office

HOTTER'N HELL HUNDRED

Reg. No. 4,065,891

WICHITA FALLS BICYCLING CLUB, INC. (TEXAS CORPORATION)
900 - 8TH STREET, SUITE 200
WICHITA FALLS, TX 76301

Registered Dec. 6, 2011

Int. Cl.: 41

FOR: RECREATIONAL SERVICES IN THE NATURE OF ORGANIZING AND CONDUCTING BICYCLE RACES AND RIDES, IN CLASS 41 (U.S. CLS. 100, 101 AND 107).

SERVICE MARK

FIRST USE 2-1-1982; IN COMMERCE 2-1-1982.

PRINCIPAL REGISTER

THE MARK CONSISTS OF STANDARD CHARACTERS WITHOUT CLAIM TO ANY PARTICULAR FONT, STYLE, SIZE, OR COLOR.

OWNER OF U.S. REG. NO. 1,610,820.

SEC. 2(F) AS TO "HUNDRED".

SER. NO. 85-169,301, FILED 11-4-2010.

KEVON CHISOLM, EXAMINING ATTORNEY



David J. Kybas

Director of the United States Patent and Trademark Office

United States of America

United States Patent and Trademark Office

CORPORATE DIRECTORS GROUP

Reg. No. 4,065,892

Registered Dec. 6, 2011

Int. Cls.: 35 and 41

SERVICE MARK

PRINCIPAL REGISTER

A.C. ALLEN & COMPANY, INC. (MASSACHUSETTS CORPORATION)
710 SOUTH STREET
NEEDHAM, MA 02492

FOR: BUSINESS NETWORKING SERVICES FOR DIRECTORS AND CHIEF EXECUTIVE OFFICERS OF PUBLIC COMPANIES, IN CLASS 35 (U.S. CLS. 100, 101 AND 102).

FIRST USE 2-0-2005; IN COMMERCE 2-0-2005.

FOR: EDUCATIONAL SERVICES, NAMELY, PROVIDING CLASSES, SEMINARS, WORKSHOPS FOR DIRECTORS AND CHIEF EXECUTIVE OFFICERS OF PUBLIC COMPANIES; EDUCATIONAL SERVICES, NAMELY, PROVIDING CERTIFICATION PROGRAMS FOR PUBLIC COMPANY DIRECTORS, CORPORATE COUNSEL AND CHIEF EXECUTIVE OFFICERS, IN CLASS 41 (U.S. CLS. 100, 101 AND 107).

FIRST USE 2-0-2005; IN COMMERCE 2-0-2005.

THE MARK CONSISTS OF STANDARD CHARACTERS WITHOUT CLAIM TO ANY PARTICULAR FONT, STYLE, SIZE, OR COLOR.

NO CLAIM IS MADE TO THE EXCLUSIVE RIGHT TO USE "GROUP", APART FROM THE MARK AS SHOWN.

SEC. 2(F).

SER. NO. 85-170,177, FILED 11-5-2010.

DAVID I, EXAMINING ATTORNEY



David J. Kybas

Director of the United States Patent and Trademark Office

United States of America

United States Patent and Trademark Office



Reg. No. 4,065,893

Registered Dec. 6, 2011

Int. Cl.: 35

SERVICE MARK

PRINCIPAL REGISTER

NATIONAL VISION, INC. (GEORGIA CORPORATION)
ATTN: LEGAL DEPT./CHARLES MINGLE
296 GRAYSON HIGHWAY
LAWRENCEVILLE, GA 300465750

FOR: CONSUMER BUYING CLUB FOR OPTICAL PRODUCTS AND FOR OPTOMETRY SERVICES; CONSUMER BUYING CLUB FOR OPTOMETRY SERVICES AND FOR OPTICAL PRODUCTS, IN CLASS 35 (U.S. CLS. 100, 101 AND 102).

FIRST USE 2-9-2007; IN COMMERCE 2-9-2007.

NO CLAIM IS MADE TO THE EXCLUSIVE RIGHT TO USE "EYECARE CLUB" AND "EYE EXAMS FREE", APART FROM THE MARK AS SHOWN.

THE COLOR(S) RED, BLUE, YELLOW, BLACK AND WHITE IS/ARE CLAIMED AS A FEATURE OF THE MARK.

THE MARK CONSISTS OF A YELLOW CIRCLE INCLUDING WORDING, A BLUE EYE WITH BLACK PUPIL AND TWO WHITE CIRCLES. THE RED WORDING "EYECARE CLUB" APPEARS ACROSS THE TOP OF THE CIRCLE AND THE BLUE WORDING "EYE EXAMS FREE. CONTACT LENSES FOR LESS." APPEARS ACROSS THE BOTTOM.

SER. NO. 85-170,430, FILED 11-5-2010.

INGRID C. EULIN, EXAMINING ATTORNEY



David J. Kybas

Director of the United States Patent and Trademark Office

United States of America

United States Patent and Trademark Office

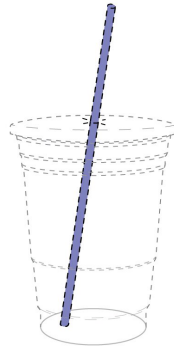

Reg. No. 4,065,894

Registered Dec. 6, 2011

Int. Cls.: 30 and 32

TRADEMARK

PRINCIPAL REGISTER

INTERNATIONAL COFFEE & TEA, LLC (DELAWARE LIMITED LIABILITY COMPANY)
1945 SOUTH LA CIENEGA BOULEVARD
LOS ANGELES, CA 90034

FOR: COFFEE, TEA, COFFEE-BASED BEVERAGES, TEA-BASED BEVERAGES, CHOCOLATE-BASED BEVERAGES, TEA-BASED BEVERAGES WITH FRUIT FLAVORING, FLAVORED SHAKES, INCLUDING COFFEE, CHOCOLATE, VANILLA, CARAMEL AND TEA AND FRUIT-BASED SHAKES, IN CLASS 30 (U.S. CL. 46).

FIRST USE 1-0-2000; IN COMMERCE 1-0-2000.

FOR: FRUIT-BASED BEVERAGES, IN CLASS 32 (U.S. CLS. 45, 46 AND 48).

FIRST USE 3-1-2006; IN COMMERCE 3-1-2006.

THE MARK CONSISTS SOLELY OF THE COLOR PURPLE AS APPLIED TO THE SURFACE OF A BEVERAGE STRAW SERVED AS PART OF THE PACKAGING OF THE GOODS. THE BROKEN LINES SHOWN IN THE DRAWING ARE NOT CLAIMED AS A FEATURE OF THE MARK, BUT ARE INTENDED ONLY TO SHOW POSITION OF THE MARK ON ELEMENTS OF PACKAGING USED WITH THE GOODS.

THE COLOR(S) PURPLE IS/ARE CLAIMED AS A FEATURE OF THE MARK.

SEC. 2(F).

SER. NO. 85-170,473, FILED 11-5-2010.

HANNO RITTNER, EXAMINING ATTORNEY



David J. Kyros

Director of the United States Patent and Trademark Office

United States of America

United States Patent and Trademark Office

MyEsafeDepositBox

Reg. No. 4,065,895

MYMEDICALRECORDS, INC. (DELAWARE CORPORATION)
4401 WILSHIRE BLVD., SECOND FLOOR
LOS ANGELES, CA 90010

Registered Dec. 6, 2011

Int. Cl.: 39

FOR: ELECTRONIC STORAGE OF PERSONAL AND HEALTH RELATED DATA; STORAGE OF ELECTRONIC MEDIA, NAMELY, IMAGES, TEXT AND AUDIO DATA; TEMPORARY ELECTRONIC STORAGE OF INFORMATION AND DATA, IN CLASS 39 (U.S. CLS. 100 AND 105).

SERVICE MARK

PRINCIPAL REGISTER

FIRST USE 8-27-2007; IN COMMERCE 10-17-2007.

THE MARK CONSISTS OF STANDARD CHARACTERS WITHOUT CLAIM TO ANY PARTICULAR FONT, STYLE, SIZE, OR COLOR.

SER. NO. 85-170,487, FILED 11-5-2010.

SETH A. RAPPAPORT, EXAMINING ATTORNEY



David J. Kybas

Director of the United States Patent and Trademark Office

United States of America

United States Patent and Trademark Office



Reg. No. 4,065,896

Registered Dec. 6, 2011

Int. Cls.: 19 and 20

TRADEMARK

PRINCIPAL REGISTER

SEMCO DISTRIBUTING, INC. (MISSOURI CORPORATION)
50 ROBINSON INDUSTRIAL DRIVE
PERRYVILLE, MO 63775

FOR: NATURAL STONE, NAMELY, SLABS, FULL VENEER, THIN CUT VENEER, FLATS, PAVERS, BLOCKS, CORNERS, JUMPERS, CAPS, COPING, EDGING, QUOINS, TRIM STONES, KEYSTONES, SILLS, TREADS, COUNTERTOPS, HEARTHES, MANTLES, TOMB-STONES, NON-MECHANICAL SIGNS, CLADDING, SAWN PANELS, AND INLAYS FOR FURNITURE, IN CLASS 19 (U.S. CLS. 1, 12, 33 AND 50).

FIRST USE 9-30-2010; IN COMMERCE 9-30-2010.

FOR: STONE BENCHES, IN CLASS 20 (U.S. CLS. 2, 13, 22, 25, 32 AND 50).

FIRST USE 2-1-2011; IN COMMERCE 2-1-2011.

NO CLAIM IS MADE TO THE EXCLUSIVE RIGHT TO USE "STONE", APART FROM THE MARK AS SHOWN.

THE MARK CONSISTS OF A DIAMOND DESIGN AT A LEFT END CONTAINING THE LETTERING "BW" AND TO THE RIGHT OF THAT DESIGN APPEARS THE STYLIZED WORDING "BRENTWOOD" THAT IS SANDWICHED BETWEEN TWO LINES WITH A STYLIZED TREE IN THE FIRST "O", THE LOWER OF THE TWO LINES ALSO DISPLAYING THE WORDING "BY SEMCO STONE".

SER. NO. 85-170,492, FILED 11-5-2010.

GEOFFREY FOSDICK, EXAMINING ATTORNEY



David J. Kybas

Director of the United States Patent and Trademark Office

United States of America

United States Patent and Trademark Office

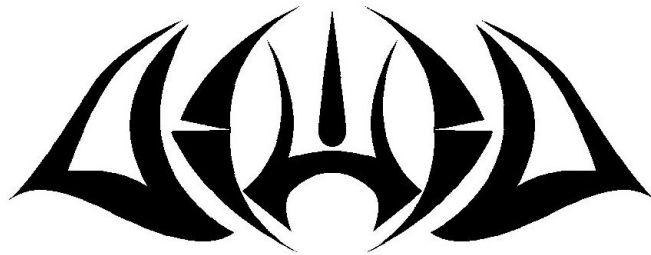

Reg. No. 4,065,897

Registered Dec. 6, 2011

Int. Cl.: 41

SERVICE MARK

PRINCIPAL REGISTER

DIWKA, LLC (CALIFORNIA LIMITED LIABILITY COMPANY)
23638 NARCISSUS CIRCLE
MORENO VALLEY, CA 92557

FOR: ENTERTAINMENT SERVICES IN THE NATURE OF LIVE MUSICAL PERFORMANCES;
ENTERTAINMENT, NAMELY, LIVE MUSIC CONCERTS, IN CLASS 41 (U.S. CLS. 100, 101
AND 107).

FIRST USE 5-1-2003; IN COMMERCE 6-10-2003.

THE MARK CONSISTS OF A SINGLE TEARDROP DESIGN IN THE CENTER, SURROUNDED
BY THREE ATTACHED CURVED BANDS, WITH TWO CURVED AND TOUCHING TRI-
ANGLES TO THE LEFT AND TO THE RIGHT OF THE CURVED BANDS, AND CURVED,
PARTIALLY COMPLETED TRIANGLES ON THE OUTER LEFT AND RIGHT SIDES.

SER. NO. 85-170,795, FILED 11-5-2010.

ANDREA K. NADELMAN, EXAMINING ATTORNEY



David J. Kybas

Director of the United States Patent and Trademark Office

United States of America

United States Patent and Trademark Office

NEVERGLARE
Advantage

Reg. No. 4,065,898

Registered Dec. 6, 2011

Int. Cl.: 9

TRADEMARK

PRINCIPAL REGISTER

NATIONAL VISION, INC. (GEORGIA CORPORATION)
ATTN: LEGAL DEPT./CHARLES MINGLE
296 GRAYSON HIGHWAY
LAWRENCEVILLE, GA 300465750

FOR: ANTI-REFLECTIVE LENSES; EYEGLOSS CASES; EYEGLOSS LENSES; LENSES FOR SUNGLASSES; OPHTHALMIC LENSES; OPTICAL LENSES; SPECTACLE LENSES; SUNGLASS LENSES, IN CLASS 9 (U.S. CLS. 21, 23, 26, 36 AND 38).

FIRST USE 6-29-2006; IN COMMERCE 6-29-2006.

OWNER OF U.S. REG. NOS. 3,312,175 AND 3,347,650.

THE COLOR(S) RED, BLACK AND WHITE IS/ARE CLAIMED AS A FEATURE OF THE MARK.

THE MARK CONSISTS OF WORD "NEVERGLARE" IN A RECTANGULAR BOX, OF WHICH THE LEFT SIDE IS BLACK WITH THE WHITE WORD "NEVER" AND THE RIGHT SIDE IS WHITE WITH THE BLACK WORD "GLARE", AND THE WORD "ADVANTAGE" BELOW IS BRIGHT RED SLOPING UP.

SER. NO. 85-170,913, FILED 11-6-2010.

INGRID C. EULIN, EXAMINING ATTORNEY



David J. Kyros

Director of the United States Patent and Trademark Office

United States of America

United States Patent and Trademark Office

WHY ISLAM

Reg. No. 4,065,899

Registered Dec. 6, 2011

Int. Cl.: 45

SERVICE MARK

PRINCIPAL REGISTER

ICNA NEW JERSEY INC. (NEW JERSEY CORPORATION)
1320 HAMILTON STREET
SOMERSET, NJ 08873

FOR: PROVIDING INFORMATION REGARDING RELIGION, NAMELY, INFORMATION REGARDING THE ISLAMIC FAITH; PROVIDING INFORMATION RELATING TO HUMAN CULTURE, NAMELY, INFORMATION REGARDING THE ISLAMIC CULTURE, IN CLASS 45 (U.S. CLS. 100 AND 101).

FIRST USE 0-0-2000; IN COMMERCE 0-0-2000.

THE MARK CONSISTS OF STANDARD CHARACTERS WITHOUT CLAIM TO ANY PARTICULAR FONT, STYLE, SIZE, OR COLOR.

NO CLAIM IS MADE TO THE EXCLUSIVE RIGHT TO USE "ISLAM", APART FROM THE MARK AS SHOWN.

SER. NO. 85-171,427, FILED 11-8-2010.

PAUL F. GAST, EXAMINING ATTORNEY



David J. Kybas

Director of the United States Patent and Trademark Office

United States of America

United States Patent and Trademark Office

LAKULISH YOGA

Reg. No. 4,065,900

Registered Dec. 6, 2011

Int. Cl.: 41

SERVICE MARK

PRINCIPAL REGISTER

LAKULISH YOGA, LLC (VIRGINIA LIMITED LIABILITY COMPANY)
PO BOX 280
BLAND, VA 24315

FOR: YOGA INSTRUCTION, IN CLASS 41 (U.S. CLS. 100, 101 AND 107).

FIRST USE 12-1-2005; IN COMMERCE 12-1-2005.

THE MARK CONSISTS OF STANDARD CHARACTERS WITHOUT CLAIM TO ANY PARTICULAR FONT, STYLE, SIZE, OR COLOR.

NO CLAIM IS MADE TO THE EXCLUSIVE RIGHT TO USE "YOGA", APART FROM THE MARK AS SHOWN.

SER. NO. 85-171,803, FILED 11-8-2010.

KATHLEEN LORENZO, EXAMINING ATTORNEY



David J. Kyffers

Director of the United States Patent and Trademark Office

United States of America

United States Patent and Trademark Office



Reg. No. 4,065,901

Registered Dec. 6, 2011

Int. Cl.: 41

SERVICE MARK

PRINCIPAL REGISTER

LAKULISH YOGA, LLC (VIRGINIA LIMITED LIABILITY COMPANY)
PO BOX 280
BLAND, VA 24315

FOR: YOGA INSTRUCTION, IN CLASS 41 (U.S. CLS. 100, 101 AND 107).

FIRST USE 1-0-2008; IN COMMERCE 1-0-2008.

NO CLAIM IS MADE TO THE EXCLUSIVE RIGHT TO USE "YOGA", APART FROM THE MARK AS SHOWN.

THE MARK CONSISTS OF THE IMAGE OF A LIGHTED CANDLE. INSIDE THE CANDLE ARE TWO CYLINDER SHAPED CIRCLES OVER WHICH AN EYE APPEARS. UNDERNEATH THE CANDLE ARE THE WORDS "LAKULISH YOGA" IN A STYLIZED TEXT.

SER. NO. 85-171,818, FILED 11-8-2010.

KATHLEEN LORENZO, EXAMINING ATTORNEY



David J. Kybas

Director of the United States Patent and Trademark Office

United States of America

United States Patent and Trademark Office

THE STATE OF AMERICAN BUSINESS

Reg. No. 4,065,902

Registered Dec. 6, 2011

Int. Cls.: 16 and 41

TRADEMARK

SERVICE MARK

PRINCIPAL REGISTER

THE CHAMBER OF COMMERCE OF THE UNITED STATES OF AMERICA (D.C. CORPORATION)
1615 H STREET, NW
WASHINGTON, DC 20062

FOR: PUBLICATIONS, NAMELY, RECURRING REPORTS IN THE FIELDS OF BUSINESS, IN CLASS 16 (U.S. CLS. 2, 5, 22, 23, 29, 37, 38 AND 50).

FIRST USE 1-24-2002; IN COMMERCE 1-24-2002.

FOR: EDUCATION SERVICES, NAMELY, PROVIDING PRESENTATIONS IN THE FIELDS OF BUSINESS, IN CLASS 41 (U.S. CLS. 100, 101 AND 107).

FIRST USE 1-24-2002; IN COMMERCE 1-24-2002.

THE MARK CONSISTS OF STANDARD CHARACTERS WITHOUT CLAIM TO ANY PARTICULAR FONT, STYLE, SIZE, OR COLOR.

NO CLAIM IS MADE TO THE EXCLUSIVE RIGHT TO USE "AMERICAN BUSINESS", APART FROM THE MARK AS SHOWN.

SER. NO. 85-172,171, FILED 11-9-2010.

LINDA MICKLEBURGH, EXAMINING ATTORNEY



David J. Kyjars

Director of the United States Patent and Trademark Office

United States of America

United States Patent and Trademark Office

TI-EYE

Reg. No. 4,065,903

Registered Dec. 6, 2011

Int. Cl.: 9

TRADEMARK

PRINCIPAL REGISTER

REMELT SCIENTIFIC INC. (FLORIDA CORPORATION)
3821 B TAMIAMI TRAIL, SUITE 301
PORT CHARLOTTE, FL 33952

FOR: FIRE ALARM AND FIRE DETECTORS USED TO DETECT FIRES OR SPARKS IN TITANIUM SCRAP PREPARATION SYSTEMS, IN CLASS 9 (U.S. CLS. 21, 23, 26, 36 AND 38).

FIRST USE 10-0-2010; IN COMMERCE 11-5-2010.

THE MARK CONSISTS OF STANDARD CHARACTERS WITHOUT CLAIM TO ANY PARTICULAR FONT, STYLE, SIZE, OR COLOR.

SER. NO. 85-172,212, FILED 11-9-2010.

GENE MACIOL, EXAMINING ATTORNEY



David J. Kybas

Director of the United States Patent and Trademark Office

United States of America

United States Patent and Trademark Office

4XE

Reg. No. 4,065,904

Registered Dec. 6, 2011

Int. Cl.: 25

TRADEMARK

PRINCIPAL REGISTER

YUN, TAE HYUN (REPUBLIC OF KOREA INDIVIDUAL)
303 N. SWALL DR. APT 203
BEVERLY HILLS, CA 90211

FOR: DO RAGS; FOOTWEAR; HOODS; PANTS; SPORTS CAPS AND HATS; T-SHIRTS;
WEARABLE GARMENTS AND CLOTHING, NAMELY, SHIRTS, IN CLASS 25 (U.S. CLS.
22 AND 39).

FIRST USE 2-8-2010; IN COMMERCE 2-8-2010.

THE MARK CONSISTS OF THE STYLIZED LETTER/NUMERAL COMBINATION "4", "X",
"E" DISPLAYED SUCH THAT THE NUMERAL "4" APPEARS IN LARGE FONT FOLLOWED
BY THE LETTER "E" IN SMALLER FONT LAYING ON ITS SIDE ABOVE THE LETTER "X"
ALSO DISPLAYED IN A SMALLER FONT FOLLOWED BY THE STYLIZED LETTER "E"
IN LARGER FONT EQUAL TO THAT OF THE NUMERAL "4".

SER. NO. 85-172,213, FILED 11-9-2010.

GENE MACIOL, EXAMINING ATTORNEY



David J. Kyros

Director of the United States Patent and Trademark Office

United States of America

United States Patent and Trademark Office

Plein Air Painting

Reg. No. 4,065,905

Registered Dec. 6, 2011

Int. Cls.: 9 and 16

TRADEMARK

PRINCIPAL REGISTER

INTERWEAVE PRESS LLC (DELAWARE LIMITED LIABILITY COMPANY)
201 EAST FOURTH STREET
LOVELAND, CO 80537

FOR: ELECTRONIC PUBLICATIONS, NAMELY, MAGAZINE FEATURING INSTRUCTIONS AND INFORMATION ABOUT PLEIN AIR PAINTING RECORDED ON COMPUTER MEDIA, IN CLASS 9 (U.S. CLS. 21, 23, 26, 36 AND 38).

FIRST USE 2-4-2010; IN COMMERCE 3-9-2010.

FOR: GENERAL FEATURE MAGAZINE IN THE FIELD OF PLEIN AIR PAINTING, IN CLASS 16 (U.S. CLS. 2, 5, 22, 23, 29, 37, 38 AND 50).

FIRST USE 2-4-2010; IN COMMERCE 3-9-2010.

THE MARK CONSISTS OF STANDARD CHARACTERS WITHOUT CLAIM TO ANY PARTICULAR FONT, STYLE, SIZE, OR COLOR.

THE ENGLISH TRANSLATION OF "PLEIN" IN THE MARK IS "OUTDOOR".

SEC. 2(F).

SER. NO. 85-172,228, FILED 11-9-2010.

JIM RINGLE, EXAMINING ATTORNEY



David J. Kybas

Director of the United States Patent and Trademark Office

United States of America

United States Patent and Trademark Office



Reg. No. 4,065,906

Registered Dec. 6, 2011

Int. Cls.: 39 and 41

SERVICE MARK

PRINCIPAL REGISTER

LAKELAND FINANCE, LLC (DELAWARE LIMITED LIABILITY COMPANY)
590 PETER JEFFERSON PARKWAY, SUITE 300
CHARLOTTESVILLE, VA 22911

FOR: TRAVEL SERVICES, NAMELY, ARRANGING TOURS, GUIDE SERVICES, ARRANGING FOR TRAVEL DOCUMENTS FOR PERSONS TRAVELING ABROAD AND DOMESTICALLY, TRAVEL BOOKING AGENCY, MAKING RESERVATIONS AND BOOKINGS FOR TRANSPORTATION, PROVIDING TRAVEL INFORMATION, ARRANGING EDUCATIONAL TRIPS FOR YOUTHS AND TRIPS FOR CLUBS AND ORGANIZATIONS, IN CLASS 39 (U.S. CLS. 100 AND 105).

FIRST USE 6-29-2010; IN COMMERCE 6-29-2010.

FOR: EDUCATIONAL SERVICES, NAMELY, ARRANGING AND CONDUCTING STUDENT PROGRAMS, SEMINARS, WORKSHOPS, COURSES, AND DISTANCE LEARNING PROGRAMS IN THE FIELDS OF SCIENCE, CULTURE, HERITAGE, HISTORY, RELIGION, AND ARTS, OF TRAVEL DESTINATIONS FOR PRIMARY, SECONDARY AND JUNIOR COLLEGE STUDENT GROUPS, IN CLASS 41 (U.S. CLS. 100, 101 AND 107).

FIRST USE 6-29-2010; IN COMMERCE 6-29-2010.

THE MARK CONSISTS OF AN ARCH ABOVE A LARGE "WS" ABOVE "WORLDSTRIDES" ON A CONTRASTING SQUARE BACKGROUND.

SER. NO. 85-172,542, FILED 11-9-2010.

CHRIS WELLS, EXAMINING ATTORNEY



David J. Kybas

Director of the United States Patent and Trademark Office

United States of America

United States Patent and Trademark Office



Reg. No. 4,065,907

Registered Dec. 6, 2011

Int. Cl.: 9

TRADEMARK

PRINCIPAL REGISTER

TECHNICAL LABORATORY SYSTEMS (TEXAS CORPORATION), AKA TECH-LABS
1113 AVE B
KATY, TX 77493

FOR: DOWNLOADABLE EDUCATIONAL TRAINING MATERIAL AND PRE-RECORDED CDS CONTAINING EDUCATIONAL TRAINING MATERIAL IN THE FIELD OF SCIENCE, GREEN ENERGY, MECHATRONICS, ADVANCED MANUFACTURING PROCESSES, HEALTH CARE, AUTOMOTIVE, REPAIR AND MAINTENANCE AND CONSTRUCTION, 3D PRINTING, TRAINING MATERIAL FOR USE WITH INTERACTIVE ELECTRONIC LEARNING ACTIVITIES, FLIGHT SIMULATOR TRAINING AND COMPUTER SOFTWARE APPLICATION TRAINING, IN CLASS 9 (U.S. CLS. 21, 23, 26, 36 AND 38).

FIRST USE 1-1-2010; IN COMMERCE 1-1-2010.

THE MARK CONSISTS OF THREE GEARS TO THE LEFT OF THE STYLIZED WORDING "TECH-LABS." THE UPPER TWO GEARS ARE IN THE COLOR BLACK AND THE LOWER GEAR IS IN THE COLOR BLUE. THE WORDING "TECH-" IS IN THE COLOR BLUE AND THE WORDING "LABS" IS IN THE COLOR BLACK.

THE COLOR(S) BLACK AND BLUE IS/ARE CLAIMED AS A FEATURE OF THE MARK.

SER. NO. 85-172,652, FILED 11-9-2010.

NAPOLEON SHARMA, EXAMINING ATTORNEY



David J. Kyffers

Director of the United States Patent and Trademark Office

United States of America

United States Patent and Trademark Office



Reg. No. 4,065,908

Registered Dec. 6, 2011

Int. Cls.: 35 and 36

SERVICE MARK

PRINCIPAL REGISTER

GREEN MOUNTAIN ENERGY COMPANY (DELAWARE CORPORATION)
300 WEST SIXTH STREET
SUITE 900
AUSTIN, TX 78701

FOR: PROCUREMENT SERVICES, NAMELY, PURCHASING ELECTRIC ENERGY FOR OTHERS; ENERGY MANAGEMENT SERVICES, NAMELY, PROVIDING A SERVICE THAT ALLOWS CUSTOMERS TO PURCHASE ELECTRICITY GENERATED BY RENEWABLE RESOURCES ON AN AS NEEDED BASIS; BUY-BACK INCENTIVE REWARD PROCUREMENT PROGRAMS FOR APPLICANT'S CUSTOMERS IN THE NATURE OF PURCHASING EXCESS ELECTRICITY GENERATED BY RENEWABLE ENERGY GENERATION SYSTEMS OWNED OR CONTROLLED BY APPLICANT'S CUSTOMERS, IN CLASS 35 (U.S. CLS. 100, 101 AND 102).

FIRST USE 12-0-2009; IN COMMERCE 12-0-2009.

FOR: PROVIDING A BUYBACK CREDIT PROGRAM FOR EXCESS ELECTRICITY GENERATED BY RENEWABLE ENERGY GENERATION SYSTEMS OWNED OR CONTROLLED BY APPLICANT'S CUSTOMERS, IN CLASS 36 (U.S. CLS. 100, 101 AND 102).

FIRST USE 12-0-2009; IN COMMERCE 12-0-2009.

OWNER OF U.S. REG. NO. 3,726,863.

NO CLAIM IS MADE TO THE EXCLUSIVE RIGHT TO USE "RENEWABLE REWARDS", APART FROM THE MARK AS SHOWN.

THE MARK CONSISTS OF AN IMAGE OF HALF OF A HOUSE WITH A STYLIZED SUN OVER IT NEXT TO THE WORD RENEWABLE IN LOWER CASE LETTERS ABOVE THE WORD REWARDS IN CAPITAL LETTERS.

SER. NO. 85-172,678, FILED 11-9-2010.

NAPOLEON SHARMA, EXAMINING ATTORNEY



David J. Kyros

Director of the United States Patent and Trademark Office

United States of America

United States Patent and Trademark Office

ROUGHY

Reg. No. 4,065,909

HOOEY, LLC (TEXAS LIMITED LIABILITY COMPANY)
291 FAWN LANE
SPRING BRANCH, TX 78070

Registered Dec. 6, 2011

Int. Cl.: 25

FOR: CAPS; HOODED SWEATSHIRTS; JACKETS; KNITTED CAPS; SHIRTS; THERMAL UNDERWEAR, IN CLASS 25 (U.S. CLS. 22 AND 39).

TRADEMARK

FIRST USE 10-20-2010; IN COMMERCE 10-20-2010.

PRINCIPAL REGISTER

THE MARK CONSISTS OF STANDARD CHARACTERS WITHOUT CLAIM TO ANY PARTICULAR FONT, STYLE, SIZE, OR COLOR.

SER. NO. 85-172,696, FILED 11-9-2010.

SALLY SHIH, EXAMINING ATTORNEY



David J. Kybas

Director of the United States Patent and Trademark Office

United States of America

United States Patent and Trademark Office



Reg. No. 4,065,910

Registered Dec. 6, 2011

Int. Cl.: 1

TRADEMARK

PRINCIPAL REGISTER

PHASE III, INC. (ARIZONA CORPORATION)
315 E. WARNER RD. SUITE 3
CHANDLER, AZ 85225

FOR: GRANULAR ABSORBENT MINERAL-BASED COMPOSITION FOR ABSORBING
SPILLS FROM FLOORS, IN CLASS 1 (U.S. CLS. 1, 5, 6, 10, 26 AND 46).

FIRST USE 12-31-2008; IN COMMERCE 12-31-2008.

THE MARK CONSISTS OF AN OBLIQUE-ANGLED SQUARE CONTAINING A DROPLET.

SER. NO. 85-172,891, FILED 11-9-2010.

ANNE FARRELL, EXAMINING ATTORNEY



David J. Kyffers

Director of the United States Patent and Trademark Office

United States of America
United States Patent and Trademark Office

SHORE THING

Reg. No. 4,065,911

Registered Dec. 6, 2011

Int. Cl.: 25

TRADEMARK

PRINCIPAL REGISTER

INCITE BRANDS INC (FLORIDA CORPORATION)
SUITE 319
327 PLAZA REAL
BOCA RATON, FL 33432

FOR: GOLF SHIRTS; HATS; SHORTS; SWIM WEAR; T-SHIRTS, IN CLASS 25 (U.S. CLS. 22 AND 39).

FIRST USE 9-22-2010; IN COMMERCE 9-24-2010.

THE MARK CONSISTS OF THE WORDING "SHORE THING" IN STYLIZED FORM WITH THE LETTER G IN THE DESIGN OF A MERMAID WITH HER RIGHT ARM CONNECTED TO THE LETTER N.

SER. NO. 85-173,022, FILED 11-9-2010.

JANET LEE, EXAMINING ATTORNEY



David J. Kybas

Director of the United States Patent and Trademark Office

United States of America

United States Patent and Trademark Office

MONEY STAY STUCK TO ME

Reg. No. 4,065,912

Registered Dec. 6, 2011

Int. Cl.: 41

SERVICE MARK

PRINCIPAL REGISTER

CAJIGAS, EDUARDO (UNITED STATES INDIVIDUAL), AKA EDDIE SNUB
640 WATER STREET, APT. 4B
NEW YORK, NY 10002 AND

QUINONES, EDWIN (UNITED STATES INDIVIDUAL), AKA E-CASHES
640 WATER STREET, APT. 4B
NEW YORK, NY 10002 AND

GARCIA, WESLEY (UNITED STATES INDIVIDUAL)
640 WATER STREET, APT. 4B
NEW YORK, NY 10002

FOR: AUDIO RECORDING AND PRODUCTION; ENTERTAINMENT IN THE NATURE OF VISUAL AND AUDIO PERFORMANCES BY A RECORDING ARTIST; ENTERTAINMENT SERVICES BY A MUSICAL ARTIST AND PRODUCER, NAMELY, MUSICAL COMPOSITION FOR OTHERS AND PRODUCTION OF MUSICAL SOUND RECORDINGS; LIVE PERFORMANCES BY A MUSICAL GROUP, IN CLASS 41 (U.S. CLS. 100, 101 AND 107).

FIRST USE 9-0-2009; IN COMMERCE 9-0-2009.

THE MARK CONSISTS OF STANDARD CHARACTERS WITHOUT CLAIM TO ANY PARTICULAR FONT, STYLE, SIZE, OR COLOR.

SER. NO. 85-173,081, FILED 11-9-2010.

HENRY S. ZAK, EXAMINING ATTORNEY



David J. Kyros

Director of the United States Patent and Trademark Office

United States of America

United States Patent and Trademark Office



Reg. No. 4,065,913

Registered Dec. 6, 2011

Int. Cl.: 9

TRADEMARK

PRINCIPAL REGISTER

CONTEXTMEDIA, INC. (ILLINOIS CORPORATION)
205 N. MICHIGAN AVE SUITE 2610
CHICAGO, IL 60601

FOR: DIGITAL MEDIA, NAMELY, PRE-RECORDED VIDEO CASSETTES, DIGITAL VIDEO DISCS, DIGITAL VERSATILE DISCS, DOWNLOADABLE AUDIO AND VIDEO RECORDINGS, DVDS, AND HIGH DEFINITION DIGITAL DISCS FEATURING EDUCATIONAL MATERIAL FOR PATIENTS WITH RHEUMATIC DISEASES, IN CLASS 9 (U.S. CLS. 21, 23, 26, 36 AND 38).

FIRST USE 9-1-2010; IN COMMERCE 9-1-2010.

OWNER OF U.S. REG. NOS. 3,625,528 AND 3,734,197.

THE COLOR(S) PURPLE, GREEN, WHILE, AND BLUE IS/ARE CLAIMED AS A FEATURE OF THE MARK.

NO CLAIM IS MADE TO THE EXCLUSIVE RIGHT TO USE "RHEUMATOID HEALTH NETWORK" AND "SERVICE", APART FROM THE MARK AS SHOWN.

THE MARK CONSISTS OF THE STYLIZED WORDING "RHEUMATOID" IN THE COLOR PURPLE ABOVE THE STYLIZED WORDING "HEALTH NETWORK A CONTEXTMEDIA SERVICE" IN THE COLOR BLUE. TO THE LEFT OF THE WORDING IS THE DESIGN OF SHIELD-LIKE CARRIER WITH A REPRESENTATION OF A HUMAN FIGURE. THE HUMAN FIGURE IS IN THE COLOR WHITE, THE BOTTOM PORTION OF THE CARRIER IS IN THE COLOR BLUE, THE LEFT AND RIGHT SIDES OF THE CARRIER ARE IN THE COLOR GREEN, AND THE TOP PORTION OF THE CARRIER IS IN THE COLOR PURPLE.

SER. NO. 85-173,330, FILED 11-10-2010.

JAY BESCH, EXAMINING ATTORNEY



David J. Kybas

Director of the United States Patent and Trademark Office

United States of America

United States Patent and Trademark Office

I · Bi

Reg. No. 4,065,914

Registered Dec. 6, 2011

Int. Cl.: 8

TRADEMARK

PRINCIPAL REGISTER

KIM, HO DAE (REPUBLIC OF KOREA INDIVIDUAL)
37-03 BROOKSIDE STREET
LITTLE NECK, NY 11363

FOR: CALLUS CUTTERS; CUTICLE SCISSORS; ELECTRIC MANICURE SETS; ELECTRIC PEDICURE SETS; FILES; FINGERNAIL CLIPPERS; HAND TOOLS, NAMELY, NAIL SETS; MANICURE IMPLEMENTS, NAMELY, ORANGE STICKS; MANICURE IMPLEMENTS, NAMELY, NAIL FILES, NAIL CLIPPERS, CUTICLE PUSHERS, TWEEZERS, NAIL BUFFERS, NAIL AND CUTICLE SCISSORS; MANICURE SETS; MANUAL CLIPPERS; NAIL BUFFERS; NAIL CLIPPERS; NAIL FILES; NAIL NIPPERS; NAIL SCISSORS; NAIL SKIN TREATMENT TRIMMERS; NON-ELECTRIC FINGERNAIL POLISHERS; PEDICURE IMPLEMENTS, NAMELY, NAIL FILES, NAIL CLIPPERS, CUTICLE PUSHERS, TWEEZERS, NAIL BUFFERS, NAIL AND CUTICLE SCISSORS; PEDICURE SETS; TWEEZERS, IN CLASS 8 (U.S. CLS. 23, 28 AND 44).

FIRST USE 2-0-2010; IN COMMERCE 2-0-2010.

THE MARK CONSISTS OF STYLIZED LETTER "I", A RAISED PERIOD, AND STYLIZED LETTERS "BI".

SER. NO. 85-173,587, FILED 11-10-2010.

GEOFFREY FOSDICK, EXAMINING ATTORNEY



David J. Kybas

Director of the United States Patent and Trademark Office

United States of America

United States Patent and Trademark Office



Reg. No. 4,065,915
Registered Dec. 6, 2011

Int. Cl.: 39

SERVICE MARK

PRINCIPAL REGISTER

LAKELAND FINANCE, LLC (DELAWARE LIMITED LIABILITY COMPANY)
590 PETER JEFFERSON PARKWAY, SUITE 300
CHARLOTTESVILLE, VA 22911

FOR: TRAVEL SERVICES, NAMELY, ARRANGING AND CONDUCTING TRAVEL TOURS AND EDUCATIONAL TRIPS FEATURING ARTS AND ENTERTAINMENT, IN CLASS 39 (U.S. CLS. 100 AND 105).

FIRST USE 9-19-2006; IN COMMERCE 9-19-2006.

OWNER OF U.S. REG. NOS. 2,149,853, 3,003,906, AND 3,479,690.

THE MARK CONSISTS OF "AHSTF" ON A CURVED HORIZON CENTERED IN A RECTANGLE ON A BLANK BACKGROUND WITH "AMERICAN HIGH SCHOOL" ABOVE THE UPPER BORDER OF THE RECTANGLE AND "THEATRE FESTIVAL" BELOW IN THE BORDER OF THE RECTANGLE IN A CONTRASTING SHADE.

SEC. 2(F) AS TO "AMERICAN HIGH SCHOOL" AND "THEATER FESTIVAL".

SER. NO. 85-174,183, FILED 11-11-2010.

CHRIS WELLS, EXAMINING ATTORNEY



David J. Kybas

Director of the United States Patent and Trademark Office

United States of America

United States Patent and Trademark Office

PATH TO THE PENNANT

Reg. No. 4,065,916

Registered Dec. 6, 2011

Int. Cl.: 41

SERVICE MARK

PRINCIPAL REGISTER

MAJOR LEAGUE BASEBALL PROPERTIES, INC. (NEW YORK CORPORATION)
245 PARK AVENUE
NEW YORK, NY 10167

FOR: ENTERTAINMENT SERVICES, NAMELY, ONGOING TELEVISION SERIES PROVIDING INFORMATION IN THE FIELD OF SPORTS AND ENTERTAINMENT AND FEATURING SPORTS GAMES AND COMPETITIONS VIA BROADCAST MEDIA, IN CLASS 41 (U.S. CLS. 100, 101 AND 107).

FIRST USE 9-18-2009; IN COMMERCE 9-18-2009.

THE MARK CONSISTS OF STANDARD CHARACTERS WITHOUT CLAIM TO ANY PARTICULAR FONT, STYLE, SIZE, OR COLOR.

SER. NO. 85-175,010, FILED 11-11-2010.

TRACY CROSS, EXAMINING ATTORNEY



David J. Kyros

Director of the United States Patent and Trademark Office

United States of America

United States Patent and Trademark Office

BRIGHT SIDE

Reg. No. 4,065,917

Registered Dec. 6, 2011

Int. Cl.: 16

TRADEMARK

PRINCIPAL REGISTER

BRIGHT SIDE, INC. (OHIO CORPORATION)
16821 PARK CIRCLE DR.
CHAGRIN FALLS, OH 44023

FOR: PRINTED MATERIALS IN THE NATURE OF BOOKLETS, BROCHURES, INFORMATIONAL SHEETS, NEWSLETTERS, PAMPHLETS AND WORKBOOKS IN THE FIELDS OF PERSONAL, TEAM OR CORPORATE MOTIVATION, AND PERSONAL OR BUSINESS EFFECTIVENESS AND ENRICHMENT, IN CLASS 16 (U.S. CLS. 2, 5, 22, 23, 29, 37, 38 AND 50).

FIRST USE 9-0-1987; IN COMMERCE 9-0-1987.

THE MARK CONSISTS OF STANDARD CHARACTERS WITHOUT CLAIM TO ANY PARTICULAR FONT, STYLE, SIZE, OR COLOR.

OWNER OF U.S. REG. NO. 1,484,703.

SER. NO. 85-175,606, FILED 11-12-2010.

SUNG IN, EXAMINING ATTORNEY



David J. Kyfos

Director of the United States Patent and Trademark Office

United States of America

United States Patent and Trademark Office

YELLOW & BLACK

Reg. No. 4,065,918

Registered Dec. 6, 2011

Int. Cl.: 7

TRADEMARK

PRINCIPAL REGISTER

THE BLACK & DECKER CORPORATION (MARYLAND CORPORATION)
TW-199
701 E. JOPPA ROAD
TOWSON, MD 21286

FOR: POWER TOOLS, NAMELY, DRILLS, CORDLESS DRILLS, HAMMERDRILLS, SCREWDRIVERS, CIRCULAR SAWS, WORM DRIVE SAW, MITER SAWS, RECIPROCATING SAWS, JIGSAWS, GRINDERS, CHOP SAWS, SANDERS, AND ROUTERS; POWER TOOL PARTS AND ACCESSORIES, NAMELY, DRILL BITS, HOLE SAWS, HOLE SAW MANDRELS, SCREWDRIVER TIPS, DUST BAGS FOR VACUUM CLEANERS, CROWN STOPS, BLADES, GRINDING WHEELS, ABRASIVE WHEELS AND COLLETS, IN CLASS 7 (U.S. CLS. 13, 19, 21, 23, 31, 34 AND 35).

FIRST USE 12-31-2009; IN COMMERCE 12-31-2009.

THE MARK CONSISTS OF "YELLOW & BLACK" IN A STRAIGHT LINE.

SEC. 2(F).

SER. NO. 85-175,711, FILED 11-12-2010.

SKYE YOUNG, EXAMINING ATTORNEY



David J. Kybas

Director of the United States Patent and Trademark Office

United States of America

United States Patent and Trademark Office

YELLOW & BLACK

Reg. No. 4,065,919

Registered Dec. 6, 2011

Int. Cl.: 7

TRADEMARK

PRINCIPAL REGISTER

THE BLACK & DECKER CORPORATION (MARYLAND CORPORATION)
TW-199
701 E. JOPPA ROAD
TOWSON, MD 21286

FOR: POWER TOOLS, NAMELY, DRILLS, CORDLESS DRILLS, HAMMERDRILLS, SCREWDRIVERS, CIRCULAR SAWS, WORM DRIVE SAW, MITER SAWS, RECIPROCATING SAWS, JIGSAWS, GRINDERS, CHOP SAWS, SANDERS, AND ROUTERS; POWER TOOL PARTS AND ACCESSORIES, NAMELY, DRILL BITS, HOLE SAWS, HOLE SAW MANDRELS, SCREWDRIVER TIPS, DUST BAGS FOR VACUUM CLEANERS, CROWN STOPS, BLADES, GRINDING WHEELS, ABRASIVE WHEELS AND COLLETS, IN CLASS 7 (U.S. CLS. 13, 19, 21, 23, 31, 34 AND 35).

FIRST USE 12-31-2009; IN COMMERCE 12-31-2009.

OWNER OF U.S. REG. NOS. 2,348,072, 2,348,074 AND OTHERS.

THE MARK CONSISTS OF "YELLOW & BLACK" IN A STACKED FORM.

SEC. 2(F).

SER. NO. 85-175,814, FILED 11-12-2010.

SKYE YOUNG, EXAMINING ATTORNEY



David J. Kybas

Director of the United States Patent and Trademark Office

United States of America

United States Patent and Trademark Office

LEAKBLOCKER

Reg. No. 4,065,920

Registered Dec. 6, 2011

Int. Cl.: 19

TRADEMARK

PRINCIPAL REGISTER

NEW PENDULUM CORP. (DELAWARE CORPORATION)
SUITE 1300
1105 N MARKET ST
WILMINGTON, DE 19801

FOR: PLASTIC AND ELASTOMERIC FLEXIBLE BARRIERS IN THE NATURE OF DIKES FOR CONTAINING AND DIVERTING LIQUIDS, IN CLASS 19 (U.S. CLS. 1, 12, 33 AND 50).

FIRST USE 5-1-1995; IN COMMERCE 5-1-1995.

THE MARK CONSISTS OF STANDARD CHARACTERS WITHOUT CLAIM TO ANY PARTICULAR FONT, STYLE, SIZE, OR COLOR.

SEC. 2(F).

SER. NO. 85-175,908, FILED 11-12-2010.

NAKIA HENRY, EXAMINING ATTORNEY



David J. Kybas

Director of the United States Patent and Trademark Office

United States of America

United States Patent and Trademark Office

Corks & Colors Studio



Reg. No. 4,065,921

Registered Dec. 6, 2011

Int. Cl.: 41

SERVICE MARK

PRINCIPAL REGISTER

CORKS & COLORS STUDIO, LLC (FLORIDA LIMITED LIABILITY COMPANY)
530 W UNIVERSITY AVE.
GAINESVILLE, FL 32601

FOR: OPERATION OF ART STUDIO; PROVIDING ART AND PAINTING CLASSES, IN CLASS 41 (U.S. CLS. 100, 101 AND 107).

FIRST USE 6-23-2010; IN COMMERCE 6-23-2010.

NO CLAIM IS MADE TO THE EXCLUSIVE RIGHT TO USE "STUDIO", APART FROM THE MARK AS SHOWN.

THE MARK CONSISTS OF THE TEXT "CORKS & COLORS" AT THE TOP, "STUDIO" BELOW IN TYPEWRITER FONT, A PAINTBRUSH BELOW "STUDIO", AND "PAINT. SIP. CREATE." BELOW THE PAINTBRUSH.

SER. NO. 85-176,051, FILED 11-12-2010.

DOMINIC J. FERRAIUOLO, EXAMINING ATTORNEY



David J. Kybas

Director of the United States Patent and Trademark Office

United States of America

United States Patent and Trademark Office



Reg. No. 4,065,922

Registered Dec. 6, 2011

Int. Cl.: 31

TRADEMARK

PRINCIPAL REGISTER

CLIFFORD PRODUCE SALES INC. (CANADA CORPORATION)
P.O. BOX 250
RUTHVEN, ONTARIO, CANADA N0P2G0

FOR: FRESH FRUITS AND VEGETABLES, IN CLASS 31 (U.S. CLS. 1 AND 46).

FIRST USE 6-13-2010; IN COMMERCE 6-13-2010.

NO CLAIM IS MADE TO THE EXCLUSIVE RIGHT TO USE "FAMILY FARMS", APART FROM THE MARK AS SHOWN.

THE MARK CONSISTS OF A CURSIVE "FAMILY" WITH A STYLIZED LEAF ABOVE THE "I" OVER THE SMALLER WORD "FARMS" IN BLOCK LETTERS AND A WATERMARK GRAPHIC OF A GREENHOUSE.

SER. NO. 85-176,529, FILED 11-15-2010.

SETH A. RAPPAPORT, EXAMINING ATTORNEY



David J. Kybas

Director of the United States Patent and Trademark Office

United States of America

United States Patent and Trademark Office

RESTAURANT RESULTS

Reg. No. 4,065,923

Registered Dec. 6, 2011

Int. Cl.: 43

SERVICE MARK

PRINCIPAL REGISTER

RESTAURANT RESULTS, INC. (NEW YORK CORPORATION)
101 BROOME CORPORATE PARKWAY
CONKLIN, NY 13748

FOR: CONSULTATION IN THE FIELD OF FOOD AND BEVERAGE PREPARATION, IN CLASS 43 (U.S. CLS. 100 AND 101).

FIRST USE 9-1-2007; IN COMMERCE 9-1-2007.

THE MARK CONSISTS OF STANDARD CHARACTERS WITHOUT CLAIM TO ANY PARTICULAR FONT, STYLE, SIZE, OR COLOR.

NO CLAIM IS MADE TO THE EXCLUSIVE RIGHT TO USE "RESTAURANT", APART FROM THE MARK AS SHOWN.

SER. NO. 85-176,589, FILED 11-15-2010.

VIVIAN MICZNIK FIRST, EXAMINING ATTORNEY



David J. Kybas

Director of the United States Patent and Trademark Office

United States of America

United States Patent and Trademark Office

HazSim

Reg. No. 4,065,924

Registered Dec. 6, 2011

Int. Cl.: 45

SERVICE MARK

PRINCIPAL REGISTER

AMBROSE, PHILIP LEO (UNITED STATES INDIVIDUAL), DBA HAZSIM
9 DAPPLEGRAY LANE
ROLLING HILLS ESTATES, CA 90274

FOR: SECURITY SERVICES, NAMELY, THREAT SIMULATION VULNERABILITY ANALYSIS AND MITIGATION AND EMERGENCY AND CRISIS RESPONSE, IN CLASS 45 (U.S. CLS. 100 AND 101).

FIRST USE 2-20-2008; IN COMMERCE 11-14-2010.

THE MARK CONSISTS OF STANDARD CHARACTERS WITHOUT CLAIM TO ANY PARTICULAR FONT, STYLE, SIZE, OR COLOR.

SER. NO. 85-176,638, FILED 11-15-2010.

WILLIAM BRECKENFELD, EXAMINING ATTORNEY



David J. Kybas

Director of the United States Patent and Trademark Office

United States of America

United States Patent and Trademark Office

WATER | ENERGY | LIFE



Reg. No. 4,065,925

Registered Dec. 6, 2011

Int. Cl.: 39

SERVICE MARK

PRINCIPAL REGISTER

RIVERSIDE PUBLIC UTILITY (CALIFORNIA AGENCY OF THE UNITED STATES GOVERNMENT)
3901 ORANGE STREET
RIVERSIDE, CA 92501

FOR: PUBLIC UTILITIES SERVICES, NAMELY, SUPPLYING WATER AND THE DISTRIBUTION AND TRANSMISSION OF ELECTRICITY, IN CLASS 39 (U.S. CLS. 100 AND 105).

FIRST USE 10-6-2010; IN COMMERCE 10-6-2010.

NO CLAIM IS MADE TO THE EXCLUSIVE RIGHT TO USE "WATER ENERGY" AND "CITY OF RIVERSIDE PUBLIC UTILITIES", APART FROM THE MARK AS SHOWN.

THE MARK CONSISTS OF 2 INDIVIDUAL SQUARES. THE SQUARE ON THE LEFT FEATURES A BELL IN A STAND WITH A RAINCROSS OVER IT ABOVE THE STYLIZED TEXT "CITY OF RIVERSIDE". THE SQUARE ON THE RIGHT HAND SIDE CONTAINS OF A WAVY ELECTRICITY LINE. ABOVE THE BOXES THERE IS THE STYLIZED TEXT "WATER ENERGY LIFE" WITH A VERTICAL LINE BETWEEN EACH WORD. BELOW THE BOXES ARE THE WORDS "PUBLIC UTILITIES".

SER. NO. 85-176,664, FILED 11-15-2010.

LINDA MICKLEBURGH, EXAMINING ATTORNEY



David J. Kyros

Director of the United States Patent and Trademark Office

United States of America

United States Patent and Trademark Office

NANCY BROWN CUSTOM JEWELER

Reg. No. 4,065,926

Registered Dec. 6, 2011

Int. Cl.: 14

TRADEMARK

PRINCIPAL REGISTER

TIMS, RUSSELL (UNITED STATES INDIVIDUAL)
6 OLD PECOS COURT
SANTA FE, NM 87508

FOR: JEWELRY, IN CLASS 14 (U.S. CLS. 2, 27, 28 AND 50).

FIRST USE 1-1-1985; IN COMMERCE 1-1-1985.

THE MARK CONSISTS OF STANDARD CHARACTERS WITHOUT CLAIM TO ANY PARTICULAR FONT, STYLE, SIZE, OR COLOR.

NO CLAIM IS MADE TO THE EXCLUSIVE RIGHT TO USE "CUSTOM JEWELER", APART FROM THE MARK AS SHOWN.

THE NAME(S), PORTRAIT(S), AND/OR SIGNATURE(S) SHOWN IN THE MARK DOES NOT IDENTIFY A PARTICULAR LIVING INDIVIDUAL.

SER. NO. 85-176,795, FILED 11-15-2010.

TOBY BULLOFF, EXAMINING ATTORNEY



David J. Kyffers

Director of the United States Patent and Trademark Office

United States of America

United States Patent and Trademark Office

DRAVER PHYSICAL THERAPY INSTITUTE

Reg. No. 4,065,927

Registered Dec. 6, 2011

Int. Cl.: 44

SERVICE MARK

PRINCIPAL REGISTER

DRAVER PHYSICAL THERAPY INSTITUTE, LLC (PENNSYLVANIA LIMITED LIABILITY COMPANY)
2ND FLOOR
8205 PRESIDENTS DRIVE
HUMMELSTOWN, PA 17036

FOR: OCCUPATIONAL THERAPY SERVICES; PHYSICAL REHABILITATION; PHYSICAL THERAPY; PROVIDING PHYSICAL REHABILITATION FACILITIES, IN CLASS 44 (U.S. CLS. 100 AND 101).

FIRST USE 10-1-2002; IN COMMERCE 10-1-2002.

THE MARK CONSISTS OF STANDARD CHARACTERS WITHOUT CLAIM TO ANY PARTICULAR FONT, STYLE, SIZE, OR COLOR.

OWNER OF U.S. REG. NO. 3,108,973.

NO CLAIM IS MADE TO THE EXCLUSIVE RIGHT TO USE "PHYSICAL THERAPY INSTITUTE", APART FROM THE MARK AS SHOWN.

SEC. 2(F).

SER. NO. 85-176,800, FILED 11-15-2010.

RAMONA ORTIGA, EXAMINING ATTORNEY



David J. Kyros

Director of the United States Patent and Trademark Office

United States of America

United States Patent and Trademark Office

AVID ASCEND

Reg. No. 4,065,928

Registered Dec. 6, 2011

Int. Cl.: 12

TRADEMARK

PRINCIPAL REGISTER

THE YOKOHAMA RUBBER CO., LTD. (JAPAN CORPORATION)
36-11, 5-CHOME SHIMBASHI
MINATO-KU, TOKYO, JAPAN

FOR: TIRES FOR AUTOMOBILES, IN CLASS 12 (U.S. CLS. 19, 21, 23, 31, 35 AND 44).

THE MARK CONSISTS OF STANDARD CHARACTERS WITHOUT CLAIM TO ANY PARTICULAR FONT, STYLE, SIZE, OR COLOR.

PRIORITY CLAIMED UNDER SEC. 44(D) ON JAPAN APPLICATION NO. 2010-087940, FILED 11-11-2010, REG. NO. 5413368, DATED 5-20-2011, EXPIRES 5-20-2021.

OWNER OF U.S. REG. NOS. 3,601,187, 3,814,991 AND OTHERS.

SER. NO. 85-177,317, FILED 11-15-2010.

ANDREW LEASER, EXAMINING ATTORNEY



David J. Kyros

Director of the United States Patent and Trademark Office

United States of America

United States Patent and Trademark Office

KEZITA

Reg. No. 4,065,929

ABLA KETOGLLO, AKPE MASSAN (TOGO INDIVIDUAL)
C/O G2M 6104 ROUTE DE KPALIME SOVIEPE
LOME, TOGO

Registered Dec. 6, 2011

Int. Cls.: 9, 14, 25 and 41

FOR: BLANK MAGNETIC DATA CARRIERS; COMPACT DISCS, OPTICAL DISCS, OPTICAL COMPACT DISCS AND RECORDING, ALL FEATURING MUSIC; COMPACT DISCS WITH READ-ONLY MEMORY AND INTERACTIVE COMPACT DISCS, ALL FEATURING MUSIC; COMPACT DISCS, VIDEO DISCS, CD-ROM'S, INTERACTIVE CD-ROM'S, ALL FEATURING MUSIC, MULTIMEDIA GOODS, NAMELY, DVDS AND CDS FEATURING MUSIC, MUSIC CONTENT, AND MUSICAL PERFORMANCES; OPTICAL GOODS, NAMELY, BLANK RECORDABLE OPTICAL DISC; SUNGLASSES; SPORTS SPECTACLES; SPECTACLE FRAMES; EYEWEAR CASES, IN CLASS 9 (U.S. CLS. 21, 23, 26, 36 AND 38).

TRADEMARK

SERVICE MARK

PRINCIPAL REGISTER

FOR: COSTUME JEWELLERY, NAMELY, RINGS, FINGER RINGS, EARRINGS, CUFF LINKS, BRACELETS, KEY RINGS, NAMELY, COSTUME TRINKETS OR FOBS, MEDALS, BROOCHES NAMELY, JEWELLERY, WATCH CHAINS; JEWELLERY CHAINS AND NECKLACES, LONG NECKLACES, TIE PINS, ORNAMENTAL PINS; HOROLOGICAL AND CHRONOMETRIC INSTRUMENTS, NAMELY, SOFT WRISTWATCHES, RIGID WRISTWATCHES, ALARM CLOCKS, IN CLASS 14 (U.S. CLS. 2, 27, 28 AND 50).

FOR: HEADWEAR; HATS; CAPS; VISORS; BERETS; HEADBANDS, BANDANAS; SCARVES; SWEATSHIRTS; OUTERCLOTHING FOR MEN, WOMEN AND CHILDREN, NAMELY, TOPS AND BOTTOMS; SPORTSWEAR, OTHER THAN FOR DIVING, NAMELY, TOPS AND BOTTOMS; PAPER CLOTHING, NAMELY, PAPER TOPS AND PAPER HATS, ALL FOR USE AS CLOTHING ITEMS; SHOES, IN CLASS 25 (U.S. CLS. 22 AND 39).



FOR: PRODUCTION SERVICES, NAMELY, PRODUCTION OF COMPACT DISCS, VIDEO DISCS, OPTICAL COMPACT DISCS, INTERACTIVE OPTICAL COMPACT DISCS, MULTIMEDIA GOODS, NAMELY, DVDS AND CASSETTES, ALL FEATURING MUSIC; RECORDING STUDIOS; ENTERTAINMENT IN THE NATURE OF LIVE PERFORMANCES BY A GOSPEL GROUP OR BY A GOSPEL SINGER PROVIDING THE ENTERTAINMENT, IN CLASS 41 (U.S. CLS. 100, 101 AND 107).

David J. Kybas

THE MARK CONSISTS OF STANDARD CHARACTERS WITHOUT CLAIM TO ANY PARTICULAR FONT, STYLE, SIZE, OR COLOR.

Reg. No. 4,065,929 PRIORITY CLAIMED UNDER SEC. 44(D) ON ERPN CMNTY TM OFC APPLICATION NO. 009200114, FILED 6-9-2010, REG. NO. 009200114, DATED 6-21-2011, EXPIRES 6-21-2021.

THE WORDING "KEZITA" HAS NO MEANING IN ENGLISH.

SER. NO. 85-177,598, FILED 11-16-2010.

PAUL MORENO, EXAMINING ATTORNEY

United States of America

United States Patent and Trademark Office

BIGR
AUDIO

Reg. No. 4,065,930

Registered Dec. 6, 2011

Int. Cl.: 9

TRADEMARK

PRINCIPAL REGISTER

BIGR AUDIO (CALIFORNIA LIMITED LIABILITY COMPANY)
P.O. BOX 234128
LEUCADIA, CA 920234128

FOR: CONSUMER ELECTRONIC PRODUCTS, NAMELY, PORTABLE AUDIO AND VIDEO COMPONENTS, NAMELY, AUDIO SPEAKERS, AUDIO AMPLIFIERS, AUDIO RECEIVERS, AUDIO DECODERS, ELECTRICAL AUDIO AND SPEAKER CABLES AND CONNECTORS, VIDEO DISPLAYS, VIDEO DECODERS, POWER CONVERTERS, POWER INVERTORS, AND SPEAKER PORTS FOR DIGITAL AUDIO PLAYERS, IN CLASS 9 (U.S. CLS. 21, 23, 26, 36 AND 38).

FIRST USE 6-1-2010; IN COMMERCE 8-1-2010.

NO CLAIM IS MADE TO THE EXCLUSIVE RIGHT TO USE "AUDIO", APART FROM THE MARK AS SHOWN.

THE MARK CONSISTS OF THE STYLIZED TEXT "BIGR AUDIO".

SER. NO. 85-177,691, FILED 11-16-2010.

ELLEN PERKINS, EXAMINING ATTORNEY



David J. Kyfos

Director of the United States Patent and Trademark Office

United States of America

United States Patent and Trademark Office

ONEFINESTAY

Reg. No. 4,065,931

Registered Dec. 6, 2011

Int. Cls.: 35 and 43

SERVICE MARK

PRINCIPAL REGISTER

LIFELIKE LIMITED (UNITED KINGDOM LIMITED COMPANY (LTD.))
7TH FLOOR, 4 CHISWELL STREET
LONDON, EC1Y 4UP, UNITED KINGDOM

FOR: ADVERTISING ON THE INTERNET FOR OTHERS; ADVERTISING SERVICES; ADVERTISING VIA ELECTRONIC MEDIA AND SPECIFICALLY THE INTERNET; INTERNET ADVERTISING SERVICES; ON-LINE BUYERS GUIDE SERVICE PROVIDING INFORMATION IN THE FIELD OF PRIVATE RESIDENTIAL PROPERTIES THAT ARE AVAILABLE FOR TEMPORARY ACCOMMODATIONS AND LISTING OF PRIVATE ACCOMMODATION FOR RENTAL PURPOSES; PROMOTING THE GOODS AND SERVICES OF OTHERS BY PROVIDING A WEB SITE AT WHICH USERS CAN LINK TO VIEW GUEST REVIEWS OF TEMPORARY ACCOMMODATION AND MAKE BOOKING AND RESERVATIONS OF PRIVATE ACCOMMODATION; PROMOTING THE GOODS AND SERVICES OF OTHERS VIA A GLOBAL COMPUTER NETWORK; PROVIDING A SEARCHABLE ONLINE ADVERTISING WEBSITE AND INFORMATIONAL GUIDE FEATURING THE GOODS AND SERVICES OF OTHER VENDORS VIA THE INTERNET IN THE FIELD OF TEMPORARY ACCOMMODATION AND PRIVATE RESIDENTIAL PROPERTIES FOR TEMPORARY STAY; PROVIDING AN ON-LINE DIRECTORY INFORMATION SERVICE FEATURING INFORMATION REGARDING PRIVATE RESIDENTIAL PROPERTIES THAT ARE AVAILABLE FOR TEMPORARY ACCOMMODATIONS FOR OTHERS; PROVIDING CONSUMER INFORMATION IN THE FIELD OF TEMPORARY ACCOMMODATIONS FEATURING PRIVATE RESIDENTIAL PROPERTIES THAT ARE AVAILABLE FOR RENT; PROVIDING CONSUMER INFORMATION IN THE FIELD OF CLASSIFIED ADVERTISING SPACE FOR TEMPORARY ACCOMMODATIONS BY MEANS OF THE INTERNET, IN CLASS 35 (U.S. CLS. 100, 101 AND 102).



David J. Kyros

Director of the United States Patent and Trademark Office

FOR: AGENCY SERVICES FOR THE RESERVATION OF TEMPORARY ACCOMMODATION; ARRANGING TEMPORARY HOUSING ACCOMMODATIONS; HOTEL ACCOMMODATION SERVICES; PROVIDING PERSONALIZED INFORMATION ABOUT HOTELS AND TEMPORARY ACCOMMODATIONS FOR TRAVEL VIA THE INTERNET; PROVIDING TEMPORARY ACCOMMODATION; PROVIDING TEMPORARY HOUSING ACCOMMODATIONS; PROVIDING TRAVEL LODGING INFORMATION SERVICES AND TRAVEL LODGING BOOKING AGENCY SERVICES FOR TRAVELERS; RENTAL OF PRIVATE MANSIONS AS TEMPORARY LIVING ACCOMMODATIONS FOR VACATION STAYS; RENTAL OF ROOMS AS TEMPORARY LIVING ACCOMMODATIONS; RESERVATION OF ROOMS FOR TRAVELLERS; SERVICES FOR THE RESERVATION OF ROOMS, IN CLASS 43 (U.S. CLS. 100 AND 101).

Reg. No. 4,065,931 THE MARK CONSISTS OF STANDARD CHARACTERS WITHOUT CLAIM TO ANY PARTICULAR FONT, STYLE, SIZE, OR COLOR.

OWNER OF UNITED KINGDOM REG. NO. 2538736, DATED 5-28-2010, EXPIRES 2-5-2020.

SER. NO. 85-177,705, FILED 11-16-2010.

DAWN FELDMAN, EXAMINING ATTORNEY

United States of America

United States Patent and Trademark Office



Reg. No. 4,065,932

Registered Dec. 6, 2011

Int. Cl.: 42

SERVICE MARK

PRINCIPAL REGISTER

WEBTAMING.COM (FLORIDA LIMITED LIABILITY COMPANY)
27539 PINE POINT DRIVE
WESLEY CHAPEL, FL 33544

FOR: COMPUTER SERVICES, NAMELY, SEARCH ENGINE OPTIMIZATION; E-MAIL SYSTEM DESIGN AND IMPLEMENTATION FOR OTHERS; WEB SITE DESIGN; WEB SITE HOSTING SERVICES, IN CLASS 42 (U.S. CLS. 100 AND 101).

FIRST USE 7-1-2010; IN COMMERCE 7-1-2010.

THE STIPLING IS FOR SHADING PURPOSES ONLY.

THE MARK CONSISTS OF A PICTURE OF A BROWN AND TAN LION LAYING IN A FIELD OF GREEN GRASS AND A ROUND YELLOW AND ORANGE SWIRL BELOW THE LION'S CHIN, FOLLOWED BY BLACK AND WHITE TEXT "WEBTAMING.COM WE WILL TAME THE WEB FOR YOU!", AND "YOUR ONE-SOURCE FOR WEBSITE DESIGN/HOSTING & SEO/SIM MARKETING!" BELOW IN A STACKED FORMATION.

SER. NO. 85-177,730, FILED 11-16-2010.

HEATHER THOMPSON, EXAMINING ATTORNEY



David J. Kyros

Director of the United States Patent and Trademark Office

United States of America

United States Patent and Trademark Office

NOVOBOLT

Reg. No. 4,065,933

Registered Dec. 6, 2011

Int. Cls.: 1, 6 and 37

TRADEMARK

SERVICE MARK

PRINCIPAL REGISTER

MINOVA INTERNATIONAL LTD (ENGLAND LIMITED LIABILITY COMPANY)
UNIT 8 FRESHWATER ROAD
PARK ROAD, HOLMEWOOD INDUSTRIAL ESTATE
CHESTERFIELD DERBYSHIRE, UNITED KINGDOM S425UY

FOR: CHEMICALS FOR USE IN INDUSTRY, MINING AND TUNNELLING; ADHESIVES FOR INDUSTRIAL AND COMMERCIAL USE, NAMELY, ADHESIVE LIQUID CEMENT AND ADHESIVE CEMENT; UNPROCESSED ARTIFICIAL RESINS, IN CLASS 1 (U.S. CLS. 1, 5, 6, 10, 26 AND 46).

FOR: FASTENERS AND ANCHORAGES BEING MADE OF METAL, NAMELY, BOLTS, NAILS, RIVETS, SCREWS, THREADED FASTENERS, FASTENING ANCHORS, MECHANICAL FASTENING ELEMENTS, METAL BARS AND CHAINS, AND ANCHORS; SELF DRILLING INJECTABLE BOLTING SYSTEMS COMPRISED PRIMARILY OF METAL BOLTS AND METAL FASTENING ANCHORS; PARTS AND FITTINGS FOR ALL THE AFORESAID, NAMELY, METAL BOLTS, METAL FASTENING ANCHORS, IN CLASS 6 (U.S. CLS. 2, 12, 13, 14, 23, 25 AND 50).

FOR: CONSTRUCTION, NAMELY, BUILDING CONSTRUCTION; REPAIR, INSTALLATION AND MAINTENANCE OF CONSTRUCTION EQUIPMENT, MINING EQUIPMENT, POWER-OPERATED PUMPS, POWER-OPERATED PUMPING MACHINES, COMPRESSORS, BOLTING MACHINES, DRILLING MACHINES, MIXING MACHINES AND SPRAYING MACHINES; CONSTRUCTION, REPAIR, INSTALLATION AND MAINTENANCE IN RELATION TO MINING, TUNNELLING, ROCK ENGINEERING STRUCTURES AND CONSTRUCTION PROJECTS, GROUND CONSOLIDATION, BUILDING AND CIVIL ENGINEERING STRUCTURES AND CONSTRUCTION PROJECTS, NAMELY, MINE RECLAMATION SERVICES, MINING EXCAVATION, CONSTRUCTION AND REPAIR OF MINES, CONSTRUCTION AND REPAIR OF TUNNELS AND UNDERGROUND STRUCTURES; BUILDING MAINTENANCE AND REPAIR, REMOVAL OF SURFACE WATERS AND GROUNDWATER TO FACILITATE THE CONSTRUCTION OF STRUCTURES AND PIPELINES, LAND RECLAMATION; RENTAL, INSTALLATION, MAINTENANCE AND REPAIR OF MACHINERY AND EQUIPMENT USED IN RELATION TO MINING, TUNNELLING, ROCK ENGINEERING, GROUND CONSOLIDATION, BUILDING AND CIVIL ENGINEERING; RENTAL, INSTALLATION, MAINTENANCE AND REPAIR OF PUMPS, MACHINES AND EQUIPMENT FOR APPLYING AND INJECTING PRODUCTS, COMPOUNDS AND FLUIDS INTO BUILDINGS, STRUCTURES AND SURFACES AND OF PUMPS, MACHINES AND EQUIPMENT FOR MIXING AND DISPENSING PRODUCTS, COMPOUNDS AND FLUIDS; PROVIDING CON-



David J. Kyffers

Director of the United States Patent and Trademark Office

Reg. No. 4,065,933 SULTATION, ADVICE AND INFORMATION IN RELATION TO ALL THE AFORESAID SERVICES; CONSTRUCTION CONSULTATION RELATING TO THE MINING, TUNNELLING, GROUND CONSOLIDATION, BUILDING CONSTRUCTION INDUSTRIES, THAT INCLUDE SUBTERRANEAN CONSTRUCTION STRATA CONTROL AND STRATA SUPPORT; CONSTRUCTION MANAGEMENT, CONSTRUCTION PLANNING, AND CONSTRUCTION PROJECT MANAGEMENT IN RELATION TO MINING PROJECTS, TUNNELLING PROJECTS, ROCK ENGINEERING CONSTRUCTION PROJECTS, GROUND CONSOLIDATION PROJECTS, BUILDING AND CIVIL ENGINEERING CONSTRUCTION PROJECTS, THAT MAY INCLUDE SUBTERRANEAN STRATA CONTROL AND STRATA SUPPORT; POST-OPERATION CONSTRUCTION PROJECT MANAGEMENT IN RELATION TO MINING PROJECTS, TUNNELLING PROJECTS, ROCK ENGINEERING CONSTRUCTION PROJECTS, GROUND CONSOLIDATION PROJECTS, BUILDING AND CIVIL ENGINEERING CONSTRUCTION PROJECTS, THAT MAY INCLUDE SUBTERRANEAN STRATA CONTROL AND STRATA SUPPORT; PROVIDING POST-OPERATION CONSULTATION, ADVICE AND INFORMATION IN RELATION TO MINING PROJECTS, TUNNELLING PROJECTS, ROCK ENGINEERING CONSTRUCTION PROJECTS, GROUND CONSOLIDATION PROJECTS, BUILDING AND CIVIL ENGINEERING CONSTRUCTIONS PROJECTS, THAT MAY INCLUDE SUBTERRANEAN STRATA CONTROL AND STRATA SUPPORT, IN CLASS 37 (U.S. CLS. 100, 103 AND 106).

THE MARK CONSISTS OF STANDARD CHARACTERS WITHOUT CLAIM TO ANY PARTICULAR FONT, STYLE, SIZE, OR COLOR.

PRIORITY CLAIMED UNDER SEC. 44(D) ON UNITED KINGDOM APPLICATION NO. 2553630, FILED 7-23-2010, REG. NO. 2553630, DATED 10-22-2010, EXPIRES 7-23-2020.

SER. NO. 85-177,990, FILED 11-16-2010.

JAY BESCH, EXAMINING ATTORNEY

United States of America

United States Patent and Trademark Office



Reg. No. 4,065,934

Registered Dec. 6, 2011

Int. Cls.: 9 and 41

TRADEMARK

SERVICE MARK

PRINCIPAL REGISTER

SPACE BEACH CLUB, S.A. (SPAIN CORPORATION)
APARTADO 132
SANT JORDI DE SES SALINES
ISLAS BALEARES, SPAIN 07817

FOR: APPARATUS FOR REPRODUCTION OF SOUND OR IMAGES, NAMELY, ACOUSTIC DISCS FEATURING MUSIC AND SOLD BLANK, RECORD ALBUMS FEATURING MUSIC AND SOLD BLANK, AUDIOCASSETTES FEATURING MUSIC AND SOLD BLANK, AND COMPACT DISCS FEATURING MUSIC AND SOLD BLANK, IN CLASS 9 (U.S. CLS. 21, 23, 26, 36 AND 38).

FOR: ENTERTAINMENT CENTERS, NAMELY, NIGHTCLUBS; CINEMA THEATERS; DISCOTHEQUES; ENTERTAINMENT IN THE NATURE OF LASER SHOWS; ENTERTAINMENT IN THE NATURE OF LIGHT SHOWS; ENTERTAINMENT, NAMELY, LIVE PERFORMANCES OF A MUSICAL BAND; ENTERTAINMENT, NAMELY, LIVE PERFORMANCES OF MUSIC CONCERTS AND SHOWS; ENTERTAINMENT, NAMELY, LIVE PERFORMANCES OF GROUPS OF SINGERS, IN CLASS 41 (U.S. CLS. 100, 101 AND 107).

OWNER OF SPAIN REG. NO. 2.823.894, DATED 9-23-2008, EXPIRES 4-17-2018.

THE COLOR(S) BLACK, BLUE, LIGHT BLUE, RED AND YELLOW IS/ARE CLAIMED AS A FEATURE OF THE MARK.

OWNER OF U.S. REG. NOS. 2,917,254 AND 3,233,552.

NO CLAIM IS MADE TO THE EXCLUSIVE RIGHT TO USE "IBIZA" AND THE REPRESENTATION OF THE ISLAND OF IBIZA, APART FROM THE MARK AS SHOWN.

THE MARK CONSISTS OF THE COLOR BLACK APPEARS IN THE WORDS "SPACE IBIZA" AND IN THE LINE UNDERLINING THE WORD "SPACE"; THE COLOR RED APPEARS IN THE PALM DESIGN; THE COLOR YELLOW APPEARS IN THE SHAPE OF THE SUN; THE COLOR BLUE APPEARS IN THE HALF MOON; AND THE COLOR LIGHT BLUE APPEARS IN THE CLOUD BEHIND THE WORD "SPACE".

SER. NO. 85-178,046, FILED 11-16-2010.

SUSAN STIGLITZ, EXAMINING ATTORNEY



David J. Kyros

Director of the United States Patent and Trademark Office

United States of America

United States Patent and Trademark Office



Reg. No. 4,065,935

Registered Dec. 6, 2011

Int. Cl.: 38

SERVICE MARK

PRINCIPAL REGISTER

SYNACAST COMPUTER SYSTEM (SHANGHAI) CO., LTD. (CHINA CORPORATION)
ROOM 501-1, BUILDING 5
NO 690, BIBO RD, ZHANGJIANG HI-TECH PARK
SHANGHAI, CHINA 201203

FOR: COMPUTER AIDED TRANSMISSION OF INFORMATION AND IMAGES; INFORMATION TRANSMISSION SERVICES VIA DIGITAL NETWORKS; PROVIDING ACCESS TO THE INTERNET; PROVIDING TELECOMMUNICATION CONNECTIONS TO THE INTERNET OR DATABASES; TELECOMMUNICATIONS ROUTING AND JUNCTION SERVICES, IN CLASS 38 (U.S. CLS. 100, 101 AND 104).

FIRST USE 12-27-2009; IN COMMERCE 12-27-2009.

OWNER OF U.S. REG. NOS. 3,802,711 AND 3,869,362.

THE COLOR(S) BLUE, WHITE AND ORANGE IS/ARE CLAIMED AS A FEATURE OF THE MARK.

THE MARK CONSISTS OF THE LETTERS "PPTV" IN BLUE WITH ORANGE DOTS SURROUNDED BY WHITE CIRCLES IN THE CENTER OF EACH LETTER "P". THE BACKGROUND OF THE MARK IS TRANSPARENT.

SER. NO. 85-178,306, FILED 11-16-2010.

ANDREA HACK, EXAMINING ATTORNEY



David J. Kybas

Director of the United States Patent and Trademark Office

United States of America

United States Patent and Trademark Office

THE YOUNG LUXURY MARKETERS' COUNCIL

Reg. No. 4,065,936

THE LUXURY MARKETING COUNCIL, LLC (NEWYORK LIMITED LIABILITY COMPANY)
64 EAST 80TH STREET, APT. G
NEW YORK, NY 10075

Registered Dec. 6, 2011

Int. Cl.: 41

FOR: PROVIDING EDUCATION AND TRAINING, NAMELY, COURSES AND SEMINARS
IN THE FIELDS OF MARKETING, ADVERTISING AND PUBLIC RELATIONS AND DIS-
TRIBUTING COURSE MATERIALS IN CONNECTION THEREWITH, IN CLASS 41 (U.S.
CLS. 100, 101 AND 107).

SERVICE MARK

PRINCIPAL REGISTER

FIRST USE 6-15-2011; IN COMMERCE 6-15-2011.

THE MARK CONSISTS OF STANDARD CHARACTERS WITHOUT CLAIM TO ANY PAR-
TICULAR FONT, STYLE, SIZE, OR COLOR.

OWNER OF U.S. REG. NOS. 2,593,399, 3,854,196 AND OTHERS.

NO CLAIM IS MADE TO THE EXCLUSIVE RIGHT TO USE "YOUNG", APART FROM THE
MARK AS SHOWN.

SEC. 2(F) AS TO "LUXURY MARKETING COUNCIL".

SER. NO. 85-178,745, FILED 11-17-2010.

FRANK LATTUCA, EXAMINING ATTORNEY



David J. Kybas

Director of the United States Patent and Trademark Office

United States of America

United States Patent and Trademark Office

MOPHIE JUICE PACK

Reg. No. 4,065,937

Registered Dec. 6, 2011

Int. Cl.: 9

TRADEMARK

PRINCIPAL REGISTER

MOPHIE, INC. (CALIFORNIA CORPORATION)
2850 RED HILL AVENUE, SUITE 128
SANTA ANA, CA 92705

FOR: RECHARGEABLE BATTERIES INTEGRATED INTO A PROTECTIVE CASE OR HOUSING WITH AN ELECTRICAL CONNECTOR FOR USE WITH MOBILE ELECTRONIC DEVICES, NAMELY MOBILE PHONES, DIGITAL AUDIO AND VIDEO PLAYERS, HANDHELD COMPUTERS, PERSONAL DIGITAL ASSISTANTS, ELECTRONIC ORGANIZERS, ELECTRONIC NOTEPADS, AND CAMERAS; RECHARGEABLE BATTERIES FOR USE WITH MOBILE ELECTRONIC DEVICES, NAMELY MOBILE PHONES, DIGITAL AUDIO AND VIDEO PLAYERS, HANDHELD COMPUTERS, PERSONAL DIGITAL ASSISTANTS, ELECTRONIC ORGANIZERS, ELECTRONIC NOTEPADS, AND CAMERAS; BATTERY CHARGERS, IN CLASS 9 (U.S. CLS. 21, 23, 26, 36 AND 38).

FIRST USE 4-22-2009; IN COMMERCE 4-22-2009.

THE MARK CONSISTS OF STANDARD CHARACTERS WITHOUT CLAIM TO ANY PARTICULAR FONT, STYLE, SIZE, OR COLOR.

OWNER OF U.S. REG. NOS. 3,227,723, 3,227,725, AND 3,949,983.

SER. NO. 85-179,481, FILED 11-17-2010.

MARY CRAWFORD, EXAMINING ATTORNEY



David J. Kypos

Director of the United States Patent and Trademark Office

United States of America

United States Patent and Trademark Office

GNC GENERAL NUTRITION CENTERS

Reg. No. 4,065,938

Registered Dec. 6, 2011

Int. Cl.: 35

SERVICE MARK

PRINCIPAL REGISTER

GENERAL NUTRITION INVESTMENT COMPANY (ARIZONA CORPORATION)
1002 SOUTH 63RD AVENUE AT BUCKEYE
PHOENIX, AZ 85043

FOR: RETAIL STORE SERVICES FEATURING HEALTH FOODS, DIETARY SUPPLEMENTS, NUTRITIONAL SUPPLEMENTS, HERBS, VITAMINS, SPORTS NUTRITION PRODUCTS, FITNESS PRODUCTS AND APPAREL, COSMETICS, BODY CARE, DIAGNOSTIC EXERCISE OR AROMATHERAPY PRODUCTS; ADVERTISING OF HEALTH FOODS, DIETARY SUPPLEMENTS, NUTRITIONAL SUPPLEMENTS, HERBS, VITAMINS, SPORTS NUTRITION PRODUCTS, FITNESS PRODUCTS AND APPAREL, COSMETICS, BODY CARE, DIAGNOSTIC EXERCISE OR AROMATHERAPY PRODUCTS, IN CLASS 35 (U.S. CLS. 100, 101 AND 102).

FIRST USE 3-4-1990; IN COMMERCE 3-4-1990.

THE MARK CONSISTS OF STANDARD CHARACTERS WITHOUT CLAIM TO ANY PARTICULAR FONT, STYLE, SIZE, OR COLOR.

OWNER OF U.S. REG. NOS. 1,786,007, 3,429,065 AND OTHERS.

SEC. 2(F) AS TO "NUTRITION CENTERS".

SER. NO. 85-179,619, FILED 11-18-2010.

JUSTINE D. PARKER, EXAMINING ATTORNEY



David J. Kyros

Director of the United States Patent and Trademark Office

United States of America

United States Patent and Trademark Office

ROSACCI

Reg. No. 4,065,939

Registered Dec. 6, 2011

Int. Cl.: 18

TRADEMARK

PRINCIPAL REGISTER

SAM DAE ENTERPRISES, INC. (CALIFORNIA CORPORATION)
518 S. MAIN STREET
LOS ANGELES, CA 90013

FOR: ATTACHE CASES; BACKPACKS; BILLFOLDS; BRIEFCASES AND ATTACHE CASES;
BUSINESS CASES; FANNY PACKS; HANDBAGS; LUGGAGE; PURSES; STRAPS FOR
HANDBAGS; SUITCASES; TRAVEL BAGS; WAIST PACKS; WALLET, IN CLASS 18 (U.S.
CLS. 1, 2, 3, 22 AND 41).

FIRST USE 0-0-1993; IN COMMERCE 0-0-1993.

THE MARK CONSISTS OF THE STYLIZED WORD "ROSACCI" WHEREIN THE LETTER
"O" IS REPRESENTED BY A ROSE DESIGN.

SER. NO. 85-179,817, FILED 11-18-2010.

TEJBIR SINGH, EXAMINING ATTORNEY



David J. Kybas

Director of the United States Patent and Trademark Office

United States of America

United States Patent and Trademark Office

How did YOU stay fit today???

Reg. No. 4,065,940

Registered Dec. 6, 2011

Int. Cl.: 45

SERVICE MARK

PRINCIPAL REGISTER

FIT-2GETHER, INC (CALIFORNIA CORPORATION), AKA FITTOGETHER.COM
1711 HORNBLEND ST. UNIT C
SAN DIEGO, CA 92109

FOR: INTERNET BASED SOCIAL NETWORKING, INTRODUCTION, AND DATING SERVICES; INTERNET-BASED DATING, SOCIAL INTRODUCTION AND SOCIAL NETWORKING SERVICES; INTERNET-BASED SOCIAL NETWORKING SERVICES; ON-LINE SOCIAL NETWORKING SERVICES; ONLINE SOCIAL NETWORKING SERVICES PROVIDED THROUGH A COMMUNITY WEBSITE; ONLINE SOCIAL NETWORKING SERVICES PROVIDED THROUGH A SPORTS COMMUNITY WEBSITE; PROVIDING A WEBSITE VIA A GLOBAL COMPUTER NETWORK FEATURING SUPPORTIVE PERSONAL STORIES ON THE SUBJECTS OF HEALTH, CANCER, CANCER RECOVERY AND SURVIVAL; SOCIAL INTRODUCTION AGENCIES, IN CLASS 45 (U.S. CLS. 100 AND 101).

FIRST USE 2-15-2009; IN COMMERCE 2-15-2009.

THE MARK CONSISTS OF STANDARD CHARACTERS WITHOUT CLAIM TO ANY PARTICULAR FONT, STYLE, SIZE, OR COLOR.

SER. NO. 85-179,820, FILED 11-18-2010.

SETH A. RAPPAPORT, EXAMINING ATTORNEY



David J. Kyros

Director of the United States Patent and Trademark Office

United States of America

United States Patent and Trademark Office

XC4

Reg. No. 4,065,941

Registered Dec. 6, 2011

Int. Cl.: 25

TRADEMARK

PRINCIPAL REGISTER

GENESCO BRANDS INC. (DELAWARE CORPORATION)
DE5403
300 DELAWARE AVENUE, 9TH FLOOR
WILMINGTON, DE 19801

FOR: FOOTWEAR, IN CLASS 25 (U.S. CLS. 22 AND 39).

FIRST USE 8-0-2003; IN COMMERCE 8-0-2003.

THE MARK CONSISTS OF STANDARD CHARACTERS WITHOUT CLAIM TO ANY PARTICULAR FONT, STYLE, SIZE, OR COLOR.

SER. NO. 85-179,840, FILED 11-18-2010.

ODESSA BIBBINS, EXAMINING ATTORNEY



David J. Kybas

Director of the United States Patent and Trademark Office

United States of America

United States Patent and Trademark Office

MOPHIE JUICE PACK PLUS

Reg. No. 4,065,942

Registered Dec. 6, 2011

Int. Cl.: 9

TRADEMARK

PRINCIPAL REGISTER

MOPHIE, INC. (CALIFORNIA CORPORATION)
2850 RED HILL AVENUE, SUITE 128
SANTA ANA, CA 92705

FOR: RECHARGEABLE BATTERIES INTEGRATED INTO A PROTECTIVE CASE OR HOUSING WITH AN ELECTRICAL CONNECTOR FOR USE WITH MOBILE ELECTRONIC DEVICES, NAMELY MOBILE PHONES, DIGITAL AUDIO AND VIDEO PLAYERS, HAND-HELD COMPUTERS, PERSONAL DIGITAL ASSISTANTS, ELECTRONIC ORGANIZERS, ELECTRONIC NOTEPADS, AND CAMERAS; BATTERY CHARGERS, IN CLASS 9 (U.S. CLS. 21, 23, 26, 36 AND 38).

FIRST USE 12-1-2010; IN COMMERCE 12-1-2010.

THE MARK CONSISTS OF STANDARD CHARACTERS WITHOUT CLAIM TO ANY PARTICULAR FONT, STYLE, SIZE, OR COLOR.

OWNER OF U.S. REG. NOS. 3,227,723, 3,227,725, AND 3,949,983.

SER. NO. 85-179,966, FILED 11-18-2010.

MARY CRAWFORD, EXAMINING ATTORNEY



David J. Kyros

Director of the United States Patent and Trademark Office

United States of America

United States Patent and Trademark Office

SACI

Reg. No. 4,065,943

Registered Dec. 6, 2011

Int. Cls.: 2 and 4

TRADEMARK

PRINCIPAL REGISTER

DAUBERT CHEMICAL COMPANY, INC. (ILLINOIS CORPORATION)
4700 SOUTH CENTRAL AVENUE
CHICAGO, IL 60638

FOR: CORROSION INHIBITING COATINGS; AND ANTI-RUST OILS AND GREASES, IN CLASS 2 (U.S. CLS. 6, 11 AND 16).

FIRST USE 3-9-2011; IN COMMERCE 3-9-2011.

FOR: LUBRICATING OILS AND GREASES, IN CLASS 4 (U.S. CLS. 1, 6 AND 15).

FIRST USE 3-9-2011; IN COMMERCE 3-9-2011.

THE MARK CONSISTS OF STANDARD CHARACTERS WITHOUT CLAIM TO ANY PARTICULAR FONT, STYLE, SIZE, OR COLOR.

SER. NO. 85-181,301, FILED 11-19-2010.

ELIZABETH KAJUBI, EXAMINING ATTORNEY



David J. Kybas

Director of the United States Patent and Trademark Office

United States of America

United States Patent and Trademark Office

UPLAND NATION

Reg. No. 4,065,944

LINDEN, SCOTT R. (UNITED STATES INDIVIDUAL)
22037 SWEETGRASS DR.
BEND, OR 97702

Registered Dec. 6, 2011

Int. Cl.: 41

FOR: EDUCATIONAL AND ENTERTAINMENT SERVICES, NAMELY, A CONTINUING PROGRAM ABOUT BIRD HUNTING AND HUNTING DOGS, SHOTGUN SPORTS AND RELATED SUBJECTS ACCESSIBLE BY RADIO, TELEVISION, SATELLITE, AUDIO, VIDEO AND COMPUTER NETWORKS, IN CLASS 41 (U.S. CLS. 100, 101 AND 107).

SERVICE MARK

PRINCIPAL REGISTER

FIRST USE 10-5-2010; IN COMMERCE 10-5-2010.

THE MARK CONSISTS OF STANDARD CHARACTERS WITHOUT CLAIM TO ANY PARTICULAR FONT, STYLE, SIZE, OR COLOR.

NO CLAIM IS MADE TO THE EXCLUSIVE RIGHT TO USE "UPLAND", APART FROM THE MARK AS SHOWN.

SER. NO. 85-181,867, FILED 11-20-2010.

LESLIE RICHARDS, EXAMINING ATTORNEY



David J. Kyros

Director of the United States Patent and Trademark Office

United States of America

United States Patent and Trademark Office

BW Rising

Reg. No. 4,065,945

Registered Dec. 6, 2011

Int. Cl.: 35

SERVICE MARK

PRINCIPAL REGISTER

BUSINESS WOMEN RISING, INC. (CALIFORNIA CORPORATION)
3334 EAST COAST HIGHWAY
3334 EAST COAST HIGHWAY, SUITE 417
NEWPORT BEACH, CA 92625

FOR: BUSINESS CONSULTATION IN THE FIELD OF BUSINESS LEADERSHIP DEVELOPMENT; BUSINESS MANAGEMENT CONSULTATION IN THE FIELD OF EXECUTIVE AND LEADERSHIP DEVELOPMENT; BUSINESS NETWORKING; CONSULTING SERVICES IN BUSINESS LEADERSHIP DEVELOPMENT AND BUSINESS MANAGEMENT; CONSULTING SERVICES IN THE FIELD OF HUMAN RESOURCES DEVELOPMENT, NAMELY, FOR THE PROMOTION OF EMPLOYEE RETENTION, CAREER GROWTH, AND INCREASED PRODUCTIVITY FOR EMPLOYEES AND EMPLOYERS; INFORMATION AND EXPERT OPINIONS RELATING TO COMPANIES AND BUSINESS; INFORMATION, ADVISORY AND CONSULTANCY SERVICES RELATING TO BUSINESS AND MANAGEMENT OR BUSINESS ADMINISTRATION, INCLUDING SUCH SERVICES PROVIDED ON LINE OR VIA THE INTERNET; MANAGEMENT AND BUSINESS CONSULTING SERVICES IN THE FIELD OF MANAGEMENT, LEADERSHIP AND EXECUTIVE DEVELOPMENT AND LEADERSHIP DIVERSITY; PROMOTING PUBLIC AWARENESS OF THE NEED FOR LEADERSHIP DIVERSITY; PROMOTING PUBLIC INTEREST IN EDUCATION, RECOGNITION, CAREER ADVANCEMENT, AND LEADERSHIP FOR ELITE MANAGERS AND EXECUTIVES IN CORPORATIONS AND PROFESSIONAL SERVICE FIRMS; PROMOTING THE GOODS AND SERVICES OF OTHERS BY PROVIDING HYPERTEXT LINKS TO THE WEB SITES OF OTHERS; PROVIDING INFORMATION ABOUT THE CORPORATE WORLD, CORPORATE CULTURE, AND THE CORPORATE SECTOR; PROVIDING NETWORKING OPPORTUNITIES FOR INDIVIDUALS SEEKING EMPLOYMENT, IN CLASS 35 (U.S. CLS. 100, 101 AND 102).

FIRST USE 10-17-2009; IN COMMERCE 8-4-2010.

THE MARK CONSISTS OF STANDARD CHARACTERS WITHOUT CLAIM TO ANY PARTICULAR FONT, STYLE, SIZE, OR COLOR.

SER. NO. 85-181,922, FILED 11-21-2010.

HOWARD SMIGA, EXAMINING ATTORNEY



David J. Kyffers

Director of the United States Patent and Trademark Office

United States of America

United States Patent and Trademark Office

BW Rising

Reg. No. 4,065,946

Registered Dec. 6, 2011

Int. Cl.: 41

SERVICE MARK

PRINCIPAL REGISTER

BUSINESS WOMEN RISING, INC. (CALIFORNIA CORPORATION)
3334 EAST COAST HIGHWAY
3334 EAST COAST HIGHWAY, SUITE 417
NEWPORT BEACH, CA 92625

FOR: BUSINESS EDUCATION AND TRAINING SERVICES, NAMELY, DEVELOPING, AND FACILITATING CUSTOMIZED IN-COMPANY LEADERSHIP AND EXECUTIVE DEVELOPMENT PROGRAMS, PROVIDING EXECUTIVE COACHING SERVICES, AND PROVIDING PUBLIC AND IN-COMPANY KEYNOTE PRESENTATIONS TO BUSINESS LEADERS; EDUCATION SERVICES, NAMELY, MENTORING IN THE FIELD OF MANAGEMENT, LEADERSHIP AND EXECUTIVE DEVELOPMENT; EDUCATION SERVICES, NAMELY, PROVIDING MENTORING, TUTORING, CLASSES, SEMINARS AND WORKSHOPS IN THE FIELD OF MANAGEMENT, LEADERSHIP AND EXECUTIVE DEVELOPMENT; PEER TO PEER COACHING SERVICES IN THE FIELD OF MANAGEMENT, LEADERSHIP AND EXECUTIVE DEVELOPMENT; PROVIDING EDUCATIONAL MENTORING SERVICES AND PROGRAMS IN THE FIELD OF MANAGEMENT, LEADERSHIP AND EXECUTIVE DEVELOPMENT; PROVIDING GROUP COACHING AND LEARNING FORUMS IN THE FIELD OF LEADERSHIP DEVELOPMENT, IN CLASS 41 (U.S. CLS. 100, 101 AND 107).

FIRST USE 10-17-2009; IN COMMERCE 8-4-2010.

THE MARK CONSISTS OF STANDARD CHARACTERS WITHOUT CLAIM TO ANY PARTICULAR FONT, STYLE, SIZE, OR COLOR.

SER. NO. 85-181,927, FILED 11-21-2010.

HOWARD SMIGA, EXAMINING ATTORNEY



David J. Kyffers

Director of the United States Patent and Trademark Office

United States of America

United States Patent and Trademark Office

ATHLETES FOR A FIT PLANET

Reg. No. 4,065,947

ATHLETES FOR A FIT PLANET LLC (MASSACHUSETTS LIMITED LIABILITY COMPANY)
153 LOCUST STREET
HOLLISTON, MA 01746

Registered Dec. 6, 2011

Int. Cl.: 42

FOR: PROFESSIONAL CONSULTING SERVICES IN THE FIELD OF ENVIRONMENTAL SCIENCES, IN CLASS 42 (U.S. CLS. 100 AND 101).

SERVICE MARK

FIRST USE 3-25-2008; IN COMMERCE 3-25-2008.

PRINCIPAL REGISTER

THE MARK CONSISTS OF STANDARD CHARACTERS WITHOUT CLAIM TO ANY PARTICULAR FONT, STYLE, SIZE, OR COLOR.

OWNER OF U.S. REG. NOS. 3,527,092, 3,812,717, AND 3,901,178.

SER. NO. 85-182,045, FILED 11-22-2010.

GEOFFREY FOSDICK, EXAMINING ATTORNEY



David J. Kybas

Director of the United States Patent and Trademark Office

United States of America

United States Patent and Trademark Office

MITM Meetings and Incentive Travel Market

Reg. No. 4,065,948

Registered Dec. 6, 2011

Int. Cl.: 35

SERVICE MARK

PRINCIPAL REGISTER

ALVAREZ, RAMON (SPAIN INDIVIDUAL), DBA RAMON ALVAREZ
QUINTANA 28 5D
MADRID, SPAIN 28008

FOR: ADVERTISING SERVICES, NAMELY, PROMOTING AND MARKETING THE GOODS AND SERVICES OF OTHERS IN THE FIELD OF UPSCALE CHOICES SUCH AS CULTURAL EVENTS, RESTAURANTS, SHOPPING, AND TRAVEL VIA PRINT AND ELECTRONIC MEDIA; ARRANGING AND CONDUCTING TRADE SHOW EXHIBITIONS IN THE FIELD OF MEETINGS, INCENTIVE TRAVEL, CONFERENCES AND EVENTS; ORGANIZING, PROMOTING AND CONDUCTING EXHIBITIONS, TRADESHOWS AND EVENTS FOR BUSINESS PURPOSES, IN CLASS 35 (U.S. CLS. 100, 101 AND 102).

FIRST USE 2-2-1998; IN COMMERCE 2-2-1998.

THE MARK CONSISTS OF STANDARD CHARACTERS WITHOUT CLAIM TO ANY PARTICULAR FONT, STYLE, SIZE, OR COLOR.

NO CLAIM IS MADE TO THE EXCLUSIVE RIGHT TO USE "MEETINGS AND INCENTIVE TRAVEL MARKET", APART FROM THE MARK AS SHOWN.

SER. NO. 85-182,292, FILED 11-22-2010.

KELLY BOULTON, EXAMINING ATTORNEY



David J. Kyros

Director of the United States Patent and Trademark Office

United States of America

United States Patent and Trademark Office



Reg. No. 4,065,949

Registered Dec. 6, 2011

Int. Cl.: 29

TRADEMARK

PRINCIPAL REGISTER

JA FOODSERVICE CORPORATION (MICHIGAN CORPORATION)
455 POST ROAD
BUCHANAN, MI 49107

FOR: PROTEINS BEING FOODSTUFFS FOR HUMAN CONSUMPTION, NAMELY CHEESE AND PRESERVED MEAT, IN CLASS 29 (U.S. CL. 46).

FIRST USE 1-0-2011; IN COMMERCE 1-0-2011.

THE MARK CONSISTS OF THE RED WORDING "ABBOTT ACRES" IN STYLIZED FONT AND OUTLINED IN BLACK, AND THE BLACK AND RED WORDING "MEAL PALS" IN STYLIZED FONT.

THE COLOR(S) PANTONE 185PC RED AND BLACK IS/ARE CLAIMED AS A FEATURE OF THE MARK.

SER. NO. 85-182,462, FILED 11-22-2010.

JOHN KELLY, EXAMINING ATTORNEY



David J. Kyffers

Director of the United States Patent and Trademark Office

United States of America

United States Patent and Trademark Office

THE NEWPORT GROUP

Reg. No. 4,065,950

Registered Dec. 6, 2011

Int. Cls.: 35 and 36

SERVICE MARK

PRINCIPAL REGISTER

NEWPORT GROUP, INC., THE (FLORIDA CORPORATION)
300 INTERNATIONAL PARKWAY
SUITE 270
HEATHROW, FL 32746

FOR: SHAREHOLDER BENEFIT PLAN RECORD-KEEPING SERVICES FOR OTHERS, IN CLASS 35 (U.S. CLS. 100, 101 AND 102).

FIRST USE 11-0-1984; IN COMMERCE 11-0-1984.

FOR: CONSULTING AND BROKERAGE SERVICES FOR OTHERS IN THE FIELDS OF EMPLOYEE BENEFITS, ESTATE PLANNING, INSURANCE, AND ANNUITIES; BROKERAGE SERVICES FOR MUTUAL FUNDS, LIFE INSURANCE, AND ANNUITIES; FINANCIAL MANAGEMENT SERVICES IN THE NATURE OF THE MANAGEMENT OF EMPLOYEE AND EXECUTIVE BENEFIT RETIREMENT PLANS FOR OTHERS; INVESTMENT ADVISORY SERVICES; FINANCIAL PLANNING AND FINANCIAL MANAGEMENT SERVICES FOR OTHERS; CONSULTATION IN THE ADMINISTRATION OF FINANCIAL COMPENSATION AND BENEFITS PLANS, HEALTH CARE AND WELFARE PLANS COVERING INSURANCE AND FINANCE, AND QUALIFIED AND NON-QUALIFIED FINANCIAL RETIREMENT PLANS, IN CLASS 36 (U.S. CLS. 100, 101 AND 102).

FIRST USE 11-0-1984; IN COMMERCE 11-0-1984.

THE MARK CONSISTS OF STANDARD CHARACTERS WITHOUT CLAIM TO ANY PARTICULAR FONT, STYLE, SIZE, OR COLOR.

OWNER OF U.S. REG. NO. 3,061,512.

NO CLAIM IS MADE TO THE EXCLUSIVE RIGHT TO USE "GROUP", APART FROM THE MARK AS SHOWN.

SER. NO. 85-183,549, FILED 11-23-2010.

HENRY S. ZAK, EXAMINING ATTORNEY



David J. Kyros

Director of the United States Patent and Trademark Office

United States of America

United States Patent and Trademark Office

TAB

Reg. No. 4,065,951

Registered Dec. 6, 2011

Int. Cls.: 9 and 16

TRADEMARK

PRINCIPAL REGISTER

THE MCGRAW-HILL COMPANIES, INC. (NEW YORK CORPORATION)
1221 AVENUE OF THE AMERICAS
NEW YORK, NY 10020

FOR: DOWNLOADABLE E-BOOKS FEATURING INSTRUCTION IN THE FIELDS OF ELECTRONICS, COMPUTER PROGRAMMING, COMPUTER CUSTOMIZING, ENGINEERING, GAMING, SCIENCE PROJECTS, FUELS, BIOFUELS, FUEL CELLS, SOLAR ENERGY, RADIO TECHNOLOGY, ASTRONOMY, MECHANICAL ENGINEERING, ELECTRICAL ENGINEERING, MATHEMATICS, MICROCONTROLLERS, ALGEBRA, DIGITAL VERSATILE DISCS, COIL DESIGN, DO-IT-YOURSELF PROJECTS, VIDEO, BUILD-YOUR-OWN PROJECTS, ELECTRIC VEHICLES, DIGITAL FILMMAKING, SOUND TECHNOLOGY, STUDIO RECORDING, PROPELLERS, AUDIO SYSTEMS, HOME NETWORKING, ACOUSTICS, TECHNOLOGY, ROBOTICS, CALCULUS, IN CLASS 9 (U.S. CLS. 21, 23, 26, 36 AND 38).

FIRST USE 0-0-1990; IN COMMERCE 0-0-1990.

FOR: SERIES OF BOOKS FEATURING INSTRUCTION IN THE FIELDS OF ELECTRONICS, ELECTRICITY, ELECTRICAL EXPERIMENTS, COMPUTER SOFTWARE, COMPUTER PROGRAMMING, COMPUTER CUSTOMIZING, COMPUTER SCIENCE, NETWORKING, WIRELESS LOCAL AREA NETWORKS, ENGINEERING, MATHEMATICAL THEORY, MODEL ROCKETS, GAMING, SCIENCE EXPERIMENTS, SCIENCE PROJECTS, BIONICS, MECHATRONICS, FUEL, FUEL CELLS, ELECTRONIC CIRCUITS, SOLAR ENERGY, RADIO TECHNOLOGY, TELECOMMUNICATIONS, HOLOGRAPHS, ENVIRONMENTALISM, RECYCLING, PHYSICS, ASTRONOMY, MECHANICAL ENGINEERING, ELECTRICAL ENGINEERING, ROBOTICS, MATH, ALGEBRA, CALCULUS, AUDIO SYSTEMS, SPEAKER SYSTEMS, RADIO, RADIO SIGNALS, SCIENCE, DIGITAL VIDEO, FILMMAKING, DIGITAL AUDIO, VIDEO, ACOUSTICS, HYBRID VEHICLES, RENEWABLE ENERGIES, DO-IT-YOURSELF AND BUILD-YOUR OWN; ELECTRIC VEHICLES, MOTORS, ENERGY, DIGITAL VERSATILE DISCS, ANTENNAE, BATTERIES, MACHINES, ANIMATION, IN CLASS 16 (U.S. CLS. 2, 5, 22, 23, 29, 37, 38 AND 50).

FIRST USE 0-0-1990; IN COMMERCE 0-0-1990.

THE MARK CONSISTS OF STANDARD CHARACTERS WITHOUT CLAIM TO ANY PARTICULAR FONT, STYLE, SIZE, OR COLOR.

SER. NO. 85-183,585, FILED 11-23-2010.



David J. Kyjars

Director of the United States Patent and Trademark Office

Reg. No. 4,065,951 SOPHIA S. KIM, EXAMINING ATTORNEY

United States of America

United States Patent and Trademark Office

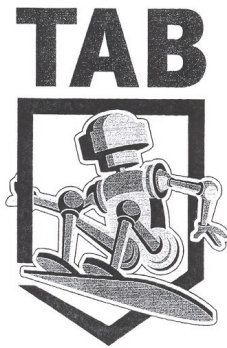

Reg. No. 4,065,952

Registered Dec. 6, 2011

Int. Cls.: 9 and 16

TRADEMARK

PRINCIPAL REGISTER

THE MCGRAW-HILL COMPANIES, INC. (NEW YORK CORPORATION)
1221 AVENUE OF THE AMERICAS
NEW YORK, NY 10021

FOR: DOWNLOADABLE E-BOOKS FEATURING INSTRUCTION IN THE FIELDS OF ELECTRONICS, COMPUTER PROGRAMMING, COMPUTER CUSTOMIZING, ENGINEERING, GAMING, SCIENCE PROJECTS, FUELS, BIOFUELS, FUEL CELLS, SOLAR ENERGY, RADIO TECHNOLOGY, ASTRONOMY, MECHANICAL ENGINEERING, ELECTRICAL ENGINEERING, MATHEMATICS, MICROCONTROLLERS, ALGEBRA, DIGITAL VERSATILE DISCS, COIL DESIGN, DO-IT-YOURSELF PROJECTS, VIDEO, BUILD-YOUR-OWN PROJECTS, ELECTRIC VEHICLES, DIGITAL FILMMAKING, SOUND TECHNOLOGY, STUDIO RECORDING, PROPELLERS, AUDIO SYSTEMS, HOME NETWORKING, ACOUSTICS, TECHNOLOGY, ROBOTICS, CALCULUS, IN CLASS 9 (U.S. CLS. 21, 23, 26, 36 AND 38).

FIRST USE 0-0-2005; IN COMMERCE 0-0-2005.

FOR: SERIES OF BOOKS FEATURING INSTRUCTION IN THE FIELDS OF ELECTRONICS, ELECTRICITY, ELECTRICAL EXPERIMENTS, COMPUTER SOFTWARE, COMPUTER PROGRAMMING, COMPUTER CUSTOMIZING, COMPUTER SCIENCE, NETWORKING, WIRELESS LOCAL AREA NETWORKS, ENGINEERING, MATHEMATICAL THEORY, MODEL ROCKETS, GAMING, SCIENCE EXPERIMENTS, SCIENCE PROJECTS, BIONICS, MECHATRONICS, FUEL, FUEL CELLS, ELECTRONIC CIRCUITS, SOLAR ENERGY, RADIO TECHNOLOGY, TELECOMMUNICATIONS, HOLOGRAPHS, ENVIRONMENTALISM, RECYCLING, PHYSICS, ASTRONOMY, MECHANICAL ENGINEERING, ELECTRICAL ENGINEERING, ROBOTICS, MATH, ALGEBRA, CALCULUS, AUDIO SYSTEMS, SPEAKER SYSTEMS, RADIO, RADIO SIGNALS, SCIENCE, DIGITAL VIDEO, FILMMAKING, DIGITAL AUDIO, VIDEO, ACOUSTICS, HYBRID VEHICLES, RENEWABLE ENERGIES, DO-IT-YOURSELF AND BUILD-YOUR OWN; ELECTRIC VEHICLES, MOTORS, ENERGY, DIGITAL VERSATILE DISCS, ANTENNAE, BATTERIES, MACHINES, ANIMATION, IN CLASS 16 (U.S. CLS. 2, 5, 22, 23, 29, 37, 38 AND 50).

FIRST USE 0-0-2005; IN COMMERCE 0-0-2005.

THE MARK CONSISTS OF A STYLIZED ROBOT RIDING A SURF BOARD WITHIN A STYLIZED SHIELD DESIGN WITH THE TERM "TAB" ABOVE THE DESIGN IN UPPERCASE LETTERS.



David J. Kyjars

Director of the United States Patent and Trademark Office

Reg. No. 4,065,952 SER. NO. 85-183,643, FILED 11-23-2010.

SOPHIA S. KIM, EXAMINING ATTORNEY

United States of America

United States Patent and Trademark Office



Reg. No. 4,065,953

Registered Dec. 6, 2011

Int. Cl.: 9

TRADEMARK

PRINCIPAL REGISTER

THE INSTITUTE OF ELECTRICAL AND ELECTRONICS ENGINEERS, INC. (NEW YORK CORPORATION)
445 HOES LANE
PISCATAWAY, NJ 08855

FOR: DOWNLOADABLE ELECTRONIC PUBLICATIONS IN THE NATURE OF JOURNALS AND MAGAZINES IN THE FIELD OF ELECTRICAL AND ELECTRONICS ENGINEERING, DIELECTRICS, AND ELECTRICAL INSULATION, IN CLASS 9 (U.S. CLS. 21, 23, 26, 36 AND 38).

FIRST USE 6-28-2004; IN COMMERCE 6-28-2004.

THE MARK CONSISTS OF THE STYLIZED LETTERS "DEIS" ABOVE AND TO THE RIGHT OF A STYLIZED DEPICTION OF A SINE WAVE.

SER. NO. 85-183,996, FILED 11-23-2010.

MATTHEW PAPPAS, EXAMINING ATTORNEY



David J. Kyppas

Director of the United States Patent and Trademark Office

United States of America

United States Patent and Trademark Office



Reg. No. 4,065,954

Registered Dec. 6, 2011

Int. Cl.: 9

TRADEMARK

PRINCIPAL REGISTER

THE INSTITUTE OF ELECTRICAL AND ELECTRONICS ENGINEERS, INC. (NEW YORK CORPORATION)
445 HOES LANE
PISCATAWAY, NJ 08855

FOR: DOWNLOADABLE ELECTRONIC PUBLICATIONS IN THE NATURE OF MAGAZINES IN THE FIELD OF THE THEORY AND APPLICATIONS OF ELECTRONICS, CONTROLS, COMMUNICATIONS, INSTRUMENTATION, AND COMPUTATIONAL INTELLIGENCE TO INDUSTRIAL AND MANUFACTURING SYSTEMS AND PROCESSES, IN CLASS 9 (U.S. CLS. 21, 23, 26, 36 AND 38).

FIRST USE 5-7-2007; IN COMMERCE 5-7-2007.

THE MARK CONSISTS OF THE STYLIZED, LOWERCASE LETTERS "IES" BETWEEN TWO HORIZONTAL LINES; THE DOT OF THE LETTER "I" RESEMBLES A SUN, WITH RAYS EXTENDING FROM IT IN EVERY DIRECTION.

SER. NO. 85-184,009, FILED 11-23-2010.

MATTHEW PAPPAS, EXAMINING ATTORNEY



David J. Kappas

Director of the United States Patent and Trademark Office

United States of America

United States Patent and Trademark Office



Reg. No. 4,065,955

Registered Dec. 6, 2011

Int. Cl.: 9

TRADEMARK

PRINCIPAL REGISTER

THE INSTITUTE OF ELECTRICAL AND ELECTRONICS ENGINEERS, INC. (NEW YORK CORPORATION)
445 HOES LANE
PISCATAWAY, NJ 08855

FOR: DOWNLOADABLE ELECTRONIC PUBLICATIONS IN THE NATURE OF NEWSLETTERS IN THE FIELD OF ELECTRICAL AND ELECTRONICS ENGINEERING, AND RESEARCH, DEVELOPMENT, TECHNOLOGY AND OPERATIONS PERTAINING TO BODIES OF WATER, IN CLASS 9 (U.S. CLS. 21, 23, 26, 36 AND 38).

FIRST USE 6-10-2002; IN COMMERCE 6-10-2002.

THE MARK CONSISTS OF THE STYLIZED UPPERCASE LETTERS "OES" ABOVE A SHADED SILHOUETTE OF OCEAN WAVES, ALL WITHIN AN OVAL DESIGN.

SER. NO. 85-184,025, FILED 11-23-2010.

MATTHEW PAPPAS, EXAMINING ATTORNEY



David J. Kappas

Director of the United States Patent and Trademark Office

United States of America

United States Patent and Trademark Office



Reg. No. 4,065,956

Registered Dec. 6, 2011

Int. Cl.: 9

TRADEMARK

PRINCIPAL REGISTER

THE INSTITUTE OF ELECTRICAL AND ELECTRONICS ENGINEERS, INC. (NEW YORK CORPORATION)
445 HOES LANE
PISCATAWAY, NJ 08855

FOR: DOWNLOADABLE ELECTRONIC PUBLICATIONS IN THE NATURE OF JOURNALS AND NEWSLETTERS IN THE FIELD OF ELECTRICAL AND ELECTRONICS ENGINEERING AND DESIGN AUTOMATION OF ELECTRONIC CIRCUITS AND SYSTEMS, IN CLASS 9 (U.S. CLS. 21, 23, 26, 36 AND 38).

FIRST USE 12-18-2009; IN COMMERCE 12-18-2009.

OWNER OF U.S. REG. NOS. 773,206, 3,898,734 AND OTHERS.

NO CLAIM IS MADE TO THE EXCLUSIVE RIGHT TO USE "COUNCIL ON ELECTRONIC DESIGN AUTOMATION", APART FROM THE MARK AS SHOWN.

THE MARK CONSISTS OF THE STYLIZED LETTERS "CEDA", WITH SHADED SQUARES AND RECTANGLES APPEARING IN A GRID PATTERN WITHIN THE LETTER "C". UNDERNEATH THE STYLIZED LETTERS "CEDA" ARE THE LETTERS/WORDS "IEEE COUNCIL ON ELECTRONIC DESIGN AUTOMATION" IN STYLIZED TEXT.

SER. NO. 85-184,062, FILED 11-23-2010.

MATTHEW PAPPAS, EXAMINING ATTORNEY



David J. Kappas

Director of the United States Patent and Trademark Office

United States of America

United States Patent and Trademark Office



Reg. No. 4,065,957

Registered Dec. 6, 2011

Int. Cl.: 9

TRADEMARK

PRINCIPAL REGISTER

THE INSTITUTE OF ELECTRICAL AND ELECTRONICS ENGINEERS, INC. (NEW YORK CORPORATION)
445 HOES LANE
PISCATAWAY, NJ 08855

FOR: DOWNLOADABLE ELECTRONIC PUBLICATIONS IN THE NATURE OF JOURNALS AND NEWSLETTERS IN THE FIELD OF ELECTRICAL AND ELECTRONICS ENGINEERING, ULTRASONICS, FERROELECTRICS, AND FREQUENCY CONTROL, IN CLASS 9 (U.S. CLS. 21, 23, 26, 36 AND 38).

FIRST USE 6-20-2005; IN COMMERCE 6-20-2005.

THE MARK CONSISTS OF A CIRCLE, THE BOTTOM TWO-THIRDS OF WHICH IS SHADED, SUPERIMPOSED UPON WHICH ARE THE STYLIZED UPPERCASE LETTERS "UFFC" ABOVE SIX WAVY LINES.

SER. NO. 85-184,072, FILED 11-23-2010.

MATTHEW PAPPAS, EXAMINING ATTORNEY



David J. Kappas

Director of the United States Patent and Trademark Office

United States of America

United States Patent and Trademark Office

ReNu COSMETIC LASER CENTER

Reg. No. 4,065,958

Registered Dec. 6, 2011

Int. Cl.: 10

ARVIND PATEL M.D.S.C. (ILLINOIS CORPORATION), DBA RENU COSMETIC LASER
CENTER
1460 MARKET STREET
THIRD FLOOR
DES PLAINES, IL 60016

TRADEMARK

FOR: LASERS FOR THE COSMETIC TREATMENT OF THE FACE AND SKIN, IN CLASS
10 (U.S. CLS. 26, 39 AND 44).

PRINCIPAL REGISTER

FIRST USE 10-10-2010; IN COMMERCE 10-10-2010.

THE MARK CONSISTS OF STANDARD CHARACTERS WITHOUT CLAIM TO ANY PAR-
TICULAR FONT, STYLE, SIZE, OR COLOR.

NO CLAIM IS MADE TO THE EXCLUSIVE RIGHT TO USE "COSMETIC LASER CENTER",
APART FROM THE MARK AS SHOWN.

SER. NO. 85-184,260, FILED 11-24-2010.

THOMAS MANOR, EXAMINING ATTORNEY



David J. Kyros

Director of the United States Patent and Trademark Office

United States of America

United States Patent and Trademark Office



Reg. No. 4,065,959

ANHUI JINHE INDUSTRIAL CO., LTD. (CHINA LIMITED LIABILITY COMPANY)
127 EAST STREET, LAIAN COUNTY
ANHUI, CHINA

Registered Dec. 6, 2011

Int. Cl.: 30

FOR: FLAVORINGS FOR BEVERAGES; FLAVORINGS FOR BEVERAGES, OTHER THAN ESSENTIAL OILS; FLAVOURINGS AND SEASONINGS; FLAVOURINGS, OTHER THAN ESSENTIAL OILS, FOR CAKES; FOOD ADDITIVES FOR NON-NUTRITIONAL PURPOSES FOR USE AS A FLAVORING; FOOD FLAVOURINGS, IN CLASS 30 (U.S. CL. 46).

TRADEMARK

PRINCIPAL REGISTER

FIRST USE 12-25-2006; IN COMMERCE 12-25-2006.

THE NON-LATIN CHARACTERS IN THE MARK TRANSLITERATE TO JINGDA AND THIS HAS NO MEANING IN A FOREIGN LANGUAGE.

SER. NO. 85-184,272, FILED 11-24-2010.

MARK SPARACINO, EXAMINING ATTORNEY



David J. Kypos

Director of the United States Patent and Trademark Office

United States of America

United States Patent and Trademark Office

Jelveh Collection

Reg. No. 4,065,960

Registered Dec. 6, 2011

Int. Cl.: 25

TRADEMARK

PRINCIPAL REGISTER

JAYIME JEAN, LLC (CALIFORNIA LIMITED LIABILITY COMPANY), DBA JELVEH
COLLECTION
1380 HERMOSA AVE
HERMOSA BEACH, CA 90254

FOR: SHIRTS FOR INFANTS, BABIES, TODDLERS AND CHILDREN, IN CLASS 25 (U.S.
CLS. 22 AND 39).

FIRST USE 11-1-2009; IN COMMERCE 1-1-2010.

THE MARK CONSISTS OF STANDARD CHARACTERS WITHOUT CLAIM TO ANY PAR-
TICULAR FONT, STYLE, SIZE, OR COLOR.

NO CLAIM IS MADE TO THE EXCLUSIVE RIGHT TO USE "COLLECTION", APART FROM
THE MARK AS SHOWN.

SER. NO. 85-184,277, FILED 11-24-2010.

MARK SPARACINO, EXAMINING ATTORNEY



David J. Kybas

Director of the United States Patent and Trademark Office

United States of America

United States Patent and Trademark Office



Reg. No. 4,065,961

Registered Dec. 6, 2011

Int. Cl.: 36

SERVICE MARK

PRINCIPAL REGISTER

VARNEY, JR., RICHARD (UNITED STATES INDIVIDUAL), DBA INSURANCE SUFFOLK
BROKERAGE
4 1/2 DOLPHIN LANE WEST
COPIAGUE, NY 11726

FOR: BROKERAGE IN THE FIELD OF INSURANCE; CONSULTING AND INFORMATION CONCERNING INSURANCE; FINANCIAL CONSULTANCY AND INSURANCE CONSULTANCY; INSURANCE BROKERAGE; INSURANCE BROKERAGE SERVICES; INSURANCE CONSULTANCY; INSURANCE CONSULTANCY SERVICES, NAMELY, PROVIDING ADVICE IN THE FIELD OF PROPERTY AND CASUALTY INSURANCE; INSURANCE CONSULTATION; INSURANCE CONSULTING IN THE FIELD OF AUTO, HOME, BUSINESS, COMMERCIAL, LIFE, DISABILITY, LONG TERM CARE, HEALTH, FIXED ANNUITIES, VOLUNTARY SUPPLEMENTAL INSURANCE; INSURANCE PREMIUM RATE COMPUTING; INSURANCE SERVICES, PROVIDING PREMIUM RATE QUOTES VIA ON-LINE, TELEPHONE AND MAIL MEANS; LIFE INSURANCE BROKERAGE; PROVIDING DETAILED INFORMATION REGARDING AVAILABLE INSURANCE PRODUCTS FOR COMMERCIAL PROPERTY AND CASUALTY, PROFESSIONAL AND PERSONAL LINES; PROVIDING INFORMATION IN INSURANCE MATTERS; PROVIDING VEHICLE INSURANCE RATE QUOTES, IN CLASS 36 (U.S. CLS. 100, 101 AND 102).

FIRST USE 7-12-2010; IN COMMERCE 9-10-2010.

NO CLAIM IS MADE TO THE EXCLUSIVE RIGHT TO USE "INSURANCE SUFFOLK", APART FROM THE MARK AS SHOWN.

THE COLOR(S) WHITE, LIGHT BLUE, DARK BLUE IS/ARE CLAIMED AS A FEATURE OF THE MARK.

THE MARK CONSISTS OF THE WORDING "INSURANCE SUFFOLK" IN DARK BLUE STYLIZED FONT WITH A DESIGN OF A DARK BLUE LIGHTHOUSE WITH A LIGHT BLUE WINDOW. A LIGHT BLUE LIGHT BEAM EXTENDS FROM THE TOP OF THE LIGHTHOUSE, GROWING LIGHTER FROM LEFT TO RIGHT AND CONTAINING THE WORD "INSURANCE". THE FOREGOING ELEMENTS APPEAR ON A WHITE BACKGROUND.



David J. Kappas

Director of the United States Patent and Trademark Office

SER. NO. 85-184,354, FILED 11-24-2010.

STEVEN PEREZ, EXAMINING ATTORNEY

United States of America

United States Patent and Trademark Office

ACCESS  Engineering

Reg. No. 4,065,962

Registered Dec. 6, 2011

Int. Cls.: 9, 41 and 42

TRADEMARK

SERVICE MARK

PRINCIPAL REGISTER

THE MCGRAW-HILL COMPANIES, INC. (NEW YORK CORPORATION)
1221 AVENUE OF THE AMERICAS
NEW YORK, NY 10020

FOR: COMPUTER SOFTWARE THAT CAN BE DOWNLOADED TO A MOBILE DEVICE CONTAINING EDUCATIONAL CONTENT IN THE FIELD OF ENGINEERING, IN CLASS 9 (U.S. CLS. 21, 23, 26, 36 AND 38).

FIRST USE 11-0-2009; IN COMMERCE 11-0-2009.

FOR: PROVIDING A WEBSITE CONTAINING NON-DOWNLOADABLE EDUCATIONAL PUBLICATIONS IN THE FIELD OF ENGINEERING, NAMELY, TEXT BOOKS AND GLOSSARIES; PROVIDING A WEBSITE FEATURING AN INTERACTIVE SELF-ASSESSMENT FOR ENGINEERING STUDENTS THAT ALLOWS STUDENTS TO CONDUCT SELF-DIAGNOSES OF THEIR EDUCATIONAL PROGRESS, IN CLASS 41 (U.S. CLS. 100, 101 AND 107).

FIRST USE 11-0-2009; IN COMMERCE 11-0-2009.

FOR: PROVIDING A WEBSITE FEATURING INFORMATIONAL, NON-DOWNLOADABLE EDUCATIONAL MATERIALS IN THE FIELD OF ENGINEERING, NAMELY, VIDEOS, ANIMATIONS, AUDIO LECTURES, PHOTOS, AND ILLUSTRATIONS, IN CLASS 42 (U.S. CLS. 100 AND 101).

FIRST USE 11-0-2009; IN COMMERCE 11-0-2009.

NO CLAIM IS MADE TO THE EXCLUSIVE RIGHT TO USE "ENGINEERING", APART FROM THE MARK AS SHOWN.

THE MARK CONSISTS OF THE TERMS "ACCESS ENGINEERING" WITH A TRIANGLE BETWEEN THE TWO TERMS AND FOUR TRIANGLES BELOW THE CENTER TRIANGLE AND SIX TRIANGLES ABOVE THE CENTER TRIANGLE.

SER. NO. 85-184,390, FILED 11-24-2010.

KIMBERLY FRYE, EXAMINING ATTORNEY



David J. Kyffers

Director of the United States Patent and Trademark Office

United States of America

United States Patent and Trademark Office

VINCAMERA

Reg. No. 4,065,963

Registered Dec. 6, 2011

Int. Cl.: 9

TRADEMARK

PRINCIPAL REGISTER

VINSOLUTIONS, INC. (DELAWARE CORPORATION)
3003 SUMMIT BOULEVARD
ATLANTA, GA 30319

FOR: DIGITAL CAMERAS, DRIVER LICENSE SCANNERS AND BATTERIES, IN CLASS 9
(U.S. CLS. 21, 23, 26, 36 AND 38).

FIRST USE 8-15-2005; IN COMMERCE 8-15-2005.

THE MARK CONSISTS OF STANDARD CHARACTERS WITHOUT CLAIM TO ANY PARTICULAR FONT, STYLE, SIZE, OR COLOR.

OWNER OF U.S. REG. NO. 3,284,006.

SER. NO. 85-184,465, FILED 11-24-2010.

MICHELLE DUBOIS, EXAMINING ATTORNEY



David J. Kybas

Director of the United States Patent and Trademark Office

United States of America

United States Patent and Trademark Office

GAGOU TAGOU

Reg. No. 4,065,964

Registered Dec. 6, 2011

Int. Cl.: 35

SERVICE MARK

PRINCIPAL REGISTER

EFFIGI INC. (CANADA CORPORATION)
1155, AUTOROUTE 13
LAVAL, QUEBEC, CANADA H7W5J8

FOR: RETAIL STORES FEATURING CLOTHING AND CLOTHING ACCESSORIES, HOUSEHOLD LINENS, FURNITURE PRODUCTS AND ACCESSORIES FOR THE KITCHEN, BEDROOM, BATHROOM AND HOUSEHOLD, IN CLASS 35 (U.S. CLS. 100, 101 AND 102).

THE MARK CONSISTS OF STANDARD CHARACTERS WITHOUT CLAIM TO ANY PARTICULAR FONT, STYLE, SIZE, OR COLOR.

PRIORITY CLAIMED UNDER SEC. 44(D) ON CANADA APPLICATION NO. 1162033-02, FILED 6-4-2010, REG. NO. TMA616917, DATED 5-9-2011, EXPIRES 8-19-2019.

OWNER OF U.S. REG. NO. 2,981,532.

SER. NO. 85-184,597, FILED 11-24-2010.

JOHN GARTNER, EXAMINING ATTORNEY



David J. Kybas

Director of the United States Patent and Trademark Office

United States of America

United States Patent and Trademark Office



Reg. No. 4,065,965

Registered Dec. 6, 2011

Int. Cl.: 41

SERVICE MARK

PRINCIPAL REGISTER

JAM PRODUCTIONS, LLC (VIRGINIA LIMITED LIABILITY COMPANY), DBA FAIRFAX
FALL BRAWL
UNIT 202
525 BELMONT BAY DR
WOODBIDGE, VA 22191

FOR: ENTERTAINMENT IN THE NATURE OF LACROSSE TOURNAMENTS, IN CLASS 41
(U.S. CLS. 100, 101 AND 107).

FIRST USE 11-23-2002; IN COMMERCE 11-23-2002.

NO CLAIM IS MADE TO THE EXCLUSIVE RIGHT TO USE "LACROSSE" AND "TOURNA-
MENT", APART FROM THE MARK AS SHOWN.

THE MARK CONSISTS OF AN OVAL WITH THE WORDS "LACROSSE" AND "TOURNA-
MENT" WITHIN THE BORDER; WITH THE STYLIZED WORDS "FALL BRAWL" SUPERIM-
POSED OVER THE OVAL WITH THE WORDING WWW.FAIRFAXFALLBRAWL.COM AP-
PEARING BELOW. TWO CROSSED LACROSSE STICKS ALSO APPEAR WITHIN THE
OVAL BEHIND THE WORDS "FALL BRAWL".

SER. NO. 85-185,346, FILED 11-25-2010.

PAM WILLIS, EXAMINING ATTORNEY



David J. Kyros

Director of the United States Patent and Trademark Office

United States of America

United States Patent and Trademark Office



Reg. No. 4,065,966

Registered Dec. 6, 2011

Int. Cl.: 43

SERVICE MARK

PRINCIPAL REGISTER

WINER, ANDREW (UNITED STATES INDIVIDUAL)
3767 SEVERN RD.
CLEVELAND HEIGHTS, OH 44118

FOR: PROVIDING AN ONLINE COMPUTER DATABASE TO CONSUMERS CONCERNING RECIPES, INGREDIENTS AND COOKING INFORMATION, IN CLASS 43 (U.S. CLS. 100 AND 101).

FIRST USE 6-1-2008; IN COMMERCE 9-30-2010.

THE MARK CONSISTS OF THE STYLIZED LETTERING AND WORDING "RG RECIPEGATE AWAKEN YOUR SENSES." "RG" IS WITHIN A CIRCLE AND IS DARK GREY WITH AN ORANGE DOT WITHIN THE "G." THE LETTERS "R", "C", AND "P" IN "RECIPEGATE" AND "AWAKEN" ARE GREEN. THE LETTERS "E", "I", AND "E" IN "RECIPEGATE" AND "YOUR SENSES" ARE DARK GREY. "GATE" IS IN LIGHT GREY, AS IS THE WHIP DESIGN OVER THE "I" IN "RECIPEGATE".

THE COLOR(S) ORANGE, GREEN, LIGHT GREY, DARK GREY IS/ARE CLAIMED AS A FEATURE OF THE MARK.

SER. NO. 85-185,444, FILED 11-26-2010.

TIMOTHY FINNEGAN, EXAMINING ATTORNEY



David J. Kybas

Director of the United States Patent and Trademark Office

United States of America

United States Patent and Trademark Office

HITCHDOC

Reg. No. 4,065,967

Registered Dec. 6, 2011

Int. Cl.: 12

TRADEMARK

PRINCIPAL REGISTER

C AND B MANUFACTURING, INC. (MINNESOTA CORPORATION)
131 COUNTY ROAD 34E
JACKSON, MN 56143

FOR: TRAILERS, IN CLASS 12 (U.S. CLS. 19, 21, 23, 31, 35 AND 44).

FIRST USE 0-0-2009; IN COMMERCE 0-0-2009.

THE MARK CONSISTS OF STANDARD CHARACTERS WITHOUT CLAIM TO ANY PARTICULAR FONT, STYLE, SIZE, OR COLOR.

OWNER OF U.S. REG. NOS. 1,790,286, 3,799,239, AND 3,814,466.

SER. NO. 85-185,970, FILED 11-29-2010.

YAT SYE, LEE, EXAMINING ATTORNEY



David J. Kybas

Director of the United States Patent and Trademark Office

United States of America

United States Patent and Trademark Office

ABROSTAR

Reg. No. 4,065,968

Registered Dec. 6, 2011

Int. Cl.: 1

TRADEMARK

PRINCIPAL REGISTER

BARANAY INVESTMENTS, LLC (INDIANA LIMITED LIABILITY COMPANY)
5342 W. VERMONT STREET
INDIANAPOLIS, IN 46224

FOR: EPOXY STEEL ADHESIVE FOR GENERAL BONDING AND REPAIR AND FOR USE
IN REPAIRING STEEL, METAL, GLASS, CERAMIC, CHINA, WOOD, MASONRY AND
PLASTIC , IN CLASS 1 (U.S. CLS. 1, 5, 6, 10, 26 AND 46).

FIRST USE 7-0-2010; IN COMMERCE 7-0-2010.

THE MARK CONSISTS OF STANDARD CHARACTERS WITHOUT CLAIM TO ANY PAR-
TICULAR FONT, STYLE, SIZE, OR COLOR.

OWNER OF U.S. REG. NOS. 2,161,554, 3,358,772 AND OTHERS.

SER. NO. 85-186,152, FILED 11-29-2010.

NAKIA HENRY, EXAMINING ATTORNEY



David J. Kybas

Director of the United States Patent and Trademark Office

United States of America

United States Patent and Trademark Office

THE SYSTEM

Reg. No. 4,065,969

Registered Dec. 6, 2011

Int. Cl.: 5

TRADEMARK

PRINCIPAL REGISTER

CIERI, DENNIS (UNITED STATES INDIVIDUAL)
6 PARK AVENUE
RUTHERFORD, NJ 07070

FOR: DIETARY AND NUTRITIONAL SUPPLEMENTS, IN CLASS 5 (U.S. CLS. 6, 18, 44, 46, 51 AND 52).

FIRST USE 8-19-2010; IN COMMERCE 8-19-2010.

THE MARK CONSISTS OF STANDARD CHARACTERS WITHOUT CLAIM TO ANY PARTICULAR FONT, STYLE, SIZE, OR COLOR.

SER. NO. 85-186,217, FILED 11-29-2010.

ALICE BENMAMAN, EXAMINING ATTORNEY



David J. Kybas

Director of the United States Patent and Trademark Office

United States of America

United States Patent and Trademark Office



Reg. No. 4,065,970

Registered Dec. 6, 2011

Int. Cl.: 30

TRADEMARK

PRINCIPAL REGISTER

PERFETTI VAN MELLE BENELUX B.V. (NETHERLANDS CORPORATION)
ZOETE INVAL 20 - 4815 HK
BREDA, NETHERLANDS

FOR: PASTRY AND CONFECTIONERY, NAMELY, CANDIES, CHEW CANDIES, CHEWING GUM, BUBBLE GUM, CANDY DROPS, GUMDROPS, CARAMEL, LOLLIPOPS, LIQUORICE, JELLIES, MINTS, SWEETS, TOFFEES; CHOCOLATE, COCOA, SUGAR, IN CLASS 30 (U.S. CL. 46).

PRIORITY CLAIMED UNDER SEC. 44(D) ON ERPN CMNTY TM OFC APPLICATION NO. 009291634, FILED 8-3-2010, REG. NO. 9291634, DATED 12-24-2010, EXPIRES 8-3-2020.

THE COLOR(S) WHITE, BLUE AND GREEN IS/ARE CLAIMED AS A FEATURE OF THE MARK.

THE MARK CONSISTS OF THE BACKGROUND OF A BLUE BACKGROUND WITH THE STYLIZED WORD "PURE" IN WHITE AND OUTLINED IN LIGHT BLUE. BELOW THE WORD "PURE" IS AN IMAGE OF AN EXPLODING GREEN LEAF ISSUING LITTLE PIECES OF ICE DEPICTED IN BLUE AND WHITE.

SER. NO. 85-186,269, FILED 11-29-2010.

RON FAIRBANKS, EXAMINING ATTORNEY



David J. Kyros

Director of the United States Patent and Trademark Office

United States of America

United States Patent and Trademark Office

ELECTROKITE

Reg. No. 4,065,971

Registered Dec. 6, 2011

Int. Cl.: 9

TRADEMARK

PRINCIPAL REGISTER

ELECTROKITE (MASSACHUSETTS PARTNERSHIP)
HTTP://WWW.ELECTROKITE.COM
8 WILLIAMS COURT
SOMERVILLE, MA 02143

FOR: EDUCATIONAL SOFTWARE FOR INSTRUCTION IN READING, LANGUAGE ARTS, MATH, SOCIAL STUDIES, SCIENCE, MUSIC, ART, HEALTH, AND SPANISH , IN CLASS 9 (U.S. CLS. 21, 23, 26, 36 AND 38).

FIRST USE 11-17-2010; IN COMMERCE 11-17-2010.

THE MARK CONSISTS OF STANDARD CHARACTERS WITHOUT CLAIM TO ANY PARTICULAR FONT, STYLE, SIZE, OR COLOR.

SER. NO. 85-186,573, FILED 11-29-2010.

SUNG IN, EXAMINING ATTORNEY



David J. Kyffers

Director of the United States Patent and Trademark Office

United States of America

United States Patent and Trademark Office

PostScript Brooklyn

Reg. No. 4,065,972

Registered Dec. 6, 2011

Int. Cl.: 16

TRADEMARK

PRINCIPAL REGISTER

POSTSCRIPT BROOKLYN, LLC (NEW YORK LIMITED LIABILITY COMPANY)
168 7TH STREET, SUITE 2L
BROOKLYN, NY 11215

FOR: INVITATION CARDS; PRINTED INVITATIONS, IN CLASS 16 (U.S. CLS. 2, 5, 22, 23, 29, 37, 38 AND 50).

FIRST USE 10-5-2010; IN COMMERCE 10-5-2010.

THE MARK CONSISTS OF STANDARD CHARACTERS WITHOUT CLAIM TO ANY PARTICULAR FONT, STYLE, SIZE, OR COLOR.

NO CLAIM IS MADE TO THE EXCLUSIVE RIGHT TO USE "BROOKLYN", APART FROM THE MARK AS SHOWN.

SER. NO. 85-186,596, FILED 11-29-2010.

ROSELLE HERRERA, EXAMINING ATTORNEY



David J. Kyjars

Director of the United States Patent and Trademark Office

United States of America

United States Patent and Trademark Office



Reg. No. 4,065,973

Registered Dec. 6, 2011

Int. Cl.: 43

SERVICE MARK

PRINCIPAL REGISTER

KOSHER KITCHEN CATERING CO., THE (VIRGINIA PARTNERSHIP)
2844 LAFORA CT.
VIENNA, VA 22180

FOR: CATERING SERVICES, NAMELY, PROVIDING KOSHER FOODS AS PART OF THE CATERING SERVICES, IN CLASS 43 (U.S. CLS. 100 AND 101).

FIRST USE 2-1-2010; IN COMMERCE 2-1-2010.

NO CLAIM IS MADE TO THE EXCLUSIVE RIGHT TO USE "THE KOSHER KITCHEN CATERING CO.", APART FROM THE MARK AS SHOWN.

THE MARK CONSISTS OF THE DESIGN OF A ROUND DINNER PLATE WITH STYLIZED WORDING "THE KOSHER KITCHEN CATERING CO." IN THE CENTER OF THE PLATE WITH A DESIGN ELEMENT OF A CHEF'S HAT ABOVE THE LETTER "K" OF THE WORDING "KOSHER."

SER. NO. 85-186,765, FILED 11-29-2010.

NAPOLEON SHARMA, EXAMINING ATTORNEY



David J. Kybas

Director of the United States Patent and Trademark Office

United States of America

United States Patent and Trademark Office

PEACHIE

Reg. No. 4,065,974

Registered Dec. 6, 2011

Int. Cl.: 21

TRADEMARK

PRINCIPAL REGISTER

CREATIVE GIFTS INTERNATIONAL, INC. (MASSACHUSETTS CORPORATION)
80 SHAWMUT ROAD
CANTON, MA 02021

FOR: GLASS TABLEWARE SOLD TO WHOLESALERS, NAMELY, BEVERAGE GLASSES, STEMWARE, WINE GLASSES, CHAMPAGNE FLUTES, SERVING BOWLS, SERVING PLATTERS, PITCHERS, CANDY DISHES, VASES AND COCKTAIL SHAKERS, IN CLASS 21 (U.S. CLS. 2, 13, 23, 29, 30, 33, 40 AND 50).

FIRST USE 12-31-2007; IN COMMERCE 12-31-2007.

THE MARK CONSISTS OF STANDARD CHARACTERS WITHOUT CLAIM TO ANY PARTICULAR FONT, STYLE, SIZE, OR COLOR.

SER. NO. 85-186,894, FILED 11-30-2010.

ESTHER A. BORSUK, EXAMINING ATTORNEY



David J. Kybas

Director of the United States Patent and Trademark Office

United States of America

United States Patent and Trademark Office

MOTEK

Reg. No. 4,065,975

Registered Dec. 6, 2011

Int. Cls.: 41 and 42

SERVICE MARK

PRINCIPAL REGISTER

MOTEK B.V. (NETHERLANDS LIMITED LIABILITY COMPANY)
KEIENBERGWEG 77
AMSTERDAM, NETHERLANDS 1011GE

FOR: ANIMATION PRODUCTION SERVICES; MOTION CAPTURE SERVICES, NAMELY, RECORDING MOVEMENT AND TRANSLATING THAT MOVEMENT TO A DIGITAL MODEL FOR USE IN COMPUTER ANIMATION; 3-DIMENSIONAL COMPUTER ANIMATION PRODUCTION AND VISUAL EFFECTS PRODUCTION FOR USE IN MOTION PICTURES, VIDEOS, MOVIE TRAILERS, COMMERCIALS, VIDEO AND COMPUTER GAMES, ONLINE AND MOBILE MEDIA AND APPLICATIONS; ENTERTAINMENT SERVICES, NAMELY, THE PRODUCTION OF COMPUTER GENERATED SPECIAL EFFECTS INCLUDING MODEL-MAKING SERVICES, COMPUTER-GENERATED IMAGERY AND COMPUTER-GENERATED GRAPHICS AND ANIMATION FOR THE PRODUCTION OF MOTION PICTURES, VIDEOS, MOVIE TRAILERS, COMMERCIALS, VIDEO AND COMPUTER GAMES, ONLINE AND MOBILE MEDIA AND APPLICATIONS, IN CLASS 41 (U.S. CLS. 100, 101 AND 107).

FIRST USE 12-15-2006; IN COMMERCE 12-15-2006.

FOR: DESIGN AND DEVELOPMENT OF HARDWARE AND SOFTWARE FOR REHABILITATION, DIAGNOSIS OF DISORDERS AND ILLNESSES AND RESEARCH AND ANALYSIS OF DISORDERS AND ILLNESSES, ALL IN CONNECTION WITH MOTION TECHNOLOGY; MOTION CAPTURE TECHNOLOGY CONSULTATION SERVICES FOR OTHERS; MOTION ANALYSIS; DESIGN AND DEVELOPMENT OF HARDWARE AND SOFTWARE FOR THE STIMULATION OF MUSCLE MOVEMENT AND IMPROVEMENT OF GAIT, LOCOMOTION AND BALANCE, IN CLASS 42 (U.S. CLS. 100 AND 101).

FIRST USE 12-15-2006; IN COMMERCE 12-15-2006.

THE MARK CONSISTS OF STANDARD CHARACTERS WITHOUT CLAIM TO ANY PARTICULAR FONT, STYLE, SIZE, OR COLOR.

OWNER OF U.S. REG. NO. 2,454,731.

SER. NO. 85-187,233, FILED 11-30-2010.

TINA MAI, EXAMINING ATTORNEY



David J. Kyros

Director of the United States Patent and Trademark Office

United States of America

United States Patent and Trademark Office

ELEARNPORTAL.COM

Reg. No. 4,065,976

Registered Dec. 6, 2011

Int. Cl.: 35

THE LEARNING HOUSE, INCORPORATED (KENTUCKY CORPORATION), DBA THE
LEARNING HOUSE, INC.
SUITE 200
333 GUTHRIE STREET
LOUISVILLE, KY 40202

SERVICE MARK

FOR: WEBSITE DIRECTORY, NAMELY, PROVIDING AN ONLINE COMMERCIAL INFORMATION DIRECTORY ON THE INTERNET, IN CLASS 35 (U.S. CLS. 100, 101 AND 102).

PRINCIPAL REGISTER

FIRST USE 6-1-2005; IN COMMERCE 6-1-2005.

THE MARK CONSISTS OF STANDARD CHARACTERS WITHOUT CLAIM TO ANY PARTICULAR FONT, STYLE, SIZE, OR COLOR.

OWNER OF U.S. REG. NO. 3,240,861.

SEC. 2(F).

SER. NO. 85-187,398, FILED 11-30-2010.

RICHARD WHITE, EXAMINING ATTORNEY



David J. Kyffers

Director of the United States Patent and Trademark Office

United States of America

United States Patent and Trademark Office

TRU-POST

Reg. No. 4,065,977

Registered Dec. 6, 2011

Int. Cls.: 6 and 19

TRADEMARK

PRINCIPAL REGISTER

TRU-POST, INC. (PENNSYLVANIA CORPORATION)
6844 FERRY ROAD
NEW HOPE, PA 18938

FOR: METAL FENCE POST COVER ATTACHMENTS FOR MOUNTING DECORATIVE ACCESSORIES, NAMELY, HOOKS, LIGHTS, LAMPS AND PLANTERS, IN CLASS 6 (U.S. CLS. 2, 12, 13, 14, 23, 25 AND 50).

FIRST USE 10-30-2008; IN COMMERCE 10-30-2008.

FOR: NON-METAL FENCE POST COVER ATTACHMENTS FOR MOUNTING DECORATIVE ACCESSORIES, NAMELY, HOOKS, LIGHTS, LAMPS AND PLANTERS, IN CLASS 19 (U.S. CLS. 1, 12, 33 AND 50).

FIRST USE 10-30-2008; IN COMMERCE 10-30-2008.

THE MARK CONSISTS OF STANDARD CHARACTERS WITHOUT CLAIM TO ANY PARTICULAR FONT, STYLE, SIZE, OR COLOR.

SER. NO. 85-187,508, FILED 11-30-2010.

ALICIA COLLINS, EXAMINING ATTORNEY



David J. Kybas

Director of the United States Patent and Trademark Office

United States of America

United States Patent and Trademark Office

CONNECTING THE HOME

Reg. No. 4,065,978

Registered Dec. 6, 2011

Int. Cl.: 9

TRADEMARK

PRINCIPAL REGISTER

ENTONE, INC. (DELAWARE CORPORATION)
20863 STEVENS CREEK BLVD., SUITE 300
CUPERTINO, CA 95014

FOR: COMPUTER HARDWARE AND SOFTWARE SOLD AS A UNIT FOR DELIVERING MULTIMEDIA DATA OVER DIGITAL COMMUNICATION CHANNELS, IN CLASS 9 (U.S. CLS. 21, 23, 26, 36 AND 38).

FIRST USE 5-31-2006; IN COMMERCE 5-31-2006.

THE MARK CONSISTS OF STANDARD CHARACTERS WITHOUT CLAIM TO ANY PARTICULAR FONT, STYLE, SIZE, OR COLOR.

SER. NO. 85-187,594, FILED 11-30-2010.

COLLEEN DOMBROW, EXAMINING ATTORNEY



David J. Kybas

Director of the United States Patent and Trademark Office

United States of America

United States Patent and Trademark Office

styleawards.com

Reg. No. 4,065,979

Registered Dec. 6, 2011

Int. Cls.: 35, 41 and 42

SERVICE MARK

PRINCIPAL REGISTER

MAIL.COM MEDIA CORPORATION (DELAWARE CORPORATION)
9800 S. LA CIENEGA BLVD., 14TH FLOOR
INGLEWOOD, CA 90203

FOR: PROVIDING ADVERTISING SERVICES FOR BUSINESSES FOR DISSEMINATION VIA ANY MEDIUM, IN CLASS 35 (U.S. CLS. 100, 101 AND 102).

FIRST USE 11-24-2010; IN COMMERCE 11-24-2010.

FOR: PRODUCTION OF DIGITAL MEDIA, NAMELY, CDS, MP3S, DVDS, DOWNLOADABLE AUDIO FILES AND DOWNLOADABLE VIDEO FILES; ELECTRONIC PUBLISHING SERVICES, NAMELY, PUBLICATION OF TEXT AND GRAPHIC WORKS OF OTHERS ON CDS, MP3S, DVDS, DOWNLOADABLE AUDIO FILES AND DOWNLOADABLE VIDEO FILES FEATURING ASPECTS OF POPULAR CULTURE, IN CLASS 41 (U.S. CLS. 100, 101 AND 107).

FIRST USE 11-24-2010; IN COMMERCE 11-24-2010.

FOR: DIGITAL MEDIA SOFTWARE AUTHORING SERVICES; HOSTING AN ON-LINE COMMUNITY WEB SITE FEATURING ASPECTS OF POPULAR CULTURE, IN CLASS 42 (U.S. CLS. 100 AND 101).

FIRST USE 11-24-2010; IN COMMERCE 11-24-2010.

THE MARK CONSISTS OF STANDARD CHARACTERS WITHOUT CLAIM TO ANY PARTICULAR FONT, STYLE, SIZE, OR COLOR.

SER. NO. 85-187,747, FILED 11-30-2010.

RENEE MCCRAY, EXAMINING ATTORNEY



David J. Kyros

Director of the United States Patent and Trademark Office

United States of America

United States Patent and Trademark Office

THE QUEEN MARY'S DARK HARBOR

Reg. No. 4,065,980

Registered Dec. 6, 2011

Int. Cl.: 41

SERVICE MARK

PRINCIPAL REGISTER

CITY OF LONG BEACH (CALIFORNIA MUNICIPAL CORPORATION)
333 WEST OCEAN BOULEVARD
LONG BEACH, CA 90802

FOR: ENTERTAINMENT SERVICES, NAMELY, PROVIDING A HAUNTED HOTEL ATTRAC-
TION TO BE HELD ON A PERMANENTLY MOORED SHIP NAMED THE QUEEN MARY ,
IN CLASS 41 (U.S. CLS. 100, 101 AND 107).

FIRST USE 10-1-2010; IN COMMERCE 10-1-2010.

THE MARK CONSISTS OF STANDARD CHARACTERS WITHOUT CLAIM TO ANY PAR-
TICULAR FONT, STYLE, SIZE, OR COLOR.

OWNER OF U.S. REG. NOS. 2,341,577 AND 2,432,514.

"QUEEN MARY" DOES NOT IDENTIFY A PARTICULAR LIVING INDIVIDUAL.

SER. NO. 85-188,224, FILED 12-1-2010.

H. M. FISHER, EXAMINING ATTORNEY



David J. Kybas

Director of the United States Patent and Trademark Office

United States of America

United States Patent and Trademark Office

the Queen Mary's
DARK
HARBOR

Reg. No. 4,065,981

Registered Dec. 6, 2011

Int. Cl.: 41

SERVICE MARK

PRINCIPAL REGISTER

CITY OF LONG BEACH (CALIFORNIA MUNICIPAL CORPORATION)
333 WEST OCEAN BOULEVARD
LONG BEACH, CA 90802

FOR: ENTERTAINMENT SERVICES, NAMELY, PROVIDING A HAUNTED HOTEL ATTRACTION TO BE HELD ON A PERMANENTLY MOORED SHIP NAMED THE "QUEEN MARY" , IN CLASS 41 (U.S. CLS. 100, 101 AND 107).

FIRST USE 10-1-2010; IN COMMERCE 10-1-2010.

OWNER OF U.S. REG. NOS. 2,341,577 AND 2,432,514.

"QUEEN MARY" DOES NOT IDENTIFY A PARTICULAR LIVING INDIVIDUAL.

THE MARK CONSISTS OF THE STYLIZED TERMS "QUEEN MARY'S" WITH THE STYLIZED TERM "THE" WITHIN THE LETTER "Q", OVER THE STYLIZED TERM "DARK" WITH THE STYLIZED TERM "HARBOR" BENEATH ALL.

SER. NO. 85-188,233, FILED 12-1-2010.

H. M. FISHER, EXAMINING ATTORNEY



David J. Kyros

Director of the United States Patent and Trademark Office

United States of America

United States Patent and Trademark Office

PacificXPOSURE

Reg. No. 4,065,982

Registered Dec. 6, 2011

Int. Cl.: 41

SERVICE MARK

PRINCIPAL REGISTER

CONFERENCE LOCATORS INTERNATIONAL, LLC (CALIFORNIA LIMITED LIABILITY COMPANY)
5708 LA JOLLA HERMOSA AVENUE
LA JOLLA, CA 92037

FOR: ORGANIZATION OF SPORTS TOURNAMENTS, IN CLASS 41 (U.S. CLS. 100, 101 AND 107).

FIRST USE 9-1-2009; IN COMMERCE 1-1-2010.

THE MARK CONSISTS OF STANDARD CHARACTERS WITHOUT CLAIM TO ANY PARTICULAR FONT, STYLE, SIZE, OR COLOR.

SER. NO. 85-188,273, FILED 12-1-2010.

PRISCILLA MILTON, EXAMINING ATTORNEY



David J. Kyffers

Director of the United States Patent and Trademark Office

United States of America

United States Patent and Trademark Office

SWEET ART BY LUCILA

Reg. No. 4,065,983

Registered Dec. 6, 2011

Int. Cl.: 30

TRADEMARK

PRINCIPAL REGISTER

SWEET ART HOLDINGS LLC (FLORIDA LIMITED LIABILITY COMPANY)
4310 SW 75TH AVENUE
MIAMI, FL 33155

FOR: BAKERY GOODS; CAKES, IN CLASS 30 (U.S. CL. 46).

FIRST USE 8-4-1999; IN COMMERCE 8-4-1999.

THE MARK CONSISTS OF STANDARD CHARACTERS WITHOUT CLAIM TO ANY PARTICULAR FONT, STYLE, SIZE, OR COLOR.

OWNER OF U.S. REG. NO. 2,679,959.

SER. NO. 85-188,309, FILED 12-1-2010.

BRIAN CALLAGHAN, EXAMINING ATTORNEY



David J. Kybas

Director of the United States Patent and Trademark Office

United States of America

United States Patent and Trademark Office

SWEET ART BY LUCILA

Reg. No. 4,065,984

Registered Dec. 6, 2011

Int. Cl.: 35

SERVICE MARK

PRINCIPAL REGISTER

SWEET ART HOLDINGS LLC (FLORIDA LIMITED LIABILITY COMPANY)
4310 SW 75TH AVENUE
MIAMI, FL 33155

FOR: RETAIL BAKERY SHOPS; TAKE-OUT BAKERY SERVICES, IN CLASS 35 (U.S. CLS. 100, 101 AND 102).

FIRST USE 8-4-1999; IN COMMERCE 8-4-1999.

THE MARK CONSISTS OF STANDARD CHARACTERS WITHOUT CLAIM TO ANY PARTICULAR FONT, STYLE, SIZE, OR COLOR.

OWNER OF U.S. REG. NO. 2,679,959.

SER. NO. 85-188,317, FILED 12-1-2010.

BRIAN CALLAGHAN, EXAMINING ATTORNEY



David J. Kybas

Director of the United States Patent and Trademark Office

United States of America

United States Patent and Trademark Office

SWEET ART BY LUCILA

Reg. No. 4,065,985

Registered Dec. 6, 2011

Int. Cl.: 40

SERVICE MARK

PRINCIPAL REGISTER

SWEET ART HOLDINGS LLC (FLORIDA LIMITED LIABILITY COMPANY)
4310 SW 75TH AVENUE
MIAMI, FL 33155

FOR: BAKERY SERVICES, NAMELY, THE MANUFACTURE OF BAKERY PRODUCTS TO ORDER AND/OR SPECIFICATION OF OTHERS; CUSTOM CAKE DECORATING SERVICES, IN CLASS 40 (U.S. CLS. 100, 103 AND 106).

FIRST USE 8-4-1999; IN COMMERCE 8-4-1999.

THE MARK CONSISTS OF STANDARD CHARACTERS WITHOUT CLAIM TO ANY PARTICULAR FONT, STYLE, SIZE, OR COLOR.

OWNER OF U.S. REG. NO. 2,679,959.

SER. NO. 85-188,326, FILED 12-1-2010.

BRIAN CALLAGHAN, EXAMINING ATTORNEY



David J. Kybas

Director of the United States Patent and Trademark Office

United States of America

United States Patent and Trademark Office



Reg. No. 4,065,986

Registered Dec. 6, 2011

Int. Cl.: 30

TRADEMARK

PRINCIPAL REGISTER

SWEET ART HOLDINGS LLC (FLORIDA LIMITED LIABILITY COMPANY)
4310 SW 75TH AVENUE
MIAMI, FL 33155

FOR: BAKERY GOODS; CAKES, IN CLASS 30 (U.S. CL. 46).

FIRST USE 8-4-1999; IN COMMERCE 8-4-1999.

OWNER OF U.S. REG. NO. 2,679,959.

THE MARK CONSISTS OF THE DESIGN OF A HEART AND CHEF'S HAT, ALONG WITH THE LITERAL ELEMENT "LUCILA", AS SHOWN.

SER. NO. 85-188,348, FILED 12-1-2010.

BRIAN CALLAGHAN, EXAMINING ATTORNEY



David J. Kybas

Director of the United States Patent and Trademark Office

United States of America

United States Patent and Trademark Office



Reg. No. 4,065,987

Registered Dec. 6, 2011

Int. Cl.: 35

SERVICE MARK

PRINCIPAL REGISTER

SWEET ART HOLDINGS LLC (FLORIDA LIMITED LIABILITY COMPANY)
4310 SW 75TH AVENUE
MIAMI, FL 33155

FOR: RETAIL BAKERY SHOPS; TAKE-OUT BAKERY SERVICES, IN CLASS 35 (U.S. CLS. 100, 101 AND 102).

FIRST USE 8-4-1999; IN COMMERCE 8-4-1999.

OWNER OF U.S. REG. NO. 2,679,959.

THE MARK CONSISTS OF THE DESIGN OF A HEART AND CHEF'S HAT WITH THE LITERAL ELEMENT "LUCILA", AS SHOWN.

SER. NO. 85-188,368, FILED 12-1-2010.

BRIAN CALLAGHAN, EXAMINING ATTORNEY



David J. Kybas

Director of the United States Patent and Trademark Office

United States of America

United States Patent and Trademark Office



Reg. No. 4,065,988

Registered Dec. 6, 2011

Int. Cl.: 40

SERVICE MARK

PRINCIPAL REGISTER

SWEET ART HOLDINGS LLC (FLORIDA LIMITED LIABILITY COMPANY)
4310 SW 75TH AVENUE
MIAMI, FL 33155

FOR: BAKERY SERVICES, NAMELY, THE MANUFACTURE OF BAKERY PRODUCTS TO ORDER AND/OR SPECIFICATION OF OTHERS; CUSTOM CAKE DECORATING SERVICES, IN CLASS 40 (U.S. CLS. 100, 103 AND 106).

FIRST USE 8-4-1999; IN COMMERCE 8-4-1999.

OWNER OF U.S. REG. NO. 2,679,959.

THE MARK CONSISTS OF THE DESIGN OF A HEART AND CHEF'S HAT WITH THE LITERAL ELEMENT "LUCILA", AS SHOWN.

SER. NO. 85-188,377, FILED 12-1-2010.

BRIAN CALLAGHAN, EXAMINING ATTORNEY



David J. Kybas

Director of the United States Patent and Trademark Office

United States of America

United States Patent and Trademark Office

DRIVETIME

Reg. No. 4,065,989

Registered Dec. 6, 2011

Int. Cl.: 41

SERVICE MARK

PRINCIPAL REGISTER

A-1 DRIVING SCHOOLS (UTAH CORPORATION)
8088 SOUTH 2000 EAST
SALT LAKE CITY, UT 84121

FOR: PROVIDING A WEBSITE FOR PERSONS TO REGISTER FOR COURSES, SCHEDULE APPOINTMENTS, TRAINING SESSIONS AND TESTS, AND CHECK SCORES AND GRADES FOR DRIVING EDUCATION PURPOSES , IN CLASS 41 (U.S. CLS. 100, 101 AND 107).

FIRST USE 6-0-2009; IN COMMERCE 1-1-2010.

THE MARK CONSISTS OF STANDARD CHARACTERS WITHOUT CLAIM TO ANY PARTICULAR FONT, STYLE, SIZE, OR COLOR.

SER. NO. 85-188,499, FILED 12-1-2010.

CIMMERIAN COLEMAN, EXAMINING ATTORNEY



David J. Kyfos

Director of the United States Patent and Trademark Office

United States of America

United States Patent and Trademark Office

BeautyMatte

Reg. No. 4,065,990

Registered Dec. 6, 2011

Int. Cl.: 24

TRADEMARK

PRINCIPAL REGISTER

BELL, MARY (UNITED STATES INDIVIDUAL)
1011 CITRINE COVE
OAK POINT, TX 75068

FOR: PLACE MATS, NOT OF PAPER, IN CLASS 24 (U.S. CLS. 42 AND 50).

FIRST USE 11-23-2010; IN COMMERCE 12-7-2010.

THE MARK CONSISTS OF STANDARD CHARACTERS WITHOUT CLAIM TO ANY PARTICULAR FONT, STYLE, SIZE, OR COLOR.

SER. NO. 85-189,040, FILED 12-2-2010.

SOPHIA S. KIM, EXAMINING ATTORNEY



David J. Kybas

Director of the United States Patent and Trademark Office

United States of America

United States Patent and Trademark Office

B.

Reg. No. 4,065,991

Registered Dec. 6, 2011

Int. Cl.: 28

TRADEMARK

PRINCIPAL REGISTER

BATTAT INCORPORATED (DELAWARE CORPORATION)
1560 MILITARY TURNPIKE
PLATTSBURGH, NY 12901

FOR: BABY MULTIPLE ACTIVITY TOYS; BATH TOYS; BATTERY OPERATED ACTION TOYS; CHILDREN'S ACTIVITY TABLES CONTAINING MANIPULATIVE TOYS WHICH CONVERT TO EASELS; CHILDREN'S MULTIPLE ACTIVITY TOYS; DRAWING TOYS; ELECTRONIC LEARNING TOYS; MECHANICAL ACTION TOYS; MECHANICAL TOYS; PLASTIC TOY HOOPS; RADIO CONTROLLED TOY VEHICLES; STACKING TOYS; TALKING ELECTRONIC PRESS-DOWN TOY; TALKING TOYS; TOY BOATS; TOY BUILDING BLOCKS; TOY BUILDING BLOCKS CAPABLE OF INTERCONNECTION; TOY, NAMELY, BATTERY-POWERED COMPUTER GAME WITH LCD SCREEN WHICH FEATURES ANIMATION AND SOUND EFFECTS; ALL THE FOREGOING NOT RELATING TO BASEBALL OR SOFTBALL OR TO A SPORTS TEAM, IN CLASS 28 (U.S. CLS. 22, 23, 38 AND 50).

FIRST USE 11-30-2009; IN COMMERCE 11-30-2009.

THE MARK CONSISTS OF STANDARD CHARACTERS WITHOUT CLAIM TO ANY PARTICULAR FONT, STYLE, SIZE, OR COLOR.

SER. NO. 85-189,158, FILED 12-2-2010.

ANTHONY RINKER, EXAMINING ATTORNEY



David J. Kyffers

Director of the United States Patent and Trademark Office

United States of America

United States Patent and Trademark Office

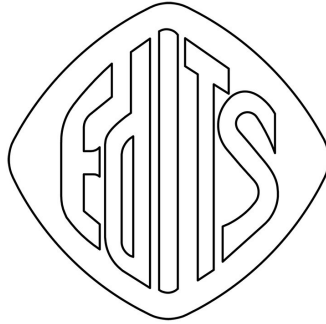

Reg. No. 4,065,992

Registered Dec. 6, 2011

Int. Cls.: 16, 35 and 44

TRADEMARK

SERVICE MARK

PRINCIPAL REGISTER

LEE PHD, LISA JUSTINE KNAPP (UNITED STATES INDIVIDUAL)
P.O. BOX 7234
SAN DIEGO, CA 92167

FOR: PRINTED MATERIALS, NAMELY, PAMPHLETS, BROCHURES, MANUALS, BOOKS, BOOKLETS, LEAFLETS, FLYERS, INFORMATIONAL SHEETS AND NEWSLETTERS, TESTING, SCORING AND INTERPRETATION MATERIALS IN THE FIELDS OF ACADEMIC AND CAREER EDUCATION FOR ELEMENTARY THROUGH COLLEGE STUDENTS; PRINTED MATERIALS, NAMELY, PAMPHLETS, BROCHURES, MANUALS, BOOKS, BOOKLETS, LEAFLETS, FLYERS, INFORMATIONAL SHEETS AND NEWSLETTERS IN THE FIELD OF ACADEMIC CURRICULUM FOR ELEMENTARY THROUGH COLLEGE STUDENTS; PRINTED MATERIALS, NAMELY, PAMPHLETS, BROCHURES, MANUALS, BOOKS, BOOKLETS, LEAFLETS, FLYERS, INFORMATIONAL SHEETS AND NEWSLETTERS IN THE FIELD OF SPECIAL NEEDS EDUCATION; PRINTED MATERIALS, NAMELY, PAMPHLETS, BROCHURES, MANUALS, BOOKS, BOOKLETS, LEAFLETS, FLYERS, INFORMATIONAL SHEETS AND NEWSLETTERS, TESTING, SCORING AND INTERPRETATION MATERIALS IN THE FIELDS OF CAREER MEASUREMENT AND GUIDANCE; PRINTED MATERIALS, NAMELY, PAMPHLETS, BROCHURES, MANUALS, BOOKS, BOOKLETS, LEAFLETS, FLYERS, INFORMATIONAL SHEETS AND NEWSLETTERS, TESTING, SCORING AND INTERPRETATION MATERIALS IN THE FIELD OF CAREER TRANSITION; PRINTED MATERIALS, NAMELY, PAMPHLETS, BROCHURES, MANUALS, BOOKS, BOOKLETS, LEAFLETS, FLYERS, INFORMATIONAL SHEETS AND NEWSLETTERS, TESTING, SCORING AND INTERPRETATION MATERIALS IN THE FIELD OF PSYCHOLOGICAL ASSESSMENTS, IN CLASS 16 (U.S. CLS. 2, 5, 22, 23, 29, 37, 38 AND 50).

FIRST USE 12-31-1973; IN COMMERCE 12-31-1973.

FOR: PROVIDING CAREER INFORMATION, NAMELY, CAREER MEASUREMENT, IN CLASS 35 (U.S. CLS. 100, 101 AND 102).

FIRST USE 12-31-1973; IN COMMERCE 12-31-1973.

FOR: PSYCHOLOGICAL TESTING SERVICES, IN CLASS 44 (U.S. CLS. 100 AND 101).

FIRST USE 12-31-1973; IN COMMERCE 12-31-1973.



David J. Kyjars

Director of the United States Patent and Trademark Office

Reg. No. 4,065,992 THE MARK CONSISTS OF STYLIZED WORD "EDITS" INSIDE DIAMOND SHAPED SHIELD WITH CURVED CORNERS.

SER. NO. 85-189,463, FILED 12-2-2010.

ANNE E. GUSTASON, EXAMINING ATTORNEY

United States of America

United States Patent and Trademark Office

THE DETOX REVOLUTION

Reg. No. 4,065,993

Registered Dec. 6, 2011

Int. Cls.: 9 and 41

TRADEMARK

SERVICE MARK

PRINCIPAL REGISTER

E REAL ESTATE, LLC (CALIFORNIA LIMITED LIABILITY COMPANY)
15526 HAMNER DR.
LOS ANGELES, CA 90077

FOR: DIGITAL MEDIA, NAMELY, DOWNLOADABLE AUDIO AND VIDEO FILES FEATURING INFORMATION IN THE FIELD OF DIET, EXERCISE, NUTRITION, WEIGHT MANAGEMENT, WEIGHT MAINTENANCE, APPETITE CONTROL, DIETARY SUPPLEMENTATION, WEIGHT LOSS, FAT CONTROL, COOKING AND LIFESTYLE, IN CLASS 9 (U.S. CLS. 21, 23, 26, 36 AND 38).

FIRST USE 8-1-2010; IN COMMERCE 8-1-2010.

FOR: PROVIDING ON-LINE TRAINING IN THE FORM OF COURSES AND SEMINARS IN THE FIELD OF DIET, EXERCISE, NUTRITION, WEIGHT MANAGEMENT, WEIGHT MAINTENANCE, APPETITE CONTROL, DIETARY SUPPLEMENTATION, WEIGHT LOSS, FAT CONTROL, COOKING AND LIFESTYLE, IN CLASS 41 (U.S. CLS. 100, 101 AND 107).

FIRST USE 8-1-2010; IN COMMERCE 8-1-2010.

THE MARK CONSISTS OF STANDARD CHARACTERS WITHOUT CLAIM TO ANY PARTICULAR FONT, STYLE, SIZE, OR COLOR.

NO CLAIM IS MADE TO THE EXCLUSIVE RIGHT TO USE "DETOX", APART FROM THE MARK AS SHOWN.

SER. NO. 85-189,860, FILED 12-3-2010.

JAMES A. RAUEN, EXAMINING ATTORNEY



David J. Kyffers

Director of the United States Patent and Trademark Office

United States of America

United States Patent and Trademark Office

DonorNet

Reg. No. 4,065,994

Registered Dec. 6, 2011

Int. Cl.: 42

SERVICE MARK

PRINCIPAL REGISTER

UNITED NETWORK FOR ORGAN SHARING (VIRGINIA CORPORATION)
700 NORTH 4TH STREET
RICHMOND, VA 23218

FOR: PROVIDING TEMPORARY USE OF NON-DOWNLOADABLE COMPUTER SOFTWARE VIA A SECURE WEB-BASED APPLICATION FOR USE IN THE HUMAN ORGAN TRANSPLANTATION PLACEMENT AND ACCEPTANCE PROCESS FOR PROVIDING DONOR INFORMATION THROUGH COMMUNICATION NETWORK SERVICES ALLOWING DONOR-RELATED FILES TO BE VIEWED PRIOR TO ACCEPTANCE OF A PARTICULAR ORGAN FOR TRANSPLANT, IN CLASS 42 (U.S. CLS. 100 AND 101).

FIRST USE 6-4-2003; IN COMMERCE 6-4-2003.

THE MARK CONSISTS OF STANDARD CHARACTERS WITHOUT CLAIM TO ANY PARTICULAR FONT, STYLE, SIZE, OR COLOR.

OWNER OF U.S. REG. NO. 2,915,387.

SEC. 2(F).

SER. NO. 85-189,974, FILED 12-3-2010.

JOHN WILKE, EXAMINING ATTORNEY



David J. Kyffers

Director of the United States Patent and Trademark Office

United States of America

United States Patent and Trademark Office

SERENITY

Reg. No. 4,065,995

Registered Dec. 6, 2011

Int. Cl.: 8

TRADEMARK

PRINCIPAL REGISTER

YPERION TECHNOLOGY (FRANCE SOCIÉTÉ PAR ACTIONS SIMPLIFIÉE (SAS))
76, 78 AVENUE DES CHAMPS ÉLYSÉES
F-75008 PARIS, FRANCE

FOR: MANUAL HAIR-REMOVAL APPARATUS AND INSTRUMENTS, NAMELY, ELECTROLYSIS APPARATUS FOR HAIR REMOVAL; MANUAL APPARATUS AND INSTRUMENTS FOR SKIN CARE, NAMELY, MANUAL APPARATUS AND INSTRUMENTS FOR APPLYING BY PHOTOTHERAPY REJUVENATION TREATMENTS; ELECTRIC HAIR-REMOVAL APPARATUS AND INSTRUMENTS, NAMELY, ELECTRIC RAZORS, ELECTRIC HAIR CUTTERS; ELECTRIC SKIN CARE APPARATUS AND INSTRUMENTS, NAMELY, NAIL SKIN TREATMENTS TRIMMERS; SHAVING CASES, NAMELY, RAZOR CASES; HAIR-REMOVING TWEEZERS; BEARD CLIPPERS; ELECTRIC OR NON-ELECTRIC HAIR CLIPPERS, IN CLASS 8 (U.S. CLS. 23, 28 AND 44).

THE MARK CONSISTS OF STANDARD CHARACTERS WITHOUT CLAIM TO ANY PARTICULAR FONT, STYLE, SIZE, OR COLOR.

OWNER OF FRANCE REG. NO. 083578961, DATED 5-30-2008, EXPIRES 5-30-2018.

SER. NO. 85-190,142, FILED 12-3-2010.

MIDGE BUTLER, EXAMINING ATTORNEY



David J. Kyros

Director of the United States Patent and Trademark Office

United States of America

United States Patent and Trademark Office



Reg. No. 4,065,996

Registered Dec. 6, 2011

Int. Cl.: 16

TRADEMARK

PRINCIPAL REGISTER

GLEIM PUBLICATIONS, INC. (FLORIDA CORPORATION)
4201 NW 95TH BLVD
GAINESVILLE, FL 32606

FOR: A SERIES OF WRITTEN ARTICLES WITHIN A COMMON PUBLICATION IN THE FIELD OF FINANCIAL ACCOUNTING, IN CLASS 16 (U.S. CLS. 2, 5, 22, 23, 29, 37, 38 AND 50).

FIRST USE 11-22-2010; IN COMMERCE 11-22-2010.

NO CLAIM IS MADE TO THE EXCLUSIVE RIGHT TO USE "SUCCESS TIPS", APART FROM THE MARK AS SHOWN.

THE MARK CONSISTS OF A SQUARE DESIGN WITH A CIRCLE WITHIN; A "CHECK" GRAPHIC DESIGN OVERLAYING THE CIRCLE, THE WORDS "SUCCESS TIPS" FOLLOWING THE OUTSIDE PERIMETER OF THE CIRCLE, AND THE WORD "GLEIM" WITHIN THE SQUARE.

SER. NO. 85-190,767, FILED 12-4-2010.

ALLISON HOLTZ, EXAMINING ATTORNEY



David J. Kybas

Director of the United States Patent and Trademark Office

United States of America

United States Patent and Trademark Office

MUZICOL

Reg. No. 4,065,997

Registered Dec. 6, 2011

Int. Cl.: 9

TRADEMARK

PRINCIPAL REGISTER

MUZICOL INTERNATIONAL CORP (FLORIDA CORPORATION)
200 SW FIRST AVENUE
200 SW FIRST AVENUE
FORT LAUDERDALE, FL 33301

FOR: AUDIO AND VIDEO RECORDINGS FEATURING MUSIC AND ARTISTIC PERFORMANCES; AUDIO TAPES FEATURING MUSIC; CHILDREN'S EDUCATIONAL MUSIC CDS AND DVDS; COMPACT DISC PLAYERS; COMPACT DISCS FEATURING MUSIC; COMPACT DISCS FEATURING MUSIC AND SPOKEN WORD IN THE FORM OF POETRY; COMPUTER HARDWARE AND SOFTWARE FOR PROCESSING DIGITAL MUSIC FILES; COMPUTER PROGRAMS FOR PROCESSING DIGITAL MUSIC FILES; COMPUTER SOFTWARE FEATURING MUSICAL SOUND RECORDINGS AND MUSICAL VIDEO RECORDINGS; COMPUTER SOFTWARE FOR CREATING AND EDITING MUSIC AND SOUNDS; COMPUTER SOFTWARE FOR PROCESSING DIGITAL MUSIC FILES; DIGITAL MUSIC DOWNLOADABLE FROM THE INTERNET; DIGITAL MUSIC SYSTEM THAT SYNCHRONIZES DIGITAL MUSIC FILES STORED ON A HOME UNIT AND A CAR UNIT; DIGITAL MUSIC SYSTEMS THAT SYNCHRONIZES DIGITAL RADIO FILES STORED ON A HOME UNIT, A CAR UNIT, OR PORTABLE UNIT AND THAT MAY BE BACKED UP TO AN INTERNET DEPOSITORY; DIGITAL PHOTO FRAMES FOR DISPLAYING DIGITAL PICTURES, VIDEO CLIPS AND MUSIC; DOWNLOADABLE MP3 FILES, MP3 RECORDINGS, ON-LINE DISCUSSION BOARDS, WEBCASTS, WEBINARS AND PODCASTS FEATURING MUSIC, AUDIO BOOKS IN THE FIELD OF LEISURE AND ENTERTAINMENT, AND NEWS BROADCASTS; DOWNLOADABLE MUSICAL SOUND RECORDINGS; DOWNLOADABLE RING TONES, GRAPHICS AND MUSIC VIA A GLOBAL COMPUTER NETWORK AND WIRELESS DEVICES; DOWNLOADABLE VIDEO RECORDINGS FEATURING MUSIC; DOWNLOADABLE MUSIC, AND SOUNDTRACKS VIA THE INTERNET AND WIRELESS DEVICES; ELECTRICAL CABLES FOR MUSICAL INSTRUMENTS; ELECTRICAL CIRCUITS FOR USE IN AMUSEMENT GAME MACHINES FOR REPRODUCING MUSIC, SPEECH AND SPECIAL EFFECTS; ELECTRICAL PICKUPS FOR USE WITH MUSICAL INSTRUMENTS; ELECTRICAL VOICE INTRA-COMMUNICATIONS SYSTEMS COMPRISING CONTROL STATIONS, INTERFACE MODULES, FRAMES, CONTROLLER CARDS, CONNECTORS, POWER SUPPLIES, PANELS AND MOUNTINGS FOR USE IN THE PRODUCTION OF LIVE MUSICAL PERFORMANCES, THEATRE, AND OTHER LIVE EVENTS; INTERACTIVE MUSIC MANUSCRIPT IN MULTIMEDIA VIDEO GAME FORMAT DISTRIBUTED AS DOWNLOADABLE OR DIGITAL MEDIA; JUKE BOXES; MACHINE READABLE COMPUTER PROGRAMS FOR USE IN THE REPRODUCTION OF MUSIC; MUSIC HEADPHONES; MUSIC RECORDINGS SOLD AS A KIT WITH A MASK; MUSIC-COMPOSITION SOFTWARE; MUSICAL INSTRUMENT AD-



David J. Kyros

Director of the United States Patent and Trademark Office

Reg. No. 4,065,997 APTORS; MUSICAL INSTRUMENT AMPLIFIERS; MUSICAL INSTRUMENT CONNECTORS; MUSICAL SOUND RECORDINGS; MUSICAL VIDEO RECORDINGS; PHONOGRAPH RECORDS FEATURING MUSIC; PRERECORDED AUDIO TAPES FEATURING MUSIC; PRERECORDED VIDEO CASSETTES FEATURING MUSIC; PRERECORDED VIDEO TAPES FEATURING MUSIC; PROTECTIVE CARRYING CASES FOR PORTABLE MUSIC PLAYERS, NAMELY, MP3 PLAYERS; SERIES OF MUSICAL SOUND RECORDINGS; SOUND RECORDINGS FEATURING MUSIC; VIDEO RECORDINGS FEATURING MUSIC; VISUAL RECORDINGS AND AUDIOVISUAL RECORDINGS FEATURING MUSIC AND ANIMATION; WIRELESS COMMUNICATION DEVICE FEATURING VOICE, DATA AND IMAGE TRANSMISSION INCLUDING VOICE, TEXT AND PICTURE MESSAGING, A VIDEO AND STILL IMAGE CAMERA, ALSO FUNCTIONAL TO PURCHASE MUSIC, GAMES, VIDEO AND SOFTWARE APPLICATIONS OVER THE AIR FOR DOWNLOADING TO THE DEVICE, IN CLASS 9 (U.S. CLS. 21, 23, 26, 36 AND 38).

FIRST USE 12-1-2010; IN COMMERCE 12-1-2010.

THE MARK CONSISTS OF STANDARD CHARACTERS WITHOUT CLAIM TO ANY PARTICULAR FONT, STYLE, SIZE, OR COLOR.

SER. NO. 85-190,877, FILED S.R. 12-5-2010 AM. P.R. 4-27-2011.

SUSAN RICHARDS, EXAMINING ATTORNEY

United States of America

United States Patent and Trademark Office

OSTEOPRENE

Reg. No. 4,065,998

Registered Dec. 6, 2011

Int. Cl.: 10

TRADEMARK

PRINCIPAL REGISTER

POLY-MED, INC. (SOUTH CAROLINA CORPORATION)
6309 HWY 187
ANDERSON, SC 29625

FOR: SUTURES, IN CLASS 10 (U.S. CLS. 26, 39 AND 44).

FIRST USE 3-22-2002; IN COMMERCE 9-12-2003.

THE MARK CONSISTS OF STANDARD CHARACTERS WITHOUT CLAIM TO ANY PARTICULAR FONT, STYLE, SIZE, OR COLOR.

SER. NO. 85-191,052, FILED 12-6-2010.

ELIZABETH KAJUBI, EXAMINING ATTORNEY



David J. Kybas

Director of the United States Patent and Trademark Office

United States of America

United States Patent and Trademark Office

PARMALAT

Reg. No. 4,065,999

Registered Dec. 6, 2011

Int. Cls.: 30 and 32

TRADEMARK

PRINCIPAL REGISTER

PARMALAT S.P.A. (ITALY JOINT STOCK COMPANY)
VIA DELLE NAZIONI UNITE 4
COLLECCHIO (PARMA), ITALY 43044

FOR: BECHAMEL SAUCE OR WHITE SAUCE, BAKERY GOODS, BISCUITS, BREADS; TEA, TEA-BASED BEVERAGES WITH FRUIT FLAVORING; CHOCOLATE; ICE CREAM, SOY-BASED ICE CREAM SUBSTITUTES, SAUCES, CUSTARDS; PASTA, PIZZA, PIZZA DOUGH, TOMATO SAUCE; WAFERS; HERB TEA FOR FOOD PURPOSES, HERBAL FOOD BEVERAGES, ICE MILK, MILKSHAKES, BASES FOR MAKING MILKSHAKES, ICE CREAM MIXES; REFRIGERATED MILK BASED SPONGE CAKES, CAKES, BUNS, HONEY, IN CLASS 30 (U.S. CL. 46).

FOR: FRUIT DRINKS, FRUIT FLAVORED SOFT DRINKS, FRUIT JUICES, AERATED FRUIT JUICES, FRUIT JUICE CONCENTRATES, FRUIT NECTARS, FRUIT-BASED SOFT DRINK FLAVORED WITH TEA, SPORTS DRINKS, SPRING WATER, AERATED WATER, NON-AERATED WATER, NAMELY TABLE WATER, SLIGHTLY AERATED WATER, MINERAL WATER, BEVERAGES, NAMELY, TOMATO JUICE, FRUIT JUICE AND FRUIT BEVERAGE CONCENTRATES FORTIFIED WITH VITAMINS AND MINERALS, FOR USE AS IN PREPARATION OF BEVERAGES MADE IN PART WITH MILK; FRUIT JUICES FORTIFIED WITH CALCIUM, FRUIT DRINKS FORTIFIED WITH CALCIUM, FRUIT JUICES FORTIFIED WITH VITAMINS, FRUIT DRINKS FORTIFIED WITH VITAMINS; FOOD PACKAGE COMBINATIONS CONSISTING PRIMARILY OF FRUIT JUICES; SYRUPS FOR MAKING SOFT DRINKS, IN CLASS 32 (U.S. CLS. 45, 46 AND 48).



THE MARK CONSISTS OF STANDARD CHARACTERS WITHOUT CLAIM TO ANY PARTICULAR FONT, STYLE, SIZE, OR COLOR.

OWNER OF ITALY REG. NO. 251337, DATED 2-11-1971, EXPIRES 2-11-2021.

OWNER OF U.S. REG. NOS. 1,141,495 AND 2,685,542.

THE WORDING "PARMALAT" HAS NO MEANING IN A FOREIGN LANGUAGE.

SER. NO. 85-191,063, FILED 12-6-2010.

JERI J. FICKES, EXAMINING ATTORNEY

David J. Kypos

Director of the United States Patent and Trademark Office

United States of America

United States Patent and Trademark Office

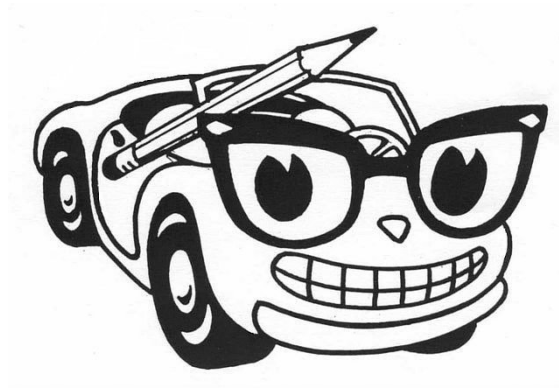

Reg. No. 4,066,000

Registered Dec. 6, 2011

Int. Cl.: 41

SERVICE MARK

PRINCIPAL REGISTER

THOMAS A ROBERTS (UNITED STATES INDIVIDUAL), DBA AUTONERDZ
4715 FIR TREE RD SE
OLYMPIA, WA, WA 98501

FOR: AUTOMOTIVE DIAGNOSTIC TRAINING SERVICES FEATURING COMPUTER SOFTWARE FOR USE BY INDEPENDENT AUTOMOTIVE REPAIR PERSONNEL, IN CLASS 41 (U.S. CLS. 100, 101 AND 107).

FIRST USE 11-15-1999; IN COMMERCE 7-10-2000.

THE MARK CONSISTS OF A CAR WEARING EYEGLASSES WITH A PENCIL.

SER. NO. 85-192,103, FILED 12-7-2010.

BRIDGETT SMITH, EXAMINING ATTORNEY



David J. Kyffers

Director of the United States Patent and Trademark Office

United States of America

United States Patent and Trademark Office

BEOLGY

Reg. No. 4,066,001

Registered Dec. 6, 2011

Int. Cl.: 3

TRADEMARK

PRINCIPAL REGISTER

HENKEL AG & CO. KGAA (FED REP GERMANY KOMMANDITGESELLSCHAFT AUF AKTIEN (KGAA))
67 HENKELSTRASSE
DUESSELDORF, FED REP GERMANY 40589

FOR: SOAPS; PERFUMERY; ESSENTIAL OILS; COSMETICS, NAMELY, PREPARATIONS FOR CARING, CLEANING, TINTING, COLORING, BLEACHING, FIXING, STYLING AND WAVING OF HAIR; COSMETICS, NAMELY, SKIN CARE AND SKIN TREATMENT PREPARATIONS, NAMELY, SKIN CREAMS, SKIN LOTIONS, FACIAL TONERS, BODY LOTIONS AND SHOWER GELS; SOAPS FOR PERSONAL USE; HAIR LOTIONS; DENTIFRICE, IN CLASS 3 (U.S. CLS. 1, 4, 6, 50, 51 AND 52).

THE MARK CONSISTS OF STANDARD CHARACTERS WITHOUT CLAIM TO ANY PARTICULAR FONT, STYLE, SIZE, OR COLOR.

OWNER OF ERPN CMNTY TM OFC REG. NO. 009336851, DATED 12-27-2010, EXPIRES 6-8-2020.

SER. NO. 85-192,190, FILED 12-7-2010.

DOMINIC FATHY, EXAMINING ATTORNEY



David J. Kybas

Director of the United States Patent and Trademark Office

United States of America

United States Patent and Trademark Office

BIOPSY SCIENCES

Reg. No. 4,066,002

Registered Dec. 6, 2011

Int. Cl.: 42

SERVICE MARK

PRINCIPAL REGISTER

BIOPSY SCIENCES, LLC (FLORIDA LIMITED LIABILITY COMPANY)
4900 CREEKSIDE DRIVE
SUITE C
CLEARWATER, FL 33760

FOR: RESEARCH AND DEVELOPMENT FOR MEDICAL AND SURGICAL PRODUCTS, IN CLASS 42 (U.S. CLS. 100 AND 101).

FIRST USE 11-1-2003; IN COMMERCE 11-1-2003.

THE MARK CONSISTS OF STANDARD CHARACTERS WITHOUT CLAIM TO ANY PARTICULAR FONT, STYLE, SIZE, OR COLOR.

OWNER OF U.S. REG. NO. 2,956,311.

SEC. 2(F).

SER. NO. 85-192,368, FILED 12-7-2010.

EUGENIA MARTIN, EXAMINING ATTORNEY



David J. Kybas

Director of the United States Patent and Trademark Office

United States of America

United States Patent and Trademark Office

Solitaire

Reg. No. 4,066,003

Registered Dec. 6, 2011

Int. Cl.: 8

TRADEMARK

PRINCIPAL REGISTER

BUCK KNIVES, INC. (NEVADA CORPORATION)
660 S. LOCHSA STREET
POST FALLS, ID 83854

FOR: HUNTING KNIVES; KNIVES FOR HOBBY USE; POCKET KNIVES; SIDE ARMS, NOT INCLUDING FIREARMS, NAMELY, HUNTING KNIVES; SPORT KNIVES, IN CLASS 8 (U.S. CLS. 23, 28 AND 44).

FIRST USE 10-31-2010; IN COMMERCE 10-31-2010.

THE MARK CONSISTS OF STANDARD CHARACTERS WITHOUT CLAIM TO ANY PARTICULAR FONT, STYLE, SIZE, OR COLOR.

SER. NO. 85-192,566, FILED 12-7-2010.

ALEXANDER L. POWERS, EXAMINING ATTORNEY



David J. Kyros

Director of the United States Patent and Trademark Office

United States of America

United States Patent and Trademark Office



Reg. No. 4,066,004

Registered Dec. 6, 2011

Int. Cl.: 36

SERVICE MARK

PRINCIPAL REGISTER

GUY HARVEY OCEAN FUND, INC. (FLORIDA CORPORATION)
10408 W. STATE ROAD 84, STE. 104
DAVIE, FL 33324

FOR: CHARITABLE FUNDRAISING SERVICES TO PROMOTE AWARENESS AND EDUCATION CONCERNING MARINE CONSERVATION, IN CLASS 36 (U.S. CLS. 100, 101 AND 102).

FIRST USE 1-15-2008; IN COMMERCE 1-15-2008.

OWNER OF U.S. REG. NOS. 1,616,722, 3,536,786 AND OTHERS.

THE COLOR(S) BLUE, GREEN, WHITE, PINK AND BLACK IS/ARE CLAIMED AS A FEATURE OF THE MARK.

NO CLAIM IS MADE TO THE EXCLUSIVE RIGHT TO USE "OCEAN FOUNDATION", APART FROM THE MARK AS SHOWN.

THE NAME(S), PORTRAIT(S), AND/OR SIGNATURE(S) SHOWN IN THE MARK IDENTIFIES "GUY HARVEY", WHOSE CONSENT(S) TO REGISTER IS MADE OF RECORD.

THE MARK CONSISTS OF A BACKGROUND OF AN ELONGATED GLOBE WITH BLUE FOR OCEAN AND GREEN FOR LAND, OUTLINED IN WHITE AND THEN BLUE AND SUPERIMPOSED OVER THE GLOBE IS THE STYLIZED WORDING "GUY HARVEY.." IN WHITE AND OUTLINED IN BLACK AND A MARLIN HAVING A BLUE UPPER BACK AND FINS WITH GREEN HIGHLIGHTING ON THE BACK, A PINK MOUTH, AND A WHITE BODY, AND THE WORDS "OCEAN", APPEARING IN BLUE, AND "FOUNDATION" APPEARING IN GREEN, APPEAR UNDER THE GLOBE.

SER. NO. 85-192,928, FILED 12-8-2010.

JAMES STEIN, EXAMINING ATTORNEY



David J. Kyffers

Director of the United States Patent and Trademark Office

United States of America

United States Patent and Trademark Office

NicoTrim

Reg. No. 4,066,005

QUALITY LIFE GENERAL, INC. (DELAWARE CORPORATION)
113 BARKSDALE PROFESSIONAL CENTER
NEWARK, DE 19711

Registered Dec. 6, 2011

Int. Cl.: 5

FOR: SMOKING CESSATION PREPARATIONS, IN CLASS 5 (U.S. CLS. 6, 18, 44, 46, 51 AND 52).

TRADEMARK

FIRST USE 11-1-2010; IN COMMERCE 11-1-2010.

PRINCIPAL REGISTER

THE MARK CONSISTS OF STANDARD CHARACTERS WITHOUT CLAIM TO ANY PARTICULAR FONT, STYLE, SIZE, OR COLOR.

SER. NO. 85-193,353, FILED 12-8-2010.

DARRYL SPRUILL, EXAMINING ATTORNEY



David J. Kybas

Director of the United States Patent and Trademark Office

United States of America

United States Patent and Trademark Office

ELSPETH VS. TEZZERET DUEL DECKS

Reg. No. 4,066,006

Registered Dec. 6, 2011

Int. Cl.: 16

TRADEMARK

PRINCIPAL REGISTER

WIZARDS OF THE COAST LLC (DELAWARE LIMITED LIABILITY COMPANY)
1027 NEWPORT AVENUE
PAWTUCKET, RI 02862

FOR: PAPER GOODS AND PRINTED MATTER, NAMELY, INSTRUCTIONAL MANUALS,
BOOKS AND PRINTED STRATEGY GUIDES FOR GAMES; TRADING CARDS , IN CLASS
16 (U.S. CLS. 2, 5, 22, 23, 29, 37, 38 AND 50).

FIRST USE 9-3-2010; IN COMMERCE 9-3-2010.

THE MARK CONSISTS OF STANDARD CHARACTERS WITHOUT CLAIM TO ANY PAR-
TICULAR FONT, STYLE, SIZE, OR COLOR.

OWNER OF U.S. REG. NO. 3,908,673.

NO CLAIM IS MADE TO THE EXCLUSIVE RIGHT TO USE "DECKS", APART FROM THE
MARK AS SHOWN.

SER. NO. 85-194,059, FILED 12-9-2010.

MATTHEW PAPPAS, EXAMINING ATTORNEY



David J. Kyffers

Director of the United States Patent and Trademark Office

United States of America

United States Patent and Trademark Office

ELSPETH VS. TEZZERET DUEL DECKS

Reg. No. 4,066,007

Registered Dec. 6, 2011

Int. Cl.: 28

TRADEMARK

PRINCIPAL REGISTER

WIZARDS OF THE COAST LLC (DELAWARE LIMITED LIABILITY COMPANY)
1027 NEWPORT AVENUE
PAWTUCKET, RI 02862

FOR: CARD GAMES, TRADING CARD GAMES, PLAYING CARDS, AND ACCESSORIES
FOR USE THEREWITH, IN CLASS 28 (U.S. CLS. 22, 23, 38 AND 50).

FIRST USE 9-3-2010; IN COMMERCE 9-3-2010.

THE MARK CONSISTS OF STANDARD CHARACTERS WITHOUT CLAIM TO ANY PAR-
TICULAR FONT, STYLE, SIZE, OR COLOR.

OWNER OF U.S. REG. NO. 3,908,673.

NO CLAIM IS MADE TO THE EXCLUSIVE RIGHT TO USE "DECKS", APART FROM THE
MARK AS SHOWN.

SER. NO. 85-194,061, FILED 12-9-2010.

MATTHEW PAPPAS, EXAMINING ATTORNEY



David J. Kypas

Director of the United States Patent and Trademark Office

United States of America

United States Patent and Trademark Office



Reg. No. 4,066,008

Registered Dec. 6, 2011

Int. Cl.: 30

TRADEMARK

PRINCIPAL REGISTER

SCHWAN'S IP, LLC (MINNESOTA LIMITED LIABILITY COMPANY)
115 W. COLLEGE DRIVE
MARSHALL, MN 56258

FOR: EGG ROLLS; WON TONS; POTSTICKERS, IN CLASS 30 (U.S. CL. 46).

FIRST USE 8-23-2010; IN COMMERCE 8-23-2010.

OWNER OF U.S. REG. NO. 3,905,100.

THE NON-LATIN CHARACTER IN THE MARK TRANSLITERATES TO "MEI", AND THIS MEANS "BEAUTIFUL" IN ENGLISH.

THE MARK CONSISTS OF THE WORDS "PAGODA EXPRESS" AND THE CHINESE SYMBOL FOR MEI IN THE LETTER "O" IN "PAGODA". "PAGODA" IS IN A RECTANGULAR BORDER.

SER. NO. 85-194,143, FILED S.R. 12-9-2010 AM. P.R. 6-27-2011.

PAUL E. FAHRENKOPF, EXAMINING ATTORNEY



David J. Kyros

Director of the United States Patent and Trademark Office

United States of America

United States Patent and Trademark Office

BECOMING A MOM/COMENZANDO BIEN

Reg. No. 4,066,009

Registered Dec. 6, 2011

Int. Cl.: 41

SERVICE MARK

PRINCIPAL REGISTER

MARCH OF DIMES FOUNDATION (NEW YORK NOT-FOR-PROFIT CORPORATION)
1275 MAMARONECK AVENUE
WHITE PLAINS, NY 10605

FOR: EDUCATION SERVICES, NAMELY, PROVIDING SEMINARS IN THE FIELD OF PRENATAL CARE AND THE DISTRIBUTION OF COURSE MATERIALS IN CONNECTION THEREWITH, IN CLASS 41 (U.S. CLS. 100, 101 AND 107).

FIRST USE 7-29-2009; IN COMMERCE 7-29-2009.

THE MARK CONSISTS OF STANDARD CHARACTERS WITHOUT CLAIM TO ANY PARTICULAR FONT, STYLE, SIZE, OR COLOR.

OWNER OF U.S. REG. NOS. 2,347,230 AND 2,350,233.

THE ENGLISH TRANSLATION OF "COMENZANDO BIEN" IN THE MARK IS "BEGINNING WELL".

SER. NO. 85-194,922, FILED 12-10-2010.

KIM MONINGHOFF, EXAMINING ATTORNEY



David J. Kybas

Director of the United States Patent and Trademark Office

United States of America

United States Patent and Trademark Office

Weatherwood

Reg. No. 4,066,010

Registered Dec. 6, 2011

Int. Cl.: 6

TRADEMARK

PRINCIPAL REGISTER

DURALUM PRODUCTS, INC. (CALIFORNIA CORPORATION)
8269 ALPINE AVENUE
SACRAMENTO, CA 95826

FOR: METAL LATTICES; METAL ROOFING PANELS FOR OUTDOOR PATIOS; PERGOLAS
PRIMARILY OF METAL SOLD ONLY TO LICENSED CONTRACTORS, IN CLASS 6 (U.S.
CLS. 2, 12, 13, 14, 23, 25 AND 50).

FIRST USE 0-0-1994; IN COMMERCE 0-0-1994.

THE MARK CONSISTS OF STANDARD CHARACTERS WITHOUT CLAIM TO ANY PAR-
TICULAR FONT, STYLE, SIZE, OR COLOR.

SER. NO. 85-195,200, FILED 12-10-2010.

RONALD MCMORROW, EXAMINING ATTORNEY



David J. Kybas

Director of the United States Patent and Trademark Office

United States of America

United States Patent and Trademark Office

BLUE WONDER

Reg. No. 4,066,011

Registered Dec. 6, 2011

Int. Cl.: 3

TRADEMARK

PRINCIPAL REGISTER

T&L SPECIALTY COMPANY, INC. (MISSISSIPPI CORPORATION)
300 AIR PARK ROAD
TUPELO, MS 38801

FOR: FLOOR CLEANER, AUTOMOBILE CLEANERS FOR TRUCKS AND CARS, GENERAL ALL-PURPOSE CLEANER FOR INDUSTRIAL USE, IN CLASS 3 (U.S. CLS. 1, 4, 6, 50, 51 AND 52).

FIRST USE 5-1-2004; IN COMMERCE 5-1-2004.

THE MARK CONSISTS OF STANDARD CHARACTERS WITHOUT CLAIM TO ANY PARTICULAR FONT, STYLE, SIZE, OR COLOR.

NO CLAIM IS MADE TO THE EXCLUSIVE RIGHT TO USE "BLUE", APART FROM THE MARK AS SHOWN.

SER. NO. 85-195,510, FILED 12-10-2010.

CARYN GLASSER, EXAMINING ATTORNEY



David J. Kyffers

Director of the United States Patent and Trademark Office

United States of America

United States Patent and Trademark Office



Reg. No. 4,066,012

Registered Dec. 6, 2011

Int. Cl.: 35

SERVICE MARK

PRINCIPAL REGISTER

CHANEL ESSENCE PAYNE (MARYLAND LIMITED LIABILITY COMPANY), DBA D'ORO
DOLCETTO GROUP,LLC
7410 LONGBRANCH DR
NEW CARROLLTON, MD 20784

FOR: CATALOG ORDERING SERVICE FEATURING CLOTHING, SHOES, COSMETICS, IN
CLASS 35 (U.S. CLS. 100, 101 AND 102).

FIRST USE 11-3-2010; IN COMMERCE 11-15-2010.

THE MARK CONSISTS OF A SPIDER WITH A FUCHSIA BODY WITH A BLUE HEART IN
ITS BACK SURROUNDED BY THE WORDING "D'ORO PRIVE' DORKDROBE D'ORO LUXE
KIITEN" IN BLACK.

THE COLOR(S) FUCHSIA, BLACK AND BLUE IS/ARE CLAIMED AS A FEATURE OF THE
MARK.

THE ENGLISH TRANSLATION OF "D'ORO PRIVE' DORKDROBE D'ORO LUXE KIITEN"
IN THE MARK IS "D'ORO" MEANS TO ILLUMINATE AND "PRIVE" MEANS ONE OF A
KIND IN ITALIAN. "DORKDROBE" MEANS NERDY AND "LUXE" MEANS LUXURIOUS.
THE WORDING "DORKDROBE" HAS NO MEANING IN A FOREIGN LANGUAGE.

SER. NO. 85-196,024, FILED 12-12-2010.

JOHN E. MICHOS, EXAMINING ATTORNEY



David J. Kyffers

Director of the United States Patent and Trademark Office

United States of America

United States Patent and Trademark Office

CAVITY ZAPPER

Reg. No. 4,066,013

Registered Dec. 6, 2011

Int. Cl.: 5

TRADEMARK

PRINCIPAL REGISTER

CALDWELL CONSUMER HEALTH, LLC (NEW JERSEY LIMITED LIABILITY COMPANY),
DBA REVIVE PERSONAL PRODUCTS COMPANY
8 ELMER STREET
MADISON, NJ 07940

FOR: MEDICATED TOOTHPASTE AND MEDICATED MOUTH RINSE, IN CLASS 5 (U.S. CLS. 6, 18, 44, 46, 51 AND 52).

FIRST USE 4-21-2010; IN COMMERCE 4-21-2010.

THE MARK CONSISTS OF STANDARD CHARACTERS WITHOUT CLAIM TO ANY PARTICULAR FONT, STYLE, SIZE, OR COLOR.

NO CLAIM IS MADE TO THE EXCLUSIVE RIGHT TO USE "CAVITY", APART FROM THE MARK AS SHOWN.

SER. NO. 85-196,293, FILED 12-13-2010.

LAURIE MAYES, EXAMINING ATTORNEY



David J. Kyros

Director of the United States Patent and Trademark Office

United States of America

United States Patent and Trademark Office

NE1

Reg. No. 4,066,014

Registered Dec. 6, 2011

Int. Cl.: 10

TRADEMARK

PRINCIPAL REGISTER

MEDLINE INDUSTRIES, INC. (ILLINOIS CORPORATION)
ONE MEDLINE PLACE
MUNDELEIN, IL 60060

FOR: MEDICAL DEVICE, NAMELY, WOUND ASSESSMENT TOOLS FOR USE IN MEASURING AND ASSESSING WOUNDS AND STANDARDIZING WOUND DOCUMENTATION, IN CLASS 10 (U.S. CLS. 26, 39 AND 44).

FIRST USE 2-15-2011; IN COMMERCE 2-15-2011.

THE MARK CONSISTS OF STANDARD CHARACTERS WITHOUT CLAIM TO ANY PARTICULAR FONT, STYLE, SIZE, OR COLOR.

SER. NO. 85-197,197, FILED 12-14-2010.

MICHAEL KEATING, EXAMINING ATTORNEY



David J. Kybas

Director of the United States Patent and Trademark Office

United States of America

United States Patent and Trademark Office



Reg. No. 4,066,015

Registered Dec. 6, 2011

Int. Cl.: 9

TRADEMARK

PRINCIPAL REGISTER

PARENTAL SOLUTIONS LLC (MISSOURI LIMITED LIABILITY COMPANY), DBA
PARENTAL SOLUTIONS LLC
1234 JUNGERMAN RD.
ST. PETERS, MO 63376

FOR: COMPUTER APPLICATION SOFTWARE FOR MOBILE PHONES, NAMELY, SOFTWARE FOR USE BY PARENTS TO MONITOR THEIR CHILD'S MEDIA FILES , IN CLASS 9 (U.S. CLS. 21, 23, 26, 36 AND 38).

FIRST USE 9-27-2010; IN COMMERCE 10-6-2010.

THE MARK CONSISTS OF A SHADED SHIELD WITH A LIGHTER BORDER CONTAINING THE FANCIFUL SILHOUETTE FIGURES OF A LIGHTER SHADE PARENT ENFOLDING A SHADED CHILD SILHOUETTE, THEIR OUTLINES ECHOING THE SHAPE OF THE SHIELD.

SER. NO. 85-197,968, FILED 12-15-2010.

JILL C. ALT, EXAMINING ATTORNEY



David J. Kybas

Director of the United States Patent and Trademark Office

United States of America

United States Patent and Trademark Office



Reg. No. 4,066,016

SHOE SPA, INC. (NEW YORK CORPORATION)
853 7TH AVENUE
NEW YORK, NY 100195215

Registered Dec. 6, 2011

Int. Cls.: 3, 10, 21 and 25

FOR: BOOT WAX; CREAMS FOR LEATHER; LEATHER POLISHES; SHOE POLISH; SHOE POLISH AND CREAMS, IN CLASS 3 (U.S. CLS. 1, 4, 6, 50, 51 AND 52).

TRADEMARK

FIRST USE 9-20-2010; IN COMMERCE 9-20-2010.

PRINCIPAL REGISTER

FOR: ARCH SUPPORTS FOR BOOTS OR SHOES, IN CLASS 10 (U.S. CLS. 26, 39 AND 44).

FIRST USE 9-20-2010; IN COMMERCE 9-20-2010.

FOR: SHOE TREES, IN CLASS 21 (U.S. CLS. 2, 13, 23, 29, 30, 33, 40 AND 50).

FIRST USE 9-20-2010; IN COMMERCE 9-20-2010.

FOR: LEATHER INNER SOLES AND INSOLES, IN CLASS 25 (U.S. CLS. 22 AND 39).

FIRST USE 9-20-2010; IN COMMERCE 9-20-2010.

OWNER OF U.S. REG. NO. 3,752,682.

NO CLAIM IS MADE TO THE EXCLUSIVE RIGHT TO USE "LEATHER", APART FROM THE MARK AS SHOWN.

THE MARK CONSISTS OF "LS" IN STYLIZED LETTERING AND THE TERM "LEATHER SPA".

SER. NO. 85-198,112, FILED 12-15-2010.

GISELLE AGOSTO, EXAMINING ATTORNEY



David J. Kybas

Director of the United States Patent and Trademark Office

United States of America

United States Patent and Trademark Office



Reg. No. 4,066,017
Registered Dec. 6, 2011
Int. Cls.: 35 and 41

SERVICE MARK

PRINCIPAL REGISTER

CHEGG, INC. (DELAWARE CORPORATION)
SUITE 1400
2350 MISSION COLLEGE BLVD.
SANTA CLARA, CA 95054

FOR: OPERATING AN ON-LINE MARKETPLACE FEATURING TEXTBOOKS; PROVIDING A BUY-BACK AND TRADE-IN PROGRAM FOR USED TEXTBOOKS OF OTHERS; ADMINISTRATION OF A TEXTBOOK RENTAL PARTNER PROGRAM FOR RETAIL STORES, NAMELY, PROVIDING EXHIBITION STANDS AND BOOTHS, INCLUDING RELATED EQUIPMENT, FOR TEXTBOOK RENTAL IN RETAIL STORES; ISSUING GIFT CERTIFICATES WHICH MAY THEN BE REDEEMED FOR GOODS OR SERVICES, IN CLASS 35 (U.S. CLS. 100, 101 AND 102).

FIRST USE 6-0-2010; IN COMMERCE 6-0-2010.

FOR: RENTAL OF TEXTBOOKS VIA AN ELECTRONIC KIOSK; ENTERTAINMENT SERVICES, NAMELY, CONDUCTING SWEEPSTAKES AND CONTESTS TO PROMOTE TEXTBOOK RENTAL SERVICES, IN CLASS 41 (U.S. CLS. 100, 101 AND 107).

FIRST USE 6-0-2010; IN COMMERCE 6-0-2010.

OWNER OF U.S. REG. NOS. 3,191,844 AND 3,749,771.

THE COLOR(S) WHITE, ORANGE, RED, AND BLACK IS/ARE CLAIMED AS A FEATURE OF THE MARK.

THE MARK CONSISTS OF A WHITE EGG WITH ORANGE BEAK AND LEGS BREAKING THROUGH THE SHELL, WITH THE COLOR BLACK APPEARING ON THE INSIDE OF THE BEAK AND INSIDE THE CRACKS IN THE SHELL, ALL LOCATED BEHIND THE TEXT "CHEGG" WRITTEN IN RED BLOCK LETTERS WITH WHITE OUTLINING.

SER. NO. 85-198,776, FILED 12-15-2010.

LIEF MARTIN, EXAMINING ATTORNEY



David J. Kyros

Director of the United States Patent and Trademark Office

United States of America

United States Patent and Trademark Office



Reg. No. 4,066,018

Registered Dec. 6, 2011

Int. Cl.: 38

SERVICE MARK

PRINCIPAL REGISTER

CENTRAL STATES INDUSTRIAL EQUIPMENT & SERVICE, INC. (MISSOURI CORPORATION)
2700 N. PARTNERSHIP BLVD.
SPRINGFIELD, MO 65803

FOR: PROVIDING AN ONLINE FORUM FOR HYGIENIC PROCESSING EQUIPMENT, IN CLASS 38 (U.S. CLS. 100, 101 AND 104).

FIRST USE 5-14-2010; IN COMMERCE 5-17-2010.

THE MARK CONSISTS OF THE TERM "FLOWGEEKS.COM" IN A STYLIZED FONT WHEREIN "FLOW" IS ABOVE "GEEKS.COM" AND THE LETTER "G" IS WITHIN A DROPLET.

SER. NO. 85-199,529, FILED 12-16-2010.

MICHAEL WIENER, EXAMINING ATTORNEY



David J. Kybas

Director of the United States Patent and Trademark Office

United States of America

United States Patent and Trademark Office

Full Funnel Attribution

Reg. No. 4,066,019

Registered Dec. 6, 2011

Int. Cl.: 42

SERVICE MARK

PRINCIPAL REGISTER

C3 METRICS, INC. (DELAWARE CORPORATION)
2711 CENTERVILLE ROAD, SUITE 400
WILMINGTON, DE 19808

FOR: PROVIDING TEMPORARY USE OF NON-DOWNLOADABLE SOFTWARE FOR USE IN CAPTURING, MEASURING, ANALYZING AND ATTRIBUTING ADVERTISING EFFECTIVENESS FOR A SPECIFIC ADVERTISER FROM THE FIRST ADVERTISEMENT SEEN OR HEARD BY A CONSUMER TO THE LAST ADVERTISEMENT PRIOR TO COMPLETING A TRANSACTION, IN CLASS 42 (U.S. CLS. 100 AND 101).

FIRST USE 2-20-2009; IN COMMERCE 2-20-2009.

THE MARK CONSISTS OF STANDARD CHARACTERS WITHOUT CLAIM TO ANY PARTICULAR FONT, STYLE, SIZE, OR COLOR.

NO CLAIM IS MADE TO THE EXCLUSIVE RIGHT TO USE "ATTRIBUTION", APART FROM THE MARK AS SHOWN.

SER. NO. 85-199,570, FILED 12-16-2010.

NICHOLAS ALTREE, EXAMINING ATTORNEY



David J. Kyffers

Director of the United States Patent and Trademark Office

United States of America

United States Patent and Trademark Office

TAMPA BAY STORM

Reg. No. 4,066,020

Registered Dec. 6, 2011

Int. Cl.: 41

SERVICE MARK

PRINCIPAL REGISTER

ARENA FOOTBALL ONE, LLC (LOUISIANA LIMITED LIABILITY COMPANY), AKA AFL
15 E. 5TH
SUITE 2221
TULSA, OK 74103

FOR: ENTERTAINMENT SERVICES, NAMELY, ORGANIZING AND PRESENTING FOOTBALL GAMES BEFORE LIVE AUDIENCES AND ON TELEVISION, RADIO, WEBCASTS AND THE GLOBAL COMPUTER NETWORK, IN CLASS 41 (U.S. CLS. 100, 101 AND 107).

FIRST USE 1-0-1991; IN COMMERCE 1-0-1991.

THE MARK CONSISTS OF STANDARD CHARACTERS WITHOUT CLAIM TO ANY PARTICULAR FONT, STYLE, SIZE, OR COLOR.

OWNER OF U.S. REG. NO. 2,929,953.

NO CLAIM IS MADE TO THE EXCLUSIVE RIGHT TO USE "TAMPA BAY", APART FROM THE MARK AS SHOWN.

SER. NO. 85-199,594, FILED 12-16-2010.

BARNEY CHARLON, EXAMINING ATTORNEY



David J. Kybas

Director of the United States Patent and Trademark Office

United States of America

United States Patent and Trademark Office

PowerGuide

Reg. No. 4,066,021

Registered Dec. 6, 2011

Int. Cl.: 9

TRADEMARK

PRINCIPAL REGISTER

OFS FITEL, LLC (DELAWARE LIMITED LIABILITY COMPANY)
DOCKET ADMINISTRATOR
2000 NORTHEAST EXPRESSWAY
NORCROSS, GA 30071

FOR: FIBER OPTIC CABLES, IN CLASS 9 (U.S. CLS. 21, 23, 26, 36 AND 38).

FIRST USE 10-0-2001; IN COMMERCE 1-0-2003.

THE MARK CONSISTS OF STANDARD CHARACTERS WITHOUT CLAIM TO ANY PARTICULAR FONT, STYLE, SIZE, OR COLOR.

SER. NO. 85-199,639, FILED 12-16-2010.

AMEEN IMAM, EXAMINING ATTORNEY



David J. Kybas

Director of the United States Patent and Trademark Office

United States of America

United States Patent and Trademark Office



Reg. No. 4,066,022

Registered Dec. 6, 2011

Int. Cl.: 30

TRADEMARK

PRINCIPAL REGISTER

NAZO PRODUCTS, INC. (CANADA CORPORATION), DBA NAZO PRODUCTS, INC.
UNIT 5
4 RACINE ROAD
TORONTO, ONTARIO, CANADA M9W-5W7

FOR: BLACK TEA; CHAI TEA; GREEN TEA; OOLONG TEA; TEA; TEA BAGS, IN CLASS
30 (U.S. CL. 46).

FIRST USE 8-25-2009; IN COMMERCE 9-20-2009.

THE MARK CONSISTS OF THE WORD "NAZO" IN THE CENTER OF AN OVAL SHAPE
AND A LEAF IN THE DESIGN TOO.

THE WORD "NAZO" HAS NO MEANING IN A FOREIGN LANGUAGE.

SER. NO. 85-201,038, FILED 12-17-2010.

MAYUR VAGHANI, EXAMINING ATTORNEY



David J. Kybas

Director of the United States Patent and Trademark Office

United States of America

United States Patent and Trademark Office

Bad Ass Moms (BAM)

Reg. No. 4,066,023

Registered Dec. 6, 2011

Int. Cl.: 41

SERVICE MARK

PRINCIPAL REGISTER

GRANITE BAY MARTIAL ARTS CENTER, INC (CALIFORNIA CORPORATION), DBA THE
STUDIO MARTIAL ARTS
8789 AUBURN FOLSOM, C340
GRANITE BAY, CA 95746 AND

AMITIS POURARIAN (UNITED STATES INDIVIDUAL)
7800 SIERRA DR
GRANITE BAY, CA 95746

FOR: CONSULTING SERVICES IN THE FIELDS OF FITNESS AND EXERCISE; EDUCATIONAL SERVICES, NAMELY, DEVELOPING AND CONDUCTING WORKOUTS, WORKSHOPS, PRESENTATIONS, RETREATS, AND PERSONAL TRAINING IN RIGHT-BRAIN FITNESS; INSTRUCTION IN THE FIELD OF MARTIAL ARTS; MARTIAL ARTS INSTRUCTION; OPERATING OF MARTIAL ARTS' SCHOOLS; OPERATING OF MARTIAL ARTS' STUDIOS; PERSONAL FITNESS TRAINING SERVICES AND CONSULTANCY; PERSONAL FITNESS TRAINING SERVICES FEATURING AEROBIC AND ANAEROBIC ACTIVITIES COMBINED WITH RESISTANCE AND FLEXIBILITY TRAINING; PHYSICAL FITNESS CONDITIONING CLASSES; PHYSICAL FITNESS CONSULTATION; PHYSICAL FITNESS INSTRUCTION; PHYSICAL FITNESS STUDIO SERVICES, NAMELY, PROVIDING EXERCISE CLASSES, BODY SCULPTING CLASSES, AND GROUP FITNESS CLASSES; PHYSICAL FITNESS STUDIO SERVICES, NAMELY, PROVIDING GROUP EXERCISE INSTRUCTION, EQUIPMENT, AND FACILITIES; PHYSICAL FITNESS TRAINING OF INDIVIDUALS AND GROUPS; PHYSICAL FITNESS TRAINING SERVICES; PROVIDING A WEB SITE FEATURING INFORMATION ON EXERCISE AND FITNESS; PROVIDING A WEB SITE FEATURING NON-DOWNLOADABLE INSTRUCTIONAL VIDEOS IN THE FIELD OF MARTIAL ARTS; PROVIDING A WEBSITE FEATURING INFORMATION ON EXERCISE AND FITNESS; PROVIDING AN INTERACTIVE WEBSITE FEATURING INFORMATION AND LINKS RELATING TO FITNESS; PROVIDING AN ON-LINE COMPUTER DATABASE FEATURING INFORMATION REGARDING EXERCISE AND FITNESS; PROVIDING ASSISTANCE, PERSONAL TRAINING AND PHYSICAL FITNESS CONSULTATION TO CORPORATE CLIENTS TO HELP THEIR EMPLOYEES MAKE PHYSICAL FITNESS, STRENGTH, CONDITIONING, AND EXERCISE ALTERATIONS IN THEIR DAILY LIVING; PROVIDING ASSISTANCE, PERSONAL TRAINING AND PHYSICAL FITNESS CONSULTATION TO INDIVIDUALS TO HELP THEM MAKE PHYSICAL FITNESS, STRENGTH, CONDITIONING, AND EXERCISE IMPROVEMENT IN THEIR DAILY LIVING; PROVIDING CLASSES, WORKSHOPS, SEMINARS AND CAMPS IN THE FIELDS OF FITNESS, EXERCISE, BOXING, KICK BOXING AND MIXED MARTIAL ARTS; PROVIDING FITNESS AND EXERCISE FACILITIES;



David J. Kyros

Director of the United States Patent and Trademark Office

Reg. No. 4,066,023 PROVIDING FITNESS AND EXERCISE STUDIO SERVICES, NAMELY, PILATES INSTRUCTION AND TRAINING; PROVIDING GENERAL FITNESS AND MIXED MARTIAL ARTS FACILITIES THAT REQUIRE MEMBERSHIPS AND ARE FOCUSED IN THE FIELDS OF GENERAL FITNESS, EXERCISE, AND MIXED MARTIAL ARTS, IN CLASS 41 (U.S. CLS. 100, 101 AND 107).

FIRST USE 1-1-2010; IN COMMERCE 5-10-2010.

THE MARK CONSISTS OF STANDARD CHARACTERS WITHOUT CLAIM TO ANY PARTICULAR FONT, STYLE, SIZE, OR COLOR.

SER. NO. 85-201,342, FILED 12-19-2010.

HEATHER BIDDULPH, EXAMINING ATTORNEY

United States of America

United States Patent and Trademark Office

EDUCATION INDUSTRY ASSOCIATION

Reg. No. 4,066,024

Registered Dec. 6, 2011

Int. Cl.: 35

SERVICE MARK

PRINCIPAL REGISTER

EDUCATION INDUSTRY ASSOCIATION, INC. (WISCONSIN CORPORATION)
5909 BARBADOS PLAC
SUITE 202
ROCKVILLE, MD 20852

FOR: ASSOCIATION SERVICES, NAMELY, PROMOTING THE INTERESTS OF PRIVATE EDUCATION PROVIDERS, NAMELY, TUTORS, ONLINE LEARNING PROVIDERS, ALTERNATIVE AND SPECIAL EDUCATION PROVIDERS, AND EDUCATION CONTENT DEVELOPERS AND PUBLISHERS; PROMOTING THE INTERESTS OF EDUCATION CONSULTANTS, NAMELY, SCHOOL MANAGEMENT AND TURNAROUND CONSULTANTS; PROMOTING THE INTERESTS OF PROVIDERS OF EDUCATIONAL SERVICES TO STUDENTS WHICH SUPPLEMENT, COMPLEMENT, AND ENHANCE THE EDUCATIONAL SERVICES OF PUBLIC EDUCATION INSTITUTIONS; PROMOTING PUBLIC AWARENESS OF THE NEED FOR AND BENEFITS OF PRIVATE EDUCATION PROVIDERS, PRIVATE EDUCATION SERVICES, ALTERNATIVES TO PUBLIC EDUCATION, AND SUPPLEMENTS TO PUBLIC EDUCATION, IN CLASS 35 (U.S. CLS. 100, 101 AND 102).

FIRST USE 0-0-2002; IN COMMERCE 0-0-2002.

THE MARK CONSISTS OF STANDARD CHARACTERS WITHOUT CLAIM TO ANY PARTICULAR FONT, STYLE, SIZE, OR COLOR.

NO CLAIM IS MADE TO THE EXCLUSIVE RIGHT TO USE "ASSOCIATION", APART FROM THE MARK AS SHOWN.

SEC. 2(F).

SER. NO. 85-201,542, FILED 12-20-2010.

EDWARD NELSON, EXAMINING ATTORNEY



David J. Kyffers

Director of the United States Patent and Trademark Office

United States of America

United States Patent and Trademark Office

HARMONIES OF HEALING

Reg. No. 4,066,025

Registered Dec. 6, 2011

Int. Cl.: 9

TRADEMARK

PRINCIPAL REGISTER

POWELL, LAUREN LANE (UNITED STATES INDIVIDUAL)
P.O. BOX 1
STANFORD, IN 47463

FOR: PRE-RECORDED CDS FEATURING MUSICAL PERFORMANCES AND INSTRUCTION;
PRE-RECORDED DIGITAL MEDIA FEATURING MUSICAL PERFORMANCES AND IN-
STRUCTION; PRE-RECORDED DVDS FEATURING MUSICAL PERFORMANCES AND IN-
STRUCTION, IN CLASS 9 (U.S. CLS. 21, 23, 26, 36 AND 38).

FIRST USE 1-1-2000; IN COMMERCE 1-1-2000.

THE MARK CONSISTS OF STANDARD CHARACTERS WITHOUT CLAIM TO ANY PAR-
TICULAR FONT, STYLE, SIZE, OR COLOR.

NO CLAIM IS MADE TO THE EXCLUSIVE RIGHT TO USE "HARMONIES", APART FROM
THE MARK AS SHOWN.

SER. NO. 85-202,019, FILED 12-20-2010.

H. M. FISHER, EXAMINING ATTORNEY



David J. Kyffers

Director of the United States Patent and Trademark Office

United States of America

United States Patent and Trademark Office

AAT BIOQUEST

Reg. No. 4,066,026

Registered Dec. 6, 2011

Int. Cls.: 1 and 42

TRADEMARK

SERVICE MARK

PRINCIPAL REGISTER

AAT BIOQUEST, INC. (CALIFORNIA CORPORATION)
923 THOMPSON PLACE
SUNNYVALE, CA 94085

FOR: ASSAY KITS FOR SCIENTIFIC RESEARCH CONSISTING PRIMARILY OF BIOCHEMICALS, CROSS-LINKING REAGENTS, FLUORESCENT DYES, ANTIBODIES IN THE NATURE OF MONOCLONAL AND POLYCLONAL ANTIBODIES USED FOR DETECTING AND ANALYZING ANTIGENS IN VITRO, PROBES IN THE NATURE OF CHEMICALS AND BIOCHEMICALS FOR DETECTING AND ANALYZING PROTEINS AND NUCLEOTIDES, AND LABELING COMPOUNDS IN THE NATURE OF CHEMICALS FOR COVALENT ATTACHMENT TO PROTEINS AND NUCLEOTIDES; REAGENTS FOR SCIENTIFIC RESEARCH USE, IN CLASS 1 (U.S. CLS. 1, 5, 6, 10, 26 AND 46).

FIRST USE 2-8-2010; IN COMMERCE 2-8-2010.

FOR: CHEMICAL AND BIOLOGICAL SCREENING FOR SCIENTIFIC PURPOSES, NAMELY, SYNTHESIS OF CHEMICAL REAGENTS, DEVELOPMENT AND PERFORMANCE OF BIOCHEMICAL ASSAYS FOR DETECTING AND ANALYZING PROTEINS AND NUCLEOTIDES, DEVELOPMENT AND PERFORMANCE OF CELLULAR ASSAYS FOR DETECTING AND ANALYZING CELLS AND CELLULAR FUNCTIONS, IN CLASS 42 (U.S. CLS. 100 AND 101).

FIRST USE 2-11-2010; IN COMMERCE 2-11-2010.

THE MARK CONSISTS OF STANDARD CHARACTERS WITHOUT CLAIM TO ANY PARTICULAR FONT, STYLE, SIZE, OR COLOR.

SER. NO. 85-202,174, FILED 12-20-2010.

TINA BROWN, EXAMINING ATTORNEY



David J. Kyjars

Director of the United States Patent and Trademark Office

United States of America

United States Patent and Trademark Office

3D Workflow

Reg. No. 4,066,027

Registered Dec. 6, 2011

Int. Cl.: 9

TRADEMARK

PRINCIPAL REGISTER

EXECUTIVE DATA SYSTEMS, INC. (FLORIDA CORPORATION)
815 NW 57TH AVENUE, SUITE 200
MIAMI, FL 33126

FOR: COMPUTER SOFTWARE THAT UTILIZES DOCKET SCHEDULED EVENTS, IMAGING, DOCUMENT ASSEMBLY, AND REPORT WRITING TO SCHEDULE AUTOMATICALLY, CREATE, PROFILE AND SAVE DOCUMENTS, IN CLASS 9 (U.S. CLS. 21, 23, 26, 36 AND 38).

FIRST USE 3-0-2005; IN COMMERCE 3-0-2005.

THE MARK CONSISTS OF STANDARD CHARACTERS WITHOUT CLAIM TO ANY PARTICULAR FONT, STYLE, SIZE, OR COLOR.

SER. NO. 85-202,455, FILED 12-21-2010.

PAUL F. GAST, EXAMINING ATTORNEY



David J. Kyffers

Director of the United States Patent and Trademark Office

United States of America

United States Patent and Trademark Office



Reg. No. 4,066,028

Registered Dec. 6, 2011

Int. Cl.: 41

SERVICE MARK

PRINCIPAL REGISTER

INDOOR KARTING CENTERS OF AMERICA, LLC (VIRGINIA LIMITED LIABILITY COMPANY)
119 LIBBIE AVENUE
RICHMOND, VA 23226

FOR: PROVIDING INDOOR ENTERTAINMENT FACILITIES FEATURING HIGH PERFORMANCE KART RACING AND ARCADE GAMES FOR BOTH ADULTS AND CHILDREN , IN CLASS 41 (U.S. CLS. 100, 101 AND 107).

FIRST USE 5-30-2009; IN COMMERCE 5-30-2009.

OWNER OF U.S. REG. NOS. 3,100,238 AND 3,993,954.

THE MARK CONSISTS OF THE WORDS "AMERICAN INDOOR KARTING" ARRANGED VERTICALLY NEXT TO A CHECKERED RACING FLAG AND THREE HORIZONTAL LINES.

SEC. 2(F) AS TO "AMERICAN INDOOR KARTING".

SER. NO. 85-202,747, FILED 12-21-2010.

TINA MAI, EXAMINING ATTORNEY



David J. Kybas

Director of the United States Patent and Trademark Office

United States of America

United States Patent and Trademark Office



ADVERTISING PRODUCTION RESOURCES

Reg. No. 4,066,029

Registered Dec. 6, 2011

Int. Cl.: 35

SERVICE MARK

PRINCIPAL REGISTER

APR CONSULTING CO. (COLORADO CORPORATION), DBA ADVERTISING PRODUCTION RESOURCES COMPANY
1201 18TH STREET, SUITE 200
DENVER, CO 802021805

FOR: CONSULTING SERVICES RELATED TO ADVERTISING PRODUCTION MANAGEMENT AND COST CONTAINMENT, IN CLASS 35 (U.S. CLS. 100, 101 AND 102).

FIRST USE 7-5-2000; IN COMMERCE 7-5-2000.

NO CLAIM IS MADE TO THE EXCLUSIVE RIGHT TO USE "ADVERTISING PRODUCTION RESOURCES", APART FROM THE MARK AS SHOWN.

THE COLOR(S) PURPLE, BLACK, AND WHITE IS/ARE CLAIMED AS A FEATURE OF THE MARK.

THE MARK CONSISTS OF THE LOWERCASE LETTERS "APR" IN THE COLOR WHITE WITHIN A CIRCLE WITH THE TEXT "ADVERTISING PRODUCTION RESOURCES" TO THE RIGHT OF THE CIRCLE. THE CIRCLE ITSELF HAS A BLACK PERIMETER, INSIDE OF WHICH THE COLOR GRADUALLY CHANGES FROM BLACK ON THE BOTTOM TO PURPLE ON THE TOP. THE LETTERS "APR" ARE CENTERED VERTICALLY WITHIN THE CIRCLE BUT HORIZONTALLY ARE LEFT JUSTIFIED, WITH THE LETTER "A" CONNECTING ITS LEFT SIDE WITH THE LEFT PERIMETER OF THE CIRCLE. THE LETTERS ARE UNDERLINED BY A STYLIZED PURPLE LINE WHICH (A) EXTENDS OUTSIDE OF THE CIRCLE, (B) IS TAPERED AT ITS ENDS, AND (C) IS CONVEX IN SHAPE, WITH ITS APEX FACING UPWARD TOWARD THE LETTERS "APR".

SER. NO. 85-203,025, FILED 12-21-2010.

WARREN L. OLANDRIA, EXAMINING ATTORNEY



David J. Kybas

Director of the United States Patent and Trademark Office

United States of America

United States Patent and Trademark Office

SIDE  SKILLS

Reg. No. 4,066,030

Registered Dec. 6, 2011

Int. Cl.: 35

SERVICE MARK

PRINCIPAL REGISTER

MCKENZIE & PARTNERS, LLC (NEVADA LIMITED LIABILITY COMPANY)
1603 AVIATION BLVD
#D
REDONDO BEACH, CA 90278

FOR: PROVIDING ON-LINE EMPLOYMENT PLACEMENT SERVICES, NAMELY, MATCHING RESUMES AND POTENTIAL EMPLOYERS VIA A GLOBAL COMPUTER NETWORK, IN CLASS 35 (U.S. CLS. 100, 101 AND 102).

FIRST USE 11-1-2010; IN COMMERCE 11-1-2010.

THE MARK CONSISTS OF THE WORD "SIDESKILLS", WITH THE LETTERS "SID" APPEARING IN BLACK, NEXT TO A STYLIZED BLUE, RED AND YELLOW LETTER "E", NEXT TO THE BLACK LETTERS "SKILLS"; AND A BLACK SHADOW APPEARS BELOW THE LETTER "E".

THE COLOR(S) RED, BLUE, YELLOW AND BLACK IS/ARE CLAIMED AS A FEATURE OF THE MARK.

SER. NO. 85-203,069, FILED 12-21-2010.

BILL DAWE, EXAMINING ATTORNEY



David J. Kyros

Director of the United States Patent and Trademark Office

United States of America

United States Patent and Trademark Office



Reg. No. 4,066,031

Registered Dec. 6, 2011

Int. Cl.: 35

SERVICE MARK

PRINCIPAL REGISTER

APPALACHIAN LONG DISTANCE HIKERS ASSOCIATION (NEW HAMPSHIRE CORPORATION)
30 DONOVAN COURT
MERRIMACK, NH 03054

FOR: CHARITABLE SERVICES, NAMELY, ORGANIZING AND CONDUCTING VOLUNTEER PROGRAMS AND COMMUNITY SERVICE PROJECTS AIMED AT MAINTAINING HIKING TRAILS; PROMOTING THE PUBLIC AWARENESS OF HIKING, HIKING TRAILS AND BACKPACKING, IN CLASS 35 (U.S. CLS. 100, 101 AND 102).

FIRST USE 12-31-1991; IN COMMERCE 12-31-1991.

THE MARK CONSISTS OF MALE HIKER CARRYING BACKPACK AND WALKING STICK IN SILHOUETTE ABOVE THE LETTERS "ALDHA".

SER. NO. 85-203,706, FILED 12-22-2010.

GEOFFREY FOSDICK, EXAMINING ATTORNEY



David J. Kybas

Director of the United States Patent and Trademark Office

United States of America

United States Patent and Trademark Office

The Donut Man

Reg. No. 4,066,032

Registered Dec. 6, 2011

Int. Cl.: 35

SERVICE MARK

PRINCIPAL REGISTER

SANTOS, JOSEPH (UNITED STATES INDIVIDUAL)
659 DALTON DIVISION ROAD
DALTON, MA 01226

FOR: RETAIL DONUT SHOP, IN CLASS 35 (U.S. CLS. 100, 101 AND 102).

FIRST USE 11-14-2001; IN COMMERCE 11-14-2001.

THE MARK CONSISTS OF STANDARD CHARACTERS WITHOUT CLAIM TO ANY PARTICULAR FONT, STYLE, SIZE, OR COLOR.

NO CLAIM IS MADE TO THE EXCLUSIVE RIGHT TO USE "DONUT", APART FROM THE MARK AS SHOWN.

SER. NO. 85-203,723, FILED 12-22-2010.

ROBERT STRUCK, EXAMINING ATTORNEY



David J. Kyffers

Director of the United States Patent and Trademark Office

United States of America

United States Patent and Trademark Office



Reg. No. 4,066,033

Registered Dec. 6, 2011

Int. Cl.: 30

TRADEMARK

PRINCIPAL REGISTER

CSM BAKERY PRODUCTS NA, INC. (DELAWARE CORPORATION)
1912 MONTREAL ROAD
TUCKER, GA 30084

FOR: BULK FOOD MIXES FOR BAKERY GOODS; CAKE MIXES; DONUT MIXES; DANISH MIXES; BISCUIT MIXES; MUFFIN MIXES; COOKIE AND BROWNIE MIXES; BREAD MIXES; ICINGS; GLAZES FOR DONUTS AND BAKERY GOODS; CHOCOLATE, MARSH-MALLOW, AND CUSTARD FILLINGS FOR BAKERY GOODS; AND A WIDE VARIETY OF BAKERY GOODS, IN CLASS 30 (U.S. CL. 46).

FIRST USE 11-0-1998; IN COMMERCE 11-0-1998.

NO CLAIM IS MADE TO THE EXCLUSIVE RIGHT TO USE "FINEST QUALITY" AND "GUARANTEED", APART FROM THE MARK AS SHOWN.

THE MARK CONSISTS OF THE WORDING "BAKEMARK FINEST QUALITY GUARANTEED" IN A CIRCULAR DESIGN INCORPORATING TWO STALKS OF WHEAT.

SER. NO. 85-203,965, FILED 12-22-2010.

JACQUELINE A. LAVINE, EXAMINING ATTORNEY



David J. Kyros

Director of the United States Patent and Trademark Office

United States of America

United States Patent and Trademark Office

VINTAGE MODERN THOMAS O'BRIEN

Reg. No. 4,066,034

TOB INTERNATIONAL MARKETING CORP. (NEW YORK CORPORATION)
419 BROOME STREET
NEW YORK, NY 10013

Registered Dec. 6, 2011

Int. Cls.: 8, 16, 26 and 28

FOR: FLATWARE, IN CLASS 8 (U.S. CLS. 23, 28 AND 44).

TRADEMARK

FIRST USE 11-1-2005; IN COMMERCE 11-1-2005.

PRINCIPAL REGISTER

FOR: STATIONERY, NOTE CARDS, PAPER HANGTAGS, BLANK WRITING JOURNALS, PAPER GIFT WRAP AND PAPER GIFT BAGS, ADHESIVE NOTE PADS, PAPER CLIPS, PAPER CLIP HOLDERS AND PENS, IN CLASS 16 (U.S. CLS. 2, 5, 22, 23, 29, 37, 38 AND 50).

FIRST USE 11-1-2005; IN COMMERCE 11-1-2005.

FOR: ARTIFICIAL FLOWER ARRANGEMENTS, WREATHS AND GARLANDS; DECORATIVE CORD, BRAID, TASSELS AND FRINGE FOR UPHOLSTERY, IN CLASS 26 (U.S. CLS. 37, 39, 40, 42 AND 50).

FIRST USE 11-1-2005; IN COMMERCE 11-1-2005.

FOR: STUFFED TOY ANIMALS; ARTIFICIAL CHRISTMAS GARLANDS, CHRISTMAS STOCKINGS, CHRISTMAS TREE ORNAMENTS, CHRISTMAS TREE SKIRTS, SNOW GLOBES, IN CLASS 28 (U.S. CLS. 22, 23, 38 AND 50).

FIRST USE 11-1-2005; IN COMMERCE 11-1-2005.

THE MARK CONSISTS OF STANDARD CHARACTERS WITHOUT CLAIM TO ANY PARTICULAR FONT, STYLE, SIZE, OR COLOR.

OWNER OF U.S. REG. NOS. 2,964,866, 3,458,543 AND OTHERS.

NO CLAIM IS MADE TO THE EXCLUSIVE RIGHT TO USE "VINTAGE MODERN", APART FROM THE MARK AS SHOWN.

THE NAME(S), PORTRAIT(S), AND/OR SIGNATURE(S) SHOWN IN THE MARK IDENTIFIES "THOMAS O'BRIEN", WHOSE CONSENT(S) TO REGISTER IS MADE OF RECORD.



David J. Kybas

Director of the United States Patent and Trademark Office

Reg. No. 4,066,034 SER. NO. 85-204,871, FILED 12-23-2010.

TINA MAI, EXAMINING ATTORNEY

United States of America

United States Patent and Trademark Office

VINTAGE MODERN THOMAS O'BRIEN

Reg. No. 4,066,035

Registered Dec. 6, 2011

**Int. Cls.: 11, 14, 20, 21,
24 and 27**

TOB INTERNATIONAL MARKETING CORP. (NEW YORK CORPORATION)
419 BROOME STREET
NEW YORK, NY 10013

FOR: LIGHTING FIXTURES, NAMELY, LAMPS, IN CLASS 11 (U.S. CLS. 13, 21, 23, 31 AND 34).

FIRST USE 10-1-2005; IN COMMERCE 10-1-2005.

TRADEMARK

FOR: CLOCKS, IN CLASS 14 (U.S. CLS. 2, 27, 28 AND 50).

PRINCIPAL REGISTER

FIRST USE 10-1-2005; IN COMMERCE 10-1-2005.

FOR: FURNITURE, NAMELY, CHAIRS, TABLES, CABINETS, DESKS, STOOLS, CHESTS, BENCHES, MIRRORS, PICTURE FRAMES, DECORATIVE PILLOWS AND MATTRESS CUSHIONS, DECORATIVE CUSHIONS, CURTAIN RODS, POLES, HOOKS AND FINIALS, CURTAIN RINGS, WINDOW BLINDS, WINDOW SHADES, IN CLASS 20 (U.S. CLS. 2, 13, 22, 25, 32 AND 50).

FIRST USE 10-1-2005; IN COMMERCE 10-1-2005.

FOR: DINNERWARE; PLATES, PITCHERS, BOWLS, TEAPOTS NOT OF PRECIOUS METAL, CUPS, MUGS, SALT AND PEPPER SHAKERS, SERVING PLATTERS, ICE BUCKETS, CASSEROLES, CANISTER SETS, CAKE PLATES, STEMWARE, DRINKING GLASSES, CANDLE STICKS AND CANDLE HOLDERS, NOT OF PRECIOUS METAL, BATHROOM ACCESSORIES, NAMELY, SOAP DISHES, LIQUID SOAP DISPENSERS, CUP HOLDERS, TOOTHBRUSH HOLDERS, PAILS, FACIAL TISSUE HOLDERS, IN CLASS 21 (U.S. CLS. 2, 13, 23, 29, 30, 33, 40 AND 50).

FIRST USE 10-1-2005; IN COMMERCE 10-1-2005.

FOR: BED AND BATH LINENS; DRAPERY; TABLE LINENS AND KITCHEN LINENS; CURTAINS; DRAPERIES; TAPESTRIES OF TEXTILE AND TEXTILE WALL HANGINGS, IN CLASS 24 (U.S. CLS. 42 AND 50).

FIRST USE 10-1-2005; IN COMMERCE 10-1-2005.



David J. Kyros

Director of the United States Patent and Trademark Office

Reg. No. 4,066,035 FOR: RUGS AND CARPETS, IN CLASS 27 (U.S. CLS. 19, 20, 37, 42 AND 50).

FIRST USE 10-1-2005; IN COMMERCE 10-1-2005.

THE MARK CONSISTS OF STANDARD CHARACTERS WITHOUT CLAIM TO ANY PARTICULAR FONT, STYLE, SIZE, OR COLOR.

OWNER OF U.S. REG. NOS. 2,964,866, 3,458,543 AND OTHERS.

NO CLAIM IS MADE TO THE EXCLUSIVE RIGHT TO USE "VINTAGE MODERN", APART FROM THE MARK AS SHOWN.

THE NAME(S), PORTRAIT(S), AND/OR SIGNATURE(S) SHOWN IN THE MARK IDENTIFIES "THOMAS O'BRIEN", WHOSE CONSENT(S) TO REGISTER IS MADE OF RECORD.

SER. NO. 85-205,032, FILED 12-23-2010.

TINA MAI, EXAMINING ATTORNEY

United States of America

United States Patent and Trademark Office

RegC

Reg. No. 4,066,036

Registered Dec. 6, 2011

Int. Cl.: 9

TRADEMARK

PRINCIPAL REGISTER

CARL ZEISS SMT AG (FED REP GERMANY CORPORATION)
CARL-ZEISS-STR. 22
OBERKOCHEN, FED REP GERMANY 73447

FOR: LASER EQUIPMENT USED TO MOVE REGISTRATION/REFERENCE MARKS ON PHOTOMASKS FOR USE IN FABRICATION OF INTEGRATED CIRCUITS, IN CLASS 9 (U.S. CLS. 21, 23, 26, 36 AND 38).

THE MARK CONSISTS OF STANDARD CHARACTERS WITHOUT CLAIM TO ANY PARTICULAR FONT, STYLE, SIZE, OR COLOR.

PRIORITY CLAIMED UNDER SEC. 44(D) ON FED REP GERMANY APPLICATION NO. 302010057306, FILED 9-29-2010, REG. NO. 302010057306, DATED 10-28-2010, EXPIRES 9-30-2020.

SER. NO. 85-205,232, FILED 12-23-2010.

AMY HELLA, EXAMINING ATTORNEY



David J. Kybas

Director of the United States Patent and Trademark Office

United States of America

United States Patent and Trademark Office

Omni Hunter

Reg. No. 4,066,037

Registered Dec. 6, 2011

Int. Cl.: 8

TRADEMARK

PRINCIPAL REGISTER

BUCK KNIVES, INC. (NEVADA CORPORATION)
660 S. LOCHSA STREET
POST FALLS, ID 83854

FOR: FOLDING KNIVES; HUNTING KNIVES; JACK KNIVES; POCKET KNIVES; SIDE ARMS, NOT INCLUDING FIREARMS, NAMELY, HUNTING KNIVES; SPORT KNIVES, IN CLASS 8 (U.S. CLS. 23, 28 AND 44).

FIRST USE 12-31-2005; IN COMMERCE 12-31-2005.

THE MARK CONSISTS OF STANDARD CHARACTERS WITHOUT CLAIM TO ANY PARTICULAR FONT, STYLE, SIZE, OR COLOR.

NO CLAIM IS MADE TO THE EXCLUSIVE RIGHT TO USE "HUNTER", APART FROM THE MARK AS SHOWN.

SER. NO. 85-205,307, FILED 12-23-2010.

ALEXANDER L. POWERS, EXAMINING ATTORNEY



David J. Kyffers

Director of the United States Patent and Trademark Office

United States of America

United States Patent and Trademark Office

message
Open. Absorb. (Be.)

Reg. No. 4,066,038

Registered Dec. 6, 2011

Int. Cl.: 3

TRADEMARK

PRINCIPAL REGISTER

DIANNA LYNN (UNITED STATES INDIVIDUAL)
15541 ELK CREEK ROAD
PINE, CO 80470

FOR: SKIN CARE PRODUCTS, NAMELY, BATH SALTS AND BATH OILS; BODY CREAMS AND BODY AND SKIN LOTIONS; BATH SOAPS AND BODY SCRUBS; BABY LOTIONS AND CONDITIONERS; FACE CREAMS AND MOISTURIZERS; AFTER SHAVE CREAMS AND MOISTURIZERS; BODY AND BEAUTY CARE TOILETRIES; FACIAL BEAUTY MASKS AND SKIN CLEANSERS; FACIAL EXFOLIATING PREPARATIONS; COSMETIC CLEANING GELS AND SOAPS; AROMATHERAPY CLEANSING SCENTS, IN CLASS 3 (U.S. CLS. 1, 4, 6, 50, 51 AND 52).

FIRST USE 7-15-2010; IN COMMERCE 7-15-2010.

THE MARK CONSISTS OF THE STYLIZED WORDS "MESSAGE", "OPEN. ABSORB. BE.".

SER. NO. 85-205,379, FILED 12-23-2010.

PAM WILLIS, EXAMINING ATTORNEY



David J. Kyros

Director of the United States Patent and Trademark Office

United States of America

United States Patent and Trademark Office

LOKAR

Reg. No. 4,066,039

Registered Dec. 6, 2011

Int. Cls.: 11, 12 and 25

TRADEMARK

PRINCIPAL REGISTER

LOKAR, INC. (TENNESSEE CORPORATION)
10924 MURDOCK DRIVE
KNOXVILLE, TN 37932

FOR: LIGHT-EMITTING-DIODE TAIL LIGHTS FOR VEHICLES, IN CLASS 11 (U.S. CLS. 13, 21, 23, 31 AND 34).

FIRST USE 10-27-1987; IN COMMERCE 10-27-1987.

FOR: TRUCK AND AUTOMOTIVE PARTS, NAMELY, FOOT BRAKES, HAND BRAKES, BRAKE CABLES, THROTTLE CABLES, TRANSMISSION DIPSTICKS, ENGINE DIPSTICKS, TRANSMISSION SHIFTERS, BOOTS FOR SHIFTERS, BOOTS FOR BRAKES, HOOD AND TRUNK RELEASE CABLES, RELEASE HANDLE AND MOUNTING FIXTURES PACKAGED AS A KIT, SPEEDOMETER CABLE AND MOUNTING FIXTURES PACKAGED AS A KIT, THROTTLE CABLE KICKDOWNS INCLUDING CABLE AND MOUNTING FIXTURES PACKAGED AS A KIT, THROTTLE PEDALS, BRAKE PEDAL PADS, CLUTCH PEDAL PADS, VEHICLE BATTERY DISCONNECT LEVERS, DOOR LATCH CABLE RELEASES, HOOD PROPS, COLUMN CABLE LINKAGE, AND VEHICLE INTERIOR ACCESSORIES, NAMELY, VEHICLE DOOR HANDLES, AND DASH BOARD INSERTS, IN CLASS 12 (U.S. CLS. 19, 21, 23, 31, 35 AND 44).

FIRST USE 10-27-1987; IN COMMERCE 10-27-1987.

FOR: CLOTHING, NAMELY, GOLF SHIRTS; T-SHIRTS AND HATS, IN CLASS 25 (U.S. CLS. 22 AND 39).

FIRST USE 0-0-1988; IN COMMERCE 0-0-1988.

THE MARK CONSISTS OF STANDARD CHARACTERS WITHOUT CLAIM TO ANY PARTICULAR FONT, STYLE, SIZE, OR COLOR.

OWNER OF U.S. REG. NOS. 2,079,242 AND 2,723,980.

SER. NO. 85-206,053, FILED 12-27-2010.

SANJEEV VOHRA, EXAMINING ATTORNEY



David J. Kyros

Director of the United States Patent and Trademark Office

United States of America

United States Patent and Trademark Office

Infosurv

Reg. No. 4,066,040

Registered Dec. 6, 2011

Int. Cl.: 35

SERVICE MARK

PRINCIPAL REGISTER

INFOSURV, INC. (DELAWARE CORPORATION), DBA INFOSURV
3340 PEACHTREE ROAD NE
SUITE 475
ATLANTA, GA 30326

FOR: CONDUCTING BUSINESS AND MARKET RESEARCH SURVEYS; CONDUCTING EMPLOYEE SURVEYS FOR OTHERS FOR PURPOSES OF IMPROVING EMPLOYEE PERFORMANCE AND MORALE; CONDUCTING ON-LINE BUSINESS MANAGEMENT RESEARCH SURVEYS; CONSUMER MARKETING RESEARCH AND CONSULTING RELATED THERETO; MARKET RESEARCH AND BUSINESS ANALYSES; MARKETING RESEARCH SERVICES, IN CLASS 35 (U.S. CLS. 100, 101 AND 102).

FIRST USE 7-31-1998; IN COMMERCE 7-31-1998.

THE MARK CONSISTS OF STANDARD CHARACTERS WITHOUT CLAIM TO ANY PARTICULAR FONT, STYLE, SIZE, OR COLOR.

OWNER OF U.S. REG. NO. 3,140,513.

SER. NO. 85-206,533, FILED 12-28-2010.

DEIRDRE ROBERTSON, EXAMINING ATTORNEY



David J. Kybas

Director of the United States Patent and Trademark Office

United States of America

United States Patent and Trademark Office

Hold The Eye Images

Reg. No. 4,066,041

Registered Dec. 6, 2011

Int. Cl.: 41

SERVICE MARK

PRINCIPAL REGISTER

WILLIAM J HENDERSON (UNITED STATES INDIVIDUAL), DBA HOLD THE EYE IMAGES
HOLD THE EYE IMAGES
110 STRATHMORE PLACE
LOS GATOS, CA 95032

FOR: PHOTOGRAPHY; PHOTOGRAPHY SERVICES, IN CLASS 41 (U.S. CLS. 100, 101 AND 107).

FIRST USE 1-4-2008; IN COMMERCE 1-4-2008.

THE MARK CONSISTS OF STANDARD CHARACTERS WITHOUT CLAIM TO ANY PARTICULAR FONT, STYLE, SIZE, OR COLOR.

NO CLAIM IS MADE TO THE EXCLUSIVE RIGHT TO USE "IMAGES", APART FROM THE MARK AS SHOWN.

SER. NO. 85-206,859, FILED 12-28-2010.

MARGARET POWER, EXAMINING ATTORNEY



David J. Kyffers

Director of the United States Patent and Trademark Office

United States of America

United States Patent and Trademark Office

North Social

Reg. No. 4,066,042

Registered Dec. 6, 2011

Int. Cl.: 42

SERVICE MARK

PRINCIPAL REGISTER

VOCUS, INC. (DELAWARE CORPORATION)
4296 FORBES BOULEVARD
LANHAM, MD 20706

FOR: APPLICATION SERVICE PROVIDER, NAMELY, HOSTING, MANAGING, DEVELOPING, ANALYZING, AND MAINTAINING APPLICATIONS, SOFTWARE, AND WEB SITES, OF OTHERS IN THE FIELDS OF ADVERTISING AND MARKETING, IN CLASS 42 (U.S. CLS. 100 AND 101).

FIRST USE 11-15-2009; IN COMMERCE 5-5-2010.

THE MARK CONSISTS OF STANDARD CHARACTERS WITHOUT CLAIM TO ANY PARTICULAR FONT, STYLE, SIZE, OR COLOR.

NO CLAIM IS MADE TO THE EXCLUSIVE RIGHT TO USE "SOCIAL", APART FROM THE MARK AS SHOWN.

SER. NO. 85-207,163, FILED 12-29-2010.

TINA BROWN, EXAMINING ATTORNEY



David J. Kybas

Director of the United States Patent and Trademark Office

United States of America

United States Patent and Trademark Office

Smart EOR

Reg. No. 4,066,043

Registered Dec. 6, 2011

Int. Cl.: 37

SERVICE MARK

PRINCIPAL REGISTER

SEMJET INTERNATIONAL LIMITED (HONG KONG CORPORATION)
ALBION PLAZA 2-6 GRANVILLE RD TST
SUITE 1001-2
KOWLOON, HONG KONG

FOR: EXTRACTION OF OIL, IN CLASS 37 (U.S. CLS. 100, 103 AND 106).

FIRST USE 5-14-2010; IN COMMERCE 5-14-2010.

THE MARK CONSISTS OF STANDARD CHARACTERS WITHOUT CLAIM TO ANY PARTICULAR FONT, STYLE, SIZE, OR COLOR.

NO CLAIM IS MADE TO THE EXCLUSIVE RIGHT TO USE "EOR", APART FROM THE MARK AS SHOWN.

SER. NO. 85-207,520, FILED 12-29-2010.

JULIE VEPPUMTHARA, EXAMINING ATTORNEY



David J. Kybas

Director of the United States Patent and Trademark Office

United States of America

United States Patent and Trademark Office

TROYSHIELD

Reg. No. 4,066,044

Registered Dec. 6, 2011

Int. Cls.: 1 and 5

TRADEMARK

PRINCIPAL REGISTER

TROY TECHNOLOGY CORPORATION, INC. (DELAWARE CORPORATION)
200 WEST NINTH STREET PLAZA, SUITE 415
WILMINGTON, DE 19801

FOR: CHEMICAL PRESERVATIVES HAVING FUNGICIDAL ACTION FOR USE IN THE
MANUFACTURE OF METAL WORKING FLUIDS , IN CLASS 1 (U.S. CLS. 1, 5, 6, 10, 26
AND 46).

FIRST USE 10-18-2002; IN COMMERCE 10-18-2002.

FOR: CHEMICALS, NAMELY, FUNGICIDES, FOR INDUSTRIAL APPLICATIONS, IN CLASS
5 (U.S. CLS. 6, 18, 44, 46, 51 AND 52).

FIRST USE 10-18-2002; IN COMMERCE 10-18-2002.

THE MARK CONSISTS OF STANDARD CHARACTERS WITHOUT CLAIM TO ANY PAR-
TICULAR FONT, STYLE, SIZE, OR COLOR.

OWNER OF U.S. REG. NOS. 724,996, 3,609,112 AND OTHERS.

SER. NO. 85-207,590, FILED 12-29-2010.

DANIEL CAPSHAW, EXAMINING ATTORNEY



David J. Kypos

Director of the United States Patent and Trademark Office

United States of America

United States Patent and Trademark Office



Reg. No. 4,066,045

Registered Dec. 6, 2011

Int. Cl.: 25

TRADEMARK

PRINCIPAL REGISTER

WHETZEL, IAN SCOTT (UNITED STATES INDIVIDUAL)
1754 MOUNT DIABLO WAY
LIVERMORE, CA 94551

FOR: ADULT NOVELTY GAG CLOTHING ITEM, NAMELY, SOCKS; BELTS; BELTS FOR CLOTHING; BOTTOMS; CHILDREN'S AND INFANTS' CLOTH BIBS; CHILDREN'S CLOTH EATING BIBS; CLOTHING FOR ATHLETIC USE, NAMELY, PADDED PANTS; CLOTHING FOR ATHLETIC USE, NAMELY, PADDED SHIRTS; CLOTHING FOR ATHLETIC USE, NAMELY, PADDED SHORTS; CLOTHING FOR BABIES, TODDLERS AND CHILDREN, TREATED WITH FIRE AND HEAT RETARDANTS, NAMELY, PAJAMAS, JACKETS, SHIRTS, PANTS, JUMPERS; CLOTHING, NAMELY, ARM WARMERS; CLOTHING, NAMELY, ATHLETIC SLEEVES; CLOTHING, NAMELY, BASE LAYERS; CLOTHING, NAMELY, HAND-WARMERS; CLOTHING, NAMELY, NECK TUBES; CLOTHING, NAMELY, WRAP-AROUNDS; CORSETS; EYESHADES; GLOVES AS CLOTHING; HEADBANDS FOR CLOTHING; HOODS; INFANT AND TODDLER ONE PIECE CLOTHING; JACKETS; JERSEYS; LEATHER BELTS; MANTLES; MUFFLERS; SHIRTS; SHORT SETS; TIES; TOPS; TRAVEL CLOTHING CONTAINED IN A PACKAGE COMPRISING REVERSIBLE JACKETS, PANTS, SKIRTS, TOPS AND A BELT OR SCARF; TRIATHLON CLOTHING, NAMELY, TRIATHLON TIGHTS, TRIATHLON SHORTS, TRIATHLON SINGLET, TRIATHLON SHIRTS, TRIATHLON SUITS; WEARABLE GARMENTS AND CLOTHING, NAMELY, SHIRTS; WRAPS, IN CLASS 25 (U.S. CLS. 22 AND 39).

FIRST USE 10-1-2009; IN COMMERCE 10-1-2009.

THE MARK CONSISTS OF THE WORDS "BOARD MONKEY", SEPARATED BY A STYLIZED BADGE DESIGN CREATED BY THE COMBINATION OF THE LETTER "B" WITH THE LETTER "M" AS AN OVERLAY.

SER. NO. 85-207,663, FILED 12-29-2010.

TINA L. SNAPP, EXAMINING ATTORNEY



David J. Kybas

Director of the United States Patent and Trademark Office

United States of America
United States Patent and Trademark Office

kittylac

Reg. No. 4,066,046

GLO-MARR PRODUCTS, INC. (KENTUCKY CORPORATION)
400 LINCOLN STREET
LAWRENCEBURG, KY 40342

Registered Dec. 6, 2011

Int. Cl.: 5

FOR: ANIMAL FEED SUPPLEMENTS FOR CATS AND LACTATING QUEENS, IN CLASS 5 (U.S. CLS. 6, 18, 44, 46, 51 AND 52).

TRADEMARK

FIRST USE 11-16-1987; IN COMMERCE 11-16-1987.

PRINCIPAL REGISTER

THE MARK CONSISTS OF STYLIZED PRINTING OF THE WORD "KITTYLAC" IN A FONT OF SERIF GOTHIC BOLD.

SER. NO. 85-207,854, FILED 12-30-2010.

MARK SPARACINO, EXAMINING ATTORNEY



David J. Kybas

Director of the United States Patent and Trademark Office

United States of America

United States Patent and Trademark Office

TNA ACTION

Reg. No. 4,066,047

Registered Dec. 6, 2011

Int. Cls.: 18 and 25

TRADEMARK

PRINCIPAL REGISTER

ARITZIA LP (CANADA LIMITED PARTNERSHIP)
SUITE 118
611 ALEXANDER STREET
VANCOUVER, BC, CANADA V6A1E1

FOR: ATHLETIC BAGS; BACKPACKS; CARRY-ALL BAGS; HANDBAGS; PURSES; WALLETS, IN CLASS 18 (U.S. CLS. 1, 2, 3, 22 AND 41).

FOR: CAPS; DRESSES; GLOVES; HATS; JACKETS; PANTS; SCARVES; SHIRTS; SHORTS; SKIRTS; SOCKS; SWEATERS; SWEATPANTS; SWEATSHIRTS; SWIMWEAR; TIGHTS; TOPS; TOQUES; UNDERWEAR; VESTS; WIND RESISTANT JACKETS, IN CLASS 25 (U.S. CLS. 22 AND 39).

THE MARK CONSISTS OF STANDARD CHARACTERS WITHOUT CLAIM TO ANY PARTICULAR FONT, STYLE, SIZE, OR COLOR.

OWNER OF CANADA REG. NO. 657775, DATED 2-1-2006, EXPIRES 2-1-2021.

OWNER OF U.S. REG. NOS. 3,562,638, 3,633,340 AND OTHERS.

SER. NO. 85-208,283, FILED 12-30-2010.

PAUL E. FAHRENKOPF, EXAMINING ATTORNEY



David J. Kybas

Director of the United States Patent and Trademark Office

United States of America

United States Patent and Trademark Office



Personal Environment Service

Reg. No. 4,066,048

Registered Dec. 6, 2011

Int. Cl.: 37

SERVICE MARK

PRINCIPAL REGISTER

CHI PERSONAL ENVIRONMENT SERVICES, LLC (NEVADA LIMITED LIABILITY COMPANY)
1315 24TH STREET
PERU, IL 61354

FOR: AUTOMOBILE CLEANING AND CAR WASHING; CAR CLEANING, IN CLASS 37 (U.S. CLS. 100, 103 AND 106).

FIRST USE 6-1-2010; IN COMMERCE 6-1-2010.

NO CLAIM IS MADE TO THE EXCLUSIVE RIGHT TO USE "SERVICES", APART FROM THE MARK AS SHOWN.

THE COLOR(S) LIGHT GREEN AND BLACK IS/ARE CLAIMED AS A FEATURE OF THE MARK.

THE MARK CONSISTS OF THE WORDS "PERSONAL ENVIRONMENT SERVICE" IN BLACK IMMEDIATELY ABOVE AND TO THE RIGHT IN LIGHT GREEN IS THE WORD "CHI". DIRECTLY TO THE LEFT OF THE WORD "CHI" IS A GREEN IMAGE OF A LEAF, OVERLAID BY A BLACK, STYLIZED CHINESE CHARACTER FOR "CHI".

THE CHINESE CHARACTER FOR "CHI" CAN BE TRANSLATED "THE LIFE FORCE".

SER. NO. 85-208,317, FILED 12-30-2010.

SAMUEL E. SHARPER JR., EXAMINING ATTORNEY



David J. Kybas

Director of the United States Patent and Trademark Office

United States of America

United States Patent and Trademark Office

10CORE

Reg. No. 4,066,049

Registered Dec. 6, 2011

Int. Cl.: 41

SERVICE MARK

PRINCIPAL REGISTER

NEVILLE COMMUNICATIONS CORPORATION (MICHIGAN CORPORATION)
19535 CUMBERLAND WAY
DETROIT, MI 48203

FOR: EDUCATIONAL SERVICES, NAMELY, PROVIDING CLASSES, SEMINARS, WORKSHOPS LIVE AND THROUGH DIFFERENT MEDIA IN THE FIELD OF REAL ESTATE LAW AND DISTRIBUTION OF COURSE MATERIALS IN CONNECTION THEREWITH IN THE NATURE OF ARTICLES PUBLISHED ON THE INTERNET IN THE FIELD OF REAL ESTATE LAW, IN CLASS 41 (U.S. CLS. 100, 101 AND 107).

FIRST USE 4-1-2008; IN COMMERCE 4-1-2008.

THE MARK CONSISTS OF STANDARD CHARACTERS WITHOUT CLAIM TO ANY PARTICULAR FONT, STYLE, SIZE, OR COLOR.

SER. NO. 85-208,420, FILED S.R. 12-31-2010 AM. P.R. 8-8-2011.

KATHERINE M. DUBRAY, EXAMINING ATTORNEY



David J. Kybas

Director of the United States Patent and Trademark Office

United States of America

United States Patent and Trademark Office



Reg. No. 4,066,050

Registered Dec. 6, 2011

Int. Cls.: 25 and 39

TRADEMARK

SERVICE MARK

PRINCIPAL REGISTER

SIGHTSEEING TOURS MANAGEMENT, INC. (FLORIDA CORPORATION)
555 NE 15 ST., SUITE 102
MIAMI, FL 33132

FOR: BASEBALL CAPS; BASEBALL CAPS AND HATS; BUCKET CAPS; JACKETS; POLO SHIRTS; SHIRTS; SHIRTS AND SHORT-SLEEVED SHIRTS; SHORT-SLEEVED OR LONG-SLEEVED T-SHIRTS; SHORT-SLEEVED SHIRTS; SPORTS CAPS AND HATS; T-SHIRTS, IN CLASS 25 (U.S. CLS. 22 AND 39).

FIRST USE 11-21-2010; IN COMMERCE 11-21-2010.

FOR: CONDUCTING SIGHTSEEING TOURS BY BOAT; ORGANIZATION, BOOKING AND ARRANGEMENT OF EXCURSIONS, DAY TRIPS AND SIGHTSEEING TOURS; YACHT AND BOAT CHARTER SERVICES; YACHT CHARTERING, IN CLASS 39 (U.S. CLS. 100 AND 105).

FIRST USE 12-31-1983; IN COMMERCE 12-31-1983.

NO CLAIM IS MADE TO THE EXCLUSIVE RIGHT TO USE "CRUISES" , APART FROM THE MARK AS SHOWN.

THE MARK CONSISTS OF A YACHT WITH A SHADED CIRCLE REPRESENTING THE SUN IN THE BACKGROUND AND THE STYLIZED WORDS "ISLAND QUEEN CRUISES" IN THE FOREGROUND.

SER. NO. 85-209,597, FILED 1-3-2011.

ZHALEH DELANEY, EXAMINING ATTORNEY



David J. Kybas

Director of the United States Patent and Trademark Office

United States of America

United States Patent and Trademark Office

1-hour MAGIC CONDOMS

Reg. No. 4,066,051

CHANG JUNG CHAI (UNITED STATES INDIVIDUAL)
1047 1/2 S SERRANO AVE
LOS ANGELES, CA 90006

Registered Dec. 6, 2011

Int. Cl.: 10

FOR: CONDOMS, IN CLASS 10 (U.S. CLS. 26, 39 AND 44).

TRADEMARK

FIRST USE 1-1-2011; IN COMMERCE 1-1-2011.

PRINCIPAL REGISTER

THE MARK CONSISTS OF STANDARD CHARACTERS WITHOUT CLAIM TO ANY PARTICULAR FONT, STYLE, SIZE, OR COLOR.

NO CLAIM IS MADE TO THE EXCLUSIVE RIGHT TO USE "1-HOUR" AND "CONDOMS", APART FROM THE MARK AS SHOWN.

SER. NO. 85-210,008, FILED 1-4-2011.

DARRYL SPRUILL, EXAMINING ATTORNEY



David J. Kyffers

Director of the United States Patent and Trademark Office

United States of America

United States Patent and Trademark Office

FILTER FOUNDRY

Reg. No. 4,066,052

Registered Dec. 6, 2011

Int. Cls.: 35 and 41

SERVICE MARK

PRINCIPAL REGISTER

FILTER PLATFORMS, INC. (DELAWARE CORPORATION)
5870 W. JEFFERSON BLVD., STUDIO D
LOS ANGELES, CA 90016

FOR: PROVIDING INFORMATION, NAMELY, BUSINESS AND COMMERCIAL INFORMATION IN THE FIELDS OF CREATIVE ARTS AND MARKETING FOR CREATIVE PROFESSIONALS, IN CLASS 35 (U.S. CLS. 100, 101 AND 102).

FIRST USE 9-14-2010; IN COMMERCE 9-14-2010.

FOR: EDUCATIONAL SERVICES, NAMELY, ONLINE TUTORIAL SESSIONS IN THE FIELDS OF CREATIVE ARTS AND MARKETING FOR CREATIVE PROFESSIONALS, IN CLASS 41 (U.S. CLS. 100, 101 AND 107).

FIRST USE 9-14-2010; IN COMMERCE 9-14-2010.

THE MARK CONSISTS OF STANDARD CHARACTERS WITHOUT CLAIM TO ANY PARTICULAR FONT, STYLE, SIZE, OR COLOR.

SER. NO. 85-210,416, FILED 1-4-2011.

REGINA DRUMMOND, EXAMINING ATTORNEY



David J. Kybas

Director of the United States Patent and Trademark Office

United States of America

United States Patent and Trademark Office

WaterRipper

Reg. No. 4,066,053

Registered Dec. 6, 2011

Int. Cl.: 28

TRADEMARK

PRINCIPAL REGISTER

LEEFELDT, TIM (UNITED STATES INDIVIDUAL)
PMB 212 236 W. EAST AVE. STE. A
CHICO, CA 95926

FOR: BALLS FOR SPORTS, IN CLASS 28 (U.S. CLS. 22, 23, 38 AND 50).

FIRST USE 1-1-2011; IN COMMERCE 1-1-2011.

THE MARK CONSISTS OF STANDARD CHARACTERS WITHOUT CLAIM TO ANY PARTICULAR FONT, STYLE, SIZE, OR COLOR.

SER. NO. 85-210,418, FILED 1-4-2011.

KATHERINE E. HALMEN, EXAMINING ATTORNEY



David J. Kybas

Director of the United States Patent and Trademark Office

United States of America

United States Patent and Trademark Office

LYLE "SPUD" MURPHY'S

Reg. No. 4,066,054

Registered Dec. 6, 2011

Int. Cl.: 41

SERVICE MARK

PRINCIPAL REGISTER

MURPHY, LILITH (UNITED STATES INDIVIDUAL)
323 EAST MATILJA STREET, SUITE 110-275
OJAI, CA 93023

FOR: EDUCATIONAL SERVICES, NAMELY, PROVIDING COURSES IN THE FIELD OF MUSIC, MUSIC THEORY AND MUSIC COMPOSITION AND DISTRIBUTION OF COURSE MATERIALS IN CONNECTION THEREWITH; BOOK PUBLISHING, IN CLASS 41 (U.S. CLS. 100, 101 AND 107).

FIRST USE 0-0-1949; IN COMMERCE 0-0-1949.

THE MARK CONSISTS OF STANDARD CHARACTERS WITHOUT CLAIM TO ANY PARTICULAR FONT, STYLE, SIZE, OR COLOR.

THE NAME(S), PORTRAIT(S), AND/OR SIGNATURE(S) SHOWN IN THE MARK DOES NOT IDENTIFY A PARTICULAR LIVING INDIVIDUAL.

SER. NO. 85-210,475, FILED 1-4-2011.

HAI-LY LAM, EXAMINING ATTORNEY



David J. Kyffers

Director of the United States Patent and Trademark Office

United States of America

United States Patent and Trademark Office

BEE CHALLENGE

Reg. No. 4,066,055

Registered Dec. 6, 2011

Int. Cl.: 9

TRADEMARK

PRINCIPAL REGISTER

ARISTOCRAT TECHNOLOGIES AUSTRALIA PTY LTD. (AUSTRALIA CORPORATION)
BUILDING A, PINNACLE OFFICE PARK
85 EPPING ROAD
NORTH RYDE, NSW, AUSTRALIA 2113

FOR: ELECTRONIC GAMING MACHINES, NAMELY, DEVICES WHICH ACCEPT A WAGER,
IN CLASS 9 (U.S. CLS. 21, 23, 26, 36 AND 38).

THE MARK CONSISTS OF STANDARD CHARACTERS WITHOUT CLAIM TO ANY PAR-
TICULAR FONT, STYLE, SIZE, OR COLOR.

PRIORITY CLAIMED UNDER SEC. 44(D) ON AUSTRALIA APPLICATION NO. 1397038,
FILED 12-7-2010, REG. NO. 1397038, DATED 12-7-2010, EXPIRES 12-7-2020.

SER. NO. 85-211,378, FILED 1-5-2011.

JENNIFER DIXON, EXAMINING ATTORNEY



David J. Kybas

Director of the United States Patent and Trademark Office

United States of America

United States Patent and Trademark Office

WONDER4

Reg. No. 4,066,056

Registered Dec. 6, 2011

Int. Cl.: 9

TRADEMARK

PRINCIPAL REGISTER

ARISTOCRAT TECHNOLOGIES AUSTRALIA PTY LTD. (AUSTRALIA CORPORATION)
BUILDING A, PINNACLE OFFICE PARK
85 EPPING ROAD
NORTH RYDE, NSW, AUSTRALIA 2113

FOR: ELECTRONIC GAMING MACHINES, NAMELY, DEVICES WHICH ACCEPT A WAGER;
ELECTRONIC GAMING MACHINES, NAMELY, DEVICES WHICH ACCEPT A WAGER, IN
CLASS 9 (U.S. CLS. 21, 23, 26, 36 AND 38).

THE MARK CONSISTS OF STANDARD CHARACTERS WITHOUT CLAIM TO ANY PAR-
TICULAR FONT, STYLE, SIZE, OR COLOR.

PRIORITY CLAIMED UNDER SEC. 44(D) ON AUSTRALIA APPLICATION NO. 1397071,
FILED 12-7-2010, REG. NO. 1397071, DATED 12-7-2010, EXPIRES 12-7-2020.

SER. NO. 85-211,386, FILED 1-5-2011.

JENNIFER DIXON, EXAMINING ATTORNEY



David J. Kyffers

Director of the United States Patent and Trademark Office

United States of America

United States Patent and Trademark Office

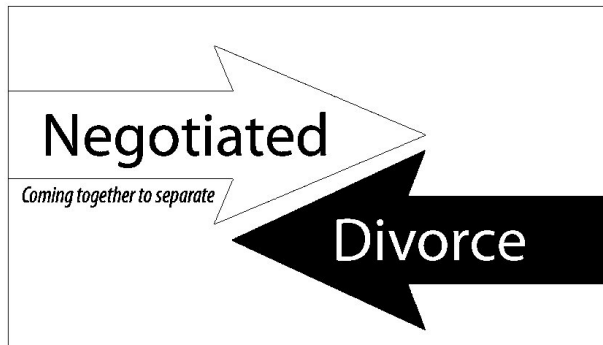

Reg. No. 4,066,057

Registered Dec. 6, 2011

Int. Cl.: 45

SERVICE MARK

PRINCIPAL REGISTER

UNTIE THE KNOT, LLC (TEXAS LIMITED LIABILITY COMPANY)
5420 LBJ FREEWAY
SUITE 626
DALLAS, TX 75240

FOR: PROVIDING A WEBSITE FEATURING INFORMATION AND INSTRUCTIONAL VIDEOS IN THE FIELD OF FAMILY LAW, IN CLASS 45 (U.S. CLS. 100 AND 101).

FIRST USE 8-14-2009; IN COMMERCE 9-25-2009.

NO CLAIM IS MADE TO THE EXCLUSIVE RIGHT TO USE "DIVORCE", APART FROM THE MARK AS SHOWN.

THE MARK CONSISTS OF TWO ARROWS GOING IN OPPOSITE DIRECTIONS WITH THE WORDING "NEGOTIATED DIVORCE" APPEARING IN THE ARROWS. THE WORDING "COMING TOGETHER TO SEPARATE" APPEARS UNDER THE TOP ARROW.

SER. NO. 85-211,882, FILED 1-6-2011.

DANNEAN HETZEL, EXAMINING ATTORNEY



David J. Kybas

Director of the United States Patent and Trademark Office

United States of America

United States Patent and Trademark Office

VALENCER

Reg. No. 4,066,058

Registered Dec. 6, 2011

Int. Cl.: 7

TRADEMARK

PRINCIPAL REGISTER

COMBUSTIVE CONTROL SYSTEMS CCS CORPORATION (MARYLAND CORPORATION)
221 DUKE OF GLOUCESTER ST.
ANNAPOLIS, MD 21401

FOR: ENVIRONMENTAL APPARATUS, NAMELY, A UNIT CONTAINING MAGNETS THAT ALTERS MOLECULAR BONDS IN FLUIDS, NAMELY, ENHANCEMENT PARTS FOR INTERNAL COMBUSTION ENGINES, NAMELY, FUEL CATALYSTS, IN CLASS 7 (U.S. CLS. 13, 19, 21, 23, 31, 34 AND 35).

FIRST USE 2-2-2010; IN COMMERCE 2-2-2010.

THE MARK CONSISTS OF STANDARD CHARACTERS WITHOUT CLAIM TO ANY PARTICULAR FONT, STYLE, SIZE, OR COLOR.

SER. NO. 85-211,999, FILED 1-6-2011.

GINA FINK, EXAMINING ATTORNEY



David J. Kyffers

Director of the United States Patent and Trademark Office

United States of America

United States Patent and Trademark Office

HAP Trading

Reg. No. 4,066,059

Registered Dec. 6, 2011

Int. Cl.: 36

SERVICE MARK

PRINCIPAL REGISTER

HAP TRADING, LLC (NEW YORK LIMITED LIABILITY COMPANY)
33 WHITEHALL ST.
6TH FLOOR
NEW YORK, NY 10004

FOR: FINANCIAL SERVICES, NAMELY, DEALING IN SECURITIES AS A MARKET MAKER AND PROPRIETARY TRADING IN SECURITIES, OPTIONS, EQUITIES, FUTURES, COMMODITIES, CURRENCIES AND FIXED INCOME IN THE UNITED STATES AND OVERSEAS SECURITIES MARKETS, IN CLASS 36 (U.S. CLS. 100, 101 AND 102).

FIRST USE 9-1-2009; IN COMMERCE 10-1-2009.

THE MARK CONSISTS OF STANDARD CHARACTERS WITHOUT CLAIM TO ANY PARTICULAR FONT, STYLE, SIZE, OR COLOR.

NO CLAIM IS MADE TO THE EXCLUSIVE RIGHT TO USE "TRADING", APART FROM THE MARK AS SHOWN.

SER. NO. 85-212,832, FILED 1-7-2011.

KYLE PEETE, EXAMINING ATTORNEY



David J. Kyros

Director of the United States Patent and Trademark Office

United States of America

United States Patent and Trademark Office



Reg. No. 4,066,060

Registered Dec. 6, 2011

Int. Cl.: 42

SERVICE MARK

PRINCIPAL REGISTER

VELAZQUEZ, ARGELIA (UNITED STATES INDIVIDUAL)
3552 N. ALBANY AVE.
CHICAGO, IL 60618

FOR: COLOR ANALYSIS FOR PURPOSES OF INTERIOR DESIGN; DESIGN OF INTERIOR DECOR; INTERIOR DECORATING; INTERIOR DECORATION CONSULTATION; INTERIOR DESIGN SERVICES, IN CLASS 42 (U.S. CLS. 100 AND 101).

FIRST USE 1-7-2011; IN COMMERCE 1-7-2011.

NO CLAIM IS MADE TO THE EXCLUSIVE RIGHT TO USE "COLOR", APART FROM THE MARK AS SHOWN.

THE MARK CONSISTS OF STYLIZED WOMAN IN CARICATURE FORM FACING TO THE LEFT. THE WORDING "COLOR ZEAL" IS STACKED ATOP EACH OTHER TO THE LEFT OF THE WOMAN. THERE ARE FIVE 5-POINTED STARS, TWO BEHIND THE WOMAN AND THREE SURROUNDING THE WORDING. THE ENTIRE DESIGN IS SURROUNDED BY TWO-CONCENTRIC CIRCLES.

SER. NO. 85-213,045, FILED 1-7-2011.

JANICE KIM, EXAMINING ATTORNEY



David J. Kyros

Director of the United States Patent and Trademark Office

United States of America

United States Patent and Trademark Office



NAVYBOOT

Reg. No. 4,066,061

NAVYBOOT AG (SWITZERLAND AKTIENGESELLSCHAFT)
TALACKER 41

Registered Dec. 6, 2011

ZURICH, SWITZERLAND 8001

Int. Cls.: 3, 9, 14, 18 and 25

FOR: PERFUMERY; SOAPS; ESSENTIAL OILS, COSMETICS, IN CLASS 3 (U.S. CLS. 1, 4, 6, 50, 51 AND 52).

TRADEMARK

FOR: SPECTACLE FRAMES FOR SPECTACLES AND SUNGLASSES, LEISURE EYEWEAR, PROTECTIVE EYEWEAR, FASHION EYEWEAR AND SPORTS GLASSES, IN CLASS 9 (U.S. CLS. 21, 23, 26, 36 AND 38).

PRINCIPAL REGISTER

FOR: WATCHES AND JEWELRY, IN CLASS 14 (U.S. CLS. 2, 27, 28 AND 50).

FOR: LEATHER AND IMITATION LEATHER; LEATHER AND IMITATION LEATHER GOODS, NAMELY, BRIEFCASES, TRAVELLING TRUNKS AND TRAVELLING BAGS; ACCESSORIES, NAMELY, TOILETRY BAGS SOLD EMPTY, HANDBAGS, WALLETS AND PURSES, IN CLASS 18 (U.S. CLS. 1, 2, 3, 22 AND 41).

FOR: CLOTHING, NAMELY, SHIRTS, PANTS, SHORTS, DRESSES AND SKIRTS; FOOTWEAR AND HEADWEAR, IN CLASS 25 (U.S. CLS. 22 AND 39).

OWNER OF SWITZERLAND REG. NO. 606170, DATED 9-30-2010, EXPIRES 9-20-2020.

THE MARK CONSISTS OF A FANCIFUL DEPICTION OF A FLOWER ABOVE THE WORDING "NAVYBOOT".

SER. NO. 85-213,065, FILED 1-7-2011.

JANICE KIM, EXAMINING ATTORNEY



David J. Kybas

Director of the United States Patent and Trademark Office

United States of America

United States Patent and Trademark Office

ShopsBox

Reg. No. 4,066,062

AUTONOMOUS (NEVADA SOLE PROPRIETORSHIP), DBA AUTONOMOUS
231 LILAC BUD ST.
HENDERSON, NV 89074

Registered Dec. 6, 2011

Int. Cl.: 42

FOR: PROVIDING A MEMBERS-ONLY WEBSITE FEATURING TECHNOLOGY WHICH PROVIDES MEMBERS WITH THE ABILITY TO POST REPAIR WORK NEEDED, RECEIVE ESTIMATES AND INVOICES AND SCHEDULE APPOINTMENTS WITH VEHICLE REPAIR SHOPS, IN CLASS 42 (U.S. CLS. 100 AND 101).

SERVICE MARK

PRINCIPAL REGISTER

FIRST USE 11-22-2010; IN COMMERCE 1-1-2011.

THE MARK CONSISTS OF STANDARD CHARACTERS WITHOUT CLAIM TO ANY PARTICULAR FONT, STYLE, SIZE, OR COLOR.

SER. NO. 85-213,413, FILED 1-8-2011.

DAVID HOFFMAN, EXAMINING ATTORNEY



David J. Kyffers

Director of the United States Patent and Trademark Office

United States of America

United States Patent and Trademark Office

toonbots

Reg. No. 4,066,063

Registered Dec. 6, 2011

Int. Cl.: 41

SERVICE MARK

PRINCIPAL REGISTER

TOONBOTS ANIMATION, L.L.C. (MICHIGAN LIMITED LIABILITY COMPANY)
907 WYANDOTTE AVENUE
ROYAL OAK, MI 48067

FOR: ANIMATION PRODUCTION SERVICES, IN CLASS 41 (U.S. CLS. 100, 101 AND 107).

FIRST USE 6-1-2009; IN COMMERCE 6-18-2009.

THE MARK CONSISTS OF STANDARD CHARACTERS WITHOUT CLAIM TO ANY PARTICULAR FONT, STYLE, SIZE, OR COLOR.

SER. NO. 85-213,577, FILED 1-9-2011.

RUDY R. SINGLETON, EXAMINING ATTORNEY



David J. Kybas

Director of the United States Patent and Trademark Office

United States of America

United States Patent and Trademark Office

SEPURA

Reg. No. 4,066,064

Registered Dec. 6, 2011

Int. Cl.: 7

TRADEMARK

PRINCIPAL REGISTER

BOWMAN STOR LIMITED (UNITED KINGDOM LIMITED COMPANY (LTD.))
UNIT 25 MAYBROOK ROAD
BROWNHILLS, WALSALL, UNITED KINGDOM WS87DG

FOR: MACHINES FOR THE SEPARATION OF CONTAMINANTS FROM FLUIDS AND MACHINES FOR THE SEPARATION OF OILY CONTAMINANTS FROM FLUID COMPRISING COMPRESSOR CONDENSATE; FILTERING MACHINES FOR FILTERING OILY CONTAMINANTS FROM FLUIDS; PARTS AND FITTINGS FOR ALL THESE GOODS, IN CLASS 7 (U.S. CLS. 13, 19, 21, 23, 31, 34 AND 35).

THE MARK CONSISTS OF STANDARD CHARACTERS WITHOUT CLAIM TO ANY PARTICULAR FONT, STYLE, SIZE, OR COLOR.

OWNER OF ERPN CMNTY TM OFC REG. NO. 005293841, DATED 11-8-2007, EXPIRES 8-15-2016.

SER. NO. 85-213,751, FILED 1-10-2011.

DAVID HOFFMAN, EXAMINING ATTORNEY



David J. Kyffers

Director of the United States Patent and Trademark Office

United States of America

United States Patent and Trademark Office

DAYACOM

Reg. No. 4,066,065

Registered Dec. 6, 2011

Int. Cl.: 16

TRADEMARK

PRINCIPAL REGISTER

DAYACOM INDUSTRIAL CO., LTD. (TAIWAN CORPORATION)
1F., NO. 13, LANE 630 PEI-AN ROAD
TACHIH, TAIPEI CITY, TAIWAN

FOR: PENS; BALL POINT PENS; COLOUR PENS; FOUNTAIN PENS; FOUNTAIN PEN INK CARTRIDGES; INK PENS; MARKING PENS; PEN NIBS; PEN RESTS; PEN CASES; PEN HOLDERS; PENCILS; COLOUR PENCILS; MAGAZINES IN THE FIELD OF STATIONERY; MEMORY BOOKS; CALENDARS; CRAYONS; WATER COLOURS BEING FINISHED PAINTINGS; PAINT BRUSHES; POSTERS; PHOTOGRAPH ALBUMS; PHOTOGRAPH ALBUM COVERS; LINING PAPER; PHOTOGRAPHS; OFFICE EQUIPMENT, NAMELY, ERASERS, FASTENERS FOR BINDING FILES IN THE NATURE OF PAPER FASTENERS AND PAPER CLIPS, MATS FOR CUTTING PAPER, NAMELY, DESK PADS, PAPER CUTTERS AND SPARE BLADES FOR PAPER CUTTER; PAPER WEIGHTS; DIARIES; FLASH CARDS; GIFT CARDS; GREETING CARDS; MUSICAL GREETING CARDS; POST CARDS; ADHESIVE TAPE DISPENSERS FOR HOUSEHOLD OR STATIONERY USE; BATHROOM AND FACIAL TISSUE; DRAWING RULERS; TOWELS AND TABLECLOTHS MADE OF PAPER; PLASTIC BAGS FOR PACKAGING; PAPER BAGS FOR PACKAGING; DOCUMENT HOLDERS; RUBBER STAMPS; STICKERS; PEN INK CARTRIDGES, IN CLASS 16 (U.S. CLS. 2, 5, 22, 23, 29, 37, 38 AND 50).

FIRST USE 3-4-1987; IN COMMERCE 12-1-1989.

THE MARK CONSISTS OF THE WORD "DAYACOM" IN STYLIZED FONT.

SER. NO. 85-213,789, FILED 1-10-2011.

JASON TURNER, EXAMINING ATTORNEY



David J. Kyros

Director of the United States Patent and Trademark Office

United States of America

United States Patent and Trademark Office

SATINADOS

Reg. No. 4,066,066

Registered Dec. 6, 2011

Int. Cl.: 21

TRADEMARK

PRINCIPAL REGISTER

ISA CORPORATION (OREGON CORPORATION)
3787 FAIRVIEW INDUSTRIAL DR SE
SALEM, OR 97302

FOR: DISPOSABLE GLOVES FOR HOME USE; DISPOSABLE LATEX AND NITRILE GLOVES FOR GENERAL USE; DISPOSABLE LATEX GLOVES FOR GENERAL USE, IN CLASS 21 (U.S. CLS. 2, 13, 23, 29, 30, 33, 40 AND 50).

FIRST USE 10-15-2010; IN COMMERCE 12-1-2010.

THE MARK CONSISTS OF STANDARD CHARACTERS WITHOUT CLAIM TO ANY PARTICULAR FONT, STYLE, SIZE, OR COLOR.

THE ENGLISH TRANSLATION OF "SATINADOS" IN THE MARK IS "SATIN".

SER. NO. 85-214,050, FILED 1-10-2011.

DARRYL SPRUILL, EXAMINING ATTORNEY



David J. Kyffers

Director of the United States Patent and Trademark Office

United States of America

United States Patent and Trademark Office

Bon Bons Girly Boutique

Reg. No. 4,066,067

Registered Dec. 6, 2011

Int. Cl.: 35

SERVICE MARK

PRINCIPAL REGISTER

BON BONS GIRLY BOUTIQUE, INC. (CALIFORNIA CORPORATION)
705-181
3830 VALLEY CENTRE DRIVE
SAN DIEGO, CA 92130

FOR: RETAIL STORE SERVICES FEATURING JEWELRY AND ACCESSORIES FOR WOMEN, NAMELY, CUSTOM GLASS AND METAL LOCKETS WITH OR WITHOUT CUBIC ZIRCONIA STONES, CHARMS, RINGS, EARRINGS, BRACELETS, NECKLACES, BROACHES, KEY CHAINS, COMPACTS, BUSINESS CARD HOLDERS, SUNGLASSES, READING GLASSES, PURSES, HANDBAGS, WALLETS, BELTS, CELL PHONE COVERS, AND ANY OTHER COSTUME OR FINE JEWELRY AND FASHION ACCESSORIES WORN BY WOMEN, IN CLASS 35 (U.S. CLS. 100, 101 AND 102).

FIRST USE 2-1-2008; IN COMMERCE 2-1-2008.

THE MARK CONSISTS OF STANDARD CHARACTERS WITHOUT CLAIM TO ANY PARTICULAR FONT, STYLE, SIZE, OR COLOR.

NO CLAIM IS MADE TO THE EXCLUSIVE RIGHT TO USE "BOUTIQUE", APART FROM THE MARK AS SHOWN.

SER. NO. 85-214,328, FILED 1-10-2011.

THOMAS MANOR, EXAMINING ATTORNEY



David J. Kyros

Director of the United States Patent and Trademark Office

United States of America

United States Patent and Trademark Office

WORKHEALTH

Reg. No. 4,066,068

Registered Dec. 6, 2011

Int. Cls.: 44 and 45

SERVICE MARK

PRINCIPAL REGISTER

SSM SELECT REHAB ST. LOUIS, LLC (DELAWARE LIMITED LIABILITY COMPANY)
6420 CLAYTON ROAD
6TH FLOOR
ST. LOUIS, MO 63117

FOR: OCCUPATIONAL HEALTH SERVICES, NAMELY, OCCUPATIONAL THERAPY SERVICES, PHYSICAL THERAPY SERVICES AND PHYSICAL THERAPY SERVICES FOR THE HAND; INDUSTRIAL REHABILITATION AND WORK SERVICES PROGRAMS, NAMELY, PROVIDING PHYSICAL AND OCCUPATIONAL THERAPY, CONDUCTING INDEPENDENT MEDICAL EXAMS AND FUNCTIONAL CAPACITY EVALUATIONS TO ENSURE ONE IS PHYSICALLY FIT TO CONTINUE THEIR EMPLOYMENT RESPONSIBILITIES, MEDICAL TESTING AND SCREENING FOR EMPLOYMENT PURPOSES, NAMELY, CONDUCTING MEDICAL SCREENING AND MEDICAL TESTING TO ENSURE ONE IS PHYSICALLY FIT TO CONTINUE THEIR EMPLOYMENT RESPONSIBILITIES, IN CLASS 44 (U.S. CLS. 100 AND 101).

FIRST USE 12-7-2005; IN COMMERCE 12-7-2005.

FOR: DRUG AND ALCOHOL SCREENING FOR EMPLOYMENT PURPOSES; HAZARDOUS SUBSTANCE SCREENING FOR EMPLOYMENT PURPOSES, IN CLASS 45 (U.S. CLS. 100 AND 101).

FIRST USE 12-7-2005; IN COMMERCE 12-7-2005.

THE MARK CONSISTS OF STANDARD CHARACTERS WITHOUT CLAIM TO ANY PARTICULAR FONT, STYLE, SIZE, OR COLOR.

SER. NO. 85-214,758, FILED 1-11-2011.

MICHAEL TANNER, EXAMINING ATTORNEY



David J. Kypos

Director of the United States Patent and Trademark Office

United States of America

United States Patent and Trademark Office

Memphis HOPE

Reg. No. 4,066,069

Registered Dec. 6, 2011

Int. Cl.: 43

SERVICE MARK

PRINCIPAL REGISTER

WOMEN'S FOUNDATION FOR A GREATER MEMPHIS (TENNESSEE CORPORATION)
8 SOUTH THIRD STREET, STE. 110
MEMPHIS, TN 38103

FOR: CHARITABLE SERVICES, NAMELY, PROVIDING SAFE AND AFFORDABLE HOUSING, PRIMARILY TO SINGLE FEMALE HEADS OF HOUSEHOLD, IN CLASS 43 (U.S. CLS. 100 AND 101).

FIRST USE 9-14-2006; IN COMMERCE 1-2-2008.

THE MARK CONSISTS OF STANDARD CHARACTERS WITHOUT CLAIM TO ANY PARTICULAR FONT, STYLE, SIZE, OR COLOR.

NO CLAIM IS MADE TO THE EXCLUSIVE RIGHT TO USE "MEMPHIS", APART FROM THE MARK AS SHOWN.

SER. NO. 85-214,766, FILED 1-11-2011.

DEBRA LEE, EXAMINING ATTORNEY



David J. Kyffers

Director of the United States Patent and Trademark Office

United States of America

United States Patent and Trademark Office

AMERICAN LAND TITLE ASSOCIATION

Reg. No. 4,066,070

Registered Dec. 6, 2011

**COLLECTIVE
MEMBERSHIP**

PRINCIPAL REGISTER

AMERICAN LAND TITLE ASSOCIATION (D.C. NON-PROFIT ASSOCIATION)
1828 L STREET, NW
SUITE 705
WASHINGTON, DC 200365104

FOR: INDICATING MEMBERSHIP IN AN ASSOCIATION IN THE TITLE INSURANCE INDUSTRY, IN CLASS 200 (U.S. CL. 200).

FIRST USE 10-1-1962; IN COMMERCE 10-1-1962.

THE MARK CONSISTS OF STANDARD CHARACTERS WITHOUT CLAIM TO ANY PARTICULAR FONT, STYLE, SIZE, OR COLOR.

OWNER OF U.S. REG. NO. 3,035,027.

NO CLAIM IS MADE TO THE EXCLUSIVE RIGHT TO USE "ASSOCIATION", APART FROM THE MARK AS SHOWN.

SEC. 2(F).

SER. NO. 85-214,841, FILED 1-11-2011.

SUZANNE BLANE, EXAMINING ATTORNEY



David J. Kyffers

Director of the United States Patent and Trademark Office

United States of America

United States Patent and Trademark Office

PACKED WITH GREAT TASTE

Reg. No. 4,066,071

Registered Dec. 6, 2011

Int. Cl.: 29

TRADEMARK

PRINCIPAL REGISTER

PRESTEVE FOODS LIMITED (CANADA CORPORATION)
20956 ERIE STREET SOUTH
WHEATLEY, ONTARIO, CANADA N0P2P0

FOR: LAKE FISH; FRESH, FROZEN, CANNED, PRESERVED, PROCESSED AND SMOKED FISH; COOKED SCALLOPS, OYSTERS AND SHRIMP; FROZEN VEGETABLES, INCLUDING COOKED AND BREADED VEGETABLES; FROZEN FRUITS; FROZEN APPETIZERS, NAMELY, BREADED AND BATTERED VEGETABLES AND CHEESES, IN CLASS 29 (U.S. CL. 46).

FIRST USE 2-18-2011; IN COMMERCE 2-21-2011.

THE MARK CONSISTS OF STANDARD CHARACTERS WITHOUT CLAIM TO ANY PARTICULAR FONT, STYLE, SIZE, OR COLOR.

NO CLAIM IS MADE TO THE EXCLUSIVE RIGHT TO USE "GREAT TASTE", APART FROM THE MARK AS SHOWN.

SER. NO. 85-214,927, FILED 1-11-2011.

WILLIAM BRECKENFELD, EXAMINING ATTORNEY



David J. Kypos

Director of the United States Patent and Trademark Office

United States of America

United States Patent and Trademark Office

Flexi-Grain Storage

Reg. No. 4,066,072

SHOW-ME SHORTLINE CO. (MISSOURI CORPORATION)
430 N. ALLEN ST.
CENTRALIA, MO 65240

Registered Dec. 6, 2011

Int. Cl.: 7

FOR: GRAIN BAGGING MACHINE FOR SORTING, BAGGING AND UNLOADING HARVESTED GRAIN, IN CLASS 7 (U.S. CLS. 13, 19, 21, 23, 31, 34 AND 35).

TRADEMARK

FIRST USE 3-1-2007; IN COMMERCE 7-1-2007.

PRINCIPAL REGISTER

THE MARK CONSISTS OF STANDARD CHARACTERS WITHOUT CLAIM TO ANY PARTICULAR FONT, STYLE, SIZE, OR COLOR.

NO CLAIM IS MADE TO THE EXCLUSIVE RIGHT TO USE "STORAGE", APART FROM THE MARK AS SHOWN.

SER. NO. 85-215,000, FILED 1-11-2011.

COLLEEN KEARNEY, EXAMINING ATTORNEY



David J. Kybas

Director of the United States Patent and Trademark Office

United States of America

United States Patent and Trademark Office

QES

Reg. No. 4,066,073

Registered Dec. 6, 2011

Int. Cls.: 35 and 41

SERVICE MARK

PRINCIPAL REGISTER

LEARNING PLUS ASSOCIATES (CALIFORNIA CORPORATION)
10602 NORTH TRADEMARK PARKWAY, SUITE 509
RANCHO CUCAMONGA, CA 91730

FOR: CONSULTING SERVICES PROVIDED TO SCHOOLS AND SCHOOL DISTRICTS TO INCREASE BUSINESS LEADERSHIP EFFECTIVENESS AND LEADERSHIP DEVELOPMENT IN THE FIELDS OF STANDARDS BASED INSTRUCTION, CURRICULUM DEVELOPMENT, DATA ANALYSIS AND STUDENT PROGRESS ASSESSMENT, IN CLASS 35 (U.S. CLS. 100, 101 AND 102).

FIRST USE 11-0-2007; IN COMMERCE 11-0-2007.

FOR: EDUCATIONAL SERVICES, NAMELY, CONDUCTING SEMINARS, CONFERENCES AND WORKSHOPS FOR PROFESSIONAL EDUCATORS IN THE FIELDS OF STANDARDS BASED INSTRUCTION AND STRATEGIES, EDUCATIONAL INTERVENTION PROGRAMS FOR STRUGGLING STUDENTS, INSTRUCTION AND EDUCATION PRACTICES, LEADERSHIP, AND WRITING; CONSULTING SERVICES PROVIDED TO SCHOOLS AND SCHOOL DISTRICTS IN THE FIELDS OF EDUCATIONAL STANDARDS BASED INSTRUCTION, CURRICULUM DEVELOPMENT, DATA ANALYSIS AND STUDENT PROGRESS ASSESSMENT, IN CLASS 41 (U.S. CLS. 100, 101 AND 107).

FIRST USE 11-0-2007; IN COMMERCE 11-0-2007.

THE MARK CONSISTS OF STANDARD CHARACTERS WITHOUT CLAIM TO ANY PARTICULAR FONT, STYLE, SIZE, OR COLOR.

SER. NO. 85-215,427, FILED 1-11-2011.

FRANK LATTUCA, EXAMINING ATTORNEY



David J. Kyros

Director of the United States Patent and Trademark Office

United States of America

United States Patent and Trademark Office

GARTH'S

Reg. No. 4,066,074

Registered Dec. 6, 2011

Int. Cls.: 35 and 36

SERVICE MARK

PRINCIPAL REGISTER

GARTH'S AUCTIONS, INC. (OHIO CORPORATION)
P.O. BOX 369
2690 STRATFORD ROAD
DELAWARE, OH 43015

FOR: AUCTION SERVICES; ONLINE AUCTION SERVICES; REAL ESTATE AUCTIONS; CONSIGNMENT SERVICES, NAMELY, PROMOTING AND MARKETING THE GOODS OF OTHERS, IN CLASS 35 (U.S. CLS. 100, 101 AND 102).

FIRST USE 0-0-1954; IN COMMERCE 0-0-1954.

FOR: APPRAISAL OF PERSONAL PROPERTY FOR OTHERS; APPRAISAL OF ANTIQUES, ART, FOLK ART, AMERICANA, ART GLASS, ART POTTERY, SILVER, COLLECTIBLES, DECORATIVE ARTS, FIREARMS, FURNITURE, HISTORIC MATERIALS, JEWELRY, RUGS AND TOYS, IN CLASS 36 (U.S. CLS. 100, 101 AND 102).

FIRST USE 0-0-1954; IN COMMERCE 0-0-1954.

THE MARK CONSISTS OF STANDARD CHARACTERS WITHOUT CLAIM TO ANY PARTICULAR FONT, STYLE, SIZE, OR COLOR.

OWNER OF U.S. REG. NO. 2,922,722.

SER. NO. 85-215,612, FILED 1-12-2011.

TINA MAI, EXAMINING ATTORNEY



David J. Kybas

Director of the United States Patent and Trademark Office

United States of America

United States Patent and Trademark Office

LEGENDS OF THE LAKE

Reg. No. 4,066,075

Registered Dec. 6, 2011

Int. Cl.: 28

TRADEMARK

PRINCIPAL REGISTER

MATTEL, INC. (DELAWARE CORPORATION)
M1-1518
333 CONTINENTAL BOULEVARD
EL SEGUNDO, CA 90245

FOR: HAND-HELD UNITS FOR PLAYING ELECTRONIC GAMES OTHER THAN THOSE ADAPTED FOR USE WITH AN EXTERNAL DISPLAY SCREEN OR MONITOR, IN CLASS 28 (U.S. CLS. 22, 23, 38 AND 50).

FIRST USE 7-26-2011; IN COMMERCE 7-26-2011.

THE MARK CONSISTS OF STANDARD CHARACTERS WITHOUT CLAIM TO ANY PARTICULAR FONT, STYLE, SIZE, OR COLOR.

SER. NO. 85-215,700, FILED 1-12-2011.

HENRY S. ZAK, EXAMINING ATTORNEY



David J. Kybas

Director of the United States Patent and Trademark Office

United States of America

United States Patent and Trademark Office

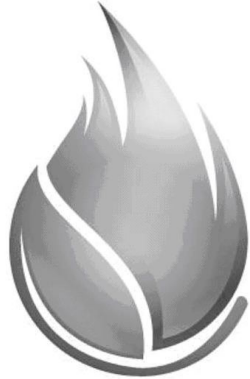

Reg. No. 4,066,076

Registered Dec. 6, 2011

Int. Cl.: 40

SERVICE MARK

PRINCIPAL REGISTER

AGL RESOURCES INC. (GEORGIA CORPORATION)
10 PEACHTREE PLACE, SUITE 1000
ATLANTA, GA 30309

FOR: GAS PRODUCTION SERVICES AND GENERATION OF ELECTRICITY FROM SUSTAINABLE RESOURCES, NAMELY, LANDFILLS, BIOMASS, BIOWASTE, FOOD WASTE AND OTHER FEEDSTOCK, IN CLASS 40 (U.S. CLS. 100, 103 AND 106).

FIRST USE 12-0-2009; IN COMMERCE 6-24-2010.

THE MARK CONSISTS OF A DROPLET OF WATER COMPRISED OF A FLAME DESIGN ON TOP AND A LEAF DESIGN ON THE BOTTOM WITH THE STEM OF THE LEAF EXTENDING TO THE BOTTOM RIGHT PORTION OF THE FLAME DESIGN.

SER. NO. 85-215,764, FILED 1-12-2011.

REGINA DRUMMOND, EXAMINING ATTORNEY



David J. Kybas

Director of the United States Patent and Trademark Office

United States of America

United States Patent and Trademark Office

Hula Swimmer

Reg. No. 4,066,077

GARY YAMAMOTO CUSTOM BAITs, INC. (ARIZONA CORPORATION)
P.O. BOX 1000, 849 S. COPPERMINE RD.
PAGE, AZ 86040

Registered Dec. 6, 2011

Int. Cl.: 28

FOR: FISHING LURES; FISHING LURES, NAMELY, PLASTIC WORMS; FISHING TACKLE,
IN CLASS 28 (U.S. CLS. 22, 23, 38 AND 50).

TRADEMARK

FIRST USE 11-1-2010; IN COMMERCE 11-1-2010.

PRINCIPAL REGISTER

THE MARK CONSISTS OF STANDARD CHARACTERS WITHOUT CLAIM TO ANY PAR-
TICULAR FONT, STYLE, SIZE, OR COLOR.

NO CLAIM IS MADE TO THE EXCLUSIVE RIGHT TO USE "SWIMMER", APART FROM
THE MARK AS SHOWN.

SER. NO. 85-216,332, FILED 1-12-2011.

MAYUR VAGHANI, EXAMINING ATTORNEY



David J. Kybas

Director of the United States Patent and Trademark Office

United States of America

United States Patent and Trademark Office

ORION

Reg. No. 4,066,078

Registered Dec. 6, 2011

Int. Cl.: 28

TRADEMARK

PRINCIPAL REGISTER

PURE DISTRIBUTION LLC (CALIFORNIA LIMITED LIABILITY COMPANY)
SUITE 311
3820 OCEANIC
OCEANSIDE, CA 92056

FOR: SKATEBOARDS, SKATEBOARD TRUCKS, SKATEBOARD PRODUCTS, NAMELY, SKATEBOARD WAX, WHEELS, NUTS AND BOLTS FOR SKATEBOARDS, BALL BEARING FOR SKATEBOARDS, PROTECTIVE PADDING FOR SKATEBOARDS, IN CLASS 28 (U.S. CLS. 22, 23, 38 AND 50).

FIRST USE 1-4-1995; IN COMMERCE 1-4-1995.

THE MARK CONSISTS OF STANDARD CHARACTERS WITHOUT CLAIM TO ANY PARTICULAR FONT, STYLE, SIZE, OR COLOR.

SER. NO. 85-216,464, FILED 1-12-2011.

ALICE BENMAMAN, EXAMINING ATTORNEY



David J. Kyros

Director of the United States Patent and Trademark Office

United States of America

United States Patent and Trademark Office



Reg. No. 4,066,079

Registered Dec. 6, 2011

Int. Cl.: 25

TRADEMARK

PRINCIPAL REGISTER

CARMACK PROPERTIES, LLC (TEXAS LIMITED LIABILITY COMPANY)
306 E 6TH ST
AUSTIN, TX 787013628

FOR: BASEBALL CAPS; CAPS; HEADGEAR, NAMELY, CAPS; SHIRTS; SHIRTS AND SHORT-SLEEVED SHIRTS; SHORT-SLEEVED OR LONG-SLEEVED T-SHIRTS; SHORT-SLEEVED SHIRTS; SPORTS CAPS AND HATS; T-SHIRTS; TEE SHIRTS; WEARABLE GARMENTS AND CLOTHING, NAMELY, SHIRTS, IN CLASS 25 (U.S. CLS. 22 AND 39).

FIRST USE 2-28-2002; IN COMMERCE 2-28-2002.

NO CLAIM IS MADE TO THE EXCLUSIVE RIGHT TO USE "AUSTIN TEXAS", APART FROM THE MARK AS SHOWN.

THE MARK CONSISTS OF A MONKEY HOLDING A BEER INSIDE OF AN OVAL WITH THE WORDS "CHUGGIN'" INSCRIBED IN THE TOP OF THE OVAL, "MONKEY" IN THE BOTTOM OF THE OVAL, "AUSTIN" IN THE LEFT OF THE OVAL, AND "TEXAS" IN THE RIGHT OF THE OVAL.

SER. NO. 85-217,573, FILED 1-14-2011.

LIEF MARTIN, EXAMINING ATTORNEY



David J. Kybas

Director of the United States Patent and Trademark Office

United States of America

United States Patent and Trademark Office

WINDSEEKER

Reg. No. 4,066,080

OPTICAL AIR DATA SYSTEMS, LLC (VIRGINIA LIMITED LIABILITY COMPANY)
10781 JAMES PAYNE COURT
MANASSAS, VA 20110

Registered Dec. 6, 2011

Int. Cl.: 9

FOR: OPTICAL LASER WIND SPEED MEASURING DEVICES, IN CLASS 9 (U.S. CLS. 21, 23, 26, 36 AND 38).

TRADEMARK

FIRST USE 6-0-2010; IN COMMERCE 6-0-2010.

PRINCIPAL REGISTER

THE MARK CONSISTS OF STANDARD CHARACTERS WITHOUT CLAIM TO ANY PARTICULAR FONT, STYLE, SIZE, OR COLOR.

SER. NO. 85-217,835, FILED 1-14-2011.

TIMOTHY FINNEGAN, EXAMINING ATTORNEY



David J. Kybas

Director of the United States Patent and Trademark Office

United States of America

United States Patent and Trademark Office



Reg. No. 4,066,081

Registered Dec. 6, 2011

**Int. Cls.: 29, 30, 32, 35
and 43**

TRADEMARK

SERVICE MARK

PRINCIPAL REGISTER

PLENUS CO., LTD. (JAPAN CORPORATION)
19-21, KAMIMUTA 1-CHOME, HAKATA-KU
FUKUOKA, JAPAN 812-8580

FOR: VEGETABLE SALAD, PROCESSED VEGETABLES AND FRUITS, PRE-COOKED SOUP, PRE-COOKED MISO SOUP; CURRY, STEW AND SOUP MIXES; DRIED FLAKES OF LAVER FOR SPRINKLING ON RICE IN HOT WATER (OCHAZUKE-NORI), SEASONED POWDER FOR SPRINKLING ON RICE (FURI-KAKE), PROCESSED MEATS, PROCESSED SEAFOOD, IN CLASS 29 (U.S. CL. 46).

FOR: BOX LUNCHES COMPRISING PREPARED MEALS CONSISTING PRIMARILY OF RICE OR PASTA; BOILED RICE, RICE BALLS, PRE-COOKED WHEAT NOODLE AND BUCKWHEAT NOODLE, CHINESE STUFFED DUMPLINGS, SANDWICHES, CHINESE STEAMED DUMPLINGS, SUSHI, FRIED BALLS OF BATTER MIX WITH SMALL PIECES OF OCTOPUS (TAKOYAKI), STEAMED BUNS STUFFED WITH MINCED MIXED MEAT, HAMBURGERS, PIZZAS, AND HOT DOGS; MEAT PIES, RAVIOLI, TEA, COFFEE AND COCOA, CONFECTIONERIES, NAMELY, SNACK FOODS, NAMELY, CHOCOLATE; CONFECTIONERY, NAMELY, FROZEN CONFECTIONERY, FRUIT JELLIES CONFECTIONERY, BREAD, BUNS, WORCESTERSHIRE SAUCE, GRAVIES SAUCE, KETCHUP, SOY SAUCE, VINEGAR, VINEGAR MIXES, SEASONING SOY SAUCE (SOBA-TSUYU), SALAD DRESSINGS, WHITE SAUCE, MAYONNAISE, SAUCE FOR BARBECUED MEAT, DELICIOUS TASTE SEASONING, CEREAL PREPARATIONS, NAMELY, CEREAL-BASED SNACK FOODS, PROCESSED CEREAL, IN CLASS 30 (U.S. CL. 46).

FOR: CARBONATED DRINKS, NAMELY, MINERAL WATERS, NON-ALCOHOLIC FRUIT JUICE BEVERAGES, WHEY BEVERAGES, VEGETABLE JUICES, IN CLASS 32 (U.S. CLS. 45, 46 AND 48).

FOR: ADVERTISING AND PUBLICITY SERVICES, BUSINESS CONSULTATION RELATING TO FRANCHISEE BUSINESS AND LICENSEE BUSINESS, BUSINESS MANAGEMENT ANALYSIS AND BUSINESS CONSULTANCY, MARKETING RESEARCH, PROVIDING CONSUMER PRODUCT INFORMATION ON COMMODITY SALES, WHOLESALE AND RETAIL STORE SERVICES FEATURING FOODS AND BEVERAGES, IN CLASS 35 (U.S. CLS. 100, 101 AND 102).

FOR: PROVIDING FOOD AND BEVERAGES FOR CONSUMPTION ON AND OFF THE RESTAURANT PREMISES, IN CLASS 43 (U.S. CLS. 100 AND 101).



David J. Kyffers

Director of the United States Patent and Trademark Office

Reg. No. 4,066,081 OWNER OF JAPAN REG. NO. 5232146, DATED 5-22-2009, EXPIRES 5-22-2019.

THE COLOR(S) RED, WHITE AND YELLOW IS/ARE CLAIMED AS A FEATURE OF THE MARK.

THE NON-LATIN CHARACTERS IN THE MARK TRANSLITERATE TO HOTTOMOTTO AND THIS HAS NO MEANING IN A FOREIGN LANGUAGE.

THE MARK CONSISTS OF THE TERM "HM" IN RED LETTERS WITH WHITE BORDERS AROUND THE LETTERS AND THE TERMS "HOTTOMOTTO" AND "HOTTOMOTTO" IN JAPANESE CHARACTERS IN WHITE LETTERS IN A RED CIRCLE CONTAINING A SMALLER RED FILLED CIRCLE DEVICE CONTAINING HORIZONTAL YELLOW LINES FORMING A SMALLER CIRCLE FURTHER CONTAINING A WHITE OBLONG DEVICE WITH YELLOW SHADING.

THE WORDING "HOTTOMOTTO" HAS NO MEANING IN A FOREIGN LANGUAGE.

SER. NO. 85-217,892, FILED 1-14-2011.

JOSETTE BEVERLY, EXAMINING ATTORNEY

United States of America

United States Patent and Trademark Office

StyLED

Reg. No. 4,066,082

Registered Dec. 6, 2011

Int. Cls.: 9 and 11

TRADEMARK

PRINCIPAL REGISTER

ZUMTOBEL LIGHTING GMBH (FED REP GERMANY GESELLSCHAFT MIT
BESCHRÄNKTER HAFTUNG (GMBH))
SCHWEIZER STRASSE 30
DORNBIRN, AUSTRIA 6850

FOR: OPTICAL FIBER LIGHTING CABLES OF GLASS OR PLASTIC FIBERS, IN CLASS 9
(U.S. CLS. 21, 23, 26, 36 AND 38).

FOR: LIGHTING INSTALLATIONS; LIGHTING DEVICES AND EQUIPMENT, NAMELY,
LIGHTING FIXTURES; EXTERIOR LIGHTS, NAMELY, EXTERIOR LIGHTING FIXTURES;
STREET LAMPS; FLOOR LAMPS; LANTERNS; STREET LIGHTS WITH LIGHT-EMITTING
DIODES AS LIGHTING DEVICES; LIGHT MODULES AND LIGHTS WITH LIGHT-EMITTING
DIODES AS THE MEANS OF LIGHTING; LIGHT FIXTURES CONTAINING LIGHT-EMITTING
DIODE; HOUSINGS, SCREENS FOR DIRECTING LIGHT, REFLECTORS AND COVERS FOR
LIGHTS, ELECTRIC LAMPS, SOCKETS FOR LAMPS, SUSPENSION PENDULUMS FOR
SUSPENSION LAMPS, IN CLASS 11 (U.S. CLS. 13, 21, 23, 31 AND 34).

THE MARK CONSISTS OF STANDARD CHARACTERS WITHOUT CLAIM TO ANY PAR-
TICULAR FONT, STYLE, SIZE, OR COLOR.

OWNER OF ERPN CMNTY TM OFC REG. NO. 9333601, DATED 1-27-2011, EXPIRES 8-5-
2020.

SER. NO. 85-218,940, FILED 1-17-2011.

DOUGLAS LEE, EXAMINING ATTORNEY



David J. Kybas

Director of the United States Patent and Trademark Office

United States of America

United States Patent and Trademark Office

LE COQ SPORTIF

Reg. No. 4,066,083

Registered Dec. 6, 2011

Int. Cls.: 18, 25 and 35

TRADEMARK

SERVICE MARK

PRINCIPAL REGISTER

LCS INTERNATIONAL B.V. (NETHERLANDS BESLOTEN VENNOOTSCHAP (B.V.))
SCHOUWBURGPLEIN 30 - 34
CL ROTTERDAM, NETHERLANDS NL-3012

FOR: LEATHER AND IMITATIONS OF LEATHER; UMBRELLAS; PARASOLS; SPORTS BAGS; LEISURE BAGS, NAMELY, CARRYALL BAGS; TRAVELLING BAGS; RUCKSACKS; BACKPACKS; HOLDALLS; SCHOOL BAGS; SCHOOL SACHELS; BELT BAGS; HAND-BAGS; BALL-SHAPED LEATHER BAGS; BEACH BAGS; GARMENT BAGS FOR TRAVEL; SUITCASES; BRIEFCASES; UNFITTED VANITY CASES; TOILETRY BAGS SOLD EMPTY; KEY WALLETS; WALLETS; AND CHANGE PURSES, IN CLASS 18 (U.S. CLS. 1, 2, 3, 22 AND 41).

FOR: CLOTHING, NAMELY, SHIRTS, KNIT SHIRTS, POLO SHIRTS, SLEEVELESS BODICES, T-SHIRTS, WAISTCOATS, DRESSES, SKIRTS, SLIPS, SHORTS, TROUSERS, PULLOVERS; SWIMWEAR; HEADWEAR; HEADWEAR, NAMELY, CAPS; HATS; VISORS; HEADBANDS; SCARVES; MUFFLERS; SPORTS OVERUNIFORMS; SWEATSHIRTS; JACKETS; BLAZERS; WATERPROOFS, NAMELY, RAINWEAR, RAIN COATS, RAIN JACKETS, RAIN SUITS, RAIN SLICKERS, PONCHOS, WATERPROOF JACKETS AND PANTS, WATERPROOF FOOTWEAR; COATS; UNIFORMS; TIES; GLOVES; APRONS; BIBS, NAMELY, SOCCER BIBS, CLOTH BIBS AND BIBS NOT OF PAPER; SPORTS JACKETS; TRACK JACKETS; PAJAMAS; ROMPERS; PLAYWEAR FOR YOUNG CHILDREN, NAMELY, PLAY SUITS, INFANTWEAR AND ONE PIECE GARMENT FOR INFANTS AND TODDLERS; SOCKS; STOCKINGS; STOCKING SUSPENDERS; BELTS; BRACES; FOOTWEAR; SPORTS FOOTWEAR; ATHLETIC FOOTWEAR; SHOES; ATHLETIC SHOES; SPORTS SHOES; TRAINING SHOES, IN CLASS 25 (U.S. CLS. 22 AND 39).

FOR: DISSEMINATION OF ADVERTISEMENTS; RENTAL OF ADVERTISING SPACE; RENTAL OF ADVERTISING TIME IN FILM CREDITS; PROVIDING TELEVISION ADVERTISING FOR OTHERS; PROVIDING RADIO ADVERTISING FOR OTHERS; ADVERTISING SERVICES USING CARTOONS; ADVERTISING AGENCIES, NAMELY, PROMOTING THE GOODS AND SERVICES OF OTHERS; PUBLIC RELATIONS; SPORTS AND PROMOTION AGENCY SERVICES, NAMELY, PROMOTION OF PRODUCTS AND SERVICES OF THIRD PARTIES THROUGH SPONSORING ARRANGEMENTS AND LICENSE AGREEMENTS RELATING TO INTERNATIONAL SPORTS EVENTS; RETAIL AND ONLINE RETAIL STORE SERVICES FEATURING MISCELLANEOUS PRODUCTS FOR OTHERS, NAMELY: CLOTHING, FOOTWEAR, HEADGEAR, SPORTING ARTICLES, BAGS, LUGGAGE, BRIEFCASES, UMBRELLAS AND FLAGS; THE BRINGING TOGETHER, FOR THE BENEFIT



David J. Kybas

Director of the United States Patent and Trademark Office

Reg. No. 4,066,083 OF OTHERS, OF A VARIETY OF GOODS EXCLUDING THE TRANSPORT THEREOF, ENABLING CUSTOMERS TO CONVENIENTLY VIEW AND PURCHASE THOSE GOODS IN THE FIELD OF CLOTHING, FOOTWEAR, HEADGEAR, SPORTING ARTICLES, BAGS, LUGGAGE, BRIEFCASES, UMBRELLAS AND FLAGS; THE BRINGING TOGETHER, FOR THE BENEFIT OF OTHERS, OF A VARIETY OF GOODS, EXCLUDING THE TRANSPORT THEREOF, ENABLING CUSTOMERS TO CONVENIENTLY VIEW AND PURCHASE THOSE GOODS ON A GLOBAL COMPUTER NETWORK OR VIA WIRELESS ELECTRONIC COMMUNICATIONS DEVICES IN THE FIELD OF CLOTHING, FOOTWEAR, HEADGEAR, SPORTING ARTICLES, LUGGAGE, BRIEFCASES, UMBRELLAS AND FLAGS; THE BRINGING TOGETHER, FOR THE BENEFIT OF OTHERS, OF A VARIETY OF GOODS AND SERVICES, ENABLING CUSTOMERS TO CONVENIENTLY VIEW AND PURCHASE THOSE GOODS AND SERVICES FROM AN INTERNET WEB SITE PARTICULARLY SPECIALIZING IN THE MARKETING OF THE SALE OF GOODS AND SERVICES OF OTHERS; SALES PROMOTION, NAMELY, ADMINISTRATION OF A CONSUMER LOYALTY PROGRAM TO PROMOTE THE GOODS AND SERVICES OF OTHERS; ADMINISTRATION OF BONUS INCENTIVE PROGRAMS FOR CUSTOMERS IN STADIUMS AT SPORTING EVENTS FOR PROMOTING THE GOODS AND SERVICES OF OTHERS BY MEANS OF THE ISSUANCE OF LOYALTY REWARDS CARDS AND MEMBERSHIP CARDS INCLUDING ENCODED LOYALTY CARDS AND MEMBERSHIP CARDS CONTAINING THE USER'S PERSONAL DATA; ADMINISTRATION OF A CONSUMER LOYALTY PROGRAM IN CONNECTION WITH SPORTING EVENTS OF OTHERS BY MEANS OF THE ISSUANCE OF LOYALTY REWARDS CARDS FOR CONTROLLING ACCESS TO SPORTS STADIUMS INCLUDING LOYALTY REWARDS CARDS THAT CONTAINS PERSONAL INFORMATION RELATING TO THE IDENTITY OF THE CARD HOLDER; E-COMMERCE SERVICES, NAMELY ARRANGING OF BUYING AND SELLING CONTRACTS FOR OTHERS ON-LINE; PROMOTING SPORTS EVENTS OF OTHERS; ADVERTISING, INCLUDING PROMOTION OF GOODS AND SERVICES OF OTHERS THROUGH CONTRACTUAL AGREEMENTS, IN PARTICULAR, SPONSORING ARRANGEMENTS AND LICENSE AGREEMENTS RELATING TO INTERNATIONAL SPORTS AND CULTURAL EVENTS; PROMOTION OF PRODUCTS AND SERVICES OF THIRD PARTIES THROUGH PROVIDING AN INCREASE IN AWARENESS AND IMAGE DERIVED FROM CULTURAL AND SPORTS EVENTS, IN PARTICULAR INTERNATIONAL EVENTS; COMPILATION OF DATA AND INFORMATION ON SPORTING PERFORMANCES INTO COMPUTER DATABASES, IN CLASS 35 (U.S. CLS. 100, 101 AND 102).

THE MARK CONSISTS OF STANDARD CHARACTERS WITHOUT CLAIM TO ANY PARTICULAR FONT, STYLE, SIZE, OR COLOR.

OWNER OF ERPN CMNTY TM OFC REG. NO. 8883671, DATED 8-2-2010, EXPIRES 2-15-2020.

OWNER OF U.S. REG. NOS. 1,189,989, 3,822,165 AND OTHERS.

THE ENGLISH TRANSLATION OF "LE COQ SPORTIF" IN THE MARK IS THE SPORTING COCK.

SER. NO. 85-218,951, FILED 1-17-2011.

CAROLINE WOOD, EXAMINING ATTORNEY

United States of America

United States Patent and Trademark Office

VAMPIRO

Reg. No. 4,066,084

Registered Dec. 6, 2011

Int. Cls.: 16 and 17

TRADEMARK

PRINCIPAL REGISTER

INIX PRODUCTS, CORP. (TEXAS CORPORATION)
SUITE 209
1600 CLOVIS R BARKER RD
SAN MARCOS, TX 78666

FOR: ABSORBENT PADS OF PAPER AND CELLULOSE FOR USE IN FOOD PACKAGES,
IN CLASS 16 (U.S. CLS. 2, 5, 22, 23, 29, 37, 38 AND 50).

FIRST USE 12-1-2009; IN COMMERCE 12-1-2009.

FOR: ABSORBENT PADS OF PLASTIC FILMS FOR USE IN FOOD PACKAGES, IN CLASS
17 (U.S. CLS. 1, 5, 12, 13, 35 AND 50).

FIRST USE 12-1-2009; IN COMMERCE 12-1-2009.

THE MARK CONSISTS OF STANDARD CHARACTERS WITHOUT CLAIM TO ANY PAR-
TICULAR FONT, STYLE, SIZE, OR COLOR.

THE ENGLISH TRANSLATION OF "VAMPIRO" IN THE MARK IS "VAMPIRE".

SER. NO. 85-219,347, FILED 1-17-2011.

MICHAEL WIENER, EXAMINING ATTORNEY



David J. Kyros

Director of the United States Patent and Trademark Office

United States of America
United States Patent and Trademark Office

VAMPIRO

Reg. No. 4,066,085

Registered Dec. 6, 2011

Int. Cls.: 16 and 17

TRADEMARK

PRINCIPAL REGISTER

INIX PRODUCTS, CORP. (TEXAS CORPORATION)
SUITE 209
1600 CLOVIS R BARKER RD
SAN MARCOS, TX 78666

FOR: ABSORBENT PADS OF PAPER AND CELLULOSE FOR USE IN FOOD PACKAGES,
IN CLASS 16 (U.S. CLS. 2, 5, 22, 23, 29, 37, 38 AND 50).

FIRST USE 12-1-2009; IN COMMERCE 12-1-2009.

FOR: ABSORBENT PADS OF PLASTIC FILMS FOR USE IN FOOD PACKAGES, IN CLASS
17 (U.S. CLS. 1, 5, 12, 13, 35 AND 50).

FIRST USE 12-1-2009; IN COMMERCE 12-1-2009.

THE MARK CONSISTS OF THE OUTLINE OF THE CAPITAL LETTERS "VA", IMMEDIATELY ADJACENT TO A STYLIZED OUTLINE OF A CAPITAL "M" SUGGESTIVE OF FANGS, IMMEDIATELY ADJACENT TO THE OUTLINE OF THE CAPITAL LETTERS "PIRO".

THE ENGLISH TRANSLATION OF "VAMPIRO" IN THE MARK IS "VAMPIRE".

SER. NO. 85-219,352, FILED 1-17-2011.

MICHAEL WIENER, EXAMINING ATTORNEY



David J. Kybas

Director of the United States Patent and Trademark Office

United States of America

United States Patent and Trademark Office

THOMPSON HOTELS

Reg. No. 4,066,086

Registered Dec. 6, 2011

Int. Cl.: 43

SERVICE MARK

PRINCIPAL REGISTER

THOMPSON HOTELS, LLC (DELAWARE LIMITED LIABILITY COMPANY)
54 THOMPSON STREET
5TH FLOOR
NEW YORK, NY 100124308

FOR: BAR AND COCKTAIL LOUNGE SERVICES; HOTEL AND RESTAURANT SERVICES,
IN CLASS 43 (U.S. CLS. 100 AND 101).

FIRST USE 1-12-2006; IN COMMERCE 1-12-2006.

THE MARK CONSISTS OF STANDARD CHARACTERS WITHOUT CLAIM TO ANY PAR-
TICULAR FONT, STYLE, SIZE, OR COLOR.

OWNER OF U.S. REG. NOS. 3,455,502, 3,620,996 AND OTHERS.

NO CLAIM IS MADE TO THE EXCLUSIVE RIGHT TO USE "HOTELS", APART FROM THE
MARK AS SHOWN.

SEC. 2(F).

SER. NO. 85-219,658, FILED 1-18-2011.

ARETHA SOMERVILLE, EXAMINING ATTORNEY



David J. Kyros

Director of the United States Patent and Trademark Office

United States of America

United States Patent and Trademark Office

SAASI

Reg. No. 4,066,087

Registered Dec. 6, 2011

Int. Cl.: 42

SERVICE MARK

PRINCIPAL REGISTER

MINDBODY, INC. (CALIFORNIA CORPORATION)
4051 BROAD STREET, SUITE 220
SAN LUIS OBISPO, CA 93401

FOR: PROVIDING ON-LINE, NON-DOWNLOADABLE POINT OF SALE WEB-BASED BUSINESS MANAGEMENT SOFTWARE FOR RETAIL STORES TO MANAGE, REPLACE AND ORDER INVENTORY, CHARGE CUSTOMERS CREDIT CARDS OR CHECKING ACCOUNTS USING AN INTEGRATED CREDIT CARD PROCESSING SYSTEM, TRACK SALES USING DAILY AND SUMMARY REPORTS, MARKET AND ANALYZE CUSTOMERS AND DEVELOP AUTOMATED MARKETING CAMPAIGNS, CUSTOMIZE GIFT CARDS, SELL PRODUCTS, SERVICES OR GIFT CARDS THROUGH AN ON-LINE STORE, CALCULATE COMMISSIONS AND PAY RATES FOR EMPLOYEES, AND RUN REPORTS ON TOP SELLING PRODUCTS, SUPPLIERS AND EMPLOYEES, IN CLASS 42 (U.S. CLS. 100 AND 101).

FIRST USE 12-22-2010; IN COMMERCE 12-22-2010.

THE MARK CONSISTS OF STANDARD CHARACTERS WITHOUT CLAIM TO ANY PARTICULAR FONT, STYLE, SIZE, OR COLOR.

SER. NO. 85-219,688, FILED 1-18-2011.

SETH A. RAPPAPORT, EXAMINING ATTORNEY



David J. Kyros

Director of the United States Patent and Trademark Office

United States of America

United States Patent and Trademark Office



Reg. No. 4,066,088

Registered Dec. 6, 2011

Int. Cl.: 42

SERVICE MARK

PRINCIPAL REGISTER

MINDBODY, INC. (CALIFORNIA CORPORATION)
4051 BROAD STREET, SUITE 220
SAN LUIS OBISPO, CA 93401

FOR: PROVIDING ON-LINE, NON-DOWNLOADABLE POINT OF SALE WEB-BASED BUSINESS MANAGEMENT SOFTWARE FOR RETAIL STORES TO MANAGE, REPLACE AND ORDER INVENTORY, CHARGE CUSTOMERS CREDIT CARDS OR CHECKING ACCOUNTS USING AN INTEGRATED CREDIT CARD PROCESSING SYSTEM, TRACK SALES USING DAILY AND SUMMARY REPORTS, MARKET AND ANALYZE CUSTOMERS AND DEVELOP AUTOMATED MARKETING CAMPAIGNS, CUSTOMIZE GIFT CARDS, SELL PRODUCTS, SERVICES OR GIFT CARDS THROUGH AN ON-LINE STORE, CALCULATE COMMISSIONS AND PAY RATES FOR EMPLOYEES, AND RUN REPORTS ON TOP SELLING PRODUCTS, SUPPLIERS AND EMPLOYEES, IN CLASS 42 (U.S. CLS. 100 AND 101).

FIRST USE 12-22-2010; IN COMMERCE 12-22-2010.

THE MARK CONSISTS OF THE WORD "SAASI" WITH A TAG ATTACHED TO THE "S" AND THE WORDS "POWERED BY MINDBODY" BENEATH.

SER. NO. 85-219,728, FILED 1-18-2011.

SETH A. RAPPAPORT, EXAMINING ATTORNEY



David J. Kyros

Director of the United States Patent and Trademark Office

United States of America

United States Patent and Trademark Office

Nature is the Original Punk

Reg. No. 4,066,089

Registered Dec. 6, 2011

Int. Cl.: 25

TRADEMARK

PRINCIPAL REGISTER

LOUDERMILK, INC. (CALIFORNIA CORPORATION)
7119 W. SUNSET BOULEVARD #301
LOS ANGELES, CA 90046

FOR: T-SHIRTS, IN CLASS 25 (U.S. CLS. 22 AND 39).

FIRST USE 12-31-2006; IN COMMERCE 12-31-2006.

THE MARK CONSISTS OF STANDARD CHARACTERS WITHOUT CLAIM TO ANY PARTICULAR FONT, STYLE, SIZE, OR COLOR.

SER. NO. 85-220,218, FILED 1-18-2011.

KIMBERLY FRYE, EXAMINING ATTORNEY



David J. Kyffers

Director of the United States Patent and Trademark Office

United States of America

United States Patent and Trademark Office

ALEENE'S PLATINUM BOND SUPER FABRIC

Reg. No. 4,066,090

Registered Dec. 6, 2011

Int. Cls.: 1 and 16

TRADEMARK

PRINCIPAL REGISTER

DUNCAN ENTERPRISES (CALIFORNIA CORPORATION), DBA ILOVETOCREATE
5673 E. SHIELDS AVE.
FRESNO, CA 93727

FOR: WASHABLE, CLEAR-DRYING ADHESIVE IN THE NATURE OF A CEMENT, SPECIFICALLY FOR HOBBY-CRAFT APPLICATIONS IN BONDING FABRICS AND TEXTILES INCLUDING FELT, LEATHER, DENIM, CANVAS, SATIN, LACE, RIBBONS, AND RHINESTONES, BUTTONS, BEADS, CHARMS AND OTHER ITEMS TO FABRICS; WASHABLE, CLEAR-DRYING ADHESIVE FOR USE BY DECORATORS, SPECIFICALLY FOR HOBBY-CRAFT APPLICATIONS IN BONDING FABRICS AND TEXTILES INCLUDING FELT, LEATHER, DENIM, CANVAS, SATIN, LACE, RIBBONS, AND RHINESTONES, BUTTONS, BEADS, CHARMS AND OTHER ITEMS TO FABRICS; WASHABLE, CLEAR-DRYING ADHESIVE FOR USE IN THE CRAFT AND HOBBY INDUSTRIES FOR BONDING FABRICS AND TEXTILES INCLUDING FELT, LEATHER, DENIM, CANVAS, SATIN, LACE, RIBBONS, AND RHINESTONES, BUTTONS, BEADS, CHARMS AND OTHER ITEMS TO FABRICS, IN CLASS 1 (U.S. CLS. 1, 5, 6, 10, 26 AND 46).

FIRST USE 12-31-1998; IN COMMERCE 12-31-1998.

FOR: WASHABLE, CLEAR-DRYING ADHESIVE, SPECIFICALLY FOR HOBBY-CRAFT APPLICATIONS IN BONDING FABRICS AND TEXTILES INCLUDING FELT, LEATHER, DENIM, CANVAS, SATIN, LACE, RIBBONS, AND RHINESTONES, BUTTONS, BEADS, CHARMS AND OTHER ITEMS TO FABRICS; CLEAR-DRYING FABRIC ADHESIVE, SPECIFICALLY FOR HOUSEHOLD APPLICATIONS FOR BONDING AND REPAIRING FABRICS, LEATHER, DENIM, CANVAS AND OTHER HOUSEHOLD FABRIC REPAIRS, IN CLASS 16 (U.S. CLS. 2, 5, 22, 23, 29, 37, 38 AND 50).

FIRST USE 12-31-1998; IN COMMERCE 12-31-1998.

THE MARK CONSISTS OF STANDARD CHARACTERS WITHOUT CLAIM TO ANY PARTICULAR FONT, STYLE, SIZE, OR COLOR.

OWNER OF U.S. REG. NOS. 2,444,937, 3,893,998 AND OTHERS.

NO CLAIM IS MADE TO THE EXCLUSIVE RIGHT TO USE "BOND SUPER FABRIC", APART FROM THE MARK AS SHOWN.



David J. Kyffers

Director of the United States Patent and Trademark Office

Reg. No. 4,066,090 SER. NO. 85-220,386, FILED 1-18-2011.

MARY ROSSMAN, EXAMINING ATTORNEY

United States of America

United States Patent and Trademark Office



Reg. No. 4,066,091

Registered Dec. 6, 2011

Int. Cl.: 43

SERVICE MARK

PRINCIPAL REGISTER

CARMACK PROPERTIES, LLC (TEXAS LIMITED LIABILITY COMPANY)
306 E 6TH ST
AUSTIN, TX 787013628

FOR: BAR AND COCKTAIL LOUNGE SERVICES; BAR SERVICES, IN CLASS 43 (U.S. CLS. 100 AND 101).

FIRST USE 2-28-2002; IN COMMERCE 2-28-2002.

NO CLAIM IS MADE TO THE EXCLUSIVE RIGHT TO USE "AUSTIN TEXAS", APART FROM THE MARK AS SHOWN.

THE MARK CONSISTS OF A MONKEY HOLDING A BEER INSIDE OF AN OVAL WITH THE WORDS "CHUGGIN'" INSCRIBED IN THE TOP OF THE OVAL, "MONKEY" IN THE BOTTOM OF THE OVAL, "AUSTIN" IN THE LEFT OF THE OVAL, AND "TEXAS" IN THE RIGHT OF THE OVAL.

SER. NO. 85-220,528, FILED 1-18-2011.

LIEF MARTIN, EXAMINING ATTORNEY



David J. Kybas

Director of the United States Patent and Trademark Office

United States of America

United States Patent and Trademark Office



Reg. No. 4,066,092

Registered Dec. 6, 2011

Int. Cl.: 9

TRADEMARK

PRINCIPAL REGISTER

ARISTOCRAT TECHNOLOGIES AUSTRALIA PTY LTD. (AUSTRALIA CORPORATION)
BUILDING A, PINNACLE OFFICE PARK
85 EPPING ROAD
NORTH RYDE, NSW, AUSTRALIA 2113

FOR: ELECTRONIC GAMING MACHINES, NAMELY, DEVICES WHICH ACCEPT A WAGER
ELECTRONIC GAMING MACHINES, NAMELY, DEVICES WHICH ACCEPT A WAGER, IN
CLASS 9 (U.S. CLS. 21, 23, 26, 36 AND 38).

PRIORITY CLAIMED UNDER SEC. 44(D) ON AUSTRALIA APPLICATION NO. 1395818,
FILED 11-29-2010, REG. NO. 1395818, DATED 11-29-2010, EXPIRES 11-29-2020.

THE MARK CONSISTS OF GLOWING, SMILING GHOST WITH ONE ARM LEANING ON
BRICK WALL, OTHER ARM FOLDED AT WAIST. THE STYLIZED WORD "SMOKEY"
APPEARS NEXT TO THE GHOST AND IS IMPOSED UPON A TWO-TONED BACKGROUND
WITH LINES RADIATING FROM THE GHOST OUTWARD.

SER. NO. 85-220,780, FILED 1-19-2011.

JENNIFER DIXON, EXAMINING ATTORNEY



David J. Kyffers

Director of the United States Patent and Trademark Office

United States of America

United States Patent and Trademark Office



WhatCostWhat
what they pay, what you pay

Reg. No. 4,066,093

Registered Dec. 6, 2011

Int. Cl.: 35

SERVICE MARK

PRINCIPAL REGISTER

WHAT COST WHAT LLC (CALIFORNIA LIMITED LIABILITY COMPANY)
P.O. BOX 39712
LOS ANGELES, CA 90039

FOR: PROVIDING A SEARCHABLE ONLINE ADVERTISING WEBSITE AND INFORMATIONAL GUIDE FEATURING THE GOODS AND SERVICES OF OTHER VENDORS VIA THE INTERNET TO ALLOW CONSUMERS TO COMPARE PRICES AND THE QUALITY OF THE GOODS AND SERVICES, IN CLASS 35 (U.S. CLS. 100, 101 AND 102).

FIRST USE 6-1-2009; IN COMMERCE 6-1-2009.

THE STIPPLING IS FOR SHADING PURPOSES ONLY.

THE MARK CONSISTS OF A SPEECH BUBBLE WITH A DOLLAR SIGN AT THE CENTER OF IT, A SECOND SPEECH BUBBLE BEHIND THE FIRST SPEECH BUBBLE, AND A SHADOW BELOW IT, AND THE TEXT "WHATCOSTWHAT WHAT THEY PAY, WHAT YOU PAY" TO THE RIGHT OF BOTH SPEECH BUBBLES, WITH "WHATCOSTWHAT" ABOVE THE WORDING "WHAT THEY PAY, WHAT YOU PAY".

SER. NO. 85-220,926, FILED 1-19-2011.

SARA BENJAMIN, EXAMINING ATTORNEY



David J. Kyros

Director of the United States Patent and Trademark Office

United States of America

United States Patent and Trademark Office

BOURDON

Reg. No. 4,066,094

Registered Dec. 6, 2011

Int. Cls.: 18 and 25

TRADEMARK

PRINCIPAL REGISTER

ALFRED DUNHILL LIMITED (UNITED KINGDOM COMPANY)
15 HILL STREET
LONDON, ENGLAND W1J5QT

FOR: TRUNKS AND TRAVELING BAGS; UMBRELLAS, COLLARS FOR PETS; LUGGAGE, BAGS AND CASES, NAMELY, MESSENGER BAGS, DOCUMENT CASES AND TRAVEL CASES, TOTE BAGS, BEACH BAGS, SACHELS, TOILETRY BAGS SOLD EMPTY; SUITCASES, BRIEFCASES, ATTACHÉ CASES, HOLDALLS, POCHETTES, GARMENT BAGS FOR TRAVEL, BACKPACKS, CREDIT-CARD CASES AND HOLDERS, WALLETS, COIN PURSES, HANDBAGS, IN CLASS 18 (U.S. CLS. 1, 2, 3, 22 AND 41).

FOR: CLOTHING, NAMELY, SHIRTS, PANTS, TROUSERS, JACKETS, EVENING JACKETS, TUXEDOS, BLAZERS, WINDCHEATERS, BLOUSONS, FLEECE PULLOVERS, QUILTED VESTS, SUITS, RAINCOATS, COATS, SHORTS, CARDIGANS, SWEATERS, TANK TOPS, WAISTCOATS, T-SHIRTS, POLO SHIRTS, CASUAL SHIRTS, BUSINESS SHIRTS, BATHROBES, DRESSING GOWNS, SOCKS, GOLF SHIRTS, GOLF SWEATERS, GOLF TROUSERS, GOLF SHOES, SWIMWEAR, SLEEPWEAR, UNDERWEAR, RAINWEAR, WATERPROOF JACKETS, SWEAT SHIRTS, SWEAT PANTS, CUMMERBUNDS, GLOVES; FOOTWEAR, HATS, CAPS, SUN VISORS, SCARVES, BELTS, TIES, IN CLASS 25 (U.S. CLS. 22 AND 39).

THE MARK CONSISTS OF STANDARD CHARACTERS WITHOUT CLAIM TO ANY PARTICULAR FONT, STYLE, SIZE, OR COLOR.

PRIORITY CLAIMED UNDER SEC. 44(D) ON ERPN CMNTY TM OFC APPLICATION NO. 009621053, FILED 12-22-2010, REG. NO. 009621053, DATED 6-3-2011, EXPIRES 12-22-2020.

OWNER OF U.S. REG. NO. 3,414,755.

SER. NO. 85-221,122, FILED 1-19-2011.

GENE MACIOL, EXAMINING ATTORNEY



David J. Kyros

Director of the United States Patent and Trademark Office

United States of America

United States Patent and Trademark Office



Reg. No. 4,066,095

Registered Dec. 6, 2011

**Int. Cls.: 9, 35, 37, 38, 42
and 44**

EUROPEAN ASSOCIATION FOR THE STUDY OF THE LIVER (SWITZERLAND REGISTERED ASSOCIATION)

C/O PESTALOZZI ATTORNEYS AT LAW LTD.

LOWENSTRASSE 1

ZURICH, SWITZERLAND CH-8001

TRADEMARK

FOR: COMPUTER SOFTWARE FOR SMART PHONES IN THE FIELD OF HEALTH, NAMELY, FOR PROVIDING CONCISE MEDICAL INFORMATION CONCERNING THE CLINICAL MANAGEMENT OF LIVER DISEASE OF DIFFERENT ETIOLOGIES; COMPUTER HARDWARE, IN CLASS 9 (U.S. CLS. 21, 23, 26, 36 AND 38).

SERVICE MARK

FOR: ADVERTISING SERVICES; BUSINESS MANAGEMENT; BUSINESS ADMINISTRATION AND OFFICE WORK, IN CLASS 35 (U.S. CLS. 100, 101 AND 102).

PRINCIPAL REGISTER

FOR: INSTALLATION, MAINTENANCE AND REPAIR OF MEDICAL IMAGING TECHNOLOGY DEVICES, IN CLASS 37 (U.S. CLS. 100, 103 AND 106).

FOR: TRANSMISSION OF MEDICAL DATA AND INFORMATION FROM DATABASES VIA COMMUNICATIONS NETWORKS, IN CLASS 38 (U.S. CLS. 100, 101 AND 104).

FOR: RESEARCH RELATING TO DESIGN AND DEVELOPMENT OF COMPUTER SOFTWARE FOCUSING ON THE DISSEMINATION OF CONCISE MEDICAL INFORMATION ON THE MANAGEMENT OF LIVER DISEASES OF DIFFERENT ETIOLOGIES; DESIGN AND DEVELOPMENT OF COMPUTER HARDWARE AND SOFTWARE, IN CLASS 42 (U.S. CLS. 100 AND 101).

FOR: TELEMEDICINE SERVICES; PROVIDING DATABASES IN THE FIELD OF HEALTH, IN CLASS 44 (U.S. CLS. 100 AND 101).

PRIORITY CLAIMED UNDER SEC. 44(D) ON SWITZERLAND APPLICATION NO. 609258, FILED 9-20-2010, REG. NO. 609258, DATED 12-16-2010, EXPIRES 9-20-2020.

SER. NO. 85-221,799, FILED 1-20-2011.

REBECCA POVARCHUK, EXAMINING ATTORNEY



David J. Kybas

Director of the United States Patent and Trademark Office

United States of America

United States Patent and Trademark Office

Black Oak Vineyard of KY

Reg. No. 4,066,096

Registered Dec. 6, 2011

Int. Cl.: 33

TRADEMARK

PRINCIPAL REGISTER

BLACK OAK VINEYARD, INC. (KENTUCKY CORPORATION)
114 EDWARDS STREET
300 MARTIN ROAD
PRINCETON, KY 42445

FOR: WINES, IN CLASS 33 (U.S. CLS. 47 AND 49).

FIRST USE 6-30-2011; IN COMMERCE 6-30-2011.

THE MARK CONSISTS OF STANDARD CHARACTERS WITHOUT CLAIM TO ANY PARTICULAR FONT, STYLE, SIZE, OR COLOR.

NO CLAIM IS MADE TO THE EXCLUSIVE RIGHT TO USE "VINEYARD OF KY", APART FROM THE MARK AS SHOWN.

SER. NO. 85-222,285, FILED 1-20-2011.

IRA J. GOODSAY, EXAMINING ATTORNEY



David J. Kyffers

Director of the United States Patent and Trademark Office

United States of America

United States Patent and Trademark Office

HEADSTRONG NATION

Reg. No. 4,066,097

Registered Dec. 6, 2011

Int. Cls.: 35, 41 and 45

SERVICE MARK

PRINCIPAL REGISTER

BEN FOSS (UNITED STATES INDIVIDUAL)
57 PETERSON AVE.
SAN FRANCISCO, CA 94110

FOR: ASSOCIATION SERVICES, NAMELY, PROMOTING THE INTERESTS OF EDUCATORS IN THE SUBJECTS OF READING, WRITING AND SPELLING FOR INDIVIDUALS WITH DYSLEXIA AND ATTENTION DEFICIT DISORDERS IN PERSON AND VIA THE INTERNET, IN CLASS 35 (U.S. CLS. 100, 101 AND 102).

FIRST USE 6-2-2007; IN COMMERCE 6-2-2007.

FOR: EDUCATION SERVICES, NAMELY, PROVIDING CLASSES IN PERSON AND ON-LINE COURSES IN THE FIELD OF DYSLEXIA AND ATTENTION DEFICIT DISORDER, IN CLASS 41 (U.S. CLS. 100, 101 AND 107).

FIRST USE 6-2-2007; IN COMMERCE 6-2-2007.

FOR: COMMUNITY OUTREACH SERVICES PROVIDED TO INDIVIDUALS WITH DYSLEXIA AND ATTENTION DEFICIT DISORDERS, NAMELY, ON-LINE SOCIAL NETWORKING SERVICES AND ORGANIZING AND CONDUCTING SUPPORT GROUPS IN THE FIELD OF DYSLEXIA AND ATTENTION DEFICIT DISORDER, IN CLASS 45 (U.S. CLS. 100 AND 101).

FIRST USE 6-2-2007; IN COMMERCE 6-2-2007.

THE MARK CONSISTS OF STANDARD CHARACTERS WITHOUT CLAIM TO ANY PARTICULAR FONT, STYLE, SIZE, OR COLOR.

SER. NO. 85-222,852, FILED 1-21-2011.

NAPOLEON SHARMA, EXAMINING ATTORNEY



David J. Kyfos

Director of the United States Patent and Trademark Office

United States of America

United States Patent and Trademark Office

BANKRUPTING AMERICA

Reg. No. 4,066,098

THE TRUSTEES OF SC G4 TRUST (DELAWARE TRUST), DBA PUBLIC NOTICE
1220 N. FILLMORE STREET, SUITE 300
ARLINGTON, VA 22201

Registered Dec. 6, 2011

Int. Cls.: 9, 16, 35 and 41

FOR: DOWNLOADABLE ELECTRONIC PUBLICATIONS, NAMELY, NEWSLETTERS IN THE FIELDS OF ECONOMIC POLICY, POLITICS, MEDIA RELATIONS, PUBLIC POLICY, LEADERSHIP, NETWORKING, AND THE LEGISLATIVE PROCESS, IN CLASS 9 (U.S. CLS. 21, 23, 26, 36 AND 38).

TRADEMARK

SERVICE MARK

FIRST USE 1-0-2010; IN COMMERCE 1-0-2010.

PRINCIPAL REGISTER

FOR: PRINT PUBLICATIONS, NAMELY, BROCHURES, PAMPHLETS, AND NEWSLETTERS IN THE FIELDS OF ECONOMIC POLICY, POLITICS, MEDIA RELATIONS, PUBLIC POLICY, LEADERSHIP, NETWORKING, AND THE LEGISLATIVE PROCESS, IN CLASS 16 (U.S. CLS. 2, 5, 22, 23, 29, 37, 38 AND 50).

FIRST USE 1-0-2010; IN COMMERCE 1-0-2010.

FOR: PROVIDING ONLINE INFORMATION AND NEWS IN THE FIELDS OF ECONOMIC POLICY, POLITICS, MEDIA RELATIONS, PUBLIC POLICY, AND THE LEGISLATIVE PROCESS AS IT RELATES TO AND CAN IMPACT BUSINESSES, ECONOMIC POLICY, POLITICS, MEDIA RELATIONS, AND PUBLIC POLICY; ASSOCIATION SERVICES, NAMELY, A GRASSROOTS ORGANIZATION THAT PROMOTES PUBLIC AWARENESS AND PARTICIPATION REGARDING POLICY AND LEGISLATIVE ISSUES IN THE FIELDS OF ECONOMIC POLICY, POLITICS, MEDIA RELATIONS, PUBLIC POLICY, LEADERSHIP, NETWORKING, AND THE LEGISLATIVE PROCESS, IN CLASS 35 (U.S. CLS. 100, 101 AND 102).

FIRST USE 1-0-2010; IN COMMERCE 1-0-2010.

FOR: EDUCATIONAL SERVICES, NAMELY, PROVIDING CLASSES, COURSES OF INSTRUCTION, SEMINARS, CLINICS, WORKSHOPS, LECTURES, AND MENTORING IN THE FIELDS OF ECONOMIC POLICY, POLITICS, MEDIA RELATIONS, PUBLIC POLICY, LEADERSHIP, NETWORKING, AND THE LEGISLATIVE PROCESS, IN CLASS 41 (U.S. CLS. 100, 101 AND 107).

FIRST USE 1-0-2010; IN COMMERCE 1-0-2010.



David J. Kyjars

Director of the United States Patent and Trademark Office

Reg. No. 4,066,098 THE MARK CONSISTS OF STANDARD CHARACTERS WITHOUT CLAIM TO ANY PARTICULAR FONT, STYLE, SIZE, OR COLOR.

NO CLAIM IS MADE TO THE EXCLUSIVE RIGHT TO USE "AMERICA", APART FROM THE MARK AS SHOWN.

SER. NO. 85-222,879, FILED 1-21-2011.

JIM RINGLE, EXAMINING ATTORNEY

United States of America

United States Patent and Trademark Office

AGPRO

Reg. No. 4,066,099

Registered Dec. 6, 2011

Int. Cl.: 12

TRADEMARK

PRINCIPAL REGISTER

LAM INDUSTRIES INC (TEXAS CORPORATION)
2099 US HWY 287 E
IOWA PARK, TX 76367

FOR: REPLACEMENT PARTS AND STRUCTURAL COMPONENTS FOR TRACTORS, NAMELY, ENGINE REBUILD PARTS, TRANSMISSION REBUILD PARTS, BRAKES, AIR FILTERS, AXLES, BEARINGS, BELTS, BLADES, BUSHINGS, CLUTCHES, COUPLINGS, DRIVES, ENGINE MUFFLERS, FILTERS, GASKETS, GEARS, IGNITION DEVICES, MOTOR STARTERS, PUMPS, RADIATORS, STARTERS, SEATS, AND VALVES, IN CLASS 12 (U.S. CLS. 19, 21, 23, 31, 35 AND 44).

FIRST USE 12-31-2009; IN COMMERCE 12-31-2009.

THE MARK CONSISTS OF THE LETTERING "AGPRO" LINED IN DARK WITH A LIGHT BACKGROUND.

SER. NO. 85-222,909, FILED 1-21-2011.

TIMOTHY FINNEGAN, EXAMINING ATTORNEY



David J. Kybas

Director of the United States Patent and Trademark Office

United States of America

United States Patent and Trademark Office

Chubby Chap

Reg. No. 4,066,100

Registered Dec. 6, 2011

Int. Cl.: 3

TRADEMARK

PRINCIPAL REGISTER

ELLI-ROSE ESSENTIALS, LLC (IDAHO LIMITED LIABILITY COMPANY)
302 HOLLEY GLEN WEST
PRIEST RIVER, ID 83856

FOR: LIP BALM, IN CLASS 3 (U.S. CLS. 1, 4, 6, 50, 51 AND 52).

FIRST USE 10-15-2010; IN COMMERCE 11-6-2010.

THE MARK CONSISTS OF STANDARD CHARACTERS WITHOUT CLAIM TO ANY PARTICULAR FONT, STYLE, SIZE, OR COLOR.

NO CLAIM IS MADE TO THE EXCLUSIVE RIGHT TO USE "CHAP", APART FROM THE MARK AS SHOWN.

SER. NO. 85-223,113, FILED 1-21-2011.

FRANK LATTUCA, EXAMINING ATTORNEY



David J. Kyffers

Director of the United States Patent and Trademark Office

United States of America

United States Patent and Trademark Office

SANIFLO

Reg. No. 4,066,101

Registered Dec. 6, 2011

Int. Cl.: 7

TRADEMARK

PRINCIPAL REGISTER

WILDEN PUMP AND ENGINEERING LLC (DELAWARE LIMITED LIABILITY COMPANY)
22069 VAN BUREN STREET
GRAND TERRACE, CA 92313

FOR: POSITIVE DISPLACEMENT PUMPS FOR PROCESSING UNCONTAMINATED MATERIALS AND PARTS SPECIFICALLY MADE THEREFOR; DRUM UNLOADER SYSTEMS COMPRISED PRIMARILY OF PNEUMATIC PISTONS, INCLUDING SUPPORTS FOR THE DRUMS AND FOLLOWER PLATES THAT ASSIST IN THE REMOVAL OF PRODUCTS FROM THE DRUMS, IN CLASS 7 (U.S. CLS. 13, 19, 21, 23, 31, 34 AND 35).

FIRST USE 12-31-1996; IN COMMERCE 12-31-1996.

THE MARK CONSISTS OF STANDARD CHARACTERS WITHOUT CLAIM TO ANY PARTICULAR FONT, STYLE, SIZE, OR COLOR.

SER. NO. 85-223,560, FILED 1-21-2011.

JUDITH HELFMAN, EXAMINING ATTORNEY



David J. Kybas

Director of the United States Patent and Trademark Office

United States of America

United States Patent and Trademark Office



Reg. No. 4,066,102

RELAX GET OUT OF GOD'S WAY, LLC (NEVADA LIMITED LIABILITY COMPANY)
5115 CROWN CYPRESS ST.
LAS VEGAS, NV 89149

Registered Dec. 6, 2011

Int. Cl.: 3

FOR: BODY AND BEAUTY CARE COSMETICS, IN CLASS 3 (U.S. CLS. 1, 4, 6, 50, 51 AND 52).

TRADEMARK

FIRST USE 1-4-2011; IN COMMERCE 1-4-2011.

PRINCIPAL REGISTER

THE MARK CONSISTS OF THE WORD "RELAX" ABOVE THE WORDING "GET OUT OF GOD'S WAY...." NEXT TO A STYLIZED DEPICTION OF A DOVE WITH A BRANCH IN ITS MOUTH.

SER. NO. 85-224,318, FILED 1-24-2011.

JIM RINGLE, EXAMINING ATTORNEY



David J. Kyffers

Director of the United States Patent and Trademark Office

United States of America

United States Patent and Trademark Office



Reg. No. 4,066,103

Registered Dec. 6, 2011

Int. Cl.: 25

TRADEMARK

PRINCIPAL REGISTER

IMAGE DEVELOPMENT MARKETING GROUP (FLORIDA CORPORATION), DBA IDGROUP
CONSULTING + CREATIVE
300 EAST INTENDENCIA STREET
PENSACOLA, FL 32502

FOR: ATHLETIC APPAREL, NAMELY, SHIRTS, PANTS, JACKETS, FOOTWEAR, HATS
AND CAPS, ATHLETIC UNIFORMS, IN CLASS 25 (U.S. CLS. 22 AND 39).

FIRST USE 1-6-2011; IN COMMERCE 1-6-2011.

THE MARK CONSISTS OF A STYLIZED LETTER "V" CONTAINING A DESIGN OF A
CROWN WITH AN OVAL BASE.

SER. NO. 85-224,418, FILED 1-24-2011.

HAI-LY LAM, EXAMINING ATTORNEY



David J. Kyros

Director of the United States Patent and Trademark Office

United States of America

United States Patent and Trademark Office

Monday Morning Sales Coach

Reg. No. 4,066,104

Registered Dec. 6, 2011

Int. Cl.: 41

SERVICE MARK

PRINCIPAL REGISTER

WHETSTONE GROUP, LLC (CALIFORNIA LIMITED LIABILITY COMPANY)
3934 MURPHY CANYON ROAD, B200
SAN DIEGO, CA 92123

FOR: ON-LINE ELECTRONIC NEWSLETTERS DELIVERED BY E-MAIL IN THE FIELD OF SALES ADVICE, IN CLASS 41 (U.S. CLS. 100, 101 AND 107).

FIRST USE 1-1-1998; IN COMMERCE 1-1-1998.

THE MARK CONSISTS OF STANDARD CHARACTERS WITHOUT CLAIM TO ANY PARTICULAR FONT, STYLE, SIZE, OR COLOR.

SEC. 2(F).

SER. NO. 85-224,637, FILED 1-24-2011.

JAMES LOVELACE, EXAMINING ATTORNEY



David J. Kyffers

Director of the United States Patent and Trademark Office

United States of America

United States Patent and Trademark Office

NOVAK

Reg. No. 4,066,105

Registered Dec. 6, 2011

Int. Cl.: 13

TRADEMARK

PRINCIPAL REGISTER

NOVAK, WAYNE F. (UNITED STATES INDIVIDUAL)
1206 30TH STREET
PARKERSBURG, WV 26101

FOR: FIREARM SIGHTS, IN CLASS 13 (U.S. CLS. 2 AND 9).

FIRST USE 9-27-1988; IN COMMERCE 9-27-1988.

THE MARK CONSISTS OF STANDARD CHARACTERS WITHOUT CLAIM TO ANY PARTICULAR FONT, STYLE, SIZE, OR COLOR.

OWNER OF U.S. REG. NOS. 2,472,719 AND 3,395,479.

SEC. 2(F).

SER. NO. 85-224,766, FILED 1-24-2011.

ADA HAN, EXAMINING ATTORNEY



David J. Kybas

Director of the United States Patent and Trademark Office

United States of America

United States Patent and Trademark Office

Feel The Clean

Reg. No. 4,066,106

Registered Dec. 6, 2011

Int. Cl.: 3

TRADEMARK

PRINCIPAL REGISTER

CYMBION LLC (KENTUCKY LIMITED LIABILITY COMPANY)
2307 RIVER ROAD, SUITE 203
LOUISVILLE, KY 40206

FOR: AROMATIC BODY CARE PRODUCTS, NAMELY, BODY LOTION, SHOWER GEL, CUTICLE CREAM, SHAMPOO, CONDITIONER, NON-MEDICATED LIP BALM, SOAP, BODY POLISH, BODY AND FOOT SCRUB AND NON-MEDICATED FOOT CREAM; COSMETIC PREPARATIONS FOR SKIN CARE; MOISTURIZING PREPARATIONS FOR THE SKIN; SKIN CLEANSERS; SKIN MOISTURIZER, IN CLASS 3 (U.S. CLS. 1, 4, 6, 50, 51 AND 52).

FIRST USE 9-20-2010; IN COMMERCE 9-20-2010.

THE MARK CONSISTS OF STANDARD CHARACTERS WITHOUT CLAIM TO ANY PARTICULAR FONT, STYLE, SIZE, OR COLOR.

SER. NO. 85-225,314, FILED 1-25-2011.

TAMARA FRAZIER, EXAMINING ATTORNEY



David J. Kybas

Director of the United States Patent and Trademark Office

United States of America

United States Patent and Trademark Office

REFLEX

Reg. No. 4,066,107

Registered Dec. 6, 2011

Int. Cl.: 15

TRADEMARK

PRINCIPAL REGISTER

REFLEX AUDIO SYSTEMS INC. (CANADA CORPORATION)
PO BOX 69010
CALGARY, ALBERTA, CANADA T2Y4T9

FOR: MUSIC SYNTHESIZERS, IN CLASS 15 (U.S. CLS. 2, 21 AND 36).

FIRST USE 3-3-2002; IN COMMERCE 3-3-2002.

THE MARK CONSISTS OF STANDARD CHARACTERS WITHOUT CLAIM TO ANY PARTICULAR FONT, STYLE, SIZE, OR COLOR.

SER. NO. 85-225,377, FILED 1-25-2011.

RAUL CORDOVA, EXAMINING ATTORNEY



David J. Kyros

Director of the United States Patent and Trademark Office

United States of America

United States Patent and Trademark Office

Discovery Peak

Reg. No. 4,066,108

Registered Dec. 6, 2011

Int. Cl.: 16

TRADEMARK

PRINCIPAL REGISTER

DISCOVERY PEAK HOLDINGS, LLC (MISSOURI LIMITED LIABILITY COMPANY)
52 HUNTLEIGH WOODS
ST. LOUIS, MO 63131

FOR: CHILDREN'S ACTIVITY BOOKS; CHILDREN'S BOOKS; CHILDREN'S INTERACTIVE EDUCATIONAL BOOKS; CHILDREN'S STORYBOOKS; TALKING CHILDREN'S BOOKS , IN CLASS 16 (U.S. CLS. 2, 5, 22, 23, 29, 37, 38 AND 50).

FIRST USE 9-14-2009; IN COMMERCE 5-7-2010.

THE MARK CONSISTS OF STANDARD CHARACTERS WITHOUT CLAIM TO ANY PARTICULAR FONT, STYLE, SIZE, OR COLOR.

SER. NO. 85-226,135, FILED 1-25-2011.

KATHERINE CHANG, EXAMINING ATTORNEY



David J. Kybas

Director of the United States Patent and Trademark Office

United States of America

United States Patent and Trademark Office

GLC ADVISORS & CO.

Reg. No. 4,066,109

Registered Dec. 6, 2011

Int. Cl.: 36

SERVICE MARK

PRINCIPAL REGISTER

GLC ADVISORS & CO., LLC (DELAWARE LIMITED LIABILITY COMPANY)
2ND FLOOR
451 JACKSON STREET
SAN FRANCISCO, CA 94111

FOR: FINANCIAL SERVICES, NAMELY, FINANCIAL RESTRUCTURING SERVICES, IN CLASS 36 (U.S. CLS. 100, 101 AND 102).

FIRST USE 10-30-2009; IN COMMERCE 10-30-2009.

THE MARK CONSISTS OF STANDARD CHARACTERS WITHOUT CLAIM TO ANY PARTICULAR FONT, STYLE, SIZE, OR COLOR.

OWNER OF U.S. REG. NO. 3,808,296.

NO CLAIM IS MADE TO THE EXCLUSIVE RIGHT TO USE "ADVISORS & CO.", APART FROM THE MARK AS SHOWN.

SER. NO. 85-226,227, FILED 1-26-2011.

KAREN BRACEY, EXAMINING ATTORNEY



David J. Kyros

Director of the United States Patent and Trademark Office

United States of America

United States Patent and Trademark Office

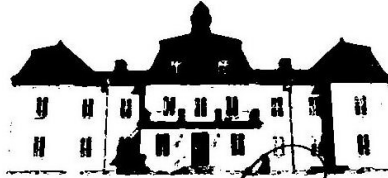

Ana Valenzuela

Reg. No. 4,066,110

ANA VALENZUELA INC. (NEW MEXICO CORPORATION)
377 CALLE LOMA NORTE
SANTA FE, NM 87501

Registered Dec. 6, 2011

Int. Cl.: 37

FOR: JANITORIAL SERVICES; RESIDENTIAL AND VACATION RENTAL HOMES' CLEANING SERVICES, IN CLASS 37 (U.S. CLS. 100, 103 AND 106).

SERVICE MARK

FIRST USE 10-31-2006; IN COMMERCE 10-31-2006.

PRINCIPAL REGISTER

"ANA VALENZUELA" IDENTIFIES THE NICKNAME OF "ANITA E. LEIVA", A LIVING INDIVIDUAL WHOSE CONSENT IS OF RECORD, PURSUANT TO TMEP SECTION 813, BY HER SIGNATURE ON THE APPLICATION.

THE MARK CONSISTS OF THE IMAGE OF A CHATEAU IN THE BACKGROUND WITH THE WORDS "ANA VALENZUELA" IN STYLIZED FONT IN FRONT AND BELOW THE CHATEAU.

SER. NO. 85-226,275, FILED 1-26-2011.

STEVEN JACKSON, EXAMINING ATTORNEY



David J. Kyffers

Director of the United States Patent and Trademark Office

United States of America

United States Patent and Trademark Office

ANA VALENZUELA

Reg. No. 4,066,111

ANA VALENZUELA INC. (NEW MEXICO CORPORATION)
377 CALLE LOMA NORTE
SANTA FE, NM 87501

Registered Dec. 6, 2011

Int. Cl.: 37

FOR: JANITORIAL SERVICES; RESIDENTIAL AND VACATION RENTAL HOMES' CLEANING SERVICES, IN CLASS 37 (U.S. CLS. 100, 103 AND 106).

SERVICE MARK

FIRST USE 6-17-2006; IN COMMERCE 6-17-2006.

PRINCIPAL REGISTER

THE MARK CONSISTS OF STANDARD CHARACTERS WITHOUT CLAIM TO ANY PARTICULAR FONT, STYLE, SIZE, OR COLOR.

"ANA VALENZUELA" IDENTIFIES THE NICKNAME OF "ANITA E. LEIVA", A LIVING INDIVIDUAL WHOSE CONSENT IS OF RECORD, PURSUANT TO TMEP SECTION 813, BY HER SIGNATURE ON THE APPLICATION.

SER. NO. 85-226,340, FILED 1-26-2011.

STEVEN JACKSON, EXAMINING ATTORNEY



David J. Kybas

Director of the United States Patent and Trademark Office

United States of America

United States Patent and Trademark Office

GUITEL

Reg. No. 4,066,112

Registered Dec. 6, 2011

Int. Cls.: 6 and 20

TRADEMARK

PRINCIPAL REGISTER

POINT M PRODUCTION - PMP (FRANCE COMPANY)
RUE MARCEL POULIN
60400 CRISOLLES, FRANCE

FOR: METAL CASTERS, IN CLASS 6 (U.S. CLS. 2, 12, 13, 14, 23, 25 AND 50).

FIRST USE 0-0-1929; IN COMMERCE 0-0-2000.

FOR: NON-METAL CASTERS , IN CLASS 20 (U.S. CLS. 2, 13, 22, 25, 32 AND 50).

FIRST USE 0-0-1929; IN COMMERCE 0-0-2000.

THE MARK CONSISTS OF STANDARD CHARACTERS WITHOUT CLAIM TO ANY PARTICULAR FONT, STYLE, SIZE, OR COLOR.

THE WORDING "GUITEL" HAS NO MEANING IN A FOREIGN LANGUAGE.

SER. NO. 85-227,025, FILED 1-26-2011.

SETH A. RAPPAPORT, EXAMINING ATTORNEY



David J. Kybas

Director of the United States Patent and Trademark Office

United States of America

United States Patent and Trademark Office

COMBOGEAR

Reg. No. 4,066,113

Registered Dec. 6, 2011

Int. Cl.: 7

TRADEMARK

PRINCIPAL REGISTER

MASTER POWER TRANSMISSION (SOUTH CAROLINA CORPORATION)
201 W. MCBEE AVE., SUITE 303
GREENVILLE, SC 29601

FOR: GEAR BOXES FOR USE IN INDUSTRIAL MACHINES, IN CLASS 7 (U.S. CLS. 13, 19, 21, 23, 31, 34 AND 35).

FIRST USE 5-25-2010; IN COMMERCE 12-17-2010.

THE MARK CONSISTS OF STANDARD CHARACTERS WITHOUT CLAIM TO ANY PARTICULAR FONT, STYLE, SIZE, OR COLOR.

SER. NO. 85-227,383, FILED 1-27-2011.

CHRISTINA SOBRAL, EXAMINING ATTORNEY



David J. Kybas

Director of the United States Patent and Trademark Office

United States of America

United States Patent and Trademark Office

TDLC.COM

Reg. No. 4,066,114

Registered Dec. 6, 2011

Int. Cl.: 41

SERVICE MARK

PRINCIPAL REGISTER

LARSON TEXTS, INC. (PENNSYLVANIA CORPORATION)
1762 NORCROSS ROAD
ERIE, PA 16510

FOR: EDUCATION SERVICES, NAMELY, PROVIDING ON-LINE COURSES OF INSTRUCTION IN THE FIELD OF MATHEMATICS, IN CLASS 41 (U.S. CLS. 100, 101 AND 107).

FIRST USE 7-31-2000; IN COMMERCE 7-31-2000.

THE MARK CONSISTS OF STANDARD CHARACTERS WITHOUT CLAIM TO ANY PARTICULAR FONT, STYLE, SIZE, OR COLOR.

SER. NO. 85-227,386, FILED 1-27-2011.

JENNIFER MARTIN, EXAMINING ATTORNEY



David J. Kybas

Director of the United States Patent and Trademark Office

United States of America

United States Patent and Trademark Office

ZTELEPHONE

Reg. No. 4,066,115

Registered Dec. 6, 2011

Int. Cl.: 9

TRADEMARK

PRINCIPAL REGISTER

SHUANG SA (CANADA INDIVIDUAL)
100-13551 VERDUN PLACE
RICHMOND, BC, CANADA V6V1W5

FOR: HOME THEATER SYSTEMS COMPRISING, AUDIO AMPLIFIERS, AUDIO SPEAKERS; AUDIO ELECTRONIC COMPONENTS, NAMELY, SPEAKERS, AUDIO SPEAKERS, SURROUND SOUND SYSTEMS; AUDIO EQUIPMENT FOR VEHICLES, NAMELY, LOUD SPEAKERS FOR AUTOMOTIVE AUDIO SYSTEMS; DESK OR CAR MOUNTED UNITS INCORPORATING A LOUDSPEAKER OR HEADSET TO ALLOW A DIGITAL HANDSET TO BE USED; DIGITAL COMMUNICATION DEVICE, NAMELY, DIGITAL TELEPHONE PLATFORMS AND SOFTWARE; COMPUTER SOFTWARE USED IN NETWORK MANAGEMENT AND DOWNLOADABLE ELECTRONIC GAME SOFTWARE VIA COMPUTER NETWORKS AND GLOBAL COMMUNICATION NETWORKS; BATTERY CHARGERS, POWER ADAPTERS, DIGITAL DATA TRANSFORMERS, NAMELY, ELECTRICAL TRANSFORMERS, ELECTRONIC ACCESSORIES FOR DIGITAL AND HANDHELD ELECTRONIC APPARATUS, NAMELY, ELECTRONIC CABLES, ADAPTERS, DOCKS, CHARGERS, PHONE CONNECTORS; HANDHELD COMPUTERS; LAPTOP COMPUTERS; NETBOOKS; DIGITAL DATA STORAGE DEVICES, NAMELY, BLANK USB FLASH DRIVES, MEMORY CARDS, MEDIA PLAYERS, MACHINES FOR PLAYING GAMES OF CHANCE, CAMCORDERS, CAMERAS AND COMPUTER PERIPHERALS; BAGS AND CASES SPECIALLY ADAPTED FOR HOLDING OR CARRYING PORTABLE ELECTRONIC EQUIPMENT AND ACCESSORIES, IN CLASS 9 (U.S. CLS. 21, 23, 26, 36 AND 38).

FIRST USE 4-27-2009; IN COMMERCE 4-27-2009.

THE MARK CONSISTS OF STANDARD CHARACTERS WITHOUT CLAIM TO ANY PARTICULAR FONT, STYLE, SIZE, OR COLOR.

SER. NO. 85-227,411, FILED 1-27-2011.

JAY FLOWERS, EXAMINING ATTORNEY



David J. Kyros

Director of the United States Patent and Trademark Office

United States of America

United States Patent and Trademark Office

DOCK-IN-DOCK

Reg. No. 4,066,116

Registered Dec. 6, 2011

Int. Cl.: 9

TRADEMARK

PRINCIPAL REGISTER

SHUANG SA (CANADA INDIVIDUAL)
100-13551 VERDUN PLACE
RICHMOND, BC, CANADA V6V1W5

FOR: BATTERY CHARGERS; POWER ADAPTERS; DIGITAL DATA TRANSFORMER, NAMELY, ELECTRICAL TRANSFORMERS; ELECTRONIC ACCESSORIES, NAMELY, ADAPTERS, HOLDERS FOR ELECTRIC COILS AND CABLES, SOCKET, PLUGS, CONNECTORS, STANDS FOR PERSONAL DIGITAL ELECTRONIC DEVICES, CONVERTERS, CONNECTORS FOR ELECTRIC CONNECTORS, ELECTRICAL PLUGS, ELECTRIC CORDS, ELECTRIC WIRES, ELECTRICAL CABLES, ELECTRONIC RECEIVERS AND TRANSMITTERS FOR HANDHELD COMPUTERS, BARCODE READERS, SCANNERS, GLOBAL POSITIONING SYSTEMS, PERSONAL DIGITAL ASSISTANTS, LAPTOP COMPUTERS, NOTEBOOKS, TOUCH PADS, DIGITAL DATA STORAGE DEVICES, NAMELY, BLANK USB FLASH DRIVES, MEMORY CARDS, MEDIA PLAYERS, ARCADE GAME MACHINES, WIRELESS TELEPHONES, CAMCORDERS, CAMERAS, REMOTE CONTROLS AND COMPUTER PERIPHERALS, SIGNAL SPLITTERS FOR ELECTRONIC APPARATUS, AMPLIFIERS; BATTERY CHARGERS FOR DIGITAL AND HANDHELD ELECTRONIC APPARATUS, NAMELY, HANDHELD COMPUTERS, BARCODE READERS, SCANNERS, GLOBAL POSITIONING SYSTEMS, PERSONAL DIGITAL ASSISTANTS, LAPTOP COMPUTERS, NOTEBOOKS, TOUCH PADS, DIGITAL DATA STORAGE DEVICES, NAMELY, BLANK USB FLASH DRIVES, MEMORY CARDS, MEDIA PLAYERS, ARCADE GAME MACHINES, WIRELESS TELEPHONES, CAMCORDERS, CAMERAS, REMOTE CONTROLS AND COMPUTER PERIPHERALS, IN CLASS 9 (U.S. CLS. 21, 23, 26, 36 AND 38).

FIRST USE 8-11-2008; IN COMMERCE 8-11-2008.

THE MARK CONSISTS OF STANDARD CHARACTERS WITHOUT CLAIM TO ANY PARTICULAR FONT, STYLE, SIZE, OR COLOR.

SER. NO. 85-227,439, FILED 1-27-2011.

JAY FLOWERS, EXAMINING ATTORNEY



David J. Kyffers

Director of the United States Patent and Trademark Office

United States of America

United States Patent and Trademark Office



Reg. No. 4,066,117

Registered Dec. 6, 2011

Int. Cl.: 28

TRADEMARK

PRINCIPAL REGISTER

COMPASS INTERNATIONAL PICTURES (CALIFORNIA CORPORATION)
2021 PONTIUS AVENUE
LOS ANGELES, CA 90025

FOR: TOYS, NAMELY, ACTION FIGURES, MINI BUSTS IN THE NATURE OF MINIATURE AND COLLECTIBLE TOY FIGURES, AND COSTUME, MASQUERADE, AND HORROR-THEMED MASKS, IN CLASS 28 (U.S. CLS. 22, 23, 38 AND 50).

FIRST USE 10-1-2002; IN COMMERCE 10-1-2002.

THE NAME "MICHAEL MYERS" AND LIKENESS IN THE MARK DO NOT IDENTIFY A LIVING INDIVIDUAL.

THE MARK CONSISTS OF THE WORDING "MICHAEL MYERS" FEATURED TO THE RIGHT OF A PARTIALLY SHADED MASK DESIGN; THE RECTANGLE CARRIER IS NOT PART OF THE MARK BUT REPRESENTS TRANSPARENT BACKGROUND.

SER. NO. 85-227,782, FILED 1-27-2011.

APRIL HESIK, EXAMINING ATTORNEY



David J. Kyros

Director of the United States Patent and Trademark Office

United States of America

United States Patent and Trademark Office



Reg. No. 4,066,118

Registered Dec. 6, 2011

Int. Cl.: 45

SERVICE MARK

PRINCIPAL REGISTER

JONES, JOHN (UNITED STATES INDIVIDUAL)
5256 PARKSIDE AVE.
PHILADELPHIA, PA 19131

FOR: CHARITABLE SERVICES, NAMELY, PROVIDING DONATED JEANS TO THOSE IN NEED AROUND THE WORLD, IN CLASS 45 (U.S. CLS. 100 AND 101).

FIRST USE 6-1-2010; IN COMMERCE 6-1-2010.

NO CLAIM IS MADE TO THE EXCLUSIVE RIGHT TO USE "JEANS DONATION" OR "GO GREEN DONATE YOUR OLD JEANS", APART FROM THE MARK AS SHOWN.

THE MARK CONSISTS OF THE STYLIZED TEXT "JEANS DONATION GO GREEN DONATE YOUR OLD JEANS " WITH AN IMAGE OF A PAIR OF JEANS SITTING ON TOP OF THE EARTH AND EIGHT PAIR OF JEANS FOLDED UNDER THE GLOBE.

SER. NO. 85-227,893, FILED 1-27-2011.

DOMINIC J. FERRAIUOLO, EXAMINING ATTORNEY



David J. Kybas

Director of the United States Patent and Trademark Office

United States of America

United States Patent and Trademark Office

Triple Rock

Reg. No. 4,066,119

Registered Dec. 6, 2011

Int. Cls.: 25, 32 and 43

TRIPLE ROCK BREWING CO., INC. (CALIFORNIA CORPORATION)
1920 SHATTUCK AVE.
BERKELEY, CA 94704

FOR: WEARABLE GARMENTS AND CLOTHING, NAMELY, SHIRTS, IN CLASS 25 (U.S. CLS. 22 AND 39).

TRADEMARK

FIRST USE 4-19-1987; IN COMMERCE 4-19-1987.

SERVICE MARK

FOR: BEER, IN CLASS 32 (U.S. CLS. 45, 46 AND 48).

PRINCIPAL REGISTER

FIRST USE 4-19-1987; IN COMMERCE 4-19-1987.

FOR: BAR AND RESTAURANT SERVICES, IN CLASS 43 (U.S. CLS. 100 AND 101).

FIRST USE 4-19-1987; IN COMMERCE 4-19-1987.

THE MARK CONSISTS OF STANDARD CHARACTERS WITHOUT CLAIM TO ANY PARTICULAR FONT, STYLE, SIZE, OR COLOR.

SER. NO. 85-227,895, FILED 1-27-2011.

DOMINIC J. FERRAIUOLO, EXAMINING ATTORNEY



David J. Kyros

Director of the United States Patent and Trademark Office

United States of America

United States Patent and Trademark Office

PROPERTY XCESS

Reg. No. 4,066,120

Registered Dec. 6, 2011

Int. Cl.: 35

SERVICE MARK

PRINCIPAL REGISTER

SHELLY, ISAAC (UNITED STATES INDIVIDUAL)
1834 S. 2ND AVE.
MAYWOOD, IL 60153

FOR: COMPUTER SERVICES, NAMELY, MATCHING CONSUMERS WITH REAL ESTATE PROFESSIONALS IN THE FIELD OF REAL ESTATE SERVICES VIA COMPUTER NETWORK; PROVIDING AN ON-LINE COMMERCIAL INFORMATION DIRECTORY ON THE INTERNET RELATING TO PERSONS PROVIDING GOODS AND SERVICES IN THE FIELD OF REAL ESTATE ON A GLOBAL COMPUTER NETWORK; PROVIDING AN INTERNET BASED SEARCHABLE REFERRAL SERVICE THAT ALLOWS PERSONS TO LIST THEIR GOODS AND SERVICES IN THE FIELD OF REAL ESTATE, IN CLASS 35 (U.S. CLS. 100, 101 AND 102).

FIRST USE 12-15-2010; IN COMMERCE 12-15-2010.

THE MARK CONSISTS OF STANDARD CHARACTERS WITHOUT CLAIM TO ANY PARTICULAR FONT, STYLE, SIZE, OR COLOR.

NO CLAIM IS MADE TO THE EXCLUSIVE RIGHT TO USE "PROPERTY", APART FROM THE MARK AS SHOWN.

SER. NO. 85-227,923, FILED 1-27-2011.

MAYUR VAGHANI, EXAMINING ATTORNEY



David J. Kyros

Director of the United States Patent and Trademark Office

United States of America

United States Patent and Trademark Office

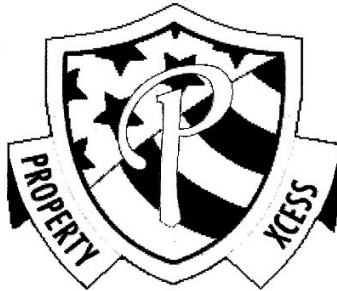

Reg. No. 4,066,121

Registered Dec. 6, 2011

Int. Cl.: 35

SERVICE MARK

PRINCIPAL REGISTER

SHELLY, ISAAC (UNITED STATES INDIVIDUAL)
1834 S. 2ND AVE.
MAYWOOD, IL 60153

FOR: COMPUTER SERVICES, NAMELY, COMPUTER-ASSISTED BUSINESS INFORMATION AND RESEARCH SERVICES, MATCHING CONSUMERS WITH REAL ESTATE PROFESSIONALS IN THE FIELD OF REAL ESTATE SERVICES VIA COMPUTER NETWORK; PROVIDING AN ON-LINE COMMERCIAL INFORMATION DIRECTORY ON THE INTERNET RELATING TO PERSONS PROVIDING GOODS AND SERVICES IN THE FIELD OF REAL ESTATE ON A GLOBAL COMPUTER NETWORK; PROVIDING AN INTERNET BASED SEARCHABLE REFERRAL SERVICE THAT ALLOWS PERSONS TO LIST THEIR GOODS AND SERVICES IN THE FIELD OF REAL ESTATE, IN CLASS 35 (U.S. CLS. 100, 101 AND 102).

FIRST USE 12-15-2010; IN COMMERCE 12-15-2010.

NO CLAIM IS MADE TO THE EXCLUSIVE RIGHT TO USE "PROPERTY" , APART FROM THE MARK AS SHOWN.

THE MARK CONSISTS OF A CREST WITH A CAPITAL "P" IN THE CENTER. BEHIND THE "P" AS A BACKGROUND ARE STARS AND PARTIAL STARS IN THE UPPER LEFT, AND ANGLED STRIPES IN THE LOWER LEFT OF THE BACKGROUND OF THE CREST. THE WORD "PROPERTY" IS ON THE LOWER LEFT BANNER, AND THE WORD "XCESS" ON THE LOWER RIGHT BANNER.

SER. NO. 85-227,933, FILED 1-27-2011.

MAYUR VAGHANI, EXAMINING ATTORNEY



David J. Kybas

Director of the United States Patent and Trademark Office

United States of America

United States Patent and Trademark Office



Reg. No. 4,066,122

Registered Dec. 6, 2011

Int. Cl.: 37

SERVICE MARK

PRINCIPAL REGISTER

GUARDIAN COMMUNITY RESOURCE MANAGEMENT, INC. (FLORIDA CORPORATION)
15380 COUNTY ROAD 565A, SUITE B
GROVELAND, FL 34736

FOR: CONSTRUCTION CONSULTANCY; CONSTRUCTION PROJECT MANAGEMENT SERVICES, IN CLASS 37 (U.S. CLS. 100, 103 AND 106).

FIRST USE 1-26-2011; IN COMMERCE 1-26-2011.

NO CLAIM IS MADE TO THE EXCLUSIVE RIGHT TO USE "COMMUNITY RESOURCE MANAGEMENT INC.", APART FROM THE MARK AS SHOWN.

THE MARK CONSISTS OF THE WORD "GUARDIAN" OVER A SHIELD WITH A SILHOUETTE OF A KNIGHT ON A HORSE INSIDE THE SHIELD AND THE WORDS "COMMUNITY RESOURCE MANAGEMENT INC." UNDER THE SHIELD IN A CURVED SHAPE AROUND THE BOTTOM EDGE OF THE SHIELD.

SER. NO. 85-228,090, FILED 1-27-2011.

KATHY DE JONGE, EXAMINING ATTORNEY



David J. Kyffers

Director of the United States Patent and Trademark Office

United States of America

United States Patent and Trademark Office

APG

Reg. No. 4,066,123

Registered Dec. 6, 2011

Int. Cl.: 7

TRADEMARK

PRINCIPAL REGISTER

MASTER POWER TRANSMISSION (SOUTH CAROLINA CORPORATION)
201 W. MCBEE AVE., SUITE 303
GREENVILLE, SC 29601

FOR: GEARS FOR MACHINES, NAMELY, GEAR REDUCERS, IN CLASS 7 (U.S. CLS. 13, 19, 21, 23, 31, 34 AND 35).

FIRST USE 4-1-2010; IN COMMERCE 4-19-2010.

THE MARK CONSISTS OF STANDARD CHARACTERS WITHOUT CLAIM TO ANY PARTICULAR FONT, STYLE, SIZE, OR COLOR.

SER. NO. 85-228,543, FILED 1-28-2011.

CHRISTINA SOBRAL, EXAMINING ATTORNEY



David J. Kyffers

Director of the United States Patent and Trademark Office

United States of America

United States Patent and Trademark Office

OMNI PARTNERS LLP

Reg. No. 4,066,124

Registered Dec. 6, 2011

Int. Cl.: 36

SERVICE MARK

PRINCIPAL REGISTER

OMNI PARTNERS LLP (UNITED KINGDOM LIMITED LIABILITY COMPANY)
2ND FLOOR, SALTERS HALL
4 FORE STREET
LONDON, UNITED KINGDOM EC2Y5DB

FOR: INVESTMENT MANAGEMENT; INVESTMENT ADVICE; WEALTH MANAGEMENT;
FUND MANAGEMENT; FINANCIAL ASSET MANAGEMENT; ALTERNATIVE INVESTMENT
MANAGEMENT, IN CLASS 36 (U.S. CLS. 100, 101 AND 102).

THE MARK CONSISTS OF STANDARD CHARACTERS WITHOUT CLAIM TO ANY PAR-
TICULAR FONT, STYLE, SIZE, OR COLOR.

PRIORITY CLAIMED UNDER SEC. 44(D) ON UNITED KINGDOM APPLICATION NO.
2568379, FILED 1-6-2011, REG. NO. 2568379, DATED 1-6-2011, EXPIRES 1-6-2021.

NO CLAIM IS MADE TO THE EXCLUSIVE RIGHT TO USE "PARTNERS LLP", APART
FROM THE MARK AS SHOWN.

SER. NO. 85-228,675, FILED 1-28-2011.

ANNE MADDEN, EXAMINING ATTORNEY



David J. Kybas

Director of the United States Patent and Trademark Office

United States of America

United States Patent and Trademark Office



Reg. No. 4,066,125

Registered Dec. 6, 2011

Int. Cl.: 36

SERVICE MARK

PRINCIPAL REGISTER

OMNI PARTNERS LLP (UNITED KINGDOM LIMITED LIABILITY COMPANY)
2ND FLOOR, SALTERS HALL
4 FORE STREET
LONDON, UNITED KINGDOM EC2Y5DB

FOR: INVESTMENT MANAGEMENT; INVESTMENT ADVICE; WEALTH MANAGEMENT;
FUND MANAGEMENT; FINANCIAL ASSET MANAGEMENT; ALTERNATIVE INVESTMENT
MANAGEMENT, IN CLASS 36 (U.S. CLS. 100, 101 AND 102).

PRIORITY CLAIMED UNDER SEC. 44(D) ON UNITED KINGDOM APPLICATION NO.
2568382, FILED 1-6-2011, REG. NO. 2568382, DATED 1-6-2011, EXPIRES 1-6-2021.

NO CLAIM IS MADE TO THE EXCLUSIVE RIGHT TO USE "PARTNERS LLP", APART
FROM THE MARK AS SHOWN.

THE MARK CONSISTS OF A RECTANGULAR BACKGROUND UPON WHICH APPEARS
A DESIGN CONSISTING OF AN OVAL DIVIDED VERTICALLY IN HALF BY A LINE
ABOVE THE LEFT HALF ONLY OF ANOTHER OVAL; THE WORDS "OMNI PARTNERS
LLP" APPEAR TO THE RIGHT OF THE DESIGN WITH THE WORD "OMNI" ABOVE THE
WORDS "PARTNERS LLP".

SER. NO. 85-228,733, FILED 1-28-2011.

ANNE MADDEN, EXAMINING ATTORNEY



David J. Kyjars

Director of the United States Patent and Trademark Office

United States of America

United States Patent and Trademark Office

Video Triangulation

Reg. No. 4,066,126

Registered Dec. 6, 2011

Int. Cls.: 9, 10 and 42

TRADEMARK

SERVICE MARK

PRINCIPAL REGISTER

POLYTEC GMBH (FED REP GERMANY GESELLSCHAFT MIT BESCHRÄNKTER HAFTUNG (GMBH))
POLYTEC PLATZ 1-7
WALDBRONN, FED REP GERMANY 76337

FOR: MEASURING APPARATUS, NAMELY, INTERFEROMETRIC VIBRATION MEASUREMENT APPARATUS; MEASURING APPARATUS FOR INTERFEROMETRIC VIBRATION MEASUREMENT, IN PARTICULAR VIBROMETERS; COMPUTERS AND COMPUTER SOFTWARE, IN PARTICULAR FOR CONTROLLING THE AFORESAID GOODS, AND FOR ANALYZING THE MEASURING DATA OBTAINED THEREWITH, IN CLASS 9 (U.S. CLS. 21, 23, 26, 36 AND 38).

FOR: MEASURING APPARATUS FOR INTERFEROMETRIC VIBRATION MEASUREMENT, IN PARTICULAR VIBROMETERS, THE AFOREMENTIONED GOODS FOR MEDICAL PURPOSES, IN CLASS 10 (U.S. CLS. 26, 39 AND 44).

FOR: TECHNICAL CONSULTING IN THE FIELDS OF ENGINEERING AND PHYSICS; SERVICES OF A PHYSICIST, NAMELY, CONSULTING IN THE FIELD OF PHYSICS; COMPUTER PROGRAMMING; COMPUTER HARDWARE AND SOFTWARE CONSULTANCY, IN CLASS 42 (U.S. CLS. 100 AND 101).

THE MARK CONSISTS OF STANDARD CHARACTERS WITHOUT CLAIM TO ANY PARTICULAR FONT, STYLE, SIZE, OR COLOR.

PRIORITY CLAIMED UNDER SEC. 44(D) ON ERPN CMNTY TM OFC APPLICATION NO. 009453325, FILED 10-1-2010, REG. NO. 009453325, DATED 4-28-2011, EXPIRES 10-1-2020.

SER. NO. 85-228,780, FILED 1-28-2011.

PRISCILLA MILTON, EXAMINING ATTORNEY



David J. Kyros

Director of the United States Patent and Trademark Office

United States of America

United States Patent and Trademark Office

The *Haymarket Group* LLC

Reg. No. 4,066,127

Registered Dec. 6, 2011

Int. Cl.: 35

SERVICE MARK

PRINCIPAL REGISTER

THE HAYMARKET GROUP, LLC (VIRGINIA LIMITED LIABILITY COMPANY)
SUITE 300E3088
4801 WOODWAY DRIVE
HOUSTON, TX 77056

FOR: ASSISTANCE, ADVISORY SERVICES AND CONSULTANCY WITH REGARD TO BUSINESS PLANNING, BUSINESS ANALYSIS, BUSINESS MANAGEMENT, AND BUSINESS ORGANIZATION, IN CLASS 35 (U.S. CLS. 100, 101 AND 102).

FIRST USE 7-1-2002; IN COMMERCE 7-1-2002.

NO CLAIM IS MADE TO THE EXCLUSIVE RIGHT TO USE "GROUP, LLC", APART FROM THE MARK AS SHOWN.

THE MARK CONSISTS OF A STYLIZED PRESENTATION OF "THE HAYMARKET GROUP, LLC".

SER. NO. 85-229,373, FILED 1-29-2011.

LINDA POWELL, EXAMINING ATTORNEY



David J. Kybas

Director of the United States Patent and Trademark Office

United States of America

United States Patent and Trademark Office

iLEGISLATE

Reg. No. 4,066,128

Registered Dec. 6, 2011

Int. Cl.: 42

SERVICE MARK

PRINCIPAL REGISTER

GRANICUS, INC. (CALIFORNIA CORPORATION)
568 HOWARD ST
SAN FRANCISCO, CA 94105

FOR: SOFTWARE AS A SERVICE (SAAS) SERVICES, NAMELY, HOSTING SOFTWARE FOR USE BY OTHERS FOR USE IN PAPERLESS AGENDA VIEWING AND EDITING, IN CLASS 42 (U.S. CLS. 100 AND 101).

FIRST USE 12-15-2010; IN COMMERCE 12-15-2010.

THE MARK CONSISTS OF STANDARD CHARACTERS WITHOUT CLAIM TO ANY PARTICULAR FONT, STYLE, SIZE, OR COLOR.

SER. NO. 85-230,051, FILED 1-31-2011.

HANNO RITTNER, EXAMINING ATTORNEY



David J. Kyffers

Director of the United States Patent and Trademark Office

United States of America

United States Patent and Trademark Office

ROUTE 128

Reg. No. 4,066,129

Registered Dec. 6, 2011

Int. Cl.: 33

TRADEMARK

PRINCIPAL REGISTER

PELU PARTNERS, LLC (CALIFORNIA LIMITED LIABILITY COMPANY)
22130 HIGHWAY 128
CLOVERDALE, CA 95425

FOR: WINE, IN CLASS 33 (U.S. CLS. 47 AND 49).

FIRST USE 4-8-2005; IN COMMERCE 4-8-2005.

THE MARK CONSISTS OF STANDARD CHARACTERS WITHOUT CLAIM TO ANY PARTICULAR FONT, STYLE, SIZE, OR COLOR.

OWNER OF U.S. REG. NO. 3,038,566.

SEC. 2(F).

SER. NO. 85-230,590, FILED 1-31-2011.

ZACHARY BELLO, EXAMINING ATTORNEY



David J. Kyffers

Director of the United States Patent and Trademark Office

United States of America

United States Patent and Trademark Office



Reg. No. 4,066,130

Registered Dec. 6, 2011

Int. Cl.: 37

SERVICE MARK

PRINCIPAL REGISTER

FLORES JR., SAMUEL (UNITED STATES INDIVIDUAL)
#C1
14265 DANIELSON STREET
POWAY, CA 92064

FOR: AIRCRAFT MAINTENANCE AND REPAIR SERVICES, IN CLASS 37 (U.S. CLS. 100, 103 AND 106).

FIRST USE 1-16-2003; IN COMMERCE 1-16-2003.

NO CLAIM IS MADE TO THE EXCLUSIVE RIGHT TO USE "SERVICES, INC.", APART FROM THE MARK AS SHOWN.

THE MARK CONSISTS OF A CIRCLE WITH THE COMPASS OF ARROWS POINTING NORTH, SOUTH, EAST, AND WEST. THE STYLIZED TEXT "PKL SERVICES, INC." APPEARS TO THE LEFT AND UNDER THE COMPASS DESIGN.

SER. NO. 85-231,064, FILED 2-1-2011.

TIMOTHY FINNEGAN, EXAMINING ATTORNEY



David J. Kybas

Director of the United States Patent and Trademark Office

United States of America

United States Patent and Trademark Office



Reg. No. 4,066,131

Registered Dec. 6, 2011

Int. Cl.: 35

SERVICE MARK

PRINCIPAL REGISTER

THE CITY OF GREENSBORO (NORTH CAROLINA CORPORATION)
300 WEST WASHINGTON STREET
GREENSBORO, NC 27401

FOR: PROVIDING FLEA MARKET SERVICES, IN CLASS 35 (U.S. CLS. 100, 101 AND 102).

FIRST USE 8-5-2004; IN COMMERCE 8-5-2004.

OWNER OF U.S. REG. NO. 2,934,533.

NO CLAIM IS MADE TO THE EXCLUSIVE RIGHT TO USE "GREENSBORO COLISEUM SINCE 1976 SUPER FLEA MARKET ANTIQUES COLLECTIBLES TREASURE", APART FROM THE MARK AS SHOWN.

THE MARK CONSISTS OF A LARGE OVAL WITH A SMALLER OVAL INSIDE, THE WORDS "GREENSBORO COLISEUM" ARE POSITIONED ACROSS THE TOP BETWEEN THE LARGE AND SMALL OVALS AND THE WORDS "ANTIQUES COLLECTIBLES TREASURE" ARE POSITIONED ACROSS THE BOTTOM BETWEEN THE LARGE AND SMALL OVALS WITH A DIAMOND SHAPE BETWEEN THE WORDS "ANTIQUES" AND "COLLECTIBLES" AND ANOTHER DIAMOND SHAPE BETWEEN THE WORDS "COLLECTIBLES" AND "TREASURE", THE WORDS "SINCE 1976 SUPER FLEA MARKET" ARE POSITIONED WITHIN THE SMALL OVAL AND FOUR DIAMOND SHAPES HAVING TRIANGLES THEREIN ARE POSITIONED ALONG THE BORDER OF THE LARGE OVAL AT APPROXIMATELY THE 12:00, 3:00, 6:00 AND 9:00 POSITIONS.

SER. NO. 85-231,072, FILED 2-1-2011.

KATHERINE M. DUBRAY, EXAMINING ATTORNEY



David J. Kyjars

Director of the United States Patent and Trademark Office

United States of America

United States Patent and Trademark Office

LOiC LEAGUE OF INDEPENDENT CONTRACTORS

Reg. No. 4,066,132

Registered Dec. 6, 2011

Int. Cl.: 35

SERVICE MARK

PRINCIPAL REGISTER

LEAGUE OF INDEPENDENT CONTRACTORS (NEW JERSEY CORPORATION)
C/O MARTIN BEARG, ESQ. P.O. BOX 2027
LIVINGSTON, NJ 07079

FOR: THE BRINGING TOGETHER OF A VARIETY OF GOODS AND SERVICE FOR THE BENEFIT OF MEMBERS, WHO ARE INDEPENDENT CONTRACTORS, TO ENABLE THEM TO CONVENIENTLY VIEW AND PURCHASE THOSE GOODS AND SERVICES USED BY INDEPENDENT CONTRACTORS AND SELF-EMPLOYED INDIVIDUALS, NAMELY, EDUCATION, MEDICAL BENEFITS, ENTERTAINMENT, TRAVEL, COMPUTER PROGRAMS, OFFICE SUPPLIES AND KNOWLEDGE REGARDING THE OPERATION OF A SMALL BUSINESS, IN CLASS 35 (U.S. CLS. 100, 101 AND 102).

FIRST USE 8-10-2010; IN COMMERCE 10-10-2010.

THE MARK CONSISTS OF STANDARD CHARACTERS WITHOUT CLAIM TO ANY PARTICULAR FONT, STYLE, SIZE, OR COLOR.

NO CLAIM IS MADE TO THE EXCLUSIVE RIGHT TO USE "LEAGUE OF INDEPENDENT CONTRACTORS", APART FROM THE MARK AS SHOWN.

SER. NO. 85-231,156, FILED 2-1-2011.

MICHELE SWAIN, EXAMINING ATTORNEY



David J. Kyros

Director of the United States Patent and Trademark Office

United States of America

United States Patent and Trademark Office



Reg. No. 4,066,133

Registered Dec. 6, 2011

Int. Cls.: 35 and 41

SERVICE MARK

PRINCIPAL REGISTER

ARMY NATIONAL GUARD (UNITED STATES AGENCY OF THE UNITED STATES GOVERNMENT)
111 SOUTH GEORGE MASON DRIVE
ARLINGTON, VA 222041382

FOR: ASSOCIATION SERVICES, NAMELY, PROMOTING THE INTERESTS OF MILITARY PERSONNEL WITH RESPECT TO RECRUITMENT AND RETENTION, AND PUBLIC AWARENESS OF THE NEED FOR COMMUNITY SERVICE; PROVIDING AN ON-LINE SEARCHABLE DATABASE FEATURING EMPLOYMENT OPPORTUNITIES AND CONTENT ABOUT EMPLOYMENT IN THE NATURE OF JOB APPLICATIONS, JOB APPLICATION FORMS AND EMPLOYMENT INFORMATION; PROVIDING ON-LINE EMPLOYMENT INFORMATION IN THE FIELD OF RECRUITMENT, CAREERS, JOB RESOURCES, AND PAY; PROVIDING A WEBSITE FEATURING NON-DOWNLOADABLE VIDEOS AND INFORMATION ABOUT SERVING IN THE NATIONAL GUARD FOR RECRUITMENT AND RETENTION PURPOSES, IN CLASS 35 (U.S. CLS. 100, 101 AND 102).

FIRST USE 7-0-2009; IN COMMERCE 7-0-2009.

FOR: ORGANIZATION OF COMMUNITY CULTURAL AND SPORTING EVENTS, IN CLASS 41 (U.S. CLS. 100, 101 AND 107).

FIRST USE 7-0-2009; IN COMMERCE 7-0-2009.

OWNER OF U.S. REG. NOS. 2,989,318, 3,222,325, AND 3,244,342.

THE MARK CONSISTS OF THE TERMS "NATIONAL" ABOVE THE TERM "GUARD" AND TO THE LEFT OF A GRAPHICAL DEPICTION OF A FLAG. THE BLACK BACKGROUND AND WHITE OUTLINE AROUND THE LITERAL AND DESIGN ELEMENTS OF THE MARK ARE DEPICTED FOR CONTRAST PURPOSES ONLY AND ARE NOT CLAIMED AS FEATURES OF THE MARK.

SEC. 2(F) AS TO "NATIONAL GUARD".

SER. NO. 85-231,305, FILED 2-1-2011.

MARC LEIPZIG, EXAMINING ATTORNEY



David J. Kyros

Director of the United States Patent and Trademark Office

United States of America

United States Patent and Trademark Office



Reg. No. 4,066,134

Registered Dec. 6, 2011

Int. Cls.: 35, 38 and 41

SERVICE MARK

PRINCIPAL REGISTER

ARMY NATIONAL GUARD (UNITED STATES AGENCY OF THE UNITED STATES GOVERNMENT)
111 SOUTH GEORGE MASON DRIVE
ARLINGTON, VA 222041382

FOR: ASSOCIATION SERVICES, NAMELY, PROMOTING THE INTERESTS OF MILITARY PERSONNEL WITH RESPECT TO RECRUITMENT AND RETENTION, AND PUBLIC AWARENESS OF THE NEED FOR COMMUNITY SERVICE; PROVIDING AN ON-LINE SEARCHABLE DATABASE FEATURING EMPLOYMENT OPPORTUNITIES AND CONTENT ABOUT EMPLOYMENT IN THE NATURE OF JOB APPLICATIONS, JOB APPLICATION FORMS AND EMPLOYMENT INFORMATION; PROVIDING ON-LINE EMPLOYMENT INFORMATION IN THE FIELD OF RECRUITMENT, CAREERS, JOB RESOURCES, AND PAY; PROVIDING A WEBSITE FEATURING NON-DOWNLOADABLE VIDEOS AND INFORMATION ABOUT SERVING IN THE NATIONAL GUARD FOR RECRUITMENT AND RETENTION PURPOSES, IN CLASS 35 (U.S. CLS. 100, 101 AND 102).

FIRST USE 9-0-2007; IN COMMERCE 9-0-2007.

FOR: PROVIDING ON-LINE FORUMS, ELECTRONIC BULLETIN BOARDS AND ON-LINE CHAT ROOMS FOR TRANSMISSION OF MESSAGES AMONG COMPUTER USERS IN THE FIELD OF ISSUES AND STORIES REGARDING INVOLVEMENT, RECRUITING AND RETENTION IN THE NATIONAL GUARD, IN CLASS 38 (U.S. CLS. 100, 101 AND 104).

FIRST USE 9-0-2007; IN COMMERCE 9-0-2007.

FOR: ORGANIZATION OF COMMUNITY CULTURAL AND SPORTING EVENTS, IN CLASS 41 (U.S. CLS. 100, 101 AND 107).

FIRST USE 9-0-2007; IN COMMERCE 9-0-2007.

OWNER OF U.S. REG. NOS. 2,989,318, 3,222,325, AND 3,244,342.

THE MARK CONSISTS OF THE TERMS "NATIONAL GUARD" TO THE LEFT OF A GRAPHICAL DEPICTION OF A FLAG. THE BLACK BACKGROUND AND WHITE OUTLINE AROUND THE LITERAL AND DESIGN ELEMENTS OF THE MARK ARE DEPICTED FOR CONTRAST PURPOSES ONLY AND ARE NOT CLAIMED AS FEATURES OF THE MARK.



David J. Kyros

Director of the United States Patent and Trademark Office

Reg. No. 4,066,134 SEC. 2(F) AS TO "NATIONAL GUARD".

SER. NO. 85-231,382, FILED 2-1-2011.

MARC LEIPZIG, EXAMINING ATTORNEY

United States of America

United States Patent and Trademark Office

STL K-Force

Reg. No. 4,066,135

Registered Dec. 6, 2011

Int. Cl.: 9

TRADEMARK

PRINCIPAL REGISTER

DEYAF, AHMED (UNITED STATES INDIVIDUAL)
218 TRADEMARK DR
SPEEDTECH LIGHTS, INC.
BUDA, TX 78610

FOR: AUTOMOTIVE, INDUSTRIAL, CONSTRUCTION, LOCOMOTIVE, AVIATION, NAVIGATION AND MARINE SAFETY-WARNING LIGHTS, NAMELY, STROBES, ROTATING LIGHTS AND BAR LIGHTS , IN CLASS 9 (U.S. CLS. 21, 23, 26, 36 AND 38).

FIRST USE 6-23-2008; IN COMMERCE 1-14-2009.

THE MARK CONSISTS OF STANDARD CHARACTERS WITHOUT CLAIM TO ANY PARTICULAR FONT, STYLE, SIZE, OR COLOR.

OWNER OF U.S. REG. NO. 3,657,261.

SER. NO. 85-231,600, FILED 2-1-2011.

RENEE MCCRAY, EXAMINING ATTORNEY



David J. Kyffers

Director of the United States Patent and Trademark Office

United States of America

United States Patent and Trademark Office

Solatube Worldwide Sales

Reg. No. 4,066,136

Registered Dec. 6, 2011

Int. Cl.: 35

SERVICE MARK

PRINCIPAL REGISTER

SOLATUBE INTERNATIONAL, INC. (DELAWARE CORPORATION)
2210 OAKRIDGE WAY
VISTA, CA 92081

FOR: INTERNATIONAL DISTRIBUTORSHIP SERVICES FEATURING NATURAL LIGHTING SYSTEMS AND EQUIPMENT, IN CLASS 35 (U.S. CLS. 100, 101 AND 102).

FIRST USE 1-31-2011; IN COMMERCE 1-31-2011.

THE MARK CONSISTS OF STANDARD CHARACTERS WITHOUT CLAIM TO ANY PARTICULAR FONT, STYLE, SIZE, OR COLOR.

OWNER OF U.S. REG. NOS. 2,051,195, 3,035,385, AND 3,035,864.

NO CLAIM IS MADE TO THE EXCLUSIVE RIGHT TO USE "WORLDWIDE SALES", APART FROM THE MARK AS SHOWN.

SER. NO. 85-231,817, FILED 2-1-2011.

JEFFREY LOOK, EXAMINING ATTORNEY



David J. Kyfos

Director of the United States Patent and Trademark Office

United States of America

United States Patent and Trademark Office



Reg. No. 4,066,137

Registered Dec. 6, 2011

Int. Cl.: 35

SERVICE MARK

PRINCIPAL REGISTER

ARMY NATIONAL GUARD (UNITED STATES AGENCY OF THE UNITED STATES GOVERNMENT)
111 SOUTH GEORGE MASON DRIVE
ARLINGTON, VA 222041382

FOR: ASSOCIATION SERVICES, NAMELY, PROMOTING THE INTERESTS OF MILITARY PERSONNEL WITH RESPECT TO RECRUITMENT AND RETENTION, AND PUBLIC AWARENESS OF THE NEED FOR COMMUNITY SERVICE; PROVIDING AN ON-LINE SEARCHABLE DATABASE FEATURING EMPLOYMENT OPPORTUNITIES AND CONTENT ABOUT EMPLOYMENT IN THE NATURE OF JOB APPLICATIONS, JOB APPLICATION FORMS AND EMPLOYMENT INFORMATION; PROVIDING ON-LINE EMPLOYMENT INFORMATION IN THE FIELD OF RECRUITMENT, CAREERS, JOB RESOURCES, AND PAY, IN CLASS 35 (U.S. CLS. 100, 101 AND 102).

FIRST USE 7-1-1996; IN COMMERCE 7-1-1996.

OWNER OF U.S. REG. NOS. 2,920,854, 3,244,342 AND OTHERS.

THE MARK CONSISTS OF THE TERM "ARMY" IN A BAR AND IN VERTICAL FORM TO THE LEFT OF THE TERMS "NATIONAL GUARD", WHICH ARE ABOVE THE TERMS "YOU CAN" AND WITH A SMALL GRAPHICAL DEPICTION OF A FLAG IN THE UPPER RIGHT HAND CORNER, AND WITH A BACKGROUND DESIGN THAT CONSISTS OF SMALL BARS AND SHADING.

SEC. 2(F) AS TO "NATIONAL GUARD".

SER. NO. 85-231,979, FILED 2-2-2011.

MARC LEIPZIG, EXAMINING ATTORNEY



David J. Kypos

Director of the United States Patent and Trademark Office

United States of America

United States Patent and Trademark Office



Reg. No. 4,066,138

Registered Dec. 6, 2011

Int. Cl.: 35

SERVICE MARK

PRINCIPAL REGISTER

NEW AUTO ONE COMPANY, INC. (MICHIGAN CORPORATION)
9981 E. GRAND RIVER
BRIGHTON, MI 48116

FOR: RETAIL STORE SERVICES FEATURING AUTO GLASS REPAIR KITS, TRAILER HITCH AND ACCESSORIES, AUTOMOTIVE ACCESSORIES, AUTOMOTIVE DETAILING KITS, ELECTRONICS, WINDOW TINTING KITS, AND GPS NAVIGATION UNITS, IN CLASS 35 (U.S. CLS. 100, 101 AND 102).

FIRST USE 8-27-2008; IN COMMERCE 8-27-2008.

OWNER OF U.S. REG. NOS. 1,652,611 AND 3,049,133.

NO CLAIM IS MADE TO THE EXCLUSIVE RIGHT TO USE "AUTO", APART FROM THE MARK AS SHOWN.

THE MARK CONSISTS OF THE WORDS "AUTO ONE" IN FRONT OF THE NUMBER "1" INSIDE A SHADED RECTANGLE WITH SINGLE LINE RECTANGLE AROUND ALL.

SER. NO. 85-232,324, FILED 2-2-2011.

KELLY BOULTON, EXAMINING ATTORNEY



David J. Kyros

Director of the United States Patent and Trademark Office

United States of America

United States Patent and Trademark Office

OLD SCHOOL DIPLOMA FRAME CO.

Reg. No. 4,066,139

Registered Dec. 6, 2011

Int. Cl.: 20

TRADEMARK

PRINCIPAL REGISTER

JKHM CORP. (CALIFORNIA CORPORATION)
1703 KELTON AVENUE
LOS ANGELES, CA 90024

FOR: DIPLOMA FRAMES, IN CLASS 20 (U.S. CLS. 2, 13, 22, 25, 32 AND 50).

FIRST USE 12-16-2009; IN COMMERCE 12-16-2009.

THE MARK CONSISTS OF STANDARD CHARACTERS WITHOUT CLAIM TO ANY PARTICULAR FONT, STYLE, SIZE, OR COLOR.

NO CLAIM IS MADE TO THE EXCLUSIVE RIGHT TO USE "DIPLOMA FRAME CO.", APART FROM THE MARK AS SHOWN.

SER. NO. 85-232,376, FILED 2-2-2011.

NELSON SNYDER, EXAMINING ATTORNEY



David J. Kyffers

Director of the United States Patent and Trademark Office

United States of America

United States Patent and Trademark Office

SALUDABLE SLIM

Reg. No. 4,066,140

Registered Dec. 6, 2011

Int. Cl.: 5

TRADEMARK

PRINCIPAL REGISTER

DANTANA SLIM CORP. (NEW YORK CORPORATION)
818 REGENT DR.
WESTBURY, NY 11590

FOR: DIETARY AND NUTRITIONAL SUPPLEMENTS USED FOR WEIGHT LOSS, IN CLASS 5 (U.S. CLS. 6, 18, 44, 46, 51 AND 52).

FIRST USE 6-0-2006; IN COMMERCE 6-0-2006.

THE MARK CONSISTS OF STANDARD CHARACTERS WITHOUT CLAIM TO ANY PARTICULAR FONT, STYLE, SIZE, OR COLOR.

NO CLAIM IS MADE TO THE EXCLUSIVE RIGHT TO USE "SLIM", APART FROM THE MARK AS SHOWN.

THE ENGLISH TRANSLATION OF "SALUDABLE" IN THE MARK IS "HEALTHY".

SEC. 2(F).

SER. NO. 85-232,507, FILED 2-2-2011.

SALLY SHIH, EXAMINING ATTORNEY



David J. Kybas

Director of the United States Patent and Trademark Office

United States of America

United States Patent and Trademark Office



Reg. No. 4,066,141

Registered Dec. 6, 2011

Int. Cl.: 40

SERVICE MARK

PRINCIPAL REGISTER

PIONEER HI-BRED INTERNATIONAL, INC. (IOWA CORPORATION)
P.O. BOX 1014
7100 NW 62ND AVENUE
JOHNSTON, IA 501311014

FOR: AGRICULTURAL SERVICES, NAMELY, SEED TREATMENT, NAMELY, THE APPLICATION OF INSECT IDES, FUNGICIDES, NEMATICIDES AND POLYMER SEED COATINGS ON SEED, IN CLASS 40 (U.S. CLS. 100, 103 AND 106).

FIRST USE 12-0-2009; IN COMMERCE 12-0-2009.

OWNER OF U.S. REG. NOS. 770,971, 1,312,705 AND OTHERS.

NO CLAIM IS MADE TO THE EXCLUSIVE RIGHT TO USE "PREMIUM SEED TREATMENT", APART FROM THE MARK AS SHOWN.

THE MARK CONSISTS OF A CIRCLE DESIGN WITH A CIRCULAR BORDER WITH THE TERM "PIONEER" INSIDE THE INNER CIRCLE ABOVE A RECTANGULAR SHAPED BAR CONTAINING THE TERM "PREMIUM" WITH THE WORDING "SEED TREATMENT" BELOW IT.

SER. NO. 85-232,551, FILED 2-2-2011.

LINDSEY RUBIN, EXAMINING ATTORNEY



David J. Kybas

Director of the United States Patent and Trademark Office

United States of America

United States Patent and Trademark Office

DESTINATION: RETIREMENT INCOME

Reg. No. 4,066,142

Registered Dec. 6, 2011

Int. Cl.: 36

SERVICE MARK

PRINCIPAL REGISTER

THE PRUDENTIAL INSURANCE COMPANY OF AMERICA (NEW JERSEY CORPORATION)
751 BROAD STREET
NEWARK, NJ 07102

FOR: ANNUITIES BROKERAGE SERVICES; UNDERWRITING AND INVESTMENT MANAGEMENT OF ANNUITIES AND DEFINED CONTRIBUTION PLANS; INVESTMENT MANAGEMENT AND ADVISORY SERVICES; ADMINISTRATION OF EMPLOYEE RETIREMENT PLANS; RETIREMENT PLANNING SERVICES; ESTATE PLANNING SERVICES; INSURANCE UNDERWRITING, ADMINISTRATION AND AGENCY SERVICES IN THE FIELDS OF LIFE, LONG TERM CARE AND DISABILITY INSURANCE; PROVIDING INSURANCE AND FINANCIAL INFORMATION AND RESEARCH BY MEANS OF A GLOBAL COMPUTER NETWORK, IN CLASS 36 (U.S. CLS. 100, 101 AND 102).

FIRST USE 1-24-2011; IN COMMERCE 1-24-2011.

THE MARK CONSISTS OF STANDARD CHARACTERS WITHOUT CLAIM TO ANY PARTICULAR FONT, STYLE, SIZE, OR COLOR.

NO CLAIM IS MADE TO THE EXCLUSIVE RIGHT TO USE "RETIREMENT INCOME", APART FROM THE MARK AS SHOWN.

SER. NO. 85-233,313, FILED 2-3-2011.

RAUL CORDOVA, EXAMINING ATTORNEY



David J. Kyjars

Director of the United States Patent and Trademark Office

United States of America

United States Patent and Trademark Office

EIS

Reg. No. 4,066,143

Registered Dec. 6, 2011

Int. Cl.: 41

SERVICE MARK

PRINCIPAL REGISTER

MURPHY, LILITH (UNITED STATES INDIVIDUAL)
323 EAST MATILJA STREET, SUITE 110-275
OJAI, CA 93023

FOR: EDUCATIONAL SERVICES, NAMELY, PROVIDING COURSES IN THE FIELD OF MUSIC, MUSIC THEORY AND MUSIC COMPOSITION AND DISTRIBUTION OF COURSE MATERIALS IN CONNECTION THEREWITH; BOOK PUBLISHING, IN CLASS 41 (U.S. CLS. 100, 101 AND 107).

FIRST USE 0-0-1978; IN COMMERCE 0-0-1978.

THE MARK CONSISTS OF STANDARD CHARACTERS WITHOUT CLAIM TO ANY PARTICULAR FONT, STYLE, SIZE, OR COLOR.

SER. NO. 85-233,885, FILED 2-3-2011.

HAI-LY LAM, EXAMINING ATTORNEY



David J. Kybas

Director of the United States Patent and Trademark Office

United States of America

United States Patent and Trademark Office

RazzyRoo Headbands

Reg. No. 4,066,144

Registered Dec. 6, 2011

Int. Cl.: 25

TRADEMARK

PRINCIPAL REGISTER

CHERYL F. WOODS (NEW MEXICO SOLE PROPRIETORSHIP), DBA RAZZYROO
HEADBANDS
704 ANASAZI
AZTEC, NM 87410

FOR: HEADBANDS, IN CLASS 25 (U.S. CLS. 22 AND 39).

FIRST USE 1-1-2010; IN COMMERCE 10-1-2010.

THE MARK CONSISTS OF STANDARD CHARACTERS WITHOUT CLAIM TO ANY PARTICULAR FONT, STYLE, SIZE, OR COLOR.

NO CLAIM IS MADE TO THE EXCLUSIVE RIGHT TO USE "HEADBANDS", APART FROM THE MARK AS SHOWN.

SER. NO. 85-233,921, FILED 2-3-2011.

JIM RINGLE, EXAMINING ATTORNEY



David J. Kybas

Director of the United States Patent and Trademark Office

United States of America

United States Patent and Trademark Office

Q-Wear When Ordinary Just Won't Do

Reg. No. 4,066,145

Registered Dec. 6, 2011

Int. Cl.: 25

TRADEMARK

PRINCIPAL REGISTER

Q-WEAR (CALIFORNIA CORPORATION), DBA Q-WEAR
2433 S. RODEO RD
LOS ANGELES, CA 90018

FOR: ANKLE SOCKS; APPAREL FOR DANCERS, NAMELY, TEE SHIRTS, SWEATSHIRTS, PANTS, LEGGINGS, SHORTS AND JACKETS; ATHLETIC APPAREL, NAMELY, SHIRTS, PANTS, JACKETS, FOOTWEAR, HATS AND CAPS, ATHLETIC UNIFORMS; ATHLETIC FOOTWEAR; ATHLETIC SHOES; ATHLETIC TIGHTS; ATHLETIC UNIFORMS; BASEBALL SHOES; BASKETBALL SNEAKERS; BATHING SUITS; BATHING SUITS FOR MEN; BERMUDA SHORTS; BIB SHORTS; BOARD SHORTS; BODY SHIRTS; BODY SUITS; BOMBER JACKETS; BOXER SHORTS; BRIEFS; BUTTON DOWN SHIRTS; BUTTON-FRONT ALOHA SHIRTS; CAMOUFLAGE JACKETS; CAMOUFLAGE PANTS; CAMOUFLAGE SHIRTS; CANVAS SHOES; CAPRI PANTS; CARGO PANTS; CHILDREN'S AND INFANT'S APPAREL, NAMELY, JUMPERS, OVERALL SLEEPWEAR, PAJAMAS, ROMPERS AND ONE-PIECE GARMENTS; CHILDREN'S AND INFANTS' APPAREL TREATED WITH FIRE AND HEAT RETARDANTS, NAMELY, JUMPERS, OVERALL SLEEPWEAR, PAJAMAS, ROMPERS AND ONE-PIECE GARMENTS; CHILDREN'S HEADWEAR; COATS; COLLARED SHIRTS; COMPRESSION GARMENTS FOR ATHLETIC OR OTHER NON-MEDICAL USE, NAMELY, LEGGINGS, AND JERSEYS; CYCLING SHOES; CYCLING SHORTS; DENIM JACKETS; DENIMS; DRY SUITS; DUST COATS; FLEECE SHORTS; FOOTBALL SHOES; FOOTWEAR FOR TRACK AND FIELD ATHLETICS; GOLF PANTS, SHIRTS AND SKIRTS; GOLF SHIRTS; GOLF SHOES; GOLF SHORTS; GYM PANTS; GYM SHORTS; GYM SUITS; GYMNASTIC SHOES; HOODED SWEAT SHIRTS; INFANT WEAR; INFANTS' SHOES AND BOOTS; IN-SOLES; JEANS; JOGGING PANTS; JOGGING SUITS; JUMP SUITS; KNIT SHIRTS; KNITTED UNDERWEAR; LADIES' UNDERWEAR; LEATHER COATS; LEATHER HEADWEAR; LEATHER JACKETS; LEATHER SHOES; LEISURE SUITS; LIGHT-REFLECTING COATS; LONG UNDERWEAR; LONG-SLEEVED SHIRTS; LOUNGE PANTS; TROUSERS, VESTS; MEN'S DRESS SOCKS; MEN'S SOCKS; MEN'S SUITS; MEN'S SUITS, MEN'S UNDERWEAR; MOISTURE-WICKING SPORTS PANTS; MOISTURE-WICKING SPORTS SHIRTS; MORNING COATS; ONE-PIECE PLAY SUITS; OPEN-NECKED SHIRTS; POLO SHIRTS; RAIN COATS; RAIN JACKETS; RAIN SUITS; RAIN WEAR; RUNNING SHOES; RUNNING SUITS; SHIRTS FOR SUITS; SHOES WITH HOOK AND PILE FASTENING TAPES; SHORT-SLEEVED OR LONG-SLEEVED T-SHIRTS; SHORT-SLEEVED SHIRTS; SKI AND SNOWBOARD SHOES AND PARTS THEREOF; SKI BIBS; SKI BOOT BAGS; SKI BOOT CASES; SKI BOOTS; SKI GLOVES; SKI JACKETS; SKI MASKS; SKI PANTS; SKI SUITS; SKI SUITS FOR COMPETITION; SKI TROUSERS; SKI WEAR; SKIING SHOES; SKIRT SUITS; SKIRTS; SKIWEAR; SNEAKERS; SNOWBOARDING SUITS; SNOW PANTS; SNOW SUITS; SNOWBOARD



David J. Kyros

Director of the United States Patent and Trademark Office

Reg. No. 4,066,145 JACKETS; SNOWBOARD PANTS; SOCCER SHOES; SPORT COATS; SPORT SHIRTS; SPORTS JACKETS; SPORTS PANTS; SPORTS SHIRTS; SPORTS SHIRTS WITH SHORT SLEEVES; STRETCH PANTS; SURF WEAR; SWEAT JACKETS; SWEAT PANTS; SWEAT SHIRTS; SWEAT SHORTS; SWEAT SUITS; SWIM WEAR; SWIM WEAR FOR GENTLEMEN AND LADIES; SWIMMING CAPS; T-SHIRTS FOR MEN, WOMEN, AND CHILDREN; TENNIS DRESSES; TENNIS SHOES; TENNIS WEAR; THERMAL UNDERWEAR; TRACK AND FIELD SHOES; TRACK JACKETS; TRACK PANTS; TRACK SUITS; TRAINING SHOES; TRAINING SUITS; TRENCH COATS; TRIATHLON CLOTHING, NAMELY, TRIATHLON TIGHTS, TRIATHLON SHORTS, TRIATHLON SHIRTS, TRIATHLON SUITS; TURTLE NECK SHIRTS; UNDERWEAR; VESTED SUITS; VOLLEYBALL SHOES; WET SUIT GLOVES; WET SUITS; WET SUITS FOR WATER-SKIING AND SUB-AQUA; WETSUITS FOR WATER-SKIING; WIND COATS; WIND PANTS; WOMEN'S ATHLETIC TOPS WITH BUILT-IN BRAS; WORK SHOES AND BOOTS; YOGA PANTS; YOGA SHIRTS, IN CLASS 25 (U.S. CLS. 22 AND 39).

FIRST USE 10-10-2006; IN COMMERCE 10-10-2006.

THE MARK CONSISTS OF STANDARD CHARACTERS WITHOUT CLAIM TO ANY PARTICULAR FONT, STYLE, SIZE, OR COLOR.

SER. NO. 85-233,934, FILED 2-4-2011.

ANNE E. GUSTASON, EXAMINING ATTORNEY

United States of America

United States Patent and Trademark Office

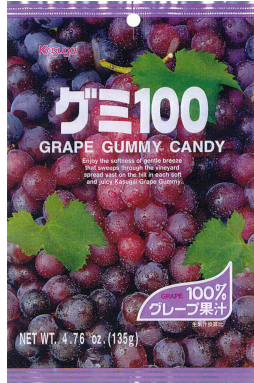

Reg. No. 4,066,146

Registered Dec. 6, 2011

Int. Cl.: 30

TRADEMARK

PRINCIPAL REGISTER

KASUGAI SEIKA CO., LTD. (JAPAN CORPORATION)
1-6-10 HANANOKI, NISHI-KU, NAGOYA-SHI
AICHI-KEN, JAPAN

FOR: GUMMY CANDIES, IN CLASS 30 (U.S. CL. 46).

FIRST USE 9-1-1990; IN COMMERCE 9-1-1990.

OWNER OF U.S. REG. NOS. 3,693,123 AND 3,693,124.

THE COLOR(S) PINK, PURPLE, RED, GREEN, SILVER AND WHITE IS/ARE CLAIMED AS A FEATURE OF THE MARK.

NO CLAIM IS MADE TO THE EXCLUSIVE RIGHT TO USE "GRAPE GUMMY CANDY", "GRAPE", "100%", "NET WT. 4.76 OZ. (135G)", THE NON-LATIN CHARACTERS THAT TRANSLITERATE TO "GUMI", "GUREEPU KAJU", "NAMAKAJU KNAZHANI", THE PICTORIAL REPRESENTATION OF THE GRAPES, AND THE OVERALL SHAPE OF THE PRODUCT PACKAGING, APART FROM THE MARK AS SHOWN.

THE MARK CONSISTS OF THE FRONT OF A PACKAGING DESIGN WITH A PHOTOGRAPH OF PURPLE AND RED GRAPES WITH GREEN LEAVES AND STEM; THE WORDING "KASUGAI" IN PINK WITH A WHITE BORDER AT THE UPPER LEFT SUPERIMPOSED OVER THE PHOTOGRAPH; STYLIZED JAPANESE CHARACTERS AND THE WORDING "100" IN WHITE CENTERED ABOVE THE WORDING "GRAPE GUMMY CANDY" IN WHITE, CENTERED ABOVE THE WORDING "ENJOY THE SOFTNESS OF GENTLE BREEZE THAT SWEEPS THROUGH THE VINEYARD SPREAD VAST ON THE HILL IN EACH SOFT AND JUICY KASUGAI GRAPE GUMMY", IN WHITE; SILVER AND PURPLE STRIPES ARE AT THE TOP AND BOTTOM OF THE PACKAGE; AT THE LOWER RIGHT, SUPERIMPOSED OVER THE GRAPES PHOTOGRAPH, THE WORD "GRAPE" IN PINK, "100%" IN WHITE, AND JAPANESE CHARACTERS IN WHITE APPEAR ON A PURPLE BACKGROUND WITH A WHITE BORDER COMPRISING A CURVED NON-STANDARD SHAPE; BENEATH THIS ARE JAPANESE CHARACTERS IN WHITE; AND AT THE BOTTOM LEFT IS THE WEIGHT STATEMENT "NET WT. 4.76 OZ. (135G)" IN WHITE SUPERIMPOSED OVER THE GRAPES PHOTOGRAPH.



David J. Kyffers

Director of the United States Patent and Trademark Office

THE NON-LATIN CHARACTERS IN THE TOP PORTION OF THE MARK TRANSLITERATE TO "GUMI", AND THIS MEANS GUMMY IN ENGLISH. THE NON-LATIN CHARACTERS

Reg. No. 4,066,146 IN THE LOWER PORTION OF THE MARK INSIDE THE THREE-SIDED SHAPE TRANSLITERATE TO "GUREEPU KAJU", AND THIS MEANS GRAPE JUICE IN ENGLISH. THE NON-LATIN CHARACTERS IN THE LOWER PORTION OF THE MARK TRANSLITERATE TO "NAMAKAJU KANZANHI", AND THIS MEANS FRESH FRUIT JUICE AND CONVERSION RATIO IN ENGLISH. THE WORDING "KASUGAI" HAS NO MEANING IN A FOREIGN LANGUAGE.

SER. NO. 85-234,211, FILED 2-4-2011.

CHRISTINE COOPER, EXAMINING ATTORNEY

United States of America

United States Patent and Trademark Office



Reg. No. 4,066,147

Registered Dec. 6, 2011

Int. Cl.: 30

TRADEMARK

PRINCIPAL REGISTER

KASUGAI SEIKA CO., LTD. (JAPAN CORPORATION)
1-6-10 HANANOKI, NISHI-KU, NAGOYA-SHI
AICHI-KEN, JAPAN

FOR: GUMMY CANDIES, IN CLASS 30 (U.S. CL. 46).

FIRST USE 9-1-1997; IN COMMERCE 9-1-1997.

OWNER OF U.S. REG. NOS. 3,693,123 AND 3,693,124.

THE COLOR(S) RED, GREEN, BLACK, SILVER, PURPLE, YELLOW, BROWN AND WHITE IS/ARE CLAIMED AS A FEATURE OF THE MARK.

THE NON-LATIN CHARACTERS IN THE MARK TRANSLITERATE TO "LAICHI GUMI" AND THIS MEANS "LYCHEE GUMMY" IN ENGLISH.

NO CLAIM IS MADE TO THE EXCLUSIVE RIGHT TO USE "LYCHEE GUMMY CANDY", "DELICIOUS AND JUICY", "NET WT. 4.41 OZ. (125G)", THE NON-LATIN CHARACTERS THAT TRANSLITERATE TO "LAICHI GUMI", THE PICTORIAL REPRESENTATION OF THE LYCHEE FRUIT, AND THE OVERALL SHAPE OF THE PRODUCT PACKAGING, APART FROM THE MARK AS SHOWN.

THE NAME "YANG GUIFEI" SHOWN IN THE MARK DOES NOT IDENTIFY A PARTICULAR LIVING INDIVIDUAL.

THE MARK CONSISTS OF THE FRONT OF A PACKAGING DESIGN WITH A PHOTOGRAPH OF RED LYCHEE FRUIT, WITH YELLOW FLESH, GREEN LEAVES AND BROWN STEMS; THE WORDING "KASUGAI" IN PURPLE ON A WHITE BACKGROUND AT THE UPPER LEFT SUPERIMPOSED OVER THE PHOTOGRAPH; STYLIZED JAPANESE CHARACTERS IN WHITE WITH A PURPLE BORDER CENTERED ABOVE THE WORDING "LYCHEE IS A FRUIT ORIGINALLY GROWN IN SOUTHERN CHINA AND SAID TO HAVE BEEN FAVORED BY YANG GUIFEI. KASUGAI'S LYCHEE GUMMIES ARE GUMMY CANDY WHICH HAS THE FLAVOR AND TEXTURE OF THE ORIGINAL FRUIT.", IN WHITE; SILVER AND PURPLE STRIPES ARE AT THE TOP AND BOTTOM OF THE PACKAGE; AT THE LOWER RIGHT, SUPERIMPOSED OVER THE LYCHEE PHOTOGRAPH, THE WORDS "LYCHEE GUMMY CANDY" IN DARK PURPLE ABOVE THE OUTLINE OF A LYCHEE FRUIT IN DARK PURPLE ABOVE THE WORDING "DELICIOUS AND JUICY" IN DARK



David J. Kyjars

Director of the United States Patent and Trademark Office

Reg. No. 4,066,147 PURPLE, ALL INSIDE A LIGHTER PURPLE ELLIPTICAL SHAPE WITH A DARK PURPLE AND WHITE BORDER; AT THE BOTTOM LEFT IS THE WEIGHT STATEMENT "NET WT. 4.41 OZ. (125G)" IN BLACK SUPERIMPOSED OVER THE LYCHEE PHOTOGRAPH.

THE WORDING "KASUGAI" HAS NO MEANING IN A FOREIGN LANGUAGE.

SER. NO. 85-234,292, FILED 2-4-2011.

CHRISTINE COOPER, EXAMINING ATTORNEY

United States of America

United States Patent and Trademark Office



Reg. No. 4,066,148

Registered Dec. 6, 2011

Int. Cl.: 30

TRADEMARK

PRINCIPAL REGISTER

KASUGAI SEIKA CO., LTD. (JAPAN CORPORATION)
1-6-10 HANANOKI, NISHI-KU, NAGOYA-SHI
AICHI-KEN, JAPAN

FOR: GUMMY CANDIES, IN CLASS 30 (U.S. CL. 46).

FIRST USE 2-1-2006; IN COMMERCE 2-1-2006.

OWNER OF U.S. REG. NOS. 3,693,123 AND 3,693,124.

THE COLOR(S) RED, GREEN, BLACK, SILVER, ORANGE, YELLOW, BROWN AND WHITE IS/ARE CLAIMED AS A FEATURE OF THE MARK.

THE NON-LATIN CHARACTERS IN THE MARK TRANSLITERATE TO "MANGOO GUMI" AND THIS MEANS "MANGO GUMMY" IN ENGLISH.

NO CLAIM IS MADE TO THE EXCLUSIVE RIGHT TO USE "MANGO GUMMY CANDY", "MANGO GUMMY", "DELICIOUS AND JUICY", "NET WT. 4.06 OZ. (115G)", THE NON-LATIN CHARACTERS THAT TRANSLITERATE TO "MANGOO GUMI", THE PICTORIAL REPRESENTATION OF THE MANGOS, AND THE OVERALL SHAPE OF THE PRODUCT PACKAGING, APART FROM THE MARK AS SHOWN.



David J. Kybas

Director of the United States Patent and Trademark Office

THE MARK CONSISTS OF THE FRONT OF A PACKAGING DESIGN WITH A PHOTOGRAPH OF ORANGE AND YELLOW MANGOS WITH A GREEN AND BROWN STEM; THE NAME "KASUGAI" IN RED ON A WHITE BACKGROUND AT THE UPPER LEFT SUPERIMPOSED OVER THE PHOTOGRAPH; STYLIZED JAPANESE CHARACTERS IN WHITE WITH A BROWN BORDER CENTERED ABOVE THE WORDING "MANGO GUMMY CANDY", IN BROWN, CENTERED ABOVE THE WORDING "MANGOS, HEALTHY FRUIT COMMONLY EATEN FOR CENTURIES, ARE NOW AVAILABLE IN THE FORM OF DELICIOUS GUMMY CANDIES. ENJOY THE TASTE OF KASUGAI MANGO GUMMY CANDIES, WHICH RETAIN THE AROMA AND FLAVOR OF FRESH MANGOS.", ALSO IN BROWN; SILVER AND BROWN STRIPES ARE AT THE TOP AND BOTTOM OF THE PACKAGE; AT THE LOWER LEFT TO THE MIDDLE, SUPERIMPOSED OVER THE MANGO PHOTOGRAPH, IS A PHOTOGRAPH OF A WHITE DISH WITH A SCALLOPED EDGE WITH A SECTION OF A YELLOW MANGO WITH CUTS ON IT; AT THE LOWER RIGHT, SUPERIMPOSED OVER THE PHOTOGRAPH, THE WORDING "MANGO GUMMY" AND THE WORDING "DELICIOUS AND JUICY" ALL IN GREEN ABOVE AND BELOW A FANCIFUL LINED DEPICTION OF

Reg. No. 4,066,148 A MANGO IN WHITE ON A YELLOW BACKGROUND IN AN ELLIPTICAL SHAPE WITH A GREEN AND SILVER BORDER; AT THE BOTTOM LEFT IS THE WEIGHT STATEMENT "NET WT. 4.06 OZ. (115G)" IN BLACK SUPERIMPOSED OVER THE PHOTOGRAPH OF THE WHITE DISH.

THE WORDING "KASUGAI" HAS NO MEANING IN A FOREIGN LANGUAGE.

SER. NO. 85-234,316, FILED 2-4-2011.

CHRISTINE COOPER, EXAMINING ATTORNEY

United States of America

United States Patent and Trademark Office

PYRDESS

Reg. No. 4,066,149

Registered Dec. 6, 2011

Int. Cls.: 5 and 10

TRADEMARK

PRINCIPAL REGISTER

BAYER AKTIENGESELLSCHAFT (FED REP GERMANY AKTIENGESELLSCHAFT)
KAISER-WILHELM ALLEE
LEVERKUSEN, FED REP GERMANY 51373

FOR: PHARMACEUTICAL PREPARATIONS, NAMELY, HORMONAL PREPARATIONS
FOR MEDICAL USE, IN CLASS 5 (U.S. CLS. 6, 18, 44, 46, 51 AND 52).

FOR: MEDICAL DEVICE, NAMELY, AN INTRAUTERINE DEVICE FOR CONTRACEPTION,
IN CLASS 10 (U.S. CLS. 26, 39 AND 44).

THE MARK CONSISTS OF STANDARD CHARACTERS WITHOUT CLAIM TO ANY PAR-
TICULAR FONT, STYLE, SIZE, OR COLOR.

OWNER OF ERPN CMNTY TM OFC REG. NO. 009140741, DATED 11-17-2010, EXPIRES 5-
31-2020.

SER. NO. 85-234,346, FILED 2-4-2011.

JULIE VEPPUMTHARA, EXAMINING ATTORNEY



David J. Kybas

Director of the United States Patent and Trademark Office

United States of America

United States Patent and Trademark Office



Reg. No. 4,066,150

Registered Dec. 6, 2011

Int. Cls.: 3 and 5

TRADEMARK

PRINCIPAL REGISTER

LABORATORIOS ZEPOL, S.A. (COSTA RICA SOCIEDAD ANONIMA (SA))
CURRIDABAT
DEL SERVICENTRO LA GALERA 75 M. AL NORTE
PROVINCIA DE SAN JOSÉ, COSTA RICA

FOR: HAND CLEANING PREPARATIONS, IN CLASS 3 (U.S. CLS. 1, 4, 6, 50, 51 AND 52).

FOR: HAND-SANITIZING PREPARATIONS, IN CLASS 5 (U.S. CLS. 6, 18, 44, 46, 51 AND 52).

PRIORITY CLAIMED UNDER SEC. 44(D) ON COSTA RICA APPLICATION NO. 2011-0000674, FILED 1-27-2011, REG. NO. 210930, DATED 7-15-2011, EXPIRES 7-15-2021.

THE COLOR(S) BLUE, SKY BLUE, AND WHITE IS/ARE CLAIMED AS A FEATURE OF THE MARK.

PRIORITY CLAIMED UNDER SEC. 44(D) ON COSTA RICA APPLICATION NO. 2011-0000675, FILED 1-27-2011, REG. NO. 210929, DATED 7-15-2011, EXPIRES 7-15-2021.

THE MARK CONSISTS OF THE WORD "ZANIZOL" IN WHITE AND OUTLINED IN SKY BLUE WITHIN A BLUE OVAL THAT GRADUALLY FADES TO SKY BLUE. THE OVAL HAS WHITE CURVED BANDS NEAR ITS TOP AND BOTTOM. THE COLOR WHITE APPEARING IN THE BACKGROUND OF THE MARK REPRESENTS TRANSPARENT AREAS AND THEREFORE IS NOT PART OF THE MARK.

THE WORDING "ZANIZOL" HAS NO MEANING IN A FOREIGN LANGUAGE.

SER. NO. 85-234,368, FILED 2-4-2011.

ANDREA K. NADELMAN, EXAMINING ATTORNEY



David J. Kybas

Director of the United States Patent and Trademark Office

United States of America

United States Patent and Trademark Office

STRIKES AGAINST CANCER

Reg. No. 4,066,151

Registered Dec. 6, 2011

Int. Cl.: 36

SERVICE MARK

PRINCIPAL REGISTER

STRIKES AGAINST CANCER (TEXAS NONPROFIT CORPORATION)
6800 COUNTY ROAD 995
MCKINNEY, TX 75071

FOR: CHARITABLE FUNDRAISING FOR CANCER RESEARCH, IN CLASS 36 (U.S. CLS. 100, 101 AND 102).

FIRST USE 12-16-2010; IN COMMERCE 12-16-2010.

THE MARK CONSISTS OF STANDARD CHARACTERS WITHOUT CLAIM TO ANY PARTICULAR FONT, STYLE, SIZE, OR COLOR.

NO CLAIM IS MADE TO THE EXCLUSIVE RIGHT TO USE "CANCER", APART FROM THE MARK AS SHOWN.

SER. NO. 85-234,765, FILED 2-4-2011.

JULIE GUTTADAURO, EXAMINING ATTORNEY



David J. Kyros

Director of the United States Patent and Trademark Office

United States of America

United States Patent and Trademark Office

NationalLink

Reg. No. 4,066,152

NATIONALLINK, INC. (CALIFORNIA CORPORATION)
2235 AUTO CENTER DRIVE
PASADENA, CA 91740

Registered Dec. 6, 2011

Int. Cls.: 35, 36 and 37

FOR: ONLINE RETAIL STORE SERVICES FEATURING AUTOMATED TELLER MACHINES, IN CLASS 35 (U.S. CLS. 100, 101 AND 102).

SERVICE MARK

FIRST USE 4-20-1994; IN COMMERCE 4-20-1994.

PRINCIPAL REGISTER

FOR: FINANCIAL SERVICES, NAMELY, PROCESSING CREDIT CARD AND DEBIT CARD TRANSACTIONS, PROCESSING ELECTRONIC FUND TRANSFERS, IN CLASS 36 (U.S. CLS. 100, 101 AND 102).

FIRST USE 4-20-1994; IN COMMERCE 4-20-1994.

FOR: REPAIR AND MAINTENANCE SERVICES FOR AUTOMATED TELLER MACHINES (ATM), IN CLASS 37 (U.S. CLS. 100, 103 AND 106).

FIRST USE 4-20-1994; IN COMMERCE 4-20-1994.

THE MARK CONSISTS OF STANDARD CHARACTERS WITHOUT CLAIM TO ANY PARTICULAR FONT, STYLE, SIZE, OR COLOR.

SER. NO. 85-234,857, FILED 2-4-2011.

ANTHONY RINKER, EXAMINING ATTORNEY



David J. Kybas

Director of the United States Patent and Trademark Office

United States of America

United States Patent and Trademark Office



Reg. No. 4,066,153

Registered Dec. 6, 2011

Int. Cl.: 25

TRADEMARK

PRINCIPAL REGISTER

LORNA GOMEZ (UNITED STATES INDIVIDUAL)
3462 CEDAR MOUNTAIN STREET
LAS VEGAS, NV 89117

FOR: APPAREL FOR DANCERS, NAMELY, TEE SHIRTS, SWEATSHIRTS, PANTS, LEGGINGS, SHORTS AND JACKETS; ATHLETIC APPAREL, NAMELY, SHIRTS, PANTS, JACKETS, FOOTWEAR, HATS AND CAPS, ATHLETIC UNIFORMS; BALLOON PANTS; BERMUDA SHORTS; BLAZERS; BOMBER JACKETS; BUTTON DOWN SHIRTS; CAMOUFLAGE JACKETS; CAMOUFLAGE PANTS; CAPRI PANTS; CARGO PANTS; COATS; COATS FOR MEN AND WOMEN; COATS MADE OF COTTON; COATS OF DENIM; COLLARED SHIRTS; CREW NECK SWEATERS; DENIM JACKETS; DENIMS; DOWN JACKETS; DRESS PANTS; DRESS SHIRTS; DRESS SUITS; DRESSES; EVENING DRESSES; FISHERMEN'S JACKETS; FISHING SHIRTS; FUR COATS; FUR COATS AND JACKETS; FUR JACKETS; GOLF PANTS, SHIRTS AND SKIRTS; GOLF SHIRTS; GYM PANTS; GYM SHORTS; HEAD SCARVES; HEAVY COATS; HEAVY JACKETS; HOODED SWEAT SHIRTS; HUNTING JACKETS; HUNTING PANTS; HUNTING SHIRTS; JACKET LINERS; JACKETS; JACKETS AND SOCKS; JEANS; JEGGINGS, NAMELY, PANTS THAT ARE PARTIALLY JEANS AND PARTIALLY LEGGINGS; JOGGING PANTS; JUMPER DRESSES; KNIT DRESSES; KNIT JACKETS; KNIT SHIRTS; KNIT SKIRTS; LEATHER COATS; LEATHER JACKETS; LEATHER PANTS; LEATHER SHIRTS; LEATHER SKIRTS; LEGGINGS; LIGHT-REFLECTING JACKETS; LONG JACKETS; LONG-SLEEVED SHIRTS; LOUNGE PANTS; MEN'S AND WOMEN'S JACKETS, COATS, TROUSERS, VESTS; MEN'S DRESS SOCKS; MOCK TURTLE-NECK SWEATERS; MOISTURE-WICKING SPORTS PANTS; MOISTURE-WICKING SPORTS SHIRTS; MOTORCYCLE JACKETS; NIGHT SHIRTS; OPEN-NECKED SHIRTS; OUTER JACKETS; OVER COATS; OVER SHIRTS; PADDED JACKETS; PANTIES, SHORTS AND BRIEFS; PANTS; PIQUE SHIRTS; POLO SHIRTS; RAIN COATS; RAIN JACKETS; RAIN-PROOF JACKETS; REVERSIBLE JACKETS; RIDING COATS; RUGBY SHIRTS; SCARVES; SHELL JACKETS; SHIRT FRONTS; SHIRT INSERTS, NAMELY, DICKIES; SHIRTS; SHIRTS AND SHORT-SLEEVED SHIRTS; SHIRTS AND SLIPS; SHIRTS FOR INFANTS, BABIES, TODDLERS AND CHILDREN; SHIRTS FOR SUITS; SHORT SETS; SHORT TROUSERS; SHORT-SLEEVED OR LONG-SLEEVED T-SHIRTS; SHORT-SLEEVED SHIRTS; SHOULDER SCARVES; SILK SCARVES; SKI JACKETS; SKI PANTS; SKIRT SUITS; SKIRTS; SKIRTS AND DRESSES; SLEEP PANTS; SLEEP SHIRTS; SLEEVED OR SLEEVELESS JACKETS; SLEEVES WORN SEPARATE AND APART FROM BLOUSES, SHIRTS AND OTHER TOPS; SMOKING JACKETS; SNOW PANTS; SNOWBOARD JACKETS; SNOWBOARD PANTS; SOCKS; SPORT COATS; SPORT SHIRTS; SPORTS JACKETS; SPORTS PANTS; SPORTS SHIRTS; SPORTS SHIRTS WITH SHORT SLEEVES; STRETCH PANTS; STUFF JACKETS;



David J. Kybas

Director of the United States Patent and Trademark Office

Reg. No. 4,066,153 SUEDE JACKETS; SUIT COATS; SWEAT JACKETS; SWEAT PANTS; SWEAT SHIRTS; SWEAT SHORTS; SWEATERS; T-SHIRTS; TAP PANTS; TEE SHIRTS; TENNIS DRESSES; TOBOGGAN HATS, PANTS AND CAPS; TRACK JACKETS; TRACK PANTS; TRAVEL CLOTHING CONTAINED IN A PACKAGE COMPRISING REVERSIBLE JACKETS, PANTS, SKIRTS, TOPS AND A BELT OR SCARF; TRENCH COATS; TROUSERS; TURTLE NECK SHIRTS; TURTLENECK SWEATERS; UNDERWEAR, NAMELY, BOY SHORTS; V-NECK SWEATERS; WALKING SHORTS; WATERPROOF JACKETS AND PANTS; WEARABLE GARMENTS AND CLOTHING, NAMELY, SHIRTS; WEDDING DRESSES; WIND COATS; WIND PANTS; WIND RESISTANT JACKETS; WIND SHIRTS; WIND-JACKETS; WOMEN'S CLOTHING, NAMELY, SHIRTS, DRESSES, SKIRTS, BLOUSES; WOVEN DRESSES; WOVEN SKIRTS; YOGA PANTS; YOGA SHIRTS, IN CLASS 25 (U.S. CLS. 22 AND 39).

FIRST USE 1-1-2011; IN COMMERCE 1-1-2011.

THE MARK CONSISTS OF LOWER CASE LETTERS OF "E" AND "X" FOLLOWED BY AN ASTERISK SYMBOL (*) THEN FOLLOWED BY, IN LOWER CASE LETTERS, THE WORD "PATRIATE".

SER. NO. 85-235,219, FILED 2-6-2011.

LESLEY LAMOTHE, EXAMINING ATTORNEY

United States of America

United States Patent and Trademark Office

FITsanity

Reg. No. 4,066,154

Registered Dec. 6, 2011

Int. Cl.: 41

SERVICE MARK

PRINCIPAL REGISTER

FITSANITY LLC (NEVADA LIMITED LIABILITY COMPANY)
4575 S. DEAN MARTIN DR. UNIT 2903
LAS VEGAS, NV 89103

FOR: PROVIDING ASSISTANCE, PERSONAL TRAINING AND PHYSICAL FITNESS CONSULTATION TO INDIVIDUALS TO HELP THEM MAKE PHYSICAL FITNESS, STRENGTH, CONDITIONING, AND EXERCISE IMPROVEMENT IN THEIR DAILY LIVING, IN CLASS 41 (U.S. CLS. 100, 101 AND 107).

FIRST USE 12-13-2009; IN COMMERCE 12-13-2009.

THE MARK CONSISTS OF STANDARD CHARACTERS WITHOUT CLAIM TO ANY PARTICULAR FONT, STYLE, SIZE, OR COLOR.

SER. NO. 85-235,239, FILED 2-6-2011.

PRISCILLA MILTON, EXAMINING ATTORNEY



David J. Kyros

Director of the United States Patent and Trademark Office

United States of America

United States Patent and Trademark Office

The Striped Pandas

Reg. No. 4,066,155

Registered Dec. 6, 2011

Int. Cl.: 9

TRADEMARK

PRINCIPAL REGISTER

HOFFMAN, BRIAN H (UNITED STATES INDIVIDUAL)
24 BARNFIELD CT
UPPER SADDLE RIVER, NJ 07458

FOR: DOWNLOADABLE MULTIMEDIA FILES CONTAINING ARTWORK, TEXT, AUDIO, VIDEO, GAMES AND INTERNET WEB LINKS RELATING TO A MUSICAL GROUP, IN CLASS 9 (U.S. CLS. 21, 23, 26, 36 AND 38).

FIRST USE 10-15-2010; IN COMMERCE 10-28-2010.

THE MARK CONSISTS OF STANDARD CHARACTERS WITHOUT CLAIM TO ANY PARTICULAR FONT, STYLE, SIZE, OR COLOR.

SER. NO. 85-235,435, FILED S.R. 2-7-2011 AM. P.R. 7-26-2011.

WARREN L. OLANDRIA, EXAMINING ATTORNEY



David J. Kybas

Director of the United States Patent and Trademark Office

United States of America

United States Patent and Trademark Office

EX*PATRIATE

Reg. No. 4,066,156

Registered Dec. 6, 2011

Int. Cl.: 25

TRADEMARK

PRINCIPAL REGISTER

LORNA GOMEZ (UNITED STATES INDIVIDUAL)
3462 CEDAR MOUNTAIN STREET
LAS VEGAS, NV 89117

FOR: BLAZERS; BUTTON DOWN SHIRTS; COLLARED SHIRTS; CREW NECK SWEATERS; DRESS SHIRTS; HOODED SWEAT SHIRTS; JACKETS; OVER COATS; PANTS; RAIN COATS; SCARVES; SHIRTS; SHIRTS AND SHORT-SLEEVED SHIRTS; SHORT TROUSERS; SHORTS; SKIRTS; SKIRTS AND DRESSES; SLEEVED OR SLEEVELESS JACKETS; SPORT COATS; SUIT COATS; SWEAT SHIRTS; SWEATERS; T-SHIRTS; TRENCH COATS; TROUSERS; TURTLENECK SWEATERS; V-NECK SWEATERS; VESTS; WOMEN'S CLOTHING, NAMELY, SHIRTS, DRESSES, SKIRTS, BLOUSES; WOVEN DRESSES, IN CLASS 25 (U.S. CLS. 22 AND 39).

FIRST USE 1-1-2011; IN COMMERCE 1-1-2011.

THE MARK CONSISTS OF STANDARD CHARACTERS WITHOUT CLAIM TO ANY PARTICULAR FONT, STYLE, SIZE, OR COLOR.

SER. NO. 85-235,671, FILED 2-7-2011.

LESLEY LAMOTHE, EXAMINING ATTORNEY



David J. Kypos

Director of the United States Patent and Trademark Office

United States of America

United States Patent and Trademark Office

NAK

Reg. No. 4,066,157

Registered Dec. 6, 2011

Int. Cl.: 37

SERVICE MARK

PRINCIPAL REGISTER

NAK CONSTRUCTION SERVICES LLC (GEORGIA LIMITED LIABILITY COMPANY), AKA
NAK KILN SERVICES; NAK KILN & DRYER SERVICES
5078 BRISTOL INDUSTRIAL WAY, SUITE 100
BUFORD, GA 30518

FOR: KILN MAINTENANCE AND REPAIR SERVICES, IN CLASS 37 (U.S. CLS. 100, 103
AND 106).

FIRST USE 0-0-1985; IN COMMERCE 0-0-1985.

THE MARK CONSISTS OF STANDARD CHARACTERS WITHOUT CLAIM TO ANY PAR-
TICULAR FONT, STYLE, SIZE, OR COLOR.

SER. NO. 85-236,125, FILED 2-7-2011.

RONALD MCMORROW, EXAMINING ATTORNEY



David J. Kybas

Director of the United States Patent and Trademark Office

United States of America

United States Patent and Trademark Office



Reg. No. 4,066,158

Registered Dec. 6, 2011

Int. Cl.: 44

SERVICE MARK

PRINCIPAL REGISTER

MARGARET LEE (UNITED STATES INDIVIDUAL)
10523 AMBERWOOD LANE
NORTHRIDGE, CA 913263941 AND

SUSU YANG (UNITED STATES INDIVIDUAL)
10523 AMBERWOOD LANE
NORTHRIDGE, CA 913263941

FOR: BEAUTY ANALYSIS TO DETERMINE COSMETICS THAT ARE BEST SUITED TO PARTICULAR INDIVIDUALS; BEAUTY CONSULTATION SERVICES; BEAUTY CONSULTATION SERVICES IN THE SELECTION AND USE OF COSMETICS, FRAGRANCES, BEAUTY AIDS, PERSONAL CARE PRODUCTS, AND BATH, BODY AND BEAUTY PRODUCTS; BEAUTY SPA SERVICES, NAMELY, COSMETIC BODY CARE; COSMETIC BODY CARE SERVICES; COSMETIC BODY CARE SERVICES IN THE NATURE OF BODY WRAPS; COSMETIC FACE CARE SERVICES; COSMETIC SKIN CARE SERVICES; HEALTH SPA SERVICES FOR HEALTH AND WELLNESS OF THE BODY AND SPIRIT, NAMELY, PROVIDING MASSAGE, FACIAL AND BODY TREATMENT SERVICES, COSMETIC BODY CARE SERVICES; HEALTH SPA SERVICES, NAMELY, COSMETIC BODY CARE SERVICES; MEDICAL SPA SERVICES, NAMELY, MINIMALLY AND NON-INVASIVE COSMETIC AND BODY FITNESS THERAPIES, IN CLASS 44 (U.S. CLS. 100 AND 101).

FIRST USE 9-20-2004; IN COMMERCE 9-20-2004.

NO CLAIM IS MADE TO THE EXCLUSIVE RIGHT TO USE THE NON-LATIN CHARACTERS THAT TRANSLITERATE TO QIAN OR XIAN, APART FROM THE MARK AS SHOWN.

THE MARK CONSISTS OF STYLIZED NON-LATIN CHARACTERS THAT TRANSLITERATE TO "QIAN ZI TANG" OR "XIAN ZI TANG" WITH "QIAN" OR "XIAN" TRANSLATES AS "FIBER" OR "SLIM", "ZI" TRANSLATES AS "STYLE", AND "TANG" TRANSLATES AS "HALL." THERE IS A CIRCLE BORDER SURROUNDING THE NON-LATIN CHARACTER SHOWN ON THE BOTTOM.

SER. NO. 85-236,209, FILED 2-7-2011.

LINDA ESTRADA, EXAMINING ATTORNEY



David J. Kybas

Director of the United States Patent and Trademark Office

United States of America

United States Patent and Trademark Office

NAK

Reg. No. 4,066,159

Registered Dec. 6, 2011

Int. Cl.: 37

SERVICE MARK

PRINCIPAL REGISTER

NAK CONSTRUCTION SERVICES LLC (GEORGIA LIMITED LIABILITY COMPANY), AKA
NAK KILN SERVICES; NAK KILN & DRYER SERVICES
5078 BRISTOL INDUSTRIAL WAY, SUITE 100
BUFORD, GA 30518

FOR: KILN MAINTENANCE AND REPAIR SERVICES, IN CLASS 37 (U.S. CLS. 100, 103
AND 106).

FIRST USE 0-0-1985; IN COMMERCE 0-0-1985.

THE MARK CONSISTS OF STYLIZED LETTERS "N", "A", AND "K".

SER. NO. 85-236,292, FILED 2-8-2011.

RONALD MCMORROW, EXAMINING ATTORNEY



David J. Kyffers

Director of the United States Patent and Trademark Office

United States of America

United States Patent and Trademark Office

DAILYCANDY DEALS

Reg. No. 4,066,160

Registered Dec. 6, 2011

Int. Cl.: 35

SERVICE MARK

PRINCIPAL REGISTER

DAILYCANDY, LLC (DELAWARE LIMITED LIABILITY COMPANY)
12200 WEST OLYMPIC BOULEVARD
SUITE 400
LOS ANGELES, CA 90064

FOR: PROMOTING THE GOODS AND SERVICES OF OTHERS BY TRANSMITTING EMAILS AND OTHER ELECTRONIC MESSAGES AND PROVIDING A WEBSITE FEATURING COUPONS, REBATES, DISCOUNTS, PRICE-COMPARISON INFORMATION, PRODUCT AND SERVICES DESCRIPTIONS AND REVIEWS, AND LINKS TO THE RETAIL WEBSITES OF OTHERS, IN CLASS 35 (U.S. CLS. 100, 101 AND 102).

FIRST USE 11-8-2010; IN COMMERCE 11-8-2010.

THE MARK CONSISTS OF STANDARD CHARACTERS WITHOUT CLAIM TO ANY PARTICULAR FONT, STYLE, SIZE, OR COLOR.

NO CLAIM IS MADE TO THE EXCLUSIVE RIGHT TO USE "DEALS", APART FROM THE MARK AS SHOWN.

SER. NO. 85-236,331, FILED 2-8-2011.

JEFF DEFORD, EXAMINING ATTORNEY



David J. Kyffers

Director of the United States Patent and Trademark Office

United States of America

United States Patent and Trademark Office

BIG GOLD

Reg. No. 4,066,161

Registered Dec. 6, 2011

Int. Cl.: 41

SERVICE MARK

PRINCIPAL REGISTER

CASEY RESEARCH, LLC (COLORADO LIMITED LIABILITY COMPANY)
C/O DIANA ETTLINGER
201 NORTH MILL ST., SUITE 201
ASPEN, CO 81611

FOR: ONLINE PUBLICATIONS, NAMELY, ONLINE NEWSLETTERS IN THE FIELDS OF FINANCIAL INVESTMENT, FINANCIAL ANALYSIS, GLOBAL FINANCIAL TRENDS, GEOPOLITICAL ISSUES, NATURAL RESOURCES AND EMERGING INVESTMENT OPPORTUNITIES, IN CLASS 41 (U.S. CLS. 100, 101 AND 107).

FIRST USE 4-24-2007; IN COMMERCE 4-24-2007.

THE MARK CONSISTS OF STANDARD CHARACTERS WITHOUT CLAIM TO ANY PARTICULAR FONT, STYLE, SIZE, OR COLOR.

NO CLAIM IS MADE TO THE EXCLUSIVE RIGHT TO USE "GOLD", APART FROM THE MARK AS SHOWN.

SER. NO. 85-236,435, FILED 2-8-2011.

KATHERINE CONNOLLY, EXAMINING ATTORNEY



David J. Kyffers

Director of the United States Patent and Trademark Office

United States of America
United States Patent and Trademark Office

BIG GOLD

Reg. No. 4,066,162

Registered Dec. 6, 2011

Int. Cl.: 9

TRADEMARK

PRINCIPAL REGISTER

CASEY RESEARCH, LLC (COLORADO LIMITED LIABILITY COMPANY)
C/O DIANA ETTLINGER
201 NORTH MILL STREET, SUITE 201
ASPEN, CO 81611

FOR: DOWNLOADABLE ELECTRONIC NEWSLETTERS IN THE FIELD OF FINANCIAL INVESTMENT, FINANCIAL ANALYSIS, GLOBAL FINANCIAL TRENDS, GEOPOLITICAL ISSUES, NATURAL RESOURCES AND EMERGING INVESTMENT OPPORTUNITIES, IN CLASS 9 (U.S. CLS. 21, 23, 26, 36 AND 38).

FIRST USE 4-24-2007; IN COMMERCE 4-24-2007.

THE MARK CONSISTS OF STANDARD CHARACTERS WITHOUT CLAIM TO ANY PARTICULAR FONT, STYLE, SIZE, OR COLOR.

NO CLAIM IS MADE TO THE EXCLUSIVE RIGHT TO USE "GOLD", APART FROM THE MARK AS SHOWN.

SER. NO. 85-236,444, FILED 2-8-2011.

KATHERINE CONNOLLY, EXAMINING ATTORNEY



David J. Kyffers

Director of the United States Patent and Trademark Office

United States of America

United States Patent and Trademark Office

XP Micro

Reg. No. 4,066,163

HI-DOW INTERNATIONAL (MISSOURI CORPORATION)
2071 CONGRESSIONAL DR.
ST. LOUIS, MO 63146

Registered Dec. 6, 2011

Int. Cl.: 10

FOR: ELECTRIC MASSAGE APPLIANCES, NAMELY, ELECTRIC VIBRATING MASSAGER,
IN CLASS 10 (U.S. CLS. 26, 39 AND 44).

TRADEMARK

FIRST USE 9-10-2008; IN COMMERCE 9-10-2008.

PRINCIPAL REGISTER

THE MARK CONSISTS OF STANDARD CHARACTERS WITHOUT CLAIM TO ANY PAR-
TICULAR FONT, STYLE, SIZE, OR COLOR.

SER. NO. 85-236,471, FILED 2-8-2011.

RICHARD WHITE, EXAMINING ATTORNEY



David J. Kyfos

Director of the United States Patent and Trademark Office

United States of America

United States Patent and Trademark Office



HARVEST
FINANCIAL PLANNING, LLC

Reg. No. 4,066,164

HARVEST FINANCIAL PLANNING, LLC (INDIANA LIMITED LIABILITY COMPANY)
930 WEST US HIGHWAY 30
SCHERERVILLE, IN 46375

Registered Dec. 6, 2011

Int. Cl.: 36

FOR: FINANCIAL PLANNING; INSURANCE BROKERAGE SERVICES, IN CLASS 36 (U.S. CLS. 100, 101 AND 102).

SERVICE MARK

FIRST USE 9-0-2008; IN COMMERCE 9-0-2008.

PRINCIPAL REGISTER

NO CLAIM IS MADE TO THE EXCLUSIVE RIGHT TO USE "FINANCIAL PLANNING, LLC", APART FROM THE MARK AS SHOWN.

THE COLOR(S) GOLD AND BLACK IS/ARE CLAIMED AS A FEATURE OF THE MARK.

THE MARK CONSISTS OF THE RENDERING OF A WHEAT STOCK IN GOLD IN A BLACK BOX FOLLOWING BY THE STYLIZED WORD HARVEST IN BLACK OVER THE STYLIZED WORDS FINANCIAL PLANNING, LLC IN GOLD.

SER. NO. 85-236,521, FILED 2-8-2011.

ROSELLE HERRERA, EXAMINING ATTORNEY



David J. Kybas

Director of the United States Patent and Trademark Office

United States of America

United States Patent and Trademark Office



Reg. No. 4,066,165

Registered Dec. 6, 2011

Int. Cl.: 37

SERVICE MARK

PRINCIPAL REGISTER

AUDIO IMPACT, INC. (CALIFORNIA CORPORATION)
7925 SILVERTON AVENUE, SUITE 512
SAN DIEGO, CA 92126

FOR: INSTALLATION, MAINTENANCE AND REPAIR OF HOME THEATER EQUIPMENT, HOME LIGHTING APPARATUS AND SMART HOME AUTOMATION EQUIPMENT, IN CLASS 37 (U.S. CLS. 100, 103 AND 106).

FIRST USE 12-30-2005; IN COMMERCE 12-30-2005.

OWNER OF U.S. REG. NO. 3,950,323.

THE COLOR(S) GRAY AND AZURE BLUE IS/ARE CLAIMED AS A FEATURE OF THE MARK.

NO CLAIM IS MADE TO THE EXCLUSIVE RIGHT TO USE "AUDIO", APART FROM THE MARK AS SHOWN.

THE MARK CONSISTS OF THE WORD "AUDIO" IN AZURE BLUE AND APPEARS ABOVE THE WORD "IMPACT", WHICH IS IN GRAY. ON THE LEFT SIDE OF THE WORDS "AUDIO IMPACT" THERE IS A SERIES OF EQUALLY SPACED OF DOTS LAID OUT IN FIVE COLUMNS. THE FIRST COLUMN CONTAINS ONE GRAY DOT WITH TWO AZURE BLUE DOTS ON TOP. THE SECOND COLUMN CONTAINS TWO GRAY DOTS WITH TWO AZURE BLUE DOTS ON TOP. THE THIRD COLUMN CONTAINS ONE GRAY DOT WITH TWO AZURE BLUE DOTS ON TOP. THE FOURTH COLUMN CONTAINS THREE GRAY DOTS WITH ONE AZURE BLUE DOT ON TOP. THE FIFTH COLUMN CONTAINS TWO GRAY DOTS WITH TWO AZURE BLUE DOTS ON TOP.

SER. NO. 85-236,590, FILED 2-8-2011.

MARLENE BELL, EXAMINING ATTORNEY



David J. Kybas

Director of the United States Patent and Trademark Office

United States of America

United States Patent and Trademark Office

THE SENTINEL

Reg. No. 4,066,166

SOLARKING, INC. (ARIZONA CORPORATION)
4637 WEST PARKVIEW CIRCLE
GLENDALE, AZ 85310

Registered Dec. 6, 2011

Int. Cl.: 11

FOR: SOLAR LIGHT FIXTURES, NAMELY, INDOOR AND OUTDOOR SOLAR POWERED LIGHTING UNITS AND FIXTURES, IN CLASS 11 (U.S. CLS. 13, 21, 23, 31 AND 34).

TRADEMARK

FIRST USE 12-31-2007; IN COMMERCE 12-31-2007.

PRINCIPAL REGISTER

THE MARK CONSISTS OF STANDARD CHARACTERS WITHOUT CLAIM TO ANY PARTICULAR FONT, STYLE, SIZE, OR COLOR.

SER. NO. 85-237,123, FILED 2-8-2011.

GINA HAYES, EXAMINING ATTORNEY



David J. Kybas

Director of the United States Patent and Trademark Office

United States of America

United States Patent and Trademark Office



Reg. No. 4,066,167

Registered Dec. 6, 2011

Int. Cl.: 31

TRADEMARK

PRINCIPAL REGISTER

TOP HAT INCORPORATED (OREGON CORPORATION)
39344 JORDAN ROAD
SCIO, OR 97374

FOR: FRESH MUSHROOMS; FRESH FRUITS; AND RAW VEGETABLES, IN CLASS 31 (U.S. CLS. 1 AND 46).

FIRST USE 5-15-1991; IN COMMERCE 5-15-1991.

THE MARK CONSISTS OF A GREEN FROG WITH BLACK TUXEDO COAT AND WHITE BUTTON UP SHIRT WITH A BLACK BOW TIE AND A BLACK TOP HAT LEANING HIS HAND ON A MUSHROOM WITH TAN STEM AND TAN GILLS WITH A BROWN CAP WITH TAN SPOTS ON THE CAP.

THE COLOR(S) GREEN, BLACK, WHITE, BROWN, AND TAN ARE CLAIMED AS A FEATURE OF THE MARK. IS/ARE CLAIMED AS A FEATURE OF THE MARK.

SER. NO. 85-237,327, FILED 2-8-2011.

ALEXANDER L. POWERS, EXAMINING ATTORNEY



David J. Kyffers

Director of the United States Patent and Trademark Office

United States of America

United States Patent and Trademark Office

VolaFriends

Reg. No. 4,066,168

Registered Dec. 6, 2011

Int. Cl.: 9

TRADEMARK

PRINCIPAL REGISTER

VOLAFRIENDS, LLC (NEW YORK LIMITED LIABILITY COMPANY)
#5E
438 12TH STREET
BROOKLYN, NY 11215

FOR: CHILDREN'S EDUCATIONAL SOFTWARE APPLICATIONS DOWNLOADABLE FROM A GLOBAL COMPUTER NETWORK; DOWNLOADABLE ELECTRONIC GAMES AIMED AT CHILDREN VIA THE INTERNET AND WIRELESS DEVICES, IN CLASS 9 (U.S. CLS. 21, 23, 26, 36 AND 38).

FIRST USE 1-31-2011; IN COMMERCE 1-31-2011.

THE MARK CONSISTS OF STANDARD CHARACTERS WITHOUT CLAIM TO ANY PARTICULAR FONT, STYLE, SIZE, OR COLOR.

SER. NO. 85-237,728, FILED 2-9-2011.

BARBARA RUTLAND, EXAMINING ATTORNEY



David J. Kybas

Director of the United States Patent and Trademark Office

United States of America

United States Patent and Trademark Office

IMPACT ZONE WRESTLING

Reg. No. 4,066,169

Registered Dec. 6, 2011

Int. Cl.: 41

SERVICE MARK

PRINCIPAL REGISTER

WOLFENBARGER II, JOHN QUINCY (UNITED STATES INDIVIDUAL), DBA IMPACT
ZONE WRESTLING
912 SW 11TH
LAWTON, OK 73501

FOR: EDUCATIONAL AND ENTERTAINMENT SERVICES, NAMELY, A CONTINUING PROGRAM ABOUT PROFESSIONAL WRESTLING SHOWS AND STORYLINES, ACCESSIBLE BY RADIO, TELEVISION, SATELLITE, AUDIO, VIDEO AND COMPUTER NETWORKS; ENTERTAINMENT IN THE NATURE OF LIVE PERFORMANCES BY PROFESSIONAL WRESTLERS; ENTERTAINMENT SERVICES, NAMELY, PROVIDING A WEB SITE FEATURING PHOTOGRAPHIC, AUDIO, VIDEO AND PROSE PRESENTATIONS FEATURING PROFESSIONAL WRESTLERS AND WRESTLING MATCHES; ENTERTAINMENT, NAMELY, PRODUCTION OF A TV SHOW ABOUT PROFESSIONAL WRESTLING AND STORYLINES, IN CLASS 41 (U.S. CLS. 100, 101 AND 107).

FIRST USE 4-1-2004; IN COMMERCE 4-1-2004.

THE MARK CONSISTS OF STANDARD CHARACTERS WITHOUT CLAIM TO ANY PARTICULAR FONT, STYLE, SIZE, OR COLOR.

NO CLAIM IS MADE TO THE EXCLUSIVE RIGHT TO USE "WRESTLING", APART FROM THE MARK AS SHOWN.

SER. NO. 85-237,895, FILED 2-9-2011.

REBECCA EISINGER, EXAMINING ATTORNEY



David J. Kybas

Director of the United States Patent and Trademark Office

United States of America

United States Patent and Trademark Office

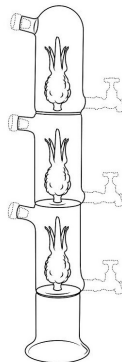

Reg. No. 4,066,170

Registered Dec. 6, 2011

Int. Cl.: 33

TRADEMARK

PRINCIPAL REGISTER

AVETISOV, MICHAEL (UNITED STATES INDIVIDUAL)
5301 FULTON AVE.
SHERMAN OAKS, CA 91401

FOR: DISTILLED SPIRITS, IN CLASS 33 (U.S. CLS. 47 AND 49).

FIRST USE 12-0-2006; IN COMMERCE 12-0-2006.

THE MARK CONSISTS OF A THREE-DIMENSIONAL CONFIGURATION OF A BOTTLE DIVIDED INTO THREE SECTIONS STACKED ON TOP OF EACH OTHER EACH WITH A THREE-DIMENSIONAL CACTUS FORM ON THE INTERIOR OF EACH SECTION OF THE BOTTLE DESIGN. THE BOTTLE IS CLEAR. EACH SECTION OF THE BOTTLE FEATURES A SPIGOT ON ONE SIDE, AND A BOTTLE NECK OPENING WITH CAP ON THE OTHER SIDE. THE THREE SPIGOTS AND THREE BOTTLE CAPS ARE NOT PART OF THE MARK, SERVE ONLY TO SHOW THE POSITION OR PLACEMENT OF THE MARK, AND ARE SHOWN IN DOTTED LINES AND SERVE ONLY TO SHOW THE POSITION OR PLACEMENT OF THE MARK.

SER. NO. 85-238,073, FILED 2-9-2011.

DEIRDRE ROBERTSON, EXAMINING ATTORNEY



David J. Kybas

Director of the United States Patent and Trademark Office

United States of America

United States Patent and Trademark Office

SQUALL

Reg. No. 4,066,171

Registered Dec. 6, 2011

Int. Cl.: 32

TRADEMARK

PRINCIPAL REGISTER

DOGFISH HEAD MARKETING, LLC (DELAWARE LIMITED LIABILITY COMPANY)
6 CANNERY VILLAGE CENTER
MILTON, DE 19968

FOR: BEER, IN CLASS 32 (U.S. CLS. 45, 46 AND 48).

FIRST USE 4-30-2009; IN COMMERCE 4-30-2009.

THE MARK CONSISTS OF STANDARD CHARACTERS WITHOUT CLAIM TO ANY PARTICULAR FONT, STYLE, SIZE, OR COLOR.

SER. NO. 85-238,151, FILED 2-9-2011.

JAY FLOWERS, EXAMINING ATTORNEY



David J. Kyffers

Director of the United States Patent and Trademark Office

United States of America

United States Patent and Trademark Office

THEINTERNETCORNER

Reg. No. 4,066,172

Registered Dec. 6, 2011

Int. Cl.: 38

SERVICE MARK

PRINCIPAL REGISTER

VIVO COMUNICACIÓN Y PRODUCCIONES, S.L. (SPAIN LIMITED LIABILITY COMPANY)
DOCTOR ESQUERDO, 8 - BAJO C
MADRID, SPAIN 28028

FOR: TELECOMMUNICATION SERVICES, NAMELY, PROVIDING ON-LINE CHAT ROOMS AND ELECTRONIC BULLETIN BOARDS FOR TRANSMISSION OF MESSAGES AMONG USERS IN THE FIELD OF GENERAL INTEREST VIA COMPUTERS, MOBILE AND HAND-HELD COMPUTERS, AND WIRED AND WIRELESS COMMUNICATION DEVICES; PROVIDING E-MAIL AND INSTANT MESSAGING SERVICES; PROVIDING ON-LINE CHAT ROOMS AND ELECTRONIC BULLETIN BOARDS FOR SOCIAL NETWORKING AND FOR TRANSMISSION OF MESSAGES AMONG USERS IN THE FIELD OF COLLEGIATE LIFE AND GENERAL INTEREST; PEER-TO-PEER PHOTO SHARING SERVICES, NAMELY, ELECTRONIC TRANSMISSION OF DIGITAL PHOTO FILES AMONG INTERNET USERS; PROVIDING ON-LINE FORUMS FOR TRANSMISSION OF MESSAGES AMONG COMPUTER USERS ON TOPICS OF GENERAL INTEREST, IN CLASS 38 (U.S. CLS. 100, 101 AND 104).

PRIORITY CLAIMED UNDER SEC. 44(D) ON ERPN CMNTY TM OFC APPLICATION NO. 9720053, FILED 2-8-2011, REG. NO. 009720053, DATED 5-30-2011, EXPIRES 2-8-2021.

THE COLOR(S) YELLOW AND BLACK IS/ARE CLAIMED AS A FEATURE OF THE MARK.

THE MARK CONSISTS OF THE WORDING "THEINTERNETCORNER" IN BLACK STYLIZED FONT WITHIN A YELLOW RECTANGULAR BORDER.

SER. NO. 85-238,264, FILED 2-9-2011.

STEVEN PEREZ, EXAMINING ATTORNEY



David J. Kyffers

Director of the United States Patent and Trademark Office

United States of America

United States Patent and Trademark Office



Reg. No. 4,066,173

Registered Dec. 6, 2011

Int. Cl.: 5

TRADEMARK

PRINCIPAL REGISTER

NOW HEALTH GROUP, INC. (ILLINOIS CORPORATION)
395 S. GLEN ELLYN ROAD
BLOOMINGDALE, IL 60108

FOR: DIETARY SUPPLEMENTS, IN CLASS 5 (U.S. CLS. 6, 18, 44, 46, 51 AND 52).

FIRST USE 1-24-2011; IN COMMERCE 1-24-2011.

NO CLAIM IS MADE TO THE EXCLUSIVE RIGHT TO USE "WEIGHT MANAGEMENT", APART FROM THE MARK AS SHOWN.

THE MARK CONSISTS OF THE WORD "T-LEAN" WITH A MEASURING TAPE WRAPPED AROUND THE BOTTOM OF THE WORDS "T-LEAN" AND THE WORDS "WEIGHT MANAGEMENT" ON THE MEASURING TAPE.

SER. NO. 85-238,465, FILED 2-9-2011.

BRIDGETT SMITH, EXAMINING ATTORNEY



David J. Kyros

Director of the United States Patent and Trademark Office

United States of America

United States Patent and Trademark Office

ROBAK

Reg. No. 4,066,174

Registered Dec. 6, 2011

Int. Cl.: 37

SERVICE MARK

PRINCIPAL REGISTER

ROBAK CONSTRUCTION INC. (ILLINOIS CORPORATION)
7624 S 78TH CT
BRIDGEVIEW, IL 60455

FOR: GENERAL CONTRACTOR SERVICES, NAMELY, PLUMBING, HEATING, AIR CONDITIONING, DRYWALL, PAINTING AND ELECTRICAL OF RESIDENTIAL AND COMMERCIAL BUILDINGS; AND CONSTRUCTION SERVICES, NAMELY, FRAMING, CARPENTRY, METAL SHEETING AND PAINTING OF RESIDENTIAL AND COMMERCIAL BUILDINGS, IN CLASS 37 (U.S. CLS. 100, 103 AND 106).

FIRST USE 1-25-2001; IN COMMERCE 1-25-2001.

THE MARK CONSISTS OF STANDARD CHARACTERS WITHOUT CLAIM TO ANY PARTICULAR FONT, STYLE, SIZE, OR COLOR.

SEC. 2(F).

SER. NO. 85-238,504, FILED 2-9-2011.

CAROLYN CATALDO, EXAMINING ATTORNEY



David J. Kybas

Director of the United States Patent and Trademark Office

United States of America

United States Patent and Trademark Office

CORONARY BYPASS BURGER

Reg. No. 4,066,175

Registered Dec. 6, 2011

Int. Cl.: 30

TRADEMARK

PRINCIPAL REGISTER

BIG-TIME MARKETING, INC. (GEORGIA CORPORATION)
438 MORELAND AVENUE
ATLANTA, GA 30307

FOR: BURGERS CONTAINED IN BREAD ROLLS; CHEESEBURGER SANDWICHES;
HAMBURGER SANDWICHES; SANDWICHES, NAMELY, BURGERS, IN CLASS 30 (U.S.
CL. 46).

FIRST USE 12-1-1999; IN COMMERCE 12-1-1999.

THE MARK CONSISTS OF STANDARD CHARACTERS WITHOUT CLAIM TO ANY PAR-
TICULAR FONT, STYLE, SIZE, OR COLOR.

NO CLAIM IS MADE TO THE EXCLUSIVE RIGHT TO USE "BURGER", APART FROM THE
MARK AS SHOWN.

SER. NO. 85-238,674, FILED 2-10-2011.

JORDAN BAKER, EXAMINING ATTORNEY



David J. Kybas

Director of the United States Patent and Trademark Office

United States of America

United States Patent and Trademark Office

UmeNow

Reg. No. 4,066,176

EVELYN CASTILLO-BACH (UNITED STATES INDIVIDUAL)
PO BOX 297392
PEMBROKE PINES, FL 33029

Registered Dec. 6, 2011

Int. Cl.: 42

FOR: COMPUTER SERVICES, NAMELY, CREATING AN ON-LINE COMMUNITY FOR REGISTERED USERS TO PARTICIPATE IN DISCUSSIONS, GET FEEDBACK FROM THEIR PEERS, FORM VIRTUAL COMMUNITIES, AND ENGAGE IN SOCIAL NETWORKING, IN CLASS 42 (U.S. CLS. 100 AND 101).

SERVICE MARK

PRINCIPAL REGISTER

FIRST USE 3-16-2009; IN COMMERCE 5-13-2010.

THE MARK CONSISTS OF STANDARD CHARACTERS WITHOUT CLAIM TO ANY PARTICULAR FONT, STYLE, SIZE, OR COLOR.

OWNER OF U.S. REG. NO. 3,938,004.

SER. NO. 85-238,693, FILED 2-10-2011.

RUDY R. SINGLETON, EXAMINING ATTORNEY



David J. Kyros

Director of the United States Patent and Trademark Office

United States of America

United States Patent and Trademark Office



Reg. No. 4,066,177

Registered Dec. 6, 2011

Int. Cl.: 3

TRADEMARK

PRINCIPAL REGISTER

SETTLE, KENNETH J (UNITED STATES INDIVIDUAL), DBA K & D DISTRIBUTING INC.
6442 SNUFFBOX TERRACE
COLUMBIA, MD 21044

FOR: COSMETIC HAIR DRESSING PREPARATIONS, IN CLASS 3 (U.S. CLS. 1, 4, 6, 50, 51 AND 52).

FIRST USE 5-6-1978; IN COMMERCE 5-6-1978.

THE MARK CONSISTS OF THE STYLIZED WORD "KAY" OVER THE STYLIZED WORD "VEL" ALL ON A RECTANGULAR BACKGROUND WITH IRREGULAR EDGES; TO THE UPPER RIGHT OF THE RECTANGULAR DESIGN IS A STAR.

SER. NO. 85-239,148, FILED 2-10-2011.

JULIE GUTTADAURO, EXAMINING ATTORNEY



David J. Kyffers

Director of the United States Patent and Trademark Office

United States of America

United States Patent and Trademark Office

SPELLBINDERS

Reg. No. 4,066,178

Registered Dec. 6, 2011

Int. Cl.: 8

SPELLBINDERS PAPER ARTS COMPANY, LLC (ARIZONA LIMITED LIABILITY COMPANY)

1125 W. PINNACLE PEAK ROAD
BLDG 3 SUITE 124
PHOENIX, AZ 85027

TRADEMARK

FOR: HAND OPERATED MACHINES FOR EMBOSSING OR DIE-CUTTING AND POLYMER PADS AND DIES FOR USE THEREWITH, IN CLASS 8 (U.S. CLS. 23, 28 AND 44).

PRINCIPAL REGISTER

FIRST USE 7-1-2003; IN COMMERCE 7-1-2003.

THE MARK CONSISTS OF STANDARD CHARACTERS WITHOUT CLAIM TO ANY PARTICULAR FONT, STYLE, SIZE, OR COLOR.

SER. NO. 85-239,252, FILED 2-10-2011.

PAULA MAHONEY, EXAMINING ATTORNEY



David J. Kyffers

Director of the United States Patent and Trademark Office

United States of America

United States Patent and Trademark Office

THE HUNTINGTON

Reg. No. 4,066,179

Registered Dec. 6, 2011

Int. Cl.: 41

SERVICE MARK

PRINCIPAL REGISTER

HENRY E. HUNTINGTON LIBRARY AND ART GALLERY (CALIFORNIA NON-PROFIT ORGANIZATION)
1151 OXFORD ROAD
SAN MARINO, CA 91108

FOR: MUSEUM SERVICES; POST DOCTORAL RESEARCH LIBRARY SERVICES; BOTANICAL GARDENS, IN CLASS 41 (U.S. CLS. 100, 101 AND 107).

FIRST USE 0-0-1919; IN COMMERCE 0-0-1919.

THE MARK CONSISTS OF STANDARD CHARACTERS WITHOUT CLAIM TO ANY PARTICULAR FONT, STYLE, SIZE, OR COLOR.

SEC. 2(F).

SER. NO. 85-239,478, FILED 2-10-2011.

CURTIS FRENCH, EXAMINING ATTORNEY



David J. Kybas

Director of the United States Patent and Trademark Office

United States of America

United States Patent and Trademark Office

LOTUS

Reg. No. 4,066,180

Registered Dec. 6, 2011

Int. Cl.: 42

SERVICE MARK

PRINCIPAL REGISTER

LOTUS (CALIFORNIA LIMITED LIABILITY COMPANY)
100 W. CALIFORNIA BLVD.
PASADENA, CA 91105

FOR: MEDICAL AND SCIENTIFIC RESEARCH, NAMELY CLINICAL STUDIES IN THE FIELD OF MEDICINE, PAIN MANAGEMENT, AND HOSPITAL-BASED PATIENT POPULATIONS, IN CLASS 42 (U.S. CLS. 100 AND 101).

FIRST USE 12-15-2007; IN COMMERCE 12-15-2007.

THE MARK CONSISTS OF STANDARD CHARACTERS WITHOUT CLAIM TO ANY PARTICULAR FONT, STYLE, SIZE, OR COLOR.

SER. NO. 85-240,352, FILED 2-11-2011.

CAROLYN CATALDO, EXAMINING ATTORNEY



David J. Kybas

Director of the United States Patent and Trademark Office

United States of America

United States Patent and Trademark Office

hpytre

Reg. No. 4,066,181

Registered Dec. 6, 2011

Int. Cl.: 25

TRADEMARK

PRINCIPAL REGISTER

HIPPY TREE, LLC (CALIFORNIA LIMITED LIABILITY COMPANY)
P.O. BOX 1137
HERMOSA BEACH, CA 90254

FOR: ATHLETIC FOOTWEAR; BANDANAS; BASEBALL CAPS; BATHING CAPS; BATHING SUITS; BATHING TRUNKS; BEACH COVERUPS; BEACH SHOES; BEACHWEAR; BEANIES; BELTS; BERETS; BERMUDA SHORTS; BIKINIS; BODY SUITS; BOXER BRIEFS; BOXER SHORTS; CAPS; FLEECE PULLOVERS; FOOTWEAR; GALOSHES; GLOVES; GYM SHORTS; GYM SUITS; HALTER TOPS; HATS; HEADBANDS; HOODED SWEATSHIRTS; INFANT-WEAR; JACKETS; KNIT SHIRTS; LOUNGEWEAR; PAJAMAS; PARKAS; PONCHOS; PULLOVERS; RAINWEAR; RASH GUARDS; SANDALS; SCARVES; SHIRTS; SHORTS; SLEEP SHIRTS; SLIPPERS; SNEAKERS; SOCKS; SPORTS SHIRTS; SUN VISORS; SURF WEAR; SWEATERS; SWEATSOCKS; SWIM CAPS; SWIM TRUNKS; SWIM WEAR; SWIM-SUITS; T-SHIRTS; TANK TOPS; THONGS; TOPS; TRACK SUITS; UNDERSHIRTS; V-NECK SWEATERS; WALKING SHORTS; WATER SOCKS; WETSUITS; WIND RESISTANT JACKETS; WIND SHIRTS; WRIST BANDS, IN CLASS 25 (U.S. CLS. 22 AND 39).

FIRST USE 9-1-2006; IN COMMERCE 9-1-2006.

THE MARK CONSISTS OF STANDARD CHARACTERS WITHOUT CLAIM TO ANY PARTICULAR FONT, STYLE, SIZE, OR COLOR.

OWNER OF U.S. REG. NO. 3,238,171.

SER. NO. 85-240,783, FILED 2-11-2011.

APRIL HESIK, EXAMINING ATTORNEY



David J. Kyros

Director of the United States Patent and Trademark Office

United States of America

United States Patent and Trademark Office

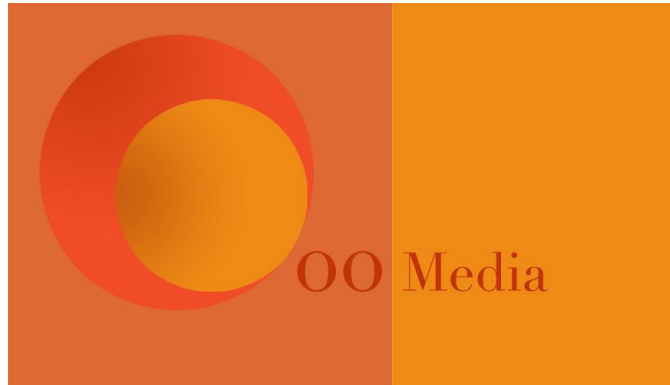

Reg. No. 4,066,182

Registered Dec. 6, 2011

Int. Cl.: 41

SERVICE MARK

PRINCIPAL REGISTER

WONG, S. CASPER (UNITED STATES INDIVIDUAL), DBA OO MEDIA, LLC
P.O. BOX 638, PECK SLIP
NEW YORK, NY 10272

FOR: FILM AND VIDEO FILM PRODUCTION SERVICES, IN CLASS 41 (U.S. CLS. 100, 101 AND 107).

FIRST USE 5-1-2004; IN COMMERCE 5-1-2005.

NO CLAIM IS MADE TO THE EXCLUSIVE RIGHT TO USE "MEDIA", APART FROM THE MARK AS SHOWN.

THE COLOR(S) ORANGE, RED, AND RUST IS/ARE CLAIMED AS A FEATURE OF THE MARK.

THE MARK CONSISTS OF A RECTANGULAR BACKGROUND, DIVIDED INTO TWO SECTIONS WITH A RUST COLORED SQUARE ON THE LEFT CONTAINING THE LETTERS "OO" IN RED AND AN ORANGE SPHERE OVERLAPPING A RED SPHERE AND AN ORANGE COLORED RECTANGLE ON THE RIGHT WITH THE WORDING "MEDIA" IN RED.

SER. NO. 85-240,983, FILED S.R. 2-13-2011 AM. P.R. 5-17-2011.

CHRISIE B. KING, EXAMINING ATTORNEY



David J. Kybas

Director of the United States Patent and Trademark Office

United States of America

United States Patent and Trademark Office

LIGHTWORKS HEALING METHOD

Reg. No. 4,066,183

Registered Dec. 6, 2011

Int. Cls.: 41 and 44

SERVICE MARK

PRINCIPAL REGISTER

MARGARET LYNN MCGONAGILL (UNITED STATES INDIVIDUAL)
4736 ACORN CIRCLE
SARASOTA, FL 34233

FOR: EDUCATIONAL SERVICES, NAMELY, CONDUCTING ONE-ON-ONE SESSIONS, CLASSES, SEMINARS, CONFERENCES AND WORKSHOPS IN THE FIELD OF PHYSICAL, MENTAL, EMOTIONAL, SPIRITUAL AND ENERGETIC HEALING METHODS AND DISTRIBUTING EDUCATIONAL MATERIALS IN CONNECTION THEREWITH; TRAINING OTHERS IN THE FIELD OF PHYSICAL, MENTAL, EMOTIONAL, SPIRITUAL AND ENERGETIC HEALING METHODS, IN CLASS 41 (U.S. CLS. 100, 101 AND 107).

FIRST USE 12-31-2009; IN COMMERCE 12-31-2009.

FOR: ENERGY HEALING SERVICES, NAMELY, CHANNELING HEALING ENERGY TO INDIVIDUALS THROUGH THE USE OF A HEALING BODY WORK METHOD, IN CLASS 44 (U.S. CLS. 100 AND 101).

FIRST USE 12-31-2009; IN COMMERCE 12-31-2009.

THE MARK CONSISTS OF STANDARD CHARACTERS WITHOUT CLAIM TO ANY PARTICULAR FONT, STYLE, SIZE, OR COLOR.

NO CLAIM IS MADE TO THE EXCLUSIVE RIGHT TO USE "HEALING METHOD", APART FROM THE MARK AS SHOWN.

SER. NO. 85-241,103, FILED 2-13-2011.

HOWARD B. LEVINE, EXAMINING ATTORNEY



David J. Kybas

Director of the United States Patent and Trademark Office

United States of America

United States Patent and Trademark Office

SEXY FITNESS

Reg. No. 4,066,184

Registered Dec. 6, 2011

Int. Cls.: 35 and 44

SERVICE MARK

PRINCIPAL REGISTER

DOWLING, COLIN (UNITED STATES INDIVIDUAL)
APARTMENT # 201
4789 SOUTH CITATION DRIVE
DELRAY BEACH, FL 33445 AND

FISCHER, MICHAEL (UNITED STATES INDIVIDUAL)
APARTMENT # 201
4789 SOUTH CITATION DRIVE
DELRAY BEACH, FL 33445

FOR: ONLINE RETAIL STORE SERVICES FEATURING DVDS IN THE FIELD OF HEALTH WELLNESS AND EXERCISE, IN CLASS 35 (U.S. CLS. 100, 101 AND 102).

FIRST USE 9-10-2009; IN COMMERCE 1-5-2010.

FOR: PROVIDING A WEBSITE FEATURING INFORMATION IN THE FIELD OF DIET, WEIGHT LOSS, DIET PLANNING AND LIFESTYLE WELLNESS; PROVIDING A WEB SITE FEATURING INFORMATION ON HEALTH, WELLNESS AND NUTRITION, IN CLASS 44 (U.S. CLS. 100 AND 101).

FIRST USE 9-10-2009; IN COMMERCE 1-5-2010.

THE MARK CONSISTS OF STANDARD CHARACTERS WITHOUT CLAIM TO ANY PARTICULAR FONT, STYLE, SIZE, OR COLOR.

NO CLAIM IS MADE TO THE EXCLUSIVE RIGHT TO USE "FITNESS", APART FROM THE MARK AS SHOWN.

SER. NO. 85-241,509, FILED 2-14-2011.

JORDAN BAKER, EXAMINING ATTORNEY



David J. Kyros

Director of the United States Patent and Trademark Office

United States of America

United States Patent and Trademark Office

AutovaxID

Reg. No. 4,066,185

Registered Dec. 6, 2011

Int. Cl.: 9

TRADEMARK

PRINCIPAL REGISTER

BIOVEST INTERNATIONAL, INC. (DELAWARE CORPORATION)
324 S. HYDE PARK AVE., SUITE 350
TAMPA, FL 33606

FOR: SCIENTIFIC INSTRUMENTS AND SYSTEMS, NAMELY, FULLY ENCLOSED AUTOMATED INSTRUMENTS CONSISTING OF A CONTROL UNIT, NAMELY, COMPUTER HARDWARE, SOFTWARE, PUMPS, AND OTHER RELATED COMPONENT PARTS THEREFORE SOLD AS A UNIT, AND A DISPOSABLE CULTUREWARE UNIT CONSISTING OF BIOREACTORS, TUBING AND OTHER RELATED COMPONENT PARTS THEREFORE SOLD AS A UNIT WITH SAID CONTROL UNIT AND/OR SEPARATELY, ALL FOR USE IN CONNECTION WITH CELL CULTURE AND THE DEVELOPMENT, PRODUCTION, AND PURIFICATION OF PROTEINS, IN CLASS 9 (U.S. CLS. 21, 23, 26, 36 AND 38).

FIRST USE 3-13-2007; IN COMMERCE 3-13-2007.

THE MARK CONSISTS OF STANDARD CHARACTERS WITHOUT CLAIM TO ANY PARTICULAR FONT, STYLE, SIZE, OR COLOR.

SER. NO. 85-241,512, FILED 2-14-2011.

SANI KHOURI, EXAMINING ATTORNEY



David J. Kypos

Director of the United States Patent and Trademark Office

United States of America

United States Patent and Trademark Office

SPIKE GUYS CHOICE

Reg. No. 4,066,186

Registered Dec. 6, 2011

Int. Cl.: 41

SERVICE MARK

PRINCIPAL REGISTER

NETWORK ENTERPRISES (DELAWARE CORPORATION)
1515 BROADWAY FL 34
NEW YORK, NY 10036

FOR: ENTERTAINMENT SERVICES IN THE NATURE OF CONTINUING PROGRAM SERIES, FEATURING LIVE ACTION, COMEDY AND DRAMA PROVIDED THROUGH CABLE TELEVISION, BROADCAST TELEVISION, INTERNET, VIDEO-ON-DEMAND, AND THROUGH OTHER DISTRIBUTION PLATFORMS; PROVIDING ONLINE INFORMATION IN THE FIELD OF ENTERTAINMENT CONCERNING TELEVISION PROGRAMS, IN CLASS 41 (U.S. CLS. 100, 101 AND 107).

FIRST USE 6-13-2007; IN COMMERCE 6-13-2007.

THE MARK CONSISTS OF STANDARD CHARACTERS WITHOUT CLAIM TO ANY PARTICULAR FONT, STYLE, SIZE, OR COLOR.

OWNER OF U.S. REG. NOS. 2,891,969, 2,900,864 AND OTHERS.

SER. NO. 85-241,678, FILED 2-14-2011.

SUNG IN, EXAMINING ATTORNEY



David J. Kypos

Director of the United States Patent and Trademark Office

United States of America
United States Patent and Trademark Office



Reg. No. 4,066,187

Registered Dec. 6, 2011

Int. Cls.: 9 and 35

TRADEMARK

SERVICE MARK

PRINCIPAL REGISTER

INDUSTRIAL ELECTRIC WIRE & CABLE, INC. (WISCONSIN CORPORATION)
5001 SOUTH TOWNE DRIVE
NEW BERLIN, WI 53151

FOR: ELECTRICAL WIRE, ELECTRICAL CABLE, ELECTRONIC AND COMMUNICATION CABLES, FIBER OPTIC CABLE, FIBER OPTIC CONNECTORS, ELECTRIC CORD SETS, ELECTRIC LUGS AND POWER CONNECTORS, ELECTRIC PLUGS, ELECTRIC RECEPTACLES AND TERMINALS, IN CLASS 9 (U.S. CLS. 21, 23, 26, 36 AND 38).

FIRST USE 8-1-2010; IN COMMERCE 8-1-2010.

FOR: DISTRIBUTORSHIP AND WHOLESALE STORE SERVICES FEATURING: ELECTRICAL WIRE, ELECTRICAL CABLE, ELECTRONIC AND COMMUNICATIONS CABLES, FIBER OPTIC CABLE, FIBER OPTIC CONNECTORS, AND ELECTRICAL WIRING PRODUCTS, NAMELY, CABLE GRIPS, CABLE TIES AND ACCESSORIES, WIRE AND CABLE CONDUIT, TUBING, SLEEVES FOR ELECTRICAL WIRE AND CABLE, CORD SETS, WIRE LABELS, HEAT SHRINK TUBING, LUGS, POWER CONNECTORS, TERMINALS, AND WIRING DUCT, IN CLASS 35 (U.S. CLS. 100, 101 AND 102).

FIRST USE 8-1-2010; IN COMMERCE 8-1-2010.

NO CLAIM IS MADE TO THE EXCLUSIVE RIGHT TO USE "GLOBAL SOLUTIONS", APART FROM THE MARK AS SHOWN.

THE MARK CONSISTS OF TWO VERTICALLY ORIENTATED INTERSECTING CURVED LINES WITH THE CONCAVE SIDES OF THE CURVES FACING ONE ANOTHER WITH "IEWC" TO THE RIGHT, AND "GLOBAL SOLUTIONS" BELOW "IEWC".

SER. NO. 85-241,845, FILED 2-14-2011.

ANNE MADDEN, EXAMINING ATTORNEY



David J. Kybas

Director of the United States Patent and Trademark Office

United States of America

United States Patent and Trademark Office



Reg. No. 4,066,188

Registered Dec. 6, 2011

Int. Cl.: 41

SERVICE MARK

PRINCIPAL REGISTER

FAMILY DYNAMICS INSTITUTE, INC. (GEORGIA CORPORATION), AKA FAMILY DYNAMICS
SUITE 316
318 SEABOARD LANE
FRANKLIN, TN 37067

FOR: EDUCATIONAL SERVICES, NAMELY, PROVIDING TRAINING WORKSHOPS, CLASSES, AND SEMINARS ALL RELATING TO TROUBLED MARRIAGES AND FAMILY INTERACTION SOCIAL SKILLS AND DISTRIBUTION OF COURSE AND EDUCATIONAL MATERIALS IN CONNECTION THEREWITH, IN CLASS 41 (U.S. CLS. 100, 101 AND 107).

FIRST USE 9-13-2006, THE MARK WAS FIRST USED ANYWHERE IN A DIFFERENT FORM OTHER THAN THAT SOUGHT TO BE REGISTERED AT LEAST AS EARLY AS 09/07/2002.; IN COMMERCE 9-13-2006, THE MARK WAS FIRST USED IN COMMERCE IN A DIFFERENT FORM OTHER THAN THAT SOUGHT TO BE REGISTERED AT LEAST AS EARLY AS 09/07/2002..

OWNER OF U.S. REG. NOS. 3,067,754 AND 3,439,575.

NO CLAIM IS MADE TO THE EXCLUSIVE RIGHT TO USE "MARRIAGE", APART FROM THE MARK AS SHOWN.

THE MARK CONSISTS OF THE TWO WORDS "DYNAMIC MARRIAGE" IN STYLIZED FONT ACCOMPANIED BY TWO OVERLAID WEDDING BANDS PLACED BETWEEN THE TWO WORDS.

SER. NO. 85-242,301, FILED 2-15-2011.

LAKEISHA LEWIS, EXAMINING ATTORNEY



David J. Kyros

Director of the United States Patent and Trademark Office

United States of America

United States Patent and Trademark Office

Pc Cured

Reg. No. 4,066,189

Registered Dec. 6, 2011

Int. Cl.: 42

SERVICE MARK

PRINCIPAL REGISTER

PETERS, JAMES (NEW JERSEY SOLE PROPRIETORSHIP), DBA PC CURED
5 PARTRIDGE CT
CRANBURY, NJ 08512

FOR: COMPUTER CONSULTATION; COMPUTER CONSULTATION IN THE FIELD OF
COMPUTER SECURITY; COMPUTER DIAGNOSTIC SERVICES, IN CLASS 42 (U.S. CLS.
100 AND 101).

FIRST USE 1-1-2009; IN COMMERCE 8-12-2010.

THE MARK CONSISTS OF STANDARD CHARACTERS WITHOUT CLAIM TO ANY PAR-
TICULAR FONT, STYLE, SIZE, OR COLOR.

NO CLAIM IS MADE TO THE EXCLUSIVE RIGHT TO USE "PC", APART FROM THE MARK
AS SHOWN.

SER. NO. 85-242,470, FILED 2-15-2011.

CHRISTINA SOBRAL, EXAMINING ATTORNEY



David J. Kybas

Director of the United States Patent and Trademark Office

United States of America

United States Patent and Trademark Office

PROPEP

Reg. No. 4,066,190

Registered Dec. 6, 2011

Int. Cl.: 5

TRADEMARK

PRINCIPAL REGISTER

INTERNATIONAL NUTRITION, INC. (NEBRASKA CORPORATION)
7706 I PLAZA
OMAHA, NE 68127

FOR: FEED SUPPLEMENT FOR LIVESTOCK, IN CLASS 5 (U.S. CLS. 6, 18, 44, 46, 51 AND 52).

FIRST USE 9-15-2006; IN COMMERCE 9-15-2006.

THE MARK CONSISTS OF STANDARD CHARACTERS WITHOUT CLAIM TO ANY PARTICULAR FONT, STYLE, SIZE, OR COLOR.

SER. NO. 85-242,910, FILED 2-15-2011.

DORITT L. CARROLL, EXAMINING ATTORNEY



David J. Kyros

Director of the United States Patent and Trademark Office

United States of America

United States Patent and Trademark Office

SPIRIT PEARLS

Reg. No. 4,066,191

Registered Dec. 6, 2011

Int. Cl.: 14

TRADEMARK

PRINCIPAL REGISTER

SPIRIT PEARL, LLC (ALABAMA LIMITED LIABILITY COMPANY)
P.O. BOX 1361
ROSWELL, GA 30077

FOR: PEARLS, IN CLASS 14 (U.S. CLS. 2, 27, 28 AND 50).

FIRST USE 6-1-2009; IN COMMERCE 7-1-2009.

THE MARK CONSISTS OF STANDARD CHARACTERS WITHOUT CLAIM TO ANY PARTICULAR FONT, STYLE, SIZE, OR COLOR.

NO CLAIM IS MADE TO THE EXCLUSIVE RIGHT TO USE "PEARLS", APART FROM THE MARK AS SHOWN.

SER. NO. 85-243,066, FILED 2-15-2011.

HEATHER BIDDULPH, EXAMINING ATTORNEY



David J. Kyros

Director of the United States Patent and Trademark Office

United States of America

United States Patent and Trademark Office

RAYS BOX

Reg. No. 4,066,192

Registered Dec. 6, 2011

Int. Cl.: 9

TRADEMARK

PRINCIPAL REGISTER

ARLINGTON INDUSTRIES, INC. (NEW YORK CORPORATION)
9051 NW 97TH TERRACE
MIAMI, FL 33178

FOR: ELECTRIC JUNCTION BOXES, IN CLASS 9 (U.S. CLS. 21, 23, 26, 36 AND 38).

FIRST USE 11-0-2008; IN COMMERCE 11-0-2008.

THE MARK CONSISTS OF STANDARD CHARACTERS WITHOUT CLAIM TO ANY PARTICULAR FONT, STYLE, SIZE, OR COLOR.

NO CLAIM IS MADE TO THE EXCLUSIVE RIGHT TO USE "BOX", APART FROM THE MARK AS SHOWN.

THE NAME(S), PORTRAIT(S), AND/OR SIGNATURE(S) SHOWN IN THE MARK IDENTIFIES "RAY KENNEDY", WHOSE CONSENT(S) TO REGISTER IS MADE OF RECORD.

SER. NO. 85-243,226, FILED 2-15-2011.

ROSELLE HERRERA, EXAMINING ATTORNEY



David J. Kyffers

Director of the United States Patent and Trademark Office

United States of America

United States Patent and Trademark Office



Reg. No. 4,066,193
Registered Dec. 6, 2011

GLOBAL IP SERVICES, PLLC (NEW HAMPSHIRE LIMITED LIABILITY COMPANY)
10, CRESTWOOD LANE,
NASHUA,, NH 03062

Int. Cl.: 45

FOR: LEGAL DOCUMENT PREPARATION AND RESEARCH SERVICES FOR ATTORNEYS; LEGAL SERVICES; LEGAL SERVICES, NAMELY, INTELLECTUAL PROPERTY CONSULTING SERVICES IN THE FIELD OF IDENTIFICATION, STRATEGY, ANALYTICS, AND INVENTION; LEGAL SERVICES, NAMELY, PREPARATION OF APPLICATIONS FOR TRADEMARK REGISTRATION; LEGAL SERVICES, NAMELY, TRADEMARK MAINTENANCE SERVICES; LEGAL SERVICES, NAMELY, TRADEMARK SEARCHING AND CLEARANCE SERVICES; LICENSING OF INTELLECTUAL PROPERTY; PATENT LICENSING; PROVIDING INFORMATION IN THE FIELD OF INTELLECTUAL PROPERTY LEGAL SERVICES; PROVIDING ON-LINE INFORMATION IN THE FIELD OF INTELLECTUAL PROPERTY LEGAL SERVICES, IN CLASS 45 (U.S. CLS. 100 AND 101).

SERVICE MARK

PRINCIPAL REGISTER

FIRST USE 1-1-2003; IN COMMERCE 1-1-2003.

NO CLAIM IS MADE TO THE EXCLUSIVE RIGHT TO USE "GLOBAL IP SERVICES", APART FROM THE MARK AS SHOWN.

THE MARK CONSISTS OF THE WORDING "GLOBAL IP SERVICES" IN THE CENTER, WITH CURVED BANDS APPEARING TO THE TOP AND TOP THE BOTTOM OF THE WORDING.

SER. NO. 85-243,363, FILED 2-16-2011.

JORDAN BAKER, EXAMINING ATTORNEY



David J. Kybas

Director of the United States Patent and Trademark Office

United States of America

United States Patent and Trademark Office

INTERNATIONAL GENOMICS CONSORTIUM

Reg. No. 4,066,194

Registered Dec. 6, 2011

Int. Cls.: 35, 39 and 42

SERVICE MARK

PRINCIPAL REGISTER

THE INTERNATIONAL GENOMICS CONSORTIUM (ARIZONA NON-PROFIT CORPORATION)
400 NORTH FIFTH STREET
PHOENIX, AZ 85004

FOR: MEDICAL RESEARCH SUPPORT SERVICES, NAMELY, RECRUITMENT OF PATIENTS AND SUBJECTS FOR VARIOUS STUDIES, IN CLASS 35 (U.S. CLS. 100, 101 AND 102).

FIRST USE 9-30-2003; IN COMMERCE 9-30-2003.

FOR: DISTRIBUTING CLINICAL SPECIMENS, SUCH AS BLOOD AND TISSUE SAMPLES, TO RESEARCH ENTITIES FOR CORRELATIVE STUDIES, IN CLASS 39 (U.S. CLS. 100 AND 105).

FIRST USE 9-30-2003; IN COMMERCE 9-30-2003.

FOR: RESEARCH AND SCIENTIFIC ANALYSIS, NAMELY, MOLECULAR AND GENOMIC SEQUENCING AND ANALYSIS COMPRISING GENOMIC RESEARCH, BIOINFORMATICS, AND DIAGNOSTIC TECHNOLOGIES TO ANALYZE COMPLEX GENETIC DISEASES; COLLECTION, PROCESSING AND STORAGE OF BLOOD AND TISSUE SAMPLES AND ASSOCIATED GENOMIC DATA AND CLINICAL OUTCOME INFORMATION, AND UTILIZING STANDARDIZED PROTOCOLS LINKED TO A CENTRALIZED MOLECULAR PROFILING LABORATORY TO PERFORM SUCH ANALYSIS. ESTABLISHING AND AUGMENTING NATIONAL AND INTERNATIONAL STANDARDS FOR CONSENT, TISSUE COLLECTION, CLINICAL ANNOTATION, MOLECULAR ANALYSIS AND REPRESENTATION OF DATA; PROVIDING ONLINE MEDICAL AND RESEARCH INFORMATION RELATING TO BIOLOGICAL SAMPLES OBTAINED UNDER STANDARDIZED CONDITIONS, ALONG WITH ASSOCIATED GENE EXPRESSION DATA AND LONG-TERM PATIENT CLINICAL OUTCOME DATA TO ACCELERATE THE DISCOVERY OF TARGETS FOR THERAPY, PROGNOSIS AND DIAGNOSIS; PROVIDING A RESEARCH PLATFORM TO ALLOW USERS TO FACILITATE TRANSITIONING OF GENOMIC DISCOVERIES FROM THE BENCH TO A PATIENT'S BEDSIDE TO IMPROVE PATIENT CARE; PHARMACEUTICAL DRUG DEVELOPMENT SERVICES, MEDICAL AND SCIENTIFIC RESEARCH CONSULTATION SERVICES IN THE FIELD OF CLINICAL TRIALS; MEDICAL RESEARCH, COLLECTING AND ANALYZING CLINICAL SAMPLES, ANALYZING CLINICAL DATA, AND DNA SEQUENCING ALL IN THE FIELDS OF GENOMICS, BIOMEDICINE, BIOSCIENCES, AND BIOINFORMATICS; COMPUTER SOFTWARE DEVELOPMENT SERVICES IN THE FIELDS



David J. Kyjars

Director of the United States Patent and Trademark Office

Reg. No. 4,066,194 OF GENOMICS, BIOMEDICINE, BIOSCIENCES, AND BIOINFORMATICS, IN CLASS 42
(U.S. CLS. 100 AND 101).

FIRST USE 2-0-2001; IN COMMERCE 2-0-2001.

THE MARK CONSISTS OF STANDARD CHARACTERS WITHOUT CLAIM TO ANY PARTICULAR FONT, STYLE, SIZE, OR COLOR.

OWNER OF U.S. REG. NO. 2,996,136.

NO CLAIM IS MADE TO THE EXCLUSIVE RIGHT TO USE "GENOMICS CONSORTIUM", APART FROM THE MARK AS SHOWN.

SEC. 2(F).

SER. NO. 85-243,484, FILED 2-16-2011.

JANICE L. MCMORROW, EXAMINING ATTORNEY

United States of America

United States Patent and Trademark Office

theKey

Reg. No. 4,066,195

Registered Dec. 6, 2011

Int. Cl.: 41

SERVICE MARK

PRINCIPAL REGISTER

THE KEY MUSIC, LLC (US VIRGIN ISLANDS LIMITED LIABILITY COMPANY)
3725 VINEVILLE AVENUE
3725 VINEVILLE AVENUE
MACON, GA 30204

FOR: ENTERTAINMENT SERVICES IN THE NATURE OF LIVE PERFORMANCES BY A MUSICAL GROUP IN CONCERT, ON TELEVISION, AND IN OTHER VENUES AND MEDIA, IN CLASS 41 (U.S. CLS. 100, 101 AND 107).

FIRST USE 1-1-2010; IN COMMERCE 1-1-2010.

THE MARK CONSISTS OF STANDARD CHARACTERS WITHOUT CLAIM TO ANY PARTICULAR FONT, STYLE, SIZE, OR COLOR.

SER. NO. 85-243,533, FILED 2-16-2011.

WARREN L. OLANDRIA, EXAMINING ATTORNEY



David J. Kyffers

Director of the United States Patent and Trademark Office

United States of America

United States Patent and Trademark Office

SWAMI RAM

Reg. No. 4,066,196

SWAMI RAM (UNITED STATES INDIVIDUAL)
12201 SW 128TH COURT, UNIT 102
MIAMI, FL 33186

Registered Dec. 6, 2011

Int. Cl.: 41

FOR: TEACHING IN THE FIELD OF RELIGIOUS SCIENCES IN VEDIC SCIENCES AND HEALING METHODS, IN CLASS 41 (U.S. CLS. 100, 101 AND 107).

SERVICE MARK

FIRST USE 2-12-1996; IN COMMERCE 8-15-2006.

PRINCIPAL REGISTER

THE MARK CONSISTS OF STANDARD CHARACTERS WITHOUT CLAIM TO ANY PARTICULAR FONT, STYLE, SIZE, OR COLOR.

THE NAME(S), PORTRAIT(S), AND/OR SIGNATURE(S) SHOWN IN THE MARK IDENTIFIES SWAMI RAM CHARRAN, WHOSE CONSENT(S) TO REGISTER IS MADE OF RECORD.

THE ENGLISH TRANSLATION OF THE WORD "SWAMI" IN THE MARK IS "TEACHER" OR "GURU".

SER. NO. 85-244,425, FILED S.R. 2-16-2011 AM. P.R. 7-14-2011.

SALLY SHIH, EXAMINING ATTORNEY



David J. Kyros

Director of the United States Patent and Trademark Office

United States of America

United States Patent and Trademark Office



Reg. No. 4,066,197

Registered Dec. 6, 2011

Int. Cl.: 7

TRADEMARK

PRINCIPAL REGISTER

MASTER POWER TRANSMISSION, INC. (SOUTH CAROLINA CORPORATION)
201 W. MCBEE AVE., SUITE 303
GREENVILLE, SC 29601

FOR: ELECTRIC MOTORS FOR MACHINES AND PARTS THEREOF, ELECTRIC GENERATORS AND PARTS THEREOF EXCLUDING THOSE FOR VEHICLES, ELECTRICALLY OPERATED VARIABLE SPEED GEAR BOX UNITS FOR MACHINES OTHER THAN FOR LAND VEHICLES AND PARTS THEREOF, MECHANICAL GEAR BOX COMPONENTS FOR MACHINES OTHER THAN FOR LAND VEHICLES, NAMELY, BEARINGS, GEARS, COUPLINGS, CLUTCHES AND BRAKES, HUBS, BUSHINGS, CONVEYOR PULLEYS AND BELTS, IN CLASS 7 (U.S. CLS. 13, 19, 21, 23, 31, 34 AND 35).

FIRST USE 4-1-2010; IN COMMERCE 4-1-2010.

NO CLAIM IS MADE TO THE EXCLUSIVE RIGHT TO USE "POWER TRANSMISSION", APART FROM THE MARK AS SHOWN.

THE MARK CONSISTS OF A LOWER CASE SCRIPT "M" INSIDE AN OCTAGON; NEXT TO IT IS THE WORD "MASTER" IN ALL CAPITAL LETTERS; UNDER "MASTER" ARE THE WORDS "POWER TRANSMISSION" IN SMALLER CAPITAL LETTERS.

SER. NO. 85-244,520, FILED 2-17-2011.

JOHN E. MICHOS, EXAMINING ATTORNEY



David J. Kybas

Director of the United States Patent and Trademark Office

United States of America

United States Patent and Trademark Office

bak home

Reg. No. 4,066,198

Registered Dec. 6, 2011

Int. Cl.: 37

SERVICE MARK

PRINCIPAL REGISTER

LUKE BAKALAR (UNITED STATES INDIVIDUAL)
712 WEST WELLINGTON, #3
CHICAGO, IL 60657

FOR: REAL ESTATE DEVELOPMENT, IN CLASS 37 (U.S. CLS. 100, 103 AND 106).

FIRST USE 7-7-2010; IN COMMERCE 7-7-2010.

THE MARK CONSISTS OF STANDARD CHARACTERS WITHOUT CLAIM TO ANY PARTICULAR FONT, STYLE, SIZE, OR COLOR.

SER. NO. 85-244,821, FILED 2-17-2011.

NELSON SNYDER, EXAMINING ATTORNEY



David J. Kyfos

Director of the United States Patent and Trademark Office

United States of America

United States Patent and Trademark Office

S.N.A.P.

Reg. No. 4,066,199

Registered Dec. 6, 2011

Int. Cl.: 45

SERVICE MARK

PRINCIPAL REGISTER

DANNIS WOLIVER KELLEY (CALIFORNIA CORPORATION)
19TH FLOOR
71 STEVENSON STREET
SAN FRANCISCO, CA 94105

FOR: LEGAL SERVICES, NAMELY, PROVIDING CUSTOMIZED INFORMATION, DOCUMENTATION, COUNSELING AND ADVICE IN ALL AREAS OF LABOR-MANAGEMENT RELATIONS LAW, IN CLASS 45 (U.S. CLS. 100 AND 101).

FIRST USE 2-11-2010; IN COMMERCE 2-11-2010.

THE MARK CONSISTS OF STANDARD CHARACTERS WITHOUT CLAIM TO ANY PARTICULAR FONT, STYLE, SIZE, OR COLOR.

SER. NO. 85-244,927, FILED 2-17-2011.

APRIL HESIK, EXAMINING ATTORNEY



David J. Kybas

Director of the United States Patent and Trademark Office

United States of America

United States Patent and Trademark Office



Reg. No. 4,066,200

Registered Dec. 6, 2011

Int. Cl.: 36

SERVICE MARK

PRINCIPAL REGISTER

THE CAPITAL GROUP COMPANIES, INC. (DELAWARE CORPORATION)
ATTN: DAVID GIVNER (DMG)
333 SOUTH HOPE ST., 55TH FLOOR
LOS ANGELES, CA 90071

FOR: FINANCIAL SERVICES, NAMELY, FINANCIAL ANALYSIS, EVALUATION AND CONSULTATION; INVESTMENT MANAGEMENT AND ADVICE; MUTUAL FUND INVESTMENT MANAGEMENT AND DISTRIBUTION; ANNUITY SERVICES, NAMELY, INVESTMENT MANAGEMENT AND DISTRIBUTION OF VARIABLE ANNUITIES; FIDUCIARY SERVICES, NAMELY, SERVING AS TRUSTEE FOR DIRECTED AND DISCRETIONARY TRUST ACCOUNTS; ESTATE PLANNING; AND FINANCIAL ADMINISTRATION OF EMPLOYEE BENEFIT, PENSION AND RETIREMENT PLANS IN CONNECTION THEREWITH, IN CLASS 36 (U.S. CLS. 100, 101 AND 102).

FIRST USE 4-1-2010; IN COMMERCE 4-1-2010.

OWNER OF U.S. REG. NOS. 2,780,121, 3,672,711 AND OTHERS.

NO CLAIM IS MADE TO THE EXCLUSIVE RIGHT TO USE "CAPITAL PRIVATE CLIENT SERVICES FUNDS", APART FROM THE MARK AS SHOWN.

THE MARK CONSISTS OF TWO INTERLOCKING BOXES FOLLOWED BY THE WORDS "CAPITAL PRIVATE CLIENT SERVICES FUNDS".

SER. NO. 85-245,078, FILED 2-17-2011.

SARA BENJAMIN, EXAMINING ATTORNEY



David J. Kyjars

Director of the United States Patent and Trademark Office

United States of America

United States Patent and Trademark Office

FREEDOM LINK

Reg. No. 4,066,201

Registered Dec. 6, 2011

Int. Cl.: 35

SERVICE MARK

PRINCIPAL REGISTER

VGM GROUP, INC. (IOWA CORPORATION)
1111 WEST SAN MARNAN DRIVE
WATERLOO, IA 50701

FOR: REFERRAL SERVICES, NAMELY, ARRANGING FOR EQUIPMENT AND SERVICES FOR OXYGEN DEPENDENT PATIENTS WHO ARE TRAVELING OR RELOCATING, IN CLASS 35 (U.S. CLS. 100, 101 AND 102).

FIRST USE 2-1-1989; IN COMMERCE 2-1-1989.

THE MARK CONSISTS OF STANDARD CHARACTERS WITHOUT CLAIM TO ANY PARTICULAR FONT, STYLE, SIZE, OR COLOR.

OWNER OF U.S. REG. NO. 2,267,404.

SER. NO. 85-245,104, FILED 2-17-2011.

TINA MAI, EXAMINING ATTORNEY



David J. Kyffers

Director of the United States Patent and Trademark Office

United States of America

United States Patent and Trademark Office



Capital Group
Private Client Services

Reg. No. 4,066,202

Registered Dec. 6, 2011

Int. Cl.: 36

SERVICE MARK

PRINCIPAL REGISTER

THE CAPITAL GROUP COMPANIES, INC. (DELAWARE CORPORATION)
ATTN: DAVID GIVNER (DMG)
333 SOUTH HOPE ST., 55TH FLOOR
LOS ANGELES, CA 90071

FOR: FINANCIAL SERVICES, NAMELY, FINANCIAL ANALYSIS, EVALUATION AND CONSULTATION; INVESTMENT MANAGEMENT AND ADVICE; MUTUAL FUND INVESTMENT MANAGEMENT AND DISTRIBUTION; ANNUITY SERVICES, NAMELY, INVESTMENT MANAGEMENT AND DISTRIBUTION OF VARIABLE ANNUITIES; FIDUCIARY SERVICES, NAMELY, SERVING AS TRUSTEE FOR DIRECTED AND DISCRETIONARY TRUST ACCOUNTS; ESTATE PLANNING; AND FINANCIAL ADMINISTRATION OF EMPLOYEE BENEFIT, PENSION AND RETIREMENT PLANS IN CONNECTION THEREWITH, IN CLASS 36 (U.S. CLS. 100, 101 AND 102).

FIRST USE 4-1-2010; IN COMMERCE 4-1-2010.

OWNER OF U.S. REG. NOS. 2,780,121, 3,672,739 AND OTHERS.

NO CLAIM IS MADE TO THE EXCLUSIVE RIGHT TO USE "CAPITAL GROUP PRIVATE CLIENT SERVICES", APART FROM THE MARK AS SHOWN.

THE MARK CONSISTS OF TWO INTERLOCKING BOXES FOLLOWED BY THE WORDS "CAPITAL GROUP" ON THE SAME LINE AND "PRIVATE CLIENT SERVICES" ON THE SECOND LINE.

SER. NO. 85-245,180, FILED 2-17-2011.

SARA BENJAMIN, EXAMINING ATTORNEY



David J. Kybas

Director of the United States Patent and Trademark Office

United States of America

United States Patent and Trademark Office



Reg. No. 4,066,203

Registered Dec. 6, 2011

Int. Cl.: 14

TRADEMARK

PRINCIPAL REGISTER

ELKINS, DICK (UNITED STATES INDIVIDUAL)
P.O. BOX 1229
THOREAU, NM 87323

FOR: JEWELRY, NAMELY, BRACELETS, PENDANTS, RINGS, NECKLACES, IN CLASS 14 (U.S. CLS. 2, 27, 28 AND 50).

FIRST USE 12-1-2009; IN COMMERCE 12-1-2009.

NO CLAIM IS MADE TO THE EXCLUSIVE RIGHT TO USE "NOVELTY CO. INC.", APART FROM THE MARK AS SHOWN.

THE MARK CONSISTS OF AN ARROW INSIDE OF A BLACK CIRCLE THE LITERAL ELEMENT OF THE MARK IS IN A CIRCLE AROUND THE ARROW. THERE IS A BLACK BORDER AROUND THE OUTER CIRCLE.

SER. NO. 85-245,229, FILED 2-17-2011.

LINDA ESTRADA, EXAMINING ATTORNEY



David J. Kybas

Director of the United States Patent and Trademark Office

United States of America

United States Patent and Trademark Office



REBOOT
WORKSHOP
transitioning america's heroes

Reg. No. 4,066,204

Registered Dec. 6, 2011

Int. Cl.: 41

SERVICE MARK

PRINCIPAL REGISTER

NATIONAL VETERANS TRANSITION SERVICES, INC. (CALIFORNIA CORPORATION)
WWW.NVTSL.ORG
4141 CAMINO DEL RIO SOUTH
SAN DIEGO, CA 92108

FOR: CONDUCTING WORKSHOPS AND SEMINARS IN TRANSITIONING VETERANS AND SEPARATING SERVICE MEMBERS TO CIVILIAN LIFE, IN CLASS 41 (U.S. CLS. 100, 101 AND 107).

FIRST USE 6-1-2010; IN COMMERCE 6-1-2010.

NO CLAIM IS MADE TO THE EXCLUSIVE RIGHT TO USE "WORKSHOP", APART FROM THE MARK AS SHOWN.

THE COLOR(S) RED, BLUE, AND BLACK IS/ARE CLAIMED AS A FEATURE OF THE MARK.

THE STIPPLING IS A FEATURE OF THE MARK.

THE MARK CONSISTS OF A FIVE-POINTED INCOMPLETE STAR WITH THE LOWER PORTION CUT OUT CREATING THE APPEARANCE OF A SECOND SMALLER STAR, TO THE LEFT OF THE STACKED WORDING, "REBOOT WORKSHOP TRANSITIONING AMERICA'S HEROES" THE COLOR BLUE APPEARS IN THE INCOMPLETE STAR, THE COLOR RED APPEARS IN THE WORD "REBOOT" AND THE STIPPLING AND THE COLOR BLACK APPEARS IN THE WORDS "WORKSHOP" AND "TRANSITIONING AMERICA'S HEROES".

SER. NO. 85-245,479, FILED 2-17-2011.

CARYN GLASSER, EXAMINING ATTORNEY



David J. Kappas

Director of the United States Patent and Trademark Office

United States of America

United States Patent and Trademark Office



Reg. No. 4,066,205

Registered Dec. 6, 2011

Int. Cl.: 30

TRADEMARK

PRINCIPAL REGISTER

LOWELL INTERNATIONAL COMPANY (ILLINOIS CORPORATION)
9234 WEST BELMONT AVENUE
FRANKLIN PARK, IL 60131

FOR: LOLLIPOPS, IN CLASS 30 (U.S. CL. 46).

FIRST USE 5-1-2005; IN COMMERCE 5-1-2005.

NO CLAIM IS MADE TO THE EXCLUSIVE RIGHT TO USE "LOLLYPOPS", APART FROM THE MARK AS SHOWN.

THE COLOR(S) BLUE, PURPLE, RED, WHITE, BLACK, ORANGE, GREEN, PINK IS/ARE CLAIMED AS A FEATURE OF THE MARK.

THE MARK CONSISTS OF THE WORD "FRUIT" AND THE WORD "SEE", WHICH APPEAR AT THE TOP OF THE MARK CONNECTED BY A HYPHEN. "FRUIT" HAS A CAPITAL "F". THE WORD "FRUIT", THE WORD "SEE", AND THE HYPHEN APPEAR IN A LIGHT BLUE COLOR WITH A DARKER BLUE OUTLINE. BELOW "FRUIT-SEE" APPEARS THE WORD "LOLLYPOPS", ALL IN CAPITAL LETTERS. EACH LETTER LEANS TO EITHER THE LEFT OR THE RIGHT. ALL THE LETTERS IN "LOLLYPOPS" ARE RED WITH DIFFERENT COLOR OUTLINES. THE OUTLINE OF THE FIRST "L" IS PINK. THE OUTLINE OF THE FIRST "O" IS GREEN. THE OUTLINE OF THE SECOND "L" IS ORANGE. THE OUTLINE OF THE THIRD "L" IS BLUE. THE OUTLINE OF THE "Y" IS GREEN. THE OUTLINE OF THE FIRST "P" IS PINK. THE OUTLINE OF THE SECOND "O" IS ORANGE. THE OUTLINE OF THE SECOND "P" IS BLUE. THE OUTLINE OF THE "S" IS GREEN. EACH OF THE LETTERS IN THE WORD "LOLLYPOPS" CASTS A PURPLE SHADOW. BOTH LETTER "O'S" IN "LOLLYPOPS" LOOK LIKE EYES WITH ONE BLACK PUPIL IN EACH EYE AND WHITE BACKGROUND. THE LEFT "O" HAS A PUPIL IN THE BOTTOM RIGHT OF THE EYE. THE RIGHT "O" HAS A PUPIL IN THE BOTTOM LEFT OF THE EYE. BELOW THE WORD "LOLLYPOPS" APPEARS A LINE OF AN ORANGE SMILING MOUTH WHICH CASTS A DARKER ORANGE SHADOW. A DARK PINK TONGUE APPEARS ON TOP OF THE SMILE AND IS ANGLED UPWARD.



David J. Kyros

Director of the United States Patent and Trademark Office

SER. NO. 85-245,531, FILED 2-17-2011.

JANICE KIM, EXAMINING ATTORNEY

United States of America

United States Patent and Trademark Office



Reg. No. 4,066,206

Registered Dec. 6, 2011

Int. Cl.: 41

SERVICE MARK

PRINCIPAL REGISTER

KIDS IN FLIGHT, INC. (OHIO CORPORATION)
C/O FKWD CORPORATE SERVICES
5333 MEADOW LANE COURT
ELYRIA, OH 44035

FOR: CHARITABLE SERVICES, NAMELY, PROVIDING CHILDREN WITH SERIOUS MEDICAL CONDITIONS OR DISABILITIES WITH AVIATION RELATED EDUCATIONAL PROGRAMS AND EVENTS, NAMELY, ARTS AND CRAFTS INSTRUCTION, EDUCATIONAL EXHIBITS, AIRCRAFT TOURS, CONVERSATIONS WITH PILOTS, AND RECREATIONAL AIRPLANE RIDES, NOT FOR THE PURPOSE OF TRANSPORTATION, IN CLASS 41 (U.S. CLS. 100, 101 AND 107).

FIRST USE 5-5-2005; IN COMMERCE 5-5-2005.

THE MARK CONSISTS OF STYLIZED WORDS "KIDS IN FLIGHT" OVER THE STYLIZED WORDS "ENCOURAGING CHILDREN TO SOAR WITH THEIR DREAMS" WITH DRAWING OF A CHILD PILOTING A SMALL PROPELLER DRIVEN AIRPLANE.

SEC. 2(F) AS TO "KIDS IN FLIGHT."

SER. NO. 85-246,369, FILED 2-18-2011.

EDWARD NELSON, EXAMINING ATTORNEY



David J. Kyffers

Director of the United States Patent and Trademark Office

United States of America

United States Patent and Trademark Office

Social Planet

Reg. No. 4,066,207

Registered Dec. 6, 2011

Int. Cls.: 9 and 41

TRADEMARK

SERVICE MARK

PRINCIPAL REGISTER

DOUGLAS, DAVID A. (UNITED STATES INDIVIDUAL)
UNIT 43
1644 TAYLOR STREET
SAN FRANCISCO, CA 94133

FOR: DOWNLOADABLE COMPUTER GAME SOFTWARE FOR USE ON WIRELESS DEVICES AND COMPUTERS, IN CLASS 9 (U.S. CLS. 21, 23, 26, 36 AND 38).

FIRST USE 5-16-2008; IN COMMERCE 5-16-2008.

FOR: ENTERTAINMENT SERVICES, NAMELY, PROVIDING ON-LINE COMPUTER GAMES, IN CLASS 41 (U.S. CLS. 100, 101 AND 107).

FIRST USE 5-16-2008; IN COMMERCE 5-16-2008.

THE MARK CONSISTS OF STANDARD CHARACTERS WITHOUT CLAIM TO ANY PARTICULAR FONT, STYLE, SIZE, OR COLOR.

OWNER OF U.S. REG. NO. 3,697,841.

NO CLAIM IS MADE TO THE EXCLUSIVE RIGHT TO USE "SOCIAL", APART FROM THE MARK AS SHOWN.

SER. NO. 85-246,436, FILED 2-18-2011.

AISHA CLARKE, EXAMINING ATTORNEY



David J. Kyjars

Director of the United States Patent and Trademark Office

United States of America

United States Patent and Trademark Office

HyR Brix

Reg. No. 4,066,208

Registered Dec. 6, 2011

Int. Cl.: 1

TRADEMARK

PRINCIPAL REGISTER

LANE, JOHN D (UNITED STATES INDIVIDUAL)
2242 BERLIN STATION RD
DELAWARE, OH 43015

FOR: FERTILIZERS, IN CLASS 1 (U.S. CLS. 1, 5, 6, 10, 26 AND 46).

FIRST USE 11-15-2010; IN COMMERCE 12-1-2010.

THE MARK CONSISTS OF STANDARD CHARACTERS WITHOUT CLAIM TO ANY PARTICULAR FONT, STYLE, SIZE, OR COLOR.

SER. NO. 85-246,688, FILED 2-18-2011.

RICHARD WHITE, EXAMINING ATTORNEY



David J. Kyffers

Director of the United States Patent and Trademark Office

United States of America

United States Patent and Trademark Office



Reg. No. 4,066,209

Registered Dec. 6, 2011

Int. Cl.: 35

SERVICE MARK

PRINCIPAL REGISTER

MALOY, NANCY (UNITED STATES INDIVIDUAL), DBA NEVER ENOUGH
1110 11TH STREET NORTH
JACKSONVILLE BEACH, FL 32250 AND

MALOY, CLAYTON D. (UNITED STATES INDIVIDUAL), DBA NEVER ENOUGH
1110 11TH STREET NORTH
JACKSONVILLE BEACH, FL 32250

FOR: WHOLESALE AND RETAIL STORE SERVICES AND ON-LINE RETAIL AND WHOLESALE STORE SERVICES FEATURING CLOTHING AND ACCESSORIES, JEWELRY, SUNGLASSES, HANDBAGS, BACKPACKS, SHOES, HOUSEWARES, DECALS, STATIONARY AND GREETING CARDS, IN CLASS 35 (U.S. CLS. 100, 101 AND 102).

FIRST USE 10-9-2010; IN COMMERCE 10-9-2010.

OWNER OF U.S. REG. NOS. 3,947,651 AND 3,966,313.

THE MARK CONSISTS OF THE WORDING "NEVER ENOUGH" IN STYLIZED FONT SUPERIMPOSED OVER AN INFINITY SYMBOL DESIGN.

SER. NO. 85-247,138, FILED 2-20-2011.

AMY C. KEAN, EXAMINING ATTORNEY



David J. Kybas

Director of the United States Patent and Trademark Office

United States of America

United States Patent and Trademark Office



Reg. No. 4,066,210

Registered Dec. 6, 2011

Int. Cl.: 9

TRADEMARK

PRINCIPAL REGISTER

MEDIA LAB SRL (ITALY CORPORATION)
VIA TRIESTE 4
FOLLO, ITALY 19020

FOR: MEDICAL SOFTWARE FOR PERFORMING SIMULATIONS OF 3D DENTAL IMPLANTS, IN CLASS 9 (U.S. CLS. 21, 23, 26, 36 AND 38).

OWNER OF ITALY REG. NO. 0001070638, DATED 1-8-2003, EXPIRES 1-8-2013.

THE MARK CONSISTS OF A SCREW-LIKE DENTAL IMPLANT ENCASED IN A TOOTH, THAT STANDS WITHIN A HEXAGON SHAPE.

SER. NO. 85-247,535, FILED 2-21-2011.

MARGERY A. TIERNEY, EXAMINING ATTORNEY



David J. Kybas

Director of the United States Patent and Trademark Office

United States of America

United States Patent and Trademark Office



Reg. No. 4,066,211
Registered Dec. 6, 2011
Int. Cls.: 1 and 12

TRADEMARK
PRINCIPAL REGISTER

CONTINENTAL TEVES AG & CO. OHG (FED REP GERMANY AKTIENGESELLSCHAFT
& OFFENE HANDELSGESELLSCHAFT)
GUERICKESTRASSE 7
FRANKFURT, FED REP GERMANY 60488

FOR: BRAKE FLUID, IN CLASS 1 (U.S. CLS. 1, 5, 6, 10, 26 AND 46).

FOR: VEHICLE PARTS, NAMELY, BRAKE SYSTEM PARTS FOR LAND VEHICLES, IN
CLASS 12 (U.S. CLS. 19, 21, 23, 31, 35 AND 44).

PRIORITY CLAIMED UNDER SEC. 44(D) ON FED REP GERMANY APPLICATION NO.
302010042325, FILED 10-19-2010, REG. NO. 302010042325, DATED 11-15-2010, EXPIRES
10-31-2020.

OWNER OF U.S. REG. NOS. 1,231,537, 3,752,354 AND OTHERS.

NO CLAIM IS MADE TO THE EXCLUSIVE RIGHT TO USE "CLASSIC", APART FROM THE
MARK AS SHOWN.

THE MARK CONSISTS OF THE WORD "ATE" IN STYLIZED LETTERS, UNDERScoreD,
WITH THE HORIZONTAL STROKE OF THE UPPERCASE "A" EXTENDING THROUGH
THE HORIZONTAL STROKE OF THE LOWERCASE "T" AND ABOVE THE "E", BOUNDED
BY A BOX, AND THE WORD "CLASSIC" IN STYLIZED LETTERS DISPOSED BELOW THE
BOX.

SER. NO. 85-247,627, FILED 2-21-2011.

ANNE E. GUSTASON, EXAMINING ATTORNEY



David J. Kybas

Director of the United States Patent and Trademark Office

United States of America

United States Patent and Trademark Office



Reg. No. 4,066,212

Registered Dec. 6, 2011

Int. Cl.: 12

TRADEMARK

PRINCIPAL REGISTER

CONTINENTAL TEVES AG & CO. OHG (FED REP GERMANY AKTIENGESELLSCHAFT
& OFFENE HANDELSGESELLSCHAFT)
GUERICKESTRASSE 7
FRANKFURT, FED REP GERMANY 60488

FOR: VEHICLE PARTS, NAMELY, BRAKE PADS AND BRAKE SYSTEM PARTS FOR LAND
VEHICLES, IN CLASS 12 (U.S. CLS. 19, 21, 23, 31, 35 AND 44).

OWNER OF FED REP GERMANY REG. NO. 302010016836, DATED 5-4-2010, EXPIRES 4-
30-2020.

OWNER OF U.S. REG. NOS. 1,231,537, 1,565,796 AND OTHERS.

NO CLAIM IS MADE TO THE EXCLUSIVE RIGHT TO USE "CERAMIC", APART FROM
THE MARK AS SHOWN.

THE MARK CONSISTS OF THE WORD "ATE" IN STYLIZED LETTERS, UNDERSCORED,
WITH THE HORIZONTAL STROKE OF THE UPPERCASE "A" EXTENDING THROUGH
THE HORIZONTAL STROKE OF THE LOWERCASE "T" AND ABOVE THE "E", BOUNDED
BY A BOX, AND THE WORD "CERAMIC" DISPOSED BELOW THE BOX.

SER. NO. 85-247,636, FILED 2-21-2011.

ANNE E. GUSTASON, EXAMINING ATTORNEY



David J. Kybas

Director of the United States Patent and Trademark Office

United States of America

United States Patent and Trademark Office

Studio Macondo

Reg. No. 4,066,213

Registered Dec. 6, 2011

Int. Cls.: 40 and 41

SERVICE MARK

PRINCIPAL REGISTER

STUDIO MACONDO LLC (COLORADO LIMITED LIABILITY COMPANY)
5569 JERICO CT.
DENVER, CO 80249

FOR: PHOTOGRAPHIC RETOUCHING, IN CLASS 40 (U.S. CLS. 100, 103 AND 106).

FIRST USE 4-1-2011; IN COMMERCE 4-1-2011.

FOR: DIGITAL IMAGING SERVICES; PHOTO EDITING, IN CLASS 41 (U.S. CLS. 100, 101 AND 107).

FIRST USE 4-1-2011; IN COMMERCE 4-1-2011.

THE MARK CONSISTS OF STANDARD CHARACTERS WITHOUT CLAIM TO ANY PARTICULAR FONT, STYLE, SIZE, OR COLOR.

NO CLAIM IS MADE TO THE EXCLUSIVE RIGHT TO USE "STUDIO", APART FROM THE MARK AS SHOWN.

SER. NO. 85-247,718, FILED 2-21-2011.

TIMOTHY FINNEGAN, EXAMINING ATTORNEY



David J. Kyffers

Director of the United States Patent and Trademark Office

United States of America

United States Patent and Trademark Office



TEXTILE RESTORATION

Reg. No. 4,066,214

Registered Dec. 6, 2011

Int. Cl.: 37

SERVICE MARK

PRINCIPAL REGISTER

COMPLETE TEXTILE RESTORATION, LLC (CALIFORNIA LIMITED LIABILITY COMPANY)
SUITE D #278
2201 E. WILLOW ST.
SIGNAL HILL, CA 90755

FOR: TEXTILE RESTORATION SERVICES, NAMELY, RESTORING TEXTILES AND GARMENTS DAMAGED BY SMOKE, MOLD, AND OTHER CONTAMINANTS, IN CLASS 37 (U.S. CLS. 100, 103 AND 106).

FIRST USE 10-20-2010; IN COMMERCE 10-20-2010.

NO CLAIM IS MADE TO THE EXCLUSIVE RIGHT TO USE "COMPLETE TEXTILE RESTORATION", APART FROM THE MARK AS SHOWN.

THE MARK CONSISTS OF 6 PROGRESSIVE DOTS ABOVE 3 WAVY LINES ABOVE "COMPLETE", ABOVE "TEXTILE RESTORATION".

SER. NO. 85-247,721, FILED 2-21-2011.

TIMOTHY FINNEGAN, EXAMINING ATTORNEY



David J. Kybas

Director of the United States Patent and Trademark Office

United States of America

United States Patent and Trademark Office

Your companion in diagnostics

Reg. No. 4,066,215

Registered Dec. 6, 2011

Int. Cls.: 40 and 42

SERVICE MARK

PRINCIPAL REGISTER

RESEARCHDX (CALIFORNIA LIMITED LIABILITY COMPANY)
13766 ALTON PARKWAY SUITE 147
IRVINE, CA 92618

FOR: MANUFACTURING SERVICES AND RELATED MANUFACTURING CONSULTING SERVICES FOR OTHERS IN THE FIELD OF MEDICAL DIAGNOSTIC PRODUCTS TO ACCOMPANY PHARMACEUTICAL PRODUCTS, IN CLASS 40 (U.S. CLS. 100, 103 AND 106).

FIRST USE 1-7-2011; IN COMMERCE 1-1-2011.

FOR: MEDICAL AND SCIENTIFIC RESEARCH, NAMELY, DESIGNING AND CONDUCTING CLINICAL TRIALS; MEDICAL AND SCIENTIFIC LABORATORY SERVICES; PHARMACEUTICAL AND RELATED MEDICAL DIAGNOSTIC PRODUCT RESEARCH AND DEVELOPMENT; CONSULTING SERVICES IN THE FIELDS OF MEDICAL AND SCIENTIFIC CLINICAL TRIALS; MEDICAL AND SCIENTIFIC LABORATORIES, AND RESEARCH AND DEVELOPMENT OF DEVELOPING DIAGNOSTIC PRODUCTS TO ACCOMPANY PHARMACEUTICALS, IN CLASS 42 (U.S. CLS. 100 AND 101).

FIRST USE 1-7-2011; IN COMMERCE 2-1-2011.

THE MARK CONSISTS OF STANDARD CHARACTERS WITHOUT CLAIM TO ANY PARTICULAR FONT, STYLE, SIZE, OR COLOR.

SER. NO. 85-248,737, FILED 2-22-2011.

ROBIN CHOSID, EXAMINING ATTORNEY



David J. Kypos

Director of the United States Patent and Trademark Office

United States of America

United States Patent and Trademark Office

rendirse

Reg. No. 4,066,216

Registered Dec. 6, 2011

Int. Cl.: 25

TRADEMARK

PRINCIPAL REGISTER

UPPER CUT PROMOTIONS LLC (FLORIDA LIMITED LIABILITY COMPANY)
6130 SW 158TH WAY
DAVIE, FL 33331

FOR: APPAREL FOR DANCERS, NAMELY, TEE SHIRTS, SWEATSHIRTS, PANTS, LEGGINGS, SHORTS AND JACKETS; ATHLETIC APPAREL, NAMELY, SHIRTS, PANTS, JACKETS, FOOTWEAR, HATS AND CAPS, ATHLETIC UNIFORMS, IN CLASS 25 (U.S. CLS. 22 AND 39).

FIRST USE 2-14-2011; IN COMMERCE 2-14-2011.

THE MARK CONSISTS OF STANDARD CHARACTERS WITHOUT CLAIM TO ANY PARTICULAR FONT, STYLE, SIZE, OR COLOR.

THE ENGLISH TRANSLATION OF "RENDIRSE" IN THE MARK IS "SUBDUE".

SER. NO. 85-249,042, FILED 2-23-2011.

WENDY JUN, EXAMINING ATTORNEY



David J. Kyros

Director of the United States Patent and Trademark Office

United States of America

United States Patent and Trademark Office

HELLBETTY

Reg. No. 4,066,217

Registered Dec. 6, 2011

Int. Cl.: 25

TRADEMARK

PRINCIPAL REGISTER

HANK 3 RECORDS, LLC (TENNESSEE LIMITED LIABILITY COMPANY), DBA HANK 3 RECORDS
C/O 1923 N. LINCOLN PARK WEST
CHICAGO, IL 60614

FOR: JACKETS; SHORT-SLEEVED OR LONG-SLEEVED T-SHIRTS; SWEATSHIRTS; T-SHIRTS, IN CLASS 25 (U.S. CLS. 22 AND 39).

FIRST USE 1-1-1998; IN COMMERCE 1-1-1999.

THE MARK CONSISTS OF STANDARD CHARACTERS WITHOUT CLAIM TO ANY PARTICULAR FONT, STYLE, SIZE, OR COLOR.

SEC. 2(F).

SER. NO. 85-249,459, FILED 2-23-2011.

ALLISON SCHRODY, EXAMINING ATTORNEY



David J. Kyffers

Director of the United States Patent and Trademark Office

United States of America

United States Patent and Trademark Office

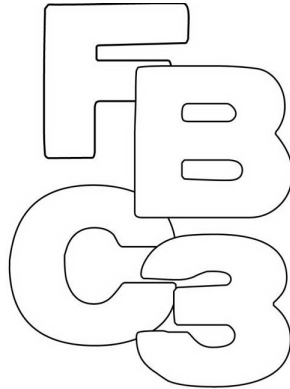

Reg. No. 4,066,218

Registered Dec. 6, 2011

Int. Cl.: 41

SERVICE MARK

PRINCIPAL REGISTER

CARROLL, DARNELL E. (UNITED STATES INDIVIDUAL)
2719 TALBOT AVENUE
OAKLAND, CA 94605

FOR: DANCE EVENTS; DANCE INSTRUCTION; DANCE INSTRUCTION FOR CHILDREN; EDUCATION SERVICES, NAMELY, PROVIDING CLASSES AND INSTRUCTION IN THE FIELD OF DANCE; EDUCATIONAL AND ENTERTAINMENT SERVICES, NAMELY, CONDUCTING CLASSES AND WORKSHOPS IN THE FIELD OF DANCE AND DISTRIBUTION OF COURSE MATERIALS IN CONNECTION THEREWITH, AND EDUCATION CONSULTING RELATED THERETO; ENCOURAGING PARTICIPATION IN CHEERLEADING, DANCE AND SPIRIT-RELATED COMPETITIONS AND EVENTS BY ESTABLISHING RULES AND PROVIDING GOVERNANCE FOR THE COMPETITIONS AND EVENTS; ENTERTAINMENT AND EDUCATION SERVICES IN THE NATURE OF LIVE DANCE AND MUSICAL PERFORMANCES; ENTERTAINMENT AND EDUCATIONAL SERVICES, NAMELY, THE PRESENTATION OF SEMINARS, WORKSHOPS AND PANEL DISCUSSIONS, AND ONGOING TELEVISION AND RADIO SHOWS ALL IN THE FIELD OF DANCE; ENTERTAINMENT IN THE NATURE OF DANCE PERFORMANCES; ORGANIZATION OF DANCING EVENTS; ORGANIZING COMMUNITY FESTIVALS FEATURING A VARIETY OF ACTIVITIES, NAMELY, ART EXHIBITIONS, HERITAGE MARKETS, ETHNIC DANCES, AND THE LIKE; TRAINING OF DANCE INSTRUCTORS, IN CLASS 41 (U.S. CLS. 100, 101 AND 107).

FIRST USE 1-0-2009; IN COMMERCE 10-18-2009.

THE MARK CONSISTS OF THE LETTERS "F", "B", AND "C" AND A NUMERAL "3".

SER. NO. 85-249,780, FILED 2-23-2011.

ALLISON HOLTZ, EXAMINING ATTORNEY



David J. Kyros

Director of the United States Patent and Trademark Office

United States of America

United States Patent and Trademark Office



Reg. No. 4,066,219

Registered Dec. 6, 2011

Int. Cl.: 10

TRADEMARK

PRINCIPAL REGISTER

POPPY POCKET, LLC (ARIZONA LIMITED LIABILITY COMPANY)
7823 E RED HAWK CIR
MESA, AZ 85207

FOR: MEDICAL BAGS DESIGNED TO HOLD INFUSION PUMPS, HEART MONITORS, PPH PUMPS, DIABETES PUMPS, IN CLASS 10 (U.S. CLS. 26, 39 AND 44).

FIRST USE 1-15-2009; IN COMMERCE 6-10-2009.

NO CLAIM IS MADE TO THE EXCLUSIVE RIGHT TO USE "POCKET", APART FROM THE MARK AS SHOWN.

THE COLOR(S) GREEN IS/ARE CLAIMED AS A FEATURE OF THE MARK.

THE MARK CONSISTS OF "POPPY POCKET" IN THE COLOR GREEN ON A BLACK BACKGROUND THAT IS NOT PART OF THE MARK.

SER. NO. 85-250,159, FILED 2-24-2011.

JOSETTE BEVERLY, EXAMINING ATTORNEY



David J. Kybas

Director of the United States Patent and Trademark Office

United States of America

United States Patent and Trademark Office

FUZZFACTORY

Reg. No. 4,066,220

VEX, ZACHARY (UNITED STATES INDIVIDUAL), DBA Z.VEX EFFECTS
401 GROVELAND AVENUE
MINNEAPOLIS, MN 55403

Registered Dec. 6, 2011

Int. Cl.: 15

FOR: ELECTRONIC EFFECTS PEDALS FOR USE WITH MUSICAL INSTRUMENTS, IN CLASS 15 (U.S. CLS. 2, 21 AND 36).

TRADEMARK

FIRST USE 12-22-1995; IN COMMERCE 12-22-1995.

PRINCIPAL REGISTER

THE MARK CONSISTS OF STANDARD CHARACTERS WITHOUT CLAIM TO ANY PARTICULAR FONT, STYLE, SIZE, OR COLOR.

SER. NO. 85-250,457, FILED 2-24-2011.

JANET LEE, EXAMINING ATTORNEY



David J. Kybas

Director of the United States Patent and Trademark Office

United States of America

United States Patent and Trademark Office

ZVEX EFFECTS

Reg. No. 4,066,221

Registered Dec. 6, 2011

Int. Cl.: 15

TRADEMARK

PRINCIPAL REGISTER

VEX, ZACHARY (UNITED STATES INDIVIDUAL), DBA Z.VEX EFFECTS
401 GROVELAND AVENUE
MINNEAPOLIS, MN 55403

FOR: ELECTRONIC EFFECTS PEDALS FOR USE WITH MUSICAL INSTRUMENTS, IN CLASS 15 (U.S. CLS. 2, 21 AND 36).

FIRST USE 6-1-1995; IN COMMERCE 6-1-1995.

THE MARK CONSISTS OF STANDARD CHARACTERS WITHOUT CLAIM TO ANY PARTICULAR FONT, STYLE, SIZE, OR COLOR.

NO CLAIM IS MADE TO THE EXCLUSIVE RIGHT TO USE "EFFECTS", APART FROM THE MARK AS SHOWN.

SER. NO. 85-250,466, FILED 2-24-2011.

JANET LEE, EXAMINING ATTORNEY



David J. Kybas

Director of the United States Patent and Trademark Office

United States of America

United States Patent and Trademark Office

Resources on-Demand

Automated Emergency Resource Management System



Reg. No. 4,066,222

Registered Dec. 6, 2011

Int. Cl.: 42

SERVICE MARK

PRINCIPAL REGISTER

MACROSOFT, INC (NEW JERSEY CORPORATION)
2 SYLVAN WAY, 3RD FLOOR
PARSIPPANY, NJ 07054

FOR: PROVIDING TEMPORARY USE OF ONLINE NON-DOWNLOADABLE SOFTWARE TO MANAGE RESOURCE REQUESTS, TRACK PERSONNEL MOVEMENTS, AND SUPPORT LOGISTICS DURING A LARGE-SCALE POWER RESTORATION EVENT, IN CLASS 42 (U.S. CLS. 100 AND 101).

FIRST USE 4-25-2005; IN COMMERCE 4-25-2005.

NO CLAIM IS MADE TO THE EXCLUSIVE RIGHT TO USE "RESOURCES ON-DEMAND" AND "AUTOMATED EMERGENCY RESOURCE MANAGEMENT SYSTEM", APART FROM THE MARK AS SHOWN.

THE COLOR(S) BLUE, BLACK AND WHITE IS/ARE CLAIMED AS A FEATURE OF THE MARK.

THE MARK CONSISTS OF THE WORDING "RESOURCES ON-DEMAND AUTOMATED EMERGENCY RESOURCE MANAGEMENT SYSTEM" AND LOGOS DEPICTING A UTILITY WORKER, HIGH POWER ELECTRICITY LINES AND A UTILITY BOX-TRUCK. EACH LOGO IS IN A SQUARE WITH ROUNDED CORNERS. THE WORD "RESOURCES" IS BLUE, WHEREAS THE WORDS "ON-DEMAND AUTOMATED EMERGENCY RESOURCE MANAGEMENT SYSTEM" ARE BLACK. THE IMAGES ARE OUTLINED IN WHITE WITH A BLUE BACKGROUND.

SER. NO. 85-250,597, FILED 2-24-2011.

MARK T. MULLEN, EXAMINING ATTORNEY



David J. Kybas

Director of the United States Patent and Trademark Office

United States of America

United States Patent and Trademark Office

InPrac

Reg. No. 4,066,223

Registered Dec. 6, 2011

Int. Cl.: 44

SERVICE MARK

PRINCIPAL REGISTER

INPRAC, LLC (ARIZONA LIMITED LIABILITY COMPANY)
23233 N. PIMA ROAD, SUITE 113-116
SCOTTSDALE, AZ 85255

FOR: ORAL SURGERY AND DENTAL IMPLANT SERVICES, IN CLASS 44 (U.S. CLS. 100 AND 101).

FIRST USE 2-2-2011; IN COMMERCE 2-2-2011.

THE MARK CONSISTS OF STANDARD CHARACTERS WITHOUT CLAIM TO ANY PARTICULAR FONT, STYLE, SIZE, OR COLOR.

SER. NO. 85-250,628, FILED 2-24-2011.

JASON BLAIR, EXAMINING ATTORNEY



David J. Kybas

Director of the United States Patent and Trademark Office

United States of America

United States Patent and Trademark Office

SOUND BEHAVIOR "LET ME INTRODUCE YOU TO YOURSELF!"

Reg. No. 4,066,224

CROSBY, DONALD J. (UNITED STATES INDIVIDUAL)
P. O. BOX 49496
CHARLOTTE, NC 28277

Registered Dec. 6, 2011

Int. Cl.: 41

FOR: EDUCATIONAL AND ENTERTAINMENT SERVICES, NAMELY, A CONTINUING PROGRAM ABOUT INTRODUCING PEOPLE TO THEMSELVES AND DISCUSSING REAL LIFE APPLICATIONS ACCESSIBLE BY RADIO, TELEVISION, SATELLITE, AUDIO, VIDEO AND COMPUTER NETWORKS, IN CLASS 41 (U.S. CLS. 100, 101 AND 107).

SERVICE MARK

PRINCIPAL REGISTER

FIRST USE 1-8-2007; IN COMMERCE 1-8-2007.

THE MARK CONSISTS OF STANDARD CHARACTERS WITHOUT CLAIM TO ANY PARTICULAR FONT, STYLE, SIZE, OR COLOR.

SER. NO. 85-250,699, FILED 2-24-2011.

NAKIA HENRY, EXAMINING ATTORNEY



David J. Kybas

Director of the United States Patent and Trademark Office

United States of America

United States Patent and Trademark Office

Spooners Frozen Yogurt

Reg. No. 4,066,225

Registered Dec. 6, 2011

Int. Cl.: 43

SERVICE MARK

PRINCIPAL REGISTER

BNF, LLC (COLORADO LIMITED LIABILITY COMPANY), DBA SPOONERS FROZEN
YOGURT
2720 COUNCIL TREE AVE, STE 166
FORT COLLINS, CO 80525

FOR: FROZEN YOGURT SHOP SERVICES IN THE NATURE OF A RESTAURANT, IN CLASS
43 (U.S. CLS. 100 AND 101).

FIRST USE 5-3-2010; IN COMMERCE 6-12-2010.

THE MARK CONSISTS OF STANDARD CHARACTERS WITHOUT CLAIM TO ANY PAR-
TICULAR FONT, STYLE, SIZE, OR COLOR.

NO CLAIM IS MADE TO THE EXCLUSIVE RIGHT TO USE "FROZEN YOGURT", APART
FROM THE MARK AS SHOWN.

SER. NO. 85-250,955, FILED 2-24-2011.

REBECCA EISINGER, EXAMINING ATTORNEY



David J. Kyffers

Director of the United States Patent and Trademark Office

United States of America

United States Patent and Trademark Office

RAPID SCORECARD

Reg. No. 4,066,226

KNOWLES, BRETT (CANADA INDIVIDUAL)
234 INDIAN RD
TORONTO, CANADA M6R2W9

Registered Dec. 6, 2011

Int. Cls.: 35 and 42

FOR: BUSINESS MANAGEMENT AND ORGANIZATION CONSULTANCY SERVICES, IN CLASS 35 (U.S. CLS. 100, 101 AND 102).

SERVICE MARK

FIRST USE 1-1-1999; IN COMMERCE 1-1-1999.

PRINCIPAL REGISTER

FOR: PROVIDING THE USE OF NON-DOWNLOADABLE SOFTWARE IN THE FIELD OF STRATEGY DEVELOPMENT AND EXECUTION, IN CLASS 42 (U.S. CLS. 100 AND 101).

FIRST USE 1-1-1999; IN COMMERCE 1-1-1999.

THE MARK CONSISTS OF STANDARD CHARACTERS WITHOUT CLAIM TO ANY PARTICULAR FONT, STYLE, SIZE, OR COLOR.

SEC. 2(F).

SER. NO. 85-251,366, FILED 2-25-2011.

DORITT L. CARROLL, EXAMINING ATTORNEY



David J. Kyros

Director of the United States Patent and Trademark Office

United States of America

United States Patent and Trademark Office

QUESTEL

Reg. No. 4,066,227

Registered Dec. 6, 2011

**Int. Cls.: 9, 16, 35, 41, 42
and 45**

TRADEMARK

SERVICE MARK

PRINCIPAL REGISTER

QUESTEL-ORBIT, INC. (DELAWARE CORPORATION)
1725 DUKE STREET
SUITE 530
ALEXANDRIA, VA 22314

FOR: DOWNLOADABLE COMPUTER SOFTWARE FOR DOCKETING INTELLECTUAL PROPERTY DEADLINES, TRACKING INTELLECTUAL PROPERTY DOCUMENTS, DOCUMENT MANAGEMENT, INVOICE MANAGEMENT, CASE MANAGEMENT, CREATING BUSINESS REPORTS IN THE FIELD OF INTELLECTUAL PROPERTY, AND FOR PROVIDING PERIODIC UPDATES OF INFORMATION ON CHANGES TO INTELLECTUAL PROPERTY LAWS IN THE US AND FOREIGN COUNTRIES FOR USE IN MANAGING INTELLECTUAL PROPERTY PORTFOLIOS ONLINE; DOWNLOADABLE COMPUTER SOFTWARE FEATURING USER-DEFINED TEMPLATES BASED ON OFFICIAL FORMS FOR REGISTERING AND MAINTAINING US AND FOREIGN TRADEMARKS, PATENTS, DOMAIN NAMES AND DESIGNS, IN CLASS 9 (U.S. CLS. 21, 23, 26, 36 AND 38).

FIRST USE 12-31-1994; IN COMMERCE 12-31-1994.

FOR: MANUALS IN THE FIELD OF INTELLECTUAL PROPERTY SEARCH STRATEGIES FOR OBTAINING USER-DEFINED INFORMATION FROM ONLINE DATABASES; PAMPHLETS IN THE FIELD OF INTELLECTUAL PROPERTY; REFERENCE BOOKS AND MANUALS IN THE FIELD OF COMPUTER HARDWARE, PERIPHERALS AND COMPUTER PROGRAMS IN THE FIELD OF INTELLECTUAL PROPERTY, IN CLASS 16 (U.S. CLS. 2, 5, 22, 23, 29, 37, 38 AND 50).

FIRST USE 12-31-1994; IN COMMERCE 12-31-1994.

FOR: ON-LINE ORDERING SERVICES FEATURING DOCUMENTS IN THE FIELD OF INTELLECTUAL PROPERTY; BUSINESS INFORMATION SERVICES, NAMELY, MANAGEMENT OF DATABASES IN THE FIELD OF INTELLECTUAL PROPERTY; PROVIDING BUSINESS INTELLIGENCE RESEARCH SERVICES IN THE FIELD OF INTELLECTUAL PROPERTY; ONLINE RETAIL STORE SERVICES FEATURING COMPUTER SOFTWARE FOR TRADEMARK AND PATENT PORTFOLIO MANAGEMENT; COMPUTERIZED DATABASE MANAGEMENT SERVICES IN THE FIELD OF INTELLECTUAL PROPERTY; BUSINESS RESEARCH IN USER-DEFINED FIELDS OF TECHNOLOGY AND PROVIDING BUSINESS INTELLIGENCE AND ALERTS AS TO CHANGES IN THOSE FIELDS; EXPERT



David J. Kybas

Director of the United States Patent and Trademark Office

Reg. No. 4,066,227 EVALUATIONS AND REPORTS RELATING TO BUSINESS MATTERS IN THE FIELD OF INTELLECTUAL PROPERTY, IN CLASS 35 (U.S. CLS. 100, 101 AND 102).

FIRST USE 12-31-1994; IN COMMERCE 12-31-1994.

FOR: TRANSLATION SERVICES, NAMELY, INSTANT COMPUTER GENERATED ONLINE TRANSLATIONS OF US AND FOREIGN PATENTS AND PUBLISHED PATENT APPLICATIONS AND REGISTERED AND PENDING TRADEMARKS, IN CLASS 41 (U.S. CLS. 100, 101 AND 107).

FIRST USE 12-31-1995; IN COMMERCE 12-31-1995.

FOR: PUBLIC DOCUMENT RETRIEVAL SERVICES; COMPUTER TECHNOLOGY SUPPORT SERVICES, NAMELY, HELP DESK SERVICES; AUTHENTICATION OF INTELLECTUAL PROPERTY DOCUMENTS; DOMAIN NAME SEARCH SERVICES, NAMELY, CONDUCTING ONLINE COMPUTERIZED SEARCHES FOR THE AVAILABILITY OF DOMAIN NAMES, IN CLASS 42 (U.S. CLS. 100 AND 101).

FIRST USE 12-31-1994; IN COMMERCE 12-31-1994.

FOR: INTELLECTUAL PROPERTY CONSULTATION SERVICES, NAMELY, PROVIDING RESEARCH, ANALYSIS, PLANNING, REPORTING, AND INFORMATION CONCERNING INTELLECTUAL PROPERTY AND INTELLECTUAL PROPERTY RIGHTS, PROVIDING PATENT PRIOR ART RESEARCH SERVICES, NOVELTY ASSESSMENT, VALIDITY ASSESSMENT, LEGAL STATUS REVIEWS, FREEDOM-TO-OPERATE SEARCHES, CITATION ANALYSIS, PATENT MAPPING, PATENT AND TECHNOLOGY LANDSCAPING, IDENTIFICATION OF NON-INFRINGEMENT PRODUCT SCOPES, PATENT PORTFOLIO ANALYSIS, COMPETITIVE IP INTELLIGENCE, INVENTOR TRACKING, CLAIM CHARTING, PATENT TO PRODUCT LINEAGES, PATENT PREPARATION AND EXAMINATION RESPONSE PREPARATION SERVICES, PATENTABILITY AND PATENT CLAIMS ANALYSES, PATENT PORTFOLIO ANALYSES, TRADEMARK SEARCHING, ANALYSIS AND REGISTRATION SERVICES, PREPARATION OF LEGAL AND TECHNICAL DOCUMENTS, LICENSING OF INTELLECTUAL PROPERTY, CONSULTATION PROVIDING LINKS TO THE WEB SITES OF OTHERS FEATURING INFORMATION IN THE FIELD OF INTELLECTUAL PROPERTY; LEGAL DOCUMENT PREPARATION AND RESEARCH SERVICES IN THE FIELD OF INTELLECTUAL PROPERTY; PROVIDING ONLINE COMPUTER DATABASES AND ONLINE SEARCHABLE DATABASES IN THE FIELD OF INTELLECTUAL PROPERTY; PROVIDING AN ONLINE SEARCHABLE DATABASE IN THE FIELD OF PATENT APPLICATIONS AND REGISTRATIONS; INTELLECTUAL PROPERTY WATCH SERVICES; PROVIDING A WEBSITE FEATURING DATABASES FOR TRACKING THE OWNERSHIP AND LEGAL STATUS OF TRADEMARKS AND PATENTS; PROVIDING AN INTERACTIVE WEBSITE FEATURING INFORMATION ON THE LEGAL STATUS OF REGISTERED PATENTS AND PUBLISHED PATENT APPLICATIONS; PROVIDING AN INTERACTIVE WEBSITE FEATURING CURRENT INFORMATION IN THE FIELD OF INTELLECTUAL PROPERTY IN THE FORM OF INTELLIGENCE ON COMPETITORS, PARTNERS, INFRINGERS, AND ACTIVITY IN USER-DEFINED TYPES AND AREAS OF TECHNOLOGY IN THE FIELD OF INTELLECTUAL PROPERTY; LEGAL SERVICES; PROVIDING PATENT AND TRADEMARK SEARCHES; PROVIDING AN ON-LINE SEARCHABLE DATABASE FEATURING SCIENTIFIC PUBLICATIONS IN THE FIELD OF INTELLECTUAL PROPERTY; PROVIDING AN INTERNET NEWS PORTAL FEATURING LINKS TO NEWS STORIES AND ARTICLES CONCERNING DEVELOPMENTS IN THE FIELD INTELLECTUAL PROPERTY; PROVIDING AN INTERNET WEBSITE PORTAL OFFERING INFORMATION IN THE FIELD OF INTELLECTUAL PROPERTY; PROVIDING AN INTERNET WEBSITE PORTAL FEATURING LINKS TO SEARCHABLE PATENT DATABASES WITHIN THE US AND FOREIGN GOVERNMENT PATENT OFFICES, IN CLASS 45 (U.S. CLS. 100 AND 101).

FIRST USE 12-31-1995; IN COMMERCE 12-31-1995.

Reg. No. 4,066,227 THE MARK CONSISTS OF STANDARD CHARACTERS WITHOUT CLAIM TO ANY PARTICULAR FONT, STYLE, SIZE, OR COLOR.

SER. NO. 85-251,450, FILED 2-25-2011.

JUSTINE D. PARKER, EXAMINING ATTORNEY

United States of America

United States Patent and Trademark Office

Crazyfish

Reg. No. 4,066,228

Registered Dec. 6, 2011

Int. Cls.: 9, 21 and 25

MANNING, MARY ELLEN (UNITED STATES INDIVIDUAL)
470 WEST END AVENUE
NEW YORK, NY 10024

FOR: SUNGLASSES, DECORATIVE MAGNETS AND MOUSE PADS, IN CLASS 9 (U.S. CLS. 21, 23, 26, 36 AND 38).

TRADEMARK

FIRST USE 2-1-2011; IN COMMERCE 2-1-2011.

PRINCIPAL REGISTER

FOR: THERMAL INSULATED CONTAINERS FOR FOOD OR BEVERAGE; ALUMINUM WATER BOTTLES, SOLD EMPTY; PLASTIC DRINKING BOTTLES, SOLD EMPTY; STAINLESS STEEL TRAVEL MUGS; COFFEE CUPS, TEA CUPS, AND MUGS, IN CLASS 21 (U.S. CLS. 2, 13, 23, 29, 30, 33, 40 AND 50).

FIRST USE 2-1-2011; IN COMMERCE 2-1-2011.

FOR: WEARING APPAREL, CLOTHING, AND CLOTHING ACCESSORIES, NAMELY, T-SHIRTS, SHIRTS, TANKS TOPS, SWEATSHIRTS, CAPS, SHORTS, BOXER SHORTS, GYM SHORTS, UNDERWEAR, JACKETS, WIND-RESISTANT JACKETS, JERSEYS, KNIT HATS, SWEATPANTS, BEACHWEAR, BATHING AND LOUNGING ROBES, LOUNGEWEAR, NIGHTSHIRTS, PAJAMAS, APRONS, HEAD AND WRISTBAND, PANTS, BANDANAS SUN VISORS, HEADBANDS AND SOCKS, IN CLASS 25 (U.S. CLS. 22 AND 39).

FIRST USE 2-1-2011; IN COMMERCE 2-1-2011.

THE MARK CONSISTS OF THE WORD "CRAZYFISH" IN A VARIATION OF THE RANDUMHOUSE FONT.

SER. NO. 85-251,487, FILED 2-25-2011.

DOMINICK J. SALEMI, EXAMINING ATTORNEY



David J. Kyros

Director of the United States Patent and Trademark Office

United States of America

United States Patent and Trademark Office

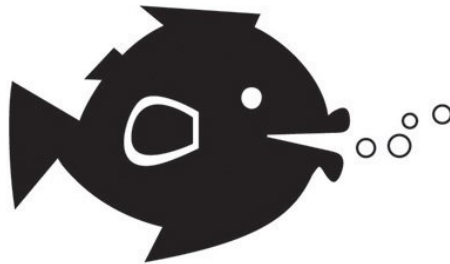

Reg. No. 4,066,229

Registered Dec. 6, 2011

Int. Cls.: 9, 21 and 25

MANNING, MARY ELLEN (UNITED STATES INDIVIDUAL)
470 WEST END AVENUE
NEW YORK, NY 10024

FOR: SUNGLASSES, DECORATIVE MAGNETS AND MOUSE PADS, IN CLASS 9 (U.S. CLS. 21, 23, 26, 36 AND 38).

TRADEMARK

FIRST USE 2-1-2010; IN COMMERCE 2-1-2010.

PRINCIPAL REGISTER

FOR: THERMAL INSULATED CONTAINERS FOR FOOD OR BEVERAGE; ALUMINUM WATER BOTTLES, SOLD EMPTY; PLASTIC DRINKING BOTTLES, SOLD EMPTY; STAINLESS STEEL TRAVEL MUGS; COFFEE CUPS, TEA CUPS, AND MUGS, IN CLASS 21 (U.S. CLS. 2, 13, 23, 29, 30, 33, 40 AND 50).

FIRST USE 2-1-2010; IN COMMERCE 2-1-2010.

FOR: WEARING APPAREL, CLOTHING, AND CLOTHING ACCESSORIES, NAMELY, T-SHIRTS, SHIRTS, TANKS TOPS, SWEATSHIRTS, CAPS, SHORTS, BOXER SHORTS, GYM SHORTS, UNDERWEAR, JACKETS, WIND-RESISTANT JACKETS, JERSEYS, KNIT HATS, SWEATPANTS, BEACHWEAR, BATHING AND LOUNGING ROBES, LOUNGEWEAR, NIGHTSHIRTS, PAJAMAS, APRONS, HEAD AND WRISTBAND, PANTS, BANDANAS SUN VISORS, HEADBANDS AND SOCKS, IN CLASS 25 (U.S. CLS. 22 AND 39).

FIRST USE 2-1-2010; IN COMMERCE 2-1-2010.

THE MARK CONSISTS OF ROUND FISH WITH ONE EYE, FINS, OPEN MOUTH WITH PROTRUDING LIPS AND BUBBLES EXITING MOUTH.

SER. NO. 85-251,526, FILED 2-25-2011.

DOMINICK J. SALEMI, EXAMINING ATTORNEY



David J. Kybas

Director of the United States Patent and Trademark Office

United States of America

United States Patent and Trademark Office



Reg. No. 4,066,230

Registered Dec. 6, 2011

Int. Cls.: 9, 21 and 25

MANNING, MARY ELLEN (UNITED STATES INDIVIDUAL)
470 WEST END AVENUE
NEW YORK, NY 10024

FOR: SUNGLASSES, DECORATIVE MAGNETS AND MOUSE PADS, IN CLASS 9 (U.S. CLS. 21, 23, 26, 36 AND 38).

TRADEMARK

FIRST USE 2-1-2011; IN COMMERCE 2-1-2011.

PRINCIPAL REGISTER

FOR: THERMAL INSULATED CONTAINERS FOR FOOD OR BEVERAGE; ALUMINUM WATER BOTTLES, SOLD EMPTY; PLASTIC DRINKING BOTTLES, SOLD EMPTY; STAINLESS STEEL TRAVEL MUGS; COFFEE CUPS, TEA CUPS, AND MUGS, IN CLASS 21 (U.S. CLS. 2, 13, 23, 29, 30, 33, 40 AND 50).

FIRST USE 2-1-2011; IN COMMERCE 2-1-2011.

FOR: WEARING APPAREL, CLOTHING, AND CLOTHING ACCESSORIES, NAMELY, T-SHIRTS, SHIRTS, TANKS TOPS, SWEATSHIRTS, CAPS, SHORTS, BOXER SHORTS, GYM SHORTS, UNDERWEAR, JACKETS, WIND-RESISTANT JACKETS, JERSEYS, KNIT HATS, SWEATPANTS, BEACHWEAR, BATHING AND LOUNGING ROBES, LOUNGEWEAR, NIGHTSHIRTS, PAJAMAS, APRONS, HEAD AND WRISTBAND, PANTS, BANDANAS SUN VISORS, HEADBANDS AND SOCKS, IN CLASS 25 (U.S. CLS. 22 AND 39).

FIRST USE 2-1-2011; IN COMMERCE 2-1-2011.

THE MARK CONSISTS OF ROUND FISH WITH FINS, ONE EYE, OPEN MOUTH WITH PROTRUDING LIPS AND BUBBLES EXITING MOUTH WITH THE WORD "CRAZYFISH" IN A VARIATION OF THE RANDUMHOUSE FONT OFFSET TO THE RIGHT OF THE FISH.

SER. NO. 85-251,556, FILED 2-25-2011.

DOMINICK J. SALEMI, EXAMINING ATTORNEY



David J. Kyros

Director of the United States Patent and Trademark Office

United States of America

United States Patent and Trademark Office

TRIPLE HEAT

Reg. No. 4,066,231

Registered Dec. 6, 2011

Int. Cl.: 28

TRADEMARK

PRINCIPAL REGISTER

ALTUS BRANDS, LLC (MICHIGAN LIMITED LIABILITY COMPANY)
448 W. WELCH COURT
TRAVERSE CITY, MI 49686

FOR: HUNTERS' SCENT LURE COLLECTED FROM THREE FEMALE DEER IN HEAT, IN CLASS 28 (U.S. CLS. 22, 23, 38 AND 50).

FIRST USE 3-1-2001; IN COMMERCE 3-1-2001.

THE MARK CONSISTS OF STANDARD CHARACTERS WITHOUT CLAIM TO ANY PARTICULAR FONT, STYLE, SIZE, OR COLOR.

NO CLAIM IS MADE TO THE EXCLUSIVE RIGHT TO USE "HEAT", APART FROM THE MARK AS SHOWN.

SER. NO. 85-251,743, FILED 2-25-2011.

MATTHEW MCDOWELL, EXAMINING ATTORNEY



David J. Kyros

Director of the United States Patent and Trademark Office

United States of America

United States Patent and Trademark Office



Reg. No. 4,066,232

Registered Dec. 6, 2011

Int. Cl.: 43

SERVICE MARK

PRINCIPAL REGISTER

BNF, LLC (COLORADO LIMITED LIABILITY COMPANY), DBA SPOONERS FROZEN YOGURT
2720 COUNCIL TREE AVE, STE 166
FORT COLLINS, CO 80525

FOR: FROZEN YOGURT SHOP SERVICES IN THE NATURE OF A RESTAURANT, IN CLASS 43 (U.S. CLS. 100 AND 101).

FIRST USE 5-3-2010; IN COMMERCE 6-12-2010.

NO CLAIM IS MADE TO THE EXCLUSIVE RIGHT TO USE "FROZEN YOGURT", APART FROM THE MARK AS SHOWN.

THE MARK CONSISTS OF THE STYLIZED TEXT "SPOONERS FROZEN YOGURT". THE LETTER "P" IN "SPOONERS" APPEARS AS A STYLIZED SPOON, WHILE THE FIRST "O" CONTAINS A STYLIZED SNOWFLAKE AND THE SECOND "O" CONTAINS A SWIRL DESIGN. THE RECTANGULAR BACKGROUND CARRIER SHOWN IN THE DRAWING IS NOT A FEATURE OF THE MARK BUT IS PRESENT MERELY TO SHOW CONTRAST.

SER. NO. 85-251,820, FILED 2-25-2011.

REBECCA EISINGER, EXAMINING ATTORNEY



David J. Kybas

Director of the United States Patent and Trademark Office

United States of America

United States Patent and Trademark Office



El Movimiento
ENTERTAINMENT

Reg. No. 4,066,233

Registered Dec. 6, 2011

Int. Cl.: 41

SERVICE MARK

PRINCIPAL REGISTER

ESPINAL, LEONARDO (UNITED STATES INDIVIDUAL), DBA EL MOVIMIENTO ENTERTAINMENT
39-09 103RD STREET
CORONA, NY 11368

FOR: ARRANGING AND CONDUCTING NIGHTCLUB ENTERTAINMENT EVENTS; ARRANGING FOR TICKET RESERVATIONS FOR SHOWS AND OTHER ENTERTAINMENT EVENTS; ENTERTAINMENT INFORMATION SERVICES, NAMELY, PROVIDING INFORMATION AND NEWS RELEASES ABOUT A MUSICAL ARTIST; ENTERTAINMENT SERVICES, NAMELY, PROVIDING INFORMATION ABOUT A RECORDING ARTIST VIA AN ONLINE NETWORK; ENTERTAINMENT, NAMELY, LIVE MUSIC CONCERTS; ENTERTAINMENT, NAMELY, LIVE PERFORMANCES BY MUSICAL BANDS, IN CLASS 41 (U.S. CLS. 100, 101 AND 107).

FIRST USE 6-1-2006; IN COMMERCE 6-1-2006.

NO CLAIM IS MADE TO THE EXCLUSIVE RIGHT TO USE "ENTERTAINMENT", APART FROM THE MARK AS SHOWN.

THE COLOR(S) RED, DARK RED, WHITE, BLUE, DARK BLUE AND BLACK IS/ARE CLAIMED AS A FEATURE OF THE MARK.

THE MARK CONSISTS OF A CIRCLE WITH AN UPPERCASE BOLD STYLIZED LETTER "M" IN WHITE SPLITTING IT IN THE MIDDLE. THE UPPER HALF OF THE CIRCLE IS A GRADIENT OF RED AND DARK RED AND THE BOTTOM HALF OF THE CIRCLE IS A GRADIENT OF BLUE AND DARK BLUE. THE WORDS "EL MOVIMIENTO" ARE STYLIZED WITH THE SAME FONT AS THE UPPERCASE "M" AND ARE IN BLACK. UNDER "EL MOVIMIENTO", THE WORD "ENTERTAINMENT" HAS A SERIF TYPE FONT IN ALL CAPITAL LETTERS IN BLACK AS WELL.

THE ENGLISH TRANSLATION OF "EL MOVIMIENTO" IN THE MARK IS "THE MOVEMENT".

SER. NO. 85-251,850, FILED S.R. 2-25-2011 AM. P.R. 7-28-2011.

ZACHARY BELLO, EXAMINING ATTORNEY



David J. Kybas

Director of the United States Patent and Trademark Office

United States of America

United States Patent and Trademark Office

WEB THAT WORKS

Reg. No. 4,066,234

Registered Dec. 6, 2011

Int. Cls.: 35, 36 and 42

SERVICE MARK

PRINCIPAL REGISTER

SHARPE GROUP LLC (TENNESSEE LIMITED LIABILITY COMPANY)
SUITE 222
8700 TRAIL LAKE DRIVE, WEST
MEMPHIS, TN 38125

FOR: PROVIDING WEB-BASED PROMOTIONAL SERVICES IN THE FIELD OF PLANNED GIVING FOR NON-PROFIT AND CHARITABLE ORGANIZATIONS, IN CLASS 35 (U.S. CLS. 100, 101 AND 102).

FIRST USE 4-1-2009; IN COMMERCE 4-1-2009.

FOR: PROVIDING WEB-BASED FINANCIAL CONSULTING SERVICES TO DONORS, ADVISORS, DEVELOPMENT PROFESSIONALS, AND OTHERS INVOLVED IN THE GIFT-MAKING PROCESS IN THE FIELD OF PLANNED GIVING FOR NON-PROFIT AND CHARITABLE ORGANIZATIONS, IN CLASS 36 (U.S. CLS. 100, 101 AND 102).

FIRST USE 4-1-2009; IN COMMERCE 4-1-2009.

FOR: DESIGN AND CREATION OF WEB SITES FOR OTHERS IN THE FIELD OF PLANNED GIVING FOR NON-PROFIT AND CHARITABLE ORGANIZATIONS, IN CLASS 42 (U.S. CLS. 100 AND 101).

FIRST USE 4-1-2009; IN COMMERCE 4-1-2009.

THE MARK CONSISTS OF STANDARD CHARACTERS WITHOUT CLAIM TO ANY PARTICULAR FONT, STYLE, SIZE, OR COLOR.

SER. NO. 85-251,949, FILED 2-25-2011.

KRISTIN CARLSON, EXAMINING ATTORNEY



David J. Kybas

Director of the United States Patent and Trademark Office

United States of America

United States Patent and Trademark Office

HORSE CHANNEL

Reg. No. 4,066,235

Registered Dec. 6, 2011

Int. Cls.: 35, 38 and 44

SERVICE MARK

PRINCIPAL REGISTER

BOWTIE, INC. (CALIFORNIA CORPORATION)
3 BURROUGHS
IRVINE, CA 926182804

FOR: PROVIDING ONLINE BUSINESS DIRECTORIES FEATURING ANIMAL BREEDERS; PROMOTING THE GOODS AND SERVICES OF OTHERS THROUGH ONLINE ADVERTISEMENTS; PROVIDING ONLINE CLASSIFIED ADVERTISING SPACE; INFORMATION DISTRIBUTION SERVICES, NAMELY, PROVIDING CONSUMER PRODUCT INFORMATION VIA THE INTERNET, FEATURING ANIMAL-RELATED PRODUCTS AND SERVICES; PROVIDING A SEARCHABLE WEBSITE FEATURING THE ANIMAL-RELATED CONSUMER PRODUCTS AND SERVICES OF OTHERS, IN CLASS 35 (U.S. CLS. 100, 101 AND 102).

FIRST USE 12-0-2006; IN COMMERCE 12-0-2006.

FOR: PROVIDING ON-LINE FORUMS FOR TRANSMISSION OF MESSAGES AMONG COMPUTER USERS CONCERNING ANIMALS AND TOPICS OF GENERAL INTEREST; PROVIDING ON-LINE ELECTRONIC BULLETIN BOARDS FOR TRANSMISSION OF MESSAGES AMONG COMPUTER USERS CONCERNING ANIMALS AND TOPICS OF GENERAL INTEREST; TRANSMISSION OF SOUND, VIDEO AND INFORMATION, IN CLASS 38 (U.S. CLS. 100, 101 AND 104).

FIRST USE 12-0-2006; IN COMMERCE 12-0-2006.

FOR: PROVIDING INFORMATION IN THE FIELDS OF ANIMALS AND PET BREEDING, SELECTION OF THE ANIMALS AND PETS, GROOMING, HEALTH AND NUTRITION, IN CLASS 44 (U.S. CLS. 100 AND 101).

FIRST USE 6-0-2005; IN COMMERCE 6-0-2005.

THE MARK CONSISTS OF STANDARD CHARACTERS WITHOUT CLAIM TO ANY PARTICULAR FONT, STYLE, SIZE, OR COLOR.

SEC. 2(F).

SER. NO. 85-252,004, FILED 2-25-2011.

NICHOLAS ALTREE, EXAMINING ATTORNEY



David J. Kyros

Director of the United States Patent and Trademark Office

United States of America
United States Patent and Trademark Office

HiDANplus

Reg. No. 4,066,236

Registered Dec. 6, 2011

Int. Cl.: 9

TRADEMARK

PRINCIPAL REGISTER

RTD EMBEDDED TECHNOLOGIES, INC. (PENNSYLVANIA CORPORATION)
103 INNOVATION BOULEVARD, P.O. BOX 906
STATE COLLEGE, PA 168040906

FOR: DATA ACQUISITION/CONTROL NODE COMPRISING OF A CENTRAL PROCESSING UNIT, MEMORY STORAGE, AND/OR STACKABLE COMPUTER EXPANSION BOARDS IN A RUGGED MODULAR ENCLOSURE, IN CLASS 9 (U.S. CLS. 21, 23, 26, 36 AND 38).

FIRST USE 4-0-2001; IN COMMERCE 4-0-2001.

THE MARK CONSISTS OF STANDARD CHARACTERS WITHOUT CLAIM TO ANY PARTICULAR FONT, STYLE, SIZE, OR COLOR.

OWNER OF U.S. REG. NO. 3,666,783.

SER. NO. 85-252,189, FILED 2-25-2011.

TIMOTHY FINNEGAN, EXAMINING ATTORNEY



David J. Kyros

Director of the United States Patent and Trademark Office

United States of America

United States Patent and Trademark Office

NO-RUST SHIELD

Reg. No. 4,066,237

Registered Dec. 6, 2011

Int. Cl.: 2

TRADEMARK

PRINCIPAL REGISTER

WD-40 COMPANY (DELAWARE CORPORATION)
1061 CUDAHY PLACE
SAN DIEGO, CA 92110

FOR: VAPOR PHASE CORROSION INHIBITORS IN THE NATURE OF A COATING, IN CLASS 2 (U.S. CLS. 6, 11 AND 16).

FIRST USE 9-5-2008; IN COMMERCE 9-5-2008.

THE MARK CONSISTS OF STANDARD CHARACTERS WITHOUT CLAIM TO ANY PARTICULAR FONT, STYLE, SIZE, OR COLOR.

OWNER OF U.S. REG. NOS. 3,604,438 AND 3,845,676.

SER. NO. 85-252,366, FILED 2-25-2011.

STEVEN R. FINE, EXAMINING ATTORNEY



David J. Kybas

Director of the United States Patent and Trademark Office

United States of America

United States Patent and Trademark Office

LIVE IT IT'S THE LAW!

Reg. No. 4,066,238

THOMAS TORRES (UNITED STATES INDIVIDUAL)
1336 HERBERT BLVD
WILLIAMSTOWN, NJ 08094

Registered Dec. 6, 2011

Int. Cl.: 25

FOR: SHORT-SLEEVED OR LONG-SLEEVED T-SHIRTS; T-SHIRTS, IN CLASS 25 (U.S. CLS. 22 AND 39).

TRADEMARK

FIRST USE 1-1-2011; IN COMMERCE 1-20-2011.

PRINCIPAL REGISTER

THE MARK CONSISTS OF STANDARD CHARACTERS WITHOUT CLAIM TO ANY PARTICULAR FONT, STYLE, SIZE, OR COLOR.

SER. NO. 85-252,404, FILED S.R. 2-25-2011 AM. P.R. 8-6-2011.

JULIE GUTTADAURO, EXAMINING ATTORNEY



David J. Kyffers

Director of the United States Patent and Trademark Office

United States of America

United States Patent and Trademark Office

SECRETS OF AN AUCTION MILLIONAIRE

Reg. No. 4,066,239

Registered Dec. 6, 2011

Int. Cls.: 35 and 41

SERVICE MARK

PRINCIPAL REGISTER

ADAM GINSBERG INTERNATIONAL, INC. (CALIFORNIA CORPORATION)
11693 SAN VICENTE BLVD., #518
LOS ANGELES, CA 90049

FOR: ADVERTISING, PROMOTION, AND MARKETING SERVICES IN THE NATURE OF DOMAIN MONETIZATION AND MONETIZING WEB TRAFFIC FOR DOMAIN NAME OWNERS; PROMOTING, ADVERTISING AND MARKETING OF THE ON-LINE WEB SITES OF OTHERS, IN CLASS 35 (U.S. CLS. 100, 101 AND 102).

FIRST USE 8-31-2004; IN COMMERCE 8-31-2004.

FOR: EDUCATIONAL SERVICES, NAMELY, CONDUCTING CLASSES, SEMINARS, CONFERENCES AND WORKSHOPS IN THE FIELDS OF ONLINE MARKETING AND DISTRIBUTION OF TRAINING MATERIALS IN CONNECTION THEREWITH, IN CLASS 41 (U.S. CLS. 100, 101 AND 107).

FIRST USE 8-31-2004; IN COMMERCE 8-31-2004.

THE MARK CONSISTS OF STANDARD CHARACTERS WITHOUT CLAIM TO ANY PARTICULAR FONT, STYLE, SIZE, OR COLOR.

SER. NO. 85-252,441, FILED 2-25-2011.

DANNEAN HETZEL, EXAMINING ATTORNEY



David J. Kyros

Director of the United States Patent and Trademark Office

United States of America

United States Patent and Trademark Office

Nomadic Media Group

Reg. No. 4,066,240

Registered Dec. 6, 2011

Int. Cl.: 35

SERVICE MARK

PRINCIPAL REGISTER

RAWLINS, KIMATNI D (MARYLAND LIMITED LIABILITY COMPANY), DBA NOMADIC MEDIA GROUP
13924 OVERTON LANE
SILVER SPRING, MD 20904

FOR: ADVERTISING SERVICES, NAMELY, PROMOTING AND MARKETING THE GOODS AND SERVICES OF OTHERS IN THE FIELD OF UPSCALE CHOICES SUCH AS CULTURAL EVENTS, RESTAURANTS, SHOPPING, AND TRAVEL VIA PRINT AND ELECTRONIC MEDIA; ADVERTISING VIA ELECTRONIC MEDIA AND SPECIFICALLY THE INTERNET; MEDIA PLANNING, NAMELY, ADVISING THE CLIENT ON THE CORRECT TIMES AND STATIONS TO ADVERTISE BASED ON MEDIA ANALYSIS OF THE MARKET FOR THAT MEDIA; MEDIA PRODUCTION LOCATION SCOUTING SERVICES FOR ADVERTISING PURPOSES; PROVIDING CONSULTING SERVICES IN THE FIELD OF FACILITATING THE PLANNING, BUYING, AND SELLING OF MEDIA; PROVIDING PROMOTIONAL MARKETING SERVICES TO BUSINESSES IN THE BROADBAND AND MEDIA INDUSTRIES; SOCIAL MEDIA STRATEGY AND MARKETING CONSULTANCY FOCUSING ON HELPING CLIENTS CREATE AND EXTEND THEIR PRODUCT AND BRAND STRATEGIES BY BUILDING VIRALLY ENGAGING MARKETING SOLUTIONS, IN CLASS 35 (U.S. CLS. 100, 101 AND 102).

FIRST USE 1-12-2009; IN COMMERCE 1-12-2009.

THE MARK CONSISTS OF STANDARD CHARACTERS WITHOUT CLAIM TO ANY PARTICULAR FONT, STYLE, SIZE, OR COLOR.

NO CLAIM IS MADE TO THE EXCLUSIVE RIGHT TO USE "MEDIA GROUP" , APART FROM THE MARK AS SHOWN.

SER. NO. 85-252,596, FILED S.R. 2-26-2011 AM. P.R. 8-7-2011.

DORITT L. CARROLL, EXAMINING ATTORNEY



David J. Kyffers

Director of the United States Patent and Trademark Office

United States of America

United States Patent and Trademark Office



RN PATIENT ADVOCATES^{PLLC}
Your Health Care Safety Net

Advocacy Education & Guidance through the Healthcare System

Reg. No. 4,066,241

Registered Dec. 6, 2011

Int. Cl.: 35

SERVICE MARK

PRINCIPAL REGISTER

RN PATIENT ADVOCATES, PLC (ARIZONA LIMITED LIABILITY COMPANY)
3035 N TOMAS
TUCSON, AZ 85745

FOR: PUBLIC ADVOCACY TO PROMOTE AWARENESS OF HEALTHCARE SYSTEMS, IN CLASS 35 (U.S. CLS. 100, 101 AND 102).

FIRST USE 9-11-2002; IN COMMERCE 9-11-2002.

NO CLAIM IS MADE TO THE EXCLUSIVE RIGHT TO USE "RN PATIENT ADVOCATES PLLC" AND "ADVOCACY EDUCATION & GUIDANCE THROUGH THE HEALTHCARE SYSTEM", APART FROM THE MARK AS SHOWN.

THE MARK CONSISTS OF THE WORDING "RN PATIENT ADVOCATES PLLC YOUR HEALTH CARE SAFETY NET ADVOCACY EDUCATION & GUIDANCE THROUGH THE HEALTHCARE SYSTEM", ALL OF WHICH APPEARS BELOW A RECTANGULAR DESIGN CONTAINING A DESIGN OF FOUR OVERLAPPING HEARTS WITH A CIRCLE APPEARING ABOVE EACH HEART.

SER. NO. 85-252,713, FILED 2-26-2011.

MARC LEIPZIG, EXAMINING ATTORNEY



David J. Kybas

Director of the United States Patent and Trademark Office

United States of America

United States Patent and Trademark Office

TUESDAY MORNING

Reg. No. 4,066,242

Registered Dec. 6, 2011

Int. Cl.: 35

SERVICE MARK

PRINCIPAL REGISTER

TUESDAY MORNING PARTNERS, LTD. (TEXAS LIMITED PARTNERSHIP)
6250 LBJ FREEWAY
DALLAS, TX 75240

FOR: ON-LINE RETAIL STORE SERVICES FEATURING A WIDE VARIETY OF CONSUMER GOODS OF OTHERS, IN CLASS 35 (U.S. CLS. 100, 101 AND 102).

FIRST USE 11-30-2006; IN COMMERCE 11-30-2006.

THE MARK CONSISTS OF STANDARD CHARACTERS WITHOUT CLAIM TO ANY PARTICULAR FONT, STYLE, SIZE, OR COLOR.

OWNER OF U.S. REG. NOS. 1,211,931 AND 1,211,932.

SER. NO. 85-252,767, FILED 2-27-2011.

MARIA-VICTORIA SUAREZ, EXAMINING ATTORNEY



David J. Kybas

Director of the United States Patent and Trademark Office

United States of America

United States Patent and Trademark Office

ONE ARTIST ROAD

Reg. No. 4,066,243

Registered Dec. 6, 2011

Int. Cl.: 16

TRADEMARK

PRINCIPAL REGISTER

ONE ARTIST ROAD (TEXAS LIMITED LIABILITY COMPANY)
2709 S CYPRESS CIR
PLANO, TX 75075

FOR: CATALOG MAGAZINE IN THE FIELD OF ART AND ARTISTS, IN CLASS 16 (U.S. CLS. 2, 5, 22, 23, 29, 37, 38 AND 50).

FIRST USE 1-1-2011; IN COMMERCE 1-1-2011.

THE MARK CONSISTS OF STANDARD CHARACTERS WITHOUT CLAIM TO ANY PARTICULAR FONT, STYLE, SIZE, OR COLOR.

NO CLAIM IS MADE TO THE EXCLUSIVE RIGHT TO USE "ARTIST", APART FROM THE MARK AS SHOWN.

SER. NO. 85-253,133, FILED 2-28-2011.

STEVEN JACKSON, EXAMINING ATTORNEY



David J. Kybas

Director of the United States Patent and Trademark Office

United States of America

United States Patent and Trademark Office



Reg. No. 4,066,244

Registered Dec. 6, 2011

Int. Cl.: 9

TRADEMARK

PRINCIPAL REGISTER

WITHERSPOON, HOLLAND D. (LOUISIANA LIMITED LIABILITY COMPANY)
2925 EUGENE ST
BOSSIER CITY, LA 71112

FOR: DIGITAL MEDIA, NAMELY, PRE-RECORDED DVDS, DOWNLOADABLE AUDIO AND VIDEO RECORDINGS, AND CDS FEATURING SOUND RECORDINGS, MUSIC VIDEO, MUSIC DOCUMENTARY, AND PHOTOGRAPHIC MATERIAL, IN CLASS 9 (U.S. CLS. 21, 23, 26, 36 AND 38).

FIRST USE 1-17-2008; IN COMMERCE 11-20-2010.

NO CLAIM IS MADE TO THE EXCLUSIVE RIGHT TO USE "RECORDS", APART FROM THE MARK AS SHOWN.

THE MARK CONSISTS OF THE STYLIZED INITIALS AND WORDING "S.S. SOUTHERN STISLES RECORDS" AND STAR DESIGN. THE WORDS "SOUTHERN STISLES RECORDS" APPEAR BELOW A ROUNDED CORNER SQUARE. SUPERIMPOSED OVER THE SQUARE IS A FOUR POINT STAR. SUPERIMPOSED OVER THE STAR ARE THE INITIALS "S.S.".

SER. NO. 85-254,117, FILED 3-1-2011.

JERI J. FICKES, EXAMINING ATTORNEY



David J. Kyffers

Director of the United States Patent and Trademark Office

United States of America

United States Patent and Trademark Office



Reg. No. 4,066,245

Registered Dec. 6, 2011

Int. Cls.: 9, 41 and 42

TRADEMARK

SERVICE MARK

PRINCIPAL REGISTER

OP5 AB (SWEDEN CORPORATION)
NORREGATAN 2
KISTA, SWEDEN 16432

FOR: RECORDED COMPUTER PROGRAMS, NAMELY, RECORDED COMPUTER PROGRAMS FOR MONITORING COMPUTER SYSTEMS; COMPUTER PERIPHERAL EQUIPMENT, NAMELY, CENTRAL PROCESSING UNITS CENTRAL PROCESSORS; NONE OF THE AFORESAID SERVICES RELATING TO INTELLECTUAL PROPERTY, IN CLASS 9 (U.S. CLS. 21, 23, 26, 36 AND 38).

FIRST USE 1-8-2008; IN COMMERCE 1-8-2008.

FOR: EDUCATION SERVICES, NAMELY, PROVIDING ON AND OFF-SITE TRAINING CLASSES IN THE FIELD OF COMPUTERS, COMPUTER SOFTWARE, COMPUTER NETWORKING AND COMPUTER SUPPORT; NONE OF THE AFORESAID SERVICES RELATING TO INTELLECTUAL PROPERTY, IN CLASS 41 (U.S. CLS. 100, 101 AND 107).

FIRST USE 1-8-2008; IN COMMERCE 1-8-2008.

FOR: CONSULTANCY SERVICES IN THE FIELD OF COMPUTER SOFTWARE; ADVICE RELATED TO THE USE OF COMPUTER PROGRAMS/SOFTWARE; TECHNICAL SUPPORT SERVICES, NAMELY, TROUBLESHOOTING OF COMPUTER SOFTWARE PROBLEMS; DESIGN AND DEVELOPMENT OF COMPUTER HARDWARE AND SOFTWARE; NONE OF THE AFORESAID SERVICES RELATING TO INTELLECTUAL PROPERTY, IN CLASS 42 (U.S. CLS. 100 AND 101).

FIRST USE 1-8-2008; IN COMMERCE 1-8-2008.

THE MARK CONSISTS OF AN INCOMPLETE CIRCULAR DESIGN RESEMBLING A CRESCENT WITH ROUNDED ENDS IN RED AND BLACK NEXT TO THE WORDING "OP5" IN BLACK.

THE COLOR(S) RED AND BLACK IS/ARE CLAIMED AS A FEATURE OF THE MARK.

SER. NO. 85-254,276, FILED 3-1-2011.

ROBERT C. CLARK JR., EXAMINING ATTORNEY



David J. Kyros

Director of the United States Patent and Trademark Office

United States of America

United States Patent and Trademark Office



Reg. No. 4,066,246

Registered Dec. 6, 2011

Int. Cls.: 35, 41 and 42

SERVICE MARK

PRINCIPAL REGISTER

NORTHBOUND DESIGN, LLC (SOUTH CAROLINA LIMITED LIABILITY COMPANY)
3RD FLOOR
1202 MAIN STREET
COLUMBIA, SC 29201

FOR: CONSULTING SERVICES IN THE FIELD OF INTERNET MARKETING; BRANDING SERVICES, NAMELY, CONSULTING, DEVELOPMENT, MANAGEMENT AND MARKETING OF BRANDS FOR BUSINESSES, IN CLASS 35 (U.S. CLS. 100, 101 AND 102).

FIRST USE 5-1-2003; IN COMMERCE 5-1-2003.

FOR: AUDIO AND VIDEO PRODUCTION; PHOTOGRAPHY SERVICES, IN CLASS 41 (U.S. CLS. 100, 101 AND 107).

FIRST USE 5-1-2003; IN COMMERCE 5-1-2003.

FOR: WEBSITE DESIGN AND DEVELOPMENT FOR OTHERS; VISUAL DESIGN SERVICES IN THE NATURE OF DESIGNING VISUAL ELEMENTS FOR ON-LINE, BROADCAST, PRINT, OUTDOOR AND OTHER COMMUNICATION MEDIA; AND BLOG DESIGN CONSULTATION, NAMELY, CONSULTATION ON BLOG WEBPAGE DESIGN, IN CLASS 42 (U.S. CLS. 100 AND 101).

FIRST USE 5-1-2003; IN COMMERCE 5-1-2003.

NO CLAIM IS MADE TO THE EXCLUSIVE RIGHT TO USE "DESIGN", APART FROM THE MARK AS SHOWN.

THE MARK CONSISTS OF TWO PEAKED CRESTS WITH THE STYLIZED TEXT "NORTHBOUND DESIGN".

SER. NO. 85-254,310, FILED 3-1-2011.

KATHERINE STOIDES, EXAMINING ATTORNEY



David J. Kybas

Director of the United States Patent and Trademark Office

United States of America

United States Patent and Trademark Office

ALPHEUS

Reg. No. 4,066,247

Registered Dec. 6, 2011

Int. Cl.: 1

TRADEMARK

PRINCIPAL REGISTER

L'AIR LIQUIDE, SOCIÉTÉ ANONYME POUR L'ETUDE ET L'EXPLOITATION DES
PROCÉDÉS GEORGES CLAUDE (FRANCE SOCIÉTÉ ANONYME (SA))
75 QUAI D'ORSAY
PARIS, FRANCE 75007

FOR: CHEMICALS TO BE USED IN THE SEMICONDUCTOR INDUSTRY, IN CLASS 1 (U.S.
CLS. 1, 5, 6, 10, 26 AND 46).

THE MARK CONSISTS OF STANDARD CHARACTERS WITHOUT CLAIM TO ANY PAR-
TICULAR FONT, STYLE, SIZE, OR COLOR.

OWNER OF FRANCE REG. NO. 103.763.850, DATED 9-3-2010, EXPIRES 9-30-2020.

SER. NO. 85-254,322, FILED 3-1-2011.

KATHERINE STOIDES, EXAMINING ATTORNEY



David J. Kybas

Director of the United States Patent and Trademark Office

United States of America

United States Patent and Trademark Office

Crime Doctor

Reg. No. 4,066,248

Registered Dec. 6, 2011

Int. Cl.: 9

TRADEMARK

PRINCIPAL REGISTER

AEGIS BOOKS, INC. (CALIFORNIA CORPORATION)
40960 CALIFORNIA OAKS ROAD #305
MURRIETA, CA 92562

FOR: DOWNLOADABLE ELECTRONIC PUBLICATIONS IN THE NATURE OF E-BOOKS, E-ZINES, VIDEOS, BOOKS, MAGAZINES, MANUALS, CATALOGS, NEWSLETTERS, ARTICLES, RESEARCH PAPERS, AND BROCHURES IN THE FIELDS OF SECURITY, CRIME PREVENTION, LOSS PREVENTION, AND LIABILITY, IN CLASS 9 (U.S. CLS. 21, 23, 26, 36 AND 38).

FIRST USE 1-1-1996; IN COMMERCE 1-1-1996.

THE MARK CONSISTS OF STANDARD CHARACTERS WITHOUT CLAIM TO ANY PARTICULAR FONT, STYLE, SIZE, OR COLOR.

NO CLAIM IS MADE TO THE EXCLUSIVE RIGHT TO USE "CRIME", APART FROM THE MARK AS SHOWN.

SER. NO. 85-254,470, FILED 3-1-2011.

LAKEISHA LEWIS, EXAMINING ATTORNEY



David J. Kyros

Director of the United States Patent and Trademark Office

United States of America

United States Patent and Trademark Office

BEST FLORAL

Reg. No. 4,066,249

Registered Dec. 6, 2011

Int. Cl.: 35

SERVICE MARK

PRINCIPAL REGISTER

POSSI, JAMES (UNITED STATES INDIVIDUAL)
918 EAST MORELAND BLVD
WAUKESHA, WI 53186

FOR: RETAIL STORE SERVICES AND ONLINE RETAIL STORE SERVICES FEATURING FLOWERS, FLOWER ARRANGEMENTS AND RELATED GIFT ITEMS, IN CLASS 35 (U.S. CLS. 100, 101 AND 102).

FIRST USE 0-0-1982; IN COMMERCE 0-0-1982.

THE MARK CONSISTS OF STANDARD CHARACTERS WITHOUT CLAIM TO ANY PARTICULAR FONT, STYLE, SIZE, OR COLOR.

OWNER OF U.S. REG. NO. 3,094,541.

NO CLAIM IS MADE TO THE EXCLUSIVE RIGHT TO USE "FLORAL", APART FROM THE MARK AS SHOWN.

SEC. 2(F).

SER. NO. 85-254,597, FILED 3-1-2011.

SUZANNE BLANE, EXAMINING ATTORNEY



David J. Kyfos

Director of the United States Patent and Trademark Office

United States of America

United States Patent and Trademark Office

WHEEL OF LIGHT

Reg. No. 4,066,250

Registered Dec. 6, 2011

Int. Cl.: 14

TRADEMARK

PRINCIPAL REGISTER

COOK, BRIAN CHARLES (UNITED STATES INDIVIDUAL), DBA NATURE'S GEOMETRY
3146 BERN DR.
LAGUNA BEACH, CA 92651

FOR: GEMSTONE JEWELRY, IN CLASS 14 (U.S. CLS. 2, 27, 28 AND 50).

FIRST USE 2-5-2009; IN COMMERCE 2-5-2009.

THE MARK CONSISTS OF STANDARD CHARACTERS WITHOUT CLAIM TO ANY PARTICULAR FONT, STYLE, SIZE, OR COLOR.

SER. NO. 85-254,740, FILED 3-1-2011.

KEVIN DINALLO, EXAMINING ATTORNEY



David J. Kyros

Director of the United States Patent and Trademark Office

United States of America

United States Patent and Trademark Office

THE MIRACLE OF COLOR

Reg. No. 4,066,251

Registered Dec. 6, 2011

Int. Cl.: 40

SERVICE MARK

PRINCIPAL REGISTER

VOGEL PAINT & WAX, INC. (IOWA CORPORATION)
1020 ALBANY PLACE SOUTH
ORANGE CITY, IA 51041

FOR: CUSTOM MANUFACTURING OF PAINT, IN CLASS 40 (U.S. CLS. 100, 103 AND 106).

FIRST USE 12-31-1977; IN COMMERCE 12-31-1977.

THE MARK CONSISTS OF STANDARD CHARACTERS WITHOUT CLAIM TO ANY PARTICULAR FONT, STYLE, SIZE, OR COLOR.

SER. NO. 85-254,870, FILED 3-1-2011.

GENE MACIOL, EXAMINING ATTORNEY



David J. Kyffers

Director of the United States Patent and Trademark Office

United States of America

United States Patent and Trademark Office

RELEASE

Reg. No. 4,066,252

Registered Dec. 6, 2011

Int. Cl.: 5

TRADEMARK

PRINCIPAL REGISTER

HERBS, ETC., INC. (NEW MEXICO CORPORATION)
1340 RUFINA CIRCLE
SANTA FE, NM 87507

FOR: HERBAL SUPPLEMENTS, IN CLASS 5 (U.S. CLS. 6, 18, 44, 46, 51 AND 52).

FIRST USE 12-30-1995; IN COMMERCE 12-30-1995.

THE MARK CONSISTS OF STANDARD CHARACTERS WITHOUT CLAIM TO ANY PARTICULAR FONT, STYLE, SIZE, OR COLOR.

OWNER OF U.S. REG. NOS. 1,876,297, 2,823,444 AND OTHERS.

SER. NO. 85-255,034, FILED 3-1-2011.

SUZANNE BLANE, EXAMINING ATTORNEY



David J. Kyros

Director of the United States Patent and Trademark Office

United States of America

United States Patent and Trademark Office

PASTEL GOURMET

Reg. No. 4,066,253

Registered Dec. 6, 2011

Int. Cl.: 43

SERVICE MARK

PRINCIPAL REGISTER

SOMAY GROUP CORP (FLORIDA CORPORATION), DBA PASTEL GOURMET
2600 NW 87TH AVENUE, STE 13
MIAMI, FL 33172

FOR: FAST-FOOD RESTAURANTS, IN CLASS 43 (U.S. CLS. 100 AND 101).

FIRST USE 2-16-2003; IN COMMERCE 2-22-2008.

THE MARK CONSISTS OF STANDARD CHARACTERS WITHOUT CLAIM TO ANY PARTICULAR FONT, STYLE, SIZE, OR COLOR.

NO CLAIM IS MADE TO THE EXCLUSIVE RIGHT TO USE "GOURMET", APART FROM THE MARK AS SHOWN.

SER. NO. 85-255,279, FILED 3-2-2011.

RUDY R. SINGLETON, EXAMINING ATTORNEY



David J. Kybas

Director of the United States Patent and Trademark Office

United States of America

United States Patent and Trademark Office



Reg. No. 4,066,254

Registered Dec. 6, 2011

Int. Cl.: 41

SERVICE MARK

PRINCIPAL REGISTER

THUNDERSHOT MEDIA, INC. (VIRGINIA CORPORATION)
PO BOX 3432
FALLS CHURCH, VA 22043

FOR: FILM AND VIDEO PRODUCTION; MULTIMEDIA ENTERTAINMENT SERVICES IN THE NATURE OF DEVELOPMENT, PRODUCTION AND POST-PRODUCTION SERVICES IN THE FIELDS OF VIDEO AND FILMS , IN CLASS 41 (U.S. CLS. 100, 101 AND 107).

FIRST USE 6-10-2010; IN COMMERCE 6-10-2010.

NO CLAIM IS MADE TO THE EXCLUSIVE RIGHT TO USE "STUDIOS", APART FROM THE MARK AS SHOWN.

THE COLOR(S) ORANGE AND GRAY IS/ARE CLAIMED AS A FEATURE OF THE MARK.

THE MARK CONSISTS OF AN ORANGE STYLIZED THUNDERBOLT NEXT TO THE TERMS "THUNDERSHOT" IN GRAY ABOVE THE TERM "STUDIO" IN GRAY.

SER. NO. 85-256,031, FILED 3-2-2011.

LINDA ORNDORFF, EXAMINING ATTORNEY



David J. Kyffers

Director of the United States Patent and Trademark Office

United States of America

United States Patent and Trademark Office

GEOCOMMAND

Reg. No. 4,066,255

Registered Dec. 6, 2011

Int. Cl.: 9

TRADEMARK

PRINCIPAL REGISTER

GEOCOMMAND, INC. (FLORIDA CORPORATION)
3700 AIRPORT ROAD, SUITE 410
BOCA RATON, FL 33431

FOR: MOBILE MAPPING COMPUTER PROGRAMS FOR EMERGENCY AND CRISIS MANAGEMENT AND EMERGENCY RESPONSE, IN CLASS 9 (U.S. CLS. 21, 23, 26, 36 AND 38).

FIRST USE 2-0-2007; IN COMMERCE 2-0-2007.

OWNER OF U.S. REG. NO. 3,144,834.

THE MARK CONSISTS OF THE WORDING "GEOCOMMAND" WITH POINTED LINES EXTENDING OUT FROM THE MIDDLE OF THE FIRST "O" AND AN ARROW DESIGN EXTENDING FROM THE MIDDLE OF THE FIRST "O" TO THE LETTER "D".

SER. NO. 85-256,044, FILED 3-2-2011.

SETH A. RAPPAPORT, EXAMINING ATTORNEY



David J. Kyffers

Director of the United States Patent and Trademark Office

United States of America

United States Patent and Trademark Office



Reg. No. 4,066,256

Registered Dec. 6, 2011

Int. Cls.: 35 and 41

SERVICE MARK

PRINCIPAL REGISTER

THUNDERSHOT MEDIA, INC. (VIRGINIA CORPORATION)
PO BOX 3432
FALLS CHURCH, VA 22043

FOR: ADVERTISING AND MARKETING, IN CLASS 35 (U.S. CLS. 100, 101 AND 102).

FIRST USE 2-2-2007; IN COMMERCE 2-2-2007.

FOR: FILM AND VIDEO FILM PRODUCTION; MULTIMEDIA ENTERTAINMENT SERVICES
IN THE NATURE OF DEVELOPMENT, PRODUCTION AND POST-PRODUCTION SERVICES
IN THE FIELDS OF VIDEO AND FILMS, IN CLASS 41 (U.S. CLS. 100, 101 AND 107).

FIRST USE 2-2-2007; IN COMMERCE 2-2-2007.

NO CLAIM IS MADE TO THE EXCLUSIVE RIGHT TO USE "MEDIA", APART FROM THE
MARK AS SHOWN.

THE COLOR(S) ORANGE AND GRAY IS/ARE CLAIMED AS A FEATURE OF THE MARK.

THE MARK CONSISTS OF A STYLIZED ORANGE THUNDERBOLT NEXT TO THE TERMS
"THUNDERSHOT" IN GRAY ABOVE THE TERM "MEDIA".

SER. NO. 85-256,075, FILED 3-2-2011.

LINDA ORNDORFF, EXAMINING ATTORNEY



David J. Kyffers

Director of the United States Patent and Trademark Office

United States of America

United States Patent and Trademark Office

DASHBOARD 360°

Reg. No. 4,066,257

Registered Dec. 6, 2011

Int. Cl.: 35

SERVICE MARK

PRINCIPAL REGISTER

PRIME NUMBERS TECHNOLOGIES, LLC (MASSACHUSETTS LIMITED LIABILITY COMPANY)
16 SPRUCE WAY
MEDFIELD, MA 020521320

FOR: TRAVEL MANAGEMENT SERVICES FEATURING THE PROVISION OF BENCHMARKING DATA, THE ANALYSIS OF TRAVEL EXPENDITURES, AND PREPARATION OF REPORTS RELATING THERETO, IN CLASS 35 (U.S. CLS. 100, 101 AND 102).

FIRST USE 8-5-2010; IN COMMERCE 8-5-2010.

THE MARK CONSISTS OF STANDARD CHARACTERS WITHOUT CLAIM TO ANY PARTICULAR FONT, STYLE, SIZE, OR COLOR.

NO CLAIM IS MADE TO THE EXCLUSIVE RIGHT TO USE "DASHBOARD", APART FROM THE MARK AS SHOWN.

SER. NO. 85-256,673, FILED 3-3-2011.

LINDA POWELL, EXAMINING ATTORNEY



David J. Kyffers

Director of the United States Patent and Trademark Office

United States of America

United States Patent and Trademark Office



Reg. No. 4,066,258

Registered Dec. 6, 2011

Int. Cl.: 45

SERVICE MARK

PRINCIPAL REGISTER

PROTECTION STRATEGIES INCORPORATED (VIRGINIA CORPORATION)
2300 9TH STREET SOUTH
SUITE 400
ARLINGTON, VA 22204

FOR: SECURITY CLEARANCE FOR PREPARATION OF IDENTIFICATION CARDS; SECURITY CONSULTANCY; SECURITY PRINTING, NAMELY, ENCODING IDENTIFICATION INFORMATION ON VALUABLE DOCUMENTS AND PRODUCTS; SECURITY SERVICES FOR INDIVIDUALS AND BUSINESS PERSONS TRAVELING INTERNATIONALLY AND DOMESTICALLY, NAMELY, PROVIDING FOREIGN COUNTRY SECURITY BRIEFINGS, EMBASSY INFORMATION FOR SECURITY PURPOSES AND SECURITY REPORTS; SECURITY SERVICES, NAMELY, PROVIDING SECURITY ASSESSMENTS FOR BUSINESSES AND GOVERNMENTAL AGENCIES; SECURITY SERVICES, NAMELY, PROVIDING SECURITY ASSESSMENTS OF PHYSICAL LOCATIONS, INFORMATION SYSTEMS, AND WORKING ENVIRONMENTS; SECURITY SERVICES, NAMELY, THREAT SIMULATION VULNERABILITY ANALYSIS AND MITIGATION AND EMERGENCY AND CRISIS RESPONSE; SECURITY SERVICES, NAMELY, WATER VULNERABILITY ASSESSMENT SERVICES, IN CLASS 45 (U.S. CLS. 100 AND 101).

FIRST USE 8-5-1998; IN COMMERCE 8-5-1998.

NO CLAIM IS MADE TO THE EXCLUSIVE RIGHT TO USE "PROTECTION STRATEGIES INCORPORATED", APART FROM THE MARK AS SHOWN.

THE COLOR(S) BLUE, GREEN, BROWN, GREY, YELLOW AND TAN IS/ARE CLAIMED AS A FEATURE OF THE MARK.

THE MARK CONSISTS OF THE WORDING "PSI" IN BLUE OVERLAYING A MULTI-COLORED GLOBE OF THE EARTH. A GLOBE WITH BLUE WATER, BLUE LATITUDINAL AND LONGITUDINAL LINES, AND GREEN, BROWN, TAN, GREY AND YELLOW LAND WESTERN HEMISPHERE. "PROTECTION STRATEGIES INCORPORATED" IN BLUE ARCHED BELOW THE GLOBE.

SER. NO. 85-256,711, FILED 3-3-2011.

DAVID HOFFMAN, EXAMINING ATTORNEY



David J. Kyfos

Director of the United States Patent and Trademark Office

United States of America

United States Patent and Trademark Office



Reg. No. 4,066,259

Registered Dec. 6, 2011

Int. Cl.: 35

SERVICE MARK

PRINCIPAL REGISTER

PRIME NUMBERS TECHNOLOGIES, LLC (MASSACHUSETTS LIMITED LIABILITY COMPANY)
16 SPRUCE WAY
MEDFIELD, MA 020521320

FOR: TRAVEL MANAGEMENT SERVICES FEATURING THE PROVISION OF BENCHMARKING DATA, THE ANALYSIS OF TRAVEL EXPENDITURES, AND PREPARATION OF REPORTS RELATING THERETO, IN CLASS 35 (U.S. CLS. 100, 101 AND 102).

FIRST USE 8-3-2009; IN COMMERCE 8-3-2009.

OWNER OF U.S. REG. NO. 3,609,535.

NO CLAIM IS MADE TO THE EXCLUSIVE RIGHT TO USE "TRAVEL", APART FROM THE MARK AS SHOWN.

THE MARK CONSISTS OF "TRAVEL" STACKED ABOVE A CHECK MARK AND "GPA", ALL IN A BOX WITH A "+" AS PART OF THE RIGHT SIDE BORDER OF THE BOX.

SER. NO. 85-256,745, FILED 3-3-2011.

LINDA POWELL, EXAMINING ATTORNEY



David J. Kybas

Director of the United States Patent and Trademark Office

United States of America

United States Patent and Trademark Office

Better, Faster, Cheaper

Reg. No. 4,066,260

Registered Dec. 6, 2011

Int. Cl.: 38

SERVICE MARK

PRINCIPAL REGISTER

RICHARD A. KELLY (UNITED STATES INDIVIDUAL)
C/O REYNWOOD COMMUNICATIONS
620 TINTON AVENUE, SUITE B103
TINTON FALLS, NJ 07724

FOR: PROVIDING TELECOMMUNICATION AND INTERNET ACCESS SERVICES TO INDIVIDUALS, COMMERCIAL AND NON-COMMERCIAL ENTITIES, IN CLASS 38 (U.S. CLS. 100, 101 AND 104).

FIRST USE 1-1-1998; IN COMMERCE 1-1-1998.

THE MARK CONSISTS OF STANDARD CHARACTERS WITHOUT CLAIM TO ANY PARTICULAR FONT, STYLE, SIZE, OR COLOR.

SER. NO. 85-256,750, FILED 3-3-2011.

KRISTIN CARLSON, EXAMINING ATTORNEY



David J. Kyffers

Director of the United States Patent and Trademark Office

United States of America

United States Patent and Trademark Office

EXPION

Reg. No. 4,066,261

Registered Dec. 6, 2011

Int. Cl.: 42

SERVICE MARK

PRINCIPAL REGISTER

EXPION, LLC (NORTH CAROLINA LIMITED LIABILITY COMPANY)
85
900 RIDGEFIELD DRIVE
RALEIGH, NC 27609

FOR: COMPUTER SOFTWARE AND COMPUTER APPLICATION SOFTWARE FOR MOBILE PHONES AND OTHER HANDHELD COMPUTING DEVICES FOR MARKETING PURPOSES, NAMELY, FOR PROMOTING AND TRACKING THE GOODS, SERVICES, AND BRANDS OF OTHERS THROUGH ALL PUBLIC COMMUNICATION MEANS, PARTICULARLY SPECIALIZING IN THE USE OF SOCIAL MEDIA, CUSTOMER RELATIONSHIP MANAGEMENT, FOR THE PURPOSE OF DRIVING CONSUMER INTEREST, ENGAGEMENT AND ACTION, IN CLASS 42 (U.S. CLS. 100 AND 101).

FIRST USE 1-11-2010; IN COMMERCE 1-11-2010.

THE MARK CONSISTS OF THE TERM "EXPION" IN A STYLIZED FONT WITH THE LETTER "X" COMPRISED OF TWO CROSSING ELLIPSES.

SER. NO. 85-256,752, FILED 3-3-2011.

RON FAIRBANKS, EXAMINING ATTORNEY



David J. Kyros

Director of the United States Patent and Trademark Office

United States of America

United States Patent and Trademark Office

Outage Central

Reg. No. 4,066,262

Registered Dec. 6, 2011

Int. Cl.: 42

SERVICE MARK

PRINCIPAL REGISTER

MACROSOFT, INC (NEW JERSEY CORPORATION)
2 SYLVAN WAY, 3RD FLOOR
PARSIPPANY, NJ 07054

FOR: COMPUTER SERVICES, NAMELY, HOSTING AND MAINTAINING AN ON-LINE WEB SITE FOR OTHERS TO ALLOW EMERGENCY RESPONDERS TO OBTAIN UTILITY INFORMATION TO DETERMINE THE NUMBER AND LOCATION OF POWER OUTAGES, AND OBTAIN ALERTS AND EMERGENCY INFORMATION, IN CLASS 42 (U.S. CLS. 100 AND 101).

FIRST USE 3-17-2010; IN COMMERCE 3-17-2010.

THE MARK CONSISTS OF STANDARD CHARACTERS WITHOUT CLAIM TO ANY PARTICULAR FONT, STYLE, SIZE, OR COLOR.

NO CLAIM IS MADE TO THE EXCLUSIVE RIGHT TO USE "OUTAGE", APART FROM THE MARK AS SHOWN.

SER. NO. 85-256,871, FILED 3-3-2011.

MARK T. MULLEN, EXAMINING ATTORNEY



David J. Kybas

Director of the United States Patent and Trademark Office

United States of America

United States Patent and Trademark Office



Reg. No. 4,066,263

Registered Dec. 6, 2011

Int. Cl.: 45

SERVICE MARK

PRINCIPAL REGISTER

OTTESON, JAMES C. (UNITED STATES INDIVIDUAL)
1900 UNIVERSITY CIRCLE, SUITE 201
EAST PALO ALTO, CA 94303

FOR: LEGAL SERVICES, IN CLASS 45 (U.S. CLS. 100 AND 101).

FIRST USE 2-4-2010; IN COMMERCE 2-4-2010.

NO CLAIM IS MADE TO THE EXCLUSIVE RIGHT TO USE "IP LAW" , APART FROM THE MARK AS SHOWN.

THE COLOR(S) BLUE AND GOLD IS/ARE CLAIMED AS A FEATURE OF THE MARK.

THE MARK CONSISTS OF A GOLD ARROW DESIGN BENEATH A BLUE CHEVRON DESIGN ABOVE THE WORDING "AGILITY IP LAW" IN BLUE.

SER. NO. 85-256,981, FILED 3-3-2011.

JOHN DWYER, EXAMINING ATTORNEY



David J. Kybas

Director of the United States Patent and Trademark Office

United States of America

United States Patent and Trademark Office

RESTAURANT BITES

Reg. No. 4,066,264

Registered Dec. 6, 2011

Int. Cl.: 16

TRADEMARK

PRINCIPAL REGISTER

FRANCE PUBLICATIONS, INC. (GEORGIA CORPORATION)
SUITE 415
3500 PIEDMONT RD.
ATLANTA, GA 30305

FOR: SYNDICATED MAGAZINE NEWS SECTIONS OF SEVERAL COMMERCIAL REAL ESTATE MAGAZINES FEATURING NEWS ABOUT THE STATUS OF RESTAURANT DEVELOPMENT, CONSTRUCTION AND LEASING, IN CLASS 16 (U.S. CLS. 2, 5, 22, 23, 29, 37, 38 AND 50).

FIRST USE 4-4-2000; IN COMMERCE 4-4-2000.

THE MARK CONSISTS OF STANDARD CHARACTERS WITHOUT CLAIM TO ANY PARTICULAR FONT, STYLE, SIZE, OR COLOR.

NO CLAIM IS MADE TO THE EXCLUSIVE RIGHT TO USE "RESTAURANT", APART FROM THE MARK AS SHOWN.

SEC. 2(F).

SER. NO. 85-257,184, FILED 3-3-2011.

KYLE PEETE, EXAMINING ATTORNEY



David J. Kyffers

Director of the United States Patent and Trademark Office

United States of America

United States Patent and Trademark Office

Effortless home improvement

Reg. No. 4,066,265

Registered Dec. 6, 2011

Int. Cl.: 37

SERVICE MARK

PRINCIPAL REGISTER

ESTISA INC. (CALIFORNIA CORPORATION)
2303 S. STOCKTON STREET
LODI, CA 95204

FOR: HOME IMPROVEMENT SERVICES, NAMELY, HOME INTERIOR AND HOME EXTERIOR REMODELING, NAMELY, INSTALLATION AND REPAIR SERVICES OF HOUSEHOLD APPLIANCES, FURNITURE, CABINETS, PLUMBING FIXTURES, TILE, MOLDINGS, DOORS, FLOORING, LIGHTING, EXCLUDING INTERIOR DECORATING AND INTERIOR DESIGN SERVICES; RENOVATION SERVICES IN THE FIELD OF HOUSEHOLD APPLIANCES, FURNITURE, CABINETS, PLUMBING FIXTURES, TILE, MOLDINGS, DOORS, FLOORING, LIGHTING; REMODELING OF RESIDENTIAL HOMES, IN CLASS 37 (U.S. CLS. 100, 103 AND 106).

FIRST USE 1-1-2009; IN COMMERCE 1-1-2009.

THE MARK CONSISTS OF STANDARD CHARACTERS WITHOUT CLAIM TO ANY PARTICULAR FONT, STYLE, SIZE, OR COLOR.

NO CLAIM IS MADE TO THE EXCLUSIVE RIGHT TO USE "HOME IMPROVEMENT", APART FROM THE MARK AS SHOWN.

SER. NO. 85-257,265, FILED 3-3-2011.

RONALD AIKENS, EXAMINING ATTORNEY



David J. Kypos

Director of the United States Patent and Trademark Office

United States of America

United States Patent and Trademark Office

GEOFUSION

Reg. No. 4,066,266

VIEGA GMBH & CO. KG (FED REP GERMANY CORPORATION)
VIEGA-PLATZ 1

Registered Dec. 6, 2011

ATTENDORN 57439, FED REP GERMANY

Int. Cl.: 19

FOR: NON-METAL PIPE FITTINGS FOR USE IN GEOTHERMAL SYSTEMS, IN CLASS 19
(U.S. CLS. 1, 12, 33 AND 50).

TRADEMARK

FIRST USE 3-1-2011; IN COMMERCE 3-1-2011.

PRINCIPAL REGISTER

THE MARK CONSISTS OF STANDARD CHARACTERS WITHOUT CLAIM TO ANY PARTICULAR FONT, STYLE, SIZE, OR COLOR.

SER. NO. 85-257,783, FILED 3-4-2011.

JAY FLOWERS, EXAMINING ATTORNEY



David J. Kybas

Director of the United States Patent and Trademark Office

United States of America

United States Patent and Trademark Office

ROBOTIKITS

Reg. No. 4,066,267

Registered Dec. 6, 2011

Int. Cl.: 28

TRADEMARK

PRINCIPAL REGISTER

NED MORIOKA (CALIFORNIA CORPORATION), DBA OWI, INC
17141 KINGSVIEW AVENUE
CARSON, CA 90746

FOR: ELECTRONIC ACTION TOYS, IN CLASS 28 (U.S. CLS. 22, 23, 38 AND 50).

FIRST USE 6-7-1999; IN COMMERCE 6-7-1999.

THE MARK CONSISTS OF STANDARD CHARACTERS WITHOUT CLAIM TO ANY PARTICULAR FONT, STYLE, SIZE, OR COLOR.

SER. NO. 85-258,035, FILED 3-4-2011.

KHANH LE, EXAMINING ATTORNEY



David J. Kyffers

Director of the United States Patent and Trademark Office

United States of America

United States Patent and Trademark Office

CLIN-ESS

Reg. No. 4,066,268

Registered Dec. 6, 2011

Int. Cl.: 5

TRADEMARK

PRINCIPAL REGISTER

ESSENTIAL PHARMACEUTICALS, LLC (DELAWARE LIMITED LIABILITY COMPANY)
770 NEWTON YARDLEY ROAD
SUITE 212
NEWTOWN, PA 18940

FOR: CULTURE MEDIA USED FOR PHARMACEUTICAL, MEDICAL, VETERINARY OR SCIENTIFIC PURPOSES, SPECIFICALLY USED IN PRESERVING CELLS AND TISSUE, IN CLASS 5 (U.S. CLS. 6, 18, 44, 46, 51 AND 52).

FIRST USE 12-10-2010; IN COMMERCE 12-10-2010.

THE MARK CONSISTS OF STANDARD CHARACTERS WITHOUT CLAIM TO ANY PARTICULAR FONT, STYLE, SIZE, OR COLOR.

SER. NO. 85-258,199, FILED 3-4-2011.

ZACHARY BELLO, EXAMINING ATTORNEY



David J. Kybas

Director of the United States Patent and Trademark Office

United States of America

United States Patent and Trademark Office

Mobil Super

Reg. No. 4,066,269

Registered Dec. 6, 2011

Int. Cl.: 4

TRADEMARK

PRINCIPAL REGISTER

EXXON MOBIL CORPORATION (NEW JERSEY CORPORATION)
LAW/TRADEMARKS
5959 LAS COLINAS BOULEVARD
IRVING, TX 750392298

FOR: MOTOR OILS, IN CLASS 4 (U.S. CLS. 1, 6 AND 15).

FIRST USE 12-31-2010; IN COMMERCE 12-31-2010.

OWNER OF U.S. REG. NOS. 3,667,735, 3,878,769, AND 3,956,485.

THE COLOR(S) BLUE, RED, AND BLACK IS/ARE CLAIMED AS A FEATURE OF THE MARK.

NO CLAIM IS MADE TO THE EXCLUSIVE RIGHT TO USE "SUPER", APART FROM THE MARK AS SHOWN.

THE MARK CONSISTS OF THE STYLIZED WORDING "MOBIL SUPER". ALL OF THE LETTERS IN "MOBIL" EXCEPT THE LETTER "O" APPEAR IN THE COLOR BLUE. THE LETTER "O" IN "MOBIL" APPEARS IN THE COLOR RED. THE WORD "SUPER" APPEARS IN THE COLOR BLACK WITH A RED CURVED LINE UNDER IT.

SER. NO. 85-258,473, FILED 3-4-2011.

CIMMERIAN COLEMAN, EXAMINING ATTORNEY



David J. Kybas

Director of the United States Patent and Trademark Office

United States of America

United States Patent and Trademark Office

HIE Trust

Reg. No. 4,066,270

Registered Dec. 6, 2011

Int. Cl.: 38

SERVICE MARK

PRINCIPAL REGISTER

BIG BEND HEALTH, LLC (FLORIDA LIMITED LIABILITY COMPANY)
3411 CAPITAL MEDICAL BLVD.
TALLAHASSEE, FL 32308

FOR: ELECTRONIC EXCHANGE OF MEDICAL RECORDS ACROSS A NATIONWIDE HEALTH INFORMATION NETWORK; PROVIDING ACCESS TO AN ELECTRONIC EXCHANGE OF MEDICAL RECORDS ACROSS A NATIONWIDE HEALTH INFORMATION NETWORK, IN CLASS 38 (U.S. CLS. 100, 101 AND 104).

FIRST USE 1-23-2011; IN COMMERCE 3-2-2011.

THE MARK CONSISTS OF STANDARD CHARACTERS WITHOUT CLAIM TO ANY PARTICULAR FONT, STYLE, SIZE, OR COLOR.

NO CLAIM IS MADE TO THE EXCLUSIVE RIGHT TO USE "HIE", APART FROM THE MARK AS SHOWN.

SER. NO. 85-258,761, FILED 3-4-2011.

DAVID TOOLEY, EXAMINING ATTORNEY



David J. Kyros

Director of the United States Patent and Trademark Office

United States of America

United States Patent and Trademark Office

Support IT All

Reg. No. 4,066,271

Registered Dec. 6, 2011

Int. Cl.: 37

SERVICE MARK

PRINCIPAL REGISTER

SUPPORT ALL IT INC (FLORIDA CORPORATION), DBA SUPPORT IT ALL
8255 LAKE DR
406
DORAL, FL 33166

FOR: TECHNICAL SUPPORT SERVICES, NAMELY, TROUBLESHOOTING IN THE NATURE OF THE REPAIR OF COMPUTER HARDWARE; TECHNICAL ADVICE RELATED TO THE REPAIR OF COMPUTER HARDWARE, IN CLASS 37 (U.S. CLS. 100, 103 AND 106).

FIRST USE 1-3-2007; IN COMMERCE 1-3-2007.

THE MARK CONSISTS OF STANDARD CHARACTERS WITHOUT CLAIM TO ANY PARTICULAR FONT, STYLE, SIZE, OR COLOR.

SER. NO. 85-259,141, FILED 3-6-2011.

ROBIN CHOSID, EXAMINING ATTORNEY



David J. Kyffers

Director of the United States Patent and Trademark Office

United States of America

United States Patent and Trademark Office

GAMEPOLITICS

Reg. No. 4,066,272

Registered Dec. 6, 2011

Int. Cls.: 35 and 38

SERVICE MARK

PRINCIPAL REGISTER

ENTERTAINMENT CONSUMERS ASSOCIATION, INC. (DELAWARE CORPORATION)
SUITE 700
64 DANBURY ROAD
WILTON, CT 06897

FOR: PROVIDING A WEBSITE FEATURING NEWS AND INFORMATION ABOUT POLITICAL ISSUES RELATING TO INTERACTIVE ENTERTAINMENT, IN CLASS 35 (U.S. CLS. 100, 101 AND 102).

FIRST USE 3-0-2005; IN COMMERCE 3-0-2005.

FOR: PROVIDING AN ON-LINE FORUM FOR DISCUSSION OF THE LEGISLATIVE, POLICY AND ISSUE AREAS RELATED TO INTERACTIVE ENTERTAINMENT, IN CLASS 38 (U.S. CLS. 100, 101 AND 104).

FIRST USE 3-0-2005; IN COMMERCE 3-0-2005.

THE MARK CONSISTS OF STANDARD CHARACTERS WITHOUT CLAIM TO ANY PARTICULAR FONT, STYLE, SIZE, OR COLOR.

SER. NO. 85-259,245, FILED 3-6-2011.

GEOFFREY FOSDICK, EXAMINING ATTORNEY



David J. Kyros

Director of the United States Patent and Trademark Office

United States of America

United States Patent and Trademark Office

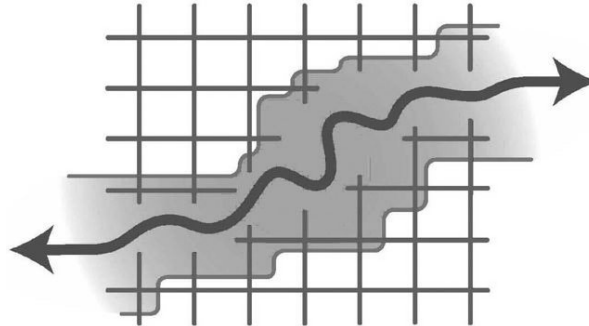

Green Infrastructure Center

Reg. No. 4,066,273

Registered Dec. 6, 2011

Int. Cls.: 41 and 42

SERVICE MARK

PRINCIPAL REGISTER

GREEN INFRASTRUCTURE CENTER, INC. (VIRGINIA CORPORATION)
921 2ND STREET SE
CHARLOTTESVILLE, VA 22902

FOR: EDUCATION SERVICES, NAMELY, PROVIDING TEACHING AND TRAINING IN HOW TO MAP, EVALUATE AND CONSERVE NATURAL RESOURCES INCLUDING CONNECTED FORESTED LANDSCAPES, WETLAND AND RIPARIAN SYSTEMS AND DUNES, GREEN CORRIDORS, AND AGRICULTURAL LANDS THROUGH CLASSES, WORKSHOPS, WEBCASTS AND CONFERENCE PRESENTATIONS IN THE FIELD OF ENVIRONMENTALLY FRIENDLY LANDSCAPE ARCHITECTURE, PLANNING AND WATERSHED AND WILDLIFE MANAGEMENT, IN CLASS 41 (U.S. CLS. 100, 101 AND 107).

FIRST USE 6-1-2007; IN COMMERCE 6-1-2007.

FOR: PROFESSIONAL CONSULTING SERVICES IN THE FIELDS OF ENVIRONMENTALLY SOUND ENGINEERING, LAND USE PLANNING, SURVEYING, LANDSCAPE ARCHITECTURE, AND ENVIRONMENTAL SCIENCES, IN CLASS 42 (U.S. CLS. 100 AND 101).

FIRST USE 6-1-2007; IN COMMERCE 6-1-2007.

NO CLAIM IS MADE TO THE EXCLUSIVE RIGHT TO USE "GREEN INFRASTRUCTURE CENTER", APART FROM THE MARK AS SHOWN.

THE MARK CONSISTS OF A BOXED GRID WITH A LAND MASS IMAGE. AN ARROW IS RUNNING THROUGH IT POINTING IN BOTH DIRECTIONS. BELOW THE GRID IS THE NAME "GREEN INFRASTRUCTURE CENTER".

SER. NO. 85-259,267, FILED 3-6-2011.

JAMES LOVELACE, EXAMINING ATTORNEY



David J. Kybas

Director of the United States Patent and Trademark Office

United States of America

United States Patent and Trademark Office

ClaimsObserver

Reg. No. 4,066,274

Registered Dec. 6, 2011

Int. Cl.: 9

TRADEMARK

PRINCIPAL REGISTER

CLAIMSVISION LLC (COLORADO LIMITED LIABILITY COMPANY), DBA
CLAIMSOPTIONS
402 HILLSBORO COURT NORTH
FORT COLLINS, CO 80525

FOR: COMPUTER SOFTWARE FOR RECORDING AND ANALYZING QUALITY ASSESSMENT OBSERVATIONS IN THE FIELD OF PROPERTY AND CASUALTY INSURANCE CLAIMS, IN CLASS 9 (U.S. CLS. 21, 23, 26, 36 AND 38).

FIRST USE 1-1-2011; IN COMMERCE 1-1-2011.

THE MARK CONSISTS OF STANDARD CHARACTERS WITHOUT CLAIM TO ANY PARTICULAR FONT, STYLE, SIZE, OR COLOR.

SER. NO. 85-259,436, FILED 3-7-2011.

MICHAEL KEATING, EXAMINING ATTORNEY



David J. Kybas

Director of the United States Patent and Trademark Office

United States of America

United States Patent and Trademark Office

Sozo Coffee Roasting and Espresso Bar

Reg. No. 4,066,275

Registered Dec. 6, 2011

Int. Cl.: 43

SERVICE MARK

PRINCIPAL REGISTER

SOZO COFFEE LLC (MICHIGAN LIMITED LIABILITY COMPANY)
924 HACKETT ST.
IONIA, MI 48846

FOR: COFFEE SHOPS, IN CLASS 43 (U.S. CLS. 100 AND 101).

FIRST USE 1-1-2006; IN COMMERCE 3-1-2006.

THE MARK CONSISTS OF STANDARD CHARACTERS WITHOUT CLAIM TO ANY PARTICULAR FONT, STYLE, SIZE, OR COLOR.

NO CLAIM IS MADE TO THE EXCLUSIVE RIGHT TO USE "COFFEE ROASTING AND ESPRESSO BAR", APART FROM THE MARK AS SHOWN.

THE ENGLISH TRANSLATION OF "SOZO" IN THE MARK IS "WHOLENESS".

SER. NO. 85-259,498, FILED 3-7-2011.

BILL DAWE, EXAMINING ATTORNEY



David J. Kyros

Director of the United States Patent and Trademark Office

United States of America

United States Patent and Trademark Office



Reg. No. 4,066,276

Registered Dec. 6, 2011

Int. Cls.: 3, 41, 43 and 44

TRADEMARK

SERVICE MARK

PRINCIPAL REGISTER

BLIND BARBER, LLC (NEW YORK LIMITED LIABILITY COMPANY)
ATTN: JEFF LAUB
750 GRAND STREET
BROOKLYN, NY 11211

FOR: AFTER SHAVE LOTIONS; AFTER-SHAVE; AFTER-SHAVE BALMS; AFTER-SHAVE CREAMS; AFTER-SHAVE EMULSIONS; AFTER-SHAVE GEL; AFTER-SHAVE LIQUID; AFTER-SHAVE LOTIONS; ALMOND SOAPS; ALOE VERA GEL FOR COSMETIC PURPOSES; ANTI-AGING MOISTURIZER; ANTIBACTERIAL SKIN SOAPS; AROMATIC BODY CARE PRODUCTS, NAMELY, BODY LOTION, SHOWER GEL, CUTICLE CREAM, SHAMPOO, CONDITIONER, NON-MEDICATED LIP BALM, SOAP, BODY POLISH, BODY AND FOOT SCRUB AND NON-MEDICATED FOOT CREAM; BAR SOAP; BATH AND SHOWER GELS AND SALTS NOT FOR MEDICAL PURPOSES; BATH GEL; BATH GELS; BATH SOAPS; BATH SOAPS IN LIQUID, SOLID OR GEL FORM; BEAUTY GELS; BEAUTY SOAP; BODY AND BEAUTY CARE COSMETICS; BODY CREAM SOAP; CAKES OF TOILET SOAP; CONDITIONERS; COSMETIC CREAMS FOR SKIN CARE; COSMETIC PREPARATIONS FOR PROTECTING THE SKIN FROM THE SUN'S RAYS; COSMETIC PREPARATIONS FOR SKIN CARE; COSMETIC PREPARATIONS FOR SKIN RENEWAL; COSMETIC PREPARATIONS FOR THE HAIR AND SCALP; COSMETIC PREPARATIONS, NAMELY, SKIN BALMS; COSMETIC PRODUCTS IN THE FORM OF AEROSOLS FOR SKIN CARE; COSMETIC SKIN FRESHENERS; COSMETIC SOAPS; CREAM SOAPS; DEODORANT SOAP; DETERGENT SOAP; DISINFECTANT SOAPS; DISINFECTING PERFUMED SOAPS; EXFOLIANTS FOR SKIN; EYE GELS; FACIAL BEAUTY MASKS; FACIAL CLEANING PREPARATION, NAMELY, SALICYLIC ACNE CLEANSER NOT FOR MEDICAL PURPOSES; FACIAL CLEANSERS; FACIAL CLEANSING GRAINS; FACIAL CLEANSING MILK; FACIAL CONCEALER; FACIAL CREAM; FACIAL CREAMS; FACIAL EMULSIONS; FACIAL LOTION; FACIAL MASKS; FACIAL MOISTURIZER WITH SPF; FACIAL SCRUBS; FACIAL WASHES; FRAGRANCED BODY CARE PREPARATIONS, NAMELY, SKIN CLEANSERS, SKIN MOISTURIZERS, AFTERSHAVES; FRAGRANCED FACE CARE PREPARATIONS, NAMELY, SKIN CLEANSERS, SKIN MOISTURIZERS, AFTERSHAVES; FRAGRANCED FACIAL MOISTURIZER; FRAGRANCED SKIN CARE PREPARATIONS, NAMELY, SKIN CLEANSERS, SKIN MOISTURIZERS, AFTERSHAVES; GEL EYE MASKS; GEL FOR SKIN; HAIR CARE CREAMS; HAIR CARE KITS COMPRISING NON-MEDICATED HAIR CARE PREPARATIONS, NAMELY, SHAMPOOS, CONDITIONERS AND GELS; HAIR CARE LOTIONS; HAIR CARE PREPARATIONS; HAIR CARE PREPARATIONS CONSISTING OF ORGANIC COCONUT VIRGIN OIL AND COCONUT VIRGIN OIL; HAIR CARE PRODUCTS, NAMELY, HEAT PROTECTION SPRAYS; HAIR GEL; HAIR GEL AND HAIR MOUSSE; HAIR GELS; HAIR



David J. Kyros

Director of the United States Patent and Trademark Office

Reg. No. 4,066,276 SPRAYS AND HAIR GELS; HAIR STYLING GEL; HAND SOAPS; HANDMADE SOAP BARS; LIP BALM; LIP BALM; MAKE-UP REMOVING MILK, GEL, LOTIONS AND CREAMS; MASSAGE GELS OTHER THAN FOR MEDICAL PURPOSES; MOISTURIZING CREAMS; MOISTURIZING MILK; MOISTURIZING MILKS; MOISTURIZING PREPARATIONS FOR THE SKIN; MOISTURIZING SOLUTIONS FOR THE SKIN; MOUSSE FOR SKIN FACIAL; NATURAL COCOA BUTTER BASED PERSONAL CARE PRODUCTS, NAMELY, BODY LOTION, SHOWER GEL, SOAP, BODY POLISH, BODY AND FOOT SCRUB AND NON-MEDICATED SKIN CREAMS; NATURAL SOAP BARS; NATURALLY HANDMADE SOAP BARS; NON-MEDICATED BALMS FOR USE ON SKIN; NON-MEDICATED CLEANSERS FOR PERSONAL USE, NAMELY, FACIAL CLEANSING, SKIN CLEANSING; NON-MEDICATED CLEANSERS, NAMELY, BAR SOAPS; NON-MEDICATED COSMETIC SKIN CARE PREPARATIONS CONSISTING OF ORGANIC COCONUT VIRGIN OIL AND COCONUT VIRGIN OIL; NON-MEDICATED FACIAL AND EYE SERUM CONTAINING ANTIOXIDANTS; NON-MEDICATED HERBAL BODY CARE PRODUCTS, NAMELY, BODY OILS, SALVES, AND LIP BALMS; NON-MEDICATED LIP BALM THAT DOES NOT CONTAIN BEESWAX; NON-MEDICATED PREPARATIONS ALL FOR THE CARE OF SKIN, HAIR AND SCALP; NON-MEDICATED SCALP TREATMENT CREAM; NON-MEDICATED SERUMS FOR USE ON SKIN; NON-MEDICATED SKIN CARE CREAMS AND LOTIONS; NON-MEDICATED SKIN CARE PREPARATION, NAMELY, BODY MIST; NON-MEDICATED SKIN CARE PREPARATIONS; NON-MEDICATED SKIN CARE PREPARATIONS, NAMELY, CREAMS, LOTIONS, GELS, TONERS, CLEANERS AND PEELS; NON-MEDICATED SKIN CARE PREPARATIONS, NAMELY, AFTERSHAVE; NON-MEDICATED SKIN CREAMS; NON-MEDICATED SKIN CREAMS WITH ESSENTIAL OILS FOR USE IN AROMATHERAPY; NON-MEDICATED SKIN TONERS; NON-MEDICATED STIMULATING LOTIONS FOR THE SKIN; NON-MEDICATED HAIR CARE PREPARATIONS; ORGANIC SOAP BARS; PERFUMED SOAP; PERFUMED SOAPS; PRE-SHAVE CREAMS; PRE-SHAVE LIQUID; SCULPTING GEL; SHAVE CREAMS; SHAVING BALM; SHAVING CREAM; SHAVING CREAMS; SHAVING FOAM; SHAVING GEL; SHAVING GELS; SHAVING LOTION; SHAVING LOTIONS; SHAVING MOUSSE; SHAVING PREPARATIONS; SHAVING SOAP; SHAVING SOAPS; SHAVING SPRITZ IN THE NATURE OF A MOISTURIZING SOLUTION FOR SHAVING; SHOWER AND BATH GEL; SHOWER GEL; SHOWER GELS; SKIN AND BODY TOPICAL LOTIONS, CREAMS AND OILS FOR COSMETIC USE; SKIN CARE PREPARATIONS, NAMELY, BODY BALM; SKIN CARE PRODUCTS, NAMELY, NON-MEDICATED SKIN SERUM; SKIN CLARIFIERS; SKIN CLEANSERS; SKIN CLEANSING CREAM; SKIN CLEANSING LOTION; SKIN CONDITIONERS; SKIN CONDITIONING CREAMS FOR COSMETIC PURPOSES; SKIN CREAMS; SKIN CREAMS IN LIQUID AND IN SOLID FORM; SKIN CREAMS IN LIQUID AND SOLID; SKIN CREAMS IN LIQUID AND SOLID FORM; SKIN EMOLLIENTS; SKIN FRESHENERS; SKIN LOTION; SKIN LOTIONS; SKIN MASKS; SKIN MOISTURIZER; SKIN MOISTURIZER MASKS; SKIN MOISTURIZING GEL; SKIN SOAP; SKIN TEXTURIZERS; SKIN TONERS; SOAPS; SOAPS FOR BODY CARE; SOAPS FOR PERSONAL USE; STYLING GELS; WRINKLE REMOVING SKIN CARE PREPARATIONS; WRINKLE-MINIMIZING COSMETIC PREPARATIONS FOR TOPICAL FACIAL USE, IN CLASS 3 (U.S. CLS. 1, 4, 6, 50, 51 AND 52).

FIRST USE 5-1-2010; IN COMMERCE 1-1-2011.

FOR: OPERATING OF A DISCOTHEQUE, IN CLASS 41 (U.S. CLS. 100, 101 AND 107).

FIRST USE 6-1-2010; IN COMMERCE 6-1-2010.

FOR: BAR AND COCKTAIL LOUNGE SERVICES; COCKTAIL LOUNGE SERVICES; COCKTAIL LOUNGES, IN CLASS 43 (U.S. CLS. 100 AND 101).

FIRST USE 6-1-2010; IN COMMERCE 6-1-2010.

FOR: BARBER SHOP SERVICES; BARBERING SERVICES; BEAUTY SALON SERVICES; BEAUTY SALONS; HAIR COLOR SALON SERVICES; HAIR SALON SERVICES; HAIR SALON SERVICES, NAMELY, HAIR CUTTING, STYLING, COLORING, AND HAIR EXTEN-

Reg. No. 4,066,276 SION SERVICES; HAIR SALON SERVICES, NAMELY, TREATMENTS TO PROTECT HAIR FROM EFFECTS OF EXPOSURE TO SUNLIGHT, HEAT, HUMIDITY AND CHLORINATED WATER; HAIRDRESSING SALONS, IN CLASS 44 (U.S. CLS. 100 AND 101).

FIRST USE 6-1-2010; IN COMMERCE 6-1-2010.

OWNER OF U.S. REG. NO. 3,948,718.

NO CLAIM IS MADE TO THE EXCLUSIVE RIGHT TO USE "BARBER", APART FROM THE MARK AS SHOWN.

THE MARK CONSISTS OF A STYLIZED PAIR OF SCISSORS WITH THE POINTS DIRECTED UP WITH A RIBBON AND THE WORDING "THE BLIND BARBER" BELOW THE SCISSORS.

SER. NO. 85-259,530, FILED 3-7-2011.

KAPIL BHANOT, EXAMINING ATTORNEY

United States of America

United States Patent and Trademark Office



Reg. No. 4,066,277

Registered Dec. 6, 2011

Int. Cl.: 41

SERVICE MARK

PRINCIPAL REGISTER

MILEY, ROBERT J. (UNITED STATES INDIVIDUAL)
332 W. LYNWOOD ST.
PHOENIX, AZ 85003

FOR: EDUCATIONAL SERVICES, NAMELY, WORKSHOPS ON THE SUBJECT OF CONFLICT RESOLUTION THROUGH THE POWER OF THE CREATIVE PROCESS, IN CLASS 41 (U.S. CLS. 100, 101 AND 107).

FIRST USE 1-4-2000; IN COMMERCE 4-24-2002.

THE MARK CONSISTS OF THE DESIGN OF A RISING HUMAN-LIKE FIGURE WITH UPWARD, OUTSTRETCHED ARMS WITH THE WORDS "RELEASE THE FEAR" BETWEEN THE ARMS ABOVE THE HEAD.

SER. NO. 85-259,688, FILED 3-7-2011.

CHARISMA HAMPTON, EXAMINING ATTORNEY



David J. Kybas

Director of the United States Patent and Trademark Office

United States of America

United States Patent and Trademark Office



Reg. No. 4,066,278

Registered Dec. 6, 2011

Int. Cl.: 43

SERVICE MARK

PRINCIPAL REGISTER

TAYLOR COMMUNITY (NEW HAMPSHIRE CHARITABLE, NON-PROFIT CORPORATION),
DBA TAYLOR COMMUNITY
435 UNION AVENUE
LACONIA, NH 03246

FOR: PROVIDING ASSISTED LIVING FACILITIES PROVIDING INDEPENDENT LIVING RESIDENCES AND LIVING FACILITIES, IN CLASS 43 (U.S. CLS. 100 AND 101).

FIRST USE 11-15-2010; IN COMMERCE 2-17-2011.

THE MARK CONSISTS OF A GREEN ARC WITH A SYMBOL OF A LEAFY BRANCH AND BLUE LETTERING OF THE ORGANIZATIONS NAME "TAYLOR" AND THE TAGLINE OF "YOUR LIFE, YOUR COMMUNITY".

THE COLOR(S) GREEN AND BLUE IS/ARE CLAIMED AS A FEATURE OF THE MARK.

SER. NO. 85-259,689, FILED 3-7-2011.

MIDGE BUTLER, EXAMINING ATTORNEY



David J. Kyffers

Director of the United States Patent and Trademark Office

United States of America

United States Patent and Trademark Office

THE SAFE CIG STARTER KIT PRO

Reg. No. 4,066,279

Registered Dec. 6, 2011

Int. Cls.: 9 and 34

TRADEMARK

PRINCIPAL REGISTER

THE SAFE CIG, LLC (CALIFORNIA LIMITED LIABILITY COMPANY)
SUITE A
1051 COLE AVENUE
LOS ANGELES, CA 90038

FOR: BATTERIES AND BATTERY CHARGERS, ADAPTERS, USB POWER ADAPTER PLUGS, IN CLASS 9 (U.S. CLS. 21, 23, 26, 36 AND 38).

FIRST USE 8-1-2010; IN COMMERCE 8-1-2010.

FOR: ELECTRONIC CIGARETTES, IN CLASS 34 (U.S. CLS. 2, 8, 9 AND 17).

FIRST USE 8-1-2010; IN COMMERCE 8-1-2010.

THE MARK CONSISTS OF STANDARD CHARACTERS WITHOUT CLAIM TO ANY PARTICULAR FONT, STYLE, SIZE, OR COLOR.

OWNER OF U.S. REG. NOS. 3,797,890 AND 3,961,222.

NO CLAIM IS MADE TO THE EXCLUSIVE RIGHT TO USE "CIG STARTER KIT PRO", APART FROM THE MARK AS SHOWN.

SER. NO. 85-259,757, FILED 3-7-2011.

DAVID TOOLEY, EXAMINING ATTORNEY



David J. Kyros

Director of the United States Patent and Trademark Office

United States of America

United States Patent and Trademark Office



Reg. No. 4,066,280

Registered Dec. 6, 2011

Int. Cl.: 35

SERVICE MARK

PRINCIPAL REGISTER

KIWANIS INTERNATIONAL, INC. (INDIANA CORPORATION)
3636 WOODVIEW TRACE
INDIANAPOLIS, IN 46268

FOR: CHARITABLE SERVICES, NAMELY, ORGANIZING AND CONDUCTING VOLUNTEER PROGRAMS AND COMMUNITY SERVICE PROJECTS, IN CLASS 35 (U.S. CLS. 100, 101 AND 102).

FIRST USE 10-30-2000; IN COMMERCE 10-30-2000.

OWNER OF U.S. REG. NOS. 672,949, 2,670,821, AND 2,670,985.

NO CLAIM IS MADE TO THE EXCLUSIVE RIGHT TO USE "CLUB", APART FROM THE MARK AS SHOWN.

THE MARK CONSISTS OF THE STYLIZED WORDING "KIWANIS AKTION CLUB SERVICE IN ACTION" WITH THE TERM "KIWANIS" AT THE TOP, THE WORDING "AKTION CLUB" DIRECTLY BELOW WITH THE LETTERS APPEARING DOUBLE WITH A SHADED BACKGROUND BEHIND THE WORDING, AND THE WORDS "SERVICE IN ACTION" DIRECTLY TO THE RIGHT OF THE TERM "CLUB".

SER. NO. 85-259,903, FILED 3-7-2011.

ASMAT KHAN, EXAMINING ATTORNEY



David J. Kyffers

Director of the United States Patent and Trademark Office

United States of America

United States Patent and Trademark Office

REGAL

Reg. No. 4,066,281

Registered Dec. 6, 2011

Int. Cl.: 16

TRADEMARK

PRINCIPAL REGISTER

GLOBAL TISSUE GROUP, INC. (NEW YORK CORPORATION)
870 EXPRESSWAY DRIVE SOUTH
MEDFORD, NY 11763

FOR: CONSUMER AND INDUSTRIAL PAPER PRODUCTS, NAMELY, FACIAL TISSUES, NAPKINS, TOWELS AND BATHROOM TISSUES, IN CLASS 16 (U.S. CLS. 2, 5, 22, 23, 29, 37, 38 AND 50).

FIRST USE 12-31-2000; IN COMMERCE 12-31-2000.

THE MARK CONSISTS OF STANDARD CHARACTERS WITHOUT CLAIM TO ANY PARTICULAR FONT, STYLE, SIZE, OR COLOR.

SER. NO. 85-260,021, FILED 3-7-2011.

KAREN BRACEY, EXAMINING ATTORNEY



David J. Kybas

Director of the United States Patent and Trademark Office

United States of America

United States Patent and Trademark Office

Ripperball.com

Reg. No. 4,066,282

Registered Dec. 6, 2011

Int. Cl.: 28

TRADEMARK

PRINCIPAL REGISTER

LEEFELDT, TIM (UNITED STATES INDIVIDUAL)
PMB 212 236 W. EAST AVE. STE. A
CHICO, CA 95926

FOR: BALLS FOR SPORTS, IN CLASS 28 (U.S. CLS. 22, 23, 38 AND 50).

FIRST USE 6-1-2010; IN COMMERCE 1-1-2011.

THE MARK CONSISTS OF STANDARD CHARACTERS WITHOUT CLAIM TO ANY PARTICULAR FONT, STYLE, SIZE, OR COLOR.

SER. NO. 85-260,243, FILED 3-7-2011.

KATHERINE E. HALMEN, EXAMINING ATTORNEY



David J. Kybas

Director of the United States Patent and Trademark Office

United States of America

United States Patent and Trademark Office



Reg. No. 4,066,283

Registered Dec. 6, 2011

Int. Cl.: 44

SERVICE MARK

PRINCIPAL REGISTER

LUCIEN, KIM (UNITED STATES INDIVIDUAL)
P.O. BOX 869
WAILUKU, HI 96793

FOR: ENERGY HEALING SERVICES, NAMELY, IN-PERSON, ON-LINE, AND LONG DISTANCE VIBRATIONAL ENERGY HEALING SERVICES, THERAPEUTIC TOUCH SERVICES, AND STRESS MANAGEMENT AND STRESS REDUCTION COUNSELING SERVICES, FOR ELIMINATING STRESS AND DEALING WITH LIFE'S PHYSICAL, EMOTIONAL AND SPIRITUAL CHALLENGES, IN CLASS 44 (U.S. CLS. 100 AND 101).

FIRST USE 11-29-2010; IN COMMERCE 11-29-2010.

NO CLAIM IS MADE TO THE EXCLUSIVE RIGHT TO USE "NATIVE HAWAIIAN HEALING", APART FROM THE MARK AS SHOWN.

THE MARK CONSISTS OF A ROUND LOGO WITH 4 SMALL SYMBOLS FOR FIRE, WIND, WATER AND NATURE IN THE MIDDLE CIRCLE, WITH THE TEXT "NATIVE HAWAIIAN HEALING" IN THE OUTER CIRCLE.

SER. NO. 85-260,291, FILED 3-7-2011.

SOPHIA S. KIM, EXAMINING ATTORNEY



David J. Kybas

Director of the United States Patent and Trademark Office

United States of America

United States Patent and Trademark Office

fastower

Reg. No. 4,066,284

Registered Dec. 6, 2011

Int. Cl.: 6

TRADEMARK

PRINCIPAL REGISTER

FASTOWER INC. (NEVADA CORPORATION)
861 SOUTH CENTER ST
MESA, AZ 85210

FOR: METAL SCAFFOLDING, IN CLASS 6 (U.S. CLS. 2, 12, 13, 14, 23, 25 AND 50).

FIRST USE 2-13-2011; IN COMMERCE 2-28-2011.

THE MARK CONSISTS OF STANDARD CHARACTERS WITHOUT CLAIM TO ANY PARTICULAR FONT, STYLE, SIZE, OR COLOR.

SER. NO. 85-260,417, FILED 3-7-2011.

KATHERINE E. HALMEN, EXAMINING ATTORNEY



David J. Kybas

Director of the United States Patent and Trademark Office

United States of America
United States Patent and Trademark Office

rēMOD

BY WILLIAMS SCOTSMAN

Reg. No. 4,066,285

Registered Dec. 6, 2011

Int. Cl.: 6

TRADEMARK

PRINCIPAL REGISTER

WILLIAMS SCOTSMAN, INC. (MARYLAND CORPORATION)
8211 TOWN CENTER DRIVE
BALTIMORE, MD 212365997

FOR: PORTABLE METAL MOBILE OFFICE BUILDINGS THAT ARE RETROFITTED WITH ECO-FRIENDLY MATERIALS AND SYSTEMS; PORTABLE METAL MOBILE OFFICE BUILDINGS THAT ARE RETROFITTED WITH ENERGY EFFICIENT ENHANCEMENTS; PORTABLE METAL MOBILE OFFICE BUILDINGS THAT ARE CUSTOMIZED TO MEET ECO-FRIENDLY AND ENERGY EFFICIENT SPECIFICATIONS OF CUSTOMERS, IN CLASS 6 (U.S. CLS. 2, 12, 13, 14, 23, 25 AND 50).

FIRST USE 2-0-2009; IN COMMERCE 12-0-2010.

OWNER OF U.S. REG. NOS. 1,766,208, 2,454,889 AND OTHERS.

THE NAME "WILLIAMS SCOTSMAN" DOES NOT IDENTIFY A LIVING INDIVIDUAL.

THE MARK CONSISTS OF THE STYLIZED WORDING "REMOT" LOCATED ABOVE A LINE THAT IS LOCATED ABOVE THE STYLIZED WORDING "BY WILLIAMS SCOTSMAN". THE LETTER "E" IN "REMOT" CONTAINS A LINE ABOVE IT, AND THE LETTER "O" IN "REMOT" CONTAINS THE DEPICTION OF A BRANCH WITH SEVEN LEAVES.

SER. NO. 85-260,544, FILED 3-8-2011.

MICHAEL TANNER, EXAMINING ATTORNEY



David J. Kybas

Director of the United States Patent and Trademark Office

United States of America

United States Patent and Trademark Office

VENJONG

Reg. No. 4,066,286

Registered Dec. 6, 2011

Int. Cls.: 3, 4 and 12

TRADEMARK

PRINCIPAL REGISTER

WEGMANN AUTOMOTIVE GMBH & CO. KG (FED REP GERMANY LIMITED PARTNERSHIP)
RUDOLF-DIESEL-STRASSE 6
VEITSHOCHHEIM, FED REP GERMANY 97209

FOR: CLEANING, POLISHING, SCOURING AND ABRASIVE PREPARATIONS, WHEEL RIM CLEANER, IN CLASS 3 (U.S. CLS. 1, 4, 6, 50, 51 AND 52).

FOR: INDUSTRIAL OILS AND GREASES, LUBRICANT, LUBRICANT PASTE, IN CLASS 4 (U.S. CLS. 1, 6 AND 15).

FOR: VALVES FOR VEHICLE TIRES, IN CLASS 12 (U.S. CLS. 19, 21, 23, 31, 35 AND 44).

THE MARK CONSISTS OF STANDARD CHARACTERS WITHOUT CLAIM TO ANY PARTICULAR FONT, STYLE, SIZE, OR COLOR.

PRIORITY CLAIMED UNDER SEC. 44(D) ON FED REP GERMANY APPLICATION NO. 302010059108, FILED 11-8-2010, REG. NO. 302010059108, DATED 2-23-2011, EXPIRES 11-30-2020.

OWNER OF U.S. REG. NOS. 3,763,845 AND 3,828,811.

THE WORDING "VENJONG" HAS NO MEANING IN A FOREIGN LANGUAGE.

SER. NO. 85-260,825, FILED 3-8-2011.

JUDITH HELFMAN, EXAMINING ATTORNEY



David J. Kyjars

Director of the United States Patent and Trademark Office

United States of America

United States Patent and Trademark Office

MY LIFE. MY STYLE. MY FLOWERS.

Reg. No. 4,066,287

Registered Dec. 6, 2011

Int. Cls.: 31 and 35

TRADEMARK

SERVICE MARK

PRINCIPAL REGISTER

GEMS GLOBAL, INC. (FLORIDA CORPORATION)
SUITE 400
7205 CORPORATE CENTER DRIVE
MIAMI, FL 33126

FOR: LIVE FLOWERS, CUT FLOWERS, FLOWER BULBS; FLOWER SEEDS; LIVE PLANTS,
IN CLASS 31 (U.S. CLS. 1 AND 46).

FIRST USE 4-2-2010; IN COMMERCE 4-2-2010.

FOR: WHOLESALE DISTRIBUTORSHIPS, WHOLESALE AND RETAIL STORE SERVICES,
AND MAIL ORDER CATALOGUE SERVICES FEATURING FLOWERS AND LIVE PLANTS;
PROVIDING MARKETING AND SALES INFORMATION ON FLOWERS AND LIVE PLANTS
TO THOSE IN THE FLOWER INDUSTRY, NAMELY, RETAILERS, WHOLESALERS, AND
GROWERS; BUSINESS SERVICES, NAMELY, FLORAL CLEARING HOUSE; ADVERTISING,
MARKETING AND PROMOTION SERVICES IN THE FIELD OF FLOWERS; ONLINE
WHOLESALE AND RETAIL STORE SERVICES AND ONLINE MAIL ORDER CATALOGUE
SERVICES FEATURING FLOWERS AND LIVE PLANTS, IN CLASS 35 (U.S. CLS. 100, 101
AND 102).

FIRST USE 4-2-2010; IN COMMERCE 4-2-2010.

THE MARK CONSISTS OF STANDARD CHARACTERS WITHOUT CLAIM TO ANY PAR-
TICULAR FONT, STYLE, SIZE, OR COLOR.

NO CLAIM IS MADE TO THE EXCLUSIVE RIGHT TO USE "FLOWERS", APART FROM
THE MARK AS SHOWN.

SER. NO. 85-261,098, FILED 3-8-2011.

TEJBIR SINGH, EXAMINING ATTORNEY



David J. Kypos

Director of the United States Patent and Trademark Office

United States of America

United States Patent and Trademark Office



Reg. No. 4,066,288

Registered Dec. 6, 2011

Int. Cl.: 29

TRADEMARK

PRINCIPAL REGISTER

LEMANN CORPORATION (CALIFORNIA CORPORATION)
20400 VIA SANLUCAR
YORBA LINDA, CA 92887

FOR: MILK POWDER MADE IN THE USA, IN CLASS 29 (U.S. CL. 46).

FIRST USE 12-30-2005; IN COMMERCE 12-30-2005.

NO CLAIM IS MADE TO THE EXCLUSIVE RIGHT TO USE "MILK", "PREMIUM #1", "CHILDREN FORMULA", "2-6 YEARS OLD", "12 OZ" AND "MADE IN U.S.A", APART FROM THE MARK AS SHOWN.

THE COLOR(S) BLUE, PINK, AND WHITE IS/ARE CLAIMED AS A FEATURE OF THE MARK.

THE MARK CONSISTS OF A BLUE BACKGROUND. BACKGROUND COLORS LIGHTENS UP SMOOTHLY TO BOTTOM. COLOR TURNS TO PINK AT BOTTOM. ABOUT 1 1/2 TO 2 INCHES DOWN FROM THE TOP IS WHITE BAND OF ABOUT 2 INCHES WIDE. THE WHITE BAND STRETCHES FROM THE LEFTHAND SIDE OF THE LABEL TO THE RIGHT HAND SIDE OF THE LABEL. IN THE MIDDLE OF THE WHITE BAND IS THE PHRASE "OMA MILK". THE WORD "OMA": LETTER "O" IS PINK, WITH BLUE SHADES; STRONGER BLUE SHADES ON THE RIGHT. THERE'S A SMALL PINK BUTTON ON THE INSIDE AND TO THE RIGHT OF THE LETTER "O". LETTER "M" CONSISTS OF TWO COLORS: THE FIRST PART OF LETTER "M" IS BLUE, THE SECOND PART OF LETTER "M" IS PINK. LETTER "A" IS PINK. THE WORD "MILK"- LETTER "M"- FIRST HALF IS PINK, SECOND HALF IS BLUE. LETTER "I" IS PINK; LETTER "L" IS BLUE, AND LETTER "K" IS PINK. RIGHT BELOW THE WHITE BAND TO THE CENTER IS THE WORD "PREMIUM" IN WHITE COLOR. BELOW "PREMIUM" IS "#1" IN WHITE COLOR. BELOW "#1" IS THE PHRASE "CHILDREN FORMULA" IN PINK WITH WHITE SHADES. BELOW THAT IS "2-6 YEARS OLD" IN WHITE WITH PINK SHADES. TO THE BOTTOM LEFT HAND CORNER IS "12OZ" IN WHITE. BOTTOM RIGHT HAND CORNER IS "MADE IN U.S.A" IN WHITE.

THE WORDING "OMA" HAS NO MEANING IN A FOREIGN LANGUAGE.

SER. NO. 85-261,465, FILED 3-8-2011.

GRETTA YAO, EXAMINING ATTORNEY



David J. Kyros

Director of the United States Patent and Trademark Office

United States of America

United States Patent and Trademark Office



Reg. No. 4,066,289

Registered Dec. 6, 2011

Int. Cl.: 29

TRADEMARK

PRINCIPAL REGISTER

LEMANN CORPORATION (CALIFORNIA CORPORATION)
20400 VIA SANLUCAR
YORBA LINDA, CA 92887

FOR: MILK POWDER MADE IN THE USA, IN CLASS 29 (U.S. CL. 46).

FIRST USE 12-30-2005; IN COMMERCE 12-30-2005.

NO CLAIM IS MADE TO THE EXCLUSIVE RIGHT TO USE "MILK" "ADULT MILK" "12 OZ" "MADE IN THE U.S.A", APART FROM THE MARK AS SHOWN.

THE COLOR(S) BEIGE, WHITE, AND PINK IS/ARE CLAIMED AS A FEATURE OF THE MARK.

THE MARK CONSISTS OF BACKGROUND CONSISTS OF TWO MAIN COLORS: BEIGE AND PINK. 60% FROM THE TOP DOWN IS IN BEIGE, WHILE THE REMAINING 40% IS IN PINK, WHICH DARKENS INTO DARK PINK AT THE BOTTOM. AT THE CENTER OF THE BEIGE PORTION IS THE PHRASE "OSSO MILK" IN WHITE COLOR AND PINK SHADES. THE ENTIRE PHRASE IS CAPITALIZED. RIGHT BELOW THE PHRASE "OSSO MILK" IS A ROUND FIGURE THAT'S WHITE IN COLOR AND SHADED WITH PINK. THE ROUND FIGURE HAS A PINK BUTTON, WHICH IS LOCATED AT THE LOWER HALF OF THE ROUND FIGURE. SURROUNDING THE PINK BUTTON IS PINK WHICH LIGHTENS UP THAT LOOKS LIKE A PINK CLOUDY AURA. BELOW THE ROUND FIGURE IS THE PHRASE "ADULT MILK" IN WHITE COLOR AND PINK SHADES. LETTERS "A" AND "M" ARE CAPITALIZED. BOTTOM LEFT HAND SIDE CORNER IS THE PHRASE "12 OZ" IN WHITE COLOR. "OZ" IS IN LOWER CASE. BOTTOM RIGHT HAND SIDE CORNER IS THE PHRASE "MADE IN U.S.A" IN WHITE COLOR. LETTERS "M" IN "MADE", "U", "S", "A" ARE CAPITALIZED.

THE ENGLISH TRANSLATION OF THE WORD "OSSO" IN THE MARK IS "BONE".

SER. NO. 85-261,551, FILED 3-8-2011.

GRETTA YAO, EXAMINING ATTORNEY



David J. Kyros

Director of the United States Patent and Trademark Office

United States of America

United States Patent and Trademark Office

GARDEN LIGHT

Reg. No. 4,066,290

Registered Dec. 6, 2011

Int. Cl.: 11

TRADEMARK

PRINCIPAL REGISTER

GARDEN LIGHT, INC. (FLORIDA CORPORATION)
6112 BENJAMIN ROAD
TAMPA, FL 336345105

FOR: LANDSCAPE LIGHTING FIXTURES, IN CLASS 11 (U.S. CLS. 13, 21, 23, 31 AND 34).

FIRST USE 3-29-1999; IN COMMERCE 3-29-1999.

THE MARK CONSISTS OF STANDARD CHARACTERS WITHOUT CLAIM TO ANY PARTICULAR FONT, STYLE, SIZE, OR COLOR.

NO CLAIM IS MADE TO THE EXCLUSIVE RIGHT TO USE "LIGHT", APART FROM THE MARK AS SHOWN.

SEC. 2(F).

SER. NO. 85-262,216, FILED 3-9-2011.

SHAUNIA CARLYLE, EXAMINING ATTORNEY



David J. Kybas

Director of the United States Patent and Trademark Office

United States of America

United States Patent and Trademark Office

Digi-Pas

Reg. No. 4,066,291

Registered Dec. 6, 2011

Int. Cl.: 9

TRADEMARK

PRINCIPAL REGISTER

DIGIPAS USA, LLC (CONNECTICUT LIMITED LIABILITY COMPANY)
304 W MAIN STREET, #120
AVON, CT 06001

FOR: LEVEL GAUGES, IN CLASS 9 (U.S. CLS. 21, 23, 26, 36 AND 38).

FIRST USE 2-0-2009; IN COMMERCE 2-0-2009.

THE MARK CONSISTS OF STANDARD CHARACTERS WITHOUT CLAIM TO ANY PARTICULAR FONT, STYLE, SIZE, OR COLOR.

SER. NO. 85-262,796, FILED 3-9-2011.

JAMES MACFARLANE, EXAMINING ATTORNEY



David J. Kyffers

Director of the United States Patent and Trademark Office

United States of America

United States Patent and Trademark Office



Reg. No. 4,066,292
Registered Dec. 6, 2011
Int. Cls.: 35 and 37

COLEMAN-TAYLOR TRANSMISSIONS, COMPANY, INC. (TENNESSEE CORPORATION),
AKA COLEMAN-TAYLOR TRANSMISSIONS, INC. AND COLEMAN-TAYLOR
TRANSMISSION, INC.
1210 MIDAS COVE, #102
CORDOVA, TN 380180306

SERVICE MARK

FOR: WHOLESALE AND RETAIL STORE SERVICES FEATURING TRANSMISSIONS, IN
CLASS 35 (U.S. CLS. 100, 101 AND 102).

PRINCIPAL REGISTER

FIRST USE 1-16-1961; IN COMMERCE 1-16-1961.

FOR: INSTALLATION, REPAIR AND MAINTENANCE OF AUTOMOBILES, PARTICULARLY
OF AUTOMOBILE TRANSMISSIONS; FRANCHISING SERVICES, NAMELY, RENDERING
TECHNICAL ASSISTANCE RELATING TO THE REPAIR, INSTALLATION, AND MAINTEN-
ANCE OF AUTOMOBILE TRANSMISSIONS, IN CLASS 37 (U.S. CLS. 100, 103 AND 106).

FIRST USE 1-16-1961; IN COMMERCE 1-16-1961.

OWNER OF U.S. REG. NO. 3,512,948.

NO CLAIM IS MADE TO THE EXCLUSIVE RIGHT TO USE "TRANSMISSIONS", APART
FROM THE MARK AS SHOWN.

THE NAME(S), PORTRAIT(S), AND/OR SIGNATURE(S) SHOWN IN THE MARK IDENTIFIES
THE SURNAMES OF LARRY E. COLEMAN AND BILLY C. TAYLOR, CO-FOUNDERS OF
APPLICANT COMPANY, WHOSE CONSENT(S) TO REGISTER IS MADE OF RECORD.

THE MARK CONSISTS OF THE WORD "COLEMAN" ABOVE THE WORD "TAYLOR" IN
AN UPPER PORTION OF THE MARK, AND THE WORD "TRANSMISSIONS" IN A LOWER
PORTION OF THE MARK, SURROUNDED BY AN OVAL.

SER. NO. 85-263,020, FILED 3-10-2011.

PAM WILLIS, EXAMINING ATTORNEY



David J. Kyffers

Director of the United States Patent and Trademark Office

United States of America

United States Patent and Trademark Office

CAPELLATAX NETWORK

Reg. No. 4,066,293

Registered Dec. 6, 2011

Int. Cls.: 35 and 36

SERVICE MARK

PRINCIPAL REGISTER

CAPELLATAX NETWORK, LLC (MARYLAND LIMITED LIABILITY COMPANY)
SUITE 300
9256 BENDIX ROAD
COLUMBIA, MD 21045

FOR: ACCOUNTING SERVICES, IN CLASS 35 (U.S. CLS. 100, 101 AND 102).

FIRST USE 9-0-2010; IN COMMERCE 12-0-2010.

FOR: ADMINISTRATION OF EMPLOYEE BENEFIT PLANS CONCERNING TAX SERVICES,
IN CLASS 36 (U.S. CLS. 100, 101 AND 102).

FIRST USE 9-0-2010; IN COMMERCE 12-0-2010.

THE MARK CONSISTS OF STANDARD CHARACTERS WITHOUT CLAIM TO ANY PARTICULAR FONT, STYLE, SIZE, OR COLOR.

NO CLAIM IS MADE TO THE EXCLUSIVE RIGHT TO USE "NETWORK", APART FROM THE MARK AS SHOWN.

SER. NO. 85-263,075, FILED 3-10-2011.

ANNE MADDEN, EXAMINING ATTORNEY



David J. Kybas

Director of the United States Patent and Trademark Office

United States of America

United States Patent and Trademark Office

Your Digital Security Is Our Business

Reg. No. 4,066,294

Registered Dec. 6, 2011

Int. Cl.: 42

SERVICE MARK

PRINCIPAL REGISTER

CAANES, LLC (NEW MEXICO LIMITED LIABILITY COMPANY)
10200 COMANCHE RD. NE
ALBUQUERQUE, NM 87111

FOR: PROVIDING COMPUTER SECURITY CONSULTANCY IN THE NATURE OF NETWORK SECURITY ASSESSMENTS AND EVALUATIONS; COMPUTER FORENSIC SERVICES; PROVIDING TECHNICAL SUPPORT SERVICES, NAMELY, TROUBLESHOOTING AND SOLUTION RECOMMENDATION IN THE NATURE OF DIAGNOSING COMPUTER HARDWARE AND SOFTWARE PROBLEMS AS SUCH PROBLEMS RELATE TO THE SECURITY OF THE CLIENT'S NETWORK, IN CLASS 42 (U.S. CLS. 100 AND 101).

FIRST USE 8-1-2006; IN COMMERCE 8-1-2006.

THE MARK CONSISTS OF STANDARD CHARACTERS WITHOUT CLAIM TO ANY PARTICULAR FONT, STYLE, SIZE, OR COLOR.

NO CLAIM IS MADE TO THE EXCLUSIVE RIGHT TO USE "DIGITAL SECURITY", APART FROM THE MARK AS SHOWN.

SER. NO. 85-263,246, FILED 3-10-2011.

JIM RINGLE, EXAMINING ATTORNEY



David J. Kyros

Director of the United States Patent and Trademark Office

United States of America

United States Patent and Trademark Office

SHEIK SHADE

Reg. No. 4,066,295

PETERSON, PAUL R (UNITED STATES INDIVIDUAL)
11850 245TH STREET EAST
LAKEVILLE, MN 55044

Registered Dec. 6, 2011

Int. Cl.: 25

FOR: HEADGEAR ACCESSORIES, NAMELY, SUN PROTECTIVE FABRIC FLAPS FOR ATTACHMENT TO HEADWEAR, IN CLASS 25 (U.S. CLS. 22 AND 39).

TRADEMARK

FIRST USE 3-9-2011; IN COMMERCE 3-10-2011.

PRINCIPAL REGISTER

THE MARK CONSISTS OF STANDARD CHARACTERS WITHOUT CLAIM TO ANY PARTICULAR FONT, STYLE, SIZE, OR COLOR.

NO CLAIM IS MADE TO THE EXCLUSIVE RIGHT TO USE "SHADE", APART FROM THE MARK AS SHOWN.

SER. NO. 85-263,547, FILED 3-10-2011.

JOSETTE BEVERLY, EXAMINING ATTORNEY



David J. Kybas

Director of the United States Patent and Trademark Office

United States of America

United States Patent and Trademark Office

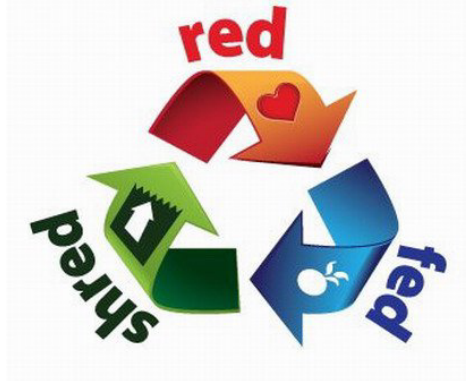

Reg. No. 4,066,296

Registered Dec. 6, 2011

Int. Cl.: 41

SERVICE MARK

PRINCIPAL REGISTER

THE FINANCIAL TEAM, INC. (CALIFORNIA CORPORATION)
C/O ICIP 2141 PALOMAR AIRPORT RD. #320
CARLSBAD, CA 92011

FOR: ORGANIZING COMMUNITY SPORTING AND CULTURAL EVENTS, WHICH ALSO FEATURE OPPORTUNITIES FOR GUESTS TO PARTICIPATE IN BLOOD DONATIONS, DOCUMENT SHREDDING, ELECTRONIC WASTE RECYCLING, DINNERS, IN CLASS 41 (U.S. CLS. 100, 101 AND 107).

FIRST USE 1-15-2011; IN COMMERCE 2-15-2011.

NO CLAIM IS MADE TO THE EXCLUSIVE RIGHT TO USE "SHRED", APART FROM THE MARK AS SHOWN.

THE COLOR(S) GREEN, ORANGE, RED, BLUE AND WHITE IS/ARE CLAIMED AS A FEATURE OF THE MARK.

THE MARK CONSISTS OF A DESIGN OF THREE ARROWS IN A TRIANGULAR SHAPE REPRESENTING A RECYCLING SYMBOL WITH THE FOLLOWING FEATURES: THE WORD "SHRED" IS SHOWN IN DARK GREEN ON THE LOWER LEFT OF THE DESIGN, NEXT TO A BENDING GREEN ARROW WITH DARK GREEN ON THE UNDERNEATH SIDE AND LIGHTER GREEN ON THE TOP ARROW PORTION, AND A DARK GREEN RECTANGLE TOWARD THE ARROW TIP WITH ONE JAGGED EDGE TOWARD THE ARROW TIP AND WITH A WHITE ARROW INSIDE THE RECTANGLE; THE WORD "RED" IS SHOWN IN RED ON THE TOP OF THE DESIGN, OVER A BENDING ORANGE ARROW WITH RED ON THE UNDERNEATH SIDE AND ORANGE ON THE TOP ARROW PORTION, GETTING GRADUALLY DARKER APPROACHING THE ARROW TIP, AND WITH A RED HEART ON THAT TOP ARROW PORTION; AND THE WORD "FED" IS SHOWN IN BLUE ON THE LOWER RIGHT OF THE DESIGN, NEXT TO A BENDING BLUE ARROW WITH CHANGING SHADES OF BLUE ON BOTH THE UNDERNEATH SIDE AND THE TOP ARROW PORTION, GETTING GRADUALLY DARKER APPROACHING THE ARROW TIP, AND WITH A WHITE PIECE OF FRUIT WITH WHITE LEAVES ON THAT TOP ARROW PORTION.



David J. Kyffers

Director of the United States Patent and Trademark Office

SER. NO. 85-263,939, FILED 3-10-2011.

JENNIFER DIXON, EXAMINING ATTORNEY

United States of America

United States Patent and Trademark Office

CAROLYN COOPER SIMPLY HEALED METHOD

Reg. No. 4,066,297

Registered Dec. 6, 2011

Int. Cls.: 41 and 44

SERVICE MARK

PRINCIPAL REGISTER

CAROLYN COOPER INTERNATIONAL (UTAH CORPORATION)
382 S. BLUFF STREET STE. 175
ST. GEORGE, UT 84770

FOR: EDUCATION SERVICES, NAMELY, PROVIDING CLASSES, SEMINARS, CONFERENCES, AND WORKSHOPS IN THE FIELD OF ENERGY HEALING, AND DISTRIBUTION OF COURSE MATERIALS IN CONNECTION THEREWITH, IN CLASS 41 (U.S. CLS. 100, 101 AND 107).

FIRST USE 3-9-2011; IN COMMERCE 3-9-2011.

FOR: PROVIDING IN-PERSON ENERGY HEALING SERVICES; PROVIDING LONG-DISTANCE ENERGY HEALING SERVICES, IN CLASS 44 (U.S. CLS. 100 AND 101).

FIRST USE 3-9-2011; IN COMMERCE 3-9-2011.

THE MARK CONSISTS OF STANDARD CHARACTERS WITHOUT CLAIM TO ANY PARTICULAR FONT, STYLE, SIZE, OR COLOR.

NO CLAIM IS MADE TO THE EXCLUSIVE RIGHT TO USE "HEALED" OR "METHOD", APART FROM THE MARK AS SHOWN.

THE NAME(S), PORTRAIT(S), AND/OR SIGNATURE(S) SHOWN IN THE MARK IDENTIFIES CAROLYN COOPER, WHOSE CONSENT(S) TO REGISTER IS MADE OF RECORD.

SER. NO. 85-263,982, FILED 3-10-2011.

JAMES GRIFFIN, EXAMINING ATTORNEY



David J. Kyffers

Director of the United States Patent and Trademark Office

United States of America

United States Patent and Trademark Office

Peace of Mind Organizing

Reg. No. 4,066,298

Registered Dec. 6, 2011

Int. Cl.: 35

SERVICE MARK

PRINCIPAL REGISTER

PEACE OF MIND ORGANIZING, LLC (MISSOURI LIMITED LIABILITY COMPANY)
3022 SHENANDOAH AVENUE
ST. LOUIS, MO 63104

FOR: PROVIDING ORGANIZING SERVICES FOR BELONGINGS AND SPACES IN A RESIDENCE OR OFFICE SUCH AS PAPERS AND TIME; PROVIDING ORGANIZING SERVICES FOR INDIVIDUALS AT HOME, IN HOME OFFICES AND IN BUSINESS OFFICES, THAT PROVIDES HELP WITH TIME AND PAPER MANAGEMENT, IN CLASS 35 (U.S. CLS. 100, 101 AND 102).

FIRST USE 9-27-2005; IN COMMERCE 9-27-2005.

THE MARK CONSISTS OF STANDARD CHARACTERS WITHOUT CLAIM TO ANY PARTICULAR FONT, STYLE, SIZE, OR COLOR.

NO CLAIM IS MADE TO THE EXCLUSIVE RIGHT TO USE "ORGANIZING", APART FROM THE MARK AS SHOWN.

SER. NO. 85-264,059, FILED 3-10-2011.

HEATHER THOMPSON, EXAMINING ATTORNEY



David J. Kybas

Director of the United States Patent and Trademark Office

United States of America

United States Patent and Trademark Office

AKYNZEO

Reg. No. 4,066,299

Registered Dec. 6, 2011

Int. Cl.: 5

TRADEMARK

PRINCIPAL REGISTER

HELSINN HEALTHCARE S.A. (SWITZERLAND SOCIÉTÉ ANONYME (SA))
VIA PIAN SCAIROLO 9
6912 LUGANO, SWITZERLAND

FOR: PHARMACEUTICAL PREPARATIONS, NAMELY, ANTI-INFLAMMATORY DRUGS, ANTI-EMETIC DRUGS, DRUGS FOR THE TREATMENT OF CANCER, CARCINOMA, LEUKEMIA, LYMPHOMA, MELANOMA; ANTI-TUMOR DRUGS AND ANTICANCER DRUGS; PHARMACEUTICAL PREPARATIONS FOR THE TREATMENT OF ONCOLOGICAL DISEASES AND THE SIDE EFFECTS OF TREATMENT; PHARMACEUTICAL PREPARATIONS FOR THE TREATMENT OF ULCERATIVE AND INFLAMMATORY CONDITIONS, ANTI-ANXIETY DRUGS, ANTI-MIGRAINE DRUGS, COGNITION ENHANCING DRUGS, DRUGS FOR THE PREVENTION AND TREATMENT OF GASTROENTEROLOGICAL, HEPATOLOGIC, NEPHROLOGIC AND CARDIOVASCULAR DISORDERS OF ANY ORIGIN; PHARMACEUTICAL PREPARATIONS FOR INTERNAL CLEANSING PURPOSES, BOWEL CLEANSERS AND EVACUANTS FOR MEDICAL AND PHARMACEUTICAL PURPOSES; VETERINARY VACCINES AND SANITARY PREPARATIONS FOR MEDICAL USE; DIETETIC FOODS ADAPTED FOR MEDICAL USE, FOOD FOR BABIES; MEDICAL AND SURGICAL PLASTERS, MATERIALS FOR DRESSINGS IN THE NATURE OF BANDAGES; MATERIAL FOR STOPPING TEETH, DENTAL WAX; DISINFECTANTS FOR SANITARY AND HYGIENE PURPOSES; PREPARATIONS FOR DESTROYING VERMIN; FUNGICIDES, HERBICIDES, IN CLASS 5 (U.S. CLS. 6, 18, 44, 46, 51 AND 52).



THE MARK CONSISTS OF STANDARD CHARACTERS WITHOUT CLAIM TO ANY PARTICULAR FONT, STYLE, SIZE, OR COLOR.

PRIORITY CLAIMED UNDER SEC. 44(D) ON SWITZERLAND APPLICATION NO. 63941/2010, FILED 12-20-2010, REG. NO. 609883, DATED 12-20-2010, EXPIRES 12-20-2020.

THE WORDING "AKYNZEO" HAS NO MEANING IN A FOREIGN LANGUAGE.

SER. NO. 85-264,083, FILED 3-11-2011.

GRETCHEN ULRICH, EXAMINING ATTORNEY

David J. Kybas

Director of the United States Patent and Trademark Office

United States of America

United States Patent and Trademark Office



Reg. No. 4,066,300

Registered Dec. 6, 2011

Int. Cl.: 6

TRADEMARK

PRINCIPAL REGISTER

KREATIONS, LLC (WASHINGTON LIMITED LIABILITY COMPANY), DBA CAMELEON
HARDWARE
1717 NE 406TH CIRCLE
WOODLAND, WA 98674

FOR: METAL KITCHEN, BATH AND CUPBOARD HARDWARE, NAMELY, PULLS; METAL
HANDLES FOR CABINETS, DRAWERS; METAL KNOBS, IN CLASS 6 (U.S. CLS. 2, 12, 13,
14, 23, 25 AND 50).

FIRST USE 3-1-2009; IN COMMERCE 5-1-2010.

NO CLAIM IS MADE TO THE EXCLUSIVE RIGHT TO USE "HARDWARE", APART FROM
THE MARK AS SHOWN.

THE MARK CONSISTS OF A STYLIZED CHAMELEON SHAPE WITH THE BODY OF THE
CHAMELEON ON THE FAR LEFT, FACING UPWARD WITH THE TAIL OF THE
CHAMELEON EXTENDING BELOW THE CAPITALIZED WORDS "CAMELEON HARD-
WARE".

SER. NO. 85-264,139, FILED 3-11-2011.

TRICIA SONNEBORN, EXAMINING ATTORNEY



David J. Kyros

Director of the United States Patent and Trademark Office

United States of America

United States Patent and Trademark Office

Orbitform

Reg. No. 4,066,301

Registered Dec. 6, 2011

Int. Cl.: 37

SERVICE MARK

PRINCIPAL REGISTER

ORBITFORM, LLC (MICHIGAN LIMITED LIABILITY COMPANY)
1600 EXECUTIVE DR.
JACKSON, MI 49203

FOR: RIVETING, IN CLASS 37 (U.S. CLS. 100, 103 AND 106).

FIRST USE 2-2-1991; IN COMMERCE 2-2-1991.

THE MARK CONSISTS OF STANDARD CHARACTERS WITHOUT CLAIM TO ANY PARTICULAR FONT, STYLE, SIZE, OR COLOR.

SER. NO. 85-264,216, FILED 3-11-2011.

SKYE YOUNG, EXAMINING ATTORNEY



David J. Kyros

Director of the United States Patent and Trademark Office

United States of America

United States Patent and Trademark Office

FIDIZO

Reg. No. 4,066,302

Registered Dec. 6, 2011

Int. Cl.: 5

TRADEMARK

PRINCIPAL REGISTER

HELSINN HEALTHCARE S.A. (SWITZERLAND SOCIÉTÉ ANONYME (SA))
VIA PIAN SCAIROLO 9
6912 LUGANO, SWITZERLAND

FOR: PHARMACEUTICAL PREPARATIONS, NAMELY, ANTI-INFLAMMATORY DRUGS, ANTI-EMETIC DRUGS, DRUGS FOR THE TREATMENT OF CANCER, CARCINOMA, LEUKEMIA, LYMPHOMA, MELANOMA; ANTI-TUMOR DRUGS AND ANTICANCER DRUGS; PHARMACEUTICAL PREPARATIONS FOR THE TREATMENT OF ONCOLOGICAL DISEASES AND THE SIDE EFFECTS OF TREATMENT; PHARMACEUTICAL PREPARATIONS FOR THE TREATMENT OF ULCERATIVE AND INFLAMMATORY CONDITIONS, ANTI-ANXIETY DRUGS, ANTI-MIGRAINE DRUGS, COGNITION ENHANCING DRUGS, DRUGS FOR THE PREVENTION AND TREATMENT OF GASTROENTEROLOGICAL, HEPATOLOGIC, NEPHROLOGIC AND CARDIOVASCULAR DISORDERS OF ANY ORIGIN; PHARMACEUTICAL PREPARATIONS FOR INTERNAL CLEANSING PURPOSES, BOWEL CLEANSERS AND EVACUANTS FOR MEDICAL AND PHARMACEUTICAL PURPOSES; VETERINARY VACCINES AND SANITARY PREPARATIONS FOR MEDICAL USE; DIETETIC FOODS ADAPTED FOR MEDICAL USE, FOOD FOR BABIES; MEDICAL AND SURGICAL PLASTERS, MATERIALS FOR DRESSINGS IN THE NATURE OF BANDAGES; MATERIAL FOR STOPPING TEETH, DENTAL WAX; DISINFECTANTS FOR SANITARY AND HYGIENE PURPOSES; PREPARATIONS FOR DESTROYING VERMIN; FUNGICIDES, HERBICIDES, IN CLASS 5 (U.S. CLS. 6, 18, 44, 46, 51 AND 52).

THE MARK CONSISTS OF STANDARD CHARACTERS WITHOUT CLAIM TO ANY PARTICULAR FONT, STYLE, SIZE, OR COLOR.

PRIORITY CLAIMED UNDER SEC. 44(D) ON SWITZERLAND APPLICATION NO. 63939/2010, FILED 12-20-2010, REG. NO. 609881, DATED 12-20-2010, EXPIRES 12-20-2020.

THE WORDING "FIDIZO" HAS NO MEANING IN A FOREIGN LANGUAGE.

SER. NO. 85-264,430, FILED 3-11-2011.

GRETCHEN ULRICH, EXAMINING ATTORNEY



David J. Kyros

Director of the United States Patent and Trademark Office

United States of America

United States Patent and Trademark Office

career focus

Reg. No. 4,066,303

Registered Dec. 6, 2011

Int. Cl.: 41

SERVICE MARK

PRINCIPAL REGISTER

ROCKHURST UNIVERSITY CONTINUING EDUCATION CENTER, INC. (KANSAS
NON-PROFIT CORPORATION)
P.O. BOX 419107
KANSAS CITY, MO 641416107

FOR: ON-LINE ELECTRONIC NEWSLETTERS DELIVERED BY E-MAIL IN THE FIELD OF
BUSINESS, IN CLASS 41 (U.S. CLS. 100, 101 AND 107).

FIRST USE 9-1-2010; IN COMMERCE 9-1-2010.

THE MARK CONSISTS OF STANDARD CHARACTERS WITHOUT CLAIM TO ANY PAR-
TICULAR FONT, STYLE, SIZE, OR COLOR.

NO CLAIM IS MADE TO THE EXCLUSIVE RIGHT TO USE "CAREER", APART FROM
THE MARK AS SHOWN.

SER. NO. 85-264,764, FILED 3-11-2011.

EDWARD FENNESSY, EXAMINING ATTORNEY



David J. Kyffers

Director of the United States Patent and Trademark Office

United States of America

United States Patent and Trademark Office

ROCKY MOUNTAINEER SILVERLEAF SERVICE

Reg. No. 4,066,304

GREAT CANADIAN RAILTOUR COMPANY LTD. (CANADA CORPORATION)
101 - 369 TERMINAL AVENUE
VANCOUVER, BC, CANADA V6A4C4

Registered Dec. 6, 2011

Int. Cl.: 39

FOR: SERVICE OF PROVIDING TRANSPORTATION OF PASSENGERS AND GOODS BY RAIL AND BUS, IN CLASS 39 (U.S. CLS. 100 AND 105).

SERVICE MARK

FIRST USE 0-0-1997; IN COMMERCE 0-0-2010.

PRINCIPAL REGISTER

THE MARK CONSISTS OF STANDARD CHARACTERS WITHOUT CLAIM TO ANY PARTICULAR FONT, STYLE, SIZE, OR COLOR.

OWNER OF CANADA REG. NO. TMA474,723, DATED 4-14-1997, EXPIRES 4-14-2027.

NO CLAIM IS MADE TO THE EXCLUSIVE RIGHT TO USE "SERVICE", APART FROM THE MARK AS SHOWN.

SER. NO. 85-265,176, FILED 3-11-2011.

LEIGH LOWRY, EXAMINING ATTORNEY



David J. Kybas

Director of the United States Patent and Trademark Office

United States of America

United States Patent and Trademark Office



Reg. No. 4,066,305

Registered Dec. 6, 2011

Int. Cl.: 42

SERVICE MARK

PRINCIPAL REGISTER

MCLAUGHLIN, JOHN M (UNITED STATES INDIVIDUAL)
1258 BROOK ROAD
MILTON, MA 02186

FOR: DESIGN AND DEVELOPMENT OF COMPUTER GRAPHICS, NAMELY, PROVIDING READY-TO-USE CUSTOM WEB SITE TEMPLATES AND WEB GRAPHICS VIA THE INTERNET; CONSULTING SERVICES IN THE FIELD OF WEB GRAPHIC DESIGN, IN CLASS 42 (U.S. CLS. 100 AND 101).

FIRST USE 1-1-2011; IN COMMERCE 1-1-2011.

THE MARK CONSISTS OF A BROWN AND SILVER PAINT BRUSH DRAWING A SMILEY FACE USING BLACK PAINT ON A CURVED PAGE OF GOLD PAPER.

THE COLOR(S) GOLD, BROWN, SILVER AND BLACK IS/ARE CLAIMED AS A FEATURE OF THE MARK.

SER. NO. 85-265,286, FILED 3-11-2011.

MARLENE BELL, EXAMINING ATTORNEY



David J. Kyros

Director of the United States Patent and Trademark Office

United States of America
United States Patent and Trademark Office

GOCLONE

Reg. No. 4,066,306

Registered Dec. 6, 2011

Int. Cl.: 1

TRADEMARK

PRINCIPAL REGISTER

SWITCHGEAR GENOMICS, INC (DELAWARE CORPORATION), DBA SWITCHGEAR
GENOMICS, INC
1455 ADAMS DR. SUITE #1317
MENLO PARK, CA 94025

FOR: REAGENT KITS COMPRISING GENERIC DNA CIRCLE, DNA PRIMERS, POLYMERASE
AND BUFFERS FOR USE IN BIOTECHNOLOGY FIELDS, IN CLASS 1 (U.S. CLS. 1, 5, 6, 10,
26 AND 46).

FIRST USE 8-10-2010; IN COMMERCE 8-10-2010.

THE MARK CONSISTS OF STANDARD CHARACTERS WITHOUT CLAIM TO ANY PAR-
TICULAR FONT, STYLE, SIZE, OR COLOR.

SER. NO. 85-265,353, FILED 3-12-2011.

AMY C. KEAN, EXAMINING ATTORNEY



David J. Kappas

Director of the United States Patent and Trademark Office

United States of America

United States Patent and Trademark Office

EOD

Reg. No. 4,066,307

Registered Dec. 6, 2011

Int. Cl.: 9

TRADEMARK

PRINCIPAL REGISTER

EODIWEAR (UNITED KINGDOM LIMITED LIABILITY COMPANY)
PO BOX 704
CHICHESTER, UNITED KINGDOM PO199NR

FOR: EYEWEAR, NAMELY, SUNGLASSES, IN CLASS 9 (U.S. CLS. 21, 23, 26, 36 AND 38).

OWNER OF UNITED KINGDOM REG. NO. 2546820, DATED 5-4-2010, EXPIRES 5-3-2020.

THE MARK CONSISTS OF "EOD" IN STYLIZED FONT.

SER. NO. 85-265,440, FILED 3-12-2011.

APRIL HESIK, EXAMINING ATTORNEY



David J. Kyffers

Director of the United States Patent and Trademark Office

United States of America

United States Patent and Trademark Office

UPSIDE CARD

Reg. No. 4,066,308

Registered Dec. 6, 2011

Int. Cl.: 36

SERVICE MARK

PRINCIPAL REGISTER

PLASTYC, INC. (NEW YORK CORPORATION)
23RD FLOOR
55 BROAD STREET
NEW YORK, NY 10004

FOR: ISSUING PREPAID CREDIT CARDS; ON-LINE PREPAID CARD SERVICES, IN CLASS 36 (U.S. CLS. 100, 101 AND 102).

FIRST USE 11-15-2005; IN COMMERCE 6-1-2006.

THE MARK CONSISTS OF STANDARD CHARACTERS WITHOUT CLAIM TO ANY PARTICULAR FONT, STYLE, SIZE, OR COLOR.

OWNER OF U.S. REG. NO. 3,510,591.

NO CLAIM IS MADE TO THE EXCLUSIVE RIGHT TO USE "CARD", APART FROM THE MARK AS SHOWN.

SER. NO. 85-265,865, FILED 3-14-2011.

BARBARA BROWN, EXAMINING ATTORNEY



David J. Kyros

Director of the United States Patent and Trademark Office

United States of America

United States Patent and Trademark Office

SLATE SHIELD

Reg. No. 4,066,309

Registered Dec. 6, 2011

Int. Cl.: 9

TRADEMARK

PRINCIPAL REGISTER

PPC TECHS, INC. (CALIFORNIA CORPORATION)
SUITE G-236
16027 BROOKHURST STREET
FOUNTAIN VALLEY, CA 92708

FOR: CARRYING CASES FOR ELECTRONIC EQUIPMENT, NAMELY, CARRYING CASES FOR HOLDING, CARRYING, ROTATING, STANDING, AND PROTECTING HAND-HELD PDAS, SMART PHONES AND PERSONAL ELECTRONIC COMPUTERS, IN CLASS 9 (U.S. CLS. 21, 23, 26, 36 AND 38).

FIRST USE 3-10-2011; IN COMMERCE 3-10-2011.

THE MARK CONSISTS OF STANDARD CHARACTERS WITHOUT CLAIM TO ANY PARTICULAR FONT, STYLE, SIZE, OR COLOR.

SER. NO. 85-265,887, FILED 3-14-2011.

SANJEEV VOHRA, EXAMINING ATTORNEY



David J. Kyros

Director of the United States Patent and Trademark Office

United States of America

United States Patent and Trademark Office



Reg. No. 4,066,310

Registered Dec. 6, 2011

Int. Cl.: 37

SERVICE MARK

PRINCIPAL REGISTER

FRONT STEPS MEDIA, LLC (NEW HAMPSHIRE LIMITED LIABILITY COMPANY)
20 RIVER VIEW ROAD
NEWPORT, NH 03773

FOR: BUILDING CONSTRUCTION, REMODELING AND REPAIR, IN CLASS 37 (U.S. CLS. 100, 103 AND 106).

FIRST USE 1-1-2009; IN COMMERCE 1-1-2009.

THE MARK CONSISTS OF THE LETTERS "H C I" UNDER AN IMAGE OF TWO HOUSE ROOF SILHOUETTES. THE ROOF SILHOUETTES BOTH SHOW A CHIMNEY AND WINDOW. THE SILHOUETTES ARE PROPORTIONALLY THE SAME WIDTH AS THE THREE LETTERS "H C I" PLACED NEXT TO EACH OTHER.

SER. NO. 85-266,038, FILED 3-14-2011.

C. DIONNE CLYBURN, EXAMINING ATTORNEY



David J. Kyffers

Director of the United States Patent and Trademark Office

United States of America

United States Patent and Trademark Office

Yinki

Reg. No. 4,066,311

Registered Dec. 6, 2011

Int. Cl.: 41

SERVICE MARK

PRINCIPAL REGISTER

MCSHANE, ALISHA (UNITED STATES INDIVIDUAL), AKA OLIVIER, ALISHA
308 A STREET
ENCINITAS, CA 92024

FOR: YIN YOGA WITH REIKI ENERGY HEALING EDUCATIONAL SERVICES, NAMELY, CONDUCTING CLASSES, SEMINARS, WORKSHOPS, CONFERENCES IN THE FIELDS OF YOGA INSTRUCTION, INCLUDING EDUCATIONAL AND TRAINING COURSES TO CERTIFY YOGA INSTRUCTORS, AND DISTRIBUTING COURSE MATERIALS IN CONNECTION THEREWITH, IN CLASS 41 (U.S. CLS. 100, 101 AND 107).

FIRST USE 3-15-2009; IN COMMERCE 1-21-2010.

THE MARK CONSISTS OF STANDARD CHARACTERS WITHOUT CLAIM TO ANY PARTICULAR FONT, STYLE, SIZE, OR COLOR.

SER. NO. 85-266,616, FILED 3-14-2011.

REBECCA GILBERT, EXAMINING ATTORNEY



David J. Kybas

Director of the United States Patent and Trademark Office

United States of America

United States Patent and Trademark Office

spill your gutz

Reg. No. 4,066,312

Registered Dec. 6, 2011

Int. Cl.: 41

SERVICE MARK

PRINCIPAL REGISTER

SPLIT LLC (NEW JERSEY LIMITED LIABILITY COMPANY)
11 CANNONADE DRIVE
MARLBORO, NJ 07746

FOR: ENTERTAINMENT SERVICES IN THE NATURE OF ON-LINE JOURNALS, NAMELY, BLOGS FEATURING USER-DEFINED CONTENT PROVIDING COMMENTS, COMPLAINTS, AND STORIES IN THE FIELDS OF RELATIONSHIPS, FRIENDS, FAMILY, WORK, SCHOOL, SPORTS, ENTERTAINMENT, PHILOSOPHY, SOCIAL AND GENERAL INTEREST, IN CLASS 41 (U.S. CLS. 100, 101 AND 107).

FIRST USE 1-20-2011; IN COMMERCE 1-20-2011.

THE MARK CONSISTS OF STANDARD CHARACTERS WITHOUT CLAIM TO ANY PARTICULAR FONT, STYLE, SIZE, OR COLOR.

SER. NO. 85-266,804, FILED 3-14-2011.

PAULA MAHONEY, EXAMINING ATTORNEY



David J. Kybas

Director of the United States Patent and Trademark Office

United States of America

United States Patent and Trademark Office

UP!

Reg. No. 4,066,313

Registered Dec. 6, 2011

Int. Cl.: 5

TRADEMARK

PRINCIPAL REGISTER

CALIFORNIA EXOTIC NOVELTIES, LLC (CALIFORNIA LIMITED LIABILITY COMPANY)
14235 RAMONA AVENUE
CHINO, CA 91710

FOR: PERSONAL SEXUAL LUBRICANTS AND SEXUAL-RELATED GELS, IN CLASS 5
(U.S. CLS. 6, 18, 44, 46, 51 AND 52).

FIRST USE 12-27-2010; IN COMMERCE 12-27-2010.

THE MARK CONSISTS OF STANDARD CHARACTERS WITHOUT CLAIM TO ANY PARTICULAR FONT, STYLE, SIZE, OR COLOR.

SER. NO. 85-266,970, FILED 3-15-2011.

JERI J. FICKES, EXAMINING ATTORNEY



David J. Kyffers

Director of the United States Patent and Trademark Office

United States of America

United States Patent and Trademark Office

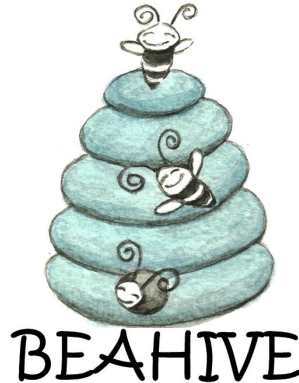

Reg. No. 4,066,314

Registered Dec. 6, 2011

Int. Cl.: 24

TRADEMARK

PRINCIPAL REGISTER

BEAHIVE DESIGNS, LLC (MICHIGAN LIMITED LIABILITY COMPANY)
2452 GAYNOR AVE NW
GRAND RAPIDS, MI 49418

FOR: BATH TOWELS; CHILDREN'S TOWELS; TOWELS, IN CLASS 24 (U.S. CLS. 42 AND 50).

FIRST USE 2-17-2011; IN COMMERCE 3-11-2011.

THE MARK CONSISTS OF A LIGHT BLUE WATERCOLOR CARTOON FIVE TIERED BEEHIVE OUTLINED IN BLACK WATERCOLOR WITH A BLACK WATERCOLOR CIRCULAR ENTRANCE CENTERED ON THE BOTTOM TIER WITH ONE WATERCOLOR BLACK AND WHITE CARTOON BEE CENTERED MID-WAY ABOVE THE TOP TIER, A SECOND BEE FLYING SLIGHTLY TO THE RIGHT OF CENTER OF THE MIDDLE TIER WITH ITS RIGHT ANTENNA EXTENDING INTO THE TIER ABOVE IT, A THIRD BLACK AND WHITE BEE'S HEAD IS VISIBLE ON THE BOTTOM TIER THROUGH THE ENTRANCE TO THE BEEHIVE, WHITE FACES OF THE BEES SURROUNDED BY WATERCOLOR BLACK LINES, WATERCOLOR BLACK SINGLE-LINE SMILES AND TWO SINGLE-LINE ARCS FOR EYES ARE PROMINENT ON ALL OF THE BEE'S FACES, TWO WATERCOLOR BLACK CURLING ANTENNA ARE ALSO PROMINENT ON EACH OF THE BEE'S HEADS, THE THORAX AND ABDOMEN OF THE TWO UPPER BEES CONSIST OF TWO ALTERNATING WIDE WATERCOLOR BLACK BANDS AND NARROW WHITE BANDS, THE STYLIZED BLACK WORDING "BEAHIVE" BELOW THE BEEHIVE DESIGN.

THE COLOR(S) LIGHT BLUE, BLACK, AND WHITE IS/ARE CLAIMED AS A FEATURE OF THE MARK.

SER. NO. 85-267,041, FILED 3-15-2011.

LINDA MICKLEBURGH, EXAMINING ATTORNEY



David J. Kypos

Director of the United States Patent and Trademark Office

United States of America

United States Patent and Trademark Office

N. Fallon Design Studio

Reg. No. 4,066,315

Registered Dec. 6, 2011

Int. Cl.: 18

TRADEMARK

PRINCIPAL REGISTER

FALLON, NANCY A (UNITED STATES INDIVIDUAL)
1270 JAMES ST.
BALTIMORE, MD 21223

FOR: HANDBAGS, PURSES AND WALLETS, IN CLASS 18 (U.S. CLS. 1, 2, 3, 22 AND 41).

FIRST USE 2-9-2011; IN COMMERCE 2-9-2011.

THE MARK CONSISTS OF STANDARD CHARACTERS WITHOUT CLAIM TO ANY PARTICULAR FONT, STYLE, SIZE, OR COLOR.

NO CLAIM IS MADE TO THE EXCLUSIVE RIGHT TO USE "DESIGN STUDIO", APART FROM THE MARK AS SHOWN.

SER. NO. 85-267,149, FILED 3-15-2011.

DAVID COLLIER, EXAMINING ATTORNEY



David J. Kyffers

Director of the United States Patent and Trademark Office

United States of America

United States Patent and Trademark Office

e miles

Reg. No. 4,066,316

Registered Dec. 6, 2011

Int. Cl.: 35

SERVICE MARK

PRINCIPAL REGISTER

E-MILES, INC. (DELAWARE CORPORATION)
5800 TENNYSON PARKWAY, SUITE 600
PLANO, TX 75024

FOR: PROVIDING AN ONLINE INCENTIVE AWARD PROGRAM FOR MEMBERS THROUGH WHICH THEY CAN EARN REWARDS FOR TRAVEL OR OTHER MERCHANDISE BY READING AND RESPONDING TO MARKETING AND ADVERTISING MESSAGES DIRECTED TO THEM BY THIRD PARTY COMPANIES; ONLINE ADVERTISING SERVICES FOR OTHERS, NAMELY, PROVIDING AN ONLINE ADVERTISING CHANNEL FOR THIRD PARTIES TO ENGAGE AND COMMUNICATE WITH CUSTOMERS, IN CLASS 35 (U.S. CLS. 100, 101 AND 102).

FIRST USE 11-1-2006; IN COMMERCE 11-1-2006.

OWNER OF U.S. REG. NO. 2,204,246.

THE MARK CONSISTS OF THE WORDING "E-MILES" COMBINED WITH A V-SHAPED DESIGN, WHICH V-SHAPED DESIGN IS INCORPORATED INTO THE FIRST "E" SHOWN IN THE MARK.

SEC. 2(F) AS TO "E-MILES".

SER. NO. 85-267,185, FILED 3-15-2011.

LINDSEY RUBIN, EXAMINING ATTORNEY



David J. Kybas

Director of the United States Patent and Trademark Office

United States of America

United States Patent and Trademark Office



Reg. No. 4,066,317

Registered Dec. 6, 2011

Int. Cl.: 45

SERVICE MARK

PRINCIPAL REGISTER

PROTECTION STRATEGIES INCORPORATED (VIRGINIA CORPORATION)
SUITE 400
2300 9TH STREET SOUTH
ARLINGTON, VA 22204

FOR: CONSULTATION SERVICES CONCERNING HOMELAND SAFETY AND SECURITY ISSUES; CONSULTING SERVICES IN THE FIELD OF HOMELAND SECURITY; CONSULTING SERVICES IN THE FIELD OF NATIONAL SECURITY; CONTROL OF BUILDING ENVIRONMENTAL ACCESS AND SECURITY SYSTEMS; ELECTRONIC MONITORING OF SECURITY AND ALARM SYSTEMS OF FACILITIES OF THE FEDERAL DRUG ADMINISTRATION; EMERGENCY RESPONSE ALARM MONITORING SERVICES, NAMELY, MONITORING OF ALERT DEVICES BY A REMOTE MONITORING CENTER FOR THE DISPATCH OF EMERGENCY PUBLIC HEALTH AND SECURITY SERVICES AND NOTIFICATION TO THIRD PARTIES; PROVIDING INFORMATION CONCERNING HOMELAND SAFETY AND SECURITY ISSUES; SECURITY CLEARANCE FOR PREPARATION OF IDENTIFICATION CARDS; SECURITY CONSULTANCY; SECURITY INSPECTION SERVICES FOR OTHERS; SECURITY SERVICES, NAMELY, PROVIDING SECURITY ASSESSMENTS FOR BUSINESSES AND GOVERNMENTAL AGENCIES; SECURITY SERVICES, NAMELY, PROVIDING SECURITY ASSESSMENTS OF PHYSICAL LOCATIONS, INFORMATION SYSTEMS, AND WORKING ENVIRONMENTS; SECURITY SERVICES, NAMELY, THREAT SIMULATION VULNERABILITY ANALYSIS AND MITIGATION AND EMERGENCY AND CRISIS RESPONSE; SECURITY SERVICES, NAMELY, WATER VULNERABILITY ASSESSMENT SERVICES, IN CLASS 45 (U.S. CLS. 100 AND 101).

FIRST USE 8-5-1998; IN COMMERCE 8-5-1998.

NO CLAIM IS MADE TO THE EXCLUSIVE RIGHT TO USE "PROTECTION STRATEGIES INCORPORATED", APART FROM THE MARK AS SHOWN.

THE MARK CONSISTS OF THE DIAGONAL LETTERS "PSI" IN STYLIZED LETTERS OVERLAYING A GLOBE OF THE WESTERN HEMISPHERE OF THE EARTH. THE WORDING "PROTECTION STRATEGIES INCORPORATED" IS FOUND CRADLING UNDERNEATH THE BOTTOM OF THE GLOBE.

SER. NO. 85-267,329, FILED 3-15-2011.

DAVID HOFFMAN, EXAMINING ATTORNEY



David J. Kyffers

Director of the United States Patent and Trademark Office

United States of America

United States Patent and Trademark Office



atlantic.net

Reg. No. 4,066,318

Registered Dec. 6, 2011

Int. Cls.: 35, 38 and 42

SERVICE MARK

PRINCIPAL REGISTER

ATLANTIC.NET, INC. (DELAWARE CORPORATION)
SUITE 3
440 WEST KENNEDY BOULEVARD
ORLANDO, FL 328106277

FOR: OPERATION AND ADMINISTRATION OF TELECOMMUNICATION SYSTEMS AND NETWORKS FOR OTHERS; TELECOMMUNICATIONS NETWORK MANAGEMENT SERVICES, NAMELY, THE OPERATION AND ADMINISTRATION OF TELECOMMUNICATION SYSTEMS AND NETWORKS FOR OTHERS, IN CLASS 35 (U.S. CLS. 100, 101 AND 102).

FIRST USE 8-3-2000; IN COMMERCE 8-3-2000.

FOR: PROVIDING TELECOMMUNICATIONS CONNECTIONS TO THE INTERNET OR DATABASES, IN CLASS 38 (U.S. CLS. 100, 101 AND 104).

FIRST USE 8-3-2000; IN COMMERCE 8-3-2000.

FOR: COMPUTER SERVICES, NAMELY, CREATING, MAINTAINING, DESIGNING AND IMPLEMENTING WEB SITES FOR OTHERS AND HOSTING THE WEB SITE OF OTHERS ON A COMPUTER SERVER FOR A GLOBAL COMPUTER NETWORK; COMPUTER SERVICES, NAMELY, HOSTING AND MAINTAINING AN ON-LINE WEB SITE FOR OTHERS TO MANAGE INFORMATION ABOUT DATABASE SERVERS; COMPUTER SERVICES, NAMELY, INTERACTIVE HOSTING SERVICES WHICH ALLOW THE USER TO PUBLISH AND SHARE THEIR OWN CONTENT AND IMAGES ON-LINE; COMPUTER SERVICES, NAMELY, REMOTE AND ON-SITE MANAGEMENT OF CLOUD COMPUTING SYSTEMS AND APPLICATIONS FOR OTHERS; HOSTING OF DIGITAL CONTENT ON THE INTERNET; HOSTING OF WEB SITES; HOSTING THE SOFTWARE, WEBSITES AND OTHER COMPUTER APPLICATIONS OF OTHERS ON A VIRTUAL PRIVATE SERVER; HOSTING THE WEB SITES OF OTHERS; HOSTING THE WEB SITES OF OTHERS ON A COMPUTER SERVER FOR A GLOBAL COMPUTER NETWORK; HOSTING WEBSITES ON THE INTERNET; WEB SITE HOSTING SERVICES, IN CLASS 42 (U.S. CLS. 100 AND 101).

FIRST USE 8-3-2000; IN COMMERCE 8-3-2000.

THE MARK CONSISTS OF THE WORDS "ATLANTIC.NET". "ATLANTIC" AND "NET" ARE IN BLACK. THE PERIOD IS IN BLUE. ABOVE THIS IS A BLUE ELLIPTICAL WHIRL DESIGN FEATURING FOUR OUTER CURVED BANDS AND TWO INNER CURVED BANDS.



David J. Kybas

Director of the United States Patent and Trademark Office

Reg. No. 4,066,318 THE COLOR(S) BLACK AND BLUE IS/ARE CLAIMED AS A FEATURE OF THE MARK.

SER. NO. 85-267,387, FILED 3-15-2011.

SIMON TENG, EXAMINING ATTORNEY

United States of America

United States Patent and Trademark Office



Reg. No. 4,066,319

Registered Dec. 6, 2011

Int. Cl.: 41

SERVICE MARK

PRINCIPAL REGISTER

TRUE LACROSSE (ILLINOIS LIMITED LIABILITY COMPANY)
655 W. GRAND AVE., SUITE 200
ELMHURST, IL 60126

FOR: LACROSSE TRAINING SERVICES, IN CLASS 41 (U.S. CLS. 100, 101 AND 107).

FIRST USE 2-19-2008; IN COMMERCE 2-19-2008.

NO CLAIM IS MADE TO THE EXCLUSIVE RIGHT TO USE "LACROSSE", APART FROM THE MARK AS SHOWN.

THE MARK CONSISTS OF RECTANGULAR SHAPED FIGURE WITH A ROUNDED BOTTOM AND AN ORNAMENTAL CROWN AT THE TOP. BELOW THE CROWN IS THE WORD "TRUE" IN CAPITAL LETTERS A LARGE STYLIZED FONT AND BELOW THE WORD "TRUE" IS THE WORD "LACROSSE" IN CAPITAL LETTERS IN THE SAME FONT TYPE BUT SMALLER FONT SIZE. BELOW THE WORD "LACROSSE" AND ABOVE THE ROUNDED BOTTOM IS A CITY SKYLINE.

SER. NO. 85-267,393, FILED 3-15-2011.

SIMON TENG, EXAMINING ATTORNEY



David J. Kybas

Director of the United States Patent and Trademark Office

United States of America

United States Patent and Trademark Office

SEACLOR

Reg. No. 4,066,320

Registered Dec. 6, 2011

Int. Cl.: 9

TRADEMARK

PRINCIPAL REGISTER

SEVERN TRENT DE NORA, L.L.C. (TEXAS LIMITED LIABILITY COMPANY)
1110 INDUSTRIAL BLVD.
SUGAR LAND, TX 77478

FOR: ELECTRONIC EQUIPMENT, NAMELY, ELECTROLYSIS CELLS FOR USE IN THE
MANUFACTURE OF VARIOUS IONIC SOLUTIONS, AND STRUCTURAL REPLACEMENTS
PARTS THEREFOR, IN CLASS 9 (U.S. CLS. 21, 23, 26, 36 AND 38).

FIRST USE 4-19-1973; IN COMMERCE 4-19-1973.

THE MARK CONSISTS OF STANDARD CHARACTERS WITHOUT CLAIM TO ANY PAR-
TICULAR FONT, STYLE, SIZE, OR COLOR.

SER. NO. 85-267,450, FILED 3-15-2011.

BARBARA RUTLAND, EXAMINING ATTORNEY



David J. Kyffers

Director of the United States Patent and Trademark Office

United States of America

United States Patent and Trademark Office

e miles

it's about time

Reg. No. 4,066,321

Registered Dec. 6, 2011

Int. Cl.: 35

SERVICE MARK

PRINCIPAL REGISTER

E-MILES, INC. (DELAWARE CORPORATION)
5800 TENNYSON PARKWAY, SUITE 600
PLANO, TX 75024

FOR: PROVIDING AN ONLINE INCENTIVE AWARD PROGRAM FOR MEMBERS THROUGH WHICH THEY CAN EARN REWARDS FOR TRAVEL OR OTHER MERCHANDISE BY READING AND RESPONDING TO MARKETING AND ADVERTISING MESSAGES DIRECTED TO THEM BY THIRD PARTY COMPANIES; ONLINE ADVERTISING SERVICES FOR OTHERS, NAMELY, PROVIDING AN ONLINE ADVERTISING CHANNEL FOR THIRD PARTIES TO ENGAGE AND COMMUNICATE WITH CUSTOMERS, IN CLASS 35 (U.S. CLS. 100, 101 AND 102).

FIRST USE 3-14-2011; IN COMMERCE 3-14-2011.

OWNER OF U.S. REG. NO. 2,204,246.

THE MARK CONSISTS OF THE WORDING "E-MILES IT'S ABOUT TIME," COMBINED WITH A V-SHAPED DESIGN, WHICH V-SHAPED DESIGN IS INCORPORATED INTO THE FIRST "E" SHOWN IN THE WORDING "E-MILES."

SEC. 2(F) AS TO "E-MILES".

SER. NO. 85-267,469, FILED 3-15-2011.

LINDSEY RUBIN, EXAMINING ATTORNEY



David J. Kybas

Director of the United States Patent and Trademark Office

United States of America

United States Patent and Trademark Office

THE SALES FACTORY

Reg. No. 4,066,322

Registered Dec. 6, 2011

Int. Cl.: 35

SERVICE MARK

PRINCIPAL REGISTER

THE SALES FACTORY, INC. (NORTH CAROLINA CORPORATION)
1301 CAROLINA ST
GREENSBORO, NC 27401

FOR: CONSULTATION SERVICES, NAMELY, CREATIVE AND STRATEGIC CONSULTATION REGARDING DEVELOPMENT AND PRODUCTION OF MARKETING CAMPAIGNS FOR OTHERS, IN CLASS 35 (U.S. CLS. 100, 101 AND 102).

FIRST USE 3-28-1984; IN COMMERCE 3-28-1984.

THE MARK CONSISTS OF STANDARD CHARACTERS WITHOUT CLAIM TO ANY PARTICULAR FONT, STYLE, SIZE, OR COLOR.

NO CLAIM IS MADE TO THE EXCLUSIVE RIGHT TO USE "SALES", APART FROM THE MARK AS SHOWN.

SER. NO. 85-267,744, FILED 3-15-2011.

SUNG IN, EXAMINING ATTORNEY



David J. Kyfos

Director of the United States Patent and Trademark Office

United States of America

United States Patent and Trademark Office

Resolute Commercial Properties

Reg. No. 4,066,323

Registered Dec. 6, 2011

Int. Cl.: 36

SERVICE MARK

PRINCIPAL REGISTER

RESOLUTE COMMERCIAL SERVICES (ARIZONA LIMITED LIABILITY COMPANY), DBA
RESOLUTE COMMERCIAL SERVICES, LLC
7030 EAST 5TH AVENUE
SCOTTSDALE, AZ 85251

FOR: REAL ESTATE SERVICES, NAMELY, RECEIVERSHIP, PROPERTY MANAGEMENT,
LEASING AND BROKERAGE WITH DISTRESSED OR OTHERWISE CHALLENGED COM-
MERCIAL REAL ESTATE PROPERTIES OR LOANS, IN CLASS 36 (U.S. CLS. 100, 101 AND
102).

FIRST USE 7-1-2008; IN COMMERCE 7-1-2008.

THE MARK CONSISTS OF STANDARD CHARACTERS WITHOUT CLAIM TO ANY PAR-
TICULAR FONT, STYLE, SIZE, OR COLOR.

NO CLAIM IS MADE TO THE EXCLUSIVE RIGHT TO USE "COMMERCIAL PROPERTIES",
APART FROM THE MARK AS SHOWN.

SER. NO. 85-267,856, FILED 3-15-2011.

DAVID TOOLEY, EXAMINING ATTORNEY



David J. Kyfos

Director of the United States Patent and Trademark Office

United States of America

United States Patent and Trademark Office

WASHINGTON FLYER

Reg. No. 4,066,324

Registered Dec. 6, 2011

Int. Cl.: 39

SERVICE MARK

PRINCIPAL REGISTER

METROPOLITAN WASHINGTON AIRPORTS AUTHORITY FEDERAL AGENCY ASSIGNEE
OF UNITED STATES (D.C. BODY POLITIC AND CORPORATE)
1 AVIATION CIRCLE
WASHINGTON, DC 20001

FOR: GROUND TRANSPORTATION OF PASSENGERS TO AND FROM AIRPORTS, IN
CLASS 39 (U.S. CLS. 100 AND 105).

FIRST USE 11-30-1983; IN COMMERCE 11-30-1983.

THE MARK CONSISTS OF STANDARD CHARACTERS WITHOUT CLAIM TO ANY PAR-
TICULAR FONT, STYLE, SIZE, OR COLOR.

OWNER OF U.S. REG. NOS. 1,356,548 AND 1,357,214.

SEC. 2(F) AS TO "WASHINGTON".

SER. NO. 85-268,100, FILED 3-16-2011.

BARNEY CHARLON, EXAMINING ATTORNEY



David J. Kybas

Director of the United States Patent and Trademark Office

United States of America

United States Patent and Trademark Office

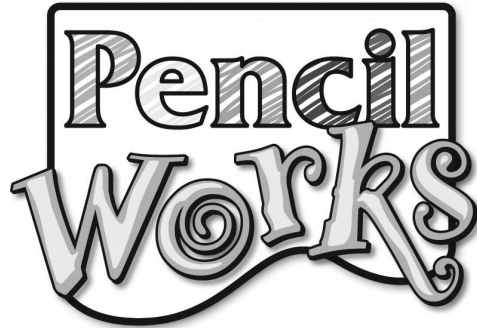

Reg. No. 4,066,325

Registered Dec. 6, 2011

Int. Cl.: 28

TRADEMARK

PRINCIPAL REGISTER

DIMENSIONS CRAFTS LLC (DELAWARE LIMITED LIABILITY COMPANY)
1801 N. 12TH STREET
READING, PA 19604

FOR: HOBBY CRAFT KIT COMPRISING PENCIL BY NUMBER SETS INCLUDING, PAPER BOARD, COLORED PENCILS, PENCIL SHARPENER, AND INSTRUCTIONS, IN CLASS 28 (U.S. CLS. 22, 23, 38 AND 50).

FIRST USE 11-5-2001; IN COMMERCE 11-5-2001.

NO CLAIM IS MADE TO THE EXCLUSIVE RIGHT TO USE "PENCIL", APART FROM THE MARK AS SHOWN.

THE MARK CONSISTS OF THE STYLIZED TERM "PENCIL WORKS" WITH A SPIRAL IN THE LETTER "O" IN "WORKS".

SER. NO. 85-268,103, FILED 3-16-2011.

BRIAN NEVILLE, EXAMINING ATTORNEY



David J. Kybas

Director of the United States Patent and Trademark Office

United States of America

United States Patent and Trademark Office

ALLEN + ROTH

Reg. No. 4,066,326

LF, LLC (DELAWARE LIMITED LIABILITY COMPANY)
P.O. BOX 39

Registered Dec. 6, 2011

MOUNT MOURNE, NC 28123

**Int. Cls.: 6, 8, 11, 14, 19,
20 and 26**

FOR: METAL KNOBS; COMMON METAL PULLS, IN CLASS 6 (U.S. CLS. 2, 12, 13, 14, 23, 25 AND 50).

FIRST USE 11-4-2009; IN COMMERCE 11-4-2009.

TRADEMARK

FOR: FIREPLACE TOOL SETS SOLD AS A UNIT, IN CLASS 8 (U.S. CLS. 23, 28 AND 44).

PRINCIPAL REGISTER

FIRST USE 8-0-2009; IN COMMERCE 8-0-2009.

FOR: ELECTRIC LIGHTING FIXTURES, NAMELY, VANITY LIGHTING, SCONCES AND SEMI-FLUSH CEILING FIXTURES; CHANDELIERS; LAMPS; OUTDOOR LIGHTING FIXTURES; LANDSCAPE LIGHTING INSTALLATIONS; CEILING FANS; ELECTRIC FIREPLACES; OUTDOOR FIREPLACES; FIREPLACES, NAMELY, WOOD BURNING PITS FOR CONTAINING FIRE; DECORATIVE WATER FOUNTAINS, IN CLASS 11 (U.S. CLS. 13, 21, 23, 31 AND 34).

FIRST USE 8-0-2009; IN COMMERCE 8-0-2009.

FOR: CLOCKS, IN CLASS 14 (U.S. CLS. 2, 27, 28 AND 50).

FIRST USE 7-19-2010; IN COMMERCE 7-19-2010.

FOR: BUILDING MATERIALS, NAMELY, NON-METAL COUNTERTOPS AND VANITY TOPS FOR FURTHER INSTALLATION, NAMELY, MARBLE COUNTERTOPS, MARBLE VANITY TOPS, GRANITE COUNTERTOPS AND GRANITE VANITY TOPS, IN CLASS 19 (U.S. CLS. 1, 12, 33 AND 50).

FIRST USE 7-14-2010; IN COMMERCE 7-14-2010.

FOR: FIREPLACE SCREENS; CLOTHES RODS; PILLOWS; NON-METAL BINS, IN CLASS 20 (U.S. CLS. 2, 13, 22, 25, 32 AND 50).

FIRST USE 7-17-2008; IN COMMERCE 7-17-2008.



David J. Kyros

Director of the United States Patent and Trademark Office

Reg. No. 4,066,326 FOR: TASSELS, IN CLASS 26 (U.S. CLS. 37, 39, 40, 42 AND 50).

FIRST USE 1-15-2010; IN COMMERCE 1-15-2010.

THE MARK CONSISTS OF STANDARD CHARACTERS WITHOUT CLAIM TO ANY PARTICULAR FONT, STYLE, SIZE, OR COLOR.

SER. NO. 85-268,573, FILED 3-16-2011.

THEODORE MCBRIDE, EXAMINING ATTORNEY

United States of America

United States Patent and Trademark Office

Resolute Commercial

Reg. No. 4,066,327

Registered Dec. 6, 2011

Int. Cl.: 36

SERVICE MARK

PRINCIPAL REGISTER

RESOLUTE COMMERCIAL SERVICES (ARIZONA LIMITED LIABILITY COMPANY), DBA
RESOLUTE COMMERCIAL SERVICES, LLC
7030 EAST 5TH AVENUE
SCOTTSDALE, AZ 85251

FOR: REAL ESTATE SERVICES, NAMELY, RECEIVERSHIP, PROPERTY MANAGEMENT,
LEASING AND BROKERAGE WITH DISTRESSED OR OTHERWISE CHALLENGED COM-
MERCIAL REAL ESTATE PROPERTIES OR LOANS, IN CLASS 36 (U.S. CLS. 100, 101 AND
102).

FIRST USE 7-1-2008; IN COMMERCE 7-1-2008.

THE MARK CONSISTS OF STANDARD CHARACTERS WITHOUT CLAIM TO ANY PAR-
TICULAR FONT, STYLE, SIZE, OR COLOR.

NO CLAIM IS MADE TO THE EXCLUSIVE RIGHT TO USE "COMMERCIAL", APART FROM
THE MARK AS SHOWN.

SER. NO. 85-268,683, FILED 3-16-2011.

DAVID TOOLEY, EXAMINING ATTORNEY



David J. Kyfos

Director of the United States Patent and Trademark Office

United States of America

United States Patent and Trademark Office

FABENJI

Reg. No. 4,066,328

Registered Dec. 6, 2011

Int. Cl.: 25

TRADEMARK

PRINCIPAL REGISTER

BYRON JAMES (UNITED STATES INDIVIDUAL)
150 ALBANY AVE
WEST BABYLON, NY 11704

FOR: APPAREL, NAMELY, TEE SHIRTS, SWEATSHIRTS, PANTS, LEGGINGS, SHORTS AND JACKETS, JEANS; ATHLETIC APPAREL, NAMELY, SHIRTS, PANTS, JACKETS, FOOTWEAR, HATS AND CAPS, ATHLETIC UNIFORMS; CHILDREN'S AND INFANT'S APPAREL, NAMELY, JUMPERS, JEANS, OVERALL SLEEPWEAR, PAJAMAS, ROMPERS AND ONE-PIECE GARMENTS; CHILDREN'S AND INFANTS' APPAREL TREATED WITH FIRE AND HEAT RETARDANTS, NAMELY, JUMPERS, JEANS, OVERALL SLEEPWEAR, PAJAMAS, ROMPERS AND ONE-PIECE GARMENTS; HOODS; INFANT AND TODDLER ONE PIECE CLOTHING; TRAVEL CLOTHING CONTAINED IN A PACKAGE COMPRISING REVERSIBLE JACKETS, PANTS, SKIRTS, TOPS AND A BELT OR SCARF; WOMEN'S CLOTHING, NAMELY, SHIRTS, DRESSES, SKIRTS, BLOUSES, JEANS, IN CLASS 25 (U.S. CLS. 22 AND 39).

FIRST USE 5-2-2007; IN COMMERCE 5-2-2007.

THE MARK CONSISTS OF STANDARD CHARACTERS WITHOUT CLAIM TO ANY PARTICULAR FONT, STYLE, SIZE, OR COLOR.

SER. NO. 85-268,762, FILED 3-16-2011.

PAUL MORENO, EXAMINING ATTORNEY



David J. Kyros

Director of the United States Patent and Trademark Office

United States of America

United States Patent and Trademark Office

GPS CADDIE

Reg. No. 4,066,329

Registered Dec. 6, 2011

Int. Cl.: 9

TRADEMARK

PRINCIPAL REGISTER

LI TECHNOLOGIES, INC. (CALIFORNIA CORPORATION)
591 CAMINO DE LA REINA STE. 200
591 CAMINO DE LA REINA STE. 200
SAN DIEGO, CA 92108

FOR: COMPUTER APPLICATION SOFTWARE FOR MOBILE COMPUTING DEVICES, MOBILE PHONES, COMPUTERS, NAMELY, SOFTWARE FOR ALLOWING USERS TO VIEW DATA ON A GOLF COURSE, INCLUDING GPS DATA, GOLF COURSE SCORECARDS, ADDRESS, MAPS, AND OTHER INFORMATION, IN CLASS 9 (U.S. CLS. 21, 23, 26, 36 AND 38).

FIRST USE 12-30-2009; IN COMMERCE 12-30-2009.

THE MARK CONSISTS OF STANDARD CHARACTERS WITHOUT CLAIM TO ANY PARTICULAR FONT, STYLE, SIZE, OR COLOR.

OWNER OF U.S. REG. NO. 3,516,527.

NO CLAIM IS MADE TO THE EXCLUSIVE RIGHT TO USE "GPS", APART FROM THE MARK AS SHOWN.

SER. NO. 85-268,991, FILED 3-16-2011.

TAMARA FRAZIER, EXAMINING ATTORNEY



David J. Kybas

Director of the United States Patent and Trademark Office

United States of America

United States Patent and Trademark Office

AMERICAN INSTITUTE OF CERTIFIED PLANNERS

Reg. No. 4,066,330

Registered Dec. 6, 2011

Int. Cl.: 35

SERVICE MARK

PRINCIPAL REGISTER

AMERICAN PLANNING ASSOCIATION (D.C. NON-PROFIT CORPORATION)
SUITE 1600
112 S. MICHIGAN AVE.
CHICAGO, IL 60603

FOR: ASSOCIATION SERVICES, NAMELY, PROMOTING THE INTERESTS OF URBAN AND OTHER COMMUNITY PLANNERS, IN CLASS 35 (U.S. CLS. 100, 101 AND 102).

FIRST USE 10-1-1978; IN COMMERCE 10-1-1978.

THE MARK CONSISTS OF STANDARD CHARACTERS WITHOUT CLAIM TO ANY PARTICULAR FONT, STYLE, SIZE, OR COLOR.

NO CLAIM IS MADE TO THE EXCLUSIVE RIGHT TO USE "INSTITUTE OF CERTIFIED PLANNERS", APART FROM THE MARK AS SHOWN.

SEC. 2(F).

SER. NO. 85-269,476, FILED 3-17-2011.

JOHN E. MICHOS, EXAMINING ATTORNEY



David J. Kyffers

Director of the United States Patent and Trademark Office

United States of America

United States Patent and Trademark Office

AMERICAN PLANNING ASSOCIATION

Reg. No. 4,066,331

Registered Dec. 6, 2011

Int. Cl.: 35

SERVICE MARK

PRINCIPAL REGISTER

AMERICAN PLANNING ASSOCIATION (D.C. NON-PROFIT CORPORATION)
SUITE 1600
112 S. MICHIGAN AVE.
CHICAGO, IL 60603

FOR: ASSOCIATION SERVICES, NAMELY, PROMOTING THE INTERESTS OF URBAN AND OTHER COMMUNITY PLANNERS, IN CLASS 35 (U.S. CLS. 100, 101 AND 102).

FIRST USE 10-1-1978; IN COMMERCE 10-1-1978.

THE MARK CONSISTS OF STANDARD CHARACTERS WITHOUT CLAIM TO ANY PARTICULAR FONT, STYLE, SIZE, OR COLOR.

NO CLAIM IS MADE TO THE EXCLUSIVE RIGHT TO USE "PLANNING ASSOCIATION", APART FROM THE MARK AS SHOWN.

SEC. 2(F).

SER. NO. 85-269,486, FILED 3-17-2011.

JOHN E. MICHOS, EXAMINING ATTORNEY



David J. Kyffers

Director of the United States Patent and Trademark Office

United States of America

United States Patent and Trademark Office

ENVIROLOGIX

Reg. No. 4,066,332

Registered Dec. 6, 2011

Int. Cl.: 1

TRADEMARK

PRINCIPAL REGISTER

ENVIROLOGIX INC. (MAINE CORPORATION)
500 RIVERSIDE INDUSTRIAL PARKWAY
PORTLAND, ME 04103

FOR: IMMUNOASSAY AND NUCLEIC ACID TESTS AND TESTING KITS CONSISTING PRIMARILY OF PREMIXED REACTANTS AND REAGENTS FOR TESTING SEEDS, GRAINS, CROPS, WATER AND SOIL, ALL NOT FOR MEDICAL USE, FOR VETERINARY, AGRICULTURAL, HORTICULTURAL AND ENVIRONMENTAL APPLICATIONS, IN CLASS 1 (U.S. CLS. 1, 5, 6, 10, 26 AND 46).

FIRST USE 4-0-1996; IN COMMERCE 4-0-1996.

THE MARK CONSISTS OF STANDARD CHARACTERS WITHOUT CLAIM TO ANY PARTICULAR FONT, STYLE, SIZE, OR COLOR.

SER. NO. 85-269,649, FILED 3-17-2011.

LINDA ORNDORFF, EXAMINING ATTORNEY



David J. Kyffers

Director of the United States Patent and Trademark Office

United States of America

United States Patent and Trademark Office

SHOTCAKES

Reg. No. 4,066,333

Registered Dec. 6, 2011

Int. Cl.: 30

TRADEMARK

PRINCIPAL REGISTER

FEOLA, ANTHONY V. (UNITED STATES INDIVIDUAL)
66 GRANT AVENUE
MEDFORD, MA 02155

FOR: FROZEN CONFECTIONS AND BAKED GOODS, NAMELY, CUPCAKES, IN CLASS
30 (U.S. CL. 46).

FIRST USE 10-14-2005; IN COMMERCE 10-14-2005.

THE MARK CONSISTS OF STANDARD CHARACTERS WITHOUT CLAIM TO ANY PAR-
TICULAR FONT, STYLE, SIZE, OR COLOR.

OWNER OF U.S. REG. NO. 3,839,224.

SER. NO. 85-269,891, FILED 3-17-2011.

DOMINICK J. SALEMI, EXAMINING ATTORNEY



David J. Kybas

Director of the United States Patent and Trademark Office

United States of America

United States Patent and Trademark Office

ENVIROLOGIX

Reg. No. 4,066,334

Registered Dec. 6, 2011

Int. Cl.: 1

TRADEMARK

PRINCIPAL REGISTER

ENVIROLOGIX INC. (MAINE CORPORATION)
500 RIVERSIDE INDUSTRIAL PARKWAY
PORTLAND, ME 04103

FOR: IMMUNOASSAY AND NUCLEIC ACID TESTS AND TESTING KITS CONSISTING PRIMARILY OF PREMIXED REACTANTS AND REAGENTS FOR TESTING SEEDS, GRAINS, CROPS, WATER AND SOIL, ALL NOT FOR MEDICAL USE, FOR VETERINARY, AGRICULTURAL, HORTICULTURAL AND ENVIRONMENTAL APPLICATIONS, IN CLASS 1 (U.S. CLS. 1, 5, 6, 10, 26 AND 46).

FIRST USE 8-0-2004; IN COMMERCE 8-0-2004.

THE MARK CONSISTS OF THE WORD "ENVIROLOGIX" WITH AN IMAGE OF THE EARTH TILTED LEFT ON AN AXIS REPLACING THE FIRST "O".

SER. NO. 85-269,894, FILED 3-17-2011.

LINDA ORNDORFF, EXAMINING ATTORNEY



David J. Kyffers

Director of the United States Patent and Trademark Office

United States of America

United States Patent and Trademark Office

Resolute Commercial Services

Reg. No. 4,066,335

Registered Dec. 6, 2011

Int. Cl.: 36

SERVICE MARK

PRINCIPAL REGISTER

RESOLUTE COMMERCIAL SERVICES (ARIZONA LIMITED LIABILITY COMPANY), DBA
RESOLUTE COMMERCIAL SERVICES, LLC
7030 EAST 5TH AVENUE
SCOTTSDALE, AZ 85251

FOR: FINANCIAL SERVICES, NAMELY, CORPORATE WORKOUT, DEBT RESTRUCTURING, RECEIVERSHIP, AND LOAN RESOLUTION FOR COMMERCIAL LOANS, IN CLASS 36 (U.S. CLS. 100, 101 AND 102).

FIRST USE 7-1-2008; IN COMMERCE 7-1-2008.

THE MARK CONSISTS OF STANDARD CHARACTERS WITHOUT CLAIM TO ANY PARTICULAR FONT, STYLE, SIZE, OR COLOR.

NO CLAIM IS MADE TO THE EXCLUSIVE RIGHT TO USE "COMMERCIAL SERVICES", APART FROM THE MARK AS SHOWN.

SER. NO. 85-269,933, FILED 3-17-2011.

DAVID TOOLEY, EXAMINING ATTORNEY



David J. Kyffers

Director of the United States Patent and Trademark Office

United States of America

United States Patent and Trademark Office

SUNLOVER



Reg. No. 4,066,336

Registered Dec. 6, 2011

Int. Cls.: 3 and 32

TRADEMARK

PRINCIPAL REGISTER

LEITE DE OLIVEIRA TAVARES, ARTUR JORGE AND DE LUCENA E VASCONCELLOS
CRUS, CARLOS MANUEL (PORTUGAL PARTNERSHIP)
HERDADE DA AROEIRA RUA DAS MARGARIDAS 52
2820 AROEIRA
CHARNECA DA CAPARICA, PORTUGAL

FOR: PREPARATIONS FOR THE TREATMENT, CARE AND BEAUTIFICATION OF THE SKIN, NAMELY, NON MEDICATED SKIN CARE PREPARATIONS; PREPARATIONS FOR SUN TANNING, IN CLASS 3 (U.S. CLS. 1, 4, 6, 50, 51 AND 52).

FOR: BEERS; MINERAL, FLAVORED AND AERATED WATERS AND OTHER NON-ALCOHOLIC DRINKS, NAMELY, CARBONATED DRINKS, TEA-BASE DRINKS, FRUIT DRINKS AND FRUIT JUICES; SYRUPS AND OTHER PREPARATIONS, NAMELY, CONCENTRATES AND POWDERS FOR MAKING BEVERAGES, IN CLASS 32 (U.S. CLS. 45, 46 AND 48).

PRIORITY CLAIMED UNDER SEC. 44(D) ON PORTUGAL APPLICATION NO. 472524, FILED 9-28-2010, REG. NO. 472524, DATED 12-20-2010, EXPIRES 12-20-2020.

THE MARK CONSISTS OF THE TERM "SUNLOVER" NEXT TO A CONCENTRIC CIRCLE DESIGN WITH A CIRCULAR OUTLINE, WITH MULTIPLE DEPICTIONS OF THE LETTER "S" JUST INSIDE THAT OUTLINE AND FORMING A CIRCULAR BORDER AND ANOTHER SINGLE LINE CIRCLE JUST INSIDE THAT, WHICH ENCOMPASSES THE TERM "SUNLOVER" WHOSE LETTERS FORM A CIRCLE WITHIN THE INNERMOST CIRCLE.

SER. NO. 85-270,081, FILED 3-17-2011.

JENNIFER DIXON, EXAMINING ATTORNEY



David J. Kybas

Director of the United States Patent and Trademark Office

United States of America

United States Patent and Trademark Office

The logo for Panacea features a stylized letter 'P' on the left. The 'P' is composed of three distinct sections: a red parallelogram at the top left, a gray parallelogram at the bottom, and a transparent area on the right side. To the right of the 'P', the word 'Panacea' is written in a bold, italicized, sans-serif font.

Reg. No. 4,066,337

CHUANG, YAO-TANG (TAIWAN INDIVIDUAL)
12F, 204, WANQING ST, WANHUA
TAIPEI, TAIWAN

Registered Dec. 6, 2011

Int. Cl.: 10

FOR: ELECTRONIC STIMULATOR FOR NERVE, SKIN, AND MUSCLE; STRAIT JACKETS;
THERMO-ELECTRIC COMPRESSES, IN CLASS 10 (U.S. CLS. 26, 39 AND 44).

TRADEMARK

FIRST USE 2-2-2011; IN COMMERCE 2-2-2011.

PRINCIPAL REGISTER

THE MARK CONSISTS OF STYLIZED WORDING "PANACEA" WITH THE TEXT "ANACEA" IN GRAY; THE LETTER "P" IS DIVIDED INTO THREE SECTIONS BY A TRANSPARENT GREEK CROSS OR PLUS SYMBOL IN WHICH THE TOP LEFT PARALLELOGRAM IS RED AND THE REMAINING SECTIONS AT RIGHT AND BOTTOM ARE GRAY. THE COLOR WHITE REPRESENTS A TRANSPARENT AREA AND IS NOT PART OF THE MARK.

THE COLOR(S) RED AND GRAY IS/ARE CLAIMED AS A FEATURE OF THE MARK.

SER. NO. 85-270,297, FILED 3-18-2011.

KATHERINE E. HALMEN, EXAMINING ATTORNEY



David J. Kybas

Director of the United States Patent and Trademark Office

United States of America

United States Patent and Trademark Office

ODYSSEY

Reg. No. 4,066,338

Registered Dec. 6, 2011

Int. Cl.: 15

TRADEMARK

PRINCIPAL REGISTER

JOHN HORNBY SKEWES & CO LTD (UNITED KINGDOM CORPORATION)
SALEM HSE, PARKINSON APPROACH, GARFORTH
LEEDS, UNITED KINGDOM LS252HR

FOR: BRASS AND WOODWIND MUSICAL INSTRUMENTS; STRUCTURAL PARTS AND FITTINGS FOR THE AFORESAID GOODS; SPECIALLY ADAPTED BAGS AND CASES FOR BRASS AND WOODWIND MUSICAL INSTRUMENTS, IN CLASS 15 (U.S. CLS. 2, 21 AND 36).

THE MARK CONSISTS OF STANDARD CHARACTERS WITHOUT CLAIM TO ANY PARTICULAR FONT, STYLE, SIZE, OR COLOR.

OWNER OF UNITED KINGDOM REG. NO. 2224586, DATED 3-4-2000, EXPIRES 3-4-2020.

SER. NO. 85-270,331, FILED 3-18-2011.

KATHERINE E. HALMEN, EXAMINING ATTORNEY



David J. Kybas

Director of the United States Patent and Trademark Office

United States of America
United States Patent and Trademark Office

sublime smiles



Reg. No. 4,066,339

Registered Dec. 6, 2011

Int. Cl.: 44

SERVICE MARK

PRINCIPAL REGISTER

EDUARDO A. AVILA, DMD, LLC (MARYLAND LIMITED LIABILITY COMPANY), DBA
SUBLIME SMILES
11400 ROCKVILLE PIKE SUITE 805
ROCKVILLE, MD 20852

FOR: ORTHODONTIC SERVICES, IN CLASS 44 (U.S. CLS. 100 AND 101).

FIRST USE 2-16-2011; IN COMMERCE 2-16-2011.

THE MARK CONSISTS OF THE WORDING "SUBLIME SMILES" WITH AN ARCH SPANNING UNDERNEATH THE WORDS AND CONNECTING THE "T"'S IN "SUBLIME SMILES". THE ARCH RESEMBLES A SMILE.

SER. NO. 85-270,984, FILED 3-18-2011.

ANNE MADDEN, EXAMINING ATTORNEY



David J. Kybas

Director of the United States Patent and Trademark Office

United States of America

United States Patent and Trademark Office

PEEKYOU

Reg. No. 4,066,340

Registered Dec. 6, 2011

Int. Cl.: 35

SERVICE MARK

PRINCIPAL REGISTER

PEEKYOU LLC (DELAWARE LIMITED LIABILITY COMPANY)
SUITE 610
265 WEST 37TH STREET
NEW YORK, NY 10036

FOR: PROVIDING ON-LINE DIRECTORY INFORMATION SERVICES ALSO FEATURING HYPERLINKS TO OTHER WEB SITES; PROVIDING AN ONLINE DIRECTORY INFORMATION SERVICE FEATURING INFORMATION REGARDING, PEOPLE, IN CLASS 35 (U.S. CLS. 100, 101 AND 102).

FIRST USE 1-1-2007; IN COMMERCE 1-1-2007.

THE MARK CONSISTS OF STANDARD CHARACTERS WITHOUT CLAIM TO ANY PARTICULAR FONT, STYLE, SIZE, OR COLOR.

SER. NO. 85-271,094, FILED 3-18-2011.

BILL DAWE, EXAMINING ATTORNEY



David J. Kybas

Director of the United States Patent and Trademark Office

United States of America

United States Patent and Trademark Office



Reg. No. 4,066,341

Registered Dec. 6, 2011

Int. Cl.: 29

TRADEMARK

PRINCIPAL REGISTER

BLACK GARLIC INC. (CALIFORNIA CORPORATION)
2499 AMERICAN AVENUE
HAYWARD, CA 94545

FOR: PROCESSED GARLIC, NAMELY, AGED GARLIC, IN CLASS 29 (U.S. CL. 46).

FIRST USE 6-1-2007; IN COMMERCE 6-1-2007.

NO CLAIM IS MADE TO THE EXCLUSIVE RIGHT TO USE "BLACK GARLIC" , APART FROM THE MARK AS SHOWN.

THE MARK CONSISTS OF THE STYLIZED WORDS "BLACK GARLIC" WRITTEN WITH THE LETTER "G" STYLIZED AS GARLIC CLOVES AND WRITTEN BELOW ARE THE STYLIZED WORDS "GARLIC JUST GOT BETTER".

SER. NO. 85-271,306, FILED 3-18-2011.

CHARLES L. JENKINS, EXAMINING ATTORNEY



David J. Kybas

Director of the United States Patent and Trademark Office

United States of America

United States Patent and Trademark Office

POLO AMERICA

Reg. No. 4,066,342

Registered Dec. 6, 2011

Int. Cl.: 41

SERVICE MARK

PRINCIPAL REGISTER

POLO AMERICA LTD., INC. (CALIFORNIA CORPORATION)
262 EASTGATE DRIVE, #326
AIKEN, SC 29803

FOR: ARRANGING, ORGANIZING, CONDUCTING, AND HOSTING SPORTING EVENTS, NAMELY, POLO TOURNAMENTS AND EVENTS; ORGANIZING AND CONDUCTING POLO SPORTING EVENTS FOR THE PURPOSE OF CHARITABLE FUNDRAISING; ENTERTAINMENT IN THE NATURE OF ON-GOING TELEVISION PROGRAMS IN THE FIELD OF POLO SPORTS EVENTS; MAGAZINE PUBLISHING; ARRANGING, ORGANIZING, CONDUCTING, AND HOSTING HOT AIR BALLOON FESTIVALS AND EVENTS, IN CLASS 41 (U.S. CLS. 100, 101 AND 107).

FIRST USE 10-1-1989; IN COMMERCE 10-8-2003.

THE MARK CONSISTS OF STANDARD CHARACTERS WITHOUT CLAIM TO ANY PARTICULAR FONT, STYLE, SIZE, OR COLOR.

NO CLAIM IS MADE TO THE EXCLUSIVE RIGHT TO USE "POLO" , APART FROM THE MARK AS SHOWN.

SEC. 2(F).

SER. NO. 85-271,435, FILED 3-19-2011.

BENJAMIN OKEKE, EXAMINING ATTORNEY



David J. Kyffers

Director of the United States Patent and Trademark Office

United States of America

United States Patent and Trademark Office

TUFFLOAT

Reg. No. 4,066,343

Registered Dec. 6, 2011

Int. Cl.: 17

TRADEMARK

PRINCIPAL REGISTER

WORTHINGTON PRODUCTS, INC. (OHIO CORPORATION)
3405 KUEMERLE AVE., NE
CANTON, OH 44705

FOR: BARRIER CURTAINS IN THE NATURE OF FLOATING BAFFLES OR BOOMS FOR THE CONTAINMENT OF POLLUTANTS, IN CLASS 17 (U.S. CLS. 1, 5, 12, 13, 35 AND 50).

FIRST USE 1-9-2001; IN COMMERCE 1-9-2001.

THE MARK CONSISTS OF STANDARD CHARACTERS WITHOUT CLAIM TO ANY PARTICULAR FONT, STYLE, SIZE, OR COLOR.

OWNER OF U.S. REG. NO. 3,037,752.

SER. NO. 85-271,511, FILED 3-19-2011.

CHARLOTTE CORWIN, EXAMINING ATTORNEY



David J. Kybas

Director of the United States Patent and Trademark Office

United States of America

United States Patent and Trademark Office

ORGANIC AND KOSHER THE BEST OF BOTH WORLDS

Reg. No. 4,066,344

Registered Dec. 6, 2011

Int. Cl.: 29

TRADEMARK

PRINCIPAL REGISTER

ANDERSON INTERNATIONAL FOODS (CALIFORNIA CORPORATION)
2 BURMA ROAD
JERSEY CITY, NJ 07305

FOR: CHEESES THAT ARE BOTH ORGANIC AND KOSHER, IN CLASS 29 (U.S. CL. 46).

FIRST USE 6-7-2009; IN COMMERCE 6-7-2009.

THE MARK CONSISTS OF STANDARD CHARACTERS WITHOUT CLAIM TO ANY PARTICULAR FONT, STYLE, SIZE, OR COLOR.

NO CLAIM IS MADE TO THE EXCLUSIVE RIGHT TO USE "ORGANIC AND KOSHER", APART FROM THE MARK AS SHOWN.

SER. NO. 85-271,863, FILED 3-21-2011.

CHARLOTTE CORWIN, EXAMINING ATTORNEY



David J. Kyros

Director of the United States Patent and Trademark Office

United States of America

United States Patent and Trademark Office

TEL - **A** - CAR
*Accelerating
Service*

Reg. No. 4,066,345

Registered Dec. 6, 2011

Int. Cl.: 39

SERVICE MARK

PRINCIPAL REGISTER

TEL-A-CAR OF NEW YORK, LLC (NEW YORK LIMITED LIABILITY COMPANY)
30-55 VERNON BOULEVARD
LONG ISLAND CITY, NY 11102

FOR: TRANSPORT OF PERSONS, IN CLASS 39 (U.S. CLS. 100 AND 105).

FIRST USE 3-5-2003; IN COMMERCE 3-5-2003.

NO CLAIM IS MADE TO THE EXCLUSIVE RIGHT TO USE "SERVICE", APART FROM THE MARK AS SHOWN.

THE MARK CONSISTS OF "TEL" FOLLOWED BY A HYPHEN FOLLOWED BY A STYLIZED CAPITAL "A" FOLLOWED BY A HYPHEN FOLLOWED BY "CAR"; "ACCELERATING" IS SET UNDER "CAR"; "SERVICE" IS SET UNDER "ACCELERATING" BEGINNING SLIGHTLY AFTER THE SECOND "A".

SER. NO. 85-271,900, FILED 3-21-2011.

ANNE MADDEN, EXAMINING ATTORNEY



David J. Kyffers

Director of the United States Patent and Trademark Office

United States of America

United States Patent and Trademark Office



Reg. No. 4,066,346

Registered Dec. 6, 2011

Int. Cls.: 12 and 22

TRADEMARK

PRINCIPAL REGISTER

OOSTDYK, JAMES M (UNITED STATES INDIVIDUAL)
2621 ROUTE 57
STEWARTSVILLE, NJ 08886

FOR: AUTOMOTIVE AND LIGHT TRUCK PARTS AND ACCESSORIES, NAMELY, LIFT KITS CONSISTING PRIMARILY OF SPRINGS, SHOCKS, STABILIZERS, BUSHINGS AND BOLTS; SHOCK ABSORBERS, GRILLE GUARDS, RING AND PINION GEAR SET, SUSPENSION SYSTEMS FOR VEHICLES, NAMELY, UPPER BALL JOINTS, LOWER BALL JOINTS, BALL JOINTS WITH CONTROL ARMS, BUSHING KITS, INNER TIE ROD ENDS, OUTER TIE ROD ENDS, SLEEVES, IDLER ARMS, CENTER LINKS, STABILIZER KITS, INNER SOCKETS, PITMAN ARMS, IN CLASS 12 (U.S. CLS. 19, 21, 23, 31, 35 AND 44).

FIRST USE 1-31-1997; IN COMMERCE 1-31-1997.

FOR: AUTOMOTIVE AND LIGHT TRUCK PARTS AND ACCESSORIES, NAMELY, TOWING STRAPS, IN CLASS 22 (U.S. CLS. 1, 2, 7, 19, 22, 42 AND 50).

FIRST USE 1-31-1997; IN COMMERCE 1-31-1997.

NO CLAIM IS MADE TO THE EXCLUSIVE RIGHT TO USE "EQUIPMENT", APART FROM THE MARK AS SHOWN.

THE MARK CONSISTS OF THE LETTER "R" FOLLOWED BY THE LETTER "O" FOLLOWED BY THE LETTER "C" AND ENDING WITH THE LETTER "K". THESE LETTERS ARE SITTING UPON STYLIZED ROCKS. THESE LETTERS ARE PLACED ABOVE THE WORD "EQUIPMENT". THE WORD "EQUIPMENT" IS PLACED WITHIN THE STYLIZED ROCKS.

SER. NO. 85-272,124, FILED 3-21-2011.

SCOTT BIBB, EXAMINING ATTORNEY



David J. Kybas

Director of the United States Patent and Trademark Office

United States of America

United States Patent and Trademark Office



MADACO SAFETY PRODUCTS, INC

Reg. No. 4,066,347

Registered Dec. 6, 2011

Int. Cl.: 9

TRADEMARK

PRINCIPAL REGISTER

MADACO SAFETY PRODUCTS, INC. (CALIFORNIA CORPORATION)
SUITE 249
1313 GRAND AVE.
WALNUT, CA 917891317

FOR: FALL PROTECTION EQUIPMENT FOR FALL RESTRAINT AND FALL ARREST, NAMELY, BARS, ANCHORS, HARNESSSES, LINES, LANYARDS, CARABINERS AND ANCHORAGE CONNECTORS; FALL PROTECTION EQUIPMENT FOR FALL RESTRAINT AND FALL ARREST, NAMELY, HARNESSSES; FALL PROTECTION EQUIPMENT FOR FALL RESTRAINT AND FALL ARREST, NAMELY, LANYARDS; LANYARDS FOR SAFETY PURPOSES FOR FALL PROTECTION, IN CLASS 9 (U.S. CLS. 21, 23, 26, 36 AND 38).

FIRST USE 12-1-2001; IN COMMERCE 12-1-2001.

NO CLAIM IS MADE TO THE EXCLUSIVE RIGHT TO USE "SAFETY PRODUCTS, INC", APART FROM THE MARK AS SHOWN.

THE COLOR(S) RED AND BLACK IS/ARE CLAIMED AS A FEATURE OF THE MARK.

THE MARK CONSISTS OF A LARGE RED UPSIDE DOWN "U" REPRESENTING SHELTER AND A SMALLER RED CIRCLE REPRESENTING THE WORLD. THE RED WORLD SITS IN THE MIDDLE OF THE RED SHELTER WITH THE WORDS "MADACO SAFETY PRODUCTS, INC" IN ALL BLACK CAPITAL LETTERS UNDERNEATH.

SER. NO. 85-272,233, FILED 3-21-2011.

NORA BUCHANAN WILL, EXAMINING ATTORNEY



David J. Kybas

Director of the United States Patent and Trademark Office

United States of America

United States Patent and Trademark Office

Tilted Taco

Reg. No. 4,066,348

Registered Dec. 6, 2011

Int. Cl.: 43

SERVICE MARK

PRINCIPAL REGISTER

EL GRINGO LOCO, INC. (ILLINOIS CORPORATION)
29W796 HURLINGHAM COURT
WARRENVILLE, IL 60555

FOR: PROVIDING FOOD, NAMELY, TACOS AND VARIOUS MEXICAN FOODS VIA A MOBILE TRUCKS, FOOD BOOTHS AND RESTAURANTS FEATURING DINE-IN OR TAKE-OUT SERVICES, IN CLASS 43 (U.S. CLS. 100 AND 101).

FIRST USE 11-13-2010; IN COMMERCE 11-13-2010.

THE MARK CONSISTS OF STANDARD CHARACTERS WITHOUT CLAIM TO ANY PARTICULAR FONT, STYLE, SIZE, OR COLOR.

NO CLAIM IS MADE TO THE EXCLUSIVE RIGHT TO USE "TACO", APART FROM THE MARK AS SHOWN.

SER. NO. 85-272,284, FILED 3-21-2011.

PAULA MAHONEY, EXAMINING ATTORNEY



David J. Kyros

Director of the United States Patent and Trademark Office

United States of America

United States Patent and Trademark Office



Reg. No. 4,066,349

PAY PER VISIT EMAIL, LLC (FLORIDA LIMITED LIABILITY COMPANY)
4104 CAUSEWAY VISTA DRIVE
TAMPA, FL 33615

Registered Dec. 6, 2011

Int. Cl.: 35

FOR: ADVERTISING AND PROMOTION SERVICES IN THE NATURE OF SENDING E-MAIL CAMPAIGNS FOR OTHERS, IN CLASS 35 (U.S. CLS. 100, 101 AND 102).

SERVICE MARK

FIRST USE 3-20-2011; IN COMMERCE 3-20-2011.

PRINCIPAL REGISTER

NO CLAIM IS MADE TO THE EXCLUSIVE RIGHT TO USE "PAYPERVISITEMAIL", APART FROM THE MARK AS SHOWN.

THE COLOR(S) BLUE, GREEN AND WHITE IS/ARE CLAIMED AS A FEATURE OF THE MARK.

THE MARK CONSISTS OF THE TERMS "PAYPERVISIT" IN GREEN, NEXT TO THE TERM "EMAIL" IN WHITE, NEXT TO A GREEN ENVELOPE, ALL OF THE AFOREMENTIONED ON A BLUE BACKGROUND.

SER. NO. 85-272,348, FILED 3-21-2011.

TRACY CROSS, EXAMINING ATTORNEY



David J. Kyros

Director of the United States Patent and Trademark Office

United States of America

United States Patent and Trademark Office

USA Gold

Reg. No. 4,066,350

Registered Dec. 6, 2011

Int. Cl.: 29

TRADEMARK

PRINCIPAL REGISTER

THOMAS HOVORE (UNITED STATES INDIVIDUAL)
9171 E. BELL ROAD, SUITE 110
SCOTTSDALE, AZ 85260

FOR: PROCESSED MEAT, IN CLASS 29 (U.S. CL. 46).

FIRST USE 2-1-2011; IN COMMERCE 2-1-2011.

THE MARK CONSISTS OF STANDARD CHARACTERS WITHOUT CLAIM TO ANY PARTICULAR FONT, STYLE, SIZE, OR COLOR.

NO CLAIM IS MADE TO THE EXCLUSIVE RIGHT TO USE "USA", APART FROM THE MARK AS SHOWN.

SER. NO. 85-272,378, FILED 3-21-2011.

REGINA DRUMMOND, EXAMINING ATTORNEY



David J. Kyros

Director of the United States Patent and Trademark Office

United States of America

United States Patent and Trademark Office

RORI'S

Reg. No. 4,066,351

Registered Dec. 6, 2011

Int. Cl.: 30

TRADEMARK

PRINCIPAL REGISTER

RORI'S ARTISANAL CREAMERY, LLC (CALIFORNIA LIMITED LIABILITY COMPANY)
920 GARDEN STREET, SUITE A
C/O KOENIG & ASSOCIATES
SANTA BARBARA, CA 93101

FOR: FROZEN CONFECTIONERY; FROZEN CONFECTIONS; ICE CREAM; AND ICE CREAMS, IN CLASS 30 (U.S. CL. 46).

FIRST USE 1-15-2010; IN COMMERCE 1-15-2010.

THE MARK CONSISTS OF STANDARD CHARACTERS WITHOUT CLAIM TO ANY PARTICULAR FONT, STYLE, SIZE, OR COLOR.

SER. NO. 85-272,911, FILED 3-21-2011.

GEORGE LORENZO, EXAMINING ATTORNEY



David J. Kyros

Director of the United States Patent and Trademark Office

United States of America

United States Patent and Trademark Office

SOCHANGE

Reg. No. 4,066,352

Registered Dec. 6, 2011

Int. Cl.: 35

SERVICE MARK

PRINCIPAL REGISTER

SOCHANGE, INC. (DELAWARE CORPORATION)
21 JEFFERSON STREET #2
CAMBRIDGE, MA 02141

FOR: PROMOTING THE GOODS AND SERVICES OF OTHERS BY MEANS OF PROVIDING A WEBSITE FEATURING INFORMATION ABOUT CHARITABLE CAUSES AND COMPANIES THAT SUPPORT THE CHARITABLE CAUSES, IN CLASS 35 (U.S. CLS. 100, 101 AND 102).

FIRST USE 9-2-2010; IN COMMERCE 9-2-2010.

THE MARK CONSISTS OF STANDARD CHARACTERS WITHOUT CLAIM TO ANY PARTICULAR FONT, STYLE, SIZE, OR COLOR.

SER. NO. 85-272,999, FILED 3-22-2011.

GINA FINK, EXAMINING ATTORNEY



David J. Kybas

Director of the United States Patent and Trademark Office

United States of America

United States Patent and Trademark Office

NORTH AMERICAN
N.A.P.W.
PRO WRESTLING

Reg. No. 4,066,353

Registered Dec. 6, 2011

Int. Cl.: 41

SERVICE MARK

PRINCIPAL REGISTER

NORTH AMERICAN PRO WRESTLING, LLC (ILLINOIS LIMITED LIABILITY COMPANY)
164 DIVISION STREET, SUITE 705
ELGIN, IL 60120

FOR: ENTERTAINMENT IN THE NATURE OF WRESTLING CONTESTS; PROVIDING WRESTLING NEWS AND INFORMATION VIA A GLOBAL COMPUTER NETWORK, IN CLASS 41 (U.S. CLS. 100, 101 AND 107).

FIRST USE 3-1-2011; IN COMMERCE 3-22-2011.

NO CLAIM IS MADE TO THE EXCLUSIVE RIGHT TO USE "NORTH AMERICAN PRO WRESTLING", APART FROM THE MARK AS SHOWN.

THE MARK CONSISTS OF STYLED LETTERS "N.A.P.W." AND THE WORDING "NORTH AMERICAN PRO WRESTLING".

SER. NO. 85-273,043, FILED 3-22-2011.

BARBARA BROWN, EXAMINING ATTORNEY



David J. Kyros

Director of the United States Patent and Trademark Office

United States of America

United States Patent and Trademark Office

Designing tomorrow's businesses today!

Reg. No. 4,066,354

Registered Dec. 6, 2011

Int. Cl.: 35

SERVICE MARK

PRINCIPAL REGISTER

HUNT CONSULTING GROUP, LLC (MASSACHUSETTS LIMITED LIABILITY COMPANY)
23 SOMERSET DR
ANDOVER, MA 01810

FOR: BUSINESS CONSULTATION SERVICES, NAMELY, BUSINESS PROCESS IMPROVEMENT AND ENTERPRISE ARCHITECTURE DESIGN; BUSINESS MANAGEMENT CONSULTANCY AS WELL AS DEVELOPMENT OF PROCESSES FOR THE ANALYSIS AND THE IMPLEMENTATION OF STRATEGY PLANS AND MANAGEMENT PROJECTS; CONSULTANCY AND ADVISORY SERVICES IN THE FIELD OF BUSINESS STRATEGY; CONSULTING SERVICES IN THE FIELDS OF BUSINESS MANAGEMENT, HUMAN RESOURCES, AND BUSINESS ORGANIZATIONAL DESIGN; MANAGEMENT CONSULTING AND ADVISORY SERVICES IN THE AREAS OF CORPORATE GROWTH STRATEGY, INNOVATION AND GROWTH PROCESSES, ORGANIZATIONAL TRANSFORMATION, AND TALENT MANAGEMENT AND DEVELOPMENT STRATEGIES, IN CLASS 35 (U.S. CLS. 100, 101 AND 102).

FIRST USE 1-28-2004; IN COMMERCE 1-28-2004.

THE MARK CONSISTS OF STANDARD CHARACTERS WITHOUT CLAIM TO ANY PARTICULAR FONT, STYLE, SIZE, OR COLOR.

SER. NO. 85-273,068, FILED 3-22-2011.

KATHERINE E. HALMEN, EXAMINING ATTORNEY



David J. Kyjars

Director of the United States Patent and Trademark Office

United States of America

United States Patent and Trademark Office

MIGUEL

Reg. No. 4,066,355

Registered Dec. 6, 2011

Int. Cls.: 9, 25 and 41

TRADEMARK

SERVICE MARK

PRINCIPAL REGISTER

MIGUEL JONTEL PIMENTEL (UNITED STATES INDIVIDUAL)
9229 SUNSET BLVD. #414
LOS ANGELES, CA 90069

FOR: MUSICAL VIDEO RECORDINGS; SOUND RECORDINGS FEATURING MUSIC, IN CLASS 9 (U.S. CLS. 21, 23, 26, 36 AND 38).

FIRST USE 12-31-2006; IN COMMERCE 12-31-2006.

FOR: CAPS; JACKETS; T-SHIRTS, IN CLASS 25 (U.S. CLS. 22 AND 39).

FIRST USE 11-1-2010; IN COMMERCE 11-1-2010.

FOR: ENTERTAINMENT SERVICES IN THE NATURE OF LIVE MUSICAL PERFORMANCES, IN CLASS 41 (U.S. CLS. 100, 101 AND 107).

FIRST USE 12-1-2003; IN COMMERCE 12-1-2003.

THE MARK CONSISTS OF STANDARD CHARACTERS WITHOUT CLAIM TO ANY PARTICULAR FONT, STYLE, SIZE, OR COLOR.

THE NAME MIGUEL IDENTIFIES A LIVING INDIVIDUAL WHOSE CONSENT IS OF RECORD.

SER. NO. 85-273,287, FILED 3-22-2011.

BRIAN NEVILLE, EXAMINING ATTORNEY



David J. Kybas

Director of the United States Patent and Trademark Office

United States of America

United States Patent and Trademark Office

Easy Brow 

Reg. No. 4,066,356

Registered Dec. 6, 2011

Int. Cl.: 3

TRADEMARK

PRINCIPAL REGISTER

EAZY BROW LLC (TEXAS LIMITED LIABILITY COMPANY)
7340 SKILLMAN ST., UNIT 401
DALLAS, TX 75231

FOR: EYEBROW COSMETICS, IN CLASS 3 (U.S. CLS. 1, 4, 6, 50, 51 AND 52).

FIRST USE 4-14-2010; IN COMMERCE 5-30-2010.

NO CLAIM IS MADE TO THE EXCLUSIVE RIGHT TO USE "BROW", APART FROM THE MARK AS SHOWN.

THE COLOR(S) TEAL IS/ARE CLAIMED AS A FEATURE OF THE MARK.

THE MARK CONSISTS OF THE LETTERS "EAZY BROW" AND AN ABSTRACT TEAL EYEBALL WITH A TEAL EYEBROW.

SER. NO. 85-273,381, FILED 3-22-2011.

REBECCA SMITH, EXAMINING ATTORNEY



David J. Kyffers

Director of the United States Patent and Trademark Office

United States of America

United States Patent and Trademark Office

HAIR CLOG BLASTER

Reg. No. 4,066,357

Registered Dec. 6, 2011

Int. Cl.: 3

TRADEMARK

PRINCIPAL REGISTER

WHINK PRODUCTS COMPANY (IOWA CORPORATION)
1901 15TH AVENUE
ELDORA, IA 50627

FOR: LIQUID DRAIN OPENER SOLD THROUGH RETAIL STORES, IN CLASS 3 (U.S. CLS. 1, 4, 6, 50, 51 AND 52).

FIRST USE 12-31-2003; IN COMMERCE 12-31-2003.

THE MARK CONSISTS OF STANDARD CHARACTERS WITHOUT CLAIM TO ANY PARTICULAR FONT, STYLE, SIZE, OR COLOR.

OWNER OF U.S. REG. NO. 3,019,323.

NO CLAIM IS MADE TO THE EXCLUSIVE RIGHT TO USE "HAIR CLOG", APART FROM THE MARK AS SHOWN.

SER. NO. 85-273,507, FILED 3-22-2011.

MARTHA SANTOMARTINO, EXAMINING ATTORNEY



David J. Kybas

Director of the United States Patent and Trademark Office

United States of America

United States Patent and Trademark Office



Reg. No. 4,066,358

Registered Dec. 6, 2011

Int. Cl.: 30

TRADEMARK

PRINCIPAL REGISTER

OPPENHEIMER CHOCOLATES, U.S.A. INC. (NEW YORK CORPORATION)
544 PARK AVENUE
BROOKLYN, NY 11205

FOR: CANDIES; CANDY; CANDY BARS; CANDY CAKE DECORATIONS; CANDY COATED APPLES; CANDY COATED POPCORN; CANDY CONTAINING ALCOHOLIC BEVERAGE CONTENT AND FLAVOR; CANDY DECORATIONS FOR CAKES; CANDY FOR FOOD; CANDY MINTS; CANDY SPRINKLES; CANDY WITH CARAMEL; CANDY WITH COCOA; CANDY, NAMELY, DRAGÉES; CHOCOLATE CANDIES; CHOCOLATES AND CHOCOLATE BASED READY TO EAT CANDIES AND SNACKS; COTTON CANDY; GIFT BASKETS CONTAINING CANDY; GUMMY CANDIES; ICE CANDIES; MEXICAN CANDY; PEPPERMINT CANDY; STARCH-BASED CANDIES (AME); SUGARLESS CANDIES; SWEETS, IN CLASS 30 (U.S. CL. 46).

FIRST USE 12-17-2007; IN COMMERCE 12-17-2007.

NO CLAIM IS MADE TO THE EXCLUSIVE RIGHT TO USE "BALA" , APART FROM THE MARK AS SHOWN.

THE MARK CONSISTS OF THE WORDS "TRI BALA" IN OUTLINED, STYLIZED LETTERING.

THE ENGLISH TRANSLATION OF "BALA" IN THE MARK IS "CANDY".

SER. NO. 85-274,029, FILED 3-22-2011.

TINA MAI, EXAMINING ATTORNEY



David J. Kybas

Director of the United States Patent and Trademark Office

United States of America

United States Patent and Trademark Office

INMIGRACIÓN A SU LADO

Reg. No. 4,066,359

Registered Dec. 6, 2011

Int. Cl.: 45

SONIA JAIMES DEVELOPMENTS, INC. (CALIFORNIA CORPORATION), DBA
INMIGRACIÓN A SU LADO
3317 W. BEVERLY BLVD., SUITE 107
3317 W. BEVERLY BLVD., SUITE 107
MONTEBELLO, CA 90640

SERVICE MARK

FOR: LEGAL CONSULTATION SERVICES; LEGAL DOCUMENT PREPARATION AND
RESEARCH SERVICES FOR ATTORNEYS, IN CLASS 45 (U.S. CLS. 100 AND 101).

PRINCIPAL REGISTER

FIRST USE 8-23-2010; IN COMMERCE 8-23-2010.

THE MARK CONSISTS OF STANDARD CHARACTERS WITHOUT CLAIM TO ANY PAR-
TICULAR FONT, STYLE, SIZE, OR COLOR.

NO CLAIM IS MADE TO THE EXCLUSIVE RIGHT TO USE "INMIGRACIÓN", APART FROM
THE MARK AS SHOWN.

THE ENGLISH TRANSLATION OF "INMIGRACIÓN A SU LADO" IS "IMMIGRATION AT
YOUR SIDE".

SER. NO. 85-274,041, FILED 3-22-2011.

CARYN GLASSER, EXAMINING ATTORNEY



David J. Kybas

Director of the United States Patent and Trademark Office

United States of America

United States Patent and Trademark Office

Playdates Made Simple

Reg. No. 4,066,360

Registered Dec. 6, 2011

Int. Cl.: 42

SERVICE MARK

PRINCIPAL REGISTER

PLAYDATION INC. (DELAWARE CORPORATION)
171 WEST 71ST STREET, APT. 6E
NEW YORK, NY 10023

FOR: PROVIDING ONLINE NON-DOWNLOADABLE SOFTWARE FOR MANAGING A CHILD'S CALENDAR AND EVENTS, IN CLASS 42 (U.S. CLS. 100 AND 101).

FIRST USE 2-12-2011; IN COMMERCE 2-12-2011.

THE MARK CONSISTS OF STANDARD CHARACTERS WITHOUT CLAIM TO ANY PARTICULAR FONT, STYLE, SIZE, OR COLOR.

NO CLAIM IS MADE TO THE EXCLUSIVE RIGHT TO USE "PLAYDATES", APART FROM THE MARK AS SHOWN.

SER. NO. 85-274,073, FILED 3-23-2011.

DEIRDRE ROBERTSON, EXAMINING ATTORNEY



David J. Kybas

Director of the United States Patent and Trademark Office

United States of America

United States Patent and Trademark Office

BURLEY

Reg. No. 4,066,361

Registered Dec. 6, 2011

Int. Cl.: 25

TRADEMARK

PRINCIPAL REGISTER

BURLEY DESIGN LLC (OREGON LIMITED LIABILITY COMPANY)
4685 CLOUDBURST WAY
EUGENE, OR 97402

FOR: CLOTHING FOR CYCLISTS, NAMELY, T-SHIRTS AND CAPS FOR CYCLISTS, IN CLASS 25 (U.S. CLS. 22 AND 39).

FIRST USE 4-8-2010; IN COMMERCE 4-8-2010.

THE MARK CONSISTS OF STANDARD CHARACTERS WITHOUT CLAIM TO ANY PARTICULAR FONT, STYLE, SIZE, OR COLOR.

OWNER OF U.S. REG. NOS. 3,079,250, 3,739,552, AND 3,890,977.

SER. NO. 85-274,423, FILED 3-23-2011.

ALYSSA STEEL, EXAMINING ATTORNEY



David J. Kybas

Director of the United States Patent and Trademark Office

United States of America

United States Patent and Trademark Office

SO GOOD TOWEL

Reg. No. 4,066,362

Registered Dec. 6, 2011

Int. Cl.: 24

TRADEMARK

PRINCIPAL REGISTER

LIFE IS SPORTS, LLC (MASSACHUSETTS LIMITED LIABILITY COMPANY)
PO BOX 81234
WELLESLEY, MA 02481

FOR: FACE TOWELS; GOLF TOWELS; HAND TOWELS; HAND-TOWELS MADE OF TEXTILE FABRICS; LARGE BATH TOWELS; TERRY TOWELS; TOWELS, IN CLASS 24 (U.S. CLS. 42 AND 50).

FIRST USE 2-11-2011; IN COMMERCE 2-11-2011.

THE MARK CONSISTS OF STANDARD CHARACTERS WITHOUT CLAIM TO ANY PARTICULAR FONT, STYLE, SIZE, OR COLOR.

NO CLAIM IS MADE TO THE EXCLUSIVE RIGHT TO USE "TOWEL", APART FROM THE MARK AS SHOWN.

SER. NO. 85-274,542, FILED 3-23-2011.

JESSICA A. POWERS, EXAMINING ATTORNEY



David J. Kyffers

Director of the United States Patent and Trademark Office

United States of America

United States Patent and Trademark Office



Reg. No. 4,066,363

Registered Dec. 6, 2011

Int. Cls.: 25 and 41

TRADEMARK

SERVICE MARK

PRINCIPAL REGISTER

IOWA STATE UNIVERSITY OF SCIENCE AND TECHNOLOGY (IOWA STATE AGENCY)
1350 BEARDSHEAR HALL
AMES, IA 50011

FOR: CLOTHING, NAMELY, T-SHIRTS, TOPS, SWEATSHIRTS, SKIRTS, DRESSES, KNIT SHIRTS, BLOUSES, SWEATERS, TANK TOPS, BEACHWEAR, LOUNGEWEAR, UNDERGARMENTS, JERSEYS, VESTS, CAPS, HATS, BELTS, PANTS, SHIRTS, GLOVES, MITTENS, TIES, SUSPENDERS, SCARVES, SOCKS, PONCHOS, JACKETS, COATS, RAINWEAR, KNITTED COATS AND SWEATERS, BANDANNAS, JOGGING AND WARM-UP SUITS, ATHLETIC JERSEYS, HEAD WEAR AND PAINTERS CAPS, CHILDREN'S AND INFANT CLOTHING, NAMELY, NIGHTSHIRTS, PAJAMAS AND BABY BUNTING; FOOTWEAR, NAMELY, SHOES, SANDALS, BOOTS, AND SNEAKERS, IN CLASS 25 (U.S. CLS. 22 AND 39).

FIRST USE 10-21-2010; IN COMMERCE 11-20-2010.

FOR: EDUCATIONAL SERVICES, NAMELY, PROVIDING COURSES OF INSTRUCTION AT THE COLLEGE LEVEL; ORGANIZING INTRAMURAL, INTERCOLLEGIATE AND EXHIBITION ATHLETIC AND SPORTING EVENTS, NAMELY, BASKETBALL, CROSS COUNTRY, FOOTBALL, TRACK AND FIELD, GOLF, GYMNASTICS, SOCCER, SOFTBALL, SWIMMING AND DIVING, TENNIS, VOLLEYBALL, WRESTLING, ARCHERY, BADMINTON, BALLROOM DANCE, BASEBALL, BASS ANGLERS, BOXING, BOWLING, BROOMBALL, CANOE AND KAYAK, CREW, CRICKET, CURLING, CYCLING, DISK GOLF, DODGE BALL, EUCHRE, EQUESTRIAN, FENCING, FLAG FOOTBALL, FLYING, FOOSBALL, HAPKIDO, JUDO, ICE HOCKEY, KARATE, KUMDO, LACROSSE, MARTIAL ARTS, MOTOCROSS, MOTORCYCLE, MOUNTAINEERING AND CLIMBING, PAINTBALL, 9-BALL POOL, RACQUETBALL, RODEO, RUGBY, RUNNING, SAILING, NORDIC SKI, SKI AND SNOWBOARDING, SKATEBOARDING, TABLE TENNIS, TAE KWON DO, TRAP AND SKEET, TRIATHLON, PLAYING FLYING DISK GAMES, WATER POLO, WATER-SKI, WEIGHT LIFTING, AND OTHER RELATED SPORTS; PROVIDING DRAMATIC THEATRICAL AND MUSICAL FLOOR SHOWS PROVIDED AT PERFORMANCE VENUES; ENTERTAINMENT IN THE NATURE OF LIVE MUSICAL PERFORMANCES; ENTERTAINMENT IN THE NATURE OF LIVE THEATRICAL PERFORMANCES; PROVIDING COLLEGE LEVEL EDUCATIONAL COURSES, IN CLASS 41 (U.S. CLS. 100, 101 AND 107).



David J. Kyjars

FIRST USE 10-21-2010; IN COMMERCE 12-4-2010.

Reg. No. 4,066,363 THE MARK CONSISTS OF A WALKING STYLIZED BIRD WITH THE WORDING "I STATE"
ON THE CHEST OF THE BIRD

SER. NO. 85-274,564, FILED 3-23-2011.

JANICE KIM, EXAMINING ATTORNEY

United States of America

United States Patent and Trademark Office

IF THE DEVIL MADE YOU DO IT,
I'LL GET YOU THROUGH IT.

Reg. No. 4,066,364

DRAKE, BRANDON (UNITED STATES INDIVIDUAL)
PO BOX 192
EVERETT, WA 98206

Registered Dec. 6, 2011

Int. Cl.: 36

FOR: INSURANCE AND FINANCIAL SERVICES, NAMELY, BAIL BONDING, IN CLASS 36 (U.S. CLS. 100, 101 AND 102).

SERVICE MARK

FIRST USE 1-1-2009; IN COMMERCE 1-1-2009.

PRINCIPAL REGISTER

THE MARK CONSISTS OF STANDARD CHARACTERS WITHOUT CLAIM TO ANY PARTICULAR FONT, STYLE, SIZE, OR COLOR.

SER. NO. 85-274,616, FILED 3-23-2011.

JUSTINE D. PARKER, EXAMINING ATTORNEY



David J. Kybas

Director of the United States Patent and Trademark Office

United States of America

United States Patent and Trademark Office

CADLearning

Reg. No. 4,066,365

Registered Dec. 6, 2011

Int. Cls.: 9 and 42

4D DESIGN SOLUTIONS, LLC (NEW HAMPSHIRE LIMITED LIABILITY COMPANY), DBA
4D TECHNOLOGIES
BUILDING E, LOWER LEVEL
116 SOUTH RIVER ROAD
BEDFORD, NH 03110

TRADEMARK

SERVICE MARK

PRINCIPAL REGISTER

FOR: EDUCATIONAL SOFTWARE FEATURING INSTRUCTION IN THE NATURE OF COMPUTER-AIDED DESIGN SOFTWARE; VIDEO RECORDINGS FEATURING TUTORIALS ON USING COMPUTER-AIDED DESIGN SOFTWARE, NAMELY, 3D DESIGN, ARCHITECTURE, ENGINEERING, ANALYSIS AND VISUALIZATION APPLICATIONS; DIGITAL MEDIA, NAMELY, CD-ROM, WITH VIDEO FILES FEATURING TUTORIALS ON COMPUTER-AIDED DESIGN SOFTWARE, NAMELY, 3D DESIGN, ARCHITECTURE, ENGINEERING, ANALYSIS AND VISUALIZATION APPLICATIONS; COMPUTER SOFTWARE THAT PROVIDES WEB-BASED ACCESS TO APPLICATIONS AND SERVICES THROUGH A WEB OPERATING SYSTEM OR PORTAL INTERFACE, IN CLASS 9 (U.S. CLS. 21, 23, 26, 36 AND 38).

FIRST USE 2-0-2005; IN COMMERCE 11-23-2005.

FOR: COMPUTER SERVICES, NAMELY, PROVIDING A WEB-BASED SYSTEM AND ON-LINE PORTAL FEATURING ON-LINE NON-DOWNLOADABLE SOFTWARE THAT ENABLES USERS TO ACCESS TRAINING AND EDUCATION MATERIALS IN THE FIELD OF COMPUTER-AIDED DESIGN, NAMELY, 3D DESIGN, ARCHITECTURE, ENGINEERING, ANALYSIS AND VISUALIZATION APPLICATIONS, IN CLASS 42 (U.S. CLS. 100 AND 101).

FIRST USE 2-0-2005; IN COMMERCE 11-23-2005.

THE MARK CONSISTS OF STANDARD CHARACTERS WITHOUT CLAIM TO ANY PARTICULAR FONT, STYLE, SIZE, OR COLOR.

SEC. 2(F).

SER. NO. 85-274,683, FILED 3-23-2011.

KAREN SEVERSON, EXAMINING ATTORNEY



David J. Kyros

Director of the United States Patent and Trademark Office

United States of America

United States Patent and Trademark Office

GOOD LUNCH

Reg. No. 4,066,366

ORE ORIGINALS, INC. (CALIFORNIA CORPORATION)
1357 CORONADO AVE.
LONG BEACH, CA 90804

Registered Dec. 6, 2011

Int. Cl.: 16

FOR: LUNCH AND SNACK BAGS MADE OF PLASTIC; TOTE BAGS MADE OF PLASTIC FOR LUNCH AND SNACKS, IN CLASS 16 (U.S. CLS. 2, 5, 22, 23, 29, 37, 38 AND 50).

TRADEMARK

FIRST USE 5-31-2010; IN COMMERCE 5-31-2010.

PRINCIPAL REGISTER

THE MARK CONSISTS OF STANDARD CHARACTERS WITHOUT CLAIM TO ANY PARTICULAR FONT, STYLE, SIZE, OR COLOR.

SER. NO. 85-274,724, FILED 3-23-2011.

JERI J. FICKES, EXAMINING ATTORNEY



David J. Kyffers

Director of the United States Patent and Trademark Office

United States of America

United States Patent and Trademark Office

Cowboy Butler

Reg. No. 4,066,367

Registered Dec. 6, 2011

Int. Cl.: 41

SERVICE MARK

PRINCIPAL REGISTER

KEITH WADE PERRAULT (UNITED STATES INDIVIDUAL), AKA COWBOY BUTLER
PO BOX 19000
AVON, CO 81620

FOR: EDUCATIONAL AND ENTERTAINMENT SERVICES IN THE NATURE OF SMALL GROUP INSTRUCTION IN THE FIELD OF SOCIAL STANDARDS, ETIQUETTE AND PROTOCOL, AND ADVICE REGARDING SAME, IN CLASS 41 (U.S. CLS. 100, 101 AND 107).

FIRST USE 2-2-2008; IN COMMERCE 2-2-2008.

THE MARK CONSISTS OF STANDARD CHARACTERS WITHOUT CLAIM TO ANY PARTICULAR FONT, STYLE, SIZE, OR COLOR.

NO CLAIM IS MADE TO THE EXCLUSIVE RIGHT TO USE "BUTLER", APART FROM THE MARK AS SHOWN.

THE NAME KEITH WADE PERRAULT IDENTIFIES A LIVING INDIVIDUAL WHOSE CONSENT IS OF RECORD.

SER. NO. 85-274,751, FILED 3-23-2011.

KARANENDRA S. CHHINA, EXAMINING ATTORNEY



David J. Kybas

Director of the United States Patent and Trademark Office

United States of America

United States Patent and Trademark Office

The Power to Conserve

Reg. No. 4,066,368

Registered Dec. 6, 2011

Int. Cl.: 9

TRADEMARK

PRINCIPAL REGISTER

ENERGY MANAGEMENT SOLUTIONS, LLC (INDIANA LIMITED LIABILITY COMPANY)
3000 TECHNOLOGY AVENUE
NEW ALBANY, IN 47150

FOR: COMPUTER HARDWARE AND SOFTWARE SYSTEMS FOR MANAGING AND REPORTING UTILITY DATA, IN CLASS 9 (U.S. CLS. 21, 23, 26, 36 AND 38).

FIRST USE 3-23-2011; IN COMMERCE 3-23-2011.

THE MARK CONSISTS OF STANDARD CHARACTERS WITHOUT CLAIM TO ANY PARTICULAR FONT, STYLE, SIZE, OR COLOR.

SER. NO. 85-274,887, FILED 3-23-2011.

APRIL HESIK, EXAMINING ATTORNEY



David J. Kybas

Director of the United States Patent and Trademark Office

United States of America

United States Patent and Trademark Office

JELLYTOONS

Reg. No. 4,066,369

Registered Dec. 6, 2011

Int. Cl.: 9

TRADEMARK

PRINCIPAL REGISTER

MINDSHAPES LIMITED (UNITED KINGDOM LIMITED COMPANY (LTD.))
GRANVILLE HOUSE, 132 SLOANE STREET
LONDON, UNITED KINGDOM SW1X9AX

FOR: COMPUTER SOFTWARE FOR USE IN INSTRUCTION IN THE FIELD OF CHILDREN'S EDUCATION FOR USE ON WIRELESS DEVICES, COMPUTERS AND TELEVISIONS AND DOWNLOADABLE VIA THE INTERNET, IN CLASS 9 (U.S. CLS. 21, 23, 26, 36 AND 38).

FIRST USE 3-16-2011; IN COMMERCE 3-16-2011.

THE MARK CONSISTS OF STANDARD CHARACTERS WITHOUT CLAIM TO ANY PARTICULAR FONT, STYLE, SIZE, OR COLOR.

SER. NO. 85-275,017, FILED 3-23-2011.

BRIAN CALLAGHAN, EXAMINING ATTORNEY



David J. Kyffers

Director of the United States Patent and Trademark Office

United States of America

United States Patent and Trademark Office

SYNCLINE

Reg. No. 4,066,370

Registered Dec. 6, 2011

Int. Cl.: 33

TRADEMARK

PRINCIPAL REGISTER

MORCHELLA WINE CELLARS, LLC (WASHINGTON LIMITED LIABILITY COMPANY),
DBA SYNCLINE WINE CELLARS
111 BALCH ROAD
LYLE, WA 98635

FOR: WINES, IN CLASS 33 (U.S. CLS. 47 AND 49).

FIRST USE 1-16-2001; IN COMMERCE 6-14-2001.

THE MARK CONSISTS OF STANDARD CHARACTERS WITHOUT CLAIM TO ANY PARTICULAR FONT, STYLE, SIZE, OR COLOR.

SER. NO. 85-275,039, FILED 3-23-2011.

MARK RADEMACHER, EXAMINING ATTORNEY



David J. Kybas

Director of the United States Patent and Trademark Office

United States of America

United States Patent and Trademark Office



Reg. No. 4,066,371

Registered Dec. 6, 2011

Int. Cl.: 36

SERVICE MARK

PRINCIPAL REGISTER

UPSTREAM INVESTMENT PARTNERS, LLC (DELAWARE LIMITED LIABILITY COMPANY)
SUITE 115
2443 WARRENVILLE ROAD
LISLE, IL 60532

FOR: FINANCIAL AND INVESTMENT SERVICES, NAMELY, MANAGEMENT AND BROKERAGE IN THE FIELDS OF STOCKS, BONDS, OPTIONS, COMMODITIES, FUTURES AND OTHER SECURITIES, AND THE INVESTMENT OF FUNDS OF OTHERS; FINANCIAL MANAGEMENT; INSURANCE AGENCIES, IN CLASS 36 (U.S. CLS. 100, 101 AND 102).

FIRST USE 1-2-2010; IN COMMERCE 1-2-2010.

NO CLAIM IS MADE TO THE EXCLUSIVE RIGHT TO USE "INVESTMENT PARTNERS", APART FROM THE MARK AS SHOWN.

THE MARK CONSISTS OF A TRIANGLE WITH A DESIGN OF A STREAM RUNNING FROM BOTTOM TO TOP. THE WORDING "UPSTREAM INVESTMENT PARTNERS" APPEARS NEXT TO THE DESIGN, WITH A DOT BETWEEN "INVESTMENT" AND "PARTNERS".

SER. NO. 85-275,109, FILED 3-23-2011.

HEATHER SAPP, EXAMINING ATTORNEY



David J. Kybas

Director of the United States Patent and Trademark Office

United States of America

United States Patent and Trademark Office

COOKIE COMBS

Reg. No. 4,066,372

Registered Dec. 6, 2011

Int. Cls.: 16 and 41

TRADEMARK

SERVICE MARK

PRINCIPAL REGISTER

COMBS, MIRIAM (UNITED STATES INDIVIDUAL)
10524 - 23RD AVE NE
SEATTLE, WA 98125

FOR: SERIES OF CHILDREN'S BOOKS, IN CLASS 16 (U.S. CLS. 2, 5, 22, 23, 29, 37, 38 AND 50).

FIRST USE 1-7-2009; IN COMMERCE 3-4-2010.

FOR: BOOK PUBLISHING; ONLINE ELECTRONIC PUBLISHING OF BOOKS; ON-LINE JOURNALS, NAMELY, BLOGS FEATURING A SERIES OF CHILDREN'S BOOKS, IN CLASS 41 (U.S. CLS. 100, 101 AND 107).

FIRST USE 1-7-2009; IN COMMERCE 3-4-2010.

THE MARK CONSISTS OF STANDARD CHARACTERS WITHOUT CLAIM TO ANY PARTICULAR FONT, STYLE, SIZE, OR COLOR.

THE NAME(S), PORTRAIT(S), AND/OR SIGNATURE(S) SHOWN IN THE MARK IDENTIFIES MIRIAM N. "COMBS", WHOSE CONSENT(S) TO REGISTER IS MADE OF RECORD.

SER. NO. 85-275,272, FILED 3-24-2011.

KYLE PEETE, EXAMINING ATTORNEY



David J. Kybas

Director of the United States Patent and Trademark Office

United States of America

United States Patent and Trademark Office

BRA PADDY BACK

Reg. No. 4,066,373

Registered Dec. 6, 2011

Int. Cl.: 25

TRADEMARK

PRINCIPAL REGISTER

MCCARTY, ROXIE LEE (UNITED STATES INDIVIDUAL), DBA BRA PADDY BACK
2636 CR 3212
2636 CR 3212
JACKSONVILLE, TX 75766

FOR: UNDERGARMENTS, IN CLASS 25 (U.S. CLS. 22 AND 39).

FIRST USE 6-2-2010; IN COMMERCE 6-2-2010.

THE MARK CONSISTS OF STANDARD CHARACTERS WITHOUT CLAIM TO ANY PARTICULAR FONT, STYLE, SIZE, OR COLOR.

NO CLAIM IS MADE TO THE EXCLUSIVE RIGHT TO USE "BRA", APART FROM THE MARK AS SHOWN.

SER. NO. 85-275,410, FILED 3-24-2011.

MICHAEL TANNER, EXAMINING ATTORNEY



David J. Kybas

Director of the United States Patent and Trademark Office

United States of America

United States Patent and Trademark Office

Whitewater learning

Reg. No. 4,066,374

Registered Dec. 6, 2011

Int. Cl.: 41

SERVICE MARK

PRINCIPAL REGISTER

WHITewater LEARNING, LLC (MINNESOTA LIMITED LIABILITY COMPANY)
4640 14TH AVENUE SOUTH
MINNEAPOLIS, MN 55407

FOR: EDUCATION SERVICES, NAMELY, PROVIDING ON-LINE WORKSHOPS, AND CLASSES IN THE FIELD OF PROFESSIONAL DEVELOPMENT FOR EDUCATORS, EDUCATIONAL LEADERS, SCHOOL HEALTH CARE AND WELLNESS PROVIDERS AND POLICY MAKERS FOCUSED ON PRE-SCHOOL THROUGH ADULT CARE AND LEARNING; EDUCATION SERVICES, NAMELY, PROVIDING ON-LINE NON-DOWNLOADABLE BOOKS FEATURING PRACTICE EXERCISES AND EDUCATIONAL ASSESSMENTS IN THE FIELD OF PROFESSIONAL DEVELOPMENT FOR EDUCATORS, EDUCATIONAL LEADERS, SCHOOL HEALTH CARE AND WELLNESS PROVIDERS AND POLICY MAKERS FOCUSED ON PRE-SCHOOL THROUGH ADULT CARE AND LEARNING, IN CLASS 41 (U.S. CLS. 100, 101 AND 107).

FIRST USE 3-16-2011; IN COMMERCE 3-16-2011.

THE MARK CONSISTS OF STANDARD CHARACTERS WITHOUT CLAIM TO ANY PARTICULAR FONT, STYLE, SIZE, OR COLOR.

NO CLAIM IS MADE TO THE EXCLUSIVE RIGHT TO USE "LEARNING", APART FROM THE MARK AS SHOWN.

SER. NO. 85-275,843, FILED 3-24-2011.

DEBRA LEE, EXAMINING ATTORNEY



David J. Kybas

Director of the United States Patent and Trademark Office

United States of America

United States Patent and Trademark Office

NTRACK

Reg. No. 4,066,375

Registered Dec. 6, 2011

Int. Cls.: 35 and 36

SERVICE MARK

PRINCIPAL REGISTER

STRONGWOOD INSURANCE HOLDINGS CORPORATION (DELAWARE CORPORATION)
70 GARDEN COURT, SUITE 100
MONTEREY, CA 93940

FOR: ADVERTISING, MARKETING AND PROMOTION SERVICES, IN CLASS 35 (U.S. CLS. 100, 101 AND 102).

FIRST USE 11-2-2009; IN COMMERCE 11-2-2009.

FOR: COMMERCIAL INSURANCE INFORMATION AND CONSULTANCY; PROPERTY AND CASUALTY INSURANCE UNDERWRITING SERVICES, IN CLASS 36 (U.S. CLS. 100, 101 AND 102).

FIRST USE 11-2-2009; IN COMMERCE 11-2-2009.

THE MARK CONSISTS OF STANDARD CHARACTERS WITHOUT CLAIM TO ANY PARTICULAR FONT, STYLE, SIZE, OR COLOR.

SER. NO. 85-275,877, FILED 3-24-2011.

KARANENDRA S. CHHINA, EXAMINING ATTORNEY



David J. Kyros

Director of the United States Patent and Trademark Office

United States of America

United States Patent and Trademark Office

Techsew

Reg. No. 4,066,376

Registered Dec. 6, 2011

Int. Cl.: 7

TRADEMARK

PRINCIPAL REGISTER

107221 CANADA INC. (CANADA CORPORATION), DBA RAPHAEL SEWING MACHINES
INC.

8440 SAINT-LAURENT BLVD, SUITE 200
MONTREAL, QUEBEC, CANADA H2P2M5

FOR: INDUSTRIAL SEWING MACHINES, IN CLASS 7 (U.S. CLS. 13, 19, 21, 23, 31, 34 AND
35).

THE MARK CONSISTS OF STANDARD CHARACTERS WITHOUT CLAIM TO ANY PAR-
TICULAR FONT, STYLE, SIZE, OR COLOR.

OWNER OF CANADA REG. NO. TMA733,711, DATED 1-30-2009, EXPIRES 1-30-2024.

SER. NO. 85-275,878, FILED 3-24-2011.

KARANENDRA S. CHHINA, EXAMINING ATTORNEY



David J. Kybas

Director of the United States Patent and Trademark Office

United States of America

United States Patent and Trademark Office

Home Affordable Foreclosure Alternatives

Reg. No. 4,066,377

Registered Dec. 6, 2011

Int. Cl.: 36

SERVICE MARK

PRINCIPAL REGISTER

UNITED STATES DEPARTMENT OF THE TREASURY (UNITED STATES AGENCY OF THE UNITED STATES GOVERNMENT)
OFFICE OF CHIEF COUNSEL - U.S. MINT
801 N. NINTH STREET, N.W.
WASHINGTON, DC 20220

FOR: MORTGAGE MITIGATION SERVICES, NAMELY, A UNITED STATES GOVERNMENT PROGRAM THAT PROVIDES FINANCIAL INCENTIVES TO PROMOTE USE OF FORECLOSURE ALTERNATIVES BY FINANCIAL INSTITUTIONS AND MORTGAGE SERVICERS FOR HOMEOWNERS WHO HAVE COMPLIED WITH SPECIAL REQUIREMENTS, IN CLASS 36 (U.S. CLS. 100, 101 AND 102).

FIRST USE 11-30-2009; IN COMMERCE 11-30-2009.

THE MARK CONSISTS OF STANDARD CHARACTERS WITHOUT CLAIM TO ANY PARTICULAR FONT, STYLE, SIZE, OR COLOR.

NO CLAIM IS MADE TO THE EXCLUSIVE RIGHT TO USE "HOME" AND "FORECLOSURE ALTERNATIVES", APART FROM THE MARK AS SHOWN.

SER. NO. 85-275,907, FILED 3-24-2011.

ARETHA SOMERVILLE, EXAMINING ATTORNEY



David J. Kybas

Director of the United States Patent and Trademark Office

United States of America

United States Patent and Trademark Office

STARFISH ETL

Reg. No. 4,066,378

Registered Dec. 6, 2011

Int. Cl.: 9

TRADEMARK

PRINCIPAL REGISTER

TECHNOLOGY ADVISORS, INC. (ILLINOIS CORPORATION)
SUITE 550
1111 E. TOUHY
DES PLAINES, IL 600185804

FOR: COMPUTER SOFTWARE FOR DATA EXTRACTION, TRANSFORMATION AND LOADING IN THE FIELDS OF DATABASE MANAGEMENT AND DATA WAREHOUSING , IN CLASS 9 (U.S. CLS. 21, 23, 26, 36 AND 38).

FIRST USE 11-0-2009; IN COMMERCE 11-0-2009.

THE MARK CONSISTS OF STANDARD CHARACTERS WITHOUT CLAIM TO ANY PARTICULAR FONT, STYLE, SIZE, OR COLOR.

NO CLAIM IS MADE TO THE EXCLUSIVE RIGHT TO USE "ETL", APART FROM THE MARK AS SHOWN.

SER. NO. 85-275,936, FILED 3-24-2011.

HEATHER THOMPSON, EXAMINING ATTORNEY



David J. Kyros

Director of the United States Patent and Trademark Office

United States of America

United States Patent and Trademark Office



Reg. No. 4,066,379

Registered Dec. 6, 2011

Int. Cl.: 11

TRADEMARK

PRINCIPAL REGISTER

FRIGITOWEL, LLC (SOUTH CAROLINA LIMITED LIABILITY COMPANY)
411 HIGHWAY 601 SOUTH
LUGOFF, SC 29078

FOR: CHEMICALLY ACTIVATED TOWELS NOT FOR MEDICAL USE, WHICH ARE SATURATED WITH NATURAL HERBS, MINERALS AND ESSENCE OILS, THAT PROVIDE A COOLING EFFECT ON PEOPLE IN HIGH TEMPERATURE ENVIRONMENTS BY LOWERING THE BODY CORE TEMPERATURE WHEN APPLIED ON ONE'S SELF, IN CLASS 11 (U.S. CLS. 13, 21, 23, 31 AND 34).

FIRST USE 11-23-2009; IN COMMERCE 12-15-2009.

NO CLAIM IS MADE TO THE EXCLUSIVE RIGHT TO USE "COOLING TOWELS", APART FROM THE MARK AS SHOWN.

THE MARK CONSISTS OF THE WORD "FRIGITOWEL" ABOVE THE WORDS "COOLING TOWELS" (IN A RECTANGLE). THESE LOWER WORDS END AND MERGE INTO A RECLINING POLAR BEAR, LEGS CROSSED, WEARING SUNGLASSES, AND A TOWEL AROUND HIS NECK.

SER. NO. 85-276,204, FILED 3-24-2011.

COLLEEN KEARNEY, EXAMINING ATTORNEY



David J. Kyros

Director of the United States Patent and Trademark Office

United States of America

United States Patent and Trademark Office



VESTALMAID

Reg. No. 4,066,380

Registered Dec. 6, 2011

Int. Cl.: 11

TRADEMARK

PRINCIPAL REGISTER

LAI KAM KEE COMPANY LIMITED (HONG KONG CORPORATION)
ROOM 9, 24TH FLOOR, WING FUNG INDUSTRIAL
40-50 SHA TSUI ROAD, TSUEN WAN
NEW TERRITORIES, HONG KONG

FOR: BEVERAGES COOLING APPARATUS; FREEZERS; FROZEN DESSERT DISPENSER; ICE BOXES; ICE CREAM FREEZERS; ICE CREAM MAKERS; ICE MACHINES AND APPARATUS; REFRIGERATED SHIPPING CONTAINERS; REFRIGERATING CABINETS; REFRIGERATING MACHINES; REFRIGERATORS, IN CLASS 11 (U.S. CLS. 13, 21, 23, 31 AND 34).

FIRST USE 3-8-2011; IN COMMERCE 3-8-2011.

THE MARK CONSISTS OF A WHITE CIRCLE AROUND A BLUE SPHERE WHEREIN THE STYLIZED DESIGN LOOSELY REPRESENTING THE LETTERS "VM" APPEARS IN WHITE AND ABOVE SUCH DESIGN IS THE SILHOUETTE OF A WOMAN'S HEAD IN WHITE. TO THE RIGHT OF THE CIRCLE DESIGN IS THE WORDING "VESTALMAID" IN BLACK STYLIZED LETTERS.

THE COLOR(S) BLUE, BLACK AND WHITE IS/ARE CLAIMED AS A FEATURE OF THE MARK.

THE WORDING "VESTALMAID" HAS NO MEANING IN A FOREIGN LANGUAGE.

SER. NO. 85-276,335, FILED 3-24-2011.

BARBARA BROWN, EXAMINING ATTORNEY



David J. Kyjars

Director of the United States Patent and Trademark Office

United States of America

United States Patent and Trademark Office

Exelene

Reg. No. 4,066,381

Registered Dec. 6, 2011

Int. Cl.: 1

TRADEMARK

PRINCIPAL REGISTER

MONTACHEM INTERNATIONAL, INC. (TEXAS CORPORATION)
1920 N. COMMERCE PARKWAY #3
WESTON, FL 33326

FOR: NATURAL AND SYNTHETIC PLASTIC AND RUBBER POLYMER COMPOSITIONS USED IN THE MANUFACTURE OF COMMERCIAL AND INDUSTRIAL GOODS; SYNTHETIC PLASTIC AND RUBBER RESINS FOR USE IN INDUSTRIAL AND COMMERCIAL MANUFACTURING INDUSTRIES, IN CLASS 1 (U.S. CLS. 1, 5, 6, 10, 26 AND 46).

FIRST USE 11-1-2006; IN COMMERCE 11-1-2006.

THE MARK CONSISTS OF STANDARD CHARACTERS WITHOUT CLAIM TO ANY PARTICULAR FONT, STYLE, SIZE, OR COLOR.

SER. NO. 85-276,379, FILED 3-24-2011.

KATHERINE CHANG, EXAMINING ATTORNEY



David J. Kybas

Director of the United States Patent and Trademark Office

United States of America

United States Patent and Trademark Office



Reg. No. 4,066,382

Registered Dec. 6, 2011

Int. Cl.: 17

TRADEMARK

PRINCIPAL REGISTER

WORTHINGTON PRODUCTS, INC. (OHIO CORPORATION)
3405 KUEMERLE AVE., NE
CANTON, OH 44705

FOR: BARRIER CURTAINS IN THE NATURE OF FLOATING BAFFLES OR BOOMS FOR THE CONTAINMENT OF POLLUTANTS, IN CLASS 17 (U.S. CLS. 1, 5, 12, 13, 35 AND 50).

FIRST USE 1-1-2011; IN COMMERCE 1-1-2011.

NO CLAIM IS MADE TO THE EXCLUSIVE RIGHT TO USE "WATERWAY BARRIERS", APART FROM THE MARK AS SHOWN.

THE COLOR(S) ORANGE, BLACK, WHITE, GRAY AND BLUE IS/ARE CLAIMED AS A FEATURE OF THE MARK.

THE MARK CONSISTS OF A GRAY MUSCULAR EAGLE FIGURE WITH A WHITE HEAD AND CHEST, BLACK EYE, AND ORANGE BEAK ALL OUTLINED IN BLACK, LEANING ON AN END-VIEW PERSPECTIVE OF AN ORANGE WATERWAY BARRIER OUTLINED IN BLACK ALSO DEPICTING THE INTERIOR STEEL CHANNEL WITHIN THE BARRIER DEVICE IN GRAY AND OUTLINED IN BLACK. THE WORD "WORTHINGTON" IS OVERLAID IN CAPITAL LETTERS IN THE COLOR BLUE ACROSS THE CUTAWAY VIEW AND THE WORDS "WATERWAY BARRIERS" IN BLUE ARE DEPICTED IN LOWERCASE LETTERS POSITIONED BELOW THE WORD "WORTHINGTON".

SER. NO. 85-276,405, FILED 3-24-2011.

CHARLOTTE CORWIN, EXAMINING ATTORNEY



David J. Kybas

Director of the United States Patent and Trademark Office

United States of America

United States Patent and Trademark Office



Reg. No. 4,066,383

Registered Dec. 6, 2011

Int. Cl.: 17

TRADEMARK

PRINCIPAL REGISTER

WORTHINGTON PRODUCTS, INC. (OHIO CORPORATION)
3405 KUEMERLE AVE., NE
CANTON, OH 44705

FOR: BARRIER CURTAINS IN THE NATURE OF FLOATING BAFFLES OR BOOMS FOR THE CONTAINMENT OF POLLUTANTS, IN CLASS 17 (U.S. CLS. 1, 5, 12, 13, 35 AND 50).

FIRST USE 1-1-2011; IN COMMERCE 3-15-2011.

NO CLAIM IS MADE TO THE EXCLUSIVE RIGHT TO USE "WATERWAY BARRIERS", APART FROM THE MARK AS SHOWN.

THE COLOR(S) ORANGE, BLACK, WHITE, GRAY AND BLUE IS/ARE CLAIMED AS A FEATURE OF THE MARK.

THE MARK CONSISTS OF GRAY MUSCULAR EAGLE FIGURE WITH A WHITE HEAD AND CHEST, BLACK EYE, AND ORANGE BEAK ALL OUTLINED IN BLACK, LEANING ON THE CAPITALIZED WORD "WORTHINGTON" IN ORANGE WITH BLACK SHADOWING AND THE WORDS "WATERWAY BARRIERS" IN BLUE ARE POSITIONED BELOW THE WORD "WORTHINGTON" AND SEPARATED BY A THIN BLUE LINE.

SER. NO. 85-276,428, FILED 3-24-2011.

CHARLOTTE CORWIN, EXAMINING ATTORNEY



David J. Kybas

Director of the United States Patent and Trademark Office

United States of America

United States Patent and Trademark Office

THE MESSAGE PIN

Reg. No. 4,066,384

Registered Dec. 6, 2011

Int. Cl.: 10

TRADEMARK

PRINCIPAL REGISTER

RICE, DAVID A. (UNITED STATES INDIVIDUAL), DBA BALANCE POINT MASSAGE
3910 NORMAL STREET, SUITE A
SAN DIEGO, CA 92103

FOR: MESSAGE APPARATUS, IN CLASS 10 (U.S. CLS. 26, 39 AND 44).

FIRST USE 3-22-2011; IN COMMERCE 3-22-2011.

THE MARK CONSISTS OF STANDARD CHARACTERS WITHOUT CLAIM TO ANY PARTICULAR FONT, STYLE, SIZE, OR COLOR.

NO CLAIM IS MADE TO THE EXCLUSIVE RIGHT TO USE "MESSAGE", APART FROM THE MARK AS SHOWN.

SER. NO. 85-276,441, FILED 3-25-2011.

JAY FLOWERS, EXAMINING ATTORNEY



David J. Kybas

Director of the United States Patent and Trademark Office

United States of America

United States Patent and Trademark Office

NITEK

Reg. No. 4,066,385

H&H SPORTS PROTECTION USA INC. (CALIFORNIA CORPORATION)
10660 EL POCHE ST
SOUTH EL MONTE, CA 91733

Registered Dec. 6, 2011

Int. Cls.: 9, 12, 25 and 28

FOR: CLOTHING FOR PROTECTION AGAINST CHEMICALS AND RADIATION; FACE-PROTECTION SHIELDS; HELMETS FOR MOTORCYCLISTS; PROTECTIVE EYEWEAR; PROTECTIVE HELMETS; PROTECTIVE WORK GLOVES; SAFETY GOGGLES; SWIMMING GOGGLES, IN CLASS 9 (U.S. CLS. 21, 23, 26, 36 AND 38).

TRADEMARK

PRINCIPAL REGISTER

FIRST USE 11-4-2010; IN COMMERCE 11-4-2010.

FOR: BICYCLE BELLS; BICYCLE PUMPS; BICYCLES; CARS; MOTORCYCLES; REARVIEW MIRRORS, IN CLASS 12 (U.S. CLS. 19, 21, 23, 31, 35 AND 44).

FIRST USE 11-4-2010; IN COMMERCE 11-4-2010.

FOR: ATHLETIC UNIFORMS; GLOVES; HATS; HOSIERY; OVERCOATS; RAINWEAR; SCARVES; SHOES; SPORT COATS; TROUSERS , IN CLASS 25 (U.S. CLS. 22 AND 39).

FIRST USE 11-4-2010; IN COMMERCE 11-4-2010.

FOR: BAGS SPECIALLY ADAPTED FOR SPORTS EQUIPMENT; ELBOW GUARDS FOR ATHLETIC USE; EXERCISE BARS; EXERCISE BENCHES; ICE SKATES; KNEE PADS FOR ATHLETIC USE; MOUTH GUARDS FOR ATHLETIC USE; SHIN GUARDS FOR ATHLETIC USE; SNOW SKIS; WATER SKIS, IN CLASS 28 (U.S. CLS. 22, 23, 38 AND 50).

FIRST USE 11-4-2010; IN COMMERCE 11-4-2010.

THE MARK CONSISTS OF STYLIZED WORD "NITEK".

SER. NO. 85-276,476, FILED 3-25-2011.

SIMON TENG, EXAMINING ATTORNEY



David J. Kyros

Director of the United States Patent and Trademark Office

United States of America

United States Patent and Trademark Office

Reneu

Reg. No. 4,066,386

Registered Dec. 6, 2011

Int. Cl.: 25

TRADEMARK

PRINCIPAL REGISTER

NEU AURA, INC. (NEW JERSEY CORPORATION)
510 MONROE STREET #403
HOBOKEN, NJ 07030

FOR: WOMEN'S SHOES, IN CLASS 25 (U.S. CLS. 22 AND 39).

FIRST USE 3-25-2011; IN COMMERCE 3-25-2011.

THE MARK CONSISTS OF STANDARD CHARACTERS WITHOUT CLAIM TO ANY PARTICULAR FONT, STYLE, SIZE, OR COLOR.

SER. NO. 85-276,826, FILED 3-25-2011.

ANNE FARRELL, EXAMINING ATTORNEY



David J. Kybas

Director of the United States Patent and Trademark Office

United States of America

United States Patent and Trademark Office

GAY CHICAGO

Reg. No. 4,066,387

Registered Dec. 6, 2011

Int. Cl.: 16

TRADEMARK

PRINCIPAL REGISTER

GAY CHICAGO FOUNDATION FOR LGBT EDUCATION AND RESEARCH (ILLINOIS
NON-PROFIT CORPORATION)
723 W. BELMONT AVE
CHICAGO, IL 60657

FOR: PERIODIC NEWSPAPER OF GENERAL INFORMATION AND COMMUNITY NEWS,
IN CLASS 16 (U.S. CLS. 2, 5, 22, 23, 29, 37, 38 AND 50).

FIRST USE 6-20-1976; IN COMMERCE 5-26-1977.

THE MARK CONSISTS OF STANDARD CHARACTERS WITHOUT CLAIM TO ANY PAR-
TICULAR FONT, STYLE, SIZE, OR COLOR.

SEC. 2(F).

SER. NO. 85-277,196, FILED 3-25-2011.

JAMES LOVELACE, EXAMINING ATTORNEY



David J. Kybas

Director of the United States Patent and Trademark Office

United States of America

United States Patent and Trademark Office

U-V-BLOCK

Reg. No. 4,066,388

Registered Dec. 6, 2011

Int. Cl.: 1

TRADEMARK

PRINCIPAL REGISTER

ATSKO, INC. (ILLINOIS CORPORATION)
2664 RUSSELL STREET
ORANGEBURG, SC 29115

FOR: CHEMICAL PREPARATIONS TO BE APPLIED TO TEXTILES, PLASTICS AND COATINGS FOR ABSORBING ULTRAVIOLET LIGHT; CHEMICAL PREPARATIONS TO BE APPLIED TO TEXTILES, PLASTICS AND COATINGS TO PREVENT DAMAGE FROM ULTRAVIOLET LIGHT; CHEMICAL PREPARATIONS TO BE APPLIED TO TEXTILES, PLASTICS AND COATINGS TO PREVENT THE PENETRATION OF ULTRAVIOLET LIGHT, IN CLASS 1 (U.S. CLS. 1, 5, 6, 10, 26 AND 46).

FIRST USE 5-29-1990; IN COMMERCE 5-29-1990.

THE MARK CONSISTS OF STANDARD CHARACTERS WITHOUT CLAIM TO ANY PARTICULAR FONT, STYLE, SIZE, OR COLOR.

OWNER OF U.S. REG. NOS. 1,675,653 AND 2,611,254.

SEC. 2(F).

SER. NO. 85-277,381, FILED 3-25-2011.

THEODORE MCBRIDE, EXAMINING ATTORNEY



David J. Kyffers

Director of the United States Patent and Trademark Office

United States of America

United States Patent and Trademark Office

Brella Binder

Reg. No. 4,066,389

Registered Dec. 6, 2011

Int. Cl.: 18

TRADEMARK

PRINCIPAL REGISTER

DIANE R. SCHMIDT-KRINGS (UNITED STATES INDIVIDUAL)
3120-Z 25TH ST S, STE 355
FARGO, ND 581035054

FOR: PATIO UMBRELLA SECURING DEVICE, NAMELY, AN UMBRELLA STRAP, IN CLASS 18 (U.S. CLS. 1, 2, 3, 22 AND 41).

FIRST USE 3-25-2011; IN COMMERCE 3-25-2011.

THE MARK CONSISTS OF STANDARD CHARACTERS WITHOUT CLAIM TO ANY PARTICULAR FONT, STYLE, SIZE, OR COLOR.

NO CLAIM IS MADE TO THE EXCLUSIVE RIGHT TO USE "BINDER", APART FROM THE MARK AS SHOWN.

SER. NO. 85-277,418, FILED 3-25-2011.

MARK SHINER, EXAMINING ATTORNEY



David J. Kybas

Director of the United States Patent and Trademark Office

United States of America

United States Patent and Trademark Office

OpsDog

Reg. No. 4,066,390

Registered Dec. 6, 2011

Int. Cl.: 35

SERVICE MARK

PRINCIPAL REGISTER

OPSDOG, INC. (DELAWARE CORPORATION)
1502 AUGUSTA DRIVE, SUITE 312
HOUSTON, TX 77057

FOR: PROVIDING A WEBSITE FEATURING COMMERCIAL BUSINESS OPERATION AND MANAGEMENT IMPROVEMENT INFORMATION, IN CLASS 35 (U.S. CLS. 100, 101 AND 102).

FIRST USE 1-7-2011; IN COMMERCE 1-7-2011.

THE MARK CONSISTS OF STANDARD CHARACTERS WITHOUT CLAIM TO ANY PARTICULAR FONT, STYLE, SIZE, OR COLOR.

SER. NO. 85-277,431, FILED 3-25-2011.

TARA PATE, EXAMINING ATTORNEY



David J. Kyffers

Director of the United States Patent and Trademark Office

United States of America

United States Patent and Trademark Office



Reg. No. 4,066,391

Registered Dec. 6, 2011

Int. Cl.: 36

SERVICE MARK

PRINCIPAL REGISTER

RUTZ, ANTHONY JAMES (UNITED STATES INDIVIDUAL)
50 CALIFORNIA ST. SUITE 1500
SAN FRANCISCO, CA 94111

FOR: REAL ESTATE BROKERAGE, IN CLASS 36 (U.S. CLS. 100, 101 AND 102).

FIRST USE 7-14-2011; IN COMMERCE 7-14-2011.

THE MARK CONSISTS OF GREEN LETTERS IN THE TERM "REVO" CONNECTING TO EACH OTHER OUTLINED IN BLACK. IN STYLIZED LETTERS WITH THE "R" HAVING A SHAPE OF A HOUSE WITHIN ITS BASE LINES INCLUDING TWO WINDOWS AND A DOOR OUTLINED IN BLACK AND WITHIN THE CENTER OF THE "O" HAVING A GLOBE WITH OUTLINED CONTINENTS. THE BLUE COLOR FILLS IN THE GLOBE WHILE THE CONTINENTS ARE GREEN WITH BLACK OUTLINE.

THE COLOR(S) BLUE, GREEN, AND BLACK IS/ARE CLAIMED AS A FEATURE OF THE MARK.

SER. NO. 85-277,482, FILED 3-25-2011.

LESLEY LAMOTHE, EXAMINING ATTORNEY



David J. Kybas

Director of the United States Patent and Trademark Office

United States of America

United States Patent and Trademark Office

303

Reg. No. 4,066,392

Registered Dec. 6, 2011

Int. Cl.: 3

TRADEMARK

PRINCIPAL REGISTER

303 PRODUCTS, INC. (CALIFORNIA CORPORATION)
10801 STARWOOD DRIVE
PALO CEDRO, CA 96073

FOR: ALL PURPOSE CLEANERS AND DEGREASING PREPARATIONS, NOT USED IN MANUFACTURING PROCESSES, IN THE NATURE OF A SOLVENT FOR USE IN CLEANING FABRICS AND MACHINERY PARTS , IN CLASS 3 (U.S. CLS. 1, 4, 6, 50, 51 AND 52).

FIRST USE 6-15-2004; IN COMMERCE 6-15-2004.

THE MARK CONSISTS OF STANDARD CHARACTERS WITHOUT CLAIM TO ANY PARTICULAR FONT, STYLE, SIZE, OR COLOR.

OWNER OF U.S. REG. NOS. 2,634,678 AND 2,682,650.

SER. NO. 85-277,705, FILED 3-25-2011.

CHRISTINE COOPER, EXAMINING ATTORNEY



David J. Kybas

Director of the United States Patent and Trademark Office

United States of America

United States Patent and Trademark Office

Mr. Winkle

Reg. No. 4,066,393

Registered Dec. 6, 2011

Int. Cl.: 16

TRADEMARK

PRINCIPAL REGISTER

REGAN, LARA JO (UNITED STATES INDIVIDUAL)
607 BUENA LOMA ST.
ALTADENA, CA 91001

FOR: PAPER GOODS AND PRINTED MATERIAL, NAMELY, PICTURE BOOKS, WALL CALENDARS, CHILDREN'S BOOKS, FICTION BOOKS, GIFT BOOKS FEATURING PHOTOS OF A DOG CHARACTER, GREETING CARDS, AND BOOKMARKS, ALL THE ABOVE GOODS FEATURING PICTURES AND PHOTOGRAPHS OF A DOG CHARACTER, IN CLASS 16 (U.S. CLS. 2, 5, 22, 23, 29, 37, 38 AND 50).

FIRST USE 8-15-2000; IN COMMERCE 8-15-2000.

THE MARK CONSISTS OF STANDARD CHARACTERS WITHOUT CLAIM TO ANY PARTICULAR FONT, STYLE, SIZE, OR COLOR.

OWNER OF U.S. REG. NO. 2,940,503.

SER. NO. 85-277,750, FILED 3-26-2011.

ROBERT STRUCK, EXAMINING ATTORNEY



David J. Kyffers

Director of the United States Patent and Trademark Office

United States of America

United States Patent and Trademark Office

N-PRIZE

Reg. No. 4,066,394

Registered Dec. 6, 2011

Int. Cls.: 35 and 41

SERVICE MARK

PRINCIPAL REGISTER

X PRIZE FOUNDATION, INC. (DELAWARE CORPORATION)
STE 100
5510 LINCOLN BOULEVARD
PLAYA VISTA, CA 90094

FOR: PROMOTING AWARENESS OF THE NEED FOR THE DEVELOPMENT AND CREATION OF TECHNOLOGICAL INNOVATIONS AND INVENTIONS, IN CLASS 35 (U.S. CLS. 100, 101 AND 102).

FIRST USE 11-18-2008; IN COMMERCE 11-18-2008.

FOR: ENTERTAINMENT SERVICES IN THE NATURE OF CONDUCTING COMPETITIONS AND AWARDING INCENTIVES AND PRIZES RELATING TO THE DEVELOPMENT AND CREATION OF TECHNOLOGICAL INNOVATIONS AND INVENTIONS, IN CLASS 41 (U.S. CLS. 100, 101 AND 107).

FIRST USE 11-18-2008; IN COMMERCE 11-18-2008.

THE MARK CONSISTS OF STANDARD CHARACTERS WITHOUT CLAIM TO ANY PARTICULAR FONT, STYLE, SIZE, OR COLOR.

SER. NO. 85-277,772, FILED 3-26-2011.

CURTIS FRENCH, EXAMINING ATTORNEY



David J. Kyjars

Director of the United States Patent and Trademark Office

United States of America

United States Patent and Trademark Office

XPRIZE

Reg. No. 4,066,395

Registered Dec. 6, 2011

Int. Cls.: 35 and 41

SERVICE MARK

PRINCIPAL REGISTER

X PRIZE FOUNDATION, INC. (DELAWARE CORPORATION)
STE 100
5510 LINCOLN BOULEVARD
PLAYA VISTA, CA 90094

FOR: PROMOTING AWARENESS OF THE NEED FOR THE DEVELOPMENT AND CREATION OF TECHNOLOGICAL INNOVATIONS AND INVENTIONS, IN CLASS 35 (U.S. CLS. 100, 101 AND 102).

FIRST USE 11-23-2004; IN COMMERCE 11-23-2004.

FOR: ENTERTAINMENT SERVICES IN THE NATURE OF CONDUCTING COMPETITIONS AND AWARDED INCENTIVES AND PRIZES RELATING TO THE DEVELOPMENT AND CREATION OF TECHNOLOGICAL INNOVATIONS AND INVENTIONS, IN CLASS 41 (U.S. CLS. 100, 101 AND 107).

FIRST USE 11-23-2004; IN COMMERCE 11-23-2004.

THE MARK CONSISTS OF STANDARD CHARACTERS WITHOUT CLAIM TO ANY PARTICULAR FONT, STYLE, SIZE, OR COLOR.

SER. NO. 85-277,775, FILED 3-26-2011.

CURTIS FRENCH, EXAMINING ATTORNEY



David J. Kyjars

Director of the United States Patent and Trademark Office

United States of America

United States Patent and Trademark Office

JAIJAI

Reg. No. 4,066,396

Registered Dec. 6, 2011

Int. Cl.: 41

SERVICE MARK

PRINCIPAL REGISTER

NATOYA M HANDY (UNITED STATES INDIVIDUAL), AKA JAI JAI
2220 NW 167 STREET
OPA LOCKA, FL 33054

FOR: ENTERTAINMENT INFORMATION SERVICES, NAMELY, PROVIDING INFORMATION AND NEWS RELEASES ABOUT A MUSICAL ARTIST; ENTERTAINMENT SERVICES BY A MUSICAL ARTIST AND PRODUCER, NAMELY, MUSICAL COMPOSITION FOR OTHERS AND PRODUCTION OF MUSICAL SOUND RECORDINGS; ENTERTAINMENT SERVICES IN THE NATURE OF LIVE MUSICAL PERFORMANCES; ENTERTAINMENT SERVICES, NAMELY, DANCE EVENTS BY A RECORDING ARTIST; ENTERTAINMENT SERVICES, NAMELY, PERFORMING AND COMPETING IN MOTOR SPORTS EVENTS; ENTERTAINMENT SERVICES, NAMELY, PROVIDING INFORMATION ABOUT A RECORDING ARTIST VIA AN ONLINE NETWORK; ENTERTAINMENT SERVICES, NAMELY, WRESTLING EXHIBITS AND PERFORMANCES BY A PROFESSIONAL WRESTLER AND ENTERTAINER; ENTERTAINMENT, NAMELY, LIVE PERFORMANCES BY A MUSICAL BAND; ENTERTAINMENT, NAMELY, LIVE PERFORMANCES BY MUSICAL BANDS; ENTERTAINMENT, NAMELY, LIVE PERFORMANCES BY ROCK GROUPS; LIVE AERIAL ACROBATIC PERFORMANCES ON FABRIC, HOOP, TRAPEZE, AERIAL AND YOGA HAMMOCK, CORDE LISSE, NET, AND BUNGEE; LIVE PERFORMANCES BY A MUSICAL GROUP; LIVE PERFORMANCES FEATURING PRERECORDED VOCAL AND INSTRUMENTAL PERFORMANCES VIEWED ON A BIG SCREEN; MAINTAINING RECORDS AND CERTIFYING RECORD PERFORMANCES OF AMATEUR ATHLETES; MODELING FOR ARTISTS; MODELLING FOR ARTISTS; PERFORMANCE HALL RENTAL SERVICES, IN CLASS 41 (U.S. CLS. 100, 101 AND 107).

FIRST USE 8-23-2003; IN COMMERCE 1-23-2004.

THE MARK CONSISTS OF STANDARD CHARACTERS WITHOUT CLAIM TO ANY PARTICULAR FONT, STYLE, SIZE, OR COLOR.

THE NAME(S), PORTRAIT(S), AND/OR SIGNATURE(S) SHOWN IN THE MARK IDENTIFIES THE STAGE NAME OR NICKNAME OF NATOYA M HANDY, AKA "JAI JAI", A LIVING INDIVIDUAL WHOSE CONSENT IS OF RECORD

THE WORDING "JAI JAI" HAS NO MEANING IN A FOREIGN LANGUAGE.



David J. Kybas

Director of the United States Patent and Trademark Office

Reg. No. 4,066,396 SER. NO. 85-277,844, FILED 3-26-2011.

B. PARADEWELAI, EXAMINING ATTORNEY

United States of America

United States Patent and Trademark Office



Reg. No. 4,066,397

Registered Dec. 6, 2011

Int. Cl.: 19

TRADEMARK

PRINCIPAL REGISTER

CHINA FORESTRY INDUSTRY GROUP, INC. (CHINA CORPORATION)
3/F JUNYUEHUATING MANSION, XINHUA ROAD
GUIYANG, CHINA

FOR: WOODEN FLOORING, IN CLASS 19 (U.S. CLS. 1, 12, 33 AND 50).

FIRST USE 6-14-1998; IN COMMERCE 6-14-1998.

THE MARK CONSISTS OF THE LETTER "Y" WITHIN WHICH IS A FLYING SWALLOW.
UNDERNEATH THE "Y" LETTER ARE THE WORDS "SILVAN TOUCH" IN A RECTANGLE.

SER. NO. 85-278,133, FILED 3-27-2011.

ANGELA M. MICHELI, EXAMINING ATTORNEY



David J. Kybas

Director of the United States Patent and Trademark Office

United States of America

United States Patent and Trademark Office

LET THE GOAT TIMES ROLL

Reg. No. 4,066,398

Registered Dec. 6, 2011

Int. Cl.: 25

TRADEMARK

PRINCIPAL REGISTER

THE TIPSY GOAT LLC (CALIFORNIA LIMITED LIABILITY COMPANY)
159 EAST THOUSAND OAKS BOULEVARD
THOUSAND OAKS, CA 91360

FOR: CLOTHING, NAMELY, T-SHIRTS, SWEATSHIRTS AND SHORTS, ALL FOR USE IN CONNECTION WITH THE RESTAURANT AND BAR SERVICES, IN CLASS 25 (U.S. CLS. 22 AND 39).

FIRST USE 11-25-2010; IN COMMERCE 3-24-2011.

THE MARK CONSISTS OF STANDARD CHARACTERS WITHOUT CLAIM TO ANY PARTICULAR FONT, STYLE, SIZE, OR COLOR.

SER. NO. 85-278,431, FILED 3-28-2011.

COLLEEN DOMBROW, EXAMINING ATTORNEY



David J. Kybas

Director of the United States Patent and Trademark Office

United States of America

United States Patent and Trademark Office

SMARTOPTIONS

Reg. No. 4,066,399

Registered Dec. 6, 2011

Int. Cl.: 35

SERVICE MARK

PRINCIPAL REGISTER

PHARMACAN PHARMACY INNOVATIONS INC. (CANADA CORPORATION)
176 CREEK PATH AVENUE
OAKVILLE, ONTARIO, CANADA L6L6T5

FOR: RETAIL PHARMACY SERVICES, IN CLASS 35 (U.S. CLS. 100, 101 AND 102).

THE MARK CONSISTS OF STANDARD CHARACTERS WITHOUT CLAIM TO ANY PARTICULAR FONT, STYLE, SIZE, OR COLOR.

OWNER OF CANADA REG. NO. TMA781356, DATED 11-2-2010, EXPIRES 11-2-2025.

SER. NO. 85-278,438, FILED 3-28-2011.

PAUL F. GAST, EXAMINING ATTORNEY



David J. Kybas

Director of the United States Patent and Trademark Office

United States of America

United States Patent and Trademark Office

CAREADVANCE PROVIDER

Reg. No. 4,066,400

Registered Dec. 6, 2011

Int. Cls.: 9 and 42

TRADEMARK

SERVICE MARK

PRINCIPAL REGISTER

THE TRIZETTO GROUP, INC. (DELAWARE CORPORATION)
6061 S. WILLOW DRIVE
GREENWOOD VILLAGE, CO 80111

FOR: COMPUTER SOFTWARE FOR HEALTH CARE PLAN MANAGEMENT AND ADMINISTRATION; COMPUTER SOFTWARE TO ENABLE THE PROVISION OF HEALTH CARE AND INSURANCE INFORMATION, IN CLASS 9 (U.S. CLS. 21, 23, 26, 36 AND 38).

FIRST USE 1-11-2011; IN COMMERCE 1-11-2011.

FOR: APPLICATION SERVICE PROVIDER (ASP) FEATURING SOFTWARE FOR HEALTH CARE PLAN MANAGEMENT AND ADMINISTRATION; APPLICATION SERVICE PROVIDER (ASP) TO ENABLE THE PROVISION OF HEALTH CARE AND INSURANCE INFORMATION, IN CLASS 42 (U.S. CLS. 100 AND 101).

FIRST USE 1-11-2011; IN COMMERCE 1-11-2011.

THE MARK CONSISTS OF STANDARD CHARACTERS WITHOUT CLAIM TO ANY PARTICULAR FONT, STYLE, SIZE, OR COLOR.

OWNER OF U.S. REG. NOS. 3,279,035, 3,279,153, AND 3,279,154.

NO CLAIM IS MADE TO THE EXCLUSIVE RIGHT TO USE "PROVIDER", APART FROM THE MARK AS SHOWN.

SER. NO. 85-278,522, FILED 3-28-2011.

JUSTINE D. PARKER, EXAMINING ATTORNEY



David J. Kybas

Director of the United States Patent and Trademark Office

United States of America

United States Patent and Trademark Office



Reg. No. 4,066,401

Registered Dec. 6, 2011

Int. Cl.: 44

SERVICE MARK

PRINCIPAL REGISTER

WASHINGTON BRAIN & SPINE INSTITUTE (D.C. PROFESSIONAL CORPORATION)
4927 AUBURN AVENUE
BETHESDA, MD 20814

FOR: MEDICAL SERVICES; PROVIDING COMPLETE MEDICAL TREATMENT FOR AILMENTS, DISEASES AND INJURIES OF THE SPINE AND PERIPHERAL NERVES; PROVIDING AN ON-LINE ELECTRONIC DATABASE ON A GLOBAL COMPUTER NETWORK IN THE FIELD OF COMPLETE MEDICAL TREATMENT FOR AILMENTS, DISEASES AND INJURIES OF THE SPINE AND PERIPHERAL NERVES, IN CLASS 44 (U.S. CLS. 100 AND 101).

FIRST USE 9-1-1996; IN COMMERCE 2-1-1997.

THE MARK CONSISTS OF A STYLIZED REPRESENTATION OF A BRAIN STEM AND A SPINAL CORD.

SER. NO. 85-278,602, FILED 3-28-2011.

JUSTINE D. PARKER, EXAMINING ATTORNEY



David J. Kybas

Director of the United States Patent and Trademark Office

United States of America

United States Patent and Trademark Office

VSTROKER

Reg. No. 4,066,402

Registered Dec. 6, 2011

Int. Cls.: 9 and 35

TRADEMARK

SERVICE MARK

PRINCIPAL REGISTER

DIGITECH MEDIA, LLC (OREGON LIMITED LIABILITY COMPANY)
1957 W. BURNSIDE 1714
PORTLAND, OR 97209

FOR: CONTROL UNITS FOR INTERACTIVE COMPUTER GAMES; PRE-RECORDED VIDEOS FEATURING ADULT-THEMED ENTERTAINMENT; DOWNLOADABLE MULTI-MEDIA VIDEO FILES FEATURING ADULT-THEMED ENTERTAINMENT, IN CLASS 9 (U.S. CLS. 21, 23, 26, 36 AND 38).

FIRST USE 7-31-2010; IN COMMERCE 7-31-2010.

FOR: ON-LINE RETAIL STORE SERVICES FEATURING INTERACTIVE COMPUTER GAMES AND PRE-RECORDED VIDEOS, IN CLASS 35 (U.S. CLS. 100, 101 AND 102).

FIRST USE 7-31-2010; IN COMMERCE 7-31-2010.

THE MARK CONSISTS OF STANDARD CHARACTERS WITHOUT CLAIM TO ANY PARTICULAR FONT, STYLE, SIZE, OR COLOR.

SER. NO. 85-278,788, FILED 3-28-2011.

ESTHER A. BORSUK, EXAMINING ATTORNEY



David J. Kypos

Director of the United States Patent and Trademark Office

United States of America

United States Patent and Trademark Office

BAGEL BUSTER

Reg. No. 4,066,403

Registered Dec. 6, 2011

Int. Cl.: 25

TRADEMARK

PRINCIPAL REGISTER

SPANX, INC. (GEORGIA CORPORATION)
SUITE 1700
3344 PEACHTREE ROAD, NE
ATLANTA, GA 30326

FOR: CLOTHING, NAMELY, BODY SHAPERS, CAMISOLES, SHIRTS AND PANTS, IN CLASS 25 (U.S. CLS. 22 AND 39).

FIRST USE 6-30-2011; IN COMMERCE 6-30-2011.

THE MARK CONSISTS OF STANDARD CHARACTERS WITHOUT CLAIM TO ANY PARTICULAR FONT, STYLE, SIZE, OR COLOR.

SER. NO. 85-278,932, FILED 3-28-2011.

ELLEN BURNS, EXAMINING ATTORNEY



David J. Kybas

Director of the United States Patent and Trademark Office

United States of America

United States Patent and Trademark Office



Reg. No. 4,066,404

Registered Dec. 6, 2011

Int. Cl.: 42

SERVICE MARK

PRINCIPAL REGISTER

HAZMAT GLOBAL SOLUTIONS, LLC (CALIFORNIA LIMITED LIABILITY COMPANY)
65 HOLLINS DRIVE
SANTA CRUZ, CA 95060

FOR: CONSULTATION IN THE FIELD OF HEALTH RISK ASSESSMENT, NAMELY, PREDICTION AND ASSESSMENT OF HEALTH RISKS TO PUBLIC AND PRIVATE AGENCIES, FACILITIES, INDIVIDUALS AND LOCATIONS FOLLOWING AN ACCIDENTAL OR TERRORIST CAUSED RELEASE OF CHEMICAL, BIOLOGICAL, RADIOLOGICAL OR NUCLEAR MATERIALS, IN CLASS 42 (U.S. CLS. 100 AND 101).

FIRST USE 3-15-2011; IN COMMERCE 3-15-2011.

NO CLAIM IS MADE TO THE EXCLUSIVE RIGHT TO USE "HAZMAT GLOBAL SOLUTIONS", APART FROM THE MARK AS SHOWN.

THE COLOR(S) BLACK, BLUE, YELLOW AND RED IS/ARE CLAIMED AS A FEATURE OF THE MARK.

THE MARK CONSISTS OF THE STYLIZED TEXT "HAZMAT GLOBAL SOLUTIONS" IN BLACK PLACED IN A CIRCLE AROUND A LINED GLOBE WHOSE LINES CONTAIN THE LETTERS "H", "G", AND "S". THE OUTLINE OF THE GLOBE AND THE LINES INSIDE IT ARE BLACK, AND THE VARIOUS SECTIONS FORMED BY THE LINES ARE FILLED WITH RED, YELLOW, AND BLUE. THE COLOR WHITE REPRESENTS BACKGROUND, OUTLINING, SHADING AND/OR TRANSPARENT AREAS AND IS NOT PART OF THE MARK.

SER. NO. 85-279,069, FILED 3-28-2011.

ROBIN MITTLER, EXAMINING ATTORNEY



David J. Kybas

Director of the United States Patent and Trademark Office

United States of America

United States Patent and Trademark Office



Reg. No. 4,066,405

Registered Dec. 6, 2011

Int. Cl.: 36

SERVICE MARK

PRINCIPAL REGISTER

MACRO CONSULTING GROUP (NEW JERSEY LIMITED LIABILITY COMPANY)
1ST FLOOR
1639 ROUTE 10 EAST
PARSIPPANY, NJ 07054

FOR: FINANCIAL ASSET MANAGEMENT; INVESTMENT ADVISORY SERVICES, IN CLASS 36 (U.S. CLS. 100, 101 AND 102).

FIRST USE 2-16-2011; IN COMMERCE 2-16-2011.

NO CLAIM IS MADE TO THE EXCLUSIVE RIGHT TO USE "FLAT FEE PORTFOLIOS", APART FROM THE MARK AS SHOWN.

THE MARK CONSISTS OF THE STYLIZED TEXT "FF FLATFEE PORTFOLIOS ANY SIZE ACCOUNT, ONE SMALL FEE. IT'S THAT SIMPLE." WITH THE SECOND "F" IN "FF" ON A SQUARE-LIKE BACKGROUND.

SER. NO. 85-279,167, FILED 3-28-2011.

HOWARD B. LEVINE, EXAMINING ATTORNEY



David J. Kybas

Director of the United States Patent and Trademark Office

United States of America

United States Patent and Trademark Office

SAMMI SWEETHEART

Reg. No. 4,066,406

Registered Dec. 6, 2011

Int. Cl.: 41

SERVICE MARK

PRINCIPAL REGISTER

SRG SWEETHEART, LLC (NEW JERSEY LIMITED LIABILITY COMPANY)
10 EVERGREEN STREET
HAZLET, NJ 07730

FOR: ENTERTAINMENT SERVICES, NAMELY, LIVE, TELEVISED AND MOVIE APPEARANCES BY A PROFESSIONAL ENTERTAINER; ENTERTAINMENT SERVICES, NAMELY, PERSONAL APPEARANCES BY A CELEBRITY, IN CLASS 41 (U.S. CLS. 100, 101 AND 107).

FIRST USE 12-3-2009; IN COMMERCE 12-3-2009.

THE MARK CONSISTS OF STANDARD CHARACTERS WITHOUT CLAIM TO ANY PARTICULAR FONT, STYLE, SIZE, OR COLOR.

THE NAME(S), PORTRAIT(S), AND/OR SIGNATURE(S) SHOWN IN THE MARK IDENTIFIES SAMANTHA GIANCOLA, WHOSE CONSENT(S) TO REGISTER IS MADE OF RECORD.

SER. NO. 85-279,266, FILED 3-28-2011.

JACLYN KIDWELL WALKER, EXAMINING ATTORNEY



David J. Kyros

Director of the United States Patent and Trademark Office

United States of America

United States Patent and Trademark Office

GRACEFIELDS

Reg. No. 4,066,407

Registered Dec. 6, 2011

Int. Cl.: 35

SERVICE MARK

PRINCIPAL REGISTER

RETAIL VANGUARD, INCORPORATED (FLORIDA CORPORATION)
2905 SAN ISIDRO STREET
TAMPA, FL 33629

FOR: RETAIL STORE AND ON-LINE RETAIL STORE SERVICES, FEATURING AIDS FOR DAILY LIVING, NAMELY, HEALTH AND BEAUTY PRODUCTS; WALKERS AND MOTORIZED MOBILIZATION DEVICES; HAIR BRUSHES; BODY SPONGES; BATHROOM SAFETY PRODUCTS, NAMELY, TOILET SEAT RISERS, SHOWER CHAIRS, SHOWER SEATS, TRANSFER BENCHES, GRAB BARS; MONITORS, NAMELY, PULSE RATE MONITORS, BLOOD PRESSURE MONITORS, MOTION SENSORS, ELECTRONIC MONITORS COMPRISED OF DIGITAL SENSORS; BEDROOM AIDS, NAMELY, PERSONAL MASSAGERS AND PERSONAL LUBRICANTS, IN CLASS 35 (U.S. CLS. 100, 101 AND 102).

FIRST USE 8-15-2008; IN COMMERCE 10-1-2010.

THE MARK CONSISTS OF STANDARD CHARACTERS WITHOUT CLAIM TO ANY PARTICULAR FONT, STYLE, SIZE, OR COLOR.

SER. NO. 85-279,335, FILED 3-29-2011.

PAUL MORENO, EXAMINING ATTORNEY



David J. Kyros

Director of the United States Patent and Trademark Office

United States of America

United States Patent and Trademark Office

Kitchen Diva

Reg. No. 4,066,408

DESTINO, CLAUDINE (UNITED STATES INDIVIDUAL)
9340 NESBIT LAKES, DR
ALPHARETTA, GA 30022

Registered Dec. 6, 2011

Int. Cls.: 16, 25 and 41

FOR: COOK BOOKS; RECIPE BOOKS, IN CLASS 16 (U.S. CLS. 2, 5, 22, 23, 29, 37, 38 AND 50).

TRADEMARK

FIRST USE 12-31-2003; IN COMMERCE 12-31-2004.

SERVICE MARK

FOR: APRONS; COBBLERS' APRONS, IN CLASS 25 (U.S. CLS. 22 AND 39).

PRINCIPAL REGISTER

FIRST USE 12-31-2006; IN COMMERCE 12-31-2009.

FOR: EDUCATIONAL SERVICES, NAMELY, CONDUCTING INSTRUCTIONAL CLASSES AND DEMONSTRATIONS IN THE FIELDS OF COOKING AND DISTRIBUTION OF TRAINING MATERIALS IN CONNECTION THEREWITH, IN CLASS 41 (U.S. CLS. 100, 101 AND 107).

FIRST USE 12-31-2002; IN COMMERCE 12-31-2004.

THE MARK CONSISTS OF STANDARD CHARACTERS WITHOUT CLAIM TO ANY PARTICULAR FONT, STYLE, SIZE, OR COLOR.

SER. NO. 85-279,367, FILED 3-29-2011.

PAUL MORENO, EXAMINING ATTORNEY



David J. Kyros

Director of the United States Patent and Trademark Office

United States of America

United States Patent and Trademark Office

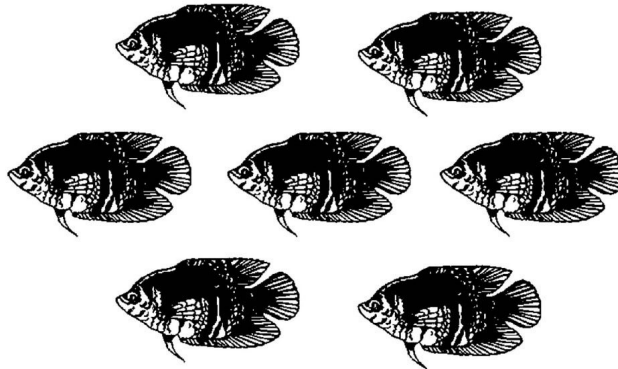

Reg. No. 4,066,409

Registered Dec. 6, 2011

Int. Cl.: 30

TRADEMARK

PRINCIPAL REGISTER

CHO LON MOI CORPORATION (WASHINGTON CORPORATION)
3400 RAINIER AVENUE SOUTH
SEATTLE, WA 98144

FOR: NOODLES, NAMELY, RICE NOODLES AND RICE STICKS; RICE; SWEET POUNDED RICE CAKES; STICKY RICE; JASMINE RICE; SAUCES FOR USE IN FOOD PREPARATION, SEASONING AND SERVICE; COCONUT SUGAR; CHILI POWDER, IN CLASS 30 (U.S. CL. 46).

FIRST USE 10-0-2007; IN COMMERCE 10-0-2007.

THE MARK CONSISTS OF SEVEN "FISH" ARRANGED IN THREE ROWS.

SER. NO. 85-279,551, FILED 3-29-2011.

GIANCARLO CASTRO, EXAMINING ATTORNEY



David J. Kyffers

Director of the United States Patent and Trademark Office

United States of America

United States Patent and Trademark Office

AKHASHENI

Reg. No. 4,066,410

Registered Dec. 6, 2011

CERTIFICATION MARK

PRINCIPAL REGISTER

NATIONAL INTELLECTUAL PROPERTY CENTER OF GEORGIA - SAKPATENTI (REP OF GEORGIA GOVERNMENT AGENCY)
30 RUSTAVELI AVE.
0108 TBILISI, REP OF GEORGIA

FOR: WINE, IN CLASS A (U.S. CL. A).

FIRST USE 0-0-2007; IN COMMERCE 0-0-2007.

THE MARK CONSISTS OF STANDARD CHARACTERS WITHOUT CLAIM TO ANY PARTICULAR FONT, STYLE, SIZE, OR COLOR.

THE CERTIFICATION MARK, AS USED BY AUTHORIZED PERSONS, CERTIFIES THAT THE GOODS HAVE BEEN PRODUCED IN ACCORDANCE WITH PRODUCTION STANDARDS ESTABLISHED BY THE CERTIFIER AND THAT THE GOODS EMANATE FROM A SPECIFIC GEOGRAPHICAL REGION, NAMELY, THAT PORTION OF INNER KAKHETI THAT INCLUDES THE VILLAGES OF AKHASHENI AND CHUMLAKI, AND OTHER LOCATIONS SPECIFIED IN THE STANDARDS, IN GEORGIA.

SER. NO. 85-279,609, FILED 3-29-2011.

MARK SHINER, EXAMINING ATTORNEY



David J. Kyffers

Director of the United States Patent and Trademark Office

United States of America

United States Patent and Trademark Office

KVARELI

Reg. No. 4,066,411

Registered Dec. 6, 2011

CERTIFICATION MARK

PRINCIPAL REGISTER

NATIONAL INTELLECTUAL PROPERTY CENTER OF GEORGIA - SAKPATENTI (REP OF GEORGIA GOVERNMENT AGENCY)
30 RUSTAVELI AVE.
0108 TBILISI, REP OF GEORGIA

FOR: WINE, IN CLASS A (U.S. CL. A).

FIRST USE 0-0-2009; IN COMMERCE 0-0-2009.

THE MARK CONSISTS OF STANDARD CHARACTERS WITHOUT CLAIM TO ANY PARTICULAR FONT, STYLE, SIZE, OR COLOR.

THE CERTIFICATION MARK, AS USED BY AUTHORIZED PERSONS, CERTIFIES THAT THE GOODS HAVE BEEN PRODUCED IN ACCORDANCE WITH PRODUCTION STANDARDS ESTABLISHED BY THE CERTIFIER AND THAT THE GOODS EMANATE FROM A SPECIFIC GEOGRAPHICAL REGION, NAMELY, THE ZONE OF KVARELI LOCATED IN THE ADMINISTRATIVE REGION OF KVARELI, AND OTHER LOCATIONS SPECIFIED IN THE STANDARDS, IN GEORGIA.

SER. NO. 85-279,637, FILED 3-29-2011.

MARK SHINER, EXAMINING ATTORNEY



David J. Kyffers

Director of the United States Patent and Trademark Office

United States of America

United States Patent and Trademark Office

Rajashree's Pregnancy Yoga

Reg. No. 4,066,412

Registered Dec. 6, 2011

Int. Cl.: 9

TRADEMARK

PRINCIPAL REGISTER

RAJASHREE CHOUDHURY (UNITED STATES INDIVIDUAL)
11500 W. OLYMPIC BLVD., SUITE 150
LOS ANGELES, CA 90064

FOR: DIGITAL MATERIALS, NAMELY, CDS, DVDS, PRE-RECORDED VIDEO CASSETTES, AND DOWNLOADABLE AUDIO AND VIDEO RECORDINGS FEATURING INSTRUCTION ON THE PRACTICE OF YOGA DURING PREGNANCY, IN CLASS 9 (U.S. CLS. 21, 23, 26, 36 AND 38).

FIRST USE 1-1-1996; IN COMMERCE 1-1-1996.

THE MARK CONSISTS OF STANDARD CHARACTERS WITHOUT CLAIM TO ANY PARTICULAR FONT, STYLE, SIZE, OR COLOR.

NO CLAIM IS MADE TO THE EXCLUSIVE RIGHT TO USE "PREGNANCY YOGA", APART FROM THE MARK AS SHOWN.

THE NAME(S), PORTRAIT(S), AND/OR SIGNATURE(S) SHOWN IN THE MARK IDENTIFIES "RAJASHREE" CHOUDHURY, WHOSE CONSENT(S) TO REGISTER IS MADE OF RECORD.

SER. NO. 85-279,672, FILED 3-29-2011.

RUSS HERMAN, EXAMINING ATTORNEY



David J. Kyros

Director of the United States Patent and Trademark Office

United States of America

United States Patent and Trademark Office

TASHODI

Reg. No. 4,066,413

Registered Dec. 6, 2011

Int. Cl.: 3

TRADEMARK

PRINCIPAL REGISTER

THE CANADIAN FAIRTRADE COSMETICS COMPANY, INC. (CANADA CORPORATION)
1183 KING STREET WEST, SUITE 100
TORONTO, ONTARIO, CANADA M6K3C5

FOR: (BASED ON USE IN COMMERCE) BATH SALTS; BODY CREAM; BODY MASKS;
BODY SCRUB; BODY SPRAYS; CONDITIONERS; DEODORANT FOR PERSONAL USE;
SCENTED LINEN SPRAYS; SCENTED ROOM SPRAYS; SHAMPOOS; SOAPS (BASED ON
44(E)) FACE CREAMS; FACIAL CLEANSERS; FACIAL LOTION; FACIAL MASKS; FACIAL
SCRUBS; PERFUMES; SHAVING CREAM; SKIN TONERS, IN CLASS 3 (U.S. CLS. 1, 4, 6,
50, 51 AND 52).

FIRST USE 4-0-2010; IN COMMERCE 4-0-2010.

THE MARK CONSISTS OF STANDARD CHARACTERS WITHOUT CLAIM TO ANY PAR-
TICULAR FONT, STYLE, SIZE, OR COLOR.

OWNER OF CANADA REG. NO. TMA767634, DATED 5-21-2010, EXPIRES 5-21-2025.

THE WORDING "TASHODI" HAS NO MEANING IN A FOREIGN LANGUAGE.

SER. NO. 85-279,685, FILED 3-29-2011.

RUSS HERMAN, EXAMINING ATTORNEY



David J. Kypos

Director of the United States Patent and Trademark Office

United States of America

United States Patent and Trademark Office

TELIANI

Reg. No. 4,066,414

Registered Dec. 6, 2011

CERTIFICATION MARK

PRINCIPAL REGISTER

NATIONAL INTELLECTUAL PROPERTY CENTER OF GEORGIA - SAKPATENTI (REP OF GEORGIA GOVERNMENT AGENCY)
30 RUSTAVELI AVE.
0108 TBILISI, REP OF GEORGIA

FOR: WINE, IN CLASS A (U.S. CL. A).

FIRST USE 0-0-2007; IN COMMERCE 0-0-2007.

THE MARK CONSISTS OF STANDARD CHARACTERS WITHOUT CLAIM TO ANY PARTICULAR FONT, STYLE, SIZE, OR COLOR.

THE CERTIFICATION MARK, AS USED BY AUTHORIZED PERSONS, CERTIFIES THAT THE GOODS HAVE BEEN PRODUCED IN ACCORDANCE WITH PRODUCTION STANDARDS ESTABLISHED BY THE CERTIFIER AND THAT THE GOODS EMANATE FROM A SPECIFIC GEOGRAPHICAL REGION, NAMELY, THE TELIANI ZONE LOCATED BETWEEN THE KISISKHEVI AND VANTISKHEVI RIVERS, AND OTHER LOCATIONS SPECIFIED IN THE STANDARDS, IN GEORGIA.

SER. NO. 85-279,697, FILED 3-29-2011.

MARK SHINER, EXAMINING ATTORNEY



David J. Kyffers

Director of the United States Patent and Trademark Office

United States of America

United States Patent and Trademark Office

CANDY SHOP VINTAGE

Reg. No. 4,066,415

Registered Dec. 6, 2011

Int. Cl.: 35

SERVICE MARK

PRINCIPAL REGISTER

DEIRDRE ZAHL (UNITED STATES INDIVIDUAL)
193 FISHBURNE STREET
CHARLESTON, SC 29403

FOR: WHOLESALE AND RETAIL STORE SERVICES FEATURING JEWELRY; ONLINE RETAIL STORE SERVICES FEATURING JEWELRY; RETAIL JEWELRY STORES; ONLINE RETAIL JEWELRY STORES, IN CLASS 35 (U.S. CLS. 100, 101 AND 102).

FIRST USE 10-31-2009; IN COMMERCE 10-31-2009.

THE MARK CONSISTS OF STANDARD CHARACTERS WITHOUT CLAIM TO ANY PARTICULAR FONT, STYLE, SIZE, OR COLOR.

NO CLAIM IS MADE TO THE EXCLUSIVE RIGHT TO USE "VINTAGE", APART FROM THE MARK AS SHOWN.

SER. NO. 85-279,819, FILED 3-29-2011.

DANNEAN HETZEL, EXAMINING ATTORNEY



David J. Kybas

Director of the United States Patent and Trademark Office

United States of America

United States Patent and Trademark Office

EVAPSELECT

Reg. No. 4,066,416

Registered Dec. 6, 2011

Int. Cl.: 35

SERVICE MARK

PRINCIPAL REGISTER

EVAPCO, INC. (MARYLAND CORPORATION)
5151 ALLENDALE LANE
TANEYTOWN, MD 21787

FOR: CONSULTING SERVICES, NAMELY, PROVIDING TO OTHERS CONSUMER PRODUCT INFORMATION AND ADVICE FOR THE SELECTION OF HVAC PRODUCTS AND REFRIGERATION PRODUCTS, IN CLASS 35 (U.S. CLS. 100, 101 AND 102).

FIRST USE 8-23-2010; IN COMMERCE 9-20-2010.

THE MARK CONSISTS OF STANDARD CHARACTERS WITHOUT CLAIM TO ANY PARTICULAR FONT, STYLE, SIZE, OR COLOR.

OWNER OF U.S. REG. NOS. 1,118,707, 1,853,302 AND OTHERS.

SER. NO. 85-279,922, FILED 3-29-2011.

DAVID COLLIER, EXAMINING ATTORNEY



David J. Kybas

Director of the United States Patent and Trademark Office

United States of America

United States Patent and Trademark Office

SERVERSIM

Reg. No. 4,066,417

Registered Dec. 6, 2011

Int. Cl.: 42

SERVICE MARK

PRINCIPAL REGISTER

KADIS, STEPHEN (UNITED STATES INDIVIDUAL)
8606 HARLEQUIN CIRCLE NW
MASSILLON, OH 446469113

FOR: COMPUTER SERVICES, NAMELY, REMOTE MANAGEMENT OF THE INFORMATION TECHNOLOGY (IT) SYSTEMS OF OTHERS, CONSULTING IN THE FIELD OF INFORMATION TECHNOLOGY, IN CLASS 42 (U.S. CLS. 100 AND 101).

FIRST USE 8-1-2000; IN COMMERCE 8-1-2000.

THE MARK CONSISTS OF STANDARD CHARACTERS WITHOUT CLAIM TO ANY PARTICULAR FONT, STYLE, SIZE, OR COLOR.

SER. NO. 85-280,154, FILED 3-29-2011.

RUDY R. SINGLETON, EXAMINING ATTORNEY



David J. Kyros

Director of the United States Patent and Trademark Office

United States of America

United States Patent and Trademark Office

FRAUD DETECTIVE

Reg. No. 4,066,418

Registered Dec. 6, 2011

Int. Cl.: 9

TRADEMARK

PRINCIPAL REGISTER

CONIX SYSTEMS, INC. (TEXAS CORPORATION)
7252 MAIN STREET, BUILDING B
MANCHESTER CENTER, VT 05255

FOR: COMPUTER SOFTWARE FOR FRAUD DETECTION IN FINANCIAL TRANSACTIONS AND USER AND INSTALLATION MANUALS DISTRIBUTED THEREWITH, IN CLASS 9 (U.S. CLS. 21, 23, 26, 36 AND 38).

FIRST USE 12-20-2010; IN COMMERCE 1-13-2011.

THE MARK CONSISTS OF STANDARD CHARACTERS WITHOUT CLAIM TO ANY PARTICULAR FONT, STYLE, SIZE, OR COLOR.

NO CLAIM IS MADE TO THE EXCLUSIVE RIGHT TO USE "FRAUD", APART FROM THE MARK AS SHOWN.

SER. NO. 85-280,168, FILED 3-29-2011.

HELENE LIWINSKI, EXAMINING ATTORNEY



David J. Kybas

Director of the United States Patent and Trademark Office

United States of America

United States Patent and Trademark Office

CONIX CLOUD SERVICES

Reg. No. 4,066,419

Registered Dec. 6, 2011

Int. Cl.: 42

SERVICE MARK

PRINCIPAL REGISTER

CONIX SYSTEMS, INC. (TEXAS CORPORATION)
7252 MAIN STREET, BUILDING B
MANCHESTER CENTER, VT 05255

FOR: PROVIDING COMPUTER SOFTWARE AS A SERVICE FOR USE IN FINANCIAL TRANSACTIONS, IN CLASS 42 (U.S. CLS. 100 AND 101).

FIRST USE 12-16-2010; IN COMMERCE 2-22-2011.

THE MARK CONSISTS OF STANDARD CHARACTERS WITHOUT CLAIM TO ANY PARTICULAR FONT, STYLE, SIZE, OR COLOR.

NO CLAIM IS MADE TO THE EXCLUSIVE RIGHT TO USE "CLOUD SERVICES", APART FROM THE MARK AS SHOWN.

SER. NO. 85-280,209, FILED 3-29-2011.

HELENE LIWINSKI, EXAMINING ATTORNEY



David J. Kyros

Director of the United States Patent and Trademark Office

United States of America

United States Patent and Trademark Office

WOLF GROUP

Reg. No. 4,066,420

Registered Dec. 6, 2011

Int. Cl.: 42

SERVICE MARK

PRINCIPAL REGISTER

WOLF SENSORY, INC. (DELAWARE CORPORATION)
10860 KENWOOD ROAD
CINCINNATI, OH 45242

FOR: SCIENTIFIC RESEARCH SERVICES FOR OTHERS IN THE FIELD OF SENSORY PERCEPTIONS, QUALITATIVE TESTING, QUANTITATIVE TESTING AND ANALYTICAL TESTING, IN CLASS 42 (U.S. CLS. 100 AND 101).

FIRST USE 0-0-1988; IN COMMERCE 0-0-1988.

THE MARK CONSISTS OF STANDARD CHARACTERS WITHOUT CLAIM TO ANY PARTICULAR FONT, STYLE, SIZE, OR COLOR.

NO CLAIM IS MADE TO THE EXCLUSIVE RIGHT TO USE "GROUP", APART FROM THE MARK AS SHOWN.

SER. NO. 85-280,217, FILED 3-29-2011.

TRACY CROSS, EXAMINING ATTORNEY



David J. Kyros

Director of the United States Patent and Trademark Office

United States of America

United States Patent and Trademark Office

THE EASIEST WAY TO RIDE

Reg. No. 4,066,421

Registered Dec. 6, 2011

Int. Cl.: 39

SERVICE MARK

PRINCIPAL REGISTER

B-CYCLE, LLC (DELAWARE LIMITED LIABILITY COMPANY)
801 WEST MADISON STREET
WATERLOO, WI 53594

FOR: RENTAL OF BICYCLES; TRANSPORT OF BICYCLES; PROVIDING INFORMATION ON THE RENTAL OF BICYCLES; COURIER SERVICES, IN CLASS 39 (U.S. CLS. 100 AND 105).

FIRST USE 2-26-2011; IN COMMERCE 2-26-2011.

THE MARK CONSISTS OF STANDARD CHARACTERS WITHOUT CLAIM TO ANY PARTICULAR FONT, STYLE, SIZE, OR COLOR.

SER. NO. 85-280,395, FILED 3-29-2011.

PAUL MORENO, EXAMINING ATTORNEY



David J. Kyffers

Director of the United States Patent and Trademark Office

United States of America

United States Patent and Trademark Office

BARON

Reg. No. 4,066,422

Registered Dec. 6, 2011

Int. Cls.: 7 and 12

TRADEMARK

PRINCIPAL REGISTER

KEITH HUBER, INC. (MISSISSIPPI CORPORATION)
14220 HWY 49N
GULFPORT, MS 39503

FOR: INDUSTRIAL VACUUM LOADING MACHINES AND HIGH PRESSURE WATER JETTING MACHINES FOR LOADING, TRANSPORTING, HANDLING, AND HYDRO-EXCAVATING OF DRY, LIQUID, SOLID, SEMI SOLID, SLUDGE AND HAZARDOUS WASTE MATERIAL, IN CLASS 7 (U.S. CLS. 13, 19, 21, 23, 31, 34 AND 35).

FIRST USE 3-1-2011; IN COMMERCE 3-1-2011.

FOR: TRUCKS EQUIPPED WITH VACUUM LOADING EQUIPMENT AND HIGH PRESSURE AND WATER JETTING MACHINES FOR LOADING, TRANSPORTING, HANDLING, AND HYDRO-EXCAVATING OF DRY, LIQUID, SOLID, SEMI SOLID, SLUDGE AND HAZARDOUS WASTE MATERIAL, IN CLASS 12 (U.S. CLS. 19, 21, 23, 31, 35 AND 44).

FIRST USE 3-1-2011; IN COMMERCE 3-1-2011.

THE MARK CONSISTS OF STANDARD CHARACTERS WITHOUT CLAIM TO ANY PARTICULAR FONT, STYLE, SIZE, OR COLOR.

SER. NO. 85-280,407, FILED 3-29-2011.

BRIDGETT SMITH, EXAMINING ATTORNEY



David J. Kybas

Director of the United States Patent and Trademark Office

United States of America

United States Patent and Trademark Office



Reg. No. 4,066,423

Registered Dec. 6, 2011

Int. Cls.: 29, 30 and 43

GRUMA CORPORATION (NEVADA CORPORATION)
1159 COTTONWOOD LANE
SUITE 200
IRVING, TX 75038

FOR: PROCESSED CHILE PEPPERS; PORK RINDS, IN CLASS 29 (U.S. CL. 46).

TRADEMARK

FIRST USE 0-0-1987; IN COMMERCE 0-0-1987.

SERVICE MARK

FOR: FLOUR TORTILLAS; CORN TORTILLAS; CHILE POWDER; CHILES RELLENOS; MASA FOR TAMALES; TAMALES; DRIED PEPPERS, NAMELY, CHILE PODS; PROCESSED CORN, NAMELY, POSOLE; SPICES; SALSA; TAQUITOS; BURRITOS; ENCHILADAS, IN CLASS 30 (U.S. CL. 46).

PRINCIPAL REGISTER

FIRST USE 0-0-1987; IN COMMERCE 0-0-1987.

FOR: FOOD PREPARATION SERVICES; TAKE OUT FOOD SERVICES, IN CLASS 43 (U.S. CLS. 100 AND 101).

FIRST USE 0-0-1995; IN COMMERCE 0-0-1995.

NO CLAIM IS MADE TO THE EXCLUSIVE RIGHT TO USE "TORTILLA COMPANY INC.", "FULL LINE OF MEXICAN FOODS" AND "4300 ALEXANDER BLVD. NE ALBUQUERQUE, N.M. 87107 505-344-4011", APART FROM THE MARK AS SHOWN.

THE COLOR(S) RED, YELLOW, WHITE, GREEN, AND BLACK IS/ARE CLAIMED AS A FEATURE OF THE MARK.

THE MARK CONSISTS OF CIRCLE DESIGN, WITH A RED AND WHITE CHECKERBOARD BACKGROUND, A HORIZONTAL YELLOW BAND ACROSS THE CENTER OF THE CIRCLE WITH THE WORDING "FULL LINE OF MEXICAN FOODS" WRITTEN IN BLACK WITH A GREEN CHILE PEPPER FIGURE ON THE LEFT SIDE OF AND A RED CHILE PEPPER FIGURE ON THE RIGHT SIDE OF THE WORDING; BLACK BORDER AROUND THE CIRCLE; THE WORDING "ALBUQUERQUE TORTILLA COMPANY, INC. 4300 ALEXANDER BLVD. NE ALBUQUERQUE, N.M. 87107 505-344-4011" WRITTEN IN RED IN THE SURROUNDING CIRCULAR BORDER, SURROUNDED BY A BLACK BORDER.



David J. Kybas

Director of the United States Patent and Trademark Office

Reg. No. 4,066,423 SEC. 2(F) AS TO "ALBUQUERQUE TORTILLA COMPANY".

SER. NO. 85-280,494, FILED 3-29-2011.

WILLIAM P. SHANAHAN, EXAMINING ATTORNEY

United States of America

United States Patent and Trademark Office

KWIK-HANDS

Reg. No. 4,066,424

Registered Dec. 6, 2011

Int. Cl.: 28

TRADEMARK

PRINCIPAL REGISTER

KWIK-HANDS, INC (MASSACHUSETTS CORPORATION)
12 PILOTS WAY
WALPOLE, MA 02081

FOR: ATHLETIC SPORTING GOODS, NAMELY, ICE HOCKEY STICK HANDLING SYSTEM FOR THE TRAINING AND CONDITIONING OF PROPER HOCKEY STICK HANDLING, CONSISTING PRIMARILY OF BALLS FOR PLAYING INDOOR AND OUTDOOR GAMES, SOLD AS A UNIT WITH INSTRUCTION MANUALS, IN CLASS 28 (U.S. CLS. 22, 23, 38 AND 50).

FIRST USE 9-1-2003; IN COMMERCE 1-1-2004.

THE MARK CONSISTS OF STANDARD CHARACTERS WITHOUT CLAIM TO ANY PARTICULAR FONT, STYLE, SIZE, OR COLOR.

SER. NO. 85-280,774, FILED 3-30-2011.

TEJBIR SINGH, EXAMINING ATTORNEY



David J. Kybas

Director of the United States Patent and Trademark Office

United States of America

United States Patent and Trademark Office

BRAZIL BUSINESS TODAY

Reg. No. 4,066,425

Registered Dec. 6, 2011

Int. Cls.: 38 and 41

SERVICE MARK

PRINCIPAL REGISTER

INTERNET PRODUCT DEVELOPMENT GROUP, INC. (MARYLAND CORPORATION)
SUITE 1000
1025 CONNECTICUT AVENUE, NW
WASHINGTON, DC 20036

FOR: TRANSMISSION OF NEWS, IN CLASS 38 (U.S. CLS. 100, 101 AND 104).

FIRST USE 3-1-2011; IN COMMERCE 3-1-2011.

FOR: NEWS AGENCIES, NAMELY, GATHERING AND DISSEMINATION OF NEWS, IN CLASS 41 (U.S. CLS. 100, 101 AND 107).

FIRST USE 3-1-2011; IN COMMERCE 3-1-2011.

THE MARK CONSISTS OF STANDARD CHARACTERS WITHOUT CLAIM TO ANY PARTICULAR FONT, STYLE, SIZE, OR COLOR.

NO CLAIM IS MADE TO THE EXCLUSIVE RIGHT TO USE "BRAZIL BUSINESS", APART FROM THE MARK AS SHOWN.

SER. NO. 85-280,782, FILED 3-30-2011.

JAY FLOWERS, EXAMINING ATTORNEY



David J. Kybas

Director of the United States Patent and Trademark Office

United States of America

United States Patent and Trademark Office

© Wrappin' Good Tortillas

Reg. No. 4,066,426

Registered Dec. 6, 2011

Int. Cl.: 30

TRADEMARK

PRINCIPAL REGISTER

WRAPPIN' GOOD TORTILLAS, LLC (CALIFORNIA LIMITED LIABILITY COMPANY)
30958 MOONFLOWER LN
MURRIETA, CA 92563

FOR: TORTILLAS, IN CLASS 30 (U.S. CL. 46).

FIRST USE 9-10-2010; IN COMMERCE 1-1-2011.

NO CLAIM IS MADE TO THE EXCLUSIVE RIGHT TO USE "GOOD TORTILLAS" , APART FROM THE MARK AS SHOWN.

THE MARK CONSISTS OF THE STYLIZED TEXT "WRAPPIN' GOOD TORTILLAS" WITH A CIRCULAR SWIRL DESIGN ATTACHED TO THE "W".

SER. NO. 85-281,364, FILED 3-30-2011.

DARRYL SPRUILL, EXAMINING ATTORNEY



David J. Kyros

Director of the United States Patent and Trademark Office

United States of America

United States Patent and Trademark Office

Austerus FIT

Reg. No. 4,066,427

SLAISE, MADINAH D. (UNITED STATES INDIVIDUAL)
241 CHAPEL LANE
DAYTON, OH 45431

Registered Dec. 6, 2011

Int. Cl.: 41

FOR: PHYSICAL FITNESS TRAINING SERVICES, IN CLASS 41 (U.S. CLS. 100, 101 AND 107).

SERVICE MARK

FIRST USE 3-14-2011; IN COMMERCE 3-14-2011.

PRINCIPAL REGISTER

THE MARK CONSISTS OF STANDARD CHARACTERS WITHOUT CLAIM TO ANY PARTICULAR FONT, STYLE, SIZE, OR COLOR.

NO CLAIM IS MADE TO THE EXCLUSIVE RIGHT TO USE "FIT", APART FROM THE MARK AS SHOWN.

SER. NO. 85-281,525, FILED 3-30-2011.

DAVID TAYLOR, EXAMINING ATTORNEY



David J. Kyffers

Director of the United States Patent and Trademark Office

United States of America

United States Patent and Trademark Office



Reg. No. 4,066,428

CASEY, JOHN (UNITED STATES INDIVIDUAL)
2801 W. WILLETTA
PHOENIX, AZ 85009

Registered Dec. 6, 2011

Int. Cl.: 35

FOR: INFORMATION IN THE FIELD OF ENERGY EFFICIENCY, IN CLASS 35 (U.S. CLS. 100, 101 AND 102).

SERVICE MARK

FIRST USE 7-1-2010; IN COMMERCE 7-1-2010.

PRINCIPAL REGISTER

NO CLAIM IS MADE TO THE EXCLUSIVE RIGHT TO USE "2011 TOUR", APART FROM THE MARK AS SHOWN.

THE MARK CONSISTS OF THE STYLIZED WORDING "RACE TO ENERGY INDEPENDENCE 2011 TOUR" IMPOSED ON A SHADED OVAL BACKGROUND WITH SMALL CHECKERBOARD IN UPPER LEFT CORNER AND A ZIG-ZAG LINE IMPOSED ON THE OVAL.

SER. NO. 85-281,585, FILED 3-30-2011.

ROBIN MITTLER, EXAMINING ATTORNEY



David J. Kybas

Director of the United States Patent and Trademark Office

United States of America

United States Patent and Trademark Office

DON'T MOW AROUND IT,
REMOVE IT

Reg. No. 4,066,429

R&R TREE&STUMP SERVICE (PENNSYLVANIA PARTNERSHIP)
155 BIRCH LN
WHITE, PA 15490

Registered Dec. 6, 2011

Int. Cl.: 44

FOR: TREE REMOVAL SERVICES, IN CLASS 44 (U.S. CLS. 100 AND 101).

SERVICE MARK

FIRST USE 3-1-2011; IN COMMERCE 3-1-2011.

PRINCIPAL REGISTER

THE MARK CONSISTS OF STANDARD CHARACTERS WITHOUT CLAIM TO ANY PARTICULAR FONT, STYLE, SIZE, OR COLOR.

SER. NO. 85-281,650, FILED 3-30-2011.

CAROLINE WOOD, EXAMINING ATTORNEY



David J. Kybas

Director of the United States Patent and Trademark Office

United States of America

United States Patent and Trademark Office

strawberry

Reg. No. 4,066,430

Registered Dec. 6, 2011

Int. Cls.: 14 and 26

TRADEMARK

PRINCIPAL REGISTER

A & E STORES INC. (NEW YORK CORPORATION)
1000 HUYLER STREET
TETERBORO, NJ 07608

FOR: JEWELRY, IN CLASS 14 (U.S. CLS. 2, 27, 28 AND 50).

FIRST USE 12-0-2010; IN COMMERCE 12-0-2010.

FOR: HAIR ORNAMENTS IN THE NATURE OF HAIR WRAPS AND PONYTAIL HOLDERS,
IN CLASS 26 (U.S. CLS. 37, 39, 40, 42 AND 50).

FIRST USE 12-0-2010; IN COMMERCE 12-0-2010.

OWNER OF U.S. REG. NOS. 1,131,972, 1,488,609, AND 2,956,939.

THE MARK CONSISTS OF THE WORD "STRAWBERRY" IN WHICH THE LETTER "A" IN
THE WORD IS A DESIGN OF A STRAWBERRY.

SER. NO. 85-281,711, FILED 3-30-2011.

KAELIE KUNG, EXAMINING ATTORNEY



David J. Kybas

Director of the United States Patent and Trademark Office

United States of America

United States Patent and Trademark Office

PROTOCOL FOR LIFE BALANCE

Reg. No. 4,066,431

Registered Dec. 6, 2011

Int. Cl.: 5

TRADEMARK

PRINCIPAL REGISTER

NOW HEALTH GROUP, INC. (ILLINOIS CORPORATION)
395 SOUTH GLEN ELLYN ROAD
BLOOMINGDALE, IL 60108

FOR: VITAMINS AND MINERALS IN THE NATURE OF SUPPLEMENTS; HERBAL, DIETARY AND SPORTS NUTRITION SUPPLEMENTS, IN CLASS 5 (U.S. CLS. 6, 18, 44, 46, 51 AND 52).

FIRST USE 7-0-2007; IN COMMERCE 7-0-2007.

THE MARK CONSISTS OF STANDARD CHARACTERS WITHOUT CLAIM TO ANY PARTICULAR FONT, STYLE, SIZE, OR COLOR.

OWNER OF U.S. REG. NO. 2,382,125.

NO CLAIM IS MADE TO THE EXCLUSIVE RIGHT TO USE "PROTOCOL", APART FROM THE MARK AS SHOWN.

SER. NO. 85-281,809, FILED 3-30-2011.

BRIDGETT SMITH, EXAMINING ATTORNEY



David J. Kyros

Director of the United States Patent and Trademark Office

United States of America

United States Patent and Trademark Office

AMERICA'S PASTURE

Reg. No. 4,066,432

Registered Dec. 6, 2011

Int. Cl.: 31

TRADEMARK

PRINCIPAL REGISTER

PENNINGTON SEED, INC. OF NEBRASKA (NEBRASKA CORPORATION)
P.O. BOX 290
MADISON, GA 30650

FOR: GRASS SEED, NAMELY, FORAGE GRASS SEED, IN CLASS 31 (U.S. CLS. 1 AND 46).

FIRST USE 5-11-2005; IN COMMERCE 5-11-2005.

THE MARK CONSISTS OF STANDARD CHARACTERS WITHOUT CLAIM TO ANY PARTICULAR FONT, STYLE, SIZE, OR COLOR.

SEC. 2(F).

SER. NO. 85-282,012, FILED 3-31-2011.

MARK PILARO, EXAMINING ATTORNEY



David J. Kyffers

Director of the United States Patent and Trademark Office

United States of America

United States Patent and Trademark Office



Reg. No. 4,066,433
Registered Dec. 6, 2011
Int. Cl.: 36

AMERICAN NATIONAL INVESTMENT ADVISORS, LLC (ILLINOIS LIMITED LIABILITY COMPANY)
SUITE 500
2001 BUTTERFIELD ROAD
DOWNERS GROVE, IL 60515

SERVICE MARK
PRINCIPAL REGISTER

FOR: FINANCIAL AND INVESTMENT SERVICES, NAMELY, MANAGEMENT AND BROKERAGE IN THE FIELDS OF STOCKS, BONDS, OPTIONS, COMMODITIES, FUTURES AND OTHER SECURITIES, AND THE INVESTMENT OF FUNDS OF OTHERS, IN CLASS 36 (U.S. CLS. 100, 101 AND 102).

FIRST USE 9-29-2010; IN COMMERCE 9-29-2010.

THE MARK CONSISTS OF THE WORDS "HONESTY", "COMPETENCE" AND "SERVICE" IN BLUE WITH THREE SPIRAL ARCS OF BLUE DOTS SURROUNDING A BLUE CIRCLE ENCLOSING A CURVED BANNER OF BLUE AND ALTERNATING WHITE AND RED STRIPES WITH A GRAY UNDERSIDE.

THE COLOR(S) BLUE, WHITE, RED AND GRAY IS/ARE CLAIMED AS A FEATURE OF THE MARK.

SER. NO. 85-282,132, FILED 3-31-2011.

ARETHA SOMERVILLE, EXAMINING ATTORNEY

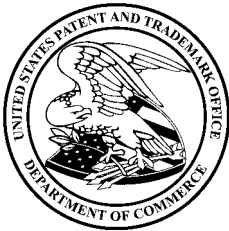

David J. Kybas

Director of the United States Patent and Trademark Office

United States of America

United States Patent and Trademark Office

Stain off

Reg. No. 4,066,434

Registered Dec. 6, 2011

Int. Cl.: 3

TRADEMARK

PRINCIPAL REGISTER

A.V.W. INC (FLORIDA CORPORATION), DBA MAX PROFESSIONAL
P.O. BOX 5501
FT LAUDERDALE, FL 33310

FOR: STAIN REMOVERS, IN CLASS 3 (U.S. CLS. 1, 4, 6, 50, 51 AND 52).

FIRST USE 1-8-2010; IN COMMERCE 10-15-2010.

THE MARK CONSISTS OF STANDARD CHARACTERS WITHOUT CLAIM TO ANY PARTICULAR FONT, STYLE, SIZE, OR COLOR.

NO CLAIM IS MADE TO THE EXCLUSIVE RIGHT TO USE "STAIN", APART FROM THE MARK AS SHOWN.

SER. NO. 85-282,154, FILED 3-31-2011.

REGINA DRUMMOND, EXAMINING ATTORNEY



David J. Kybas

Director of the United States Patent and Trademark Office

United States of America

United States Patent and Trademark Office

(((•)))
VOICE
TELESERVICES

Reg. No. 4,066,435

Registered Dec. 6, 2011

Int. Cl.: 35

SERVICE MARK

PRINCIPAL REGISTER

USA TELESERVICES LLC (PENNSYLVANIA LIMITED LIABILITY COMPANY)
371 FORE STREET, 2ND FLOOR
PORTLAND, ME 04101

FOR: MANAGEMENT OF TELEPHONE CALL CENTERS FOR OTHERS, NAMELY, CALL CENTER OUTSOURCE SERVICES, INCLUDING BUSINESS PROCESS OUTSOURCING, CALL MANAGEMENT SERVICES FOR INBOUND AND OUTBOUND CALL SERVICES, TELEMARKETING, CUSTOMER SERVICE MANAGEMENT AND TELEPHONE CALL CENTER MANAGEMENT CONSULTING SERVICES, IN CLASS 35 (U.S. CLS. 100, 101 AND 102).

FIRST USE 7-15-2005; IN COMMERCE 7-15-2005.

NO CLAIM IS MADE TO THE EXCLUSIVE RIGHT TO USE "TELESERVICES", APART FROM THE MARK AS SHOWN.

THE MARK CONSISTS OF THE STYLIZED WORDS "VOICE TELESERVICES". SOUND WAVES COMING OFF THE DOT IN THE LETTER "I".

SER. NO. 85-282,292, FILED 3-31-2011.

PRISCILLA MILTON, EXAMINING ATTORNEY



David J. Kyjars

Director of the United States Patent and Trademark Office

United States of America

United States Patent and Trademark Office

SimScreen

Reg. No. 4,066,436

APPLETON INC. (PENNSYLVANIA CORPORATION)
1496 YEATMANS STATION RD.
LANDENBERG, PA 19350

Registered Dec. 6, 2011

Int. Cl.: 9

FOR: MOBILE PANEL HAVING A TWO-WAY MIRROR USED FOR VIEWING NURSING STUDENTS IN A LABORATORY, IN CLASS 9 (U.S. CLS. 21, 23, 26, 36 AND 38).

TRADEMARK

FIRST USE 2-6-2011; IN COMMERCE 2-7-2011.

PRINCIPAL REGISTER

THE MARK CONSISTS OF STANDARD CHARACTERS WITHOUT CLAIM TO ANY PARTICULAR FONT, STYLE, SIZE, OR COLOR.

SER. NO. 85-282,296, FILED 3-31-2011.

PRISCILLA MILTON, EXAMINING ATTORNEY



David J. Kybas

Director of the United States Patent and Trademark Office

United States of America

United States Patent and Trademark Office

Prinly

Reg. No. 4,066,437

Registered Dec. 6, 2011

Int. Cl.: 16

TRADEMARK

PRINCIPAL REGISTER

DUBOYS, JEREMY (UNITED STATES INDIVIDUAL), DBA PRINLY
UNIT M
3 S WEYMOUTH AVENUE
VENTNOR CITY, NJ 08406

FOR: CUSTOM PRINTED STATIONERY; BUSINESS CARDS; LETTERHEAD PAPER; ENVELOPES; PRINTED INVITATIONS, PRINTED PAPER SIGNS, PAPER BANNERS, POSTERS AND GREETING CARDS, IN CLASS 16 (U.S. CLS. 2, 5, 22, 23, 29, 37, 38 AND 50).

FIRST USE 1-1-2011; IN COMMERCE 1-1-2011.

THE MARK CONSISTS OF STANDARD CHARACTERS WITHOUT CLAIM TO ANY PARTICULAR FONT, STYLE, SIZE, OR COLOR.

SER. NO. 85-282,327, FILED 3-31-2011.

SKYE YOUNG, EXAMINING ATTORNEY



David J. Kyffers

Director of the United States Patent and Trademark Office

United States of America

United States Patent and Trademark Office

Barking Spiders Poetry

Reg. No. 4,066,438

Registered Dec. 6, 2011

Int. Cl.: 16

TRADEMARK

PRINCIPAL REGISTER

HECK, CJ (UNITED STATES INDIVIDUAL)
705 W. LONG AVE
DUBOIS, PA 15801

FOR: CHILDREN'S BOOKS, IN CLASS 16 (U.S. CLS. 2, 5, 22, 23, 29, 37, 38 AND 50).

FIRST USE 6-0-1998; IN COMMERCE 6-0-2000.

THE MARK CONSISTS OF STANDARD CHARACTERS WITHOUT CLAIM TO ANY PARTICULAR FONT, STYLE, SIZE, OR COLOR.

NO CLAIM IS MADE TO THE EXCLUSIVE RIGHT TO USE "POETRY", APART FROM THE MARK AS SHOWN.

SER. NO. 85-282,357, FILED 3-31-2011.

TIMOTHY FINNEGAN, EXAMINING ATTORNEY



David J. Kybas

Director of the United States Patent and Trademark Office

United States of America

United States Patent and Trademark Office

SkillDrum

Reg. No. 4,066,439

Registered Dec. 6, 2011

Int. Cl.: 38

SERVICE MARK

PRINCIPAL REGISTER

APPVault LLC (GEORGIA LIMITED LIABILITY COMPANY)
1200 ABERNATHY ROAD, NE, SUITE 425
ATLANTA, GA 30328

FOR: BROADCASTING SERVICES OVER THE INTERNET OR OTHER COMMUNICATIONS NETWORK, NAMELY, ELECTRONICALLY TRANSMITTING INFORMATION, IN CLASS 38 (U.S. CLS. 100, 101 AND 104).

FIRST USE 1-31-2010; IN COMMERCE 1-31-2010.

THE MARK CONSISTS OF STANDARD CHARACTERS WITHOUT CLAIM TO ANY PARTICULAR FONT, STYLE, SIZE, OR COLOR.

SER. NO. 85-282,454, FILED 3-31-2011.

NAKIA HENRY, EXAMINING ATTORNEY



David J. Kyros

Director of the United States Patent and Trademark Office

United States of America

United States Patent and Trademark Office

SkillDrum

Reg. No. 4,066,440

Registered Dec. 6, 2011

Int. Cl.: 42

SERVICE MARK

PRINCIPAL REGISTER

APPVAULT LLC (GEORGIA LIMITED LIABILITY COMPANY)
1200 ABERNATHY ROAD, NE, SUITE 425
ATLANTA, GA 30328

FOR: APPLICATION SERVICE PROVIDER FEATURING SOFTWARE TO ENABLE COMMUNICATION, NAMELY, UPLOADING, DOWNLOADING, POSTING, SHOWING, DISPLAYING, SHARING, TRACKING, AND PROVIDING ELECTRONIC MEDIA OR INFORMATION OVER THE INTERNET OR OTHER COMMUNICATIONS NETWORK IN THE FIELDS OF EMPLOYMENT, RECRUITMENT, AND SOCIAL NETWORKING, IN CLASS 42 (U.S. CLS. 100 AND 101).

FIRST USE 1-31-2010; IN COMMERCE 1-31-2010.

THE MARK CONSISTS OF STANDARD CHARACTERS WITHOUT CLAIM TO ANY PARTICULAR FONT, STYLE, SIZE, OR COLOR.

SER. NO. 85-282,458, FILED 3-31-2011.

NAKIA HENRY, EXAMINING ATTORNEY



David J. Kybas

Director of the United States Patent and Trademark Office

United States of America

United States Patent and Trademark Office

EAGLE TOPCOAT PROTECT

Reg. No. 4,066,441

Registered Dec. 6, 2011

Int. Cl.: 36

SERVICE MARK

PRINCIPAL REGISTER

AKITA, INC (DELAWARE CORPORATION)
SUITE 400
2711 CENTERVILLE ROAD
WILMINGTON, DE 19808

FOR: INSURANCE UNDERWRITING IN THE FIELD OF POLLUTION LEGAL LIABILITY INSURANCE, IN CLASS 36 (U.S. CLS. 100, 101 AND 102).

FIRST USE 9-2-2010; IN COMMERCE 9-2-2010.

THE MARK CONSISTS OF STANDARD CHARACTERS WITHOUT CLAIM TO ANY PARTICULAR FONT, STYLE, SIZE, OR COLOR.

OWNER OF U.S. REG. NO. 2,069,597.

NO CLAIM IS MADE TO THE EXCLUSIVE RIGHT TO USE "TOPCOAT", APART FROM THE MARK AS SHOWN.

SER. NO. 85-282,565, FILED 3-31-2011.

SUSAN RICHARDS, EXAMINING ATTORNEY



David J. Kybas

Director of the United States Patent and Trademark Office

United States of America

United States Patent and Trademark Office

MARCO POLO DESIGNS

Reg. No. 4,066,442

Registered Dec. 6, 2011

Int. Cl.: 14

TRADEMARK

PRINCIPAL REGISTER

LIGHT AND FIRE, LLC (OREGON LIMITED LIABILITY COMPANY)
4831 NE FREMONT STREET,#3
PORTLAND, OR 97213 AND

CRUZ, PENNY (UNITED STATES INDIVIDUAL)
16227 NW SOMERSET DRIVE
BEAVERTON, OR 97006

FOR: JEWELRY, IN CLASS 14 (U.S. CLS. 2, 27, 28 AND 50).

FIRST USE 3-18-1993; IN COMMERCE 3-18-1993.

THE MARK CONSISTS OF STANDARD CHARACTERS WITHOUT CLAIM TO ANY PARTICULAR FONT, STYLE, SIZE, OR COLOR.

NO CLAIM IS MADE TO THE EXCLUSIVE RIGHT TO USE "DESIGNS", APART FROM THE MARK AS SHOWN.

SER. NO. 85-283,083, FILED 3-31-2011.

ERNEST SHOSHO, EXAMINING ATTORNEY



David J. Kyfos

Director of the United States Patent and Trademark Office

United States of America

United States Patent and Trademark Office

Zagray Farm

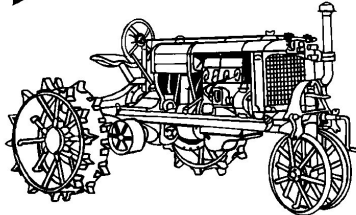

Museum

Reg. No. 4,066,443

Registered Dec. 6, 2011

Int. Cl.: 41

SERVICE MARK

PRINCIPAL REGISTER

QUINEBAUG VALLEY ENGINEERS ASSOCIATION (CONNECTICUT CORPORATION)
180 SOUTH PLUMB ROAD
MIDDLETOWN, CT 064571929

FOR: MUSEUM SERVICES, IN CLASS 41 (U.S. CLS. 100, 101 AND 107).

FIRST USE 5-5-2008; IN COMMERCE 5-5-2008.

NO CLAIM IS MADE TO THE EXCLUSIVE RIGHT TO USE "FARM" AND "MUSEUM" AND THE DEPICTION OF AN ANTIQUE TRACTOR, APART FROM THE MARK AS SHOWN.

THE MARK CONSISTS OF A LINE DRAWING OF AN ANTIQUE TRACTOR SURROUNDED BY THE WORDS "ZAGRAY FARM MUSEUM".

SER. NO. 85-283,168, FILED 3-31-2011.

AMY HELLA, EXAMINING ATTORNEY



David J. Kyffers

Director of the United States Patent and Trademark Office

United States of America

United States Patent and Trademark Office

TERRY SPROULE

Reg. No. 4,066,444

Registered Dec. 6, 2011

Int. Cl.: 16

TRADEMARK

PRINCIPAL REGISTER

SPROULE, TERRANCE (TERRY) ANDREW (CANADA INDIVIDUAL)
361-52258 RANGE ROAD 231
SHERWOOD PARK, ALBERTA, CANADA

FOR: PUBLICATIONS, NAMELY, BOOKS, FLYERS, PAMPHLETS, BOOKLETS, BROCHURES, NEWSLETTERS, MAGAZINES, LEAFLETS, AND INFORMATIONAL SHEETS FEATURING COLLECTIONS OF SERMONS AND ARTICLES, ON BIBLICAL TEACHING AND CHRISTIAN PRINCIPLES, IN CLASS 16 (U.S. CLS. 2, 5, 22, 23, 29, 37, 38 AND 50).

FIRST USE 12-31-1973; IN COMMERCE 12-31-1975.

THE MARK CONSISTS OF STANDARD CHARACTERS WITHOUT CLAIM TO ANY PARTICULAR FONT, STYLE, SIZE, OR COLOR.

OWNER OF U.S. REG. NO. 3,930,571.

THE NAME(S), PORTRAIT(S), AND/OR SIGNATURE(S) SHOWN IN THE MARK IDENTIFIES TERRANCE "TERRY" ANDREW "SPROULE", WHOSE CONSENT(S) TO REGISTER IS MADE OF RECORD.

SER. NO. 85-283,234, FILED 3-31-2011.

THEODORE MCBRIDE, EXAMINING ATTORNEY



David J. Kyros

Director of the United States Patent and Trademark Office

United States of America

United States Patent and Trademark Office

IDLE WORSHIP

Reg. No. 4,066,445

Registered Dec. 6, 2011

Int. Cls.: 9, 41, 42 and 45

TRADEMARK

SERVICE MARK

PRINCIPAL REGISTER

IDLE GAMES, INC. (DELAWARE CORPORATION)
875 HOWARD ST.
4TH FL
SAN FRANCISCO, CA 94103

FOR: COMPUTER GAME SOFTWARE; VIDEO GAME PROGRAMS; COMPUTER SOFTWARE PLATFORMS FOR SOCIAL NETWORKING; INTERACTIVE VIDEO GAME PROGRAMS; DOWNLOADABLE ELECTRONIC GAME PROGRAMS AND COMPUTER SOFTWARE PLATFORMS FOR SOCIAL NETWORKING THAT MAY BE ACCESSED VIA THE INTERNET, COMPUTERS, MEDIA PLAYERS, CELLULAR PHONES, WIRELESS DEVICES AND PORTABLE AND HANDHELD DIGITAL ELECTRONIC DEVICES; COMPUTER SOFTWARE TO ENABLE UPLOADING, POSTING, SHOWING, DISPLAYING, TAGGING, BLOGGING, SHARING OR OTHERWISE PROVIDING ELECTRONIC MEDIA OR INFORMATION IN THE FIELDS OF VIRTUAL COMMUNITIES, ELECTRONIC GAMING, ENTERTAINMENT, AND GENERAL INTEREST VIA THE INTERNET, COMPUTERS, MEDIA PLAYERS, CELLULAR PHONES, WIRELESS DEVICES AND PORTABLE AND HANDHELD DIGITAL ELECTRONIC DEVICES, IN CLASS 9 (U.S. CLS. 21, 23, 26, 36 AND 38).

FIRST USE 10-1-2010; IN COMMERCE 10-1-2010.

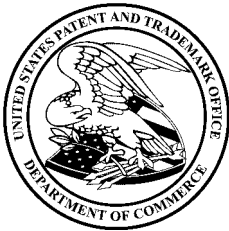

David J. Kyros

Director of the United States Patent and Trademark Office

FOR: ENTERTAINMENT SERVICES, NAMELY, PROVIDING ONLINE COMPUTER GAMES, ONLINE ENHANCEMENTS FOR COMPUTER GAMES, AND PROVIDING ONLINE GAMES; PROVIDING INFORMATION RELATING TO COMPUTER GAMES AND GAME ENHANCEMENTS VIA GLOBAL COMPUTER NETWORKS AND ELECTRONIC COMMUNICATION NETWORKS FOR USE IN CONNECTION WITH COMPUTERS, MOBILE COMPUTERS, MEDIA PLAYERS, CELLULAR PHONES, WIRELESS DEVICES AND PORTABLE AND HANDHELD DIGITAL ELECTRONIC DEVICES; PROVIDING AN ONLINE ENTERTAINMENT INFORMATION SERVICE FEATURING INFORMATION REGARDING COMPUTER GAMES, ENHANCEMENTS FOR COMPUTER GAMES, ONLINE GAMES, AND GAME APPLICATIONS VIA GLOBAL COMPUTER NETWORKS AND ELECTRONIC COMMUNICATION NETWORKS FOR USE IN CONNECTION WITH COMPUTERS, MOBILE COMPUTERS, MEDIA PLAYERS, CELLULAR PHONES, WIRELESS DEVICES AND PORTABLE AND HANDHELD DIGITAL ELECTRONIC DEVICES; ENTERTAINMENT SERVICES, NAMELY, PROVIDING TEMPORARY USE OF NON-DOWNLOADABLE COMPUTER GAMES; ENTERTAINMENT SERVICES, NAMELY, PROVIDING TEMPORARY USE OF NON-DOWNLOADABLE SOFTWARE FOR PLAYING COMPUTER GAMES; ENTERTAINMENT SERVICES, NAMELY, PROVIDING TEMPORARY USE OF NON-DOWNLOADABLE SOFTWARE TO ENABLE

Reg. No. 4,066,445 VIEWING, PREVIEWING, SHARING, MANIPULATING, PLAYING AND OTHERWISE PROVIDING COMPUTER GAMES, ENHANCEMENTS FOR COMPUTER GAMES, ONLINE GAMES, AND GAME APPLICATIONS AND INFORMATION RELATING TO COMPUTER GAMES AND GAME ENHANCEMENTS VIA GLOBAL COMPUTER NETWORKS AND ELECTRONIC COMMUNICATION NETWORKS FOR USE IN CONNECTION WITH COMPUTERS, MOBILE COMPUTERS, MEDIA PLAYERS, CELLULAR PHONES, WIRELESS DEVICES AND PORTABLE AND HANDHELD DIGITAL ELECTRONIC DEVICES; PROVIDING AN INTERNET WEBSITE PORTAL IN THE FIELD OF COMPUTER GAMES AND GAMING; PROVIDING VIRTUAL ENVIRONMENTS IN WHICH USERS CAN INTERACT THROUGH SOCIAL GAMES FOR RECREATIONAL, LEISURE OR ENTERTAINMENT PURPOSES, IN CLASS 41 (U.S. CLS. 100, 101 AND 107).

FIRST USE 10-1-2010; IN COMMERCE 10-1-2010.

FOR: COMPUTER SERVICES, NAMELY, CREATING AN ON-LINE VIRTUAL COMMUNITY FOR REGISTERED USERS TO PARTICIPATE IN AND HOLD COMPETITIONS, SHOWCASE THEIR SKILLS, IMPROVE THEIR TALENT, PARTICIPATE IN INCENTIVE AWARD PROGRAMS, GET FEEDBACK FROM THEIR PEERS, FORM VIRTUAL COMMUNITIES, TRADE, BUY AND SELL VIRTUAL GOODS, CONDUCT VIRTUAL TOURS, FACILITATE INTERACTION AMONG USERS, RANK USERS, ENGAGE IN SOCIAL NETWORKING, AND PARTICIPATE IN ON-LINE DISCUSSION BOARDS IN THE FIELDS OF COMPUTER GAMES; PROVIDING TEMPORARY USE OF NON-DOWNLOADABLE SOFTWARE TO ENABLE VIEWING, PREVIEWING, SHARING, MANIPULATING, AND CREATING BLOGS REGARDING COMPUTER GAMES VIA GLOBAL COMPUTER NETWORKS AND ELECTRONIC COMMUNICATION NETWORKS FOR USE IN CONNECTION WITH COMPUTERS, MOBILE COMPUTERS, MEDIA PLAYERS, CELLULAR PHONES, WIRELESS DEVICES AND PORTABLE AND HANDHELD DIGITAL ELECTRONIC DEVICES, IN CLASS 42 (U.S. CLS. 100 AND 101).

FIRST USE 10-1-2010; IN COMMERCE 10-1-2010.

FOR: ONLINE SOCIAL NETWORKING, IN CLASS 45 (U.S. CLS. 100 AND 101).

FIRST USE 10-1-2010; IN COMMERCE 10-1-2010.

THE MARK CONSISTS OF STANDARD CHARACTERS WITHOUT CLAIM TO ANY PARTICULAR FONT, STYLE, SIZE, OR COLOR.

SER. NO. 85-283,265, FILED 3-31-2011.

BERYL GARDNER, EXAMINING ATTORNEY

United States of America

United States Patent and Trademark Office

ALOHA MAILBOX

Reg. No. 4,066,446

Registered Dec. 6, 2011

Int. Cl.: 6

TRADEMARK

PRINCIPAL REGISTER

WILINSKI, CHRISTOPHER, J (UNITED STATES INDIVIDUAL), DBA ALOHA MAILBOX
26282 VIA CALIFORNIA UNIT A
CAPISTRANO BEACH, CA 92624

FOR: CUSTOM DECORATED METAL MAILBOXES, IN CLASS 6 (U.S. CLS. 2, 12, 13, 14, 23, 25 AND 50).

FIRST USE 8-1-2000; IN COMMERCE 8-1-2000.

NO CLAIM IS MADE TO THE EXCLUSIVE RIGHT TO USE "MAILBOX", APART FROM THE MARK AS SHOWN.

THE MARK CONSISTS OF "ALOHA MAILBOX" IS PRINTED IN A MATISSE FONT WITH RED, "ALOHA" AND BLUE, "MAILBOX". THE TWO WORDS DIFFERENTIATED BY THE COLORS.

SER. NO. 85-283,318, FILED 4-1-2011.

CHARLOTTE CORWIN, EXAMINING ATTORNEY



David J. Kyros

Director of the United States Patent and Trademark Office

United States of America

United States Patent and Trademark Office

SOCIAL SECURITY MAX

Reg. No. 4,066,447

ESCH, ROBERT (UNITED STATES INDIVIDUAL)
6703 FRANSEN RD.
ALHAMBRA, IL 62001

Registered Dec. 6, 2011

Int. Cl.: 36

FOR: FINANCIAL ADVISORY AND CONSULTANCY SERVICES, IN CLASS 36 (U.S. CLS. 100, 101 AND 102).

SERVICE MARK

FIRST USE 3-29-2011; IN COMMERCE 3-29-2011.

PRINCIPAL REGISTER

THE MARK CONSISTS OF STANDARD CHARACTERS WITHOUT CLAIM TO ANY PARTICULAR FONT, STYLE, SIZE, OR COLOR.

NO CLAIM IS MADE TO THE EXCLUSIVE RIGHT TO USE "SOCIAL SECURITY", APART FROM THE MARK AS SHOWN.

SER. NO. 85-283,332, FILED 4-1-2011.

JERI J. FICKES, EXAMINING ATTORNEY



David J. Kybas

Director of the United States Patent and Trademark Office

United States of America

United States Patent and Trademark Office

NMD

Reg. No. 4,066,448

Registered Dec. 6, 2011

Int. Cl.: 7

TRADEMARK

PRINCIPAL REGISTER

HEYDARY, NADER (UNITED STATES INDIVIDUAL)
2414 PINEVIEW DR.
GREENSBORO, NC 27407

FOR: ENGINE BEARINGS; BEARINGS, AS PARTS OF MACHINES; MACHINE PARTS, NAMELY, BEARINGS AND BUSHINGS; ROLLER BEARINGS FOR MACHINES; MECHANICAL SEALS; MACHINE PARTS, NAMELY, ENGINE SEALS AND OIL SEALS, IN CLASS 7 (U.S. CLS. 13, 19, 21, 23, 31, 34 AND 35).

FIRST USE 1-1-2009; IN COMMERCE 1-1-2009.

THE MARK CONSISTS OF STANDARD CHARACTERS WITHOUT CLAIM TO ANY PARTICULAR FONT, STYLE, SIZE, OR COLOR.

SER. NO. 85-283,352, FILED 4-1-2011.

TIMOTHY FINNEGAN, EXAMINING ATTORNEY



David J. Kyffers

Director of the United States Patent and Trademark Office

United States of America

United States Patent and Trademark Office

EZ Pedo

Reg. No. 4,066,449

Registered Dec. 6, 2011

Int. Cl.: 10

TRADEMARK

PRINCIPAL REGISTER

EZ-PEDO, INC. (CALIFORNIA CORPORATION)
4944 WINDPLAY DRIVE, SUITE 118
EL DORADO HILLS, CA 95762

FOR: DENTAL CROWNS; DENTAL PROSTHESES, IN CLASS 10 (U.S. CLS. 26, 39 AND 44).

FIRST USE 9-14-2010; IN COMMERCE 10-8-2010.

THE MARK CONSISTS OF STANDARD CHARACTERS WITHOUT CLAIM TO ANY PARTICULAR FONT, STYLE, SIZE, OR COLOR.

NO CLAIM IS MADE TO THE EXCLUSIVE RIGHT TO USE "PEDO", APART FROM THE MARK AS SHOWN.

SER. NO. 85-283,438, FILED 4-1-2011.

DAVID ELTON, EXAMINING ATTORNEY



David J. Kyffers

Director of the United States Patent and Trademark Office

United States of America

United States Patent and Trademark Office

Dekker PMIS

Reg. No. 4,066,450

Registered Dec. 6, 2011

Int. Cl.: 9

TRADEMARK

PRINCIPAL REGISTER

DEKKER, LTD. (CALIFORNIA CORPORATION)
3633 INLAND EMPIRE BLVD.
SUITE 450
ONTARIO, CA 91764

FOR: A SUITE OF COMPUTER PROGRAMS FOR THE MANAGEMENT AND ANALYSIS OF AN ORGANIZATION'S PROJECTS AND PROGRAMS, IN CLASS 9 (U.S. CLS. 21, 23, 26, 36 AND 38).

FIRST USE 7-27-2007; IN COMMERCE 7-27-2007.

THE MARK CONSISTS OF STANDARD CHARACTERS WITHOUT CLAIM TO ANY PARTICULAR FONT, STYLE, SIZE, OR COLOR.

OWNER OF U.S. REG. NOS. 2,562,933, 2,628,982 AND OTHERS.

NO CLAIM IS MADE TO THE EXCLUSIVE RIGHT TO USE "PMIS", APART FROM THE MARK AS SHOWN.

SER. NO. 85-284,065, FILED 4-1-2011.

KATHERINE CHANG, EXAMINING ATTORNEY



David J. Kybas

Director of the United States Patent and Trademark Office

United States of America

United States Patent and Trademark Office

CORR-FX

Reg. No. 4,066,451

Registered Dec. 6, 2011

Int. Cl.: 2

TRADEMARK

PRINCIPAL REGISTER

REFRACTORY ANCHORS, INC. (OKLAHOMA CORPORATION)
9836 SOUTH 219TH EAST AVENUE
BROKEN ARROW, OK 74014

FOR: CORROSION INHIBITORS IN THE NATURE OF A COATING, NAMELY, HIGH TEMPERATURE WATER BASED PROTECTIVE COATING DERIVED FROM ASPHALT FOR THE PROTECTION OF MILD STEEL SURFACES FROM CORROSION AND OXIDATION FROM ACIDIC, ALKALI AND AGGRESSIVE COMPOUNDS IN INDUSTRIAL APPLICATIONS, IN CLASS 2 (U.S. CLS. 6, 11 AND 16).

FIRST USE 1-1-2010; IN COMMERCE 1-1-2010.

THE MARK CONSISTS OF STANDARD CHARACTERS WITHOUT CLAIM TO ANY PARTICULAR FONT, STYLE, SIZE, OR COLOR.

SER. NO. 85-284,155, FILED 4-1-2011.

MARK SPARACINO, EXAMINING ATTORNEY



David J. Kyffers

Director of the United States Patent and Trademark Office

United States of America

United States Patent and Trademark Office

FAT & RICH BOTANICALS

Reg. No. 4,066,452

Registered Dec. 6, 2011

Int. Cl.: 3

TRADEMARK

PRINCIPAL REGISTER

THE ESSENCE CRAFT COMPANY, LTD (OHIO LIMITED LIABILITY COMPANY), DBA
FAT & RICH BOTANICALS
P.O. BOX 43062
RICHMOND HEIGHTS, OH 44143

FOR: AROMATIC BODY CARE PRODUCTS, NAMELY, BODY LOTION, SHOWER GEL,
CUTICLE CREAM, SHAMPOO, CONDITIONER, NON-MEDICATED LIP BALM, SOAP,
BODY POLISH, BODY AND FOOT SCRUB AND NON-MEDICATED FOOT CREAM, IN
CLASS 3 (U.S. CLS. 1, 4, 6, 50, 51 AND 52).

FIRST USE 4-1-2010; IN COMMERCE 4-1-2010.

THE MARK CONSISTS OF STANDARD CHARACTERS WITHOUT CLAIM TO ANY PAR-
TICULAR FONT, STYLE, SIZE, OR COLOR.

NO CLAIM IS MADE TO THE EXCLUSIVE RIGHT TO USE "BOTANICALS", APART FROM
THE MARK AS SHOWN.

SER. NO. 85-284,263, FILED 4-1-2011.

RAMONA ORTIGA, EXAMINING ATTORNEY



David J. Kyros

Director of the United States Patent and Trademark Office

United States of America

United States Patent and Trademark Office

GIZZI'S COFFEE

Reg. No. 4,066,453

MIYAR, MANNY (UNITED STATES INDIVIDUAL)
109 WEST PAGO PAGO DRIVE
NAPLES, FL 34113

Registered Dec. 6, 2011

Int. Cl.: 30

FOR: ARTIFICIAL COFFEE, COFFEE-BASED BEVERAGES, CHICORY BASED COFFEE SUBSTITUTE, COFFEE, ARTIFICIAL COFFEE, UNROASTED COFFEE, COFFEE BEVERAGES WITH MILK, COFFEE FLAVORINGS, VEGETABLE PREPARATIONS FOR USE AS COFFEE SUBSTITUTES, IN CLASS 30 (U.S. CL. 46).

TRADEMARK

PRINCIPAL REGISTER

FIRST USE 10-1-2009; IN COMMERCE 10-1-2009.

THE MARK CONSISTS OF STANDARD CHARACTERS WITHOUT CLAIM TO ANY PARTICULAR FONT, STYLE, SIZE, OR COLOR.

NO CLAIM IS MADE TO THE EXCLUSIVE RIGHT TO USE "COFFEE", APART FROM THE MARK AS SHOWN.

SER. NO. 85-284,588, FILED 4-2-2011.

RAUL CORDOVA, EXAMINING ATTORNEY



David J. Kyros

Director of the United States Patent and Trademark Office

United States of America

United States Patent and Trademark Office

Take It National

Reg. No. 4,066,454

Registered Dec. 6, 2011

Int. Cl.: 35

SERVICE MARK

PRINCIPAL REGISTER

TAKE IT NATIONAL, INC. (FLORIDA CORPORATION)
7050 WEST PALMETTO PARK ROAD, #15-231
BOCA RATON, FL 33433

FOR: PROVIDING ON-LINE EVENT REGISTRATION, EVENT MANAGEMENT AND ADVISORY SERVICES FOR BUSINESS EVENTS, SEMINARS AND WORKSHOPS, SOCIAL EVENTS, MEETINGS, NETWORKING EVENTS, CHARITY EVENTS AND OTHER GATHERINGS, IN CLASS 35 (U.S. CLS. 100, 101 AND 102).

FIRST USE 7-23-2010; IN COMMERCE 7-23-2010.

THE MARK CONSISTS OF STANDARD CHARACTERS WITHOUT CLAIM TO ANY PARTICULAR FONT, STYLE, SIZE, OR COLOR.

NO CLAIM IS MADE TO THE EXCLUSIVE RIGHT TO USE "NATIONAL", APART FROM THE MARK AS SHOWN.

SER. NO. 85-284,648, FILED 4-2-2011.

REGINA DRUMMOND, EXAMINING ATTORNEY



David J. Kyros

Director of the United States Patent and Trademark Office

United States of America

United States Patent and Trademark Office



Reg. No. 4,066,455

Registered Dec. 6, 2011

Int. Cl.: 35

SERVICE MARK

PRINCIPAL REGISTER

TRUTH SEAL CORP/ (CALIFORNIA CORPORATION)
54 MARIANNA LANE
ATHERTON, CA 94027

FOR: ADVERTISING AND PUBLICITY SERVICES, NAMELY, PROMOTING THE GOODS, SERVICES, BRAND IDENTITY AND COMMERCIAL INFORMATION AND NEWS OF THIRD PARTIES THROUGH PRINT, AUDIO, VIDEO, DIGITAL AND ON-LINE MEDIUM, IN CLASS 35 (U.S. CLS. 100, 101 AND 102).

FIRST USE 1-15-2011; IN COMMERCE 3-1-2011.

THE MARK CONSISTS OF A GOLD TORCH THAT IS CENTERED IN A CIRCULAR SEAL WITH A SERRATED BORDER, THE SEAL CONSISTING PRIMARILY OF A BLUE BACKGROUND, INCLUDING A GOLD CIRCULAR RING AROUND THE TORCH AND GOLD EDGING AROUND THE SERRATED BORDER. ABOVE THE TORCH AND APPARENTLY IN FRONT OF THE SEAL IS A BLUE BANNER BEARING THE LITERAL MARK "TRUTH-SEAL" IN CONTRASTING GOLD. THE GOLD CIRCULAR RING AROUND THE TORCH HAS A DIAMETER OF APPROXIMATELY 2/3 THE DIAMETER OF THE SERRATED CIRCULAR SEAL AND IS SEPARATED FROM THE GOLD-TRIMMED SERRATED EDGE OF THE CIRCULAR BLUE SEAL BY SOME AN AREA OF BLUE.

THE COLOR(S) BLUE AND GOLD IS/ARE CLAIMED AS A FEATURE OF THE MARK.

SER. NO. 85-284,659, FILED 4-2-2011.

KATINA MISTER, EXAMINING ATTORNEY



David J. Kyjars

Director of the United States Patent and Trademark Office

United States of America

United States Patent and Trademark Office



Reg. No. 4,066,456

Registered Dec. 6, 2011

Int. Cl.: 41

SERVICE MARK

PRINCIPAL REGISTER

CONFIDENTIAL CONCEPTS, INC. (DELAWARE CORPORATION)
9E LOOKERMAN STE 205
DOVER, DE 19901

FOR: PUBLICATION OF BOOKS; PUBLICATION OF ELECTRONIC BOOKS AND JOURNALS ON-LINE; MULTIMEDIA PUBLISHING OF BOOKS, MAGAZINES, JOURNALS, SOFTWARE, GAMES, MUSIC, AND ELECTRONIC PUBLICATIONS, IN CLASS 41 (U.S. CLS. 100, 101 AND 107).

FIRST USE 1-1-2000; IN COMMERCE 1-1-2000.

NO CLAIM IS MADE TO THE EXCLUSIVE RIGHT TO USE "INTERNATIONAL", APART FROM THE MARK AS SHOWN.

THE MARK CONSISTS OF THE LITERAL ELEMENTS "PARKSTONE INTERNATIONAL" INSIDE A RECTANGLE WHEREIN THE WORDS "INTERNATIONAL" IS PLACED BELOW THE WORD "PARKSTONE" AND TO THE RIGHT OF IT THERE ARE THREE CURVED LINES SLOPPING UPWARDS AND A BOLD LINE IS PLACED BELOW IT AS SHOWN IN THE MARK.

SER. NO. 85-284,839, FILED 4-4-2011.

KELLY TRUSILO, EXAMINING ATTORNEY



David J. Kyros

Director of the United States Patent and Trademark Office

United States of America

United States Patent and Trademark Office

Global Vision

Reg. No. 4,066,457

Registered Dec. 6, 2011

Int. Cl.: 9

TRADEMARK

PRINCIPAL REGISTER

GLOBAL VISION EYEWEAR CORPORATION (MICHIGAN CORPORATION)
7381 ARDITH CT. SUITE D
BYRON CENTER, MI 49315

FOR: EYEWEAR, NAMELY, GOGGLES FOR SPORTS; MOTORCYCLE GOGGLES; SAFETY GOGGLES; SUNGLASSES; EYEGLASSES; CASES FOR EYEGLASSES AND SUNGLASSES, IN CLASS 9 (U.S. CLS. 21, 23, 26, 36 AND 38).

FIRST USE 3-31-1994; IN COMMERCE 6-30-1994.

THE MARK CONSISTS OF STANDARD CHARACTERS WITHOUT CLAIM TO ANY PARTICULAR FONT, STYLE, SIZE, OR COLOR.

NO CLAIM IS MADE TO THE EXCLUSIVE RIGHT TO USE "VISION", APART FROM THE MARK AS SHOWN.

SER. NO. 85-284,914, FILED 4-4-2011.

ALLISON SCHRODY, EXAMINING ATTORNEY



David J. Kybas

Director of the United States Patent and Trademark Office

United States of America

United States Patent and Trademark Office



Reg. No. 4,066,458

Registered Dec. 6, 2011

Int. Cl.: 40

SERVICE MARK

PRINCIPAL REGISTER

SANTA FE DISTILLERY, LLC (NEW MEXICO LIMITED LIABILITY COMPANY)
7505 MALLARD WAY, UNIT I
SANTA FE, NM 87507

FOR: SPIRITS DISTILLERY SERVICES, IN CLASS 40 (U.S. CLS. 100, 103 AND 106).

FIRST USE 9-1-2010; IN COMMERCE 9-1-2010.

NO CLAIM IS MADE TO THE EXCLUSIVE RIGHT TO USE "SANTA FE SPIRITS", APART FROM THE MARK AS SHOWN.

THE MARK CONSISTS OF A THIN LINE OVAL SHAPE SURROUNDING A THICKER LINE OVAL SHAPE. THE WORDS "SANTA FE" ARCHED AT THE TOP WITHIN THE THICKER LINE OVAL SHAPE, AND THE WORDS "SPIRITS" ARCHED BELOW WITHIN THE THICK LINE OVAL SHAPE. WITHIN THE CENTER OF THE OVAL SHAPE IS AN ABSTRACT HALF OF AN APPLE SHAPE TO THE LEFT, AND AN ABSTRACT SHAPE OF A BRANCH OF WHEAT TO THE RIGHT.

SER. NO. 85-285,029, FILED 4-4-2011.

SCOTT BIBB, EXAMINING ATTORNEY



David J. Kybas

Director of the United States Patent and Trademark Office

United States of America

United States Patent and Trademark Office

THERA-SPIN

Reg. No. 4,066,459

Registered Dec. 6, 2011

Int. Cl.: 8

TRADEMARK

PRINCIPAL REGISTER

ADVANTAGE DIRECT INTERNATIONAL (NEW YORK CORPORATION)
SUITE 205
14 ELM PLACE
RYE, NY 10580

FOR: BATTERY OPERATED FOOT CALLUS REMOVERS, IN CLASS 8 (U.S. CLS. 23, 28 AND 44).

FIRST USE 3-29-2011; IN COMMERCE 3-29-2011.

THE MARK CONSISTS OF STANDARD CHARACTERS WITHOUT CLAIM TO ANY PARTICULAR FONT, STYLE, SIZE, OR COLOR.

SER. NO. 85-285,431, FILED 4-4-2011.

GIANCARLO CASTRO, EXAMINING ATTORNEY



David J. Kyffers

Director of the United States Patent and Trademark Office

United States of America

United States Patent and Trademark Office

CLARUS IMAGING CENTER

Reg. No. 4,066,460

Registered Dec. 6, 2011

Int. Cl.: 44

SERVICE MARK

PRINCIPAL REGISTER

ZT WEALTH, INC. (TEXAS CORPORATION)
11233 SHADOW CREEK PARKWAY
PEARLAND, TX 77584

FOR: MEDICAL IMAGING SERVICES, IN CLASS 44 (U.S. CLS. 100 AND 101).

FIRST USE 10-1-2005; IN COMMERCE 11-23-2005.

THE MARK CONSISTS OF STANDARD CHARACTERS WITHOUT CLAIM TO ANY PARTICULAR FONT, STYLE, SIZE, OR COLOR.

NO CLAIM IS MADE TO THE EXCLUSIVE RIGHT TO USE "IMAGING CENTER", APART FROM THE MARK AS SHOWN.

SER. NO. 85-285,477, FILED 4-4-2011.

DANNEAN HETZEL, EXAMINING ATTORNEY



David J. Kybas

Director of the United States Patent and Trademark Office

United States of America

United States Patent and Trademark Office

Problems Solved

Reg. No. 4,066,461

Registered Dec. 6, 2011

Int. Cl.: 36

SERVICE MARK

PRINCIPAL REGISTER

RESOLUTE COMMERCIAL SERVICES (ARIZONA LIMITED LIABILITY COMPANY), DBA
RESOLUTE COMMERCIAL SERVICES, INC.
7030 EAST 5TH AVENUE
SCOTTSDALE, AZ 85251

FOR: FINANCIAL SERVICES, NAMELY, CORPORATE WORKOUT, DEBT RESTRUCTURING, RECEIVERSHIP, AND LOAN RESOLUTION FOR COMMERCIAL LOANS, IN CLASS 36 (U.S. CLS. 100, 101 AND 102).

FIRST USE 7-1-2008; IN COMMERCE 7-1-2008.

THE MARK CONSISTS OF STANDARD CHARACTERS WITHOUT CLAIM TO ANY PARTICULAR FONT, STYLE, SIZE, OR COLOR.

SER. NO. 85-285,529, FILED 4-4-2011.

DAVID TOOLEY, EXAMINING ATTORNEY



David J. Kyros

Director of the United States Patent and Trademark Office

United States of America

United States Patent and Trademark Office



Reg. No. 4,066,462

Registered Dec. 6, 2011

Int. Cl.: 37

SERVICE MARK

PRINCIPAL REGISTER

CONVERGINT TECHNOLOGIES LLC (DELAWARE LIMITED LIABILITY COMPANY)
1651 WILKENING ROAD
SCHAUMBURG, IL 60173

FOR: INSTALLATION, MAINTENANCE AND REPAIR OF COMMUNICATIONS SYSTEMS, NAMELY, RESCUE ASSISTANCE SYSTEMS, PAGING AND INTERCOM SYSTEMS, MASS NOTIFICATION SYSTEMS, NURSE CALL SYSTEMS, PATIENT WANDERING SYSTEMS AND INFANT PROTECTION SYSTEMS, IN CLASS 37 (U.S. CLS. 100, 103 AND 106).

FIRST USE 0-0-2010; IN COMMERCE 0-0-2010.

OWNER OF U.S. REG. NOS. 2,578,517 AND 2,602,791.

THE COLOR(S) RED AND BLACK IS/ARE CLAIMED AS A FEATURE OF THE MARK.

NO CLAIM IS MADE TO THE EXCLUSIVE RIGHT TO USE "TECHNOLOGIES", APART FROM THE MARK AS SHOWN.

THE MARK CONSISTS OF THE WORD "CONVERGINT" ABOVE THE WORD "TECHNOLOGIES". THE LETTER "I" IN THE WORD "CONVERGINT" APPEARS IN RED AND ALSO FORMS THE LETTER "I" IN THE WORD "TECHNOLOGIES". RED LINES RADIATE TO THE LEFT FROM THE DOT IN THE LETTER "I". THE REMAINING LETTERS APPEAR IN BLACK.

SER. NO. 85-285,631, FILED 4-4-2011.

DEBRA LEE, EXAMINING ATTORNEY



David J. Kybas

Director of the United States Patent and Trademark Office

United States of America

United States Patent and Trademark Office

Illuminara

Reg. No. 4,066,463

Registered Dec. 6, 2011

Int. Cl.: 41

SERVICE MARK

PRINCIPAL REGISTER

WOLFE, CHARLENE (UNITED STATES INDIVIDUAL)
6733 S. 2345 E
SALT LAKE CITY, UT 84121

FOR: ENTERTAINMENT AND EDUCATIONAL SERVICES IN THE NATURE OF LIVE MUSICAL, SPOKEN WORD, WORKSHOPS, AND INTERACTIVE PERFORMANCE THAT INCLUDES AUDIENCE PARTICIPATION FOR RAISING CONSCIOUSNESS AWARENESS; PROVIDING PROFESSIONAL COACHING IN THE FIELD OF CONSCIOUSNESS RAISING, IN CLASS 41 (U.S. CLS. 100, 101 AND 107).

FIRST USE 1-1-1995; IN COMMERCE 1-1-1996.

THE MARK CONSISTS OF STANDARD CHARACTERS WITHOUT CLAIM TO ANY PARTICULAR FONT, STYLE, SIZE, OR COLOR.

THE ENGLISH TRANSLATION OF "ILLUMINARA" IS "ALIGHT".

SER. NO. 85-285,815, FILED 4-4-2011.

LESLEY LAMOTHE, EXAMINING ATTORNEY



David J. Kyros

Director of the United States Patent and Trademark Office

United States of America

United States Patent and Trademark Office

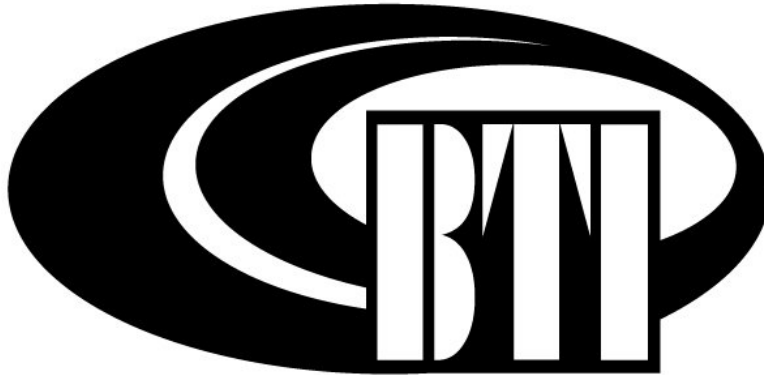

Reg. No. 4,066,464

Registered Dec. 6, 2011

Int. Cl.: 9

TRADEMARK

PRINCIPAL REGISTER

BRAVO TECH INTERNATIONAL LIMITED (HONG KONG CORPORATION), DBA BTI
CHEVALIER COMMERCIAL CENTRE RMS 713-714
8 WANG HOI ROAD, KOWLOON BAY
HONG KONG, HONG KONG

FOR: AMPLIFIER FOR WIRELESS COMMUNICATIONS; AMPLIFIERS; ANTENNAS; AN-
TENNAS FOR WIRELESS COMMUNICATIONS APPARATUS; BROADBAND WIRELESS
EQUIPMENT, NAMELY, TELECOMMUNICATIONS BASE STATION EQUIPMENT FOR
CELLULAR AND FIXED NETWORKING AND COMMUNICATIONS APPLICATIONS;
DISTRIBUTION AMPLIFIERS FOR AUDIO AND VIDEO SIGNALS; POWER AMPLIFIERS,
IN CLASS 9 (U.S. CLS. 21, 23, 26, 36 AND 38).

FIRST USE 3-22-2011; IN COMMERCE 3-22-2011.

OWNER OF U.S. REG. NO. 3,856,694.

THE MARK CONSISTS OF AN OVAL SHAPE DESIGN OF COMBINATION OF 3 LETTERS
AND OVAL SHAPE CIRCLES. THE LETTERS "BTI" WITH ARTISTIC DESIGN WITH BLACK
BORDERS AND WHITE HOLLOW SPACE WITHIN THE LETTERS. BEHIND THE LETTERS
"BTI" THERE ARE DRAWN DESIGNS OF 4 OVAL SHAPE CIRCLES FROM INSIDE OUT
WITH AN EGG SHAPE WHITE SPACE IN THE UPPER RIGHT CENTER CIRCLED BY BLACK
OVAL LINE, WHITE OVAL LINE, AND BLACK OVAL LINE.

SER. NO. 85-285,872, FILED 4-4-2011.

CIMMERIAN COLEMAN, EXAMINING ATTORNEY



David J. Kypos

Director of the United States Patent and Trademark Office

United States of America

United States Patent and Trademark Office

CANobey

Reg. No. 4,066,465

Registered Dec. 6, 2011

Int. Cl.: 18

TRADEMARK

PRINCIPAL REGISTER

BALANCED LIFE INVESTMENTS, LLC (TEXAS LIMITED LIABILITY COMPANY)
343 OVERHILL DRIVE
SAN ANTONIO, TX 78228

FOR: PET TRAINING DEVICE, NAMELY, A HANDHELD TRAINING BEHAVIORAL DEVICE THAT EMITS AN UNCOMFORTABLE SOUND TO AID IN BEHAVIORAL TRAIT CONDITIONING IN PETS , IN CLASS 18 (U.S. CLS. 1, 2, 3, 22 AND 41).

FIRST USE 2-2-2011; IN COMMERCE 4-1-2011.

THE MARK CONSISTS OF STANDARD CHARACTERS WITHOUT CLAIM TO ANY PARTICULAR FONT, STYLE, SIZE, OR COLOR.

SER. NO. 85-285,939, FILED 4-4-2011.

REGINA DRUMMOND, EXAMINING ATTORNEY



David J. Kybas

Director of the United States Patent and Trademark Office

United States of America

United States Patent and Trademark Office

Stump! Trivia Quiz

Reg. No. 4,066,466

Registered Dec. 6, 2011

Int. Cl.: 16

TRADEMARK

PRINCIPAL REGISTER

TRAILSIDE ENTERTAINMENT, INC. (MASSACHUSETTS CORPORATION)
41 CAROLINA TRAIL
MARSHFIELD, MA 02050

FOR: TRIVIA GAME PACKAGES, NAMELY, TRIVIA KITS COMPRISING PRINTED TRIVIA CARDS CONTAINING TRIVIA QUESTIONS, PRINTED SCORE SHEETS AND PENS , IN CLASS 16 (U.S. CLS. 2, 5, 22, 23, 29, 37, 38 AND 50).

FIRST USE 6-1-2001; IN COMMERCE 6-1-2001.

THE MARK CONSISTS OF STANDARD CHARACTERS WITHOUT CLAIM TO ANY PARTICULAR FONT, STYLE, SIZE, OR COLOR.

NO CLAIM IS MADE TO THE EXCLUSIVE RIGHT TO USE "TRIVIA QUIZ", APART FROM THE MARK AS SHOWN.

SER. NO. 85-286,154, FILED 4-5-2011.

ERIN FALK, EXAMINING ATTORNEY



David J. Kyffers

Director of the United States Patent and Trademark Office

United States of America

United States Patent and Trademark Office



Franklin Adams & Company, LLC

Reg. No. 4,066,467

FRANKLIN ADAMS & COMPANY, LLC (PENNSYLVANIA LIMITED LIABILITY COMPANY)
282 HANNAHSTOWN RD.
CABOT, PA 16023

Registered Dec. 6, 2011

Int. Cl.: 45

FOR: LEGAL DOCUMENT PREPARATION AND RESEARCH SERVICES FOR ATTORNEYS;
LEGAL RESEARCH; LEGAL SERVICES, IN CLASS 45 (U.S. CLS. 100 AND 101).

SERVICE MARK

FIRST USE 8-1-2010; IN COMMERCE 3-30-2011.

PRINCIPAL REGISTER

NO CLAIM IS MADE TO THE EXCLUSIVE RIGHT TO USE "COMPANY, LLC", APART
FROM THE MARK AS SHOWN.

THE NAME "FRANKLIN ADAMS" DOES NOT IDENTIFY A LIVING INDIVIDUAL.

THE MARK CONSISTS OF A BACKWARDS LETTER "F" WITH HALF OF THE LETTER
"A," WHICH HALF IS THE RIGHT HALF OF THE LETTER. THE HALF LETTER "A" APPEARS
TO THE RIGHT OF THE BACKWARDS "F," AND ADJOINS THE BACKWARDS "F" AT THE
TOP OF THE VERTICAL COLUMN AND AT THE LOWER LINE IN THE BACKWARDS "F."
UNDERNEATH THE BACKWARDS "F" AND THE HALF LETTER "A" APPEARS THE
COMPANY NAME OF "FRANKLIN ADAMS & COMPANY, LLC". THE FONT USED, IN
BOTH THE DESIGN ELEMENT AND THE LITERAL ELEMENT, IS "BASKERVILLE".

SER. NO. 85-286,500, FILED 4-5-2011.

JAMES STEIN, EXAMINING ATTORNEY



David J. Kybas

Director of the United States Patent and Trademark Office

United States of America

United States Patent and Trademark Office

LOTAME SMART DATA

Reg. No. 4,066,468

Registered Dec. 6, 2011

Int. Cl.: 35

SERVICE MARK

PRINCIPAL REGISTER

LOTAME SOLUTIONS, INC. (DELAWARE CORPORATION)
6095 MARSHALEE DRIVE, SUITE 210
ELKRIDGE, MD 21075

FOR: ADVERTISING AND MARKETING SERVICES; ADVERTISING AND MARKETING CONSULTANCY; BUSINESS INFORMATION MANAGEMENT SERVICES FOR USE IN THE ELECTRONIC COLLECTION, ORGANIZATION, MAINTENANCE, PROCESSING, AND REPORTING OF CONSUMER INFORMATION, IN CLASS 35 (U.S. CLS. 100, 101 AND 102).

FIRST USE 4-1-2011; IN COMMERCE 4-1-2011.

THE MARK CONSISTS OF STANDARD CHARACTERS WITHOUT CLAIM TO ANY PARTICULAR FONT, STYLE, SIZE, OR COLOR.

OWNER OF U.S. REG. NO. 3,676,952.

NO CLAIM IS MADE TO THE EXCLUSIVE RIGHT TO USE "DATA", APART FROM THE MARK AS SHOWN.

SER. NO. 85-286,543, FILED 4-5-2011.

PAUL MORENO, EXAMINING ATTORNEY



David J. Kyffers

Director of the United States Patent and Trademark Office

United States of America

United States Patent and Trademark Office

THE BIG PARADE

Reg. No. 4,066,469

Registered Dec. 6, 2011

Int. Cl.: 35

SERVICE MARK

PRINCIPAL REGISTER

THE BIG PARADE, LLC (NEW YORK LIMITED LIABILITY COMPANY)
1595 MOSELEY ROAD
VICTOR, NY 14564

FOR: ADVERTISING AGENCIES AND PUBLIC RELATION SERVICES FOR NONPROFIT ORGANIZATIONS AND PUBLIC INTEREST GROUPS; ADVERTISING AGENCY SERVICES, NAMELY, PROMOTING THE INTERESTS OF NONPROFIT ORGANIZATIONS AND PUBLIC INTEREST GROUPS AND THE SOCIAL INTEREST OF NONPROFIT ORGANIZATIONS AND PUBLIC INTEREST GROUPS THROUGH THE DISTRIBUTION OF PRINTED AND AUDIO PROMOTIONAL MATERIALS AND BY RENDERING SALES PROMOTION ADVICE; DEVELOPING PROMOTIONAL AND CHARITABLE CAMPAIGNS FOR NONPROFIT ORGANIZATIONS AND PUBLIC INTEREST GROUPS; BUSINESS ORGANIZATIONAL AND MANAGEMENT CONSULTATION SERVICES; PROMOTING PUBLIC INTEREST IN AND AWARENESS OF THE NEED FOR FINANCIAL SUPPORT TO INTERNATIONAL RELIEF AGENCIES AND THEIR PROGRAMS; PROMOTING PUBLIC INTEREST IN NONPROFIT ORGANIZATIONS AND PUBLIC INTEREST GROUPS; AND BUSINESS MANAGEMENT AND CONSULTING IN THE FIELD OF CHARITABLE FUND RAISING FOR NONPROFIT ORGANIZATIONS AND PUBLIC INTEREST GROUPS, IN CLASS 35 (U.S. CLS. 100, 101 AND 102).

FIRST USE 11-19-2003; IN COMMERCE 11-19-2003.

THE MARK CONSISTS OF STANDARD CHARACTERS WITHOUT CLAIM TO ANY PARTICULAR FONT, STYLE, SIZE, OR COLOR.

SER. NO. 85-286,671, FILED 4-5-2011.

SUZANNE BLANE, EXAMINING ATTORNEY



David J. Kyjars

Director of the United States Patent and Trademark Office

United States of America

United States Patent and Trademark Office



Reg. No. 4,066,470

RAYBESTOS POWERTRAIN LLC (DELAWARE LIMITED LIABILITY COMPANY)
609 E CHANEY STREET
SULLIVAN, IN 47882

Registered Dec. 6, 2011

Int. Cl.: 12

FOR: AUTOMOBILE TRANSMISSION PARTS, NAMELY, FRICTION PLATES, IN CLASS 12 (U.S. CLS. 19, 21, 23, 31, 35 AND 44).

TRADEMARK

FIRST USE 5-0-2010; IN COMMERCE 5-0-2010.

PRINCIPAL REGISTER

THE MARK CONSISTS OF THE WORD "GPXX". THE LETTERS "GP" ARE IN BLACK AND THE LETTERS "XX" ARE IN RED, ORANGE AND YELLOW.

THE COLOR(S) BLACK, RED, ORANGE AND YELLOW IS/ARE CLAIMED AS A FEATURE OF THE MARK.

SER. NO. 85-286,743, FILED 4-5-2011.

TINA BROWN, EXAMINING ATTORNEY



David J. Kybas

Director of the United States Patent and Trademark Office

United States of America

United States Patent and Trademark Office

EDGE THERAPEUTICS

Reg. No. 4,066,471

BRIAN LEUTHNER (UNITED STATES INDIVIDUAL)
211 WARREN STREET
NEWARK, NJ 07103

Registered Dec. 6, 2011

Int. Cl.: 42

FOR: RESEARCH AND DEVELOPMENT SERVICE, NAMELY, FOR PHARMACEUTICAL PRODUCTS, IN CLASS 42 (U.S. CLS. 100 AND 101).

SERVICE MARK

FIRST USE 3-9-2011; IN COMMERCE 3-9-2011.

PRINCIPAL REGISTER

THE MARK CONSISTS OF STANDARD CHARACTERS WITHOUT CLAIM TO ANY PARTICULAR FONT, STYLE, SIZE, OR COLOR.

NO CLAIM IS MADE TO THE EXCLUSIVE RIGHT TO USE "THERAPEUTICS", APART FROM THE MARK AS SHOWN.

SER. NO. 85-286,751, FILED 4-5-2011.

PAUL MORENO, EXAMINING ATTORNEY



David J. Kybas

Director of the United States Patent and Trademark Office

United States of America

United States Patent and Trademark Office

Alliance FarmPRO

Reg. No. 4,066,472

Registered Dec. 6, 2011

Int. Cl.: 12

TRADEMARK

PRINCIPAL REGISTER

ALLIANCE TIRE COMPANY LTD. (ISRAEL CORPORATION)
P.O. BOX 48
1 FRIEDLANDER STREET
HADERA, ISRAEL 38100

FOR: TIRES, IN CLASS 12 (U.S. CLS. 19, 21, 23, 31, 35 AND 44).

FIRST USE 1-9-2011; IN COMMERCE 4-1-2011.

THE MARK CONSISTS OF STANDARD CHARACTERS WITHOUT CLAIM TO ANY PARTICULAR FONT, STYLE, SIZE, OR COLOR.

SER. NO. 85-286,853, FILED 4-5-2011.

ELI HELLMAN, EXAMINING ATTORNEY



David J. Kybas

Director of the United States Patent and Trademark Office

United States of America

United States Patent and Trademark Office

W Whistler
MADE IN USA
S B Whistler & Sons, Inc.

Reg. No. 4,066,473

Registered Dec. 6, 2011

Int. Cl.: 7

TRADEMARK

PRINCIPAL REGISTER

S. B. WHISTLER & SONS, INC. (NEW YORK CORPORATION)
11023 WEST CENTER STREET EXT.
P.O. BOX 270
MEDINA, NY 14103

FOR: TOOLING FOR USE IN MACHINE TOOLS FOR PUNCHING, STAMPING, AND NOTCHING SHEET METAL, NAMELY, PUNCHING DIES, SHEET METAL PUNCHES, PUNCH DRIVERS, PUNCH GUIDES, PUNCH RETAINERS, PUNCH TEMPLATES, PUNCH STRIPPERS, DIE BUSHINGS, DIE TEMPLATES, AND DIE RETAINERS, IN CLASS 7 (U.S. CLS. 13, 19, 21, 23, 31, 34 AND 35).

FIRST USE 5-1-2006; IN COMMERCE 5-1-2006.

NO CLAIM IS MADE TO THE EXCLUSIVE RIGHT TO USE "MADE IN USA" AND "& SONS, INC.", APART FROM THE MARK AS SHOWN.

THE NAME IN THE MARK DOES NOT IDENTIFY A LIVING INDIVIDUAL.

THE MARK CONSISTS OF THE CAPITAL LETTER "W" IN REVERSE TYPE INSIDE A BLACK SQUARE BOX. TO THE RIGHT OF THE BLACK SQUARE BOX IS THE WORD "WHISTLER". THE WORDING "MADE IN USA" IN CAPITAL LETTERS IS BENEATH THE WORD "WHISTLER" AND THE WORDING " S B WHISTLER & SONS, INC." IS BENEATH THE WORDING "MADE IN USA".

SER. NO. 85-286,934, FILED 4-5-2011.

STEVEN R. FINE, EXAMINING ATTORNEY



David J. Kyffers

Director of the United States Patent and Trademark Office

United States of America

United States Patent and Trademark Office

NEXTERA

Reg. No. 4,066,474

Registered Dec. 6, 2011

Int. Cl.: 1

TRADEMARK

PRINCIPAL REGISTER

ILLUMINA, INC. (DELAWARE CORPORATION)
9885 TOWNE CENTRE DRIVE
SAN DIEGO, CA 92121

FOR: ENZYMES, NUCLEIC ACIDS, AND CHEMICAL PREPARATIONS FOR SCIENTIFIC AND RESEARCH PURPOSES, ALL IN THE FIELD OF BIOTECHNOLOGY; KITS COMPRISED OF ENZYMES, NUCLEIC ACIDS, AND CHEMICAL PREPARATIONS FOR SCIENTIFIC AND RESEARCH PURPOSES, ALL IN THE FIELD OF BIOTECHNOLOGY, IN CLASS 1 (U.S. CLS. 1, 5, 6, 10, 26 AND 46).

FIRST USE 10-8-2009; IN COMMERCE 12-17-2009.

THE MARK CONSISTS OF STANDARD CHARACTERS WITHOUT CLAIM TO ANY PARTICULAR FONT, STYLE, SIZE, OR COLOR.

SER. NO. 85-287,105, FILED 4-5-2011.

LEIGH LOWRY, EXAMINING ATTORNEY



David J. Kyffers

Director of the United States Patent and Trademark Office

United States of America

United States Patent and Trademark Office

DYNALIGHT

Reg. No. 4,066,475

Registered Dec. 6, 2011

Int. Cl.: 9

TRADEMARK

PRINCIPAL REGISTER

TOSHIBA AMERICA INFORMATION SYSTEMS, INC. (CALIFORNIA CORPORATION)
9740 IRVINE BOULEVARD
IRVINE, CA 92618

FOR: TELEVISION SETS; A FEATURE OF TELEVISION SETS, NAMELY, A BACKLIGHTING DEVICE RELATED TO IMAGE QUALITY IMPROVEMENT, IN CLASS 9 (U.S. CLS. 21, 23, 26, 36 AND 38).

FIRST USE 9-16-2008; IN COMMERCE 9-16-2008.

THE MARK CONSISTS OF STANDARD CHARACTERS WITHOUT CLAIM TO ANY PARTICULAR FONT, STYLE, SIZE, OR COLOR.

SER. NO. 85-287,139, FILED 4-5-2011.

ZACHARY BELLO, EXAMINING ATTORNEY



David J. Kyffers

Director of the United States Patent and Trademark Office

United States of America

United States Patent and Trademark Office

Assembly New York

Reg. No. 4,066,476

DAVID GREGORY ARMAS (UNITED STATES INDIVIDUAL), DBA ASSEMBLY NEW YORK
170 LUDLOW ST
NEW YORK, NY 10002

Registered Dec. 6, 2011

Int. Cl.: 25

FOR: MEN'S AND WOMEN'S JACKETS, COATS, TROUSERS, VESTS, IN CLASS 25 (U.S. CLS. 22 AND 39).

TRADEMARK

FIRST USE 1-1-2008; IN COMMERCE 1-1-2008.

PRINCIPAL REGISTER

THE MARK CONSISTS OF STANDARD CHARACTERS WITHOUT CLAIM TO ANY PARTICULAR FONT, STYLE, SIZE, OR COLOR.

NO CLAIM IS MADE TO THE EXCLUSIVE RIGHT TO USE "NEW YORK", APART FROM THE MARK AS SHOWN.

SER. NO. 85-287,143, FILED 4-5-2011.

NICHOLAS ALTREE, EXAMINING ATTORNEY



David J. Kybas

Director of the United States Patent and Trademark Office

United States of America

United States Patent and Trademark Office

Nessacary

Reg. No. 4,066,477

LILLARD, GWENNEISA (UNITED STATES INDIVIDUAL), AKA NESSACARY
4458 E131ST ST
CLEVELAND, OH 44105

Registered Dec. 6, 2011

Int. Cl.: 41

FOR: ENTERTAINMENT SERVICES, NAMELY, LIVE PERFORMANCES BY A PROFESSIONAL ENTERTAINER, IN CLASS 41 (U.S. CLS. 100, 101 AND 107).

SERVICE MARK

FIRST USE 1-1-2003; IN COMMERCE 1-1-2003.

PRINCIPAL REGISTER

THE MARK CONSISTS OF STANDARD CHARACTERS WITHOUT CLAIM TO ANY PARTICULAR FONT, STYLE, SIZE, OR COLOR.

THE NAME "NESSACARY" IDENTIFIES A LIVING INDIVIDUAL WHOSE CONSENT IS OF RECORD.

SER. NO. 85-287,175, FILED 4-5-2011.

KATHERINE M. DUBRAY, EXAMINING ATTORNEY



David J. Kyros

Director of the United States Patent and Trademark Office

United States of America

United States Patent and Trademark Office

VISUAL NEWS

Reg. No. 4,066,478

Registered Dec. 6, 2011

Int. Cl.: 35

SERVICE MARK

PRINCIPAL REGISTER

COLUMN FIVE MEDIA, INC. (CALIFORNIA CORPORATION)
355 OLD NEWPORT BLVD.
NEWPORT BEACH, CA 92663

FOR: ADVERTISING ON THE INTERNET FOR OTHERS; ADVERTISING SERVICES, IN CLASS 35 (U.S. CLS. 100, 101 AND 102).

FIRST USE 1-0-2011; IN COMMERCE 1-0-2011.

THE MARK CONSISTS OF STANDARD CHARACTERS WITHOUT CLAIM TO ANY PARTICULAR FONT, STYLE, SIZE, OR COLOR.

NO CLAIM IS MADE TO THE EXCLUSIVE RIGHT TO USE "VISUAL", APART FROM THE MARK AS SHOWN.

SER. NO. 85-287,266, FILED 4-5-2011.

KATHERINE M. DUBRAY, EXAMINING ATTORNEY



David J. Kybas

Director of the United States Patent and Trademark Office

United States of America

United States Patent and Trademark Office

TWIRLYGIRL

Reg. No. 4,066,479

Registered Dec. 6, 2011

Int. Cls.: 25 and 36

TRADEMARK

SERVICE MARK

PRINCIPAL REGISTER

TWIRLYGIRL LLC (CALIFORNIA LIMITED LIABILITY COMPANY)
117 W. 9TH ST. SUITE 1016
LOS ANGELES, CA 90015

FOR: WOMEN'S AND CHILDREN'S APPAREL, NAMELY, DRESSES, SKIRTS, JUMPERS, T-SHIRTS, TANK TOPS, SHIRTS, TUNICS, SHORTS, PANTS, JACKETS AND HATS AND HEADBANDS, IN CLASS 25 (U.S. CLS. 22 AND 39).

FIRST USE 11-5-2006; IN COMMERCE 11-5-2006.

FOR: ONLINE WHOLESALE AND RETAIL STORE SERVICES OF APPAREL AND ACCESSORIES, IN CLASS 36 (U.S. CLS. 100, 101 AND 102).

FIRST USE 11-5-2006; IN COMMERCE 11-5-2006.

THE MARK CONSISTS OF STANDARD CHARACTERS WITHOUT CLAIM TO ANY PARTICULAR FONT, STYLE, SIZE, OR COLOR.

OWNER OF U.S. REG. NO. 3,301,244.

SER. NO. 85-287,282, FILED 4-5-2011.

DAWN FELDMAN, EXAMINING ATTORNEY



David J. Kyros

Director of the United States Patent and Trademark Office

United States of America

United States Patent and Trademark Office

TWIRLY

Reg. No. 4,066,480

Registered Dec. 6, 2011

Int. Cl.: 25

TRADEMARK

PRINCIPAL REGISTER

TWIRLYGIRL LLC (CALIFORNIA LIMITED LIABILITY COMPANY)
117 W. 9TH ST. SUITE 1016
LOS ANGELES, CA 90015

FOR: WOMEN'S AND CHILDREN'S APPAREL, NAMELY, DRESSES, SKIRTS, JUMPERS, T-SHIRTS, TANK TOPS, SHIRTS, TUNICS, SHORTS, PANTS, JACKETS AND HATS AND HEADBANDS, IN CLASS 25 (U.S. CLS. 22 AND 39).

FIRST USE 11-5-2006; IN COMMERCE 11-5-2006.

THE MARK CONSISTS OF STANDARD CHARACTERS WITHOUT CLAIM TO ANY PARTICULAR FONT, STYLE, SIZE, OR COLOR.

OWNER OF U.S. REG. NO. 3,301,244.

SER. NO. 85-287,287, FILED 4-6-2011.

DAWN FELDMAN, EXAMINING ATTORNEY



David J. Kybas

Director of the United States Patent and Trademark Office

United States of America

United States Patent and Trademark Office

ADAM'S JEWELRY

Reg. No. 4,066,481

ADAM'S JEWELRY NETWORK PA INC. (PENNSYLVANIA CORPORATION)
RR14 BOX 8, ROUTE 611
STROUDSBURG, PA 18360

Registered Dec. 6, 2011

Int. Cl.: 35

FOR: ON-LINE RETAIL STORE SERVICES FEATURING JEWELRY; RETAIL STORE SERVICES FEATURING JEWELRY, IN CLASS 35 (U.S. CLS. 100, 101 AND 102).

SERVICE MARK

FIRST USE 10-12-1992; IN COMMERCE 10-1-1994.

PRINCIPAL REGISTER

NO CLAIM IS MADE TO THE EXCLUSIVE RIGHT TO USE "JEWELRY" AND THE PICTORIAL REPRESENTATION OF DIAMONDS, APART FROM THE MARK AS SHOWN.

THE COLOR(S) GRAY, SILVER, BLACK, BLUE AND NAVY BLUE IS/ARE CLAIMED AS A FEATURE OF THE MARK.

THE MARK CONSISTS OF 2 DIAMONDS PLACED ON RIGHT AND LEFT SIDES OF THE WORDS "ADAM'S JEWELRY". THE WORDS ARE IN UPPERCASE AND THE COLOR IS NAVY BLUE. THE DIAMONDS INCLUDE SHADES OF GRAY, SILVER, BLACK, AND BLUE COLORS AS SHOWN IN THE MARK.

SER. NO. 85-287,303, FILED 4-6-2011.

LINDA M. KING, EXAMINING ATTORNEY



David J. Kybas

Director of the United States Patent and Trademark Office

United States of America

United States Patent and Trademark Office

CONSULTANTS PREFERRED

Reg. No. 4,066,482

Registered Dec. 6, 2011

Int. Cl.: 36

SERVICE MARK

PRINCIPAL REGISTER

AKITA, INC. (DELAWARE CORPORATION)
SUITE 400
2711 CENTERVILLE ROAD
WILMINGTON, DE 19808

FOR: INSURANCE UNDERWRITING IN THE FIELD OF PROFESSIONAL LIABILITY, IN CLASS 36 (U.S. CLS. 100, 101 AND 102).

FIRST USE 8-23-2004; IN COMMERCE 8-23-2004.

THE MARK CONSISTS OF STANDARD CHARACTERS WITHOUT CLAIM TO ANY PARTICULAR FONT, STYLE, SIZE, OR COLOR.

OWNER OF U.S. REG. NO. 2,984,399.

SEC. 2(F).

SER. NO. 85-287,483, FILED 4-6-2011.

SUSAN RICHARDS, EXAMINING ATTORNEY



David J. Kybas

Director of the United States Patent and Trademark Office

United States of America

United States Patent and Trademark Office

Pinhole Economy

Reg. No. 4,066,483

Registered Dec. 6, 2011

Int. Cl.: 35

SERVICE MARK

PRINCIPAL REGISTER

POINT TO POINT (OHIO CORPORATION)
SUITE 200
23240 CHAGRIN BLVD.
CLEVELAND, OH 44122

FOR: ADVERTISING AGENCY SPECIALIZING IN THE DESIGN AND EXECUTION OF WORD OF MOUTH, VIRAL, BUZZ AND EXPERIENTIAL MARKETING PROGRAMS; ADVERTISING AND BUSINESS MANAGEMENT CONSULTANCY; ADVERTISING AND MARKETING; ADVERTISING AND MARKETING CONSULTANCY; ADVERTISING AND MARKETING SERVICES PROVIDED BY MEANS OF INDIRECT METHODS OF MARKETING COMMUNICATIONS, NAMELY, SOCIAL MEDIA, SEARCH ENGINE MARKETING, INQUIRY MARKETING, INTERNET MARKETING, MOBILE MARKETING, BLOGGING AND OTHER FORMS OF PASSIVE, SHARABLE OR VIRAL COMMUNICATIONS CHANNELS; ADVERTISING AND MARKETING SERVICES, NAMELY, PROMOTING THE GOODS AND SERVICES OF OTHERS; ADVERTISING SERVICES, NAMELY, PROMOTING AND MARKETING THE GOODS AND SERVICES OF OTHERS THROUGH ALL PUBLIC COMMUNICATION MEANS; ADVERTISING THE SERVICES OF OTHERS VIA WEB PAGES OPTIMIZED FOR ONLINE SEARCH ENGINES; ADVERTISING THROUGH ALL PUBLIC COMMUNICATION MEANS; ADVICE IN THE FIELD OF BUSINESS MANAGEMENT AND MARKETING; ANALYSIS OF ADVERTISING RESPONSE; ANALYSIS OF MARKET RESEARCH DATA AND STATISTICS; ASSISTANCE, ADVISORY SERVICES AND CONSULTANCY WITH REGARD TO BUSINESS PLANNING, BUSINESS ANALYSIS, BUSINESS MANAGEMENT, BUSINESS ORGANIZATION, MARKETING AND CUSTOMER ANALYSIS; BUSINESS ADVICE AND ANALYSIS OF MARKETS; BUSINESS CONSULTATION; BUSINESS CONSULTATION AND MANAGEMENT REGARDING MARKETING ACTIVITIES AND LAUNCHING OF NEW PRODUCTS; BUSINESS MARKETING SERVICES; BUSINESS MONITORING AND CONSULTING SERVICES, NAMELY, TRACKING WEB SITES AND APPLICATIONS OF OTHERS TO PROVIDE STRATEGY, INSIGHT, MARKETING, SALES, OPERATION, PRODUCT DESIGN, PARTICULARLY SPECIALIZING IN THE USE OF ANALYTIC AND STATISTIC MODELS FOR THE UNDERSTANDING AND PREDICTING OF CONSUMERS, BUSINESSES, AND MARKET TRENDS AND ACTIONS; CONSUMER STRATEGY BUSINESS CONSULTING IN THE FIELDS OF MARKETING, SALES, OPERATION, AND PRODUCT DESIGN PARTICULARLY SPECIALIZING IN THE USE OF ANALYTIC MODELS FOR THE UNDERSTANDING AND PREDICTING OF CONSUMER, BUSINESS, AND RETAIL MARKET TRENDS AND ACTIONS; DEVELOPMENT OF MARKETING STRATEGIES AND CONCEPTS; DEVELOPMENT OF MARKETING STRATEGIES, CONCEPTS AND TACTICS, NAMELY, AUDIENCE DEVELOPMENT, BRAND AWARENESS, CUSTOMER RELATIONS, ONLINE COMMUNITY



David J. Kybas

Director of the United States Patent and Trademark Office

Reg. No. 4,066,483 BUILDING AND DIGITAL WORD OF MOUTH COMMUNICATIONS; MARKET ANALYSIS; MARKET RESEARCH AND BUSINESS ANALYSES; MARKET RESEARCH AND MARKET INTELLIGENCE SERVICES; MARKET RESEARCH STUDIES; MARKETING AND BRANDING SERVICES, NAMELY, PROVIDING CUSTOMIZED COMMUNICATION PROGRAMS TO OBTAIN CONSUMER INSIGHTS AND DEVELOP BRANDING STRATEGIES; MARKETING SERVICES, NAMELY, PROMOTING OR ADVERTISING THE GOODS AND SERVICES OF OTHERS; PROMOTING THE GOODS AND SERVICES OF OTHERS BY MEANS OF WORD-OF-MOUTH AND NONTRADITIONAL MARKETING PROGRAMS; PROMOTING, MARKETING AND ADVERTISING THE BRANDS AND GOODS OF OTHERS RELATED TO ALL INDUSTRIES, THROUGH ALL PUBLIC AND PRIVATE COMMUNICATION MEANS, NAMELY, PROMOTING THE BRANDS AND GOODS OF OTHERS MADE IN THE UNITED STATES; PROVIDING BUSINESS MARKETING INFORMATION, IN CLASS 35 (U.S. CLS. 100, 101 AND 102).

FIRST USE 1-15-2011; IN COMMERCE 4-1-2011.

THE MARK CONSISTS OF STANDARD CHARACTERS WITHOUT CLAIM TO ANY PARTICULAR FONT, STYLE, SIZE, OR COLOR.

NO CLAIM IS MADE TO THE EXCLUSIVE RIGHT TO USE "ECONOMY", APART FROM THE MARK AS SHOWN.

SER. NO. 85-287,540, FILED 4-6-2011.

JIM RINGLE, EXAMINING ATTORNEY

United States of America

United States Patent and Trademark Office



Reg. No. 4,066,484

Registered Dec. 6, 2011

Int. Cl.: 35

SERVICE MARK

PRINCIPAL REGISTER

SECONDHAND CONCEPTS, INC. (NORTH CAROLINA CORPORATION)
2835 DAISY LANE NORTH, UNIT B
WILSON, NC 27896

FOR: SECOND HAND DEALERSHIP AND RETAIL STORE SERVICES FEATURING USED ELECTRICAL GOODS, AUDIO VISUAL EQUIPMENT, AUTOMOTIVE ACCESSORIES, HAND AND POWER TOOLS, COMPUTERS AND GAMES, JEWELRY AND HOUSEHOLD MERCHANDISE, IN CLASS 35 (U.S. CLS. 100, 101 AND 102).

FIRST USE 10-31-2008; IN COMMERCE 10-31-2008.

OWNER OF U.S. REG. NO. 3,630,220.

THE COLOR(S) RED, GREEN, AND BLUE IS/ARE CLAIMED AS A FEATURE OF THE MARK.

NO CLAIM IS MADE TO THE EXCLUSIVE RIGHT TO USE "TRADE IT", APART FROM THE MARK AS SHOWN.

THE MARK CONSISTS OF A DESIGN FEATURING THREE ARROWS (GREEN, RED AND BLUE, RESPECTIVELY) ON THE LEFT SIDE OF THE MARK, ARRANGED TO FORM A CIRCLE OR RING. TO THE RIGHT OF THE DESIGN, THE WORDING "TRADE" IN BLUE, TELESCOPED WITH THE WORD "IT" IN RED, FOLLOWED BY A BLUE EXCLAMATION POINT. BELOW THESE ARE THE PHRASES "SELL IT" "BUY IT" AND "LOVE IT", EACH IN GREEN. "SELL IT" AND "BUY IT" ARE SEPARATED BY A RED STAR AND "BUY IT" AND "LOVE IT" ARE SEPARATED BY A BLUE STAR.

SER. NO. 85-287,691, FILED 4-6-2011.

TRACY WHITTAKER-BROWN, EXAMINING ATTORNEY



David J. Kyffers

Director of the United States Patent and Trademark Office

United States of America

United States Patent and Trademark Office

THE SENIOR SOURCE

Reg. No. 4,066,485

THE SENIOR SOURCE (DELAWARE CORPORATION)
3910 HARRY HINES BLVD.
DALLAS, TX 75219

Registered Dec. 6, 2011

Int. Cl.: 35

FOR: JOB PLACEMENT SERVICES, NAMELY, ASSISTING MATURE ADULTS AND RETIREES WITH EMPLOYMENT OPPORTUNITIES, IN CLASS 35 (U.S. CLS. 100, 101 AND 102).

SERVICE MARK

FIRST USE 12-3-2002; IN COMMERCE 12-3-2002.

PRINCIPAL REGISTER

THE MARK CONSISTS OF STANDARD CHARACTERS WITHOUT CLAIM TO ANY PARTICULAR FONT, STYLE, SIZE, OR COLOR.

NO CLAIM IS MADE TO THE EXCLUSIVE RIGHT TO USE "SENIOR", APART FROM THE MARK AS SHOWN.

SER. NO. 85-287,792, FILED 4-6-2011.

APRIL ROACH, EXAMINING ATTORNEY



David J. Kyffers

Director of the United States Patent and Trademark Office

United States of America

United States Patent and Trademark Office

ORIGINAL REVERSIBLE TWIRLY DRESSES

Reg. No. 4,066,486

Registered Dec. 6, 2011

Int. Cls.: 25 and 35

TRADEMARK

SERVICE MARK

PRINCIPAL REGISTER

TWIRLYGIRL LLC (CALIFORNIA LIMITED LIABILITY COMPANY)
117 W. 9TH ST. SUITE 1016
LOS ANGELES, CA 90015

FOR: WOMEN'S AND CHILDREN'S APPAREL, NAMELY, DRESSES, SKIRTS, JUMPERS, T-SHIRTS, TANK TOPS, SHIRTS, TUNICS, SHORTS, PANTS, JACKETS AND HATS AND HEADBANDS, IN CLASS 25 (U.S. CLS. 22 AND 39).

FIRST USE 11-1-2006; IN COMMERCE 11-1-2006.

FOR: ONLINE WHOLESALE AND RETAIL STORE SERVICES FEATURING APPAREL AND ACCESSORIES, IN CLASS 35 (U.S. CLS. 100, 101 AND 102).

FIRST USE 11-1-2006; IN COMMERCE 11-1-2006.

THE MARK CONSISTS OF STANDARD CHARACTERS WITHOUT CLAIM TO ANY PARTICULAR FONT, STYLE, SIZE, OR COLOR.

OWNER OF U.S. REG. NO. 3,301,244.

NO CLAIM IS MADE TO THE EXCLUSIVE RIGHT TO USE "ORIGINAL REVERSIBLE" AND "DRESSES", APART FROM THE MARK AS SHOWN.

SER. NO. 85-287,847, FILED 4-6-2011.

DAWN FELDMAN, EXAMINING ATTORNEY



David J. Kyjars

Director of the United States Patent and Trademark Office

United States of America

United States Patent and Trademark Office

Financial Freedom For Smart People

Reg. No. 4,066,487

Registered Dec. 6, 2011

Int. Cl.: 41

SERVICE MARK

PRINCIPAL REGISTER

CREATECORP BUSINESS SOLUTIONS, INC. (NEVADA CORPORATION), DBA
FINANCIALMENTOR.COM
14085 RAIDER RUN ROAD
RENO, NV 89511

FOR: PROVIDING FINANCIAL EDUCATION SERVICES, NAMELY, COURSES OF INSTRUCTION ON INVESTMENT, RETIREMENT, AND WEALTH PLANNING AND EDUCATIONAL COURSE MATERIALS THEREWITH, IN CLASS 41 (U.S. CLS. 100, 101 AND 107).

FIRST USE 3-15-2011; IN COMMERCE 3-15-2011.

THE MARK CONSISTS OF STANDARD CHARACTERS WITHOUT CLAIM TO ANY PARTICULAR FONT, STYLE, SIZE, OR COLOR.

SER. NO. 85-287,901, FILED 4-6-2011.

JOHN HWANG, EXAMINING ATTORNEY



David J. Kybas

Director of the United States Patent and Trademark Office

United States of America

United States Patent and Trademark Office



Reg. No. 4,066,488

Registered Dec. 6, 2011

Int. Cl.: 6

TRADEMARK

PRINCIPAL REGISTER

REFRACTORY ANCHORS, INC. (OKLAHOMA CORPORATION)
9836 SOUTH 219TH EAST AVENUE
BROKEN ARROW, OK 74014

FOR: METAL FASTENERS, HIGH TEMPERATURE ALLOY AND STAINLESS STEEL ANCHORS USED TO ANCHOR REFRACTORIES IN FURNACES AND PROCESS EQUIPMENT, IN CLASS 6 (U.S. CLS. 2, 12, 13, 14, 23, 25 AND 50).

FIRST USE 7-1-1980; IN COMMERCE 1-0-1987.

THE MARK CONSISTS OF THE LETTERS "RAI" INSIDE A POLYGON WITH ROUNDED CORNERS.

SER. NO. 85-287,964, FILED 4-6-2011.

MARK SPARACINO, EXAMINING ATTORNEY



David J. Kyffers

Director of the United States Patent and Trademark Office

United States of America

United States Patent and Trademark Office

Life and Homes

BRINGING *PEOPLE* AND *HOMES* TOGETHER

Reg. No. 4,066,489

Registered Dec. 6, 2011

Int. Cl.: 35

SERVICE MARK

PRINCIPAL REGISTER

LIFE AND HOMES FRANCHISE, LLC. (NEW YORK LIMITED LIABILITY COMPANY)
P. O. BOX 18
8262 ROUTE 274
HOLLAND PATENT, NY 13354

FOR: REAL ESTATE ADVERTISING SERVICES, IN CLASS 35 (U.S. CLS. 100, 101 AND 102).

FIRST USE 12-5-2005; IN COMMERCE 12-5-2005.

NO CLAIM IS MADE TO THE EXCLUSIVE RIGHT TO USE "HOMES", APART FROM THE MARK AS SHOWN.

THE MARK CONSISTS OF THE WORD "HOMES" IN LARGE SENTENCE CASE LETTERS WITH THE WORDS "LIFE AND" SUSPENDED ABOVE AND TO THE RIGHT OF THE WORD "HOMES" ALSO IN SENTENCE CASE LETTERS BUT IN SMALLER FONT AND THE WORDS "BRINGING PEOPLE AND HOMES TOGETHER" IN ALL CAPS AND SMALLER FONT WITH THE WORDS "PEOPLE" AND "HOMES" ITALICIZED AND PLACED BELOW THE WORD "HOMES".

SER. NO. 85-288,054, FILED 4-6-2011.

TRACY FLETCHER, EXAMINING ATTORNEY



David J. Kyffers

Director of the United States Patent and Trademark Office

United States of America

United States Patent and Trademark Office

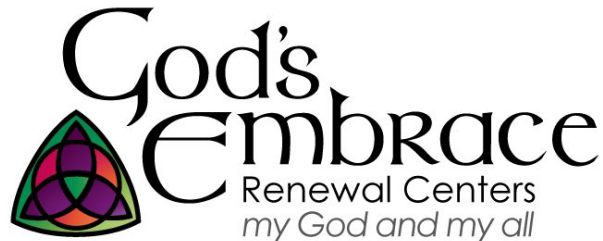

Reg. No. 4,066,490

Registered Dec. 6, 2011

Int. Cls.: 16, 41 and 45

TRADEMARK

SERVICE MARK

PRINCIPAL REGISTER

WINCEL, JEFFREY P (UNITED STATES INDIVIDUAL)
SUITE #3
728 E. 8TH STREET
HOLLAND, MI 49423 AND

FONSECA, MICHAEL (UNITED STATES INDIVIDUAL)
SUITE #3
728 E. 8TH STREET
HOLLAND, MI 49423

FOR: RELIGIOUS BOOKS; RELIGIOUS CIRCULAR LETTERS, IN CLASS 16 (U.S. CLS. 2, 5, 22, 23, 29, 37, 38 AND 50).

FIRST USE 2-1-2009; IN COMMERCE 3-1-2009.

FOR: PROVIDING ON-LINE RELIGIOUS INSTRUCTION PROMOTING CHRISTIAN AND FAMILY VALUES; RELIGIOUS INSTRUCTION SERVICES, IN CLASS 41 (U.S. CLS. 100, 101 AND 107).

FIRST USE 2-1-2009; IN COMMERCE 3-1-2009.

FOR: CONDUCTING RELIGIOUS PRAYER SERVICES; MINISTERIAL SERVICES, NAMELY, HOLDING SPIRITUAL RETREATS TO ASSIST RELIGIOUS LEADERS, BOTH CLERGY AND LAY, TO DEVELOP AND ENHANCE THEIR SPIRITUAL LIVES; PROVIDING A WEBSITE FEATURING INFORMATION ABOUT RELIGIOUS BELIEF SYSTEMS; RELIGIOUS AND SPIRITUAL SERVICES, NAMELY, PROVIDING GATHERINGS AND RETREATS TO DEVELOP AND ENHANCE THE SPIRITUAL LIVES OF INDIVIDUALS; RELIGIOUS SERVICES, NAMELY, PRAYER MEETINGS, IN CLASS 45 (U.S. CLS. 100 AND 101).

FIRST USE 2-1-2009; IN COMMERCE 3-1-2009.

NO CLAIM IS MADE TO THE EXCLUSIVE RIGHT TO USE "CENTERS", APART FROM THE MARK AS SHOWN.

THE COLOR(S) GREEN, PURPLE, RED AND BLACK IS/ARE CLAIMED AS A FEATURE OF THE MARK.



David J. Kyjars

Director of the United States Patent and Trademark Office

Reg. No. 4,066,490 THE MARK CONSISTS OF A STYLIZED 3 ELEMENT TRINITARIAN SYMBOL IN LITURGICAL COLORS OF GREEN, PURPLE AND RED DARKER SHADES OF THESE COLORS ON THE LEFT SIDE OF THE SYMBOL TRANSITIONING TO LIGHTER SHADES AT THE LOWER RIGHT OF THE SYMBOL. THE SYMBOL IS OUTLINED IN BLACK AND BLACK LINES SEPARATE THE INDIVIDUAL COLORS WITHIN THE SYMBOL. THE LITERAL ELEMENTS OF "GOD'S EMBRACE RENEWAL CENTERS" AND A SUBHEADING OF "MY GOD AND MY ALL" ARE IN BLACK AND APPEAR TO THE RIGHT OF THE SYMBOL. THE WORDS "GOD'S EMBRACE" ARE A STYLIZED CELTIC TYPE FONT WITH THE WORDING "RENEWAL CENTERS" AND "MY GOD AND MY ALL" IN SMALLER BLOCK LETTERING UNDERNEATH "GOD'S EMBRACE."

SER. NO. 85-288,113, FILED 4-6-2011.

JEFFREY LOOK, EXAMINING ATTORNEY

United States of America

United States Patent and Trademark Office

PLUMP IT UP

Reg. No. 4,066,491

SENSPA, LLC (CALIFORNIA LIMITED LIABILITY COMPANY)
1161 GORGAS AVENUE
SAN FRANCISCO, CA 94129

Registered Dec. 6, 2011

Int. Cl.: 3

FOR: PERSONAL CARE PRODUCTS, NAMELY, NON-MEDICATED SKIN TREATMENT SERUM, IN CLASS 3 (U.S. CLS. 1, 4, 6, 50, 51 AND 52).

TRADEMARK

FIRST USE 4-1-2010; IN COMMERCE 4-1-2010.

PRINCIPAL REGISTER

THE MARK CONSISTS OF STANDARD CHARACTERS WITHOUT CLAIM TO ANY PARTICULAR FONT, STYLE, SIZE, OR COLOR.

SER. NO. 85-288,147, FILED 4-6-2011.

KYLE PEETE, EXAMINING ATTORNEY



David J. Kybas

Director of the United States Patent and Trademark Office

United States of America

United States Patent and Trademark Office

ON THE MATTE

Reg. No. 4,066,492

SENSPA, LLC (CALIFORNIA LIMITED LIABILITY COMPANY)
1161 GORGAS AVENUE
SAN FRANCISCO, CA 94129

Registered Dec. 6, 2011

Int. Cl.: 3

FOR: PERSONAL CARE PRODUCTS, NAMELY, NON-MEDICATED SKIN TREATMENT SERUM, IN CLASS 3 (U.S. CLS. 1, 4, 6, 50, 51 AND 52).

TRADEMARK

FIRST USE 4-1-2010; IN COMMERCE 4-1-2010.

PRINCIPAL REGISTER

THE MARK CONSISTS OF STANDARD CHARACTERS WITHOUT CLAIM TO ANY PARTICULAR FONT, STYLE, SIZE, OR COLOR.

SER. NO. 85-288,161, FILED 4-6-2011.

KYLE PEETE, EXAMINING ATTORNEY



David J. Kyffers

Director of the United States Patent and Trademark Office

United States of America

United States Patent and Trademark Office

WE ♥
LOCALS

Reg. No. 4,066,493

Registered Dec. 6, 2011

Int. Cl.: 43

SERVICE MARK

PRINCIPAL REGISTER

NP IP HOLDINGS LLC (NEVADA LIMITED LIABILITY COMPANY)
1505 SOUTH PAVILION CENTER DRIVE
LAS VEGAS, NV 89135

FOR: COCKTAIL LOUNGES; HOTEL, BAR AND RESTAURANT SERVICES; PROVISION OF CONFERENCE, EXHIBITION AND MEETING FACILITIES, IN CLASS 43 (U.S. CLS. 100 AND 101).

FIRST USE 12-5-2010; IN COMMERCE 12-5-2010.

THE MARK CONSISTS OF THE STYLIZED WORD "WE" WHICH IS TO THE LEFT OF A DRAWING OF A HEART BOTH OF WHICH ARE OVER THE STYLIZED WORD "LOCALS".

SER. NO. 85-288,283, FILED 4-6-2011.

KELLY BOULTON, EXAMINING ATTORNEY



David J. Kyffers

Director of the United States Patent and Trademark Office

United States of America

United States Patent and Trademark Office

BREATH OF LIFE

Reg. No. 4,066,494

SENSPA, LLC (CALIFORNIA LIMITED LIABILITY COMPANY)
1161 GORGAS AVENUE
SAN FRANCISCO, CA 94129

Registered Dec. 6, 2011

Int. Cl.: 3

FOR: PERSONAL CARE PRODUCTS, NAMELY, NON-MEDICATED SKIN TREATMENT SERUM, IN CLASS 3 (U.S. CLS. 1, 4, 6, 50, 51 AND 52).

TRADEMARK

FIRST USE 4-1-2010; IN COMMERCE 4-1-2010.

PRINCIPAL REGISTER

THE MARK CONSISTS OF STANDARD CHARACTERS WITHOUT CLAIM TO ANY PARTICULAR FONT, STYLE, SIZE, OR COLOR.

SER. NO. 85-288,287, FILED 4-6-2011.

KYLE PEETE, EXAMINING ATTORNEY



David J. Kyffers

Director of the United States Patent and Trademark Office

United States of America

United States Patent and Trademark Office

WE ♥
LOCALS

Reg. No. 4,066,495

NP IP HOLDINGS LLC (NEVADA LIMITED LIABILITY COMPANY)
1505 SOUTH PAVILION CENTER DRIVE
LAS VEGAS, NV 89135

Registered Dec. 6, 2011

Int. Cl.: 41

FOR: ENTERTAINMENT IN THE NATURE OF CASINO SERVICES, AND LIVE PERFORMANCES BY SINGERS, MUSICIANS, MUSICAL GROUPS AND COMEDIANS; NIGHT CLUBS , IN CLASS 41 (U.S. CLS. 100, 101 AND 107).

SERVICE MARK

FIRST USE 12-5-2010; IN COMMERCE 12-5-2010.

PRINCIPAL REGISTER

THE MARK CONSISTS OF THE STYLIZED WORD "WE" WHICH IS TO THE LEFT OF A DRAWING OF A HEART BOTH OF WHICH ARE OVER THE STYLIZED WORD "LOCALS".

SER. NO. 85-288,297, FILED 4-6-2011.

KELLY BOULTON, EXAMINING ATTORNEY



David J. Kyffers

Director of the United States Patent and Trademark Office

United States of America

United States Patent and Trademark Office

BIDWELL BOTANICALS

Reg. No. 4,066,496

Registered Dec. 6, 2011

Int. Cl.: 3

TRADEMARK

PRINCIPAL REGISTER

JONES, JILL (UNITED STATES INDIVIDUAL)
122 THOMPSON STREET
ALPHARETTA, GA 30009

FOR: ANTI-AGING CREAM, BATH OIL, BATH SALTS, BATH SOAPS IN LIQUID, SOLID OR GEL FORM, BEAUTY SERUMS, BODY CREAMS, BODY LOTIONS, BODY OIL, BODY SCRUB, BUBBLE BATH, EXFOLIANT CREAMS, FACE CREAMS, FACIAL CLEANSERS, FACIAL MASKS, FACIAL SCRUBS, HAIR CONDITIONER, HAIR SHAMPOO, MAKE-UP REMOVER, MASSAGE OILS, NON-MEDICATED BATH PREPARATIONS, NON-MEDICATED FOOT CREAM, NON-MEDICATED FOOT SOAKS, SKIN CARE PREPARATIONS, NAMELY, SKIN MASKS, SKIN TONERS; NON-MEDICATED SKIN CARE PREPARATIONS, NAMELY, BODY MISTS, NON-MEDICATED SKIN BALMS, NON-MEDICATED LIP BALMS, IN CLASS 3 (U.S. CLS. 1, 4, 6, 50, 51 AND 52).

FIRST USE 8-1-2002; IN COMMERCE 10-1-2002.

THE MARK CONSISTS OF STANDARD CHARACTERS WITHOUT CLAIM TO ANY PARTICULAR FONT, STYLE, SIZE, OR COLOR.

NO CLAIM IS MADE TO THE EXCLUSIVE RIGHT TO USE "BOTANICALS", APART FROM THE MARK AS SHOWN.

SER. NO. 85-288,319, FILED 4-6-2011.

HEATHER SAPP, EXAMINING ATTORNEY



David J. Kybas

Director of the United States Patent and Trademark Office

United States of America

United States Patent and Trademark Office

GREAT MOUNTAIN

Reg. No. 4,066,497

Registered Dec. 6, 2011

Int. Cl.: 30

ROGER W. ZAK (UNITED STATES INDIVIDUAL), DBA THE UNLIMITED/ALASKA HAT
& APPAREL
PO BOX 4102
13428 E. VERDA DRIVE
PALMER, AK 996454102 AND

TRADEMARK

PRINCIPAL REGISTER

RHONDA I. ZAK (UNITED STATES INDIVIDUAL), DBA THE UNLIMITED/ALASKA HAT
& APPAREL
PO BOX 4102
13428 E. VERDA DRIVE
PALMER, AK 996454102

FOR: COFFEE, IN CLASS 30 (U.S. CL. 46).

FIRST USE 8-21-2010; IN COMMERCE 8-21-2010.

THE MARK CONSISTS OF STANDARD CHARACTERS WITHOUT CLAIM TO ANY PARTICULAR FONT, STYLE, SIZE, OR COLOR.

SER. NO. 85-288,359, FILED 4-6-2011.

MARK RADEMACHER, EXAMINING ATTORNEY



David J. Kyffers

Director of the United States Patent and Trademark Office

United States of America

United States Patent and Trademark Office

NIKI SAINT PIERRE BOTANICAL COSMECEUTICALS

Reg. No. 4,066,498

NIKI SAINT PIERRE, INC. (FLORIDA CORPORATION)
411 N NEW RIVER DR E, SUITE 702
FORT LAUDERDALE, FL 33301

Registered Dec. 6, 2011

Int. Cl.: 3

FOR: NON-MEDICATED SKIN CARE PREPARATIONS, IN CLASS 3 (U.S. CLS. 1, 4, 6, 50, 51 AND 52).

TRADEMARK

FIRST USE 3-0-2011; IN COMMERCE 3-0-2011.

PRINCIPAL REGISTER

THE MARK CONSISTS OF STANDARD CHARACTERS WITHOUT CLAIM TO ANY PARTICULAR FONT, STYLE, SIZE, OR COLOR.

NO CLAIM IS MADE TO THE EXCLUSIVE RIGHT TO USE "BOTANICAL COSMECEUTICALS", APART FROM THE MARK AS SHOWN.

THE NAME(S), PORTRAIT(S), AND/OR SIGNATURE(S) SHOWN IN THE MARK IDENTIFIES "NIKI ST. PIERRE", WHOSE CONSENT(S) TO REGISTER IS MADE OF RECORD.

SER. NO. 85-288,436, FILED 4-7-2011.

SHAILA SETTLES, EXAMINING ATTORNEY



David J. Kyros

Director of the United States Patent and Trademark Office

United States of America

United States Patent and Trademark Office

GovSmart

Reg. No. 4,066,499

Registered Dec. 6, 2011

Int. Cl.: 35

SERVICE MARK

PRINCIPAL REGISTER

GOVSMART, INC. (VIRGINIA CORPORATION)
120B SUMMIT STREET
CHARLOTTESVILLE, VA 22903

FOR: BUSINESS SERVICES, NAMELY, ASSISTING FEDERAL AND LOCAL GOVERNMENT ENTITIES TO PROCURE AND ACQUIRE GOODS AND SERVICES; DISTRIBUTORSHIP SERVICES IN THE FIELD OF COMPUTER HARDWARE, SOFTWARE, INFORMATION TECHNOLOGY SERVICES, OFFICE SUPPLIES, OFFICE EQUIPMENT AND OFFICE FURNITURE, IN CLASS 35 (U.S. CLS. 100, 101 AND 102).

FIRST USE 1-18-2010; IN COMMERCE 1-18-2010.

THE MARK CONSISTS OF STANDARD CHARACTERS WITHOUT CLAIM TO ANY PARTICULAR FONT, STYLE, SIZE, OR COLOR.

SER. NO. 85-288,439, FILED 4-7-2011.

FRANK LATTUCA, EXAMINING ATTORNEY



David J. Kyffers

Director of the United States Patent and Trademark Office

United States of America

United States Patent and Trademark Office

GovSmart

Reg. No. 4,066,500

Registered Dec. 6, 2011

Int. Cl.: 35

SERVICE MARK

PRINCIPAL REGISTER

GOVSMART, INC. (VIRGINIA CORPORATION)
120B SUMMIT STREET
CHARLOTTESVILLE, VA 22903

FOR: BUSINESS SERVICES, NAMELY, ASSISTING FEDERAL AND LOCAL GOVERNMENT ENTITIES TO PROCURE AND ACQUIRE GOODS AND SERVICES; DISTRIBUTORSHIP SERVICES IN THE FIELD OF COMPUTER HARDWARE, SOFTWARE, INFORMATION TECHNOLOGY SERVICES, OFFICE SUPPLIES, OFFICE EQUIPMENT AND OFFICE FURNITURE, IN CLASS 35 (U.S. CLS. 100, 101 AND 102).

FIRST USE 1-18-2010; IN COMMERCE 1-18-2010.

THE MARK CONSISTS OF THE WORD "GOVSMART" ABOVE A STAR WITH A TAIL EXTENDING THE FULL LENGTH OF THE WORD.

SER. NO. 85-288,443, FILED 4-7-2011.

FRANK LATTUCA, EXAMINING ATTORNEY



David J. Kyffers

Director of the United States Patent and Trademark Office

United States of America

United States Patent and Trademark Office

ClearPath 

Reg. No. 4,066,501

Registered Dec. 6, 2011

Int. Cl.: 9

TRADEMARK

PRINCIPAL REGISTER

MS SEDCO INC. (INDIANA CORPORATION)
8701 CASTLE PARK DRIVE
INDIANAPOLIS, IN 46256

FOR: ELECTRONIC SYSTEMS, NAMELY, RADIO FREQUENCY TRANSMITTERS, RADIO FREQUENCY RECEIVERS, MICROWAVE FREQUENCY DETECTORS, AND INFRARED SENSORS FOR TRANSMITTING AND RECEIVING RADIO FREQUENCY SIGNALS AND FOR DETECTING, MEASURING, AND SENSING THE PRESENCE OF PEOPLE AND OBJECTS FOR THE PURPOSE OF CONTROLLING AUTOMATIC DOORS, GARAGE DOORS, EMERGENCY DOORS, INDUSTRIAL DOORS, DOOR LOCKS, WINDOW LOCKS, ELECTRONIC PADLOCKS, ELECTRONIC ACCESS DEVICES, LIGHTING CONTROLLERS, SIGNAL LIGHTS, STATUS LIGHTS, WARNING LIGHTS, ELECTRONIC SENSING DEVICES, AND TRAFFIC CONTROL DEVICES, IN CLASS 9 (U.S. CLS. 21, 23, 26, 36 AND 38).

FIRST USE 3-15-2003; IN COMMERCE 4-22-2003.

THE MARK CONSISTS OF THE WORD "CLEARPATH" WHICH IS ADJACENT TO A ZIG ZAG LINE OF VARYING HEIGHT.

SER. NO. 85-288,469, FILED 4-7-2011.

ALYSSA STEEL, EXAMINING ATTORNEY



David J. Kyros

Director of the United States Patent and Trademark Office

United States of America

United States Patent and Trademark Office

The Beefmastor Inn

Reg. No. 4,066,502

Registered Dec. 6, 2011

Int. Cl.: 43

SERVICE MARK

PRINCIPAL REGISTER

BEEFMASTOR INN, INC. (NORTH CAROLINA CORPORATION)
2656 US HWY 301 SOUTH
WILSON, NC 27896

FOR: RESTAURANT SERVICES, IN CLASS 43 (U.S. CLS. 100 AND 101).

FIRST USE 0-0-1966; IN COMMERCE 0-0-1966.

THE MARK CONSISTS OF STANDARD CHARACTERS WITHOUT CLAIM TO ANY PARTICULAR FONT, STYLE, SIZE, OR COLOR.

NO CLAIM IS MADE TO THE EXCLUSIVE RIGHT TO USE "INN", APART FROM THE MARK AS SHOWN.

SER. NO. 85-288,558, FILED 4-7-2011.

STEVEN JACKSON, EXAMINING ATTORNEY



David J. Kyffers

Director of the United States Patent and Trademark Office

United States of America

United States Patent and Trademark Office

clearspire



Reg. No. 4,066,503

Registered Dec. 6, 2011

Int. Cl.: 45

SERVICE MARK

PRINCIPAL REGISTER

CLEARSPIRE SERVICE COMPANY, LLC (DELAWARE LIMITED LIABILITY COMPANY)
11804 PINEY GLEN LANE
C/O BRYCE ARROWOOD
POTOMAC, MD 20004

FOR: LEGAL SERVICES, IN CLASS 45 (U.S. CLS. 100 AND 101).

FIRST USE 9-15-2010; IN COMMERCE 9-15-2010.

THE MARK CONSISTS OF THE WORD "CLEARSPIRE" ALL IN LOWER-CASE LETTERS WITH THE DESIGN OF A SPIRE TO THE RIGHT COMPRISED OF THREE CURVED TRIANGULAR DESIGNS.

SER. NO. 85-288,597, FILED 4-7-2011.

LEIGH CAROLINE CASE, EXAMINING ATTORNEY



David J. Kybas

Director of the United States Patent and Trademark Office

United States of America

United States Patent and Trademark Office

SellMobile Marketing

Reg. No. 4,066,504

Registered Dec. 6, 2011

Int. Cl.: 35

SERVICE MARK

PRINCIPAL REGISTER

LAKWOOD ENTERPRISES, LLC (TENNESSEE LIMITED LIABILITY COMPANY), DBA
SELLMOBILE MARKETING
POB 397, 420 WOODLAND CIRCLE
BEAN STATION, TN 37708

FOR: PROMOTING AND MARKETING THE GOODS AND SERVICES OF OTHERS BY
DISTRIBUTING ADVERTISING MATERIAL, COUPONS AND DISCOUNT OFFERS VIA
TEXT MESSAGES, IN CLASS 35 (U.S. CLS. 100, 101 AND 102).

FIRST USE 2-25-2011; IN COMMERCE 3-1-2011.

THE MARK CONSISTS OF STANDARD CHARACTERS WITHOUT CLAIM TO ANY PAR-
TICULAR FONT, STYLE, SIZE, OR COLOR.

NO CLAIM IS MADE TO THE EXCLUSIVE RIGHT TO USE "MARKETING", APART FROM
THE MARK AS SHOWN.

SER. NO. 85-288,669, FILED 4-7-2011.

JOSETTE BEVERLY, EXAMINING ATTORNEY



David J. Kyros

Director of the United States Patent and Trademark Office

United States of America

United States Patent and Trademark Office

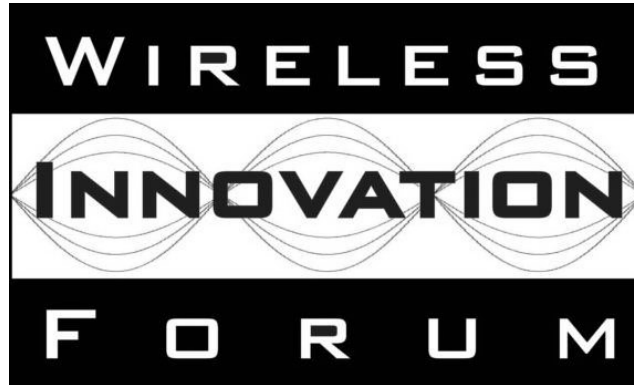

Reg. No. 4,066,505
Registered Dec. 6, 2011
Int. Cls.: 9, 35 and 42

THE SOFTWARE DEFINED RADIO FORUM, INC. (CALIFORNIA CORPORATION), DBA
THE WIRELESS INNOVATION FORUM
SUITE 158-436
18631 N 19TH AVENUE
PHOENIX, AZ 850275800

TRADEMARK

FOR: ELECTRONIC DOWNLOADABLE PUBLICATIONS IN THE NATURE OF INSTRUCTIONAL MATERIALS, PAMPHLETS, WHITE PAPERS, PRESENTATION LECTURE NOTES, AND MANUALS IN THE FIELDS OF SOFTWARE-DEFINED RADIO (SDR) COMMUNICATIONS AND WIRELESS COMMUNICATIONS INDUSTRY TECHNICAL STANDARDS, SPECIFICATIONS, AND INFORMATION TECHNOLOGY, IN CLASS 9 (U.S. CLS. 21, 23, 26, 36 AND 38).

SERVICE MARK

FIRST USE 12-3-2009; IN COMMERCE 12-3-2009.

PRINCIPAL REGISTER

FOR: ASSOCIATION SERVICES, NAMELY, PROMOTING THE INTERESTS OF THE SDR COMMUNICATIONS AND WIRELESS COMMUNICATIONS INDUSTRIES AND THEIR DEVELOPMENT OF VOLUNTARY STANDARDS; ARRANGING AND CONDUCTING BUSINESS CONFERENCES AND BUSINESS MEETINGS IN THE FIELDS OF SDR RADIO COMMUNICATIONS AND WIRELESS COMMUNICATIONS, IN CLASS 35 (U.S. CLS. 100, 101 AND 102).

FIRST USE 12-3-2009; IN COMMERCE 12-3-2009.



FOR: DEVELOPMENT OF VOLUNTARY STANDARDS FOR FACILITATING INTEROPERABILITY IN THE FIELDS OF SDR RADIO COMMUNICATIONS AND WIRELESS COMMUNICATIONS; COMPUTER SERVICES, NAMELY, DEVELOPMENT AND ESTABLISHMENT OF TESTING SPECIFICATIONS AND PROCEDURES IN THE FIELDS OF SDR RADIO COMMUNICATIONS AND WIRELESS COMMUNICATIONS; PROVIDING A WEB SITE FOR THE DISSEMINATION OF TECHNOLOGICAL INFORMATION IN THE FIELDS OF SDR RADIO COMMUNICATIONS AND WIRELESS COMMUNICATIONS, IN CLASS 42 (U.S. CLS. 100 AND 101).

FIRST USE 12-3-2009; IN COMMERCE 12-3-2009.

David J. Kyjars

NO CLAIM IS MADE TO THE EXCLUSIVE RIGHT TO USE "WIRELESS INNOVATION FORUM", APART FROM THE MARK AS SHOWN.

Director of the United States Patent and Trademark Office

Reg. No. 4,066,505 THE MARK CONSISTS OF THREE STACKED BLOCKS WITH THE WORDING WIRELESS INNOVATION FORUM OVER A STYLIZED REPRESENTATION OF ELLIPSES.

SER. NO. 85-288,755, FILED 4-7-2011.

TRACY FLETCHER, EXAMINING ATTORNEY

United States of America

United States Patent and Trademark Office

Pink Ink Art

Reg. No. 4,066,506

Registered Dec. 6, 2011

Int. Cl.: 35

SERVICE MARK

PRINCIPAL REGISTER

EMCODIA, INC. (CALIFORNIA CORPORATION)
28081 CASCABEL
MISSION VIEJO, CA 92692

FOR: ON-LINE RETAIL GIFT SHOPS, IN CLASS 35 (U.S. CLS. 100, 101 AND 102).

FIRST USE 10-30-2006; IN COMMERCE 12-2-2006.

THE MARK CONSISTS OF STANDARD CHARACTERS WITHOUT CLAIM TO ANY PARTICULAR FONT, STYLE, SIZE, OR COLOR.

NO CLAIM IS MADE TO THE EXCLUSIVE RIGHT TO USE "ART", APART FROM THE MARK AS SHOWN.

SER. NO. 85-288,782, FILED 4-7-2011.

JAMES LOVELACE, EXAMINING ATTORNEY



David J. Kyffers

Director of the United States Patent and Trademark Office

United States of America

United States Patent and Trademark Office

A HEALTHY WORKFORCE IS A HEALTHY BUSINESS

Reg. No. 4,066,507

Registered Dec. 6, 2011

Int. Cl.: 44

SERVICE MARK

PRINCIPAL REGISTER

MOBILE HEALTH MANAGEMENT SERVICES, INC. (NEW YORK CORPORATION)
26 HARBOR PARK DRIVE
PORT WASHINGTON, NY 11050

FOR: MEDICAL SERVICES; HEALTH CARE SERVICES, NAMELY, WELLNESS PROGRAMS;
AND MEDICAL SERVICES, NAMELY, PRE-EMPLOYMENT HEALTH ASSESSMENT AND
SCREENING , IN CLASS 44 (U.S. CLS. 100 AND 101).

FIRST USE 12-31-2007; IN COMMERCE 12-31-2007.

THE MARK CONSISTS OF STANDARD CHARACTERS WITHOUT CLAIM TO ANY PAR-
TICULAR FONT, STYLE, SIZE, OR COLOR.

SER. NO. 85-288,880, FILED 4-7-2011.

MARK SPARACINO, EXAMINING ATTORNEY



David J. Kyffers

Director of the United States Patent and Trademark Office

United States of America

United States Patent and Trademark Office

ONEJUSTICE

Reg. No. 4,066,508

Registered Dec. 6, 2011

Int. Cls.: 9 and 16

TRADEMARK

PRINCIPAL REGISTER

PUBLIC INTEREST CLEARINGHOUSE (CALIFORNIA NON-PROFIT CORPORATION), DBA
ONEJUSTICE
433 CALIFORNIA STREET, SUITE 815
SAN FRANCISCO, CA 94104

FOR: DOWNLOADABLE ELECTRONIC NEWSLETTERS IN THE FIELD OF LEGAL SERVICES; DOWNLOADABLE INSTRUCTIONAL VIDEO RECORDINGS AND RECORDED WEBINARS IN THE FIELD OF LEGAL SERVICES, IN CLASS 9 (U.S. CLS. 21, 23, 26, 36 AND 38).

FIRST USE 12-29-2010; IN COMMERCE 2-18-2011.

FOR: PRINTED REPORTS AND WRITTEN ARTICLES IN THE FIELD OF LEGAL SERVICES; LAW REPORTS; ADHESIVE NOTE PADS; SELF-ADHESIVE TAPES FOR STATIONERY AND HOUSEHOLD PURPOSES, IN CLASS 16 (U.S. CLS. 2, 5, 22, 23, 29, 37, 38 AND 50).

FIRST USE 1-27-2011; IN COMMERCE 3-1-2011.

THE MARK CONSISTS OF STANDARD CHARACTERS WITHOUT CLAIM TO ANY PARTICULAR FONT, STYLE, SIZE, OR COLOR.

SER. NO. 85-289,172, FILED 4-7-2011.

TRACY WHITTAKER-BROWN, EXAMINING ATTORNEY



David J. Kybas

Director of the United States Patent and Trademark Office

United States of America

United States Patent and Trademark Office

WORKING SOLUTIONS

Reg. No. 4,066,509

Registered Dec. 6, 2011

Int. Cl.: 36

SERVICE MARK

PRINCIPAL REGISTER

TMC DEVELOPMENT WORKING SOLUTIONS (CALIFORNIA NON-PROFIT ORGANIZATION)
440 PACIFIC AVENUE
SAN FRANCISCO, CA 94133

FOR: ARRANGING MICROLOANS AND SMALL BUSINESS LOANS FOR ESTABLISHED AND START-UP BUSINESSES; PROVIDING FINANCIAL ADVISORY AND CONSULTANCY SERVICES FOR MICRO-ENTREPRENEURS AND SMALL BUSINESSES, IN CLASS 36 (U.S. CLS. 100, 101 AND 102).

FIRST USE 2-11-2005; IN COMMERCE 2-11-2005.

THE MARK CONSISTS OF STANDARD CHARACTERS WITHOUT CLAIM TO ANY PARTICULAR FONT, STYLE, SIZE, OR COLOR.

NO CLAIM IS MADE TO THE EXCLUSIVE RIGHT TO USE "SOLUTIONS", APART FROM THE MARK AS SHOWN.

SER. NO. 85-289,278, FILED 4-7-2011.

SANI KHOURI, EXAMINING ATTORNEY



David J. Kybas

Director of the United States Patent and Trademark Office

United States of America

United States Patent and Trademark Office

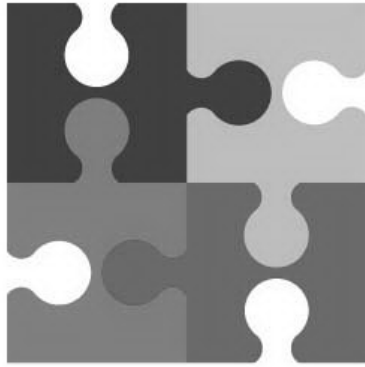

Working Solutions

Reg. No. 4,066,510

Registered Dec. 6, 2011

Int. Cl.: 36

SERVICE MARK

PRINCIPAL REGISTER

TMC DEVELOPMENT WORKING SOLUTIONS (CALIFORNIA NON-PROFIT ORGANIZATION)
440 PACIFIC AVENUE
SAN FRANCISCO, CA 94133

FOR: ARRANGING MICROLOANS AND SMALL BUSINESS LOANS FOR ESTABLISHED AND START-UP BUSINESSES; PROVIDING FINANCIAL ADVISORY AND CONSULTANCY SERVICES FOR MICRO-ENTREPRENEURS AND SMALL BUSINESSES, IN CLASS 36 (U.S. CLS. 100, 101 AND 102).

FIRST USE 2-9-2011; IN COMMERCE 2-9-2011.

NO CLAIM IS MADE TO THE EXCLUSIVE RIGHT TO USE "SOLUTIONS", APART FROM THE MARK AS SHOWN.

THE MARK CONSISTS OF FOUR INTERLOCKING PUZZLE PIECES OF ROUGHLY EQUAL SIZE, WHICH FORM A SQUARE NEXT TO THE WORDS "WORKING SOLUTIONS".

SER. NO. 85-289,306, FILED 4-7-2011.

SANI KHOURI, EXAMINING ATTORNEY



David J. Kybas

Director of the United States Patent and Trademark Office

United States of America

United States Patent and Trademark Office



Reg. No. 4,066,511

Registered Dec. 6, 2011

Int. Cls.: 16 and 44

TRADEMARK

SERVICE MARK

PRINCIPAL REGISTER

LAWYERS HELPING LAWYERS (VIRGINIA CORPORATION)
700 E. MAIN STREET
SUITE 1501
RICHMOND, VA 23219

FOR: EDUCATIONAL MATERIALS RELATED TO SUBSTANCE ABUSE COUNSELING, NAMELY, PAMPHLETS, BOOKLETS, BROCHURES AND RELATED PRINTED CONFERENCE MATERIALS, NAMELY, PRESENTATION OUTLINES, HARD COPY PRINTOUTS OF ELECTRONIC SLIDE PRESENTATIONS, AGENDAS AND DONOR LISTS, IN CLASS 16 (U.S. CLS. 2, 5, 22, 23, 29, 37, 38 AND 50).

FIRST USE 9-30-1995; IN COMMERCE 9-30-1995.

FOR: SUBSTANCE ABUSE COUNSELING AND MONITORING OF ATTORNEYS HAVING SUBSTANCE ABUSE ISSUES, IN CLASS 44 (U.S. CLS. 100 AND 101).

FIRST USE 9-30-1995; IN COMMERCE 9-30-1995.

THE MARK CONSISTS OF ONE PERSON SITTING ON A CURB AND ONE PERSON WITH A BRIEFCASE KNEELING NEXT TO HIM, ALL ENCLOSED IN A CIRCLE.

SER. NO. 85-289,377, FILED 4-7-2011.

LAURIE KAUFMAN, EXAMINING ATTORNEY



David J. Kybas

Director of the United States Patent and Trademark Office

United States of America

United States Patent and Trademark Office

PORTFOLIO RECOVERY ASSOCIATES

Reg. No. 4,066,512

PORTFOLIO RECOVERY ASSOCIATES, INC. (DELAWARE CORPORATION)
120 CORPORATE BLVD., SUITE 100
NORFOLK, VA 23502

Registered Dec. 6, 2011

Int. Cl.: 36

FOR: DEBT RECOVERY AND COLLECTION AGENCIES, IN CLASS 36 (U.S. CLS. 100, 101 AND 102).

SERVICE MARK

FIRST USE 7-1-1999; IN COMMERCE 7-1-1999.

PRINCIPAL REGISTER

THE MARK CONSISTS OF STANDARD CHARACTERS WITHOUT CLAIM TO ANY PARTICULAR FONT, STYLE, SIZE, OR COLOR.

OWNER OF U.S. REG. NOS. 2,442,511, 3,844,304 AND OTHERS.

NO CLAIM IS MADE TO THE EXCLUSIVE RIGHT TO USE "RECOVERY ASSOCIATES", APART FROM THE MARK AS SHOWN.

SEC. 2(F) AS TO "PORTFOLIO".

SER. NO. 85-289,463, FILED 4-7-2011.

ANDREA K. NADELMAN, EXAMINING ATTORNEY



David J. Kyros

Director of the United States Patent and Trademark Office

United States of America

United States Patent and Trademark Office



Reg. No. 4,066,513

Registered Dec. 6, 2011

Int. Cl.: 41

SERVICE MARK

PRINCIPAL REGISTER

CAESARS INTERACTIVE ENTERTAINMENT, INC. (DELAWARE CORPORATION)
ONE CAESARS PALACE DRIVE
LAS VEGAS, NV 89109

FOR: ENTERTAINMENT SERVICES, NAMELY, CONDUCTING LIVE POKER EVENTS, IN CLASS 41 (U.S. CLS. 100, 101 AND 107).

FIRST USE 8-11-2005; IN COMMERCE 8-11-2005.

OWNER OF U.S. REG. NOS. 3,154,905, 3,267,802, AND 3,290,269.

THE COLOR(S) RED, BLACK, WHITE AND GRAY IS/ARE CLAIMED AS A FEATURE OF THE MARK.

NO CLAIM IS MADE TO THE EXCLUSIVE RIGHT TO USE "POKER CIRCUIT EVENTS", APART FROM THE MARK AS SHOWN.

THE MARK CONSISTS OF THE WORDS "WORLD SERIES OF POKER CIRCUIT EVENTS". THE COLOR RED APPEARS ON THE DEPICTION OF THE LETTERING FOR THE TERMS "WORLD SERIES", AND THE DIAMOND AND THE HEART DESIGN ELEMENTS; THE COLOR BLACK APPEARS ON THE DEPICTION OF THE LETTERING FOR THE TERMS "OF POKER", THE LINE ABOVE AND BELOW THE TERM "POKER", THE SPADE AND THE CLUB DESIGN ELEMENTS, AND IS PART OF AN ALTERNATING CHECKERBOARD PATTERN AROUND THE RIM OF THE DEPICTION OF THE POKER CHIPS; THE COLOR GRAY APPEARS IN THE SHADOW OF THE STACK OF THREE CHIPS; AND THE COLOR WHITE APPEARS AS THE BACKGROUND OF THE FACE OF THE POKER CHIP, IN THE WORDS "CIRCUIT EVENTS" AND AS PART OF AN ALTERNATING CHECKERBOARD PATTERN AROUND THE RIM OF THE DEPICTION OF THE POKER CHIP.

SER. NO. 85-289,571, FILED 4-7-2011.

MARK T. MULLEN, EXAMINING ATTORNEY



David J. Kyffers

Director of the United States Patent and Trademark Office

United States of America

United States Patent and Trademark Office

FIDES

Reg. No. 4,066,514

Registered Dec. 6, 2011

Int. Cl.: 3

TRADEMARK

PRINCIPAL REGISTER

ANDREW HAHN (UNITED STATES INDIVIDUAL)
122 S. ST. ANDREWS PLACE, #346
LOS ANGELES, CA 90004

FOR: NON-MEDICATED SKIN CARE PREPARATIONS, NAMELY, CREAMS, LOTIONS, GELS, TONERS, CLEANERS AND PEELS, IN CLASS 3 (U.S. CLS. 1, 4, 6, 50, 51 AND 52).

FIRST USE 3-1-2011; IN COMMERCE 3-1-2011.

THE MARK CONSISTS OF STANDARD CHARACTERS WITHOUT CLAIM TO ANY PARTICULAR FONT, STYLE, SIZE, OR COLOR.

THE ENGLISH TRANSLATION OF "FIDES" IN THE MARK IS "FAITH."

SER. NO. 85-289,668, FILED 4-7-2011.

RUSS HERMAN, EXAMINING ATTORNEY



David J. Kyros

Director of the United States Patent and Trademark Office

United States of America

United States Patent and Trademark Office

BEYOND THE CALL

Reg. No. 4,066,515

GRANFORS, MELANIE (UNITED STATES INDIVIDUAL)
5801 223RD PLACE SW
MOUNTLAKE TERRACE, WA 98043

Registered Dec. 6, 2011

Int. Cl.: 35

FOR: PUBLIC RELATIONS IN THE FIELD OF EMERGENCY RESPONSE SERVICES, IN CLASS 35 (U.S. CLS. 100, 101 AND 102).

SERVICE MARK

FIRST USE 3-12-2011; IN COMMERCE 3-12-2011.

PRINCIPAL REGISTER

THE MARK CONSISTS OF STANDARD CHARACTERS WITHOUT CLAIM TO ANY PARTICULAR FONT, STYLE, SIZE, OR COLOR.

SER. NO. 85-289,771, FILED 4-8-2011.

KAREN BRACEY, EXAMINING ATTORNEY



David J. Kyffers

Director of the United States Patent and Trademark Office

United States of America

United States Patent and Trademark Office

WOWindow Posters

Reg. No. 4,066,516

Registered Dec. 6, 2011

Int. Cl.: 16

TRADEMARK

PRINCIPAL REGISTER

WOWINDOWS, LLC (NEW JERSEY LIMITED LIABILITY COMPANY)
SUITE 107
123 N. UNION AVE.
CRANFORD, NJ 07016

FOR: POSTERS; UNMOUNTED POSTERS, IN CLASS 16 (U.S. CLS. 2, 5, 22, 23, 29, 37, 38 AND 50).

FIRST USE 1-31-2005; IN COMMERCE 9-0-2005.

THE MARK CONSISTS OF STANDARD CHARACTERS WITHOUT CLAIM TO ANY PARTICULAR FONT, STYLE, SIZE, OR COLOR.

NO CLAIM IS MADE TO THE EXCLUSIVE RIGHT TO USE "POSTERS", APART FROM THE MARK AS SHOWN.

SER. NO. 85-289,788, FILED 4-8-2011.

GENE MACIOL, EXAMINING ATTORNEY



David J. Kybas

Director of the United States Patent and Trademark Office

United States of America

United States Patent and Trademark Office



Reg. No. 4,066,517

Registered Dec. 6, 2011

Int. Cl.: 42

SERVICE MARK

PRINCIPAL REGISTER

DUROSEAU, LOWINSKY (UNITED STATES INDIVIDUAL)
750 NE 146 STREET
MIAMI, FL 33161

FOR: PROVIDING A WEB SITE FEATURING TECHNOLOGY THAT ENABLES INTERNET USERS TO BOOK TRAVEL; PROVIDING A WEBSITE FEATURING TECHNOLOGY THAT ENABLES USERS TO EXCHANGE INFORMATION RELATED TO TRAVEL; PROVIDING A WEBSITE THAT FEATURES TECHNOLOGY THAT ENABLES THE SECURE EXCHANGE OF INFORMATION BY USERS, IN CLASS 42 (U.S. CLS. 100 AND 101).

FIRST USE 4-1-2011; IN COMMERCE 4-1-2011.

NO CLAIM IS MADE TO THE EXCLUSIVE RIGHT TO USE ".COM", APART FROM THE MARK AS SHOWN.

THE MARK CONSISTS OF THE STYLIZED TEXT "SURFTHECARIBBEAN.COM" WITH A STYLIZED IMAGE OF MAN HOLDING A SURF BOARD SURROUNDED BY STYLIZED IMAGES OF A SUN, WATER, SAND AND TREES.

SER. NO. 85-289,789, FILED 4-8-2011.

GENE MACIOL, EXAMINING ATTORNEY



David J. Kybas

Director of the United States Patent and Trademark Office

United States of America

United States Patent and Trademark Office

KEOLA

Reg. No. 4,066,518

Registered Dec. 6, 2011

Int. Cls.: 25 and 41

TRADEMARK

SERVICE MARK

PRINCIPAL REGISTER

BECKER, ALLISON L (UNITED STATES INDIVIDUAL)
2130 GREY RIDGE RD
MARYVILLE, TN 37801

FOR: HEADWEAR, FOOTWEAR AND CLOTHING; NAMELY, T-SHIRTS, TANK TOPS, SWEATSHIRTS, SWEATPANTS, YOGAPANTS, SHORTS, TIGHTS, TUNICS, SPORTS BRAS, HATS, JACKETS, SOCKS, BANDANAS, WRISTBANDS, LONG SLEEVE SHIRTS, SLEEVELESS SHIRTS, SCARVES, HEADBANDS AND HEADWEAR, DRESSES, PULLOVERS, ATHLETIC FOOTWEAR, SANDALS, PANTS, SHIRTS, GLOVES, WAISTBANDS, IN CLASS 25 (U.S. CLS. 22 AND 39).

FIRST USE 8-28-2008; IN COMMERCE 3-24-2009.

FOR: CHRISTIAN EDUCATIONAL SERVICES AND ENTERTAINMENT;, NAMELY, CONDUCTING CLASSES, WORKSHOPS, CONFERENCES, SEMINARS, AND INSTRUCTION IN THE FIELD OF HEALTH, FITNESS, YOGA, PILATES, NUTRITION, MOTIVATION, ACCOUNTABILITY, AND MIND-BODY-SPIRIT TRAINING WITH CHRISTIAN FOCUS DESIGNED TO PROMOTE THE PHYSICAL, NUTRITIONAL, AND SPIRITUAL DEVELOPMENT OF OTHERS, IN CLASS 41 (U.S. CLS. 100, 101 AND 107).

FIRST USE 8-28-2008; IN COMMERCE 2-8-2009.

THE MARK CONSISTS OF STANDARD CHARACTERS WITHOUT CLAIM TO ANY PARTICULAR FONT, STYLE, SIZE, OR COLOR.

OWNER OF U.S. REG. NO. 3,679,249.

THE ENGLISH TRANSLATION OF "KEOLA" IN THE MARK IS "THE HEALTH, THE LIFE AND THE WELL-BEING".

SER. NO. 85-289,802, FILED 4-8-2011.

GENE MACIOL, EXAMINING ATTORNEY



David J. Kyros

Director of the United States Patent and Trademark Office

United States of America

United States Patent and Trademark Office

ALUTUFF

Reg. No. 4,066,519

Registered Dec. 6, 2011

Int. Cl.: 19

TRADEMARK

PRINCIPAL REGISTER

VESUVIUS CRUCIBLE COMPANY (DELAWARE CORPORATION)
LEGAL DEPARTMENT
250 PARK WEST DRIVE
PITTSBURGH, PA 15275

FOR: REFRACTORY CASTABLE MIXES, NOT OF METAL, IN CLASS 19 (U.S. CLS. 1, 12, 33 AND 50).

FIRST USE 3-25-2011; IN COMMERCE 3-25-2011.

THE MARK CONSISTS OF STANDARD CHARACTERS WITHOUT CLAIM TO ANY PARTICULAR FONT, STYLE, SIZE, OR COLOR.

SER. NO. 85-289,818, FILED 4-8-2011.

SEAN CROWLEY, EXAMINING ATTORNEY



David J. Kybas

Director of the United States Patent and Trademark Office

United States of America

United States Patent and Trademark Office

TRIG

Reg. No. 4,066,520

Registered Dec. 6, 2011

Int. Cl.: 42

SERVICE MARK

PRINCIPAL REGISTER

TY HAGLER (UNITED STATES INDIVIDUAL)
12 STRAWBERRY RIDGE LANE
DURHAM, NC 27713

FOR: DRAFTING; GRAPHIC DESIGN SERVICES; INDUSTRIAL DESIGN; INNOVATION CONSULTING SERVICES, NAMELY, ADVISING OTHERS IN THE AREAS OF PRODUCT DEVELOPMENT; PACKAGING DESIGN; PRODUCT DEVELOPMENT AND ENGINEERING SERVICES FOR OTHERS, IN CLASS 42 (U.S. CLS. 100 AND 101).

FIRST USE 1-24-2011; IN COMMERCE 2-15-2011.

THE MARK CONSISTS OF STANDARD CHARACTERS WITHOUT CLAIM TO ANY PARTICULAR FONT, STYLE, SIZE, OR COLOR.

SER. NO. 85-289,851, FILED 4-8-2011.

JEFFREY LOOK, EXAMINING ATTORNEY



David J. Kybas

Director of the United States Patent and Trademark Office

United States of America

United States Patent and Trademark Office



Reg. No. 4,066,521

Registered Dec. 6, 2011

Int. Cl.: 36

SERVICE MARK

PRINCIPAL REGISTER

INVESTINGBYNUMBERS, LLC (MISSOURI LIMITED LIABILITY COMPANY)
SUITE 269
1732 CLARKSON ROAD
CHESTERFIELD, MO 63017

FOR: PROVIDING CONSULTATIVE SESSIONS, NAMELY, CONSULTING IN THE FIELD OF INVESTMENTS RELATED TO THE INVESTMENT DECISION-MAKING PROCESS, IN CLASS 36 (U.S. CLS. 100, 101 AND 102).

FIRST USE 3-24-2011; IN COMMERCE 3-24-2011.

NO CLAIM IS MADE TO THE EXCLUSIVE RIGHT TO USE "INVESTING" AND "SERVICES FOR FIDUCIARIES", APART FROM THE MARK AS SHOWN.

THE COLOR(S) ORANGE, BLUE, GREEN, GREY, BLACK, AND WHITE IS/ARE CLAIMED AS A FEATURE OF THE MARK.

THE MARK CONSISTS OF A CUBE FORMATION DESIGN, WITH THE TOP FACE OF THE CUBE APPEARING IN THE COLOR ORANGE WITH THE CAPITALIZED LETTERS "IBN" IN WHITE, AND THE RIGHT FACE OF THE CUBE APPEARING IN THE COLOR GREEN WITH A DOLLAR SIGN IN WHITE, AND THE LEFT FACE OF THE CUBE APPEARING IN THE COLOR BLUE WITH A WHITE CHECK MARK SYMBOL. A GREY SHADOW APPEARS UNDER THE CUBE. A GREY VERTICAL LINE IS TO THE RIGHT OF THE CUBE DESIGN, AND TO THE RIGHT OF THE GREY VERTICAL LINE THE WORDS "INVESTING BY NUMBERS SERVICES FOR FIDUCIARIES" APPEARS IN BOLD STYLIZED CAPITALIZED LETTERS. THE WORDS "INVESTING" AND "NUMBERS" APPEAR IN BLACK, AND THE WORDS "BY" AND "SERVICES FOR FIDUCIARIES" APPEAR IN GREY. THE WORD "INVESTING" IS SHOWN ON ONE LINE, WITH THE WORDS "BYNUMBERS" POSITIONED BELOW IT, AND THEN THE WORDS "SERVICES FOR FIDUCIARIES" POSITIONED ON THE BOTTOM.



SER. NO. 85-289,896, FILED 4-8-2011.

David J. Kyros

KAPIL BHANOT, EXAMINING ATTORNEY

United States of America

United States Patent and Trademark Office



Reg. No. 4,066,522

Registered Dec. 6, 2011

Int. Cl.: 37

SERVICE MARK

PRINCIPAL REGISTER

CROWTHER ROOFING AND SHEET METAL OF FLORIDA, INC. (FLORIDA CORPORATION)
2543 ROCKFILL ROAD
FORT MYERS, FL 33916

FOR: ROOFING SERVICES, NAMELY, ROOF REPAIR, ROOF INSTALLATION, ROOF MAINTENANCE, ROOF CONTRACTING, AND ROOF REPAIR, MAINTENANCE, INSTALLATION, AND CONTRACTING CONSULTATION; ROOFING SERVICES, NAMELY, SECURING ROOFTOP EQUIPMENT AND OTHER ROOF MATERIALS WITH HURRICANE STRAPPING AND TIE DOWNS; HVAC (HEATING VENTILATION AND AIR CONDITIONING) SERVICES, NAMELY, HVAC REPAIR, HVAC INSTALLATION, HVAC MAINTENANCE, HVAC CONTRACTING AND HVAC REPAIR, MAINTENANCE, INSTALLATION, AND CONTRACTING CONSULTATION; INSTALLATION OF ROOF TRUSSES, ARCHITECTURAL SHEET METAL, METAL ROOFING, TILE ROOFING, WATERPROOFING MATERIALS, AND LIGHTWEIGHT INSULATING CONCRETE; BUILDING CONSTRUCTION SERVICES; ELECTRICAL CONTRACTOR SERVICES, IN CLASS 37 (U.S. CLS. 100, 103 AND 106).

FIRST USE 0-0-1952; IN COMMERCE 0-0-1955.

OWNER OF U.S. REG. NO. 1,965,299.

THE COLOR(S) BLACK AND ORANGE IS/ARE CLAIMED AS A FEATURE OF THE MARK.

THE MARK CONSISTS OF THE STYLIZED BLACK WORDING "CROWTHER" AND ORANGE GLOBE DESIGN.

SEC. 2(F).

SER. NO. 85-289,930, FILED 4-8-2011.

BRIAN PINO, EXAMINING ATTORNEY



David J. Kybas

Director of the United States Patent and Trademark Office

United States of America

United States Patent and Trademark Office



Reg. No. 4,066,523

Registered Dec. 6, 2011

Int. Cl.: 42

SERVICE MARK

PRINCIPAL REGISTER

AMERISPEC, INC. (DELAWARE CORPORATION)
3839 FOREST HILL-IRENE RD.
MEMPHIS, TN 38125

FOR: COMPREHENSIVE RESIDENTIAL HOME AND COMMERCIAL PROPERTY INSPECTION SERVICES, NAMELY: EVALUATION OF SITE CHARACTERISTICS, NAMELY, PAVING, LANDSCAPING AND UTILITIES; NEW CONSTRUCTION REVIEWS; STRUCTURAL, SAFETY, ENVIRONMENTAL, EXTERIOR INSULATION AND FINISHING SYSTEM (EIFS), ELEVATOR, ESCALATOR, ROOFING, CHIMNEY, FIREPLACE, POOL AND SPA, OUT BUILDINGS, BUILT IN APPLIANCES, FENESTRATION, LEAD-BASED PAINT, WATER ANALYSIS, TERMITE, ASBESTOS AND RADON INSPECTIONS; HVAC, PLUMBING, ELECTRICAL, SEWAGE AND WASTE TREATMENT, SOLAR, PHOTOVOLTAIC, LAWN SPRINKLER, EMERGENCY GENERATOR, AND FIRE PROTECTION SYSTEMS; AND INDOOR AIR QUALITY AND ENERGY EFFICIENCY ASSESSMENTS , IN CLASS 42 (U.S. CLS. 100 AND 101).

FIRST USE 1-31-2000; IN COMMERCE 1-31-2000.

OWNER OF U.S. REG. NOS. 1,497,266, 1,968,902, AND 2,524,568.

NO CLAIM IS MADE TO THE EXCLUSIVE RIGHT TO USE "INSPECTION SERVICES", APART FROM THE MARK AS SHOWN.

THE MARK CONSISTS OF A DESIGN WHEREIN THE LEFT HALF IS COMPRISED OF A PARTIAL STAR OUTLINE AND THE RIGHT HALF CONSISTS OF A PARTIAL HOUSE OUTLINE WITH THE WORDS "AMERISPEC INSPECTION SERVICES" LOCATED TO THE RIGHT OF THE DESIGN ELEMENT.

SER. NO. 85-290,193, FILED 4-8-2011.

VIVIAN MICZNIK FIRST, EXAMINING ATTORNEY



David J. Kybas

Director of the United States Patent and Trademark Office

United States of America

United States Patent and Trademark Office

AMERISPEC

Reg. No. 4,066,524

Registered Dec. 6, 2011

Int. Cl.: 42

SERVICE MARK

PRINCIPAL REGISTER

AMERISPEC, INC. (DELAWARE CORPORATION)
3839 FOREST HILL-IRENE RD.
MEMPHIS, TN 38125

FOR: COMPREHENSIVE RESIDENTIAL HOME AND COMMERCIAL PROPERTY INSPECTION SERVICES, NAMELY: EVALUATION OF SITE CHARACTERISTICS, NAMELY, PAVING, LANDSCAPING AND UTILITIES; NEW CONSTRUCTION REVIEWS; STRUCTURAL, SAFETY, ENVIRONMENTAL, EXTERIOR INSULATION AND FINISHING SYSTEM (EIFS), ELEVATOR, ESCALATOR, ROOFING, CHIMNEY, FIREPLACE, POOL AND SPA, OUT BUILDINGS, BUILT IN APPLIANCES, FENESTRATION, LEAD-BASED PAINT, WATER ANALYSIS, TERMITE, ASBESTOS AND RADON INSPECTIONS; HVAC, PLUMBING, ELECTRICAL, SEWAGE AND WASTE TREATMENT, SOLAR, PHOTOVOLTAIC, LAWN SPRINKLER, EMERGENCY GENERATOR, AND FIRE PROTECTION SYSTEMS; AND INDOOR AIR QUALITY AND ENERGY EFFICIENCY ASSESSMENTS , IN CLASS 42 (U.S. CLS. 100 AND 101).

FIRST USE 10-8-1987; IN COMMERCE 10-8-1987.

THE MARK CONSISTS OF STANDARD CHARACTERS WITHOUT CLAIM TO ANY PARTICULAR FONT, STYLE, SIZE, OR COLOR.

OWNER OF U.S. REG. NOS. 1,497,266, 2,524,568, AND 2,649,445.

SER. NO. 85-290,218, FILED 4-8-2011.

VIVIAN MICZNIK FIRST, EXAMINING ATTORNEY



David J. Kyros

Director of the United States Patent and Trademark Office

United States of America

United States Patent and Trademark Office



Reg. No. 4,066,525

Registered Dec. 6, 2011

Int. Cl.: 42

SERVICE MARK

PRINCIPAL REGISTER

AMERISPEC, INC. (DELAWARE CORPORATION)
3839 FOREST HILL-IRENE RD.
MEMPHIS, TN 38125

FOR: COMPREHENSIVE RESIDENTIAL HOME AND COMMERCIAL PROPERTY INSPECTION SERVICES, NAMELY: EVALUATION OF SITE CHARACTERISTICS, NAMELY, PAVING, LANDSCAPING AND UTILITIES; NEW CONSTRUCTION REVIEWS; STRUCTURAL, SAFETY, ENVIRONMENTAL, EXTERIOR INSULATION AND FINISHING SYSTEM (EIFS), ELEVATOR, ESCALATOR, ROOFING, CHIMNEY, FIREPLACE, POOL AND SPA, OUT BUILDINGS, BUILT IN APPLIANCES, FENESTRATION, LEAD-BASED PAINT, WATER ANALYSIS, TERMITE, ASBESTOS AND RADON INSPECTIONS; HVAC, PLUMBING, ELECTRICAL, SEWAGE AND WASTE TREATMENT, SOLAR, PHOTOVOLTAIC, LAWN SPRINKLER, EMERGENCY GENERATOR, AND FIRE PROTECTION SYSTEMS; AND INDOOR AIR QUALITY AND ENERGY EFFICIENCY ASSESSMENTS , IN CLASS 42 (U.S. CLS. 100 AND 101).

FIRST USE 4-30-1988; IN COMMERCE 4-30-1988.

OWNER OF U.S. REG. NOS. 1,968,902, 2,524,568, AND 2,649,445.

THE MARK CONSISTS OF A DESIGN WHEREIN THE LEFT HALF IS COMPRISED OF A PARTIAL "STAR" OUTLINE AND THE RIGHT HALF CONSISTS OF A PARTIAL "HOUSE" OUTLINE.

SER. NO. 85-290,223, FILED 4-8-2011.

VIVIAN MICZNIK FIRST, EXAMINING ATTORNEY



David J. Kyros

Director of the United States Patent and Trademark Office

United States of America

United States Patent and Trademark Office

Dirty Paws
AZ

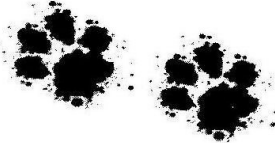

Reg. No. 4,066,526

Registered Dec. 6, 2011

Int. Cl.: 18

TRADEMARK

PRINCIPAL REGISTER

DIRTY PAWS OF AZ, LLC (ARIZONA LIMITED LIABILITY COMPANY)
3510 N. BRINDELY AVE
LITCHFIELD PARK, AZ 85340

FOR: DOG APPAREL, IN CLASS 18 (U.S. CLS. 1, 2, 3, 22 AND 41).

FIRST USE 3-1-2011; IN COMMERCE 3-1-2011.

NO CLAIM IS MADE TO THE EXCLUSIVE RIGHT TO USE "AZ", APART FROM THE MARK AS SHOWN.

THE MARK CONSISTS OF THE WORDS "DIRTY PAWS AZ". THE WORDS ARE LOCATED OVER THE TWO DIRTY PAW PRINTS.

SER. NO. 85-290,378, FILED 4-8-2011.

Laurie Kaufman, Examining Attorney



David J. Kyffers

Director of the United States Patent and Trademark Office

United States of America

United States Patent and Trademark Office

ALUMISHIELD

Reg. No. 4,066,527

Registered Dec. 6, 2011

Int. Cl.: 6

TRADEMARK

PRINCIPAL REGISTER

DDB UNLIMITED, INC. (OKLAHOMA CORPORATION)
ROUTE 1, BOX 15C
WYNNEWOOD, OK 73098

FOR: METAL STORAGE SHELTER STRUCTURES FOR STORING ELECTRONIC EQUIPMENT, IN CLASS 6 (U.S. CLS. 2, 12, 13, 14, 23, 25 AND 50).

FIRST USE 2-13-1997; IN COMMERCE 2-11-2011.

THE MARK CONSISTS OF STANDARD CHARACTERS WITHOUT CLAIM TO ANY PARTICULAR FONT, STYLE, SIZE, OR COLOR.

SER. NO. 85-290,428, FILED 4-8-2011.

DAVID C. REIHNER, EXAMINING ATTORNEY



David J. Kybas

Director of the United States Patent and Trademark Office

United States of America

United States Patent and Trademark Office



Reg. No. 4,066,528

Registered Dec. 6, 2011

Int. Cl.: 7

TRADEMARK

PRINCIPAL REGISTER

PEDDINGHAUS CORPORATION (DELAWARE CORPORATION)
300 N WASHINGTON AVE
BRADLEY, IL 60915

FOR: PLASMA ETCHING MACHINES, IN CLASS 7 (U.S. CLS. 13, 19, 21, 23, 31, 34 AND 35).

FIRST USE 4-8-2011; IN COMMERCE 4-8-2011.

NO CLAIM IS MADE TO THE EXCLUSIVE RIGHT TO USE "4-SURFACE DETAIL LAYOUT MARKING", APART FROM THE MARK AS SHOWN.

THE COLOR(S) GRAY, DARK GRAY, ORANGE, DARK ORANGE, LIGHT ORANGE AND WHITE IS/ARE CLAIMED AS A FEATURE OF THE MARK.

THE MARK CONSISTS OF "PEDDIWRITER 4 - SURFACE DETAIL LAYOUT MARKING" WITH TOP GRAY TO BOTTOM DARK GRAY "PEDDI" AND TOP DARK ORANGE TO BOTTOM LIGHT ORANGE "WRITER" AND TOP DARK ORANGE TO BOTTOM LIGHT ORANGE "4-SURFACE" AND TOP GRAY TO BOTTOM DARK GRAY "DETAIL LAYOUT MARKING". IN THE MIDDLE OF THE LOGO A WHITE STRIP GOES THROUGH THE WORDS "PEDDIWRITER" ENDING WITH AN ORANGE SPARK IN THE LETTER "R". AN EXTENSION OF THE SPARK FLARES IN A 45 DEGREE ANGLE IN THE UPWARD DIRECTION.

SER. NO. 85-290,464, FILED 4-8-2011.

PRISCILLA MILTON, EXAMINING ATTORNEY



David J. Kyros

Director of the United States Patent and Trademark Office

United States of America

United States Patent and Trademark Office

cSquad

Reg. No. 4,066,529

Registered Dec. 6, 2011

Int. Cl.: 37

SERVICE MARK

PRINCIPAL REGISTER

YADEGARI, MICHAEL (UNITED STATES INDIVIDUAL), DBA CSQUAD
919 S WOOSTER ST LOS ANGELES, CA 90035
LOS ANGELES, CA 90035

FOR: COMPUTER HARDWARE INSTALLATION AND REPAIR, INCLUDING MOBILE PERFORMANCE OF SUCH SERVICES ON CUSTOMER PREMISES; COMPUTER INSTALLATION AND REPAIR; CONSULTING IN THE FIELD OF MAINTENANCE AND REPAIR OF TELECOMMUNICATIONS NETWORKS, APPARATUS, AND INSTRUMENTS; INSTALLATION AND REPAIR OF BUSINESS AND OFFICE MACHINERY AND EQUIPMENT; INSTALLATION AND REPAIR OF COMPUTER HARDWARE; INSTALLATION OF COMPUTER NETWORKING HARDWARE; INSTALLATION, REPAIR AND MAINTENANCE OF COMPUTERS AND COMPUTER PERIPHERALS; REPAIR OF COMPUTER HARDWARE; REPAIR OF DAMAGED COMPUTERS; REPAIR OF FACSIMILE MACHINES, IN CLASS 37 (U.S. CLS. 100, 103 AND 106).

FIRST USE 2-4-2008; IN COMMERCE 2-4-2008.

THE MARK CONSISTS OF STANDARD CHARACTERS WITHOUT CLAIM TO ANY PARTICULAR FONT, STYLE, SIZE, OR COLOR.

SER. NO. 85-290,782, FILED 4-8-2011.

JANICE L. MCMORROW, EXAMINING ATTORNEY



David J. Kyros

Director of the United States Patent and Trademark Office

United States of America

United States Patent and Trademark Office

Emerge Transformed

Reg. No. 4,066,530

ALDERDICE, CHERRIL (FLORIDA LIMITED LIABILITY COMPANY)
24123 PEACHLAND BLVD C-4 #159
PORT CHARLOTTE, FL 33954

Registered Dec. 6, 2011

Int. Cl.: 35

FOR: BUSINESS CONSULTING SERVICES IN THE FIELD OF ORGANIZATIONAL CHANGE MANAGEMENT, IN CLASS 35 (U.S. CLS. 100, 101 AND 102).

SERVICE MARK

FIRST USE 2-18-2011; IN COMMERCE 2-18-2011.

PRINCIPAL REGISTER

THE MARK CONSISTS OF STANDARD CHARACTERS WITHOUT CLAIM TO ANY PARTICULAR FONT, STYLE, SIZE, OR COLOR.

SER. NO. 85-290,826, FILED 4-8-2011.

BARBARA BROWN, EXAMINING ATTORNEY



David J. Kyffers

Director of the United States Patent and Trademark Office

United States of America

United States Patent and Trademark Office



Reg. No. 4,066,531

Registered Dec. 6, 2011

Int. Cl.: 16

TRADEMARK

PRINCIPAL REGISTER

JUDO MATH INC. (CALIFORNIA CORPORATION)
6472 BOULDER LAKE AVE.
SAN DIEGO, CA 92119

FOR: EDUCATIONAL KITS SOLD AS A UNIT IN THE FIELD OF MATHEMATICS CONSISTING PRIMARILY OF PRINTED INSTRUCTIONAL MATERIALS AND ALSO INCLUDING DVDS ; POSTERS ; PRINTED MATTER, NAMELY, CURRICULUM IN THE FIELD OF MATHEMATICS, IN CLASS 16 (U.S. CLS. 2, 5, 22, 23, 29, 37, 38 AND 50).

FIRST USE 10-23-2007; IN COMMERCE 10-1-2010.

NO CLAIM IS MADE TO THE EXCLUSIVE RIGHT TO USE "Y = MX + B" AND "A² + B² = C²" AND "MATH", APART FROM THE MARK AS SHOWN.

THE MARK CONSISTS OF A MARTIAL ARTS STUDENT KICKING MATHEMATICS SYMBOLS, AND THE TEXT "Y=MX+B - - X / A² + B² + C² JUDO MATH".

SER. NO. 85-290,851, FILED 4-8-2011.

CHRISTINA SOBRAL, EXAMINING ATTORNEY



David J. Kybas

Director of the United States Patent and Trademark Office

United States of America

United States Patent and Trademark Office

The Ultimate Vacation Spot for Cool Cats and Hot Dogs

Reg. No. 4,066,532

PAPARELLA, ANNMARIE (UNITED STATES INDIVIDUAL)
6600 KINGSPONTE PY
ORLANDO, FL 32819

Registered Dec. 6, 2011

Int. Cl.: 43

FOR: KENNEL SERVICES, NAMELY, BOARDING FOR PETS, IN CLASS 43 (U.S. CLS. 100 AND 101).

SERVICE MARK

FIRST USE 10-1-2001; IN COMMERCE 10-1-2001.

PRINCIPAL REGISTER

THE MARK CONSISTS OF STANDARD CHARACTERS WITHOUT CLAIM TO ANY PARTICULAR FONT, STYLE, SIZE, OR COLOR.

SER. NO. 85-291,088, FILED 4-9-2011.

HENRY S. ZAK, EXAMINING ATTORNEY



David J. Kybas

Director of the United States Patent and Trademark Office

United States of America

United States Patent and Trademark Office



Reg. No. 4,066,533

Registered Dec. 6, 2011

Int. Cl.: 14

TRADEMARK

PRINCIPAL REGISTER

CELIA DE FLERS DESIGNS, LLC (CALIFORNIA LIMITED LIABILITY COMPANY)
4709 DUNMAN AVENUE
WOODLAND HILLS, CA 91364

FOR: JEWELRY, NAMELY, NECKLACES, EARRINGS, RINGS, BRACELETS, PINS, CUFF-LINKS, KEYCHAINS, IN CLASS 14 (U.S. CLS. 2, 27, 28 AND 50).

FIRST USE 11-1-2002; IN COMMERCE 8-25-2010.

THE NAME(S), PORTRAIT(S), AND/OR SIGNATURE(S) SHOWN IN THE MARK IDENTIFIES "CELIA DE FLERS", A LIVING INDIVIDUAL,, WHOSE CONSENT(S) TO REGISTER IS MADE OF RECORD.

THE MARK CONSISTS OF THE LETTER "C" WITH A SNOWFLAKE-SHAPED OBJECT IN THE CENTER OF THE "C" NEXT TO THE LETTER "F" WITH THE WORDS "CELIA DE FLERS" WRITTEN BELOW THE "F".

SER. NO. 85-291,174, FILED 4-10-2011.

ANGELA DUONG, EXAMINING ATTORNEY



David J. Kybas

Director of the United States Patent and Trademark Office

United States of America

United States Patent and Trademark Office

EyePRO

Reg. No. 4,066,534

Registered Dec. 6, 2011

Int. Cl.: 42

SERVICE MARK

PRINCIPAL REGISTER

DR. THOMAS A BLANKENSHIP (UNITED STATES INDIVIDUAL), DBA EYEPRO
3520 KNICKERBOCKER RD STE B PMB 337
SAN ANGELO, TX 76904

FOR: PROVIDING TEMPORARY USE OF ON-LINE NON-DOWNLOADABLE PRACTICE MANAGEMENT SOFTWARE FOR USE BY EYE CARE PROFESSIONALS, OPHTHALMOLOGISTS, OPTOMETRISTS, AND OPTICIANS; PROVIDING A WEBSITE FEATURING NON-DOWNLOADABLE PRACTICE MANAGEMENT SOFTWARE FOR USE BY EYE CARE PROFESSIONALS, IN CLASS 42 (U.S. CLS. 100 AND 101).

FIRST USE 1-1-2011; IN COMMERCE 1-1-2011.

THE MARK CONSISTS OF THE TERM "EYE" IN GRAY AND THE TERM "PRO" IN ORANGE, WITH BOTH TERMS LISTED TOGETHER AND MAKING UP A COMPOUND WORD.

THE COLOR(S) GRAY AND ORANGE IS/ARE CLAIMED AS A FEATURE OF THE MARK.

SER. NO. 85-291,199, FILED 4-10-2011.

MICHAEL WIENER, EXAMINING ATTORNEY



David J. Kyffers

Director of the United States Patent and Trademark Office

United States of America

United States Patent and Trademark Office

MICA MICROWAVE

Reg. No. 4,066,535

Registered Dec. 6, 2011

Int. Cl.: 9

TRADEMARK

PRINCIPAL REGISTER

MICRONETICS, INC. (DELAWARE CORPORATION)
26 HAMPSHIRE DRIVE
HUDSON, NH 03051

FOR: ELECTRONIC MICROWAVE FERRITE COMPONENTS FOR USE IN THE FIELD OF COMMUNICATIONS, NAMELY, MICROWAVE CIRCULATORS AND ISOLATORS AND STRUCTURAL PARTS THEREFOR, RADIO FREQUENCY MIXERS, AMPLIFIERS, VOLTAGE CONTROLLED OSCILLATORS, AND RADIO FREQUENCY DETECTORS, IN CLASS 9 (U.S. CLS. 21, 23, 26, 36 AND 38).

FIRST USE 3-8-1984; IN COMMERCE 3-8-1984.

THE MARK CONSISTS OF STANDARD CHARACTERS WITHOUT CLAIM TO ANY PARTICULAR FONT, STYLE, SIZE, OR COLOR.

NO CLAIM IS MADE TO THE EXCLUSIVE RIGHT TO USE "MICROWAVE", APART FROM THE MARK AS SHOWN.

SER. NO. 85-291,229, FILED 4-10-2011.

ELISSA GARBER KON, EXAMINING ATTORNEY



David J. Kyffers

Director of the United States Patent and Trademark Office

United States of America

United States Patent and Trademark Office

RSI RURAL SOURCING INC.

Reg. No. 4,066,536

Registered Dec. 6, 2011

Int. Cl.: 42

SERVICE MARK

PRINCIPAL REGISTER

RURAL SOURCING INC. (DELAWARE CORPORATION)
817 WEST PEACHTREE STREET, SUITE 201
ATLANTA, GA 30308

FOR: INFORMATION TECHNOLOGY SERVICES IN THE FIELD OF DOMESTIC OUT-SOURCING, NAMELY, INFORMATION TECHNOLOGY (IT) CONSULTING, COMPUTER SOFTWARE DEVELOPMENT, REMOTE AND ON-SITE MANAGEMENT OF THE IT SYSTEMS OF OTHERS, IN CLASS 42 (U.S. CLS. 100 AND 101).

FIRST USE 9-9-2004; IN COMMERCE 9-9-2004.

THE MARK CONSISTS OF STANDARD CHARACTERS WITHOUT CLAIM TO ANY PARTICULAR FONT, STYLE, SIZE, OR COLOR.

NO CLAIM IS MADE TO THE EXCLUSIVE RIGHT TO USE "RURAL SOURCING INC.", APART FROM THE MARK AS SHOWN.

SER. NO. 85-291,624, FILED 4-11-2011.

ANDREW LEASER, EXAMINING ATTORNEY



David J. Kyffers

Director of the United States Patent and Trademark Office

United States of America

United States Patent and Trademark Office

BECRS - Ballistic Elevation Calculator for Rifle Scopes

Reg. No. 4,066,537

Registered Dec. 6, 2011

Int. Cl.: 9

TRADEMARK

PRINCIPAL REGISTER

HINKLE, BURL SHANNON (UNITED STATES INDIVIDUAL), DBA HINKLE ENTERPRISES
816 VIRGINIA AVE
BLUEFIELD, VA 24605

FOR: BALLISTICS CALCULATION SOFTWARE FOR USE WITH SHOOTING SCOPES, IN
CLASS 9 (U.S. CLS. 21, 23, 26, 36 AND 38).

FIRST USE 6-1-2006; IN COMMERCE 6-1-2009.

THE MARK CONSISTS OF STANDARD CHARACTERS WITHOUT CLAIM TO ANY PAR-
TICULAR FONT, STYLE, SIZE, OR COLOR.

NO CLAIM IS MADE TO THE EXCLUSIVE RIGHT TO USE "BALLISTIC ELEVATION
CALCULATOR FOR RIFLE SCOPES", APART FROM THE MARK AS SHOWN.

SER. NO. 85-291,648, FILED 4-11-2011.

MICHELE SWAIN, EXAMINING ATTORNEY



David J. Kybas

Director of the United States Patent and Trademark Office

United States of America

United States Patent and Trademark Office

TASTEMAKER

Reg. No. 4,066,538

Registered Dec. 6, 2011

Int. Cl.: 32

TRADEMARK

PRINCIPAL REGISTER

MAD SCIENTISTS BREWING PARTNERS LLC (NEW YORK LIMITED LIABILITY COMPANY), DBA SIXPOINT CRAFT ALES
40 VAN DYKE STREET
BROOKLYN, NY 11231

FOR: BEER, IN CLASS 32 (U.S. CLS. 45, 46 AND 48).

FIRST USE 3-31-2011; IN COMMERCE 3-31-2011.

THE MARK CONSISTS OF STANDARD CHARACTERS WITHOUT CLAIM TO ANY PARTICULAR FONT, STYLE, SIZE, OR COLOR.

SER. NO. 85-291,778, FILED 4-11-2011.

ROSELLE HERRERA, EXAMINING ATTORNEY



David J. Kybas

Director of the United States Patent and Trademark Office

United States of America

United States Patent and Trademark Office



Reg. No. 4,066,539

Registered Dec. 6, 2011

Int. Cl.: 41

SERVICE MARK

PRINCIPAL REGISTER

AMERICAN COLLEGE COUNSELING, INC. (FLORIDA CORPORATION)
10758 WILES ROAD
CORAL SPRINGS, FL 33076

FOR: EDUCATIONAL COUNSELING SERVICES TO ASSIST STUDENTS IN PLANNING AND PREPARING FOR FURTHER EDUCATION, IN CLASS 41 (U.S. CLS. 100, 101 AND 107).

FIRST USE 8-1-2010, THE MARK WAS FIRST USED ANYWHERE IN A DIFFERENT FORM OTHER THAN THAT SOUGHT TO BE REGISTERED AT LEAST AS EARLY AS 08/01/2010.; IN COMMERCE 9-1-2010, THE MARK WAS FIRST USED IN COMMERCE IN A DIFFERENT FORM OTHER THAN THAT SOUGHT TO BE REGISTERED AT LEAST AS EARLY AS 09/01/2010..

THE MARK CONSISTS OF A STYLIZED HEDGEHOG WITH TEETH, A NOSE, EYES, AND HAIR IN A SWEATSHIRT CONTAINING THE LETTERS "ACCI" ON THE FRONT OF IT, WITH A MP3 PLAYER AND CONTAINING A DOT ON THE PLAYER ALONG WITH HEADPHONES, WITH SNEAKERS CONTAINING LINES, LACES, AND SOLES.

SER. NO. 85-291,791, FILED 4-11-2011.

KARANENDRA S. CHHINA, EXAMINING ATTORNEY



David J. Kybas

Director of the United States Patent and Trademark Office

United States of America

United States Patent and Trademark Office

NATIONAL CENTER FOR SCHOOL ENGAGEMENT

Reg. No. 4,066,540

Registered Dec. 6, 2011

Int. Cl.: 35

SERVICE MARK

PRINCIPAL REGISTER

THE PARTNERSHIP FOR FAMILIES & CHILDREN (COLORADO CORPORATION),
FORMERLY THE COLORADO FOUNDATION FOR FAMILIES AND CHILDREN
SUITE 100
450 LINCOLN STREET
DENVER, CO 80203

FOR: PROMOTING PUBLIC AWARENESS OF THE NEED TO IMPROVE EDUCATION,
HEALTH AND SOCIAL SERVICES FOR CHILDREN AND FAMILIES BY PROVIDING AD-
VOCACY, TECHNICAL ASSISTANCE AND PUBLIC POLICY RESEARCH, IN CLASS 35
(U.S. CLS. 100, 101 AND 102).

FIRST USE 9-30-2003; IN COMMERCE 9-30-2003.

THE MARK CONSISTS OF STANDARD CHARACTERS WITHOUT CLAIM TO ANY PAR-
TICULAR FONT, STYLE, SIZE, OR COLOR.

OWNER OF U.S. REG. NO. 2,937,099.

SEC. 2(F).

SER. NO. 85-291,828, FILED 4-11-2011.

NAPOLEON SHARMA, EXAMINING ATTORNEY



David J. Kyffers

Director of the United States Patent and Trademark Office

United States of America

United States Patent and Trademark Office

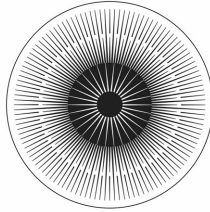

GOLD RING
VINEYARDS

Reg. No. 4,066,541

Registered Dec. 6, 2011

Int. Cl.: 33

TRADEMARK

PRINCIPAL REGISTER

ROUND HILL CELLARS (CALIFORNIA CORPORATION), DBA RUTHERFORD WINE COMPANY
1680 SILVERADO TRAIL
ST. HELENA, CA 94574

FOR: ALCOHOLIC BEVERAGES EXCEPT BEERS, IN CLASS 33 (U.S. CLS. 47 AND 49).

FIRST USE 7-30-2010; IN COMMERCE 7-30-2010.

OWNER OF U.S. REG. NO. 3,855,037.

NO CLAIM IS MADE TO THE EXCLUSIVE RIGHT TO USE "VINEYARDS", APART FROM THE MARK AS SHOWN.

THE MARK CONSISTS OF A CIRCLE WITHIN WHICH ARE RAYS EMANATING FROM A SMALLER CIRCLE, BENEATH WHICH ARE THE STYLIZED WORDS "GOLD RING VINEYARDS" APPEARING PERPENDICULAR TO THE CIRCLE DESIGN.

SER. NO. 85-292,224, FILED 4-11-2011.

DAWN FELDMAN, EXAMINING ATTORNEY



David J. Kybas

Director of the United States Patent and Trademark Office

United States of America

United States Patent and Trademark Office



Reg. No. 4,066,542

JASON CHEN (UNITED STATES INDIVIDUAL)
345 ESTUDILLO AVE # 102
SAN LEANDRO, CA 94577

Registered Dec. 6, 2011

Int. Cl.: 44

FOR: DENTISTRY, IN CLASS 44 (U.S. CLS. 100 AND 101).

SERVICE MARK

FIRST USE 4-1-2011; IN COMMERCE 4-1-2011.

PRINCIPAL REGISTER

NO CLAIM IS MADE TO THE EXCLUSIVE RIGHT TO USE "TEETH" , APART FROM THE MARK AS SHOWN.

THE MARK CONSISTS OF A DESIGN WITH THREE LEAVES IN A ROW, WHERE THE MIDDLE OF EACH LEAF RESEMBLES A DENTAL PICK, AND TO THE RIGHT OF THE DESIGN IS THE LITERAL ELEMENT "NICE TEETH".

SER. NO. 85-292,233, FILED 4-11-2011.

CURTIS FRENCH, EXAMINING ATTORNEY



David J. Kybas

Director of the United States Patent and Trademark Office

United States of America

United States Patent and Trademark Office

ZOOSK'S SCIENTIFIC MATCHMAKING SERVICE

Reg. No. 4,066,543

Registered Dec. 6, 2011

Int. Cl.: 45

SERVICE MARK

PRINCIPAL REGISTER

ZOOSK, INC. (DELAWARE CORPORATION)
475 SANSOME STREET, 10TH FLOOR
SAN FRANCISCO, CA 94111

FOR: ONLINE DATING SERVICES, IN CLASS 45 (U.S. CLS. 100 AND 101).

FIRST USE 8-10-2010; IN COMMERCE 8-10-2010.

THE MARK CONSISTS OF STANDARD CHARACTERS WITHOUT CLAIM TO ANY PARTICULAR FONT, STYLE, SIZE, OR COLOR.

OWNER OF U.S. REG. NOS. 3,476,277, 3,860,597 AND OTHERS.

NO CLAIM IS MADE TO THE EXCLUSIVE RIGHT TO USE "SCIENTIFIC MATCHMAKING SERVICE", APART FROM THE MARK AS SHOWN.

SER. NO. 85-292,239, FILED 4-11-2011.

MATTHEW EINSTEIN, EXAMINING ATTORNEY



David J. Kybas

Director of the United States Patent and Trademark Office

United States of America

United States Patent and Trademark Office

B O S S
M A N U F A C T U R I N G

Reg. No. 4,066,544

BOSS, MICHAEL (UNITED STATES INDIVIDUAL)
4217 COUNTY ROAD S
ORLAND, CA 95963

Registered Dec. 6, 2011

Int. Cl.: 21

FOR: CAKE STANDS; CAKE SUPPORTS, NAMELY, CAKE BASES; CAKE TINS; CUP CAKE MOLDS, IN CLASS 21 (U.S. CLS. 2, 13, 23, 29, 30, 33, 40 AND 50).

TRADEMARK

FIRST USE 1-1-2000; IN COMMERCE 1-1-2000.

PRINCIPAL REGISTER

NO CLAIM IS MADE TO THE EXCLUSIVE RIGHT TO USE "MANUFACTURING", APART FROM THE MARK AS SHOWN.

THE MARK CONSISTS OF THE WORDS "BOSS MANUFACTURING" IN STYLIZED FONT. THE WORD "BOSS" IS DIRECTLY ABOVE THE WORD "MANUFACTURING". EACH LETTER OF THE WORD "BOSS" IS CAPITALIZED AND IS CONTAINED IN A SEPARATE RECTANGLE. THE WORD "MANUFACTURING" IS CAPITALIZED.

SER. NO. 85-292,241, FILED 4-11-2011.

MICHAEL WEBSTER, EXAMINING ATTORNEY



David J. Kyffers

Director of the United States Patent and Trademark Office

United States of America

United States Patent and Trademark Office

ONLINE DATING. YOUR WAY.

Reg. No. 4,066,545

Registered Dec. 6, 2011

Int. Cl.: 45

SERVICE MARK

PRINCIPAL REGISTER

ZOOSK, INC. (DELAWARE CORPORATION)
475 SANSOME STREET, 10TH FLOOR
SAN FRANCISCO, CA 94111

FOR: ONLINE DATING SERVICES, IN CLASS 45 (U.S. CLS. 100 AND 101).

FIRST USE 6-30-2010; IN COMMERCE 6-30-2010.

THE MARK CONSISTS OF STANDARD CHARACTERS WITHOUT CLAIM TO ANY PARTICULAR FONT, STYLE, SIZE, OR COLOR.

NO CLAIM IS MADE TO THE EXCLUSIVE RIGHT TO USE "ONLINE DATING", APART FROM THE MARK AS SHOWN.

SER. NO. 85-292,253, FILED 4-11-2011.

MATTHEW EINSTEIN, EXAMINING ATTORNEY



David J. Kybas

Director of the United States Patent and Trademark Office

United States of America

United States Patent and Trademark Office

GIANNIS FINE FOODS

Reg. No. 4,066,546

Registered Dec. 6, 2011

Int. Cl.: 30

TRADEMARK

PRINCIPAL REGISTER

PARKER, JACQUELINE SUE (UNITED STATES INDIVIDUAL), DBA J & J GOURMET
1002 SE 2ND ST.
ENTERPRISE, OR 97828

FOR: VINEGAR, IN CLASS 30 (U.S. CL. 46).

FIRST USE 1-1-2011; IN COMMERCE 1-1-2011.

THE MARK CONSISTS OF STANDARD CHARACTERS WITHOUT CLAIM TO ANY PARTICULAR FONT, STYLE, SIZE, OR COLOR.

NO CLAIM IS MADE TO THE EXCLUSIVE RIGHT TO USE "FINE FOODS", APART FROM THE MARK AS SHOWN.

SER. NO. 85-292,365, FILED S.R. 4-11-2011 AM. P.R. 7-19-2011.

RAUL CORDOVA, EXAMINING ATTORNEY



David J. Kyffers

Director of the United States Patent and Trademark Office

United States of America

United States Patent and Trademark Office

OPERATION ORGANIZATION

Reg. No. 4,066,547

Registered Dec. 6, 2011

Int. Cl.: 42

SERVICE MARK

PRINCIPAL REGISTER

OPERATION ORGANIZATION, INC. (CALIFORNIA CORPORATION)
15206 BURBANK BOULEVARD, SUITE 309
SHERMAN OAKS, CA 91411

FOR: INTERIOR DECORATING, IN CLASS 42 (U.S. CLS. 100 AND 101).

FIRST USE 6-26-2005; IN COMMERCE 6-26-2005.

THE MARK CONSISTS OF STANDARD CHARACTERS WITHOUT CLAIM TO ANY PARTICULAR FONT, STYLE, SIZE, OR COLOR.

OWNER OF U.S. REG. NO. 3,966,657.

NO CLAIM IS MADE TO THE EXCLUSIVE RIGHT TO USE "ORGANIZATION", APART FROM THE MARK AS SHOWN.

SER. NO. 85-292,441, FILED 4-12-2011.

BARBARA BROWN, EXAMINING ATTORNEY



David J. Kybas

Director of the United States Patent and Trademark Office

United States of America

United States Patent and Trademark Office

bellasole' studio

Reg. No. 4,066,548

Registered Dec. 6, 2011

Int. Cl.: 44

SERVICE MARK

PRINCIPAL REGISTER

BELLA SOLE' STUDIO LLC (NORTH CAROLINA LIMITED LIABILITY COMPANY)
1550 HENDERSONVILLE ROAD SUITE 212
ASHEVILLE, NC 28730

FOR: AIRBRUSH SKIN TANNING SERVICES FOR HUMANS FOR COSMETIC PURPOSES,
IN CLASS 44 (U.S. CLS. 100 AND 101).

FIRST USE 12-1-2010; IN COMMERCE 12-15-2010.

THE MARK CONSISTS OF STANDARD CHARACTERS WITHOUT CLAIM TO ANY PAR-
TICULAR FONT, STYLE, SIZE, OR COLOR.

NO CLAIM IS MADE TO THE EXCLUSIVE RIGHT TO USE "STUDIO", APART FROM THE
MARK AS SHOWN.

THE ENGLISH TRANSLATION OF THE WORD "BELLASOLE" IN THE MARK IS "BEAUTI-
FUL SUN".

SER. NO. 85-292,696, FILED 4-12-2011.

DAVID I, EXAMINING ATTORNEY



David J. Kyffers

Director of the United States Patent and Trademark Office

United States of America

United States Patent and Trademark Office

CUBOID

SURRENDER YOUR CORKSCREW

Reg. No. 4,066,549

Registered Dec. 6, 2011

Int. Cl.: 33

TRADEMARK

PRINCIPAL REGISTER

ROUND HILL CELLARS (CALIFORNIA CORPORATION), DBA RUTHERFORD WINE
COMPANY
1680 SILVERADO TRAIL
ST. HELENA, CA 94574

FOR: ALCOHOLIC BEVERAGES EXCEPT BEERS, IN CLASS 33 (U.S. CLS. 47 AND 49).

FIRST USE 2-16-2011; IN COMMERCE 2-16-2011.

OWNER OF U.S. REG. NO. 3,971,866.

THE MARK CONSISTS OF THE STYLIZED WORD "CUBOID" ABOVE THE STYLIZED
WORDS "SURRENDER YOUR CORKSCREW".

SER. NO. 85-292,813, FILED 4-12-2011.

DAWN FELDMAN, EXAMINING ATTORNEY



David J. Kyros

Director of the United States Patent and Trademark Office

United States of America

United States Patent and Trademark Office

Thrive

Reg. No. 4,066,550

Registered Dec. 6, 2011

Int. Cl.: 43

SERVICE MARK

PRINCIPAL REGISTER

MINERVA ORGANICS LLC (WASHINGTON LIMITED LIABILITY COMPANY), DBA
THRIVE
1026 NE 65TH ST #A102
SEATTLE, WA 98115

FOR: CAFE AND RESTAURANT SERVICES; HEALTH RESORT SERVICES, NAMELY, PROVIDING FOOD AND LODGING THAT SPECIALIZE IN PROMOTING PATRONS' GENERAL HEALTH AND WELL-BEING; HOTEL AND RESTAURANT SERVICES; RESTAURANT SERVICES, NAMELY, PROVIDING OF FOOD AND BEVERAGES FOR CONSUMPTION ON AND OFF THE PREMISES, IN CLASS 43 (U.S. CLS. 100 AND 101).

FIRST USE 3-27-2008; IN COMMERCE 12-17-2008.

THE MARK CONSISTS OF STANDARD CHARACTERS WITHOUT CLAIM TO ANY PARTICULAR FONT, STYLE, SIZE, OR COLOR.

SER. NO. 85-292,936, FILED 4-12-2011.

JAMES LOVELACE, EXAMINING ATTORNEY



David J. Kybas

Director of the United States Patent and Trademark Office

United States of America

United States Patent and Trademark Office

GLASSIX

Reg. No. 4,066,551

THE SEFA GROUP, INC. (GEORGIA CORPORATION)
217 CEDAR ROAD
LEXINGTON, SC 29073

Registered Dec. 6, 2011

Int. Cl.: 19

FOR: GLASS POWDER MADE FROM RECYCLED GLASS WASTE FOR BUILDING PURPOSES, IN CLASS 19 (U.S. CLS. 1, 12, 33 AND 50).

TRADEMARK

FIRST USE 5-13-2011; IN COMMERCE 5-13-2011.

PRINCIPAL REGISTER

THE MARK CONSISTS OF STANDARD CHARACTERS WITHOUT CLAIM TO ANY PARTICULAR FONT, STYLE, SIZE, OR COLOR.

SER. NO. 85-292,952, FILED 4-12-2011.

JASON TURNER, EXAMINING ATTORNEY



David J. Kybas

Director of the United States Patent and Trademark Office

United States of America

United States Patent and Trademark Office

Tecno Lite

Reg. No. 4,066,552

Registered Dec. 6, 2011

Int. Cl.: 11

TRADEMARK

PRINCIPAL REGISTER

ILUMINACION ESPECIALIZADA DE OCCIDENTE, SA. DE C.V. (MEXICO CORPORATION)
INT. B, NAVE 2, FRACC. LOS ROBLES
AV. DR. ANGEL LEAÑO # 401
ZAPOPAN, JALISCO, MEXICO 45200

FOR: APPARATUS FOR LIGHTING, NAMELY, CEILING LIGHTS, ELECTRIC LAMPS, LAMP GLASSES, LAMP GLOBES, LAMP REFLECTORS, LAMP SHADES, LAMPS, LIGHT BULBS, LIGHT DIFFUSERS, LIGHT FIXTURES, LIGHT SWITCHES, LIGHTING INSTALLATIONS, LUMINOUS TUBES FOR LIGHTING, PROJECTOR LAMPS, AND SOCKETS FOR ELECTRIC LIGHTS, IN CLASS 11 (U.S. CLS. 13, 21, 23, 31 AND 34).

OWNER OF MEXICO REG. NO. 1203566, DATED 10-5-2010, EXPIRES 10-5-2020.

NO CLAIM IS MADE TO THE EXCLUSIVE RIGHT TO USE "LITE", APART FROM THE MARK AS SHOWN.

THE MARK CONSISTS OF THE WORDS "TECNO LITE" WRITTEN IN STYLIZED LETTERING.

SER. NO. 85-293,054, FILED 4-12-2011.

LOURDES AYALA, EXAMINING ATTORNEY



David J. Kybas

Director of the United States Patent and Trademark Office

United States of America

United States Patent and Trademark Office

Bet the Rake

Reg. No. 4,066,553

Registered Dec. 6, 2011

Int. Cl.: 28

TRADEMARK

PRINCIPAL REGISTER

O'BRIEN, FRANCIS M. (UNITED STATES INDIVIDUAL)
603 PULASKI ST.
LA PORTE, IN 46350

FOR: CARD GAMES, IN CLASS 28 (U.S. CLS. 22, 23, 38 AND 50).

FIRST USE 3-30-2011; IN COMMERCE 3-30-2011.

THE MARK CONSISTS OF STANDARD CHARACTERS WITHOUT CLAIM TO ANY PARTICULAR FONT, STYLE, SIZE, OR COLOR.

SER. NO. 85-293,566, FILED 4-13-2011.

KEVIN DINALLO, EXAMINING ATTORNEY



David J. Kybas

Director of the United States Patent and Trademark Office

United States of America

United States Patent and Trademark Office

Jimmy Hula's

Reg. No. 4,066,554

Registered Dec. 6, 2011

Int. Cl.: 43

SERVICE MARK

PRINCIPAL REGISTER

JIMMY HULA'S LICENSING LLC (FLORIDA LIMITED LIABILITY COMPANY)
2522 ALOMA AVE
WINTER PARK, FL 32789

FOR: RESTAURANT AND BAR SERVICES; RESTAURANT SERVICES FEATURING FISH TACOS, BURGERS AND BEER; RESTAURANT SERVICES, INCLUDING SIT-DOWN SERVICE OF FOOD AND TAKE-OUT RESTAURANT SERVICES, IN CLASS 43 (U.S. CLS. 100 AND 101).

FIRST USE 7-1-2010; IN COMMERCE 7-1-2010.

THE MARK CONSISTS OF STANDARD CHARACTERS WITHOUT CLAIM TO ANY PARTICULAR FONT, STYLE, SIZE, OR COLOR.

THE NAME(S), PORTRAIT(S), AND/OR SIGNATURE(S) SHOWN IN THE MARK DOES NOT IDENTIFY A PARTICULAR LIVING INDIVIDUAL.

SER. NO. 85-293,674, FILED 4-13-2011.

MATTHEW PAPPAS, EXAMINING ATTORNEY



David J. Kypas

Director of the United States Patent and Trademark Office

United States of America

United States Patent and Trademark Office



Reg. No. 4,066,555

Registered Dec. 6, 2011

Int. Cl.: 36

SERVICE MARK

PRINCIPAL REGISTER

FACCESS LLC (GEORGIA LIMITED LIABILITY COMPANY)
5337 REDFIELD ROAD
DUNWOODY, GA 30338

FOR: FINANCIAL SERVICES, NAMELY, ASSISTING OTHERS WITH THE COMPLETION OF FINANCIAL TRANSACTIONS FOR STOCKS, BONDS, SECURITIES AND EQUITIES; FINANCIAL SERVICES, NAMELY, INVESTMENT ADVICE, INVESTMENT MANAGEMENT, INVESTMENT CONSULTATION AND INVESTMENT OF FUNDS FOR OTHERS, INCLUDING PRIVATE AND PUBLIC EQUITY AND DEBT INVESTMENT SERVICES; PROVIDING FINANCIAL SERVICES WITH RESPECT TO SECURITIES AND OTHER FINANCIAL INSTRUMENTS AND PRODUCTS, NAMELY, MONEY MANAGEMENT SERVICES; PROVIDING FINANCIAL SERVICES WITH RESPECT TO SECURITIES AND OTHER FINANCIAL INSTRUMENTS AND PRODUCTS, NAMELY, TRADING OF AND INVESTMENTS IN SECURITIES AND FINANCIAL INSTRUMENTS AND PRODUCTS FOR OTHERS, IN CLASS 36 (U.S. CLS. 100, 101 AND 102).

FIRST USE 10-4-2010; IN COMMERCE 10-4-2010.

THE MARK CONSISTS OF A LOWER CASE GREEN "F" WITH AN EXTENDED TAIL ON THE "F" FOLLOWED BY A CAPITAL LETTER GREEN "A" AND LOWER CASE SILVER LETTERS "CCESS" WITH ALL LETTERS UNDERLINED BY A GREY AND SILVER STREAK. THE COLOR BLACK IS ONLY A BACKGROUND COLOR.

THE COLOR(S) GREEN, GREY AND SILVER IS/ARE CLAIMED AS A FEATURE OF THE MARK.

SER. NO. 85-293,744, FILED 4-13-2011.

MATTHEW KLINE, EXAMINING ATTORNEY



David J. Kappas

Director of the United States Patent and Trademark Office

United States of America

United States Patent and Trademark Office

Results. Driven. Creative.

Reg. No. 4,066,556

RED RACER ADVERTISING (TEXAS LIMITED LIABILITY COMPANY)
6455 AXTON LANE
DALLAS, TX 75214

Registered Dec. 6, 2011

Int. Cl.: 35

FOR: ADVERTISING AGENCIES, NAMELY, PROMOTING THE GOODS AND SERVICES OF OTHERS, IN CLASS 35 (U.S. CLS. 100, 101 AND 102).

SERVICE MARK

FIRST USE 3-18-2009; IN COMMERCE 9-3-2009.

PRINCIPAL REGISTER

THE MARK CONSISTS OF STANDARD CHARACTERS WITHOUT CLAIM TO ANY PARTICULAR FONT, STYLE, SIZE, OR COLOR.

SER. NO. 85-293,804, FILED 4-13-2011.

KEVIN CORWIN, EXAMINING ATTORNEY



David J. Kybas

Director of the United States Patent and Trademark Office

United States of America
United States Patent and Trademark Office

zveloLABS

Reg. No. 4,066,557

Registered Dec. 6, 2011

Int. Cl.: 42

SERVICE MARK

PRINCIPAL REGISTER

ZVELO, INC. (DELAWARE CORPORATION)
SUITE 240
5575 DTC PARKWAY
GREENWOOD VILLAGE, CO 80111

FOR: COMPUTER SERVICES IN THE FIELD OF INTERNET SECURITY, NAMELY, RE-SEARCHING AND IDENTIFYING MALICIOUS WEBSITES, IN CLASS 42 (U.S. CLS. 100 AND 101).

FIRST USE 1-0-2011; IN COMMERCE 1-0-2011.

THE MARK CONSISTS OF STANDARD CHARACTERS WITHOUT CLAIM TO ANY PARTICULAR FONT, STYLE, SIZE, OR COLOR.

SER. NO. 85-293,869, FILED 4-13-2011.

EUGENIA MARTIN, EXAMINING ATTORNEY



David J. Kybas

Director of the United States Patent and Trademark Office

United States of America

United States Patent and Trademark Office



Reg. No. 4,066,558

Registered Dec. 6, 2011

Int. Cl.: 30

TRADEMARK

PRINCIPAL REGISTER

ZOJO COFFEE, INC. (WASHINGTON CORPORATION)
1335 14TH AVENUE, SUITE 100
LONGVIEW, WA 98632

FOR: GROUND COFFEE BEANS, ROASTED COFFEE BEANS, WHOLE COFFEE BEANS,
IN CLASS 30 (U.S. CL. 46).

FIRST USE 7-0-2009; IN COMMERCE 2-1-2011.

NO CLAIM IS MADE TO THE EXCLUSIVE RIGHT TO USE "COFFEE", APART FROM THE
MARK AS SHOWN.

THE MARK CONSISTS OF THE WORDS "ZOJO" AND "COFFEE" SUPERIMPOSED OVER
A STYLIZED "Z" CENTERED IN AN OVAL.

SER. NO. 85-293,884, FILED 4-13-2011.

WON TEAK OH, EXAMINING ATTORNEY



David J. Kybas

Director of the United States Patent and Trademark Office

United States of America

United States Patent and Trademark Office

ZOJO

Reg. No. 4,066,559

Registered Dec. 6, 2011

Int. Cl.: 30

TRADEMARK

PRINCIPAL REGISTER

ZOJO COFFEE, INC. (WASHINGTON CORPORATION)
1335 14TH AVENUE, SUITE 100
LONGVIEW, WA 98632

FOR: GROUND COFFEE BEANS, ROASTED COFFEE BEANS, WHOLE COFFEE BEANS,
IN CLASS 30 (U.S. CL. 46).

FIRST USE 7-0-2009; IN COMMERCE 2-1-2011.

THE MARK CONSISTS OF STANDARD CHARACTERS WITHOUT CLAIM TO ANY PAR-
TICULAR FONT, STYLE, SIZE, OR COLOR.

SER. NO. 85-293,888, FILED 4-13-2011.

WON TEAK OH, EXAMINING ATTORNEY



David J. Kyffers

Director of the United States Patent and Trademark Office

United States of America

United States Patent and Trademark Office

RESURGENCE

Reg. No. 4,066,560

MARS HILL FELLOWSHIP (WASHINGTON CORPORATION), DBA MARS HILL CHURCH
1411 NW 50TH ST.
SEATTLE, WA 98107

Registered Dec. 6, 2011

Int. Cls.: 9, 35, 41 and 45

FOR: SOUND RECORDINGS FEATURING RELIGIOUS INSTRUCTION AND MUSIC; DIGITAL MEDIA, NAMELY, PRE-RECORDED CDS, DOWNLOADABLE AUDIO AND VIDEO RECORDINGS FEATURING RELIGIOUS INSTRUCTION AND MUSIC, IN CLASS 9 (U.S. CLS. 21, 23, 26, 36 AND 38).

TRADEMARK

SERVICE MARK

FIRST USE 12-0-2005; IN COMMERCE 12-0-2005.

PRINCIPAL REGISTER

FOR: INTERNSHIP PLACEMENT SERVICES, IN CLASS 35 (U.S. CLS. 100, 101 AND 102).

FIRST USE 3-0-2006; IN COMMERCE 3-0-2006.

FOR: EDUCATION SERVICES, NAMELY, LECTURES, COURSES AND WORKSHOPS IN THE FIELD OF THEOLOGY; EDUCATION SERVICES IN THE NATURE OF COURSES AT THE UNIVERSITY LEVEL; ON-LINE JOURNALS, NAMELY, BLOGS AND ARTICLES IN THE FIELD OF THEOLOGY; PROVIDING ON-LINE ARTICLES AND NEWSLETTERS IN THE FIELD OF THEOLOGY; ARRANGING AND CONDUCTING SPECIAL EVENTS FOR RELIGIOUS PURPOSES; PROVIDING A WEBSITE CONTAINING INFORMATION AND NON-DOWNLOADABLE SOUND AND VIDEO RECORDINGS FEATURING INSTRUCTION AND MUSIC, ALL OF A RELIGIOUS NATURE, IN CLASS 41 (U.S. CLS. 100, 101 AND 107).

FIRST USE 12-0-2005; IN COMMERCE 12-0-2005.

FOR: CHURCH RELATED SERVICES, NAMELY, MINISTERIAL SERVICES AND EVANGELISTIC SERVICES, IN CLASS 45 (U.S. CLS. 100 AND 101).

FIRST USE 12-0-2005; IN COMMERCE 12-0-2005.

THE MARK CONSISTS OF STANDARD CHARACTERS WITHOUT CLAIM TO ANY PARTICULAR FONT, STYLE, SIZE, OR COLOR.

SER. NO. 85-293,987, FILED 4-13-2011.

JAMES A. RAUEN, EXAMINING ATTORNEY



David J. Kyffers

Director of the United States Patent and Trademark Office

United States of America

United States Patent and Trademark Office

Emergency Made Easy

Reg. No. 4,066,561

Registered Dec. 6, 2011

Int. Cls.: 35 and 45

SERVICE MARK

PRINCIPAL REGISTER

BLUE BOX CORP (UTAH CORPORATION)
UNIT B
65 W GIRARD AVE.
SALT LAKE CITY, UT 84103

FOR: ON-LINE RETAIL STORE SERVICES FEATURING EMERGENCY SURVIVAL KITS AND ACCESSORIES, IN CLASS 35 (U.S. CLS. 100, 101 AND 102).

FIRST USE 1-30-2009; IN COMMERCE 1-30-2009.

FOR: PROVIDING A WEBSITE FEATURING INFORMATION ON SURVIVAL IN THE EVENT OF A DISASTER, IN CLASS 45 (U.S. CLS. 100 AND 101).

FIRST USE 1-30-2009; IN COMMERCE 1-30-2009.

THE MARK CONSISTS OF STANDARD CHARACTERS WITHOUT CLAIM TO ANY PARTICULAR FONT, STYLE, SIZE, OR COLOR.

NO CLAIM IS MADE TO THE EXCLUSIVE RIGHT TO USE "EMERGENCY", APART FROM THE MARK AS SHOWN.

SER. NO. 85-294,049, FILED 4-13-2011.

KATHERINE M. DUBRAY, EXAMINING ATTORNEY



David J. Kyjars

Director of the United States Patent and Trademark Office

United States of America

United States Patent and Trademark Office

Artists In Action

Reg. No. 4,066,562

Registered Dec. 6, 2011

Int. Cl.: 9

TRADEMARK

PRINCIPAL REGISTER

CAPES COACHING, INC. (NEW YORK CORPORATION)
4TH FLOOR
826 BROADWAY
NEW YORK, NY 10003

FOR: EDUCATIONAL KITS SOLD AS A UNIT COMPRISING CDS, DVDS FEATURING AUDIO LECTURES AND PRINTED WORKBOOK RELATING TO CAREER COACHING FOR ARTISTS, PACKAGED TOGETHER ALONG WITH A TRANSCRIPT OF THE AUDIO LECTURES, IN CLASS 9 (U.S. CLS. 21, 23, 26, 36 AND 38).

FIRST USE 10-22-2009; IN COMMERCE 2-22-2010.

THE MARK CONSISTS OF STANDARD CHARACTERS WITHOUT CLAIM TO ANY PARTICULAR FONT, STYLE, SIZE, OR COLOR.

NO CLAIM IS MADE TO THE EXCLUSIVE RIGHT TO USE "ARTISTS", APART FROM THE MARK AS SHOWN.

SER. NO. 85-294,053, FILED 4-13-2011.

KATHERINE M. DUBRAY, EXAMINING ATTORNEY



David J. Kybas

Director of the United States Patent and Trademark Office

United States of America

United States Patent and Trademark Office

Structured Discovery Cane Travel (SDCT)

Reg. No. 4,066,563

Registered Dec. 6, 2011

Int. Cl.: 41

SERVICE MARK

PRINCIPAL REGISTER

NATIONAL BLINDNESS PROFESSIONAL CERTIFICATION BOARD (NBPCB) (MARYLAND
NON-PROFIT ORGANIZATION)
101 SOUTH TRENTON STREET
RUSTON, LA 71270

FOR: EDUCATIONAL SERVICES, NAMELY, PROVIDING INSTRUCTION AND TEACHING
INDIVIDUALS WHO ARE BLIND OR SIGNIFICANTLY VISUALLY IMPAIRED TO TRAVEL
THE WORLD EFFECTIVELY AND EFFICIENTLY BY USING PROBLEM SOLVING, REAL-
WORLD EXPERIENCE, AND ROLE MODELING, IN CLASS 41 (U.S. CLS. 100, 101 AND
107).

FIRST USE 7-1-1984; IN COMMERCE 1-1-1995.

THE MARK CONSISTS OF STANDARD CHARACTERS WITHOUT CLAIM TO ANY PAR-
TICULAR FONT, STYLE, SIZE, OR COLOR.

NO CLAIM IS MADE TO THE EXCLUSIVE RIGHT TO USE "STRUCTURED DISCOVERY
CANE TRAVEL", APART FROM THE MARK AS SHOWN.

SER. NO. 85-294,068, FILED 4-13-2011.

YAT SYE, LEE, EXAMINING ATTORNEY



David J. Kyros

Director of the United States Patent and Trademark Office

United States of America

United States Patent and Trademark Office



Reg. No. 4,066,564
Registered Dec. 6, 2011

MARS HILL FELLOWSHIP (WASHINGTON CORPORATION), DBA MARS HILL CHURCH
1411 NW 50TH ST.
SEATTLE, WA 98107

**Int. Cls.: 9, 16, 35, 41
and 45**

FOR: SOUND RECORDINGS FEATURING RELIGIOUS INSTRUCTION AND MUSIC; DIGITAL MEDIA, NAMELY, PRE-RECORDED CDS, DOWNLOADABLE AUDIO AND VIDEO RECORDINGS FEATURING RELIGIOUS INSTRUCTION AND MUSIC, IN CLASS 9 (U.S. CLS. 21, 23, 26, 36 AND 38).

TRADEMARK

FIRST USE 12-0-2005; IN COMMERCE 12-0-2005.

SERVICE MARK

FOR: PRINTED MATERIALS, NAMELY, BOOKS IN THE FIELD OF THEOLOGY, IN CLASS 16 (U.S. CLS. 2, 5, 22, 23, 29, 37, 38 AND 50).

PRINCIPAL REGISTER

FIRST USE 2-0-2008; IN COMMERCE 2-0-2008.

FOR: INTERNSHIP PLACEMENT SERVICES, IN CLASS 35 (U.S. CLS. 100, 101 AND 102).

FIRST USE 3-0-2006; IN COMMERCE 3-0-2006.

FOR: BOOK PUBLISHING; EDUCATION SERVICES, NAMELY, LECTURES, COURSES AND WORKSHOPS IN THE FIELD OF THEOLOGY; EDUCATION SERVICES IN THE NATURE OF COURSES AT THE UNIVERSITY LEVEL; ON-LINE JOURNALS, NAMELY, BLOGS AND ARTICLES IN THE FIELD OF THEOLOGY; PROVIDING ON-LINE ARTICLES AND NEWSLETTERS IN THE FIELD OF THEOLOGY; ARRANGING AND CONDUCTING SPECIAL EVENTS FOR RELIGIOUS PURPOSES; PROVIDING A WEBSITE CONTAINING INFORMATION AND NON-DOWNLOADABLE SOUND AND VIDEO RECORDINGS FEATURING INSTRUCTION AND MUSIC, ALL OF A RELIGIOUS NATURE, IN CLASS 41 (U.S. CLS. 100, 101 AND 107).

FIRST USE 12-0-2005; IN COMMERCE 12-0-2005.

FOR: CHURCH RELATED SERVICES, NAMELY, MINISTERIAL SERVICES AND EVANGELISTIC SERVICES, IN CLASS 45 (U.S. CLS. 100 AND 101).

FIRST USE 12-0-2005; IN COMMERCE 12-0-2005.



David J. Kyjars

Director of the United States Patent and Trademark Office

Reg. No. 4,066,564 THE MARK CONSISTS OF THE LETTER "R" WITH A RIGHT-POINTING ARROW DESIGN INCORPORATED INTO THE UPPER PORTION OF THE LETTER.

SER. NO. 85-294,112, FILED 4-13-2011.

JAMES A. RAUEN, EXAMINING ATTORNEY

United States of America

United States Patent and Trademark Office

ARTIFACT BAG CO.

Reg. No. 4,066,565

Registered Dec. 6, 2011

Int. Cl.: 18

TRADEMARK

PRINCIPAL REGISTER

CHRISTOPHER T. HUGHES (UNITED STATES INDIVIDUAL)
5707 PACIFIC STREET
OMAHA, NE 68106

FOR: ALL-PURPOSE CARRYING BAGS, IN CLASS 18 (U.S. CLS. 1, 2, 3, 22 AND 41).

FIRST USE 2-28-2010; IN COMMERCE 2-28-2010.

THE MARK CONSISTS OF STANDARD CHARACTERS WITHOUT CLAIM TO ANY PARTICULAR FONT, STYLE, SIZE, OR COLOR.

NO CLAIM IS MADE TO THE EXCLUSIVE RIGHT TO USE "BAG CO.", APART FROM THE MARK AS SHOWN.

SER. NO. 85-294,115, FILED 4-13-2011.

CHRISTINE MARTIN, EXAMINING ATTORNEY



David J. Kyffers

Director of the United States Patent and Trademark Office

United States of America

United States Patent and Trademark Office

STYLISH SAFETY

Reg. No. 4,066,566

Registered Dec. 6, 2011

Int. Cls.: 9 and 41

TRADEMARK

SERVICE MARK

PRINCIPAL REGISTER

EVERYTHING LIDIA, INCORPORATED (NEW YORK CORPORATION)
2067 JERICHO TURNPIKE
COMMACK, NY 11725

FOR: SAFETY AND SIGNAL WHISTLES, IN CLASS 9 (U.S. CLS. 21, 23, 26, 36 AND 38).

FIRST USE 3-8-2011; IN COMMERCE 3-8-2011.

FOR: EDUCATION SERVICES, NAMELY, PROVIDING CLASSES, SEMINARS, WORKSHOPS, TUTORING AND MENTORING IN THE FIELD OF WOMEN'S SAFETY AWARENESS, IN CLASS 41 (U.S. CLS. 100, 101 AND 107).

FIRST USE 1-31-2007; IN COMMERCE 1-31-2007.

THE MARK CONSISTS OF STANDARD CHARACTERS WITHOUT CLAIM TO ANY PARTICULAR FONT, STYLE, SIZE, OR COLOR.

NO CLAIM IS MADE TO THE EXCLUSIVE RIGHT TO USE "SAFETY", APART FROM THE MARK AS SHOWN.

SER. NO. 85-294,197, FILED 4-13-2011.

WON TEAK OH, EXAMINING ATTORNEY



David J. Kypos

Director of the United States Patent and Trademark Office

United States of America

United States Patent and Trademark Office

KidzHitz

Reg. No. 4,066,567

Registered Dec. 6, 2011

Int. Cl.: 41

SERVICE MARK

PRINCIPAL REGISTER

PATRIZIA FLORO (UNITED STATES INDIVIDUAL)
226 OAKWOOD ROAD
HUNTINGTON STATION, NY 11746

FOR: KIDS MUSIC SCHOOL, IN CLASS 41 (U.S. CLS. 100, 101 AND 107).

FIRST USE 10-22-2008; IN COMMERCE 10-22-2008.

THE MARK CONSISTS OF STANDARD CHARACTERS WITHOUT CLAIM TO ANY PARTICULAR FONT, STYLE, SIZE, OR COLOR.

SER. NO. 85-294,272, FILED 4-13-2011.

MARK SPARACINO, EXAMINING ATTORNEY



David J. Kybas

Director of the United States Patent and Trademark Office

United States of America

United States Patent and Trademark Office

CAR PRO

Reg. No. 4,066,568

ACUITY MARKETING, INC. (TEXAS CORPORATION)
2951 MARINA BAY DRIVE, SUITE 130-142
LEAGUE CITY, TX 77573

Registered Dec. 6, 2011

Int. Cls.: 9, 35, 38 and 41

FOR: DOWNLOADABLE PRERECORDED VIDEO CLIPS IN THE FIELDS OF AUTOMOBILE CONSUMER EDUCATION, AUTOMOBILE SHOPPING, AUTOMOBILE BUYING AND THE AUTOMOTIVE INDUSTRY, IN CLASS 9 (U.S. CLS. 21, 23, 26, 36 AND 38).

TRADEMARK

FIRST USE 3-1-2011; IN COMMERCE 3-1-2011.

SERVICE MARK

PRINCIPAL REGISTER

FOR: ADVERTISEMENTS FOR OTHERS ON THE INTERNET, NAMELY, ADVERTISING FOR OTHERS IN THE FIELDS OF AUTOMOBILE CONSUMER EDUCATION, AUTOMOBILE SHOPPING, AUTOMOBILE BUYING AND THE AUTOMOTIVE INDUSTRY PROVIDED BY AN ONLINE ELECTRONIC NEWSLETTER; PROVIDING OF ONLINE NON-DOWNLOADABLE VIDEOS FEATURING GENERAL INTEREST NEWS AND COMMENTARY IN THE FIELD AUTOMOBILE SHOPPING AND AUTOMOBILE BUYING, IN CLASS 35 (U.S. CLS. 100, 101 AND 102).

FIRST USE 3-1-2011; IN COMMERCE 3-1-2011.

FOR: STREAMING OF VIDEO MATERIAL ON THE INTERNET IN THE FIELDS OF AUTOMOBILE CONSUMER EDUCATION, AUTOMOBILE SHOPPING, AUTOMOBILE BUYING AND THE AUTOMOTIVE INDUSTRY, IN CLASS 38 (U.S. CLS. 100, 101 AND 104).

FIRST USE 3-1-2011; IN COMMERCE 3-1-2011.

FOR: ENTERTAINMENT SERVICES, NAMELY, PROVIDING NON-DOWNLOADABLE PRE-RECORDED MUSIC, VIA THE INTERNET AND MOBILE PHONES; ENTERTAINMENT SERVICES, NAMELY, PROVIDING NON-DOWNLOADABLE COMPUTER GAME SOFTWARE VIA THE INTERNET AND MOBILE PHONES; PROVIDING ON-GOING TELEVISION PROGRAMS IN THE FIELD OF PRE-RECORDED MUSIC; PROVIDING OF ONLINE NON-DOWNLOADABLE VIDEOS FEATURING GENERAL INTEREST NEWS AND COMMENTARY IN THE FIELD OF AUTOMOBILE CONSUMER EDUCATION, IN CLASS 41 (U.S. CLS. 100, 101 AND 107).

FIRST USE 3-1-2011; IN COMMERCE 3-1-2011.



David J. Kyjars

Director of the United States Patent and Trademark Office

Reg. No. 4,066,568 THE MARK CONSISTS OF STANDARD CHARACTERS WITHOUT CLAIM TO ANY PARTICULAR FONT, STYLE, SIZE, OR COLOR.

OWNER OF U.S. REG. NO. 3,911,217.

NO CLAIM IS MADE TO THE EXCLUSIVE RIGHT TO USE "CAR", APART FROM THE MARK AS SHOWN.

SER. NO. 85-294,281, FILED 4-13-2011.

MARK SPARACINO, EXAMINING ATTORNEY

United States of America

United States Patent and Trademark Office

IT'S WHAT ALL THE BUZZ IS
ABOUT!

Reg. No. 4,066,569

Registered Dec. 6, 2011

Int. Cl.: 35

SERVICE MARK

PRINCIPAL REGISTER

MOMENTUM MANAGEMENT, LLC (CALIFORNIA LIMITED LIABILITY COMPANY), DBA
BUSHMAN PRODUCTS
1206 W. JON STREET
TORRANCE, CA 90502

FOR: DISTRIBUTORSHIP SERVICES IN THE FIELD OF ADULT SEXUAL AIDS, NAMELY,
VIBRATING RUBBER RINGS FOR THE PENIS, VIBRATORS AND CONDOMS , IN CLASS
35 (U.S. CLS. 100, 101 AND 102).

FIRST USE 12-0-2006; IN COMMERCE 12-0-2006.

THE MARK CONSISTS OF STANDARD CHARACTERS WITHOUT CLAIM TO ANY PAR-
TICULAR FONT, STYLE, SIZE, OR COLOR.

SER. NO. 85-294,396, FILED 4-13-2011.

ANNE E. GUSTASON, EXAMINING ATTORNEY



David J. Kybas

Director of the United States Patent and Trademark Office

United States of America

United States Patent and Trademark Office

SHOOT FILM NOT PEOPLE

Reg. No. 4,066,570

Registered Dec. 6, 2011

Int. Cl.: 35

SERVICE MARK

PRINCIPAL REGISTER

STRIKE ANYWHERE LLC (CALIFORNIA LIMITED LIABILITY COMPANY)
546 ROSE AVE. #2
VENICE, CA 90291

FOR: ADVERTISING AND ADVERTISEMENT SERVICES; PREPARING ADVERTISEMENTS FOR OTHERS; PRODUCTION OF ADVERTISING MATTER AND COMMERCIALS, IN CLASS 35 (U.S. CLS. 100, 101 AND 102).

FIRST USE 5-1-2009; IN COMMERCE 5-1-2009.

THE MARK CONSISTS OF STANDARD CHARACTERS WITHOUT CLAIM TO ANY PARTICULAR FONT, STYLE, SIZE, OR COLOR.

SER. NO. 85-294,402, FILED 4-13-2011.

REBECCA GILBERT, EXAMINING ATTORNEY



David J. Kybas

Director of the United States Patent and Trademark Office

United States of America

United States Patent and Trademark Office

Good Vibrations Family Chiropractic

Reg. No. 4,066,571

Registered Dec. 6, 2011

Int. Cl.: 44

SERVICE MARK

PRINCIPAL REGISTER

MERLO CHIROPRACTIC INC (CALIFORNIA CORPORATION)
4060 ADAMS AVE
SAN DIEGO, CA 92116

FOR: CHIROPRACTIC SERVICES, IN CLASS 44 (U.S. CLS. 100 AND 101).

FIRST USE 9-10-2005; IN COMMERCE 9-10-2005.

THE MARK CONSISTS OF STANDARD CHARACTERS WITHOUT CLAIM TO ANY PARTICULAR FONT, STYLE, SIZE, OR COLOR.

NO CLAIM IS MADE TO THE EXCLUSIVE RIGHT TO USE "FAMILY CHIROPRACTIC", APART FROM THE MARK AS SHOWN.

SER. NO. 85-294,430, FILED 4-13-2011.

JOHN WILKE, EXAMINING ATTORNEY



David J. Kybas

Director of the United States Patent and Trademark Office

United States of America

United States Patent and Trademark Office

Flo Water

Reg. No. 4,066,572

FLO WATER LLC (HAWAII LIMITED LIABILITY COMPANY)
P.O. BOX 298
KILAUEA, HI 96754

Registered Dec. 6, 2011

Int. Cl.: 21

FOR: REUSABLE ALUMINUM WATER BOTTLES SOLD EMPTY, IN CLASS 21 (U.S. CLS. 2, 13, 23, 29, 30, 33, 40 AND 50).

TRADEMARK

FIRST USE 4-7-2010; IN COMMERCE 2-1-2011.

PRINCIPAL REGISTER

OWNER OF U.S. REG. NO. 3,959,529.

THE COLOR(S) BLUE IS/ARE CLAIMED AS A FEATURE OF THE MARK.

NO CLAIM IS MADE TO THE EXCLUSIVE RIGHT TO USE "WATER", APART FROM THE MARK AS SHOWN.

THE MARK CONSISTS OF THE STYLIZED FORM OF THE WORDS "FLO WATER". THE COLOR OF THE MARK IS BLUE, WITH A LIGHTER SHADE OF BLUE AT THE BOTTOM OF THE MARK BLENDING INTO A DARKER SHADE TOWARD THE TOP OF THE MARK.

SER. NO. 85-294,640, FILED 4-13-2011.

KATHERINE CHANG, EXAMINING ATTORNEY



David J. Kyros

Director of the United States Patent and Trademark Office

United States of America

United States Patent and Trademark Office



Reg. No. 4,066,573

Registered Dec. 6, 2011

Int. Cl.: 41

SERVICE MARK

PRINCIPAL REGISTER

220 FITNESS CONCEPTS, LLC (CALIFORNIA LIMITED LIABILITY COMPANY)
3002 MAIN STREET
SANTA MONICA, CA 90405

FOR: PROVIDING FITNESS AND EXERCISE FACILITIES, IN CLASS 41 (U.S. CLS. 100, 101 AND 107).

FIRST USE 6-1-2010; IN COMMERCE 6-1-2010.

THE MARK CONSISTS OF A CIRCULAR BLACK BACKGROUND WITH THE NUMBER 2 CONNECTED TO A MIRRORED BACKWARDS NUMBER 2. BOTH NUMBER 2S ARE CONNECTED TO A NUMBER 0 BELOW THEM. THE NUMBERS ARE RED AND OUTLINED IN WHITE. THE NUMBERS ARE CENTERED ON THE CIRCULAR BLACK BACKGROUND. BELOW THE NUMBERS ARE THE WORDS SECOND TO NONE. THE WORDS ARE WHITE. THE WORDS ARE PRECEDED BY A WHITE 5 POINTED STAR OVERLAPPING A RED 5 POINTED STAR. THE WORDS ARE FOLLOWED BY A WHITE 5 POINTED STAR OVERLAPPING A RED 5 POINTED STAR. THERE ARE FIVE POINTED STARS IN A CIRCULAR BORDER ON THE INSIDE EDGE OF THE CIRCULAR BLACK BACKGROUND.

THE COLOR(S) RED, BLACK AND WHITE IS/ARE CLAIMED AS A FEATURE OF THE MARK.

SER. NO. 85-294,714, FILED 4-13-2011.

ANDREA HACK, EXAMINING ATTORNEY



David J. Kyffers

Director of the United States Patent and Trademark Office

United States of America

United States Patent and Trademark Office

sm[ART]2

Reg. No. 4,066,574

Registered Dec. 6, 2011

Int. Cl.: 16

TRADEMARK

PRINCIPAL REGISTER

BAKHJET, SARAH, MUKHTAR (UNITED STATES INDIVIDUAL)
8971 VIA ANDAR
SAN DIEGO, CA 92122

FOR: SCHOOL SUPPLY KITS CONTAINING VARIOUS COMBINATIONS OF SELECTED SCHOOL SUPPLIES, NAMELY, WRITING INSTRUMENTS, PENS, PENCILS, MECHANICAL PENCILS, ERASERS, MARKERS, CRAYONS, HIGHLIGHTER PENS, FOLDERS, NOTEBOOKS, PAPER, PROTRACTORS, PAPER CLIPS, PENCIL SHARPENERS, WRITING GRIPS, GLUE AND BOOK MARKS, IN CLASS 16 (U.S. CLS. 2, 5, 22, 23, 29, 37, 38 AND 50).

FIRST USE 7-9-2010; IN COMMERCE 7-9-2010.

THE MARK CONSISTS OF STANDARD CHARACTERS WITHOUT CLAIM TO ANY PARTICULAR FONT, STYLE, SIZE, OR COLOR.

OWNER OF U.S. REG. NO. 3,966,877.

SER. NO. 85-294,748, FILED 4-14-2011.

WILLIAM VERHOSEK, EXAMINING ATTORNEY



David J. Kyros

Director of the United States Patent and Trademark Office

United States of America

United States Patent and Trademark Office

RULER REVOLUTION

Reg. No. 4,066,575

Registered Dec. 6, 2011

Int. Cl.: 16

TRADEMARK

PRINCIPAL REGISTER

PATTI NETHERY (UNITED STATES INDIVIDUAL)
922 N RIVERSHIRE DRIVE
CONROE, TX 77304

FOR: MARKING TEMPLATES; DRAWING RULERS, IN CLASS 16 (U.S. CLS. 2, 5, 22, 23, 29, 37, 38 AND 50).

FIRST USE 4-7-2011; IN COMMERCE 4-7-2011.

THE MARK CONSISTS OF STANDARD CHARACTERS WITHOUT CLAIM TO ANY PARTICULAR FONT, STYLE, SIZE, OR COLOR.

NO CLAIM IS MADE TO THE EXCLUSIVE RIGHT TO USE "RULER", APART FROM THE MARK AS SHOWN.

SER. NO. 85-294,826, FILED 4-14-2011.

IRA J. GOODSAY, EXAMINING ATTORNEY



David J. Kyffers

Director of the United States Patent and Trademark Office

United States of America

United States Patent and Trademark Office



Reg. No. 4,066,576

Registered Dec. 6, 2011

Int. Cl.: 38

SERVICE MARK

PRINCIPAL REGISTER

GUBSER & SCHNAKENBERG, LLC (NEBRASKA LIMITED LIABILITY COMPANY), DBA
GSC
8620 OAKMONT DRIVE
LINCOLN, NE 68526

FOR: BROADBAND RADIO COMMUNICATION SERVICES; BROADCASTING SERVICES, NAMELY, TRANSMISSION OF ADVERTISING PROGRAMS AND MEDIA ADVERTISING COMMUNICATIONS VIA DIGITAL COMMUNICATIONS NETWORKS; CELLULAR TELEPHONE COMMUNICATION; COMMUNICATION BY MOBILE TELEPHONE; COMMUNICATION BY TELEGRAM; COMMUNICATION SERVICES, NAMELY, TRANSMISSION OF VOICE, AUDIO, VISUAL IMAGES AND DATA BY TELECOMMUNICATIONS NETWORKS, WIRELESS COMMUNICATION NETWORKS, THE INTERNET, INFORMATION SERVICES NETWORKS AND DATA NETWORKS; COMMUNICATION VIA FIBRE OPTICAL NETWORKS; COMMUNICATION VIA FIBRE-OPTIC NETWORKS; COMMUNICATION VIA RADIO, TELEGRAPH, TELEPHONE AND TELEVISION TRANSMISSIONS; COMMUNICATIONS BY COMPUTER TERMINALS; COMMUNICATIONS BY MOBILE PHONES; COMMUNICATIONS BY TELEPHONE; COMMUNICATIONS VIA ANALOGUE AND DIGITAL COMPUTER TERMINALS; COMMUNICATIONS VIA FIBER-OPTIC NETWORKS; COMMUNICATIONS VIA FIBRE-OPTIC NETWORKS; CONSULTING SERVICES IN THE FIELD OF COMMUNICATIONS; INFORMATION TRANSMISSION VIA ELECTRONIC COMMUNICATIONS NETWORKS; MOBILE RADIO COMMUNICATION; MOBILE TELEPHONE COMMUNICATION; PROVIDING TECHNICAL SUPPORT SERVICES REGARDING THE USAGE OF COMMUNICATIONS EQUIPMENT; RADIO COMMUNICATION; RADIO, TELEPHONE, TELEGRAPH COMMUNICATION SERVICES; TELECOMMUNICATION CONSULTATION IN THE NATURE OF TECHNICAL CONSULTING IN THE FIELD OF AUDIO, TEXT AND VISUAL DATA TRANSMISSION AND COMMUNICATION; TELECOMMUNICATION SERVICES, NAMELY, TRANSMISSION OF VOICE, DATA, GRAPHICS, IMAGES, AUDIO AND VIDEO BY MEANS OF TELECOMMUNICATIONS NETWORKS, WIRELESS COMMUNICATION NETWORKS, AND THE INTERNET; TELEPHONE COMMUNICATION SERVICES; TELEPHONE COMMUNICATIONS; TRANSMISSION OF INFORMATION BY DATA COMMUNICATIONS FOR ASSISTING DECISION MAKING; TRANSMISSION OF INFORMATION BY ELECTRONIC COMMUNICATIONS NETWORKS; TRANSMISSION OF INFORMATION THROUGH VIDEO COMMUNICATION SYSTEMS; WIRELESS BROADBAND COMMUNICATION SERVICES, IN CLASS 38 (U.S. CLS. 100, 101 AND 104).



David J. Kyjars

Director of the United States Patent and Trademark Office

FIRST USE 6-11-2010; IN COMMERCE 6-11-2010.

Reg. No. 4,066,576 THE MARK CONSISTS OF STYLIZED UPWARD RED SWOOSH ABOVE STYLIZED DOWNWARD RED SWOOSH FOLLOWED BY BLUE BLOCK LETTERS "GSC" ON WHITE BACKGROUND.

THE COLOR(S) RED, WHITE, AND BLUE IS/ARE CLAIMED AS A FEATURE OF THE MARK.

SER. NO. 85-294,929, FILED 4-14-2011.

WILLIAM VERHOSEK, EXAMINING ATTORNEY

United States of America

United States Patent and Trademark Office

REDU-GEL

Reg. No. 4,066,577

NATURAL PREMIER SUPPLEMENTS CORP. (FLORIDA CORPORATION)
1421 N. VENETIAN WAY
MIAMI, FL 33139

Registered Dec. 6, 2011

Int. Cl.: 3

FOR: SKIN CREAMS AND LOTIONS FOR CELLULITE REDUCTION, IN CLASS 3 (U.S. CLS. 1, 4, 6, 50, 51 AND 52).

TRADEMARK

FIRST USE 2-15-2011; IN COMMERCE 2-15-2011.

PRINCIPAL REGISTER

THE MARK CONSISTS OF STANDARD CHARACTERS WITHOUT CLAIM TO ANY PARTICULAR FONT, STYLE, SIZE, OR COLOR.

SER. NO. 85-294,984, FILED 4-14-2011.

APRIL HESIK, EXAMINING ATTORNEY



David J. Kybas

Director of the United States Patent and Trademark Office

United States of America

United States Patent and Trademark Office



Reg. No. 4,066,578

Registered Dec. 6, 2011

Int. Cl.: 31

TRADEMARK

PRINCIPAL REGISTER

TEDDY BEAR FRESH (MARYLAND LIMITED LIABILITY COMPANY)
28595 MARY'S CT.
EASTON, MD 21601

FOR: FRESH FRUIT AND VEGETABLES, IN CLASS 31 (U.S. CLS. 1 AND 46).

FIRST USE 4-4-2009; IN COMMERCE 4-4-2009.

NO CLAIM IS MADE TO THE EXCLUSIVE RIGHT TO USE "FRESH" , APART FROM THE MARK AS SHOWN.

THE STIPPLING IS A FEATURE OF THE MARK AND DOES NOT INDICATE COLOR.

THE MARK CONSISTS OF A TEDDY BEAR DESIGN WITH THE WORDS "TEDDY BEAR FRESH" ARCHED ABOVE IT.

SER. NO. 85-295,167, FILED 4-14-2011.

GENE MACIOL, EXAMINING ATTORNEY



David J. Kybas

Director of the United States Patent and Trademark Office

United States of America

United States Patent and Trademark Office



Reg. No. 4,066,579

Registered Dec. 6, 2011

Int. Cl.: 9

TRADEMARK

PRINCIPAL REGISTER

BOOMBOTIX INC. (NEVADA CORPORATION)
30 ANGUIDO CT.
BURLINGAME, CA 94010

FOR: AUDIO AMPLIFIERS; AUDIO CABLES; AUDIO SPEAKERS, IN CLASS 9 (U.S. CLS. 21, 23, 26, 36 AND 38).

FIRST USE 3-1-2011; IN COMMERCE 3-1-2011.

THE MARK CONSISTS OF A WHITE ROUND FACE WITH BLACK ASYMMETRICAL EYES, TWO ELECTRIC BLUE CROSSBONES, TWO LIGHT GREY CONCENTRIC RINGS, AND THE WORDING "BOOMBOTIX" WITH "BOOM" IN ELECTRIC BLUE AND "BOTIX" IN PURPLE, ALL ON A BLACK BACKGROUND.

THE COLOR(S) ELECTRIC BLUE, PURPLE, GREY, BLACK AND WHITE IS/ARE CLAIMED AS A FEATURE OF THE MARK.

SER. NO. 85-295,285, FILED 4-14-2011.

JOHN E. MICHOS, EXAMINING ATTORNEY



David J. Kyffers

Director of the United States Patent and Trademark Office

United States of America

United States Patent and Trademark Office

Future Simple

Reg. No. 4,066,580

Registered Dec. 6, 2011

Int. Cl.: 42

SERVICE MARK

PRINCIPAL REGISTER

FUTURESIMPLE INC. (ILLINOIS CORPORATION), AKA FUTURE SIMPLE
5807 S. WOODLAWN
CHICAGO, IL 60637

FOR: PROVIDING ONLINE HOSTED NON-DOWNLOADABLE SOFTWARE FOR TRACKING SALES, MANAGING CONTACTS AND CUSTOMER RELATIONS, TRACKING TIME, PREPARING AND PROCESSING INVOICES, EXPENSE TRACKING, DOCUMENT SHARING, RECORDING FINANCIAL DATA AND CREATING WEBSITES, IN CLASS 42 (U.S. CLS. 100 AND 101).

FIRST USE 11-28-2009; IN COMMERCE 11-28-2009.

THE MARK CONSISTS OF STANDARD CHARACTERS WITHOUT CLAIM TO ANY PARTICULAR FONT, STYLE, SIZE, OR COLOR.

SER. NO. 85-295,291, FILED 4-14-2011.

GENE MACIOL, EXAMINING ATTORNEY



David J. Kyffers

Director of the United States Patent and Trademark Office

United States of America

United States Patent and Trademark Office



Reg. No. 4,066,581

Registered Dec. 6, 2011

Int. Cl.: 25

TRADEMARK

PRINCIPAL REGISTER

WAL-MART STORES, INC. (DELAWARE CORPORATION)
702 SW 8TH STREET
BENTONVILLE, AR 727160520

FOR: PANTS; SHIRTS, IN CLASS 25 (U.S. CLS. 22 AND 39).

FIRST USE 2-0-2006; IN COMMERCE 2-0-2006.

OWNER OF U.S. REG. NO. 3,036,240.

THE MARK CONSISTS OF A STYLIZED LETTER "S" ENCLOSED IN A CIRCLE, WITH CIRCULAR BUBBLES EMANATING FROM THE TOP OF THE LETTER AND CROSSING OUTSIDE THE CIRCLE.

SER. NO. 85-295,493, FILED 4-14-2011.

CORY BOONE, EXAMINING ATTORNEY



David J. Kyffers

Director of the United States Patent and Trademark Office

United States of America

United States Patent and Trademark Office

Swifter 
Efficiency. Performance. Innovation.

Reg. No. 4,066,582

Registered Dec. 6, 2011

Int. Cl.: 11

TRADEMARK

PRINCIPAL REGISTER

GLOCON, INC. (NEW JERSEY CORPORATION)
600 PARSIPPANY ROAD
PARSIPPANY, NJ 07054

FOR: ELECTRIC FANS; FANS FOR AIR CONDITIONING APPARATUS; VENTILATING EXHAUST FANS; VENTILATING FANS FOR COMMERCIAL AND INDUSTRIAL USE, IN CLASS 11 (U.S. CLS. 13, 21, 23, 31 AND 34).

FIRST USE 12-12-1998; IN COMMERCE 12-12-1998.

NO CLAIM IS MADE TO THE EXCLUSIVE RIGHT TO USE "EFFICIENCY. PERFORMANCE. INNOVATION.", APART FROM THE MARK AS SHOWN.

THE COLOR(S) BLACK, GREEN AND BLUE IS/ARE CLAIMED AS A FEATURE OF THE MARK.

THE MARK CONSISTS OF THE BLACK STYLIZED WORD "SWIFTER" TO THE LEFT OF A DRAWING OF TWO WAVES, THE TOP BEING GREEN, THE BOTTOM BLUE. BELOW THE DESCRIBED WORD AND DRAWING ARE THE WORDS "EFFICIENCY. PERFORMANCE. INNOVATION." IN BLACK STYLIZED FONT. THE WHITE BACKGROUND IS NOT CLAIMED AS PART OF THE MARK.

SER. NO. 85-295,524, FILED 4-14-2011.

LINDA E. BLOHM, EXAMINING ATTORNEY



David J. Kyros

Director of the United States Patent and Trademark Office

United States of America

United States Patent and Trademark Office



TRAK PAQ

Reg. No. 4,066,583

Registered Dec. 6, 2011

Int. Cl.: 42

SERVICE MARK

PRINCIPAL REGISTER

GLOCON, INC. (NEW JERSEY CORPORATION)
600 PARSIPPANY ROAD
PARSIPPANY, NJ 07054

FOR: PROVIDING TEMPORARY USE OF A WEB-BASED SOFTWARE APPLICATION FOR TRACKING PACKAGES OVER COMPUTER NETWORKS, INTRANETS AND THE INTERNET, IN CLASS 42 (U.S. CLS. 100 AND 101).

FIRST USE 3-12-2008; IN COMMERCE 3-12-2008.

THE MARK CONSISTS OF THE STYLIZED WORDS "TRAK PAQ" SEPARATED BY TWO UPWARD ARCHING ARROWS.

SER. NO. 85-295,534, FILED 4-14-2011.

LINDA E. BLOHM, EXAMINING ATTORNEY



David J. Kybas

Director of the United States Patent and Trademark Office

United States of America

United States Patent and Trademark Office

MOBILE GENIE

Reg. No. 4,066,584

Registered Dec. 6, 2011

Int. Cl.: 9

TRADEMARK

PRINCIPAL REGISTER

SUSTEEN, INC. (CALIFORNIA CORPORATION)
8001 IRVINE CENTER DRIVE, SUITE 1500
IRVINE, CA 92618

FOR: COMPUTER SOFTWARE AND HARDWARE FOR MOBILE CONTENT TRANSFER AND BACKUP AT THE CELL PHONE RETAILER POINT OF SALE, IN CLASS 9 (U.S. CLS. 21, 23, 26, 36 AND 38).

FIRST USE 5-12-2007; IN COMMERCE 5-12-2007.

THE MARK CONSISTS OF STANDARD CHARACTERS WITHOUT CLAIM TO ANY PARTICULAR FONT, STYLE, SIZE, OR COLOR.

NO CLAIM IS MADE TO THE EXCLUSIVE RIGHT TO USE "MOBILE", APART FROM THE MARK AS SHOWN.

SER. NO. 85-295,759, FILED 4-14-2011.

MATTHEW PAPPAS, EXAMINING ATTORNEY



David J. Kyppas

Director of the United States Patent and Trademark Office

United States of America

United States Patent and Trademark Office



Reg. No. 4,066,585

Registered Dec. 6, 2011

Int. Cl.: 35

SERVICE MARK

PRINCIPAL REGISTER

SUSTAINABLE ECONOMIC DEVELOPMENT STRATEGIES LLC (DELAWARE LIMITED LIABILITY COMPANY)
10 WILMINGTON AVE.
REHOBOTH, DE 19971

FOR: BUSINESS ADVISORY SERVICES, CONSULTANCY AND INFORMATION, IN CLASS 35 (U.S. CLS. 100, 101 AND 102).

FIRST USE 3-15-2011; IN COMMERCE 3-15-2011.

NO CLAIM IS MADE TO THE EXCLUSIVE RIGHT TO USE "SUSTAINABILITY" AND "SUSTAINABLE ECONOMIC DEVELOPMENT" AND "ECONOMIC DEVELOPMENT", APART FROM THE MARK AS SHOWN.

THE MARK CONSISTS OF THE WORD "SUSTAINABILITY" IN THE LEFT RECTANGLE, THE WORDS "SUSTAINABLE ECONOMIC DEVELOPMENT" IN THE ADJACENT CENTER DIAMOND, AND THE WORDS "ECONOMIC DEVELOPMENT" IN THE ADJACENT RIGHT RECTANGLE.

SER. NO. 85-295,854, FILED 4-14-2011.

REBECCA SMITH, EXAMINING ATTORNEY



David J. Kyffers

Director of the United States Patent and Trademark Office

United States of America

United States Patent and Trademark Office

ATHENA COLLEGE OF BEAUTY

Reg. No. 4,066,586

FOREST LAKE EDUCATION MANAGEMENT (ARIZONA LIMITED LIABILITY COMPANY)
43 E. 14TH ST
TEMPE, AZ 85281

Registered Dec. 6, 2011

Int. Cl.: 41

FOR: EDUCATIONAL SERVICES IN THE NATURE OF BEAUTY SCHOOLS, IN CLASS 41
(U.S. CLS. 100, 101 AND 107).

SERVICE MARK

FIRST USE 8-16-2010; IN COMMERCE 8-16-2010.

PRINCIPAL REGISTER

THE MARK CONSISTS OF STANDARD CHARACTERS WITHOUT CLAIM TO ANY PARTICULAR FONT, STYLE, SIZE, OR COLOR.

NO CLAIM IS MADE TO THE EXCLUSIVE RIGHT TO USE "COLLEGE OF BEAUTY",
APART FROM THE MARK AS SHOWN.

SER. NO. 85-295,913, FILED 4-15-2011.

BRIAN CALLAGHAN, EXAMINING ATTORNEY



David J. Kyros

Director of the United States Patent and Trademark Office

United States of America

United States Patent and Trademark Office

ZEROLITE

Reg. No. 4,066,587

Registered Dec. 6, 2011

Int. Cl.: 12

TRADEMARK

PRINCIPAL REGISTER

KEMCO INTERNATIONAL, INC. (CALIFORNIA CORPORATION)
12350 MONTAGUE STREET, UNIT "L"
PACOIMA, CA 91331

FOR: BICYCLE WHEELS, IN CLASS 12 (U.S. CLS. 19, 21, 23, 31, 35 AND 44).

FIRST USE 12-31-2005; IN COMMERCE 12-31-2005.

THE MARK CONSISTS OF STANDARD CHARACTERS WITHOUT CLAIM TO ANY PARTICULAR FONT, STYLE, SIZE, OR COLOR.

SER. NO. 85-296,062, FILED 4-15-2011.

SANI KHOURI, EXAMINING ATTORNEY



David J. Kybas

Director of the United States Patent and Trademark Office

United States of America

United States Patent and Trademark Office

UtiliTech

ENERGY & TELECOM EXPERTS

Reg. No. 4,066,588

Registered Dec. 6, 2011

Int. Cl.: 35

SERVICE MARK

PRINCIPAL REGISTER

UTILITECH (PENNSYLVANIA CORPORATION)
3020 PENN AVENUE
WEST LAWN, PA 19609

FOR: BUSINESS AUDITING; CONDUCTING ENERGY AUDITS OF COMMERCIAL AND INSTITUTIONAL FACILITIES FOR THE PURPOSE OF IMPROVING ENERGY EFFICIENCY; ENERGY AUDITING, IN CLASS 35 (U.S. CLS. 100, 101 AND 102).

FIRST USE 1-1-1993; IN COMMERCE 1-1-1993.

NO CLAIM IS MADE TO THE EXCLUSIVE RIGHT TO USE "ENERGY & TELECOM EXPERTS", APART FROM THE MARK AS SHOWN.

THE COLOR(S) GREEN, BLUE IS/ARE CLAIMED AS A FEATURE OF THE MARK.

THE MARK CONSISTS OF THE WORDING "UTILITECH" WITH "UTIL" IN GREEN AND "TECH" IN BLUE. A THIN BLUE LINE AND THE WORDING "ENERGY & TELECOM EXPERTS" IN BLUE APPEAR UNDERNEATH.

SER. NO. 85-296,074, FILED 4-15-2011.

SANI KHOURI, EXAMINING ATTORNEY



David J. Kyros

Director of the United States Patent and Trademark Office

United States of America

United States Patent and Trademark Office

REDSTONE
AMERICAN GRILL

Reg. No. 4,066,589

Registered Dec. 6, 2011

Int. Cl.: 43

SERVICE MARK

PRINCIPAL REGISTER

REDSTONE AMERICAN GRILL, INC. (DELAWARE CORPORATION)
294 GROVE LANE, SUITE 113
WAYZATA, MN 55391

FOR: RESTAURANT AND BAR SERVICES, IN CLASS 43 (U.S. CLS. 100 AND 101).

FIRST USE 0-0-1999; IN COMMERCE 0-0-1999.

OWNER OF U.S. REG. NOS. 3,762,040, 3,762,041, AND 3,762,042.

NO CLAIM IS MADE TO THE EXCLUSIVE RIGHT TO USE "AMERICAN GRILL", APART FROM THE MARK AS SHOWN.

THE MARK CONSISTS OF "REDSTONE" WITH "AMERICAN GRILL" IN SMALLER LETTERS CENTERED AND UNDERNEATH "REDSTONE" WITH TWO LINES ALIGNED WITH AND ON OPPOSITE SIDES OF "AMERICAN GRILL".

SER. NO. 85-296,142, FILED 4-15-2011.

DAWN FELDMAN, EXAMINING ATTORNEY



David J. Kyffers

Director of the United States Patent and Trademark Office

United States of America

United States Patent and Trademark Office

INSTANTRAPPORT

Reg. No. 4,066,590

Registered Dec. 6, 2011

Int. Cl.: 42

SERVICE MARK

PRINCIPAL REGISTER

LEEPFROG TECHNOLOGIES, INC. (IOWA CORPORATION)
2105 ACT CIRCLE
IOWA CITY, IA 52245

FOR: PROVIDING ON-LINE NON-DOWNLOADABLE SOFTWARE FOR DIRECT AND INTERACTIVE MESSAGING BETWEEN AN ORIGINATOR AND A SELECTED MEMBER OF A GROUP OR THE FIRST AVAILABLE MEMBER OF THE GROUP, IN CLASS 42 (U.S. CLS. 100 AND 101).

FIRST USE 10-24-2003; IN COMMERCE 10-24-2003.

THE MARK CONSISTS OF STANDARD CHARACTERS WITHOUT CLAIM TO ANY PARTICULAR FONT, STYLE, SIZE, OR COLOR.

OWNER OF U.S. REG. NO. 3,074,324.

SER. NO. 85-296,189, FILED 4-15-2011.

LEIGH CAROLINE CASE, EXAMINING ATTORNEY



David J. Kyffers

Director of the United States Patent and Trademark Office

United States of America

United States Patent and Trademark Office



Reg. No. 4,066,591

Registered Dec. 6, 2011

Int. Cl.: 44

SERVICE MARK

PRINCIPAL REGISTER

CALIFORNIA KIDDS PEDIATRIC DENTISTRY, PRACTICE OF JEFFREY EVANS, D.D.S.,
INC. AND JEFFREY KUNKEL, D.D.S., INC. (CALIFORNIA PARTNERSHIP)
SUITE 105
7525 N. CEDAR AVENUE
FRESNO, CA 93720

FOR: DENTISTRY, IN CLASS 44 (U.S. CLS. 100 AND 101).

FIRST USE 12-1-2010; IN COMMERCE 4-1-2011.

NO CLAIM IS MADE TO THE EXCLUSIVE RIGHT TO USE "CALIFORNIA KIDS PEDIATRIC DENTISTRY", APART FROM THE MARK AS SHOWN.

THE MARK CONSISTS OF A SUN AT THE TOP RISING OVER A SUBTLE MOUNTAIN PEAK. JUST BELOW IT ARE THE WORDS "CALIFORNIA KIDDS". A RECTANGLE LIES JUST BELOW THIS WITH THE WORDS "PEDIATRIC DENTISTRY" INSIDE.

SER. NO. 85-296,223, FILED 4-15-2011.

ROBIN MITTLER, EXAMINING ATTORNEY



David J. Kybas

Director of the United States Patent and Trademark Office

United States of America

United States Patent and Trademark Office



Reg. No. 4,066,592

Registered Dec. 6, 2011

Int. Cl.: 43

SERVICE MARK

PRINCIPAL REGISTER

PHO 95 NOODLE HOUSE, LLC (COLORADO LIMITED LIABILITY COMPANY)
6879 S. VINE ST., UNIT # 714
CENTENNIAL, CO 80122

FOR: RESTAURANT; RESTAURANT AND BAR SERVICES, INCLUDING RESTAURANT CARRYOUT SERVICES; RESTAURANT SERVICES FEATURING VIETNAMESE CUISINE, IN CLASS 43 (U.S. CLS. 100 AND 101).

FIRST USE 3-6-2008; IN COMMERCE 3-6-2008.

NO CLAIM IS MADE TO THE EXCLUSIVE RIGHT TO USE "PHO" AND "NOODLE HOUSE AND GRILL", APART FROM THE MARK AS SHOWN.

THE MARK CONSISTS OF TWO CHOPSTICKS HOLDING A LIME AND A CHILE WITH THE WORDS "PHO 95" BELOW ON TOP OF TWO LEAVES AND THE WORDS "NOODLE HOUSE AND GRILL" UNDER THE LEAVES.

THE ENGLISH TRANSLATION OF "PHO" IN THE MARK IS "BEEF NOODLE SOUP".

SER. NO. 85-296,226, FILED 4-15-2011.

TOBY BULLOFF, EXAMINING ATTORNEY



David J. Kyffers

Director of the United States Patent and Trademark Office

United States of America

United States Patent and Trademark Office

The Mycelia Project

Reg. No. 4,066,593

Registered Dec. 6, 2011

Int. Cl.: 41

SERVICE MARK

PRINCIPAL REGISTER

EMMANUEL PRATT (UNITED STATES INDIVIDUAL)
1931 S CLARK ST UNIT C
CHICAGO, IL 60616

FOR: EDUCATION SERVICES, NAMELY, PROVIDING MENTORING, TUTORING, CLASSES, SEMINARS AND WORKSHOPS IN THE FIELD OF SUSTAINABILITY THROUGH SCIENCE, TECHNOLOGY, ENGINEERING, MATHEMATICS AND ART; EDUCATION SERVICES, NAMELY, PROVIDING ON-LINE LESSON PLANS, COLLABORATION AND SOCIAL NETWORKING IN THE FIELD OF SUSTAINABILITY THROUGH SCIENCE, TECHNOLOGY, ENGINEERING, MATHEMATICS AND ART, IN CLASS 41 (U.S. CLS. 100, 101 AND 107).

FIRST USE 5-1-2010; IN COMMERCE 1-1-2011.

THE MARK CONSISTS OF STANDARD CHARACTERS WITHOUT CLAIM TO ANY PARTICULAR FONT, STYLE, SIZE, OR COLOR.

NO CLAIM IS MADE TO THE EXCLUSIVE RIGHT TO USE "PROJECT", APART FROM THE MARK AS SHOWN.

SER. NO. 85-296,311, FILED 4-15-2011.

KATINA MISTER, EXAMINING ATTORNEY



David J. Kyros

Director of the United States Patent and Trademark Office

United States of America

United States Patent and Trademark Office

ASHTON GROUP

Reg. No. 4,066,594

Registered Dec. 6, 2011

Int. Cl.: 36

SERVICE MARK

PRINCIPAL REGISTER

ASHTON GROUP (WISCONSIN CORPORATION)
SUITE 700
544 EAST OGDEN AVENUE
MILWAUKEE, WI 53202

FOR: FINANCIAL ADVISORY SERVICES, IN CLASS 36 (U.S. CLS. 100, 101 AND 102).

FIRST USE 10-1-2008; IN COMMERCE 10-1-2008.

THE MARK CONSISTS OF STANDARD CHARACTERS WITHOUT CLAIM TO ANY PARTICULAR FONT, STYLE, SIZE, OR COLOR.

NO CLAIM IS MADE TO THE EXCLUSIVE RIGHT TO USE "GROUP", APART FROM THE MARK AS SHOWN.

SER. NO. 85-296,387, FILED 4-15-2011.

DAVID I, EXAMINING ATTORNEY



David J. Kyffers

Director of the United States Patent and Trademark Office

United States of America

United States Patent and Trademark Office

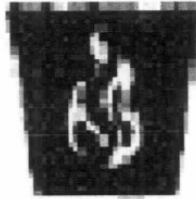

REDSTONE
AMERICAN GRILL

Reg. No. 4,066,595

Registered Dec. 6, 2011

Int. Cl.: 43

SERVICE MARK

PRINCIPAL REGISTER

REDSTONE AMERICAN GRILL, INC. (DELAWARE CORPORATION)
294 GROVE LANE, SUITE 113
WAYZATA, MN 55391

FOR: RESTAURANT AND BAR SERVICES, IN CLASS 43 (U.S. CLS. 100 AND 101).

FIRST USE 0-0-1999; IN COMMERCE 0-0-1999.

OWNER OF U.S. REG. NOS. 3,762,040, 3,762,041, AND 3,762,042.

NO CLAIM IS MADE TO THE EXCLUSIVE RIGHT TO USE "AMERICAN GRILL", APART FROM THE MARK AS SHOWN.

THE MARK CONSISTS OF THREE FLAMES WITHIN A BOX CENTERED AND ABOVE "REDSTONE" AND "AMERICAN GRILL" IN SMALLER LETTERS UNDERNEATH "REDSTONE" WITH TWO LINES ALIGNED WITH AND ON OPPOSITE SIDES OF "AMERICAN GRILL".

SER. NO. 85-296,403, FILED 4-15-2011.

DAWN FELDMAN, EXAMINING ATTORNEY



David J. Kybas

Director of the United States Patent and Trademark Office

United States of America

United States Patent and Trademark Office

CELARTIA

Reg. No. 4,066,596

Registered Dec. 6, 2011

Int. Cl.: 9

TRADEMARK

PRINCIPAL REGISTER

CELARTIA, LTD. (OHIO LIMITED LIABILITY COMPANY)
974 CHECKREIN AVE
COLUMBUS, OH 43229

FOR: LABORATORY EQUIPMENT FOR COMMERCIAL, INDUSTRIAL, CLINICAL, MEDICAL, AND SCIENTIFIC PURPOSES, NAMELY, ENCLOSED STORAGE CHAMBERS WITH ACCESS PORTS, USED AS INCUBATORS AND BIOREACTORS FOR CELL AND TISSUE CULTURE APPLICATIONS, IN CLASS 9 (U.S. CLS. 21, 23, 26, 36 AND 38).

FIRST USE 4-15-2011; IN COMMERCE 4-15-2011.

THE MARK CONSISTS OF STANDARD CHARACTERS WITHOUT CLAIM TO ANY PARTICULAR FONT, STYLE, SIZE, OR COLOR.

THE WORDING "CELARTIA" HAS NO MEANING IN A FOREIGN LANGUAGE.

SER. NO. 85-296,458, FILED 4-15-2011.

ODESSA BIBBINS, EXAMINING ATTORNEY



David J. Kybas

Director of the United States Patent and Trademark Office

United States of America

United States Patent and Trademark Office



Reg. No. 4,066,597

Registered Dec. 6, 2011

Int. Cl.: 33

TRADEMARK

PRINCIPAL REGISTER

DAKOTA SPIRITS DISTILLERY, L.L.C. (SOUTH DAKOTA LIMITED LIABILITY COMPANY)
3601 AIRPORT ROAD
PIERRE, SD 57501

FOR: ALCOHOLIC BEVERAGES EXCEPT BEER, IN CLASS 33 (U.S. CLS. 47 AND 49).

FIRST USE 9-22-2010; IN COMMERCE 9-22-2010.

THE MARK CONSISTS OF TWO STYLIZED CAPITAL "B"'S, CONTAINING SOME FLECKS; ONE IS FACING LEFT, THE UPPER PORTION OF THE LETTER SIMULATES THE LEFT SIDE OF THE FACE OF A CREATURE, AND HAS STRANDS OF HAIR SPIKING OUT FROM THE TOP AND BACK; THE OTHER "B" IS FACING RIGHT AND IS A MIRROR IMAGE OF THE OTHER WITH THE MARK "BICKERING BROTHERS" ARCED OVER THE TOP OF THE TWO "B"'S.

SER. NO. 85-296,503, FILED 4-15-2011.

HENRY S. ZAK, EXAMINING ATTORNEY



David J. Kybas

Director of the United States Patent and Trademark Office

United States of America

United States Patent and Trademark Office

CANYON LAKES

Reg. No. 4,066,598

Registered Dec. 6, 2011

Int. Cl.: 37

SERVICE MARK

PRINCIPAL REGISTER

LAND TEJAS COMPANY LLC (TEXAS LIMITED LIABILITY COMPANY)
2450 FONDREN RD, SUITE 210
HOUSTON, TX 77063

FOR: REAL ESTATE DEVELOPMENT, IN CLASS 37 (U.S. CLS. 100, 103 AND 106).

FIRST USE 5-1-2001; IN COMMERCE 5-1-2001.

THE MARK CONSISTS OF STANDARD CHARACTERS WITHOUT CLAIM TO ANY PARTICULAR FONT, STYLE, SIZE, OR COLOR.

NO CLAIM IS MADE TO THE EXCLUSIVE RIGHT TO USE "LAKES", APART FROM THE MARK AS SHOWN.

SER. NO. 85-296,535, FILED 4-15-2011.

COURTNEY ALVAREZ, EXAMINING ATTORNEY



David J. Kyffers

Director of the United States Patent and Trademark Office

United States of America

United States Patent and Trademark Office

PARK LAKES

Reg. No. 4,066,599

Registered Dec. 6, 2011

Int. Cl.: 37

SERVICE MARK

PRINCIPAL REGISTER

LAND TEJAS COMPANY LLC (TEXAS LIMITED LIABILITY COMPANY)
2450 FONDREN RD. SUITE 210
HOUSTON, TX 77063

FOR: REAL ESTATE DEVELOPMENT, IN CLASS 37 (U.S. CLS. 100, 103 AND 106).

FIRST USE 7-1-2002; IN COMMERCE 7-2-2002.

THE MARK CONSISTS OF STANDARD CHARACTERS WITHOUT CLAIM TO ANY PARTICULAR FONT, STYLE, SIZE, OR COLOR.

NO CLAIM IS MADE TO THE EXCLUSIVE RIGHT TO USE "LAKES", APART FROM THE MARK AS SHOWN.

SER. NO. 85-296,585, FILED 4-15-2011.

COURTNEY ALVAREZ, EXAMINING ATTORNEY



David J. Kyffers

Director of the United States Patent and Trademark Office

United States of America

United States Patent and Trademark Office

WESTHEIMER LAKES

Reg. No. 4,066,600

Registered Dec. 6, 2011

Int. Cl.: 37

SERVICE MARK

PRINCIPAL REGISTER

LAND TEJAS COMPANY LLC (TEXAS LIMITED LIABILITY COMPANY)
2450 FONDREN RD., SUITE 210
HOUSTON, TX 77063

FOR: REAL ESTATE DEVELOPMENT, IN CLASS 37 (U.S. CLS. 100, 103 AND 106).

FIRST USE 4-1-2002; IN COMMERCE 4-1-2002.

THE MARK CONSISTS OF STANDARD CHARACTERS WITHOUT CLAIM TO ANY PARTICULAR FONT, STYLE, SIZE, OR COLOR.

NO CLAIM IS MADE TO THE EXCLUSIVE RIGHT TO USE "LAKES", APART FROM THE MARK AS SHOWN.

SER. NO. 85-296,619, FILED 4-15-2011.

COURTNEY ALVAREZ, EXAMINING ATTORNEY



David J. Kybas

Director of the United States Patent and Trademark Office

United States of America

United States Patent and Trademark Office

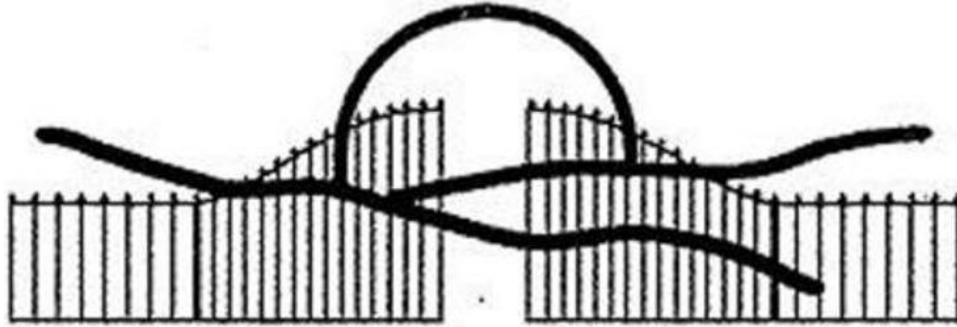

Reg. No. 4,066,601

Registered Dec. 6, 2011

Int. Cl.: 37

SERVICE MARK

PRINCIPAL REGISTER

LAND TEJAS COMPANY LLC (TEXAS LIMITED LIABILITY COMPANY)
2450 FONDREN RD. SUITE 210
HOUSTON, TX 77063

FOR: REAL ESTATE DEVELOPMENT, IN CLASS 37 (U.S. CLS. 100, 103 AND 106).

FIRST USE 1-1-1998; IN COMMERCE 1-1-1998.

THE MARK CONSISTS OF STYLIZED FENCE, GATE, HORIZON AND SUN.

SER. NO. 85-296,651, FILED 4-15-2011.

COURTNEY ALVAREZ, EXAMINING ATTORNEY



David J. Kybas

Director of the United States Patent and Trademark Office

United States of America

United States Patent and Trademark Office



IF YOU LOVE YOUR SMILE

Reg. No. 4,066,602

Registered Dec. 6, 2011

Int. Cl.: 5

TRADEMARK

PRINCIPAL REGISTER

R & B TOOTH ARMOUR LLC (NEVADA LIMITED LIABILITY COMPANY)
618 GLENNEYRE
LAGUNA BEACH, CA 92651

FOR: LIQUID AND FROZEN FRUIT FLAVORED DRINKS FOR THE PREVENTION OF TOOTH DECAY, IN CLASS 5 (U.S. CLS. 6, 18, 44, 46, 51 AND 52).

FIRST USE 3-18-2011; IN COMMERCE 3-18-2011.

NO CLAIM IS MADE TO THE EXCLUSIVE RIGHT TO USE "GUARDS AGAINST DECAY", APART FROM THE MARK AS SHOWN.

THE MARK CONSISTS OF A TOOTH WITH A FEATHER ON ITS HEAD, EYES, EYEBROWS, AND MOUTH, WEARING SHOES, HOLDING A LANCE UPRIGHT WITH THE STYLIZED WORDS "GUARDS AGAINST DECAY" ON A BANNER ABOVE THE IMAGE; THE TOOTH IS HOLDING A SHIELD WITH AN IMAGE OF A CROWN ON THE FRONT; THE STYLIZED WORDS "IF YOU LOVE YOUR SMILE" APPEAR BELOW THE TOOTH DESIGN.

SER. NO. 85-296,652, FILED 4-15-2011.

LAKEISHA LEWIS, EXAMINING ATTORNEY



David J. Kyros

Director of the United States Patent and Trademark Office

United States of America

United States Patent and Trademark Office

DESIGNLIGHTS CONSORTIUM

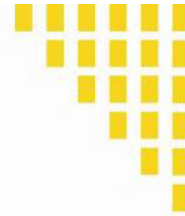

Reg. No. 4,066,603

Registered Dec. 6, 2011

Int. Cl.: 35

SERVICE MARK

PRINCIPAL REGISTER

NORTHEAST ENERGY EFFICIENCY PARTNERSHIPS, INC. (MASSACHUSETTS CORPORATION)
91 HARTWELL AVE.
LEXINGTON, MA 02421

FOR: PROMOTING THE BENEFITS OF ENERGY EFFICIENT LIGHTING TECHNOLOGIES TO PROFESSIONALS IN THE LIGHTING FIELD, IN CLASS 35 (U.S. CLS. 100, 101 AND 102).

FIRST USE 4-30-2009; IN COMMERCE 4-30-2009.

NO CLAIM IS MADE TO THE EXCLUSIVE RIGHT TO USE "CONSORTIUM", APART FROM THE MARK AS SHOWN.

THE COLOR(S) BLACK, YELLOW, AND WHITE IS/ARE CLAIMED AS A FEATURE OF THE MARK.

THE MARK CONSISTS OF THE WORD "DESIGNLIGHTS" IN BLACK ON TOP OF THE WORD "CONSORTIUM" IN BLACK. TO THE RIGHT OF THE WORDS ARE 21 YELLOW RECTANGULAR BOXES ARRANGED IN THE SHAPE OF A TRIANGLE. ALL OF THE ELEMENTS ARE ON A WHITE BACKGROUND.

SER. NO. 85-296,726, FILED 4-15-2011.

CHRISTINA SOBRAL, EXAMINING ATTORNEY



David J. Kybas

Director of the United States Patent and Trademark Office

United States of America

United States Patent and Trademark Office



Reg. No. 4,066,604

Registered Dec. 6, 2011

Int. Cl.: 36

SERVICE MARK

PRINCIPAL REGISTER

MASSACHUSETTS HOSPITAL ASSOCIATION INC. (MASSACHUSETTS NON-PROFIT CORPORATION)
5 NEW ENGLAND EXECUTIVE PARK
BURLINGTON, MA 01803

FOR: FUNDRAISING SERVICES, NAMELY, RAISING FUNDS FOR POLITICAL ACTION COMMITTEES CONCERNING HEALTHCARE ISSUES, IN CLASS 36 (U.S. CLS. 100, 101 AND 102).

FIRST USE 2-18-2011; IN COMMERCE 2-18-2011.

NO CLAIM IS MADE TO THE EXCLUSIVE RIGHT TO USE "HOSPITAL" AND "ADVOCACY FUND", APART FROM THE MARK AS SHOWN.

THE MARK CONSISTS OF THE WORDING "MHA ADVOCACY FUND" BELOW THE WORDING "HOSPITAL VOICES" ALL ENCLOSED WITHIN A CIRCLE WITH A DOME ABOVE THE WORDING "HOSPITAL VOICES" AND FIVE STARS BELOW THE "MHA ADVOCACY FUND".

SER. NO. 85-296,852, FILED 4-15-2011.

WON TEAK OH, EXAMINING ATTORNEY



David J. Kybas

Director of the United States Patent and Trademark Office

United States of America

United States Patent and Trademark Office

HOSPITAL VOICES

Reg. No. 4,066,605

Registered Dec. 6, 2011

Int. Cl.: 36

SERVICE MARK

PRINCIPAL REGISTER

MASSACHUSETTS HOSPITAL ASSOCIATION INC. (MASSACHUSETTS NON-PROFIT CORPORATION)
5 NEW ENGLAND EXECUTIVE PARK
BURLINGTON, MA 01803

FOR: FUNDRAISING SERVICES, NAMELY, RAISING FUNDS FOR POLITICAL ACTION COMMITTEES CONCERNING HEALTHCARE ISSUES, IN CLASS 36 (U.S. CLS. 100, 101 AND 102).

FIRST USE 2-18-2011; IN COMMERCE 2-18-2011.

THE MARK CONSISTS OF STANDARD CHARACTERS WITHOUT CLAIM TO ANY PARTICULAR FONT, STYLE, SIZE, OR COLOR.

NO CLAIM IS MADE TO THE EXCLUSIVE RIGHT TO USE "HOSPITAL", APART FROM THE MARK AS SHOWN.

SER. NO. 85-296,860, FILED 4-15-2011.

WON TEAK OH, EXAMINING ATTORNEY



David J. Kyffers

Director of the United States Patent and Trademark Office

United States of America

United States Patent and Trademark Office

Are you entertaining?

Reg. No. 4,066,606

Registered Dec. 6, 2011

Int. Cl.: 30

TRADEMARK

PRINCIPAL REGISTER

THE VIRGINIA CHUTNEY COMPANY LLC (VIRGINIA LIMITED LIABILITY COMPANY)
195 PIEDMONT AVE
WASHINGTON, VA 22747

FOR: CHUTNEYS, IN CLASS 30 (U.S. CL. 46).

FIRST USE 5-1-2010; IN COMMERCE 5-22-2010.

THE MARK CONSISTS OF STANDARD CHARACTERS WITHOUT CLAIM TO ANY PARTICULAR FONT, STYLE, SIZE, OR COLOR.

SER. NO. 85-296,870, FILED 4-15-2011.

KHANH LE, EXAMINING ATTORNEY



David J. Kyffers

Director of the United States Patent and Trademark Office

United States of America

United States Patent and Trademark Office

Space Bicycle

Reg. No. 4,066,607

Registered Dec. 6, 2011

Int. Cl.: 12

TRADEMARK

PRINCIPAL REGISTER

HARRELL, JAMES M (UNITED STATES INDIVIDUAL)
13485 E. CIENEGA CREEK DRIVE
VAIL, AZ 85641

FOR: ROAD RACING BICYCLES, IN CLASS 12 (U.S. CLS. 19, 21, 23, 31, 35 AND 44).

FIRST USE 4-15-2011; IN COMMERCE 4-15-2011.

THE MARK CONSISTS OF STANDARD CHARACTERS WITHOUT CLAIM TO ANY PARTICULAR FONT, STYLE, SIZE, OR COLOR.

NO CLAIM IS MADE TO THE EXCLUSIVE RIGHT TO USE "BICYCLE", APART FROM THE MARK AS SHOWN.

SER. NO. 85-296,905, FILED 4-15-2011.

HENRY S. ZAK, EXAMINING ATTORNEY



David J. Kyffers

Director of the United States Patent and Trademark Office

United States of America

United States Patent and Trademark Office

Acumen Enterprises

Reg. No. 4,066,608

Registered Dec. 6, 2011

Int. Cl.: 42

SERVICE MARK

PRINCIPAL REGISTER

MORGAN, JONATHAN M. (UNITED STATES INDIVIDUAL)
1579 RICHAMOND AVE.
COLUMBUS, OH 43203

FOR: MECHANICAL ENGINEERING; PRODUCT DEVELOPMENT AND ENGINEERING SERVICES FOR OTHERS; RESEARCH RELATING TO MECHANICAL ENGINEERING, IN CLASS 42 (U.S. CLS. 100 AND 101).

FIRST USE 1-12-2010; IN COMMERCE 1-12-2010.

THE MARK CONSISTS OF STANDARD CHARACTERS WITHOUT CLAIM TO ANY PARTICULAR FONT, STYLE, SIZE, OR COLOR.

NO CLAIM IS MADE TO THE EXCLUSIVE RIGHT TO USE "ENTERPRISES", APART FROM THE MARK AS SHOWN.

SER. NO. 85-297,043, FILED 4-16-2011.

JOHN GARTNER, EXAMINING ATTORNEY



David J. Kybas

Director of the United States Patent and Trademark Office

United States of America

United States Patent and Trademark Office



clover market

LUCKY FINDS FOR THE HOME

Reg. No. 4,066,609

Registered Dec. 6, 2011

Int. Cl.: 35

SERVICE MARK

PRINCIPAL REGISTER

CLOVER MARKET LLC (PENNSYLVANIA LIMITED LIABILITY COMPANY)
115 LLANFAIR ROAD
ARDMORE, PA 19003

FOR: ORGANIZING, PROMOTING AND CONDUCTING EXHIBITIONS AND TRADESHOWS FOR BUSINESS PURPOSES FEATURING BOOTHS AND DISPLAYS RELATING TO ANTIQUES AND COLLECTIBLES, IN CLASS 35 (U.S. CLS. 100, 101 AND 102).

FIRST USE 2-9-2009; IN COMMERCE 2-9-2009.

NO CLAIM IS MADE TO THE EXCLUSIVE RIGHT TO USE "MARKET", APART FROM THE MARK AS SHOWN.

THE COLOR(S) GREEN AND BLACK IS/ARE CLAIMED AS A FEATURE OF THE MARK.

THE MARK CONSISTS OF THE FOLLOWING: A GREEN COLORED FOUR LEAF CLOVER CENTERED ABOVE THE COMPANY NAME "CLOVER MARKET" AND TAGLINE "LUCKY FINDS FOR THE HOME", ALL RENDERED IN BLACK.

SER. NO. 85-297,046, FILED 4-16-2011.

KATINA MISTER, EXAMINING ATTORNEY



David J. Kybas

Director of the United States Patent and Trademark Office

United States of America

United States Patent and Trademark Office

RED CARPET DETOX

Reg. No. 4,066,610

Registered Dec. 6, 2011

Int. Cl.: 16

TRADEMARK

PRINCIPAL REGISTER

RIPPED TIDE NUTRITION, INC. (CALIFORNIA CORPORATION), DBA SOCAL CLEANSE
PO BOX 2321
LOS ANGELES, CA 90078

FOR: PRINTED PUBLICATIONS AND PRINTED MATTER, NAMELY, MAGAZINES, NEWSLETTERS, JOURNALS, BOOKS, MANUALS, DIARIES, CALENDARS, CHARTS, ALBUMS, PHOTOGRAPHS, POSTERS, STICKERS AND PRINTED RECIPES IN THE FIELDS OF HEALTH, HEALTHCARE, NUTRITION, DETOXIFICATION, DIET, WEIGHT LOSS, EXERCISE, FITNESS, MENU PLANNING, AND A HEALTHY LIFESTYLE; PRINTED INSTRUCTIONAL AND TEACHING MATERIALS IN THE FIELDS OF HEALTH, HEALTHCARE, NUTRITION, DETOXIFICATION, DIET, WEIGHT LOSS, EXERCISE, FITNESS, MENU PLANNING, AND A HEALTHY LIFESTYLE, IN CLASS 16 (U.S. CLS. 2, 5, 22, 23, 29, 37, 38 AND 50).

FIRST USE 3-15-2009; IN COMMERCE 3-15-2009.

THE MARK CONSISTS OF STANDARD CHARACTERS WITHOUT CLAIM TO ANY PARTICULAR FONT, STYLE, SIZE, OR COLOR.

NO CLAIM IS MADE TO THE EXCLUSIVE RIGHT TO USE "DETOX", APART FROM THE MARK AS SHOWN.

SER. NO. 85-297,065, FILED 4-16-2011.

ELI HELLMAN, EXAMINING ATTORNEY



David J. Kyros

Director of the United States Patent and Trademark Office

United States of America

United States Patent and Trademark Office



**SOLDIER'S
BEST ★ FRIEND**

Reg. No. 4,066,611

BURNHAM, JOHN (UNITED STATES INDIVIDUAL)
7020 W. EVANS DR.
PEORIA, AZ 85381

Registered Dec. 6, 2011

Int. Cl.: 41

FOR: CHARITABLE SERVICES, NAMELY, TRAINING SERVICE DOGS FOR VETERANS,
IN CLASS 41 (U.S. CLS. 100, 101 AND 107).

SERVICE MARK

FIRST USE 2-15-2011; IN COMMERCE 2-15-2011.

PRINCIPAL REGISTER

THE MARK CONSISTS OF THE LITERAL ELEMENTS "SOLDIER'S BEST FRIEND". THE
IMAGE INCLUDES A DOG PUTTING IT'S PAW ON A KNEELING SOLDIER WHO HAS
THEIR ARM ON THE DOG THERE IS A STAR BETWEEN "BEST" AND "FRIEND" LITERAL
ELEMENTS.

SER. NO. 85-297,116, FILED 4-16-2011.

KATINA MISTER, EXAMINING ATTORNEY



David J. Kybas

Director of the United States Patent and Trademark Office

United States of America

United States Patent and Trademark Office



Reg. No. 4,066,612

Registered Dec. 6, 2011

Int. Cls.: 18, 25 and 35

TRADEMARK

SERVICE MARK

PRINCIPAL REGISTER

HLASKA, INC. (CALIFORNIA CORPORATION)
1147 CALIFORNIA DRIVE
BURLINGAME, CA 94010

FOR: LUGGAGE, HANDBAGS, BACKPACKS, SUITCASES, BRIEFCASES, BRIEFCASE-TYPE PORTFOLIOS, DUFFEL BAGS, TOTE BAGS, ALL PURPOSE BAGS, COSMETIC CASES SOLD EMPTY, IN CLASS 18 (U.S. CLS. 1, 2, 3, 22 AND 41).

FIRST USE 6-1-2010; IN COMMERCE 6-1-2010.

FOR: CLOTHING, NAMELY, JACKETS, SHIRTS, PANTS, TIES, BELTS, SHOES, HATS, IN CLASS 25 (U.S. CLS. 22 AND 39).

FIRST USE 1-1-2010; IN COMMERCE 1-1-2010.

FOR: ONLINE AND RETAIL STORE SERVICES FEATURING LUGGAGE, HANDBAGS, BACKPACKS, SUITCASES, BRIEFCASES, BRIEFCASE-TYPE PORTFOLIOS, DUFFEL BAGS, TOTE BAGS, ALL PURPOSE BAGS, COSMETIC CASES SOLD EMPTY, WATCHES, KEY FOBS, CAMERAS, CELLULAR PHONES, SUNGLASSES AND PRESCRIPTION EYEGLASSES, AND CLOTHING, NAMELY, JACKETS, SHIRTS, PANTS, TIES, BELTS, SHOES, HATS, IN CLASS 35 (U.S. CLS. 100, 101 AND 102).

FIRST USE 12-14-2010; IN COMMERCE 12-14-2010.

OWNER OF U.S. REG. NOS. 3,165,025 AND 3,928,009.

THE MARK CONSISTS OF A RECTANGULAR BOX, WITH THE STYLIZED TERM "HLASKA" INSIDE THE BOTTOM LEFT OF THE BOX, AND THE DESIGN OF A BUILDING RAFTER INSIDE THE TOP RIGHT OF THE BOX.

SER. NO. 85-297,157, FILED 4-17-2011.

RUSS HERMAN, EXAMINING ATTORNEY



David J. Kyros

Director of the United States Patent and Trademark Office

United States of America

United States Patent and Trademark Office



Reg. No. 4,066,613
Registered Dec. 6, 2011
Int. Cl.: 13

WAYNE'S WORLD FIREWORKS, LLC (INDIANA LIMITED LIABILITY COMPANY)
383 SOUTH COUNTY ROAD 700 EAST
BOWLING GREEN, IN 47833

FOR: FIREWORKS, IN CLASS 13 (U.S. CLS. 2 AND 9).

FIRST USE 1-1-2011; IN COMMERCE 1-1-2011.

TRADEMARK

NO CLAIM IS MADE TO THE EXCLUSIVE RIGHT TO USE "FIREWORKS", APART FROM THE MARK AS SHOWN.

PRINCIPAL REGISTER

THE MARK CONSISTS OF AN IMAGE OF A RAM IN THE FOREFRONT AND THE AMERICAN FLAG IN THE BACKGROUND AND WITH THE WORD "FATHEAD" ABOVE THE RAM AND THE WORD "FIREWORKS" UNDERNEATH THE RAM.

SER. NO. 85-297,179, FILED 4-17-2011.

JOHN DWYER, EXAMINING ATTORNEY



David J. Kybas

Director of the United States Patent and Trademark Office

United States of America

United States Patent and Trademark Office



Reg. No. 4,066,614

Registered Dec. 6, 2011

Int. Cl.: 35

SERVICE MARK

PRINCIPAL REGISTER

BUYERS DEVELOPMENT GROUP LLC (MICHIGAN LIMITED LIABILITY COMPANY)
#303
2232 S. MAIN ST.
ANN ARBOR, MI 48103

FOR: ON-LINE WHOLESALE AND RETAIL STORE SERVICES FEATURING A WIDE VARIETY OF HORTICULTURAL PRODUCTS AND GARDENING PRODUCTS; WHOLESALE AND RETAIL STORE SERVICES FEATURING A WIDE VARIETY OF HORTICULTURAL PRODUCTS AND GARDENING PRODUCTS, DISTRIBUTORSHIP SERVICES FEATURING A WIDE VARIETY OF HORTICULTURAL PRODUCTS AND GARDENING PRODUCTS, IN CLASS 35 (U.S. CLS. 100, 101 AND 102).

FIRST USE 6-1-2009; IN COMMERCE 6-1-2009.

OWNER OF U.S. REG. NO. 3,822,993.

NO CLAIM IS MADE TO THE EXCLUSIVE RIGHT TO USE "HYDROPONIC SUPPLY", APART FROM THE MARK AS SHOWN.

THE MARK CONSISTS OF THE STYLIZED DEPICTION OF THE WORDS "THE GROW SHOW" WITH THE "O" IN THE WORD "SHOW" REPRESENTED AS A STYLIZED TOMATO. THE WORD "GROW" IS DEPICTED IN LARGER FONT WITH THE WORDS "THE" AND "SHOW" ON EITHER END OF THE WORD "GROW" AND DEPICTED IN SMALLER FONT. UNDER THE WORDING "THE GROW SHOW" THE WORDING "HYDROPONIC SUPPLY" IS DEPICTED IN SMALLER FONT AND SUPERIMPOSED OVER A STYLIZED DEPICTION OF GRASS ON AN INCOMPLETE OVAL FROM WHICH LINES EXTEND HORIZONTALLY LEFT AND RIGHT.

SER. NO. 85-297,207, FILED 4-17-2011.

LINDA POWELL, EXAMINING ATTORNEY



David J. Kybas

Director of the United States Patent and Trademark Office

United States of America
United States Patent and Trademark Office

Acropolis

Reg. No. 4,066,615

Registered Dec. 6, 2011

Int. Cl.: 43

SERVICE MARK

PRINCIPAL REGISTER

ACROPOLIS MEDITERRANEAN RESTAURANT INC (FLORIDA CORPORATION)
1833 E. 7TH AVENUE
YBOR CITY, FL 33605

FOR: BAR AND RESTAURANT SERVICES, IN CLASS 43 (U.S. CLS. 100 AND 101).

FIRST USE 1-1-2002; IN COMMERCE 1-1-2002.

THE MARK CONSISTS OF STANDARD CHARACTERS WITHOUT CLAIM TO ANY PARTICULAR FONT, STYLE, SIZE, OR COLOR.

SER. NO. 85-297,274, FILED 4-17-2011.

ROSELLE HERRERA, EXAMINING ATTORNEY



David J. Kybas

Director of the United States Patent and Trademark Office

United States of America

United States Patent and Trademark Office

SMOKY MOUNTAIN

Reg. No. 4,066,616

Registered Dec. 6, 2011

Int. Cl.: 43

SERVICE MARK

PRINCIPAL REGISTER

TRIPLE T ENTERPRISES (IDAHO CORPORATION)
408 EAST 41ST STREET
BOISE, ID 83714

FOR: RESTAURANT SERVICES, RESTAURANTS FEATURING IN RESTAURANT DINING, HOME DELIVERY, CATERING AND FOOD CARRY OUT SERVICES; PROVIDING OF BEVERAGES; PREPARATION OF FOOD, NAMELY, GRILLED FOOD, PIZZA, PASTA AND SANDWICHES, IN CLASS 43 (U.S. CLS. 100 AND 101).

FIRST USE 2-1-1992; IN COMMERCE 2-1-1992.

THE MARK CONSISTS OF STANDARD CHARACTERS WITHOUT CLAIM TO ANY PARTICULAR FONT, STYLE, SIZE, OR COLOR.

OWNER OF U.S. REG. NOS. 2,841,465, 3,504,730 AND OTHERS.

SER. NO. 85-297,280, FILED 4-17-2011.

MARGARET POWER, EXAMINING ATTORNEY



David J. Kyros

Director of the United States Patent and Trademark Office

United States of America

United States Patent and Trademark Office



Reg. No. 4,066,617

Registered Dec. 6, 2011

Int. Cls.: 18 and 25

TRADEMARK

PRINCIPAL REGISTER

SILLS ENTERPRISES (TENNESSEE PARTNERSHIP), DBA HATCHIE BOTTOM OUTDOOR PRODUCTS
68 EXECUTIVE DR.
JACKSON, TN 38305

FOR: DUFFLE BAGS AND GYM BAGS, IN CLASS 18 (U.S. CLS. 1, 2, 3, 22 AND 41).

FIRST USE 1-5-2009; IN COMMERCE 1-5-2009.

FOR: ATHLETIC APPAREL, NAMELY, SHIRTS, TOPS, JERSEYS, T-SHIRTS, CAMP SKIRTS, SHORTS, ELASTIC WAIST SHORTS, COMPRESSION SHORTS, SLIDING SHORTS, FOOTBALL CAPES, PANTS, GIRDLES, WARM UP PANTS, FLEECE SHIRTS, FLEECE JACKETS, FLEECE PANTS, CAPS, POCKET SHIRTS, BLANK SHIRTS, PLACKET SHIRTS, SKORTS, ATHLETIC SHOES, TEAM UNIFORMS, AND CHEERLEADING UNIFORMS, IN CLASS 25 (U.S. CLS. 22 AND 39).

FIRST USE 1-5-2009; IN COMMERCE 1-5-2009.

THE MARK CONSISTS OF A STYLIZED GRAPHIC REPRESENTATION OF THE LETTER "S".

SER. NO. 85-297,284, FILED 4-18-2011.

H. M. FISHER, EXAMINING ATTORNEY



David J. Kybas

Director of the United States Patent and Trademark Office

United States of America

United States Patent and Trademark Office

ALUMIFLEX

Reg. No. 4,066,618

Registered Dec. 6, 2011

Int. Cl.: 6

TRADEMARK

PRINCIPAL REGISTER

DDB UNLIMITED, INC. (OKLAHOMA CORPORATION)
ROUTE 1, BOX 15C
WYNNEWOOD, OK 73098

FOR: METAL STORAGE SHELTER STRUCTURES FOR STORING ELECTRONIC EQUIPMENT USED BY THE TELECOMMUNICATION AND RAILROAD INDUSTRIES, IN CLASS 6 (U.S. CLS. 2, 12, 13, 14, 23, 25 AND 50).

FIRST USE 2-13-1997; IN COMMERCE 2-11-2011.

THE MARK CONSISTS OF STANDARD CHARACTERS WITHOUT CLAIM TO ANY PARTICULAR FONT, STYLE, SIZE, OR COLOR.

SER. NO. 85-297,317, FILED 4-18-2011.

DAVID C. REIHNER, EXAMINING ATTORNEY



David J. Kyros

Director of the United States Patent and Trademark Office

United States of America

United States Patent and Trademark Office



Reg. No. 4,066,619

Registered Dec. 6, 2011

Int. Cl.: 35

SERVICE MARK

PRINCIPAL REGISTER

BLOGFROG, INC. (DELAWARE CORPORATION)
SUITE C
4895 RIVERBEND ROAD
BOULDER, CO 80301

FOR: ADVERTISING AND MARKETING SERVICES PROVIDED BY MEANS OF INDIRECT METHODS OF MARKETING COMMUNICATIONS, NAMELY, SOCIAL MEDIA, SEARCH ENGINE MARKETING, INQUIRY MARKETING, INTERNET MARKETING, MOBILE MARKETING, BLOGGING AND OTHER FORMS OF PASSIVE, SHARABLE OR VIRAL COMMUNICATIONS CHANNELS, IN CLASS 35 (U.S. CLS. 100, 101 AND 102).

FIRST USE 5-1-2009; IN COMMERCE 5-1-2009.

THE MARK CONSISTS OF THE STYLIZED WORD "BLOGFROG" WITH THE WORD "BLOG" IN BLUE, WITH EACH LETTER SURROUNDED WITH WHITE AND GRAY LINES, THE WORD "FROG" IN ORANGE WITH EACH LETTER SURROUNDED WITH WHITE AND GRAY LINES, AND A GREEN AND WHITE STYLIZED IMAGE OF A FROG AT THE END OF THE WORD "BLOGFROG". A GRAY DOTTED LINE RUNS FROM THE LETTER "B" TOUCHING THE FIRST LETTER "O" AND ENDING AT THE IMAGE OF THE FROG.

THE COLOR(S) BLUE, ORANGE, GREEN, GRAY AND WHITE IS/ARE CLAIMED AS A FEATURE OF THE MARK.

SER. NO. 85-297,337, FILED 4-18-2011.

LEIGH CAROLINE CASE, EXAMINING ATTORNEY



David J. Kyros

Director of the United States Patent and Trademark Office

United States of America

United States Patent and Trademark Office

DIRECTORS DESK

Reg. No. 4,066,620

THE NASDAQ OMX GROUP, INC. (DELAWARE CORPORATION)
ONE LIBERTY PLAZA, 165 BROADWAY
NEW YORK, NY 10006

Registered Dec. 6, 2011

Int. Cl.: 42

FOR: ELECTRONIC FILE AND DOCUMENT SHARING AND MANAGEMENT SERVICES, NAMELY, PROVIDING AN ELECTRONIC COMPUTER PLATFORM FEATURING TECHNOLOGY ENABLING USERS TO SECURELY UPLOAD, ACCESS, MANAGE AND SHARE ELECTRONIC DOCUMENTS AND FILES ONLINE, IN CLASS 42 (U.S. CLS. 100 AND 101).

SERVICE MARK

PRINCIPAL REGISTER

FIRST USE 2-0-2004; IN COMMERCE 2-4-2004.

THE MARK CONSISTS OF STANDARD CHARACTERS WITHOUT CLAIM TO ANY PARTICULAR FONT, STYLE, SIZE, OR COLOR.

SER. NO. 85-297,453, FILED 4-18-2011.

MATTHEW KLINE, EXAMINING ATTORNEY



David J. Kyjars

Director of the United States Patent and Trademark Office

United States of America

United States Patent and Trademark Office



Reg. No. 4,066,621

Registered Dec. 6, 2011

Int. Cl.: 45

SERVICE MARK

PRINCIPAL REGISTER

MAKE-UP HOUSE INC. (CALIFORNIA CORPORATION)
761 SABLE DR
RANCHO SANTA MARGARITA, CA 92688

FOR: SOCIAL NETWORKING SERVICES IN THE FIELD OF SELF BEAUTY THROUGH POSTING PICTURES, VIDEOS, CREATING GROUPS, EVENTS, CHATING WITH FRIENDS AND MEMBERS, COMPOSING AND CHECKING MESSAGES PROVIDED VIA A WEBSITE, IN CLASS 45 (U.S. CLS. 100 AND 101).

FIRST USE 11-17-2009; IN COMMERCE 3-26-2011.

NO CLAIM IS MADE TO THE EXCLUSIVE RIGHT TO USE "MAKE-UP", APART FROM THE MARK AS SHOWN.

THE MARK CONSISTS OF THE WORDING "MAKE-UP HOUSE" INSIDE A DESIGN OF A HOUSE WITH A HEART DESIGN ABOVE IT. THE WORDING "EXPERIENCE SHARE LUVMAKEUP" APPEARS BELOW THE HOUSE DESIGN.

SER. NO. 85-297,472, FILED 4-18-2011.

SETH A. RAPPAPORT, EXAMINING ATTORNEY



David J. Kybas

Director of the United States Patent and Trademark Office

United States of America

United States Patent and Trademark Office

KEEP CALM AND CARRY ON

Reg. No. 4,066,622

Registered Dec. 6, 2011

**Int. Cls.: 6, 14, 16, 18, 20,
21, 24 and 25**

TRADEMARK

PRINCIPAL REGISTER

KEEP CALM AND CARRY ON LTD. (UNITED KINGDOM COMPANY)
14-15 THE ANNEXE, INVESTMENT HOUSE
28 QUEENS ROAD, WEYBRIDGE
SURREY, UNITED KINGDOM KT13 9UT

FOR: (BASED ON 44(D) PRIORITY APPLICATION) GENERAL PURPOSE METAL STORAGE CONTAINERS; METAL KEY RINGS; NON-LUMINOUS AND NON-MECHANICAL METAL SIGNS (BASED ON 44(E)) GENERAL PURPOSE METAL STORAGE CONTAINERS; METAL KEY RINGS; NON-LUMINOUS AND NON-MECHANICAL METAL SIGNS, IN CLASS 6 (U.S. CLS. 2, 12, 13, 14, 23, 25 AND 50).

FOR: (BASED ON 44(D) PRIORITY APPLICATION) CUFFLINKS; JEWELLERY, CLOCKS AND WATCHES (BASED ON 44(E)) CUFFLINKS; JEWELLERY, CLOCKS AND WATCHES, IN CLASS 14 (U.S. CLS. 2, 27, 28 AND 50).

FOR: (BASED ON 44(D) PRIORITY APPLICATION) ADDRESS BOOKS; BLACKBOARDS; BOOKS IN THE FIELD OF HISTORY AND BOOKS IN THE FIELD OF HUMOR; CALENDARS; COASTERS OF PAPER; DIARIES; FOLDERS; GREETING CARDS; NOTEBOARDS; NOTEBOOKS; PASSPORT COVERS; PENS; PICTURES; POSTCARDS; POSTERS; STATIONERY; STICKERS; TABLE MATS OF PAPER; CHALKBOARDS; TABLE MATS MADE OF CARDBOARD; COASTERS MADE OF CARDBOARD (BASED ON 44(E)) ADDRESS BOOKS; BLACKBOARDS; BOOKS IN THE FIELD OF HISTORY AND BOOKS IN THE FIELD OF HUMOR; CALENDARS; COASTERS OF PAPER; DIARIES; FOLDERS; GREETING CARDS; NOTEBOARDS; NOTEBOOKS; PASSPORT COVERS; PENS; PICTURES; POSTCARDS; POSTERS; STATIONERY; STICKERS; TABLE MATS OF PAPER; CHALKBOARDS; TABLE MATS MADE OF CARDBOARD; COASTERS MADE OF CARDBOARD, IN CLASS 16 (U.S. CLS. 2, 5, 22, 23, 29, 37, 38 AND 50).

FOR: (BASED ON 44(D) PRIORITY APPLICATION) BEACH BAGS; DUFFEL BAGS; FLIGHT BAGS; LUGGAGE AND TRUNKS; LUGGAGE TAGS; TOTE BAGS; TRAVEL BAGS; WALLETS (BASED ON 44(E)) BEACH BAGS; DUFFEL BAGS; FLIGHT BAGS; LUGGAGE AND TRUNKS; LUGGAGE TAGS; TOTE BAGS; TRAVEL BAGS; WALLETS, IN CLASS 18 (U.S. CLS. 1, 2, 3, 22 AND 41).

FOR: (BASED ON 44(D) PRIORITY APPLICATION) CUSHIONS; DECK CHAIRS; NON-METAL KEY RINGS (BASED ON 44(E)) CUSHIONS; DECK CHAIRS; NON-METAL KEY RINGS, IN CLASS 20 (U.S. CLS. 2, 13, 22, 25, 32 AND 50).



David J. Kybas

Director of the United States Patent and Trademark Office

Reg. No. 4,066,622 FOR: (BASED ON 44(D) PRIORITY APPLICATION) CAKE TINS; COASTERS, NOT OF PAPER AND OTHER THAN TABLE LINEN; CONTAINERS FOR HOUSEHOLD OR KITCHEN USE; CROCKERY, NAMELY, POTS, DISHES, DRINKING CUPS AND SAUCERS, BOWLS, SERVING BOWLS AND TRAYS; LUNCH BOXES; LUNCH PAILS; MUGS; PERSONAL DISPENSERS FOR STICKING PLASTERS FOR DOMESTIC USE; PLATES; TEA POTS; TRAYS FOR DOMESTIC PURPOSES (BASED ON 44(E)) CAKE TINS; COASTERS, NOT OF PAPER AND OTHER THAN TABLE LINEN; CONTAINERS FOR HOUSEHOLD OR KITCHEN USE; CROCKERY, NAMELY, POTS, DISHES, DRINKING CUPS AND SAUCERS, BOWLS, SERVING BOWLS AND TRAYS; LUNCH BOXES; LUNCH PAILS; MUGS; PERSONAL DISPENSERS FOR STICKING PLASTERS FOR DOMESTIC USE; PLATES; TEA POTS; TRAYS FOR DOMESTIC PURPOSES, IN CLASS 21 (U.S. CLS. 2, 13, 23, 29, 30, 33, 40 AND 50).

FOR: (BASED ON 44(D) PRIORITY APPLICATION) BATH TOWELS; BEACH TOWELS; BED AND TABLE LINEN; BED BLANKETS; BLANKET THROWS; BLANKETS FOR OUTDOOR USE; LAP BLANKETS; OVEN MITTS; TABLE LINEN OF TEXTILE; TABLE LINEN, NAMELY, COASTERS; TEA TOWELS; TOWELS; TRAVELLING BLANKETS; WOOLLEN BLANKETS (BASED ON 44(E)) BATH TOWELS; BEACH TOWELS; BED AND TABLE LINEN; BED BLANKETS; BLANKET THROWS; BLANKETS FOR OUTDOOR USE; LAP BLANKETS; OVEN MITTS; TABLE LINEN OF TEXTILE; TABLE LINEN, NAMELY, COASTERS; TEA TOWELS; TOWELS; TRAVELLING BLANKETS; WOOLLEN BLANKETS, IN CLASS 24 (U.S. CLS. 42 AND 50).

FOR: (BASED ON 44(D) PRIORITY APPLICATION) APRONS; BASEBALL CAPS AND HATS; EYESHADES; FOOTWEAR; JACKETS; JUMPERS; SHIRTS; SWEATSHIRTS; T-SHIRTS; UNDERWEAR (BASED ON 44(E)) APRONS; BASEBALL CAPS AND HATS; EYESHADES; FOOTWEAR; JACKETS; JUMPERS; SHIRTS; SWEATSHIRTS; T-SHIRTS; UNDERWEAR, IN CLASS 25 (U.S. CLS. 22 AND 39).

THE MARK CONSISTS OF STANDARD CHARACTERS WITHOUT CLAIM TO ANY PARTICULAR FONT, STYLE, SIZE, OR COLOR.

PRIORITY CLAIMED UNDER SEC. 44(D) ON ERPN CMNTY TM OFC APPLICATION NO. 009455619, FILED 10-18-2010, REG. NO. 009455619, DATED 3-25-2011, EXPIRES 10-18-2020.

SER. NO. 85-297,485, FILED 4-18-2011.

KYLE PEETE, EXAMINING ATTORNEY

United States of America

United States Patent and Trademark Office

VISION 4 LESS

Reg. No. 4,066,623

EYEMART EXPRESS, LTD. (TEXAS LIMITED PARTNERSHIP)
13800 SENLAC DR., SUITE 200
FARMERS BRANCH, TX 75234

Registered Dec. 6, 2011

Int. Cl.: 35

FOR: RETAIL STORE SERVICES FEATURING EYEGLASSES, SUNGLASSES, FRAMES, CONTACT LENSES AND EYECARE PRODUCTS; RETAIL OPTICAL STORES , IN CLASS 35 (U.S. CLS. 100, 101 AND 102).

SERVICE MARK

FIRST USE 2-27-1992; IN COMMERCE 2-27-1992.

PRINCIPAL REGISTER

THE MARK CONSISTS OF STANDARD CHARACTERS WITHOUT CLAIM TO ANY PARTICULAR FONT, STYLE, SIZE, OR COLOR.

OWNER OF U.S. REG. NOS. 3,022,421, 3,897,110 AND OTHERS.

NO CLAIM IS MADE TO THE EXCLUSIVE RIGHT TO USE "VISION", APART FROM THE MARK AS SHOWN.

SER. NO. 85-297,489, FILED 4-18-2011.

KYLE PEETE, EXAMINING ATTORNEY



David J. Kyros

Director of the United States Patent and Trademark Office

United States of America

United States Patent and Trademark Office



Reg. No. 4,066,624

Registered Dec. 6, 2011

Int. Cl.: 42

SERVICE MARK

PRINCIPAL REGISTER

PASCULLI, MARK (UNITED STATES INDIVIDUAL)
PO BOX 2535
MCCALL, ID 83638

FOR: DEVELOPMENT AND IMPLEMENTATION OF SOFTWARE, HARDWARE AND TECHNOLOGY SOLUTIONS FOR THE PURPOSE OF PRODUCTIZATION OF ELECTRONIC COMPONENTS AND ELECTRONIC SYSTEMS; PROVIDING TEMPORARY USE OF A WEB-BASED SOFTWARE APPLICATION FOR MANAGING ALL ASPECTS FOR A RESTORATION COMPANY, FOR USE IN DATABASE MANAGEMENT, TRACKING, REFERRAL DATABASE MANAGEMENT, REPORTING ANALYTICAL ANALYSIS, FORM GENERATION, USE AS A SPREADSHEET, AND WORD PROCESSING, IN CLASS 42 (U.S. CLS. 100 AND 101).

FIRST USE 4-23-2009; IN COMMERCE 4-1-2010.

NO CLAIM IS MADE TO THE EXCLUSIVE RIGHT TO USE "RESTORATION MANAGEMENT SOFTWARE", APART FROM THE MARK AS SHOWN.

THE MARK CONSISTS OF A ROOF WITH A CHIMNEY AND A SIDE WALL. THERE IS A SUN ON THE TOP OF THE ROOF. INSIDE THE HOUSE THERE IS THE STYLIZED TEXT "RMS RESTORATION MANAGEMENT SOFTWARE". ON THE LEFT THERE IS A STICK FIGURE PERSON.

SER. NO. 85-297,499, FILED 4-18-2011.

MARGERY A. TIERNEY, EXAMINING ATTORNEY



David J. Kybas

Director of the United States Patent and Trademark Office

United States of America

United States Patent and Trademark Office



Reg. No. 4,066,625

Registered Dec. 6, 2011

Int. Cls.: 35 and 41

SERVICE MARK

PRINCIPAL REGISTER

BLACK STAR STRATEGIES, INC. (NORTH CAROLINA CORPORATION)
206 WOODLEAF DRIVE
CHAPEL HILL, NC 275167984

FOR: BUSINESS CONSULTING SERVICES, NAMELY, PROVIDING ASSISTANCE IN DEVELOPMENT OF BUSINESS STRATEGIES AND CREATIVE IDEATION ; BUSINESS MANAGEMENT CONSULTANCY AS WELL AS DEVELOPMENT OF PROCESSES FOR THE ANALYSIS AND THE IMPLEMENTATION OF STRATEGY PLANS AND MANAGEMENT PROJECTS ; BUSINESS STRATEGY DEVELOPMENT SERVICES ; BUSINESS MANAGEMENT CONSULTATION IN THE FIELD OF EXECUTIVE AND LEADERSHIP DEVELOPMENT, IN CLASS 35 (U.S. CLS. 100, 101 AND 102).

FIRST USE 10-1-2007; IN COMMERCE 10-1-2007.

FOR: BUSINESS EDUCATION AND TRAINING SERVICES, NAMELY, DEVELOPING, AND FACILITATING CUSTOMIZED IN-COMPANY LEADERSHIP AND EXECUTIVE DEVELOPMENT PROGRAMS, PROVIDING EXECUTIVE COACHING SERVICES, AND PROVIDING PUBLIC AND IN-COMPANY KEYNOTE PRESENTATIONS TO BUSINESS LEADERS, IN CLASS 41 (U.S. CLS. 100, 101 AND 107).

FIRST USE 10-1-2007; IN COMMERCE 10-1-2007.

NO CLAIM IS MADE TO THE EXCLUSIVE RIGHT TO USE "STRATEGIES", APART FROM THE MARK AS SHOWN.

THE MARK CONSISTS OF THE LETTERS "BS" SUPERIMPOSED ON EACH OTHER INSIDE A CIRCLE THAT IS SURROUNDED BY FIVE STAR POINTS. TO THE RIGHT OF THE STAR IS THE WORDING "BLACK STAR," WITH THE WORD "STRATEGIES" INSIDE OF A HORIZONTAL BAND BELOW. BELOW THE HORIZONTAL BAND IS THE WORDING "CREATIVE SOLUTIONS FOR ENHANCED PERFORMANCE".

SER. NO. 85-297,522, FILED 4-18-2011.

JASON BLAIR, EXAMINING ATTORNEY



David J. Kyjars

Director of the United States Patent and Trademark Office

United States of America

United States Patent and Trademark Office



Reg. No. 4,066,626

Registered Dec. 6, 2011

Int. Cl.: 45

SERVICE MARK

PRINCIPAL REGISTER

OPERATIONAL ADVOCATES SUPPORTING INJURED SOLDIERS (O.A.S.I.S)
(WASHINGTON NON-PROFIT CORPORATION)
5527 TOPAZ ST SE
LACEY, WA 98513

FOR: REPRESENTATION OF PERSONS FOR SOCIAL SECURITY AND DISABILITY RELATED CLAIMS, IN CLASS 45 (U.S. CLS. 100 AND 101).

FIRST USE 6-1-2008; IN COMMERCE 6-1-2008.

NO CLAIM IS MADE TO THE EXCLUSIVE RIGHT TO USE "OPERATIONAL ADVOCATES SUPPORTING INJURED SOLDIERS" AND "GROUP", APART FROM THE MARK AS SHOWN.

THE MARK CONSISTS OF THE STYLIZED TEXT "O.A.S.I.S" WITH A PALM TREE INSIDE THE LETTER "O." BELOW THERE IS THE STYLIZED TEXT "OPERATIONAL ADVOCATES SUPPORTING INJURED SOLDIERS" WITH A STAR ON EACH SIDE INSIDE OF A HORIZONTAL BAND. BELOW THAT IS THE STYLIZED TEXT "GROUP".

SER. NO. 85-297,524, FILED 4-18-2011.

JASON BLAIR, EXAMINING ATTORNEY



David J. Kyros

Director of the United States Patent and Trademark Office

United States of America

United States Patent and Trademark Office

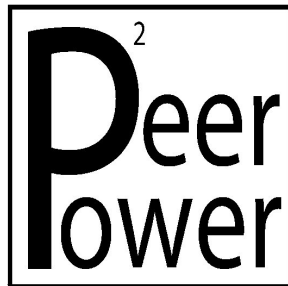

Reg. No. 4,066,627

Registered Dec. 6, 2011

Int. Cl.: 41

SERVICE MARK

PRINCIPAL REGISTER

PEER POWER FOUNDATION, INC. (TENNESSEE CORPORATION)
SUITE ONE
850 RIDGE LAKE BLVD
MEMPHIS, TN 38120

FOR: EDUCATIONAL SERVICES, NAMELY, CONDUCTING TUTORING IN THE FIELD OF MATH, SCIENCES, LANGUAGE, AND LEADERSHIP AND DISTRIBUTION OF COURSE MATERIAL IN CONNECTION THEREWITH, IN CLASS 41 (U.S. CLS. 100, 101 AND 107).

FIRST USE 12-1-2007; IN COMMERCE 12-1-2007.

THE MARK CONSISTS OF A SQUARE CONTAINING THE STYLIZED TEXT "PEER POWER", WITH THE TWO WORDS SHARING THE SAME INITIAL LETTER "P", AND WITH THE NUMBER "2" APPEARING JUST ABOVE AND TO THE RIGHT OF THE LETTER "P" TO CONNOTE "P SQUARED".

SER. NO. 85-297,555, FILED 4-18-2011.

ELIZABETH HUGHITT, EXAMINING ATTORNEY



David J. Kyjars

Director of the United States Patent and Trademark Office

United States of America

United States Patent and Trademark Office



Reg. No. 4,066,628

Registered Dec. 6, 2011

Int. Cl.: 42

SERVICE MARK

PRINCIPAL REGISTER

ANDERSON, QUENTIN (UNITED STATES INDIVIDUAL)
6183 PRINCETON AVE
MOROW, GA 30260

FOR: COMPUTER SERVICES, NAMELY, ON-SITE MANAGEMENT OF INFORMATION TECHNOLOGY (IT) SYSTEMS; INSTALLATION, MAINTENANCE AND REPAIR OF COMPUTER SOFTWARE, IN CLASS 42 (U.S. CLS. 100 AND 101).

FIRST USE 9-10-2003; IN COMMERCE 9-10-2003.

NO CLAIM IS MADE TO THE EXCLUSIVE RIGHT TO USE "NETWORK", APART FROM THE MARK AS SHOWN.

THE STIPPLING IS FOR SHADING PURPOSES ONLY.

THE MARK CONSISTS OF THE DESIGN OF A SPHERE CONTAINING SEVERAL CONNECTED SQUARES THAT REPRESENT A GROUP OF NETWORKED COMPUTERS, WITH THE STYLIZED TEXT "NETWORK CREATIONS" TO THE RIGHT. A SYMBOL OF A COMPUTER MOUSE IS LOCATED BELOW THE "N" IN THE WORD "NETWORK", WITH THE LETTER "N" REPRESENTING THE CABLE FOR THE MOUSE.

SER. NO. 85-297,558, FILED 4-18-2011.

ELIZABETH HUGHITT, EXAMINING ATTORNEY



David J. Kyjars

Director of the United States Patent and Trademark Office

United States of America

United States Patent and Trademark Office

FIT ACADEMY

Reg. No. 4,066,629

Registered Dec. 6, 2011

Int. Cl.: 41

SERVICE MARK

PRINCIPAL REGISTER

SPRINGBOARD NON-PROFIT CONSUMER CREDIT MANAGEMENT, INC. (CALIFORNIA CORPORATION)
4351 LATHAM STREET
RIVERSIDE, CA 925016370

FOR: EDUCATIONAL SERVICES, NAMELY, CONDUCTING CLASSES, SEMINARS AND WORKSHOPS IN THE FIELDS OF DEBT MANAGEMENT, CONSUMER CREDIT, HOME OWNERSHIP, MONEY MANAGEMENT AND PERSONAL FINANCE, STUDENT LOANS AND BANKRUPTCY, IN CLASS 41 (U.S. CLS. 100, 101 AND 107).

FIRST USE 10-0-2009; IN COMMERCE 10-0-2009.

THE MARK CONSISTS OF STANDARD CHARACTERS WITHOUT CLAIM TO ANY PARTICULAR FONT, STYLE, SIZE, OR COLOR.

NO CLAIM IS MADE TO THE EXCLUSIVE RIGHT TO USE "ACADEMY", APART FROM THE MARK AS SHOWN.

SER. NO. 85-297,668, FILED 4-18-2011.

PAM WILLIS, EXAMINING ATTORNEY



David J. Kyffers

Director of the United States Patent and Trademark Office

United States of America

United States Patent and Trademark Office



Reg. No. 4,066,630

Registered Dec. 6, 2011

Int. Cls.: 29 and 30

TRADEMARK

PRINCIPAL REGISTER

NATIONAL DELI, LLC (DELAWARE LIMITED LIABILITY COMPANY)
7250 N.W. 35 TERRACE
MIAMI, FL 33122

FOR: COOKED MEATS, NAMELY, SALAMI AND TURKEY; COOKED BEEF AND PRIME RIB, IN CLASS 29 (U.S. CL. 46).

FIRST USE 12-0-1985; IN COMMERCE 12-0-1985.

FOR: MUSTARD , IN CLASS 30 (U.S. CL. 46).

FIRST USE 12-0-1985; IN COMMERCE 12-0-1985.

OWNER OF U.S. REG. NO. 2,763,861.

THE COLOR(S) BLUE AND RED IS/ARE CLAIMED AS A FEATURE OF THE MARK.

THE MARK CONSISTS OF A FLAG THE TOP PART OF WHICH IS IN THE COLOR BLUE AND THE BOTTOM PART OF WHICH IS IN RED AND SEPARATED FROM THE BLUE PORTION BY A WHITE LINE AND INCLUDES THE WORDS "NATIONAL DELI".

SEC. 2(F).

SER. NO. 85-297,713, FILED 4-18-2011.

GEORGE LORENZO, EXAMINING ATTORNEY



David J. Kybas

Director of the United States Patent and Trademark Office

United States of America

United States Patent and Trademark Office

ZOO PALS

Reg. No. 4,066,631

Registered Dec. 6, 2011

Int. Cl.: 28

TRADEMARK

PRINCIPAL REGISTER

RICE, MARK (UNITED STATES INDIVIDUAL)
WWW.GAMES2REMEMBER.COM
785 OLDE CLUBS DRIVE
ALPHARETTA, GA 30022

FOR: PARLOR GAMES, IN CLASS 28 (U.S. CLS. 22, 23, 38 AND 50).

FIRST USE 1-22-2002; IN COMMERCE 1-22-2002.

THE MARK CONSISTS OF STANDARD CHARACTERS WITHOUT CLAIM TO ANY PARTICULAR FONT, STYLE, SIZE, OR COLOR.

SER. NO. 85-297,806, FILED 4-18-2011.

PAUL E. FAHRENKOPF, EXAMINING ATTORNEY



David J. Kybas

Director of the United States Patent and Trademark Office

United States of America

United States Patent and Trademark Office

Water With A Work Ethic

Reg. No. 4,066,632

Registered Dec. 6, 2011

Int. Cl.: 32

TRADEMARK

PRINCIPAL REGISTER

WATER CONCEPTS, INC. (ILLINOIS CORPORATION)
561 PLATE DRIVE, SUITE 1
EAST DUNDEE, IL 60118

FOR: BEVERAGES, NAMELY, CAFFEINE-ENHANCED WATER, IN CLASS 32 (U.S. CLS. 45, 46 AND 48).

FIRST USE 4-12-2007; IN COMMERCE 5-28-2007.

THE MARK CONSISTS OF STANDARD CHARACTERS WITHOUT CLAIM TO ANY PARTICULAR FONT, STYLE, SIZE, OR COLOR.

NO CLAIM IS MADE TO THE EXCLUSIVE RIGHT TO USE "WATER", APART FROM THE MARK AS SHOWN.

SER. NO. 85-297,891, FILED 4-18-2011.

JORDAN BAKER, EXAMINING ATTORNEY



David J. Kyffers

Director of the United States Patent and Trademark Office

United States of America

United States Patent and Trademark Office



Reg. No. 4,066,633

Registered Dec. 6, 2011

Int. Cl.: 26

TRADEMARK

PRINCIPAL REGISTER

MORRIS, LORI (UNITED STATES INDIVIDUAL)
SUITE 407
10330 CHEDOAK COURT
JACKSONVILLE, FL 32218

FOR: ARTIFICIAL HAIR, NAMELY, BRAIDED HAIR PIECES SIMULATING A GIRL'S PIGTAILS THAT ARE ATTACHABLE TO A MOTORCYCLE HELMET WITH A SUCTION CUP, IN CLASS 26 (U.S. CLS. 37, 39, 40, 42 AND 50).

FIRST USE 1-10-2010; IN COMMERCE 1-10-2010.

NO CLAIM IS MADE TO THE EXCLUSIVE RIGHT TO USE "BIKER BRAIDS UNLIMITED JACKSONVILLE, FLORIDA", APART FROM THE MARK AS SHOWN.

THE MARK CONSISTS OF THE OUTLINE OF AN OVAL CONTAINING THE STYLIZED WORDS "BIKER BRAIDS" STACKED ONE ON TOP OF THE OTHER WITH FLAMES TRAILING FROM THE "BS" AND A CIRCLE CONTAINING THE LETTERS "LJ'S" APPEARING OVER THE UPPER PORTION OF THE FLAMES. THE SILHOUETTE OF A WOMAN ON A MOTORCYCLE WITH A LONG BRAID TRAILING BEHIND HER APPEARS TO THE RIGHT OF "BIKER BRAIDS". THE STYLIZED WORD "UNLIMITED" APPEARS BENEATH THE WORD "BRAIDS" AND THE STYLIZED WORDING "JACKSONVILLE, FLORIDA" APPEARS BELOW "UNLIMITED".

SER. NO. 85-297,926, FILED 4-18-2011.

AMY KERTGATE, EXAMINING ATTORNEY



David J. Kyffers

Director of the United States Patent and Trademark Office

United States of America

United States Patent and Trademark Office



CHALIT'S
THAI BISTRO

Reg. No. 4,066,634

Registered Dec. 6, 2011

Int. Cl.: 43

SERVICE MARK

PRINCIPAL REGISTER

CHALIT'S THAI BISTRO LLC (PENNSYLVANIA LIMITED LIABILITY COMPANY)
5103 CARLISE PIKE
MECHANICSBURG, PA 17050

FOR: RESTAURANT AND CATERING SERVICES, IN CLASS 43 (U.S. CLS. 100 AND 101).

FIRST USE 10-16-2009; IN COMMERCE 10-16-2009.

NO CLAIM IS MADE TO THE EXCLUSIVE RIGHT TO USE "THAI BISTRO", APART FROM THE MARK AS SHOWN.

THE STIPPLING IS FOR SHADING PURPOSES ONLY.

THE MARK CONSISTS OF THE WORDING "CHALIT'S THAI BISTRO" IN A STYLIZED FONT BELOW THE STYLIZED DESIGN OF A CIRCLE WITH TWO CURVED LINES.

SER. NO. 85-297,978, FILED 4-18-2011.

COLLEEN DOMBROW, EXAMINING ATTORNEY



David J. Kyffers

Director of the United States Patent and Trademark Office

United States of America

United States Patent and Trademark Office

MASTER CLEAR MISTING SYSTEM

Reg. No. 4,066,635

Registered Dec. 6, 2011

Int. Cl.: 42

SERVICE MARK

PRINCIPAL REGISTER

THE MUD MASTERS GROUP LLC (LOUISIANA LIMITED LIABILITY COMPANY)
740 JOLIMAR TRAIL SE
SUMMIT, MS 39666

FOR: TECHNICAL CONSULTATION AND ENGINEERING SERVICES IN THE OIL AND GAS FIELD, NAMELY, PROVIDING WELL DRILLING FLUIDS AND FLUID ADDITIVES FOR AIR DRILLING, IN CLASS 42 (U.S. CLS. 100 AND 101).

FIRST USE 3-15-2010; IN COMMERCE 3-15-2010.

THE MARK CONSISTS OF STANDARD CHARACTERS WITHOUT CLAIM TO ANY PARTICULAR FONT, STYLE, SIZE, OR COLOR.

OWNER OF U.S. REG. NOS. 3,394,584, 3,656,248 AND OTHERS.

NO CLAIM IS MADE TO THE EXCLUSIVE RIGHT TO USE "CLEAR MISTING SYSTEM", APART FROM THE MARK AS SHOWN.

SER. NO. 85-298,044, FILED 4-18-2011.

KAREN K. BUSH, EXAMINING ATTORNEY



David J. Kybas

Director of the United States Patent and Trademark Office

United States of America

United States Patent and Trademark Office

FRESH PAK

Reg. No. 4,066,636

QUALITY PACKAGING, INC. (CALIFORNIA CORPORATION), DBA NATURE KIST SNACKS
1820 INDUSTRIAL DR.
STOCKTON, CA 95206

Registered Dec. 6, 2011

Int. Cl.: 29

FOR: PROCESSED NUTS AND PROCESSED EDIBLE SEEDS, IN CLASS 29 (U.S. CL. 46).

TRADEMARK

FIRST USE 0-0-1964; IN COMMERCE 0-0-1964.

PRINCIPAL REGISTER

THE MARK CONSISTS OF STANDARD CHARACTERS WITHOUT CLAIM TO ANY PARTICULAR FONT, STYLE, SIZE, OR COLOR.

NO CLAIM IS MADE TO THE EXCLUSIVE RIGHT TO USE "FRESH", APART FROM THE MARK AS SHOWN.

SEC. 2(F).

SER. NO. 85-298,052, FILED 4-18-2011.

EDWARD NELSON, EXAMINING ATTORNEY



David J. Kyffers

Director of the United States Patent and Trademark Office

United States of America

United States Patent and Trademark Office

BARCODEGUY.COM

Reg. No. 4,066,637

Registered Dec. 6, 2011

Int. Cls.: 35 and 42

SERVICE MARK

PRINCIPAL REGISTER

CAROLINA BARCODE, INC. (NORTH CAROLINA CORPORATION), DBA
BARCODEGUY.COM
2078 WILSON ROAD
PISGAH FOREST, NC 28768

FOR: ONLINE RETAIL STORE SERVICES FEATURING BARCODE DEVICES AND BAR-
CODE ACCESSORIES, IN CLASS 35 (U.S. CLS. 100, 101 AND 102).

FIRST USE 3-15-2010; IN COMMERCE 3-15-2010.

FOR: COMPUTER SOFTWARE CONSULTING AND PROGRAMMING OF COMPUTER
SOFTWARE FOR OTHERS, IN CLASS 42 (U.S. CLS. 100 AND 101).

FIRST USE 3-15-2010; IN COMMERCE 3-15-2010.

THE MARK CONSISTS OF STANDARD CHARACTERS WITHOUT CLAIM TO ANY PAR-
TICULAR FONT, STYLE, SIZE, OR COLOR.

SER. NO. 85-298,053, FILED 4-18-2011.

JOHN GARTNER, EXAMINING ATTORNEY



David J. Kybas

Director of the United States Patent and Trademark Office

United States of America

United States Patent and Trademark Office



Reg. No. 4,066,638

Registered Dec. 6, 2011

Int. Cl.: 9

TRADEMARK

PRINCIPAL REGISTER

ZUNZUN BOOKS, LLC (NEW YORK LIMITED LIABILITY COMPANY)
136 JAMESON HILL ROAD
CLINTON CORNERS, NY 12514

FOR: DIGITAL MATERIALS, NAMELY, DOWNLOADABLE E-BOOKS FEATURING STORIES FOR CHILDREN; COMPUTER GAME SOFTWARE, NAMELY, GAMES FOR KIDS DESIGNED FOR ELECTRONIC MEDIA, IN CLASS 9 (U.S. CLS. 21, 23, 26, 36 AND 38).

FIRST USE 12-27-2010; IN COMMERCE 12-27-2010.

NO CLAIM IS MADE TO THE EXCLUSIVE RIGHT TO USE "BIBLE STORIES FOR YOUNG CHILDREN ", APART FROM THE MARK AS SHOWN.

THE STIPPLING IS FOR SHADING PURPOSES.

THE MARK CONSISTS OF TWO BANNERS WITH THE STYLIZED TEXT "MANY YEARS AGO" ON THE TOP BANNER AND THE STYLIZED TEXT "BIBLE STORIES FOR YOUNG CHILDREN" ON THE BOTTOM BANNER. THERE IS A HUMMINGBIRD IN THE MIDDLE.

SER. NO. 85-298,083, FILED 4-18-2011.

JOHN DWYER, EXAMINING ATTORNEY



David J. Kybas

Director of the United States Patent and Trademark Office

United States of America

United States Patent and Trademark Office



Reg. No. 4,066,639

Registered Dec. 6, 2011

Int. Cl.: 41

SERVICE MARK

PRINCIPAL REGISTER

VIION NETWORK, LLC (FLORIDA LIMITED LIABILITY COMPANY), DBA MCKINLEY
PIERRE PRODUCTION
PO BOX 668215
MIAMI, FL 331669412

FOR: ENTERTAINMENT SERVICES, NAMELY, THE PROVISION OF CONTINUING TV PROGRAMS FEATURING PROFESSIONAL AND HOME CHEFS COOKING DELIVERED BY TELEVISION, INTERNET, AND SATELLITE, IN CLASS 41 (U.S. CLS. 100, 101 AND 107).

FIRST USE 3-18-2008; IN COMMERCE 3-18-2008.

NO CLAIM IS MADE TO THE EXCLUSIVE RIGHT TO USE "CHEF", APART FROM THE MARK AS SHOWN.

THE MARK CONSISTS OF TWO LONG CURVED KNIVES CROSSING EACH OTHER AT THE KNIFE HANDLES. THE HANDLES EACH HAVE 3 HALF CIRCLE DESIGNS ON EACH HANDLE. A STRIPED CHEF HAT SITS ON THE OVERLAPPING KNIFE HANDLE WITH THE WORD "CHEF" WRITTEN ON THE BOTTOM HALF OF THE HAT WHICH NARROWS FROM LEFT TO RIGHT. THE WORDS "FOR TODAY" ARE WRITTEN UNDERNEATH THE OVERLAPPING KNIFE HANDLE AND ARE SLIGHTLY ARCHED UP AND GET WIDER TOWARDS THE LAST LETTER. ALL TEXT IS IN CAPITAL LETTERS.

SER. NO. 85-298,267, FILED 4-19-2011.

JAMES GRIFFIN, EXAMINING ATTORNEY



David J. Kyros

Director of the United States Patent and Trademark Office

United States of America

United States Patent and Trademark Office

ZEN BY KAREN MOORE

Reg. No. 4,066,640

Registered Dec. 6, 2011

Int. Cl.: 14

TRADEMARK

PRINCIPAL REGISTER

K & C MOORE VENTURES, LLC (FLORIDA LIMITED LIABILITY COMPANY)
1107 KEY PLAZA #318
KEY WEST, FL 33040

FOR: JEWELRY, IN CLASS 14 (U.S. CLS. 2, 27, 28 AND 50).

FIRST USE 1-1-2008; IN COMMERCE 1-1-2008.

THE MARK CONSISTS OF STANDARD CHARACTERS WITHOUT CLAIM TO ANY PARTICULAR FONT, STYLE, SIZE, OR COLOR.

THE NAME(S), PORTRAIT(S), AND/OR SIGNATURE(S) SHOWN IN THE MARK IDENTIFIES "KAREN MOORE", WHOSE CONSENT(S) TO REGISTER IS MADE OF RECORD.

SER. NO. 85-298,269, FILED 4-19-2011.

ALICE BENMAMAN, EXAMINING ATTORNEY



David J. Kybas

Director of the United States Patent and Trademark Office

United States of America

United States Patent and Trademark Office

THE BEST CANCER CARE. ANYWHERE.

Reg. No. 4,066,641

Registered Dec. 6, 2011

Int. Cl.: 44

SERVICE MARK

PRINCIPAL REGISTER

MEMORIAL SLOAN-KETTERING CANCER CENTER (NEW YORK CORPORATION)
1275 YORK AVENUE
NEW YORK, NY 10065

FOR: MEDICAL SERVICES, IN CLASS 44 (U.S. CLS. 100 AND 101).

FIRST USE 1-16-1995; IN COMMERCE 1-16-1995.

THE MARK CONSISTS OF STANDARD CHARACTERS WITHOUT CLAIM TO ANY PARTICULAR FONT, STYLE, SIZE, OR COLOR.

NO CLAIM IS MADE TO THE EXCLUSIVE RIGHT TO USE "CANCER CARE", APART FROM THE MARK AS SHOWN.

SEC. 2(F).

SER. NO. 85-298,342, FILED 4-19-2011.

RUSS HERMAN, EXAMINING ATTORNEY



David J. Kybas

Director of the United States Patent and Trademark Office

United States of America

United States Patent and Trademark Office

FLOWER ME WITH CANDY

Reg. No. 4,066,642

BUTTS-CORNISH, BARBARA A. (UNITED STATES INDIVIDUAL)
PO BOX 881
NORCO, CA 92860

Registered Dec. 6, 2011

Int. Cl.: 26

FOR: ARTIFICIAL FLOWER ARRANGEMENTS, IN CLASS 26 (U.S. CLS. 37, 39, 40, 42 AND 50).

TRADEMARK

FIRST USE 3-31-2011; IN COMMERCE 3-31-2011.

PRINCIPAL REGISTER

THE MARK CONSISTS OF STANDARD CHARACTERS WITHOUT CLAIM TO ANY PARTICULAR FONT, STYLE, SIZE, OR COLOR.

SER. NO. 85-298,365, FILED 4-19-2011.

ANGELA DUONG, EXAMINING ATTORNEY



David J. Kybas

Director of the United States Patent and Trademark Office

United States of America

United States Patent and Trademark Office



Josephine's
feast!

Reg. No. 4,066,643

Registered Dec. 6, 2011

Int. Cl.: 29

TRADEMARK

PRINCIPAL REGISTER

BLEU INDIGO, INC. (NEW YORK CORPORATION)
STE. 8F
30 FIFTH AVENUE
NEW YORK, NY 10011

FOR: FRUIT PRESERVES, JAMS, MARMALADES, APPLE BUTTER, IN CLASS 29 (U.S. CL. 46).

FIRST USE 8-1-2009; IN COMMERCE 8-1-2009.

THE MARK CONSISTS OF THE WORDS "JOSEPHINE'S FEAST!" IN TWO STYLIZED FONTS WITH AN OPEN CROWN DESIGN ABOVE THE WORDS.

SER. NO. 85-298,402, FILED 4-19-2011.

KAREN K. BUSH, EXAMINING ATTORNEY



David J. Kybas

Director of the United States Patent and Trademark Office

United States of America

United States Patent and Trademark Office



Reg. No. 4,066,644

Registered Dec. 6, 2011

Int. Cl.: 43

SERVICE MARK

PRINCIPAL REGISTER

FLAVOR 180, INC (ILLINOIS CORPORATION)
1511 S. STATE STREET
CHICAGO, IL 60605

FOR: BAR AND RESTAURANT SERVICES; RESTAURANT, IN CLASS 43 (U.S. CLS. 100 AND 101).

FIRST USE 4-1-2011; IN COMMERCE 4-1-2011.

THE MARK CONSISTS OF THE WORD "FLAVOR 180" WITH THE LETTER "F" BEING STYLIZED AND EXTENDING HORIZONTAL WITH A FIRE BURNING ON TOP. THE NUMBERS "180" IS BENEATH THE WORD "FLAVOR" WITH THE NUMBER "0" BEING STYLIZED AS A SWIRL WHICH REPRESENTS THE "0", SURROUNDED BY AN OVAL WITH TWO SWIRLS WHICH WRAPS AROUND THE WORDS "FLAVOR 180". THE DARK BACKGROUND OUTSIDE OF THE OVAL IS NOT PART OF THE MARK.

SER. NO. 85-298,404, FILED 4-19-2011.

FONG HSU, EXAMINING ATTORNEY



David J. Kybas

Director of the United States Patent and Trademark Office

United States of America

United States Patent and Trademark Office



Josephine's
feast!

Reg. No. 4,066,645

Registered Dec. 6, 2011

Int. Cl.: 30

TRADEMARK

PRINCIPAL REGISTER

BLEU INDIGO, INC. (NEW YORK CORPORATION)
STE. 8F
30 FIFTH AVENUE
NEW YORK, NY 10011

FOR: SPICE RUBS, SPICE BLENDS, PEPPER, SALT, CHUTNEYS, CAKES, IN CLASS 30
(U.S. CL. 46).

FIRST USE 8-1-2009; IN COMMERCE 8-1-2009.

THE MARK CONSISTS OF THE WORDS "JOSEPHINE'S FEAST!" IN TWO STYLIZED FONTS
WITH AN OPEN CROWN DESIGN ABOVE THE WORDS.

SER. NO. 85-298,410, FILED 4-19-2011.

KAREN K. BUSH, EXAMINING ATTORNEY



David J. Kybas

Director of the United States Patent and Trademark Office

United States of America

United States Patent and Trademark Office



Josephine's
feast!

Reg. No. 4,066,646

Registered Dec. 6, 2011

Int. Cl.: 35

SERVICE MARK

PRINCIPAL REGISTER

BLEU INDIGO, INC. (NEW YORK CORPORATION)
STE. 8F
30 FIFTH AVENUE
NEW YORK, NY 10011

FOR: PROVIDING A WEBSITE WITH MERCHANDISE FOR RETAIL SALES, IN CLASS 35
(U.S. CLS. 100, 101 AND 102).

FIRST USE 8-1-2009; IN COMMERCE 8-1-2009.

THE MARK CONSISTS OF THE WORDS "JOSEPHINE'S FEAST!" IN TWO STYLIZED FONTS
WITH AN OPEN CROWN DESIGN ABOVE THE WORDS.

SER. NO. 85-298,411, FILED 4-19-2011.

KAREN K. BUSH, EXAMINING ATTORNEY



David J. Kybas

Director of the United States Patent and Trademark Office

United States of America

United States Patent and Trademark Office



Reg. No. 4,066,647

Registered Dec. 6, 2011

Int. Cl.: 29

TRADEMARK

PRINCIPAL REGISTER

BLEU INDIGO, INC. (NEW YORK CORPORATION)
STE. 8F
30 FIFTH AVENUE
NEW YORK, NY 10011

FOR: FRUIT PRESERVES, JAMS, MARMALADES, APPLE BUTTER, IN CLASS 29 (U.S. CL. 46).

FIRST USE 8-1-2009; IN COMMERCE 8-1-2009.

THE MARK CONSISTS OF AN DRAWING OF A GIRL STANDING INSIDE AN OVAL SHAPE WEARING A CROWN, STRIPED SOCKS AND A DRESS AND HOLDING A BASKET OF FRUIT.

SER. NO. 85-298,414, FILED 4-19-2011.

KAREN K. BUSH, EXAMINING ATTORNEY



David J. Kybas

Director of the United States Patent and Trademark Office

United States of America

United States Patent and Trademark Office



Reg. No. 4,066,648

Registered Dec. 6, 2011

Int. Cl.: 30

TRADEMARK

PRINCIPAL REGISTER

BLEU INDIGO, INC. (NEW YORK CORPORATION)
STE. 8F
30 FIFTH AVENUE
NEW YORK, NY 10011

FOR: SPICE RUBS, SPICE BLENDS, PEPPER, SALT, CHUTNEYS, COOKIES, CAKES, IN CLASS 30 (U.S. CL. 46).

FIRST USE 8-1-2009; IN COMMERCE 8-1-2009.

THE MARK CONSISTS OF AN DRAWING OF A GIRL STANDING INSIDE AN OVAL SHAPE WEARING A CROWN, STRIPED SOCKS AND A DRESS AND HOLDING A BASKET OF FRUIT.

SER. NO. 85-298,418, FILED 4-19-2011.

KAREN K. BUSH, EXAMINING ATTORNEY



David J. Kybas

Director of the United States Patent and Trademark Office

United States of America

United States Patent and Trademark Office



Reg. No. 4,066,649

Registered Dec. 6, 2011

Int. Cl.: 35

SERVICE MARK

PRINCIPAL REGISTER

BLEU INDIGO, INC. (NEW YORK CORPORATION)
STE. 8F
30 FIFTH AVENUE
NEW YORK, NY 10011

FOR: ONLINE RETAIL STORE FEATURING FOOD, IN CLASS 35 (U.S. CLS. 100, 101 AND 102).

FIRST USE 8-1-2009; IN COMMERCE 8-1-2009.

THE MARK CONSISTS OF AN DRAWING OF A GIRL STANDING INSIDE AN OVAL SHAPE WEARING A CROWN, STRIPED SOCKS AND A DRESS AND HOLDING A BASKET OF FRUIT.

SER. NO. 85-298,419, FILED 4-19-2011.

KAREN K. BUSH, EXAMINING ATTORNEY



David J. Kybas

Director of the United States Patent and Trademark Office

United States of America

United States Patent and Trademark Office

TEAMERA

Reg. No. 4,066,650

Registered Dec. 6, 2011

Int. Cl.: 36

SERVICE MARK

PRINCIPAL REGISTER

ERA FRANCHISE SYSTEMS LLC (DELAWARE LIMITED LIABILITY COMPANY)
1 CAMPUS DRIVE
PARSIPPANY, NJ 07054

FOR: PROVIDING ONLINE INFORMATION AND RESOURCES IN THE FIELD OF REAL ESTATE, IN CLASS 36 (U.S. CLS. 100, 101 AND 102).

FIRST USE 12-0-2001; IN COMMERCE 12-0-2001.

THE MARK CONSISTS OF STANDARD CHARACTERS WITHOUT CLAIM TO ANY PARTICULAR FONT, STYLE, SIZE, OR COLOR.

OWNER OF U.S. REG. NO. 1,645,223.

SER. NO. 85-298,427, FILED 4-19-2011.

FONG HSU, EXAMINING ATTORNEY



David J. Kybas

Director of the United States Patent and Trademark Office

United States of America

United States Patent and Trademark Office

Main Street Mini Mart

Reg. No. 4,066,651

Registered Dec. 6, 2011

Int. Cl.: 35

SERVICE MARK

PRINCIPAL REGISTER

C. L. SWANSON CORPORATION (WISCONSIN CORPORATION)
4501 FEMRITE DRIVE
MADISON, WI 53716

FOR: VENDING MACHINE SERVICES, IN CLASS 35 (U.S. CLS. 100, 101 AND 102).

FIRST USE 12-31-1995; IN COMMERCE 12-31-1995.

THE MARK CONSISTS OF STANDARD CHARACTERS WITHOUT CLAIM TO ANY PARTICULAR FONT, STYLE, SIZE, OR COLOR.

NO CLAIM IS MADE TO THE EXCLUSIVE RIGHT TO USE "MINI MART", APART FROM THE MARK AS SHOWN.

SER. NO. 85-298,440, FILED 4-19-2011.

DAVID COLLIER, EXAMINING ATTORNEY



David J. Kyffers

Director of the United States Patent and Trademark Office

United States of America

United States Patent and Trademark Office

EVerest

Reg. No. 4,066,652

VISION MOTOR CARS, INC. (TENNESSEE CORPORATION)
545 HAMBERTON COURT
CONCORD, NC 28027

Registered Dec. 6, 2011

Int. Cl.: 12

FOR: ELECTRIC VEHICLES, NAMELY, HIGHWAY-SPEED ELECTRIC TRUCKS; SELF-PROPELLED ELECTRIC VEHICLE, IN CLASS 12 (U.S. CLS. 19, 21, 23, 31, 35 AND 44).

TRADEMARK

FIRST USE 11-21-2009; IN COMMERCE 5-27-2010.

PRINCIPAL REGISTER

THE MARK CONSISTS OF STANDARD CHARACTERS WITHOUT CLAIM TO ANY PARTICULAR FONT, STYLE, SIZE, OR COLOR.

SER. NO. 85-298,461, FILED 4-19-2011.

RONALD MCMORROW, EXAMINING ATTORNEY



David J. Kybas

Director of the United States Patent and Trademark Office

United States of America

United States Patent and Trademark Office

J.S. Bogdanovich Guitars

Reg. No. 4,066,653

BOGDANOVICH, JOHN S. (UNITED STATES INDIVIDUAL)
82 SEAN DR
SWANNANOA, NC 28778

Registered Dec. 6, 2011

Int. Cl.: 35

FOR: RETAIL STORE SERVICES FEATURING GUITARS AND GUITAR MAKING PRODUCTS, IN CLASS 35 (U.S. CLS. 100, 101 AND 102).

SERVICE MARK

FIRST USE 6-1-1998; IN COMMERCE 6-1-1998.

PRINCIPAL REGISTER

THE MARK CONSISTS OF STANDARD CHARACTERS WITHOUT CLAIM TO ANY PARTICULAR FONT, STYLE, SIZE, OR COLOR.

NO CLAIM IS MADE TO THE EXCLUSIVE RIGHT TO USE "GUITARS", APART FROM THE MARK AS SHOWN.

THE NAME "J.S. BOGDANOVICH" IDENTIFIES "JOHN S. BOGDANOVICH", A LIVING INDIVIDUAL WHOSE CONSENT IS OF RECORD.

SER. NO. 85-298,546, FILED 4-19-2011.

DOUGLAS LEE, EXAMINING ATTORNEY



David J. Kyros

Director of the United States Patent and Trademark Office

United States of America

United States Patent and Trademark Office

MEZZE

Reg. No. 4,066,654

Registered Dec. 6, 2011

Int. Cl.: 43

SERVICE MARK

PRINCIPAL REGISTER

REAL RESTAURANT GROUP, LLC (CALIFORNIA LIMITED LIABILITY COMPANY)
404 N. LA CIENEGA BOULEVARD
LOS ANGELES, CA 90048

FOR: RESTAURANT, BAR AND CATERING SERVICES; TAKE-OUT RESTAURANT SERVICES; RESTAURANT SERVICES, IN CLASS 43 (U.S. CLS. 100 AND 101).

FIRST USE 3-28-2011; IN COMMERCE 3-28-2011.

NO CLAIM IS MADE TO THE EXCLUSIVE RIGHT TO USE "MEZZE", APART FROM THE MARK AS SHOWN.

THE MARK CONSISTS OF THE TEXT "MEZZE" IN A STYLIZED FONT ABOVE A DEPICTION OF A TWIG WITH THREE LEAVES AND AN OLIVE.

SER. NO. 85-298,557, FILED 4-19-2011.

RUSS HERMAN, EXAMINING ATTORNEY



David J. Kybas

Director of the United States Patent and Trademark Office

United States of America

United States Patent and Trademark Office

GOLD XTRACT

Reg. No. 4,066,655

FREMONT INDUSTRIES, INC. (MINNESOTA CORPORATION)
4400 VALLEY INDUSTRIAL BOULEVARD NORTH
SHAKOPEE, MN 553791859

Registered Dec. 6, 2011

Int. Cl.: 1

FOR: CHEMICALS USED IN INDUSTRY AS AN ETHANOL PRODUCTION PROCESS AID,
IN CLASS 1 (U.S. CLS. 1, 5, 6, 10, 26 AND 46).

TRADEMARK

FIRST USE 4-8-2011; IN COMMERCE 4-8-2011.

PRINCIPAL REGISTER

THE MARK CONSISTS OF STANDARD CHARACTERS WITHOUT CLAIM TO ANY PAR-
TICULAR FONT, STYLE, SIZE, OR COLOR.

NO CLAIM IS MADE TO THE EXCLUSIVE RIGHT TO USE "EXTRACT", APART FROM
THE MARK AS SHOWN.

SER. NO. 85-298,564, FILED 4-19-2011.

DAVID HOFFMAN, EXAMINING ATTORNEY



David J. Kyfos

Director of the United States Patent and Trademark Office

United States of America

United States Patent and Trademark Office



Reg. No. 4,066,656

Registered Dec. 6, 2011

Int. Cls.: 16 and 41

TRADEMARK

SERVICE MARK

PRINCIPAL REGISTER

PARIKH WORLDWIDE MEDIA LLC (NEW JERSEY LIMITED LIABILITY COMPANY)
37 WEST 20TH STREET, SUITE 1009
NEW YORK, NY 10011

FOR: A WEEKLY NEWSPAPER PUBLICATION FOR THE INDIAN COMMUNITY, IN CLASS 16 (U.S. CLS. 2, 5, 22, 23, 29, 37, 38 AND 50).

FIRST USE 9-30-1997; IN COMMERCE 9-30-1997.

FOR: PROVIDING ONLINE PUBLICATION WEBSITE FEATURING NEWS FOR THE INDIAN COMMUNITY, IN CLASS 41 (U.S. CLS. 100, 101 AND 107).

FIRST USE 9-30-1997; IN COMMERCE 9-30-1997.

OWNER OF U.S. REG. NO. 3,092,409.

THE COLOR(S) BLACK, WHITE AND YELLOW IS/ARE CLAIMED AS A FEATURE OF THE MARK.

NO CLAIM IS MADE TO THE EXCLUSIVE RIGHT TO USE "DESI", APART FROM THE MARK AS SHOWN.

THE MARK CONSISTS OF THE WORD "DESI" IN UPPER CASE, IN YELLOW, AGAINST A BLACK BACKGROUND, FOLLOWED BY THE WORD "TALK" IN UPPER CASE, IN YELLOW, AGAINST A WHITE BACKGROUND.

THE FOREIGN WORDING IN THE MARK TRANSLATES INTO ENGLISH AS "ONE FROM OUR COUNTRY".

SER. NO. 85-298,578, FILED 4-19-2011.

PAUL F. GAST, EXAMINING ATTORNEY



David J. Kyppas

Director of the United States Patent and Trademark Office

United States of America

United States Patent and Trademark Office



CHERISHED HEARTS

Reg. No. 4,066,657

Registered Dec. 6, 2011

Int. Cl.: 14

TRADEMARK

PRINCIPAL REGISTER

FABRIKANT-TARA INTERNATIONAL LLC (DELAWARE LIMITED LIABILITY COMPANY)
1441 BROADWAY, SUITE 2307
NEW YORK, NY 10018

FOR: JEWELRY, IN CLASS 14 (U.S. CLS. 2, 27, 28 AND 50).

FIRST USE 2-1-2011; IN COMMERCE 2-1-2011.

OWNER OF U.S. REG. NO. 3,945,047.

THE MARK CONSISTS OF THE STYLIZED WORDING "CHERISHED HEARTS" AND THE DESIGN OF A STYLIZED HEART FORMED BY VARIOUS REPRESENTATIONS OF FLOWERS, VINES, LEAVES, AND CIRCLES ABOVE THE STYLIZED WORDING.

SER. NO. 85-298,583, FILED 4-19-2011.

JAY BESCH, EXAMINING ATTORNEY



David J. Kyffers

Director of the United States Patent and Trademark Office

United States of America

United States Patent and Trademark Office

upyours

Reg. No. 4,066,658

Registered Dec. 6, 2011

Int. Cl.: 38

SERVICE MARK

PRINCIPAL REGISTER

UP YOURS GREETINGS, LLC (CALIFORNIA LIMITED LIABILITY COMPANY)
16 BONSALL
IRVINE, CA 92602

FOR: TRANSMISSION OF GREETING CARDS ONLINE, IN CLASS 38 (U.S. CLS. 100, 101 AND 104).

FIRST USE 11-14-2010; IN COMMERCE 4-11-2011.

THE MARK CONSISTS OF "UPYOURS" IN ALL LOWER CASE WITHOUT SPACING TYPED IN RED LETTERS USING THE ARIAL FONT.

THE COLOR(S) RED IS/ARE CLAIMED AS A FEATURE OF THE MARK.

SER. NO. 85-298,597, FILED 4-19-2011.

JOHN WILKE, EXAMINING ATTORNEY



David J. Kyffers

Director of the United States Patent and Trademark Office

United States of America

United States Patent and Trademark Office



Reg. No. 4,066,659

Registered Dec. 6, 2011

Int. Cls.: 16 and 41

TRADEMARK

SERVICE MARK

PRINCIPAL REGISTER

PARIKH WORLDWIDEMEDIA LLC (NEW JERSEY LIMITED LIABILITY COMPANY)
37 WEST 20TH STREET, SUITE 1009
NEW YORK, NY 10011

FOR: A BIMONTHLY NEWSPAPER PUBLICATION FOR THE INDIAN COMMUNITY, IN CLASS 16 (U.S. CLS. 2, 5, 22, 23, 29, 37, 38 AND 50).

FIRST USE 9-30-1997; IN COMMERCE 9-30-1997.

FOR: PROVIDING ONLINE PUBLICATION WEBSITE FEATURING NEWS FOR THE INDIAN COMMUNITY, IN CLASS 41 (U.S. CLS. 100, 101 AND 107).

FIRST USE 9-30-1997; IN COMMERCE 9-30-1997.

OWNER OF U.S. REG. NO. 3,092,409.

THE COLOR(S) BLACK, YELLOW, WHITE AND GREEN IS/ARE CLAIMED AS A FEATURE OF THE MARK.

NO CLAIM IS MADE TO THE EXCLUSIVE RIGHT TO USE "DESI" AND "NEW YORK", APART FROM THE MARK AS SHOWN.

THE MARK CONSISTS OF THE WORD "DESI" IN UPPER CASE, IN YELLOW, AGAINST A BLACK BACKGROUND FOLLOWED BY THE WORD "TALK" IN UPPER CASE, IN YELLOW, WITH THE WORDS "IN NEW YORK", IN UPPER CASE, IN GREEN, BELOW IT. BOTH "TALK" AND "IN NEW YORK" ARE AGAINST A WHITE BACKGROUND.

THE FOREIGN WORDING IN THE MARK TRANSLATES INTO ENGLISH AS "ONE FROM OUR COUNTRY".

SER. NO. 85-298,629, FILED 4-19-2011.

PAUL F. GAST, EXAMINING ATTORNEY



David J. Kappas

Director of the United States Patent and Trademark Office

United States of America

United States Patent and Trademark Office

Statx

Reg. No. 4,066,660

Registered Dec. 6, 2011

Int. Cl.: 41

SERVICE MARK

PRINCIPAL REGISTER

STATX ENTERTAINMENT, LLC (TEXAS LIMITED LIABILITY COMPANY)
#516
9801 WEST PARMER LANE
AUSTIN, TX 78717

FOR: AUDIO RECORDING AND PRODUCTION; DISC JOCKEY SERVICES; ENTERTAINMENT SERVICES IN THE NATURE OF LIVE MUSICAL PERFORMANCES; MUSIC PRODUCTION SERVICES; PRESENTATION OF MUSICAL PERFORMANCE, IN CLASS 41 (U.S. CLS. 100, 101 AND 107).

FIRST USE 6-24-2010; IN COMMERCE 6-24-2010.

THE MARK CONSISTS OF STANDARD CHARACTERS WITHOUT CLAIM TO ANY PARTICULAR FONT, STYLE, SIZE, OR COLOR.

SER. NO. 85-298,689, FILED 4-19-2011.

MARGARET POWER, EXAMINING ATTORNEY



David J. Kybas

Director of the United States Patent and Trademark Office

United States of America

United States Patent and Trademark Office

ProForce Personnel Group

Reg. No. 4,066,661

Registered Dec. 6, 2011

Int. Cl.: 35

SERVICE MARK

PRINCIPAL REGISTER

PROFORCE PERSONNEL GROUP, INC. (MARYLAND CORPORATION)
703 CASIMIR WAY
GAMBRILLS, MD 21054

FOR: EMPLOYMENT AGENCY SERVICES, NAMELY, FILLING THE TEMPORARY AND PERMANENT STAFFING NEEDS OF BUSINESSES, IN CLASS 35 (U.S. CLS. 100, 101 AND 102).

FIRST USE 12-20-2009; IN COMMERCE 12-20-2009.

THE MARK CONSISTS OF STANDARD CHARACTERS WITHOUT CLAIM TO ANY PARTICULAR FONT, STYLE, SIZE, OR COLOR.

NO CLAIM IS MADE TO THE EXCLUSIVE RIGHT TO USE "PERSONNEL GROUP", APART FROM THE MARK AS SHOWN.

SER. NO. 85-298,691, FILED 4-19-2011.

MARGARET POWER, EXAMINING ATTORNEY



David J. Kybas

Director of the United States Patent and Trademark Office

United States of America

United States Patent and Trademark Office

MYX TV

Reg. No. 4,066,662

ABS-CBN INTERNATIONAL (CALIFORNIA CORPORATION)
150 SHORELINE DRIVE
REDWOOD CITY, CA 94065

Registered Dec. 6, 2011

Int. Cls.: 38 and 41

FOR: TELEVISION BROADCASTING SERVICES; TELEVISION BROADCASTING SERVICES VIA CABLE AND SATELLITE, IN CLASS 38 (U.S. CLS. 100, 101 AND 104).

SERVICE MARK

FIRST USE 4-11-2011; IN COMMERCE 4-11-2011.

PRINCIPAL REGISTER

FOR: PRODUCTION AND PROGRAMMING OF TELEVISION SHOWS; PRODUCTION OF AWARD SHOWS, DANCE SHOWS AND MUSIC SHOWS; ENTERTAINMENT IN THE NATURE OF ON-GOING PROGRAMS IN THE FIELDS OF MUSIC, MUSIC VIDEOS, FILMS, LIFESTYLE, LIVE ACTION, ENTERTAINMENT, POP CULTURE, NEWS AND ENTERTAINMENT NEWS, ASIAN CULTURE, ROMANCE, RELATIONSHIPS, AND VARIETY DISTRIBUTED OVER TELEVISION, SATELLITE, AND VIA A GLOBAL COMPUTER NETWORK; PROVIDING ONLINE INFORMATION IN THE FIELDS OF MUSIC, MUSIC VIDEOS, FILMS, ENTERTAINMENT, CURRENT EVENT NEWS AND ENTERTAINMENT NEWS, ENTERTAINMENT REGARDING ROMANCE AND RELATIONSHIPS VIA A GLOBAL COMPUTER NETWORK, IN CLASS 41 (U.S. CLS. 100, 101 AND 107).

FIRST USE 4-11-2011; IN COMMERCE 4-11-2011.

THE MARK CONSISTS OF STANDARD CHARACTERS WITHOUT CLAIM TO ANY PARTICULAR FONT, STYLE, SIZE, OR COLOR.

OWNER OF U.S. REG. NOS. 3,351,255, 3,606,784 AND OTHERS.

NO CLAIM IS MADE TO THE EXCLUSIVE RIGHT TO USE "TV" , APART FROM THE MARK AS SHOWN.

SER. NO. 85-298,877, FILED 4-19-2011.

EDWARD NELSON, EXAMINING ATTORNEY



David J. Kyros

Director of the United States Patent and Trademark Office

United States of America

United States Patent and Trademark Office

CYCLING FOR CHANGE

Reg. No. 4,066,663

Registered Dec. 6, 2011

Int. Cl.: 36

SERVICE MARK

PRINCIPAL REGISTER

CATHOLIC CHARITIES OF KANSAS CITY-ST.JOSEPH (MISSOURI CORPORATION)
20 WEST 9TH STREET
KANSAS CITY, MO 64105

FOR: CHARITABLE FUNDRAISING SERVICES, IN CLASS 36 (U.S. CLS. 100, 101 AND 102).

FIRST USE 3-1-2009; IN COMMERCE 3-1-2009.

THE MARK CONSISTS OF STANDARD CHARACTERS WITHOUT CLAIM TO ANY PARTICULAR FONT, STYLE, SIZE, OR COLOR.

NO CLAIM IS MADE TO THE EXCLUSIVE RIGHT TO USE "CYCLING", APART FROM THE MARK AS SHOWN.

SER. NO. 85-298,951, FILED 4-19-2011.

EUGENIA MARTIN, EXAMINING ATTORNEY



David J. Kyros

Director of the United States Patent and Trademark Office

United States of America

United States Patent and Trademark Office

CROWN INTERNATIONAL STEEL BUILDING SYSTEMS

Reg. No. 4,066,664

Registered Dec. 6, 2011

Int. Cl.: 6

TRADEMARK

PRINCIPAL REGISTER

KING DAVID INTERACTIVE CORP. (PENNSYLVANIA LIMITED LIABILITY COMPANY)
400 ISLAND AVENUE
MCKEES ROCKS, PA 15136

FOR: PREFABRICATED AND PRE-ENGINEERED STEEL BUILDINGS, IN CLASS 6 (U.S. CLS. 2, 12, 13, 14, 23, 25 AND 50).

FIRST USE 3-17-2008; IN COMMERCE 3-17-2008.

THE MARK CONSISTS OF STANDARD CHARACTERS WITHOUT CLAIM TO ANY PARTICULAR FONT, STYLE, SIZE, OR COLOR.

OWNER OF U.S. REG. NOS. 2,894,701 AND 2,926,671.

NO CLAIM IS MADE TO THE EXCLUSIVE RIGHT TO USE "INTERNATIONAL STEEL BUILDING SYSTEMS", APART FROM THE MARK AS SHOWN.

SER. NO. 85-299,027, FILED 4-19-2011.

ALEX KEAM, EXAMINING ATTORNEY



David J. Kybas

Director of the United States Patent and Trademark Office

United States of America

United States Patent and Trademark Office



Reg. No. 4,066,665

Registered Dec. 6, 2011

Int. Cl.: 35

SERVICE MARK

PRINCIPAL REGISTER

WALGREEN CO. (ILLINOIS CORPORATION)
200 WILMOT ROAD
DEERFIELD, IL 60015

FOR: EMPLOYMENT HIRING, RECRUITING, PLACEMENT AND STAFFING SERVICES FOR THE DISABLED, IN CLASS 35 (U.S. CLS. 100, 101 AND 102).

FIRST USE 4-9-2009; IN COMMERCE 4-9-2009.

NO CLAIM IS MADE TO THE EXCLUSIVE RIGHT TO USE THE PROHIBITION SYMBOL, APART FROM THE MARK AS SHOWN.

THE COLOR(S) RED AND BLACK IS/ARE CLAIMED AS A FEATURE OF THE MARK.

THE MARK CONSISTS OF A RED CIRCLE WITH A RED LINE GOING FROM THE UPPER LEFT OF THE CIRCLE TO THE BOTTOM RIGHT OF THE CIRCLE FORMING A PROHIBITION SYMBOL WITH THE WORD "THEM" IN BLACK WITHIN THE CIRCLE

SER. NO. 85-299,041, FILED 4-19-2011.

THOMAS MANOR, EXAMINING ATTORNEY



David J. Kybas

Director of the United States Patent and Trademark Office

United States of America

United States Patent and Trademark Office

Bistro Box Lunch

Reg. No. 4,066,666

Registered Dec. 6, 2011

Int. Cls.: 29, 30 and 31

TRADEMARK

PRINCIPAL REGISTER

C. L. SWANSON CORPORATION (WISCONSIN CORPORATION)
4501 FEMRITE DRIVE
MADISON, WI 53716

FOR: PICKLES; POTATO CHIPS, IN CLASS 29 (U.S. CL. 46).

FIRST USE 9-30-2010; IN COMMERCE 9-30-2010.

FOR: COOKIES; SALAD DRESSINGS; SANDWICHES, IN CLASS 30 (U.S. CL. 46).

FIRST USE 9-30-2010; IN COMMERCE 9-30-2010.

FOR: FRESH VEGETABLES; RAW VEGETABLES, IN CLASS 31 (U.S. CLS. 1 AND 46).

FIRST USE 9-30-2010; IN COMMERCE 9-30-2010.

THE MARK CONSISTS OF STANDARD CHARACTERS WITHOUT CLAIM TO ANY PARTICULAR FONT, STYLE, SIZE, OR COLOR.

NO CLAIM IS MADE TO THE EXCLUSIVE RIGHT TO USE "BOX LUNCH", APART FROM THE MARK AS SHOWN.

SER. NO. 85-299,054, FILED 4-19-2011.

DAVID COLLIER, EXAMINING ATTORNEY



David J. Kybas

Director of the United States Patent and Trademark Office

United States of America

United States Patent and Trademark Office



Reg. No. 4,066,667

Registered Dec. 6, 2011

Int. Cl.: 34

TRADEMARK

PRINCIPAL REGISTER

LBD COFFEE, LLC (NEW HAMPSHIRE LIMITED LIABILITY COMPANY)
6200-B KAWAIHAU ROAD
KAPAA, HI 96746

FOR: CIGARS, IN CLASS 34 (U.S. CLS. 2, 8, 9 AND 17).

FIRST USE 8-19-2006; IN COMMERCE 9-25-2006.

NO CLAIM IS MADE TO THE EXCLUSIVE RIGHT TO USE "HAWAII", "KAUAI CIGAR CO.", AND "HAND ROLLED", APART FROM THE MARK AS SHOWN.

THE MARK CONSISTS OF A STYLIZED CIGAR BAND DISPLAYING OBLONG SHAPES AND DESIGNS WITH OVERALL RECTANGULAR SHAPE AND THE WORDING "MOMONA", "HAWAII", "ISLAND PRINCE", "KAUAI CIGAR CO." AND "HAND ROLLED". THE WORDING "ISLAND PRINCE" IS INSIDE A DIAMOND-SHAPED RECTANGLE WITH BANDS AND LINES.

THE ENGLISH TRANSLATION OF "MOMONA" IN THE MARK IS "SWEET AND FAT".

SER. NO. 85-299,124, FILED 4-19-2011.

YAT SYE, LEE, EXAMINING ATTORNEY



David J. Kyffers

Director of the United States Patent and Trademark Office

United States of America

United States Patent and Trademark Office



Reg. No. 4,066,668

Registered Dec. 6, 2011

Int. Cl.: 35

SERVICE MARK

PRINCIPAL REGISTER

MORMAII INDUSTRIA COMERCIO IMPORTACAO E EXPORTACAO DE ARTIGOS ESPORTIVOS LTDA. (BRAZIL CORPORATION)
ROD. SC 434 KM 03
GAROPABA, BRAZIL

FOR: ASSISTANCE IN BUSINESS MANAGEMENT AND PRODUCT COMMERCIALIZATION, WITHIN THE FRAMEWORK OF A FRANCHISE CONTRACT; GOODS IMPORT-EXPORT AGENCIES; WHOLESALE AND RETAIL STORE SERVICES AND ON-LINE RETAIL AND WHOLESALE STORE SERVICES FEATURING ANTIREFLECTION EYEGLASSES, BELTS, CAPS, CASES FOR ANTIREFLECTION EYEGLASSES, EYEGLASSES AND SUNGLASSES, CHAINS AND CORDS FOR ANTIREFLECTION EYEGLASSES, EYEGLASSES AND SUNGLASSES, CHAINS FOR POCKET WATCHES MADE OF NON-PRECIOUS METALS, PLASTICS AND FABRIC, EGG AND FOOD TIMERS, EYEGLASSES, FRAMES FOR ANTI-REFLECTION EYEGLASSES, EYEGLASSES AND SUNGLASSES, HOLDERS FOR ANTIREFLECTION EYEGLASSES, EYEGLASSES AND SUNGLASSES, HOLDERS FOR WRISTWATCHES AND POCKET WATCHES MADE FROM NON-PRECIOUS METALS AND PLASTICS, LENSES FOR EYEGLASSES AND SUNGLASSES, PARTS FOR WRIST WATCHES, POCKET WATCHES, CHRONOMETERS AND CLOCKS MADE OF NON-PRECIOUS METALS AND PLASTICS, SPORTSWEAR, NAMELY, ATHLETIC UNIFORMS, BERMUDA SHORTS, BIKINIS, BLOUSES, COATS, DRESSES, FOOTWEAR, NAMELY, ATHLETIC SHOES AND SNEAKERS, BOOTS, SANDALS, AND SHOES, GLOVES, JACKETS, AND PANTS, RAIN CLOTHES, NAMELY, RAIN COATS, RAIN JACKETS, AND RAIN SUITS, ROBES, SHIRTS, SLIPPERS, STOCKINGS, SWEATERS, SWIMMING SUITS, T-SHIRTS, VESTS, SUNDIAL CLOCKS, SUNGLASSES, SWIMMING CAPS, WATCH AND CLOCK MECHANISMS, WRIST WATCH BRACELETS AND STRAPS, WRIST WATCHES AND CLOCKS AUTOMATICALLY AND REMOTELY SET THROUGH RECEIPT AND PROCESSING OF RADIO SIGNALS FROM GOVERNMENT-SPONSORED ATOMIC CLOCKS, WRIST WATCHES AND CLOCKS, CHRONOMETERS AND POCKET WATCHES, MADE OF NON-PRECIOUS METALS AND PLASTICS, IN CLASS 35 (U.S. CLS. 100, 101 AND 102).

FIRST USE 3-0-1996; IN COMMERCE 2-0-2003.

OWNER OF U.S. REG. NOS. 2,756,287, 2,908,482, AND 3,091,073.

THE MARK CONSISTS OF TWO CURVED DEVICES FORMING THE OUTLINE OF A HOLLOW CIRCLE AS SEEN FROM AN ANGLE, DIVIDED WITH A HORIZONTAL BAR



David J. Kybas

Director of the United States Patent and Trademark Office

Reg. No. 4,066,668 HAVING A POINTED END ON ITS RIGHT SIDE, WITH THE LITERAL ELEMENT "MORMAI" IN SPECIAL FORM DISPLAYED TO THE RIGHT OF THE DESIGN.

SER. NO. 85-299,141, FILED 4-19-2011.

TEJBIR SINGH, EXAMINING ATTORNEY

United States of America

United States Patent and Trademark Office

Salmon Air

Reg. No. 4,066,669

Registered Dec. 6, 2011

Int. Cl.: 39

SERVICE MARK

PRINCIPAL REGISTER

MCCALL AVIATION, INC. (IDAHO CORPORATION), DBA SALMON AIR
300 DEINHARD LANE
MCCALL, ID 83638

FOR: AIR CHARTER SERVICES; AIR CHARTER TRANSPORTATION SERVICES; AIR
TRANSPORT SERVICES; AIR TRANSPORTATION; AIR TRANSPORTATION OF PASSENGERS
AND FREIGHT, IN CLASS 39 (U.S. CLS. 100 AND 105).

FIRST USE 12-15-1998; IN COMMERCE 12-15-1998.

THE MARK CONSISTS OF STANDARD CHARACTERS WITHOUT CLAIM TO ANY PARTICULAR
FONT, STYLE, SIZE, OR COLOR.

NO CLAIM IS MADE TO THE EXCLUSIVE RIGHT TO USE "AIR", APART FROM THE
MARK AS SHOWN.

SER. NO. 85-299,195, FILED 4-19-2011.

DANIEL CAPSHAW, EXAMINING ATTORNEY



David J. Kyros

Director of the United States Patent and Trademark Office

United States of America

United States Patent and Trademark Office

Dakota Rising

Reg. No. 4,066,670

SOUTH DAKOTA RURAL ENTERPRISE, INC. (SOUTH DAKOTA CORPORATION)
629 S. MINNESOTA AVENUE SUITE 201
SIOUX FALLS, SD 57104

Registered Dec. 6, 2011

Int. Cl.: 35

FOR: PROMOTING PROFESSIONAL AND ENTREPRENEURIAL DEVELOPMENT IN RURAL COMMUNITIES IN SOUTH DAKOTA, IN CLASS 35 (U.S. CLS. 100, 101 AND 102).

SERVICE MARK

FIRST USE 4-9-2008; IN COMMERCE 4-9-2008.

PRINCIPAL REGISTER

THE MARK CONSISTS OF STANDARD CHARACTERS WITHOUT CLAIM TO ANY PARTICULAR FONT, STYLE, SIZE, OR COLOR.

NO CLAIM IS MADE TO THE EXCLUSIVE RIGHT TO USE "DAKOTA", APART FROM THE MARK AS SHOWN.

SER. NO. 85-299,247, FILED 4-19-2011.

ALYSSA STEEL, EXAMINING ATTORNEY



David J. Kybas

Director of the United States Patent and Trademark Office

United States of America

United States Patent and Trademark Office

WIZARD OF YOUTH

Reg. No. 4,066,671

Registered Dec. 6, 2011

Int. Cl.: 16

TRADEMARK

PRINCIPAL REGISTER

OUIVIER, JOHN (UNITED STATES INDIVIDUAL)
22647 VENTURA BLVD., #262
WOODLAND HILLS, CA 91364

FOR: BOOKS ON HEALTH AND WELL-BEING, IN CLASS 16 (U.S. CLS. 2, 5, 22, 23, 29, 37, 38 AND 50).

FIRST USE 5-27-2010; IN COMMERCE 9-9-2010.

THE MARK CONSISTS OF STANDARD CHARACTERS WITHOUT CLAIM TO ANY PARTICULAR FONT, STYLE, SIZE, OR COLOR.

OWNER OF U.S. REG. NO. 3,518,521.

SER. NO. 85-299,285, FILED 4-19-2011.

KATHLEEN M. VANSTON, EXAMINING ATTORNEY



David J. Kybas

Director of the United States Patent and Trademark Office

United States of America

United States Patent and Trademark Office

THE PROGRESSION OF WEALTH

Reg. No. 4,066,672

Registered Dec. 6, 2011

Int. Cl.: 36

SERVICE MARK

PRINCIPAL REGISTER

JAY HELLER (UNITED STATES INDIVIDUAL)
1000 GERMANTOWN PIKE, SUITE H-1
PLYMOUTH MEETING, PA 19462 AND

BRIAN KOHUTE (UNITED STATES INDIVIDUAL)
1000 GERMANTOWN PIKE, SUITE H-1
PLYMOUTH MEETING, PA 19462

FOR: FINANCIAL PLANNING SERVICES, IN CLASS 36 (U.S. CLS. 100, 101 AND 102).

FIRST USE 1-1-2001; IN COMMERCE 1-2-2001.

THE MARK CONSISTS OF STANDARD CHARACTERS WITHOUT CLAIM TO ANY PARTICULAR FONT, STYLE, SIZE, OR COLOR.

NO CLAIM IS MADE TO THE EXCLUSIVE RIGHT TO USE "WEALTH", APART FROM THE MARK AS SHOWN.

SER. NO. 85-299,291, FILED 4-19-2011.

H. M. FISHER, EXAMINING ATTORNEY



David J. Kybas

Director of the United States Patent and Trademark Office

United States of America

United States Patent and Trademark Office



Technology Tee Box

Reg. No. 4,066,673

Registered Dec. 6, 2011

Int. Cl.: 35

SERVICE MARK

PRINCIPAL REGISTER

TECHNOLOGY TEE BOX (MARYLAND LIMITED LIABILITY COMPANY)
1034 WHITEHALL CV
ANNAPOLIS, MD 21409

FOR: BUSINESS CONSULTING IN THE CONSUMER PRODUCTS INDUSTRY; BUSINESS MANAGEMENT CONSULTING WITH RELATION TO STRATEGY, MARKETING, SALES, OPERATION, PRODUCT DESIGN PARTICULARLY SPECIALIZING IN THE USE OF ANALYTIC AND STATISTIC MODELS FOR THE UNDERSTANDING AND PREDICTING OF CONSUMERS, BUSINESSES, AND MARKET TRENDS AND ACTIONS; ORGANIZING, PROMOTING AND CONDUCTING EXHIBITIONS, TRADESHOWS AND EVENTS FOR BUSINESS PURPOSES, IN CLASS 35 (U.S. CLS. 100, 101 AND 102).

FIRST USE 11-0-2009; IN COMMERCE 12-18-2009.

NO CLAIM IS MADE TO THE EXCLUSIVE RIGHT TO USE "TECHNOLOGY", APART FROM THE MARK AS SHOWN.

THE MARK CONSISTS OF AN OUTLINED RECTANGLE HOLDING A STYLIZED DESIGN OF A GOLF BALL ON A GOLF TEE; THE RECTANGLE IS CENTERED ABOVE THE TERM "TECHNOLOGY" WHICH IS ABOVE "TEE BOX".

SER. NO. 85-299,332, FILED 4-19-2011.

ANTHONY RINKER, EXAMINING ATTORNEY



David J. Kybas

Director of the United States Patent and Trademark Office

United States of America

United States Patent and Trademark Office

Decipher Pictures

Reg. No. 4,066,674

Registered Dec. 6, 2011

Int. Cls.: 35 and 41

SERVICE MARK

PRINCIPAL REGISTER

DECIPHER PICTURES (DELAWARE LIMITED LIABILITY COMPANY)
#108
5424 FRANKLIN AVE.
LOS ANGELES, CA 90027

FOR: BRANDING SERVICES, NAMELY, CONSULTING, DEVELOPMENT, MANAGEMENT AND MARKETING OF BRANDS FOR BUSINESSES; PRODUCTION OF ADVERTISING MATTER AND COMMERCIALS; PRODUCTION OF TELEVISION COMMERCIALS, IN CLASS 35 (U.S. CLS. 100, 101 AND 102).

FIRST USE 7-14-2008; IN COMMERCE 7-27-2008.

FOR: FILM PRODUCTION; MULTIMEDIA ENTERTAINMENT SERVICES IN THE NATURE OF RECORDING, PRODUCTION AND POST-PRODUCTION SERVICES IN THE FIELDS OF MUSIC, VIDEO, AND FILMS; MUSIC PRODUCTION SERVICES; MUSIC VIDEO PRODUCTION; PRODUCTION OF TELEVISION PROGRAMS, IN CLASS 41 (U.S. CLS. 100, 101 AND 107).

FIRST USE 7-14-2008; IN COMMERCE 7-27-2008.

THE MARK CONSISTS OF STANDARD CHARACTERS WITHOUT CLAIM TO ANY PARTICULAR FONT, STYLE, SIZE, OR COLOR.

NO CLAIM IS MADE TO THE EXCLUSIVE RIGHT TO USE "PICTURES", APART FROM THE MARK AS SHOWN.

SER. NO. 85-299,351, FILED 4-19-2011.

ZHALEH DELANEY, EXAMINING ATTORNEY



David J. Kybas

Director of the United States Patent and Trademark Office

United States of America

United States Patent and Trademark Office

5280

Reg. No. 4,066,675

Registered Dec. 6, 2011

Int. Cl.: 16

TRADEMARK

PRINCIPAL REGISTER

5280 PUBLISHING, INC. (COLORADO CORPORATION)
1515 WAZEE STREET, SUITE 400
DENVER, CO 80202

FOR: PRINTED MAGAZINES FEATURING INFORMATION LOCAL TO THE CITY OF DENVER AND THE STATE OF COLORADO, IN CLASS 16 (U.S. CLS. 2, 5, 22, 23, 29, 37, 38 AND 50).

FIRST USE 7-30-1993; IN COMMERCE 7-30-1993.

THE MARK CONSISTS OF STANDARD CHARACTERS WITHOUT CLAIM TO ANY PARTICULAR FONT, STYLE, SIZE, OR COLOR.

OWNER OF U.S. REG. NOS. 3,158,264, 3,158,266 AND OTHERS.

SER. NO. 85-299,414, FILED 4-19-2011.

GRETТА YAO, EXAMINING ATTORNEY



David J. Kybas

Director of the United States Patent and Trademark Office

United States of America

United States Patent and Trademark Office

EXTREME EXPOSURE

Reg. No. 4,066,676

Registered Dec. 6, 2011

Int. Cl.: 35

SERVICE MARK

PRINCIPAL REGISTER

EXTREME EXPOSURE, LLC (HAWAII LIMITED LIABILITY COMPANY), DBA EXTREME EXPOSURE FINE ART GALLERY
141 KUAKAHI PLACE
141 KUAKAHI PLACE
HILO, HI 96720

FOR: ART GALLERIES, IN CLASS 35 (U.S. CLS. 100, 101 AND 102).

FIRST USE 9-24-2010; IN COMMERCE 9-24-2010.

THE MARK CONSISTS OF STANDARD CHARACTERS WITHOUT CLAIM TO ANY PARTICULAR FONT, STYLE, SIZE, OR COLOR.

SER. NO. 85-299,442, FILED 4-20-2011.

DANIEL CAPSHAW, EXAMINING ATTORNEY



David J. Kyros

Director of the United States Patent and Trademark Office

United States of America

United States Patent and Trademark Office

Dental Departures

Reg. No. 4,066,677

Registered Dec. 6, 2011

Int. Cls.: 35 and 44

SERVICE MARK

PRINCIPAL REGISTER

DENTAL DEPARTURES INC. (DELAWARE CORPORATION)
3105 E. SPRING ST.
SEATTLE, WA 98122

FOR: PROVIDING ONLINE REFERRALS OF MEDICAL AND DENTAL PROFESSIONALS AND REFERRALS IN THE FIELD OF MEDICINE AND DENTISTRY; PROVIDING ONLINE MARKETING FOR MEDICAL AND DENTAL PROFESSIONALS, IN CLASS 35 (U.S. CLS. 100, 101 AND 102).

FIRST USE 9-30-2010; IN COMMERCE 9-30-2010.

FOR: PROVIDING INFORMATION IN THE FIELD OF DENTISTRY VIA AN ELECTRONIC COMMUNICATIONS NETWORK, IN CLASS 44 (U.S. CLS. 100 AND 101).

FIRST USE 9-30-2010; IN COMMERCE 9-30-2010.

THE MARK CONSISTS OF STANDARD CHARACTERS WITHOUT CLAIM TO ANY PARTICULAR FONT, STYLE, SIZE, OR COLOR.

NO CLAIM IS MADE TO THE EXCLUSIVE RIGHT TO USE "DENTAL", APART FROM THE MARK AS SHOWN.

SER. NO. 85-299,443, FILED 4-20-2011.

LOURDES AYALA, EXAMINING ATTORNEY



David J. Kybas

Director of the United States Patent and Trademark Office

United States of America

United States Patent and Trademark Office



Reg. No. 4,066,678

Registered Dec. 6, 2011

Int. Cl.: 45

SERVICE MARK

PRINCIPAL REGISTER

A2Z FILINGS, INC. (FLORIDA CORPORATION)
PO BOX 880785
BOCA RATON, FL 33488

FOR: PREPARING AND FILING INCORPORATION PAPERS; PUBLIC DOCUMENT FILING SERVICES, IN CLASS 45 (U.S. CLS. 100 AND 101).

FIRST USE 2-0-2010; IN COMMERCE 2-0-2010.

NO CLAIM IS MADE TO THE EXCLUSIVE RIGHT TO USE "FILINGS", APART FROM THE MARK AS SHOWN.

THE MARK CONSISTS OF THE WORDING/LETTERS "A2Z FILINGS" INSIDE OF A SINGLE LINE SQUARE FEATURED OVER A STACK OF FIVE SHEETS OF PAPER. THE "A2Z" IS ABOVE THE WORDING "FILINGS". THE WORDING "FILINGS" IS REPRESENTED IN SHADOW FORM BELOW THE WORD "FILINGS".

SER. NO. 85-299,445, FILED 4-20-2011.

LOURDES AYALA, EXAMINING ATTORNEY



David J. Kybas

Director of the United States Patent and Trademark Office

United States of America

United States Patent and Trademark Office

MAGICGLASS

Reg. No. 4,066,679

Registered Dec. 6, 2011

Int. Cl.: 21

TRADEMARK

PRINCIPAL REGISTER

GIANLUIGI, REALDON (ITALY INDIVIDUAL)
VIA CA' MEGLIADINO 39
MONTAGNANA PD, ITALY

FOR: CLEANING BRUSHES FOR HOUSEHOLD USE; CLEANING CLOTHS; CLEANING SPONGES; MANUALLY ACTUATED PUMP DISPENSERS FOR ATTACHMENT TO CONTAINERS FOR USE IN DISPENSING LIQUIDS; WINDOW CLEANERS IN THE NATURE OF A COMBINATION SQUEEGEE AND SCRUBBER, IN CLASS 21 (U.S. CLS. 2, 13, 23, 29, 30, 33, 40 AND 50).

FIRST USE 6-25-1997; IN COMMERCE 6-25-1997.

THE MARK CONSISTS OF STANDARD CHARACTERS WITHOUT CLAIM TO ANY PARTICULAR FONT, STYLE, SIZE, OR COLOR.

SER. NO. 85-299,449, FILED 4-20-2011.

LAURIE MAYES, EXAMINING ATTORNEY



David J. Kyffers

Director of the United States Patent and Trademark Office

United States of America

United States Patent and Trademark Office

SNAP OFF GARDEN TAG

Reg. No. 4,066,680

Registered Dec. 6, 2011

Int. Cl.: 20

TRADEMARK

PRINCIPAL REGISTER

GILBERTIE'S HERB GARDENS, INC. (CONNECTICUT CORPORATION)
65 ADAMS ROAD
EASTON, CT 06612

FOR: PRINTED PLASTIC LABELS FOR USE IN IDENTIFYING PLANTS, IN CLASS 20 (U.S. CLS. 2, 13, 22, 25, 32 AND 50).

FIRST USE 2-1-2004; IN COMMERCE 2-1-2004.

THE MARK CONSISTS OF STANDARD CHARACTERS WITHOUT CLAIM TO ANY PARTICULAR FONT, STYLE, SIZE, OR COLOR.

OWNER OF U.S. REG. NO. 2,945,347.

NO CLAIM IS MADE TO THE EXCLUSIVE RIGHT TO USE "GARDEN TAG", APART FROM THE MARK AS SHOWN.

SEC. 2(F).

SER. NO. 85-299,525, FILED 4-20-2011.

SARA BENJAMIN, EXAMINING ATTORNEY



David J. Kybas

Director of the United States Patent and Trademark Office

United States of America

United States Patent and Trademark Office

ACS MOBILE

Reg. No. 4,066,681

Registered Dec. 6, 2011

Int. Cl.: 9

TRADEMARK

PRINCIPAL REGISTER

AMERICAN CHEMICAL SOCIETY (D.C. CONGRESSIONALLY CHARTERED NONPROFIT ORGANIZATION)
1155 SIXTEENTH STREET, NW
WASHINGTON, DC 20036

FOR: COMPUTER APPLICATION SOFTWARE FOR MOBILE PHONES, PORTABLE MEDIA PLAYERS, AND HANDHELD COMPUTERS, NAMELY, SOFTWARE FOR RETRIEVING SCIENTIFIC ARTICLES FROM ELECTRONIC JOURNALS AND SCIENTIFIC NEWS SOURCES, RETRIEVING LISTS OF SCIENTIFIC JOURNALS AND NEWS ARTICLES AVAILABLE FOR DOWNLOAD, SEARCHING LISTS OF SCIENTIFIC ARTICLES, JOURNALS AND NEWS AVAILABLE FOR DOWNLOAD, SEARCHING LISTS OF SCIENTIFIC ARTICLES, JOURNALS AND NEWS, NOTIFYING USERS OF UPDATES TO SCIENTIFIC ARTICLES, JOURNALS AND NEWS, BROWSING ABSTRACTS OF SCIENTIFIC ARTICLES, JOURNALS AND NEWS, AND CONNECTING WITH A DATABASE OF SCIENTIFIC ARTICLES, JOURNALS AND NEWS FOR DOWNLOAD AND REVIEW, IN CLASS 9 (U.S. CLS. 21, 23, 26, 36 AND 38).

FIRST USE 3-15-2010; IN COMMERCE 3-15-2010.

THE MARK CONSISTS OF STANDARD CHARACTERS WITHOUT CLAIM TO ANY PARTICULAR FONT, STYLE, SIZE, OR COLOR.

OWNER OF U.S. REG. NOS. 1,082,875, 3,121,332 AND OTHERS.

NO CLAIM IS MADE TO THE EXCLUSIVE RIGHT TO USE "MOBILE", APART FROM THE MARK AS SHOWN.

SER. NO. 85-299,557, FILED 4-20-2011.

NELSON SNYDER, EXAMINING ATTORNEY



David J. Kybas

Director of the United States Patent and Trademark Office

United States of America

United States Patent and Trademark Office

ACS CATALYSIS

Reg. No. 4,066,682

Registered Dec. 6, 2011

Int. Cls.: 9 and 41

TRADEMARK

SERVICE MARK

PRINCIPAL REGISTER

AMERICAN CHEMICAL SOCIETY (D.C. CONGRESSIONALLY CHARTERED NONPROFIT ORGANIZATION)
1155 SIXTEENTH STREET, NW
WASHINGTON, DC 20036

FOR: DOWNLOADABLE PUBLICATIONS, NAMELY, A SCIENTIFIC RESEARCH JOURNAL CONTAINING ARTICLES AND INFORMATION IN THE FIELD OF CATALYSIS SCIENCE, IN CLASS 9 (U.S. CLS. 21, 23, 26, 36 AND 38).

FIRST USE 1-7-2011; IN COMMERCE 1-7-2011.

FOR: NON-DOWNLOADABLE PUBLICATIONS, NAMELY, A SCIENTIFIC RESEARCH JOURNAL CONTAINING ARTICLES AND INFORMATION IN THE FIELD OF CATALYSIS SCIENCE, IN CLASS 41 (U.S. CLS. 100, 101 AND 107).

FIRST USE 1-7-2011; IN COMMERCE 1-7-2011.

THE MARK CONSISTS OF STANDARD CHARACTERS WITHOUT CLAIM TO ANY PARTICULAR FONT, STYLE, SIZE, OR COLOR.

OWNER OF U.S. REG. NOS. 1,082,875, 3,121,332 AND OTHERS.

NO CLAIM IS MADE TO THE EXCLUSIVE RIGHT TO USE "CATALYSIS", APART FROM THE MARK AS SHOWN.

SER. NO. 85-299,567, FILED 4-20-2011.

NELSON SNYDER, EXAMINING ATTORNEY



David J. Kyjars

Director of the United States Patent and Trademark Office

United States of America

United States Patent and Trademark Office

SENTINEL SATELLITE, INC.

Reg. No. 4,066,683

Registered Dec. 6, 2011

Int. Cl.: 38

SERVICE MARK

PRINCIPAL REGISTER

SENTINEL SATELLITE, INC. (TEXAS CORPORATION)
SUITE J
2536 AMHERST STREET
HOUSTON, TX 770053207

FOR: SATELLITE TRANSMISSION SERVICES, IN CLASS 38 (U.S. CLS. 100, 101 AND 104).

FIRST USE 12-10-2008; IN COMMERCE 1-26-2009.

THE MARK CONSISTS OF STANDARD CHARACTERS WITHOUT CLAIM TO ANY PARTICULAR FONT, STYLE, SIZE, OR COLOR.

OWNER OF U.S. REG. NO. 3,660,833.

NO CLAIM IS MADE TO THE EXCLUSIVE RIGHT TO USE "SATELLITE, INC", APART FROM THE MARK AS SHOWN.

SER. NO. 85-299,661, FILED 4-20-2011.

FRANK LATTUCA, EXAMINING ATTORNEY



David J. Kybas

Director of the United States Patent and Trademark Office

United States of America

United States Patent and Trademark Office

The Coleman Transitions Intervention Model

Reg. No. 4,066,684

Registered Dec. 6, 2011

Int. Cl.: 44

SERVICE MARK

PRINCIPAL REGISTER

COLEMAN, ERIC A. (UNITED STATES INDIVIDUAL)
SUITE 400
13199 E MONTVIEW BLVD
AURORA, CO 800457201

FOR: HEALTH CARE SERVICES FOR IMPROVING QUALITY CARE AND SAFETY OF PATIENTS DURING TRANSITIONS ACROSS CARE SETTINGS, IN CLASS 44 (U.S. CLS. 100 AND 101).

FIRST USE 3-1-2005; IN COMMERCE 3-1-2005.

THE MARK CONSISTS OF STANDARD CHARACTERS WITHOUT CLAIM TO ANY PARTICULAR FONT, STYLE, SIZE, OR COLOR.

OWNER OF U.S. REG. NOS. 3,993,200, 3,996,838 AND OTHERS.

NO CLAIM IS MADE TO THE EXCLUSIVE RIGHT TO USE "TRANSITIONS INTERVENTION MODEL", APART FROM THE MARK AS SHOWN.

SER. NO. 85-299,662, FILED 4-20-2011.

JORDAN BAKER, EXAMINING ATTORNEY



David J. Kyros

Director of the United States Patent and Trademark Office

United States of America

United States Patent and Trademark Office

THE PARTRIDGE & PEAR RESTAURANT AT CHRISTMAS PLACE

Reg. No. 4,066,685

Registered Dec. 6, 2011

Int. Cl.: 43

SERVICE MARK

PRINCIPAL REGISTER

CHRISTMAS PLACE, INC. (TENNESSEE CORPORATION)
2740 PARKWAY
PIGEON FORGE, TN 37868

FOR: RESTAURANT SERVICES, IN CLASS 43 (U.S. CLS. 100 AND 101).

FIRST USE 4-12-2011; IN COMMERCE 4-12-2011.

THE MARK CONSISTS OF STANDARD CHARACTERS WITHOUT CLAIM TO ANY PARTICULAR FONT, STYLE, SIZE, OR COLOR.

OWNER OF U.S. REG. NOS. 3,336,434, 3,918,119 AND OTHERS.

NO CLAIM IS MADE TO THE EXCLUSIVE RIGHT TO USE "RESTAURANT", APART FROM THE MARK AS SHOWN.

SER. NO. 85-299,705, FILED 4-20-2011.

KAREN SEVERSON, EXAMINING ATTORNEY



David J. Kybas

Director of the United States Patent and Trademark Office

United States of America

United States Patent and Trademark Office



AmegaBuilders

Reg. No. 4,066,686

BC GLOBAL, LLC (NEVADA LIMITED LIABILITY COMPANY)
P.O. BOX 1384
MESA, AZ 85211

Registered Dec. 6, 2011

Int. Cl.: 35

FOR: ADVERTISING AND MARKETING SERVICES, NAMELY, PROMOTING THE GOODS AND SERVICES OF OTHERS, IN CLASS 35 (U.S. CLS. 100, 101 AND 102).

SERVICE MARK

FIRST USE 2-28-2011; IN COMMERCE 2-28-2011.

PRINCIPAL REGISTER

THE MARK CONSISTS OF THE WORDING "AMEGABUILDERS" BENEATH THREE CURVED LINES.

SER. NO. 85-299,719, FILED 4-20-2011.

JOHN DWYER, EXAMINING ATTORNEY



David J. Kybas

Director of the United States Patent and Trademark Office

United States of America

United States Patent and Trademark Office

Cupcake Mavens

Reg. No. 4,066,687

GORDON, THERESA L (UNITED STATES INDIVIDUAL)
4207 MILLEDGE BLVD
SUITLAND, MD 20746

Registered Dec. 6, 2011

Int. Cl.: 30

FOR: BAKERY DESSERTS; BAKERY GOODS AND DESSERT ITEMS, NAMELY, CHEESECAKES FOR RETAIL AND WHOLESALE DISTRIBUTION AND CONSUMPTION ON OR OFF THE PREMISES; CUPCAKES THAT CONTAIN ALCOHOL , IN CLASS 30 (U.S. CL. 46).

TRADEMARK

PRINCIPAL REGISTER

FIRST USE 3-1-2011; IN COMMERCE 3-1-2011.

THE MARK CONSISTS OF STANDARD CHARACTERS WITHOUT CLAIM TO ANY PARTICULAR FONT, STYLE, SIZE, OR COLOR.

NO CLAIM IS MADE TO THE EXCLUSIVE RIGHT TO USE "CUPCAKE", APART FROM THE MARK AS SHOWN.

SER. NO. 85-299,724, FILED 4-20-2011.

GIANCARLO CASTRO, EXAMINING ATTORNEY



David J. Kyffers

Director of the United States Patent and Trademark Office

United States of America

United States Patent and Trademark Office

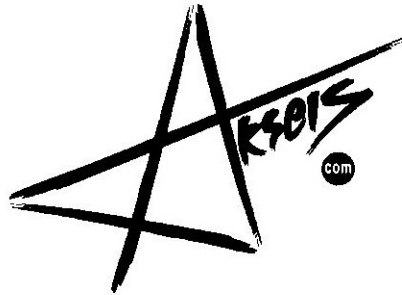

Reg. No. 4,066,688

Registered Dec. 6, 2011

Int. Cl.: 25

TRADEMARK

PRINCIPAL REGISTER

BURNESON, DANE (UNITED STATES INDIVIDUAL)
3A
1617 CALIFORNIA ST
DENVER, CO 80202

FOR: CLOTHING, NAMELY, T-SHIRTS, HOODED SWEAT SHIRTS, HATS, IN CLASS 25
(U.S. CLS. 22 AND 39).

FIRST USE 9-1-2007; IN COMMERCE 9-1-2007.

THE MARK CONSISTS OF THE STYLIZED TEXT "AKEELS" WITH THE LETTER "A" RESEMBLING A STYLIZED STAR. BELOW THE WORDING "AKEELS" THERE IS A DOT WITH THE STYLIZED TEXT "COM" INSIDE.

SER. NO. 85-299,727, FILED 4-20-2011.

GIANCARLO CASTRO, EXAMINING ATTORNEY



David J. Kyffers

Director of the United States Patent and Trademark Office

United States of America

United States Patent and Trademark Office

BESPOKE

Reg. No. 4,066,689

Registered Dec. 6, 2011

Int. Cl.: 19

TRADEMARK

PRINCIPAL REGISTER

LV WOOD FLOORS, INC. (NEW YORK CORPORATION), DBA LV WOOD FLOORS
3283 WALDEN AVENUE
DEPEW, NY 14043

FOR: BAMBOO FLOORING; CHEMICALLY TREATED WOOD, NAMELY, WOOD BEAMS, WOOD BOARDS, WOOD JOISTS, WOOD RAFTERS, WOOD SIDING, WOOD TILE FLOORS AND FLOORING, WOOD TRIM, WOODEN BEAMS, WOODEN FLOORING, WOODEN RAILINGS, AND WOODEN WAINSCOTING, ALL OF THE ABOVE CONTAINING A FIRE RETARDANT CHEMICAL; CONSTRUCTION MATERIALS, NAMELY, NON-METAL FLOORING MATERIALS; CONSTRUCTION MATERIALS, NAMELY, NON-METAL MATERIALS FOR CONSTRUCTING FLOORS; CORK TILES AND TILES OF CORK-BASED CONGLOMERATES FOR FLOOR, WALL AND CEILING COVERINGS; ENGINEERED HARDWOOD FLOORING; FLOOR BOARDS; FLOOR PANELS NOT OF METAL; FLOOR TILES OF WOOD; FLOORING UNDERLAYMENT MADE OF CORK; FLOORING UNDERLAYMENTS; HARDWOOD FLOORING; HARDWOOD DECKING AND FLOORING; HARDWOOD FLOORING; LAMINATE FLOORING; NON-METAL FLOOR TILES; NON-METAL FLOORS; NON-METAL TILES FOR WALLS, FLOORS OR CEILINGS; NONMETAL DOOR PARTS FOR BUILDINGS, NAMELY, ADJUSTERS FOR ADJUSTING THE HEIGHT OF A DOOR, FLOOR BOARDS, COLUMNS, BEAMS, PANELING BOARDS, SILLS, SLEEPERS, BACKINGS FOR CEILINGS OR WALLS, STILES, RAILS AND CEILING BOARDS; PARQUET FLOOR BOARDS; PARQUET FLOORING; PARQUET FLOORING AND PARQUET SLABS; PARQUET FLOORING MADE OF CORK; PARQUET FLOORING MADE OF WOOD; PARQUET FLOORING OF CORK; PARQUET FLOORING OF CORK AND OF CORK-BASED CONGLOMERATES; PARQUET FLOORING OF WOOD; PARQUET WOOD FLOORING; PORTABLE DANCE FLOORS; SYNTHETIC FLOORING MATERIALS OR WALL-CLADDINGS; VENEER FOR FLOORS; WOOD SPORTS FLOORS; WOOD TILE FLOORS; WOODEN FLOORING, IN CLASS 19 (U.S. CLS. 1, 12, 33 AND 50).

FIRST USE 3-1-2009; IN COMMERCE 3-1-2009.

THE MARK CONSISTS OF THE STYLIZED TERM "BESPOKE" WHERE ALL THE LETTERS ARE CAPITALIZED, OUTLINED IN BLACK WITH BOLD BLACK BORDERS ON THE RIGHT SIDE OF THE LETTERS, AND ALL HAVE A WHITE FILL COLOR WITH EVENLY SPACED BLACK HORIZONTAL LINES.

SER. NO. 85-299,753, FILED 4-20-2011.



David J. Kyros

Director of the United States Patent and Trademark Office

Reg. No. 4,066,689 ANTHONY RINKER, EXAMINING ATTORNEY

United States of America

United States Patent and Trademark Office

True Blue Water Solutions

Reg. No. 4,066,690

Registered Dec. 6, 2011

Int. Cl.: 11

TRADEMARK

PRINCIPAL REGISTER

DEFENDER SECURITY COMPANY (INDIANA CORPORATION)
3750 PRIORITY WAY SOUTH DRIVE
INDIANAPOLIS, IN 46240

FOR: WATER SOFTENING APPARATUS AND INSTALLATIONS; WATER TREATMENT EQUIPMENT, NAMELY, REVERSE OSMOSIS FILTRATION UNITS, IN CLASS 11 (U.S. CLS. 13, 21, 23, 31 AND 34).

FIRST USE 4-20-2011; IN COMMERCE 4-20-2011.

THE MARK CONSISTS OF STANDARD CHARACTERS WITHOUT CLAIM TO ANY PARTICULAR FONT, STYLE, SIZE, OR COLOR.

NO CLAIM IS MADE TO THE EXCLUSIVE RIGHT TO USE "WATER SOLUTIONS", APART FROM THE MARK AS SHOWN.

SER. NO. 85-299,773, FILED 4-20-2011.

ANGELA DUONG, EXAMINING ATTORNEY



David J. Kyffers

Director of the United States Patent and Trademark Office

United States of America

United States Patent and Trademark Office



Reg. No. 4,066,691

LEE, WEILING J (UNITED STATES INDIVIDUAL)
5535 COTTAGE FARM ROAD
ALPHARETTA, GA 30022

Registered Dec. 6, 2011

Int. Cl.: 30

FOR: COOKED RICE; PACKAGED MEAL KITS CONSISTING PRIMARILY OF PASTA OR RICE, IN CLASS 30 (U.S. CL. 46).

TRADEMARK

FIRST USE 12-15-2008; IN COMMERCE 12-15-2008.

PRINCIPAL REGISTER

OWNER OF U.S. REG. NOS. 3,760,895 AND 3,843,887.

NO CLAIM IS MADE TO THE EXCLUSIVE RIGHT TO USE "RICE", APART FROM THE MARK AS SHOWN.

THE MARK CONSISTS OF THE WORDS "RICE N SIMPLE" WITH "I" IN THE WORD "RICE" COMPRISED OF A DANCING GIRL DESIGN. ALSO, THERE ARE TWO RICE GRAINS COMPRISING THE LETTERS "I" AND "P" IN THE WORD "SIMPLE". THERE ARE ALSO THE WORDS "GABBY'S CHOICE" AGAINST AN OVAL BACKGROUND WITH AN EXTERNAL BORDER ON TOP OF THE WORD "RICE N SIMPLE", ALL AGAINST A RECTANGULAR BACKGROUND WITH AN EXTERNAL BORDER.

SER. NO. 85-299,820, FILED 4-20-2011.

TINA MAI, EXAMINING ATTORNEY



David J. Kybas

Director of the United States Patent and Trademark Office

United States of America

United States Patent and Trademark Office

VOICE

Reg. No. 4,066,692

Registered Dec. 6, 2011

Int. Cl.: 36

SERVICE MARK

PRINCIPAL REGISTER

LEISURE LOGISTICS, LLC (NEVADA LIMITED LIABILITY COMPANY)
C/O MIKE MACIEL, ESQ., NORTH BAY GROUP
3554 ROUND BARN BLVD., SUITE 310
SANTA ROSA, CA 95403

FOR: EXCHANGE SERVICES, NAMELY, OWNERS OF TIMESHARES OR VACATIONS INTERVALS EXCHANGE OR REDEEM THE USAGE INTEREST FOR ALTERNATIVE TRAVEL OR VACATION OPTIONS, IN CLASS 36 (U.S. CLS. 100, 101 AND 102).

FIRST USE 12-10-2010; IN COMMERCE 12-10-2010.

THE MARK CONSISTS OF STANDARD CHARACTERS WITHOUT CLAIM TO ANY PARTICULAR FONT, STYLE, SIZE, OR COLOR.

SER. NO. 85-299,821, FILED 4-20-2011.

MICHAEL WEBSTER, EXAMINING ATTORNEY



David J. Kybas

Director of the United States Patent and Trademark Office

United States of America

United States Patent and Trademark Office

RECKLESS SONS

Reg. No. 4,066,693

Registered Dec. 6, 2011

Int. Cl.: 41

SERVICE MARK

PRINCIPAL REGISTER

MATT BUTLER MUSIC, LLC (NEW YORK LIMITED LIABILITY COMPANY)
142 EAST 57TH STREET, 16TH FLOOR
NEW YORK, NY 10019

FOR: ENTERTAINMENT IN THE NATURE OF LIVE PERFORMANCES BY A MUSICAL BAND; ENTERTAINMENT SERVICES, NAMELY, PROVIDING A WEB SITE FEATURING NON-DOWNLOADABLE MUSICAL PERFORMANCES, MUSICAL VIDEOS, RELATED FILM CLIPS, PHOTOGRAPHS, AND OTHER MULTIMEDIA MATERIALS FEATURING MUSICAL PERFORMANCES, IN CLASS 41 (U.S. CLS. 100, 101 AND 107).

FIRST USE 5-6-2007; IN COMMERCE 5-6-2007.

THE MARK CONSISTS OF STANDARD CHARACTERS WITHOUT CLAIM TO ANY PARTICULAR FONT, STYLE, SIZE, OR COLOR.

SER. NO. 85-299,866, FILED 4-20-2011.

IRA J. GOODSaid, EXAMINING ATTORNEY



David J. Kyffers

Director of the United States Patent and Trademark Office

United States of America

United States Patent and Trademark Office

Bass Fishing Addiction

Reg. No. 4,066,694

CHANEY, DELTON, G (UNITED STATES INDIVIDUAL)
12178 VIA SERRANO
EL CAJON, CA 92019

Registered Dec. 6, 2011

Int. Cl.: 25

FOR: CLOTHING ITEMS, NAMELY, T-SHIRTS, TANK TOPS, HATS, VISORS, HOODED SWEAT SHIRTS, SHORTS, JACKETS, POLO SHIRTS, DRESS SHIRTS, PANTS, SOCKS, UNDERWEAR, SWIMSUITS, IN CLASS 25 (U.S. CLS. 22 AND 39).

TRADEMARK

FIRST USE 1-7-2011; IN COMMERCE 1-7-2011.

PRINCIPAL REGISTER

THE MARK CONSISTS OF STANDARD CHARACTERS WITHOUT CLAIM TO ANY PARTICULAR FONT, STYLE, SIZE, OR COLOR.

SER. NO. 85-299,883, FILED 4-20-2011.

RICHARD WHITE, EXAMINING ATTORNEY



David J. Kybas

Director of the United States Patent and Trademark Office

United States of America

United States Patent and Trademark Office

TEAM EVERGREEN

Reg. No. 4,066,695

TEAM EVERGREEN BICYCLE CLUB, INC. (COLORADO CORPORATION)
4465 KIPLING STREET
WHEAT RIDGE, CO 80033

Registered Dec. 6, 2011

Int. Cl.: 35

FOR: CLUB SERVICES, NAMELY, PROMOTING THE INTERESTS OF CYCLISTS, IN CLASS 35 (U.S. CLS. 100, 101 AND 102).

SERVICE MARK

FIRST USE 0-0-1988; IN COMMERCE 0-0-1988.

PRINCIPAL REGISTER

THE MARK CONSISTS OF STANDARD CHARACTERS WITHOUT CLAIM TO ANY PARTICULAR FONT, STYLE, SIZE, OR COLOR.

SER. NO. 85-299,903, FILED 4-20-2011.

BARBARA BROWN, EXAMINING ATTORNEY



David J. Kybas

Director of the United States Patent and Trademark Office

United States of America

United States Patent and Trademark Office

NEWSIndiaTIMES

Reg. No. 4,066,696

Registered Dec. 6, 2011

Int. Cls.: 16 and 41

TRADEMARK

SERVICE MARK

PRINCIPAL REGISTER

PARIKH WORLDWIDE MEDIA LLC (NEW JERSEY LIMITED LIABILITY COMPANY)
18 NORTH THIRD AVENUE
HIGHLAND PARK, NJ 08904

FOR: WEEKLY NEWSPAPER PUBLICATION FOR THE INDIAN COMMUNITY, IN CLASS 16 (U.S. CLS. 2, 5, 22, 23, 29, 37, 38 AND 50).

FIRST USE 9-30-1997; IN COMMERCE 9-30-1997.

FOR: PROVIDING AN ONLINE PUBLICATION WEBSITE FEATURING NEWS FOR THE INDIAN COMMUNITY, IN CLASS 41 (U.S. CLS. 100, 101 AND 107).

FIRST USE 9-30-1997; IN COMMERCE 9-30-1997.

THE MARK CONSISTS OF THE WORD "NEWS" IN RED, FOLLOWED BY THE WORD "INDIA" IN BLUE, FOLLOWED BY THE WORD "TIMES" IN RED.

THE COLOR(S) RED AND BLUE IS/ARE CLAIMED AS A FEATURE OF THE MARK.

SER. NO. 85-299,940, FILED 4-20-2011.

PAUL F. GAST, EXAMINING ATTORNEY



David J. Kybas

Director of the United States Patent and Trademark Office

United States of America

United States Patent and Trademark Office

DIGDEV DIRECT

Reg. No. 4,066,697

DIGITAL DEVELOPMENT INC. (FLORIDA CORPORATION)
260 SW NATURA AVE.
DEERFIELD BEACH, FL 33441

Registered Dec. 6, 2011

Int. Cl.: 35

FOR: ADVERTISING, MARKETING AND PROMOTION SERVICES; DATABASE MANAGEMENT; MARKETING SERVICES, NAMELY, CONSUMER TREND ANALYSIS; PROVIDING CONSULTING SERVICES IN THE FIELD OF FACILITATING THE PLANNING, BUYING, AND SELLING OF MEDIA, IN CLASS 35 (U.S. CLS. 100, 101 AND 102).

SERVICE MARK

PRINCIPAL REGISTER

FIRST USE 11-0-2010; IN COMMERCE 11-0-2010.

THE MARK CONSISTS OF STANDARD CHARACTERS WITHOUT CLAIM TO ANY PARTICULAR FONT, STYLE, SIZE, OR COLOR.

NO CLAIM IS MADE TO THE EXCLUSIVE RIGHT TO USE "DIRECT", APART FROM THE MARK AS SHOWN.

SER. NO. 85-299,972, FILED 4-20-2011.

KATHERINE CONNOLLY, EXAMINING ATTORNEY



David J. Kybas

Director of the United States Patent and Trademark Office

United States of America

United States Patent and Trademark Office

How to Cold Call on Executives without Fear

Reg. No. 4,066,698

Registered Dec. 6, 2011

Int. Cl.: 41

SERVICE MARK

PRINCIPAL REGISTER

LAVINE, RONALD SCOTT (UNITED STATES INDIVIDUAL), DBA ACCELERATED SALES TRAINING, INC.
210 CONCERTO DRIVE
OAK PARK, CA 91377

FOR: EDUCATION SERVICES, NAMELY, PROVIDING TRAINING THROUGH BOOKS, WORKBOOKS, CLASSES, SEMINARS, MEETINGS, WORKSHOPS AND ON-LINE PRESENTATIONS, ALL IN THE FIELD OF COLD CALLING, PROSPECTING FOR NEW CLIENTS, SALES OR SALES MANAGEMENT, IN CLASS 41 (U.S. CLS. 100, 101 AND 107).

FIRST USE 1-10-2011; IN COMMERCE 1-10-2011.

THE MARK CONSISTS OF STANDARD CHARACTERS WITHOUT CLAIM TO ANY PARTICULAR FONT, STYLE, SIZE, OR COLOR.

SER. NO. 85-300,022, FILED 4-20-2011.

MARILYN IZZI, EXAMINING ATTORNEY



David J. Kybas

Director of the United States Patent and Trademark Office

United States of America

United States Patent and Trademark Office

McHarrie Towne

Reg. No. 4,066,699

Registered Dec. 6, 2011

Int. Cl.: 43

SERVICE MARK

PRINCIPAL REGISTER

SYRACUSE HOME ASSOCIATION (NEW YORK CORPORATION)
7740 MEIGS ROAD
ATTN: MARK J. MURPHY, CEO
BALDWINVILLE, NY 13027

FOR: RETIREMENT HOMES, IN CLASS 43 (U.S. CLS. 100 AND 101).

FIRST USE 6-28-1988; IN COMMERCE 6-28-1988.

THE MARK CONSISTS OF STANDARD CHARACTERS WITHOUT CLAIM TO ANY PARTICULAR FONT, STYLE, SIZE, OR COLOR.

SER. NO. 85-300,050, FILED 4-20-2011.

BRENDAN MCCAULEY, EXAMINING ATTORNEY



David J. Kybas

Director of the United States Patent and Trademark Office

United States of America

United States Patent and Trademark Office



Reg. No. 4,066,700

Registered Dec. 6, 2011

Int. Cl.: 42

SERVICE MARK

PRINCIPAL REGISTER

ILLUSIONS ON THE WALL, INC. (WISCONSIN CORPORATION)
2415 SOUTH 59TH STREET
WEST ALLIS, WI 53219

FOR: DESIGN OF CUSTOM PAINTINGS, IN CLASS 42 (U.S. CLS. 100 AND 101).

FIRST USE 6-6-2010; IN COMMERCE 10-8-2010.

THE MARK CONSISTS OF A RUST COLORED CROSS OUTLINED WITH BLACK WITH A BLACK CAPITAL LETTER "S" ON THE LOWER LEFT-HAND SIDE OF THE CROSS AND A BLACK CAPITAL LETTER "H" ON THE LOWER RIGHT-HAND SIDE OF THE CROSS AND UNDERNEATH THE CROSS IN BLACK IN AN INVERTED PITCHFORK SHAPED LETTER "M"; THERE IS A BLACK SHADOW UNDERNEATH ALL ASPECTS OF THE MARK.

THE COLOR(S) RUST AND BLACK IS/ARE CLAIMED AS A FEATURE OF THE MARK.

SER. NO. 85-300,053, FILED 4-20-2011.

LAURA HAMMEL, EXAMINING ATTORNEY



David J. Kybas

Director of the United States Patent and Trademark Office

United States of America

United States Patent and Trademark Office

ILLUSIONS ON THE WALL

Reg. No. 4,066,701

Registered Dec. 6, 2011

Int. Cl.: 42

SERVICE MARK

PRINCIPAL REGISTER

ILLUSIONS ON THE WALL, INC. (WISCONSIN CORPORATION)
2415 SOUTH 59TH STREET
WEST ALLIS, WI 53219

FOR: DESIGN OF CUSTOM PAINTINGS, IN CLASS 42 (U.S. CLS. 100 AND 101).

FIRST USE 6-6-2010; IN COMMERCE 10-8-2010.

THE MARK CONSISTS OF THE WORDS "ILLUSIONS ON THE WALL" IN SPECIAL FONT LETTERS.

SER. NO. 85-300,130, FILED 4-20-2011.

LAURA HAMMEL, EXAMINING ATTORNEY



David J. Kybas

Director of the United States Patent and Trademark Office

United States of America

United States Patent and Trademark Office

McHarrie Pointe

Reg. No. 4,066,702

Registered Dec. 6, 2011

Int. Cl.: 43

SERVICE MARK

PRINCIPAL REGISTER

SYRACUSE HOME ASSOCIATION (NEW YORK CORPORATION)
7740 MEIGS ROAD
ATTN: MARK J. MURPHY, CEO
BALDWINVILLE, NY 13027

FOR: RETIREMENT HOMES, IN CLASS 43 (U.S. CLS. 100 AND 101).

FIRST USE 3-1-2010; IN COMMERCE 3-1-2010.

THE MARK CONSISTS OF STANDARD CHARACTERS WITHOUT CLAIM TO ANY PARTICULAR FONT, STYLE, SIZE, OR COLOR.

SER. NO. 85-300,204, FILED 4-20-2011.

BRENDAN MCCAULEY, EXAMINING ATTORNEY



David J. Kybas

Director of the United States Patent and Trademark Office

United States of America

United States Patent and Trademark Office

SYNCSOCKETS

Reg. No. 4,066,703

Registered Dec. 6, 2011

Int. Cl.: 9

TRADEMARK

PRINCIPAL REGISTER

GCOM, INCORPORATED (ILLINOIS CORPORATION)
1800 WOODFIELD DRIVE
SAVOY, IL 61874

FOR: DATA COMMUNICATIONS COMPUTER SOFTWARE PROGRAM WHICH NORMALIZES LEGACY PROTOCOLS TO THE TCP PROTOCOL THROUGH A PROPRIETARY PROTOCOL-SPECIFIC HEADER REPLACEMENT MECHANISM AND PRINTED USER GUIDES OR MANUALS FOR SAME SOLD AS A UNIT WITH THE SOFTWARE, IN CLASS 9 (U.S. CLS. 21, 23, 26, 36 AND 38).

FIRST USE 8-15-2003; IN COMMERCE 8-15-2003.

THE MARK CONSISTS OF STANDARD CHARACTERS WITHOUT CLAIM TO ANY PARTICULAR FONT, STYLE, SIZE, OR COLOR.

SER. NO. 85-300,209, FILED 4-20-2011.

JEFFREY LOOK, EXAMINING ATTORNEY



David J. Kybas

Director of the United States Patent and Trademark Office

United States of America

United States Patent and Trademark Office

PHIL LEMPERT

Reg. No. 4,066,704

Registered Dec. 6, 2011

**Int. Cls.: 35, 38, 41, 42,
43 and 44**

SERVICE MARK

PRINCIPAL REGISTER

CONSUMER INSIGHT, INC. (DELAWARE CORPORATION)
130 OCEAN PARK BLVD., #415
SANTA MONICA, CA 90405

FOR: MARKET RESEARCH SERVICES; PROVIDING COMMERCIAL INFORMATION VIA COMPUTER AND COMMUNICATIONS NETWORKS IN THE FIELD OF RETAIL FOOD INDUSTRY; PROVIDING MARKET RESEARCH INFORMATION VIA COMPUTER AND COMMUNICATION NETWORKS IN THE FIELD OF NEW FOOD PRODUCTS AND CONSUMER FOOD-BUYING HABITS; PROVIDING A WEBSITE FOR FEATURING REVIEWS OF FOOD PRODUCTS OF OTHERS PRIMARILY FOR MAKING PURCHASING DECISIONS; CONDUCTING MARKET RESEARCH SURVEYS; DISTRIBUTION OF ADVERTISEMENTS AND OF ADVERTISING MATERIAL OF OTHERS, NAMELY, BROCHURES LEAFLETS AND PRODUCT SAMPLES; ADVERTISING, MARKETING AND PROMOTING THE GOODS OF OTHERS; PROVIDING A CLEARINGHOUSE FOR PRODUCT MANUFACTURERS AND ADVERTISERS FOR THE DISTRIBUTION OF ADVERTISING INFORMATION AND PRODUCT SAMPLES AND THE COLLECTION OF CONSUMER FEEDBACK, IN CLASS 35 (U.S. CLS. 100, 101 AND 102).

FIRST USE 1-1-1995; IN COMMERCE 1-1-1995.

FOR: PROVIDING ON-LINE FACILITIES FOR REAL-TIME INTERACTION WITH OTHER COMPUTER USERS AND ELECTRONIC BULLETIN BOARDS FOR TRANSMISSION OF MESSAGES AMONG USERS IN THE FIELD OF THE RETAIL FOOD INDUSTRY, CONSUMER FOOD-BUYING HABITS AND TRENDS, AND NEW FOOD PRODUCTS, IN CLASS 38 (U.S. CLS. 100, 101 AND 104).

FIRST USE 10-28-2010; IN COMMERCE 10-28-2010.

FOR: ENTERTAINMENT AND EDUCATION SERVICES, NAMELY, ONGOING TELEVISION PROGRAMS AND ONGOING AUDIO/VISUAL SEGMENTS PROVIDING INFORMATION CONCERNING THE RETAIL FOOD INDUSTRY, CONSUMER FOOD-BUYING HABITS AND TRENDS, AND NEW FOOD PRODUCTS DELIVERED BY INTERNET, GLOBAL COMPUTER NETWORKS, COMPUTER AND COMMUNICATION NETWORKS; PROVIDING NEWSLETTERS WITH INFORMATION CONCERNING THE RETAIL FOOD INDUSTRY, CONSUMER FOOD-BUYING HABITS AND TRENDS, AND NEW FOOD PRODUCTS, VIA E-MAIL; ENTERTAINMENT AND EDUCATION SERVICES, NAMELY, THE PRESENTATION OF LIVE SPEECHES AND LECTURES IN THE FIELD OF RETAIL FOOD INDUSTRY, CONSUMER



David J. Kyjars

Director of the United States Patent and Trademark Office

Reg. No. 4,066,704 FOOD-BUYING HABITS AND TRENDS, AND NEW FOOD PRODUCTS, IN CLASS 41 (U.S. CLS. 100, 101 AND 107).

FIRST USE 2-15-1996; IN COMMERCE 2-15-1996.

FOR: ONLINE TOOLS, NAMELY, PROVIDING TEMPORARY USE OF A WEB-BASED SOFTWARE APPLICATION FOR TRACKING EATING HABITS AND TRACKING HEALTH AND FITNESS ACTIVITIES, IN CLASS 42 (U.S. CLS. 100 AND 101).

FIRST USE 2-15-1996; IN COMMERCE 2-15-1996.

FOR: PROVIDING A WEB SITE FEATURING INFORMATION REGARDING RECIPES, IN CLASS 43 (U.S. CLS. 100 AND 101).

FIRST USE 2-15-1996; IN COMMERCE 2-15-1996.

FOR: PROVIDING A WEB SITE FEATURING INFORMATION ON HEALTH AND NUTRITION; PROVIDING FOOD NUTRITION INFORMATION VIA COMPUTER AND COMMUNICATION NETWORKS ABOUT NEW FOOD PRODUCTS, IN CLASS 44 (U.S. CLS. 100 AND 101).

FIRST USE 2-15-1996; IN COMMERCE 2-15-1996.

THE MARK CONSISTS OF STANDARD CHARACTERS WITHOUT CLAIM TO ANY PARTICULAR FONT, STYLE, SIZE, OR COLOR.

OWNER OF U.S. REG. NO. 3,996,703.

THE NAME(S), PORTRAIT(S), AND/OR SIGNATURE(S) SHOWN IN THE MARK IDENTIFIES "PHILIP LEMPert", WHOSE CONSENT(S) TO REGISTER IS MADE OF RECORD.

SER. NO. 85-300,249, FILED 4-20-2011.

WON TEAK OH, EXAMINING ATTORNEY

United States of America

United States Patent and Trademark Office

B&B

Reg. No. 4,066,705

Registered Dec. 6, 2011

Int. Cl.: 36

SERVICE MARK

PRINCIPAL REGISTER

BROWN & BROWN, INC. (FLORIDA CORPORATION)
SUITE 400
3101 W. MARTIN LUTHER KING BLVD.
TAMPA, FL 33607

FOR: INSURANCE ADMINISTRATION, INSURANCE BROKERAGE AND INSURANCE UNDERWRITING SERVICES IN THE FIELD OF PROPERTY AND CASUALTY, IN CLASS 36 (U.S. CLS. 100, 101 AND 102).

FIRST USE 0-0-1999; IN COMMERCE 0-0-1999.

THE MARK CONSISTS OF STANDARD CHARACTERS WITHOUT CLAIM TO ANY PARTICULAR FONT, STYLE, SIZE, OR COLOR.

OWNER OF U.S. REG. NOS. 3,173,945, 3,324,705 AND OTHERS.

SER. NO. 85-300,272, FILED 4-20-2011.

KEVIN DINALLO, EXAMINING ATTORNEY



David J. Kybas

Director of the United States Patent and Trademark Office

United States of America

United States Patent and Trademark Office



GenFi
Family & Fiduciary Services

Reg. No. 4,066,706

Registered Dec. 6, 2011

Int. Cl.: 36

SERVICE MARK

PRINCIPAL REGISTER

GENFI (ILLINOIS LIMITED LIABILITY COMPANY)
401
1016 WEST JACKSON
CHICAGO, IL 60607

FOR: FINANCIAL PLANNING AND INVESTMENT ADVISORY SERVICES, IN CLASS 36
(U.S. CLS. 100, 101 AND 102).

FIRST USE 2-1-2011; IN COMMERCE 2-1-2011.

NO CLAIM IS MADE TO THE EXCLUSIVE RIGHT TO USE "FAMILY & FIDUCIARY SERVICES", APART FROM THE MARK AS SHOWN.

THE STIPPLING IS FOR SHADING PURPOSES ONLY.

THE MARK CONSISTS OF AN ABSTRACT CIRCULAR DESIGN CONTAINING A STYLIZED TREE, ABOVE THE STYLIZED TEXT "GENFI FAMILY & FIDUCIARY SERVICES".

SER. NO. 85-300,299, FILED 4-20-2011.

ANDREA K. NADELMAN, EXAMINING ATTORNEY



David J. Kybas

Director of the United States Patent and Trademark Office

United States of America

United States Patent and Trademark Office

Kindergarten Tech

Reg. No. 4,066,707

Registered Dec. 6, 2011

Int. Cl.: 41

SERVICE MARK

PRINCIPAL REGISTER

MINNIELAND PRIVATE DAY SCHOOL, INC. (VIRGINIA CORPORATION), AKA
MINNIELAND ACADEMY
4300 PRINCE WILLIAM PARKWAY
WOODBIDGE, VA 22192

FOR: EDUCATION SERVICES IN THE NATURE OF EARLY CHILDHOOD INSTRUCTION;
EDUCATION SERVICES, NAMELY, PROVIDING KINDERGARTEN THROUGH 12TH
GRADE (K-12) CLASSROOM INSTRUCTION, IN CLASS 41 (U.S. CLS. 100, 101 AND 107).

FIRST USE 3-1-2010; IN COMMERCE 9-7-2010.

THE MARK CONSISTS OF STANDARD CHARACTERS WITHOUT CLAIM TO ANY PAR-
TICULAR FONT, STYLE, SIZE, OR COLOR.

NO CLAIM IS MADE TO THE EXCLUSIVE RIGHT TO USE "KINDERGARTEN", APART
FROM THE MARK AS SHOWN.

SER. NO. 85-300,334, FILED 4-20-2011.

LAURA KOVALSKY, EXAMINING ATTORNEY



David J. Kyros

Director of the United States Patent and Trademark Office

United States of America

United States Patent and Trademark Office

ULTIMATE COLLECTION

Reg. No. 4,066,708

Registered Dec. 6, 2011

Int. Cl.: 16

TRADEMARK

PRINCIPAL REGISTER

THE UPPER DECK COMPANY (NEVADA CORPORATION)
2251 RUTHERFORD ROAD
CARLSBAD, CA 92008

FOR: TRADING CARDS, IN CLASS 16 (U.S. CLS. 2, 5, 22, 23, 29, 37, 38 AND 50).

FIRST USE 1-31-2001; IN COMMERCE 1-31-2001.

THE MARK CONSISTS OF STANDARD CHARACTERS WITHOUT CLAIM TO ANY PARTICULAR FONT, STYLE, SIZE, OR COLOR.

OWNER OF U.S. REG. NO. 2,950,466.

NO CLAIM IS MADE TO THE EXCLUSIVE RIGHT TO USE "COLLECTION", APART FROM THE MARK AS SHOWN.

SEC. 2(F).

SER. NO. 85-300,349, FILED 4-20-2011.

NELSON SNYDER, EXAMINING ATTORNEY



David J. Kyffers

Director of the United States Patent and Trademark Office

United States of America

United States Patent and Trademark Office



Reg. No. 4,066,709

AMPLA HEALTH (CALIFORNIA CORPORATION)
935 MARKET STREET
YUBA CITY, CA 95991

Registered Dec. 6, 2011

Int. Cl.: 44

FOR: HEALTH CARE SERVICES AND MEDICAL CLINICS, IN CLASS 44 (U.S. CLS. 100 AND 101).

SERVICE MARK

FIRST USE 4-15-2011; IN COMMERCE 4-15-2011.

PRINCIPAL REGISTER

NO CLAIM IS MADE TO THE EXCLUSIVE RIGHT TO USE "HEALTH", APART FROM THE MARK AS SHOWN.

THE COLOR(S) GREEN AND PURPLE IS/ARE CLAIMED AS A FEATURE OF THE MARK.

THE MARK CONSISTS OF A GREEN LEAF DESIGN AGAINST A PURPLE QUADRILATERAL WITH A CURVED LEFT SIDE, WHICH IS ABOVE THE WORD "AMPLA" IN PURPLE, WHICH IS ABOVE THE WORD "HEALTH" IN GREEN, WHICH IS ABOVE THE WORDS "CARE TO IMPROVE YOUR LIFE." IN PURPLE.

SER. NO. 85-300,469, FILED 4-20-2011.

ANDREW LEASER, EXAMINING ATTORNEY



David J. Kyros

Director of the United States Patent and Trademark Office

United States of America

United States Patent and Trademark Office



Reg. No. 4,066,710

Registered Dec. 6, 2011

Int. Cl.: 44

SERVICE MARK

PRINCIPAL REGISTER

AMPLA HEALTH (CALIFORNIA CORPORATION)
935 MARKET STREET
YUBA CITY, CA 95991

FOR: HEALTH CARE SERVICES AND MEDICAL CLINICS, IN CLASS 44 (U.S. CLS. 100 AND 101).

FIRST USE 4-15-2011; IN COMMERCE 4-15-2011.

THE MARK CONSISTS OF A GREEN LEAF DESIGN AGAINST A PURPLE QUADRILATERAL WITH A CURVED LEFT SIDE.

THE COLOR(S) GREEN AND PURPLE IS/ARE CLAIMED AS A FEATURE OF THE MARK.

SER. NO. 85-300,474, FILED 4-20-2011.

ANDREW LEASER, EXAMINING ATTORNEY



David J. Kyffers

Director of the United States Patent and Trademark Office

United States of America

United States Patent and Trademark Office



Reg. No. 4,066,711

Registered Dec. 6, 2011

Int. Cl.: 43

SERVICE MARK

PRINCIPAL REGISTER

TRIPLE T ENTERPRISES (IDAHO CORPORATION)
408 EAST 41ST STREET
BOISE, ID 83714

FOR: RESTAURANT SERVICES, RESTAURANTS FEATURING IN RESTAURANT DINING, HOME DELIVERY, CATERING AND FOOD CARRY OUT SERVICES; PROVIDING OF BEVERAGES; PREPARATION OF FOOD, NAMELY, GRILLED FOOD, PIZZA, PASTA AND SANDWICHES, IN CLASS 43 (U.S. CLS. 100 AND 101).

FIRST USE 2-1-1992; IN COMMERCE 2-1-1992.

OWNER OF U.S. REG. NOS. 2,841,465, 3,504,730 AND OTHERS.

THE MARK CONSISTS OF THE WORDS "SMOKY MOUNTAIN" ARE IN THE FOREGROUND AND THE OUTLINE OF MOUNTAINS ARE IN THE BACKGROUND.

SER. NO. 85-300,477, FILED 4-20-2011.

MARGARET POWER, EXAMINING ATTORNEY



David J. Kybas

Director of the United States Patent and Trademark Office

United States of America

United States Patent and Trademark Office

AMPLA HEALTH

Reg. No. 4,066,712

AMPLA HEALTH (CALIFORNIA CORPORATION)
935 MARKET STREET
YUBA CITY, CA 95991

Registered Dec. 6, 2011

Int. Cl.: 44

FOR: HEALTH CARE SERVICES AND MEDICAL CLINICS, IN CLASS 44 (U.S. CLS. 100 AND 101).

SERVICE MARK

FIRST USE 4-15-2011; IN COMMERCE 4-15-2011.

PRINCIPAL REGISTER

THE MARK CONSISTS OF STANDARD CHARACTERS WITHOUT CLAIM TO ANY PARTICULAR FONT, STYLE, SIZE, OR COLOR.

NO CLAIM IS MADE TO THE EXCLUSIVE RIGHT TO USE "HEALTH", APART FROM THE MARK AS SHOWN.

SER. NO. 85-300,480, FILED 4-20-2011.

ANDREW LEASER, EXAMINING ATTORNEY



David J. Kyffers

Director of the United States Patent and Trademark Office

United States of America

United States Patent and Trademark Office

Come Together Trading Company

Reg. No. 4,066,713

MARSHALL, TAMMY (UNITED STATES INDIVIDUAL)
P.O. BOX 896
CANTON, TX 75103

Registered Dec. 6, 2011

Int. Cl.: 35

FOR: ON-LINE RETAIL STORE SERVICES FEATURING A WIDE VARIETY OF CONSUMER GOODS OF OTHERS, IN CLASS 35 (U.S. CLS. 100, 101 AND 102).

SERVICE MARK

FIRST USE 10-1-2009; IN COMMERCE 10-30-2009.

PRINCIPAL REGISTER

THE MARK CONSISTS OF STANDARD CHARACTERS WITHOUT CLAIM TO ANY PARTICULAR FONT, STYLE, SIZE, OR COLOR.

NO CLAIM IS MADE TO THE EXCLUSIVE RIGHT TO USE "TRADING COMPANY", APART FROM THE MARK AS SHOWN.

SER. NO. 85-300,572, FILED 4-20-2011.

JAY FLOWERS, EXAMINING ATTORNEY



David J. Kyffers

Director of the United States Patent and Trademark Office

United States of America

United States Patent and Trademark Office

THUNDERSNOW STUDIOS

Reg. No. 4,066,714

Registered Dec. 6, 2011

Int. Cl.: 9

TRADEMARK

PRINCIPAL REGISTER

FERRELL, STEVEN (UNITED STATES INDIVIDUAL)
3201 LANDOVER
ST 1620
ALEXANDRIA, VA 22305

FOR: COMPUTER APPLICATION SOFTWARE FOR MOBILE PHONES, NAMELY, DOWNLOADABLE SOFTWARE FOR DATABASE MANAGEMENT AND COMPUTER GAME SOFTWARE, IN CLASS 9 (U.S. CLS. 21, 23, 26, 36 AND 38).

FIRST USE 4-11-2011; IN COMMERCE 4-11-2011.

THE MARK CONSISTS OF STANDARD CHARACTERS WITHOUT CLAIM TO ANY PARTICULAR FONT, STYLE, SIZE, OR COLOR.

NO CLAIM IS MADE TO THE EXCLUSIVE RIGHT TO USE "STUDIOS", APART FROM THE MARK AS SHOWN.

SER. NO. 85-300,682, FILED 4-21-2011.

SAMUEL E. SHARPER JR., EXAMINING ATTORNEY



David J. Kyffers

Director of the United States Patent and Trademark Office

United States of America

United States Patent and Trademark Office

WINSUM PRESS

Reg. No. 4,066,715

Registered Dec. 6, 2011

Int. Cl.: 41

SERVICE MARK

PRINCIPAL REGISTER

WINSUM PRESS, INC. (FLORIDA CORPORATION)
8920 WOODSIDE COURT
DAVIE, FL 33328

FOR: PUBLISHING OF BOOKS AND REVIEWS; PUBLISHING OF BOOKS, E-BOOKS, AUDIO BOOKS, MUSIC AND ILLUSTRATIONS, IN CLASS 41 (U.S. CLS. 100, 101 AND 107).

FIRST USE 1-28-2011; IN COMMERCE 1-28-2011.

THE MARK CONSISTS OF STANDARD CHARACTERS WITHOUT CLAIM TO ANY PARTICULAR FONT, STYLE, SIZE, OR COLOR.

NO CLAIM IS MADE TO THE EXCLUSIVE RIGHT TO USE "PRESS", APART FROM THE MARK AS SHOWN.

SER. NO. 85-300,688, FILED 4-21-2011.

TRACY FLETCHER, EXAMINING ATTORNEY



David J. Kybas

Director of the United States Patent and Trademark Office

United States of America

United States Patent and Trademark Office

VERSION-NOW

Reg. No. 4,066,716

Registered Dec. 6, 2011

Int. Cl.: 42

SERVICE MARK

PRINCIPAL REGISTER

DOTLOOP, LLC (OHIO LIMITED LIABILITY COMPANY), DBA THE DOTLOOP COMPANY
SUITE 415
4445 LAKE FOREST DRIVE
CINCINNATI, OH 45242

FOR: COMPUTER SERVICES, NAMELY, HOSTING AND MAINTAINING AN ON-LINE
WEB SITE FOR OTHERS TO UPLOAD, STORE AND SHARE REAL ESTATE-RELATED
DOCUMENTS AND INFORMATION, ELECTRONICALLY SIGN REAL ESTATE-RELATED
DOCUMENTS AND CREATE AND MAINTAIN REAL ESTATE-RELATED DOCUMENTS
AND CONTRACTS, IN CLASS 42 (U.S. CLS. 100 AND 101).

FIRST USE 2-17-2011; IN COMMERCE 2-17-2011.

THE MARK CONSISTS OF STANDARD CHARACTERS WITHOUT CLAIM TO ANY PAR-
TICULAR FONT, STYLE, SIZE, OR COLOR.

SER. NO. 85-300,735, FILED 4-21-2011.

BARBARA A. GOLD, EXAMINING ATTORNEY



David J. Kybas

Director of the United States Patent and Trademark Office

United States of America
United States Patent and Trademark Office

ANYROOM

Reg. No. 4,066,717

Registered Dec. 6, 2011

Int. Cl.: 41

SERVICE MARK

PRINCIPAL REGISTER

COMCAST CORPORATIONN (PENNSYLVANIA CORPORATION)
1701 JOHN F. KENNEDY BOULEVARD
PHILADELPHIA, PA 19103

FOR: DIGITAL VIDEO RECORDING SERVICES, IN CLASS 41 (U.S. CLS. 100, 101 AND 107).

FIRST USE 12-23-2009; IN COMMERCE 12-23-2009.

THE MARK CONSISTS OF STANDARD CHARACTERS WITHOUT CLAIM TO ANY PARTICULAR FONT, STYLE, SIZE, OR COLOR.

OWNER OF U.S. REG. NO. 3,723,742.

SER. NO. 85-300,791, FILED 4-21-2011.

MARC LEIPZIG, EXAMINING ATTORNEY



David J. Kyffers

Director of the United States Patent and Trademark Office

United States of America

United States Patent and Trademark Office

Taboo Jive

Reg. No. 4,066,718

Registered Dec. 6, 2011

Int. Cl.: 38

SERVICE MARK

PRINCIPAL REGISTER

SCOTT HACKER (UNITED STATES INDIVIDUAL)
5900 PLANTATION DRIVE
ROSWELL, GA 30075

FOR: ONLINE ELECTRONIC BULLETIN BOARD FOR TRANSMISSION OF MESSAGES CONCERNING TOPICS THAT ARE TYPICALLY SUPPRESSED, FORBIDDEN OR CONTROVERSIAL FOR THE SAKE OF EDUCATIONAL AWARENESS, SOCIAL SUSTAINABILITY, ENTERTAINMENT AND PERSONAL GROWTH, BEYOND THE LIMITATIONS OF CULTURE, IN CLASS 38 (U.S. CLS. 100, 101 AND 104).

FIRST USE 3-1-2011; IN COMMERCE 3-1-2011.

THE MARK CONSISTS OF STANDARD CHARACTERS WITHOUT CLAIM TO ANY PARTICULAR FONT, STYLE, SIZE, OR COLOR.

NO CLAIM IS MADE TO THE EXCLUSIVE RIGHT TO USE "TABOO", APART FROM THE MARK AS SHOWN.

SER. NO. 85-300,834, FILED 4-21-2011.

RUSS HERMAN, EXAMINING ATTORNEY



David J. Kyros

Director of the United States Patent and Trademark Office

United States of America

United States Patent and Trademark Office

MYCARDIOPAD

Reg. No. 4,066,719

Registered Dec. 6, 2011

Int. Cl.: 10

TRADEMARK

PRINCIPAL REGISTER

ESAOTE, S.P.A. (ITALY CORPORATION)
VIALE BIANCA MARIA 25
MILANO, ITALY 20100

FOR: ELECTROCARDIOGRAPHS; CARDIOVASCULAR EVALUATION DEVICES FOR PERFORMING EXERCISE STRESS TESTS, IN CLASS 10 (U.S. CLS. 26, 39 AND 44).

THE MARK CONSISTS OF STANDARD CHARACTERS WITHOUT CLAIM TO ANY PARTICULAR FONT, STYLE, SIZE, OR COLOR.

PRIORITY CLAIMED UNDER SEC. 44(D) ON ERPN CMNTY TM OFC APPLICATION NO. 009525965, FILED 11-16-2010, REG. NO. 009525965, DATED 4-1-2011, EXPIRES 11-16-2021.

SER. NO. 85-300,864, FILED 4-21-2011.

JOHN WILKE, EXAMINING ATTORNEY



David J. Kybas

Director of the United States Patent and Trademark Office

United States of America

United States Patent and Trademark Office

STRIKE GROUP

Reg. No. 4,066,720

Registered Dec. 6, 2011

Int. Cl.: 35

SERVICE MARK

PRINCIPAL REGISTER

STRIKE GROUP LLC (MICHIGAN LIMITED LIABILITY COMPANY)
18800 FAIRWAY DRIVE, SUITE 10
DETROIT, MI 48221

FOR: BUSINESS MANAGEMENT SERVICES, NAMELY, SUPPLY CHAIN LOGISTICS, REVERSE LOGISTICS, AND SOURCING OF GOODS OF OTHERS; LOGISTICS MANAGEMENT; BUSINESS MANAGEMENT SERVICES; BUSINESS CONSULTING SERVICES; BUSINESS ADMINISTRATION SERVICES; PROVIDING FACILITIES FOR LOGISTICS MANAGEMENT; PROVIDING COMPUTERIZED TRACKING AND TRACING OF GOODS IN TRANSIT; LICENSING OF COMPUTER SOFTWARE; PROVIDING SUPPORT FOR IT NETWORKS HANDLING IMAGES AND DATA; DATA PROCESSING SERVICES; MANAGEMENT OF COMMODITY SERVICES, IN CLASS 35 (U.S. CLS. 100, 101 AND 102).

FIRST USE 10-19-1998; IN COMMERCE 8-30-1999.

THE MARK CONSISTS OF STANDARD CHARACTERS WITHOUT CLAIM TO ANY PARTICULAR FONT, STYLE, SIZE, OR COLOR.

NO CLAIM IS MADE TO THE EXCLUSIVE RIGHT TO USE "GROUP", APART FROM THE MARK AS SHOWN.

SER. NO. 85-300,865, FILED 4-21-2011.

JOHN WILKE, EXAMINING ATTORNEY



David J. Kybas

Director of the United States Patent and Trademark Office

United States of America

United States Patent and Trademark Office

PayProtect

Reg. No. 4,066,721

JOHNSON, AARON R. (UNITED STATES INDIVIDUAL)
1504 HIGHTOP TR.
KNOXVILLE, TN 37923 AND

Registered Dec. 6, 2011

Int. Cl.: 42

JOHNSON, JARED L. (UNITED STATES INDIVIDUAL)
624 SUNNYDALE
KNOXVILLE, TN 37923

SERVICE MARK

PRINCIPAL REGISTER

FOR: PROVIDING A SECURE ELECTRONIC ONLINE SYSTEM FEATURING TECHNOLOGY WHICH ALLOWS CUSTOMERS TO PAY FOR SUBCONTRACTOR LABOR WITH CREDIT CARD, BUT MAINTAINING THE ABILITY TO RELEASE THE FUNDS ONLY WHEN THE WORK IS PERFORMED TO THEIR SATISFACTION AND IN ACCORDANCE WITH INDUSTRY STANDARDS, IN CLASS 42 (U.S. CLS. 100 AND 101).

FIRST USE 12-14-2009; IN COMMERCE 7-2-2010.

THE MARK CONSISTS OF STANDARD CHARACTERS WITHOUT CLAIM TO ANY PARTICULAR FONT, STYLE, SIZE, OR COLOR.

SER. NO. 85-300,876, FILED 4-21-2011.

ANNE MADDEN, EXAMINING ATTORNEY



David J. Kybas

Director of the United States Patent and Trademark Office

United States of America
United States Patent and Trademark Office

omg

Reg. No. 4,066,722

P. BRIAN O'SHEA (UNITED STATES INDIVIDUAL)
703 HAWKSHEAD ROAD
TIMONIUM, MD 21093

Registered Dec. 6, 2011

Int. Cl.: 41

FOR: ENTERTAINMENT MEDIA PRODUCTION SERVICES FOR MOTION PICTURES,
TELEVISION AND INTERNET, IN CLASS 41 (U.S. CLS. 100, 101 AND 107).

SERVICE MARK

FIRST USE 10-15-2010; IN COMMERCE 10-15-2010.

PRINCIPAL REGISTER

THE MARK CONSISTS OF THE LOWER-CASE LETTERS "OMG," WITH RINGS SURROUND-
ING THE LETTER "O".

SER. NO. 85-300,877, FILED 4-21-2011.

ANNE MADDEN, EXAMINING ATTORNEY



David J. Kyros

Director of the United States Patent and Trademark Office

United States of America
United States Patent and Trademark Office

AGORA

Reg. No. 4,066,723

SOTIROPOULOS, MICHAEL (UNITED STATES INDIVIDUAL)
1712 WESTHEIMER
HOUSTON, TX 77098

Registered Dec. 6, 2011

Int. Cl.: 43

FOR: COFFEE BARS; COFFEE SHOPS; COFFEE-HOUSE AND SNACK-BAR SERVICES;
WINE BARS, IN CLASS 43 (U.S. CLS. 100 AND 101).

SERVICE MARK

FIRST USE 10-26-2001; IN COMMERCE 12-0-2001.

PRINCIPAL REGISTER

THE MARK CONSISTS OF STANDARD CHARACTERS WITHOUT CLAIM TO ANY PARTICULAR FONT, STYLE, SIZE, OR COLOR.

SER. NO. 85-300,878, FILED 4-21-2011.

ANNE MADDEN, EXAMINING ATTORNEY



David J. Kybas

Director of the United States Patent and Trademark Office

United States of America

United States Patent and Trademark Office

HWH GROUP

Reg. No. 4,066,724

Registered Dec. 6, 2011

Int. Cls.: 35 and 36

SERVICE MARK

PRINCIPAL REGISTER

HARRISON WALKER & HARPER, LP (TEXAS LIMITED PARTNERSHIP)
222 EAST HICKORY ST
PARIS, TX 75460

FOR: BUSINESS DEVELOPMENT CONSULTING SERVICES; BUSINESS RELOCATION CONSULTING, IN CLASS 35 (U.S. CLS. 100, 101 AND 102).

FIRST USE 3-15-2011; IN COMMERCE 3-15-2011.

FOR: CAPITAL INVESTMENT CONSULTING, IN CLASS 36 (U.S. CLS. 100, 101 AND 102).

FIRST USE 3-15-2011; IN COMMERCE 3-15-2011.

THE MARK CONSISTS OF STANDARD CHARACTERS WITHOUT CLAIM TO ANY PARTICULAR FONT, STYLE, SIZE, OR COLOR.

NO CLAIM IS MADE TO THE EXCLUSIVE RIGHT TO USE "GROUP", APART FROM THE MARK AS SHOWN.

SER. NO. 85-300,887, FILED 4-21-2011.

SOPHIA S. KIM, EXAMINING ATTORNEY



David J. Kybas

Director of the United States Patent and Trademark Office

United States of America

United States Patent and Trademark Office

MusicLites

Reg. No. 4,066,725

Registered Dec. 6, 2011

Int. Cl.: 9

TRADEMARK

PRINCIPAL REGISTER

ARTISON LLC (NEVADA LIMITED LIABILITY COMPANY)
774 MAYS BLVD. SUITE 10-183
INCLINE VILLAGE, NV 89451

FOR: AUDIO ELECTRONIC COMPONENTS, NAMELY, SURROUND SOUND SYSTEMS; AUDIO SPEAKERS; HOME THEATER SYSTEMS COMPRISING AUDIO SPEAKER SYSTEMS, NAMELY, SPEAKERS, POWERED SUBWOOFERS, AMPLIFIERS, PREAMPLIFIERS AND COMPACT DISC PLAYERS; LOUD SPEAKER SYSTEMS; LOUD SPEAKERS; SPEAKER ENCLOSURES; SPEAKER MICROPHONES, IN CLASS 9 (U.S. CLS. 21, 23, 26, 36 AND 38).

FIRST USE 9-1-2010; IN COMMERCE 9-10-2010.

THE MARK CONSISTS OF THE WORD "MUSICLITES" WITH A CLEF ON THE RIGHT VERTICAL LEG OF THE LETTER "M" AND SEVERAL STARS SURROUNDING THE DOT OF THE SECOND "I" IN "MUSICLITES".

SER. NO. 85-300,900, FILED 4-21-2011.

SOPHIA S. KIM, EXAMINING ATTORNEY



David J. Kyjars

Director of the United States Patent and Trademark Office

United States of America

United States Patent and Trademark Office

Inspiring Leadership Innovation

Reg. No. 4,066,726

Registered Dec. 6, 2011

Int. Cl.: 41

SERVICE MARK

PRINCIPAL REGISTER

METCALF & ASSOCIATES, INC. (OHIO CORPORATION)
351 GUDRUN ROAD
COLUMBUS, OH 43202

FOR: PROFESSIONAL COACHING SERVICES IN THE FIELD OF LEADERSHIP IN BUSINESS; TRAINING SERVICES IN THE FIELD OF LEADERSHIP IN BUSINESS, IN CLASS 41 (U.S. CLS. 100, 101 AND 107).

FIRST USE 9-10-2010; IN COMMERCE 9-10-2010.

THE MARK CONSISTS OF STANDARD CHARACTERS WITHOUT CLAIM TO ANY PARTICULAR FONT, STYLE, SIZE, OR COLOR.

NO CLAIM IS MADE TO THE EXCLUSIVE RIGHT TO USE "LEADERSHIP", APART FROM THE MARK AS SHOWN.

SER. NO. 85-300,917, FILED 4-21-2011.

MARC LEIPZIG, EXAMINING ATTORNEY



David J. Kybas

Director of the United States Patent and Trademark Office

United States of America

United States Patent and Trademark Office

FEARLESS MEDIA

Reg. No. 4,066,727

FEARLESS MEDIA, LLC (NEW YORK LIMITED LIABILITY COMPANY)
575 MADISON AVE. SUITE 1006
NEW YORK, NY 10022

Registered Dec. 6, 2011

Int. Cl.: 35

FOR: ADVERTISING SERVICES, NAMELY, PROMOTING THE BRANDS, GOODS AND SERVICES OF OTHERS, IN CLASS 35 (U.S. CLS. 100, 101 AND 102).

SERVICE MARK

FIRST USE 10-27-2009; IN COMMERCE 10-27-2009.

PRINCIPAL REGISTER

THE MARK CONSISTS OF STANDARD CHARACTERS WITHOUT CLAIM TO ANY PARTICULAR FONT, STYLE, SIZE, OR COLOR.

NO CLAIM IS MADE TO THE EXCLUSIVE RIGHT TO USE "MEDIA", APART FROM THE MARK AS SHOWN.

SER. NO. 85-300,977, FILED 4-21-2011.

NAPOLEON SHARMA, EXAMINING ATTORNEY



David J. Kybas

Director of the United States Patent and Trademark Office

United States of America

United States Patent and Trademark Office

Delectus

Reg. No. 4,066,728

Registered Dec. 6, 2011

Int. Cl.: 33

TRADEMARK

PRINCIPAL REGISTER

DELECTUS WINERY (CALIFORNIA PARTNERSHIP)
908 C ENTERPRISE WAY
NAPA, CA 94558

FOR: WINE, IN CLASS 33 (U.S. CLS. 47 AND 49).

FIRST USE 3-1-1996; IN COMMERCE 3-1-1996.

THE MARK CONSISTS OF STANDARD CHARACTERS WITHOUT CLAIM TO ANY PARTICULAR FONT, STYLE, SIZE, OR COLOR.

THE ENGLISH TRANSLATION OF "DELECTUS" IN THE MARK IS "ULTIMATE CHOICE".

SER. NO. 85-301,001, FILED 4-21-2011.

KATINA MISTER, EXAMINING ATTORNEY



David J. Kybas

Director of the United States Patent and Trademark Office

United States of America

United States Patent and Trademark Office



Reg. No. 4,066,729

Registered Dec. 6, 2011

Int. Cl.: 43

SERVICE MARK

PRINCIPAL REGISTER

MINERVA ORGANICS LLC (WASHINGTON LIMITED LIABILITY COMPANY), DBA
THRIVE
1026 NE 65TH ST #A102
SEATTLE, WA 98115

FOR: CAFE AND RESTAURANT SERVICES; HEALTH RESORT SERVICES, NAMELY, PROVIDING FOOD AND LODGING THAT SPECIALIZE IN PROMOTING PATRONS' GENERAL HEALTH AND WELL-BEING; HOTEL AND RESTAURANT SERVICES; RESTAURANT SERVICES, NAMELY, PROVIDING OF FOOD AND BEVERAGES FOR CONSUMPTION ON AND OFF THE PREMISES, IN CLASS 43 (U.S. CLS. 100 AND 101).

FIRST USE 3-27-2008; IN COMMERCE 12-17-2008.

THE MARK CONSISTS OF A STYLIZED IMAGE OF THE WORD "THRIVE" WITH VERTICAL, ASYMMETRICAL S-SHAPED FIGURES ABOVE THE LETTER "I" THAT IS SITUATED ABOVE A RECTANGLE WITH ROUNDED EDGES, WHERE BOTH THE RECTANGLE AND STYLIZED WORD ARE BISECTED BY A HORIZONTAL S-SHAPED LINE.

SER. NO. 85-301,035, FILED 4-21-2011.

JAMES LOVELACE, EXAMINING ATTORNEY



David J. Kypos

Director of the United States Patent and Trademark Office

United States of America

United States Patent and Trademark Office

POLLENIQUE JUVENESCENT

Reg. No. 4,066,730

Registered Dec. 6, 2011

Int. Cl.: 3

TRADEMARK

PRINCIPAL REGISTER

GRAMINEX, L.L.C. (MICHIGAN LIMITED LIABILITY COMPANY)
95 MIDLAND ROAD
SAGINAW, MI 48603

FOR: SKIN CREAMS; SKIN MOISTURIZERS; SKIN CONDITIONERS; COSMETIC PREPARATIONS FOR SKIN CARE, IN CLASS 3 (U.S. CLS. 1, 4, 6, 50, 51 AND 52).

FIRST USE 12-23-2009; IN COMMERCE 12-23-2009.

THE MARK CONSISTS OF STANDARD CHARACTERS WITHOUT CLAIM TO ANY PARTICULAR FONT, STYLE, SIZE, OR COLOR.

OWNER OF U.S. REG. NO. 3,446,187.

SER. NO. 85-301,045, FILED 4-21-2011.

DANIEL CAPSHAW, EXAMINING ATTORNEY



David J. Kyffers

Director of the United States Patent and Trademark Office

United States of America

United States Patent and Trademark Office

H.U.M.A.N.

Reg. No. 4,066,731

Registered Dec. 6, 2011

Int. Cls.: 9 and 35

TRADEMARK

SERVICE MARK

PRINCIPAL REGISTER

NUTRITION WITHOUT BORDERS (NEVADA LIMITED LIABILITY COMPANY)
333 S. WILTON PL. STE. 9
LOS ANGELES., CA 90020

FOR: VENDING MACHINES, IN CLASS 9 (U.S. CLS. 21, 23, 26, 36 AND 38).

FIRST USE 6-24-2008; IN COMMERCE 12-1-2008.

FOR: VENDING IN THE FIELD OF FOOD, DRINK, AND NUTRITIONAL SUPPLEMENTS,
IN CLASS 35 (U.S. CLS. 100, 101 AND 102).

FIRST USE 6-24-2008; IN COMMERCE 12-1-2008.

THE MARK CONSISTS OF STANDARD CHARACTERS WITHOUT CLAIM TO ANY PARTICULAR FONT, STYLE, SIZE, OR COLOR.

OWNER OF U.S. REG. NO. 3,666,406.

SER. NO. 85-301,145, FILED 4-21-2011.

SHAILA SETTLES, EXAMINING ATTORNEY



David J. Kypos

Director of the United States Patent and Trademark Office

United States of America

United States Patent and Trademark Office



Reg. No. 4,066,732

Registered Dec. 6, 2011

Int. Cl.: 45

SERVICE MARK

PRINCIPAL REGISTER

THE KOEWLER LAW FIRM, INC. (OHIO CORPORATION)
3578 BURRWOOD DRIVE
RICHFIELD, OH 442869406

FOR: LEGAL SERVICES IN THE NATURE OF WEALTH PRESERVATION FOR PERSONS
IN LONG-TERM CARE FACILITIES, IN CLASS 45 (U.S. CLS. 100 AND 101).

FIRST USE 8-21-2008; IN COMMERCE 8-21-2008.

THE MARK CONSISTS OF A DARK BLUE SQUARE WITH A LIGHT BLUE OUTLINE
HAVING THE LETTERS "JK" IN WHITE AND SHARING A COMMON VERTICAL ELEMENT,
WHEREIN DOT ATOP THE LETTER "J" IS IN LIGHT BLUE.

THE COLOR(S) DARK BLUE, LIGHT BLUE, AND WHITE IS/ARE CLAIMED AS A FEATURE
OF THE MARK.

SER. NO. 85-301,175, FILED 4-21-2011.

SUE LAWRENCE, EXAMINING ATTORNEY



David J. Kybas

Director of the United States Patent and Trademark Office

United States of America

United States Patent and Trademark Office

JANDY MONROE

Reg. No. 4,066,733

Registered Dec. 6, 2011

Int. Cl.: 45

SERVICE MARK

PRINCIPAL REGISTER

JANDY MONROE, LLC (NEW YORK LIMITED LIABILITY COMPANY)
18 CORNWALL LANE
HEMPSTEAD, NY 11550

FOR: PROVIDING A WEBSITE FEATURING INFORMATION IN THE FIELD OF FASHION, NAMELY, NEWS AND INFORMATION ON THE LATEST FASHION TRENDS AND STYLES, IN CLASS 45 (U.S. CLS. 100 AND 101).

FIRST USE 4-2-2011; IN COMMERCE 4-2-2011.

THE MARK CONSISTS OF STANDARD CHARACTERS WITHOUT CLAIM TO ANY PARTICULAR FONT, STYLE, SIZE, OR COLOR.

THE NAME "JANDY MONROE" DOES NOT IDENTIFY A LIVING INDIVIDUAL.

SER. NO. 85-301,182, FILED 4-21-2011.

MICHAEL TANNER, EXAMINING ATTORNEY



David J. Kybas

Director of the United States Patent and Trademark Office

United States of America

United States Patent and Trademark Office

THE FASHION BLOG AND MAGAZINE FOR THE EVERYDAY GIRL AND GAY

Reg. No. 4,066,734

JANDY MONROE, LLC (NEW YORK LIMITED LIABILITY COMPANY)
18 CORNWALL LANE
HEMPSTEAD, NY 11550

Registered Dec. 6, 2011

Int. Cl.: 45

FOR: PROVIDING A WEBSITE FEATURING INFORMATION IN THE FIELD OF FASHION, NAMELY, NEWS AND INFORMATION ON THE LATEST FASHION TRENDS AND STYLES, IN CLASS 45 (U.S. CLS. 100 AND 101).

SERVICE MARK

FIRST USE 4-2-2011; IN COMMERCE 4-2-2011.

PRINCIPAL REGISTER

THE MARK CONSISTS OF STANDARD CHARACTERS WITHOUT CLAIM TO ANY PARTICULAR FONT, STYLE, SIZE, OR COLOR.

NO CLAIM IS MADE TO THE EXCLUSIVE RIGHT TO USE "THE FASHION BLOG AND MAGAZINE", APART FROM THE MARK AS SHOWN.

SER. NO. 85-301,243, FILED 4-21-2011.

MICHAEL TANNER, EXAMINING ATTORNEY



David J. Kybas

Director of the United States Patent and Trademark Office

United States of America

United States Patent and Trademark Office

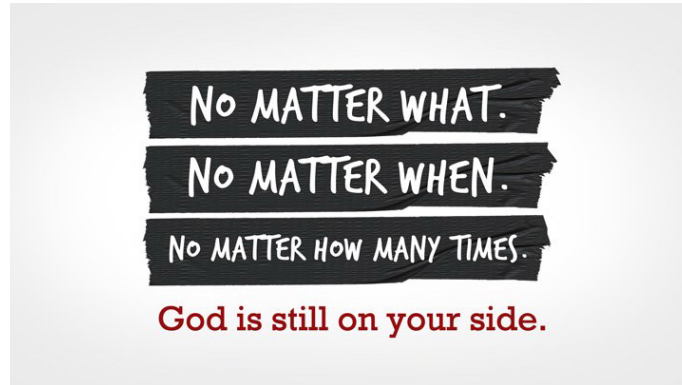

Reg. No. 4,066,735

Registered Dec. 6, 2011

Int. Cl.: 45

SERVICE MARK

PRINCIPAL REGISTER

ABUNDANT LIVING FAITH CENTER CHURCH, INC. (TEXAS CORPORATION)
1000A VALLEY CREST
EL PASO, TX 79907

FOR: RELIGIOUS AND SPIRITUAL SERVICES, NAMELY, CONDUCTING RELIGIOUS WORSHIP, EVANGELISTIC AND MINISTERIAL SERVICES, IN CLASS 45 (U.S. CLS. 100 AND 101).

FIRST USE 3-1-2011; IN COMMERCE 3-1-2011.

THE COLOR WHITE APPEARS IN THE WORDING "NO MATTER WHAT. NO MATTER WHEN. NO MATTER HOW MANY TIMES.". THE COLOR RED APPEARS IN THE WORDING "GOD IS STILL ON YOUR SIDE.". THE COLOR WHITE ALSO APPEARS IN THE BACKGROUND OF THE WORDING "GOD IS STILL ON YOUR SIDE.". THE COLOR BLACK APPEARS IN THE THREE DUCT TAPE LIKE BACKGROUND STRIPES WHICH BEAR THE WORDING "NO MATTER WHAT. NO MATTER WHEN. NO MATTER HOW MANY TIMES.".

THE COLOR(S) BLACK, WHITE, AND RED IS/ARE CLAIMED AS A FEATURE OF THE MARK.

SER. NO. 85-301,254, FILED 4-21-2011.

EVELYN BRADLEY, EXAMINING ATTORNEY



David J. Kyros

Director of the United States Patent and Trademark Office

United States of America

United States Patent and Trademark Office

ALLIANT POWDER

Reg. No. 4,066,736

Registered Dec. 6, 2011

Int. Cl.: 13

TRADEMARK

PRINCIPAL REGISTER

ALLIANT TECHSYSTEMS INC. (DELAWARE CORPORATION)
7480 FLYING CLOUD DRIVE
MINNEAPOLIS, MN 55344

FOR: SMOKELESS GUN POWDER, IN CLASS 13 (U.S. CLS. 2 AND 9).

FIRST USE 5-15-1995; IN COMMERCE 5-15-1995.

THE MARK CONSISTS OF STANDARD CHARACTERS WITHOUT CLAIM TO ANY PARTICULAR FONT, STYLE, SIZE, OR COLOR.

OWNER OF U.S. REG. NOS. 2,002,913 AND 2,375,888.

NO CLAIM IS MADE TO THE EXCLUSIVE RIGHT TO USE "POWDER", APART FROM THE MARK AS SHOWN.

SER. NO. 85-301,284, FILED 4-21-2011.

HELENE LIWINSKI, EXAMINING ATTORNEY



David J. Kybas

Director of the United States Patent and Trademark Office

United States of America

United States Patent and Trademark Office



Reg. No. 4,066,737

Registered Dec. 6, 2011

Int. Cl.: 45

DRUG PROCESS LICENSING ASSOCIATES, LLC (TEXAS LIMITED LIABILITY COMPANY),
DBA DPLA, LLC
SUITE 516
12160 N. ABRAMS ROAD
DALLAS, TX 75243

SERVICE MARK

FOR: PATENT LICENSING, IN CLASS 45 (U.S. CLS. 100 AND 101).

PRINCIPAL REGISTER

FIRST USE 1-11-2011; IN COMMERCE 1-11-2011.

THE MARK CONSISTS OF A HELIX DESIGN SUPERIMPOSED OVER AN INCOMPLETE CIRCLE AND THE LETTERS "DPLA" IN STYLIZED FORM, ALL WITHIN A RECTANGULAR CARRIER DESIGN. THE HELIX DESIGN LOGO IS DEPICTED IN THE COLORS RED, BLACK, WHITE AND GRAY. THE LETTERS "DPLA" AND THE RECTANGULAR CARRIER ARE BLACK.

THE COLOR(S) BLACK, RED, GRAY AND WHITE IS/ARE CLAIMED AS A FEATURE OF THE MARK.

SER. NO. 85-301,301, FILED 4-21-2011.

DAVID H. STINE, EXAMINING ATTORNEY



David J. Kybas

Director of the United States Patent and Trademark Office

United States of America

United States Patent and Trademark Office



Reg. No. 4,066,738

Registered Dec. 6, 2011

Int. Cl.: 35

SERVICE MARK

PRINCIPAL REGISTER

BISCO INDUSTRIES, INC. (CALIFORNIA CORPORATION)
1500 N. LAKEVIEW AVE.
ANAHEIM, CA 92807

FOR: WHOLESALE DISTRIBUTORSHIPS FEATURING FASTENERS AND ELECTRONIC HARDWARE; WHOLESALE ORDERING SERVICES IN THE FIELD OF FASTENERS AND ELECTRONIC HARDWARE, IN CLASS 35 (U.S. CLS. 100, 101 AND 102).

FIRST USE 6-18-2008; IN COMMERCE 6-18-2008.

OWNER OF U.S. REG. NOS. 3,817,601 AND 3,817,603.

NO CLAIM IS MADE TO THE EXCLUSIVE RIGHT TO USE "NATIONAL" AND THE OUTLINE OF THE UNITED STATES, APART FROM THE MARK AS SHOWN.

THE MARK CONSISTS OF A SILHOUETTE OF THE CONTINENTAL UNITED STATES OF AMERICA WITH THE STYLIZED THREE-DIMENSIONAL WORDS "NATIONAL- PRECISION" SUPERIMPOSED THERE OVER.

SER. NO. 85-301,313, FILED 4-21-2011.

MARC LEIPZIG, EXAMINING ATTORNEY



David J. Kypos

Director of the United States Patent and Trademark Office

United States of America

United States Patent and Trademark Office

BUG-N-SLUGGO

Reg. No. 4,066,739

Registered Dec. 6, 2011

Int. Cl.: 5

TRADEMARK

PRINCIPAL REGISTER

W. NEUDORFF GMBH KG (FED REP GERMANY CORPORATION)
POSTFACH 1209
31857 EMMERTHAL, FED REP GERMANY

FOR: HERBICIDES, INSECTICIDES, PESTICIDES AND FUNGICIDES FOR HOME, GARDEN AND LAWN USE AND FOR PROFESSIONAL USE; INSECTICIDES FOR AGRICULTURAL USE; PESTICIDES FOR AGRICULTURAL USE, IN CLASS 5 (U.S. CLS. 6, 18, 44, 46, 51 AND 52).

FIRST USE 2-10-2011; IN COMMERCE 2-10-2011.

THE MARK CONSISTS OF STANDARD CHARACTERS WITHOUT CLAIM TO ANY PARTICULAR FONT, STYLE, SIZE, OR COLOR.

OWNER OF U.S. REG. NOS. 2,276,681 AND 2,736,752.

SER. NO. 85-301,336, FILED 4-21-2011.

CHRISTINE MARTIN, EXAMINING ATTORNEY



David J. Kybas

Director of the United States Patent and Trademark Office

United States of America

United States Patent and Trademark Office

LFR Designs

Reg. No. 4,066,740

Registered Dec. 6, 2011

Int. Cl.: 14

TRADEMARK

PRINCIPAL REGISTER

RUSSO, LESLIE FASTLICHT (UNITED STATES INDIVIDUAL)
6464 CAMINITO NORTHLAND
LA JOLLA, CA 92037

FOR: JEWELRY, IN CLASS 14 (U.S. CLS. 2, 27, 28 AND 50).

FIRST USE 4-21-2011; IN COMMERCE 4-21-2011.

THE MARK CONSISTS OF STANDARD CHARACTERS WITHOUT CLAIM TO ANY PARTICULAR FONT, STYLE, SIZE, OR COLOR.

NO CLAIM IS MADE TO THE EXCLUSIVE RIGHT TO USE "DESIGNS", APART FROM THE MARK AS SHOWN.

SER. NO. 85-301,439, FILED 4-21-2011.

KATINA MISTER, EXAMINING ATTORNEY



David J. Kyffers

Director of the United States Patent and Trademark Office

United States of America

United States Patent and Trademark Office

BUG JUICE NATURALS

Reg. No. 4,066,741

Registered Dec. 6, 2011

Int. Cl.: 32

TRADEMARK

PRINCIPAL REGISTER

JOSEPH J. NORTON (UNITED STATES INDIVIDUAL)
7701 GRAND RIVER
SUITE 2
BRIGHTON, MI 48114

FOR: FRUIT AND VEGETABLE FLAVORED BEVERAGES, IN CLASS 32 (U.S. CLS. 45, 46 AND 48).

FIRST USE 2-14-2011; IN COMMERCE 2-14-2011.

THE MARK CONSISTS OF STANDARD CHARACTERS WITHOUT CLAIM TO ANY PARTICULAR FONT, STYLE, SIZE, OR COLOR.

OWNER OF U.S. REG. NOS. 3,317,139, 3,786,339 AND OTHERS.

NO CLAIM IS MADE TO THE EXCLUSIVE RIGHT TO USE "NATURALS", APART FROM THE MARK AS SHOWN.

SEC. 2(F) AS TO "BUG JUICE".

SER. NO. 85-301,456, FILED 4-21-2011.

ZHALEH DELANEY, EXAMINING ATTORNEY



David J. Kybas

Director of the United States Patent and Trademark Office

United States of America

United States Patent and Trademark Office

Cow Harbor Brewing Company

Reg. No. 4,066,742

STORCK, ROBERT (UNITED STATES INDIVIDUAL)
33 CAIRO AVE
NORTHPORT, NY 11768

Registered Dec. 6, 2011

Int. Cl.: 32

FOR: BEER, IN CLASS 32 (U.S. CLS. 45, 46 AND 48).

TRADEMARK

FIRST USE 1-15-2011; IN COMMERCE 3-16-2011.

PRINCIPAL REGISTER

THE MARK CONSISTS OF STANDARD CHARACTERS WITHOUT CLAIM TO ANY PARTICULAR FONT, STYLE, SIZE, OR COLOR.

NO CLAIM IS MADE TO THE EXCLUSIVE RIGHT TO USE "BREWING COMPANY", APART FROM THE MARK AS SHOWN.

SER. NO. 85-301,534, FILED 4-21-2011.

DANNEAN HETZEL, EXAMINING ATTORNEY



David J. Kybas

Director of the United States Patent and Trademark Office

United States of America

United States Patent and Trademark Office

CLEANSE SENSOR

Reg. No. 4,066,743

Registered Dec. 6, 2011

Int. Cl.: 3

TRADEMARK

PRINCIPAL REGISTER

USP, LLC (CALIFORNIA LIMITED LIABILITY COMPANY), AKA ENJOY PROFESSIONAL
HAIR CARE
1818 ORD WAY
OCEANSIDE, CA 92056

FOR: HAIR BALSAM; HAIR BLEACH; HAIR BLEACHING PREPARATIONS; HAIR CARE CREAMS; HAIR CARE LOTIONS; HAIR CARE PREPARATIONS; HAIR CARE PRODUCTS, NAMELY, HEAT PROTECTION SPRAYS; HAIR CLEANING PREPARATIONS; HAIR COLOR; HAIR COLOR REMOVERS; HAIR COLORANTS; HAIR COLORING PREPARATIONS; HAIR COLOURING AND DYES; HAIR COLOURING PREPARATIONS; HAIR CONDITIONERS; HAIR CONDITIONERS FOR BABIES; HAIR CREAMS; HAIR CURLING PREPARATIONS; HAIR DECOLORANTS; HAIR DRESSINGS FOR MEN; HAIR DRESSINGS FOR WOMEN; HAIR DYES; HAIR EMOLLIENTS; HAIR FIXERS; HAIR FROSTS; HAIR GELS; HAIR GLAZE; HAIR LACQUERS; HAIR LIGHTENERS; HAIR LOTIONS; HAIR MASCARA; HAIR MASKS; HAIR MOUSSES; HAIR NOURISHERS; HAIR OILS; HAIR POMADES; HAIR PRODUCTS, NAMELY, THICKENING CONTROL CREAMS; HAIR RELAXERS; HAIR RELAXING PREPARATIONS; HAIR RINSES; HAIR SHAMPOO; HAIR SHAMPOOS AND CONDITIONERS; HAIR SHEEN SPRAY; HAIR SPRAYS; HAIR STRAIGHTENING PREPARATIONS; HAIR STYLING FIXATIVE IN THE NATURE OF HAIR WAX; HAIR STYLING GEL; HAIR STYLING PREPARATIONS; HAIR STYLING SPRAY; HAIR TONICS; HAIR WAVING LOTION; HAIR WAVING PREPARATIONS; HAIR WAX; STYLING CLAY FOR HAIR; STYLING FOAM FOR HAIR; STYLING PASTE FOR HAIR, IN CLASS 3 (U.S. CLS. 1, 4, 6, 50, 51 AND 52).

FIRST USE 1-1-2003; IN COMMERCE 1-1-2003.

THE MARK CONSISTS OF STANDARD CHARACTERS WITHOUT CLAIM TO ANY PARTICULAR FONT, STYLE, SIZE, OR COLOR.

NO CLAIM IS MADE TO THE EXCLUSIVE RIGHT TO USE "CLEANSE", APART FROM THE MARK AS SHOWN.

SER. NO. 85-301,567, FILED 4-21-2011.

GINA FINK, EXAMINING ATTORNEY



David J. Kyros

Director of the United States Patent and Trademark Office

United States of America

United States Patent and Trademark Office

t2 (Helaine Ciporen's
DIABETES FAMILIES

Reg. No. 4,066,744

Registered Dec. 6, 2011

Int. Cl.: 44

SERVICE MARK

PRINCIPAL REGISTER

CIPOREN, HELAINE (UNITED STATES INDIVIDUAL)
#83
782 WEST END AVE
NEW YORK, NY 10025

FOR: PROVIDING A WEBSITE FEATURING INFORMATION IN THE FIELD OF DIABETES;
PROVIDING A WEBSITE FEATURING INFORMATION ABOUT HEALTH AND WELLNESS,
IN CLASS 44 (U.S. CLS. 100 AND 101).

FIRST USE 3-1-2011; IN COMMERCE 3-1-2011.

NO CLAIM IS MADE TO THE EXCLUSIVE RIGHT TO USE "T2" OR "DIABETES FAMILIES",
APART FROM THE MARK AS SHOWN.

THE NAME "HELAINE CIPOREN" IDENTIFIES A LIVING INDIVIDUAL WHOSE CONSENT
IS OF RECORD.

SER. NO. 85-301,599, FILED 4-21-2011.

CHRISTINE MARTIN, EXAMINING ATTORNEY



David J. Kyffers

Director of the United States Patent and Trademark Office

United States of America

United States Patent and Trademark Office

MARINA BIOTECH

Reg. No. 4,066,745

Registered Dec. 6, 2011

Int. Cl.: 42

SERVICE MARK

PRINCIPAL REGISTER

MARINA BIOTECH, INC (DELAWARE CORPORATION)
3830 MONTE VILLA PARKWAY
BOTHELL, WA 98021

FOR: RESEARCH AND DEVELOPMENT SERVICES IN THE FIELDS OF RNAI-BASED DRUGS AND THERAPEUTICS; PHARMACEUTICAL RESEARCH AND DEVELOPMENT IN THE FIELDS OF THERAPEUTICS, FORMULATIONS TO IMPROVE DRUG DELIVERY IN THE BODY AND DRUGS FOR TREATING A VARIETY OF DISEASES; RESEARCH AND DEVELOPMENT OF THERAPEUTICS IN THE AREA OF ONCOLOGY, IN CLASS 42 (U.S. CLS. 100 AND 101).

FIRST USE 8-8-2010; IN COMMERCE 8-8-2010.

THE MARK CONSISTS OF STANDARD CHARACTERS WITHOUT CLAIM TO ANY PARTICULAR FONT, STYLE, SIZE, OR COLOR.

NO CLAIM IS MADE TO THE EXCLUSIVE RIGHT TO USE "BIOTECH", APART FROM THE MARK AS SHOWN.

SER. NO. 85-301,656, FILED 4-21-2011.

PATRICIA EVANKO, EXAMINING ATTORNEY



David J. Kybas

Director of the United States Patent and Trademark Office

United States of America

United States Patent and Trademark Office



BUCH
CONSTRUCTION

Reg. No. 4,066,746

Registered Dec. 6, 2011

Int. Cl.: 37

SERVICE MARK

PRINCIPAL REGISTER

BUCH CONSTRUCTION, INC. (MARYLAND CORPORATION)
10945 JOHNS HOPKINS ROAD
LAUREL, MD 20723

FOR: GENERAL CONSTRUCTION CONTRACTING; BUILDING CONSTRUCTION SERVICES;
RENOVATION OF BUILDINGS; BUILDING MAINTENANCE; CARPENTRY; AND PAINTING,
IN CLASS 37 (U.S. CLS. 100, 103 AND 106).

FIRST USE 1-0-2008; IN COMMERCE 1-0-2008.

NO CLAIM IS MADE TO THE EXCLUSIVE RIGHT TO USE "CONSTRUCTION", APART
FROM THE MARK AS SHOWN.

THE MARK CONSISTS OF A STYLIZED "B" ON A CIRCLE ABOVE THE WORD "BUCH"
ABOVE THE WORD "CONSTRUCTION".

SER. NO. 85-301,667, FILED 4-21-2011.

PATRICIA EVANKO, EXAMINING ATTORNEY



David J. Kybas

Director of the United States Patent and Trademark Office

United States of America

United States Patent and Trademark Office



**AGILE
SEISMIC**

Reg. No. 4,066,747

AGILE SEISMIC, LLC (TEXAS LIMITED LIABILITY COMPANY)
10590 WESTOFFICE DR., SUITE 250
HOUSTON, TX 77042

Registered Dec. 6, 2011

Int. Cl.: 42

FOR: SEISMIC ACQUISITION, PROCESSING, IMAGING AND INTERPRETATION SERVICES FOR THE OIL AND GAS INDUSTRY, IN CLASS 42 (U.S. CLS. 100 AND 101).

SERVICE MARK

FIRST USE 2-24-2005; IN COMMERCE 2-24-2005.

PRINCIPAL REGISTER

NO CLAIM IS MADE TO THE EXCLUSIVE RIGHT TO USE "SEISMIC", APART FROM THE MARK AS SHOWN.

THE COLOR(S) RED, BLACK AND WHITE IS/ARE CLAIMED AS A FEATURE OF THE MARK.

THE MARK CONSISTS OF A CAPITAL LETTER "A" IN WHITE STYLIZED FONT LOCATED INSIDE OF A RED RECTANGULAR SHAPED DESIGN, AND DIRECTLY ABOVE THE TERMS "AGILE SEISMIC" IN BLACK STYLIZED FONT.

SER. NO. 85-301,673, FILED 4-21-2011.

PATRICIA EVANKO, EXAMINING ATTORNEY



David J. Kybas

Director of the United States Patent and Trademark Office

United States of America

United States Patent and Trademark Office



Reg. No. 4,066,748

Registered Dec. 6, 2011

Int. Cl.: 29

TRADEMARK

PRINCIPAL REGISTER

LEE'S SANDWICHES INTERNATIONAL, INC. (CALIFORNIA CORPORATION)
660 E. GISH ROAD
SAN JOSE, CA 95112

FOR: VIETNAMESE COLD CUTS MADE OF PORK EARS, PORK TONGUE AND PEPPER (GIO THU); VIETNAMESE COOKED MEATS, NAMELY, HAM (JAMBON); VIETNAMESE COOKED MEATS, NAMELY, PORK HOT DOGS (CHA LUA), IN CLASS 29 (U.S. CL. 46).

FIRST USE 1-1-1999; IN COMMERCE 1-1-1999.

NO CLAIM IS MADE TO THE EXCLUSIVE RIGHT TO USE "SAIGON STYLE GOURMET" OR THE MAP REPRESENTATION OF VIETNAM, APART FROM THE MARK AS SHOWN.

THE MARK CONSISTS OF THE STYLIZED WORDING "SAIGON STYLE GOURMET" TRANPOSED ON AN IMAGE OF THE COUNTRY OF VIETNAM, ALL SUPERIMPOSED ON A CIRCULAR BACKGROUND DESIGN BEARING THE STYLIZED REPRESENTATION OF BIRDS IN FLIGHT.

SER. NO. 85-301,697, FILED 4-21-2011.

DAVID H. STINE, EXAMINING ATTORNEY



David J. Kybas

Director of the United States Patent and Trademark Office

United States of America

United States Patent and Trademark Office



Reg. No. 4,066,749

Registered Dec. 6, 2011

Int. Cl.: 30

TRADEMARK

PRINCIPAL REGISTER

LEVANDOWSKI, MICHAEL C. (UNITED STATES INDIVIDUAL)
49119 N. 13TH AVENUE
NEW RIVER, AZ 85087 AND

LEVANDOWSKI, SHARON L. (UNITED STATES INDIVIDUAL)
49119 N. 13TH AVENUE
NEW RIVER, AZ 85087

FOR: POPCORN, IN CLASS 30 (U.S. CL. 46).

FIRST USE 1-17-1998; IN COMMERCE 1-24-1998.

NO CLAIM IS MADE TO THE EXCLUSIVE RIGHT TO USE "CORN", APART FROM THE MARK AS SHOWN.

THE MARK CONSISTS OF THE WORDS "CACTUS" AND "CORN" SEPARATED BY A SAGUARO CACTUS WITH EARS OF CORN SPROUTING FROM IT ON A ROCK BASE. A CIRCLE APPEARS ABOVE THE WORD "CACTUS". THE ENTIRE MARK IS ENCOMPASSED IN A CIRCLE.

SER. NO. 85-301,755, FILED 4-21-2011.

JENNIFER VASQUEZ, EXAMINING ATTORNEY



David J. Kyffers

Director of the United States Patent and Trademark Office

United States of America

United States Patent and Trademark Office

Loyalty Staffing Services

Reg. No. 4,066,750

Registered Dec. 6, 2011

Int. Cl.: 35

SERVICE MARK

PRINCIPAL REGISTER

LOYALTY STAFFING SERVICES (CALIFORNIA CORPORATION)
SUITE 4
22410 HAWTHORNE BLVD.
TORRANCE, CA 90505

FOR: EMPLOYMENT STAFFING CONSULTING SERVICES FEATURING TEMPORARY, TEMPORARY-TO-DIRECT HIRE, AND DIRECT HIRE PLACEMENTS, IN CLASS 35 (U.S. CLS. 100, 101 AND 102).

FIRST USE 6-1-2009; IN COMMERCE 6-1-2009.

THE MARK CONSISTS OF STANDARD CHARACTERS WITHOUT CLAIM TO ANY PARTICULAR FONT, STYLE, SIZE, OR COLOR.

NO CLAIM IS MADE TO THE EXCLUSIVE RIGHT TO USE "STAFFING SERVICES", APART FROM THE MARK AS SHOWN.

SER. NO. 85-301,759, FILED 4-21-2011.

B. PARADEWELAI, EXAMINING ATTORNEY



David J. Kyffers

Director of the United States Patent and Trademark Office

United States of America

United States Patent and Trademark Office

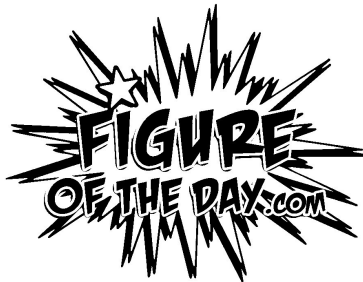

There Is One For All Of Us

Reg. No. 4,066,751

CABRAL, ROBERTO (DOMINICAN REP INDIVIDUAL)
6251 ANNAN WAY
LOS ANGELES, CA 90042

Registered Dec. 6, 2011

Int. Cl.: 35

FOR: RETAIL STORE SERVICES FEATURING ACTION FIGURES, IN CLASS 35 (U.S. CLS. 100, 101 AND 102).

SERVICE MARK

FIRST USE 3-9-2011; IN COMMERCE 3-9-2011.

PRINCIPAL REGISTER

NO CLAIM IS MADE TO THE EXCLUSIVE RIGHT TO USE "FIGURE" AND ".COM", APART FROM THE MARK AS SHOWN.

THE MARK CONSISTS OF THE OUTLINED TEXT "FIGURE OF THE DAY .COM", AND ON THE "I" IT HAS A STAR, AND IT'S INSIDE LIKE A SHATTERED GLASS WITH BORDERS, WITH THE SLOGAN BELOW STATING: "THERE IS ONE FOR ALL OF US".

SER. NO. 85-301,768, FILED 4-21-2011.

EMILY CHUO, EXAMINING ATTORNEY



David J. Kyffers

Director of the United States Patent and Trademark Office

United States of America

United States Patent and Trademark Office



Reg. No. 4,066,752

RTPR LLC (OKLAHOMA LIMITED LIABILITY COMPANY)
7631 NW 192ND ST.
CABOT, AR 73012

Registered Dec. 6, 2011

Int. Cl.: 5

FOR: SKIN AND BODY TOPICAL LOTIONS, CREAMS AND OILS FOR THE RELIEF OF PAIN, IN CLASS 5 (U.S. CLS. 6, 18, 44, 46, 51 AND 52).

TRADEMARK

FIRST USE 5-6-2007; IN COMMERCE 5-6-2007.

PRINCIPAL REGISTER

NO CLAIM IS MADE TO THE EXCLUSIVE RIGHT TO USE "REAL TIME PAIN RELIEF", APART FROM THE MARK AS SHOWN.

THE MARK CONSISTS OF THE WORDS "REAL TIME" AT THE TOP, "PAIN RELIEF" UNDERNEATH, AND AN ABSTRACT DESIGN OF A CLOCK FACE IN THE BACKGROUND.

SER. NO. 85-301,771, FILED 4-21-2011.

B. PARADEWELAI, EXAMINING ATTORNEY



David J. Kybas

Director of the United States Patent and Trademark Office

United States of America

United States Patent and Trademark Office



Reg. No. 4,066,753

Registered Dec. 6, 2011

Int. Cl.: 28

TRADEMARK

PRINCIPAL REGISTER

ALL FISHIN LLC (CALIFORNIA LIMITED LIABILITY COMPANY)
14847 VISTA DEL OCEANO
DEL MAR, CA 92014

FOR: FISHING ROD BLANKS; FISHING ROD HANDLES; FISHING RODS, IN CLASS 28
(U.S. CLS. 22, 23, 38 AND 50).

FIRST USE 1-15-1996; IN COMMERCE 1-15-1996.

THE MARK CONSISTS OF THE WORDING "VARMAC" WITH THE LETTER "V" IN LARGE
FONT IN AN OVAL AND "ARMAC" IN ANOTHER OVAL.

SER. NO. 85-301,791, FILED 4-21-2011.

KAPIL BHANOT, EXAMINING ATTORNEY



David J. Kyffers

Director of the United States Patent and Trademark Office

United States of America

United States Patent and Trademark Office



Reg. No. 4,066,754

Registered Dec. 6, 2011

Int. Cl.: 9

TRADEMARK

PRINCIPAL REGISTER

CONNECTBUSINESS, LLC. (COLORADO LIMITED LIABILITY COMPANY)
5950 S WILLOW DR.
STE 212
GREENWOOD VILLAGE, CO 80111

FOR: COMPUTER SOFTWARE FOR CRM - CUSTOMER RELATIONSHIP MANAGEMENT,
IN CLASS 9 (U.S. CLS. 21, 23, 26, 36 AND 38).

FIRST USE 10-1-2009; IN COMMERCE 10-1-2009.

THE MARK CONSISTS OF THE STYLIZED LETTERS "CB" FORMING A STYLIZED INFIN-
ITY SYMBOL AND THE STYLIZED WORDING "CONNECTEDBUSINESS".

SER. NO. 85-301,815, FILED 4-21-2011.

BRIAN PINO, EXAMINING ATTORNEY



David J. Kybas

Director of the United States Patent and Trademark Office

United States of America

United States Patent and Trademark Office

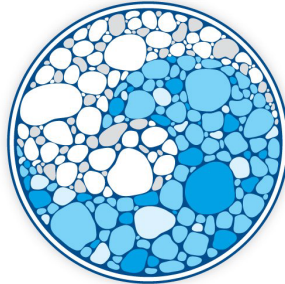

pebblescapes

Reg. No. 4,066,755

Registered Dec. 6, 2011

Int. Cl.: 19

TRADEMARK

PRINCIPAL REGISTER

PEBBLESCAPES LLC (ARIZONA LIMITED LIABILITY COMPANY), DBA PEBBLESCAPES
PO BOX 7747
PHOENIX, AZ 85011

FOR: PEBBLE AGGREGATE MATERIALS COMPOSED OF CEMENT AND DYES FOR USE
IN SWIMMING POOL SURFACES, IN CLASS 19 (U.S. CLS. 1, 12, 33 AND 50).

FIRST USE 1-5-2011; IN COMMERCE 2-16-2011.

THE MARK CONSISTS OF A CIRCLE OUTLINED IN DARK BLUE AND WHITE WITH A
DARK BLUE BACKGROUND CONTAINING PEBBLES OF DARK BLUE, BLUE, LIGHT
BLUE, GRAY, BLACK AND WHITE THAT FORM A WAVE WITHIN THE CIRCLE, AND
THE WORDING "PEBBLESCAPES" UNDERNEATH THE CIRCLE WITH "PEBBLE" IN DARK
BLUE AND "SCAPES" IN LIGHT BLUE.

THE COLOR(S) DARK BLUE, BLUE, LIGHT BLUE, GRAY, BLACK, AND WHITE IS/ARE
CLAIMED AS A FEATURE OF THE MARK.

SER. NO. 85-301,851, FILED S.R. 4-22-2011 AM. P.R. 8-3-2011.

APRIL ROACH, EXAMINING ATTORNEY



David J. Kypos

Director of the United States Patent and Trademark Office

United States of America

United States Patent and Trademark Office



Reg. No. 4,066,756

Registered Dec. 6, 2011

Int. Cl.: 33

TRADEMARK

PRINCIPAL REGISTER

WRIGHT, BRUCE P (UNITED STATES INDIVIDUAL)
4029 COUNTRY VILLAGE DR
RALEIGH, NC 27606 AND

KOAN, JIM (UNITED STATES INDIVIDUAL)
4029 COUNTRY VILLAGE DR
RALEIGH, NC 27606

FOR: ORGANIC HARD CIDER, IN CLASS 33 (U.S. CLS. 47 AND 49).

FIRST USE 0-0-2007; IN COMMERCE 0-0-2007.

NO CLAIM IS MADE TO THE EXCLUSIVE RIGHT TO USE "HARD CIDER FARMHOUSE ORGANIC", "UNFILTERED & ORGANIC", AND "TWENTY-TWO OUNCES", APART FROM THE MARK AS SHOWN.

THE COLOR(S) "RED", "GOLD", "BLACK" AND "GREEN" IS/ARE CLAIMED AS A FEATURE OF THE MARK.

THE MARK CONSISTS OF AN OVAL CARRIER IN BLACK AND GOLD, WITH THE STYLIZED IMAGE OF THREE RED APPLES WITH GREEN LEAVES OR STEMS LOCATED ON THE TOP HALF OF THE CARRIER, AND THE IMAGE OF A GOLD GATE LOCATED ON THE BOTTOM HALF OF THE CARRIER, WITH THE WORDING "J.K.'S SCRUMPY HARD CIDER FARMHOUSE ORGANIC" APPEARING IN GOLD IN THE MIDDLE OF THE CARRIER, AND THE WORDING "ORCHARD GATE GOLD" APPEARING IN BLACK BELOW THE IMAGE OF THE GATE, AND THE WORDING "UNFILTERED & ORGANIC" APPEARING IN GOLD ABOVE THE IMAGE OF THE APPLES, AND THE WORDING "TWENTY-TWO OUNCES" APPEARING IN GOLD BELOW THE IMAGE OF THE GATE. A DOT APPEARS IN GOLD BETWEEN "HARD" AND "CIDER".

SER. NO. 85-301,862, FILED 4-22-2011.

JORDAN BAKER, EXAMINING ATTORNEY



David J. Kyjars

Director of the United States Patent and Trademark Office

United States of America

United States Patent and Trademark Office

R&R Soda Works

Reg. No. 4,066,757

Registered Dec. 6, 2011

Int. Cl.: 32

TRADEMARK

PRINCIPAL REGISTER

THE TOMLINSON CORPORATION (HAWAII CORPORATION), DBA R&R SODA WORKS
898 NININI WAY
HONOLULU, HI 96825

FOR: SOFT DRINKS, NAMELY, SODAS, IN CLASS 32 (U.S. CLS. 45, 46 AND 48).

FIRST USE 8-31-2009; IN COMMERCE 8-31-2009.

THE MARK CONSISTS OF STANDARD CHARACTERS WITHOUT CLAIM TO ANY PARTICULAR FONT, STYLE, SIZE, OR COLOR.

NO CLAIM IS MADE TO THE EXCLUSIVE RIGHT TO USE "SODA WORKS", APART FROM THE MARK AS SHOWN.

SER. NO. 85-301,868, FILED 4-22-2011.

CARRIE GENOVESE, EXAMINING ATTORNEY



David J. Kyros

Director of the United States Patent and Trademark Office

United States of America

United States Patent and Trademark Office

GARLAN CHAIN CO., INC.

Reg. No. 4,066,758

Registered Dec. 6, 2011

Int. Cl.: 14

TRADEMARK

PRINCIPAL REGISTER

GARLAN CHAIN CO., INC. (MASSACHUSETTS CORPORATION)
1903 COUNTY ST.
ATTLEBORO, MA 02703

FOR: JEWELRY CHAINS, IN CLASS 14 (U.S. CLS. 2, 27, 28 AND 50).

FIRST USE 1-1-1967; IN COMMERCE 1-1-1967.

THE MARK CONSISTS OF STANDARD CHARACTERS WITHOUT CLAIM TO ANY PARTICULAR FONT, STYLE, SIZE, OR COLOR.

NO CLAIM IS MADE TO THE EXCLUSIVE RIGHT TO USE "CHAIN CO., INC.", APART FROM THE MARK AS SHOWN.

SER. NO. 85-301,959, FILED 4-22-2011.

STEVEN JACKSON, EXAMINING ATTORNEY



David J. Kybas

Director of the United States Patent and Trademark Office

United States of America

United States Patent and Trademark Office



Reg. No. 4,066,759

Registered Dec. 6, 2011

Int. Cl.: 30

TRADEMARK

PRINCIPAL REGISTER

YOGEL'S YOGURT LLC (NEVADA LIMITED LIABILITY COMPANY), DBA YOGEL'S
FROZEN YOGURT
4186 MELODIA SONGO COURT
LAS VEGAS, NV 89135

FOR: NON-FAT, LOW-CARBOHYDRATE, HIGH-PROTEIN DAIRY-BASED MIX FOR
MAKING DESSERTS, NAMELY, FROZEN YOGURT, IN CLASS 30 (U.S. CL. 46).

FIRST USE 11-1-2009; IN COMMERCE 11-1-2009.

NO CLAIM IS MADE TO THE EXCLUSIVE RIGHT TO USE "FROZEN YOGURT", APART
FROM THE MARK AS SHOWN.

THE COLOR(S) RED, BLACK, BLUE, YELLOW, WHITE, GRAY AND PINK IS/ARE CLAIMED
AS A FEATURE OF THE MARK.

THE MARK CONSISTS OF THE TERM "YOGEL'S" IN STYLIZED RED LETTERS IN FRONT
OF A STYLIZED IMAGE OF COW APPEARING IN WHITE, BLACK, GRAY, PINK AND
BLUE THAT IS WEARING A PINK AND BLUE COLLAR WITH A YELLOW AND WHITE
COWBELL THAT PROTRUDES THROUGH THE "O" IN "YOGEL'S"; BELOW THIS ARE
THE TERMS "FROZEN YOGURT" IN UPPER-CASE BLACK LETTERS.

SER. NO. 85-301,966, FILED 4-22-2011.

RENEE MCCRAY, EXAMINING ATTORNEY



David J. Kybas

Director of the United States Patent and Trademark Office

United States of America

United States Patent and Trademark Office

MICHAEL'S COOKIES

Reg. No. 4,066,760

Registered Dec. 6, 2011

Int. Cl.: 30

TRADEMARK

PRINCIPAL REGISTER

MICHAEL'S BAKERY PRODUCTS, LLC (DELAWARE LIMITED LIABILITY COMPANY)
10635 SCRIPPS RANCH BLVD SUITE D
SAN DIEGO, CA 92131

FOR: COOKIE DOUGH; COOKIES, IN CLASS 30 (U.S. CL. 46).

FIRST USE 12-1-1987; IN COMMERCE 8-15-1989.

THE MARK CONSISTS OF STANDARD CHARACTERS WITHOUT CLAIM TO ANY PARTICULAR FONT, STYLE, SIZE, OR COLOR.

OWNER OF U.S. REG. NO. 3,116,699.

NO CLAIM IS MADE TO THE EXCLUSIVE RIGHT TO USE "COOKIES", APART FROM THE MARK AS SHOWN.

SER. NO. 85-301,967, FILED 4-22-2011.

KIM MONINGHOFF, EXAMINING ATTORNEY



David J. Kyros

Director of the United States Patent and Trademark Office

United States of America

United States Patent and Trademark Office

MIKROS

Reg. No. 4,066,761

Registered Dec. 6, 2011

Int. Cl.: 21

TRADEMARK

PRINCIPAL REGISTER

SANG JIN CO., LTD. (REPUBLIC OF KOREA CORPORATION)
-DONG, SEONGSAN-GU, CHANGWON-CITY,
#307, NEX ZONE, SK TECHNO PARK, SEONGSAN
GYEONGNAM, REPUBLIC OF KOREA 642-971

FOR: MICRO-FIBER LENS CLEANING CLOTH, IN CLASS 21 (U.S. CLS. 2, 13, 23, 29, 30,
33, 40 AND 50).

FIRST USE 3-10-2000; IN COMMERCE 3-10-2000.

THE MARK CONSISTS OF STANDARD CHARACTERS WITHOUT CLAIM TO ANY PAR-
TICULAR FONT, STYLE, SIZE, OR COLOR.

SER. NO. 85-301,988, FILED 4-22-2011.

REBECCA EISINGER, EXAMINING ATTORNEY



David J. Kybas

Director of the United States Patent and Trademark Office

United States of America

United States Patent and Trademark Office

GREATER THAN GAMES

Reg. No. 4,066,762

Registered Dec. 6, 2011

Int. Cl.: 28

TRADEMARK

PRINCIPAL REGISTER

GREATER THAN GAMES, LLC (MISSOURI LIMITED LIABILITY COMPANY)
9697 HURON DR
ST. LOUIS, MO 63132

FOR: BOARD GAMES; CARD GAMES, IN CLASS 28 (U.S. CLS. 22, 23, 38 AND 50).

FIRST USE 7-1-2011; IN COMMERCE 7-8-2011.

THE MARK CONSISTS OF STANDARD CHARACTERS WITHOUT CLAIM TO ANY PARTICULAR FONT, STYLE, SIZE, OR COLOR.

NO CLAIM IS MADE TO THE EXCLUSIVE RIGHT TO USE "GAMES", APART FROM THE MARK AS SHOWN.

SER. NO. 85-301,998, FILED 4-22-2011.

REBECCA GILBERT, EXAMINING ATTORNEY



David J. Kyros

Director of the United States Patent and Trademark Office

United States of America

United States Patent and Trademark Office

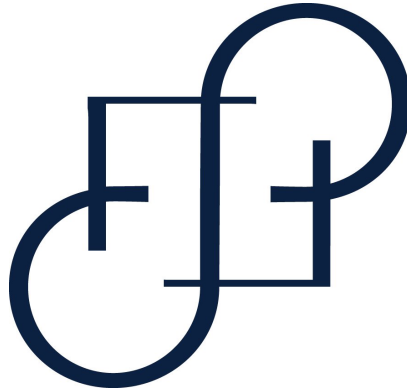

Reg. No. 4,066,763

Registered Dec. 6, 2011

Int. Cls.: 16 and 42

TRADEMARK

SERVICE MARK

PRINCIPAL REGISTER

SIMMONS FOUTS FICHTEL ARCHITECTURE AND DESIGN, INC. (GEORGIA CORPORATION)
160 CLAIREMONT AVENUE, SUITE 200
DECATUR, GA 30030

FOR: ARCHITECTURAL PLANS AND SPECIFICATIONS; PLANS FOR BUILDING CONSTRUCTION, NAMELY, RESIDENTIAL AND LIGHT COMMERCIAL CONSTRUCTION, SINGLE-FAMILY AND MULTI-FAMILY DWELLINGS; PLANS FOR FURNITURE CONSTRUCTION; PLANS FOR LANDSCAPING LAYOUTS; PRINTED GUIDES IN THE FIELDS OF ARCHITECTURE, INTERIOR DESIGN, LANDSCAPE DESIGN, AND GRAPHIC DESIGN; PRINTED INFORMATIONAL CARDS IN THE FIELDS OF ARCHITECTURE, INTERIOR DESIGN, LANDSCAPE DESIGN, AND GRAPHIC DESIGN; PRINTED INFORMATIONAL FOLDERS IN THE FIELDS OF ARCHITECTURE, INTERIOR DESIGN, LANDSCAPE DESIGN, AND GRAPHIC DESIGN; PRINTED MATERIALS, NAMELY, WRITTEN ARTICLES IN THE FIELDS OF ARCHITECTURE, INTERIOR DESIGN, LANDSCAPE DESIGN, AND GRAPHIC DESIGN; PRINTED PLANS, IN CLASS 16 (U.S. CLS. 2, 5, 22, 23, 29, 37, 38 AND 50).

FIRST USE 3-10-2011; IN COMMERCE 3-10-2011.

FOR: ARCHITECTURAL AND ENGINEERING SERVICES; ARCHITECTURAL CONSULTANCY; ARCHITECTURAL CONSULTATION; ARCHITECTURAL DESIGN; CONSULTING IN THE FIELDS OF ENGINEERING AND ARCHITECTURE; LANDSCAPE ARCHITECTURAL DESIGN; LIGHTING DESIGN AND TECHNOLOGY SPECIFICATION SERVICES PERTAINING TO PERMANENT OR TEMPORARY ARCHITECTURAL, THEATRICAL, ENTERTAINMENT, COMMERCIAL AND/OR RESIDENTIAL APPLICATIONS; PROVIDING A WEBSITE FEATURING INFORMATION IN THE FIELD OF INTERIOR DESIGN AND ARCHITECTURE FOR USE BY INTERIOR DESIGNERS AND ARCHITECTS, IN CLASS 42 (U.S. CLS. 100 AND 101).

FIRST USE 3-10-2011; IN COMMERCE 3-10-2011.

THE MARK CONSISTS OF THE LETTER "S" DIAGONALLY DISPOSED FROM UPPER RIGHT TO LOWER LEFT, THE LETTER "F" FORMED FROM TWO LINES FORMING A RIGHT ANGLE AND UTILIZING THE TAIL OF THE LETTER S AS THE MIDDLE BAR OF THE LETTER "F", AND THE INVERTED LETTER "F" FORMED FROM TWO LINES FORMING A RIGHT ANGLE AND UTILIZING THE LEADING PORTION OF THE LETTER "S" AS THE MIDDLE BAR OF THE LETTER "F".



David J. Kybas

Director of the United States Patent and Trademark Office

Reg. No. 4,066,763 SER. NO. 85-301,999, FILED 4-22-2011.

JIM RINGLE, EXAMINING ATTORNEY

United States of America

United States Patent and Trademark Office

SENTINELS OF THE MULTIVERSE

Reg. No. 4,066,764

GREATER THAN GAMES, LLC (MISSOURI LIMITED LIABILITY COMPANY)
9697 HURON DR
ST. LOUIS, MO 63132

Registered Dec. 6, 2011

Int. Cl.: 28

FOR: BOARD GAMES; CARD GAMES, IN CLASS 28 (U.S. CLS. 22, 23, 38 AND 50).

TRADEMARK

FIRST USE 7-1-2011; IN COMMERCE 7-8-2011.

PRINCIPAL REGISTER

THE MARK CONSISTS OF STANDARD CHARACTERS WITHOUT CLAIM TO ANY PARTICULAR FONT, STYLE, SIZE, OR COLOR.

SER. NO. 85-302,004, FILED 4-22-2011.

REBECCA GILBERT, EXAMINING ATTORNEY



David J. Kyffers

Director of the United States Patent and Trademark Office

United States of America

United States Patent and Trademark Office

Ahiska

Reg. No. 4,066,765

Registered Dec. 6, 2011

Int. Cl.: 39

SERVICE MARK

PRINCIPAL REGISTER

AHISKA TRUCKING, LLC (MICHIGAN LIMITED LIABILITY COMPANY), DBA AHISKA TRUCKING, LLC
2360 JOLLY OAK ROAD
OKEMOS, MI 48864

FOR: FREIGHT TRANSPORTATION BY TRUCK, IN CLASS 39 (U.S. CLS. 100 AND 105).

FIRST USE 1-26-2009; IN COMMERCE 1-26-2009.

THE MARK CONSISTS OF STANDARD CHARACTERS WITHOUT CLAIM TO ANY PARTICULAR FONT, STYLE, SIZE, OR COLOR.

THE WORDING "AHISKA" HAS NO MEANING IN A FOREIGN LANGUAGE.

SER. NO. 85-302,012, FILED 4-22-2011.

HANNO RITTNER, EXAMINING ATTORNEY



David J. Kybas

Director of the United States Patent and Trademark Office

United States of America

United States Patent and Trademark Office

Factor X Fitness

Reg. No. 4,066,766

Registered Dec. 6, 2011

Int. Cl.: 41

SERVICE MARK

PRINCIPAL REGISTER

FACTOR X FITNESS OF SOUTH GEORGIA, LLC (GEORGIA LIMITED LIABILITY COMPANY)
PO BOX 8230
THOMASVILLE, GA 31758

FOR: PROVIDING FITNESS AND EXERCISE FACILITIES, IN CLASS 41 (U.S. CLS. 100, 101 AND 107).

FIRST USE 7-1-2010; IN COMMERCE 12-1-2010.

THE MARK CONSISTS OF STANDARD CHARACTERS WITHOUT CLAIM TO ANY PARTICULAR FONT, STYLE, SIZE, OR COLOR.

OWNER OF U.S. REG. NO. 3,982,654.

NO CLAIM IS MADE TO THE EXCLUSIVE RIGHT TO USE "FITNESS", APART FROM THE MARK AS SHOWN.

SER. NO. 85-302,038, FILED 4-22-2011.

DORITT L. CARROLL, EXAMINING ATTORNEY



David J. Kyffers

Director of the United States Patent and Trademark Office

United States of America

United States Patent and Trademark Office

BUTTERNUTS BEER & ALE

Reg. No. 4,066,767

Registered Dec. 6, 2011

Int. Cl.: 32

TRADEMARK

PRINCIPAL REGISTER

BUTTERNUTS BEER & ALE, LLC (NEW YORK LIMITED LIABILITY COMPANY)
4020 STATE HWY 51
GARRATTSVILLE, NY 13342

FOR: BEER, ALE, LAGER, STOUT AND PORTER, IN CLASS 32 (U.S. CLS. 45, 46 AND 48).

FIRST USE 6-29-2005; IN COMMERCE 2-16-2006.

THE MARK CONSISTS OF STANDARD CHARACTERS WITHOUT CLAIM TO ANY PARTICULAR FONT, STYLE, SIZE, OR COLOR.

NO CLAIM IS MADE TO THE EXCLUSIVE RIGHT TO USE "BEER & ALE", APART FROM THE MARK AS SHOWN.

SER. NO. 85-302,070, FILED 4-22-2011.

RONALD DELGIZZI, EXAMINING ATTORNEY



David J. Kyros

Director of the United States Patent and Trademark Office

United States of America

United States Patent and Trademark Office

Empower The Village

Reg. No. 4,066,768

Registered Dec. 6, 2011

Int. Cl.: 41

SERVICE MARK

PRINCIPAL REGISTER

VILLANUEVA, ELIZABETH (UNITED STATES INDIVIDUAL)
1405 HOOPER AVE.
LOS ANGELES, CA 90021 AND

VILLANUEVA, GABRIEL (UNITED STATES INDIVIDUAL)
1405 HOOPER AVE.
LOS ANGELES, CA 90021

FOR: EDUCATION SERVICES, NAMELY, PROVIDING TUTORIAL SESSIONS IN THE FIELD OF PLAY THERAPY INCORPORATING COGNITIVE, LANGUAGE, FINE MOTOR, GROSS MOTOR, SOCIAL EMOTIONAL AND SELF-HELP SKILL DEVELOPMENT CONCEPTS AND TECHNIQUES, IN CLASS 41 (U.S. CLS. 100, 101 AND 107).

FIRST USE 8-6-2010; IN COMMERCE 3-4-2011.

THE MARK CONSISTS OF STANDARD CHARACTERS WITHOUT CLAIM TO ANY PARTICULAR FONT, STYLE, SIZE, OR COLOR.

SER. NO. 85-302,079, FILED 4-22-2011.

DAVID YONTEF, EXAMINING ATTORNEY



David J. Kyros

Director of the United States Patent and Trademark Office

United States of America

United States Patent and Trademark Office

Retirees Looking Out for Retirees

Reg. No. 4,066,769

Registered Dec. 6, 2011

Int. Cl.: 36

SERVICE MARK

PRINCIPAL REGISTER

THE TRUSTEES OF THE INSURANCE TRUST FOR DELTA RETIREES (DELAWARE TRUST),
FORMERLY THE TRUSTEES OF DALRC RETIREE BENEFIT TRUST
C/O J. SMITH LANIER & CO.
11330 LAKEFIELD DR., BUILDING 1
DULUTH, GA 30097

FOR: ADMINISTRATION OF RETIREE INSURANCE TRUST PLANS CONCERNING INSUR-
ANCE AND FINANCE, IN CLASS 36 (U.S. CLS. 100, 101 AND 102).

FIRST USE 3-10-2011; IN COMMERCE 3-10-2011.

THE MARK CONSISTS OF STANDARD CHARACTERS WITHOUT CLAIM TO ANY PAR-
TICULAR FONT, STYLE, SIZE, OR COLOR.

SER. NO. 85-302,090, FILED 4-22-2011.

DAVID YONTEF, EXAMINING ATTORNEY



David J. Kyffers

Director of the United States Patent and Trademark Office

United States of America

United States Patent and Trademark Office



Reg. No. 4,066,770

Registered Dec. 6, 2011

Int. Cl.: 32

TRADEMARK

PRINCIPAL REGISTER

BUTTERNUTS BEER & ALE, LLC (NEW YORK LIMITED LIABILITY COMPANY)
4020 STATE HWY 51
GARRATTSVILLE, NY 13342

FOR: BEER, IN CLASS 32 (U.S. CLS. 45, 46 AND 48).

FIRST USE 6-29-2005; IN COMMERCE 3-26-2007.

NO CLAIM IS MADE TO THE EXCLUSIVE RIGHT TO USE "STOUT" "FARMHOUSE ALE" AND "ALL MALT", APART FROM THE MARK AS SHOWN.

THE MARK CONSISTS OF THE WORDING "MOO THUNDER" AND "STOUT" AND "FARMHOUSE ALE" AND "ALL MALT" WITH A COW APPEARING TO BE STRUCK BY A LIGHTNING BOLT.

SER. NO. 85-302,135, FILED 4-22-2011.

RONALD DELGIZZI, EXAMINING ATTORNEY



David J. Kyffers

Director of the United States Patent and Trademark Office

United States of America

United States Patent and Trademark Office

Just Malibu

Reg. No. 4,066,771

Registered Dec. 6, 2011

Int. Cl.: 25

TRADEMARK

PRINCIPAL REGISTER

DETRIXHE, ROMY (UNITED STATES INDIVIDUAL), DBA JUST MALIBU
31841 SEAFIELD DRIVE
MALIBU, CA 90265

FOR: HOODED SWEATSHIRTS; SHORT-SLEEVED OR LONG-SLEEVED T-SHIRTS;
SWEATERS; SWEATPANTS; SWEATSHIRTS; T-SHIRTS, IN CLASS 25 (U.S. CLS. 22 AND
39).

FIRST USE 2-7-2011; IN COMMERCE 3-30-2011.

THE MARK CONSISTS OF STANDARD CHARACTERS WITHOUT CLAIM TO ANY PAR-
TICULAR FONT, STYLE, SIZE, OR COLOR.

NO CLAIM IS MADE TO THE EXCLUSIVE RIGHT TO USE "MALIBU", APART FROM THE
MARK AS SHOWN.

SER. NO. 85-302,173, FILED 4-22-2011.

EMILY CHUO, EXAMINING ATTORNEY



David J. Kybas

Director of the United States Patent and Trademark Office

United States of America

United States Patent and Trademark Office

THE GOLD STANDARD IN EGG SAFETY!

Reg. No. 4,066,772

Registered Dec. 6, 2011

Int. Cl.: 29

TRADEMARK

PRINCIPAL REGISTER

HOOVER, JAMES (UNITED STATES INDIVIDUAL)
33700 WILDWOOD CANYON ROAD
YUCAIPA, CA 92399

FOR: EGGS, IN CLASS 29 (U.S. CL. 46).

FIRST USE 1-31-2011; IN COMMERCE 3-31-2011.

THE MARK CONSISTS OF STANDARD CHARACTERS WITHOUT CLAIM TO ANY PARTICULAR FONT, STYLE, SIZE, OR COLOR.

SER. NO. 85-302,194, FILED 4-22-2011.

COURTNEY ALVAREZ, EXAMINING ATTORNEY



David J. Kybas

Director of the United States Patent and Trademark Office

United States of America

United States Patent and Trademark Office

Hip-Hop:live it...love it...be it!

Reg. No. 4,066,773

Registered Dec. 6, 2011

Int. Cl.: 9

TRADEMARK

PRINCIPAL REGISTER

BLACK NICKEL MUSIC (CALIFORNIA LIMITED LIABILITY COMPANY)
2009 VILLA DR #108
PITTSBURG, CA 94565

FOR: SOUND RECORDINGS FEATURING MUSIC, IN CLASS 9 (U.S. CLS. 21, 23, 26, 36 AND 38).

FIRST USE 1-26-2009; IN COMMERCE 7-15-2010.

THE MARK CONSISTS OF STANDARD CHARACTERS WITHOUT CLAIM TO ANY PARTICULAR FONT, STYLE, SIZE, OR COLOR.

NO CLAIM IS MADE TO THE EXCLUSIVE RIGHT TO USE "HIP-HOP", APART FROM THE MARK AS SHOWN.

SER. NO. 85-302,195, FILED 4-22-2011.

COURTNEY ALVAREZ, EXAMINING ATTORNEY



David J. Kybas

Director of the United States Patent and Trademark Office

United States of America

United States Patent and Trademark Office

VIVER

Reg. No. 4,066,774

Registered Dec. 6, 2011

Int. Cl.: 16

TRADEMARK

PRINCIPAL REGISTER

VIVER MAGAZINE, LLC (GEORGIA LIMITED LIABILITY COMPANY)
417 WINDCLIFF DRIVE SE
MARIETTA, GA 30067

FOR: GENERAL FEATURE MAGAZINES, IN CLASS 16 (U.S. CLS. 2, 5, 22, 23, 29, 37, 38 AND 50).

FIRST USE 7-9-2009; IN COMMERCE 7-9-2009.

THE MARK CONSISTS OF STANDARD CHARACTERS WITHOUT CLAIM TO ANY PARTICULAR FONT, STYLE, SIZE, OR COLOR.

THE ENGLISH TRANSLATION OF "VIVER" IN THE MARK IS "TO LIVE".

SER. NO. 85-302,239, FILED 4-22-2011.

BRENDAN MCCAULEY, EXAMINING ATTORNEY



David J. Kybas

Director of the United States Patent and Trademark Office

United States of America

United States Patent and Trademark Office

BALI JAMES

Reg. No. 4,066,775

Registered Dec. 6, 2011

Int. Cl.: 3

TRADEMARK

PRINCIPAL REGISTER

TAYLOR, DAWN (UNITED STATES INDIVIDUAL)
4061 WEST 4TH STREET #6
LOS ANGELES, CA 90020

FOR: NON-MEDICATED SKIN LOTIONS, BODY OILS, CUTICLE OILS, BODY SCRUBS, LIP BALM, SHEA BUTTER FOR COSMETIC PURPOSES, PERFUME OILS, SEA SALTS FOR USE AS BATH SALTS, HYDROSOLS, NAMELY, DISTILLATES OF ESSENTIAL OILS FOR USE AS NON-MEDICATED SKIN CARE PREPARATIONS AND FACIAL OILS, IN CLASS 3 (U.S. CLS. 1, 4, 6, 50, 51 AND 52).

FIRST USE 2-0-2010; IN COMMERCE 2-0-2010.

THE MARK CONSISTS OF STANDARD CHARACTERS WITHOUT CLAIM TO ANY PARTICULAR FONT, STYLE, SIZE, OR COLOR.

THE NAME(S), PORTRAIT(S), AND/OR SIGNATURE(S) SHOWN IN THE MARK IDENTIFIES DAWN TAYLOR, WHOSE CONSENT(S) TO REGISTER IS MADE OF RECORD.

SER. NO. 85-302,244, FILED 4-22-2011.

MARY CRAWFORD, EXAMINING ATTORNEY



David J. Kyros

Director of the United States Patent and Trademark Office

United States of America

United States Patent and Trademark Office

STARBOUND STORYBOOKS

Reg. No. 4,066,776

ABERNATHY, JOHN (UNITED STATES INDIVIDUAL)
2500 COVEY DRIVE
JONESBORO, AR 72401

Registered Dec. 6, 2011

Int. Cl.: 16

FOR: PERSONALIZED CHILDREN'S BOOKS; CALENDARS; PORTRAITS, IN CLASS 16
(U.S. CLS. 2, 5, 22, 23, 29, 37, 38 AND 50).

TRADEMARK

FIRST USE 10-0-2010; IN COMMERCE 10-0-2010.

PRINCIPAL REGISTER

THE MARK CONSISTS OF STANDARD CHARACTERS WITHOUT CLAIM TO ANY PARTICULAR FONT, STYLE, SIZE, OR COLOR.

NO CLAIM IS MADE TO THE EXCLUSIVE RIGHT TO USE "STORYBOOKS", APART FROM THE MARK AS SHOWN.

SER. NO. 85-302,265, FILED 4-22-2011.

TINA L. SNAPP, EXAMINING ATTORNEY



David J. Kybas

Director of the United States Patent and Trademark Office

United States of America

United States Patent and Trademark Office

Advantage Tech

Reg. No. 4,066,777

Registered Dec. 6, 2011

Int. Cls.: 37 and 42

SERVICE MARK

PRINCIPAL REGISTER

ADVANTAGE TECHNOLOGIES CONSULTING, INC. (MICHIGAN CORPORATION)
900 WILSHIRE DRIVE; SUITE 202
TROY, MI 48084

FOR: COMPUTER HARDWARE INSTALLATION AND REPAIR, INCLUDING MOBILE PERFORMANCE OF SUCH SERVICES ON CUSTOMER PREMISES; INSTALLATION OF COMPUTER NETWORKING HARDWARE; INSTALLATION, MAINTENANCE AND REPAIR OF COMPUTER HARDWARE; INSTALLATION, REPAIR AND MAINTENANCE OF COMPUTERS AND COMPUTER PERIPHERALS; MAINTENANCE AND REPAIR OF COMPUTER NETWORKING HARDWARE, IN CLASS 37 (U.S. CLS. 100, 103 AND 106).

FIRST USE 7-1-1999; IN COMMERCE 7-1-1999.

FOR: COMPUTER DISASTER RECOVERY PLANNING; COMPUTER HARDWARE AND SOFTWARE CONSULTING SERVICES; COMPUTER NETWORK CONFIGURATION SERVICES; COMPUTER SERVICES, NAMELY, INTEGRATION OF COMPUTER SOFTWARE INTO MULTIPLE SYSTEMS AND NETWORKS; COMPUTER SYSTEM DESIGN SERVICES; COMPUTER SYSTEMS ANALYSIS; COMPUTER TECHNICAL SUPPORT SERVICES, NAMELY, 24/7 SERVICE DESK/HELP DESK SERVICES FOR IT INFRASTRUCTURE, OPERATING SYSTEMS, DATABASE SYSTEMS, AND WEB APPLICATIONS, IN CLASS 42 (U.S. CLS. 100 AND 101).

FIRST USE 7-1-1999; IN COMMERCE 7-1-1999.

THE MARK CONSISTS OF STANDARD CHARACTERS WITHOUT CLAIM TO ANY PARTICULAR FONT, STYLE, SIZE, OR COLOR.

NO CLAIM IS MADE TO THE EXCLUSIVE RIGHT TO USE "TECH", APART FROM THE MARK AS SHOWN.

SER. NO. 85-302,287, FILED 4-22-2011.

JAMES LOVELACE, EXAMINING ATTORNEY



David J. Kyros

Director of the United States Patent and Trademark Office

United States of America

United States Patent and Trademark Office

The Queen of Weight Loss

Reg. No. 4,066,778

Registered Dec. 6, 2011

Int. Cl.: 41

SERVICE MARK

PRINCIPAL REGISTER

THE QUEEN OF WEIGHT LOSS (TENNESSEE LIMITED LIABILITY COMPANY)
4009 TAZEWELL PIKE
KNOXVILLE, TN 37918

FOR: PROFESSIONAL COACHING SERVICES IN THE FIELD OF WEIGHT LOSS, IN CLASS
41 (U.S. CLS. 100, 101 AND 107).

FIRST USE 8-4-2009; IN COMMERCE 1-4-2010.

THE MARK CONSISTS OF STANDARD CHARACTERS WITHOUT CLAIM TO ANY PAR-
TICULAR FONT, STYLE, SIZE, OR COLOR.

NO CLAIM IS MADE TO THE EXCLUSIVE RIGHT TO USE "WEIGHT LOSS", APART FROM
THE MARK AS SHOWN.

SER. NO. 85-302,313, FILED 4-22-2011.

MATTHEW KLINE, EXAMINING ATTORNEY



David J. Kyros

Director of the United States Patent and Trademark Office

United States of America

United States Patent and Trademark Office

Mighty Tanaka

Reg. No. 4,066,779

Registered Dec. 6, 2011

Int. Cl.: 35

SERVICE MARK

PRINCIPAL REGISTER

MIGHTY TANAKA LLC (NEW YORK LIMITED LIABILITY COMPANY)
SUITE 416
68 JAY STREET
BROOKLYN, NY 11201

FOR: ART GALLERIES; ART GALLERY SERVICES; ON-LINE ART GALLERIES; PROMOTING VISUAL AND PERFORMING ARTS EVENTS BY MEANS OF PROVIDING AN ONLINE EVENTS CALENDAR, ORIGINAL ARTICLES, INTERVIEWS, AND INFORMATION ABOUT ART, ARTISTS AND ARTS EVENTS VIA AN INTERNET WEB SITE, ALL FOR PROMOTIONAL PURPOSES, IN CLASS 35 (U.S. CLS. 100, 101 AND 102).

FIRST USE 6-1-2007; IN COMMERCE 6-1-2007.

THE MARK CONSISTS OF STANDARD CHARACTERS WITHOUT CLAIM TO ANY PARTICULAR FONT, STYLE, SIZE, OR COLOR.

THE WORDING "TANAKA" HAS NO MEANING IN A FOREIGN LANGUAGE.

SER. NO. 85-302,325, FILED 4-22-2011.

ZACHARY BELLO, EXAMINING ATTORNEY



David J. Kyros

Director of the United States Patent and Trademark Office

United States of America

United States Patent and Trademark Office

Bringing quality and cost full circle

Reg. No. 4,066,780

Registered Dec. 6, 2011

Int. Cl.: 44

SERVICE MARK

PRINCIPAL REGISTER

OBJECTIVE DIAGNOSTICS LLC (INDIANA LIMITED LIABILITY COMPANY)
6745 THOROUGHBRED DRIVE
INDIANAPOLIS, IN 46278

FOR: CONSULTING SERVICES IN THE FIELD OF MEDICAL CARE; CONSULTING SERVICES IN THE FIELDS OF DIAGNOSTIC MEDICAL TESTING AND NUTRITION; MEDICAL CONSULTATIONS; MEDICAL COUNSELING; MEDICAL DIAGNOSTIC TESTING, MONITORING AND REPORTING SERVICES; MEDICAL EVALUATION SERVICES, NAMELY, FUNCTIONAL ASSESSMENT PROGRAM FOR PATIENTS RECEIVING MEDICAL REHABILITATION SERVICES FOR PURPOSES OF GUIDING TREATMENT AND ASSESSING PROGRAM EFFECTIVENESS; MEDICAL IMAGING SERVICES; MEDICAL IMAGING SERVICES, NAMELY, CONSULTING SERVICES IN THE FIELD OF USING AND OPERATING MEDICAL IMAGING APPARATUS INCLUDING X-RAY, COMPUTED TOMOGRAPHY, MAGNETIC RESONANCE IMAGING, ULTRASOUND, AND POSITRON EMISSION TOMOGRAPHY APPARATUS; MEDICAL RADIOLOGY SERVICES; MEDICAL SERVICES, IN CLASS 44 (U.S. CLS. 100 AND 101).

FIRST USE 4-1-2011; IN COMMERCE 4-1-2011.

THE MARK CONSISTS OF STANDARD CHARACTERS WITHOUT CLAIM TO ANY PARTICULAR FONT, STYLE, SIZE, OR COLOR.

SER. NO. 85-302,354, FILED 4-22-2011.

SHARON MEIER, EXAMINING ATTORNEY



David J. Kyffers

Director of the United States Patent and Trademark Office

United States of America

United States Patent and Trademark Office

KIDZ SAFETY BRITE

Reg. No. 4,066,781

Registered Dec. 6, 2011

Int. Cl.: 18

TRADEMARK

PRINCIPAL REGISTER

BLOOM, MARTIN (UNITED STATES INDIVIDUAL)
20281 EAST COUNTRY CLUB DRIVE, APT. 1401
AVENTURA, FL 33180

FOR: UMBRELLAS, IN CLASS 18 (U.S. CLS. 1, 2, 3, 22 AND 41).

FIRST USE 10-11-2006; IN COMMERCE 10-11-2006.

NO CLAIM IS MADE TO THE EXCLUSIVE RIGHT TO USE "KIDS SAFETY", APART FROM THE MARK AS SHOWN.

SER. NO. 85-302,417, FILED 4-22-2011.

SEAN CROWLEY, EXAMINING ATTORNEY



David J. Kybas

Director of the United States Patent and Trademark Office

United States of America

United States Patent and Trademark Office

CHATEAU COS LABORY

Reg. No. 4,066,782

Registered Dec. 6, 2011

Int. Cl.: 33

TRADEMARK

PRINCIPAL REGISTER

GROUPEMENT FONCIER AGRICOLE DU CHATEAU COS LABORY (FRANCE CORPORATION)
 CHATEAU COS LABORY
 33180 SAINT-ESTEPHE, FRANCE

FOR: WINE, IN CLASS 33 (U.S. CLS. 47 AND 49).

FIRST USE 1-0-1972; IN COMMERCE 1-0-1972.

THE MARK CONSISTS OF STANDARD CHARACTERS WITHOUT CLAIM TO ANY PARTICULAR FONT, STYLE, SIZE, OR COLOR.

NO CLAIM IS MADE TO THE EXCLUSIVE RIGHT TO USE "CHATEAU", APART FROM THE MARK AS SHOWN.

THE ENGLISH TRANSLATION OF "CHATEAU COS LABORY" IN THE MARK IS "CASTLE COS LABORY".

SER. NO. 85-302,458, FILED 4-22-2011.

FRANK LATTUCA, EXAMINING ATTORNEY



David J. Kybas

Director of the United States Patent and Trademark Office

United States of America

United States Patent and Trademark Office

Distinctly Dutch

Reg. No. 4,066,783

Registered Dec. 6, 2011

Int. Cl.: 41

SERVICE MARK

PRINCIPAL REGISTER

DISTINCTLY DUTCH, LTD. (ILLINOIS CORPORATION)
5716 S. BLACKSTONE AVENUE
CHICAGO, IL 60637

FOR: INTERPRETER SERVICES; LANGUAGE INTERPRETATION; LANGUAGE INTERPRETATION SERVICES PROVIDED BY TELEPHONE; LANGUAGE INTERPRETER SERVICES; LANGUAGE INTERPRETING; LANGUAGE TRANSLATION, IN CLASS 41 (U.S. CLS. 100, 101 AND 107).

FIRST USE 7-26-2004; IN COMMERCE 7-26-2004.

THE MARK CONSISTS OF STANDARD CHARACTERS WITHOUT CLAIM TO ANY PARTICULAR FONT, STYLE, SIZE, OR COLOR.

NO CLAIM IS MADE TO THE EXCLUSIVE RIGHT TO USE "DUTCH", APART FROM THE MARK AS SHOWN.

SER. NO. 85-302,481, FILED 4-22-2011.

DORITT L. CARROLL, EXAMINING ATTORNEY



David J. Kyros

Director of the United States Patent and Trademark Office

United States of America
United States Patent and Trademark Office

CURIAN

SERIES TRUST

Reg. No. 4,066,784

JACKSON NATIONAL LIFE INSURANCE COMPANY (MICHIGAN CORPORATION)
1 CORPORATE WAY
LANSING, MI 48951

Registered Dec. 6, 2011

Int. Cl.: 36

FOR: FINANCIAL SERVICES, NAMELY, OFFERING SHARES OF MUTUAL FUNDS, IN CLASS 36 (U.S. CLS. 100, 101 AND 102).

SERVICE MARK

FIRST USE 4-13-2011; IN COMMERCE 4-13-2011.

PRINCIPAL REGISTER

OWNER OF U.S. REG. NOS. 2,897,748, 2,952,505, AND 3,840,075.

NO CLAIM IS MADE TO THE EXCLUSIVE RIGHT TO USE "SERIES TRUST", APART FROM THE MARK AS SHOWN.

THE MARK CONSISTS OF THE WORD "CURIAN" LOCATED ABOVE THE WORDS "SERIES TRUST" WITH A HORIZONTAL LINE IN THE MIDDLE.

SER. NO. 85-302,507, FILED 4-22-2011.

MIDGE BUTLER, EXAMINING ATTORNEY



David J. Kybas

Director of the United States Patent and Trademark Office

United States of America
United States Patent and Trademark Office

Моя Семья

Reg. No. 4,066,785

Registered Dec. 6, 2011

Int. Cl.: 32

TRADEMARK

PRINCIPAL REGISTER

FRUIT MASTER FOODS (UKRAINE LIMITED LIABILITY COMPANY)
163 B. KHMELNYTSKOGO STREET
BEREGOVO, UKRAINE 90202

FOR: CONCENTRATES AND POWDERS USED IN THE PREPARATION OF ENERGY DRINKS AND FRUIT-FLAVORED BEVERAGES; CONCENTRATES FOR MAKING FRUIT DRINKS; CONCENTRATES, SYRUPS OR POWDERS FOR MAKING SOFT DRINKS OR TEA-FLAVORED BEVERAGES; CONCENTRATES, SYRUPS OR POWDERS USED IN THE PREPARATION OF SOFT DRINKS; CONCENTRATES, SYRUPS OR POWDERS USED IN THE PREPARATION OF SPORTS AND ENERGY DRINKS; ESSENCES FOR MAKING NON-ALCOHOLIC BEVERAGES; ESSENCES FOR USE IN MAKING SOFT DRINKS; FRUIT DRINKS; FRUIT DRINKS AND FRUIT JUICES; FRUIT DRINKS AND JUICES; FRUIT FLAVORED DRINKS; FRUIT FLAVORED SOFT DRINKS; FRUIT FLAVOURED CARBONATED DRINKS; FRUIT FLAVOURED DRINKS; FRUIT JUICES AND FRUIT DRINKS; VEGETABLE DRINKS, IN CLASS 32 (U.S. CLS. 45, 46 AND 48).

FIRST USE 1-1-2007; IN COMMERCE 3-12-2009.

OWNER OF U.S. REG. NO. 3,602,771.

THE NON-LATIN CHARACTERS IN THE MARK TRANSLITERATE TO "MOYA SEMYA" AND THIS MEANS "MY FAMILY" IN ENGLISH.

THE MARK CONSISTS OF CYRILLIC RUSSIAN CHARACTERS THAT TRANSLITERATE TO "MOYA SEMYA".

THE ENGLISH TRANSLATION OF THE FOREIGN WORDS IN THE MARK IS "MY FAMILY".

SER. NO. 85-302,514, FILED 4-22-2011.

CORY BOONE, EXAMINING ATTORNEY



David J. Kyros

Director of the United States Patent and Trademark Office

United States of America

United States Patent and Trademark Office



Allison Enterprise LLC
Home Inspection Specialist

Reg. No. 4,066,786

Registered Dec. 6, 2011

Int. Cl.: 42

SERVICE MARK

PRINCIPAL REGISTER

ALLISON ENTERPRISE (PENNSYLVANIA LIMITED LIABILITY COMPANY)
153 SALLY ROAD
JOHNSTOWN, PA 15906

FOR: INSPECTIONS OF HOUSE, BUILDINGS AND EXTERIOR COMPONENTS AND SURROUNDINGS FOR THE PURPOSE OF HOME REPAIR, IN THE COURSE OF RENTING OR PURCHASING A PROPERTY, IN CLASS 42 (U.S. CLS. 100 AND 101).

FIRST USE 4-14-2009; IN COMMERCE 4-14-2009.

NO CLAIM IS MADE TO THE EXCLUSIVE RIGHT TO USE "ENTERPRISE LLC HOME INSPECTION SPECIALIST", APART FROM THE MARK AS SHOWN.

THE COLOR(S) RED AND BLACK IS/ARE CLAIMED AS A FEATURE OF THE MARK.

THE MARK CONSISTS OF A RED LETTER "A" THAT APPEARS AS THOUGH IT WAS PAINTED. THE LINES OF THE RED "A" ARE VERY JAGGED AND BROKEN UP AS THOUGH PAINTED WITH A DRY BRUSH. THE RED LETTER "A" IS SURROUNDED BY A PARTIAL CIRCLE THAT STARTS OUT IN THE MIDDLE OF THE RED "A" WITH A VERY FINE LINE AND GETS THICKER TOWARDS THE BOTTOM, AS THOUGH IT IS BEING VIEWED AT AN ANGLE, THEN CONTINUES AROUND THE OTHER SIDE OF THE RED "A" TO THE RIGHT SIDE HALF WAY UP THE RED LETTER "A", THE COLOR OF THIS SEMI CIRCLE IS BLACK. UNDER THE SEMI-CIRCLE IN BOLD RED LETTERING APPEAR THE WORDS "ALLISON ENTERPRISE LLC" IN EXACT CASE CENTERED ON THE MARK. UNDER THOSE WORDS APPEAR THE WORDS "HOME INSPECTION SPECIALIST" IN EXACT CASE, CENTERED ON THE MARK, AND IN BOLD BLACK LETTERING. THE MARK HAS NO BACKGROUND COLORING.

SER. NO. 85-302,518, FILED 4-22-2011.

FRANK LATTUCA, EXAMINING ATTORNEY



David J. Kyros

Director of the United States Patent and Trademark Office

United States of America

United States Patent and Trademark Office

Swimwitdafishes



Reg. No. 4,066,787

Registered Dec. 6, 2011

Int. Cl.: 25

TRADEMARK

PRINCIPAL REGISTER

SWIMWITDAFISHES LLC (SOUTH CAROLINA LIMITED LIABILITY COMPANY)
360 FOXRIDGE DR
MYRTLE BEACH, SC 29588

FOR: CLOTHING, NAMELY, HATS, T-SHIRTS, SWEAT SHIRTS, IN CLASS 25 (U.S. CLS. 22 AND 39).

FIRST USE 11-1-2010; IN COMMERCE 11-1-2010.

NO CLAIM IS MADE TO THE EXCLUSIVE RIGHT TO USE THE PICTORIAL REPRESENTATION OF THE DIVER DOWN FLAG, APART FROM THE MARK AS SHOWN.

THE MARK CONSISTS OF THE STYLIZED TEXT "SWIMWITDAFISHES" WITH A DIVE FLAG AT THE BOTTOM.

SER. NO. 85-302,537, FILED 4-22-2011.

YAT SYE, LEE, EXAMINING ATTORNEY



David J. Kyffers

Director of the United States Patent and Trademark Office

United States of America

United States Patent and Trademark Office



Reg. No. 4,066,788

Registered Dec. 6, 2011

Int. Cl.: 44

SERVICE MARK

PRINCIPAL REGISTER

FRIEMOTH, LISBETH (UNITED STATES INDIVIDUAL), DBA THE GARDEN HOE
P.O. BOX 58
SPRINGFIELD, WI 53176

FOR: CONSULTING SERVICES IN THE FIELD OF HORTICULTURE, NAMELY, PLANT SELECTION FOR A GIVEN LAND USE, PLANT CARE AND DIAGNOSIS OF PLANT ILLNESS, AND GARDENING CONSULTATION, IN CLASS 44 (U.S. CLS. 100 AND 101).

FIRST USE 10-0-2003; IN COMMERCE 10-0-2003.

NO CLAIM IS MADE TO THE EXCLUSIVE RIGHT TO USE "GARDEN", APART FROM THE MARK AS SHOWN.

THE MARK CONSISTS OF THE WORDS "THE GARDEN HOE" STACKED VERTICALLY. A STYLIZED HOE IN THE FORM OF A HIGH HEELED SHOE APPEARS TO THE LEFT OF THE WORD "HOE" WITH ITS SHAFT EXTENDING UP AND TO THE LEFT THROUGH THE LETTER "G" IN "GARDEN".

SER. NO. 85-302,648, FILED 4-22-2011.

KATHERINE CHANG, EXAMINING ATTORNEY



David J. Kyros

Director of the United States Patent and Trademark Office

United States of America

United States Patent and Trademark Office

BULOVA ACCUTRON

Reg. No. 4,066,789

Registered Dec. 6, 2011

Int. Cl.: 14

TRADEMARK

PRINCIPAL REGISTER

BULOVA CORPORATION (NEW YORK CORPORATION)
ONE BULOVA AVENUE
WOODSIDE, NY 11377

FOR: WATCHES, IN CLASS 14 (U.S. CLS. 2, 27, 28 AND 50).

FIRST USE 1-15-2010; IN COMMERCE 1-15-2010.

THE MARK CONSISTS OF STANDARD CHARACTERS WITHOUT CLAIM TO ANY PARTICULAR FONT, STYLE, SIZE, OR COLOR.

OWNER OF U.S. REG. NOS. 513,364, 519,601, AND 2,773,393.

SER. NO. 85-302,705, FILED 4-22-2011.

BRIDGETT SMITH, EXAMINING ATTORNEY



David J. Kybas

Director of the United States Patent and Trademark Office

United States of America

United States Patent and Trademark Office



Reg. No. 4,066,790

Registered Dec. 6, 2011

Int. Cl.: 9

TRADEMARK

PRINCIPAL REGISTER

AMERICAN FUTURE TECHNOLOGY CORP. (CALIFORNIA CORPORATION)
11581 FEDERAL DRIVE
EL MONTE, CA 91731

FOR: COMPUTER HARDWARE AND COMPUTER PERIPHERALS, IN CLASS 9 (U.S. CLS. 21, 23, 26, 36 AND 38).

FIRST USE 1-12-2008; IN COMMERCE 1-12-2008.

OWNER OF U.S. REG. NO. 3,586,957.

THE MARK CONSISTS OF AN ANIMAL HEAD.

SER. NO. 85-302,757, FILED S.R. 4-22-2011 AM. P.R. 4-27-2011.

MARY CRAWFORD, EXAMINING ATTORNEY



David J. Kyffers

Director of the United States Patent and Trademark Office

United States of America

United States Patent and Trademark Office

Calming Zinc

Reg. No. 4,066,791

Registered Dec. 6, 2011

Int. Cl.: 3

TRADEMARK

PRINCIPAL REGISTER

ONLY THE BEST SKIN CARE, LLC (CALIFORNIA LIMITED LIABILITY COMPANY)
7064 CORLINE COURT SUITE C
SEBASTOPOL, CA 95472

FOR: BAR SOAP; BEAUTY SOAP; MEDICATED SOAP; MEDICATED SOAPS; NATURAL SOAP BARS; SKIN SOAP; SOAPS FOR BODY CARE; SOAPS FOR PERSONAL USE , IN CLASS 3 (U.S. CLS. 1, 4, 6, 50, 51 AND 52).

FIRST USE 2-28-2011; IN COMMERCE 3-1-2011.

THE MARK CONSISTS OF STANDARD CHARACTERS WITHOUT CLAIM TO ANY PARTICULAR FONT, STYLE, SIZE, OR COLOR.

NO CLAIM IS MADE TO THE EXCLUSIVE RIGHT TO USE "ZINC", APART FROM THE MARK AS SHOWN.

SER. NO. 85-302,760, FILED 4-22-2011.

SETH A. RAPPAPORT, EXAMINING ATTORNEY



David J. Kyffers

Director of the United States Patent and Trademark Office

United States of America

United States Patent and Trademark Office



Reg. No. 4,066,792

Registered Dec. 6, 2011

Int. Cl.: 9

TRADEMARK

PRINCIPAL REGISTER

SOFTWARE OPS LLC (ARIZONA LIMITED LIABILITY COMPANY)
5020 E. PRESIDIO RD.
SCOTTSDALE, AZ 85254

FOR: COMPUTER APPLICATION SOFTWARE FOR MOBILE PHONES AND HANDHELD COMPUTERS, NAMELY, SOFTWARE FOR USE IN ELECTRONIC STORAGE OF DATA, IN CLASS 9 (U.S. CLS. 21, 23, 26, 36 AND 38).

FIRST USE 8-27-2008; IN COMMERCE 8-27-2008.

THE MARK CONSISTS OF A BLUE EYEBALL WITH A BLACK IRIS THAT HAS WHITE LINES AND WHITE NUMBERS "0" "5" "10" "15" "20" "25" "30" "35" PERPENDICULAR TO THE BLACK IRIS AROUND THE INNER EDGE OF THE BLUE EYEBALL. THE EYEBALL HAS TWO WHITE SPOTS, ONE WHITE SPOT IS BELOW THE NUMBER "5" AND THE SECOND WHITE SPOT IS BETWEEN THE "25" AND "30" WITH BOTH OF THE SPOTS COVERING A SMALL PORTION OF THE BLACK IRIS. THE WORDING "MY EYES ONLY" IS BELOW THE BLUE EYEBALL AND APPEARS IN WHITE ON A BLACK BACKGROUND, THE BLACK BACKGROUND IS CLAIMED AS A FEATURE OF THE MARK.

THE COLOR(S) BLUE, BLACK AND WHITE IS/ARE CLAIMED AS A FEATURE OF THE MARK.

SER. NO. 85-302,763, FILED 4-22-2011.

JORDAN BAKER, EXAMINING ATTORNEY



David J. Kyros

Director of the United States Patent and Trademark Office

United States of America

United States Patent and Trademark Office

HIGHLAWN PAVILION

Reg. No. 4,066,793

Registered Dec. 6, 2011

Int. Cl.: 43

SERVICE MARK

PRINCIPAL REGISTER

HIGHLAWN PAVILION CORPORATION (NEW JERSEY CORPORATION)
111 PROSPECT STREET
WEST ORANGE, NJ 07052

FOR: RESTAURANT SERVICES, IN CLASS 43 (U.S. CLS. 100 AND 101).

FIRST USE 12-31-1986; IN COMMERCE 12-31-1986.

THE MARK CONSISTS OF STANDARD CHARACTERS WITHOUT CLAIM TO ANY PARTICULAR FONT, STYLE, SIZE, OR COLOR.

NO CLAIM IS MADE TO THE EXCLUSIVE RIGHT TO USE "PAVILION", APART FROM THE MARK AS SHOWN.

SER. NO. 85-302,773, FILED 4-22-2011.

MARIA-VICTORIA SUAREZ, EXAMINING ATTORNEY



David J. Kybas

Director of the United States Patent and Trademark Office

United States of America

United States Patent and Trademark Office

PADDY MELON LABRADOODLES

Reg. No. 4,066,794

MCGRATH, CHARLOTTE (AUSTRALIA INDIVIDUAL)
208 ROUGHIT LANE
SCOTTS FLAT, AUSTRALIA 2330

Registered Dec. 6, 2011

Int. Cl.: 44

FOR: VETERINARY SERVICES; KENNEL SERVICES, NAMELY, DOG BREEDING SERVICES, IN CLASS 44 (U.S. CLS. 100 AND 101).

SERVICE MARK

FIRST USE 4-19-2011; IN COMMERCE 4-20-2011.

PRINCIPAL REGISTER

THE MARK CONSISTS OF STANDARD CHARACTERS WITHOUT CLAIM TO ANY PARTICULAR FONT, STYLE, SIZE, OR COLOR.

NO CLAIM IS MADE TO THE EXCLUSIVE RIGHT TO USE "LABRADOODLES", APART FROM THE MARK AS SHOWN.

SER. NO. 85-302,843, FILED 4-23-2011.

MARK T. MULLEN, EXAMINING ATTORNEY



David J. Kybas

Director of the United States Patent and Trademark Office

United States of America

United States Patent and Trademark Office

XIXI

Reg. No. 4,066,795

Registered Dec. 6, 2011

Int. Cl.: 25

TRADEMARK

PRINCIPAL REGISTER

PIASAA USA LLC. (NEW YORK LIMITED LIABILITY COMPANY), AKA PRIDE USA (BD),
INC.
441 SOUTHERN BLVD
BRONX, NY 10455

FOR: APPAREL FOR DANCERS, NAMELY, TEE SHIRTS, SWEATSHIRTS, PANTS, LEGGINGS, SHORTS AND JACKETS; ATHLETIC APPAREL, NAMELY, SHIRTS, PANTS, JACKETS, FOOTWEAR, HATS AND CAPS, ATHLETIC UNIFORMS; BODY SHIRTS; BUTTON DOWN SHIRTS; BUTTON-FRONT ALOHA SHIRTS; CAMOUFLAGE SHIRTS; CLOTHING FOR ATHLETIC USE, NAMELY, PADDED SHIRTS; CLOTHING FOR BABIES, TODDLERS AND CHILDREN, TREATED WITH FIRE AND HEAT RETARDANTS, NAMELY, PAJAMAS, JACKETS, SHIRTS, PANTS, JUMPERS; CLOTHING SHIELDS, NAMELY, PADS APPLIED TO THE UNDERARMS OF SHIRTS, BLOUSES AND SWEATERS; KNITTED UNDERWEAR; LADIES' UNDERWEAR; MEN'S UNDERWEAR; PERSPIRATION ABSORBENT UNDERWEAR CLOTHING; THERMAL UNDERWEAR; THONGS; UNDERWEAR; UNDERWEAR, NAMELY, BOY SHORTS; WOMEN'S UNDERWEAR, IN CLASS 25 (U.S. CLS. 22 AND 39).

FIRST USE 11-30-2003; IN COMMERCE 11-30-2003.

THE MARK CONSISTS OF STANDARD CHARACTERS WITHOUT CLAIM TO ANY PARTICULAR FONT, STYLE, SIZE, OR COLOR.

THE WORDING "XIXI" HAS NO MEANING IN A FOREIGN LANGUAGE.

SER. NO. 85-302,845, FILED 4-23-2011.

TOBY BULLOFF, EXAMINING ATTORNEY



David J. Kypos

Director of the United States Patent and Trademark Office

United States of America

United States Patent and Trademark Office



Reg. No. 4,066,796

Registered Dec. 6, 2011

Int. Cl.: 36

SERVICE MARK

PRINCIPAL REGISTER

WHISPERING SEAS BEACH RENTALS (FLORIDA LIMITED LIABILITY COMPANY), DBA
PANAMA BEACH TIME
3820 PYTHON STREET
PANAMA CITY BEACH, FL 32408

FOR: REAL ESTATE SERVICES, NAMELY, VACATION HOME RENTAL MANAGEMENT
SERVICES, IN CLASS 36 (U.S. CLS. 100, 101 AND 102).

FIRST USE 2-15-2011; IN COMMERCE 2-15-2011.

NO CLAIM IS MADE TO THE EXCLUSIVE RIGHT TO USE "PANAMA BEACH", APART
FROM THE MARK AS SHOWN.

THE COLOR(S) "ORANGE", "BLUE", AND "TURQUOISE" IS/ARE CLAIMED AS A FEATURE
OF THE MARK.

THE MARK CONSISTS OF ORANGE SUN RAYS WITH TWO TURQUOISE WAVES AND
THE WORDING "PANAMA BEACH TIME" IN BLUE.

SER. NO. 85-302,925, FILED 4-23-2011.

JORDAN BAKER, EXAMINING ATTORNEY



David J. Kyros

Director of the United States Patent and Trademark Office

United States of America

United States Patent and Trademark Office

Rose Books

Reg. No. 4,066,797

Registered Dec. 6, 2011

Int. Cl.: 41

SERVICE MARK

PRINCIPAL REGISTER

AROSE BOOKS PUBLISHING, LLC (PENNSYLVANIA LIMITED LIABILITY COMPANY)
1779 SAMPLE RD.
ALLISON PARK, PA 15101

FOR: MULTIMEDIA PUBLISHING OF BOOKS, MAGAZINES, JOURNALS, SOFTWARE, GAMES, MUSIC, AND ELECTRONIC PUBLICATIONS, IN CLASS 41 (U.S. CLS. 100, 101 AND 107).

FIRST USE 7-1-2002; IN COMMERCE 7-1-2002.

NO CLAIM IS MADE TO THE EXCLUSIVE RIGHT TO USE "BOOKS", APART FROM THE MARK AS SHOWN.

THE STIPPLING IS FOR SHADING PURPOSES ONLY.

THE MARK CONSISTS OF THE WORDS "AROSE BOOKS", THE LETTERS "A", "R", AND "B" CAPITALIZED, AND THE LETTER "A" IN SCRIPTED TEXT WITH A ROSE WOVEN THROUGH IT.

SER. NO. 85-302,934, FILED 4-23-2011.

MICHAEL WEBSTER, EXAMINING ATTORNEY



David J. Kybas

Director of the United States Patent and Trademark Office

United States of America

United States Patent and Trademark Office



Reg. No. 4,066,798

Registered Dec. 6, 2011

Int. Cl.: 35

SERVICE MARK

PRINCIPAL REGISTER

PINA, MIGUEL (UNITED STATES INDIVIDUAL)
2005 NW DALLAS ST
GRAND PRAIRIE, TX 75050

FOR: CLUB SERVICES, NAMELY, PROMOTING THE INTERESTS OF CAR ENTHUSIASTS,
IN CLASS 35 (U.S. CLS. 100, 101 AND 102).

FIRST USE 1-1-1977; IN COMMERCE 1-1-1977.

NO CLAIM IS MADE TO THE EXCLUSIVE RIGHT TO USE "CLASSICS" AND "CAR CLUB",
APART FROM THE MARK AS SHOWN.

THE MARK CONSISTS OF AN ABSTRACT DESIGN ENCLOSING A CROWN IN THE
CENTER, THE STYLIZED TEXT "LOS ROYAL CLASSICS CAR CLUB", AND A MEDIEVAL
HELMET AT THE TOP.

SER. NO. 85-302,990, FILED 4-23-2011.

MICHAEL ENGEL, EXAMINING ATTORNEY



David J. Kybas

Director of the United States Patent and Trademark Office

United States of America

United States Patent and Trademark Office



Reg. No. 4,066,799

Registered Dec. 6, 2011

Int. Cl.: 37

SERVICE MARK

PRINCIPAL REGISTER

ALPHA ALARM & AUDIO INC. (CALIFORNIA CORPORATION)
P.O. BOX 911
DIXON, CA 95620

FOR: INSTALLATION OF ALARM SYSTEMS, CAMERA SYSTEMS, CARD ACCESS SYSTEMS, HOME THEATERS, COMMERCIAL AUDIO, AND VIDEO EQUIPMENT, IN CLASS 37 (U.S. CLS. 100, 103 AND 106).

FIRST USE 1-1-2010; IN COMMERCE 1-1-2010.

NO CLAIM IS MADE TO THE EXCLUSIVE RIGHT TO USE "ALARM & AUDIO INC.", APART FROM THE MARK AS SHOWN.

THE MARK CONSISTS OF AN OUTLINED BELL, WITH THE STYLIZED WORD "ALPHA" APPEARING IN FRONT OF THE BELL AND UNDERLINED, AND AT THE BOTTOM OF THE MARK APPEARS THE STYLIZED WORDING "ALARM & AUDIO INC."

SER. NO. 85-303,013, FILED 4-23-2011.

ANDREW LEASER, EXAMINING ATTORNEY



David J. Kyros

Director of the United States Patent and Trademark Office

United States of America

United States Patent and Trademark Office

Aftelier Perfumes

Reg. No. 4,066,800

Registered Dec. 6, 2011

Int. Cl.: 3

TRADEMARK

PRINCIPAL REGISTER

AFTELIER PERFUMES (US VIRGIN ISLANDS CORPORATION)
1518 WALNUT STREET
BERKELEY, CA 94709

FOR: AROMATIC ESSENTIAL OILS; COLOGNES, PERFUMES AND COSMETICS; COSMETICS IN GENERAL, INCLUDING PERFUMES; EAU DE PERFUME; ESSENTIAL OILS; ESSENTIAL OILS FOR FLAVORING BEVERAGES; ESSENTIAL OILS FOR FOOD FLAVORINGS; ESSENTIAL OILS FOR PERSONAL USE; ESSENTIAL OILS FOR USE IN THE MANUFACTURE OF SCENTED PRODUCTS; FOOD FLAVORING, BEING ESSENTIAL OILS; FOOD FLAVORINGS PREPARED FROM ESSENTIAL OILS; LIQUID PERFUMES; NATURAL ESSENTIAL OILS; OILS FOR PERFUMES AND SCENTS; PERFUME; PERFUMES; PERFUMES AND COLOGNES; PERFUMES AND TOILET WATERS; PERFUMES FOR INDUSTRIAL PURPOSES; PERFUMES IN SOLID FORM, IN CLASS 3 (U.S. CLS. 1, 4, 6, 50, 51 AND 52).

FIRST USE 4-2-1991; IN COMMERCE 4-2-1991.

THE MARK CONSISTS OF STANDARD CHARACTERS WITHOUT CLAIM TO ANY PARTICULAR FONT, STYLE, SIZE, OR COLOR.

NO CLAIM IS MADE TO THE EXCLUSIVE RIGHT TO USE "PERFUMES", APART FROM THE MARK AS SHOWN.

THE WORDING "AFTELIER" HAS NO MEANING IN A FOREIGN LANGUAGE.

SER. NO. 85-303,023, FILED 4-23-2011.

CHRISTINA SOBRAL, EXAMINING ATTORNEY



David J. Kybas

Director of the United States Patent and Trademark Office

United States of America

United States Patent and Trademark Office

MR. DADDY BLOG

Reg. No. 4,066,801

Registered Dec. 6, 2011

Int. Cl.: 41

SERVICE MARK

PRINCIPAL REGISTER

ROBERT P. NICKELL (UNITED STATES INDIVIDUAL)
381 VAN NESS AVENUE, SUITE 1507
TORRANCE, CA 90501

FOR: ON-LINE JOURNALS, NAMELY, BLOGS FEATURING FACTS, TIPS, ADVICE, PRODUCT INFORMATION AND RESOURCES FOR EXPECTANT FATHERS AND NEW FATHERS; PROVIDING A WEBSITE FEATURING BLOGS AND NON-DOWNLOADABLE PUBLICATIONS IN THE NATURE OF ARTICLES AND ELECTRONIC NEWSLETTERS IN THE FIELD(S) OF FACTS, TIPS AND ADVICE FOR EXPECTANT FATHERS AND NEW FATHERS; PROVIDING A WEBSITE FEATURING RESOURCES, NAMELY, NON-DOWNLOADABLE PUBLICATIONS IN THE NATURE OF ARTICLES AND ELECTRONIC NEWSLETTERS IN THE FIELD OF FACTS, TIPS AND ADVICE FOR EXPECTANT FATHERS AND NEW FATHERS, IN CLASS 41 (U.S. CLS. 100, 101 AND 107).

FIRST USE 8-13-2009; IN COMMERCE 8-13-2009.

THE MARK CONSISTS OF STANDARD CHARACTERS WITHOUT CLAIM TO ANY PARTICULAR FONT, STYLE, SIZE, OR COLOR.

NO CLAIM IS MADE TO THE EXCLUSIVE RIGHT TO USE "BLOG", APART FROM THE MARK AS SHOWN.

SER. NO. 85-303,064, FILED 4-24-2011.

JACLYN KIDWELL WALKER, EXAMINING ATTORNEY



David J. Kybas

Director of the United States Patent and Trademark Office

United States of America

United States Patent and Trademark Office

BLUE BIBLE

Reg. No. 4,066,802

Registered Dec. 6, 2011

Int. Cl.: 45

SERVICE MARK

PRINCIPAL REGISTER

HIPPOCRATES UNIVERSITY (OREGON CORPORATION)
5516 BOULDER HIGHWAY SUITE 2F #113
LAS VEGAS, NV 89122 AND

HRABAL, ANTONIN (CZECH REPUBLIC INDIVIDUAL)
5516 BOULDER HIGHWAY SUITE 2F #113
LAS VEGAS, NV 89122

FOR: RELIGIOUS AND SPIRITUAL SERVICES, NAMELY, PROVIDING GATHERINGS AND RETREATS TO DEVELOP AND ENHANCE THE SPIRITUAL LIVES OF INDIVIDUALS, IN CLASS 45 (U.S. CLS. 100 AND 101).

FIRST USE 12-10-2002; IN COMMERCE 12-10-2002.

THE MARK CONSISTS OF STANDARD CHARACTERS WITHOUT CLAIM TO ANY PARTICULAR FONT, STYLE, SIZE, OR COLOR.

SER. NO. 85-303,158, FILED 4-25-2011.

JACQUELINE A. LAVINE, EXAMINING ATTORNEY



David J. Kyros

Director of the United States Patent and Trademark Office

United States of America

United States Patent and Trademark Office

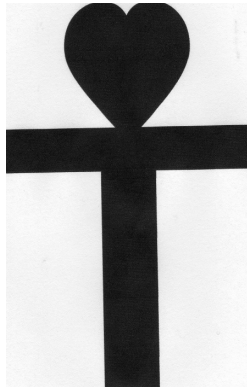

Reg. No. 4,066,803

Registered Dec. 6, 2011

Int. Cl.: 45

SERVICE MARK

PRINCIPAL REGISTER

HIPPOCRATES UNIVERSITY (OREGON CORPORATION)
5516 BOULDER HIGHWAY SUITE 2F #113
LAS VEGAS, NV 89122 AND

HRABAL, ANTONIN (CZECH REPUBLIC INDIVIDUAL)
5516 BOULDER HIGHWAY SUITE 2F #113
LAS VEGAS, NV 89122

FOR: RELIGIOUS AND SPIRITUAL SERVICES, NAMELY, PROVIDING GATHERINGS AND RETREATS TO DEVELOP AND ENHANCE THE SPIRITUAL LIVES OF INDIVIDUALS, IN CLASS 45 (U.S. CLS. 100 AND 101).

FIRST USE 12-1-2002; IN COMMERCE 12-1-2002.

THE MARK CONSISTS OF A CROSS WITH A HEART SHAPE COMPRISING THE UPPER PORTION OF THE CROSS.

SER. NO. 85-303,162, FILED 4-25-2011.

JACQUELINE A. LAVINE, EXAMINING ATTORNEY



David J. Kyffers

Director of the United States Patent and Trademark Office

United States of America

United States Patent and Trademark Office



Reg. No. 4,066,804

GEHLON, HARMAT (UNITED STATES INDIVIDUAL)
4229 MOUNT PLEASANT
MODESTO, CA 95357

Registered Dec. 6, 2011

Int. Cl.: 35

FOR: PROVIDING ADVERTISING, MARKETING AND PROMOTIONAL SERVICES, NAMELY, AT WWW.SAMPLEON.COM WHERE BUSINESSES CAN HOST THEIR SAMPLE PROMOTION CAMPAIGNS AND CREATE SAMPLE PROMOTIONS TO ATTRACT NEW CLIENTS, IN CLASS 35 (U.S. CLS. 100, 101 AND 102).

SERVICE MARK

PRINCIPAL REGISTER

FIRST USE 8-31-2010; IN COMMERCE 9-1-2010.

THE MARK CONSISTS OF WORDS "SAMPLE" WRITTEN ABOVE THE WORDS "LEAD BY A SAMPLE" IN GREY COLOR AND THE WORD "ON" IS WRITTEN IN WHITE COLOR ON GREEN BACKGROUND ON THE RIGHT SIDE OF THE WORD "SAMPLE" AS SHOWN IN THE MARK.

THE COLOR(S) GREY, WHITE AND GREEN IS/ARE CLAIMED AS A FEATURE OF THE MARK.

SER. NO. 85-303,179, FILED 4-25-2011.

MARIA-VICTORIA SUAREZ, EXAMINING ATTORNEY



David J. Kyros

Director of the United States Patent and Trademark Office

United States of America

United States Patent and Trademark Office

LIFTOFF LEADERSHIP

Reg. No. 4,066,805

Registered Dec. 6, 2011

Int. Cl.: 41

SERVICE MARK

PRINCIPAL REGISTER

LIFTOFF LEADERSHIP, LLC (NORTH CAROLINA LIMITED LIABILITY COMPANY)
PO BOX 126
OCRACOKE, NC 27960

FOR: EDUCATIONAL AND ENTERTAINMENT SERVICES, NAMELY, PROVIDING MOTIVATIONAL SPEAKING SERVICES IN THE FIELD OF BUSINESS; ON-LINE JOURNALS, NAMELY, BLOGS FEATURING MOTIVATIONAL TOPICS FOR BUSINESSES, IN CLASS 41 (U.S. CLS. 100, 101 AND 107).

FIRST USE 3-0-2009; IN COMMERCE 3-0-2009.

THE MARK CONSISTS OF STANDARD CHARACTERS WITHOUT CLAIM TO ANY PARTICULAR FONT, STYLE, SIZE, OR COLOR.

NO CLAIM IS MADE TO THE EXCLUSIVE RIGHT TO USE "LEADERSHIP", APART FROM THE MARK AS SHOWN.

SER. NO. 85-303,259, FILED 4-25-2011.

CARYN GLASSER, EXAMINING ATTORNEY



David J. Kyros

Director of the United States Patent and Trademark Office

United States of America

United States Patent and Trademark Office

Chic Lure

Reg. No. 4,066,806

BEKKALA, MICHAEL (UNITED STATES INDIVIDUAL)
137 FLORIDA ST
LAURIUM, MI 499132063

Registered Dec. 6, 2011

Int. Cl.: 28

FOR: FISHING LURES, IN CLASS 28 (U.S. CLS. 22, 23, 38 AND 50).

TRADEMARK

FIRST USE 5-1-2010; IN COMMERCE 12-1-2010.

PRINCIPAL REGISTER

THE MARK CONSISTS OF STANDARD CHARACTERS WITHOUT CLAIM TO ANY PARTICULAR FONT, STYLE, SIZE, OR COLOR.

NO CLAIM IS MADE TO THE EXCLUSIVE RIGHT TO USE "LURE", APART FROM THE MARK AS SHOWN.

SER. NO. 85-303,346, FILED 4-25-2011.

CURTIS FRENCH, EXAMINING ATTORNEY



David J. Kyffers

Director of the United States Patent and Trademark Office

United States of America

United States Patent and Trademark Office

Game Day Undies

Reg. No. 4,066,807

Registered Dec. 6, 2011

Int. Cl.: 25

TRADEMARK

PRINCIPAL REGISTER

GAME DAY UNDIES LLC (MINNESOTA LIMITED LIABILITY COMPANY), DBA GAME DAY UNDIES
771 HARRISON DRIVE
BIG LAKE, MN 55309

FOR: UNDERWEAR, IN CLASS 25 (U.S. CLS. 22 AND 39).

FIRST USE 8-14-2008; IN COMMERCE 8-14-2008.

THE MARK CONSISTS OF STANDARD CHARACTERS WITHOUT CLAIM TO ANY PARTICULAR FONT, STYLE, SIZE, OR COLOR.

NO CLAIM IS MADE TO THE EXCLUSIVE RIGHT TO USE "UNDIES", APART FROM THE MARK AS SHOWN.

SER. NO. 85-303,369, FILED 4-25-2011.

JAMES GRIFFIN, EXAMINING ATTORNEY



David J. Kyffers

Director of the United States Patent and Trademark Office

United States of America

United States Patent and Trademark Office

WHAT KIDS WANT!

Reg. No. 4,066,808

Registered Dec. 6, 2011

Int. Cl.: 28

TRADEMARK

PRINCIPAL REGISTER

WHAT KIDS WANT, INC. (CALIFORNIA CORPORATION)
19428 LONDELIUS ST. M
NORTHRIDGE, CA 91324

FOR: BUBBLE MAKING WAND AND SOLUTION SETS; BUBBLE BLOWING DEVICES, NAMELY, BUBBLE WANDS AND BUBBLE GUNS; JUMP ROPES; TOY ROCKETS; TOY JEWELRY; TOYS, NAMELY, CHILDREN'S DRESS-UP ACCESSORIES; YO-YOS; TOY GOLF SETS; TOY BOWLING SETS; TOY BOUNCE BALLS, FLYING DISCS, IN CLASS 28 (U.S. CLS. 22, 23, 38 AND 50).

FIRST USE 8-25-1999; IN COMMERCE 12-10-1999.

THE MARK CONSISTS OF STANDARD CHARACTERS WITHOUT CLAIM TO ANY PARTICULAR FONT, STYLE, SIZE, OR COLOR.

SER. NO. 85-303,425, FILED 4-25-2011.

LOURDES AYALA, EXAMINING ATTORNEY



David J. Kybas

Director of the United States Patent and Trademark Office

United States of America

United States Patent and Trademark Office

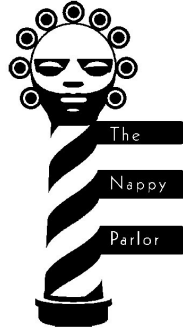

Reg. No. 4,066,809

Registered Dec. 6, 2011

Int. Cl.: 44

SERVICE MARK

PRINCIPAL REGISTER

TAYLOR, TAURA (UNITED STATES INDIVIDUAL)
1376 FAIRBANKS ST
ATLANTA, GA 30310

FOR: HAIR CARE AND BEAUTY SALON SERVICES, IN CLASS 44 (U.S. CLS. 100 AND 101).

FIRST USE 5-13-2005; IN COMMERCE 5-13-2005.

NO CLAIM IS MADE TO THE EXCLUSIVE RIGHT TO USE "PARLOR", APART FROM THE MARK AS SHOWN.

THE MARK CONSISTS OF A DESIGN OF A BARBER POLE WITH THREE POLE STRIPES. ON TOP OF THE BARBER POLE IS AN ETHNIC FACE WITH NINE CIRCLES AROUND THE HEAD. THE WORDS "THE NAPPY PARLOR" ARE LISTED INDIVIDUALLY IN BARS EXTENDING FROM EACH OF THE THREE POLE STRIPES.

SER. NO. 85-303,450, FILED 4-25-2011.

KAREN K. BUSH, EXAMINING ATTORNEY



David J. Kybas

Director of the United States Patent and Trademark Office

United States of America

United States Patent and Trademark Office

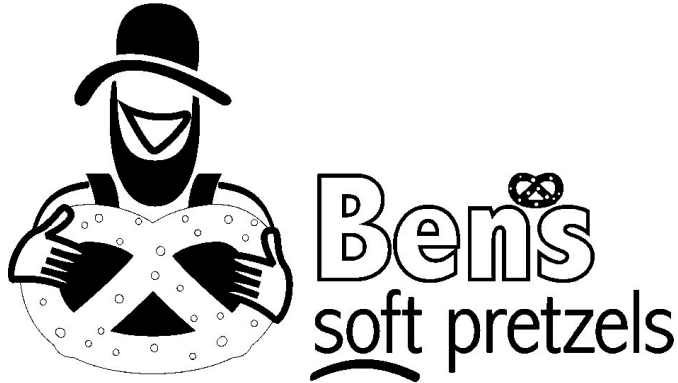

Reg. No. 4,066,810

Registered Dec. 6, 2011

Int. Cl.: 30

TRADEMARK

PRINCIPAL REGISTER

BEN'S SOFT PRETZELS, LLC (INDIANA LIMITED LIABILITY COMPANY)
3701 S. MAIN ST.
ELKHART, IN 46517

FOR: SOFT PRETZELS, IN CLASS 30 (U.S. CL. 46).

FIRST USE 5-1-2008; IN COMMERCE 5-1-2008.

NO CLAIM IS MADE TO THE EXCLUSIVE RIGHT TO USE "SOFT PRETZELS", APART FROM THE MARK AS SHOWN.

THE MARK CONSISTS OF A DESIGN OF A MAN HOLDING A PRETZEL AND WEARING A HAT NEXT TO THE STYLIZED TEXT "BEN'S SOFT PRETZELS" WITH THE WORD "SOFT" UNDERLINED AND A PRETZEL DESIGN IN THE PLACE OF AN APOSTROPHE.

SER. NO. 85-303,453, FILED 4-25-2011.

SEAN CROWLEY, EXAMINING ATTORNEY



David J. Kybas

Director of the United States Patent and Trademark Office

United States of America

United States Patent and Trademark Office



Reg. No. 4,066,811
Registered Dec. 6, 2011
Int. Cl.: 41

STATX ENTERTAINMENT, LLC (TEXAS LIMITED LIABILITY COMPANY)
#516
9801 WEST PARMER LANE
AUSTIN, TX 78717

SERVICE MARK
PRINCIPAL REGISTER

FOR: ENTERTAINMENT SERVICES, NAMELY, PROVIDING A WEB SITE FEATURING NON-DOWNLOADABLE MUSICAL PERFORMANCES, MUSICAL VIDEOS, RELATED FILM CLIPS, PHOTOGRAPHS, AND OTHER MULTIMEDIA MATERIALS FEATURING MUSIC; FAN CLUBS; MULTIMEDIA ENTERTAINMENT SERVICES IN THE NATURE OF RECORDING, PRODUCTION AND POST-PRODUCTION SERVICES IN THE FIELDS OF MUSIC, VIDEO, AND FILMS; MUSIC PRODUCTION SERVICES; MUSIC PUBLISHING SERVICES; PRODUCTION OF MUSICAL SOUND RECORDING; PROVIDING AN INTERNET WEBSITE PORTAL FEATURING LINKS TO MUSICAL ARTIST WEBSITES AND MUSIC PERFORMANCE TICKET INFORMATION; RECORDING STUDIO SERVICES, IN CLASS 41 (U.S. CLS. 100, 101 AND 107).

FIRST USE 6-24-2010; IN COMMERCE 6-24-2010.

NO CLAIM IS MADE TO THE EXCLUSIVE RIGHT TO USE "ENTERTAINMENT", APART FROM THE MARK AS SHOWN.

THE MARK CONSISTS OF A DESIGN OF A VINYL RECORD OVER A LETTER "S" SURROUNDED BY LIGHTNING WITH THE STYLIZED TEXT "STATX ENTERTAINMENT" UNDERNEATH.

SER. NO. 85-303,456, FILED 4-25-2011.

MARGARET POWER, EXAMINING ATTORNEY



David J. Kyffers

Director of the United States Patent and Trademark Office

United States of America

United States Patent and Trademark Office

KOMODO

Reg. No. 4,066,812

Registered Dec. 6, 2011

Int. Cl.: 30

TRADEMARK

PRINCIPAL REGISTER

GUNN, STEVE, D. (UNITED STATES INDIVIDUAL), DBA JJS CO.
232 POPE BEND SOUTH
CEDAR CREEK, TX 78612

FOR: SAUCES, IN CLASS 30 (U.S. CL. 46).

FIRST USE 8-11-2010; IN COMMERCE 2-3-2011.

THE MARK CONSISTS OF STANDARD CHARACTERS WITHOUT CLAIM TO ANY PARTICULAR FONT, STYLE, SIZE, OR COLOR.

SER. NO. 85-303,473, FILED 4-25-2011.

CHRISTINE MARTIN, EXAMINING ATTORNEY



David J. Kybas

Director of the United States Patent and Trademark Office

United States of America

United States Patent and Trademark Office

UVITA SYSTEM

Reg. No. 4,066,813

Registered Dec. 6, 2011

Int. Cl.: 5

TRADEMARK

PRINCIPAL REGISTER

UVITA SYSTEM LLC (DELAWARE LIMITED LIABILITY COMPANY)
458 BROCKTON DRIVE
MIDDLETOWN, DE 19709

FOR: DIETARY AND NUTRITIONAL SUPPLEMENTS; VITAMIN AND MINERAL SUPPLEMENTS, IN CLASS 5 (U.S. CLS. 6, 18, 44, 46, 51 AND 52).

FIRST USE 1-12-2011; IN COMMERCE 1-12-2011.

THE MARK CONSISTS OF STANDARD CHARACTERS WITHOUT CLAIM TO ANY PARTICULAR FONT, STYLE, SIZE, OR COLOR.

NO CLAIM IS MADE TO THE EXCLUSIVE RIGHT TO USE "SYSTEM", APART FROM THE MARK AS SHOWN.

SER. NO. 85-303,476, FILED 4-25-2011.

HOWARD B. LEVINE, EXAMINING ATTORNEY



David J. Kybas

Director of the United States Patent and Trademark Office

United States of America

United States Patent and Trademark Office

THE NAME YOU TRUST FOR THE CRAFT TOOLS YOU LOVE

Reg. No. 4,066,814

Registered Dec. 6, 2011

Int. Cl.: 26

TRADEMARK

PRINCIPAL REGISTER

WM. WRIGHT CO. (DELAWARE CORPORATION)
6050 DANA WAY
ANTIOCH, TN 37013

FOR: KNITTING NEEDLES FOR HAND KNITTING, NAMELY, STRAIGHT, CIRCULAR AND DOUBLE-POINTED NEEDLES MADE OF ALUMINUM, PLASTIC AND WOOD; CROCHET HOOKS FOR HAND CROCHETING, MADE OF STEEL, ALUMINUM, PLASTIC AND WOOD; CROCHET HOOKS SETS; KNITTING AND CROCHET ACCESSORIES, NAMELY, HAIRPIN LACE TOOLS, POMPON MAKERS, SPOOL KNITTERS FOR MAKING CORDS AND TUBES FROM YARN; YARN SWIFTS MADE OF NYLON, STEEL OR PLASTIC FOR WINDING HANKS OF YARN INTO SKEINS; YARN COUNTERS; YARN WINDERS, IN CLASS 26 (U.S. CLS. 37, 39, 40, 42 AND 50).

FIRST USE 6-0-2009; IN COMMERCE 6-0-2009.

THE MARK CONSISTS OF STANDARD CHARACTERS WITHOUT CLAIM TO ANY PARTICULAR FONT, STYLE, SIZE, OR COLOR.

SER. NO. 85-303,479, FILED 4-25-2011.

DORITT L. CARROLL, EXAMINING ATTORNEY



David J. Kyros

Director of the United States Patent and Trademark Office

United States of America

United States Patent and Trademark Office



Reg. No. 4,066,815

Registered Dec. 6, 2011

Int. Cl.: 11

TRADEMARK

PRINCIPAL REGISTER

POWERTECH, INC (TENNESSEE CORPORATION)
360 EAST SOUTH STREET
COLLIERVILLE, TN 38017

FOR: FLASHLIGHTS; TACTICAL FLASHLIGHTS, IN CLASS 11 (U.S. CLS. 13, 21, 23, 31 AND 34).

FIRST USE 1-1-2011; IN COMMERCE 1-25-2011.

OWNER OF U.S. REG. NO. 3,062,944.

THE COLOR(S) RED, BLUE, SILVER, AND WHITE IS/ARE CLAIMED AS A FEATURE OF THE MARK.

THE MARK CONSISTS OF "DELTA2" IN WHITE ON TOP OF A RED BACKGROUND WITH A SILVER UPPER AND LOWER BORDER AND A LARGER BLUE UPPER AND LOWER BORDER. THE COLOR BLUE ALSO APPEARS AS A SHADOW ON THE NUMBER "2".

SER. NO. 85-303,483, FILED 4-25-2011.

MARK SHINER, EXAMINING ATTORNEY



David J. Kybas

Director of the United States Patent and Trademark Office

United States of America

United States Patent and Trademark Office

MINDSALT

Reg. No. 4,066,816

MINDSALT CORPORATION (FLORIDA CORPORATION)
P.O. BOX 561286
ROCKLEDGE, FL 329561286

Registered Dec. 6, 2011

Int. Cl.: 42

FOR: PROVIDING ON-LINE NON-DOWNLOADABLE COMPUTER SOFTWARE FOR TIME AND EXPENSE MANAGEMENT, IN CLASS 42 (U.S. CLS. 100 AND 101).

SERVICE MARK

FIRST USE 12-11-2006; IN COMMERCE 3-24-2007.

PRINCIPAL REGISTER

THE MARK CONSISTS OF STANDARD CHARACTERS WITHOUT CLAIM TO ANY PARTICULAR FONT, STYLE, SIZE, OR COLOR.

SER. NO. 85-303,501, FILED 4-25-2011.

BRENDAN MCCAULEY, EXAMINING ATTORNEY



David J. Kybas

Director of the United States Patent and Trademark Office

United States of America

United States Patent and Trademark Office



Reg. No. 4,066,817

Registered Dec. 6, 2011

Int. Cl.: 43

SERVICE MARK

PRINCIPAL REGISTER

LISSADELL INC. (NEW YORK CORPORATION)
IN
30-30 49TH STREET
ASTORIA, NY 11103

FOR: RESTAURANT SERVICES FEATURING SANDWICHES, IN CLASS 43 (U.S. CLS. 100 AND 101).

FIRST USE 12-17-2006; IN COMMERCE 4-1-2007.

NO CLAIM IS MADE TO THE EXCLUSIVE RIGHT TO USE "PANINI", APART FROM THE MARK AS SHOWN.

THE MARK CONSISTS OF THE STYLIZED WORDING "IL BAMBINO" IN AN ARC-SHAPED ORIENTATION OVER THE STYLIZED WORDING "PANINI", THE DESIGN OF A SILHOUETTE OF A PIG BELOW THE WORDING, AND THE FLOWER-LIKE DESIGN BETWEEN THE WORDING "IL" AND "BAMBINO".

THE ENGLISH TRANSLATION OF "IL BAMBINO PANINI" IN THE MARK IS "THE BABE SANDWICHES".

SER. NO. 85-303,503, FILED 4-25-2011.

JAY BESCH, EXAMINING ATTORNEY



David J. Kyffers

Director of the United States Patent and Trademark Office

United States of America

United States Patent and Trademark Office



Reg. No. 4,066,818

MINDSALT CORPORATION (FLORIDA CORPORATION)

Registered Dec. 6, 2011

P.O. BOX 561286
ROCKLEDGE, FL 329561286

Int. Cl.: 42

FOR: PROVIDING ON-LINE NON-DOWNLOADABLE COMPUTER SOFTWARE FOR TIME AND EXPENSE MANAGEMENT, IN CLASS 42 (U.S. CLS. 100 AND 101).

SERVICE MARK

FIRST USE 3-24-2007; IN COMMERCE 3-24-2007.

PRINCIPAL REGISTER

NO CLAIM IS MADE TO THE EXCLUSIVE RIGHT TO USE "TIME" AND "EXPENSE", APART FROM THE MARK AS SHOWN.

THE MARK CONSISTS OF THE TERM "MINDSALT" WRITTEN IN LOWERCASE LETTERS ABOVE THE TERMS "TIME & EXPENSE" WRITTEN IN UPPERCASE LETTERS. THE WORD "MIND" IS WRITTEN IN A DARKER SHADE THAN THE OTHER TERMS AND THERE IS A CONTRAIL EXTENDING FROM THE UPPER LEFT PORTION OF THE DOT ABOVE THE "I" IN "MINDSALT" AND EXTENDING AROUND, WITH A CURVE TO TAPER AND END BY THE BOTTOM LEFT SIDE OF THE "T" IN "TIME".

SER. NO. 85-303,514, FILED 4-25-2011.

BRENDAN MCCAULEY, EXAMINING ATTORNEY



David J. Kyros

Director of the United States Patent and Trademark Office

United States of America

United States Patent and Trademark Office

RAYLEN VINEYARDS COLLECTION

Reg. No. 4,066,819

Registered Dec. 6, 2011

Int. Cl.: 20

TRADEMARK

PRINCIPAL REGISTER

RAYLEN VINEYARDS INC. (NORTH CAROLINA CORPORATION)
3577 US HIGHWAY 158
MOCKSVILLE, NC 27028

FOR: FURNITURE, IN CLASS 20 (U.S. CLS. 2, 13, 22, 25, 32 AND 50).

FIRST USE 7-1-2003; IN COMMERCE 7-1-2003.

THE MARK CONSISTS OF STANDARD CHARACTERS WITHOUT CLAIM TO ANY PARTICULAR FONT, STYLE, SIZE, OR COLOR.

OWNER OF U.S. REG. NO. 2,878,802.

NO CLAIM IS MADE TO THE EXCLUSIVE RIGHT TO USE "COLLECTION", APART FROM THE MARK AS SHOWN.

SER. NO. 85-303,525, FILED 4-25-2011.

REBECCA POVARCHUK, EXAMINING ATTORNEY



David J. Kybas

Director of the United States Patent and Trademark Office

United States of America

United States Patent and Trademark Office



Reg. No. 4,066,820

Registered Dec. 6, 2011

Int. Cl.: 29

TRADEMARK

PRINCIPAL REGISTER

DGM COMMODITIES, CORP. (NEW YORK CORPORATION)
49 WATERMILL LANE
GREAT NECK, NY 11021

FOR: POULTRY, NAMELY, CHICKEN, IN CLASS 29 (U.S. CL. 46).

FIRST USE 3-24-2011; IN COMMERCE 3-24-2011.

OWNER OF U.S. REG. NO. 2,983,838.

THE COLOR(S) BLACK AND BLUE IS/ARE CLAIMED AS A FEATURE OF THE MARK.

THE MARK CONSISTS OF THE STYLIZED TERM "DELINI" APPEARING IN THE COLOR BLACK ABOVE A DESIGN ELEMENT COMPRISING A BLUE LILY-SHAPED FIVE-POINT STAR SYMBOL WITH A CIRCLE IN THE CENTER. THE DESIGN ELEMENT IS OUTLINED IN BLACK. THE COLOR WHITE REPRESENTS TRANSPARENT AREAS AND IS NOT PART OF THE MARK.

SER. NO. 85-303,554, FILED 4-25-2011.

GEOFFREY FOSDICK, EXAMINING ATTORNEY



David J. Kybas

Director of the United States Patent and Trademark Office

United States of America

United States Patent and Trademark Office

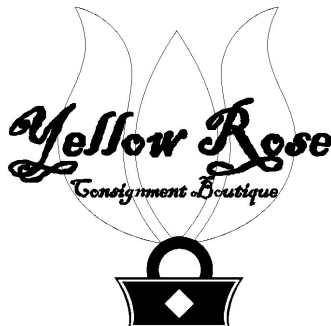

Reg. No. 4,066,821

Registered Dec. 6, 2011

Int. Cl.: 35

SERVICE MARK

PRINCIPAL REGISTER

CHASE MANAGEMENT, LLC. (COLORADO LIMITED LIABILITY COMPANY)
5893 LASSO PL.
PARKER, CO 80134

FOR: RETAIL CONSIGNMENT STORES FEATURING HOME DECORATIONS AND FURNITURE, IN CLASS 35 (U.S. CLS. 100, 101 AND 102).

FIRST USE 4-1-2010; IN COMMERCE 4-1-2010.

NO CLAIM IS MADE TO THE EXCLUSIVE RIGHT TO USE "CONSIGNMENT BOUTIQUE", APART FROM THE MARK AS SHOWN.

THE MARK CONSISTS OF A STYLIZED ROSE CONSISTING OF THREE PETALS. BELOW THIS IS A STYLIZED PURSE BAG WITH A DIAMOND CENTER. IN THE CENTER OF THE ROSE ARE THE STYLIZED WORDS "YELLOW ROSE CONSIGNMENT BOUTIQUE".

SER. NO. 85-303,573, FILED 4-25-2011.

SIMON TENG, EXAMINING ATTORNEY



David J. Kyros

Director of the United States Patent and Trademark Office

United States of America

United States Patent and Trademark Office

CLASSY

Reg. No. 4,066,822

Registered Dec. 6, 2011

Int. Cl.: 26

TRADEMARK

PRINCIPAL REGISTER

JK TRADING, INC. (NORTH CAROLINA CORPORATION)
209 CREEKRIDGE ROAD, SUITE F
GREENSBORO, NC 27406

FOR: ADD-IN AND ADD-ON HAIR ACCESSORIES CONSTRUCTED PRIMARILY OF HUMAN HAIR FOR USE IN MAKING WIGS, HAIRPIECES, AND HAIR EXTENSIONS , IN CLASS 26 (U.S. CLS. 37, 39, 40, 42 AND 50).

FIRST USE 2-1-2009; IN COMMERCE 2-1-2009.

THE MARK CONSISTS OF STANDARD CHARACTERS WITHOUT CLAIM TO ANY PARTICULAR FONT, STYLE, SIZE, OR COLOR.

SER. NO. 85-303,576, FILED 4-25-2011.

MICHAEL TANNER, EXAMINING ATTORNEY



David J. Kybas

Director of the United States Patent and Trademark Office

United States of America

United States Patent and Trademark Office

BONA HARDWOOD FLOOR MOP

Reg. No. 4,066,823

Registered Dec. 6, 2011

Int. Cl.: 21

TRADEMARK

PRINCIPAL REGISTER

BONA AB (SWEDEN CORPORATION)
P.O. BOX 21074, MURMANSGATAN 130
SE-200 21 MALMÖ, SWEDEN

FOR: FLOOR MOPS, IN CLASS 21 (U.S. CLS. 2, 13, 23, 29, 30, 33, 40 AND 50).

FIRST USE 4-0-2008; IN COMMERCE 4-0-2008.

THE MARK CONSISTS OF STANDARD CHARACTERS WITHOUT CLAIM TO ANY PARTICULAR FONT, STYLE, SIZE, OR COLOR.

OWNER OF U.S. REG. NOS. 1,640,991, 3,925,024 AND OTHERS.

NO CLAIM IS MADE TO THE EXCLUSIVE RIGHT TO USE "HARDWOOD FLOOR MOP", APART FROM THE MARK AS SHOWN.

SER. NO. 85-303,579, FILED 4-25-2011.

ELIZABETH KAJUBI, EXAMINING ATTORNEY



David J. Kybas

Director of the United States Patent and Trademark Office

United States of America

United States Patent and Trademark Office

TRIMLAND

Reg. No. 4,066,824

Registered Dec. 6, 2011

Int. Cl.: 26

TRADEMARK

PRINCIPAL REGISTER

JANAJ INTERNATIONAL, LTD. (NEW YORK CORPORATION), DBA TRIMLAND
60 E. JEFRYN BOULEVARD
DEER PARK, NY 11729

FOR: DECORATIVE CORDING; DECORATIVE CORDS; DECORATIVE NOVELTY TACKS FOR PINNING DRAPERY OR CLOTHING TO AID IN MAKING ALTERATIONS; DECORATIVE RIBBONS; FABRIC APPLIQUES; FRINGES; LACE TRIMMING; ORNAMENTAL BOWS OF TEXTILE FOR DECORATION; ORNAMENTAL RIBBONS MADE OF TEXTILES; RIBBONS OF TEXTILE MATERIALS; SEAM BINDING; TASSELS; WEBBING IN THE NATURE OF WOVEN FABRIC TAPE FOR SEWING PURPOSES, IN CLASS 26 (U.S. CLS. 37, 39, 40, 42 AND 50).

FIRST USE 12-31-2003; IN COMMERCE 12-31-2003.

THE MARK CONSISTS OF STANDARD CHARACTERS WITHOUT CLAIM TO ANY PARTICULAR FONT, STYLE, SIZE, OR COLOR.

OWNER OF U.S. REG. NO. 2,446,898.

SER. NO. 85-303,589, FILED 4-25-2011.

MARK T. MULLEN, EXAMINING ATTORNEY



David J. Kyros

Director of the United States Patent and Trademark Office

United States of America

United States Patent and Trademark Office



PUSFACE CUSTOMS

Reg. No. 4,066,825

Registered Dec. 6, 2011

Int. Cl.: 37

SERVICE MARK

PRINCIPAL REGISTER

MCKINSEY, SHARON (UNITED STATES INDIVIDUAL)
221 ROCKY ROAD
RED LION, PA 17356 AND

MCKINSEY, RICKY (UNITED STATES INDIVIDUAL)
221 ROCKY ROAD
RED LION, PA 17356

FOR: VEHICLE REPAIR AND MAINTENANCE, IN CLASS 37 (U.S. CLS. 100, 103 AND 106).

FIRST USE 3-25-2008; IN COMMERCE 3-25-2008.

NO CLAIM IS MADE TO THE EXCLUSIVE RIGHT TO USE "CUSTOMS", APART FROM THE MARK AS SHOWN.

THE MARK CONSISTS OF AN ACE OF SPADE WITH BASE, STYLIZED LETTERS AT BASE SPELLING "PUSFACE CUSTOMS", CAPITAL LETTERS IN CENTER OF SPADE "PFC", AND SCROLLINGS.

SER. NO. 85-303,646, FILED 4-25-2011.

PAM WILLIS, EXAMINING ATTORNEY



David J. Kybas

Director of the United States Patent and Trademark Office

United States of America

United States Patent and Trademark Office

LJ MEDICAL

Reg. No. 4,066,826

Registered Dec. 6, 2011

Int. Cl.: 35

SERVICE MARK

PRINCIPAL REGISTER

LJ MEDICAL, LLC (MARYLAND LIMITED LIABILITY COMPANY)
15914B SHADY GROVE ROAD
GAITHERSBURG, MD 20877

FOR: BUSINESS CONSULTING SERVICES RELATING TO PRODUCT DISTRIBUTION, OPERATIONS MANAGEMENT SERVICES, LOGISTICS, SUPPLY CHAIN, AND DISTRIBUTION SOLUTIONS, IN CLASS 35 (U.S. CLS. 100, 101 AND 102).

FIRST USE 2-1-2010; IN COMMERCE 2-1-2010.

THE MARK CONSISTS OF STANDARD CHARACTERS WITHOUT CLAIM TO ANY PARTICULAR FONT, STYLE, SIZE, OR COLOR.

NO CLAIM IS MADE TO THE EXCLUSIVE RIGHT TO USE "MEDICAL", APART FROM THE MARK AS SHOWN.

SER. NO. 85-303,722, FILED 4-25-2011.

LIEF MARTIN, EXAMINING ATTORNEY



David J. Kyros

Director of the United States Patent and Trademark Office

United States of America
United States Patent and Trademark Office

DEVEDGE

Reg. No. 4,066,827

Registered Dec. 6, 2011

Int. Cl.: 9

TRADEMARK

PRINCIPAL REGISTER

CALAVISTA (TEXAS LIMITED LIABILITY COMPANY)
BUILDING F, SUITE 200
12912 HILL COUNTRY BLVD.
AUSTIN, TX 78759

FOR: COMPUTER SOFTWARE FOR COMPILER SOFTWARE DEVELOPMENT, IN CLASS
9 (U.S. CLS. 21, 23, 26, 36 AND 38).

FIRST USE 6-0-2005; IN COMMERCE 6-0-2005.

THE MARK CONSISTS OF STANDARD CHARACTERS WITHOUT CLAIM TO ANY PAR-
TICULAR FONT, STYLE, SIZE, OR COLOR.

SER. NO. 85-303,810, FILED 4-25-2011.

INGA ERVIN, EXAMINING ATTORNEY



David J. Kybas

Director of the United States Patent and Trademark Office

United States of America

United States Patent and Trademark Office

3TCDESIGN

Reg. No. 4,066,828

Registered Dec. 6, 2011

Int. Cl.: 42

SERVICE MARK

PRINCIPAL REGISTER

KLEIN, STEVEN P. (UNITED STATES INDIVIDUAL)
2896 EAST GALBRAITH RD.
CINCINNATI, OH 45237

FOR: PROVIDING GRAPHIC AND MULTIMEDIA GRAPHIC DESIGN SERVICES FOR THE PURPOSE OF PROMOTING THE GOODS AND SERVICES OF OTHERS, IN CLASS 42 (U.S. CLS. 100 AND 101).

FIRST USE 5-3-2010; IN COMMERCE 5-3-2010.

THE MARK CONSISTS OF STANDARD CHARACTERS WITHOUT CLAIM TO ANY PARTICULAR FONT, STYLE, SIZE, OR COLOR.

SER. NO. 85-303,818, FILED 4-25-2011.

SETH A. RAPPAPORT, EXAMINING ATTORNEY



David J. Kyros

Director of the United States Patent and Trademark Office

United States of America

United States Patent and Trademark Office

AMERICAN HARVEST

Reg. No. 4,066,829

Registered Dec. 6, 2011

Int. Cl.: 33

TRADEMARK

PRINCIPAL REGISTER

SIDNEY FRANK IMPORTING CO., INC. (NEW YORK CORPORATION)
20 CEDAR STREET, SUITE 203
NEW ROCHELLE, NY 10801

FOR: DISTILLED SPIRITS, IN CLASS 33 (U.S. CLS. 47 AND 49).

FIRST USE 4-21-2011; IN COMMERCE 4-21-2011.

THE MARK CONSISTS OF STANDARD CHARACTERS WITHOUT CLAIM TO ANY PARTICULAR FONT, STYLE, SIZE, OR COLOR.

OWNER OF U.S. REG. NO. 3,990,795.

NO CLAIM IS MADE TO THE EXCLUSIVE RIGHT TO USE "AMERICAN", APART FROM THE MARK AS SHOWN.

SER. NO. 85-303,831, FILED 4-25-2011.

DAVID YONTEF, EXAMINING ATTORNEY



David J. Kyffers

Director of the United States Patent and Trademark Office

United States of America

United States Patent and Trademark Office

Moanikeala Hula Festival

Reg. No. 4,066,830

Registered Dec. 6, 2011

Int. Cl.: 41

SERVICE MARK

PRINCIPAL REGISTER

POLYNESIAN CULTURAL CENTER (HAWAII CORPORATION)
55-370 KAMEHAMEHA HWY
LAIE, HI 96762

FOR: ENTERTAINMENT SERVICES IN THE NATURE OF LIVE DANCE AND THEATRICAL PERFORMANCES, AND ARRANGING AND CONDUCTING FESTIVALS FEATURING POLYNESIAN DANCE; EDUCATION SERVICES, NAMELY, PROVIDING CLASSES, INFORMATION, AND INSTRUCTION IN THE FIELD OF DANCE, IN CLASS 41 (U.S. CLS. 100, 101 AND 107).

FIRST USE 1-31-1991; IN COMMERCE 1-31-1991.

THE MARK CONSISTS OF STANDARD CHARACTERS WITHOUT CLAIM TO ANY PARTICULAR FONT, STYLE, SIZE, OR COLOR.

NO CLAIM IS MADE TO THE EXCLUSIVE RIGHT TO USE "HULA FESTIVAL", APART FROM THE MARK AS SHOWN.

THE ENGLISH TRANSLATION OF "MOANIKEALA" IN THE MARK IS "WIND BORNE FRAGRANCE".

SER. NO. 85-303,905, FILED 4-25-2011.

KATHLEEN M. VANSTON, EXAMINING ATTORNEY



David J. Kyros

Director of the United States Patent and Trademark Office

United States of America

United States Patent and Trademark Office

FLIGHT LANDATA

Reg. No. 4,066,831

Registered Dec. 6, 2011

Int. Cls.: 9 and 42

TRADEMARK

SERVICE MARK

PRINCIPAL REGISTER

FLIGHT LANDATA, INC. (MASSACHUSETTS CORPORATION)
250 CLARK STREET
NORTH ANDOVER, MA 01845

FOR: ELECTRICAL AND SCIENTIFIC APPARATUS, NAMELY, HIGH RESOLUTION, ELECTRO-OPTICAL AIRBORNE DIGITAL CAMERAS, AND ULTRA-HIGH-RESOLUTION AERIAL IMAGING SYSTEMS, IN CLASS 9 (U.S. CLS. 21, 23, 26, 36 AND 38).

FIRST USE 1-31-2006; IN COMMERCE 1-31-2006.

FOR: SCIENTIFIC AND TECHNOLOGICAL SERVICES, NAMELY, PERFORMING HIGH RESOLUTION DIGITAL MAPPING, ELEVATION MODELING AND CHANGE DETECTION FOR MAPPING AND INTELLIGENCE APPLICATIONS, IN CLASS 42 (U.S. CLS. 100 AND 101).

FIRST USE 1-31-2006; IN COMMERCE 1-31-2006.

NO CLAIM IS MADE TO THE EXCLUSIVE RIGHT TO USE "FLIGHT", APART FROM THE MARK AS SHOWN.

THE MARK CONSISTS OF A 4X4 MATRIX OF SOLID SQUARES LOCATED BETWEEN THE WORDS "FLIGHT LANDATA".

SER. NO. 85-303,933, FILED 4-25-2011.

EDWARD NELSON, EXAMINING ATTORNEY



David J. Kyjars

Director of the United States Patent and Trademark Office

United States of America

United States Patent and Trademark Office

engenuity^{SC}

Imagine More

Reg. No. 4,066,832

ENGENUITYSC (SOUTH CAROLINA CORPORATION)
1000 CATAWBA STREET, SUITE 130
COLUMBIA, SC 29201

Registered Dec. 6, 2011

Int. Cl.: 35

FOR: PROMOTING THE ECONOMIC DEVELOPMENT IN THE MIDLANDS OF SOUTH CAROLINA, IN CLASS 35 (U.S. CLS. 100, 101 AND 102).

SERVICE MARK

FIRST USE 1-31-2004; IN COMMERCE 1-31-2004.

PRINCIPAL REGISTER

THE MARK CONSISTS OF THE STYLIZED COINED WORD "ENGENUITYSC" WITH THE "SC" SHOWN AS A SUPERSCRIPT OVER THE PHRASE "IMAGINE MORE".

SER. NO. 85-303,941, FILED 4-25-2011.

DOUGLAS LEE, EXAMINING ATTORNEY



David J. Kyffers

Director of the United States Patent and Trademark Office

United States of America

United States Patent and Trademark Office



Reg. No. 4,066,833

Registered Dec. 6, 2011

Int. Cls.: 35 and 37

SERVICE MARK

PRINCIPAL REGISTER

I-LUXURY ENTERPRISES, INC. (GEORGIA CORPORATION)
3340 PEACHTREE ROAD, NE, SUITE 1700
ATLANTA, GA 30326

FOR: JEWELRY RETAIL, WHOLESALE AND ONLINE RETAIL AND WHOLESALE STORE SERVICES, IN CLASS 35 (U.S. CLS. 100, 101 AND 102).

FIRST USE 9-1-2005; IN COMMERCE 9-1-2005.

FOR: JEWELRY AND WATCH REPAIR SERVICES, IN CLASS 37 (U.S. CLS. 100, 103 AND 106).

FIRST USE 9-1-2005; IN COMMERCE 9-1-2005.

THE MARK CONSISTS OF THE STYLIZED LETTERS "S" AND "B".

SER. NO. 85-303,955, FILED 4-25-2011.

ROBIN MITTLER, EXAMINING ATTORNEY



David J. Kybas

Director of the United States Patent and Trademark Office

United States of America

United States Patent and Trademark Office

WIRELESS GIANT

Reg. No. 4,066,834

Registered Dec. 6, 2011

Int. Cl.: 35

SERVICE MARK

PRINCIPAL REGISTER

GLOBAL NETWORK COMMUNICATIONS, INC. (MICHIGAN CORPORATION)
32600 STEPHENSON HIGHWAY
MADISON HEIGHTS, MI 48071

FOR: ON-LINE RETAIL STORE SERVICES FEATURING ELECTRONICS, IN CLASS 35 (U.S. CLS. 100, 101 AND 102).

FIRST USE 4-4-2011; IN COMMERCE 4-4-2011.

THE MARK CONSISTS OF STANDARD CHARACTERS WITHOUT CLAIM TO ANY PARTICULAR FONT, STYLE, SIZE, OR COLOR.

OWNER OF U.S. REG. NOS. 2,991,993, 3,026,791, AND 3,537,106.

NO CLAIM IS MADE TO THE EXCLUSIVE RIGHT TO USE "WIRELESS", APART FROM THE MARK AS SHOWN.

SER. NO. 85-303,969, FILED 4-25-2011.

JANICE KIM, EXAMINING ATTORNEY



David J. Kybas

Director of the United States Patent and Trademark Office

United States of America

United States Patent and Trademark Office

EUFORA

Reg. No. 4,066,835

Registered Dec. 6, 2011

Int. Cls.: 35 and 41

SERVICE MARK

PRINCIPAL REGISTER

EDEN BEAUTY CONCEPTS (CALIFORNIA CORPORATION)
3215 EXECUTIVE RIDGE
VISTA, CA 92081

FOR: BUSINESS CONSULTATION SERVICES, IN CLASS 35 (U.S. CLS. 100, 101 AND 102).

FIRST USE 6-30-1995; IN COMMERCE 6-30-1995.

FOR: EDUCATION SERVICES, NAMELY, PROVIDING CLASSES, SEMINARS AND WORKSHOPS IN THE FIELDS OF HAIR SALONS, HAIR CARE, AND BODY CARE, IN CLASS 41 (U.S. CLS. 100, 101 AND 107).

FIRST USE 6-30-1995; IN COMMERCE 6-30-1995.

THE MARK CONSISTS OF STANDARD CHARACTERS WITHOUT CLAIM TO ANY PARTICULAR FONT, STYLE, SIZE, OR COLOR.

OWNER OF U.S. REG. NOS. 3,067,693, 3,684,917, AND 3,959,522.

SER. NO. 85-304,054, FILED 4-25-2011.

SIMON TENG, EXAMINING ATTORNEY



David J. Kybas

Director of the United States Patent and Trademark Office

United States of America

United States Patent and Trademark Office

MISSION CRITICAL LITIGATION

Reg. No. 4,066,836

Registered Dec. 6, 2011

Int. Cl.: 45

SERVICE MARK

PRINCIPAL REGISTER

GODWIN RONQUILLO PC (TEXAS CORPORATION)
1201 ELM STREET, SUITE 1700
DALLAS, TX 75270

FOR: ATTORNEY SERVICES, IN CLASS 45 (U.S. CLS. 100 AND 101).

FIRST USE 6-29-2001; IN COMMERCE 6-29-2001.

THE MARK CONSISTS OF STANDARD CHARACTERS WITHOUT CLAIM TO ANY PARTICULAR FONT, STYLE, SIZE, OR COLOR.

NO CLAIM IS MADE TO THE EXCLUSIVE RIGHT TO USE "LITIGATION", APART FROM THE MARK AS SHOWN.

SER. NO. 85-304,078, FILED 4-25-2011.

TRACY WHITTAKER-BROWN, EXAMINING ATTORNEY



David J. Kybas

Director of the United States Patent and Trademark Office

United States of America

United States Patent and Trademark Office

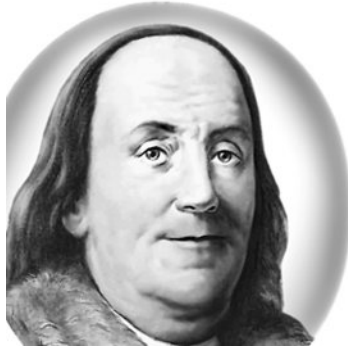

Reg. No. 4,066,837
Registered Dec. 6, 2011
Int. Cl.: 36

SERVICE MARK

PRINCIPAL REGISTER

FRANKLIN RESOURCES, INC. (DELAWARE CORPORATION), DBA FRANKLIN
TEMPLETON INVESTMENTS
ONE FRANKLIN PARKWAY
SAN MATEO, CA 944031906

FOR: ADVICE RELATING TO INVESTMENTS; FINANCIAL ADVISORY AND CONSULTANCY SERVICES; FINANCIAL ANALYSIS AND CONSULTATION; FINANCIAL INFORMATION AND ADVISORY SERVICES; FINANCIAL SERVICES, NAMELY, INVESTMENT ADVICE, INVESTMENT MANAGEMENT, INVESTMENT CONSULTATION AND INVESTMENT OF FUNDS FOR OTHERS, INCLUDING PRIVATE AND PUBLIC EQUITY AND DEBT INVESTMENT SERVICES; FUNDS INVESTMENT; INVESTMENT ADVISORY SERVICES; INVESTMENT CONSULTATION; INVESTMENT MANAGEMENT; INVESTMENT OF FUNDS FOR OTHERS; MUTUAL FUND DISTRIBUTION; MUTUAL FUND INVESTMENT; MUTUAL FUNDS AND CAPITAL INVESTMENT, IN CLASS 36 (U.S. CLS. 100, 101 AND 102).

FIRST USE 3-0-2011, THE MARK WAS FIRST USED ANYWHERE IN A DIFFERENT FORM OTHER THAN THAT SOUGHT TO BE REGISTERED AT LEAST AS EARLY AS 04/00/1958; IN COMMERCE 3-0-2011, THE MARK WAS FIRST USED IN COMMERCE IN A DIFFERENT FORM OTHER THAN THAT SOUGHT TO BE REGISTERED AT LEAST AS EARLY AS 04/00/1958.

OWNER OF U.S. REG. NOS. 2,576,903, 3,325,442 AND OTHERS.

THE NAME(S), PORTRAIT(S), AND/OR SIGNATURE(S) SHOWN IN THE MARK DOES NOT IDENTIFY A PARTICULAR LIVING INDIVIDUAL.

THE MARK CONSISTS OF A DESIGN CONSISTING OF A "BEN FRANKLIN" HEAD PORTRAIT WITHIN A CIRCLE WITH A STRAIGHT LEFT AND BOTTOM EDGE.

SER. NO. 85-304,102, FILED 4-25-2011.

MAYUR VAGHANI, EXAMINING ATTORNEY



David J. Kybas

Director of the United States Patent and Trademark Office

United States of America

United States Patent and Trademark Office

Safety is Life

Reg. No. 4,066,838

Registered Dec. 6, 2011

Int. Cl.: 41

SERVICE MARK

PRINCIPAL REGISTER

MANAGED RESPONSE, INC. (TEXAS CORPORATION)
#1240
3040 POST OAK BLVD.
HOUSTON, TX 77056

FOR: TRAINING SERVICES IN THE FIELD OF INDUSTRIAL AND CONSTRUCTION SAFETY, IN CLASS 41 (U.S. CLS. 100, 101 AND 107).

FIRST USE 6-1-2008; IN COMMERCE 6-1-2008.

THE MARK CONSISTS OF STANDARD CHARACTERS WITHOUT CLAIM TO ANY PARTICULAR FONT, STYLE, SIZE, OR COLOR.

NO CLAIM IS MADE TO THE EXCLUSIVE RIGHT TO USE "SAFETY", APART FROM THE MARK AS SHOWN.

SER. NO. 85-304,203, FILED 4-25-2011.

TEJBIR SINGH, EXAMINING ATTORNEY



David J. Kybas

Director of the United States Patent and Trademark Office

United States of America

United States Patent and Trademark Office

GRAMERCY PROTOCOL

Reg. No. 4,066,839

Registered Dec. 6, 2011

Int. Cl.: 35

SERVICE MARK

PRINCIPAL REGISTER

KOROPEY, LENA (UNITED STATES INDIVIDUAL)
4C
82 IRVING PLACE
NEW YORK, NY 10003

FOR: CORPORATE ETIQUETTE AND INTERNATIONAL PROTOCOL CONSULTING, IN CLASS 35 (U.S. CLS. 100, 101 AND 102).

FIRST USE 12-6-2010; IN COMMERCE 12-28-2010.

NO CLAIM IS MADE TO THE EXCLUSIVE RIGHT TO USE "PROTOCOL", APART FROM THE MARK AS SHOWN.

THE MARK CONSISTS OF THE STYLIZED TEXT "GRAMERCY PROTOCOL" WITH A DESIGN OF AN ANTIQUE KEY IN BETWEEN THE WORDS.

SER. NO. 85-304,206, FILED 4-25-2011.

JOHN WILKE, EXAMINING ATTORNEY



David J. Kybas

Director of the United States Patent and Trademark Office

United States of America

United States Patent and Trademark Office

BONITAFEST

Reg. No. 4,066,840

Registered Dec. 6, 2011

Int. Cl.: 41

SERVICE MARK

PRINCIPAL REGISTER

BONITA BUSINESS & PROFESSIONAL ASSOCIATION, INC. (CALIFORNIA CORPORATION)
P.O. BOX 284
BONITA, CA 91908

FOR: ORGANIZING COMMUNITY FESTIVALS FEATURING PRIMARILY STREET FAIRS,
PARADES, MUSICAL ENTERTAINMENT AND ALSO PROVIDING FOOD AND BEVERAGES
, IN CLASS 41 (U.S. CLS. 100, 101 AND 107).

FIRST USE 7-1-1972; IN COMMERCE 7-1-1972.

THE MARK CONSISTS OF STANDARD CHARACTERS WITHOUT CLAIM TO ANY PAR-
TICULAR FONT, STYLE, SIZE, OR COLOR.

SEC. 2(F).

SER. NO. 85-304,207, FILED 4-25-2011.

BARBARA GAYNOR, EXAMINING ATTORNEY



David J. Kybas

Director of the United States Patent and Trademark Office

United States of America

United States Patent and Trademark Office

KEEP YOUR
COOL

Reg. No. 4,066,841

Registered Dec. 6, 2011

Int. Cl.: 35

SERVICE MARK

PRINCIPAL REGISTER

CASTROVILLA, INC. (CALIFORNIA CORPORATION)
253 POLARIS AVENUE
MOUNTAIN VIEW, CA 94043

FOR: CONDUCTING AND ADMINISTERING AN ENERGY EFFICIENCY PROGRAM, NAMELY, CONSULTATION IN THE FIELD OF ENERGY EFFICIENCY; CONDUCTING ENERGY AUDITS OF COMMERCIAL AND INSTITUTIONAL FACILITIES FOR THE PURPOSE OF IMPROVING ENERGY EFFICIENCY; ARRANGING FOR OTHERS THE REPAIR AND RETROFITTING OF COMMERCIAL APPLIANCES, IN CLASS 35 (U.S. CLS. 100, 101 AND 102).

FIRST USE 7-16-2007; IN COMMERCE 7-16-2007.

THE MARK CONSISTS OF THE WORDING "KEEP YOUR" WITH A SNOWFLAKE IN PLACE OF THE LETTER "O" IN THE WORD "YOUR". THE WORD "COOL" IS DIRECTLY BELOW THE WORDING "KEEP YOUR". A STRAIGHT HORIZONTAL LINE APPEARS ABOVE THE WORDING "KEEP YOUR" AND THE WORD "COOL" IS SURROUNDED BY A RECTANGLE DESIGN.

SER. NO. 85-304,227, FILED 4-25-2011.

ANDREW RHIM, EXAMINING ATTORNEY



David J. Kybas

Director of the United States Patent and Trademark Office

United States of America

United States Patent and Trademark Office

A MILLION DOORS

Reg. No. 4,066,842

HOLY TRINITY MONTESSORI (UNITED STATES INDIVIDUAL)
525 SNEED ROAD
NASHVILLE, TN 37221

Registered Dec. 6, 2011

Int. Cl.: 36

FOR: FINANCIAL PLANNING, NAMELY, CHARITABLE FUNDRAISING, IN CLASS 36
(U.S. CLS. 100, 101 AND 102).

SERVICE MARK

FIRST USE 4-15-2011; IN COMMERCE 4-15-2011.

PRINCIPAL REGISTER

THE MARK CONSISTS OF "A MILLION DOORS" WRITTEN IN BLACK AND DARK PINK CAPS, WITH THE I AS A DARK PINK MONTESSORI TOWER OF CUBES, 10 CUBES. A IS IN BLACK COLOR. "MILLION" IS IN DARK PINK AND "DOORS" IS IN ALL CAPS/BLACK.

THE COLOR(S) "BLACK", "DARK PINK" IS/ARE CLAIMED AS A FEATURE OF THE MARK.

SER. NO. 85-304,243, FILED 4-25-2011.

TRACY WHITTAKER-BROWN, EXAMINING ATTORNEY



David J. Kybas

Director of the United States Patent and Trademark Office

United States of America

United States Patent and Trademark Office

RetroHomeMiami Exceptional Historic Properties

Reg. No. 4,066,843

Registered Dec. 6, 2011

Int. Cl.: 36

SERVICE MARK

PRINCIPAL REGISTER

MILLER, NATHAN (UNITED STATES INDIVIDUAL)
7100 NE 5TH AVENUE
MIAMI, FL 33138

FOR: REAL ESTATE BROKERAGE AND RENTAL SERVICES OF HISTORIC REAL ESTATE IN SOUTH FLORIDA, WITH A FOCUS ON MIAMI AND MIAMI BEACH, IN CLASS 36 (U.S. CLS. 100, 101 AND 102).

FIRST USE 7-14-2009; IN COMMERCE 11-1-2009.

THE MARK CONSISTS OF STANDARD CHARACTERS WITHOUT CLAIM TO ANY PARTICULAR FONT, STYLE, SIZE, OR COLOR.

NO CLAIM IS MADE TO THE EXCLUSIVE RIGHT TO USE "EXCEPTIONAL HISTORIC PROPERTIES", APART FROM THE MARK AS SHOWN.

SER. NO. 85-304,279, FILED 4-25-2011.

ELISSA GARBER KON, EXAMINING ATTORNEY



David J. Kybas

Director of the United States Patent and Trademark Office

United States of America

United States Patent and Trademark Office

NYKA

Reg. No. 4,066,844

Registered Dec. 6, 2011

Int. Cl.: 42

SERVICE MARK

PRINCIPAL REGISTER

NYKA ENTERPRISES, LLC (GEORGIA LIMITED LIABILITY COMPANY)
4898 TARRY GLEN DR.
SUWANEE, GA 30024

FOR: HEALTH CARE INFORMATION TECHNOLOGY CONSULTING SERVICES, IN CLASS
42 (U.S. CLS. 100 AND 101).

FIRST USE 9-15-2006; IN COMMERCE 9-15-2006.

THE MARK CONSISTS OF STANDARD CHARACTERS WITHOUT CLAIM TO ANY PAR-
TICULAR FONT, STYLE, SIZE, OR COLOR.

SER. NO. 85-304,295, FILED 4-25-2011.

APRIL ROACH, EXAMINING ATTORNEY



David J. Kybas

Director of the United States Patent and Trademark Office

United States of America

United States Patent and Trademark Office

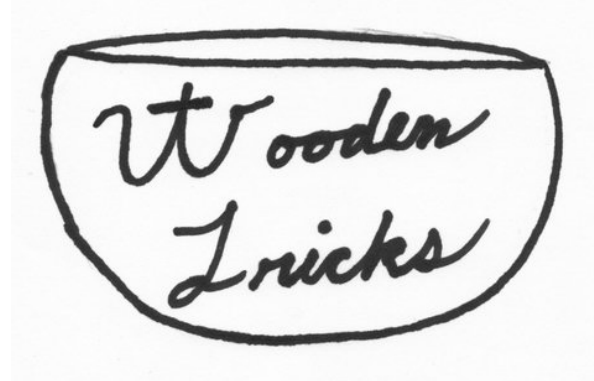

Reg. No. 4,066,845

Registered Dec. 6, 2011

Int. Cl.: 20

TRADEMARK

PRINCIPAL REGISTER

ADAMS, RICHARD R. (KENTUCKY SOLE PROPRIETORSHIP), DBA WOODEN TRICKS
N/A
15 ASHWOOD DR.
LONDON, KY 40744

FOR: DECORATIVE BOXES MADE OF WOOD; FURNITURE MADE FROM WOOD OR SUBSTITUTES FOR WOOD; SCULPTURES OF WOOD; WOOD CARVINGS; WORKS OF ART MADE OF WOOD; WORKS OF ART OF WOOD, WAX, PLASTER OR PLASTIC; WORKS OF ART OF WOOD, IN CLASS 20 (U.S. CLS. 2, 13, 22, 25, 32 AND 50).

FIRST USE 2-23-2006; IN COMMERCE 7-25-2007.

NO CLAIM IS MADE TO THE EXCLUSIVE RIGHT TO USE "WOODEN", APART FROM THE MARK AS SHOWN.

THE MARK CONSISTS OF THE WORDING "WOODEN TRICKS" IN A STYLIZED CURSIVE FONT, WITH THE "W" CROSSED TO FORM A SECOND "T" SET WITHIN THE STYLIZED DESIGN OF A SIMPLE BOWL SHAPED OUTLINE.

SER. NO. 85-304,353, FILED 4-25-2011.

SEAN CROWLEY, EXAMINING ATTORNEY



David J. Kyffers

Director of the United States Patent and Trademark Office

United States of America

United States Patent and Trademark Office

WHAT WOMEN AUTO-KNOW

Reg. No. 4,066,846

Registered Dec. 6, 2011

Int. Cl.: 41

SERVICE MARK

PRINCIPAL REGISTER

FORDIN, AUDRA (UNITED STATES INDIVIDUAL)
105 BROWERS LANE
ROSLYN HEIGHTS, NY 11577

FOR: EDUCATIONAL SERVICES, NAMELY, CONDUCTING WORKSHOPS, EDUCATIONAL RADIO SHOWS, AND EDUCATIONAL TELEVISION SHOWS IN THE FIELD OF AUTOMOBILE MAINTENANCE, REPAIR AND SAFETY AND DISTRIBUTION OF EDUCATIONAL MATERIALS IN CONNECTION THEREWITH; ENTERTAINMENT AND EDUCATION SERVICES IN THE NATURE OF A SERIES OF SHORT SHOWS FEATURING EDUCATIONAL INFORMATION ABOUT AUTOMOBILE MAINTENANCE, REPAIR AND SAFETY DISTRIBUTED TO MOBILE HANDSETS, WHICH MAY INCLUDE VIDEO, TEXT, PHOTOS, ILLUSTRATIONS OR HYPERTEXT, IN CLASS 41 (U.S. CLS. 100, 101 AND 107).

FIRST USE 11-0-2009; IN COMMERCE 11-0-2009.

THE MARK CONSISTS OF STANDARD CHARACTERS WITHOUT CLAIM TO ANY PARTICULAR FONT, STYLE, SIZE, OR COLOR.

SER. NO. 85-304,378, FILED 4-26-2011.

JASON LOTT, EXAMINING ATTORNEY



David J. Kyffers

Director of the United States Patent and Trademark Office

United States of America

United States Patent and Trademark Office

FIRST BLOOM

Reg. No. 4,066,847

Registered Dec. 6, 2011

Int. Cl.: 1

TRADEMARK

PRINCIPAL REGISTER

NOVOZYMES A/S (DENMARK CORPORATION)
KROGSHOEJVEJ 36
BAGSVAERD, DENMARK DK-2880

FOR: PLANTING SOIL; POTTING SOIL, IN CLASS 1 (U.S. CLS. 1, 5, 6, 10, 26 AND 46).

FIRST USE 3-0-2009; IN COMMERCE 3-0-2009.

THE MARK CONSISTS OF STANDARD CHARACTERS WITHOUT CLAIM TO ANY PARTICULAR FONT, STYLE, SIZE, OR COLOR.

SER. NO. 85-304,422, FILED 4-26-2011.

STEVEN R. FINE, EXAMINING ATTORNEY



David J. Kyffers

Director of the United States Patent and Trademark Office

United States of America

United States Patent and Trademark Office

Sharklance

Reg. No. 4,066,848

Registered Dec. 6, 2011

Int. Cl.: 35

SERVICE MARK

PRINCIPAL REGISTER

SHARKLANCE LLC (TEXAS LIMITED LIABILITY COMPANY)
SUITE 300
5068 W. PLANO PARKWAY
PLANO, TX 75093

FOR: PROVIDING AUCTION, REVERSE AUCTION, REQUEST FOR QUOTES, ADVERTISING, AND MARKETING SERVICES FOR OTHERS VIA THE INTERNET AND OTHER ELECTRONIC MEDIA, FOR THE PURCHASE AND SALE OF LAW-RELATED SERVICES, IN CLASS 35 (U.S. CLS. 100, 101 AND 102).

FIRST USE 9-15-2007; IN COMMERCE 10-8-2007.

THE MARK CONSISTS OF STANDARD CHARACTERS WITHOUT CLAIM TO ANY PARTICULAR FONT, STYLE, SIZE, OR COLOR.

SER. NO. 85-304,464, FILED 4-26-2011.

ELIZABETH KAJUBI, EXAMINING ATTORNEY



David J. Kybas

Director of the United States Patent and Trademark Office

United States of America

United States Patent and Trademark Office

Milwaukee Engine House 19

Reg. No. 4,066,849

Registered Dec. 6, 2011

Int. Cl.: 30

TRADEMARK

PRINCIPAL REGISTER

STF ENTERPRISES, LLC (WISCONSIN LIMITED LIABILITY COMPANY)
3144 S. 47TH STREET
MILWAUKEE, WI 53219

FOR: CHILI SEASONING; COCOA MIXES; COFFEE; HOTCAKE MIXES; PANCAKE MIXES;
POPCORN, IN CLASS 30 (U.S. CL. 46).

FIRST USE 3-26-2011; IN COMMERCE 3-26-2011.

THE MARK CONSISTS OF STANDARD CHARACTERS WITHOUT CLAIM TO ANY PARTICULAR FONT, STYLE, SIZE, OR COLOR.

NO CLAIM IS MADE TO THE EXCLUSIVE RIGHT TO USE "MILWAUKEE", APART FROM THE MARK AS SHOWN.

SER. NO. 85-304,513, FILED 4-26-2011.

REBECCA SMITH, EXAMINING ATTORNEY



David J. Kyffers

Director of the United States Patent and Trademark Office

United States of America

United States Patent and Trademark Office

Office Leaks

Reg. No. 4,066,850

Registered Dec. 6, 2011

Int. Cls.: 38, 42 and 45

SERVICE MARK

PRINCIPAL REGISTER

OFFICE LEAKS, LLC (MINNESOTA LIMITED LIABILITY COMPANY)
C/O KUNKLE LAW PLC
1769 LEXINGTON #182
ST. PAUL, MN 55113

FOR: PROVIDING ON-LINE CHAT ROOMS AND ELECTRONIC BULLETIN BOARDS FOR TRANSMISSION OF MESSAGES AMONG USERS IN THE FIELD OF WORK ENVIRONMENTS, CONCERNING WORKPLACE CONDITIONS, COMPENSATION, OFFICE POLITICS, SOCIAL ENVIRONMENTS, RUMORS, ORGANIZATIONAL CHANGES AND MATTERS OF GENERAL INTEREST; PROVIDING ON-LINE CHAT ROOMS FOR SOCIAL NETWORKING, IN CLASS 38 (U.S. CLS. 100, 101 AND 104).

FIRST USE 4-4-2011; IN COMMERCE 4-4-2011.

FOR: COMPUTER SERVICES, NAMELY, CREATING AN ON-LINE COMMUNITY FOR REGISTERED USERS TO PARTICIPATE IN DISCUSSIONS REGARDING WORKPLACE CONDITIONS, COMPENSATION, OFFICE POLITICS, SOCIAL ENVIRONMENTS, RUMORS, ORGANIZATIONAL CHANGES AND MATTERS OF GENERAL INTEREST; PROVIDING A WEBSITE FEATURING NON-DOWNLOADABLE SOFTWARE FOR TRANSMISSION OF MESSAGES CONCERNING WORKPLACE CONDITIONS, COMPENSATION, OFFICE POLITICS, SOCIAL ENVIRONMENTS, RUMORS, ORGANIZATIONAL CHANGES AND MATTERS OF GENERAL INTEREST, IN CLASS 42 (U.S. CLS. 100 AND 101).

FIRST USE 4-4-2011; IN COMMERCE 4-4-2011.

FOR: ONLINE SOCIAL NETWORKING SERVICES PROVIDED THROUGH A COMMUNITY WEBSITE; ONLINE SOCIAL NETWORKING SERVICES IN THE FIELD OF WORK ENVIRONMENTS, CONCERNING WORKPLACE CONDITIONS, COMPENSATION, OFFICE POLITICS, SOCIAL ENVIRONMENTS, RUMORS, ORGANIZATIONAL CHANGES AND MATTERS OF GENERAL INTEREST PROVIDED VIA A WEBSITE; PROVIDING A SOCIAL NETWORKING WEBSITE FOR ENTERTAINMENT PURPOSES; PROVIDING ON-LINE COMPUTER DATABASES AND ON-LINE SEARCHABLE DATABASES IN THE FIELD OF SOCIAL NETWORKING, IN CLASS 45 (U.S. CLS. 100 AND 101).

FIRST USE 4-4-2011; IN COMMERCE 4-4-2011.



David J. Kappas

Director of the United States Patent and Trademark Office

Reg. No. 4,066,850 THE MARK CONSISTS OF STANDARD CHARACTERS WITHOUT CLAIM TO ANY PARTICULAR FONT, STYLE, SIZE, OR COLOR.

SER. NO. 85-304,631, FILED 4-26-2011.

THEODORE MCBRIDE, EXAMINING ATTORNEY

United States of America

United States Patent and Trademark Office

OF AAFO

Reg. No. 4,066,851

Registered Dec. 6, 2011

Int. Cl.: 25

TRADEMARK

PRINCIPAL REGISTER

KEVIN BURKLEY (UNITED STATES INDIVIDUAL)
30 CALISTOGA
IRVINE, CA 92602

FOR: CAPS; DENIMS; DRESS PANTS; DRESS SHIRTS; PANTS; POLO SHIRTS; SHIRTS;
SHOES; SLACKS; SWEATERS; SWEATSHIRTS; T-SHIRTS, IN CLASS 25 (U.S. CLS. 22 AND
39).

FIRST USE 6-18-1995; IN COMMERCE 6-18-1995.

THE MARK CONSISTS OF STANDARD CHARACTERS WITHOUT CLAIM TO ANY PAR-
TICULAR FONT, STYLE, SIZE, OR COLOR.

OWNER OF U.S. REG. NO. 3,757,285.

SER. NO. 85-304,634, FILED 4-26-2011.

DANNEAN HETZEL, EXAMINING ATTORNEY



David J. Kybas

Director of the United States Patent and Trademark Office

United States of America

United States Patent and Trademark Office



Reg. No. 4,066,852

Registered Dec. 6, 2011

Int. Cls.: 38, 42 and 45

SERVICE MARK

PRINCIPAL REGISTER

OFFICE LEAKS, LLC (MINNESOTA LIMITED LIABILITY COMPANY)
C/O KUNKLE LAW PLC
1769 LEXINGTON #182
ST. PAUL, MN 55113

FOR: PROVIDING ON-LINE CHAT ROOMS AND ELECTRONIC BULLETIN BOARDS FOR TRANSMISSION OF MESSAGES AMONG USERS IN THE FIELD OF WORK ENVIRONMENTS, CONCERNING WORKPLACE CONDITIONS, COMPENSATION, OFFICE POLITICS, SOCIAL ENVIRONMENTS, RUMORS, ORGANIZATIONAL CHANGES AND MATTERS OF GENERAL INTEREST; PROVIDING ON-LINE CHAT ROOMS FOR SOCIAL NETWORKING, IN CLASS 38 (U.S. CLS. 100, 101 AND 104).

FIRST USE 4-4-2011; IN COMMERCE 4-4-2011.

FOR: COMPUTER SERVICES, NAMELY, CREATING AN ON-LINE COMMUNITY FOR REGISTERED USERS TO PARTICIPATE IN DISCUSSIONS REGARDING WORKPLACE CONDITIONS, COMPENSATION, OFFICE POLITICS, SOCIAL ENVIRONMENTS, RUMORS, ORGANIZATIONAL CHANGES AND MATTERS OF GENERAL INTEREST; PROVIDING A WEBSITE FEATURING NON-DOWNLOADABLE SOFTWARE FOR TRANSMISSION OF MESSAGES CONCERNING WORKPLACE CONDITIONS, COMPENSATION, OFFICE POLITICS, SOCIAL ENVIRONMENTS, RUMORS, ORGANIZATIONAL CHANGES AND MATTERS OF GENERAL INTEREST, IN CLASS 42 (U.S. CLS. 100 AND 101).

FIRST USE 4-4-2011; IN COMMERCE 4-4-2011.

FOR: ONLINE SOCIAL NETWORKING SERVICES PROVIDED THROUGH A COMMUNITY WEBSITE; ONLINE SOCIAL NETWORKING SERVICES IN THE FIELD OF WORK ENVIRONMENTS, CONCERNING WORKPLACE CONDITIONS, COMPENSATION, OFFICE POLITICS, SOCIAL ENVIRONMENTS, RUMORS, ORGANIZATIONAL CHANGES AND MATTERS OF GENERAL INTEREST PROVIDED VIA A WEBSITE; PROVIDING A SOCIAL NETWORKING WEBSITE FOR ENTERTAINMENT PURPOSES; PROVIDING ON-LINE COMPUTER DATABASES AND ON-LINE SEARCHABLE DATABASES IN THE FIELD OF SOCIAL NETWORKING, IN CLASS 45 (U.S. CLS. 100 AND 101).

FIRST USE 4-4-2011; IN COMMERCE 4-4-2011.



David J. Kappas

Director of the United States Patent and Trademark Office

Reg. No. 4,066,852 THE MARK CONSISTS OF A GRADIENT BROWN RECTANGULAR WORD BOX CONTAINING A GRADIENT BLUE DROPLET WHICH SERVES AS THE LETTER "O" TO BEGIN THE LITERAL ELEMENT "OFFICE LEAKS", WHICH IS COMPLETED BY USING STYLIZED LETTERS.

THE COLOR(S) BROWN AND BLUE IS/ARE CLAIMED AS A FEATURE OF THE MARK.

SER. NO. 85-304,712, FILED 4-26-2011.

THEODORE MCBRIDE, EXAMINING ATTORNEY

United States of America

United States Patent and Trademark Office

buzzin' dozen

Reg. No. 4,066,853

Registered Dec. 6, 2011

Int. Cl.: 30

TRADEMARK

PRINCIPAL REGISTER

LISA IRION (UNITED STATES INDIVIDUAL)
10723 CHICKEN CREEK ROAD
SPEARFISH, SD 57783

FOR: HONEY, IN CLASS 30 (U.S. CL. 46).

FIRST USE 8-27-2010; IN COMMERCE 4-1-2011.

THE MARK CONSISTS OF STANDARD CHARACTERS WITHOUT CLAIM TO ANY PARTICULAR FONT, STYLE, SIZE, OR COLOR.

SER. NO. 85-304,759, FILED 4-26-2011.

JEFF DEFORD, EXAMINING ATTORNEY



David J. Kybas

Director of the United States Patent and Trademark Office

United States of America

United States Patent and Trademark Office

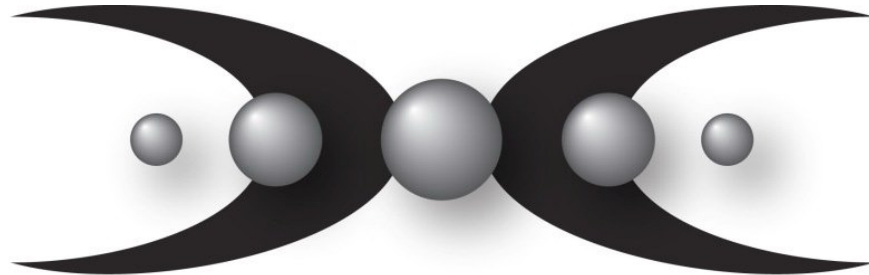

Reg. No. 4,066,854

Registered Dec. 6, 2011

Int. Cl.: 35

SERVICE MARK

PRINCIPAL REGISTER

BAIR, LISA B. (UNITED STATES INDIVIDUAL)
240 MAIN STREET, SUITE 400
GLADSTONE, NJ 07934

FOR: CONSULTING SERVICES, NAMELY, ADVISING COMPANIES IN THE PHARMACEUTICAL AND BIOTECHNOLOGY FIELDS ABOUT BUSINESS STRATEGIES, IN CLASS 35 (U.S. CLS. 100, 101 AND 102).

FIRST USE 5-0-2006; IN COMMERCE 5-0-2006.

SER. NO. 85-304,777, FILED 4-26-2011.

SARA BENJAMIN, EXAMINING ATTORNEY



David J. Kybas

Director of the United States Patent and Trademark Office

United States of America

United States Patent and Trademark Office



Reg. No. 4,066,855

Registered Dec. 6, 2011

Int. Cl.: 41

SERVICE MARK

PRINCIPAL REGISTER

GIFTRAPPED, LLC (NEW YORK LIMITED LIABILITY COMPANY)
SUITE 8C
230 EAST 73RD STREET
NEW YORK, NY 10021

FOR: PROVIDING ONLINE AND MOBILE SERVICES, NAMELY, SONG WRITING SERVICES AND VIDEO PRODUCTION SERVICES, NAMELY, WRITING RAP MUSIC AND ACCOMPANYING VIDEO FOR OTHERS, IN CLASS 41 (U.S. CLS. 100, 101 AND 107).

FIRST USE 11-22-2010; IN COMMERCE 12-8-2010.

THE MARK CONSISTS OF A GOLD RIBBON ON A BLUE GIFT BOX WITH THE WORDS "GIFT RAPPED" IN SCRIPT IN WHITE, OUTLINED IN BLACK, THAT APPEAR IN FRONT OF THE GIFT BOX. ON THE WRAPPING OF THE GIFT BOX, THE COLORS PINK, WHITE, BLACK AND GOLD APPEAR AS RIBBONS AND DESIGNS.

THE COLOR(S) BLACK, GOLD, PURPLE, WHITE AND PINK IS/ARE CLAIMED AS A FEATURE OF THE MARK.

SER. NO. 85-304,825, FILED 4-26-2011.

FRANK LATTUCA, EXAMINING ATTORNEY



David J. Kybas

Director of the United States Patent and Trademark Office

United States of America

United States Patent and Trademark Office

Baby Talk

Reg. No. 4,066,856

Registered Dec. 6, 2011

Int. Cls.: 16 and 26

TRADEMARK

PRINCIPAL REGISTER

HORIZON GROUP USA, INC. (NEW JERSEY CORPORATION)
76 STIRLING ROAD
WARREN, NJ 07059

FOR: IRON-ON TRANSFERS; APPLIQUÉS IN THE FORM OF DECALS, IN CLASS 16 (U.S. CLS. 2, 5, 22, 23, 29, 37, 38 AND 50).

FIRST USE 6-8-2009; IN COMMERCE 6-8-2009.

FOR: FABRIC APPLIQUÉS; EMBROIDERED AND FABRIC IRON-ON APPLIQUÉS, IN CLASS 26 (U.S. CLS. 37, 39, 40, 42 AND 50).

FIRST USE 6-8-2009; IN COMMERCE 6-8-2009.

THE MARK CONSISTS OF STANDARD CHARACTERS WITHOUT CLAIM TO ANY PARTICULAR FONT, STYLE, SIZE, OR COLOR.

SER. NO. 85-304,827, FILED 4-26-2011.

KHANH LE, EXAMINING ATTORNEY



David J. Kybas

Director of the United States Patent and Trademark Office

United States of America

United States Patent and Trademark Office



Reg. No. 4,066,857

BURAU, PAMELA (UNITED STATES INDIVIDUAL), DBA AUTOS FOR SWAP
6640 ENTIAT RIVER RD.
ENTIAT, WA 98822

Registered Dec. 6, 2011

Int. Cl.: 35

FOR: ARRANGING AND CONDUCTING SWAP MEETS IN THE FIELD OF AUTOMOBILES;
AUTOMOBILE DEALERSHIPS, IN CLASS 35 (U.S. CLS. 100, 101 AND 102).

SERVICE MARK

FIRST USE 9-17-2010; IN COMMERCE 9-17-2010.

PRINCIPAL REGISTER

NO CLAIM IS MADE TO THE EXCLUSIVE RIGHT TO USE "AUTOS FOR SWAP", APART
FROM THE MARK AS SHOWN.

THE COLOR(S) "RED" AND "YELLOW" IS/ARE CLAIMED AS A FEATURE OF THE MARK.

THE MARK CONSISTS OF RED AND YELLOW STYLIZED CAR WITH "AUTOS FOR SWAP"
IN RED STYLIZED LETTERS OUTLINED IN YELLOW WITHIN IT.

SER. NO. 85-304,839, FILED 4-26-2011.

DAWN FELDMAN, EXAMINING ATTORNEY



David J. Kybas

Director of the United States Patent and Trademark Office

United States of America

United States Patent and Trademark Office

PANĀCEA

Reg. No. 4,066,858

Registered Dec. 6, 2011

Int. Cls.: 3, 29 and 30

TRADEMARK

PRINCIPAL REGISTER

PANACEA FARMS, LLC (CALIFORNIA LIMITED LIABILITY COMPANY)
627 W. VERNALIS ROAD
TRACY, CA 95304

FOR: BODY LOTIONS, COSMETIC CREAMS, BODY BUTTER, BAR SOAPS, LIQUID SOAPS,
LIP BALMS AND MOISTURIZERS, IN CLASS 3 (U.S. CLS. 1, 4, 6, 50, 51 AND 52).

FIRST USE 5-1-2009; IN COMMERCE 3-2-2010.

FOR: OLIVE OIL, IN CLASS 29 (U.S. CL. 46).

FIRST USE 5-1-2009; IN COMMERCE 3-2-2010.

FOR: VINEGARS AND BALSAMIC VINEGARS, IN CLASS 30 (U.S. CL. 46).

FIRST USE 5-1-2009; IN COMMERCE 3-2-2010.

THE MARK CONSISTS OF THE WORD "PANACEA" WITHIN A RECTANGLE. THERE IS
A LONG LINE OVER THE LETTER "A" AFTER "N".

SER. NO. 85-304,886, FILED 4-26-2011.

TEJBIR SINGH, EXAMINING ATTORNEY



David J. Kyros

Director of the United States Patent and Trademark Office

United States of America

United States Patent and Trademark Office

it's so me!

Reg. No. 4,066,859

Registered Dec. 6, 2011

Int. Cls.: 16 and 26

TRADEMARK

PRINCIPAL REGISTER

HORIZON GROUP USA, INC. (NEW JERSEY CORPORATION)
76 STIRLING ROAD
WARREN, NJ 07059

FOR: IRON-ON TRANSFERS; APPLIQUÉS IN THE FORM OF DECALS; IRON-ON STUD TRANSFERS; IRON-ON RHINESTONE TRANSFERS, IN CLASS 16 (U.S. CLS. 2, 5, 22, 23, 29, 37, 38 AND 50).

FIRST USE 7-2-2009; IN COMMERCE 7-2-2009.

FOR: FABRIC APPLIQUÉS; EMBROIDERED AND FABRIC IRON-ON APPLIQUÉS, IN CLASS 26 (U.S. CLS. 37, 39, 40, 42 AND 50).

FIRST USE 7-2-2009; IN COMMERCE 7-2-2009.

THE MARK CONSISTS OF STANDARD CHARACTERS WITHOUT CLAIM TO ANY PARTICULAR FONT, STYLE, SIZE, OR COLOR.

OWNER OF U.S. REG. NO. 3,090,680.

SER. NO. 85-304,924, FILED 4-26-2011.

KHANH LE, EXAMINING ATTORNEY



David J. Kybas

Director of the United States Patent and Trademark Office

United States of America

United States Patent and Trademark Office



FINALPROOF

Reg. No. 4,066,860

Registered Dec. 6, 2011

Int. Cl.: 41

SERVICE MARK

PRINCIPAL REGISTER

ELEVATED EXPRESSIONS, LLC (FLORIDA LIMITED LIABILITY COMPANY)
APT. 52
1951 NORTH MERIDIAN ROAD
TALLAHASSEE, FL 32303

FOR: WRITING SERVICES, NAMELY, WRITING, EDITING, AND PROOFREADING FOR OTHERS; EDUCATIONAL SERVICES, NAMELY, WORKSHOPS IN THE FIELD OF WRITING, IN CLASS 41 (U.S. CLS. 100, 101 AND 107).

FIRST USE 3-16-2011; IN COMMERCE 3-16-2011.

THE MARK CONSISTS OF THE GRAY STYLIZED WORD "FINAL" AND BLUE STYLIZED WORD "PROOF" CENTERED BELOW A LETTER "P" IN UPPERCASE STYLIZED FONT, IT'S STEM FORMED BY A FOUNTAIN PEN TIP. THE LEFT HALF OF THE LETTER "P" IS BLUE, THE RIGHT HALF GRAY.

THE COLOR(S) BLUE AND GRAY IS/ARE CLAIMED AS A FEATURE OF THE MARK.

SER. NO. 85-304,961, FILED 4-26-2011.

ZHALEH DELANEY, EXAMINING ATTORNEY



David J. Kybas

Director of the United States Patent and Trademark Office

United States of America

United States Patent and Trademark Office

PTR

Reg. No. 4,066,861

Registered Dec. 6, 2011

Int. Cl.: 6

TRADEMARK

PRINCIPAL REGISTER

PREMIERE, INC. (LOUISIANA CORPORATION)
615 N LANADRY RD.
NEW IBERIA, LA 70563

FOR: METAL RINGS DESIGNED TO BE PLACED INSIDE COUPLINGS WHICH HOLD TWO PIPES TOGETHER, IN CLASS 6 (U.S. CLS. 2, 12, 13, 14, 23, 25 AND 50).

FIRST USE 0-0-2009; IN COMMERCE 0-0-2009.

THE MARK CONSISTS OF STANDARD CHARACTERS WITHOUT CLAIM TO ANY PARTICULAR FONT, STYLE, SIZE, OR COLOR.

SER. NO. 85-304,989, FILED 4-26-2011.

TEJBIR SINGH, EXAMINING ATTORNEY



David J. Kybas

Director of the United States Patent and Trademark Office

United States of America

United States Patent and Trademark Office

WEMCO

Reg. No. 4,066,862

Registered Dec. 6, 2011

Int. Cls.: 7, 9 and 12

TRADEMARK

PRINCIPAL REGISTER

WEBER ELECTRIC MANUFACTURING CO. (MICHIGAN CORPORATION)
2465 23 MILE ROAD
SHELBY TOWNSHIP, MI 48316

FOR: ELECTRICAL WIRE HANDLING APPARATUS, NAMELY COILING MACHINES, SPOOL PAYOUT AND TAKEUP MACHINES, MECHANIZED SUPPORTS FOR HOLDING AND RAISING AND LOWERING SPOOLS OF WIRE FOR WINDING OR UNWINDING THE SAME, IN CLASS 7 (U.S. CLS. 13, 19, 21, 23, 31, 34 AND 35).

FIRST USE 6-0-1966; IN COMMERCE 6-0-1966.

FOR: ELECTRICAL WIRE STORAGE AND DISPENSING RACKS; ELECTRIC CONDUIT STORAGE RACKS; AND MECHANICAL METERS FOR MEASURING THE LENGTH OF ELECTRIC WIRE, CORDAGE AND CABLE, IN CLASS 9 (U.S. CLS. 21, 23, 26, 36 AND 38).

FIRST USE 0-0-1971; IN COMMERCE 0-0-1971.

FOR: ELECTRIC CONDUIT TRANSPORT CARTS, IN CLASS 12 (U.S. CLS. 19, 21, 23, 31, 35 AND 44).

FIRST USE 0-0-1973; IN COMMERCE 0-0-1973.

THE MARK CONSISTS OF STANDARD CHARACTERS WITHOUT CLAIM TO ANY PARTICULAR FONT, STYLE, SIZE, OR COLOR.

SER. NO. 85-305,057, FILED 4-26-2011.

ELLEN BURNS, EXAMINING ATTORNEY



David J. Kyros

Director of the United States Patent and Trademark Office

United States of America

United States Patent and Trademark Office

BROTHER

Reg. No. 4,066,863

Registered Dec. 6, 2011

Int. Cl.: 9

TRADEMARK

PRINCIPAL REGISTER

ANGUS RICHARDSON (AUSTRALIA INDIVIDUAL)
1163 N. MAIN STREET
ASHLAND, OR 97520 AND

HAMISH RICHARDSON (AUSTRALIA INDIVIDUAL)
1163 N. MAIN STREET
ASHLAND, OR 97520

FOR: SERIES OF RECORDED MUSICAL PERFORMANCES; MUSICAL SOUND RECORDINGS, IN CLASS 9 (U.S. CLS. 21, 23, 26, 36 AND 38).

FIRST USE 0-0-1992; IN COMMERCE 0-0-1992.

THE MARK CONSISTS OF STANDARD CHARACTERS WITHOUT CLAIM TO ANY PARTICULAR FONT, STYLE, SIZE, OR COLOR.

OWNER OF U.S. REG. NO. 2,996,409.

SER. NO. 85-305,058, FILED 4-26-2011.

EMILY CHUO, EXAMINING ATTORNEY



David J. Kybas

Director of the United States Patent and Trademark Office

United States of America

United States Patent and Trademark Office

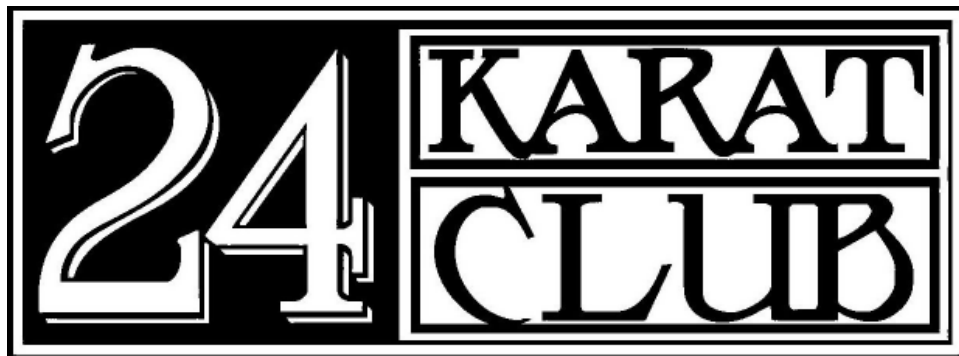

Reg. No. 4,066,864

Registered Dec. 6, 2011

Int. Cl.: 41

SERVICE MARK

PRINCIPAL REGISTER

GNLV CORP. (NEVADA CORPORATION)
1510 WEST LOOP SOUTH
HOUSTON, TX 77027

FOR: CASINOS, IN CLASS 41 (U.S. CLS. 100, 101 AND 107).

FIRST USE 1-24-1983; IN COMMERCE 1-24-1983.

OWNER OF U.S. REG. NOS. 2,888,060 AND 2,991,111.

NO CLAIM IS MADE TO THE EXCLUSIVE RIGHT TO USE "CLUB", APART FROM THE MARK AS SHOWN.

THE MARK CONSISTS OF THE NUMBER "24" AGAINST A DARK SQUARE BACKGROUND FOLLOWED WITH THE WORD "KARAT" IN A RECTANGLE WITH A NARROW BORDER, OVER THE WORD "CLUB" IN A RECTANGLE WITH A NARROW BORDER, CONTAINED ALL TOGETHER IN A RECTANGLE WITH A NARROW OUTER BORDER.

SER. NO. 85-305,165, FILED 4-26-2011.

KEVIN DINALLO, EXAMINING ATTORNEY



David J. Kyros

Director of the United States Patent and Trademark Office

United States of America

United States Patent and Trademark Office

FLOORSPACE

Reg. No. 4,066,865

Registered Dec. 6, 2011

Int. Cl.: 19

TRADEMARK

PRINCIPAL REGISTER

ARCHITECTURAL SYSTEMS, INC. (NEW YORK CORPORATION)
8TH FLOOR
150 W. 25TH STREET
NEW YORK, NY 10001

FOR: PORTABLE MODULAR FLOOR SYSTEMS COMPRISED OF NONMETAL FLOORING
TILES AND FLOOR UNDERLAYMENTS, IN CLASS 19 (U.S. CLS. 1, 12, 33 AND 50).

FIRST USE 9-18-1998; IN COMMERCE 9-18-1998.

THE MARK CONSISTS OF STANDARD CHARACTERS WITHOUT CLAIM TO ANY PAR-
TICULAR FONT, STYLE, SIZE, OR COLOR.

SER. NO. 85-305,239, FILED 4-26-2011.

B. PARADEWELAI, EXAMINING ATTORNEY



David J. Kyros

Director of the United States Patent and Trademark Office

United States of America

United States Patent and Trademark Office



Reg. No. 4,066,866

Registered Dec. 6, 2011

Int. Cls.: 37 and 42

SERVICE MARK

PRINCIPAL REGISTER

FRYMIRE ENGINEERING CO., INC. (TEXAS CORPORATION)
2818 SATSUMA DRIVE
DALLAS, TX 75229

FOR: MECHANICAL CONTRACTING SERVICES, NAMELY, INSTALLATION, MAINTENANCE AND REPAIR OF HEATING, VENTILATING, AIR CONDITIONING, PLUMBING, ELECTRICAL SYSTEMS AND INDOOR AIR QUALITY EQUIPMENT IN AND FOR RESIDENTIAL AND COMMERCIAL BUILDINGS AND OTHER STRUCTURES, IN CLASS 37 (U.S. CLS. 100, 103 AND 106).

FIRST USE 12-31-1972; IN COMMERCE 12-31-1972.

FOR: CUSTOM DESIGN OF HEATING, VENTILATING, AIR CONDITIONING, PLUMBING, AND ELECTRICAL SYSTEMS IN AND FOR RESIDENTIAL AND COMMERCIAL BUILDINGS AND OTHER STRUCTURES, IN CLASS 42 (U.S. CLS. 100 AND 101).

FIRST USE 12-31-1972; IN COMMERCE 12-31-1972.

NO CLAIM IS MADE TO THE EXCLUSIVE RIGHT TO USE "SERVICES", APART FROM THE MARK AS SHOWN.

THE MARK CONSISTS OF A RECTANGLE BORDER CONTAINING THE WORDS "FRYMIRE SERVICES" AND A SQUARE, CONTAINING AN ITALIC CAPITAL LETTER "F" PRECEDED BY A DEGREE SYMBOL. THE SQUARE IS FURTHER DIVIDED INTO FORTY NINE EQUALLY SIZED SMALLER SQUARES FORMING A SYMMETRICAL GRID PATTERN.

SER. NO. 85-305,249, FILED 4-26-2011.

ANDREA K. NADELMAN, EXAMINING ATTORNEY



David J. Kybas

Director of the United States Patent and Trademark Office

United States of America

United States Patent and Trademark Office

PriceStats

Reg. No. 4,066,867

Registered Dec. 6, 2011

Int. Cl.: 35

SERVICE MARK

PRINCIPAL REGISTER

PRICE STATS LLC (DELAWARE CORPORATION)
APT 502
221 MOUNT AUBURN ST
CAMBRIDGE, MA 02138

FOR: RESEARCH AND ANALYSIS IN THE FIELDS OF ECONOMICS; MARKET ANALYSIS AND RESEARCH SERVICES, IN CLASS 35 (U.S. CLS. 100, 101 AND 102).

FIRST USE 8-30-2010; IN COMMERCE 8-30-2010.

THE MARK CONSISTS OF STANDARD CHARACTERS WITHOUT CLAIM TO ANY PARTICULAR FONT, STYLE, SIZE, OR COLOR.

SER. NO. 85-305,312, FILED 4-26-2011.

RAUL CORDOVA, EXAMINING ATTORNEY



David J. Kyros

Director of the United States Patent and Trademark Office

United States of America

United States Patent and Trademark Office

X-PRESS

Reg. No. 4,066,868

Registered Dec. 6, 2011

Int. Cl.: 28

TRADEMARK

PRINCIPAL REGISTER

FIELD LOGIC, INC. (MINNESOTA CORPORATION)
101 MAIN STREET
SUPERIOR, WI 54880

FOR: ARCHERY EQUIPMENT, NAMELY, FREE-STANDING BOW PRESSES AND BOW PRESSES FOR ATTACHMENT TO A STAND OR ANOTHER SURFACE AND ACCESSORIES THEREFOR SOLD AS A UNIT; STANDS FOR SAID BOW PRESSES, IN CLASS 28 (U.S. CLS. 22, 23, 38 AND 50).

FIRST USE 1-31-2004; IN COMMERCE 1-31-2004.

THE MARK CONSISTS OF STANDARD CHARACTERS WITHOUT CLAIM TO ANY PARTICULAR FONT, STYLE, SIZE, OR COLOR.

SER. NO. 85-305,331, FILED 4-26-2011.

LINDA E. BLOHM, EXAMINING ATTORNEY



David J. Kybas

Director of the United States Patent and Trademark Office

United States of America

United States Patent and Trademark Office

HURRICANE

Reg. No. 4,066,869

FIELD LOGIC, INC. (MINNESOTA CORPORATION)
101 MAIN STREET
SUPERIOR, WI 54880

Registered Dec. 6, 2011

Int. Cl.: 28

FOR: TARGETS AND TARGET COVERS, AND TARGET EQUIPMENT, NAMELY, STANDS FOR TARGETS, IN CLASS 28 (U.S. CLS. 22, 23, 38 AND 50).

TRADEMARK

FIRST USE 1-9-2010; IN COMMERCE 1-9-2010.

PRINCIPAL REGISTER

THE MARK CONSISTS OF STANDARD CHARACTERS WITHOUT CLAIM TO ANY PARTICULAR FONT, STYLE, SIZE, OR COLOR.

SER. NO. 85-305,342, FILED 4-26-2011.

LINDA E. BLOHM, EXAMINING ATTORNEY



David J. Kybas

Director of the United States Patent and Trademark Office

United States of America

United States Patent and Trademark Office

ADVENTURALLY

Reg. No. 4,066,870

Registered Dec. 6, 2011

Int. Cl.: 41

SERVICE MARK

PRINCIPAL REGISTER

CATALYST HOLDINGS INC. (FLORIDA CORPORATION)
1000 UNIVERSAL STUDIOS PLZ.; B22A; STE25
ORLANDA, FL 32819

FOR: ORGANIZING MOTOR RACING AND ROAD RALLY EVENTS; ENTERTAINMENT IN THE NATURE OF MOTOR RACING AND ROAD RALLY EVENTS; ENTERTAINMENT IN THE NATURE OF COMPETITIONS IN THE FIELD OF MOTOR RACING CONTESTS; MOTION PICTURE FILM PRODUCTION; PRODUCTION OF RADIO OR TELEVISION PROGRAMS; ORGANIZING ENTERTAINMENT AND SOCIAL EVENTS NAMELY POST RACING AND RALLY PARTIES, IN CLASS 41 (U.S. CLS. 100, 101 AND 107).

FIRST USE 1-0-2008; IN COMMERCE 1-0-2009.

THE MARK CONSISTS OF STANDARD CHARACTERS WITHOUT CLAIM TO ANY PARTICULAR FONT, STYLE, SIZE, OR COLOR.

SER. NO. 85-305,584, FILED 4-27-2011.

NICHOLAS ALTREE, EXAMINING ATTORNEY



David J. Kyffers

Director of the United States Patent and Trademark Office

United States of America

United States Patent and Trademark Office

Zing

Reg. No. 4,066,871

Registered Dec. 6, 2011

Int. Cl.: 28

TRADEMARK

PRINCIPAL REGISTER

ZING TOYS, INC (OREGON CORPORATION)
P.O. BOX 520
BANKS, OR 97106

FOR: ACTION SKILL GAMES; ACTION TARGET GAMES; ACTION-TYPE TARGET GAMES; AERO-DYNAMIC DISK FOR USE IN PLAYING CATCHING GAMES; ARROWS; DISC TOSS TOYS; HAND-POWERED NON-MECHANICAL FLYING TOY; MECHANICAL ACTION TOYS; MECHANICAL TOYS; MODELED PLASTIC TOY FIGURINES; MOLDED TOY FIGURES; PLASTIC CHARACTER TOYS; POP UP TOYS; RUBBER CHARACTER TOYS; STACKING TOYS; TOSSING DISC TOYS; TOY AIRPLANES; TOY ANIMALS; TOY BOWS AND ARROWS; TOY FIGURES; TOY GLIDERS; TOY GUNS; TOY ROCKETS; TOY SLING PLANES; TOY WEAPONS; WATER SQUIRTING TOYS; WATER TOYS, IN CLASS 28 (U.S. CLS. 22, 23, 38 AND 50).

FIRST USE 2-1-2008; IN COMMERCE 2-1-2008.

THE MARK CONSISTS OF STANDARD CHARACTERS WITHOUT CLAIM TO ANY PARTICULAR FONT, STYLE, SIZE, OR COLOR.

OWNER OF U.S. REG. NOS. 3,469,484 AND 3,626,244.

SER. NO. 85-305,603, FILED 4-27-2011.

ZACHARY BELLO, EXAMINING ATTORNEY



David J. Kybas

Director of the United States Patent and Trademark Office

United States of America

United States Patent and Trademark Office

Boomers Mean Business

Reg. No. 4,066,872

Registered Dec. 6, 2011

Int. Cl.: 35

SERVICE MARK

PRINCIPAL REGISTER

WORK AT HOME VINTAGE EMPLOYEES, LLC (DELAWARE LIMITED LIABILITY COMPANY)
386 PARK AVENUE SOUTH
NEW YORK, NY 10016

FOR: EMPLOYMENT AGENCY SERVICES, NAMELY, FILLING THE TEMPORARY AND PERMANENT STAFFING NEEDS OF BUSINESSES; EMPLOYMENT HIRING, RECRUITING, PLACEMENT, STAFFING AND CAREER NETWORKING SERVICES; EMPLOYMENT STAFFING IN THE FIELD OF INSURANCE; PROFESSIONAL STAFFING AND RECRUITING SERVICES, IN CLASS 35 (U.S. CLS. 100, 101 AND 102).

FIRST USE 4-21-2011; IN COMMERCE 4-21-2011.

THE MARK CONSISTS OF STANDARD CHARACTERS WITHOUT CLAIM TO ANY PARTICULAR FONT, STYLE, SIZE, OR COLOR.

SER. NO. 85-305,623, FILED 4-27-2011.

LAURA HAMMEL, EXAMINING ATTORNEY



David J. Kybas

Director of the United States Patent and Trademark Office

United States of America

United States Patent and Trademark Office

SuperGravy

Reg. No. 4,066,873

CLEAR CONSCIENCE PET, LLC (CONNECTICUT LIMITED LIABILITY COMPANY)
52 OLD BOSTON RD.
WILTON, CT 06897

Registered Dec. 6, 2011

Int. Cl.: 31

FOR: PET FOOD CONTAINING NUTRITIONAL SUPPLEMENTS, IN CLASS 31 (U.S. CLS. 1 AND 46).

TRADEMARK

FIRST USE 2-1-2011; IN COMMERCE 3-20-2011.

PRINCIPAL REGISTER

THE MARK CONSISTS OF STANDARD CHARACTERS WITHOUT CLAIM TO ANY PARTICULAR FONT, STYLE, SIZE, OR COLOR.

SER. NO. 85-305,691, FILED 4-27-2011.

DAVID C. REIHNER, EXAMINING ATTORNEY



David J. Kyffers

Director of the United States Patent and Trademark Office

United States of America

United States Patent and Trademark Office

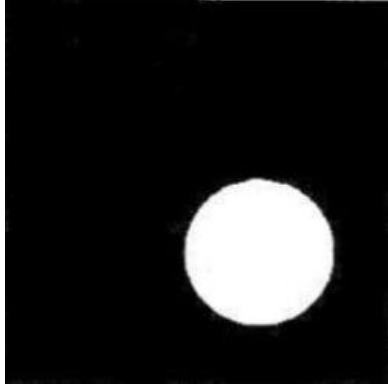

Reg. No. 4,066,874

Registered Dec. 6, 2011

Int. Cl.: 36

SERVICE MARK

PRINCIPAL REGISTER

ASSURANT, INC. (DELAWARE CORPORATION)
ONE CHASE MANHATTAN PLAZA
41ST FLOOR
NEW YORK, NY 10005

FOR: FINANCIAL GUARANTEE AND SURETY SERVICES, IN CLASS 36 (U.S. CLS. 100, 101 AND 102).

FIRST USE 4-0-2001; IN COMMERCE 4-0-2001.

THE MARK CONSISTS OF A SQUARE WITH A CIRCLE IN THE LOWER RIGHT QUADRANT OF THE SQUARE.

SER. NO. 85-305,742, FILED 4-27-2011.

JULIE WATSON, EXAMINING ATTORNEY



David J. Kybas

Director of the United States Patent and Trademark Office

United States of America

United States Patent and Trademark Office



Reg. No. 4,066,875

Registered Dec. 6, 2011

Int. Cl.: 41

SERVICE MARK

PRINCIPAL REGISTER

HILL, MARK (UNITED STATES INDIVIDUAL)
#237
2913 EL CAMINO REAL
TUSTIN, CA 92782

FOR: ENTERTAINMENT SERVICES, NAMELY, THE PROVISION OF CONTINUING ENTERTAINMENT SHOWS FEATURING MUSICAL PERFORMANCES DELIVERED BY TELEVISION, INTERNET, OR LIVE, IN CLASS 41 (U.S. CLS. 100, 101 AND 107).

FIRST USE 11-1-2009; IN COMMERCE 4-1-2010.

NO CLAIM IS MADE TO THE EXCLUSIVE RIGHT TO USE "HIT MUSIC CENTRAL" AND "USA", APART FROM THE MARK AS SHOWN.

THE MARK CONSISTS OF A GLOBE IN THE BACKGROUND OF THE TEXT "HIT MUSIC CENTRAL USA".

SER. NO. 85-305,770, FILED 4-27-2011.

TEJBIR SINGH, EXAMINING ATTORNEY



David J. Kyffers

Director of the United States Patent and Trademark Office

United States of America

United States Patent and Trademark Office

CALLVINE

Reg. No. 4,066,876

Registered Dec. 6, 2011

Int. Cls.: 9 and 38

TRADEMARK

SERVICE MARK

PRINCIPAL REGISTER

CALLVINE, INC. (DELAWARE CORPORATION)
200 W. 33RD STREET
AUSTIN, TX 78705

FOR: DOWNLOADABLE SOFTWARE IN THE NATURE OF A MOBILE APPLICATION FOR TELEPHONE CONFERENCING AND GROUP TEXT MESSAGING, IN CLASS 9 (U.S. CLS. 21, 23, 26, 36 AND 38).

FIRST USE 8-0-2010; IN COMMERCE 8-0-2010.

FOR: PROVIDING TELEPHONE CONFERENCING SERVICES; TEXT AND NUMERIC WIRELESS DIGITAL MESSAGING SERVICES, IN CLASS 38 (U.S. CLS. 100, 101 AND 104).

FIRST USE 8-0-2010; IN COMMERCE 8-0-2010.

THE MARK CONSISTS OF STANDARD CHARACTERS WITHOUT CLAIM TO ANY PARTICULAR FONT, STYLE, SIZE, OR COLOR.

SER. NO. 85-305,784, FILED 4-27-2011.

AMY KERTGATE, EXAMINING ATTORNEY



David J. Kyros

Director of the United States Patent and Trademark Office

United States of America

United States Patent and Trademark Office

Bésoleil

Reg. No. 4,066,877

Registered Dec. 6, 2011

Int. Cl.: 33

TRADEMARK

PRINCIPAL REGISTER

BETZ CELLARS LLC (WASHINGTON LIMITED LIABILITY COMPANY)
4930 E. PALOMINO ROAD
PHOENIX, AZ 85018

FOR: WINES, IN CLASS 33 (U.S. CLS. 47 AND 49).

FIRST USE 9-0-2005; IN COMMERCE 9-0-2005.

THE MARK CONSISTS OF STANDARD CHARACTERS WITHOUT CLAIM TO ANY PARTICULAR FONT, STYLE, SIZE, OR COLOR.

SER. NO. 85-305,797, FILED 4-27-2011.

RAMONA ORTIGA, EXAMINING ATTORNEY



David J. Kybas

Director of the United States Patent and Trademark Office

United States of America

United States Patent and Trademark Office



Reg. No. 4,066,878

Registered Dec. 6, 2011

Int. Cl.: 29

TRADEMARK

PRINCIPAL REGISTER

HP HOOD LLC (DELAWARE LIMITED LIABILITY COMPANY)
SIX KIMBALL LANE
LYNNFIELD, MA 01940

FOR: DAIRY-BASED DIPS, IN CLASS 29 (U.S. CL. 46).

FIRST USE 11-0-2006, THE MARK WAS FIRST USED ANYWHERE IN A DIFFERENT FORM OTHER THAN THAT SOUGHT TO BE REGISTERED AT LEAST AS EARLY AS 03/15/1963; IN COMMERCE 11-0-2006, THE MARK WAS FIRST USED IN COMMERCE IN A DIFFERENT FORM OTHER THAN THAT SOUGHT TO BE REGISTERED AT LEAST AS EARLY AS 03/15/1963.

OWNER OF U.S. REG. NOS. 3,659,308, 3,839,915 AND OTHERS.

THE MARK CONSISTS OF THE WORDS HELUVA GOOD! IN STYLIZED TYPE; ABOVE THE WORDS APPEARS A BROKEN CIRCLE CONTAINING AN IMAGE OF A BEARDED MAN; THE MAN IS WEARING A CHECKERED HAT AND HAS A FOOD ITEM IN ONE HAND.

SER. NO. 85-305,926, FILED 4-27-2011.

DEBRA LEE, EXAMINING ATTORNEY



David J. Kybas

Director of the United States Patent and Trademark Office

United States of America

United States Patent and Trademark Office

BOMONSTER

Reg. No. 4,066,879

Registered Dec. 6, 2011

Int. Cl.: 42

SERVICE MARK

PRINCIPAL REGISTER

BEAUMONT, STEVEN R. (CALIFORNIA CORPORATION), DBA BOMONSTER
7210 SPIGNO PLACE
AGUA DULCE, CA 91390

FOR: GRAPHIC ART DESIGN, IN CLASS 42 (U.S. CLS. 100 AND 101).

FIRST USE 4-1-2011; IN COMMERCE 4-1-2011.

THE MARK CONSISTS OF STANDARD CHARACTERS WITHOUT CLAIM TO ANY PARTICULAR FONT, STYLE, SIZE, OR COLOR.

SER. NO. 85-306,056, FILED 4-27-2011.

ZACHARY BELLO, EXAMINING ATTORNEY



David J. Kyffers

Director of the United States Patent and Trademark Office

United States of America

United States Patent and Trademark Office

THE FITNESS EQUIPMENT EXPERTS

Reg. No. 4,066,880

Registered Dec. 6, 2011

Int. Cl.: 35

SERVICE MARK

PRINCIPAL REGISTER

FITNESS RESOURCE, INC. (VIRGINIA CORPORATION)
2721 DORR AVENUE
FAIRFAX, VA 22031

FOR: RETAIL STORE SERVICES FEATURING EXERCISE EQUIPMENT FOR THE HOME
AND WORK PLACE, IN CLASS 35 (U.S. CLS. 100, 101 AND 102).

FIRST USE 10-9-1999; IN COMMERCE 10-9-1999.

THE MARK CONSISTS OF STANDARD CHARACTERS WITHOUT CLAIM TO ANY PAR-
TICULAR FONT, STYLE, SIZE, OR COLOR.

SEC. 2(F).

SER. NO. 85-306,125, FILED 4-27-2011.

ANTHONY RINKER, EXAMINING ATTORNEY



David J. Kybas

Director of the United States Patent and Trademark Office

United States of America

United States Patent and Trademark Office

PERFECT BLOCKS

Reg. No. 4,066,881

Registered Dec. 6, 2011

Int. Cl.: 5

TRADEMARK

PRINCIPAL REGISTER

FORTIFIED NUTRITIONAL BRANDS, LLC (WISCONSIN LIMITED LIABILITY COMPANY),
DBA FORTIFIED NUTRITION
W142 N10246 BERRYWOOD LN
GERMANTOWN, WI 53022

FOR: NUTRITIONAL DRINK MIX FOR USE AS A MEAL REPLACEMENT, IN CLASS 5 (U.S.
CLS. 6, 18, 44, 46, 51 AND 52).

FIRST USE 4-1-2011; IN COMMERCE 4-21-2011.

THE MARK CONSISTS OF STANDARD CHARACTERS WITHOUT CLAIM TO ANY PAR-
TICULAR FONT, STYLE, SIZE, OR COLOR.

SER. NO. 85-306,155, FILED 4-27-2011.

NELSON SNYDER, EXAMINING ATTORNEY



David J. Kybas

Director of the United States Patent and Trademark Office

United States of America

United States Patent and Trademark Office

RIO LUNA

Reg. No. 4,066,882

Registered Dec. 6, 2011

Int. Cls.: 29 and 30

TRADEMARK

PRINCIPAL REGISTER

BORDER FOODS, INC. (TEXAS CORPORATION)
4065 J STREET SE
DEMING, NM 88030

FOR: PROCESSED PEPPERS; PROCESSED CHILES; AND PROCESSED TOMATILLOS, IN CLASS 29 (U.S. CL. 46).

FIRST USE 0-0-1973; IN COMMERCE 0-0-1973.

FOR: SALSA AND ENCHILADA SAUCE, IN CLASS 30 (U.S. CL. 46).

FIRST USE 7-0-2003; IN COMMERCE 7-0-2003.

THE MARK CONSISTS OF STANDARD CHARACTERS WITHOUT CLAIM TO ANY PARTICULAR FONT, STYLE, SIZE, OR COLOR.

THE ENGLISH TRANSLATION OF RIO LUNA IN THE MARK IS RIVER MOON.

SER. NO. 85-306,181, FILED 4-27-2011.

RON FAIRBANKS, EXAMINING ATTORNEY



David J. Kyros

Director of the United States Patent and Trademark Office

United States of America

United States Patent and Trademark Office

AUTODATA

Reg. No. 4,066,883

Registered Dec. 6, 2011

Int. Cl.: 16

TRADEMARK

PRINCIPAL REGISTER

AUTODATA LTD. (UNITED KINGDOM LIMITED COMPANY (LTD.))
PRIORS WAY
MAIDENHEAD BERKSHIRE, UNITED KINGDOM SL62HP

FOR: PRINTED INSTRUCTIONAL AND TEACHING MATERIALS NAMELY, MANUALS, BOOKS, NEWSLETTERS, MAGAZINES, REPORTS, AND CHARTS FEATURING VEHICLE SPECIFICATIONS AND INFORMATION, DIAGRAMS FOR ELECTRICAL WIRING AND SYSTEMS FOR THE PURPOSE OF CARRYING OUT FAULT DIAGNOSING, MAINTENANCE, AND REPAIR OF VEHICLES, AND VEHICLE SYSTEMS COMPONENTS, IN CLASS 16 (U.S. CLS. 2, 5, 22, 23, 29, 37, 38 AND 50).

FIRST USE 12-0-1976; IN COMMERCE 10-0-1996.

THE MARK CONSISTS OF STANDARD CHARACTERS WITHOUT CLAIM TO ANY PARTICULAR FONT, STYLE, SIZE, OR COLOR.

OWNER OF U.S. REG. NOS. 2,161,081, 2,376,214, AND 2,956,444.

SEC. 2(F).

SER. NO. 85-306,265, FILED 4-27-2011.

LINDA POWELL, EXAMINING ATTORNEY



David J. Kyffers

Director of the United States Patent and Trademark Office

United States of America

United States Patent and Trademark Office



Reg. No. 4,066,884

Registered Dec. 6, 2011

Int. Cl.: 17

ASIA INTL ENTERPRISE (HONG KONG) LIMITED (HONG KONG LIMITED LIABILITY COMPANY)

RM B12, BLOCK B, 3/F SHEUNG SHUI PLAZA

3 KA FU CLOSE SHEUNG SHUI NT

HONG KONG, HONG KONG

TRADEMARK

PRINCIPAL REGISTER

FOR: PLASTIC COMPOSITE MATERIAL IN THE FORM OF PROFILES, BOARDS, SHEETS, BLOCKS, RODS, POWDER, AND PELLETS FOR USE IN MANUFACTURING; PLASTIC IN BARS, BLOCKS, PELLETS, RODS, SHEETS AND TUBES FOR GENERAL INDUSTRIAL USE; PLASTIC IN THE FORM OF BARS, BLOCKS, PELLETS, RODS, SHEETS AND TUBES FOR USE IN MANUFACTURING; PLASTIC MATERIAL IN EXTRUDED FORM FOR USE IN PRODUCTION; POLYPROPYLENE RESINS IN PELLET FORM FOR USE IN FURTHER MANUFACTURE; RESINS IN BARS, BLOCKS, PELLETS, RODS, SHEETS AND TUBES FOR GENERAL INDUSTRIAL USE; RESINS IN EXTRUDED FORM FOR GENERAL INDUSTRIAL USE; THERMOPLASTIC COMPOUNDS, THERMOPLASTIC ELASTOMER RESINS AND THERMOPLASTIC CONCENTRATES IN PELLET FORM FOR USE IN MANUFACTURING IN A WIDE VARIETY OF INDUSTRIES; THERMOPLASTIC ELASTOMER RESINS IN PELLET FORM FOR USE IN FURTHER MANUFACTURE, IN CLASS 17 (U.S. CLS. 1, 5, 12, 13, 35 AND 50).

FIRST USE 6-10-1999; IN COMMERCE 3-8-2011.

THE MARK CONSISTS OF THE LETTERS "AIE" IN A CIRCLE WITH THE LETTER "A" APPEARING ABOVE THE "I" AND "E" WITH A RING AROUND THE CIRCLE ON TOP OF PART OF THE "A".

SER. NO. 85-306,273, FILED 4-27-2011.

LINDA POWELL, EXAMINING ATTORNEY



David J. Kybas

Director of the United States Patent and Trademark Office

United States of America

United States Patent and Trademark Office

calmspace

Reg. No. 4,066,885

Registered Dec. 6, 2011

Int. Cl.: 3

TRADEMARK

PRINCIPAL REGISTER

HEALTHY BRANDS, LLC (WISCONSIN LIMITED LIABILITY COMPANY)
SUITE 280
633 SKOKIE BLVD.
NORTHBROOK, IL 60062

FOR: NON-MEDICATED COMPOSITION OF ESSENTIAL OILS FOR TREATING CLAUSTROPHOBIA, IN CLASS 3 (U.S. CLS. 1, 4, 6, 50, 51 AND 52).

FIRST USE 12-20-2010; IN COMMERCE 12-20-2010.

THE MARK CONSISTS OF STANDARD CHARACTERS WITHOUT CLAIM TO ANY PARTICULAR FONT, STYLE, SIZE, OR COLOR.

SER. NO. 85-306,367, FILED 4-27-2011.

ANDREA K. NADELMAN, EXAMINING ATTORNEY



David J. Kybas

Director of the United States Patent and Trademark Office

United States of America

United States Patent and Trademark Office

Greatfull Taco LIVE!

Reg. No. 4,066,886

Registered Dec. 6, 2011

Int. Cl.: 41

SERVICE MARK

PRINCIPAL REGISTER

GREATFULL TACO LIVE, L.L.C. (TEXAS LIMITED LIABILITY COMPANY), DBA
GREATFULL TACO LIVE!
2411 S. SHEPHERD DRIVE
HOUSTON, TX 77019

FOR: ENTERTAINMENT SERVICES IN THE NATURE OF PRESENTING LIVE MUSICAL
PERFORMANCES, IN CLASS 41 (U.S. CLS. 100, 101 AND 107).

FIRST USE 3-1-2011; IN COMMERCE 3-1-2011.

THE MARK CONSISTS OF STANDARD CHARACTERS WITHOUT CLAIM TO ANY PAR-
TICULAR FONT, STYLE, SIZE, OR COLOR.

NO CLAIM IS MADE TO THE EXCLUSIVE RIGHT TO USE "LIVE OR TACO", APART FROM
THE MARK AS SHOWN.

SER. NO. 85-306,382, FILED 4-27-2011.

KATHRYN COWARD, EXAMINING ATTORNEY



David J. Kybas

Director of the United States Patent and Trademark Office

United States of America

United States Patent and Trademark Office



FURBY THE TALKING EASTER BUNNY UNFOLDS THE MAGIC OF EASTER

Reg. No. 4,066,887

STEPHENS, LENORA (UNITED STATES INDIVIDUAL)
2624 BURKE LANE
FAYETTEVILLE, NC 28306

Registered Dec. 6, 2011

Int. Cl.: 36

FOR: CHARITABLE FUNDRAISING SERVICES BY MEANS OF AN ENTERTAINMENT
EVENT, IN CLASS 36 (U.S. CLS. 100, 101 AND 102).

SERVICE MARK

FIRST USE 4-8-2011; IN COMMERCE 4-12-2011.

PRINCIPAL REGISTER

SER. NO. 85-306,422, FILED 4-27-2011.

DAVID TOOLEY, EXAMINING ATTORNEY



David J. Kyffers

Director of the United States Patent and Trademark Office

United States of America

United States Patent and Trademark Office

Fashion Fusion

Reg. No. 4,066,888

Registered Dec. 6, 2011

Int. Cls.: 9 and 16

TRADEMARK

PRINCIPAL REGISTER

HORIZON GROUP USA, INC. (NEW JERSEY CORPORATION)
76 STIRLING ROAD
WARREN, NJ 07059

FOR: MINI ELECTRIC IRONS; ELECTRIC IRONS, IN CLASS 9 (U.S. CLS. 21, 23, 26, 36 AND 38).

FIRST USE 3-1-2008; IN COMMERCE 3-1-2008.

FOR: IRON-ON TRANSFERS; APPLIQUÉS IN THE FORM OF DECALS; IRON-ON RHINESTONE TRANSFERS; IRON-ON STUD TRANSFERS, IN CLASS 16 (U.S. CLS. 2, 5, 22, 23, 29, 37, 38 AND 50).

FIRST USE 3-1-2008; IN COMMERCE 3-1-2008.

THE MARK CONSISTS OF STANDARD CHARACTERS WITHOUT CLAIM TO ANY PARTICULAR FONT, STYLE, SIZE, OR COLOR.

NO CLAIM IS MADE TO THE EXCLUSIVE RIGHT TO USE "FASHION" FOR INTERNATIONAL CLASS 16, APART FROM THE MARK AS SHOWN.

SER. NO. 85-306,460, FILED 4-27-2011.

KHANH LE, EXAMINING ATTORNEY



David J. Kybas

Director of the United States Patent and Trademark Office

United States of America

United States Patent and Trademark Office

tap 

from Mindwave Research

Reg. No. 4,066,889

Registered Dec. 6, 2011

Int. Cl.: 35

SERVICE MARK

PRINCIPAL REGISTER

MIND WAVE RESEARCH, INC. (TEXAS CORPORATION)
SUITE 700
4412 SPICEWOOD SPRINGS ROAD
AUSTIN, TX 78759

FOR: PROVIDING MARKETING AND MEDIA PLANNING SYNDICATED RESEARCH DATA FOR OTHERS, IN CLASS 35 (U.S. CLS. 100, 101 AND 102).

FIRST USE 1-0-2011; IN COMMERCE 1-0-2011.

OWNER OF U.S. REG. NOS. 3,109,152, 3,252,915, AND 3,351,959.

THE COLOR(S) PALE BLUE, LIGHT BLUE, DARK BLUE, AND BLACK IS/ARE CLAIMED AS A FEATURE OF THE MARK.

NO CLAIM IS MADE TO THE EXCLUSIVE RIGHT TO USE "RESEARCH", APART FROM THE MARK AS SHOWN.

THE MARK CONSISTS OF THE "TAP" ABOVE A LINE AND THE WORDING "FROM MINDWAVE RESEARCH" BELOW THE LINE, ALL LETTERS AND THE LINE IN APPEAR IN BLACK, AND A FANCIFUL 4 POINTED DESIGN APPEARS IN CONCENTRIC SHADES OF PALE BLUE, LIGHT BLUE, AND DARK BLUE TO THE RIGHT OF THE LETTER "P" IN THE TERM "TAP".

SER. NO. 85-306,494, FILED 4-27-2011.

JACLYN KIDWELL WALKER, EXAMINING ATTORNEY



David J. Kybas

Director of the United States Patent and Trademark Office

United States of America

United States Patent and Trademark Office

Transformations

Reg. No. 4,066,890

Registered Dec. 6, 2011

Int. Cl.: 16

TRADEMARK

PRINCIPAL REGISTER

HORIZON GROUP USA, INC. (NEW JERSEY CORPORATION)
76 STIRLING ROAD
WARREN, NJ 07059

FOR: IRON-ON TRANSFERS; IRON-ON LETTER TRANSFERS; PHOTO-QUALITY, PRINTER TRANSFER PAPER; PHOTO-QUALITY PRINTER TRANSFER PAPER IN THE FORM OF SHEETS, IN CLASS 16 (U.S. CLS. 2, 5, 22, 23, 29, 37, 38 AND 50).

FIRST USE 12-1-2006; IN COMMERCE 12-1-2006.

THE MARK CONSISTS OF STANDARD CHARACTERS WITHOUT CLAIM TO ANY PARTICULAR FONT, STYLE, SIZE, OR COLOR.

SER. NO. 85-306,569, FILED 4-27-2011.

KHANH LE, EXAMINING ATTORNEY



David J. Kybas

Director of the United States Patent and Trademark Office

United States of America

United States Patent and Trademark Office

MICRO TOUCH

Reg. No. 4,066,891

Registered Dec. 6, 2011

Int. Cl.: 24

TRADEMARK

PRINCIPAL REGISTER

S. S. DWECK & SONS INC. (NEW YORK CORPORATION)
345 NYE AVENUE
IRVINGTON, NJ 07111

FOR: BATH TOWELS; BED BLANKETS; BED SHEETS; DISH CLOTHS; HAND TOWELS;
KITCHEN LINENS; KITCHEN TOWELS; TOWELS; WASHCLOTHS, IN CLASS 24 (U.S. CLS.
42 AND 50).

FIRST USE 1-1-2011; IN COMMERCE 4-15-2011.

THE MARK CONSISTS OF STANDARD CHARACTERS WITHOUT CLAIM TO ANY PAR-
TICULAR FONT, STYLE, SIZE, OR COLOR.

SER. NO. 85-306,587, FILED 4-27-2011.

JASON LOTT, EXAMINING ATTORNEY



David J. Kyffers

Director of the United States Patent and Trademark Office

United States of America

United States Patent and Trademark Office

EARTHCRUISER

Reg. No. 4,066,892

Registered Dec. 6, 2011

Int. Cl.: 12

TRADEMARK

PRINCIPAL REGISTER

EARTHCRUISER OVERLAND VEHICLES PTY LTD (AUSTRALIA PROPRIETARY LIMITED COMPANY)
PO BOX 2602
FORTITUDE VALLEY B.C., AUSTRALIA 4006

FOR: MOTOR HOMES; CAMPER VANS; CAMPING VEHICLES, IN CLASS 12 (U.S. CLS. 19, 21, 23, 31, 35 AND 44).

THE MARK CONSISTS OF STANDARD CHARACTERS WITHOUT CLAIM TO ANY PARTICULAR FONT, STYLE, SIZE, OR COLOR.

OWNER OF AUSTRALIA REG. NO. 1226308, DATED 2-26-2008, EXPIRES 2-26-2018.

SER. NO. 85-306,591, FILED 4-27-2011.

SUSAN RICHARDS, EXAMINING ATTORNEY



David J. Kyffers

Director of the United States Patent and Trademark Office

United States of America

United States Patent and Trademark Office

Superbarket where dogs shop!

Reg. No. 4,066,893

FRANKLY CONSULTING LLC (VIRGINIA LIMITED LIABILITY COMPANY)
2203 WESTCOURT LANE, SUITE 305
HERNDON, VA 20170

Registered Dec. 6, 2011

Int. Cl.: 35

FOR: RETAIL STORE AND ON-LINE RETAIL STORE SERVICES FEATURING DOG FOOD,
IN CLASS 35 (U.S. CLS. 100, 101 AND 102).

SERVICE MARK

FIRST USE 5-1-2010; IN COMMERCE 5-1-2010.

PRINCIPAL REGISTER

THE MARK CONSISTS OF STANDARD CHARACTERS WITHOUT CLAIM TO ANY PAR-
TICULAR FONT, STYLE, SIZE, OR COLOR.

SER. NO. 85-306,606, FILED 4-27-2011.

JASON LOTT, EXAMINING ATTORNEY



David J. Kybas

Director of the United States Patent and Trademark Office

United States of America

United States Patent and Trademark Office

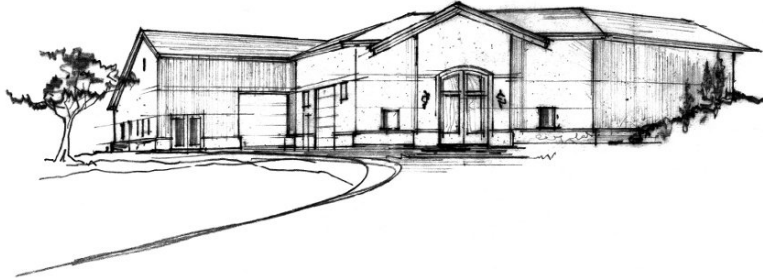

Reg. No. 4,066,894

Registered Dec. 6, 2011

Int. Cl.: 33

TRADEMARK

PRINCIPAL REGISTER

BETZ CELLARS LLC (WASHINGTON LIMITED LIABILITY COMPANY)
4930 E. PALOMINO ROAD
PHOENIX, AZ 85018

FOR: WINES, IN CLASS 33 (U.S. CLS. 47 AND 49).

FIRST USE 9-0-2007; IN COMMERCE 9-0-2007.

THE MARK CONSISTS OF A LINE DRAWING OF A WINERY BUILDING WITH A TREE TO THE LEFT, AN APPROACH ROAD IN FRONT CENTER, AND A HILLSIDE WITH BUSHES IN FRONT OF THE RIGHT-MOST WING OF THE BUILDING.

SER. NO. 85-306,688, FILED 4-27-2011.

RAMONA ORTIGA, EXAMINING ATTORNEY



David J. Kyffers

Director of the United States Patent and Trademark Office

United States of America

United States Patent and Trademark Office

BETZ

Reg. No. 4,066,895

Registered Dec. 6, 2011

Int. Cl.: 33

TRADEMARK

PRINCIPAL REGISTER

BETZ CELLARS LLC (WASHINGTON LIMITED LIABILITY COMPANY)
4930 E. PALOMINO ROAD
PHOENIX, AZ 85018

FOR: WINES, IN CLASS 33 (U.S. CLS. 47 AND 49).

FIRST USE 4-0-2000; IN COMMERCE 4-0-2000.

THE MARK CONSISTS OF STANDARD CHARACTERS WITHOUT CLAIM TO ANY PARTICULAR FONT, STYLE, SIZE, OR COLOR.

SEC. 2(F).

SER. NO. 85-306,691, FILED 4-27-2011.

RAMONA ORTIGA, EXAMINING ATTORNEY



David J. Kybas

Director of the United States Patent and Trademark Office

United States of America

United States Patent and Trademark Office

SOCIAL BUGS

Reg. No. 4,066,896

Registered Dec. 6, 2011

Int. Cl.: 45

SERVICE MARK

PRINCIPAL REGISTER

NEWFRIENDZ.NET LLC (NEW JERSEY LIMITED LIABILITY COMPANY)
39 LAWRENCE DRIVE
MANAHAWKIN, NJ 08050

FOR: ON-LINE SOCIAL NETWORKING SERVICES, IN CLASS 45 (U.S. CLS. 100 AND 101).

FIRST USE 2-0-2011; IN COMMERCE 2-0-2011.

THE MARK CONSISTS OF STANDARD CHARACTERS WITHOUT CLAIM TO ANY PARTICULAR FONT, STYLE, SIZE, OR COLOR.

NO CLAIM IS MADE TO THE EXCLUSIVE RIGHT TO USE "SOCIAL", APART FROM THE MARK AS SHOWN.

SER. NO. 85-306,703, FILED 4-27-2011.

TEJBIR SINGH, EXAMINING ATTORNEY



David J. Kyffers

Director of the United States Patent and Trademark Office

United States of America

United States Patent and Trademark Office

Mr. Rescue Heating and Cooling

Reg. No. 4,066,897

Registered Dec. 6, 2011

Int. Cl.: 37

SERVICE MARK

PRINCIPAL REGISTER

MR. RESCUE CORPORATION (CALIFORNIA CORPORATION), DBA MR. RESCUE HVAC
SUITE 12
4231 BUSINESS CENTER DR
FREMONT, CA 94538

FOR: HVAC CONTRACTOR SERVICES, IN CLASS 37 (U.S. CLS. 100, 103 AND 106).

FIRST USE 12-20-2006; IN COMMERCE 12-20-2006.

THE MARK CONSISTS OF STANDARD CHARACTERS WITHOUT CLAIM TO ANY PARTICULAR FONT, STYLE, SIZE, OR COLOR.

NO CLAIM IS MADE TO THE EXCLUSIVE RIGHT TO USE "HEATING AND COOLING", APART FROM THE MARK AS SHOWN.

SER. NO. 85-306,749, FILED 4-28-2011.

JOHN E. MICHOS, EXAMINING ATTORNEY



David J. Kyffers

Director of the United States Patent and Trademark Office

United States of America

United States Patent and Trademark Office

Mr. Rescue Restoration

Reg. No. 4,066,898

Registered Dec. 6, 2011

Int. Cl.: 37

SERVICE MARK

PRINCIPAL REGISTER

MR. RESCUE CORPORATION (CALIFORNIA CORPORATION), DBA MR. RESCUE RESTORATION INC
SUITE 12
4231 BUSINESS CENTER DR
FREMONT, CA 94538

FOR: RESTORATION SERVICES IN THE FIELD OF WATER, SMOKE AND FIRE DAMAGE, IN CLASS 37 (U.S. CLS. 100, 103 AND 106).

FIRST USE 12-20-2006; IN COMMERCE 12-20-2006.

THE MARK CONSISTS OF STANDARD CHARACTERS WITHOUT CLAIM TO ANY PARTICULAR FONT, STYLE, SIZE, OR COLOR.

NO CLAIM IS MADE TO THE EXCLUSIVE RIGHT TO USE "RESTORATION", APART FROM THE MARK AS SHOWN.

SER. NO. 85-306,752, FILED 4-28-2011.

JOHN E. MICHOS, EXAMINING ATTORNEY



David J. Kyffers

Director of the United States Patent and Trademark Office

United States of America

United States Patent and Trademark Office

SAVE THE FUN

Reg. No. 4,066,899

Registered Dec. 6, 2011

Int. Cl.: 41

SERVICE MARK

PRINCIPAL REGISTER

HARRIS, RANDY C (UNITED STATES INDIVIDUAL)
913 KEOKI CT
KEMP, TX 75143

FOR: ENTERTAINMENT INFORMATION; ENTERTAINMENT MEDIA PRODUCTION SERVICES FOR MOTION PICTURES, TELEVISION AND INTERNET; ENTERTAINMENT, NAMELY, A CONTINUING TRAVEL, ADVENTURE AND SCUBA DIVING SHOW BROADCAST OVER TELEVISION AND THE INTERNET; PRODUCTION AND DISTRIBUTION OF TELEVISION SHOWS AND MOVIES; PRODUCTION OF TELEVISION PROGRAMS; PROVIDING A WEBSITE FEATURING ENTERTAINMENT INFORMATION; PROVIDING ON-LINE ENTERTAINMENT INFORMATION, NAMELY, INFORMATION ABOUT TELEVISION PROGRAMMING, IN CLASS 41 (U.S. CLS. 100, 101 AND 107).

FIRST USE 3-1-2011; IN COMMERCE 3-1-2011.

THE MARK CONSISTS OF STANDARD CHARACTERS WITHOUT CLAIM TO ANY PARTICULAR FONT, STYLE, SIZE, OR COLOR.

SER. NO. 85-306,761, FILED 4-28-2011.

ANDREW LEASER, EXAMINING ATTORNEY



David J. Kypos

Director of the United States Patent and Trademark Office

United States of America

United States Patent and Trademark Office



Reg. No. 4,066,900

Registered Dec. 6, 2011

Int. Cl.: 30

TRADEMARK

PRINCIPAL REGISTER

KAIHUA DUKANG TEA CO., LTD. (CHINA LIMITED COMPANY (LTD.))
NO. 28, HUASHAN ROAD, CHENGGUAN TOWN
KAIHUA COUNTY, ZHEJIANG PROVINCE
324300, CHINA

FOR: HONEY; TEA; TEA SUBSTITUTES; TEA-BASED BEVERAGES, IN CLASS 30 (U.S. CL. 46).

FIRST USE 10-28-2009; IN COMMERCE 3-3-2011.

THE MARK CONSISTS OF THE STYLIZED WORDS "DU KANG" IN A CURVED BAND, A CURVE WITH TWO ARROWS, AND TWO CHINESE CHARACTERS WHICH TRANSLITERATE INTO "DU KANG", ALL IN FRONT OF A CIRCLE DESIGN WHICH IS DIVIDED BY AN S-SHAPED CURVE AND WITH TWO SMALLER CIRCLES INSIDE.

THE NON-LATIN CHARACTERS IN THE MARK TRANSLITERATE TO "DU KANG" AND THIS MEANS "SHUT OUT HEALTH" IN ENGLISH.

SER. NO. 85-306,766, FILED 4-28-2011.

ANDREW LEASER, EXAMINING ATTORNEY



David J. Kyros

Director of the United States Patent and Trademark Office

United States of America

United States Patent and Trademark Office



Reg. No. 4,066,901

Registered Dec. 6, 2011

Int. Cl.: 15

TRADEMARK

PRINCIPAL REGISTER

ACOSTA, ANTONIO (UNITED STATES INDIVIDUAL)
341 WEST 44TH ST.
NEW YORK, NY 10036

FOR: MUSICAL INSTRUMENT PRODUCTS, NAMELY, GUITAR STRINGS, IN CLASS 15
(U.S. CLS. 2, 21 AND 36).

FIRST USE 2-1-1982; IN COMMERCE 4-1-1982.

THE MARK CONSISTS OF A TREBLE CLEF WRITTEN INSIDE TWO CONCENTRIC CIRCLES
WITH A SPIKED BORDER BETWEEN THE FIRST AND SECOND CIRCLE AND THE IMAGE
OF GUITAR STRINGS CROSSING ACROSS THE CIRCLES.

SER. NO. 85-306,768, FILED 4-28-2011.

ANDREW LEASER, EXAMINING ATTORNEY



David J. Kybas

Director of the United States Patent and Trademark Office

United States of America

United States Patent and Trademark Office

Pah!

Reg. No. 4,066,902

Registered Dec. 6, 2011

Int. Cl.: 9

TRADEMARK

PRINCIPAL REGISTER

ROTH ISRAEL (ISRAEL INDIVIDUAL)
SUITE 3
45 RAMBAM ST.
RAANANA, ISRAEL 43601 AND

TAGURI YOSEPH (ISRAEL INDIVIDUAL)
16 BEIT ZURI ST. RAMAT-AVIV
TEL-AVIV, ISRAEL 69122 AND

SHAHAR EYAL (ISRAEL INDIVIDUAL)
APT. 21
15 TABENKIN ST.
RAMAT-GAN, ISRAEL 52302

FOR: COMPUTER GAME SOFTWARE; COMPUTER GAME SOFTWARE FOR USE ON MOBILE AND CELLULAR PHONES; COMPUTER GAME SOFTWARE FOR USE WITH PERSONAL COMPUTERS, HOME VIDEO GAME CONSOLES USED WITH TELEVISIONS AND ARCADE-BASED VIDEO GAME CONSOLES; ELECTRONIC GAME SOFTWARE; ELECTRONIC GAME SOFTWARE FOR CELLULAR TELEPHONES; ELECTRONIC GAME SOFTWARE FOR HANDHELD ELECTRONIC DEVICES; ELECTRONIC GAME SOFTWARE FOR WIRELESS DEVICES, IN CLASS 9 (U.S. CLS. 21, 23, 26, 36 AND 38).

FIRST USE 5-5-2004; IN COMMERCE 3-23-2011.

THE MARK CONSISTS OF STANDARD CHARACTERS WITHOUT CLAIM TO ANY PARTICULAR FONT, STYLE, SIZE, OR COLOR.

SER. NO. 85-306,775, FILED 4-28-2011.

ANDREW LEASER, EXAMINING ATTORNEY



David J. Kyros

Director of the United States Patent and Trademark Office

United States of America

United States Patent and Trademark Office

ATOMIC #7

Reg. No. 4,066,903

Registered Dec. 6, 2011

Int. Cl.: 43

SERVICE MARK

PRINCIPAL REGISTER

FOURNIER, GINGER CORBETT (UNITED STATES INDIVIDUAL)
3157 N RAINBOW BLVD #307
3157 N RAINBOW BLVD #307
LAS VEGAS, NV 89108 AND

FOURNIER, RACHELLE (CANADA INDIVIDUAL)
3157 N RAINBOW BLVD #307
LAS VEGAS, NV 89108

FOR: ICE CREAM PARLORS; ICE CREAM SHOP SERVICES IN THE NATURE OF A RESTAURANT, IN CLASS 43 (U.S. CLS. 100 AND 101).

FIRST USE 8-3-2009; IN COMMERCE 5-30-2010.

THE MARK CONSISTS OF STANDARD CHARACTERS WITHOUT CLAIM TO ANY PARTICULAR FONT, STYLE, SIZE, OR COLOR.

SER. NO. 85-306,779, FILED 4-28-2011.

ANDREW LEASER, EXAMINING ATTORNEY



David J. Kyros

Director of the United States Patent and Trademark Office

United States of America

United States Patent and Trademark Office

SOBRIETYSTONES

Reg. No. 4,066,904

Registered Dec. 6, 2011

Int. Cl.: 14

TRADEMARK

PRINCIPAL REGISTER

GORDON, SHIRLEY (UNITED STATES INDIVIDUAL)
601 WESTERLY DRIVE
MARLTON, NJ 08053

FOR: JEWELRY, IN CLASS 14 (U.S. CLS. 2, 27, 28 AND 50).

FIRST USE 6-1-2003; IN COMMERCE 6-1-2003.

THE MARK CONSISTS OF STANDARD CHARACTERS WITHOUT CLAIM TO ANY PARTICULAR FONT, STYLE, SIZE, OR COLOR.

SER. NO. 85-306,789, FILED 4-28-2011.

ANDREW LEASER, EXAMINING ATTORNEY



David J. Kybas

Director of the United States Patent and Trademark Office

United States of America

United States Patent and Trademark Office

IFB

Reg. No. 4,066,905

Registered Dec. 6, 2011

Int. Cl.: 35

SERVICE MARK

PRINCIPAL REGISTER

COVETED MEDIA LLC (NEW YORK LIMITED LIABILITY COMPANY)
154 GRAND STREET
NEW YORK, NY 10013

FOR: ADVERTISING AND MARKETING SERVICES PROVIDED BY MEANS OF INDIRECT METHODS OF MARKETING COMMUNICATIONS, NAMELY, SOCIAL MEDIA, SEARCH ENGINE MARKETING, INQUIRY MARKETING, INTERNET MARKETING, MOBILE MARKETING, BLOGGING AND OTHER FORMS OF PASSIVE, SHARABLE OR VIRAL COMMUNICATIONS CHANNELS; DEVELOPMENT OF MARKETING STRATEGIES, CONCEPTS AND TACTICS, NAMELY, AUDIENCE DEVELOPMENT, BRAND AWARENESS, ONLINE COMMUNITY BUILDING AND DIGITAL WORD OF MOUTH COMMUNICATIONS; DISSEMINATION OF ADVERTISING FOR OTHERS VIA AN ON-LINE COMMUNICATIONS NETWORK ON THE INTERNET; MARKETING AND CONSULTING SERVICES IN THE FIELD OF PROMOTING AND TRACKING THE GOODS, SERVICES, AND BRANDS OF OTHERS THROUGH ALL PUBLIC COMMUNICATION MEANS, PARTICULARLY SPECIALIZING IN THE USE OF MOBILE, SOCIAL, AND PRINT MEDIA TO DRIVE CONSUMER INTEREST, ENGAGEMENT AND ACTION; SOCIAL MEDIA STRATEGY AND MARKETING CONSULTANCY FOCUSING ON HELPING CLIENTS CREATE AND EXTEND THEIR PRODUCT AND BRAND STRATEGIES BY BUILDING VIRALLY ENGAGING MARKETING SOLUTIONS, IN CLASS 35 (U.S. CLS. 100, 101 AND 102).

FIRST USE 6-1-2007; IN COMMERCE 6-1-2007.

THE MARK CONSISTS OF STANDARD CHARACTERS WITHOUT CLAIM TO ANY PARTICULAR FONT, STYLE, SIZE, OR COLOR.

SER. NO. 85-306,821, FILED S.R. 4-28-2011 AM. P.R. 5-5-2011.

NICHOLAS COLEMAN, EXAMINING ATTORNEY



David J. Kyffers

Director of the United States Patent and Trademark Office

United States of America

United States Patent and Trademark Office

DREAD

Reg. No. 4,066,906

Registered Dec. 6, 2011

Int. Cl.: 28

TRADEMARK

PRINCIPAL REGISTER

THE NELSON PAINT COMPANY (DELAWARE CORPORATION)
ONE NELSON DRIVE, P.O. BOX 2040
KINGSFORD, MI 49802

FOR: PAINTBALLS, IN CLASS 28 (U.S. CLS. 22, 23, 38 AND 50).

FIRST USE 11-17-2010; IN COMMERCE 11-17-2010.

THE MARK CONSISTS OF STANDARD CHARACTERS WITHOUT CLAIM TO ANY PARTICULAR FONT, STYLE, SIZE, OR COLOR.

SER. NO. 85-306,840, FILED 4-28-2011.

LOURDES AYALA, EXAMINING ATTORNEY



David J. Kybas

Director of the United States Patent and Trademark Office

United States of America

United States Patent and Trademark Office

BOOSTER

Reg. No. 4,066,907

Registered Dec. 6, 2011

Int. Cls.: 28 and 41

TRADEMARK

SERVICE MARK

PRINCIPAL REGISTER

GTECH RHODE ISLAND CORPORATION (RHODE ISLAND CORPORATION)
10 MEMORIAL BOULEVARD
PROVIDENCE, RI 02903

FOR: LOTTERY GAME TICKETS AND PLAYCARDS, IN CLASS 28 (U.S. CLS. 22, 23, 38 AND 50).

FIRST USE 7-25-2010; IN COMMERCE 7-25-2010.

FOR: LOTTERY SERVICES, IN CLASS 41 (U.S. CLS. 100, 101 AND 107).

FIRST USE 7-25-2010; IN COMMERCE 7-25-2010.

THE MARK CONSISTS OF STANDARD CHARACTERS WITHOUT CLAIM TO ANY PARTICULAR FONT, STYLE, SIZE, OR COLOR.

SER. NO. 85-306,877, FILED 4-28-2011.

BRENDAN REGAN, EXAMINING ATTORNEY



David J. Kybas

Director of the United States Patent and Trademark Office

United States of America

United States Patent and Trademark Office

RHEOTRACK

Reg. No. 4,066,908

Registered Dec. 6, 2011

Int. Cl.: 9

TRADEMARK

PRINCIPAL REGISTER

RICHARD J. BAGAN, INC. (INDIANA CORPORATION)
1280 SOUTH WILLIAMS DRIVE, P.O. BOX 169
COLUMBIA CITY, IN 46725

FOR: COMPUTER SOFTWARE FOR COLLECTING AND REPORTING RUBBER AND PLASTIC TEST DATA, IN CLASS 9 (U.S. CLS. 21, 23, 26, 36 AND 38).

FIRST USE 4-27-2011; IN COMMERCE 4-27-2011.

THE MARK CONSISTS OF STANDARD CHARACTERS WITHOUT CLAIM TO ANY PARTICULAR FONT, STYLE, SIZE, OR COLOR.

SER. NO. 85-306,909, FILED 4-28-2011.

ROBIN CHOSID, EXAMINING ATTORNEY



David J. Kybas

Director of the United States Patent and Trademark Office

United States of America

United States Patent and Trademark Office



Reg. No. 4,066,909

Registered Dec. 6, 2011

Int. Cl.: 41

SERVICE MARK

PRINCIPAL REGISTER

SAN ANTONIO LIVESTOCK EXPOSITION, INC. (TEXAS CORPORATION)
3201 EAST HOUSTON
SAN ANTONIO, TX 78219

FOR: ENTERTAINMENT SERVICES, NAMELY, ORGANIZING, CONDUCTING, PROVIDING AND OPERATING LIVESTOCK SHOWS, LIVESTOCK EXHIBITS, RODEOS, LIVE PERFORMANCES BY A MUSICAL BAND, LIVE PERFORMANCES BY RODEO BULLFIGHTERS, EDUCATIONAL SERVICES, NAMELY, TRAINING IN THE FIELD OF LIVESTOCK AND AGRICULTURE, IN CLASS 41 (U.S. CLS. 100, 101 AND 107).

FIRST USE 2-28-2003; IN COMMERCE 2-28-2003.

THE MARK CONSISTS OF THE LETTER "S" DESIGNED TO FORM A COWBOY HAT.

SER. NO. 85-307,001, FILED 4-28-2011.

THEODORE MCBRIDE, EXAMINING ATTORNEY



David J. Kybas

Director of the United States Patent and Trademark Office

United States of America

United States Patent and Trademark Office



Reg. No. 4,066,910

Registered Dec. 6, 2011

Int. Cl.: 25

TRADEMARK

PRINCIPAL REGISTER

SAN ANTONIO LIVESTOCK EXPOSITION, INC. (TEXAS CORPORATION)
3201 EAST HOUSTON
SAN ANTONIO, TX 78219

FOR: CLOTHING, NAMELY, HATS, JACKETS, VESTS, TOPS, BOTTOMS, BANDANAS, IN CLASS 25 (U.S. CLS. 22 AND 39).

FIRST USE 2-28-2003; IN COMMERCE 2-28-2003.

THE MARK CONSISTS OF THE LETTER S DESIGNED TO FORM A COWBOY HAT.

SER. NO. 85-307,003, FILED 4-28-2011.

THEODORE MCBRIDE, EXAMINING ATTORNEY



David J. Kybas

Director of the United States Patent and Trademark Office

United States of America

United States Patent and Trademark Office

BE-VIDA

Reg. No. 4,066,911

RAMIREZ MORELES, SELOMITH (MEXICO INDIVIDUAL)
ALVARO OBREGON 145 CENTRO
IRAPUATO, MEXICO

Registered Dec. 6, 2011

Int. Cl.: 5

FOR: DIETARY AND NUTRITIONAL SUPPLEMENTS, IN CLASS 5 (U.S. CLS. 6, 18, 44, 46, 51 AND 52).

TRADEMARK

FIRST USE 1-2-2006; IN COMMERCE 10-5-2008.

PRINCIPAL REGISTER

THE MARK CONSISTS OF STANDARD CHARACTERS WITHOUT CLAIM TO ANY PARTICULAR FONT, STYLE, SIZE, OR COLOR.

OWNER OF U.S. REG. NO. 3,891,205.

SER. NO. 85-307,069, FILED 4-28-2011.

EMILY CARLSEN, EXAMINING ATTORNEY



David J. Kybas

Director of the United States Patent and Trademark Office

United States of America

United States Patent and Trademark Office



Association of Certified Handyman Professionals

Reg. No. 4,066,912

PADILLA, ED (UNITED STATES INDIVIDUAL)
171 DOMMERICH DR
MAITLAND, FL 32751

Registered Dec. 6, 2011

Int. Cl.: 35

FOR: ASSOCIATION SERVICES, NAMELY, PROMOTING THE INTERESTS OF HANDYMAN PROFESSIONALS, IN CLASS 35 (U.S. CLS. 100, 101 AND 102).

SERVICE MARK

FIRST USE 5-6-2009; IN COMMERCE 5-6-2009.

PRINCIPAL REGISTER

NO CLAIM IS MADE TO THE EXCLUSIVE RIGHT TO USE "ASSOCIATION OF CERTIFIED HANDYMAN PROFESSIONALS", APART FROM THE MARK AS SHOWN.

THE MARK CONSISTS OF A GABLE ROOF IS OVER TOP OF THE STYLIZED LETTERS "ACHP" ATTACHED TO A HAMMER OVER THE STYLIZED TEXT "ASSOCIATION OF CERTIFIED HANDYMAN PROFESSIONALS".

SER. NO. 85-307,138, FILED 4-28-2011.

GINA HAYES, EXAMINING ATTORNEY



David J. Kyros

Director of the United States Patent and Trademark Office

United States of America

United States Patent and Trademark Office

SUREDEPOSIT

Reg. No. 4,066,913

Registered Dec. 6, 2011

Int. Cl.: 36

SERVICE MARK

PRINCIPAL REGISTER

ASSURANT, INC. (DELAWARE CORPORATION)
ONE CHASE MANHATTAN PLAZA
41ST FLOOR
NEW YORK, NY 10005

FOR: FINANCIAL GUARANTEE AND SURETY SERVICES, IN CLASS 36 (U.S. CLS. 100, 101 AND 102).

FIRST USE 5-0-2000; IN COMMERCE 5-0-2000.

THE MARK CONSISTS OF STANDARD CHARACTERS WITHOUT CLAIM TO ANY PARTICULAR FONT, STYLE, SIZE, OR COLOR.

SER. NO. 85-307,159, FILED 4-28-2011.

JULIE WATSON, EXAMINING ATTORNEY



David J. Kyffers

Director of the United States Patent and Trademark Office

United States of America

United States Patent and Trademark Office

Jelly the Pug

Reg. No. 4,066,914

Registered Dec. 6, 2011

Int. Cl.: 25

TRADEMARK

PRINCIPAL REGISTER

JELLY THE PUG LLC (CALIFORNIA LIMITED LIABILITY COMPANY)
20185 ROCKWELL RD
CORONA, CA 92881

FOR: DRESSES; SKIRTS; TOPS, IN CLASS 25 (U.S. CLS. 22 AND 39).

FIRST USE 2-1-2008; IN COMMERCE 2-1-2008.

THE MARK CONSISTS OF STANDARD CHARACTERS WITHOUT CLAIM TO ANY PARTICULAR FONT, STYLE, SIZE, OR COLOR.

SER. NO. 85-307,169, FILED 4-28-2011.

STEVEN R. FINE, EXAMINING ATTORNEY



David J. Kybas

Director of the United States Patent and Trademark Office

United States of America

United States Patent and Trademark Office

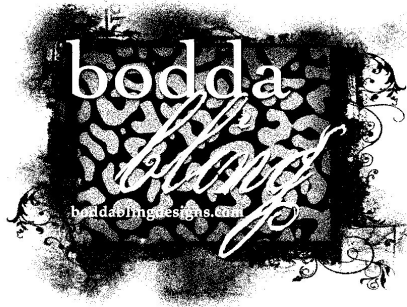

Reg. No. 4,066,915

Registered Dec. 6, 2011

Int. Cl.: 42

SERVICE MARK

PRINCIPAL REGISTER

BALMA, KIMBERLY (UNITED STATES INDIVIDUAL)
5561 BIG RIVER DR.
THE COLONY, TX 75056

FOR: CUSTOM DESIGN OF WEARABLE APPAREL AND OTHER FABRIC-BASED MERCHANDISE BY APPLYING HEAT-FIXED RHINESTONE DESIGNS TO THE FABRIC BASED ON PERSONAL SELECTIONS MADE BY THE CUSTOMER , IN CLASS 42 (U.S. CLS. 100 AND 101).

FIRST USE 1-1-2009; IN COMMERCE 2-1-2009.

THE MARK CONSISTS OF SWIRLING AND FADED FRAMING THE INSIDE OF A LEOPARD BACKGROUND AND THE STYLIZED TEXT "BODDA BLING BODDABLING-DESIGNS.COM".

SER. NO. 85-307,188, FILED 4-28-2011.

MARK SPARACINO, EXAMINING ATTORNEY



David J. Kyffers

Director of the United States Patent and Trademark Office

United States of America

United States Patent and Trademark Office

Insite

Reg. No. 4,066,916

Registered Dec. 6, 2011

Int. Cl.: 35

SERVICE MARK

PRINCIPAL REGISTER

SATISFACTS RESEARCH, LLC (MARYLAND LIMITED LIABILITY COMPANY)
SUITE 322
2360 W. JOPPA ROAD
LUTHERVILLE, MD 21093

FOR: BUSINESS ASSISTANCE SERVICES, NAMELY, ASSISTING PROPERTY OWNERS, LANDLORDS AND OTHER LESSORS WITH RESIDENT AND PROSPECT MONITORING AND FOLLOW-UP, TO IMPROVE RESIDENT ACQUISITION, RETENTION AND SATISFACTION, IN CLASS 35 (U.S. CLS. 100, 101 AND 102).

FIRST USE 0-0-2007; IN COMMERCE 0-0-2007.

THE MARK CONSISTS OF STANDARD CHARACTERS WITHOUT CLAIM TO ANY PARTICULAR FONT, STYLE, SIZE, OR COLOR.

SER. NO. 85-307,246, FILED 4-28-2011.

JORDAN BAKER, EXAMINING ATTORNEY



David J. Kybas

Director of the United States Patent and Trademark Office

United States of America

United States Patent and Trademark Office

VID-AZ FORTE

Reg. No. 4,066,917

RAMIREZ MORELES, SELOMITH (MEXICO INDIVIDUAL)
ALVARO OBREGON 145 CENTRO
IRAPUATO, MEXICO

Registered Dec. 6, 2011

Int. Cl.: 5

FOR: DIETARY AND NUTRITIONAL SUPPLEMENTS, IN CLASS 5 (U.S. CLS. 6, 18, 44, 46, 51 AND 52).

TRADEMARK

FIRST USE 1-2-2006; IN COMMERCE 10-5-2008.

PRINCIPAL REGISTER

THE MARK CONSISTS OF STANDARD CHARACTERS WITHOUT CLAIM TO ANY PARTICULAR FONT, STYLE, SIZE, OR COLOR.

OWNER OF U.S. REG. NO. 3,897,991.

SER. NO. 85-307,321, FILED 4-28-2011.

JULIE VEPPUMTHARA, EXAMINING ATTORNEY



David J. Kybas

Director of the United States Patent and Trademark Office

United States of America

United States Patent and Trademark Office

Imago Divina

Reg. No. 4,066,918

KAREN KUCHAN (UNITED STATES INDIVIDUAL)
2826 SAINT JAMES PLACE
ALTADENA, CA 91001

Registered Dec. 6, 2011

Int. Cl.: 45

FOR: CHARITABLE OUTREACH SERVICES, NAMELY, PROVIDING COUNSELING SERVICES IN THE FIELD OF RELIGION TO THE NEEDY, THE IMPRISONED, AND THE SICK; PROVIDING BOTH IN-PERSON AND ON-LINE HOLISTIC SPIRITUAL COUNSELING SERVICES, IN CLASS 45 (U.S. CLS. 100 AND 101).

SERVICE MARK

PRINCIPAL REGISTER

FIRST USE 4-1-2009; IN COMMERCE 9-1-2009.

THE MARK CONSISTS OF STANDARD CHARACTERS WITHOUT CLAIM TO ANY PARTICULAR FONT, STYLE, SIZE, OR COLOR.

SER. NO. 85-307,367, FILED 4-28-2011.

GEOFFREY FOSDICK, EXAMINING ATTORNEY



David J. Kyffers

Director of the United States Patent and Trademark Office

United States of America

United States Patent and Trademark Office

PEACE LOVE AND PIZZA

Reg. No. 4,066,919

Registered Dec. 6, 2011

Int. Cls.: 25 and 43

TRADEMARK

SERVICE MARK

PRINCIPAL REGISTER

EXTREME FOOD CONCEPTS, INC. (GEORGIA CORPORATION), DBA PEACE LOVE AND PIZZA
100 ROTHERHITHE LANE
MARIETTA, GA 30066

FOR: BEANIES; CAPS; CAPS WITH VISORS; T-SHIRTS, IN CLASS 25 (U.S. CLS. 22 AND 39).

FIRST USE 2-2-2010; IN COMMERCE 2-2-2010.

FOR: CARRY-OUT RESTAURANTS; CATERING SERVICES; RESTAURANT SERVICES, IN CLASS 43 (U.S. CLS. 100 AND 101).

FIRST USE 2-2-2010; IN COMMERCE 2-2-2010.

THE MARK CONSISTS OF STANDARD CHARACTERS WITHOUT CLAIM TO ANY PARTICULAR FONT, STYLE, SIZE, OR COLOR.

NO CLAIM IS MADE TO THE EXCLUSIVE RIGHT TO USE "PIZZA", APART FROM THE MARK AS SHOWN.

SER. NO. 85-307,373, FILED 4-28-2011.

TEJBIR SINGH, EXAMINING ATTORNEY



David J. Kypos

Director of the United States Patent and Trademark Office

United States of America

United States Patent and Trademark Office

MURRUSKA

Reg. No. 4,066,920

RAMIREZ MORELES, SELOMITH (MEXICO INDIVIDUAL)
ALVARO OBREGON 145 CENTRO
IRAPUATO, MEXICO

Registered Dec. 6, 2011

Int. Cl.: 3

FOR: COSMETIC CREAMS; COSMETIC CREAMS FOR SKIN CARE, IN CLASS 3 (U.S. CLS. 1, 4, 6, 50, 51 AND 52).

TRADEMARK

FIRST USE 1-2-2006; IN COMMERCE 10-5-2008.

PRINCIPAL REGISTER

THE MARK CONSISTS OF STANDARD CHARACTERS WITHOUT CLAIM TO ANY PARTICULAR FONT, STYLE, SIZE, OR COLOR.

OWNER OF U.S. REG. NO. 3,932,045.

SER. NO. 85-307,390, FILED 4-28-2011.

JULIE VEPPUMTHARA, EXAMINING ATTORNEY



David J. Kybas

Director of the United States Patent and Trademark Office

United States of America

United States Patent and Trademark Office

GYM-PACT

Reg. No. 4,066,921

Registered Dec. 6, 2011

Int. Cl.: 41

SERVICE MARK

PRINCIPAL REGISTER

GYM-PACT, LLC (DELAWARE LIMITED LIABILITY COMPANY)
67 MOUNT AUBURN STREET
CAMBRIDGE, MA 02138

FOR: ARRANGING AND CONDUCTING INCENTIVE AWARD PROGRAMS TO ENCOURAGE THE FREQUENT, CONTINUED AND EFFECTIVE PRACTICE OF PHYSICAL EXERCISE, IN CLASS 41 (U.S. CLS. 100, 101 AND 107).

FIRST USE 3-2-2011; IN COMMERCE 3-2-2011.

THE MARK CONSISTS OF STANDARD CHARACTERS WITHOUT CLAIM TO ANY PARTICULAR FONT, STYLE, SIZE, OR COLOR.

SER. NO. 85-307,401, FILED 4-28-2011.

KHANH LE, EXAMINING ATTORNEY



David J. Kybas

Director of the United States Patent and Trademark Office

United States of America

United States Patent and Trademark Office

PERFECT MEN

Reg. No. 4,066,922

RAMIREZ MORELES, SELOMITH (MEXICO INDIVIDUAL)
ALVARO OBREGON 145 CENTRO
IRAPUATO, MEXICO

Registered Dec. 6, 2011

Int. Cl.: 5

FOR: DIETARY AND NUTRITIONAL SUPPLEMENTS, IN CLASS 5 (U.S. CLS. 6, 18, 44, 46, 51 AND 52).

TRADEMARK

FIRST USE 1-2-2006; IN COMMERCE 10-5-2008.

PRINCIPAL REGISTER

THE MARK CONSISTS OF STANDARD CHARACTERS WITHOUT CLAIM TO ANY PARTICULAR FONT, STYLE, SIZE, OR COLOR.

OWNER OF U.S. REG. NO. 3,938,686.

NO CLAIM IS MADE TO THE EXCLUSIVE RIGHT TO USE "MEN", APART FROM THE MARK AS SHOWN.

SER. NO. 85-307,449, FILED 4-28-2011.

JULIE VEPPUMTHARA, EXAMINING ATTORNEY



David J. Kyros

Director of the United States Patent and Trademark Office

United States of America

United States Patent and Trademark Office

farcaster

Reg. No. 4,066,923

Registered Dec. 6, 2011

Int. Cl.: 42

SERVICE MARK

PRINCIPAL REGISTER

LAMACCHIA, BRIAN A (UNITED STATES INDIVIDUAL)
14150 NE 20TH ST. STE F-1, #246
BELLEVUE, WA 98007

FOR: CONSULTING IN THE FIELD OF INFORMATION TECHNOLOGY, IN CLASS 42 (U.S. CLS. 100 AND 101).

FIRST USE 1-1-2005; IN COMMERCE 1-1-2005.

THE MARK CONSISTS OF STANDARD CHARACTERS WITHOUT CLAIM TO ANY PARTICULAR FONT, STYLE, SIZE, OR COLOR.

SER. NO. 85-307,550, FILED 4-28-2011.

MARGARET POWER, EXAMINING ATTORNEY



David J. Kyros

Director of the United States Patent and Trademark Office

United States of America

United States Patent and Trademark Office

GOBALTO

Reg. No. 4,066,924

Registered Dec. 6, 2011

Int. Cl.: 42

SERVICE MARK

PRINCIPAL REGISTER

GOBALTO, INC. (DELAWARE CORPORATION)
230 CALIFORNIA STREET, SUITE 601
SAN FRANCISCO, CA 94111

FOR: PROVIDING AN INTERACTIVE WEB SITE THAT ENABLES USERS TO ENTER, POST, ACCESS, TRACK, MONITOR, MANAGE AND GENERATE CLINICAL STUDY INFORMATION, STATUS, DOCUMENTATION AND REPORTS, IN CLASS 42 (U.S. CLS. 100 AND 101).

FIRST USE 1-5-2011; IN COMMERCE 2-8-2011.

THE MARK CONSISTS OF STANDARD CHARACTERS WITHOUT CLAIM TO ANY PARTICULAR FONT, STYLE, SIZE, OR COLOR.

OWNER OF U.S. REG. NOS. 3,759,011 AND 3,824,894.

SER. NO. 85-307,554, FILED 4-28-2011.

NATALIE POLZER, EXAMINING ATTORNEY



David J. Kybas

Director of the United States Patent and Trademark Office

United States of America

United States Patent and Trademark Office



SANGRE
De los Andes

Reg. No. 4,066,925

Registered Dec. 6, 2011

Int. Cl.: 33

TRADEMARK

PRINCIPAL REGISTER

PALUMBO GOTTARDINI, CARLOS ROBERTO (ARGENTINA INDIVIDUAL)
SAN JUAN 593, DPTO 1, CIUDAD
MENDOZA, ARGENTINA 5500 AND

MARTI, PABLO ANDRES (ARGENTINA INDIVIDUAL)
LAMADRID 666, DPTO 5
PLANTA BAJA, CIUDAD
MENDOZA, ARGENTINA 5500

FOR: WINES , IN CLASS 33 (U.S. CLS. 47 AND 49).

FIRST USE 11-0-2009; IN COMMERCE 12-0-2009.

NO CLAIM IS MADE TO THE EXCLUSIVE RIGHT TO USE "ANDES", APART FROM THE MARK AS SHOWN.

THE MARK CONSISTS OF THE STYLIZED LETTER S WITH THE STYLIZED WORD SANGRE APPEARING BELOW IT AND THE STYLIZED WORDING DE LOS ANDES APPEARING PARTIALLY BEHIND AND PARTIALLY BELOW THE WORD SANGRE.

THE ENGLISH TRANSLATION OF "SANGRE DE LOS ANDES" IN THE MARK IS "BLOOD FROM THE ANDES".

SER. NO. 85-307,587, FILED 4-28-2011.

JULIE VEPPUMTHARA, EXAMINING ATTORNEY



David J. Kybas

Director of the United States Patent and Trademark Office

United States of America

United States Patent and Trademark Office

OLIVER & HENRY'S

Reg. No. 4,066,926

Registered Dec. 6, 2011

Int. Cls.: 30 and 32

TRADEMARK

PRINCIPAL REGISTER

OLIVER & HENRY LLC (FLORIDA LIMITED LIABILITY COMPANY)
17619 ESPRIT DRIVE
TAMPA, FL 33647

FOR: BAKERY DESSERTS; BAKERY GOODS; BAKERY GOODS AND DESSERT ITEMS, NAMELY, CHEESECAKES FOR RETAIL AND WHOLESALE DISTRIBUTION AND CONSUMPTION ON OR OFF THE PREMISES; BAKERY GOODS, NAMELY, FLAN AND CREME CARAMEL FOR RETAIL AND WHOLESALE DISTRIBUTION AND CONSUMPTION ON OR OFF THE PREMISES; BAKERY PRODUCTS; BAKERY PRODUCTS, NAMELY, SWEET BAKERY GOODS; CRÈME BRULÉE; CRÈME CARAMEL; CUSTARD; CUSTARDS; DESSERT PUDDINGS; FLAN; FLAVOR ENHANCERS USED IN FOOD AND BEVERAGE PRODUCTS; FLAVORED AND SWEETENED GELATINS; FLAVORED, SWEETENED GELATIN DESSERTS; FLAVORING SYRUP; FLAVORINGS; FLAVORINGS FOR BEVERAGES; FLAVORINGS FOR BEVERAGES, OTHER THAN ESSENTIAL OILS; FLAVOURINGS; FLAVOURINGS FOR FOODS; FOOD FLAVORINGS; FOOD FLAVOURINGS; PIES; PUDDINGS; PUDDINGS FOR USE AS DESSERTS; TABLE SYRUP; TOPPING SYRUP, IN CLASS 30 (U.S. CL. 46).

FIRST USE 3-15-2011; IN COMMERCE 3-15-2011.

FOR: NON-ALCOHOLIC COCKTAIL BASES; NON-ALCOHOLIC COCKTAIL MIXES; PREPARATIONS FOR MAKING BEVERAGES, NAMELY, CARAMEL SYRUP, IN CLASS 32 (U.S. CLS. 45, 46 AND 48).

FIRST USE 3-15-2011; IN COMMERCE 3-15-2011.

THE MARK CONSISTS OF STANDARD CHARACTERS WITHOUT CLAIM TO ANY PARTICULAR FONT, STYLE, SIZE, OR COLOR.

SER. NO. 85-307,599, FILED 4-28-2011.

LINDA ORNDORFF, EXAMINING ATTORNEY



David J. Kyros

Director of the United States Patent and Trademark Office

United States of America

United States Patent and Trademark Office

advertise2gro

Reg. No. 4,066,927

Registered Dec. 6, 2011

Int. Cl.: 35

SERVICE MARK

PRINCIPAL REGISTER

MYWEBGROCER, INC. (DELAWARE CORPORATION)
SUITE 350
354 MOUNTAIN VIEW DRIVE
COLCHESTER, VT 05446

FOR: ADVERTISING SERVICES; INTERNET ADVERTISING SERVICES, IN CLASS 35 (U.S. CLS. 100, 101 AND 102).

FIRST USE 4-15-2011; IN COMMERCE 4-15-2011.

THE MARK CONSISTS OF STANDARD CHARACTERS WITHOUT CLAIM TO ANY PARTICULAR FONT, STYLE, SIZE, OR COLOR.

NO CLAIM IS MADE TO THE EXCLUSIVE RIGHT TO USE "ADVERTISE", APART FROM THE MARK AS SHOWN.

SER. NO. 85-307,635, FILED 4-28-2011.

TINA L. SNAPP, EXAMINING ATTORNEY



David J. Kybas

Director of the United States Patent and Trademark Office

United States of America

United States Patent and Trademark Office

CloudMaster

Reg. No. 4,066,928

Registered Dec. 6, 2011

Int. Cl.: 9

TRADEMARK

PRINCIPAL REGISTER

VELLO SYSTEMS, INC. (CALIFORNIA CORPORATION)
1530 O'BRIEN DRIVE
MENLO PARK, CA 94025

FOR: COMPUTER SOFTWARE FOR MANAGING AND PROVISIONING WIDE-AREA NETWORKS, IN CLASS 9 (U.S. CLS. 21, 23, 26, 36 AND 38).

FIRST USE 11-30-2010; IN COMMERCE 11-30-2010.

THE MARK CONSISTS OF STANDARD CHARACTERS WITHOUT CLAIM TO ANY PARTICULAR FONT, STYLE, SIZE, OR COLOR.

SER. NO. 85-307,663, FILED 4-28-2011.

BARBARA RUTLAND, EXAMINING ATTORNEY



David J. Kybas

Director of the United States Patent and Trademark Office

United States of America

United States Patent and Trademark Office

ArtBinder

Reg. No. 4,066,929

ANC BINDER, LLC (DELAWARE LIMITED LIABILITY COMPANY), DBA ARTBINDER
1270 AVENUE OF THE AMERICAS
NEW YORK, NY 10020

Registered Dec. 6, 2011

Int. Cl.: 9

FOR: DOWNLOADABLE SOFTWARE IN THE NATURE OF A MOBILE APPLICATION FOR ART GALLERIES, IN CLASS 9 (U.S. CLS. 21, 23, 26, 36 AND 38).

TRADEMARK

FIRST USE 7-1-2010; IN COMMERCE 7-1-2010.

PRINCIPAL REGISTER

THE MARK CONSISTS OF THE WORD "ARTBINDER" IN WHICH THE LETTERS "A", "R", AND "T" ARE AN OUTLINED FONT AND THE LETTERS "B", "I", "N", "D", "E", AND "R" ARE SOLID; THE LETTERS "A" AND "B" ARE UPPER CASE; AND THERE ARE THREE CIRCLES ON THE UPRIGHT PART OF THE "B".

SER. NO. 85-307,666, FILED 4-28-2011.

SANJEEV VOHRA, EXAMINING ATTORNEY



David J. Kyros

Director of the United States Patent and Trademark Office

United States of America

United States Patent and Trademark Office

ARTBINDER

Reg. No. 4,066,930

ANC BINDER, LLC (DELAWARE LIMITED LIABILITY COMPANY), DBA ARTBINDER
1270 AVENUE OF THE AMERICAS
NEW YORK, NY 10020

Registered Dec. 6, 2011

Int. Cl.: 9

FOR: DOWNLOADABLE SOFTWARE IN THE NATURE OF A MOBILE APPLICATION FOR
ART GALLERIES, IN CLASS 9 (U.S. CLS. 21, 23, 26, 36 AND 38).

TRADEMARK

FIRST USE 7-1-2010; IN COMMERCE 7-1-2010.

PRINCIPAL REGISTER

THE MARK CONSISTS OF STANDARD CHARACTERS WITHOUT CLAIM TO ANY PAR-
TICULAR FONT, STYLE, SIZE, OR COLOR.

SER. NO. 85-307,686, FILED 4-28-2011.

SANJEEV VOHRA, EXAMINING ATTORNEY



David J. Kybas

Director of the United States Patent and Trademark Office

United States of America

United States Patent and Trademark Office

FunCPE

Reg. No. 4,066,931

Registered Dec. 6, 2011

Int. Cl.: 41

SERVICE MARK

PRINCIPAL REGISTER

WEAVER, CAROLYN C. (UNITED STATES INDIVIDUAL), DBA FUNCPE
38 PLEASANT BEND DRIVE
SPRING, TX 773821297

FOR: EDUCATION INFORMATION; EDUCATION SERVICES, NAMELY, PROVIDING ON-LINE COURSES IN THE FIELD OF ACCOUNTING, TAXATION, BUSINESS AND FINANCE, FOR CONTINUING PROFESSIONAL EDUCATION AND PREPARATION FOR PROFESSIONAL LICENSING AND CERTIFICATION EXAMINATIONS, IN CLASS 41 (U.S. CLS. 100, 101 AND 107).

FIRST USE 3-31-2001; IN COMMERCE 3-31-2001.

THE MARK CONSISTS OF STANDARD CHARACTERS WITHOUT CLAIM TO ANY PARTICULAR FONT, STYLE, SIZE, OR COLOR.

SER. NO. 85-307,743, FILED 4-28-2011.

FONG HSU, EXAMINING ATTORNEY



David J. Kybas

Director of the United States Patent and Trademark Office

United States of America

United States Patent and Trademark Office

BEDOL

Reg. No. 4,066,932

Registered Dec. 6, 2011

Int. Cls.: 9, 14 and 16

TRADEMARK

PRINCIPAL REGISTER

BEDOL INTERNATIONAL GROUP, INC. (CALIFORNIA CORPORATION)
1420 N. CLAREMONT BLVD, STE 205A
CLAREMONT, CA 91711

FOR: COMPUTER MEMORIES; COMPUTER MEMORY HARDWARE; ELECTRONIC CALCULATORS; POCKET CALCULATORS; POCKET-SIZED ELECTRONIC CALCULATORS, IN CLASS 9 (U.S. CLS. 21, 23, 26, 36 AND 38).

FIRST USE 6-15-1988; IN COMMERCE 6-15-1988.

FOR: CLOCKS, IN CLASS 14 (U.S. CLS. 2, 27, 28 AND 50).

FIRST USE 6-15-1993; IN COMMERCE 6-15-1993.

FOR: CHECKBOOK COVERS; PAPER HOLE PUNCHES, IN CLASS 16 (U.S. CLS. 2, 5, 22, 23, 29, 37, 38 AND 50).

FIRST USE 8-17-1991; IN COMMERCE 8-17-1991.

THE MARK CONSISTS OF STANDARD CHARACTERS WITHOUT CLAIM TO ANY PARTICULAR FONT, STYLE, SIZE, OR COLOR.

OWNER OF U.S. REG. NO. 3,212,651.

SEC. 2(F).

SER. NO. 85-307,897, FILED 4-28-2011.

MICHELE SWAIN, EXAMINING ATTORNEY



David J. Kybas

Director of the United States Patent and Trademark Office

United States of America

United States Patent and Trademark Office

MOTION GARAGE

Reg. No. 4,066,933

MOTION GARAGE, LLC (CALIFORNIA LIMITED LIABILITY COMPANY)
1770 SATURN WAY
SEAL BEACH, CA 90740

Registered Dec. 6, 2011

Int. Cl.: 41

FOR: PROVIDING A WEBSITE FEATURING CAR RESTORATION CONTENT, IN CLASS 41 (U.S. CLS. 100, 101 AND 107).

SERVICE MARK

FIRST USE 1-3-2011; IN COMMERCE 1-3-2011.

PRINCIPAL REGISTER

THE MARK CONSISTS OF STANDARD CHARACTERS WITHOUT CLAIM TO ANY PARTICULAR FONT, STYLE, SIZE, OR COLOR.

SER. NO. 85-307,931, FILED 4-29-2011.

JEFF DEFORD, EXAMINING ATTORNEY



David J. Kybas

Director of the United States Patent and Trademark Office

United States of America

United States Patent and Trademark Office

DYOH

Reg. No. 4,066,934

Registered Dec. 6, 2011

Int. Cl.: 14

TRADEMARK

PRINCIPAL REGISTER

HAAS, STEVE (UNITED STATES INDIVIDUAL)
1212 WYOMING ST
BOULDER CITY, NV 89005

FOR: JEWELRY, IN CLASS 14 (U.S. CLS. 2, 27, 28 AND 50).

FIRST USE 5-13-2009; IN COMMERCE 7-10-2009.

THE MARK CONSISTS OF STANDARD CHARACTERS WITHOUT CLAIM TO ANY PARTICULAR FONT, STYLE, SIZE, OR COLOR.

SER. NO. 85-307,965, FILED 4-29-2011.

JIM RINGLE, EXAMINING ATTORNEY



David J. Kybas

Director of the United States Patent and Trademark Office

United States of America

United States Patent and Trademark Office

GLOWSTREET

Reg. No. 4,066,935

Registered Dec. 6, 2011

Int. Cl.: 25

TRADEMARK

PRINCIPAL REGISTER

DEPERINI, SHANE J (UNITED STATES INDIVIDUAL)
6061 SHAKERWOOD CIRCLE, E 104
TAMARAC, FL 33319

FOR: ATHLETIC APPAREL, NAMELY, SHIRTS, PANTS, JACKETS, FOOTWEAR, HATS AND CAPS, ATHLETIC UNIFORMS; BANDANAS; BEANIES; BELTS FOR CLOTHING; BOOTS; BUTTON DOWN SHIRTS; COATS FOR MEN AND WOMEN; COATS MADE OF COTTON; COATS OF DENIM; DO RAGS; DRESS SHIRTS; FOOTWEAR; FOOTWEAR FOR MEN AND WOMEN; GLOVES AS CLOTHING; GYM PANTS; HAT BANDS; HATS; HEAD-BANDS FOR CLOTHING; HEAVY COATS; HOODED SWEAT SHIRTS; HOODS; INFANT AND TODDLER ONE PIECE CLOTHING; JACKETS; JERSEYS; JOGGING PANTS; LEATHER BELTS; LEATHER COATS; LIGHT-REFLECTING COATS; LONG-SLEEVED SHIRTS; MEN'S AND WOMEN'S JACKETS, COATS, TROUSERS, VESTS; NIGHT SHIRTS; OPEN-NECKED SHIRTS; OUTER JACKETS; OVER COATS; OVER SHIRTS; PANTS; PARTY HATS; POLO SHIRTS; RAIN COATS; SHIRTS AND SHORT-SLEEVED SHIRTS; SHORT SETS; SHORT-SLEEVED OR LONG-SLEEVED T-SHIRTS; SLEEP PANTS; SLIPPERS; SOCKS; SPORT COATS; SUIT COATS; SWEAT BANDS; SWEAT PANTS; SWEAT SHIRTS; T-SHIRTS; TANK-TOPS; TEE SHIRTS; TIES; TOPS; WOMEN'S CLOTHING, NAMELY, SHIRTS, DRESSES, SKIRTS, BLOUSES; WRIST BANDS, IN CLASS 25 (U.S. CLS. 22 AND 39).

FIRST USE 9-26-2010; IN COMMERCE 1-17-2011.

THE MARK CONSISTS OF STANDARD CHARACTERS WITHOUT CLAIM TO ANY PARTICULAR FONT, STYLE, SIZE, OR COLOR.

SER. NO. 85-307,972, FILED 4-29-2011.

JIM RINGLE, EXAMINING ATTORNEY



David J. Kybas

Director of the United States Patent and Trademark Office

United States of America

United States Patent and Trademark Office

GRLURE

Reg. No. 4,066,936

Registered Dec. 6, 2011

Int. Cl.: 25

TRADEMARK

PRINCIPAL REGISTER

GRASS ROOTS LURE COMPANY (MICHIGAN CORPORATION)
7135 DEER HILL DRIVE
CLARKSTON, MI 48346

FOR: A-SHIRTS; ATHLETIC APPAREL, NAMELY, SHIRTS, PANTS, JACKETS, FOOTWEAR, HATS AND CAPS, ATHLETIC UNIFORMS; BASEBALL CAPS AND HATS; BODY SHIRTS; BUTTON DOWN SHIRTS; BUTTON-FRONT ALOHA SHIRTS; CAMOUFLAGE SHIRTS; CAMP SHIRTS; CHEF'S HATS; CLOTHING FOR ATHLETIC USE, NAMELY, PADDED SHIRTS; COLLARED SHIRTS; DRESS SHIRTS; FISHING SHIRTS; GOLF PANTS, SHIRTS AND SKIRTS; GOLF SHIRTS; HATS; HATS FOR INFANTS, BABIES, TODDLERS AND CHILDREN; HOODED SWEAT SHIRTS; HUNTING SHIRTS; KNIT SHIRTS; LEATHER HATS; LEATHER SHIRTS; LONG-SLEEVED SHIRTS; MOISTURE-WICKING SPORTS SHIRTS; NIGHT SHIRTS; OPEN-NECKED SHIRTS; OVER SHIRTS; PIQUE SHIRTS; POLO SHIRTS; RAIN HATS; RUGBY SHIRTS; SCIENTIFIC AND TECHNOLOGICAL APPAREL, NAMELY, SHIRTS, PANTS, JACKETS, FOOTWEAR, HATS AND CAPS, UNIFORMS; SHIRTS; SHIRTS AND SHORT-SLEEVED SHIRTS; SHIRTS FOR INFANTS, BABIES, TODDLERS AND CHILDREN; SHORT-SLEEVED OR LONG-SLEEVED T-SHIRTS; SHORT-SLEEVED SHIRTS; SLEEP SHIRTS; SNAP CROTCH SHIRTS FOR INFANTS AND TODDLERS; SPORTS CAPS AND HATS; SPORTS SHIRTS; SPORTS SHIRTS WITH SHORT SLEEVES; SWEAT SHIRTS; T-SHIRTS; TEE SHIRTS; TURTLE NECK SHIRTS; WEARABLE GARMENTS AND CLOTHING, NAMELY, SHIRTS; WIND SHIRTS; WOMEN'S CLOTHING, NAMELY, SHIRTS, DRESSES, SKIRTS, BLOUSES; WOMEN'S HATS AND HOODS; WOOLLY HATS, IN CLASS 25 (U.S. CLS. 22 AND 39).

FIRST USE 3-1-2009; IN COMMERCE 3-1-2009.

THE MARK CONSISTS OF STANDARD CHARACTERS WITHOUT CLAIM TO ANY PARTICULAR FONT, STYLE, SIZE, OR COLOR.

SER. NO. 85-307,979, FILED 4-29-2011.

JEAN IM, EXAMINING ATTORNEY



David J. Kyros

Director of the United States Patent and Trademark Office

United States of America

United States Patent and Trademark Office

BibJib

Reg. No. 4,066,937

Registered Dec. 6, 2011

Int. Cl.: 21

TRADEMARK

PRINCIPAL REGISTER

BIBJIB, INC. (LOUISIANA CORPORATION)
207 LOUIS DRIVE
HOUMA, LA 70364

FOR: NAPKIN HOLDERS, NOT OF PRECIOUS METAL, IN CLASS 21 (U.S. CLS. 2, 13, 23, 29, 30, 33, 40 AND 50).

FIRST USE 1-25-2011; IN COMMERCE 4-29-2011.

THE MARK CONSISTS OF STANDARD CHARACTERS WITHOUT CLAIM TO ANY PARTICULAR FONT, STYLE, SIZE, OR COLOR.

SER. NO. 85-308,009, FILED 4-29-2011.

MICHAEL ENGEL, EXAMINING ATTORNEY



David J. Kybas

Director of the United States Patent and Trademark Office

United States of America

United States Patent and Trademark Office

ZERO

Reg. No. 4,066,938

Registered Dec. 6, 2011

Int. Cls.: 41 and 42

SERVICE MARK

PRINCIPAL REGISTER

ZERO VFX, LLC (MASSACHUSETTS LIMITED LIABILITY COMPANY)
91 NEWBURY STREET
BOSTON, MA 02116

FOR: ENTERTAINMENT SERVICES, NAMELY, PRODUCTION OF SPECIAL EFFECTS INCLUDING MODEL-MAKING SERVICES, COMPUTER-GENERATED IMAGERY AND COMPUTER-GENERATED GRAPHICS FOR THE PRODUCTION OF MOTION PICTURES, VIDEOS, AND MOVIE TRAILERS; ENTERTAINMENT, NAMELY, PREPARATION OF SPECIAL EFFECTS; PRODUCTION OF VIDEO AND CREATION OF VISUAL EFFECTS FOR OTHERS FOR USE IN DVDS, TELEVISION PROGRAMS AND ON WEB SITES; PRODUCTION OF VISUAL EFFECTS FOR VIDEOS, DVDS, TELEVISION AND FOR INTERNET WEB SITES; SPECIAL EFFECTS ANIMATION SERVICES FOR FILM AND VIDEO, IN CLASS 41 (U.S. CLS. 100, 101 AND 107).

FIRST USE 1-1-2009; IN COMMERCE 1-1-2009.

FOR: VISUAL DESIGN SERVICES IN THE NATURE OF DESIGNING VISUAL ELEMENTS FOR ON-LINE, BROADCAST, PRINT, OUTDOOR AND OTHER COMMUNICATION MEDIA, IN CLASS 42 (U.S. CLS. 100 AND 101).

FIRST USE 1-1-2009; IN COMMERCE 1-1-2009.

THE MARK CONSISTS OF STANDARD CHARACTERS WITHOUT CLAIM TO ANY PARTICULAR FONT, STYLE, SIZE, OR COLOR.

SER. NO. 85-308,014, FILED 4-29-2011.

ALYSSA STEEL, EXAMINING ATTORNEY



David J. Kybas

Director of the United States Patent and Trademark Office

United States of America

United States Patent and Trademark Office

AIRMAX

Reg. No. 4,066,939

Registered Dec. 6, 2011

Int. Cl.: 2

TRADEMARK

PRINCIPAL REGISTER

SIERRA CORPORATION (MINNESOTA CORPORATION), DBA TK PRODUCTS
11400 WEST 47TH STREET
MINNETONKA, MN 55343

FOR: COATING COMPOSITIONS IN THE NATURE OF RUBBERIZED POLYMER COATINGS
USED FOR CREATING AIR/VAPOR BARRIERS FOR ENERGY EFFICIENCY IN BUILDINGS,
IN CLASS 2 (U.S. CLS. 6, 11 AND 16).

FIRST USE 1-0-2010; IN COMMERCE 1-0-2010.

THE MARK CONSISTS OF STANDARD CHARACTERS WITHOUT CLAIM TO ANY PAR-
TICULAR FONT, STYLE, SIZE, OR COLOR.

SER. NO. 85-308,029, FILED 4-29-2011.

FRANK LATTUCA, EXAMINING ATTORNEY



David J. Kyros

Director of the United States Patent and Trademark Office

United States of America

United States Patent and Trademark Office



Reg. No. 4,066,940

Registered Dec. 6, 2011

Int. Cl.: 25

TRADEMARK

PRINCIPAL REGISTER

RAMOS, ROXANNE (UNITED STATES INDIVIDUAL)
360 CONNECTICUT AVE, #143
NORWALK, CT 06854

FOR: HATS; PANTS; SHIRTS, IN CLASS 25 (U.S. CLS. 22 AND 39).

FIRST USE 9-21-2010; IN COMMERCE 9-21-2010.

THE MARK CONSISTS OF A STYLIZED PINK IMAGE OF A WOMAN WITH THE LETTER I TO THE LEFT OF HER HEAD IN PINK, THE PINK WORD AM UNDER HER RIGHT ELBOW, THE PINK LETTER A NEXT TO HER LEFT LEG, THE PINK WORD OF IN BETWEEN HER LEGS AND THE PINK WORD GOD BELOW THE IMAGE, ALL ON A BLACK BACKGROUND.

THE COLOR(S) PINK AND BLACK IS/ARE CLAIMED AS A FEATURE OF THE MARK.

SER. NO. 85-308,051, FILED 4-29-2011.

DAVID C. REIHNER, EXAMINING ATTORNEY



David J. Kyffers

Director of the United States Patent and Trademark Office

United States of America

United States Patent and Trademark Office

ZYNC

Reg. No. 4,066,941

Registered Dec. 6, 2011

Int. Cls.: 41 and 42

SERVICE MARK

PRINCIPAL REGISTER

ZERO VFX, LLC (MASSACHUSETTS LIMITED LIABILITY COMPANY)
91 NEWBURY STREET
BOSTON, MA 02116

FOR: ENTERTAINMENT SERVICES, NAMELY, PRODUCTION OF SPECIAL EFFECTS INCLUDING MODEL-MAKING SERVICES, COMPUTER-GENERATED IMAGERY AND COMPUTER-GENERATED GRAPHICS FOR THE PRODUCTION OF MOTION PICTURES, VIDEOS, AND MOVIE TRAILERS; ENTERTAINMENT, NAMELY, PREPARATION OF SPECIAL EFFECTS; PRODUCTION OF VIDEO AND CREATION OF VISUAL EFFECTS FOR OTHERS FOR USE IN DVDS, TELEVISION PROGRAMS AND ON WEB SITES; PRODUCTION OF VISUAL EFFECTS FOR VIDEOS, DVDS, TELEVISION AND FOR INTERNET WEB SITES; SPECIAL EFFECTS ANIMATION SERVICES FOR FILM AND VIDEO, IN CLASS 41 (U.S. CLS. 100, 101 AND 107).

FIRST USE 4-11-2011; IN COMMERCE 4-11-2011.

FOR: DESIGN AND DEVELOPMENT OF COMPUTER SOFTWARE; DESIGN, DEVELOPMENT AND IMPLEMENTATION OF SOFTWARE; VISUAL DESIGN SERVICES IN THE NATURE OF DESIGNING VISUAL ELEMENTS FOR ON-LINE, BROADCAST, PRINT, OUTDOOR AND OTHER COMMUNICATION MEDIA, IN CLASS 42 (U.S. CLS. 100 AND 101).

FIRST USE 4-11-2011; IN COMMERCE 4-11-2011.

THE MARK CONSISTS OF STANDARD CHARACTERS WITHOUT CLAIM TO ANY PARTICULAR FONT, STYLE, SIZE, OR COLOR.

SER. NO. 85-308,069, FILED 4-29-2011.

ALYSSA STEEL, EXAMINING ATTORNEY



David J. Kyros

Director of the United States Patent and Trademark Office

United States of America

United States Patent and Trademark Office

Fundimensionals

Reg. No. 4,066,942

Registered Dec. 6, 2011

Int. Cl.: 41

SERVICE MARK

PRINCIPAL REGISTER

FUNDIMENSIONALS, INC. (NEW YORK CORPORATION)
986 PLYMOUTH STREET
PELHAM, NY 10803

FOR: ENTERTAINMENT SERVICES, NAMELY, PERFORMANCES AND PUBLIC APPEARANCES BY A LIVE MUSICAL GROUP; PROVIDING A WEB SITE VIA A GLOBAL COMPUTER NETWORK FEATURING NON-DOWNLOADABLE PRERECORDED MUSIC, MUSICAL VIDEOS, RELATED FILM CLIPS, PHOTOGRAPHS, OTHER MULTIMEDIA MATERIALS, AND NEWS AND INFORMATION REGARDING A MUSICAL GROUP; FAN CLUB SERVICES, IN CLASS 41 (U.S. CLS. 100, 101 AND 107).

FIRST USE 1-30-2010; IN COMMERCE 1-30-2010.

THE MARK CONSISTS OF STANDARD CHARACTERS WITHOUT CLAIM TO ANY PARTICULAR FONT, STYLE, SIZE, OR COLOR.

SER. NO. 85-308,091, FILED 4-29-2011.

REBECCA EISINGER, EXAMINING ATTORNEY



David J. Kybas

Director of the United States Patent and Trademark Office

United States of America

United States Patent and Trademark Office

REAL CHEMISTRY FOR CARWASH OPERATORS BY CARWASH OPERATORS

Reg. No. 4,066,943

QUAL CHEM LLC (MICHIGAN LIMITED LIABILITY COMPANY)
86 MERZ BLVD.
AKRON, OH 44333

Registered Dec. 6, 2011

Int. Cl.: 40

FOR: CUSTOM MANUFACTURE OF CHEMICALS FOR USE IN CAR WASHES, IN CLASS 40 (U.S. CLS. 100, 103 AND 106).

SERVICE MARK

FIRST USE 5-31-2003; IN COMMERCE 5-31-2003.

PRINCIPAL REGISTER

THE MARK CONSISTS OF STANDARD CHARACTERS WITHOUT CLAIM TO ANY PARTICULAR FONT, STYLE, SIZE, OR COLOR.

SER. NO. 85-308,093, FILED 4-29-2011.

REBECCA EISINGER, EXAMINING ATTORNEY



David J. Kybas

Director of the United States Patent and Trademark Office

United States of America

United States Patent and Trademark Office



Reg. No. 4,066,944

Registered Dec. 6, 2011

Int. Cls.: 5 and 42

TRADEMARK

SERVICE MARK

PRINCIPAL REGISTER

ENDOCYTE, INC. (DELAWARE CORPORATION)
3000 KENT AVENUE, SUITE A1-100
WEST LAFAYETTE, IN 47906

FOR: PHARMACEUTICAL PREPARATIONS FOR THE DIAGNOSIS AND TREATMENT OF CANCER; PHARMACEUTICAL PREPARATIONS FOR THE DIAGNOSIS AND TREATMENT OF DISEASES; PHARMACEUTICAL PREPARATIONS FOR THE PURPOSE OF INCREASING THE EFFECTIVENESS OF OTHER PHARMACEUTICAL PRODUCTS; DRUG DELIVERY AGENTS CONSISTING OF COMPOUNDS THAT FACILITATE DELIVERY OF A WIDE RANGE OF PHARMACEUTICALS, IN CLASS 5 (U.S. CLS. 6, 18, 44, 46, 51 AND 52).

FIRST USE 7-6-2000; IN COMMERCE 7-6-2000.

FOR: SCIENTIFIC RESEARCH AND DEVELOPMENT; SCIENTIFIC INVESTIGATIONS FOR MEDICAL PURPOSES; PROVIDING MEDICAL AND SCIENTIFIC RESEARCH INFORMATION IN THE FIELD OF PHARMACEUTICALS AND CLINICAL TRIALS, IN CLASS 42 (U.S. CLS. 100 AND 101).

FIRST USE 7-6-2000; IN COMMERCE 7-6-2000.

THE MARK CONSISTS OF A SPHERE DISPLAYED WITHIN A SPHERE ENCOMPASSED BY A LOWERCASE LETTER "E" ENCOMPASSED BY A LOWERCASE LETTER "C".

SER. NO. 85-308,116, FILED 4-29-2011.

KAPIL BHANOT, EXAMINING ATTORNEY



David J. Kybas

Director of the United States Patent and Trademark Office

United States of America

United States Patent and Trademark Office

LEVAREAL

Reg. No. 4,066,945

Registered Dec. 6, 2011

Int. Cl.: 30

TRADEMARK

PRINCIPAL REGISTER

LALLEMAND USA, INC. (DELAWARE CORPORATION)
1620 PREFONTAINE STREET
MONTREAL, CANADA H1W2N8

FOR: YEAST, IN CLASS 30 (U.S. CL. 46).

FIRST USE 9-16-2010; IN COMMERCE 9-16-2010.

THE MARK CONSISTS OF STANDARD CHARACTERS WITHOUT CLAIM TO ANY PARTICULAR FONT, STYLE, SIZE, OR COLOR.

SER. NO. 85-308,117, FILED 4-29-2011.

EVELYN BRADLEY, EXAMINING ATTORNEY



David J. Kybas

Director of the United States Patent and Trademark Office

United States of America

United States Patent and Trademark Office

BikeGlow

Reg. No. 4,066,946

Registered Dec. 6, 2011

Int. Cl.: 11

TRADEMARK

PRINCIPAL REGISTER

BIKEGLOW, INC. (CALIFORNIA CORPORATION)
637 COLUMBIA STREET
SANTA CRUZ, CA 95060

FOR: BICYCLE LIGHTS, IN CLASS 11 (U.S. CLS. 13, 21, 23, 31 AND 34).

FIRST USE 11-25-2008; IN COMMERCE 12-15-2008.

THE MARK CONSISTS OF STANDARD CHARACTERS WITHOUT CLAIM TO ANY PARTICULAR FONT, STYLE, SIZE, OR COLOR.

SER. NO. 85-308,129, FILED 4-29-2011.

INGRID C. EULIN, EXAMINING ATTORNEY



David J. Kybas

Director of the United States Patent and Trademark Office

United States of America

United States Patent and Trademark Office

Joyheart

Reg. No. 4,066,947

Registered Dec. 6, 2011

Int. Cl.: 33

TRADEMARK

PRINCIPAL REGISTER

DOUBLE EIGHT BEVERAGES, INC. (NEW YORK CORPORATION)
162-18 71 AVENUE
FRESH MEADOWS, NY 11365

FOR: ALCOHOLIC BEVERAGES, EXCEPT BEER, IN CLASS 33 (U.S. CLS. 47 AND 49).

FIRST USE 1-20-2011; IN COMMERCE 1-20-2011.

THE MARK CONSISTS OF STANDARD CHARACTERS WITHOUT CLAIM TO ANY PARTICULAR FONT, STYLE, SIZE, OR COLOR.

SER. NO. 85-308,130, FILED 4-29-2011.

KAPIL BHANOT, EXAMINING ATTORNEY



David J. Kybas

Director of the United States Patent and Trademark Office

United States of America

United States Patent and Trademark Office

Simplicity is the Solution

Reg. No. 4,066,948

Registered Dec. 6, 2011

Int. Cl.: 35

SERVICE MARK

PRINCIPAL REGISTER

VIRTUAL DATA PRODUCTS, LLC (GEORGIA LIMITED LIABILITY COMPANY)
SUITE 104 #154
3276 BUFORD DRIVE
BUFORD, GA 30519

FOR: VALUE-ADDED RESELLER SERVICES, NAMELY, DISTRIBUTORSHIP SERVICES
FEATURING COMPUTER SECURITY AND INFORMATION TECHNOLOGY PRODUCTS ,
IN CLASS 35 (U.S. CLS. 100, 101 AND 102).

FIRST USE 5-29-2009; IN COMMERCE 5-29-2009.

THE MARK CONSISTS OF STANDARD CHARACTERS WITHOUT CLAIM TO ANY PAR-
TICULAR FONT, STYLE, SIZE, OR COLOR.

SER. NO. 85-308,170, FILED 4-29-2011.

AMY KERTGATE, EXAMINING ATTORNEY



David J. Kyffers

Director of the United States Patent and Trademark Office

United States of America

United States Patent and Trademark Office

NUBAR

Reg. No. 4,066,949

Registered Dec. 6, 2011

Int. Cls.: 3, 8 and 21

TRADEMARK

PRINCIPAL REGISTER

ARMINEX INTERNATIONAL, INC. (CALIFORNIA CORPORATION)
4200 VERDANT ST., SUITE A
LOS ANGELES, CA 90039

FOR: COSMETIC MASKS; DECORATIVE TRANSFERS AND SKIN JEWELS FOR COSMETIC PURPOSES; FOOT SCRUBS; NAIL POLISH REMOVERS; NON-MEDICATED FOOT CREAM; SKIN ABRASIVE PREPARATIONS; SKIN CLEANSERS; SKIN CONDITIONERS; SKIN MASKS, IN CLASS 3 (U.S. CLS. 1, 4, 6, 50, 51 AND 52).

FIRST USE 8-4-2000; IN COMMERCE 8-4-2000.

FOR: NAIL BUFFERS; NAIL CLIPPERS; NAIL FILES; NAIL SCISSORS; NAIL SKIN TREATMENT TRIMMERS, IN CLASS 8 (U.S. CLS. 23, 28 AND 44).

FIRST USE 0-0-2007; IN COMMERCE 0-0-2007.

FOR: COSMETIC BRUSHES; MAKE-UP BRUSHES; NAIL BRUSHES, IN CLASS 21 (U.S. CLS. 2, 13, 23, 29, 30, 33, 40 AND 50).

FIRST USE 0-0-2007; IN COMMERCE 0-0-2007.

THE MARK CONSISTS OF STANDARD CHARACTERS WITHOUT CLAIM TO ANY PARTICULAR FONT, STYLE, SIZE, OR COLOR.

OWNER OF U.S. REG. NO. 3,643,135.

SER. NO. 85-308,171, FILED 4-29-2011.

AMY KERTGATE, EXAMINING ATTORNEY



David J. Kyros

Director of the United States Patent and Trademark Office

United States of America

United States Patent and Trademark Office

Citri-Med

Reg. No. 4,066,950

Registered Dec. 6, 2011

Int. Cl.: 3

TRADEMARK

PRINCIPAL REGISTER

ADVANCED DEVICES INC. (NEW YORK CORPORATION)
P.O. BOX 370599
BROOKLYN, NY 11237

FOR: ADHESIVE REMOVERS, IN CLASS 3 (U.S. CLS. 1, 4, 6, 50, 51 AND 52).

FIRST USE 4-20-2011; IN COMMERCE 4-20-2011.

THE MARK CONSISTS OF STANDARD CHARACTERS WITHOUT CLAIM TO ANY PARTICULAR FONT, STYLE, SIZE, OR COLOR.

SER. NO. 85-308,180, FILED 4-29-2011.

LOURDES AYALA, EXAMINING ATTORNEY



David J. Kyffers

Director of the United States Patent and Trademark Office

United States of America

United States Patent and Trademark Office

WSC

Reg. No. 4,066,951

Registered Dec. 6, 2011

Int. Cl.: 1

TRADEMARK

PRINCIPAL REGISTER

EIWEISS CHEMICAL CORPORATION (JAPAN CORPORATION)
1295-1, TANAGASHIRA OYAMA-CHO, SUNTO-GUN
SHIZUOKA, JAPAN

FOR: INTERMEDIATE ORGANIC CHEMICALS, NAMELY, ALCOHOLS, PHENOLS, ETHERS, KETONES, ORGANIC ACIDS AND SALTS THEREOF, ESTERS, NITROGEN COMPOUNDS, HETEROCYCLIC COMPOUNDS, CARBOHYDRATES, PROTEINS, AND ENZYMES, ALL FOR USE IN THE MANUFACTURE OF MEDICINES AND DRUGS, IN CLASS 1 (U.S. CLS. 1, 5, 6, 10, 26 AND 46).

THE MARK CONSISTS OF STANDARD CHARACTERS WITHOUT CLAIM TO ANY PARTICULAR FONT, STYLE, SIZE, OR COLOR.

OWNER OF JAPAN REG. NO. 2309018, DATED 5-31-1991, EXPIRES 5-31-2020.

SER. NO. 85-308,199, FILED 4-29-2011.

PAUL MORENO, EXAMINING ATTORNEY



David J. Kybas

Director of the United States Patent and Trademark Office

United States of America

United States Patent and Trademark Office

NFLIGHT

Reg. No. 4,066,952

Registered Dec. 6, 2011

Int. Cl.: 41

SERVICE MARK

PRINCIPAL REGISTER

KARSTEN MANUFACTURING CORPORATION (ARIZONA CORPORATION)
2201 WEST DESERT COVE
PHOENIX, AZ 85029

FOR: TRAINING AND EDUCATING SPORTING GOODS DEALERS TO FIT GOLF CLUBS TO CUSTOMERS; CUSTOM GOLF CLUB FITTING, IN CLASS 41 (U.S. CLS. 100, 101 AND 107).

FIRST USE 2-6-2009; IN COMMERCE 2-6-2009.

THE MARK CONSISTS OF STANDARD CHARACTERS WITHOUT CLAIM TO ANY PARTICULAR FONT, STYLE, SIZE, OR COLOR.

OWNER OF U.S. REG. NOS. 3,599,860 AND 3,603,720.

SER. NO. 85-308,232, FILED 4-29-2011.

HENRY S. ZAK, EXAMINING ATTORNEY



David J. Kybas

Director of the United States Patent and Trademark Office

United States of America

United States Patent and Trademark Office

TrigGuide

Reg. No. 4,066,953

Registered Dec. 6, 2011

Int. Cl.: 10

TRADEMARK

PRINCIPAL REGISTER

TRIG MEDICAL INC. (DELAWARE CORPORATION)
3394 FORESTWOOD DR.
SUWANEE, GA 30024

FOR: MEDICAL DEVICES AND APPARATUS, NAMELY, ULTRASOUND IMAGING APPARATUS, ULTRASOUND GUIDANCE SYSTEMS, POSITION TRACKING SYSTEMS, SCANNERS AND NEEDLE GUIDES, AND PARTS AND FITTINGS THEREFOR; MEDICAL ULTRASOUND APPARATUS; ULTRASOUND DIAGNOSTIC AND THERAPEUTIC GUIDANCE APPARATUS, IN CLASS 10 (U.S. CLS. 26, 39 AND 44).

FIRST USE 0-0-2008; IN COMMERCE 11-0-2009.

THE MARK CONSISTS OF STANDARD CHARACTERS WITHOUT CLAIM TO ANY PARTICULAR FONT, STYLE, SIZE, OR COLOR.

SER. NO. 85-308,240, FILED 4-29-2011.

KATHERINE M. DUBRAY, EXAMINING ATTORNEY



David J. Kybas

Director of the United States Patent and Trademark Office

United States of America

United States Patent and Trademark Office

Design a Deal

Reg. No. 4,066,954

Registered Dec. 6, 2011

Int. Cl.: 41

SERVICE MARK

PRINCIPAL REGISTER

CE RESOURCE, INC. (CALIFORNIA CORPORATION), DBA CME RESOURCE AND NETCE
1482 STONE POINT DRIVE, SUITE 120
ROSEVILLE, CA 95661

FOR: CONTINUING EDUCATION SERVICES, NAMELY, PROVIDING LIVE AND ON-LINE CONTINUING PROFESSIONAL EDUCATION SEMINARS IN THE LEGAL, MEDICAL, ACCOUNTING, AND REAL ESTATE FIELDS; PROVIDING CONTINUING MEDICAL EDUCATION COURSES; PROVIDING CONTINUING NURSING EDUCATION COURSES, IN CLASS 41 (U.S. CLS. 100, 101 AND 107).

FIRST USE 4-29-2011; IN COMMERCE 4-29-2011.

THE MARK CONSISTS OF STANDARD CHARACTERS WITHOUT CLAIM TO ANY PARTICULAR FONT, STYLE, SIZE, OR COLOR.

SER. NO. 85-308,256, FILED 4-29-2011.

ESTHER A. BORSUK, EXAMINING ATTORNEY



David J. Kyffers

Director of the United States Patent and Trademark Office

United States of America

United States Patent and Trademark Office



Reg. No. 4,066,955

Registered Dec. 6, 2011

Int. Cl.: 41

SERVICE MARK

PRINCIPAL REGISTER

STANBRIDGE COLLEGE (CALIFORNIA CORPORATION)
2041 BUSINESS CENTER DRIVE, SUITE 107
IRVINE, CA 92612

FOR: TRAINING SERVICES IN THE FIELD OF INFORMATION TECHNOLOGY, BUSINESS AND MEDICINE, IN CLASS 41 (U.S. CLS. 100, 101 AND 107).

FIRST USE 8-3-2004; IN COMMERCE 8-3-2004.

THE MARK CONSISTS OF A DESIGN DESCRIBED AS THE OUTLINE OF A SHIELD SPLIT DIAGONALLY FROM THE UPPER LEFT SIDE TO THE BOTTOM RIGHT AND CONTAINING A FLEUR DE LIS IN THE CENTER OF THE DIAGONAL SPLIT.

SER. NO. 85-308,267, FILED 4-29-2011.

ESTHER A. BORSUK, EXAMINING ATTORNEY



David J. Kybas

Director of the United States Patent and Trademark Office

United States of America

United States Patent and Trademark Office



Reg. No. 4,066,956

Registered Dec. 6, 2011

Int. Cl.: 37

SERVICE MARK

PRINCIPAL REGISTER

I NETWORK SOLUTIONS USA, INC. (TEXAS CORPORATION)
7155 OLD KATY RD STE 215
HOUSTON, TX 77024

FOR: INSTALLATION AND MAINTENANCE OF VOICE TRANSMISSION, DATA, FIBER OPTICS, CCTV, ACCESS CONTROL AND ELECTRICAL NETWORKS, IN CLASS 37 (U.S. CLS. 100, 103 AND 106).

FIRST USE 4-19-2009; IN COMMERCE 4-19-2009.

THE MARK CONSISTS OF A WORLD GLOBE WITH THE COLOR SILVER FOR THE WATER AND THE CONTINENTS IN GREY WITH A BLUE RIBBON CIRCLING THE GLOBE.

THE COLOR(S) SILVER, BLUE AND GREY IS/ARE CLAIMED AS A FEATURE OF THE MARK.

SER. NO. 85-308,304, FILED 4-29-2011.

WARREN L. OLANDRIA, EXAMINING ATTORNEY



David J. Kyros

Director of the United States Patent and Trademark Office

United States of America

United States Patent and Trademark Office

My Bouquet

Reg. No. 4,066,957

Registered Dec. 6, 2011

Int. Cl.: 31

TRADEMARK

PRINCIPAL REGISTER

GREENHEART FARMS, INC. (CALIFORNIA CORPORATION)
902 ZENON WAY
ARROYO GRANDE, CA 93420

FOR: LIVE PLANTS, NAMELY, ROSES, IN CLASS 31 (U.S. CLS. 1 AND 46).

FIRST USE 7-8-2008; IN COMMERCE 7-8-2008.

THE MARK CONSISTS OF STANDARD CHARACTERS WITHOUT CLAIM TO ANY PARTICULAR FONT, STYLE, SIZE, OR COLOR.

SER. NO. 85-308,316, FILED 4-29-2011.

ESTHER BELENKER, EXAMINING ATTORNEY



David J. Kyffers

Director of the United States Patent and Trademark Office

United States of America

United States Patent and Trademark Office

ECLIPSE

Reg. No. 4,066,958

NOVARTIS AG (SWITZERLAND CORPORATION)
CH-4002

Registered Dec. 6, 2011

BASEL, SWITZERLAND

Int. Cl.: 41

FOR: EDUCATIONAL SERVICES, NAMELY, CONDUCTING PROGRAMS IN THE FIELD OF OPHTHALMOLOGY, IN CLASS 41 (U.S. CLS. 100, 101 AND 107).

SERVICE MARK

FIRST USE 6-30-2007; IN COMMERCE 6-30-2007.

PRINCIPAL REGISTER

THE MARK CONSISTS OF STANDARD CHARACTERS WITHOUT CLAIM TO ANY PARTICULAR FONT, STYLE, SIZE, OR COLOR.

SER. NO. 85-308,324, FILED 4-29-2011.

BENJAMIN OKEKE, EXAMINING ATTORNEY



David J. Kybas

Director of the United States Patent and Trademark Office

United States of America

United States Patent and Trademark Office

DADS ARE THE ORIGINAL HIPSTERS

Reg. No. 4,066,959

Registered Dec. 6, 2011

Int. Cl.: 41

SERVICE MARK

PRINCIPAL REGISTER

BRADLEY C. GETTY (UNITED STATES INDIVIDUAL)
2734 MISSION ST.
SAN FRANCISCO, CA 94110

FOR: PROVIDING A WEBSITE FOR ENTERTAINMENT PURPOSES WHERE USERS CAN VIEW AND POST PHOTOS FEATURING PHOTOS OF DADS WITH FUNNY CAPTIONS, IN CLASS 41 (U.S. CLS. 100, 101 AND 107).

FIRST USE 1-31-2011; IN COMMERCE 1-31-2011.

THE MARK CONSISTS OF STANDARD CHARACTERS WITHOUT CLAIM TO ANY PARTICULAR FONT, STYLE, SIZE, OR COLOR.

SER. NO. 85-308,349, FILED 4-29-2011.

LEIGH CAROLINE CASE, EXAMINING ATTORNEY



David J. Kyffers

Director of the United States Patent and Trademark Office

United States of America

United States Patent and Trademark Office

NYPC

Reg. No. 4,066,960

NEW YORK PORTFOLIO CLEARING, LLC (DELAWARE LIMITED LIABILITY COMPANY)
55 WATER STREET, 31ST FLOOR
NEW YORK, NY 10041

Registered Dec. 6, 2011

Int. Cl.: 36

FOR: FINANCIAL CLEARINGHOUSE SERVICES, IN CLASS 36 (U.S. CLS. 100, 101 AND 102).

SERVICE MARK

FIRST USE 3-21-2011; IN COMMERCE 3-21-2011.

PRINCIPAL REGISTER

THE MARK CONSISTS OF STANDARD CHARACTERS WITHOUT CLAIM TO ANY PARTICULAR FONT, STYLE, SIZE, OR COLOR.

SER. NO. 85-308,426, FILED 4-29-2011.

LEIGH CAROLINE CASE, EXAMINING ATTORNEY



David J. Kybas

Director of the United States Patent and Trademark Office

United States of America

United States Patent and Trademark Office

VITECH

Reg. No. 4,066,961

Registered Dec. 6, 2011

Int. Cl.: 40

SERVICE MARK

PRINCIPAL REGISTER

BRUNSWICK CORPORATION (DELAWARE CORPORATION)
ONE NORTH FIELD COURT
LAKE FOREST, IL 60045

FOR: CUSTOM MANUFACTURE OF FIBERGLASS BOAT HULLS, IN CLASS 40 (U.S. CLS. 100, 103 AND 106).

FIRST USE 1-0-2000; IN COMMERCE 1-0-2000.

THE MARK CONSISTS OF STANDARD CHARACTERS WITHOUT CLAIM TO ANY PARTICULAR FONT, STYLE, SIZE, OR COLOR.

SER. NO. 85-308,433, FILED 4-29-2011.

ELI HELLMAN, EXAMINING ATTORNEY



David J. Kybas

Director of the United States Patent and Trademark Office

United States of America

United States Patent and Trademark Office

REWARD PINPOINT

Reg. No. 4,066,962

Registered Dec. 6, 2011

Int. Cls.: 35 and 41

SERVICE MARK

PRINCIPAL REGISTER

HAY GROUP HOLDINGS, INC. (DELAWARE CORPORATION)
2711 CENTERVILLE ROAD, SUITE 400
WILMINGTON, DE 19803

FOR: PROVIDING BUSINESS MANAGEMENT SERVICES AND CONSULTING SERVICES RELATING THERETO, IN CLASS 35 (U.S. CLS. 100, 101 AND 102).

FIRST USE 1-11-2010; IN COMMERCE 1-11-2011.

FOR: PROVIDING TRAINING SERVICES IN THE FIELDS OF ESTABLISHING COMPENSATION PLANS, ORGANIZING MANAGEMENT PERFORMANCE APPRAISALS, CREATING STRATEGIC PLANS, MEASURING CORPORATE PERFORMANCE AND EVALUATING EMPLOYEE BENEFIT PLANS AND CONSULTING SERVICES RELATING THERETO, IN CLASS 41 (U.S. CLS. 100, 101 AND 107).

FIRST USE 1-11-2010; IN COMMERCE 1-11-2010.

THE MARK CONSISTS OF STANDARD CHARACTERS WITHOUT CLAIM TO ANY PARTICULAR FONT, STYLE, SIZE, OR COLOR.

OWNER OF U.S. REG. NO. 3,912,349.

NO CLAIM IS MADE TO THE EXCLUSIVE RIGHT TO USE "REWARD", APART FROM THE MARK AS SHOWN.

SER. NO. 85-308,434, FILED 4-29-2011.

SUE LAWRENCE, EXAMINING ATTORNEY



David J. Kyros

Director of the United States Patent and Trademark Office

United States of America

United States Patent and Trademark Office

BARON & BARON

Reg. No. 4,066,963

Registered Dec. 6, 2011

Int. Cl.: 35

SERVICE MARK

PRINCIPAL REGISTER

BARON & BARON INC. (NEW YORK CORPORATION)
5TH FLOOR
435 HUDSON STREET
NEW YORK, NY 10014

FOR: ADVERTISING AND BRAND-BUILDING SERVICES, IN CLASS 35 (U.S. CLS. 100, 101 AND 102).

FIRST USE 0-0-1990; IN COMMERCE 0-0-1990.

THE MARK CONSISTS OF STANDARD CHARACTERS WITHOUT CLAIM TO ANY PARTICULAR FONT, STYLE, SIZE, OR COLOR.

SER. NO. 85-308,463, FILED 4-29-2011.

GRETТА YAO, EXAMINING ATTORNEY



David J. Kyffers

Director of the United States Patent and Trademark Office

United States of America

United States Patent and Trademark Office

FRESHANA

Reg. No. 4,066,964

Registered Dec. 6, 2011

Int. Cl.: 5

TRADEMARK

PRINCIPAL REGISTER

PETROMIST HOSPITALITY SOLUTIONS (GEORGIA LIMITED LIABILITY COMPANY)
3340 PEACHTREE RD NE
ATLANTA, GA 30326

FOR: AIR DEODORIZER; AIR FRESHENERS; CLEANING PREPARATIONS, NAMELY, ODOR ELIMINATORS NOT FOR PERSONAL USE, IN CLASS 5 (U.S. CLS. 6, 18, 44, 46, 51 AND 52).

FIRST USE 4-22-2010; IN COMMERCE 4-22-2010.

THE MARK CONSISTS OF STANDARD CHARACTERS WITHOUT CLAIM TO ANY PARTICULAR FONT, STYLE, SIZE, OR COLOR.

SER. NO. 85-308,489, FILED 4-29-2011.

SHARON MEIER, EXAMINING ATTORNEY



David J. Kyffers

Director of the United States Patent and Trademark Office

United States of America

United States Patent and Trademark Office

TRADE PASS

Reg. No. 4,066,965

Registered Dec. 6, 2011

Int. Cl.: 36

SERVICE MARK

PRINCIPAL REGISTER

PM FACTORS, INC. (CALIFORNIA CORPORATION), DBA 1ST PMF BANCORP
9701 WEST PICO BOULEVARD, SUITE 115
LOS ANGELES, CA 90035

FOR: BANKING AND FINANCING SERVICES, IN CLASS 36 (U.S. CLS. 100, 101 AND 102).

FIRST USE 10-25-2010; IN COMMERCE 3-31-2011.

THE MARK CONSISTS OF STANDARD CHARACTERS WITHOUT CLAIM TO ANY PARTICULAR FONT, STYLE, SIZE, OR COLOR.

SER. NO. 85-308,507, FILED 4-29-2011.

SUSAN LESLIE DUBOIS, EXAMINING ATTORNEY



David J. Kybas

Director of the United States Patent and Trademark Office

United States of America

United States Patent and Trademark Office

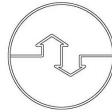

Reg. No. 4,066,966
Registered Dec. 6, 2011

THE NEW TEACHER PROJECT, INC. (DELAWARE NON-PROFIT CORPORATION)
186 JORALEMON STREET, SUITE 300
BROOKLYN, NY 11201

Int. Cl.: 41

FOR: EDUCATIONAL SERVICES, NAMELY, TRAINING INDIVIDUALS TO TEACH CLASSES IN PRIMARY AND SECONDARY PUBLIC SCHOOLS IN THE FIELDS OF READING, WRITING, SPELLING, GRAMMAR, LANGUAGES, GEOGRAPHY, SOCIAL STUDIES, MATHEMATICS, SCIENCE, NUTRITION, HEALTH, PHYSICAL EDUCATION, COMPUTER AND INFORMATION TECHNOLOGY, MUSIC, ART AND LITERATURE AND DISTRIBUTION OF TRAINING MATERIAL IN CONNECTION THEREWITH, IN CLASS 41 (U.S. CLS. 100, 101 AND 107).

SERVICE MARK

PRINCIPAL REGISTER

FIRST USE 4-0-2004; IN COMMERCE 4-0-2004.

THE MARK CONSISTS OF A CIRCLE DIVIDED BY AN UPWARD POINTING ARROW EXTENDING INTO THE UPPER PORTION OF THE CIRCLE AND A DOWNWARD POINTING ARROW EXTENDING INTO THE LOWER PORTION OF THE CIRCLE.

SER. NO. 85-308,628, FILED 4-29-2011.

LEIGH CAROLINE CASE, EXAMINING ATTORNEY



David J. Kyffers

Director of the United States Patent and Trademark Office

United States of America

United States Patent and Trademark Office

FLAME-SIM

Reg. No. 4,066,967

Registered Dec. 6, 2011

Int. Cl.: 9

TRADEMARK

PRINCIPAL REGISTER

FLAME SIM, LLC (ILLINOIS LIMITED LIABILITY COMPANY)
2345 PEMBROKE AVENUE
HOFFMAN ESTATES, IL 60195

FOR: COMPUTER SOFTWARE SIMULATORS FOR TRAINING FIREFIGHTERS, IN CLASS
9 (U.S. CLS. 21, 23, 26, 36 AND 38).

FIRST USE 6-10-2008; IN COMMERCE 6-10-2008.

THE MARK CONSISTS OF STANDARD CHARACTERS WITHOUT CLAIM TO ANY PAR-
TICULAR FONT, STYLE, SIZE, OR COLOR.

SER. NO. 85-308,633, FILED 4-29-2011.

HELENE LIWINSKI, EXAMINING ATTORNEY



David J. Kybas

Director of the United States Patent and Trademark Office

United States of America

United States Patent and Trademark Office

LJIPM

Reg. No. 4,066,968

Registered Dec. 6, 2011

Int. Cl.: 44

SERVICE MARK

PRINCIPAL REGISTER

MDREVOLUTION LLC (DELAWARE LIMITED LIABILITY COMPANY)
2711 CENTERVILLE ROAD, SUITE 400
WILMINGTON, DE 19808

FOR: HEALTHCARE SERVICES, IN CLASS 44 (U.S. CLS. 100 AND 101).

FIRST USE 5-6-2011; IN COMMERCE 5-6-2011.

THE MARK CONSISTS OF STANDARD CHARACTERS WITHOUT CLAIM TO ANY PARTICULAR FONT, STYLE, SIZE, OR COLOR.

SER. NO. 85-308,638, FILED 4-29-2011.

MARY BOAGNI, EXAMINING ATTORNEY



David J. Kybas

Director of the United States Patent and Trademark Office

United States of America

United States Patent and Trademark Office

VELLUM

Reg. No. 4,066,969

Registered Dec. 6, 2011

Int. Cl.: 33

TRADEMARK

PRINCIPAL REGISTER

VELLUM WINE CRAFT, LLC (CALIFORNIA LIMITED LIABILITY COMPANY)
P.O. BOX 10800
NAPA, CA 94581

FOR: WINES, IN CLASS 33 (U.S. CLS. 47 AND 49).

FIRST USE 3-31-2009; IN COMMERCE 3-31-2009.

THE MARK CONSISTS OF STANDARD CHARACTERS WITHOUT CLAIM TO ANY PARTICULAR FONT, STYLE, SIZE, OR COLOR.

SER. NO. 85-308,666, FILED 4-29-2011.

JULIE GUTTADAURO, EXAMINING ATTORNEY



David J. Kybas

Director of the United States Patent and Trademark Office

United States of America

United States Patent and Trademark Office

First Impression

Reg. No. 4,066,970

Registered Dec. 6, 2011

Int. Cl.: 31

TRADEMARK

PRINCIPAL REGISTER

GREENHEART FARMS, INC. (CALIFORNIA CORPORATION)
902 ZENON WAY
ARROYO GRANDE, CA 93420

FOR: LIVE PLANTS, NAMELY, ROSES, IN CLASS 31 (U.S. CLS. 1 AND 46).

FIRST USE 7-8-2008; IN COMMERCE 7-8-2008.

THE MARK CONSISTS OF STANDARD CHARACTERS WITHOUT CLAIM TO ANY PARTICULAR FONT, STYLE, SIZE, OR COLOR.

SER. NO. 85-308,725, FILED 4-29-2011.

ESTHER BELENKER, EXAMINING ATTORNEY



David J. Kybas

Director of the United States Patent and Trademark Office

United States of America

United States Patent and Trademark Office

LOCKIT

Reg. No. 4,066,971

RGB SYSTEMS, INCORPORATED (CALIFORNIA CORPORATION)
1230 S. LEWIS ST.
ANAHEIM, CA 92805

Registered Dec. 6, 2011

Int. Cl.: 20

FOR: NON-METAL MOUNTING BRACKETS FOR USE IN AFFIXING A CABLE TO AN INPUT/OUTPUT CONNECTOR, IN CLASS 20 (U.S. CLS. 2, 13, 22, 25, 32 AND 50).

TRADEMARK

FIRST USE 4-11-2011; IN COMMERCE 4-11-2011.

PRINCIPAL REGISTER

THE MARK CONSISTS OF STANDARD CHARACTERS WITHOUT CLAIM TO ANY PARTICULAR FONT, STYLE, SIZE, OR COLOR.

SER. NO. 85-308,734, FILED 4-29-2011.

GEOFFREY FOSDICK, EXAMINING ATTORNEY



David J. Kyfos

Director of the United States Patent and Trademark Office

United States of America

United States Patent and Trademark Office

NFLIGHT

Reg. No. 4,066,972

Registered Dec. 6, 2011

Int. Cl.: 42

SERVICE MARK

PRINCIPAL REGISTER

KARSTEN MANUFACTURING CORPORATION (ARIZONA CORPORATION)
2201 WEST DESERT COVE
PHOENIX, AZ 85029

FOR: APPLICATION SERVICE PROVIDER FEATURING NON-DOWNLOADABLE SOFTWARE FOR PROVIDING AN ON-LINE DATABASE TO ENABLE FILE SHARING AND EXTRACTION AND RETRIEVAL OF DOCUMENTARY INFORMATION; TECHNICAL SUPPORT SERVICES, NAMELY, TROUBLESHOOTING IN THE NATURE OF DIAGNOSING COMPUTER HARDWARE AND SOFTWARE PROBLEMS; UPDATING AND MAINTENANCE OF COMPUTER SOFTWARE, IN CLASS 42 (U.S. CLS. 100 AND 101).

FIRST USE 3-31-2008; IN COMMERCE 3-31-2008.

THE MARK CONSISTS OF STANDARD CHARACTERS WITHOUT CLAIM TO ANY PARTICULAR FONT, STYLE, SIZE, OR COLOR.

OWNER OF U.S. REG. NOS. 3,599,860 AND 3,603,720.

SER. NO. 85-308,738, FILED 4-29-2011.

HENRY S. ZAK, EXAMINING ATTORNEY



David J. Kybas

Director of the United States Patent and Trademark Office

United States of America

United States Patent and Trademark Office



Reg. No. 4,066,973

Registered Dec. 6, 2011

Int. Cl.: 9

TRADEMARK

PRINCIPAL REGISTER

SMITH, HOWARD HERBERT (UNITED STATES INDIVIDUAL), AKA SMITH, HEWARD HERBERT
42554 DRENNON COURT
TEMECULA, CA 92592

FOR: COMPUTER STYLUS; INSTRUMENT TO FACILITATE TEXT-MESSAGING IN THE NATURE OF A STYLUS-TYPE DEVICE THAT IS ATTACHED TO THE HAND FOR USE IN CONJUNCTION WITH PERSONAL DIGITAL ASSISTANTS; PHONOGRAPHIC RECORD CLEANING KITS COMPRISED PRIMARILY OF REPLACEMENT STYLUS NEEDLES AND ALSO INCLUDING CLEANING SOLUTION AND BRUSHES, IN CLASS 9 (U.S. CLS. 21, 23, 26, 36 AND 38).

FIRST USE 4-15-2011; IN COMMERCE 4-15-2011.

THE MARK CONSISTS OF A GLOBE SHOWING LAND CONTINENTS IN GREEN AND WHITE WITH THE OCEANS IN BLUE. THE GLOBE IS SURROUNDED BY THE WORDING "GLOBASCOPE" IN BLACK, ARCHING ABOVE THE GLOBE FROM THE LEFT EQUATOR AROUND THE NORTHERN HEMISPHERE ENDING ON THE WEST EQUATOR, AND THE WORDING "GLOBASCOPE" IN BLACK ARCHING BELOW THE GLOBE STARTING FROM THE LEFT EQUATOR AROUND THE SOUTHERN HEMISPHERE ENDING ON THE WEST EQUATOR. THERE IS A BLUE DOT ON THE LEFT EQUATOR AND A BLUE DOT ON THE WEST EQUATOR. THE WORDS ""NOT JUST OUR WAY."" APPEAR IN BLACK WITH QUOTATION MARKS UNDER THE WORDS AND DESIGN.

THE COLOR(S) GREEN, BLUE, BLACK, WHITE IS/ARE CLAIMED AS A FEATURE OF THE MARK.

SER. NO. 85-308,739, FILED 4-29-2011.

HENRY S. ZAK, EXAMINING ATTORNEY



David J. Kybas

Director of the United States Patent and Trademark Office

United States of America

United States Patent and Trademark Office

SUPERMASSIVE

Reg. No. 4,066,974

SUPERMASSIVE, LLC (WASHINGTON LIMITED LIABILITY COMPANY)
1415 SOUTH FOREST STREET
SEATTLE, WA 98144

Registered Dec. 6, 2011

Int. Cl.: 41

FOR: PROVIDING CURRENT EVENT NEWS AND INFORMATION VIA A GLOBAL COMPUTER NETWORK, IN CLASS 41 (U.S. CLS. 100, 101 AND 107).

SERVICE MARK

FIRST USE 7-1-2005; IN COMMERCE 7-1-2005.

PRINCIPAL REGISTER

THE MARK CONSISTS OF STANDARD CHARACTERS WITHOUT CLAIM TO ANY PARTICULAR FONT, STYLE, SIZE, OR COLOR.

SER. NO. 85-308,754, FILED 4-29-2011.

HENRY S. ZAK, EXAMINING ATTORNEY



David J. Kybas

Director of the United States Patent and Trademark Office

United States of America

United States Patent and Trademark Office

ACTRIMS

Reg. No. 4,066,975

Registered Dec. 6, 2011

Int. Cl.: 41

AMERICAN COMMITTEE FOR TREATMENT AND RESEARCH IN MULTIPLE SCLEROSIS,
INC. (WISCONSIN CORPORATION)
THIRD FLOOR
733 THIRD AVENUE
NEW YORK, NY 10017

SERVICE MARK

PRINCIPAL REGISTER

FOR: EDUCATIONAL SERVICES, NAMELY, CONDUCTING CLASSES, SEMINARS, CONFERENCES, AND WORKSHOPS IN THE FIELD OF MULTIPLE SCLEROSIS AND DISTRIBUTION OF COURSE MATERIAL IN CONNECTION THEREWITH; EDUCATIONAL SERVICES, NAMELY, PROVIDING INFORMATION ABOUT MULTIPLE SCLEROSIS TO PHYSICIANS AND RESEARCHERS, IN CLASS 41 (U.S. CLS. 100, 101 AND 107).

FIRST USE 10-13-1996; IN COMMERCE 10-13-1996.

THE MARK CONSISTS OF STANDARD CHARACTERS WITHOUT CLAIM TO ANY PARTICULAR FONT, STYLE, SIZE, OR COLOR.

SER. NO. 85-308,759, FILED 4-29-2011.

HENRY S. ZAK, EXAMINING ATTORNEY



David J. Kyffers

Director of the United States Patent and Trademark Office

United States of America

United States Patent and Trademark Office

PIVOTAL PLAYS

Reg. No. 4,066,976

Registered Dec. 6, 2011

Int. Cl.: 41

SERVICE MARK

PRINCIPAL REGISTER

MORGANFRANKLIN CORPORATION (MARYLAND CORPORATION)
1753 PINNACLE DRIVE, SUITE 1200
MCLEAN, VA 22102

FOR: PROVIDING RECOGNITION AND INCENTIVES BY THE WAY OF AWARDS TO DEMONSTRATE EXCELLENCE IN THE FIELD OF BUSINESS AND GOVERNMENT , IN CLASS 41 (U.S. CLS. 100, 101 AND 107).

FIRST USE 7-0-2010; IN COMMERCE 7-0-2010.

THE MARK CONSISTS OF STANDARD CHARACTERS WITHOUT CLAIM TO ANY PARTICULAR FONT, STYLE, SIZE, OR COLOR.

SER. NO. 85-308,772, FILED 4-29-2011.

KATHERINE M. DUBRAY, EXAMINING ATTORNEY



David J. Kybas

Director of the United States Patent and Trademark Office

United States of America

United States Patent and Trademark Office



Reg. No. 4,066,977

Registered Dec. 6, 2011

Int. Cl.: 35

SERVICE MARK

PRINCIPAL REGISTER

ARTIST INTERSECT INC. (CALIFORNIA CORPORATION)
3863 PIMA LANE
LAS VEGAS, NV 89169

FOR: PROVIDING A WEBSITE FEATURING INFORMATION AND LINKS RELATING TO THE MUSIC INDUSTRY, NAMELY, PROMOTION, MARKETING AND BUSINESS ADVICE TO MUSICIANS, IN CLASS 35 (U.S. CLS. 100, 101 AND 102).

FIRST USE 3-20-2010; IN COMMERCE 3-20-2010.

NO CLAIM IS MADE TO THE EXCLUSIVE RIGHT TO USE "ARTIST", APART FROM THE MARK AS SHOWN.

THE MARK CONSISTS OF THE STYLIZED WORDS ARTIST INTERSECT TO THE RIGHT OF A DRAWING OF A SHADED SQUARE WITH TWO TRIANGLES, ONE IN FRONT OF THE OTHER, APPEARING AS SPOTLIGHTS FROM ABOVE AND BELOW. INSIDE THE SQUARE, CENTERED AT THE BOTTOM IS A HIGHLY STYLIZED HUMAN FORMED BY TWO GEOMETRIC SHAPES. THE ARM ON THE RIGHT IS A TURNTABLE TONEARM. THE SHADING IN THE BACKGROUND IS FOR CONTRAST PURPOSES AND IS NOT CLAIMED AS A FEATURE OF THE MARK.

SER. NO. 85-308,879, FILED 4-29-2011.

DANNAN HETZEL, EXAMINING ATTORNEY



David J. Kyros

Director of the United States Patent and Trademark Office

United States of America

United States Patent and Trademark Office



Reg. No. 4,066,978

Registered Dec. 6, 2011

Int. Cl.: 35

SERVICE MARK

PRINCIPAL REGISTER

RJB WHOLESALE, INC. (WASHINGTON CORPORATION)
12418 NE 124TH ST
KIRKLAND, WA 98034

FOR: RETAIL STORES FEATURING RAW MATERIALS, CONSTRUCTION MATERIALS AND CONSTRUCTION SUPPLIES; WHOLESALE DISTRIBUTORSHIPS FEATURING RAW MATERIALS, CONSTRUCTION MATERIALS AND CONSTRUCTION SUPPLIES, IN CLASS 35 (U.S. CLS. 100, 101 AND 102).

FIRST USE 3-1-1977; IN COMMERCE 3-1-1977.

THE MARK CONSISTS OF THE LETTERS RJB WITH THE DESIGN OF THE GLOBE IN THE BACKGROUND, BEHIND THE LETTER R AND PART OF J ARE PARALLEL AND HORIZONTAL LINES, BEHIND PART OF J AND THE LETTER B IS BLANK, THREE PIPES UNDER THE LETTERS JB.

SER. NO. 85-308,887, FILED 4-29-2011.

MARGERY A. TIERNEY, EXAMINING ATTORNEY



David J. Kybas

Director of the United States Patent and Trademark Office

United States of America

United States Patent and Trademark Office

TEAMCARNEY

Reg. No. 4,066,979

Registered Dec. 6, 2011

Int. Cl.: 35

SERVICE MARK

PRINCIPAL REGISTER

CARNEY, INC. (VIRGINIA CORPORATION)
SUITE 401
100 N. PITT STREET
ALEXANDRIA, VA 22314

FOR: BUSINESS CONSULTING FOR HUMAN PERFORMANCE IMPROVEMENT, IN CLASS 35 (U.S. CLS. 100, 101 AND 102).

FIRST USE 6-19-1998; IN COMMERCE 6-19-1998.

THE MARK CONSISTS OF STANDARD CHARACTERS WITHOUT CLAIM TO ANY PARTICULAR FONT, STYLE, SIZE, OR COLOR.

SER. NO. 85-308,911, FILED 4-29-2011.

MATTHEW KLINE, EXAMINING ATTORNEY



David J. Kybas

Director of the United States Patent and Trademark Office

United States of America

United States Patent and Trademark Office

CYBERPROTECT

Reg. No. 4,066,980

Registered Dec. 6, 2011

Int. Cl.: 9

TRADEMARK

PRINCIPAL REGISTER

CARNEY, INC. (VIRGINIA CORPORATION)
SUITE 401
100 N. PITT STREET
ALEXANDRIA, VA 22314

FOR: COMPUTER PROGRAMS AND INTERACTIVE MULTIMEDIA PROGRAMS ON CD-ROM AND DOWNLOADABLE ON-LINE FOR PURPOSES OF EDUCATING AND TRAINING OTHERS IN METHODS OF PROTECTING COMPUTER HARD DRIVE INFORMATION STORAGE AND INFORMATION AND COMMUNICATIONS DELIVERED THROUGH COMPUTER NETWORKS FROM INTRUDER INTERFERENCE, IN CLASS 9 (U.S. CLS. 21, 23, 26, 36 AND 38).

FIRST USE 6-19-1998; IN COMMERCE 6-19-1998.

THE MARK CONSISTS OF STANDARD CHARACTERS WITHOUT CLAIM TO ANY PARTICULAR FONT, STYLE, SIZE, OR COLOR.

SER. NO. 85-308,918, FILED 4-29-2011.

MATTHEW KLINE, EXAMINING ATTORNEY



David J. Kyjars

Director of the United States Patent and Trademark Office

United States of America

United States Patent and Trademark Office

SPELLBINDERS

Reg. No. 4,066,981

Registered Dec. 6, 2011

Int. Cl.: 16

TRADEMARK

PRINCIPAL REGISTER

SPELLBINDERS PAPER ARTS COMPANY, LLC (ARIZONA LIMITED LIABILITY COMPANY)
BLDG 3 SUITE 124
1125 W. PINNACLE PEAK ROAD
PHOENIX, AZ 85027

FOR: STENCILS, IN CLASS 16 (U.S. CLS. 2, 5, 22, 23, 29, 37, 38 AND 50).

FIRST USE 7-31-2005; IN COMMERCE 7-31-2005.

THE MARK CONSISTS OF STANDARD CHARACTERS WITHOUT CLAIM TO ANY PARTICULAR FONT, STYLE, SIZE, OR COLOR.

SER. NO. 85-308,928, FILED 4-29-2011.

LEIGH LOWRY, EXAMINING ATTORNEY



David J. Kyffers

Director of the United States Patent and Trademark Office

United States of America

United States Patent and Trademark Office

PRESTO PUNCH

Reg. No. 4,066,982

Registered Dec. 6, 2011

Int. Cls.: 8 and 16

TRADEMARK

PRINCIPAL REGISTER

SPELLBINDERS PAPER ARTS, LLC (ARIZONA LIMITED LIABILITY COMPANY)
BLDG 3 SUITE 124
1125 W. PINNACLE PEAK ROAD
PHOENIX, AZ 85027

FOR: HAND TOOLS, NAMELY, DIES, IN CLASS 8 (U.S. CLS. 23, 28 AND 44).

FIRST USE 2-28-2010; IN COMMERCE 2-28-2010.

FOR: STENCILS, IN CLASS 16 (U.S. CLS. 2, 5, 22, 23, 29, 37, 38 AND 50).

FIRST USE 2-28-2010; IN COMMERCE 2-28-2010.

THE MARK CONSISTS OF STANDARD CHARACTERS WITHOUT CLAIM TO ANY PARTICULAR FONT, STYLE, SIZE, OR COLOR.

OWNER OF U.S. REG. NO. 3,897,900.

NO CLAIM IS MADE TO THE EXCLUSIVE RIGHT TO USE "PUNCH", APART FROM THE MARK AS SHOWN.

SER. NO. 85-308,960, FILED 4-29-2011.

MATTHEW EINSTEIN, EXAMINING ATTORNEY



David J. Kybas

Director of the United States Patent and Trademark Office

United States of America

United States Patent and Trademark Office

HUMIDIFALL

Reg. No. 4,066,983

HUMIDIFALL, LLC (DELAWARE LIMITED LIABILITY COMPANY)
5988 MID RIVERS MALL DRIVE
ST. CHARLES, MO 63304

Registered Dec. 6, 2011

Int. Cl.: 11

FOR: HUMIDIFIERS AND DEHUMIDIFIERS; INDOOR DECORATIVE WATERFALL HUMIDIFIERS AND DEHUMIDIFIERS, IN CLASS 11 (U.S. CLS. 13, 21, 23, 31 AND 34).

TRADEMARK

FIRST USE 6-0-1998; IN COMMERCE 6-0-1998.

PRINCIPAL REGISTER

THE MARK CONSISTS OF STANDARD CHARACTERS WITHOUT CLAIM TO ANY PARTICULAR FONT, STYLE, SIZE, OR COLOR.

SER. NO. 85-309,036, FILED 4-30-2011.

APRIL ROACH, EXAMINING ATTORNEY



David J. Kyros

Director of the United States Patent and Trademark Office

United States of America

United States Patent and Trademark Office

NO ROOF LEFT BEHIND

Reg. No. 4,066,984

Registered Dec. 6, 2011

Int. Cl.: 37

SERVICE MARK

PRINCIPAL REGISTER

RIDGECON CONSTRUCTION, INC. (MICHIGAN CORPORATION)
51019 CELESTE
SHELBY TOWNSHIP, MI 48315

FOR: CHARITABLE SERVICES, NAMELY, PROVIDING MAINTENANCE AND REPAIRS
ON THE HOMES OF THOSE IN NEED, IN CLASS 37 (U.S. CLS. 100, 103 AND 106).

FIRST USE 6-0-2009; IN COMMERCE 6-0-2009.

THE MARK CONSISTS OF STANDARD CHARACTERS WITHOUT CLAIM TO ANY PAR-
TICULAR FONT, STYLE, SIZE, OR COLOR.

SER. NO. 85-309,068, FILED 4-30-2011.

LEIGH CAROLINE CASE, EXAMINING ATTORNEY



David J. Kybas

Director of the United States Patent and Trademark Office

United States of America

United States Patent and Trademark Office

Blue Sky

Reg. No. 4,066,985

Registered Dec. 6, 2011

Int. Cl.: 35

SERVICE MARK

PRINCIPAL REGISTER

BLUE SKY SOFTWARE SOLUTIONS, INC. (ARIZONA CORPORATION)
1230 W WASHINGTON STREET, SUITE 207
TEMPE, AZ 85281

FOR: UTILITY BILL MANAGEMENT SERVICES, NAMELY, TRACKING, REPORTING, ANALYZING AND DELIVERING ENERGY INFORMATION IN THE FORM OF UTILITY BILLS AND UTILITY METER DATA RATE SCHEDULES, IN CLASS 35 (U.S. CLS. 100, 101 AND 102).

FIRST USE 2-15-2011; IN COMMERCE 4-15-2011.

THE MARK CONSISTS OF STANDARD CHARACTERS WITHOUT CLAIM TO ANY PARTICULAR FONT, STYLE, SIZE, OR COLOR.

SER. NO. 85-309,078, FILED 4-30-2011.

SHAILA SETTLES, EXAMINING ATTORNEY



David J. Kyros

Director of the United States Patent and Trademark Office

United States of America

United States Patent and Trademark Office

Luxe Basics

Reg. No. 4,066,986

Registered Dec. 6, 2011

Int. Cls.: 20 and 24

TRADEMARK

PRINCIPAL REGISTER

LUXE BASICS, LLC (ILLINOIS LIMITED LIABILITY COMPANY), DBA LUXE BASICS
SUITE 125
1658 N MILWAUKEE AVE
CHICAGO, IL 60647

FOR: BUMPER GUARDS FOR CRIBS; FITTED FABRIC SLIPCOVERS FOR FURNITURE,
IN CLASS 20 (U.S. CLS. 2, 13, 22, 25, 32 AND 50).

FIRST USE 1-1-2008; IN COMMERCE 1-1-2008.

FOR: BABY BEDDING, NAMELY, BUNDLE BAGS, SWADDLING BLANKETS, CRIB
BUMPERS, FITTED CRIB SHEETS, CRIB SKIRTS, CRIB BLANKETS, AND DIAPER
CHANGING PAD COVERS NOT OF PAPER, IN CLASS 24 (U.S. CLS. 42 AND 50).

FIRST USE 1-1-2009; IN COMMERCE 1-1-2009.

THE MARK CONSISTS OF STANDARD CHARACTERS WITHOUT CLAIM TO ANY PAR-
TICULAR FONT, STYLE, SIZE, OR COLOR.

SER. NO. 85-309,086, FILED 4-30-2011.

MICHAEL WEBSTER, EXAMINING ATTORNEY



David J. Kybas

Director of the United States Patent and Trademark Office

United States of America

United States Patent and Trademark Office



Reg. No. 4,066,987

Registered Dec. 6, 2011

Int. Cl.: 9

TRADEMARK

PRINCIPAL REGISTER

LOUSIGNONT, PH.D., GREGORY (UNITED STATES INDIVIDUAL)
3740 ROYAL CREST STREET
LAS VEGAS, NV 89119

FOR: METAL DETECTING ACCESSORY, NAMELY, AN OVER THE SHOULDER, STRAP-LIKE DEVICE USED TO IMPROVE AND ASSIST IN THE USABILITY OF METAL DETECTORS, IN CLASS 9 (U.S. CLS. 21, 23, 26, 36 AND 38).

FIRST USE 1-1-2005; IN COMMERCE 1-1-2005.

THE MARK CONSISTS OF A STYLIZED STICK FIGURE OF A MAN SWINGING A METAL DETECTOR WITH THE WORDS "SWINGY THINGY" BESIDE IT.

SER. NO. 85-309,096, FILED 4-30-2011.

CURTIS FRENCH, EXAMINING ATTORNEY



David J. Kybas

Director of the United States Patent and Trademark Office

United States of America

United States Patent and Trademark Office

Schoolgrader

Reg. No. 4,066,988

NISSIMOV, RONEN (UNITED STATES INDIVIDUAL)
6711 WEST COLLEGE ST
HOUSTON, TX 77005

Registered Dec. 6, 2011

Int. Cl.: 41

FOR: PROVIDING INFORMATION AND NEWS IN THE FIELD OF TEACHING METHODOLOGY AND EDUCATION, IN CLASS 41 (U.S. CLS. 100, 101 AND 107).

SERVICE MARK

FIRST USE 3-2-2011; IN COMMERCE 4-18-2011.

PRINCIPAL REGISTER

THE MARK CONSISTS OF STANDARD CHARACTERS WITHOUT CLAIM TO ANY PARTICULAR FONT, STYLE, SIZE, OR COLOR.

SER. NO. 85-309,108, FILED 4-30-2011.

LEIGH CAROLINE CASE, EXAMINING ATTORNEY



David J. Kyros

Director of the United States Patent and Trademark Office

United States of America

United States Patent and Trademark Office

KIMMAYTUBE

Reg. No. 4,066,989

Registered Dec. 6, 2011

Int. Cl.: 44

SERVICE MARK

PRINCIPAL REGISTER

LUV NATURALS, LLC (MARYLAND LIMITED LIABILITY COMPANY)
PMB #1
8787 BRANCH AVENUE
CLINTON, MD 20735

FOR: PROVIDING ONLINE INSTRUCTIONAL VIDEOS IN THE FIELD OF HAIR CARE, IN CLASS 44 (U.S. CLS. 100 AND 101).

FIRST USE 2-14-2010; IN COMMERCE 2-14-2010.

THE MARK CONSISTS OF STANDARD CHARACTERS WITHOUT CLAIM TO ANY PARTICULAR FONT, STYLE, SIZE, OR COLOR.

SER. NO. 85-309,115, FILED 4-30-2011.

GINA HAYES, EXAMINING ATTORNEY



David J. Kyros

Director of the United States Patent and Trademark Office

United States of America

United States Patent and Trademark Office

Core Intelligence

Reg. No. 4,066,990

Registered Dec. 6, 2011

Int. Cls.: 41, 44 and 45

SERVICE MARK

PRINCIPAL REGISTER

CLIFFORD, TRACEY (UNITED STATES INDIVIDUAL)
920 VIEWPOINTE DR
ST. CHARLES, IL 60174

FOR: EDUCATION SERVICES, NAMELY, PROVIDING WORKSHOPS, SEMINARS, CLASSES IN THE FIELD OF BUSINESS LEADERSHIP, TEAM DEVELOPMENT, AND PSYCHOLOGY; PROFESSIONAL COACHING SERVICES IN THE FIELD OF PSYCHOLOGY, IN CLASS 41 (U.S. CLS. 100, 101 AND 107).

FIRST USE 7-3-2005; IN COMMERCE 7-3-2006.

FOR: PSYCHOLOGICAL COUNSELING, IN CLASS 44 (U.S. CLS. 100 AND 101).

FIRST USE 7-3-2005; IN COMMERCE 7-3-2006.

FOR: COUNSELING IN THE FIELD OF PERSONAL DEVELOPMENT, NAMELY, SELF-IMPROVEMENT, SELF-FULFILLMENT, AND INTERPERSONAL COMMUNICATION, IN CLASS 45 (U.S. CLS. 100 AND 101).

FIRST USE 7-3-2005; IN COMMERCE 7-3-2006.

THE MARK CONSISTS OF STANDARD CHARACTERS WITHOUT CLAIM TO ANY PARTICULAR FONT, STYLE, SIZE, OR COLOR.

SER. NO. 85-309,126, FILED 4-30-2011.

JAMES STEIN, EXAMINING ATTORNEY



David J. Kyjars

Director of the United States Patent and Trademark Office

United States of America

United States Patent and Trademark Office

OXYHEALTH

Reg. No. 4,066,991

Registered Dec. 6, 2011

Int. Cl.: 10

TRADEMARK

PRINCIPAL REGISTER

OXY-HEALTH, LLC (CALIFORNIA LIMITED LIABILITY COMPANY)
10719 NORWALK BLVD
SANTA FE SPRINGS, CA 90670

FOR: HYPERBARIC OXYGEN CHAMBERS FOR MEDICAL PURPOSES, IN CLASS 10 (U.S. CLS. 26, 39 AND 44).

FIRST USE 12-8-2000; IN COMMERCE 12-8-2000.

THE MARK CONSISTS OF STANDARD CHARACTERS WITHOUT CLAIM TO ANY PARTICULAR FONT, STYLE, SIZE, OR COLOR.

SER. NO. 85-309,144, FILED 4-30-2011.

KATHERINE CHANG, EXAMINING ATTORNEY



David J. Kybas

Director of the United States Patent and Trademark Office

United States of America

United States Patent and Trademark Office



Reg. No. 4,066,992

Registered Dec. 6, 2011

Int. Cl.: 29

TRADEMARK

PRINCIPAL REGISTER

SYSCO CORPORATION (DELAWARE CORPORATION)
1390 ENCLAVE PARKWAY
HOUSTON, TX 770771390

FOR: CANNED VEGETABLES; FROZEN VEGETABLES, IN CLASS 29 (U.S. CL. 46).

FIRST USE 9-15-1987; IN COMMERCE 9-15-1987.

OWNER OF U.S. REG. NO. 1,641,393.

THE MARK CONSISTS OF AN EAGLE.

SER. NO. 85-309,146, FILED 4-30-2011.

WARREN L. OLANDRIA, EXAMINING ATTORNEY



David J. Kyffers

Director of the United States Patent and Trademark Office

United States of America

United States Patent and Trademark Office

SO, YOU WANT TO BE A JUDGE

Reg. No. 4,066,993

Registered Dec. 6, 2011

Int. Cl.: 41

SERVICE MARK

PRINCIPAL REGISTER

CALIFORNIA WOMEN LAWYERS (CALIFORNIA CORPORATION)
650 HOWE AVENUE, SUITE 1050
SACRAMENTO, CA 95825

FOR: CONDUCTING WORKSHOPS AND SEMINARS IN THE FIELD OF THE JUDICIAL APPLICATION PROCESS; EDUCATIONAL SERVICES, NAMELY, ARRANGING AND CONDUCTING EDUCATIONAL AND NETWORKING SEMINARS IN THE LEGAL FIELD; EDUCATIONAL SERVICES, NAMELY, CONDUCTING SEMINARS IN THE FIELD OF THE JUDICIAL APPLICATION PROCESS AND DISTRIBUTION OF PRINTED MATERIALS IN CONNECTION THEREWITH IN HARD COPY OR ELECTRONIC FORMAT ON THE SAME TOPICS, IN CLASS 41 (U.S. CLS. 100, 101 AND 107).

FIRST USE 12-31-1985; IN COMMERCE 12-31-1985.

THE MARK CONSISTS OF STANDARD CHARACTERS WITHOUT CLAIM TO ANY PARTICULAR FONT, STYLE, SIZE, OR COLOR.

SER. NO. 85-309,151, FILED 4-30-2011.

ANDREA HACK, EXAMINING ATTORNEY



David J. Kybas

Director of the United States Patent and Trademark Office

United States of America

United States Patent and Trademark Office

Confetti Couture

Reg. No. 4,066,994

Registered Dec. 6, 2011

Int. Cl.: 16

TRADEMARK

PRINCIPAL REGISTER

FIREPIT FRIENDS, LLC (COLORADO LIMITED LIABILITY COMPANY), DBA CONFETTI
COUTURE
181 CAMINO REAL
FORT COLLINS, CO 80524

FOR: FOOD WRAPPERS, IN CLASS 16 (U.S. CLS. 2, 5, 22, 23, 29, 37, 38 AND 50).

FIRST USE 11-9-2010; IN COMMERCE 12-8-2010.

THE MARK CONSISTS OF STANDARD CHARACTERS WITHOUT CLAIM TO ANY PARTICULAR FONT, STYLE, SIZE, OR COLOR.

SER. NO. 85-309,173, FILED 4-30-2011.

KATINA MISTER, EXAMINING ATTORNEY



David J. Kybas

Director of the United States Patent and Trademark Office

United States of America

United States Patent and Trademark Office



Reg. No. 4,066,995

Registered Dec. 6, 2011

Int. Cl.: 16

TRADEMARK

PRINCIPAL REGISTER

LIMELIGHT PRODUCTIONS, LLC (LOUISIANA LIMITED LIABILITY COMPANY), DBA
BAYOU BUCKS
SUITE 7
1216 SOUTH MORRISON BOULEVARD
HAMMOND, LA 70403

FOR: MAGAZINES FEATURING HUNTING AND FISHING, IN CLASS 16 (U.S. CLS. 2, 5,
22, 23, 29, 37, 38 AND 50).

FIRST USE 12-1-2009; IN COMMERCE 3-1-2010.

THE MARK CONSISTS OF SILHOUETTE OF MAN WITH HUNTING TREESTAND AT-
TACHED TO HIS BACK AND ARCHERY BOW IN ONE HAND WHO IS DRAGGING, BY
MEANS OF HIS OTHER HAND, A DECEASED WHITETAIL DEER BUCK BY BUCK'S
ANTLERS WHILE LAYING ON ITS SIDE, ALTOGETHER PERCEIVED TO BE MOVING IN
A FORWARD FASHION IN THE GENERAL DIRECTION MAN IS FACING.

SER. NO. 85-309,185, FILED 4-30-2011.

ERNEST SHOSHO, EXAMINING ATTORNEY



David J. Kyros

Director of the United States Patent and Trademark Office

United States of America

United States Patent and Trademark Office

TOMAHAWK

Reg. No. 4,066,996

Registered Dec. 6, 2011

Int. Cl.: 9

TRADEMARK

PRINCIPAL REGISTER

BORIN MANUFACTURING, INC. (CALIFORNIA CORPORATION)
UNIT B
5741 BUCKINGHAM PARKWAY
CULVER CITY, CA 90230

FOR: ELECTRICAL SURGE PROTECTOR, NAMELY TRANSIENT VOLTAGE TRAP, IN CLASS 9 (U.S. CLS. 21, 23, 26, 36 AND 38).

FIRST USE 3-4-1993; IN COMMERCE 3-4-1993.

THE MARK CONSISTS OF STANDARD CHARACTERS WITHOUT CLAIM TO ANY PARTICULAR FONT, STYLE, SIZE, OR COLOR.

SER. NO. 85-309,195, FILED 4-30-2011.

HEATHER BIDDULPH, EXAMINING ATTORNEY



David J. Kyffers

Director of the United States Patent and Trademark Office

United States of America

United States Patent and Trademark Office

LA LEJANIA

Reg. No. 4,066,997

Registered Dec. 6, 2011

Int. Cl.: 33

VIÑA CARTA VIEJA S.A. (CHILE CORPORATION)
AV. FRANCISCO ANTONIO ENCINA, NO. 231
VILLA ALEGRE DE LONCOMILLA
SÉPTIMA REGIÓN, CHILE

FOR: WINES, IN CLASS 33 (U.S. CLS. 47 AND 49).

TRADEMARK

FIRST USE 2-1-2009; IN COMMERCE 4-25-2009.

PRINCIPAL REGISTER

THE MARK CONSISTS OF STANDARD CHARACTERS WITHOUT CLAIM TO ANY PARTICULAR FONT, STYLE, SIZE, OR COLOR.

THE ENGLISH TRANSLATION OF "LA LEJANIA" IN THE MARK IS "THE REMOTENESS".

SER. NO. 85-309,198, FILED 4-30-2011.

HANNO RITTNER, EXAMINING ATTORNEY



David J. Kybas

Director of the United States Patent and Trademark Office

United States of America

United States Patent and Trademark Office

HEAVY-ZIP

Reg. No. 4,066,998

Registered Dec. 6, 2011

Int. Cl.: 20

TRADEMARK

PRINCIPAL REGISTER

EP LLC (KENTUCKY LIMITED LIABILITY COMPANY)
UNIT F
639 MERIDIAN CIRCLE
COLD SPRING, KY 41076

FOR: PLASTIC ZIPPER TAPES FOR USE AS CLOSURES FOR PACKAGING CONTAINERS
AND PACKAGING BAGS OF PLASTIC, IN CLASS 20 (U.S. CLS. 2, 13, 22, 25, 32 AND 50).

FIRST USE 3-21-2011; IN COMMERCE 3-21-2011.

THE MARK CONSISTS OF STANDARD CHARACTERS WITHOUT CLAIM TO ANY PAR-
TICULAR FONT, STYLE, SIZE, OR COLOR.

SER. NO. 85-309,203, FILED 4-30-2011.

HANNO RITTNER, EXAMINING ATTORNEY



David J. Kyffers

Director of the United States Patent and Trademark Office

United States of America

United States Patent and Trademark Office

THE COMMUTERS

Reg. No. 4,066,999

Registered Dec. 6, 2011

Int. Cl.: 41

SERVICE MARK

PRINCIPAL REGISTER

ZAIDI, ZEESHAN HUSSAIN (UNITED STATES INDIVIDUAL)
4 BAYBERRY DRIVE
PRINCETON, NJ 08540

FOR: ENTERTAINMENT, NAMELY, LIVE PERFORMANCES BY A MUSICAL BAND;
PRODUCTION OF SOUND AND MUSIC VIDEO RECORDINGS; PROVIDING A WEBSITE
FEATURING ENTERTAINMENT INFORMATION, IN CLASS 41 (U.S. CLS. 100, 101 AND
107).

FIRST USE 3-1-2011; IN COMMERCE 4-26-2011.

THE MARK CONSISTS OF STANDARD CHARACTERS WITHOUT CLAIM TO ANY PAR-
TICULAR FONT, STYLE, SIZE, OR COLOR.

SER. NO. 85-309,213, FILED 4-30-2011.

HANNO RITTNER, EXAMINING ATTORNEY



David J. Kyffers

Director of the United States Patent and Trademark Office

United States of America

United States Patent and Trademark Office

First Frost

Reg. No. 4,067,000

ALLENTOWN TRAIN MEET ASSOCIATES (PENNSYLVANIA PARTNERSHIP)
1120 SOUTH JEFFERSON STREET
ALLENTOWN, PA 18103

Registered Dec. 6, 2011

Int. Cl.: 35

FOR: ARRANGING AND CONDUCTING TRADE SHOWS IN THE FIELD OF TOY TRAINS,
IN CLASS 35 (U.S. CLS. 100, 101 AND 102).

SERVICE MARK

FIRST USE 11-1-1979; IN COMMERCE 11-1-1979.

PRINCIPAL REGISTER

THE MARK CONSISTS OF STANDARD CHARACTERS WITHOUT CLAIM TO ANY PARTICULAR FONT, STYLE, SIZE, OR COLOR.

SER. NO. 85-309,291, FILED 5-1-2011.

ANTHONY RINKER, EXAMINING ATTORNEY



David J. Kybas

Director of the United States Patent and Trademark Office

United States of America

United States Patent and Trademark Office

CAMO

Reg. No. 4,067,001

Registered Dec. 6, 2011

Int. Cl.: 32

TRADEMARK

PRINCIPAL REGISTER

WILLIAMS III, ROBERT K (UNITED STATES INDIVIDUAL)
44 GULF STREAM CT
LAS VEGAS, NV 89113

FOR: BEER, ALE AND LAGER, IN CLASS 32 (U.S. CLS. 45, 46 AND 48).

FIRST USE 10-27-1998; IN COMMERCE 10-27-1998.

THE MARK CONSISTS OF STANDARD CHARACTERS WITHOUT CLAIM TO ANY PARTICULAR FONT, STYLE, SIZE, OR COLOR.

SER. NO. 85-309,297, FILED 5-1-2011.

COLLEEN KEARNEY, EXAMINING ATTORNEY



David J. Kybas

Director of the United States Patent and Trademark Office

United States of America

United States Patent and Trademark Office

STEEL STANDING

Reg. No. 4,067,002

Registered Dec. 6, 2011

Int. Cl.: 6

TRADEMARK

PRINCIPAL REGISTER

KMT ENTERPRISES LLC (DELAWARE CORPORATION)
245 WEST 123RD ST. SUITE #3
NEW YORK, NY 10027

FOR: ALUMINUM RECOGNITION PLAQUES; BRONZE RECOGNITION PLAQUES; COMMEMORATIVE STATUARY CUPS MADE OF NON-PRECIOUS METAL; DECORATIVE BOXES MADE OF NON-PRECIOUS METAL; FIGURINES MADE OF IMITATION GOLD; FIGURINES OF COMMON METAL; METAL CASH BOXES; METAL CASH DEPOSIT BOXES; METAL CASTINGS; METAL DOG TAGS; METAL LICENSE PLATES; METAL MAIL PLATES; METAL MAILBOXES; METAL MONEY BOXES; PEWTER FIGURINES; SCULPTURES MADE OF NON-PRECIOUS METAL; SCULPTURES OF METAL; SOUVENIR LICENSE PLATES OF METAL; STATUES OF NON-PRECIOUS METAL; STATUETTES OF NON-PRECIOUS METAL; WALL PLAQUES MADE OF COMMON METAL; WORKS OF ART OF COMMON METAL, IN CLASS 6 (U.S. CLS. 2, 12, 13, 14, 23, 25 AND 50).

FIRST USE 5-11-2002; IN COMMERCE 5-11-2002.

THE MARK CONSISTS OF STANDARD CHARACTERS WITHOUT CLAIM TO ANY PARTICULAR FONT, STYLE, SIZE, OR COLOR.

OWNER OF U.S. REG. NOS. 2,649,252 AND 3,893,175.

SER. NO. 85-309,303, FILED 5-1-2011.

KIMBERLY FRYE, EXAMINING ATTORNEY



David J. Kybas

Director of the United States Patent and Trademark Office

United States of America
United States Patent and Trademark Office

BALSAMIQ

Reg. No. 4,067,003

Registered Dec. 6, 2011

Int. Cl.: 9

TRADEMARK

PRINCIPAL REGISTER

GIACOMO GUILIZZONI (ITALY INDIVIDUAL)
VIA SAN DONATO 22
BOLOGNA, ITALY 40127

FOR: COMPUTER SOFTWARE FOR USE IN THE DESIGN AND DEVELOPMENT OF WEB SITES, APPLICATIONS AND COMPUTER SOFTWARE, IN CLASS 9 (U.S. CLS. 21, 23, 26, 36 AND 38).

FIRST USE 6-0-2008; IN COMMERCE 6-0-2008.

THE MARK CONSISTS OF STANDARD CHARACTERS WITHOUT CLAIM TO ANY PARTICULAR FONT, STYLE, SIZE, OR COLOR.

SER. NO. 85-309,313, FILED 5-1-2011.

COLLEEN KEARNEY, EXAMINING ATTORNEY



David J. Kybas

Director of the United States Patent and Trademark Office

United States of America

United States Patent and Trademark Office

NU-ECO

Reg. No. 4,067,004

Registered Dec. 6, 2011

Int. Cl.: 2

TRADEMARK

PRINCIPAL REGISTER

GREEN DYNAMICS LLC (COLORADO LIMITED LIABILITY COMPANY)
5545 W 56TH AVENUE, UNIT A
ARVADA, CO 80002

FOR: EXTERIOR PAINT; HOUSE PAINT; INTERIOR PAINT; PAINT PRIMERS; PAINTS FOR INTERIOR AND EXTERIOR BUILDINGS AND COMPONENTS; PRIMERS FOR PREPARING SURFACES TO BE PAINTED , IN CLASS 2 (U.S. CLS. 6, 11 AND 16).

FIRST USE 4-1-2011; IN COMMERCE 4-20-2011.

THE MARK CONSISTS OF STANDARD CHARACTERS WITHOUT CLAIM TO ANY PARTICULAR FONT, STYLE, SIZE, OR COLOR.

SER. NO. 85-309,320, FILED 5-1-2011.

JUSTINE D. PARKER, EXAMINING ATTORNEY



David J. Kybas

Director of the United States Patent and Trademark Office

United States of America

United States Patent and Trademark Office

AirTurn

Reg. No. 4,067,005

Registered Dec. 6, 2011

Int. Cl.: 9

TRADEMARK

PRINCIPAL REGISTER

AIRTURN, INC. (COLORADO CORPORATION)
2525 ARAPAHOE AVE. E4-451
BOULDER, CO 80302

FOR: COMPUTER HARDWARE FOR WIRELESS CONTENT DELIVERY; COMPUTER KEYBOARD CONTROLLERS; COMPUTER KEYBOARDS; COMPUTER SOFTWARE FOR WIRELESS CONTENT DELIVERY; COMPUTER SWITCHES; DEVICES FOR WIRELESS RADIO TRANSMISSION; ELECTRIC CIRCUIT SWITCHES; ELECTRIC CURRENT SWITCHES; ELECTRIC SWITCHES; ELECTRICAL SWITCHES; ELECTRONIC MOTION SENSITIVE SWITCHES; ELECTRONIC PROXIMITY SENSORS AND SWITCHES; ELECTRONIC TOUCH SENSITIVE SWITCHES; KEYBOARDS; SWITCH BOXES; WIRELESS ADAPTERS FOR COMPUTERS; WIRELESS COMPUTER MICE; WIRELESS COMPUTER PERIPHERALS; WIRELESS CONTROLLER TO MONITOR AND CONTROL THE FUNCTIONING OF OTHER ELECTRONIC DEVICES; WIRELESS PRESENTER IN THE NATURE OF A WIRELESS REMOTE POINTER; WIRELESS RECEIVERS AND TRANSMITTERS FOR PORTABLE MEDIA PLAYERS, IN CLASS 9 (U.S. CLS. 21, 23, 26, 36 AND 38).

FIRST USE 12-1-2008; IN COMMERCE 12-1-2008.

THE MARK CONSISTS OF STANDARD CHARACTERS WITHOUT CLAIM TO ANY PARTICULAR FONT, STYLE, SIZE, OR COLOR.

SER. NO. 85-309,345, FILED 5-1-2011.

ROSELLE HERRERA, EXAMINING ATTORNEY



David J. Kybas

Director of the United States Patent and Trademark Office

United States of America

United States Patent and Trademark Office

Somatica

Reg. No. 4,067,006

Registered Dec. 6, 2011

Int. Cls.: 41 and 45

SERVICE MARK

PRINCIPAL REGISTER

SOMATICA LLC (CALIFORNIA LIMITED LIABILITY COMPANY)
1548 BLACKHAWK DR.
SUNNYVALE, CA 94087

FOR: EDUCATION SERVICES, NAMELY, PROVIDING SEMINARS, CLASSES, TRAININGS, COACHING, AND WORKSHOPS IN THE FIELDS OF HUMAN SEXUALITY AND RELATIONSHIP; PERSONAL COACHING SERVICES IN THE FIELD OF HUMAN SEXUALITY AND RELATIONSHIP; PROVIDING GROUP COACHING IN THE FIELD OF HUMAN SEXUALITY AND RELATIONSHIP; PROVIDING ON-LINE TRAINING SEMINARS, CLASSES, TRAININGS, COACHING, AND WORKSHOPS IN THE FIELD OF HUMAN SEXUALITY AND RELATIONSHIP, IN CLASS 41 (U.S. CLS. 100, 101 AND 107).

FIRST USE 1-14-2010; IN COMMERCE 1-14-2010.

FOR: COUNSELING IN THE FIELD OF PERSONAL DEVELOPMENT, NAMELY, SELF-IMPROVEMENT, SELF-FULFILLMENT, AND INTERPERSONAL COMMUNICATION; MARRIAGE COUNSELING; PROVIDING COUNSELING AND INFORMATION IN THE FIELD OF IMPROVEMENT OF SOCIAL SKILLS, IN CLASS 45 (U.S. CLS. 100 AND 101).

FIRST USE 1-14-2010; IN COMMERCE 1-14-2010.

THE MARK CONSISTS OF STANDARD CHARACTERS WITHOUT CLAIM TO ANY PARTICULAR FONT, STYLE, SIZE, OR COLOR.

SER. NO. 85-309,347, FILED 5-1-2011.

TIMOTHY FINNEGAN, EXAMINING ATTORNEY



David J. Kyjars

Director of the United States Patent and Trademark Office

United States of America

United States Patent and Trademark Office



Reg. No. 4,067,007

Registered Dec. 6, 2011

Int. Cl.: 9

TRADEMARK

PRINCIPAL REGISTER

AIRTURN, INC. (COLORADO CORPORATION)
2525 ARAPAHOE AVE. E4-451
BOULDER, CO 80302

FOR: COMPUTER HARDWARE FOR WIRELESS CONTENT DELIVERY; COMPUTER KEYBOARD CONTROLLERS; COMPUTER KEYBOARDS; COMPUTER SOFTWARE FOR WIRELESS CONTENT DELIVERY; DEVICES FOR WIRELESS RADIO TRANSMISSION; ELECTRIC CIRCUIT SWITCHES; ELECTRIC CURRENT SWITCHES; ELECTRIC SWITCHES; ELECTRICAL SWITCHES; ELECTRONIC MOTION SENSITIVE SWITCHES; ELECTRONIC TOUCH SENSITIVE SWITCHES; KEYBOARDS; MULTIFUNCTION KEYBOARDS; SWITCH BOXES; WIRELESS ADAPTERS FOR COMPUTERS; WIRELESS COMPUTER MICE; WIRELESS COMPUTER PERIPHERALS; WIRELESS CONTROLLER TO MONITOR AND CONTROL THE FUNCTIONING OF OTHER ELECTRONIC DEVICES; WIRELESS PRESENTER IN THE NATURE OF A WIRELESS REMOTE POINTER; WIRELESS RECEIVERS AND TRANSMITTERS FOR PORTABLE MEDIA PLAYERS; WIRELESS TRANSCEIVER RADIO; WIRELESS TRANSMITTERS AND RECEIVERS, IN CLASS 9 (U.S. CLS. 21, 23, 26, 36 AND 38).

FIRST USE 12-1-2008; IN COMMERCE 12-1-2008.

THE MARK CONSISTS OF A BLUE LETTER "A" AND A GREEN LETTER "T" COMBINED IN THE SHAPE OF A 4-POINTED STAR.

THE COLOR(S) BLUE AND GREEN IS/ARE CLAIMED AS A FEATURE OF THE MARK.

SER. NO. 85-309,368, FILED 5-1-2011.

ROSELLE HERRERA, EXAMINING ATTORNEY



David J. Kybas

Director of the United States Patent and Trademark Office

United States of America

United States Patent and Trademark Office



Reg. No. 4,067,008

Registered Dec. 6, 2011

Int. Cl.: 37

SERVICE MARK

PRINCIPAL REGISTER

SAFE ZONE SHELTERS, INC. (VIRGINIA CORPORATION)
P.O. BOX 397
RUTHER GLEN, VA 22546

FOR: BUILDING CONSTRUCTION SERVICES, NAMELY, CONSTRUCTION OF STEEL AND FIBERGLASS STORM SHELTERS, HOME CONSTRUCTION, HOME RENOVATION, AND COMMERCIAL BUILD OUTS, IN CLASS 37 (U.S. CLS. 100, 103 AND 106).

FIRST USE 5-1-2008; IN COMMERCE 5-1-2008.

NO CLAIM IS MADE TO THE EXCLUSIVE RIGHT TO USE "SHELTERS INC.", APART FROM THE MARK AS SHOWN.

THE COLOR(S) YELLOW, WHITE AND BLACK IS/ARE CLAIMED AS A FEATURE OF THE MARK.

THE MARK CONSISTS OF THE LITERAL ELEMENTS "SAFE ZONE SHELTERS INC." WHEREIN THE WORDS "SHELTERS INC." WRITTEN ON A BLACK BROAD STRIP IN YELLOW COLOR SHOWING THE WORD "INC." IN THE UPPER RIGHT CORNER ARE BELOW THE WORDS "SAFE ZONE" WHICH ARE IN YELLOW COLOR WITH BLACK OUTLINE WITH A BLACK AND WHITE SWIRL SUPERIMPOSED ON THE LETTER "Z".

SER. NO. 85-309,391, FILED 5-2-2011.

LIEF MARTIN, EXAMINING ATTORNEY



David J. Kybas

Director of the United States Patent and Trademark Office

United States of America

United States Patent and Trademark Office

CF-SPEC

Reg. No. 4,067,009

Registered Dec. 6, 2011

Int. Cl.: 3

TRADEMARK

PRINCIPAL REGISTER

TURN3 CREATIVE, INC. (CALIFORNIA CORPORATION)
PO BOX 661476
ARCADIA, CA 910661476

FOR: AUTOMOBILE CLEANERS, IN CLASS 3 (U.S. CLS. 1, 4, 6, 50, 51 AND 52).

FIRST USE 4-18-2011; IN COMMERCE 4-18-2011.

THE MARK CONSISTS OF STANDARD CHARACTERS WITHOUT CLAIM TO ANY PARTICULAR FONT, STYLE, SIZE, OR COLOR.

SER. NO. 85-309,409, FILED 5-2-2011.

PRISCILLA MILTON, EXAMINING ATTORNEY



David J. Kybas

Director of the United States Patent and Trademark Office

United States of America

United States Patent and Trademark Office



Reg. No. 4,067,010

Registered Dec. 6, 2011

Int. Cl.: 22

TRADEMARK

PRINCIPAL REGISTER

FLEET WHOLESALE SUPPLY CO., INC. (WISCONSIN CORPORATION)
1300 SOUTH LYNNDALE DRIVE
APPLETON, WI 54912

FOR: UNFITTED LINERS FOR THE CARGO AREA OF VEHICLES IN THE NATURE OF A TARP, IN CLASS 22 (U.S. CLS. 1, 2, 7, 19, 22, 42 AND 50).

FIRST USE 12-28-2004; IN COMMERCE 12-28-2004.

OWNER OF U.S. REG. NOS. 2,566,746, 3,930,804 AND OTHERS.

THE MARK CONSISTS OF A DOG.

SER. NO. 85-309,432, FILED 5-2-2011.

KAREN K. BUSH, EXAMINING ATTORNEY



David J. Kybas

Director of the United States Patent and Trademark Office

United States of America

United States Patent and Trademark Office

patience

Reg. No. 4,067,011

Registered Dec. 6, 2011

Int. Cl.: 3

TRADEMARK

PRINCIPAL REGISTER

PATIENCE FOR LONG HAIR, INC. (NEW YORK CORPORATION)
P.O. BOX 3801071
BROOKLYN, NY 11238

FOR: HAIR CARE CREAMS; HAIR CARE LOTIONS; HAIR CARE PREPARATIONS; HAIR CLEANING PREPARATIONS; HAIR COLOR; HAIR COLOR REMOVERS; HAIR COLORANTS; HAIR CONDITIONERS; HAIR DRESSINGS FOR MEN; HAIR DRESSINGS FOR WOMEN; HAIR GEL; HAIR LOTION; HAIR NOURISHERS; HAIR OILS; HAIR POMADES; HAIR PRODUCTS, NAMELY, THICKENING CONTROL CREAMS; HAIR RELAXERS; HAIR RELAXING PREPARATIONS; HAIR REMOVING CREAM; HAIR SHAMPOOS AND CONDITIONERS; HAIR SHEEN SPRAY; HAIR STRAIGHTENING PREPARATIONS; HAIR STYLING PREPARATIONS; NON-MEDICATED HAIR TREATMENT PREPARATIONS FOR COSMETIC PURPOSES; OIL BATHS FOR HAIR CARE, IN CLASS 3 (U.S. CLS. 1, 4, 6, 50, 51 AND 52).

FIRST USE 5-1-2008; IN COMMERCE 5-1-2008.

THE MARK CONSISTS OF STANDARD CHARACTERS WITHOUT CLAIM TO ANY PARTICULAR FONT, STYLE, SIZE, OR COLOR.

SER. NO. 85-309,439, FILED 5-2-2011.

MARIA-VICTORIA SUAREZ, EXAMINING ATTORNEY



David J. Kybas

Director of the United States Patent and Trademark Office

United States of America

United States Patent and Trademark Office

Chile, Tomate, y Cebolla

Reg. No. 4,067,012

Registered Dec. 6, 2011

Int. Cl.: 41

SERVICE MARK

PRINCIPAL REGISTER

CROCODILE BROADCASTING CORP., INC. (LOUISIANA CORPORATION)
P.O. BOX 50790
NEW ORLEANS, LA 701500790

FOR: ENTERTAINMENT SERVICES, NAMELY, AN ON-GOING SERIES FEATURING REGIONAL MEXICAN MUSIC, ENTERTAINMENT, AND CURRENT EVENTS PROVIDED THROUGH RADIO AND WEBCAST, IN CLASS 41 (U.S. CLS. 100, 101 AND 107).

FIRST USE 1-1-2004; IN COMMERCE 1-1-2004.

THE MARK CONSISTS OF STANDARD CHARACTERS WITHOUT CLAIM TO ANY PARTICULAR FONT, STYLE, SIZE, OR COLOR.

THE ENGLISH TRANSLATION OF "CHILE, TOMATE, Y CEBOLLA" IN THE MARK IS "CHILE, TOMATO, AND ONION."

SER. NO. 85-309,442, FILED 5-2-2011.

MARIA-VICTORIA SUAREZ, EXAMINING ATTORNEY



David J. Kybas

Director of the United States Patent and Trademark Office

United States of America

United States Patent and Trademark Office

STOP BUYING TRANSPORTATION. PROCURE IT!

Reg. No. 4,067,013

Registered Dec. 6, 2011

Int. Cl.: 35

SERVICE MARK

PRINCIPAL REGISTER

BIRDDOG SOLUTIONS, INC. (NEVADA CORPORATION)
138 RIVER ROAD, SUITE 201
ANDOVER, MA 01820

FOR: TRANSPORTATION CONSULTING AND PROCUREMENT SERVICES, NAMELY, CONSULTING IN THE FIELDS OF TRANSPORTATION NEGOTIATION, PROCUREMENT, IMPLEMENTATION AND MONITORING; PROCUREMENT AND LOGISTICS SERVICES FOR OTHERS IN THE FIELD OF TRANSPORTATION, IN CLASS 35 (U.S. CLS. 100, 101 AND 102).

FIRST USE 4-22-2011; IN COMMERCE 4-22-2011.

THE MARK CONSISTS OF STANDARD CHARACTERS WITHOUT CLAIM TO ANY PARTICULAR FONT, STYLE, SIZE, OR COLOR.

SER. NO. 85-309,446, FILED 5-2-2011.

MARIA-VICTORIA SUAREZ, EXAMINING ATTORNEY



David J. Kybas

Director of the United States Patent and Trademark Office

United States of America

United States Patent and Trademark Office



Reg. No. 4,067,014

Registered Dec. 6, 2011

Int. Cl.: 36

SERVICE MARK

PRINCIPAL REGISTER

APLIN PEER & ASSOCIATES, INC. (FLORIDA CORPORATION)
3598 W. PROSPECT ROAD
FT. LAUDERDALE, FL 33309

FOR: CLAIMS ADJUSTMENT IN THE FIELD OF INSURANCE, IN CLASS 36 (U.S. CLS. 100, 101 AND 102).

FIRST USE 6-1-2003; IN COMMERCE 6-1-2003.

THE MARK CONSISTS OF AN OVAL SHAPE WITH DARK BACKGROUND WITH THE LETTERS "A" AND "P" SUPERIMPOSED THEREON.

SER. NO. 85-309,454, FILED 5-2-2011.

MARIA-VICTORIA SUAREZ, EXAMINING ATTORNEY



David J. Kybas

Director of the United States Patent and Trademark Office

United States of America

United States Patent and Trademark Office



Reg. No. 4,067,015

Registered Dec. 6, 2011

Int. Cl.: 36

SERVICE MARK

PRINCIPAL REGISTER

SUIT ALTERNATIVE INTERNATIONAL, INC. (FLORIDA CORPORATION)
3598 W. PROSPECT ROAD
FT. LAUDERDALE, FL 33309

FOR: APPRAISALS FOR INSURANCE CLAIMS OF PERSONAL PROPERTY AND REAL PROPERTY; INSURANCE CLAIM DISPUTE RESOLUTION SERVICES, IN CLASS 36 (U.S. CLS. 100, 101 AND 102).

FIRST USE 10-1-2005; IN COMMERCE 10-1-2005.

THE MARK CONSISTS OF AN OVAL SHAPE WITH DARK BACKGROUND WITH THE LETTERS "SAI" SUPERIMPOSED.

SER. NO. 85-309,460, FILED 5-2-2011.

MARIA-VICTORIA SUAREZ, EXAMINING ATTORNEY



David J. Kyffers

Director of the United States Patent and Trademark Office

United States of America

United States Patent and Trademark Office

BEARS CHOICE

Reg. No. 4,067,016

VILLAGRA, SANTIAGO JAVIER (ARGENTINA INDIVIDUAL)

Registered Dec. 6, 2011

LINIERS 1651 PB A

SAN ISIDRO - BS. AS., ARGENTINA 1642

Int. Cl.: 30

FOR: HONEY, IN CLASS 30 (U.S. CL. 46).

TRADEMARK

FIRST USE 4-1-2011; IN COMMERCE 4-1-2011.

PRINCIPAL REGISTER

THE MARK CONSISTS OF STANDARD CHARACTERS WITHOUT CLAIM TO ANY PARTICULAR FONT, STYLE, SIZE, OR COLOR.

SER. NO. 85-309,465, FILED 5-2-2011.

WILLIAM ROSSMAN, EXAMINING ATTORNEY



David J. Kyffers

Director of the United States Patent and Trademark Office

United States of America

United States Patent and Trademark Office



Reg. No. 4,067,017

Registered Dec. 6, 2011

Int. Cl.: 44

SERVICE MARK

PRINCIPAL REGISTER

KINDERMENDER, LLC (MARYLAND LIMITED LIABILITY COMPANY)
10609 HARPOON HILL
COLUMBIA, MD 21044

FOR: MEDICAL SERVICES, IN CLASS 44 (U.S. CLS. 100 AND 101).

FIRST USE 9-8-2010; IN COMMERCE 4-22-2011.

NO CLAIM IS MADE TO THE EXCLUSIVE RIGHT TO USE "WALK-IN PEDIATRIC CENTER", APART FROM THE MARK AS SHOWN.

THE COLOR(S) ORANGE, YELLOW, PURPLE, GREEN, BLUE, RED, BROWN AND GRAY IS/ARE CLAIMED AS A FEATURE OF THE MARK.

THE MARK CONSISTS OF THE TERM "KINDER MENDER" ABOVE THE WORDS "WALK-IN PEDIATRIC CENTER", WITH AN UPPER CASE LETTER "K" IN RED, A LOWER CASE LETTER "I" IN YELLOW, A LOWER CASE LETTER "N" IN PURPLE, A LOWER CASE LETTER "D" IN GREEN, A LOWER CASE LETTER "E" IN BLUE, A LOWER CASE LETTER "R" IN RED, ALL ABOVE THE WORD "MENDER" IN BLUE LETTERS, SUCH WORDS APPEARING ABOVE THE TERM "WALK-IN PEDIATRIC CENTER" IN GRAY LETTERS, AND ALL WORDS APPEARING TO THE LEFT OF A BROWN TEDDY BEAR WEARING A GRAY STETHOSCOPE AROUND ITS NECK.

SER. NO. 85-309,468, FILED 5-2-2011.

JENNIFER VASQUEZ, EXAMINING ATTORNEY



David J. Kybas

Director of the United States Patent and Trademark Office

United States of America

United States Patent and Trademark Office

GOCAISA

Reg. No. 4,067,018

Registered Dec. 6, 2011

Int. Cl.: 3

TRADEMARK

PRINCIPAL REGISTER

JOHAN & JESSIE, LLC (VIRGINIA LIMITED LIABILITY COMPANY)
4019 GRAND ISLE DRIVE
CHESAPEAKE, VA 23323

FOR: AFTER SUN CREAMS; AFTER-SHAVE CREAMS; AFTER-SUN GELS; AFTER-SUN MILKS; AFTER-SUN OILS; AFTERSHAVE MOISTURISING CREAM; AGE SPOT REDUCING CREAMS; ALMOND MILK FOR COSMETIC PURPOSES; ALOE VERA GEL FOR COSMETIC PURPOSES; ANTI-AGING CREAM; ANTI-AGING CREAM CONTAINING A RETINOIC INGREDIENT NOT FOR MEDICAL PURPOSES; ANTI-AGING CREAMS; ANTI-FRECKLE CREAMS; ANTI-WRINKLE CREAM; ANTI-WRINKLE CREAMS; COSMETIC CREAMS; COSMETIC CREAMS FOR SKIN CARE; COSMETIC MASSAGE CREAMS; COSMETIC NOURISHING CREAMS; COSMETIC OILS; COSMETIC PREPARATIONS FOR BATH AND SHOWER; COSMETIC PREPARATIONS, NAMELY, FIRING LOTIONS; COSMETIC PREPARATIONS, NAMELY, SKIN BALSAMS; COSMETIC SOAPS; FACE AND BODY BEAUTY CREAMS; FACIAL CREAM; FACIAL CREAMS; HAIR CARE CREAMS; HAIR RINSES; HAIR SHAMPOO; HAIR SHAMPOOS AND CONDITIONERS; MOISTURIZING CREAMS; SHAMPOO-CONDITIONERS; SHAMPOOS, IN CLASS 3 (U.S. CLS. 1, 4, 6, 50, 51 AND 52).

FIRST USE 3-1-2010; IN COMMERCE 3-1-2010.

THE MARK CONSISTS OF STANDARD CHARACTERS WITHOUT CLAIM TO ANY PARTICULAR FONT, STYLE, SIZE, OR COLOR.

SER. NO. 85-309,505, FILED 5-2-2011.

WILLIAM ROSSMAN, EXAMINING ATTORNEY



David J. Kyros

Director of the United States Patent and Trademark Office

United States of America

United States Patent and Trademark Office

UncookMe

Reg. No. 4,067,019

Registered Dec. 6, 2011

Int. Cl.: 44

SERVICE MARK

PRINCIPAL REGISTER

IGLESIAS, TAMARA (UNITED STATES INDIVIDUAL)
17 MANOR DRIVE
MORRISTOWN, NJ 07960

FOR: CONDUCTING TELEPHONE AND IN-PERSON PERSONAL LIFESTYLE WELLNESS ASSESSMENTS; COUNSELING SERVICES IN THE FIELDS OF HEALTH, NUTRITION AND LIFESTYLE WELLNESS; DIETARY AND NUTRITIONAL GUIDANCE; FOOD NUTRITION CONSULTATION; NUTRITION COUNSELING; PROVIDING A WEB SITE FEATURING INFORMATION ON HEALTH AND NUTRITION; PROVIDING A WEBSITE FEATURING INFORMATION ABOUT HEALTH, WELLNESS AND NUTRITION; PROVIDING A WEBSITE FEATURING INFORMATION AND ADVICE IN THE FIELDS OF DIET, WEIGHT LOSS, DIET PLANNING AND LIFESTYLE WELLNESS; PROVIDING ASSISTANCE, FITNESS EVALUATION AND CONSULTATION TO CORPORATE CLIENTS TO HELP THEIR EMPLOYEES MAKE HEALTH, WELLNESS AND NUTRITIONAL CHANGES IN THEIR DAILY LIVING TO IMPROVE HEALTH; PROVIDING ASSISTANCE, FITNESS EVALUATION AND CONSULTATION TO INDIVIDUALS TO HELP THEM MAKE HEALTH, WELLNESS AND NUTRITIONAL CHANGES IN THEIR DAILY LIVING TO IMPROVE HEALTH; PROVIDING HEALTHY LIFESTYLE AND NUTRITION SERVICES, NAMELY, PERSONAL ASSESSMENTS, PERSONALIZED ROUTINES, MAINTENANCE SCHEDULES, AND COUNSELING; PROVIDING INFORMATION, NEWS AND COMMENTARY IN THE FIELD OF NUTRITION, HEALTH AND WELLNESS; WELLNESS AND HEALTH-RELATED CONSULTING SERVICES, IN CLASS 44 (U.S. CLS. 100 AND 101).

FIRST USE 1-1-2010; IN COMMERCE 1-1-2010.

THE MARK CONSISTS OF STANDARD CHARACTERS WITHOUT CLAIM TO ANY PARTICULAR FONT, STYLE, SIZE, OR COLOR.

SER. NO. 85-309,512, FILED 5-2-2011.

PRISCILLA MILTON, EXAMINING ATTORNEY



David J. Kyros

Director of the United States Patent and Trademark Office

United States of America

United States Patent and Trademark Office

BOOMBUSTOLOGY

Reg. No. 4,067,020

Registered Dec. 6, 2011

Int. Cl.: 41

SERVICE MARK

PRINCIPAL REGISTER

VIKRAM MANSHARAMANI (UNITED STATES INDIVIDUAL)
APARTMENT CPH01
20 CHAPEL STREET
BROOKLINE, MA 02446

FOR: EDUCATION SERVICES, NAMELY, PROVIDING CLASSES, SEMINARS, LECTURES, AND WORKSHOPS CONCERNING A MULTI-DISCIPLINARY APPROACH TO ADDRESSING DECISION-MAKING IN THE FACE OF UNCERTAINTY, IN CLASS 41 (U.S. CLS. 100, 101 AND 107).

FIRST USE 3-17-2011; IN COMMERCE 3-17-2011.

THE MARK CONSISTS OF STANDARD CHARACTERS WITHOUT CLAIM TO ANY PARTICULAR FONT, STYLE, SIZE, OR COLOR.

SER. NO. 85-309,545, FILED 5-2-2011.

CHRISTINE MARTIN, EXAMINING ATTORNEY



David J. Kybas

Director of the United States Patent and Trademark Office

United States of America

United States Patent and Trademark Office

CaféSpot

Reg. No. 4,067,021

Registered Dec. 6, 2011

Int. Cl.: 9

TRADEMARK

PRINCIPAL REGISTER

OMNI-WIFI, LLC (MAINE LIMITED LIABILITY COMPANY)
107 PINE HILL ROAD
BERWICK, ME 03901

FOR: APPARATUS FOR TRANSMISSION OF COMMUNICATION; COMPUTER HARDWARE, NAMELY, WIRELESS ACCESS POINT (WAP) DEVICES; WIRELESS COMMUNICATION DEVICES FOR VOICE, DATA OR IMAGE TRANSMISSION; WIRELESS TRANSMITTERS AND RECEIVERS, IN CLASS 9 (U.S. CLS. 21, 23, 26, 36 AND 38).

FIRST USE 3-1-2005; IN COMMERCE 3-1-2005.

THE MARK CONSISTS OF STANDARD CHARACTERS WITHOUT CLAIM TO ANY PARTICULAR FONT, STYLE, SIZE, OR COLOR.

SER. NO. 85-309,562, FILED 5-2-2011.

ERNEST SHOSHO, EXAMINING ATTORNEY



David J. Kybas

Director of the United States Patent and Trademark Office

United States of America

United States Patent and Trademark Office

CondoSpot

Reg. No. 4,067,022

Registered Dec. 6, 2011

Int. Cl.: 9

TRADEMARK

PRINCIPAL REGISTER

OMNI-WIFI, LLC (MAINE LIMITED LIABILITY COMPANY)
107 PINE HILL ROAD
BERWICK, ME 03901

FOR: APPARATUS FOR TRANSMISSION OF COMMUNICATION; COMPUTER HARDWARE, NAMELY, WIRELESS ACCESS POINT (WAP) DEVICES; WIRELESS COMMUNICATION DEVICES FOR VOICE, DATA OR IMAGE TRANSMISSION; WIRELESS TRANSMITTERS AND RECEIVERS, IN CLASS 9 (U.S. CLS. 21, 23, 26, 36 AND 38).

FIRST USE 7-1-2006; IN COMMERCE 7-1-2006.

THE MARK CONSISTS OF STANDARD CHARACTERS WITHOUT CLAIM TO ANY PARTICULAR FONT, STYLE, SIZE, OR COLOR.

SER. NO. 85-309,566, FILED 5-2-2011.

ERNEST SHOSHO, EXAMINING ATTORNEY



David J. Kyffers

Director of the United States Patent and Trademark Office

United States of America

United States Patent and Trademark Office

HotelSpot

Reg. No. 4,067,023

Registered Dec. 6, 2011

Int. Cl.: 9

TRADEMARK

PRINCIPAL REGISTER

OMNI-WIFI, LLC (MAINE LIMITED LIABILITY COMPANY)
107 PINE HILL ROAD
BERWICK, ME 03901

FOR: APPARATUS FOR TRANSMISSION OF COMMUNICATION; COMPUTER HARDWARE, NAMELY, WIRELESS ACCESS POINT (WAP) DEVICES; WIRELESS COMMUNICATION DEVICES FOR VOICE, DATA OR IMAGE TRANSMISSION; WIRELESS TRANSMITTERS AND RECEIVERS, IN CLASS 9 (U.S. CLS. 21, 23, 26, 36 AND 38).

FIRST USE 3-1-2005; IN COMMERCE 3-1-2005.

THE MARK CONSISTS OF STANDARD CHARACTERS WITHOUT CLAIM TO ANY PARTICULAR FONT, STYLE, SIZE, OR COLOR.

SER. NO. 85-309,571, FILED 5-2-2011.

ERNEST SHOSHO, EXAMINING ATTORNEY



David J. Kybas

Director of the United States Patent and Trademark Office

United States of America
United States Patent and Trademark Office

HouseSpot

Reg. No. 4,067,024

OMNI-WIFI, LLC (MAINE LIMITED LIABILITY COMPANY)
107 PINE HILL ROAD
BERWICK, ME 03901

Registered Dec. 6, 2011

Int. Cl.: 9

FOR: APPARATUS FOR TRANSMISSION OF COMMUNICATION; COMPUTER HARDWARE, NAMELY, WIRELESS ACCESS POINT (WAP) DEVICES; WIRELESS COMMUNICATION DEVICES FOR VOICE, DATA OR IMAGE TRANSMISSION; WIRELESS TRANSMITTERS AND RECEIVERS, IN CLASS 9 (U.S. CLS. 21, 23, 26, 36 AND 38).

TRADEMARK

PRINCIPAL REGISTER

FIRST USE 3-1-2007; IN COMMERCE 3-1-2007.

THE MARK CONSISTS OF STANDARD CHARACTERS WITHOUT CLAIM TO ANY PARTICULAR FONT, STYLE, SIZE, OR COLOR.

SER. NO. 85-309,575, FILED 5-2-2011.

ERNEST SHOSHO, EXAMINING ATTORNEY



David J. Kyros

Director of the United States Patent and Trademark Office

United States of America

United States Patent and Trademark Office

MarinaSpot

Reg. No. 4,067,025

Registered Dec. 6, 2011

Int. Cl.: 9

TRADEMARK

PRINCIPAL REGISTER

OMNI-WIFI, LLC (MAINE LIMITED LIABILITY COMPANY)
107 PINE HILL ROAD
BERWICK, ME 03901

FOR: APPARATUS FOR TRANSMISSION OF COMMUNICATION; COMPUTER HARDWARE, NAMELY, WIRELESS ACCESS POINT (WAP) DEVICES; WIRELESS COMMUNICATION DEVICES FOR VOICE, DATA OR IMAGE TRANSMISSION; WIRELESS TRANSMITTERS AND RECEIVERS, IN CLASS 9 (U.S. CLS. 21, 23, 26, 36 AND 38).

FIRST USE 6-1-2007; IN COMMERCE 6-1-2007.

THE MARK CONSISTS OF STANDARD CHARACTERS WITHOUT CLAIM TO ANY PARTICULAR FONT, STYLE, SIZE, OR COLOR.

SER. NO. 85-309,581, FILED 5-2-2011.

ERNEST SHOSHO, EXAMINING ATTORNEY



David J. Kyros

Director of the United States Patent and Trademark Office

United States of America

United States Patent and Trademark Office

ParkCampSpot

Reg. No. 4,067,026

OMNI-WIFI, LLC (MAINE LIMITED LIABILITY COMPANY)
107 PINE HILL ROAD
BERWICK, ME 03901

Registered Dec. 6, 2011

Int. Cl.: 9

FOR: APPARATUS FOR TRANSMISSION OF COMMUNICATION; COMPUTER HARDWARE, NAMELY, WIRELESS ACCESS POINT (WAP) DEVICES; WIRELESS COMMUNICATION DEVICES FOR VOICE, DATA OR IMAGE TRANSMISSION; WIRELESS TRANSMITTERS AND RECEIVERS, IN CLASS 9 (U.S. CLS. 21, 23, 26, 36 AND 38).

TRADEMARK

PRINCIPAL REGISTER

FIRST USE 6-1-2007; IN COMMERCE 6-1-2007.

THE MARK CONSISTS OF STANDARD CHARACTERS WITHOUT CLAIM TO ANY PARTICULAR FONT, STYLE, SIZE, OR COLOR.

SER. NO. 85-309,583, FILED 5-2-2011.

ERNEST SHOSHO, EXAMINING ATTORNEY



David J. Kyffers

Director of the United States Patent and Trademark Office

United States of America

United States Patent and Trademark Office

Jane in the Jungle

Reg. No. 4,067,027

Registered Dec. 6, 2011

Int. Cl.: 41

SERVICE MARK

PRINCIPAL REGISTER

SMITH, KELLY (UNITED STATES INDIVIDUAL)
31
6815 ACADEMY
HOUSTON, TX 77025

FOR: EDUCATIONAL AND ENTERTAINMENT SERVICES, NAMELY, PROVIDING MOTIVATIONAL SPEAKING SERVICES IN THE FIELD OF EMPOWERMENT AND SUCCESS, IN CLASS 41 (U.S. CLS. 100, 101 AND 107).

FIRST USE 1-0-2008; IN COMMERCE 1-0-2008.

THE MARK CONSISTS OF STANDARD CHARACTERS WITHOUT CLAIM TO ANY PARTICULAR FONT, STYLE, SIZE, OR COLOR.

SER. NO. 85-309,639, FILED 5-2-2011.

MARC LEIPZIG, EXAMINING ATTORNEY



David J. Kyffers

Director of the United States Patent and Trademark Office

United States of America
United States Patent and Trademark Office

SPREEMO

Reg. No. 4,067,028

Registered Dec. 6, 2011

Int. Cl.: 44

SERVICE MARK

PRINCIPAL REGISTER

TRIFIVE TECH, LLC (DELAWARE LIMITED LIABILITY COMPANY)
SPREEMO LLC
33-41 NEWARK STREET, SUITE 4A
HOBOKEN, NJ 07030

FOR: MEDICAL DIAGNOSTIC TESTING, MONITORING AND REPORTING SERVICES;
MEDICAL IMAGING SERVICES, IN CLASS 44 (U.S. CLS. 100 AND 101).

FIRST USE 4-4-2011; IN COMMERCE 4-4-2011.

THE MARK CONSISTS OF STANDARD CHARACTERS WITHOUT CLAIM TO ANY PARTICULAR FONT, STYLE, SIZE, OR COLOR.

SER. NO. 85-309,649, FILED 5-2-2011.

SOPHIA S. KIM, EXAMINING ATTORNEY



David J. Kybas

Director of the United States Patent and Trademark Office

United States of America

United States Patent and Trademark Office

LOVE IS RIGHT AROUND THE CORNER

Reg. No. 4,067,029

Registered Dec. 6, 2011

Int. Cl.: 45

SERVICE MARK

PRINCIPAL REGISTER

SUCCESSFULMATCH.COM (CALIFORNIA CORPORATION)
800 WEST EL CAMINO REAL, #180
MOUNTAIN VIEW, CA 94040

FOR: COMPUTER DATING AND INTRODUCTION SERVICES; INTERNET BASED SOCIAL NETWORKING, INTRODUCTION, AND DATING SERVICES, NAMELY, PROVIDING AN ON-LINE DATABASE OF PERSONAL ADS TO FACILITATE ON-LINE DATING AND INTRODUCTIONS AND INFORMATION REGARDING ON-LINE PERSONALS, SOCIAL INTRODUCTION AND SOCIAL NETWORKING ACTIVITIES AND SERVICES, IN CLASS 45 (U.S. CLS. 100 AND 101).

FIRST USE 4-29-2011; IN COMMERCE 4-29-2011.

THE MARK CONSISTS OF STANDARD CHARACTERS WITHOUT CLAIM TO ANY PARTICULAR FONT, STYLE, SIZE, OR COLOR.

SER. NO. 85-309,677, FILED 5-2-2011.

NICHOLAS ALTREE, EXAMINING ATTORNEY



David J. Kybas

Director of the United States Patent and Trademark Office

United States of America

United States Patent and Trademark Office

le Tour de Femme

Reg. No. 4,067,030

Registered Dec. 6, 2011

Int. Cl.: 36

SERVICE MARK

PRINCIPAL REGISTER

GRAB MY WHEEL, INC. (NORTH CAROLINA CORPORATION)
5611 YATES GARDEN LANE
RALEIGH, NC 27606

FOR: CHARITABLE FUND-RAISING SERVICES, NAMELY, SOLICITING DONATIONS FOR SELECTED CHARITABLE ORGANIZATIONS FROM SPONSORS AND PARTICIPANTS IN BICYCLING EVENTS, AND CHARITABLE FUNDRAISING SERVICES BY MEANS OF SELLING GOODS TO RAISE FUNDS, IN CLASS 36 (U.S. CLS. 100, 101 AND 102).

FIRST USE 3-25-2005; IN COMMERCE 3-25-2005.

THE MARK CONSISTS OF STANDARD CHARACTERS WITHOUT CLAIM TO ANY PARTICULAR FONT, STYLE, SIZE, OR COLOR.

NO CLAIM IS MADE TO THE EXCLUSIVE RIGHT TO USE "FEMME", APART FROM THE MARK AS SHOWN.

THE ENGLISH TRANSLATION OF "LE TOUR DE FEMME" IN THE MARK IS "THE TOUR OF WOMEN".

SER. NO. 85-309,697, FILED 5-2-2011.

DARRYL SPRUILL, EXAMINING ATTORNEY



David J. Kyffers

Director of the United States Patent and Trademark Office

United States of America
United States Patent and Trademark Office

QSalesData

Reg. No. 4,067,031

Registered Dec. 6, 2011

Int. Cl.: 9

TRADEMARK

PRINCIPAL REGISTER

GRUBOR SOLUTIONS, INC. (WISCONSIN CORPORATION)
13160 W. BURLEIGH RD.
BROOKFIELD, WI 53005

FOR: DOWNLOADABLE SOFTWARE FOR ALLOWING USERS TO LINK SALES SOFTWARE AND ACCOUNTING SOFTWARE TOGETHER, IN CLASS 9 (U.S. CLS. 21, 23, 26, 36 AND 38).

FIRST USE 11-1-2009; IN COMMERCE 11-1-2009.

THE MARK CONSISTS OF STANDARD CHARACTERS WITHOUT CLAIM TO ANY PARTICULAR FONT, STYLE, SIZE, OR COLOR.

SER. NO. 85-309,698, FILED 5-2-2011.

KRISTINA MORRIS, EXAMINING ATTORNEY



David J. Kybas

Director of the United States Patent and Trademark Office

United States of America

United States Patent and Trademark Office

DARTCO

Reg. No. 4,067,032

Registered Dec. 6, 2011

Int. Cls.: 12 and 37

TRADEMARK

SERVICE MARK

PRINCIPAL REGISTER

DARTCO TRANSMISSION SALES & SERVICE (CALIFORNIA CORPORATION)
4390 LONG RD.
COLUMBUS, IN 47203

FOR: LAND VEHICLE TRANSMISSIONS AND REPLACEMENT PARTS THEREOF, IN CLASS 12 (U.S. CLS. 19, 21, 23, 31, 35 AND 44).

FIRST USE 0-0-1978; IN COMMERCE 0-0-1978.

FOR: REBUILDING OF MOTOR VEHICLE PARTS AND EXCHANGE TRANSMISSIONS, IN CLASS 37 (U.S. CLS. 100, 103 AND 106).

FIRST USE 0-0-1978; IN COMMERCE 0-0-1978.

THE MARK CONSISTS OF STANDARD CHARACTERS WITHOUT CLAIM TO ANY PARTICULAR FONT, STYLE, SIZE, OR COLOR.

SER. NO. 85-309,721, FILED 5-2-2011.

BARBARA GAYNOR, EXAMINING ATTORNEY



David J. Kybas

Director of the United States Patent and Trademark Office

United States of America

United States Patent and Trademark Office

A.H.M.A.D.

Reg. No. 4,067,033

Registered Dec. 6, 2011

Int. Cl.: 41

SERVICE MARK

PRINCIPAL REGISTER

MAZBOUDI, AHMAD (LEBANON INDIVIDUAL)
260 MONTANA ST.
SAN FRANCISCO, CA 941122953

FOR: ENTERTAINMENT SERVICES, NAMELY, PROVIDING A WEB SITE FEATURING NON-DOWNLOADABLE MUSICAL PERFORMANCES, MUSICAL VIDEOS, RELATED FILM CLIPS, PHOTOGRAPHS, AND OTHER MULTIMEDIA MATERIALS FEATURING PERFORMANCES BY A MUSICAL GROUP; ENTERTAINMENT, NAMELY, LIVE MUSIC CONCERTS; PRODUCTION OF SOUND AND MUSIC VIDEO RECORDINGS, IN CLASS 41 (U.S. CLS. 100, 101 AND 107).

FIRST USE 1-24-1992; IN COMMERCE 1-24-1992.

THE MARK CONSISTS OF STANDARD CHARACTERS WITHOUT CLAIM TO ANY PARTICULAR FONT, STYLE, SIZE, OR COLOR.

SER. NO. 85-309,780, FILED 5-2-2011.

BARBARA GAYNOR, EXAMINING ATTORNEY



David J. Kyros

Director of the United States Patent and Trademark Office

United States of America

United States Patent and Trademark Office

LOVE STOUT

Reg. No. 4,067,034

Registered Dec. 6, 2011

Int. Cls.: 21, 25 and 32

TRADEMARK

PRINCIPAL REGISTER

YARDS BREWING COMPANY, LLC (PENNSYLVANIA LIMITED LIABILITY COMPANY)
901 N. DELAWARE AVENUE
PHILADELPHIA, PA 19123

FOR: DRINKING GLASSES, IN CLASS 21 (U.S. CLS. 2, 13, 23, 29, 30, 33, 40 AND 50).

FIRST USE 9-1-2010; IN COMMERCE 9-1-2010.

FOR: SHIRTS, IN CLASS 25 (U.S. CLS. 22 AND 39).

FIRST USE 9-1-2010; IN COMMERCE 9-1-2010.

FOR: BEER, ALE, LAGER, STOUT AND PORTER, IN CLASS 32 (U.S. CLS. 45, 46 AND 48).

FIRST USE 1-15-1997; IN COMMERCE 1-15-1997.

THE MARK CONSISTS OF STANDARD CHARACTERS WITHOUT CLAIM TO ANY PARTICULAR FONT, STYLE, SIZE, OR COLOR.

NO CLAIM IS MADE TO THE EXCLUSIVE RIGHT TO USE "STOUT", APART FROM THE MARK AS SHOWN.

SER. NO. 85-309,799, FILED 5-2-2011.

JAMES LOVELACE, EXAMINING ATTORNEY



David J. Kybas

Director of the United States Patent and Trademark Office

United States of America

United States Patent and Trademark Office

OLDE BARTHOLOMEW

Reg. No. 4,067,035

Registered Dec. 6, 2011

Int. Cl.: 32

TRADEMARK

PRINCIPAL REGISTER

YARDS BREWING COMPANY, LLC (PENNSYLVANIA LIMITED LIABILITY COMPANY)
901 N. DELAWARE AVENUE
PHILADELPHIA, PA 19123

FOR: BEER, IN CLASS 32 (U.S. CLS. 45, 46 AND 48).

FIRST USE 12-15-1995; IN COMMERCE 12-15-1995.

THE MARK CONSISTS OF STANDARD CHARACTERS WITHOUT CLAIM TO ANY PARTICULAR FONT, STYLE, SIZE, OR COLOR.

SER. NO. 85-309,803, FILED 5-2-2011.

JAMES LOVELACE, EXAMINING ATTORNEY



David J. Kybas

Director of the United States Patent and Trademark Office

United States of America

United States Patent and Trademark Office

TRUBBEL DE YARDS

Reg. No. 4,067,036

Registered Dec. 6, 2011

Int. Cl.: 32

TRADEMARK

PRINCIPAL REGISTER

YARDS BREWING COMPANY, LLC (PENNSYLVANIA LIMITED LIABILITY COMPANY)
901 N. DELAWARE AVENUE
PHILADELPHIA, PA 19123

FOR: BEER, ALE, LAGER, STOUT AND PORTER, IN CLASS 32 (U.S. CLS. 45, 46 AND 48).

FIRST USE 11-15-2001; IN COMMERCE 11-15-2001.

THE MARK CONSISTS OF STANDARD CHARACTERS WITHOUT CLAIM TO ANY PARTICULAR FONT, STYLE, SIZE, OR COLOR.

OWNER OF U.S. REG. NO. 2,200,071.

SER. NO. 85-309,806, FILED 5-2-2011.

JAMES LOVELACE, EXAMINING ATTORNEY



David J. Kybas

Director of the United States Patent and Trademark Office

United States of America

United States Patent and Trademark Office

be strong. be yourself.
believe.

Reg. No. 4,067,037

Registered Dec. 6, 2011

Int. Cl.: 9

TRADEMARK

PRINCIPAL REGISTER

RAMDASS, SOPHIA N. (UNITED STATES INDIVIDUAL)
316 GREENBRIAR BLVD.
POPLAR GROVE, IL 61065

FOR: MOUSEPADS, IN CLASS 9 (U.S. CLS. 21, 23, 26, 36 AND 38).

FIRST USE 12-1-2009; IN COMMERCE 7-31-2010.

THE MARK CONSISTS OF STANDARD CHARACTERS WITHOUT CLAIM TO ANY PARTICULAR FONT, STYLE, SIZE, OR COLOR.

SER. NO. 85-309,809, FILED 5-2-2011.

JAMES LOVELACE, EXAMINING ATTORNEY



David J. Kybas

Director of the United States Patent and Trademark Office

United States of America

United States Patent and Trademark Office

SOLIDARITY SLEEP OUT

Reg. No. 4,067,038

Registered Dec. 6, 2011

Int. Cls.: 35 and 36

SERVICE MARK

PRINCIPAL REGISTER

COVENANT HOUSE (NEW YORK CORPORATION)
5 PENN PLAZA, 3RD FLOOR
NEW YORK, NY 10001

FOR: PROMOTING PUBLIC AWARENESS OF YOUTH HOMELESSNESS, IN CLASS 35
(U.S. CLS. 100, 101 AND 102).

FIRST USE 3-31-2011; IN COMMERCE 3-31-2011.

FOR: CHARITABLE FUNDRAISING, IN CLASS 36 (U.S. CLS. 100, 101 AND 102).

FIRST USE 3-31-2011; IN COMMERCE 3-31-2011.

THE MARK CONSISTS OF STANDARD CHARACTERS WITHOUT CLAIM TO ANY PARTICULAR FONT, STYLE, SIZE, OR COLOR.

NO CLAIM IS MADE TO THE EXCLUSIVE RIGHT TO USE "SLEEP OUT", APART FROM THE MARK AS SHOWN.

SER. NO. 85-309,815, FILED 5-2-2011.

KRISTIN CARLSON, EXAMINING ATTORNEY



David J. Kybas

Director of the United States Patent and Trademark Office

United States of America

United States Patent and Trademark Office

THE NETTER PRESENTER

Reg. No. 4,067,039

Registered Dec. 6, 2011

Int. Cl.: 41

SERVICE MARK

PRINCIPAL REGISTER

ELSEVIER INC. (DELAWARE CORPORATION)
360 PARK AVENUE SOUTH
NEW YORK, NY 10010

FOR: ONLINE SEARCHABLE DATABASE OF ILLUSTRATIONS OF HUMAN ANATOMY FOR USE AS AN EDUCATIONAL AID BY INSTRUCTORS AT UNIVERSITIES AND MEDICAL SCHOOLS, IN CLASS 41 (U.S. CLS. 100, 101 AND 107).

FIRST USE 8-31-2006; IN COMMERCE 8-31-2006.

THE MARK CONSISTS OF STANDARD CHARACTERS WITHOUT CLAIM TO ANY PARTICULAR FONT, STYLE, SIZE, OR COLOR.

OWNER OF U.S. REG. NO. 3,075,058.

NO CLAIM IS MADE TO THE EXCLUSIVE RIGHT TO USE "PRESENTER", APART FROM THE MARK AS SHOWN.

SER. NO. 85-309,831, FILED 5-2-2011.

SAIMA MAKHDOOM, EXAMINING ATTORNEY



David J. Kyros

Director of the United States Patent and Trademark Office

United States of America

United States Patent and Trademark Office

toobalink

Reg. No. 4,067,040

Registered Dec. 6, 2011

Int. Cl.: 28

TRADEMARK

PRINCIPAL REGISTER

METRE IDEAS AND DESIGN, LLC (NEW YORK LIMITED LIABILITY COMPANY)
308 ATLANTIC AVENUE, #4
BROOKLYN, NY 11201

FOR: CONSTRUCTION TOYS; TOY BUILDING BLOCKS CAPABLE OF INTERCONNECTION;
TOY CONSTRUCTION SETS, IN CLASS 28 (U.S. CLS. 22, 23, 38 AND 50).

FIRST USE 1-29-2011; IN COMMERCE 1-29-2011.

THE MARK CONSISTS OF STANDARD CHARACTERS WITHOUT CLAIM TO ANY PARTICULAR FONT, STYLE, SIZE, OR COLOR.

SER. NO. 85-309,859, FILED 5-2-2011.

MATTHEW PAPPAS, EXAMINING ATTORNEY



David J. Kyffers

Director of the United States Patent and Trademark Office

United States of America

United States Patent and Trademark Office

QUINTESS COLLECTION

Reg. No. 4,067,041

Registered Dec. 6, 2011

Int. Cl.: 43

SERVICE MARK

PRINCIPAL REGISTER

CLUB HOLDINGS, LLC (DELAWARE LIMITED LIABILITY COMPANY)
SUITE 300
11101 WEST 120TH AVENUE
BROOMFIELD, CO 80021

FOR: VACATION CLUB SERVICES, NAMELY, PROVIDING TEMPORARY LODGING ACCOMMODATIONS; MEMBERSHIP CLUB SERVICES, NAMELY, PROVIDING ACCOMMODATIONS TO CLUB MEMBERS IN AFFILIATED CLUB-OWNED, OPERATED, LEASED OR SPONSORED VACATION HOMES; PROVIDING INFORMATION ABOUT VACATION CLUB TEMPORARY ACCOMMODATIONS OVER THE INTERNET, IN CLASS 43 (U.S. CLS. 100 AND 101).

FIRST USE 5-2-2011; IN COMMERCE 5-2-2011.

THE MARK CONSISTS OF STANDARD CHARACTERS WITHOUT CLAIM TO ANY PARTICULAR FONT, STYLE, SIZE, OR COLOR.

OWNER OF U.S. REG. NOS. 3,122,187 AND 3,972,038.

NO CLAIM IS MADE TO THE EXCLUSIVE RIGHT TO USE "COLLECTION", APART FROM THE MARK AS SHOWN.

THE WORDING "QUINTESS" HAS NO MEANING IN A FOREIGN LANGUAGE.

SER. NO. 85-309,868, FILED 5-2-2011.

BRIAN PINO, EXAMINING ATTORNEY



David J. Kyffers

Director of the United States Patent and Trademark Office

United States of America

United States Patent and Trademark Office

ADSESSION

Reg. No. 4,067,042

THE ABOVE NETWORK, LLC (DELAWARE CORPORATION)
450 SEVENTH AVENUE SUITE 2000
NEW YORK, NY 10123

Registered Dec. 6, 2011

Int. Cl.: 35

FOR: PROMOTING THE GOODS AND SERVICES OF OTHERS BY MEANS OF DISTRIBUTING ADVERTISING ON THE INTERNET, IN CLASS 35 (U.S. CLS. 100, 101 AND 102).

SERVICE MARK

FIRST USE 10-0-2010; IN COMMERCE 10-0-2010.

PRINCIPAL REGISTER

THE MARK CONSISTS OF STANDARD CHARACTERS WITHOUT CLAIM TO ANY PARTICULAR FONT, STYLE, SIZE, OR COLOR.

SER. NO. 85-309,876, FILED 5-2-2011.

HEATHER THOMPSON, EXAMINING ATTORNEY



David J. Kybas

Director of the United States Patent and Trademark Office

United States of America

United States Patent and Trademark Office

Cock-a-doodle Doughnuts

Reg. No. 4,067,043

Registered Dec. 6, 2011

Int. Cl.: 30

TRADEMARK

PRINCIPAL REGISTER

COCKADOODLE DOUGHNUTS LLC (WASHINGTON LIMITED LIABILITY COMPANY)
105 E FRONT STREET
PORT ANGELES, WA 98362

FOR: DOUGHNUTS, IN CLASS 30 (U.S. CL. 46).

FIRST USE 5-19-2007; IN COMMERCE 5-3-2008.

THE MARK CONSISTS OF STANDARD CHARACTERS WITHOUT CLAIM TO ANY PARTICULAR FONT, STYLE, SIZE, OR COLOR.

NO CLAIM IS MADE TO THE EXCLUSIVE RIGHT TO USE "DOUGHNUTS", APART FROM THE MARK AS SHOWN.

SER. NO. 85-309,882, FILED 5-2-2011.

ANDREA HACK, EXAMINING ATTORNEY



David J. Kybas

Director of the United States Patent and Trademark Office

United States of America

United States Patent and Trademark Office



Reg. No. 4,067,044

Registered Dec. 6, 2011

Int. Cl.: 42

SERVICE MARK

PRINCIPAL REGISTER

MARY MCDONALD INC. (CALIFORNIA CORPORATION)
9165 PHYLLIS STREET
LOS ANGELES, CA 90069

FOR: FASHION DESIGN CONSULTING SERVICES; FURNITURE DESIGN SERVICES; INTERIOR DESIGN SERVICES; LANDSCAPE LIGHTING DESIGN; NEW PRODUCT DESIGN SERVICES, IN CLASS 42 (U.S. CLS. 100 AND 101).

FIRST USE 1-1-2007; IN COMMERCE 1-1-2007.

THE MARK CONSISTS OF RINGS SURROUNDING THE LETTERS "M'S". TWO "M'S" ARE ON TOP OF EACH OTHER.

SER. NO. 85-309,924, FILED 5-2-2011.

CHRIS WELLS, EXAMINING ATTORNEY



David J. Kybas

Director of the United States Patent and Trademark Office

United States of America

United States Patent and Trademark Office

Mary McDonald

Reg. No. 4,067,045

Registered Dec. 6, 2011

Int. Cl.: 42

SERVICE MARK

PRINCIPAL REGISTER

MARY MCDONALD INC. (CALIFORNIA CORPORATION)
9165 PHYLLIS STREET
LOS ANGELES, CA 90069

FOR: FASHION DESIGN CONSULTING SERVICES; FURNITURE DESIGN SERVICES; INTERIOR DESIGN SERVICES; LANDSCAPE LIGHTING DESIGN; NEW PRODUCT DESIGN SERVICES, IN CLASS 42 (U.S. CLS. 100 AND 101).

FIRST USE 1-1-1985; IN COMMERCE 1-1-1985.

THE MARK CONSISTS OF STANDARD CHARACTERS WITHOUT CLAIM TO ANY PARTICULAR FONT, STYLE, SIZE, OR COLOR.

THE NAME SHOWN IN THE MARK IDENTIFIES A LIVING INDIVIDUAL WHOSE CONSENT IS OF RECORD.

SER. NO. 85-309,930, FILED 5-2-2011.

CHRIS WELLS, EXAMINING ATTORNEY



David J. Kybas

Director of the United States Patent and Trademark Office

United States of America

United States Patent and Trademark Office

Huge

Reg. No. 4,067,046

Registered Dec. 6, 2011

Int. Cl.: 35

SERVICE MARK

PRINCIPAL REGISTER

HUGE DEALS, LLC (FLORIDA LIMITED LIABILITY COMPANY)
C/O BRYN & ASSOCIATES, P.A.
2 SOUTH BISCAYNE BLVD., SUITE 2600
MIAMI, FL 331311815

FOR: OPERATING A WEBSITE FOR THE MARKETING OF THIRD-PARTY GOODS AND SERVICES BY PROVIDING COUPONS, REBATES, PRICE-COMPARISON INFORMATION, PRODUCT REVIEWS, DISCOUNT INFORMATION, AND LINKS TO THE RETAIL WEBSITES OF SAID THIRD-PARTY GOODS AND SERVICES, IN CLASS 35 (U.S. CLS. 100, 101 AND 102).

FIRST USE 4-13-2011; IN COMMERCE 4-13-2011.

THE MARK CONSISTS OF STANDARD CHARACTERS WITHOUT CLAIM TO ANY PARTICULAR FONT, STYLE, SIZE, OR COLOR.

SER. NO. 85-309,962, FILED 5-2-2011.

BRENDAN MCCAULEY, EXAMINING ATTORNEY



David J. Kybas

Director of the United States Patent and Trademark Office

United States of America

United States Patent and Trademark Office

IN-HEAT WHEAT

Reg. No. 4,067,047

Registered Dec. 6, 2011

Int. Cl.: 32

FLYING DOG BREWERY, LLLP (COLORADO LIMITED LIABILITY LIMITED
PARTNERSHIP)
SUITE 104
2330 BROADWAY
DENVER, CO 80205

TRADEMARK

FOR: BREWED MALT-BASED ALCOHOLIC BEVERAGE IN THE NATURE OF A BEER, IN
CLASS 32 (U.S. CLS. 45, 46 AND 48).

PRINCIPAL REGISTER

FIRST USE 8-0-2001; IN COMMERCE 8-0-2001.

THE MARK CONSISTS OF STANDARD CHARACTERS WITHOUT CLAIM TO ANY PAR-
TICULAR FONT, STYLE, SIZE, OR COLOR.

NO CLAIM IS MADE TO THE EXCLUSIVE RIGHT TO USE "WHEAT", APART FROM THE
MARK AS SHOWN.

SER. NO. 85-309,974, FILED 5-2-2011.

ODESSA BIBBINS, EXAMINING ATTORNEY



David J. Kyffers

Director of the United States Patent and Trademark Office

United States of America

United States Patent and Trademark Office

TREESTORY

Reg. No. 4,067,048

Registered Dec. 6, 2011

Int. Cl.: 35

SERVICE MARK

PRINCIPAL REGISTER

SILBER, JERE (UNITED STATES INDIVIDUAL), DBA MORGAN'S MAGICAL BOOKS & MUCH MORE
4245 SANDCASTLE LANE
OLNEY, MD 20832

FOR: ONLINE AND MAIL ORDER RETAIL STORE SERVICES FEATURING BOOKS, AUDIO TAPES, VIDEO TAPES, INTERACTIVE COMPACT DISCS, MULTIMEDIA PRODUCTS, PRINTED MATTER AND CLOTHING, IN CLASS 35 (U.S. CLS. 100, 101 AND 102).

FIRST USE 3-11-2001; IN COMMERCE 3-11-2001.

THE MARK CONSISTS OF STANDARD CHARACTERS WITHOUT CLAIM TO ANY PARTICULAR FONT, STYLE, SIZE, OR COLOR.

SER. NO. 85-309,979, FILED 5-2-2011.

DAVID I, EXAMINING ATTORNEY



David J. Kyros

Director of the United States Patent and Trademark Office

United States of America

United States Patent and Trademark Office

REUMA-ART

Reg. No. 4,067,049

Registered Dec. 6, 2011

Int. Cl.: 5

TRADEMARK

PRINCIPAL REGISTER

FULL LIFE NATURAL HEALTH PRODUCTS, LLC (FLORIDA LIMITED LIABILITY COMPANY)
1932 HOLLYWOOD BLVD.
HOLLYWOOD, FL 33020

FOR: NATURAL PRODUCT FOR THE TREATMENT OF PAIN, NAMELY, DIETARY SUPPLEMENTS, IN CLASS 5 (U.S. CLS. 6, 18, 44, 46, 51 AND 52).

FIRST USE 10-17-2007; IN COMMERCE 10-17-2007.

THE MARK CONSISTS OF STANDARD CHARACTERS WITHOUT CLAIM TO ANY PARTICULAR FONT, STYLE, SIZE, OR COLOR.

OWNER OF U.S. REG. NO. 3,778,722.

SER. NO. 85-309,999, FILED 5-2-2011.

DAVID I, EXAMINING ATTORNEY



David J. Kyros

Director of the United States Patent and Trademark Office

United States of America

United States Patent and Trademark Office

TO KNOW JOY

Reg. No. 4,067,050

Registered Dec. 6, 2011

Int. Cl.: 41

SERVICE MARK

PRINCIPAL REGISTER

TO KNOW JOY, INC. (MISSOURI CORPORATION)
601 CEDAR FALLS COURT
RAYMORE, MO 64083

FOR: LIFE COACHING SERVICES IN THE FIELD OF PERSONAL AND PROFESSIONAL PLANNING, GROWTH, DEVELOPMENT, AND IMPROVEMENT; EDUCATIONAL SERVICES, NAMELY, CONDUCTING INDIVIDUALIZED AND GROUP PROGRAMS, CLASSES, WORKSHOPS AND SEMINARS IN THE FIELD OF PERSONAL AND PROFESSIONAL PLANNING, GROWTH, DEVELOPMENT, AND IMPROVEMENT, IN CLASS 41 (U.S. CLS. 100, 101 AND 107).

FIRST USE 5-31-2010; IN COMMERCE 5-31-2010.

THE MARK CONSISTS OF STANDARD CHARACTERS WITHOUT CLAIM TO ANY PARTICULAR FONT, STYLE, SIZE, OR COLOR.

SER. NO. 85-310,058, FILED 5-2-2011.

CAROLINE WOOD, EXAMINING ATTORNEY



David J. Kyffers

Director of the United States Patent and Trademark Office

United States of America
United States Patent and Trademark Office

Womaid

Reg. No. 4,067,051

Registered Dec. 6, 2011

Int. Cl.: 5

TRADEMARK

PRINCIPAL REGISTER

GREENSIDE, S.A. DE C.V. (MEXICO SOCIEDAD ANONIMA (SA DE CV))
CALLE BARBADILLO 416 NTE., CENTRO
GUADALUPE, NUEVO LEÓN, MEXICO 67100

FOR: CALCIUM SUPPLEMENTS; DIETARY AND NUTRITIONAL SUPPLEMENTS; HERBAL DRINKS USED TO AID IN SLEEP AND RELAXATION; HERBAL PILLS FOR DIABETICS; HERBAL PRODUCTS, NAMELY, AROMATHERAPY PACKS CONTAINING HERBS USED FOR RELIEF FROM HEADACHES, INSOMNIA AND SINUS DISCOMFORT; HERBAL SUPPLEMENTS; HERBAL SUPPLEMENTS FOR SLEEPING PROBLEMS; HERBAL TEAS FOR MEDICINAL PURPOSES; MEDICINAL HERBAL EXTRACTS FOR MEDICAL PURPOSES; MEDICINAL HERBAL PREPARATIONS; MEDICINAL TEA; NATURAL HERBAL SUPPLEMENTS; VITAMIN AND MINERAL SUPPLEMENTS, IN CLASS 5 (U.S. CLS. 6, 18, 44, 46, 51 AND 52).

FIRST USE 3-2-2011; IN COMMERCE 4-15-2011.

THE MARK CONSISTS OF THE LITERAL ELEMENT "WOMAID" WITH STYLIZED LETTERS.

SER. NO. 85-310,065, FILED 5-2-2011.

STEVEN R. FINE, EXAMINING ATTORNEY



David J. Kyros

Director of the United States Patent and Trademark Office

United States of America

United States Patent and Trademark Office



Quintess Collection

Reg. No. 4,067,052

Registered Dec. 6, 2011

Int. Cl.: 43

SERVICE MARK

PRINCIPAL REGISTER

CLUB HOLDINGS, LLC (DELAWARE LIMITED LIABILITY COMPANY)
SUITE 300
11101 WEST 120TH AVENUE
BROOMFIELD, CO 80021

FOR: VACATION CLUB SERVICES, NAMELY, PROVIDING TEMPORARY LODGING ACCOMMODATIONS; MEMBERSHIP CLUB SERVICES, NAMELY, PROVIDING ACCOMMODATIONS TO CLUB MEMBERS IN AFFILIATED CLUB-OWNED, OPERATED, LEASED OR SPONSORED VACATION HOMES; PROVIDING INFORMATION ABOUT VACATION CLUB TEMPORARY ACCOMMODATIONS OVER THE INTERNET, IN CLASS 43 (U.S. CLS. 100 AND 101).

FIRST USE 5-2-2011; IN COMMERCE 5-2-2011.

OWNER OF U.S. REG. NOS. 3,122,187 AND 3,972,038.

NO CLAIM IS MADE TO THE EXCLUSIVE RIGHT TO USE "COLLECTION", APART FROM THE MARK AS SHOWN.

THE MARK CONSISTS OF A STYLIZED LETTER "Q" ABOVE THE WORDS "QUINTESS COLLECTION" IN A STYLIZED FONT.

THE WORDING "QUINTESS" HAS NO MEANING IN A FOREIGN LANGUAGE.

SER. NO. 85-310,109, FILED 5-2-2011.

BRIAN PINO, EXAMINING ATTORNEY



David J. Kyffers

Director of the United States Patent and Trademark Office

United States of America

United States Patent and Trademark Office

WHAT'S IN YOUR TACO?

Reg. No. 4,067,053

Registered Dec. 6, 2011

Int. Cl.: 25

TRADEMARK

PRINCIPAL REGISTER

FUZZY'S TACO HOLDINGS, LLC (TEXAS LIMITED LIABILITY COMPANY)
SUITE 100
200 BAILEY AVENUE
FORT WORTH, TX 76107

FOR: CLOTHING, NAMELY, T-SHIRTS, SWEATSHIRTS, HOODED SWEATSHIRTS, JACKETS, SHIRTS; HEADWEAR, NAMELY CAPS, HATS, SCARVES AND BANDANAS , IN CLASS 25 (U.S. CLS. 22 AND 39).

FIRST USE 4-25-2011; IN COMMERCE 4-25-2011.

THE MARK CONSISTS OF STANDARD CHARACTERS WITHOUT CLAIM TO ANY PARTICULAR FONT, STYLE, SIZE, OR COLOR.

SER. NO. 85-310,117, FILED 5-2-2011.

KATHLEEN LORENZO, EXAMINING ATTORNEY



David J. Kybas

Director of the United States Patent and Trademark Office

United States of America

United States Patent and Trademark Office

UNWRAPPING THE BOX

Reg. No. 4,067,054

Registered Dec. 6, 2011

Int. Cl.: 36

SERVICE MARK

PRINCIPAL REGISTER

NEUBERGER BERMAN GROUP LLC (DELAWARE LIMITED LIABILITY COMPANY)
605 THIRD AVENUE
NEW YORK, NY 10158

FOR: FINANCIAL SERVICES, NAMELY, INVESTMENT ADVISORY, INVESTMENT MANAGEMENT, ASSET MANAGEMENT, PORTFOLIO MANAGEMENT, INVESTMENT BROKERAGE, SECURITIES BROKERAGE, INVESTMENT CONSULTATION, WEALTH MANAGEMENT, AND FINANCIAL PLANNING SERVICES; FINANCIAL AND INVESTMENT SERVICES, NAMELY, INVESTMENT ADVISORY AND INVESTMENT MANAGEMENT AND BROKERAGE OF SECURITIES, HEDGE FUNDS, PRIVATE EQUITY FUNDS, WRAP FEE PROGRAMS, SEPARATE ACCOUNTS, VARIABLE ANNUITY PROGRAMS, STOCKS, BONDS, COMMODITIES, DERIVATIVES AND DEBT INVESTMENT, AND LIMITED PARTNERSHIPS; FINANCIAL SERVICES, NAMELY, FINANCIAL RESEARCH, FINANCIAL ANALYSIS, CONSULTATION, RECORD KEEPING AND INFORMATION SERVICES, TRANSFER AGENT SERVICES, CUSTODIAN SERVICES, MANAGEMENT AND INVESTMENT OF FUNDS AND ASSETS OF OTHERS, CAPITAL INVESTMENT SERVICES, AND FINANCIAL TRANSACTION SERVICES; FINANCIAL SERVICES, NAMELY, MUTUAL FUND ADVISORY AND INVESTMENT MANAGEMENT SERVICES, MUTUAL FUND DISTRIBUTION SERVICES, MUTUAL FUND UNDERWRITING AND ADMINISTRATION SERVICES, AND VARIABLE ANNUITIES INVESTMENT SERVICES, IN CLASS 36 (U.S. CLS. 100, 101 AND 102).

FIRST USE 4-1-2002; IN COMMERCE 4-1-2002.

THE MARK CONSISTS OF STANDARD CHARACTERS WITHOUT CLAIM TO ANY PARTICULAR FONT, STYLE, SIZE, OR COLOR.

SER. NO. 85-310,120, FILED 5-2-2011.

RICHARD WHITE, EXAMINING ATTORNEY



David J. Kyros

Director of the United States Patent and Trademark Office

United States of America

United States Patent and Trademark Office

WHAT'S IN YOUR TACO?

Reg. No. 4,067,055

Registered Dec. 6, 2011

Int. Cl.: 43

SERVICE MARK

PRINCIPAL REGISTER

FUZZY'S TACO HOLDINGS, LLC (TEXAS LIMITED LIABILITY COMPANY)
SUITE 100
200 BAILEY AVENUE
FORT WORTH, TX 76107

FOR: RESTAURANT AND CATERING SERVICES, IN CLASS 43 (U.S. CLS. 100 AND 101).

FIRST USE 1-6-2010; IN COMMERCE 1-6-2010.

THE MARK CONSISTS OF STANDARD CHARACTERS WITHOUT CLAIM TO ANY PARTICULAR FONT, STYLE, SIZE, OR COLOR.

SER. NO. 85-310,132, FILED 5-2-2011.

KATHLEEN LORENZO, EXAMINING ATTORNEY



David J. Kybas

Director of the United States Patent and Trademark Office

United States of America

United States Patent and Trademark Office

ORION

Reg. No. 4,067,056

Registered Dec. 6, 2011

Int. Cl.: 9

TRADEMARK

PRINCIPAL REGISTER

NAVAJO MANUFACTURING COMPANY (COLORADO CORPORATION)
5330 FOX STREET
DENVER, CO 80216

FOR: SUNGLASSES, IN CLASS 9 (U.S. CLS. 21, 23, 26, 36 AND 38).

FIRST USE 0-0-1996; IN COMMERCE 0-0-1996.

THE MARK CONSISTS OF STANDARD CHARACTERS WITHOUT CLAIM TO ANY PARTICULAR FONT, STYLE, SIZE, OR COLOR.

SER. NO. 85-310,138, FILED 5-2-2011.

ROBIN CHOSID, EXAMINING ATTORNEY



David J. Kybas

Director of the United States Patent and Trademark Office

United States of America

United States Patent and Trademark Office

DOOR-MART

Reg. No. 4,067,057

Registered Dec. 6, 2011

Int. Cl.: 37

SERVICE MARK

PRINCIPAL REGISTER

PAM MARTIN ENTERPRISES, INC. (CALIFORNIA CORPORATION)
11286 PYRITES WAY
RANCHO CORDOVA, CA 95670

FOR: INSTALLATION, MAINTENANCE AND REPAIR OF GARAGE DOORS, GARAGE DOOR OPENERS AND ACCESSORIES, IN CLASS 37 (U.S. CLS. 100, 103 AND 106).

FIRST USE 9-0-1992; IN COMMERCE 9-0-1992.

THE MARK CONSISTS OF STANDARD CHARACTERS WITHOUT CLAIM TO ANY PARTICULAR FONT, STYLE, SIZE, OR COLOR.

SER. NO. 85-310,140, FILED 5-2-2011.

DAVID HOFFMAN, EXAMINING ATTORNEY



David J. Kyffers

Director of the United States Patent and Trademark Office

United States of America

United States Patent and Trademark Office

UNWRAPPING THE STYLE BOX

Reg. No. 4,067,058

Registered Dec. 6, 2011

Int. Cl.: 36

SERVICE MARK

PRINCIPAL REGISTER

NEUBERGER BERMAN GROUP LLC (DELAWARE LIMITED LIABILITY COMPANY)
605 THIRD AVENUE
NEW YORK, NY 10158

FOR: FINANCIAL SERVICES, NAMELY, INVESTMENT ADVISORY, INVESTMENT MANAGEMENT, ASSET MANAGEMENT, PORTFOLIO MANAGEMENT, INVESTMENT BROKERAGE, SECURITIES BROKERAGE, INVESTMENT CONSULTATION, WEALTH MANAGEMENT, AND FINANCIAL PLANNING SERVICES; FINANCIAL AND INVESTMENT SERVICES, NAMELY, INVESTMENT ADVISORY AND INVESTMENT MANAGEMENT AND BROKERAGE OF SECURITIES, HEDGE FUNDS, PRIVATE EQUITY FUNDS, WRAP FEE PROGRAMS, SEPARATE ACCOUNTS, VARIABLE ANNUITY PROGRAMS, STOCKS, BONDS, COMMODITIES, DERIVATIVES AND DEBT INVESTMENT, AND LIMITED PARTNERSHIPS; FINANCIAL SERVICES, NAMELY, FINANCIAL RESEARCH, FINANCIAL ANALYSIS, CONSULTATION, RECORD KEEPING AND INFORMATION SERVICES, TRANSFER AGENT SERVICES, CUSTODIAN SERVICES, MANAGEMENT AND INVESTMENT OF FUNDS AND ASSETS OF OTHERS, CAPITAL INVESTMENT SERVICES, AND FINANCIAL TRANSACTION SERVICES; FINANCIAL SERVICES, NAMELY, MUTUAL FUND ADVISORY AND INVESTMENT MANAGEMENT SERVICES, MUTUAL FUND DISTRIBUTION SERVICES, MUTUAL FUND UNDERWRITING AND ADMINISTRATION SERVICES, AND VARIABLE ANNUITIES INVESTMENT SERVICES, IN CLASS 36 (U.S. CLS. 100, 101 AND 102).

FIRST USE 4-1-2002; IN COMMERCE 4-1-2002.

THE MARK CONSISTS OF STANDARD CHARACTERS WITHOUT CLAIM TO ANY PARTICULAR FONT, STYLE, SIZE, OR COLOR.

NO CLAIM IS MADE TO THE EXCLUSIVE RIGHT TO USE "STYLE BOX", APART FROM THE MARK AS SHOWN.

SER. NO. 85-310,147, FILED 5-2-2011.

RICHARD WHITE, EXAMINING ATTORNEY



David J. Kyffers

Director of the United States Patent and Trademark Office

United States of America

United States Patent and Trademark Office

PARABLE AGENCY

Reg. No. 4,067,059

Registered Dec. 6, 2011

Int. Cls.: 35 and 42

SERVICE MARK

PRINCIPAL REGISTER

THE PARABLE GROUP, INC. (CALIFORNIA CORPORATION)
3563 EMPLEO STREET
SAN LUIS OBISPO, CA 93401

FOR: BUSINESS MARKETING CONSULTING SERVICES; CONSULTING SERVICES IN THE FIELD OF INTERNET MARKETING; DISSEMINATION OF ADVERTISING FOR OTHERS VIA THE INTERNET; MARKET RESEARCH SERVICES; ORDER FULFILLMENT SERVICES, IN CLASS 35 (U.S. CLS. 100, 101 AND 102).

FIRST USE 8-16-2010; IN COMMERCE 8-16-2010.

FOR: COMPUTER SERVICES, NAMELY, CREATING AND MAINTAINING WEB SITES FOR OTHERS; COMPUTER SERVICES, NAMELY, DESIGNING AND IMPLEMENTING WEB SITES FOR OTHERS; CONSULTING SERVICES IN THE FIELD OF IDENTIFICATION, SUPPORT, AND IMPLEMENTATION OF COMPUTER-BASED INFORMATION SYSTEMS FOR BUSINESSES; DATABASE DESIGN AND DEVELOPMENT, IN CLASS 42 (U.S. CLS. 100 AND 101).

FIRST USE 8-16-2010; IN COMMERCE 8-16-2010.

THE MARK CONSISTS OF STANDARD CHARACTERS WITHOUT CLAIM TO ANY PARTICULAR FONT, STYLE, SIZE, OR COLOR.

OWNER OF U.S. REG. NO. 2,552,342.

NO CLAIM IS MADE TO THE EXCLUSIVE RIGHT TO USE "AGENCY", APART FROM THE MARK AS SHOWN.

SER. NO. 85-310,150, FILED 5-2-2011.

INGRID C. EULIN, EXAMINING ATTORNEY



David J. Kyros

Director of the United States Patent and Trademark Office

United States of America

United States Patent and Trademark Office

PARISI

Reg. No. 4,067,060

Registered Dec. 6, 2011

Int. Cl.: 30

TRADEMARK

PRINCIPAL REGISTER

PARIS BROTHERS, INC. (MISSOURI CORPORATION)
8800 N.E. UNDERGROUND DRIVE
KANSAS CITY, MO 64161

FOR: COFFEE; ROASTED COFFEE BEANS AND TEA, IN CLASS 30 (U.S. CL. 46).

FIRST USE 8-0-2005; IN COMMERCE 8-0-2005.

THE MARK CONSISTS OF STANDARD CHARACTERS WITHOUT CLAIM TO ANY PARTICULAR FONT, STYLE, SIZE, OR COLOR.

OWNER OF U.S. REG. NOS. 3,328,086 AND 3,350,540.

SEC. 2(F).

SER. NO. 85-310,197, FILED 5-2-2011.

ERNEST SHOSHO, EXAMINING ATTORNEY



David J. Kybas

Director of the United States Patent and Trademark Office

United States of America

United States Patent and Trademark Office

Vanishing Red

Reg. No. 4,067,061

Registered Dec. 6, 2011

Int. Cl.: 41

SERVICE MARK

PRINCIPAL REGISTER

CHRISTOPHER WILZBACH (UNITED STATES INDIVIDUAL)
6111 EL ESCORPION RD.
WOODLAND HILLS, CA 91367

FOR: ENTERTAINMENT IN THE NATURE OF LIVE PERFORMANCES BY A MUSICAL GROUP; ENTERTAINMENT SERVICES, NAMELY, PROVIDING A WEB SITE FEATURING NON-DOWNLOADABLE MUSICAL PERFORMANCES, MUSICAL VIDEOS, RELATED FILM CLIPS, PHOTOGRAPHS, AND OTHER MULTIMEDIA MATERIALS FEATURING THE MUSICAL BAND VANISHING RED AND IT'S GROUP MEMBERS; PRODUCTION OF MUSICAL SOUND RECORDING; PRODUCTION OF SOUND AND MUSIC VIDEO RECORDINGS, IN CLASS 41 (U.S. CLS. 100, 101 AND 107).

FIRST USE 1-4-2010; IN COMMERCE 4-1-2011.

THE MARK CONSISTS OF STANDARD CHARACTERS WITHOUT CLAIM TO ANY PARTICULAR FONT, STYLE, SIZE, OR COLOR.

SER. NO. 85-310,222, FILED 5-2-2011.

ERNEST SHOSHO, EXAMINING ATTORNEY



David J. Kyffers

Director of the United States Patent and Trademark Office

United States of America

United States Patent and Trademark Office

MAPSNESHOP

Reg. No. 4,067,062

Registered Dec. 6, 2011

Int. Cl.: 35

SERVICE MARK

PRINCIPAL REGISTER

ECZELL CORPORATION (ILLINOIS CORPORATION)
1924 GEORGETOWN LN.
HOFFMAN ESTATES, IL 60169

FOR: ONLINE BUSINESS NETWORKING SERVICES; PROVIDING BUSINESS NETWORKING SERVICES AND INFORMATION RELATING TO BUSINESSES, NAMELY, INFORMATION RELATING TO GOODS/SERVICES AND LOCATIONS OF BUSINESSES, IN CLASS 35 (U.S. CLS. 100, 101 AND 102).

FIRST USE 1-15-2011; IN COMMERCE 1-15-2011.

THE MARK CONSISTS OF STANDARD CHARACTERS WITHOUT CLAIM TO ANY PARTICULAR FONT, STYLE, SIZE, OR COLOR.

SER. NO. 85-310,229, FILED 5-2-2011.

KATHY DE JONGE, EXAMINING ATTORNEY



David J. Kybas

Director of the United States Patent and Trademark Office

United States of America

United States Patent and Trademark Office

BADfortheBRAND

Reg. No. 4,067,063

Registered Dec. 6, 2011

Int. Cl.: 45

SERVICE MARK

PRINCIPAL REGISTER

FITZGARRALD, JONATHAN (UNITED STATES INDIVIDUAL)
21 FL
1900 AVENUE OF THE STARS
LOS ANGELES, CA 90067

FOR: PERSONAL IMAGE CONSULTING SERVICES; PERSONAL IMAGE DEVELOPMENT CONSULTATION; PROVIDING INFORMATION IN THE FIELD OF PERSONAL IMAGE DEVELOPMENT , IN CLASS 45 (U.S. CLS. 100 AND 101).

FIRST USE 3-22-2011; IN COMMERCE 3-22-2011.

THE MARK CONSISTS OF STANDARD CHARACTERS WITHOUT CLAIM TO ANY PARTICULAR FONT, STYLE, SIZE, OR COLOR.

SER. NO. 85-310,238, FILED 5-2-2011.

JUSTINE D. PARKER, EXAMINING ATTORNEY



David J. Kybas

Director of the United States Patent and Trademark Office

United States of America

United States Patent and Trademark Office

CLOSET REVIVAL

Reg. No. 4,067,064

BASECAMP FRANCHISING, LLC (UTAH LIMITED LIABILITY COMPANY)
170 SOUTH 1000 EAST
SALT LAKE CITY, UT 84102

Registered Dec. 6, 2011

Int. Cl.: 35

FOR: RETAIL CONSIGNMENT STORES FEATURING CLOTHING, FASHION ACCESSORIES,
AND JEWELRY, IN CLASS 35 (U.S. CLS. 100, 101 AND 102).

SERVICE MARK

FIRST USE 10-0-2010; IN COMMERCE 10-0-2010.

PRINCIPAL REGISTER

THE MARK CONSISTS OF STANDARD CHARACTERS WITHOUT CLAIM TO ANY PAR-
TICULAR FONT, STYLE, SIZE, OR COLOR.

SER. NO. 85-310,243, FILED S.R. 5-2-2011 AM. P.R. 6-29-2011.

TINA MAI, EXAMINING ATTORNEY



David J. Kybas

Director of the United States Patent and Trademark Office

United States of America

United States Patent and Trademark Office

Gauge City

Reg. No. 4,067,065

Registered Dec. 6, 2011

Int. Cl.: 9

TRADEMARK

PRINCIPAL REGISTER

HOTO, INC. (ILLINOIS CORPORATION)
SUITE 708
3100 DUNDEE ROAD
NORTHBROOK, IL 60062

FOR: INDUSTRIAL AND SCIENTIFIC MEASURING INSTRUMENTS, NAMELY, MECHANICAL AND DIGITAL FORCE GAUGES, DIGITAL TORQUE GAUGES, TORQUE TESTERS, PUSH/PULL TESTERS, WIRE PULL TESTERS, PEEL TESTERS, SPRING TESTERS, PUNCTURE TESTERS, COMPRESSION TESTERS, STRENGTH TESTERS AND SOFTWARE, TEST STANDS AND ATTACHMENTS THEREFOR IN THE NATURE OF MEASURING FORCE, TORQUE, HARDNESS, DYNAMOMETER, WEIGHT, CALIBRATION, DUROMETER, THICKNESS, DISTANCE, SPEED, TACHOMETER, STROBO SCOPE, VIBRATION, FLOW, AIR FLOW, TEMPERATURE, HUMIDITY, ELECTRICAL VOLTAGE AND ELECTRICAL CURRENT, IN CLASS 9 (U.S. CLS. 21, 23, 26, 36 AND 38).

FIRST USE 3-1-2011; IN COMMERCE 3-1-2011.

THE MARK CONSISTS OF STANDARD CHARACTERS WITHOUT CLAIM TO ANY PARTICULAR FONT, STYLE, SIZE, OR COLOR.

NO CLAIM IS MADE TO THE EXCLUSIVE RIGHT TO USE "GAUGE", APART FROM THE MARK AS SHOWN.

SER. NO. 85-310,244, FILED 5-2-2011.

PAUL MORENO, EXAMINING ATTORNEY



David J. Kypos

Director of the United States Patent and Trademark Office

United States of America

United States Patent and Trademark Office

NINE AFTER NINE

Reg. No. 4,067,066

CARIBBEAN SOURCING APPAREL, LLC (CALIFORNIA LIMITED LIABILITY COMPANY)
3470 WILSHIRE BOULEVARD, SUITE 950
LOS ANGELES, CA 90005

Registered Dec. 6, 2011

Int. Cl.: 25

FOR: KNIT TOPS; T-SHIRTS, IN CLASS 25 (U.S. CLS. 22 AND 39).

TRADEMARK

FIRST USE 3-0-2011; IN COMMERCE 3-0-2011.

PRINCIPAL REGISTER

THE MARK CONSISTS OF STANDARD CHARACTERS WITHOUT CLAIM TO ANY PARTICULAR FONT, STYLE, SIZE, OR COLOR.

SER. NO. 85-310,258, FILED 5-2-2011.

TINA MAI, EXAMINING ATTORNEY



David J. Kybas

Director of the United States Patent and Trademark Office

United States of America

United States Patent and Trademark Office

AtticTran

Reg. No. 4,067,067

CASCADE VECTOR LLC (WASHINGTON LIMITED LIABILITY COMPANY)
22836 96TH AVE
KENT, WA 98031

Registered Dec. 6, 2011

Int. Cl.: 12

FOR: SLEDS FOR TRANSPORT PURPOSES, IN CLASS 12 (U.S. CLS. 19, 21, 23, 31, 35 AND 44).

TRADEMARK

FIRST USE 4-14-2011; IN COMMERCE 4-14-2011.

PRINCIPAL REGISTER

THE MARK CONSISTS OF STANDARD CHARACTERS WITHOUT CLAIM TO ANY PARTICULAR FONT, STYLE, SIZE, OR COLOR.

SER. NO. 85-310,310, FILED 5-2-2011.

LINDA ORNDORFF, EXAMINING ATTORNEY



David J. Kyffers

Director of the United States Patent and Trademark Office

United States of America

United States Patent and Trademark Office

BROOKWOOD FARMS

Reg. No. 4,067,068

Registered Dec. 6, 2011

Int. Cl.: 29

TRADEMARK

PRINCIPAL REGISTER

BROOKWOOD FARMS, INC. (NORTH CAROLINA CORPORATION)
1015 ALSTON BRIDGE ROAD
SILER CITY, NC 27344

FOR: PORK, PULLED PORK, CHOPPED PORK, AND PORK BUTTS; CHICKEN, CHICKEN
QUARTERS; BARBECUE RIBS, BRUNSWICK STEW; AND BEEF BRISKET, IN CLASS 29
(U.S. CL. 46).

FIRST USE 1-1-1965; IN COMMERCE 4-1-1965.

THE MARK CONSISTS OF STANDARD CHARACTERS WITHOUT CLAIM TO ANY PAR-
TICULAR FONT, STYLE, SIZE, OR COLOR.

OWNER OF U.S. REG. NOS. 2,521,979 AND 2,539,505.

SER. NO. 85-310,329, FILED 5-2-2011.

AMY HELLA, EXAMINING ATTORNEY



David J. Kybas

Director of the United States Patent and Trademark Office

United States of America

United States Patent and Trademark Office

The Capicola Brothers

Reg. No. 4,067,069

Registered Dec. 6, 2011

Int. Cl.: 41

SERVICE MARK

PRINCIPAL REGISTER

ELEVEN ELEVEN PRODUCTIONS, LLC (NEW JERSEY LIMITED LIABILITY COMPANY)
11 BALTIMORE ST.
NUTLEY, NJ 07110

FOR: ENTERTAINMENT SERVICES, NAMELY, AN ON-GOING SERIES FEATURING COMEDY PROVIDED THROUGH WEBCASTS; ENTERTAINMENT, NAMELY, LIVE MUSIC CONCERTS, IN CLASS 41 (U.S. CLS. 100, 101 AND 107).

FIRST USE 10-27-2010; IN COMMERCE 10-27-2010.

THE MARK CONSISTS OF STANDARD CHARACTERS WITHOUT CLAIM TO ANY PARTICULAR FONT, STYLE, SIZE, OR COLOR.

SER. NO. 85-310,334, FILED 5-2-2011.

JOHN WILKE, EXAMINING ATTORNEY



David J. Kybas

Director of the United States Patent and Trademark Office

United States of America

United States Patent and Trademark Office

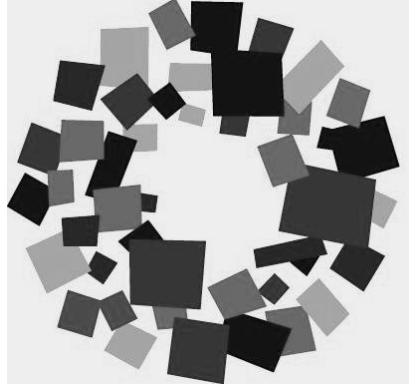

Reg. No. 4,067,070

Registered Dec. 6, 2011

Int. Cl.: 18

TRADEMARK

PRINCIPAL REGISTER

ATLANTA BELTLINE, INC. (GEORGIA NON-PROFIT CORPORATION)
86 PRYOR STREET, SUITE 200
ATLANTA, GA 30303

FOR: TOTE BAGS, IN CLASS 18 (U.S. CLS. 1, 2, 3, 22 AND 41).

FIRST USE 8-1-2010; IN COMMERCE 8-1-2010.

OWNER OF U.S. REG. NO. 3,892,547.

THE MARK CONSISTS OF CIRCULAR MOSAIC LOGO MADE UP OF SQUARE PIECES OF DIFFERENT SHADES AND SIZES ARRANGED IN A CIRCLE.

SER. NO. 85-310,377, FILED 5-2-2011.

TRACY CROSS, EXAMINING ATTORNEY



David J. Kyffers

Director of the United States Patent and Trademark Office

United States of America

United States Patent and Trademark Office

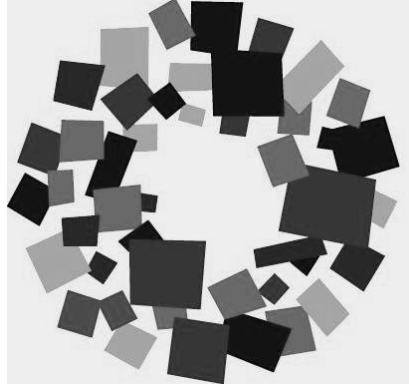

Reg. No. 4,067,071

Registered Dec. 6, 2011

Int. Cl.: 25

TRADEMARK

PRINCIPAL REGISTER

ATLANTA BELTLINE, INC. (GEORGIA NON-PROFIT CORPORATION)
86 PRYOR STREET, SUITE 200
ATLANTA, GA 30303

FOR: HEADWEAR; SHIRTS, IN CLASS 25 (U.S. CLS. 22 AND 39).

FIRST USE 8-1-2010; IN COMMERCE 8-1-2010.

OWNER OF U.S. REG. NO. 3,892,547.

THE MARK CONSISTS OF CIRCULAR MOSAIC LOGO MADE UP OF SQUARE PIECES OF DIFFERENT SHADES AND SIZES ARRANGED IN A CIRCLE.

SER. NO. 85-310,393, FILED 5-2-2011.

TRACY CROSS, EXAMINING ATTORNEY



David J. Kyffers

Director of the United States Patent and Trademark Office

United States of America

United States Patent and Trademark Office

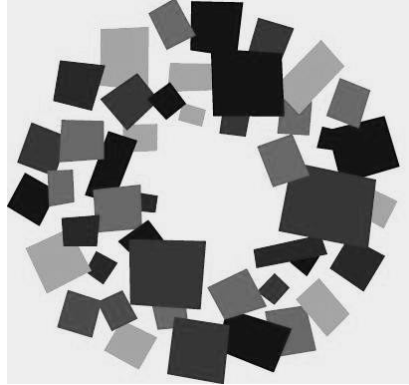

Reg. No. 4,067,072

Registered Dec. 6, 2011

Int. Cl.: 16

TRADEMARK

PRINCIPAL REGISTER

ATLANTA BELTLINE, INC. (GEORGIA NON-PROFIT CORPORATION)
86 PRYOR STREET, SUITE 200
ATLANTA, GA 30303

FOR: BROCHURES ABOUT URBAN REDEVELOPMENT PROJECTS IN ATLANTA; BUMPER STICKERS; INFORMATIONAL FLYERS FEATURING INFORMATION RELATING TO URBAN REDEVELOPMENT PROJECTS IN ATLANTA; MAPS, NEWSLETTERS IN THE FIELD OF URBAN REDEVELOPMENT PROJECTS IN ATLANTA; PHOTOGRAPHS, PRINTED GUIDES FOR TOURS OF SECTIONS OF ATLANTA; PRINTED PAPER SIGNS AND STATIONERY, IN CLASS 16 (U.S. CLS. 2, 5, 22, 23, 29, 37, 38 AND 50).

FIRST USE 8-1-2010; IN COMMERCE 8-1-2010.

OWNER OF U.S. REG. NO. 3,892,547.

THE MARK CONSISTS OF CIRCULAR MOSAIC LOGO MADE UP OF SQUARE PIECES OF DIFFERENT SHADES AND SIZES ARRANGED IN A CIRCLE.

SER. NO. 85-310,398, FILED 5-2-2011.

TRACY CROSS, EXAMINING ATTORNEY



David J. Kypos

Director of the United States Patent and Trademark Office

United States of America

United States Patent and Trademark Office



Reg. No. 4,067,073

Registered Dec. 6, 2011

Int. Cl.: 8

TRADEMARK

PRINCIPAL REGISTER

NINGBO YINZHOU JUNHANG TRDG CO., LTD. (CHINA LIMITED LIABILITY COMPANY)
2ND FLOOR, ROBOT BUSINESS CENTER
#301 JINGUZHONG RD, YINZHOU INVEST DIST.
NINGBO, CHINA

FOR: ABRADING TOOLS; CAULKING GUNS; CUTLERY; GARDENING SHEARS AND SCISSORS; GARDENING TROWELS; HAND TOOLS, NAMELY, AWLS; HAND TOOLS, NAMELY, CLAMPS; HAND TOOLS, NAMELY, CUTTER BARS; HAND TOOLS, NAMELY, GRAVING TOOLS; HAND TOOLS, NAMELY, PRUNERS; HAND TOOLS, NAMELY, SAWS; HAND-POWERED STAPLE GUNS; KNIVES; NON-ELECTRIC CAN OPENERS; PEDICURE SETS, IN CLASS 8 (U.S. CLS. 23, 28 AND 44).

FIRST USE 3-2-2008; IN COMMERCE 3-2-2008.

THE MARK CONSISTS OF STYLIZED WORD "CLIFF" AND MOUNTAIN DESIGN.

SER. NO. 85-310,411, FILED 5-2-2011.

TRACY CROSS, EXAMINING ATTORNEY



David J. Kyffers

Director of the United States Patent and Trademark Office

United States of America

United States Patent and Trademark Office

SACRED ENERGY ARTS

Reg. No. 4,067,074

Registered Dec. 6, 2011

Int. Cl.: 41

SERVICE MARK

PRINCIPAL REGISTER

MATTHEW COHEN (UNITED STATES INDIVIDUAL)
220 PIER AVENUE
SANTA MONICA, CA 90405

FOR: CONDUCTING WORKSHOPS AND SEMINARS IN MIND-BODY FITNESS SERVICES, NAMELY YOGA, TAI-CHI, QI GONG, AND MARTIAL ARTS.; MARTIAL ARTS INSTRUCTION; PHYSICAL FITNESS CONDITIONING CLASSES; PROVIDING FITNESS AND EXERCISE FACILITIES; YOGA INSTRUCTION, IN CLASS 41 (U.S. CLS. 100, 101 AND 107).

FIRST USE 3-1-2006; IN COMMERCE 3-1-2006.

THE MARK CONSISTS OF STANDARD CHARACTERS WITHOUT CLAIM TO ANY PARTICULAR FONT, STYLE, SIZE, OR COLOR.

NO CLAIM IS MADE TO THE EXCLUSIVE RIGHT TO USE "ARTS", APART FROM THE MARK AS SHOWN.

SER. NO. 85-310,453, FILED 5-3-2011.

ADA HAN, EXAMINING ATTORNEY



David J. Kybas

Director of the United States Patent and Trademark Office

United States of America

United States Patent and Trademark Office

GEEKS ON SUPPORT

Reg. No. 4,067,075

Registered Dec. 6, 2011

Int. Cl.: 42

SERVICE MARK

PRINCIPAL REGISTER

PEREZ, JUAN GUILLERMO (UNITED STATES INDIVIDUAL)
2710 THORNES AVE., SUITE 943
CHEYENNE, WY 82001

FOR: COMPUTER AND TECHNOLOGICAL PROFESSIONAL SERVICES, NAMELY, INSTALLATION, REPAIR AND MAINTENANCE OF COMPUTER SOFTWARE; TECHNICAL SUPPORT SERVICES, NAMELY, TROUBLESHOOTING IN THE NATURE OF DIAGNOSING COMPUTER HARDWARE AND SOFTWARE PROBLEMS, IN CLASS 42 (U.S. CLS. 100 AND 101).

FIRST USE 4-18-2011; IN COMMERCE 4-20-2011.

THE MARK CONSISTS OF STANDARD CHARACTERS WITHOUT CLAIM TO ANY PARTICULAR FONT, STYLE, SIZE, OR COLOR.

SER. NO. 85-310,519, FILED 5-3-2011.

DAVID YONTEF, EXAMINING ATTORNEY



David J. Kyffers

Director of the United States Patent and Trademark Office

United States of America

United States Patent and Trademark Office

I VIVO. DO YOU?

Reg. No. 4,067,076

Registered Dec. 6, 2011

Int. Cl.: 43

SERVICE MARK

PRINCIPAL REGISTER

BAB LIQUOR LLC (NEW JERSEY LIMITED LIABILITY COMPANY), DBA VIVO TAPAS LOUNGE
167 FERRY ST.
NEWARK, NJ 07105

FOR: RESTAURANT AND BAR SERVICES, IN CLASS 43 (U.S. CLS. 100 AND 101).

FIRST USE 2-0-2007; IN COMMERCE 2-0-2007.

THE MARK CONSISTS OF STANDARD CHARACTERS WITHOUT CLAIM TO ANY PARTICULAR FONT, STYLE, SIZE, OR COLOR.

THE ENGLISH TRANSLATION OF VIVO IN THE MARK IS "LIVING".

SER. NO. 85-310,529, FILED 5-3-2011.

JOHN WILKE, EXAMINING ATTORNEY



David J. Kybas

Director of the United States Patent and Trademark Office

United States of America

United States Patent and Trademark Office

LAUNCH

Reg. No. 4,067,077

Registered Dec. 6, 2011

Int. Cl.: 25

TRADEMARK

PRINCIPAL REGISTER

GARY FLAKS (UNITED STATES INDIVIDUAL)
LAUNCH FOOTWEAR
601 MURRAY ROAD
EAST HANOVER, NJ 07936

FOR: FOOTWEAR, IN CLASS 25 (U.S. CLS. 22 AND 39).

FIRST USE 2-1-2011; IN COMMERCE 2-1-2011.

THE MARK CONSISTS OF STANDARD CHARACTERS WITHOUT CLAIM TO ANY PARTICULAR FONT, STYLE, SIZE, OR COLOR.

SER. NO. 85-310,541, FILED 5-3-2011.

PAUL F. GAST, EXAMINING ATTORNEY



David J. Kyffers

Director of the United States Patent and Trademark Office

United States of America

United States Patent and Trademark Office

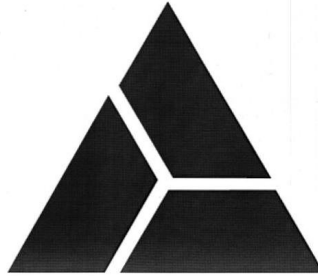

Reg. No. 4,067,078

Registered Dec. 6, 2011

Int. Cl.: 36

SERVICE MARK

PRINCIPAL REGISTER

PARAMOUNT GROUP, INC. (DELAWARE CORPORATION)
SUITE 1801
1633 BROADWAY
NEW YORK, NY 10019

FOR: FUNDS INVESTMENT; MANAGEMENT OF A CAPITAL INVESTMENT FUND; REAL ESTATE FUNDS INVESTMENT SERVICES; FINANCING OF REAL ESTATE DEVELOPMENT PROJECTS; REAL ESTATE FINANCING SERVICES; MANAGEMENT OF PRIVATE EQUITY FUNDS; AND REAL ESTATE INVESTMENT TRUST MANAGEMENT SERVICES, IN CLASS 36 (U.S. CLS. 100, 101 AND 102).

FIRST USE 11-28-1979; IN COMMERCE 11-28-1979.

OWNER OF U.S. REG. NO. 2,685,613.

THE MARK CONSISTS OF A TRIANGLE FORMED OF THREE TRAPEZOIDS.

SER. NO. 85-310,545, FILED 5-3-2011.

BRENDAN MCCAULEY, EXAMINING ATTORNEY



David J. Kybas

Director of the United States Patent and Trademark Office

United States of America

United States Patent and Trademark Office

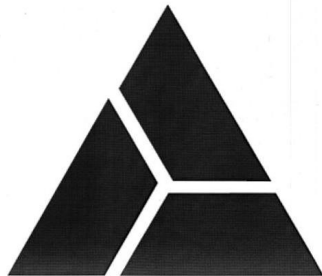

Reg. No. 4,067,079

Registered Dec. 6, 2011

Int. Cl.: 36

SERVICE MARK

PRINCIPAL REGISTER

PARAMOUNT GROUP, INC. (DELAWARE CORPORATION)
SUITE 1801
1633 BROADWAY
NEW YORK, NY 10019

FOR: REAL ESTATE SERVICES, NAMELY, RENTAL, LEASING, AND MANAGEMENT OF COMMERCIAL PROPERTY, OFFICES, AND OFFICE SPACE, IN CLASS 36 (U.S. CLS. 100, 101 AND 102).

FIRST USE 11-28-1979; IN COMMERCE 11-28-1979.

OWNER OF U.S. REG. NO. 2,685,613.

THE MARK CONSISTS OF A TRIANGLE FORMED OF THREE TRAPEZOIDS.

SER. NO. 85-310,546, FILED 5-3-2011.

BRENDAN MCCAULEY, EXAMINING ATTORNEY



David J. Kybas

Director of the United States Patent and Trademark Office

United States of America

United States Patent and Trademark Office

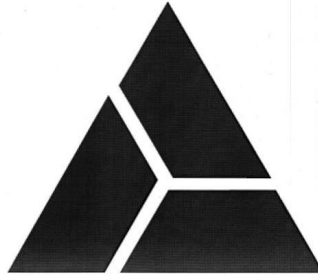

Reg. No. 4,067,080

Registered Dec. 6, 2011

Int. Cl.: 37

SERVICE MARK

PRINCIPAL REGISTER

PARAMOUNT GROUP, INC. (DELAWARE CORPORATION)
SUITE 1801
1633 BROADWAY
NEW YORK, NY 10019

FOR: CONSTRUCTION PROJECT MANAGEMENT SERVICES; REAL ESTATE DEVELOPMENT AND CONSTRUCTION OF COMMERCIAL, RESIDENTIAL, AND RETAIL PROPERTY, IN CLASS 37 (U.S. CLS. 100, 103 AND 106).

FIRST USE 11-28-1979; IN COMMERCE 11-28-1979.

OWNER OF U.S. REG. NO. 2,685,613.

THE MARK CONSISTS OF A TRIANGLE FORMED OF THREE TRAPEZOIDS.

SER. NO. 85-310,548, FILED 5-3-2011.

BRENDAN MCCAULEY, EXAMINING ATTORNEY



David J. Kybas

Director of the United States Patent and Trademark Office

United States of America

United States Patent and Trademark Office

ERLink

Reg. No. 4,067,081

Registered Dec. 6, 2011

Int. Cl.: 42

SERVICE MARK

PRINCIPAL REGISTER

ERLINK, INC. (GEORGIA CORPORATION)
2451 CUMBERLAND PARKWAY, SUITE 3818
ATLANTA, GA 30339

FOR: PROVIDING MEDICAL AND CLINICAL RESEARCH INFORMATION IN THE FIELD OF EMERGENCY MEDICINE, IN CLASS 42 (U.S. CLS. 100 AND 101).

FIRST USE 3-8-2010; IN COMMERCE 3-11-2010.

THE MARK CONSISTS OF STANDARD CHARACTERS WITHOUT CLAIM TO ANY PARTICULAR FONT, STYLE, SIZE, OR COLOR.

SER. NO. 85-310,557, FILED 5-3-2011.

CHARLES L. JENKINS, EXAMINING ATTORNEY



David J. Kybas

Director of the United States Patent and Trademark Office

United States of America

United States Patent and Trademark Office

StockCision

Reg. No. 4,067,082

Registered Dec. 6, 2011

Int. Cl.: 9

TRADEMARK

PRINCIPAL REGISTER

DATAFLWSOLUTIONS, INC. (GEORGIA CORPORATION), FORMERLY BING
CONSULTING
P.O. BOX 695
WOODSTOCK, GA 30188

FOR: COMPUTER APPLICATION SOFTWARE FOR MOBILE PHONES, HANDHELD COMPUTERS, LAPTOPS AND DESKTOPS, NAMELY, SOFTWARE FOR BUSINESS FINANCIAL RESEARCH AS IT RELATES TO STOCK ANALYSIS AND MONITORING, IN CLASS 9 (U.S. CLS. 21, 23, 26, 36 AND 38).

FIRST USE 12-28-2010; IN COMMERCE 3-28-2011.

THE MARK CONSISTS OF STANDARD CHARACTERS WITHOUT CLAIM TO ANY PARTICULAR FONT, STYLE, SIZE, OR COLOR.

SER. NO. 85-310,597, FILED 5-3-2011.

JOHN GARTNER, EXAMINING ATTORNEY



David J. Kybas

Director of the United States Patent and Trademark Office

United States of America

United States Patent and Trademark Office

BEAUTICONTROL ON THE LIPS OF EVERY WOMAN

Reg. No. 4,067,083

Registered Dec. 6, 2011

Int. Cls.: 35 and 41

SERVICE MARK

PRINCIPAL REGISTER

BC INTERNATIONAL COSMETIC & IMAGE SERVICES, INC. (DELAWARE CORPORATION)
14901 S. ORANGE BLOSSOM TRAIL
ORLANDO, FL 32837

FOR: PROVIDING CONSULTING AND BUSINESS INFORMATION IN THE FIELDS OF
COSMETICS AND BEAUTY CARE PRODUCTS, AND THE DIRECT SALES OF COSMETICS
AND BEAUTY CARE PRODUCTS, IN CLASS 35 (U.S. CLS. 100, 101 AND 102).

FIRST USE 4-1-2011; IN COMMERCE 4-1-2011.

FOR: PROVIDING SEMINARS IN THE FIELDS OF COSMETICS AND BEAUTY CARE
PRODUCTS, AND THE DIRECT SALES OF COSMETICS AND BEAUTY CARE PRODUCTS,
IN CLASS 41 (U.S. CLS. 100, 101 AND 107).

FIRST USE 4-27-2011; IN COMMERCE 4-27-2011.

THE MARK CONSISTS OF STANDARD CHARACTERS WITHOUT CLAIM TO ANY PAR-
TICULAR FONT, STYLE, SIZE, OR COLOR.

OWNER OF U.S. REG. NOS. 1,856,494 AND 2,084,900.

SER. NO. 85-310,632, FILED 5-3-2011.

GIANCARLO CASTRO, EXAMINING ATTORNEY



David J. Kyros

Director of the United States Patent and Trademark Office

United States of America

United States Patent and Trademark Office

BERKELEY CARES

Reg. No. 4,067,084

Registered Dec. 6, 2011

Int. Cls.: 25, 35 and 36

TRADEMARK

SERVICE MARK

PRINCIPAL REGISTER

BERKELEY EDUCATIONAL SERVICES OF NEW JERSEY, INC. (NEW JERSEY CORPORATION)
64 E. MIDLAND AVENUE
PARAMUS, NJ 07652

FOR: CLOTHING, NAMELY TSHIRTS, SWEATSHIRTS, CAPS, IN CLASS 25 (U.S. CLS. 22 AND 39).

FIRST USE 6-11-2010; IN COMMERCE 6-11-2010.

FOR: CHARITABLE SERVICES, NAMELY PROMOTING AND ENCOURAGING VOLUNTEERISM ON INDIVIDUAL AND GROUP BASES, ORGANIZING AND CONDUCTING COMMUNITY OUTREACH INITIATIVES IN THE NATURE OF VOLUNTEER PROGRAMS AND COMMUNITY SERVICE PROJECTS, IN CLASS 35 (U.S. CLS. 100, 101 AND 102).

FIRST USE 6-11-2010; IN COMMERCE 6-11-2010.

FOR: CHARITABLE FUND RAISING FOR VOLUNTEER PROGRAMS, COMMUNITY SERVICE PROJECTS AND COMMUNITY OUTREACH PROGRAMS, IN CLASS 36 (U.S. CLS. 100, 101 AND 102).

FIRST USE 3-23-2011; IN COMMERCE 3-23-2011.

THE MARK CONSISTS OF THE WORDS BERKELEY CARES WITH A HEART DESIGN THROUGH THE A IN CARES.

SER. NO. 85-310,634, FILED 5-3-2011.

ROBIN CHOSID, EXAMINING ATTORNEY



David J. Kyros

Director of the United States Patent and Trademark Office

United States of America

United States Patent and Trademark Office

great dogs don't just
happen

Reg. No. 4,067,085

Registered Dec. 6, 2011

Int. Cl.: 41

SERVICE MARK

PRINCIPAL REGISTER

SMOKEN DAKOTA KENNELS, LLC (SOUTH DAKOTA LIMITED LIABILITY COMPANY)
46573 269TH STREET
SIOUX FALLS, SD 57106

FOR: ANIMAL TRAINING; KENNEL SERVICES, NAMELY, DOG TRAINING SERVICES;
OBEDIENCE SCHOOL TRAINING FOR ANIMALS; TRAINING ANIMALS FOR OTHERS ,
IN CLASS 41 (U.S. CLS. 100, 101 AND 107).

FIRST USE 1-1-2008; IN COMMERCE 1-1-2008.

THE MARK CONSISTS OF STANDARD CHARACTERS WITHOUT CLAIM TO ANY PAR-
TICULAR FONT, STYLE, SIZE, OR COLOR.

SER. NO. 85-310,639, FILED 5-3-2011.

ESTHER BELENKER, EXAMINING ATTORNEY



David J. Kyffers

Director of the United States Patent and Trademark Office

United States of America

United States Patent and Trademark Office

BE A DESTINATION...NOT A LAST RESORT

Reg. No. 4,067,086

Registered Dec. 6, 2011

Int. Cl.: 35

SERVICE MARK

PRINCIPAL REGISTER

GRILL, KIM H. (UNITED STATES INDIVIDUAL)
204 EDGEVALE ROAD
BALTIMORE, MD 21210

FOR: EMPLOYMENT STAFFING CONSULTATION SERVICES, IN CLASS 35 (U.S. CLS. 100, 101 AND 102).

FIRST USE 5-1-2011; IN COMMERCE 5-1-2011.

THE MARK CONSISTS OF STANDARD CHARACTERS WITHOUT CLAIM TO ANY PARTICULAR FONT, STYLE, SIZE, OR COLOR.

SER. NO. 85-310,648, FILED 5-3-2011.

TINA MAI, EXAMINING ATTORNEY



David J. Kyffers

Director of the United States Patent and Trademark Office

United States of America

United States Patent and Trademark Office

GET BUFFED!

Reg. No. 4,067,087

Registered Dec. 6, 2011

Int. Cl.: 9

TRADEMARK

PRINCIPAL REGISTER

KING SPORTS INTERNATIONAL, INC. (NEVADA CORPORATION)
1135 TERMINAL WAY, SUITE 209
RENO, NV 89502

FOR: DIGITAL MATERIALS, NAMELY, DVDS FEATURING INSTRUCTION IN THE FIELD OF WEIGHT TRAINING AND PHYSICAL FITNESS, IN CLASS 9 (U.S. CLS. 21, 23, 26, 36 AND 38).

FIRST USE 0-0-2005; IN COMMERCE 0-0-2005.

THE MARK CONSISTS OF STANDARD CHARACTERS WITHOUT CLAIM TO ANY PARTICULAR FONT, STYLE, SIZE, OR COLOR.

OWNER OF U.S. REG. NO. 2,558,506.

SER. NO. 85-310,657, FILED 5-3-2011.

FONG HSU, EXAMINING ATTORNEY



David J. Kybas

Director of the United States Patent and Trademark Office

United States of America

United States Patent and Trademark Office

ONE OF AMERICA'S FINEST HEALING ENVIRONMENTS

Reg. No. 4,067,088

Registered Dec. 6, 2011

Int. Cl.: 44

SERVICE MARK

PRINCIPAL REGISTER

NORTH BREVARD COUNTY HOSPITAL DISTRICT (FLORIDA A POLITICAL SUBDIVISION AND TAXING DISTRICT OF THE STATE OF FLORIDA LEGALLY ORGANIZED UNDER THE LAWS OF FLORIDA), DBA PARRISH MEDICAL CENTER
951 NORTH WASHINGTON AVENUE
TITUSVILLE, FL 32796

FOR: HEALTH CARE , IN CLASS 44 (U.S. CLS. 100 AND 101).

FIRST USE 1-31-2002; IN COMMERCE 1-31-2002.

THE MARK CONSISTS OF STANDARD CHARACTERS WITHOUT CLAIM TO ANY PARTICULAR FONT, STYLE, SIZE, OR COLOR.

OWNER OF U.S. REG. NO. 3,080,949.

SEC. 2(F).

SER. NO. 85-310,659, FILED 5-3-2011.

CHERYL CLAYTON, EXAMINING ATTORNEY



David J. Kybas

Director of the United States Patent and Trademark Office

United States of America

United States Patent and Trademark Office

SKYHAWK

Reg. No. 4,067,089

CATHERINE CORELL (UNITED STATES INDIVIDUAL)
1231 E. DYER ROAD, SUITE 170
SANTA ANA, CA 92705

Registered Dec. 6, 2011

Int. Cl.: 35

FOR: TEMPORARY AND PERMANENT EMPLOYMENT AND PLACEMENT SERVICES, IN CLASS 35 (U.S. CLS. 100, 101 AND 102).

SERVICE MARK

FIRST USE 10-0-2008; IN COMMERCE 10-0-2008.

PRINCIPAL REGISTER

THE MARK CONSISTS OF STANDARD CHARACTERS WITHOUT CLAIM TO ANY PARTICULAR FONT, STYLE, SIZE, OR COLOR.

SER. NO. 85-310,700, FILED 5-3-2011.

DARRYL SPRUILL, EXAMINING ATTORNEY



David J. Kybas

Director of the United States Patent and Trademark Office

United States of America

United States Patent and Trademark Office

PERSONA

Reg. No. 4,067,090

Registered Dec. 6, 2011

Int. Cl.: 16

TRADEMARK

PRINCIPAL REGISTER

TSS PHOTOGRAPHY, INC. (GEORGIA CORPORATION)
2150 BOGGS ROAD, SUITE 200
DULUTH, GA 30096

FOR: PHOTOGRAPHS; PRINTS IN THE NATURE OF PHOTOGRAPHS; UNMOUNTED AND MOUNTED PHOTOGRAPHS, IN CLASS 16 (U.S. CLS. 2, 5, 22, 23, 29, 37, 38 AND 50).

FIRST USE 1-31-2011; IN COMMERCE 1-31-2011.

THE MARK CONSISTS OF STANDARD CHARACTERS WITHOUT CLAIM TO ANY PARTICULAR FONT, STYLE, SIZE, OR COLOR.

OWNER OF U.S. REG. NO. 3,913,627.

SER. NO. 85-310,701, FILED 5-3-2011.

DARRYL SPRUILL, EXAMINING ATTORNEY



David J. Kybas

Director of the United States Patent and Trademark Office

United States of America

United States Patent and Trademark Office

MobiAssist

Reg. No. 4,067,091

Registered Dec. 6, 2011

Int. Cl.: 9

TRADEMARK

PRINCIPAL REGISTER

SOTI INC. (CANADA CORPORATION)
30-5155 SPECTRUM WAY
MISSISSAUGA, ONTARIO, CANADA L4W5A1

FOR: COMPUTER SOFTWARE, NAMELY FOR SOFTWARE FOR THE SYNCHRONIZATION, MANAGEMENT, TRACKING AND SECURITY OF DATA TRANSMITTED OVER WIRELESS DATA NETWORKS BETWEEN A STATIONARY UNIT AND MULTIPLE MOBILE COMPUTERS OR ELECTRONIC DEVICES IN THE FIELD OF MOBILE DEVICE MANAGEMENT, IN CLASS 9 (U.S. CLS. 21, 23, 26, 36 AND 38).

FIRST USE 2-28-2011; IN COMMERCE 2-28-2011.

THE MARK CONSISTS OF STANDARD CHARACTERS WITHOUT CLAIM TO ANY PARTICULAR FONT, STYLE, SIZE, OR COLOR.

SER. NO. 85-310,711, FILED 5-3-2011.

LINDA POWELL, EXAMINING ATTORNEY



David J. Kybas

Director of the United States Patent and Trademark Office

United States of America

United States Patent and Trademark Office

POCKET CONTROLLER

Reg. No. 4,067,092

Registered Dec. 6, 2011

Int. Cl.: 9

TRADEMARK

PRINCIPAL REGISTER

SOTI INC. (CANADA CORPORATION)
30-5155 SPECTRUM WAY
MISSISSAUGA, ONTARIO, CANADA L4W5A1

FOR: COMPUTER SOFTWARE, NAMELY FOR SOFTWARE FOR THE SYNCHRONIZATION, MANAGEMENT, TRACKING AND SECURITY OF DATA TRANSMITTED OVER WIRELESS DATA NETWORKS BETWEEN A STATIONARY UNIT AND MULTIPLE MOBILE COMPUTERS OR ELECTRONIC DEVICES IN THE FIELD OF MOBILE DEVICE MANAGEMENT, IN CLASS 9 (U.S. CLS. 21, 23, 26, 36 AND 38).

FIRST USE 7-31-2001; IN COMMERCE 7-31-2001.

THE MARK CONSISTS OF STANDARD CHARACTERS WITHOUT CLAIM TO ANY PARTICULAR FONT, STYLE, SIZE, OR COLOR.

SER. NO. 85-310,715, FILED 5-3-2011.

LINDA POWELL, EXAMINING ATTORNEY



David J. Kybas

Director of the United States Patent and Trademark Office

United States of America

United States Patent and Trademark Office

TransFUNation

Reg. No. 4,067,093

Registered Dec. 6, 2011

Int. Cl.: 41

SERVICE MARK

PRINCIPAL REGISTER

GLOBAL EVOLUTIONARY NETWORK (WYOMING LIMITED LIABILITY COMPANY)
SUITE 428
6300 N. SAGEWOOD DRIVE
PARK CITY, UT 84098

FOR: EDUCATIONAL SERVICES, NAMELY, CONDUCTING GAMES, SIMULATIONS, SEMINARS AND WORKSHOPS IN THE FIELDS OF PERSONAL, BUSINESS AND PROFESSIONAL DEVELOPMENT AND DISTRIBUTION OF TRAINING MATERIALS IN CONNECTION THEREWITH, IN CLASS 41 (U.S. CLS. 100, 101 AND 107).

FIRST USE 10-1-2010; IN COMMERCE 12-1-2010.

THE MARK CONSISTS OF STANDARD CHARACTERS WITHOUT CLAIM TO ANY PARTICULAR FONT, STYLE, SIZE, OR COLOR.

SER. NO. 85-310,726, FILED 5-3-2011.

ANNE MADDEN, EXAMINING ATTORNEY



David J. Kyros

Director of the United States Patent and Trademark Office

United States of America
United States Patent and Trademark Office

JATARA

Reg. No. 4,067,094

JATARA SOLUTIONS, INC. (ILLINOIS CORPORATION)
1112 WEST BURNSIDE DR
PEORIA, IL 61614

Registered Dec. 6, 2011

Int. Cl.: 36

FOR: ADMINISTRATION OF PRE-PAID HEALTH CARE PLANS; ORGANIZING PRE-PAID HEALTH CARE PLANS, IN CLASS 36 (U.S. CLS. 100, 101 AND 102).

SERVICE MARK

FIRST USE 8-2-2010; IN COMMERCE 11-11-2010.

PRINCIPAL REGISTER

THE MARK CONSISTS OF STANDARD CHARACTERS WITHOUT CLAIM TO ANY PARTICULAR FONT, STYLE, SIZE, OR COLOR.

SER. NO. 85-310,737, FILED 5-3-2011.

DANNEAN HETZEL, EXAMINING ATTORNEY



David J. Kybas

Director of the United States Patent and Trademark Office

United States of America

United States Patent and Trademark Office

TransFUNational

Reg. No. 4,067,095

Registered Dec. 6, 2011

Int. Cl.: 41

SERVICE MARK

PRINCIPAL REGISTER

GLOBAL EVOLUTIONARY NETWORK (WYOMING LIMITED LIABILITY COMPANY)
SUITE 428
6300 N. SAGEWOOD DRIVE
PARK CITY, UT 84098

FOR: EDUCATIONAL SERVICES, NAMELY, CONDUCTING GAMES, SIMULATIONS, SEMINARS AND WORKSHOPS IN THE FIELDS OF PERSONAL, BUSINESS AND PROFESSIONAL DEVELOPMENT AND DISTRIBUTION OF TRAINING MATERIALS IN CONNECTION THEREWITH, IN CLASS 41 (U.S. CLS. 100, 101 AND 107).

FIRST USE 10-1-2010; IN COMMERCE 12-1-2010.

THE MARK CONSISTS OF STANDARD CHARACTERS WITHOUT CLAIM TO ANY PARTICULAR FONT, STYLE, SIZE, OR COLOR.

SER. NO. 85-310,753, FILED 5-3-2011.

ANNE MADDEN, EXAMINING ATTORNEY



David J. Kyffers

Director of the United States Patent and Trademark Office

United States of America

United States Patent and Trademark Office

IxDA

Reg. No. 4,067,096

Registered Dec. 6, 2011

Int. Cls.: 35, 41 and 42

SERVICE MARK

PRINCIPAL REGISTER

INTERACTION DESIGN ASSOCIATION, INC. (OREGON CORPORATION)
15500 SW JAY STREET #49749
BEAVERTON, OR 97006

FOR: ARRANGING AND CONDUCTING TRADE SHOWS IN THE FIELD OF INTERACTION DESIGN; ASSOCIATION SERVICES, NAMELY, PROMOTING THE INTERESTS OF PROFESSIONALS AND FIRMS IN THE FIELD OF INTERACTION DESIGN; PROMOTING AND CONDUCTING TRADE SHOWS IN THE FIELD OF INTERACTION DESIGN, IN CLASS 35 (U.S. CLS. 100, 101 AND 102).

FIRST USE 10-4-2005; IN COMMERCE 11-1-2005.

FOR: EDUCATIONAL SERVICES, NAMELY, CONDUCTING CONFERENCES, SEMINARS, WORKSHOPS, ONLINE PROGRAMS AND INFORMAL PROGRAMS IN THE FIELD OF INTERACTION DESIGN AND DISTRIBUTION OF COURSE MATERIAL IN CONNECTION THEREWITH, IN CLASS 41 (U.S. CLS. 100, 101 AND 107).

FIRST USE 10-4-2005; IN COMMERCE 11-1-2005.

FOR: COMPUTER SERVICES, NAMELY, CREATING AN ON-LINE COMMUNITY FOR REGISTERED USERS TO PARTICIPATE IN DISCUSSIONS, GET FEEDBACK FROM THEIR PEERS, FORM VIRTUAL COMMUNITIES, AND ENGAGE IN SOCIAL NETWORKING FEATURING INFORMATION RELATING TO INTERACTION DESIGN AND INTERACTION DESIGN EMPLOYMENT; COMPUTER SERVICES, NAMELY, HOSTING AND MAINTAINING AN ON-LINE WEB SITE FOR OTHERS TO OBTAIN INFORMATION REGARDING INTERACTION DESIGN, IN CLASS 42 (U.S. CLS. 100 AND 101).

FIRST USE 10-4-2005; IN COMMERCE 11-1-2005.

THE MARK CONSISTS OF STANDARD CHARACTERS WITHOUT CLAIM TO ANY PARTICULAR FONT, STYLE, SIZE, OR COLOR.

SER. NO. 85-310,759, FILED 5-3-2011.

JOHN WILKE, EXAMINING ATTORNEY



David J. Kyffers

Director of the United States Patent and Trademark Office

United States of America

United States Patent and Trademark Office

Thor's Hammer

Reg. No. 4,067,097

Registered Dec. 6, 2011

Int. Cl.: 5

TRADEMARK

PRINCIPAL REGISTER

BAZLER ENTERPRISES, INC. (IDAHO CORPORATION)
3911 N. SCHREIBER WAY
COEUR D'ALENE, ID 83815

FOR: DIETARY AND NUTRITIONAL SUPPLEMENTS, IN CLASS 5 (U.S. CLS. 6, 18, 44, 46, 51 AND 52).

FIRST USE 4-21-2010; IN COMMERCE 4-21-2010.

THE MARK CONSISTS OF STANDARD CHARACTERS WITHOUT CLAIM TO ANY PARTICULAR FONT, STYLE, SIZE, OR COLOR.

SER. NO. 85-310,761, FILED 5-3-2011.

LINDA POWELL, EXAMINING ATTORNEY



David J. Kyffers

Director of the United States Patent and Trademark Office

United States of America

United States Patent and Trademark Office



Reg. No. 4,067,098

Registered Dec. 6, 2011

Int. Cl.: 6

TRADEMARK

PRINCIPAL REGISTER

ROBERT KING AND JAMES NOWAK, PARTNERSHIP (CALIFORNIA PARTNERSHIP)
1424 S. RITCHEY UNIT C
SANTA ANA, CA 92705

FOR: HOSE HANGERS OF METAL; METAL HOOKS, IN CLASS 6 (U.S. CLS. 2, 12, 13, 14, 23, 25 AND 50).

FIRST USE 4-15-2011; IN COMMERCE 4-15-2011.

THE MARK CONSISTS OF THE HEAD OF AN OX.

SER. NO. 85-310,773, FILED 5-3-2011.

DAVID COLLIER, EXAMINING ATTORNEY



David J. Kyffers

Director of the United States Patent and Trademark Office

United States of America

United States Patent and Trademark Office

WHOmmunity

Reg. No. 4,067,099

Registered Dec. 6, 2011

Int. Cl.: 45

SERVICE MARK

PRINCIPAL REGISTER

WHOMMUNITY WHO'S WHO, INC. (NEVADA CORPORATION)
631 N. STEPHANIE ST. #296
HENDERSON, NV 89014

FOR: ON-LINE SOCIAL NETWORKING SERVICES; ONLINE SOCIAL NETWORKING SERVICES PROVIDED THROUGH A COMMUNITY WEBSITE, IN CLASS 45 (U.S. CLS. 100 AND 101).

FIRST USE 2-1-2011; IN COMMERCE 4-3-2011.

THE MARK CONSISTS OF STANDARD CHARACTERS WITHOUT CLAIM TO ANY PARTICULAR FONT, STYLE, SIZE, OR COLOR.

SER. NO. 85-310,801, FILED 5-3-2011.

BILL DAWE, EXAMINING ATTORNEY



David J. Kyffers

Director of the United States Patent and Trademark Office

United States of America

United States Patent and Trademark Office

Caveau Wine Bar

Reg. No. 4,067,100

Registered Dec. 6, 2011

Int. Cl.: 43

SERVICE MARK

PRINCIPAL REGISTER

WINEMARQ, LLC (COLORADO LIMITED LIABILITY COMPANY), DBA CAVEAU WINE BAR
450 E. 17TH AVE.
DENVER, CO 80203

FOR: BAR AND COCKTAIL LOUNGE SERVICES; RESTAURANT; WINE BARS, IN CLASS 43 (U.S. CLS. 100 AND 101).

FIRST USE 8-1-2009; IN COMMERCE 8-1-2009.

THE MARK CONSISTS OF STANDARD CHARACTERS WITHOUT CLAIM TO ANY PARTICULAR FONT, STYLE, SIZE, OR COLOR.

NO CLAIM IS MADE TO THE EXCLUSIVE RIGHT TO USE "WINE BAR", APART FROM THE MARK AS SHOWN.

THE ENGLISH TRANSLATION OF "CAVEAU" IN THE MARK IS "VAULT".

SER. NO. 85-310,855, FILED 5-3-2011.

CAROLYN CATALDO, EXAMINING ATTORNEY



David J. Kybas

Director of the United States Patent and Trademark Office

United States of America

United States Patent and Trademark Office

KALIO

Reg. No. 4,067,101

Registered Dec. 6, 2011

Int. Cl.: 42

SERVICE MARK

PRINCIPAL REGISTER

KALIO, INC. (DELAWARE CORPORATION)
SUITE 500
100 E. RIVERCENTER BLVD.
COVINGTON, KY 41011

FOR: SOFTWARE AS A SERVICE (SAAS) SERVICES, NAMELY, DEVELOPING AND HOSTING SOFTWARE FOR USE BY OTHERS FOR USE IN MANAGING ECOMMERCE ACTIVITIES FOR RETAIL BUSINESSES AND CATALOGERS, IN CLASS 42 (U.S. CLS. 100 AND 101).

FIRST USE 2-14-2011; IN COMMERCE 2-14-2011.

THE MARK CONSISTS OF STANDARD CHARACTERS WITHOUT CLAIM TO ANY PARTICULAR FONT, STYLE, SIZE, OR COLOR.

SER. NO. 85-310,856, FILED 5-3-2011.

CAROLYN CATALDO, EXAMINING ATTORNEY



David J. Kybas

Director of the United States Patent and Trademark Office

United States of America

United States Patent and Trademark Office

BUZZ GUARD

Reg. No. 4,067,102

Registered Dec. 6, 2011

Int. Cl.: 5

TRADEMARK

PRINCIPAL REGISTER

EARTH HEART INC. (ILLINOIS CORPORATION)
PO BOX 427
DUNDEE, IL 60118

FOR: INSECT REPELLENTS, IN CLASS 5 (U.S. CLS. 6, 18, 44, 46, 51 AND 52).

FIRST USE 4-26-2011; IN COMMERCE 4-26-2011.

THE MARK CONSISTS OF STANDARD CHARACTERS WITHOUT CLAIM TO ANY PARTICULAR FONT, STYLE, SIZE, OR COLOR.

SER. NO. 85-310,861, FILED 5-3-2011.

CAROLYN CATALDO, EXAMINING ATTORNEY



David J. Kybas

Director of the United States Patent and Trademark Office

United States of America

United States Patent and Trademark Office

GOSPEL

Reg. No. 4,067,103

Registered Dec. 6, 2011

Int. Cl.: 35

SERVICE MARK

PRINCIPAL REGISTER

VEDA GROUP, INC. (NEVADA CORPORATION)
8659 HAVEN AVE, SUITE 100
RANCHO CUCAMONGA, CA 91730

FOR: BUSINESS PLANNING SERVICES, IN CLASS 35 (U.S. CLS. 100, 101 AND 102).

FIRST USE 9-30-1998; IN COMMERCE 9-30-1998.

THE MARK CONSISTS OF STANDARD CHARACTERS WITHOUT CLAIM TO ANY PARTICULAR FONT, STYLE, SIZE, OR COLOR.

SER. NO. 85-310,866, FILED 5-3-2011.

CAROLYN CATALDO, EXAMINING ATTORNEY



David J. Kybas

Director of the United States Patent and Trademark Office

United States of America

United States Patent and Trademark Office

Jump Start Your Injury Claim

Reg. No. 4,067,104

Registered Dec. 6, 2011

Int. Cl.: 45

SERVICE MARK

PRINCIPAL REGISTER

ERIC H. WOODS, LTD. (NEVADA CORPORATION), DBA LAW OFFICES OF ERIC WOODS
SUITE A
2055 W. CHARLESTON BLVD.
LAS VEGAS, NV 89102

FOR: LITIGATION SERVICES, IN CLASS 45 (U.S. CLS. 100 AND 101).

FIRST USE 5-2-2011; IN COMMERCE 5-2-2011.

THE MARK CONSISTS OF STANDARD CHARACTERS WITHOUT CLAIM TO ANY PARTICULAR FONT, STYLE, SIZE, OR COLOR.

SER. NO. 85-310,869, FILED 5-3-2011.

JOHN WILKE, EXAMINING ATTORNEY



David J. Kybas

Director of the United States Patent and Trademark Office

United States of America

United States Patent and Trademark Office

GRAND TRUNK

Reg. No. 4,067,105

Registered Dec. 6, 2011

Int. Cls.: 18, 20, 22 and 24

THE TRAVEL HAMMOCK INC. (ILLINOIS CORPORATION)
1316 HOLLYWOOD AVENUE
GLENVIEW, IL 60025

FOR: TRAVEL BAGS, IN CLASS 18 (U.S. CLS. 1, 2, 3, 22 AND 41).

FIRST USE 8-1-2008; IN COMMERCE 8-1-2008.

TRADEMARK

FOR: PILLOWS; SLEEPING BAGS, IN CLASS 20 (U.S. CLS. 2, 13, 22, 25, 32 AND 50).

PRINCIPAL REGISTER

FIRST USE 8-1-2008; IN COMMERCE 8-1-2008.

FOR: HAMMOCKS; TENTS, IN CLASS 22 (U.S. CLS. 1, 2, 7, 19, 22, 42 AND 50).

FIRST USE 8-1-2008; IN COMMERCE 8-1-2008.

FOR: BLANKETS FOR OUTDOOR USE; TOWELS, IN CLASS 24 (U.S. CLS. 42 AND 50).

FIRST USE 8-1-2008; IN COMMERCE 8-1-2008.

THE MARK CONSISTS OF STANDARD CHARACTERS WITHOUT CLAIM TO ANY PARTICULAR FONT, STYLE, SIZE, OR COLOR.

OWNER OF U.S. REG. NO. 3,628,412.

SER. NO. 85-310,875, FILED 5-3-2011.

KAREN BRACEY, EXAMINING ATTORNEY



David J. Kybas

Director of the United States Patent and Trademark Office

United States of America

United States Patent and Trademark Office

ACTIVE RELEASE TECHNIQUES

Reg. No. 4,067,106

Registered Dec. 6, 2011

Int. Cl.: 9

TRADEMARK

PRINCIPAL REGISTER

ACTIVE RELEASE TECHNIQUES, LLC (COLORADO LIMITED LIABILITY COMPANY)
9240 EXPLORER DRIVE SUITE 210
COLORADO SPRINGS, CO 80920

FOR: PRERECORDED AUDIO AND VIDEO CASSETTES FEATURING TRAINING INSTRUCTION AND INFORMATION REGARDING NEURAL-MYO-FASCIAL MEDICAL TREATMENT AND INSTRUCTION MANUALS SOLD THEREWITH AS A UNIT, IN CLASS 9 (U.S. CLS. 21, 23, 26, 36 AND 38).

FIRST USE 7-26-1993; IN COMMERCE 7-26-1993.

THE MARK CONSISTS OF STANDARD CHARACTERS WITHOUT CLAIM TO ANY PARTICULAR FONT, STYLE, SIZE, OR COLOR.

OWNER OF U.S. REG. NO. 1,903,898.

SEC. 2(F).

SER. NO. 85-310,889, FILED 5-3-2011.

ELISSA GARBER KON, EXAMINING ATTORNEY



David J. Kyffers

Director of the United States Patent and Trademark Office

United States of America
United States Patent and Trademark Office

sickdonkey

Reg. No. 4,067,107

Registered Dec. 6, 2011

Int. Cls.: 35 and 41

SERVICE MARK

PRINCIPAL REGISTER

BERTRAND FINANCIAL, LLC (ILLINOIS LIMITED LIABILITY COMPANY)
528 WILLIAMSBURG DRIVE, APT. D
BELLEVILLE, IL 62221

FOR: ORGANIZATION OF EVENTS, EXHIBITIONS, FAIRS AND SHOWS FOR COMMERCIAL, PROMOTIONAL AND ADVERTISING PURPOSES, IN CLASS 35 (U.S. CLS. 100, 101 AND 102).

FIRST USE 8-30-2010; IN COMMERCE 8-30-2010.

FOR: ENTERTAINMENT IN THE NATURE OF POKER GAMES; ENTERTAINMENT IN THE NATURE OF POKER TOURNAMENTS; ENTERTAINMENT SERVICES, NAMELY, CASINO GAMING; ENTERTAINMENT SERVICES, NAMELY, CONDUCTING LIVE POKER GAMES; PROVIDING INSTRUCTIONAL INFORMATION ON POKER, IN CLASS 41 (U.S. CLS. 100, 101 AND 107).

FIRST USE 8-30-2010; IN COMMERCE 8-30-2010.

THE MARK CONSISTS OF STANDARD CHARACTERS WITHOUT CLAIM TO ANY PARTICULAR FONT, STYLE, SIZE, OR COLOR.

SER. NO. 85-310,904, FILED 5-3-2011.

STEVEN R. FINE, EXAMINING ATTORNEY



David J. Kybas

Director of the United States Patent and Trademark Office

United States of America

United States Patent and Trademark Office

IXDA

Reg. No. 4,067,108

Registered Dec. 6, 2011

Int. Cls.: 35, 41 and 42

SERVICE MARK

PRINCIPAL REGISTER

INTERACTION DESIGN ASSOCIATION, INC. (OREGON CORPORATION)
15500 SW JAY STREET #49749
BEAVERTON, OR 97006

FOR: ARRANGING AND CONDUCTING TRADE SHOWS IN THE FIELD OF INTERACTION DESIGN; ASSOCIATION SERVICES, NAMELY, PROMOTING THE INTERESTS OF PROFESSIONALS AND FIRMS IN THE FIELD OF INTERACTION DESIGN; PROMOTING AND CONDUCTING TRADE SHOWS IN THE FIELD OF INTERACTION DESIGN, IN CLASS 35 (U.S. CLS. 100, 101 AND 102).

FIRST USE 4-1-2006; IN COMMERCE 4-1-2006.

FOR: EDUCATIONAL SERVICES, NAMELY, CONDUCTING CONFERENCES, SEMINARS, WORKSHOPS, ONLINE PROGRAMS AND INFORMAL PROGRAMS IN THE FIELD OF INTERACTION DESIGN AND DISTRIBUTION OF COURSE MATERIAL IN CONNECTION THEREWITH, IN CLASS 41 (U.S. CLS. 100, 101 AND 107).

FIRST USE 4-1-2006; IN COMMERCE 4-1-2006.

FOR: COMPUTER SERVICES, NAMELY, CREATING AN ON-LINE COMMUNITY FOR REGISTERED USERS TO PARTICIPATE IN DISCUSSIONS, GET FEEDBACK FROM THEIR PEERS, FORM VIRTUAL COMMUNITIES, AND ENGAGE IN SOCIAL NETWORKING FEATURING INFORMATION RELATING TO INTERACTION DESIGN AND INTERACTION DESIGN EMPLOYMENT; COMPUTER SERVICES, NAMELY, HOSTING AND MAINTAINING AN ON-LINE WEB SITE FOR OTHERS TO OBTAIN INFORMATION REGARDING INTERACTION DESIGN, IN CLASS 42 (U.S. CLS. 100 AND 101).

FIRST USE 4-1-2006; IN COMMERCE 4-1-2006.

THE MARK CONSISTS OF A REPRESENTATION OF THE LETTERS IXDA, WHERE THE LETTER I, D, AND A ARE IN UPPER-CASE LETTERS, AND THE LETTER X FORMS A STYLIZED REPRESENTATION OF A HUMAN BEING, WHEREIN DARKER SQUARES ARE PLACED AT THE END OF THE FOUR STEMS OF THE X, AND A DIAMOND SHAPE APPEARS ABOVE THE X.

SER. NO. 85-310,905, FILED 5-3-2011.



David J. Kyjars

Director of the United States Patent and Trademark Office

Reg. No. 4,067,108 JOHN WILKE, EXAMINING ATTORNEY

United States of America

United States Patent and Trademark Office

FIERCE BEAUTY

Reg. No. 4,067,109

ALMQUIST, JENNIFER A. (UNITED STATES INDIVIDUAL), DBA FIERCE BEAUTY
603 FIRST AVE.
COLFAX, WI 54730

Registered Dec. 6, 2011

Int. Cl.: 25

FOR: SCARVES, IN CLASS 25 (U.S. CLS. 22 AND 39).

TRADEMARK

FIRST USE 10-24-2009; IN COMMERCE 10-24-2009.

PRINCIPAL REGISTER

THE MARK CONSISTS OF THE WORDS "FIERCE BEAUTY" IN A STYLIZED FONT.

SER. NO. 85-310,909, FILED 5-3-2011.

JESSICA A. POWERS, EXAMINING ATTORNEY



David J. Kyffers

Director of the United States Patent and Trademark Office

United States of America

United States Patent and Trademark Office

Crovel

Reg. No. 4,067,110

Registered Dec. 6, 2011

Int. Cl.: 8

TRADEMARK

PRINCIPAL REGISTER

THE RECON AGENCY (ARIZONA LIMITED LIABILITY COMPANY)
16410 NORTH 91ST STREET · SUITE 104
SCOTTSDALE, AZ 85260

FOR: HAND TOOLS, NAMELY, SHOVEL, CROWBAR; MANUALLY OPERATED HAND TOOLS, NAMELY, CROWBAR, SHOVEL; SHOVELS, IN CLASS 8 (U.S. CLS. 23, 28 AND 44).

FIRST USE 1-2-2011; IN COMMERCE 1-2-2011.

THE MARK CONSISTS OF STANDARD CHARACTERS WITHOUT CLAIM TO ANY PARTICULAR FONT, STYLE, SIZE, OR COLOR.

SER. NO. 85-310,911, FILED 5-3-2011.

JESSICA A. POWERS, EXAMINING ATTORNEY



David J. Kybas

Director of the United States Patent and Trademark Office

United States of America

United States Patent and Trademark Office

EDRINKIT

Reg. No. 4,067,111

Registered Dec. 6, 2011

Int. Cl.: 35

SERVICE MARK

PRINCIPAL REGISTER

SABET, OMID (UNITED STATES INDIVIDUAL)
5228 OCEAN BREEZE CT.
SAN DIEGO, CA 92109 AND

ROIZEN, ALEXANDER (UNITED STATES INDIVIDUAL)
6252 CHARING ST.
SAN DIEGO, CA 92117

FOR: PROMOTING, MARKETING AND ADVERTISING THE GOODS AND SERVICES OF OTHERS BY PROVIDING A WEBSITE FEATURING COUPONS, DEALS, PRICE-COMPARISON INFORMATION, PRODUCT REVIEWS, LINKS TO THE RETAIL WEBSITES OF OTHERS, AND DISCOUNT INFORMATION AND OFFERINGS, IN CLASS 35 (U.S. CLS. 100, 101 AND 102).

FIRST USE 2-1-2011; IN COMMERCE 2-1-2011.

THE MARK CONSISTS OF STANDARD CHARACTERS WITHOUT CLAIM TO ANY PARTICULAR FONT, STYLE, SIZE, OR COLOR.

SER. NO. 85-310,912, FILED 5-3-2011.

JESSICA A. POWERS, EXAMINING ATTORNEY



David J. Kyffers

Director of the United States Patent and Trademark Office

United States of America

United States Patent and Trademark Office

NIRSAT

Reg. No. 4,067,112

Registered Dec. 6, 2011

Int. Cl.: 42

SERVICE MARK

PRINCIPAL REGISTER

EME INTERNATIONAL, INC. (MASSACHUSETTS CORPORATION), DBA AMERICAN
ACADEMY OF EXPERT MEDICAL EVALUATORS
10 TIOGA WAY
MARBLEHEAD, MA 01945

FOR: TESTING, ANALYSIS, AND EVALUATION OF THE KNOWLEDGE, SKILLS AND
ABILITIES OF OTHERS FOR THE PURPOSE OF CERTIFICATION AND RE-CERTIFICATION
IN THE FIELD OF IMPAIRMENT RATINGS FOR EXPERT MEDICAL EVALUATIONS, IN
CLASS 42 (U.S. CLS. 100 AND 101).

FIRST USE 6-1-2006; IN COMMERCE 6-1-2006.

THE MARK CONSISTS OF STANDARD CHARACTERS WITHOUT CLAIM TO ANY PAR-
TICULAR FONT, STYLE, SIZE, OR COLOR.

SER. NO. 85-310,916, FILED 5-3-2011.

VERNA BETH RIRIE, EXAMINING ATTORNEY



David J. Kyffers

Director of the United States Patent and Trademark Office

United States of America

United States Patent and Trademark Office

TIRSAT

Reg. No. 4,067,113

Registered Dec. 6, 2011

Int. Cl.: 42

SERVICE MARK

PRINCIPAL REGISTER

EME INTERNATIONAL, INC. (MASSACHUSETTS CORPORATION), DBA AMERICAN
ACADEMY OF EXPERT MEDICAL EVALUATORS
10 TIOGA WAY
MARBLEHEAD, MA 01945

FOR: TESTING, ANALYSIS, AND EVALUATION OF THE KNOWLEDGE, SKILLS AND
ABILITIES OF OTHERS FOR THE PURPOSE OF CERTIFICATION AND RE-CERTIFICATION
IN THE FIELD OF IMPAIRMENT RATINGS FOR EXPERT MEDICAL EVALUATIONS, IN
CLASS 42 (U.S. CLS. 100 AND 101).

FIRST USE 6-13-2003; IN COMMERCE 6-13-2003.

THE MARK CONSISTS OF STANDARD CHARACTERS WITHOUT CLAIM TO ANY PAR-
TICULAR FONT, STYLE, SIZE, OR COLOR.

SER. NO. 85-310,921, FILED 5-3-2011.

VERNA BETH RIRIE, EXAMINING ATTORNEY



David J. Kyffers

Director of the United States Patent and Trademark Office

United States of America

United States Patent and Trademark Office

CIRS

Reg. No. 4,067,114

Registered Dec. 6, 2011

Int. Cl.: 42

SERVICE MARK

PRINCIPAL REGISTER

EME INTERNATIONAL, INC. (MASSACHUSETTS CORPORATION), DBA AMERICAN
ACADEMY OF EXPERT MEDICAL EVALUATORS
10 TIOGA WAY
MARBLEHEAD, MA 01945

FOR: TESTING, ANALYSIS, AND EVALUATION OF THE KNOWLEDGE, SKILLS AND
ABILITIES OF OTHERS FOR THE PURPOSE OF CERTIFICATION AND RE-CERTIFICATION
IN THE FIELD OF IMPAIRMENT RATINGS FOR EXPERT MEDICAL EVALUATIONS, IN
CLASS 42 (U.S. CLS. 100 AND 101).

FIRST USE 7-17-2005; IN COMMERCE 7-17-2005.

THE MARK CONSISTS OF STANDARD CHARACTERS WITHOUT CLAIM TO ANY PAR-
TICULAR FONT, STYLE, SIZE, OR COLOR.

SER. NO. 85-310,923, FILED 5-3-2011.

VERNA BETH RIRIE, EXAMINING ATTORNEY



David J. Kybas

Director of the United States Patent and Trademark Office

United States of America

United States Patent and Trademark Office



Reg. No. 4,067,115

Registered Dec. 6, 2011

Int. Cl.: 29

TRADEMARK

PRINCIPAL REGISTER

BROOKWOOD FARMS, INC. (NORTH CAROLINA CORPORATION)
1015 ALSTON BRIDGE ROAD
SILER CITY, NC 27344

FOR: PORK, PULLED PORK, CHOPPED PORK, AND PORK BUTTS; CHICKEN, CHICKEN QUARTERS; BARBECUE RIBS, BRUNSWICK STEW; AND BEEF BRISKET, IN CLASS 29 (U.S. CL. 46).

FIRST USE 9-1-1978; IN COMMERCE 9-1-1978.

OWNER OF U.S. REG. NOS. 2,521,979 AND 2,539,505.

THE MARK CONSISTS OF FRONT OF BARN WITH DOORS OPEN WITH BROOKWOOD FARMS IN BETWEEN BARN DOORS.

SER. NO. 85-310,940, FILED 5-3-2011.

AMY HELLA, EXAMINING ATTORNEY



David J. Kybas

Director of the United States Patent and Trademark Office

United States of America

United States Patent and Trademark Office



Reg. No. 4,067,116

Registered Dec. 6, 2011

Int. Cl.: 9

TRADEMARK

PRINCIPAL REGISTER

AQUAWAYS CO., LTD. (TAIWAN CORPORATION)
NO.26 GAOCING RD., YANGMEI TOWNSHIP
TAOYUAN COUNTY, TAIWAN

FOR: FULL LINE OF PARTS FOR MOBILE TELEPHONES AND MOBILE PHONE ACCESSORIES, NAMELY, MOBILE TELEPHONE COVERS, MOBILE TELEPHONE CASES, BATTERIES, RECHARGEABLE BATTERIES, BATTERY CHARGERS, CHARGERS FOR ELECTRIC BATTERIES, HEADPHONES, STEREO HEADPHONES, IN-EAR HEADPHONES, STEREO SPEAKERS, AUDIO SPEAKERS FOR HOME, PERSONAL STEREO SPEAKER APPARATUS, MICROPHONES, CAR AUDIO ADAPTERS, HEADSETS, REMOTE CONTROLS, CONNECTION CABLES, POWER ADAPTERS, DOCKING STATIONS, AND ADAPTER PLUGS, PROTECTIVE COVERS AND CASES FOR CELL PHONES, IN CLASS 9 (U.S. CLS. 21, 23, 26, 36 AND 38).

FIRST USE 1-1-2011; IN COMMERCE 1-1-2011.

THE MARK CONSISTS OF A LETTER "W" IN A STYLIZED FONT WITH A DOT OVER THE RIGHT SIDE; UNDERNEATH THE "W" IS THE WORD "WISEWAYS" IN A SMALLER FONT.

SER. NO. 85-310,963, FILED 5-3-2011.

ZACHARY BELLO, EXAMINING ATTORNEY



David J. Kyros

Director of the United States Patent and Trademark Office

United States of America

United States Patent and Trademark Office

SNAKE DOG

Reg. No. 4,067,117

Registered Dec. 6, 2011

Int. Cl.: 32

TRADEMARK

PRINCIPAL REGISTER

FLYING DOG BREWERY, LLLP (COLORADO LIMITED LIABILITY LIMITED
PARTNERSHIP)
SUITE 104
2330 BROADWAY
DENVER, CO 80205

FOR: BREWED MALT-BASED ALCOHOLIC BEVERAGE IN THE NATURE OF A BEER, IN
CLASS 32 (U.S. CLS. 45, 46 AND 48).

FIRST USE 4-0-1998; IN COMMERCE 7-0-1998.

THE MARK CONSISTS OF STANDARD CHARACTERS WITHOUT CLAIM TO ANY PAR-
TICULAR FONT, STYLE, SIZE, OR COLOR.

OWNER OF U.S. REG. NOS. 3,448,951, 3,495,109, AND 3,546,139.

SER. NO. 85-310,967, FILED 5-3-2011.

WILLIAM P. SHANAHAN, EXAMINING ATTORNEY



David J. Kyffers

Director of the United States Patent and Trademark Office

United States of America

United States Patent and Trademark Office

Jump Start Your Auto Accident Claim

Reg. No. 4,067,118

Registered Dec. 6, 2011

Int. Cl.: 45

SERVICE MARK

PRINCIPAL REGISTER

ERIC H. WOODS, LTD. (NEVADA CORPORATION), DBA LAW OFFICES OF ERIC WOODS
SUITE A
2055 W. CHARLESTON BLVD.
LAS VEGAS, NV 89102

FOR: LITIGATION SERVICES, IN CLASS 45 (U.S. CLS. 100 AND 101).

FIRST USE 5-2-2011; IN COMMERCE 5-2-2011.

THE MARK CONSISTS OF STANDARD CHARACTERS WITHOUT CLAIM TO ANY PARTICULAR FONT, STYLE, SIZE, OR COLOR.

SER. NO. 85-311,041, FILED 5-3-2011.

JOHN WILKE, EXAMINING ATTORNEY



David J. Kyffers

Director of the United States Patent and Trademark Office

United States of America

United States Patent and Trademark Office

Global Reach. Local Values.

Reg. No. 4,067,119

HOKU SOLAR, INC. (DELAWARE CORPORATION)
1288 ALA MOANA BLVD., SUITE 220
HONOLULU, HI 96814

Registered Dec. 6, 2011

Int. Cl.: 37

FOR: INSTALLATION AND MAINTENANCE OF PHOTOVOLTAIC INSTALLATIONS, IN CLASS 37 (U.S. CLS. 100, 103 AND 106).

SERVICE MARK

FIRST USE 6-1-2010; IN COMMERCE 5-2-2011.

PRINCIPAL REGISTER

THE MARK CONSISTS OF STANDARD CHARACTERS WITHOUT CLAIM TO ANY PARTICULAR FONT, STYLE, SIZE, OR COLOR.

SER. NO. 85-311,046, FILED 5-3-2011.

LESLIE RICHARDS, EXAMINING ATTORNEY



David J. Kyffers

Director of the United States Patent and Trademark Office

United States of America

United States Patent and Trademark Office

D.S. & DURGA

Reg. No. 4,067,120

Registered Dec. 6, 2011

Int. Cl.: 3

TRADEMARK

PRINCIPAL REGISTER

D.S. & DURGA, LLC (NEW YORK LIMITED LIABILITY COMPANY)
UNIT A
333 GRAND AVENUE
BROOKLYN, NY 11238

FOR: FRAGRANCES; PERFUMES, IN CLASS 3 (U.S. CLS. 1, 4, 6, 50, 51 AND 52).

FIRST USE 12-0-2007; IN COMMERCE 1-0-2008.

THE MARK CONSISTS OF STANDARD CHARACTERS WITHOUT CLAIM TO ANY PARTICULAR FONT, STYLE, SIZE, OR COLOR.

SER. NO. 85-311,047, FILED 5-3-2011.

KATHLEEN LORENZO, EXAMINING ATTORNEY



David J. Kybas

Director of the United States Patent and Trademark Office

United States of America

United States Patent and Trademark Office

Monkey Prism

Reg. No. 4,067,121

Registered Dec. 6, 2011

Int. Cl.: 42

SERVICE MARK

PRINCIPAL REGISTER

DANIELSON, INC. (CALIFORNIA CORPORATION)
UNIT 125
10454 SCRIPPS POWAY PKWY
SAN DIEGO, CA 92131

FOR: COMPUTER SOFTWARE TECHNOLOGY DEVELOPMENT, IN CLASS 42 (U.S. CLS. 100 AND 101).

FIRST USE 1-15-2011; IN COMMERCE 1-17-2011.

THE MARK CONSISTS OF STANDARD CHARACTERS WITHOUT CLAIM TO ANY PARTICULAR FONT, STYLE, SIZE, OR COLOR.

SER. NO. 85-311,086, FILED 5-3-2011.

MARGERIE A. TIERNEY, EXAMINING ATTORNEY



David J. Kybas

Director of the United States Patent and Trademark Office

United States of America

United States Patent and Trademark Office

PHYTO +

Reg. No. 4,067,122

Registered Dec. 6, 2011

Int. Cl.: 3

TRADEMARK

PRINCIPAL REGISTER

L'OREAL USA CREATIVE, INC. (DELAWARE CORPORATION)
575 FIFTH AVENUE
NEW YORK, NY 10017

FOR: NON-MEDICATED SKINCARE PREPARATION, IN CLASS 3 (U.S. CLS. 1, 4, 6, 50, 51 AND 52).

FIRST USE 1-0-2004, THE MARK WAS FIRST USED ANYWHERE IN A DIFFERENT FORM OTHER THAN THAT SOUGHT TO BE REGISTERED AT LEAST AS EARLY AS 09/28/1999; IN COMMERCE 1-0-2004, THE MARK WAS FIRST USED IN COMMERCE IN A DIFFERENT FORM OTHER THAN THAT SOUGHT TO BE REGISTERED AT LEAST AS EARLY AS 09/28/1999.

THE MARK CONSISTS OF STANDARD CHARACTERS WITHOUT CLAIM TO ANY PARTICULAR FONT, STYLE, SIZE, OR COLOR.

OWNER OF U.S. REG. NO. 2,945,671.

SER. NO. 85-311,095, FILED 5-3-2011.

ELIZABETH HUGHITT, EXAMINING ATTORNEY



David J. Kyros

Director of the United States Patent and Trademark Office

United States of America

United States Patent and Trademark Office

Goose Barnacle

Reg. No. 4,067,123

Registered Dec. 6, 2011

Int. Cl.: 35

SERVICE MARK

PRINCIPAL REGISTER

GOOSE BARNACLE LLC (NEW YORK LIMITED LIABILITY COMPANY)
91 ATLANTIC AVE
BROOKLYN, NY 11201

FOR: WHOLESALE AND RETAIL STORE SERVICES FEATURING CLOTHING, IN CLASS 35 (U.S. CLS. 100, 101 AND 102).

FIRST USE 6-1-2010; IN COMMERCE 9-28-2010.

THE MARK CONSISTS OF STANDARD CHARACTERS WITHOUT CLAIM TO ANY PARTICULAR FONT, STYLE, SIZE, OR COLOR.

SER. NO. 85-311,097, FILED 5-3-2011.

ELIZABETH HUGHITT, EXAMINING ATTORNEY



David J. Kyros

Director of the United States Patent and Trademark Office

United States of America

United States Patent and Trademark Office

* J ILLERY *

Reg. No. 4,067,124

Registered Dec. 6, 2011

Int. Cl.: 14

TRADEMARK

PRINCIPAL REGISTER

HARTER-FOIST, JILL M. (UNITED STATES INDIVIDUAL)
17182 COBRA LANE
HUNTINGTON BEACH, CA 92647

FOR: JEWELRY, IN CLASS 14 (U.S. CLS. 2, 27, 28 AND 50).

FIRST USE 3-0-2010; IN COMMERCE 6-0-2010.

THE MARK CONSISTS OF THE STYLIZED TEXT "JILLERY" WITH A DIAMOND OVER THE LETTER "I". THERE ARE THREE "SPARKLES" AROUND THE STYLIZED TEXT.

SER. NO. 85-311,107, FILED 5-3-2011.

WILLIAM P. SHANAHAN, EXAMINING ATTORNEY



David J. Kybas

Director of the United States Patent and Trademark Office

United States of America

United States Patent and Trademark Office



Reg. No. 4,067,125

Registered Dec. 6, 2011

Int. Cl.: 17

TRADEMARK

PRINCIPAL REGISTER

PARAGON FILMS, INC. (OKLAHOMA CORPORATION)
3500 W. TACOMA
BROKEN ARROW, OK 74012

FOR: PLASTIC FILM FOR INDUSTRIAL AND COMMERCIAL PACKING USE, IN CLASS 17 (U.S. CLS. 1, 5, 12, 13, 35 AND 50).

FIRST USE 6-6-2011; IN COMMERCE 6-6-2011.

OWNER OF U.S. REG. NOS. 3,655,744 AND 3,718,149.

THE MARK CONSISTS OF THE STYLIZED WORD "TORQUE" OVERLAID UPON A STYLIZED BIRD DESIGN WITH OUTSTRETCHED WINGS ON A CIRCULAR BACKGROUND WITH A GEAR-TOOTH BORDER.

SER. NO. 85-311,176, FILED 5-3-2011.

ALICE BENMAMAN, EXAMINING ATTORNEY



David J. Kybas

Director of the United States Patent and Trademark Office

United States of America

United States Patent and Trademark Office



Reg. No. 4,067,126

Registered Dec. 6, 2011

Int. Cl.: 9

TRADEMARK

PRINCIPAL REGISTER

SPARTAN MOTORS, INC. (MICHIGAN CORPORATION)
1000 REYNOLDS ROAD
CHARLOTTE, MI 48813

FOR: FIRE TRUCKS; RESCUE TRUCKS SPECIALLY EQUIPPED FOR PHYSICAL RESCUE AND NOT MEDICAL CARE; AERIALS, IN CLASS 9 (U.S. CLS. 21, 23, 26, 36 AND 38).

FIRST USE 1-31-2003; IN COMMERCE 1-31-2003.

THE MARK CONSISTS OF A RING. INSIDE THE RING IS A STYLIZED SHAPE HAVING FOUR CURVED SIDES, THE CURVED SIDES MEETING AT FOUR POINTS, SUCH THAT THE FOUR POINTS ARE DIRECTED, RESPECTIVELY, TO THE TOP, BOTTOM AND TO THE OPPOSITE SIDES OF THE RING.

SER. NO. 85-311,177, FILED 5-3-2011.

ANNE E. GUSTASON, EXAMINING ATTORNEY



David J. Kybas

Director of the United States Patent and Trademark Office

United States of America

United States Patent and Trademark Office

WHEN ROCK MET COUNTRY

Reg. No. 4,067,127

KEVIN SHOOPMAN (UNITED STATES INDIVIDUAL)
5117 PRESTWICK SQUARE
MARION, IN 46953

Registered Dec. 6, 2011

Int. Cl.: 41

FOR: ENTERTAINMENT SERVICES IN THE NATURE OF LIVE MUSICAL PERFORMANCES,
IN CLASS 41 (U.S. CLS. 100, 101 AND 107).

SERVICE MARK

FIRST USE 2-25-2011; IN COMMERCE 2-25-2011.

PRINCIPAL REGISTER

THE MARK CONSISTS OF STANDARD CHARACTERS WITHOUT CLAIM TO ANY PARTICULAR FONT, STYLE, SIZE, OR COLOR.

SER. NO. 85-311,182, FILED 5-3-2011.

LAURIE KAUFMAN, EXAMINING ATTORNEY



David J. Kybas

Director of the United States Patent and Trademark Office

United States of America

United States Patent and Trademark Office

Endodontist NYC

Reg. No. 4,067,128

Registered Dec. 6, 2011

Int. Cl.: 44

SERVICE MARK

PRINCIPAL REGISTER

CEZARY M. MITRUT, D.M.D., PLLC (NEW YORK LIMITED LIABILITY COMPANY)
SUITE 1D
30-44 29TH STREET
ASTORIA, NY 11102

FOR: DENTAL SERVICES, NAMELY PERFORMING ENDODONTICS; PROVIDING A WEBSITE FEATURING INFORMATION FOR PATIENTS IN THE FIELD OF DENTAL HEALTH, IN CLASS 44 (U.S. CLS. 100 AND 101).

FIRST USE 9-23-2005; IN COMMERCE 9-23-2005.

THE MARK CONSISTS OF STANDARD CHARACTERS WITHOUT CLAIM TO ANY PARTICULAR FONT, STYLE, SIZE, OR COLOR.

NO CLAIM IS MADE TO THE EXCLUSIVE RIGHT TO USE "ENDODONTIST", APART FROM THE MARK AS SHOWN.

SEC. 2(F).

SER. NO. 85-311,198, FILED 5-3-2011.

MARK RADEMACHER, EXAMINING ATTORNEY



David J. Kybas

Director of the United States Patent and Trademark Office

United States of America

United States Patent and Trademark Office

IN YOUR COMMUNITY, ON YOUR
SIDE

Reg. No. 4,067,129

Registered Dec. 6, 2011

Int. Cl.: 45

SERVICE MARK

PRINCIPAL REGISTER

RUE & ZIFFRA, P.A. (FLORIDA CORPORATION)
632 DUNLAWTON AVE.
PORT ORANGE, FL 32127

FOR: LEGAL SERVICES, IN CLASS 45 (U.S. CLS. 100 AND 101).

FIRST USE 1-1-2009; IN COMMERCE 1-1-2009.

THE MARK CONSISTS OF STANDARD CHARACTERS WITHOUT CLAIM TO ANY PARTICULAR FONT, STYLE, SIZE, OR COLOR.

SER. NO. 85-311,204, FILED 5-3-2011.

KHANH LE, EXAMINING ATTORNEY



David J. Kyffers

Director of the United States Patent and Trademark Office

United States of America

United States Patent and Trademark Office

THE NEW SOCIAL

Reg. No. 4,067,130

Registered Dec. 6, 2011

Int. Cl.: 25

TRADEMARK

PRINCIPAL REGISTER

CARIBBEAN SOURCING APPAREL, LLC (CALIFORNIA LIMITED LIABILITY COMPANY)
3470 WILSHIRE BOULEVARD, SUITE 950
LOS ANGELES, CA 90005

FOR: KNIT SHIRTS; T-SHIRTS, IN CLASS 25 (U.S. CLS. 22 AND 39).

FIRST USE 3-0-2011; IN COMMERCE 3-0-2011.

THE MARK CONSISTS OF STANDARD CHARACTERS WITHOUT CLAIM TO ANY PARTICULAR FONT, STYLE, SIZE, OR COLOR.

SER. NO. 85-311,208, FILED 5-3-2011.

TINA MAI, EXAMINING ATTORNEY



David J. Kyffers

Director of the United States Patent and Trademark Office

United States of America

United States Patent and Trademark Office



Reg. No. 4,067,131

Registered Dec. 6, 2011

Int. Cl.: 25

TRADEMARK

PRINCIPAL REGISTER

PUNAHOU SCHOOL (HAWAII CORPORATION)
1601 PUNAHOU STREET
HONOLULU, HI 96822

FOR: GOLF SHIRTS; HOODED SWEAT SHIRTS; SWEAT PANTS; SWEAT SHIRTS; T-SHIRTS, IN CLASS 25 (U.S. CLS. 22 AND 39).

FIRST USE 8-29-1989; IN COMMERCE 8-29-1989.

THE MARK CONSISTS OF THE STYLIZED IMAGE OF A HALA TREE.

SER. NO. 85-311,225, FILED 5-3-2011.

THEODORE MCBRIDE, EXAMINING ATTORNEY



David J. Kyffers

Director of the United States Patent and Trademark Office

United States of America

United States Patent and Trademark Office

OPTYMUS

Reg. No. 4,067,132

Registered Dec. 6, 2011

Int. Cl.: 1

TRADEMARK

PRINCIPAL REGISTER

BRILLYANT RESOURCES, LLC (DELAWARE LIMITED LIABILITY COMPANY)
3007 W. COMMERCIAL BLVD, SUITE 101
FORT LAUDERDALE, FL 33309

FOR: FERTILIZERS, IN CLASS 1 (U.S. CLS. 1, 5, 6, 10, 26 AND 46).

FIRST USE 11-0-2009; IN COMMERCE 11-0-2009.

THE MARK CONSISTS OF STANDARD CHARACTERS WITHOUT CLAIM TO ANY PARTICULAR FONT, STYLE, SIZE, OR COLOR.

SER. NO. 85-311,227, FILED 5-3-2011.

WILLIAM P. SHANAHAN, EXAMINING ATTORNEY



David J. Kybas

Director of the United States Patent and Trademark Office

United States of America

United States Patent and Trademark Office

leadself
lead others
moving your story forward

Reg. No. 4,067,133

Registered Dec. 6, 2011

Int. Cl.: 41

SERVICE MARK

PRINCIPAL REGISTER

BAXTER, NATHAN (UNITED STATES INDIVIDUAL)
4416 WEST COLLEGE COURT
BROKEN ARROW, OK 74012

FOR: EDUCATION SERVICES, NAMELY, PROVIDING COACHING, WORKSHOPS, CONFERENCES, WEBINARS IN THE FIELD OF LEADERSHIP AND SELF-HELP, IN CLASS 41 (U.S. CLS. 100, 101 AND 107).

FIRST USE 2-1-2001; IN COMMERCE 2-1-2001.

THE MARK CONSISTS OF THE STYLIZED TEXT "LEAD SELF LEAD OTHERS MOVING YOUR STORY FORWARD". THE D IN THE SECOND "LEAD" TAKES THE FORM OF AN ARROW.

SER. NO. 85-311,286, FILED 5-3-2011.

EMILY CHUO, EXAMINING ATTORNEY



David J. Kyjars

Director of the United States Patent and Trademark Office

United States of America

United States Patent and Trademark Office



Reg. No. 4,067,134

Registered Dec. 6, 2011

Int. Cl.: 9

TRADEMARK

PRINCIPAL REGISTER

SOUNDGATE STUDIO, INC. (CANADA CORPORATION)
129 ROWNTREE DAIRY ROAD, UNIT #4
VAUGHAN, ONTARIO, CANADA L4L6C9

FOR: COMPUTER APPLICATION SOFTWARE FOR MOBILE PHONES, NAMELY, SOFTWARE FOR USE IN DATA PROCESSING AND GRAPHIC DISPLAY; COMPUTER GAME SOFTWARE; COMPUTER GAME SOFTWARE DOWNLOADABLE FROM A GLOBAL COMPUTER NETWORK; COMPUTER GAME SOFTWARE FOR USE ON MOBILE AND CELLULAR PHONES; DOWNLOADABLE COMPUTER GAME SOFTWARE VIA A GLOBAL COMPUTER NETWORK AND WIRELESS DEVICES; DOWNLOADABLE SOFTWARE IN THE NATURE OF A MOBILE APPLICATION FOR USE IN DATA PROCESSING AND GRAPHIC DISPLAY; ELECTRONIC GAME SOFTWARE; ELECTRONIC GAME SOFTWARE FOR CELLULAR TELEPHONES; ELECTRONIC GAME SOFTWARE FOR HANDHELD ELECTRONIC DEVICES; ELECTRONIC GAME SOFTWARE FOR WIRELESS DEVICES , IN CLASS 9 (U.S. CLS. 21, 23, 26, 36 AND 38).

FIRST USE 4-29-2011; IN COMMERCE 4-29-2011.

THE MARK CONSISTS OF THE WORDING "SGS SOUNDGATE STUDIO" AND TWO SPEAKERS.

SER. NO. 85-311,292, FILED 5-3-2011.

DANNEAN HETZEL, EXAMINING ATTORNEY



David J. Kybas

Director of the United States Patent and Trademark Office

United States of America

United States Patent and Trademark Office

SKYYTRACKS

Reg. No. 4,067,135

Registered Dec. 6, 2011

Int. Cl.: 35

SERVICE MARK

PRINCIPAL REGISTER

DNG CONSULTING LLC (DELAWARE LIMITED LIABILITY COMPANY)
222 VALLEY CT
HAWORTH, NJ 07641

FOR: ON-LINE RETAIL STORE SERVICES FEATURING DOWNLOADABLE PRE-RECORDED MUSIC AND VIDEO; ONLINE MUSIC PROMOTION SERVICES, IN CLASS 35 (U.S. CLS. 100, 101 AND 102).

FIRST USE 1-1-2011; IN COMMERCE 1-11-2011.

THE MARK CONSISTS OF STANDARD CHARACTERS WITHOUT CLAIM TO ANY PARTICULAR FONT, STYLE, SIZE, OR COLOR.

SER. NO. 85-311,296, FILED 5-3-2011.

MARK RADEMACHER, EXAMINING ATTORNEY



David J. Kyffers

Director of the United States Patent and Trademark Office

United States of America

United States Patent and Trademark Office

TabSite

Reg. No. 4,067,136

Registered Dec. 6, 2011

Int. Cl.: 42

SERVICE MARK

PRINCIPAL REGISTER

RUMFELT, TROY (UNITED STATES INDIVIDUAL)
10018 CRABAPPLE LN.
MIDDLEBURY, IN 46540

FOR: PROVIDING TEMPORARY USE OF ON-LINE NONDOWNLOADABLE SOFTWARE AND APPLICATIONS FOR USE IN WEBSITE DESIGN, IN CLASS 42 (U.S. CLS. 100 AND 101).

FIRST USE 3-17-2010; IN COMMERCE 3-17-2010.

THE MARK CONSISTS OF STANDARD CHARACTERS WITHOUT CLAIM TO ANY PARTICULAR FONT, STYLE, SIZE, OR COLOR.

SER. NO. 85-311,301, FILED 5-3-2011.

CHRISTINA SOBRAL, EXAMINING ATTORNEY



David J. Kyffers

Director of the United States Patent and Trademark Office

United States of America

United States Patent and Trademark Office

COACH

Reg. No. 4,067,137

Registered Dec. 6, 2011

Int. Cl.: 9

TRADEMARK

PRINCIPAL REGISTER

ZORAN CORPORATION (DELAWARE CORPORATION)
1390 KIFER ROAD
SUNNYVALE, CA 94086

FOR: COMPUTER HARDWARE, NAMELY, INTEGRATED CIRCUITS AND MICROPROCESSORS, IN CLASS 9 (U.S. CLS. 21, 23, 26, 36 AND 38).

FIRST USE 1-0-1999; IN COMMERCE 1-0-1999.

THE MARK CONSISTS OF STANDARD CHARACTERS WITHOUT CLAIM TO ANY PARTICULAR FONT, STYLE, SIZE, OR COLOR.

SER. NO. 85-311,305, FILED 5-3-2011.

CHRISTINA SOBRAL, EXAMINING ATTORNEY



David J. Kybas

Director of the United States Patent and Trademark Office

United States of America

United States Patent and Trademark Office

DyVal

Reg. No. 4,067,138

Registered Dec. 6, 2011

Int. Cl.: 41

SERVICE MARK

PRINCIPAL REGISTER

GLOBAL EVOLUTIONARY NETWORK (WYOMING LIMITED LIABILITY COMPANY)
SUITE 428
6300 N. SAGEWOOD DRIVE
PARK CITY, UT 84098

FOR: EDUCATIONAL SERVICES, NAMELY, CONDUCTING GAMES, SIMULATIONS, SEMINARS AND WORKSHOPS IN THE FIELDS OF PERSONAL, BUSINESS AND PROFESSIONAL DEVELOPMENT AND DISTRIBUTION OF TRAINING MATERIALS IN CONNECTION THEREWITH, IN CLASS 41 (U.S. CLS. 100, 101 AND 107).

FIRST USE 2-1-2003; IN COMMERCE 1-25-2005.

THE MARK CONSISTS OF STANDARD CHARACTERS WITHOUT CLAIM TO ANY PARTICULAR FONT, STYLE, SIZE, OR COLOR.

SER. NO. 85-311,307, FILED 5-3-2011.

ANNE MADDEN, EXAMINING ATTORNEY



David J. Kyjars

Director of the United States Patent and Trademark Office

United States of America

United States Patent and Trademark Office

Damaboo

Reg. No. 4,067,139

LANCASTER, CHRISTOPHER DOUGLAS (UNITED STATES INDIVIDUAL), DBA DAMABOO
554 4TH AVE WEST N.
KALISPELL, MT 59901

Registered Dec. 6, 2011

Int. Cl.: 42

FOR: DESIGNING, CREATING, MAINTAINING, AND HOSTING OF PERSONAL AND BUSINESS WEBSITES FOR OTHERS, IN CLASS 42 (U.S. CLS. 100 AND 101).

SERVICE MARK

FIRST USE 2-1-1995; IN COMMERCE 2-1-1997.

PRINCIPAL REGISTER

THE MARK CONSISTS OF STANDARD CHARACTERS WITHOUT CLAIM TO ANY PARTICULAR FONT, STYLE, SIZE, OR COLOR.

SER. NO. 85-311,313, FILED 5-3-2011.

TINA MAI, EXAMINING ATTORNEY



David J. Kybas

Director of the United States Patent and Trademark Office

United States of America

United States Patent and Trademark Office



Reg. No. 4,067,140

Registered Dec. 6, 2011

Int. Cl.: 29

TRADEMARK

PRINCIPAL REGISTER

FRIENDSHIP DAIRIES, LLC (DELAWARE LIMITED LIABILITY COMPANY)
SUITE 3400
2711 NORTH HASKELL AVENUE
DALLAS, TX 75204

FOR: DAIRY PRODUCTS EXCLUDING ICE CREAM, ICE MILK AND FROZEN YOGURT,
IN CLASS 29 (U.S. CL. 46).

FIRST USE 7-13-2011; IN COMMERCE 7-13-2011.

OWNER OF U.S. REG. NO. 3,599,791.

THE MARK CONSISTS OF A GEOMETRIC FIGURE OF A WOMAN WITH ARMS EXTENDED.

SER. NO. 85-311,333, FILED 5-3-2011.

PAUL F. GAST, EXAMINING ATTORNEY



David J. Kybas

Director of the United States Patent and Trademark Office

United States of America

United States Patent and Trademark Office

THE SPAW

Reg. No. 4,067,141

Registered Dec. 6, 2011

Int. Cl.: 44

SERVICE MARK

PRINCIPAL REGISTER

HYDE, CARRIE (UNITED STATES INDIVIDUAL)
1821 ROYAL OAK ROAD
TUSTIN, CA 92780

FOR: PET CARE SERVICES, NAMELY, DOG WALKING, DOG BATHING AND NON-MEDICATED PET GROOMING; PET DENTIST SERVICES; PET GROOMING SERVICES, IN CLASS 44 (U.S. CLS. 100 AND 101).

FIRST USE 1-1-2005; IN COMMERCE 1-1-2005.

THE MARK CONSISTS OF STANDARD CHARACTERS WITHOUT CLAIM TO ANY PARTICULAR FONT, STYLE, SIZE, OR COLOR.

SER. NO. 85-311,356, FILED 5-3-2011.

JESSICA A. POWERS, EXAMINING ATTORNEY



David J. Kybas

Director of the United States Patent and Trademark Office

United States of America

United States Patent and Trademark Office

Fox Chase Farm

Reg. No. 4,067,142

Registered Dec. 6, 2011

Int. Cl.: 41

SERVICE MARK

PRINCIPAL REGISTER

FOX CHASE FARM, LLC (VIRGINIA LIMITED LIABILITY COMPANY)
P.O. BOX 743
MIDDLEBURG, VA 20118

FOR: HORSE SHOWING; HORSE TRAINING, IN CLASS 41 (U.S. CLS. 100, 101 AND 107).

FIRST USE 9-15-2000; IN COMMERCE 9-15-2000.

THE MARK CONSISTS OF STANDARD CHARACTERS WITHOUT CLAIM TO ANY PARTICULAR FONT, STYLE, SIZE, OR COLOR.

NO CLAIM IS MADE TO THE EXCLUSIVE RIGHT TO USE "FARM", APART FROM THE MARK AS SHOWN.

SER. NO. 85-311,368, FILED 5-3-2011.

GEORGE LORENZO, EXAMINING ATTORNEY



David J. Kybas

Director of the United States Patent and Trademark Office

United States of America

United States Patent and Trademark Office



Reg. No. 4,067,143

Registered Dec. 6, 2011

Int. Cl.: 41

SERVICE MARK

PRINCIPAL REGISTER

FOX CHASE FARM, LLC (VIRGINIA LIMITED LIABILITY COMPANY)
P.O. BOX 743
MIDDLEBURG, VA 20118

FOR: HORSE SHOWING; HORSE TRAINING, IN CLASS 41 (U.S. CLS. 100, 101 AND 107).

FIRST USE 9-15-2000; IN COMMERCE 9-15-2000.

NO CLAIM IS MADE TO THE EXCLUSIVE RIGHT TO USE "FARM", APART FROM THE MARK AS SHOWN.

THE COLOR(S) HUNTER GREEN AND GOLD IS/ARE CLAIMED AS A FEATURE OF THE MARK.

THE MARK CONSISTS OF OVAL LOGO WITH HUNTER GREEN BACKGROUND WITH GOLD LETTERS THAT SAY "FOX CHASE FARM" AND GOLD PICTURE OF HORSE AND RIDER AND GOLD BORDERING THE GREEN OVAL AND GOLD LINE UNDER "FOX CHAS" AND HORSE AND RIDER.

SER. NO. 85-311,394, FILED 5-3-2011.

GEORGE LORENZO, EXAMINING ATTORNEY



David J. Kybas

Director of the United States Patent and Trademark Office

United States of America

United States Patent and Trademark Office

Engage the Christ Commitment

Reg. No. 4,067,144

Registered Dec. 6, 2011

Int. Cl.: 41

SERVICE MARK

PRINCIPAL REGISTER

THREE ANGELS BROADCASTING NETWORK, INC. (ILLINOIS CORPORATION)
P.O. BOX 220
WEST FRANKFORT, IL 62896

FOR: EDUCATIONAL AND ENTERTAINMENT SERVICES, NAMELY, A CONTINUING PROGRAM ABOUT RELIGION, CHRISTIANITY AND BIBLE STUDY INSTRUCTION ACCESSIBLE BY RADIO, TELEVISION, SATELLITE, AUDIO, VIDEO AND COMPUTER NETWORKS, IN CLASS 41 (U.S. CLS. 100, 101 AND 107).

FIRST USE 5-1-2011; IN COMMERCE 5-1-2011.

THE MARK CONSISTS OF STANDARD CHARACTERS WITHOUT CLAIM TO ANY PARTICULAR FONT, STYLE, SIZE, OR COLOR.

SER. NO. 85-311,398, FILED 5-3-2011.

JEAN IM, EXAMINING ATTORNEY



David J. Kyffers

Director of the United States Patent and Trademark Office

United States of America

United States Patent and Trademark Office



Reg. No. 4,067,145

Registered Dec. 6, 2011

Int. Cl.: 43

SERVICE MARK

PRINCIPAL REGISTER

CUMA, LLC (TEXAS LIMITED LIABILITY COMPANY)
2450 WESTCHESTER DR.
ALLEN, TX 75002

FOR: RESTAURANT, BAR AND CATERING SERVICES, IN CLASS 43 (U.S. CLS. 100 AND 101).

FIRST USE 10-31-2008; IN COMMERCE 10-31-2008.

THE MARK CONSISTS OF A STYLIZED RED CIRCLE WITH A RED DOG INSIDE THE CIRCLE.

THE COLOR(S) RED IS/ARE CLAIMED AS A FEATURE OF THE MARK.

SER. NO. 85-311,419, FILED 5-3-2011.

JAMES STEIN, EXAMINING ATTORNEY



David J. Kybas

Director of the United States Patent and Trademark Office

United States of America

United States Patent and Trademark Office

JUST THINK IN A PREVIOUS
LIFE, THIS WAS PROBABLY
SOMEBODY ELSE'S NOTEBOOK

Reg. No. 4,067,146

Registered Dec. 6, 2011

Int. Cl.: 16

TRADEMARK

PRINCIPAL REGISTER

NEW LEAF PAPER, INC. (DELAWARE CORPORATION)
STE 830
116 NEW MONTGOMERY STREET
SAN FRANCISCO, CA 94105

FOR: NOTEBOOKS, IN CLASS 16 (U.S. CLS. 2, 5, 22, 23, 29, 37, 38 AND 50).

FIRST USE 4-1-2008; IN COMMERCE 4-1-2008.

THE MARK CONSISTS OF STANDARD CHARACTERS WITHOUT CLAIM TO ANY PARTICULAR FONT, STYLE, SIZE, OR COLOR.

SER. NO. 85-311,424, FILED 5-3-2011.

JORDAN BAKER, EXAMINING ATTORNEY



David J. Kybas

Director of the United States Patent and Trademark Office

United States of America

United States Patent and Trademark Office

PHARMABOLIC

Reg. No. 4,067,147

Registered Dec. 6, 2011

Int. Cl.: 5

TRADEMARK

PRINCIPAL REGISTER

BUCAI, JOSE (UNITED STATES INDIVIDUAL)
SUITE #3
5421 BROADWAY STREET
SAN ANTONIO, TX 78209

FOR: DIETARY AND NUTRITIONAL SUPPLEMENTS AND VITAMIN SUPPLEMENTS, IN CLASS 5 (U.S. CLS. 6, 18, 44, 46, 51 AND 52).

FIRST USE 9-17-2008; IN COMMERCE 4-17-2009.

THE MARK CONSISTS OF STANDARD CHARACTERS WITHOUT CLAIM TO ANY PARTICULAR FONT, STYLE, SIZE, OR COLOR.

SER. NO. 85-311,455, FILED 5-3-2011.

SETH A. RAPPAPORT, EXAMINING ATTORNEY



David J. Kyros

Director of the United States Patent and Trademark Office

United States of America

United States Patent and Trademark Office

Castelmuro

Reg. No. 4,067,148

Registered Dec. 6, 2011

Int. Cls.: 29 and 30

TRADEMARK

PRINCIPAL REGISTER

CLOVER SPECIALTIES INC (CALIFORNIA CORPORATION)
RUTH@CLOVERSPECIALTIES.COM
1702 WEST EL SEGUNDO BLVD
GARDENA, CA 90249 AND

BOTENGAN, RUTH (UNITED STATES INDIVIDUAL)
1702 WEST EL SEGUNDO BLVD
GARDENA, CA 90249 AND

REUX, THIERRY (UNITED STATES INDIVIDUAL)
1702 WEST EL SEGUNDO BLVD
GARDENA, CA 90249

FOR: EDIBLE OIL; EDIBLE OILS; INFUSED OILS FOR COOKING; OIL, NAMELY, EDIBLE OIL; PRESERVED, FROZEN, DRIED OR COOKED VEGETABLES; PROCESSED MUSHROOMS; PUMPKIN SEED OIL; SUNFLOWER OIL, IN CLASS 29 (U.S. CL. 46).

FIRST USE 6-1-1995; IN COMMERCE 6-1-1995.

FOR: COFFEE EXTRACTS; EXTRACTS USED AS FLAVORING; VANILLA FLAVORINGS, IN CLASS 30 (U.S. CL. 46).

FIRST USE 6-1-1995; IN COMMERCE 6-1-1995.

THE MARK CONSISTS OF STANDARD CHARACTERS WITHOUT CLAIM TO ANY PARTICULAR FONT, STYLE, SIZE, OR COLOR.

SER. NO. 85-311,460, FILED 5-3-2011.

AMY HELLA, EXAMINING ATTORNEY



David J. Kybas

Director of the United States Patent and Trademark Office

United States of America

United States Patent and Trademark Office

VISIT A DEAL

Reg. No. 4,067,149

Registered Dec. 6, 2011

Int. Cl.: 35

SERVICE MARK

PRINCIPAL REGISTER

CITY SAVINGS SOLUTIONS LLC. (CALIFORNIA LIMITED LIABILITY COMPANY)
13233 BLACK MOUNTAIN RD. #220
SAN DIEGO, CA 92129

FOR: PROMOTING THE GOODS AND SERVICES OF OTHERS BY PROVIDING A WEBSITE FEATURING COUPONS, REBATES, PRICE-COMPARISON INFORMATION, PRODUCT REVIEWS, LINKS TO THE RETAIL WEBSITES OF OTHERS, AND DISCOUNT INFORMATION, IN CLASS 35 (U.S. CLS. 100, 101 AND 102).

FIRST USE 11-23-2010; IN COMMERCE 1-15-2011.

THE MARK CONSISTS OF STANDARD CHARACTERS WITHOUT CLAIM TO ANY PARTICULAR FONT, STYLE, SIZE, OR COLOR.

SER. NO. 85-311,463, FILED 5-3-2011.

AMY HELLA, EXAMINING ATTORNEY



David J. Kyffers

Director of the United States Patent and Trademark Office

United States of America

United States Patent and Trademark Office

Born Social

Reg. No. 4,067,150

KATIE CHAMBERS (UNITED STATES INDIVIDUAL)
3122 STAHLBUSH ISLAND RD.
CORVALLIS, OR 97333

Registered Dec. 6, 2011

Int. Cl.: 35

FOR: BUSINESS ADVISORY SERVICES, CONSULTANCY AND INFORMATION, IN CLASS 35 (U.S. CLS. 100, 101 AND 102).

SERVICE MARK

FIRST USE 4-1-2011; IN COMMERCE 4-1-2011.

PRINCIPAL REGISTER

THE MARK CONSISTS OF STANDARD CHARACTERS WITHOUT CLAIM TO ANY PARTICULAR FONT, STYLE, SIZE, OR COLOR.

SER. NO. 85-311,482, FILED 5-3-2011.

SAMUEL E. SHARPER JR., EXAMINING ATTORNEY



David J. Kyros

Director of the United States Patent and Trademark Office

United States of America

United States Patent and Trademark Office

bot buddies

Reg. No. 4,067,151

HECK, CATHERINE C. (UNITED STATES INDIVIDUAL)
3403 MOUNTAIN TOP CIRCLE
AUSTIN, TX 78731

Registered Dec. 6, 2011

Int. Cl.: 24

FOR: TEXTILE FABRICS FOR USE IN MAKING CLOTHING AND HOUSEHOLD FURNISHINGS, IN CLASS 24 (U.S. CLS. 42 AND 50).

TRADEMARK

FIRST USE 10-4-2010; IN COMMERCE 10-4-2010.

PRINCIPAL REGISTER

THE MARK CONSISTS OF STANDARD CHARACTERS WITHOUT CLAIM TO ANY PARTICULAR FONT, STYLE, SIZE, OR COLOR.

SER. NO. 85-311,492, FILED 5-3-2011.

KELLY BOULTON, EXAMINING ATTORNEY



David J. Kybas

Director of the United States Patent and Trademark Office

United States of America

United States Patent and Trademark Office

LITTLE SOCIAL

Reg. No. 4,067,152

CARIBBEAN SOURCING APPAREL, LLC (CALIFORNIA LIMITED LIABILITY COMPANY)
3470 WILSHIRE BOULEVARD, SUITE 950
LOS ANGELES, CA 90005

Registered Dec. 6, 2011

Int. Cl.: 25

FOR: KNIT SHIRTS; T-SHIRTS, IN CLASS 25 (U.S. CLS. 22 AND 39).

TRADEMARK

FIRST USE 3-0-2011; IN COMMERCE 3-0-2011.

PRINCIPAL REGISTER

THE MARK CONSISTS OF STANDARD CHARACTERS WITHOUT CLAIM TO ANY PARTICULAR FONT, STYLE, SIZE, OR COLOR.

SER. NO. 85-311,503, FILED 5-3-2011.

TINA MAI, EXAMINING ATTORNEY



David J. Kybas

Director of the United States Patent and Trademark Office

United States of America

United States Patent and Trademark Office

The Applesmith

Original Handcrafted Designs

Reg. No. 4,067,153

Registered Dec. 6, 2011

Int. Cls.: 4 and 35

TRADEMARK

SERVICE MARK

PRINCIPAL REGISTER

THE APPLESMITH, LLC (NEBRASKA LIMITED LIABILITY COMPANY)
11357 724 ROAD
HOLDREGE, NE 68949

FOR: CANDLES, IN CLASS 4 (U.S. CLS. 1, 6 AND 15).

FIRST USE 11-1-1999; IN COMMERCE 11-1-1999.

FOR: ON-LINE RETAIL STORE SERVICES FEATURING CANDLES AND CANDLE ACCESSORIES, IN CLASS 35 (U.S. CLS. 100, 101 AND 102).

FIRST USE 11-1-1999; IN COMMERCE 11-1-1999.

NO CLAIM IS MADE TO THE EXCLUSIVE RIGHT TO USE "ORIGINAL HANDCRAFTED DESIGNS", APART FROM THE MARK AS SHOWN.

THE MARK CONSISTS OF THE STYLIZED WORD THE ABOVE THE WORD APPLESMITH IN STYLIZED FONT. A DRAWING OF AN APPLE SERVES TO DOT THE "I" IN APPLESMITH. CENTERED BELOW THE DESCRIBED WORDS ARE TWO SOLID HORIZONTAL LINES, CENTERED BELOW WHICH ARE THE STYLIZED WORDS ORIGINAL HANDCRAFTED DESIGNS.

SER. NO. 85-311,540, FILED 5-3-2011.

DORITT L. CARROLL, EXAMINING ATTORNEY



David J. Kybas

Director of the United States Patent and Trademark Office

United States of America

United States Patent and Trademark Office

ARTBATTLES

Reg. No. 4,067,154

Registered Dec. 6, 2011

Int. Cl.: 41

SERVICE MARK

PRINCIPAL REGISTER

SEAN BONO (UNITED STATES INDIVIDUAL)
APT. 3N
109 SPRING STREET
NEW YORK, NY 10012

FOR: ENTERTAINMENT SERVICES, NAMELY, ARRANGING AND CONDUCTING OF COMPETITIONS FOR A LIVE ART SHOW CONSISTING OF TWO OR MORE ARTISTS.; ENTERTAINMENT SERVICES, NAMELY, THE PROVISION OF CONTINUING ART EXHIBITIONS FEATURING COMPETITION AND COMMENTARY DELIVERED BY STAGE, TELEVISION, RADIO, THE INTERNET OR LIVE, IN CLASS 41 (U.S. CLS. 100, 101 AND 107).

FIRST USE 1-1-2006; IN COMMERCE 1-1-2006.

THE MARK CONSISTS OF STANDARD CHARACTERS WITHOUT CLAIM TO ANY PARTICULAR FONT, STYLE, SIZE, OR COLOR.

SER. NO. 85-311,563, FILED 5-3-2011.

KAELIE KUNG, EXAMINING ATTORNEY



David J. Kyros

Director of the United States Patent and Trademark Office

United States of America

United States Patent and Trademark Office

PHILO

Reg. No. 4,067,155

Registered Dec. 6, 2011

Int. Cl.: 41

SERVICE MARK

PRINCIPAL REGISTER

HOLMAN MITCHELL R (UNITED STATES INDIVIDUAL)
PO BOX 975
BOONVILLE, CA 95415

FOR: ENTERTAINMENT AND EDUCATION SERVICES IN THE NATURE OF LIVE DANCE AND MUSICAL PERFORMANCES, IN CLASS 41 (U.S. CLS. 100, 101 AND 107).

FIRST USE 4-23-2011; IN COMMERCE 4-23-2011.

THE MARK CONSISTS OF STANDARD CHARACTERS WITHOUT CLAIM TO ANY PARTICULAR FONT, STYLE, SIZE, OR COLOR.

SER. NO. 85-311,565, FILED 5-3-2011.

KAELIE KUNG, EXAMINING ATTORNEY



David J. Kappas

Director of the United States Patent and Trademark Office

United States of America

United States Patent and Trademark Office

TRUE FAN LOYALTY REWARDS CARD

Reg. No. 4,067,156

Registered Dec. 6, 2011

Int. Cl.: 35

SERVICE MARK

PRINCIPAL REGISTER

WILLIAMS, EMORY L (UNITED STATES INDIVIDUAL)
11261 DOUGLAS DRIVE
MIAMI, FL 33176

FOR: ADMINISTRATION OF A DISCOUNT PROGRAM FOR ENABLING PARTICIPANTS TO OBTAIN DISCOUNTS ON GOODS AND SERVICES THROUGH USE OF A DISCOUNT MEMBERSHIP CARD, IN CLASS 35 (U.S. CLS. 100, 101 AND 102).

FIRST USE 2-11-2011; IN COMMERCE 2-11-2011.

THE MARK CONSISTS OF STANDARD CHARACTERS WITHOUT CLAIM TO ANY PARTICULAR FONT, STYLE, SIZE, OR COLOR.

NO CLAIM IS MADE TO THE EXCLUSIVE RIGHT TO USE "LOYALTY REWARDS CARD", APART FROM THE MARK AS SHOWN.

SER. NO. 85-311,591, FILED 5-3-2011.

LAKEISHA LEWIS, EXAMINING ATTORNEY



David J. Kyffers

Director of the United States Patent and Trademark Office

United States of America

United States Patent and Trademark Office

RIO SOUL

Reg. No. 4,067,157

Registered Dec. 6, 2011

Int. Cl.: 25

TRADEMARK

PRINCIPAL REGISTER

RIO SOUL, INC. (NEW JERSEY CORPORATION)
380 PROSPECT AVENUE, SUITE 4K
HACKENSACK, NJ 07601

FOR: CLOTHING FOR ATHLETIC USE, NAMELY, TANK TOPS, LONG SLEEVE SHIRTS, SHORT SLEEVE SHIRTS, CAT SUITS, PANTS, BELTS; FOOTWEAR, IN CLASS 25 (U.S. CLS. 22 AND 39).

FIRST USE 11-30-2009; IN COMMERCE 11-30-2009.

THE MARK CONSISTS OF STANDARD CHARACTERS WITHOUT CLAIM TO ANY PARTICULAR FONT, STYLE, SIZE, OR COLOR.

SER. NO. 85-311,598, FILED 5-3-2011.

JESSICA A. POWERS, EXAMINING ATTORNEY



David J. Kybas

Director of the United States Patent and Trademark Office

United States of America

United States Patent and Trademark Office

LOKR

Reg. No. 4,067,158

Registered Dec. 6, 2011

Int. Cl.: 39

SERVICE MARK

PRINCIPAL REGISTER

PNG MEDIA (CALIFORNIA SOLE PROPRIETORSHIP)
P.O. BOX 277317
SACRAMENTO, CA 95827

FOR: ELECTRONIC STORAGE OF DATA, IN CLASS 39 (U.S. CLS. 100 AND 105).

FIRST USE 5-15-2008; IN COMMERCE 5-15-2008.

THE MARK CONSISTS OF STANDARD CHARACTERS WITHOUT CLAIM TO ANY PARTICULAR FONT, STYLE, SIZE, OR COLOR.

SER. NO. 85-311,619, FILED 5-4-2011.

DAVID HOFFMAN, EXAMINING ATTORNEY



David J. Kyfos

Director of the United States Patent and Trademark Office

United States of America

United States Patent and Trademark Office



Reg. No. 4,067,159

Registered Dec. 6, 2011

Int. Cl.: 9

TRADEMARK

PRINCIPAL REGISTER

INNOV8 GB LIMITED (UNITED KINGDOM LIMITED LIABILITY COMPANY)
5 MILL FARM ROAD,
HORSHAM, WEST SUSSEX, UNITED KINGDOM RH136SL

FOR: BAGS, CASES AND CARRIERS SPECIALLY ADAPTED OR SHAPED TO CONTAIN APPARATUS FOR RECORDING, TRANSMISSION OR REPRODUCTION OF SOUND OR IMAGES, CAMERAS, VIDEO CAMERAS, MP3 PLAYERS, MP4 PLAYERS, HAND HELD COMPUTERS, COMPUTERS, COMPUTER HARDWARE, PERSONAL DIGITAL ASSISTANTS, ELECTRONIC ORGANIZERS, ELECTRONIC NOTEPADS, SATELLITE NAVIGATION SYSTEMS, MOBILE PHONES, TELECOMMUNICATIONS APPARATUS, HANDHELD PROJECTORS, ELECTRONIC BOOK READERS, RADIOS, IN CLASS 9 (U.S. CLS. 21, 23, 26, 36 AND 38).

FIRST USE 9-22-2010; IN COMMERCE 9-22-2010.

THE MARK CONSISTS OF VARIOUS BLOCKS STACKED ABOVE EACH OTHER AND SURROUNDED BY A BOX LIKE SHAPE.

SER. NO. 85-311,620, FILED 5-4-2011.

ADA HAN, EXAMINING ATTORNEY



David J. Kyjars

Director of the United States Patent and Trademark Office

United States of America

United States Patent and Trademark Office

Reshape Your World

Reg. No. 4,067,160

Registered Dec. 6, 2011

Int. Cl.: 9

TRADEMARK

PRINCIPAL REGISTER

REVWARE, INC. (NORTH CAROLINA CORPORATION)
P.O. BOX 90786
RALEIGH, NC 276750786

FOR: MEASURING INSTRUMENTATION AND APPARATUS, NAMELY, DIGITIZERS; AND REVERSE-ENGINEERING SOFTWARE FOR PRODUCT DESIGNS, IN CLASS 9 (U.S. CLS. 21, 23, 26, 36 AND 38).

FIRST USE 11-9-2001; IN COMMERCE 11-9-2001.

THE MARK CONSISTS OF STANDARD CHARACTERS WITHOUT CLAIM TO ANY PARTICULAR FONT, STYLE, SIZE, OR COLOR.

SER. NO. 85-311,666, FILED 5-4-2011.

MARK RADEMACHER, EXAMINING ATTORNEY



David J. Kyffers

Director of the United States Patent and Trademark Office

United States of America

United States Patent and Trademark Office

MEET THE BREEDS

Reg. No. 4,067,161

Registered Dec. 6, 2011

Int. Cl.: 41

SERVICE MARK

PRINCIPAL REGISTER

THE AMERICAN KENNEL CLUB INCORPORATED (NEW YORK CORPORATION)
260 MADISON AVENUE
NEW YORK, NY 10016

FOR: EDUCATIONAL SERVICES NAMELY, PROVIDING INTERACTIVE EDUCATIONAL SEMINARS, MEETINGS AND CONFERENCES IN THE FIELD OF PET OWNERSHIP AND PROVIDING DISSEMINATION OF EDUCATIONAL MATERIALS IN THE FIELD OF PET OWNERSHIP, IN CLASS 41 (U.S. CLS. 100, 101 AND 107).

FIRST USE 3-20-2009; IN COMMERCE 3-20-2009.

THE MARK CONSISTS OF STANDARD CHARACTERS WITHOUT CLAIM TO ANY PARTICULAR FONT, STYLE, SIZE, OR COLOR.

OWNER OF U.S. REG. NO. 3,285,316.

SER. NO. 85-311,706, FILED 5-4-2011.

MATTHEW EINSTEIN, EXAMINING ATTORNEY



David J. Kybas

Director of the United States Patent and Trademark Office

United States of America

United States Patent and Trademark Office



Reg. No. 4,067,162

Registered Dec. 6, 2011

Int. Cl.: 9

TRADEMARK

PRINCIPAL REGISTER

FLAME SIM, LLC (ILLINOIS LIMITED LIABILITY COMPANY)
2345 PEMBROKE AVENUE
HOFFMAN ESTATES, IL 60195

FOR: COMPUTER SOFTWARE SIMULATORS FOR TRAINING FIREFIGHTERS, IN CLASS
9 (U.S. CLS. 21, 23, 26, 36 AND 38).

FIRST USE 6-10-2008; IN COMMERCE 6-10-2008.

THE MARK CONSISTS OF A FLAME DESIGN INSIDE A TRIANGLE, AND THE WORDS
"FLAME-SIM" UNDERNEATH THE TRIANGLE.

SER. NO. 85-311,800, FILED 5-4-2011.

HELENE LIWINSKI, EXAMINING ATTORNEY



David J. Kybas

Director of the United States Patent and Trademark Office

United States of America

United States Patent and Trademark Office

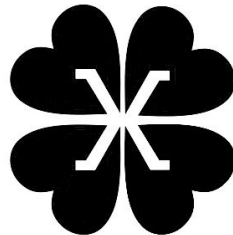

diverxos

Reg. No. 4,067,163

Registered Dec. 6, 2011

Int. Cl.: 18

TRADEMARK

PRINCIPAL REGISTER

GUERRA, ANGEL VICENTE (VENEZUELA INDIVIDUAL)
EDIFICIO SOLARENA NORTE
CALLE ARISMENDI, PISO 10, APT 10-B
LECHERIA, ANZOATEGUI, VENEZUELA 6016

FOR: FASHION HANDBAGS, IN CLASS 18 (U.S. CLS. 1, 2, 3, 22 AND 41).

FIRST USE 12-12-2010; IN COMMERCE 12-12-2010.

THE MARK CONSISTS OF FOUR HEARTS TOGETHER CREATING THE SHAPE OF A FLOWER. ALL FOUR HEARTS ARE CONNECTED BY THE LETTER "X". THE WORD "DIVERXOS" APPEARS BELOW THE HEART SHAPED FLOWER IN A LOWER CASE STYLIZED FONT.

SER. NO. 85-311,809, FILED 5-4-2011.

KATHERINE CHANG, EXAMINING ATTORNEY



David J. Kybas

Director of the United States Patent and Trademark Office

United States of America

United States Patent and Trademark Office

MEX IT UP!

Reg. No. 4,067,164

Registered Dec. 6, 2011

Int. Cl.: 43

SERVICE MARK

PRINCIPAL REGISTER

RUBY TEQUILA'S MEXICAN KITCHEN, LLC (DELAWARE LIMITED LIABILITY COMPANY)
3117 SW 27TH
AMARILLO, TX 79109

FOR: RESTAURANT SERVICES, IN CLASS 43 (U.S. CLS. 100 AND 101).

FIRST USE 6-1-2010; IN COMMERCE 6-1-2010.

THE MARK CONSISTS OF STANDARD CHARACTERS WITHOUT CLAIM TO ANY PARTICULAR FONT, STYLE, SIZE, OR COLOR.

SER. NO. 85-311,814, FILED 5-4-2011.

MARK SHINER, EXAMINING ATTORNEY



David J. Kybas

Director of the United States Patent and Trademark Office

United States of America

United States Patent and Trademark Office

Ocumyst

Reg. No. 4,067,165

Registered Dec. 6, 2011

Int. Cl.: 10

TRADEMARK

PRINCIPAL REGISTER

MYSTIC PHARMACEUTICALS, INC. (DELAWARE CORPORATION)
2006 WINDY TERRACE
CEDAR PARK, TX 78613

FOR: MEDICAL APPARATUS FOR INTRODUCING PHARMACEUTICAL PREPARATIONS INTO THE HUMAN BODY, IN CLASS 10 (U.S. CLS. 26, 39 AND 44).

FIRST USE 8-3-2003; IN COMMERCE 8-3-2003.

THE MARK CONSISTS OF STANDARD CHARACTERS WITHOUT CLAIM TO ANY PARTICULAR FONT, STYLE, SIZE, OR COLOR.

SER. NO. 85-311,826, FILED 5-4-2011.

COURTNEY ALVAREZ, EXAMINING ATTORNEY



David J. Kybas

Director of the United States Patent and Trademark Office

United States of America

United States Patent and Trademark Office

PROFESSIONAL SELECT

Reg. No. 4,067,166

Registered Dec. 6, 2011

Int. Cl.: 21

TRADEMARK

PRINCIPAL REGISTER

BORGHESE TRADEMARKS, INC. (DELAWARE CORPORATION)
SUITE 713
1201 ORANGE ST. ONE COMMERCE CTR.
WILMINGTON, DE 19801

FOR: COSMETIC BRUSHES; EYEBROW BRUSHES; MAKE-UP BRUSHES, IN CLASS 21
(U.S. CLS. 2, 13, 23, 29, 30, 33, 40 AND 50).

FIRST USE 4-1-2011; IN COMMERCE 4-1-2011.

THE MARK CONSISTS OF STANDARD CHARACTERS WITHOUT CLAIM TO ANY PARTICULAR FONT, STYLE, SIZE, OR COLOR.

NO CLAIM IS MADE TO THE EXCLUSIVE RIGHT TO USE "PROFESSIONAL", APART FROM THE MARK AS SHOWN.

SER. NO. 85-311,835, FILED 5-4-2011.

JOHN KELLY, EXAMINING ATTORNEY



David J. Kyros

Director of the United States Patent and Trademark Office

United States of America

United States Patent and Trademark Office

PS09

Reg. No. 4,067,167

Registered Dec. 6, 2011

Int. Cls.: 9, 18 and 25

TRADEMARK

PRINCIPAL REGISTER

AEROPOSTALE PROCUREMENT COMPANY, INC. (DELAWARE CORPORATION)
112 W. 34TH STREET, 22ND FLOOR
NEW YORK, NY 10120

FOR: EYEWEAR, EYEGLASSES, AND SUNGLASSES, ALL AVAILABLE IN PS FROM AEROPOSTALE AND AEROPOSTALE RETAIL STORES AND ONLINE RETAIL STORES, IN CLASS 9 (U.S. CLS. 21, 23, 26, 36 AND 38).

FIRST USE 10-21-2009; IN COMMERCE 10-21-2009.

FOR: HANDBAGS, ALL-PURPOSE CARRYING BAGS, BACKPACKS, BEACH BAGS, BOOK BAGS, COIN PURSES, CLUTCH BAGS, COSMETIC BAGS SOLD EMPTY, MESSENGER BAGS, PURSES, TOTE BAGS, WALLETS AND UMBRELLAS, ALL AVAILABLE IN PS FROM AEROPOSTALE AND AEROPOSTALE RETAIL STORES AND ONLINE RETAIL STORES, IN CLASS 18 (U.S. CLS. 1, 2, 3, 22 AND 41).

FIRST USE 3-2-2009; IN COMMERCE 3-2-2009.

FOR: CLOTHING, NAMELY GIRLS' AND BOYS' WEARING APPAREL, NAMELY JEANS, SHIRTS, T-SHIRTS, POLO SHIRTS, KNIT SHIRTS, TANK TOPS; OUTERWEAR, NAMELY, JACKETS, COATS, RAINCOATS, SCARVES; PANTS, SWEATERS, SWEATSHIRTS, HOODED SWEATSHIRTS, SWEATPANTS, SHORTS, BOARD SHORTS, SWIMSUITS, RASH GUARDS, LOUNGEWEAR, PAJAMAS, BELTS, SOCKS, GLOVES; UNDERGARMENTS, NAMELY, PANTIES, BOXER SHORTS AND BRIEFS; FOOTWEAR, NAMELY SHOES, BOOTS, FLIP FLOPS, SANDALS, SLIPPERS AND SNEAKERS; AND HEADGEAR, NAMELY HATS AND CAPS, ALL AVAILABLE IN PS FROM AEROPOSTALE AND AEROPOSTALE RETAIL STORES AND ONLINE RETAIL STORES, IN CLASS 25 (U.S. CLS. 22 AND 39).

FIRST USE 11-21-2008; IN COMMERCE 11-21-2008.

THE MARK CONSISTS OF STANDARD CHARACTERS WITHOUT CLAIM TO ANY PARTICULAR FONT, STYLE, SIZE, OR COLOR.

OWNER OF U.S. REG. NOS. 3,716,916 AND 3,794,934.

SER. NO. 85-311,863, FILED 5-4-2011.



David J. Kyffers

Director of the United States Patent and Trademark Office

Reg. No. 4,067,167 GRETTA YAO, EXAMINING ATTORNEY

United States of America

United States Patent and Trademark Office

CATTLE PRO

Reg. No. 4,067,168

CAUDILL SEED AND WAREHOUSE COMPANY, INC. (KENTUCKY CORPORATION)
1402 W. MAIN STREET
LOUISVILLE, KY 40203

Registered Dec. 6, 2011

Int. Cl.: 31

FOR: RYE GRASS SEED, ORCHARD GRASS SEED, FESCUE GRASS SEED AND GRASS SEED BLENDS, IN CLASS 31 (U.S. CLS. 1 AND 46).

TRADEMARK

FIRST USE 10-1-2010; IN COMMERCE 10-1-2010.

PRINCIPAL REGISTER

THE MARK CONSISTS OF STANDARD CHARACTERS WITHOUT CLAIM TO ANY PARTICULAR FONT, STYLE, SIZE, OR COLOR.

NO CLAIM IS MADE TO THE EXCLUSIVE RIGHT TO USE "CATTLE", APART FROM THE MARK AS SHOWN.

SER. NO. 85-311,883, FILED 5-4-2011.

JOHN HWANG, EXAMINING ATTORNEY



David J. Kybas

Director of the United States Patent and Trademark Office

United States of America

United States Patent and Trademark Office

IN BED

Reg. No. 4,067,169

Registered Dec. 6, 2011

Int. Cl.: 9

TRADEMARK

PRINCIPAL REGISTER

SEALY TECHNOLOGY LLC (NORTH CAROLINA LIMITED LIABILITY COMPANY)
ONE OFFICE PARKWAY
TRINITY, NC 27370

FOR: COMPUTER APPLICATION SOFTWARE FOR MOBILE PHONES, PORTABLE MEDIA PLAYERS, AND HANDHELD COMPUTERS, NAMELY, SOFTWARE FOR USE IN CREATING IMAGES, IN CLASS 9 (U.S. CLS. 21, 23, 26, 36 AND 38).

FIRST USE 2-14-2011; IN COMMERCE 2-14-2011.

THE MARK CONSISTS OF STANDARD CHARACTERS WITHOUT CLAIM TO ANY PARTICULAR FONT, STYLE, SIZE, OR COLOR.

SER. NO. 85-311,898, FILED 5-4-2011.

WILLIAM P. SHANAHAN, EXAMINING ATTORNEY



David J. Kyffers

Director of the United States Patent and Trademark Office

United States of America

United States Patent and Trademark Office

PS4U

Reg. No. 4,067,170

Registered Dec. 6, 2011

Int. Cls.: 9, 18 and 25

TRADEMARK

PRINCIPAL REGISTER

AEROPOSTALE PROCUREMENT COMPANY, INC. (DELAWARE CORPORATION)
112 W. 34TH STREET, 22ND FLOOR
NEW YORK, NY 10120

FOR: EYEWEAR, EYEGLASSES, AND SUNGLASSES, ALL AVAILABLE IN PS FROM AEROPOSTALE AND AEROPOSTALE RETAIL STORES AND ONLINE RETAIL STORES, IN CLASS 9 (U.S. CLS. 21, 23, 26, 36 AND 38).

FIRST USE 10-21-2009; IN COMMERCE 10-21-2009.

FOR: HAND BAGS, ALL-PURPOSE CARRYING BAGS, BACKPACKS, BEACH BAGS, BOOK BAGS, COIN PURSES, CLUTCH BAGS, COSMETIC BAGS SOLD EMPTY, MESSENGER BAGS, PURSES, TOTE BAGS, WALLETS AND UMBRELLAS, ALL AVAILABLE IN PS FROM AEROPOSTALE AND AEROPOSTALE RETAIL STORES AND ONLINE RETAIL STORES, IN CLASS 18 (U.S. CLS. 1, 2, 3, 22 AND 41).

FIRST USE 3-2-2009; IN COMMERCE 3-2-2009.

FOR: CLOTHING, NAMELY GIRLS' AND BOYS' WEARING APPAREL, NAMELY JEANS, SHIRTS, T-SHIRTS, POLO SHIRTS, KNIT SHIRTS, TANK TOPS; OUTERWEAR, NAMELY, JACKETS, COATS, RAINCOATS, SCARVES; PANTS, SWEATERS, SWEATSHIRTS, HOODED SWEATSHIRTS, SWEATPANTS, SHORTS, BOARD SHORTS, SWIMSUITS, RASH GUARDS, LOUNGEWEAR, PAJAMAS, BELTS, SOCKS, GLOVES; UNDERGARMENTS, NAMELY, PANTIES, BOXER SHORTS AND BRIEFS; FOOTWEAR, NAMELY SHOES, BOOTS, FLIP FLOPS, SANDALS, SLIPPERS AND SNEAKERS; AND HEADGEAR, NAMELY HATS AND CAPS, ALL AVAILABLE IN PS FROM AEROPOSTALE AND AEROPOSTALE RETAIL STORES AND ONLINE RETAIL STORES, IN CLASS 25 (U.S. CLS. 22 AND 39).

FIRST USE 11-21-2008; IN COMMERCE 11-21-2008.

THE MARK CONSISTS OF STANDARD CHARACTERS WITHOUT CLAIM TO ANY PARTICULAR FONT, STYLE, SIZE, OR COLOR.

OWNER OF U.S. REG. NOS. 3,716,916 AND 3,794,934.

SER. NO. 85-311,949, FILED 5-4-2011.



David J. Kyjars

Director of the United States Patent and Trademark Office

Reg. No. 4,067,170 GRETTA YAO, EXAMINING ATTORNEY

United States of America

United States Patent and Trademark Office

PHANTOM OF THE ARTS

Reg. No. 4,067,171

Registered Dec. 6, 2011

Int. Cl.: 38

SERVICE MARK

PRINCIPAL REGISTER

KENNETH DAVID GOULD (UNITED STATES INDIVIDUAL)
PALISADE
FORT LEE, NJ 07732

FOR: ELECTRONIC DELIVERY OF IMAGES, PHOTOGRAPHS, ART, GRAPHIC IMAGES AND GRAPHIC DESIGN, CLIP ART, NEWS IMAGES, ILLUSTRATIONS, DIGITAL ANIMATION, VIDEO CLIPS, FILM FOOTAGE AND AUDIO DATA VIA A GLOBAL COMPUTER NETWORK AND OTHER COMPUTER NETWORKS, IN CLASS 38 (U.S. CLS. 100, 101 AND 104).

FIRST USE 8-1-2010; IN COMMERCE 8-1-2010.

THE MARK CONSISTS OF STANDARD CHARACTERS WITHOUT CLAIM TO ANY PARTICULAR FONT, STYLE, SIZE, OR COLOR.

SER. NO. 85-311,952, FILED 5-4-2011.

LINDA E. BLOHM, EXAMINING ATTORNEY



David J. Kybas

Director of the United States Patent and Trademark Office

United States of America

United States Patent and Trademark Office

ATLANTIX

Reg. No. 4,067,172

Registered Dec. 6, 2011

Int. Cl.: 40

SERVICE MARK

PRINCIPAL REGISTER

ATLANTIX COMPANY OF NEW YORK, INC. (NEW YORK CORPORATION)
152 WEST 25TH STREET
NEW YORK, NY 10001

FOR: PRINTING SERVICES, IN CLASS 40 (U.S. CLS. 100, 103 AND 106).

FIRST USE 2-0-2000; IN COMMERCE 2-0-2000.

THE MARK CONSISTS OF STANDARD CHARACTERS WITHOUT CLAIM TO ANY PARTICULAR FONT, STYLE, SIZE, OR COLOR.

SER. NO. 85-311,968, FILED 5-4-2011.

KAPIL BHANOT, EXAMINING ATTORNEY



David J. Kybas

Director of the United States Patent and Trademark Office

United States of America

United States Patent and Trademark Office

RE-LASTICITY

Reg. No. 4,067,173

WEI EAST INC. (PENNSYLVANIA CORPORATION)
4107 GOSHEN ROAD
NEWTOWN SQUARE, PA 19073

Registered Dec. 6, 2011

Int. Cl.: 3

FOR: WRINKLE-MINIMIZING COSMETIC PREPARATIONS FOR TOPICAL FACIAL USE,
IN CLASS 3 (U.S. CLS. 1, 4, 6, 50, 51 AND 52).

TRADEMARK

FIRST USE 12-1-2010; IN COMMERCE 12-1-2010.

PRINCIPAL REGISTER

THE MARK CONSISTS OF STANDARD CHARACTERS WITHOUT CLAIM TO ANY PAR-
TICULAR FONT, STYLE, SIZE, OR COLOR.

SER. NO. 85-311,987, FILED 5-4-2011.

SHANNON TWOHIG, EXAMINING ATTORNEY



David J. Kybas

Director of the United States Patent and Trademark Office

United States of America

United States Patent and Trademark Office

BUMP 'N' BUNDLE

Reg. No. 4,067,174

Registered Dec. 6, 2011

Int. Cl.: 41

SERVICE MARK

PRINCIPAL REGISTER

BUMP 'N' BUNDLE, LLC (TENNESSEE LIMITED LIABILITY COMPANY)
211 UNION STREET, APT. 802
NASHVILLE, TX 37201

FOR: ONLINE PUBLICATIONS IN THE NATURE OF RESOURCE GUIDES FOR WOMEN WITH FERTILITY ISSUES, WOMEN WHO ARE PREGNANT, WOMEN WHO WOULD LIKE TO BECOME PREGNANT, AND NEW MOTHERS, IN CLASS 41 (U.S. CLS. 100, 101 AND 107).

FIRST USE 5-1-2011; IN COMMERCE 5-1-2011.

THE MARK CONSISTS OF STANDARD CHARACTERS WITHOUT CLAIM TO ANY PARTICULAR FONT, STYLE, SIZE, OR COLOR.

SER. NO. 85-312,000, FILED 5-4-2011.

PAUL F. GAST, EXAMINING ATTORNEY



David J. Kyffers

Director of the United States Patent and Trademark Office

United States of America

United States Patent and Trademark Office



Reg. No. 4,067,175

Registered Dec. 6, 2011

Int. Cl.: 25

TRADEMARK

PRINCIPAL REGISTER

GUGLIELMO, PETE JR. (UNITED STATES INDIVIDUAL), DBA CHILDREN OF THE DIRT
P.O. BOX 507
LOS OLIVOS, CA 93441

FOR: HATS; HOODED SWEATSHIRTS; T-SHIRTS; TANK TOPS, IN CLASS 25 (U.S. CLS. 22 AND 39).

FIRST USE 12-19-2008; IN COMMERCE 12-19-2008.

THE MARK CONSISTS OF THE LETTERS "CD" IN A STYLIZED FONT ABOVE THE WORDS "CHILDREN OF THE DIRT" IN A STYLIZED FONT WITH A FIVE POINT STAR AT THE CENTER OF A FOUR POINT STAR, SUPERIMPOSED ON THE LETTERS "CD".

SER. NO. 85-312,002, FILED 5-4-2011.

ALICE BENMAMAN, EXAMINING ATTORNEY



David J. Kyffers

Director of the United States Patent and Trademark Office

United States of America

United States Patent and Trademark Office

JMCL

Reg. No. 4,067,176

Registered Dec. 6, 2011

Int. Cls.: 14, 18, 25 and 35

SEA ISLAND CLOTHIERS INC. (NEW YORK CORPORATION)
#6, 2ND FLOOR
236-250 GREENPOINT AVENUE
BROOKLYN, NY 11222

FOR: JEWELRY, IN CLASS 14 (U.S. CLS. 2, 27, 28 AND 50).

FIRST USE 1-1-2008; IN COMMERCE 1-1-2008.

TRADEMARK

FOR: HANDBAGS; LUGGAGE; TOTE BAGS, IN CLASS 18 (U.S. CLS. 1, 2, 3, 22 AND 41).

SERVICE MARK

FIRST USE 1-1-2008; IN COMMERCE 1-1-2008.

PRINCIPAL REGISTER

FOR: MEN'S, WOMEN'S AND CHILDREN'S CLOTHING, NAMELY, BLOUSES, SKIRTS, SWEATERS, T-SHIRTS, HATS, SCARVES, BELTS, SHIRTS, PANTS, SOCKS, PANTYHOSE, SHOES, GLOVES, ROBES, SLEEPWEAR, DRESS SHIRTS, TIES, SPORTS SHIRTS, SUITS, SPORTS COATS, UNDERWEAR, KNIT SHIRTS, COATS, JACKETS, SWIMWEAR AND DRESSES, IN CLASS 25 (U.S. CLS. 22 AND 39).

FIRST USE 1-1-2008; IN COMMERCE 1-1-2008.

FOR: RETAIL STORE SERVICES FEATURING CLOTHING, HANDBAGS, JEWELRY AND FASHION ACCESSORIES; ON-LINE RETAIL STORE SERVICES FEATURING CLOTHING, HANDBAGS AND FASHION ACCESSORIES, IN CLASS 35 (U.S. CLS. 100, 101 AND 102).

FIRST USE 1-1-2008; IN COMMERCE 1-1-2008.

THE MARK CONSISTS OF THE LETTERS J M C L IN A STYLIZED FORM.

SER. NO. 85-312,008, FILED 5-4-2011.

RONALD MCMORROW, EXAMINING ATTORNEY



David J. Kyros

Director of the United States Patent and Trademark Office

United States of America

United States Patent and Trademark Office

TENTCRAFT

Reg. No. 4,067,177

Registered Dec. 6, 2011

Int. Cls.: 22 and 40

TRADEMARK

SERVICE MARK

PRINCIPAL REGISTER

TENTCRAFT, INC. (MICHIGAN CORPORATION)
2322 CASS RD.
TRAVERSE CITY, MI 49684

FOR: TENTS, IN CLASS 22 (U.S. CLS. 1, 2, 7, 19, 22, 42 AND 50).

FIRST USE 4-11-2011; IN COMMERCE 4-11-2011.

FOR: CUSTOM MANUFACTURE OF TENTS, CANOPIES, AND SIDEWALLS; PRINTING,
IN CLASS 40 (U.S. CLS. 100, 103 AND 106).

FIRST USE 5-4-2011; IN COMMERCE 5-4-2011.

THE MARK CONSISTS OF STANDARD CHARACTERS WITHOUT CLAIM TO ANY PARTICULAR FONT, STYLE, SIZE, OR COLOR.

SER. NO. 85-312,014, FILED 5-4-2011.

ALICE BENMAMAN, EXAMINING ATTORNEY



David J. Kybas

Director of the United States Patent and Trademark Office

United States of America

United States Patent and Trademark Office

Dirigible

Reg. No. 4,067,178

Registered Dec. 6, 2011

Int. Cl.: 42

SERVICE MARK

PRINCIPAL REGISTER

DIRIGIBLE LLC (MINNESOTA LIMITED LIABILITY COMPANY)
PO BOX 2582
SAINT PAUL, MN 55102

FOR: COMPUTER SERVICES, NAMELY, DESIGNING AND IMPLEMENTING WEB SITES FOR OTHERS; DESIGN, CREATION, HOSTING, MAINTENANCE OF WEBSITES FOR OTHERS; HOSTING THE SOFTWARE, WEBSITES AND OTHER COMPUTER APPLICATIONS OF OTHERS ON A VIRTUAL PRIVATE SERVER; MAINTENANCE OF WEBSITES AND HOSTING ON-LINE WEB FACILITIES FOR OTHERS; PLANNING, DESIGN, DEVELOPMENT, MAINTENANCE AND OPTIMIZATION OF ONLINE WEBSITES FOR THIRD PARTIES, IN CLASS 42 (U.S. CLS. 100 AND 101).

FIRST USE 2-2-2011; IN COMMERCE 2-2-2011.

THE MARK CONSISTS OF STANDARD CHARACTERS WITHOUT CLAIM TO ANY PARTICULAR FONT, STYLE, SIZE, OR COLOR.

SER. NO. 85-312,043, FILED 5-4-2011.

GIANCARLO CASTRO, EXAMINING ATTORNEY



David J. Kyffers

Director of the United States Patent and Trademark Office

United States of America

United States Patent and Trademark Office

MEADOWS HARVEST

Reg. No. 4,067,179

AMERICAN MEADOWS INC. (VERMONT CORPORATION)
223 AVENUE D, SUITE 30
WILLISTON, VT 05495

Registered Dec. 6, 2011

Int. Cl.: 31

FOR: FLOWER SEEDS; HERB SEEDS FOR PLANTING; VEGETABLE SEEDS FOR PLANTING, IN CLASS 31 (U.S. CLS. 1 AND 46).

TRADEMARK

FIRST USE 12-7-2009; IN COMMERCE 12-7-2009.

PRINCIPAL REGISTER

THE MARK CONSISTS OF STANDARD CHARACTERS WITHOUT CLAIM TO ANY PARTICULAR FONT, STYLE, SIZE, OR COLOR.

SER. NO. 85-312,054, FILED 5-4-2011.

SUZANNE BLANE, EXAMINING ATTORNEY



David J. Kybas

Director of the United States Patent and Trademark Office

United States of America

United States Patent and Trademark Office

Protecting America's health, one immunization at a time

Reg. No. 4,067,180

MOLLEN IMMUNIZATION CLINICS, LLC (ARIZONA LIMITED LIABILITY COMPANY)
8328 E. HARTFORD DRIVE
SCOTTSDALE, AZ 85255

Registered Dec. 6, 2011

Int. Cl.: 44

FOR: MEDICAL SERVICES, NAMELY, PROVIDING IMMUNIZATIONS AND VACCINES,
IN CLASS 44 (U.S. CLS. 100 AND 101).

SERVICE MARK

FIRST USE 4-1-2008; IN COMMERCE 4-1-2008.

PRINCIPAL REGISTER

THE MARK CONSISTS OF STANDARD CHARACTERS WITHOUT CLAIM TO ANY PAR-
TICULAR FONT, STYLE, SIZE, OR COLOR.

SER. NO. 85-312,057, FILED 5-4-2011.

ZACHARY BELLO, EXAMINING ATTORNEY



David J. Kyffers

Director of the United States Patent and Trademark Office

United States of America

United States Patent and Trademark Office

GRABBLE

Reg. No. 4,067,181

Registered Dec. 6, 2011

Int. Cl.: 16

TRADEMARK

PRINCIPAL REGISTER

THE DAILY PRESS, INC. (DELAWARE CORPORATION)
7505 WARWICK BOULEVARD
NEWPORT NEWS, VA 23607

FOR: NEWSPAPERS FOR GENERAL CIRCULATION, IN CLASS 16 (U.S. CLS. 2, 5, 22, 23, 29, 37, 38 AND 50).

FIRST USE 9-13-2009; IN COMMERCE 9-13-2009.

THE MARK CONSISTS OF STANDARD CHARACTERS WITHOUT CLAIM TO ANY PARTICULAR FONT, STYLE, SIZE, OR COLOR.

SER. NO. 85-312,143, FILED 5-4-2011.

JACLYN KIDWELL WALKER, EXAMINING ATTORNEY



David J. Kyffers

Director of the United States Patent and Trademark Office

United States of America

United States Patent and Trademark Office

PROFIDERALL

Reg. No. 4,067,182

Registered Dec. 6, 2011

Int. Cl.: 5

TRADEMARK

PRINCIPAL REGISTER

PROFIDERALL LLC (NEVADA LIMITED LIABILITY COMPANY)
200 S VIRGINIA 8TH FLOOR
RENO, NV 89501

FOR: DIETARY AND NUTRITIONAL SUPPLEMENTS, IN CLASS 5 (U.S. CLS. 6, 18, 44, 46, 51 AND 52).

FIRST USE 9-1-2009; IN COMMERCE 9-1-2009.

THE MARK CONSISTS OF STANDARD CHARACTERS WITHOUT CLAIM TO ANY PARTICULAR FONT, STYLE, SIZE, OR COLOR.

SER. NO. 85-312,203, FILED 5-4-2011.

EDWARD FENNESSY, EXAMINING ATTORNEY



David J. Kybas

Director of the United States Patent and Trademark Office

United States of America

United States Patent and Trademark Office



Reg. No. 4,067,183

Registered Dec. 6, 2011

Int. Cls.: 35, 39 and 42

SERVICE MARK

PRINCIPAL REGISTER

KAYAK SOFTWARE CORPORATION (DELAWARE CORPORATION)
55 NORTH WATER STREET
NORWALK, CT 06854

FOR: PROVIDING ON-LINE PRICE COMPARISONS OF TRAVEL AND LODGING SERVICES; ONLINE REFERRAL SERVICES IN THE TRAVEL COMMUNITY; A SEARCHABLE DIRECTORY OF TRAVEL INFORMATION FOR OBTAINING DATA AND INFORMATION FROM OTHERS VIA THE INTERNET, IN CLASS 35 (U.S. CLS. 100, 101 AND 102).

FIRST USE 8-2-2009; IN COMMERCE 8-2-2009.

FOR: PROVIDING TRAVEL INFORMATION OVER GLOBAL COMPUTER NETWORKS, NAMELY, PROVIDING SEARCH SERVICES FOR TRAVEL LISTINGS, TRAVEL INFORMATION AND RELATED TOPICS, AND FOR MAKING RESERVATIONS AND BOOKINGS FOR TRANSPORTATION, IN CLASS 39 (U.S. CLS. 100 AND 105).

FIRST USE 8-2-2009; IN COMMERCE 8-2-2009.

FOR: PROVIDING AN INTERNET SEARCH ENGINE TO LOCATE AND COMPARE PRICES AND RATINGS FOR TRAVEL RESERVATIONS, IN CLASS 42 (U.S. CLS. 100 AND 101).

FIRST USE 8-2-2009; IN COMMERCE 8-2-2009.

OWNER OF U.S. REG. NOS. 3,110,651, 3,865,653 AND OTHERS.

THE MARK CONSISTS OF THE WORD 'KAYAK' ON A SPLIT-FLAP DISPLAY (ALSO KNOWN AS A FLAP DISPLAY, OR FLIPPY BOARD), OFTEN USED AS A PUBLIC TRANSPORT TIMETABLE IN SOME AIRPORTS OR RAILWAY STATIONS.

SER. NO. 85-312,214, FILED 5-4-2011.

ELI HELLMAN, EXAMINING ATTORNEY



David J. Kyffers

Director of the United States Patent and Trademark Office

United States of America

United States Patent and Trademark Office

Innocently Addictive

Reg. No. 4,067,184

Registered Dec. 6, 2011

Int. Cl.: 29

TRADEMARK

PRINCIPAL REGISTER

NUTORIOUS, LLC (DELAWARE LIMITED LIABILITY COMPANY)
PO BOX 28383
GREEN BAY, WI 54324

FOR: CANDIED NUTS; FLAVORED NUTS; NUT-BASED SNACK FOODS; PROCESSED NUTS, IN CLASS 29 (U.S. CL. 46).

FIRST USE 6-1-2008; IN COMMERCE 8-1-2008.

THE MARK CONSISTS OF STANDARD CHARACTERS WITHOUT CLAIM TO ANY PARTICULAR FONT, STYLE, SIZE, OR COLOR.

SER. NO. 85-312,222, FILED 5-4-2011.

JOHN HWANG, EXAMINING ATTORNEY



David J. Kybas

Director of the United States Patent and Trademark Office

United States of America

United States Patent and Trademark Office

OPEN YOUR HEART TO THE CHILDREN BENEFIT

Reg. No. 4,067,185

Registered Dec. 6, 2011

Int. Cl.: 36

SERVICE MARK

PRINCIPAL REGISTER

HEDGE FUNDS CARE INC. (NEW YORK NON-PROFIT CORPORATION)
SUITE 1404
70 WEST 36TH STREET
NEW YORK, NY 10018

FOR: CHARITABLE FUNDRAISING SERVICES, IN CLASS 36 (U.S. CLS. 100, 101 AND 102).

FIRST USE 12-0-1998; IN COMMERCE 12-0-1998.

THE MARK CONSISTS OF STANDARD CHARACTERS WITHOUT CLAIM TO ANY PARTICULAR FONT, STYLE, SIZE, OR COLOR.

SER. NO. 85-312,230, FILED 5-4-2011.

EDWARD NELSON, EXAMINING ATTORNEY



David J. Kyffers

Director of the United States Patent and Trademark Office

United States of America

United States Patent and Trademark Office

ESTATE

Reg. No. 4,067,186

Registered Dec. 6, 2011

Int. Cl.: 24

TRADEMARK

PRINCIPAL REGISTER

THE DOLLFUS MIEG COMPANY, INC. (DELAWARE CORPORATION)
10 BASIN DRIVE, SUITE 130
KEARNY, NJ 07032

FOR: TOWELS, IN CLASS 24 (U.S. CLS. 42 AND 50).

FIRST USE 0-0-1986; IN COMMERCE 0-0-1986.

THE MARK CONSISTS OF STANDARD CHARACTERS WITHOUT CLAIM TO ANY PARTICULAR FONT, STYLE, SIZE, OR COLOR.

SER. NO. 85-312,242, FILED 5-4-2011.

JUDITH HELFMAN, EXAMINING ATTORNEY



David J. Kybas

Director of the United States Patent and Trademark Office

United States of America

United States Patent and Trademark Office

Zap the Flu at School

Reg. No. 4,067,187

Registered Dec. 6, 2011

Int. Cl.: 44

SERVICE MARK

PRINCIPAL REGISTER

MOLLEN IMMUNIZATION CLINICS, LLC (ARIZONA LIMITED LIABILITY COMPANY)
8328 E. HARTFORD DRIVE
SCOTTSDALE, AZ 85255

FOR: MEDICAL SERVICES, NAMELY, PROVIDING IMMUNIZATIONS AND VACCINES,
IN CLASS 44 (U.S. CLS. 100 AND 101).

FIRST USE 4-1-2008; IN COMMERCE 4-1-2008.

THE MARK CONSISTS OF STANDARD CHARACTERS WITHOUT CLAIM TO ANY PAR-
TICULAR FONT, STYLE, SIZE, OR COLOR.

SER. NO. 85-312,256, FILED 5-4-2011.

ZACHARY BELLO, EXAMINING ATTORNEY



David J. Kyros

Director of the United States Patent and Trademark Office

United States of America

United States Patent and Trademark Office



Reg. No. 4,067,188

Registered Dec. 6, 2011

Int. Cl.: 41

SERVICE MARK

PRINCIPAL REGISTER

READING IN MOTION (ILLINOIS NON-PROFIT CORPORATION)
SUITE 1800
65 EAST WACKER PLACE
CHICAGO, IL 60601

FOR: EDUCATIONAL SERVICES, NAMELY, PROVIDING CLASSES, SEMINARS, COURSES AND AFTER-SCHOOL WORKSHOPS IN THE FIELDS OF LITERACY FOR STUDENTS AND TEACHERS; AND DISTRIBUTING TRAINING MANUALS AND BOOKS USED IN CONNECTION THEREWITH, IN CLASS 41 (U.S. CLS. 100, 101 AND 107).

FIRST USE 6-0-2009; IN COMMERCE 6-0-2009.

OWNER OF U.S. REG. NOS. 2,979,448 AND 2,995,909.

NO CLAIM IS MADE TO THE EXCLUSIVE RIGHT TO USE "READING", APART FROM THE MARK AS SHOWN.

THE MARK CONSISTS OF THE WORDS "READING IN MOTION" WITH AN OPEN BOOK/FAN DESIGN.

SER. NO. 85-312,272, FILED 5-4-2011.

KATHY DE JONGE, EXAMINING ATTORNEY



David J. Kybas

Director of the United States Patent and Trademark Office

United States of America

United States Patent and Trademark Office

Grad Tales

Reg. No. 4,067,189

Registered Dec. 6, 2011

Int. Cl.: 20

TRADEMARK

PRINCIPAL REGISTER

STADIUM WRAP AMERICA, LLC (MISSISSIPPI LIMITED LIABILITY COMPANY)
P.O. BOX 23126
JACKSON, MS 39225

FOR: ADJUSTABLE VINYL BANNERS SUSPENDED ON METAL POLES INSERTED INTO SQUARE METAL GROUND SLEEVES; PLASTIC BANNERS; VINYL BANNERS, IN CLASS 20 (U.S. CLS. 2, 13, 22, 25, 32 AND 50).

FIRST USE 4-1-2011; IN COMMERCE 4-1-2011.

THE MARK CONSISTS OF STANDARD CHARACTERS WITHOUT CLAIM TO ANY PARTICULAR FONT, STYLE, SIZE, OR COLOR.

SER. NO. 85-312,277, FILED 5-4-2011.

IRA J. GOODSaid, EXAMINING ATTORNEY



David J. Kyffers

Director of the United States Patent and Trademark Office

United States of America

United States Patent and Trademark Office

LA MAESTRA

Reg. No. 4,067,190

Registered Dec. 6, 2011

Int. Cl.: 33

TRADEMARK

PRINCIPAL REGISTER

RUSTON FAMILY WINE COMPANY, LLC (CALIFORNIA LIMITED LIABILITY COMPANY)
2798 SPRING STREET
ST. HELENA, CA 94574

FOR: WINE, IN CLASS 33 (U.S. CLS. 47 AND 49).

FIRST USE 10-22-2002; IN COMMERCE 10-22-2002.

THE MARK CONSISTS OF STANDARD CHARACTERS WITHOUT CLAIM TO ANY PARTICULAR FONT, STYLE, SIZE, OR COLOR.

THE ENGLISH TRANSLATION OF "LA MAESTRA" IN THE MARK IS "THE MASTER".

SER. NO. 85-312,295, FILED 5-4-2011.

WILLIAM P. SHANAHAN, EXAMINING ATTORNEY



David J. Kyffers

Director of the United States Patent and Trademark Office

United States of America

United States Patent and Trademark Office



Reg. No. 4,067,191

Registered Dec. 6, 2011

Int. Cls.: 16 and 41

TRADEMARK

SERVICE MARK

PRINCIPAL REGISTER

PAIKH WORLDWIDE MEDIA LLC (NEW JERSEY LIMITED LIABILITY COMPANY)
37 WEST 20TH STREET, SUITE 1009
NEW YORK, NY 10011

FOR: A BIMONTHLY NEWSPAPER PUBLICATION FOR THE INDIAN COMMUNITY, IN CLASS 16 (U.S. CLS. 2, 5, 22, 23, 29, 37, 38 AND 50).

FIRST USE 7-30-2004; IN COMMERCE 7-30-2004.

FOR: PROVIDING ONLINE PUBLICATION WEBSITE FEATURING NEWS FOR THE INDIAN COMMUNITY, IN CLASS 41 (U.S. CLS. 100, 101 AND 107).

FIRST USE 7-30-2004; IN COMMERCE 7-30-2004.

OWNER OF U.S. REG. NO. 3,092,409.

THE COLOR(S) BLACK, WHITE, YELLOW AND GREEN IS/ARE CLAIMED AS A FEATURE OF THE MARK.

NO CLAIM IS MADE TO THE EXCLUSIVE RIGHT TO USE "DESI" AND "CHICAGO", APART FROM THE MARK AS SHOWN.

THE MARK CONSISTS OF THE WORD "DESI" IN UPPER CASE, IN YELLOW, AGAINST A BLACK BACKGROUND FOLLOWED BY THE WORD "TALK" IN UPPERCASE, IN YELLOW, WITH THE WORDS "IN CHICAGO", IN UPPER CASE, IN GREEN, BELOW IT. BOTH "TALK" AND "IN CHICAGO" ARE AGAINST A WHITE BACKGROUND.

THE FOREIGN WORDING IN THE MARK TRANSLATES INTO ENGLISH AS "ONE FROM OUR COUNTRY".

SER. NO. 85-312,300, FILED 5-4-2011.

PAUL F. GAST, EXAMINING ATTORNEY



David J. Kyffers

Director of the United States Patent and Trademark Office

United States of America

United States Patent and Trademark Office

RandyIsTops.com

Reg. No. 4,067,192

CPW SPORTSWEAR INC. (NEW YORK CORPORATION)
230 W. 39TH STREET
NEW YORK, NY 10016

Registered Dec. 6, 2011

Int. Cl.: 35

FOR: ONLINE WHOLESALE ORDERING SERVICES IN THE FIELD OF CLOTHING, IN CLASS 35 (U.S. CLS. 100, 101 AND 102).

SERVICE MARK

FIRST USE 3-1-2011; IN COMMERCE 3-1-2011.

PRINCIPAL REGISTER

THE MARK CONSISTS OF STANDARD CHARACTERS WITHOUT CLAIM TO ANY PARTICULAR FONT, STYLE, SIZE, OR COLOR.

SER. NO. 85-312,314, FILED 5-4-2011.

DORITT L. CARROLL, EXAMINING ATTORNEY



David J. Kybas

Director of the United States Patent and Trademark Office

United States of America

United States Patent and Trademark Office

tillowz

Reg. No. 4,067,193

Registered Dec. 6, 2011

Int. Cl.: 24

TRADEMARK

PRINCIPAL REGISTER

TILLOWZ LLC (VIRGINIA LIMITED LIABILITY COMPANY)
42230 BIG SPRINGS COURT
LEESBURG, VA 20176

FOR: BEACH TOWELS; PILLOW CASES, IN CLASS 24 (U.S. CLS. 42 AND 50).

FIRST USE 4-8-2011; IN COMMERCE 4-15-2011.

THE MARK CONSISTS OF THE STYLIZED WORD TILLOWZ WITH A STYLIZED SUN
ICON REPRESENTING THE LETTER O IN THE WORD TILLOWZ.

SER. NO. 85-312,331, FILED 5-4-2011.

JEAN IM, EXAMINING ATTORNEY



David J. Kyros

Director of the United States Patent and Trademark Office

United States of America

United States Patent and Trademark Office

LET'S GO SEA.

Reg. No. 4,067,194

Registered Dec. 6, 2011

Int. Cl.: 41

SERVICE MARK

PRINCIPAL REGISTER

SOUTH CAROLINA AQUARIUM (SOUTH CAROLINA NON-PROFIT CORPORATION)
100 AQUARIUM WHARF
CHARLESTON, SC 29401

FOR: EDUCATIONAL AND ENTERTAINMENT SERVICES, NAMELY, PROVIDING
AQUARIUM FACILITIES TO THE PUBLIC, IN CLASS 41 (U.S. CLS. 100, 101 AND 107).

FIRST USE 3-1-2011; IN COMMERCE 3-1-2011.

THE MARK CONSISTS OF STANDARD CHARACTERS WITHOUT CLAIM TO ANY PAR-
TICULAR FONT, STYLE, SIZE, OR COLOR.

SER. NO. 85-312,334, FILED 5-4-2011.

FRANK LATTUCA, EXAMINING ATTORNEY



David J. Kyffers

Director of the United States Patent and Trademark Office

United States of America

United States Patent and Trademark Office

StoveTec

Reg. No. 4,067,195

Registered Dec. 6, 2011

Int. Cl.: 11

TRADEMARK

PRINCIPAL REGISTER

ASAT, INC (OREGON CORPORATION), DBA STOVETEC
79093 HIGHWAY 99
COTTAGE GROVE, OR 97424

FOR: CERAMIC STOVES; JAPANESE CHARCOAL COOKING STOVES FOR HOUSEHOLD PURPOSES (SHICHIRIN); PORTABLE STOVES; SOLID FUEL BURNING STOVES; WOOD BURNING STOVES, IN CLASS 11 (U.S. CLS. 13, 21, 23, 31 AND 34).

FIRST USE 9-1-2008; IN COMMERCE 9-1-2008.

THE MARK CONSISTS OF STANDARD CHARACTERS WITHOUT CLAIM TO ANY PARTICULAR FONT, STYLE, SIZE, OR COLOR.

SER. NO. 85-312,340, FILED 5-4-2011.

MICHAEL WEBSTER, EXAMINING ATTORNEY



David J. Kyros

Director of the United States Patent and Trademark Office

United States of America

United States Patent and Trademark Office



Reg. No. 4,067,196
Registered Dec. 6, 2011
Int. Cl.: 45

SERVICE MARK

PRINCIPAL REGISTER

LING, LISA M. (WASHINGTON LIMITED LIABILITY COMPANY), DBA FEAR2LOVE LLC
SUITE L
232 BOUNDARY BAY ROAD
POINT ROBERTS, WA 98281

FOR: COUNSELING IN THE FIELD OF PERSONAL DEVELOPMENT, NAMELY, SELF-IMPROVEMENT, SELF-FULFILLMENT, AND INTERPERSONAL COMMUNICATION; MEMBERSHIP CLUB SERVICES, NAMELY, PROVIDING ON-LINE INFORMATION TO MEMBERS IN THE FIELDS OF PERSONAL GROWTH AND MOTIVATION, PERSONAL IMAGE DEVELOPMENT, AND PERSONAL DEVELOPMENT, NAMELY, SELF-IMPROVEMENT, SELF-FULFILLMENT, AND INTERPERSONAL COMMUNICATION; PERSONAL GROWTH AND MOTIVATION CONSULTING SERVICES; PROVIDING A MOTIVATIONAL WEBSITE THE PRIMARY MISSION OF WHICH IS TO INCREASE PERSONAL HAPPINESS IN TERMS OF PERSONAL RELATIONSHIPS, PERSONAL GROWTH AND MOTIVATION, AND SELF-FULFILLMENT; PROVIDING A WEB SITE FEATURING INFORMATION AND CONTENT IN THE FIELDS OF PERSONAL RELATIONSHIPS, PERSONAL GROWTH AND MOTIVATION, AND SELF-FULFILLMENT; PROVIDING INFORMATION IN THE FIELD OF PERSONAL DEVELOPMENT, NAMELY, SELF-IMPROVEMENT, SELF-FULFILLMENT, AND INTERPERSONAL COMMUNICATION; PROVIDING INFORMATION IN THE FIELD OF SELF-IMPROVEMENT, IN CLASS 45 (U.S. CLS. 100 AND 101).

FIRST USE 10-20-2010; IN COMMERCE 10-20-2010.

THE MARK CONSISTS OF THE WORDING FEAR2LOVE IN GREY AND GOLD. FEAR2 IN GREY AND LOVE IN GOLD. A GREY AND GOLD BRUSHSTROKE CIRCLE ENDING IN A GOLDEN HEART, SITS ABOVE THE WORDING.

THE COLOR(S) GREY AND GOLD IS/ARE CLAIMED AS A FEATURE OF THE MARK.

SER. NO. 85-312,344, FILED 5-4-2011.

FRANK LATTUCA, EXAMINING ATTORNEY



David J. Kyffers

Director of the United States Patent and Trademark Office

United States of America

United States Patent and Trademark Office

KEEPIN' IT WEIRD

Reg. No. 4,067,197

Registered Dec. 6, 2011

Int. Cl.: 25

TRADEMARK

PRINCIPAL REGISTER

T LINE DESIGN INC. (OREGON CORPORATION)
158 SW 1ST AVE.
CANBY, OR 97013

FOR: HATS; T-SHIRTS, IN CLASS 25 (U.S. CLS. 22 AND 39).

FIRST USE 7-28-2011; IN COMMERCE 7-28-2011.

THE MARK CONSISTS OF STANDARD CHARACTERS WITHOUT CLAIM TO ANY PARTICULAR FONT, STYLE, SIZE, OR COLOR.

SER. NO. 85-312,345, FILED 5-4-2011.

SANJEEV VOHRA, EXAMINING ATTORNEY



David J. Kybas

Director of the United States Patent and Trademark Office

United States of America

United States Patent and Trademark Office

LIVING INSIDE OUT

Reg. No. 4,067,198

Registered Dec. 6, 2011

Int. Cl.: 25

TRADEMARK

PRINCIPAL REGISTER

COTTON, ELLOUISE M. (UNITED STATES INDIVIDUAL)
832 PRINCETON AVENUE, SW
BIRMINGHAM, AL 35211

FOR: CLOTHING, NAMELY, SPORTSWEAR AND CASUAL WEAR FOR MEN, WOMEN AND CHILDREN - NAMELY, T-SHIRTS, SHIRTS, SWEATSHIRTS, AND TOPS, IN CLASS 25 (U.S. CLS. 22 AND 39).

FIRST USE 1-12-2011; IN COMMERCE 2-26-2011.

THE MARK CONSISTS OF STANDARD CHARACTERS WITHOUT CLAIM TO ANY PARTICULAR FONT, STYLE, SIZE, OR COLOR.

SER. NO. 85-312,486, FILED 5-4-2011.

MARGERIE A. TIERNEY, EXAMINING ATTORNEY



David J. Kyffers

Director of the United States Patent and Trademark Office

United States of America

United States Patent and Trademark Office

INFLATAMANIACS

Reg. No. 4,067,199

INFLATAMANIACS LLC (KENTUCKY LIMITED LIABILITY COMPANY)
8004 SYCAMORE CREEK
LOUISVILLE, KY 40222

Registered Dec. 6, 2011

Int. Cl.: 41

FOR: ENTERTAINMENT SERVICES, NAMELY, LIVE INFLATABLE MASCOT SHOWS AND APPEARANCES, IN CLASS 41 (U.S. CLS. 100, 101 AND 107).

SERVICE MARK

FIRST USE 2-25-2008; IN COMMERCE 9-22-2008.

PRINCIPAL REGISTER

THE MARK CONSISTS OF STANDARD CHARACTERS WITHOUT CLAIM TO ANY PARTICULAR FONT, STYLE, SIZE, OR COLOR.

SER. NO. 85-312,497, FILED 5-4-2011.

KATHERINE CHANG, EXAMINING ATTORNEY



David J. Kyffers

Director of the United States Patent and Trademark Office

United States of America

United States Patent and Trademark Office

I Zapped the Flu at School

Reg. No. 4,067,200

Registered Dec. 6, 2011

Int. Cl.: 44

SERVICE MARK

PRINCIPAL REGISTER

MOLLEN IMMUNIZATION CLINICS, LLC (ARIZONA LIMITED LIABILITY COMPANY)
8328 E. HARTFORD DRIVE
SCOTTSDALE, AZ 85255

FOR: MEDICAL SERVICES, NAMELY, PROVIDING IMMUNIZATIONS AND VACCINES,
IN CLASS 44 (U.S. CLS. 100 AND 101).

FIRST USE 4-1-2008; IN COMMERCE 4-1-2008.

THE MARK CONSISTS OF STANDARD CHARACTERS WITHOUT CLAIM TO ANY PAR-
TICULAR FONT, STYLE, SIZE, OR COLOR.

SER. NO. 85-312,503, FILED 5-4-2011.

ZACHARY BELLO, EXAMINING ATTORNEY



David J. Kyffers

Director of the United States Patent and Trademark Office

United States of America

United States Patent and Trademark Office

ELKONIC

Reg. No. 4,067,201

Registered Dec. 6, 2011

Int. Cl.: 5

TRADEMARK

PRINCIPAL REGISTER

ELKONIC NUTRITIONALS RESEARCH INSTITUTE, INC. (MARYLAND CORPORATION)
10502 GREAT ARBOR DR.
POTOMAC, MD 20854

FOR: MULTI-VITAMIN, DIETARY AND NUTRITIONAL SUPPLEMENTS, FOOD SUPPLEMENTS, HEALTH FOOD SUPPLEMENTS, IN CLASS 5 (U.S. CLS. 6, 18, 44, 46, 51 AND 52).

FIRST USE 4-26-2011; IN COMMERCE 4-26-2011.

THE MARK CONSISTS OF STANDARD CHARACTERS WITHOUT CLAIM TO ANY PARTICULAR FONT, STYLE, SIZE, OR COLOR.

THE WORDING ELKONIC HAS NO MEANING IN A FOREIGN LANGUAGE.

SER. NO. 85-312,510, FILED 5-4-2011.

GEORGE LORENZO, EXAMINING ATTORNEY



David J. Kyros

Director of the United States Patent and Trademark Office

United States of America

United States Patent and Trademark Office

TRUE TO SIZE

Reg. No. 4,067,202

Registered Dec. 6, 2011

Int. Cl.: 41

SERVICE MARK

PRINCIPAL REGISTER

CLOTHING 4 ALL, INC. (CALIFORNIA CORPORATION)
#320
1400 EXECUTIVE PARKWAY
EUGENE, OR 97401

FOR: PROVIDING ON-LINE MAGAZINES IN THE FIELD OF CLOTHING, APPAREL AND ACCESSORIES, IN CLASS 41 (U.S. CLS. 100, 101 AND 107).

FIRST USE 4-1-2011; IN COMMERCE 4-1-2011.

THE MARK CONSISTS OF STANDARD CHARACTERS WITHOUT CLAIM TO ANY PARTICULAR FONT, STYLE, SIZE, OR COLOR.

SER. NO. 85-312,515, FILED 5-4-2011.

TIMOTHY FINNEGAN, EXAMINING ATTORNEY



David J. Kybas

Director of the United States Patent and Trademark Office

United States of America

United States Patent and Trademark Office

FastBook

Reg. No. 4,067,203

Registered Dec. 6, 2011

Int. Cl.: 9

TRADEMARK

PRINCIPAL REGISTER

DEALER'S LINK, INC. (COLORADO CORPORATION)
400
11001 W 120TH AVENUE
BROOMFIELD, CO 80021

FOR: AUTOMOTIVE DEALER SOFTWARE, NAMELY, COMPUTER SOFTWARE APPLICATION AND APPLICATION SOFTWARE FOR MOBILE PHONES FOR USE IN ACCESSING AND RUNNING POPULAR VALUATION REPORTS AND OTHER GUIDES PERTAINING TO AUTOMOTIVE VEHICLES, SO THAT ONE CAN HAVE AS REFERENCE AND FOR COMPARING REPORTS AMONG THEM, IN CLASS 9 (U.S. CLS. 21, 23, 26, 36 AND 38).

FIRST USE 10-1-2008; IN COMMERCE 10-1-2008.

THE MARK CONSISTS OF STANDARD CHARACTERS WITHOUT CLAIM TO ANY PARTICULAR FONT, STYLE, SIZE, OR COLOR.

SER. NO. 85-312,521, FILED 5-4-2011.

KIM MONINGHOFF, EXAMINING ATTORNEY



David J. Kyffers

Director of the United States Patent and Trademark Office

United States of America

United States Patent and Trademark Office

CONCH HARBOR

Reg. No. 4,067,204

Registered Dec. 6, 2011

Int. Cl.: 35

SERVICE MARK

PRINCIPAL REGISTER

CONCH HARBOR RETAIL CENTER LLC (FLORIDA LIMITED LIABILITY COMPANY)
951 CAROLINE STREET
KEY WEST, FL 33040

FOR: RETAIL STORE SERVICES FEATURING CONVENIENCE STORE ITEMS AND GASOLINE; RETAIL STORE SERVICES FEATURING MARINE EQUIPMENT AND SUPPLIES, CLOTHING AND HATS, FISHING GEAR, FOOD, TOWELS, BEACH EQUIPMENT AND SUPPLIES, SWIMMING EQUIPMENT AND SUPPLIES, IN CLASS 35 (U.S. CLS. 100, 101 AND 102).

FIRST USE 0-0-1998; IN COMMERCE 0-0-1998.

THE MARK CONSISTS OF STANDARD CHARACTERS WITHOUT CLAIM TO ANY PARTICULAR FONT, STYLE, SIZE, OR COLOR.

SER. NO. 85-312,533, FILED 5-4-2011.

KIMBERLY FRYE, EXAMINING ATTORNEY



David J. Kybas

Director of the United States Patent and Trademark Office

United States of America

United States Patent and Trademark Office



Reg. No. 4,067,205

ROSE COFFEE COMPANY (MISSOURI CORPORATION)
4241 SARPY

Registered Dec. 6, 2011

ST. LOUIS, MO 63110

Int. Cl.: 32

FOR: DRINKING WATER, IN CLASS 32 (U.S. CLS. 45, 46 AND 48).

TRADEMARK

FIRST USE 12-8-1999; IN COMMERCE 12-8-1999.

PRINCIPAL REGISTER

OWNER OF U.S. REG. NO. 3,079,510.

THE MARK CONSISTS OF THE WORD CLEARBROOK AND A DESIGN OF SMALL BROOK
IN A VALLEY FLOWING TOWARD THE HORIZON.

SER. NO. 85-312,549, FILED 5-4-2011.

KAPIL BHANOT, EXAMINING ATTORNEY



David J. Kybas

Director of the United States Patent and Trademark Office

United States of America

United States Patent and Trademark Office

4ORCE

Reg. No. 4,067,206

Registered Dec. 6, 2011

Int. Cl.: 12

TRADEMARK

PRINCIPAL REGISTER

ETV, INC. (OREGON CORPORATION), DBA 4ORCE MOBILITY INC
17300 SW BASELINE RD
BEAVERTON, OR 97006

FOR: CUSTOM BUILT ALL-TERRAIN VEHICLES AND STRUCTURAL PARTS THEREFOR
FOR USE IN UTILITY, FOREST FIRE FIGHTING, SKI AREA, MILITARY AND AGRICUL-
TURAL APPLICATIONS , IN CLASS 12 (U.S. CLS. 19, 21, 23, 31, 35 AND 44).

FIRST USE 4-4-2002; IN COMMERCE 5-1-2002.

THE MARK CONSISTS OF STANDARD CHARACTERS WITHOUT CLAIM TO ANY PAR-
TICULAR FONT, STYLE, SIZE, OR COLOR.

SER. NO. 85-312,553, FILED 5-4-2011.

LINDA E. BLOHM, EXAMINING ATTORNEY



David J. Kybas

Director of the United States Patent and Trademark Office

United States of America

United States Patent and Trademark Office

It's Gotta be The Shades.

Reg. No. 4,067,207

Registered Dec. 6, 2011

Int. Cl.: 9

TRADEMARK

PRINCIPAL REGISTER

SHADY PEEPS, LLC (OREGON LIMITED LIABILITY COMPANY)
SUITE 113
1900 MILLRACE DR
EUGENE, OR 97403

FOR: EYEWEAR, IN CLASS 9 (U.S. CLS. 21, 23, 26, 36 AND 38).

FIRST USE 4-0-2010; IN COMMERCE 4-0-2010.

THE MARK CONSISTS OF STANDARD CHARACTERS WITHOUT CLAIM TO ANY PARTICULAR FONT, STYLE, SIZE, OR COLOR.

SER. NO. 85-312,554, FILED 5-4-2011.

SUNG IN, EXAMINING ATTORNEY



David J. Kyffers

Director of the United States Patent and Trademark Office

United States of America

United States Patent and Trademark Office

Milhaus

Reg. No. 4,067,208

Registered Dec. 6, 2011

Int. Cls.: 36 and 37

SERVICE MARK

PRINCIPAL REGISTER

MILHAUS DEVELOPMENT LLC (INDIANA LIMITED LIABILITY COMPANY)
530 EAST OHIO STREET, SUITE F
INDIANAPOLIS, IN 46204

FOR: REAL ESTATE CONSULTATION, IN CLASS 36 (U.S. CLS. 100, 101 AND 102).

FIRST USE 7-1-2009; IN COMMERCE 7-15-2009.

FOR: REAL ESTATE DEVELOPMENT, IN CLASS 37 (U.S. CLS. 100, 103 AND 106).

FIRST USE 7-1-2009; IN COMMERCE 7-15-2009.

THE MARK CONSISTS OF STANDARD CHARACTERS WITHOUT CLAIM TO ANY PARTICULAR FONT, STYLE, SIZE, OR COLOR.

SER. NO. 85-312,575, FILED 5-4-2011.

SUNG IN, EXAMINING ATTORNEY



David J. Kyffers

Director of the United States Patent and Trademark Office

United States of America

United States Patent and Trademark Office

Think mixed use

Reg. No. 4,067,209

Registered Dec. 6, 2011

Int. Cls.: 36 and 37

SERVICE MARK

PRINCIPAL REGISTER

MILHAUS DEVELOPMENT LLC (INDIANA LIMITED LIABILITY COMPANY)
530 EAST OHIO STREET, SUITE F
INDIANAPOLIS, IN 46204

FOR: REAL ESTATE CONSULTATION, IN CLASS 36 (U.S. CLS. 100, 101 AND 102).

FIRST USE 4-27-2010; IN COMMERCE 5-19-2010.

FOR: REAL ESTATE DEVELOPMENT, IN CLASS 37 (U.S. CLS. 100, 103 AND 106).

FIRST USE 4-27-2010; IN COMMERCE 5-19-2010.

THE MARK CONSISTS OF STANDARD CHARACTERS WITHOUT CLAIM TO ANY PARTICULAR FONT, STYLE, SIZE, OR COLOR.

SER. NO. 85-312,594, FILED 5-4-2011.

SUNG IN, EXAMINING ATTORNEY



David J. Kyffers

Director of the United States Patent and Trademark Office

United States of America

United States Patent and Trademark Office

Some Script

Reg. No. 4,067,210

SOME SCRIPT LLC (TEXAS LIMITED LIABILITY COMPANY)
PO BOX 152320
AUSTIN, TX 78715

Registered Dec. 6, 2011

Int. Cl.: 42

FOR: COMPUTER SOFTWARE DEVELOPMENT; WEBSITE DESIGN AND DEVELOPMENT FOR OTHERS, IN CLASS 42 (U.S. CLS. 100 AND 101).

SERVICE MARK

FIRST USE 4-1-2011; IN COMMERCE 4-1-2011.

PRINCIPAL REGISTER

THE MARK CONSISTS OF STANDARD CHARACTERS WITHOUT CLAIM TO ANY PARTICULAR FONT, STYLE, SIZE, OR COLOR.

NO CLAIM IS MADE TO THE EXCLUSIVE RIGHT TO USE "SCRIPT", APART FROM THE MARK AS SHOWN.

SER. NO. 85-312,633, FILED 5-4-2011.

TEJBIR SINGH, EXAMINING ATTORNEY



David J. Kybas

Director of the United States Patent and Trademark Office

United States of America

United States Patent and Trademark Office

SAGA

Reg. No. 4,067,211

Registered Dec. 6, 2011

Int. Cl.: 9

TRADEMARK

PRINCIPAL REGISTER

L2 TECH, INC (CALIFORNIA CORPORATION)
2260 S ARCHIBALD AVE. #B
ONTARIO, CA 91761

FOR: SCALES, IN CLASS 9 (U.S. CLS. 21, 23, 26, 36 AND 38).

FIRST USE 8-1-2010; IN COMMERCE 8-1-2010.

THE MARK CONSISTS OF STANDARD CHARACTERS WITHOUT CLAIM TO ANY PARTICULAR FONT, STYLE, SIZE, OR COLOR.

THE WORDING SAGA HAS NO MEANING IN A FOREIGN LANGUAGE.

SER. NO. 85-312,634, FILED 5-4-2011.

MAYUR VAGHANI, EXAMINING ATTORNEY



David J. Kyros

Director of the United States Patent and Trademark Office

United States of America

United States Patent and Trademark Office

TENACIOUS TURTLES

Reg. No. 4,067,212

Registered Dec. 6, 2011

Int. Cls.: 25 and 41

TRADEMARK

SERVICE MARK

PRINCIPAL REGISTER

LACROSSE UNLIMITED, INC. (NEW YORK CORPORATION)
59 GILPIN AVENUE
HAUPPAUGE, NY 11788

FOR: CLOTHING, NAMELY, JERSEYS, JACKETS, SHORTS, SWEATSHIRTS, SWEATPANTS, T-SHIRTS, GOLF SHIRTS, HATS, IN CLASS 25 (U.S. CLS. 22 AND 39).

FIRST USE 3-31-2009; IN COMMERCE 3-31-2009.

FOR: AMATEUR YOUTH SPORTS SERVICES, NAMELY, ORGANIZING AND PROVIDING YOUTH SPORTS ACTIVITIES, IN CLASS 41 (U.S. CLS. 100, 101 AND 107).

FIRST USE 12-28-2008; IN COMMERCE 12-28-2008.

THE MARK CONSISTS OF STANDARD CHARACTERS WITHOUT CLAIM TO ANY PARTICULAR FONT, STYLE, SIZE, OR COLOR.

SER. NO. 85-312,671, FILED 5-4-2011.

HEATHER BIDDULPH, EXAMINING ATTORNEY



David J. Kybas

Director of the United States Patent and Trademark Office

United States of America

United States Patent and Trademark Office

Content Magnet

Reg. No. 4,067,213

Registered Dec. 6, 2011

Int. Cl.: 35

SERVICE MARK

PRINCIPAL REGISTER

RIGHT SOURCE MARKETING, LLC (VIRGINIA LIMITED LIABILITY COMPANY)
11919 LATIGO LANE
OAKTON, VA 22124

FOR: MARKETING SERVICES, NAMELY, CREATING AND DISTRIBUTING MARKETING CONTENT FOR BUSINESSES, IN CLASS 35 (U.S. CLS. 100, 101 AND 102).

FIRST USE 12-1-2010; IN COMMERCE 12-15-2010.

THE MARK CONSISTS OF STANDARD CHARACTERS WITHOUT CLAIM TO ANY PARTICULAR FONT, STYLE, SIZE, OR COLOR.

NO CLAIM IS MADE TO THE EXCLUSIVE RIGHT TO USE "CONTENT", APART FROM THE MARK AS SHOWN.

SER. NO. 85-312,672, FILED 5-4-2011.

TEJBIR SINGH, EXAMINING ATTORNEY



David J. Kyros

Director of the United States Patent and Trademark Office

United States of America

United States Patent and Trademark Office

BRUTTLES

Reg. No. 4,067,214

Registered Dec. 6, 2011

Int. Cl.: 30

TRADEMARK

PRINCIPAL REGISTER

MEASEL, CAROL (UNITED STATES INDIVIDUAL)
101 NORTH UNIVERSITY ROAD
SPOKANE, WA 99206

FOR: CANDY, IN CLASS 30 (U.S. CL. 46).

FIRST USE 9-1-1989; IN COMMERCE 9-1-1989.

THE MARK CONSISTS OF STANDARD CHARACTERS WITHOUT CLAIM TO ANY PARTICULAR FONT, STYLE, SIZE, OR COLOR.

SER. NO. 85-312,677, FILED 5-4-2011.

KIMBERLY FRYE, EXAMINING ATTORNEY



David J. Kybas

Director of the United States Patent and Trademark Office

United States of America

United States Patent and Trademark Office

soaVIZ

Reg. No. 4,067,215

Registered Dec. 6, 2011

Int. Cl.: 9

TRADEMARK

PRINCIPAL REGISTER

MNB TECHNOLOGIES, INC. (INDIANA CORPORATION)
1194 E WINNERS CIR.
BLOOMINGTON, IN 47401

FOR: COMPUTER SOFTWARE FOR MODELING AND SIMULATION OF ELECTRONIC SYSTEMS THAT MAY BE DOWNLOADED FROM A GLOBAL COMPUTER NETWORK, IN CLASS 9 (U.S. CLS. 21, 23, 26, 36 AND 38).

FIRST USE 9-11-2009; IN COMMERCE 9-11-2009.

THE MARK CONSISTS OF STANDARD CHARACTERS WITHOUT CLAIM TO ANY PARTICULAR FONT, STYLE, SIZE, OR COLOR.

SER. NO. 85-312,687, FILED 5-4-2011.

JIM RINGLE, EXAMINING ATTORNEY



David J. Kyffers

Director of the United States Patent and Trademark Office

United States of America

United States Patent and Trademark Office

make the pain familiar

Reg. No. 4,067,216

Registered Dec. 6, 2011

Int. Cl.: 25

TRADEMARK

PRINCIPAL REGISTER

CREATUREBOY PRODUCTS (CALIFORNIA CORPORATION)
PO BOX 8727
CALABASAS, CA 91372

FOR: ATHLETIC WEAR, NAMELY, T-SHIRTS, SWEATSHIRTS, SWEATPANTS, HOODED SWEATSHIRTS, HATS, CAPS, JACKETS, TANK TOPS, JERSEYS, LONG JOHNS, GLOVES, BANDANAS, SWEATBANDS, WRISTBANDS, AND CYCLING SHORTS, IN CLASS 25 (U.S. CLS. 22 AND 39).

FIRST USE 5-27-1997; IN COMMERCE 7-13-2010.

THE MARK CONSISTS OF STANDARD CHARACTERS WITHOUT CLAIM TO ANY PARTICULAR FONT, STYLE, SIZE, OR COLOR.

SER. NO. 85-312,704, FILED 5-4-2011.

LAURIE MAYES, EXAMINING ATTORNEY



David J. Kyros

Director of the United States Patent and Trademark Office

United States of America

United States Patent and Trademark Office

Huckberry

Reg. No. 4,067,217

HUCKBERRY LLC (CALIFORNIA LIMITED LIABILITY COMPANY)
2230 TAYLOR ST
SAN FRANCISCO, CA 94133

Registered Dec. 6, 2011

Int. Cl.: 35

FOR: ON-LINE RETAIL STORE SERVICES FEATURING A WIDE VARIETY OF CONSUMER GOODS OF OTHERS, IN CLASS 35 (U.S. CLS. 100, 101 AND 102).

SERVICE MARK

FIRST USE 7-1-2010; IN COMMERCE 8-1-2010.

PRINCIPAL REGISTER

THE MARK CONSISTS OF STANDARD CHARACTERS WITHOUT CLAIM TO ANY PARTICULAR FONT, STYLE, SIZE, OR COLOR.

SER. NO. 85-312,708, FILED 5-4-2011.

GEORGE LORENZO, EXAMINING ATTORNEY



David J. Kybas

Director of the United States Patent and Trademark Office

United States of America

United States Patent and Trademark Office

BUILDERS BELT

Reg. No. 4,067,218

Registered Dec. 6, 2011

Int. Cl.: 42

SERVICE MARK

PRINCIPAL REGISTER

BUILDERS BELT, LLC (DELAWARE LIMITED LIABILITY COMPANY)
599 MAIN STREET
SEWELL, NJ 08080

FOR: CLOUD COMPUTING FEATURING SOFTWARE FOR USE IN THE CONSTRUCTION INDUSTRY FOR CONTRACT BIDDING AND JOB ACCOUNTING; COMPUTER SERVICE, NAMELY, ACTING AS AN APPLICATION SERVICE PROVIDER IN THE FIELD OF INFORMATION MANAGEMENT TO HOST COMPUTER APPLICATION SOFTWARE FOR THE PURPOSE OF MANAGING, ORGANIZING, ACCESSING AND REPORTING DATA USED IN THE CONSTRUCTION INDUSTRY FOR CONTRACT BIDDING AND JOB ACCOUNTING; COMPUTER SERVICE, NAMELY, ACTING AS AN APPLICATION SERVICE PROVIDER IN THE FIELD OF KNOWLEDGE MANAGEMENT TO HOST COMPUTER APPLICATION SOFTWARE FOR CREATING SEARCHABLE DATABASES OF INFORMATION AND DATA; COMPUTER SERVICE, NAMELY, ACTING AS AN APPLICATION SERVICE PROVIDER IN THE FIELD OF KNOWLEDGE MANAGEMENT TO HOST COMPUTER APPLICATION SOFTWARE FOR THE COLLECTION, EDITING, ORGANIZING, MODIFYING, BOOK MARKING, TRANSMISSION, STORAGE AND SHARING OF DATA AND INFORMATION; PROVIDING A WEBSITE FEATURING NON-DOWNLOADABLE SOFTWARE FOR USE IN THE CONSTRUCTION INDUSTRY FOR CONTRACT BIDDING AND JOB ACCOUNTING; SOFTWARE AS A SERVICE (SAAS) SERVICES FEATURING SOFTWARE FOR USE IN THE CONSTRUCTION INDUSTRY FOR CONTRACT BIDDING AND JOB ACCOUNTING, IN CLASS 42 (U.S. CLS. 100 AND 101).

FIRST USE 3-11-2010; IN COMMERCE 3-11-2010.

THE MARK CONSISTS OF STANDARD CHARACTERS WITHOUT CLAIM TO ANY PARTICULAR FONT, STYLE, SIZE, OR COLOR.

SER. NO. 85-312,736, FILED 5-4-2011.

SALLY SHIH, EXAMINING ATTORNEY



David J. Kypos

Director of the United States Patent and Trademark Office

United States of America

United States Patent and Trademark Office



Reg. No. 4,067,219

Registered Dec. 6, 2011

Int. Cl.: 43

SERVICE MARK

PRINCIPAL REGISTER

JIROAM, INC. (FLORIDA CORPORATION)
321 WEST SUNRISE BLVD
FORT LAUDERDALE, FL 33311

FOR: RESTAURANT AND BAR SERVICES, IN CLASS 43 (U.S. CLS. 100 AND 101).

FIRST USE 4-15-1975; IN COMMERCE 4-15-1975.

THE MARK CONSISTS OF THE STYLIZED WORD "PLATO'S" ABOVE THE WORD "RETREAT" IN STYLIZED FONT. BETWEEN THE WORDS IS A DRAWING OF A STYLIZED HEART.

SER. NO. 85-312,746, FILED 5-4-2011.

SALLY SHIH, EXAMINING ATTORNEY



David J. Kybas

Director of the United States Patent and Trademark Office

United States of America

United States Patent and Trademark Office

RED JAVELIN

Reg. No. 4,067,220

Registered Dec. 6, 2011

Int. Cl.: 35

SERVICE MARK

PRINCIPAL REGISTER

RED JAVELIN COMMUNICATIONS, INC. (MASSACHUSETTS CORPORATION)
30 PELHAM ISLAND ROAD
SUDBURY, MA 01776

FOR: PUBLIC RELATIONS, IN CLASS 35 (U.S. CLS. 100, 101 AND 102).

FIRST USE 7-17-2001; IN COMMERCE 7-17-2001.

THE MARK CONSISTS OF STANDARD CHARACTERS WITHOUT CLAIM TO ANY PARTICULAR FONT, STYLE, SIZE, OR COLOR.

SER. NO. 85-312,751, FILED 5-4-2011.

DAVID I, EXAMINING ATTORNEY



David J. Kyros

Director of the United States Patent and Trademark Office

United States of America

United States Patent and Trademark Office

HAKKO

Reg. No. 4,067,221

MATALA WATER TECHNOLOGY CO., LTD. (TAIWAN CORPORATION)
NO. 121, TZU LI 2ND ST., WU CHI DIST.
TAICHUNG CITY, TAIWAN

Registered Dec. 6, 2011

Int. Cl.: 7

FOR: WATER PUMPS FOR WATER FILTERING UNITS, IN CLASS 7 (U.S. CLS. 13, 19, 21, 23, 31, 34 AND 35).

TRADEMARK

FIRST USE 4-9-2003; IN COMMERCE 4-9-2003.

PRINCIPAL REGISTER

THE MARK CONSISTS OF STYLIZED WORD "HAKKO".

THE WORDING "HAKKO" HAS NO MEANING IN A FOREIGN LANGUAGE.

SER. NO. 85-312,778, FILED 5-4-2011.

KAPIL BHANOT, EXAMINING ATTORNEY



David J. Kybas

Director of the United States Patent and Trademark Office

United States of America

United States Patent and Trademark Office



Reg. No. 4,067,222

Registered Dec. 6, 2011

Int. Cl.: 35

SERVICE MARK

PRINCIPAL REGISTER

I-LUXURY ENTERPRISES, INC. (GEORGIA CORPORATION)
3340 PEACHTREE ROAD, NE, SUITE 1700
ATLANTA, GA 30326

FOR: JEWELRY RETAIL AND WHOLESALE STORE SERVICES, IN CLASS 35 (U.S. CLS. 100, 101 AND 102).

FIRST USE 9-1-2005; IN COMMERCE 9-1-2005.

THE MARK CONSISTS OF THE STYLIZED LETTERS "S" AND "B".

SER. NO. 85-313,177, FILED 5-5-2011.

ROBIN MITTLER, EXAMINING ATTORNEY



David J. Kybas

Director of the United States Patent and Trademark Office

United States of America

United States Patent and Trademark Office



Reg. No. 4,067,223

Registered Dec. 6, 2011

Int. Cl.: 33

TRADEMARK

PRINCIPAL REGISTER

DOUBLE EIGHT BEVERAGES, INC (NEW YORK CORPORATION)
162-18 71ST AVENUE
FRESH MEADOWS, NY 11365

FOR: ALCOHOLIC BEVERAGES, EXCEPT BEERS, IN CLASS 33 (U.S. CLS. 47 AND 49).

FIRST USE 1-20-2011; IN COMMERCE 1-20-2011.

THE MARK CONSISTS OF A DRAWING OF A HOUSE WITH TREES BOTH IN FRONT OF THE LEFT HAND SIDE OF THE HOUSE AND BACK OF THE RIGHT HAND SIDE OF THE HOUSE.

SER. NO. 85-313,185, FILED 5-5-2011.

KAPIL BHANOT, EXAMINING ATTORNEY



David J. Kybas

Director of the United States Patent and Trademark Office

United States of America

United States Patent and Trademark Office



Reg. No. 4,067,224

Registered Dec. 6, 2011

Int. Cl.: 33

TRADEMARK

PRINCIPAL REGISTER

DOUBLE EIGHT BEVERAGES, INC. (NEW YORK CORPORATION)
162-18 71ST AVENUE
FRESH MEADOWS, NY 11365

FOR: ALCOHOLIC BEVERAGES, EXCEPT BEER, IN CLASS 33 (U.S. CLS. 47 AND 49).

FIRST USE 1-20-2011; IN COMMERCE 1-20-2011.

THE MARK CONSISTS OF A DRAWING OF A HOUSE WITH 13 WINDOWS AND TREES AROUND THE HOUSE.

SER. NO. 85-313,225, FILED 5-5-2011.

KAPIL BHANOT, EXAMINING ATTORNEY



David J. Kybas

Director of the United States Patent and Trademark Office

United States of America

United States Patent and Trademark Office

KALUSTYAN'S

Reg. No. 4,067,225

Registered Dec. 6, 2011

Int. Cl.: 35

SERVICE MARK

PRINCIPAL REGISTER

OHANNES J. BAS (UNITED STATES INDIVIDUAL)
27 WARE ROAD
UPPER SADDLE RIVER, NJ 07458

FOR: RETAIL STORE SERVICES FEATURING SPICES, NUTS, PROCESSED HERBS, HEALTHY SNACKS, CONFECTIONARIES, AND OTHER FOOD PRODUCTS, IN CLASS 35 (U.S. CLS. 100, 101 AND 102).

FIRST USE 12-31-1977; IN COMMERCE 12-31-1977.

THE MARK CONSISTS OF STANDARD CHARACTERS WITHOUT CLAIM TO ANY PARTICULAR FONT, STYLE, SIZE, OR COLOR.

SER. NO. 85-313,251, FILED 5-5-2011.

CHRIS WELLS, EXAMINING ATTORNEY



David J. Kyffers

Director of the United States Patent and Trademark Office

United States of America

United States Patent and Trademark Office

DENVER TRIATHLON

Reg. No. 4,067,226

Registered Dec. 6, 2011

Int. Cl.: 41

SERVICE MARK

PRINCIPAL REGISTER

DENVER TRIATHLON LLC (COLORADO LIMITED LIABILITY COMPANY)
9658 S. JOHNSON WAY
LITTLETON, CO 80127

FOR: ORGANIZING, PRODUCING, ARRANGING, CONDUCTING, PLANNING, GOVERNING AND REGULATING SPORTING EVENTS, NAMELY, TRIATHLONS; ORGANIZING RELATED SPORTING AND ENTERTAINMENT EVENTS, NAMELY, ARRANGING AND CONDUCTING ATHLETIC COMPETITIONS, PROVIDING ATHLETIC TRAINING SERVICES, AND ORGANIZING COMMUNITY FAIRS FEATURING VARIOUS VENDORS FOR ENTERTAINMENT PURPOSES, IN CLASS 41 (U.S. CLS. 100, 101 AND 107).

FIRST USE 1-5-2011; IN COMMERCE 1-5-2011.

NO CLAIM IS MADE TO THE EXCLUSIVE RIGHT TO USE "DENVER TRIATHLON", APART FROM THE MARK AS SHOWN.

THE COLOR(S) BROWN, GREY, AND WHITE IS/ARE CLAIMED AS A FEATURE OF THE MARK.

THE MARK CONSISTS OF THE WORDS "DENVER TRIATHLON" IN GREY, ROUNDED BLOCK FONT WITH THE LETTER "A" COMPRISED OF A BROWN MOUNTAINSCAPE WITH WHITE SNOW CAPPING THE PEAKS.

SER. NO. 85-313,277, FILED 5-5-2011.

ANDREW LEASER, EXAMINING ATTORNEY



David J. Kyros

Director of the United States Patent and Trademark Office

United States of America

United States Patent and Trademark Office

internalGPS

Reg. No. 4,067,227

Registered Dec. 6, 2011

Int. Cl.: 41

SERVICE MARK

PRINCIPAL REGISTER

SHOUP, PAULA (UNITED STATES INDIVIDUAL)
10743 E. CARIBBEAN LANE
SCOTTSDALE, AZ 85255

FOR: EDUCATION SERVICES, NAMELY, PROVIDING SEMINARS AND WORKSHOPS IN THE FIELD OF SUCCESS IN BUSINESS; EDUCATIONAL AND ENTERTAINMENT SERVICES, NAMELY, PROVIDING MOTIVATIONAL SPEAKING SERVICES IN THE FIELD OF SUCCESS IN BUSINESS; PROFESSIONAL COACHING SERVICES IN THE FIELD OF SUCCESS IN BUSINESS, IN CLASS 41 (U.S. CLS. 100, 101 AND 107).

FIRST USE 6-1-2009; IN COMMERCE 6-1-2009.

THE MARK CONSISTS OF STANDARD CHARACTERS WITHOUT CLAIM TO ANY PARTICULAR FONT, STYLE, SIZE, OR COLOR.

SER. NO. 85-313,280, FILED 5-5-2011.

DAVID I, EXAMINING ATTORNEY



David J. Kyfos

Director of the United States Patent and Trademark Office

United States of America

United States Patent and Trademark Office

REOR

Reg. No. 4,067,228

VISIO SERVICES INTERNATIONAL, LTD. (CYPRUS LIMITED LIABILITY COMPANY)
1 AVLANOS ST., MARIA HOUSE, P.C. 1075
NICOSIA, CYPRUS

Registered Dec. 6, 2011

Int. Cl.: 9

FOR: EYEGLOSS FRAMES; EYEGLOSSSES; SPECTACLES, IN CLASS 9 (U.S. CLS. 21, 23, 26, 36 AND 38).

TRADEMARK

FIRST USE 4-1-2011; IN COMMERCE 4-1-2011.

PRINCIPAL REGISTER

THE MARK CONSISTS OF THE WORD "REOR", IN ALL CAPITAL LETTERS, WITH A LINE UNDER THE WHOLE WORD AND THE FIRST AND LAST "R" APPEARING LARGER THAN THE "E" AND THE "O", WHICH HAVE A LINE ABOVE THEM THAT DOES NOT REACH TO THE TWO "R"'S.

SER. NO. 85-313,322, FILED 5-5-2011.

LAURA HAMMEL, EXAMINING ATTORNEY



David J. Kyffers

Director of the United States Patent and Trademark Office

United States of America

United States Patent and Trademark Office

PRELONE

Reg. No. 4,067,229

Registered Dec. 6, 2011

Int. Cl.: 5

TRADEMARK

PRINCIPAL REGISTER

ADAMIS LABORATORIES, INC. (DELAWARE CORPORATION)
SUITE 17
4911 LYONS TECHNOLOGY PARKWAY
COCONUT CREEK, FL 33073

FOR: PHARMACEUTICAL PREPARATIONS FOR THE TREATMENT OF INFLAMMATORY EFFECTS IN DISORDERS OF MANY ORGAN SYSTEMS; PHARMACEUTICAL PREPARATIONS FOR TREATING ALLERGIC RHINITIS AND ASTHMA; SYRUPS FOR PHARMACEUTICAL PURPOSES FOR THE TREATMENT OF ADRENOCORTICAL DEFICIENCY, IN CLASS 5 (U.S. CLS. 6, 18, 44, 46, 51 AND 52).

FIRST USE 2-4-1986; IN COMMERCE 2-4-1986.

THE MARK CONSISTS OF STANDARD CHARACTERS WITHOUT CLAIM TO ANY PARTICULAR FONT, STYLE, SIZE, OR COLOR.

SER. NO. 85-313,531, FILED 5-5-2011.

NATALIE POLZER, EXAMINING ATTORNEY



David J. Kybas

Director of the United States Patent and Trademark Office

United States of America

United States Patent and Trademark Office

RHYTHM ON THE RIVER

Reg. No. 4,067,230

Registered Dec. 6, 2011

Int. Cl.: 41

SERVICE MARK

PRINCIPAL REGISTER

FRONT ROE RESTAURANTS, INC. (SOUTH CAROLINA CORPORATION)
142 WATERS EDGE COURT
LAKE LURE, NC 28746

FOR: ORGANIZING CULTURAL AND ARTS EVENTS; ORGANIZING COMMUNITY FESTIVALS FEATURING A VARIETY OF ACTIVITIES, NAMELY, ART EXHIBITIONS, MUSIC, FOOD, AND THE LIKE , IN CLASS 41 (U.S. CLS. 100, 101 AND 107).

FIRST USE 0-0-2005; IN COMMERCE 0-0-2005.

THE MARK CONSISTS OF STANDARD CHARACTERS WITHOUT CLAIM TO ANY PARTICULAR FONT, STYLE, SIZE, OR COLOR.

SER. NO. 85-313,555, FILED 5-5-2011.

NAAKWAMA ANKRAH, EXAMINING ATTORNEY



David J. Kyros

Director of the United States Patent and Trademark Office

United States of America

United States Patent and Trademark Office



Reg. No. 4,067,231

Registered Dec. 6, 2011

Int. Cl.: 35

SERVICE MARK

PRINCIPAL REGISTER

THE PIE HOLE, LLC (GEORGIA LIMITED LIABILITY COMPANY)
1025 CANTON STREET
ROSWELL, GA 30075

FOR: RETAIL BAKERY SHOPS; RETAIL STORE AND ON-LINE RETAIL STORE SERVICES FEATURING PIES AND BAKERY PRODUCTS; RETAIL STORE SERVICES FEATURING PIES AND BAKERY PRODUCTS; TAKE-OUT BAKERY SERVICES, IN CLASS 35 (U.S. CLS. 100, 101 AND 102).

FIRST USE 4-27-2009; IN COMMERCE 10-26-2009.

THE MARK CONSISTS OF A CARTOON IMAGE OF A PIE WITH THREE WISPS OF STEAM ESCAPING FROM FOUR SLITS IN THE TOP OF THE PIE.

SER. NO. 85-313,569, FILED 5-5-2011.

ROBIN MITTLER, EXAMINING ATTORNEY



David J. Kyffers

Director of the United States Patent and Trademark Office

United States of America

United States Patent and Trademark Office



Reg. No. 4,067,232

Registered Dec. 6, 2011

Int. Cl.: 25

TRADEMARK

PRINCIPAL REGISTER

LIBERATED CHINA LLC (NEW YORK LIMITED LIABILITY COMPANY)
JEFFREY FAGEN
90 FRANKLIN ST. 11TH FLOOR
NEW YORK, NY 10013

FOR: CLOTHING, NAMELY BOARDSHORTS, RASH GUARDS, SHORTS, BELTS, T-SHIRTS, POLO SHIRTS, JACKETS, HATS, CAPS, AND BABY BODYSUITS, IN CLASS 25 (U.S. CLS. 22 AND 39).

FIRST USE 4-22-2010; IN COMMERCE 12-1-2010.

THE MARK CONSISTS OF A PANDA HEAD.

SER. NO. 85-313,576, FILED 5-5-2011.

KATINA MISTER, EXAMINING ATTORNEY



David J. Kybas

Director of the United States Patent and Trademark Office

United States of America

United States Patent and Trademark Office

SHELL SHOCK

Reg. No. 4,067,233

Registered Dec. 6, 2011

Int. Cl.: 3

TRADEMARK

PRINCIPAL REGISTER

ZEP IP HOLDING LLC (GEORGIA LIMITED LIABILITY COMPANY)
1310 SEABOARD INDUSTRIAL BOULEVARD
ATLANTA, GA 30318

FOR: HAND CLEANERS, IN CLASS 3 (U.S. CLS. 1, 4, 6, 50, 51 AND 52).

FIRST USE 4-10-2007; IN COMMERCE 4-10-2007.

THE MARK CONSISTS OF STANDARD CHARACTERS WITHOUT CLAIM TO ANY PARTICULAR FONT, STYLE, SIZE, OR COLOR.

SER. NO. 85-313,587, FILED 5-5-2011.

GEORGE LORENZO, EXAMINING ATTORNEY



David J. Kyffers

Director of the United States Patent and Trademark Office

United States of America

United States Patent and Trademark Office

The tab key is my friend!

Reg. No. 4,067,234

Registered Dec. 6, 2011

Int. Cl.: 35

SERVICE MARK

PRINCIPAL REGISTER

BRACEY, CARLA (UNITED STATES INDIVIDUAL)
17 RED OAK LN.
HATTIESBURG, MS 39402

FOR: ACCOUNTING CONSULTATION, IN CLASS 35 (U.S. CLS. 100, 101 AND 102).

FIRST USE 6-1-2006; IN COMMERCE 6-1-2006.

THE MARK CONSISTS OF STANDARD CHARACTERS WITHOUT CLAIM TO ANY PARTICULAR FONT, STYLE, SIZE, OR COLOR.

SER. NO. 85-313,744, FILED 5-5-2011.

LAURIE KAUFMAN, EXAMINING ATTORNEY



David J. Kyffers

Director of the United States Patent and Trademark Office

United States of America

United States Patent and Trademark Office

PERFORMA

Reg. No. 4,067,235

CAROLINA PRIDE CARWASH, INC. (NORTH CAROLINA CORPORATION)
417 S. MADISON BLVD.
ROXBORO, NC 27573

Registered Dec. 6, 2011

Int. Cl.: 7

FOR: VEHICLE WASHING MACHINES AND REPLACEMENT PARTS THEREFOR, IN CLASS 7 (U.S. CLS. 13, 19, 21, 23, 31, 34 AND 35).

TRADEMARK

FIRST USE 9-12-1996; IN COMMERCE 9-12-1996.

PRINCIPAL REGISTER

THE MARK CONSISTS OF STANDARD CHARACTERS WITHOUT CLAIM TO ANY PARTICULAR FONT, STYLE, SIZE, OR COLOR.

SER. NO. 85-313,764, FILED 5-5-2011.

DANNEAN HETZEL, EXAMINING ATTORNEY



David J. Kybas

Director of the United States Patent and Trademark Office

United States of America

United States Patent and Trademark Office

WALL PACK

Reg. No. 4,067,236

Registered Dec. 6, 2011

Int. Cl.: 7

TRADEMARK

PRINCIPAL REGISTER

CAROLINA PRIDE CARWASH, INC. (NORTH CAROLINA CORPORATION)
417 S. MADISON BLVD.
ROXBORO, NC 27573

FOR: VEHICLE WASHING MACHINES AND REPLACEMENT PARTS THEREFOR, IN CLASS
7 (U.S. CLS. 13, 19, 21, 23, 31, 34 AND 35).

FIRST USE 9-12-1996; IN COMMERCE 9-12-1996.

THE MARK CONSISTS OF STANDARD CHARACTERS WITHOUT CLAIM TO ANY PAR-
TICULAR FONT, STYLE, SIZE, OR COLOR.

NO CLAIM IS MADE TO THE EXCLUSIVE RIGHT TO USE "WALL", APART FROM THE
MARK AS SHOWN.

SER. NO. 85-313,770, FILED 5-5-2011.

DANNEAN HETZEL, EXAMINING ATTORNEY



David J. Kybas

Director of the United States Patent and Trademark Office

United States of America

United States Patent and Trademark Office

ICEBATTERY EXPRESS

Reg. No. 4,067,237

Registered Dec. 6, 2011

Int. Cl.: 11

TRADEMARK

PRINCIPAL REGISTER

INNOVATION THRU ENERGY CO. LTD (JAPAN CORPORATION)
748 PINON OAK DRIVE
PRESCOTT, AZ 86305

FOR: COOLING APPARATUS FOR USE IN SHIPPING TO MAINTAIN A CONSTANT TEMPERATURE OVER PROLONGED PERIODS FOR FOOD, GOODS, CRYOGENICS, HUMAN ORGANS AND LIVING TISSUE, IN CLASS 11 (U.S. CLS. 13, 21, 23, 31 AND 34).

FIRST USE 5-0-2011; IN COMMERCE 5-0-2011.

THE MARK CONSISTS OF STANDARD CHARACTERS WITHOUT CLAIM TO ANY PARTICULAR FONT, STYLE, SIZE, OR COLOR.

SER. NO. 85-313,773, FILED 5-5-2011.

DANNEAN HETZEL, EXAMINING ATTORNEY



David J. Kybas

Director of the United States Patent and Trademark Office

United States of America

United States Patent and Trademark Office

EV

Reg. No. 4,067,238

Registered Dec. 6, 2011

Int. Cls.: 9 and 41

TRADEMARK

SERVICE MARK

PRINCIPAL REGISTER

EV TOURING, INC. (NEVADA CORPORATION)
1900 S. CORGIAT DRIVE
SEATTLE, WA 98108

FOR: MUSICAL SOUND RECORDINGS, IN CLASS 9 (U.S. CLS. 21, 23, 26, 36 AND 38).

FIRST USE 9-0-2009; IN COMMERCE 9-0-2009.

FOR: ENTERTAINMENT SERVICES RENDERED BY A MUSICAL ARTIST, NAMELY, LIVE MUSICAL PERFORMANCES AND LIVE MUSIC CONCERTS, IN CLASS 41 (U.S. CLS. 100, 101 AND 107).

FIRST USE 12-0-2008; IN COMMERCE 11-29-2010.

THE MARK CONSISTS OF STANDARD CHARACTERS WITHOUT CLAIM TO ANY PARTICULAR FONT, STYLE, SIZE, OR COLOR.

SER. NO. 85-313,780, FILED 5-5-2011.

DANNEAN HETZEL, EXAMINING ATTORNEY



David J. Kyffers

Director of the United States Patent and Trademark Office

United States of America

United States Patent and Trademark Office

emetabolic

Reg. No. 4,067,239

Registered Dec. 6, 2011

Int. Cl.: 44

SERVICE MARK

PRINCIPAL REGISTER

PBC SUPPLY, INC. (FLORIDA CORPORATION)
3339 HIGHWAY 17
GREEN COVE SPRINGS, FL 32043

FOR: NUTRITION COUNSELING; WEIGHT MANAGEMENT SERVICES, NAMELY, PROVIDING WEIGHT LOSS AND/OR WEIGHT MAINTENANCE PROGRAMS, IN CLASS 44 (U.S. CLS. 100 AND 101).

FIRST USE 3-16-2004; IN COMMERCE 3-16-2004.

THE MARK CONSISTS OF STANDARD CHARACTERS WITHOUT CLAIM TO ANY PARTICULAR FONT, STYLE, SIZE, OR COLOR.

SER. NO. 85-313,808, FILED 5-5-2011.

MAYUR VAGHANI, EXAMINING ATTORNEY



David J. Kyros

Director of the United States Patent and Trademark Office

United States of America

United States Patent and Trademark Office

Tart Nouveau

Reg. No. 4,067,240

Registered Dec. 6, 2011

Int. Cl.: 30

TRADEMARK

PRINCIPAL REGISTER

YOGURTOLOGY FRANCHISING LLC (ARIZONA LIMITED LIABILITY COMPANY)
B107
15029 N THOMPSON PEAK PKWY
SCOTTSDALE, AZ 85260

FOR: FROZEN YOGURT; GELATO; ICE CREAM; SORBET, IN CLASS 30 (U.S. CL. 46).

FIRST USE 12-12-2008; IN COMMERCE 12-12-2008.

THE MARK CONSISTS OF STANDARD CHARACTERS WITHOUT CLAIM TO ANY PARTICULAR FONT, STYLE, SIZE, OR COLOR.

THE ENGLISH TRANSLATION OF "NOUVEAU" IN THE MARK IS "NEW OR FASHIONABLE".

SER. NO. 85-313,817, FILED 5-5-2011.

MARK SHINER, EXAMINING ATTORNEY



David J. Kybas

Director of the United States Patent and Trademark Office

United States of America

United States Patent and Trademark Office



Reg. No. 4,067,241

Registered Dec. 6, 2011

Int. Cl.: 5

TRADEMARK

PRINCIPAL REGISTER

USA HPSON PHARMACEUTICALS GROUP LTD (CALIFORNIA CORPORATION)
9440 TELSTAR AVE., #1
EL MONTE, CA 91731

FOR: AMINO ACIDS FOR NUTRITIONAL PURPOSES; MINERAL NUTRITIONAL SUPPLEMENTS; MINERAL SUPPLEMENTS; MIXED VITAMIN PREPARATIONS; MULTI-VITAMIN PREPARATIONS; VITAMIN AND MINERAL PREPARATIONS FOR USE AS INGREDIENTS IN THE FOOD AND PHARMACEUTICAL INDUSTRY; VITAMIN AND MINERAL SUPPLEMENTS; VITAMIN B PREPARATIONS; VITAMIN C PREPARATIONS; VITAMIN D PREPARATIONS; VITAMIN PREPARATIONS; VITAMIN SUPPLEMENTS; VITAMIN TABLETS; VITAMINS AND VITAMIN PREPARATIONS, IN CLASS 5 (U.S. CLS. 6, 18, 44, 46, 51 AND 52).

FIRST USE 6-25-2009; IN COMMERCE 6-25-2009.

THE MARK CONSISTS OF THE WORD "HPSON", AND ITS CHINESE TRANSLITERATION IN WHITE. THE STYLIZED WORDS ARE CONTAINED IN A BLUE RECTANGULAR SHAPE WITH YELLOW OUTLINE.

THE COLOR(S) YELLOW, WHITE, AND BLUE IS/ARE CLAIMED AS A FEATURE OF THE MARK.

THE NON-LATIN CHARACTERS IN THE MARK TRANSLITERATE TO "HPSON" AND THIS HAS NO MEANING IN A FOREIGN LANGUAGE.

SER. NO. 85-313,821, FILED 5-5-2011.

TINA L. SNAPP, EXAMINING ATTORNEY



David J. Kybas

Director of the United States Patent and Trademark Office

United States of America

United States Patent and Trademark Office

Hibernia

Reg. No. 4,067,242

Registered Dec. 6, 2011

Int. Cl.: 33

TRADEMARK

PRINCIPAL REGISTER

CARLANTINO ESTATES, LLC (CALIFORNIA LIMITED LIABILITY COMPANY)
PO BOX 30
RUTHERFORD, CA 94573

FOR: WINE, IN CLASS 33 (U.S. CLS. 47 AND 49).

FIRST USE 10-1-2008; IN COMMERCE 6-20-2009.

THE MARK CONSISTS OF STANDARD CHARACTERS WITHOUT CLAIM TO ANY PARTICULAR FONT, STYLE, SIZE, OR COLOR.

SER. NO. 85-313,869, FILED 5-5-2011.

DOMINIC J. FERRAIUOLO, EXAMINING ATTORNEY



David J. Kybas

Director of the United States Patent and Trademark Office

United States of America

United States Patent and Trademark Office

SmartLeash

Reg. No. 4,067,243

Registered Dec. 6, 2011

Int. Cl.: 18

TRADEMARK

PRINCIPAL REGISTER

IPP LLC (DELAWARE LIMITED LIABILITY COMPANY)
2004 WEST DEMPSTER
EVANSTON, IL 60202

FOR: DOG LEASHES, IN CLASS 18 (U.S. CLS. 1, 2, 3, 22 AND 41).

FIRST USE 4-8-2011; IN COMMERCE 4-8-2011.

THE MARK CONSISTS OF STANDARD CHARACTERS WITHOUT CLAIM TO ANY PARTICULAR FONT, STYLE, SIZE, OR COLOR.

SER. NO. 85-313,873, FILED 5-5-2011.

CHRISTINA SOBRAL, EXAMINING ATTORNEY



David J. Kybas

Director of the United States Patent and Trademark Office

United States of America

United States Patent and Trademark Office



Reg. No. 4,067,244

Registered Dec. 6, 2011

Int. Cl.: 43

SERVICE MARK

PRINCIPAL REGISTER

DISCO SUSHI, INC. (NEW YORK CORPORATION)
133 WEST 25TH STREET, SUITE 7W
NEW YORK, NY 10001

FOR: RESTAURANT AND BAR SERVICES, IN CLASS 43 (U.S. CLS. 100 AND 101).

FIRST USE 3-15-2011; IN COMMERCE 3-15-2011.

NO CLAIM IS MADE TO THE EXCLUSIVE RIGHT TO USE "NYC" , APART FROM THE MARK AS SHOWN.

THE MARK CONSISTS OF THE WORDS "LITTLE TOWN" IN A BANNER ABOVE THE LETTERS "NYC".

SER. NO. 85-314,013, FILED 5-6-2011.

SAIMA MAKHDOOM, EXAMINING ATTORNEY



David J. Kyros

Director of the United States Patent and Trademark Office

United States of America

United States Patent and Trademark Office

PS09

Reg. No. 4,067,245

Registered Dec. 6, 2011

Int. Cl.: 3

TRADEMARK

PRINCIPAL REGISTER

AEROPOSTALE PROCUREMENT COMPANY, INC. (DELAWARE CORPORATION)
112 W. 34TH STREET, 22ND FLOOR
NEW YORK, NY 10120

FOR: COSMETICS AND PERSONAL CARE PRODUCTS FOR CHILDREN, NAMELY, BATH BEADS, BATH FIZZIES, BATH SOAP, BODY GLITTER, BODY SCRUB, BODY WASH, BUBBLE BATH; COSMETICS AND MAKE-UP, NAMELY, BLUSH, EYE SHADOW, FOUNDATION MAKE-UP, LIPSTICK, MAKE-UP PENCILS, MAKE-UP POWDER, MAKE-UP REMOVER; NAIL POLISH, NAIL ART STICKERS, FACIAL CLEANSERS, SKIN CLEANSERS, FOOT SCRUBS, HAIR CONDITIONER, HAIR SHAMPOO; NON-MEDICATED SKIN CARE PREPARATIONS, NAMELY, LOTION FOR THE FACE, LOTION FOR THE HANDS, SKIN MOISTURIZER; STYLING GELS, LIP BALM, LIP GLOSS, MOUTHWASH, SHOWER GEL, SUNSCREEN PREPARATIONS, SUN BLOCK AND SUN TAN LOTION ALL AVAILABLE IN PS FROM AEROPOSTALE AND AEROPOSTALE RETAIL STORES AND ONLINE RETAIL STORES, IN CLASS 3 (U.S. CLS. 1, 4, 6, 50, 51 AND 52).

FIRST USE 4-6-2009; IN COMMERCE 4-6-2009.

THE MARK CONSISTS OF STANDARD CHARACTERS WITHOUT CLAIM TO ANY PARTICULAR FONT, STYLE, SIZE, OR COLOR.

OWNER OF U.S. REG. NOS. 3,693,636 AND 3,709,721.

SER. NO. 85-314,169, FILED 5-6-2011.

GRETTA YAO, EXAMINING ATTORNEY



David J. Kyffers

Director of the United States Patent and Trademark Office

United States of America

United States Patent and Trademark Office

PS4U

Reg. No. 4,067,246

Registered Dec. 6, 2011

Int. Cl.: 3

TRADEMARK

PRINCIPAL REGISTER

AEROPOSTALE PROCUREMENT COMPANY, INC. (DELAWARE CORPORATION)
112 W. 34TH STREET, 22ND FLOOR
NEW YORK, NY 10120

FOR: COSMETICS AND PERSONAL CARE PRODUCTS FOR CHILDREN, NAMELY, BATH BEADS, BATH FIZZIES, BATH SOAP, BODY GLITTER, BODY SCRUB, BODY WASH, BUBBLE BATH; COSMETICS AND MAKE-UP, NAMELY, BLUSH, EYE SHADOW, FOUNDATION MAKE-UP, LIPSTICK, MAKE-UP PENCILS, MAKE-UP POWDER, MAKE-UP REMOVER; NAIL POLISH, NAIL ART STICKERS, FACIAL CLEANSERS, SKIN CLEANSERS, FOOT SCRUBS, HAIR CONDITIONER, HAIR SHAMPOO; NON-MEDICATED SKIN CARE PREPARATIONS, NAMELY, LOTION FOR THE FACE, LOTION FOR THE HANDS, SKIN MOISTURIZER; STYLING GELS, LIP BALM, LIP GLOSS, MOUTHWASH, SHOWER GEL, SUNSCREEN PREPARATIONS, SUN BLOCK AND SUN TAN LOTION ALL AVAILABLE IN PS FROM AEROPOSTALE AND AEROPOSTALE RETAIL STORES AND ONLINE RETAIL STORES, IN CLASS 3 (U.S. CLS. 1, 4, 6, 50, 51 AND 52).

FIRST USE 4-6-2009; IN COMMERCE 4-6-2009.

THE MARK CONSISTS OF STANDARD CHARACTERS WITHOUT CLAIM TO ANY PARTICULAR FONT, STYLE, SIZE, OR COLOR.

OWNER OF U.S. REG. NOS. 3,693,636 AND 3,709,721.

SER. NO. 85-314,287, FILED 5-6-2011.

GRETTA YAO, EXAMINING ATTORNEY



David J. Kyffers

Director of the United States Patent and Trademark Office

United States of America

United States Patent and Trademark Office



Reg. No. 4,067,247

Registered Dec. 6, 2011

Int. Cls.: 25 and 28

TRADEMARK

PRINCIPAL REGISTER

NOLL, JED (UNITED STATES INDIVIDUAL)
1709 NO EL CAMINO REAL
SAN CLEMENTE, CA 92672 AND

NOLL, GREG (UNITED STATES INDIVIDUAL)
1709 NO EL CAMINO REAL
SAN CLEMENTE, CA 92672

FOR: BEACH FOOTWEAR; BEANIES; HATS; HOODED SWEATSHIRTS; JACKETS; PANTS; SHIRTS; SHORTS; SWEATERS; SWEATSHIRTS; SWIMWEAR, IN CLASS 25 (U.S. CLS. 22 AND 39).

FIRST USE 6-0-1962; IN COMMERCE 6-0-1965.

FOR: SURFBOARD FINS; SURFBOARDS, IN CLASS 28 (U.S. CLS. 22, 23, 38 AND 50).

FIRST USE 6-0-1962; IN COMMERCE 6-0-1965.

NO CLAIM IS MADE TO THE EXCLUSIVE RIGHT TO USE "CUSTOM SURFBOARDS", APART FROM THE MARK AS SHOWN.

THE NAME(S), PORTRAIT(S), AND/OR SIGNATURE(S) SHOWN IN THE MARK IDENTIFIES "GREG NOLL", WHOSE CONSENT(S) TO REGISTER IS MADE OF RECORD.

THE MARK CONSISTS OF THE WORDS "GREG NOLL CUSTOM SURFBOARDS", STYLIZED, WITH AN IMAGE OF A MAN SURFING TO THE RIGHT OF THE WORDS, ENCASED IN AN OVAL SHAPED BORDER.

SER. NO. 85-314,694, FILED 5-6-2011.

SUSAN RICHARDS, EXAMINING ATTORNEY



David J. Kybas

Director of the United States Patent and Trademark Office

United States of America

United States Patent and Trademark Office

Healthy Pets are Happy Pets!

Reg. No. 4,067,248

LALLI, JASPREET (UNITED STATES INDIVIDUAL)
3250 ARDEN RD.
HAYWARD, CA 94545

Registered Dec. 6, 2011

Int. Cl.: 35

FOR: RETAIL VETERINARY PHARMACY SERVICES, IN CLASS 35 (U.S. CLS. 100, 101 AND 102).

SERVICE MARK

FIRST USE 1-1-2010; IN COMMERCE 7-1-2010.

PRINCIPAL REGISTER

THE MARK CONSISTS OF STANDARD CHARACTERS WITHOUT CLAIM TO ANY PARTICULAR FONT, STYLE, SIZE, OR COLOR.

SER. NO. 85-314,837, FILED 5-6-2011.

EDWARD FENNESSY, EXAMINING ATTORNEY



David J. Kybas

Director of the United States Patent and Trademark Office

United States of America

United States Patent and Trademark Office

LEARNINGDNA

Reg. No. 4,067,249

Registered Dec. 6, 2011

Int. Cl.: 42

SERVICE MARK

PRINCIPAL REGISTER

CARNEY, INC. (VIRGINIA CORPORATION)
SUITE 401
100 N. PITT STREET
ALEXANDRIA, VA 22314

FOR: APPLICATION SERVICE PROVIDER FEATURING SOFTWARE FOR PROVIDING AN ON-LINE DATABASE OF HUMAN TRAITS, INCLUDING INDIVIDUAL PROFILES OF SKILLS, COMPETENCIES, EXPERIENCES, ATTITUDES, AND PERSONAL TRAITS, AND PRODUCE NOTIFICATIONS AND REPORTS THAT CAN INTERFACE WITH OTHER SOFTWARE APPLICATIONS, FOR EMPLOYEE PERFORMANCE EVALUATIONS; COMPUTER SERVICES, NAMELY, PROVIDING A WEB-BASED SYSTEM AND ONLINE PORTAL FEATURING ON-LINE NON-DOWNLOADABLE SOFTWARE THAT ENABLES USERS TO ACCESS TRAINING, EDUCATION, TESTING AND CERTIFICATION MATERIALS FOR GOVERNMENT EMPLOYEES, IN CLASS 42 (U.S. CLS. 100 AND 101).

FIRST USE 11-30-2000; IN COMMERCE 11-30-2000.

THE MARK CONSISTS OF STANDARD CHARACTERS WITHOUT CLAIM TO ANY PARTICULAR FONT, STYLE, SIZE, OR COLOR.

SER. NO. 85-314,983, FILED 5-6-2011.

MATTHEW KLINE, EXAMINING ATTORNEY



David J. Kybas

Director of the United States Patent and Trademark Office

United States of America

United States Patent and Trademark Office

BJ'S

Reg. No. 4,067,250

Registered Dec. 6, 2011

Int. Cl.: 43

SERVICE MARK

PRINCIPAL REGISTER

BJ'S RESTAURANTS, INC. (CALIFORNIA CORPORATION)
7755 CENTER AVENUE, SUITE 300
HUNTINGTON BEACH, CA 92647

FOR: RESTAURANT AND BAR SERVICES, TAKE-OUT RESTAURANT SERVICES; RESTAURANT CARRY OUT SERVICES, IN CLASS 43 (U.S. CLS. 100 AND 101).

FIRST USE 9-5-1980; IN COMMERCE 9-5-1980.

THE MARK CONSISTS OF STANDARD CHARACTERS WITHOUT CLAIM TO ANY PARTICULAR FONT, STYLE, SIZE, OR COLOR.

OWNER OF U.S. REG. NOS. 1,199,125, 2,534,325 AND OTHERS.

SER. NO. 85-314,987, FILED 5-6-2011.

WON TEAK OH, EXAMINING ATTORNEY



David J. Kyffers

Director of the United States Patent and Trademark Office

United States of America

United States Patent and Trademark Office



Reg. No. 4,067,251

Registered Dec. 6, 2011

Int. Cl.: 41

SERVICE MARK

PRINCIPAL REGISTER

LEDERER, DANIEL (UNITED STATES INDIVIDUAL)
940 N. ARDMORE AVENUE, APT. 201
LOS ANGELES, CA 90029

FOR: EDUCATION AND ENTERTAINMENT SERVICES, NAMELY PROVIDING ASSISTANCE, INFORMATION, INSTRUCTION, COACHING, PERSONAL TRAINING AND PHYSICAL FITNESS CONSULTATION TO INDIVIDUALS TO HELP THEM MAKE PHYSICAL FITNESS, STRENGTH, CONDITIONING, AND EXERCISE IMPROVEMENT IN THEIR DAILY LIVING, IN CLASS 41 (U.S. CLS. 100, 101 AND 107).

FIRST USE 3-19-2011; IN COMMERCE 3-19-2011.

THE MARK CONSISTS OF A COMPLETE CIRCLE THAT ENCLOSES A LETTER "A" AND TWO "F"'S WHEREIN THE TWO LEGS OF THE "A" TOUCH THE INSIDE OF THE CIRCLE AT THE BOTTOM OF THE CIRCLE AND THE TOP OF THE "A" DOES NOT TOUCH THE CIRCLE. THE VERTICAL LINE OF EACH "F" IS ALSO A LEG OF THE CENTERED "A". HENCE, THE TOP LINE OF EACH "F" ORIGINATES OUT OF THE TOP OF THE "A" AND EACH MIDDLE LINE OF THE "F" ORIGINATES FROM THE MIDDLE OF THE EACH "A" LEG. BOTH TOP AND MIDDLE "F" LINES CONTINUE OUT TO THE BORDER OF THE CIRCLE ON THEIR OWN RESPECTIVE SIDES, SUCH THAT, ONE "F" IS A MIRROR IMAGE OF THE OTHER. THE CROSS-LINE OF THE "A" FORMS A WIDE-ANGLED "V" AND A "DIAMOND" SHAPED OPEN SPACE INSIDE THE CENTER OF THE "A" AS SHOWN IN THE MARK.

SER. NO. 85-315,042, FILED 5-7-2011.

MARK RADEMACHER, EXAMINING ATTORNEY



David J. Kyros

Director of the United States Patent and Trademark Office

United States of America

United States Patent and Trademark Office



Reg. No. 4,067,252

Registered Dec. 6, 2011

Int. Cl.: 36

SERVICE MARK

PRINCIPAL REGISTER

MORGAN STANLEY SMITH BARNEY HOLDINGS LLC (DELAWARE LIMITED LIABILITY COMPANY)
2000 WESTCHESTER AVENUE
PURCHASE, NY 10577

FOR: FINANCIAL AND INVESTMENT ADVISORY SERVICES, IN CLASS 36 (U.S. CLS. 100, 101 AND 102).

FIRST USE 4-25-2011; IN COMMERCE 4-25-2011.

THE MARK CONSISTS OF A GLOBE DESIGN BEARING STYLIZED LONGITUDE AND LATITUDE LINES SUCH THAT THE WORD CLIENT IS SET FORTH IN THE CENTER OF THE GLOBE DESIGN. THE FOLLOWING WORDS SURROUND THE GLOBE DESIGN FROM THE TOP AND IN A CLOCKWISE DIRECTION: PEOPLE FAMILY FRIENDS CLIENTS COLLEAGUES ADVISORS MENTORS SCHOOLMATES CLERGY ACTIVITIES PROFESSIONAL COMMUNITY CHARITY HOBBIES LEISURE TRAVEL POLITICAL SPIRITUAL IDEAS VALUES GOALS CONCERNS LEGACY CHALLENGES FEARS RISKS OPPORTUNITIES THINGS BUSINESS ACCOUNTS REAL PROPERTY COLLECTIBLES CARS JEWELRY ART BOATS. THE GRAY SET FORTH IN THE DRAWING OF THE MARK IS INTENDED TO INDICATE SHADING. COLOR IS NOT A FEATURE OF THE MARK.

SER. NO. 85-315,190, FILED 5-8-2011.

BENJAMIN OKEKE, EXAMINING ATTORNEY



David J. Kybas

Director of the United States Patent and Trademark Office

United States of America

United States Patent and Trademark Office

RAVI

Reg. No. 4,067,253

Registered Dec. 6, 2011

Int. Cl.: 30

TRADEMARK

PRINCIPAL REGISTER

RAVI CANDY'S LLC (TEXAS LIMITED LIABILITY COMPANY)
1714 S. 28 AVE
EDINBURG, TX 78542

FOR: CANDIES; SWEETS, IN CLASS 30 (U.S. CL. 46).

FIRST USE 10-20-2009; IN COMMERCE 10-20-2009.

THE MARK CONSISTS OF STANDARD CHARACTERS WITHOUT CLAIM TO ANY PARTICULAR FONT, STYLE, SIZE, OR COLOR.

THE ENGLISH TRANSLATION OF "RAVI" IN THE MARK IS "SUN".

SER. NO. 85-315,277, FILED 5-8-2011.

MARK T. MULLEN, EXAMINING ATTORNEY



David J. Kybas

Director of the United States Patent and Trademark Office

United States of America

United States Patent and Trademark Office

BLOCK & BARREL

Reg. No. 4,067,254

Registered Dec. 6, 2011

Int. Cl.: 29

TRADEMARK

PRINCIPAL REGISTER

SYSCO CORPORATION (DELAWARE CORPORATION)
1390 ENCLAVE PARKWAY
HOUSTON, TX 770771390

FOR: BACON; CHEESE SPREADS; CHICKEN; MEATBALLS; PICKLED VEGETABLES;
PORK; PROCESSED BEANS; PROCESSED OLIVES; PROCESSED PEANUTS; PROCESSED
PEPPERS; SALADS EXCEPT MACARONI, RICE, AND PASTA SALAD; SAUSAGES, IN
CLASS 29 (U.S. CL. 46).

FIRST USE 10-1-1997; IN COMMERCE 10-1-1997.

THE MARK CONSISTS OF STANDARD CHARACTERS WITHOUT CLAIM TO ANY PAR-
TICULAR FONT, STYLE, SIZE, OR COLOR.

OWNER OF U.S. REG. NOS. 1,970,403, 3,032,214 AND OTHERS.

SER. NO. 85-315,370, FILED 5-9-2011.

WARREN L. OLANDRIA, EXAMINING ATTORNEY



David J. Kybas

Director of the United States Patent and Trademark Office

United States of America

United States Patent and Trademark Office



Reg. No. 4,067,255

Registered Dec. 6, 2011

Int. Cl.: 29

TRADEMARK

PRINCIPAL REGISTER

SYSCO CORPORATION (DELAWARE CORPORATION)
1390 ENCLAVE PARKWAY
HOUSTON, TX 770771390

FOR: BACON; CHEESE SPREADS; CHICKEN; MEATBALLS; PICKLED VEGETABLES; PORK; PROCESSED BEANS; PROCESSED OLIVES; PROCESSED PEANUTS; PROCESSED PEPPERS; SALADS EXCEPT MACARONI, RICE, AND PASTA SALAD; SAUSAGES, IN CLASS 29 (U.S. CL. 46).

FIRST USE 10-1-1997; IN COMMERCE 10-1-1997.

OWNER OF U.S. REG. NOS. 1,970,403, 3,032,214 AND OTHERS.

THE MARK CONSISTS OF AN AMPERSAND INSIDE OF A CIRCLE INSIDE OF THE WORDS BLOCK AND BARREL INSIDE ANOTHER CIRCLE. THE LINING IS A FEATURE OF THE MARK AND DOES NOT INDICATE COLOR.

SER. NO. 85-315,372, FILED 5-9-2011.

WARREN L. OLANDRIA, EXAMINING ATTORNEY



David J. Kybas

Director of the United States Patent and Trademark Office

United States of America

United States Patent and Trademark Office

YARD & GARDEN

Reg. No. 4,067,256

Registered Dec. 6, 2011

Int. Cl.: 16

TRADEMARK

PRINCIPAL REGISTER

CYGNUS BUSINESS MEDIA, INC. (DELAWARE CORPORATION)
1233 JANESVILLE AVENUE
FORT ATKINSON, WI 53538

FOR: MAGAZINES IN THE FIELD OF LANDSCAPING AND RELATING TO RETAILING AND WHOLESALING OF DOMESTIC AND INDUSTRIAL LANDSCAPING PRODUCTS , IN CLASS 16 (U.S. CLS. 2, 5, 22, 23, 29, 37, 38 AND 50).

FIRST USE 0-0-1984; IN COMMERCE 0-0-1984.

THE MARK CONSISTS OF STANDARD CHARACTERS WITHOUT CLAIM TO ANY PARTICULAR FONT, STYLE, SIZE, OR COLOR.

OWNER OF U.S. REG. NO. 1,654,305.

SEC. 2(F).

SER. NO. 85-315,598, FILED 5-9-2011.

SANJEEV VOHRA, EXAMINING ATTORNEY



David J. Kybas

Director of the United States Patent and Trademark Office

United States of America

United States Patent and Trademark Office

PRO

Reg. No. 4,067,257

Registered Dec. 6, 2011

Int. Cl.: 16

TRADEMARK

PRINCIPAL REGISTER

CYGNUS BUSINESS MEDIA, INC. (DELAWARE CORPORATION)
1233 JANESVILLE AVENUE
FORT ATKINSON, WI 53538

FOR: MAGAZINES IN THE FIELD OF LANDSCAPING, IN CLASS 16 (U.S. CLS. 2, 5, 22, 23, 29, 37, 38 AND 50).

FIRST USE 11-0-1988; IN COMMERCE 11-0-1988.

THE MARK CONSISTS OF STANDARD CHARACTERS WITHOUT CLAIM TO ANY PARTICULAR FONT, STYLE, SIZE, OR COLOR.

OWNER OF U.S. REG. NO. 1,632,347.

SEC. 2(F).

SER. NO. 85-315,614, FILED 5-9-2011.

SANJEEV VOHRA, EXAMINING ATTORNEY



David J. Kybas

Director of the United States Patent and Trademark Office

United States of America

United States Patent and Trademark Office

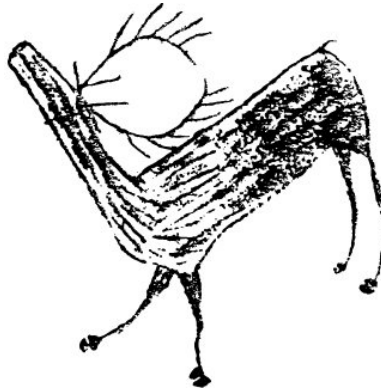

Reg. No. 4,067,258

Registered Dec. 6, 2011

Int. Cl.: 35

SERVICE MARK

PRINCIPAL REGISTER

SAVAGE DESIGN GROUP, INC. (TEXAS CORPORATION)
4203 YOAKUM BOULEVARD, FOURTH FLOOR
HOUSTON, TX 77006

FOR: ADVERTISING AND MARKETING SERVICES FOR OTHERS; BRANDING SERVICES, NAMELY, CONSULTING, DEVELOPMENT, MANAGEMENT, AND MARKETING OF BRANDS FOR BUSINESS, IN CLASS 35 (U.S. CLS. 100, 101 AND 102).

FIRST USE 11-3-1977; IN COMMERCE 11-3-1977.

THE MARK CONSISTS OF A DEER STANDING, NOSE TIPPED UP WITH ANTLERS HORIZONTAL TO SPINE.

SER. NO. 85-315,674, FILED 5-9-2011.

KATHY DE JONGE, EXAMINING ATTORNEY



David J. Kybas

Director of the United States Patent and Trademark Office

United States of America

United States Patent and Trademark Office



Reg. No. 4,067,259

Registered Dec. 6, 2011

Int. Cl.: 9

TRADEMARK

PRINCIPAL REGISTER

CHECKPOINT SYSTEMS, INC. (PENNSYLVANIA CORPORATION)
2005 MARKET STREET, 24TH FLOOR
PHILADELPHIA, PA 191037016

FOR: ELECTRONIC SECURITY GATES AND ELECTRONIC SECURITY TAGS TO BE APPLIED TO RETAIL MERCHANDISE, IN CLASS 9 (U.S. CLS. 21, 23, 26, 36 AND 38).

FIRST USE 8-1-2010; IN COMMERCE 8-1-2010.

THE MARK CONSISTS OF A STYLIZED PADLOCK WITH STYLIZED SOUND WAVES EMITTING FROM EACH SIDE OF THE LOCK; THE PADLOCK IS SPLIT DIAGONALLY WITH THE TOP OF THE PADLOCK AND UPPER LEFT SIDE BLACK AND WHITE AND THE LOWER RIGHT SIDE OF THE PADLOCK IS RED AND WHITE.

THE COLOR(S) RED, BLACK, AND WHITE IS/ARE CLAIMED AS A FEATURE OF THE MARK.

SER. NO. 85-316,058, FILED 5-9-2011.

WILLIAM ROSSMAN, EXAMINING ATTORNEY



David J. Kyffers

Director of the United States Patent and Trademark Office

United States of America

United States Patent and Trademark Office

Inward, Outward and Upward

Reg. No. 4,067,260

Registered Dec. 6, 2011

Int. Cls.: 41, 44 and 45

SERVICE MARK

PRINCIPAL REGISTER

CLIFFORD, TRACEY (UNITED STATES INDIVIDUAL)
920 VIEWPOINTE DR
ST. CHARLES, IL 60174

FOR: EDUCATION SERVICES, NAMELY, PROVIDING WORKSHOPS, SEMINARS, CLASSES IN THE FIELD OF BUSINESS LEADERSHIP, TEAM DEVELOPMENT, AND PSYCHOLOGY; PROFESSIONAL COACHING SERVICES IN THE FIELD OF PSYCHOLOGY, IN CLASS 41 (U.S. CLS. 100, 101 AND 107).

FIRST USE 7-15-2003; IN COMMERCE 6-6-2005.

FOR: PSYCHOLOGICAL COUNSELING, IN CLASS 44 (U.S. CLS. 100 AND 101).

FIRST USE 7-15-2003; IN COMMERCE 6-6-2005.

FOR: COUNSELING IN THE FIELD OF PERSONAL DEVELOPMENT, NAMELY, SELF-IMPROVEMENT, SELF-FULFILLMENT, AND INTERPERSONAL COMMUNICATION, IN CLASS 45 (U.S. CLS. 100 AND 101).

FIRST USE 7-15-2003; IN COMMERCE 6-6-2005.

THE MARK CONSISTS OF STANDARD CHARACTERS WITHOUT CLAIM TO ANY PARTICULAR FONT, STYLE, SIZE, OR COLOR.

SER. NO. 85-316,318, FILED 5-9-2011.

JAMES STEIN, EXAMINING ATTORNEY



David J. Kybas

Director of the United States Patent and Trademark Office

United States of America

United States Patent and Trademark Office



Reg. No. 4,067,261

Registered Dec. 6, 2011

Int. Cl.: 35

SERVICE MARK

PRINCIPAL REGISTER

PSS WORLD MEDICAL, INC. (FLORIDA CORPORATION)
4345 SOUTHPOINT BOULEVARD
JACKSONVILLE, FL 32216

FOR: BUSINESS MANAGEMENT AND CONSULTATION IN THE FIELD OF CLINICAL LABORATORY SETUP AND OPERATION, IN CLASS 35 (U.S. CLS. 100, 101 AND 102).

FIRST USE 4-0-2011; IN COMMERCE 4-0-2011.

NO CLAIM IS MADE TO THE EXCLUSIVE RIGHT TO USE "CALL PROGRAM" AND THE PICTORIAL REPRESENTATIONS OF THE TELEPHONE RECEIVER AND FAX MACHINE, APART FROM THE MARK AS SHOWN.

THE MARK CONSISTS OF THREE SQUARE CARRIERS EACH FEATURING A TELEPHONE RECEIVER, A FAX MACHINE AND COMPUTER MOUSE DESIGN, AND TO THE RIGHT APPEARS THE PARTIALLY UNDERLINED WORDING "CALL PROGRAM".

SER. NO. 85-316,910, FILED 5-10-2011.

AMY C. KEAN, EXAMINING ATTORNEY



David J. Kappas

Director of the United States Patent and Trademark Office

United States of America

United States Patent and Trademark Office

Fashionista Rx

Reg. No. 4,067,262

Registered Dec. 6, 2011

Int. Cl.: 25

TRADEMARK

PRINCIPAL REGISTER

LUXE BRANDS, INC. (TEXAS CORPORATION)
8601 COBBLESTONE
AUSTIN, TX 78735

FOR: BOOT ACCESSORIES, NAMELY, FITTED DECORATIVE COVERS FOR BOOTS; BRAS; LADIES' UNDERWEAR; LINGERIE ACCESSORIES, NAMELY, REMOVABLE SILICONE BREAST ENHANCER PADS USED IN A BRA; NIPPLE COVERS, NAMELY, PASTIES; SHAPEWEAR, NAMELY, SHAPER THONGS, GIRDLES, WAIST CINCHERS; STRAPS FOR BRAS; THONGS; UNDERGARMENT ACCESSORIES, NAMELY, REMOVABLE SILICONE BUTTOCK ENHANCER PADS; UNDERGARMENTS; UNDERGARMENTS, NAMELY, WASPIES; WOMEN'S ATHLETIC TOPS WITH BUILT-IN BRAS; WOMEN'S UNDERWEAR, IN CLASS 25 (U.S. CLS. 22 AND 39).

FIRST USE 4-11-2011; IN COMMERCE 5-12-2011.

THE MARK CONSISTS OF STANDARD CHARACTERS WITHOUT CLAIM TO ANY PARTICULAR FONT, STYLE, SIZE, OR COLOR.

NO CLAIM IS MADE TO THE EXCLUSIVE RIGHT TO USE "FASHIONISTA", APART FROM THE MARK AS SHOWN.

SER. NO. 85-318,922, FILED 5-12-2011.

ANNE FARRELL, EXAMINING ATTORNEY



David J. Kybas

Director of the United States Patent and Trademark Office

United States of America

United States Patent and Trademark Office

Chris America

Reg. No. 4,067,263

Registered Dec. 6, 2011

Int. Cl.: 41

SERVICE MARK

PRINCIPAL REGISTER

SPECSTACK LLC (VIRGINIA LIMITED LIABILITY COMPANY)
SUITE 108-109
5393 WESLEYAN DRIVE
VIRGINIA BEACH, VA 23455

FOR: ENTERTAINMENT SERVICES, NAMELY, LIVE MUSICAL, DANCE, AND DRAMATIC PERFORMANCES, AND LIVE PUBLIC APPEARANCES BY A CELEBRITY IMPERSONATOR, IN CLASS 41 (U.S. CLS. 100, 101 AND 107).

FIRST USE 8-0-1983; IN COMMERCE 8-0-1983.

THE MARK CONSISTS OF STANDARD CHARACTERS WITHOUT CLAIM TO ANY PARTICULAR FONT, STYLE, SIZE, OR COLOR.

THE NAME(S), PORTRAIT(S), AND/OR SIGNATURE(S) SHOWN IN THE MARK IDENTIFIES CHRISTINA A. ENSTICE, WHOSE CONSENT(S) TO REGISTER IS MADE OF RECORD.

SER. NO. 85-319,010, FILED 5-12-2011.

JAY FLOWERS, EXAMINING ATTORNEY



David J. Kyros

Director of the United States Patent and Trademark Office

United States of America

United States Patent and Trademark Office

SAFARI SAM'S SPLASHLAND

Reg. No. 4,067,264

Registered Dec. 6, 2011

Int. Cl.: 41

SERVICE MARK

PRINCIPAL REGISTER

KOCH DEVELOPMENT CORPORATION (INDIANA CORPORATION)
452 E. CHRISTMAS BOULEVARD
SANTA CLAUS, IN 47579

FOR: ENTERTAINMENT IN THE NATURE OF AN AMUSEMENT PARK RIDE, IN CLASS
41 (U.S. CLS. 100, 101 AND 107).

FIRST USE 1-22-2011; IN COMMERCE 1-22-2011.

THE MARK CONSISTS OF STANDARD CHARACTERS WITHOUT CLAIM TO ANY PAR-
TICULAR FONT, STYLE, SIZE, OR COLOR.

SER. NO. 85-319,469, FILED 5-12-2011.

JACQUELINE A. LAVINE, EXAMINING ATTORNEY



David J. Kybas

Director of the United States Patent and Trademark Office

United States of America

United States Patent and Trademark Office

27+

Reg. No. 4,067,265

Registered Dec. 6, 2011

Int. Cl.: 10

TRADEMARK

PRINCIPAL REGISTER

NOVARTIS AG (SWITZERLAND CORPORATION)
CH-4002
BASEL, SWITZERLAND

FOR: SURGICAL APPARATUS AND INSTRUMENTS FOR USE IN OPHTHALMIC SURGERY,
IN CLASS 10 (U.S. CLS. 26, 39 AND 44).

THE MARK CONSISTS OF STANDARD CHARACTERS WITHOUT CLAIM TO ANY PAR-
TICULAR FONT, STYLE, SIZE, OR COLOR.

OWNER OF SWITZERLAND REG. NO. 612876, DATED 3-10-2011, EXPIRES 11-18-2020.

SER. NO. 85-319,553, FILED 5-12-2011.

BENJAMIN OKEKE, EXAMINING ATTORNEY



David J. Kybas

Director of the United States Patent and Trademark Office

United States of America

United States Patent and Trademark Office

UNLOCK THE DRAMA

Reg. No. 4,067,266

Registered Dec. 6, 2011

Int. Cl.: 41

SERVICE MARK

PRINCIPAL REGISTER

TURNER NETWORK TELEVISION, INC. (DELAWARE CORPORATION)
C/O TURNER BROADCASTING SYSTEM, INC.
ONE CNN CENTER, 10N
ATLANTA, GA 30303

FOR: PROVISION OF NON-DOWNLOADABLE FILMS AND CONTINUING TELEVISION PROGRAMS FEATURING COMEDY, DRAMA, ACTION, NEWS, REALITY, AND ADVENTURE ACCESSIBLE VIA THE INTERNET, IN CLASS 41 (U.S. CLS. 100, 101 AND 107).

FIRST USE 5-26-2010; IN COMMERCE 5-26-2010.

THE MARK CONSISTS OF STANDARD CHARACTERS WITHOUT CLAIM TO ANY PARTICULAR FONT, STYLE, SIZE, OR COLOR.

SER. NO. 85-320,010, FILED 5-13-2011.

ANNE E. GUSTASON, EXAMINING ATTORNEY



David J. Kybas

Director of the United States Patent and Trademark Office

United States of America

United States Patent and Trademark Office

FANMUG

Reg. No. 4,067,267

Registered Dec. 6, 2011

Int. Cl.: 40

SERVICE MARK

PRINCIPAL REGISTER

MILLER, LARRY (UNITED STATES INDIVIDUAL)
207 JEFFERSON STREET
WAPAKONETA, OH 45895

FOR: PRINTING OF PHOTOGRAPHIC FAMILY IMAGES ONLY FOR OTHERS ONTO GIFT ITEMS, NAMELY, SNOW GLOBES, CHARM BRACELETS, KEY CHAINS, DOG TAG CHAINS, BOBBLE HEADS, PICTURE FRAME, PHOTO BUTTONS, CHECKBOOK COVER, DESKTOP ORGANIZER, PERSONAL COMPACT MIRRORS, AND WALL CLOCKS, IN CLASS 40 (U.S. CLS. 100, 103 AND 106).

FIRST USE 8-31-2007; IN COMMERCE 8-31-2007.

THE MARK CONSISTS OF STANDARD CHARACTERS WITHOUT CLAIM TO ANY PARTICULAR FONT, STYLE, SIZE, OR COLOR.

SER. NO. 85-320,563, FILED 5-13-2011.

SIMON TENG, EXAMINING ATTORNEY



David J. Kybas

Director of the United States Patent and Trademark Office

United States of America

United States Patent and Trademark Office



Reg. No. 4,067,268

Registered Dec. 6, 2011

Int. Cl.: 41

SERVICE MARK

PRINCIPAL REGISTER

SHUFFLE MASTER, INC. (MINNESOTA CORPORATION)
1106 PALMS AIRPORT DRIVE
LAS VEGAS, NV 89119

FOR: ENTERTAINMENT SERVICES, NAMELY, PROVIDING A LIVE GAME OF CHANCE ON A GAMING TABLE, IN CLASS 41 (U.S. CLS. 100, 101 AND 107).

FIRST USE 10-1-2010; IN COMMERCE 10-1-2010.

OWNER OF U.S. REG. NOS. 3,281,264, 3,940,931 AND OTHERS.

NO CLAIM IS MADE TO THE EXCLUSIVE RIGHT TO USE "PROGRESSIVE TEXAS HOLD 'EM BONUS", APART FROM THE MARK AS SHOWN.

THE MARK CONSISTS OF AN OUTLINE OF THE STATE OF TEXAS WITH TWO ACE PLAYING CARDS IN THE UPPER LEFT HAND CORNER, THE TOP CARD AN ACE OF SPADES AND THE BOTTOM CARD AN ACE OF DIAMONDS, WITH A FIVE-POINT STAR ABOVE THE WORD "TEXAS" TO THE RIGHT OF THE ACES, AND THE WORD "PROGRESSIVE" TO THE LEFT, JUST UNDER THE FIVE-POINT STAR, THE WORD "TEXAS" IS WRITTEN ACROSS THE MIDDLE OF THE STATE DESIGN OVER THE WORDS "HOLD 'EM" BETWEEN TWO FIVE-POINT STARS WRITTEN ACROSS A RIBBON-LIKE BANNER, THE WORD "BONUS" WRITTEN UNDER THE RIBBON OVER THE BOTTOM PORTION OF THE STATE DESIGN.

SER. NO. 85-322,150, FILED 5-16-2011.

WON TEAK OH, EXAMINING ATTORNEY



David J. Kypos

Director of the United States Patent and Trademark Office

United States of America

United States Patent and Trademark Office

MEGA MASTURBATOR

Reg. No. 4,067,269

Registered Dec. 6, 2011

Int. Cl.: 10

TRADEMARK

PRINCIPAL REGISTER

PIPEDREAM PRODUCTS, INC. (CALIFORNIA CORPORATION)
21350 LASSEN ST.
CHATSWORTH, CA 91311

FOR: ADULT SEXUAL STIMULATION AIDS, NAMELY, ARTIFICIAL VAGINAS, LEGS, BREASTS AND BUTTOCKS, IN CLASS 10 (U.S. CLS. 26, 39 AND 44).

FIRST USE 3-30-2010; IN COMMERCE 3-30-2010.

THE MARK CONSISTS OF STANDARD CHARACTERS WITHOUT CLAIM TO ANY PARTICULAR FONT, STYLE, SIZE, OR COLOR.

NO CLAIM IS MADE TO THE EXCLUSIVE RIGHT TO USE "MASTURBATOR", APART FROM THE MARK AS SHOWN.

SER. NO. 85-322,241, FILED 5-16-2011.

H. M. FISHER, EXAMINING ATTORNEY



David J. Kyros

Director of the United States Patent and Trademark Office

United States of America

United States Patent and Trademark Office

STARTERNAUTS

Reg. No. 4,067,270

Registered Dec. 6, 2011

Int. Cl.: 41

SERVICE MARK

PRINCIPAL REGISTER

GAME TRUCK LICENSING, LLC (DELAWARE LIMITED LIABILITY COMPANY)
1501 W FOUNTAINHEAD PARKWAY, #520
TEMPE, AZ 85282

FOR: EDUCATION SERVICES, NAMELY, PROVIDING HANDS-ON OPPORTUNITIES FOR CHILDREN IN THE FIELD OF EARTH AND SPACE EXPLORATION THROUGH LIVE, BROADCAST, AND ON-LINE CLASSES, SEMINARS, WORKSHOPS, TRAINING AND CURRICULUM DEVELOPMENT FOR CHILDREN, PARENTS AND EDUCATORS, IN CLASS 41 (U.S. CLS. 100, 101 AND 107).

FIRST USE 5-10-2011; IN COMMERCE 5-10-2011.

THE MARK CONSISTS OF STANDARD CHARACTERS WITHOUT CLAIM TO ANY PARTICULAR FONT, STYLE, SIZE, OR COLOR.

SER. NO. 85-322,659, FILED 5-17-2011.

KAREN K. BUSH, EXAMINING ATTORNEY



David J. Kyffers

Director of the United States Patent and Trademark Office

United States of America

United States Patent and Trademark Office

Goga Studios

Reg. No. 4,067,271

GOGA STUDIOS, INC. (DELAWARE CORPORATION)
63 BARBOUR ROAD
HAMPTON, NH 03842

Registered Dec. 6, 2011

Int. Cl.: 44

FOR: COUNSELING SERVICES IN THE FIELDS OF HEALTH AND LIFESTYLE WELLNESS,
FOR THE BODY, MIND AND SPIRIT, IN CLASS 44 (U.S. CLS. 100 AND 101).

SERVICE MARK

FIRST USE 5-1-2011; IN COMMERCE 5-1-2011.

PRINCIPAL REGISTER

THE MARK CONSISTS OF STANDARD CHARACTERS WITHOUT CLAIM TO ANY PAR-
TICULAR FONT, STYLE, SIZE, OR COLOR.

NO CLAIM IS MADE TO THE EXCLUSIVE RIGHT TO USE "STUDIOS", APART FROM THE
MARK AS SHOWN.

THE WORDING "GOGA" HAS NO MEANING IN A FOREIGN LANGUAGE.

SER. NO. 85-322,852, FILED 5-17-2011.

RICHARD WHITE, EXAMINING ATTORNEY



David J. Kyros

Director of the United States Patent and Trademark Office

United States of America

United States Patent and Trademark Office



Reg. No. 4,067,272

Registered Dec. 6, 2011

Int. Cl.: 35

SERVICE MARK

PRINCIPAL REGISTER

LHS INTERNATIONAL, INC. (NEW YORK CORPORATION), DBA BLOSSOM
3016 JERICHO TURNPIKE
EAST NORTHPORT, NY 11731

FOR: COMPUTERIZED ON-LINE RETAIL STORE SERVICES IN THE FIELD OF JEWELRY AND FASHION ACCESSORIES; FRANCHISING, NAMELY, OFFERING BUSINESS MANAGEMENT ASSISTANCE IN THE ESTABLISHMENT AND/OR OPERATION OF JEWELRY AND FASHION ACCESSORIES; MARKETING SERVICES, NAMELY, RETAIL STORE SERVICES IN THE FIELD OF JEWELRY AND FASHION ACCESSORIES; ON-LINE CONSIGNMENT SERVICES WHEREBY GOODS ARE RECEIVED ON CONSIGNMENT IN ON-LINE RETAIL STORES FEATURING JEWELRY AND FASHION ACCESSORIES; ON-LINE RETAIL STORE SERVICES FEATURING A WIDE VARIETY OF CONSUMER GOODS OF OTHERS; ON-LINE WHOLESALE AND RETAIL STORE SERVICES FEATURING JEWELRY AND FASHION ACCESSORIES; RETAIL JEWELRY STORES; RETAIL STORE AND ON-LINE RETAIL STORE SERVICES FEATURING JEWELRY AND FASHION ACCESSORIES; RETAIL STORE SERVICES FEATURING A WIDE VARIETY OF CONSUMER GOODS OF OTHERS; RETAIL JEWELRY AND FASHION ACCESSORIES STORES; WHOLESALE AND RETAIL STORE SERVICES FEATURING JEWELRY AND FASHION ACCESSORIES; WHOLESALE STORES FEATURING JEWELRY AND FASHION ACCESSORIES, IN CLASS 35 (U.S. CLS. 100, 101 AND 102).

FIRST USE 3-1-2006; IN COMMERCE 3-1-2006.



THE MARK CONSISTS OF THE WORD "BLOSSOM" IN GREEN WITH TWO GREEN DOTS BELOW EACH "O". THERE IS A YELLOW AND ORANGE FLOWER TO THE RIGHT OF THE WORD. ALL OF THE FOREGOING APPEARS ON A PURPLE RECTANGULAR BACKGROUND.

THE COLOR(S) PURPLE, GREEN, YELLOW AND ORANGE IS/ARE CLAIMED AS A FEATURE OF THE MARK.

SER. NO. 85-322,968, FILED 5-17-2011.

KATHERINE CHANG, EXAMINING ATTORNEY

David J. Kyffers

Director of the United States Patent and Trademark Office

United States of America

United States Patent and Trademark Office

EKO VALVE

Reg. No. 4,067,273

Registered Dec. 6, 2011

Int. Cl.: 28

TRADEMARK

PRINCIPAL REGISTER

KINGMAN INTERNATIONAL CORPORATION (CALIFORNIA CORPORATION)
14010 LIVE OAK AVENUE
BALDWIN PARK, CA 91706

FOR: PAINTBALL GUNS, IN CLASS 28 (U.S. CLS. 22, 23, 38 AND 50).

FIRST USE 2-28-2010; IN COMMERCE 2-28-2010.

THE MARK CONSISTS OF STANDARD CHARACTERS WITHOUT CLAIM TO ANY PARTICULAR FONT, STYLE, SIZE, OR COLOR.

NO CLAIM IS MADE TO THE EXCLUSIVE RIGHT TO USE "VALVE", APART FROM THE MARK AS SHOWN.

SER. NO. 85-323,155, FILED 5-17-2011.

JASON TURNER, EXAMINING ATTORNEY



David J. Kyffers

Director of the United States Patent and Trademark Office

United States of America

United States Patent and Trademark Office



Reg. No. 4,067,274

Registered Dec. 6, 2011

Int. Cls.: 3, 29, 30 and 33

TRADEMARK

PRINCIPAL REGISTER

CHACEWATER, INC. (CALIFORNIA CORPORATION)
908 TAYLORVILLE ROAD
SUITE 200
GRASS VALLEY, CA 95959

FOR: SOAPS FOR HOUSEHOLD USE; SOAPS FOR PERSONAL USE, IN CLASS 3 (U.S. CLS. 1, 4, 6, 50, 51 AND 52).

FIRST USE 2-1-2011; IN COMMERCE 2-1-2011.

FOR: OLIVE OILS, IN CLASS 29 (U.S. CL. 46).

FIRST USE 2-1-2011; IN COMMERCE 2-1-2011.

FOR: VINEGAR, IN CLASS 30 (U.S. CL. 46).

FIRST USE 2-1-2011; IN COMMERCE 2-1-2011.

FOR: WINE, IN CLASS 33 (U.S. CLS. 47 AND 49).

FIRST USE 2-1-2011; IN COMMERCE 2-1-2011.

THE MARK CONSISTS OF A VERTICAL LAYOUT SYMBOL CONTAINING THE LITERAL ELEMENTS "4" AND "W".

SER. NO. 85-323,240, FILED 5-17-2011.

STEVEN JACKSON, EXAMINING ATTORNEY



David J. Kybas

Director of the United States Patent and Trademark Office

United States of America

United States Patent and Trademark Office

COMMUNITY FROM COVENTRY HEALTH CARE

Reg. No. 4,067,275

Registered Dec. 6, 2011

Int. Cls.: 36 and 44

SERVICE MARK

PRINCIPAL REGISTER

COVENTRY HEALTH CARE, INC. (DELAWARE CORPORATION)
8TH FLOOR
6720 B ROCKLEDGE DRIVE
BETHESDA, MD 20817

FOR: ADMINISTRATION AND FINANCING OF PREPAID HEALTH INSURANCE BENEFIT PLANS, IN CLASS 36 (U.S. CLS. 100, 101 AND 102).

FIRST USE 2-24-2011; IN COMMERCE 4-1-2011.

FOR: MANAGED HEALTH CARE SERVICES, IN CLASS 44 (U.S. CLS. 100 AND 101).

FIRST USE 2-24-2011; IN COMMERCE 4-1-2011.

THE MARK CONSISTS OF STANDARD CHARACTERS WITHOUT CLAIM TO ANY PARTICULAR FONT, STYLE, SIZE, OR COLOR.

OWNER OF U.S. REG. NO. 3,543,085.

NO CLAIM IS MADE TO THE EXCLUSIVE RIGHT TO USE " HEALTH CARE", APART FROM THE MARK AS SHOWN.

SER. NO. 85-324,745, FILED 5-19-2011.

KAREN BRACEY, EXAMINING ATTORNEY



David J. Kybas

Director of the United States Patent and Trademark Office

United States of America

United States Patent and Trademark Office

BUBBLE BREEZE

Reg. No. 4,067,276

Registered Dec. 6, 2011

Int. Cl.: 30

TRADEMARK

PRINCIPAL REGISTER

HERSHEY CHOCOLATE & CONFECTIONERY CORPORATION (DELAWARE CORPORATION)
4860 ROBB STREET, SUITE 204
WHEAT RIDGE, CO 80033

FOR: CONFECTIONERY; NAMELY, CHEWING GUM, IN CLASS 30 (U.S. CL. 46).

FIRST USE 6-30-2006; IN COMMERCE 6-30-2006.

THE MARK CONSISTS OF STANDARD CHARACTERS WITHOUT CLAIM TO ANY PARTICULAR FONT, STYLE, SIZE, OR COLOR.

NO CLAIM IS MADE TO THE EXCLUSIVE RIGHT TO USE "BUBBLE", APART FROM THE MARK AS SHOWN.

SER. NO. 85-325,943, FILED 5-20-2011.

KATINA MISTER, EXAMINING ATTORNEY



David J. Kyros

Director of the United States Patent and Trademark Office

United States of America

United States Patent and Trademark Office



Reg. No. 4,067,277

Registered Dec. 6, 2011

Int. Cl.: 36

SERVICE MARK

PRINCIPAL REGISTER

STUMPE FOUNDATION, INC. (GEORGIA CORPORATION)
STE 400
1600 PARKWOOD CIRCLE
ATLANTA, GA 30339

FOR: CHARITABLE FUNDRAISING, IN CLASS 36 (U.S. CLS. 100, 101 AND 102).

FIRST USE 3-30-2011; IN COMMERCE 3-30-2011.

THE MARK CONSISTS OF A DRAWING OF THE FACE OF A MONKEY WITH THE HAIR/FUR OF THE MONKEY'S FACE OUTLINED WITH THE POINTED TOPS OF EQUILATERAL TRIANGLE CIRCLING THE FACE AND ONLY INTERRUPTED BY THE MONKEY'S EARS.

SER. NO. 85-328,815, FILED 5-24-2011.

EMILY CARLSEN, EXAMINING ATTORNEY



David J. Kybas

Director of the United States Patent and Trademark Office

United States of America

United States Patent and Trademark Office

Stump! Trivia Quiz

Reg. No. 4,067,278

Registered Dec. 6, 2011

Int. Cl.: 41

SERVICE MARK

PRINCIPAL REGISTER

TRAILSIDE ENTERTAINMENT, INC. (MASSACHUSETTS CORPORATION)
41 CAROLINA TRAIL
MARSHFIELD, MA 02050

FOR: ENTERTAINMENT SERVICES, NAMELY, PROVIDING TEMPORARY USE OF NON-DOWNLOADABLE INTERACTIVE GAMES, NAMELY, LIVE HOSTED TRIVIA GAME SHOWS, IN CLASS 41 (U.S. CLS. 100, 101 AND 107).

FIRST USE 6-1-2001; IN COMMERCE 6-1-2001.

THE MARK CONSISTS OF STANDARD CHARACTERS WITHOUT CLAIM TO ANY PARTICULAR FONT, STYLE, SIZE, OR COLOR.

NO CLAIM IS MADE TO THE EXCLUSIVE RIGHT TO USE "TRIVIA QUIZ", APART FROM THE MARK AS SHOWN.

SER. NO. 85-330,775, FILED 5-26-2011.

ERIN FALK, EXAMINING ATTORNEY



David J. Kybas

Director of the United States Patent and Trademark Office

United States of America

United States Patent and Trademark Office



GOGA STUDIOS

Reg. No. 4,067,279

Registered Dec. 6, 2011

Int. Cl.: 44

SERVICE MARK

PRINCIPAL REGISTER

GOGA STUDIOS, INC. (DELAWARE CORPORATION)
63 BARBOUR ROAD
HAMPTON, NH 03842

FOR: COUNSELING SERVICES IN THE FIELDS OF HEALTH AND LIFESTYLE WELLNESS,
FOR THE BODY, MIND AND SPIRIT, IN CLASS 44 (U.S. CLS. 100 AND 101).

FIRST USE 5-1-2011; IN COMMERCE 5-1-2011.

NO CLAIM IS MADE TO THE EXCLUSIVE RIGHT TO USE "STUDIOS", APART FROM THE
MARK AS SHOWN.

THE MARK CONSISTS OF SETS OF PARENTHESES () DECREASING IN THICKNESS AND
INCREASING IN SHADING FROM AN OUTER SET TO AN INNER SET OVER THE TEXT
"GOGA STUDIOS".

THE WORDING "GOGA" HAS NO MEANING IN A FOREIGN LANGUAGE.

SER. NO. 85-331,177, FILED 5-26-2011.

RICHARD WHITE, EXAMINING ATTORNEY



David J. Kybas

Director of the United States Patent and Trademark Office

United States of America

United States Patent and Trademark Office

MÁSCARA DE FUEGO

Reg. No. 4,067,280

Registered Dec. 6, 2011

Int. Cl.: 33

TRADEMARK

PRINCIPAL REGISTER

FINCA FLICHMAN S.A. (ARGENTINA CORPORATION)
MAIPÚ 757, 8TH FLOOR (1006)
BUENOS AIRES, ARGENTINA

FOR: WINES AND SPARKLING WINES, IN CLASS 33 (U.S. CLS. 47 AND 49).

THE MARK CONSISTS OF STANDARD CHARACTERS WITHOUT CLAIM TO ANY PARTICULAR FONT, STYLE, SIZE, OR COLOR.

OWNER OF ARGENTINA REG. NO. 2,113,583, DATED 9-14-2006, EXPIRES 9-14-2016.

THE ENGLISH TRANSLATION OF "MÁSCARA DE FUEGO" IS "FIRE MASK".

SER. NO. 85-332,620, FILED 5-27-2011.

BENJAMIN OKEKE, EXAMINING ATTORNEY



David J. Kyfos

Director of the United States Patent and Trademark Office

United States of America

United States Patent and Trademark Office

LUNCH DONE BETTER!

Reg. No. 4,067,281

Registered Dec. 6, 2011

Int. Cls.: 29 and 30

TRADEMARK

PRINCIPAL REGISTER

JONMOR INVESTMENTS, INC. (DELAWARE CORPORATION)
103 BAYNARD BUILDING
3411 SILVERSIDE ROAD
WILMINGTON, DE 19810

FOR: PORTABLE PREPACKAGED MEAL KITS CONSISTING PRIMARILY OF CHICKEN NUGGETS WITH DIPPING SAUCE, PACKAGED TOGETHER WITH ANY COMBINATION OF THE FOLLOWING SNACK FOODS: FRUIT, GRAIN-BASED SNACK FOODS AND DIPPING SAUCE, IN CLASS 29 (U.S. CL. 46).

FIRST USE 1-0-2011; IN COMMERCE 1-0-2011.

FOR: PORTABLE PREPACKAGED MEAL KITS CONSISTING PRIMARILY OF TURKEY AND CHEESE WRAPS AND HAM AND CHEESE WRAPS, PACKAGED TOGETHER WITH ANY COMBINATION OF THE FOLLOWING SNACK FOODS: FRUIT, GRAIN-BASED SNACK FOODS AND DIPPING SAUCE; PORTABLE PREPACKAGED MEAL KITS CONSISTING PRIMARILY OF INGREDIENTS FOR PREPARING PIZZA SOLD AS A UNIT, COMPRISING PIZZA CRUST, PIZZA SAUCE AND CHEESE, PACKAGED TOGETHER WITH A FRUIT SNACK AND DIPPING SAUCE, IN CLASS 30 (U.S. CL. 46).

FIRST USE 1-0-2011; IN COMMERCE 1-0-2011.

THE MARK CONSISTS OF STANDARD CHARACTERS WITHOUT CLAIM TO ANY PARTICULAR FONT, STYLE, SIZE, OR COLOR.

SER. NO. 85-335,094, FILED 6-1-2011.

MARY CRAWFORD, EXAMINING ATTORNEY



David J. Kyros

Director of the United States Patent and Trademark Office

United States of America

United States Patent and Trademark Office

INVICTA SEA SPIDER

Reg. No. 4,067,282

Registered Dec. 6, 2011

Int. Cl.: 14

TRADEMARK

PRINCIPAL REGISTER

INVICTA WATCH COMPANY OF AMERICA, INC. (FLORIDA CORPORATION)
3069 TAFT STREET
HOLLYWOOD, FL 33021

FOR: WATCHES, IN CLASS 14 (U.S. CLS. 2, 27, 28 AND 50).

FIRST USE 6-0-2010; IN COMMERCE 6-0-2010.

THE MARK CONSISTS OF STANDARD CHARACTERS WITHOUT CLAIM TO ANY PARTICULAR FONT, STYLE, SIZE, OR COLOR.

OWNER OF U.S. REG. NOS. 2,947,259, 3,314,314, AND 3,811,810.

THE ENGLISH TRANSLATION OF "INVICTA" IN THE MARK IS "UNCONQUERED".

SER. NO. 85-335,130, FILED 6-1-2011.

ROSELLE HERRERA, EXAMINING ATTORNEY



David J. Kyffers

Director of the United States Patent and Trademark Office

United States of America

United States Patent and Trademark Office

IDOL CHATTER

Reg. No. 4,067,283

Registered Dec. 6, 2011

Int. Cl.: 41

SERVICE MARK

PRINCIPAL REGISTER

FREMANTLEMEDIA NORTH AMERICA, INC. (DELAWARE CORPORATION)
4000 WEST ALAMEDA AVE.
3RD FLOOR
BURBANK, CA 91505

FOR: ENTERTAINMENT SERVICES, NAMELY, PROVIDING INFORMATION IN THE FIELD OF TALENT SHOWS, AVAILABLE ON-LINE AND THROUGH MOBILE TELEPHONE OR COMMUNICATIONS NETWORKS, IN CLASS 41 (U.S. CLS. 100, 101 AND 107).

FIRST USE 3-31-2011; IN COMMERCE 3-31-2011.

THE MARK CONSISTS OF STANDARD CHARACTERS WITHOUT CLAIM TO ANY PARTICULAR FONT, STYLE, SIZE, OR COLOR.

OWNER OF U.S. REG. NOS. 2,715,725, 3,352,837 AND OTHERS.

SER. NO. 85-335,822, FILED 6-1-2011.

KATHY DE JONGE, EXAMINING ATTORNEY



David J. Kyffers

Director of the United States Patent and Trademark Office

United States of America

United States Patent and Trademark Office

OUT WITH THE OLD...IN WITH
THE GOLD!

Reg. No. 4,067,284

Registered Dec. 6, 2011

Int. Cl.: 41

SERVICE MARK

PRINCIPAL REGISTER

GNLV CORP. (NEVADA CORPORATION)
1510 WEST LOOP SOUTH
HOUSTON, TX 77027

FOR: CASINOS AND CASINO SERVICES; ENTERTAINMENT IN THE NATURE OF THEATER PRODUCTIONS, LIVE MUSIC CONCERTS, SPORTING CONTESTS, VARIETY, AND COMEDY SHOWS; ARRANGING FOR TICKET RESERVATIONS FOR SHOWS AND OTHER ENTERTAINMENT EVENTS; AMUSEMENT ARCADES; CABARETS; NIGHT CLUB SERVICES; GYMNASIUMS; HEALTH CLUB SERVICES, NAMELY, PROVIDING INSTRUCTION AND EQUIPMENT IN THE FIELD OF PHYSICAL EXERCISE; PROVIDING FACILITIES FOR RECREATION ACTIVITIES; PROVIDING FACILITIES FOR CASINO TOURNAMENTS; SPECIAL EVENT PLANNING FOR SOCIAL ENTERTAINMENT PURPOSES, IN CLASS 41 (U.S. CLS. 100, 101 AND 107).

FIRST USE 5-19-2011; IN COMMERCE 5-19-2011.

THE MARK CONSISTS OF STANDARD CHARACTERS WITHOUT CLAIM TO ANY PARTICULAR FONT, STYLE, SIZE, OR COLOR.

SER. NO. 85-336,887, FILED 6-2-2011.

KEVIN DINALLO, EXAMINING ATTORNEY



David J. Kyros

Director of the United States Patent and Trademark Office

United States of America

United States Patent and Trademark Office

COLD PLASMA SUB-D

Reg. No. 4,067,285

Registered Dec. 6, 2011

Int. Cl.: 3

TRADEMARK

PRINCIPAL REGISTER

N.V. PERRICONE LLC (DELAWARE LIMITED LIABILITY COMPANY)
639 RESEARCH PARKWAY
MERIDEN, CT 06450

FOR: COSMETIC PREPARATIONS, NAMELY, FIRMING CREAMS, IN CLASS 3 (U.S. CLS. 1, 4, 6, 50, 51 AND 52).

FIRST USE 6-2-2010; IN COMMERCE 6-2-2010.

THE MARK CONSISTS OF STANDARD CHARACTERS WITHOUT CLAIM TO ANY PARTICULAR FONT, STYLE, SIZE, OR COLOR.

OWNER OF U.S. REG. NO. 3,670,677.

SER. NO. 85-337,446, FILED 6-3-2011.

KAPIL BHANOT, EXAMINING ATTORNEY



David J. Kybas

Director of the United States Patent and Trademark Office

United States of America

United States Patent and Trademark Office

SUB-D

Reg. No. 4,067,286

N.V. PERRICONE LLC (DELAWARE LIMITED LIABILITY COMPANY)
639 RESEARCH PARKWAY
MERIDEN, CT 06450

Registered Dec. 6, 2011

Int. Cl.: 3

FOR: COSMETIC PREPARATIONS, NAMELY, FIRMING CREAMS, IN CLASS 3 (U.S. CLS. 1, 4, 6, 50, 51 AND 52).

TRADEMARK

FIRST USE 6-2-2010; IN COMMERCE 6-2-2010.

PRINCIPAL REGISTER

THE MARK CONSISTS OF STANDARD CHARACTERS WITHOUT CLAIM TO ANY PARTICULAR FONT, STYLE, SIZE, OR COLOR.

SER. NO. 85-337,457, FILED 6-3-2011.

KAPIL BHANOT, EXAMINING ATTORNEY



David J. Kybas

Director of the United States Patent and Trademark Office

United States of America

United States Patent and Trademark Office

OPTIFIBER PES-14

Reg. No. 4,067,287

Registered Dec. 6, 2011

Int. Cls.: 11 and 24

TRADEMARK

PRINCIPAL REGISTER

AQUA-AEROBIC SYSTEMS, INC. (ILLINOIS CORPORATION)
6306 N. ALPINE ROAD
ROCKFORD, IL 61111

FOR: WATER, WASTEWATER AND PROCESS WATER STREAM TREATMENT APPARATUS, IN THE NATURE OF A FILTER HAVING NATURAL AND SYNTHETIC FABRIC AND CLOTH FILTRATION MEDIA, IN CLASS 11 (U.S. CLS. 13, 21, 23, 31 AND 34).

FIRST USE 6-30-2010; IN COMMERCE 6-30-2010.

FOR: SYNTHETIC AND NATURAL TEXTILES FOR USE IN THE MANUFACTURE, REPAIR, REPLACEMENT OR RETROFIT OF CLOTH FILTRATION MEDIA FOR WATER, WASTEWATER AND PROCESS WATER STREAM TREATMENT, IN CLASS 24 (U.S. CLS. 42 AND 50).

FIRST USE 6-30-2010; IN COMMERCE 6-30-2010.

THE MARK CONSISTS OF STANDARD CHARACTERS WITHOUT CLAIM TO ANY PARTICULAR FONT, STYLE, SIZE, OR COLOR.

OWNER OF U.S. REG. NOS. 3,265,024, 3,633,808 AND OTHERS.

SER. NO. 85-340,782, FILED 6-8-2011.

WON TEAK OH, EXAMINING ATTORNEY



David J. Kyros

Director of the United States Patent and Trademark Office

United States of America

United States Patent and Trademark Office

In the heart of Wine Country

Reg. No. 4,067,288

Registered Dec. 6, 2011

Int. Cl.: 41

SERVICE MARK

PRINCIPAL REGISTER

RIVER ROCK ENTERTAINMENT AUTHORITY, GOVERNMENT INSTRUMENTALITY OF
THE DRY CREEK RANCHERIA OF POMO INDIANS (UNITED STATES
FEDERALLY-RECOGNIZED INDIAN TRIBE), DBA RIVER ROCK CASINO
3250 HWY 128
GEYSERVILLE, CA 95441

FOR: CASINOS, IN CLASS 41 (U.S. CLS. 100, 101 AND 107).

FIRST USE 7-26-2005; IN COMMERCE 5-1-2006.

THE MARK CONSISTS OF STANDARD CHARACTERS WITHOUT CLAIM TO ANY PARTICULAR FONT, STYLE, SIZE, OR COLOR.

NO CLAIM IS MADE TO THE EXCLUSIVE RIGHT TO USE "WINE COUNTRY", APART FROM THE MARK AS SHOWN.

SER. NO. 85-341,454, FILED 6-8-2011.

KATHLEEN M. VANSTON, EXAMINING ATTORNEY



David J. Kybas

Director of the United States Patent and Trademark Office

United States of America

United States Patent and Trademark Office

EAT. PLAY. WIN.

Reg. No. 4,067,289

Registered Dec. 6, 2011

Int. Cl.: 41

SERVICE MARK

PRINCIPAL REGISTER

RIVER ROCK ENTERTAINMENT AUTHORITY, A GOVERNMENT INSTRUMENTALITY
OF THE DRY CREEK RANCHERIA OF POMO INDIANS (UNITED STATES
FEDERALLY-RECOGNIZED INDIAN TRIBE), DBA RIVER ROCK CASINO
3250 HWY 128
GEYSERVILLE, CA 95441

FOR: CASINOS, IN CLASS 41 (U.S. CLS. 100, 101 AND 107).

FIRST USE 2-1-2011; IN COMMERCE 5-1-2011.

THE MARK CONSISTS OF STANDARD CHARACTERS WITHOUT CLAIM TO ANY PARTICULAR FONT, STYLE, SIZE, OR COLOR.

SER. NO. 85-341,486, FILED 6-8-2011.

KATHLEEN M. VANSTON, EXAMINING ATTORNEY



David J. Kybas

Director of the United States Patent and Trademark Office

United States of America

United States Patent and Trademark Office



Reg. No. 4,067,290
Registered Dec. 6, 2011
Int. Cl.: 7

TRADEMARK
PRINCIPAL REGISTER

CONTINENTAL MOTORS, INC. (DELAWARE CORPORATION), FORMERLY TELEDYNE
CONTINENTAL MOTORS, INC.
2039 BROAD STREET
MOBILE, AL 36615

FOR: INTERNAL COMBUSTION ENGINES, FOR AVIATION POWER APPLICATION; REPLACEMENT AND SPARE PARTS FOR SUCH ENGINES, NAMELY, INDUCTION MANIFOLD PARTS, ENGINE SUPERCHARGERS, GOVERNORS, AND ENGINE SPEED CONTROLLING MECHANISMS, GEARING AND TRANSMISSION ASSEMBLIES AND CLUTCHES, LUBRICANT PRESSURE AND SCAVENGE PUMPS FOR SAME; FUEL PUMPS AND FUEL INJECTION MECHANISMS, ACCESSORY MOUNTINGS AND ACCESSORY DRIVING MECHANISMS, AND ENGINE VIBRATION DAMPERS, IN CLASS 7 (U.S. CLS. 13, 19, 21, 23, 31, 34 AND 35).

FIRST USE 4-19-2011; IN COMMERCE 4-19-2011.

OWNER OF U.S. REG. NOS. 786,333, 2,547,164 AND OTHERS.

NO CLAIM IS MADE TO THE EXCLUSIVE RIGHT TO USE "MOTORS", APART FROM THE MARK AS SHOWN.

THE MARK CONSISTS OF A STYLIZED EAGLE WITH OUTSTRETCHED WINGS, FIVE FIVE-POINTED STARS IN A SEMI-CIRCLE ABOVE THE EAGLE'S HEAD, AND THE WORDS "CONTINENTAL MOTORS" TO THE RIGHT OF THE EAGLE.

SER. NO. 85-343,633, FILED 6-10-2011.

DAVID HOFFMAN, EXAMINING ATTORNEY



David J. Kyffers

Director of the United States Patent and Trademark Office

United States of America

United States Patent and Trademark Office



Reg. No. 4,067,291

Registered Dec. 6, 2011

Int. Cl.: 41

SERVICE MARK

PRINCIPAL REGISTER

ANNOYING ORANGE, LLC (CALIFORNIA LIMITED LIABILITY COMPANY)
2121 GRIFFITH PARK BLVD
LOS ANGELES, CA 90039

FOR: FILM AND VIDEO PRODUCTION, IN CLASS 41 (U.S. CLS. 100, 101 AND 107).

FIRST USE 6-13-2011; IN COMMERCE 6-13-2011.

A STYLIZED MARSHMALLOW WITH FACE. THE MARSHMALLOW IS WHITE. THE EYES ARE WHITE, GREEN AND BLACK. THE EYELASHES ARE BLACK. THE MOUTH IS PINK, BLACK AND WHITE. THE TEETH ARE WHITE. THE MARSHMALLOW DESIGN IS SHADOWED IN BLACK AND GRAY.

THE COLOR(S) BLACK, PINK, WHITE, GREEN AND GRAY IS/ARE CLAIMED AS A FEATURE OF THE MARK.

SER. NO. 85-346,668, FILED 6-15-2011.

MARK T. MULLEN, EXAMINING ATTORNEY



David J. Kybas

Director of the United States Patent and Trademark Office

United States of America

United States Patent and Trademark Office



Reg. No. 4,067,292

Registered Dec. 6, 2011

Int. Cl.: 41

SERVICE MARK

PRINCIPAL REGISTER

ANNOYING ORANGE, LLC (CALIFORNIA LIMITED LIABILITY COMPANY)
2121 GRIFFITH PARK BLVD
LOS ANGELES, CA 90039

FOR: FILM AND VIDEO PRODUCTION, IN CLASS 41 (U.S. CLS. 100, 101 AND 107).

FIRST USE 6-13-2011; IN COMMERCE 6-13-2011.

A STYLIZED APPLE WITH FACE. THE APPLE IS RED. THE EYES ARE BLACK AND WHITE. THE MOUTH AND TEETH ARE BLACK AND GRAY. THE APPLE IS SHADOWED IN GRAY.

THE COLOR(S) RED, BLACK, WHITE AND GRAY IS/ARE CLAIMED AS A FEATURE OF THE MARK.

SER. NO. 85-346,680, FILED 6-15-2011.

MARK T. MULLEN, EXAMINING ATTORNEY



David J. Kybas

Director of the United States Patent and Trademark Office

United States of America

United States Patent and Trademark Office

SPINE

Reg. No. 4,067,293

Registered Dec. 6, 2011

Int. Cl.: 28

TRADEMARK

PRINCIPAL REGISTER

KM KUSTOM MADE, LLC (CALIFORNIA LIMITED LIABILITY COMPANY)
P.O. BOX 130056
CARLSBAD, CA 92013

FOR: PAINTBALL FEED SYSTEM MADE OF RUBBER, NAMELY, A DISC SHAPED RUBBER FEED SYSTEM FOR PAINTBALL HOPPERS, IN CLASS 28 (U.S. CLS. 22, 23, 38 AND 50).

FIRST USE 6-1-2010; IN COMMERCE 6-1-2010.

THE MARK CONSISTS OF STANDARD CHARACTERS WITHOUT CLAIM TO ANY PARTICULAR FONT, STYLE, SIZE, OR COLOR.

SER. NO. 85-346,840, FILED 6-15-2011.

JESSICA A. POWERS, EXAMINING ATTORNEY



David J. Kybas

Director of the United States Patent and Trademark Office

United States of America

United States Patent and Trademark Office

CAMPUSAUCTION BID FOR A BETTER WORLD

Reg. No. 4,067,294

Registered Dec. 6, 2011

Int. Cl.: 35

SERVICE MARK

PRINCIPAL REGISTER

VANCOUVER HILLEL FOUNDATION (CANADA NOT-FOR-PROFIT CORPORATION)
6145 STUDENT UNION BLVD.
VANCOUVER, BC, CANADA V6T1Z1

FOR: ON-LINE AUCTION SERVICES FOR COLLEGE STUDENTS; PROVIDING INCENTIVE
AWARD PROGRAMS FOR CUSTOMERS THROUGH ISSUANCE AND PROCESSING OF
LOYALTY POINTS FOR REFERRAL OF NEW CUSTOMERS, IN CLASS 35 (U.S. CLS. 100,
101 AND 102).

FIRST USE 10-17-2009; IN COMMERCE 10-17-2009.

THE MARK CONSISTS OF STANDARD CHARACTERS WITHOUT CLAIM TO ANY PAR-
TICULAR FONT, STYLE, SIZE, OR COLOR.

NO CLAIM IS MADE TO THE EXCLUSIVE RIGHT TO USE "CAMPUSAUCTION", APART
FROM THE MARK AS SHOWN.

SER. NO. 85-347,779, FILED 6-16-2011.

DORITT L. CARROLL, EXAMINING ATTORNEY



David J. Kyros

Director of the United States Patent and Trademark Office

United States of America

United States Patent and Trademark Office

campus@uction
bid for a better world

Reg. No. 4,067,295

VANCOUVER HILLEL FOUNDATION (CANADA NOT-FOR-PROFIT CORPORATION)
6145 STUDENT UNION BLVD.
VANCOUVER, BC, CANADA V6T1Z1

Registered Dec. 6, 2011

Int. Cl.: 35

FOR: ON-LINE AUCTION SERVICES FOR COLLEGE STUDENTS; PROVIDING INCENTIVE AWARD PROGRAMS FOR CUSTOMERS THROUGH ISSUANCE AND PROCESSING OF LOYALTY POINTS FOR REFERRAL OF NEW CUSTOMERS, IN CLASS 35 (U.S. CLS. 100, 101 AND 102).

SERVICE MARK

PRINCIPAL REGISTER

FIRST USE 10-17-2009; IN COMMERCE 10-17-2009.

NO CLAIM IS MADE TO THE EXCLUSIVE RIGHT TO USE CAMPUSAUCTION, APART FROM THE MARK AS SHOWN.

THE MARK CONSISTS OF THE WORDING "CAMPUSAUCTION" IN ALL LOWERCASE LETTERS. THE LETTER "A" IN THE WORD "AUCTION" APPEARS IN SCRIPT AND HAS A HAND HOLDING THE BOTTOM HALF OF THE "A." THE WORDING "BID FOR A BETTER WORLD" APPEARS IN ALL LOWERCASE LETTERS UNDERNEATH.

SER. NO. 85-347,817, FILED 6-16-2011.

DORITT L. CARROLL, EXAMINING ATTORNEY



David J. Kyros

Director of the United States Patent and Trademark Office

United States of America

United States Patent and Trademark Office



Reg. No. 4,067,296

FRIENDS OF HERMAN CAIN, INC. (GEORGIA CORPORATION)
PO BOX 2158
STOCKBRIDGE, GA 30281

Registered Dec. 6, 2011

Int. Cl.: 35

FOR: INFORMATION ABOUT POLITICAL ELECTIONS, IN CLASS 35 (U.S. CLS. 100, 101 AND 102).

SERVICE MARK

FIRST USE 5-21-2011; IN COMMERCE 5-21-2011.

PRINCIPAL REGISTER

NO CLAIM IS MADE TO THE EXCLUSIVE RIGHT TO USE "PRESIDENT 2012", APART FROM THE MARK AS SHOWN.

THE NAME(S), PORTRAIT(S), AND/OR SIGNATURE(S) SHOWN IN THE MARK IDENTIFIES "HERMAN CAIN", WHOSE CONSENT(S) TO REGISTER IS MADE OF RECORD.

THE MARK CONSISTS OF AN IMAGE OF A TORCH WITH THE WORDS "HERMAN" AND "PRESIDENT" APPEARING TO THE LEFT OF THE TORCH, AND "CAIN" AND "2012" APPEARING TO THE RIGHT OF THE TORCH.

SER. NO. 85-348,860, FILED 6-17-2011.

KAREN K. BUSH, EXAMINING ATTORNEY



David J. Kybas

Director of the United States Patent and Trademark Office

United States of America

United States Patent and Trademark Office

HIGHLAND

Reg. No. 4,067,297

Registered Dec. 6, 2011

Int. Cl.: 11

TRADEMARK

PRINCIPAL REGISTER

3M COMPANY (DELAWARE CORPORATION)
220-9E-01
3M CENTER, 2501 HUDSON ROAD
ST. PAUL, MN 55144

FOR: AIR FILTERS FOR FURNACES AND AIR CONDITIONERS, IN CLASS 11 (U.S. CLS. 13, 21, 23, 31 AND 34).

FIRST USE 3-23-2011; IN COMMERCE 3-23-2011.

THE MARK CONSISTS OF STANDARD CHARACTERS WITHOUT CLAIM TO ANY PARTICULAR FONT, STYLE, SIZE, OR COLOR.

OWNER OF U.S. REG. NOS. 919,634, 1,492,199, AND 1,884,939.

SER. NO. 85-349,473, FILED 6-17-2011.

SUNG IN, EXAMINING ATTORNEY



David J. Kyffers

Director of the United States Patent and Trademark Office

United States of America

United States Patent and Trademark Office

PERUVIOL

Reg. No. 4,067,298

ACTIVE HEALTH SCIENCES, LLC (FLORIDA LIMITED LIABILITY COMPANY)
949 HUNTLEY AVENUE
DUNEDIN, FL 34698

Registered Dec. 6, 2011

Int. Cl.: 5

FOR: NUTRITIONAL, FOOD AND DIETARY SUPPLEMENT, IN CLASS 5 (U.S. CLS. 6, 18, 44, 46, 51 AND 52).

TRADEMARK

FIRST USE 4-18-2011; IN COMMERCE 4-22-2011.

PRINCIPAL REGISTER

THE MARK CONSISTS OF STANDARD CHARACTERS WITHOUT CLAIM TO ANY PARTICULAR FONT, STYLE, SIZE, OR COLOR.

SER. NO. 85-349,517, FILED 6-17-2011.

JORDAN BAKER, EXAMINING ATTORNEY



David J. Kybas

Director of the United States Patent and Trademark Office

United States of America

United States Patent and Trademark Office

POP & WIN

Reg. No. 4,067,299

CONAGRA FOODS RDM, INC. (DELAWARE CORPORATION)
ONE CONAGRA DRIVE
OMAHA, NE 68102

Registered Dec. 6, 2011

Int. Cl.: 41

FOR: ENTERTAINMENT SERVICES, NAMELY, PROVIDING GAMES OF CHANCE VIA THE INTERNET, IN CLASS 41 (U.S. CLS. 100, 101 AND 107).

SERVICE MARK

FIRST USE 12-9-2010; IN COMMERCE 12-9-2010.

PRINCIPAL REGISTER

THE MARK CONSISTS OF STANDARD CHARACTERS WITHOUT CLAIM TO ANY PARTICULAR FONT, STYLE, SIZE, OR COLOR.

SER. NO. 85-350,278, FILED 6-20-2011.

SCOTT BIBB, EXAMINING ATTORNEY



David J. Kyffers

Director of the United States Patent and Trademark Office

United States of America

United States Patent and Trademark Office

POP & WIN

Reg. No. 4,067,300

Registered Dec. 6, 2011

Int. Cl.: 30

TRADEMARK

PRINCIPAL REGISTER

CONAGRA FOODS RDM, INC. (DELAWARE CORPORATION)
ONE CONAGRA DRIVE
OMAHA, NE 68102

FOR: MICROWAVE POPCORN, IN CLASS 30 (U.S. CL. 46).

FIRST USE 12-9-2010; IN COMMERCE 12-9-2010.

THE MARK CONSISTS OF STANDARD CHARACTERS WITHOUT CLAIM TO ANY PARTICULAR FONT, STYLE, SIZE, OR COLOR.

SER. NO. 85-350,286, FILED 6-20-2011.

SCOTT BIBB, EXAMINING ATTORNEY



David J. Kybas

Director of the United States Patent and Trademark Office

United States of America

United States Patent and Trademark Office

CAMPUS IN DETAIL

Reg. No. 4,067,301

LISCOVITZ, CAROL (UNITED STATES INDIVIDUAL)
11 BERRY STREET
BRUNSWICK, ME 04011

Registered Dec. 6, 2011

Int. Cl.: 16

FOR: GREETING CARDS; NOTE CARDS, IN CLASS 16 (U.S. CLS. 2, 5, 22, 23, 29, 37, 38 AND 50).

TRADEMARK

FIRST USE 2-22-2011; IN COMMERCE 2-22-2011.

PRINCIPAL REGISTER

THE MARK CONSISTS OF STANDARD CHARACTERS WITHOUT CLAIM TO ANY PARTICULAR FONT, STYLE, SIZE, OR COLOR.

SER. NO. 85-350,412, FILED 6-20-2011.

DARRYL SPRUILL, EXAMINING ATTORNEY



David J. Kybas

Director of the United States Patent and Trademark Office

United States of America

United States Patent and Trademark Office

HIDDEN EXPEDITION

Reg. No. 4,067,302

Registered Dec. 6, 2011

Int. Cl.: 41

SERVICE MARK

PRINCIPAL REGISTER

BIG FISH GAMES, INC. (WASHINGTON CORPORATION)
SUITE 200
333 ELLIOTT AVENUE WEST
SEATTLE, WA 98119

FOR: ENTERTAINMENT SERVICES, NAMELY, PROVIDING ONLINE INTERACTIVE, COMPUTER, VIDEO AND ELECTRONIC GAMES; ONLINE NON-DOWNLOADABLE COMPUTER GAMES PROVIDED VIA A GLOBAL COMPUTER NETWORK; PROVIDING A NON-DOWNLOADABLE COMPUTER GAME THAT MAY BE ACCESSED NETWORK-WIDE BY NETWORK USERS; PROVIDING ON-LINE INFORMATION IN THE FIELD OF VIDEO GAMES; PROVIDING INSTRUCTION AND TUTORIAL SESSIONS IN THE FIELD OF VIDEO GAMES VIA ONLINE VIDEOS; PROVIDING ONLINE COMPUTER GAME CONTENT, NAMELY, INFORMATION ABOUT ONLINE COMPUTER GAMES, AND COURSES OF INSTRUCTION PROVIDED VIA STREAMING VIDEO IN THE FIELD OF PLAYING COMPUTER GAMES; PROVIDING ONLINE COMPUTER GAME CONTENT, NAMELY, INFORMATION ABOUT ONLINE ELECTRONIC GAMES, AND COURSES OF INSTRUCTION PROVIDED VIA STREAMING VIDEO IN THE FIELD OF PLAYING ELECTRONIC GAMES; PROVIDING ONLINE VIDEO GAME CONTENT, NAMELY, INFORMATION ABOUT VIDEO GAMES, AND COURSES OF INSTRUCTION PROVIDED VIA STREAMING VIDEO IN THE FIELD OF PLAYING VIDEO GAMES; PROVIDING TEMPORARY USE OF NON-DOWNLOADABLE INTERACTIVE GAMES, ELECTRONIC GAMES, COMPUTER GAMES OR VIDEO GAMES, IN CLASS 41 (U.S. CLS. 100, 101 AND 107).

FIRST USE 6-20-2008; IN COMMERCE 6-20-2008.

THE MARK CONSISTS OF STANDARD CHARACTERS WITHOUT CLAIM TO ANY PARTICULAR FONT, STYLE, SIZE, OR COLOR.

OWNER OF U.S. REG. NO. 3,343,266.

SER. NO. 85-351,062, FILED 6-20-2011.

JOHN WILKE, EXAMINING ATTORNEY



David J. Kyros

Director of the United States Patent and Trademark Office

United States of America

United States Patent and Trademark Office



Reg. No. 4,067,303

Registered Dec. 6, 2011

Int. Cl.: 41

SERVICE MARK

PRINCIPAL REGISTER

SHUFFLE MASTER, INC. (NEVADA CORPORATION)
1106 PALMS AIRPORT DRIVE
LAS VEGAS, NV 89119

FOR: ENTERTAINMENT SERVICES, NAMELY, PROVIDING LIVE GAMES OF CHANCE IN GAMING ESTABLISHMENTS, IN CLASS 41 (U.S. CLS. 100, 101 AND 107).

FIRST USE 4-23-2011; IN COMMERCE 4-23-2011.

NO CLAIM IS MADE TO THE EXCLUSIVE RIGHT TO USE "STRAIGHT", APART FROM THE MARK AS SHOWN.

THE MARK CONSISTS OF THE FACE CARDS OF THE ACE OF SPADES, 2 OF DIAMONDS, 3 OF CLUBS, 4 OF HEARS, 5 OF SPADES AND 6 OF DIAMONDS. THE WORDS "STRAIGHT JACK" ARE IN A HALF-MOON SHAPE UNDERNEATH THE PLAYING CARDS. A FACE CARD OF A JACK SITS BELOW THE WORDS "STRAIGHT JACK". THE PLAYING CARDS AND JACK ARE OUTLINED AND THE JACK HAS 3 THREE-QUARTER CIRCLES OUTLINING THE BOTTOM OF HIS FACE.

SER. NO. 85-351,087, FILED 6-20-2011.

WON TEAK OH, EXAMINING ATTORNEY



David J. Kyfos

Director of the United States Patent and Trademark Office

United States of America

United States Patent and Trademark Office

BE YOUR CHANGE

Reg. No. 4,067,304

Registered Dec. 6, 2011

Int. Cl.: 36

SERVICE MARK

PRINCIPAL REGISTER

PENNSYLVANIA STATE EMPLOYEES CREDIT UNION (PENNSYLVANIA CORPORATION)
ONE CREDIT UNION PLACE
HARRISBURG, PA 17110

FOR: CREDIT UNION SERVICES, IN CLASS 36 (U.S. CLS. 100, 101 AND 102).

FIRST USE 4-0-2010; IN COMMERCE 4-0-2010.

THE MARK CONSISTS OF STANDARD CHARACTERS WITHOUT CLAIM TO ANY PARTICULAR FONT, STYLE, SIZE, OR COLOR.

SER. NO. 85-351,345, FILED 6-21-2011.

RENEE MCCRAY, EXAMINING ATTORNEY



David J. Kybas

Director of the United States Patent and Trademark Office

United States of America

United States Patent and Trademark Office

ULTRA ESSENCE

Reg. No. 4,067,305

Registered Dec. 6, 2011

Int. Cls.: 20 and 24

TRADEMARK

PRINCIPAL REGISTER

PACIFIC COAST FEATHER COMPANY (WASHINGTON CORPORATION)
P.O. BOX 80385
SEATTLE, WA 98108

FOR: PILLOWS, IN CLASS 20 (U.S. CLS. 2, 13, 22, 25, 32 AND 50).

FIRST USE 4-1-2010; IN COMMERCE 4-1-2010.

FOR: COMFORTERS , IN CLASS 24 (U.S. CLS. 42 AND 50).

FIRST USE 4-1-2010; IN COMMERCE 4-1-2010.

THE MARK CONSISTS OF STANDARD CHARACTERS WITHOUT CLAIM TO ANY PARTICULAR FONT, STYLE, SIZE, OR COLOR.

SER. NO. 85-351,553, FILED 6-21-2011.

GEOFFREY FOSDICK, EXAMINING ATTORNEY



David J. Kyros

Director of the United States Patent and Trademark Office

United States of America

United States Patent and Trademark Office



Reg. No. 4,067,306

Registered Dec. 6, 2011

Int. Cl.: 9

TRADEMARK

PRINCIPAL REGISTER

HERSHEY CHOCOLATE & CONFECTIONERY CORPORATION (DELAWARE CORPORATION)
SUITE 204
4860 ROBB STREET
WHEAT RIDGE, CO 80033

FOR: COMPUTER APPLICATION SOFTWARE FOR MOBILE PHONES, NAMELY, SOFTWARE FOR DIGITALLY MONITORING AND TRACKING BREAKS OF PHYSICAL ACTIVITY THROUGHOUT THE DAY USED AS PART OF A CONSUMER HEALTH AND WELLNESS PROGRAM, IN CLASS 9 (U.S. CLS. 21, 23, 26, 36 AND 38).

FIRST USE 9-15-2010; IN COMMERCE 9-15-2010.

OWNER OF U.S. REG. NO. 3,999,744.

THE MARK CONSISTS OF THREE HUMAN FIGURES, ONE STRETCHING, ONE CLIMBING STEPS AND ONE HOISTING A CHILD INTO THE AIR, STANDING ON A RECTANGLE BAR WITH THE WORDS "ACTIVITY" ABOVE AND THE WORD "SNACK" BELOW. A DOWNWARD ARROW IS CONFIGURATED BETWEEN TWO OF THE FIGURES.

SER. NO. 85-351,731, FILED 6-21-2011.

KATINA MISTER, EXAMINING ATTORNEY



David J. Kybas

Director of the United States Patent and Trademark Office

United States of America

United States Patent and Trademark Office

FIRE-BUDDY

Reg. No. 4,067,307

DORON, RONEN (UNITED STATES INDIVIDUAL)
13304 VIRTUOSO
IRVINE, CA 92620

Registered Dec. 6, 2011

Int. Cl.: 20

FOR: CORNER CABINETS FOR FIRE EXTINGUISHERS, IN CLASS 20 (U.S. CLS. 2, 13, 22, 25, 32 AND 50).

TRADEMARK

FIRST USE 4-22-2011; IN COMMERCE 4-22-2011.

PRINCIPAL REGISTER

THE MARK CONSISTS OF STANDARD CHARACTERS WITHOUT CLAIM TO ANY PARTICULAR FONT, STYLE, SIZE, OR COLOR.

SER. NO. 85-351,893, FILED 6-21-2011.

ELIZABETH KAJUBI, EXAMINING ATTORNEY



David J. Kybas

Director of the United States Patent and Trademark Office

United States of America
United States Patent and Trademark Office

Symphony

Reg. No. 4,067,308

Registered Dec. 6, 2011

Int. Cl.: 30

HERSHEY CHOCOLATE & CONFECTIONERY CORPORATION (DELAWARE CORPORATION)
SUITE 204
4860 ROBB STREET
WHEAT RIDGE, PA 80033

TRADEMARK

PRINCIPAL REGISTER

FOR: CANDY; CHOCOLATE, IN CLASS 30 (U.S. CL. 46).

FIRST USE 11-9-1978; IN COMMERCE 11-9-1978.

OWNER OF U.S. REG. NOS. 1,173,491 AND 3,961,916.

THE COLOR(S) BLUE IS/ARE CLAIMED AS A FEATURE OF THE MARK.

THE MARK CONSISTS OF THE WORD "SYMPHONY" IN BLUE STYLIZED LETTERS.

SER. NO. 85-351,908, FILED 6-21-2011.

KATINA MISTER, EXAMINING ATTORNEY



David J. Kybas

Director of the United States Patent and Trademark Office

United States of America

United States Patent and Trademark Office

Symphony

Reg. No. 4,067,309

Registered Dec. 6, 2011

Int. Cl.: 30

TRADEMARK

PRINCIPAL REGISTER

HERSHEY CHOCOLATE & CONFECTIONERY CORPORATION (DELAWARE CORPORATION)
SUITE 204
4860 ROBB STREET
WHEAT RIDGE, CO 80033

FOR: CANDY; CHOCOLATE, IN CLASS 30 (U.S. CL. 46).

FIRST USE 11-9-1978; IN COMMERCE 11-9-1978.

OWNER OF U.S. REG. NOS. 1,173,491 AND 3,961,916.

THE COLOR(S) RED IS/ARE CLAIMED AS A FEATURE OF THE MARK.

THE MARK CONSISTS OF THE WORD "SYMPHONY" IN RED STYLIZED LETTERS.

SER. NO. 85-351,947, FILED 6-21-2011.

KATINA MISTER, EXAMINING ATTORNEY



David J. Kybas

Director of the United States Patent and Trademark Office

United States of America

United States Patent and Trademark Office

Fun Zeez

Reg. No. 4,067,310

Registered Dec. 6, 2011

Int. Cl.: 27

TRADEMARK

PRINCIPAL REGISTER

LA RUG, INC. (CALIFORNIA CORPORATION), DBA FUN RUGS, INC.
6200 AVALON BLVD.
LOS ANGELES, CA 90003

FOR: RUGS, IN CLASS 27 (U.S. CLS. 19, 20, 37, 42 AND 50).

FIRST USE 1-1-2005; IN COMMERCE 1-1-2005.

THE MARK CONSISTS OF STANDARD CHARACTERS WITHOUT CLAIM TO ANY PARTICULAR FONT, STYLE, SIZE, OR COLOR.

SER. NO. 85-352,199, FILED 6-21-2011.

HOWARD SMIGA, EXAMINING ATTORNEY



David J. Kyros

Director of the United States Patent and Trademark Office

United States of America

United States Patent and Trademark Office

protect. share. nurture.

Reg. No. 4,067,311

Registered Dec. 6, 2011

Int. Cl.: 39

SERVICE MARK

PRINCIPAL REGISTER

PETHUB, INC. (DELAWARE CORPORATION)
2258 NEWPORT WAY NW
ISSAQUAH, WA 98027

FOR: PROVIDING A WEBSITE FOR THE ELECTRONIC STORAGE OF MEDICAL, TRAINING AND SOCIAL RECORDS OF PETS THAT ALSO ALLOWS THE RECORDS TO BE SHARED WITH PET SITTERS, TRAINERS, DOG WALKERS, VETERINARIANS AND OTHER PET SERVICE PROVIDERS, IN CLASS 39 (U.S. CLS. 100 AND 105).

FIRST USE 6-15-2011; IN COMMERCE 6-15-2011.

THE MARK CONSISTS OF STANDARD CHARACTERS WITHOUT CLAIM TO ANY PARTICULAR FONT, STYLE, SIZE, OR COLOR.

SER. NO. 85-353,044, FILED 6-22-2011.

SUSAN LESLIE DUBOIS, EXAMINING ATTORNEY



David J. Kyffers

Director of the United States Patent and Trademark Office

United States of America

United States Patent and Trademark Office

HARD

Reg. No. 4,067,312

Registered Dec. 6, 2011

Int. Cls.: 25 and 41

TRADEMARK

SERVICE MARK

PRINCIPAL REGISTER

SIX FIFTEEN SIXTY SEVEN, LLC (CALIFORNIA LIMITED LIABILITY COMPANY)
820 SEWARD STREET
LOS ANGELES, CA 90038

FOR: FOOTWEAR; HATS; HEADBANDS; JACKETS; SCARVES; SHIRTS; SHORTS; SOCKS;
SWEAT SHIRTS; SWEATERS; T-SHIRTS; TANK TOPS; VISORS, IN CLASS 25 (U.S. CLS.
22 AND 39).

FIRST USE 7-0-2008; IN COMMERCE 7-0-2008.

FOR: ARRANGING AND CONDUCTING OF CONCERTS; ENTERTAINMENT IN THE
NATURE OF LIVE PERFORMANCES BY VARIOUS MUSIC GROUPS; ENTERTAINMENT,
NAMELY, LIVE MUSIC CONCERTS, IN CLASS 41 (U.S. CLS. 100, 101 AND 107).

FIRST USE 3-0-2008; IN COMMERCE 3-0-2008.

OWNER OF U.S. REG. NO. 3,589,921.

THE MARK CONSISTS OF THE WORD "HARD" IN MONOLITHIC STYLE SHADED LET-
TERING.

SER. NO. 85-353,457, FILED 6-22-2011.

PAM WILLIS, EXAMINING ATTORNEY



David J. Kyffers

Director of the United States Patent and Trademark Office

United States of America

United States Patent and Trademark Office



Reg. No. 4,067,313

Registered Dec. 6, 2011

Int. Cl.: 42

SERVICE MARK

PRINCIPAL REGISTER

MARINA BIOTECH, INC (DELAWARE CORPORATION)
3830 MONTE VILLA PARKWAY
BOTHELL, WA 98021

FOR: RESEARCH AND DEVELOPMENT SERVICES IN THE FIELDS OF RNAI-BASED DRUGS AND THERAPEUTICS; PHARMACEUTICAL RESEARCH AND DEVELOPMENT IN THE FIELDS OF THERAPEUTICS, FORMULATIONS TO IMPROVE DRUG DELIVERY IN THE BODY AND DRUGS FOR TREATING A VARIETY OF DISEASES; RESEARCH AND DEVELOPMENT OF THERAPEUTICS IN THE AREA OF ONCOLOGY, IN CLASS 42 (U.S. CLS. 100 AND 101).

FIRST USE 8-8-2010; IN COMMERCE 8-8-2010.

NO CLAIM IS MADE TO THE EXCLUSIVE RIGHT TO USE "BIOTECH", APART FROM THE MARK AS SHOWN.

THE MARK CONSISTS OF THE TERM "MARINA BIOTECH" PROXIMATE THE DESIGN OF A MOLECULE WITH DIAGONAL LINES WITH A PORTION OF THE MOLECULE DESIGN ENCLOSED IN THE DESIGN OF A CIRCLE.

SER. NO. 85-353,617, FILED 6-22-2011.

PATRICIA EVANKO, EXAMINING ATTORNEY



David J. Kyjars

Director of the United States Patent and Trademark Office

United States of America

United States Patent and Trademark Office

GOGH JEWELRY DESIGN

Reg. No. 4,067,314

Registered Dec. 6, 2011

Int. Cl.: 14

TRADEMARK

PRINCIPAL REGISTER

GOGH, SZILVIA (UNITED STATES INDIVIDUAL)
1631 CARVER ST
REDONDO BEACH, CA 90278

FOR: JEWELRY, NAMELY, AMULETS, BRACELETS, BROOCHES, CHAINS , CHARMS, COSTUME JEWELRY, NECKLACES, PEARLS, RINGS, THREADS OF PRECIOUS METAL, TRINKETS, WIRES OF PRECIOUS METAL, AND EARRINGS, IN CLASS 14 (U.S. CLS. 2, 27, 28 AND 50).

FIRST USE 1-1-2009; IN COMMERCE 1-1-2009.

THE MARK CONSISTS OF STANDARD CHARACTERS WITHOUT CLAIM TO ANY PARTICULAR FONT, STYLE, SIZE, OR COLOR.

NO CLAIM IS MADE TO THE EXCLUSIVE RIGHT TO USE "JEWELRY DESIGN", APART FROM THE MARK AS SHOWN.

SER. NO. 85-353,667, FILED 6-23-2011.

ADA HAN, EXAMINING ATTORNEY



David J. Kyffers

Director of the United States Patent and Trademark Office

United States of America

United States Patent and Trademark Office

MAMA DELUCA'S TAKE-OR-BAKE

Reg. No. 4,067,315

MD PIZZA, LLC. (DELAWARE LIMITED LIABILITY COMPANY)
300 BIC DRIVE
MILFORD, CT 06461

Registered Dec. 6, 2011

Int. Cl.: 43

FOR: RESTAURANT SERVICES, IN CLASS 43 (U.S. CLS. 100 AND 101).

SERVICE MARK

FIRST USE 7-31-2010; IN COMMERCE 7-31-2010.

PRINCIPAL REGISTER

THE MARK CONSISTS OF STANDARD CHARACTERS WITHOUT CLAIM TO ANY PARTICULAR FONT, STYLE, SIZE, OR COLOR.

OWNER OF U.S. REG. NOS. 3,063,761, 3,066,066 AND OTHERS.

NO CLAIM IS MADE TO THE EXCLUSIVE RIGHT TO USE "TAKE-OR-BAKE", APART FROM THE MARK AS SHOWN.

THE NAME "MAMA DELUCA" DOES NOT IDENTIFY A LIVING INDIVIDUAL.

SER. NO. 85-355,059, FILED 6-24-2011.

LIEF MARTIN, EXAMINING ATTORNEY



David J. Kyffers

Director of the United States Patent and Trademark Office

United States of America

United States Patent and Trademark Office

menthol ice

Reg. No. 4,067,316

Registered Dec. 6, 2011

Int. Cl.: 34

TRADEMARK

PRINCIPAL REGISTER

SORSA HOLDINGS INC (FLORIDA CORPORATION)
MENTHOL ICE
719 EASTERN PK ST3
BKLYN, NY 11213

FOR: ELECTRONIC GOODS, NAMELY, ELECTRONIC CIGARETTES AND THEIR ELECTRONIC COMPONENTS AND STRUCTURAL PARTS, NAMELY, CARTRIDGE REFILL CARTOMISERS AND ATOMISERS, IN CLASS 34 (U.S. CLS. 2, 8, 9 AND 17).

FIRST USE 12-20-2008; IN COMMERCE 12-20-2008.

THE MARK CONSISTS OF STANDARD CHARACTERS WITHOUT CLAIM TO ANY PARTICULAR FONT, STYLE, SIZE, OR COLOR.

NO CLAIM IS MADE TO THE EXCLUSIVE RIGHT TO USE "MENTHOL", APART FROM THE MARK AS SHOWN.

SER. NO. 85-357,143, FILED 6-27-2011.

JACLYN KIDWELL WALKER, EXAMINING ATTORNEY



David J. Kybas

Director of the United States Patent and Trademark Office

United States of America

United States Patent and Trademark Office



Reg. No. 4,067,317

Registered Dec. 6, 2011

Int. Cl.: 43

SERVICE MARK

PRINCIPAL REGISTER

CHICKASAW NATION, THE (UNITED STATES FEDERALLY-RECOGNIZED INDIAN TRIBE)
520 E. ARLINGTON BLVD.
ADA, OK 74820

FOR: EXTENDED-STAY HOTELS; HEALTH RESORT SERVICES, NAMELY, PROVIDING FOOD AND LODGING THAT SPECIALIZE IN PROMOTING PATRONS' GENERAL HEALTH AND WELL-BEING; HOTEL ACCOMMODATION SERVICES; HOTEL AND MOTEL SERVICES; HOTEL AND RESTAURANT RESERVATION SERVICES; HOTEL AND RESTAURANT SERVICES; HOTEL SERVICES; HOTEL SERVICES FOR PREFERRED CUSTOMERS; HOTEL, BAR AND RESTAURANT SERVICES; HOTEL, MOTEL, RESTAURANT, BAR AND CATERING SERVICES; HOTEL, RESTAURANT AND BAR SERVICES; HOTEL, RESTAURANT AND CATERING SERVICES; HOTELS; PROVIDING HOTEL ACCOMMODATION; RESERVATION OF HOTEL ROOMS FOR TRAVELLERS; RESORT HOTELS; RESORT LODGING SERVICES, IN CLASS 43 (U.S. CLS. 100 AND 101).

FIRST USE 2-0-2011; IN COMMERCE 2-0-2011.

OWNER OF U.S. REG. NO. 3,592,811.

NO CLAIM IS MADE TO THE EXCLUSIVE RIGHT TO USE "WORLD RESORTS", APART FROM THE MARK AS SHOWN.

THE MARK CONSISTS OF THE STYLIZED WORDS "WINSTAR WORLD RESORTS" WITH A STAR AT THE TIP OF THE "W" IN "WINSTAR" AND A CAPITALIZED, CURVED "S" IN "WINSTAR", AND WITH A CURVED LINE SEPARATING THE WORD "WINSTAR" FROM THE REST OF THE MARK.

SER. NO. 85-374,222, FILED 7-18-2011.

KATHLEEN M. VANSTON, EXAMINING ATTORNEY



David J. Kybas

Director of the United States Patent and Trademark Office

United States of America

United States Patent and Trademark Office



Reg. No. 4,067,318

Registered Dec. 6, 2011

Int. Cl.: 25

TRADEMARK

PRINCIPAL REGISTER

HOANG, REMI (UNITED STATES INDIVIDUAL)
311 N. ROBERTSON BLVD #705
BEVERLY HILLS, CA 90211

FOR: MEN'S AND WOMEN'S CLOTHING, NAMELY, FORMAL WEAR, NAMELY, TUXEDOS, SUITS, JACKETS, PANTS, DRESSES, EVENING GOWNS, SHIRTS, VESTS, FORMAL ACCESSORIES, NAMELY, TIES, BOW TIES AND SCARVES, IN CLASS 25 (U.S. CLS. 22 AND 39).

FIRST USE 6-1-1999; IN COMMERCE 6-1-1999.

NO CLAIM IS MADE TO THE EXCLUSIVE RIGHT TO USE "BEVERLY HILLS", APART FROM THE MARK AS SHOWN.

THE MARK CONSISTS OF "REMI H BEVERLY HILLS" IN A STYLIZED FONT.

SER. NO. 85-380,267, FILED 7-25-2011.

JOHN HWANG, EXAMINING ATTORNEY



David J. Kyros

Director of the United States Patent and Trademark Office

United States of America

United States Patent and Trademark Office



Reg. No. 4,067,319

Registered Dec. 6, 2011

Int. Cl.: 11

TRADEMARK

PRINCIPAL REGISTER

POWERTECH, INC (TENNESSEE CORPORATION)
360 EAST SOUTH STREET
COLLIERVILLE, TN 38017

FOR: FLASHLIGHT HOLDERS; FLASHLIGHT POINTERS; FLASHLIGHTS; RED LED FLASHLIGHTS FOR ILLUMINATION PURPOSES; TACTICAL FLASHLIGHTS, IN CLASS 11 (U.S. CLS. 13, 21, 23, 31 AND 34).

FIRST USE 0-0-2010; IN COMMERCE 1-10-2011.

OWNER OF U.S. REG. NO. 3,062,944.

THE COLOR(S) RED, BLUE, SILVER, AND WHITE IS/ARE CLAIMED AS A FEATURE OF THE MARK.

THE MARK CONSISTS OF "DELTA2" IN WHITE ON TOP OF A RED BACKGROUND WITH A SILVER UPPER AND LOWER BORDER AND A LARGER BLUE UPPER AND LOWER BORDER. THE COLOR BLUE ALSO APPEARS AS A SHADOW ON THE NUMBER "2".

SER. NO. 85-380,341, FILED 7-25-2011.

MARK SHINER, EXAMINING ATTORNEY



David J. Kyffers

Director of the United States Patent and Trademark Office

United States of America

United States Patent and Trademark Office

ADVANTIX

Reg. No. 4,067,320

Registered Dec. 6, 2011

Int. Cl.: 11

TRADEMARK

PRINCIPAL REGISTER

DUCOOL, USA, INC. (DELAWARE CORPORATION)
19591 NE 10TH AVE. BAY D
NORTH MIAMI BEACH, FL 33179

FOR: AIR CONDITIONERS; ELECTRIC, THERMAL, AND RENEWABLE -ENERGY POWERED SPACE COOLING APPARATUS AND INSTRUMENTS; AIR-CONDITIONING, AIR COOLING AND VENTILATION APPARATUS AND INSTRUMENTS; DEHUMIDIFIERS; EQUIPMENT FOR WATER CONDENSATION AND EXTRACTION FROM AIR AND WATER DESALINATION, NAMELY, DEHUMIDIFIERS; DEHUMIDIFICATION SYSTEMS COMPRISING DEHUMIDIFIERS, COMPRESSORS FOR DEHUMIDIFIERS, METERING DEVICES FOR MEASURING FLUID LEVELS IN DEHUMIDIFIERS, HEAT EXCHANGERS FOR DEHUMIDIFIERS, SOLENOIDS, AIR DRIERS, HUMIDITY GAUGES, PRESSURE TRANSDUCERS, DEHUMIDIFIER VALVES, HEAT ACCUMULATORS, COOLING AND HEATING COILS, WATER PUMPS, WATER STRAINERS FOR DEHUMIDIFIERS, AIR FILTERS, RUBBER HOSES FOR DEHUMIDIFIERS, CLAMPS FOR DEHUMIDIFIER HOSES, LIQUID GATEWAYS BEING ORIFICES FOR NATURAL DIFFUSION PROCESS, MANIFOLDS BEING PARTS FOR DEHUMIDIFIERS, HONEYCOMB ABSORPTION MEDIA FOR DEHUMIDIFIERS, DIGITAL CONTROLLERS AND DISPLAYS FOR DEHUMIDIFIERS, DEHUMIDIFIER SWITCHES, ELECTRICAL SENSORS, ELECTRICAL ENCLOSURES FOR DEHUMIDIFIERS, CIRCUIT BREAKERS, ELECTRICAL OVERLOAD CONTROLS, ELECTRIC CONTACTORS, ELECTRIC RELAYS, HUMIDITY MONITORING DEVICES, ELECTRICAL FUSES, POWER SUPPLIES, DEHUMIDIFIER FANS AND MOTORS FOR DEHUMIDIFIERS, SOLD AS A UNIT, IN CLASS 11 (U.S. CLS. 13, 21, 23, 31 AND 34).

FIRST USE 2-28-2011; IN COMMERCE 2-28-2011.

THE MARK CONSISTS OF STANDARD CHARACTERS WITHOUT CLAIM TO ANY PARTICULAR FONT, STYLE, SIZE, OR COLOR.

SER. NO. 85-975,139, FILED 7-6-2010.

KATHY DE JONGE, EXAMINING ATTORNEY



David J. Kyros

Director of the United States Patent and Trademark Office

United States of America

United States Patent and Trademark Office

TOPSERIES AVANT

Reg. No. 4,067,321

Registered Dec. 6, 2011

Int. Cl.: 38

SERVICE MARK

PRINCIPAL REGISTER

THALES AVIONICS, INC. (DELAWARE CORPORATION)
58 DISCOVERY
IRVINE, CA 92618

FOR: DIGITAL MULTIMEDIA SERVICES FOR IN-FLIGHT PASSENGER ENTERTAINMENT AND AIRLINE OPERATIONS, NAMELY, COMMUNICATIONS AND EMAIL/INTERNET CONNECTIONS, IN CLASS 38 (U.S. CLS. 100, 101 AND 104).

FIRST USE 5-2-2011; IN COMMERCE 5-2-2011.

THE MARK CONSISTS OF STANDARD CHARACTERS WITHOUT CLAIM TO ANY PARTICULAR FONT, STYLE, SIZE, OR COLOR.

OWNER OF U.S. REG. NO. 2,916,271.

THE ENGLISH TRANSLATION OF "AVANT" IN THE MARK IS "FRONT".

SER. NO. 85-975,271, FILED 4-25-2011.

NAAKWAMA ANKRAH, EXAMINING ATTORNEY



David J. Kyfos

Director of the United States Patent and Trademark Office

United States of America

United States Patent and Trademark Office

HARRIS FLUX

Reg. No. 4,067,322

Registered Dec. 6, 2011

Int. Cl.: 6

TRADEMARK

PRINCIPAL REGISTER

J.W. HARRIS CO., INC. (OHIO CORPORATION)
4501 QUALITY PLACE
MASON, OH 45040

FOR: METAL ALLOYS FOR USE IN WELDING; BRAZING ALLOYS; BRAZING RODS; WELDING CONSUMABLES, NAMELY, METAL ALLOYS, METAL RODS, WIRE, AND HARD AND SOFT SOLDER, IN CLASS 6 (U.S. CLS. 2, 12, 13, 14, 23, 25 AND 50).

FIRST USE 10-27-2010; IN COMMERCE 10-27-2010.

THE MARK CONSISTS OF STANDARD CHARACTERS WITHOUT CLAIM TO ANY PARTICULAR FONT, STYLE, SIZE, OR COLOR.

OWNER OF U.S. REG. NOS. 913,433, 1,450,474 AND OTHERS.

NO CLAIM IS MADE TO THE EXCLUSIVE RIGHT TO USE "FLUX", APART FROM THE MARK AS SHOWN.

SER. NO. 85-975,851, FILED 10-27-2010.

DEIRDRE ROBERTSON, EXAMINING ATTORNEY



David J. Kybas

Director of the United States Patent and Trademark Office

United States of America

United States Patent and Trademark Office

Details for Men

Reg. No. 4,067,323

Registered Dec. 6, 2011

Int. Cl.: 35

SERVICE MARK

PRINCIPAL REGISTER

EAST END SALES & MARKETING INCORPORATED (NEW YORK CORPORATION)
57 BAUER AVENUE
MANORVILLE, NY 11949

FOR: ONLINE RETAIL STORE SERVICES IN THE FIELD OF COSMETICS, GROOMING, BEAUTY, SHAVING PRODUCTS, BODY CARE PRODUCTS, DENTAL AND ORAL CARE PRODUCTS, SUN PRODUCTS, SKIN AND HAIR CARE PRODUCTS AND RELATED GIFTS FOR MEN; PROVIDING CONSUMER INFORMATION IN THE FIELD OF COSMETICS, BEAUTY, SKIN AND HAIR CARE PRODUCTS, FITNESS, HEALTH, WELLNESS AND GROOMING FOR MEN, IN CLASS 35 (U.S. CLS. 100, 101 AND 102).

FIRST USE 7-0-2006; IN COMMERCE 7-0-2006.

THE MARK CONSISTS OF STANDARD CHARACTERS WITHOUT CLAIM TO ANY PARTICULAR FONT, STYLE, SIZE, OR COLOR.

NO CLAIM IS MADE TO THE EXCLUSIVE RIGHT TO USE "FOR MEN", APART FROM THE MARK AS SHOWN.

SER. NO. 85-975,890, FILED 10-6-2010.

JIM RINGLE, EXAMINING ATTORNEY



David J. Kybas

Director of the United States Patent and Trademark Office

United States of America

United States Patent and Trademark Office

SMaRT

Reg. No. 4,067,324

Registered Dec. 6, 2011

Int. Cls.: 1, 5, 42, and 44

TRADEMARK

SERVICE MARK

PRINCIPAL REGISTER

VIRXSYS CORPORATION (DELAWARE CORPORATION)
200 PERRY PARKWAY, SUITE A
GAITHERSBURG, MD 20877

FOR: BIOCHEMICALS USED IN THE SCIENCE AND TECHNOLOGY INDUSTRY, NAMELY, PRECURSORS FOR IN VITRO GENETIC ENGINEERING USE, PRECURSORS USED FOR CREATING GENETICALLY ENGINEERED PLANTS, PRECURSORS USED FOR CREATING GENERICALLY ENGINEERED AGRICULTURAL CROPS, AND PRECURSORS USED AS DIAGNOSTIC PREPARATIONS AND REAGENTS FOR SCIENTIFIC OR RESEARCH USE; REAGENTS FOR SCIENTIFIC OR MEDICAL RESEARCH USE; KITS CONSISTING PRIMARILY OF RNA MOLECULES, PRE-TRANS-SPLICING MOLECULES, CULTURED CELLS AND MOLECULAR PROBES, FOR RESEARCH IN LABORATORIES, NAMELY, BIOTECHNOLOGY RELATED RESEARCH AND GENETIC ENGINEERING RESEARCH, IN CLASS 1 (U.S. CLS. 1, 5, 6, 10, 26 AND 46).

FIRST USE 10-19-2010; IN COMMERCE 10-19-2010.

FOR: PHARMACEUTICAL PREPARATIONS FOR MEDICAL USES, NAMELY, FOR THE TREATMENT OF GENETIC DISEASES, CANCER, AND INFECTIONS WITH PATHOGENIC ORGANISMS; REAGENTS FOR MEDICAL DIAGNOSTICS; VACCINES FOR THE TREATMENT OF BOTH ANIMAL AND HUMAN DISEASES INCLUDING BACTERIAL AND VIRAL DISEASES; BIOCHEMICALS FOR USE IN THE TREATMENT OF CARDIOVASCULAR DISEASE, HEMOPHILIA, CANCER, AND DISEASES LINKED TO OR CAUSED BY ONE OR MORE GENES; KITS FOR DIAGNOSING PATHOLOGICAL OR GENETIC DISORDERS CONSISTING PRIMARILY OF ONE OR MORE OF THE FOLLOWING - PRE-TRANS-SPLICING MOLECULES PLASMID DNA; LENTIVIRAL VECTOR CONTAINING PRE-TRANS-SPLICING MOLECULES; PRE-TRANS-SPLICING MOLECULES WITH FLUORESCENT DYES ATTACHED; BUFFER FOR THE REACTIONS; MOLECULAR BIOLOGY REAGENTS; GENES WITHIN PRE-TRANS-SPLICING MOLECULES FOR FLUORESCENT PROBES, IN CLASS 5 (U.S. CLS. 6, 18, 44, 46, 51 AND 52).

FIRST USE 10-19-2010; IN COMMERCE 10-19-2010.

FOR: SCIENTIFIC RESEARCH AND PRODUCT RESEARCH, NAMELY, RESEARCH ON GENOMES, IN CLASS 42 (U.S. CLS. 100 AND 101).

FIRST USE 10-11-2010; IN COMMERCE 10-11-2010.



David J. Kyjars

Director of the United States Patent and Trademark Office

Reg. No. 4,067,324 FOR: MEDICAL SERVICES AND MEDICAL TESTING, NAMELY, DIAGNOSTICS AND PROGNOSTICS; AGRICULTURAL ADVICE, IN CLASS 44 (U.S. CLS. 100 AND 101).

FIRST USE 10-11-2010; IN COMMERCE 10-11-2010.

SN 76-476,554, FILED 12-18-2002.

MICHAEL SOUDERS, EXAMINING ATTORNEY

United States of America

United States Patent and Trademark Office

BRAINFUEL

Reg. No. 4,067,325

THE LEARNING ANNEX, L.P. (DELAWARE LIMITED PARTNERSHIP)
443 PARK AVENUE SOUTH, SUITE 501
NEW YORK, NY 10016

Registered Dec. 6, 2011

Int. Cl.: 5

FOR: DIETARY SUPPLEMENT TO ENHANCE MENTAL PERFORMANCE, IN CLASS 5 (U.S. CLS. 6, 18, 44, 46, 51 AND 52).

TRADEMARK

FIRST USE 8-31-2011; IN COMMERCE 8-31-2011.

PRINCIPAL REGISTER

SN 76-515,898, FILED 5-21-2003.

NAKIA HENRY, EXAMINING ATTORNEY



David J. Kyffers

Director of the United States Patent and Trademark Office

United States of America

United States Patent and Trademark Office

IMID

Reg. No. 4,067,326

Registered Dec. 6, 2011

Int. Cl.: 41

SERVICE MARK

PRINCIPAL REGISTER

IMAGEMOVERS DIGITAL, LLC (DELAWARE LIMITED LIABILITY COMPANY)
500 SOUTH BUENA VISTA STREET
BURBANK, CA 91521

FOR: ENTERTAINMENT SERVICES, NAMELY, DISTRIBUTION, OF MOTION PICTURE FILMS; PROVIDING ENTERTAINMENT SERVICES VIA A GLOBAL COMMUNICATION NETWORK IN THE NATURE OF WEBSITES FEATURING A WIDE VARIETY OF GENERAL INTEREST ENTERTAINMENT INFORMATION RELATING TO MOTION PICTURE FILMS, RELATED FILM CLIPS, PHOTOGRAPHS, AND OTHER MULTIMEDIA MATERIALS, IN CLASS 41 (U.S. CLS. 100, 101 AND 107).

FIRST USE 11-6-2009; IN COMMERCE 11-6-2009.

THE MARK CONSISTS OF STANDARD CHARACTERS WITHOUT CLAIM TO ANY PARTICULAR FONT, STYLE, SIZE, OR COLOR.

SN 76-680,994, FILED 8-22-2007.

KATHRYN COWARD, EXAMINING ATTORNEY



David J. Kyffers

Director of the United States Patent and Trademark Office

United States of America

United States Patent and Trademark Office

GREAT GIFTS MADE SIMPLE

Reg. No. 4,067,327

Registered Dec. 6, 2011

Int. Cl.: 35

SERVICE MARK

PRINCIPAL REGISTER

BLACKHAWK NETWORK, INC. (ARIZONA CORPORATION)
5918 STONERIDGE MALL ROAD
PLEASANTON, CA 94588

FOR: DISSEMINATION OF ADVERTISING MATERIALS, NAMELY, NEWSLETTERS, PAMPHLETS, BROCHURES, PRESS RELEASES AND BULLETINS, DISSEMINATED THROUGH ALL PUBLIC COMMUNICATION MEANS; DISSEMINATION OF ADVERTISING FOR OTHERS VIA AN ON-LINE COMMUNICATIONS NETWORK ON THE INTERNET; PREPARATION OF ADVERTISING MATERIALS, NAMELY, NEWSLETTERS, PAMPHLETS, BROCHURES, PRESS RELEASES AND BULLETINS; SERVICES RELATING TO THE CREATION AND BRAND ESTABLISHMENT OF DOMAIN NAMES; RETAIL STORE SERVICES FEATURING GIFT CARDS, INCENTIVE CARDS; PRODUCT MERCHANDISING, NAMELY, MERCHANDISING OF GIFT CARDS, INCENTIVE CARDS; ON-LINE RETAIL STORE SERVICES FEATURING GIFT CARDS, INCENTIVE CARDS, AND PROMOTING THE GIFT CARDS, INCENTIVE CARDS, THROUGH THE DISTRIBUTION OF PRINTED MATERIALS AND PROMOTIONAL CONTESTS, IN CLASS 35 (U.S. CLS. 100, 101 AND 102).

FIRST USE 5-0-2007; IN COMMERCE 5-0-2007.

THE MARK CONSISTS OF STANDARD CHARACTERS WITHOUT CLAIM TO ANY PARTICULAR FONT, STYLE, SIZE, OR COLOR.

NO CLAIM IS MADE TO THE EXCLUSIVE RIGHT TO USE "GIFTS", APART FROM THE MARK AS SHOWN.

SN 76-681,073, FILED 8-22-2007.

WENDY JUN, EXAMINING ATTORNEY



David J. Kyffers

Director of the United States Patent and Trademark Office

United States of America

United States Patent and Trademark Office

M-SONIC

Reg. No. 4,067,328

Registered Dec. 6, 2011

Int. Cl.: 9

TRADEMARK

PRINCIPAL REGISTER

KBC AMERICA, INC. (CALIFORNIA CORPORATION)
2830 N. ONTARIO STREET
BURBANK, CA 91504

FOR: WIRELESS COMMUNICATION SYSTEM FOR CYCLISTS COMPRISED OF HEADSETS, MICROPHONES, EARPHONES, CONTROL KEYS, ADAPTORS FOR THE WIRELESS DEVICES OF OTHERS THAT USE WIRELESS PROTOCOL FOR EXCHANGING DATA OVER SHORT DISTANCES FROM FIXED AND MOBILE DEVICES, DC CHARGE ADAPTORS AND BATTERIES ADAPTORS, IN CLASS 9 (U.S. CLS. 21, 23, 26, 36 AND 38).

FIRST USE 4-1-2011; IN COMMERCE 4-1-2011.

THE MARK CONSISTS OF STANDARD CHARACTERS WITHOUT CLAIM TO ANY PARTICULAR FONT, STYLE, SIZE, OR COLOR.

SN 76-692,029, FILED 8-12-2008.

JILL C. ALT, EXAMINING ATTORNEY



David J. Kyros

Director of the United States Patent and Trademark Office

United States of America

United States Patent and Trademark Office

FLIP DUNK

Reg. No. 4,067,329

WOOLF, BOB (UNITED STATES INDIVIDUAL)
9253 N 24TH WAY
PHOENIX, AZ 85028

Registered Dec. 6, 2011

Int. Cl.: 41

FOR: FAMILY FITNESS, TRAINING AND EXERCISE FACILITIES, IN CLASS 41 (U.S. CLS. 100, 101 AND 107).

SERVICE MARK

FIRST USE 10-15-2011; IN COMMERCE 10-15-2011.

PRINCIPAL REGISTER

THE MARK CONSISTS OF STANDARD CHARACTERS WITHOUT CLAIM TO ANY PARTICULAR FONT, STYLE, SIZE, OR COLOR.

SN 76-692,642, FILED 9-9-2008.

TASNEEM HUSSAIN, EXAMINING ATTORNEY



David J. Kyffers

Director of the United States Patent and Trademark Office

United States of America

United States Patent and Trademark Office

STARWAGON ENTERTAINMENT

Reg. No. 4,067,330

Registered Dec. 6, 2011

Int. Cls.: 35 and 41

SERVICE MARK

PRINCIPAL REGISTER

STARWAGON ENTERTAINMENT, LP (TEXAS LIMITED PARTNERSHIP)
2100 MCKINNEY AVE.
DALLAS, TX 75201

FOR: BUSINESS MANAGEMENT AND CONSULTATION IN THE FIELD OF MUSIC;
MANAGEMENT OF PERFORMING ARTISTS, IN CLASS 35 (U.S. CLS. 100, 101 AND 102).

FIRST USE 8-17-2011; IN COMMERCE 8-17-2011.

FOR: MUSICAL SOUND RECORDING AND PRODUCTION SERVICES; PRODUCTION OF
MUSICAL SOUND RECORDINGS ON AUDIO TAPES AND COMPACT DISCS; ENTERTAIN-
MENT SERVICES, NAMELY, PRODUCTION OF VIDEO AND AUDIO RECORDINGS FEAT-
URING MUSIC AND ENTERTAINMENT; MUSIC PUBLISHING SERVICES; COMPOSITION
OF MUSIC FOR OTHERS, IN CLASS 41 (U.S. CLS. 100, 101 AND 107).

FIRST USE 8-17-2011; IN COMMERCE 8-17-2011.

THE MARK CONSISTS OF STANDARD CHARACTERS WITHOUT CLAIM TO ANY PAR-
TICULAR FONT, STYLE, SIZE, OR COLOR.

NO CLAIM IS MADE TO THE EXCLUSIVE RIGHT TO USE "ENTERTAINMENT", APART
FROM THE MARK AS SHOWN.

SN 76-697,895, FILED 6-15-2009.

KAREN BRACEY, EXAMINING ATTORNEY



David J. Kybas

Director of the United States Patent and Trademark Office

United States of America

United States Patent and Trademark Office

HEMI-SYNC.COM

Reg. No. 4,067,331

Registered Dec. 6, 2011

Int. Cl.: 16

TRADEMARK

PRINCIPAL REGISTER

INTERSTATE INDUSTRIES, INC. (VIRGINIA CORPORATION)
PO BOX 505
LOVINGSTON, VA 229490505

FOR: PRINTED PUBLICATIONS, NAMELY, CATALOGS IN THE AREA OF MENTAL
CONDITIONING AND RELAXATION TECHNIQUES, IN CLASS 16 (U.S. CLS. 2, 5, 22, 23,
29, 37, 38 AND 50).

FIRST USE 4-1-2010; IN COMMERCE 4-1-2010.

THE MARK CONSISTS OF STANDARD CHARACTERS WITHOUT CLAIM TO ANY PAR-
TICULAR FONT, STYLE, SIZE, OR COLOR.

OWNER OF U.S. REG. NOS. 1,276,849, 3,015,866, AND OTHERS.

SN 76-698,721, FILED 7-31-2009.

MARLENE BELL, EXAMINING ATTORNEY



David J. Kyffers

Director of the United States Patent and Trademark Office

United States of America

United States Patent and Trademark Office

SCHOOL ZONE

Reg. No. 4,067,332

Registered Dec. 6, 2011

Int. Cl.: 25

TRADEMARK

PRINCIPAL REGISTER

ARMOUTH INTERNATIONAL INC. (NEW YORK CORPORATION)
18 WEST 33RD STREET
NEW YORK, NY 10001

FOR: CLOTHING, NAMELY, SCHOOL UNIFORMS, SHIRTS, BLOUSES, PANTS, SKIRTS, SOCKS, JACKETS, SWEATERS, SHORTS AND FOOTWEAR, IN CLASS 25 (U.S. CLS. 22 AND 39).

FIRST USE 4-0-2010; IN COMMERCE 4-0-2010.

THE MARK CONSISTS OF STANDARD CHARACTERS WITHOUT CLAIM TO ANY PARTICULAR FONT, STYLE, SIZE, OR COLOR.

NO CLAIM IS MADE TO THE EXCLUSIVE RIGHT TO USE "SCHOOL", APART FROM THE MARK AS SHOWN.

SN 76-699,181, FILED 8-26-2009.

PAUL F. GAST, EXAMINING ATTORNEY



David J. Kyffers

Director of the United States Patent and Trademark Office

United States of America

United States Patent and Trademark Office

REBECCA CREEK

Reg. No. 4,067,333

REBECCA CREEK DISTILLERY, LLC, (TEXAS LIMITED LIABILITY CORPORATION)
1383 E. BITTERS ROAD #1
SAN ANTONIO, TX 78216

Registered Dec. 6, 2011

Int. Cl.: 33

FOR: ALCOHOLIC BEVERAGES, NAMELY, WHISKEY, IN CLASS 33 (U.S. CLS. 47 AND 49).

TRADEMARK

FIRST USE 10-13-2011; IN COMMERCE 10-13-2011.

PRINCIPAL REGISTER

THE MARK CONSISTS OF STANDARD CHARACTERS WITHOUT CLAIM TO ANY PARTICULAR FONT, STYLE, SIZE, OR COLOR.

SN 76-699,877, FILED 10-15-2009.

JULIE WATSON, EXAMINING ATTORNEY



David J. Kybas

Director of the United States Patent and Trademark Office

United States of America

United States Patent and Trademark Office

CLICK N' CHARGE

Reg. No. 4,067,334

Registered Dec. 6, 2011

Int. Cl.: 9

TRADEMARK

PRINCIPAL REGISTER

PREMIER ACCESSORY GROUP, INC (NEW YORK CORPORATION)
11-11 44TH DRIVE
LONG ISLAND CITY, NY 11101

FOR: BATTERY CHARGERS FOR CELL PHONES AND HAND HELD COMPUTERS; BATTERY CHARGER BUILT INTO A CASE OR HOLSTER; CASES AND HOLDERS IN THE NATURE OF SPECIALTY HOLSTERS FOR CARRYING AND CHARGING CELL PHONES; BATTERIES; AND HANDS FREE DEVICES FOR MOBILE-PHONES, IN CLASS 9 (U.S. CLS. 21, 23, 26, 36 AND 38).

FIRST USE 10-12-2011; IN COMMERCE 10-12-2011.

THE MARK CONSISTS OF STANDARD CHARACTERS WITHOUT CLAIM TO ANY PARTICULAR FONT, STYLE, SIZE, OR COLOR.

NO CLAIM IS MADE TO THE EXCLUSIVE RIGHT TO USE "AND CHARGE", APART FROM THE MARK AS SHOWN.

SN 76-701,677, FILED 2-18-2010.

GINA FINK, EXAMINING ATTORNEY



David J. Kyffers

Director of the United States Patent and Trademark Office

United States of America

United States Patent and Trademark Office

DROP N' CHARGE

Reg. No. 4,067,335

Registered Dec. 6, 2011

Int. Cl.: 9

TRADEMARK

PRINCIPAL REGISTER

PREMIER ACCESSORY GROUP, INC (NEW YORK CORPORATION)
11-11 44TH DRIVE
LONG ISLAND CITY, NY 11101

FOR: BATTERY CHARGERS FOR CELL PHONES AND HAND HELD COMPUTERS; BATTERY CHARGER BUILT INTO A CASE OR HOLSTER; CASES AND HOLDERS IN THE NATURE OF SPECIALTY HOLSTERS FOR CARRYING AND CHARGING CELL PHONES; BATTERIES; AND HANDS FREE DEVICES FOR MOBILE-PHONES, IN CLASS 9 (U.S. CLS. 21, 23, 26, 36 AND 38).

FIRST USE 10-12-2011; IN COMMERCE 10-12-2011.

THE MARK CONSISTS OF STANDARD CHARACTERS WITHOUT CLAIM TO ANY PARTICULAR FONT, STYLE, SIZE, OR COLOR.

NO CLAIM IS MADE TO THE EXCLUSIVE RIGHT TO USE "AND CHARGE", APART FROM THE MARK AS SHOWN.

SN 76-701,727, FILED 2-22-2010.

GINA FINK, EXAMINING ATTORNEY



David J. Kyffers

Director of the United States Patent and Trademark Office

United States of America

United States Patent and Trademark Office

PUT A LITTLE MAGIC IN YOUR GAME

Reg. No. 4,067,336

Registered Dec. 6, 2011

Int. Cl.: 25

TRADEMARK

PRINCIPAL REGISTER

COLEMAN, RICHARD W. (UNITED STATES INDIVIDUAL)
303 MAIN STREET
COTUIT, MA 02655

FOR: SHIRTS, HATS, T-SHIRTS, TIES, SHORTS, PANTS AND OUTERWEAR, NAMELY, SWEATERS AND SWEATSHIRTS, IN CLASS 25 (U.S. CLS. 22 AND 39).

FIRST USE 8-1-2011; IN COMMERCE 8-1-2011.

THE MARK CONSISTS OF STANDARD CHARACTERS WITHOUT CLAIM TO ANY PARTICULAR FONT, STYLE, SIZE, OR COLOR.

SN 76-701,790, FILED 2-24-2010.

ROBIN CHOSID, EXAMINING ATTORNEY



David J. Kybas

Director of the United States Patent and Trademark Office

United States of America

United States Patent and Trademark Office

LAMBDA DRIVER

Reg. No. 4,067,337

Registered Dec. 6, 2011

Int. Cl.: 9

TRADEMARK

PRINCIPAL REGISTER

MRV COMMUNICATIONS, INC. (DELAWARE CORPORATION)
20415 NORDHOFF STREET
CHATSWORTH, CA 91311

FOR: COMPUTER TELECOMMUNICATIONS AND NETWORKING EQUIPMENT, NAMELY, CONVERTERS, NETWORK ROUTERS, COMPUTER NETWORK SWITCHES, COARSE WAVE DIVISION MULTIPLEXER MODULES, AND TIME DIVISION MULTIPLEXER MODULES SOLD SEPARATELY AND IN COMBINATION UNITS, FOR LOCAL, ACCESS, WIDE, AND METROPOLITAN AREA NETWORKS, ALL FOR USE IN PROVIDING SERVICES AND MANAGEMENT WITH RESPECT TO COMMUNICATIONS AND NETWORKING EQUIPMENT IN THE DATA TRANSMISSION AND TELECOMMUNICATIONS INDUSTRY, IN CLASS 9 (U.S. CLS. 21, 23, 26, 36 AND 38).

FIRST USE 10-1-2005; IN COMMERCE 10-1-2005.

THE MARK CONSISTS OF STANDARD CHARACTERS WITHOUT CLAIM TO ANY PARTICULAR FONT, STYLE, SIZE, OR COLOR.

SN 76-702,016, FILED 3-11-2010.

CARYN GLASSER, EXAMINING ATTORNEY



David J. Kyffers

Director of the United States Patent and Trademark Office

United States of America

United States Patent and Trademark Office

NASHVILLE'S NEXT BIG TWANG

Reg. No. 4,067,338

Registered Dec. 6, 2011

Int. Cl.: 41

SERVICE MARK

PRINCIPAL REGISTER

VISION MUSIC, INC. (TENNESSEE CORPORATION)
5361 STEWARTS FERRY PIKE
MOUNT JULIET, TN 37122

FOR: ORGANIZING CONCERTS FEATURING LIVE MUSICAL PERFORMANCES; ARRANGING OF TALENT CONTESTS, IN CLASS 41 (U.S. CLS. 100, 101 AND 107).

FIRST USE 3-31-2011; IN COMMERCE 3-31-2011.

THE MARK CONSISTS OF STANDARD CHARACTERS WITHOUT CLAIM TO ANY PARTICULAR FONT, STYLE, SIZE, OR COLOR.

NO CLAIM IS MADE TO THE EXCLUSIVE RIGHT TO USE "NASHVILLE'S", APART FROM THE MARK AS SHOWN.

SN 76-702,238, FILED 3-26-2010.

BARBARA RUTLAND, EXAMINING ATTORNEY



David J. Kybas

Director of the United States Patent and Trademark Office

United States of America

United States Patent and Trademark Office

PAM AND ALICE RULE OF THUMB

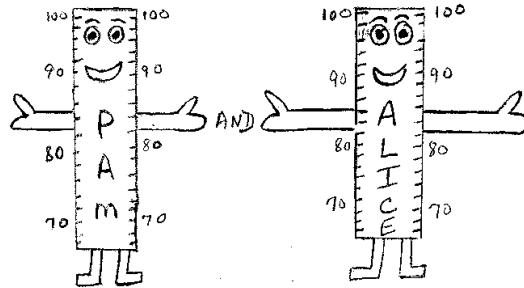

Reg. No. 4,067,339

Registered Dec. 6, 2011

Int. Cl.: 16

TRADEMARK

PRINCIPAL REGISTER

PAUL, DWAIN CHARLES (UNITED STATES INDIVIDUAL)
424 LEVER ROAD
MORGAN CITY, LA 70380

FOR: TEXTBOOKS, FLYERS, PAMPHLETS AND BOOKS ALL IN THE FIELD OF EDUCATION AND STUDENT RESOURCES, IN CLASS 16 (U.S. CLS. 2, 5, 22, 23, 29, 37, 38 AND 50).

FIRST USE 2-2-2011; IN COMMERCE 2-2-2011.

SN 76-703,048, FILED 5-21-2010.

JACQUELINE A. LAVINE, EXAMINING ATTORNEY



David J. Kyffers

Director of the United States Patent and Trademark Office

United States of America

United States Patent and Trademark Office

RAUL PENARANDA

Reg. No. 4,067,340

Registered Dec. 6, 2011

Int. Cl.: 25

TRADEMARK

PRINCIPAL REGISTER

RAUL PENARANDA LLC (DELAWARE LIMITED LIABILITY COMPANY)
312 WEST 48TH STREET
NEW YORK, NY 10036

FOR: WOMEN'S TOPS; WOMEN'S SHIRTS; WOMEN'S SHORTS; WOMEN'S SKIRTS; WOMEN'S PANTS AND LEGGINGS; WOMEN'S EVENING GOWNS, IN CLASS 25 (U.S. CLS. 22 AND 39).

FIRST USE 12-0-2010; IN COMMERCE 12-0-2010.

THE MARK CONSISTS OF STANDARD CHARACTERS WITHOUT CLAIM TO ANY PARTICULAR FONT, STYLE, SIZE, OR COLOR.

THE NAME "RAUL PENARANDA" IDENTIFIES A LIVING INDIVIDUAL WHOSE CONSENT IS OF RECORD.

SN 76-703,144, FILED 5-27-2010.

ADA HAN, EXAMINING ATTORNEY



David J. Kyffers

Director of the United States Patent and Trademark Office

United States of America

United States Patent and Trademark Office



Reg. No. 4,067,341

Registered Dec. 6, 2011

Int. Cl.: 5

TRADEMARK

PRINCIPAL REGISTER

TRADCO, LTD. (GEORGIA CORPORATION)
4609 LEWIS ROAD
STONE MOUNTAIN, GA 30083

FOR: BAKERY GOODS WHICH ARE WHEAT AND GLUTEN FREE TO ACCOMMODATE SPECIAL MEDICAL AND HEALTH CONDITIONS, IN CLASS 5 (U.S. CLS. 6, 18, 44, 46, 51 AND 52).

FIRST USE 3-11-2011; IN COMMERCE 3-11-2011.

THE NAME IN THE MARK DOES NOT REFER TO ANY PARTICULAR LIVING INDIVIDUAL.

THE COLOR(S) BLACK, YELLOW, BLUE, AND RED IS/ARE CLAIMED AS A FEATURE OF THE MARK.

THE MARK CONSISTS OF THE WORDS "MINA'S PURELY DIVINE" IN BLACK AROUND CONCENTRIC TRIANGLES. THE INSIDE TRIANGLE IS RED, THE MIDDLE TRIANGLE IS BLUE AND THE OUTSIDE TRIANGLE IS YELLOW.

SN 76-704,034, FILED 8-6-2010.

PAUL F. GAST, EXAMINING ATTORNEY



David J. Kyffers

Director of the United States Patent and Trademark Office

United States of America

United States Patent and Trademark Office

SONARRAY

Reg. No. 4,067,342

Registered Dec. 6, 2011

Int. Cl.: 9

TRADEMARK

PRINCIPAL REGISTER

AMBISONIC SYSTEMS, LLC (ARIZONA LIMITED LIABILITY COMPANY)
1990 MCCULLOCH BLVD., STE. D 222
LAKE HAVASU CITY, AZ 86403

FOR: LOUDSPEAKERS AND AUDIO SYSTEMS COMPRISING OF FULL RANGE SPEAKERS,
SUB-WOOFERS AND AMPLIFIERS, IN CLASS 9 (U.S. CLS. 21, 23, 26, 36 AND 38).

FIRST USE 10-10-2011; IN COMMERCE 10-10-2011.

THE MARK CONSISTS OF STANDARD CHARACTERS WITHOUT CLAIM TO ANY PAR-
TICULAR FONT, STYLE, SIZE, OR COLOR.

SN 76-704,147, FILED 8-18-2010.

MATTHEW EINSTEIN, EXAMINING ATTORNEY



David J. Kybas

Director of the United States Patent and Trademark Office

United States of America

United States Patent and Trademark Office



Reg. No. 4,067,343

Registered Dec. 6, 2011

Int. Cls.: 40 and 42

SERVICE MARK

PRINCIPAL REGISTER

ASTUTEPACK, LLC (NEW HAMPSHIRE LIMITED LIABILITY COMPANY)
172 ELM STREET
GOFFSTOWN, NH 03045

FOR: MANUFACTURING SERVICES IN THE FIELD OF PAPERBOARD AND PLASTIC PACKAGING AND THERMOFORMED PARTS, IN CLASS 40 (U.S. CLS. 100, 103 AND 106).

FIRST USE 10-15-2011; IN COMMERCE 10-15-2011.

FOR: PACKAGING DESIGN SERVICES, IN CLASS 42 (U.S. CLS. 100 AND 101).

FIRST USE 10-15-2011; IN COMMERCE 10-15-2011.

THE MARK CONSISTS OF THE STYLIZED WORDING "ASTUTEPACK" PLACED IN THE CENTER OF A BOX VIEWED ISOMETRICALLY.

SN 76-704,286, FILED 8-27-2010.

JULIE GUTTADAURO, EXAMINING ATTORNEY



David J. Kybas

Director of the United States Patent and Trademark Office

United States of America

United States Patent and Trademark Office

BATHMARK

Reg. No. 4,067,344

Registered Dec. 6, 2011

Int. Cl.: 8

TRADEMARK

PRINCIPAL REGISTER

ACCESSORY ZONE L.L.C. (NEW YORK LIMITED LIABILITY COMPANY)
350 FIFTH AVENUE, 4TH FLOOR
NEW YORK, NY 10118

FOR: MANICURE IMPLEMENTS, NAMELY, NAIL FILES, NAIL CLIPPERS, CUTICLE
PUSHERS, TWEEZERS, NAIL AND CUTICLE SCISSORS AND MANICURE SETS; PEDICURE
IMPLEMENTS, NAMELY, NAIL FILES, NAIL CLIPPERS, CUTICLE PUSHERS, TWEEZERS,
NAIL AND PEDICURE SETS, IN CLASS 8 (U.S. CLS. 23, 28 AND 44).

FIRST USE 10-12-2011; IN COMMERCE 10-12-2011.

THE MARK CONSISTS OF STANDARD CHARACTERS WITHOUT CLAIM TO ANY PAR-
TICULAR FONT, STYLE, SIZE, OR COLOR.

OWNER OF U.S. REG. NOS. 2,871,282 AND 3,623,325.

SN 76-704,315, FILED 8-31-2010.

KATHERINE E. HALMEN, EXAMINING ATTORNEY



David J. Kyros

Director of the United States Patent and Trademark Office

United States of America

United States Patent and Trademark Office

Think Inside the Pizza Box

Reg. No. 4,067,345

Registered Dec. 6, 2011

Int. Cl.: 16

TRADEMARK

PRINCIPAL REGISTER

KTP HOLDING COMPANY, INC. (NEW JERSEY CORPORATION)
123 COLUMBIA TURNPIKE
SUITE 202A
FLORHAM PARK, NJ 07932

FOR: PIZZA BOXES OF CARDBOARD, PAPER NAPKINS, PAPER MENUS AND PAPER PLACE MATS, IN CLASS 16 (U.S. CLS. 2, 5, 22, 23, 29, 37, 38 AND 50).

FIRST USE 8-24-2011; IN COMMERCE 8-24-2011.

SN 76-704,411, FILED 9-8-2010.

DAVID HOFFMAN, EXAMINING ATTORNEY



David J. Kyffers

Director of the United States Patent and Trademark Office

United States of America

United States Patent and Trademark Office

VERBA HEALTHCARE PROMOTIONS PRINT. PROMOTE. GROW.

Reg. No. 4,067,346

Registered Dec. 6, 2011

Int. Cl.: 35

SERVICE MARK

PRINCIPAL REGISTER

VERBA HEALTHCARE PROMOTIONS, LLC (TEXAS LIMITED LIABILITY COMPANY)
2909 S.F. AUSTIN DRIVE
P.O. BOX 1314
BROWNWOOD, TX 76804

FOR: PROVIDING MARKETING AND PROMOTIONAL SERVICES FOR THE HEALTHCARE INDUSTRY AND DISTRIBUTION AND DISSEMINATION OF PRINTED ADVERTISING MATERIALS FOR OTHERS, IN CLASS 35 (U.S. CLS. 100, 101 AND 102).

FIRST USE 2-4-2011; IN COMMERCE 2-4-2011.

THE MARK CONSISTS OF STANDARD CHARACTERS WITHOUT CLAIM TO ANY PARTICULAR FONT, STYLE, SIZE, OR COLOR.

NO CLAIM IS MADE TO THE EXCLUSIVE RIGHT TO USE "HEALTHCARE PROMOTIONS PRINT. PROMOTE.", APART FROM THE MARK AS SHOWN.

SN 76-706,150, FILED 1-27-2011.

MAYUR VAGHANI, EXAMINING ATTORNEY



David J. Kyros

Director of the United States Patent and Trademark Office

United States of America

United States Patent and Trademark Office

VERBA HEALTHCARE PROMOTIONS

Reg. No. 4,067,347

Registered Dec. 6, 2011

Int. Cl.: 35

SERVICE MARK

PRINCIPAL REGISTER

VERBA HEALTHCARE PROMOTIONS, LLC (TEXAS LIMITED LIABILITY COMPANY)
2909 S.F. AUSTIN DRIVE
P.O. BOX 1314
BROWNWOOD, TX 76804

FOR: PROVIDING MARKETING AND PROMOTIONAL SERVICES FOR THE HEALTHCARE INDUSTRY AND DISTRIBUTION AND DISSEMINATION OF PRINTED ADVERTISING MATERIALS FOR OTHERS, IN CLASS 35 (U.S. CLS. 100, 101 AND 102).

FIRST USE 2-4-2011; IN COMMERCE 2-4-2011.

THE MARK CONSISTS OF STANDARD CHARACTERS WITHOUT CLAIM TO ANY PARTICULAR FONT, STYLE, SIZE, OR COLOR.

NO CLAIM IS MADE TO THE EXCLUSIVE RIGHT TO USE "HEALTHCARE PROMOTIONS", APART FROM THE MARK AS SHOWN.

SN 76-706,151, FILED 1-27-2011.

MAYUR VAGHANI, EXAMINING ATTORNEY



David J. Kyros

Director of the United States Patent and Trademark Office

United States of America

United States Patent and Trademark Office

FLEET START

Reg. No. 4,067,348

Registered Dec. 6, 2011

Int. Cl.: 9

TRADEMARK

PRINCIPAL REGISTER

GOODALL MFG. LLC (MINNESOTA LIMITED LIABILITY COMPANY)
7558 WASHINGTON AVENUE SOUTH
EDEN PRAIRIE, MN 55344

FOR: BATTERY PACK WITH CABLES FOR JUMPSTARTING VEHICLES WITH DIS-
CHARGED BATTERIES, IN CLASS 9 (U.S. CLS. 21, 23, 26, 36 AND 38).

FIRST USE 3-22-2011; IN COMMERCE 3-22-2011.

THE MARK CONSISTS OF STANDARD CHARACTERS WITHOUT CLAIM TO ANY PAR-
TICULAR FONT, STYLE, SIZE, OR COLOR.

NO CLAIM IS MADE TO THE EXCLUSIVE RIGHT TO USE "START", APART FROM THE
MARK AS SHOWN.

SN 76-706,340, FILED 2-8-2011.

MATTHEW EINSTEIN, EXAMINING ATTORNEY



David J. Kybas

Director of the United States Patent and Trademark Office

United States of America

United States Patent and Trademark Office

PSYBERIA

Reg. No. 4,067,349

Registered Dec. 6, 2011

Int. Cl.: 25

TRADEMARK

PRINCIPAL REGISTER

DJ NETWORKS INC. (NEW YORK CORPORATION)
853 BROADWAY
NEW YORK, NY 10003

FOR: CLOTHING, NAMELY, SHIRTS, PANTS, JEANS, UNDERWEAR AND BELTS; OUTERWEAR, NAMELY, JACKETS, AND RAINCOATS; FOOTWEAR, IN CLASS 25 (U.S. CLS. 22 AND 39).

FIRST USE 1-0-2011; IN COMMERCE 1-0-2011.

THE MARK CONSISTS OF STANDARD CHARACTERS WITHOUT CLAIM TO ANY PARTICULAR FONT, STYLE, SIZE, OR COLOR.

SN 76-979,179, FILED 10-4-2010.

KIM MONINGHOFF, EXAMINING ATTORNEY



David J. Kyffers

Director of the United States Patent and Trademark Office

United States of America

United States Patent and Trademark Office

INCHES OFF

Reg. No. 4,067,350

Registered Dec. 6, 2011

Int. Cl.: 25

TRADEMARK

PRINCIPAL REGISTER

SOLOW, NEIL DAVID (UNITED STATES INDIVIDUAL)
251 GEARY DRIVE
MIDDLETOWN, NJ 07748

FOR: CLOTHING, NAMELY, DRESSES, IN CLASS 25 (U.S. CLS. 22 AND 39).

FIRST USE 11-11-2010; IN COMMERCE 11-11-2010.

THE MARK CONSISTS OF STANDARD CHARACTERS WITHOUT CLAIM TO ANY PARTICULAR FONT, STYLE, SIZE, OR COLOR.

OWNER OF U.S. REG. NO. 1,542,619.

SN 76-979,186, FILED 8-20-2010.

KAREN SEVERSON, EXAMINING ATTORNEY



David J. Kybas

Director of the United States Patent and Trademark Office

United States of America

United States Patent and Trademark Office

CSA MEDICAL

Reg. No. 4,067,351

Registered Dec. 6, 2011

Int. Cls.: 9, 10, and 41

TRADEMARK

SERVICE MARK

PRINCIPAL REGISTER

CSA MEDICAL, INC. (MARYLAND CORPORATION)
1101 EAST 33RD STREET
BALTIMORE, MD 21218

FOR: VIDEO MONITORS, COMPUTERS FOR CONTROLLING CRYOTHERAPY AND CRYOSURGERY DEVICES AND CRYOTHERAPY DELIVERY SYSTEMS AND PRINTERS, IN CLASS 9 (U.S. CLS. 21, 23, 26, 36 AND 38).

FIRST USE 6-12-2006; IN COMMERCE 6-12-2006.

FOR: CRYOSURGICAL APPARATUS FOR USE IN PERFORMING ABLATIVE SURGERY; MEDICAL DEVICES, NAMELY, CRYOTHERAPY AND CRYOSURGICAL DEVICES, NAMELY, SURGICAL AND TREATMENT PROBES, CATHETERS, ENDOSCOPES, AND CONTROL SYSTEMS FOR SAID CRYOTHERAPY AND CRYOSURGICAL DEVICES, NAMELY, APPARATUSES FOR CONTROLLING THE FLOW OF CRYOGENS, BLEEDER AND PRESSURE REDUCTION VALVES FOR MAINTAINING PRESSURE IN CRYOTHERAPY AND CRYOSURGICAL DEVICES AND DELIVERY SYSTEMS, RIGID AND FLEXIBLE MEDICAL ENDOSCOPES, CATHETERS, LUMEN BLOCKING BALLOONS AND SHIELDS FOR GASTRIC BLOCKING, NASOGASTRIC TUBES, SUCTION DEVICES FOR CRYOGENS REMOVAL AND ENDOSCOPY CAMERAS; CRYOSURGICAL TOOLS OR UNITS USED TO DESTROY TISSUE DURING SURGICAL PROCEDURES, NAMELY, CATHETERS FOR THE INTRODUCTION OF A CRYOGEN TO A TARGET TISSUE; THERAPY AND SURGICAL DELIVERY SYSTEMS AND COMPONENTS THEREOF FOR DELIVERING CRYOGENS TO A PATIENT, NAMELY, SURGICAL AND TREATMENT PROBES, CATHETERS AND ENDOSCOPES; CRYOSURGICAL AND CRYOTHERAPY DEVICE CONTROL SYSTEMS, NAMELY, APPARATUSES FOR CONTROLLING THE FLOW OF CRYOGENS, BLEEDER AND PRESSURE REDUCTION VALVES FOR MAINTAINING PRESSURE IN CRYOTHERAPY AND CRYOSURGICAL DEVICES AND DELIVERY SYSTEMS, RIGID AND FLEXIBLE MEDICAL ENDOSCOPES, CATHETERS, LUMEN BLOCKING BALLOONS AND SHIELDS FOR GASTRIC BLOCKING, NASOGASTRIC TUBES, SUCTION DEVICES FOR CRYOGENS REMOVAL AND ENDOSCOPY CAMERAS; THERAPY AND SURGICAL DELIVERY SYSTEMS AND COMPONENTS THEREOF, NAMELY, APPARATUSES FOR CONTROLLING THE FLOW OF CRYOGENS, BLEEDER AND PRESSURE REDUCTION VALVES FOR MAINTAINING PRESSURE IN THE CRYOTHERAPY AND CRYOSURGICAL DEVICES AND DELIVERY SYSTEMS, RIGID AND FLEXIBLE MEDICAL ENDOSCOPES, CATHETERS, LUMEN BLOCKING BALLOONS AND SHIELDS FOR GASTRIC BLOCKING, NASOGASTRIC TUBES,



David J. Kyjars

Director of the United States Patent and Trademark Office

Reg. No. 4,067,351 SUCTION DEVICES FOR CRYOGENS REMOVAL, ENDOSCOPY CAMERAS, IN CLASS 10 (U.S. CLS. 26, 39 AND 44).

FIRST USE 6-12-2006; IN COMMERCE 6-12-2006.

FOR: TRAINING OF PHYSICIANS AND MEDICAL PERSONNEL IN THE USE OF CRYOTHERAPY AND CRYOSURGERY; TRAINING OF PHYSICIANS AND MEDICAL PERSONNEL IN THE USE OF CRYOTHERAPY AND CRYOSURGICAL EQUIPMENT, NAMELY, SURGICAL AND TREATMENT PROBES, CATHETERS AND ENDOSCOPES; TRAINING OF PHYSICIANS AND MEDICAL PERSONNEL IN THE USE OF CRYOSURGICAL AND CRYOTHERAPY DEVICE CONTROL SYSTEMS, NAMELY, APPARATUSES FOR CONTROLLING THE FLOW OF CRYOGENS, BLEEDER AND PRESSURE REDUCTION VALVES FOR MAINTAINING PRESSURE IN CRYOTHERAPY AND CRYOSURGICAL DEVICES AND DELIVERY SYSTEMS, RIGID AND FLEXIBLE MEDICAL ENDOSCOPES, CATHETERS, LUMEN BLOCKING BALLOONS AND SHIELDS FOR GASTRIC BLOCKING, NASOGASTRIC TUBES, SUCTION DEVICES FOR CRYOGENS REMOVAL AND ENDOSCOPY CAMERAS; TRAINING OF PHYSICIANS AND MEDICAL PERSONNEL IN THE USE OF THERAPY AND SURGICAL DELIVERY SYSTEMS FOR DELIVERING CRYOGENS, NAMELY, RIGID AND FLEXIBLE MEDICAL ENDOSCOPES, CATHETERS, LUMEN BLOCKING BALLOONS AND SHIELDS FOR GASTRIC BLOCKING, NASOGASTRIC TUBES, SUCTION DEVICES FOR CRYOGENS REMOVAL AND ENDOSCOPY CAMERAS; TRAINING OF PHYSICIANS AND MEDICAL PERSONNEL IN PERFORMING MEDICAL PROCEDURES INVOLVING CRYOTHERAPY AND CRYOSURGERY; AND TRAINING OF PHYSICIANS AND MEDICAL PERSONNEL IN PERFORMING MEDICAL PROCEDURES INVOLVING ABDOMINAL, BLADDER, PANCREATIC, KIDNEY, LUNG, STOMACH, ESOPHAGEAL AND UPPER AND LOWER GASTROINTESTINAL TISSUE IDENTIFICATION, SEPARATION, ABLATION OR ERADICATION, IN CLASS 41 (U.S. CLS. 100, 101 AND 107).

FIRST USE 6-12-2006; IN COMMERCE 6-12-2006.

THE MARK CONSISTS OF STANDARD CHARACTERS WITHOUT CLAIM TO ANY PARTICULAR FONT, STYLE, SIZE, OR COLOR.

NO CLAIM IS MADE TO THE EXCLUSIVE RIGHT TO USE "MEDICAL", APART FROM THE MARK AS SHOWN.

SN 77-018,420, FILED 10-11-2006.

RENEE SERVANCE, EXAMINING ATTORNEY

United States of America

United States Patent and Trademark Office



Reg. No. 4,067,352

Registered Dec. 6, 2011

Int. Cls.: 9 and 10

TRADEMARK

PRINCIPAL REGISTER

CSA MEDICAL, INC. (MARYLAND CORPORATION)
1101 EAST 33RD STREET
BALTIMORE, MD 21218

FOR: VIDEO MONITORS, COMPUTERS FOR CONTROLLING CRYOTHERAPY AND CRYOSURGERY DEVICES AND CRYOTHERAPY DELIVERY SYSTEMS AND PRINTERS , IN CLASS 9 (U.S. CLS. 21, 23, 26, 36 AND 38).

FIRST USE 6-12-2006; IN COMMERCE 6-12-2006.

FOR: CRYOSURGICAL APPARATUS FOR USE IN PERFORMING ABLATIVE SURGERY; MEDICAL DEVICES, NAMELY, CRYOSURGICAL AND CRYOTHERAPY DEVICES, NAMELY, CATHETERS AND SURGICAL AND TREATMENT PROBES; CRYOSURGICAL TOOLS OR UNITS USED TO DESTROY TISSUE DURING SURGICAL PROCEDURES, NAMELY, CATHETERS FOR THE INTRODUCTION OF A CRYOGEN TO A TARGET TISSUE; THERAPY AND SURGICAL DELIVERY SYSTEMS AND COMPONENTS THEREOF FOR DELIVERING CRYOGENS TO A PATIENT, NAMELY, SURGICAL AND TREATMENT PROBES, CATHETERS, ENDOSCOPES; CRYOSURGERY AND CRYOTHERAPY DEVICE CONTROL SYSTEMS, NAMELY, APPARATUSES FOR CONTROLLING THE FLOW OF CRYOGENS, BLEEDER AND PRESSURE REDUCTION VALVES FOR MAINTAINING PRESSURE IN CRYOTHERAPY AND CRYOSURGICAL DEVICES AND DELIVERY SYSTEMS, RIGID AND FLEXIBLE MEDICAL ENDOSCOPES, CATHETERS, LUMEN BLOCKING BALLOONS AND SHIELDS FOR GASTRIC BLOCKING, NASOGASTRIC TUBES, SUCTION DEVICES FOR CRYOGENS REMOVAL AND ENDOSCOPY CAMERAS, IN CLASS 10 (U.S. CLS. 26, 39 AND 44).

FIRST USE 6-12-2006; IN COMMERCE 6-12-2006.

NO CLAIM IS MADE TO THE EXCLUSIVE RIGHT TO USE "MEDICAL", APART FROM THE MARK AS SHOWN.

THE MARK CONSISTS OF DOTS ARRANGED IN A CONICAL SHAPE WITH AN INCOMPLETE OVAL AT THE BASE OF THE CONE. THE WORDING "CSA MEDICAL" IS DISPLAYED UNDER DESIGN.

SN 77-018,591, FILED 10-11-2006.



David J. Kybas

Director of the United States Patent and Trademark Office

Reg. No. 4,067,352 RENEE SERVANCE, EXAMINING ATTORNEY

United States of America

United States Patent and Trademark Office

COLOR FOR THE HAIR DOWN THERE

Reg. No. 4,067,353

Registered Dec. 6, 2011

Int. Cl.: 3

TRADEMARK

PRINCIPAL REGISTER

BETTYBEAUTY, INC. (DELAWARE CORPORATION)
C/O VOGEL & COMPANY
685 POST ROAD
DARIEN, CT 06820

FOR: HAIR CARE PREPARATIONS, NAMELY, HAIR COLORING, HAIR TINT AND HAIR DYE, IN CLASS 3 (U.S. CLS. 1, 4, 6, 50, 51 AND 52).

FIRST USE 7-31-2006; IN COMMERCE 9-30-2006.

THE MARK CONSISTS OF STANDARD CHARACTERS WITHOUT CLAIM TO ANY PARTICULAR FONT, STYLE, SIZE, OR COLOR.

SN 77-023,314, FILED 10-17-2006.

DEZMONA MIZELLE, EXAMINING ATTORNEY



David J. Kyffers

Director of the United States Patent and Trademark Office

United States of America

United States Patent and Trademark Office

MILLENNIUM PARK REALTY

Reg. No. 4,067,354

Registered Dec. 6, 2011

Int. Cl.: 36

SERVICE MARK

PRINCIPAL REGISTER

MILLENNIUM PARK REALTY, LLC (ILLINOIS LIMITED LIABILITY COMPANY)
340 EAST RANDOLPH STREET, #3704
CHICAGO, IL 60601

FOR: REAL ESTATE BROKERAGE; REAL ESTATE CONSULTATION; REAL ESTATE AGENCIES; LEASING OF REAL ESTATE; REAL ESTATE INVESTMENT; REAL ESTATE MANAGEMENT SERVICES; REAL ESTATE ACQUISITION; REAL ESTATE FINANCING AND FINANCIAL ANALYSIS, IN CLASS 36 (U.S. CLS. 100, 101 AND 102).

FIRST USE 12-1-2006; IN COMMERCE 12-1-2006.

THE MARK CONSISTS OF STANDARD CHARACTERS WITHOUT CLAIM TO ANY PARTICULAR FONT, STYLE, SIZE, OR COLOR.

NO CLAIM IS MADE TO THE EXCLUSIVE RIGHT TO USE "REALTY", APART FROM THE MARK AS SHOWN.

SN 77-061,552, FILED 12-11-2006.

KATHY DE JONGE, EXAMINING ATTORNEY



David J. Kyjars

Director of the United States Patent and Trademark Office

United States of America

United States Patent and Trademark Office

ESQUIRE

Reg. No. 4,067,355

Registered Dec. 6, 2011

Int. Cls.: 16 and 28

TRADEMARK

PRINCIPAL REGISTER

HEARST COMMUNICATIONS, INC. (DELAWARE CORPORATION)
300 WEST 57TH STREET
NEW YORK, NY 10019

FOR: EXECUTIVE DESK SETS, COMPRISED OF SOME OR ALL OF THE FOLLOWING GOODS, BLOTTERS, STAPLERS, BUSINESS CARD HOLDERS, AND PUZZLE PAPERWEIGHTS AND INTERACTIVE PAPERWEIGHTS, IN CLASS 16 (U.S. CLS. 2, 5, 22, 23, 29, 37, 38 AND 50).

FIRST USE 10-1-2010; IN COMMERCE 10-1-2010.

FOR: EXECUTIVE TOYS, NAMELY, DESKTOP POOL TABLES, DESKTOP STRESS RELIEVING TOYS, NAMELY, STRESS BALLS FOR SQUEEZING, DICE, EXECUTIVE BOARD GAMES, FOOTBALLS, BASKETBALLS, CHESS AND CHECKERS SETS, IN CLASS 28 (U.S. CLS. 22, 23, 38 AND 50).

FIRST USE 10-1-2010; IN COMMERCE 10-1-2010.

THE MARK CONSISTS OF STANDARD CHARACTERS WITHOUT CLAIM TO ANY PARTICULAR FONT, STYLE, SIZE, OR COLOR.

OWNER OF U.S. REG. NOS. 313,768, 1,489,930, AND OTHERS.

SN 77-076,628, FILED 1-5-2007.

DAVID I, EXAMINING ATTORNEY



David J. Kypos

Director of the United States Patent and Trademark Office

United States of America

United States Patent and Trademark Office

TENNMAN RECORDS

Reg. No. 4,067,356

Registered Dec. 6, 2011

Int. Cl.: 9

TRADEMARK

PRINCIPAL REGISTER

TENNMAN BRANDS, LLC (DELAWARE LIMITED LIABILITY COMPANY)
7 TIMES SQUARE, C/O PRYOR CASHMAN LLP
NEW YORK, NY 10036

FOR: MUSICAL SOUND RECORDINGS; AUDIO-VISUAL RECORDINGS, NAMELY, PRERECORDED COMPACT DISCS, AUDIO DISCS, PHONOGRAPH RECORDS, CD-ROMS, VIDEO DISCS, DVDS, MP3S, ALL FEATURING MUSIC; DOWNLOADABLE MUSICAL SOUND RECORDINGS; DOWNLOADABLE VIDEO RECORDINGS FEATURING MUSIC; DOWNLOADABLE RING TONES VIA A GLOBAL COMPUTER NETWORK AND WIRELESS DEVICES; JACKETS FOR COMPACT DISCS; SOFTWARE FOR THE REDIRECTION OF MESSAGES, GLOBAL COMPUTER NETWORK E-MAIL, AND OTHER DATA TO ONE OR MORE ELECTRONIC HANDHELD UNITS FROM A DATA STORE ON OR ASSOCIATED WITH A PERSONAL COMPUTER OR A SERVER, IN CLASS 9 (U.S. CLS. 21, 23, 26, 36 AND 38).

FIRST USE 11-0-2007; IN COMMERCE 11-0-2007.

THE MARK CONSISTS OF STANDARD CHARACTERS WITHOUT CLAIM TO ANY PARTICULAR FONT, STYLE, SIZE, OR COLOR.

NO CLAIM IS MADE TO THE EXCLUSIVE RIGHT TO USE "RECORDS", APART FROM THE MARK AS SHOWN.

SN 77-094,690, FILED 1-30-2007.

SETH A. RAPPAPORT, EXAMINING ATTORNEY



David J. Kyros

Director of the United States Patent and Trademark Office

United States of America

United States Patent and Trademark Office

BABY ON BOARD

Reg. No. 4,067,357

Registered Dec. 6, 2011

Int. Cl.: 12

TRADEMARK

PRINCIPAL REGISTER

DOREL JUVENILE GROUP, INC. (MASSACHUSETTS CORPORATION)
25 FORBES BLVD, STE 4
FOXBORO, MA 02035

FOR: STROLLER ACCESSORIES, NAMELY, PROTECTIVE INSECT NETTING AND WEATHER SHIELDS IN THE NATURE OF PLASTIC COVERS, IN CLASS 12 (U.S. CLS. 19, 21, 23, 31, 35 AND 44).

FIRST USE 8-0-2011; IN COMMERCE 8-0-2011.

THE MARK CONSISTS OF STANDARD CHARACTERS WITHOUT CLAIM TO ANY PARTICULAR FONT, STYLE, SIZE, OR COLOR.

OWNER OF U.S. REG. NO. 2,898,525.

SN 77-097,169, FILED 2-1-2007.

LINDA ESTRADA, EXAMINING ATTORNEY



David J. Kyffers

Director of the United States Patent and Trademark Office

United States of America

United States Patent and Trademark Office

VISTA POINT

Reg. No. 4,067,358

Registered Dec. 6, 2011

Int. Cl.: 9

TRADEMARK

PRINCIPAL REGISTER

FLEXTRONICS INTERNATIONAL, LTD. (SINGAPORE CORPORATION)
NO. 2 CHANGI SOUTH LANE
SINGAPORE, SINGAPORE 486123

FOR: CAMERAS, ELECTRONIC DEVICES, NAMELY, CAMERA MODULES, NONE OF THE FOREGOING FOR USE AS COMPUTER CONFERENCING COMPONENTS, IN CLASS 9 (U.S. CLS. 21, 23, 26, 36 AND 38).

FIRST USE 3-1-2007; IN COMMERCE 6-1-2007.

THE MARK CONSISTS OF STANDARD CHARACTERS WITHOUT CLAIM TO ANY PARTICULAR FONT, STYLE, SIZE, OR COLOR.

SN 77-098,519, FILED 2-2-2007.

CURTIS FRENCH, EXAMINING ATTORNEY



David J. Kyros

Director of the United States Patent and Trademark Office

United States of America

United States Patent and Trademark Office

GSHIP

Reg. No. 4,067,359

Registered Dec. 6, 2011

Int. Cl.: 35

SERVICE MARK

PRINCIPAL REGISTER

HERTEL, ANDREW DAVID (UNITED STATES INDIVIDUAL)
11847 SE 319TH PL
AUBURN, WA 98092

FOR: INFORMATION MANAGEMENT SERVICES, NAMELY, SHIPMENT PROCESSING, PREPARING SHIPPING DOCUMENTS AND INVOICES, TRACKING DOCUMENTS, PACKAGES AND FREIGHT OVER COMPUTER NETWORKS, INTRANETS AND INTERNETS, IN CLASS 35 (U.S. CLS. 100, 101 AND 102).

FIRST USE 4-21-2007; IN COMMERCE 8-11-2011.

THE MARK CONSISTS OF STANDARD CHARACTERS WITHOUT CLAIM TO ANY PARTICULAR FONT, STYLE, SIZE, OR COLOR.

SN 77-128,996, FILED 3-12-2007.

ALICE BENMAMAN, EXAMINING ATTORNEY



David J. Kybas

Director of the United States Patent and Trademark Office

United States of America

United States Patent and Trademark Office

BLACK WIDOW

Reg. No. 4,067,360

Registered Dec. 6, 2011

Int. Cl.: 7

TRADEMARK

PRINCIPAL REGISTER

Q.E.P. CO., INC. (DELAWARE CORPORATION)
1001 BROKEN SOUND PARKWAY, NW SUITE A
BOCA RATON, FL 33487

FOR: CIRCULAR DIAMOND SAW BLADES FOR POWER SAWS FOR USE BY TILE INSTALLERS IN CUTTING TILE, IN CLASS 7 (U.S. CLS. 13, 19, 21, 23, 31, 34 AND 35).

FIRST USE 10-0-2007; IN COMMERCE 10-0-2007.

THE MARK CONSISTS OF STANDARD CHARACTERS WITHOUT CLAIM TO ANY PARTICULAR FONT, STYLE, SIZE, OR COLOR.

SN 77-149,752, FILED 4-5-2007.

SANI KHOURI, EXAMINING ATTORNEY



David J. Kybas

Director of the United States Patent and Trademark Office

United States of America

United States Patent and Trademark Office

DIAMOND DRE

Reg. No. 4,067,361

Registered Dec. 6, 2011

Int. Cl.: 41

SERVICE MARK

PRINCIPAL REGISTER

REYES, DREW, HAYNES (UNITED STATES INDIVIDUAL)
131 PRAIRIE VIEW CT.
AVONDALE, LA 70094

FOR: MULTIMEDIA ENTERTAINMENT SERVICES IN THE NATURE OF RECORDING, PRODUCTION AND POST-PRODUCTION SERVICES IN THE FIELDS OF MUSIC AND VIDEO; ENTERTAINMENT SERVICES IN THE NATURE OF AN ON-GOING REALITY BASED TELEVISION PROGRAM; ENTERTAINMENT SERVICES, NAMELY, PROVIDING A TELEVISION PROGRAM IN THE FIELD OF MUSIC VIA A GLOBAL COMPUTER NETWORK; ENTERTAINMENT SERVICES, NAMELY, PROVIDING A WEB SITE FEATURING MUSICAL PERFORMANCES, MUSICAL VIDEOS, RELATED FILM CLIPS, PHOTOGRAPHS, AND OTHER MULTIMEDIA MATERIALS, IN CLASS 41 (U.S. CLS. 100, 101 AND 107).

FIRST USE 11-6-2010; IN COMMERCE 11-6-2010.

THE MARK CONSISTS OF STANDARD CHARACTERS WITHOUT CLAIM TO ANY PARTICULAR FONT, STYLE, SIZE, OR COLOR.

SN 77-153,539, FILED 4-10-2007.

DAVID I, EXAMINING ATTORNEY



David J. Kyffers

Director of the United States Patent and Trademark Office

United States of America

United States Patent and Trademark Office

MEDICAL DATASOFT INTERNATIONAL

Reg. No. 4,067,362

Registered Dec. 6, 2011

Int. Cls.: 42 and 44

SERVICE MARK

PRINCIPAL REGISTER

MEDICAL DATASOFT INTERNATIONAL, INC. (CALIFORNIA CORPORATION)
9606 SWAN LAKE DRIVE
GRANITE BAY, CA 95746

FOR: PROVIDING ON-LINE NON-DOWNLOADABLE SOFTWARE AND GRAPHICAL USER INTERFACE SOFTWARE FOR USE IN THE GENERATION, ACCESS, AND MANAGEMENT OF ELECTRONIC MEDICAL RECORDS PROVIDED VIA AN ONLINE WEB SITE ACCESSED THROUGH A GLOBAL COMPUTER NETWORK, IN CLASS 42 (U.S. CLS. 100 AND 101).

FIRST USE 3-8-2007; IN COMMERCE 12-1-2010.

FOR: PROVIDING AN ON-LINE COMPUTER DATABASE IN THE FIELD OF ELECTRONIC MEDICAL RECORDS, IN CLASS 44 (U.S. CLS. 100 AND 101).

FIRST USE 3-8-2007; IN COMMERCE 12-1-2010.

THE MARK CONSISTS OF STANDARD CHARACTERS WITHOUT CLAIM TO ANY PARTICULAR FONT, STYLE, SIZE, OR COLOR.

NO CLAIM IS MADE TO THE EXCLUSIVE RIGHT TO USE "MEDICAL" AND "INTERNATIONAL", APART FROM THE MARK AS SHOWN.

SN 77-156,340, FILED 4-13-2007.

DOMINIC FATHY, EXAMINING ATTORNEY



David J. Kyros

Director of the United States Patent and Trademark Office

United States of America

United States Patent and Trademark Office



Reg. No. 4,067,363

Registered Dec. 6, 2011

Int. Cl.: 16

TRADEMARK

PRINCIPAL REGISTER

RODRIGUEZ, MICHAEL A. (UNITED STATES INDIVIDUAL)
3039 LAVITA LANE
FARMERS BRANCH, TX 75234

FOR: BUMPER STICKERS; STICKERS; PAPER EMBLEMS; PRINTED EMBLEMS; BOOK-MARKS, IN CLASS 16 (U.S. CLS. 2, 5, 22, 23, 29, 37, 38 AND 50).

FIRST USE 2-9-2010; IN COMMERCE 2-9-2010.

THE STIPLING IS FOR SHADING PURPOSES ONLY.

THE MARK CONSISTS OF THE WORD "GRACE" IN WHICH THE LETTER "G" INCLUDES THE SHAPE OF A STYLIZED FISH.

SN 77-168,153, FILED 4-27-2007.

ANGELA M. MICHELLI, EXAMINING ATTORNEY



David J. Kybas

Director of the United States Patent and Trademark Office

United States of America

United States Patent and Trademark Office

Love

Reg. No. 4,067,364

Registered Dec. 6, 2011

Int. Cl.: 16

TRADEMARK

PRINCIPAL REGISTER

RODRIGUEZ, MICHAEL A. (UNITED STATES INDIVIDUAL)
3039 LAVITA LANE
FARMERS BRANCH, TX 75234

FOR: BUMPER STICKERS; STICKERS; PAPER EMBLEMS; PRINTED EMBLEMS; BOOK-MARKS, IN CLASS 16 (U.S. CLS. 2, 5, 22, 23, 29, 37, 38 AND 50).

FIRST USE 2-9-2010; IN COMMERCE 2-9-2010.

THE STIPLING IS FOR SHADING PURPOSES ONLY.

THE MARK CONSISTS OF WORD "LOVE" WITH THE "L" FORMED USING THE SHAPE OF A STYLIZED FISH.

SN 77-168,170, FILED 4-27-2007.

ANGELA M. MICHELLI, EXAMINING ATTORNEY



David J. Kybas

Director of the United States Patent and Trademark Office

United States of America

United States Patent and Trademark Office

SOCIAL NETWORK OF FRAUD

Reg. No. 4,067,365

Registered Dec. 6, 2011

Int. Cl.: 45

SERVICE MARK

PRINCIPAL REGISTER

EARLY WARNING SERVICES, LLC (DELAWARE LIMITED LIABILITY COMPANY)
16552 N 90TH STREET, SUITE 100
SCOTTSDALE, AZ 85260

FOR: FRAUD DETECTION SERVICES, NAMELY, IDENTIFICATION OF SOCIAL CONNECTIONS BETWEEN PEOPLE, THEIR ASSETS, AND THEIR FINANCIAL TRANSACTIONS FOR THE PURPOSE OF AVOIDING PAYMENT SYSTEM FRAUD AND ABUSE TO PREVENT LOSS, IN CLASS 45 (U.S. CLS. 100 AND 101).

FIRST USE 10-31-2007; IN COMMERCE 1-31-2009.

THE MARK CONSISTS OF STANDARD CHARACTERS WITHOUT CLAIM TO ANY PARTICULAR FONT, STYLE, SIZE, OR COLOR.

NO CLAIM IS MADE TO THE EXCLUSIVE RIGHT TO USE "FRAUD", APART FROM THE MARK AS SHOWN.

SN 77-172,475, FILED 5-3-2007.

LEIGH CAROLINE CASE, EXAMINING ATTORNEY



David J. Kyros

Director of the United States Patent and Trademark Office

United States of America

United States Patent and Trademark Office



Reg. No. 4,067,366

Registered Dec. 6, 2011

Int. Cl.: 25

TRADEMARK

PRINCIPAL REGISTER

PILOBOLUS, INC. (CONNECTICUT CORPORATION)
P.O. BOX 388
WASHINGTON DEPOT, CT 06794

FOR: CLOTHING, NAMELY, T-SHIRTS AND SWEATSHIRTS, IN CLASS 25 (U.S. CLS. 22 AND 39).

FIRST USE 8-0-2007; IN COMMERCE 8-0-2007.

THE MARK CONSISTS OF THE WORD "PILOBOLUS" USING HUMAN BODIES TO FORM EACH LETTER.

THE FOREIGN WORDING IN THE MARK TRANSLATES INTO ENGLISH AS "A THROWING BALL".

SN 77-192,910, FILED 5-30-2007.

MATTHEW EINSTEIN, EXAMINING ATTORNEY



David J. Kybas

Director of the United States Patent and Trademark Office

United States of America

United States Patent and Trademark Office

ACCENDO

Reg. No. 4,067,367

Registered Dec. 6, 2011

Int. Cl.: 36

SERVICE MARK

PRINCIPAL REGISTER

LONGS DRUG STORES CALIFORNIA, LLC (CALIFORNIA LIMITED LIABILITY COMPANY)
141 NORTH CIVIC DRIVE
WALNUT CREEK, CA 94596

FOR: INSURANCE UNDERWRITING, ADMINISTRATION, AND CLAIMS PROCESSING IN THE FIELDS OF PRESCRIPTION DRUGS, PHARMACY, AND SERVICES RELATED TO PRESCRIPTION DRUGS AND PHARMACY; PROVIDING HEALTH CARE INSURANCE INFORMATION, IN CLASS 36 (U.S. CLS. 100, 101 AND 102).

FIRST USE 10-15-2007; IN COMMERCE 10-15-2007.

THE MARK CONSISTS OF STANDARD CHARACTERS WITHOUT CLAIM TO ANY PARTICULAR FONT, STYLE, SIZE, OR COLOR.

SN 77-196,197, FILED 6-2-2007.

JOHN WILKE, EXAMINING ATTORNEY



David J. Kybas

Director of the United States Patent and Trademark Office

United States of America

United States Patent and Trademark Office

BILBO

Reg. No. 4,067,368

Registered Dec. 6, 2011

Int. Cl.: 6

TRADEMARK

PRINCIPAL REGISTER

THE SAUL ZAENTZ COMPANY DBA TOLKIEN ENTERPRISES (DELAWARE CORPORATION)
2600 TENTH STREET
BERKELEY, CA 94710

FOR: COLLECTIBLE FIGURINES MADE OF COMMON METALS AND THEIR ALLOYS; FIGURES OF COMMON METAL; FIGURINES OF COMMON METAL, IN CLASS 6 (U.S. CLS. 2, 12, 13, 14, 23, 25 AND 50).

FIRST USE 0-0-1994; IN COMMERCE 0-0-1994.

THE MARK CONSISTS OF STANDARD CHARACTERS WITHOUT CLAIM TO ANY PARTICULAR FONT, STYLE, SIZE, OR COLOR.

SN 77-203,305, FILED 6-11-2007.

ALEX KEAM, EXAMINING ATTORNEY



David J. Kybas

Director of the United States Patent and Trademark Office

United States of America

United States Patent and Trademark Office

FREAKIE LABS

Reg. No. 4,067,369

Registered Dec. 6, 2011

Int. Cl.: 5

TRADEMARK

PRINCIPAL REGISTER

NASSRY, LEILA JACQUELINE (UNITED STATES INDIVIDUAL)
24627 BAY HILL BLVD
KATY, TX 77494

FOR: NUTRITIONAL SUPPLEMENTS; DIETARY AND NUTRITIONAL SUPPLEMENTS;
DIETARY SUPPLEMENTS FOR HUMAN CONSUMPTION, IN CLASS 5 (U.S. CLS. 6, 18, 44,
46, 51 AND 52).

FIRST USE 10-21-2011; IN COMMERCE 10-21-2011.

THE MARK CONSISTS OF STANDARD CHARACTERS WITHOUT CLAIM TO ANY PAR-
TICULAR FONT, STYLE, SIZE, OR COLOR.

NO CLAIM IS MADE TO THE EXCLUSIVE RIGHT TO USE "LABS", APART FROM THE
MARK AS SHOWN.

SN 77-217,298, FILED 6-27-2007.

ELLEN BURNS, EXAMINING ATTORNEY



David J. Kyros

Director of the United States Patent and Trademark Office

United States of America

United States Patent and Trademark Office



The logo for "SmartMig" is displayed in a stylized, blocky font. The word "SmartMig" is rendered in gray with a black shadow effect. A red checkmark is positioned above the letter "i" in "Mig".

Reg. No. 4,067,370

Registered Dec. 6, 2011

Int. Cl.: 9

TRADEMARK

PRINCIPAL REGISTER

VICTOR EQUIPMENT COMPANY (DELAWARE CORPORATION)
16052 SWINGLEY RIDGE ROAD, SUITE 300
CHESTERFIELD, MO 63017

FOR: POWER SUPPLIES FOR WELDING EQUIPMENT, NAMELY, INVERTERS FOR ARC WELDERS, IN CLASS 9 (U.S. CLS. 21, 23, 26, 36 AND 38).

FIRST USE 0-0-2006; IN COMMERCE 0-0-2006.

THE WORDING "SMARTMIG" APPEARS IN GRAY WITH BLACK SHADOWING AND THE CHECK MARK APPEARS IN RED.

THE COLOR(S) GRAY, BLACK AND RED IS/ARE CLAIMED AS A FEATURE OF THE MARK.

SN 77-223,569, FILED 7-6-2007.

KAREN K. BUSH, EXAMINING ATTORNEY



David J. Kybas

Director of the United States Patent and Trademark Office

United States of America

United States Patent and Trademark Office

DECISION BLUEPRINTS

Reg. No. 4,067,371

Registered Dec. 6, 2011

Int. Cls.: 9, 35, and 42

TRADEMARK

SERVICE MARK

PRINCIPAL REGISTER

DECISION LENS, INC. (DELAWARE CORPORATION)
4250 NORTH FAIRFAX DRIVE, SUITE 1410
ARLINGTON, VA 22203

FOR: COMPUTER SOFTWARE FOR WORKGROUP AND PROJECT MANAGEMENT FOR USE IN MANAGING COMPLEX ANALYSES TO MAXIMIZE VALUE OUT OF PROJECTS, VENDORS, PEOPLE AND ORGANIZATIONAL STRATEGIES; COMPUTER SOFTWARE FOR SEARCHING, RETRIEVING, VIEWING AND ANALYZING INFORMATION AND FOR CREATING CUSTOM DISPLAYS OF INFORMATION; COMPUTER SOFTWARE FOR ACCESSING, CREATING, EDITING AND MANAGING DATABASE AND TRANSFERRING DATA TO AND FROM DATABASES, IN CLASS 9 (U.S. CLS. 21, 23, 26, 36 AND 38).

FIRST USE 4-7-2011; IN COMMERCE 4-7-2011.

FOR: BUSINESS MANAGEMENT CONSULTING AND ADVISORY SERVICES, IN CLASS 35 (U.S. CLS. 100, 101 AND 102).

FIRST USE 4-7-2011; IN COMMERCE 4-7-2011.

FOR: DESIGN AND DEVELOPMENT OF INFORMATION AND DATA BASES; DESIGN, DEVELOPMENT AND IMPLEMENTATION OF SOFTWARE, IN CLASS 42 (U.S. CLS. 100 AND 101).

FIRST USE 4-7-2011; IN COMMERCE 4-7-2011.

THE MARK CONSISTS OF STANDARD CHARACTERS WITHOUT CLAIM TO ANY PARTICULAR FONT, STYLE, SIZE, OR COLOR.

OWNER OF U.S. REG. NOS. 2,884,823, 2,887,138, AND 2,919,426.

SN 77-230,443, FILED 7-16-2007.

DANNEAN HETZEL, EXAMINING ATTORNEY



David J. Kyffers

Director of the United States Patent and Trademark Office

United States of America

United States Patent and Trademark Office

Niche House Perfumes

Reg. No. 4,067,372

Registered Dec. 6, 2011

Int. Cl.: 3

TRADEMARK

PRINCIPAL REGISTER

JACOBS, MARK E. (UNITED STATES INDIVIDUAL)
913 HICKORY GROVE RD
GASTONIA, NC 28056

FOR: PERFUMERY; PERFUMES; SOLID PERFUMES; LIQUID PERFUMES; GEL PERFUMES; HERBAL PERFUMERY; LEATHER PERFUMERY; OILS FOR COSMETIC PURPOSES, NAMELY, ROSE PERFUME BASE, LIQUID PERFUME BASE, AND NATURAL ROSE PERFUME BASE; EAU-DE PERFUME; EAU-DE-COLOGNE; MUSK, NAMELY, NATURAL MUSK AND SYNTHETIC MUSK; SPICE, NAMELY, NATURAL SPICE PERFUMES, NATURAL HERBAL PERFUMES, NATURAL FLORAL PERFUMES, NATURAL WOOD PERFUMES, BLENDED PERFUME CONSISTING OF VARIOUS OILS AND SPICES; FRAGRANCES FOR PERSONAL USE; SOAPS; DEODORANT PREPARATION FOR PERSONAL USE, NAMELY, ANTIPERSPIRANTS; DEODORANT SOAP; BATH ESSENCES, NAMELY, PERFUME OILS FOR USE IN BATHS, BATH SALTS; BATH SOAP; LIQUID SOAP; TOILET SOAP; BATH PRODUCTS, NAMELY, BATH AND MASSAGE OILS, BATH AND SHOWER CREAM, BATH AND SHOWER GEL, BATH BEADS, BATH FIZZIES, BATH CRYSTALS, BATH MILK, BATH BEADS, BATH POWDER, SKIN CLEANSERS, SKIN MOISTURIZERS, BUBBLE BATH POWDER, EXFOLIATING BODY WASH, FACE AND BODY POWDERS, COCOA BUTTER FOR COSMETIC PURPOSES, HAIR SHAMPOOS, NON-MEDICATED BATH SALTS, FACIAL SCRUBS AND BATH FOAMS, SHAVING SOAPS; BUBBLE BATH; BATH LIQUID SOAPS; BATH GELS; BATH OILS, BATH OILS FOR COSMETIC PURPOSES, BATH PEARLS, BODY GLITTER, BODY SHAMPOOS, SKIN AND FACIAL SOAPS; SHAMPOOS; HAIR CONDITIONERS; HAIR LOTIONS; HAIR TONIC; SHAVING PREPARATIONS, NAMELY, AFTER SHAVE, AFTER SHAVE BALM, SHAVING CREAM, PRE-SHAVE LOTIONS AND OILS; BEAUTY PRODUCTS AND MAKEUP, NAMELY, BLUSH, COSMETICS, FOUNDATION, FACIAL FOUNDATION, LIP BALM, LIP LINER, LIP STICK, LIP GLOSS, MASCARA, EYE SHADOW, ROUGE; LIP AND SHAVING BALM; CREAMS, NAMELY, ANTI-AGING CREAM, ANTI-WRINKLE CREAM, EYE CREAM, BATH CREAM, BEAUTY CREAM, FACE CREAMS, BODY CREAMS, COLD CREAM, COSMETIC CREAMS, CUTICLE CREAM, NIGHT CREAMS, FACE AND BODY CREAMS, FOOT CREAM, SKIN TIGHTENING CREAMS, HAND CREAM, MOISTURIZING EYE CREAMS, EXFOLIATING CREAM, TOPICAL HERBAL CREAM FOR FIRING AND ENHANCING BREASTS, NIGHT CREAM, NON-MEDICATED OINTMENTS FOR THE PREVENTION AND TREATMENT OF SUNBURN, BODY SCRUB, SHOWER CREAM, SKIN CLEANSING CREAM, SKIN CREAMS, SUN CREAM, VANISHING CREAM, NON-MEDICATED SKIN CREAMS, NON-MEDICATED FOOT CREAM; BATH FOAMS; SHAVING FOAMS; BATH AND HAIR GELS; SHOWER GELS; LOTIONS, NAMELY, SKIN LOTION, FACIAL LOTION, BABY LOTION, BATH LOTION, MOISTURIZING LOTION,



David J. Kybas

Director of the United States Patent and Trademark Office

Reg. No. 4,067,372 HAND LOTION, NON-MEDICATED TONING LOTIONS, NON-MEDICATED FOOT LOTIONS, AFTER SHAVE LOTION; PERFUMED CREAMS FOR BODY AND BATH; BODY LOTION; SKIN MOISTURIZERS; PERFUMED MOISTURIZING CREAM; ESSENTIAL OILS; ESSENTIAL OILS FOR PERSONAL USE; SCENTED LINEN WATERS AND SCENTED TOILET WATERS; PERFUMED COSMETIC OILS; COSMETIC OILS AND PERFUMES FOR THE HOME; PERFUMED BODY POWDER; PERFUMED BODY SPRAY; BODY WASH; POMANDERS; POTPOURRI; SACHET-LIKE EYE PILLOWS CONTAINING FRAGRANCES; ROOM FRAGRANCES; ROOM FRAGRANCE REFILLS FOR NON-ELECTRIC ROOM FRAGRANCE DISPENSERS; INCENSE; PRODUCTS FOR PERFUMING THE ATMOSPHERE, NAMELY, SCENTED ROOM SPRAYS; PERFUMED INCENSE; SCENTED OILS USED TO PRODUCE AROMAS WHEN HEATED; FLORAL PERFUMERY; FABRIC SOFTENER; PRE-MOISTENED COSMETIC TOWELETES; NON-MEDICATED CREAMS FOR THE SKIN AND FACE; HAND AND FOOT CARE PREPARATIONS, NAMELY, SKIN MOISTURIZERS, HAND SCRUBS, BODY MASKS, BODY AND BEAUTY CARE COSMETICS, FOOT DEODORANT SPRAY, GELS TO COOL FEET, NON-MEDICATED FOOT POWDERS AND SPRAYS, FOOT SCRUB, NAIL CARE PREPARATIONS, NAMELY, SCENTED NAIL POLISH AND POLISH REMOVER, SCENTED LOTIONS FOR STRENGTHENING THE NAILS, SCENTED NAIL VARNISH AND POLISH, FOOT CARE PREPARATIONS, NAMELY, FOOT BEAUTY PRODUCTS, NAMELY, NON-MEDICATED FOOT SOAKS, GELS FOR SOFTENING SKIN CALLUSES, MASSAGING CREAMS AND OILS; NON-MEDICATED FOOT POWDERS AND SPRAYS; FOOT MOISTURIZING CREAMS; BODY SCRUBS; SKIN TONERS; LIQUID FACIAL CLEANSER; SUNSCREEN CREAMS; MASSAGE PREPARATIONS, NAMELY, BODY OILS; LAUNDRY DETERGENT; FACIAL MASKS, IN CLASS 3 (U.S. CLS. 1, 4, 6, 50, 51 AND 52).

FIRST USE 6-25-2009; IN COMMERCE 7-15-2011.

THE MARK CONSISTS OF STANDARD CHARACTERS WITHOUT CLAIM TO ANY PARTICULAR FONT, STYLE, SIZE, OR COLOR.

NO CLAIM IS MADE TO THE EXCLUSIVE RIGHT TO USE "PERFUMES", APART FROM THE MARK AS SHOWN.

SN 77-237,732, FILED 7-24-2007.

TIMOTHY FINNEGAN, EXAMINING ATTORNEY

United States of America

United States Patent and Trademark Office

ALUMINATOR

Reg. No. 4,067,373

Registered Dec. 6, 2011

Int. Cl.: 12

TRADEMARK

PRINCIPAL REGISTER

FORD MOTOR COMPANY (DELAWARE CORPORATION)
ONE AMERICAN ROAD
DEARBORN, MI 48126

FOR: AUTOMOBILE ENGINES, IN CLASS 12 (U.S. CLS. 19, 21, 23, 31, 35 AND 44).

FIRST USE 10-30-2007; IN COMMERCE 10-30-2007.

THE MARK CONSISTS OF STANDARD CHARACTERS WITHOUT CLAIM TO ANY PARTICULAR FONT, STYLE, SIZE, OR COLOR.

SN 77-240,459, FILED 7-27-2007.

REBECCA SMITH, EXAMINING ATTORNEY



David J. Kybas

Director of the United States Patent and Trademark Office

United States of America

United States Patent and Trademark Office

CLOS DU CIEL

Reg. No. 4,067,374

Registered Dec. 6, 2011

Int. Cl.: 33

TRADEMARK

PRINCIPAL REGISTER

SUGARLOAF FARMING CORPORATION (CALIFORNIA CORPORATION)
12400 IDA CLAYTON ROAD
CALISTOGA, CA 94515

FOR: WINES, IN CLASS 33 (U.S. CLS. 47 AND 49).

FIRST USE 4-12-2011; IN COMMERCE 4-12-2011.

THE MARK CONSISTS OF STANDARD CHARACTERS WITHOUT CLAIM TO ANY PARTICULAR FONT, STYLE, SIZE, OR COLOR.

THE ENGLISH TRANSLATION OF THE MARK IS VINEYARD IN THE SKY.

SN 77-247,090, FILED 8-3-2007.

LINDSEY RUBIN, EXAMINING ATTORNEY



David J. Kybas

Director of the United States Patent and Trademark Office

United States of America

United States Patent and Trademark Office

TRIBAL Hollywood

Reg. No. 4,067,375

Registered Dec. 6, 2011

Int. Cl.: 35

SERVICE MARK

PRINCIPAL REGISTER

TRIBAL HOLLYWOOD LLC (CALIFORNIA LIMITED LIABILITY COMPANY)
P.O. BOX 3030
HOLLYWOOD, CA 900783030

FOR: RETAIL AND ONLINE RETAIL STORES FEATURING JEWELRY, WATCHES, KEY CHAINS AND MONEY CLIPS MADE OF METAL, LEATHER, PLASTIC, WOOD AND OTHER MATERIALS, IN CLASS 35 (U.S. CLS. 100, 101 AND 102).

FIRST USE 7-0-2006; IN COMMERCE 7-0-2006.

THE MARK CONSISTS OF STANDARD CHARACTERS WITHOUT CLAIM TO ANY PARTICULAR FONT, STYLE, SIZE, OR COLOR.

SN 77-259,860, FILED 8-20-2007.

FRED CARL, EXAMINING ATTORNEY



David J. Kybas

Director of the United States Patent and Trademark Office

United States of America
United States Patent and Trademark Office

PRASADA

Reg. No. 4,067,376

Registered Dec. 6, 2011

Int. Cls.: 35, 36, and 37

SERVICE MARK

PRINCIPAL REGISTER

WESTCOR/SURPRISE LLC (ARIZONA LIMITED LIABILITY COMPANY)
SUITE 700
401 WILSHIRE BOULEVARD
SANTA MONICA, CA 90401

FOR: PROMOTING THE GOODS AND SERVICES OF OTHERS BY CREATING AND DISTRIBUTING PROMOTIONAL AND INFORMATIONAL MATERIALS; BUSINESS MARKETING CONSULTING SERVICES IN THE FIELD OF LOCATIONS FOR RETAIL SHOPPING CENTER AND MALL TENANTS, IN CLASS 35 (U.S. CLS. 100, 101 AND 102).

FIRST USE 6-30-2006; IN COMMERCE 6-30-2006.

FOR: SHOPPING CENTER SERVICES, NAMELY, LEASING AND MANAGEMENT OF SHOPPING CENTERS; REAL ESTATE LEASING; LEASING OF SHOPPING MALL SPACE AND PROVIDING LEASING INFORMATION IN CONNECTION THEREWITH; BUILDING MANAGEMENT OF SHOPPING CENTERS, IN CLASS 36 (U.S. CLS. 100, 101 AND 102).

FIRST USE 6-30-2006; IN COMMERCE 6-30-2006.

FOR: REAL ESTATE DEVELOPMENT AND SITE SELECTION; CONSTRUCTION SERVICES, NAMELY, PLANNING AND BUILDING; CUSTOM CONSTRUCTION AND DEVELOPMENT OF SHOPPING CENTERS AND MALLS AND PROVIDING ON-LINE INFORMATION IN CONNECTION THEREWITH, IN CLASS 37 (U.S. CLS. 100, 103 AND 106).

FIRST USE 6-30-2006; IN COMMERCE 6-30-2006.

THE MARK CONSISTS OF STANDARD CHARACTERS WITHOUT CLAIM TO ANY PARTICULAR FONT, STYLE, SIZE, OR COLOR.

THE FOREIGN WORDING IN THE MARK TRANSLATES INTO ENGLISH AS CLARITY, BRIGHTNESS; GRACE.

SN 77-262,178, FILED 8-22-2007.

BARBARA BROWN, EXAMINING ATTORNEY



David J. Kyros

Director of the United States Patent and Trademark Office

United States of America

United States Patent and Trademark Office

PRASADA

Reg. No. 4,067,377

Registered Dec. 6, 2011

Int. Cls.: 35, 36, and 37

SERVICE MARK

PRINCIPAL REGISTER

WESTCOR/SURPRISE LLC (ARIZONA LIMITED LIABILITY COMPANY)
SUITE 700
401 WILSHIRE BOULEVARD
SANTA MONICA, CA 90401

FOR: PROMOTING THE GOODS AND SERVICES OF OTHERS BY CREATING AND DISTRIBUTING PROMOTIONAL AND INFORMATIONAL MATERIALS; BUSINESS MARKETING CONSULTING SERVICES IN THE FIELD OF LOCATIONS FOR RETAIL SHOPPING CENTER AND MALL TENANTS, IN CLASS 35 (U.S. CLS. 100, 101 AND 102).

FIRST USE 6-30-2011; IN COMMERCE 6-30-2011.

FOR: SHOPPING CENTER SERVICES, NAMELY, LEASING AND MANAGEMENT OF SHOPPING CENTERS; REAL ESTATE LEASING; LEASING OF SHOPPING MALL SPACE AND PROVIDING LEASING INFORMATION IN CONNECTION THEREWITH; BUILDING MANAGEMENT OF SHOPPING CENTERS, IN CLASS 36 (U.S. CLS. 100, 101 AND 102).

FIRST USE 6-30-2011; IN COMMERCE 6-30-2011.

FOR: REAL ESTATE DEVELOPMENT AND SITE SELECTION; CONSTRUCTION SERVICES, NAMELY, PLANNING AND BUILDING; CUSTOM CONSTRUCTION AND DEVELOPMENT OF SHOPPING CENTERS AND MALLS AND PROVIDING ON-LINE INFORMATION IN CONNECTION THEREWITH, IN CLASS 37 (U.S. CLS. 100, 103 AND 106).

FIRST USE 6-30-2011; IN COMMERCE 6-30-2011.

THE MARK CONSISTS OF THE WORD "PRASADA" WITH UNDULATED LACE LIKE LINES ABOVE GIVING IT A FANCIFUL APPEARANCE.

THE FOREIGN WORDING IN THE MARK TRANSLATES INTO ENGLISH AS CLARITY, BRIGHTNESS; GRACE.

SN 77-262,181, FILED 8-22-2007.

BARBARA BROWN, EXAMINING ATTORNEY



David J. Kyros

Director of the United States Patent and Trademark Office

United States of America

United States Patent and Trademark Office

TINY TEARS

Reg. No. 4,067,378

Registered Dec. 6, 2011

Int. Cl.: 28

TRADEMARK

PRINCIPAL REGISTER

MATTEL, INC. (DELAWARE CORPORATION)
333 CONTINENTAL BLVD.
M1-1518
EL SEGUNDO, CA 90245

FOR: DOLLS, IN CLASS 28 (U.S. CLS. 22, 23, 38 AND 50).

FIRST USE 9-19-2011; IN COMMERCE 9-19-2011.

THE MARK CONSISTS OF STANDARD CHARACTERS WITHOUT CLAIM TO ANY PARTICULAR FONT, STYLE, SIZE, OR COLOR.

OWNER OF U.S. REG. NO. 2,929,053.

SN 77-267,607, FILED 8-29-2007.

JAY FLOWERS, EXAMINING ATTORNEY



David J. Kyros

Director of the United States Patent and Trademark Office

United States of America
United States Patent and Trademark Office

DCX

Reg. No. 4,067,379

Registered Dec. 6, 2011

Int. Cl.: 42

SERVICE MARK

PRINCIPAL REGISTER

BROCADE COMMUNICATIONS SYSTEMS, INC. (CALIFORNIA CORPORATION)
130 HOLGER WAY
SAN JOSE, CA 95134

FOR: TECHNICAL SUPPORT SERVICES, NAMELY, TROUBLESHOOTING OF COMPUTER HARDWARE AND SOFTWARE PROBLEMS; PROVIDING ONLINE DATABASES WHICH PROVIDE A CATALOG OF COMPUTER SOFTWARE IN THE FIELD OF STORAGE AREA NETWORKS THAT MAY BE DOWNLOADED FROM THE DATABASE; ONSITE TECHNICAL SUPPORT SERVICES, NAMELY, TROUBLESHOOTING OF COMPUTER HARDWARE AND SOFTWARE PROBLEMS, IN CLASS 42 (U.S. CLS. 100 AND 101).

FIRST USE 1-31-2008; IN COMMERCE 1-31-2008.

THE MARK CONSISTS OF STANDARD CHARACTERS WITHOUT CLAIM TO ANY PARTICULAR FONT, STYLE, SIZE, OR COLOR.

SN 77-273,136, FILED 9-6-2007.

JENNIFER MARTIN, EXAMINING ATTORNEY



David J. Kyros

Director of the United States Patent and Trademark Office

United States of America

United States Patent and Trademark Office

GYPSY CARDS

Reg. No. 4,067,380

KONAMI AUSTRALIA PTY LTD (AUSTRALIA AUSTRALIAN PRIVATE COMPANY)
28 LORD STREET
BOTANY, AUSTRALIA 2019

Registered Dec. 6, 2011

Int. Cl.: 9

FOR: ELECTRONIC GAME PROGRAMS; GAMING EQUIPMENT, NAMELY, SLOT MACHINES WITH OR WITHOUT VIDEO OUTPUT; GAMING MACHINES; MACHINES FOR PLAYING GAMES OF CHANCE; SLOT MACHINES, IN CLASS 9 (U.S. CLS. 21, 23, 26, 36 AND 38).

TRADEMARK

PRINCIPAL REGISTER

FIRST USE 10-9-2007; IN COMMERCE 10-9-2007.

THE MARK CONSISTS OF STANDARD CHARACTERS WITHOUT CLAIM TO ANY PARTICULAR FONT, STYLE, SIZE, OR COLOR.

NO CLAIM IS MADE TO THE EXCLUSIVE RIGHT TO USE "CARDS", APART FROM THE MARK AS SHOWN.

SN 77-273,735, FILED 9-7-2007.

JESSICA A. POWERS, EXAMINING ATTORNEY



David J. Kybas

Director of the United States Patent and Trademark Office

United States of America

United States Patent and Trademark Office



Reg. No. 4,067,381

Registered Dec. 6, 2011

Int. Cl.: 9

TRADEMARK

PRINCIPAL REGISTER

CUSTOM MANUFACTURING & ENGINEERING, INC. (FLORIDA CORPORATION)
3690 70TH AVE., N.
PINELLAS PARK, FL 33781

FOR: ELECTRONIC SENSORS AND DETECTORS FOR DETECTING AND IMAGING OBJECTS AND FOR TRANSMISSION OF ELECTRONIC IMAGES TO A REMOTE LOCATION, IN CLASS 9 (U.S. CLS. 21, 23, 26, 36 AND 38).

FIRST USE 9-30-2011; IN COMMERCE 9-30-2011.

NO CLAIM IS MADE TO THE EXCLUSIVE RIGHT TO USE "SURVEILLANCE", APART FROM THE MARK AS SHOWN.

THE MARK CONSISTS OF THE WORDS "OUTPOST SURVEILLANCE" AND A MOUNTAIN LANDSCAPE.

SN 77-279,351, FILED 9-14-2007.

WENDY GOODMAN, EXAMINING ATTORNEY



David J. Kybas

Director of the United States Patent and Trademark Office

United States of America

United States Patent and Trademark Office

SOLADIGM

Reg. No. 4,067,382

Registered Dec. 6, 2011

Int. Cl.: 19

TRADEMARK

PRINCIPAL REGISTER

SOLADIGM, INC. (DELAWARE CORPORATION)
195 SOUTH MILPITAS BOULEVARD
MILPITAS, CA 95035

FOR: WINDOWS, NAMELY, GLASS PANELS FOR BUILDING CONSTRUCTION, IN CLASS 19 (U.S. CLS. 1, 12, 33 AND 50).

FIRST USE 10-12-2011; IN COMMERCE 10-12-2011.

THE MARK CONSISTS OF STANDARD CHARACTERS WITHOUT CLAIM TO ANY PARTICULAR FONT, STYLE, SIZE, OR COLOR.

SN 77-284,419, FILED 9-20-2007.

SANJEEV VOHRA, EXAMINING ATTORNEY



David J. Kybas

Director of the United States Patent and Trademark Office

United States of America

United States Patent and Trademark Office

KISS N GIGGLES

Reg. No. 4,067,383

Registered Dec. 6, 2011

Int. Cl.: 28

TRADEMARK

PRINCIPAL REGISTER

NEW ADVENTURES LLC (NEW JERSEY LIMITED LIABILITY COMPANY)
6 DEFOREST AVENUE, SUITE 7
EAST HANOVER, NJ 07936

FOR: DOLLS AND TOYS, NAMELY, TOY PLAY SETS FOR DOLLS AND DOLL ACCESSORIES, IN CLASS 28 (U.S. CLS. 22, 23, 38 AND 50).

FIRST USE 10-1-2010; IN COMMERCE 10-1-2010.

THE MARK CONSISTS OF STANDARD CHARACTERS WITHOUT CLAIM TO ANY PARTICULAR FONT, STYLE, SIZE, OR COLOR.

SN 77-288,022, FILED 9-25-2007.

SETH A. RAPPAPORT, EXAMINING ATTORNEY



David J. Kybas

Director of the United States Patent and Trademark Office

United States of America

United States Patent and Trademark Office



Soul of India
cooking co.
— — — — —
— — — — —

Reg. No. 4,067,384

Registered Dec. 6, 2011

Int. Cls.: 11 and 30

TRADEMARK

PRINCIPAL REGISTER

SOUL OF INDIA LLC (DELAWARE LIMITED LIABILITY COMPANY)
312 SNOWBERRY CIRCLE
VENETIA, PA 15367

FOR: SMALL ELECTRICAL APPLIANCES, NAMELY, FLATBREAD MAKER, IN CLASS 11
(U.S. CLS. 13, 21, 23, 31 AND 34).

FIRST USE 7-9-2011; IN COMMERCE 7-9-2011.

FOR: DOSA MIX, CHUTNEY, SPICES, NAMELY, SAMBAR, SAMBAR POWDER, POTATO
MASALA, IN CLASS 30 (U.S. CL. 46).

FIRST USE 10-10-2011; IN COMMERCE 10-10-2011.

NO CLAIM IS MADE TO THE EXCLUSIVE RIGHT TO USE "INDIA" AND "COOKING CO.",
APART FROM THE MARK AS SHOWN.

THE MARK CONSISTS OF A HAND DESIGN OVER THE WORDS "SOUL OF INDIA
COOKING CO.".

SN 77-290,880, FILED 9-27-2007.

PATRICIA EVANKO, EXAMINING ATTORNEY



David J. Kybas

Director of the United States Patent and Trademark Office

United States of America

United States Patent and Trademark Office

NEW INDEX

Reg. No. 4,067,385

Registered Dec. 6, 2011

Int. Cl.: 9

TRADEMARK

PRINCIPAL REGISTER

NEW INDEX AS (NORWAY CORPORATION)
RICHARD BIRKELANDSV 2B
TRONDEIM, NORWAY 7491

FOR: COMPUTER PERIPHERALS; INSTRUMENTS AND EQUIPMENT FOR COMPUTERS AND OTHER PLATFORMS, NAMELY, PERSONAL DIGITAL ASSISTANTS (PDAS) AND MOBILE PHONES; INTERACTION DEVICES FOR MAN-MACHINES, HUMAN-COMPUTER AND OR HUMAN-HUMAN INTERACTION USING OPTICAL, ELECTROMAGNETIC, RADIO BASED, INERTIAL, GRAVITATIONAL SENSOR TECHNOLOGIES, TACTILE, OPTICAL FEEDBACK, NAMELY, COMPUTER CHIPS, ELECTRONIC COMPUTERS, MICRO COMPUTERS, OPTICAL AND DIGITAL TRANSMITTERS, RADIOS; ELECTRONIC PENS AND POINTING DEVICES, NAMELY, LASER POINTERS AND WIRELESS PRESENTERS IN THE NATURE OF A WIRELESS REMOTE POINTER FOR DRAWING AND WRITING FOR COMPUTER ASSISTED PRESENTATIONS AND COMPUTER ASSISTED OFFICE WORK; ELECTRONIC PENS USING PATTERN RECOGNITION AND IDENTIFICATION; ELECTRONIC POSITION MARKERS AND INDICATORS, NAMELY, FOR OPTICAL MOTION CAPTURE AND OPTICAL MOTION TRACKING; EQUIPMENT AND INSTRUMENTS FOR ELECTRONIC WRITING ON WALLS OR OTHER SURFACES, NAMELY, INTERACTIVE WHITEBOARDS, ELECTRONIC ERASERS, CAMERA CHIPS IN THE NATURE OF IMAGE SENSOR AND PROCESSING CHIPS TO BE USED IN CAMERAS, CAMERAS WITH SENSORS FOR USE WITH/OR INTEGRATED IN VIDEO PROJECTORS, PROJECTING SYSTEMS AND SCREENS; COMPUTER SOFTWARE FOR COMMUNICATING BETWEEN COMPUTERS, COMPUTER NETWORKS AND COMPUTER PERIPHERALS, IN CLASS 9 (U.S. CLS. 21, 23, 26, 36 AND 38).

FIRST USE 0-0-2004; IN COMMERCE 0-0-2004.

THE MARK CONSISTS OF STANDARD CHARACTERS WITHOUT CLAIM TO ANY PARTICULAR FONT, STYLE, SIZE, OR COLOR.

SN 77-294,182, FILED 10-2-2007.

MICHAEL KEATING, EXAMINING ATTORNEY



David J. Kyffers

Director of the United States Patent and Trademark Office

United States of America

United States Patent and Trademark Office

GREEN CEMENT FOR A BLUE PLANET

Reg. No. 4,067,386

Registered Dec. 6, 2011

Int. Cl.: 19

TRADEMARK

PRINCIPAL REGISTER

CALERA CORPORATION (CALIFORNIA CORPORATION)
14600 WINCHESTER BLVD.
LOS GATOS, CA 94032

FOR: NON-METALLIC CONSTRUCTION MATERIALS, NAMELY, MINERAL-BASED CEMENTITIOUS MATERIALS IN THE NATURE OF PORTLAND, HYDRAULIC, WHITE, MASONRY, PLASTIC, STUCCO, AND OIL WELL CEMENT, OTHER MINERAL-BASED CEMENTITIOUS MATERIALS; SUPPLEMENTARY CEMENTITIOUS MATERIALS, NAMELY, POZZOLANIC MATERIALS, IN CLASS 19 (U.S. CLS. 1, 12, 33 AND 50).

FIRST USE 10-12-2011; IN COMMERCE 10-12-2011.

THE MARK CONSISTS OF STANDARD CHARACTERS WITHOUT CLAIM TO ANY PARTICULAR FONT, STYLE, SIZE, OR COLOR.

SN 77-304,745, FILED 10-15-2007.

JOHN HWANG, EXAMINING ATTORNEY



David J. Kyros

Director of the United States Patent and Trademark Office

United States of America

United States Patent and Trademark Office

THEODORE ROOSEVELT

Reg. No. 4,067,387

Registered Dec. 6, 2011

Int. Cl.: 13

TRADEMARK

PRINCIPAL REGISTER

OLIN CORPORATION (VIRGINIA CORPORATION)
190 CARONDELET PLAZA, SUITE 1530
ST. LOUIS, MO 63105

FOR: AMMUNITION; FIREARMS, IN CLASS 13 (U.S. CLS. 2 AND 9).

FIRST USE 10-21-2009; IN COMMERCE 10-21-2009.

THE MARK CONSISTS OF STANDARD CHARACTERS WITHOUT CLAIM TO ANY PARTICULAR FONT, STYLE, SIZE, OR COLOR.

SN 77-312,090, FILED 10-24-2007.

RICHARD WHITE, EXAMINING ATTORNEY



David J. Kybas

Director of the United States Patent and Trademark Office

United States of America

United States Patent and Trademark Office

HACE FELIZ A TU NARIZ

Reg. No. 4,067,388

COLGATE-PALMOLIVE COMPANY (DELAWARE CORPORATION)
300 PARK AVENUE
NEW YORK, NY 10022

Registered Dec. 6, 2011

Int. Cl.: 3

FOR: ALL PURPOSE HOUSEHOLD CLEANING PREPARATION, IN CLASS 3 (U.S. CLS. 1, 4, 6, 50, 51 AND 52).

TRADEMARK

FIRST USE 10-22-2011; IN COMMERCE 10-22-2011.

PRINCIPAL REGISTER

THE MARK CONSISTS OF STANDARD CHARACTERS WITHOUT CLAIM TO ANY PARTICULAR FONT, STYLE, SIZE, OR COLOR.

THE FOREIGN WORDING IN THE MARK TRANSLATES INTO ENGLISH AS MAKES YOUR NOSE HAPPY.

SN 77-316,157, FILED 10-29-2007.

JACQUELINE A. LAVINE, EXAMINING ATTORNEY



David J. Kybas

Director of the United States Patent and Trademark Office

United States of America

United States Patent and Trademark Office

INVISIBLE CHILDREN

Reg. No. 4,067,389

Registered Dec. 6, 2011

Int. Cl.: 25

TRADEMARK

PRINCIPAL REGISTER

INVISIBLE CHILDREN INC. (CALIFORNIA CORPORATION)
SUITE 400
1620 5TH AVENUE
SAN DIEGO, CA 92101

FOR: SWEATSHIRTS, HATS AND BASEBALL CAPS, IN CLASS 25 (U.S. CLS. 22 AND 39).

FIRST USE 9-1-2005; IN COMMERCE 9-1-2005.

THE MARK CONSISTS OF STANDARD CHARACTERS WITHOUT CLAIM TO ANY PARTICULAR FONT, STYLE, SIZE, OR COLOR.

OWNER OF U.S. REG. NO. 3,352,370.

NO CLAIM IS MADE TO THE EXCLUSIVE RIGHT TO USE "CHILDREN", APART FROM THE MARK AS SHOWN.

SN 77-317,615, FILED 10-31-2007.

KEVIN CORWIN, EXAMINING ATTORNEY



David J. Kybas

Director of the United States Patent and Trademark Office

United States of America

United States Patent and Trademark Office

GREEN-AGE CEMENT FOR A BLUE PLANET

Reg. No. 4,067,390

Registered Dec. 6, 2011

Int. Cl.: 19

TRADEMARK

PRINCIPAL REGISTER

CALERA CORPORATION (CALIFORNIA CORPORATION)
14600 WINCHESTER BLVD.
LOS GATOS, CA 94032

FOR: NON-METALLIC CONSTRUCTION MATERIALS, NAMELY, MINERAL-BASED CEMENTITIOUS MATERIALS IN THE NATURE OF PORTLAND, HYDRAULIC, WHITE, MASONRY, PLASTIC, STUCCO, AND OIL WELL CEMENT, OTHER MINERAL-BASED CEMENTITIOUS MATERIALS; SUPPLEMENTARY CEMENTITIOUS MATERIALS, NAMELY, POZZOLANIC MATERIALS, IN CLASS 19 (U.S. CLS. 1, 12, 33 AND 50).

FIRST USE 10-12-2011; IN COMMERCE 10-12-2011.

THE MARK CONSISTS OF STANDARD CHARACTERS WITHOUT CLAIM TO ANY PARTICULAR FONT, STYLE, SIZE, OR COLOR.

NO CLAIM IS MADE TO THE EXCLUSIVE RIGHT TO USE "CEMENT", APART FROM THE MARK AS SHOWN.

SN 77-318,566, FILED 10-31-2007.

BRENDAN MCCAULEY, EXAMINING ATTORNEY



David J. Kyros

Director of the United States Patent and Trademark Office

United States of America

United States Patent and Trademark Office

PERFECT-DRY COTTON

Reg. No. 4,067,391

Registered Dec. 6, 2011

Int. Cls.: 24 and 25

TRADEMARK

PRINCIPAL REGISTER

PERFECT-DRY INC. (DELAWARE CORPORATION)
PIONEER STATION #4666
SEATTLE, WA 98194

FOR: WATERPROOF FABRIC MADE SUBSTANTIALLY IN PART OF COTTON AND PARTIALLY OF NATURAL FIBERS USED FOR MANUFACTURING CLOTHING, IN CLASS 24 (U.S. CLS. 42 AND 50).

FIRST USE 10-24-2011; IN COMMERCE 10-24-2011.

FOR: WEARING APPAREL MADE WHOLLY OR SUBSTANTIALLY IN PART OF COTTON, NAMELY, SWIMSUITS, SHIRTS, T-SHIRTS, SHORTS, PANTS, SWEATSHIRTS, SWEAT-PANTS, HATS, VISORS, SHOES AND BELTS, IN CLASS 25 (U.S. CLS. 22 AND 39).

FIRST USE 10-24-2011; IN COMMERCE 10-24-2011.

THE MARK CONSISTS OF STANDARD CHARACTERS WITHOUT CLAIM TO ANY PARTICULAR FONT, STYLE, SIZE, OR COLOR.

NO CLAIM IS MADE TO THE EXCLUSIVE RIGHT TO USE "COTTON", APART FROM THE MARK AS SHOWN.

SN 77-321,630, FILED 11-5-2007.

NATALIE POLZER, EXAMINING ATTORNEY



David J. Kybas

Director of the United States Patent and Trademark Office

United States of America
United States Patent and Trademark Office

ABN

Reg. No. 4,067,392

Registered Dec. 6, 2011

Int. Cl.: 3

TRADEMARK

PRINCIPAL REGISTER

ELEMENT SIX (IRELAND COMPANY)
SHANNON AIRPORT ESTATE
COUNTY CLARE, IRELAND

FOR: ABRASIVES, GRINDING PREPARATIONS AND POLISHING PREPARATIONS FOR DRILLS, SAW BLADES, BAND SAW BLADES, HACKSAWS, FRAME SAWS, CONCRETE POLISHING, ORE DRILL BITS, WIRE BEADS, IMPREGNATED BITS, ROLLER CONE BITS, TWIST DRILLS, WEAR PARTS, GRINDING WHEELS, GRINDING TIPS, ROTARY DRESSERS, DRESSER LOGS FOR SINGLE AND MULTIPLE LOG DRESSERS, PROFILE DRESSERS, STRAIGHT AND PROFILED ROUTERS, POLISHING CUPS, SINGLE POINT TOOLS, CALIBRATION ROLLERS, WIRE DRAWING DIES, SINGLE POINT TURNING TOOLS, GAUGE MATERIALS AND HARD FACING; DIAMOND GRIT, METAL COATED DIAMOND GRIT, DIAMOND POWDER AND POWDER COMPOUNDS USED AS ABRASIVES AND FOR GRINDING AND POLISHING FOR INDUSTRIAL USE IN THE FIELDS OF AUTOMOTIVE, AEROSPACE, CONSTRUCTION, STONE, PRECISION POLISHING, OIL AND GAS, AND MINING, IN CLASS 3 (U.S. CLS. 1, 4, 6, 50, 51 AND 52).

FIRST USE 0-0-1975; IN COMMERCE 0-0-2007.

THE MARK CONSISTS OF STANDARD CHARACTERS WITHOUT CLAIM TO ANY PARTICULAR FONT, STYLE, SIZE, OR COLOR.

SN 77-321,826, FILED 11-5-2007.

ALICIA COLLINS, EXAMINING ATTORNEY



David J. Kybas

Director of the United States Patent and Trademark Office

United States of America

United States Patent and Trademark Office



Reg. No. 4,067,393
Registered Dec. 6, 2011
Int. Cl.: 38

AMAZON TECHNOLOGIES, INC. (NEVADA CORPORATION)
ATTN: TRADEMARKS
P.O. BOX 8102
RENO, NV 89507

SERVICE MARK

PRINCIPAL REGISTER

FOR: TELECOMMUNICATIONS SERVICES, NAMELY, ELECTRONIC TRANSMISSION OF STREAMED AND DOWNLOADABLE AUDIO AND VIDEO FILES VIA COMPUTER AND OTHER COMMUNICATIONS NETWORKS; PROVIDING ONLINE ELECTRONIC BULLETIN BOARDS FOR THE TRANSMISSION OF MESSAGES AMONG COMPUTER USERS IN THE FIELD OF CONSUMER PRODUCT INFORMATION; TELECOMMUNICATION SERVICES, NAMELY, ELECTRONIC TRANSMISSION OF STREAMED AND DOWNLOADABLE AUDIO AND VIDEO AND MULTIMEDIA CONTENT FILES VIA COMPUTER AND OTHER COMMUNICATIONS NETWORKS; AUDIO BROADCASTING OF SPOKEN WORD, MUSIC, CONCERTS AND RADIO PROGRAMS, IN CLASS 38 (U.S. CLS. 100, 101 AND 104).

FIRST USE 6-0-2007; IN COMMERCE 6-0-2007.

THE MARK CONSISTS OF THE LETTER "A" ABOVE A SMILE OR CURVED ARROW.

SN 77-329,865, FILED 11-14-2007.

EVELYN BRADLEY, EXAMINING ATTORNEY



David J. Kyffers

Director of the United States Patent and Trademark Office

United States of America

United States Patent and Trademark Office

WE HARVEST GOODNESS

Reg. No. 4,067,394

Registered Dec. 6, 2011

Int. Cl.: 29

TRADEMARK

PRINCIPAL REGISTER

PERDUE HOLDINGS, INC. (DELAWARE CORPORATION)
1105 N. MARKET STREET
WILMINGTON, DE 19801

FOR: POULTRY, IN CLASS 29 (U.S. CL. 46).

FIRST USE 7-11-2011; IN COMMERCE 7-11-2011.

THE MARK CONSISTS OF STANDARD CHARACTERS WITHOUT CLAIM TO ANY PARTICULAR FONT, STYLE, SIZE, OR COLOR.

SN 77-333,823, FILED 11-20-2007.

ALEX KEAM, EXAMINING ATTORNEY



David J. Kybas

Director of the United States Patent and Trademark Office

United States of America

United States Patent and Trademark Office

SIMPLE GOODNESS

Reg. No. 4,067,395

Registered Dec. 6, 2011

Int. Cl.: 29

TRADEMARK

PRINCIPAL REGISTER

PERDUE HOLDINGS, INC. (DELAWARE CORPORATION)
SUITE 1300
1105 N. MARKET STREET
WILMINGTON, DE 19801

FOR: POULTRY, IN CLASS 29 (U.S. CL. 46).

FIRST USE 9-19-2011; IN COMMERCE 9-19-2011.

THE MARK CONSISTS OF STANDARD CHARACTERS WITHOUT CLAIM TO ANY PARTICULAR FONT, STYLE, SIZE, OR COLOR.

SN 77-334,317, FILED 11-20-2007.

ALEX KEAM, EXAMINING ATTORNEY



David J. Kybas

Director of the United States Patent and Trademark Office

United States of America

United States Patent and Trademark Office

A stylized Arabic calligraphic trademark consisting of the word 'الصفاة' (Al Safwa) in a bold, flowing script. The letters are interconnected, with a prominent vertical stroke on the right side that curves upwards and then loops back down.

Reg. No. 4,067,396

Registered Dec. 6, 2011

Int. Cl.: 38

SERVICE MARK

PRINCIPAL REGISTER

OCC ESTABLISHMENT (LIECHTENSTEIN ANSTALT)
STAEDTLE 36
FL-9490 VADUZ, LIECHTENSTEIN

FOR: TELEVISION BROADCASTING SERVICES, IN CLASS 38 (U.S. CLS. 100, 101 AND 104).

FIRST USE 0-0-2003; IN COMMERCE 2-15-2010.

THE MARK CONSISTS OF ARABIC CHARACTERS.

THE NON-LATIN CHARACTER(S) IN THE MARK TRANSLITERATE INTO AL SAFWA, AND THIS MEANS "THE ELITE" IN ENGLISH.

SN 77-354,542, FILED 12-18-2007.

APRIL ROACH, EXAMINING ATTORNEY



David J. Kybas

Director of the United States Patent and Trademark Office

United States of America

United States Patent and Trademark Office

Smile Shutter

Reg. No. 4,067,397

Registered Dec. 6, 2011

Int. Cl.: 9

TRADEMARK

PRINCIPAL REGISTER

SONY CORPORATION (JAPAN CORPORATION)
1-7-1 KONAN, MINATO-KU
TOKYO, JAPAN

FOR: DIGITAL STILL CAMERAS; VIDEO CAMERAS, IN CLASS 9 (U.S. CLS. 21, 23, 26, 36 AND 38).

FIRST USE 8-31-2007; IN COMMERCE 8-31-2007.

THE MARK CONSISTS OF STANDARD CHARACTERS WITHOUT CLAIM TO ANY PARTICULAR FONT, STYLE, SIZE, OR COLOR.

SN 77-355,500, FILED 12-19-2007.

JEFFERY COWARD, EXAMINING ATTORNEY



David J. Kybas

Director of the United States Patent and Trademark Office

United States of America

United States Patent and Trademark Office



Reg. No. 4,067,398

Registered Dec. 6, 2011

Int. Cl.: 16

TRADEMARK

PRINCIPAL REGISTER

CARVAJAL S.A. (COLOMBIA CORPORATION)
CALLE 29 NORTE NO. 6A-40
CALI, COLOMBIA

FOR: NOTE-BOOKS, IN CLASS 16 (U.S. CLS. 2, 5, 22, 23, 29, 37, 38 AND 50).

FIRST USE 7-0-2011; IN COMMERCE 7-0-2011.

SN 77-366,208, FILED 1-8-2008.

CHRISTOPHER BUONGIORNO, EXAMINING ATTORNEY



David J. Kyffers

Director of the United States Patent and Trademark Office

United States of America

United States Patent and Trademark Office

ALIAS

Reg. No. 4,067,399

Registered Dec. 6, 2011

Int. Cl.: 9

TRADEMARK

PRINCIPAL REGISTER

CELLCO PARTNERSHIP (DELAWARE PARTNERSHIP), DBA D/B/A VERIZON WIRELESS,
ONE VERIZON WAY, VC52N058
BASKING RIDGE, NJ 079201097

FOR: CELLULAR TELEPHONE FEATURING VOICE, DATA AND IMAGE WIRELESS TRANSMISSION SERVICES INCLUDING VOICE, TEXT AND PICTURE MESSAGING, A VIDEO AND STILL IMAGE CAMERA, ALSO FUNCTIONAL TO SHOP AND PURCHASE MUSIC, GAMES AND VIDEO OVER THE AIR FOR DOWNLOADING TO THE DEVICE, IN CLASS 9 (U.S. CLS. 21, 23, 26, 36 AND 38).

FIRST USE 3-13-2008; IN COMMERCE 3-13-2008.

THE MARK CONSISTS OF STANDARD CHARACTERS WITHOUT CLAIM TO ANY PARTICULAR FONT, STYLE, SIZE, OR COLOR.

SN 77-367,174, FILED 1-9-2008.

RENEE MCCRAY, EXAMINING ATTORNEY



David J. Kyffers

Director of the United States Patent and Trademark Office

United States of America

United States Patent and Trademark Office

IMAGINATION IS JUST THE BEGINNING

Reg. No. 4,067,400

Registered Dec. 6, 2011

Int. Cls.: 9 and 10

TRADEMARK

PRINCIPAL REGISTER

SENO MEDICAL INSTRUMENTS, INC. (TEXAS CORPORATION)
SUITE 101
3838 MEDICAL DRIVE
SAN ANTONIO, TX 78229

FOR: IMAGING APPARATUS FOR USE IN ANALYSIS IN THE LIFE SCIENCE RESEARCH FIELD, IN CLASS 9 (U.S. CLS. 21, 23, 26, 36 AND 38).

FIRST USE 1-9-2008; IN COMMERCE 1-9-2008.

FOR: APPARATUS FOR CLINICAL DIAGNOSIS; MEDICAL DEVICES, NAMELY, SURGICAL DEVICES THAT FACILITATE THE IDENTIFICATION, SEPARATION OR ABLATION OF BIOLOGIC TISSUES, IN CLASS 10 (U.S. CLS. 26, 39 AND 44).

FIRST USE 1-9-2008; IN COMMERCE 11-0-2010.

THE MARK CONSISTS OF STANDARD CHARACTERS WITHOUT CLAIM TO ANY PARTICULAR FONT, STYLE, SIZE, OR COLOR.

SN 77-367,734, FILED 1-9-2008.

PAM WILLIS, EXAMINING ATTORNEY



David J. Kybas

Director of the United States Patent and Trademark Office

United States of America

United States Patent and Trademark Office



CANINE STYLES

A LIFESTYLE FOR DOGS
NEW YORK, NY • EST. 1959

Reg. No. 4,067,401

CANINE STYLES, INC. (NEW YORK CORPORATION)
830 LEXINGTON AVENUE
NEW YORK, NY 10021

Registered Dec. 6, 2011

Int. Cls.: 18, 20, 35, and 44

FOR: CLOTHING FOR ANIMALS; CLOTHING FOR DOMESTIC PETS; PET CLOTHING; PET CARRIERS, TOTE BAGS AND BAGS FOR CARRYING PETS; PET ACCESSORIES, NAMELY, LEASHES, LEADS, HARNESSSES, COLLARS, BOWS IN THE NATURE OF PET COLLAR ACCESSORIES, IN CLASS 18 (U.S. CLS. 1, 2, 3, 22 AND 41).

TRADEMARK

FIRST USE 8-0-2005; IN COMMERCE 8-0-2005.

SERVICE MARK

PRINCIPAL REGISTER

FOR: PORTABLE BEDS FOR PETS; PET BEDS; PET PADS FOR USE AS PET BEDS; CUSHIONED PILLOWS FOR PETS; AND MATS FOR PETS TO REST, IN CLASS 20 (U.S. CLS. 2, 13, 22, 25, 32 AND 50).

FIRST USE 8-0-2005; IN COMMERCE 8-0-2005.

FOR: PET SUPPLY RETAIL AND WHOLESALE STORE SERVICES AND ONLINE PET SUPPLY RETAIL AND WHOLESALE STORE SERVICES FEATURING PET GOODS, NAMELY, PET CLOTHES, PET CARRIERS, PET BEDS, PET COLLARS, LEADS, HARNESSSES AND LEASHES, PET TOYS, FOOD BOWLS AND FEEDERS, PET FURNITURE, PET CHARMS AND JEWELRY, GIFT ITEMS RELATED TO PETS, BOOKS ON PETS, STATIONERY RELATED TO PETS, PET SUPPLIES AND RELATED PET ACCESSORIES, CHEWS FOR DOGS, GROOMING ACCESSORIES FOR CATS AND DOGS, NAMELY, LINT ROLLERS, CLEANING SPONGES, COMBS AND BRUSHES, PET TOYS, PET FOOD, NAMELY, DOG BISCUITS, CANNED DOG AND CAT FOOD, DRY DOG AND CAT FOOD, AND EDIBLE PET TREATS, PET BEVERAGES, ANIMAL LITTER, EDIBLE CHEWS FOR ANIMALS, DOG TAGS, PET STROLLERS AND CLOTHING FOR ADULTS AND CHILDREN, NAMELY, SHIRTS, SWEATSHIRTS, JACKETS, HATS, COATS, BELTS, IN CLASS 35 (U.S. CLS. 100, 101 AND 102).

FIRST USE 2-1-2007; IN COMMERCE 2-1-2007.

FOR: ANIMAL GROOMING, IN CLASS 44 (U.S. CLS. 100 AND 101).

FIRST USE 2-1-2007; IN COMMERCE 2-1-2007.



David J. Kyjars

Director of the United States Patent and Trademark Office

Reg. No. 4,067,401 NO CLAIM IS MADE TO THE EXCLUSIVE RIGHT TO USE "DOGS", "NEW YORK, NY" AND "EST. 1959", APART FROM THE MARK AS SHOWN.

THE COLOR(S) BLACK, GREEN, AND ORANGE IS/ARE CLAIMED AS A FEATURE OF THE MARK.

SEC. 2(F) AS TO "CANINE STYLES".

THE MARK CONSISTS OF THE WORDING "CANINE STYLES" WRITTEN IN BLACK WITH "CANINE" AND "STYLES" SEPARATED HORIZONTALLY BY THE DESIGN OF A DOG SILHOUETTE AND LAUREL WREATH IN ORANGE, ALL OF WHICH APPEAR ABOVE A HORIZONTAL GREEN LINE, BELOW WHICH IS "A LIFESTYLE FOR DOGS" WRITTEN IN BLACK, BELOW WHICH IS "NEW YORK, NY EST. 1959" WRITTEN IN BLACK.

SN 77-375,411, FILED 1-18-2008.

VERNA BETH RIRIE, EXAMINING ATTORNEY

United States of America

United States Patent and Trademark Office

Trans-Ramp

Reg. No. 4,067,402

Registered Dec. 6, 2011

Int. Cl.: 10

TRADEMARK

PRINCIPAL REGISTER

TRIPLE O INTERNATIONAL, LTD. (TEXAS LIMITED PARTNERSHIP)
200 E. PECAN
GAINESVILLE, TX 76240

FOR: ORTHODONTIC APPLIANCES, IN CLASS 10 (U.S. CLS. 26, 39 AND 44).

FIRST USE 6-1-2011; IN COMMERCE 6-1-2011.

THE MARK CONSISTS OF STANDARD CHARACTERS WITHOUT CLAIM TO ANY PARTICULAR FONT, STYLE, SIZE, OR COLOR.

SN 77-378,001, FILED 1-22-2008.

TRACY CROSS, EXAMINING ATTORNEY



David J. Kyfos

Director of the United States Patent and Trademark Office

United States of America

United States Patent and Trademark Office

HOOLOGAN BEAR

Reg. No. 4,067,403

Registered Dec. 6, 2011

Int. Cl.: 16

TRADEMARK

PRINCIPAL REGISTER

HOOLOGAN BEAR, INC. (CALIFORNIA CORPORATION)
840 NOWITA PLACE
VENICE, CA 90291

FOR: PRINTED PUBLICATIONS, NAMELY, BOOKS, COMIC BOOKS, CHILDREN'S BOOKS, MAGAZINES, COLORING BOOKS, AND ACTIVITY BOOKS FEATURING ANIMATED CHARACTERS, IN CLASS 16 (U.S. CLS. 2, 5, 22, 23, 29, 37, 38 AND 50).

FIRST USE 8-30-2011; IN COMMERCE 8-30-2011.

THE MARK CONSISTS OF STANDARD CHARACTERS WITHOUT CLAIM TO ANY PARTICULAR FONT, STYLE, SIZE, OR COLOR.

NO CLAIM IS MADE TO THE EXCLUSIVE RIGHT TO USE "BEAR", APART FROM THE MARK AS SHOWN.

SN 77-379,088, FILED 1-23-2008.

SHAUNIA CARLYLE, EXAMINING ATTORNEY



David J. Kyros

Director of the United States Patent and Trademark Office

United States of America

United States Patent and Trademark Office

RESPONSEDX: COLON

Reg. No. 4,067,404

Registered Dec. 6, 2011

Int. Cls.: 42 and 44

SERVICE MARK

PRINCIPAL REGISTER

RESPONSE GENETICS, INC. (DELAWARE CORPORATION)
1640 MARENGO STREET, 6TH FLOOR
LOS ANGELES, CA 90033

FOR: MEDICAL RESEARCH; SCIENTIFIC RESEARCH AND DEVELOPMENT, MEDICAL AND SCIENTIFIC RESEARCH CONSULTING; DIAGNOSTIC TESTING SERVICES, NAMELY, PROVIDING DIAGNOSTIC SERVICES FOR OTHERS IN THE FIELDS OF SCIENCE AND RESEARCH RELATED THERETO; PROVIDING SCIENTIFIC RESEARCH INFORMATION IN THE FIELD OF PHARMACEUTICALS AND CLINICAL TRIALS; PROVIDING SCIENTIFIC RESEARCH INFORMATION IN THE FIELD OF CANCER DIAGNOSIS, SCIENTIFIC RESEARCH INFORMATION IN THE FIELD OF CLINICAL TRIAL DESIGN AND SCIENTIFIC RESEARCH INFORMATION IN THE FIELD OF BIOTECHNOLOGY; PRODUCT DEVELOPMENT SERVICES FOR OTHERS IN THE BIOMEDICAL, GENOMICS, PHARMACOGENOMICS, DIAGNOSTIC, CLINICAL TRIAL DESIGN AND BIOTECHNOLOGY FIELDS, IN CLASS 42 (U.S. CLS. 100 AND 101).

FIRST USE 3-20-2008; IN COMMERCE 3-20-2008.

FOR: PROVIDING MEDICAL DIAGNOSTIC TESTING SERVICES FOR DIAGNOSTIC AND PROGNOSTIC PURPOSES; AND PROVIDING MEDICAL INFORMATION, IN CLASS 44 (U.S. CLS. 100 AND 101).

FIRST USE 3-20-2008; IN COMMERCE 3-20-2008.

THE MARK CONSISTS OF STANDARD CHARACTERS WITHOUT CLAIM TO ANY PARTICULAR FONT, STYLE, SIZE, OR COLOR.

OWNER OF U.S. REG. NOS. 2,800,718 AND 3,085,742.

NO CLAIM IS MADE TO THE EXCLUSIVE RIGHT TO USE "COLON", APART FROM THE MARK AS SHOWN.

SN 77-381,009, FILED 1-25-2008.

COLLEEN DOMBROW, EXAMINING ATTORNEY



David J. Kyros

Director of the United States Patent and Trademark Office

United States of America

United States Patent and Trademark Office

MOUNTAINEERADE

Reg. No. 4,067,405

Registered Dec. 6, 2011

Int. Cl.: 32

TRADEMARK

PRINCIPAL REGISTER

SUPER BAKERY, INCORPORATED (PENNSYLVANIA CORPORATION)
SUITE 455
5700 CORPORATE DRIVE
PITTSBURGH, PA 15237

FOR: SPORTS DRINKS, IN CLASS 32 (U.S. CLS. 45, 46 AND 48).

FIRST USE 12-3-2010; IN COMMERCE 12-3-2010.

THE MARK CONSISTS OF STANDARD CHARACTERS WITHOUT CLAIM TO ANY PARTICULAR FONT, STYLE, SIZE, OR COLOR.

SN 77-383,048, FILED 1-29-2008.

MICHAEL WIENER, EXAMINING ATTORNEY



David J. Kybas

Director of the United States Patent and Trademark Office

United States of America

United States Patent and Trademark Office

SWEET GOODNESS

Reg. No. 4,067,406

Registered Dec. 6, 2011

Int. Cl.: 30

TRADEMARK

PRINCIPAL REGISTER

DAWN FOODS, INC. (MICHIGAN CORPORATION)
3333 SARGENT ROAD
JACKSON, MI 49201

FOR: BAKERY GOODS, NAMELY, MUFFINS, LOAF CAKES, BUNDT CAKES, DECORATIVE CAKES, PUDDING CAKES, CREME CAKES, PASTY, SWEET DOUGH, COOKIES, DONUTS, BROWNIES, AND ICINGS, IN CLASS 30 (U.S. CL. 46).

FIRST USE 9-6-2011; IN COMMERCE 9-6-2011.

THE MARK CONSISTS OF STANDARD CHARACTERS WITHOUT CLAIM TO ANY PARTICULAR FONT, STYLE, SIZE, OR COLOR.

NO CLAIM IS MADE TO THE EXCLUSIVE RIGHT TO USE "SWEET", APART FROM THE MARK AS SHOWN.

SN 77-384,366, FILED 1-30-2008.

JUSTINE D. PARKER, EXAMINING ATTORNEY



David J. Kyros

Director of the United States Patent and Trademark Office

United States of America

United States Patent and Trademark Office

STREETS OF MOSCOW

Reg. No. 4,067,407

Registered Dec. 6, 2011

Int. Cls.: 9 and 16

TRADEMARK

PRINCIPAL REGISTER

1C JOINT STOCK VENTURE (RUSSIAN FED. CORPORATION)
1, KOR. 2, BASHILOVSKAYA STREET
MOSCOW, RUSSIAN FED. RU-103220

FOR: COMPUTER GAME PROGRAMS, VIDEO GAME CARTRIDGES, DOWNLOADABLE ELECTRONIC PUBLICATIONS, NAMELY, MAGAZINES AND NEWSLETTERS ABOUT COMPUTER GAMES AND VIDEO GAMES, IN CLASS 9 (U.S. CLS. 21, 23, 26, 36 AND 38).

FIRST USE 5-6-2010; IN COMMERCE 5-6-2010.

FOR: PRINTED PUBLICATIONS, NAMELY, PRINTED MANUALS WITH INSTRUCTIONS FOR PLAYING AND USING COMPUTER GAME PROGRAMS, VIDEO GAME PROGRAMS AND VIDEO GAME MACHINES, IN CLASS 16 (U.S. CLS. 2, 5, 22, 23, 29, 37, 38 AND 50).

FIRST USE 5-6-2010; IN COMMERCE 5-6-2010.

THE MARK CONSISTS OF STANDARD CHARACTERS WITHOUT CLAIM TO ANY PARTICULAR FONT, STYLE, SIZE, OR COLOR.

SN 77-384,837, FILED 1-30-2008.

SCOTT BIBB, EXAMINING ATTORNEY



David J. Kyffers

Director of the United States Patent and Trademark Office

United States of America

United States Patent and Trademark Office

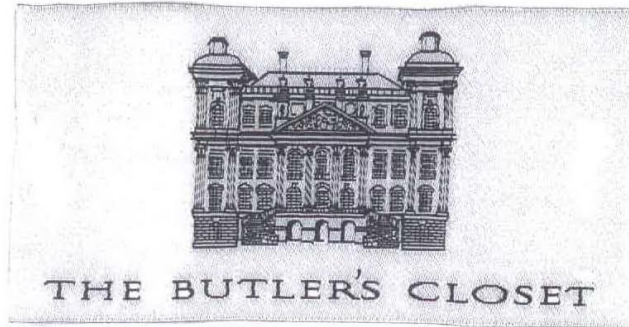

Reg. No. 4,067,408

Registered Dec. 6, 2011

Int. Cls.: 22 and 24

TRADEMARK

PRINCIPAL REGISTER

BARBARA KOTLIKOFF (UNITED STATES INDIVIDUAL), DBA THE BUTLER'S CLOSET,
RIVERMERE - APT. 4B - LAKE AVENUE
BRONXVILLE, NY 10708

FOR: GARMENT BAGS FOR STORAGE, SHOE BAGS FOR STORAGE, IN CLASS 22 (U.S. CLS. 1, 2, 7, 19, 22, 42 AND 50).

FIRST USE 3-25-2011; IN COMMERCE 3-25-2011.

FOR: LINEN COVERS, NAMELY, TABLE LINEN AND BED LINEN; AND UNFITTED FABRIC FURNITURE COVERS, IN CLASS 24 (U.S. CLS. 42 AND 50).

FIRST USE 11-26-2010; IN COMMERCE 11-26-2010.

THE MARK CONSISTS OF THE WORDS "THE BUTLER'S CLOSET" PLUS A DESIGN.

SN 77-385,338, FILED 1-31-2008.

ROBERT STRUCK, EXAMINING ATTORNEY



David J. Kyros

Director of the United States Patent and Trademark Office

United States of America

United States Patent and Trademark Office

FLIGHT BITES

Reg. No. 4,067,409

Registered Dec. 6, 2011

Int. Cl.: 21

TRADEMARK

PRINCIPAL REGISTER

IMERNET LLP (WASHINGTON LIMITED LIABILITY PARTNERSHIP)
SUITE 3200
1001 4TH AVENUE PLAZA
SEATTLE, WA 981541003

FOR: BASKETS OF CLOTH; LUNCH BOXES; NAPKIN HOLDERS; MEAL TRAYS, IN CLASS
21 (U.S. CLS. 2, 13, 23, 29, 30, 33, 40 AND 50).

FIRST USE 9-9-2011; IN COMMERCE 9-9-2011.

THE MARK CONSISTS OF STANDARD CHARACTERS WITHOUT CLAIM TO ANY PAR-
TICULAR FONT, STYLE, SIZE, OR COLOR.

SN 77-386,289, FILED 2-1-2008.

KRISTIN CARLSON, EXAMINING ATTORNEY



David J. Kyros

Director of the United States Patent and Trademark Office

United States of America

United States Patent and Trademark Office

CARBON LINK

Reg. No. 4,067,410

Registered Dec. 6, 2011

Int. Cl.: 1

TRADEMARK

PRINCIPAL REGISTER

CARBON LINK CORPORATION (OHIO CORPORATION)
118 EAST HIGH STREET
SUITE C
MOUNT VERNON, OH 43050

FOR: ACTIVATED CARBON FOR USE IN VAPOR AND LIQUID PHASE ADSORPTION APPLICATIONS, SPECIFICALLY RELATED TO APPLICATIONS INVOLVING SOLVENT RECOVERY, CARBON DIOXIDE, INDUSTRIAL RESPIRATORS, WASTE DISPOSAL, CIGARETTES, AIR CONDITIONING, COMPOSITE FIBERS, FRIDGE DEODORIZERS, POTABLE WATER, SOFTDRINKS, BREWING, SEMI-CONDUCTORS, GOLD RECOVERY, PETRO-CHEMICAL, GROUNDWATER, PROCESS EFFLUENT, AND SWIMMING POOLS, IN CLASS 1 (U.S. CLS. 1, 5, 6, 10, 26 AND 46).

FIRST USE 1-0-2005; IN COMMERCE 1-0-2005.

THE MARK CONSISTS OF STANDARD CHARACTERS WITHOUT CLAIM TO ANY PARTICULAR FONT, STYLE, SIZE, OR COLOR.

OWNER OF U.S. REG. NOS. 2,532,821, 2,640,244, AND OTHERS.

NO CLAIM IS MADE TO THE EXCLUSIVE RIGHT TO USE "CARBON", APART FROM THE MARK AS SHOWN.

SN 77-386,463, FILED 2-1-2008.

RAUL CORDOVA, EXAMINING ATTORNEY



David J. Kyros

Director of the United States Patent and Trademark Office

United States of America
United States Patent and Trademark Office

KTF

Reg. No. 4,067,411

Registered Dec. 6, 2011

Int. Cl.: 33

TRADEMARK

PRINCIPAL REGISTER

DIAGEO NORTH AMERICA, INC. (CONNECTICUT CORPORATION)
801 MAIN AVENUE
NORWALK, CT 06851

FOR: ALCOHOLIC BEVERAGES EXCEPT BEERS, IN CLASS 33 (U.S. CLS. 47 AND 49).

FIRST USE 12-31-2007; IN COMMERCE 12-31-2007.

THE MARK CONSISTS OF STANDARD CHARACTERS WITHOUT CLAIM TO ANY PARTICULAR FONT, STYLE, SIZE, OR COLOR.

SN 77-390,272, FILED 2-6-2008.

MARIA-VICTORIA SUAREZ, EXAMINING ATTORNEY



David J. Kyffers

Director of the United States Patent and Trademark Office

United States of America

United States Patent and Trademark Office

ST AUGUSTINE

Reg. No. 4,067,412

FERGUSON ENTERPRISES, INC. (VIRGINIA CORPORATION)
12500 JEFFERSON AVENUE
NEWPORT NEWS, VA 22602

Registered Dec. 6, 2011

Int. Cl.: 11

FOR: PLUMBING FIXTURES, NAMELY, SINKS, PEDESTAL SINKS AND TOILETS, IN CLASS 11 (U.S. CLS. 13, 21, 23, 31 AND 34).

TRADEMARK

FIRST USE 3-31-2009; IN COMMERCE 3-31-2009.

PRINCIPAL REGISTER

THE MARK CONSISTS OF STANDARD CHARACTERS WITHOUT CLAIM TO ANY PARTICULAR FONT, STYLE, SIZE, OR COLOR.

SN 77-391,177, FILED 2-7-2008.

EVELYN BRADLEY, EXAMINING ATTORNEY



David J. Kybas

Director of the United States Patent and Trademark Office

United States of America

United States Patent and Trademark Office

AVES DEL SUR

Reg. No. 4,067,413

Registered Dec. 6, 2011

Int. Cl.: 33

TRADEMARK

PRINCIPAL REGISTER

VINA CARTA VIEJA S.A. (CHILE CORPORATION)
AVENIDA FRANCISCO ANTONIO ENCINA NO. 231
SEPTIMA REGION, CHILE

FOR: ALCOHOLIC BEVERAGES EXCEPT BEERS, IN CLASS 33 (U.S. CLS. 47 AND 49).

FIRST USE 6-18-2009; IN COMMERCE 8-26-2011.

THE MARK CONSISTS OF STANDARD CHARACTERS WITHOUT CLAIM TO ANY PARTICULAR FONT, STYLE, SIZE, OR COLOR.

THE FOREIGN WORDING IN THE MARK TRANSLATES INTO ENGLISH AS BIRDS OF THE SOUTH.

SN 77-391,961, FILED 2-8-2008.

ELIZABETH HUGHITT, EXAMINING ATTORNEY



David J. Kybas

Director of the United States Patent and Trademark Office

United States of America

United States Patent and Trademark Office

BUSY PERSON'S INTRO

Reg. No. 4,067,414

Registered Dec. 6, 2011

Int. Cl.: 16

TRADEMARK

PRINCIPAL REGISTER

DD TRADERS, INC. (DELAWARE CORPORATION), DBA DEMDACO,
5000 WEST 134TH STREET
LEAWOOD, KS 66209

FOR: PUBLICATIONS, NAMELY, A SERIES OF NON-FICTION BOOKS IN THE FIELDS OF HISTORY, BIOGRAPHIES AND CURRENT EVENTS, IN CLASS 16 (U.S. CLS. 2, 5, 22, 23, 29, 37, 38 AND 50).

FIRST USE 0-0-2009; IN COMMERCE 0-0-2009.

THE MARK CONSISTS OF STANDARD CHARACTERS WITHOUT CLAIM TO ANY PARTICULAR FONT, STYLE, SIZE, OR COLOR.

SN 77-392,589, FILED 2-8-2008.

LINDA MICKLEBURGH, EXAMINING ATTORNEY



David J. Kyffers

Director of the United States Patent and Trademark Office

United States of America

United States Patent and Trademark Office

SOLAR POWERED

Reg. No. 4,067,415

Registered Dec. 6, 2011

Int. Cl.: 3

TRADEMARK

PRINCIPAL REGISTER

C&K, LLC (CALIFORNIA LIMITED LIABILITY COMPANY)
6210 GLEN AIRY STREET
HOLLYWOOD, CA 900582241

FOR: COSMETICS, MAKEUP, SKIN MOISTURIZERS, LIP BALM, FACE AND BODY LOTIONS, AND PREPARATIONS FOR SUNBLOCK, SUNSCREEN AND SUN TANNING , IN CLASS 3 (U.S. CLS. 1, 4, 6, 50, 51 AND 52).

FIRST USE 7-2-2011; IN COMMERCE 7-2-2011.

THE MARK CONSISTS OF STANDARD CHARACTERS WITHOUT CLAIM TO ANY PARTICULAR FONT, STYLE, SIZE, OR COLOR.

SN 77-392,628, FILED 2-8-2008.

GRETТА YAO, EXAMINING ATTORNEY



David J. Kybas

Director of the United States Patent and Trademark Office

United States of America

United States Patent and Trademark Office



Reg. No. 4,067,416

Registered Dec. 6, 2011

Int. Cl.: 41

SERVICE MARK

PRINCIPAL REGISTER

NATIONAL LAW ENFORCEMENT OFFICERS MEMORIAL FUND, INC. (D.C. NON-PROFIT CORPORATION)
901 E STREET, NW, SUITE 100
WASHINGTON, DC 200042025

FOR: OPERATING A MEMORIAL TO LAW ENFORCEMENT OFFICERS WHO HAVE DIED IN THE LINE OF DUTY , IN CLASS 41 (U.S. CLS. 100, 101 AND 107).

FIRST USE 10-15-1991; IN COMMERCE 10-15-1991.

THE MARK CONSISTS OF A DESIGN OF A LONG STEM ROSE IN FRONT OF A SHIELD DESIGN.

SN 77-392,773, FILED 2-8-2008.

RUDY R. SINGLETON, EXAMINING ATTORNEY



David J. Kybas

Director of the United States Patent and Trademark Office

United States of America

United States Patent and Trademark Office

Power Trampologa

Reg. No. 4,067,417

Registered Dec. 6, 2011

Int. Cls.: 28 and 41

TRADEMARK

SERVICE MARK

PRINCIPAL REGISTER

POWER TRAMPOLOGA, LLC (GEORGIA LIMITED LIABILITY COMPANY)
5585 GLENRIDGE DRIVE
ATLANTA, GA 30305

FOR: EXERCISE TRAMPOLINES, IN CLASS 28 (U.S. CLS. 22, 23, 38 AND 50).

FIRST USE 9-21-2011; IN COMMERCE 9-21-2011.

FOR: PHYSICAL FITNESS TRAINING SERVICES UTILIZING A TRAMPOLINE AND OTHER FITNESS EXERCISES INCORPORATING THE FUNDAMENTALS OF YOGA, CORE STABILITY AEROBICS AND RESISTANCE TRAINING, IN CLASS 41 (U.S. CLS. 100, 101 AND 107).

FIRST USE 1-1-2005; IN COMMERCE 1-1-2005.

THE MARK CONSISTS OF STANDARD CHARACTERS WITHOUT CLAIM TO ANY PARTICULAR FONT, STYLE, SIZE, OR COLOR.

SN 77-394,098, FILED 2-11-2008.

KAPIL BHANOT, EXAMINING ATTORNEY



David J. Kyffers

Director of the United States Patent and Trademark Office

United States of America

United States Patent and Trademark Office



Reg. No. 4,067,418

Registered Dec. 6, 2011

Int. Cls.: 28 and 41

TRADEMARK

SERVICE MARK

PRINCIPAL REGISTER

POWER TRAMPOLOGA, LLC (GEORGIA LIMITED LIABILITY COMPANY)
5585 GLENRIDGE DRIVE
ATLANTA, GA 30342

FOR: EXERCISE TRAMPOLINES, IN CLASS 28 (U.S. CLS. 22, 23, 38 AND 50).

FIRST USE 9-21-2011; IN COMMERCE 9-21-2011.

FOR: PHYSICAL FITNESS TRAINING SERVICES UTILIZING A TRAMPOLINE AND OTHER FITNESS EXERCISES INCORPORATING THE FUNDAMENTALS OF YOGA, CORE STABILITY AEROBICS, AND RESISTANCE TRAINING, IN CLASS 41 (U.S. CLS. 100, 101 AND 107).

FIRST USE 1-1-2005; IN COMMERCE 1-1-2005.

THE NAME JAIMYN THOMPSON A/K/A "JAIMYN JUPITER" IDENTIFIES A LIVING INDIVIDUAL WHOSE CONSENT IS OF RECORD.

THE COLOR(S) RED, BLACK AND PURPLE IS/ARE CLAIMED AS A FEATURE OF THE MARK.

THE MARK CONSISTS OF THE TERM "POWER TRAMPOLOGA". THE TERM "POWER" IS POSITIONED ABOVE THE TERM "TRAMPOLOGA". THE LETTERS COMPRISING THE TERM "POWER" ARE SHADED IN BLACK AND ARE POSITIONED IN A STRAIGHT LINE. THE LETTERS COMPRISING THE TERM "TRAMPOLOGA" ARE OUTLINED IN BLACK AND SHADED IN RED. IN ADDITION, THE LETTERS CONSISTING OF THE TERM "TRAMPOLOGA" ARE CURVED TO FORM THE BOTTOM HALF OF AN ELLIPSE. ABOVE THE TERM "POWER TRAMPOLOGA" IS THE TERM "JAIMYN JUPITER'S". THE LETTERS COMPRISING THE TERM "JAIMYN JUPITER'S" ARE IN A SMALLER FONT THAN THE LETTERS COMPRISING "POWER" AND "TRAMPOLOGA", ARE SHADED IN PURPLE AND ARE CURVED TO FORM THE TOP HALF OF AN ELLIPSE. TWO CURVED LINES (COMPLETING THE ELLIPSE) IN RED CONNECT THE TERM "TRAMPOLOGA" TO "JAIMYN JUPITER'S". ONE CURVED RED LINE EXTENDS FROM THE "T" IN "TRAMPOLOGA" TO A BLACK SPHERE ADJACENT TO THE "J" IN "JAIMYN". THE OTHER CURVED RED LINE EXTENDS FROM THE "A" IN "TRAMPOLOGA" TO A BLACK SPHERE ADJACENT TO THE "S" IN "JUPITER'S". ABOVE THE WORDS "JAIMYN JUPITER'S" IS A HUMAN FIGURE IN



David J. Kyros

Director of the United States Patent and Trademark Office

Reg. No. 4,067,418 BLACK REPRESENTING THE MYTHOLOGICAL FIGURE, ATLAS, CARRYING A LARGE RED GLOBE ON HIS BACK WITHIN WHICH ARE CLOUD SHAPES OF PURPLE.

SN 77-394,187, FILED 2-11-2008.

KAPIL BHANOT, EXAMINING ATTORNEY

United States of America

United States Patent and Trademark Office

EVERYDAY PRODUCTS. EXTRAORDINARY DESIGN.

Reg. No. 4,067,419

Registered Dec. 6, 2011

Int. Cl.: 16

TRADEMARK

PRINCIPAL REGISTER

CPP INTERNATIONAL, LLC (NORTH CAROLINA LIMITED LIABILITY COMPANY)
9144 ARROWPOINT BLVD., SUITE 200
CHARLOTTE, NC 28273

FOR: ADDRESS BOOKS, ADHESIVE NOTE PAPER, APPOINTMENT BOOKS, BALL POINT PENS, BINDERS, BLANK JOURNALS, CALENDARS, DAILY PLANNERS, DESK CALENDARS, DESK PADS, DRY ERASE BOARDS, ENVELOPES, FILE CARDS, FILE FOLDERS, FOLDERS, HIGHLIGHTER PENS, INDEX CARDS, INK PENS, NOTEBOOK DIVIDERS, NOTEBOOKS, PADFOLIOS, PEN AND PENCIL CASES, PENCILS, POCKET CALENDARS, RULED PAPER, STATIONERY AND TIME PLANNERS, IN CLASS 16 (U.S. CLS. 2, 5, 22, 23, 29, 37, 38 AND 50).

FIRST USE 10-0-2010; IN COMMERCE 10-0-2010.

THE MARK CONSISTS OF STANDARD CHARACTERS WITHOUT CLAIM TO ANY PARTICULAR FONT, STYLE, SIZE, OR COLOR.

SN 77-395,190, FILED 2-12-2008.

JUDITH HELFMAN, EXAMINING ATTORNEY



David J. Kyros

Director of the United States Patent and Trademark Office

United States of America

United States Patent and Trademark Office

CRYOSTASIS

Reg. No. 4,067,420

Registered Dec. 6, 2011

Int. Cls.: 9 and 16

TRADEMARK

PRINCIPAL REGISTER

IC JOINT STOCK VENTURE (RUSSIAN FED. CORPORATION)
1, KOR. 2, BASHILOVSKAYA STREET
MOSCOW, RUSSIAN FED. RU-103220

FOR: COMPUTER GAME PROGRAMS, VIDEO GAME CARTRIDGES, DOWNLOADABLE ELECTRONIC PUBLICATIONS, NAMELY, MAGAZINES AND NEWSLETTERS ABOUT COMPUTER GAMES AND VIDEO GAMES, IN CLASS 9 (U.S. CLS. 21, 23, 26, 36 AND 38).

FIRST USE 12-5-2008; IN COMMERCE 4-20-2009.

FOR: PRINTED PUBLICATIONS, NAMELY, PRINTED MANUALS WITH INSTRUCTIONS FOR PLAYING AND USING COMPUTER GAME PROGRAMS, VIDEO GAME PROGRAMS AND VIDEO GAME MACHINES, IN CLASS 16 (U.S. CLS. 2, 5, 22, 23, 29, 37, 38 AND 50).

FIRST USE 12-5-2008; IN COMMERCE 4-20-2009.

THE MARK CONSISTS OF STANDARD CHARACTERS WITHOUT CLAIM TO ANY PARTICULAR FONT, STYLE, SIZE, OR COLOR.

SN 77-396,462, FILED 2-13-2008.

SCOTT BIBB, EXAMINING ATTORNEY



David J. Kyffers

Director of the United States Patent and Trademark Office

United States of America

United States Patent and Trademark Office

CHAMPLEVÉ

Reg. No. 4,067,421

IZER, EVAN (UNITED STATES INDIVIDUAL)
240 BROADWAY #304
BROOKLYN, NY 112116203

Registered Dec. 6, 2011

Int. Cl.: 3

FOR: EAU DE PARFUM; EAU DE TOILETTE; EAU-DE-COLOGNE; PERFUME, IN CLASS 3 (U.S. CLS. 1, 4, 6, 50, 51 AND 52).

TRADEMARK

FIRST USE 9-26-2011; IN COMMERCE 9-26-2011.

PRINCIPAL REGISTER

THE MARK CONSISTS OF STANDARD CHARACTERS WITHOUT CLAIM TO ANY PARTICULAR FONT, STYLE, SIZE, OR COLOR.

SN 77-396,636, FILED 2-14-2008.

JOHN GARTNER, EXAMINING ATTORNEY



David J. Kyros

Director of the United States Patent and Trademark Office

United States of America
United States Patent and Trademark Office

DAYTONA

Reg. No. 4,067,422

RENEGADE TOBACCO COMPANY, INC. (NORTH CAROLINA CORPORATION)
321 FARMINGTON ROAD
MOCKSVILLE, NC 27028

Registered Dec. 6, 2011

Int. Cl.: 34

FOR: TOBACCO, CIGARS AND CIGARETTES, IN CLASS 34 (U.S. CLS. 2, 8, 9 AND 17).

TRADEMARK

FIRST USE 10-24-2011; IN COMMERCE 10-24-2011.

PRINCIPAL REGISTER

THE MARK CONSISTS OF STANDARD CHARACTERS WITHOUT CLAIM TO ANY PARTICULAR FONT, STYLE, SIZE, OR COLOR.

SN 77-399,453, FILED 2-18-2008.

BENJAMIN OKEKE, EXAMINING ATTORNEY



David J. Kyffers

Director of the United States Patent and Trademark Office

United States of America

United States Patent and Trademark Office

Feminostic

Reg. No. 4,067,423

Registered Dec. 6, 2011

Int. Cl.: 16

TRADEMARK

PRINCIPAL REGISTER

LUMINA SPHERE LLC (ARIZONA LIMITED LIABILITY COMPANY)
3655 W. ANTHEM WAY #A109-419
ANTHEM, AZ 85086

FOR: GREETING CARDS; CALENDARS; POSTERS; STATIONERY; PAPER MACHE; PAPER MACHE FIGURINES, IN CLASS 16 (U.S. CLS. 2, 5, 22, 23, 29, 37, 38 AND 50).

FIRST USE 1-7-2009; IN COMMERCE 6-7-2011.

THE MARK CONSISTS OF STANDARD CHARACTERS WITHOUT CLAIM TO ANY PARTICULAR FONT, STYLE, SIZE, OR COLOR.

SN 77-399,844, FILED 2-18-2008.

KATHRYN COWARD, EXAMINING ATTORNEY



David J. Kybas

Director of the United States Patent and Trademark Office

United States of America

United States Patent and Trademark Office

ROYALSILK

Reg. No. 4,067,424

Registered Dec. 6, 2011

Int. Cl.: 10

TRADEMARK

PRINCIPAL REGISTER

ALLEGIANCE CORPORATION (DELAWARE CORPORATION)
1430 WAUKEGAN ROAD, KB-1A
MCGAW PARK, IL 60085

FOR: NON-WOVEN MEDICAL GOWNS AND NON-WOVEN SURGICAL DRAPES, IN CLASS 10 (U.S. CLS. 26, 39 AND 44).

FIRST USE 8-0-2009; IN COMMERCE 8-0-2009.

THE MARK CONSISTS OF STANDARD CHARACTERS WITHOUT CLAIM TO ANY PARTICULAR FONT, STYLE, SIZE, OR COLOR.

SN 77-400,376, FILED 2-19-2008.

H. M. FISHER, EXAMINING ATTORNEY



David J. Kybas

Director of the United States Patent and Trademark Office

United States of America

United States Patent and Trademark Office

LONG

Reg. No. 4,067,425

Registered Dec. 6, 2011

Int. Cls.: 37 and 42

SERVICE MARK

PRINCIPAL REGISTER

LONG FENCE COMPANY, INC. (D.C. CORPORATION)
8545 EDGEWORTH DRIVE
CAPITOL HEIGHTS, MD 20743

FOR: CONSTRUCTION AND INSTALLATION OF SPRINKLERS AND OUTDOOR LIGHTING;
SOIL EROSION CONTROL, IN CLASS 37 (U.S. CLS. 100, 103 AND 106).

FIRST USE 4-30-2001; IN COMMERCE 4-30-2001.

FOR: LANDSCAPE LIGHTING DESIGN, IN CLASS 42 (U.S. CLS. 100 AND 101).

FIRST USE 12-18-2008; IN COMMERCE 12-18-2008.

THE MARK CONSISTS OF STANDARD CHARACTERS WITHOUT CLAIM TO ANY PARTICULAR FONT, STYLE, SIZE, OR COLOR.

OWNER OF U.S. REG. NOS. 900,585, 2,688,028, AND OTHERS.

SN 77-400,845, FILED 2-19-2008.

SUSAN STIGLITZ, EXAMINING ATTORNEY



David J. Kybas

Director of the United States Patent and Trademark Office

United States of America

United States Patent and Trademark Office

LONG FENCE

Reg. No. 4,067,426

Registered Dec. 6, 2011

Int. Cls.: 37 and 42

SERVICE MARK

PRINCIPAL REGISTER

LONG FENCE COMPANY, INC. (D.C. CORPORATION)
8545 EDGEWORTH DRIVE
CAPITOL HEIGHTS, MD 20743

FOR: CONSTRUCTION AND INSTALLATION OF SPRINKLERS AND OUTDOOR LIGHTING;
SOIL EROSION CONTROL, IN CLASS 37 (U.S. CLS. 100, 103 AND 106).

FIRST USE 4-30-2001; IN COMMERCE 4-30-2001.

FOR: LANDSCAPE LIGHTING DESIGN, IN CLASS 42 (U.S. CLS. 100 AND 101).

FIRST USE 12-18-2008; IN COMMERCE 12-18-2008.

THE MARK CONSISTS OF STANDARD CHARACTERS WITHOUT CLAIM TO ANY PARTICULAR FONT, STYLE, SIZE, OR COLOR.

OWNER OF U.S. REG. NOS. 900,585, 2,688,028, AND OTHERS.

SN 77-400,850, FILED 2-19-2008.

SUSAN STIGLITZ, EXAMINING ATTORNEY



David J. Kybas

Director of the United States Patent and Trademark Office

United States of America

United States Patent and Trademark Office

LONG FENCE

Reg. No. 4,067,427

Registered Dec. 6, 2011

Int. Cls.: 37 and 42

SERVICE MARK

PRINCIPAL REGISTER

LONG FENCE COMPANY, INC. (D.C. CORPORATION)
8545 EDGEWORTH DRIVE
CAPITOL HEIGHTS, MD 20743

FOR: CONSTRUCTION AND INSTALLATION OF SPRINKLERS AND OUTDOOR LIGHTING;
SOIL EROSION CONTROL, IN CLASS 37 (U.S. CLS. 100, 103 AND 106).

FIRST USE 4-30-2001; IN COMMERCE 4-30-2001.

FOR: LANDSCAPE LIGHTING DESIGN, IN CLASS 42 (U.S. CLS. 100 AND 101).

FIRST USE 12-18-2008; IN COMMERCE 12-18-2008.

OWNER OF U.S. REG. NOS. 900,585, 2,688,028, AND OTHERS.

SN 77-400,858, FILED 2-19-2008.

SUSAN STIGLITZ, EXAMINING ATTORNEY



David J. Kybas

Director of the United States Patent and Trademark Office

United States of America

United States Patent and Trademark Office

1-800-917-LONG

Reg. No. 4,067,428

Registered Dec. 6, 2011

Int. Cls.: 37 and 42

SERVICE MARK

PRINCIPAL REGISTER

LONG FENCE COMPANY, INC. (D.C. CORPORATION)
8545 EDGEWORTH DRIVE
CAPITOL HEIGHTS, MD 20743

FOR: CONSTRUCTION AND INSTALLATION OF SPRINKLERS AND OUTDOOR LIGHTING;
SOIL EROSION CONTROL, IN CLASS 37 (U.S. CLS. 100, 103 AND 106).

FIRST USE 4-30-2001; IN COMMERCE 4-30-2001.

FOR: LANDSCAPE LIGHTING DESIGN, IN CLASS 42 (U.S. CLS. 100 AND 101).

FIRST USE 12-18-2008; IN COMMERCE 12-18-2008.

THE MARK CONSISTS OF STANDARD CHARACTERS WITHOUT CLAIM TO ANY PARTICULAR FONT, STYLE, SIZE, OR COLOR.

OWNER OF U.S. REG. NOS. 900,585, 2,688,028, AND OTHERS.

SN 77-400,864, FILED 2-19-2008.

SUSAN STIGLITZ, EXAMINING ATTORNEY



David J. Kyffers

Director of the United States Patent and Trademark Office

United States of America

United States Patent and Trademark Office

COLLABORATIVE INNOVATION

Reg. No. 4,067,429

Registered Dec. 6, 2011

Int. Cls.: 35, 38, and 42

SERVICE MARK

PRINCIPAL REGISTER

INTERNATIONAL BUSINESS MACHINES CORPORATION (NEW YORK CORPORATION)
NEW ORCHARD ROAD
ARMONK, NY 10504

FOR: BUSINESS CONSULTING SERVICES, NAMELY, PROVIDING ASSISTANCE IN DEVELOPMENT OF BUSINESS STRATEGIES AND CREATIVE IDEATION; BUSINESS RESEARCH SERVICES, NAMELY, PROVIDING RESEARCH AND ANALYSIS OF DATA COLLECTED FROM AN ONLINE INTERACTIVE EVENT FORUM; PROMOTING ONLINE INTERACTIVE EVENT FORUMS FOR OTHERS, IN CLASS 35 (U.S. CLS. 100, 101 AND 102).

FIRST USE 12-0-2007; IN COMMERCE 12-0-2007.

FOR: PROVIDING AN ONLINE FORUM WHICH ALLOWS MULTIPLE PARTICIPANTS TO SHARE AND DEVELOP BUSINESS AND SOCIETAL IDEAS AND SOLUTIONS; COMPUTER SERVICES, NAMELY, PROVIDING ON-LINE FACILITIES FOR REAL-TIME INTERACTION WITH OTHER COMPUTER USERS CONCERNING TOPICS OF GENERAL INTEREST SUBMITTED DURING AN ONLINE INTERACTIVE EVENT FORUM, IN CLASS 38 (U.S. CLS. 100, 101 AND 104).

FIRST USE 12-0-2007; IN COMMERCE 12-0-2007.

FOR: COMPUTER SERVICES, NAMELY, HOSTING ON-LINE INTERACTIVE EVENT FORUMS THAT ALLOW MULTIPLE PARTICIPANTS TO SHARE AND DEVELOP BUSINESS AND SOCIETAL IDEAS AND SOLUTIONS; DATAMINING, IN CLASS 42 (U.S. CLS. 100 AND 101).

FIRST USE 12-0-2007; IN COMMERCE 12-0-2007.

THE MARK CONSISTS OF STANDARD CHARACTERS WITHOUT CLAIM TO ANY PARTICULAR FONT, STYLE, SIZE, OR COLOR.

SN 77-402,148, FILED 2-20-2008.

BRENDAN REGAN, EXAMINING ATTORNEY



David J. Kyros

Director of the United States Patent and Trademark Office

United States of America

United States Patent and Trademark Office

XTREME WHITE

Reg. No. 4,067,430

Registered Dec. 6, 2011

Int. Cl.: 21

TRADEMARK

PRINCIPAL REGISTER

RANIR, LLC (DELAWARE LIMITED LIABILITY COMPANY)
4701 EAST PARIS AVE. S.E.
GRAND RAPIDS, MI, MI 49512

FOR: TOOTH BRUSHES, IN CLASS 21 (U.S. CLS. 2, 13, 23, 29, 30, 33, 40 AND 50).

FIRST USE 8-12-2011; IN COMMERCE 8-12-2011.

THE MARK CONSISTS OF STANDARD CHARACTERS WITHOUT CLAIM TO ANY PARTICULAR FONT, STYLE, SIZE, OR COLOR.

OWNER OF U.S. REG. NO. 2,701,356.

NO CLAIM IS MADE TO THE EXCLUSIVE RIGHT TO USE "WHITE", APART FROM THE MARK AS SHOWN.

SN 77-402,754, FILED 2-21-2008.

DARRYL SPRUILL, EXAMINING ATTORNEY



David J. Kyfos

Director of the United States Patent and Trademark Office

United States of America

United States Patent and Trademark Office

BAHAMA MAMAS

Reg. No. 4,067,431

Registered Dec. 6, 2011

Int. Cl.: 34

TRADEMARK

PRINCIPAL REGISTER

BAHAMA MAMAS HOLDING, LLC (NEVADA LIMITED LIABILITY COMPANY)
7437 S EASTERN AVE
#128
LAS VEGAS, NV 89123

FOR: ABSORBENT PAPER FOR TOBACCO PIPES; ASHTRAYS, NOT OF PRECIOUS METAL; CIGAR CASES; CIGAR HUMIDIFIERS; CIGAR TUBES; MATCH BOXES; MATCHES; NON-ELECTRIC CIGAR LIGHTERS NOT OF PRECIOUS METAL; CIGARETTE ASH RECEPTACLES; CIGARETTES; HUMIDORS; ASHTRAYS; CIGARETTE BOXES; CIGAR CUTTERS, IN CLASS 34 (U.S. CLS. 2, 8, 9 AND 17).

FIRST USE 1-1-2010; IN COMMERCE 1-1-2010.

THE MARK CONSISTS OF STANDARD CHARACTERS WITHOUT CLAIM TO ANY PARTICULAR FONT, STYLE, SIZE, OR COLOR.

SN 77-403,258, FILED 2-21-2008.

JORDAN BAKER, EXAMINING ATTORNEY



David J. Kyffers

Director of the United States Patent and Trademark Office

United States of America

United States Patent and Trademark Office

LITTLE BIRD

Reg. No. 4,067,432

Registered Dec. 6, 2011

Int. Cl.: 28

TRADEMARK

PRINCIPAL REGISTER

NINGAI GANG, LLC (HAWAII LIMITED LIABILITY COMPANY)
PO BOX 1916
KAILUA, HI 96734

FOR: FLYING DISCS, BALLOONS, TOY WEAPONS AND RUBBER ACTION BALLS, IN CLASS 28 (U.S. CLS. 22, 23, 38 AND 50).

FIRST USE 9-23-2011; IN COMMERCE 9-23-2011.

THE MARK CONSISTS OF STANDARD CHARACTERS WITHOUT CLAIM TO ANY PARTICULAR FONT, STYLE, SIZE, OR COLOR.

SN 77-404,313, FILED 2-22-2008.

JENNIFER DIXON, EXAMINING ATTORNEY



David J. Kyros

Director of the United States Patent and Trademark Office

United States of America

United States Patent and Trademark Office

The Designing Child

Reg. No. 4,067,433

Registered Dec. 6, 2011

Int. Cl.: 16

TRADEMARK

PRINCIPAL REGISTER

JUDITH E. SANDERS (UNITED STATES INDIVIDUAL)
P.O. BOX 477
LEXINGTON, MA 02420

FOR: BLANK JOURNAL BOOKS; BLANK NOTE CARDS; CARDS, NAMELY, GREETING CARDS AND NOTE CARDS; CHILDREN'S BOOKS; CHILDREN'S STORYBOOKS; COLORING BOOKS; GREETING CARDS; GREETING CARDS AND POSTCARDS; NOTE BOOKS; NOTE CARDS; POST CARDS; POSTCARDS AND GREETING CARDS; POSTERS; POSTERS MADE OF PAPER; SKETCH BOOKS; SKETCH PADS; STORY BOOKS, IN CLASS 16 (U.S. CLS. 2, 5, 22, 23, 29, 37, 38 AND 50).

FIRST USE 7-5-2011; IN COMMERCE 9-27-2011.

THE MARK CONSISTS OF STANDARD CHARACTERS WITHOUT CLAIM TO ANY PARTICULAR FONT, STYLE, SIZE, OR COLOR.

SN 77-404,587, FILED 2-23-2008.

MIDGE BUTLER, EXAMINING ATTORNEY



David J. Kyffers

Director of the United States Patent and Trademark Office

United States of America

United States Patent and Trademark Office

THE SWEET TASTE OF THE ISLANDS

Reg. No. 4,067,434

Registered Dec. 6, 2011

Int. Cl.: 34

TRADEMARK

PRINCIPAL REGISTER

BAHAMA MAMAS HOLDING, LLC (NEVADA LIMITED LIABILITY COMPANY)
#128
7437 S EASTERN AVE
LAS VEGAS, NV 89123

FOR: ABSORBENT PAPER FOR TOBACCO PIPES; ASHTRAYS, NOT OF PRECIOUS METAL; CIGAR BANDS; CIGAR CASES; CIGAR HUMIDIFIERS; CIGAR TUBES; MATCH BOXES; MATCHES; NON-ELECTRIC CIGAR LIGHTERS NOT OF PRECIOUS METAL; CIGARETTE ASH RECEPTACLES; CIGARETTES; HUMIDORS; ASHTRAYS; CIGARETTE BOXES; CIGAR CUTTERS, IN CLASS 34 (U.S. CLS. 2, 8, 9 AND 17).

FIRST USE 1-1-2010; IN COMMERCE 1-1-2010.

THE MARK CONSISTS OF STANDARD CHARACTERS WITHOUT CLAIM TO ANY PARTICULAR FONT, STYLE, SIZE, OR COLOR.

SN 77-405,494, FILED 2-25-2008.

JORDAN BAKER, EXAMINING ATTORNEY



David J. Kyros

Director of the United States Patent and Trademark Office

United States of America

United States Patent and Trademark Office

ECOPARTY

Reg. No. 4,067,435

Registered Dec. 6, 2011

Int. Cls.: 8, 16, and 21

TRADEMARK

PRINCIPAL REGISTER

PARTY CITY CORPORATION (DELAWARE CORPORATION)
80 GRASSLANDS ROAD
ELMSFORD, NY 10523

FOR: CUTLERY, NAMELY, FORKS, KNIVES AND SPOONS, IN CLASS 8 (U.S. CLS. 23, 28 AND 44).

FIRST USE 2-28-2009; IN COMMERCE 2-28-2009.

FOR: PAPER NAPKINS, IN CLASS 16 (U.S. CLS. 2, 5, 22, 23, 29, 37, 38 AND 50).

FIRST USE 2-28-2009; IN COMMERCE 2-28-2009.

FOR: PLATES, PAPER CUPS, BOWLS, AND SERVINGWARE FOR SERVING FOOD, IN CLASS 21 (U.S. CLS. 2, 13, 23, 29, 30, 33, 40 AND 50).

FIRST USE 2-28-2009; IN COMMERCE 2-28-2009.

THE MARK CONSISTS OF STANDARD CHARACTERS WITHOUT CLAIM TO ANY PARTICULAR FONT, STYLE, SIZE, OR COLOR.

NO CLAIM IS MADE TO THE EXCLUSIVE RIGHT TO USE "ECO" , APART FROM THE MARK AS SHOWN.

SN 77-405,846, FILED 2-26-2008.

WENDY JUN, EXAMINING ATTORNEY



David J. Kyros

Director of the United States Patent and Trademark Office

United States of America

United States Patent and Trademark Office

AMERICAN LIFESTYLES

Reg. No. 4,067,436

Registered Dec. 6, 2011

Int. Cls.: 20 and 24

TRADEMARK

PRINCIPAL REGISTER

IDEA NUOVA, INC. (NEW YORK CORPORATION)
302 FIFTH AVENUE
NEW YORK, NY 10001

FOR: PILLOWS, IN CLASS 20 (U.S. CLS. 2, 13, 22, 25, 32 AND 50).

FIRST USE 7-10-2010; IN COMMERCE 8-10-2010.

FOR: BED BLANKETS; BED CANOPIES; BED LINEN; BED SHEETS; BED SKIRTS; BED SPREADS; PILLOW CASES; PILLOW COVERS; PILLOW SHAMS; COVERLETS; BLANKET THROWS; QUILTS; DUVET COVERS; DUVETS; COMFORTERS; DUST RUFFLES, IN CLASS 24 (U.S. CLS. 42 AND 50).

FIRST USE 7-10-2010; IN COMMERCE 8-10-2010.

THE MARK CONSISTS OF STANDARD CHARACTERS WITHOUT CLAIM TO ANY PARTICULAR FONT, STYLE, SIZE, OR COLOR.

SN 77-406,366, FILED 2-26-2008.

LESLEY LAMOTHE, EXAMINING ATTORNEY



David J. Kybas

Director of the United States Patent and Trademark Office

United States of America

United States Patent and Trademark Office



Reg. No. 4,067,437

Registered Dec. 6, 2011

Int. Cl.: 3

TRADEMARK

PRINCIPAL REGISTER

JS IP LLC (DELAWARE LIMITED LIABILITY COMPANY)
19950 W COUNTRY CLUB DR 10TH FL
AVENTURA, FL 33180

FOR: BODY SPRAY; SOAPS FOR PERSONAL USE, BATH SOAPS, SKIN SOAPS, TOILET SOAPS; SKIN LOTIONS FOR BODY, HANDS AND FACE; SKIN CREAMS FOR BODY, HANDS AND FACE; SKIN MOISTURIZER FOR BODY, HANDS AND FACE, SKIN CLEANSERS FOR BODY, SUNTAN LOTIONS AND SUN SCREENS, IN CLASS 3 (U.S. CLS. 1, 4, 6, 50, 51 AND 52).

FIRST USE 11-0-2008; IN COMMERCE 11-0-2008.

THE MARK CONSISTS OF THE STYLIZED LETTERS "F" AND "B".

SN 77-406,529, FILED 2-26-2008.

ROBERT STRUCK, EXAMINING ATTORNEY



David J. Kybas

Director of the United States Patent and Trademark Office

United States of America

United States Patent and Trademark Office



Reg. No. 4,067,438

Registered Dec. 6, 2011

Int. Cl.: 18

TRADEMARK

PRINCIPAL REGISTER

JS IP LLC (DELAWARE LIMITED LIABILITY COMPANY)
19950 WEST COUNTRY CLUB DRIVE
AVENTURA, FL 33180

FOR: UMBRELLAS, IN CLASS 18 (U.S. CLS. 1, 2, 3, 22 AND 41).

FIRST USE 11-0-2008; IN COMMERCE 11-0-2008.

THE MARK CONSISTS OF THE STYLIZED LETTERS "F" AND "B".

SN 77-406,596, FILED 2-26-2008.

ROBERT STRUCK, EXAMINING ATTORNEY



David J. Kyfos

Director of the United States Patent and Trademark Office

United States of America

United States Patent and Trademark Office



Reg. No. 4,067,439

Registered Dec. 6, 2011

Int. Cl.: 21

TRADEMARK

PRINCIPAL REGISTER

JS IP LLC (DELAWARE LIMITED LIABILITY COMPANY)
19950 W COUNTRY CLUB DR 10TH FL
AVENTURA, FL 33180

FOR: DRINKING GLASSES, MUGS, CUPS, SHOT GLASSES, WATER BOTTLES SOLD EMPTY, INSULATED SLEEVE HOLDERS FOR BEVERAGE CANS, THERMAL INSULATED CONTAINERS FOR BEVERAGES, COASTERS NOT OF PAPER AND NOT BEING TABLE LINEN, BOTTLE OPENERS, CORK SCREWS, DECORATIVE BOXES OF CRYSTAL, HAIR COMBS AND NON-METAL COIN BANKS, IN CLASS 21 (U.S. CLS. 2, 13, 23, 29, 30, 33, 40 AND 50).

FIRST USE 11-0-2008; IN COMMERCE 11-0-2008.

THE MARK CONSISTS OF THE STYLIZED LETTERS "F" AND "B".

SN 77-406,607, FILED 2-26-2008.

ROBERT STRUCK, EXAMINING ATTORNEY



David J. Kybas

Director of the United States Patent and Trademark Office

United States of America

United States Patent and Trademark Office



Reg. No. 4,067,440

Registered Dec. 6, 2011

Int. Cl.: 24

TRADEMARK

PRINCIPAL REGISTER

JS IP LLC (DELAWARE LIMITED LIABILITY COMPANY)
19950 W COUNTRY CLUB DR 10TH FL
AVENTURA, FL 33180

FOR: BEACH TOWELS, IN CLASS 24 (U.S. CLS. 42 AND 50).

FIRST USE 11-0-2008; IN COMMERCE 11-0-2008.

THE MARK CONSISTS OF THE STYLIZED LETTERS "F" AND "B".

SN 77-406,620, FILED 2-26-2008.

ROBERT STRUCK, EXAMINING ATTORNEY



David J. Kyffers

Director of the United States Patent and Trademark Office

United States of America

United States Patent and Trademark Office



Reg. No. 4,067,441

Registered Dec. 6, 2011

Int. Cl.: 28

TRADEMARK

PRINCIPAL REGISTER

JS IP LLC (DELAWARE LIMITED LIABILITY COMPANY)
19950 W COUNTRY CLUB DR 10TH FL
AVENTURA, FL 33180

FOR: PLAYING CARDS, GAMES AND TOYS, NAMELY, PLUSH ANIMALS, AND JIGSAW PUZZLES, IN CLASS 28 (U.S. CLS. 22, 23, 38 AND 50).

FIRST USE 11-0-2008; IN COMMERCE 11-0-2008.

THE MARK CONSISTS OF THE STYLIZED LETTERS "F" AND "B".

SN 77-406,645, FILED 2-26-2008.

ROBERT STRUCK, EXAMINING ATTORNEY



David J. Kyros

Director of the United States Patent and Trademark Office

United States of America

United States Patent and Trademark Office



Reg. No. 4,067,442

Registered Dec. 6, 2011

Int. Cl.: 36

SERVICE MARK

PRINCIPAL REGISTER

JS IP LLC (DELAWARE LIMITED LIABILITY COMPANY)
19950 W COUNTRY CLUB DR 10TH FL
AVENTURA, FL 33180

FOR: SHOPPING MALL SERVICES, NAMELY, THE LEASING AND MANAGEMENT OF MALL SPACE TO DEPARTMENT STORES, SPECIALTY STORES, RETAILERS, RESTAURANTS, AND PARTIES PROVIDING SERVICES TO OTHERS, IN CLASS 36 (U.S. CLS. 100, 101 AND 102).

FIRST USE 11-8-2008; IN COMMERCE 11-8-2008.

THE MARK CONSISTS OF THE STYLIZED LETTERS "F" AND "B".

SN 77-406,677, FILED 2-26-2008.

ROBERT STRUCK, EXAMINING ATTORNEY



David J. Kyfos

Director of the United States Patent and Trademark Office

United States of America

United States Patent and Trademark Office

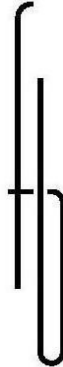

Reg. No. 4,067,443

Registered Dec. 6, 2011

Int. Cl.: 41

SERVICE MARK

PRINCIPAL REGISTER

JS IP LLC (DELAWARE LIMITED LIABILITY COMPANY)
19950 W COUNTRY CLUB DR 10TH FL
AVENTURA, FL 33180

FOR: ENTERTAINMENT SERVICES IN THE NATURE OF LIVE PERFORMANCES BY SINGERS, COMEDIANS, DANCERS, AND MUSICAL GROUPS; PROVIDING HEALTH CLUB SERVICES, NAMELY, PROVIDING INSTRUCTION AND EQUIPMENT FOR PHYSICAL EXERCISE; PHOTOGRAPHY SERVICES; PROVIDING FACILITIES FOR GOLF, TENNIS, AND RECREATION ACTIVITIES AND SWIMMING POOLS, IN CLASS 41 (U.S. CLS. 100, 101 AND 107).

FIRST USE 11-0-2008; IN COMMERCE 11-0-2008.

THE MARK CONSISTS OF THE STYLIZED LETTERS "F" AND "B".

SN 77-406,686, FILED 2-26-2008.

ROBERT STRUCK, EXAMINING ATTORNEY



David J. Kyffers

Director of the United States Patent and Trademark Office

United States of America

United States Patent and Trademark Office

ULTRA-MED

Reg. No. 4,067,444

Registered Dec. 6, 2011

Int. Cl.: 5

TRADEMARK

PRINCIPAL REGISTER

BLISTEX INC. (ILLINOIS CORPORATION)
1800 SWIFT DRIVE
OAK BROOK, IL 60523

FOR: MEDICATED TOPICAL PREPARATIONS FOR HUMAN USE FOR LIP DRYNESS, COLD SORES, BURNS, ITCHING AND FOR LIP CARE, IN CLASS 5 (U.S. CLS. 6, 18, 44, 46, 51 AND 52).

FIRST USE 8-0-2011; IN COMMERCE 8-0-2011.

THE MARK CONSISTS OF STANDARD CHARACTERS WITHOUT CLAIM TO ANY PARTICULAR FONT, STYLE, SIZE, OR COLOR.

SN 77-406,767, FILED 2-26-2008.

TRACY CROSS, EXAMINING ATTORNEY



David J. Kyffers

Director of the United States Patent and Trademark Office

United States of America

United States Patent and Trademark Office

OXANE MATERIALS

Reg. No. 4,067,445

OXANE MATERIALS, INC. (DELAWARE CORPORATION)
467 WEST 38TH STREET
HOUSTON, TX 77018

Registered Dec. 6, 2011

Int. Cls.: 1, 9, 21, and 40

FOR: CHEMICAL FOR USE AS A FLUID LOSS ADDITIVE EMPLOYED TO MINIMIZE FLUID LOSSES IN SUBTERRANEAN FORMATIONS; CHEMICAL AGENTS FOR USE IN TREATMENT, SERVICING, AND WORKING OF OIL WELLS AND GAS WELLS, NAMELY, SUBTERRANEAN FORMATION FILLING AGENTS, PROPPANTS, AND ABRASIVE AGENTS FOR SUBTERRANEAN FORMATIONS, IN CLASS 1 (U.S. CLS. 1, 5, 6, 10, 26 AND 46).

TRADEMARK

SERVICE MARK

PRINCIPAL REGISTER

FIRST USE 5-25-2011; IN COMMERCE 5-25-2011.

FOR: MATERIALS FOR SENSING GEOMETRIES OF PROPPED FRACTURES IN SUBTERRANEAN FORMATIONS; MATERIALS FOR IDENTIFYING LOCATIONS OF PROPPANTS IN SUBTERRANEAN FORMATIONS; TRACERS; MATERIALS FOR SENSING FLOW BACK OF PROPPANTS IN SUBTERRANEAN FORMATIONS; MATERIALS CAPABLE OF INDICATING CHANGES OF PROPPANT PLACEMENT DYNAMICALLY OVER TIME, IN CLASS 9 (U.S. CLS. 21, 23, 26, 36 AND 38).

FIRST USE 5-25-2011; IN COMMERCE 5-25-2011.

FOR: CERAMIC MATERIALS FOR USE IN THE OIL WELL AND GAS WELL INDUSTRY, NAMELY, CERAMIC PELLETS, SHOTS, AND SPHERES FOR USE IN OIL WELL AND GAS WELL HYDRAULIC FRACTURING, AND AS GRAVEL PACK MATERIALS FOR SAND CONTROL OPERATION, AND FOR USE AS STRENGTHENING AGENTS FOR SUBTERRANEAN FORMATIONS, IN CLASS 21 (U.S. CLS. 2, 13, 23, 29, 30, 33, 40 AND 50).

FIRST USE 5-25-2011; IN COMMERCE 5-25-2011.

FOR: OIL WELL AND GAS WELL FRACTURING SERVICES USING PROPPANTS, IN CLASS 40 (U.S. CLS. 100, 103 AND 106).

FIRST USE 5-25-2011; IN COMMERCE 5-25-2011.

THE MARK CONSISTS OF STANDARD CHARACTERS WITHOUT CLAIM TO ANY PARTICULAR FONT, STYLE, SIZE, OR COLOR.



David J. Kybas

Director of the United States Patent and Trademark Office

Reg. No. 4,067,445 NO CLAIM IS MADE TO THE EXCLUSIVE RIGHT TO USE "MATERIALS" , APART FROM THE MARK AS SHOWN.

SN 77-409,072, FILED 2-28-2008.

KIMBERLY PERRY, EXAMINING ATTORNEY

United States of America
United States Patent and Trademark Office

OXANE

Reg. No. 4,067,446

OXANE MATERIALS, INC. (DELAWARE CORPORATION)
467 WEST 38TH STREET
HOUSTON, TX 77018

Registered Dec. 6, 2011

Int. Cls.: 1, 9, 21, and 40

FOR: CHEMICAL FOR USE AS A FLUID LOSS ADDITIVE EMPLOYED TO MINIMIZE FLUID LOSSES IN SUBTERRANEAN FORMATIONS; CHEMICAL AGENTS FOR USE IN TREATMENT, SERVICING, AND WORKING OF OIL WELLS AND GAS WELLS, NAMELY, SUBTERRANEAN FORMATION FILLING AGENTS, PROPPANTS AND ABRASIVE AGENTS FOR SUBTERRANEAN FORMATIONS, IN CLASS 1 (U.S. CLS. 1, 5, 6, 10, 26 AND 46).

TRADEMARK

SERVICE MARK

PRINCIPAL REGISTER

FIRST USE 5-25-2011; IN COMMERCE 5-25-2011.

FOR: MATERIALS FOR SENSING GEOMETRIES OF PROPPED FRACTURES IN SUBTERRANEAN FORMATIONS; TRACERS, MATERIALS FOR SENSING FLOW BACK OF PROPPANTS IN SUBTERRANEAN FORMATIONS AND MATERIALS CAPABLE OF INDICATING CHANGES OF PROPPANT PLACEMENTS DYNAMICALLY OVER TIME, IN CLASS 9 (U.S. CLS. 21, 23, 26, 36 AND 38).

FIRST USE 5-25-2011; IN COMMERCE 5-25-2011.

FOR: CERAMIC MATERIALS FOR USE IN THE OIL WELL AND GAS WELL INDUSTRY, NAMELY, CERAMIC PELLETS, SHOTS, AND SPHERES FOR USE IN OIL WELL AND GAS WELL HYDRAULIC FRACTURING, AND AS GRAVEL PACK MATERIALS FOR SAND CONTROL OPERATION, AND FOR USE AS STRENGTHENING AGENTS FOR SUBTERRANEAN FORMATIONS, IN CLASS 21 (U.S. CLS. 2, 13, 23, 29, 30, 33, 40 AND 50).

FIRST USE 5-25-2011; IN COMMERCE 5-25-2011.

FOR: OIL WELL AND GAS WELL FRACTURING SERVICES USING PROPPANTS, IN CLASS 40 (U.S. CLS. 100, 103 AND 106).

FIRST USE 5-25-2011; IN COMMERCE 5-25-2011.

THE MARK CONSISTS OF LETTERS "O", "A", "N", AND "E" IN BLACK, AND "X" IN BLUE. THE "O" IS BIGGER THAN THE LETTERS "XANE". THE LETTERS "XANE" ARE ALL THE SAME SIZE. A BLUE LINE PROTRUDES DOWNWARD FROM THE LOWER LEFT HAND



David J. Kyros

Director of the United States Patent and Trademark Office

Reg. No. 4,067,446 CORNER OF THE BLUE "X", FORMS AN ACUTE ANGLE TO THE RIGHT, AND EXTENDS TO THE END OF THE LETTER "E", UNDERSCORING THE LETTERS "X","A","N","E".

THE COLOR(S) BLUE AND BLACK IS/ARE CLAIMED AS A FEATURE OF THE MARK.

SN 77-409,093, FILED 2-28-2008.

KIMBERLY PERRY, EXAMINING ATTORNEY

United States of America

United States Patent and Trademark Office

MONDOLIFE

Reg. No. 4,067,447

Registered Dec. 6, 2011

Int. Cl.: 45

SERVICE MARK

PRINCIPAL REGISTER

MONDOLIFE, INC. (CALIFORNIA CORPORATION)
2031 26TH STREET, #101
SAN FRANCISCO, CA 94107

FOR: ONLINE SOCIAL NETWORKING SERVICES, IN CLASS 45 (U.S. CLS. 100 AND 101).

FIRST USE 11-8-2009; IN COMMERCE 11-8-2009.

THE MARK CONSISTS OF STANDARD CHARACTERS WITHOUT CLAIM TO ANY PARTICULAR FONT, STYLE, SIZE, OR COLOR.

SN 77-409,136, FILED 2-28-2008.

DOMINIC J. FERRAIUOLO, EXAMINING ATTORNEY



David J. Kybas

Director of the United States Patent and Trademark Office

United States of America

United States Patent and Trademark Office

ANYTHING GLOWS

Reg. No. 4,067,448

Registered Dec. 6, 2011

Int. Cls.: 20 and 24

TRADEMARK

PRINCIPAL REGISTER

IDEA NUOVA, INC. (NEW YORK CORPORATION)
302 FIFTH AVENUE
NEW YORK, NY 10001

FOR: PILLOWS, IN CLASS 20 (U.S. CLS. 2, 13, 22, 25, 32 AND 50).

FIRST USE 1-10-2010; IN COMMERCE 3-29-2010.

FOR: BED AND TABLE LINEN, WALL HANGINGS OF TEXTILE; BED BLANKETS; BED CANOPIES; BED LINEN; BED SHEETS; BED SKIRTS; BED SPREADS; PILLOW CASES; PILLOW COVERS; PILLOW SHAMS; COVERLETS; TOWELS; CURTAINS; BLANKET THROWS; QUILTS; DUVET COVERS; DUVETS; COMFORTERS; DUST RUFFLES, IN CLASS 24 (U.S. CLS. 42 AND 50).

FIRST USE 1-20-2010; IN COMMERCE 3-10-2010.

THE MARK CONSISTS OF STANDARD CHARACTERS WITHOUT CLAIM TO ANY PARTICULAR FONT, STYLE, SIZE, OR COLOR.

SN 77-409,724, FILED 2-29-2008.

LESLEY LAMOTHE, EXAMINING ATTORNEY



David J. Kybas

Director of the United States Patent and Trademark Office

United States of America

United States Patent and Trademark Office

THE ORIGINAL TOBACCO TRADERS

Reg. No. 4,067,449

Registered Dec. 6, 2011

Int. Cl.: 34

TRADEMARK

PRINCIPAL REGISTER

JESMER, SUSAN M. (UNITED STATES INDIVIDUAL), DBA NATIVE TRADING ASSOCIATES,
442 FROGTOWN ROAD
HOGANSBURG, NY 13655

FOR: CIGARETTE ROLLING MACHINES; CIGARETTE PAPERS; CIGARETTE TUBES; MACHINES ALLOWING SMOKERS TO MAKE CIGARETTES BY THEMSELVES, IN CLASS 34 (U.S. CLS. 2, 8, 9 AND 17).

FIRST USE 12-5-2009; IN COMMERCE 12-5-2009.

THE MARK CONSISTS OF STANDARD CHARACTERS WITHOUT CLAIM TO ANY PARTICULAR FONT, STYLE, SIZE, OR COLOR.

OWNER OF U.S. REG. NO. 3,098,762.

SN 77-410,236, FILED 2-29-2008.

MAYUR VAGHANI, EXAMINING ATTORNEY



David J. Kyros

Director of the United States Patent and Trademark Office

United States of America

United States Patent and Trademark Office

IDEA NUOVA

Reg. No. 4,067,450

Registered Dec. 6, 2011

Int. Cls.: 20 and 24

TRADEMARK

PRINCIPAL REGISTER

IDEA NUOVA, INC. (NEW YORK CORPORATION)
302 FIFTH AVENUE
NEW YORK, NY 10001

FOR: BEDROOM FURNITURE; FURNITURE; FURNITURE CHESTS; FURNITURE, NAMELY, DRESSERS; FURNITURE, NAMELY, WALL UNITS; MIRRORS; STOOLS; CHAIRS; TABLES; NIGHTSTANDS; OTTOMANS; HAMPERS; PILLOWS, IN CLASS 20 (U.S. CLS. 2, 13, 22, 25, 32 AND 50).

FIRST USE 4-25-2009; IN COMMERCE 7-10-2009.

FOR: BED AND TABLE LINEN, WALL HANGINGS OF TEXTILE; BED BLANKETS; BED CANOPIES; BED LINEN; BED SHEETS; BED SKIRTS; BED SPREADS; PILLOW CASES; PILLOW COVERS; PILLOW SHAMS; COVERLETS; TOWELS; CURTAINS; FABRIC WINDOW COVERINGS AND TREATMENTS, NAMELY, CURTAINS, DRAPERIES, SHEERS, SWAGS AND VALANCES; BLANKET THROWS; QUILTS; DUVET COVERS; DUVETS; COMFORTERS; DUST RUFFLES, IN CLASS 24 (U.S. CLS. 42 AND 50).

FIRST USE 4-20-2010; IN COMMERCE 7-10-2010.

THE MARK CONSISTS OF STANDARD CHARACTERS WITHOUT CLAIM TO ANY PARTICULAR FONT, STYLE, SIZE, OR COLOR.

THE FOREIGN WORDING IN THE MARK TRANSLATES INTO ENGLISH AS "NEW".

SN 77-412,076, FILED 3-4-2008.

LESLEY LAMOTHE, EXAMINING ATTORNEY



David J. Kyros

Director of the United States Patent and Trademark Office

United States of America

United States Patent and Trademark Office

3.1

Phillip Lim

Reg. No. 4,067,451

Registered Dec. 6, 2011

**Int. Cls.: 9, 14, 18, 25,
and 35**

3.1 PHILLIP LIM LLC (NEW YORK LIMITED LIABILITY COMPANY)
260 WEST 39TH STREET, 17TH FLOOR
NEW YORK, NY 10018

FOR: OPTICAL GLASSES AND SUNGLASSES, IN CLASS 9 (U.S. CLS. 21, 23, 26, 36 AND 38).

FIRST USE 2-0-2008; IN COMMERCE 2-0-2008.

TRADEMARK

FOR: JEWELRY, NECKLACES, IN CLASS 14 (U.S. CLS. 2, 27, 28 AND 50).

SERVICE MARK

FIRST USE 0-0-2008; IN COMMERCE 0-0-2009.

PRINCIPAL REGISTER

FOR: LEATHER BAGS, HANDBAGS, NAMELY, FABRIC BAGS, TOTE BAGS, LEATHER BAGS, NAMELY, LEATHER POUCHES, LEATHER BAGS, NAMELY, SUEDE POUCHES; HANDBAGS, NAMELY, FABRIC POUCHES; SHOPPING TOTES, IN CLASS 18 (U.S. CLS. 1, 2, 3, 22 AND 41).

FIRST USE 1-0-2008; IN COMMERCE 1-0-2008.

FOR: FOOTWEAR, NAMELY, SHOES, SANDALS; CLOTHING, NAMELY, JACKETS, WOVEN JACKETS, KNIT JACKETS, VESTS, CAPLETS, PANTS, SHORTS, GAUCHOS, SKIRTS, LONG SKIRTS, KNIT SKIRTS, ROMPERS, SKORTS, KNIT SKIRTS, TOPS, T-SHIRTS, SHIRTS, WOVEN DRESSES, SWEATER DRESSES, JERSEY DRESSES, EVENING DRESSES, GOWNS, JEANS, DENIM JACKETS, DENIM SKIRTS, DENIM JUMPERS, SWEATERS, CARDIGANS, PULL OVERS, JUMPERS, LEATHER VESTS, LEATHER JACKETS, LEATHER COATS, LEATHER PANTS, LEATHER SKIRTS, SUEDE COATS, FUR COATS; PAJAMAS, BATHING SUITS; HEADWEAR, NAMELY, TOP HATS; HEAD BANDS; BELTS, LEATHER BELTS, SUEDE BELTS, FABRIC BELTS, WOVEN BELTS, IN CLASS 25 (U.S. CLS. 22 AND 39).

FIRST USE 1-0-2008; IN COMMERCE 1-0-2008.

FOR: RETAIL STORE SERVICES FEATURING GLASSES, JEWELRY, HANDBAGS AND CLOTHING; ONLINE RETAIL STORE SERVICES FEATURING GLASSES, JEWELRY, HANDBAGS, AND CLOTHING, IN CLASS 35 (U.S. CLS. 100, 101 AND 102).

FIRST USE 6-0-2007; IN COMMERCE 6-0-2007.



David J. Kyros

Director of the United States Patent and Trademark Office

Reg. No. 4,067,451 OWNER OF U.S. REG. NO. 3,305,862.

THE NAME "PHILLIP LIM" IDENTIFIES A LIVING INDIVIDUAL WHOSE CONSENT IS OF RECORD.

SN 77-412,929, FILED 3-4-2008.

CHRISTINA SOBRAL, EXAMINING ATTORNEY

United States of America

United States Patent and Trademark Office

EAST END LIVING

Reg. No. 4,067,452

Registered Dec. 6, 2011

Int. Cls.: 20 and 24

TRADEMARK

PRINCIPAL REGISTER

IDEA NUOVA, INC. (NEW YORK CORPORATION)
302 FIFTH AVENUE
NEW YORK, NY 10001

FOR: PILLOWS, IN CLASS 20 (U.S. CLS. 2, 13, 22, 25, 32 AND 50).

FIRST USE 12-10-2009; IN COMMERCE 2-15-2010.

FOR: BED AND TABLE LINEN, WALL HANGINGS OF TEXTILE; BED BLANKETS; BED CANOPIES; BED LINEN; BED SHEETS; BED SKIRTS; BED SPREADS; PILLOW CASES; PILLOW COVERS; PILLOW SHAMS; COVERLETS; BLANKET THROWS; QUILTS; DUVET COVERS; DUVETS; COMFORTERS; DUST RUFFLES, IN CLASS 24 (U.S. CLS. 42 AND 50).

FIRST USE 12-10-2009; IN COMMERCE 2-10-2010.

THE MARK CONSISTS OF STANDARD CHARACTERS WITHOUT CLAIM TO ANY PARTICULAR FONT, STYLE, SIZE, OR COLOR.

SN 77-413,229, FILED 3-5-2008.

LESLEY LAMOTHE, EXAMINING ATTORNEY



David J. Kyros

Director of the United States Patent and Trademark Office

United States of America

United States Patent and Trademark Office

BACKPACK ANGELS

Reg. No. 4,067,453

Registered Dec. 6, 2011

Int. Cl.: 14

TRADEMARK

PRINCIPAL REGISTER

DENIGRIS, NINA (UNITED STATES INDIVIDUAL)
1 WOODDED COURT
HUNTINGTON, NY 11743

FOR: JEWELRY, IN CLASS 14 (U.S. CLS. 2, 27, 28 AND 50).

FIRST USE 10-13-2011; IN COMMERCE 10-13-2011.

THE MARK CONSISTS OF STANDARD CHARACTERS WITHOUT CLAIM TO ANY PARTICULAR FONT, STYLE, SIZE, OR COLOR.

SN 77-414,135, FILED 3-5-2008.

JOHN DALIER, EXAMINING ATTORNEY



David J. Kyffers

Director of the United States Patent and Trademark Office

United States of America

United States Patent and Trademark Office

WUNDERSTRUCK

Reg. No. 4,067,454

Registered Dec. 6, 2011

Int. Cl.: 45

SERVICE MARK

PRINCIPAL REGISTER

MERRICK, TYLER (UNITED STATES INDIVIDUAL)
1560 E. SOUTHLAKE BLVD., SUITE 220
SOUTHLAKE, TX 76092

FOR: PROVIDING A WEBSITE FEATURING INFORMATION IN THE FIELD OF MINISTERIAL SERVICES FEATURING RESOURCES FOR THE CHRISTIAN COMMUNITY, IN CLASS 45 (U.S. CLS. 100 AND 101).

FIRST USE 10-28-2011; IN COMMERCE 10-28-2011.

THE MARK CONSISTS OF STANDARD CHARACTERS WITHOUT CLAIM TO ANY PARTICULAR FONT, STYLE, SIZE, OR COLOR.

SN 77-414,746, FILED 3-6-2008.

EVELYN BRADLEY, EXAMINING ATTORNEY



David J. Kybas

Director of the United States Patent and Trademark Office

United States of America

United States Patent and Trademark Office

ENERGIZER

Reg. No. 4,067,455

Registered Dec. 6, 2011

Int. Cl.: 9

TRADEMARK

PRINCIPAL REGISTER

EVEREADY BATTERY COMPANY, INC. (DELAWARE CORPORATION)
533 MARYVILLE UNIVERSITY DRIVE
ST. LOUIS, MO 63141

FOR: SOLAR CELLS, AND BATTERY CHARGERS INCORPORATING SOLAR CELLS AND SOLAR PANELS FOR THE GENERATION OF ELECTRICITY, IN CLASS 9 (U.S. CLS. 21, 23, 26, 36 AND 38).

FIRST USE 4-21-2010; IN COMMERCE 4-21-2010.

THE MARK CONSISTS OF STANDARD CHARACTERS WITHOUT CLAIM TO ANY PARTICULAR FONT, STYLE, SIZE, OR COLOR.

OWNER OF U.S. REG. NOS. 1,502,902, 2,742,019, AND OTHERS.

SN 77-415,351, FILED 3-6-2008.

NANCY CLARKE, EXAMINING ATTORNEY



David J. Kyffers

Director of the United States Patent and Trademark Office

United States of America
United States Patent and Trademark Office

OBALON

Reg. No. 4,067,456

Registered Dec. 6, 2011

Int. Cl.: 10

TRADEMARK

PRINCIPAL REGISTER

OBALON THERAPEUTICS, INC. (DELAWARE CORPORATION)
12481 HIGH BLUFF DRIVE, SUITE 150
SAN DIEGO, CA 92130

FOR: MEDICAL DEVICES FOR THE TREATMENT OF OBESITY, IN CLASS 10 (U.S. CLS. 26, 39 AND 44).

FIRST USE 1-12-2011; IN COMMERCE 1-12-2011.

THE MARK CONSISTS OF STANDARD CHARACTERS WITHOUT CLAIM TO ANY PARTICULAR FONT, STYLE, SIZE, OR COLOR.

THE WORDING "OBALON" HAS NO MEANING IN A FOREIGN LANGUAGE.

SN 77-416,644, FILED 3-7-2008.

SUZANNE BLANE, EXAMINING ATTORNEY



David J. Kyffers

Director of the United States Patent and Trademark Office

United States of America

United States Patent and Trademark Office

Africville Brown Bombers

Reg. No. 4,067,457

Registered Dec. 6, 2011

Int. Cl.: 25

TRADEMARK

PRINCIPAL REGISTER

STRYKER-INDIGO PUBLISHING COMPANY, INC. (NEW YORK CORPORATION), DBA
STRYKER-INDIGO NEW YORK,
37 ROLLING LANE
LEVITTOWN, NY 11756

FOR: SPORTS JERSEYS, IN CLASS 25 (U.S. CLS. 22 AND 39).

FIRST USE 9-26-2011; IN COMMERCE 9-26-2011.

THE MARK CONSISTS OF STANDARD CHARACTERS WITHOUT CLAIM TO ANY PARTICULAR FONT, STYLE, SIZE, OR COLOR.

SN 77-416,798, FILED 3-8-2008.

CARRIE GENOVESE, EXAMINING ATTORNEY



David J. Kybas

Director of the United States Patent and Trademark Office

United States of America

United States Patent and Trademark Office

Caring is Timeless

Reg. No. 4,067,458

Registered Dec. 6, 2011

Int. Cl.: 36

SERVICE MARK

PRINCIPAL REGISTER

BROADLAWNS MEDICAL CENTER FOUNDATION (IOWA NON-PROFIT CORPORATION)
1801 HICKMAN ROAD
DES MOINES, IA 50309

FOR: CHARITABLE FUND RAISING, IN CLASS 36 (U.S. CLS. 100, 101 AND 102).

FIRST USE 7-1-2011; IN COMMERCE 7-1-2011.

THE MARK CONSISTS OF STANDARD CHARACTERS WITHOUT CLAIM TO ANY PARTICULAR FONT, STYLE, SIZE, OR COLOR.

SN 77-417,436, FILED 3-10-2008.

MARY I. SPARROW, EXAMINING ATTORNEY



David J. Kybas

Director of the United States Patent and Trademark Office

United States of America

United States Patent and Trademark Office

PH(X)

Reg. No. 4,067,459

Registered Dec. 6, 2011

Int. Cl.: 35

SERVICE MARK

PRINCIPAL REGISTER

PH(X) GLASS, LLC (DELAWARE LIMITED LIABILITY COMPANY)
17287 SKYLINE BLVD.
WOODSIDE, CA 94062

FOR: ONLINE ORDERING SERVICES FEATURING SHIRTS, SMOKING WATER AND
GLASS PIP, IN CLASS 35 (U.S. CLS. 100, 101 AND 102).

FIRST USE 2-0-2011; IN COMMERCE 2-0-2011.

THE MARK CONSISTS OF STANDARD CHARACTERS WITHOUT CLAIM TO ANY PAR-
TICULAR FONT, STYLE, SIZE, OR COLOR.

SN 77-418,012, FILED 3-10-2008.

ANN E. SAPPENFIELD, EXAMINING ATTORNEY



David J. Kybas

Director of the United States Patent and Trademark Office

United States of America

United States Patent and Trademark Office

Reg. No. 4,067,460

PH(X) GLASS, LLC (DELAWARE LIMITED LIABILITY COMPANY)
17287 SKYLINE BLVD.
WOODSIDE, CA 94062

Registered Dec. 6, 2011

Int. Cl.: 35

FOR: ONLINE ORDERING SERVICES FEATURING SHIRTS, SMOKING WATER AND GLASS PIPES, IN CLASS 35 (U.S. CLS. 100, 101 AND 102).

SERVICE MARK

FIRST USE 2-0-2011; IN COMMERCE 2-0-2011.

PRINCIPAL REGISTER

THE MARK CONSISTS OF THE LETTERS "P","H","X' WITH A SOLID LINE ABOVE THE LETTERS "P" AND "X" AND A SOLID LINE BELOW THE LETTERS "P" "H" AND "X" WITH PARENTHESES AROUND THE LETTER "X".

SN 77-418,033, FILED 3-10-2008.

ANN E. SAPPENFIELD, EXAMINING ATTORNEY



David J. Kybas

Director of the United States Patent and Trademark Office

United States of America

United States Patent and Trademark Office

GREEN BEGINNINGS

Reg. No. 4,067,461

Registered Dec. 6, 2011

Int. Cl.: 25

TRADEMARK

PRINCIPAL REGISTER

TAILORED TECHNOLOGIES, INC. (NORTH CAROLINA CORPORATION)
400 STANTON COURT
WINSTON-SALEM, NC 27106

FOR: GIFT SET FOR INFANTS AND TODDLERS CONSISTING OF CLOTH DIAPERS, TEXTILE DIAPER COVERS, REUSABLE TEXTILE TRAINING PANTS, AND HOODED TOWELS, IN CLASS 25 (U.S. CLS. 22 AND 39).

FIRST USE 9-28-2011; IN COMMERCE 9-28-2011.

THE MARK CONSISTS OF STANDARD CHARACTERS WITHOUT CLAIM TO ANY PARTICULAR FONT, STYLE, SIZE, OR COLOR.

SN 77-418,346, FILED 3-11-2008.

ALICE BENMAMAN, EXAMINING ATTORNEY



David J. Kybas

Director of the United States Patent and Trademark Office

United States of America

United States Patent and Trademark Office

FB-MESH/IP

Reg. No. 4,067,462

Registered Dec. 6, 2011

Int. Cl.: 9

TRADEMARK

PRINCIPAL REGISTER

FIREBUS SYSTEMS INC. (TEXAS CORPORATION)
12818 CENTURY DRIVE
STAFFORD, TX 77477

FOR: COMPUTER HARDWARE, NAMELY, FIRE ALARM AND SIGNALING HARDWARE FOR RESIDENTIAL, COMMERCIAL, INDUSTRIAL, MARINE, AVIATION AND TRANSPORTATION FIRE PROTECTION AND SAFETY SYSTEMS USING MULTI-PATH ETHERNET SAFETY HUB OVER INTERNET PROTOCOL TECHNOLOGY, WHICH UTILIZES PASSIVE, ACTIVE OR INTELLIGENT HUBS TO PROVIDE MULTIPLE ETHERNET PATHS FOR THE TRANSFER OF SAFETY/SECURITY DATA BETWEEN NETWORKED DEVICES, IN CLASS 9 (U.S. CLS. 21, 23, 26, 36 AND 38).

FIRST USE 10-11-2011; IN COMMERCE 10-11-2011.

THE MARK CONSISTS OF STANDARD CHARACTERS WITHOUT CLAIM TO ANY PARTICULAR FONT, STYLE, SIZE, OR COLOR.

SN 77-418,370, FILED 3-11-2008.

CARRIE GENOVESE, EXAMINING ATTORNEY



David J. Kyros

Director of the United States Patent and Trademark Office

United States of America

United States Patent and Trademark Office

GREENLIFE

Reg. No. 4,067,463

Registered Dec. 6, 2011

Int. Cl.: 21

TRADEMARK

PRINCIPAL REGISTER

GREENPAN LTD (HONG KONG CORPORATION)
WING ON HOUSE, ROOM 1502-3A
71 DES VOEUX ROAD CENTRAL, 15/F
TSIM SHA TSUI, KOWLOON, HONG KONG

FOR: PANS; POTS; NON-ELECTRIC GRATERS FOR HOUSEHOLD PURPOSES; NON-ELECTRIC COOKING UTENSILS, NAMELY, GRILLS; NON-ELECTRIC WOKS; NON-ELECTRIC KETTLES; CONTAINERS FOR HOUSEHOLD OR KITCHEN USE; THERMAL INSULATED CONTAINERS FOR FOOD OR BEVERAGE; SERVINGWARE FOR SERVING FOOD, IN CLASS 21 (U.S. CLS. 2, 13, 23, 29, 30, 33, 40 AND 50).

FIRST USE 9-26-2011; IN COMMERCE 9-26-2011.

THE MARK CONSISTS OF STANDARD CHARACTERS WITHOUT CLAIM TO ANY PARTICULAR FONT, STYLE, SIZE, OR COLOR.

SN 77-418,492, FILED 3-11-2008.

KHANH LE, EXAMINING ATTORNEY



David J. Kyros

Director of the United States Patent and Trademark Office

United States of America

United States Patent and Trademark Office

SANDOKAN

Reg. No. 4,067,464

Registered Dec. 6, 2011

Int. Cls.: 25 and 28

TRADEMARK

PRINCIPAL REGISTER

TROIANI, DARIO (ITALY INDIVIDUAL)
954 THREE TREES ROAD
CHARLESTON, SC 29412

FOR: LONG-SLEEVED SHIRTS; SHIRTS; TEE SHIRTS, IN CLASS 25 (U.S. CLS. 22 AND 39).

FIRST USE 7-13-2011; IN COMMERCE 7-13-2011.

FOR: COLLECTABLE TOY FIGURES; ELECTRIC ACTION TOYS; FANTASY CHARACTER TOYS; MECHANICAL ACTION TOYS, IN CLASS 28 (U.S. CLS. 22, 23, 38 AND 50).

FIRST USE 7-19-2011; IN COMMERCE 7-19-2011.

THE MARK CONSISTS OF STANDARD CHARACTERS WITHOUT CLAIM TO ANY PARTICULAR FONT, STYLE, SIZE, OR COLOR.

SN 77-418,556, FILED 3-11-2008.

ROBERT C. CLARK JR., EXAMINING ATTORNEY



David J. Kyros

Director of the United States Patent and Trademark Office

United States of America

United States Patent and Trademark Office

MY LIFE

Reg. No. 4,067,465

Registered Dec. 6, 2011

Int. Cl.: 3

TRADEMARK

PRINCIPAL REGISTER

CAROL'S DAUGHTER HOLDINGS, LLC (DELAWARE LIMITED LIABILITY COMPANY)
99 HUDSON STREET, 6TH FLOOR
NEW YORK, NY 100132815

FOR: BODY CREAMS; COSMETIC SOAPS, IN CLASS 3 (U.S. CLS. 1, 4, 6, 50, 51 AND 52).

FIRST USE 8-0-2011; IN COMMERCE 8-0-2011.

THE MARK CONSISTS OF STANDARD CHARACTERS WITHOUT CLAIM TO ANY PARTICULAR FONT, STYLE, SIZE, OR COLOR.

SN 77-421,545, FILED 3-13-2008.

BRENDAN MCCAULEY, EXAMINING ATTORNEY



David J. Kybas

Director of the United States Patent and Trademark Office

United States of America

United States Patent and Trademark Office

blue since birth

Reg. No. 4,067,466

Registered Dec. 6, 2011

Int. Cl.: 25

TRADEMARK

PRINCIPAL REGISTER

VARCANO LIMITED (BR.VIRGIN ISLANDS LIMITED LIABILITY COMPANY)
P.O. BOX 957
OFFSHORE INCORPORATIONS CENTRE
ROAD TOWN, TORTOLA, BR.VIRGIN ISLANDS

FOR: BELTS; GLOVES; HATS; JACKETS; MUFFLERS; PANTS; SHIRTS; SHOES; SOCKS;
UNDERWEAR; TIES; NECKWEAR; NECKERCHIEFS; SPORTS JERSEYS AND BREECHES
FOR SPORTS, IN CLASS 25 (U.S. CLS. 22 AND 39).

FIRST USE 1-1-2010; IN COMMERCE 1-1-2010.

SN 77-423,340, FILED 3-17-2008.

LAURIE KAUFMAN, EXAMINING ATTORNEY



David J. Kyros

Director of the United States Patent and Trademark Office

United States of America

United States Patent and Trademark Office

SIMPLE FOR YOU. PERFECT
FOR THEM.

Reg. No. 4,067,467

AGC, LLC (DELAWARE LIMITED LIABILITY COMPANY)
ONE AMERICAN ROAD
CLEVELAND, OH 44144

Registered Dec. 6, 2011

Int. Cl.: 16

FOR: GREETING CARDS; ENVELOPES; GIFT CARDS, IN CLASS 16 (U.S. CLS. 2, 5, 22, 23, 29, 37, 38 AND 50).

TRADEMARK

FIRST USE 7-31-2008; IN COMMERCE 7-31-2008.

PRINCIPAL REGISTER

THE MARK CONSISTS OF STANDARD CHARACTERS WITHOUT CLAIM TO ANY PARTICULAR FONT, STYLE, SIZE, OR COLOR.

SN 77-423,720, FILED 3-17-2008.

JUDITH HELFMAN, EXAMINING ATTORNEY



David J. Kyffers

Director of the United States Patent and Trademark Office

United States of America
United States Patent and Trademark Office

ATCHISON

Reg. No. 4,067,468

Registered Dec. 6, 2011

Int. Cl.: 21

TRADEMARK

PRINCIPAL REGISTER

BIC CORPORATION (CONNECTICUT CORPORATION)
ONE BIC WAY
SHELTON, CT 06484

FOR: PORTABLE COOLERS, IN CLASS 21 (U.S. CLS. 2, 13, 23, 29, 30, 33, 40 AND 50).

FIRST USE 1-1-2007; IN COMMERCE 1-1-2007.

THE MARK CONSISTS OF STANDARD CHARACTERS WITHOUT CLAIM TO ANY PARTICULAR FONT, STYLE, SIZE, OR COLOR.

SEC. 2(F).

OWNER OF U.S. REG. NO. 2,146,094.

SN 77-424,488, FILED 3-18-2008.

KAPIL BHANOT, EXAMINING ATTORNEY



David J. Kybas

Director of the United States Patent and Trademark Office

United States of America

United States Patent and Trademark Office

OPENING DOORS FOR FRANCHISORS AROUND THE WORLD

Reg. No. 4,067,469

Registered Dec. 6, 2011

Int. Cl.: 45

SERVICE MARK

PRINCIPAL REGISTER

FAEGRE & BENSON LLP (MINNESOTA LIMITED LIABILITY PARTNERSHIP)
2200 WELLS FARGO CENTER
90 SOUTH SEVENTH STREET
MINNEAPOLIS, MN 55402

FOR: LEGAL SERVICES, IN CLASS 45 (U.S. CLS. 100 AND 101).

FIRST USE 5-9-2011; IN COMMERCE 5-9-2011.

THE MARK CONSISTS OF STANDARD CHARACTERS WITHOUT CLAIM TO ANY PARTICULAR FONT, STYLE, SIZE, OR COLOR.

SN 77-424,677, FILED 3-18-2008.

RUSS HERMAN, EXAMINING ATTORNEY



David J. Kybas

Director of the United States Patent and Trademark Office

United States of America

United States Patent and Trademark Office

HUMBABY

Reg. No. 4,067,470

TAMMY G. ROBERTSON (UNITED STATES INDIVIDUAL)
1339 STELLAR WAY
MOUNT SHASTA, CA 96067

Registered Dec. 6, 2011

Int. Cl.: 25

FOR: SHORT-SLEEVED OR LONG-SLEEVED T-SHIRTS, IN CLASS 25 (U.S. CLS. 22 AND 39).

TRADEMARK

FIRST USE 9-7-2011; IN COMMERCE 10-7-2011.

PRINCIPAL REGISTER

THE MARK CONSISTS OF STANDARD CHARACTERS WITHOUT CLAIM TO ANY PARTICULAR FONT, STYLE, SIZE, OR COLOR.

SN 77-425,088, FILED 3-18-2008.

JANICE L. MCMORROW, EXAMINING ATTORNEY



David J. Kybas

Director of the United States Patent and Trademark Office

United States of America

United States Patent and Trademark Office

ROCKET CITY BONANZA

Reg. No. 4,067,471

Registered Dec. 6, 2011

Int. Cl.: 9

TRADEMARK

PRINCIPAL REGISTER

KING SHOW GAMES INC. (MINNESOTA CORPORATION)
SUITE 100
10275 WAYZATA BOULEVARD
MINNETONKA, MN 55305

FOR: GAMBLING MACHINES; GAMING EQUIPMENT, NAMELY, SLOT MACHINES WITH OR WITHOUT VIDEO OUTPUT; GAMING MACHINES; SLOT MACHINES; COMPUTER SOFTWARE PLATFORMS FOR USE IN GAMBLING AND GAMING MACHINES, IN CLASS 9 (U.S. CLS. 21, 23, 26, 36 AND 38).

FIRST USE 10-4-2011; IN COMMERCE 10-4-2011.

THE MARK CONSISTS OF STANDARD CHARACTERS WITHOUT CLAIM TO ANY PARTICULAR FONT, STYLE, SIZE, OR COLOR.

NO CLAIM IS MADE TO THE EXCLUSIVE RIGHT TO USE "ROCKET CITY", APART FROM THE MARK AS SHOWN.

SN 77-428,730, FILED 3-21-2008.

NAPOLEON SHARMA, EXAMINING ATTORNEY



David J. Kyffers

Director of the United States Patent and Trademark Office

United States of America

United States Patent and Trademark Office

JOE'S

Reg. No. 4,067,472

Registered Dec. 6, 2011

Int. Cl.: 33

TRADEMARK

PRINCIPAL REGISTER

SANCHEZ, JOSEPH (UNITED STATES INDIVIDUAL)
5119 VAIL CREEK CT.
SAN DIEGO, CA 92130

FOR: TEQUILA, IN CLASS 33 (U.S. CLS. 47 AND 49).

FIRST USE 8-29-2011; IN COMMERCE 8-29-2011.

THE MARK CONSISTS OF STANDARD CHARACTERS WITHOUT CLAIM TO ANY PARTICULAR FONT, STYLE, SIZE, OR COLOR.

SN 77-428,969, FILED 3-22-2008.

RONALD MCMORROW, EXAMINING ATTORNEY



David J. Kybas

Director of the United States Patent and Trademark Office

United States of America

United States Patent and Trademark Office

NEOCORTEX

Reg. No. 4,067,473

UNIVERSAL ROBOTICS, INC. (TENNESSEE CORPORATION)
P.O. BOX 171062
NASHVILLE, TN 37217

Registered Dec. 6, 2011

Int. Cl.: 9

FOR: COMPUTER SOFTWARE, NAMELY, INTELLIGENT MACHINE SOFTWARE THAT EMPLOYS A SELF-LEARNING ALGORITHM TO ASSESS AND ANALYZE INFORMATION IN ORDER TO ADAPT TO SITUATIONS, FOR USE IN A WIDE VARIETY OF FIELDS, IN CLASS 9 (U.S. CLS. 21, 23, 26, 36 AND 38).

TRADEMARK

PRINCIPAL REGISTER

FIRST USE 10-26-2010; IN COMMERCE 10-26-2010.

THE MARK CONSISTS OF STANDARD CHARACTERS WITHOUT CLAIM TO ANY PARTICULAR FONT, STYLE, SIZE, OR COLOR.

SN 77-429,971, FILED 3-24-2008.

ALEXANDER L. POWERS, EXAMINING ATTORNEY



David J. Kybas

Director of the United States Patent and Trademark Office

United States of America

United States Patent and Trademark Office

SOFTWARE WITH AN IQ

Reg. No. 4,067,474

Registered Dec. 6, 2011

Int. Cl.: 9

TRADEMARK

PRINCIPAL REGISTER

UNIVERSAL ROBOTICS, INC. (TENNESSEE CORPORATION)
P.O. BOX 171062
NASHVILLE, TN 37217

FOR: COMPUTER SOFTWARE, NAMELY, INTELLIGENT MACHINE SOFTWARE THAT EMPLOYS A SELF-LEARNING ALGORITHM TO ASSESS AND ANALYZE INFORMATION IN ORDER TO ADAPT TO SITUATIONS, FOR USE IN A WIDE VARIETY OF FIELDS, IN CLASS 9 (U.S. CLS. 21, 23, 26, 36 AND 38).

FIRST USE 10-26-2010; IN COMMERCE 10-26-2010.

THE MARK CONSISTS OF STANDARD CHARACTERS WITHOUT CLAIM TO ANY PARTICULAR FONT, STYLE, SIZE, OR COLOR.

NO CLAIM IS MADE TO THE EXCLUSIVE RIGHT TO USE "SOFTWARE", APART FROM THE MARK AS SHOWN.

SN 77-430,048, FILED 3-24-2008.

ALEXANDER L. POWERS, EXAMINING ATTORNEY



David J. Kybas

Director of the United States Patent and Trademark Office

United States of America

United States Patent and Trademark Office

CROP CIRCLES JEWELRY

Reg. No. 4,067,475

Registered Dec. 6, 2011

Int. Cl.: 14

TRADEMARK

PRINCIPAL REGISTER

FIRE MOUNTAIN GEMS & BEADS, INC. (OREGON CORPORATION)
ONE FIRE MOUNTAIN WAY
GRANTS PASS, OR 975262373

FOR: JEWELRY, IN CLASS 14 (U.S. CLS. 2, 27, 28 AND 50).

FIRST USE 8-24-2011; IN COMMERCE 8-24-2011.

THE MARK CONSISTS OF STANDARD CHARACTERS WITHOUT CLAIM TO ANY PARTICULAR FONT, STYLE, SIZE, OR COLOR.

NO CLAIM IS MADE TO THE EXCLUSIVE RIGHT TO USE "JEWELRY", APART FROM THE MARK AS SHOWN.

SN 77-430,412, FILED 3-25-2008.

MAYUR VAGHANI, EXAMINING ATTORNEY



David J. Kyros

Director of the United States Patent and Trademark Office

United States of America

United States Patent and Trademark Office

RELIA-SERVE

Reg. No. 4,067,476

Registered Dec. 6, 2011

Int. Cls.: 35 and 41

SERVICE MARK

PRINCIPAL REGISTER

RELIA-SERVE CORPORATION (CONNECTICUT CORPORATION)
25 PROGRESS AVENUE
SEYMOUR, CT 06483

FOR: BUSINESS CONSULTANCY SERVICES; CORPORATE STRATEGY CONSULTANCY SERVICES; BUSINESS PLANNING IN THE NATURE OF GOAL-SETTING SERVICES AND LEADERSHIP DEVELOPMENT AND MODELING; BUSINESS MANAGEMENT CONSULTANCY IN THE FIELD OF BUSINESS GOAL-SETTING; BUSINESS MANAGEMENT CONSULTING SERVICES; ORGANIZATIONAL SERVICES FOR BUSINESS PURPOSES; ADVISORY SERVICES RELATING TO BUSINESS MANAGEMENT, LEADERSHIP DEVELOPMENT, AND TEAM BUILDING TECHNIQUES BUSINESS MARKETING; MARKETING STUDIES; ADVERTISING; SALES PROMOTION SERVICES; AD BUSINESS MANAGEMENT, LEADERSHIP DEVELOPMENT, AND TEAM BUILDING TECHNIQUES; ADVISORY SERVICES RELATING TO BUSINESS MANAGEMENT AND BUSINESS OPERATIONS FOR NEW BUSINESSES, IN CLASS 35 (U.S. CLS. 100, 101 AND 102).

FIRST USE 12-0-2009; IN COMMERCE 12-0-2009.

FOR: BUSINESS TRAINING SERVICES; PERSONAL COACHING SERVICES IN THE FIELD OF BUSINESS; CORPORATE STRATEGY TRAINING; BUSINESS TRAINING PROGRAMS IN THE FIELD OF BUSINESS MANAGEMENT, LEADERSHIP DEVELOPMENT, AND TEAM BUILDING TECHNIQUES; NEWSLETTERS VIA E-MAIL IN THE FIELD OF PROFESSIONAL COACHING; TRAINING PROGRAMS FOR BUSINESS MANAGEMENT, LEADERSHIP DEVELOPMENT, AND TEAM BUILDING TECHNIQUES; EDUCATIONAL SERVICES AND TRAINING, NAMELY, CONDUCTING BOTH INTERNET BASED AND LIVE CLASSES, SEMINARS, SPEECHES, TRAINING PROGRAMS, CONFERENCES, WORKSHOPS, INTERACTIVE EDUCATIONAL DISCUSSION GROUPS, INSTRUCTIONAL SESSIONS AND TRAINING IN THE FIELD OF BUSINESS MANAGEMENT, LEADERSHIP DEVELOPMENT, AND TEAM BUILDING TECHNIQUES AND DISTRIBUTION OF COURSE MATERIAL IN CONNECTION THEREWITH; ON-LINE AND INTERNET TRAINING AND EDUCATION IN THE NATURE OF CLASSES, WORKSHOPS AND SEMINARS IN THE FIELD OF BUSINESS MANAGEMENT, LEADERSHIP DEVELOPMENT, AND TEAM BUILDING TECHNIQUES; PERSONAL COACHING SERVICES WITH A FOCUS ON BUSINESS MANAGEMENT, LEADERSHIP DEVELOPMENT, AND TEAM BUILDING TECHNIQUES; AND PROVIDING ONLINE WORKSHOPS, ONLINE CLASSES AND ONLINE TRAINING AND PROVIDING ONLINE TRAINING PUBLICATIONS, NAMELY, BOOKS AND PAMPHLETS, ALL IN THE FIELDS OF LEADERSHIP, MANAGEMENT, SALES AND COMMUNICATIONS, AND IM-



David J. Kyffers

Director of the United States Patent and Trademark Office

Reg. No. 4,067,476 PROVING PERSONAL PERFORMANCE, BUSINESS MANAGEMENT ABILITIES AND SALES SKILLS, AND DISTRIBUTION OF COURSE MATERIALS THEREWITH, IN CLASS 41 (U.S. CLS. 100, 101 AND 107).

FIRST USE 12-0-2009; IN COMMERCE 12-0-2009.

THE MARK CONSISTS OF STANDARD CHARACTERS WITHOUT CLAIM TO ANY PARTICULAR FONT, STYLE, SIZE, OR COLOR.

SN 77-430,638, FILED 3-25-2008.

LINDA ESTRADA, EXAMINING ATTORNEY

United States of America

United States Patent and Trademark Office

ROOM STYLES

Reg. No. 4,067,477

Registered Dec. 6, 2011

Int. Cls.: 20 and 24

TRADEMARK

PRINCIPAL REGISTER

IDEA NUOVA, INC. (NEW YORK CORPORATION)
302 FIFTH AVENUE
NEW YORK, NY 10001

FOR: BEDROOM FURNITURE; FURNITURE; FURNITURE CHESTS; FURNITURE, NAMELY, DRESSERS; FURNITURE, NAMELY, WALL UNITS; MIRRORS; STOOLS; CHAIRS; TABLES; NIGHTSTANDS; OTTOMANS; HAMPERS; PILLOWS, IN CLASS 20 (U.S. CLS. 2, 13, 22, 25, 32 AND 50).

FIRST USE 4-10-2010; IN COMMERCE 6-15-2010.

FOR: BED AND TABLE LINEN, WALL HANGINGS OF TEXTILE; BED BLANKETS; BED CANOPIES; BED LINEN; BED SHEETS; BED SKIRTS; BED SPREADS; PILLOW CASES; PILLOW COVERS; PILLOW SHAMS; COVERLETS; TOWELS; CURTAINS; FABRIC WINDOW COVERINGS AND TREATMENTS, NAMELY, CURTAINS, DRAPERIES, SHEERS, SWAGS AND VALANCES; BLANKET THROWS; QUILTS; DUVET COVERS; DUVETS; COMFORTERS; DUST RUFFLES, IN CLASS 24 (U.S. CLS. 42 AND 50).

FIRST USE 4-12-2010; IN COMMERCE 5-10-2010.

THE MARK CONSISTS OF STANDARD CHARACTERS WITHOUT CLAIM TO ANY PARTICULAR FONT, STYLE, SIZE, OR COLOR.

SN 77-431,550, FILED 3-26-2008.

LESLEY LAMOTHE, EXAMINING ATTORNEY



David J. Kyros

Director of the United States Patent and Trademark Office

United States of America

United States Patent and Trademark Office

VICE

Reg. No. 4,067,478

Registered Dec. 6, 2011

Int. Cl.: 3

TRADEMARK

PRINCIPAL REGISTER

URBAN DECAY COSMETICS, LLC (DELAWARE LIMITED LIABILITY COMPANY)
833 WEST 16TH STREET
NEWPORT BEACH, CA 92663

FOR: COSMETICS, IN CLASS 3 (U.S. CLS. 1, 4, 6, 50, 51 AND 52).

FIRST USE 1-15-1997; IN COMMERCE 1-15-1997.

THE MARK CONSISTS OF STANDARD CHARACTERS WITHOUT CLAIM TO ANY PARTICULAR FONT, STYLE, SIZE, OR COLOR.

OWNER OF U.S. REG. NO. 2,551,403.

SN 77-431,916, FILED 3-26-2008.

JASON BLAIR, EXAMINING ATTORNEY



David J. Kyffers

Director of the United States Patent and Trademark Office

United States of America

United States Patent and Trademark Office

SAVILE

Reg. No. 4,067,479

Registered Dec. 6, 2011

Int. Cl.: 11

TRADEMARK

PRINCIPAL REGISTER

MASCO CORPORATION OF INDIANA (INDIANA CORPORATION)
55 EAST 111TH STREET
INDIANAPOLIS, IN 46280

FOR: PLUMBING PRODUCTS, NAMELY, FAUCETS, IN CLASS 11 (U.S. CLS. 13, 21, 23, 31 AND 34).

FIRST USE 7-0-2010; IN COMMERCE 7-0-2010.

THE MARK CONSISTS OF STANDARD CHARACTERS WITHOUT CLAIM TO ANY PARTICULAR FONT, STYLE, SIZE, OR COLOR.

SN 77-439,086, FILED 4-3-2008.

MICHELE SWAIN, EXAMINING ATTORNEY



David J. Kybas

Director of the United States Patent and Trademark Office

United States of America

United States Patent and Trademark Office

ASHTON

Reg. No. 4,067,480

Registered Dec. 6, 2011

Int. Cl.: 11

TRADEMARK

PRINCIPAL REGISTER

MASCO CORPORATION OF INDIANA (INDIANA CORPORATION)
55 EAST 111TH STREET
INDIANAPOLIS, IN 46280

FOR: PLUMBING PRODUCTS, NAMELY, FAUCETS, IN CLASS 11 (U.S. CLS. 13, 21, 23, 31 AND 34).

FIRST USE 7-0-2010; IN COMMERCE 7-0-2010.

THE MARK CONSISTS OF STANDARD CHARACTERS WITHOUT CLAIM TO ANY PARTICULAR FONT, STYLE, SIZE, OR COLOR.

SN 77-439,110, FILED 4-3-2008.

MICHELE SWAIN, EXAMINING ATTORNEY



David J. Kybas

Director of the United States Patent and Trademark Office

United States of America
United States Patent and Trademark Office

GreenDrive

Reg. No. 4,067,481

Registered Dec. 6, 2011

Int. Cl.: 9

TRADEMARK

PRINCIPAL REGISTER

NIDEC MOTOR CORPORATION (DELAWARE CORPORATION)
8050 WEST FLORISSANT AVENUE
LAW DEPARTMENT
ST. LOUIS, MO 63136

FOR: ELECTRONIC CONTROLS FOR MOTORS, IN CLASS 9 (U.S. CLS. 21, 23, 26, 36 AND 38).

FIRST USE 10-24-2011; IN COMMERCE 10-24-2011.

THE MARK CONSISTS OF STANDARD CHARACTERS WITHOUT CLAIM TO ANY PARTICULAR FONT, STYLE, SIZE, OR COLOR.

SN 77-439,891, FILED 4-4-2008.

GINA FINK, EXAMINING ATTORNEY



David J. Kybas

Director of the United States Patent and Trademark Office

United States of America

United States Patent and Trademark Office

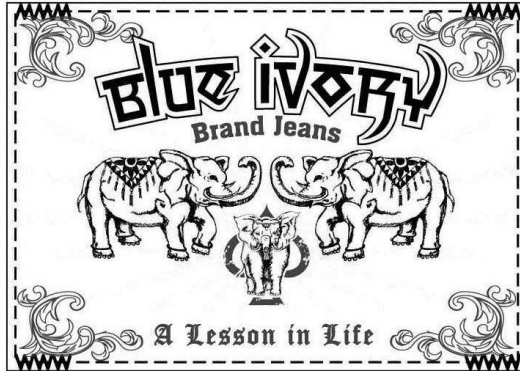

Reg. No. 4,067,482

Registered Dec. 6, 2011

Int. Cl.: 25

TRADEMARK

PRINCIPAL REGISTER

SKYTEX INTERNATIONAL FASHIONS COMPANY LIMITED (HONG KONG CORPORATION)
MANHATTAN CENTRE, 8 KWAI CHEONG ROAD
ROOM 1308/1312
KWAI CHUNG, HONG KONG

FOR: JEANS, PANTS, TROUSERS, IN CLASS 25 (U.S. CLS. 22 AND 39).

FIRST USE 9-30-2011; IN COMMERCE 9-30-2011.

NO CLAIM IS MADE TO THE EXCLUSIVE RIGHT TO USE "BRAND JEANS", APART FROM THE MARK AS SHOWN.

THE MARK CONSISTS OF THE WORDS "BLUE IVORY BRAND JEANS" ABOVE A DEPICTION OF THREE ELEPHANTS ABOVE THE WORDING "A LESSON IN LIFE" WITHIN A RECTANGLE BORDERED BY DASHES AND A FANCIFUL SCROLL DESIGN.

SN 77-442,795, FILED 4-8-2008.

COURTNEY ALVAREZ, EXAMINING ATTORNEY



David J. Kybas

Director of the United States Patent and Trademark Office

United States of America

United States Patent and Trademark Office

MYLATINLAB

Reg. No. 4,067,483

Registered Dec. 6, 2011

Int. Cl.: 41

SERVICE MARK

PRINCIPAL REGISTER

PEARSON EDUCATION, INC. (DELAWARE CORPORATION)
ONE LAKE STREET
UPPER SADDLE RIVER, NJ 07458

FOR: EDUCATIONAL SERVICES, NAMELY, DEVELOPMENT AND DISSEMINATION OF EDUCATIONAL TOOLS, CONTENT, AND MATERIALS OF OTHERS TO UNIVERSITY PROFESSORS AND THEIR STUDENTS VIA THE INTERNET, NAMELY, DIGITAL TEXTBOOKS, INSTRUCTORS MANUALS, SUPPLEMENTARY READING MATERIALS, INSTRUCTIONAL MATERIALS IN THE NATURE OF SELF-ASSESSMENT AND STUDY TOOLS FOR STUDENTS, HOMEWORK ASSIGNMENTS, COURSE ASSESSMENT AND COURSE MANAGEMENT MATERIALS FOR USE IN CONNECTION WITH THE STUDY OF THE LATIN LANGUAGE, IN CLASS 41 (U.S. CLS. 100, 101 AND 107).

FIRST USE 8-22-2011; IN COMMERCE 8-22-2011.

THE MARK CONSISTS OF STANDARD CHARACTERS WITHOUT CLAIM TO ANY PARTICULAR FONT, STYLE, SIZE, OR COLOR.

SN 77-444,018, FILED 4-9-2008.

SIMON TENG, EXAMINING ATTORNEY



David J. Kypos

Director of the United States Patent and Trademark Office

United States of America

United States Patent and Trademark Office

PING

Reg. No. 4,067,484

Registered Dec. 6, 2011

Int. Cl.: 33

TRADEMARK

PRINCIPAL REGISTER

KARSTEN MANUFACTURING CORPORATION (ARIZONA CORPORATION)
ATTN: LEGAL DEPARTMENT
2201 WEST DESERT COVE
PHOENIX, AZ 85029

FOR: WINE, IN CLASS 33 (U.S. CLS. 47 AND 49).

FIRST USE 9-21-2011; IN COMMERCE 9-21-2011.

THE MARK CONSISTS OF STANDARD CHARACTERS WITHOUT CLAIM TO ANY PARTICULAR FONT, STYLE, SIZE, OR COLOR.

SN 77-444,124, FILED 4-9-2008.

ROBIN CHOSID, EXAMINING ATTORNEY



David J. Kybas

Director of the United States Patent and Trademark Office

United States of America

United States Patent and Trademark Office

MPASSION

Reg. No. 4,067,485

MPASSION, LLC (DELAWARE LIMITED LIABILITY COMPANY)
3481 GLEN OAKS COURT
LEWIS CENTER, OH 43035

Registered Dec. 6, 2011

Int. Cl.: 25

FOR: LINGERIE, BRAS, PANTIES, BUSTIERS, CORSETS AND GARTER BELTS, IN CLASS 25 (U.S. CLS. 22 AND 39).

TRADEMARK

FIRST USE 9-12-2011; IN COMMERCE 9-12-2011.

PRINCIPAL REGISTER

THE MARK CONSISTS OF STANDARD CHARACTERS WITHOUT CLAIM TO ANY PARTICULAR FONT, STYLE, SIZE, OR COLOR.

SN 77-445,756, FILED 4-11-2008.

APRIL ROACH, EXAMINING ATTORNEY



David J. Kybas

Director of the United States Patent and Trademark Office

United States of America

United States Patent and Trademark Office

TERSI

Reg. No. 4,067,486

Registered Dec. 6, 2011

Int. Cl.: 5

TRADEMARK

PRINCIPAL REGISTER

QUINNOVA PHARMACEUTICALS, INC. (DELAWARE CORPORATION)
411 SOUTH STATE STREET, THIRD FLOOR
NEWTOWN, PA 18940

FOR: DERMATOLOGICAL PHARMACEUTICAL PREPARATIONS FOR THE TREATMENT OF SEBORRHEIC DERMATITIS AND TINEA VERSICOLOR, IN CLASS 5 (U.S. CLS. 6, 18, 44, 46, 51 AND 52).

FIRST USE 8-0-2007; IN COMMERCE 8-0-2007.

THE MARK CONSISTS OF STANDARD CHARACTERS WITHOUT CLAIM TO ANY PARTICULAR FONT, STYLE, SIZE, OR COLOR.

SN 77-447,767, FILED 4-14-2008.

RENEE SERVANCE, EXAMINING ATTORNEY



David J. Kyros

Director of the United States Patent and Trademark Office

United States of America

United States Patent and Trademark Office

STOLEN HORSE

Reg. No. 4,067,487

Registered Dec. 6, 2011

Int. Cl.: 33

TRADEMARK

PRINCIPAL REGISTER

FLYING B VINEYARD, LIMITED PARTNERSHIP (OREGON LIMITED PARTNERSHIP)
61727 TAM MCARTHUR LOOP
BEND, OR 97702

FOR: WINE, IN CLASS 33 (U.S. CLS. 47 AND 49).

FIRST USE 8-19-2011; IN COMMERCE 10-1-2011.

THE MARK CONSISTS OF STANDARD CHARACTERS WITHOUT CLAIM TO ANY PARTICULAR FONT, STYLE, SIZE, OR COLOR.

SN 77-448,611, FILED 4-15-2008.

ANDREA BUTLER, EXAMINING ATTORNEY



David J. Kybas

Director of the United States Patent and Trademark Office

United States of America

United States Patent and Trademark Office

Joshua Built Homes

Reg. No. 4,067,488

JOSHUA BUILT HOMES, L.L.C. (IOWA LIMITED LIABILITY COMPANY)
PO BOX 960
NIXA, MO 65714

Registered Dec. 6, 2011

Int. Cl.: 37

FOR: RESIDENTIAL BUILDING CONSTRUCTION, IN CLASS 37 (U.S. CLS. 100, 103 AND 106).

SERVICE MARK

FIRST USE 8-31-2011; IN COMMERCE 8-31-2011.

PRINCIPAL REGISTER

THE MARK CONSISTS OF STANDARD CHARACTERS WITHOUT CLAIM TO ANY PARTICULAR FONT, STYLE, SIZE, OR COLOR.

NO CLAIM IS MADE TO THE EXCLUSIVE RIGHT TO USE "BUILT HOMES", APART FROM THE MARK AS SHOWN.

SN 77-452,404, FILED 4-18-2008.

PAUL MORENO, EXAMINING ATTORNEY



David J. Kyffers

Director of the United States Patent and Trademark Office

United States of America

United States Patent and Trademark Office

WRONG GEAR

Reg. No. 4,067,489

Registered Dec. 6, 2011

Int. Cls.: 16, 25, and 28

TRADEMARK

PRINCIPAL REGISTER

WRONG GEAR, INC. (CALIFORNIA CORPORATION)
269 S. BEVERLY DRIVE, #1076
BEVERLY HILLS, CA 90212

FOR: STICKERS, IN CLASS 16 (U.S. CLS. 2, 5, 22, 23, 29, 37, 38 AND 50).

FIRST USE 11-0-2007; IN COMMERCE 11-0-2007.

FOR: CLOTHING, NAMELY, HATS, CAPS, BEANIE HATS, BANDANAS, FACE MASKS, HEADBANDS, SCARVES, T-SHIRTS, SHIRTS, THERMAL SHIRTS, SWEATSHIRTS, SOCKS, JACKETS, SWEATPANTS, IN CLASS 25 (U.S. CLS. 22 AND 39).

FIRST USE 11-0-2008; IN COMMERCE 11-0-2008.

FOR: SNOWBOARDS, IN CLASS 28 (U.S. CLS. 22, 23, 38 AND 50).

FIRST USE 1-0-2009; IN COMMERCE 1-0-2009.

THE MARK CONSISTS OF STANDARD CHARACTERS WITHOUT CLAIM TO ANY PARTICULAR FONT, STYLE, SIZE, OR COLOR.

NO CLAIM IS MADE TO THE EXCLUSIVE RIGHT TO USE "GEAR", APART FROM THE MARK AS SHOWN.

SN 77-452,544, FILED 4-18-2008.

LINDSEY RUBIN, EXAMINING ATTORNEY



David J. Kybas

Director of the United States Patent and Trademark Office

United States of America

United States Patent and Trademark Office

BIRDS OF PREY

Reg. No. 4,067,490

Registered Dec. 6, 2011

Int. Cls.: 9 and 16

TRADEMARK

PRINCIPAL REGISTER

1C JOINT STOCK VENTURE (RUSSIAN FED. CORPORATION)
1, KOR. 2, BASHILOVSKAYA STREET
MOSCOW, RUSSIAN FED. RU-103220

FOR: COMPUTER GAME PROGRAMS AND VIDEO GAME CARTRIDGES FEATURING LARGE-SCALE AERIAL COMBAT AND GROUND MILITARY OPERATIONS OF WORLD WAR II; DOWNLOADABLE ELECTRONIC PUBLICATIONS, NAMELY, MAGAZINES AND NEWSLETTERS ABOUT COMPUTER GAMES AND VIDEO GAMES FEATURING LARGE-SCALE AERIAL COMBAT AND GROUND MILITARY OPERATIONS OF WORLD WAR II, IN CLASS 9 (U.S. CLS. 21, 23, 26, 36 AND 38).

FIRST USE 9-8-2009; IN COMMERCE 9-8-2009.

FOR: PRINTED PUBLICATIONS, NAMELY, PRINTED MANUALS WITH INSTRUCTIONS FOR PLAYING AND USING COMPUTER GAME PROGRAMS, VIDEO GAME PROGRAMS AND VIDEO GAME MACHINES FEATURING LARGE-SCALE AERIAL COMBAT AND GROUND MILITARY OPERATIONS OF WORLD WAR II, IN CLASS 16 (U.S. CLS. 2, 5, 22, 23, 29, 37, 38 AND 50).

FIRST USE 9-8-2009; IN COMMERCE 9-8-2009.

THE MARK CONSISTS OF STANDARD CHARACTERS WITHOUT CLAIM TO ANY PARTICULAR FONT, STYLE, SIZE, OR COLOR.

SN 77-454,048, FILED 4-21-2008.

JULIE GUTTADAURO, EXAMINING ATTORNEY



David J. Kyros

Director of the United States Patent and Trademark Office

United States of America

United States Patent and Trademark Office

Frunchies

Reg. No. 4,067,491

Registered Dec. 6, 2011

Int. Cl.: 29

TRADEMARK

PRINCIPAL REGISTER

WAYMOUTH FARMS, INC. (MINNESOTA CORPORATION)
5300 BOONE AVE. N.
NEW HOPE, MN 55428

FOR: SNACK MIX CONSISTING OF DRIED FRUIT, IN CLASS 29 (U.S. CL. 46).

FIRST USE 10-5-2011; IN COMMERCE 10-5-2011.

THE MARK CONSISTS OF STANDARD CHARACTERS WITHOUT CLAIM TO ANY PARTICULAR FONT, STYLE, SIZE, OR COLOR.

OWNER OF U.S. REG. NO. 2,704,871.

SN 77-460,992, FILED 4-29-2008.

AMY HELLA, EXAMINING ATTORNEY



David J. Kybas

Director of the United States Patent and Trademark Office

United States of America

United States Patent and Trademark Office

ASIMO

Reg. No. 4,067,492

Registered Dec. 6, 2011

Int. Cls.: 7 and 35

TRADEMARK

SERVICE MARK

PRINCIPAL REGISTER

HONDA GIKEN KOGYO KABUSHIKI KAISHA (JAPAN CORPORATION), TA HONDA
MOTOR CO., LTD.,
1-1, MINAMI-AOYAMA 2-CHOME
MINATO-KU, TOKYO, JAPAN 1078556

FOR: INDUSTRIAL ROBOTS HAVING HUMAN LIKE MOTION AND MOBILITY AND
STRUCTURAL PARTS THEREFOR, IN CLASS 7 (U.S. CLS. 13, 19, 21, 23, 31, 34 AND 35).

FIRST USE 11-0-2000; IN COMMERCE 11-0-2000.

FOR: PROMOTIONAL SERVICES NAMELY, PROMOTIONAL APPEARANCES BY A ROBOT
HAVING HUMAN LIKE MOTION AND MOBILITY FOR THE PURPOSE OF PROMOTING
THE GOODS AND SERVICES OF OTHERS, IN CLASS 35 (U.S. CLS. 100, 101 AND 102).

FIRST USE 1-0-2003; IN COMMERCE 1-0-2003.

THE MARK CONSISTS OF STANDARD CHARACTERS WITHOUT CLAIM TO ANY PAR-
TICULAR FONT, STYLE, SIZE, OR COLOR.

THE WORDING "ASIMO" HAS NO MEANING IN A FOREIGN LANGUAGE.

SN 77-462,765, FILED 5-1-2008.

WON TEAK OH, EXAMINING ATTORNEY



David J. Kybas

Director of the United States Patent and Trademark Office

United States of America

United States Patent and Trademark Office

feminostic

Reg. No. 4,067,493

Registered Dec. 6, 2011

Int. Cl.: 6

TRADEMARK

PRINCIPAL REGISTER

LUMINA SPHERE LLC (ARIZONA LIMITED LIABILITY COMPANY)
3655 W. ANTHEM WAY, SUITE A109-419
ANTHEM, AZ 85086

FOR: SCULPTURES OF METAL, IN CLASS 6 (U.S. CLS. 2, 12, 13, 14, 23, 25 AND 50).

FIRST USE 1-7-2009; IN COMMERCE 9-28-2011.

THE MARK CONSISTS OF STANDARD CHARACTERS WITHOUT CLAIM TO ANY PARTICULAR FONT, STYLE, SIZE, OR COLOR.

SN 77-468,384, FILED 5-7-2008.

KATHRYN COWARD, EXAMINING ATTORNEY



David J. Kyros

Director of the United States Patent and Trademark Office

United States of America

United States Patent and Trademark Office

i-bit

Reg. No. 4,067,494

Registered Dec. 6, 2011

Int. Cl.: 41

SERVICE MARK

PRINCIPAL REGISTER

THOMAS, JOHNATHAN (UNITED STATES INDIVIDUAL)
21392 MAIDSVILLE COURT
ASHBURN, VA 20147

FOR: PROVIDING INFORMATION IN THE FIELD OF GENERAL ENCYCLOPEDIA, REFERENCE AND TRIVIA KNOWLEDGE VIA THE INTERNET FOR EDUCATIONAL AND ENTERTAINMENT PURPOSES, IN CLASS 41 (U.S. CLS. 100, 101 AND 107).

FIRST USE 1-1-2009; IN COMMERCE 1-1-2009.

THE MARK CONSISTS OF STANDARD CHARACTERS WITHOUT CLAIM TO ANY PARTICULAR FONT, STYLE, SIZE, OR COLOR.

SN 77-468,997, FILED 5-8-2008.

FLORENTINA BLANDU, EXAMINING ATTORNEY



David J. Kyros

Director of the United States Patent and Trademark Office

United States of America

United States Patent and Trademark Office

Amy Gibson

Reg. No. 4,067,495

Registered Dec. 6, 2011

Int. Cl.: 26

TRADEMARK

PRINCIPAL REGISTER

GIBSON, AMY JANE (UNITED STATES INDIVIDUAL)
10390 WILSHIRE BOULEVARD #801
LOS ANGELES, CA 90024

FOR: HAIR PIECES AND WIGS, IN CLASS 26 (U.S. CLS. 37, 39, 40, 42 AND 50).

FIRST USE 11-0-2001; IN COMMERCE 11-0-2001.

THE MARK CONSISTS OF STANDARD CHARACTERS WITHOUT CLAIM TO ANY PARTICULAR FONT, STYLE, SIZE, OR COLOR.

THE NAME "AMY GIBSON" IDENTIFIES A LIVING INDIVIDUAL WHOSE CONSENT IS OF RECORD.

SN 77-469,563, FILED 5-8-2008.

LINDA POWELL, EXAMINING ATTORNEY



David J. Kyffers

Director of the United States Patent and Trademark Office

United States of America

United States Patent and Trademark Office

YO COCINO MEJOR QUE MI SUEGRA

Reg. No. 4,067,496

UNIVISION COMMUNICATIONS INC. (DELAWARE CORPORATION)
5999 CENTER DRIVE
LOS ANGELES, CA 90045

Registered Dec. 6, 2011

Int. Cl.: 41

FOR: ENTERTAINMENT SERVICES IN THE NATURE OF A TELEVISION SERIES FEATURING COOKING COMPETITIONS, IN CLASS 41 (U.S. CLS. 100, 101 AND 107).

SERVICE MARK

FIRST USE 5-30-2009; IN COMMERCE 5-30-2009.

PRINCIPAL REGISTER

THE MARK CONSISTS OF STANDARD CHARACTERS WITHOUT CLAIM TO ANY PARTICULAR FONT, STYLE, SIZE, OR COLOR.

THE FOREIGN WORDING IN THE MARK TRANSLATES INTO ENGLISH AS "I COOK BETTER THAN MY MOTHER IN LAW".

SN 77-470,358, FILED 5-9-2008.

KEVIN CORWIN, EXAMINING ATTORNEY



David J. Kybas

Director of the United States Patent and Trademark Office

United States of America

United States Patent and Trademark Office

The logo consists of the letter 'I' followed by a solid black heart symbol, and then the word 'RONSON' in a bold, sans-serif font.

Reg. No. 4,067,497

Registered Dec. 6, 2011

Int. Cl.: 25

TRADEMARK

PRINCIPAL REGISTER

CHARLOTTE RONSON LLC (NEW YORK LIMITED LIABILITY COMPANY)
1071 AVENUE OF THE AMERICAS
SUITE 301
NEW YORK, NY 10018

FOR: CLOTHING, NAMELY, JACKETS AND COATS, IN CLASS 25 (U.S. CLS. 22 AND 39).

FIRST USE 2-28-2009; IN COMMERCE 2-28-2009.

OWNER OF U.S. REG. NO. 2,637,647.

THE NAME SHOWN IN THE MARK IDENTIFIES "CHARLOTTE RONSON" WHOSE CONSENT IS OF RECORD.

THE MARK CONSISTS OF THE WORDS "I" AND "RONSON" SEPARATED BY A HEART SHAPE.

SN 77-471,000, FILED 5-9-2008.

COURTNEY ALVAREZ, EXAMINING ATTORNEY



David J. Kybas

Director of the United States Patent and Trademark Office

United States of America

United States Patent and Trademark Office

ROOFING ESSENTIALS

Reg. No. 4,067,498

Registered Dec. 6, 2011

Int. Cl.: 19

TRADEMARK

PRINCIPAL REGISTER

OWENS CORNING INTELLECTUAL CAPITAL, LLC (DELAWARE LIMITED LIABILITY COMPANY)
ONE OWENS CORNING PARKWAY
TOLEDO, OH 43659

FOR: NON-METAL RIDGE VENTS; NON-METAL SHINGLES; SHINGLE UNDERLAYMENT; NON-METAL BUILDING FLASHING IN THE NATURE OF ICE AND WATER BARRIERS , IN CLASS 19 (U.S. CLS. 1, 12, 33 AND 50).

FIRST USE 9-30-2010; IN COMMERCE 9-30-2010.

THE MARK CONSISTS OF STANDARD CHARACTERS WITHOUT CLAIM TO ANY PARTICULAR FONT, STYLE, SIZE, OR COLOR.

NO CLAIM IS MADE TO THE EXCLUSIVE RIGHT TO USE "ROOFING", APART FROM THE MARK AS SHOWN.

SN 77-471,493, FILED 5-12-2008.

MARLENE BELL, EXAMINING ATTORNEY



David J. Kybas

Director of the United States Patent and Trademark Office

United States of America

United States Patent and Trademark Office

VERVE LIVING SYSTEMS

Reg. No. 4,067,499

Registered Dec. 6, 2011

Int. Cl.: 9

TRADEMARK

PRINCIPAL REGISTER

LIBERTY HARDWARE MFG. CORP. (FLORIDA CORPORATION)
140 BUSINESS PARK DRIVE
WINSTON-SALEM, NC 27107

FOR: ELECTROMECHANICAL AND ELECTRONIC APPARATUS, DEVICES AND INSTRUMENTS, NAMELY, LIGHTING CONTROL PANELS, ELECTRIC LIGHT DIMMERS, ELECTRICAL CONTROLLERS FOR APPLIANCES, WIRELESS REMOTE HUMIDITY AND TEMPERATURE MONITORS FOR BUILDING MAINTENANCE, TEMPERATURE SENSORS AND ELECTRICAL CONTROLLERS FOR HVAC UNITS, OCCUPANCY SENSORS BEING ELECTRONIC DEVICES WHICH DETECT THE PRESENCE OF OCCUPANTS AND CONTROL THE LIGHTING SYSTEM ACCORDINGLY, MOTION DETECTORS, PROGRAMMABLE LOGIC CONTROLLERS FOR LIGHTING CONSOLES, UTILITY UTILIZATION MONITORS FOR MONITORING ELECTRICAL USAGE AND, RADIO CONTROLLED ELECTRIC SWITCHES, LIGHTING TRANSCIEVER CONSOLES BEING LIGHTING CONTROL PANELS, SIGNAL TRANSMITTERS AND TRANSCIEVERS AND WIRELESS NETWORK REPEATERS, IN CLASS 9 (U.S. CLS. 21, 23, 26, 36 AND 38).

FIRST USE 12-0-2009; IN COMMERCE 12-0-2009.

THE MARK CONSISTS OF STANDARD CHARACTERS WITHOUT CLAIM TO ANY PARTICULAR FONT, STYLE, SIZE, OR COLOR.

NO CLAIM IS MADE TO THE EXCLUSIVE RIGHT TO USE "SYSTEMS", APART FROM THE MARK AS SHOWN.

SN 77-473,860, FILED 5-14-2008.

JOHN DWYER, EXAMINING ATTORNEY



David J. Kyros

Director of the United States Patent and Trademark Office

United States of America

United States Patent and Trademark Office

GEOCROPICAL

Reg. No. 4,067,500

Registered Dec. 6, 2011

Int. Cls.: 11, 37, and 42

NELSON IRRIGATION CORPORATION (WASHINGTON CORPORATION)
848 AIRPORT ROAD
WALLA WALLA, WA 993622271

FOR: IRRIGATION SPRINKLERS, IN CLASS 11 (U.S. CLS. 13, 21, 23, 31 AND 34).

FIRST USE 0-0-2008; IN COMMERCE 0-0-2008.

TRADEMARK

FOR: PROVIDING INFORMATION REGARDING INSTALLATION AND MAINTENANCE OF WATER IRRIGATION SYSTEMS, IN CLASS 37 (U.S. CLS. 100, 103 AND 106).

SERVICE MARK

PRINCIPAL REGISTER

FIRST USE 0-0-2009; IN COMMERCE 0-0-2009.

FOR: PROVIDING INFORMATION ABOUT DESIGNING WATER IRRIGATION SYSTEMS, IN CLASS 42 (U.S. CLS. 100 AND 101).

FIRST USE 0-0-2009; IN COMMERCE 0-0-2009.

THE MARK CONSISTS OF STANDARD CHARACTERS WITHOUT CLAIM TO ANY PARTICULAR FONT, STYLE, SIZE, OR COLOR.

SN 77-475,326, FILED 5-15-2008.

H. M. FISHER, EXAMINING ATTORNEY



David J. Kybas

Director of the United States Patent and Trademark Office

United States of America

United States Patent and Trademark Office

SOLARMAGIC

Reg. No. 4,067,501

Registered Dec. 6, 2011

Int. Cl.: 9

TRADEMARK

PRINCIPAL REGISTER

NATIONAL SEMICONDUCTOR CORPORATION (DELAWARE CORPORATION)
2900 SEMICONDUCTOR DRIVE
SANTA CLARA, CA 95051

FOR: INTEGRATED CIRCUITS, CONVERTERS, ELECTRONIC CONTROLLERS FOR USE WITH POWER CONVERTERS, AND HIGH FREQUENCY SWITCHING POWER SUPPLIES, IN CLASS 9 (U.S. CLS. 21, 23, 26, 36 AND 38).

FIRST USE 6-0-2009; IN COMMERCE 6-0-2009.

THE MARK CONSISTS OF STANDARD CHARACTERS WITHOUT CLAIM TO ANY PARTICULAR FONT, STYLE, SIZE, OR COLOR.

SN 77-476,050, FILED 5-15-2008.

KELLY CHOE, EXAMINING ATTORNEY



David J. Kyjars

Director of the United States Patent and Trademark Office

United States of America

United States Patent and Trademark Office

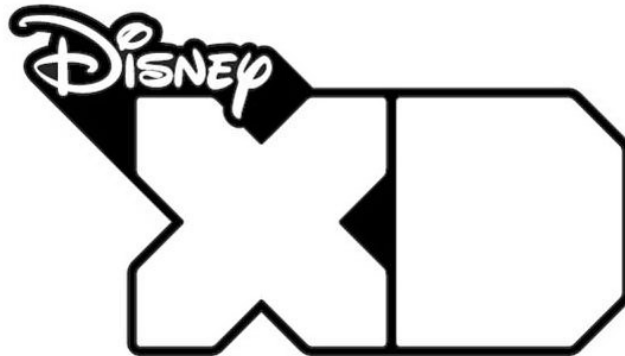

Reg. No. 4,067,502

Registered Dec. 6, 2011

Int. Cl.: 14

TRADEMARK

PRINCIPAL REGISTER

DISNEY ENTERPRISES, INC. (DELAWARE CORPORATION)
CORPORATE LEGAL- TRADEMARK DEPARTMENT
500 SOUTH BUENA VISTA STREET
BURBANK, CA 915210854

FOR: CLOCKS; WATCHES; WRISTWATCHES, IN CLASS 14 (U.S. CLS. 2, 27, 28 AND 50).

FIRST USE 4-30-2011; IN COMMERCE 4-30-2011.

OWNER OF U.S. REG. NOS. 3,122,193, 3,379,422, AND OTHERS.

SN 77-478,254, FILED 5-19-2008.

BRIDGETT SMITH, EXAMINING ATTORNEY



David J. Kyffers

Director of the United States Patent and Trademark Office

United States of America

United States Patent and Trademark Office

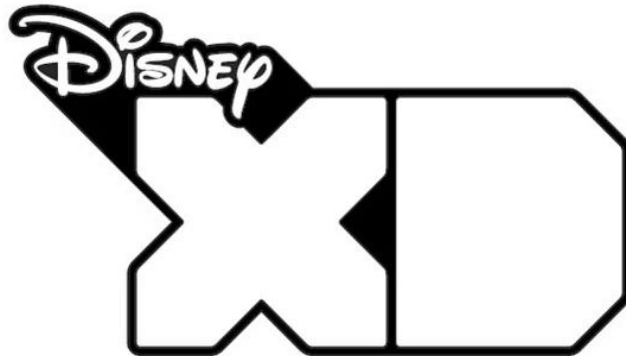

Reg. No. 4,067,503

Registered Dec. 6, 2011

Int. Cl.: 16

TRADEMARK

PRINCIPAL REGISTER

DISNEY ENTERPRISES, INC. (DELAWARE CORPORATION)
500 SOUTH BUENA VISTA STREET
BURBANK, CA 915216800

FOR: APPLIQUES IN THE FORM OF DECALS; AUTOGRAPH BOOKS; BALL POINT PENS; BOOKMARKS; CALENDARS; CHILDREN'S ACTIVITY BOOKS; COLOR PENCILS; COMIC BOOKS; DECALS; DECORATIVE PAPER CENTERPIECES; DRAWING RULERS; ERASERS; FELT PENS; GREETING CARDS; MEMO PADS; NOTEBOOKS; PAPER PARTY DECORATIONS; PENCILS; PENCIL SHARPENERS; PENS; PRINTED INVITATIONS; STATIONERY; STICKERS; WRITING PAPER; WRITING IMPLEMENTS, IN CLASS 16 (U.S. CLS. 2, 5, 22, 23, 29, 37, 38 AND 50).

FIRST USE 4-30-2011; IN COMMERCE 4-30-2011.

OWNER OF U.S. REG. NOS. 1,162,727, 3,390,317, AND OTHERS.

SN 77-478,261, FILED 5-19-2008.

BRIDGETT SMITH, EXAMINING ATTORNEY



David J. Kyros

Director of the United States Patent and Trademark Office

United States of America

United States Patent and Trademark Office

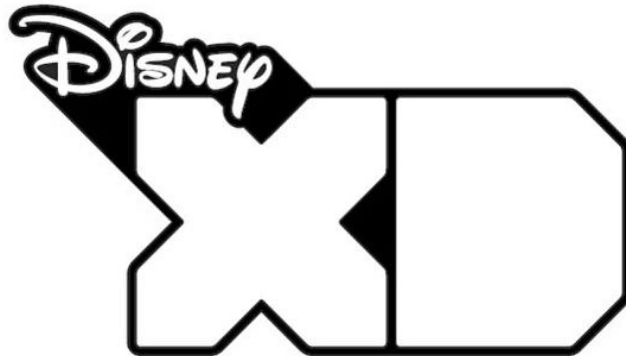

Reg. No. 4,067,504

Registered Dec. 6, 2011

Int. Cl.: 20

TRADEMARK

PRINCIPAL REGISTER

DISNEY ENTERPRISES, INC. (DELAWARE CORPORATION)
500 SOUTH BUENA VISTA STREET
BURBANK, CA 915216800

FOR: KEY FOBS NOT OF METAL; DECORATIVE WALL PLAQUES, IN CLASS 20 (U.S. CLS. 2, 13, 22, 25, 32 AND 50).

FIRST USE 4-30-2011; IN COMMERCE 4-30-2011.

OWNER OF U.S. REG. NOS. 3,354,461, 3,396,582, AND OTHERS.

SN 77-478,269, FILED 5-19-2008.

BRIDGETT SMITH, EXAMINING ATTORNEY



David J. Kybas

Director of the United States Patent and Trademark Office

United States of America

United States Patent and Trademark Office

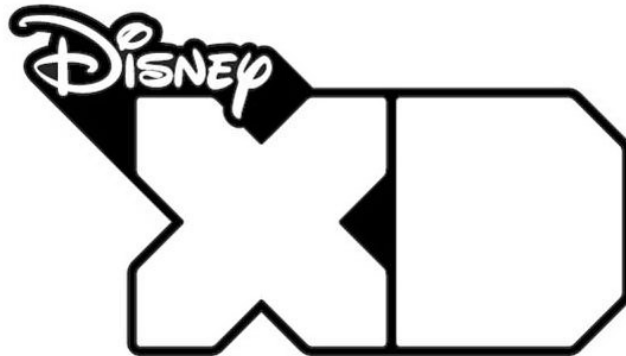

Reg. No. 4,067,505

Registered Dec. 6, 2011

Int. Cl.: 24

TRADEMARK

PRINCIPAL REGISTER

DISNEY ENTERPRISES, INC. (DELAWARE CORPORATION)
500 SOUTH BUENA VISTA STREET
BURBANK, CA 915216800

FOR: BED BLANKETS; BED LINEN; BED SHEETS; BLANKET THROWS; CHILDREN'S BLANKETS; COMFORTERS; CURTAINS; HOUSEHOLD LINEN; THROWS; TOWELS, IN CLASS 24 (U.S. CLS. 42 AND 50).

FIRST USE 4-30-2011; IN COMMERCE 4-30-2011.

OWNER OF U.S. REG. NOS. 3,060,962, 3,415,503, AND OTHERS.

SN 77-478,277, FILED 5-19-2008.

BRIDGETT SMITH, EXAMINING ATTORNEY



David J. Kyffers

Director of the United States Patent and Trademark Office

United States of America

United States Patent and Trademark Office

Strix NB

Reg. No. 4,067,506

Registered Dec. 6, 2011

Int. Cl.: 5

TRADEMARK

PRINCIPAL REGISTER

KANE BIOTECH INC. (CANADA CORPORATION)
5-1250 WAVERLEY STREET
WINNIPEG, CANADA R3T6C6

FOR: ANTIMICROBIAL, ANTIBACTERIAL AND ANTIFUNGAL COMPOSITIONS FOR THE PREPARATION OF ORAL AND DENTAL CARE PRODUCTS FOR VETERINARY USE, NAMELY, MEDICATED BRUSH-ON ORAL CARE GELS; LIQUID, SOLID AND GEL NUTRITIONAL ADDITIVES FOR ANIMAL FOOD AND/OR WATER; DENTAL PADS, NAMELY, DENTAL COMPOSITE MATERIALS FOR HUMAN AND VETERINARY USE; DENTAL RINSES FOR HUMAN AND VETERINARY USE; ANTIMICROBIAL, ANTIBACTERIAL AND ANTIFUNGAL PROTECTIVE COATING COMPOSITIONS APPLIED TO VETERINARY DEVICES, APPARATUS AND INSTRUMENTS FOR THE TREATMENT AND PREVENTION OF THE GROWTH OF MOLD, MILDEW, BACTERIA AND FUNGUS IN THE FIELD OF ANIMAL CARE; ANTIBACTERIAL/ANTIMICROBIAL TAPE FOR ORAL AND DENTAL VETERINARY PRODUCTS FOR THE PURPOSE OF DESTROYING BACTERIA, MOLD AND MILDEW; ANTIMICROBIAL COATINGS FOR VETERINARY USE AND ANIMAL CARE TO TREAT THE GROWTH OF MOLD, MILDEW, BACTERIA AND FUNGUS ON VARIOUS SURFACES; ANTIMICROBIAL PREPARATIONS FOR INHIBITING MICROBIOLOGICAL DECOMPOSITION IN FOOD, ANIMAL FEED AND WATER; ANTIBACTERIAL CLEANERS FOR VETERINARY USE AND ANIMAL CARE; ANTIBACTERIAL SPRAY FOR VETERINARY USE AND ANIMAL CARE; ANTIBACTERIAL SUBSTANCES FOR VETERINARY MEDICAL USE AND ANIMAL CARE; ANTIFUNGAL CREAMS FOR VETERINARY MEDICAL USE AND ANIMAL CARE, IN CLASS 5 (U.S. CLS. 6, 18, 44, 46, 51 AND 52).



FIRST USE 10-6-2011; IN COMMERCE 10-6-2011.

THE MARK CONSISTS OF STANDARD CHARACTERS WITHOUT CLAIM TO ANY PARTICULAR FONT, STYLE, SIZE, OR COLOR.

SN 77-482,372, FILED 5-23-2008.

SAMUEL E. SHARPER JR., EXAMINING ATTORNEY

David J. Kyffers

Director of the United States Patent and Trademark Office

United States of America

United States Patent and Trademark Office

ELASTO LOCK

Reg. No. 4,067,507

Registered Dec. 6, 2011

Int. Cl.: 2

TRADEMARK

PRINCIPAL REGISTER

DAICH COATINGS CORP (CANADA CORPORATION)
2360A SOUTHFIELD ROAD
MISSISSAUGA, CANADA MISSISSAU

FOR: CONCRETE FLOOR PAINT; WATER REPELLENT COATINGS IN THE NATURE OF PAINTS; WATER REPELLENT COATINGS IN THE NATURE OF PAINTS, NAMELY, ELASTOMERIC WATERPROOFING PAINTS; MASONRY WATERPROOFING PAINT; MASONRY PAINT, PAINT SEALERS AND PRIMERS; TOP COAT SEALER COATINGS FOR MASONRY; MASONRY BASE COAT PRIMERS, IN CLASS 2 (U.S. CLS. 6, 11 AND 16).

FIRST USE 4-30-2010; IN COMMERCE 5-30-2010.

THE MARK CONSISTS OF STANDARD CHARACTERS WITHOUT CLAIM TO ANY PARTICULAR FONT, STYLE, SIZE, OR COLOR.

SN 77-483,404, FILED 5-26-2008.

STEVEN PEREZ, EXAMINING ATTORNEY



David J. Kyros

Director of the United States Patent and Trademark Office

United States of America

United States Patent and Trademark Office

ZOE ZANNA

Reg. No. 4,067,508

Registered Dec. 6, 2011

Int. Cl.: 25

TRADEMARK

PRINCIPAL REGISTER

SIENNA ROSE, INC. (CALIFORNIA CORPORATION)
2247 SOUTH CANFIELD
LOS ANGELES, CA 90034

FOR: CHILDREN'S CLOTHING, NAMELY, TOPS, DRESSES, SKIRTS, T-SHIRTS, BLOUSES, HOODED SWEATSHIRTS, PANTS, JACKETS, SWEATERS, SWEAT PANTS, SWEAT SHIRTS AND SHORTS, IN CLASS 25 (U.S. CLS. 22 AND 39).

FIRST USE 6-30-2011; IN COMMERCE 6-30-2011.

THE MARK CONSISTS OF STANDARD CHARACTERS WITHOUT CLAIM TO ANY PARTICULAR FONT, STYLE, SIZE, OR COLOR.

THE NAME "ZOE ZANNA" DOES NOT IDENTIFY A LIVING INDIVIDUAL.

SN 77-487,239, FILED 5-30-2008.

GISELLE AGOSTO, EXAMINING ATTORNEY



David J. Kybas

Director of the United States Patent and Trademark Office

United States of America

United States Patent and Trademark Office

MIGHTY 8TH MEDIA

Reg. No. 4,067,509

Registered Dec. 6, 2011

Int. Cl.: 35

SERVICE MARK

PRINCIPAL REGISTER

MIGHTY 8TH MEDIA, LLC (GEORGIA LIMITED LIABILITY COMPANY)
83 EAST MAIN STREET
BUFORD, GA 30518

FOR: ADVERTISING, MARKETING, PROMOTIONAL, PUBLICITY AND PUBLIC RELATIONS SERVICES AND RELATED CONSULTING, IN CLASS 35 (U.S. CLS. 100, 101 AND 102).

FIRST USE 1-1-2011; IN COMMERCE 1-1-2011.

THE MARK CONSISTS OF STANDARD CHARACTERS WITHOUT CLAIM TO ANY PARTICULAR FONT, STYLE, SIZE, OR COLOR.

NO CLAIM IS MADE TO THE EXCLUSIVE RIGHT TO USE "MEDIA", APART FROM THE MARK AS SHOWN.

SN 77-497,700, FILED 6-12-2008.

BARBARA RUTLAND, EXAMINING ATTORNEY



David J. Kybas

Director of the United States Patent and Trademark Office

United States of America

United States Patent and Trademark Office

UNDERHYDRATION

Reg. No. 4,067,510

Registered Dec. 6, 2011

Int. Cl.: 21

TRADEMARK

PRINCIPAL REGISTER

MID2, LLC (NEW YORK LIMITED LIABILITY COMPANY)
176 GNARLED HOLLOW ROAD
E. SETAUKET, NY 11733

FOR: PERSONAL FLUID HYDRATION SYSTEM, COMPRISING, A FLUID RESERVOIR, A DELIVERY TUBE, A MOUTHPIECE, A CARRYING PACK, IN CLASS 21 (U.S. CLS. 2, 13, 23, 29, 30, 33, 40 AND 50).

FIRST USE 9-1-2011; IN COMMERCE 9-1-2011.

THE MARK CONSISTS OF STANDARD CHARACTERS WITHOUT CLAIM TO ANY PARTICULAR FONT, STYLE, SIZE, OR COLOR.

SN 77-501,998, FILED 6-18-2008.

WILLIAM BRECKENFELD, EXAMINING ATTORNEY



David J. Kyffers

Director of the United States Patent and Trademark Office

United States of America

United States Patent and Trademark Office

STOOL SMOCKS

Reg. No. 4,067,511

CROWN SEATING, LLC (COLORADO LIMITED LIABILITY COMPANY)
7300 S. TUCSON WAY
CENTENNIAL, CO 80112

Registered Dec. 6, 2011

Int. Cl.: 20

FOR: FITTED DISPOSABLE COVERS FOR MEDICAL AND DENTAL CHAIRS, IN CLASS 20 (U.S. CLS. 2, 13, 22, 25, 32 AND 50).

TRADEMARK

FIRST USE 10-1-2011; IN COMMERCE 10-1-2011.

PRINCIPAL REGISTER

THE MARK CONSISTS OF STANDARD CHARACTERS WITHOUT CLAIM TO ANY PARTICULAR FONT, STYLE, SIZE, OR COLOR.

NO CLAIM IS MADE TO THE EXCLUSIVE RIGHT TO USE "STOOL", APART FROM THE MARK AS SHOWN.

SN 77-502,964, FILED 6-19-2008.

LAURIE MAYES, EXAMINING ATTORNEY



David J. Kybas

Director of the United States Patent and Trademark Office

United States of America

United States Patent and Trademark Office

JOURNEY OF CHANGE

Reg. No. 4,067,512

Registered Dec. 6, 2011

Int. Cls.: 6 and 16

TRADEMARK

PRINCIPAL REGISTER

JOURNEY OF CHANGE, INC. (COLORADO CORPORATION)
3089 S. CLARKSON
ENGLEWOOD, CO 80113

FOR: NON-PRECIOUS, METAL COINS, NAMELY, COLLECTABLE COINS, COMMEMORATIVE COINS, COMMEMORATIVE TOKENS, AND MEDALLIONS, IN CLASS 6 (U.S. CLS. 2, 12, 13, 14, 23, 25 AND 50).

FIRST USE 7-29-2011; IN COMMERCE 8-1-2011.

FOR: PRINTED MATTER, NAMELY, STICKERS, CALENDARS, POSTERS, AND CARDS, NAMELY, BUSINESS CARDS, GREETING CARDS, POSTCARDS, TAROT CARDS, AND CREDIT-CARD SHAPED CARDS OF PLASTIC INTENDED TO BE CARRIED ON OR WITH A PERSON IN A POCKET, WALLET OR PURSE FOR USE AS MOTIVATIONAL CARDS, IN CLASS 16 (U.S. CLS. 2, 5, 22, 23, 29, 37, 38 AND 50).

FIRST USE 8-31-2011; IN COMMERCE 8-31-2011.

THE MARK CONSISTS OF STANDARD CHARACTERS WITHOUT CLAIM TO ANY PARTICULAR FONT, STYLE, SIZE, OR COLOR.

SN 77-507,872, FILED 6-25-2008.

MARK PILARO, EXAMINING ATTORNEY



David J. Kyffers

Director of the United States Patent and Trademark Office

United States of America

United States Patent and Trademark Office

TWILIGHT

Reg. No. 4,067,513

Registered Dec. 6, 2011

Int. Cl.: 16

TRADEMARK

PRINCIPAL REGISTER

SUMMIT ENTERTAINMENT, LLC (DELAWARE LIMITED LIABILITY COMPANY)
1630 STEWART STREET, STE. 120
SANTA MONICA, CA 90404

FOR: CALENDARS; STICKERS; POSTERS; GREETING CARDS, MAGAZINES FEATURING
MOTION PICTURES, TRADING CARDS, ART PICTURES, ART PAPERS, AND DECALS, IN
CLASS 16 (U.S. CLS. 2, 5, 22, 23, 29, 37, 38 AND 50).

FIRST USE 9-22-2008; IN COMMERCE 9-22-2008.

THE MARK CONSISTS OF STANDARD CHARACTERS WITHOUT CLAIM TO ANY PAR-
TICULAR FONT, STYLE, SIZE, OR COLOR.

SN 77-509,417, FILED 6-26-2008.

SKYE YOUNG, EXAMINING ATTORNEY



David J. Kybas

Director of the United States Patent and Trademark Office

United States of America

United States Patent and Trademark Office

Piggy Pockets

Reg. No. 4,067,514

Registered Dec. 6, 2011

Int. Cl.: 25

TRADEMARK

PRINCIPAL REGISTER

PIGGY POCKETS, LLC (MISSOURI LIMITED LIABILITY COMPANY), AKA GELNER,
MELISSA L.,
5301 S. WHITMORE AVE
SPRINGFIELD, MO 65810

FOR: FOOTWEAR, IN CLASS 25 (U.S. CLS. 22 AND 39).

FIRST USE 8-1-2009; IN COMMERCE 4-20-2010.

THE MARK CONSISTS OF STANDARD CHARACTERS WITHOUT CLAIM TO ANY PARTICULAR FONT, STYLE, SIZE, OR COLOR.

SN 77-517,171, FILED 7-8-2008.

JASON BLAIR, EXAMINING ATTORNEY



David J. Kyffers

Director of the United States Patent and Trademark Office

United States of America

United States Patent and Trademark Office

Fused Reality

Reg. No. 4,067,515

Registered Dec. 6, 2011

Int. Cl.: 9

TRADEMARK

PRINCIPAL REGISTER

SYSTEMS TECHNOLOGY, INC. (CALIFORNIA CORPORATION)
13766 S. HAWTHORNE BLVD.
HAWTHORNE, CA 902507083

FOR: COMPUTER SOFTWARE, HEAD-MOUNTED VIDEO DISPLAY AND CAMERA SYSTEM
FOR REAL TIME INTERACTIVE FUSION OF PHYSICAL AND VIRTUAL ENVIRONMENTS
, IN CLASS 9 (U.S. CLS. 21, 23, 26, 36 AND 38).

FIRST USE 11-29-2010; IN COMMERCE 11-29-2010.

THE MARK CONSISTS OF STANDARD CHARACTERS WITHOUT CLAIM TO ANY PAR-
TICULAR FONT, STYLE, SIZE, OR COLOR.

SN 77-518,024, FILED 7-9-2008.

NATALIE POLZER, EXAMINING ATTORNEY



David J. Kybas

Director of the United States Patent and Trademark Office

United States of America

United States Patent and Trademark Office

SPINNAKER

Reg. No. 4,067,516

NAUTICA APPAREL, INC. (DELAWARE CORPORATION)
40 WEST 57TH STREET
NEW YORK, NY 10019

Registered Dec. 6, 2011

Int. Cl.: 3

FOR: FRAGRANCES; PERFUMES AND COLOGNES, IN CLASS 3 (U.S. CLS. 1, 4, 6, 50, 51 AND 52).

TRADEMARK

FIRST USE 10-1-2011; IN COMMERCE 10-1-2011.

PRINCIPAL REGISTER

THE MARK CONSISTS OF STANDARD CHARACTERS WITHOUT CLAIM TO ANY PARTICULAR FONT, STYLE, SIZE, OR COLOR.

SN 77-523,282, FILED 7-16-2008.

ZACHARY BELLO, EXAMINING ATTORNEY



David J. Kyffers

Director of the United States Patent and Trademark Office

United States of America

United States Patent and Trademark Office

ARTIST'S LOFT

Reg. No. 4,067,517

Registered Dec. 6, 2011

Int. Cl.: 16

TRADEMARK

PRINCIPAL REGISTER

MICHAELS STORES PROCUREMENT COMPANY, INC. (DELAWARE CORPORATION)
8000 BENT BRANCH DRIVE
IRVING, TX 75063

FOR: ART SUPPLIES, NAMELY, PENS, MARKERS, PENCILS, WATERCOLORS, PASTELS, PALETTES, BRUSHES, DRAWING INSTRUMENTS, ART PADS, CANVAS, EASELS, ART AND CRAFT PAINT KITS, AND ART PORTFOLIO CASES, IN CLASS 16 (U.S. CLS. 2, 5, 22, 23, 29, 37, 38 AND 50).

FIRST USE 5-0-2011; IN COMMERCE 5-0-2011.

THE MARK CONSISTS OF STANDARD CHARACTERS WITHOUT CLAIM TO ANY PARTICULAR FONT, STYLE, SIZE, OR COLOR.

SN 77-523,662, FILED 7-16-2008.

FLORENTINA BLANDU, EXAMINING ATTORNEY



David J. Kybas

Director of the United States Patent and Trademark Office

United States of America
United States Patent and Trademark Office

BIOBERRY

Reg. No. 4,067,518

Registered Dec. 6, 2011

Int. Cl.: 5

TRADEMARK

PRINCIPAL REGISTER

HEALTH LOGICS LABORATORIES, INC. (CALIFORNIA CORPORATION)
8001 IRVINE CENTER DRIVE, 4TH FLOOR
IRVINE, CA 92618

FOR: FOOD SUPPLEMENTS IN POWDERED DRINK MIX AND BEVERAGE FORM, IN CLASS 5 (U.S. CLS. 6, 18, 44, 46, 51 AND 52).

FIRST USE 8-22-2011; IN COMMERCE 8-22-2011.

THE MARK CONSISTS OF STANDARD CHARACTERS WITHOUT CLAIM TO ANY PARTICULAR FONT, STYLE, SIZE, OR COLOR.

SN 77-525,842, FILED 7-18-2008.

LAURA KOVALSKY, EXAMINING ATTORNEY



David J. Kybas

Director of the United States Patent and Trademark Office

United States of America

United States Patent and Trademark Office

EDWARDS SAPIEN XT

Reg. No. 4,067,519

Registered Dec. 6, 2011

Int. Cl.: 10

TRADEMARK

PRINCIPAL REGISTER

EDWARDS LIFESCIENCES CORPORATION (DELAWARE CORPORATION)
C/O TRADEMARK ADMINISTRATOR, LEGAL DEPT.
ONE EDWARDS WAY
IRVINE, CA 92614

FOR: MEDICAL DEVICES, NAMELY, HEART VALVE AND HEART VALVE DELIVERY CATHETER, IN CLASS 10 (U.S. CLS. 26, 39 AND 44).

FIRST USE 3-1-2010; IN COMMERCE 3-1-2010.

THE MARK CONSISTS OF STANDARD CHARACTERS WITHOUT CLAIM TO ANY PARTICULAR FONT, STYLE, SIZE, OR COLOR.

OWNER OF U.S. REG. NO. 3,463,069.

SN 77-528,759, FILED 7-22-2008.

RON FAIRBANKS, EXAMINING ATTORNEY



David J. Kybas

Director of the United States Patent and Trademark Office

United States of America

United States Patent and Trademark Office



confindex

Reg. No. 4,067,520

Registered Dec. 6, 2011

Int. Cl.: 35

CONSTRUCTION FINANCIAL MANAGEMENT ASSOCIATION (NEW JERSEY NON-PROFIT CORPORATION)

SUITE 200, PRINCETON FORRESTAL VILLAGE
100 VILLAGE BLVD.

PRINCETON FORRESTAL VILLAGE, NJ 085405783

SERVICE MARK

PRINCIPAL REGISTER

FOR: PROVIDING BUSINESS AND STATISTICAL INFORMATION AND INDEXES OF THE ECONOMIC OUTLOOK OF THE CONSTRUCTION INDUSTRY IN THE UNITED STATES; PROVIDING A WEBSITE FEATURING BUSINESS INFORMATION, SURVEYS AND DATA FOR OTHERS IN THE FIELD OF ECONOMICS AND THE ECONOMIC OUTLOOK OF THE CONSTRUCTION INDUSTRY IN THE UNITED STATES, IN CLASS 35 (U.S. CLS. 100, 101 AND 102).

FIRST USE 7-0-2009; IN COMMERCE 7-0-2009.

SN 77-530,186, FILED 7-24-2008.

BENJAMIN OKEKE, EXAMINING ATTORNEY



David J. Kyros

Director of the United States Patent and Trademark Office

United States of America

United States Patent and Trademark Office

ADMD

Reg. No. 4,067,521

Registered Dec. 6, 2011

Int. Cl.: 35

SERVICE MARK

PRINCIPAL REGISTER

TYCO HEALTHCARE GROUP, LP (DELAWARE LIMITED PARTNERSHIP)
15 HAMPSHIRE STREET
MANSFIELD, MA 02048

FOR: ADVERTISING AND MARKETING SERVICES IN THE FIELD OF MEDICAL PRACTICES, IN CLASS 35 (U.S. CLS. 100, 101 AND 102).

FIRST USE 8-30-2007; IN COMMERCE 8-30-2007.

THE MARK CONSISTS OF STANDARD CHARACTERS WITHOUT CLAIM TO ANY PARTICULAR FONT, STYLE, SIZE, OR COLOR.

SN 77-531,023, FILED 7-24-2008.

ALICE BENMAMAN, EXAMINING ATTORNEY



David J. Kybas

Director of the United States Patent and Trademark Office

United States of America

United States Patent and Trademark Office

IMMUNUTRIN

Reg. No. 4,067,522

Registered Dec. 6, 2011

Int. Cl.: 5

TRADEMARK

PRINCIPAL REGISTER

NUTRAGENESIS, LLC (VERMONT LIMITED LIABILITY COMPANY)
167 MAIN STREET, #208
BRATTLEBORO, VT 05301

FOR: NUTRITIONAL INGREDIENT WITH IMMUNITY ENHANCING FUNCTIONALITY
SOLD AS A COMPONENT FEATURE OF DIETARY SUPPLEMENTS, IN CLASS 5 (U.S. CLS.
6, 18, 44, 46, 51 AND 52).

FIRST USE 9-15-2009; IN COMMERCE 9-15-2009.

THE MARK CONSISTS OF STANDARD CHARACTERS WITHOUT CLAIM TO ANY PAR-
TICULAR FONT, STYLE, SIZE, OR COLOR.

SN 77-533,777, FILED 7-29-2008.

JACLYN KIDWELL WALKER, EXAMINING ATTORNEY



David J. Kyffers

Director of the United States Patent and Trademark Office

United States of America

United States Patent and Trademark Office

KIDSEMBRACE

Reg. No. 4,067,523

Registered Dec. 6, 2011

Int. Cl.: 12

TRADEMARK

PRINCIPAL REGISTER

INSPIRED PRODUCTS GROUP, LLC (CALIFORNIA LIMITED LIABILITY COMPANY)
3940 LAUREL CANYON BLVD., SUITE 1172
STUDIO CITY, CA 91604

FOR: BABY STROLLERS; BOOSTER SEATS FOR USE IN VEHICLES; CHILDREN'S CAR SEATS; STROLLERS, IN CLASS 12 (U.S. CLS. 19, 21, 23, 31, 35 AND 44).

FIRST USE 7-1-2009; IN COMMERCE 7-1-2009.

THE MARK CONSISTS OF STANDARD CHARACTERS WITHOUT CLAIM TO ANY PARTICULAR FONT, STYLE, SIZE, OR COLOR.

SN 77-537,104, FILED 8-1-2008.

BARBARA A. GOLD, EXAMINING ATTORNEY



David J. Kybas

Director of the United States Patent and Trademark Office

United States of America

United States Patent and Trademark Office

CallSpace

Reg. No. 4,067,524

Registered Dec. 6, 2011

Int. Cls.: 9, 35, 38, and 41

TRADEMARK

SERVICE MARK

PRINCIPAL REGISTER

CALLSPACE, INC. (DELAWARE CORPORATION)
13508 BULLICK HOLLOW ROAD
AUSTIN, TX 78726

FOR: ELECTRONIC SYSTEMS COMPRISING CALL SWITCHING AND AUDIO DELIVERY DEVICES PROVIDING CALL MESSAGING, ON-HOLD TELEPHONIC MESSAGING AND MUSIC TO WIRE LINE AND WIRELESS PHONES; COMPUTER SOFTWARE COMPRISING FUNCTIONALITY FOR DEPLOYMENT, PLAYBACK, SCHEDULING, UPDATING, MAINTENANCE AND CALL STATISTIC GATHERING OF CALL AND ON-HOLD MESSAGES TO TELEPHONE SYSTEMS, IN CLASS 9 (U.S. CLS. 21, 23, 26, 36 AND 38).

FIRST USE 3-17-2008; IN COMMERCE 11-19-2008.

FOR: ADVERTISING SERVICES, NAMELY, PROMOTING GOODS AND SERVICES OF ANOTHER BY PLACING ADVERTISEMENTS ON LAND AND MOBILE PHONES WHEN PERSONS ARE ON HOLD OR WAITING FOR A CALL TO BE CONNECTED, IN CLASS 35 (U.S. CLS. 100, 101 AND 102).

FIRST USE 3-17-2008; IN COMMERCE 11-19-2008.

FOR: AUDIO BROADCASTING; DELIVERY OF MESSAGES BY ELECTRONIC TRANSMISSION; ELECTRONIC VOICE MESSAGING, NAMELY, THE RECORDING AND SUBSEQUENT TRANSMISSION OF VOICE MESSAGES BY TELEPHONE; MESSAGING, NAMELY, THE RECORDING AND SUBSEQUENT TRANSMISSION OF VOICE MESSAGES BY TELEPHONE; TELEPHONE VOICE MESSAGING SERVICES; TRANSMISSION AND DISTRIBUTION OF AUDIO MESSAGES AND PROGRAMMED MUSIC VIA A GLOBAL COMPUTER NETWORK TO USERS; DELIVERY OF DIGITAL AUDIO MESSAGES AND PROGRAMMED MUSIC BY ELECTRONIC TRANSMISSION, ALL OF THE AFOREMENTIONED SERVICES MARKETED TO BUSINESSES, IN CLASS 38 (U.S. CLS. 100, 101 AND 104).

FIRST USE 3-17-2008; IN COMMERCE 11-19-2008.

FOR: PRODUCTION OF RECORDED AUDIO MESSAGES AND SOUND MUSIC RECORDINGS VIA A GLOBAL COMPUTER NETWORK OR OTHER COMPUTER READABLE MEDIUM TO USERS; AUDIO RECORDING AND PRODUCTION SERVICES FOR OTHERS, IN CLASS 41 (U.S. CLS. 100, 101 AND 107).



David J. Kyjars

Director of the United States Patent and Trademark Office

Reg. No. 4,067,524 FIRST USE 3-17-2008; IN COMMERCE 11-19-2008.

THE MARK CONSISTS OF STANDARD CHARACTERS WITHOUT CLAIM TO ANY PARTICULAR FONT, STYLE, SIZE, OR COLOR.

SN 77-538,244, FILED 8-4-2008.

PAULA MAHONEY, EXAMINING ATTORNEY

United States of America

United States Patent and Trademark Office

HIGHBURY

Reg. No. 4,067,525

Registered Dec. 6, 2011

Int. Cl.: 18

TRADEMARK

PRINCIPAL REGISTER

ZAPPOS IP, INC. (DELAWARE CORPORATION)
ATTN: TRADEMARKS
2280 CORPORATE CIRCLE, SUITE 100
HENDERSON, NV 89074

FOR: WINE CARRYING CASES, IN CLASS 18 (U.S. CLS. 1, 2, 3, 22 AND 41).

FIRST USE 8-10-2011; IN COMMERCE 8-10-2011.

THE MARK CONSISTS OF STANDARD CHARACTERS WITHOUT CLAIM TO ANY PARTICULAR FONT, STYLE, SIZE, OR COLOR.

SN 77-538,819, FILED 8-4-2008.

TARA PATE, EXAMINING ATTORNEY



David J. Kyjars

Director of the United States Patent and Trademark Office

United States of America

United States Patent and Trademark Office

HIGHBURY

Reg. No. 4,067,526

Registered Dec. 6, 2011

Int. Cl.: 27

TRADEMARK

PRINCIPAL REGISTER

ZAPPOS IP, INC. (DELAWARE CORPORATION)
ATTN: TRADEMARKS
2280 CORPORATE CIRCLE, SUITE 100
HENDERSON, NV 89074

FOR: NON-TEXTILE WALL HANGINGS, IN CLASS 27 (U.S. CLS. 19, 20, 37, 42 AND 50).

FIRST USE 6-15-2009; IN COMMERCE 6-15-2009.

THE MARK CONSISTS OF STANDARD CHARACTERS WITHOUT CLAIM TO ANY PARTICULAR FONT, STYLE, SIZE, OR COLOR.

SN 77-539,098, FILED 8-5-2008.

TARA PATE, EXAMINING ATTORNEY



David J. Kyffers

Director of the United States Patent and Trademark Office

United States of America
United States Patent and Trademark Office

HIGHBURY

Reg. No. 4,067,527

Registered Dec. 6, 2011

Int. Cl.: 21

TRADEMARK

PRINCIPAL REGISTER

ZAPPOS IP, INC. (DELAWARE CORPORATION)
2280 CORPORATE CIRCLE, SUITE 100
ATTN: TRADEMARKS
HENDERSON, NV 89074

FOR: WINEGLASSES; BEVERAGE GLASSWARE; DINNERWARE; BAKEWARE; SERVING TRAYS; SPICE RACKS; CANDLE HOLDER; PAPER TOWEL DISPENSERS, IN CLASS 21 (U.S. CLS. 2, 13, 23, 29, 30, 33, 40 AND 50).

FIRST USE 8-10-2011; IN COMMERCE 8-10-2011.

THE MARK CONSISTS OF STANDARD CHARACTERS WITHOUT CLAIM TO ANY PARTICULAR FONT, STYLE, SIZE, OR COLOR.

SN 77-539,099, FILED 8-5-2008.

TARA PATE, EXAMINING ATTORNEY



David J. Kyjars

Director of the United States Patent and Trademark Office

United States of America

United States Patent and Trademark Office

KEISER UNIVERSITY CENTER FOR CULINARY ARTS

Reg. No. 4,067,528

Registered Dec. 6, 2011

Int. Cl.: 41

SERVICE MARK

PRINCIPAL REGISTER

THE KEISER SCHOOL, INC. (FLORIDA CORPORATION)
1900 W. COMMERCIAL BLVD.
SUITE 180
FT. LAUDERDALE, FL 33309

FOR: EDUCATIONAL SERVICES FEATURING COURSES OF STUDY AND INSTRUCTION
IN THE FIELDS OF THE CULINARY, BAKING AND PASTRY ARTS, IN CLASS 41 (U.S.
CLS. 100, 101 AND 107).

FIRST USE 1-1-2010; IN COMMERCE 1-1-2010.

THE MARK CONSISTS OF STANDARD CHARACTERS WITHOUT CLAIM TO ANY PAR-
TICULAR FONT, STYLE, SIZE, OR COLOR.

NO CLAIM IS MADE TO THE EXCLUSIVE RIGHT TO USE "UNIVERSITY CENTER FOR
CULINARY ARTS", APART FROM THE MARK AS SHOWN.

SN 77-539,325, FILED 8-5-2008.

COLLEEN DOMBROW, EXAMINING ATTORNEY



David J. Kyros

Director of the United States Patent and Trademark Office

United States of America

United States Patent and Trademark Office



Reg. No. 4,067,529

Registered Dec. 6, 2011

Int. Cl.: 41

SERVICE MARK

PRINCIPAL REGISTER

THE KEISER SCHOOL, INC. (FLORIDA CORPORATION)
SUITE 180
1900 W. COMMERCIAL BLVD.
FT. LAUDERDALE, FL 33309

FOR: EDUCATIONAL SERVICES FEATURING COURSES OF STUDY AND INSTRUCTION IN THE FIELDS OF THE CULINARY, BAKING AND PASTRY ARTS, IN CLASS 41 (U.S. CLS. 100, 101 AND 107).

FIRST USE 1-1-2010; IN COMMERCE 1-1-2010.

NO CLAIM IS MADE TO THE EXCLUSIVE RIGHT TO USE "UNIVERSITY" AND "CENTER FOR CULINARY ARTS", APART FROM THE MARK AS SHOWN.

THE MARK CONSISTS OF THE WORD "KEISER" ABOVE A FLAME DESIGN, THE WORD "UNIVERSITY" BELOW THE FLAME DESIGN, AN ORNAMENTAL BORDER BELOW THE WORDING "UNIVERSITY", AND THE WORDS "CENTER FOR CULINARY ARTS" IN STYLIZED TYPE AT THE BOTTOM OF THE DESIGN.

SN 77-539,363, FILED 8-5-2008.

COLLEEN DOMBROW, EXAMINING ATTORNEY



David J. Kybas

Director of the United States Patent and Trademark Office

United States of America

United States Patent and Trademark Office

CAPITAL CULINARY INSTITUTE

Reg. No. 4,067,530

Registered Dec. 6, 2011

Int. Cl.: 41

SERVICE MARK

PRINCIPAL REGISTER

THE KEISER SCHOOL, INC. (FLORIDA CORPORATION)
SUITE 180
1900 W. COMMERCIAL BLVD.
FT. LAUDERDALE, FL 33309

FOR: EDUCATIONAL SERVICES FEATURING COURSES OF STUDY AND INSTRUCTION
IN THE CULINARY, BAKING AND PASTRY ARTS, IN CLASS 41 (U.S. CLS. 100, 101 AND
107).

FIRST USE 1-1-2010; IN COMMERCE 1-1-2010.

THE MARK CONSISTS OF STANDARD CHARACTERS WITHOUT CLAIM TO ANY PAR-
TICULAR FONT, STYLE, SIZE, OR COLOR.

NO CLAIM IS MADE TO THE EXCLUSIVE RIGHT TO USE "CULINARY INSTITUTE",
APART FROM THE MARK AS SHOWN.

SN 77-539,400, FILED 8-5-2008.

COLLEEN DOMBROW, EXAMINING ATTORNEY



David J. Kyros

Director of the United States Patent and Trademark Office

United States of America

United States Patent and Trademark Office



Reg. No. 4,067,531

Registered Dec. 6, 2011

Int. Cl.: 41

SERVICE MARK

PRINCIPAL REGISTER

THE KEISER SCHOOL, INC. (FLORIDA CORPORATION)
SUITE 180
1900 W. COMMERCIAL BLVD.
FT. LAUDERDALE, FL 33309

FOR: EDUCATIONAL SERVICES FEATURING COURSES OF STUDY AND INSTRUCTION AT THE POST-SECONDARY LEVEL IN BUSINESS RELATED AND CAREER FIELDS , IN CLASS 41 (U.S. CLS. 100, 101 AND 107).

FIRST USE 1-1-2010; IN COMMERCE 1-1-2010.

NO CLAIM IS MADE TO THE EXCLUSIVE RIGHT TO USE "CAREER COLLEGE", APART FROM THE MARK AS SHOWN.

THE MARK CONSISTS OF THE WORDING "KEISER CAREER COLLEGE" WITH AN UNDERLINE BENEATH THE WORD "KEISER". THE WORDING APPEARS TO THE RIGHT OF A STYLIZED DESIGN OF A FLAME.

SN 77-539,487, FILED 8-5-2008.

COLLEEN DOMBROW, EXAMINING ATTORNEY



David J. Kybas

Director of the United States Patent and Trademark Office

United States of America

United States Patent and Trademark Office



Reg. No. 4,067,532

Registered Dec. 6, 2011

Int. Cl.: 41

SERVICE MARK

PRINCIPAL REGISTER

THE KEISER SCHOOL, INC. (FLORIDA CORPORATION)
SUITE 180
1900 W. COMMERCIAL BLVD.
FT. LAUDERDALE, FL 33309

FOR: EDUCATIONAL SERVICES FEATURING COURSES OF STUDY AND INSTRUCTION AT THE POST-SECONDARY LEVEL IN BUSINESS RELATED AND CAREER FIELDS , IN CLASS 41 (U.S. CLS. 100, 101 AND 107).

FIRST USE 1-1-2010; IN COMMERCE 1-1-2010.

NO CLAIM IS MADE TO THE EXCLUSIVE RIGHT TO USE "CAREER COLLEGE", APART FROM THE MARK AS SHOWN.

THE COLOR(S) DARK BLUE, ORANGE, AND GRAY IS/ARE CLAIMED AS A FEATURE OF THE MARK.

THE COLOR DARK BLUE APPEARS ON THE WORDING "KEISER CAREER COLLEGE" AND ON THE HORIZONTAL LINE UNDERNEATH THE WORDING "KEISER", THE COLORS ORANGE AND GREY APPEAR ON THE STYLIZED DESIGN OF THE FLAME.

SN 77-539,508, FILED 8-5-2008.

COLLEEN DOMBROW, EXAMINING ATTORNEY



David J. Kybas

Director of the United States Patent and Trademark Office

United States of America

United States Patent and Trademark Office

KEISER WRITES

Reg. No. 4,067,533

Registered Dec. 6, 2011

Int. Cl.: 41

SERVICE MARK

PRINCIPAL REGISTER

THE KEISER SCHOOL, INC. (FLORIDA CORPORATION)
1900 W. COMMERCIAL BLVD.
SUITE 180
FT. LAUDERDALE, FL 33309

FOR: EDUCATIONAL SERVICES FEATURING COURSES OF STUDY AND INSTRUCTION
IN WRITING SKILLS, IN CLASS 41 (U.S. CLS. 100, 101 AND 107).

FIRST USE 1-1-2010; IN COMMERCE 1-1-2010.

THE MARK CONSISTS OF STANDARD CHARACTERS WITHOUT CLAIM TO ANY PAR-
TICULAR FONT, STYLE, SIZE, OR COLOR.

SN 77-540,131, FILED 8-6-2008.

COLLEEN DOMBROW, EXAMINING ATTORNEY



David J. Kyros

Director of the United States Patent and Trademark Office

United States of America

United States Patent and Trademark Office

VIVA MEXICO!

Reg. No. 4,067,534

Registered Dec. 6, 2011

Int. Cls.: 29 and 30

TRADEMARK

PRINCIPAL REGISTER

BRUCE FOODS CORPORATION (LOUISIANA CORPORATION)
HIGHWAY 182 WEST
NEW IBERIA, LA 70560

FOR: PROCESSED BEANS, IN CLASS 29 (U.S. CL. 46).

FIRST USE 0-0-1994; IN COMMERCE 0-0-1994.

FOR: TACO DINNER KITS COMPRISED OF SOFT OR HARD TACO SHELLS, TACO SEASONING MIX AND TACO SAUCE, IN CLASS 30 (U.S. CL. 46).

FIRST USE 0-0-1994; IN COMMERCE 0-0-1994.

THE MARK CONSISTS OF STANDARD CHARACTERS WITHOUT CLAIM TO ANY PARTICULAR FONT, STYLE, SIZE, OR COLOR.

OWNER OF U.S. REG. NO. 2,916,914.

NO CLAIM IS MADE TO THE EXCLUSIVE RIGHT TO USE "MEXICO", APART FROM THE MARK AS SHOWN.

SN 77-543,527, FILED 8-11-2008.

KELLEY WELLS, EXAMINING ATTORNEY



David J. Kyffers

Director of the United States Patent and Trademark Office

United States of America

United States Patent and Trademark Office

HEARTISAN

Reg. No. 4,067,535

Registered Dec. 6, 2011

Int. Cl.: 30

TRADEMARK

PRINCIPAL REGISTER

WISH LIST DESIGNS, INC. (DELAWARE CORPORATION)
20929 VENTURA BLVD., SUITE 47-205
WOODLAND HILLS, CA 91364

FOR: SALAD DRESSINGS; SAUCES; SPICES; MARINADES; GIFT BASKETS CONTAINING
SALAD DRESSINGS, SAUCES, SPICES OR MARINADES, IN CLASS 30 (U.S. CL. 46).

FIRST USE 8-12-2011; IN COMMERCE 8-12-2011.

THE MARK CONSISTS OF STANDARD CHARACTERS WITHOUT CLAIM TO ANY PAR-
TICULAR FONT, STYLE, SIZE, OR COLOR.

SN 77-543,702, FILED 8-11-2008.

DARRYL SPRUILL, EXAMINING ATTORNEY



David J. Kybas

Director of the United States Patent and Trademark Office

United States of America
United States Patent and Trademark Office

WaveAngle

Reg. No. 4,067,536

Registered Dec. 6, 2011

Int. Cls.: 9 and 15

TRADEMARK

PRINCIPAL REGISTER

WAVE ANGLE, INC. (NEVADA CORPORATION)
10816 BEACHMONT LANE
AUSTIN, TX 78739

FOR: MUSICAL INSTRUMENT ADAPTORS; MUSICAL INSTRUMENT CONNECTORS, IN CLASS 9 (U.S. CLS. 21, 23, 26, 36 AND 38).

FIRST USE 1-14-2008; IN COMMERCE 9-12-2011.

FOR: TUNERS FOR MUSICAL INSTRUMENTS, IN CLASS 15 (U.S. CLS. 2, 21 AND 36).

FIRST USE 1-14-2008; IN COMMERCE 9-12-2011.

THE MARK CONSISTS OF STANDARD CHARACTERS WITHOUT CLAIM TO ANY PARTICULAR FONT, STYLE, SIZE, OR COLOR.

SN 77-545,821, FILED 8-13-2008.

JUDITH HELFMAN, EXAMINING ATTORNEY



David J. Kybas

Director of the United States Patent and Trademark Office

United States of America

United States Patent and Trademark Office

ESC SKINCARE INSTITUTE

Reg. No. 4,067,537

Registered Dec. 6, 2011

Int. Cl.: 3

TRADEMARK

PRINCIPAL REGISTER

ELYSEE SCIENTIFIC COSMETICS, INC. (WISCONSIN CORPORATION)
203 LEGION STREET
VERONA, WI 53593

FOR: NON-MEDICATED SKIN CARE PREPARATIONS, NAMELY, SERUMS, LOTIONS, CREAMS, GELS, CLEANSERS, TONERS, EXFOLIANTS, SCRUBS, MASKS AND SPRAYS ALL FOR THE FACE AND BODY; SKIN MOISTURIZERS; NON-MEDICATED, ANTI-AGING CREAMS, LOTIONS AND SERUMS; NON-MEDICATED CREAMS AND LOTIONS FOR TREATMENT AND REDUCTION OF THE APPEARANCE OF CELLULITE; NON-MEDICATED ACNE TREATMENT PREPARATIONS; NON-MEDICATED TOPICAL PREPARATIONS FOR THE TREATMENT OF ROSACEA AND HYPERPIGMENTED SKIN; NON-MEDICATED SUNCARE PREPARATIONS, NAMELY, SUNSCREENS AND SUN BLOCKS; COLOR COSMETICS, NAMELY, FOUNDATION, FACIAL CONCEALER, BLUSH, PRESSED FACE POWDER, LIPSTICK, LIP GLOSS, LIP BALM, LIP LINER, MASCARA, EYE LINER, EYE SHADOW, EYEBROW PENCIL, MAKEUP REMOVER; HAIR CARE PREPARATIONS, NAMELY, SHAMPOO AND CONDITIONER; FRAGRANCE, PERFUME, COLOGNE, AFTER-SHAVE; NAIL CARE PREPARATIONS, NAMELY, NAIL POLISH AND NAIL POLISH REMOVER, IN CLASS 3 (U.S. CLS. 1, 4, 6, 50, 51 AND 52).

FIRST USE 7-18-2011; IN COMMERCE 7-18-2011.

THE MARK CONSISTS OF STANDARD CHARACTERS WITHOUT CLAIM TO ANY PARTICULAR FONT, STYLE, SIZE, OR COLOR.

NO CLAIM IS MADE TO THE EXCLUSIVE RIGHT TO USE "SKINCARE INSTITUTE", APART FROM THE MARK AS SHOWN.

SN 77-546,382, FILED 8-13-2008.

BARBARA GAYNOR, EXAMINING ATTORNEY



David J. Kyros

Director of the United States Patent and Trademark Office

United States of America

United States Patent and Trademark Office

Oasis Breeze

Reg. No. 4,067,538

Registered Dec. 6, 2011

Int. Cl.: 32

TRADEMARK

PRINCIPAL REGISTER

CLEMENT PAPPAS & CO., INC. (NEW JERSEY CORPORATION)
1 COLLINS DRIVE
SUITE 200
CARNEYS POINT, NJ 08069

FOR: FRUIT DRINKS AND JUICES; FRUIT JUICES, IN CLASS 32 (U.S. CLS. 45, 46 AND 48).

FIRST USE 5-2-2011; IN COMMERCE 5-2-2011.

THE MARK CONSISTS OF STANDARD CHARACTERS WITHOUT CLAIM TO ANY PARTICULAR FONT, STYLE, SIZE, OR COLOR.

SN 77-547,279, FILED 8-14-2008.

SIMON TENG, EXAMINING ATTORNEY



David J. Kyffers

Director of the United States Patent and Trademark Office

United States of America

United States Patent and Trademark Office

LENNON

Reg. No. 4,067,539

Registered Dec. 6, 2011

Int. Cl.: 25

TRADEMARK

PRINCIPAL REGISTER

LENNON, YOKO ONO (JAPAN INDIVIDUAL)
ONE WEST 72ND STREET
NEW YORK, NY 10023

FOR: MEN'S AND WOMEN'S CLOTHING, NAMELY, PANTS, JEANS, SHORTS, OVERALLS, SHIRTS, T-SHIRTS, BLOUSES, VESTS, SKIRTS, JACKETS, COATS, SPORT COATS, SWEATERS, SWEATSHIRTS, SWEATPANTS, HATS, TIES, BELTS, SOCKS AND UNDERWEAR, AND CHILDREN'S AND INFANTS' CLOTHING, NAMELY, SHORTS, SHORT SETS CONSISTING OF TOP AND BOTTOM; SHIRTS, PANTS, DRESSES, COVERALLS, ROMPERS, CREEPERS, OVERALLS, OVERALL SETS COMPRISED OF OVERALL AND TOP; INFANTS' AND CHILDREN'S UNDERWEAR, SHORTALLS, SHORTALL SETS COMPRISED OF SHORTALL AND TOP; T-SHIRTS, THREE-PIECE SETS CONSISTING OF DIAPER SHIRTS, TOPS AND BOTTOMS; COORDINATING SETS CONSISTING OF TOPS AND BOTTOMS; LAYETTE SETS COMPRISED OF GOWN AND CAP, TOP AND PANT, CARDIGAN, TOP AND PANT, SHORTALL AND TOP, OVERALL AND TOP, CARDIGAN AND PANT, CREEPER AND PANT, CREEPER AND SHORTS OR COVERALLS AND BLANKET; SLEEPWEAR; JACKETS; ZIPPERED PULL-OVER JACKETS, WINDSUITS, BABY BUNTINGS, SNOWSUITS, RAINCOATS, PONCHOS, RAIN JACKETS, RAIN SUITS, SWIM SUITS, SWIM COVER-UPS; SWIMWEAR SETS CONSISTING OF SWIMSUIT OR SWIM TRUNKS AND COVER-UP; SHORT SETS CONSISTING OF SHORTS AND TOPS, IN CLASS 25 (U.S. CLS. 22 AND 39).

FIRST USE 8-24-2011; IN COMMERCE 8-24-2011.

THE MARK CONSISTS OF STANDARD CHARACTERS WITHOUT CLAIM TO ANY PARTICULAR FONT, STYLE, SIZE, OR COLOR.

SEC. 2(F).

OWNER OF U.S. REG. NOS. 1,488,395 AND 1,769,796.

SN 77-547,506, FILED 8-14-2008.

SEAN CROWLEY, EXAMINING ATTORNEY



David J. Kyros

Director of the United States Patent and Trademark Office

United States of America
United States Patent and Trademark Office

LENNON

Reg. No. 4,067,540

LENNON, YOKO ONO (JAPAN INDIVIDUAL)
ONE WEST 72ND STREET
NEW YORK, NY 10023

Registered Dec. 6, 2011

Int. Cl.: 16

FOR: POSTERS; PRINTS; STICKERS, IN CLASS 16 (U.S. CLS. 2, 5, 22, 23, 29, 37, 38 AND 50).

TRADEMARK

FIRST USE 8-24-2011; IN COMMERCE 8-24-2011.

PRINCIPAL REGISTER

THE MARK CONSISTS OF STANDARD CHARACTERS WITHOUT CLAIM TO ANY PARTICULAR FONT, STYLE, SIZE, OR COLOR.

SEC. 2(F).

SN 77-547,570, FILED 8-14-2008.

SEAN CROWLEY, EXAMINING ATTORNEY



David J. Kybas

Director of the United States Patent and Trademark Office

United States of America

United States Patent and Trademark Office

PAPER BOAT

Reg. No. 4,067,541

Registered Dec. 6, 2011

Int. Cl.: 25

TRADEMARK

PRINCIPAL REGISTER

SHOJI, YOONAH (UNITED STATES INDIVIDUAL), DBA PAPER BOAT,
5013 CATHANN ST.
TORRANCE, CA 90503

FOR: BLOUSES; CAPRI PANTS; DENIMS; HATS; JACKETS; LONG-SLEEVED SHIRTS;
PANTS; SHORTS; SKIRTS AND DRESSES; TEE SHIRTS, IN CLASS 25 (U.S. CLS. 22 AND
39).

FIRST USE 0-0-2009; IN COMMERCE 0-0-2009.

THE MARK CONSISTS OF STANDARD CHARACTERS WITHOUT CLAIM TO ANY PAR-
TICULAR FONT, STYLE, SIZE, OR COLOR.

SN 77-548,100, FILED 8-15-2008.

LINDA M. KING, EXAMINING ATTORNEY



David J. Kyffers

Director of the United States Patent and Trademark Office

United States of America

United States Patent and Trademark Office

LITHERA

Reg. No. 4,067,542

LITHERA, INC. (DELAWARE CORPORATION)
9191 TOWNE CENTER DRIVE, SUITE 400
SAN DIEGO, CA 92122

Registered Dec. 6, 2011

Int. Cl.: 5

FOR: PHARMACEUTICAL PREPARATIONS FOR REDUCING THE SIZE AND APPEARANCE OF ADIPOSE DEPOSITS IN A BODY, IN CLASS 5 (U.S. CLS. 6, 18, 44, 46, 51 AND 52).

TRADEMARK

FIRST USE 9-20-2011; IN COMMERCE 9-20-2011.

PRINCIPAL REGISTER

THE MARK CONSISTS OF STANDARD CHARACTERS WITHOUT CLAIM TO ANY PARTICULAR FONT, STYLE, SIZE, OR COLOR.

SN 77-548,326, FILED 8-15-2008.

RON FAIRBANKS, EXAMINING ATTORNEY



David J. Kyffers

Director of the United States Patent and Trademark Office

United States of America

United States Patent and Trademark Office

Wishes & Prayers

Reg. No. 4,067,543

Registered Dec. 6, 2011

Int. Cl.: 36

SERVICE MARK

PRINCIPAL REGISTER

WISHES AND PRAYERS (TEXAS CORPORATION)
19276 REDLAND ROAD
SAN ANTONIO, TX 78259

FOR: PHILANTHROPIC SERVICES CONCERNING MONETARY DONATIONS AND CHARITABLE FUNDRAISING SERVICES, EXCLUDING SUCH SERVICES FOR THE BENEFIT OF CHILDREN WITH LIFE-THREATENING MEDICAL CONDITIONS AND THEIR FAMILIES, IN CLASS 36 (U.S. CLS. 100, 101 AND 102).

FIRST USE 1-23-2004; IN COMMERCE 1-23-2004.

THE MARK CONSISTS OF STANDARD CHARACTERS WITHOUT CLAIM TO ANY PARTICULAR FONT, STYLE, SIZE, OR COLOR.

SN 77-548,723, FILED 8-16-2008.

JESSICA A. POWERS, EXAMINING ATTORNEY



David J. Kyjars

Director of the United States Patent and Trademark Office

United States of America

United States Patent and Trademark Office

TiCarbonite Armor

Reg. No. 4,067,544

Registered Dec. 6, 2011

Int. Cl.: 9

TRADEMARK

PRINCIPAL REGISTER

ACCUSHAPE, INC. (OREGON CORPORATION)
4344 SW CHESAPEAKE AVE
PORTLAND, OR 972391347

FOR: BODY ARMOR, IN CLASS 9 (U.S. CLS. 21, 23, 26, 36 AND 38).

FIRST USE 10-2-2010; IN COMMERCE 9-21-2011.

THE MARK CONSISTS OF STANDARD CHARACTERS WITHOUT CLAIM TO ANY PARTICULAR FONT, STYLE, SIZE, OR COLOR.

NO CLAIM IS MADE TO THE EXCLUSIVE RIGHT TO USE "ARMOR", APART FROM THE MARK AS SHOWN.

SN 77-548,809, FILED 8-16-2008.

STEVEN JACKSON, EXAMINING ATTORNEY



David J. Kyffers

Director of the United States Patent and Trademark Office

United States of America

United States Patent and Trademark Office

TRADE SHOW TREASURES

Reg. No. 4,067,545

Registered Dec. 6, 2011

Int. Cl.: 14

TRADEMARK

PRINCIPAL REGISTER

AMERICA'S COLLECTIBLES NETWORK, INC. (TENNESSEE CORPORATION)
10001 KINGSTON PK
SUITE 57
KNOXVILLE, TN 37922

FOR: GEMSTONES, IN CLASS 14 (U.S. CLS. 2, 27, 28 AND 50).

FIRST USE 11-0-2008; IN COMMERCE 11-0-2008.

THE MARK CONSISTS OF STANDARD CHARACTERS WITHOUT CLAIM TO ANY PARTICULAR FONT, STYLE, SIZE, OR COLOR.

NO CLAIM IS MADE TO THE EXCLUSIVE RIGHT TO USE "TRADE SHOW", APART FROM THE MARK AS SHOWN.

SN 77-549,041, FILED 8-18-2008.

MICHELLE DUBOIS, EXAMINING ATTORNEY



David J. Kybas

Director of the United States Patent and Trademark Office

United States of America

United States Patent and Trademark Office

HEARTISAN

Reg. No. 4,067,546

Registered Dec. 6, 2011

Int. Cl.: 35

SERVICE MARK

PRINCIPAL REGISTER

WISH LIST DESIGNS, INC. (DELAWARE CORPORATION)
20929 VENTURA BLVD., SUITE 47-205
WOODLAND HILLS, CA 91364

FOR: ON-LINE RETAIL STORE SERVICES FEATURING SALAD DRESSINGS, SAUCES, SPICES, MARINADES AND GIFT BASKETS CONTAINING SALAD DRESSINGS, SAUCES, SPICES OR MARINADES, IN CLASS 35 (U.S. CLS. 100, 101 AND 102).

FIRST USE 9-17-2011; IN COMMERCE 9-17-2011.

THE MARK CONSISTS OF STANDARD CHARACTERS WITHOUT CLAIM TO ANY PARTICULAR FONT, STYLE, SIZE, OR COLOR.

SN 77-549,400, FILED 8-18-2008.

DARRYL SPRUILL, EXAMINING ATTORNEY



David J. Kyffers

Director of the United States Patent and Trademark Office

United States of America

United States Patent and Trademark Office

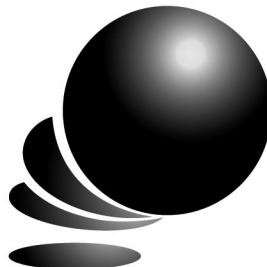

Reg. No. 4,067,547

Registered Dec. 6, 2011

Int. Cl.: 41

SERVICE MARK

PRINCIPAL REGISTER

INTEL CORPORATION (DELAWARE CORPORATION)
2200 MISSION COLLEGE BOULEVARD
SANTA CLARA, CA 95052

FOR: ENTERTAINMENT SERVICES, NAMELY, PRODUCTION OF MOTION PICTURES, VIDEOS AND FILMS; SPECIAL EFFECTS ANIMATION SERVICES FOR TELEVISION, VIDEO AND MOTION PICTURES; ANIMATION PRODUCTION SERVICES; MULTIMEDIA ENTERTAINMENT SOFTWARE PRODUCTION SERVICES, IN CLASS 41 (U.S. CLS. 100, 101 AND 107).

FIRST USE 1-9-2009; IN COMMERCE 1-9-2009.

PRIORITY CLAIMED UNDER SEC. 44(D) ON FED REP GERMANY APPLICATION NO. 302008049380, FILED 7-30-2008, REG. NO. 302008049380, DATED 4-8-2009, EXPIRES 7-13-2018.

THE MARK CONSISTS OF A BOUNCING BALL DESIGN.

SN 77-549,914, FILED 8-18-2008.

JORDAN BAKER, EXAMINING ATTORNEY



David J. Kybas

Director of the United States Patent and Trademark Office

United States of America

United States Patent and Trademark Office

REACH FOR SUCCESS

Reg. No. 4,067,548

Registered Dec. 6, 2011

Int. Cl.: 41

SERVICE MARK

PRINCIPAL REGISTER

REED SMITH LLP (DELAWARE LIMITED LIABILITY PARTNERSHIP)
435 SIXTH AVENUE
PITTSBURGH, PA 15219

FOR: EDUCATIONAL SERVICES, NAMELY, CONDUCTING CONFERENCES, CLASSES AND SEMINARS IN THE FIELD OF LAW, PROFESSIONAL DEVELOPMENT AND CAREER MANAGEMENT, IN CLASS 41 (U.S. CLS. 100, 101 AND 107).

FIRST USE 4-0-2010; IN COMMERCE 4-0-2010.

THE MARK CONSISTS OF STANDARD CHARACTERS WITHOUT CLAIM TO ANY PARTICULAR FONT, STYLE, SIZE, OR COLOR.

SN 77-555,872, FILED 8-26-2008.

JOHN HWANG, EXAMINING ATTORNEY



David J. Kybas

Director of the United States Patent and Trademark Office

United States of America

United States Patent and Trademark Office



Reg. No. 4,067,549

Registered Dec. 6, 2011

Int. Cl.: 41

SERVICE MARK

PRINCIPAL REGISTER

WHOLE FOODS MARKET IP, L.P. (DELAWARE LIMITED PARTNERSHIP)
550 BOWIE STREET, 6TH FLOOR
AUSTIN, TX 78703

FOR: ON-LINE JOURNALS, NAMELY, BLOGS CONCERNING MONEY SAVING TIPS, RECIPES, MENU PLANNERS, SHOPPING, AND NUTRITION, IN CLASS 41 (U.S. CLS. 100, 101 AND 107).

FIRST USE 7-27-2009; IN COMMERCE 7-27-2009.

THE MARK CONSISTS OF A DEPICTION OF AN INK STAMP WITH THE WORDS "I'M A" HANDWRITTEN ABOVE THE WORD "LOCAL", SURROUNDED BY A RECTANGULAR BORDER WITH A TRACTOR IN THE TOP LEFT CORNER OF THE BORDER.

SN 77-556,039, FILED 8-26-2008.

REGINA DRUMMOND, EXAMINING ATTORNEY



David J. Kyjars

Director of the United States Patent and Trademark Office

United States of America

United States Patent and Trademark Office

TARGETPOINT

Reg. No. 4,067,550

Registered Dec. 6, 2011

Int. Cl.: 9

TRADEMARK

PRINCIPAL REGISTER

PNI CORPORATION (CALIFORNIA CORPORATION)
133 AVIATION BLVD., SUITE 101
SANTA ROSA, CA 95403

FOR: ELECTRONIC SENSORS AND SENSOR MODULES THAT MEASURE POSITION, MOTION, ORIENTATION, FORCE, MAGNETIC FIELDS, ACCELERATION, ROTATION, OR A COMBINATION OF THESE EFFECTS FOR USE IN THE FIELD OF ENVIRONMENTAL DETECTION, SENSING, AND REPORTING; ELECTRONIC SOFTWARE FEATURING ALGORITHMS FOR SENSOR INTEGRATION FROM SENSED DATA; APPLICATION SPECIFIC INTEGRATED CIRCUITS, MICROPROCESSORS, PROGRAMMABLE ELECTRONIC MEMORY AND PROGRAMMABLE SEMICONDUCTOR DEVICES, IN CLASS 9 (U.S. CLS. 21, 23, 26, 36 AND 38).

FIRST USE 9-0-2011; IN COMMERCE 9-0-2011.

THE MARK CONSISTS OF STANDARD CHARACTERS WITHOUT CLAIM TO ANY PARTICULAR FONT, STYLE, SIZE, OR COLOR.

SN 77-556,991, FILED 8-27-2008.

JENNIFER MARTIN, EXAMINING ATTORNEY



David J. Kyros

Director of the United States Patent and Trademark Office

United States of America

United States Patent and Trademark Office

The Future Times

Reg. No. 4,067,551

Registered Dec. 6, 2011

Int. Cls.: 38 and 41

SERVICE MARK

PRINCIPAL REGISTER

MIRAISHIMBUN INC. (JAPAN CORPORATION)
24-15-414, 5-CHOME WAKABAYASHI
SETAGAYA-KU, TOKYO, JAPAN

FOR: PROVIDING ONLINE BULLETIN BOARDS AND CHAT ROOMS FOR THE EXCHANGE OF MESSAGES AMONG WEBSITE MEMBERS OF PREDICTIONS AND FORECASTS RELATING TO ARTS, CRAFTS, SPORTS OR GENERAL KNOWLEDGE, IN CLASS 38 (U.S. CLS. 100, 101 AND 104).

FIRST USE 6-30-2009; IN COMMERCE 6-30-2009.

FOR: PROVIDING NON-DOWNLOADABLE ELECTRONIC PUBLICATIONS, NAMELY, A NEWSPAPER FEATURING PREDICTIONS AND FORECASTS IN THE FIELDS OF POLITICS, ECONOMICS, SOCIETY, SPORTS, INTERNATIONAL RELATIONS, CULTURE, ECOLOGY, AND SCIENCE; ENTERTAINMENT INFORMATION, IN CLASS 41 (U.S. CLS. 100, 101 AND 107).

FIRST USE 6-30-2009; IN COMMERCE 6-30-2009.

THE MARK CONSISTS OF STANDARD CHARACTERS WITHOUT CLAIM TO ANY PARTICULAR FONT, STYLE, SIZE, OR COLOR.

SN 77-557,469, FILED 8-27-2008.

LAURIE KAUFMAN, EXAMINING ATTORNEY



David J. Kyros

Director of the United States Patent and Trademark Office

United States of America

United States Patent and Trademark Office

RODEO RAGE

Reg. No. 4,067,552

WHEATLEY, TERRY (UNITED STATES INDIVIDUAL)
5061 MOUNTAIN VIEW ROAD
HUGHSON, CA 95326

Registered Dec. 6, 2011

Int. Cl.: 25

FOR: CLOTHING, NAMELY, T-SHIRTS AND SWEATSHIRTS; HEADGEAR, NAMELY, CAPS, IN CLASS 25 (U.S. CLS. 22 AND 39).

TRADEMARK

FIRST USE 12-31-2010; IN COMMERCE 12-31-2010.

PRINCIPAL REGISTER

THE MARK CONSISTS OF STANDARD CHARACTERS WITHOUT CLAIM TO ANY PARTICULAR FONT, STYLE, SIZE, OR COLOR.

SN 77-558,041, FILED 8-28-2008.

JENNIFER MARTIN, EXAMINING ATTORNEY



David J. Kybas

Director of the United States Patent and Trademark Office

United States of America

United States Patent and Trademark Office

AREA CODE 707

Reg. No. 4,067,553

VYENIELO, CHRIS (UNITED STATES INDIVIDUAL)
2 GLENAIRE DRIVE
SAN RAFAEL, CA 94901

Registered Dec. 6, 2011

Int. Cl.: 33

FOR: WINES, IN CLASS 33 (U.S. CLS. 47 AND 49).

TRADEMARK

FIRST USE 3-29-2011; IN COMMERCE 3-29-2011.

PRINCIPAL REGISTER

THE MARK CONSISTS OF STANDARD CHARACTERS WITHOUT CLAIM TO ANY PARTICULAR FONT, STYLE, SIZE, OR COLOR.

SN 77-560,158, FILED 9-2-2008.

KARANENDRA S. CHHINA, EXAMINING ATTORNEY



David J. Kybas

Director of the United States Patent and Trademark Office

United States of America

United States Patent and Trademark Office

IT'S NOT JUST PRODUCE, IT'S A PROMISE

Reg. No. 4,067,554

Registered Dec. 6, 2011

Int. Cl.: 31

TRADEMARK

PRINCIPAL REGISTER

INDEX FRESH, INC. (CALIFORNIA CORPORATION)
18184 SLOVER AVENUE
BLOOMINGTON, CA 92316

FOR: FRESH AVOCADOS, IN CLASS 31 (U.S. CLS. 1 AND 46).

FIRST USE 11-1-2008; IN COMMERCE 4-1-2011.

THE MARK CONSISTS OF STANDARD CHARACTERS WITHOUT CLAIM TO ANY PARTICULAR FONT, STYLE, SIZE, OR COLOR.

SN 77-560,772, FILED 9-2-2008.

JANICE L. MCMORROW, EXAMINING ATTORNEY



David J. Kybas

Director of the United States Patent and Trademark Office

United States of America

United States Patent and Trademark Office



Reg. No. 4,067,555

Registered Dec. 6, 2011

Int. Cl.: 21

TRADEMARK

PRINCIPAL REGISTER

HEB GROCERY COMPANY, LP (TEXAS LIMITED PARTNERSHIP)
CORPORATE LAW DEPARTMENT
646 SOUTH MAIN
SAN ANTONIO, TX 78204

FOR: PLANTERS FOR FLOWERS AND PLANTS; FLOWER POTS; POTTING SOIL, VEGETABLE AND FLOWER SEEDS, IN CLASS 21 (U.S. CLS. 2, 13, 23, 29, 30, 33, 40 AND 50).

FIRST USE 3-31-2007; IN COMMERCE 3-31-2007.

OWNER OF U.S. REG. NOS. 3,124,867, 3,134,295, AND 3,330,843.

NO CLAIM IS MADE TO THE EXCLUSIVE RIGHT TO USE "TEXAS", APART FROM THE MARK AS SHOWN.

THE MARK CONSISTS OF THE WORD "TEXAS" WITH THE LETTER "X" REPRESENTED BY A STAR FLOWER DESIGN. THE LETTERS "TE" AND "AS" OF THE WORD "TEXAS" ARE UNDERLINED. AT THE BASE OF THE FLOWER DESIGN ARE THE LETTERS "H-E-B" SUPERIMPOSED OVER AN OVAL DESIGN. BELOW THE WORD "TEXAS" IS THE WORD "BACKYARD". THE LETTERS "BA" AND "RD" OF THE WORD "BACKYARD" ARE UNDERLINED. BELOW THE WORD "BACKYARD" IS THE PHRASE "WE'VE GOT TEXAS ROOTS!".

SN 77-561,018, FILED 9-3-2008.

INGRID C. EULIN, EXAMINING ATTORNEY



David J. Kyros

Director of the United States Patent and Trademark Office

United States of America

United States Patent and Trademark Office



Reg. No. 4,067,556

Registered Dec. 6, 2011

Int. Cl.: 31

TRADEMARK

PRINCIPAL REGISTER

HEB GROCERY COMPANY, L.P. (TEXAS LIMITED PARTNERSHIP)
646 SOUTH MAIN
CORPORATE LAW DEPARTMENT
SAN ANTONIO, TX 78204

FOR: LIVING PLANTS; LIVE FLOWERING PLANTS; LIVING LANDSCAPING PLANTS, SHRUBS, BUSHES, AND FLOWERS; LIVING FLOWERS; LIVING TREES; SEEDS; FRESH LIVING HERB PLANTS; TOPSOIL, IN CLASS 31 (U.S. CLS. 1 AND 46).

FIRST USE 3-31-2011; IN COMMERCE 3-31-2011.

OWNER OF U.S. REG. NOS. 3,124,867, 3,134,295, AND 3,330,843.

NO CLAIM IS MADE TO THE EXCLUSIVE RIGHT TO USE "TEXAS", APART FROM THE MARK AS SHOWN.

THE MARK CONSISTS OF THE WORD "TEXAS" WITH THE LETTER "X" REPRESENTED BY A STAR FLOWER DESIGN. THE LETTERS "TE" AND "AS" OF THE WORD "TEXAS" ARE UNDERLINED. AT THE BASE OF THE FLOWER DESIGN ARE THE LETTERS "H-E-B" SUPERIMPOSED OVER AN OVAL DESIGN. BELOW THE WORD "TEXAS" IS THE WORD "BACKYARD". THE LETTERS "BA" AND "RD" OF THE WORD "BACKYARD" ARE UNDERLINED. BELOW THE WORD "BACKYARD" IS THE PHRASE "WE'VE GOT TEXAS ROOTS!".

SN 77-561,031, FILED 9-3-2008.

INGRID C. EULIN, EXAMINING ATTORNEY



David J. Kybas

Director of the United States Patent and Trademark Office

United States of America

United States Patent and Trademark Office

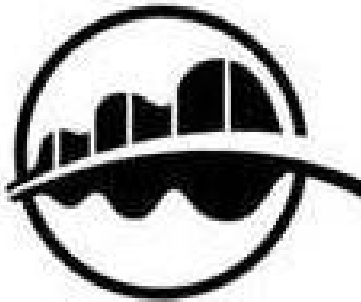

Reg. No. 4,067,557

Registered Dec. 6, 2011

Int. Cl.: 25

TRADEMARK

PRINCIPAL REGISTER

NATUREBRIDGE (CALIFORNIA CORPORATION)
28 GEARY ST., SUITE 650
SAN FRANCISCO, CA 94108

FOR: SHIRTS; HEADGEAR, NAMELY, HATS AND CAPS; SWEAT SHIRTS; JACKETS, IN
CLASS 25 (U.S. CLS. 22 AND 39).

FIRST USE 9-8-2009; IN COMMERCE 9-8-2009.

THE MARK CONSISTS OF A STYLIZED LEAF SURROUNDED BY A CIRCLE.

SN 77-561,794, FILED 9-3-2008.

CIMMERIAN COLEMAN, EXAMINING ATTORNEY



David J. Kyffers

Director of the United States Patent and Trademark Office

United States of America

United States Patent and Trademark Office

FUNGOPLAY

Reg. No. 4,067,558

Registered Dec. 6, 2011

Int. Cl.: 41

SERVICE MARK

PRINCIPAL REGISTER

FUNGOPLAY, LLC (DELAWARE LIMITED LIABILITY COMPANY)
1313 NORTH MARKET STREET, SUITE 5100
C/O PHS CORPORATE SERVICES, INC.
WILMINGTON, DE 19801

FOR: ENTERTAINMENT SERVICES, NAMELY, PROVIDING ONLINE COMPUTER GAMES RELATING TO SPORTS FOR CHILDREN; ENTERTAINMENT AND EDUCATIONAL SERVICES, NAMELY, PROVIDING INFORMATION RELATING TO SPORTS FOR CHILDREN VIA ONLINE COMPUTER NETWORK, IN CLASS 41 (U.S. CLS. 100, 101 AND 107).

FIRST USE 6-15-2011; IN COMMERCE 6-15-2011.

THE MARK CONSISTS OF STANDARD CHARACTERS WITHOUT CLAIM TO ANY PARTICULAR FONT, STYLE, SIZE, OR COLOR.

SN 77-565,316, FILED 9-9-2008.

CARRIE GENOVESE, EXAMINING ATTORNEY



David J. Kyjars

Director of the United States Patent and Trademark Office

United States of America

United States Patent and Trademark Office

ECO V A T I O N S

Reg. No. 4,067,559

Registered Dec. 6, 2011

Int. Cls.: 4, 35, and 39

TRADEMARK

SERVICE MARK

PRINCIPAL REGISTER

INTEGRYS ENERGY GROUP, INC. (WISCONSIN CORPORATION)
130 EAST RANDOLPH DRIVE
CHICAGO, IL 60601

FOR: NATURAL GAS AND ELECTRICAL ENERGY, IN CLASS 4 (U.S. CLS. 1, 6 AND 15).

FIRST USE 8-29-2008; IN COMMERCE 8-29-2008.

FOR: ENERGY MANAGEMENT SERVICES, NAMELY, PROVIDING A SERVICE THAT ALLOWS CUSTOMERS TO PURCHASE ENERGY, NAMELY, ELECTRICITY AND NATURAL GAS; CONSULTATION IN THE FIELD OF ENERGY MANAGEMENT SERVICES, IN CLASS 35 (U.S. CLS. 100, 101 AND 102).

FIRST USE 8-29-2008; IN COMMERCE 8-29-2008.

FOR: DISTRIBUTION, TRANSMISSION AND STORAGE OF ELECTRICITY, STEAM FOR USE AS ENERGY, NATURAL GAS, HYDROELECTRIC AND OTHER RENEWABLE POWER; CONSULTING SERVICES RELATED TO THE FOREGOING; ENERGY SUPPLY SERVICES FOR OTHERS FEATURING THE TRANSMISSION, DISTRIBUTION AND STORAGE OF ENERGY; CONSULTATION SERVICES IN THE FIELD OF DISTRIBUTION, TRANSMISSION AND STORAGE OF ENERGY, IN CLASS 39 (U.S. CLS. 100 AND 105).

FIRST USE 10-30-2008; IN COMMERCE 10-30-2008.

THE MARK CONSISTS OF STANDARD CHARACTERS WITHOUT CLAIM TO ANY PARTICULAR FONT, STYLE, SIZE, OR COLOR.

SN 77-565,970, FILED 9-9-2008.

JANET LEE, EXAMINING ATTORNEY



David J. Kybas

Director of the United States Patent and Trademark Office

United States of America

United States Patent and Trademark Office

The logo for 'ecovations' features a stylized leaf above the letter 'o' in 'eco', which is rendered in a lowercase, sans-serif font. The word 'vations' follows in the same font style.

Reg. No. 4,067,560

INTEGRYS ENERGY GROUP, INC. (WISCONSIN CORPORATION)
130 EAST RANDOLPH DRIVE
CHICAGO, IL 60601

Registered Dec. 6, 2011

Int. Cls.: 4, 35, and 39

FOR: NATURAL GAS AND ELECTRICAL ENERGY, IN CLASS 4 (U.S. CLS. 1, 6 AND 15).

FIRST USE 4-28-2009; IN COMMERCE 4-28-2009.

TRADEMARK

FOR: ENERGY MANAGEMENT SERVICES, NAMELY, PROVIDING A SERVICE THAT ALLOWS CUSTOMERS TO PURCHASE ENERGY, NAMELY, ELECTRICITY AND NATURAL GAS; CONSULTATION IN THE FIELD OF ENERGY MANAGEMENT SERVICES, IN CLASS 35 (U.S. CLS. 100, 101 AND 102).

SERVICE MARK

FIRST USE 4-28-2009; IN COMMERCE 4-28-2009.

PRINCIPAL REGISTER

FOR: DISTRIBUTION, TRANSMISSION AND STORAGE OF ELECTRICITY, STEAM FOR USE AS ENERGY, NATURAL GAS, HYDROELECTRIC AND OTHER RENEWABLE POWER; CONSULTING SERVICES RELATED TO THE FOREGOING; ENERGY SUPPLY SERVICES FOR OTHERS FEATURING THE TRANSMISSION, DISTRIBUTION AND STORAGE OF ENERGY; CONSULTATION SERVICES IN THE FIELD OF DISTRIBUTION, TRANSMISSION AND STORAGE OF ENERGY, IN CLASS 39 (U.S. CLS. 100 AND 105).

FIRST USE 10-30-2008; IN COMMERCE 10-30-2008.

THE MARK CONSISTS OF A LEAF DESIGN OVER THE "O" IN "ECOVATIONS".

SN 77-565,999, FILED 9-9-2008.

JANET LEE, EXAMINING ATTORNEY



David J. Kybas

Director of the United States Patent and Trademark Office

United States of America

United States Patent and Trademark Office



Reg. No. 4,067,561

Registered Dec. 6, 2011

Int. Cls.: 4, 35, and 39

TRADEMARK

SERVICE MARK

PRINCIPAL REGISTER

INTEGRYS ENERGY GROUP, INC. (WISCONSIN CORPORATION)
130 EAST RANDOLPH DRIVE
CHICAGO, IL 60601

FOR: NATURAL GAS AND ELECTRICAL ENERGY, IN CLASS 4 (U.S. CLS. 1, 6 AND 15).

FIRST USE 9-13-2008; IN COMMERCE 9-13-2008.

FOR: ENERGY MANAGEMENT SERVICES, NAMELY, PROVIDING A SERVICE THAT ALLOWS CUSTOMERS TO PURCHASE ENERGY, NAMELY, ELECTRICITY AND NATURAL GAS; CONSULTATION IN THE FIELD OF ENERGY MANAGEMENT SERVICES, IN CLASS 35 (U.S. CLS. 100, 101 AND 102).

FIRST USE 8-29-2008; IN COMMERCE 8-29-2008.

FOR: DISTRIBUTION, TRANSMISSION AND STORAGE OF ELECTRICITY, STEAM FOR USE AS ENERGY, NATURAL GAS, HYDROELECTRIC AND OTHER RENEWABLE POWER; CONSULTING SERVICES RELATED TO THE FOREGOING; ENERGY SUPPLY SERVICES FOR OTHERS FEATURING THE TRANSMISSION, DISTRIBUTION AND STORAGE OF ENERGY; CONSULTATION SERVICES IN THE FIELD OF DISTRIBUTION, TRANSMISSION AND STORAGE OF ENERGY, IN CLASS 39 (U.S. CLS. 100 AND 105).

FIRST USE 3-0-2009; IN COMMERCE 3-0-2009.

THE MARK CONSISTS OF A FLAME AND LEAF DESIGN OVER THE "O" IN "ECOVA-TIONS".

SN 77-566,016, FILED 9-9-2008.

JANET LEE, EXAMINING ATTORNEY



David J. Kyjars

Director of the United States Patent and Trademark Office

United States of America

United States Patent and Trademark Office

NEWPORT SOURCING

Reg. No. 4,067,562

Registered Dec. 6, 2011

Int. Cls.: 35, 42, and 45

SERVICE MARK

PRINCIPAL REGISTER

THOMSON REUTERS (SCIENTIFIC) INC. (PENNSYLVANIA CORPORATION)
3501 MARKET STREET
PHILADELPHIA, PA 19104

FOR: PROVIDING BUSINESS INTELLIGENCE SERVICES, NAMELY, PROVIDING ONLINE COMPUTER DATABASES FEATURING COMPETITIVE BUSINESS INTELLIGENCE ON PHARMACEUTICAL COMPANIES AND PHARMACEUTICAL SALES; PROVIDING ONLINE DATABASES FEATURING INFORMATION ON THE CREATION OF MARKETING TOOLS DESIGNED TO INCREASE A CLIENT COMPANY'S KNOWLEDGE OF ITS COMPETITORS' PRODUCTS AND SERVICES, PRICING AND SALES STRATEGY, FOR USE IN THE FIELD OF PHARMACEUTICAL PRODUCT TARGETING; PROVIDING ONLINE DATABASES FEATURING INFORMATION ON NEW REGULATORY FILINGS AND APPROVALS, NAMELY, BUSINESS INFORMATION MANAGEMENT FEATURING INFORMATION ON THE STATUS OF REGULATORY SUBMISSIONS MADE BY COMPETITORS, IN CLASS 35 (U.S. CLS. 100, 101 AND 102).

FIRST USE 12-31-2007; IN COMMERCE 12-31-2007.

FOR: PROVIDING ONLINE COMPUTER DATABASES FEATURING INFORMATION IN THE FIELD OF PHARMACEUTICAL PRODUCT EVALUATION; PROVIDING ONLINE COMPUTER DATABASES FEATURING PRODUCT INFORMATION IN THE FIELD OF PHARMACEUTICAL ACTIVE INGREDIENTS TO PHARMACEUTICAL COMPANIES FOR SCIENTIFIC RESEARCH PURPOSES AND PRODUCT DEVELOPMENT, IN CLASS 42 (U.S. CLS. 100 AND 101).

FIRST USE 12-31-2007; IN COMMERCE 12-31-2007.

FOR: PROVIDING ONLINE DATABASES FEATURING INFORMATION IN THE FIELD OF LICENSING OF PHARMACEUTICALS; PROVIDING ONLINE DATABASES FEATURING INFORMATION IN THE FIELD OF PHARMACEUTICAL PATENT LICENSING, IN CLASS 45 (U.S. CLS. 100 AND 101).

FIRST USE 12-31-2007; IN COMMERCE 12-31-2007.

THE MARK CONSISTS OF STANDARD CHARACTERS WITHOUT CLAIM TO ANY PARTICULAR FONT, STYLE, SIZE, OR COLOR.



David J. Kybas

Director of the United States Patent and Trademark Office

Reg. No. 4,067,562 OWNER OF U.S. REG. NO. 2,784,742.

NO CLAIM IS MADE TO THE EXCLUSIVE RIGHT TO USE "SOURCING", APART FROM
THE MARK AS SHOWN.

SN 77-567,400, FILED 9-11-2008.

TASNEEM HUSSAIN, EXAMINING ATTORNEY

United States of America

United States Patent and Trademark Office

NEWPORT PREMIUM

Reg. No. 4,067,563

Registered Dec. 6, 2011

Int. Cls.: 35, 42, and 45

SERVICE MARK

PRINCIPAL REGISTER

THOMSON REUTERS (SCIENTIFIC) INC. (PENNSYLVANIA CORPORATION)
3501 MARKET STREET
PHILADELPHIA, PA 19104

FOR: PROVIDING BUSINESS INTELLIGENCE SERVICES, NAMELY, PROVIDING ONLINE COMPUTER DATABASES FEATURING COMPETITIVE BUSINESS INTELLIGENCE ON PHARMACEUTICAL COMPANIES AND PHARMACEUTICAL SALES; PROVIDING ONLINE DATABASES FEATURING INFORMATION ON THE CREATION OF MARKETING TOOLS DESIGNED TO INCREASE A CLIENT COMPANY'S KNOWLEDGE OF ITS COMPETITORS' PRODUCTS AND SERVICES, PRICING AND SALES STRATEGY, FOR USE IN THE FIELD OF PHARMACEUTICAL PRODUCT TARGETING; PROVIDING ONLINE DATABASES FEATURING INFORMATION ON NEW REGULATORY FILINGS AND APPROVALS, NAMELY, BUSINESS INFORMATION MANAGEMENT FEATURING INFORMATION ON THE STATUS OF REGULATORY SUBMISSIONS MADE BY COMPETITORS, IN CLASS 35 (U.S. CLS. 100, 101 AND 102).

FIRST USE 12-31-2007; IN COMMERCE 12-31-2007.

FOR: PROVIDING ONLINE COMPUTER DATABASES FEATURING INFORMATION IN THE FIELD OF PHARMACEUTICAL PRODUCT EVALUATION; PROVIDING ONLINE COMPUTER DATABASES FEATURING PRODUCT INFORMATION IN THE FIELD OF PHARMACEUTICAL ACTIVE INGREDIENTS TO PHARMACEUTICAL COMPANIES FOR SCIENTIFIC RESEARCH PURPOSES AND PRODUCT DEVELOPMENT, IN CLASS 42 (U.S. CLS. 100 AND 101).

FIRST USE 12-31-2007; IN COMMERCE 12-31-2007.

FOR: PROVIDING ONLINE DATABASES FEATURING INFORMATION IN THE FIELD OF LICENSING OF PHARMACEUTICALS; PROVIDING ONLINE DATABASES FEATURING INFORMATION IN THE FIELD OF PHARMACEUTICAL PATENT LICENSING, IN CLASS 45 (U.S. CLS. 100 AND 101).

FIRST USE 12-31-2007; IN COMMERCE 12-31-2007.

THE MARK CONSISTS OF STANDARD CHARACTERS WITHOUT CLAIM TO ANY PARTICULAR FONT, STYLE, SIZE, OR COLOR.



David J. Kybas

Director of the United States Patent and Trademark Office

Reg. No. 4,067,563 OWNER OF U.S. REG. NO. 2,784,742.

NO CLAIM IS MADE TO THE EXCLUSIVE RIGHT TO USE "PREMIUM", APART FROM
THE MARK AS SHOWN.

SN 77-567,413, FILED 9-11-2008.

TASNEEM HUSSAIN, EXAMINING ATTORNEY

United States of America

United States Patent and Trademark Office

KEEP IT SQUARE AND LEVEL

Reg. No. 4,067,564

Registered Dec. 6, 2011

Int. Cl.: 41

SERVICE MARK

PRINCIPAL REGISTER

SQUARE AND LEVEL MEDIA PRODUCTIONS, INC. (ILLINOIS CORPORATION)
1951 JOHN'S DRIVE
GLENVIEW, IL 600251615

FOR: ENTERTAINMENT SERVICES, NAMELY, PROVIDING AN ON-GOING RADIO PROGRAM IN THE FIELD OF HOME REPAIR AND HOME IMPROVEMENT, IN CLASS 41 (U.S. CLS. 100, 101 AND 107).

FIRST USE 2-17-2008; IN COMMERCE 2-17-2008.

THE MARK CONSISTS OF STANDARD CHARACTERS WITHOUT CLAIM TO ANY PARTICULAR FONT, STYLE, SIZE, OR COLOR.

SN 77-567,616, FILED 9-11-2008.

NANCY CLARKE, EXAMINING ATTORNEY



David J. Kybas

Director of the United States Patent and Trademark Office

United States of America

United States Patent and Trademark Office

ICSYNERGY

Reg. No. 4,067,565

Registered Dec. 6, 2011

Int. Cls.: 9 and 42

TRADEMARK

SERVICE MARK

PRINCIPAL REGISTER

ICSYNERGY INTERNATIONAL, LP (TEXAS LIMITED PARTNERSHIP)
SUITE 205
5601 DEMOCRACY DRIVE
PLANO, TX 75024

FOR: COMPUTER SOFTWARE FOR MANAGING AND MONITORING USERS, APPLICATION ACCESS AND INFORMATION AND FOR INTEGRATING APPLICATIONS WITH IDENTITY MANAGEMENT PROGRAMS, IN THE FIELDS OF ENTERPRISE IDENTITY MANAGEMENT, AND ACCESS CONTROL AND SECURITY FOR APPLICATIONS, NETWORKS AND INFRASTRUCTURE, IN CLASS 9 (U.S. CLS. 21, 23, 26, 36 AND 38).

FIRST USE 4-11-2011; IN COMMERCE 4-11-2011.

FOR: COMPUTER SOFTWARE CONSULTING AND INTEGRATION SERVICES IN THE FIELDS OF ENTERPRISE IDENTITY MANAGEMENT, AND ACCESS CONTROL AND SECURITY FOR APPLICATIONS, NETWORKS AND INFRASTRUCTURE, IN CLASS 42 (U.S. CLS. 100 AND 101).

FIRST USE 2-17-2000; IN COMMERCE 2-17-2000.

THE MARK CONSISTS OF STANDARD CHARACTERS WITHOUT CLAIM TO ANY PARTICULAR FONT, STYLE, SIZE, OR COLOR.

SN 77-568,145, FILED 9-11-2008.

TRACY CROSS, EXAMINING ATTORNEY



David J. Kyros

Director of the United States Patent and Trademark Office

United States of America

United States Patent and Trademark Office

Vida Mar

Reg. No. 4,067,566

Registered Dec. 6, 2011

Int. Cl.: 33

TRADEMARK

PRINCIPAL REGISTER

LIQUOR STORES LIMITED PARTNERSHIP (CANADA LIMITED PARTNERSHIP)
10508-82 AVENUE
SUITE 300
EDMONTON, ALBERTA, CANADA T6E 2A4

FOR: GRAPE WINE, IN CLASS 33 (U.S. CLS. 47 AND 49).

FIRST USE 2-10-2011; IN COMMERCE 2-10-2011.

THE MARK CONSISTS OF STANDARD CHARACTERS WITHOUT CLAIM TO ANY PARTICULAR FONT, STYLE, SIZE, OR COLOR.

THE ENGLISH TRANSLATION OF THE WORD "VIDA MAR" IN THE MARK IS "LIFE SEA".

SN 77-568,754, FILED 9-12-2008.

ODESSA BIBBINS, EXAMINING ATTORNEY



David J. Kybas

Director of the United States Patent and Trademark Office

United States of America

United States Patent and Trademark Office

ILLUMARAD

Reg. No. 4,067,567

Registered Dec. 6, 2011

Int. Cl.: 44

SERVICE MARK

PRINCIPAL REGISTER

GENERAL HOSPITAL CORPORATION, THE (MASSACHUSETTS CORPORATION)
32 FRUIT STREET
BOSTON, MA 02114

FOR: PROVIDING INFORMATION IN THE FIELD OF RADIOLOGY AND MEDICAL IMAGING; PROVIDING AN ONLINE COMPUTER DATABASE FEATURING INFORMATION ABOUT RADIOLOGY AND MEDICAL IMAGING , IN CLASS 44 (U.S. CLS. 100 AND 101).

FIRST USE 9-0-2011; IN COMMERCE 9-0-2011.

THE MARK CONSISTS OF STANDARD CHARACTERS WITHOUT CLAIM TO ANY PARTICULAR FONT, STYLE, SIZE, OR COLOR.

SN 77-571,754, FILED 9-17-2008.

BENJAMIN OKEKE, EXAMINING ATTORNEY



David J. Kybas

Director of the United States Patent and Trademark Office

United States of America

United States Patent and Trademark Office

Billy London

Reg. No. 4,067,568

Registered Dec. 6, 2011

Int. Cl.: 25

TRADEMARK

PRINCIPAL REGISTER

OXFORD INDUSTRIES, INC. (GEORGIA CORPORATION)
222 PIEDMONT AVE., NE
ATLANTA, GA 30308

FOR: BELTS MADE OF LEATHER, IN CLASS 25 (U.S. CLS. 22 AND 39).

FIRST USE 7-1-2011; IN COMMERCE 7-1-2011.

THE MARK CONSISTS OF STANDARD CHARACTERS WITHOUT CLAIM TO ANY PARTICULAR FONT, STYLE, SIZE, OR COLOR.

OWNER OF U.S. REG. NO. 3,134,172.

THE NAME(S), PORTRAIT(S), AND/OR SIGNATURE(S) SHOWN IN THE MARK DOES NOT IDENTIFY A PARTICULAR LIVING INDIVIDUAL.

SN 77-573,236, FILED 9-18-2008.

LINDSEY RUBIN, EXAMINING ATTORNEY



David J. Kyros

Director of the United States Patent and Trademark Office

United States of America

United States Patent and Trademark Office

ESU RECORDS

Reg. No. 4,067,569

Registered Dec. 6, 2011

Int. Cls.: 35 and 41

SERVICE MARK

PRINCIPAL REGISTER

ESU RECORDS LLC (ILLINOIS LIMITED LIABILITY COMPANY)
3400 NORTH LAKE SHORE DRIVE, SUITE 5A
CHICAGO, IL 60657

FOR: ENTERTAINMENT MARKETING SERVICES, NAMELY, MARKETING, PROMOTION AND ADVERTISING FOR INDEPENDENT RECORDING ARTISTS; PERSONAL MANAGEMENT SERVICES FOR MUSICAL PERFORMERS; RETAIL STORE SERVICES FEATURING DIGITAL MEDIA CONTAINING MUSIC PERFORMANCES; ON-LINE RETAIL STORE SERVICES FEATURING DOWNLOADABLE AND DIGITAL MEDIA CONTAINING MUSIC PERFORMANCES, IN CLASS 35 (U.S. CLS. 100, 101 AND 102).

FIRST USE 9-16-2011; IN COMMERCE 9-16-2011.

FOR: MULTIMEDIA ENTERTAINMENT SERVICES IN THE NATURE OF RECORDING, PRODUCTION AND POST-PRODUCTION SERVICES IN THE FIELDS OF MUSIC AND MUSIC VIDEOS; ENTERTAINMENT IN THE NATURE OF LIVE MUSICAL BAND PERFORMANCES; MUSIC PUBLISHING SERVICES, IN CLASS 41 (U.S. CLS. 100, 101 AND 107).

FIRST USE 9-16-2011; IN COMMERCE 9-16-2011.

THE MARK CONSISTS OF STANDARD CHARACTERS WITHOUT CLAIM TO ANY PARTICULAR FONT, STYLE, SIZE, OR COLOR.

NO CLAIM IS MADE TO THE EXCLUSIVE RIGHT TO USE "RECORDS", APART FROM THE MARK AS SHOWN.

SN 77-573,476, FILED 9-18-2008.

DARRYL SPRUILL, EXAMINING ATTORNEY



David J. Kyros

Director of the United States Patent and Trademark Office

United States of America

United States Patent and Trademark Office

JUST BECAUSE YOU COULDN'T
GET IT, DOESN'T MEAN IT WAS
OUT

Reg. No. 4,067,570

WILLIAMS, CHRISTELLE (UNITED STATES INDIVIDUAL)
131 BURDETTE ROAD
ATLANTA, GA 30327

Registered Dec. 6, 2011

Int. Cl.: 25

FOR: CLOTHING, NAMELY, TENNIS WEAR, SHIRTS, JACKETS, IN CLASS 25 (U.S. CLS. 22 AND 39).

TRADEMARK

FIRST USE 8-0-2008; IN COMMERCE 8-0-2008.

PRINCIPAL REGISTER

THE MARK CONSISTS OF STANDARD CHARACTERS WITHOUT CLAIM TO ANY PARTICULAR FONT, STYLE, SIZE, OR COLOR.

SN 77-574,448, FILED 9-19-2008.

KAREN BRACEY, EXAMINING ATTORNEY



David J. Kyffers

Director of the United States Patent and Trademark Office

United States of America

United States Patent and Trademark Office

SWEETIE PIG

Reg. No. 4,067,571

STACKENFELD, BRUCE (UNITED STATES INDIVIDUAL)
29 ROLLING HILL DRIVE
CHATHAM, NJ 07928

Registered Dec. 6, 2011

Int. Cl.: 36

FOR: CHARITABLE FOUNDATION SERVICES, NAMELY, PHILANTHROPIC SERVICES CONCERNING MONETARY DONATIONS, IN CLASS 36 (U.S. CLS. 100, 101 AND 102).

SERVICE MARK

FIRST USE 10-1-2011; IN COMMERCE 10-1-2011.

PRINCIPAL REGISTER

THE MARK CONSISTS OF STANDARD CHARACTERS WITHOUT CLAIM TO ANY PARTICULAR FONT, STYLE, SIZE, OR COLOR.

SN 77-575,160, FILED 9-21-2008.

HEATHER THOMPSON, EXAMINING ATTORNEY



David J. Kybas

Director of the United States Patent and Trademark Office

United States of America

United States Patent and Trademark Office

AFFORDABLE HOUSING MATTERS, WE'RE ON IT

Reg. No. 4,067,572

VALSPAR SOURCING, INC. (MINNESOTA CORPORATION)
P.O. BOX 1461
MINNEAPOLIS, MN 55440

Registered Dec. 6, 2011

Int. Cl.: 37

FOR: BUILDING CONSTRUCTION, REPAIR, AND RENOVATION SERVICES; AND
PAINTING SERVICES, IN CLASS 37 (U.S. CLS. 100, 103 AND 106).

SERVICE MARK

FIRST USE 7-0-2009; IN COMMERCE 7-0-2009.

PRINCIPAL REGISTER

THE MARK CONSISTS OF STANDARD CHARACTERS WITHOUT CLAIM TO ANY PAR-
TICULAR FONT, STYLE, SIZE, OR COLOR.

SN 77-575,727, FILED 9-22-2008.

RUDY R. SINGLETON, EXAMINING ATTORNEY



David J. Kybas

Director of the United States Patent and Trademark Office

United States of America

United States Patent and Trademark Office

NEIGHBORHOODS MATTER, WE'RE ON IT

Reg. No. 4,067,573

VALSPAR SOURCING, INC. (MINNESOTA CORPORATION)
P.O. BOX 1461
MINNEAPOLIS, MN 55440

Registered Dec. 6, 2011

Int. Cl.: 37

FOR: BUILDING CONSTRUCTION, REPAIR, AND RENOVATION SERVICES; AND
PAINTING SERVICES, IN CLASS 37 (U.S. CLS. 100, 103 AND 106).

SERVICE MARK

FIRST USE 7-0-2009; IN COMMERCE 7-0-2009.

PRINCIPAL REGISTER

THE MARK CONSISTS OF STANDARD CHARACTERS WITHOUT CLAIM TO ANY PAR-
TICULAR FONT, STYLE, SIZE, OR COLOR.

SN 77-575,930, FILED 9-22-2008.

RUDY R. SINGLETON, EXAMINING ATTORNEY



David J. Kybas

Director of the United States Patent and Trademark Office

United States of America

United States Patent and Trademark Office

FUTURA

Reg. No. 4,067,574

Registered Dec. 6, 2011

Int. Cl.: 17

TRADEMARK

PRINCIPAL REGISTER

VEYANCE TECHNOLOGIES, INC. (DELAWARE CORPORATION)
703 S. CLEVELAND-MASSILLON RD.
FAIRLAWN, OH 44333023

FOR: CONVEYING HOSES FOR FUELS NOT SOLD IN THE AUTOMOTIVE AFTERMARKET, NAMELY, HOSES SOLD FOR USE IN DISPENSING FUELS, IN CLASS 17 (U.S. CLS. 1, 5, 12, 13, 35 AND 50).

FIRST USE 6-1-2009; IN COMMERCE 6-1-2009.

THE MARK CONSISTS OF STANDARD CHARACTERS WITHOUT CLAIM TO ANY PARTICULAR FONT, STYLE, SIZE, OR COLOR.

SN 77-577,417, FILED 9-24-2008.

LESLEY LAMOTHE, EXAMINING ATTORNEY



David J. Kybas

Director of the United States Patent and Trademark Office

United States of America

United States Patent and Trademark Office

SICURE

Reg. No. 4,067,575

Registered Dec. 6, 2011

Int. Cl.: 11

TRADEMARK

PRINCIPAL REGISTER

SIEMENS INDUSTRY, INC. (DELAWARE CORPORATION)
3333 OLD MILTON PARKWAY
ALPHARETTA, GA 30005

FOR: BALLAST WATER TREATMENT UNIT, IN CLASS 11 (U.S. CLS. 13, 21, 23, 31 AND 34).

FIRST USE 11-24-2008; IN COMMERCE 11-24-2008.

THE MARK CONSISTS OF STANDARD CHARACTERS WITHOUT CLAIM TO ANY PARTICULAR FONT, STYLE, SIZE, OR COLOR.

SN 77-577,865, FILED 9-24-2008.

JACQUELINE A. LAVINE, EXAMINING ATTORNEY



David J. Kybas

Director of the United States Patent and Trademark Office

United States of America

United States Patent and Trademark Office

INCREMENTAL DISCOVERIES ... TODAY

Reg. No. 4,067,576

Registered Dec. 6, 2011

Int. Cls.: 10, 42, and 45

TRADEMARK

SERVICE MARK

PRINCIPAL REGISTER

INVIVO THERAPEUTICS CORPORATION (DELAWARE CORPORATION)
ONE BROADWAY, 14TH FLOOR
CAMBRIDGE, MA 02142

FOR: IMPLANTS CONSISTING OF ARTIFICIAL MATERIALS, NAMELY, POLYMER BASED IMPLANTS USED EITHER ALONE OR AS CARRIERS TO ADMINISTER CELLS OR DRUGS FOR THE REPAIR OF SPINAL INJURY AND THE TREATMENT OF CENTRAL NERVOUS SYSTEM DISEASES OR CONDITIONS, IN CLASS 10 (U.S. CLS. 26, 39 AND 44).

FIRST USE 7-21-2011; IN COMMERCE 7-21-2011.

FOR: MEDICAL AND SCIENTIFIC RESEARCH AND DEVELOPMENT AND CONSULTATION RELATED THERETO IN THE FIELD OF POLYMER IMPLANTS, SPINAL CORD INJURIES AND CENTRAL NERVOUS SYSTEM DISEASES AND CONDITIONS; DESIGN OF POLYMER IMPLANTS SUITABLE FOR THE REPAIR OF SPINAL INJURY, IN CLASS 42 (U.S. CLS. 100 AND 101).

FIRST USE 6-19-2011; IN COMMERCE 6-19-2011.

FOR: LICENSING OF INTELLECTUAL PROPERTY TO OTHERS, IN CLASS 45 (U.S. CLS. 100 AND 101).

FIRST USE 7-29-2011; IN COMMERCE 7-29-2011.

THE MARK CONSISTS OF STANDARD CHARACTERS WITHOUT CLAIM TO ANY PARTICULAR FONT, STYLE, SIZE, OR COLOR.

SN 77-577,901, FILED 9-24-2008.

RENEE MCCRAY, EXAMINING ATTORNEY



David J. Kyjars

Director of the United States Patent and Trademark Office

United States of America

United States Patent and Trademark Office

VITALA

Reg. No. 4,067,577

Registered Dec. 6, 2011

Int. Cl.: 10

TRADEMARK

PRINCIPAL REGISTER

CONVATEC INC. (DELAWARE CORPORATION)
200 HEADQUARTERS PARK DRIVE
SKILLMAN, NJ 08558

FOR: OSTOMY APPLIANCES AND DEVICES, NAMELY, A STOMA CLOSURE DEVICE WITH INTEGRATED FECAL COLLECTION CONTAINER, IN CLASS 10 (U.S. CLS. 26, 39 AND 44).

FIRST USE 10-31-2007; IN COMMERCE 10-31-2007.

THE MARK CONSISTS OF STANDARD CHARACTERS WITHOUT CLAIM TO ANY PARTICULAR FONT, STYLE, SIZE, OR COLOR.

THE WORDING "VITALA" HAS NO MEANING IN A FOREIGN LANGUAGE.

SN 77-583,216, FILED 10-1-2008.

REBECCA EISINGER, EXAMINING ATTORNEY



David J. Kyros

Director of the United States Patent and Trademark Office

United States of America

United States Patent and Trademark Office



Reg. No. 4,067,578

Registered Dec. 6, 2011

Int. Cl.: 14

TRADEMARK

PRINCIPAL REGISTER

METALLICA (CALIFORNIA PARTNERSHIP)
C/O PROVIDENT FINANCIAL MANAGEMENT
2020 UNION STREET
SAN FRANCISCO, CA 94123

FOR: JEWELRY, IN CLASS 14 (U.S. CLS. 2, 27, 28 AND 50).

FIRST USE 10-16-2008; IN COMMERCE 10-16-2008.

THE MARK CONSISTS OF A STYLIZED LETTER "M" FOLLOWED BY A STYLIZED, SUPERSCRIPT NUMBER "4".

SN 77-593,712, FILED 10-16-2008.

BRIDGETT SMITH, EXAMINING ATTORNEY



David J. Kybas

Director of the United States Patent and Trademark Office

United States of America

United States Patent and Trademark Office

ILLUSION ENGINE

Reg. No. 4,067,579

Registered Dec. 6, 2011

Int. Cl.: 9

TRADEMARK

PRINCIPAL REGISTER

TAKE-TWO INTERACTIVE SOFTWARE, INC. (DELAWARE CORPORATION)
622 BROADWAY
NEW YORK, NY 10012

FOR: COMPUTER SOFTWARE FOR USE IN GRAPHIC RENDERING AND DISTRIBUTED AS A PART OF OTHER VIDEO GAME SOFTWARE, IN CLASS 9 (U.S. CLS. 21, 23, 26, 36 AND 38).

FIRST USE 8-24-2010; IN COMMERCE 8-24-2010.

THE MARK CONSISTS OF STANDARD CHARACTERS WITHOUT CLAIM TO ANY PARTICULAR FONT, STYLE, SIZE, OR COLOR.

NO CLAIM IS MADE TO THE EXCLUSIVE RIGHT TO USE "ENGINE", APART FROM THE MARK AS SHOWN.

SN 77-597,552, FILED 10-21-2008.

MARCIE MILONE, EXAMINING ATTORNEY



David J. Kyros

Director of the United States Patent and Trademark Office

United States of America

United States Patent and Trademark Office

APPROACH

Reg. No. 4,067,580

Registered Dec. 6, 2011

Int. Cl.: 9

TRADEMARK

PRINCIPAL REGISTER

WGI INNOVATIONS, LTD. (TEXAS LIMITED PARTNERSHIP)
602 FOUNTAIN PARKWAY
GRAND PRAIRIE, TX 75050

FOR: LASER RANGEFINDERS FOR GOLF, IN CLASS 9 (U.S. CLS. 21, 23, 26, 36 AND 38).

FIRST USE 6-0-2011; IN COMMERCE 6-0-2011.

THE MARK CONSISTS OF STANDARD CHARACTERS WITHOUT CLAIM TO ANY PARTICULAR FONT, STYLE, SIZE, OR COLOR.

SN 77-603,516, FILED 10-29-2008.

SETH A. RAPPAPORT, EXAMINING ATTORNEY



David J. Kybas

Director of the United States Patent and Trademark Office

United States of America

United States Patent and Trademark Office



Reg. No. 4,067,581

Registered Dec. 6, 2011

Int. Cl.: 7

TRADEMARK

PRINCIPAL REGISTER

DIETRICH, DAVID WAYNE (CANADA INDIVIDUAL)
BOX 1599
ASSINIBOIA, CANADA S0H0B0

FOR: ACCESSORIES FOR AGRICULTURAL CROP HARVESTER CUTTING HEADERS,
NAMELY, CROP LIFTERS, IN CLASS 7 (U.S. CLS. 13, 19, 21, 23, 31, 34 AND 35).

FIRST USE 6-28-2006; IN COMMERCE 6-28-2006.

PRIORITY CLAIMED UNDER SEC. 44(D) ON CANADA APPLICATION NO. 1406870, FILED
8-11-2008, REG. NO. TMA764405, DATED 4-19-2010, EXPIRES 4-19-2025.

THE MARK CONSISTS OF THE LETTER SEQUENCE "FXXF", WHEREIN THE TWO "X"
LETTERS APPEAR INTERTWINED AND THE FINAL LETTER "F" APPEARS IN REVERSED
FORM.

SN 77-606,183, FILED 11-3-2008.

MICHAEL WEBSTER, EXAMINING ATTORNEY



David J. Kybas

Director of the United States Patent and Trademark Office

United States of America

United States Patent and Trademark Office

FIFTH WOUND

Reg. No. 4,067,582

JIMENEZ, ARMANDO JOSE (UNITED STATES INDIVIDUAL)
5409 WHITESTONE DRIVE
SALIDA, CA 95368

Registered Dec. 6, 2011

Int. Cl.: 41

FOR: ENTERTAINMENT, NAMELY, LIVE PERFORMANCES BY A MUSICAL BAND, IN CLASS 41 (U.S. CLS. 100, 101 AND 107).

SERVICE MARK

FIRST USE 9-1-2009; IN COMMERCE 9-1-2009.

PRINCIPAL REGISTER

THE MARK CONSISTS OF STANDARD CHARACTERS WITHOUT CLAIM TO ANY PARTICULAR FONT, STYLE, SIZE, OR COLOR.

SN 77-606,797, FILED 11-4-2008.

MARK RADEMACHER, EXAMINING ATTORNEY



David J. Kybas

Director of the United States Patent and Trademark Office

United States of America

United States Patent and Trademark Office

A BLUEPRINT FOR DELIVERING BETTER HEALTHCARE

Reg. No. 4,067,583

Registered Dec. 6, 2011

Int. Cls.: 35 and 41

SERVICE MARK

PRINCIPAL REGISTER

VHA INC. (DELAWARE CORPORATION)
220 EAST LAS COLINAS BOULEVARD
IRVING, TX 75039

FOR: BUSINESS CONSULTATION, NAMELY, CONDUCTING RESEARCH AND ANALYSIS ON CLINICAL PROCESSES IN THE HEALTH CARE FIELD, IN CLASS 35 (U.S. CLS. 100, 101 AND 102).

FIRST USE 4-0-2008; IN COMMERCE 4-0-2008.

FOR: PROVIDING ONLINE REPORTS IN THE FIELD OF CLINICAL RESEARCH; EDUCATIONAL SERVICES, NAMELY, CONDUCTING TRAINING COURSES REGARDING RESEARCH AND ANALYSIS ON CLINICAL PROCESSES IN THE HEALTH CARE FIELD, IN CLASS 41 (U.S. CLS. 100, 101 AND 107).

FIRST USE 4-0-2008; IN COMMERCE 4-0-2008.

THE MARK CONSISTS OF STANDARD CHARACTERS WITHOUT CLAIM TO ANY PARTICULAR FONT, STYLE, SIZE, OR COLOR.

SN 77-609,889, FILED 11-7-2008.

DEIRDRE ROBERTSON, EXAMINING ATTORNEY



David J. Kyjars

Director of the United States Patent and Trademark Office

United States of America

United States Patent and Trademark Office

PunchPass

Reg. No. 4,067,584

CYBATROL, INC. (FLORIDA CORPORATION)
8654 COUNTRY CROSSINGS STREET
LAS VEGAS, NV 89123

Registered Dec. 6, 2011

Int. Cl.: 38

FOR: ELECTRONIC TRANSMISSION OF NUMERIC CODES USED FOR IDENTIFICATION AND AS AN INFORMATIONAL ENTRY PASS, IN CLASS 38 (U.S. CLS. 100, 101 AND 104).

SERVICE MARK

FIRST USE 5-15-2011; IN COMMERCE 5-15-2011.

PRINCIPAL REGISTER

THE MARK CONSISTS OF STANDARD CHARACTERS WITHOUT CLAIM TO ANY PARTICULAR FONT, STYLE, SIZE, OR COLOR.

SN 77-609,893, FILED 11-7-2008.

KHANH LE, EXAMINING ATTORNEY



David J. Kybas

Director of the United States Patent and Trademark Office

United States of America

United States Patent and Trademark Office

Trish McEvoy Line Eraser

Reg. No. 4,067,585

Registered Dec. 6, 2011

Int. Cl.: 3

TRADEMARK

PRINCIPAL REGISTER

TRISH MCEVOY, LTD (NEW YORK CORPORATION)
800A FIFTH AVENUE
NEW YORK, NY 10021

FOR: COSMETICS, NAMELY, SKIN CREAMS AND LOTIONS, IN CLASS 3 (U.S. CLS. 1, 4, 6, 50, 51 AND 52).

FIRST USE 11-12-2008; IN COMMERCE 11-12-2008.

THE MARK CONSISTS OF STANDARD CHARACTERS WITHOUT CLAIM TO ANY PARTICULAR FONT, STYLE, SIZE, OR COLOR.

OWNER OF U.S. REG. NOS. 1,541,143 AND 3,558,992.

NO CLAIM IS MADE TO THE EXCLUSIVE RIGHT TO USE "LINE", APART FROM THE MARK AS SHOWN.

THE NAME(S), PORTRAIT(S), AND/OR SIGNATURE(S) SHOWN IN THE MARK IDENTIFIES "TRISH MCEVOY", WHOSE CONSENT(S) TO REGISTER IS MADE OF RECORD.

SN 77-612,926, FILED 11-12-2008.

SEAN CROWLEY, EXAMINING ATTORNEY



David J. Kyffers

Director of the United States Patent and Trademark Office

United States of America

United States Patent and Trademark Office

BETAPLUS

Reg. No. 4,067,586

Registered Dec. 6, 2011

Int. Cls.: 41 and 44

SERVICE MARK

PRINCIPAL REGISTER

BAYER SCHERING PHARMA AG (FED REP GERMANY CORPORATION)
MULLERSTRASSE 178
BERLIN, FED REP GERMANY 13353

FOR: EDUCATIONAL SERVICES, NAMELY, PROVIDING TRAINING IN THE FIELD OF MEDICINE, IN CLASS 41 (U.S. CLS. 100, 101 AND 107).

FIRST USE 10-31-2008; IN COMMERCE 10-31-2008.

FOR: MEDICAL SERVICES IN THE FIELD OF MULTIPLE SCLEROSIS, IN CLASS 44 (U.S. CLS. 100 AND 101).

FIRST USE 10-31-2008; IN COMMERCE 10-31-2008.

THE MARK CONSISTS OF STANDARD CHARACTERS WITHOUT CLAIM TO ANY PARTICULAR FONT, STYLE, SIZE, OR COLOR.

OWNER OF U.S. REG. NO. 3,445,631.

SN 77-615,596, FILED 11-17-2008.

ESTHER A. BORSUK, EXAMINING ATTORNEY



David J. Kybas

Director of the United States Patent and Trademark Office

United States of America

United States Patent and Trademark Office

Parmalito

Reg. No. 4,067,587

Registered Dec. 6, 2011

Int. Cl.: 29

TRADEMARK

PRINCIPAL REGISTER

EMMI ROTH USA, INC. (WISCONSIN CORPORATION)
657 2ND STREET
MONROE, WI 53566

FOR: CHEESE, IN CLASS 29 (U.S. CL. 46).

FIRST USE 10-11-2011; IN COMMERCE 10-11-2011.

THE MARK CONSISTS OF STANDARD CHARACTERS WITHOUT CLAIM TO ANY PARTICULAR FONT, STYLE, SIZE, OR COLOR.

THE WORDING "PARMALITO" HAS NO MEANING IN A FOREIGN LANGUAGE.

SN 77-616,580, FILED 11-18-2008.

FRANK LATTUCA, EXAMINING ATTORNEY



David J. Kybas

Director of the United States Patent and Trademark Office

United States of America

United States Patent and Trademark Office

LAKE ERIE CRUSHERS

Reg. No. 4,067,588

Registered Dec. 6, 2011

Int. Cl.: 28

TRADEMARK

PRINCIPAL REGISTER

AVON BASEBALL L.L.C. (ILLINOIS LIMITED LIABILITY COMPANY)
3201 OLD GLENVIEW STE 235
WILMETTE, IL 60091

FOR: PLAYING CARDS, BASEBALLS, BASEBALL BATS, STUFFED TOY BASEBALLS, TEDDY BEARS, STUFFED TOY ANIMALS, PLAYGROUND BALLS, RUBBER ACTION BALLS, INFLATABLE BASEBALL BATS, NOVELTY FOAM FINGERS, IN CLASS 28 (U.S. CLS. 22, 23, 38 AND 50).

FIRST USE 5-0-2009; IN COMMERCE 5-0-2009.

THE MARK CONSISTS OF STANDARD CHARACTERS WITHOUT CLAIM TO ANY PARTICULAR FONT, STYLE, SIZE, OR COLOR.

NO CLAIM IS MADE TO THE EXCLUSIVE RIGHT TO USE "LAKE ERIE", APART FROM THE MARK AS SHOWN.

SN 77-617,883, FILED 11-19-2008.

DAVID TOOLEY, EXAMINING ATTORNEY



David J. Kyros

Director of the United States Patent and Trademark Office

United States of America

United States Patent and Trademark Office

Aztec Brewery

Reg. No. 4,067,589

Registered Dec. 6, 2011

Int. Cl.: 32

TRADEMARK

PRINCIPAL REGISTER

WEBSTER, JOHN, C. (UNITED STATES INDIVIDUAL), DBA WEBSTER DESIGN,
1357 FERN PLACE
VISTA, CA 92081

FOR: BEER; BREWED MALT-BASED ALCOHOLIC BEVERAGE IN THE NATURE OF A
BEER, IN CLASS 32 (U.S. CLS. 45, 46 AND 48).

FIRST USE 8-25-2011; IN COMMERCE 8-25-2011.

THE MARK CONSISTS OF STANDARD CHARACTERS WITHOUT CLAIM TO ANY PAR-
TICULAR FONT, STYLE, SIZE, OR COLOR.

NO CLAIM IS MADE TO THE EXCLUSIVE RIGHT TO USE "BREWERY", APART FROM
THE MARK AS SHOWN.

SN 77-618,005, FILED 11-19-2008.

JEFFREY LOOK, EXAMINING ATTORNEY



David J. Kybas

Director of the United States Patent and Trademark Office

United States of America

United States Patent and Trademark Office

POWER TAME

Reg. No. 4,067,590

Registered Dec. 6, 2011

Int. Cl.: 3

TRADEMARK

PRINCIPAL REGISTER

L'OREAL USA CREATIVE, INC. (DELAWARE CORPORATION)
575 FIFTH AVENUE
NEW YORK, NY 10017

FOR: HAIR STYLING PREPARATION, IN CLASS 3 (U.S. CLS. 1, 4, 6, 50, 51 AND 52).

FIRST USE 7-1-2011; IN COMMERCE 7-1-2011.

THE MARK CONSISTS OF STANDARD CHARACTERS WITHOUT CLAIM TO ANY PARTICULAR FONT, STYLE, SIZE, OR COLOR.

SN 77-621,648, FILED 11-25-2008.

JOHN HWANG, EXAMINING ATTORNEY



David J. Kybas

Director of the United States Patent and Trademark Office

United States of America

United States Patent and Trademark Office

DIGITAL LIFEBOAT

Reg. No. 4,067,591

Registered Dec. 6, 2011

Int. Cls.: 9, 38, 39, and 42

DIGITAL LIFEBOAT, INC. (DELAWARE CORPORATION)
7114 180TH AVE NE, SUITE B101
REDMOND, WA 90852

FOR: COMPUTER SOFTWARE FOR THE BACK-UP, STORAGE, ARCHIVING, RECOVERY, MIGRATION AND TRANSFER OF ELECTRONIC DATA , IN CLASS 9 (U.S. CLS. 21, 23, 26, 36 AND 38).

TRADEMARK

FIRST USE 4-0-2010; IN COMMERCE 4-0-2010.

SERVICE MARK

FOR: TRANSFER OF DATA BY TELECOMMUNICATIONS, IN CLASS 38 (U.S. CLS. 100, 101 AND 104).

PRINCIPAL REGISTER

FIRST USE 4-0-2010; IN COMMERCE 4-0-2010.

FOR: PROVIDING TECHNICAL SUPPORT RELATED TO THE STORAGE, PROTECTION AND RETRIEVAL OF ELECTRONIC DATA; PROVIDING INFORMATION IN THE FIELD OF ELECTRONIC DATA STORAGE, PROTECTION AND RETRIEVAL; ELECTRONIC STORAGE AND ARCHIVING OF DATA, IN CLASS 39 (U.S. CLS. 100 AND 105).

FIRST USE 4-0-2010; IN COMMERCE 4-0-2010.

FOR: COMPUTER SERVICES, NAMELY, REMOTE BACK-UP, RECOVERY, MIGRATION OF ELECTRONIC DATA, IN CLASS 42 (U.S. CLS. 100 AND 101).

FIRST USE 4-0-2010; IN COMMERCE 4-0-2010.

THE MARK CONSISTS OF STANDARD CHARACTERS WITHOUT CLAIM TO ANY PARTICULAR FONT, STYLE, SIZE, OR COLOR.

NO CLAIM IS MADE TO THE EXCLUSIVE RIGHT TO USE "DIGITAL", APART FROM THE MARK AS SHOWN.

SN 77-622,449, FILED 11-26-2008.

ANNE E. GUSTASON, EXAMINING ATTORNEY



David J. Kyros

Director of the United States Patent and Trademark Office

United States of America

United States Patent and Trademark Office

LAVALUE

Reg. No. 4,067,592

GRAND A INTERNATIONAL CO., INC. (CALIFORNIA CORPORATION)
2019 SANTA ANITA AVE.
S. EL MONTE, CA 91733

Registered Dec. 6, 2011

Int. Cl.: 16

FOR: GENERAL PURPOSE PLASTIC BAGS, PLASTIC TRASH BAGS, SANDWICH BAGS, PLASTIC FREEZER BAGS, PAPER DROP CLOTH; ALL RELATED PRODUCTS, NAMELY, DRAWING STRING TRASH BAGS, PLASTIC WRAP; PLASTIC PET WASTE BAGS, IN CLASS 16 (U.S. CLS. 2, 5, 22, 23, 29, 37, 38 AND 50).

TRADEMARK

PRINCIPAL REGISTER

FIRST USE 3-0-2011; IN COMMERCE 3-0-2011.

THE MARK CONSISTS OF STANDARD CHARACTERS WITHOUT CLAIM TO ANY PARTICULAR FONT, STYLE, SIZE, OR COLOR.

SN 77-627,037, FILED 12-5-2008.

BRIAN CALLAGHAN, EXAMINING ATTORNEY



David J. Kyros

Director of the United States Patent and Trademark Office

United States of America

United States Patent and Trademark Office



Reg. No. 4,067,593

Registered Dec. 6, 2011

Int. Cls.: 30 and 43

TRADEMARK

SERVICE MARK

PRINCIPAL REGISTER

PATTON, MICHAEL J.T. (UNITED STATES INDIVIDUAL)
1849 S. LAKE STOREY ROAD
GALESBURG, IL 61401

FOR: DOUGHNUTS AND BAKERY PRODUCTS; BEIGNETS; CAKES; AND PIES, IN CLASS 30 (U.S. CL. 46).

FIRST USE 8-26-2011; IN COMMERCE 8-26-2011.

FOR: RESTAURANT AND CARRY-OUT FOOD SERVICES, IN CLASS 43 (U.S. CLS. 100 AND 101).

FIRST USE 4-23-2009; IN COMMERCE 8-26-2011.

NO CLAIM IS MADE TO THE EXCLUSIVE RIGHT TO USE "DONUTS", APART FROM THE MARK AS SHOWN.

THE COLOR(S) RED, WHITE, GOLD, AND BLACK IS/ARE CLAIMED AS A FEATURE OF THE MARK.

THE MARK CONSISTS OF THE COLOR(S) RED, WHITE, GOLD AND BLACK, WITH THE COLOR RED APPEARING IN THE WORDING "SPUD S", "D NUTS", "AND MORE", AND IN THE RECTANGULAR CARRIER, THE COLOR WHITE APPEARING IN THE BACKGROUND, THE COLOR GOLD APPEARING IN THE DOUGHNUT SHAPED "O"'S IN THE WORDING "SPUDOS" AND "DONUTS", AND THE COLOR BLACK APPEARING AS AN OUTLINE INSIDE THE RED RECTANGULAR CARRIER.

SN 77-633,326, FILED 12-15-2008.

TINA L. SNAPP, EXAMINING ATTORNEY



David J. Kybas

Director of the United States Patent and Trademark Office

United States of America

United States Patent and Trademark Office

OTOKA ENERGY

Reg. No. 4,067,594

Registered Dec. 6, 2011

Int. Cl.: 40

SERVICE MARK

PRINCIPAL REGISTER

OTOKA ENERGY CORPORATION (DELAWARE CORPORATION)
SUITE 710
8300 NORMAN CENTER DRIVE
BLOOMINGTON, MN 55437

FOR: ENERGY PRODUCTION SERVICES; ENERGY CONSULTING SERVICES IN THE
FIELDS OF RENEWABLE ENERGY AND BIOMASS TO ENERGY PRODUCTION, IN CLASS
40 (U.S. CLS. 100, 103 AND 106).

FIRST USE 11-1-2007; IN COMMERCE 11-1-2007.

THE MARK CONSISTS OF STANDARD CHARACTERS WITHOUT CLAIM TO ANY PAR-
TICULAR FONT, STYLE, SIZE, OR COLOR.

NO CLAIM IS MADE TO THE EXCLUSIVE RIGHT TO USE "ENERGY", APART FROM THE
MARK AS SHOWN.

THE ENGLISH TRANSLATION OF "OTOKA" IN THE MARK IS BEGINNING.

SN 77-634,193, FILED 12-16-2008.

NAKIA HENRY, EXAMINING ATTORNEY



David J. Kyros

Director of the United States Patent and Trademark Office

United States of America

United States Patent and Trademark Office

INSURANCE ADVANTAGE

Reg. No. 4,067,595

Registered Dec. 6, 2011

Int. Cl.: 36

SERVICE MARK

PRINCIPAL REGISTER

THOMPSON, BRIAN (UNITED STATES INDIVIDUAL)
11 HOLLY BERRY COURT
GLEN ARM, MD 21057

FOR: CHARGE CARD AND CREDIT CARD SERVICES; CREDIT AND CASH CARD SERVICES; CREDIT AND DEBIT CARD SERVICES; CREDIT CARD AND DEBIT CARD SERVICES; CREDIT CARD AND PAYMENT CARD SERVICES; CREDIT CARD PAYMENT PROCESSING SERVICES; CREDIT CARD TRANSACTION PROCESSING SERVICES, IN CLASS 36 (U.S. CLS. 100, 101 AND 102).

FIRST USE 3-18-2009; IN COMMERCE 3-18-2009.

THE MARK CONSISTS OF STANDARD CHARACTERS WITHOUT CLAIM TO ANY PARTICULAR FONT, STYLE, SIZE, OR COLOR.

SN 77-635,752, FILED 12-18-2008.

MATTHEW EINSTEIN, EXAMINING ATTORNEY



David J. Kybas

Director of the United States Patent and Trademark Office

United States of America

United States Patent and Trademark Office



Sounds Better

Reg. No. 4,067,596

Registered Dec. 6, 2011

Int. Cl.: 9

TRADEMARK

PRINCIPAL REGISTER

AUDIOCODES LTD. (ISRAEL CORPORATION)
1 HAYARDEN ST.
AIRPORT CITY, LOD 701, ISRAEL

FOR: WIRELESS AND MOBILE PHONES; HANDSETS; TELEPHONES; VIDEO PHONE; COMMUNICATIONS SOFTWARE AND HARDWARE FOR TRANSMISSION AND DISSEMINATION OF AUDIO, VIDEO, SIGNALS AND DATA VIA COMMUNICATIONS NETWORKS; SEMICONDUCTOR CHIPS; COMPUTER HARDWARE, NAMELY, COMMUNICATION AND PROCESSING BOARDS AND APPARATUS; MEDIA GATEWAY SYSTEMS COMPRISING COMMUNICATIONS SERVERS, COMPUTER SERVERS, MEDIA SERVERS, APPLICATION SERVERS, COMPUTER HARDWARE, FIRMWARE AND SOFTWARE FOR PROCESSING AND HANDLING VOICE, FAX, VIDEO AND OTHER DATA OVER NETWORKS, IN CLASS 9 (U.S. CLS. 21, 23, 26, 36 AND 38).

FIRST USE 9-14-2011; IN COMMERCE 9-14-2011.

NO CLAIM IS MADE TO THE EXCLUSIVE RIGHT TO USE "HD VOIP" AND "SOUNDS BETTER", APART FROM THE MARK AS SHOWN.

THE MARK CONSISTS OF STYLIZED LETTERING WITH A MUSICAL NOTE NEXT TO THE LETTER "H".

SN 77-637,516, FILED 12-21-2008.

JANICE L. MCMORROW, EXAMINING ATTORNEY



David J. Kybas

Director of the United States Patent and Trademark Office

United States of America

United States Patent and Trademark Office

HOT NEW FACE

Reg. No. 4,067,597

Registered Dec. 6, 2011

Int. Cl.: 41

SERVICE MARK

PRINCIPAL REGISTER

DELICIOUS LTD. (BAHAMAS LIMITED COMPANY (LTD.))
111 WEST 57TH STREET, SUITE 1120
ATTN: J. JEFFREY HAFER, ESQ.
NEW YORK, NY 10019

FOR: ENTERTAINMENT, NAMELY, AN ONGOING REALITY-BASED, COMPETITION ENTERTAINMENT SERIES DISTRIBUTED VIA BROADCAST OR TRANSMISSION OVER TELEVISION AND THE INTERNET, IN CLASS 41 (U.S. CLS. 100, 101 AND 107).

FIRST USE 1-13-2009; IN COMMERCE 1-13-2009.

THE MARK CONSISTS OF STANDARD CHARACTERS WITHOUT CLAIM TO ANY PARTICULAR FONT, STYLE, SIZE, OR COLOR.

SN 77-637,743, FILED 12-22-2008.

C. DIONNE CLYBURN, EXAMINING ATTORNEY



David J. Kybas

Director of the United States Patent and Trademark Office

United States of America

United States Patent and Trademark Office

BUDGET911

Reg. No. 4,067,598

Registered Dec. 6, 2011

Int. Cl.: 36

SERVICE MARK

PRINCIPAL REGISTER

SPRINGBOARD NON-PROFIT CONSUMER CREDIT MANAGEMENT, INC. (CALIFORNIA CORPORATION)
4351 LATHAM
RIVERSIDE, CA 925016370

FOR: FINANCIAL CONSULTING IN THE FIELDS OF CREDIT, DEBT MANAGEMENT, AND HOME OWNERSHIP; EDUCATIONAL SERVICES, NAMELY, PROVIDING INFORMATION ABOUT CREDIT, DEBT MANAGEMENT, AND FINANCIAL ASPECTS OF HOME OWNERSHIP, IN CLASS 36 (U.S. CLS. 100, 101 AND 102).

FIRST USE 1-24-2011; IN COMMERCE 1-24-2011.

THE MARK CONSISTS OF STANDARD CHARACTERS WITHOUT CLAIM TO ANY PARTICULAR FONT, STYLE, SIZE, OR COLOR.

SN 77-638,936, FILED 12-23-2008.

ALEX KEAM, EXAMINING ATTORNEY



David J. Kybas

Director of the United States Patent and Trademark Office

United States of America

United States Patent and Trademark Office

PROHEAT 2X HEALTHY HOME

Reg. No. 4,067,599

Registered Dec. 6, 2011

Int. Cl.: 7

TRADEMARK

PRINCIPAL REGISTER

BISELL HOMECARE, INC. (MICHIGAN CORPORATION)
2345 WALKER AVENUE NW
GRAND RAPIDS, MI 49544

FOR: ELECTRICAL CLEANING DEVICES, NAMELY, CARPET, BARE FLOOR, AND UPHOLSTERY CLEANING EXTRACTORS, AND ACCESSORIES THEREFOR, IN CLASS 7 (U.S. CLS. 13, 19, 21, 23, 31, 34 AND 35).

FIRST USE 5-11-2009; IN COMMERCE 5-11-2009.

THE MARK CONSISTS OF STANDARD CHARACTERS WITHOUT CLAIM TO ANY PARTICULAR FONT, STYLE, SIZE, OR COLOR.

OWNER OF U.S. REG. NO. 3,099,400.

SN 77-639,113, FILED 12-23-2008.

MARGERY A. TIERNEY, EXAMINING ATTORNEY



David J. Kybas

Director of the United States Patent and Trademark Office

United States of America

United States Patent and Trademark Office

Charismathics

Reg. No. 4,067,600

Registered Dec. 6, 2011

Int. Cls.: 9 and 42

TRADEMARK

SERVICE MARK

PRINCIPAL REGISTER

CHARISMATHICS GMBH (FED REP GERMANY GESELLSCHAFT MIT BESCHRÄNKTER HAFTUNG (GMBH))
SENDLINGER STRASSE 47
MUNICH, FED REP GERMANY 80331

FOR: DATA PROCESSING EQUIPMENT AND COMPUTERS, ESPECIALLY DATA PROCESSING APPARATUS FOR SECURELY STORING AND TRANSMITTING DATA; HARDWARE SECURITY TOKEN USED BY AN AUTHORIZED USER OF A COMPUTER SYSTEM, A DATA TRANSMISSION NETWORK, OR A MOBILE COMMUNICATION APPARATUS TO FACILITATE AUTHENTICATION; INTEGRATED CIRCUITS IN THE NATURE OF PUBLIC KEY INFRASTRUCTURE SECURITY COMPONENTS; FINGERPRINT RECOGNITION SCANNERS; COMPUTER SOFTWARE FOR SECURELY STORING AND TRANSMITTING DATA AND FOR AUTHENTICATION PURPOSES, IN CLASS 9 (U.S. CLS. 21, 23, 26, 36 AND 38).

FIRST USE 1-31-2007; IN COMMERCE 1-31-2007.

FOR: COMPUTER SOFTWARE DESIGN, COMPUTER SOFTWARE CONSULTANCY, UPDATING OF COMPUTER SOFTWARE, RENTAL OF COMPUTER SOFTWARE, MAINTENANCE OF COMPUTER SOFTWARE, IN CLASS 42 (U.S. CLS. 100 AND 101).

FIRST USE 1-31-2007; IN COMMERCE 1-31-2007.

THE MARK CONSISTS OF STANDARD CHARACTERS WITHOUT CLAIM TO ANY PARTICULAR FONT, STYLE, SIZE, OR COLOR.

SN 77-645,206, FILED 1-7-2009.

MICHAEL ENGEL, EXAMINING ATTORNEY



David J. Kypos

Director of the United States Patent and Trademark Office

United States of America

United States Patent and Trademark Office

FIESTA FRENZY

Reg. No. 4,067,601

Registered Dec. 6, 2011

Int. Cl.: 9

TRADEMARK

PRINCIPAL REGISTER

TOURNAMENT ONE CORP (DELAWARE CORPORATION)
1200 HIGH RIDGE ROAD
STAMFORD, CT 06905

FOR: COMPUTER GAME SOFTWARE; COMPUTER GRAPHICS SOFTWARE; ELECTRONIC GAME SOFTWARE; ELECTRONIC GAME SOFTWARE FOR CELLULAR TELEPHONES; ELECTRONIC GAME SOFTWARE FOR WIRELESS DEVICES; GAME SOFTWARE; GAMING SOFTWARE THAT GENERATES OR DISPLAYS WAGER OUTCOMES OF GAMING MACHINES; VIDEO GAME SOFTWARE; DOWNLOADABLE COMPUTER GAME SOFTWARE FOR PLAYING GAMES, CASINO GAMES AND KENO AND FOR USE IN GAMING MACHINES AND VIDEO LOTTERY TERMINALS; DOWNLOADABLE COMPUTER SOFTWARE AND FIRMWARE FOR GAMES OF CHANCE ON ANY COMPUTERIZED PLATFORM, INCLUDING DEDICATED GAMING CONSOLES, VIDEO BASED SLOT MACHINES, REEL BASED SLOT MACHINES, AND VIDEO LOTTERY TERMINALS; VIRTUAL REALITY GAME SOFTWARE FOR CASINOS FEATURING LOTTERY AND KENO GAMES, IN CLASS 9 (U.S. CLS. 21, 23, 26, 36 AND 38).

FIRST USE 1-15-2009; IN COMMERCE 10-31-2010.

THE MARK CONSISTS OF STANDARD CHARACTERS WITHOUT CLAIM TO ANY PARTICULAR FONT, STYLE, SIZE, OR COLOR.

SN 77-646,052, FILED 1-8-2009.

WILLIAM ROSSMAN, EXAMINING ATTORNEY



David J. Kyros

Director of the United States Patent and Trademark Office

United States of America

United States Patent and Trademark Office

TUNESAT

Reg. No. 4,067,602

Registered Dec. 6, 2011

Int. Cl.: 45

SERVICE MARK

PRINCIPAL REGISTER

TUNESAT, LLC (DELAWARE LIMITED LIABILITY COMPANY)
1650 BROADWAY, SUITE 1108
NEW YORK, NY 10019

FOR: COPYRIGHT MONITORING AND ENFORCEMENT SERVICES, NAMELY, MONITORING VARIOUS TYPES OF MEDIA, SUCH AS TELEVISION BROADCASTS AND ONLINE AUDIOVISUAL WORKS, TO DETECT USE OF COPYRIGHTED SOUND RECORDINGS, AND PROVIDING ANALYSIS AND REPORTS RELATED THERETO, IN CLASS 45 (U.S. CLS. 100 AND 101).

FIRST USE 1-1-2011; IN COMMERCE 1-1-2011.

THE MARK CONSISTS OF STANDARD CHARACTERS WITHOUT CLAIM TO ANY PARTICULAR FONT, STYLE, SIZE, OR COLOR.

SN 77-655,692, FILED 1-23-2009.

KIMBERLY FRYE, EXAMINING ATTORNEY



David J. Kybas

Director of the United States Patent and Trademark Office

United States of America

United States Patent and Trademark Office

WE ARE LISTENING

Reg. No. 4,067,603

Registered Dec. 6, 2011

Int. Cl.: 45

SERVICE MARK

PRINCIPAL REGISTER

TUNESAT, LLC (DELAWARE LIMITED LIABILITY COMPANY)
1650 BROADWAY, SUITE 1108
NEW YORK, NY 10019

FOR: COPYRIGHT MONITORING AND ENFORCEMENT SERVICES, NAMELY, MONITORING VARIOUS TYPES OF MEDIA, SUCH AS TELEVISION BROADCASTS AND ONLINE AUDIOVISUAL WORKS, TO DETECT USE OF COPYRIGHTED SOUND RECORDINGS, AND PROVIDING ANALYSIS AND REPORTS RELATED THERETO, IN CLASS 45 (U.S. CLS. 100 AND 101).

FIRST USE 1-1-2011; IN COMMERCE 1-1-2011.

THE MARK CONSISTS OF STANDARD CHARACTERS WITHOUT CLAIM TO ANY PARTICULAR FONT, STYLE, SIZE, OR COLOR.

SN 77-655,701, FILED 1-23-2009.

KIMBERLY FRYE, EXAMINING ATTORNEY



David J. Kybas

Director of the United States Patent and Trademark Office

United States of America

United States Patent and Trademark Office

YOUSENDIT

Reg. No. 4,067,604

Registered Dec. 6, 2011

Int. Cl.: 9

TRADEMARK

PRINCIPAL REGISTER

YOUSENDIT, INC. (DELAWARE CORPORATION)
1919 SOUTH BASCOM AVENUE, 3RD FLOOR
CAMPBELL, CA 95008

FOR: COMPUTER SOFTWARE FOR FILE AND DATA TRANSFERS OVER THE INTERNET, WITHIN AN ENTERPRISE, AND ACROSS DIFFERENT PLATFORMS; COMPUTER SOFTWARE FOR USERS TO SEND, RECEIVE, AND TRACK DIGITAL FILES OVER THE INTERNET, WITHIN AN ENTERPRISE, AND ACROSS DIFFERENT PLATFORMS; COMPUTER SOFTWARE, NAMELY, COLLABORATION SOFTWARE FOR THE SHARING AND COLLABORATION OF DATA, INFORMATION, DOCUMENTS, ELECTRONIC FILES, VIDEOS, AUDIO, IMAGES, PHOTOS, CALENDARS, CONTACTS, TASK DATA, AND PROJECT MANAGEMENT AND WORKFLOW; COMPUTER SOFTWARE WHICH ALLOWS USERS TO PUBLISH AND SHARE DATA, INFORMATION, DOCUMENTS, ELECTRONIC FILES, VIDEOS, AUDIO, IMAGES, PHOTOS, CALENDARS, CONTACTS, TASK DATA, AND PROJECT MANAGEMENT AND WORKFLOW ONLINE, IN CLASS 9 (U.S. CLS. 21, 23, 26, 36 AND 38).

FIRST USE 1-31-2006; IN COMMERCE 1-31-2006.

THE MARK CONSISTS OF STANDARD CHARACTERS WITHOUT CLAIM TO ANY PARTICULAR FONT, STYLE, SIZE, OR COLOR.

SN 77-655,794, FILED 1-23-2009.

FRED CARL, EXAMINING ATTORNEY



David J. Kyros

Director of the United States Patent and Trademark Office

United States of America

United States Patent and Trademark Office

JBoss Certified Application Administrator

Reg. No. 4,067,605

Registered Dec. 6, 2011

Int. Cl.: 41

SERVICE MARK

PRINCIPAL REGISTER

RED HAT, INC. (DELAWARE CORPORATION)
1801 VARSITY DRIVE
RALEIGH, NC 27606

FOR: EDUCATIONAL SERVICES, NAMELY, CONDUCTING SEMINARS, COURSES AND WORKSHOPS IN THE USE, MAINTENANCE, UPDATING, CONFIGURATION, INSTALLATION, SUPPORT AND PROGRAMMING OF COMPUTER SOFTWARE, IN THE PLANNING, DESIGN, AND DEPLOYMENT OF COMPUTER NETWORKS, IN COMPUTER NETWORK SECURITY AND IN MANAGEMENT OF ENTERPRISE NETWORK INFRASTRUCTURES; PROVIDING ONLINE PUBLICATIONS, NAMELY, INSTRUCTIONAL BOOKS, INSTRUCTION MANUALS, INSTRUCTOR'S GUIDES, TEACHING MATERIALS AND TEST BOOKLETS, ALL IN THE FIELDS OF THE USAGE, MAINTENANCE, UPDATING, CONFIGURATION, INSTALLATION, SUPPORT AND PROGRAMMING OF COMPUTER SOFTWARE, OF THE PLANNING, DESIGN, AND DEPLOYMENT OF COMPUTER NETWORKS, OF COMPUTER NETWORK SECURITY AND OF MANAGEMENT OF ENTERPRISE NETWORK INFRASTRUCTURES; PROVIDING EDUCATIONAL SERVICES OVER A GLOBAL COMPUTER NETWORK, NAMELY, CONDUCTING CLASSES AND SEMINARS OVER THE INTERNET IN THE FIELDS OF OPERATING SYSTEM SOFTWARE, OF APPLICATION SOFTWARE AND OF PROGRAMMING LANGUAGES, IN CLASS 41 (U.S. CLS. 100, 101 AND 107).

FIRST USE 10-1-2009; IN COMMERCE 10-1-2009.

THE MARK CONSISTS OF STANDARD CHARACTERS WITHOUT CLAIM TO ANY PARTICULAR FONT, STYLE, SIZE, OR COLOR.

NO CLAIM IS MADE TO THE EXCLUSIVE RIGHT TO USE "CERTIFIED APPLICATION ADMINISTRATOR", APART FROM THE MARK AS SHOWN.

SN 77-657,335, FILED 1-27-2009.

RICHARD WHITE, EXAMINING ATTORNEY



David J. Kyros

Director of the United States Patent and Trademark Office

United States of America

United States Patent and Trademark Office

KWIQMATE

Reg. No. 4,067,606

Registered Dec. 6, 2011

Int. Cl.: 9

TRADEMARK

PRINCIPAL REGISTER

EMERSON NETWORK POWER CONNECTIVITY SOLUTIONS, INC. (DELAWARE CORPORATION)
3000 LAKESIDE DRIVE, SUITE 308N
BANNOCKBURN, IL 60015

FOR: ELECTRONIC COMPONENTS, NAMELY, INTERCONNECT PRODUCTS, NAMELY, CO-AXIAL CONNECTORS, IN CLASS 9 (U.S. CLS. 21, 23, 26, 36 AND 38).

FIRST USE 9-22-2011; IN COMMERCE 9-22-2011.

THE MARK CONSISTS OF STANDARD CHARACTERS WITHOUT CLAIM TO ANY PARTICULAR FONT, STYLE, SIZE, OR COLOR.

SN 77-660,113, FILED 1-30-2009.

GIANCARLO CASTRO, EXAMINING ATTORNEY



David J. Kyros

Director of the United States Patent and Trademark Office

United States of America

United States Patent and Trademark Office



Reg. No. 4,067,607

Registered Dec. 6, 2011

Int. Cls.: 7 and 37

TRADEMARK

SERVICE MARK

PRINCIPAL REGISTER

B-DRY SYSTEM, INC. (OHIO CORPORATION)
350 HERTZ STARKS BUILDING
LOUISVILLE, KY 40202

FOR: BASEMENT WATERPROOFING SYSTEM COMPRISED OF WATER REMOVAL PUMPS AND PIPING, SHEETING ATTACHED TO WALLS FOR WATERPROOFING PURPOSES, WATERPROOFING PIPING AND SEALANT, AND ANTIMICROBIAL SPRAY TREATMENT, ALL SOLD TOGETHER AS A UNIT; CRAWLSPACE WATERPROOFING SYSTEM COMPRISED OF WATER REMOVAL PUMPS AND PIPING, AND ENCAPSULATION SHEETING, ALL SOLD TOGETHER AS A UNIT; SUMP PUMPS FOR USE IN REMOVING WATER FROM BASEMENTS AND CRAWLSPACES, IN CLASS 7 (U.S. CLS. 13, 19, 21, 23, 31, 34 AND 35).

FIRST USE 10-27-2010; IN COMMERCE 10-27-2010.

FOR: REPAIR, MAINTENANCE AND CONSULTATION IN THE FIELDS OF WATERPROOFING OF BASEMENTS AND WATERPROOFING OF CRAWL SPACES, IN CLASS 37 (U.S. CLS. 100, 103 AND 106).

FIRST USE 10-27-2010; IN COMMERCE 10-27-2010.

THE MARK CONSISTS OF A FANCIFUL DEPICTION OF A SUPERHERO BEE WEARING A UNIFORM WITH A CAPE AND THE LETTER "B" ACROSS THE FRONT OF THE UNIFORM.

SN 77-662,437, FILED 2-3-2009.

NICHOLAS ALTREE, EXAMINING ATTORNEY



David J. Kybas

Director of the United States Patent and Trademark Office

United States of America

United States Patent and Trademark Office



Reg. No. 4,067,608

Registered Dec. 6, 2011

Int. Cls.: 7 and 37

TRADEMARK

SERVICE MARK

PRINCIPAL REGISTER

B-DRY SYSTEM, INC. (OHIO CORPORATION)
350 HERTZ STARKS BUILDING
455 SOUTH 4TH STREET
LOUISVILLE, KY 40202

FOR: BASEMENT WATERPROOFING SYSTEM COMPRISED OF WATER REMOVAL PUMPS AND PIPING, SHEETING ATTACHED TO WALLS FOR WATERPROOFING PURPOSES, WATERPROOFING PIPING AND SEALANT, AND ANTIMICROBIAL SPRAY TREATMENT, ALL SOLD TOGETHER AS A UNIT; CRAWLSPACE WATERPROOFING SYSTEM COMPRISED OF WATER REMOVAL PUMPS AND PIPING, AND ENCAPSULATION SHEETING, ALL SOLD TOGETHER AS A UNIT; SUMP PUMPS FOR USE IN REMOVING WATER FROM BASEMENTS AND CRAWLSPACES, IN CLASS 7 (U.S. CLS. 13, 19, 21, 23, 31, 34 AND 35).

FIRST USE 10-27-2010; IN COMMERCE 10-27-2010.

FOR: REPAIR, MAINTENANCE AND CONSULTATION IN THE FIELDS OF WATERPROOFING OF BASEMENTS AND WATERPROOFING OF CRAWLSPACES, IN CLASS 37 (U.S. CLS. 100, 103 AND 106).

FIRST USE 10-27-2010; IN COMMERCE 10-27-2010.

THE MARK CONSISTS OF A FANCIFUL DEPICTION OF A BEE WEARING A CAPE AND A HEXAGONAL ICON BEARING THE LETTER "B", THE BODY OF THE BEE APPEARING IN GRAY WITH YELLOW STRIPES, THE HEAD OF THE BEE APPEARING IN YELLOW WITH THE INTERIOR OF ITS OPENED MOUTH APPEARING IN RED, ITS EYEBROWS AND FACIAL FEATURE OUTLINING APPEARING IN BLACK, AND ITS ANTENNAE AND EYES APPEARING IN BLACK AND WHITE, THE CAPE APPEARING IN RED, AND THE HEXAGONAL ICON APPEARING IN YELLOW WITH THE LETTER "B" IN BLACK AND THE ICON OUTLINED IN BLACK, WITH A RED STRIPE TO THE LEFT AND RIGHT OF THE LOWER PORTION OF THE ICON.

THE COLOR(S) GRAY, BLACK, RED, WHITE, AND YELLOW IS/ARE CLAIMED AS A FEATURE OF THE MARK.

SN 77-662,550, FILED 2-3-2009.

NICHOLAS ALTREE, EXAMINING ATTORNEY



David J. Kypos

Director of the United States Patent and Trademark Office

United States of America

United States Patent and Trademark Office

I.N. WORK

Reg. No. 4,067,609

IDEA NUOVA, INC. (NEW YORK CORPORATION)
302 FIFTH AVENUE
NEW YORK, NY 10001

Registered Dec. 6, 2011

Int. Cls.: 20 and 24

FOR: BEDROOM FURNITURE, NAMELY, TWIN BED FURNITURE AND NIGHTSTANDS;
MIRRORS, IN CLASS 20 (U.S. CLS. 2, 13, 22, 25, 32 AND 50).

TRADEMARK

FIRST USE 9-15-2009; IN COMMERCE 11-21-2009.

PRINCIPAL REGISTER

FOR: BED SKIRTS; COMFORTERS; PILLOW CASES; PILLOW SHAMS, IN CLASS 24 (U.S.
CLS. 42 AND 50).

FIRST USE 3-11-2009; IN COMMERCE 11-21-2009.

THE MARK CONSISTS OF STANDARD CHARACTERS WITHOUT CLAIM TO ANY PAR-
TICULAR FONT, STYLE, SIZE, OR COLOR.

SN 77-666,896, FILED 2-10-2009.

BARBARA A. GOLD, EXAMINING ATTORNEY



David J. Kybas

Director of the United States Patent and Trademark Office

United States of America

United States Patent and Trademark Office

TRADEHELM

Reg. No. 4,067,610

Registered Dec. 6, 2011

Int. Cls.: 9 and 42

TRADEMARK

SERVICE MARK

PRINCIPAL REGISTER

TRADEHELM, INC. (DELAWARE CORPORATION)
5727 S. LEWIS AVE., STE 500
TULSA, OK 74105

FOR: COMPUTER SOFTWARE, NAMELY, SOFTWARE FOR FACILITATING ELECTRONIC TRADING OF FINANCIAL INSTRUMENTS; SOFTWARE FOR ENABLING A USER TO DEFINE CHARACTERISTICS AND/OR RELATIONSHIPS OF FINANCIAL INSTRUMENTS; SOFTWARE FOR GAUGING THE DIFFERENCE BETWEEN THE CURRENT MARKET PRICE OF A FINANCIAL INSTRUMENT AND A TARGET PRICE OF THE INSTRUMENT; SOFTWARE FOR ADJUSTING PARAMETERS OF TRADE ORDERS THAT ARE PENDING AT AN ELECTRONIC EXCHANGE; SOFTWARE FOR RECOGNIZING AND ACTING ON FINANCIAL INSTRUMENT PRICE DISCREPANCIES BETWEEN DIFFERENT MARKETS; SOFTWARE FOR ALGORITHMIC TRADING OF FINANCIAL INSTRUMENTS; GRAPHICAL USER INTERFACE SOFTWARE FOR USE WITHIN AN ELECTRONIC TRADING ENVIRONMENT, IN CLASS 9 (U.S. CLS. 21, 23, 26, 36 AND 38).

FIRST USE 4-8-2011; IN COMMERCE 4-8-2011.

FOR: COMPUTER SOFTWARE DESIGN, DEVELOPMENT AND IMPLEMENTATION; CUSTOMIZATION OF COMPUTER SOFTWARE; COMPUTER SOFTWARE INSTALLATION AND MAINTENANCE; CONSULTATION SERVICES IN THE FIELDS OF COMPUTER HARDWARE AND SOFTWARE SYSTEMS FOR OTHERS, IN CLASS 42 (U.S. CLS. 100 AND 101).

FIRST USE 4-8-2011; IN COMMERCE 4-8-2011.

THE MARK CONSISTS OF STANDARD CHARACTERS WITHOUT CLAIM TO ANY PARTICULAR FONT, STYLE, SIZE, OR COLOR.

SN 77-669,013, FILED 2-12-2009.

DOMINICK J. SALEMI, EXAMINING ATTORNEY



David J. Kybas

Director of the United States Patent and Trademark Office

United States of America

United States Patent and Trademark Office

CURIOSITY

Reg. No. 4,067,611

Registered Dec. 6, 2011

Int. Cl.: 5

COMMONWEALTH OF AUSTRALIA AS REPRESENTED BY AND ACTING THROUGH
THE DEPARTMENT OF THE ENVIRONMENT, WATER, HERITAGE AND THE ARTS
(AUSTRALIA CORPORATION)
JOHN GORTON BUILDING
KING EDWARD TERRACE
PARKES, AUSTRALIA 2600

TRADEMARK

FOR: PREPARATIONS FOR THE CONTROL, DESTRUCTION AND ERADICATION OF
VERMIN AND PESTS, IN CLASS 5 (U.S. CLS. 6, 18, 44, 46, 51 AND 52).

PRINCIPAL REGISTER

FIRST USE 1-22-2011; IN COMMERCE 1-22-2011.

THE MARK CONSISTS OF STANDARD CHARACTERS WITHOUT CLAIM TO ANY PAR-
TICULAR FONT, STYLE, SIZE, OR COLOR.

PRIORITY CLAIMED UNDER SEC. 44(D) ON AUSTRALIA APPLICATION NO. 1258766,
FILED 8-22-2008.

SN 77-669,301, FILED 2-12-2009.

MARIA-VICTORIA SUAREZ, EXAMINING ATTORNEY



David J. Kybas

Director of the United States Patent and Trademark Office

United States of America

United States Patent and Trademark Office

LINKING CREATIVE SOLUTIONS TO INDUSTRY NEEDS

Reg. No. 4,067,612

Registered Dec. 6, 2011

Int. Cls.: 1, 4, 40, and 42

TRADEMARK

SERVICE MARK

PRINCIPAL REGISTER

OMNI INDUSTRIES, INC. (LOUISIANA CORPORATION)
7031 BRYCE CANYON AVENUE
GREENWELL SPRINGS, LA 70739

FOR: BRAKE FLUIDS; ANTIFREEZE, COOLANT; CHEMICALS FOR USE IN AUTOMOTIVE, AGRICULTURAL, OIL AND GAS, MINING, PETROCHEMICAL, PAPER MILL, LAWN AND GARDEN AND LIKE BUSINESSES AND INDUSTRIES, NAMELY, CHEMICALS FOR USE IN THE FIELD OF OIL EXPLORATION AND PRODUCTION, CHEMICALS FOR USE IN INDUSTRY, CHEMICALS FOR USE IN AGRICULTURE, EXCEPT FUNGICIDES, HERBICIDES, INSECTICIDES AND PARASITICIDES, IN CLASS 1 (U.S. CLS. 1, 5, 6, 10, 26 AND 46).

FIRST USE 5-0-2010; IN COMMERCE 5-0-2010.

FOR: LUBRICANTS FOR USE IN AUTOMOTIVE, AGRICULTURAL, OIL AND GAS, MINING, PETROCHEMICAL, PAPER MILL, LAWN AND GARDEN AND LIKE BUSINESSES AND INDUSTRIES, NAMELY, DRILLING LUBRICANTS, AUTOMOTIVE LUBRICANTS, INDUSTRIAL LUBRICANTS; ALL-PURPOSE LUBRICANTS, IN CLASS 4 (U.S. CLS. 1, 6 AND 15).

FIRST USE 5-0-2010; IN COMMERCE 5-0-2010.

FOR: CUSTOM BLENDING OF LUBRICANTS FOR INDUSTRIAL APPLICATIONS, MOTOR OILS, ENGINE OILS, AND WATER-BASED CHEMICALS, IN CLASS 40 (U.S. CLS. 100, 103 AND 106).

FIRST USE 5-0-2010; IN COMMERCE 5-0-2010.

FOR: PRODUCT TESTING, NAMELY, PRODUCT APPLICATION TESTING AND TRIALS; PROVIDING LABORATORY SERVICES FOR LUBRICANT, CHEMICAL, WATER, AND SOLVENT ANALYSIS, IN CLASS 42 (U.S. CLS. 100 AND 101).

FIRST USE 5-0-2010; IN COMMERCE 5-0-2010.

THE MARK CONSISTS OF STANDARD CHARACTERS WITHOUT CLAIM TO ANY PARTICULAR FONT, STYLE, SIZE, OR COLOR.

SN 77-669,692, FILED 2-12-2009.



David J. Kyros

Director of the United States Patent and Trademark Office

Reg. No. 4,067,612 ANDREA BUTLER, EXAMINING ATTORNEY

United States of America

United States Patent and Trademark Office

CARVEGA

Reg. No. 4,067,613

Registered Dec. 6, 2011

Int. Cl.: 18

TRADEMARK

PRINCIPAL REGISTER

TUITT, ASHLEY A (UNITED KINGDOM INDIVIDUAL)
2285 PEACHTREE RD #801
ATLANTA, GA 30309

FOR: ALL PURPOSE SPORT BAGS; ALL-PURPOSE ATHLETIC BAGS; ALL-PURPOSE CARRYING BAGS; ANIMAL CARRIERS; ANIMAL HARNESSSES; ANIMAL HIDES; ANIMAL LEASHES; ANIMAL SKINS; ANIMAL SKINS AND HIDES; ATHLETIC BAGS; ATTACHE CASES; BABY BACKPACKS; BABY CARRIERS WORN ON THE BODY; BABY CARRYING BAGS; BACK FRAMES FOR CARRYING CHILDREN; BACK PACKS; BACKPACKS; BACKPACKS; BACKPACKS, BOOK BAGS, SPORTS BAGS, BUM BAGS, WALLETS AND HANDBAGS; BAGS AND HOLDALLS FOR SPORTS CLOTHING; BAGS FOR CARRYING BABIES' ACCESSORIES; BAGS FOR SPORTS; BAGS FOR UMBRELLAS; BANDS OF LEATHER; BANKNOTE HOLDERS; BARREL BAGS; BEACH BAGS; BEACH UMBRELLAS; BEACH UMBRELLAS; BEACHBAGS; BELT BAGS; BELT BAGS AND HIP BAGS; BILL-FOLDS; BITS; BITS FOR ANIMALS; BLINDERS FOR HORSES; BLINKERS FOR HORSES; BOOK BAGS; BOSTON BAGS; BRIEFBAGS; BRIEFCASE-TYPE LEATHER BUSINESS FOLDERS; BRIEFCASE-TYPE PORTFOLIOS; BRIEFCASES; BRIEFCASES; BRIEFCASES; BRIEFCASES AND ATTACHE CASES; BRIEFCASES FOR DOCUMENTS; BUM BAGS; BUMBAGS; BUSINESS CARD CASES; BUSINESS CASES; CALLING CARD CASES; CANE HANDLES; CANES; CANES AND WALKING STICKS; CANTLE BAGS; CANVAS SHOPPING BAGS; CANVAS WOOD CARRIERS; CARD WALLETS; CARRY-ALL BAGS; CARRY-ON BAGS; CARRYALLS; CARRYING CASES; CARRYING CASES FOR DOCUMENTS; CATALOG CASES; CHANGE PURSES; CLOTHING FOR ANIMALS; CLOTHING FOR DOMESTIC PETS; CLUTCH BAGS; CLUTCH PURSES; CLUTCHES; COIN HOLDERS IN THE NATURE OF WALLETS; COIN PURSES; COIN PURSES NOT MADE OF PRECIOUS METAL; COIN PURSES, NOT OF PRECIOUS METALS; COLLARS FOR ANIMALS; COLLARS FOR PETS; COLLARS FOR PETS BEARING MEDICAL INFORMATION; COSMETIC BAGS SOLD EMPTY; COSMETIC CARRYING CASES SOLD EMPTY; COSMETIC CASES SOLD EMPTY; CREDIT CARD CASES; DAYPACKS; DIAPER BAGS; DOCUMENT CASES; DOG APPAREL; DOG CLOTHING; DOG COATS; DOG COLLARS; DOG COLLARS AND LEADS; DOG LEASHES; DOG PARKAS; DOG SHOES; DRAWSTRING BAGS; DRAWSTRING POUCHES; DUFFEL BAGS; DUFFEL BAGS FOR TRAVEL; DUFFEL BAGS; EQUINE LEG WRAPS; EVENING HANDBAGS; FACE MASKS FOR EQUINES; FANNY PACKS; FASHION HANDBAGS; FEED BAGS FOR ANIMALS; FELT POUCHES; FLEXIBLE BAGS FOR GARMENTS; FLIGHT BAGS; FOLDING BRIEFCASES; FOOTLOCKERS; FUR; GAITERS, NAMELY, JUMPING BOOTS FOR HORSES; GARMENT BAGS FOR TRAVEL; GARMENTS FOR PETS; GENERAL PURPOSE BAGS FOR CARRYING YOGA EQUIPMENT; GENERAL PURPOSE



David J. Kyros

Director of the United States Patent and Trademark Office

Reg. No. 4,067,613 BAGS FOR HOLDING DANCE EQUIPMENT; GLADSTONE BAGS; GOLF UMBRELLAS; GRIPSACKS; GYM BAGS; HANDBAG FRAMES; HANDBAGS; HANDBAGS FOR MEN; HANDBAGS, PURSES AND WALLETS; HANDLES OF CANES AND WALKING-STICKS; HARNESS FITTINGS; HARNESS FITTINGS NOT OF PRECIOUS METAL; HARNESS FITTINGS OF IRON; HARNESS STRAPS; HARNESS TRACES; HARNESSES; HARNESSES AND SADDLERY; HARNESSES SPECIALLY ADAPTED FOR CARRYING, HOLDING AND SECURING AIR BOTTLES USED BY UNDERWATER DIVERS; HAT BOXES FOR TRAVEL NOT OF PAPER OR CARDBOARD; HAT BOXES OF LEATHER; HAVERSACKS; HIKING BAGS; HIKING POLES; HIKING RUCKSACKS; HIKING STICKS; HIPSACKS; HOLDALLS; HOOF GUARDS; HORSE BLANKETS; HORSE BRIDLES; HORSE COLLARS; HORSE FLANKS AND SHANKS, NAMELY, HORSE PROTECTIVE PADDING, BRACES, AND LEG BOOTS FOR THE FLANKS AND LEGS; HORSE FLY VEILS FOR HORSES; HORSE HALTERS; HORSE RUGS; HORSE TAIL BAGS; HORSE TAIL WRAPS; HUNTING BAGS; IMITATION LEATHER; IMITATION LEATHER KEY CHAINS; INFANT CARRIERS WORN ON THE BODY; JAPANESE UTILITY POUCHES (SHINGEN-BUKURO); JEWELRY ORGANIZERS FOR TRAVEL; KEY BAGS; KEY CASE; KEY CASES; KEY WALLETS; KEY-CASES; KEY-CASES OF LEATHER AND SKINS; KEYCASES; KIT BAGS; KNAP SACKS; KNAPSACKS; LEASHES FOR ANIMALS; LEATHER; LEATHER AND IMITATION LEATHER; LEATHER AND IMITATION LEATHER BAGS; LEATHER BAGS AND WALLETS; LEATHER BAGS FOR MERCHANDISE PACKAGING; LEATHER BAGS, SUITCASES AND WALLETS; LEATHER BINDERS FOR TRAVEL PURPOSES; LEATHER BOXES FOR STORING GREETING CARDS; LEATHER BRIEFCASES; LEATHER CASES; LEATHER CASES FOR KEYS; LEATHER FOR FURNITURE; LEATHER FOR HARNESSES; LEATHER FOR SHOES; LEATHER HANDBAGS; LEATHER KEY CASES; LEATHER KEY CHAINS; LEATHER OR LEATHER-BOARD BOXES; LEATHER POUCHES; LEATHER PURSES; LEATHER SHOPPING BAGS; LEATHER SHOULDER BELTS; LEATHER SOLD IN BULK; LEATHER STRAPS; LEATHER THREAD; LEGGINGS FOR ANIMALS; LUGGAGE; LUGGAGE AND TRUNKS; LUGGAGE TAGS; MAKE-UP BAGS SOLD EMPTY; MEN'S CLUTCH BAGS; MESH SHOPPING BAGS; MESSENGER BAGS; MULTI-PURPOSE PURSES; MUZZLES; NAME CARD CASES; NON-MOTORIZED, COLLAPSIBLE LUGGAGE CARTS; OVERNIGHT BAGS; OVERNIGHT CASES; OVERNIGHT SUITCASES; PADS FOR HORSE SADDLES; PARASOLS; PARASOLS; PATIO UMBRELLAS; PELTS; PET ACCESSORIES, NAMELY, CANVAS, VINYL AND LEATHER POUCHES FOR HOLDING DISPOSABLE BAGS TO PLACE PET WASTE IN; PET ACCESSORIES, NAMELY, SPECIALLY DESIGNED CANVAS, VINYL OR LEATHER BAGS ATTACHED TO ANIMAL LEASHES FOR HOLDING SMALL ITEMS SUCH AS KEYS, CREDIT CARDS, MONEY OR DISPOSABLE BAGS FOR DISPOSING OF PET WASTE; PET CLOTHING; PET COLLAR ACCESSORIES, NAMELY, BOWS AND CHARMS; PET COLLAR ACCESSORIES, NAMELY, CHARMS; POCKET WALLETS; POCKETBOOKS; POLYURETHANE LEATHER; POMMEL BAGS; PORTMANTEAUS; PORTMANTEAUX; POUCHES AND BAGS SOLD EMPTY FOR ATTACHMENT TO BACKPACKS; POUCHES FOR HOLDING KEYS; POUCHES FOR HOLDING SCHOOL SUPPLIES THAT FITS OVER THE BACK OF A CHAIR; POUCHES OF LEATHER; PROTECTIVE FITTED LINERS FOR BACKPACKS AND LUGGAGE; PULLMANS; PURSE FRAMES; PURSES; PURSES; PURSES AND WALLETS; PURSES AND WALLETS OF PRECIOUS METAL; PURSES MADE OF PRECIOUS METAL; PURSES NOT MADE OF PRECIOUS METAL; PURSES OF PRECIOUS METAL; PURSES, NOT OF PRECIOUS METAL; RAINPROOF PARASOLS; REINS; REINS; REUSABLE SHOPPING BAGS; RIDING CROPS; RIDING SADDLES; ROLL BAGS; RUCK SACKS; RUCKSACKS; RUCKSACKS FOR MOUNTAINEERS; RUCKSACKS ON CASTORS; SADDLE BELTS; SADDLE BLANKETS; SADDLE COVERS; SADDLE HORN BAGS; SADDLE RACKS; SADDLEBAGS; SADDLERY; SADDLERY OF LEATHER; SADDLERY, NAMELY, HORN BAGS; SADDLES; SADDLETREES; SACHELS; SCHOOL BAGS; SCHOOL BOOK BAGS; SCHOOL KNAPSACKS; SCHOOL SATCHELS; SCHOOLBAGS; SCHOOLCHILDREN'S BACKPACKS; SHAVING BAGS SOLD EMPTY; SHOE BAGS FOR TRAVEL; SHOPPING BAGS MADE OF SKIN; SHOPPING BAGS WITH WHEELS ATTACHED; SHOULDER BAGS; SHOULDER STRAPS; SKINS AND HIDES; SLING BAGS; SLING BAGS FOR CARRYING INFANTS; SLINGS FOR CARRYING INFANTS; SMALL BACKPACKS; SMALL BAGS FOR MEN; SMALL CLUTCH PURSES; SMALL PURSES; SMALL RUCKSACKS; SMALL SUITCASES; SOUVENIR BAGS; SPORT BAGS; SPORTS BAGS; SPORTS PACKS; SPORTSMAN'S

Reg. No. 4,067,613 HUNTING BAGS; STIRRUPS; STIRRUPS OF METAL; STRAPS FOR CARRYALLS; STRAPS FOR CARRYING CASES; STRAPS FOR HANDBAGS; STRAPS FOR HOLDALLS; STRAPS FOR LUGGAGE; STRING BAGS FOR SHOPPING; SUIT BAGS; SUIT CARRIERS; SUITCASES; SUNSHADE PARASOLS; TABLE UMBRELLAS; TACK RACKS FOR EQUESTRIAN EQUIPMENT; TANNED LEATHER; TELESCOPIC UMBRELLAS; TEXTILE SHOPPING BAGS; THONGS; TICKET POUCHES; TIE CASES; TOILETRY BAGS SOLD EMPTY; TOILETRY CASES SOLD EMPTY; TOTE BAGS; TRAIN CASES; TRAINING FORKS FOR HORSES; TRAINING LEADS FOR HORSES; TRAVEL BAGS; TRAVEL CASES; TRAVELING BAGS; TRAVELLING BAGS; TRAVELLING CASES OF LEATHER; TRAVELLING TRUNKS; TRUNKS; UMBRELLA BASES; UMBRELLA COVERS; UMBRELLA FRAMES; UMBRELLA HANDLES; UMBRELLA RINGS; UMBRELLAS; UMBRELLAS AND PARASOLS; UMBRELLAS AND THEIR PARTS; UMBRELLAS FOR CHILDREN; UNFITTED VANITY CASES; VALISES; VANITY CASES SOLD EMPTY; WADING STAFFS; WAIST BAGS; WAIST PACKS; WALKING CANES; WALKING STICK HANDLES; WALKING STICK SEATS; WALKING STICKS; WALLET CHAINS; WALLETS; WALLETS; WALLETS AND WALLET INSERTS; WALLETS MADE OF LEATHER OR OTHER MATERIALS; WALLETS WITH CARD COMPARTMENTS; WASH BAGS FOR CARRYING TOILETRIES; WEARABLE STRAP-ON POUCH; WHEELED BAGS; WHEELED DUFFEL BAGS; WHEELED MESSENGER BAGS; WHEELED SHOPPING BAGS; WHEELED TOTE BAGS; WINE BAGS WITH HANDLES FOR CARRYING OR HOLDING WINE; WINE CARRYING CASES; WRIST MOUNTED CARRYALL BAGS; WRIST MOUNTED PURSES; WRISTLET BAGS , IN CLASS 18 (U.S. CLS. 1, 2, 3, 22 AND 41).

FIRST USE 8-30-2008; IN COMMERCE 9-20-2011.

THE MARK CONSISTS OF STANDARD CHARACTERS WITHOUT CLAIM TO ANY PARTICULAR FONT, STYLE, SIZE, OR COLOR.

SN 77-672,224, FILED S.R. 2-17-2009; AM. P.R. 11-7-2009.

MARGARET POWER, EXAMINING ATTORNEY

United States of America

United States Patent and Trademark Office



Reg. No. 4,067,614

Registered Dec. 6, 2011

Int. Cl.: 18

TRADEMARK

PRINCIPAL REGISTER

TUITT, ASHLEY A (UNITED KINGDOM INDIVIDUAL)
2285 PEACHTREE RD #801
ATLANTA, GA 30309

FOR: ALL PURPOSE SPORT BAGS; ALL-PURPOSE ATHLETIC BAGS; ALL-PURPOSE CARRYING BAGS; ANIMAL CARRIERS; ANIMAL HARNESSSES; ANIMAL HIDES; ANIMAL LEASHES; ANIMAL SKINS; ANIMAL SKINS AND HIDES; ATHLETIC BAGS; ATTACHE CASES; BABY BACKPACKS; BABY CARRIERS WORN ON THE BODY; BABY CARRYING BAGS; BACK FRAMES FOR CARRYING CHILDREN; BACK PACKS; BACKPACKS; BACKPACKS; BACKPACKS, BOOK BAGS, SPORTS BAGS, BUM BAGS, WALLETS AND HANDBAGS; BAGS AND HOLDALLS FOR SPORTS CLOTHING; BAGS FOR CARRYING BABIES' ACCESSORIES; BAGS FOR SPORTS; BAGS FOR UMBRELLAS; BANDS OF LEATHER; BANK NOTE HOLDERS; BARREL BAGS; BEACH BAGS; BEACH UMBRELLAS; BEACH UMBRELLAS; BEACH BAGS; BELT BAGS; BELT BAGS AND HIP BAGS; BILL-FOLDS; BITS; BITS FOR ANIMALS; BLINDERS FOR HORSES; BLINKERS FOR HORSES; BOOK BAGS; BOSTON BAGS; BRIEF BAGS; BRIEFCASE-TYPE LEATHER BUSINESS FOLDERS; BRIEFCASE-TYPE PORTFOLIOS; BRIEFCASES; BRIEFCASES; BRIEFCASES; BRIEFCASES AND ATTACHE CASES; BRIEFCASES FOR DOCUMENTS; BUM BAGS; BUMBAGS; BUSINESS CARD CASES; BUSINESS CASES; CALLING CARD CASES; CANE HANDLES; CANES; CANES AND WALKING STICKS; CANTLE BAGS; CANVAS SHOPPING BAGS; CANVAS WOOD CARRIERS; CARD WALLETS; CARRY-ALL BAGS; CARRY-ON BAGS; CARRYALLS; CARRYING CASES; CARRYING CASES FOR DOCUMENTS; CATALOG CASES; CHANGE PURSES; CLOTHING FOR ANIMALS; CLOTHING FOR DOMESTIC PETS; CLUTCH BAGS; CLUTCH PURSES; CLUTCHES; COIN HOLDERS IN THE NATURE OF WALLETS; COIN PURSES; COIN PURSES NOT MADE OF PRECIOUS METAL; COIN PURSES, NOT OF PRECIOUS METALS; COLLARS FOR ANIMALS; COLLARS FOR PETS; COLLARS FOR PETS BEARING MEDICAL INFORMATION; COSMETIC BAGS SOLD EMPTY; COSMETIC CARRYING CASES SOLD EMPTY; COSMETIC CASES SOLD EMPTY; CREDIT CARD CASES; DAY PACKS; DIAPER BAGS; DOCUMENT CASES; DOG APPAREL; DOG CLOTHING; DOG COATS; DOG COLLARS; DOG COLLARS AND LEADS; DOG LEASHES; DOG PARKAS; DOG SHOES; DRAWSTRING BAGS; DRAWSTRING POUCHES; DUFFEL BAGS; DUFFEL BAGS FOR TRAVEL; DUFFLE BAGS; EQUINE LEG WRAPS; EVENING HANDBAGS; FACE MASKS FOR EQUINES; FANNY PACKS; FASHION HANDBAGS; FEED BAGS FOR ANIMALS; FELT POUCHES; FLEXIBLE BAGS FOR GARMENTS; FLIGHT BAGS; FOLDING BRIEFCASES; FOOTLOCKERS; FUR; GAITERS, NAMELY, JUMPING BOOTS FOR HORSES; GARMENT BAGS FOR TRAVEL; GARMENTS FOR PETS; GENERAL PURPOSE BAGS FOR CARRYING YOGA EQUIPMENT; GENERAL PURPOSE



David J. Kyros

Director of the United States Patent and Trademark Office

Reg. No. 4,067,614 BAGS FOR HOLDING DANCE EQUIPMENT; GLADSTONE BAGS; GOLF UMBRELLAS; GRIPSACKS; GYM BAGS; HANDBAG FRAMES; HANDBAGS; HANDBAGS FOR MEN; HANDBAGS, PURSES AND WALLETS; HANDLES OF CANES AND WALKING-STICKS; HARNESS FITTINGS; HARNESS FITTINGS NOT OF PRECIOUS METAL; HARNESS FITTINGS OF IRON; HARNESS STRAPS; HARNESS TRACES; HARNESES; HARNESES AND SADDLERY; HARNESES SPECIALLY ADAPTED FOR CARRYING, HOLDING AND SECURING AIR BOTTLES USED BY UNDERWATER DIVERS; HAT BOXES FOR TRAVEL NOT OF PAPER OR CARDBOARD; HAT BOXES OF LEATHER; HAVERSACKS; HIKING BAGS; HIKING POLES; HIKING RUCKSACKS; HIKING STICKS; HIPSACKS; HOLDALLS; HOOF GUARDS; HORSE BLANKETS; HORSE BRIDLES; HORSE COLLARS; HORSE FLANKS AND SHANKS, NAMELY, HORSE PROTECTIVE PADDING, BRACES, AND LEG BOOTS FOR THE FLANKS AND LEGS; HORSE FLY VEILS FOR HORSES; HORSE HALTERS; HORSE RUGS; HORSE TAIL BAGS; HORSE TAIL WRAPS; HUNTING BAGS; IMITATION LEATHER; IMITATION LEATHER KEY CHAINS; INFANT CARRIERS WORN ON THE BODY; JAPANESE UTILITY POUCHES (SHINGEN-BUKURO); JEWELRY ORGANIZERS FOR TRAVEL; KEY BAGS; KEY CASE; KEY CASES; KEY WALLETS; KEY-CASES; KEY-CASES OF LEATHER AND SKINS; KEY CASES; KIT BAGS; KNAP SACKS; KNAPSACKS; LEASHES FOR ANIMALS; LEATHER; LEATHER AND IMITATION LEATHER; LEATHER AND IMITATION LEATHER BAGS; LEATHER BAGS AND WALLETS; LEATHER BAGS FOR MERCHANDISE PACKAGING; LEATHER BAGS, SUITCASES AND WALLETS; LEATHER BINDERS FOR TRAVEL PURPOSES; LEATHER BOXES FOR STORING GREETING CARDS; LEATHER BRIEFCASES; LEATHER CASES; LEATHER CASES FOR KEYS; LEATHER FOR FURNITURE; LEATHER FOR HARNESES; LEATHER FOR SHOES; LEATHER HANDBAGS; LEATHER KEY CASES; LEATHER KEY CHAINS; LEATHER OR LEATHER-BOARD BOXES; LEATHER POUCHES; LEATHER PURSES; LEATHER SHOPPING BAGS; LEATHER SHOULDER BELTS; LEATHER SOLD IN BULK; LEATHER STRAPS; LEATHER THREAD; LEGGINGS FOR ANIMALS; LUGGAGE; LUGGAGE AND TRUNKS; LUGGAGE TAGS; MAKE-UP BAGS SOLD EMPTY; MEN'S CLUTCH BAGS; MESH SHOPPING BAGS; MESSENGER BAGS; MULTI-PURPOSE PURSES; MUZZLES; NAME CARD CASES; NON-MOTORIZED, COLLAPSIBLE LUGGAGE CARTS; OVERNIGHT BAGS; OVERNIGHT CASES; OVERNIGHT SUITCASES; PADS FOR HORSE SADDLES; PARASOLS; PARASOLS; PATIO UMBRELLAS; PELTS; PET ACCESSORIES, NAMELY, CANVAS, VINYL AND LEATHER POUCHES FOR HOLDING DISPOSABLE BAGS TO PLACE PET WASTE IN; PET ACCESSORIES, NAMELY, SPECIALLY DESIGNED CANVAS, VINYL OR LEATHER BAGS ATTACHED TO ANIMAL LEASHES FOR HOLDING SMALL ITEMS SUCH AS KEYS, CREDIT CARDS, MONEY OR DISPOSABLE BAGS FOR DISPOSING OF PET WASTE; PET CLOTHING; PET COLLAR ACCESSORIES, NAMELY, BOWS AND CHARMS; PET COLLAR ACCESSORIES, NAMELY, CHARMS; POCKET WALLETS; POCKETBOOKS; POLYURETHANE LEATHER; POMMEL BAGS; PORTMANTEAUS; PORTMANTEAUX; POUCHES AND BAGS SOLD EMPTY FOR ATTACHMENT TO BACKPACKS; POUCHES FOR HOLDING KEYS; POUCHES FOR HOLDING SCHOOL SUPPLIES THAT FITS OVER THE BACK OF A CHAIR; POUCHES OF LEATHER; PROTECTIVE FITTED LINERS FOR BACKPACKS AND LUGGAGE; PULLMANS; PURSE FRAMES; PURSES; PURSES; PURSES AND WALLETS; PURSES AND WALLETS OF PRECIOUS METAL; PURSES MADE OF PRECIOUS METAL; PURSES NOT MADE OF PRECIOUS METAL; PURSES OF PRECIOUS METAL; PURSES, NOT OF PRECIOUS METAL; RAINPROOF PARASOLS; REINS; REINS; REUSABLE SHOPPING BAGS; RIDING CROPS; RIDING SADDLES; ROLL BAGS; RUCK SACKS; RUCKSACKS; RUCKSACKS FOR MOUNTAINEERS; RUCKSACKS ON CASTORS; SADDLE BELTS; SADDLE BLANKETS; SADDLE COVERS; SADDLE HORN BAGS; SADDLE RACKS; SADDLEBAGS; SADDLERY; SADDLERY OF LEATHER; SADDLERY, NAMELY, HORN BAGS; SADDLES; SADDLETREES; SACHELS; SCHOOL BAGS; SCHOOL BOOK BAGS; SCHOOL KNAPSACKS; SCHOOL SATCHELS; SCHOOLBAGS; SCHOOLCHILDREN'S BACKPACKS; SHAVING BAGS SOLD EMPTY; SHOE BAGS FOR TRAVEL; SHOPPING BAGS MADE OF SKIN; SHOPPING BAGS WITH WHEELS ATTACHED; SHOULDER BAGS; SHOULDER STRAPS; SKINS AND HIDES; SLING BAGS; SLING BAGS FOR CARRYING INFANTS; SLINGS FOR CARRYING INFANTS; SMALL BACKPACKS; SMALL BAGS FOR MEN; SMALL CLUTCH PURSES; SMALL PURSES; SMALL RUCKSACKS; SMALL SUITCASES; SOUVENIR BAGS; SPORT BAGS; SPORTS BAGS; SPORTS PACKS; SPORTSMAN'S

Reg. No. 4,067,614 HUNTING BAGS; STIRRUPS; STIRRUPS OF METAL; STRAPS FOR CARRYALLS; STRAPS FOR CARRYING CASES; STRAPS FOR HANDBAGS; STRAPS FOR HOLDALLS; STRAPS FOR LUGGAGE; STRING BAGS FOR SHOPPING; SUIT BAGS; SUIT CARRIERS; SUITCASES; SUNSHADE PARASOLS; TABLE UMBRELLAS; TACK RACKS FOR EQUESTRIAN EQUIPMENT; TANNED LEATHER; TELESCOPIC UMBRELLAS; TEXTILE SHOPPING BAGS; THONGS; TICKET POUCHES; TIE CASES; TOILETRY BAGS SOLD EMPTY; TOILETRY CASES SOLD EMPTY; TOTE BAGS; TRAIN CASES; TRAINING FORKS FOR HORSES; TRAINING LEADS FOR HORSES; TRAVEL BAGS; TRAVEL CASES; TRAVELING BAGS; TRAVELLING BAGS; TRAVELLING CASES OF LEATHER; TRAVELLING TRUNKS; TRUNKS; UMBRELLA BASES; UMBRELLA COVERS; UMBRELLA FRAMES; UMBRELLA HANDLES; UMBRELLA RINGS; UMBRELLAS; UMBRELLAS AND PARASOLS; UMBRELLAS AND THEIR PARTS; UMBRELLAS FOR CHILDREN; UNFITTED VANITY CASES; VALISES; VANITY CASES SOLD EMPTY; WADING STAFFS; WAIST BAGS; WAIST PACKS; WALKING CANES; WALKING STICK HANDLES; WALKING STICK SEATS; WALKING STICKS; WALLET CHAINS; WALLETS; WALLETS; WALLETS AND WALLET INSERTS; WALLETS MADE OF LEATHER OR OTHER MATERIALS; WALLETS WITH CARD COMPARTMENTS; WASH BAGS FOR CARRYING TOILETRIES; WEARABLE STRAP-ON POUCH; WHEELED BAGS; WHEELED DUFFLE BAGS; WHEELED MESSENGER BAGS; WHEELED SHOPPING BAGS; WHEELED TOTE BAGS; WINE BAGS WITH HANDLES FOR CARRYING OR HOLDING WINE; WINE CARRYING CASES; WRIST MOUNTED CARRYALL BAGS; WRIST MOUNTED PURSES; WRISTLET BAGS , IN CLASS 18 (U.S. CLS. 1, 2, 3, 22 AND 41).

FIRST USE 8-30-2008; IN COMMERCE 9-20-2011.

THE MARK CONSISTS OF THE WORD "CARVEGA" IN A STYLIZED FONT.

SN 77-672,326, FILED S.R. 2-17-2009; AM. P.R. 11-7-2009.

MARGARET POWER, EXAMINING ATTORNEY

United States of America

United States Patent and Trademark Office

THE CARVEGA COMPANY

Reg. No. 4,067,615

Registered Dec. 6, 2011

Int. Cl.: 18

TRADEMARK

PRINCIPAL REGISTER

TUITT, ASHLEY A (UNITED KINGDOM INDIVIDUAL)
2285 PEACHTREE RD #801
ATLANTA, GA 30309

FOR: ALL PURPOSE SPORT BAGS; ALL-PURPOSE ATHLETIC BAGS; ALL-PURPOSE CARRYING BAGS; ANIMAL CARRIERS; ANIMAL HARNESSSES; ANIMAL HIDES; ANIMAL LEASHES; ANIMAL SKINS; ANIMAL SKINS AND HIDES; ATHLETIC BAGS; ATTACHE CASES; BABY BACKPACKS; BABY CARRIERS WORN ON THE BODY; BABY CARRYING BAGS; BACK FRAMES FOR CARRYING CHILDREN; BACK PACKS; BACKPACKS; BACKPACKS; BACKPACKS, BOOK BAGS, SPORTS BAGS, BUM BAGS, WALLETS AND HANDBAGS; BAGS AND HOLDALLS FOR SPORTS CLOTHING; BAGS FOR CARRYING BABIES' ACCESSORIES; BAGS FOR SPORTS; BAGS FOR UMBRELLAS; BANDS OF LEATHER; BANK NOTE HOLDERS; BARREL BAGS; BEACH BAGS; BEACH UMBRELLAS; BEACH UMBRELLAS; BEACH BAGS; BELT BAGS; BELT BAGS AND HIP BAGS; BILL-FOLDS; BITS; BITS FOR ANIMALS; BLINDERS FOR HORSES; BLINKERS FOR HORSES; BOOK BAGS; BOSTON BAGS; BRIEF BAGS; BRIEFCASE-TYPE LEATHER BUSINESS FOLDERS; BRIEFCASE-TYPE PORTFOLIOS; BRIEFCASES; BRIEFCASES; BRIEFCASES; BRIEFCASES AND ATTACHE CASES; BRIEFCASES FOR DOCUMENTS; BUM BAGS; BUMBAGS; BUSINESS CARD CASES; BUSINESS CASES; CALLING CARD CASES; CANE HANDLES; CANES; CANES AND WALKING STICKS; CANTLE BAGS; CANVAS SHOPPING BAGS; CANVAS WOOD CARRIERS; CARD WALLETS; CARRY-ALL BAGS; CARRY-ON BAGS; CARRYALLS; CARRYING CASES; CARRYING CASES FOR DOCUMENTS; CATALOG CASES; CHANGE PURSES; CLOTHING FOR ANIMALS; CLOTHING FOR DOMESTIC PETS; CLUTCH BAGS; CLUTCH PURSES; CLUTCHES; COIN HOLDERS IN THE NATURE OF WALLETS; COIN PURSES; COIN PURSES NOT MADE OF PRECIOUS METAL; COIN PURSES, NOT OF PRECIOUS METALS; COLLARS FOR ANIMALS; COLLARS FOR PETS; COLLARS FOR PETS BEARING MEDICAL INFORMATION; COSMETIC BAGS SOLD EMPTY; COSMETIC CARRYING CASES SOLD EMPTY; COSMETIC CASES SOLD EMPTY; CREDIT CARD CASES; DAY PACKS; DIAPER BAGS; DOCUMENT CASES; DOG APPAREL; DOG CLOTHING; DOG COATS; DOG COLLARS; DOG COLLARS AND LEADS; DOG LEASHES; DOG PARKAS; DOG SHOES; DRAWSTRING BAGS; DRAWSTRING POUCHES; DUFFEL BAGS; DUFFEL BAGS FOR TRAVEL; DUFFLE BAGS; EQUINE LEG WRAPS; EVENING HANDBAGS; FACE MASKS FOR EQUINES; FANNY PACKS; FASHION HANDBAGS; FEED BAGS FOR ANIMALS; FELT POUCHES; FLEXIBLE BAGS FOR GARMENTS; FLIGHT BAGS; FOLDING BRIEFCASES; FOOTLOCKERS; FUR; GAITERS, NAMELY, JUMPING BOOTS FOR HORSES; GARMENT BAGS FOR TRAVEL; GARMENTS FOR PETS; GENERAL PURPOSE BAGS FOR CARRYING YOGA EQUIPMENT; GENERAL PURPOSE



David J. Kyros

Director of the United States Patent and Trademark Office

Reg. No. 4,067,615 BAGS FOR HOLDING DANCE EQUIPMENT; GLADSTONE BAGS; GOLF UMBRELLAS; GRIPSACKS; GYM BAGS; HANDBAG FRAMES; HANDBAGS; HANDBAGS FOR MEN; HANDBAGS, PURSES AND WALLETS; HANDLES OF CANES AND WALKING-STICKS; HARNESS FITTINGS; HARNESS FITTINGS NOT OF PRECIOUS METAL; HARNESS FITTINGS OF IRON; HARNESS STRAPS; HARNESS TRACES; HARNESES; HARNESES AND SADDLERY; HARNESES SPECIALLY ADAPTED FOR CARRYING, HOLDING AND SECURING AIR BOTTLES USED BY UNDERWATER DIVERS; HAT BOXES FOR TRAVEL NOT OF PAPER OR CARDBOARD; HAT BOXES OF LEATHER; HAVERSACKS; HIKING BAGS; HIKING POLES; HIKING RUCKSACKS; HIKING STICKS; HIPSACKS; HOLDALLS; HOOF GUARDS; HORSE BLANKETS; HORSE BRIDLES; HORSE COLLARS; HORSE FLANKS AND SHANKS, NAMELY, HORSE PROTECTIVE PADDING, BRACES, AND LEG BOOTS FOR THE FLANKS AND LEGS; HORSE FLY VEILS FOR HORSES; HORSE HALTERS; HORSE RUGS; HORSE TAIL BAGS; HORSE TAIL WRAPS; HUNTING BAGS; IMITATION LEATHER; IMITATION LEATHER KEY CHAINS; INFANT CARRIERS WORN ON THE BODY; JAPANESE UTILITY POUCHES (SHINGEN-BUKURO); JEWELRY ORGANIZERS FOR TRAVEL; KEY BAGS; KEY CASE; KEY CASES; KEY WALLETS; KEY-CASES; KEY-CASES OF LEATHER AND SKINS; KEY CASES; KIT BAGS; KNAP SACKS; KNAPSACKS; LEASHES FOR ANIMALS; LEATHER; LEATHER AND IMITATION LEATHER; LEATHER AND IMITATION LEATHER BAGS; LEATHER BAGS AND WALLETS; LEATHER BAGS FOR MERCHANDISE PACKAGING; LEATHER BAGS, SUITCASES AND WALLETS; LEATHER BINDERS FOR TRAVEL PURPOSES; LEATHER BOXES FOR STORING GREETING CARDS; LEATHER BRIEFCASES; LEATHER CASES; LEATHER CASES FOR KEYS; LEATHER FOR FURNITURE; LEATHER FOR HARNESES; LEATHER FOR SHOES; LEATHER HANDBAGS; LEATHER KEY CASES; LEATHER KEY CHAINS; LEATHER OR LEATHER-BOARD BOXES; LEATHER POUCHES; LEATHER PURSES; LEATHER SHOPPING BAGS; LEATHER SHOULDER BELTS; LEATHER SOLD IN BULK; LEATHER STRAPS; LEATHER THREAD; LEGGINGS FOR ANIMALS; LUGGAGE; LUGGAGE AND TRUNKS; LUGGAGE TAGS; MAKE-UP BAGS SOLD EMPTY; MEN'S CLUTCH BAGS; MESH SHOPPING BAGS; MESSENGER BAGS; MULTI-PURPOSE PURSES; MUZZLES; NAME CARD CASES; NON-MOTORIZED, COLLAPSIBLE LUGGAGE CARTS; OVERNIGHT BAGS; OVERNIGHT CASES; OVERNIGHT SUITCASES; PADS FOR HORSE SADDLES; PARASOLS; PARASOLS; PATIO UMBRELLAS; PELTS; PET ACCESSORIES, NAMELY, CANVAS, VINYL AND LEATHER POUCHES FOR HOLDING DISPOSABLE BAGS TO PLACE PET WASTE IN; PET ACCESSORIES, NAMELY, SPECIALLY DESIGNED CANVAS, VINYL OR LEATHER BAGS ATTACHED TO ANIMAL LEASHES FOR HOLDING SMALL ITEMS SUCH AS KEYS, CREDIT CARDS, MONEY OR DISPOSABLE BAGS FOR DISPOSING OF PET WASTE; PET CLOTHING; PET COLLAR ACCESSORIES, NAMELY, BOWS AND CHARMS; PET COLLAR ACCESSORIES, NAMELY, CHARMS; POCKET WALLETS; POCKETBOOKS; POLYURETHANE LEATHER; POMMEL BAGS; PORTMANTEAUS; PORTMANTEAUX; POUCHES AND BAGS SOLD EMPTY FOR ATTACHMENT TO BACKPACKS; POUCHES FOR HOLDING KEYS; POUCHES FOR HOLDING SCHOOL SUPPLIES THAT FITS OVER THE BACK OF A CHAIR; POUCHES OF LEATHER; PROTECTIVE FITTED LINERS FOR BACKPACKS AND LUGGAGE; PULLMANS; PURSE FRAMES; PURSES; PURSES; PURSES AND WALLETS; PURSES AND WALLETS OF PRECIOUS METAL; PURSES MADE OF PRECIOUS METAL; PURSES NOT MADE OF PRECIOUS METAL; PURSES OF PRECIOUS METAL; PURSES, NOT OF PRECIOUS METAL; RAINPROOF PARASOLS; REINS; REINS; REUSABLE SHOPPING BAGS; RIDING CROPS; RIDING SADDLES; ROLL BAGS; RUCK SACKS; RUCKSACKS; RUCKSACKS FOR MOUNTAINEERS; RUCKSACKS ON CASTORS; SADDLE BELTS; SADDLE BLANKETS; SADDLE COVERS; SADDLE HORN BAGS; SADDLE RACKS; SADDLEBAGS; SADDLERY; SADDLERY OF LEATHER; SADDLERY, NAMELY, HORN BAGS; SADDLES; SADDLETREES; SACHELS; SCHOOL BAGS; SCHOOL BOOK BAGS; SCHOOL KNAPSACKS; SCHOOL SATCHELS; SCHOOLBAGS; SCHOOLCHILDREN'S BACKPACKS; SHAVING BAGS SOLD EMPTY; SHOE BAGS FOR TRAVEL; SHOPPING BAGS MADE OF SKIN; SHOPPING BAGS WITH WHEELS ATTACHED; SHOULDER BAGS; SHOULDER STRAPS; SKINS AND HIDES; SLING BAGS; SLING BAGS FOR CARRYING INFANTS; SLINGS FOR CARRYING INFANTS; SMALL BACKPACKS; SMALL BAGS FOR MEN; SMALL CLUTCH PURSES; SMALL PURSES; SMALL RUCKSACKS; SMALL SUITCASES; SOUVENIR BAGS; SPORT BAGS; SPORTS BAGS; SPORTS PACKS; SPORTSMAN'S

Reg. No. 4,067,615 HUNTING BAGS; STIRRUPS; STIRRUPS OF METAL; STRAPS FOR CARRYALLS; STRAPS FOR CARRYING CASES; STRAPS FOR HANDBAGS; STRAPS FOR HOLDALLS; STRAPS FOR LUGGAGE; STRING BAGS FOR SHOPPING; SUIT BAGS; SUIT CARRIERS; SUITCASES; SUNSHADE PARASOLS; TABLE UMBRELLAS; TACK RACKS FOR EQUESTRIAN EQUIPMENT; TANNED LEATHER; TELESCOPIC UMBRELLAS; TEXTILE SHOPPING BAGS; THONGS; TICKET POUCHES; TIE CASES; TOILETRY BAGS SOLD EMPTY; TOILETRY CASES SOLD EMPTY; TOTE BAGS; TRAIN CASES; TRAINING FORKS FOR HORSES; TRAINING LEADS FOR HORSES; TRAVEL BAGS; TRAVEL CASES; TRAVELING BAGS; TRAVELLING BAGS; TRAVELLING CASES OF LEATHER; TRAVELLING TRUNKS; TRUNKS; UMBRELLA BASES; UMBRELLA COVERS; UMBRELLA FRAMES; UMBRELLA HANDLES; UMBRELLA RINGS; UMBRELLAS; UMBRELLAS AND PARASOLS; UMBRELLAS AND THEIR PARTS; UMBRELLAS FOR CHILDREN; UNFITTED VANITY CASES; VALISES; VANITY CASES SOLD EMPTY; WADING STAFFS; WAIST BAGS; WAIST PACKS; WALKING CANES; WALKING STICK HANDLES; WALKING STICK SEATS; WALKING STICKS; WALLET CHAINS; WALLETS; WALLETS; WALLETS AND WALLET INSERTS; WALLETS MADE OF LEATHER OR OTHER MATERIALS; WALLETS WITH CARD COMPARTMENTS; WASH BAGS FOR CARRYING TOILETRIES; WEARABLE STRAP-ON POUCH; WHEELED BAGS; WHEELED DUFFLE BAGS; WHEELED MESSENGER BAGS; WHEELED SHOPPING BAGS; WHEELED TOTE BAGS; WHIPS; WINE BAGS WITH HANDLES FOR CARRYING OR HOLDING WINE; WINE CARRYING CASES; WRIST MOUNTED CARRYALL BAGS; WRIST MOUNTED PURSES; WRISTLET BAGS , IN CLASS 18 (U.S. CLS. 1, 2, 3, 22 AND 41).

FIRST USE 8-30-2008; IN COMMERCE 9-20-2011.

THE MARK CONSISTS OF STANDARD CHARACTERS WITHOUT CLAIM TO ANY PARTICULAR FONT, STYLE, SIZE, OR COLOR.

NO CLAIM IS MADE TO THE EXCLUSIVE RIGHT TO USE "COMPANY", APART FROM THE MARK AS SHOWN.

THE WORDING "CARVEGA" HAS NO MEANING IN A FOREIGN LANGUAGE.

SN 77-672,356, FILED S.R. 2-17-2009; AM. P.R. 11-7-2009.

MARGARET POWER, EXAMINING ATTORNEY

United States of America

United States Patent and Trademark Office

carbo
CleanAir 

Reg. No. 4,067,616

Registered Dec. 6, 2011

Int. Cls.: 3 and 7

TRADEMARK

PRINCIPAL REGISTER

SAINT-GOBAIN ABRASIVES, INC. (MASSACHUSETTS CORPORATION)
ONE NEW BOND STREET
WORCESTER, MA 01615

FOR: COATED ABRASIVE DISCS AND BACK-UP PADS USED ON PORTABLE MACHINES ON PAINTED AND PRIMED SURFACES, COMPOSITES AND GEL COAT, AND NONFERROUS METALS AND WOOD, IN CLASS 3 (U.S. CLS. 1, 4, 6, 50, 51 AND 52).

FIRST USE 5-0-2009; IN COMMERCE 5-0-2009.

FOR: MACHINES TOOLS, NAMELY, POWER OPERATED ABRASIVE DISCS, ALL FOR USE WITH POWER-OPERATED MACHINES FOR ABRADING, GRINDING, SHARPENING, TRIMMING, SURFACING AND POLISHING; AND REPLACEMENT VACUUM BAGS, IN CLASS 7 (U.S. CLS. 13, 19, 21, 23, 31, 34 AND 35).

FIRST USE 5-0-2009; IN COMMERCE 5-0-2009.

NO CLAIM IS MADE TO THE EXCLUSIVE RIGHT TO USE "CLEAN AIR", APART FROM THE MARK AS SHOWN.

THE MARK CONSISTS OF THE WORDS "CARBO CLEAN AIR", WITH THE WORD "CARBO" APPEARING ABOVE THE WORDS "CLEAN AIR", AND A CIRCLE DESIGN WITH DOTS THROUGHOUT THE CIRCLE, APPEARING AFTER THE WORD "AIR".

SN 77-672,481, FILED 2-18-2009.

LINDA ESTRADA, EXAMINING ATTORNEY



David J. Kybas

Director of the United States Patent and Trademark Office

United States of America

United States Patent and Trademark Office

SMART LIGHTS!

Reg. No. 4,067,617

Registered Dec. 6, 2011

Int. Cl.: 28

TRADEMARK

PRINCIPAL REGISTER

HOBBY LOBBY STORES, INC. (OKLAHOMA CORPORATION)
7707 SOUTHWEST 44TH STREET
OKLAHOMA CITY, OK 73179

FOR: ARTIFICIAL CHRISTMAS TREES; PRE-LIT ARTIFICIAL CHRISTMAS TREES, IN CLASS 28 (U.S. CLS. 22, 23, 38 AND 50).

FIRST USE 8-15-2009; IN COMMERCE 8-15-2009.

THE MARK CONSISTS OF STANDARD CHARACTERS WITHOUT CLAIM TO ANY PARTICULAR FONT, STYLE, SIZE, OR COLOR.

NO CLAIM IS MADE TO THE EXCLUSIVE RIGHT TO USE "LIGHTS", APART FROM THE MARK AS SHOWN.

SN 77-673,442, FILED 2-19-2009.

BARBARA RUTLAND, EXAMINING ATTORNEY



David J. Kybas

Director of the United States Patent and Trademark Office

United States of America

United States Patent and Trademark Office

ANAVERO

Reg. No. 4,067,618

Registered Dec. 6, 2011

Int. Cl.: 35

SERVICE MARK

PRINCIPAL REGISTER

WILSON, VERONICA (UNITED STATES INDIVIDUAL)
3791 PARKDALE ROAD
CLEVELAND HEIGHTS, OH 44121

FOR: ADVERTISING AND PROMOTION SERVICES AND RELATED CONSULTING; ADVERTISING SERVICES, NAMELY, CREATING CORPORATE AND BRAND IDENTITY FOR OTHERS; BRAND IMAGERY CONSULTING SERVICES; BRANDING SERVICES, NAMELY, CONSULTING, DEVELOPMENT, MANAGEMENT AND MARKETING OF BRANDS FOR BUSINESSES; BUSINESS CONSULTATION AND MANAGEMENT REGARDING MARKETING ACTIVITIES AND LAUNCHING OF NEW PRODUCTS; BUSINESS MANAGEMENT AND CONSULTATION; ON-LINE RETAIL STORE SERVICES FEATURING JEWELRY, CLOTHING, ACCESSORIES, BEAUTY PRODUCTS, NAMELY, SOAPS, LOTIONS, CREAMS, FRAGRANCES, INCENSE, OILS, BATH AND BODY PRODUCTS; OPERATING AN ON-LINE SHOPPING SITE IN THE FIELD OF JEWELRY, CLOTHING, ACCESSORIES, BEAUTY PRODUCTS, NAMELY, SOAPS, LOTIONS, CREAMS, FRAGRANCES, INCENSE, OILS, BATH AND BODY PRODUCTS; PROMOTING THE GOODS AND SERVICES OF OTHERS VIA A GLOBAL COMPUTER NETWORK; PROMOTION AND MARKETING SERVICES AND RELATED CONSULTING; PROVIDING A WEB SITE WHICH FEATURES ADVERTISEMENTS FOR THE GOODS AND SERVICES OF OTHERS ON A GLOBAL COMPUTER NETWORK; RETAIL STORE AND ON-LINE RETAIL STORE SERVICES FEATURING JEWELRY, CLOTHING, ACCESSORIES, BEAUTY PRODUCTS, NAMELY, SOAPS, LOTIONS, CREAMS, FRAGRANCES, INCENSE, OILS, BATH AND BODY PRODUCTS, IN CLASS 35 (U.S. CLS. 100, 101 AND 102).

FIRST USE 12-1-2009; IN COMMERCE 7-1-2010.

THE MARK CONSISTS OF STANDARD CHARACTERS WITHOUT CLAIM TO ANY PARTICULAR FONT, STYLE, SIZE, OR COLOR.

SN 77-675,609, FILED 2-23-2009.

MICHAEL WEBSTER, EXAMINING ATTORNEY



David J. Kyffers

Director of the United States Patent and Trademark Office

United States of America

United States Patent and Trademark Office

MAXIMINT

Reg. No. 4,067,619

Registered Dec. 6, 2011

Int. Cl.: 34

TRADEMARK

PRINCIPAL REGISTER

CROSS FARMS, INC. (DELAWARE CORPORATION)
222 DELAWARE AVENUE, SUITE 1200
WILMINGTON, DE 19801

FOR: CHEWING TOBACCO; CIGARS; CIGARETTE PAPERS; CIGARETTE TUBES; CIGARILLOS; HAND-ROLLING TOBACCO; ROLL YOUR OWN TOBACCO; ROLLING TOBACCO; SMOKER'S ARTICLES, NAMELY, FILTER TUBES; SMOKELESS TOBACCO; SMOKING TOBACCO; TOBACCO; PIPE TOBACCO; SNUFF; TOBACCO SUBSTITUTES, IN CLASS 34 (U.S. CLS. 2, 8, 9 AND 17).

FIRST USE 3-1-2009; IN COMMERCE 3-1-2009.

THE MARK CONSISTS OF STANDARD CHARACTERS WITHOUT CLAIM TO ANY PARTICULAR FONT, STYLE, SIZE, OR COLOR.

SN 77-675,723, FILED 2-23-2009.

CAROLYN CATALDO, EXAMINING ATTORNEY



David J. Kybas

Director of the United States Patent and Trademark Office

United States of America

United States Patent and Trademark Office

Regalia

Reg. No. 4,067,620

Registered Dec. 6, 2011

Int. Cl.: 10

TRADEMARK

PRINCIPAL REGISTER

ASAHI INTECC CO., LTD. (JAPAN CORPORATION)
1703 WAKITA-CHO, MORIYAMA-KU, NAGOYA-SHI
AICHI 463-0024, JAPAN

FOR: MEDICAL GUIDE WIRES; IVR (INTERVENTIONAL RADIOLOGY) GUIDE WIRES;
MEDICAL SPRING GUIDE WIRES; MEDICAL PLASTIC CLAD GUIDE WIRES , IN CLASS
10 (U.S. CLS. 26, 39 AND 44).

FIRST USE 8-0-2011; IN COMMERCE 8-0-2011.

THE MARK CONSISTS OF STANDARD CHARACTERS WITHOUT CLAIM TO ANY PAR-
TICULAR FONT, STYLE, SIZE, OR COLOR.

SN 77-677,141, FILED 2-24-2009.

JENNY PARK, EXAMINING ATTORNEY



David J. Kybas

Director of the United States Patent and Trademark Office

United States of America

United States Patent and Trademark Office



Reg. No. 4,067,621

Registered Dec. 6, 2011

Int. Cl.: 41

SERVICE MARK

PRINCIPAL REGISTER

HTV, LLC (DELAWARE LIMITED LIABILITY COMPANY)
SOUTH TOWER - 12TH FLOOR
1 CNN CENTER
ATLANTA, DE 30303

FOR: ENTERTAINMENT SERVICES, NAMELY, PROVISION OF ONGOING MULTIMEDIA PROGRAMS IN THE FIELD OF MUSIC DISTRIBUTED VIA VARIOUS PLATFORMS ACROSS MULTIPLE FORMS OF TRANSMISSION MEDIA, IN CLASS 41 (U.S. CLS. 100, 101 AND 107).

FIRST USE 5-31-2009; IN COMMERCE 5-31-2009.

OWNER OF U.S. REG. NO. 2,938,454.

THE MARK CONSISTS OF "HTV" STYLIZED.

SN 77-678,200, FILED 2-25-2009.

ANDREA BUTLER, EXAMINING ATTORNEY



David J. Kybas

Director of the United States Patent and Trademark Office

United States of America

United States Patent and Trademark Office



Reg. No. 4,067,622

Registered Dec. 6, 2011

Int. Cl.: 38

SERVICE MARK

PRINCIPAL REGISTER

HTV, LLC (DELAWARE LIMITED LIABILITY COMPANY)
SOUTH TOWER - 12TH FLOOR
1 CNN CENTER
ATLANTA, GA 30303

FOR: CABLE TELEVISION AND SATELLITE BROADCASTING SERVICES, STREAMING OF AUDIO, VIDEO AND AUDIO/VIDEO MATERIALS OVER THE INTERNET , IN CLASS 38 (U.S. CLS. 100, 101 AND 104).

FIRST USE 5-31-2009; IN COMMERCE 5-31-2009.

OWNER OF U.S. REG. NO. 2,938,454.

THE MARK CONSISTS OF THE STYLIZED LETTERS "HTV" ENCLOSED IN A SHADED TEARDROP DESIGN.

SN 77-678,203, FILED 2-25-2009.

ANDREA BUTLER, EXAMINING ATTORNEY



David J. Kybas

Director of the United States Patent and Trademark Office

United States of America

United States Patent and Trademark Office

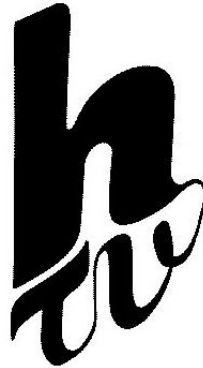

Reg. No. 4,067,623

Registered Dec. 6, 2011

Int. Cl.: 38

SERVICE MARK

PRINCIPAL REGISTER

HTV, LLC (DELAWARE LIMITED LIABILITY COMPANY)
SOUTH TOWER - 12TH FLOOR
1 CNN CENTER
ATLANTA, GA 30303

FOR: CABLE TELEVISION AND SATELLITE BROADCASTING SERVICES, STREAMING OF AUDIO, VIDEO AND AUDIO/VIDEO MATERIALS OVER THE INTERNET , IN CLASS 38 (U.S. CLS. 100, 101 AND 104).

FIRST USE 5-31-2009; IN COMMERCE 5-31-2009.

OWNER OF U.S. REG. NO. 2,938,454.

THE MARK CONSISTS OF "HTV" STYLIZED.

SN 77-678,230, FILED 2-25-2009.

ANDREA BUTLER, EXAMINING ATTORNEY



David J. Kybas

Director of the United States Patent and Trademark Office

United States of America

United States Patent and Trademark Office



Reg. No. 4,067,624

Registered Dec. 6, 2011

Int. Cl.: 41

SERVICE MARK

PRINCIPAL REGISTER

HTV, LLC (DELAWARE LIMITED LIABILITY COMPANY)
SOUTH TOWER - 12TH FLOOR
1 CNN CENTER
ATLANTA, GA 30303

FOR: ENTERTAINMENT SERVICES, NAMELY, PROVISION OF ONGOING MULTIMEDIA PROGRAMS IN THE FIELD OF MUSIC DISTRIBUTED VIA VARIOUS PLATFORMS ACROSS MULTIPLE FORMS OF TRANSMISSION MEDIA, IN CLASS 41 (U.S. CLS. 100, 101 AND 107).

FIRST USE 5-31-2009; IN COMMERCE 5-31-2009.

OWNER OF U.S. REG. NO. 2,938,454.

THE MARK CONSISTS OF THE STYLIZED LETTERS "HTV" ENCLOSED IN A SHADED TEARDROP DESIGN.

SN 77-678,258, FILED 2-25-2009.

ANDREA BUTLER, EXAMINING ATTORNEY



David J. Kybas

Director of the United States Patent and Trademark Office

United States of America

United States Patent and Trademark Office

Ballooniatic

Reg. No. 4,067,625

Registered Dec. 6, 2011

Int. Cl.: 28

TRADEMARK

PRINCIPAL REGISTER

GOLD, MICHAEL W. (UNITED STATES INDIVIDUAL), DBA BALLOONIATIC,
3001 FORT HAMILTON PARKWAY
APT. #4A
BROOKLYN, NY 11218

FOR: BABY MULTIPLE ACTIVITY TOYS; BATH TOYS; BATTERY OPERATED ACTION TOYS; BENDABLE TOYS; CHILDREN'S MULTIPLE ACTIVITY TOYS; CHILDREN'S MULTIPLE ACTIVITY TOYS SOLD AS A UNIT WITH PRINTED BOOKS; COLLECTABLE TOY FIGURES; CONSTRUCTION TOYS; ELECTRIC ACTION TOYS; ELECTRONIC NOVELTY TOYS, NAMELY, TOYS THAT ELECTRONICALLY RECORD, PLAY BACK, AND DISTORT OR MANIPULATE VOICES AND SOUNDS; INFLATABLE TOYS; MECHANICAL TOYS; MUSICAL TOYS; PLUSH TOYS; SQUEEZE TOYS; STUFFED AND PLUSH TOYS; TALKING TOYS; TOY BALLOONS; TOY FIGURES; WIND-UP TOYS, IN CLASS 28 (U.S. CLS. 22, 23, 38 AND 50).

FIRST USE 6-5-2008; IN COMMERCE 1-20-2011.

THE MARK CONSISTS OF STANDARD CHARACTERS WITHOUT CLAIM TO ANY PARTICULAR FONT, STYLE, SIZE, OR COLOR.

SN 77-680,222, FILED 2-27-2009.

MATTHEW EINSTEIN, EXAMINING ATTORNEY



David J. Kybas

Director of the United States Patent and Trademark Office

United States of America

United States Patent and Trademark Office

FIND YOUR ELEMENT

Reg. No. 4,067,626

Registered Dec. 6, 2011

Int. Cl.: 45

SERVICE MARK

PRINCIPAL REGISTER

THE INSPIRATIONAL NETWORK, INC. (NORTH CAROLINA NON-PROFIT CORPORATION)
3000 WORLDREACH DRIVE
INDIAN LAND, SC 29707

FOR: PROVIDING A WEBSITE FEATURING RELIGIOUS, SPIRITUAL, AND FAMILY-ORIENTED RELIGIOUS INFORMATION AND CONTENT, IN CLASS 45 (U.S. CLS. 100 AND 101).

FIRST USE 9-14-2011; IN COMMERCE 9-14-2011.

THE MARK CONSISTS OF STANDARD CHARACTERS WITHOUT CLAIM TO ANY PARTICULAR FONT, STYLE, SIZE, OR COLOR.

SN 77-685,332, FILED 3-6-2009.

KEVIN DINALLO, EXAMINING ATTORNEY



David J. Kybas

Director of the United States Patent and Trademark Office

United States of America

United States Patent and Trademark Office

SOCIAL EYES

Reg. No. 4,067,627

Registered Dec. 6, 2011

Int. Cl.: 35

SERVICE MARK

PRINCIPAL REGISTER

ENZER, TALIA (UNITED STATES INDIVIDUAL)
11 ADMIRALS COURT
PALM BEACH GARDENS, FL 33418

FOR: MEMBERSHIP CLUB SERVICES PROVIDING DISCOUNTS AND PROCESSING REBATES FOR THE GOODS AND SERVICES OF OTHERS; ADVERTISING AND MARKETING SERVICES; PROMOTING THE SALE OF THE WORKS OF ART OF OTHERS, IN CLASS 35 (U.S. CLS. 100, 101 AND 102).

FIRST USE 11-0-2006; IN COMMERCE 11-0-2009.

THE MARK CONSISTS OF STANDARD CHARACTERS WITHOUT CLAIM TO ANY PARTICULAR FONT, STYLE, SIZE, OR COLOR.

SN 77-687,204, FILED 3-10-2009.

LESLIE RICHARDS, EXAMINING ATTORNEY



David J. Kyros

Director of the United States Patent and Trademark Office

United States of America

United States Patent and Trademark Office

MIKEN RZR

Reg. No. 4,067,628

Registered Dec. 6, 2011

Int. Cl.: 28

TRADEMARK

PRINCIPAL REGISTER

MIKEN SPORTS, LLC (DELAWARE LIMITED LIABILITY COMPANY)
415 EAST SOUTH STREET
CALEDONIA, MN 55921

FOR: SPORTING GOODS, NAMELY, BASEBALL BATS, SOFTBALL BATS, IN CLASS 28
(U.S. CLS. 22, 23, 38 AND 50).

FIRST USE 12-1-2010; IN COMMERCE 12-1-2010.

THE MARK CONSISTS OF STANDARD CHARACTERS WITHOUT CLAIM TO ANY PARTICULAR FONT, STYLE, SIZE, OR COLOR.

SN 77-689,455, FILED 3-12-2009.

CYNTHIA TRIPI, EXAMINING ATTORNEY



David J. Kyffers

Director of the United States Patent and Trademark Office

United States of America

United States Patent and Trademark Office

ENVIROPRO

Reg. No. 4,067,629

Registered Dec. 6, 2011

Int. Cl.: 36

SERVICE MARK

PRINCIPAL REGISTER

AMWINS GROUP, INC. (DELAWARE CORPORATION)
4725 PIEDMONT ROW DRIVE
SUITE 600
CHARLOTTE, NC 28210

FOR: INSURANCE SERVICES, NAMELY, THE BROKERAGE, UNDERWRITING, ISSUANCE AND ADMINISTRATION OF POLLUTION LIABILITY COVERAGE FOR ENVIRONMENTAL CONTRACTORS AND CONSULTANTS, IN CLASS 36 (U.S. CLS. 100, 101 AND 102).

FIRST USE 4-18-2011; IN COMMERCE 4-18-2011.

THE MARK CONSISTS OF STANDARD CHARACTERS WITHOUT CLAIM TO ANY PARTICULAR FONT, STYLE, SIZE, OR COLOR.

SN 77-690,696, FILED 3-13-2009.

JASON TURNER, EXAMINING ATTORNEY



David J. Kybas

Director of the United States Patent and Trademark Office

United States of America

United States Patent and Trademark Office

IRON HORSE

Reg. No. 4,067,630

Registered Dec. 6, 2011

Int. Cl.: 25

TRADEMARK

PRINCIPAL REGISTER

PRO LINE MANUFACTURING CO. (NEW JERSEY CORPORATION)
186 PARIS DRIVE
WAYNE, NJ 07470

FOR: FOOTWEAR, IN CLASS 25 (U.S. CLS. 22 AND 39).

FIRST USE 11-30-2008; IN COMMERCE 11-30-2008.

THE MARK CONSISTS OF STANDARD CHARACTERS WITHOUT CLAIM TO ANY PARTICULAR FONT, STYLE, SIZE, OR COLOR.

SN 77-691,241, FILED 3-14-2009.

KATHERINE E. HALMEN, EXAMINING ATTORNEY



David J. Kybas

Director of the United States Patent and Trademark Office

United States of America

United States Patent and Trademark Office

OUTFILL

Reg. No. 4,067,631

Registered Dec. 6, 2011

Int. Cls.: 17 and 19

TRADEMARK

PRINCIPAL REGISTER

TURF ALLIANCE, LLC (DELAWARE LIMITED LIABILITY COMPANY)
23022-800 NIAGARA ROAD
WELLAND, ONTARIO, CANADA L3C7E7

FOR: RUBBER OR POLYMER GRANULES FOR USE AS SYNTHETIC TURF INFILL, IN CLASS 17 (U.S. CLS. 1, 5, 12, 13, 35 AND 50).

FIRST USE 9-1-2011; IN COMMERCE 9-1-2011.

FOR: SAND FOR USE IN SYNTHETIC TURF SYSTEMS, IN CLASS 19 (U.S. CLS. 1, 12, 33 AND 50).

FIRST USE 9-1-2011; IN COMMERCE 9-1-2011.

THE MARK CONSISTS OF STANDARD CHARACTERS WITHOUT CLAIM TO ANY PARTICULAR FONT, STYLE, SIZE, OR COLOR.

SN 77-692,692, FILED 3-17-2009.

IRA J. GOODSaid, EXAMINING ATTORNEY



David J. Kypos

Director of the United States Patent and Trademark Office

United States of America

United States Patent and Trademark Office

SHIELD FIRE PROTECTION

Reg. No. 4,067,632

Registered Dec. 6, 2011

Int. Cl.: 9

TRADEMARK

PRINCIPAL REGISTER

BUCKEYE FIRE EQUIPMENT COMPANY (OHIO CORPORATION)
P.O. BOX 428
KINGS MOUNTAIN, NC 28086

FOR: FIRE EXTINGUISHERS, IN CLASS 9 (U.S. CLS. 21, 23, 26, 36 AND 38).

FIRST USE 3-1-2009; IN COMMERCE 5-1-2011.

THE MARK CONSISTS OF STANDARD CHARACTERS WITHOUT CLAIM TO ANY PARTICULAR FONT, STYLE, SIZE, OR COLOR.

NO CLAIM IS MADE TO THE EXCLUSIVE RIGHT TO USE "FIRE PROTECTION", APART FROM THE MARK AS SHOWN.

SN 77-693,756, FILED 3-18-2009.

MARK PILARO, EXAMINING ATTORNEY



David J. Kyffers

Director of the United States Patent and Trademark Office

United States of America

United States Patent and Trademark Office

HOME GUARD

Reg. No. 4,067,633

Registered Dec. 6, 2011

Int. Cl.: 9

TRADEMARK

PRINCIPAL REGISTER

BUCKEYE FIRE EQUIPMENT COMPANY (OHIO CORPORATION)
P.O. BOX 428 KINGS MOUNTAIN
KINGS MOUNTAIN, NC 28086

FOR: FIRE EXTINGUISHERS, IN CLASS 9 (U.S. CLS. 21, 23, 26, 36 AND 38).

FIRST USE 3-1-2009; IN COMMERCE 5-1-2011.

THE MARK CONSISTS OF STANDARD CHARACTERS WITHOUT CLAIM TO ANY PARTICULAR FONT, STYLE, SIZE, OR COLOR.

NO CLAIM IS MADE TO THE EXCLUSIVE RIGHT TO USE "HOME", APART FROM THE MARK AS SHOWN.

SN 77-693,800, FILED 3-18-2009.

MARK PILARO, EXAMINING ATTORNEY



David J. Kyffers

Director of the United States Patent and Trademark Office

United States of America

United States Patent and Trademark Office

INSTA-CREDIT

Reg. No. 4,067,634

Registered Dec. 6, 2011

Int. Cl.: 36

SERVICE MARK

PRINCIPAL REGISTER

VALERO MARKETING AND SUPPLY COMPANY (DELAWARE CORPORATION)
COMMERCIAL LAW DEPARTMENT
ONE VALERO WAY
SAN ANTONIO, TX 78249

FOR: CREDIT CARD SERVICES IN THE FIELD OF RETAIL GASOLINE STATION SERVICES,
IN CLASS 36 (U.S. CLS. 100, 101 AND 102).

FIRST USE 3-1-2011; IN COMMERCE 3-1-2011.

THE MARK CONSISTS OF STANDARD CHARACTERS WITHOUT CLAIM TO ANY PAR-
TICULAR FONT, STYLE, SIZE, OR COLOR.

SN 77-694,221, FILED 3-18-2009.

LINDA MICKLEBURGH, EXAMINING ATTORNEY



David J. Kyros

Director of the United States Patent and Trademark Office

United States of America

United States Patent and Trademark Office

DARK MATTER

Reg. No. 4,067,635

Registered Dec. 6, 2011

Int. Cl.: 33

TRADEMARK

PRINCIPAL REGISTER

M & J MONDAVI FAMILY, LLC (CALIFORNIA LIMITED LIABILITY COMPANY)
2800 MAIN STREET
ST. HELENA, CA 94574

FOR: WINES, IN CLASS 33 (U.S. CLS. 47 AND 49).

FIRST USE 9-19-2011; IN COMMERCE 9-19-2011.

THE MARK CONSISTS OF STANDARD CHARACTERS WITHOUT CLAIM TO ANY PARTICULAR FONT, STYLE, SIZE, OR COLOR.

SN 77-696,718, FILED 3-23-2009.

BARNEY CHARLON, EXAMINING ATTORNEY



David J. Kyffers

Director of the United States Patent and Trademark Office

United States of America

United States Patent and Trademark Office

NFX WORLD CURRENCY FUTURES

Reg. No. 4,067,636

THE NASDAQ OMX GROUP, INC. (DELAWARE CORPORATION)
ONE LIBERTY PLAZA, 165 BROADWAY
NEW YORK, NY 10006

Registered Dec. 6, 2011

Int. Cl.: 36

FOR: FINANCIAL SERVICES, NAMELY, TRADING OF U.S. DOLLAR-SETTLED FUTURES
ON UNITS OF CURRENCIES, IN CLASS 36 (U.S. CLS. 100, 101 AND 102).

SERVICE MARK

FIRST USE 4-0-2009; IN COMMERCE 4-0-2009.

PRINCIPAL REGISTER

THE MARK CONSISTS OF STANDARD CHARACTERS WITHOUT CLAIM TO ANY PAR-
TICULAR FONT, STYLE, SIZE, OR COLOR.

NO CLAIM IS MADE TO THE EXCLUSIVE RIGHT TO USE "WORLD CURRENCY FUTURES",
APART FROM THE MARK AS SHOWN.

SN 77-697,923, FILED 3-24-2009.

JOHN HWANG, EXAMINING ATTORNEY



David J. Kyjars

Director of the United States Patent and Trademark Office

United States of America
United States Patent and Trademark Office

nextlink



Reg. No. 4,067,637

NEXTLINK WIRELESS, INC. (DELAWARE CORPORATION)
13865 SUNRISE VALLEY DRIVE
HERNDON, VA 20171

Registered Dec. 6, 2011

Int. Cl.: 38

FOR: TELECOMMUNICATIONS SERVICES, NAMELY, BROADBAND COMMUNICATIONS AND TRANSMISSION OF VOICE, VIDEO, IMAGES AND DATA, IN CLASS 38 (U.S. CLS. 100, 101 AND 104).

SERVICE MARK

FIRST USE 6-1-2011; IN COMMERCE 6-1-2011.

PRINCIPAL REGISTER

OWNER OF U.S. REG. NO. 3,139,494.

SN 77-698,160, FILED 3-24-2009.

DEBRA LEE, EXAMINING ATTORNEY



David J. Kyffers

Director of the United States Patent and Trademark Office

United States of America

United States Patent and Trademark Office

DR. HOLEC'S CENTER FOR HEALTHY LIVING

Reg. No. 4,067,638

Registered Dec. 6, 2011

Int. Cls.: 35 and 44

SERVICE MARK

PRINCIPAL REGISTER

DR. SUSAN HOLEC-IWASKO, D.O. (UNITED STATES INDIVIDUAL)
8460 MARY COURT
BROWNSBURG, IN 46112

FOR: ON-LINE RETAIL STORE SERVICES FEATURING HEALTH FOODS, ORGANIC AND GLUTEN-FREE FOODS, DIETARY SUPPLEMENTS, NUTRITIONAL SUPPLEMENTS, HERBS, VITAMINS, NUTRACEUTICALS, ANTIOXIDANTS, TINCTURES, TEAS, CREAMS, LINIMENTS, OINTMENTS, SHAMPOOS, EXFOLIANTS, SOAP, GLUTEN-FREE BATH AND SKINCARE PRODUCTS, CLOTHING, BOOKS, AND BIOFEEDBACK DEVICES, IN CLASS 35 (U.S. CLS. 100, 101 AND 102).

FIRST USE 9-1-2011; IN COMMERCE 9-1-2011.

FOR: NUTRITIONAL COUNSELING SERVICES, IN CLASS 44 (U.S. CLS. 100 AND 101).

FIRST USE 9-1-2011; IN COMMERCE 9-1-2011.

THE MARK CONSISTS OF STANDARD CHARACTERS WITHOUT CLAIM TO ANY PARTICULAR FONT, STYLE, SIZE, OR COLOR.

NO CLAIM IS MADE TO THE EXCLUSIVE RIGHT TO USE "CENTER FOR HEALTHY LIVING", APART FROM THE MARK AS SHOWN.

SN 77-698,685, FILED 3-25-2009.

REBECCA GILBERT, EXAMINING ATTORNEY



David J. Kyjars

Director of the United States Patent and Trademark Office

United States of America

United States Patent and Trademark Office

Paycheck

PRINTER

Reg. No. 4,067,639

Registered Dec. 6, 2011

Int. Cl.: 9

TRADEMARK

PRINCIPAL REGISTER

NANOPTIX INC. (CANADA CORPORATION)
699 CHAMPLAIN STREET
DIEPPE, NEW BRUNSWICK, CANADA E1A1P6

FOR: THERMAL PRINTERS FOR PRINTING TICKETS FOR THE GAMING, LOTTERY, AND AMUSEMENT INDUSTRIES, IN CLASS 9 (U.S. CLS. 21, 23, 26, 36 AND 38).

FIRST USE 3-10-2011; IN COMMERCE 3-10-2011.

PRIORITY CLAIMED UNDER SEC. 44(D) ON CANADA APPLICATION NO. 1412366, FILED 9-26-2008, REG. NO. TMA760220, DATED 2-25-2010, EXPIRES 2-25-2025.

NO CLAIM IS MADE TO THE EXCLUSIVE RIGHT TO USE "PRINTER", APART FROM THE MARK AS SHOWN.

THE MARK CONSISTS OF THE WORD "PAYCHECK" WITH A CHECKMARK THROUGH THE LETTER "C" AND THE WORD "PRINTER" BELOW IN SMALLER LETTERING.

SN 77-699,620, FILED 3-26-2009.

MICHAEL SOUDERS, EXAMINING ATTORNEY



David J. Kyros

Director of the United States Patent and Trademark Office

United States of America

United States Patent and Trademark Office

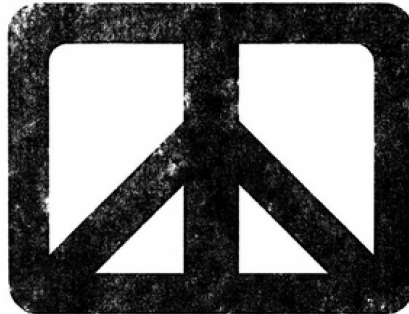

CHICKENFOOT

Reg. No. 4,067,640

Registered Dec. 6, 2011

Int. Cl.: 9

TRADEMARK

PRINCIPAL REGISTER

CHICKEN FOOT, LLC (CALIFORNIA LIMITED LIABILITY COMPANY)
P.O. BOX 5395
NOVATO, CA 94948

FOR: SERIES OF MUSICAL SOUND RECORDINGS AND AUDIOVISUAL RECORDINGS
FEATURING MUSIC AND MUSICAL ENTERTAINMENT, IN CLASS 9 (U.S. CLS. 21, 23, 26,
36 AND 38).

FIRST USE 6-5-2009; IN COMMERCE 6-5-2009.

THE MARK CONSISTS OF A THICK DISTRESSED RECTANGLE DESIGN WITH A LINE
CUTTING THROUGH THE CENTER FROM TOP TO BOTTOM OF THE RECTANGLE AND
TWO LINES ANGLED DOWN FROM HALFWAY ON THE CENTER LINE OUT TOWARD
THE BOTTOM CORNERS. DIRECTLY BELOW THE DESIGN ELEMENT OF THE MARK IS
THE LITERAL ELEMENT OF THE MARK, "CHICKENFOOT" WITH THE "K" BACKWARDS.

SN 77-699,825, FILED 3-26-2009.

JASON TURNER, EXAMINING ATTORNEY



David J. Kybas

Director of the United States Patent and Trademark Office

United States of America

United States Patent and Trademark Office

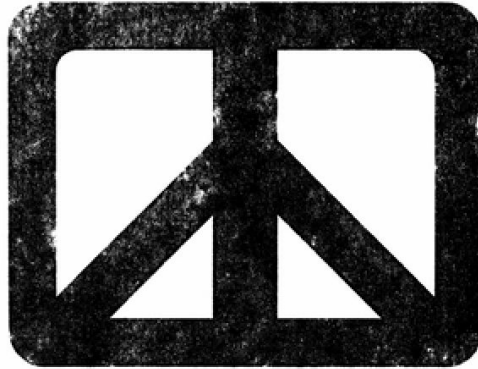

Reg. No. 4,067,641

Registered Dec. 6, 2011

Int. Cl.: 9

TRADEMARK

PRINCIPAL REGISTER

CHICKEN FOOT, LLC (CALIFORNIA LIMITED LIABILITY COMPANY)
P.O. BOX 5395
NOVATO, CA 94948

FOR: SERIES OF MUSICAL SOUND RECORDINGS AND AUDIOVISUAL RECORDINGS
FEATURING MUSIC AND MUSICAL ENTERTAINMENT, IN CLASS 9 (U.S. CLS. 21, 23, 26,
36 AND 38).

FIRST USE 6-5-2009; IN COMMERCE 6-5-2009.

THE MARK CONSISTS OF A THICK DISTRESSED RECTANGLE DESIGN WITH A LINE
CUTTING THROUGH THE CENTER FROM TOP TO BOTTOM OF THE RECTANGLE AND
TWO LINES ANGLED DOWN FROM HALFWAY ON THE CENTER LINE OUT TOWARD
THE BOTTOM CORNERS.

SN 77-699,832, FILED 3-26-2009.

JASON TURNER, EXAMINING ATTORNEY



David J. Kybas

Director of the United States Patent and Trademark Office

United States of America

United States Patent and Trademark Office

CHICKENFOOT

Reg. No. 4,067,642

Registered Dec. 6, 2011

Int. Cl.: 9

TRADEMARK

PRINCIPAL REGISTER

CHICKEN FOOT, LLC (CALIFORNIA LIMITED LIABILITY COMPANY)
P.O. BOX 5395
NOVATO, CA 94948

FOR: SERIES OF MUSICAL SOUND RECORDINGS AND AUDIOVISUAL RECORDINGS
FEATURING MUSIC AND MUSICAL ENTERTAINMENT, IN CLASS 9 (U.S. CLS. 21, 23, 26,
36 AND 38).

FIRST USE 6-5-2009; IN COMMERCE 6-5-2009.

THE MARK CONSISTS OF A STYLIZED VERSION OF THE WORD "CHICKENFOOT" WITH
THE "K" TURNED BACKWARDS.

SN 77-699,843, FILED 3-26-2009.

JASON TURNER, EXAMINING ATTORNEY



David J. Kybas

Director of the United States Patent and Trademark Office

United States of America

United States Patent and Trademark Office

SATIN WRITER

Reg. No. 4,067,643

Registered Dec. 6, 2011

Int. Cl.: 16

TRADEMARK

PRINCIPAL REGISTER

LAROSE INDUSTRIES, LLC (NEW JERSEY LIMITED LIABILITY COMPANY)
BUILDING 5
1578 SUSSEX TURNPIKE
RANDOLPH, NJ 07869

FOR: WRITING INSTRUMENTS, NAMELY, PENS, IN CLASS 16 (U.S. CLS. 2, 5, 22, 23, 29, 37, 38 AND 50).

FIRST USE 8-31-2011; IN COMMERCE 8-31-2011.

THE MARK CONSISTS OF STANDARD CHARACTERS WITHOUT CLAIM TO ANY PARTICULAR FONT, STYLE, SIZE, OR COLOR.

NO CLAIM IS MADE TO THE EXCLUSIVE RIGHT TO USE "WRITER", APART FROM THE MARK AS SHOWN.

SN 77-700,641, FILED 3-27-2009.

KEVIN CORWIN, EXAMINING ATTORNEY



David J. Kybas

Director of the United States Patent and Trademark Office

United States of America

United States Patent and Trademark Office

COLOR SOLUTIONS

Reg. No. 4,067,644

Registered Dec. 6, 2011

Int. Cl.: 24

TRADEMARK

PRINCIPAL REGISTER

WP IP, LLC (NEVADA LIMITED LIABILITY COMPANY)
8TH FLOOR
28 EAST 28TH STREET
NEW YORK, NY 10016

FOR: BED SHEETS, PILLOW CASES, COMFORTERS, BEDSPREADS, QUILTS, PILLOW SHAMS, BED DUST RUFFLES, BED SKIRTS, DUVET COVERS, COMFORTER COVERS, MATTRESS PADS, BED BLANKETS, THROW BLANKETS, BATH TOWELS, BEACH TOWELS, KITCHEN TOWELS, BATH SHEETS, WASH CLOTHS, FABRIC SHOWER CURTAINS, FITTED TOILET LID AND TANK COVERS; CURTAINS, DRAPERIES, FABRIC VALANCES, FABRIC POUFS, PUFFS AND SWAGS; TEXTILE WALL HANGINGS, TEXTILE TABLECLOTHS, TEXTILE NAPKINS, TEXTILE PLACEMATS, FABRIC TABLE RUNNERS, OVEN MITTS AND POT HOLDERS; BED CANOPIES, CRIB BUMPERS, CRIB CANOPIES, CRIB SHEETS, CRIB COMFORTERS, FABRIC DIAPER STACKERS, CRIB DUST RUFFLES, CRIB BLANKETS, IN CLASS 24 (U.S. CLS. 42 AND 50).

FIRST USE 5-24-2011; IN COMMERCE 5-24-2011.

THE MARK CONSISTS OF STANDARD CHARACTERS WITHOUT CLAIM TO ANY PARTICULAR FONT, STYLE, SIZE, OR COLOR.

SN 77-700,958, FILED 3-27-2009.

JOHN E. MICHOS, EXAMINING ATTORNEY



David J. Kyros

Director of the United States Patent and Trademark Office

United States of America

United States Patent and Trademark Office

SHEER SILK

Reg. No. 4,067,645

CONOPCO, INC. (NEW YORK CORPORATION)
800 SYLVAN AVENUE
ENGLEWOOD CLIFFS, NJ 07632

Registered Dec. 6, 2011

Int. Cl.: 3

FOR: DEODORANTS AND ANTI-PERSPIRANTS, IN CLASS 3 (U.S. CLS. 1, 4, 6, 50, 51 AND 52).

TRADEMARK

FIRST USE 0-0-2010; IN COMMERCE 0-0-2010.

PRINCIPAL REGISTER

THE MARK CONSISTS OF STANDARD CHARACTERS WITHOUT CLAIM TO ANY PARTICULAR FONT, STYLE, SIZE, OR COLOR.

NO CLAIM IS MADE TO THE EXCLUSIVE RIGHT TO USE "SILK", APART FROM THE MARK AS SHOWN.

SN 77-702,527, FILED 3-30-2009.

ANDREW RHIM, EXAMINING ATTORNEY



David J. Kybas

Director of the United States Patent and Trademark Office

United States of America

United States Patent and Trademark Office

Nutrition-Ate

Reg. No. 4,067,646

Registered Dec. 6, 2011

Int. Cls.: 16 and 41

TRADEMARK

SERVICE MARK

PRINCIPAL REGISTER

TUCKER GRAEF (UNITED STATES INDIVIDUAL)
1814 ALTACREST DRIVE
GRAPEVINE, TX 76051

FOR: PRINTED EDUCATIONAL MATERIALS IN THE FIELD OF NUTRITION, IN CLASS 16 (U.S. CLS. 2, 5, 22, 23, 29, 37, 38 AND 50).

FIRST USE 9-28-2011; IN COMMERCE 9-28-2011.

FOR: CONDUCTING WORKSHOPS AND SEMINARS IN NUTRITION, IN CLASS 41 (U.S. CLS. 100, 101 AND 107).

FIRST USE 9-28-2011; IN COMMERCE 9-28-2011.

THE MARK CONSISTS OF THE WORDS "NUTRITION" AND "ATE" IN GREEN, CONNECTED WITH A GREEN HYPHEN.

THE COLOR(S) GREEN IS/ARE CLAIMED AS A FEATURE OF THE MARK.

SN 77-702,912, FILED 3-31-2009.

TARAH HARDY, EXAMINING ATTORNEY



David J. Kyros

Director of the United States Patent and Trademark Office

United States of America

United States Patent and Trademark Office

COMPANALITY

Reg. No. 4,067,647

FALES, STEVEN (UNITED STATES INDIVIDUAL)
15715 SW 7TH PLACE
SUNRISE, FL 33326

Registered Dec. 6, 2011

Int. Cl.: 41

FOR: EDUCATIONAL SERVICES, NAMELY, WORKSHOPS, SEMINARS AND LECTURES IN THE FIELD OF CREATING A CORPORATE CULTURE WITHIN A BUSINESS AND THE DISTRIBUTION OF COURSE MATERIALS, NAMELY, BOOKS AND CDS, IN CONNECTION THEREWITH, IN CLASS 41 (U.S. CLS. 100, 101 AND 107).

SERVICE MARK

PRINCIPAL REGISTER

FIRST USE 9-27-2011; IN COMMERCE 9-27-2011.

THE MARK CONSISTS OF STANDARD CHARACTERS WITHOUT CLAIM TO ANY PARTICULAR FONT, STYLE, SIZE, OR COLOR.

SN 77-704,360, FILED 4-1-2009.

DAVID TAYLOR, EXAMINING ATTORNEY



David J. Kyfos

Director of the United States Patent and Trademark Office

United States of America

United States Patent and Trademark Office



Reg. No. 4,067,648

Registered Dec. 6, 2011

Int. Cls.: 29, 30, and 32

SMITHFIELD PACKING COMPANY, INCORPORATED, THE (DELAWARE CORPORATION)
111 COMMERCE STREET
SMITHFIELD, VA 23430

FOR: SOUPS, PREPARED NUTS, SNACK MIXES CONSISTING PRIMARILY OF PROCESSED NUTS, IN CLASS 29 (U.S. CL. 46).

TRADEMARK

FIRST USE 1-0-2009; IN COMMERCE 4-0-2009.

PRINCIPAL REGISTER

FOR: SAUCES; SEAFOOD SAUCES; MARINADES; SEASONING MIXES; SEASONINGS; DRY SEASONING MIXES, MIXES FOR MAKING BAKING BATTERS; MIXES FOR MAKING BATTERS FOR FRIED FOODS; MIXES FOR MAKING BATTER FOR HUSH PUPPIES; HUSH PUPPY MIX; DRY GRIT MIX; PRE-MIXED BREADING FOR SEAFOOD, IN CLASS 30 (U.S. CL. 46).

FIRST USE 1-0-2009; IN COMMERCE 4-0-2009.

FOR: NON-ALCOHOLIC BEVERAGE MIXES, NAMELY, MIXES FOR PREPARING COCKTAILS, IN CLASS 32 (U.S. CLS. 45, 46 AND 48).

FIRST USE 1-0-2009; IN COMMERCE 4-0-2009.

NO CLAIM IS MADE TO THE EXCLUSIVE RIGHT TO USE "SPECIALTIES", APART FROM THE MARK AS SHOWN.

THE COLOR(S) WHITE, BROWN, BLACK AND GRAY IS/ARE CLAIMED AS A FEATURE OF THE MARK.

THE MARK CONSISTS OF THE WORDS "SOUTHERN SHORES" IN LARGE, WHITE SCRIPT, PARTIALLY OUTLINED IN BROWN. BELOW THE WORDS "SOUTHERN SHORES" IS THE WORD "SPECIALTIES" IN SMALL, BROWN PRINT, WITH A LARGER BROWN PRINTED "S" AT THE BEGINNING AND END OF THE WORD "SPECIALTIES," AND HAVING A WHITE, HORIZONTAL LINE AND CURVING LINE DIRECTLY UNDERNEATH THE WORD "SPECIALTIES". THE HORIZONTAL LINE AND THE CURVING LINE ARE PARTIALLY OUTLINED IN BLACK. ALL OF THE FOREGOING IS ENCLOSED WITHIN A GRAY RECTANGLE .



David J. Kybas

Director of the United States Patent and Trademark Office

Reg. No. 4,067,648 SN 77-704,383, FILED 4-1-2009.

NANCY CLARKE, EXAMINING ATTORNEY

United States of America

United States Patent and Trademark Office



Reg. No. 4,067,649

Registered Dec. 6, 2011

Int. Cls.: 29, 30, and 32

TRADEMARK

PRINCIPAL REGISTER

SMITHFIELD PACKING COMPANY, INCORPORATED, THE (DELAWARE CORPORATION)
111 COMMERCE STREET
SMITHFIELD, VA 23430

FOR: SOUPS, PREPARED NUTS, SNACK MIXES CONSISTING PRIMARILY OF PROCESSED NUTS, IN CLASS 29 (U.S. CL. 46).

FIRST USE 1-0-2009; IN COMMERCE 4-0-2009.

FOR: SAUCES; SEAFOOD SAUCES; MARINADES; SEASONING MIXES; SEASONINGS; DRY SEASONING MIXES, MIXES FOR MAKING BAKING BATTERS; MIXES FOR MAKING BATTERS FOR FRIED FOODS; MIXES FOR MAKING BATTER FOR HUSH PUPPIES; HUSH PUPPY MIX; DRY GRIT MIX; PRE-MIXED BREADING FOR SEAFOOD, IN CLASS 30 (U.S. CL. 46).

FIRST USE 1-0-2009; IN COMMERCE 4-0-2009.

FOR: NON-ALCOHOLIC BEVERAGE MIXES, NAMELY, MIXES FOR PREPARING COCKTAILS, IN CLASS 32 (U.S. CLS. 45, 46 AND 48).

FIRST USE 1-0-2009; IN COMMERCE 4-0-2009.

THE MARK CONSISTS OF A DEPICTION OF A LABEL OUTLINED WITH A PICTURE OF GRAY PLANKS OF WOOD, WITH THE SPACES BETWEEN EACH PIECE OF WOOD BEING BLACK IN COLOR. WITHIN THE LABEL IS A DEPICTION OF A BEACH SCENE, OUTLINED WITH A THIN, BROWN LINE. THE BEACH SCENE CONSISTS OF TAN COLORED SAND, AND GREEN WATER WITH WHITE FOAM. AT THE TOP OF THE LABEL IS A SEASHELL IN VARYING SHADES OF BROWN, TAN, WHITE, AND BLACK.

THE COLOR(S) GRAY, WHITE, BLACK, GREEN, TAN, AND BROWN IS/ARE CLAIMED AS A FEATURE OF THE MARK.

SN 77-704,388, FILED 4-1-2009.

NANCY CLARKE, EXAMINING ATTORNEY



David J. Kyros

Director of the United States Patent and Trademark Office

United States of America

United States Patent and Trademark Office

BONE COLLAGENIZER MATRIX

Reg. No. 4,067,650

BIO MINERALS NAAMLOZE VENNOOTSCHAP (BELGIUM CORPORATION)
ZENDERSTRAAT 12
DESTELBERGEN 9070, BELGIUM

Registered Dec. 6, 2011

Int. Cl.: 5

FOR: ORAL PREPARATIONS CONTAINING SILICON FOR HUMAN USE ONLY, NAMELY,
ORAL FOOD SUPPLEMENTS, IN CLASS 5 (U.S. CLS. 6, 18, 44, 46, 51 AND 52).

TRADEMARK

FIRST USE 8-11-2011; IN COMMERCE 8-11-2011.

PRINCIPAL REGISTER

THE MARK CONSISTS OF STANDARD CHARACTERS WITHOUT CLAIM TO ANY PAR-
TICULAR FONT, STYLE, SIZE, OR COLOR.

NO CLAIM IS MADE TO THE EXCLUSIVE RIGHT TO USE "BONE", APART FROM THE
MARK AS SHOWN.

SN 77-704,514, FILED 4-1-2009.

JENNIFER VASQUEZ, EXAMINING ATTORNEY



David J. Kybas

Director of the United States Patent and Trademark Office

United States of America

United States Patent and Trademark Office

BONE MINERALIZER MATRIX

Reg. No. 4,067,651

BIO MINERALS NAAMLOZE VENNOOTSCHAP (BELGIUM CORPORATION)
ZENDERSTRAAT 12
DESTELBERGEN 9070, BELGIUM

Registered Dec. 6, 2011

Int. Cl.: 5

FOR: ORAL PREPARATIONS CONTAINING SILICON FOR HUMAN USE ONLY, NAMELY, ORAL FOOD SUPPLEMENTS AND ORAL NUTRITIONAL SUPPLEMENTS FOR STRUCTURAL IMPROVEMENT AND PROTECTION OF EPIDERMAL STRUCTURES, IN CLASS 5 (U.S. CLS. 6, 18, 44, 46, 51 AND 52).

TRADEMARK

PRINCIPAL REGISTER

FIRST USE 8-11-2011; IN COMMERCE 8-11-2011.

THE MARK CONSISTS OF STANDARD CHARACTERS WITHOUT CLAIM TO ANY PARTICULAR FONT, STYLE, SIZE, OR COLOR.

NO CLAIM IS MADE TO THE EXCLUSIVE RIGHT TO USE "BONE", APART FROM THE MARK AS SHOWN.

SN 77-704,520, FILED 4-1-2009.

JENNIFER VASQUEZ, EXAMINING ATTORNEY



David J. Kyros

Director of the United States Patent and Trademark Office

United States of America

United States Patent and Trademark Office

MINERALIZER

Reg. No. 4,067,652

Registered Dec. 6, 2011

Int. Cls.: 3 and 5

TRADEMARK

PRINCIPAL REGISTER

BIO MINERALS NAAMLOZE VENNOOTSCHAP (BELGIUM CORPORATION)
ZENDERSTRAAT 12
DESTELBERGEN 9070, BELGIUM

FOR: ORAL PREPARATIONS CONTAINING SILICON FOR HUMAN USE ONLY, NAMELY, ORAL NON-MEDICATED NAIL, HAIR AND SKIN CARE PREPARATIONS FOR STRUCTURAL IMPROVEMENT AND PROTECTION OF EPIDERMAL STRUCTURES, IN CLASS 3 (U.S. CLS. 1, 4, 6, 50, 51 AND 52).

FIRST USE 8-11-2011; IN COMMERCE 8-11-2011.

FOR: ORAL PREPARATIONS CONTAINING SILICON FOR HUMAN USE ONLY, NAMELY, ORAL FOOD SUPPLEMENTS, ORAL PHARMACEUTICAL PREPARATIONS AND ORAL PREPARATIONS FOR STRUCTURAL IMPROVEMENT AND PROTECTION OF EPIDERMAL STRUCTURES AND FOR USE IN THE PREVENTION AND TREATMENT OF CARDIOVASCULAR, MUSCULOSKELETAL, DERMATOLOGICAL, NEUROLOGICAL, MUCOSA AND CONNECTIVE TISSUE RELATED DISORDERS, IN CLASS 5 (U.S. CLS. 6, 18, 44, 46, 51 AND 52).

FIRST USE 8-11-2011; IN COMMERCE 8-11-2011.

THE MARK CONSISTS OF STANDARD CHARACTERS WITHOUT CLAIM TO ANY PARTICULAR FONT, STYLE, SIZE, OR COLOR.

SN 77-704,525, FILED 4-1-2009.

JENNIFER VASQUEZ, EXAMINING ATTORNEY



David J. Kyros

Director of the United States Patent and Trademark Office

United States of America

United States Patent and Trademark Office

COLLAGENIZER

Reg. No. 4,067,653

BIO MINERALS NAAMLOZE VENNOOTSCHAP (BELGIUM CORPORATION)
ZENDERSTRAAT 12
DESTELBERGEN 9070, BELGIUM

Registered Dec. 6, 2011

Int. Cl.: 5

FOR: ORAL PREPARATIONS CONTAINING SILICON FOR HUMAN USE ONLY, NAMELY,
ORAL FOOD SUPPLEMENTS, IN CLASS 5 (U.S. CLS. 6, 18, 44, 46, 51 AND 52).

TRADEMARK

FIRST USE 8-11-2011; IN COMMERCE 8-11-2011.

PRINCIPAL REGISTER

THE MARK CONSISTS OF STANDARD CHARACTERS WITHOUT CLAIM TO ANY PAR-
TICULAR FONT, STYLE, SIZE, OR COLOR.

SN 77-704,531, FILED 4-1-2009.

JENNIFER VASQUEZ, EXAMINING ATTORNEY



David J. Kybas

Director of the United States Patent and Trademark Office

United States of America

United States Patent and Trademark Office

HEALTHY BONES PLUS

Reg. No. 4,067,654

Registered Dec. 6, 2011

Int. Cls.: 3 and 5

TRADEMARK

PRINCIPAL REGISTER

BIO MINERALS NAAMLOZE VENNOOTSCHAP (BELGIUM CORPORATION)
ZENDERSTRAAT 12
DESTELBERGEN 9070, BELGIUM

FOR: ORAL PREPARATIONS CONTAINING SILICON FOR HUMAN USE ONLY, NAMELY, ORAL NON-MEDICATED NAIL, HAIR AND SKIN CARE PREPARATIONS FOR STRUCTURAL IMPROVEMENT AND PROTECTION OF EPIDERMAL STRUCTURES, IN CLASS 3 (U.S. CLS. 1, 4, 6, 50, 51 AND 52).

FIRST USE 8-11-2011; IN COMMERCE 8-11-2011.

FOR: ORAL PREPARATIONS CONTAINING SILICON FOR HUMAN USE ONLY, NAMELY, ORAL FOOD SUPPLEMENTS AND ORAL NUTRITIONAL SUPPLEMENTS FOR STRUCTURAL IMPROVEMENT AND PROTECTION OF EPIDERMAL STRUCTURES, IN CLASS 5 (U.S. CLS. 6, 18, 44, 46, 51 AND 52).

FIRST USE 8-11-2011; IN COMMERCE 8-11-2011.

THE MARK CONSISTS OF STANDARD CHARACTERS WITHOUT CLAIM TO ANY PARTICULAR FONT, STYLE, SIZE, OR COLOR.

NO CLAIM IS MADE TO THE EXCLUSIVE RIGHT TO USE "HEALTHY BONES", APART FROM THE MARK AS SHOWN.

SN 77-704,777, FILED 4-1-2009.

JENNIFER VASQUEZ, EXAMINING ATTORNEY



David J. Kyros

Director of the United States Patent and Trademark Office

United States of America

United States Patent and Trademark Office

PRIMETIME

Reg. No. 4,067,655

Registered Dec. 6, 2011

Int. Cl.: 28

TRADEMARK

PRINCIPAL REGISTER

HUNTER'S SPECIALTIES, INC. (IOWA CORPORATION)
6000 HUNTINGTON COURT NE
CEDAR RAPIDS, IA 52402

FOR: ANIMAL HUNTING DECOYS, IN CLASS 28 (U.S. CLS. 22, 23, 38 AND 50).

FIRST USE 6-27-2011; IN COMMERCE 6-27-2011.

THE MARK CONSISTS OF STANDARD CHARACTERS WITHOUT CLAIM TO ANY PARTICULAR FONT, STYLE, SIZE, OR COLOR.

OWNER OF U.S. REG. NO. 1,863,805.

SN 77-705,391, FILED 4-2-2009.

LINDA ESTRADA, EXAMINING ATTORNEY



David J. Kybas

Director of the United States Patent and Trademark Office

United States of America

United States Patent and Trademark Office



Reg. No. 4,067,656

Registered Dec. 6, 2011

Int. Cls.: 16 and 20

TRADEMARK

PRINCIPAL REGISTER

NG, TSING KOU (CALIFORNIA CORPORATION)
1280 VAN DYKE AVE
SAN FRANCISCO, CA 94124

FOR: PACKAGING CONTAINERS OF PAPER, IN CLASS 16 (U.S. CLS. 2, 5, 22, 23, 29, 37, 38 AND 50).

FIRST USE 8-8-2009; IN COMMERCE 8-8-2009.

FOR: PACKAGING CONTAINERS OF PLASTIC; PLASTIC CONTAINERS AND COVERS SOLD AS A UNIT TO THE FAST FOOD INDUSTRY FOR MADE TO ORDER FOOD PRODUCTS, IN CLASS 20 (U.S. CLS. 2, 13, 22, 25, 32 AND 50).

FIRST USE 8-8-2009; IN COMMERCE 8-8-2009.

NO CLAIM IS MADE TO THE EXCLUSIVE RIGHT TO USE THE NON-LATIN CHARACTERS THAT TRANSLITERATE TO "MEI" AND "BAO" AND "TRADE CORP", APART FROM THE MARK AS SHOWN.

THE COLOR(S) GREEN AND WHITE IS/ARE CLAIMED AS A FEATURE OF THE MARK.

THE NON-LATIN CHARACTERS IN THE MARK TRANSLITERATE TO MEI AND BAO AND THIS MEANS BEAUTIFUL AND ENVIRONMENTALLY FRIENDLY IN ENGLISH.

THE MARK CONSISTS OF A GREEN CONCENTRIC CIRCLE CONTAINING THE WORDING "MTC" AND "MAPLE TRADE CORP" IN WHITE COLOR, AND ASIAN CHARACTERS AS WELL AS A SPECIAL FORM DRAWING OF A MAPLE LEAF IN GREEN.

SN 77-705,843, FILED 4-2-2009.

PAM WILLIS, EXAMINING ATTORNEY



David J. Kybas

Director of the United States Patent and Trademark Office

United States of America

United States Patent and Trademark Office

rawQicafé

Reg. No. 4,067,657

Registered Dec. 6, 2011

Int. Cl.: 30

TRADEMARK

PRINCIPAL REGISTER

STEPHEN JAMES LUXURY ORGANICS LIMITED (BR. VIRGIN ISLANDS CORPORATION)
19TH FLOOR CODA PLAZA
51 GARDEN ROAD
CENTRAL, HONG KONG

FOR: SALT, IN CLASS 30 (U.S. CL. 46).

FIRST USE 12-13-2010; IN COMMERCE 12-13-2010.

THE MARK CONSISTS OF LOWER CASE LETTERS "RAW", UPPER CASE LETTER "Q", LOWER CASE LETTERS "ICAFÉ" WITH ACCENT MARK OVER THE "E" WITH NO SPACES BETWEEN LETTERS.

SN 77-708,882, FILED 4-7-2009.

JAMES A. RAUEN, EXAMINING ATTORNEY



David J. Kyffers

Director of the United States Patent and Trademark Office

United States of America

United States Patent and Trademark Office

LA MINA TV

Reg. No. 4,067,658

Registered Dec. 6, 2011

Int. Cls.: 38, 41, and 45

SERVICE MARK

PRINCIPAL REGISTER

LA MINA TV, LLC (DELAWARE LIMITED LIABILITY COMPANY)
SUITE F
11757 W. KEN CARYL AVENUE
LITTLETON, CO 80127

FOR: AUDIO AND VIDEO BROADCASTING VIA THE INTERNET AND WIRELESS COMMUNICATIONS NETWORKS; INTERNET BROADCASTING SERVICES; MULTIMEDIA BROADCASTING VIA THE INTERNET AND WIRELESS COMMUNICATIONS NETWORKS, NAMELY, WEBVIDEO BROADCASTING; WEBCASTING SERVICES; VIDEO STREAMING SERVICES VIA THE INTERNET FEATURING INDEPENDENT FILMS AND MOVIES, IN CLASS 38 (U.S. CLS. 100, 101 AND 104).

FIRST USE 11-1-2007; IN COMMERCE 7-8-2011.

FOR: ENTERTAINMENT SERVICES, NAMELY, NON-DOWNLOADABLE PRE-RECORDED MUSICAL PERFORMANCES, VIDEO AND GRAPHICS PRESENTED TO MOBILE COMMUNICATIONS DEVICES VIA A GLOBAL COMPUTER NETWORK AND WIRELESS NETWORKS; ENTERTAINMENT SERVICES, NAMELY, PROVIDING A WEB SITE FEATURING USER-GENERATED VIDEOS ON A WIDE VARIETY OF TOPICS AND SUBJECTS; ENTERTAINMENT SERVICES, NAMELY, PROVIDING A WEB SITE FEATURING MUSICAL PERFORMANCES, MUSICAL VIDEOS, RELATED FILM CLIPS, PHOTOGRAPHS, AND OTHER MULTIMEDIA MATERIALS FEATURING MUSIC AND DRAMA; ENTERTAINMENT AND EDUCATION SERVICES IN THE NATURE OF A SERIES OF SHORT SHOWS FEATURING DRAMA DISTRIBUTED TO MOBILE HANDSETS, WHICH MAY INCLUDE VIDEO, TEXT, PHOTOS, ILLUSTRATIONS OR HYPERTEXT, IN CLASS 41 (U.S. CLS. 100, 101 AND 107).

FIRST USE 11-1-2007; IN COMMERCE 7-8-2011.

FOR: ONLINE SOCIAL NETWORKING SERVICES, IN CLASS 45 (U.S. CLS. 100 AND 101).

FIRST USE 11-1-2007; IN COMMERCE 7-8-2011.

THE MARK CONSISTS OF STANDARD CHARACTERS WITHOUT CLAIM TO ANY PARTICULAR FONT, STYLE, SIZE, OR COLOR.



David J. Kybas

Director of the United States Patent and Trademark Office

Reg. No. 4,067,658 NO CLAIM IS MADE TO THE EXCLUSIVE RIGHT TO USE "TV", APART FROM THE MARK AS SHOWN.

THE ENGLISH TRANSLATION OF "LA MINA" IN THE MARK IS "THE MINE."

SN 77-710,468, FILED 4-9-2009.

ZHALEH DELANEY, EXAMINING ATTORNEY

United States of America

United States Patent and Trademark Office

BITZILLA

Reg. No. 4,067,659

Registered Dec. 6, 2011

Int. Cl.: 7

TRADEMARK

PRINCIPAL REGISTER

SMITH INTERNATIONAL, INC. (DELAWARE CORPORATION)
PATENT SERVICES
16740 HARDY STREET
HOUSTON, TX 77073

FOR: POWER-OPERATED DRILL BIT USED IN THE OIL AND GAS INDUSTRY, IN CLASS 7 (U.S. CLS. 13, 19, 21, 23, 31, 34 AND 35).

FIRST USE 12-1-2009; IN COMMERCE 12-1-2009.

THE MARK CONSISTS OF STANDARD CHARACTERS WITHOUT CLAIM TO ANY PARTICULAR FONT, STYLE, SIZE, OR COLOR.

SN 77-715,058, FILED 4-16-2009.

LINDA ESTRADA, EXAMINING ATTORNEY



David J. Kybas

Director of the United States Patent and Trademark Office

United States of America

United States Patent and Trademark Office



Reg. No. 4,067,660

Registered Dec. 6, 2011

Int. Cl.: 25

TRADEMARK

PRINCIPAL REGISTER

TASSEL, JEFF VAN (UNITED STATES INDIVIDUAL)
541 KRIS LANE
MOSINEE, WI 54455 AND

ROBINSON, MARK (UNITED STATES INDIVIDUAL)
541 KRIS LANE
MOSINEE, WI 54455

FOR: HATS; JACKETS; SHIRTS, IN CLASS 25 (U.S. CLS. 22 AND 39).

FIRST USE 6-1-1971; IN COMMERCE 3-17-2010.

NO CLAIM IS MADE TO THE EXCLUSIVE RIGHT TO USE "ROCKY MTN. CHAP.", APART FROM THE MARK AS SHOWN.

THE MARK CONSISTS OF THE STYLIZED TEXT "RAVINOS ROCKY MTN. CHAP." AND DESIGN WITH A ROCK FACE ON EITHER SIDE OF A FLAMING SKULL IN THE MIDDLE OF A CIRCLE.

THE ENGLISH TRANSLATION OF THE WORD "RAVINOS" IN THE MARK IS "RABBIS".

SN 77-715,777, FILED 4-16-2009.

BRIAN PINO, EXAMINING ATTORNEY



David J. Kybas

Director of the United States Patent and Trademark Office

United States of America

United States Patent and Trademark Office

THE GSN GAME SHOW AWARDS

Reg. No. 4,067,661

Registered Dec. 6, 2011

Int. Cl.: 41

SERVICE MARK

PRINCIPAL REGISTER

GAME SHOW NETWORK, LLC (DELAWARE LIMITED LIABILITY COMPANY)
2150 COLORADO AVENUE
SANTA MONICA, CA 90404

FOR: ENTERTAINMENT SERVICES, NAMELY, AN ANNUAL LIVE TELEVISION PROGRAM RELATING TO GAME SHOWS WITH AN INTERACTIVE FEATURE AND LIVE GAMES , IN CLASS 41 (U.S. CLS. 100, 101 AND 107).

FIRST USE 6-6-2009; IN COMMERCE 6-6-2009.

THE MARK CONSISTS OF STANDARD CHARACTERS WITHOUT CLAIM TO ANY PARTICULAR FONT, STYLE, SIZE, OR COLOR.

OWNER OF U.S. REG. NOS. 2,509,248 AND 2,984,112.

NO CLAIM IS MADE TO THE EXCLUSIVE RIGHT TO USE "GAME SHOW AWARDS", APART FROM THE MARK AS SHOWN.

SN 77-715,842, FILED 4-16-2009.

JULIE WATSON, EXAMINING ATTORNEY



David J. Kybas

Director of the United States Patent and Trademark Office

United States of America

United States Patent and Trademark Office

KEEPING BEAUTY CURRENT

Reg. No. 4,067,662

Registered Dec. 6, 2011

Int. Cl.: 10

TRADEMARK

PRINCIPAL REGISTER

CAROL COLE COMPANY (CALIFORNIA CORPORATION)
SUITE 109
3146 TIGER RUN CT.
CARLSBAD, CA 92010

FOR: SKIN TONING MACHINES FOR COSMETIC USE, IN CLASS 10 (U.S. CLS. 26, 39 AND 44).

FIRST USE 1-0-2011; IN COMMERCE 1-0-2011.

THE MARK CONSISTS OF STANDARD CHARACTERS WITHOUT CLAIM TO ANY PARTICULAR FONT, STYLE, SIZE, OR COLOR.

SN 77-716,392, FILED 4-17-2009.

KATHERINE CHANG, EXAMINING ATTORNEY



David J. Kybas

Director of the United States Patent and Trademark Office

United States of America

United States Patent and Trademark Office

OVERHORDE



ENTERTAINMENT, INC.

Reg. No. 4,067,663

Registered Dec. 6, 2011

Int. Cls.: 25 and 41

TRADEMARK

SERVICE MARK

PRINCIPAL REGISTER

ALLEN III, EUGENE M. (UNITED STATES INDIVIDUAL), AKA ETARE NEGED,
5A
1922 W HOOD AVE
CHICAGO, IL 60660

FOR: A-SHIRTS; ATHLETIC APPAREL, NAMELY, SHIRTS, PANTS, JACKETS, FOOTWEAR, HATS AND CAPS, ATHLETIC UNIFORMS; CAMP SHIRTS; CARGO PANTS; DENIMS; DRESS SHIRTS; GOLF PANTS, SHIRTS AND SKIRTS; GOLF SHIRTS; GYM PANTS; HATS; HEADGEAR, NAMELY, HATS; HOODED SWEAT SHIRTS; JOGGING PANTS; KNIT SHIRTS; LONG-SLEEVED SHIRTS; LOUNGE PANTS; PANTS; PIQUE SHIRTS; POLO SHIRTS; SHIRTS; SHIRTS FOR SUITS; SWEAT PANTS; T-SHIRTS; TEE SHIRTS; WEARABLE GARMENTS AND CLOTHING, NAMELY, SHIRTS; WIND PANTS; WIND SHIRTS, IN CLASS 25 (U.S. CLS. 22 AND 39).

FIRST USE 1-10-2008; IN COMMERCE 6-15-2008.

FOR: ENTERTAINMENT IN THE NATURE OF LIVE PERFORMANCES BY MUSICAL ARTISTS; ENTERTAINMENT IN THE NATURE OF VISUAL AND AUDIO PERFORMANCES, AND MUSICAL, VARIETY, NEWS AND COMEDY SHOWS; ENTERTAINMENT IN THE NATURE OF VISUAL AND AUDIO PERFORMANCES, NAMELY, MUSICAL BAND, ROCK GROUP, GYMNASTIC, DANCE, AND BALLET PERFORMANCES; ENTERTAINMENT SERVICES IN THE NATURE OF LIVE MUSICAL PERFORMANCES; ENTERTAINMENT SERVICES, NAMELY, A MULTIMEDIA PROGRAM SERIES FEATURING COMEDY, ACTION AND ADVENTURE DISTRIBUTED VIA VARIOUS PLATFORMS ACROSS MULTIPLE FORMS OF TRANSMISSION MEDIA; ENTERTAINMENT SERVICES, NAMELY, DANCE EVENTS BY A RECORDING ARTIST; ENTERTAINMENT SERVICES, NAMELY, LIVE, TELEVISED AND MOVIE APPEARANCES BY A PROFESSIONAL ENTERTAINER; ENTERTAINMENT SERVICES, NAMELY, MULTIMEDIA PRODUCTION SERVICES; ENTERTAINMENT SERVICES, NAMELY, NON-DOWNLOADABLE RINGTONES, PRE-RECORDED MUSIC, VIDEO AND GRAPHICS PRESENTED TO MOBILE COMMUNICATIONS DEVICES VIA A GLOBAL COMPUTER NETWORK AND WIRELESS NETWORKS; ENTERTAINMENT SERVICES, NAMELY, PERSONAL APPEARANCES BY A MUSICAL ARTIST; ENTERTAINMENT SERVICES, NAMELY, PROVIDING A RADIO PROGRAM IN THE FIELD OF HIP HOP VIA A GLOBAL COMPUTER NETWORK; ENTERTAINMENT SERVICES, NAMELY, PROVIDING A TELEVISION PROGRAM IN THE FIELD OF MUSIC, VIDEO, LITERATURE VIA A GLOBAL COMPUTER NETWORK; ENTERTAINMENT SERVICES, NAMELY, PROVIDING A WEB SITE FEATURING MUSICAL PERFORMANCES, MUSICAL VIDEOS,



David J. Kyros

Director of the United States Patent and Trademark Office

Reg. No. 4,067,663 RELATED FILM CLIPS, PHOTOGRAPHS, AND OTHER MULTIMEDIA MATERIALS FEATURING MUSICAL ARTISTS; ENTERTAINMENT SERVICES, NAMELY, PROVIDING A WEB SITE FEATURING PHOTOGRAPHIC AND PROSE PRESENTATIONS FEATURING MUSICAL ARTISTS; ENTERTAINMENT SERVICES, NAMELY, PROVIDING A WEB SITE FEATURING PHOTOGRAPHIC, AUDIO, VIDEO AND PROSE PRESENTATIONS FEATURING MUSICAL ARTISTS; ENTERTAINMENT SERVICES, NAMELY, PROVIDING A WEB SITE FEATURING PHOTOGRAPHIC, VIDEO AND PROSE PRESENTATIONS FEATURING MUSICAL ARTISTS; ENTERTAINMENT SERVICES, NAMELY, PROVIDING PRERECORDED MUSIC, INFORMATION IN THE FIELD OF MUSIC, AND COMMENTARY AND ARTICLES ABOUT MUSIC, ALL ON-LINE VIA A GLOBAL COMPUTER NETWORK; ENTERTAINMENT, NAMELY, LIVE PERFORMANCES BY MUSICAL BANDS; MUSIC VIDEO PRODUCTION SERVICES, IN CLASS 41 (U.S. CLS. 100, 101 AND 107).

FIRST USE 6-12-2009; IN COMMERCE 9-16-2009.

NO CLAIM IS MADE TO THE EXCLUSIVE RIGHT TO USE "ENTERTAINMENT, INC.", APART FROM THE MARK AS SHOWN.

THE MARK CONSISTS OF THE WORDS "OVERHORDE ENTERTAINMENT, INC." INTERCEDED IN THE MIDDLE BY THE STYLIZED LETTERS "O" AND "H".

SN 77-716,928, FILED 4-18-2009.

RAUL CORDOVA, EXAMINING ATTORNEY

United States of America

United States Patent and Trademark Office

RTF IV

Reg. No. 4,067,664

Registered Dec. 6, 2011

Int. Cl.: 25

TRADEMARK

PRINCIPAL REGISTER

COREA, ARMANDO ANTHONY (UNITED STATES INDIVIDUAL)
411 CLEVELAND ST., SUITE 215
CLEARWATER, FL 33755

FOR: HATS; SHIRTS, IN CLASS 25 (U.S. CLS. 22 AND 39).

FIRST USE 8-7-2011; IN COMMERCE 8-7-2011.

THE MARK CONSISTS OF STANDARD CHARACTERS WITHOUT CLAIM TO ANY PARTICULAR FONT, STYLE, SIZE, OR COLOR.

SN 77-717,248, FILED 4-20-2009.

BRIDGETT SMITH, EXAMINING ATTORNEY



David J. Kybas

Director of the United States Patent and Trademark Office

United States of America

United States Patent and Trademark Office

FD695 PLUS

Reg. No. 4,067,665

Registered Dec. 6, 2011

Int. Cl.: 12

TRADEMARK

PRINCIPAL REGISTER

BRIDGESTONE BRANDS, LLC (DELAWARE LIMITED LIABILITY COMPANY)
535 MARRIOTT DRIVE
NASHVILLE, TN 37214

FOR: VEHICLE TIRES, IN CLASS 12 (U.S. CLS. 19, 21, 23, 31, 35 AND 44).

FIRST USE 12-31-2010; IN COMMERCE 12-31-2010.

THE MARK CONSISTS OF STANDARD CHARACTERS WITHOUT CLAIM TO ANY PARTICULAR FONT, STYLE, SIZE, OR COLOR.

SN 77-717,619, FILED 4-20-2009.

KARANENDRA S. CHHINA, EXAMINING ATTORNEY



David J. Kybas

Director of the United States Patent and Trademark Office

United States of America

United States Patent and Trademark Office

SELECTILYTE

Reg. No. 4,067,666

MERCK KGAA (FED REP GERMANY KOMMANDITGESELLSCHAFT AUF AKTIEN (KGAA))
FRANKFURTER STR. 250
DARMSTADT, FED REP GERMANY 64293

Registered Dec. 6, 2011

Int. Cl.: 1

FOR: CHEMICALS USED IN INDUSTRY, SCIENCE, IN CLASS 1 (U.S. CLS. 1, 5, 6, 10, 26 AND 46).

TRADEMARK

FIRST USE 4-0-2009; IN COMMERCE 1-0-2011.

PRINCIPAL REGISTER

THE MARK CONSISTS OF STANDARD CHARACTERS WITHOUT CLAIM TO ANY PARTICULAR FONT, STYLE, SIZE, OR COLOR.

OWNER OF FED REP GERMANY REG. NO. 302008070489, DATED 12-3-2008, EXPIRES 11-30-2018.

SN 77-717,688, FILED 4-20-2009.

LINDSEY RUBIN, EXAMINING ATTORNEY



David J. Kybas

Director of the United States Patent and Trademark Office

United States of America

United States Patent and Trademark Office

ACIST

Reg. No. 4,067,667

Registered Dec. 6, 2011

Int. Cls.: 9 and 10

TRADEMARK

PRINCIPAL REGISTER

ACIST MEDICAL SYSTEMS, INC. (DELAWARE CORPORATION)
7905 FULLER ROAD
EDEN PRAIRIE, MN 55344

FOR: COMPUTER SOFTWARE FOR MANAGING THE ADMINISTRATION OF CONTRAST AGENTS DURING MEDICAL PROCEDURES, IN CLASS 9 (U.S. CLS. 21, 23, 26, 36 AND 38).

FIRST USE 9-20-1997; IN COMMERCE 9-20-1997.

FOR: MEDICAL PRODUCTS, NAMELY, CONTRAST DELIVERY PRODUCTS, NAMELY, CONTRAST INJECTORS, SYRINGES, TUBING, HAND-HELD CONTROLS FOR DELIVERING CONTRAST MEDIA TO PATIENTS DURING MEDICAL PROCEDURES, IN CLASS 10 (U.S. CLS. 26, 39 AND 44).

FIRST USE 9-20-1997; IN COMMERCE 9-20-1997.

THE MARK CONSISTS OF STANDARD CHARACTERS WITHOUT CLAIM TO ANY PARTICULAR FONT, STYLE, SIZE, OR COLOR.

OWNER OF U.S. REG. NOS. 2,280,320, 3,361,658, AND OTHERS.

SN 77-717,965, FILED 4-20-2009.

FRANK LATTUCA, EXAMINING ATTORNEY



David J. Kybas

Director of the United States Patent and Trademark Office

United States of America

United States Patent and Trademark Office

A COUPLES-ONLY ESCAPE

Reg. No. 4,067,668

Registered Dec. 6, 2011

Int. Cl.: 43

SERVICE MARK

PRINCIPAL REGISTER

PALACE HOLDING, S.A. DE C.V. (MEXICO CORPORATION)
HOTEL CANCUN PALACE, ZONA HOTELERA
BOULEVARD KUKULCAN, KM. 14.5
CANCUN, QUINTANA ROO, MEXICO

FOR: HOTELS; RESORT HOTELS; RESTAURANT AND BAR SERVICES, IN CLASS 43 (U.S. CLS. 100 AND 101).

FIRST USE 6-1-2009; IN COMMERCE 6-1-2009.

THE MARK CONSISTS OF STANDARD CHARACTERS WITHOUT CLAIM TO ANY PARTICULAR FONT, STYLE, SIZE, OR COLOR.

NO CLAIM IS MADE TO THE EXCLUSIVE RIGHT TO USE "COUPLES-ONLY", APART FROM THE MARK AS SHOWN.

SN 77-719,537, FILED 4-22-2009.

JULIE WATSON, EXAMINING ATTORNEY



David J. Kyffers

Director of the United States Patent and Trademark Office

United States of America

United States Patent and Trademark Office

ADULTS-ONLY RELAXING GETAWAY

Reg. No. 4,067,669

Registered Dec. 6, 2011

Int. Cl.: 43

SERVICE MARK

PRINCIPAL REGISTER

PALACE HOLDING, S.A. DE C.V. (MEXICO CORPORATION)
HOTEL CANCUN PALACE, ZONA HOTELERA
BOULEVARD KUKULCAN, KM. 14.5
CANCUN, QUINTANA ROO, MEXICO

FOR: HOTELS; RESORT HOTELS; RESTAURANT AND BAR SERVICES, IN CLASS 43 (U.S. CLS. 100 AND 101).

FIRST USE 6-1-2009; IN COMMERCE 6-1-2009.

THE MARK CONSISTS OF STANDARD CHARACTERS WITHOUT CLAIM TO ANY PARTICULAR FONT, STYLE, SIZE, OR COLOR.

NO CLAIM IS MADE TO THE EXCLUSIVE RIGHT TO USE "ADULTS-ONLY" AND "GETAWAY", APART FROM THE MARK AS SHOWN.

SN 77-719,547, FILED 4-22-2009.

JULIE WATSON, EXAMINING ATTORNEY



David J. Kyffers

Director of the United States Patent and Trademark Office

United States of America

United States Patent and Trademark Office

MEMORABLE FAMILY VACATIONS

Reg. No. 4,067,670

Registered Dec. 6, 2011

Int. Cl.: 43

SERVICE MARK

PRINCIPAL REGISTER

PALACE HOLDING, S.A. DE C.V. (MEXICO CORPORATION)
HOTEL CANCUN PALACE, ZONA HOTELERA
BOULEVARD KUKULCAN, KM. 14.5
CANCUN, QUINTANA ROO, MEXICO

FOR: HOTELS; RESORT HOTELS; RESTAURANT AND BAR SERVICES, IN CLASS 43 (U.S. CLS. 100 AND 101).

FIRST USE 6-1-2009; IN COMMERCE 6-1-2009.

THE MARK CONSISTS OF STANDARD CHARACTERS WITHOUT CLAIM TO ANY PARTICULAR FONT, STYLE, SIZE, OR COLOR.

NO CLAIM IS MADE TO THE EXCLUSIVE RIGHT TO USE "FAMILY VACATIONS", APART FROM THE MARK AS SHOWN.

SN 77-719,555, FILED 4-22-2009.

JULIE WATSON, EXAMINING ATTORNEY



David J. Kybas

Director of the United States Patent and Trademark Office

United States of America

United States Patent and Trademark Office

AN INTIMATE CARIBBEAN GEM

Reg. No. 4,067,671

Registered Dec. 6, 2011

Int. Cl.: 43

SERVICE MARK

PRINCIPAL REGISTER

PALACE HOLDING, S.A. DE C.V. (MEXICO CORPORATION)
HOTEL CANCUN PALACE, ZONA HOTELERA
BOULEVARD KUKULCAN, KM. 14.5
CANCUN, QUINTANA ROO, MEXICO

FOR: HOTELS; RESORT HOTELS; RESTAURANT AND BAR SERVICES, IN CLASS 43 (U.S. CLS. 100 AND 101).

FIRST USE 6-1-2009; IN COMMERCE 6-1-2009.

THE MARK CONSISTS OF STANDARD CHARACTERS WITHOUT CLAIM TO ANY PARTICULAR FONT, STYLE, SIZE, OR COLOR.

NO CLAIM IS MADE TO THE EXCLUSIVE RIGHT TO USE "CARIBBEAN", APART FROM THE MARK AS SHOWN.

SN 77-719,564, FILED 4-22-2009.

JULIE WATSON, EXAMINING ATTORNEY



David J. Kyffers

Director of the United States Patent and Trademark Office

United States of America
United States Patent and Trademark Office

PROLIFIC

Reg. No. 4,067,672

Registered Dec. 6, 2011

Int. Cl.: 11

TRADEMARK

PRINCIPAL REGISTER

LIGHTING SCIENCE GROUP CORPORATION (DELAWARE CORPORATION)
BUILDING 2A
1227 SOUTH PATRICK DRIVE
SATELLITE BEACH, FL 32937

FOR: LUMINAIRES, USING LIGHT EMITTING DIODES (LEDS) AS A LIGHT SOURCE, FOR STREET OR ROADWAY LIGHTING, IN CLASS 11 (U.S. CLS. 13, 21, 23, 31 AND 34).

FIRST USE 8-0-2009; IN COMMERCE 8-0-2009.

THE MARK CONSISTS OF STANDARD CHARACTERS WITHOUT CLAIM TO ANY PARTICULAR FONT, STYLE, SIZE, OR COLOR.

SN 77-720,823, FILED 4-23-2009.

TIMOTHY FINNEGAN, EXAMINING ATTORNEY



David J. Kybas

Director of the United States Patent and Trademark Office

United States of America

United States Patent and Trademark Office

JMS

Reg. No. 4,067,673

Registered Dec. 6, 2011

Int. Cl.: 25

TRADEMARK

PRINCIPAL REGISTER

HBI BRANDED APPAREL ENTERPRISES, LLC (DELAWARE LIMITED LIABILITY COMPANY)
1000 EAST HANES MILL ROAD
WINSTON-SALEM, NC 27105

FOR: BELTS FOR CLOTHING; SCARVES, IN CLASS 25 (U.S. CLS. 22 AND 39).

FIRST USE 8-31-2011; IN COMMERCE 8-31-2011.

THE MARK CONSISTS OF STANDARD CHARACTERS WITHOUT CLAIM TO ANY PARTICULAR FONT, STYLE, SIZE, OR COLOR.

OWNER OF U.S. REG. NOS. 2,817,823, 3,595,560, AND OTHERS.

SN 77-721,439, FILED 4-24-2009.

LINDA POWELL, EXAMINING ATTORNEY



David J. Kybas

Director of the United States Patent and Trademark Office

United States of America

United States Patent and Trademark Office

SPIRIT OF ALLIANCE

Reg. No. 4,067,674

Registered Dec. 6, 2011

Int. Cl.: 16

TRADEMARK

PRINCIPAL REGISTER

HILLWOOD DEVELOPMENT COMPANY, LLC (TEXAS LIMITED LIABILITY COMPANY)
SUITE 800
5430 LBJ FREEWAY
DALLAS, TX 75240

FOR: PUBLICATIONS, NAMELY, NEWSPAPERS, BROCHURES, AND PAMPHLETS IN THE
FIELD OF REAL ESTATE AND RELATED MULTI-USE LAND DEVELOPMENT SERVICES,
IN CLASS 16 (U.S. CLS. 2, 5, 22, 23, 29, 37, 38 AND 50).

FIRST USE 8-11-2011; IN COMMERCE 8-11-2011.

THE MARK CONSISTS OF STANDARD CHARACTERS WITHOUT CLAIM TO ANY PAR-
TICULAR FONT, STYLE, SIZE, OR COLOR.

OWNER OF U.S. REG. NO. 3,070,016.

SN 77-724,539, FILED 4-28-2009.

GENE MACIOL, EXAMINING ATTORNEY



David J. Kybas

Director of the United States Patent and Trademark Office

United States of America

United States Patent and Trademark Office

ACADEMY OF COLOUR

Reg. No. 4,067,675

Registered Dec. 6, 2011

Int. Cl.: 3

TRADEMARK

PRINCIPAL REGISTER

PACIFIC SALES (UK) LTD. (UNITED KINGDOM CORPORATION)
VALE ROYAL HOUSE, VALE ROYAL DRIVE
WHITEGATE, CHESHIRE, UNITED KINGDOM CW82BA

FOR: COSMETICS; LIP GLOSS; LIPSTICK; LIP LINER; EYE SHADOW; EYELINER; EYE CREAM; EYE MAKE-UP; NAIL POLISH; MASCARA; SKIN BRONZING CREAMS; BODY POWDER, IN CLASS 3 (U.S. CLS. 1, 4, 6, 50, 51 AND 52).

FIRST USE 9-14-2011; IN COMMERCE 9-14-2011.

THE MARK CONSISTS OF STANDARD CHARACTERS WITHOUT CLAIM TO ANY PARTICULAR FONT, STYLE, SIZE, OR COLOR.

NO CLAIM IS MADE TO THE EXCLUSIVE RIGHT TO USE "COLOR", APART FROM THE MARK AS SHOWN.

SN 77-726,187, FILED 4-30-2009.

MARK SHINER, EXAMINING ATTORNEY



David J. Kybas

Director of the United States Patent and Trademark Office

United States of America

United States Patent and Trademark Office

Charlie's Jeans

Reg. No. 4,067,676

Registered Dec. 6, 2011

Int. Cl.: 25

TRADEMARK

PRINCIPAL REGISTER

CHARLES PORTER BOUTIQUE, INC. (PENNSYLVANIA CORPORATION), DBA CHARLIE'S
JEANS,
502 POPLAR STREET
PHILADELPHIA, PA 19123

FOR: BELTS; COATS; DENIMS; HATS; JACKETS; JEANS; PANTIES; PANTS; SHIRTS;
SHOES; SHORTS; SKIRTS AND DRESSES; SOCKS; SWEAT SHIRTS; SWEATERS; T-SHIRTS;
TOPS; UNDERGARMENTS; UNDERWEAR, IN CLASS 25 (U.S. CLS. 22 AND 39).

FIRST USE 10-1-2011; IN COMMERCE 10-1-2011.

THE MARK CONSISTS OF STANDARD CHARACTERS WITHOUT CLAIM TO ANY PAR-
TICULAR FONT, STYLE, SIZE, OR COLOR.

NO CLAIM IS MADE TO THE EXCLUSIVE RIGHT TO USE "JEANS", APART FROM THE
MARK AS SHOWN.

SN 77-726,841, FILED 5-1-2009.

MARIA-VICTORIA SUAREZ, EXAMINING ATTORNEY



David J. Kybas

Director of the United States Patent and Trademark Office

United States of America

United States Patent and Trademark Office

QUANTA FLASH

Reg. No. 4,067,677

Registered Dec. 6, 2011

Int. Cl.: 5

TRADEMARK

PRINCIPAL REGISTER

INOVA DIAGNOSTICS, INC. (CALIFORNIA CORPORATION)
9900 OLD GROVE ROAD
SAN DIEGO, CA 92131

FOR: CLINICAL DIAGNOSTIC ASSAYS FOR MEDICAL PURPOSES, NAMELY, THE DIAGNOSIS OF AUTOIMMUNE DISEASES, IN CLASS 5 (U.S. CLS. 6, 18, 44, 46, 51 AND 52).

FIRST USE 7-26-2011; IN COMMERCE 7-26-2011.

THE MARK CONSISTS OF STANDARD CHARACTERS WITHOUT CLAIM TO ANY PARTICULAR FONT, STYLE, SIZE, OR COLOR.

OWNER OF U.S. REG. NO. 2,115,253.

NO CLAIM IS MADE TO THE EXCLUSIVE RIGHT TO USE "FLASH", APART FROM THE MARK AS SHOWN.

SN 77-729,358, FILED 5-5-2009.

CHRISTINE COOPER, EXAMINING ATTORNEY



David J. Kybas

Director of the United States Patent and Trademark Office

United States of America

United States Patent and Trademark Office

TOY STORY

Reg. No. 4,067,678

Registered Dec. 6, 2011

Int. Cl.: 20

TRADEMARK

PRINCIPAL REGISTER

DISNEY ENTERPRISES, INC. (DELAWARE CORPORATION)
500 SOUTH BUENA VISTA STREET
BURBANK, CA 91521

FOR: MIRRORS, IN CLASS 20 (U.S. CLS. 2, 13, 22, 25, 32 AND 50).

FIRST USE 10-31-2010; IN COMMERCE 10-31-2010.

THE MARK CONSISTS OF STANDARD CHARACTERS WITHOUT CLAIM TO ANY PARTICULAR FONT, STYLE, SIZE, OR COLOR.

OWNER OF U.S. REG. NO. 2,520,404.

SN 77-729,765, FILED 5-5-2009.

CHRISIE B. KING, EXAMINING ATTORNEY



David J. Kyffers

Director of the United States Patent and Trademark Office

United States of America

United States Patent and Trademark Office

Transforming Information, Delivering Insight

Reg. No. 4,067,679

Registered Dec. 6, 2011

Int. Cl.: 35

SERVICE MARK

PRINCIPAL REGISTER

LITIGATION MANAGEMENT, INC. (OHIO CORPORATION)
SUITE 200
300 ALLEN-BRADLEY DRIVE
MAYFIELD HEIGHTS, OH 44124

FOR: RECORDS AND CASE MANAGEMENT SERVICES, NAMELY, ANALYSIS AND INDEXING OF DOCUMENTS FOR RECORDS MANAGEMENT, INCLUDING EVIDENCE AND DOCKET MANAGEMENT FOR LITIGATION MATTERS, FOR OTHERS, IN CLASS 35 (U.S. CLS. 100, 101 AND 102).

FIRST USE 9-18-2001; IN COMMERCE 9-18-2011.

THE MARK CONSISTS OF STANDARD CHARACTERS WITHOUT CLAIM TO ANY PARTICULAR FONT, STYLE, SIZE, OR COLOR.

SN 77-730,027, FILED 5-6-2009.

JOHN E. MICHOS, EXAMINING ATTORNEY



David J. Kybas

Director of the United States Patent and Trademark Office

United States of America

United States Patent and Trademark Office

BIPHENTIN

Reg. No. 4,067,680

Registered Dec. 6, 2011

Int. Cl.: 5

TRADEMARK

PRINCIPAL REGISTER

RHODES PHARMACEUTICALS L.P. (DELAWARE LIMITED PARTNERSHIP)
498 WASHINGTON STREET
COVENTRY, RI 02816

FOR: PHARMACEUTICAL PREPARATIONS FOR THE TREATMENT OF ATTENTION DEFICIT HYPERACTIVITY DISORDER (ADHD), IN CLASS 5 (U.S. CLS. 6, 18, 44, 46, 51 AND 52).

FIRST USE 1-4-2011; IN COMMERCE 1-4-2011.

THE MARK CONSISTS OF STANDARD CHARACTERS WITHOUT CLAIM TO ANY PARTICULAR FONT, STYLE, SIZE, OR COLOR.

SN 77-730,600, FILED 5-6-2009.

AMEEN IMAM, EXAMINING ATTORNEY



David J. Kyffers

Director of the United States Patent and Trademark Office

United States of America

United States Patent and Trademark Office

VOODOO PANTHER

Reg. No. 4,067,681

KABBANI, WAEL (SAUDI ARABIA INDIVIDUAL)

Registered Dec. 6, 2011

P.O. BOX 14901

SAN FRANCISCO, CA 941140901

Int. Cl.: 41

FOR: ENTERTAINMENT SERVICES, NAMELY, PROVIDING A WEBSITE FEATURING CARTOONS, COMIC BOOK CHARACTERS AND NON-DOWNLOADABLE INTERACTIVE GAMES, IN CLASS 41 (U.S. CLS. 100, 101 AND 107).

SERVICE MARK

FIRST USE 9-14-2011; IN COMMERCE 9-14-2011.

PRINCIPAL REGISTER

THE MARK CONSISTS OF STANDARD CHARACTERS WITHOUT CLAIM TO ANY PARTICULAR FONT, STYLE, SIZE, OR COLOR.

SN 77-733,601, FILED 5-11-2009.

ANDREA BUTLER, EXAMINING ATTORNEY



David J. Kyros

Director of the United States Patent and Trademark Office

United States of America

United States Patent and Trademark Office

The Inland Empire Good Time Guide

Reg. No. 4,067,682

Registered Dec. 6, 2011

Int. Cl.: 35

SERVICE MARK

PRINCIPAL REGISTER

PAK, SU (UNITED STATES INDIVIDUAL)
610 SOUTH MAIN STREET
LOS ANGELES, CA 90014

FOR: PROVIDING A WEBSITE FEATURING ONLINE TELEPHONE DIRECTORY INFORMATION AND ONLINE CITY GUIDE SERVICES FOR THE INLAND EMPIRE; MARKET OPINION POLLING, NAMELY, PROVIDING AN ONLINE INTERACTIVE WEBSITE OBTAINING USERS COMMENTS CONCERNING BUSINESS ORGANIZATIONS, SERVICE PROVIDERS, AND OTHER RESOURCES IN THE INLAND EMPIRE; PROVIDING BUSINESS INFORMATION, ALSO VIA INTERNET, THE CABLE NETWORK OR OTHER FORMS OF DATA TRANSFER, NAMELY, COMPILATIONS, RANKINGS, RATINGS, REVIEWS, REFERRALS AND RECOMMENDATIONS RELATING TO BUSINESS ORGANIZATIONS AND SERVICE PROVIDERS AND OTHER RESOURCES IN THE INLAND EMPIRE, IN CLASS 35 (U.S. CLS. 100, 101 AND 102).

FIRST USE 9-23-2011; IN COMMERCE 9-23-2011.

THE MARK CONSISTS OF STANDARD CHARACTERS WITHOUT CLAIM TO ANY PARTICULAR FONT, STYLE, SIZE, OR COLOR.

NO CLAIM IS MADE TO THE EXCLUSIVE RIGHT TO USE "INLAND EMPIRE" AND "GUIDE", APART FROM THE MARK AS SHOWN.

SN 77-734,388, FILED 5-11-2009.

BENJAMIN OKEKE, EXAMINING ATTORNEY



David J. Kyros

Director of the United States Patent and Trademark Office

United States of America
United States Patent and Trademark Office

Sunbeam

Reg. No. 4,067,683

Registered Dec. 6, 2011

Int. Cls.: 11 and 20

TRADEMARK

PRINCIPAL REGISTER

SUNBEAM PRODUCTS, INC. (DELAWARE CORPORATION)
2381 EXECUTIVE CENTER DRIVE
BOCA RATON, FL 33431

FOR: ELECTRICALLY HEATED BEDDING PRODUCTS FOR ANIMALS, NAMELY, BEDS, BED COVERS, BLANKETS, THROWS, AND HEATING PADS NOT FOR MEDICAL PURPOSES, IN CLASS 11 (U.S. CLS. 13, 21, 23, 31 AND 34).

FIRST USE 8-11-2011; IN COMMERCE 8-11-2011.

FOR: BEDDING PRODUCTS FOR ANIMALS, NAMELY, BEDS, IN CLASS 20 (U.S. CLS. 2, 13, 22, 25, 32 AND 50).

FIRST USE 8-11-2011; IN COMMERCE 8-11-2011.

OWNER OF U.S. REG. NOS. 390,181, 534,785, AND 747,286.

THE MARK CONSISTS OF THE LITERAL ELEMENT "SUNBEAM" WITH AN ARCH HAVING TAPERED ENDS WITH ONE TAPERED END CONNECTED TO THE TOP OF THE "S" IN THE LITERAL ELEMENT AND EXTENDING ACROSS THE TOP OF THE ENTIRE LITERAL ELEMENT.

SN 77-734,855, FILED 5-12-2009.

JAMES A. RAUEN, EXAMINING ATTORNEY



David J. Kyros

Director of the United States Patent and Trademark Office

United States of America

United States Patent and Trademark Office

leila lou

Reg. No. 4,067,684

ROSIE JANE COSMETICS INC. (CALIFORNIA CORPORATION)
137 N. LARCHMONT BLVD, #176
LOS ANGELES, CA 90004

Registered Dec. 6, 2011

Int. Cl.: 3

FOR: FRAGRANCES AND PERFUMERY, IN CLASS 3 (U.S. CLS. 1, 4, 6, 50, 51 AND 52).

TRADEMARK

FIRST USE 6-1-2009; IN COMMERCE 11-1-2009.

PRINCIPAL REGISTER

THE NAME "LEILA LOU" JOHNSTON IDENTIFIES A LIVING INDIVIDUAL WHOSE CONSENT IS OF RECORD.

THE COLOR(S) PINK IS/ARE CLAIMED AS A FEATURE OF THE MARK.

THE MARK CONSISTS OF THE FOLLOWING: THE STYLIZED WORDING "LEILA LOU" IN PINK.

SN 77-739,217, FILED 5-18-2009.

LOURDES AYALA, EXAMINING ATTORNEY



David J. Kyffers

Director of the United States Patent and Trademark Office

United States of America

United States Patent and Trademark Office



Reg. No. 4,067,685

Registered Dec. 6, 2011

Int. Cl.: 5

TRADEMARK

PRINCIPAL REGISTER

LEE, WILLIAM (UNITED STATES INDIVIDUAL)
341 EVENING CANYON ROAD
CORONA DEL MAR, CA 92625

FOR: ANALGESICS, IN CLASS 5 (U.S. CLS. 6, 18, 44, 46, 51 AND 52).

FIRST USE 8-13-2011; IN COMMERCE 8-13-2011.

OWNER OF U.S. REG. NO. 2,417,383.

NO CLAIM IS MADE TO THE EXCLUSIVE RIGHT TO USE "CT CREAM", APART FROM THE MARK AS SHOWN.

THE MARK CONSISTS OF WORDS "CT CREAM" INSIDE A RULED BOX AND THE WORD "PLUS" OUTSIDE OF THE BOX.

SN 77-739,644, FILED 5-18-2009.

SANI KHOURI, EXAMINING ATTORNEY



David J. Kybas

Director of the United States Patent and Trademark Office

United States of America

United States Patent and Trademark Office

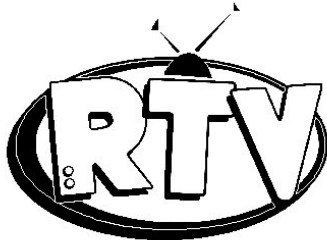

Reg. No. 4,067,686

Registered Dec. 6, 2011

Int. Cl.: 41

SERVICE MARK

PRINCIPAL REGISTER

RETRO TELEVISION, INC. (TENNESSEE CORPORATION)
735 BROAD STREET
SUITE 1204
CHATTANOOGA, TN 37402

FOR: A CABLE TELEVISION NETWORK FEATURING CLASSIC FAMILY-ORIENTED TELEVISION SERIES FROM THE 1950S THROUGH THE 1980S, IN CLASS 41 (U.S. CLS. 100, 101 AND 107).

FIRST USE 6-30-2009; IN COMMERCE 6-30-2009.

OWNER OF U.S. REG. NOS. 3,487,017 AND 3,487,018.

THE MARK CONSISTS OF THE CAPITAL LETTERS "RTV" IN A STYLIZED SHADOWED FONT SUPERIMPOSED ON AN OVAL BACKGROUND WITH A FANCIFUL ANTENNA ATOP THE MIDDLE LETTER "T" AND SIMULATED CONTROL KNOBS ADJACENT THE LOWER LEFT SIDE CORNER OF THE LEFT-HAND LETTER "R".

SN 77-741,318, FILED 5-20-2009.

GINA FINK, EXAMINING ATTORNEY



David J. Kybas

Director of the United States Patent and Trademark Office

United States of America

United States Patent and Trademark Office

Imperioso

Reg. No. 4,067,687

Registered Dec. 6, 2011

Int. Cl.: 30

TRADEMARK

PRINCIPAL REGISTER

ALVAREZ, FRANCISCO (UNITED STATES INDIVIDUAL)
92 B WYANDANCH AVE UNIT 92-B
WYANDANCH, NY 11798

FOR: PROCESSED GRAINS, IN CLASS 30 (U.S. CL. 46).

FIRST USE 5-31-2009; IN COMMERCE 5-31-2009.

THE MARK CONSISTS OF STANDARD CHARACTERS WITHOUT CLAIM TO ANY PARTICULAR FONT, STYLE, SIZE, OR COLOR.

THE ENGLISH TRANSLATION OF "IMPERIOSO" IN THE MARK IS URGENT.

SN 77-743,566, FILED 5-22-2009.

FRED CARL, EXAMINING ATTORNEY



David J. Kyffers

Director of the United States Patent and Trademark Office

United States of America

United States Patent and Trademark Office

Toilet Boot

Reg. No. 4,067,688

DEAN FLOYD LLC (NORTH DAKOTA LIMITED LIABILITY COMPANY)
1715 3RD ST SE
MINOT, ND 58701

Registered Dec. 6, 2011

Int. Cl.: 17

FOR: PLASTIC SHEETING WITH DRAWSTRINGS FOR DISPOSAL OF TOILETS, IN CLASS 17 (U.S. CLS. 1, 5, 12, 13, 35 AND 50).

TRADEMARK

FIRST USE 9-6-2009; IN COMMERCE 10-21-2009.

PRINCIPAL REGISTER

THE MARK CONSISTS OF STANDARD CHARACTERS WITHOUT CLAIM TO ANY PARTICULAR FONT, STYLE, SIZE, OR COLOR.

NO CLAIM IS MADE TO THE EXCLUSIVE RIGHT TO USE "TOILET", APART FROM THE MARK AS SHOWN.

SN 77-743,822, FILED 5-24-2009.

JEFF DEFORD, EXAMINING ATTORNEY



David J. Kybas

Director of the United States Patent and Trademark Office

United States of America

United States Patent and Trademark Office

LOVE AT FIRST GLIDE

Reg. No. 4,067,689

Registered Dec. 6, 2011

Int. Cl.: 9

TRADEMARK

PRINCIPAL REGISTER

IZUNAMI, INC. (NEW YORK CORPORATION)
83 HARBOR ROAD
PORT WASHINGTON, NY 11050

FOR: ELECTRIC HARDWARE FOR HAIR, NAMELY, ELECTRIC CURLING IRONS AND FLAT IRONS, IN CLASS 9 (U.S. CLS. 21, 23, 26, 36 AND 38).

FIRST USE 5-1-2009; IN COMMERCE 5-1-2009.

THE MARK CONSISTS OF STANDARD CHARACTERS WITHOUT CLAIM TO ANY PARTICULAR FONT, STYLE, SIZE, OR COLOR.

SN 77-745,689, FILED 5-27-2009.

BRIAN NEVILLE, EXAMINING ATTORNEY



David J. Kybas

Director of the United States Patent and Trademark Office

United States of America

United States Patent and Trademark Office

REQD

Reg. No. 4,067,690

Registered Dec. 6, 2011

Int. Cl.: 9

TRADEMARK

PRINCIPAL REGISTER

IZUNAMI, INC. (NEW YORK CORPORATION)
83 HARBOR ROAD
PORT WASHINGTON, NY 11050

FOR: ELECTRIC HARDWARE FOR HAIR, NAMELY, ELECTRIC CURLING IRONS AND FLAT IRONS, IN CLASS 9 (U.S. CLS. 21, 23, 26, 36 AND 38).

FIRST USE 5-1-2009; IN COMMERCE 5-1-2009.

THE MARK CONSISTS OF STANDARD CHARACTERS WITHOUT CLAIM TO ANY PARTICULAR FONT, STYLE, SIZE, OR COLOR.

SN 77-745,813, FILED 5-27-2009.

BRIAN NEVILLE, EXAMINING ATTORNEY



David J. Kybas

Director of the United States Patent and Trademark Office

United States of America

United States Patent and Trademark Office

GOT HOOKAH

Reg. No. 4,067,691

Registered Dec. 6, 2011

Int. Cls.: 25 and 34

TRADEMARK

PRINCIPAL REGISTER

TAQSEEM, INC. (CALIFORNIA CORPORATION)
5710 AUBURN BLVD., SUITE 8
SACRAMENTO, CA 95841

FOR: ATHLETIC APPAREL, NAMELY, SHIRTS, PANTS, JACKETS, FOOTWEAR, HATS AND CAPS, ATHLETIC UNIFORMS; CAPS; DRESS SHIRTS; GOLF SHIRTS; HATS; HOODED SWEAT SHIRTS; LONG-SLEEVED SHIRTS; NIGHT SHIRTS; OPEN-NECKED SHIRTS; OVER SHIRTS; PANTS; POLO SHIRTS; RUGBY SHIRTS; SHIRTS; SHORT-SLEEVED OR LONG-SLEEVED T-SHIRTS; SHORT-SLEEVED SHIRTS; SPORT SHIRTS; SPORTS SHIRTS WITH SHORT SLEEVES; SWEAT SHIRTS; T-SHIRTS; WEARABLE GARMENTS AND CLOTHING, NAMELY, SHIRTS, IN CLASS 25 (U.S. CLS. 22 AND 39).

FIRST USE 6-30-2011; IN COMMERCE 6-30-2011.

FOR: HOOKAHS; SMOKING TOBACCO; TOBACCO; TOBACCO PIPES; TOBACCO TINS, IN CLASS 34 (U.S. CLS. 2, 8, 9 AND 17).

FIRST USE 8-30-2011; IN COMMERCE 8-30-2011.

THE MARK CONSISTS OF STANDARD CHARACTERS WITHOUT CLAIM TO ANY PARTICULAR FONT, STYLE, SIZE, OR COLOR.

NO CLAIM IS MADE TO THE EXCLUSIVE RIGHT TO USE "HOOKAH" IN CLASS 34, APART FROM THE MARK AS SHOWN.

SN 77-747,423, FILED 5-29-2009.

DAVID TOOLEY, EXAMINING ATTORNEY



David J. Kyffers

Director of the United States Patent and Trademark Office

United States of America

United States Patent and Trademark Office

PRILIGY

Reg. No. 4,067,692

JOHNSON & JOHNSON (NEW JERSEY CORPORATION)
ONE JOHNSON & JOHNSON PLAZA
NEW BRUNSWICK, NJ 089337001

Registered Dec. 6, 2011

Int. Cl.: 5

FOR: PHARMACEUTICAL PREPARATIONS FOR THE TREATMENT OF PREMATURE EJACULATION, ERECTILE DYSFUNCTION, SEXUAL DYSFUNCTION, UROLOGICAL, UROGENITAL AND URINARY DISORDERS, IN CLASS 5 (U.S. CLS. 6, 18, 44, 46, 51 AND 52).

TRADEMARK

PRINCIPAL REGISTER

FIRST USE 4-27-2010; IN COMMERCE 4-27-2010.

THE MARK CONSISTS OF STANDARD CHARACTERS WITHOUT CLAIM TO ANY PARTICULAR FONT, STYLE, SIZE, OR COLOR.

SN 77-749,577, FILED 6-2-2009.

ROBIN MITTLER, EXAMINING ATTORNEY



David J. Kyffers

Director of the United States Patent and Trademark Office

United States of America

United States Patent and Trademark Office

SAN DIEGO PRIVATE BANK

Reg. No. 4,067,693

Registered Dec. 6, 2011

Int. Cl.: 25

TRADEMARK

PRINCIPAL REGISTER

SAN DIEGO PRIVATE BANK (CALIFORNIA CORPORATION)
9404 GENESSE AVE, SUITE 100
LA JOLLA, CA 92037

FOR: CLOTHING, NAMELY, HATS, SPORT SHIRTS, T-SHIRTS, GOLF SHIRTS, LADIES BABY TEES, HATS, BELTS, VISORS, SOCKS, JACKETS, SWEATSHIRTS, SCARVES, GLOVES, BLAZERS, SPORTS JACKETS, SHORTS, SKIRTS, TANK TOPS, PANTS, TIES, SWEAT PANTS, HOODED RAIN COVER UPS, PONCHOS, IN CLASS 25 (U.S. CLS. 22 AND 39).

FIRST USE 5-9-2005; IN COMMERCE 5-9-2005.

THE MARK CONSISTS OF STANDARD CHARACTERS WITHOUT CLAIM TO ANY PARTICULAR FONT, STYLE, SIZE, OR COLOR.

NO CLAIM IS MADE TO THE EXCLUSIVE RIGHT TO USE "SAN DIEGO", APART FROM THE MARK AS SHOWN.

SN 77-750,199, FILED 6-2-2009.

KIM SAITO, EXAMINING ATTORNEY



David J. Kybas

Director of the United States Patent and Trademark Office

United States of America

United States Patent and Trademark Office

AMAGINE

Reg. No. 4,067,694

Registered Dec. 6, 2011

**Int. Cls.: 16, 19, 35, 39,
40, 41, and 42**

TRADEMARK

SERVICE MARK

PRINCIPAL REGISTER

PRIME INVESTMENTS INC. (ARIZONA CORPORATION)
1755 SO. HORNE
MESA, AZ 85204

FOR: PRINTED VISUALS IN THE NATURE OF LARGE FORMAT AND TRADESHOW GRAPHICS; PRINTED PAPER SIGNS; POSTERS; PAPER BANNERS, IN CLASS 16 (U.S. CLS. 2, 5, 22, 23, 29, 37, 38 AND 50).

FIRST USE 9-0-2009; IN COMMERCE 9-0-2009.

FOR: NON-LUMINOUS, NON-MECHANICAL SIGNS NOT OF METAL, IN CLASS 19 (U.S. CLS. 1, 12, 33 AND 50).

FIRST USE 9-0-2009; IN COMMERCE 9-0-2009.

FOR: ADVERTISING SERVICES; BUSINESS MANAGEMENT; SERVICES COMPRISING DATA MANAGEMENT, NAMELY, THE COMPILATION AND SYSTEMATIZATION OF CONSUMER INFORMATION AND ACCOUNTING, BILLING, AND FINANCIAL DATA INTO DATABASES; INFORMATION AND DATA COMPILING AND ANALYZING RELATING TO BUSINESS MANAGEMENT, NAMELY, COMPILATION OF INFORMATION INTO COMPUTER DATABASES AND BUSINESS DATA ANALYSIS; ORDER FULFILLMENT SERVICES; PUBLIC OPINION SURVEYS; PUBLIC OPINION POLLING; CAMPAIGNING, NAMELY, DEVELOPING PROMOTIONAL CAMPAIGNS FOR BUSINESS AND POLITICAL CAMPAIGNS; POLITICAL CAMPAIGN MANAGEMENT AND ANALYSIS, NAMELY, PROVIDING INFORMATION ABOUT POLITICAL ELECTIONS IN THE FIELDS OF ANALYSIS OF VOTERS, CANDIDATES AND ISSUES; TRADESHOW MANAGEMENT, NAMELY, ORGANIZING, PROMOTING AND CONDUCTING TRADESHOWS FOR BUSINESS PURPOSES; MAILING SERVICES, NAMELY, DIRECT MAIL ADVERTISING AND MAIL HANDLING OF MATERIALS PREPARED BY US OR OTHERS; DIRECT MAIL ADVERTISING SERVICES; MAILING LIST PREPARATION; ONLINE ADVERTISING AND MARKETING SERVICES; ONLINE RETAIL STORE SERVICES FEATURING BUSINESS DATA ANALYSIS AND DATA PROCESSING SERVICES; ADVERTISING AND MARKETING SERVICES; COPY SERVICES, NAMELY, DUPLICATION OF DOCUMENTS; CREATIVE SERVICES, NAMELY, CREATIVE MARKETING DESIGN SERVICES FOR MARKETING AND PROMOTING INFORMATION; BUSINESS SUPPORT SERVICES, NAMELY, PROVIDING BUSINESS AND OFFICE SUPPORT STAFF SERVICES; BILLING AND BILLING STATEMENT SERVICES;



David J. Kybas

Director of the United States Patent and Trademark Office

Reg. No. 4,067,694 OPERATION OF TELEPHONE CALL CENTERS FOR OTHERS; ACCOUNTING SERVICES, IN CLASS 35 (U.S. CLS. 100, 101 AND 102).

FIRST USE 9-0-2009; IN COMMERCE 9-0-2009.

FOR: MERCHANDISE PACKAGING FOR OTHERS; ELECTRONIC STORAGE OF DATA; GOODS WAREHOUSING; DELIVERY OF GOODS , IN CLASS 39 (U.S. CLS. 100 AND 105).

FIRST USE 9-0-2009; IN COMMERCE 9-0-2009.

FOR: PRINTING; DIGITAL PRINTING; VARIABLE DATA PRINTING; PRINTING SERVICES, NAMELY, COMPLETE OFFSET AND WEB PRINTING; BINDERY SERVICES FOR OTHERS, NAMELY, COLLATING, FOLDING, STAPLING, PERFORATING, CUTTING AND BINDING OF PRINTED, PHOTOCOPIED AND TYPEWRITTEN MATERIALS; PAPER FINISHING, IN CLASS 40 (U.S. CLS. 100, 103 AND 106).

FIRST USE 9-0-2009; IN COMMERCE 9-0-2009.

FOR: PUBLISHING OF BOOKS AND MAGAZINES; VIDEO PRODUCTION; DESKTOP PUBLISHING FOR OTHERS, IN CLASS 41 (U.S. CLS. 100, 101 AND 107).

FIRST USE 9-0-2009; IN COMMERCE 9-0-2009.

FOR: WEB SITE DESIGN AND DEVELOPMENT FOR OTHERS; COMPUTER PROGRAMMING; COMPUTER TECHNOLOGY SUPPORT SERVICES, NAMELY, COMPUTER CONSULTING SERVICES IN THE FIELD OF BUSINESS COMPUTER AND COMPUTER INFORMATION SERVICES; HOSTING OF WEB SITES; GRAPHIC DESIGN; WEBSITE CREATION AND MANAGEMENT FOR OTHERS; IT SERVICES, NAMELY, IT CONSULTING SERVICES; COMPUTER TECHNICAL SUPPORT SERVICES, NAMELY, HELP DESK SERVICES FOR IT INFRASTRUCTURE, WEBSITE MANAGEMENT, DATABASE SYSTEMS, AND WEB APPLICATIONS, IN CLASS 42 (U.S. CLS. 100 AND 101).

FIRST USE 9-0-2009; IN COMMERCE 9-0-2009.

THE MARK CONSISTS OF STANDARD CHARACTERS WITHOUT CLAIM TO ANY PARTICULAR FONT, STYLE, SIZE, OR COLOR.

SN 77-750,444, FILED 6-2-2009.

KATHERINE E. HALMEN, EXAMINING ATTORNEY

United States of America

United States Patent and Trademark Office

UNFOLDER

Reg. No. 4,067,695

Registered Dec. 6, 2011

Int. Cl.: 10

TRADEMARK

PRINCIPAL REGISTER

ABBOTT MEDICAL OPTICS INC. (DELAWARE CORPORATION)
1700 E. ST. ANDREW PLACE
SANTA ANA, CA 92705

FOR: SURGICAL HAND TOOLS, NAMELY, AN INTRAOCULAR LENS IMPLANTATION DEVICE USED IN CONNECTION WITH A SURGICALLY IMPLANTED INTRAOCULAR LENS, IN CLASS 10 (U.S. CLS. 26, 39 AND 44).

FIRST USE 8-1-1996; IN COMMERCE 10-1-1996.

THE MARK CONSISTS OF STANDARD CHARACTERS WITHOUT CLAIM TO ANY PARTICULAR FONT, STYLE, SIZE, OR COLOR.

SN 77-752,677, FILED 6-4-2009.

BARNEY CHARLON, EXAMINING ATTORNEY



David J. Kyfos

Director of the United States Patent and Trademark Office

United States of America

United States Patent and Trademark Office

FLUIDMASTER

Reg. No. 4,067,696

Registered Dec. 6, 2011

Int. Cl.: 35

SERVICE MARK

PRINCIPAL REGISTER

FLUIDMASTER, INC. (CALIFORNIA CORPORATION)
30800 RANCH VIEJO ROAD
SAN JUAN CAPISTRANO, CA 92675

FOR: ARRANGING AND CONDUCTING INCENTIVE REWARD PROGRAMS TO PROMOTE THE SALE OF TOILET AND PLUMBING SUPPLIES, IN CLASS 35 (U.S. CLS. 100, 101 AND 102).

FIRST USE 2-11-2011; IN COMMERCE 2-11-2011.

THE MARK CONSISTS OF STANDARD CHARACTERS WITHOUT CLAIM TO ANY PARTICULAR FONT, STYLE, SIZE, OR COLOR.

OWNER OF U.S. REG. NOS. 1,505,464, 2,631,591, AND OTHERS.

SN 77-756,864, FILED 6-10-2009.

ESTHER A. BORSUK, EXAMINING ATTORNEY



David J. Kyffers

Director of the United States Patent and Trademark Office

United States of America

United States Patent and Trademark Office

C PACK

Reg. No. 4,067,697

Registered Dec. 6, 2011

Int. Cl.: 3

TRADEMARK

PRINCIPAL REGISTER

SPARTAN CHEMICAL COMPANY, INC. (OHIO CORPORATION)
1110 SPARTAN DRIVE
MAUMEE, OH 43537

FOR: ALL PURPOSE CLEANER; DEGREASING PREPARATIONS FOR USE ON GLASS, ACRYLIC GLASS, MIRRORS, FLOORS, WALLS, RESTROOM AND KITCHEN SURFACES, AND TILE; GLASS CLEANER, IN CLASS 3 (U.S. CLS. 1, 4, 6, 50, 51 AND 52).

FIRST USE 8-22-2011; IN COMMERCE 8-22-2011.

THE MARK CONSISTS OF STANDARD CHARACTERS WITHOUT CLAIM TO ANY PARTICULAR FONT, STYLE, SIZE, OR COLOR.

SN 77-760,566, FILED 6-16-2009.

SALLY SHIH, EXAMINING ATTORNEY



David J. Kybas

Director of the United States Patent and Trademark Office

United States of America

United States Patent and Trademark Office

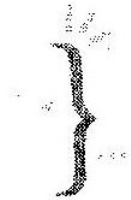

Reg. No. 4,067,698

Registered Dec. 6, 2011

Int. Cls.: 9, 16, and 41

TRADEMARK

SERVICE MARK

PRINCIPAL REGISTER

SMART PEOPLE COMMUNICATIONS, INC. (COLORADO CORPORATION)
3000 BLUE SKY CIRCLE
ERIE, CO 80516

FOR: ELECTRONIC MEDIA, NAMELY, PRE-RECORDED VIDEO CASSETTES AND DVDS FEATURING EDUCATIONAL MATTER IN THE FIELDS OF COMMUNICATION, LANGUAGE SKILLS, JOURNALISM, PROOFREADING, EDITING, COPYWRITING, PRESENTATIONS, PUBLIC SPEAKING AND CUSTOM WRITING FOR BUSINESSES AND INDIVIDUALS, IN CLASS 9 (U.S. CLS. 21, 23, 26, 36 AND 38).

FIRST USE 6-17-2009; IN COMMERCE 6-17-2009.

FOR: PAPER AND PRINTED MATTER, NAMELY, A SERIES OF WRITTEN ARTICLES FOR PUBLICATION IN BOOKLETS, BROCHURES, CATALOGS, DIRECTORIES, MAGAZINES, MANUALS, NEWSLETTERS, NEWSPAPERS, PAMPHLETS AND PERIODICALS IN THE FIELD OF COMMUNICATION, LANGUAGE SKILLS, JOURNALISM, PROOFREADING, EDITING, COPYWRITING, PRESENTATIONS, PUBLIC SPEAKING AND CUSTOM WRITING FOR BUSINESSES AND INDIVIDUALS; AGENDAS, EVENT ALBUMS, BUSINESS CARDS, BOOKMARKS, CALENDARS, DESK DIARIES; PHOTOGRAPHS; PRINTED GREETING CARDS; PRINTED EDUCATIONAL, INSTRUCTIONAL AND TEACHING MATERIALS IN THE FIELD OF COMMUNICATION, LANGUAGE SKILLS, JOURNALISM, PROOFREADING, EDITING, COPYWRITING, PRESENTATIONS, PUBLIC SPEAKING AND CUSTOM WRITING FOR BUSINESSES AND INDIVIDUALS; PROMOTIONAL POSTCARDS AND POSTERS, SERIES OF BOOKS IN THE FIELD OF COMMUNICATION, LANGUAGE SKILLS, JOURNALISM, PROOFREADING, EDITING, COPYWRITING, PRESENTATIONS, PUBLIC SPEAKING AND CUSTOM WRITING FOR BUSINESSES AND INDIVIDUALS; STICKERS AND DECALS, IN CLASS 16 (U.S. CLS. 2, 5, 22, 23, 29, 37, 38 AND 50).

FIRST USE 6-17-2009; IN COMMERCE 6-17-2009.

FOR: TRAINING SERVICES IN THE FIELDS OF COMMUNICATION, LANGUAGE SKILLS, JOURNALISM, PROOFREADING, EDITING, COPYWRITING PRESENTATIONS, PUBLIC SPEAKING AND CUSTOM WRITING FOR BUSINESSES AND INDIVIDUALS; CONSULTATION IN THE FIELDS OF JOURNALISM, LANGUAGE SKILLS, WRITTEN TEXT EDITING AND VIDEO EDITING, PROOF READING OF MANUSCRIPTS, WRITTEN TEXT COPY WRITING, NOT OF LEGAL SERVICES; CONSULTATION IN THE FIELD OF EDUCATIONAL INSTRUCTION ON GIVING PRESENTATIONS, PUBLIC SPEAKING AND CUSTOM



David J. Kybas

Director of the United States Patent and Trademark Office

Reg. No. 4,067,698 WRITING FOR BUSINESSES AND INDIVIDUALS; ENTERTAINMENT SERVICES, NAMELY, PROVIDING PODCASTS AND LIVE SPEAKING PERFORMANCES IN THE FIELDS OF COMMUNICATION, LANGUAGE SKILLS, JOURNALISM, PROOFREADING, EDITING, COPYWRITING, PRESENTATIONS AND CUSTOM WRITING FOR BUSINESSES AND INDIVIDUALS, IN CLASS 41 (U.S. CLS. 100, 101 AND 107).

FIRST USE 6-17-2009; IN COMMERCE 6-17-2009.

THE MARK CONSISTS OF ONE PARENTHESIS MARK REPRESENTING A HUMAN PROFILE WITH ONE PERIOD MARK REPRESENTING AN EYE AND THREE SLASH LINES REPRESENTING HAIR OR THOUGHTS.

SN 77-761,144, FILED 6-16-2009.

DANIEL CAPSHAW, EXAMINING ATTORNEY

United States of America
United States Patent and Trademark Office

ISANI

Reg. No. 4,067,699

Registered Dec. 6, 2011

Int. Cl.: 7

TRADEMARK

PRINCIPAL REGISTER

APPLIED MATERIALS, INC. (DELAWARE CORPORATION)
M/S 1241
3050 BOWERS AVENUE
SANTA CLARA, CA 95054

FOR: EQUIPMENT AND MACHINES FOR THE PROCESSING AND PRODUCTION OF SEMICONDUCTOR SUBSTRATES, THIN FILMS, SILICON DISCS AND WAFERS, NAMELY, SEMICONDUCTOR PROCESSING EQUIPMENT, POLISHING AND CLEANING EQUIPMENT, AND WATER TREATMENT ASSEMBLIES AND CHAMBERS, IN CLASS 7 (U.S. CLS. 13, 19, 21, 23, 31, 34 AND 35).

FIRST USE 7-31-2011; IN COMMERCE 7-31-2011.

THE MARK CONSISTS OF STANDARD CHARACTERS WITHOUT CLAIM TO ANY PARTICULAR FONT, STYLE, SIZE, OR COLOR.

THE ENGLISH TRANSLATION OF "ISANI" IS STRONGHOLD.

SN 77-761,393, FILED 6-16-2009.

SKYE YOUNG, EXAMINING ATTORNEY



David J. Kyros

Director of the United States Patent and Trademark Office

United States of America

United States Patent and Trademark Office

AFA

Reg. No. 4,067,700

AMERICAN FIDELITY ASSURANCE COMPANY (OKLAHOMA CORPORATION)
2000 NORTH CLASSEN BLVD.
OKLAHOMA CITY, OK 73106

Registered Dec. 6, 2011

Int. Cl.: 36

FOR: INSURANCE UNDERWRITING SERVICES IN THE FIELD OF DISABILITY, LIFE AND HEALTH INSURANCE, IN CLASS 36 (U.S. CLS. 100, 101 AND 102).

SERVICE MARK

FIRST USE 4-15-2011; IN COMMERCE 4-15-2011.

PRINCIPAL REGISTER

THE MARK CONSISTS OF STANDARD CHARACTERS WITHOUT CLAIM TO ANY PARTICULAR FONT, STYLE, SIZE, OR COLOR.

SN 77-763,104, FILED 6-18-2009.

KARANENDRA S. CHHINA, EXAMINING ATTORNEY



David J. Kybas

Director of the United States Patent and Trademark Office

United States of America

United States Patent and Trademark Office

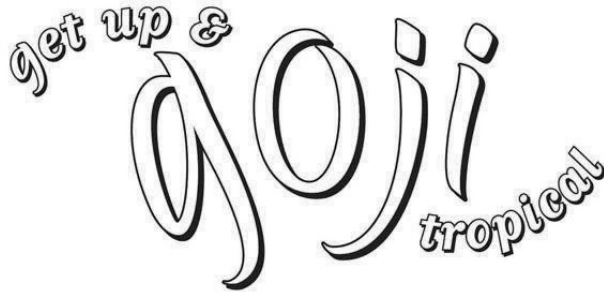

Reg. No. 4,067,701

Registered Dec. 6, 2011

Int. Cl.: 32

TRADEMARK

PRINCIPAL REGISTER

S. MARTINELLI & COMPANY (CALIFORNIA CORPORATION)
P.O. BOX 1868
WATSONVILLE, CA 95077

FOR: FRUIT JUICES MADE IN WHOLE OR SUBSTANTIAL PART OF GOJI BERRY JUICE,
IN CLASS 32 (U.S. CLS. 45, 46 AND 48).

FIRST USE 3-18-2010; IN COMMERCE 3-29-2010.

NO CLAIM IS MADE TO THE EXCLUSIVE RIGHT TO USE "GOJI TROPICAL", APART
FROM THE MARK AS SHOWN.

THE MARK CONSISTS OF THE WORDS "GET UP & GOJI TROPICAL" WITH "GET UP &"
IN A SMALLER FONT SIZE POSITIONED ABOVE THE LETTERS "G" OF THE WORD "GOJI"
AND "TROPICAL" IN A SMALLER FONT SIZE POSITIONED BELOW THE LETTER "I" OF
THE WORD "GOJI".

SN 77-764,318, FILED 6-19-2009.

COLLEEN DOMBROW, EXAMINING ATTORNEY



David J. Kybas

Director of the United States Patent and Trademark Office

United States of America

United States Patent and Trademark Office

SELECT DIAMONDS & GEMS

Reg. No. 4,067,702

Registered Dec. 6, 2011

Int. Cls.: 14 and 35

TRADEMARK

SERVICE MARK

PRINCIPAL REGISTER

SELECT JEWELRY, INC. (NEW YORK CORPORATION)
3RD FLOOR
47-28 37TH STREET
LONG ISLAND CITY, NY 11101

FOR: JEWELRY, CONTAINING DIAMONDS, GEMS OR ANY COMBINATION THEREOF, NAMELY, WEDDING BANDS, RINGS, BRACELETS, PENDANTS, EARRINGS, NECKLACES, BROOCHES AND PINS, IN CLASS 14 (U.S. CLS. 2, 27, 28 AND 50).

FIRST USE 10-0-2009; IN COMMERCE 10-0-2009.

FOR: ADVERTISING SERVICES, NAMELY, DISSEMINATION OF ADVERTISING MATTER FOR JEWELRY, IN CLASS 35 (U.S. CLS. 100, 101 AND 102).

FIRST USE 10-0-2009; IN COMMERCE 10-0-2009.

THE MARK CONSISTS OF STANDARD CHARACTERS WITHOUT CLAIM TO ANY PARTICULAR FONT, STYLE, SIZE, OR COLOR.

SEC. 2(F) AS TO "SELECT".

OWNER OF U.S. REG. NO. 3,151,515.

NO CLAIM IS MADE TO THE EXCLUSIVE RIGHT TO USE "DIAMOND & GEMS", APART FROM THE MARK AS SHOWN.

SN 77-764,899, FILED 6-22-2009.

PAM WILLIS, EXAMINING ATTORNEY



David J. Kyros

Director of the United States Patent and Trademark Office

United States of America

United States Patent and Trademark Office

Reputation 360

Reg. No. 4,067,703

Registered Dec. 6, 2011

Int. Cl.: 35

SERVICE MARK

PRINCIPAL REGISTER

BAMJI, CYRUS E. (UNITED STATES INDIVIDUAL), DBA REPUTATION 360,
13123 LUTES DRIVE
SILVER SPRING, MD 20906

FOR: BRANDING SERVICES, NAMELY, CONSULTING, DEVELOPMENT, MANAGEMENT
AND MARKETING OF BRANDS FOR BUSINESSES, IN CLASS 35 (U.S. CLS. 100, 101 AND
102).

FIRST USE 9-7-2010; IN COMMERCE 1-5-2011.

THE MARK CONSISTS OF STANDARD CHARACTERS WITHOUT CLAIM TO ANY PAR-
TICULAR FONT, STYLE, SIZE, OR COLOR.

NO CLAIM IS MADE TO THE EXCLUSIVE RIGHT TO USE "REPUTATION", APART FROM
THE MARK AS SHOWN.

SN 77-765,776, FILED 6-23-2009.

MARC LEIPZIG, EXAMINING ATTORNEY



David J. Kyros

Director of the United States Patent and Trademark Office

United States of America

United States Patent and Trademark Office



Reg. No. 4,067,704

Registered Dec. 6, 2011

Int. Cl.: 42

SERVICE MARK

PRINCIPAL REGISTER

PEYLEI TECHNOLOGY, INC. (MINNESOTA CORPORATION), DBA PASKEY COMPUTER SERVICES,
1415 NORTH LILAC DRIVE, SUITE 210
GOLDEN VALLEY, MN 55422

FOR: COMPUTER CONSULTATION, IN CLASS 42 (U.S. CLS. 100 AND 101).

FIRST USE 1-28-2007; IN COMMERCE 1-28-2007.

NO CLAIM IS MADE TO THE EXCLUSIVE RIGHT TO USE "COMPUTER SERVICES", APART FROM THE MARK AS SHOWN.

THE COLOR(S) BLACK, GREEN, BLUE, AND GRAY IS/ARE CLAIMED AS A FEATURE OF THE MARK.

THE MARK CONSISTS OF BLACK LOWER CASE "PA" FOLLOWED BY GREEN SQUIGGLE "S" FOLLOWED BY BLUE SQUIGGLE "S" FOLLOWED BY BLACK LOWER CASE "KEY". BELOW THIS, UPPER CASE GRAY "COMPUTER SERVICES".

SN 77-768,928, FILED 6-26-2009.

BARNEY CHARLON, EXAMINING ATTORNEY



David J. Kybas

Director of the United States Patent and Trademark Office

United States of America

United States Patent and Trademark Office

CATACLYSM

Reg. No. 4,067,705

Registered Dec. 6, 2011

Int. Cl.: 16

TRADEMARK

PRINCIPAL REGISTER

BLIZZARD ENTERTAINMENT, INC. (DELAWARE CORPORATION)
16215 ALTON PARKWAY
IRVINE, CA 92618

FOR: COMPUTER GAME STRATEGY GUIDES, TRADING CARDS, POSTERS, COMPUTER GAME INSTRUCTION MANUALS, ADVERTISEMENT BOARDS OF PAPER OR CARDBOARD, ART PRINTS, IN CLASS 16 (U.S. CLS. 2, 5, 22, 23, 29, 37, 38 AND 50).

FIRST USE 8-21-2009; IN COMMERCE 12-7-2010.

THE MARK CONSISTS OF STANDARD CHARACTERS WITHOUT CLAIM TO ANY PARTICULAR FONT, STYLE, SIZE, OR COLOR.

SN 77-769,019, FILED 6-26-2009.

MARTHA FROMM, EXAMINING ATTORNEY



David J. Kyros

Director of the United States Patent and Trademark Office

United States of America

United States Patent and Trademark Office

ADOPTER'S ADVANTAGE

Reg. No. 4,067,706

Registered Dec. 6, 2011

Int. Cls.: 35 and 36

SERVICE MARK

PRINCIPAL REGISTER

THE PET SAVERS FOUNDATION, INC. (NEW YORK CORPORATION)
59 SOUTH BAYLES STREET
PORT WASHINGTON, NY 11050

FOR: PROVIDING AN INTERNET PORTAL THROUGH WHICH CONSUMERS CAN PURCHASE PET INSURANCE, NAMELY, OPERATING AN ON-LINE MARKETPLACE FOR SELLERS OF PET INSURANCE; AND MANAGING AND OPERATING A COOPERATIVE BUYING PROGRAM WHERE PARTICIPANT MEMBERS RECEIVE BENEFITS RELATED TO PET CARE AND ADOPTION, IN CLASS 35 (U.S. CLS. 100, 101 AND 102).

FIRST USE 10-7-2011; IN COMMERCE 10-7-2011.

FOR: PET HEALTH INSURANCE SERVICES, NAMELY, BROKERAGE IN THE FIELD OF PET INSURANCE, PROVIDING INFORMATION CONCERNING PET INSURANCE, AND CHARITABLE FUNDRAISING SERVICES, IN CLASS 36 (U.S. CLS. 100, 101 AND 102).

FIRST USE 10-7-2011; IN COMMERCE 10-7-2011.

THE MARK CONSISTS OF STANDARD CHARACTERS WITHOUT CLAIM TO ANY PARTICULAR FONT, STYLE, SIZE, OR COLOR.

NO CLAIM IS MADE TO THE EXCLUSIVE RIGHT TO USE "ADOPTER'S", APART FROM THE MARK AS SHOWN.

SN 77-769,029, FILED 6-26-2009.

ERIN FALK, EXAMINING ATTORNEY



David J. Kyffers

Director of the United States Patent and Trademark Office

United States of America

United States Patent and Trademark Office

Golden Valley Brand

Reg. No. 4,067,707

Registered Dec. 6, 2011

Int. Cl.: 29

TRADEMARK

PRINCIPAL REGISTER

AMERICAN GOLDEN GROUP, INC. (CALIFORNIA CORPORATION)
123 N. SUNSET AVENUE
CITY OF INDUSTRY, CA 91744

FOR: OIL, NAMELY, VEGETABLE OIL, GRAPSEED OIL, CANOLA OIL, PEANUT OIL, SUNFLOWER OIL, OLIVE OIL, POMUS, EXTRA VIRGIN OLIVE OIL AND ANY COMBINATION THEREOF, IN CLASS 29 (U.S. CL. 46).

FIRST USE 9-20-2010; IN COMMERCE 9-20-2010.

THE MARK CONSISTS OF STANDARD CHARACTERS WITHOUT CLAIM TO ANY PARTICULAR FONT, STYLE, SIZE, OR COLOR.

NO CLAIM IS MADE TO THE EXCLUSIVE RIGHT TO USE "BRAND", APART FROM THE MARK AS SHOWN.

SN 77-769,415, FILED 6-26-2009.

JEFFREY LOOK, EXAMINING ATTORNEY



David J. Kyros

Director of the United States Patent and Trademark Office

United States of America

United States Patent and Trademark Office

STABLE 26

Reg. No. 4,067,708

Registered Dec. 6, 2011

Int. Cl.: 25

TRADEMARK

PRINCIPAL REGISTER

STABLE 26 INC. (CANADA CORPORATION)
SUITE 300
180 KING STREET SOUTH
WATERLOO, ONTARIO, CANADA N2J1P8

FOR: SOCKS WITH POCKETS CONTAINING GEL OR MEMORY FOAM USED TO IMPROVE THE FIT AND STABILITY OF ATHLETIC FOOTWEAR, IN CLASS 25 (U.S. CLS. 22 AND 39).

FIRST USE 7-29-2011; IN COMMERCE 7-29-2011.

THE MARK CONSISTS OF STANDARD CHARACTERS WITHOUT CLAIM TO ANY PARTICULAR FONT, STYLE, SIZE, OR COLOR.

PRIORITY CLAIMED UNDER SEC. 44(D) ON CANADA APPLICATION NO. 1437316, FILED 5-7-2009.

SN 77-769,944, FILED 6-29-2009.

JILL PRATER, EXAMINING ATTORNEY



David J. Kybas

Director of the United States Patent and Trademark Office

United States of America

United States Patent and Trademark Office

SNAPIO

Reg. No. 4,067,709

Registered Dec. 6, 2011

Int. Cls.: 16, 40, and 41

TRADEMARK

SERVICE MARK

PRINCIPAL REGISTER

SNAPIO, INC. (TEXAS CORPORATION)
SUITE 500
2500 WEST LOOP SOUTH
HOUSTON, TX 77027

FOR: PRINTED MATTER, NAMELY, DIRECT MAIL PIECES IN THE NATURE OF POSTCARDS, IN THE FIELDS OF ART, MUSIC, CHILDCARE, ENTERTAINMENT, EDUCATION, CLEANING SERVICES, HEALTH AND BEAUTY, LAW, AUTOMOTIVE INDUSTRY, CONSTRUCTION, DENTISTRY, FOOD AND BEVERAGE, HOME IMPROVEMENT, REAL ESTATE, SALON AND SPA, RELIGION, FINANCIAL SERVICES, MEDICAL INFORMATION, AND TRAVEL; PRINTED MATTER, NAMELY, SALES LITERATURE IN THE NATURE OF POSTCARDS, AND BROCHURES, ALL IN THE FIELDS OF ART, MUSIC, CHILDCARE, ENTERTAINMENT, EDUCATION, CLEANING SERVICES, HEALTH AND BEAUTY, LAW, AUTOMOTIVE INDUSTRY, CONSTRUCTION, DENTISTRY, FOOD AND BEVERAGE, HOME IMPROVEMENT, REAL ESTATE, SALON AND SPA, RELIGION, FINANCIAL SERVICES, MEDICAL INFORMATION, AND TRAVEL, IN CLASS 16 (U.S. CLS. 2, 5, 22, 23, 29, 37, 38 AND 50).

FIRST USE 6-1-2009; IN COMMERCE 7-19-2009.

FOR: PRINTING AND ONLINE PRINTING SERVICES FOR PRINTED MATERIALS; BINDERY SERVICES FOR OTHERS, NAMELY, COLLATING, FOLDING, STAPLING, PERFORATING, CUTTING AND BINDING OF PRINTED AND PHOTOCOPIED MATERIALS; PRINTING OF ADVERTISING BROCHURES AND CATALOGS FOR OTHERS, IN CLASS 40 (U.S. CLS. 100, 103 AND 106).

FIRST USE 6-1-2009; IN COMMERCE 7-19-2009.

FOR: PUBLICATION AND EDITING OF PRINTED MATTER, IN CLASS 41 (U.S. CLS. 100, 101 AND 107).

FIRST USE 6-1-2009; IN COMMERCE 7-19-2009.

THE MARK CONSISTS OF STANDARD CHARACTERS WITHOUT CLAIM TO ANY PARTICULAR FONT, STYLE, SIZE, OR COLOR.

SN 77-771,380, FILED 6-30-2009.



David J. Kybas

Director of the United States Patent and Trademark Office

Reg. No. 4,067,709 AMY ALFIERI, EXAMINING ATTORNEY

United States of America

United States Patent and Trademark Office

CLEANPASTE

Reg. No. 4,067,710

JOHNSON & JOHNSON (NEW JERSEY CORPORATION)
ONE JOHNSON & JOHNSON PLAZA
NEW BRUNSWICK, NJ 089337001

Registered Dec. 6, 2011

Int. Cl.: 21

FOR: DENTAL FLOSS REFILLS FOR HAND HELD DENTAL FLOSSERS, IN CLASS 21 (U.S. CLS. 2, 13, 23, 29, 30, 33, 40 AND 50).

TRADEMARK

FIRST USE 9-21-2009; IN COMMERCE 9-21-2009.

PRINCIPAL REGISTER

THE MARK CONSISTS OF STANDARD CHARACTERS WITHOUT CLAIM TO ANY PARTICULAR FONT, STYLE, SIZE, OR COLOR.

SN 77-772,458, FILED 7-1-2009.

ROSELLE HERRERA, EXAMINING ATTORNEY



David J. Kyffers

Director of the United States Patent and Trademark Office

United States of America

United States Patent and Trademark Office

jacobmedingerfinnegan.net

Reg. No. 4,067,711

JACOB, MEDINGER & FINNEGAN, LLP (NEW YORK LIMITED LIABILITY PARTNERSHIP)
1270 AVENUE OF THE AMERICAS
NEW YORK, NY 10020

Registered Dec. 6, 2011

Int. Cl.: 45

FOR: LEGAL SERVICES, IN CLASS 45 (U.S. CLS. 100 AND 101).

SERVICE MARK

FIRST USE 8-20-2007; IN COMMERCE 8-20-2007.

PRINCIPAL REGISTER

THE MARK CONSISTS OF STANDARD CHARACTERS WITHOUT CLAIM TO ANY PARTICULAR FONT, STYLE, SIZE, OR COLOR.

THE NAME "JACOB MEDINGER FINNEGAN" DOES NOT IDENTIFY A LIVING INDIVIDUAL.

SN 77-773,474, FILED 7-2-2009.

SUNG IN, EXAMINING ATTORNEY



David J. Kybas

Director of the United States Patent and Trademark Office

United States of America

United States Patent and Trademark Office



Reg. No. 4,067,712

Registered Dec. 6, 2011

Int. Cl.: 3

TRADEMARK

PRINCIPAL REGISTER

MSD CONSUMER CARE, INC. (DELAWARE CORPORATION)
3030 JACKSON AVENUE
MEMPHIS, TN 38151

FOR: SUN BLOCK PREPARATIONS; SUN SCREEN PREPARATIONS, IN CLASS 3 (U.S. CLS. 1, 4, 6, 50, 51 AND 52).

FIRST USE 1-0-2010; IN COMMERCE 1-0-2010.

OWNER OF U.S. REG. NOS. 917,825, 3,363,846, AND OTHERS.

THE COLOR(S) BLUE, DARK BLUE, WHITE, TAN, BEIGE, YELLOW, BROWN AND DARK PINK IS/ARE CLAIMED AS A FEATURE OF THE MARK.

NO CLAIM IS MADE TO THE EXCLUSIVE RIGHT TO USE "CLEAR NO-RUB SPRAY", "SUNSCREEN", "CONTINUOUS SPRAY", "BROAD SPECTRUM UVA/UVB PROTECTION", "WATERPROOF", "QUICK & EVEN COVERAGE", AND "SPRAYS AT ANY ANGLE", APART FROM THE MARK AS SHOWN.

THE MARK CONSISTS OF THE COLOR BLUE APPLIED TO THE CAP OF THE CONTAINER OF THE GOODS. THE MIDDLE TO TOP PORTION OF THE BOTTLE IS WHITE AND THE MIDDLE TO BOTTOM PORTION OF THE BOTTLE IS DARK PINK. THERE IS A BLUE AND WHITE HORIZON IN A SEMI-CIRCLE AT THE UPPER PORTION OF THE BOTTLE WITH A LITTLE GIRL AND DOG IN FRONT OF IT. THE GIRL IS BEIGE WITH BLUE SHORTS, BLUE BOWS, BLUE EYES AND YELLOW HAIR, AND IS OUTLINED IN BLUE. THE DOG IS BROWN AND WHITE. THE WORD "COPPERTONE" IS UNDERNEATH THIS IMAGE IN WHITE AND OUTLINED IN DARK BLUE. THERE IS A DARK BLUE SEMI-SWIRL AT THE UPPER LEFT PORTION OF THE FRONT OF THE BOTTLE. THE TERMS "CLEAR NO-RUB SPRAY" IN WHITE ARE ACROSS THE DARK BLUE SEMI-SWIRL. UNDERNEATH THE WORD "COPPERTONE" ARE THE TERMS "ULTRAGUARD SUNSCREEN" IN BLUE. UNDERNEATH THIS ARE THE TERMS "CONTINUOUS SPRAY" IN DARK BLUE. THERE IS A BLUE SPRAY DESIGN ABOVE THE LETTER "I". BELOW THIS IS A DESIGN OF A YELLOW SUN. THERE IS A STYLIZED SWIRL OF BLUE WATER AND A STYLIZED SWIRL OF TAN SAND UNDERNEATH THE SUN. ACROSS THE LOWER DARK PINK AREA IS A DARK BLUE BAR WITH A WHITE OUTLINE ACROSS THE TOP AND BOTTOM OF IT. THE TERMS "BROAD SPECTRUM" IN YELLOW AND THE TERMS "UVA/UVB PROTECTION" IN WHITE ARE ACROSS THE DARK BLUE BAR. THERE IS A DARK PINK OVAL



David J. Kybas

Director of the United States Patent and Trademark Office

Reg. No. 4,067,712 WITH A WHITE OUTLINE OVERLAPPING THE LEFT SIDE OF THE BAR. UNDERNEATH THE DARK BLUE BAR IS THE TERM "WATERPROOF" IN WHITE LETTERS WITH A WHITE UNDERLINE. UNDERNEATH THIS ARE THE TERMS "QUICK & EVEN COVERAGE" IN WHITE WITH A WHITE UNDERLINE. UNDERNEATH THIS ARE THE TERMS "SPRAYS AT ANY ANGLE" IN WHITE. THE DOTTED LINES OUTLINING THE CONTAINER AND ITS CAP INDICATE PLACEMENT OF THE MARK ON THE GOODS AND ARE NOT PART OF THE MARK.

SN 77-775,260, FILED 7-7-2009.

KIM MONINGHOFF, EXAMINING ATTORNEY

United States of America

United States Patent and Trademark Office

DREAMLOFT

Reg. No. 4,067,713

Registered Dec. 6, 2011

Int. Cl.: 24

TRADEMARK

PRINCIPAL REGISTER

LOUISVILLE BEDDING COMPANY (DELAWARE CORPORATION)
10400 BUNSEN WAY
LOUISVILLE, KY 40299

FOR: FIBERFILL AS AN INTEGRAL COMPONENT OF COMFORTERS AND MATTRESS PADS, IN CLASS 24 (U.S. CLS. 42 AND 50).

FIRST USE 6-26-2009; IN COMMERCE 6-26-2009.

THE MARK CONSISTS OF STANDARD CHARACTERS WITHOUT CLAIM TO ANY PARTICULAR FONT, STYLE, SIZE, OR COLOR.

OWNER OF U.S. REG. NO. 3,477,576.

SN 77-780,564, FILED 7-14-2009.

AISHA CLARKE, EXAMINING ATTORNEY



David J. Kybas

Director of the United States Patent and Trademark Office

United States of America

United States Patent and Trademark Office

MINDMELD ALLIANCE

Reg. No. 4,067,714

Registered Dec. 6, 2011

Int. Cls.: 35 and 41

SERVICE MARK

PRINCIPAL REGISTER

MINDMELD ALLIANCE, LLC (TEXAS LIMITED LIABILITY COMPANY)
828 W. 6TH STREET
AUSTIN, TX 78703

FOR: BRANDING SERVICES, NAMELY, CONSULTING, DEVELOPMENT, MANAGEMENT AND MARKETING OF BRANDS FOR BUSINESS; MARKETING CONSULTING SERVICES; CREATIVE MARKETING DESIGN SERVICES, IN CLASS 35 (U.S. CLS. 100, 101 AND 102).

FIRST USE 9-9-2011; IN COMMERCE 9-9-2011.

FOR: MULTIMEDIA ENTERTAINMENT SERVICES IN THE NATURE OF RECORDING, PRODUCTION AND POST-PRODUCTION SERVICES IN THE FIELDS OF MUSIC, VIDEO, FILMS, 3D PRESENTATIONS AND HOLOGRAPHY, IN CLASS 41 (U.S. CLS. 100, 101 AND 107).

FIRST USE 9-9-2011; IN COMMERCE 9-9-2011.

THE MARK CONSISTS OF STANDARD CHARACTERS WITHOUT CLAIM TO ANY PARTICULAR FONT, STYLE, SIZE, OR COLOR.

NO CLAIM IS MADE TO THE EXCLUSIVE RIGHT TO USE "ALLIANCE", APART FROM THE MARK AS SHOWN.

SN 77-783,534, FILED 7-17-2009.

SHAILA SETTLES, EXAMINING ATTORNEY



David J. Kyros

Director of the United States Patent and Trademark Office

United States of America

United States Patent and Trademark Office

BEACON

Reg. No. 4,067,715

LG ELECTRONICS INC. (REPUBLIC OF KOREA CORPORATION)
20, YOIDO-DONG, YONGDUNGPO-GU
SEOUL 150-721, REPUBLIC OF KOREA

Registered Dec. 6, 2011

Int. Cl.: 9

FOR: MOBILE PHONES; TELEVISION RECEIVERS, IN CLASS 9 (U.S. CLS. 21, 23, 26, 36 AND 38).

TRADEMARK

FIRST USE 9-28-2011; IN COMMERCE 9-28-2011.

PRINCIPAL REGISTER

THE MARK CONSISTS OF STANDARD CHARACTERS WITHOUT CLAIM TO ANY PARTICULAR FONT, STYLE, SIZE, OR COLOR.

SN 77-784,682, FILED 7-20-2009.

DOUGLAS LEE, EXAMINING ATTORNEY



David J. Kybas

Director of the United States Patent and Trademark Office

United States of America

United States Patent and Trademark Office

BREATHE EASY

Reg. No. 4,067,716

Registered Dec. 6, 2011

Int. Cl.: 16

TRADEMARK

PRINCIPAL REGISTER

BAYER HEALTHCARE LLC (DELAWARE LIMITED LIABILITY COMPANY)
100 BAYER ROAD
PITTSBURGH, PA 15205

FOR: A PACKAGED KIT COMPRISED PRIMARILY OF PRINTED MATTER IN THE NATURE OF A SYMPTOM-IDENTIFICATION GUIDE AND SCORECARD RECORD KEEPING BOOKLET ON BOVINE RESPIRATORY DISEASE, AND ALSO CONTAINING POUCHES AND SYRINGES FOR THE ADMINISTRATION OF AN ANTIMICROBIAL DRUG FOR ANIMAL USE, DISTRIBUTED AS A UNIT, IN CLASS 16 (U.S. CLS. 2, 5, 22, 23, 29, 37, 38 AND 50).

FIRST USE 4-8-2009; IN COMMERCE 4-8-2009.

THE MARK CONSISTS OF STANDARD CHARACTERS WITHOUT CLAIM TO ANY PARTICULAR FONT, STYLE, SIZE, OR COLOR.

SN 77-784,838, FILED 7-20-2009.

CHRISTINE COOPER, EXAMINING ATTORNEY



David J. Kyjars

Director of the United States Patent and Trademark Office

United States of America

United States Patent and Trademark Office

COCO POLO

Reg. No. 4,067,717

Registered Dec. 6, 2011

Int. Cl.: 30

TRADEMARK

PRINCIPAL REGISTER

YAMATE, DIANE K. (UNITED STATES INDIVIDUAL)
#14B
7 GREEN STREET
METUCHEN, NJ 08840

FOR: CHOCOLATE AND CONFECTIONERY, NAMELY, CANDY, IN CLASS 30 (U.S. CL. 46).

FIRST USE 7-1-2010; IN COMMERCE 7-1-2010.

THE MARK CONSISTS OF STANDARD CHARACTERS WITHOUT CLAIM TO ANY PARTICULAR FONT, STYLE, SIZE, OR COLOR.

SN 77-786,617, FILED 7-22-2009.

WILLIAM VERHOSEK, EXAMINING ATTORNEY



David J. Kybas

Director of the United States Patent and Trademark Office

United States of America

United States Patent and Trademark Office

PARBUCKLES

Reg. No. 4,067,718

Registered Dec. 6, 2011

Int. Cls.: 20 and 35

TRADEMARK

SERVICE MARK

PRINCIPAL REGISTER

THOS. BAKER LLC (WASHINGTON LIMITED LIABILITY COMPANY)
175 PARFITT WAY SW #N160
BAINBRIDGE ISLAND, WA 98110

FOR: FURNITURE; FURNITURE AND HOME FURNISHING ACCESSORIES, NAMELY, ARMCHAIRS, ARMOIRES, BATHROOM VANITIES, BEACH CHAIRS, BED FRAMES, BED HEADBOARDS, BEDROOM FURNITURE, BEDSIDE TABLES, BENCHES, BOLSTERS, BOOKSTANDS, BOOKCASES, BOOKSHELVES, BOTTLE RACKS, BUFFETS, CABINETS, CHAIRS, CHAISE LOUNGES, CHEST OF DRAWERS, COAT RACKS, COAT STANDS, COUCHES, CREDENZAS, CUSHIONS, DECK CHAIRS, DESKS, DINING CHAIRS, DINING TABLE, END TABLES, ÉTAGÈRE, FIREPLACE SCREENS, FOOTSTOOLS, FURNITURE CHESTS, FURNITURE PARTITIONS, HAT RACKS, HAT STANDS, HUTCHES, LAWN FURNITURE, LIVING ROOM FURNITURE, LOUNGE CHAIRS, LOVE SEATS, MAGAZINE RACKS, MIRRORS, NIGHT TABLES, NIGHT STANDS, OFFICE CHAIRS, OFFICE TABLES, OTTOMANS, OUTDOOR FURNITURE, PILLOWS, RECLINING CHAIRS, RESIDENTIAL AND COMMERCIAL FURNITURE, ROCKING CHAIRS, SCREENS BEING FURNITURE, SETTEES, SHELVES, SHOE CABINETS, SIDEBOARDS, SOFAS, TABLES, UMBRELLA STANDS, UPHOLSTERED FURNITURE, WARDROBES, WASHSTANDS, WINE RACKS AND WRITING DESKS, IN CLASS 20 (U.S. CLS. 2, 13, 22, 25, 32 AND 50).

FIRST USE 10-31-2009; IN COMMERCE 10-31-2009.

FOR: ONLINE RETAIL STORE SERVICES IN THE FIELDS OF FURNITURE AND HOME FURNISHING ACCESSORIES, IN CLASS 35 (U.S. CLS. 100, 101 AND 102).

FIRST USE 5-13-2009; IN COMMERCE 5-13-2009.

THE MARK CONSISTS OF STANDARD CHARACTERS WITHOUT CLAIM TO ANY PARTICULAR FONT, STYLE, SIZE, OR COLOR.

SN 77-786,960, FILED 7-22-2009.

EVELYN BRADLEY, EXAMINING ATTORNEY



David J. Kyros

Director of the United States Patent and Trademark Office

United States of America

United States Patent and Trademark Office

INTERSTATE RESOURCES

Reg. No. 4,067,719

Registered Dec. 6, 2011

Int. Cl.: 40

SERVICE MARK

PRINCIPAL REGISTER

INTERSTATE RESOURCES, INC. (DELAWARE CORPORATION)
1300 WILSON BOULEVARD, SUITE 1075
ARLINGTON, VA 22209

FOR: GENERATION OF ELECTRICITY, IN CLASS 40 (U.S. CLS. 100, 103 AND 106).

FIRST USE 9-0-2009; IN COMMERCE 9-0-2009.

THE MARK CONSISTS OF STANDARD CHARACTERS WITHOUT CLAIM TO ANY PARTICULAR FONT, STYLE, SIZE, OR COLOR.

NO CLAIM IS MADE TO THE EXCLUSIVE RIGHT TO USE "INTERSTATE", APART FROM THE MARK AS SHOWN.

SN 77-787,077, FILED 7-22-2009.

JERI J. FICKES, EXAMINING ATTORNEY



David J. Kyffers

Director of the United States Patent and Trademark Office

United States of America

United States Patent and Trademark Office

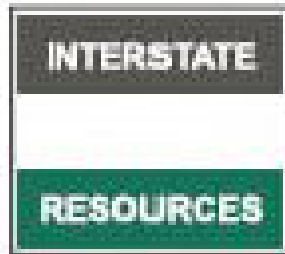

Reg. No. 4,067,720

Registered Dec. 6, 2011

Int. Cl.: 40

SERVICE MARK

PRINCIPAL REGISTER

INTERSTATE RESOURCES, INC. (DELAWARE CORPORATION)
SUITE 1075
1300 WILSON BOULEVARD
ARLINGTON, VA 22209

FOR: GENERATION OF ELECTRICITY, IN CLASS 40 (U.S. CLS. 100, 103 AND 106).

FIRST USE 9-0-2009; IN COMMERCE 9-0-2009.

NO CLAIM IS MADE TO THE EXCLUSIVE RIGHT TO USE "INTERSTATE", APART FROM THE MARK AS SHOWN.

THE COLOR(S) GREY, WHITE AND TEAL IS/ARE CLAIMED AS A FEATURE OF THE MARK.

THE MARK CONSISTS OF A BOX BORDERED IN GREY WITH A GREY BAND AT THE TOP WITH THE WORD "INTERSTATE" IN WHITE LETTERING WITHIN, AN EMPTY WHITE BAND, AND A TEAL BAND AT THE BOTTOM WITH THE WORD "RESOURCES" IN WHITE LETTERING WITHIN.

SN 77-787,101, FILED 7-22-2009.

JERI J. FICKES, EXAMINING ATTORNEY



David J. Kyros

Director of the United States Patent and Trademark Office

United States of America

United States Patent and Trademark Office

SYSTEM OF A DOWN

Reg. No. 4,067,721

Registered Dec. 6, 2011

Int. Cl.: 41

SERVICE MARK

PRINCIPAL REGISTER

SYSTEM OF A DOWN (CALIFORNIA PARTNERSHIP)
C/O COUNSEL, LLP
650 FIFTH STREET, SUITE 402
SAN FRANCISCO, CA 94107

FOR: ENTERTAINMENT SERVICES, NAMELY, PERSONAL APPEARANCES BY A MUSICAL GROUP AND LIVE MUSICAL PERFORMANCES BY A MUSICAL GROUP, IN CLASS 41 (U.S. CLS. 100, 101 AND 107).

FIRST USE 1-21-2003; IN COMMERCE 1-21-2003.

THE MARK CONSISTS OF STANDARD CHARACTERS WITHOUT CLAIM TO ANY PARTICULAR FONT, STYLE, SIZE, OR COLOR.

OWNER OF U.S. REG. NOS. 2,672,027 AND 2,672,028.

SN 77-787,115, FILED 7-22-2009.

KATHERINE E. HALMEN, EXAMINING ATTORNEY



David J. Kybas

Director of the United States Patent and Trademark Office

United States of America

United States Patent and Trademark Office

NORTHERN SHIELD

Reg. No. 4,067,722

620369 ONTARIO INC. (CANADA CORPORATION)

Registered Dec. 6, 2011

P.O. BOX 1390
ST. CATHARINES, CANADA L2R7J8

Int. Cl.: 19

FOR: ROOFING MEMBRANES, IN CLASS 19 (U.S. CLS. 1, 12, 33 AND 50).

TRADEMARK

FIRST USE 4-0-2006; IN COMMERCE 10-27-2010.

PRINCIPAL REGISTER

THE MARK CONSISTS OF STANDARD CHARACTERS WITHOUT CLAIM TO ANY PARTICULAR FONT, STYLE, SIZE, OR COLOR.

PRIORITY CLAIMED UNDER SEC. 44(D) ON CANADA APPLICATION NO. 1441929, FILED 6-17-2009.

NO CLAIM IS MADE TO THE EXCLUSIVE RIGHT TO USE "SHIELD", APART FROM THE MARK AS SHOWN.

SN 77-787,785, FILED 7-23-2009.

HEATHER SAPP, EXAMINING ATTORNEY



David J. Kybas

Director of the United States Patent and Trademark Office

United States of America

United States Patent and Trademark Office

CITYFIT

Reg. No. 4,067,723

Registered Dec. 6, 2011

Int. Cl.: 41

SERVICE MARK

PRINCIPAL REGISTER

CITYFIT.COM, LLC (ILLINOIS LIMITED LIABILITY COMPANY)
3506 PARK AVENUE
BROOKFIELD, IL 60513

FOR: PROVIDING A WEB SITE FEATURING INFORMATION ON EXERCISE AND FITNESS,
IN CLASS 41 (U.S. CLS. 100, 101 AND 107).

FIRST USE 9-30-2011; IN COMMERCE 9-30-2011.

THE MARK CONSISTS OF STANDARD CHARACTERS WITHOUT CLAIM TO ANY PAR-
TICULAR FONT, STYLE, SIZE, OR COLOR.

SN 77-787,791, FILED 7-23-2009.

STEVEN JACKSON, EXAMINING ATTORNEY



David J. Kybas

Director of the United States Patent and Trademark Office

United States of America

United States Patent and Trademark Office

BELLA PANÈ

Reg. No. 4,067,724

PALERMO VILLA, INC. (WISCONSIN CORPORATION)
3301 CANAL STREET
MILWAUKEE, WI 53208

Registered Dec. 6, 2011

Int. Cl.: 30

FOR: FROZEN AND FRESH PREPARED ITALIAN APPETIZERS, NAMELY, FLAT BREAD APPETIZERS, IN CLASS 30 (U.S. CL. 46).

TRADEMARK

FIRST USE 9-0-2009; IN COMMERCE 9-0-2009.

PRINCIPAL REGISTER

THE MARK CONSISTS OF STANDARD CHARACTERS WITHOUT CLAIM TO ANY PARTICULAR FONT, STYLE, SIZE, OR COLOR.

NO CLAIM IS MADE TO THE EXCLUSIVE RIGHT TO USE "PANE", APART FROM THE MARK AS SHOWN.

THE ENGLISH TRANSLATION OF "BELLA PANE" IN THE MARK IS BEAUTIFUL BREAD.

SN 77-790,573, FILED 7-27-2009.

TINA L. SNAPP, EXAMINING ATTORNEY



David J. Kybas

Director of the United States Patent and Trademark Office

United States of America

United States Patent and Trademark Office

Protect-it

Reg. No. 4,067,725

W.S. BADCOCK CORPORATION (FLORIDA CORPORATION)
200 NORTH PHOSPHATE BOULEVARD
MULBERRY, FL 33860

Registered Dec. 6, 2011

Int. Cl.: 36

FOR: PROVIDING EXTENDED WARRANTIES ON HOME FURNISHINGS, FURNITURE AND UPHOLSTERY, IN CLASS 36 (U.S. CLS. 100, 101 AND 102).

SERVICE MARK

FIRST USE 8-0-2011; IN COMMERCE 8-0-2011.

PRINCIPAL REGISTER

THE MARK CONSISTS OF THE TERM "PROTECT-IT" IN RED AND OUTLINED IN WHITE AND GRAY WITH A RED HYPHEN REPRESENTED BY A DOT BETWEEN THE TERMS "PROTECT" AND "IT"

THE COLOR(S) RED, WHITE, AND GRAY IS/ARE CLAIMED AS A FEATURE OF THE MARK.

SN 77-790,884, FILED 7-28-2009.

GRETTA YAO, EXAMINING ATTORNEY



David J. Kyros

Director of the United States Patent and Trademark Office

United States of America

United States Patent and Trademark Office

TULSI RECORDS

Reg. No. 4,067,726

Registered Dec. 6, 2011

Int. Cls.: 9 and 41

TRADEMARK

SERVICE MARK

PRINCIPAL REGISTER

LUV BUZZ, INC. (NEW YORK CORPORATION)
450 N. ROXBURY DRIVE, 8TH FLOOR
C/O HERTZ & LICHTENSTEIN, LLP
BEVERLY HILLS, CA 90210

FOR: DIGITAL MEDIA, NAMELY, DOWNLOADABLE AUDIO AND CDS FEATURING ENTERTAINMENT COMPRISING OF MUSICAL PERFORMANCES, IN CLASS 9 (U.S. CLS. 21, 23, 26, 36 AND 38).

FIRST USE 10-13-2009; IN COMMERCE 10-13-2009.

FOR: RECORD COMPANY SERVICES, NAMELY, PRODUCTION OF SOUND RECORDINGS, RECORDING STUDIOS SERVICES; RECORD PRODUCTION SERVICES, IN CLASS 41 (U.S. CLS. 100, 101 AND 107).

FIRST USE 10-13-2009; IN COMMERCE 10-13-2009.

THE MARK CONSISTS OF STANDARD CHARACTERS WITHOUT CLAIM TO ANY PARTICULAR FONT, STYLE, SIZE, OR COLOR.

NO CLAIM IS MADE TO THE EXCLUSIVE RIGHT TO USE "RECORDS", APART FROM THE MARK AS SHOWN.

SN 77-790,896, FILED 7-28-2009.

MATTHEW EINSTEIN, EXAMINING ATTORNEY



David J. Kyros

Director of the United States Patent and Trademark Office

United States of America

United States Patent and Trademark Office

FABRIC WORLD

Reg. No. 4,067,727

Registered Dec. 6, 2011

Int. Cls.: 24 and 26

TRADEMARK

PRINCIPAL REGISTER

JO-ANN STORES, INC. (OHIO CORPORATION)
5555 DARROW ROAD
HUDSON, OH 44236

FOR: COTTON FABRIC; WOVEN FABRICS, IN CLASS 24 (U.S. CLS. 42 AND 50).

FIRST USE 10-0-2010; IN COMMERCE 10-0-2010.

FOR: BUTTONS, IN CLASS 26 (U.S. CLS. 37, 39, 40, 42 AND 50).

FIRST USE 4-4-2010; IN COMMERCE 4-4-2010.

THE MARK CONSISTS OF STANDARD CHARACTERS WITHOUT CLAIM TO ANY PARTICULAR FONT, STYLE, SIZE, OR COLOR.

NO CLAIM IS MADE TO THE EXCLUSIVE RIGHT TO USE "FABRIC", APART FROM THE MARK AS SHOWN.

SN 77-793,481, FILED 7-30-2009.

CAROLINE WOOD, EXAMINING ATTORNEY



David J. Kyffers

Director of the United States Patent and Trademark Office

United States of America

United States Patent and Trademark Office



Reg. No. 4,067,728

Registered Dec. 6, 2011

Int. Cl.: 41

SERVICE MARK

PRINCIPAL REGISTER

CHATTANOOGA PUBLISHING COMPANY (TENNESSEE CORPORATION)
400 EAST 11TH STREET
CHATTANOOGA, TN 37403

FOR: CONDUCTING AWARDS CEREMONIES CELEBRATING THE ACHIEVEMENTS OF WOMEN, IN CLASS 41 (U.S. CLS. 100, 101 AND 107).

FIRST USE 7-16-2011; IN COMMERCE 7-16-2011.

NO CLAIM IS MADE TO THE EXCLUSIVE RIGHT TO USE "SHE" AND "AN EXPO FOR WOMEN", APART FROM THE MARK AS SHOWN.

THE MARK CONSISTS OF THE WORD "SHE" ON A SHOPPING BAG NEXT TO THE WORDS "AN EXPO FOR WOMEN". THE "O" IN THE WORD WOMEN CONSISTS OF THE SYMBOL OF VENUS.

SN 77-793,700, FILED 7-30-2009.

ODESSA BIBBINS, EXAMINING ATTORNEY



David J. Kybas

Director of the United States Patent and Trademark Office

United States of America

United States Patent and Trademark Office

SEVEN SEAS RUM

Reg. No. 4,067,729

Registered Dec. 6, 2011

Int. Cl.: 33

TRADEMARK

PRINCIPAL REGISTER

UNITED STATES DISTILLED PRODUCTS COMPANY (MINNESOTA CORPORATION)
1607 SOUTH 12TH STREET
PRINCETON, MN 55371

FOR: DISTILLED SPIRITS, IN CLASS 33 (U.S. CLS. 47 AND 49).

FIRST USE 4-30-2011; IN COMMERCE 4-30-2011.

THE MARK CONSISTS OF STANDARD CHARACTERS WITHOUT CLAIM TO ANY PARTICULAR FONT, STYLE, SIZE, OR COLOR.

NO CLAIM IS MADE TO THE EXCLUSIVE RIGHT TO USE "RUM", APART FROM THE MARK AS SHOWN.

SN 77-794,373, FILED 7-31-2009.

CHRIS WELLS, EXAMINING ATTORNEY



David J. Kyffers

Director of the United States Patent and Trademark Office

United States of America

United States Patent and Trademark Office

CHILERIAS

Reg. No. 4,067,730

Registered Dec. 6, 2011

Int. Cl.: 33

TRADEMARK

PRINCIPAL REGISTER

HACIENDA SAN JOSE DE MIRAVALLE S. DE R.L. DE C.V. (MEXICO CORPORATION)
OBREGON 13 COL. CENTRO
SAN MARTIN HIDALGO, JALISCO, MEXICO CP46770

FOR: TEQUILA, IN CLASS 33 (U.S. CLS. 47 AND 49).

FIRST USE 1-1-2011; IN COMMERCE 1-1-2011.

THE MARK CONSISTS OF STANDARD CHARACTERS WITHOUT CLAIM TO ANY PARTICULAR FONT, STYLE, SIZE, OR COLOR.

THE ENGLISH TRANSLATION OF "CHILERIAS" IN THE MARK IS "BUNCH OF HOT PEPPERS".

SN 77-795,020, FILED 8-1-2009.

MATTHEW EINSTEIN, EXAMINING ATTORNEY



David J. Kyros

Director of the United States Patent and Trademark Office

United States of America

United States Patent and Trademark Office

PAY-TO-PLAY LAND

Reg. No. 4,067,731

SEXTON, KEUNGSUK (UNITED STATES INDIVIDUAL)
21 ERIE STREET
JERSEY CITY, NJ 07302

Registered Dec. 6, 2011

Int. Cls.: 16 and 25

FOR: ART PRINTS; BUMPER STICKERS; PAPER STATIONERY; POSTERS, IN CLASS 16 (U.S. CLS. 2, 5, 22, 23, 29, 37, 38 AND 50).

TRADEMARK

FIRST USE 9-10-2011; IN COMMERCE 9-10-2011.

PRINCIPAL REGISTER

FOR: HATS; SWEAT SHIRTS; T-SHIRTS, IN CLASS 25 (U.S. CLS. 22 AND 39).

FIRST USE 9-10-2011; IN COMMERCE 9-10-2011.

THE MARK CONSISTS OF STANDARD CHARACTERS WITHOUT CLAIM TO ANY PARTICULAR FONT, STYLE, SIZE, OR COLOR.

SN 77-796,102, FILED 8-3-2009.

CHARLES L. JENKINS, EXAMINING ATTORNEY



David J. Kybas

Director of the United States Patent and Trademark Office

United States of America

United States Patent and Trademark Office

HERITAGE CLUB

Reg. No. 4,067,732

Registered Dec. 6, 2011

Int. Cls.: 20 and 24

TRADEMARK

PRINCIPAL REGISTER

IDEA NUOVA, INC. (NEW YORK CORPORATION)
302 FIFTH AVENUE
NEW YORK, NY 10001

FOR: BED PILLOWS, IN CLASS 20 (U.S. CLS. 2, 13, 22, 25, 32 AND 50).

FIRST USE 1-10-2009; IN COMMERCE 4-15-2009.

FOR: BED AND TABLE LINEN, WALL HANGINGS OF TEXTILE; BED BLANKETS; BED CANOPIES; BED COVERS; BED SHEETS; BED SKIRTS; BED SPREADS; BLANKET THROWS; COMFORTERS; COVERLETS; DUST RUFFLES; DUVET COVERS; DUVETS; PILLOW CASES; PILLOW COVERS; PILLOW SHAMS; QUILTS, IN CLASS 24 (U.S. CLS. 42 AND 50).

FIRST USE 1-10-2009; IN COMMERCE 4-15-2009.

THE MARK CONSISTS OF STANDARD CHARACTERS WITHOUT CLAIM TO ANY PARTICULAR FONT, STYLE, SIZE, OR COLOR.

SN 77-796,171, FILED 8-4-2009.

BARNEY CHARLON, EXAMINING ATTORNEY



David J. Kybas

Director of the United States Patent and Trademark Office

United States of America

United States Patent and Trademark Office

CHICKIE CAMO

Reg. No. 4,067,733

CHICKIE CAMO, LLC (OHIO LIMITED LIABILITY COMPANY)
4522 ARROWHEAD DRIVE
CARROLL, OH 43112

Registered Dec. 6, 2011

Int. Cl.: 40

FOR: CUSTOM IMPRINTING OF TOPS AND T-SHIRTS, IN CLASS 40 (U.S. CLS. 100, 103 AND 106).

SERVICE MARK

FIRST USE 9-27-2011; IN COMMERCE 9-27-2011.

PRINCIPAL REGISTER

THE MARK CONSISTS OF STANDARD CHARACTERS WITHOUT CLAIM TO ANY PARTICULAR FONT, STYLE, SIZE, OR COLOR.

SN 77-797,506, FILED 8-5-2009.

SAIMA MAKHDOOM, EXAMINING ATTORNEY



David J. Kyffers

Director of the United States Patent and Trademark Office

United States of America

United States Patent and Trademark Office

UNITED WAY LIFE

Reg. No. 4,067,734

Registered Dec. 6, 2011

Int. Cls.: 35 and 36

SERVICE MARK

PRINCIPAL REGISTER

UNITED WAY WORLDWIDE (NEW YORK NON-PROFIT CORPORATION)
701 N. FAIRFAX STREET
ALEXANDRIA, VA 22314

FOR: CHARITABLE SERVICES IN THE NATURE OF ADMINISTERING CHARITABLE GIVING LIFE INSURANCE PROGRAMS OF OTHERS, NAMELY, ADMINSTRATING A PROGRAM ENABLING PARTICIPATING DONORS TO PAY FOR LIFE INSURANCE PREMIUMS FOR OTHERS; ELEEMOSYNARY SERVICES, NAMELY, PROGRAM ADMINISTRATION TO PROMOTE COMMUNITY CHARITABLE GIVING BY ASSISTING PARTICIPANTS WITH ENROLLING AND MAINTAINING ENROLLMENT IN LIFE INSURANCE PROGRAMS INCORPORATING CHARITABLE CONTRIBUTIONS INTO THEIR LEGACY PLANNING, IN CLASS 35 (U.S. CLS. 100, 101 AND 102).

FIRST USE 8-27-2009; IN COMMERCE 8-27-2009.

FOR: PROVIDING INFORMATION, ADVICE AND CONSULTATION REGARDING LEGACY PLANNING THROUGH USE OF LIFE INSURANCE PROGRAMS AS A MEANS OF CHARITABLE FUNDRAISING, IN CLASS 36 (U.S. CLS. 100, 101 AND 102).

FIRST USE 8-27-2009; IN COMMERCE 8-27-2009.

THE MARK CONSISTS OF STANDARD CHARACTERS WITHOUT CLAIM TO ANY PARTICULAR FONT, STYLE, SIZE, OR COLOR.

OWNER OF U.S. REG. NOS. 1,021,242, 2,374,762, AND OTHERS.

SN 77-798,003, FILED 8-5-2009.

JUDITH HELFMAN, EXAMINING ATTORNEY



David J. Kypos

Director of the United States Patent and Trademark Office

United States of America

United States Patent and Trademark Office

ADVISORWORKS

Reg. No. 4,067,735

Registered Dec. 6, 2011

Int. Cl.: 36

SERVICE MARK

PRINCIPAL REGISTER

NETHERBY ADVISORS LLC (CONNECTICUT LIMITED LIABILITY COMPANY)
943 POST ROAD EAST
WESTPORT, CT 06880

FOR: FINANCIAL PORTFOLIO MANAGEMENT, FINANCIAL PLANNING CONSULTATION,
FINANCIAL INVESTMENT MANAGEMENT, AND INVESTMENT CONSULTATION , IN
CLASS 36 (U.S. CLS. 100, 101 AND 102).

FIRST USE 11-9-2009; IN COMMERCE 11-9-2009.

THE MARK CONSISTS OF STANDARD CHARACTERS WITHOUT CLAIM TO ANY PAR-
TICULAR FONT, STYLE, SIZE, OR COLOR.

SN 77-799,620, FILED 8-7-2009.

CARYN GLASSER, EXAMINING ATTORNEY



David J. Kybas

Director of the United States Patent and Trademark Office

United States of America

United States Patent and Trademark Office

Kato

Reg. No. 4,067,736

Registered Dec. 6, 2011

Int. Cls.: 16 and 28

TRADEMARK

PRINCIPAL REGISTER

THE GREEN HORNET, INC. (NEVADA CORPORATION)
C/O LOEB & LOEB LLP
10100 SANTA MONICA BLVD., SUITE 2200
LOS ANGELES, CA 90067

FOR: COMIC BOOKS, IN CLASS 16 (U.S. CLS. 2, 5, 22, 23, 29, 37, 38 AND 50).

FIRST USE 0-0-1991; IN COMMERCE 0-0-1991.

FOR: ACTION FIGURES AND ACCESSORIES THEREFOR, IN CLASS 28 (U.S. CLS. 22, 23, 38 AND 50).

FIRST USE 0-0-1998; IN COMMERCE 0-0-1998.

THE MARK CONSISTS OF STANDARD CHARACTERS WITHOUT CLAIM TO ANY PARTICULAR FONT, STYLE, SIZE, OR COLOR.

SN 77-800,181, FILED 8-7-2009.

DAVID COLLIER, EXAMINING ATTORNEY



David J. Kyros

Director of the United States Patent and Trademark Office

United States of America

United States Patent and Trademark Office

CALIFDREAM

Reg. No. 4,067,737

Registered Dec. 6, 2011

Int. Cls.: 18 and 25

TRADEMARK

PRINCIPAL REGISTER

E.LAND LTD. (REPUBLIC OF KOREA CORPORATION)
19-8 CHANGJEON-DONG, MAPO-GU
SEOUL, REPUBLIC OF KOREA

FOR: IMITATION LEATHER; CREDIT CARD CASES; BACKPACKS; WALLETS OF NON-PRECIOUS METAL; HANDBAGS; TRAVELING BAGS; BEACH BAGS; VANITY CASES SOLD EMPTY; UMBRELLAS; AND HIKING STICKS, IN CLASS 18 (U.S. CLS. 1, 2, 3, 22 AND 41).

FIRST USE 8-1-2009; IN COMMERCE 8-1-2009.

FOR: PANTS; SKIRTS; T-SHIRTS; SHIRTS; SWEATSHIRTS; VESTS; JERSEYS; SHORTS; GLOVES; BEACHWEAR; BOTTOMS; DRESSES; SWIMWEAR; TANK TOPS; TRACK SUITS; TROUSERS; UNDERWEAR; WET SUITS; JACKETS; KNITWEAR, NAMELY, KNIT SHIRTS, KNITTED CAPS, KNITTED PANTS, AND KNITTED SWEATERS; SWEATERS; COATS; SWIMSUITS; RAINCOATS; CLOTHING FOR DANCING, NAMELY, TIGHTS, LEOTARDS, DANCE SHOES, DANCE COSTUMES, BALLET SLIPPERS, BALLET SHOES, TAP PANTS, AND TAP SHOES; SHOES; HATS; HOSIERY; SCARVES; AND BELTS BEING CLOTHING, IN CLASS 25 (U.S. CLS. 22 AND 39).

FIRST USE 8-1-2009; IN COMMERCE 8-1-2009.

THE MARK CONSISTS OF STANDARD CHARACTERS WITHOUT CLAIM TO ANY PARTICULAR FONT, STYLE, SIZE, OR COLOR.

OWNER OF U.S. REG. NO. 3,565,291.

SN 77-800,491, FILED 8-10-2009.

JANET LEE, EXAMINING ATTORNEY



David J. Kyros

Director of the United States Patent and Trademark Office

United States of America

United States Patent and Trademark Office

GAIT MATE

Reg. No. 4,067,738

Registered Dec. 6, 2011

Int. Cl.: 10

TRADEMARK

PRINCIPAL REGISTER

INTERACTIVE METRONOME, INC. (VIRGINIA CORPORATION)
SUITE 204
13794 NW 4TH STREET
SUNRISE, FL 33325

FOR: THERAPEUTIC WALKING APPARATUS FOR USE IN IMPROVING PATIENT WALKING SKILLS AND RELATED HARDWARE AND OPERATING SOFTWARE SOLD AS A UNIT; APPARATUS FOR MEDICAL PURPOSES, NAMELY, APPARATUS COMPRISING SHOE INSOLES WITH SENSORS AND WIRELESS DATA TRANSMITTERS TO DETECT HEEL STRIKES AND TRANSMIT HEEL STRIKE DATA TO A COMPUTER, AND TO DELIVER A BEAT TO PATIENT THROUGH SPEAKERS OR HEADPHONES, AND TO PROVIDE FEEDBACK TO PATIENT, IN CLASS 10 (U.S. CLS. 26, 39 AND 44).

FIRST USE 7-31-2008; IN COMMERCE 7-31-2008.

THE MARK CONSISTS OF STANDARD CHARACTERS WITHOUT CLAIM TO ANY PARTICULAR FONT, STYLE, SIZE, OR COLOR.

NO CLAIM IS MADE TO THE EXCLUSIVE RIGHT TO USE "GAIT", APART FROM THE MARK AS SHOWN.

SN 77-802,760, FILED 8-12-2009.

LEIGH CAROLINE CASE, EXAMINING ATTORNEY



David J. Kypos

Director of the United States Patent and Trademark Office

United States of America

United States Patent and Trademark Office



Paperless Post

Reg. No. 4,067,739

Registered Dec. 6, 2011

Int. Cls.: 35, 38, and 42

SERVICE MARK

PRINCIPAL REGISTER

PAPERLESS, INC. (DELAWARE CORPORATION)
151 WEST 25TH STREET, 9TH FLOOR
NEW YORK, NY 10001

FOR: ON-LINE RETAIL STORE SERVICES FEATURING CUSTOMIZED ELECTRONIC STATIONERY, ANNOUNCEMENTS, GREETING CARDS AND INVITATIONS, IN CLASS 35 (U.S. CLS. 100, 101 AND 102).

FIRST USE 10-25-2011; IN COMMERCE 10-25-2011.

FOR: TRANSMISSION OF PERSONAL STATIONERY, DATA, DOCUMENTS, ELECTRONIC MAIL, CARDS, ANNOUNCEMENTS AND INVITATIONS VIA AN ELECTRONIC COMMUNICATIONS NETWORK, IN CLASS 38 (U.S. CLS. 100, 101 AND 104).

FIRST USE 10-25-2011; IN COMMERCE 10-25-2011.

FOR: APPLICATION SERVICE PROVIDER (ASP) FEATURING SOFTWARE FOR USE IN ENABLING USERS TO CREATE AND SHARE CUSTOMIZED ELECTRONIC STATIONERY, ANNOUNCEMENTS, INVITATIONS, AND CARDS, WHICH MAY INCLUDE UPLOADED IMAGE FILES; COMPUTER SERVICES, NAMELY, PROVIDING A WEB SITE THAT AUTOMATES PARTY AND ENTERTAINMENT EVENTS MANAGEMENT THAT CONSISTS OF GUEST LISTS, GUEST INFORMATION, EVENT DETAILS, AND INVITATION CREATION AND DELIVERY, IN CLASS 42 (U.S. CLS. 100 AND 101).

FIRST USE 10-25-2011; IN COMMERCE 10-25-2011.

NO CLAIM IS MADE TO THE EXCLUSIVE RIGHT TO USE "PAPERLESS POST", APART FROM THE MARK AS SHOWN.

THE MARK CONSISTS OF A STAMP DESIGN FEATURING AN IMAGE OF A BIRD WITH AN ENVELOPE IN ITS BEAK, AND THE LETTER "P" APPEARING NEXT TO THE ENVELOPE IN STYLIZED TYPE. THE WORDS "PAPERLESS POST" APPEAR TO THE RIGHT OF THE STAMP DESIGN IN STYLIZED TYPE, WITH THE WORD "PAPERLESS" ABOVE THE WORD "POST".

SN 77-803,024, FILED 8-12-2009.



David J. Kyros

Director of the United States Patent and Trademark Office

Reg. No. 4,067,739 ROBERT C. CLARK JR., EXAMINING ATTORNEY

United States of America

United States Patent and Trademark Office

CYBERCHOICE 1.0

Reg. No. 4,067,740

HARTFORD FIRE INSURANCE COMPANY (CONNECTICUT CORPORATION)
LAW DEPT. IP TRADEMARK UNIT HO109
HARTFORD, CT 06155

Registered Dec. 6, 2011

Int. Cl.: 36

FOR: INSURANCE SERVICES, NAMELY, INSURANCE AND REINSURANCE UNDERWRITING, CLAIMS ADMINISTRATION AND LOSS CONTROL SERVICES IN THE FIELDS OF DIGITAL ASSET LOSS, CYBER EXTORTION RISK AND FIRST AND THIRD PARTY NETWORK RISK, IN CLASS 36 (U.S. CLS. 100, 101 AND 102).

SERVICE MARK

PRINCIPAL REGISTER

FIRST USE 2-5-2010; IN COMMERCE 2-5-2010.

THE MARK CONSISTS OF STANDARD CHARACTERS WITHOUT CLAIM TO ANY PARTICULAR FONT, STYLE, SIZE, OR COLOR.

SN 77-803,644, FILED 8-13-2009.

GRETТА YAO, EXAMINING ATTORNEY



David J. Kybas

Director of the United States Patent and Trademark Office

United States of America

United States Patent and Trademark Office

CYBERCHOICE 2.09

Reg. No. 4,067,741

HARTFORD FIRE INSURANCE COMPANY (CONNECTICUT CORPORATION)
LAW DEPT. IP TRADEMARK UNIT HO109
HARTFORD, CT 06155

Registered Dec. 6, 2011

Int. Cl.: 36

FOR: INSURANCE SERVICES, NAMELY, INSURANCE AND REINSURANCE UNDERWRITING, CLAIMS ADMINISTRATION AND LOSS CONTROL SERVICES IN THE FIELDS OF DIGITAL ASSET LOSS, CYBER EXTORTION RISK AND FIRST AND THIRD PARTY NETWORK RISK, IN CLASS 36 (U.S. CLS. 100, 101 AND 102).

SERVICE MARK

PRINCIPAL REGISTER

FIRST USE 2-24-2009; IN COMMERCE 2-24-2009.

THE MARK CONSISTS OF STANDARD CHARACTERS WITHOUT CLAIM TO ANY PARTICULAR FONT, STYLE, SIZE, OR COLOR.

SN 77-803,650, FILED 8-13-2009.

GRETТА YAO, EXAMINING ATTORNEY



David J. Kybas

Director of the United States Patent and Trademark Office

United States of America

United States Patent and Trademark Office

BRYANT PARK

Reg. No. 4,067,742

Registered Dec. 6, 2011

Int. Cl.: 14

TRADEMARK

PRINCIPAL REGISTER

RICHLINE GROUP, INC. (DELAWARE CORPORATION)
1385 BROADWAY
NEW YORK, NY 10018

FOR: JEWELRY, IN CLASS 14 (U.S. CLS. 2, 27, 28 AND 50).

FIRST USE 6-1-2011; IN COMMERCE 6-1-2011.

THE MARK CONSISTS OF STANDARD CHARACTERS WITHOUT CLAIM TO ANY PARTICULAR FONT, STYLE, SIZE, OR COLOR.

SN 77-806,215, FILED 8-17-2009.

GINA FINK, EXAMINING ATTORNEY



David J. Kybas

Director of the United States Patent and Trademark Office

United States of America

United States Patent and Trademark Office

QUICKJAB LTD.

Reg. No. 4,067,743

Registered Dec. 6, 2011

Int. Cl.: 25

TRADEMARK

PRINCIPAL REGISTER

JOSE CASTANEDA (UNITED STATES INDIVIDUAL)
APT. B
4221 45TH STREET
SAN DIEGO, CA 92115

FOR: T-SHIRTS, IN CLASS 25 (U.S. CLS. 22 AND 39).

FIRST USE 3-17-2011; IN COMMERCE 3-17-2011.

THE MARK CONSISTS OF STANDARD CHARACTERS WITHOUT CLAIM TO ANY PARTICULAR FONT, STYLE, SIZE, OR COLOR.

NO CLAIM IS MADE TO THE EXCLUSIVE RIGHT TO USE "LTD.", APART FROM THE MARK AS SHOWN.

SN 77-806,720, FILED 8-18-2009.

SUSAN LESLIE DUBOIS, EXAMINING ATTORNEY



David J. Kybas

Director of the United States Patent and Trademark Office

United States of America

United States Patent and Trademark Office

A Well-Seasoned Kitchen

Reg. No. 4,067,744

Registered Dec. 6, 2011

Int. Cl.: 41

SERVICE MARK

PRINCIPAL REGISTER

MLC PUBLISHING, LLC (COLORADO LIMITED LIABILITY COMPANY)
PO BOX 6374
DENVER, CO 80206

FOR: EDUCATIONAL AND ENTERTAINMENT SERVICES, NAMELY, A CONTINUING PROGRAM ABOUT FRIENDS' AND FAMILY'S FAVORITE RECIPES, COOKING AND ENTERTAINING TIPS ACCESSIBLE BY RADIO, TELEVISION, SATELLITE, AUDIO, VIDEO AND COMPUTER NETWORKS, IN CLASS 41 (U.S. CLS. 100, 101 AND 107).

FIRST USE 1-1-2009; IN COMMERCE 1-1-2009.

THE MARK CONSISTS OF STANDARD CHARACTERS WITHOUT CLAIM TO ANY PARTICULAR FONT, STYLE, SIZE, OR COLOR.

SN 77-807,733, FILED 8-19-2009.

KEVIN DINALLO, EXAMINING ATTORNEY



David J. Kyffers

Director of the United States Patent and Trademark Office

United States of America
United States Patent and Trademark Office

Lazair

Reg. No. 4,067,745

KRAMER, DALE C. (CANADA INDIVIDUAL)
10034 EAST LAKE ROAD
HAMMONDSPORT, NY 14840

Registered Dec. 6, 2011

Int. Cl.: 12

FOR: AIRPLANES AND STRUCTURAL PARTS THEREFOR, IN CLASS 12 (U.S. CLS. 19, 21, 23, 31, 35 AND 44).

TRADEMARK

FIRST USE 2-0-2011; IN COMMERCE 2-0-2011.

PRINCIPAL REGISTER

THE MARK CONSISTS OF THE WORD "LAZAIR" AND STYLIZED LETTERING.

SN 77-808,546, FILED 8-19-2009.

SAIMA MAKHDOOM, EXAMINING ATTORNEY



David J. Kyffers

Director of the United States Patent and Trademark Office

United States of America

United States Patent and Trademark Office

Calikay

Reg. No. 4,067,746

Registered Dec. 6, 2011

Int. Cl.: 35

SERVICE MARK

PRINCIPAL REGISTER

VASHOU, CALIKAY (UNITED STATES INDIVIDUAL)
7616 CURRELL BLVD STE 200
WOODBURY, MN 55125

FOR: BUSINESS DEVELOPMENT CONSULTING SERVICES, IN CLASS 35 (U.S. CLS. 100, 101 AND 102).

FIRST USE 2-18-2010; IN COMMERCE 12-1-2010.

THE MARK CONSISTS OF STANDARD CHARACTERS WITHOUT CLAIM TO ANY PARTICULAR FONT, STYLE, SIZE, OR COLOR.

SN 77-810,733, FILED 8-22-2009.

KELLEY WELLS, EXAMINING ATTORNEY



David J. Kybas

Director of the United States Patent and Trademark Office

United States of America

United States Patent and Trademark Office

FULL PLATE DIET

Reg. No. 4,067,747

Registered Dec. 6, 2011

Int. Cl.: 41

SERVICE MARK

PRINCIPAL REGISTER

OTEY JOHNSON FOUNDATION (OKLAHOMA CORPORATION)
3650 CHICKASAW BLVD.
ARDMORE, OK 73401

FOR: EDUCATIONAL SERVICES, NAMELY, PROVIDING CLASSES, SEMINARS, WORKSHOPS, CLINICS, AND ON-LINE TRAINING IN THE FIELD OF BEHAVIOR CHANGE FOR DIETING, EXERCISE AND OTHER HEALTH-RELATED BEHAVIORS AND DISTRIBUTION OF COURSE MATERIALS IN CONNECTION THEREWITH; ONLINE PUBLICATION OF ARTICLES IN THE FIELD OF BEHAVIOR CHANGE FOR DIETING, EXERCISE AND OTHER HEALTH-RELATED BEHAVIORS, IN CLASS 41 (U.S. CLS. 100, 101 AND 107).

FIRST USE 1-1-2011; IN COMMERCE 1-1-2011.

THE MARK CONSISTS OF STANDARD CHARACTERS WITHOUT CLAIM TO ANY PARTICULAR FONT, STYLE, SIZE, OR COLOR.

NO CLAIM IS MADE TO THE EXCLUSIVE RIGHT TO USE "DIET", APART FROM THE MARK AS SHOWN.

SN 77-811,589, FILED 8-24-2009.

WILLIAM ROSSMAN, EXAMINING ATTORNEY



David J. Kyros

Director of the United States Patent and Trademark Office

United States of America

United States Patent and Trademark Office

RELIEVA FLEX

Reg. No. 4,067,748

Registered Dec. 6, 2011

Int. Cl.: 10

TRADEMARK

PRINCIPAL REGISTER

ACCLARENT, INC. (DELAWARE CORPORATION)
1525-B O'BRIEN DRIVE
MENLO PARK, CA 94025

FOR: CATHETERS AND PARTS AND FITTINGS THEREFOR, IN CLASS 10 (U.S. CLS. 26, 39 AND 44).

FIRST USE 9-19-2009; IN COMMERCE 9-19-2009.

THE MARK CONSISTS OF STANDARD CHARACTERS WITHOUT CLAIM TO ANY PARTICULAR FONT, STYLE, SIZE, OR COLOR.

OWNER OF U.S. REG. NOS. 3,176,146, 3,595,415, AND OTHERS.

SN 77-811,741, FILED 8-24-2009.

ALEXANDER L. POWERS, EXAMINING ATTORNEY



David J. Kyros

Director of the United States Patent and Trademark Office

United States of America

United States Patent and Trademark Office

WEARFORCE

Reg. No. 4,067,749

Registered Dec. 6, 2011

Int. Cl.: 7

TRADEMARK

PRINCIPAL REGISTER

WEARFORCE PTY LTD (AUSTRALIA LIMITED LIABILITY COMPANY)
533 ABERNETHY RD
KEWDALE, AUSTRALIA 6105

FOR: METAL GROUND ENGAGING TOOLS AND ABRASION RESISTANT PARTS FOR USE ON EARTHMOVING MACHINES, NAMELY, DIGGING TEETH, TEETH ADAPTERS, CHEEK AND BASE PLATES, AND BUCKET LIP SHROUDS; METAL MATERIAL HANDLING MACHINES, NAMELY, PALLETIZERS, CASE ELEVATORS, AUTOMATIC PALLET DISPENSING MACHINES AND AUTOMATIC SLIP SHEET DISPENSING MACHINES; CONVEYORS, IN CLASS 7 (U.S. CLS. 13, 19, 21, 23, 31, 34 AND 35).

FIRST USE 4-1-2003; IN COMMERCE 3-3-2011.

THE MARK CONSISTS OF STANDARD CHARACTERS WITHOUT CLAIM TO ANY PARTICULAR FONT, STYLE, SIZE, OR COLOR.

SN 77-811,746, FILED 8-24-2009.

JENNIFER MARTIN, EXAMINING ATTORNEY



David J. Kyros

Director of the United States Patent and Trademark Office

United States of America

United States Patent and Trademark Office

GO GREEN! **\$AVE GREEN!**

Reg. No. 4,067,750

HANDI-FOIL CORPORATION (ILLINOIS CORPORATION)
135 E. HINTZ RD.
WHEELING, IL 60090

Registered Dec. 6, 2011

Int. Cl.: 21

FOR: NON-ELECTRIC ALUMINUM AND ROASTING PANS, CONTAINERS FORMED OF ALUMINUM FOIL WITH PLASTIC LIDS FOR HOUSEHOLD USE, PANS FORMED OF ALUMINUM FOIL WITH WIRE HANDLES, AND PANS FORMED OF ALUMINUM FOIL, IN CLASS 21 (U.S. CLS. 2, 13, 23, 29, 30, 33, 40 AND 50).

TRADEMARK

PRINCIPAL REGISTER

FIRST USE 9-24-2010; IN COMMERCE 9-24-2010.

THE MARK CONSISTS OF THE WORDS "GO GREEN!" ABOVE THE WORDS "\$AVE GREEN!" IN BOLD BLOCK LETTERS.

SN 77-812,352, FILED 8-25-2009.

SETH A. RAPPAPORT, EXAMINING ATTORNEY



David J. Kybas

Director of the United States Patent and Trademark Office

United States of America

United States Patent and Trademark Office



Reg. No. 4,067,751

Registered Dec. 6, 2011

Int. Cls.: 16, 21, and 30

TRADEMARK

PRINCIPAL REGISTER

DUANE READE INTERNATIONAL, LLC (DELAWARE LIMITED LIABILITY COMPANY)
440 9TH AVENUE, 6TH FLOOR
NEW YORK, NY 10001

FOR: PAPER TOWELS; TOILET PAPER, IN CLASS 16 (U.S. CLS. 2, 5, 22, 23, 29, 37, 38 AND 50).

FIRST USE 9-30-2009; IN COMMERCE 9-30-2009.

FOR: PAPER CUPS, IN CLASS 21 (U.S. CLS. 2, 13, 23, 29, 30, 33, 40 AND 50).

FIRST USE 10-31-2010; IN COMMERCE 10-31-2010.

FOR: CHOCOLATE COVERED SNACKS, NAMELY, NUTS, RAISINS, PRETZELS AND FRUITS, IN CLASS 30 (U.S. CL. 46).

FIRST USE 11-30-2009; IN COMMERCE 11-30-2009.

THE MARK CONSISTS OF A BLACK AND WHITE BAR CODE DESIGN IN THE IMAGE OF THE BROOKLYN BRIDGE.

THE COLOR(S) BLACK AND WHITE IS/ARE CLAIMED AS A FEATURE OF THE MARK.

SN 77-813,163, FILED 8-26-2009.

JANICE L. MCMORROW, EXAMINING ATTORNEY



David J. Kybas

Director of the United States Patent and Trademark Office

United States of America

United States Patent and Trademark Office

STRATUS

Reg. No. 4,067,752

Registered Dec. 6, 2011

Int. Cl.: 11

TRADEMARK

PRINCIPAL REGISTER

AS IP HOLDCO, LLC (DELAWARE LIMITED LIABILITY COMPANY)
1 CENTENNIAL AVENUE
PISCATAWAY, NJ 08855

FOR: TOILETS, IN CLASS 11 (U.S. CLS. 13, 21, 23, 31 AND 34).

FIRST USE 1-1-2010; IN COMMERCE 1-1-2010.

THE MARK CONSISTS OF STANDARD CHARACTERS WITHOUT CLAIM TO ANY PARTICULAR FONT, STYLE, SIZE, OR COLOR.

SN 77-813,932, FILED 8-27-2009.

DOUGLAS LEE, EXAMINING ATTORNEY



David J. Kyffers

Director of the United States Patent and Trademark Office

United States of America

United States Patent and Trademark Office



Reg. No. 4,067,753

Registered Dec. 6, 2011

Int. Cl.: 5

TRADEMARK

PRINCIPAL REGISTER

WORLD TRIATHLON CORPORATION (FLORIDA CORPORATION)
2701 NORTH ROCKY POINT DR
SUITE 1250
TAMPA, FL 33607

FOR: DIETARY SUPPLEMENTS, NAMELY, VITAMIN AND MINERAL SUPPLEMENTS,
BEVERAGES USED AS A MEAL REPLACEMENT; NUTRITIONALLY FORTIFIED WATER
, IN CLASS 5 (U.S. CLS. 6, 18, 44, 46, 51 AND 52).

FIRST USE 12-17-2007; IN COMMERCE 12-17-2007.

THE MARK CONSISTS OF THE LETTER "K" WITH A DOT ABOVE.

SN 77-814,254, FILED 8-27-2009.

CHRISTINE COOPER, EXAMINING ATTORNEY



David J. Kybas

Director of the United States Patent and Trademark Office

United States of America

United States Patent and Trademark Office

CONTROLTALK

Reg. No. 4,067,754

Registered Dec. 6, 2011

Int. Cl.: 9

TRADEMARK

PRINCIPAL REGISTER

MONSTER CABLE PRODUCTS, INC. (CALIFORNIA CORPORATION)
455 VALLEY DRIVE
BRISBANE, CA 94005

FOR: HEADPHONE MECHANISM THAT FUNCTIONS AS A MICROPHONE AND MANAGER OF ATTACHED DEVICES, NAMELY, AUDIO EQUIPMENT, VIDEO EQUIPMENT AND CELLULAR PHONES, IN CLASS 9 (U.S. CLS. 21, 23, 26, 36 AND 38).

FIRST USE 7-22-2009; IN COMMERCE 7-22-2009.

THE MARK CONSISTS OF STANDARD CHARACTERS WITHOUT CLAIM TO ANY PARTICULAR FONT, STYLE, SIZE, OR COLOR.

SN 77-814,501, FILED 8-27-2009.

DEZMONA MIZELLE, EXAMINING ATTORNEY



David J. Kyros

Director of the United States Patent and Trademark Office

United States of America

United States Patent and Trademark Office

CLIPVAC

Reg. No. 4,067,755

Registered Dec. 6, 2011

Int. Cl.: 7

TRADEMARK

PRINCIPAL REGISTER

SURGICAL SITE SOLUTIONS, INC. (WISCONSIN CORPORATION)
1360 LINDALE LANE
GREEN BAY, WI 54313

FOR: VACUUM PUMPS, IN CLASS 7 (U.S. CLS. 13, 19, 21, 23, 31, 34 AND 35).

FIRST USE 8-19-2011; IN COMMERCE 8-19-2011.

THE MARK CONSISTS OF STANDARD CHARACTERS WITHOUT CLAIM TO ANY PARTICULAR FONT, STYLE, SIZE, OR COLOR.

SN 77-814,828, FILED 8-28-2009.

CHRISTOPHER LAW, EXAMINING ATTORNEY



David J. Kybas

Director of the United States Patent and Trademark Office

United States of America

United States Patent and Trademark Office



Reg. No. 4,067,756

Registered Dec. 6, 2011

Int. Cl.: 25

TRADEMARK

PRINCIPAL REGISTER

CURTIS, CATHY (UNITED STATES INDIVIDUAL)
9871 CITADEL LANE
UNIT 207
BONITA SPRINGS, FL 34135

FOR: CLOTHING, NAMELY, T-SHIRTS, IN CLASS 25 (U.S. CLS. 22 AND 39).

FIRST USE 10-19-2011; IN COMMERCE 10-19-2011.

THE MARK CONSISTS OF THE DESIGN OF A GLOBE, WITH THE APPEARANCE OF LIGHT EMANATING FROM THE CENTER OF THE GLOBE DESIGN.

SN 77-815,286, FILED 8-28-2009.

BRENDAN REGAN, EXAMINING ATTORNEY



David J. Kybas

Director of the United States Patent and Trademark Office

United States of America

United States Patent and Trademark Office

ABACO GOLD

Reg. No. 4,067,757

Registered Dec. 6, 2011

Int. Cl.: 30

TRADEMARK

PRINCIPAL REGISTER

MARKET PLACEMENTS, LLC (FLORIDA LIMITED LIABILITY COMPANY)
P O BOX 1505
DESTIN, FL 32540

FOR: BEER, IN CLASS 30 (U.S. CL. 46).

FIRST USE 9-1-2011; IN COMMERCE 9-1-2011.

THE MARK CONSISTS OF STANDARD CHARACTERS WITHOUT CLAIM TO ANY PARTICULAR FONT, STYLE, SIZE, OR COLOR.

NO CLAIM IS MADE TO THE EXCLUSIVE RIGHT TO USE "GOLD", APART FROM THE MARK AS SHOWN.

SN 77-816,687, FILED 8-31-2009.

JENNY PARK, EXAMINING ATTORNEY



David J. Kybas

Director of the United States Patent and Trademark Office

United States of America

United States Patent and Trademark Office



Reg. No. 4,067,758

Registered Dec. 6, 2011

Int. Cl.: 5

TRADEMARK

PRINCIPAL REGISTER

DBC, LLC (UTAH LIMITED LIABILITY COMPANY)
2889 ASHTON BOULEVARD
LEHI, UT 84043

FOR: HAND-SANITIZING PREPARATIONS; ANTIBACTERIAL CLEANERS, IN CLASS 5
(U.S. CLS. 6, 18, 44, 46, 51 AND 52).

FIRST USE 10-31-2010; IN COMMERCE 10-31-2010.

OWNER OF U.S. REG. NOS. 3,104,280, 3,152,299, AND 3,577,822.

THE MARK CONSISTS OF THE WORD "JUNI" IN BLOCK LETTERS ON TOP OF THE WORD
"BY XANGO" WITH AN OUTLINE DRAWING OF A MANGOSTEEN FRUIT IN BETWEEN
THE WORDS "BY" AND "XANGO".

SN 77-817,904, FILED 9-1-2009.

JESSICA FATHY, EXAMINING ATTORNEY



David J. Kybas

Director of the United States Patent and Trademark Office

United States of America

United States Patent and Trademark Office

BEVERLY'S BEAUTY BLESSINGS

Reg. No. 4,067,759

Registered Dec. 6, 2011

Int. Cl.: 3

TRADEMARK

PRINCIPAL REGISTER

BOLDEN, BEVERLY R (UNITED STATES INDIVIDUAL)
271 HALSEY STREET #1R
BROOKLYN, NY 11216

FOR: AFTERSHAVE PREPARATIONS; BAR SOAP; BEAUTY LOTIONS; BODY AND BEAUTY CARE COSMETICS; BODY BUTTER; BODY LOTIONS; BODY OILS; NON-MEDICATED WASHING PREPARATIONS FOR THE BODY; COSMETIC OILS; ESSENTIAL OILS; FRAGRANCES; GREASES FOR COSMETIC PURPOSES; HAIR CARE PREPARATIONS; HAIR SHAMPOOS AND CONDITIONERS; HAIR SPRAYS; HAIR STYLING PREPARATIONS; NON-MEDICATED ACNE TREATMENT PREPARATIONS; NON-MEDICATED HAIR TREATMENT PREPARATIONS FOR COSMETIC PURPOSES; NON-MEDICATED SKIN CARE PREPARATIONS; SHAVING PREPARATIONS; SHAVING SOAPS; SKIN LOTIONS; SOAPS; SOAPS FOR BODY CARE; SOAPS FOR PERSONAL USE, IN CLASS 3 (U.S. CLS. 1, 4, 6, 50, 51 AND 52).

FIRST USE 0-0-2009; IN COMMERCE 0-0-2009.

THE MARK CONSISTS OF STANDARD CHARACTERS WITHOUT CLAIM TO ANY PARTICULAR FONT, STYLE, SIZE, OR COLOR.

NO CLAIM IS MADE TO THE EXCLUSIVE RIGHT TO USE "BEAUTY", APART FROM THE MARK AS SHOWN.

SN 77-818,008, FILED 9-1-2009.

FRED CARL, EXAMINING ATTORNEY



David J. Kyros

Director of the United States Patent and Trademark Office

United States of America

United States Patent and Trademark Office

50150

Reg. No. 4,067,760

Registered Dec. 6, 2011

Int. Cl.: 35

SERVICE MARK

PRINCIPAL REGISTER

LAURENT MARTENOT (FRANCE INDIVIDUAL)
VILLA IMPERIAL 549, QUINTA LAS VILLAS
IRAPUATO, GTO, MEXICO 36643

FOR: ASSISTANCE IN BUSINESS MANAGEMENT AND PRODUCT COMMERCIALIZATION,
WITHIN THE FRAMEWORK OF A LICENCE CONTRACT, IN CLASS 35 (U.S. CLS. 100, 101
AND 102).

FIRST USE 1-3-2011; IN COMMERCE 1-3-2011.

THE MARK CONSISTS OF STANDARD CHARACTERS WITHOUT CLAIM TO ANY PAR-
TICULAR FONT, STYLE, SIZE, OR COLOR.

SN 77-818,355, FILED 9-2-2009.

ASMAT KHAN, EXAMINING ATTORNEY



David J. Kybas

Director of the United States Patent and Trademark Office

United States of America

United States Patent and Trademark Office



Reg. No. 4,067,761

Registered Dec. 6, 2011

Int. Cl.: 21

TRADEMARK

PRINCIPAL REGISTER

SAVAGE, LISA ANN (UNITED STATES INDIVIDUAL), DBA DIPPYCUPS,
5357 E. WARDLOW RD.
LONG BEACH, CA 90808

FOR: SERVINGWARE FOR SERVING FOOD, IN CLASS 21 (U.S. CLS. 2, 13, 23, 29, 30, 33,
40 AND 50).

FIRST USE 2-14-2008; IN COMMERCE 9-14-2009.

OWNER OF U.S. REG. NO. 3,402,540.

THE COLOR(S) RED, GREEN, DARK GREEN, BLUE, LIGHT BLUE, DARK BLUE, BLACK,
WHITE, TAN, BROWN AND GREY IS/ARE CLAIMED AS A FEATURE OF THE MARK.

NO CLAIM IS MADE TO THE EXCLUSIVE RIGHT TO USE "CUPS", APART FROM THE
MARK AS SHOWN.

THE MARK CONSISTS OF STYLIZED WORDING "DIPPY CUPS" WITH THE TERM "DIPPY"
IN RED CENTERED ABOVE THE TERM "CUPS" IN GREEN. ABOVE THE "PPY" PORTION
OF THE TERM "DIPPY" IS A BLUE SERVING CUP, OUTLINED IN DARK BLUE WITH
LIGHT BLUE SHADING. INSIDE THE CUP IS A CONDIMENT APPEARING IN WHITE,
TAN AND BROWN. DIPPED IN THE CONDIMENT IS A RED STRAWBERRY WITH BLACK
EYES, BLACK SEEDS AND A BLACK OUTLINE OF THE MOUTH. THE INTERIOR PORTION
OF THE MOUTH OF THE STRAWBERRY IS WHITE. THE STEM FOR THE STRAWBERRY
APPEARS IN GREEN WITH A DARK GREEN OUTLINE. THE BACKGROUND OF THE
MARK IS WHITE. THE ENTIRE MARK IS OUTLINED WITH A SINGLE BLACK LINE WITH
A GREY SHADOW EFFECT.

SN 77-818,518, FILED 9-2-2009.

PAULA MAHONEY, EXAMINING ATTORNEY



David J. Kybas

Director of the United States Patent and Trademark Office

United States of America

United States Patent and Trademark Office

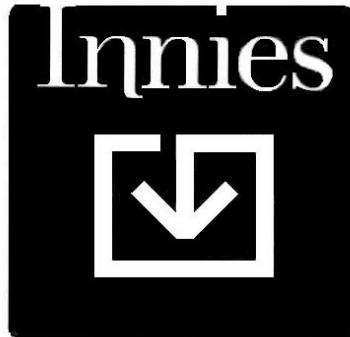

Reg. No. 4,067,762

Registered Dec. 6, 2011

Int. Cl.: 22

TRADEMARK

PRINCIPAL REGISTER

TM OUT!, INC. (CALIFORNIA CORPORATION)
12100 WILSHIRE BLVD.
15TH FLOOR
LOS ANGELES, CA 90025

FOR: PROTECTION POUCHES MADE OF FABRIC FOR STORING PURSES WHEN NOT IN USE, IN CLASS 22 (U.S. CLS. 1, 2, 7, 19, 22, 42 AND 50).

FIRST USE 1-1-2010; IN COMMERCE 1-1-2010.

THE MARK CONSISTS OF THE WORD "INNIES" OVER AN ARROW WHICH FORMS AN INCOMPLETE, SINGLE-LINE RECTANGLE CONTAINED IN A SQUARE CARRIER.

SN 77-818,638, FILED 9-2-2009.

JOHN SCHUYLER YARD, EXAMINING ATTORNEY



David J. Kybas

Director of the United States Patent and Trademark Office

United States of America

United States Patent and Trademark Office

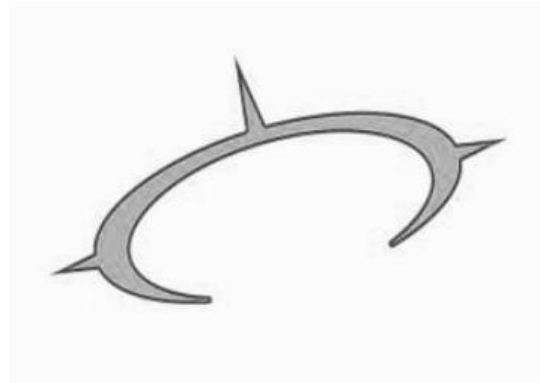

Reg. No. 4,067,763

Registered Dec. 6, 2011

Int. Cls.: 12, 25, and 35

TRADEMARK

SERVICE MARK

PRINCIPAL REGISTER

MYRTLE WEST CYCLE, INC. (SOUTH CAROLINA CORPORATION)
2675 HIGHWAY 9W
LONGS, SC 29568

FOR: STRUCTURAL PARTS OF MOTORCYCLES, NAMELY, WHEELS, SWING ARMS, SWING ARM EXTENSIONS, KICKSTANDS, TRIPLE TREES, LOWERING LINKS, IN CLASS 12 (U.S. CLS. 19, 21, 23, 31, 35 AND 44).

FIRST USE 10-8-2004; IN COMMERCE 10-8-2004.

FOR: CLOTHING, NAMELY, SHIRTS, HATS, JACKETS, IN CLASS 25 (U.S. CLS. 22 AND 39).

FIRST USE 10-8-2004; IN COMMERCE 10-8-2004.

FOR: ONLINE RETAIL STORE SERVICES AND RETAIL STORE SERVICES FEATURING MOTORCYCLES, MOTORCYCLE PARTS, MOTORCYCLE ACCESSORIES, AND CLOTHING, IN CLASS 35 (U.S. CLS. 100, 101 AND 102).

FIRST USE 10-8-2004; IN COMMERCE 10-8-2004.

THE MARK CONSISTS OF A PARTIAL ELLIPSE WITH 3 POINTS.

SN 77-818,696, FILED 9-2-2009.

STEVEN PEREZ, EXAMINING ATTORNEY



David J. Kypos

Director of the United States Patent and Trademark Office

United States of America

United States Patent and Trademark Office

KAPSource

Reg. No. 4,067,764

Registered Dec. 6, 2011

Int. Cl.: 35

SERVICE MARK

PRINCIPAL REGISTER

KAPLAN, INC. (DELAWARE CORPORATION)
395 HUDSON STREET
4TH FLOOR
NEW YORK, NY 10014

FOR: COMPUTERIZED ON-LINE ORDERING SERVICES IN THE FIELD OF CUSTOMIZED ADVERTISEMENTS AND PROMOTIONAL MATERIALS; PROVIDING A WEBSITE FEATURING SAMPLE ADVERTISEMENTS AND PROMOTIONAL MATERIALS FOR USE IN EDUCATIONAL AND TRAINING PROGRAMS; PREPARATION OF CUSTOMIZED ADVERTISEMENTS AND PROMOTIONAL MATERIALS FOR OTHERS, IN CLASS 35 (U.S. CLS. 100, 101 AND 102).

FIRST USE 12-0-2009; IN COMMERCE 12-0-2009.

THE MARK CONSISTS OF STANDARD CHARACTERS WITHOUT CLAIM TO ANY PARTICULAR FONT, STYLE, SIZE, OR COLOR.

OWNER OF U.S. REG. NOS. 1,822,683, 3,366,941, AND OTHERS.

SN 77-818,803, FILED 9-2-2009.

KATHERINE CONNOLLY, EXAMINING ATTORNEY



David J. Kyffers

Director of the United States Patent and Trademark Office

United States of America

United States Patent and Trademark Office

VERITAS

Reg. No. 4,067,765

Registered Dec. 6, 2011

Int. Cl.: 28

TRADEMARK

PRINCIPAL REGISTER

PURE FISHING, INC. (IOWA CORPORATION)
3801 WESTMORE DRIVE
COLUMBIA, SC 29223

FOR: FISHING RODS, IN CLASS 28 (U.S. CLS. 22, 23, 38 AND 50).

FIRST USE 8-0-2010; IN COMMERCE 8-0-2010.

THE MARK CONSISTS OF STANDARD CHARACTERS WITHOUT CLAIM TO ANY PARTICULAR FONT, STYLE, SIZE, OR COLOR.

THE ENGLISH TRANSLATION OF "VERITAS" IS "TRUTH".

SN 77-820,573, FILED 9-4-2009.

PATRICIA EVANKO, EXAMINING ATTORNEY



David J. Kybas

Director of the United States Patent and Trademark Office

United States of America

United States Patent and Trademark Office

SPECIAL FINCH

Reg. No. 4,067,766

Registered Dec. 6, 2011

Int. Cl.: 31

TRADEMARK

PRINCIPAL REGISTER

D & D COMMODITIES LIMITED (MINNESOTA CORPORATION)
P.O. BOX 359
HIGHWAY 75 SOUTH
STEPHEN, MN 56757

FOR: BIRD FOOD, IN CLASS 31 (U.S. CLS. 1 AND 46).

FIRST USE 1-0-2011; IN COMMERCE 1-0-2011.

THE MARK CONSISTS OF STANDARD CHARACTERS WITHOUT CLAIM TO ANY PARTICULAR FONT, STYLE, SIZE, OR COLOR.

NO CLAIM IS MADE TO THE EXCLUSIVE RIGHT TO USE "FINCH", APART FROM THE MARK AS SHOWN.

SN 77-821,396, FILED 9-8-2009.

RENEE MCCRAY, EXAMINING ATTORNEY



David J. Kyros

Director of the United States Patent and Trademark Office

United States of America

United States Patent and Trademark Office

AVIAT NETWORKS

Reg. No. 4,067,767

Registered Dec. 6, 2011

**Int. Cls.: 9, 35, 37, 38,
and 42**

TRADEMARK

SERVICE MARK

PRINCIPAL REGISTER

AVIAT NETWORKS, INC. (DELAWARE CORPORATION)
637 DAVIS DRIVE
MORRISVILLE, NC 27560

FOR: WIRELESS COMMUNICATIONS SYSTEMS, NAMELY, DIGITAL MODEMS, MULTI-
PLEXERS, MICROWAVE RADIO TRANSMITTERS AND RECEIVERS, ANTENNAS, AND
RELATED OPERATING SOFTWARE, ALL SOLD SEPARATELY, OR AS A UNIT USED
TOGETHER TO INTERCONNECT STATIONS IN MOBILE NETWORKS OR PROVIDE
LOCAL ACCESS TO TELECOMMUNICATIONS SYSTEMS FOR VOICE, DATA OR VIDEO
SERVICES, AND MANUALS SOLD AS A UNIT; NETWORK COMPUTER SYSTEMS CON-
SISTING OF COMPUTER TERMINALS AND COMPUTER SOFTWARE FOR USE IN DIA-
GNOSTIC MONITORING, MAINTENANCE AND CONTROL OF SUCH WIRELESS COMMU-
NICATIONS SYSTEMS, AND MANUALS SOLD AS A UNIT; EQUIPMENT AND ACCESSOR-
IES FOR BROADBAND WIRELESS ACCESS, NAMELY, COMPUTER HARDWARE, COM-
PUTER SOFTWARE FOR BROADBAND WIRELESS ACCESS, MODEMS, TELECOMMU-
NICATIONS SWITCHES, ANTENNAS, TELECOMMUNICATIONS TRANSMITTERS,
TELECOMMUNICATIONS RECEIVERS, CIRCUIT BOARDS FOR BROADBAND WIRELESS
ACCESS, WIRELESS ADAPTERS, AND WIRELESS NETWORK BRIDGES; COMPUTER
HARDWARE AND SOFTWARE FOR INTERCONNECTING, MANAGING AND OPERATING
LOCAL AND WIDE AREA NETWORKS; COMPUTER SOFTWARE FOR NETWORKING,
NAMELY, SOFTWARE WHICH PROVIDES CONNECTIVITY, INTEROPERABILITY AND
MANAGEMENT CAPABILITY AMONG NETWORKED COMPONENTS AND SYSTEMS;
WIRELESS TELECOMMUNICATIONS AND ELECTRONIC EQUIPMENT, NAMELY,
WIRELESS MODEMS, WIRELESS ETHERNET BRIDGES, NETWORK MULTIPLEXERS,
DATA COMMUNICATION MULTIPLEXERS, RADIO MODULATORS AND DEMODULAT-
ORS, RADIO TRANSMITTERS, RADIO RECEIVERS, ANTENNAS FOR TRANSMITTING
AND RECEIVING DATA IN LOCAL AREA NETWORKS, MULTIFREQUENCY SCRAM-
BLERS; COMPUTER SOFTWARE FOR USE IN CONTROLLING, OPERATING, MANAGING,
OR MAINTAINING WIRELESS COMMUNICATIONS SYSTEMS OR WIRELESS INFRA-
STRUCTURE EQUIPMENT; TELECOMMUNICATIONS AND DATA NETWORKING
HARDWARE, NAMELY, DEVICES FOR TRANSPORTING AND AGGREGATING VOICE,
DATA, AND VIDEO COMMUNICATIONS ACROSS MULTIPLE NETWORK INFRASTRUC-
TURES AND COMMUNICATIONS PROTOCOLS; BROADBAND WIRELESS EQUIPMENT,
NAMELY, TELECOMMUNICATIONS BASE STATION EQUIPMENT FOR CELLULAR AND
FIXED NETWORKING AND COMMUNICATIONS APPLICATIONS; RADIO RECEIVERS
AND TRANSMITTERS; RADIO TRANSCEIVERS, IN CLASS 9 (U.S. CLS. 21, 23, 26, 36 AND
38).



David J. Kyjars

Director of the United States Patent and Trademark Office

Reg. No. 4,067,767 FIRST USE 1-0-2010; IN COMMERCE 1-0-2010.

FOR: OPERATION AND ADMINISTRATION OF TELECOMMUNICATION SYSTEMS AND NETWORKS FOR OTHERS; TELECOMMUNICATIONS NETWORK MANAGEMENT SERVICES, NAMELY, THE OPERATION AND ADMINISTRATION OF TELECOMMUNICATION SYSTEMS AND NETWORKS FOR OTHERS; PROVIDING INFORMATION VIA A GLOBAL COMPUTER NETWORK IN THE FIELDS OF DATA COMMUNICATION AND RELATED TECHNOLOGIES, NAMELY, CUSTOMER PRODUCT INFORMATION ABOUT WIRELESS COMMUNICATIONS HARDWARE, IN CLASS 35 (U.S. CLS. 100, 101 AND 102).

FIRST USE 1-0-2010; IN COMMERCE 1-0-2010.

FOR: INSTALLATION, MAINTENANCE AND REPAIR SERVICES OF HARDWARE FOR WIRELESS COMMUNICATIONS SYSTEMS FOR OTHERS, IN CLASS 37 (U.S. CLS. 100, 103 AND 106).

FIRST USE 1-0-2010; IN COMMERCE 1-0-2010.

FOR: TELECOMMUNICATION CONSULTATION IN THE NATURE OF TECHNICAL CONSULTING IN THE FIELD OF AUDIO, TEXT AND VISUAL DATA TRANSMISSION AND COMMUNICATION; TELECOMMUNICATIONS CONSULTATION; PROVIDING INFORMATION VIA A GLOBAL COMPUTER NETWORK IN THE FIELDS OF DATA COMMUNICATIONS AND RELATED TECHNOLOGIES, NAMELY, WIRELESS ELECTRONIC TRANSMISSION OF VOICE SIGNALS, DATA, FACSIMILES, IMAGES AND INFORMATION, IN CLASS 38 (U.S. CLS. 100, 101 AND 104).

FIRST USE 1-0-2010; IN COMMERCE 1-0-2010.

FOR: DESIGN SERVICES FOR OTHERS IN THE FIELD OF WIRELESS COMMUNICATIONS SYSTEMS; CONSULTING SERVICES, NAMELY, DESIGN, IMPLEMENTATION AND TESTING OF WIRELESS COMMUNICATIONS SYSTEMS SOFTWARE; COMPUTER NETWORK DESIGN FOR OTHERS; TELECOMMUNICATIONS TECHNOLOGY CONSULTING SERVICES, NAMELY, THE DEVELOPMENT OF CUSTOMIZED TELECOMMUNICATIONS EQUIPMENT FOR OTHERS; RESEARCH AND DEVELOPMENT FOR NEW WIRELESS TELECOMMUNICATIONS EQUIPMENT; INSTALLATION OF SOFTWARE FOR WIRELESS WIDE AREA NETWORKS; CUSTOM DESIGN OF TELECOMMUNICATION SYSTEMS FOR OTHERS; COMPUTER SYSTEM DESIGN AND DEVELOPMENT OF HIGH-SPEED EQUIPMENT, NAMELY, COMPUTER TERMINALS FOR OPERATORS OF PUBLIC NETWORKS AND COMPANIES; COMPUTER ENGINEERING SERVICES FOR LARGE OR MEDIUM COMPUTER SYSTEM APPLICATIONS; UPDATING AND MAINTENANCE OF SOFTWARE, TECHNICAL CONSULTING AND ASSISTANCE WITH TELECOMMUNICATIONS SYSTEMS AND COMPONENTS; TELECOMMUNICATION NETWORK ENGINEERING AND TELECOMMUNICATION COMPUTER SYSTEMS ADMINISTRATION, NAMELY, COMPUTER PROGRAMMING FOR OTHERS; ENGINEERING SERVICES FOR OPERATING TELECOMMUNICATION TERMINALS; ACTING AS AN APPLICATION SERVICE PROVIDER IN THE FIELD OF KNOWLEDGE MANAGEMENT TO HOST COMPUTER APPLICATION SOFTWARE FOR SEARCHING AND RETRIEVING INFORMATION FOR DATABASES AND COMPUTER NETWORKS; DEVELOPMENT AND DESIGN OF SOFTWARE, AND PARTICULARLY OF TELECOMMUNICATION SOFTWARE; SOFTWARE MAINTENANCE SERVICES; PROVIDING PLANNING AND ENGINEERING SERVICES IN THE FIELD OF INFORMATION AND COMMUNICATIONS NETWORKS; INSTALLATION, MAINTENANCE AND REPAIR SERVICES FOR SOFTWARE FOR WIRELESS COMMUNICATIONS SYSTEMS FOR OTHERS; CONSULTING SERVICES, NAMELY, DESIGN, IMPLEMENTATION AND TESTING OF WIRELESS COMMUNICATIONS HARDWARE, IN CLASS 42 (U.S. CLS. 100 AND 101).

FIRST USE 1-0-2010; IN COMMERCE 1-0-2010.

Reg. No. 4,067,767 THE MARK CONSISTS OF STANDARD CHARACTERS WITHOUT CLAIM TO ANY PARTICULAR FONT, STYLE, SIZE, OR COLOR.

NO CLAIM IS MADE TO THE EXCLUSIVE RIGHT TO USE "NETWORKS", APART FROM THE MARK AS SHOWN.

SN 77-822,178, FILED 9-8-2009.

MAYUR VAGHANI, EXAMINING ATTORNEY

United States of America

United States Patent and Trademark Office

MAKING SOCIAL WORK

Reg. No. 4,067,768

Registered Dec. 6, 2011

Int. Cl.: 9

TRADEMARK

PRINCIPAL REGISTER

OUTSTART, INC. (DELAWARE CORPORATION)
745 ATLANTIC AVENUE
BOSTON, MA 02111

FOR: COMPUTER SOFTWARE PLATFORMS FOR FACILITATING THE SHARING OF KNOWLEDGE THROUGHOUT AN ENTERPRISE AND THE DEVELOPMENT OF ONLINE COMMUNITIES, IN CLASS 9 (U.S. CLS. 21, 23, 26, 36 AND 38).

FIRST USE 5-9-2011; IN COMMERCE 5-9-2011.

THE MARK CONSISTS OF STANDARD CHARACTERS WITHOUT CLAIM TO ANY PARTICULAR FONT, STYLE, SIZE, OR COLOR.

SN 77-822,376, FILED 9-9-2009.

KEVIN DINALLO, EXAMINING ATTORNEY



David J. Kyros

Director of the United States Patent and Trademark Office

United States of America

United States Patent and Trademark Office

TWO THUMBS UP

Reg. No. 4,067,769

THUMBS UP, LLC (DELAWARE LIMITED LIABILITY COMPANY)
250 CAMBRIDGE AVE.
KENSINGTON, CA 94708

Registered Dec. 6, 2011

Int. Cl.: 43

FOR: PROVIDING A WEBSITE FEATURING INFORMATION RELATING TO BEVERAGES,
IN CLASS 43 (U.S. CLS. 100 AND 101).

SERVICE MARK

FIRST USE 7-22-2011; IN COMMERCE 7-22-2011.

PRINCIPAL REGISTER

THE MARK CONSISTS OF STANDARD CHARACTERS WITHOUT CLAIM TO ANY PAR-
TICULAR FONT, STYLE, SIZE, OR COLOR.

SN 77-824,115, FILED 9-10-2009.

CHARISMA HAMPTON, EXAMINING ATTORNEY



David J. Kyffers

Director of the United States Patent and Trademark Office

United States of America

United States Patent and Trademark Office



firefend

Reg. No. 4,067,770

Registered Dec. 6, 2011

Int. Cl.: 24

TRADEMARK

PRINCIPAL REGISTER

LOUIS HORNICK III (UNITED STATES INDIVIDUAL)
203 EAST 72ND STREET
NEW YORK, NY 10021

FOR: CURTAIN FABRIC; FABRIC WINDOW COVERINGS AND TREATMENTS, NAMELY, CURTAINS, DRAPERIES, SHEERS, SWAGS AND VALANCES, IN CLASS 24 (U.S. CLS. 42 AND 50).

FIRST USE 10-28-2010; IN COMMERCE 10-28-2010.

THE MARK CONSISTS OF A STYLIZED DESIGN OF A DOG UNDERNEATH WHICH IS THE WORD "FIREFEND" IN STYLIZED LETTERING.

SN 77-824,830, FILED 9-11-2009.

GEORGE LORENZO, EXAMINING ATTORNEY



David J. Kyros

Director of the United States Patent and Trademark Office

United States of America

United States Patent and Trademark Office

IN A WORD: SECURE

Reg. No. 4,067,771

Registered Dec. 6, 2011

Int. Cl.: 6

TRADEMARK

PRINCIPAL REGISTER

WORDLOCK, INC. (CALIFORNIA CORPORATION)
2855 KIFER ROAD, SUITE 105
SANTA CLARA, CA 95051

FOR: METAL COMBINATION LOCKS; METAL PADLOCKS; METAL BICYCLES LOCKS;
METAL LUGGAGE LOCKS; METAL COMPUTER AND LAPTOP LOCKS; METAL LOCKS
FOR LOCKERS; METAL BACKPACK LOCKS; METAL LOCK BOXES, IN CLASS 6 (U.S.
CLS. 2, 12, 13, 14, 23, 25 AND 50).

FIRST USE 6-30-2010; IN COMMERCE 9-30-2011.

THE MARK CONSISTS OF STANDARD CHARACTERS WITHOUT CLAIM TO ANY PAR-
TICULAR FONT, STYLE, SIZE, OR COLOR.

SN 77-825,110, FILED 9-11-2009.

GEORGE LORENZO, EXAMINING ATTORNEY



David J. Kyffers

Director of the United States Patent and Trademark Office

United States of America

United States Patent and Trademark Office

HARMONYX

Reg. No. 4,067,772

API INDUSTRIES, INC. (NEW JERSEY CORPORATION)
2 GLENSHAW STREET
ORANGEBURG, NY 10962

Registered Dec. 6, 2011

Int. Cl.: 16

FOR: PLASTIC TRASH BAGS; PLASTIC LINERS FOR TRASH RECEPTACLES, IN CLASS 16 (U.S. CLS. 2, 5, 22, 23, 29, 37, 38 AND 50).

TRADEMARK

FIRST USE 9-28-2011; IN COMMERCE 9-28-2011.

PRINCIPAL REGISTER

THE MARK CONSISTS OF STANDARD CHARACTERS WITHOUT CLAIM TO ANY PARTICULAR FONT, STYLE, SIZE, OR COLOR.

SN 77-826,756, FILED 9-15-2009.

ELI HELLMAN, EXAMINING ATTORNEY



David J. Kybas

Director of the United States Patent and Trademark Office

United States of America

United States Patent and Trademark Office

360RUSH

Reg. No. 4,067,773

SPLASHTACULAR, INC. (KANSAS CORPORATION)
78-670 HIGHWAY 111
LA QUINTA, CA 92253

Registered Dec. 6, 2011

Int. Cls.: 28 and 41

FOR: AMUSEMENT PARK RIDES, IN CLASS 28 (U.S. CLS. 22, 23, 38 AND 50).

TRADEMARK

FIRST USE 7-1-2011; IN COMMERCE 7-1-2011.

SERVICE MARK

FOR: ENTERTAINMENT IN THE NATURE OF AN AMUSEMENT PARK RIDE, IN CLASS 41 (U.S. CLS. 100, 101 AND 107).

PRINCIPAL REGISTER

FIRST USE 7-1-2011; IN COMMERCE 7-1-2011.

THE MARK CONSISTS OF STANDARD CHARACTERS WITHOUT CLAIM TO ANY PARTICULAR FONT, STYLE, SIZE, OR COLOR.

SN 77-828,818, FILED 9-17-2009.

VIVIAN MICZNIK FIRST, EXAMINING ATTORNEY



David J. Kybas

Director of the United States Patent and Trademark Office

United States of America

United States Patent and Trademark Office



Reg. No. 4,067,774

FILTREX HOLDINGS PTE LTD. (SINGAPORE CORPORATION)
#04-07, 35 SELEGIE ROAD
PARKLANE MALL, SINGAPORE

Registered Dec. 6, 2011

Int. Cl.: 11

FOR: CARBON FILTERS FOR WATER FILTRATION, IN CLASS 11 (U.S. CLS. 13, 21, 23, 31 AND 34).

TRADEMARK

FIRST USE 11-0-2010; IN COMMERCE 11-0-2010.

PRINCIPAL REGISTER

THE MARK CONSISTS OF A 9-DOT DESIGN NEXT TO WHICH THE WORD "BIOSAFE" IS DISPLAYED AND UNDERLINED.

SN 77-829,020, FILED 9-17-2009.

WILLIAM P. SHANAHAN, EXAMINING ATTORNEY



David J. Kybas

Director of the United States Patent and Trademark Office

United States of America
United States Patent and Trademark Office

SURELIFE

Reg. No. 4,067,775

Registered Dec. 6, 2011

Int. Cl.: 10

TRADEMARK

PRINCIPAL REGISTER

MHC MEDICAL PRODUCTS, LLC (OHIO LTD LIAB JT ST CO)
8695 SEWARD ROAD
FAIRFIELD, OH 45011

FOR: BLOOD PRESSURE MONITORS, IN CLASS 10 (U.S. CLS. 26, 39 AND 44).

FIRST USE 9-26-2011; IN COMMERCE 9-26-2011.

THE MARK CONSISTS OF STANDARD CHARACTERS WITHOUT CLAIM TO ANY PARTICULAR FONT, STYLE, SIZE, OR COLOR.

SN 77-829,622, FILED 9-18-2009.

TRACY FLETCHER, EXAMINING ATTORNEY



David J. Kybas

Director of the United States Patent and Trademark Office

United States of America

United States Patent and Trademark Office

Rocket Cafe

Reg. No. 4,067,776

Registered Dec. 6, 2011

Int. Cl.: 43

SERVICE MARK

PRINCIPAL REGISTER

ROCKET FOODS, LLC (WASHINGTON LIMITED LIABILITY COMPANY)
306 WEST HOLLY
BELLINGHAM, WA 98225

FOR: CAFE-RESTAURANTS, IN CLASS 43 (U.S. CLS. 100 AND 101).

FIRST USE 9-15-2011; IN COMMERCE 9-15-2011.

THE MARK CONSISTS OF STANDARD CHARACTERS WITHOUT CLAIM TO ANY PARTICULAR FONT, STYLE, SIZE, OR COLOR.

NO CLAIM IS MADE TO THE EXCLUSIVE RIGHT TO USE "CAFE", APART FROM THE MARK AS SHOWN.

SN 77-831,360, FILED 9-21-2009.

KATHERINE CONNOLLY, EXAMINING ATTORNEY



David J. Kybas

Director of the United States Patent and Trademark Office

United States of America

United States Patent and Trademark Office

ZEGLIO

Reg. No. 4,067,777

Registered Dec. 6, 2011

Int. Cl.: 25

TRADEMARK

PRINCIPAL REGISTER

PARK, SOONMIN (REPUBLIC OF KOREA INDIVIDUAL)
306 S DEARBORN ST
400 N LASALLE DR
CHICAGO, IL 60604

FOR: OVERCOATS; PANTS; SHIRTS; SUITS; TIES; TUXEDOS, IN CLASS 25 (U.S. CLS. 22 AND 39).

FIRST USE 7-1-2009; IN COMMERCE 7-1-2009.

THE MARK CONSISTS OF STANDARD CHARACTERS WITHOUT CLAIM TO ANY PARTICULAR FONT, STYLE, SIZE, OR COLOR.

SN 77-831,830, FILED 9-22-2009.

KAELIE KUNG, EXAMINING ATTORNEY



David J. Kybas

Director of the United States Patent and Trademark Office

United States of America

United States Patent and Trademark Office

SIMPLE FARMER

Reg. No. 4,067,778

BYRNE, JEFF (UNITED STATES INDIVIDUAL)
2973 HARBOR BLVD., #60
COSTA MESA, CA 92626

Registered Dec. 6, 2011

Int. Cl.: 25

FOR: BASEBALL CAPS; HATS; SHIRTS; T-SHIRTS; TEE SHIRTS, IN CLASS 25 (U.S. CLS. 22 AND 39).

TRADEMARK

FIRST USE 9-1-2008; IN COMMERCE 12-1-2009.

PRINCIPAL REGISTER

THE MARK CONSISTS OF STANDARD CHARACTERS WITHOUT CLAIM TO ANY PARTICULAR FONT, STYLE, SIZE, OR COLOR.

SN 77-834,633, FILED 9-24-2009.

KELLY TRUSILO, EXAMINING ATTORNEY



David J. Kybas

Director of the United States Patent and Trademark Office

United States of America

United States Patent and Trademark Office

PRIVATE MEMBER

Reg. No. 4,067,779

Registered Dec. 6, 2011

Int. Cl.: 25

TRADEMARK

PRINCIPAL REGISTER

IMPORTATIONS RALLYE INC. (CANADA CORPORATION)
433 CHABANEL OUEST - SUITE 1000
MONTREAL, QUEBEC, CANADA H2N2J8

FOR: MEN'S, WOMEN'S AND CHILDREN'S CLOTHING, SPORTSWEAR AND ACCESSORIES, NAMELY, JACKETS, SKIRTS, BLOUSES, PULLOVERS, DRESSES, VESTS, SHORTS, BERMUDAS SHORTS, PANTS, PANT SUITS, SHIRTS, COATS, SUIT COATS, SWEATERS, TUNICS, JUMPERS, BELTS, JEANS, DENIM TOPS, T-SHIRTS, SOCKS, NYLON STOCKINGS, UNDERWEAR, UNDERGARMENT, CAPS, HATS, BONNET, SCARVES, GLOVES, FOOTWEAR, PAJAMAS, IN CLASS 25 (U.S. CLS. 22 AND 39).

FIRST USE 12-31-1976; IN COMMERCE 10-31-2009.

THE MARK CONSISTS OF STANDARD CHARACTERS WITHOUT CLAIM TO ANY PARTICULAR FONT, STYLE, SIZE, OR COLOR.

SN 77-834,689, FILED 9-25-2009.

RAUL CORDOVA, EXAMINING ATTORNEY



David J. Kybas

Director of the United States Patent and Trademark Office

United States of America

United States Patent and Trademark Office



Reg. No. 4,067,780

Registered Dec. 6, 2011

Int. Cl.: 37

SERVICE MARK

PRINCIPAL REGISTER

DELUXE AUTO BODY, LLC (CALIFORNIA LIMITED LIABILITY COMPANY), DBA DELUXE AUTO BODY,
4252 40TH STREET
SAN DIEGO, CA 92105

FOR: AUTOMOBILE BODY REPAIR AND FINISHING FOR OTHERS; AUTOMOBILE CLEANING; AUTOMOBILE CLEANING AND CAR WASHING; AUTOMOBILE CUSTOMIZATION SERVICES; AUTOMOBILE DETAILING; AUTOMOBILE GREASING; AUTOMOBILE LUBRICATION; AUTOMOBILE PAINTING; AUTOMOBILE PINSTRIPING; AUTOMOBILE POLISHING; AUTOMOBILE REPAIR AND MAINTENANCE; AUTOMOBILE SERVICE STATION SERVICES; AUTOMOBILE UNDERCOATING SERVICES; AUTOMOBILE WASHING; AUTOMOTIVE CONVERSION SERVICES, NAMELY, CONVERTING AUTOMOBILES AND TRUCKS TO ELECTRIC POWER; AUTOMOTIVE CONVERSION SERVICES, NAMELY, INSTALLING SPECIALTY AUTOMOTIVE EQUIPMENT; AUTOMOTIVE MAINTENANCE AND REPAIR; AUTOMOTIVE MAINTENANCE SERVICES, NAMELY, AUTOMOTIVE UPGRADING; AUTOMOTIVE REFINISHING; GARAGE SERVICES, NAMELY, REPAIR OF AUTOMOBILES; PROVIDING A WEB SITE FEATURING INFORMATION FOR AUTOMOBILE DEALERSHIPS AND CUSTOMERS ABOUT AUTOMOBILE EXTERIOR AND INTERIOR COATINGS AND PROTECTANTS; REPAIR OF AUTOMOBILES; REPAIR OF AUTOMOTIVE FRAME STRETCHING MACHINES; REPAIR OR MAINTENANCE OF AUTOMOBILES; VULCANIZING OF AUTOMOBILE TIRES, IN CLASS 37 (U.S. CLS. 100, 103 AND 106).

FIRST USE 9-27-2009; IN COMMERCE 5-22-2010.

NO CLAIM IS MADE TO THE EXCLUSIVE RIGHT TO USE "DELUXE AUTO BODY", APART FROM THE MARK AS SHOWN.

THE COLOR(S) BLUE, GREEN, RED, GREY AND BLACK IS/ARE CLAIMED AS A FEATURE OF THE MARK.

THE COLOR GREY APPEARS IN THE WORDING "DELUXE AUTO BODY" AND IN THE SHADOW OF THIS WORDING. THE COLORS BLUE, GREEN, RED, GREY AND BLACK APPEAR IN THE SWIRLS THAT MAKE UP THE CIRCLE. THE COLOR BLACK ALSO APPEARS IN THE RECTANGLE WHICH FORMS THE BACKGROUND OF THE MARK.



David J. Kappas

Director of the United States Patent and Trademark Office

SN 77-835,930, FILED 9-27-2009.

Reg. No. 4,067,780 EVELYN BRADLEY, EXAMINING ATTORNEY

United States of America

United States Patent and Trademark Office

HELL IN A CELL

Reg. No. 4,067,781

Registered Dec. 6, 2011

Int. Cl.: 9

TRADEMARK

PRINCIPAL REGISTER

WORLD WRESTLING ENTERTAINMENT, INC. (DELAWARE CORPORATION)
1241 EAST MAIN STREET
STAMFORD, CT 06902

FOR: DECORATIVE REFRIGERATOR MAGNETS; VIDEO AND COMPUTER GAME TAPES, VIDEO AND COMPUTER GAME DISCS, VIDEO AND COMPUTER GAME CASSETTES, VIDEO AND COMPUTER GAME CARTRIDGES, VIDEO AND COMPUTER GAME CD-ROMS, VIDEO OUTPUT GAME MACHINES FOR USE WITH TELEVISIONS; VIDEO AND COMPUTER GAME SOFTWARE; CINEMATOGRAPHIC FILMS FEATURING SPORTS ENTERTAINMENT; TELEVISION FILMS FEATURING SPORTS ENTERTAINMENT; MOTION PICTURE FILMS IN THE NATURE OF SPORTS ENTERTAINMENT; PRE-RECORDED PHONOGRAPH RECORDS, PRE-RECORDED COMPACT DISCS, PRE-RECORDED VIDEO TAPES, PRE-RECORDED VIDEO CASSETTE TAPES, PRE-RECORDED DVDS, AND PRE-RECORDED AUDIO CASSETTES ALL FEATURING SPORTS ENTERTAINMENT; INTERACTIVE VIDEO GAME PROGRAMS, COMPUTER GAME CARTRIDGES; MOUSE PADS; DISPOSABLE CAMERAS; SUNGLASSES; SUNGLASS CASES; PRESCRIPTION GLASSES; OPTICAL CASES, NAMELY, CASES FOR SPECTACLES AND SUNGLASSES; WALKIE-TALKIES, PROTECTIVE HELMETS; SPORTS HELMETS, IN CLASS 9 (U.S. CLS. 21, 23, 26, 36 AND 38).

FIRST USE 11-2-2010; IN COMMERCE 11-2-2010.

THE MARK CONSISTS OF STANDARD CHARACTERS WITHOUT CLAIM TO ANY PARTICULAR FONT, STYLE, SIZE, OR COLOR.

SN 77-837,045, FILED 9-29-2009.

KRISTIN DAHLING, EXAMINING ATTORNEY



David J. Kyros

Director of the United States Patent and Trademark Office

United States of America

United States Patent and Trademark Office

BNY MELLON FORESIGHT

Reg. No. 4,067,782

Registered Dec. 6, 2011

Int. Cl.: 36

SERVICE MARK

PRINCIPAL REGISTER

THE BANK OF NEW YORK MELLON CORPORATION (DELAWARE CORPORATION)
15TH FLOOR
ONE WALL STREET
NEW YORK, NY 10286

FOR: FINANCIAL SERVICES, NAMELY, PROVIDING FINANCIAL ADVISORY AND FINANCIAL MANAGEMENT SERVICES TO OTHERS, IN CLASS 36 (U.S. CLS. 100, 101 AND 102).

FIRST USE 4-1-2010; IN COMMERCE 4-1-2010.

THE MARK CONSISTS OF STANDARD CHARACTERS WITHOUT CLAIM TO ANY PARTICULAR FONT, STYLE, SIZE, OR COLOR.

OWNER OF U.S. REG. NO. 3,585,488.

SN 77-837,894, FILED 9-30-2009.

ROBERT C. CLARK JR., EXAMINING ATTORNEY



David J. Kyros

Director of the United States Patent and Trademark Office

United States of America

United States Patent and Trademark Office



Reg. No. 4,067,783

Registered Dec. 6, 2011

**Int. Cls.: 9, 35, 37, 38,
and 42**

TRADEMARK

SERVICE MARK

PRINCIPAL REGISTER

AVIAT NETWORKS, INC. (DELAWARE CORPORATION)
637 DAVIS DRIVE
MORRISVILLE, NC 27560

FOR: WIRELESS COMMUNICATIONS SYSTEMS, NAMELY, DIGITAL MODEMS, MULTI-
PLEXERS, MICROWAVE RADIO TRANSMITTERS AND RECEIVERS, ANTENNAS, AND
RELATED OPERATING SOFTWARE, ALL SOLD SEPARATELY, OR AS A UNIT USED
TOGETHER TO INTERCONNECT STATIONS IN MOBILE NETWORKS OR PROVIDE
LOCAL ACCESS TO TELECOMMUNICATIONS SYSTEMS FOR VOICE, DATA OR VIDEO
SERVICES, AND MANUALS SOLD AS A UNIT; NETWORK COMPUTER SYSTEMS CON-
SISTING OF COMPUTER TERMINALS AND COMPUTER SOFTWARE FOR USE IN DIA-
GNOSTIC MONITORING, MAINTENANCE AND CONTROL OF SUCH WIRELESS COMMU-
NICATIONS SYSTEMS, AND MANUALS SOLD AS A UNIT; EQUIPMENT AND ACCESSOR-
IES FOR BROADBAND WIRELESS ACCESS, NAMELY, COMPUTER HARDWARE, COM-
PUTER SOFTWARE FOR BROADBAND WIRELESS ACCESS, MODEMS, TELECOMMU-
NICATIONS SWITCHES, ANTENNAS, TELECOMMUNICATIONS TRANSMITTERS,
TELECOMMUNICATIONS RECEIVERS, CIRCUIT BOARDS FOR BROADBAND WIRELESS
ACCESS, WIRELESS ADAPTERS, AND WIRELESS NETWORK BRIDGES; COMPUTER
HARDWARE AND SOFTWARE FOR INTERCONNECTING, MANAGING AND OPERATING
LOCAL AND WIDE AREA NETWORKS; COMPUTER SOFTWARE FOR NETWORKING,
NAMELY, SOFTWARE WHICH PROVIDES CONNECTIVITY, INTEROPERABILITY AND
MANAGEMENT CAPABILITY AMONG NETWORKED COMPONENTS AND SYSTEMS;
WIRELESS TELECOMMUNICATIONS AND ELECTRONIC EQUIPMENT, NAMELY,
WIRELESS MODEMS, WIRELESS ETHERNET BRIDGES, NETWORK MULTIPLEXERS,
DATA COMMUNICATION MULTIPLEXERS, RADIO MODULATORS AND DEMODULAT-
ORS, RADIO TRANSMITTERS, RADIO RECEIVERS, ANTENNAS FOR TRANSMITTING
AND RECEIVING DATA IN LOCAL AREA NETWORKS, MULTIFREQUENCY SCRAM-
BLERS; COMPUTER SOFTWARE FOR USE IN CONTROLLING, OPERATING, MANAGING,
OR MAINTAINING WIRELESS COMMUNICATIONS SYSTEMS OR WIRELESS INFRA-
STRUCTURE EQUIPMENT; TELECOMMUNICATIONS AND DATA NETWORKING
HARDWARE, NAMELY, DEVICES FOR TRANSPORTING AND AGGREGATING VOICE,
DATA, AND VIDEO COMMUNICATIONS ACROSS MULTIPLE NETWORK INFRASTRUC-
TURES AND COMMUNICATIONS PROTOCOLS; BROADBAND WIRELESS EQUIPMENT,
NAMELY, TELECOMMUNICATIONS BASE STATION EQUIPMENT FOR CELLULAR AND
FIXED NETWORKING AND COMMUNICATIONS APPLICATIONS; RADIO RECEIVERS
AND TRANSMITTERS; RADIO TRANSCEIVERS, IN CLASS 9 (U.S. CLS. 21, 23, 26, 36 AND
38).



David J. Kybas

Director of the United States Patent and Trademark Office

Reg. No. 4,067,783 FIRST USE 1-0-2010; IN COMMERCE 1-0-2010.

FOR: OPERATION AND ADMINISTRATION OF TELECOMMUNICATION SYSTEMS AND NETWORKS FOR OTHERS; TELECOMMUNICATIONS NETWORK MANAGEMENT SERVICES, NAMELY, THE OPERATION AND ADMINISTRATION OF TELECOMMUNICATION SYSTEMS AND NETWORKS FOR OTHERS; PROVIDING INFORMATION VIA A GLOBAL COMPUTER NETWORK IN THE FIELDS OF DATA COMMUNICATION AND RELATED TECHNOLOGIES, NAMELY, CUSTOMER PRODUCT INFORMATION ABOUT WIRELESS COMMUNICATIONS HARDWARE, IN CLASS 35 (U.S. CLS. 100, 101 AND 102).

FIRST USE 1-0-2010; IN COMMERCE 1-0-2010.

FOR: INSTALLATION, MAINTENANCE AND REPAIR SERVICES OF HARDWARE FOR WIRELESS COMMUNICATIONS SYSTEMS FOR OTHERS, IN CLASS 37 (U.S. CLS. 100, 103 AND 106).

FIRST USE 1-0-2010; IN COMMERCE 1-0-2010.

FOR: TELECOMMUNICATION CONSULTATION IN THE NATURE OF TECHNICAL CONSULTING IN THE FIELD OF AUDIO, TEXT AND VISUAL DATA TRANSMISSION AND COMMUNICATION; TELECOMMUNICATIONS CONSULTATION; PROVIDING INFORMATION VIA A GLOBAL COMPUTER NETWORK IN THE FIELDS OF DATA COMMUNICATIONS AND RELATED TECHNOLOGIES, NAMELY, WIRELESS ELECTRONIC TRANSMISSION OF VOICE SIGNALS, DATA, FACSIMILES, IMAGES AND INFORMATION, IN CLASS 38 (U.S. CLS. 100, 101 AND 104).

FIRST USE 1-0-2010; IN COMMERCE 1-0-2010.

FOR: DESIGN SERVICES FOR OTHERS IN THE FIELD OF WIRELESS COMMUNICATIONS SYSTEMS; CONSULTING SERVICES, NAMELY, DESIGN, IMPLEMENTATION AND TESTING OF WIRELESS COMMUNICATIONS SYSTEMS SOFTWARE; COMPUTER NETWORK DESIGN FOR OTHERS; TELECOMMUNICATIONS TECHNOLOGY CONSULTING SERVICES, NAMELY, THE DEVELOPMENT OF CUSTOMIZED TELECOMMUNICATIONS EQUIPMENT FOR OTHERS; RESEARCH AND DEVELOPMENT FOR NEW WIRELESS TELECOMMUNICATIONS EQUIPMENT; INSTALLATION OF SOFTWARE FOR WIRELESS WIDE AREA NETWORKS; CUSTOM DESIGN OF TELECOMMUNICATION SYSTEMS FOR OTHERS; COMPUTER SYSTEM DESIGN AND DEVELOPMENT OF HIGH-SPEED EQUIPMENT, NAMELY, COMPUTER TERMINALS FOR OPERATORS OF PUBLIC NETWORKS AND COMPANIES; COMPUTER ENGINEERING SERVICES FOR LARGE OR MEDIUM COMPUTER SYSTEM APPLICATIONS; UPDATING AND MAINTENANCE OF SOFTWARE, TECHNICAL CONSULTING AND ASSISTANCE WITH TELECOMMUNICATIONS SYSTEMS AND COMPONENTS; TELECOMMUNICATION NETWORK ENGINEERING AND TELECOMMUNICATION COMPUTER SYSTEMS ADMINISTRATION, NAMELY, COMPUTER PROGRAMMING FOR OTHERS; ENGINEERING SERVICES FOR OPERATING TELECOMMUNICATION TERMINALS; ACTING AS AN APPLICATION SERVICE PROVIDER IN THE FIELD OF KNOWLEDGE MANAGEMENT TO HOST COMPUTER APPLICATION SOFTWARE FOR SEARCHING AND RETRIEVING INFORMATION FOR DATABASES AND COMPUTER NETWORKS; DEVELOPMENT AND DESIGN OF SOFTWARE, AND PARTICULARLY OF TELECOMMUNICATION SOFTWARE; SOFTWARE MAINTENANCE SERVICES; PROVIDING PLANNING AND ENGINEERING SERVICES IN THE FIELD OF INFORMATION AND COMMUNICATIONS NETWORKS; INSTALLATION, MAINTENANCE AND REPAIR SERVICES FOR SOFTWARE FOR WIRELESS COMMUNICATIONS SYSTEMS FOR OTHERS; CONSULTING SERVICES, NAMELY, DESIGN, IMPLEMENTATION AND TESTING OF WIRELESS COMMUNICATIONS HARDWARE, IN CLASS 42 (U.S. CLS. 100 AND 101).

FIRST USE 1-0-2010; IN COMMERCE 1-0-2010.

Reg. No. 4,067,783 NO CLAIM IS MADE TO THE EXCLUSIVE RIGHT TO USE "NETWORKS", APART FROM THE MARK AS SHOWN.

THE MARK CONSISTS OF A STYLIZED LETTER "V" WITH THE WORD "AVIAT" OVER THE WORD "NETWORKS".

SN 77-838,556, FILED 9-30-2009.

MAYUR VAGHANI, EXAMINING ATTORNEY

United States of America

United States Patent and Trademark Office



working together to resolve debt

Reg. No. 4,067,784

Registered Dec. 6, 2011

Int. Cl.: 36

SERVICE MARK

PRINCIPAL REGISTER

PROFESSIONAL FINANCE COMPANY, INC. (COLORADO CORPORATION)
5754 WEST 11TH STREET, SUITE 100
GREELEY, CO 80634

FOR: DEBT COLLECTION AGENCIES, IN CLASS 36 (U.S. CLS. 100, 101 AND 102).

FIRST USE 12-31-2009; IN COMMERCE 12-31-2009.

THE MARK CONSISTS OF A PINWHEEL SHAPE WITH A STAR BURST CENTER. THE LETTERING "PFC" IS TO THE RIGHT OF THE STAR BURST DESIGN. THE WORDING "WORKING TOGETHER TO RESOLVE DEBT" APPEARS CENTERED AT THE BOTTOM OF THE MARK.

SN 77-838,595, FILED 9-30-2009.

PAULA MAHONEY, EXAMINING ATTORNEY



David J. Kyffers

Director of the United States Patent and Trademark Office

United States of America
United States Patent and Trademark Office

bullet

Reg. No. 4,067,785

Registered Dec. 6, 2011

Int. Cl.: 35

SERVICE MARK

PRINCIPAL REGISTER

BULLET LINE, LLC (PENNSYLVANIA LIMITED LIABILITY COMPANY)
15959 NW 15TH AVENUE
MIAMI, FL 33169

FOR: MAIL ORDER CATALOG SERVICES FEATURING ADVERTISING AND PROMOTIONAL PRODUCTS, PENS, LETTER OPENERS, PORTFOLIOS, CALCULATORS, CUPS, MUGS, TUMBLERS, PLASTIC KEY TAGS, AND WINDSHIELD SCRAPERS; WHOLESALE DISTRIBUTORSHIPS FEATURING ADVERTISING AND PROMOTIONAL PRODUCTS, PENS, LETTER OPENERS, PORTFOLIOS, CALCULATORS, CUPS, MUGS, TUMBLERS, SUNGLASSES, PLASTIC KEY TAGS, AND WINDSHIELD SCRAPERS, IN CLASS 35 (U.S. CLS. 100, 101 AND 102).

FIRST USE 12-16-2009; IN COMMERCE 1-4-2010.

OWNER OF U.S. REG. NOS. 2,646,275 AND 3,586,285.

THE MARK CONSISTS OF THE TERM "BULLET" WITH A DESIGN OF A FILLED CIRCLE INSIDE OF THE LOWER PORTION OF THE LETTER "B".

SN 77-838,913, FILED 10-1-2009.

CHARLOTTE CORWIN, EXAMINING ATTORNEY



David J. Kypos

Director of the United States Patent and Trademark Office

United States of America

United States Patent and Trademark Office

PIG

Reg. No. 4,067,786

Registered Dec. 6, 2011

Int. Cl.: 35

SERVICE MARK

PRINCIPAL REGISTER

NEW PENDULUM CORP. (DELAWARE CORPORATION)
1105 N. MARKET STREET, SUITE 1300
WILMINGTON, DE 19801

FOR: PROVIDING CONSUMER INFORMATION IN THE FIELD OF PRODUCTS USED IN FACILITY SAFETY AND MAINTENANCE, SPECIFICALLY, FILTRATION AND MATERIAL HANDLING PRODUCTS, SYNTHETIC AND NATURAL ABSORBENT PRODUCTS SUCH AS ABSORBENT SOCKS, PADS, MATS AND WIPES FOR ABSORBING LIQUID SPILLS, DRIPS, AND OVERSPRAY, AND RELATED ITEMS FOR INDUSTRIAL, COMMERCIAL AND HOUSEHOLD USE, IN CLASS 35 (U.S. CLS. 100, 101 AND 102).

FIRST USE 3-6-2010; IN COMMERCE 3-6-2010.

THE MARK CONSISTS OF STANDARD CHARACTERS WITHOUT CLAIM TO ANY PARTICULAR FONT, STYLE, SIZE, OR COLOR.

OWNER OF U.S. REG. NOS. 2,522,480, 2,790,645, AND 2,790,646.

SN 77-839,189, FILED 10-1-2009.

EVELYN BRADLEY, EXAMINING ATTORNEY



David J. Kybas

Director of the United States Patent and Trademark Office

United States of America

United States Patent and Trademark Office

SONESTA BEACH RESORT

Reg. No. 4,067,787

Registered Dec. 6, 2011

Int. Cl.: 43

SERVICE MARK

PRINCIPAL REGISTER

SONESTA INTERNATIONAL HOTELS CORPORATION (NEW YORK CORPORATION)
116 HUNTINGTON AVENUE
BOSTON, MA 02116

FOR: HOTEL, RESTAURANT AND RESORT HOTEL SERVICES, IN CLASS 43 (U.S. CLS. 100 AND 101).

FIRST USE 0-0-1979; IN COMMERCE 0-0-1979.

THE MARK CONSISTS OF STANDARD CHARACTERS WITHOUT CLAIM TO ANY PARTICULAR FONT, STYLE, SIZE, OR COLOR.

OWNER OF U.S. REG. NOS. 893,020, 1,369,137, AND 3,685,842.

NO CLAIM IS MADE TO THE EXCLUSIVE RIGHT TO USE "BEACH RESORT", APART FROM THE MARK AS SHOWN.

THE WORDING "SONESTA" HAS NO MEANING IN A FOREIGN LANGUAGE.

SN 77-839,406, FILED 10-1-2009.

MYRIAH HABEEB, EXAMINING ATTORNEY



David J. Kypos

Director of the United States Patent and Trademark Office

United States of America

United States Patent and Trademark Office

ASPIRE

Reg. No. 4,067,788

Registered Dec. 6, 2011

Int. Cls.: 1, 3, and 5

TRADEMARK

PRINCIPAL REGISTER

CASSCO PRODUCTS, INC. (MISSOURI CORPORATION)
1701 DIELMAN ROAD
ST. LOUIS, MO 63132

FOR: WATER CONDITIONER PRODUCTS, NAMELY, CHEMICAL AGENTS USED IN WATER MAINTENANCE, FOR USE IN PONDS, WATER GARDENS, AND AQUARIUMS; PHOSPHATE BINDER PRODUCTS FOR USE IN PONDS, LAKES, AND WATER GARDENS; BARLEY AND BARLEY-BASED PRODUCTS, NAMELY, BARLEY STRAW EXTRACT WITH AND WITHOUT NATURAL MICROORGANISMS, FOR USE IN PONDS, LAKES, WATER GARDENS, AND AQUARIUMS; DEFOAMER PRODUCTS FOR USE IN PONDS, LAKES, AND WATER GARDENS; CHEMICAL FLOCCULANTS FOR USE IN PONDS, LAKES, AND WATER GARDENS; BACTERIA PRODUCTS FOR WATER TREATMENT FOR USE IN PONDS, LAKES, WATER GARDENS, AND AQUARIUMS; WATER CLEANING PRODUCTS, NAMELY, NATURAL MICROORGANISMS AND CHEMICAL AGENTS, FOR USE IN PONDS, LAKES, WATER GARDENS, AND AQUARIUMS; ROCK AND GRAVEL CLEANER FOR WATERFALLS AND WATER FEATURES, NAMELY, CHEMICAL AGENTS FOR USE IN PONDS, WATER GARDENS, AND AQUARIUMS; PH DECREASER CHEMICALS FOR USE IN PONDS AND WATER GARDENS; PH INCREASER CHEMICALS FOR USE IN PONDS AND WATER GARDENS; FISH STRESS REDUCER PRODUCTS, NAMELY, WATER PURIFYING CHEMICALS, FOR USE IN PONDS, WATER GARDENS, AND AQUARIUMS; NITRIFICATION PRODUCTS, NAMELY, NATURAL MICROORGANISMS, FOR USE IN PONDS, WATER GARDENS, AND AQUARIUMS; AND EQUINE WATER CLEANER, NAMELY, NATURAL MICROORGANISMS, IN CLASS 1 (U.S. CLS. 1, 5, 6, 10, 26 AND 46).

FIRST USE 9-19-2011; IN COMMERCE 9-19-2011.

FOR: NON-MEDICATED GROOMING PREPARATIONS FOR PETS AND HORSES, NAMELY, BODY WASH FOR HORSES; BODY WASH FOR PETS; EQUINE EAR WASH; PET EAR WASH; EQUINE EYE-STAIN REMOVER; AND PET EYE-STAIN REMOVER; AND PET ODOR REMOVER, IN CLASS 3 (U.S. CLS. 1, 4, 6, 50, 51 AND 52).

FIRST USE 9-19-2011; IN COMMERCE 9-19-2011.

FOR: PREPARATIONS FOR TREATING BACTERIAL INFECTIONS, SUCH AS RAIN ROT, IN EQUINES; PREPARATIONS FOR TREATING BACTERIAL INFECTIONS, SUCH AS THRUSH, IN EQUINES, IN CLASS 5 (U.S. CLS. 6, 18, 44, 46, 51 AND 52).



David J. Kybas

Director of the United States Patent and Trademark Office

Reg. No. 4,067,788 FIRST USE 9-19-2011; IN COMMERCE 9-19-2011.

THE MARK CONSISTS OF STANDARD CHARACTERS WITHOUT CLAIM TO ANY PARTICULAR FONT, STYLE, SIZE, OR COLOR.

SN 77-841,693, FILED 10-5-2009.

ALLISON SCHRODY, EXAMINING ATTORNEY

United States of America

United States Patent and Trademark Office

PARTICIPANT MUSIC

Reg. No. 4,067,789

Registered Dec. 6, 2011

Int. Cls.: 9, 38, and 41

TRADEMARK

SERVICE MARK

PRINCIPAL REGISTER

PARTICIPANT MEDIA, LLC (DELAWARE LIMITED LIABILITY COMPANY)
331 FOOTHILL ROAD
3RD FLOOR
BEVERLY HILLS, CA 90210

FOR: MUSICAL SOUND RECORDINGS; AUDIOVISUAL RECORDINGS FEATURING MUSIC; DOWNLOADABLE MUSICAL SOUND RECORDINGS AND AUDIOVISUAL RECORDINGS FEATURING MUSIC; DOWNLOADABLE RING TONES VIA THE INTERNET AND WIRELESS DEVICES; PRERECORDED DVDS, CDS, PHONOGRAPH RECORDS, DIGITAL DISCS FEATURING MUSICAL PERFORMANCES; PRE-RECORDED DVDS, CDS, PHONOGRAPH RECORDS, DIGITAL DISCS FEATURING MUSICAL AUDIO AND VIDEO RECORDINGS, IN CLASS 9 (U.S. CLS. 21, 23, 26, 36 AND 38).

FIRST USE 7-13-2011; IN COMMERCE 10-18-2011.

FOR: INTERNET BROADCASTING SERVICES, NAMELY, THE AUDIO AND VIDEO TRANSMISSION OF LIVE AND PRERECORDED RADIO AND LIVE EVENTS OVER A GLOBAL COMPUTER NETWORK AND RELATED AUDIO AND VIDEO ENTERTAINMENT, IN CLASS 38 (U.S. CLS. 100, 101 AND 104).

FIRST USE 7-13-2011; IN COMMERCE 10-18-2011.

FOR: ENTERTAINMENT SERVICES, NAMELY, PRODUCING MUSICAL AUDIO AND VIDEO RECORDINGS; MUSIC PUBLISHING SERVICES; PRODUCTION OF LIVE ENTERTAINMENT EVENTS, NAMELY, LIVE CONCERTS, FESTIVALS, AND THEATRICAL SHOWS; ENTERTAINMENT SERVICES IN THE NATURE OF ORGANIZING MUSICAL TOURS AND PRESENTATIONS, IN CLASS 41 (U.S. CLS. 100, 101 AND 107).

FIRST USE 7-13-2011; IN COMMERCE 10-18-2011.

THE MARK CONSISTS OF STANDARD CHARACTERS WITHOUT CLAIM TO ANY PARTICULAR FONT, STYLE, SIZE, OR COLOR.

OWNER OF U.S. REG. NOS. 3,042,629, 3,729,233, AND OTHERS.

NO CLAIM IS MADE TO THE EXCLUSIVE RIGHT TO USE "MUSIC", APART FROM THE MARK AS SHOWN.



David J. Kyros

Director of the United States Patent and Trademark Office

Reg. No. 4,067,789 SN 77-841,899, FILED 10-5-2009.

JOHN WILKE, EXAMINING ATTORNEY

United States of America

United States Patent and Trademark Office

BNY MELLON GDR INDEX

Reg. No. 4,067,790

Registered Dec. 6, 2011

Int. Cl.: 36

SERVICE MARK

PRINCIPAL REGISTER

THE BANK OF NEW YORK MELLON CORPORATION (DELAWARE CORPORATION)
15TH FLOOR
ONE WALL STREET
NEW YORK, NY 10286

FOR: FINANCIAL REPORTING SERVICES, NAMELY, CALCULATING, MEASURING, INDEXING IN RELATION TO A BASE VALUE AND REPORTING THE FLUCTUATION IN AGGREGATE MARKET VALUE OF A SELECT GROUP OF GLOBAL DEPOSITARY RECEIPTS, IN CLASS 36 (U.S. CLS. 100, 101 AND 102).

FIRST USE 12-31-2009; IN COMMERCE 12-31-2009.

THE MARK CONSISTS OF STANDARD CHARACTERS WITHOUT CLAIM TO ANY PARTICULAR FONT, STYLE, SIZE, OR COLOR.

NO CLAIM IS MADE TO THE EXCLUSIVE RIGHT TO USE "GDR INDEX", APART FROM THE MARK AS SHOWN.

SN 77-842,038, FILED 10-6-2009.

ROBERT C. CLARK JR., EXAMINING ATTORNEY



David J. Kyros

Director of the United States Patent and Trademark Office

United States of America

United States Patent and Trademark Office

Pigamoose

Reg. No. 4,067,791

ALEXANDER E. BARNETT (UNITED STATES INDIVIDUAL)
144 W. 72ND STREET, #3D
NEW YORK, NY 10023

Registered Dec. 6, 2011

Int. Cl.: 28

FOR: PLUSH TOYS; SOFT SCULPTURE PLUSH TOYS; SOFT SCULPTURE TOYS; STUFFED AND PLUSH TOYS; STUFFED TOY ANIMALS; STUFFED TOYS; TOY ANIMALS; TOY ANIMALS AND ACCESSORIES THEREFOR, IN CLASS 28 (U.S. CLS. 22, 23, 38 AND 50).

TRADEMARK

FIRST USE 8-26-2011; IN COMMERCE 8-26-2011.

PRINCIPAL REGISTER

THE MARK CONSISTS OF STANDARD CHARACTERS WITHOUT CLAIM TO ANY PARTICULAR FONT, STYLE, SIZE, OR COLOR.

SN 77-842,868, FILED 10-6-2009.

ANDREA BUTLER, EXAMINING ATTORNEY



David J. Kyros

Director of the United States Patent and Trademark Office

United States of America

United States Patent and Trademark Office

DABA

Reg. No. 4,067,792

Registered Dec. 6, 2011

Int. Cl.: 20

TRADEMARK

PRINCIPAL REGISTER

O.T.PARK, LLC (WEST VIRGINIA LIMITED LIABILITY COMPANY)
2805 MCCORKLE AVENUE
ST. ALBANS, WV 25177

FOR: NON-METAL FASTENERS, NAMELY, ORNAMENTAL AND DECORATIVE ATTACHMENTS FOR DRAWSTRINGS AND ITEMS CONTAINING LACES SUCH AS OUTERWEAR, SHOES, AND MEN'S, WOMEN'S AND CHILDREN'S CLOTHING, NAMELY, HOODED SWEATSHIRTS, IN CLASS 20 (U.S. CLS. 2, 13, 22, 25, 32 AND 50).

FIRST USE 10-10-2011; IN COMMERCE 10-10-2011.

THE MARK CONSISTS OF STANDARD CHARACTERS WITHOUT CLAIM TO ANY PARTICULAR FONT, STYLE, SIZE, OR COLOR.

SN 77-844,093, FILED 10-8-2009.

KIMBERLY PERRY, EXAMINING ATTORNEY



David J. Kybas

Director of the United States Patent and Trademark Office

United States of America

United States Patent and Trademark Office

SloppyPockets

Reg. No. 4,067,793

Registered Dec. 6, 2011

Int. Cls.: 30 and 43

TRADEMARK

SERVICE MARK

PRINCIPAL REGISTER

SULLIVAN, CHERYL A (UNITED STATES INDIVIDUAL)
80 PIGEON ROOST RD. P.O. BOX 56
BRUSH CREEK, TN 38547

FOR: SANDWICHES, IN CLASS 30 (U.S. CL. 46).

FIRST USE 10-17-2010; IN COMMERCE 10-17-2010.

FOR: RESTAURANT SERVICES FEATURING SANDWICHES, IN CLASS 43 (U.S. CLS. 100 AND 101).

FIRST USE 10-17-2010; IN COMMERCE 10-17-2010.

THE MARK CONSISTS OF STANDARD CHARACTERS WITHOUT CLAIM TO ANY PARTICULAR FONT, STYLE, SIZE, OR COLOR.

SN 77-846,187, FILED 10-11-2009.

MIDGE BUTLER, EXAMINING ATTORNEY



David J. Kybas

Director of the United States Patent and Trademark Office

United States of America

United States Patent and Trademark Office

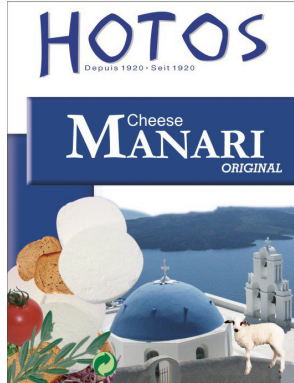

Reg. No. 4,067,794

Registered Dec. 6, 2011

Int. Cl.: 29

TRADEMARK

PRINCIPAL REGISTER

HOTOS S.A. (GREECE CORPORATION)
10 VLAHAVA STREET
FALANI-LARISSA, GREECE

FOR: CHEESES, IN CLASS 29 (U.S. CL. 46).

FIRST USE 8-10-2011; IN COMMERCE 8-10-2011.

OWNER OF U.S. REG. NO. 3,648,276.

THE COLOR(S) BLUE, WHITE, RED, GREEN, BROWN, PURPLE, BLACK, AND GREY IS/ARE CLAIMED AS A FEATURE OF THE MARK.

NO CLAIM IS MADE TO THE EXCLUSIVE RIGHT TO USE THE DESIGN OF CHEESE , APART FROM THE MARK AS SHOWN.

THE MARK CONSISTS OF THE WORDING "HOTOS" IN BLUE, ABOVE THE WORDING "DEPUIS 1920 SEIT 1920" IN BLUE, WITH A WHITE BACKGROUND, ABOVE A BLUE RECTANGLE CONTAINING THE WORDING "CHEESE MANARI ORIGINAL" IN WHITE ON TOP OF A DESIGN OF WHITE CHEESE, BROWN BREAD, RED TOMATOES, GREEN AND PURPLE LEAVES, A WHITE AND BLACK SHEEP, A LANDSCAPE WITH WHITE AND BLUE BUILDINGS AND BLUE OCEAN.

THE ENGLISH TRANSLATION OF "DEPUIS" AND "SEIT" IN THE MARK IS "SINCE" AND THE ENGLISH TRANSLATION OF "MANARI" IN THE MARK IS "SUCKING LAMP".

SN 77-846,345, FILED 10-12-2009.

SALLY SHIH, EXAMINING ATTORNEY



David J. Kyros

Director of the United States Patent and Trademark Office

United States of America

United States Patent and Trademark Office



Reg. No. 4,067,795

Registered Dec. 6, 2011

Int. Cl.: 10

TRADEMARK

PRINCIPAL REGISTER

BIOMECHANICA INDUSTRIA E COMERCIO DE PRODUTOS ORTOPEDICOS LTDA. (BRAZIL SOCIEDADE LIMITADA)
RUA DOIS, S/N - 1 DISTRITO INDUSTRIAL
JAU - SAO PAULO, BRAZIL 17201-970

FOR: SURGICAL INSTRUMENTS FOR PLACEMENT OF PROSTHESIS OF HIPS, KNEES, SHOULDER, PLATES AND SCREWS, IMPLANTS FOR THE COLUMN, INTRAMEDULLARY NAILS, FITTINGS, NAMELY, PROSTHESIS FOR REPLACEMENT OF HIP, KNEE, SHOULDER, ELBOWS, ORTHOPEDIC TIES, ORTHOPEDIC SCREWS, SPACERS, PLATES; SURGICAL APPARATUS FOR SETTING COLUMNS, NAMELY, SYSTEMS FOR FIXATION OF POST COLUMN, PREVIOUS COLUMN, PEDICLE COLUMN, IN CLASS 10 (U.S. CLS. 26, 39 AND 44).

FIRST USE 2-25-2009; IN COMMERCE 2-25-2009.

NO CLAIM IS MADE TO THE EXCLUSIVE RIGHT TO USE "BIOMECHANICA", APART FROM THE MARK AS SHOWN.

THE ENGLISH TRANSLATION OF "BIOMECHANICA" IN THE MARK IS "BIOMECHANICS".

SN 77-846,453, FILED 10-12-2009.

MARK RADEMACHER, EXAMINING ATTORNEY



David J. Kypos

Director of the United States Patent and Trademark Office

United States of America

United States Patent and Trademark Office



Reg. No. 4,067,796

Registered Dec. 6, 2011

Int. Cls.: 35 and 39

SERVICE MARK

PRINCIPAL REGISTER

DEUTSCHE POST AG (FED REP GERMANY JOINT STOCK COMPANY)
CHARLES-DE-GUALLE-STRASSE 20
BONN, FED REP GERMANY 53113

FOR: TRACKING AND TRACING BY MEANS OF THE ELECTRONIC TRACKING OF GOODS, IN PARTICULAR DOCUMENTS, PACKAGES, PARCELS, LETTERS AND PALLETS; WAREHOUSE MANAGEMENT, NAMELY, OPERATING, ASSISTING AND OUTSOURCING THE OPERATION OF A DISTRIBUTION CENTER OR WAREHOUSE FACILITY CONTAINING MAIL ORDER OR DISTRIBUTION INVENTORY; LOGISTICS IN THE TRANSPORT SECTOR, NAMELY, ARRANGING THE TRANSPORTATION OF GOODS FOR OTHERS, IN CLASS 35 (U.S. CLS. 100, 101 AND 102).

FIRST USE 7-0-2010; IN COMMERCE 7-0-2010.

FOR: TRANSPORT, IN PARTICULAR TRANSPORT OF GOODS BY MOTOR VEHICLE, LORRY, RAIL, SHIP AND AEROPLANE; PACKAGING AND STORAGE OF GOODS; TRANSPORTATION INFORMATION; FREIGHT BROKERAGE, UNLOADING OF FREIGHT; FREIGHT STORAGE INFORMATION; COURIER SERVICES; COLLECTION, TRANSPORT AND DELIVERY OF GOODS, IN PARTICULAR DOCUMENTS, PACKAGES, PARCELS, LETTERS, AND PALLETS BY VARIOUS MODES OF TRANSPORTATION; FREIGHTING BY SHIP, AEROPLANE, RAIL, MOTOR VEHICLE AND LORRY; RENTAL OF STORAGE CONTAINERS; LETTER, FREIGHT AND EXPRESS DELIVERY OF GOODS BY MOTOR VEHICLE, LORRY, RAIL, SHIP AND AEROPLANE SERVICES; RENTAL OF WAREHOUSES; LOGISTICS CONSULTANCY IN THE FIELDS OF STORAGE, TRANSPORTATION AND DELIVERY OF GOODS FOR OTHERS BY AIR, RAIL, SHIP OR TRUCK, IN CLASS 39 (U.S. CLS. 100 AND 105).

FIRST USE 7-0-2010; IN COMMERCE 7-0-2010.

OWNER OF U.S. REG. NOS. 1,398,896, 3,600,383, AND OTHERS.

THE COLOR(S) YELLOW AND RED IS/ARE CLAIMED AS A FEATURE OF THE MARK.

NO CLAIM IS MADE TO THE EXCLUSIVE RIGHT TO USE "EXCELLENCE", APART FROM THE MARK AS SHOWN.



David J. Kyjars

Director of the United States Patent and Trademark Office

Reg. No. 4,067,796 THE MARK CONSISTS OF THE WORDS "EXCELLENCE. SIMPLY DELIVERED". AND THE LETTERS "DHL" IN BETWEEN TWO SERIES OF HORIZONTAL LINES, IN RED AND STYLIZED FONT, WITH A YELLOW BACKGROUND.

SN 77-846,948, FILED 10-12-2009.

AMY HELLA, EXAMINING ATTORNEY

United States of America

United States Patent and Trademark Office

NINTENDO

Reg. No. 4,067,797

NINTENDO OF AMERICA INC. (WASHINGTON CORPORATION)
4600 - 150TH AVENUE NE
REDMOND, WA 98052

Registered Dec. 6, 2011

Int. Cl.: 35

FOR: ON-LINE RETAIL STORE SERVICES FEATURING: TOYS; GAMES; BOARD GAMES; PLUSH TOYS; TOY ACTION FIGURES; TOY FIGURINES; CLOTHING; STATIONERY; PRE-RECORDED DISCS FEATURING CHILDREN'S ENTERTAINMENT CONTENT, NAMELY, MUSIC AND GAMES, IN CLASS 35 (U.S. CLS. 100, 101 AND 102).

SERVICE MARK

PRINCIPAL REGISTER

FIRST USE 3-2-2010; IN COMMERCE 3-2-2010.

THE MARK CONSISTS OF STANDARD CHARACTERS WITHOUT CLAIM TO ANY PARTICULAR FONT, STYLE, SIZE, OR COLOR.

OWNER OF U.S. REG. NOS. 1,213,822, 1,628,966, AND OTHERS.

SN 77-847,457, FILED 10-13-2009.

MICHAEL ENGEL, EXAMINING ATTORNEY



David J. Kyros

Director of the United States Patent and Trademark Office

United States of America

United States Patent and Trademark Office

SHATTER

Reg. No. 4,067,798

Registered Dec. 6, 2011

Int. Cl.: 33

TRADEMARK

PRINCIPAL REGISTER

PHINNEY, DAVID S. (UNITED STATES INDIVIDUAL)
POST OFFICE BOX 475
RUTHERFORD, CA 94573

FOR: WINES, IN CLASS 33 (U.S. CLS. 47 AND 49).

FIRST USE 8-17-2011; IN COMMERCE 8-17-2011.

THE MARK CONSISTS OF STANDARD CHARACTERS WITHOUT CLAIM TO ANY PARTICULAR FONT, STYLE, SIZE, OR COLOR.

SN 77-848,524, FILED 10-14-2009.

ANNE E. GUSTASON, EXAMINING ATTORNEY



David J. Kybas

Director of the United States Patent and Trademark Office

United States of America

United States Patent and Trademark Office

FLUSH FEVER

Reg. No. 4,067,799

IGT (NEVADA CORPORATION)
9295 PROTOTYPE DRIVE
RENO, NV 895218986

Registered Dec. 6, 2011

Int. Cl.: 9

FOR: GAMING MACHINES, NAMELY, DEVICES WHICH ACCEPT A WAGER, IN CLASS 9 (U.S. CLS. 21, 23, 26, 36 AND 38).

TRADEMARK

FIRST USE 1-2-2004; IN COMMERCE 1-2-2004.

PRINCIPAL REGISTER

THE MARK CONSISTS OF STANDARD CHARACTERS WITHOUT CLAIM TO ANY PARTICULAR FONT, STYLE, SIZE, OR COLOR.

NO CLAIM IS MADE TO THE EXCLUSIVE RIGHT TO USE "FLUSH", APART FROM THE MARK AS SHOWN.

SN 77-848,576, FILED 10-14-2009.

BRIDGETT SMITH, EXAMINING ATTORNEY



David J. Kyffers

Director of the United States Patent and Trademark Office

United States of America

United States Patent and Trademark Office

D.DOP

Reg. No. 4,067,800

SANOFI (FRANCE SOCIETE ANONYME)
174, AVENUE DE FRANCE
PARIS, FRANCE 75013

Registered Dec. 6, 2011

Int. Cl.: 44

FOR: PROVIDING INFORMATION IN THE FIELD OF DIABETES; PROVIDING A WEB SITE AND DATABASE FOR MEDICAL PROFESSIONALS AND MEDICAL PATIENTS FOR PURPOSES OF MONITORING BLOOD GLUCOSE LEVELS , IN CLASS 44 (U.S. CLS. 100 AND 101).

SERVICE MARK

PRINCIPAL REGISTER

FIRST USE 0-0-2006; IN COMMERCE 0-0-2006.

THE MARK CONSISTS OF STANDARD CHARACTERS WITHOUT CLAIM TO ANY PARTICULAR FONT, STYLE, SIZE, OR COLOR.

SN 77-850,487, FILED 10-16-2009.

DAVID ELTON, EXAMINING ATTORNEY



David J. Kyros

Director of the United States Patent and Trademark Office

United States of America

United States Patent and Trademark Office



Reg. No. 4,067,801

Registered Dec. 6, 2011

Int. Cl.: 36

SERVICE MARK

PRINCIPAL REGISTER

GIVE KIDS THE WORLD, INC. (FLORIDA NON-PROFIT CORPORATION)
210 SOUTH BASS ROAD
KISSIMMEE, FL 34746

FOR: CHARITABLE FUND-RAISING SERVICES, NAMELY, RAISING FUNDS TO PROVIDE CHILDREN WITH LIFE-THREATENING ILLNESSES AND THEIR FAMILIES WITH TICKETS TO AMUSEMENT PARKS AT NO COST TO THEM AS PART OF A WEEK-LONG DREAM VACATION, IN CLASS 36 (U.S. CLS. 100, 101 AND 102).

FIRST USE 3-0-2009; IN COMMERCE 3-0-2009.

OWNER OF U.S. REG. NOS. 2,812,934, 2,812,935, AND 2,825,053.

THE COLOR(S) RED AND WHITE IS/ARE CLAIMED AS A FEATURE OF THE MARK.

THE MARK CONSISTS OF A DESIGN OF A RED RIBBON FEATURING WHITE POLKA DOTS AND THE WORDING "GIVE KIDS THE WORLD" IN WHITE. THE COLOR GRAY DEPICTS SHADING AROUND THE MARK AND IS NOT CLAIMED AS A FEATURE OF THE MARK.

SN 77-852,490, FILED 10-20-2009.

JULIE GUTTADAURO, EXAMINING ATTORNEY



David J. Kyros

Director of the United States Patent and Trademark Office

United States of America

United States Patent and Trademark Office

ZAGA

Reg. No. 4,067,802

Registered Dec. 6, 2011

Int. Cls.: 9 and 35

TRADEMARK

SERVICE MARK

PRINCIPAL REGISTER

ZARATE, MIGUEL R (UNITED STATES INDIVIDUAL), DBA ZAGA CUSTOM,
1545 TIDELANDS AVE., STE. D
NATIONAL CITY, CA 91950 AND

ZARATE, MELISSA (UNITED STATES INDIVIDUAL), DBA ZAGA CUSTOM,
1545 TIDELANDS AVE., STE. D
NATIONAL CITY, CA 91950

FOR: DUTY GEAR AND TACTICAL GEAR PRODUCTS FOR LAW ENFORCEMENT AGENCIES AND MILITARY AND SECURITY PERSONNEL, NAMELY, BODY ARMOR AS A PART OF PROTECTIVE CLOTHING, IN CLASS 9 (U.S. CLS. 21, 23, 26, 36 AND 38).

FIRST USE 10-1-2009; IN COMMERCE 10-1-2009.

FOR: CATALOG ORDERING SERVICES AND ONLINE RETAIL STORE SERVICES FEATURING DUTY GEAR AND TACTICAL GEAR PRODUCTS FOR LAW ENFORCEMENT AGENCIES AND MILITARY AND SECURITY PERSONNEL, IN CLASS 35 (U.S. CLS. 100, 101 AND 102).

FIRST USE 5-15-2011; IN COMMERCE 5-15-2011.

THE MARK CONSISTS OF STANDARD CHARACTERS WITHOUT CLAIM TO ANY PARTICULAR FONT, STYLE, SIZE, OR COLOR.

THE ENGLISH TRANSLATION OF THE WORD "ZAGA" IN THE MARK IS BACKSIDE.

SN 77-853,821, FILED 10-21-2009.

ODESSA BIBBINS, EXAMINING ATTORNEY



David J. Kyffers

Director of the United States Patent and Trademark Office

United States of America

United States Patent and Trademark Office

OUTLANDER

Reg. No. 4,067,803

SML SPORT LTD. (NEW YORK CORPORATION)
512 7TH AVENUE, 17TH FLOOR
NEW YORK, NY 10018

Registered Dec. 6, 2011

Int. Cl.: 25

FOR: LADIES' APPAREL, NAMELY, SWEATERS, T-SHIRTS, JACKETS, BLOUSES, HATS
AND SCARVES, IN CLASS 25 (U.S. CLS. 22 AND 39).

TRADEMARK

FIRST USE 8-19-2011; IN COMMERCE 8-19-2011.

PRINCIPAL REGISTER

THE MARK CONSISTS OF STANDARD CHARACTERS WITHOUT CLAIM TO ANY PARTICULAR FONT, STYLE, SIZE, OR COLOR.

SN 77-855,305, FILED 10-22-2009.

DAVID H. STINE, EXAMINING ATTORNEY



David J. Kybas

Director of the United States Patent and Trademark Office

United States of America

United States Patent and Trademark Office

TIP IT UP

Reg. No. 4,067,804

Registered Dec. 6, 2011

Int. Cls.: 10 and 21

TRADEMARK

PRINCIPAL REGISTER

JACKEL INTERNATIONAL LIMITED (UNITED KINGDOM COMPANY)
DUDLEY LANE
CRAMLINGTON
NORTHUMBERLAND NE237RH, UNITED KINGDOM

FOR: (BASED ON 44(E)) FEEDING BOTTLES; FEEDING BOTTLE TEATS; TEATS FOR BABIES, INFANTS AND CHILDREN; RE-USABLE AND DISPOSABLE TEATS FOR BOTTLES AND DRINKING CUPS FOR BABIES, INFANTS AND CHILDREN; GLOVES FOR MEDICAL PURPOSES; BELTS FOR MEDICAL PURPOSES, NAMELY, MATERNITY BELTS; PHYSICAL EXERCISE APPARATUS FOR MEDICAL PURPOSES; INCONTINENCE SHEETS FOR BABIES, INFANTS AND CHILDREN AND ADULTS; PLASTIC AND PAPER BAGS AND WRAPS FOR DISPOSAL OF HOSPITAL MEDICAL WASTE; DISPOSABLE BAGS AND PRECURSORS THEREFOR FOR HOSPITAL MEDICAL WASTE, NAMELY, TAGS AND SEALS FOR CLOSING DISPOSAL BAGS FOR HOSPITAL MEDICAL WASTE; SURGICAL AND MEDICAL SPONGES; ELECTRICAL, NON-ELECTRICAL, AND DIGITAL MEDICAL THERMOMETERS; TEETHING RINGS; TEETHERS INCORPORATING BABY RATTLES; PACIFIERS FOR BABIES; ; BREAST SHIELDS; BREAST PUMPS; NIPPLE SHIELDS; MEDICAL SYRINGES; MEDICINE DISPENSERS, NAMELY, DROPPERS AND DROPPER BOTTLES FOR ADMINISTERING MEDICATION, SOLD EMPTY; AND NASAL ASPIRATORS, IN CLASS 10 (U.S. CLS. 26, 39 AND 44).

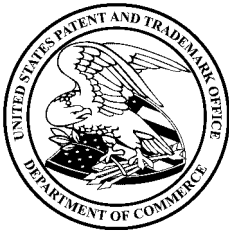

David J. Kybas

Director of the United States Patent and Trademark Office

FOR: (BASED ON 44(E)) HOUSEHOLD OR KITCHEN UTENSILS, NAMELY, SERVING SPOONS; HOUSEHOLD OR KITCHEN CONTAINERS, NAMELY, GLASS STORAGE JARS, PLASTIC STORAGE BOXES AND CONTAINERS OF GLASS, PLASTIC, SILICONE RUBBER, THERMOPLASTIC ELASTOMERS AND ANY COMBINATION OF THESE MATERIALS; UTENSILS AND CONTAINERS FOR BABIES, INFANTS AND CHILDREN, NAMELY, PLASTIC CUPS, POTS, BOWLS AND WEANING BOWLS WITH LIDS FOR STORAGE AND SERVING OF FOOD AND BEVERAGE, SERVING SPOONS, PLASTIC CUPS AND POTS FOR STORAGE, DISPENSING AND MIXING OF DRY INFANT FORMULA, PLASTIC CUPS AND POTS WITH LIDS FOR COLLECTION, STORAGE AND DISPENSING OF EXPRESSED BREAST MILK; CUPS; DRINKING CUPS FOR CHILDREN; DRINKING CUPS FOR CHILDREN AND PARTS AND FITTINGS THEREFOR, NAMELY, DRINKING CUPS FOR CHILDREN SOLD AS A UNIT WITH NON-INSULATED LIDS; DRINKING CUPS FOR BABIES AND CHILDREN AND PARTS AND FITTINGS THEREFOR, NAMELY, CUPS FOR BABIES AND CHILDREN SOLD AS A UNIT WITH VALVES AND LIDS; DRINKING CUPS FOR BABIES AND CHILDREN AND PARTS AND FITTINGS THEREFOR, NAMELY, CUPS FOR BABIES AND CHILDREN SOLD AS A UNIT WITH REPLACEMENT VALVES USED FOR TRAINING

Reg. No. 4,067,804 BABIES AND CHILDREN; RE-USABLE OR DISPOSABLE PLASTIC OR SILICONE VALVES SOLD FOR USE WITH TRAINING CUPS FOR BABIES AND CHILDREN; PLATES; DISHES; CROCKERY, NAMELY, BOWLS, CUPS, SAUCERS; HEAT INSULATED HOUSEHOLD CONTAINERS FOR BEVERAGES AND FOOD; SERVING UTENSILS FOR BEVERAGES AND FOOD, NAMELY, SERVING FORKS AND SPOONS; PAPER AND PLASTIC PLATES; SIEVES; VACUUM CONTAINERS FOR HOUSEHOLD OR KITCHEN USE; COMBS; HAIR BRUSHES; BRUSHES FOR CLEANING BABIES' BOTTLES; SPONGES; SPONGES AND OTHER CLEANING ARTICLES FOR CLEANING CHILDREN'S FEEDING EQUIPMENT, NAMELY, SPONGES, CLOTHS AND SCOURING PADS; ARTICLES FOR CLEANING PURPOSES, NAMELY, SPONGES, CLOTHS AND SCOURING PADS; CLOTHES DRYING RACKS; BOTTLES SOLD EMPTY AND FLASKS FOR HOT WATER; TOOTHBRUSHES; TOILET UTENSILS, NAMELY, TOILET BRUSHES; CHAMBER POTS; HOUSEHOLD CONTAINERS, NAMELY, SANITARY STORAGE AND DISPOSAL CONTAINERS; HOUSEHOLD CONTAINERS FOR STORAGE AND DISPOSAL OF WASTE, INCLUDING SANITARY WASTE SUCH AS DIAPERS AND NAPPIES, FEMININE HYGIENE PRODUCTS AND INCONTINENCE PRODUCTS, NAMELY, SANITARY WASTE DISPOSAL UNITS COMPRISING TUBS OR BINS WITH OR WITHOUT REELS OR CASSETTES CONTAINING WRAPPING MATERIALS FOR ENVELOPING WASTE; WRAPPING MATERIAL DISPENSERS WITH OR WITHOUT REELS OR CASSETTES CONTAINING WRAPPING MATERIALS, FOR ENVELOPING WASTE, INCLUDING SANITARY WASTE SUCH AS DIAPERS AND NAPPIES, FEMININE HYGIENE PRODUCTS AND INCONTINENCE PRODUCTS, FOR STORAGE AND DISPOSAL; REFUSE BINS, NAMELY, PORTABLE DIAPER DISPOSAL TUBS; CONTAINERS FOR HOUSEHOLD USE BEING ADAPTED FOR THE PACKAGING AND SUBSEQUENT DISPOSAL OF DOMESTIC WASTE, INCLUDING DIAPERS AND NAPPIES; CONTAINERS FOR HOUSEHOLD USE BEING ADAPTED FOR THE PACKAGING AND SUBSEQUENT DISPOSAL OF PET-WASTE; REFUSE BINS, NAMELY, NAPPY BINS; DIAPER PAILS; REFUSE BINS; PORTABLE BATHS FOR BABIES AND INFANTS; NON-ELECTRIC BLENDERS FOR FOOD PREPARATION; GLOVES FOR HOUSEHOLD PURPOSES, NAMELY, TEXTILE GLOVES FOR CLEANING; STRUCTURAL PARTS AND FITTINGS FOR ALL THE AFOREMENTIONED GOODS; NON-SPILL DRINKING BOTTLES FOR CHILDREN, SOLD EMPTY, IN CLASS 21 (U.S. CLS. 2, 13, 23, 29, 30, 33, 40 AND 50).

FIRST USE 9-0-2010; IN COMMERCE 9-0-2010.

THE MARK CONSISTS OF STANDARD CHARACTERS WITHOUT CLAIM TO ANY PARTICULAR FONT, STYLE, SIZE, OR COLOR.

OWNER OF ERPN CMNTY TM OFC REG. NO. 008418717, DATED 2-17-2010, EXPIRES 7-10-2019.

SN 77-857,399, FILED 10-26-2009.

DAYNA BROWNE, EXAMINING ATTORNEY

United States of America

United States Patent and Trademark Office

DIGITAL PARENT

Reg. No. 4,067,805

Registered Dec. 6, 2011

Int. Cl.: 41

SERVICE MARK

PRINCIPAL REGISTER

DIGITAL PARENT LLC (CALIFORNIA LIMITED LIABILITY COMPANY)
1060 PALO ALTO AVE.
PALO ALTO, CA 94301

FOR: EDUCATIONAL SERVICES, NAMELY, PROVIDING A WEBSITE FEATURING ADVICE, INFORMATION AND INFORMATION ABOUT RESOURCES IN THE FIELD OF PARENTING CONCERNING EDUCATION OF CHILDREN; EDUCATIONAL SERVICES, NAMELY, PROVIDING ONLINE AND LIVE WORKSHOPS, CLASSES AND MENTORING IN THE FIELD OF PARENTING AND DISTRIBUTION OF COURSE MATERIALS IN CONNECTION THEREWITH, IN CLASS 41 (U.S. CLS. 100, 101 AND 107).

FIRST USE 9-6-2011; IN COMMERCE 9-6-2011.

THE MARK CONSISTS OF STANDARD CHARACTERS WITHOUT CLAIM TO ANY PARTICULAR FONT, STYLE, SIZE, OR COLOR.

NO CLAIM IS MADE TO THE EXCLUSIVE RIGHT TO USE "PARENT", APART FROM THE MARK AS SHOWN.

SN 77-857,527, FILED 10-26-2009.

TINA BROWN, EXAMINING ATTORNEY



David J. Kybas

Director of the United States Patent and Trademark Office

United States of America

United States Patent and Trademark Office

DIGITAL PARENT

Reg. No. 4,067,806

Registered Dec. 6, 2011

Int. Cl.: 44

SERVICE MARK

PRINCIPAL REGISTER

DIGITAL PARENT LLC (CALIFORNIA LIMITED LIABILITY COMPANY)
1060 PALO ALTO AVE.
PALO ALTO, CA 94301

FOR: PROVIDING A WEBSITE FEATURING ADVICE, INFORMATION AND RESOURCES
IN THE FIELD OF PARENTING CONCERNING THE HEALTH OF CHILDREN, IN CLASS
44 (U.S. CLS. 100 AND 101).

FIRST USE 9-6-2011; IN COMMERCE 9-6-2011.

THE MARK CONSISTS OF STANDARD CHARACTERS WITHOUT CLAIM TO ANY PAR-
TICULAR FONT, STYLE, SIZE, OR COLOR.

NO CLAIM IS MADE TO THE EXCLUSIVE RIGHT TO USE "PARENT", APART FROM THE
MARK AS SHOWN.

SN 77-857,528, FILED 10-26-2009.

TINA BROWN, EXAMINING ATTORNEY



David J. Kybas

Director of the United States Patent and Trademark Office

United States of America

United States Patent and Trademark Office

DIGITAL PARENT

Reg. No. 4,067,807

Registered Dec. 6, 2011

Int. Cl.: 45

SERVICE MARK

PRINCIPAL REGISTER

DIGITAL PARENT LLC (CALIFORNIA LIMITED LIABILITY COMPANY)
1060 PALO ALTO AVE.
PALO ALTO, CA 94301

FOR: PROVIDING A WEBSITE FEATURING ADVICE, INFORMATION AND RESOURCES
IN THE FIELD OF PARENTING CONCERNING INTRAFAMILY RELATIONSHIPS; ONLINE
SOCIAL NETWORKING SERVICES , IN CLASS 45 (U.S. CLS. 100 AND 101).

FIRST USE 9-6-2011; IN COMMERCE 9-6-2011.

THE MARK CONSISTS OF STANDARD CHARACTERS WITHOUT CLAIM TO ANY PAR-
TICULAR FONT, STYLE, SIZE, OR COLOR.

NO CLAIM IS MADE TO THE EXCLUSIVE RIGHT TO USE "PARENT", APART FROM THE
MARK AS SHOWN.

SN 77-857,530, FILED 10-26-2009.

TINA BROWN, EXAMINING ATTORNEY



David J. Kyros

Director of the United States Patent and Trademark Office

United States of America

United States Patent and Trademark Office

PRINCE OF PERSIA: THE SANDS OF TIME

Reg. No. 4,067,808

Registered Dec. 6, 2011

Int. Cl.: 9

TRADEMARK

PRINCIPAL REGISTER

WATERWHEEL LICENSING LLC (DELAWARE LIMITED LIABILITY COMPANY)
LOEB & LOEB LLP, 10100 SANTA MONICA
LOS ANGELES, CA 90067

FOR: AUDIO AND VIDEO RECORDINGS FEATURING LIVE-ACTION ENTERTAINMENT;
AUDIO AND VISUAL RECORDINGS FEATURING LIVE-ACTION ENTERTAINMENT; PRE-
RECORDED AUDIO DISCS AND COMPACT DISCS FEATURING MUSIC; PRE-RECORDED
DVDS, DIGITAL VERSATILE DISCS AND DIGITAL VIDEO DISCS FEATURING LIVE-
ACTION ENTERTAINMENT, IN CLASS 9 (U.S. CLS. 21, 23, 26, 36 AND 38).

FIRST USE 9-14-2010; IN COMMERCE 9-14-2010.

THE MARK CONSISTS OF STANDARD CHARACTERS WITHOUT CLAIM TO ANY PAR-
TICULAR FONT, STYLE, SIZE, OR COLOR.

OWNER OF U.S. REG. NOS. 1,646,934, 3,074,103, AND OTHERS.

SN 77-857,643, FILED 10-26-2009.

KEVIN CORWIN, EXAMINING ATTORNEY



David J. Kyros

Director of the United States Patent and Trademark Office

United States of America

United States Patent and Trademark Office

liquitex free·style

Reg. No. 4,067,809

Registered Dec. 6, 2011

Int. Cl.: 16

TRADEMARK

PRINCIPAL REGISTER

COLART AMERICAS, INC. (NEW JERSEY CORPORATION)
11 CONSTITUTION AVENUE
P.O. BOX 1396
PISCATAWAY, NJ 088551396

FOR: ARTISTS' PAINT BRUSHES, IN CLASS 16 (U.S. CLS. 2, 5, 22, 23, 29, 37, 38 AND 50).

FIRST USE 3-1-2010; IN COMMERCE 3-1-2010.

OWNER OF U.S. REG. NOS. 834,250, 1,206,993, AND OTHERS.

THE MARK CONSISTS OF THE WORDS "LIQUITEX" IN STYLIZED FORM AND THE "L" IN "LIQUITEX" EXTENDS TO UNDERLINE THE OTHER LETTERS IN THE WORD; THE WORDS "FREE STYLE" ARE WRITTEN IN PLAIN BLOCK LETTERS WITH A DOT BETWEEN THEM.

SN 77-858,125, FILED 10-27-2009.

APRIL HESIK, EXAMINING ATTORNEY



David J. Kyros

Director of the United States Patent and Trademark Office

United States of America

United States Patent and Trademark Office

AMERICAN FARM BUREAU
FOUNDATION  FOR AGRICULTURE

Reg. No. 4,067,810

Registered Dec. 6, 2011

Int. Cls.: 35 and 41

SERVICE MARK

PRINCIPAL REGISTER

AMERICAN FARM BUREAU FEDERATION (ILLINOIS CORPORATION)
SUITE 1000W
600 MARYLAND AVENUE, S.W.
WASHINGTON, DC 20024

FOR: PROMOTING THE INTERESTS OF FARMERS AND RANCHERS AND PROMOTING PUBLIC AWARENESS OF AGRICULTURE, IN CLASS 35 (U.S. CLS. 100, 101 AND 102).

FIRST USE 1-7-2010; IN COMMERCE 1-7-2010.

FOR: EDUCATIONAL SERVICES, NAMELY, CONDUCTING PROGRAMS IN THE FIELD OF AGRICULTURE, IN CLASS 41 (U.S. CLS. 100, 101 AND 107).

FIRST USE 1-7-2010; IN COMMERCE 1-7-2010.

OWNER OF U.S. REG. NOS. 1,465,000, 2,054,690, AND OTHERS.

NO CLAIM IS MADE TO THE EXCLUSIVE RIGHT TO USE "FOUNDATION FOR AGRICULTURE", APART FROM THE MARK AS SHOWN.

THE MARK CONSISTS OF THE WORDS "AMERICAN FARM BUREAU FOUNDATION FOR AGRICULTURE" WITH THE WORD "FOR" ENCLOSED IN A LEAF DESIGN.

SN 77-860,169, FILED 10-29-2009.

KATINA MISTER, EXAMINING ATTORNEY



David J. Kybas

Director of the United States Patent and Trademark Office

United States of America

United States Patent and Trademark Office

GRIZZLY BEAR

Reg. No. 4,067,811

Registered Dec. 6, 2011

Int. Cl.: 41

SERVICE MARK

PRINCIPAL REGISTER

DROSTE, EDWARD (UNITED STATES INDIVIDUAL)
9111 SUNSET BLVD.
ATTN: K. PALS
LOS ANGELES, CA 90069

FOR: PROVIDING A WEB SITE ON A GLOBAL COMPUTER NETWORK FEATURING INFORMATION ON MUSIC AND ENTERTAINMENT; ENTERTAINMENT SERVICES, NAMELY, LIVE ENTERTAINMENT CONSISTING OF DRAMATIC PERFORMANCES BY AN ACTOR; ENTERTAINMENT, NAMELY, LIVE PERFORMANCES BY A MUSICIAN AND A MUSICAL GROUP; RECORDING SERVICES FOR OTHERS IN THE FIELDS OF MUSIC, VIDEO, TELEVISION AND FILM; ENTERTAINMENT SERVICES, NAMELY, PROVIDING NON-DOWNLOADABLE MUSICAL SOUND AND VIDEO RECORDINGS BY MEANS OF A GLOBAL COMPUTER NETWORK; PROVIDING INFORMATION ABOUT ENTERTAINMENT SERVICES PERFORMED BY AN ACTOR, OR MUSICAL PERFORMER OR GROUP; ENTERTAINMENT INFORMATION, NAMELY, PROVIDING MUSIC, TELEVISION AND FILM INFORMATION VIA A WEB SITE; PROVIDING A WEB SITE FEATURING MUSICAL PERFORMANCES, MUSICAL VIDEOS, PHOTOGRAPHS AND OTHER MULTIMEDIA MATERIALS, AND PERSONAL INFORMATION REGARDING AN ACTOR, OR MUSICAL PERFORMER OR GROUP; PROVIDING A WEB SITE FEATURING MUSICAL PERFORMANCES, MUSICAL VIDEOS, PHOTOGRAPHS AND OTHER MULTIMEDIA MATERIALS FEATURING MUSIC, AND PERSONAL INFORMATION REGARDING AN ACTOR, OR MUSICAL PERFORMER OR GROUP AND THEIR LIVE AND RECORDED PERFORMANCES; PROVIDING NON-DOWNLOADABLE PRERECORDED MUSICAL SOUND AND VIDEO RECORDINGS DELIVERED VIA TELECOMMUNICATIONS TECHNOLOGY; FAN CLUB SERVICES, IN CLASS 41 (U.S. CLS. 100, 101 AND 107).



FIRST USE 10-1-2004; IN COMMERCE 2-7-2005.

THE MARK CONSISTS OF STANDARD CHARACTERS WITHOUT CLAIM TO ANY PARTICULAR FONT, STYLE, SIZE, OR COLOR.

SN 77-861,809, FILED 10-30-2009.

MAYUR VAGHANI, EXAMINING ATTORNEY

David J. Kyros

Director of the United States Patent and Trademark Office

United States of America

United States Patent and Trademark Office

DENIZEN

Reg. No. 4,067,812

Registered Dec. 6, 2011

Int. Cls.: 18 and 25

TRADEMARK

PRINCIPAL REGISTER

LEVI STRAUSS & CO. (DELAWARE CORPORATION)
1155 BATTERY STREET
LEGAL DEPARTMENT
SAN FRANCISCO, CA 94111

FOR: WALLET, IN CLASS 18 (U.S. CLS. 1, 2, 3, 22 AND 41).

FIRST USE 10-3-2011; IN COMMERCE 10-3-2011.

FOR: BELTS; JEANS; PANTS, IN CLASS 25 (U.S. CLS. 22 AND 39).

FIRST USE 6-10-2011; IN COMMERCE 6-10-2011.

THE MARK CONSISTS OF STANDARD CHARACTERS WITHOUT CLAIM TO ANY PARTICULAR FONT, STYLE, SIZE, OR COLOR.

SN 77-862,481, FILED 11-2-2009.

SAIMA MAKHDOOM, EXAMINING ATTORNEY



David J. Kybas

Director of the United States Patent and Trademark Office

United States of America

United States Patent and Trademark Office



Brazen

Reg. No. 4,067,813

Registered Dec. 6, 2011

Int. Cls.: 30 and 43

TRADEMARK

SERVICE MARK

PRINCIPAL REGISTER

BRAZEN BBQ, LLC (CALIFORNIA LIMITED LIABILITY COMPANY)
P.O. BOX 504248
SAN DIEGO, CA 921504248

FOR: SPICE RUBS; SPICES, IN CLASS 30 (U.S. CL. 46).

FIRST USE 8-17-2011; IN COMMERCE 8-17-2011.

FOR: RESTAURANT AND CATERING SERVICES, IN CLASS 43 (U.S. CLS. 100 AND 101).

FIRST USE 8-17-2011; IN COMMERCE 8-17-2011.

THE MARK CONSISTS OF THE TERM "BRAZEN" POSITIONED BELOW AN ENCIRCLED STYLIZED "B".

SN 77-863,042, FILED 11-2-2009.

KATHERINE E. HALMEN, EXAMINING ATTORNEY



David J. Kybas

Director of the United States Patent and Trademark Office

United States of America

United States Patent and Trademark Office

BRAZEN

Reg. No. 4,067,814

Registered Dec. 6, 2011

Int. Cls.: 30 and 43

TRADEMARK

SERVICE MARK

PRINCIPAL REGISTER

BRAZEN BBQ, LLC (CALIFORNIA LIMITED LIABILITY COMPANY)
P.O. BOX 504248
SAN DIEGO, CA 921504248

FOR: SPICE RUBS; SPICES, IN CLASS 30 (U.S. CL. 46).

FIRST USE 8-17-2011; IN COMMERCE 8-17-2011.

FOR: RESTAURANT AND CATERING SERVICES , IN CLASS 43 (U.S. CLS. 100 AND 101).

FIRST USE 8-17-2011; IN COMMERCE 8-17-2011.

THE MARK CONSISTS OF STANDARD CHARACTERS WITHOUT CLAIM TO ANY PARTICULAR FONT, STYLE, SIZE, OR COLOR.

SN 77-863,044, FILED 11-2-2009.

KATHERINE E. HALMEN, EXAMINING ATTORNEY



David J. Kyros

Director of the United States Patent and Trademark Office

United States of America

United States Patent and Trademark Office



Reg. No. 4,067,815

Registered Dec. 6, 2011

Int. Cls.: 30 and 43

TRADEMARK

SERVICE MARK

PRINCIPAL REGISTER

BRAZEN BBQ, LLC (CALIFORNIA LIMITED LIABILITY COMPANY)
P.O. BOX 504248
SAN DIEGO, CA 921504248

FOR: SPICE RUBS; SPICES, IN CLASS 30 (U.S. CL. 46).

FIRST USE 8-17-2011; IN COMMERCE 8-17-2011.

FOR: RESTAURANT AND CATERING SERVICES, IN CLASS 43 (U.S. CLS. 100 AND 101).

FIRST USE 8-17-2011; IN COMMERCE 8-17-2011.

THE MARK CONSISTS OF AN ENCIRCLED STYLIZED "B".

SN 77-863,051, FILED 11-2-2009.

KATHERINE E. HALMEN, EXAMINING ATTORNEY



David J. Kybas

Director of the United States Patent and Trademark Office

United States of America

United States Patent and Trademark Office



Reg. No. 4,067,816

Registered Dec. 6, 2011

Int. Cl.: 41

SERVICE MARK

PRINCIPAL REGISTER

WARNER BROS. ENTERTAINMENT INC. (DELAWARE CORPORATION)
4000 WARNER BOULEVARD
BURBANK, CA 91522

FOR: PROVIDING INFORMATION FOR AND ACTUAL ENTERTAINMENT VIA AN ELECTRONIC GLOBAL COMMUNICATIONS NETWORK IN THE NATURE OF ON-GOING COMEDY AND ANIMATED PROGRAMS, IN CLASS 41 (U.S. CLS. 100, 101 AND 107).

FIRST USE 5-3-2011; IN COMMERCE 5-3-2011.

OWNER OF U.S. REG. NOS. 1,297,890, 2,838,386, AND OTHERS.

NO CLAIM IS MADE TO THE EXCLUSIVE RIGHT TO USE "SHOW", APART FROM THE MARK AS SHOWN.

THE MARK CONSISTS OF THE WORDS "THE LOONEY TUNES SHOW" IN A STYLIZED TARGET DESIGN.

SN 77-863,223, FILED 11-2-2009.

MATTHEW MCDOWELL, EXAMINING ATTORNEY



David J. Kybas

Director of the United States Patent and Trademark Office

United States of America

United States Patent and Trademark Office



Reg. No. 4,067,817
Registered Dec. 6, 2011
Int. Cl.: 25

UNITED STATES SWIMMING, INC. (COLORADO NON-PROFIT CORPORATION), DBA
USA SWIMMING,
ONE OLYMPIC PLAZA
COLORADO SPRINGS, CO 80909

TRADEMARK

FOR: CLOTHING, NAMELY, SWIM CAPS, SHIRTS, T-SHIRTS, POLO SHIRTS, JACKETS,
AND SWIM WEAR, ALL FOR ACTIVITIES RELATED TO THE GENERAL SPORT OF
SWIMMING, IN CLASS 25 (U.S. CLS. 22 AND 39).

PRINCIPAL REGISTER

FIRST USE 8-1-2010; IN COMMERCE 8-2-2010.

OWNER OF U.S. REG. NOS. 1,222,932, 3,141,187, AND OTHERS.

SEC. 2(F) AS TO "USA SWIMMING".

THE MARK CONSISTS OF THE STYLIZED WORDING "AMERICA'S SWIM TEAM" WITH
A STYLIZED DRAWING OF A SOLID CIRCLE CONTAINING A STAR BETWEEN THE
WORDS "SWIM" AND "TEAM"; A STYLIZED DRAWING OF A SHIELD APPEARS ABOVE
CONTAINING THE STYLIZED WORDING "USA SWIMMING" AT THE TOP, VERTICAL
STRIPES REPRESENTING SWIMMING LANES AT THE BOTTOM AND A STAR IN THE
MIDDLE.

SN 77-863,618, FILED 11-3-2009.

AMEEN IMAM, EXAMINING ATTORNEY



David J. Kyros

Director of the United States Patent and Trademark Office

United States of America

United States Patent and Trademark Office



Reg. No. 4,067,818

Registered Dec. 6, 2011

Int. Cl.: 35

SERVICE MARK

PRINCIPAL REGISTER

UNITED STATES SWIMMING, INC. (COLORADO NON-PROFIT CORPORATION), DBA
USA SWIMMING,
ONE OLYMPIC PLAZA
COLORADO SPRINGS, CO 80909

FOR: ASSOCIATION SERVICES, NAMELY, PROMOTING THE SPORT OF SWIMMING;
PROMOTING INTEREST AND PARTICIPATION IN THE SPORT OF SWIMMING, IN CLASS
35 (U.S. CLS. 100, 101 AND 102).

FIRST USE 5-15-2010; IN COMMERCE 5-15-2010.

OWNER OF U.S. REG. NOS. 1,222,932, 3,015,366, AND OTHERS.

SEC. 2(F) AS TO "USA SWIMMING".

THE MARK CONSISTS OF THE STYLIZED WORDING "AMERICA'S SWIM TEAM" WITH
A STYLIZED DRAWING OF A SOLID CIRCLE CONTAINING A STAR BETWEEN THE
WORDS "SWIM" AND "TEAM"; A STYLIZED DRAWING OF A SHIELD APPEARS ABOVE
CONTAINING THE STYLIZED WORDING "USA SWIMMING" AT THE TOP AND A
STYLIZED DRAWING OF VERTICAL STRIPES REPRESENTING SWIMMING LANES AT
THE BOTTOM WITH A STYLIZED DRAWING OF A STAR IN THE MIDDLE.

SN 77-863,620, FILED 11-3-2009.

AMEEN IMAM, EXAMINING ATTORNEY



David J. Kyjars

Director of the United States Patent and Trademark Office

United States of America

United States Patent and Trademark Office



Reg. No. 4,067,819

Registered Dec. 6, 2011

Int. Cl.: 16

TRADEMARK

PRINCIPAL REGISTER

UNITED STATES SWIMMING, INC. (COLORADO NON-PROFIT CORPORATION), DBA
USA SWIMMING,
ONE OLYMPIC PLAZA
COLORADO SPRINGS, CO 80909

FOR: PRINTED MATERIALS, NAMELY, POSTERS AND MAGAZINES, ALL IN THE FIELD
OF THE GENERAL SPORT OF SWIMMING, IN CLASS 16 (U.S. CLS. 2, 5, 22, 23, 29, 37, 38
AND 50).

FIRST USE 5-15-2010; IN COMMERCE 5-15-2010.

OWNER OF U.S. REG. NOS. 1,222,932, 3,062,502, AND OTHERS.

SEC. 2(F) AS TO "USA SWIMMING".

THE MARK CONSISTS OF THE STYLIZED WORDING "AMERICA'S SWIM TEAM" WITH
A STYLIZED DRAWING OF A SOLID CIRCLE CONTAINING A STAR BETWEEN THE
WORDS "SWIM" AND "TEAM"; A STYLIZED DRAWING OF A SHIELD APPEARS TO THE
LEFT CONTAINING THE STYLIZED WORDING "USA SWIMMING" AT THE TOP, VERTI-
CAL STRIPES REPRESENTING SWIMMING LANES AT THE BOTTOM AND A STAR IN THE
MIDDLE.

SN 77-863,624, FILED 11-3-2009.

AMEEN IMAM, EXAMINING ATTORNEY



David J. Kyros

Director of the United States Patent and Trademark Office

United States of America

United States Patent and Trademark Office



Reg. No. 4,067,820

Registered Dec. 6, 2011

Int. Cl.: 25

TRADEMARK

PRINCIPAL REGISTER

UNITED STATES SWIMMING, INC. (COLORADO NON-PROFIT CORPORATION), DBA
USA SWIMMING,
ONE OLYMPIC PLAZA
COLORADO SPRINGS, CO 80909

FOR: CLOTHING, NAMELY, SWIM CAPS, SHIRTS, T-SHIRTS, POLO SHIRTS, AND SWIM WEAR, ALL FOR ACTIVITIES RELATED TO THE GENERAL SPORT OF SWIMMING, IN CLASS 25 (U.S. CLS. 22 AND 39).

FIRST USE 8-1-2010; IN COMMERCE 8-1-2010.

OWNER OF U.S. REG. NOS. 1,222,932, 3,141,187, AND OTHERS.

SEC. 2(F) AS TO "USA SWIMMING".

THE MARK CONSISTS OF THE STYLIZED WORDING "AMERICA'S SWIM TEAM" WITH A STYLIZED DRAWING OF A SOLID CIRCLE CONTAINING A STAR BETWEEN THE WORDS "SWIM" AND "TEAM"; A STYLIZED DRAWING OF A SHIELD APPEARS TO THE LEFT CONTAINING THE STYLIZED WORDING "USA SWIMMING" AT THE TOP, VERTICAL STRIPES REPRESENTING SWIMMING LANES AT THE BOTTOM AND A STAR IN THE MIDDLE.

SN 77-863,626, FILED 11-3-2009.

AMEEN IMAM, EXAMINING ATTORNEY



David J. Kybas

Director of the United States Patent and Trademark Office

United States of America

United States Patent and Trademark Office

HYACTIVE

Reg. No. 4,067,821

Registered Dec. 6, 2011

Int. Cl.: 25

TRADEMARK

PRINCIPAL REGISTER

THE NORTH FACE APPAREL CORP. (DELAWARE CORPORATION)
3411 SILVERSIDE ROAD
200 HANBY BUILDING
WILMINGTON, DE 19810

FOR: UNDERWEAR, THERMAL UNDERWEAR, BASELAYER TOPS, BASELAYER BOTTOMS, IN CLASS 25 (U.S. CLS. 22 AND 39).

FIRST USE 8-31-2010; IN COMMERCE 8-31-2010.

THE MARK CONSISTS OF STANDARD CHARACTERS WITHOUT CLAIM TO ANY PARTICULAR FONT, STYLE, SIZE, OR COLOR.

SN 77-864,610, FILED 11-4-2009.

NANCY CLARKE, EXAMINING ATTORNEY



David J. Kyjars

Director of the United States Patent and Trademark Office

United States of America

United States Patent and Trademark Office

DIAMOND LOYALTY

Reg. No. 4,067,822

DIAMOND RESORTS HOLDINGS, LLC (NEVADA LIMITED LIABILITY COMPANY)
3745 LAS VEGAS BLVD. SOUTH
LAS VEGAS, NV 89109

Registered Dec. 6, 2011

Int. Cls.: 36, 38, 43, and 45

FOR: REAL ESTATE EQUITY SHARING, NAMELY, MANAGING AND ARRANGING FOR CO-OWNERSHIP OF REAL ESTATE; REAL ESTATE SERVICES, NAMELY, RENTAL OF SHORT TERM FURNISHED APARTMENTS; REAL ESTATE TIME-SHARING; VACATION REAL ESTATE TIME SHARING; VACATION REAL ESTATE TIME-SHARING SERVICES, IN CLASS 36 (U.S. CLS. 100, 101 AND 102).

SERVICE MARK

PRINCIPAL REGISTER

FIRST USE 12-0-2009; IN COMMERCE 12-0-2009.

FOR: PROVIDING FREE INTERNET ACCESS; PROVIDING A DEDICATED WEB PORTAL IN THE NATURE OF PROVIDING ACCESS TO INTERACTIVE ONLINE CHAT ROOM; PROVIDING DEDICATED RESERVATION TELEPHONE LINES FOR SECURING ACCOMMODATIONS, IN CLASS 38 (U.S. CLS. 100, 101 AND 104).

FIRST USE 12-0-2009; IN COMMERCE 12-0-2009.

FOR: TRAVEL SERVICES, NAMELY, PROVIDING TRAVEL LODGING INFORMATION SERVICES AND TRAVEL AGENCY BOOKING SERVICES FOR TRAVELERS; ARRANGING FOR ROOMS IN RESORTS, ACCOMMODATION EXCHANGE AND RESERVATION SERVICES; MAKING ARRANGEMENTS FOR TRAVELERS TO EXTEND LODGING RESERVATIONS, REDEEM UNUSED LODGING RESERVATIONS, OR TO BE ALLOWED TO WAIVE REDEMPTION DATES IN CONNECTION WITH ACCOMMODATION PROMOTIONS, IN CLASS 43 (U.S. CLS. 100 AND 101).

FIRST USE 12-0-2009; IN COMMERCE 12-0-2009.

FOR: CONCIERGE SERVICES FOR OTHERS, COMPRISING MAKING REQUESTED PERSONAL ARRANGEMENTS AND RESERVATIONS AND PROVIDING CUSTOMER SPECIFIC INFORMATION TO MEET INDIVIDUAL NEEDS RENDERED TOGETHER IN A HOTEL AND RESORT, APARTMENT TIMESHARE ENVIRONMENT; PROVIDING CUSTOMIZED GIFT BASKETS INCLUDING BATHROOM AMENITIES, IN CLASS 45 (U.S. CLS. 100 AND 101).

FIRST USE 12-0-2009; IN COMMERCE 12-0-2009.



David J. Kyffers

Director of the United States Patent and Trademark Office

Reg. No. 4,067,822 THE MARK CONSISTS OF STANDARD CHARACTERS WITHOUT CLAIM TO ANY PARTICULAR FONT, STYLE, SIZE, OR COLOR.

OWNER OF U.S. REG. NOS. 2,411,329 AND 2,432,190.

SN 77-866,295, FILED 11-5-2009.

MATTHEW KLINE, EXAMINING ATTORNEY

United States of America

United States Patent and Trademark Office

KTX

Reg. No. 4,067,823

Registered Dec. 6, 2011

Int. Cl.: 9

TRADEMARK

PRINCIPAL REGISTER

IZUNAMI, INC. (NEW YORK CORPORATION)
83 HARBOR ROAD
PORT WASHINGTON, NY 11050

FOR: ELECTRIC HARDWARE FOR HAIR, NAMELY, ELECTRIC IRONS FOR STYLING HAIR, ELECTRIC CURLING IRONS AND ELECTRIC FLAT IRONS, IN CLASS 9 (U.S. CLS. 21, 23, 26, 36 AND 38).

FIRST USE 7-19-2011; IN COMMERCE 7-19-2011.

THE MARK CONSISTS OF STANDARD CHARACTERS WITHOUT CLAIM TO ANY PARTICULAR FONT, STYLE, SIZE, OR COLOR.

SN 77-867,074, FILED 11-6-2009.

LINDA ESTRADA, EXAMINING ATTORNEY



David J. Kybas

Director of the United States Patent and Trademark Office

United States of America

United States Patent and Trademark Office



Reg. No. 4,067,824

Registered Dec. 6, 2011

Int. Cl.: 16

TRADEMARK

PRINCIPAL REGISTER

ELEANOR AVINOR (ISRAEL INDIVIDUAL)
P.O. BOX 56008
24 SHLONSKY ST.
HAIFA, ISRAEL 34987

FOR: PRINTED MATERIALS, NAMELY, BOOKS, PAMPHLETS, AND NEWSLETTERS IN THE FIELD OF THERAPY; THERAPY NOTE CARDS; THERAPY BOOKS, IN CLASS 16 (U.S. CLS. 2, 5, 22, 23, 29, 37, 38 AND 50).

FIRST USE 10-1-2009; IN COMMERCE 6-1-2010.

NO CLAIM IS MADE TO THE EXCLUSIVE RIGHT TO USE "CARDS", APART FROM THE MARK AS SHOWN.

THE MARK CONSISTS OF A SINGLE LINE OVAL INSIDE OF WHICH IS THE WORD "KEG CARDS" POSITIONED ABOVE THE DESIGN OF A SILHOUETTE OF A SEATED PERSON; INSIDE THE OVAL AND BELOW THE SILHOUETTE DESIGN ARE THE WORDS "KEYS TO EMOTIONAL GROWTH".

SN 77-867,732, FILED 11-8-2009.

MICHAEL LITZAU, EXAMINING ATTORNEY



David J. Kyjars

Director of the United States Patent and Trademark Office

United States of America

United States Patent and Trademark Office

The logo for PosiCash features the word "PosiCash" in a bold, yellow, 3D-style font with black outlines and highlights. The letters are set against a white, rounded rectangular background that has a slight shadow effect, making it appear to float above a light-colored surface.

Reg. No. 4,067,825

Registered Dec. 6, 2011

Int. Cl.: 36

SERVICE MARK

PRINCIPAL REGISTER

AMBESS ENTERPRISES, INC. (PENNSYLVANIA CORPORATION)
1103 E. WALTON AVE
ALTOONA, PA 16602

FOR: PROVIDING ELECTRONIC PROCESSING OF ACH AND CREDIT CARD TRANSACTIONS AND ELECTRONIC PAYMENTS VIA A GLOBAL COMPUTER NETWORK; PROVIDING ELECTRONIC PROCESSING OF CREDIT CARD TRANSACTIONS AND ELECTRONIC PAYMENTS VIA A GLOBAL COMPUTER NETWORK; PROVIDING ELECTRONIC PROCESSING OF ELECTRONIC FUNDS TRANSFER, ACH, CREDIT CARD, DEBIT CARD, ELECTRONIC CHECK AND ELECTRONIC PAYMENTS, IN CLASS 36 (U.S. CLS. 100, 101 AND 102).

FIRST USE 10-17-2006; IN COMMERCE 10-17-2006.

THE MARK CONSISTS OF THE TERM "POSICASH" IN YELLOW AND WITH WHITE HIGHLIGHTS AND IN THREE DIMENSIONS WITH BLACK, GRAY AND WHITE AND YELLOW AND WHITE LINES.

THE COLOR(S) YELLOW, WHITE, BLACK, AND GRAY IS/ARE CLAIMED AS A FEATURE OF THE MARK.

SN 77-868,402, FILED 11-9-2009.

NICHOLAS ALTREE, EXAMINING ATTORNEY



David J. Kybas

Director of the United States Patent and Trademark Office

United States of America

United States Patent and Trademark Office

DURGA

Reg. No. 4,067,826

Registered Dec. 6, 2011

Int. Cl.: 41

SERVICE MARK

PRINCIPAL REGISTER

DURGA DIGITAL LLC (CALIFORNIA LIMITED LIABILITY COMPANY)
3 LOVE STREET
FAIRFAX, CA 94930

FOR: FILM PRODUCTION, IN CLASS 41 (U.S. CLS. 100, 101 AND 107).

FIRST USE 10-10-2011; IN COMMERCE 10-10-2011.

THE MARK CONSISTS OF STANDARD CHARACTERS WITHOUT CLAIM TO ANY PARTICULAR FONT, STYLE, SIZE, OR COLOR.

SN 77-868,943, FILED 11-10-2009.

ROBERT STRUCK, EXAMINING ATTORNEY



David J. Kybas

Director of the United States Patent and Trademark Office

United States of America

United States Patent and Trademark Office

NUtech Ventures

Reg. No. 4,067,827

Registered Dec. 6, 2011

Int. Cl.: 45

SERVICE MARK

PRINCIPAL REGISTER

UNL TECHNOLOGY DEVELOPMENT CORPORATION (NEBRASKA CORPORATION),
DBA NUTECH VENTURES,
1320 Q STREET
LINCOLN, NE 68508

FOR: TECHNOLOGY PROTECTION SERVICES, NAMELY, PROVIDING INFORMATION ABOUT LICENSING OF INTELLECTUAL PROPERTY; TECHNOLOGY PROTECTION, NAMELY, PROVIDING INFORMATION ABOUT INTELLECTUAL PROPERTY RIGHTS, IN CLASS 45 (U.S. CLS. 100 AND 101).

FIRST USE 6-1-2010; IN COMMERCE 6-1-2010.

THE MARK CONSISTS OF STANDARD CHARACTERS WITHOUT CLAIM TO ANY PARTICULAR FONT, STYLE, SIZE, OR COLOR.

NO CLAIM IS MADE TO THE EXCLUSIVE RIGHT TO USE "VENTURES", APART FROM THE MARK AS SHOWN.

SN 77-870,079, FILED 11-11-2009.

GEOFFREY FOSDICK, EXAMINING ATTORNEY



David J. Kybas

Director of the United States Patent and Trademark Office

United States of America

United States Patent and Trademark Office

Intelli-ad

Reg. No. 4,067,828

Registered Dec. 6, 2011

Int. Cl.: 35

SERVICE MARK

PRINCIPAL REGISTER

DMARKETS, LLC (DELAWARE LIMITED LIABILITY COMPANY)
SUITE 101
160 GREENTREE DRIVE
DOVER, DE 19904

FOR: ON-LINE ADVERTISING AND MARKETING SERVICES, IN CLASS 35 (U.S. CLS. 100, 101 AND 102).

FIRST USE 2-10-2009; IN COMMERCE 1-10-2010.

THE MARK CONSISTS OF STANDARD CHARACTERS WITHOUT CLAIM TO ANY PARTICULAR FONT, STYLE, SIZE, OR COLOR.

SN 77-870,602, FILED 11-11-2009.

GINA HAYES, EXAMINING ATTORNEY



David J. Kybas

Director of the United States Patent and Trademark Office

United States of America

United States Patent and Trademark Office

SIMSTREAM

Reg. No. 4,067,829

Registered Dec. 6, 2011

Int. Cl.: 9

TRADEMARK

PRINCIPAL REGISTER

DRAKE SYSTEMS GROUP (CALIFORNIA CORPORATION)
SUITE G
23655 VIA DEL RIO
YORBA LINDA, CA 92887

FOR: AUDIO/VISUAL SYSTEMS FOR USE IN THE HEALTHCARE INDUSTRY COMPRISED OF COMPUTERS, COMPUTER MONITORS, LCD MONITORS, ELECTRONIC DISPLAY INTERFACES AND MULTIMEDIA PROJECTORS, AUDIO PROCESSING EQUIPMENT, NAMELY, LIMITERS AND COMPRESSORS, MULTIMEDIA PROJECTORS, ELECTRICAL CONTROLLING DEVICES, CAMERAS, SIGNAL DISTRIBUTION DEVICES, NAMELY, DISTRIBUTION AMPLIFIERS FOR AUDIO AND VIDEO SIGNALS, AND ELECTRONIC DATA RECORDERS, IN CLASS 9 (U.S. CLS. 21, 23, 26, 36 AND 38).

FIRST USE 12-31-2010; IN COMMERCE 12-31-2010.

THE MARK CONSISTS OF STANDARD CHARACTERS WITHOUT CLAIM TO ANY PARTICULAR FONT, STYLE, SIZE, OR COLOR.

SN 77-872,546, FILED 11-13-2009.

KATHERINE E. HALMEN, EXAMINING ATTORNEY



David J. Kyros

Director of the United States Patent and Trademark Office

United States of America

United States Patent and Trademark Office

Sprinkle Sprackle & Bunny Books

Reg. No. 4,067,830

Registered Dec. 6, 2011

Int. Cl.: 41

SERVICE MARK

PRINCIPAL REGISTER

SMITH, ROBIN H. (UNITED STATES INDIVIDUAL)
PO BX 1188
3045 FOURTH ST
BIGGS, CA 95917

FOR: PUBLISHING OF BOOKS, E-BOOKS, AUDIO BOOKS, MUSIC AND ILLUSTRATIONS,
IN CLASS 41 (U.S. CLS. 100, 101 AND 107).

FIRST USE 1-1-2006; IN COMMERCE 9-1-2011.

THE MARK CONSISTS OF STANDARD CHARACTERS WITHOUT CLAIM TO ANY PAR-
TICULAR FONT, STYLE, SIZE, OR COLOR.

NO CLAIM IS MADE TO THE EXCLUSIVE RIGHT TO USE "BUNNY BOOKS", APART
FROM THE MARK AS SHOWN.

SN 77-872,934, FILED 11-15-2009.

LOURDES AYALA, EXAMINING ATTORNEY



David J. Kybas

Director of the United States Patent and Trademark Office

United States of America

United States Patent and Trademark Office

SPHERICHROME

Reg. No. 4,067,831

Registered Dec. 6, 2011

Int. Cl.: 1

TRADEMARK

PRINCIPAL REGISTER

OREGON RESOURCES CORPORATION (OREGON CORPORATION)
PO BOX 1350
COOS BAY, OR 97420

FOR: FOUNDRY SAND, IN CLASS 1 (U.S. CLS. 1, 5, 6, 10, 26 AND 46).

FIRST USE 7-28-2011; IN COMMERCE 7-28-2011.

THE MARK CONSISTS OF STANDARD CHARACTERS WITHOUT CLAIM TO ANY PARTICULAR FONT, STYLE, SIZE, OR COLOR.

SN 77-873,745, FILED 11-16-2009.

TINA MAI, EXAMINING ATTORNEY



David J. Kybas

Director of the United States Patent and Trademark Office

United States of America

United States Patent and Trademark Office

Hello Teeney Weeney

Reg. No. 4,067,832

MELISSA A. KIDD (UNITED STATES INDIVIDUAL)
738 BROOKSIDE DR. APT 301
NEWPORT NEWS, VA 23602

Registered Dec. 6, 2011

Int. Cl.: 28

FOR: PLUSH DOLL AND PLUSH DOLL HOUSE FOR USE THEREWITH, IN CLASS 28 (U.S. CLS. 22, 23, 38 AND 50).

TRADEMARK

FIRST USE 10-0-2009; IN COMMERCE 10-0-2009.

PRINCIPAL REGISTER

THE MARK CONSISTS OF STANDARD CHARACTERS WITHOUT CLAIM TO ANY PARTICULAR FONT, STYLE, SIZE, OR COLOR.

SN 77-876,315, FILED 11-19-2009.

NELSON SNYDER, EXAMINING ATTORNEY



David J. Kybas

Director of the United States Patent and Trademark Office

United States of America

United States Patent and Trademark Office

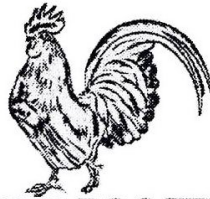

GOLDEN ROOSTER
BRAND

Reg. No. 4,067,833

Registered Dec. 6, 2011

Int. Cls.: 29 and 30

TRADEMARK

PRINCIPAL REGISTER

THAI WORLD IMPORT & EXPORT CO., LTD. (THAILAND LIMITED LIABILITY COMPANY)
2532 TROK NOKKET, RATCHADAPHISEK ROAD
BANGKLO, BANGKHOLAEM
BANGKOK 10120, THAILAND

FOR: COOKED FRUITS AND VEGETABLES; DRIED FRUITS; DRIED VEGETABLES; MILK;
MILK PRODUCTS EXCLUDING ICE CREAM, ICE MILK AND FROZEN YOGURT; PRE-
SERVED FRUITS; PRESERVED VEGETABLES; SOUPS, IN CLASS 29 (U.S. CL. 46).

FIRST USE 10-10-2011; IN COMMERCE 10-10-2011.

FOR: ARTIFICIAL COFFEE; BAKING POWDER; BREAD; COCOA; COFFEE; CONFECTION-
ERY, NAMELY, PASTILLES; CURRY PASTES; CURRY POWDER; FLOUR; HONEY; MUS-
TARD; PASTRY; PREPARATIONS MADE FROM CEREALS, NAMELY, BREAD ROLLS,
BISCUITS, CRACKERS AND BAKERY GOODS; RICE; SAGO; SALT; SAUCES; SPICES;
SUGAR; TAPIOCA; TEA; TREACLE; VINEGAR; YEAST, IN CLASS 30 (U.S. CL. 46).

FIRST USE 10-10-2011; IN COMMERCE 10-10-2011.

NO CLAIM IS MADE TO THE EXCLUSIVE RIGHT TO USE "BRAND", APART FROM THE
MARK AS SHOWN.

THE STIPPLING IS FOR SHADING PURPOSES ONLY.

THE MARK CONSISTS OF AN IMAGE OF A ROOSTER ABOVE THE WORDS "GOLDEN
ROOSTER BRAND".

SN 77-876,764, FILED 11-19-2009.

AMEEN IMAM, EXAMINING ATTORNEY



David J. Kyros

Director of the United States Patent and Trademark Office

United States of America

United States Patent and Trademark Office



Reg. No. 4,067,834

Registered Dec. 6, 2011

Int. Cl.: 43

SERVICE MARK

PRINCIPAL REGISTER

ANGEL URCELLU SALINAS (MEXICO INDIVIDUAL)
AV. JUAREZ # 301
VILLA NUEVO PROGRESO, MEXICO

FOR: BAR AND RESTAURANT SERVICES FEATURING TACOS; CAFE AND RESTAURANT SERVICES FEATURING TACOS; CAFETERIA AND RESTAURANT SERVICES FEATURING TACOS; FAST FOOD AND NON-STOP RESTAURANT SERVICES FEATURING TACOS; FAST-FOOD RESTAURANTS AND SNACKBARS FEATURING TACOS, IN CLASS 43 (U.S. CLS. 100 AND 101).

FIRST USE 7-28-2011; IN COMMERCE 7-28-2011.

NO CLAIM IS MADE TO THE EXCLUSIVE RIGHT TO USE "TACO", APART FROM THE MARK AS SHOWN.

THE COLOR(S) YELLOW, ORANGE, WHITE, RED AND GREEN IS/ARE CLAIMED AS A FEATURE OF THE MARK.

THE MARK CONSISTS OF THE WORDINGS "TACO MY WAY", AND A TORTILLA DESIGN ELEMENT. THE COLOR WHITE APPEARS IN THE WORDS "TACO MY WAY". THE COLOR RED APPEARS AS SHADOW TO WORDS "TACO" AND "WAY". THE COLOR GREEN APPEARS IN THE OUTLINE OF THE WORD "MY". THE THREE WORDS "TACO MY WAY" ARE INSIDE THE STYLIZED FIGURE OF A SEMI-FOLDED TORTILLA WITH ITS INNER FACE IN ORANGE COLOR, AND THE OUTSIDE FACE IN YELLOW COLOR.

SN 77-877,947, FILED 11-20-2009.

MICHAEL KEATING, EXAMINING ATTORNEY



David J. Kybas

Director of the United States Patent and Trademark Office

United States of America

United States Patent and Trademark Office

ADRENASMART

Reg. No. 4,067,835

Registered Dec. 6, 2011

Int. Cl.: 5

TRADEMARK

PRINCIPAL REGISTER

LORNA VANDERHAEGHE HEALTH SOLUTIONS, INC. (CANADA CORPORATION),
FORMERLY HEADLINES PROMOTIONS LTD.,
400-353 WATER STREET
VANCOUVER, BC, CANADA V6B 1B8

FOR: DIETARY AND NUTRITIONAL SUPPLEMENTS, IN CLASS 5 (U.S. CLS. 6, 18, 44, 46,
51 AND 52).

FIRST USE 11-20-2009; IN COMMERCE 11-20-2009.

THE MARK CONSISTS OF STANDARD CHARACTERS WITHOUT CLAIM TO ANY PAR-
TICULAR FONT, STYLE, SIZE, OR COLOR.

SN 77-877,980, FILED 11-20-2009.

FLORENTINA BLANDU, EXAMINING ATTORNEY



David J. Kybas

Director of the United States Patent and Trademark Office

United States of America

United States Patent and Trademark Office

Healthy Living for a Lifetime

Reg. No. 4,067,836

Registered Dec. 6, 2011

Int. Cl.: 44

SERVICE MARK

PRINCIPAL REGISTER

NORTH CAROLINA FARM BUREAU FEDERATION, INC. (NORTH CAROLINA CORPORATION)
5301 GLENWOOD AVENUE
RALEIGH, NC 27612

FOR: HEALTH SCREENING SERVICES, IN CLASS 44 (U.S. CLS. 100 AND 101).

FIRST USE 10-7-2010; IN COMMERCE 10-7-2010.

THE MARK CONSISTS OF STANDARD CHARACTERS WITHOUT CLAIM TO ANY PARTICULAR FONT, STYLE, SIZE, OR COLOR.

SN 77-878,545, FILED 11-23-2009.

DAVID C. REIHNER, EXAMINING ATTORNEY



David J. Kybas

Director of the United States Patent and Trademark Office

United States of America

United States Patent and Trademark Office

THOM MCAN SIGNATURE

Reg. No. 4,067,837

Registered Dec. 6, 2011

Int. Cl.: 25

TRADEMARK

PRINCIPAL REGISTER

SEARS BRANDS, LLC (ILLINOIS LIMITED LIABILITY COMPANY)
3333 BEVERLY ROAD
HOFFMAN ESTATES, IL 60179

FOR: FOOTWEAR, IN CLASS 25 (U.S. CLS. 22 AND 39).

FIRST USE 7-0-2011; IN COMMERCE 7-0-2011.

THE MARK CONSISTS OF STANDARD CHARACTERS WITHOUT CLAIM TO ANY PARTICULAR FONT, STYLE, SIZE, OR COLOR.

OWNER OF U.S. REG. NOS. 751,033, 3,107,818, AND OTHERS.

THE NAME "THOM MCAN" DOES NOT IDENTIFY A LIVING INDIVIDUAL.

SN 77-878,636, FILED 11-23-2009.

ELISSA GARBER KON, EXAMINING ATTORNEY



David J. Kybas

Director of the United States Patent and Trademark Office

United States of America

United States Patent and Trademark Office

junglenuTs

Reg. No. 4,067,838

Registered Dec. 6, 2011

Int. Cl.: 16

TRADEMARK

PRINCIPAL REGISTER

PATRICK GUETTA (UNITED STATES INDIVIDUAL)
1110 SEWARD ST
LOS ANGELES, CA 90038

FOR: ART PICTURES; ART PRINTS; ART PRINTS ON CANVAS; BOOK MARKS; BUMPER STICKERS; CALENDAR DESK PADS; CALENDARS; CARDS, NAMELY, GREETING, BIRTHDAY; CHILDREN'S BOOKS; COASTERS MADE OF PAPER; COLORING BOOKS; COMIC BOOKS; DECALS; FRAMED ART PRINTS; LITHOGRAPHIC PRINTS; LITHOGRAPHIC WORKS OF ART; NAPKIN PAPER; NOTE BOOKS; PENS FOR MARKING; POSTCARDS; POSTCARDS AND GREETING CARDS; POSTERS; POSTERS MADE OF PAPER; PRINTED CALENDARS; SERIES OF FICTION WORKS, NAMELY, NOVELS AND BOOKS; STICKERS; STICKERS AND DECALCOMANIAS; TALKING CHILDREN'S BOOKS; TEAR-OFF CALENDARS; WALL CALENDARS, IN CLASS 16 (U.S. CLS. 2, 5, 22, 23, 29, 37, 38 AND 50).

FIRST USE 5-5-2003; IN COMMERCE 5-5-2003.

THE MARK CONSISTS OF STANDARD CHARACTERS WITHOUT CLAIM TO ANY PARTICULAR FONT, STYLE, SIZE, OR COLOR.

SN 77-881,085, FILED 11-25-2009.

BRENDAN MCCAULEY, EXAMINING ATTORNEY



David J. Kybas

Director of the United States Patent and Trademark Office

United States of America

United States Patent and Trademark Office

STACKIN BILLS

Reg. No. 4,067,839

Registered Dec. 6, 2011

Int. Cl.: 25

TRADEMARK

PRINCIPAL REGISTER

STACKIN BILLS,LLC (TEXAS LIMITED LIABILITY COMPANY)
722 SOUTH BOLTON STREET
JACKSONVILLE, TX 75766

FOR: CLOTHING, FOOTWEAR, AND HEADGEAR, NAMELY, T-SHIRTS, SHIRTS, TURTLE-NECKS, SWEAT SHIRTS, WIND SHIRTS, COATS, RAIN WEAR, JACKETS, VESTS, HOODED SWEATSHIRTS, SWEATERS, PANTS, SHORTS, JUMPERS, SKIRTS, COVERALLS, OVERALLS, PARKAS, CLOTH BIBS, HATS, SOCKS, BOOTS, AND FISHING AND HUNTING WADERS FOR SPORTSMEN, ADULTS, CHILDREN, ATHLETES, HUNTERS, HIKERS OF ALL AGES, IN CLASS 25 (U.S. CLS. 22 AND 39).

FIRST USE 9-8-2011; IN COMMERCE 9-8-2011.

THE MARK CONSISTS OF STANDARD CHARACTERS WITHOUT CLAIM TO ANY PARTICULAR FONT, STYLE, SIZE, OR COLOR.

SN 77-881,317, FILED 11-26-2009.

LAURA KOVALSKY, EXAMINING ATTORNEY



David J. Kybas

Director of the United States Patent and Trademark Office

United States of America

United States Patent and Trademark Office

MOODSMART

Reg. No. 4,067,840

Registered Dec. 6, 2011

Int. Cl.: 5

TRADEMARK

PRINCIPAL REGISTER

LORNA VANDERHAEGHE HEALTH SOLUTIONS, INC. (CANADA CORPORATION),
FORMERLY HEADLINES PROMOTIONS LTD.,
400-353 WATER STREET
VANCOUVER, BC, CANADA V6B 1B8

FOR: DIETARY AND NUTRITIONAL SUPPLEMENTS, IN CLASS 5 (U.S. CLS. 6, 18, 44, 46,
51 AND 52).

FIRST USE 11-27-2009; IN COMMERCE 11-27-2009.

THE MARK CONSISTS OF STANDARD CHARACTERS WITHOUT CLAIM TO ANY PAR-
TICULAR FONT, STYLE, SIZE, OR COLOR.

SN 77-881,569, FILED 11-27-2009.

FLORENTINA BLANDU, EXAMINING ATTORNEY



David J. Kyffers

Director of the United States Patent and Trademark Office

United States of America

United States Patent and Trademark Office

MULTISMART

Reg. No. 4,067,841

Registered Dec. 6, 2011

Int. Cl.: 5

TRADEMARK

PRINCIPAL REGISTER

LORNA VANDERHAEGHE HEALTH SOLUTIONS, INC. (CANADA CORPORATION),
FORMERLY HEADLINES PROMOTIONS LTD.,
400-353 WATER STREET
VANCOUVER, BC, CANADA V6B 1B8

FOR: DIETARY AND NUTRITIONAL SUPPLEMENTS, IN CLASS 5 (U.S. CLS. 6, 18, 44, 46,
51 AND 52).

FIRST USE 11-27-2009; IN COMMERCE 11-27-2009.

THE MARK CONSISTS OF STANDARD CHARACTERS WITHOUT CLAIM TO ANY PAR-
TICULAR FONT, STYLE, SIZE, OR COLOR.

SN 77-881,574, FILED 11-27-2009.

FLORENTINA BLANDU, EXAMINING ATTORNEY



David J. Kyjars

Director of the United States Patent and Trademark Office

United States of America

United States Patent and Trademark Office

AMAZON TEMPLE

Reg. No. 4,067,842

Registered Dec. 6, 2011

Int. Cl.: 9

TRADEMARK

PRINCIPAL REGISTER

ARISTOCRAT TECHNOLOGIES AUSTRALIA PTY LTD. (AUSTRALIA CORPORATION)
85 EPPING ROAD
BUILDING A, PINNACLE OFFICE PARK
NORTH RYDE, NSW, AUSTRALIA 2113

FOR: ELECTRONIC GAMING MACHINES, NAMELY, DEVICES WHICH ACCEPT A WAGER;
ELECTRONIC GAMING MACHINES, NAMELY, DEVICES WHICH ACCEPT A WAGER, IN
CLASS 9 (U.S. CLS. 21, 23, 26, 36 AND 38).

FIRST USE 6-1-2011; IN COMMERCE 6-1-2011.

THE MARK CONSISTS OF STANDARD CHARACTERS WITHOUT CLAIM TO ANY PARTICULAR FONT, STYLE, SIZE, OR COLOR.

OWNER OF AUSTRALIA REG. NO. 1302079, DATED 6-2-2009, EXPIRES 6-2-2019.

OWNER OF U.S. REG. NO. 2,624,479.

SN 77-883,037, FILED 12-1-2009.

ELLEN BURNS, EXAMINING ATTORNEY



David J. Kyffers

Director of the United States Patent and Trademark Office

United States of America

United States Patent and Trademark Office

IF IT'S NOT ALLISON, IT'S
NOT OPTIMIZED.

Reg. No. 4,067,843

Registered Dec. 6, 2011

Int. Cls.: 12 and 37

TRADEMARK

SERVICE MARK

PRINCIPAL REGISTER

ALLISON TRANSMISSION, INC. (DELAWARE CORPORATION)
4700 WEST 10TH STREET
INDIANAPOLIS, IN 46222

FOR: DRIVETRAINS FOR MOTOR LAND VEHICLES, IN CLASS 12 (U.S. CLS. 19, 21, 23, 31, 35 AND 44).

FIRST USE 3-25-2010; IN COMMERCE 3-25-2010.

FOR: MAINTENANCE AND REPAIR OF DRIVETRAINS FOR LAND VEHICLES, IN CLASS 37 (U.S. CLS. 100, 103 AND 106).

FIRST USE 3-25-2010; IN COMMERCE 3-25-2010.

THE MARK CONSISTS OF STANDARD CHARACTERS WITHOUT CLAIM TO ANY PARTICULAR FONT, STYLE, SIZE, OR COLOR.

OWNER OF U.S. REG. NOS. 2,686,798, 3,678,354, AND OTHERS.

SN 77-883,585, FILED 12-1-2009.

MIDGE BUTLER, EXAMINING ATTORNEY



David J. Kyros

Director of the United States Patent and Trademark Office

United States of America

United States Patent and Trademark Office

GRACIE BULLYPROOF

Reg. No. 4,067,844

Registered Dec. 6, 2011

Int. Cl.: 9

TRADEMARK

PRINCIPAL REGISTER

GRACIE, RORION (UNITED STATES INDIVIDUAL)
C/O KOENIG & ASSOCIATES
920 GARDEN STREET, SUITE A
SANTA BARBARA, CA 93101

FOR: DOWNLOADABLE VIDEO RECORDINGS IN THE FIELDS OF SPORTS ENTERTAINMENT; DVDS FEATURING LIVE ACTION AND SPORTS ENTERTAINMENT; MOTION PICTURE FILMS AND DIGITALLY STORED MEDIA, NAMELY, PRERECORDED DVD'S FEATURING SPORTS; PRE-RECORDED AUDIO VIDEO DISC FEATURING ACTION, ADVENTURE, AND/OR SPORTS; PRE-RECORDED LASER DISKS AND DVDS FEATURING ACTION, ACTION-ADVENTURE, AND SPORTS ENTERTAINMENT; PRE-RECORDED OPTICAL DISCS FEATURING MARTIAL ARTS; PRE-RECORDED DIGITAL MATERIALS, NAMELY, DVDS, DOWNLOADABLE AUDIO AND VIDEO FILES, DIGITAL VIDEO DISCS, DIGITAL VERSATILE DISCS, DOWNLOADABLE AUDIO AND VIDEO RECORDINGS, DVDS, AND HIGH DEFINITION DIGITAL DISKS FEATURING ACTION, ADVENTURE, INSTRUCTIONAL TRAINING AND SPORTS; PRE-RECORDED DIGITAL MEDIA IN THE FIELDS OF ACTION, ADVENTURE, INSTRUCTIONAL TRAINING AND SPORTS; PRE-RECORDED DVDS FEATURING SPORTS, MIXED MARTIAL ARTS, AND RELATED EVENTS AND SPORTS PROGRAMMING; PRE-RECORDED PERFORMANCES FEATURING MIXED MARTIAL ARTS ON AUDIO AND VIDEO MEDIA, NAMELY, PRERECORDED DVD'S, LASER DISCS, AND COMPUTER DISCS FEATURING SPORTS AND MARTIAL ARTS PROGRAMS; PRE-RECORDED DIGITAL MEDIA, DIGITAL VIDEO DISCS, DIGITAL VERSATILE DISCS, AND DVD'S ALL FEATURING SPORTS, INSTRUCTIONAL, AND TRAINING PROGRAMS IN THE ART OF JIU-JITSU, MARTIAL ARTS, NON-LETHAL MARTIAL ARTS TECHNIQUES, SELF-DEFENSE, ATTACK PREVENTION, SEXUAL ASSAULT PREVENTION, PHYSICAL ATTACK ESCAPE TECHNIQUES, PERSONAL SAFETY, PHYSICAL EXERCISE AND EDUCATION, AND PHYSICAL FITNESS; PRE-RECORDED AUDIO/VIDEO DISCS FEATURING MIXED MARTIAL ARTS, COMMENTARIES, AND DOCUMENTARIES; PRERECORDED VIDEOS AND DVD'S FEATURING, INSTRUCTIONAL AND TRAINING PROGRAMS IN JIU-JITSU, MARTIAL ARTS, MARTIAL ARTS TECHNIQUES, ATTACK PREVENTION, ESCAPE TECHNIQUES, PHYSICAL EXERCISE AND EDUCATION, AND PHYSICAL FITNESS; RECORDED DVDS AND VIDEO DISCS IN THE FIELD OF MARTIAL ARTS; VIDEO RECORDINGS FEATURING SPORTS, MIXED MARTIAL ARTS, SPORTS EVENTS AND SPORTS PROGRAMMING, IN CLASS 9 (U.S. CLS. 21, 23, 26, 36 AND 38).



David J. Kappas

FIRST USE 10-31-2010; IN COMMERCE 10-31-2010.

Reg. No. 4,067,844 THE MARK CONSISTS OF STANDARD CHARACTERS WITHOUT CLAIM TO ANY PARTICULAR FONT, STYLE, SIZE, OR COLOR.

OWNER OF U.S. REG. NOS. 1,570,322, 3,573,305, AND OTHERS.

SN 77-883,726, FILED 12-1-2009.

KATHRYN COWARD, EXAMINING ATTORNEY

United States of America

United States Patent and Trademark Office

 Twitten



Reg. No. 4,067,845

Registered Dec. 6, 2011

Int. Cl.: 25

TRADEMARK

PRINCIPAL REGISTER

TWITTEN, LLC (NEW MEXICO LIMITED LIABILITY COMPANY)
322 READ ST
SANTA FE, NM 87501

FOR: MITTENS, IN CLASS 25 (U.S. CLS. 22 AND 39).

FIRST USE 2-1-2010; IN COMMERCE 7-25-2010.

OWNER OF U.S. REG. NO. 3,603,438.

THE MARK CONSISTS OF THE WORD "TWITTEN". TO THE LEFT OF THE WORDING IS THE DESIGN OF SWIRLS SURROUNDED BY AN OVAL. BELOW THE WORDING IS THE DESIGN OF TWO INCOMPLETE ARMS, ONE OF WHICH IS DEPICTED WITH A CUFFED SHIRT. THE HANDS ARE DRESSED IN MITTENS. CURVED LINES APPEAR BELOW THE HANDS SIMULATING MOTION.

SN 77-886,203, FILED 12-4-2009.

MATTHEW KLINE, EXAMINING ATTORNEY



David J. Kybas

Director of the United States Patent and Trademark Office

United States of America

United States Patent and Trademark Office

FRESH GOURMET

Reg. No. 4,067,846

Registered Dec. 6, 2011

Int. Cl.: 29

TRADEMARK

PRINCIPAL REGISTER

SUGAR FOODS CORPORATION (NEW YORK CORPORATION)
950 THIRD AVENUE
NEW YORK, NY 10022

FOR: PREPARED SEAFOOD IN CUBED SHAPES RESEMBLING CROUTONS, FOR USE PRIMARILY AS A SALAD TOPPING; PREPARED FISH IN CUBED SHAPES RESEMBLING CROUTONS, FOR USE PRIMARILY AS A SALAD TOPPING , IN CLASS 29 (U.S. CL. 46).

FIRST USE 3-15-2011; IN COMMERCE 3-15-2011.

THE MARK CONSISTS OF STANDARD CHARACTERS WITHOUT CLAIM TO ANY PARTICULAR FONT, STYLE, SIZE, OR COLOR.

SEC. 2(F).

OWNER OF U.S. REG. NO. 2,496,296.

SN 77-887,301, FILED 12-7-2009.

TOBY BULLOFF, EXAMINING ATTORNEY



David J. Kyffers

Director of the United States Patent and Trademark Office

United States of America

United States Patent and Trademark Office

TOP GUN

Reg. No. 4,067,847

Registered Dec. 6, 2011

Int. Cl.: 5

TRADEMARK

PRINCIPAL REGISTER

LOVELAND PRODUCTS, INC. (COLORADO CORPORATION)
3005 ROCKY MOUNTAIN AVENUE
LOVELAND, CO 80538

FOR: PESTICIDES, NAMELY, HERBICIDES FOR AGRICULTURAL AND COMMERCIAL USE, IN CLASS 5 (U.S. CLS. 6, 18, 44, 46, 51 AND 52).

FIRST USE 3-24-2011; IN COMMERCE 3-24-2011.

THE MARK CONSISTS OF STANDARD CHARACTERS WITHOUT CLAIM TO ANY PARTICULAR FONT, STYLE, SIZE, OR COLOR.

OWNER OF U.S. REG. NO. 2,510,769.

SN 77-888,788, FILED 12-8-2009.

SETH A. RAPPAPORT, EXAMINING ATTORNEY



David J. Kybas

Director of the United States Patent and Trademark Office

United States of America

United States Patent and Trademark Office

OSTEOSMART

Reg. No. 4,067,848

LORNA VANDERHAEGHE HEALTH SOLUTIONS, INC. (CANADA CORPORATION)
400-353 WATER STREET
VANCOUVER, BC, CANADA V6B 1B8

Registered Dec. 6, 2011

Int. Cl.: 5

FOR: DIETARY AND NUTRITIONAL SUPPLEMENTS, IN CLASS 5 (U.S. CLS. 6, 18, 44, 46, 51 AND 52).

TRADEMARK

FIRST USE 12-9-2009; IN COMMERCE 12-9-2009.

PRINCIPAL REGISTER

THE MARK CONSISTS OF STANDARD CHARACTERS WITHOUT CLAIM TO ANY PARTICULAR FONT, STYLE, SIZE, OR COLOR.

SN 77-889,493, FILED 12-9-2009.

FLORENTINA BLANDU, EXAMINING ATTORNEY



David J. Kyros

Director of the United States Patent and Trademark Office

United States of America

United States Patent and Trademark Office

DINING OUT FOR EQUALITY

Reg. No. 4,067,849

EQUALITY ILLINOIS (ILLINOIS CORPORATION)
3318 N. HALSTED STREET
CHICAGO, IL 60657

Registered Dec. 6, 2011

Int. Cl.: 36

FOR: CHARITABLE FUND RAISING SERVICES, IN CLASS 36 (U.S. CLS. 100, 101 AND 102).

SERVICE MARK

FIRST USE 9-0-2011; IN COMMERCE 9-0-2011.

PRINCIPAL REGISTER

THE MARK CONSISTS OF STANDARD CHARACTERS WITHOUT CLAIM TO ANY PARTICULAR FONT, STYLE, SIZE, OR COLOR.

SN 77-892,202, FILED 12-13-2009.

MARGERY A. TIERNEY, EXAMINING ATTORNEY



David J. Kybas

Director of the United States Patent and Trademark Office

United States of America

United States Patent and Trademark Office

SERVE YOURSELF WELL

Reg. No. 4,067,850

Registered Dec. 6, 2011

Int. Cl.: 43

SERVICE MARK

PRINCIPAL REGISTER

RMI FROZEN YOGURT, LLC (CALIFORNIA LIMITED LIABILITY COMPANY)
2811 MCKINNEY AVENUE, SUITE 18
DALLAS, TX 75204

FOR: SERVING OF FOOD AND DRINK/BEVERAGES AT RESTAURANTS, CAFES AND DRINK BARS; RESTAURANT, CAFE, DRINK AND YOGURT BAR SERVICES , IN CLASS 43 (U.S. CLS. 100 AND 101).

FIRST USE 4-0-2010; IN COMMERCE 4-0-2010.

THE MARK CONSISTS OF STANDARD CHARACTERS WITHOUT CLAIM TO ANY PARTICULAR FONT, STYLE, SIZE, OR COLOR.

OWNER OF U.S. REG. NO. 3,493,577.

SN 77-892,939, FILED 12-14-2009.

SALLY SHIH, EXAMINING ATTORNEY



David J. Kyros

Director of the United States Patent and Trademark Office

United States of America

United States Patent and Trademark Office

YAK PAK

Reg. No. 4,067,851

ACCESSORY NETWORK GROUP, LLC (NEW YORK LIMITED LIABILITY COMPANY)
350 FIFTH AVENUE
NEW YORK, NY 10001

Registered Dec. 6, 2011

Int. Cls.: 16, 18, 20, and 21

FOR: COMPOSITION BOOKS; FITTED FABRIC NOTEBOOK COVERS; FOLDERS; NOTEBOOKS; STATIONERY, IN CLASS 16 (U.S. CLS. 2, 5, 22, 23, 29, 37, 38 AND 50).

FIRST USE 5-0-2010; IN COMMERCE 5-0-2010.

TRADEMARK

FOR: BEACH UMBRELLAS; PATIO UMBRELLAS; UMBRELLAS, IN CLASS 18 (U.S. CLS. 1, 2, 3, 22 AND 41).

PRINCIPAL REGISTER

FIRST USE 1-1-1990; IN COMMERCE 1-1-1990.

FOR: CHAIRS, IN CLASS 20 (U.S. CLS. 2, 13, 22, 25, 32 AND 50).

FIRST USE 6-0-2008; IN COMMERCE 6-0-2008.

FOR: INSULATED BAGS FOR FOOD OR BEVERAGE FOR DOMESTIC USE; INSULATED CONTAINERS FOR BEVERAGE CANS FOR DOMESTIC USE; INSULATED CONTAINERS FOR FOOD OR BEVERAGE FOR DOMESTIC USE; INSULATING SLEEVE HOLDER FOR BEVERAGE CUPS; INSULATING SLEEVE HOLDERS FOR BEVERAGE CANS; LUNCH BOXES; PORTABLE COOLERS; SPORTS BOTTLES SOLD EMPTY; THERMAL INSULATED BAGS FOR FOOD OR BEVERAGES; THERMAL INSULATED CONTAINERS FOR FOOD OR BEVERAGE, IN CLASS 21 (U.S. CLS. 2, 13, 23, 29, 30, 33, 40 AND 50).

FIRST USE 5-0-2011; IN COMMERCE 5-0-2011.

THE MARK CONSISTS OF STANDARD CHARACTERS WITHOUT CLAIM TO ANY PARTICULAR FONT, STYLE, SIZE, OR COLOR.

OWNER OF U.S. REG. NOS. 1,727,613, 2,327,571, AND 3,643,385.

NO CLAIM IS MADE TO THE EXCLUSIVE RIGHT TO USE "PACK", APART FROM THE MARK AS SHOWN.

SN 77-894,355, FILED 12-16-2009.



David J. Kyros

Director of the United States Patent and Trademark Office

Reg. No. 4,067,851 ARETHA SOMERVILLE, EXAMINING ATTORNEY

United States of America

United States Patent and Trademark Office

ARISTOCRAT ALL STARS

Reg. No. 4,067,852

Registered Dec. 6, 2011

Int. Cl.: 9

TRADEMARK

PRINCIPAL REGISTER

ARISTOCRAT TECHNOLOGIES AUSTRALIA PTY LTD. (AUSTRALIA CORPORATION)
BUILDING A, PINNACLE OFFICE PARK
85 EPPING ROAD
NORTH RYDE, NSW, AUSTRALIA 2113

FOR: ELECTRONIC GAMING MACHINES, NAMELY, DEVICES WHICH ACCEPT A WAGER;
ELECTRONIC GAMING MACHINES, NAMELY, DEVICES WHICH ACCEPT A WAGER, IN
CLASS 9 (U.S. CLS. 21, 23, 26, 36 AND 38).

FIRST USE 6-1-2011; IN COMMERCE 6-1-2011.

THE MARK CONSISTS OF STANDARD CHARACTERS WITHOUT CLAIM TO ANY PAR-
TICULAR FONT, STYLE, SIZE, OR COLOR.

PRIORITY CLAIMED UNDER SEC. 44(D) ON AUSTRALIA APPLICATION NO. 1306267,
FILED 6-25-2009, REG. NO. 1306267, DATED 6-25-2009, EXPIRES 6-25-2019.

OWNER OF U.S. REG. NOS. 2,682,133 AND 2,787,810.

SN 77-894,700, FILED 12-16-2009.

ELLEN BURNS, EXAMINING ATTORNEY



David J. Kybas

Director of the United States Patent and Trademark Office

United States of America

United States Patent and Trademark Office

RECOGNIZE THE MOMENT

Reg. No. 4,067,853

Registered Dec. 6, 2011

Int. Cl.: 41

SERVICE MARK

PRINCIPAL REGISTER

HUHTAMAKI, INC. (KANSAS CORPORATION)
9201 PACKAGING DRIVE
DESOTO, KS 66018

FOR: PROVIDING AN ON-LINE PUBLICATION IN THE NATURE OF A NEWSLETTER IN THE FIELD OF NAPKINS, DISPOSABLE DINNERWARE, NAMELY, PLATES AND CUPS, IN CLASS 41 (U.S. CLS. 100, 101 AND 107).

FIRST USE 11-0-2009; IN COMMERCE 11-0-2009.

THE MARK CONSISTS OF STANDARD CHARACTERS WITHOUT CLAIM TO ANY PARTICULAR FONT, STYLE, SIZE, OR COLOR.

SN 77-895,044, FILED 12-16-2009.

TARA PATE, EXAMINING ATTORNEY



David J. Kybas

Director of the United States Patent and Trademark Office

United States of America

United States Patent and Trademark Office

Geekosystem

Reg. No. 4,067,854

Registered Dec. 6, 2011

Int. Cl.: 35

SERVICE MARK

PRINCIPAL REGISTER

GEEKOSYSTEM (NEW YORK LIMITED LIABILITY COMPANY)
584 BROADWAY SUITE 510
NEW YORK, NY 10012

FOR: PROVIDING A WEBSITE THAT FEATURES CONSUMER INFORMATION ABOUT NEW PRODUCTS, NAMELY, HIGH TECH GADGETS, IN CLASS 35 (U.S. CLS. 100, 101 AND 102).

FIRST USE 1-25-2010; IN COMMERCE 1-25-2010.

THE MARK CONSISTS OF STANDARD CHARACTERS WITHOUT CLAIM TO ANY PARTICULAR FONT, STYLE, SIZE, OR COLOR.

SN 77-895,123, FILED 12-16-2009.

JAMES A. RAUEN, EXAMINING ATTORNEY



David J. Kybas

Director of the United States Patent and Trademark Office

United States of America

United States Patent and Trademark Office

SCHWAB ADVISOR UNIVERSITY

Reg. No. 4,067,855

Registered Dec. 6, 2011

Int. Cl.: 41

SERVICE MARK

PRINCIPAL REGISTER

CHARLES SCHWAB & CO., INC. (CALIFORNIA CORPORATION)
211 MAIN STREET
SAN FRANCISCO, CA 94105

FOR: EDUCATIONAL SERVICES, NAMELY, PROVIDING ONLINE TRAINING SESSIONS FOR INVESTMENT ADVISORS IN THE FIELDS OF PRACTICE MANAGEMENT, FINANCIAL SOFTWARE, TRADING AND ANALYSIS OF INVESTMENTS, FINANCES AND FINANCIAL PLANNING, IN CLASS 41 (U.S. CLS. 100, 101 AND 107).

FIRST USE 6-16-2010; IN COMMERCE 6-16-2010.

THE MARK CONSISTS OF STANDARD CHARACTERS WITHOUT CLAIM TO ANY PARTICULAR FONT, STYLE, SIZE, OR COLOR.

OWNER OF U.S. REG. NOS. 2,316,505, 3,130,550, AND OTHERS.

NO CLAIM IS MADE TO THE EXCLUSIVE RIGHT TO USE "ADVISOR", APART FROM THE MARK AS SHOWN.

SN 77-895,823, FILED 12-17-2009.

B. PARADEWELAI, EXAMINING ATTORNEY



David J. Kyffers

Director of the United States Patent and Trademark Office

United States of America

United States Patent and Trademark Office

MedContour

Reg. No. 4,067,856

Registered Dec. 6, 2011

Int. Cl.: 10

TRADEMARK

PRINCIPAL REGISTER

GENERAL PROJECT S.R.L. (ITALY LIMITED LIABILITY COMPANY)
VIA DELLA GORA, 15/13
MONTESPERTOLI, ITALY

FOR: ELECTROMEDICAL INSTRUMENTS, NAMELY, LASERS FOR THE COSMETIC TREATMENT FOR THE SKIN AND LASERS FOR MEDICAL AND AESTHETIC USE; CONVENTIONAL SURGICAL AND ULTRASOUND APPARATUS FOR LOCALIZED WEIGHT LOSS, TREATMENT OF CELLULITE AND LOCALIZED OBESITY, LIPOSCULPTURE, STRETCH MARK AND MASSAGE THERAPIES, NAMELY, ULTRASOUND PROBE FOR MEDICAL USE, MEDICAL X-RAY APPARATUS, PHOTOTHERAPEUTIC APPARATUS FOR MEDICAL PURPOSES, ULTRASONIC MEDICAL DIAGNOSTIC APPARATUS; COMPUTERIZED INSTRUMENTS FOR AESTHETIC TREATMENT OF THE BODY, NAMELY, APPARATUS FOR DISPENSING NON-MEDICAL OXYGEN AND AROMATHERAPY THAT ALSO UTILIZES LIGHT, SOUND AND VIBRATION FOR RELAXATION THERAPY; STRUCTURAL AND REPLACEMENT PARTS FOR ALL THE AFORESAID PRODUCTS; ALL OF THE AFORESAID PRODUCTS WITH THE EXCLUSION OF MEDICAL APPARATUS FOR THE DIAGNOSIS, MANAGEMENT AND TREATMENT OF DIABETES, IN CLASS 10 (U.S. CLS. 26, 39 AND 44).

FIRST USE 6-20-2008; IN COMMERCE 5-27-2010.

NO CLAIM IS MADE TO THE EXCLUSIVE RIGHT TO USE "MED", APART FROM THE MARK AS SHOWN.

THE MARK CONSISTS OF THE WORDS "MED CONTOUR" WITH AN ARROW POINTING DOWN INTO THE SECOND "O" IN "CONTOUR" WITH TWO SMALLER SOLID CIRCLES BENEATH THAT SAME "O".

SN 77-895,893, FILED 12-17-2009.

LINDSEY RUBIN, EXAMINING ATTORNEY



David J. Kybas

Director of the United States Patent and Trademark Office

United States of America

United States Patent and Trademark Office

PROTEXURE

Reg. No. 4,067,857

Registered Dec. 6, 2011

Int. Cl.: 36

SERVICE MARK

PRINCIPAL REGISTER

AMERINST PROFESSIONAL SERVICES, LIMITED (DELAWARE CORPORATION)
SUITE 102
4200 COMMERCE COURT
LISLE, IL 60532

FOR: INSURANCE SERVICES, NAMELY, ISSUING AND ADMINISTERING INSURANCE POLICIES; INSURANCE BROKERAGE; INSURANCE UNDERWRITING OF PROFESSIONALS AND PROFESSIONAL SERVICES FIRMS IN THE FIELDS OF CASUALTY, IN CLASS 36 (U.S. CLS. 100, 101 AND 102).

FIRST USE 3-31-2010; IN COMMERCE 3-31-2010.

THE MARK CONSISTS OF STANDARD CHARACTERS WITHOUT CLAIM TO ANY PARTICULAR FONT, STYLE, SIZE, OR COLOR.

SN 77-900,063, FILED 12-23-2009.

BERNICE MIDDLETON, EXAMINING ATTORNEY



David J. Kybas

Director of the United States Patent and Trademark Office

United States of America

United States Patent and Trademark Office

THE PERFECT RUG

Reg. No. 4,067,858

Registered Dec. 6, 2011

Int. Cls.: 27 and 35

TRADEMARK

SERVICE MARK

PRINCIPAL REGISTER

CALIFORNIA CARPET LLC (DELAWARE LIMITED LIABILITY COMPANY)
1197 FOLSOM STREET
SAN FRANCISCO, CA 94103

FOR: CARPET PADDING; CARPET UNDERLAYS; CARPETS AND RUGS, IN CLASS 27 (U.S. CLS. 19, 20, 37, 42 AND 50).

FIRST USE 3-19-2010; IN COMMERCE 3-19-2010.

FOR: ON-LINE RETAIL STORE SERVICES FEATURING CARPETS, RUGS, CARPET PADDING, CARPET UNDERLAYS AND ACCESSORIES, IN CLASS 35 (U.S. CLS. 100, 101 AND 102).

FIRST USE 3-19-2010; IN COMMERCE 3-19-2010.

THE MARK CONSISTS OF STANDARD CHARACTERS WITHOUT CLAIM TO ANY PARTICULAR FONT, STYLE, SIZE, OR COLOR.

NO CLAIM IS MADE TO THE EXCLUSIVE RIGHT TO USE "RUG", APART FROM THE MARK AS SHOWN.

SN 77-900,851, FILED 12-24-2009.

KATHERINE STOIDES, EXAMINING ATTORNEY



David J. Kyros

Director of the United States Patent and Trademark Office

United States of America

United States Patent and Trademark Office



Reg. No. 4,067,859

Registered Dec. 6, 2011

Int. Cls.: 39 and 43

SERVICE MARK

PRINCIPAL REGISTER

CRYSTAL ROCK LLC (DELAWARE LIMITED LIABILITY COMPANY)
1050 BUCKINGHAM STREET
WATERTOWN, CT 06795

FOR: DELIVERY OF GOODS TO OFFICES, NAMELY, SUPPLYING UTENSILS AND TABLEWARE MADE OF PAPER, FOAM, OR PLASTIC, IN CLASS 39 (U.S. CLS. 100 AND 105).

FIRST USE 5-0-2010; IN COMMERCE 5-0-2010.

FOR: CATERING SERVICES FOR OFFICES, NAMELY, SUPPLYING BEVERAGES AND SNACKS; RENTAL OF FOOD AND BEVERAGE SERVICES EQUIPMENT, IN CLASS 43 (U.S. CLS. 100 AND 101).

FIRST USE 5-0-2010; IN COMMERCE 5-0-2010.

THE MARK CONSISTS OF A DEPICTION OF A COFFEE BEAN MARKED WITH THE LETTER "B" ENCIRCLING THE LETTER "C".

SN 77-902,569, FILED 12-30-2009.

ELLEN PERKINS, EXAMINING ATTORNEY



David J. Kybas

Director of the United States Patent and Trademark Office

United States of America

United States Patent and Trademark Office

CNC

Certified
Nonprofit
Consultant

Reg. No. 4,067,860

Registered Dec. 6, 2011

Int. Cl.: 35

SERVICE MARK

PRINCIPAL REGISTER

JAMES P. LAROSE (UNITED STATES INDIVIDUAL)
711 E. MAIN STREET
WEST COLUMBIA, SC 29170

FOR: BUSINESS CONSULTATION SERVICES TO ASSIST NON-PROFIT ORGANIZATIONS IN PLANNING, MANAGING, AND CONDUCTING FUND RAISING ACTIVITIES VIA A GLOBAL COMPUTER NETWORK; BUSINESS SUPPORT SERVICES, NAMELY, BUSINESS CONSULTING TO FREELANCERS, START-UPS, EXISTING BUSINESSES AND NON-PROFIT ORGANIZATIONS, IN CLASS 35 (U.S. CLS. 100, 101 AND 102).

FIRST USE 1-1-2010; IN COMMERCE 1-1-2010.

NO CLAIM IS MADE TO THE EXCLUSIVE RIGHT TO USE "CERTIFIED NONPROFIT CONSULTANT", APART FROM THE MARK AS SHOWN.

THE COLOR(S) NAVY BLUE IS/ARE CLAIMED AS A FEATURE OF THE MARK.

THE MARK CONSISTS OF THE LETTERS "CNC" AND THE WORDING "CERTIFIED NONPROFIT CONSULTANT", WITH ALL LETTERING AND WORDING APPEARING IN NAVY BLUE.

SN 77-904,092, FILED 1-4-2010.

DAVID ELTON, EXAMINING ATTORNEY



David J. Kyros

Director of the United States Patent and Trademark Office

United States of America

United States Patent and Trademark Office

MOTY DESIGNS

Reg. No. 4,067,861

Registered Dec. 6, 2011

Int. Cl.: 25

TRADEMARK

PRINCIPAL REGISTER

O'BRIEN, KELLI R. (UNITED STATES INDIVIDUAL), DBA MOTY DESIGNS,
SUITE 3
167 MARLBOROUGH STREET
BOSTON, MA 02116

FOR: ATHLETIC APPAREL, NAMELY, SHIRTS, PANTS, JACKETS, FOOTWEAR, HATS AND CAPS, ATHLETIC UNIFORMS; BABY TOPS; BANDANAS; BASEBALL CAPS; BERMUDA SHORTS; BIBS NOT OF PAPER; BOXER BRIEFS; BOXER SHORTS; CAMP SHIRTS; CAP VISORS; CAPRI PANTS; CAPS; CAPS WITH VISORS; CHILDREN'S AND INFANT'S APPAREL, NAMELY, JUMPERS, OVERALL SLEEPWEAR, PAJAMAS, ROMPERS AND ONE-PIECE GARMENTS; CHILDREN'S AND INFANTS' CLOTH BIBS; CHILDREN'S CLOTH EATING BIBS; CHILDREN'S HEADWEAR; CROP TOPS; DENIM JACKETS; FLEECE PULLOVERS; FLEECE SHORTS; FLEECE VESTS; FLIP FLOPS; GOLF CAPS; GOLF SHIRTS; GYM SHORTS; HATS; HATS FOR INFANTS, BABIES, TODDLERS AND CHILDREN; HEAD WEAR; HOODED PULLOVERS; HOODED SWEAT SHIRTS; INFANT AND TODDLER ONE PIECE CLOTHING; INFANT SLEEPERS; INFANT WEAR; INFANTWEAR; LONG SLEEVE PULLOVERS; LONG SLEEVED VESTS; LONG-SLEEVED SHIRTS; LOUNGE PANTS; LOUNGEWEAR; MUSCLE TOPS; NIGHT SHIRTS; NIGHTIES; ONE-PIECE PLAY SUITS; OPEN-NECKED SHIRTS; PAJAMA BOTTOMS; PAJAMAS; PANTALOONS; PULLOVERS; SHIRTS; SHIRTS AND SHORT-SLEEVED SHIRTS; SHIRTS FOR INFANTS, BABIES, TODDLERS AND CHILDREN; SHORT SETS; SHORT-SLEEVED OR LONG-SLEEVED T-SHIRTS; SHORT-SLEEVED SHIRTS; SHORTS; SINGLET; SLEEP SHIRTS; SLEEPING GARMENTS; SLEEPWEAR; SLEEVED OR SLEEVELESS JACKETS; SLEEVELESS JERSEYS; SWEAT BANDS; SWEAT PANTS; SWEAT SHIRTS; SWEAT SHORTS; SWEAT SUITS; SWEATBANDS; T-SHIRTS; TANK TOPS; TANK-TOPS; TANKINIS; TAP PANTS; TEE SHIRTS; TOPS; TUBE TOPS; VISORS; WARM UP SUITS; WRIST BANDS; WRISTBANDS; YOGA PANTS; YOGA SHIRTS, IN CLASS 25 (U.S. CLS. 22 AND 39).



FIRST USE 4-1-2010; IN COMMERCE 4-1-2010.

THE MARK CONSISTS OF STANDARD CHARACTERS WITHOUT CLAIM TO ANY PARTICULAR FONT, STYLE, SIZE, OR COLOR.

NO CLAIM IS MADE TO THE EXCLUSIVE RIGHT TO USE "DESIGNS", APART FROM THE MARK AS SHOWN.

SN 77-904,374, FILED 1-4-2010.

David J. Kyros

Director of the United States Patent and Trademark Office

Reg. No. 4,067,861 SUNG IN, EXAMINING ATTORNEY

United States of America

United States Patent and Trademark Office

NO CUTS! NO GLORY!

Reg. No. 4,067,862

Registered Dec. 6, 2011

Int. Cl.: 37

SERVICE MARK

PRINCIPAL REGISTER

NORSE CUTTING & ABANDONMENT, INC. (TEXAS CORPORATION)
C/O LEGAL DEPARTMENT
11917 FM 529
HOUSTON, TX 77041

FOR: REPAIR AND MAINTENANCE OF OFFSHORE INSTALLATIONS, REFINERIES, POWER/HYDRAULIC PLANTS AND FABRICATION YARDS; OIL AND GAS WELL DE-COMMISSIONING SERVICES, NAMELY, RIGLESS PLUG AND ABANDONMENT OF OIL AND GAS WELLS; REMOVAL OF OFFSHORE INSTALLATIONS, IN CLASS 37 (U.S. CLS. 100, 103 AND 106).

FIRST USE 9-15-2011; IN COMMERCE 9-15-2011.

THE MARK CONSISTS OF STANDARD CHARACTERS WITHOUT CLAIM TO ANY PARTICULAR FONT, STYLE, SIZE, OR COLOR.

SN 77-905,054, FILED 1-5-2010.

BARBARA BROWN, EXAMINING ATTORNEY



David J. Kybas

Director of the United States Patent and Trademark Office

United States of America

United States Patent and Trademark Office

EVENSPIN VIBRATION CONTROL

Reg. No. 4,067,863

Registered Dec. 6, 2011

Int. Cl.: 7

TRADEMARK

PRINCIPAL REGISTER

MAYTAG PROPERTIES, LLC (MICHIGAN LIMITED LIABILITY COMPANY)
500 RENAISSANCE DRIVE
SUITE 101
ST. JOSEPH, MI 49085

FOR: WASH BASKET STABILIZERS FOR REDUCED VIBRATION AND NOISE DURING THE WASH CYCLE, SOLD AS AN INTEGRAL COMPONENT OF CLOTHES WASHING MACHINES, IN CLASS 7 (U.S. CLS. 13, 19, 21, 23, 31, 34 AND 35).

FIRST USE 4-1-2011; IN COMMERCE 4-1-2011.

THE MARK CONSISTS OF STANDARD CHARACTERS WITHOUT CLAIM TO ANY PARTICULAR FONT, STYLE, SIZE, OR COLOR.

NO CLAIM IS MADE TO THE EXCLUSIVE RIGHT TO USE "VIBRATION CONTROL", APART FROM THE MARK AS SHOWN.

SN 77-906,674, FILED 1-7-2010.

MATTHEW PAPPAS, EXAMINING ATTORNEY



David J. Kypas

Director of the United States Patent and Trademark Office

United States of America

United States Patent and Trademark Office

MATE

Reg. No. 4,067,864

Registered Dec. 6, 2011

Int. Cl.: 3

TRADEMARK

PRINCIPAL REGISTER

MELALEUCA, INC. (IDAHO CORPORATION)
3910 S. YELLOWSTONE HWY.
ATTN: LEGAL DEPT.
IDAHO FALLS, ID 83402

FOR: COLOGNE, IN CLASS 3 (U.S. CLS. 1, 4, 6, 50, 51 AND 52).

FIRST USE 10-1-2011; IN COMMERCE 10-1-2011.

THE MARK CONSISTS OF STANDARD CHARACTERS WITHOUT CLAIM TO ANY PARTICULAR FONT, STYLE, SIZE, OR COLOR.

OWNER OF U.S. REG. NOS. 1,575,949 AND 2,393,607.

SN 77-907,287, FILED 1-7-2010.

HENRY S. ZAK, EXAMINING ATTORNEY



David J. Kybas

Director of the United States Patent and Trademark Office

United States of America

United States Patent and Trademark Office

Go Groove Move

Reg. No. 4,067,865

Registered Dec. 6, 2011

Int. Cl.: 9

TRADEMARK

PRINCIPAL REGISTER

BRIGHT IDEAS, INC (CALIFORNIA CORPORATION)
30242 BELMONT COURT
AGOURA HILLS, CA 91301

FOR: BATTERY CHARGING DOCK FOR MP3 PLAYERS; SPEAKERS FOR MP3 PLAYERS,
IN CLASS 9 (U.S. CLS. 21, 23, 26, 36 AND 38).

FIRST USE 1-1-2010; IN COMMERCE 1-1-2010.

THE MARK CONSISTS OF STANDARD CHARACTERS WITHOUT CLAIM TO ANY PAR-
TICULAR FONT, STYLE, SIZE, OR COLOR.

SN 77-908,962, FILED 1-11-2010.

MICHELLE DUBOIS, EXAMINING ATTORNEY



David J. Kybas

Director of the United States Patent and Trademark Office

United States of America

United States Patent and Trademark Office

D&W FINE PACK

Reg. No. 4,067,866

D&W FINE PACK LLC (DELAWARE LIMITED LIABILITY COMPANY)
1372 N. OLD LAURENS ROAD
FOUNTAIN INN, SC 29644

Registered Dec. 6, 2011

**Int. Cls.: 6, 8, 16, 20, 21,
and 42**

FOR: METAL FOIL FOR USE IN FOOD SERVICE; METAL FOOD CONTAINERS FOR COMMERCIAL USE, IN CLASS 6 (U.S. CLS. 2, 12, 13, 14, 23, 25 AND 50).

FIRST USE 10-10-2011; IN COMMERCE 10-10-2011.

TRADEMARK

FOR: DISPOSABLE PRODUCTS FOR THE FOOD SERVICE INDUSTRY, NAMELY, CUTLERY, NAMELY, KNIVES, FORKS AND SPOONS; DISPOSABLE PRODUCTS FOR THE FOOD SERVICE INDUSTRY, NAMELY, DINNER KITS CONSISTING PRIMARILY OF PRE-PACKAGED CUTLERY COMPRISING, KNIVES, FORKS AND SPOONS, INCLUDING A NAPKIN, CONDIMENTS AND PACKETS OF SKIN CLEANSER WIPES, IN CLASS 8 (U.S. CLS. 23, 28 AND 44).

SERVICE MARK

FIRST USE 10-10-2011; IN COMMERCE 10-10-2011.

PRINCIPAL REGISTER

FOR: DISPOSABLE PRODUCTS FOR THE FOOD SERVICE INDUSTRY, NAMELY, PAPER BAKING PAN LINERS AND PAPER AND CARDBOARD FOOD CONTAINERS FOR TAKE-OUT AND MADE TO ORDER FOODS; DISPOSABLE, BIODEGRADABLE FIBER PULP PRODUCTS FOR THE FOOD SERVICE INDUSTRY, NAMELY, CONTAINERS; DISPOSABLE PRODUCTS FOR USE WITH COFFEE BEVERAGES, NAMELY, PAPER NAPKINS, IN CLASS 16 (U.S. CLS. 2, 5, 22, 23, 29, 37, 38 AND 50).

FIRST USE 10-10-2011; IN COMMERCE 10-10-2011.



David J. Kyros

Director of the United States Patent and Trademark Office

FOR: PLASTIC CONTAINERS FOR COMMERCIAL USE, NAMELY, FOR STORING AND DISPENSING BULK FOODS; PLASTIC CONTAINERS AND COVERS FOR COMMERCIAL USE, NAMELY, FOR THE FOOD INDUSTRY; PLASTIC CONTAINERS AND COVERS SOLD AS A UNIT TO THE FOOD INDUSTRY FOR MADE TO ORDER FOOD PRODUCTS; DISPOSABLE PRODUCTS FOR THE FOOD SERVICE INDUSTRY, NAMELY, DRINKING STRAWS AND PIZZA SAVERS, NAMELY, SPACERS MADE OF PLASTIC FOR USE IN PREVENTING FOOD CONTAINERS FROM CONTACTING OR CRUSHING FOOD; COMMERCIAL PACKAGING MATERIALS, NAMELY, DISPOSABLE PRODUCTS FOR THE FOOD SERVICE INDUSTRY, NAMELY, FOAM CONTAINERS FOR TAKE-OUT AND MADE TO ORDER FOODS; PLASTIC BOXES; DISPOSABLE PRODUCTS FOR THE FOOD SERVICE INDUSTRY,

Reg. No. 4,067,866 NAMELY, FOAM CONTAINERS FOR COMMERCIAL USE; DISPOSABLE PRODUCTS FOR THE FOOD SERVICE INDUSTRY, NAMELY, PLASTIC FOOD CONTAINERS FOR TAKE-OUT AND MADE TO ORDER FOODS, IN CLASS 20 (U.S. CLS. 2, 13, 22, 25, 32 AND 50).

FIRST USE 10-10-2011; IN COMMERCE 10-10-2011.

FOR: DISPOSABLE FOAM FOOD SERVING TRAYS; DISPOSABLE FOAM FOOD SERVING TRAYS SOLD IN COMBINATION WITH DISPOSABLE TABLEWARE, NAMELY, SPORKS, FORKS, SPOONS, KNIVES, DRINKING STRAWS, AND/OR PAPER NAPKINS; DISPOSABLE, BIODEGRADABLE PRODUCTS FOR THE FOOD SERVICE INDUSTRY, NAMELY, PLATES, BOWLS, TRAYS; DISPOSABLE FOAM TABLEWARE, NAMELY, PLATES, CUPS, BOWLS AND SERVING TRAYS; DISPOSABLE PRODUCTS FOR USE WITH COFFEE BEVERAGES, NAMELY, BEVERAGE STIRRERS; DISPOSABLE PRODUCTS FOR THE FOOD SERVICE INDUSTRY, NAMELY, FOAM PLATES, BOWLS AND TRAYS; DISPOSABLE PRODUCTS FOR THE FOOD SERVICE INDUSTRY, NAMELY, PLATES, BOWLS AND TRAYS; DISPOSABLE, BIODEGRADABLE FIBER PULP PRODUCTS FOR THE FOOD SERVICE INDUSTRY, NAMELY, PLATES, BOWLS AND TRAYS; COMMERCIAL PACKAGING MATERIALS, NAMELY, DISPOSABLE PRODUCTS FOR THE FOOD SERVICE INDUSTRY, NAMELY, PLATES, BOWLS AND TRAYS FOR TAKE-OUT AND MADE TO ORDER FOODS, IN CLASS 21 (U.S. CLS. 2, 13, 23, 29, 30, 33, 40 AND 50).

FIRST USE 10-10-2011; IN COMMERCE 10-10-2011.

FOR: DESIGN OF PLASTIC FOOD SERVICE CONTAINERS, PLATES, BOWLS, TRAYS, DRINKING STRAWS, AND CUTLERY; DESIGN OF PREPACKAGED KITS OF CUTLERY, CONDIMENTS, BEVERAGE STIRRERS, CLEANSER WIPES AND NAPKINS; DESIGN OF METAL FOIL FOR USE WITH FOOD; DESIGN OF METAL FOOD SERVICE CONTAINERS, PLATES, BOWLS, AND TRAYS; DESIGN OF FIBER PULP FOOD SERVICE CONTAINERS, PLATES, BOWLS, AND TRAYS, IN CLASS 42 (U.S. CLS. 100 AND 101).

FIRST USE 10-10-2011; IN COMMERCE 10-10-2011.

THE MARK CONSISTS OF STANDARD CHARACTERS WITHOUT CLAIM TO ANY PARTICULAR FONT, STYLE, SIZE, OR COLOR.

NO CLAIM IS MADE TO THE EXCLUSIVE RIGHT TO USE "PACK", APART FROM THE MARK AS SHOWN.

SN 77-909,236, FILED 1-11-2010.

MATTHEW PAPPAS, EXAMINING ATTORNEY

United States of America

United States Patent and Trademark Office

PINHO'S FAMOUS CUSTARD CUPS

Reg. No. 4,067,867

Registered Dec. 6, 2011

Int. Cl.: 30

TRADEMARK

PRINCIPAL REGISTER

PINHO'S BAKERY, INC. (NEW JERSEY CORPORATION)
1027 CHESTNUT STREET
ROSELLE, NJ 07203

FOR: CUSTARDS, IN CLASS 30 (U.S. CL. 46).

FIRST USE 11-8-2010; IN COMMERCE 11-8-2010.

THE MARK CONSISTS OF STANDARD CHARACTERS WITHOUT CLAIM TO ANY PARTICULAR FONT, STYLE, SIZE, OR COLOR.

OWNER OF U.S. REG. NO. 3,730,607.

NO CLAIM IS MADE TO THE EXCLUSIVE RIGHT TO USE "FAMOUS CUSTARD CUPS", APART FROM THE MARK AS SHOWN.

SN 77-909,676, FILED 1-12-2010.

MARIAM MAHMOUDI, EXAMINING ATTORNEY



David J. Kyjars

Director of the United States Patent and Trademark Office

United States of America

United States Patent and Trademark Office

TRUEATTRIBUTION

Reg. No. 4,067,868

Registered Dec. 6, 2011

Int. Cl.: 35

SERVICE MARK

PRINCIPAL REGISTER

VISUAL IQ, INC. (DELAWARE CORPORATION)
SUITE 330
75 SECOND AVENUE
NEEDHAM, MA 02494

FOR: MARKETING SERVICES, NAMELY, CONSUMER MARKETING RESEARCH;
PROVIDING INFORMATION IN THE FIELD OF MARKETING AND ON-LINE MARKETING
MEDIA VIA THE INTERNET, IN CLASS 35 (U.S. CLS. 100, 101 AND 102).

FIRST USE 7-1-2008; IN COMMERCE 7-1-2008.

THE MARK CONSISTS OF STANDARD CHARACTERS WITHOUT CLAIM TO ANY PAR-
TICULAR FONT, STYLE, SIZE, OR COLOR.

SN 77-910,496, FILED 1-12-2010.

LINDA POWELL, EXAMINING ATTORNEY



David J. Kybas

Director of the United States Patent and Trademark Office

United States of America

United States Patent and Trademark Office

TRUEMETRICS

Reg. No. 4,067,869

Registered Dec. 6, 2011

Int. Cl.: 35

SERVICE MARK

PRINCIPAL REGISTER

VISUAL IQ, INC. (DELAWARE CORPORATION)
SUITE 330
75 SECOND AVENUE
NEEDHAM, MA 02494

FOR: MARKETING SERVICES, NAMELY, CONSUMER MARKETING RESEARCH;
PROVIDING INFORMATION IN THE FIELD OF MARKETING AND ON-LINE MARKETING
MEDIA VIA THE INTERNET, IN CLASS 35 (U.S. CLS. 100, 101 AND 102).

FIRST USE 7-1-2008; IN COMMERCE 7-1-2008.

THE MARK CONSISTS OF STANDARD CHARACTERS WITHOUT CLAIM TO ANY PAR-
TICULAR FONT, STYLE, SIZE, OR COLOR.

SN 77-910,500, FILED 1-12-2010.

LINDA POWELL, EXAMINING ATTORNEY



David J. Kybas

Director of the United States Patent and Trademark Office

United States of America

United States Patent and Trademark Office



ADVOCATION 4 VET TECHS, LLC

ADVOCACY THROUGH EDUCATION

Reg. No. 4,067,870

Registered Dec. 6, 2011

Int. Cl.: 41

SERVICE MARK

PRINCIPAL REGISTER

ADVOCATION 4 VET TECHS (VIRGINIA LIMITED LIABILITY COMPANY)
17522 MADISON AVENUE
HAMILTON, VA 20158

FOR: EDUCATIONAL SERVICES, NAMELY, PROVIDING CONTINUING PROFESSIONAL EDUCATION COURSES IN THE FIELD OF VETERINARY MEDICINE, IN CLASS 41 (U.S. CLS. 100, 101 AND 107).

FIRST USE 4-12-2010; IN COMMERCE 4-12-2010.

NO CLAIM IS MADE TO THE EXCLUSIVE RIGHT TO USE "4 VET TECHS, LLC", APART FROM THE MARK AS SHOWN.

THE COLOR(S) RED, BLACK AND GREY IS/ARE CLAIMED AS A FEATURE OF THE MARK.

THE MARK CONSISTS OF THE PHRASE, "ADVOCATION 4 VET TECHS, LLC", IN BLACK AND UNDERLINED IN RED. THE PHRASE, "ADVOCACY THROUGH EDUCATION", APPEARS DIRECTLY BELOW THE RED LINE IN BLACK. THE MARK ALSO CONSISTS OF A RED UPWARD ARROW WITH A GREY SNAKE ENTWINED AROUND THE ARROW CONTAINED WITHIN A RED CIRCLE CONSISTING OF FOUR SMALLER ARROWS, ALL APPEARING TO THE LEFT OF THE WORDING.

SN 77-910,677, FILED 1-13-2010.

KEVIN DINALLO, EXAMINING ATTORNEY



David J. Kybas

Director of the United States Patent and Trademark Office

United States of America

United States Patent and Trademark Office

GABBY

Reg. No. 4,067,871

Registered Dec. 6, 2011

Int. Cl.: 21

TRADEMARK

PRINCIPAL REGISTER

SUMMER CLASSICS, INC. (DELAWARE CORPORATION)
7000 HIGHWAY 25
MONTEVALLO, AL 35115

FOR: SCULPTURES OF EARTHENWARE, SCULPTURES OF TERRA COTTA, IN CLASS 21
(U.S. CLS. 2, 13, 23, 29, 30, 33, 40 AND 50).

FIRST USE 11-15-2010; IN COMMERCE 11-15-2010.

THE MARK CONSISTS OF STANDARD CHARACTERS WITHOUT CLAIM TO ANY PARTICULAR FONT, STYLE, SIZE, OR COLOR.

SN 77-911,494, FILED 1-13-2010.

GIANCARLO CASTRO, EXAMINING ATTORNEY



David J. Kybas

Director of the United States Patent and Trademark Office

United States of America

United States Patent and Trademark Office

Emzuri

Reg. No. 4,067,872

Registered Dec. 6, 2011

Int. Cls.: 14 and 25

TRADEMARK

PRINCIPAL REGISTER

MADHI, YASER EDHAH BIN (SAUDI ARABIA INDIVIDUAL), DBA YASER EDHAH BIN MADHI,
2ND FLOOR, BALHMER NEWBUILDING, BAB SHARIF
JEDDAH, SAUDI ARABIA 18172

FOR: WATCHES AND WATCH PARTS, NAMELY, WRIST WATCHES, CHRONOGRAPHS FOR USE AS WATCHES, CHRONOMETERS, CALENDAR WATCHES, STOP WATCHES, TRAVELING WATCHES, POCKET WATCHES, TABLE CLOCKS, ALARM CLOCKS; PRECIOUS AND SEMI-PRECIOUS STONES AND BEADS FOR USE IN THE MANUFACTURE OF JEWELRY, PEARL JEWELRY CHAINS, BANGLE BRACELET, CHAIN BRACELETS, BRASS JEWELRY CHAINS, FULL CERAMIC JEWELRY, FULL TUNGSTEN JEWELRY, NECKLACES, BRACELETS, RINGS, EAR-RINGS, RINGS, DECORATIVE PINS BEING JEWELRY, BADGES OF PRECIOUS METAL, MEDALS, ORNAMENTAL PINS, PRECIOUS STONES, PRECIOUS METALS AND ALLOYS THEREOF, AND BRACELETS MADE OF BRASS, STAINLESS STEEL, METAL ALLOYS, STONES AND BEADS; PEARL CHAINS, BANGLE BRACELETS, CHAIN BRACELETS, BRASS WATCH CASES, PEARL WATCH DIAL OR STONE WATCH DIALS, IN CLASS 14 (U.S. CLS. 2, 27, 28 AND 50).

FIRST USE 6-1-2010; IN COMMERCE 6-1-2010.

FOR: CLOTHING, NAMELY, PANTS, TROUSERS, JEANS, LONG PANTS, SHORT PANTS, COATS, RAIN COATS, KNITTED SHIRTS, KNITTED SWEATERS, KNITTED CAPS, KNITTED JACKETS, SWEATERS AND MUFFLERS, WOOLEN SHAWLS, FUR COATS, SCARVES, SHIRTS, WOVEN SHIRTS, LOOSE SHIRTS, VELVET SHIRTS, POLO-NECK SHIRTS, HALF SLEEVES SHIRTS, FULL SLEEVES SHIRTS, SLEEVELESS SHIRTS, T-SHIRTS, JACKETS, APRONS, PAJAMAS, SLEEPING SUITS, DRESSES, EVENING DRESSES, LEGGINGS, TIGHTS, STOCKING, VESTS AND BRIEFS, SKIRTS, SOCKS, BELTS AND BANDANAS, HATS, CAPS, SPORTS JACKETS, SWIMMING SUITS, SPORTS T SHIRTS, UNIFORMS FOR JOGGING AND TRAINING, SWIM-WEAR AND BEACH LINGERIE, BRASSIERES, SHOWER AND SWIMMING CAP, UNDERWEAR, SLEEPING SUITS, NIGHT SUITS, NIGHTIES, SLIPS, NIGHT GOWNS, GOWNS, SHAWLS, HEAD TIES BEING HEADBANDS, WRIST TIES BEING WRIST BANDS, NECK TIES, NECK BOWS BEING BOW TIES, BATH GOWNS, GLOVES AS CLOTHING, SUSPENDERS, WOMEN'S SCARVES, SWEATERS, JACKETS, CAPS, GLOVES, SOCKS, LONG SLEEVE TOPS, SWEATERS AND CARDIGANS, PANTS, JEANS, BODYSUITS, COVERALLS, OVERALLS, LEGGINGS, CLOTH DIAPERS, SHOES, SLIPPERS, SANDALS, BEACH SANDALS, SPORT SHOES, CLIMBING SHOES, LONG SHOES, IN CLASS 25 (U.S. CLS. 22 AND 39).



David J. Kybas

Director of the United States Patent and Trademark Office

Reg. No. 4,067,872 FIRST USE 6-1-2010; IN COMMERCE 6-1-2010.

THE MARK CONSISTS OF STANDARD CHARACTERS WITHOUT CLAIM TO ANY PARTICULAR FONT, STYLE, SIZE, OR COLOR.

THE WORDING "EMZURI" HAS NO MEANING IN A FOREIGN LANGUAGE.

SN 77-912,088, FILED 1-14-2010.

JOHN DWYER, EXAMINING ATTORNEY

United States of America

United States Patent and Trademark Office

FLOODGATE FUND

Reg. No. 4,067,873

Registered Dec. 6, 2011

Int. Cl.: 36

SERVICE MARK

PRINCIPAL REGISTER

MAPLES MANAGEMENT COMPANY, L.L.C. (DELAWARE LIMITED LIABILITY COMPANY)
2440 SAND HILL ROAD, SUITE 100
MENLO PARK, CA 94025

FOR: INVESTMENT SERVICES, NAMELY, VENTURE CAPITAL FUNDING SERVICES TO EMERGING AND START-UP COMPANIES, FUNDS INVESTMENT CONSULTATION, INVESTMENT MANAGEMENT; VENTURE CAPITAL SERVICES, NAMELY, PROVIDING FINANCING TO EMERGING AND START-UP COMPANIES; PRIVATE EQUITY FUND INVESTMENT SERVICES; MANAGEMENT OF CAPITAL INVESTMENT FUNDS; FINANCIAL ADVICE, FINANCIAL ANALYSIS AND CONSULTATION, FINANCIAL ASSET MANAGEMENT, FINANCIAL CONSULTING AND ADVISING IN THE FIELD OF MERGERS AND ACQUISITIONS, FINANCIAL INVESTMENT IN THE FIELD OF TECHNOLOGY, IN CLASS 36 (U.S. CLS. 100, 101 AND 102).

FIRST USE 3-0-2010; IN COMMERCE 3-0-2010.

THE MARK CONSISTS OF STANDARD CHARACTERS WITHOUT CLAIM TO ANY PARTICULAR FONT, STYLE, SIZE, OR COLOR.

NO CLAIM IS MADE TO THE EXCLUSIVE RIGHT TO USE "FUND", APART FROM THE MARK AS SHOWN.

SN 77-912,358, FILED 1-14-2010.

MICHAEL SOUDERS, EXAMINING ATTORNEY



David J. Kybas

Director of the United States Patent and Trademark Office

United States of America

United States Patent and Trademark Office

THE MEANING PROJECT

Reg. No. 4,067,874

Registered Dec. 6, 2011

Int. Cl.: 42

SERVICE MARK

PRINCIPAL REGISTER

THE MEANING PROJECT, L.L.C. (OKLAHOMA LIMITED LIABILITY COMPANY)
SUITE A
1230 S.W. 89TH STREET
OKLAHOMA CITY, OK 73139

FOR: PROVIDING A WEBSITE THAT ALLOWS USERS TO CREATE AND SHARE ONLINE JOURNALS, NAMELY, BLOGS, FEATURING USER DEFINED CONTENT IN THE FIELD OF GENERAL KNOWLEDGE REGARDING LITERATURE, MUSIC, PERSONAL EXPERIENCES, AND THE EMOTIONS THEY CONVEY, IN CLASS 42 (U.S. CLS. 100 AND 101).

FIRST USE 6-11-2010; IN COMMERCE 6-11-2010.

THE MARK CONSISTS OF STANDARD CHARACTERS WITHOUT CLAIM TO ANY PARTICULAR FONT, STYLE, SIZE, OR COLOR.

SN 77-913,022, FILED 1-15-2010.

MATTHEW KLINE, EXAMINING ATTORNEY



David J. Kybas

Director of the United States Patent and Trademark Office

United States of America

United States Patent and Trademark Office

METRO STATION

Reg. No. 4,067,875

Registered Dec. 6, 2011

Int. Cl.: 25

TRADEMARK

PRINCIPAL REGISTER

METRO STATION, INC. (TENNESSEE CORPORATION)
130 N. BRAND BOULEVARD, SUITE 400
GLENDALE, CA 91203

FOR: FOOTWEAR; HATS; HEADWEAR; HOODED SWEAT SHIRTS; SHIRTS; SHORTS;
SWEAT SHIRTS; T-SHIRTS; UNDERWEAR, IN CLASS 25 (U.S. CLS. 22 AND 39).

FIRST USE 5-1-2007; IN COMMERCE 5-1-2007.

THE MARK CONSISTS OF STANDARD CHARACTERS WITHOUT CLAIM TO ANY PARTICULAR FONT, STYLE, SIZE, OR COLOR.

SN 77-913,289, FILED 1-15-2010.

CHRIS DONINGER, EXAMINING ATTORNEY



David J. Kybas

Director of the United States Patent and Trademark Office

United States of America

United States Patent and Trademark Office

The People's Connection

Reg. No. 4,067,876

Registered Dec. 6, 2011

Int. Cl.: 45

SERVICE MARK

PRINCIPAL REGISTER

THE PEOPLE'S CONNECTION, LLC (NORTH CAROLINA LIMITED LIABILITY COMPANY)
7097 HIGH MEADOW DR.
MATTHEWS, NC 28104

FOR: PROVIDING INFORMATION IN THE FIELD OF PERSONAL DEVELOPMENT,
NAMELY, SELF-IMPROVEMENT, SELF-FULFILLMENT, AND INTERPERSONAL COMMU-
NICATION , IN CLASS 45 (U.S. CLS. 100 AND 101).

FIRST USE 3-1-2009; IN COMMERCE 3-6-2010.

THE MARK CONSISTS OF STANDARD CHARACTERS WITHOUT CLAIM TO ANY PAR-
TICULAR FONT, STYLE, SIZE, OR COLOR.

SN 77-913,653, FILED 1-17-2010.

LINDA POWELL, EXAMINING ATTORNEY



David J. Kybas

Director of the United States Patent and Trademark Office

United States of America

United States Patent and Trademark Office

EMPOWERING PEOPLE TO TRANSFORM THE LIVES OF PETS

Reg. No. 4,067,877

M.I. INDUSTRIES, INC. (NEBRASKA CORPORATION)
6200 N 56TH ST
LINCOLN, NE 685041763

Registered Dec. 6, 2011

Int. Cl.: 31

FOR: ANIMAL FOODSTUFFS; PET FOOD; PET TREATS, IN CLASS 31 (U.S. CLS. 1 AND 46).

TRADEMARK

FIRST USE 7-16-2009; IN COMMERCE 12-19-2009.

PRINCIPAL REGISTER

THE MARK CONSISTS OF STANDARD CHARACTERS WITHOUT CLAIM TO ANY PARTICULAR FONT, STYLE, SIZE, OR COLOR.

SN 77-914,370, FILED 1-19-2010.

JENNIFER MARTIN, EXAMINING ATTORNEY



David J. Kybas

Director of the United States Patent and Trademark Office

United States of America

United States Patent and Trademark Office



Reg. No. 4,067,878

Registered Dec. 6, 2011

Int. Cl.: 38

SERVICE MARK

PRINCIPAL REGISTER

AMERICAN FARM BUREAU FEDERATION (ILLINOIS CORPORATION)
SUITE 1000W
600 MARYLAND AVENUE, S.W.
WASHINGTON, DC 20024

FOR: PROVIDING APPLICANT'S MEMBERS AND OTHERS ACCESS TO INFORMATION REGARDING THEIR ELECTED OFFICIALS, INCLUDING CONTACT INFORMATION, STAFF CONTACTS, BIOGRAPHICAL INFORMATION, INFORMATION ON VOTES, BILLS AND PACS CONTRIBUTIONS, AND OTHER SIMILAR INFORMATION VIA THE INTERNET --, IN CLASS 38 (U.S. CLS. 100, 101 AND 104).

FIRST USE 1-1-2011; IN COMMERCE 1-1-2011.

NO CLAIM IS MADE TO THE EXCLUSIVE RIGHT TO USE "CONNECTION", APART FROM THE MARK AS SHOWN.

THE MARK CONSISTS OF THE STYLIZED LETTER "FB" AND THE TERM "FB CONNECTION" TO THE RIGHT OF A PICTURE OF A COMPUTER ATOP A BALE OF HAY.

SN 77-917,233, FILED 1-21-2010.

KATINA MISTER, EXAMINING ATTORNEY



David J. Kybas

Director of the United States Patent and Trademark Office

United States of America

United States Patent and Trademark Office



Reg. No. 4,067,879

Registered Dec. 6, 2011

Int. Cl.: 42

SERVICE MARK

PRINCIPAL REGISTER

AETHLON MEDICAL, INC. (NEVADA CORPORATION)
8910 UNIVERSITY CENTER LANE
SUITE 660
SAN DIEGO, CA 92122

FOR: PROVIDING MEDICAL AND SCIENTIFIC RESEARCH INFORMATION IN THE FIELD OF FILTRATION OF EXOSOMES FROM BLOOD, IN CLASS 42 (U.S. CLS. 100 AND 101).

FIRST USE 4-12-2011; IN COMMERCE 4-12-2011.

NO CLAIM IS MADE TO THE EXCLUSIVE RIGHT TO USE "EXOSOME SCIENCES", APART FROM THE MARK AS SHOWN.

THE MARK CONSISTS OF THE WORD "EXOSOME" ABOVE THE WORD "SCIENCES", TO THE RIGHT OF A DESIGN CONSISTING OF FOUR ROWS OF DOTS, THE TOP ROWING HAVING FIVE DOTS, THE SECOND ROW HAVING EIGHT DOTS, THE THIRD ROW HAVING SIX DOTS, AND THE FOURTH ROW HAVING NINE DOTS.

SN 77-917,937, FILED 1-22-2010.

EUGENIA MARTIN, EXAMINING ATTORNEY



David J. Kybas

Director of the United States Patent and Trademark Office

United States of America

United States Patent and Trademark Office

tipit

Reg. No. 4,067,880

Registered Dec. 6, 2011

Int. Cl.: 35

SERVICE MARK

PRINCIPAL REGISTER

AJAY, SHAMALA (INDIA INDIVIDUAL), DBA TIPIT,
4 MILLAR CT
WEST WINDSOR, NJ 08550

FOR: AN INTERACTIVE WEB SITE FOR USERS TO REVIEW AND RATE INTERNET CONTENT, PEOPLE, COMPANIES, PRODUCTS AND/OR SERVICES UTILIZING A SOFTWARE APPLICATION TO AWARD POINTS WHEREBY WEB SITE USERS ARE ELIGIBLE TO EXCHANGE POINTS EARNED FOR PROMOTIONAL ITEMS CONSISTING OF COUPONS, REBATES, DISCOUNTS OR SPECIAL OFFERINGS ON GOODS AND/OR SERVICE PROVIDED BY WEB SITE SPONSORS; DISSEMINATION OF ADVERTISING FOR OTHERS VIA PUBLIC AND PRIVATE WIRELESS NETWORKS FOR DISPLAY ON MOBILE DEVICES; MARKETING AND CONSULTING SERVICES IN THE FIELD OF PROMOTING AND TRACKING THE GOODS, SERVICES, AND BRANDS OF OTHERS THROUGH ALL PUBLIC COMMUNICATION MEANS, PARTICULARLY SPECIALIZING IN THE USE OF MOBILE, SOCIAL, AND PRINT MEDIA TO DRIVE CONSUMER INTEREST, ENGAGEMENT AND ACTION; MARKETING, PROMOTIONAL AND ADVERTISING SERVICES PROVIDED BY MOBILE TELEPHONE CONNECTIONS; PROCESSING MANUFACTURER'S COUPONS; PROMOTING THE GOODS AND SERVICES OF OTHERS BY PROVIDING A COMMUNITY-DRIVEN WEB SITE FEATURING USER-SUBMITTED CONTENT IN THE NATURE OF COUPONS, REBATES, PRICE-COMPARISON INFORMATION, PRODUCT REVIEWS, LINKS TO THE RETAIL WEB SITES OF OTHERS, AND DISCOUNT INFORMATION; PROMOTING THE GOODS AND SERVICES OF OTHERS BY PROVIDING A WEB SITE FEATURING COUPONS, REBATES, PRICE-COMPARISON INFORMATION, PRODUCT REVIEWS, LINKS TO THE RETAIL WEB SITES OF OTHERS, AND DISCOUNT INFORMATION; PROMOTING THE GOODS AND SERVICES OF OTHERS BY PROVIDING A WEBSITE FEATURING COUPONS, REBATES, PRICE-COMPARISON INFORMATION, PRODUCT REVIEWS, LINKS TO THE RETAIL WEBSITES OF OTHERS, AND DISCOUNT INFORMATION; PROMOTING THE GOODS OF OTHERS, NAMELY, PROVIDING COUPONS, REBATES AND VOUCHERS FOR THE GOODS OF OTHERS; PROMOTING THE GOODS OF OTHERS, NAMELY, PROVIDING INFORMATION REGARDING DISCOUNTS, COUPONS, REBATES, VOUCHERS AND SPECIAL OFFERS FOR THE GOODS OF OTHERS; PROMOTIONAL SERVICES, NAMELY, DISTRIBUTION OF ADVERTISING FLYERS, COUPONS, CATALOGS AND PROMOTIONAL ITEMS OF OTHERS; PROVIDING INCENTIVE AWARD PROGRAMS FOR CUSTOMERS THROUGH THE ISSUANCE AND PROCESSING OF LOYALTY COUPONS FOR FREQUENT USE OF PARTICIPATING BUSINESSES; PROVIDING ON-LINE CONSUMER INFORMATION CONCERNING THE LOCATION OF MOBILE RESTAURANTS , IN CLASS 35 (U.S. CLS. 100, 101 AND 102).



David J. Kybas

Director of the United States Patent and Trademark Office

Reg. No. 4,067,880 FIRST USE 3-1-2010; IN COMMERCE 4-1-2010.

THE MARK CONSISTS OF STANDARD CHARACTERS WITHOUT CLAIM TO ANY PARTICULAR FONT, STYLE, SIZE, OR COLOR.

SN 77-919,266, FILED 1-25-2010.

HOWARD B. LEVINE, EXAMINING ATTORNEY

United States of America

United States Patent and Trademark Office

HEELIFT AFO

Reg. No. 4,067,881

Registered Dec. 6, 2011

Int. Cl.: 10

TRADEMARK

PRINCIPAL REGISTER

DM SYSTEMS, INC. (ILLINOIS CORPORATION)
1316 SHERMAN AVENUE
EVANSTON, IL 60201

FOR: ANKLE FOOT ORTHOSIS, IN CLASS 10 (U.S. CLS. 26, 39 AND 44).

FIRST USE 11-26-2010; IN COMMERCE 11-26-2010.

THE MARK CONSISTS OF STANDARD CHARACTERS WITHOUT CLAIM TO ANY PARTICULAR FONT, STYLE, SIZE, OR COLOR.

SEC. 2(F).

OWNER OF U.S. REG. NOS. 1,884,414 AND 2,504,470.

NO CLAIM IS MADE TO THE EXCLUSIVE RIGHT TO USE "AFO", APART FROM THE MARK AS SHOWN.

SN 77-919,745, FILED 1-25-2010.

SUSAN LESLIE DUBOIS, EXAMINING ATTORNEY



David J. Kyffers

Director of the United States Patent and Trademark Office

United States of America

United States Patent and Trademark Office

DOLECO

Reg. No. 4,067,882

Registered Dec. 6, 2011

Int. Cls.: 6, 8, and 22

TRADEMARK

PRINCIPAL REGISTER

WESTDEUTSCHER DRAHTSEIL-VERKAUF DOLEZYCH CMBH & CO. (FED REP GERMANY LIMITED PARTNERSHIP)
HARTMANNSTRASSE 8
DORTMUND, FED REP GERMANY 44147

FOR: METAL SLINGS FOR LOADING, METAL CHAINS AND METAL CHAIN STOPS, METAL CHAIN HOISTS USED FOR LIFTING AND RIGGING, METAL ROPES, STEEL WIRE ROPES, METAL SLINGING ROPES, METAL FLANGES, METAL LIFTING SLINGS FOR LOADS, METAL BELTS FOR HANDLING LOADS, METAL HOOKS FOR FASTENING LOADS, METAL CLAMPS, METAL LOCKS, METAL CRAMPS; PARTS OF METAL CLAMPS IN THE NATURE OF JAWS; METAL WIRE MESHES, METAL BRACKETS/LATCH FASTENERS FOR FERRULES FOR USE IN SECURING LOADS, METAL BANDS FOR USE IN SECURING LOADS, NON-ELECTRIC WIRES FOR USE SECURING LOADS, STEEL BANDS FOR USE IN SECURING LOADS, STEEL WIRES FOR USE IN SECURING LOADS, AND METAL POLES, IN CLASS 6 (U.S. CLS. 2, 12, 13, 14, 23, 25 AND 50).

FIRST USE 12-31-2005; IN COMMERCE 12-31-2005.

FOR: MANUALLY OPERATED LIFTING EQUIPMENT, NAMELY, MANUAL HOISTS, JACKS; MANUALLY OPERATED CABLE WINCHES, MANUALLY OPERATED BREAST DRILLS, IN CLASS 8 (U.S. CLS. 23, 28 AND 44).

FIRST USE 12-31-2005; IN COMMERCE 12-31-2005.

FOR: TENTS, UNFITTED CANVAS TARPULINS, SAILS, GENERAL UTILITY BAGS FOR COMMERCIAL USE; LOAD LIFTING STRAPS; CARGO ROPE HANGERS; ROUND SLINGS MADE FROM NON-METAL CHEMICAL/SYNTHETIC FIBERS; LOAD LIFTING STRAPS MADE FROM NON-METAL CHEMICAL/SYNTHETIC FIBERS; NON-METAL CLAMP BELTS FOR HANDLING LOADS; TEXTILE SLINGS FOR LOADING; NON-METAL BELTS FOR SECURING LOADS; NON-METAL SUSPENSION CORDS FOR HANDLING LOADS; NON-METAL LIFTING SLINGS FOR LOADS; HEMP BELTS FOR SECURING LOADS; NON-METAL CARRYING STRAPS FOR HANDLING LOADS, IN CLASS 22 (U.S. CLS. 1, 2, 7, 19, 22, 42 AND 50).

FIRST USE 12-31-2005; IN COMMERCE 12-31-2005.



David J. Kyjars

Director of the United States Patent and Trademark Office

Reg. No. 4,067,882 THE MARK CONSISTS OF STANDARD CHARACTERS WITHOUT CLAIM TO ANY PARTICULAR FONT, STYLE, SIZE, OR COLOR.

PRIORITY CLAIMED UNDER SEC. 44(D) ON ERPN CMNTY TM OFC APPLICATION NO. 008806994, FILED 1-13-2010, REG. NO. 008806994, DATED 5-7-2010, EXPIRES 1-13-2020.

SN 77-920,055, FILED 1-26-2010.

KHANH LE, EXAMINING ATTORNEY

United States of America

United States Patent and Trademark Office

UNITEDHEALTHCARE NAVIGATE

Reg. No. 4,067,883

Registered Dec. 6, 2011

Int. Cls.: 35, 36, and 44

SERVICE MARK

PRINCIPAL REGISTER

UNITEDHEALTH GROUP INCORPORATED (MINNESOTA CORPORATION)
9900 BREN ROAD EAST
MN008-T202
MINNETONKA, MN 55343

FOR: HEALTH CARE COST MANAGEMENT SERVICES FOR HEALTH CARE BENEFIT PLANS AND HEALTH CARE SERVICE PLANS OF OTHERS; HEALTH CARE UTILIZATION MANAGEMENT SERVICES; HEALTH CARE UTILIZATION, REVIEW AND COST CONTAINMENT SERVICES, IN CLASS 35 (U.S. CLS. 100, 101 AND 102).

FIRST USE 4-12-2011; IN COMMERCE 4-12-2011.

FOR: ORGANIZATION AND ADMINISTRATION OF HEALTH CARE BENEFIT PLANS AND HEALTH CARE SERVICE PLANS; INSURANCE SERVICES, NAMELY, CLAIMS ADMINISTRATION OF HEALTH CARE BENEFIT PLANS AND HEALTH CARE SERVICE PLANS; INSURANCE UNDERWRITING IN THE FIELD OF HEALTH CARE; ORGANIZATION AND ADMINISTRATION OF PRE-PAID HEALTH CARE PLANS; ORGANIZATION AND ADMINISTRATION OF NETWORKS OF PREFERRED HEALTH CARE PROVIDERS; ORGANIZING AND ADMINISTERING EMPLOYEE BENEFITS PLANS CONCERNING INSURANCE; ADMINISTRATION OF EMPLOYEE WELFARE BENEFIT PLANS CONCERNING INSURANCE AND FINANCE, IN CLASS 36 (U.S. CLS. 100, 101 AND 102).

FIRST USE 4-12-2011; IN COMMERCE 4-12-2011.

FOR: MANAGED HEALTH CARE SERVICES; HEALTH CARE IN THE NATURE OF HEALTH MAINTENANCE ORGANIZATIONS (HMOS), PREFERRED PROVIDER ORGANIZATIONS (PPOS) AND CONSUMER DIRECTED HEALTH PLANS; HEALTH CARE SERVICES, NAMELY, DISEASE MANAGEMENT PROGRAMS, AND HEALTH AND WELLNESS PROGRAMS; PROVIDING HEALTH INFORMATION, IN CLASS 44 (U.S. CLS. 100 AND 101).

FIRST USE 4-12-2011; IN COMMERCE 4-12-2011.

THE MARK CONSISTS OF STANDARD CHARACTERS WITHOUT CLAIM TO ANY PARTICULAR FONT, STYLE, SIZE, OR COLOR.

OWNER OF U.S. REG. NOS. 1,967,622, 3,269,588, AND OTHERS.



David J. Kyros

Director of the United States Patent and Trademark Office

Reg. No. 4,067,883 SN 77-920,193, FILED 1-26-2010.

LAURA HAMMEL, EXAMINING ATTORNEY

United States of America

United States Patent and Trademark Office

UNITEDHEALTHCARE NAVIGATE BALANCED

Reg. No. 4,067,884

Registered Dec. 6, 2011

Int. Cls.: 35, 36, and 44

SERVICE MARK

PRINCIPAL REGISTER

UNITEDHEALTH GROUP INCORPORATED (MINNESOTA CORPORATION)
9900 BREN ROAD EAST
MN008-T202
MINNETONKA, MN 55343

FOR: HEALTH CARE COST MANAGEMENT SERVICES FOR HEALTH CARE BENEFIT PLANS AND HEALTH CARE SERVICE PLANS OF OTHERS; HEALTH CARE UTILIZATION MANAGEMENT SERVICES; HEALTH CARE UTILIZATION, REVIEW AND COST CONTAINMENT SERVICES, IN CLASS 35 (U.S. CLS. 100, 101 AND 102).

FIRST USE 4-12-2011; IN COMMERCE 4-12-2011.

FOR: ORGANIZATION AND ADMINISTRATION OF HEALTH CARE BENEFIT PLANS AND HEALTH CARE SERVICE PLANS; INSURANCE SERVICES, NAMELY, CLAIMS ADMINISTRATION OF HEALTH CARE BENEFIT PLANS AND HEALTH CARE SERVICE PLANS; INSURANCE UNDERWRITING IN THE FIELD OF HEALTH CARE; ORGANIZATION AND ADMINISTRATION OF PRE-PAID HEALTH CARE PLANS; ORGANIZATION AND ADMINISTRATION OF NETWORKS OF PREFERRED HEALTH CARE PROVIDERS; ORGANIZING AND ADMINISTERING EMPLOYEE BENEFITS PLANS CONCERNING INSURANCE; ADMINISTRATION OF EMPLOYEE WELFARE BENEFIT PLANS CONCERNING INSURANCE AND FINANCE, IN CLASS 36 (U.S. CLS. 100, 101 AND 102).

FIRST USE 4-12-2011; IN COMMERCE 4-12-2011.

FOR: MANAGED HEALTH CARE SERVICES; HEALTH CARE IN THE NATURE OF HEALTH MAINTENANCE ORGANIZATIONS (HMOS), PREFERRED PROVIDER ORGANIZATIONS (PPOS) AND CONSUMER DIRECTED HEALTH PLANS; HEALTH CARE SERVICES, NAMELY, DISEASE MANAGEMENT PROGRAMS, AND HEALTH AND WELLNESS PROGRAMS; PROVIDING HEALTH INFORMATION, IN CLASS 44 (U.S. CLS. 100 AND 101).

FIRST USE 4-12-2011; IN COMMERCE 4-12-2011.

THE MARK CONSISTS OF STANDARD CHARACTERS WITHOUT CLAIM TO ANY PARTICULAR FONT, STYLE, SIZE, OR COLOR.

OWNER OF U.S. REG. NOS. 1,967,622, 3,269,588, AND OTHERS.



David J. Kybas

Director of the United States Patent and Trademark Office

Reg. No. 4,067,884 SN 77-920,209, FILED 1-26-2010.

LAURA HAMMEL, EXAMINING ATTORNEY

United States of America

United States Patent and Trademark Office

UNITEDHEALTHCARE NAVIGATE PLUS

Reg. No. 4,067,885

Registered Dec. 6, 2011

Int. Cls.: 35, 36, and 44

SERVICE MARK

PRINCIPAL REGISTER

UNITEDHEALTH GROUP INCORPORATED (MINNESOTA CORPORATION)
9900 BREN ROAD EAST
MN008-T202
MINNETONKA, MN 55343

FOR: HEALTH CARE COST MANAGEMENT SERVICES FOR HEALTH CARE BENEFIT PLANS AND HEALTH CARE SERVICE PLANS OF OTHERS; HEALTH CARE UTILIZATION MANAGEMENT SERVICES; HEALTH CARE UTILIZATION, REVIEW AND COST CONTAINMENT SERVICES, IN CLASS 35 (U.S. CLS. 100, 101 AND 102).

FIRST USE 4-12-2011; IN COMMERCE 4-12-2011.

FOR: ORGANIZATION AND ADMINISTRATION OF HEALTH CARE BENEFIT PLANS AND HEALTH CARE SERVICE PLANS; INSURANCE SERVICES, NAMELY, CLAIMS ADMINISTRATION OF HEALTH CARE BENEFIT PLANS AND HEALTH CARE SERVICE PLANS; INSURANCE UNDERWRITING IN THE FIELD OF HEALTH CARE; ORGANIZATION AND ADMINISTRATION OF PRE-PAID HEALTH CARE PLANS; ORGANIZATION AND ADMINISTRATION OF NETWORKS OF PREFERRED HEALTH CARE PROVIDERS; ORGANIZING AND ADMINISTERING EMPLOYEE BENEFITS PLANS CONCERNING INSURANCE; ADMINISTRATION OF EMPLOYEE WELFARE BENEFIT PLANS CONCERNING INSURANCE AND FINANCE, IN CLASS 36 (U.S. CLS. 100, 101 AND 102).

FIRST USE 4-12-2011; IN COMMERCE 4-12-2011.

FOR: MANAGED HEALTH CARE SERVICES; HEALTH CARE IN THE NATURE OF HEALTH MAINTENANCE ORGANIZATIONS (HMOS), PREFERRED PROVIDER ORGANIZATIONS (PPOS) AND CONSUMER DIRECTED HEALTH PLANS; HEALTH CARE SERVICES, NAMELY, DISEASE MANAGEMENT PROGRAMS, AND HEALTH AND WELLNESS PROGRAMS; PROVIDING HEALTH INFORMATION, IN CLASS 44 (U.S. CLS. 100 AND 101).

FIRST USE 4-12-2011; IN COMMERCE 4-12-2011.

THE MARK CONSISTS OF STANDARD CHARACTERS WITHOUT CLAIM TO ANY PARTICULAR FONT, STYLE, SIZE, OR COLOR.

OWNER OF U.S. REG. NOS. 1,967,622, 3,269,588, AND OTHERS.



David J. Kybas

Director of the United States Patent and Trademark Office

Reg. No. 4,067,885 SN 77-920,229, FILED 1-26-2010.

LAURA HAMMEL, EXAMINING ATTORNEY

United States of America

United States Patent and Trademark Office

MODERN MOM

Reg. No. 4,067,886

Registered Dec. 6, 2011

Int. Cl.: 16

TRADEMARK

PRINCIPAL REGISTER

MOM, INC. (DELAWARE CORPORATION)
P.O. BOX 1239
PACIFIC PALISADES, CA 90272

FOR: PRINTED PUBLICATIONS, NAMELY, BOOKS AND MAGAZINES IN THE FIELD OF PARENTING, IN CLASS 16 (U.S. CLS. 2, 5, 22, 23, 29, 37, 38 AND 50).

FIRST USE 9-30-2011; IN COMMERCE 9-30-2011.

THE MARK CONSISTS OF STANDARD CHARACTERS WITHOUT CLAIM TO ANY PARTICULAR FONT, STYLE, SIZE, OR COLOR.

OWNER OF U.S. REG. NOS. 3,483,872 AND 3,714,545.

NO CLAIM IS MADE TO THE EXCLUSIVE RIGHT TO USE "MOM", APART FROM THE MARK AS SHOWN.

SN 77-920,525, FILED 1-26-2010.

JESSICA A. POWERS, EXAMINING ATTORNEY



David J. Kybas

Director of the United States Patent and Trademark Office

United States of America

United States Patent and Trademark Office

BLUE TSUNAMI

Reg. No. 4,067,887

Wael Kabbani (SAUDI ARABIA INDIVIDUAL)

Registered Dec. 6, 2011

P. O. BOX 14901
SAN FRANCISCO, CA 941140901

Int. Cl.: 41

FOR: ENTERTAINMENT SERVICES, NAMELY, PROVIDING A WEBSITE FEATURING CARTOONS, COMIC BOOK CHARACTERS AND NON-DOWNLOADABLE INTERACTIVE GAMES, IN CLASS 41 (U.S. CLS. 100, 101 AND 107).

SERVICE MARK

FIRST USE 9-14-2011; IN COMMERCE 9-14-2011.

PRINCIPAL REGISTER

THE MARK CONSISTS OF STANDARD CHARACTERS WITHOUT CLAIM TO ANY PARTICULAR FONT, STYLE, SIZE, OR COLOR.

SN 77-921,134, FILED 1-27-2010.

INGRID C. EULIN, EXAMINING ATTORNEY



David J. Kyros

Director of the United States Patent and Trademark Office

United States of America

United States Patent and Trademark Office

SLV

Reg. No. 4,067,888

Registered Dec. 6, 2011

Int. Cls.: 9 and 11

TRADEMARK

PRINCIPAL REGISTER

SLV ELEKTRONIK GMBH (FED REP GERMANY CORPORATION)
DAIMLER STRAÙE 21-23
ÜBACH-PALENBERG, FED REP GERMANY 52531

FOR: LIGHTING EQUIPMENT, APPARATUS, AND DEVICES, NAMELY, BALLASTS, CONTROL PANELS, JUNCTION BOX HOUSINGS AND ELECTRICAL CONNECTOR FITTINGS; ELECTRICAL WIRE FOR LAMPS AND LIGHTS, IN CLASS 9 (U.S. CLS. 21, 23, 26, 36 AND 38).

FIRST USE 12-31-1979; IN COMMERCE 12-31-1990.

FOR: LIGHTING FIXTURES, LAMPS, INCANDESCENT LAMPS, VOLTAGE LED LAMPS, FLUORESCENT LAMPS, TUBULAR LAMPS; LIGHTING EQUIPMENT, APPARATUS, AND DEVICES, NAMELY, LIGHTING TRACKS, LIGHTING TUBES, LANDSCAPE LIGHTING INSTALLATIONS AND FLUORESCENT LAMP TUBES; LAMP REFLECTORS; LIGHT REFLECTORS; HOLDERS FOR LAMPS; HOLDERS FOR LIGHTS, NAMELY, SOCKETS FOR ELECTRIC LIGHTS, IN CLASS 11 (U.S. CLS. 13, 21, 23, 31 AND 34).

FIRST USE 12-31-1979; IN COMMERCE 12-31-1990.

THE MARK CONSISTS OF STANDARD CHARACTERS WITHOUT CLAIM TO ANY PARTICULAR FONT, STYLE, SIZE, OR COLOR.

SN 77-921,723, FILED 1-27-2010.

HANNO RITTNER, EXAMINING ATTORNEY



David J. Kyffers

Director of the United States Patent and Trademark Office

United States of America

United States Patent and Trademark Office

Z-ORTHOTIC

Reg. No. 4,067,889

Registered Dec. 6, 2011

Int. Cl.: 25

TRADEMARK

PRINCIPAL REGISTER

Z-TECH, INC. (NEW MEXICO CORPORATION)
6932 4TH STREET, N.W.
ALBUQUERQUE, NM 87107

FOR: FOOTWEAR, IN CLASS 25 (U.S. CLS. 22 AND 39).

FIRST USE 10-6-2011; IN COMMERCE 10-6-2011.

THE MARK CONSISTS OF STANDARD CHARACTERS WITHOUT CLAIM TO ANY PARTICULAR FONT, STYLE, SIZE, OR COLOR.

SN 77-922,816, FILED 1-28-2010.

TRACY WHITTAKER-BROWN, EXAMINING ATTORNEY



David J. Kyffers

Director of the United States Patent and Trademark Office

United States of America

United States Patent and Trademark Office



Reg. No. 4,067,890

Registered Dec. 6, 2011

Int. Cls.: 3 and 8

TRADEMARK

PRINCIPAL REGISTER

VOLUME DISTRIBUTORS (CALIFORNIA CORPORATION)
4199 BANDINI BLVD.
VERNON, CA 90058

FOR: SHAMPOOS, HAIR CONDITIONERS, BODY WASH FOR HUMANS, SKIN LOTIONS, HAIR GEL, HAIR SPRAY, HAIR MOUSSES, FACE SCRUBS, FACE WASH, AFTER-SHAVE CREAMS, PRE-SHAVE CREAMS, PRE-SHAVE GELS, SKIN MOISTURIZER, DEODORANT FOR BODY CARE, IN CLASS 3 (U.S. CLS. 1, 4, 6, 50, 51 AND 52).

FIRST USE 3-1-2007; IN COMMERCE 3-1-2007.

FOR: RAZORS, IN CLASS 8 (U.S. CLS. 23, 28 AND 44).

FIRST USE 5-24-2007; IN COMMERCE 5-24-2007.

NO CLAIM IS MADE TO THE EXCLUSIVE RIGHT TO USE "FOR MEN", APART FROM THE MARK AS SHOWN.

THE MARK CONSISTS OF AN OVAL SHAPE WITH THE WORD "MARX" HAVING A LONG RECTANGULAR SHAPE UNDER THE WORD "MARX" AND WITHIN THE RECTANGULAR SHAPE HAVING THE WORDS (IN SMALLER UPPERCASE FORMAT) "FOR MEN", ALSO HAVING TWO SEMI OUTLINE OF OVAL SHAPES ADJACENT TO THE OVAL SHAPE.

SN 77-923,016, FILED 1-28-2010.

BILL DAWE, EXAMINING ATTORNEY



David J. Kyros

Director of the United States Patent and Trademark Office

United States of America

United States Patent and Trademark Office

MEDEVOLUTION

Reg. No. 4,067,891

Registered Dec. 6, 2011

Int. Cls.: 38 and 42

SERVICE MARK

PRINCIPAL REGISTER

ROBERT KELLY (UNITED STATES INDIVIDUAL)
7433 PINE ISLAND ROAD
CLERMONT, FL 34711

FOR: TRANSMISSION OF INFORMATION THROUGH VIDEO COMMUNICATION SYSTEMS; PROVIDING A WEBSITE THAT ENABLES COMMUNICATION SYNCHRONOUSLY AND ASYNCHRONOUSLY AND CONNECTION OF PHYSICIANS WITH THEIR PATIENTS REGARDLESS OF MEDICAL ORGANIZATION OR GEOGRAPHIC LOCATION, IN CLASS 38 (U.S. CLS. 100, 101 AND 104).

FIRST USE 2-15-2010; IN COMMERCE 2-15-2010.

FOR: COMPUTER SERVICES, NAMELY, PROVIDING A WEB-BASED SYSTEM AND ON-LINE PORTAL FEATURING ON-LINE NON-DOWNLOADABLE SOFTWARE THAT ENABLES USERS TO ACCESS PATIENT INFORMATION, PHYSICIAN SERVICES AND MEDICAL EDUCATION; PROVIDING COMPUTER PROGRAMMING SERVICES TO CUSTOMERS THAT ENABLES THEM TO PROVIDE VIDEO AND AUDIO CONTENT ON THEIR WEBSITES, IN CLASS 42 (U.S. CLS. 100 AND 101).

FIRST USE 2-15-2010; IN COMMERCE 2-15-2010.

THE MARK CONSISTS OF STANDARD CHARACTERS WITHOUT CLAIM TO ANY PARTICULAR FONT, STYLE, SIZE, OR COLOR.

SN 77-924,009, FILED 1-29-2010.

MARY ROSSMAN, EXAMINING ATTORNEY



David J. Kyjars

Director of the United States Patent and Trademark Office

United States of America

United States Patent and Trademark Office



THE PENINSULA ACADEMY

NEW YORK

Reg. No. 4,067,892

Registered Dec. 6, 2011

Int. Cls.: 39 and 41

SERVICE MARK

PRINCIPAL REGISTER

PENINSULA INTERNATIONAL (USA) LIMITED (DELAWARE CORPORATION)
1209 ORANGE STREET
WILMINGTON, DE 19801

FOR: TRANSPORT BY LIMOUSINE, BICYCLE, BOAT AND FOOT; PACKAGING ARTICLES FOR TRANSPORTATION; ARRANGING TRAVEL TOURS; CHAUFFEUR SERVICES; ARRANGING OF CRUISES; TRANSPORT OF PASSENGERS; TRANSPORTATION RESERVATION SERVICES; ARRANGING OF TOURS; ESCORTING OF TRAVELERS, IN CLASS 39 (U.S. CLS. 100 AND 105).

FIRST USE 12-0-2007; IN COMMERCE 12-0-2007.

FOR: EDUCATIONAL SERVICES, NAMELY, CONDUCTING PROGRAMS IN THE FIELDS OF SIGHTSEEING, EVENT PLANNING, SHOPPING, AND CULINARY EXPERIENCES; ORGANIZATION OF EXHIBITIONS FOR CULTURAL OR EDUCATIONAL PURPOSES; ARRANGING AND CONDUCTING WORKSHOPS IN THE FIELDS OF CULINARY ARTS, SIGHTSEEING, EVENT PLANNING, SHOPPING; EDUCATIONAL SERVICES, NAMELY, CONDUCTING CLASSES IN THE FIELDS OF CULINARY ARTS, SIGHTSEEING, EVENT PLANNING, SHOPPING; PRACTICAL TRAINING IN THE FIELDS OF SIGHTSEEING, EVENT PLANNING, SHOPPING; PRACTICAL TRAINING IN THE FIELD OF COOKING, IN CLASS 41 (U.S. CLS. 100, 101 AND 107).

FIRST USE 12-0-2007; IN COMMERCE 12-0-2007.

NO CLAIM IS MADE TO THE EXCLUSIVE RIGHT TO USE "NEW YORK" AS TO CLASS 39 AND "ACADEMY NEW YORK" AS TO CLASS 41", APART FROM THE MARK AS SHOWN.

THE MARK CONSISTS OF A STYLIZED WOMAN DRESSED IN FORMAL ROBES AND HOLDING A BOOK. TO THE RIGHT OF THE STYLIZED WOMAN IS THE WORDING "THE PENINSULA", WHICH APPEARS ABOVE THE WORDING "ACADEMY". A HORIZONTAL LINE APPEARS BELOW THE WORDING "ACADEMY" AND ABOVE THE WORDING "NEW YORK".



David J. Kypas

SN 77-924,049, FILED 1-29-2010.

JOHN DWYER, EXAMINING ATTORNEY

United States of America

United States Patent and Trademark Office

Girlability Empowering Women One Girl at a Time

Reg. No. 4,067,893

Registered Dec. 6, 2011

Int. Cl.: 45

SERVICE MARK

PRINCIPAL REGISTER

WAGGONER, SHUREE (WASHINGTON LIMITED LIABILITY COMPANY), DBA
GIRLABILITY LLC,
P.O BOX 2885
REDMOND, WA 98073

FOR: COUNSELING IN THE FIELD OF PERSONAL DEVELOPMENT, NAMELY, SELF-IMPROVEMENT, SELF-FULFILLMENT, AND INTERPERSONAL COMMUNICATION , IN CLASS 45 (U.S. CLS. 100 AND 101).

FIRST USE 1-1-2009; IN COMMERCE 1-1-2010.

THE MARK CONSISTS OF STANDARD CHARACTERS WITHOUT CLAIM TO ANY PARTICULAR FONT, STYLE, SIZE, OR COLOR.

SN 77-924,112, FILED 1-29-2010.

HEATHER THOMPSON, EXAMINING ATTORNEY



David J. Kybas

Director of the United States Patent and Trademark Office

United States of America

United States Patent and Trademark Office

LIFEPRINT

Reg. No. 4,067,894

Registered Dec. 6, 2011

Int. Cls.: 35, 42, and 44

SERVICE MARK

PRINCIPAL REGISTER

UNITEDHEALTH GROUP INCORPORATED (MINNESOTA CORPORATION)
MN008-T202
9900 BREN ROAD EAST
MINNETONKA, MN 55343

FOR: HEALTH CARE AND MEDICAL PRACTICE ADMINISTRATION SERVICES, NAMELY, PROVIDING BACK OFFICE SERVICES FOR PHYSICIAN PRACTICES, MEDICAL BILLING SERVICES; MANAGED HEALTH CARE SERVICES, NAMELY, ELECTRONIC PROCESSING OF HEALTH CARE INFORMATION; PROVIDING INFORMATION IN THE FIELD OF BUSINESS ADMINISTRATION OF HEALTH CARE AND MEDICAL PRACTICES; CONSULTATION IN THE FIELD OF MANAGEMENT, OPERATION, AND DEVELOPMENT OF BUSINESS SYSTEMS FOR THE DELIVERY OF HEALTH CARE; HEALTHCARE MANAGEMENT SERVICE ORGANIZATION (MSO) SERVICES, NAMELY, PROVIDING PRACTICE ORGANIZATION, MANAGEMENT AND ADMINISTRATIVE SUPPORT SERVICES TO INDIVIDUAL PHYSICIANS OR SMALL GROUP PRACTICES, IN CLASS 35 (U.S. CLS. 100, 101 AND 102).

FIRST USE 2-0-2011; IN COMMERCE 2-0-2011.

FOR: HEALTH CARE AND MEDICAL BUSINESS SERVICES, NAMELY, DEVELOPMENT OF ONLINE COMPUTER SOFTWARE SYSTEMS FOR HEALTH CARE DELIVERY BETWEEN BUSINESSES; INFORMATION TECHNOLOGY SUPPORT SERVICES IN THE NATURE OF PROVIDING SUPPORT TO PHYSICIANS AND PATIENTS BY MEANS OF A WEBSITE FEATURING TEMPORARY USE OF ONLINE NON-DOWNLOADABLE SOFTWARE FOR USE IN ACCESSING ELECTRONIC HEALTH RECORDS, EXCHANGING HEALTH INFORMATION, AND CLAIMS PROCESSING IN THE FIELD OF TELEMEDICINE, IN CLASS 42 (U.S. CLS. 100 AND 101).

FIRST USE 2-0-2011; IN COMMERCE 2-0-2011.

FOR: PROVIDING INFORMATION IN THE FIELD OF HEALTH CARE, IN CLASS 44 (U.S. CLS. 100 AND 101).

FIRST USE 2-0-2011; IN COMMERCE 2-0-2011.

THE MARK CONSISTS OF STANDARD CHARACTERS WITHOUT CLAIM TO ANY PARTICULAR FONT, STYLE, SIZE, OR COLOR.



David J. Kybas

Director of the United States Patent and Trademark Office

Reg. No. 4,067,894 SN 77-925,069, FILED 2-1-2010.

LAURA HAMMEL, EXAMINING ATTORNEY

United States of America

United States Patent and Trademark Office

EVEREST

Reg. No. 4,067,895

Registered Dec. 6, 2011

Int. Cl.: 10

TRADEMARK

PRINCIPAL REGISTER

K2M, INC. (DELAWARE CORPORATION)
SUITE F-1
751 MILLER DRIVE, SE
LEESBURG, VA 20175

FOR: SURGICAL INSTRUMENTS AND SURGICAL IMPLANTS COMPRISING ARTIFICIAL MATERIALS USED IN SPINAL SURGERY, IN CLASS 10 (U.S. CLS. 26, 39 AND 44).

FIRST USE 4-5-2011; IN COMMERCE 4-5-2011.

THE MARK CONSISTS OF STANDARD CHARACTERS WITHOUT CLAIM TO ANY PARTICULAR FONT, STYLE, SIZE, OR COLOR.

SN 77-925,565, FILED 2-2-2010.

JAMES STEIN, EXAMINING ATTORNEY



David J. Kybas

Director of the United States Patent and Trademark Office

United States of America

United States Patent and Trademark Office

IGNITE-NOT

Reg. No. 4,067,896

Registered Dec. 6, 2011

Int. Cl.: 24

TRADEMARK

PRINCIPAL REGISTER

LOUIS HORNICK & CO., INC. (NEW YORK CORPORATION)
117 EAST 38TH STREET
NEW YORK, NY 10016

FOR: CURTAIN FABRIC; FABRIC WINDOW COVERINGS AND TREATMENTS, NAMELY, CURTAINS, DRAPERIES, SHEERS, SWAGS AND VALANCES, IN CLASS 24 (U.S. CLS. 42 AND 50).

FIRST USE 10-28-2010; IN COMMERCE 10-28-2010.

THE MARK CONSISTS OF STANDARD CHARACTERS WITHOUT CLAIM TO ANY PARTICULAR FONT, STYLE, SIZE, OR COLOR.

SN 77-926,015, FILED 2-2-2010.

TARAH HARDY, EXAMINING ATTORNEY



David J. Kyffers

Director of the United States Patent and Trademark Office

United States of America

United States Patent and Trademark Office

Urban & Fierce

Reg. No. 4,067,897

Registered Dec. 6, 2011

Int. Cls.: 3 and 25

TRADEMARK

PRINCIPAL REGISTER

URBAN INTIMATES LINGERIE, LLC (UNITED STATES LIMITED LIABILITY COMPANY),
AKA URBAN INTIMATES,
1003 SWAN LAKE DR.
FRISCO, TX 75034

FOR: BODY AND BEAUTY CARE COSMETICS, IN CLASS 3 (U.S. CLS. 1, 4, 6, 50, 51 AND 52).

FIRST USE 8-1-2009; IN COMMERCE 12-10-2009.

FOR: BOTTOMS; HATS; JEANS; LOUNGEWEAR; SHORT-SLEEVED OR LONG-SLEEVED T-SHIRTS; T-SHIRTS; TOPS, IN CLASS 25 (U.S. CLS. 22 AND 39).

FIRST USE 8-1-2009; IN COMMERCE 12-10-2009.

THE MARK CONSISTS OF STANDARD CHARACTERS WITHOUT CLAIM TO ANY PARTICULAR FONT, STYLE, SIZE, OR COLOR.

SN 77-927,629, FILED 2-4-2010.

BARBARA A. GOLD, EXAMINING ATTORNEY



David J. Kybas

Director of the United States Patent and Trademark Office

United States of America

United States Patent and Trademark Office

Wall Buttler

Reg. No. 4,067,898

LUSK, SAMANTHA (UNITED STATES INDIVIDUAL), DBA HY GENIE PRODUCTS,
7575 KATY FREEWAY #101
HOUSTON, TX 77024

Registered Dec. 6, 2011

Int. Cl.: 21

FOR: DISPENSERS FOR CLEANING AND DISINFECTING SOLUTIONS, IN CLASS 21 (U.S. CLS. 2, 13, 23, 29, 30, 33, 40 AND 50).

TRADEMARK

FIRST USE 1-1-2011; IN COMMERCE 1-1-2011.

PRINCIPAL REGISTER

THE MARK CONSISTS OF STANDARD CHARACTERS WITHOUT CLAIM TO ANY PARTICULAR FONT, STYLE, SIZE, OR COLOR.

SN 77-929,506, FILED 2-5-2010.

JENNIFER MARTIN, EXAMINING ATTORNEY



David J. Kybas

Director of the United States Patent and Trademark Office

United States of America

United States Patent and Trademark Office



Reg. No. 4,067,899
Registered Dec. 6, 2011
Int. Cl.: 30

SECK, GAIL (UNITED STATES INDIVIDUAL), AKA PURPLE GRACE,
125 LONGHILL RD.
12B
LITTLE FALLS, NJ 07042

FOR: BEVERAGES MADE OF TEA, IN CLASS 30 (U.S. CL. 46).

TRADEMARK

FIRST USE 12-8-2010; IN COMMERCE 3-1-2011.

PRINCIPAL REGISTER

THE NAME IN THE MARK IDENTIFIES GAIL SECK, A LIVING INDIVIDUAL WHOSE CONSENT TO THE REGISTRATION OF THE NAME AS A MARK IS IMPLIED BY HER SIGNATURE TO THE APPLICATION.

THE MARK CONSISTS OF THE WORDS "PURPLE" AND "GRACE" WITHIN A BORDER ON BOTH TOP AND BOTTOM WITH AN IMAGE OF TEA LEAVES ON TOP AND A DIAMOND SHAPE LOCATED BELOW WITHIN THE BORDER UNDER THE WORD "GRACE".

SN 77-929,726, FILED 2-6-2010.

DAVID ELTON, EXAMINING ATTORNEY



David J. Kybas

Director of the United States Patent and Trademark Office

United States of America

United States Patent and Trademark Office

MIRINDA FIESTA

Reg. No. 4,067,900

Registered Dec. 6, 2011

Int. Cl.: 32

TRADEMARK

PRINCIPAL REGISTER

PEPSICO, INC. (NORTH CAROLINA CORPORATION)
700 ANDERSON HILL ROAD
PURCHASE, NY 10577

FOR: CONCENTRATES, SYRUPS OR POWDERS USED IN THE PREPARATION OF SOFT DRINKS; SOFT DRINKS, IN CLASS 32 (U.S. CLS. 45, 46 AND 48).

FIRST USE 9-23-2011; IN COMMERCE 9-23-2011.

THE MARK CONSISTS OF STANDARD CHARACTERS WITHOUT CLAIM TO ANY PARTICULAR FONT, STYLE, SIZE, OR COLOR.

OWNER OF U.S. REG. NOS. 811,787, 3,673,798, AND OTHERS.

SN 77-931,696, FILED 2-9-2010.

KATHLEEN LORENZO, EXAMINING ATTORNEY



David J. Kybas

Director of the United States Patent and Trademark Office

United States of America

United States Patent and Trademark Office



Reg. No. 4,067,901

Registered Dec. 6, 2011

Int. Cl.: 25

TRADEMARK

PRINCIPAL REGISTER

STACKIN BILLS (TEXAS CORPORATION)
722 S. BOLTON STREET
JACKSONVILLE, TX 75766

FOR: CLOTHING PRODUCTS, NAMELY, FOOTWEAR AND HEADGEAR, NAMELY, CAPS AND HATS, T-SHIRTS, SHIRTS, TURTLENECKS, SWEAT SHIRTS, WIND SHIRTS, COATS, RAIN-WEAR, JACKETS, VESTS, HOODED SWEAT SHIRTS AND PULLOVERS, SWEATERS, PANTS, SHORTS, JUMPERS, SKIRTS, COVERALLS, OVERALLS, PARKAS, CLOTH BIBS, SOCKS, BOOTS, AND FISHING WADERS FOR CONSUMERS, IN CLASS 25 (U.S. CLS. 22 AND 39).

FIRST USE 9-8-2011; IN COMMERCE 9-8-2011.

THE MARK CONSISTS OF THE STYLIZED CONNECTED LETTERS "SB", WITH THE UPPER LOOP OF THE LETTER, "B" AND UPPER PORTION OF THE LETTER "S" CONSISTING OF A DUCK'S UPPER NECK HEAD, EYE, AND BILL.

SN 77-932,210, FILED 2-10-2010.

ODESSA BIBBINS, EXAMINING ATTORNEY



David J. Kypos

Director of the United States Patent and Trademark Office

United States of America

United States Patent and Trademark Office



Reg. No. 4,067,902

Registered Dec. 6, 2011

Int. Cl.: 25

TRADEMARK

PRINCIPAL REGISTER

SNOVER, CHRISTOPHER F. (UNITED STATES INDIVIDUAL), DBA I DEFY,
931 MULBERRY RD.
CLAYTON, NC 27520

FOR: ATHLETIC APPAREL, NAMELY, SHIRTS, PANTS, JACKETS, FOOTWEAR, HATS AND CAPS, ATHLETIC UNIFORMS; BANDANAS; BASEBALL CAPS AND HATS; CHILDREN'S AND INFANT'S APPAREL, NAMELY, JUMPERS, OVERALL SLEEPWEAR, PAJAMAS, ROMPERS AND ONE-PIECE GARMENTS; DO RAGS; GOLF CAPS; GOLF SHIRTS; HATS; HEADBANDS; HEADGEAR, NAMELY, HATS; HOODED SWEAT SHIRTS; JACKETS; LEATHER BELTS; LONG-SLEEVED SHIRTS; MOCK TURTLE-NECK SWEATERS; MOCKNECKS; POLO SHIRTS; SCARFS; SHIRTS; SHIRTS AND SHORT-SLEEVED SHIRTS; SHIRTS FOR INFANTS, BABIES, TODDLERS AND CHILDREN; SHORT-SLEEVED OR LONG-SLEEVED T-SHIRTS; SHORT-SLEEVED SHIRTS; SHORTS; SKULL CAPS; SKULLIES; SPORTS CAPS AND HATS; SWEAT SHIRTS; T-SHIRTS; TOBOGGAN HATS, PANTS AND CAPS, IN CLASS 25 (U.S. CLS. 22 AND 39).

FIRST USE 6-20-2010; IN COMMERCE 8-2-2010.

THE MARK CONSISTS OF AN OVAL FRAME WITH A CROSS PLACED INSIDE THE LEFT SIDE PORTION. A LOWER CASE PHRASE "I DEFY" ALSO INSIDE THE OVAL. THE LETTER "I" IS SET INSIDE THE IMAGE OF THE CROSS WITH THE WORD "DEFY" NEXT TO THE CROSS.

SN 77-932,336, FILED 2-10-2010.

MARGERY A. TIERNEY, EXAMINING ATTORNEY



David J. Kybas

Director of the United States Patent and Trademark Office

United States of America

United States Patent and Trademark Office

EXTRACARE ADVANTAGE FOR DIABETES

Reg. No. 4,067,903

Registered Dec. 6, 2011

Int. Cls.: 35 and 44

SERVICE MARK

PRINCIPAL REGISTER

CVS PHARMACY, INC (RHODE ISLAND CORPORATION)
ONE CVS DRIVE
WOONSOCKET, RI 02895

FOR: PROMOTING PUBLIC AWARENESS OF THE IMPORTANCE OF DIABETES MANAGEMENT AND CARE; PROMOTING DIABETES-RELATED CONSUMER AND PHARMACEUTICAL GOODS OF OTHERS THROUGH DISTRIBUTION OF DISCOUNT CARDS AND COUPONS AND THE ADMINISTRATION OF INCENTIVE AWARD PROGRAMS, IN CLASS 35 (U.S. CLS. 100, 101 AND 102).

FIRST USE 5-11-2010; IN COMMERCE 5-11-2010.

FOR: PROVIDING INFORMATION IN THE FIELD OF DIABETES; DIABETES MONITORING SERVICES, IN CLASS 44 (U.S. CLS. 100 AND 101).

FIRST USE 5-11-2010; IN COMMERCE 5-11-2010.

THE MARK CONSISTS OF STANDARD CHARACTERS WITHOUT CLAIM TO ANY PARTICULAR FONT, STYLE, SIZE, OR COLOR.

NO CLAIM IS MADE TO THE EXCLUSIVE RIGHT TO USE "DIABETES", APART FROM THE MARK AS SHOWN.

SN 77-934,223, FILED 2-12-2010.

THOMAS MANOR, EXAMINING ATTORNEY



David J. Kyros

Director of the United States Patent and Trademark Office

United States of America

United States Patent and Trademark Office

CGI GATEWAY360

Reg. No. 4,067,904

Registered Dec. 6, 2011

Int. Cl.: 42

SERVICE MARK

PRINCIPAL REGISTER

CGI TECHNOLOGIES AND SOLUTIONS INC. (DELAWARE CORPORATION)
4050 LEGATO ROAD
FAIRFAX, VA 22033

FOR: PROVIDING TEMPORARY USE OF ON-LINE NON-DOWNLOADABLE SOFTWARE FOR USE BY FINANCIAL SERVICE PROVIDERS TO REQUEST, RETRIEVE AND ANALYZE DATA FROM VARIOUS DATA SOURCES FOR USE IN CREDIT AND LOAN ORIGINATIONS, COLLECTIONS AND RECOVERY, IN CLASS 42 (U.S. CLS. 100 AND 101).

FIRST USE 10-18-2011; IN COMMERCE 10-18-2011.

THE MARK CONSISTS OF STANDARD CHARACTERS WITHOUT CLAIM TO ANY PARTICULAR FONT, STYLE, SIZE, OR COLOR.

OWNER OF U.S. REG. NOS. 3,664,147 AND 3,669,855.

SN 77-934,270, FILED 2-12-2010.

TIMOTHY FINNEGAN, EXAMINING ATTORNEY



David J. Kyffers

Director of the United States Patent and Trademark Office

United States of America

United States Patent and Trademark Office

UniversitEPublishing

Reg. No. 4,067,905

Registered Dec. 6, 2011

Int. Cls.: 16 and 41

TRADEMARK

SERVICE MARK

PRINCIPAL REGISTER

UNIVERSITEPUBLISHING, LLC (DELAWARE LIMITED LIABILITY COMPANY)
SUITE 700
700 12TH ST. NW
WASHINGTON, DC 20006

FOR: EDUCATIONAL PUBLICATIONS, NAMELY, RESEARCH PAPERS IN THE FIELDS OF ORGANIZATION AND PERSONAL PROBLEM SOLVING, IN CLASS 16 (U.S. CLS. 2, 5, 22, 23, 29, 37, 38 AND 50).

FIRST USE 8-15-2011; IN COMMERCE 8-15-2011.

FOR: EDUCATING AT SENIOR HIGH SCHOOLS; EDUCATING AT UNIVERSITY OR COLLEGES; EDUCATION SERVICES, NAMELY, MENTORING IN THE FIELD OF ORGANIZATION AND PERSONAL PROBLEM SOLVING; ELECTRONIC PUBLISHING SERVICES, NAMELY, PUBLICATION OF TEXT AND GRAPHIC WORKS OF OTHERS ON PDF AND ONLINE MEDIA FEATURING NON-FICTION AND FICTION MATERIAL; PHYSICAL EDUCATION; PROVIDING INFORMATION ON TEACHING METHODOLOGY AND EDUCATION ISSUES TO MUSIC EDUCATORS; PROVISION OF INFORMATION RELATING TO PUBLISHING OF ELECTRONIC PUBLICATIONS, IN CLASS 41 (U.S. CLS. 100, 101 AND 107).

FIRST USE 8-15-2011; IN COMMERCE 8-15-2011.

THE MARK CONSISTS OF STANDARD CHARACTERS WITHOUT CLAIM TO ANY PARTICULAR FONT, STYLE, SIZE, OR COLOR.

SN 77-934,336, FILED 2-12-2010.

KAPIL BHANOT, EXAMINING ATTORNEY



David J. Kybas

Director of the United States Patent and Trademark Office

United States of America

United States Patent and Trademark Office

EARTH RANGERS BRING BACK THE WILD

Reg. No. 4,067,906

Registered Dec. 6, 2011

Int. Cl.: 36

SERVICE MARK

PRINCIPAL REGISTER

EARTH RANGERS FOUNDATION (CANADA NOT FOR PROFIT CORPORATION)
9520 PINE VALLEY DRIVE
WOODBIDGE, ONTARIO, CANADA L4L1A6

FOR: CHARITABLE FUNDRAISING SERVICES, IN CLASS 36 (U.S. CLS. 100, 101 AND 102).

FIRST USE 6-29-2010; IN COMMERCE 6-29-2010.

THE MARK CONSISTS OF STANDARD CHARACTERS WITHOUT CLAIM TO ANY PARTICULAR FONT, STYLE, SIZE, OR COLOR.

OWNER OF U.S. REG. NOS. 1,810,838, 3,021,238, AND 3,029,554.

SN 77-934,712, FILED 2-12-2010.

BRIDGETT SMITH, EXAMINING ATTORNEY



David J. Kybas

Director of the United States Patent and Trademark Office

United States of America

United States Patent and Trademark Office

BE THERE

Reg. No. 4,067,907

Registered Dec. 6, 2011

Int. Cls.: 35, 36, and 39

SERVICE MARK

PRINCIPAL REGISTER

COLUMBIA INSURANCE COMPANY (NEBRASKA CORPORATION)
3024 HARNEY STREET
OMAHA, NE 68131

FOR: AIRCRAFT BUSINESS MANAGEMENT SERVICES, NAMELY, MANAGING AND ARRANGING AIRCRAFT OPERATIONS AND AIRCRAFT CREW SCHEDULING FOR OTHERS, IN CLASS 35 (U.S. CLS. 100, 101 AND 102).

FIRST USE 1-22-2010; IN COMMERCE 1-22-2010.

FOR: OFFERING AIRCRAFT FRACTIONAL OWNERSHIP PROGRAMS FOR OTHERS, IN CLASS 36 (U.S. CLS. 100, 101 AND 102).

FIRST USE 1-22-2010; IN COMMERCE 1-22-2010.

FOR: AIRCRAFT CHARTERING SERVICES; FLIGHT PLANNING SERVICES; AND FRACTIONAL AIRCRAFT SERVICES FOR PASSENGERS, NAMELY, FURNISHING JET AIR TRANSPORTATION FOR PASSENGERS; JET TRANSPORTATION SERVICES, IN CLASS 39 (U.S. CLS. 100 AND 105).

FIRST USE 1-22-2010; IN COMMERCE 1-22-2010.

THE MARK CONSISTS OF STANDARD CHARACTERS WITHOUT CLAIM TO ANY PARTICULAR FONT, STYLE, SIZE, OR COLOR.

SN 77-936,060, FILED 2-15-2010.

CARYN GLASSER, EXAMINING ATTORNEY



David J. Kypos

Director of the United States Patent and Trademark Office

United States of America

United States Patent and Trademark Office

DLS

Reg. No. 4,067,908

Registered Dec. 6, 2011

Int. Cl.: 9

BAE SYSTEMS INFORMATION AND ELECTRONIC SYSTEMS INTEGRATION INC.
(DELAWARE CORPORATION)
P.O. BOX 868
NHQ1-719
NASHUA, NH 03061

TRADEMARK

PRINCIPAL REGISTER

FOR: SOFTWARE DEFINED RADIO (SDR) TRANSCEIVERS CAPABLE OF PROVIDING TWO-WAY COMMUNICATIONS FOR USE IN SITUATIONAL AWARENESS TO AIR, NAVAL, AND GROUND PLATFORMS, ALL FOR NATIONAL SECURITY PURPOSES, IN CLASS 9 (U.S. CLS. 21, 23, 26, 36 AND 38).

FIRST USE 7-31-2006; IN COMMERCE 7-31-2006.

THE MARK CONSISTS OF STANDARD CHARACTERS WITHOUT CLAIM TO ANY PARTICULAR FONT, STYLE, SIZE, OR COLOR.

SN 77-937,433, FILED 2-17-2010.

KIMBERLY PERRY, EXAMINING ATTORNEY



David J. Kyros

Director of the United States Patent and Trademark Office

United States of America

United States Patent and Trademark Office

BankON

Reg. No. 4,067,909

Registered Dec. 6, 2011

Int. Cl.: 9

TRADEMARK

PRINCIPAL REGISTER

HITACHI CONSULTING CORPORATION (DELAWARE CORPORATION)
SUITE 3600
2001 BRYAN STREET
DALLAS, TX 75201

FOR: BUSINESS SOFTWARE THAT INTEGRATES BANKS WITH THEIR CORPORATE CUSTOMERS, IN CLASS 9 (U.S. CLS. 21, 23, 26, 36 AND 38).

FIRST USE 4-23-2010; IN COMMERCE 6-25-2010.

THE MARK CONSISTS OF THE WORD ELEMENT "BANKON" WITH THE "O" RESEMBLING A POWER BUTTON.

SN 77-937,554, FILED 2-17-2010.

JENNIFER VASQUEZ, EXAMINING ATTORNEY



David J. Kybas

Director of the United States Patent and Trademark Office

United States of America

United States Patent and Trademark Office



Improving Care. Improving Business.

Reg. No. 4,067,910

Registered Dec. 6, 2011

Int. Cl.: 35

SERVICE MARK

PRINCIPAL REGISTER

DEROYAL INDUSTRIES, INC. (TENNESSEE CORPORATION)
200 DEBUSK LANE
POWELL, TN 37849

FOR: PROVIDING RECOMMENDATIONS OF MEDICAL SUPPLIES TO CONSUMERS FOR COMMERCIAL PURPOSES, NAMELY, RECOMMENDATIONS RELATED TO THE COST-EFFECTIVE SELECTION AND USE OF MEDICAL SUPPLIES, AND CONSULTATION RELATED THERETO, IN CLASS 35 (U.S. CLS. 100, 101 AND 102).

FIRST USE 2-1-2010; IN COMMERCE 1-15-2011.

OWNER OF U.S. REG. NOS. 2,727,248, 2,741,924, AND 2,829,823.

THE COLOR(S) BLUE IS/ARE CLAIMED AS A FEATURE OF THE MARK.

THE MARK CONSISTS OF A FANCIFUL DESIGN IN THE NATURE OF A BLUE INCOMPLETE OVAL, TO THE RIGHT OF WHICH APPEARS THE BLUE WORD "DEROYAL", BELOW WHICH APPEARS THE BLUE WORDING "IMPROVING CARE. IMPROVING BUSINESS.".

SN 77-938,022, FILED 2-17-2010.

KRISTIN CARLSON, EXAMINING ATTORNEY



David J. Kybas

Director of the United States Patent and Trademark Office

United States of America

United States Patent and Trademark Office

Paysage

Reg. No. 4,067,911

Registered Dec. 6, 2011

Int. Cl.: 33

TRADEMARK

PRINCIPAL REGISTER

THE TRUSTEES OF THE LASSETER LIVING TRUST, A CALIFORNIA TRUST, THE TRUSTEES COMPRISING JOHN A. LASSETER AND NANCY T. LASSETER, BOTH U.S. CITIZENS (CALIFORNIA TRUST)
ONE VINTAGE LANE
GLEN ELLEN, CA 95442

FOR: WINES, IN CLASS 33 (U.S. CLS. 47 AND 49).

FIRST USE 3-10-2011; IN COMMERCE 3-10-2011.

THE MARK CONSISTS OF STANDARD CHARACTERS WITHOUT CLAIM TO ANY PARTICULAR FONT, STYLE, SIZE, OR COLOR.

THE ENGLISH TRANSLATION OF "PAYSAGE" IN THE MARK IS "LANDSCAPE".

SN 77-938,024, FILED 2-17-2010.

KATHERINE E. HALMEN, EXAMINING ATTORNEY



David J. Kybas

Director of the United States Patent and Trademark Office

United States of America

United States Patent and Trademark Office

GREEN IS EVERYONE'S BUSINESS

Reg. No. 4,067,912

Registered Dec. 6, 2011

Int. Cl.: 35

SERVICE MARK

PRINCIPAL REGISTER

ZAHN, PETER (UNITED STATES INDIVIDUAL)
12625 HIGH BLUFF DRIVE, SUITE 110
SAN DIEGO, CA 92130

FOR: ADVERTISING, MARKETING AND PROMOTION SERVICES; ADVICE IN THE FIELD OF BUSINESS MANAGEMENT AND MARKETING; ASSISTANCE, ADVISORY SERVICES AND CONSULTANCY WITH REGARD TO BUSINESS PLANNING, BUSINESS ANALYSIS, BUSINESS MANAGEMENT, BUSINESS ORGANIZATION, MARKETING AND CUSTOMER ANALYSIS; BUSINESS CONSULTATION AND MANAGEMENT REGARDING MARKETING ACTIVITIES AND LAUNCHING OF NEW PRODUCTS; BUSINESS MANAGEMENT CONSULTING WITH RELATION TO STRATEGY, MARKETING, PRODUCTION, PERSONNEL AND RETAIL SALE MATTERS; BUSINESS TO BUSINESS DIRECT MARKETING SERVICES; CHAMBER OF COMMERCE SERVICES, NAMELY, PROMOTING BUSINESS AND TOURISM IN VARIOUS METROPOLITAN AREAS ACROSS THE UNITED STATES; COOPERATIVE ADVERTISING AND MARKETING; MARKET RESEARCH SERVICES; MARKETING, ADVERTISING AND PROMOTING THE GOODS AND SERVICES OF OTHERS IN THE FIELD OF TRAVEL AND TOURISM, NAMELY, PROVIDING INFORMATION VIA MAIL AND ELECTRONIC MAIL; PROMOTION, ADVERTISING AND MARKETING OF ON-LINE WEBSITES; PROVIDING MARKETING AND PROMOTION OF SPECIAL EVENTS, IN CLASS 35 (U.S. CLS. 100, 101 AND 102).

FIRST USE 4-13-2010; IN COMMERCE 4-13-2010.

THE MARK CONSISTS OF STANDARD CHARACTERS WITHOUT CLAIM TO ANY PARTICULAR FONT, STYLE, SIZE, OR COLOR.

SN 77-938,910, FILED 2-18-2010.

LINDSEY RUBIN, EXAMINING ATTORNEY



David J. Kyros

Director of the United States Patent and Trademark Office

United States of America

United States Patent and Trademark Office

MICHAEL PRINCE

Reg. No. 4,067,913

Registered Dec. 6, 2011

Int. Cl.: 25

TRADEMARK

PRINCIPAL REGISTER

MORALDO, PRINCE MICHAEL (UNITED STATES INDIVIDUAL), DBA MICHAEL PRINCE,
80 FAIRLAWN AVE APT D8
BOSTON, MA 02126

FOR: PANTS, SHIRTS, JEANS, BELTS, CAPS, SWEAT SUITS, AND COATS, IN CLASS 25
(U.S. CLS. 22 AND 39).

FIRST USE 11-9-2010; IN COMMERCE 11-9-2010.

THE MARK CONSISTS OF STANDARD CHARACTERS WITHOUT CLAIM TO ANY PAR-
TICULAR FONT, STYLE, SIZE, OR COLOR.

THE NAME "MICHAEL PRINCE" IDENTIFIES A LIVING INDIVIDUAL WHOSE CONSENT
IS OF RECORD.

SN 77-939,448, FILED 2-18-2010.

ELIZABETH KAJUBI, EXAMINING ATTORNEY



David J. Kybas

Director of the United States Patent and Trademark Office

United States of America

United States Patent and Trademark Office

LUMENBEAM

Reg. No. 4,067,914

Registered Dec. 6, 2011

Int. Cl.: 11

TRADEMARK

PRINCIPAL REGISTER

LUMENPULSE LIGHTING, INC. (CANADA CORPORATION)
1751 RUE RICHARDSON
MONTREAL, QUEBEC, CANADA H3K1G6

FOR: LIGHTING FIXTURES; OUTDOOR FACADE LIGHTING FIXTURES; LIGHTING FIXTURES FOR OUTDOOR LIGHTING APPLICATIONS, IN CLASS 11 (U.S. CLS. 13, 21, 23, 31 AND 34).

FIRST USE 1-0-2010; IN COMMERCE 1-0-2010.

THE MARK CONSISTS OF STANDARD CHARACTERS WITHOUT CLAIM TO ANY PARTICULAR FONT, STYLE, SIZE, OR COLOR.

SN 77-940,152, FILED 2-19-2010.

JENNIFER MARTIN, EXAMINING ATTORNEY



David J. Kybas

Director of the United States Patent and Trademark Office

United States of America

United States Patent and Trademark Office

LUMENSUB

Reg. No. 4,067,915

Registered Dec. 6, 2011

Int. Cl.: 11

TRADEMARK

PRINCIPAL REGISTER

LUMENPULSE LIGHTING, INC. (CANADA CORPORATION)
1751 RUE RICHARDSON
MONTREAL, QUEBEC, CANADA H3K1G6

FOR: LIGHTING FIXTURES; OUTDOOR FACADE LIGHTING FIXTURES; LIGHTING FIXTURES FOR OUTDOOR LIGHTING APPLICATIONS, IN CLASS 11 (U.S. CLS. 13, 21, 23, 31 AND 34).

FIRST USE 1-0-2010; IN COMMERCE 1-0-2010.

THE MARK CONSISTS OF STANDARD CHARACTERS WITHOUT CLAIM TO ANY PARTICULAR FONT, STYLE, SIZE, OR COLOR.

SN 77-940,160, FILED 2-19-2010.

JENNIFER MARTIN, EXAMINING ATTORNEY



David J. Kybas

Director of the United States Patent and Trademark Office

United States of America

United States Patent and Trademark Office

LUMENFACADEFX

Reg. No. 4,067,916

Registered Dec. 6, 2011

Int. Cl.: 11

TRADEMARK

PRINCIPAL REGISTER

LUMENPULSE LIGHTING, INC. (CANADA CORPORATION)
1751 RUE RICHARDSON
MONTREAL, QUEBEC, CANADA H3K1G6

FOR: LIGHTING FIXTURES; OUTDOOR FACADE LIGHTING FIXTURES; LIGHTING FIXTURES FOR OUTDOOR LIGHTING APPLICATIONS, IN CLASS 11 (U.S. CLS. 13, 21, 23, 31 AND 34).

FIRST USE 1-0-2010; IN COMMERCE 1-0-2010.

THE MARK CONSISTS OF STANDARD CHARACTERS WITHOUT CLAIM TO ANY PARTICULAR FONT, STYLE, SIZE, OR COLOR.

SN 77-940,169, FILED 2-19-2010.

JENNIFER MARTIN, EXAMINING ATTORNEY



David J. Kybas

Director of the United States Patent and Trademark Office

United States of America

United States Patent and Trademark Office

LUMENTOUCH

Reg. No. 4,067,917

Registered Dec. 6, 2011

Int. Cl.: 11

TRADEMARK

PRINCIPAL REGISTER

LUMENPULSE LIGHTING, INC. (CANADA CORPORATION)
1751 RUE RICHARDSON
MONTREAL, QUEBEC, CANADA 03301

FOR: LIGHTING FIXTURES, IN CLASS 11 (U.S. CLS. 13, 21, 23, 31 AND 34).

FIRST USE 1-0-2010; IN COMMERCE 1-0-2010.

THE MARK CONSISTS OF STANDARD CHARACTERS WITHOUT CLAIM TO ANY PARTICULAR FONT, STYLE, SIZE, OR COLOR.

SN 77-940,179, FILED 2-19-2010.

JENNIFER MARTIN, EXAMINING ATTORNEY



David J. Kybas

Director of the United States Patent and Trademark Office

United States of America

United States Patent and Trademark Office

LUMENCUE

Reg. No. 4,067,918

Registered Dec. 6, 2011

Int. Cl.: 11

TRADEMARK

PRINCIPAL REGISTER

LUMENPULSE LIGHTING, INC. (CANADA CORPORATION)
1751 RUE RICHARDSON
MONTREAL, QUEBEC, CANADA H3K1G6

FOR: LIGHTING FIXTURES, IN CLASS 11 (U.S. CLS. 13, 21, 23, 31 AND 34).

FIRST USE 1-0-2010; IN COMMERCE 1-0-2010.

THE MARK CONSISTS OF STANDARD CHARACTERS WITHOUT CLAIM TO ANY PARTICULAR FONT, STYLE, SIZE, OR COLOR.

SN 77-940,183, FILED 2-19-2010.

JENNIFER MARTIN, EXAMINING ATTORNEY



David J. Kybas

Director of the United States Patent and Trademark Office

United States of America

United States Patent and Trademark Office

LUMENFACADE

Reg. No. 4,067,919

Registered Dec. 6, 2011

Int. Cl.: 11

TRADEMARK

PRINCIPAL REGISTER

LUMENPULSE LIGHTING, INC. (CANADA CORPORATION)
1751 RUE RICHARDSON
MONTREAL, QUEBEC, CANADA H3K1G6

FOR: LIGHTING FIXTURES; OUTDOOR FACADE LIGHTING FIXTURES; LIGHTING FIXTURES FOR OUTDOOR LIGHTING APPLICATIONS, IN CLASS 11 (U.S. CLS. 13, 21, 23, 31 AND 34).

FIRST USE 1-0-2010; IN COMMERCE 1-0-2010.

THE MARK CONSISTS OF STANDARD CHARACTERS WITHOUT CLAIM TO ANY PARTICULAR FONT, STYLE, SIZE, OR COLOR.

SN 77-940,225, FILED 2-19-2010.

JENNIFER MARTIN, EXAMINING ATTORNEY



David J. Kybas

Director of the United States Patent and Trademark Office

United States of America

United States Patent and Trademark Office

Digiwatts

Reg. No. 4,067,920

Registered Dec. 6, 2011

Int. Cl.: 9

TRADEMARK

PRINCIPAL REGISTER

RENOVO POWER SYSTEMS LLC (MICHIGAN LIMITED LIABILITY COMPANY)
2215 WILDOAK LN
ANN ARBOR, MI 48105

FOR: APPARATUS AND INSTRUMENTS FOR CONVEYING, DISTRIBUTING, TRANSFORMING, STORING, REGULATING OR CONTROLLING ELECTRIC CURRENT; BATTERY CHARGE DEVICES; ELECTRONIC DEVICES, NAMELY, ENERGY METERS FOR TRACKING AND MONITORING ENERGY USAGE; INVERTERS; POWER INVERTERS; TRANSFORMERS, IN CLASS 9 (U.S. CLS. 21, 23, 26, 36 AND 38).

FIRST USE 10-8-2011; IN COMMERCE 10-8-2011.

THE MARK CONSISTS OF STANDARD CHARACTERS WITHOUT CLAIM TO ANY PARTICULAR FONT, STYLE, SIZE, OR COLOR.

SN 77-940,856, FILED 2-21-2010.

FRED CARL, EXAMINING ATTORNEY



David J. Kyffers

Director of the United States Patent and Trademark Office

United States of America

United States Patent and Trademark Office

A

Reg. No. 4,067,921

Registered Dec. 6, 2011

Int. Cl.: 6

TRADEMARK

PRINCIPAL REGISTER

AUGE INDUSTRIAL FASTENERS, LLC (TEXAS LIMITED LIABILITY COMPANY)
SUITE 150
10350 CLAY ROAD
HOUSTON, TX 77041

FOR: METAL FASTENERS, NAMELY, BOLTS AND PLAIN BARS; METAL THREADED NUTS; METAL WIRE ROPE FITTINGS, NAMELY, DOUBLE END STUDS AND HEX STUDS, ALL FOR USE IN THE OIL, GAS, AND ENERGY INDUSTRIES, IN CLASS 6 (U.S. CLS. 2, 12, 13, 14, 23, 25 AND 50).

FIRST USE 0-0-1965; IN COMMERCE 0-0-2001.

THE MARK CONSISTS OF STANDARD CHARACTERS WITHOUT CLAIM TO ANY PARTICULAR FONT, STYLE, SIZE, OR COLOR.

SN 77-941,203, FILED 2-22-2010.

MARK PILARO, EXAMINING ATTORNEY



David J. Kybas

Director of the United States Patent and Trademark Office

United States of America

United States Patent and Trademark Office

HIGH PERFORMANCE BUREAUCRACY

Reg. No. 4,067,922

Registered Dec. 6, 2011

Int. Cl.: 35

SERVICE MARK

PRINCIPAL REGISTER

MONITOR COMPANY GROUP LIMITED PARTNERSHIP (DELAWARE LIMITED PARTNERSHIP)
TWO CANAL PARK
CAMBRIDGE, MA 02141

FOR: BUSINESS CONSULTING AND INFORMATION SERVICES, IN CLASS 35 (U.S. CLS. 100, 101 AND 102).

FIRST USE 2-3-2010; IN COMMERCE 2-3-2010.

THE MARK CONSISTS OF STANDARD CHARACTERS WITHOUT CLAIM TO ANY PARTICULAR FONT, STYLE, SIZE, OR COLOR.

NO CLAIM IS MADE TO THE EXCLUSIVE RIGHT TO USE "BUREAUCRACY", APART FROM THE MARK AS SHOWN.

SN 77-941,380, FILED 2-22-2010.

MICHELLE DUBOIS, EXAMINING ATTORNEY



David J. Kyros

Director of the United States Patent and Trademark Office

United States of America

United States Patent and Trademark Office

Libero Ferrero

Reg. No. 4,067,923

LIBERO FERRERO, LLC (MICHIGAN LIMITED LIABILITY COMPANY)
117 E. 24TH STREET, UNIT 224
NEW YORK, NY 10010

Registered Dec. 6, 2011

Int. Cl.: 18

FOR: HANDBAGS FOR MEN; MEN'S CLUTCH BAGS; SMALL BAGS FOR MEN; LEATHER BAGS AND WALLETS FOR MEN, IN CLASS 18 (U.S. CLS. 1, 2, 3, 22 AND 41).

TRADEMARK

FIRST USE 11-15-2009; IN COMMERCE 9-29-2011.

PRINCIPAL REGISTER

THE MARK CONSISTS OF STANDARD CHARACTERS WITHOUT CLAIM TO ANY PARTICULAR FONT, STYLE, SIZE, OR COLOR.

THE NAME(S), PORTRAIT(S), AND/OR SIGNATURE(S) SHOWN IN THE MARK DOES NOT IDENTIFY A PARTICULAR LIVING INDIVIDUAL.

THE ENGLISH TRANSLATION OF "LIBERO" IN THE MARK IS "FREE".

SN 77-941,401, FILED 2-22-2010.

MICHELLE DUBOIS, EXAMINING ATTORNEY



David J. Kybas

Director of the United States Patent and Trademark Office

United States of America

United States Patent and Trademark Office

NEUROASIS

Reg. No. 4,067,924

Registered Dec. 6, 2011

Int. Cls.: 5 and 44

TRADEMARK

SERVICE MARK

PRINCIPAL REGISTER

ANTHONY P. GERACI, M.D., PC (NEW YORK CORPORATION)
SUITE 205
350 BROADWAY
NEW YORK, NY 10013

FOR: VITAMINS AND HERBAL SUPPLEMENTS, IN CLASS 5 (U.S. CLS. 6, 18, 44, 46, 51 AND 52).

FIRST USE 10-13-2011; IN COMMERCE 10-13-2011.

FOR: MEDICAL SERVICES AND MEDICAL CONSULTATION SERVICES VIA TELEPHONE AND OTHER TELECOMMUNICATION DEVICES; PROVIDING AN PATIENT-INITIATED, PATIENT-AUTHORIZED, FEE-FOR-SERVICE, MEDICAL PROFILE AND MEDICAL RECORD ANALYSIS SERVICE DESIGNED TO PROVIDE PATIENTS WITH CUSTOM TAILORED INFORMATION ABOUT THE RANGE OF POSSIBLE DIAGNOSES AND THERAPIES ASSOCIATED WITH A DEFINED SET OF SYMPTOMS, IN CLASS 44 (U.S. CLS. 100 AND 101).

FIRST USE 12-1-2010; IN COMMERCE 12-1-2010.

THE MARK CONSISTS OF STANDARD CHARACTERS WITHOUT CLAIM TO ANY PARTICULAR FONT, STYLE, SIZE, OR COLOR.

SN 77-941,537, FILED 2-22-2010.

ANDREA K. NADELMAN, EXAMINING ATTORNEY



David J. Kyros

Director of the United States Patent and Trademark Office

United States of America

United States Patent and Trademark Office

DASH

Reg. No. 4,067,925

Registered Dec. 6, 2011

Int. Cl.: 9

TRADEMARK

PRINCIPAL REGISTER

PASULKA, DARIEN C. (UNITED STATES INDIVIDUAL)
C/O DONALD PASULKA, APT. 3011
233 E. WACKER
CHICAGO, IL 60601

FOR: SOUND RECORDINGS AND DOWNLOADABLE SOUND RECORDINGS FEATURING MUSIC AND MUSIC PERFORMANCES; DVDS AND AUDIOVISUAL RECORDINGS AND DOWNLOADABLE AUDIOVISUAL RECORDINGS FEATURING MUSIC AND MUSIC PERFORMANCES; AUDIO AND VIDEO CASSETTES AND AUDIO AND VIDEO COMPACT DISCS, ALL FEATURING MUSICAL SOUND RECORDINGS AND PERFORMANCES; PHONOGRAPH RECORDS FEATURING SOUND RECORDINGS AND MUSICAL PERFORMANCES; LASER DISCS FEATURING SOUND RECORDINGS AND MUSICAL PERFORMANCES, IN CLASS 9 (U.S. CLS. 21, 23, 26, 36 AND 38).

FIRST USE 9-1-2010; IN COMMERCE 9-1-2010.

THE MARK CONSISTS OF STANDARD CHARACTERS WITHOUT CLAIM TO ANY PARTICULAR FONT, STYLE, SIZE, OR COLOR.

SN 77-943,503, FILED 2-24-2010.

ERNEST SHOSHO, EXAMINING ATTORNEY



David J. Kyffers

Director of the United States Patent and Trademark Office

United States of America

United States Patent and Trademark Office



Reg. No. 4,067,926

Registered Dec. 6, 2011

Int. Cl.: 11

TRADEMARK

PRINCIPAL REGISTER

AQUA BEST TECHNOLOGY LIMITED (BELIZE LIMITED LIABILITY COMPANY)
NO. 10 EVE STREET
SUITE 2, 3RD FLOOR
BELIZE CITY, BELIZE

FOR: WATER PURIFICATION INSTALLATIONS; WATER FILTERS FOR HOUSEHOLD OR INDUSTRIAL INSTALLATIONS; WATER PURIFYING APPARATUS; STERILIZERS NOT FOR MEDICAL PURPOSES; SEWAGE PURIFICATION APPARATUS; WATER FOUNTAINS; FILTERS FOR DRINKING WATER; ULTRAVIOLET RADIATION DISINFECTION CABINETS NOT FOR MEDICAL USE, USED IN DRINKING WATER APPLICATIONS, UNDER SINK INSTALLS AND WATER VENDING MACHINES, AIRCRAFT, BOATS AND RECREATIONAL VEHICLES, WATER WELLS AND WATER CISTERNS, SWIMMING POOL AND HOT TUBS, FARMS, RANCHES AND TRAILER PARKS, SCHOOLS AND HOTELS, AQUARIUM, HATCHERIES AND NURSERIES, AND ICE MAKING; AND WATER DESALINATION PLANTS , IN CLASS 11 (U.S. CLS. 13, 21, 23, 31 AND 34).

FIRST USE 3-9-2010; IN COMMERCE 3-9-2010.

THE MARK CONSISTS OF WORD "SPLENVUE" APPEARING ON A STRIPED BACKGROUND WITH THE STRIPES APPEARING IN FRONT OF THE LETTERS "NVUE", WHICH APPEAR LIGHTER THAN THE LETTERS "SPLE".

SN 77-943,950, FILED 2-24-2010.

ELIZABETH KAJUBI, EXAMINING ATTORNEY



David J. Kyffers

Director of the United States Patent and Trademark Office

United States of America

United States Patent and Trademark Office

RAPID TRAP

Reg. No. 4,067,927

Registered Dec. 6, 2011

Int. Cl.: 6

TRADEMARK

PRINCIPAL REGISTER

TOURATECH AG (FED REP GERMANY AKTIENGESELLSCHAFT)
AUF DEM ZIMMERMANN 7-9
NIEDERESCHACH, FED REP GERMANY 78078

FOR: METAL LOCKING DEVICE FOR A MOTORCYCLE CASE COMPRISED OF AN ATTACHMENT FOR CASES WITH LOCKING MECHANISM FOR MOUNTING THE CASE TO A MOTORCYCLE LUGGAGE RACK OR BRACKET, IN CLASS 6 (U.S. CLS. 2, 12, 13, 14, 23, 25 AND 50).

FIRST USE 4-8-2011; IN COMMERCE 4-18-2011.

THE MARK CONSISTS OF STANDARD CHARACTERS WITHOUT CLAIM TO ANY PARTICULAR FONT, STYLE, SIZE, OR COLOR.

SN 77-945,802, FILED 2-26-2010.

JASON TURNER, EXAMINING ATTORNEY



David J. Kybas

Director of the United States Patent and Trademark Office

United States of America

United States Patent and Trademark Office

TURBOLIGHT

Reg. No. 4,067,928

Registered Dec. 6, 2011

Int. Cl.: 9

TRADEMARK

PRINCIPAL REGISTER

JOHN PAUL MITCHELL SYSTEMS (CALIFORNIA CORPORATION)
20705 CENTRE POINTE PARKWAY
SAUGUS, CA 91350

FOR: ELECTRIC HAND-HELD HAIR STYLING IRONS, IN CLASS 9 (U.S. CLS. 21, 23, 26, 36 AND 38).

FIRST USE 7-1-2011; IN COMMERCE 7-1-2011.

THE MARK CONSISTS OF STANDARD CHARACTERS WITHOUT CLAIM TO ANY PARTICULAR FONT, STYLE, SIZE, OR COLOR.

SN 77-946,383, FILED 2-26-2010.

DAVID COLLIER, EXAMINING ATTORNEY



David J. Kyffers

Director of the United States Patent and Trademark Office

United States of America

United States Patent and Trademark Office

COLLISION GUARD

Reg. No. 4,067,929

Registered Dec. 6, 2011

Int. Cl.: 35

SERVICE MARK

PRINCIPAL REGISTER

NICHOLS ENTERPRISES, LLC (UTAH LIMITED LIABILITY COMPANY)
1005 NORTH STATE ST.
OREM, UT 84057

FOR: MEMBERSHIP CLUB SERVICES, NAMELY, COORDINATING DISCOUNTS AND REBATES FOR THE SERVICES OF OTHERS IN THE FIELD OF VEHICLE SAFETY, MAINTENANCE, RESTORATION AND REPAIR; CONDUCTING AND ADMINISTERING A DISCOUNT PROGRAM FOR ENABLING PARTICIPANTS TO OBTAIN DISCOUNTS ON THE COST OF SERVICES OR RECEIVE IMPROVED SERVICES THROUGH USE OF A MEMBERSHIP ACCOUNT IN THE FIELD OF VEHICLE SAFETY, MAINTENANCE, RESTORATION AND REPAIR, IN CLASS 35 (U.S. CLS. 100, 101 AND 102).

FIRST USE 9-1-2010; IN COMMERCE 9-1-2010.

THE MARK CONSISTS OF STANDARD CHARACTERS WITHOUT CLAIM TO ANY PARTICULAR FONT, STYLE, SIZE, OR COLOR.

NO CLAIM IS MADE TO THE EXCLUSIVE RIGHT TO USE "COLLISION", APART FROM THE MARK AS SHOWN.

SN 77-946,399, FILED 2-26-2010.

BARBARA RUTLAND, EXAMINING ATTORNEY



David J. Kyjars

Director of the United States Patent and Trademark Office

United States of America

United States Patent and Trademark Office



**Collision
Guard**

Reg. No. 4,067,930

Registered Dec. 6, 2011

Int. Cl.: 35

SERVICE MARK

PRINCIPAL REGISTER

NICHOLS ENTERPRISES, LLC (UTAH LIMITED LIABILITY COMPANY)
1005 NORTH STATE ST.
OREM, UT 84057

FOR: MEMBERSHIP CLUB SERVICES, NAMELY, COORDINATING DISCOUNTS AND REBATES FOR THE SERVICES OF OTHERS IN THE FIELD OF VEHICLE SAFETY, MAINTENANCE, RESTORATION AND REPAIR; CONDUCTING AND ADMINISTERING A DISCOUNT PROGRAM FOR ENABLING PARTICIPANTS TO OBTAIN DISCOUNTS ON THE COST OF SERVICES OR RECEIVE IMPROVED SERVICES THROUGH USE OF A MEMBERSHIP ACCOUNT IN THE FIELD OF VEHICLE SAFETY, MAINTENANCE, RESTORATION AND REPAIR, IN CLASS 35 (U.S. CLS. 100, 101 AND 102).

FIRST USE 9-1-2010; IN COMMERCE 9-1-2010.

NO CLAIM IS MADE TO THE EXCLUSIVE RIGHT TO USE "COLLISION", APART FROM THE MARK AS SHOWN.

THE MARK CONSISTS OF A TWO PANEL SHIELD SET TO THE LEFT OF THE WORDS "COLLISION GUARD" WITH THE WORD "COLLISION" ON TOP OF THE WORD "GUARD".

SN 77-946,433, FILED 2-26-2010.

BARBARA RUTLAND, EXAMINING ATTORNEY



David J. Kyjars

Director of the United States Patent and Trademark Office

United States of America

United States Patent and Trademark Office

BLUE COW THE ORIGINAL STRESS-RELIEF DRINK

Reg. No. 4,067,931

BD BLUE COW LLC (DELAWARE LIMITED LIABILITY COMPANY)
42161 BEACON HILL
PALM DESERT, CA 92211

Registered Dec. 6, 2011

Int. Cl.: 32

FOR: PURIFIED DRINKING WATER; PURIFIED DRINKING WATER WITH NON-MEDICINAL HERBS AND OTHER NON-MEDICINAL NATURAL INGREDIENTS/ADDITIVES, IN CLASS 32 (U.S. CLS. 45, 46 AND 48).

TRADEMARK

FIRST USE 3-1-2010; IN COMMERCE 4-1-2010.

PRINCIPAL REGISTER

THE MARK CONSISTS OF STANDARD CHARACTERS WITHOUT CLAIM TO ANY PARTICULAR FONT, STYLE, SIZE, OR COLOR.

NO CLAIM IS MADE TO THE EXCLUSIVE RIGHT TO USE "THE ORIGINAL STRESS-RELIEF DRINK", APART FROM THE MARK AS SHOWN.

SN 77-947,697, FILED 3-1-2010.

JANET LEE, EXAMINING ATTORNEY



David J. Kyros

Director of the United States Patent and Trademark Office

United States of America

United States Patent and Trademark Office

HUMONGO

Reg. No. 4,067,932

Registered Dec. 6, 2011

Int. Cls.: 35 and 42

SERVICE MARK

PRINCIPAL REGISTER

SOURCE MARKETING LLC (NEW YORK LIMITED LIABILITY COMPANY)
761 MAIN AVENUE
NORWALK, CT 06851

FOR: ADVERTISING AGENCY SERVICES; SOCIAL MEDIA SERVICES, NAMELY, SOCIAL MEDIA STRATEGY AND MARKETING CONSULTANCY FOCUSING ON HELPING CLIENTS CREATE AND EXTEND THEIR PRODUCT AND BRAND STRATEGIES BY BUILDING VIRTUALLY ENGAGING MARKETING SOLUTIONS; BUSINESS MARKETING CONSULTING SERVICES; PROMOTIONAL SERVICES; MARKETING PLAN DEVELOPMENT; DEVELOPMENT OF MARKETING PLANS AND STRATEGIES; PROVIDING MARKETING AND PROMOTION OF SPECIAL EVENTS; SPONSORSHIP SEARCH; MEDIA BUYING ADVICE, NAMELY, ADVISING THE CLIENT HOW MUCH MEDIA TIME, AND AT WHAT TIMES THE CLIENT SHOULD BE PURCHASING ADVERTISING; ADVERTISING AND BUSINESS SERVICES, NAMELY, SECURING AIRTIME ON ALL FORMS OF MEDIA COMMUNICATIONS STATIONS, SYSTEMS, NETWORKS, AND SERVICES FOR THE PURPOSE OF PROMOTING THE GOODS AND SERVICES OF OTHERS; BUSINESS MARKETING AND DIRECT MAIL CONSULTING SERVICES, IN CLASS 35 (U.S. CLS. 100, 101 AND 102).

FIRST USE 3-0-2010; IN COMMERCE 3-0-2010.

FOR: WEB DESIGN, NAMELY, WEB SITE DESIGN, GRAPHIC DESIGN SERVICES, IN CLASS 42 (U.S. CLS. 100 AND 101).

FIRST USE 3-0-2010; IN COMMERCE 3-0-2010.

THE MARK CONSISTS OF STANDARD CHARACTERS WITHOUT CLAIM TO ANY PARTICULAR FONT, STYLE, SIZE, OR COLOR.

SN 77-947,717, FILED 3-1-2010.

YAT SYE, LEE, EXAMINING ATTORNEY



David J. Kypos

Director of the United States Patent and Trademark Office

United States of America

United States Patent and Trademark Office

PRIV^ATEGIG

Reg. No. 4,067,933

Registered Dec. 6, 2011

Int. Cl.: 41

SERVICE MARK

PRINCIPAL REGISTER

EVERGREEN PROMOTIONS LTD (GREAT BRITAIN LIMITED LIABILITY COMPANY)
SUITE 323
258 BELSIZE ROAD
LONDON NW6 4BT, UNITED KINGDOM

FOR: ENTERTAINMENT SERVICES, NAMELY, PROVIDING A WEB SITE FEATURING
NON-DOWNLOADABLE ADULT-THEMED PHOTOGRAPHS AND VIDEOS, IN CLASS 41
(U.S. CLS. 100, 101 AND 107).

FIRST USE 1-1-2010; IN COMMERCE 1-1-2010.

THE MARK CONSISTS OF THE STYLIZED WORDING "PRIVATEGIG" WITH THE LETTER
"A" REPRESENTED BY THE SILHOUETTE OF A NUDE WOMAN.

SN 77-947,924, FILED 3-2-2010.

JAMES LOVELACE, EXAMINING ATTORNEY



David J. Kyffers

Director of the United States Patent and Trademark Office

United States of America

United States Patent and Trademark Office

harmonyx

Reg. No. 4,067,934

API INDUSTRIES, INC. (NEW JERSEY CORPORATION)
2 GLENSHAW STREET
ORANGEBURG, NY 10962

Registered Dec. 6, 2011

Int. Cl.: 16

FOR: PLASTIC TRASH BAGS; PLASTIC TRASH CAN LINERS, IN CLASS 16 (U.S. CLS. 2, 5, 22, 23, 29, 37, 38 AND 50).

TRADEMARK

FIRST USE 9-28-2011; IN COMMERCE 9-28-2011.

PRINCIPAL REGISTER

THE MARK CONSISTS OF THE TERM "HARMONYX" IN BLACK. TWO GREEN CIRCLES APPEAR CONNECTED TO THE LETTER "O". THE COLOR WHITE IN THE MARK REPRESENTS TRANSPARENT AREA AND IS NOT PART OF THE MARK.

THE COLOR(S) BLACK AND GREEN IS/ARE CLAIMED AS A FEATURE OF THE MARK.

SN 77-947,934, FILED 3-2-2010.

DAVID MILLER, EXAMINING ATTORNEY



David J. Kyros

Director of the United States Patent and Trademark Office

United States of America

United States Patent and Trademark Office

TYVEK

Reg. No. 4,067,935

Registered Dec. 6, 2011

Int. Cls.: 2 and 19

TRADEMARK

PRINCIPAL REGISTER

E. I. DU PONT DE NEMOURS AND COMPANY (DELAWARE CORPORATION)
TRADEMARK & COPYRIGHT GROUP
1007 MARKET STREET
WILMINGTON, DE 19898

FOR: FLUID BARRIER COATINGS FOR THE BUILDING ENVELOPE, NAMELY, FLUID APPLIED VAPOR BARRIER, FLUID APPLIED MOISTURE BARRIER, FLUID APPLIED AIR BARRIER, AND FLUID APPLIED WEATHER BARRIER, IN CLASS 2 (U.S. CLS. 6, 11 AND 16).

FIRST USE 4-1-2010; IN COMMERCE 4-1-2010.

FOR: NON-METAL BUILDING FLASHING, NAMELY, FLUID APPLIED FLASHING, IN CLASS 19 (U.S. CLS. 1, 12, 33 AND 50).

FIRST USE 4-1-2010; IN COMMERCE 4-1-2010.

THE MARK CONSISTS OF STANDARD CHARACTERS WITHOUT CLAIM TO ANY PARTICULAR FONT, STYLE, SIZE, OR COLOR.

OWNER OF U.S. REG. NOS. 817,194, 2,307,777, AND OTHERS.

SN 77-948,325, FILED 3-2-2010.

GINA FINK, EXAMINING ATTORNEY



David J. Kybas

Director of the United States Patent and Trademark Office

United States of America

United States Patent and Trademark Office



Reg. No. 4,067,936

Registered Dec. 6, 2011

Int. Cl.: 25

TRADEMARK

PRINCIPAL REGISTER

PROM QUEEN-II, LLC (FLORIDA LIMITED LIABILITY COMPANY)
400 PENSACOLA BEACH BOULEVARD
PENSACOLA, FL 33056

FOR: CLOTHING, NAMELY, SHIRTS, SWEATSHIRTS, JACKETS, OUTERWEAR, NAMELY, WIND RESISTANT JACKETS, SWEATERS AND HEADWEAR, IN CLASS 25 (U.S. CLS. 22 AND 39).

FIRST USE 3-20-2010; IN COMMERCE 3-20-2010.

NO CLAIM IS MADE TO THE EXCLUSIVE RIGHT TO USE "PENSACOLA BEACH", APART FROM THE MARK AS SHOWN.

THE MARK CONSISTS OF A RIGHT-FACING MARLIN SILHOUETTE WITH A CURVED TAIL, A DORSAL FIN, AND A SPEAR-LIKE BILL, ENCLOSED WITHIN CONCENTRIC CIRCLES, WHICH CONTAIN THE WORDS "THE NORTH DROP" ARCHED ACROSS THE TOP AND "PENSACOLA BEACH" ARCHED ACROSS THE BOTTOM.

SN 77-948,766, FILED 3-2-2010.

H. M. FISHER, EXAMINING ATTORNEY



David J. Kybas

Director of the United States Patent and Trademark Office

United States of America

United States Patent and Trademark Office

Rescue Warrior

Reg. No. 4,067,937

DAWN LABOSCO (UNITED STATES INDIVIDUAL)
9430 STANTON ROAD
LANTANA, TX 76226

Registered Dec. 6, 2011

Int. Cl.: 25

FOR: ATHLETIC APPAREL, NAMELY, SHIRTS, PANTS, JACKETS, FOOTWEAR, HATS AND CAPS, ATHLETIC UNIFORMS; CAMOUFLAGE JACKETS; CAMOUFLAGE SHIRTS; DENIM JACKETS; LONG-SLEEVED SHIRTS, IN CLASS 25 (U.S. CLS. 22 AND 39).

TRADEMARK

FIRST USE 8-1-2011; IN COMMERCE 8-1-2011.

PRINCIPAL REGISTER

THE MARK CONSISTS OF STANDARD CHARACTERS WITHOUT CLAIM TO ANY PARTICULAR FONT, STYLE, SIZE, OR COLOR.

SN 77-948,857, FILED 3-2-2010.

TRACY CROSS, EXAMINING ATTORNEY



David J. Kyfos

Director of the United States Patent and Trademark Office

United States of America

United States Patent and Trademark Office

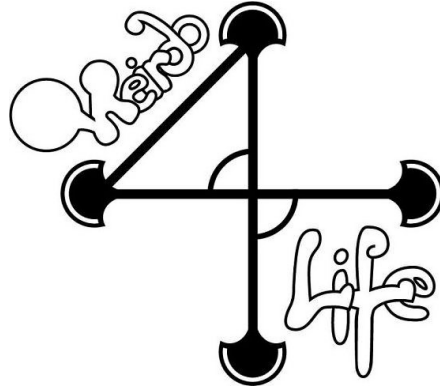

Reg. No. 4,067,938

Registered Dec. 6, 2011

Int. Cl.: 25

TRADEMARK

PRINCIPAL REGISTER

POUYA TORABI (UNITED STATES INDIVIDUAL)
33342 PALO ALTO STREET
DANA POINT, CA 92629

FOR: ATHLETIC APPAREL, NAMELY, SHIRTS, PANTS, JACKETS, FOOTWEAR, HATS AND CAPS, ATHLETIC UNIFORMS; BASEBALL CAPS; CAPRI PANTS; CAPS; CARGO PANTS; CREW NECK SWEATERS; DOWN JACKETS; GYM PANTS; HATS; HEAVY JACKETS; JACKETS; JACKETS AND SOCKS; JOGGING PANTS; KNITTED CAPS; KNOT CAPS; KNOTTED CAPS; LEATHER JACKETS; LONG JACKETS; LONG SLEEVE PULLOVERS; LONG SLEEVED VESTS; LONG UNDERWEAR; LONG-SLEEVED SHIRTS; MEN'S AND WOMEN'S JACKETS, COATS, TROUSERS, VESTS; MOTORCYCLE JACKETS; PANTS; SHIRTS AND SHORT-SLEEVED SHIRTS; SHORT-SLEEVED OR LONG-SLEEVED T-SHIRTS; SHORT-SLEEVED SHIRTS; SKI JACKETS; SKULL CAPS; SLEEVED OR SLEEVELESS JACKETS; SNOW PANTS; SNOWBOARD PANTS; SPORTS PANTS; SPORTS SHIRTS WITH SHORT SLEEVES; STRETCH PANTS; SWEAT JACKETS; SWEAT PANTS; SWEATERS; T-SHIRTS; TRACK JACKETS; TRACK PANTS; TURTLENECK SWEATERS; V-NECK SWEATERS; WARM UP OUTFITS; WARM UP SUITS; WATERPROOF JACKETS AND PANTS; WIND RESISTANT JACKETS; WIND-JACKETS, IN CLASS 25 (U.S. CLS. 22 AND 39).

FIRST USE 9-15-2011; IN COMMERCE 9-15-2011.

THE MARK CONSISTS OF THE WORDS "WEIRDO" AND "LIFE" WITH THE NUMBER "4" IN BETWEEN THESE WORDS. THE NUMBER "4" APPEARS WITH FOUR SEMI-CIRCLES ON EACH POINT OF THE NUMBER WITH A SEMI-CIRCLE APPEARING IN THE MIDDLE OF THE NUMBER.

SN 77-948,911, FILED 3-2-2010.

DAVID COLLIER, EXAMINING ATTORNEY



David J. Kyros

Director of the United States Patent and Trademark Office

United States of America

United States Patent and Trademark Office

FORBIDDEN CITY RITUALS

Reg. No. 4,067,939

Registered Dec. 6, 2011

Int. Cl.: 3

TRADEMARK

PRINCIPAL REGISTER

GENGHIS PRODUCTIONS LIMITED (HONG KONG LIMITED LIABILITY COMPANY)
C/O CROSSCHECK PRODUCTIONS
6650 SPENCER STREET #110
LAS VEGAS, NV 89119

FOR: COSMETICS, MAKEUP, FACE AND BODY SCRUBS, SKIN MASKS, BODY OILS, IN CLASS 3 (U.S. CLS. 1, 4, 6, 50, 51 AND 52).

FIRST USE 4-30-2011; IN COMMERCE 4-30-2011.

THE MARK CONSISTS OF STANDARD CHARACTERS WITHOUT CLAIM TO ANY PARTICULAR FONT, STYLE, SIZE, OR COLOR.

OWNER OF U.S. REG. NOS. 3,321,498, 3,745,488, AND OTHERS.

SN 77-949,171, FILED 3-3-2010.

DAVID COLLIER, EXAMINING ATTORNEY



David J. Kyffers

Director of the United States Patent and Trademark Office

United States of America

United States Patent and Trademark Office

Lexo the Great

Reg. No. 4,067,940

Registered Dec. 6, 2011

Int. Cl.: 41

SERVICE MARK

PRINCIPAL REGISTER

MEDINA, ALEJANDRO R. (UNITED STATES INDIVIDUAL)
10 ATLANTIC AVE., #502
LONG BEACH, CA 90802

FOR: COMPOSITION OF MUSIC FOR OTHERS; ENTERTAINMENT IN THE NATURE OF VISUAL AND AUDIO PERFORMANCES, NAMELY, MUSICAL BAND, ROCK GROUP, GYMNASTIC, DANCE, AND BALLET PERFORMANCES; ENTERTAINMENT SERVICES IN THE NATURE OF LIVE MUSICAL PERFORMANCES; ENTERTAINMENT, NAMELY, LIVE MUSIC CONCERTS; MUSIC COMPOSITION AND TRANSCRIPTION FOR OTHERS; MUSIC COMPOSITION FOR OTHERS; MUSIC PRODUCTION SERVICES; MUSIC VIDEO PRODUCTION; PRESENTATION OF MUSICAL PERFORMANCE; PRODUCTION OF MUSICAL SOUND RECORDING; PRODUCTION OF SOUND AND MUSIC VIDEO RECORDINGS, IN CLASS 41 (U.S. CLS. 100, 101 AND 107).

FIRST USE 1-1-2009; IN COMMERCE 1-1-2009.

THE MARK CONSISTS OF STANDARD CHARACTERS WITHOUT CLAIM TO ANY PARTICULAR FONT, STYLE, SIZE, OR COLOR.

THE NAME(S), PORTRAIT(S), AND/OR SIGNATURE(S) SHOWN IN THE MARK IDENTIFIES "ALEJANDRO MEDINA", WHOSE CONSENT(S) TO REGISTER IS MADE OF RECORD.

SN 77-949,335, FILED 3-3-2010.

KELLEY WELLS, EXAMINING ATTORNEY



David J. Kybas

Director of the United States Patent and Trademark Office

United States of America

United States Patent and Trademark Office

WISR

Reg. No. 4,067,941

Registered Dec. 6, 2011

Int. Cl.: 7

TRADEMARK

PRINCIPAL REGISTER

JACKSON MSC LLC (DELAWARE LIMITED LIABILITY COMPANY)
SUITE 400
2711 CENTERVILLE ROAD
WILMINGTON, DE 19808

FOR: DISHWASHER FEATURE SOLD AS A FUNCTIONING COMPONENT OF THE MACHINES, NAMELY, PUMP MOTOR AND WASH ARMS, IN CLASS 7 (U.S. CLS. 13, 19, 21, 23, 31, 34 AND 35).

FIRST USE 10-25-2011; IN COMMERCE 10-25-2011.

THE MARK CONSISTS OF STANDARD CHARACTERS WITHOUT CLAIM TO ANY PARTICULAR FONT, STYLE, SIZE, OR COLOR.

SN 77-949,724, FILED 3-3-2010.

ELLEN PERKINS, EXAMINING ATTORNEY



David J. Kybas

Director of the United States Patent and Trademark Office

United States of America

United States Patent and Trademark Office

IMPLADONTICS

Reg. No. 4,067,942

SHLOSBERG, STUART (UNITED KINGDOM INDIVIDUAL)
414 N CAMDEN DRIVE, SUITE 925
BEVERLY HILLS, CA 90210

Registered Dec. 6, 2011

Int. Cl.: 44

FOR: SPECIALTY DENTAL SERVICES, NAMELY, REPLACEMENT OF MISSING TEETH,
IN CLASS 44 (U.S. CLS. 100 AND 101).

SERVICE MARK

FIRST USE 10-14-2007; IN COMMERCE 10-10-2011.

PRINCIPAL REGISTER

THE MARK CONSISTS OF STANDARD CHARACTERS WITHOUT CLAIM TO ANY PAR-
TICULAR FONT, STYLE, SIZE, OR COLOR.

SN 77-950,417, FILED 3-4-2010.

MARIA-VICTORIA SUAREZ, EXAMINING ATTORNEY



David J. Kybas

Director of the United States Patent and Trademark Office

United States of America
United States Patent and Trademark Office

RE:SOLVE

Reg. No. 4,067,943

WAGIC, INC. (CALIFORNIA CORPORATION)
16780 LARK AVENUE
LOS GATOS, CA 95032

Registered Dec. 6, 2011

Int. Cl.: 8

FOR: HAND TOOLS, NAMELY, SCREWDRIVERS, RATCHETS, SOCKETS, HAMMERS, DRILL BITS FOR HAND TOOLS, HEX WRENCHES, HANDLES FOR HEX WRENCHES, RATCHET HANDLES AND HOLDERS FOR HEX WRENCHES , IN CLASS 8 (U.S. CLS. 23, 28 AND 44).

TRADEMARK

PRINCIPAL REGISTER

FIRST USE 5-31-2010; IN COMMERCE 5-31-2010.

THE MARK CONSISTS OF STANDARD CHARACTERS WITHOUT CLAIM TO ANY PARTICULAR FONT, STYLE, SIZE, OR COLOR.

SN 77-950,541, FILED 3-4-2010.

JASON TURNER, EXAMINING ATTORNEY



David J. Kybas

Director of the United States Patent and Trademark Office

United States of America

United States Patent and Trademark Office

Stant

Reg. No. 4,067,944

STANT USA CORP. (DELAWARE CORPORATION)
1620 COLUMBIA AVENUE
CONNERSVILLE, IN 473311696

Registered Dec. 6, 2011

Int. Cls.: 7, 9, 11, and 12

FOR: VEHICLE ENGINE PARTS, NAMELY, OIL CAPS FOR LAND VEHICLES, IN CLASS 7 (U.S. CLS. 13, 19, 21, 23, 31, 34 AND 35).

TRADEMARK

FIRST USE 4-0-2010; IN COMMERCE 4-0-2010.

PRINCIPAL REGISTER

FOR: VEHICLE ENGINE PARTS, NAMELY, THERMOSTATS, IN CLASS 9 (U.S. CLS. 21, 23, 26, 36 AND 38).

FIRST USE 4-0-2010; IN COMMERCE 4-0-2010.

FOR: RADIATOR CAPS FOR LAND VEHICLES, IN CLASS 11 (U.S. CLS. 13, 21, 23, 31 AND 34).

FIRST USE 4-0-2010; IN COMMERCE 4-0-2010.

FOR: VEHICLE GAS CAPS FOR LAND VEHICLES, IN CLASS 12 (U.S. CLS. 19, 21, 23, 31, 35 AND 44).

FIRST USE 4-0-2010; IN COMMERCE 4-0-2010.

OWNER OF U.S. REG. NOS. 1,258,376, 1,258,459, AND 1,261,641.

THE MARK CONSISTS OF THE WORD "STANT" WITH A STAR INSIDE THE A IN "STANT".

SN 77-951,663, FILED S.R. 3-5-2010; AM. P.R. 5-17-2011.

MARLENE BELL, EXAMINING ATTORNEY



David J. Kybas

Director of the United States Patent and Trademark Office

United States of America

United States Patent and Trademark Office

STARLICIOUS

Reg. No. 4,067,945

Registered Dec. 6, 2011

Int. Cl.: 41

SERVICE MARK

PRINCIPAL REGISTER

NO SOAP RADIO ENTERTAINMENT, LLC (DELAWARE LIMITED LIABILITY COMPANY)
25 WEST 13TH STREET, SUITE 2JN
NEW YORK, NY 10011

FOR: ENTERTAINMENT SERVICES, NAMELY, AN ON-GOING SERIES FEATURING A GAME SHOW PROVIDED THROUGH TELEVISION, WEBCASTS, AND RADIO BROADCASTS; ENTERTAINMENT SERVICES, NAMELY, PROVIDING ON-LINE COMPUTER GAMES, IN CLASS 41 (U.S. CLS. 100, 101 AND 107).

FIRST USE 3-15-2010; IN COMMERCE 3-15-2010.

THE MARK CONSISTS OF STANDARD CHARACTERS WITHOUT CLAIM TO ANY PARTICULAR FONT, STYLE, SIZE, OR COLOR.

SN 77-951,836, FILED 3-5-2010.

JACQUELINE A. LAVINE, EXAMINING ATTORNEY



David J. Kybas

Director of the United States Patent and Trademark Office

United States of America

United States Patent and Trademark Office

BARISTA

Reg. No. 4,067,946

Registered Dec. 6, 2011

Int. Cls.: 35 and 38

SERVICE MARK

PRINCIPAL REGISTER

PULSE 360, INC. (DELAWARE CORPORATION)
2390 NORTH FOREST ROAD
GETZVILLE, NY 14068

FOR: ADVERTISING SERVICES, NAMELY, DISSEMINATION OF ADVERTISING FOR PUBLISHERS, ADVERTISERS AND MARKETERS VIA AN ON-LINE HIGH-SPEED COMMUNICATIONS NETWORK ON THE INTERNET, IN CLASS 35 (U.S. CLS. 100, 101 AND 102).

FIRST USE 7-0-2011; IN COMMERCE 7-0-2011.

FOR: BROADCASTING SERVICES, NAMELY, TRANSMISSION OF ADVERTISING PROGRAMS AND MEDIA ADVERTISING COMMUNICATIONS FOR PUBLISHERS, ADVERTISERS AND MARKETERS VIA HIGH-SPEED INTERNET, IN CLASS 38 (U.S. CLS. 100, 101 AND 104).

FIRST USE 7-0-2011; IN COMMERCE 7-0-2011.

THE MARK CONSISTS OF STANDARD CHARACTERS WITHOUT CLAIM TO ANY PARTICULAR FONT, STYLE, SIZE, OR COLOR.

SN 77-951,841, FILED 3-5-2010.

CYNTHIA TRIPI, EXAMINING ATTORNEY



David J. Kyffers

Director of the United States Patent and Trademark Office

United States of America

United States Patent and Trademark Office

Storybook Workshop

Reg. No. 4,067,947

Registered Dec. 6, 2011

Int. Cl.: 9

TRADEMARK

PRINCIPAL REGISTER

KONAMI DIGITAL ENTERTAINMENT CO., LTD. (JAPAN CORPORATION)
9-7-2, AKASAKA, MINATO-KU
TOKYO, JAPAN

FOR: VIDEO GAME SOFTWARE; VIDEO GAME PROGRAMS; COMPUTER GAME PROGRAMS; COMPUTER GAME SOFTWARE, IN CLASS 9 (U.S. CLS. 21, 23, 26, 36 AND 38).

FIRST USE 12-1-2009; IN COMMERCE 12-1-2009.

THE MARK CONSISTS OF STANDARD CHARACTERS WITHOUT CLAIM TO ANY PARTICULAR FONT, STYLE, SIZE, OR COLOR.

NO CLAIM IS MADE TO THE EXCLUSIVE RIGHT TO USE "STORYBOOK", APART FROM THE MARK AS SHOWN.

SN 77-951,954, FILED 3-5-2010.

LINDSEY RUBIN, EXAMINING ATTORNEY



David J. Kybas

Director of the United States Patent and Trademark Office

United States of America

United States Patent and Trademark Office

HEALTH NUT APPROVED

Reg. No. 4,067,948

JENA HATFIELD (UNITED STATES INDIVIDUAL)
3347 SE FEDERAL HWY
STUART, FL 34997

Registered Dec. 6, 2011

Int. Cls.: 16 and 25

FOR: DECALS; STICKERS, IN CLASS 16 (U.S. CLS. 2, 5, 22, 23, 29, 37, 38 AND 50).

TRADEMARK

FIRST USE 5-13-2009; IN COMMERCE 7-9-2011.

PRINCIPAL REGISTER

FOR: CLOTHING AND APPAREL, NAMELY, T-SHIRTS, HATS, VISORS, SWEATERS, JACKETS, UNDERGARMENTS; CHILDREN'S AND INFANTS APPAREL, NAMELY, T-SHIRTS, HATS, SWEATERS AND ONE-PIECE GARMENTS, IN CLASS 25 (U.S. CLS. 22 AND 39).

FIRST USE 5-13-2009; IN COMMERCE 6-21-2011.

THE MARK CONSISTS OF STANDARD CHARACTERS WITHOUT CLAIM TO ANY PARTICULAR FONT, STYLE, SIZE, OR COLOR.

SN 77-951,968, FILED 3-5-2010.

RAUL CORDOVA, EXAMINING ATTORNEY



David J. Kybas

Director of the United States Patent and Trademark Office

United States of America

United States Patent and Trademark Office

BOASTER

Reg. No. 4,067,949

Registered Dec. 6, 2011

Int. Cl.: 28

TRADEMARK

PRINCIPAL REGISTER

RYAN WILLIAMSON FISHING TECHNIQUES CC (SOUTH AFRICA CLOSE CORPORATION),
DBA PULSATOR LURES,
107 WOODFORD GROVE
DURBAN, KWA ZULU NATAL, SOUTH AFRICA

FOR: FISHING TACKLE, REELS FOR FISHING, RODS FOR FISHING, LINES FOR FISHING;
LINE GUIDES FOR USE ON FISHING RODS, HOOKS FOR FISHING, ARTIFICIAL LURES
FOR FISHING, ARTIFICIAL BAIT FOR FISHING; FISHING CREELS, FLOATS FOR FISHING,
FISHING WEIGHTS, NAMELY, SINKERS, LANDING NETS FOR ANGLERS, FISHING BAGS,
FISHING GLOVES; FISHING ROD CASES AND FISHING TACKLE CONTAINERS, IN CLASS
28 (U.S. CLS. 22, 23, 38 AND 50).

FIRST USE 6-24-2010; IN COMMERCE 6-24-2010.

THE MARK CONSISTS OF STANDARD CHARACTERS WITHOUT CLAIM TO ANY PAR-
TICULAR FONT, STYLE, SIZE, OR COLOR.

SN 77-951,989, FILED 3-5-2010.

SANI KHOURI, EXAMINING ATTORNEY



David J. Kyros

Director of the United States Patent and Trademark Office

United States of America

United States Patent and Trademark Office

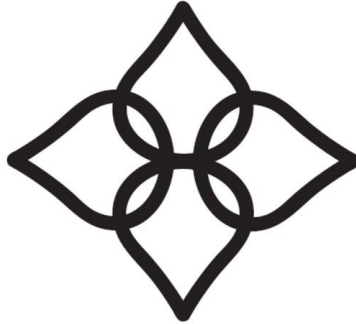

Reg. No. 4,067,950

Registered Dec. 6, 2011

Int. Cls.: 18 and 25

TRADEMARK

PRINCIPAL REGISTER

SENGSTAKEN ENTERPRISES, INC. (CALIFORNIA CORPORATION)
561 KINETIC DRIVE, UNIT B
OXNARD, CA 93030

FOR: HANDBAGS; UMBRELLAS, IN CLASS 18 (U.S. CLS. 1, 2, 3, 22 AND 41).

FIRST USE 4-1-2010; IN COMMERCE 4-1-2010.

FOR: BOOTS; SOCKS; SWEAT SHIRTS; T-SHIRTS, IN CLASS 25 (U.S. CLS. 22 AND 39).

FIRST USE 4-1-2010; IN COMMERCE 4-1-2010.

THE MARK CONSISTS OF A SERIES OF FOUR INTERLOCKING TEARDROP OR RAINDROP SHAPES IN A DIAMOND PATTERN RESEMBLING A FLOWER.

SN 77-952,237, FILED 3-5-2010.

LEIGH LOWRY, EXAMINING ATTORNEY



David J. Kybas

Director of the United States Patent and Trademark Office

United States of America

United States Patent and Trademark Office

STARSPELL

Reg. No. 4,067,951

Registered Dec. 6, 2011

Int. Cls.: 16 and 41

TRADEMARK

SERVICE MARK

PRINCIPAL REGISTER

PENNY PUBLICATIONS, LLC (CONNECTICUT LIMITED LIABILITY COMPANY)
6 PROWITT STREET
NORWALK, CT 06855

FOR: PUBLICATIONS, NAMELY, PUZZLE GAME BOOKS AND MAGAZINES, AND WORD PUZZLE BOOKS AND MAGAZINES, IN CLASS 16 (U.S. CLS. 2, 5, 22, 23, 29, 37, 38 AND 50).

FIRST USE 1-0-1978; IN COMMERCE 1-0-1978.

FOR: ENTERTAINMENT SERVICES, NAMELY, PROVIDING ONLINE ELECTRONIC GAMES, IN CLASS 41 (U.S. CLS. 100, 101 AND 107).

FIRST USE 10-10-2011; IN COMMERCE 10-10-2011.

THE MARK CONSISTS OF STANDARD CHARACTERS WITHOUT CLAIM TO ANY PARTICULAR FONT, STYLE, SIZE, OR COLOR.

SN 77-952,771, FILED 3-8-2010.

JIM RINGLE, EXAMINING ATTORNEY



David J. Kybas

Director of the United States Patent and Trademark Office

United States of America

United States Patent and Trademark Office



Reg. No. 4,067,952

Registered Dec. 6, 2011

Int. Cl.: 36

SERVICE MARK

PRINCIPAL REGISTER

PAMLICO CAPITAL MANAGEMENT, LP (NORTH CAROLINA LIMITED PARTNERSHIP)
150 NORTH COLLEGE STREET
SUITE 2400
CHARLOTTE, NC 28202

FOR: MANAGEMENT OF PRIVATE EQUITY FUNDS AND HEDGE FUNDS; PRIVATE EQUITY FUND AND HEDGE FUND INVESTMENT SERVICES; FUND INVESTMENT CONSULTATION, IN CLASS 36 (U.S. CLS. 100, 101 AND 102).

FIRST USE 3-24-2010; IN COMMERCE 3-24-2010.

NO CLAIM IS MADE TO THE EXCLUSIVE RIGHT TO USE "CAPITAL", APART FROM THE MARK AS SHOWN.

THE MARK CONSISTS OF THE WORD "PAMLICO" APPEARING ABOVE THE WORD "CAPITAL" IN SMALLER TYPE ADJACENT TO A SQUARE SHAPED LOGO CONSISTING OF AN ILLUSTRATION OF A CONFLUENCE OF A GROUP OF RIVERS AND STREAMS.

SN 77-953,187, FILED 3-8-2010.

MARILYN IZZI, EXAMINING ATTORNEY



David J. Kyffers

Director of the United States Patent and Trademark Office

United States of America

United States Patent and Trademark Office

CHENINISTA

Reg. No. 4,067,953

Registered Dec. 6, 2011

Int. Cl.: 41

SERVICE MARK

PRINCIPAL REGISTER

CAPE CLASSICS BRANDS, LLC (FLORIDA LIMITED LIABILITY COMPANY)
220 PURITAN ROAD
WEST PALM BEACH, FL 33405

FOR: PROVIDING ON-LINE MAGAZINES AND NEWSLETTERS IN RESPECT OF WINE; PROVIDING ON-LINE EDUCATIONAL SERVICES, NAMELY, PROVIDING CLASSES, SEMINARS, AND WORKSHOPS IN THE FIELD OF WINE; ENTERTAINMENT SERVICES, NAMELY, WINE TASTING; ORGANIZATION OF EXHIBITIONS ON WINES FOR CULTURAL AND EDUCATIONAL PURPOSES, IN CLASS 41 (U.S. CLS. 100, 101 AND 107).

FIRST USE 9-20-2011; IN COMMERCE 9-20-2011.

THE MARK CONSISTS OF STANDARD CHARACTERS WITHOUT CLAIM TO ANY PARTICULAR FONT, STYLE, SIZE, OR COLOR.

SN 77-953,962, FILED 3-9-2010.

ELLEN PERKINS, EXAMINING ATTORNEY



David J. Kyros

Director of the United States Patent and Trademark Office

United States of America

United States Patent and Trademark Office

VMS RACING

Reg. No. 4,067,954

BAIZ, ENRIQUE (UNITED STATES INDIVIDUAL)
7878 B NW 103RD STREET
HIALEAH, FL 33016

Registered Dec. 6, 2011

Int. Cls.: 7, 9, 11, 12, and 27

FOR: AUTOMOBILE AND TRUCK PARTS, NAMELY, BILLET PARTS IN THE NATURE OF CRANKCASE BREATHERS, SPARK PLUG WIRES, DISTRIBUTOR CAPS, DISTRIBUTOR ROTORS, AIR FILTERS FOR VEHICLE MOTORS AND ENGINES, OIL CAPS, GROUND WIRE KITS CONSISTING OF IGNITION WIRES AND SPARK PLUG WIRES, FUEL FILTERS, PULLEYS BEING PARTS OF MACHINES, BLOW OFF VALVES FOR ENGINES, TURBO CHARGERS, PRESSURE REDUCERS AS PARTS OF MACHINES, ENGINE DRESS UP KITS COMPRISED OF ENGINE CASES AND ENGINE VALVE COVERS, MUFFLERS FOR MOTORS AND ENGINES, ENGINE EXHAUST SYSTEMS COMPRISED OF PIPES, COLLECTOR AND MUFFLER, ENGINE EXHAUST TIPS, IN CLASS 7 (U.S. CLS. 13, 19, 21, 23, 31, 34 AND 35).

TRADEMARK

PRINCIPAL REGISTER

FIRST USE 3-31-2010; IN COMMERCE 4-30-2010.

FOR: AUTOMOBILE AND TRUCK PARTS, NAMELY, ANTENNAS, FUEL PRESSURE GAUGES, NITROUS PRESSURE GAUGES, FUEL PRESSURE REGULATORS, FUEL PRESSURE REGULATOR ADAPTERS, IN CLASS 9 (U.S. CLS. 21, 23, 26, 36 AND 38).

FIRST USE 3-31-2010; IN COMMERCE 4-30-2010.

FOR: AUTOMOBILE AND TRUCK PARTS, NAMELY, RADIATOR CAPS, VEHICLE TURN SIGNAL LIGHT BULB, LIGHT BULBS, IN CLASS 11 (U.S. CLS. 13, 21, 23, 31 AND 34).

FIRST USE 3-31-2010; IN COMMERCE 4-30-2010.

FOR: AUTOMOBILE AND TRUCK PARTS, NAMELY, LUG NUTS, WHEEL LOCKS, CARBON FIBER BODY PARTS IN THE NATURE OF VEHICLE HOODS, SUSPENSION STRUT BARS, CAMBER KITS COMPRISED OF BOLTS, BUSHINGS, NUTS, SLEEVES AND OFFSET SLEEVES, GEAR SHIFT KNOBS AND SHORT SHIFTERS, BUSHINGS, LOWERING KITS COMPRISED OF COIL SPRINGS, MAGNETIC OIL DRAIN PLUGS, CAM GEARS FOR VEHICLES, IN CLASS 12 (U.S. CLS. 19, 21, 23, 31, 35 AND 44).

FIRST USE 3-31-2010; IN COMMERCE 4-30-2010.



David J. Kybas

Director of the United States Patent and Trademark Office

Reg. No. 4,067,954 FOR: AUTOMOBILE AND TRUCK PARTS, NAMELY, FLOOR MATS, IN CLASS 27 (U.S. CLS. 19, 20, 37, 42 AND 50).

FIRST USE 3-31-2010; IN COMMERCE 4-30-2010.

THE MARK CONSISTS OF STANDARD CHARACTERS WITHOUT CLAIM TO ANY PARTICULAR FONT, STYLE, SIZE, OR COLOR.

NO CLAIM IS MADE TO THE EXCLUSIVE RIGHT TO USE "RACING", APART FROM THE MARK AS SHOWN.

SN 77-955,223, FILED 3-10-2010.

NATALIE POLZER, EXAMINING ATTORNEY

United States of America

United States Patent and Trademark Office



Reg. No. 4,067,955

Registered Dec. 6, 2011

Int. Cls.: 7, 16, 18, and 21

SAGE BEARS, LLC (NEW YORK LIMITED LIABILITY COMPANY)
187 WELLINGTON ROAD
GARDEN CITY, NY 11530

FOR: ELECTRIC HANDHELD MIXERS FOR HOUSEHOLD USE, IN CLASS 7 (U.S. CLS. 13, 19, 21, 23, 31, 34 AND 35).

FIRST USE 6-0-2011; IN COMMERCE 6-0-2011.

TRADEMARK

FOR: PRINTED MATERIALS, NAMELY, BABY FOOD COOKBOOKS, TODDLER COOKBOOKS, CHILDREN'S COOKBOOKS; PARTIALLY PRINTED PAPER LABELS, IN CLASS 16 (U.S. CLS. 2, 5, 22, 23, 29, 37, 38 AND 50).

FIRST USE 6-0-2011; IN COMMERCE 6-0-2011.

PRINCIPAL REGISTER

FOR: BAGS, NAMELY, TOTE BAGS, TRAVEL BAGS, TEXTILE SHOPPING BAGS, IN CLASS 18 (U.S. CLS. 1, 2, 3, 22 AND 41).

FIRST USE 6-0-2011; IN COMMERCE 6-0-2011.

FOR: BABY FOOD PRESERVING OR STORAGE JARS NOT MADE OF METAL OR PAPER FOR FOOD STORAGE FOR DOMESTIC USE; INSULATED FOOD STORAGE BAGS FOR DOMESTIC USE, IN CLASS 21 (U.S. CLS. 2, 13, 23, 29, 30, 33, 40 AND 50).

FIRST USE 6-0-2011; IN COMMERCE 6-0-2011.

THE MARK CONSISTS OF A STYLIZED IMAGE OF A CHILD.

SN 77-957,078, FILED 3-11-2010.

KRISTINA MORRIS, EXAMINING ATTORNEY



David J. Kybas

Director of the United States Patent and Trademark Office

United States of America

United States Patent and Trademark Office

TROPICAL REMIX

Reg. No. 4,067,956

Registered Dec. 6, 2011

Int. Cl.: 30

TRADEMARK

PRINCIPAL REGISTER

WM. WRIGLEY JR. COMPANY (DELAWARE CORPORATION)
410 NORTH MICHIGAN AVENUE
CHICAGO, IL 60611

FOR: CHEWING GUM, IN CLASS 30 (U.S. CL. 46).

FIRST USE 6-1-2010; IN COMMERCE 6-1-2010.

THE MARK CONSISTS OF STANDARD CHARACTERS WITHOUT CLAIM TO ANY PARTICULAR FONT, STYLE, SIZE, OR COLOR.

SN 77-957,425, FILED 3-12-2010.

MARK PILARO, EXAMINING ATTORNEY



David J. Kybas

Director of the United States Patent and Trademark Office

United States of America

United States Patent and Trademark Office



Reg. No. 4,067,957

Registered Dec. 6, 2011

Int. Cl.: 25

TRADEMARK

PRINCIPAL REGISTER

MICHAEL R. MARTINEZ (UNITED STATES INDIVIDUAL), AKA MICHAEL R. MARTINEZ,
530 W 37TH ST #8
SAN PEDRO, CA 90731

FOR: MARTIAL ARTS UNIFORMS, NAMELY, GIS, KIMONOS, IN CLASS 25 (U.S. CLS. 22
AND 39).

FIRST USE 4-1-2010; IN COMMERCE 4-1-2010.

NO CLAIM IS MADE TO THE EXCLUSIVE RIGHT TO USE "KIMONOS", APART FROM
THE MARK AS SHOWN.

THE COLOR(S) RED, BLACK AND WHITE IS/ARE CLAIMED AS A FEATURE OF THE
MARK.

THE MARK CONSISTS OF KANJI MEANING DESTROY ON THE LEFT SIDE OF THE RED
CIRCLE WITH A WHITE IN COLOR LETTER "H" INSIDE OF THE RED CIRCLE. TWO
WORDS IN BLACK, "HAKAI KIMONOS". "HAKAI" HAS A LINE UNDER IT AND "KI-
MONOS" IS BELOW IT.

THE ENGLISH TRANSLATION OF "HAKAI" IN THE MARK IS "DESTROY".

SN 77-958,442, FILED 3-13-2010.

DORITT L. CARROLL, EXAMINING ATTORNEY



David J. Kybas

Director of the United States Patent and Trademark Office

United States of America
United States Patent and Trademark Office

SOCACIZE

Reg. No. 4,067,958

Registered Dec. 6, 2011

Int. Cls.: 9, 25, and 41

TRADEMARK

SERVICE MARK

PRINCIPAL REGISTER

LEE-RIVEARS, AYANNA (CANADA INDIVIDUAL)
28 FIELDCROFT CT
MAPLE, ONTARIO, CANADA L6A1J3

FOR: DIGITAL MEDIA, NAMELY, PRE-RECORDED CDS, DVDS AND DOWNLOADABLE AUDIO AND VIDEO RECORDINGS FEATURING INSTRUCTION IN THE FIELD OF DANCE AND GENERAL PHYSICAL FITNESS, IN CLASS 9 (U.S. CLS. 21, 23, 26, 36 AND 38).

FIRST USE 8-24-2009; IN COMMERCE 8-24-2009.

FOR: ATHLETIC APPAREL, NAMELY, SHIRTS, SHORTS, PANTS, JACKETS, FOOTWEAR, HATS AND CAPS, ATHLETIC UNIFORMS, IN CLASS 25 (U.S. CLS. 22 AND 39).

FIRST USE 4-1-2010; IN COMMERCE 4-1-2010.

FOR: PHYSICAL FITNESS TRAINING SERVICES; PHYSICAL FITNESS INSTRUCTION; DANCE INSTRUCTION; CHOREOGRAPHY SERVICES FOR OTHERS; PERFORMANCE SERVICES IN THE NATURE OF LIVE DANCE PERFORMANCES; FITNESS EXHIBITIONS IN THE NATURE OF LIVE FITNESS ROUTINE PERFORMANCES, IN CLASS 41 (U.S. CLS. 100, 101 AND 107).

FIRST USE 3-27-2008; IN COMMERCE 8-24-2009.

THE MARK CONSISTS OF STANDARD CHARACTERS WITHOUT CLAIM TO ANY PARTICULAR FONT, STYLE, SIZE, OR COLOR.

SN 77-958,792, FILED 3-15-2010.

PAULA MAHONEY, EXAMINING ATTORNEY



David J. Kyros

Director of the United States Patent and Trademark Office

United States of America

United States Patent and Trademark Office

Install confidence.

Reg. No. 4,067,959

Registered Dec. 6, 2011

Int. Cl.: 9

TRADEMARK

PRINCIPAL REGISTER

ESET, LLC (CALIFORNIA LIMITED LIABILITY COMPANY)
610 W. ASH STREET, SUITE 1900
SAN DIEGO, CA 92101

FOR: SOFTWARE FOR USE IN PROTECTING COMPUTER DATABASES, OPERATING PROGRAMS AND APPLICATION PROGRAMS AGAINST UNAUTHORIZED INFILTRATION AND CORRUPTION; DATA PROTECTION SOFTWARE; MACHINES AND APPARATUS FOR DATA PROCESSING PURPOSES, NAMELY, DATA PROCESSORS; COMPUTERS AND PARTS THEREOF; COMPUTER PERIPHERAL DEVICES, IN CLASS 9 (U.S. CLS. 21, 23, 26, 36 AND 38).

FIRST USE 9-13-2011; IN COMMERCE 9-13-2011.

THE MARK CONSISTS OF THE WORDS "INSTALL CONFIDENCE." WITH A CAPITAL "I" AND THE REMAINING LETTERS IN LOWER CASE ENDING WITH A PERIOD.

SN 77-960,338, FILED 3-16-2010.

DORITT L. CARROLL, EXAMINING ATTORNEY



David J. Kyros

Director of the United States Patent and Trademark Office

United States of America

United States Patent and Trademark Office

ULTRA BUSINESS BROKERS

Reg. No. 4,067,960

Registered Dec. 6, 2011

Int. Cl.: 36

SERVICE MARK

PRINCIPAL REGISTER

UNITED BUSINESS BROKERS INC. (ILLINOIS CORPORATION)
267 TIGER ST
BOLING BROOK, IL 60490

FOR: BUSINESS BROKERAGE; BUSINESS BROKERAGE SERVICES AND RELATED CONSULTING PERTAINING TO PROCUREMENT, BUYING, SELLING AND TENDERING INFORMATION AND OPPORTUNITIES, IN CLASS 36 (U.S. CLS. 100, 101 AND 102).

FIRST USE 0-0-2009; IN COMMERCE 0-0-2009.

THE MARK CONSISTS OF STANDARD CHARACTERS WITHOUT CLAIM TO ANY PARTICULAR FONT, STYLE, SIZE, OR COLOR.

NO CLAIM IS MADE TO THE EXCLUSIVE RIGHT TO USE "BUSINESS BROKERS", APART FROM THE MARK AS SHOWN.

SN 77-961,748, FILED 3-17-2010.

DAVID TOOLEY, EXAMINING ATTORNEY



David J. Kyros

Director of the United States Patent and Trademark Office

United States of America

United States Patent and Trademark Office

BACKSPIN

Reg. No. 4,067,961

INVISIBLE GADGET GUARD, INC. (UTAH CORPORATION)
3939 SOUTH WASATCH BLVD.
SALT LAKE CITY, UT 84124

Registered Dec. 6, 2011

Int. Cl.: 9

FOR: COVERS FOR CELL PHONES AND MP3 PLAYERS, IN CLASS 9 (U.S. CLS. 21, 23, 26, 36 AND 38).

TRADEMARK

FIRST USE 3-24-2010; IN COMMERCE 3-24-2010.

PRINCIPAL REGISTER

THE MARK CONSISTS OF STANDARD CHARACTERS WITHOUT CLAIM TO ANY PARTICULAR FONT, STYLE, SIZE, OR COLOR.

SN 77-962,083, FILED 3-18-2010.

BERNICE MIDDLETON, EXAMINING ATTORNEY



David J. Kybas

Director of the United States Patent and Trademark Office

United States of America

United States Patent and Trademark Office

ADFLEX

Reg. No. 4,067,962

GOLDWIN INC. (JAPAN CORPORATION)
210 KIYOSAWA, OYABE-SHI
TOYAMA-KEN, JAPAN

Registered Dec. 6, 2011

Int. Cl.: 25

FOR: JACKETS; SNOW BOARDING SUITS; SKI SUITS, IN CLASS 25 (U.S. CLS. 22 AND 39).

TRADEMARK

FIRST USE 9-30-2009; IN COMMERCE 9-30-2010.

PRINCIPAL REGISTER

THE MARK CONSISTS OF STANDARD CHARACTERS WITHOUT CLAIM TO ANY PARTICULAR FONT, STYLE, SIZE, OR COLOR.

SN 77-962,173, FILED 3-18-2010.

ARETHA SOMERVILLE, EXAMINING ATTORNEY



David J. Kybas

Director of the United States Patent and Trademark Office

United States of America

United States Patent and Trademark Office

RICH TOWN

Reg. No. 4,067,963

Registered Dec. 6, 2011

Int. Cls.: 41 and 42

SERVICE MARK

PRINCIPAL REGISTER

NHN CORPORATION (REPUBLIC OF KOREA CORPORATION)
VENTURE TOWN BLDG
25-1 JEONGJA-DONG, BUNDANG-GU
SEONGNAMSI, GYEONGGIDO, REPUBLIC OF KOREA 463-844

FOR: ENTERTAINMENT SERVICES, NAMELY, PROVIDING AN ON-LINE COMPUTER GAME; PROVIDING A COMPUTER GAME FOR USE NETWORK-WIDE BY NETWORK USERS; ORGANIZATION OF ON-LINE GAME COMPETITION, NAMELY, COMPUTER GAMES, IN CLASS 41 (U.S. CLS. 100, 101 AND 107).

FIRST USE 6-28-2010; IN COMMERCE 6-28-2010.

FOR: MAINTENANCE OF WEBSITES AND HOSTING ONLINE WEB FACILITIES FOR OTHERS; HOSTING AN ON-LINE COMMUNITY WEBSITE FEATURING SHARED COMMUNICATIONS BETWEEN COMMUNITY MEMBERS INTERESTED IN PERSONAL AND BUSINESS GAME INFORMATION, IN CLASS 42 (U.S. CLS. 100 AND 101).

FIRST USE 6-28-2010; IN COMMERCE 6-28-2010.

THE MARK CONSISTS OF STANDARD CHARACTERS WITHOUT CLAIM TO ANY PARTICULAR FONT, STYLE, SIZE, OR COLOR.

SN 77-963,586, FILED 3-19-2010.

LINDA ORNDORFF, EXAMINING ATTORNEY



David J. Kybas

Director of the United States Patent and Trademark Office

United States of America

United States Patent and Trademark Office

NORTHERN LIGHTS

Reg. No. 4,067,964

Registered Dec. 6, 2011

Int. Cls.: 7 and 11

TRADEMARK

PRINCIPAL REGISTER

NORTHERN LIGHTS, INC. (WASHINGTON CORPORATION)
425 SOUTH HACIENDA BOULEVARD
CITY OF INDUSTRY, CA 917451123

FOR: ELECTRICAL GENERATOR POWER SETS, COMPRISING ENGINES, GENERATORS, PUMPS, AND CONTROL PANELS, IN CLASS 7 (U.S. CLS. 13, 19, 21, 23, 31, 34 AND 35).

FIRST USE 0-0-1967; IN COMMERCE 0-0-1970.

FOR: AIR CONDITIONING AND REFRIGERATION APPARATUS FOR MARINE VESSELS, NAMELY, REMOTE AND HERMETIC AIR-CONDITIONING UNITS, INCLUDING AIR- AND WATER-COOLED CONDITIONING UNITS, AIR-DUCT COOLED CONDITIONING UNITS, AND BELT-DRIVEN CONDITIONING UNITS; REMOTE AIR-CONDITIONING EVAPORATOR UNITS; SELF-CONTAINED AIR-CONDITIONING UNITS; CHILLED WATER AIR-CONDITIONING UNITS; CHILLED WATER AIR HANDLERS FOR COOLING AND/OR CIRCULATING AIR; REFRIGERATION SYSTEMS, NAMELY, REFRIGERATION UNITS COMPRISED OF A CONVENTIONAL, ROTARY, HERMETIC OR SEMI-HERMETIC COMPRESSOR, EVAPORATOR, IMMERSION AND HOLD-OVER PLATES; AND REFRIGERATED SEA WATER SYSTEMS FOR COOLING THE CONTENTS OF A SHIP'S HOLD, COMPRISED PRIMARILY OF EVAPORATORS AND COMPRESSORS, IN CLASS 11 (U.S. CLS. 13, 21, 23, 31 AND 34).

FIRST USE 1-31-2008; IN COMMERCE 2-22-2008.

THE MARK CONSISTS OF STANDARD CHARACTERS WITHOUT CLAIM TO ANY PARTICULAR FONT, STYLE, SIZE, OR COLOR.

OWNER OF U.S. REG. NO. 1,232,499.

SN 77-963,603, FILED 3-19-2010.

CAROLINE WOOD, EXAMINING ATTORNEY



David J. Kyros

Director of the United States Patent and Trademark Office

United States of America

United States Patent and Trademark Office

WELLNESS FOR ALL

Reg. No. 4,067,965

Registered Dec. 6, 2011

Int. Cls.: 35, 42, and 44

SERVICE MARK

PRINCIPAL REGISTER

HEALTHALLY, INC. (DELAWARE CORPORATION)
SUITE 323
8343 ROSWELL ROAD
ATLANTA, GA 30350

FOR: PROVIDING ASSISTANCE, FITNESS EVALUATION AND CONSULTATION TO CORPORATE AND INDIVIDUAL CLIENTS TO HELP EMPLOYEES AND INDIVIDUALS MAKE HEALTH, WELLNESS AND NUTRITIONAL CHANGES IN THEIR DAILY LIVING TO INCREASE PRODUCTIVITY AND LOWER HEALTH CARE COSTS, IN CLASS 35 (U.S. CLS. 100, 101 AND 102).

FIRST USE 10-4-2011; IN COMMERCE 10-4-2011.

FOR: APPLICATION SERVICE PROVIDER (ASP) FEATURING SOFTWARE FOR CREATING SEARCHABLE DATABASES OF INFORMATION AND DATA, FOR ORGANIZING AND VIEWING DIGITAL IMAGES AND PHOTOGRAPHS, FOR CONTROLLING AND MANAGING PATIENT MEDICAL INFORMATION, FOR TRACKING PERSONALIZED PROGRESS IN HEALTHCARE, WELLNESS, DIET, EXERCISE, AND FOR MANAGING INCENTIVE AND REWARD PROGRAMS BY PUBLIC HEALTH, PRIVATE HEALTH, PRIVATE ENTERPRISES AND INDIVIDUALS, IN CLASS 42 (U.S. CLS. 100 AND 101).

FIRST USE 10-4-2011; IN COMMERCE 10-4-2011.

FOR: MAINTAINING AND MANAGING PERSONAL MEDICAL RECORDS AND FILES FOR PATIENTS AND HEALTHCARE PROVIDERS; NUTRITION COUNSELING; HEALTH CARE SERVICES, NAMELY, WELLNESS PROGRAMS; WELLNESS SERVICES, NAMELY, PERSONAL ASSESSMENTS, PERSONALIZED ROUTINES, MAINTENANCE SCHEDULES, AND COUNSELING, IN CLASS 44 (U.S. CLS. 100 AND 101).

FIRST USE 10-4-2011; IN COMMERCE 10-4-2011.

THE MARK CONSISTS OF STANDARD CHARACTERS WITHOUT CLAIM TO ANY PARTICULAR FONT, STYLE, SIZE, OR COLOR.

SN 77-963,844, FILED 3-19-2010.

BARNEY CHARLON, EXAMINING ATTORNEY



David J. Kyros

Director of the United States Patent and Trademark Office

United States of America

United States Patent and Trademark Office

SLUMBER BEAR

Reg. No. 4,067,966

Registered Dec. 6, 2011

Int. Cl.: 9

TRADEMARK

PRINCIPAL REGISTER

HUGGING MATTRESS, INC. (MARYLAND CORPORATION)
8336 MARKETREE CIRCLE
GAITHERSBURG, MD 20886

FOR: LASER MEASURING SYSTEMS AND ELECTRONIC MEASURING DEVICES, EMBEDDED IN STUFFED TOY ANIMALS, FOR DETERMINING THE STIFFNESS OF MATTRESSES AND OTHER FURNITURE, IN CLASS 9 (U.S. CLS. 21, 23, 26, 36 AND 38).

FIRST USE 3-23-2011; IN COMMERCE 3-23-2011.

THE MARK CONSISTS OF STANDARD CHARACTERS WITHOUT CLAIM TO ANY PARTICULAR FONT, STYLE, SIZE, OR COLOR.

SN 77-964,973, FILED 3-22-2010.

WENDY JUN, EXAMINING ATTORNEY



David J. Kyros

Director of the United States Patent and Trademark Office

United States of America

United States Patent and Trademark Office

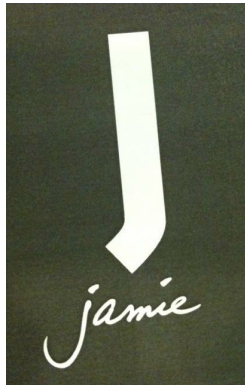

Reg. No. 4,067,967

Registered Dec. 6, 2011

Int. Cl.: 35

SERVICE MARK

PRINCIPAL REGISTER

JAMIE ENTERPRISES, INC. (CALIFORNIA CORPORATION)
301 N. CANON DRIVE, SUITE 302
BEVERLY HILLS, CA 90210

FOR: PROVIDING BUSINESS INFORMATION IN THE FIELDS OF LEADERSHIP DEVELOPMENT, MOTIVATION, EDUCATIONAL ACHIEVEMENT, BUSINESS MANAGEMENT, COMMUNITY DEVELOPMENT AND FUNDRAISING OVER THE INTERNET, IN CLASS 35 (U.S. CLS. 100, 101 AND 102).

FIRST USE 3-31-2010; IN COMMERCE 3-31-2010.

THE NAME(S), PORTRAIT(S), AND/OR SIGNATURE(S) SHOWN IN THE MARK IDENTIFIES "JAMIE" MCCOURT, WHOSE CONSENT(S) TO REGISTER IS MADE OF RECORD.

THE MARK CONSISTS OF A STYLIZED LETTER "J" WITH THE STYLIZED WORD/NAME "JAMIE" UNDERNEATH.

SN 77-965,232, FILED 3-22-2010.

JENNIFER VASQUEZ, EXAMINING ATTORNEY



David J. Kybas

Director of the United States Patent and Trademark Office

United States of America

United States Patent and Trademark Office



Reg. No. 4,067,968

Registered Dec. 6, 2011

Int. Cls.: 25 and 41

TRADEMARK

SERVICE MARK

PRINCIPAL REGISTER

ALPHA KAPPA ALPHA SORORITY, INC. (ILLINOIS CORPORATION)
5656 S. STONY ISLAND AVENUE
CHICAGO, IL 60637

FOR: T-SHIRTS, POLO SHIRTS, JOGGING SUITS AND SOCKS, IN CLASS 25 (U.S. CLS. 22 AND 39).

FIRST USE 9-1-2011; IN COMMERCE 9-1-2011.

FOR: EDUCATIONAL SERVICES, NAMELY, MENTORING IN THE FIELD OF SELF-AWARENESS, SELF-ESTEEM AND LEADERSHIP; EDUCATIONAL SERVICES, NAMELY, PROVIDING CLASSES, SEMINARS, WORKSHOPS IN THE FIELD OF SELF-AWARENESS, SELF-ESTEEM, AND LEADERSHIP; AND EDUCATIONAL AND ENTERTAINMENT SERVICES, NAMELY, PROVIDING MOTIVATIONAL AND EDUCATIONAL SPEAKERS, IN CLASS 41 (U.S. CLS. 100, 101 AND 107).

FIRST USE 6-1-2011; IN COMMERCE 6-1-2011.

NO CLAIM IS MADE TO THE EXCLUSIVE RIGHT TO USE "GLOBAL LEADERSHIP" AND "YOUNG LEADERS", APART FROM THE MARK AS SHOWN.

THE MARK CONSISTS OF THE WORDING "GLOBAL LEADERSHIP" BORDERING THE TOP HALF AND "THROUGH TIMELESS SERVICES" BORDERING THE BOTTOM HALF OF CONCENTRIC CIRCLES. THE WORDING IS SEPARATED BY DESIGN ELEMENTS OF TWO MAPLE LEAVES, ONE ON EACH SIDE OF THE CIRCLE. AT THE CENTER OF THE CIRCLE IS A DESIGN ELEMENT OF A GIRL HOLDING A MAP OF THE WORLD WITH THE WORDING "EMERGING YOUNG" AT THE TOP AND "LEADERS" AT THE BOTTOM. PEARLS ARE CIRCLING OUTSIDE THE INNER CIRCLE.

SN 77-965,514, FILED 3-23-2010.

WENDY JUN, EXAMINING ATTORNEY



David J. Kyjars

Director of the United States Patent and Trademark Office

United States of America

United States Patent and Trademark Office

SVC
SENIOR VALUE
CELLPHONE

Reg. No. 4,067,969

Registered Dec. 6, 2011

Int. Cl.: 38

SERVICE MARK

PRINCIPAL REGISTER

TRACFONE WIRELESS, INC. (DELAWARE CORPORATION)
9700 NW 112 AVE
MIAMI, FL 33178

FOR: CELLULAR TELEPHONE COMMUNICATIONS SERVICES; CELLULAR TELEPHONE TELECOMMUNICATIONS SERVICES PROVIDED VIA PREPAID AIR TIME CELLULAR TELEPHONES AND PREPAID AIR TIME CELLULAR TELEPHONE CALLING CARD SERVICES, IN CLASS 38 (U.S. CLS. 100, 101 AND 104).

FIRST USE 8-31-2010; IN COMMERCE 8-31-2010.

NO CLAIM IS MADE TO THE EXCLUSIVE RIGHT TO USE "SENIOR" AND "CELLPHONE", APART FROM THE MARK AS SHOWN.

THE MARK CONSISTS OF THE LETTERS "SVC" IN STYLIZED FORM WITH THE "S" SLANTED FORWARD AND THE UPPER END OF THE "S" CONNECTED TO THE UPPER LEFT END OF THE "V", AND THE LEFT SIDE OF THE "C" PARTIALLY SUPERIMPOSED OVER THE RIGHT SIDE OF THE "V" WITH THE WORDS "SENIOR VALUE CELLPHONE" BELOW OF "SVC," WITH THE "S" IN THE WORD "SENIOR" SLANTED FORWARD .

SN 77-965,815, FILED 3-23-2010.

KRISTINA MORRIS, EXAMINING ATTORNEY



David J. Kyros

Director of the United States Patent and Trademark Office

United States of America

United States Patent and Trademark Office

Incentease

Reg. No. 4,067,970

Registered Dec. 6, 2011

Int. Cl.: 36

SERVICE MARK

PRINCIPAL REGISTER

HRN MANAGEMENT GROUP, INC. (MICHIGAN CORPORATION)
SUITE 200
38695 W. SEVEN MILE ROAD
LIVONIA, MI 481527097

FOR: PROVIDING A WEBSITE FEATURING EMPLOYEE INCENTIVE PLANNING INFORMATION, NAMELY, INFORMATION IN THE FIELD OF EMPLOYEE BENEFIT PLANS CONCERNING INSURANCE AND FINANCE, IN CLASS 36 (U.S. CLS. 100, 101 AND 102).

FIRST USE 7-0-2009; IN COMMERCE 7-0-2009.

THE MARK CONSISTS OF STANDARD CHARACTERS WITHOUT CLAIM TO ANY PARTICULAR FONT, STYLE, SIZE, OR COLOR.

SN 77-966,185, FILED 3-23-2010.

KATHERINE E. HALMEN, EXAMINING ATTORNEY



David J. Kybas

Director of the United States Patent and Trademark Office

United States of America

United States Patent and Trademark Office

FIN

Reg. No. 4,067,971

Registered Dec. 6, 2011

Int. Cl.: 21

TRADEMARK

PRINCIPAL REGISTER

JOHN S. LETCHINGER (UNITED STATES JOINT APPLICANT)
SUITE 2800
225 WEST WACKER DRIVE
CHICAGO, IL 60606 AND

THOMAS J. RING (UNITED STATES JOINT APPLICANT)
SUITE 2800
225 WEST WACKER DRIVE
CHICAGO, IL 60606

FOR: DRINKING CONTAINER , IN CLASS 21 (U.S. CLS. 2, 13, 23, 29, 30, 33, 40 AND 50).

FIRST USE 8-13-2010; IN COMMERCE 8-13-2010.

THE MARK CONSISTS OF STANDARD CHARACTERS WITHOUT CLAIM TO ANY PARTICULAR FONT, STYLE, SIZE, OR COLOR.

SN 77-966,198, FILED 3-23-2010.

RAUL CORDOVA, EXAMINING ATTORNEY



David J. Kybas

Director of the United States Patent and Trademark Office

United States of America

United States Patent and Trademark Office

FEATHERDECK

Reg. No. 4,067,972

Registered Dec. 6, 2011

Int. Cl.: 20

TRADEMARK

PRINCIPAL REGISTER

LIST INDUSTRIES, INC. (ILLINOIS CORPORATION)
401 JIM MORAN BOULEVARD
DEERFIELD BEACH, FL 33442

FOR: SHELVES, IN CLASS 20 (U.S. CLS. 2, 13, 22, 25, 32 AND 50).

FIRST USE 10-28-2010; IN COMMERCE 2-1-2011.

THE MARK CONSISTS OF STANDARD CHARACTERS WITHOUT CLAIM TO ANY PARTICULAR FONT, STYLE, SIZE, OR COLOR.

SN 77-966,261, FILED 3-23-2010.

BRIAN CALLAGHAN, EXAMINING ATTORNEY



David J. Kyfos

Director of the United States Patent and Trademark Office

United States of America

United States Patent and Trademark Office

Globee

Reg. No. 4,067,973

Registered Dec. 6, 2011

Int. Cl.: 7

TRADEMARK

PRINCIPAL REGISTER

MERLIN GLOW PLUGS INC. (ILLINOIS CORPORATION)
4616 HARVEY AVENUE
WESTERN SPRINGS, IL 60558

FOR: ENGINES AND MOTORS FOR MODEL VEHICLES, AIRCRAFT AND BOATS; ENGINES FOR MODEL VEHICLES; GLOW PLUGS, IN CLASS 7 (U.S. CLS. 13, 19, 21, 23, 31, 34 AND 35).

FIRST USE 4-1-2011; IN COMMERCE 4-1-2011.

THE MARK CONSISTS OF STANDARD CHARACTERS WITHOUT CLAIM TO ANY PARTICULAR FONT, STYLE, SIZE, OR COLOR.

SN 77-967,211, FILED 3-24-2010.

KATHERINE STOIDES, EXAMINING ATTORNEY



David J. Kybas

Director of the United States Patent and Trademark Office

United States of America

United States Patent and Trademark Office

LOKAL

Reg. No. 4,067,974

Registered Dec. 6, 2011

Int. Cl.: 25

TRADEMARK

PRINCIPAL REGISTER

LOKAL LLC (NEW JERSEY LIMITED LIABILITY COMPANY)
110 19TH AVE
BELMAR, NJ 07719

FOR: BIKINIS; HATS; SHIRTS; SHORTS, IN CLASS 25 (U.S. CLS. 22 AND 39).

FIRST USE 3-4-2011; IN COMMERCE 3-4-2011.

THE MARK CONSISTS OF THE STYLIZED TEXT "LOKAL" WITH AN ABSTRACT DESIGN OVER THE LETTER "K".

SN 77-967,624, FILED 3-24-2010.

MARY ROSSMAN, EXAMINING ATTORNEY



David J. Kyros

Director of the United States Patent and Trademark Office

United States of America

United States Patent and Trademark Office



Reg. No. 4,067,975

Registered Dec. 6, 2011

Int. Cl.: 1

TRADEMARK

PRINCIPAL REGISTER

NOVAX MATERIAL & TECHNOLOGY INC. (TAIWAN CORPORATION)
33759NO.19,DAGONG RD., DAYUAN INDUSTRIAL
TAOYUAN COUNTY, TAIWAN

FOR: CHEMICAL ADDITIVES FOR MOTOR FUEL; CHEMICAL ADDITIVES FOR OIL; COMBUSTING PREPARATIONS, NAMELY, CHEMICAL ADDITIVES FOR USE WITH INTERNAL COMBUSTION ENGINE FUELS; DETERGENT ADDITIVE FOR USE WITH GASOLINE; FUEL SAVING PREPARATIONS, NAMELY, CHEMICAL ADDITIVES FOR ENHANCING THE PERFORMANCE OF ENGINE FUELS; GAS PURIFYING PREPARATIONS, NAMELY, DETERGENT ADDITIVES TO GASOLINE; PURIFYING CHEMICALS FOR OIL, IN CLASS 1 (U.S. CLS. 1, 5, 6, 10, 26 AND 46).

FIRST USE 4-1-2011; IN COMMERCE 5-11-2011.

THE MARK CONSISTS OF A GREEN LEAF ON THE LEFT WITH WHITE VEINS AND A BLUE WATER-LIKE DROP WITH A WHITE CIRCLE ON THE LOWER RIGHT SIDE OF LEAF, AND THE BLUE WORD "NOVAX" TO THE RIGHT OF THE LEAF.

THE COLOR(S) BLUE, GREEN AND WHITE IS/ARE CLAIMED AS A FEATURE OF THE MARK.

SN 77-967,895, FILED 3-24-2010.

JESSICA A. POWERS, EXAMINING ATTORNEY



David J. Kyros

Director of the United States Patent and Trademark Office

United States of America

United States Patent and Trademark Office

REIMAGINE RECYCLE CENTER

Reg. No. 4,067,976

Registered Dec. 6, 2011

Int. Cl.: 40

SERVICE MARK

PRINCIPAL REGISTER

ENVIRONMENTAL PRODUCTS CORPORATION (DELAWARE CORPORATION)
99 GREAT HILL ROAD
NAUGATUCK, CT 06770

FOR: RECYCLING SERVICES, IN CLASS 40 (U.S. CLS. 100, 103 AND 106).

FIRST USE 11-30-2010; IN COMMERCE 11-30-2010.

THE MARK CONSISTS OF STANDARD CHARACTERS WITHOUT CLAIM TO ANY PARTICULAR FONT, STYLE, SIZE, OR COLOR.

NO CLAIM IS MADE TO THE EXCLUSIVE RIGHT TO USE "RECYCLE CENTER", APART FROM THE MARK AS SHOWN.

SN 77-968,073, FILED 3-25-2010.

RENEE SERVANCE, EXAMINING ATTORNEY



David J. Kyffers

Director of the United States Patent and Trademark Office

United States of America

United States Patent and Trademark Office

REIMAGINE BEVERAGE CONTAINER RECYCLING

Reg. No. 4,067,977

Registered Dec. 6, 2011

Int. Cl.: 35

SERVICE MARK

PRINCIPAL REGISTER

ENVIRONMENTAL PRODUCTS CORPORATION (DELAWARE CORPORATION)
99 GREAT HILL ROAD
NAUGATUCK, CT 06770

FOR: CONDUCTING RECYCLING INCENTIVE AWARDS PROGRAMS WHEREBY PARTICIPANTS RECEIVE BONUS REWARD POINTS TOWARD THE PURCHASE OF THE GOODS AND SERVICES OF OTHERS , IN CLASS 35 (U.S. CLS. 100, 101 AND 102).

FIRST USE 11-30-2010; IN COMMERCE 11-30-2010.

THE MARK CONSISTS OF STANDARD CHARACTERS WITHOUT CLAIM TO ANY PARTICULAR FONT, STYLE, SIZE, OR COLOR.

NO CLAIM IS MADE TO THE EXCLUSIVE RIGHT TO USE "BEVERAGE CONTAINER RECYCLING", APART FROM THE MARK AS SHOWN.

SN 77-968,081, FILED 3-25-2010.

RENEE SERVANCE, EXAMINING ATTORNEY



David J. Kyros

Director of the United States Patent and Trademark Office

United States of America
United States Patent and Trademark Office

DIABLITO

Reg. No. 4,067,978

RAVANDI, DAVID (UNITED STATES INDIVIDUAL)
P.O. BOX 6715
BEVERLY HILLS, CA 90212

Registered Dec. 6, 2011

Int. Cl.: 33

FOR: MEZCAL; TEQUILA; TEQUILA INFUSED WITH VITAMINS, IN CLASS 33 (U.S. CLS. 47 AND 49).

TRADEMARK

FIRST USE 10-1-2011; IN COMMERCE 10-3-2011.

PRINCIPAL REGISTER

THE MARK CONSISTS OF STANDARD CHARACTERS WITHOUT CLAIM TO ANY PARTICULAR FONT, STYLE, SIZE, OR COLOR.

THE ENGLISH TRANSLATION OF "DIABLITO" IN THE MARK IS "LITTLE DEVIL".

SN 77-968,347, FILED 3-25-2010.

SANI KHOURI, EXAMINING ATTORNEY



David J. Kybas

Director of the United States Patent and Trademark Office

United States of America

United States Patent and Trademark Office

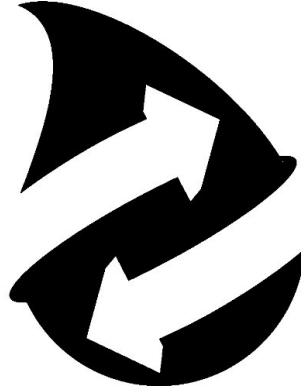

Reg. No. 4,067,979

Registered Dec. 6, 2011

Int. Cl.: 40

SERVICE MARK

PRINCIPAL REGISTER

JBI, INC. (NEVADA CORPORATION)
1783 ALLANPORT ROAD
THOROLD
ONTARIO, CANADA L0S 1K0

FOR: CONVERTING POLYMER-BASED WASTE INTO PETROLEUM FUEL, IN CLASS 40
(U.S. CLS. 100, 103 AND 106).

FIRST USE 4-24-2010; IN COMMERCE 4-24-2010.

THE MARK CONSISTS OF TWO COUNTER OPPOSING ARROWS ENCIRCLING A DROPLET.

SN 77-968,364, FILED 3-25-2010.

STEVEN JACKSON, EXAMINING ATTORNEY



David J. Kybas

Director of the United States Patent and Trademark Office

United States of America

United States Patent and Trademark Office

PRINCESS FREE ZONE

Reg. No. 4,067,980

Registered Dec. 6, 2011

Int. Cl.: 25

TRADEMARK

PRINCIPAL REGISTER

PRINCESS FREE ZONE, INC. (GEORGIA CORPORATION)
2891 TEMPLAR KNIGHT DR.
TUCKER, GA 30084

FOR: SHIRTS, IN CLASS 25 (U.S. CLS. 22 AND 39).

FIRST USE 6-4-2011; IN COMMERCE 6-4-2011.

THE MARK CONSISTS OF STANDARD CHARACTERS WITHOUT CLAIM TO ANY PARTICULAR FONT, STYLE, SIZE, OR COLOR.

SN 77-968,415, FILED 3-25-2010.

ESTHER BELENKER, EXAMINING ATTORNEY



David J. Kybas

Director of the United States Patent and Trademark Office

United States of America

United States Patent and Trademark Office

RAINWATER COLANDER

Reg. No. 4,067,981

AMERIMAX HOME PRODUCTS, INC. (DELAWARE CORPORATION)
4455 RIVER GREEN PARKWAY
DULUTH, GA 30096

Registered Dec. 6, 2011

Int. Cl.: 11

FOR: RAINWATER COLLECTION DEVICES, NAMELY, A COLLECTOR INSTALLED IN A DOWNSPOUT FOR COLLECTING, FILTERING AND DIVERTING RAINWATER FROM THE DOWNSPOUT INTO A REMOTE RAINWATER STORAGE FACILITY, IN CLASS 11 (U.S. CLS. 13, 21, 23, 31 AND 34).

TRADEMARK

PRINCIPAL REGISTER

FIRST USE 8-2-2011; IN COMMERCE 8-2-2011.

THE MARK CONSISTS OF STANDARD CHARACTERS WITHOUT CLAIM TO ANY PARTICULAR FONT, STYLE, SIZE, OR COLOR.

NO CLAIM IS MADE TO THE EXCLUSIVE RIGHT TO USE "RAINWATER", APART FROM THE MARK AS SHOWN.

SN 77-968,840, FILED 3-25-2010.

NAAKWAMA ANKRAH, EXAMINING ATTORNEY



David J. Kyros

Director of the United States Patent and Trademark Office

United States of America

United States Patent and Trademark Office

PARENT PREP SCHOOL

Reg. No. 4,067,982

Registered Dec. 6, 2011

Int. Cls.: 9 and 41

TRADEMARK

SERVICE MARK

PRINCIPAL REGISTER

PARENT PREP SCHOOL, LLC (TEXAS LIMITED LIABILITY COMPANY)
2500 WOODMONT
AUSTIN, TX 78703

FOR: COMPUTER APPLICATION SOFTWARE FOR MOBILE PHONES, PORTABLE MEDIA PLAYERS AND HANDHELD COMPUTERS, NAMELY, SOFTWARE THAT POPULATES AN ELECTRONIC CALENDAR WITH INFORMATION RELATING TO PREGNANCY, PARENTING AND INFANT CARE; PRE-RECORDED VIDEOS, AUDIO AND VIDEO RECORDINGS, AND DOWNLOADABLE VIDEO RECORDINGS ALL FEATURING INFORMATION ON PREGNANCY, PARENTING AND INFANT CARE, IN CLASS 9 (U.S. CLS. 21, 23, 26, 36 AND 38).

FIRST USE 12-21-2010; IN COMMERCE 12-21-2010.

FOR: PROVIDING A WEBSITE FEATURING INSTRUCTIONAL INFORMATION IN THE FIELDS OF PREGNANCY, PARENTING AND INFANT CARE, IN CLASS 41 (U.S. CLS. 100, 101 AND 107).

FIRST USE 11-30-2010; IN COMMERCE 11-30-2010.

THE MARK CONSISTS OF STANDARD CHARACTERS WITHOUT CLAIM TO ANY PARTICULAR FONT, STYLE, SIZE, OR COLOR.

NO CLAIM IS MADE TO THE EXCLUSIVE RIGHT TO USE "PARENT", APART FROM THE MARK AS SHOWN.

SN 77-969,007, FILED 3-25-2010.

BERYL GARDNER, EXAMINING ATTORNEY



David J. Kyros

Director of the United States Patent and Trademark Office

United States of America

United States Patent and Trademark Office



Reg. No. 4,067,983

Registered Dec. 6, 2011

Int. Cl.: 25

TRADEMARK

PRINCIPAL REGISTER

ROTHHAMMER-SHEETZ, DIANNE (UNITED STATES INDIVIDUAL)
30 AMBASSADOR GLADE
APT. B-65
OREWA, RODNEY, NEW ZEALAND 0931

FOR: SWIMSUITS, IN CLASS 25 (U.S. CLS. 22 AND 39).

FIRST USE 8-31-2011; IN COMMERCE 8-31-2011.

NO CLAIM IS MADE TO THE EXCLUSIVE RIGHT TO USE "SLIP ON", APART FROM THE MARK AS SHOWN.

THE MARK CONSISTS OF THE WORDS "SLIP ON" WITH A DESIGN ABOVE THE WORD PORTION OF THE MARK. THE DESIGN CONSISTS OF AN UPSIDE DOWN U-SHAPED ELEMENT LOCATED ABOVE, AND CENTERED WITH RESPECT TO, TWO UPWARDLY AND OUTWARDLY ARCING ELEMENTS, THAT GENERALLY TAPER TOWARD THEIR ENDS. THE RIGHT SIDE ARCING ELEMENT ORIGINATING CENTRALLY BELOW THE UPSIDE DOWN U-SHAPED ELEMENT AND HAVING A LENGTH GREATER THAN THE LEFT SIDE ARCING ELEMENT, WHICH ORIGINATES SLIGHTLY ABOVE THE RIGHT-SIDE ARCING ELEMENT. THE OVERALL IMPRESSION OF THE DESIGN BEING THAT OF A PERSON WITH OUTSTRETCHED ARMS.

SN 77-969,303, FILED 3-26-2010.

SCOTT BIBB, EXAMINING ATTORNEY



David J. Kybas

Director of the United States Patent and Trademark Office

United States of America

United States Patent and Trademark Office

CAPRI

Reg. No. 4,067,984

Registered Dec. 6, 2011

Int. Cl.: 21

TRADEMARK

PRINCIPAL REGISTER

SPORNETTE INTERNATIONAL, INC. (ILLINOIS CORPORATION)
18240 HARWOOD AVENUE
HOMWOOD, IL 60430

FOR: HAIRBRUSHES, IN CLASS 21 (U.S. CLS. 2, 13, 23, 29, 30, 33, 40 AND 50).

FIRST USE 10-19-2007; IN COMMERCE 10-19-2007.

THE MARK CONSISTS OF STANDARD CHARACTERS WITHOUT CLAIM TO ANY PARTICULAR FONT, STYLE, SIZE, OR COLOR.

SN 77-969,564, FILED 3-26-2010.

MICHAEL TANNER, EXAMINING ATTORNEY



David J. Kyffers

Director of the United States Patent and Trademark Office

United States of America

United States Patent and Trademark Office



Reg. No. 4,067,985

Registered Dec. 6, 2011

Int. Cl.: 36

SERVICE MARK

PRINCIPAL REGISTER

QUEST FEDERAL CREDIT UNION (UNITED STATES FEDERALLY CHARTERED CREDIT UNION)
12837 STATE ROUTE 68 SOUTH
KENTON, OH 43326

FOR: CREDIT UNION SERVICES AT THE RETAIL LEVEL TO INDIVIDUALS AND BUSINESSES; NOT INCLUDING ELECTRONIC FUND TRANSFER, DEBIT CARD SERVICES, OR MORTGAGE CONSULTING SERVICES TO FINANCIAL INSTITUTIONS; NOT INCLUDING ELECTRONIC BENEFIT TRANSFER SERVICES; NOT INCLUDING COMPLIANCE AUDITING SERVICES TO FINANCIAL SERVICES, IN CLASS 36 (U.S. CLS. 100, 101 AND 102).

FIRST USE 6-1-2010; IN COMMERCE 6-1-2010.

NO CLAIM IS MADE TO THE EXCLUSIVE RIGHT TO USE "FEDERAL CREDIT UNION", APART FROM THE MARK AS SHOWN.

THE MARK CONSISTS OF WORDING AND DESIGNS. THE WORD "QUEST" IS WRITTEN IN LARGE LETTERS AND APPEARS ABOVE A HORIZONTAL LINE, WHICH IS IN TURN ABOVE THE WORDING "FEDERAL CREDIT UNION". TO THE RIGHT OF THE WORDING AND HORIZONTAL LINE, THERE IS A DESIGN OF A COMPASS ROSE FEATURING A TWELVE-POINTED STAR ON A CIRCULAR BACKGROUND.

SN 77-969,804, FILED 3-26-2010.

CORY BOONE, EXAMINING ATTORNEY



David J. Kybas

Director of the United States Patent and Trademark Office

United States of America

United States Patent and Trademark Office

DIGITAL DEALER

Reg. No. 4,067,986

Registered Dec. 6, 2011

Int. Cl.: 35

SERVICE MARK

PRINCIPAL REGISTER

IRON SOLUTIONS, INC. (DELAWARE CORPORATION)
1855 BOWLES AVENUE, SUITE 202
FENTON, MO 63026

FOR: PROVIDING MARKETING, ADVERTISING, AND SALES PROMOTION SERVICES FOR THIRD PARTIES; PROVIDING LEAD GENERATION SERVICES; PROVIDING LEAD OPTIMIZATION SERVICES, NAMELY, ENHANCING SALES LEADS BY GATHERING AND PROVIDING ENHANCED INFORMATION ABOUT PROSPECTIVE PURCHASERS; INFORMATIONAL SERVICES, NAMELY, FACILITATING TRANSACTIONS BETWEEN BUYERS AND SELLERS BY PROVIDING SELLERS WITH INFORMATION ABOUT QUALIFIED BUYERS, CONSUMER BEHAVIOR TRENDS, AND INDUSTRY TRENDS, IN CLASS 35 (U.S. CLS. 100, 101 AND 102).

FIRST USE 2-0-2010; IN COMMERCE 2-0-2010.

THE MARK CONSISTS OF STANDARD CHARACTERS WITHOUT CLAIM TO ANY PARTICULAR FONT, STYLE, SIZE, OR COLOR.

NO CLAIM IS MADE TO THE EXCLUSIVE RIGHT TO USE "DIGITAL", APART FROM THE MARK AS SHOWN.

SN 77-969,897, FILED 3-26-2010.

KELLEY WELLS, EXAMINING ATTORNEY



David J. Kyjars

Director of the United States Patent and Trademark Office

United States of America

United States Patent and Trademark Office

DEBT DIVA

Reg. No. 4,067,987

Registered Dec. 6, 2011

Int. Cls.: 16, 36, and 41

TRADEMARK

SERVICE MARK

PRINCIPAL REGISTER

3C INCORPORATED (MARYLAND CORPORATION)
8930 STANFORD BOULEVARD
COLUMBIA, MD 21045

FOR: BROCHURES IN THE FIELD OF CREDIT, FINANCE, HOUSEHOLD FINANCIAL MATTERS AND GENERAL FINANCIAL MATTERS, IN CLASS 16 (U.S. CLS. 2, 5, 22, 23, 29, 37, 38 AND 50).

FIRST USE 1-0-2008; IN COMMERCE 1-0-2008.

FOR: PROVIDING INFORMATION IN THE FIELD OF CREDIT, FINANCE, HOUSEHOLD FINANCIAL MATTERS AND GENERAL FINANCIAL MATTERS, VIA A WEBSITE AND A GLOBAL COMPUTER NETWORK; FINANCIAL COUNSELING; FINANCIAL CONSULTING, IN CLASS 36 (U.S. CLS. 100, 101 AND 102).

FIRST USE 1-0-2008; IN COMMERCE 1-0-2008.

FOR: CONDUCTING EDUCATIONAL PROGRAMS, CLASSES, CONFERENCES, WORKSHOPS AND SEMINARS IN THE FIELD OF CREDIT, FINANCE, HOUSEHOLD FINANCIAL MATTERS AND GENERAL FINANCIAL MATTERS, IN CLASS 41 (U.S. CLS. 100, 101 AND 107).

FIRST USE 1-7-2010; IN COMMERCE 1-7-2010.

THE MARK CONSISTS OF STANDARD CHARACTERS WITHOUT CLAIM TO ANY PARTICULAR FONT, STYLE, SIZE, OR COLOR.

NO CLAIM IS MADE TO THE EXCLUSIVE RIGHT TO USE "DEBT", APART FROM THE MARK AS SHOWN.

THE NAME(S), PORTRAIT(S), AND/OR SIGNATURE(S) SHOWN IN THE MARK IDENTIFIES "CLARKY DAVIS", WHOSE CONSENT(S) TO REGISTER IS MADE OF RECORD.

SN 77-979,909, FILED 5-6-2008.

YAT SYE, LEE, EXAMINING ATTORNEY



David J. Kyros

Director of the United States Patent and Trademark Office

United States of America

United States Patent and Trademark Office

THE DEBT DIVA

Reg. No. 4,067,988

Registered Dec. 6, 2011

Int. Cls.: 16, 36, and 41

TRADEMARK

SERVICE MARK

PRINCIPAL REGISTER

3C INCORPORATED (MARYLAND CORPORATION)
8930 STANFORD BOULEVARD
COLUMBIA, MD 21045

FOR: BROCHURES IN THE FIELD OF CREDIT, FINANCE, HOUSEHOLD FINANCIAL MATTERS AND GENERAL FINANCIAL MATTERS, IN CLASS 16 (U.S. CLS. 2, 5, 22, 23, 29, 37, 38 AND 50).

FIRST USE 1-0-2008; IN COMMERCE 1-0-2008.

FOR: PROVIDING INFORMATION IN THE FIELD OF CREDIT, FINANCE, HOUSEHOLD FINANCIAL MATTERS AND GENERAL FINANCIAL MATTERS, VIA A WEBSITE AND A GLOBAL COMPUTER NETWORK; FINANCIAL COUNSELING; FINANCIAL CONSULTING, IN CLASS 36 (U.S. CLS. 100, 101 AND 102).

FIRST USE 1-0-2008; IN COMMERCE 1-0-2008.

FOR: CONDUCTING EDUCATIONAL PROGRAMS, CLASSES, CONFERENCES, WORKSHOPS AND SEMINARS IN THE FIELD OF CREDIT, FINANCE, HOUSEHOLD FINANCIAL MATTERS AND GENERAL FINANCIAL MATTERS, IN CLASS 41 (U.S. CLS. 100, 101 AND 107).

FIRST USE 1-7-2010; IN COMMERCE 1-7-2010.

THE MARK CONSISTS OF STANDARD CHARACTERS WITHOUT CLAIM TO ANY PARTICULAR FONT, STYLE, SIZE, OR COLOR.

NO CLAIM IS MADE TO THE EXCLUSIVE RIGHT TO USE "DEBT", APART FROM THE MARK AS SHOWN.

THE NAME(S), PORTRAIT(S), AND/OR SIGNATURE(S) SHOWN IN THE MARK IDENTIFIES "CLARKY DAVIS", WHOSE CONSENT(S) TO REGISTER IS MADE OF RECORD.

SN 77-979,910, FILED 5-6-2008.

YAT SYE, LEE, EXAMINING ATTORNEY



David J. Kyros

Director of the United States Patent and Trademark Office

United States of America

United States Patent and Trademark Office

CHICAGO BOOTH

The University of Chicago Booth School of Business

Reg. No. 4,067,989

UNIVERSITY OF CHICAGO, THE (ILLINOIS NOT-FOR-PROFIT CORPORATION)
5801 ELLIS AVENUE
CHICAGO, IL 60637

Registered Dec. 6, 2011

Int. Cl.: 25

FOR: CLOTHING, NAMELY, T-SHIRTS, SWEATSHIRTS, AND SHIRTS, IN CLASS 25 (U.S. CLS. 22 AND 39).

TRADEMARK

FIRST USE 0-0-2010; IN COMMERCE 0-0-2010.

PRINCIPAL REGISTER

OWNER OF U.S. REG. NOS. 1,876,527 AND 2,668,437.

NO CLAIM IS MADE TO THE EXCLUSIVE RIGHT TO USE "CHICAGO", APART FROM THE MARK AS SHOWN.

THE MARK CONSISTS OF THE WORDS "CHICAGO BOOTH" TOGETHER WITH A DESIGN AND THE WORDS "THE UNIVERSITY OF CHICAGO BOOTH SCHOOL OF BUSINESS".

SN 77-981,441, FILED 11-6-2008.

MICHELE SWAIN, EXAMINING ATTORNEY



David J. Kyros

Director of the United States Patent and Trademark Office

United States of America

United States Patent and Trademark Office

CHICAGO BOOTH

The University of Chicago Booth School of Business

Reg. No. 4,067,990

UNIVERSITY OF CHICAGO, THE (ILLINOIS NOT-FOR-PROFIT CORPORATION)
5801 ELLIS AVENUE
CHICAGO, IL 60637

Registered Dec. 6, 2011

Int. Cl.: 21

FOR: COFFEE MUGS; BEVERAGE GLASSWARE, DRINKING GLASSES, AND MUGS, IN CLASS 21 (U.S. CLS. 2, 13, 23, 29, 30, 33, 40 AND 50).

TRADEMARK

FIRST USE 0-0-2010; IN COMMERCE 0-0-2010.

PRINCIPAL REGISTER

OWNER OF U.S. REG. NOS. 1,876,527 AND 2,668,437.

NO CLAIM IS MADE TO THE EXCLUSIVE RIGHT TO USE "CHICAGO", APART FROM THE MARK AS SHOWN.

THE MARK CONSISTS OF THE WORDS "CHICAGO BOOTH" TOGETHER WITH A DESIGN AND THE WORDS "THE UNIVERSITY OF CHICAGO BOOTH SCHOOL OF BUSINESS".

SN 77-981,442, FILED 11-6-2008.

MICHELE SWAIN, EXAMINING ATTORNEY



David J. Kyros

Director of the United States Patent and Trademark Office

United States of America

United States Patent and Trademark Office

CHICAGO BOOTH

The University of Chicago Booth School of Business

Reg. No. 4,067,991

Registered Dec. 6, 2011

Int. Cl.: 16

TRADEMARK

PRINCIPAL REGISTER

UNIVERSITY OF CHICAGO, THE (ILLINOIS NOT-FOR-PROFIT CORPORATION)
5801 ELLIS AVENUE
CHICAGO, IL 60637

FOR: EXECUTIVE GIFT PRODUCTS, NAMELY, PAPERWEIGHTS, PENS, PENCILS AND PENCIL HOLDERS, DESK TOP BUSINESS CARD HOLDERS; PAPER GOODS AND PRINTED MATTER, NAMELY, NOTEBOOKS AND BINDERS, IN CLASS 16 (U.S. CLS. 2, 5, 22, 23, 29, 37, 38 AND 50).

FIRST USE 0-0-2010; IN COMMERCE 0-0-2010.

OWNER OF U.S. REG. NOS. 1,876,527 AND 2,668,437.

SEC. 2(F) AS TO "UNIVERSITY OF CHICAGO" .

NO CLAIM IS MADE TO THE EXCLUSIVE RIGHT TO USE "CHICAGO" AND "SCHOOL OF BUSINESS", APART FROM THE MARK AS SHOWN.

THE MARK CONSISTS OF THE WORDS "CHICAGO BOOTH" TOGETHER WITH A DESIGN AND THE WORDS "THE UNIVERSITY OF CHICAGO BOOTH SCHOOL OF BUSINESS".

SN 77-981,524, FILED 11-6-2008.

MICHELE SWAIN, EXAMINING ATTORNEY



David J. Kyjars

Director of the United States Patent and Trademark Office

United States of America

United States Patent and Trademark Office

CHICAGO BOOTH

Reg. No. 4,067,992

Registered Dec. 6, 2011

Int. Cl.: 16

TRADEMARK

PRINCIPAL REGISTER

UNIVERSITY OF CHICAGO, THE (ILLINOIS NOT-FOR-PROFIT CORPORATION)
5801 ELLIS AVENUE
CHICAGO, IL 60637

FOR: EXECUTIVE GIFT PRODUCTS, NAMELY, PAPERWEIGHTS, PENS, PENCILS AND PENCIL HOLDERS, DESK TOP BUSINESS CARD HOLDERS; NOTEBOOKS, BINDERS; PUBLICATIONS, NAMELY, NEWSLETTER AND MAGAZINES RELATING TO BUSINESS AND MANAGEMENT, IN CLASS 16 (U.S. CLS. 2, 5, 22, 23, 29, 37, 38 AND 50).

FIRST USE 0-0-2010; IN COMMERCE 0-0-2010.

THE MARK CONSISTS OF STANDARD CHARACTERS WITHOUT CLAIM TO ANY PARTICULAR FONT, STYLE, SIZE, OR COLOR.

OWNER OF U.S. REG. NOS. 1,876,527 AND 2,668,437.

NO CLAIM IS MADE TO THE EXCLUSIVE RIGHT TO USE "CHICAGO", APART FROM THE MARK AS SHOWN.

SN 77-981,525, FILED 11-6-2008.

MICHELE SWAIN, EXAMINING ATTORNEY



David J. Kyjars

Director of the United States Patent and Trademark Office

United States of America

United States Patent and Trademark Office

One Nation

Reg. No. 4,067,993

Registered Dec. 6, 2011

Int. Cl.: 25

TRADEMARK

PRINCIPAL REGISTER

ORTEGA, DENNIS (UNITED STATES INDIVIDUAL)
711 ORANGE DRIVE
OXNARD, CA 93036

FOR: GLOVES, IN CLASS 25 (U.S. CLS. 22 AND 39).

FIRST USE 2-28-2010; IN COMMERCE 2-28-2010.

THE MARK CONSISTS OF STANDARD CHARACTERS WITHOUT CLAIM TO ANY PARTICULAR FONT, STYLE, SIZE, OR COLOR.

SN 77-981,681, FILED 9-1-2009.

GISELLE AGOSTO, EXAMINING ATTORNEY



David J. Kybas

Director of the United States Patent and Trademark Office

United States of America

United States Patent and Trademark Office

CARDIOTEL

Reg. No. 4,067,994

Registered Dec. 6, 2011

**Int. Cls.: 9, 10, 39, and
44**

TRADEMARK

SERVICE MARK

PRINCIPAL REGISTER

GLUCOTEL SCIENTIFIC INC. (NEVADA CORPORATION)
SUITE 500
6100 NEIL ROAD
RENO, NV 89511

FOR: ELECTRONIC EVALUATION SYSTEMS FOR CARDIAC FUNCTION MEASURING VALUES, NAMELY, A SOFTWARE APPLICATION IMPLEMENTED IN A CELL PHONE FOR EVALUATING HEART RATE, HEART RHYTHM, HEART BEAT STRENGTH AND HEART ACTIVITY OVER TIME TO RESPECTIVE MEDICAL VALUES, DISPLAYING THE ABOVE MEASURED VALUES ON THE MOBILE PHONE'S DISPLAY AND SENDING THE VALUES TO A REMOTE DATABASE, FOR USE IN MEDICAL CARE, IN CLASS 9 (U.S. CLS. 21, 23, 26, 36 AND 38).

FIRST USE 1-0-2010; IN COMMERCE 1-0-2010.

FOR: MEASURING SYSTEMS AND MEASURING DEVICES FOR CARDIAC FUNCTIONS, NAMELY, ELECTRIC ACTIVITY SENSORS FOR USE IN MEASURING PHYSIOLOGICAL PROPERTIES, NAMELY, HEART RATE, HEART RHYTHM, HEART BEAT STRENGTH AND HEART ACTIVITY OVER TIME, FOR USE IN MEDICAL CARE; DEVICES FOR SENSING CARDIAC FUNCTION DATA, NAMELY, ELECTROCARDIOGRAM SENSORS FOR USE IN MONITORING HEART ACTIVITY, IN CLASS 10 (U.S. CLS. 26, 39 AND 44).

FIRST USE 1-0-2010; IN COMMERCE 1-0-2010.

FOR: ELECTRONIC STORAGE OF PERSONAL BODY-RELATED DATA, NAMELY, DIASTOLIC/SYSTOLIC BLOOD PRESSURE, PULSE, PULSE-FREQUENCY, AND CARDIAC DATA, IN CLASS 39 (U.S. CLS. 100 AND 105).

FIRST USE 1-0-2010; IN COMMERCE 1-0-2010.

FOR: PERSONALIZED MEDICAL CONSULTING SERVICES BASED ON PERSONAL BODY-RELATED DATA, NAMELY, DIASTOLIC/SYSTOLIC BLOOD PRESSURE, PULSE, PULSE-FREQUENCY, AND CARDIAC DATA FOR USE IN PERSONAL FITNESS AND PERSONAL HEALTH MONITORING SERVICES; PROVIDING AN ONLINE DATABASE IN THE FIELD OF CARDIOLOGY INFORMATION AND FEATURING INPUTTING AND COLLECTING OF DATA INFORMATION FOR TREATMENT AND DIAGNOSTIC PURPOSES; MAINTAINING PERSONAL MEDICAL HISTORY RECORDS AND FILES VIA AN ONLINE WEBSITE FOR



David J. Kyros

Director of the United States Patent and Trademark Office

Reg. No. 4,067,994 PEOPLE WHO MEASURE THEIR OWN PHYSIOLOGICAL PROPERTIES FOR USE IN THE MANAGEMENT AND EVALUATION OF PERSONAL BODY-RELATED DATA, NAMELY, DIASTOLIC/SYSTOLIC BLOOD PRESSURE, PULSE, PULSE-FREQUENCY, AND CARDIAC DATA, IN CLASS 44 (U.S. CLS. 100 AND 101).

FIRST USE 1-0-2010; IN COMMERCE 1-0-2010.

THE MARK CONSISTS OF STANDARD CHARACTERS WITHOUT CLAIM TO ANY PARTICULAR FONT, STYLE, SIZE, OR COLOR.

SN 77-981,796, FILED 3-13-2008.

KELLY CHOE, EXAMINING ATTORNEY

United States of America

United States Patent and Trademark Office



Reg. No. 4,067,995

Registered Dec. 6, 2011

Int. Cls.: 29, 35, and 43

TRADEMARK

SERVICE MARK

PRINCIPAL REGISTER

JONMOR INVESTMENTS, INC. (DELAWARE CORPORATION)
103 BAYNARD BUILDING
3411 SILVERSIDE ROAD
WILMINGTON, DE 19810

FOR: MEAT; POULTRY; PORK; HAM; BACON; SAUSAGE; BREAKFAST SAUSAGE; SMOKED SAUSAGE; BRATWURST; HOT DOGS; HOT DOGS WITH CHEESE; FRANKFURTERS; LUNCHEON MEATS; BOLOGNA, SALAMI, LOAVES CONSISTING PRIMARILY OF MEAT; TURKEY, IN CLASS 29 (U.S. CL. 46).

FIRST USE 11-11-2004; IN COMMERCE 11-11-2004.

FOR: PROVIDING CONSUMER PRODUCT INFORMATION IN THE FIELD OF COOKING, IN CLASS 35 (U.S. CLS. 100, 101 AND 102).

FIRST USE 4-0-2010; IN COMMERCE 4-0-2010.

FOR: PROVIDING INFORMATION IN THE FIELD OF RECIPES AND COOKING INFORMATION, IN CLASS 43 (U.S. CLS. 100 AND 101).

FIRST USE 11-11-2004; IN COMMERCE 11-11-2004.

OWNER OF U.S. REG. NOS. 2,674,993, 3,112,406, AND OTHERS.

THE COLOR(S) GREEN, LIGHT GREEN, GOLD, RED AND LIGHT BLUE IS/ARE CLAIMED AS A FEATURE OF THE MARK.

NO CLAIM IS MADE TO THE EXCLUSIVE RIGHT TO USE "SINCE 1894", APART FROM THE MARK AS SHOWN.

THE MARK CONSISTS OF A GOLD OVAL SHAPED LOGO WITH A THIN GREEN OUTLINE; WITHIN THE OVAL IS AN IMAGE OF A GREEN HOUSE WITH A STYLIZED RED UPPER CASE LETTER "E" INSIDE, BENEATH THAT IS THE WORD "ECKRICH" IN STYLIZED GREEN LETTERS WITH LIGHT BLUE SHADOWING; BENEATH THAT IS THE PHRASE "SINCE 1894" IN STYLIZED GREEN CHARACTERS. THE GOLD SHADING IN THE OVAL IS GRADIENT, RANGING FROM DARK GOLD ON TOP TO LIGHT GOLD ON THE BOTTOM



David J. Kyros

Director of the United States Patent and Trademark Office

Reg. No. 4,067,995 AND IT IS PUNCTUATED WITH STRIATED THIN RED HORIZONTAL LINES THROUGH-
OUT.

SN 77-981,926, FILED 10-9-2009.

AMY C. KEAN, EXAMINING ATTORNEY

United States of America

United States Patent and Trademark Office

Linked

Reg. No. 4,067,996

Registered Dec. 6, 2011

Int. Cl.: 35

SERVICE MARK

PRINCIPAL REGISTER

LINKEDIN CORPORATION (DELAWARE CORPORATION)
2029 STIERLIN COURT
MOUNTAIN VIEW, CA 94043

FOR: PROVIDING INFORMATION ALL RELATING TO CONSUMER PRODUCTS, SERVICES, EVENTS AND ACTIVITIES IN A PARTICULAR GEOGRAPHIC REGION, IN CLASS 35 (U.S. CLS. 100, 101 AND 102).

FIRST USE 11-0-2010; IN COMMERCE 11-0-2010.

OWNER OF U.S. REG. NOS. 3,074,241, 3,074,242, AND 3,303,349.

THE MARK CONSISTS OF THE WORD "LINKED" NEXT TO A SQUARE WITH A SHADED BACKGROUND CONTAINING THE WORD "IN".

SN 77-982,578, FILED 7-16-2009.

BERYL GARDNER, EXAMINING ATTORNEY



David J. Kyros

Director of the United States Patent and Trademark Office

United States of America

United States Patent and Trademark Office

DISNEY

Reg. No. 4,067,997

Registered Dec. 6, 2011

Int. Cl.: 41

SERVICE MARK

PRINCIPAL REGISTER

DISNEY ENTERPRISES, INC. (DELAWARE CORPORATION)
500 SOUTH BUENA VISTA STREET
BURBANK, CA 91521

FOR: PRODUCTION AND DISTRIBUTION OF MOTION PICTURE FILMS; PRODUCTION AND DISTRIBUTION OF TELEVISION AND RADIO PROGRAMS; PRODUCTION OF SOUND AND VIDEO RECORDINGS FOR OTHERS; PRODUCTION AND PROVISION OF ENTERTAINMENT, NAMELY, NEWS, AND INFORMATION IN THE FIELD OF ENTERTAINMENT VIA COMMUNICATION AND COMPUTER NETWORKS; PROVIDING ENTERTAINMENT SERVICES VIA A GLOBAL COMMUNICATION NETWORK IN THE NATURE OF ONLINE GAMES AND WEBSITES FEATURING A WIDE VARIETY OF GENERAL INTEREST ENTERTAINMENT INFORMATION RELATING TO MOTION PICTURE FILMS, TELEVISION SHOW PROGRAMS, MUSICAL VIDEOS, RELATED FILM CLIPS, PHOTOGRAPHS, AND OTHER MULTIMEDIA MATERIALS; AMUSEMENT PARK AND THEME PARK SERVICES; PRODUCTION OF LIVE STAGE SHOWS; PRESENTATION OF LIVE SHOW PERFORMANCES; THEATER PRODUCTIONS; AND ENTERTAINER SERVICES IN THE NATURE OF LIVE APPEARANCES BY A PROFESSIONAL ENTERTAINER, IN CLASS 41 (U.S. CLS. 100, 101 AND 107).

FIRST USE 2-28-1996; IN COMMERCE 2-28-1996.

THE MARK CONSISTS OF STANDARD CHARACTERS WITHOUT CLAIM TO ANY PARTICULAR FONT, STYLE, SIZE, OR COLOR.

SEC. 2(F).

OWNER OF U.S. REG. NOS. 1,162,727, 3,328,009, AND OTHERS.

SN 77-982,580, FILED 2-2-2007.

ELISSA GARBER KON, EXAMINING ATTORNEY



David J. Kyffers

Director of the United States Patent and Trademark Office

United States of America

United States Patent and Trademark Office

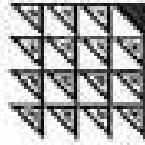

CONCORDE HOTEL NEW YORK

Reg. No. 4,067,998

Registered Dec. 6, 2011

Int. Cl.: 43

SERVICE MARK

PRINCIPAL REGISTER

NYC 55 CORP. (DELAWARE CORPORATION)
9TH FLOOR
111 EIGHT AVENUE
NEW YORK, NY 10011

FOR: HOTEL SERVICES; HOTEL, BAR AND RESTAURANT SERVICES; HOTEL, MOTEL, RESTAURANT, BAR AND CATERING SERVICES; HOTEL, RESTAURANT AND BAR SERVICES; HOTEL, RESTAURANT AND CATERING SERVICES; HOTELS; RESIDENTIAL HOTELS; RESORT HOTELS; RESTAURANT; RESTAURANT AND BAR SERVICES; RESTAURANT AND CAFE SERVICES; RESTAURANT AND HOTEL SERVICES; RESTAURANT SERVICES, IN CLASS 43 (U.S. CLS. 100 AND 101).

FIRST USE 3-10-2009; IN COMMERCE 5-11-2009.

NO CLAIM IS MADE TO THE EXCLUSIVE RIGHT TO USE "HOTEL NEW YORK", APART FROM THE MARK AS SHOWN.

THE MARK CONSISTS OF A LOGO + TEXT. THE LOGO CONSISTS OF 16 SMALL AND EQUAL SIZED TRIANGLES GROUPED IN THE SHAPE OF A SQUARE. THE SQUARE-SHAPED LOGO RESTS CENTERED AND ABOVE THE TEXT PORTION OF THE MARK. THE TEXT PORTION OF THE MARK CONSISTS OF TWO LINES OF TEXT CENTERED BENEATH THE SQUARE-SHAPED LOGO. THE FIRST LINE OF TEXT READS AS FOLLOWS: "CONCORDE HOTEL". CENTERED BENEATH THE FIRST LINE OF TEXT IN A SMALLER SIZED FONT, THE SECOND LINE READS AS FOLLOWS: "NEW YORK".



SN 77-982,601, FILED 3-30-2009.

JOHN DALIER, EXAMINING ATTORNEY

David J. Kybas

Director of the United States Patent and Trademark Office

United States of America

United States Patent and Trademark Office

PUMP PURSUIT

Reg. No. 4,067,999

MEDINGO LTD. (ISRAEL LIMITED LIABILITY COMPANY)
P.O. BOX 261
YOKNEAM 20692, ISRAEL

Registered Dec. 6, 2011

Int. Cl.: 41

FOR: ENTERTAINMENT SERVICES, NAMELY, PROVIDING AN ON-LINE COMPUTER GAME, IN CLASS 41 (U.S. CLS. 100, 101 AND 107).

SERVICE MARK

FIRST USE 8-0-2009; IN COMMERCE 8-0-2009.

PRINCIPAL REGISTER

THE MARK CONSISTS OF STANDARD CHARACTERS WITHOUT CLAIM TO ANY PARTICULAR FONT, STYLE, SIZE, OR COLOR.

NO CLAIM IS MADE TO THE EXCLUSIVE RIGHT TO USE "PUMP", APART FROM THE MARK AS SHOWN.

SN 77-982,627, FILED 8-10-2009.

ODESSA BIBBINS, EXAMINING ATTORNEY



David J. Kybas

Director of the United States Patent and Trademark Office

United States of America

United States Patent and Trademark Office

BETTER FOOD BETTER WORLD

Reg. No. 4,068,000

AGRAQUEST, INC. (DELAWARE CORPORATION)
1540 DREW AVENUE
DAVIS, CA 95618

Registered Dec. 6, 2011

Int. Cl.: 5

FOR: FUNGICIDES; INSECTICIDES; PESTICIDES, IN CLASS 5 (U.S. CLS. 6, 18, 44, 46, 51 AND 52).

TRADEMARK

FIRST USE 10-18-2010; IN COMMERCE 10-18-2010.

PRINCIPAL REGISTER

THE MARK CONSISTS OF STANDARD CHARACTERS WITHOUT CLAIM TO ANY PARTICULAR FONT, STYLE, SIZE, OR COLOR.

SN 77-982,683, FILED 8-24-2009.

RENEE MCCRAY, EXAMINING ATTORNEY



David J. Kybas

Director of the United States Patent and Trademark Office

United States of America

United States Patent and Trademark Office



Reg. No. 4,068,001

Registered Dec. 6, 2011

Int. Cl.: 27

TRADEMARK

PRINCIPAL REGISTER

TSA STORES, INC. (DELAWARE CORPORATION)
1050 WEST HAMPDEN AVENUE
ENGLEWOOD, CO 80110

FOR: GYMNASIUM EXERCISE MATS, WRESTLING MATS, IN CLASS 27 (U.S. CLS. 19, 20, 37, 42 AND 50).

FIRST USE 2-0-2010; IN COMMERCE 2-0-2010.

NO CLAIM IS MADE TO THE EXCLUSIVE RIGHT TO USE "GEAR", APART FROM THE MARK AS SHOWN.

THE COLOR(S) RED, WHITE AND BLACK IS/ARE CLAIMED AS A FEATURE OF THE MARK.

THE MARK CONSISTS OF THE LETTERS "S" AND "A" EACH FOLLOWED BY A PERIOD, IN RED, TWO CHEVRONS IN WHITE AND THE WORD "GEAR" IN WHITE ON A BLACK, RECTANGULAR BACKGROUND.

SN 77-982,690, FILED 3-19-2010.

MIDGE BUTLER, EXAMINING ATTORNEY



David J. Kyros

Director of the United States Patent and Trademark Office

United States of America

United States Patent and Trademark Office

HALOGEN

Reg. No. 4,068,002

Registered Dec. 6, 2011

Int. Cls.: 38 and 41

SERVICE MARK

PRINCIPAL REGISTER

THE INSPIRATIONAL NETWORK, INC. (NORTH CAROLINA NON-PROFIT CORPORATION)
CITY OF LIGHT
3000 WORLDREACH DRIVE
INDIAN LAND, SC 29707

FOR: TELEVISION BROADCASTING SERVICES, IN CLASS 38 (U.S. CLS. 100, 101 AND 104).

FIRST USE 10-0-2009; IN COMMERCE 10-0-2009.

FOR: TELEVISION PROGRAMMING SERVICES; PROVIDING ON-LINE E-ZINES FEATURING CONTENT THAT PROMOTES CHRISTIAN AND FAMILY VALUES, IN CLASS 41 (U.S. CLS. 100, 101 AND 107).

FIRST USE 10-0-2009; IN COMMERCE 10-0-2009.

THE MARK CONSISTS OF STANDARD CHARACTERS WITHOUT CLAIM TO ANY PARTICULAR FONT, STYLE, SIZE, OR COLOR.

SN 77-982,704, FILED 5-6-2008.

DANNEAN HETZEL, EXAMINING ATTORNEY



David J. Kybas

Director of the United States Patent and Trademark Office

United States of America

United States Patent and Trademark Office

TOURIST TROPHY

Reg. No. 4,068,003

Registered Dec. 6, 2011

Int. Cl.: 12

TRADEMARK

PRINCIPAL REGISTER

MOSS MOTORS, LTD. (CALIFORNIA CORPORATION)
920 GARDEN STREET, SUITE A
C/O KOENIG & ASSOCIATES
SANTA BARBARA, CA 93101

FOR: BODY TRIM BADGES; GAUGE EMBLEM TAGS; CHROME PLATED PLASTIC CONTROL KNOBS; CHROME AND POLISHED METAL HOOD ORNAMENTS; WINDOW HANDLES; WINDOW HANDLE KNOBS; DOOR LOCK KNOBS; GEARSHIFT HANDLES AND KNOBS; SEAT ADJUSTMENT KNOBS; TEMPERATURE CONTROL KNOBS; UTILITY KNOBS; LICENSE PLATE PARTS; INTERIOR AND EXTERIOR MIRRORS AND ACTUATORS THEREFOR; MOUNTING HARDWARE THEREFOR; AND COVERS THEREFOR; CONSOLES AND PARTS THEREOF AND MOUNTING HARDWARE THEREFOR; BUMPERS AND PARTS THEREOF AND MOUNTING HARDWARE THEREFOR; EXTERIOR AND INTERIOR TRIM COMPONENTS; DOOR FITTINGS; GRILLES; LUGGAGE; BIKE AND STORAGE RACKS FOR VEHICLES; STEERING WHEELS AND COVERS THEREFOR; SUN VISORS AND SUNSHADE TRIM ASSEMBLIES AND PARTS THEREOF; TONNEAUS AND TONNEAU SIDE CURTAINS; INSTRUMENT PANEL COMPONENTS; CONSOLES; CUP HOLDERS; INTERIOR TRIM PANELS AND PARTS THEREOF; RADIATOR GRILLES; AUTOMOTIVE GRILL ORNAMENTS; AUTOMOTIVE HOOD ORNAMENTS; LOCKS AND PARTS THEREOF AND RELEASES THEREFOR; SPLASH SHIELDS; STONE DEFLECTORS; DASH PANELS; GLOVE COMPARTMENT DOORS AND PARTS THEREOF; REMOVABLE ROOFS AND MOUNTING HARDWARE THEREFOR; LUGGAGE COMPARTMENT COVERS; LUGGAGE COMPARTMENT DOORS AND PARTS THEREOF; SUN VISOR ASSEMBLIES AND PARTS THEREOF; LICENSE PLATE BRACKET ASSEMBLIES AND PARTS THEREOF; AUTOMOTIVE GRILL EMBLEMS; FITTED OR SEMI-FITTED VEHICLE COVERS; ASH RECEPTACLES; FOOT PEDALS; WHEEL CAPS; HUB CAPS; WHEEL COVERS; WHEEL CAP RINGS; TURN SIGNAL FLASHER ASSEMBLIES AND PARTS THEREOF; ELECTRIC HORNS; AUTOMOTIVE CARGO RACKS; AUTOMOTIVE ROOF RACKS FOR CARRYING ITEMS, IN CLASS 12 (U.S. CLS. 19, 21, 23, 31, 35 AND 44).

FIRST USE 2-16-2003; IN COMMERCE 2-16-2003.

SN 78-202,228, FILED 1-10-2003.

MARY I. SPARROW, EXAMINING ATTORNEY



David J. Kybas

Director of the United States Patent and Trademark Office

United States of America

United States Patent and Trademark Office

IRONHEAD

Reg. No. 4,068,004

DYNAMIC TIRE CORP. (CANADA CORPORATION)
155 DELTA PARK BOULEVARD
BRAMPTON, ONTARIO, CANADA L6T 5M8

Registered Dec. 6, 2011

Int. Cl.: 12

FOR: TIRES FOR PASSENGER VEHICLES, TRUCKS, OFF ROAD AND MILITARY VEHICLES, INDUSTRIAL VEHICLES AND MATERIAL HANDLING EQUIPMENT , IN CLASS 12 (U.S. CLS. 19, 21, 23, 31, 35 AND 44).

TRADEMARK

FIRST USE 10-6-2011; IN COMMERCE 10-6-2011.

PRINCIPAL REGISTER

SN 78-266,035, FILED 6-23-2003.

DAVID ELTON, EXAMINING ATTORNEY



David J. Kyffers

Director of the United States Patent and Trademark Office

United States of America

United States Patent and Trademark Office

Michael R. Sloane

Reg. No. 4,068,005

Registered Dec. 6, 2011

Int. Cl.: 16

TRADEMARK

PRINCIPAL REGISTER

MCFARLANE, ADALBERTO, MR. (UNITED STATES INDIVIDUAL), DBA NINE NAPPY PRODUCTIONS,
3351 DUCKHORN DRIVE, #426
SACRAMENTO, CA 95834

FOR: SERIES OF COMIC BOOKS, IN CLASS 16 (U.S. CLS. 2, 5, 22, 23, 29, 37, 38 AND 50).

FIRST USE 12-14-2004; IN COMMERCE 5-5-2007.

THE MARK CONSISTS OF STANDARD CHARACTERS WITHOUT CLAIM TO ANY PARTICULAR FONT, STYLE, SIZE, OR COLOR.

THE NAME(S), PORTRAIT(S), AND/OR SIGNATURE(S) SHOWN IN THE MARK DOES NOT IDENTIFY A PARTICULAR LIVING INDIVIDUAL.

SN 78-525,600, FILED 12-2-2004.

LINDA ESTRADA, EXAMINING ATTORNEY



David J. Kybas

Director of the United States Patent and Trademark Office

United States of America

United States Patent and Trademark Office



Reg. No. 4,068,006

Registered Dec. 6, 2011

Int. Cls.: 25 and 28

TRADEMARK

PRINCIPAL REGISTER

HIGH 5 SPORTSWEAR, INC. (WASHINGTON CORPORATION)
18200 SEGAL PARK DRIVE B
SEATTLE, WA 98188

FOR: ACTIVE SPORTSWEAR, NAMELY, JACKETS, PANTS, VESTS, SHIRTS, T-SHIRTS, BELTS, JERSEYS, SHORTS, CAPS, HATS, AND SOCKS, IN CLASS 25 (U.S. CLS. 22 AND 39).

FIRST USE 12-31-2006; IN COMMERCE 12-31-2006.

FOR: SPORTS EQUIPMENT, NAMELY, SHIN GUARDS, PROTECTIVE GLOVES FOR USE IN SOCCER AND BASEBALL, SOCCER BALLS, EXCLUDING GOLF CLUBS, GOLF BAGS, AND GOLF BALLS, IN CLASS 28 (U.S. CLS. 22, 23, 38 AND 50).

FIRST USE 12-31-2006; IN COMMERCE 12-31-2006.

OWNER OF U.S. REG. NOS. 1,826,408 AND 2,655,715.

NO CLAIM IS MADE TO THE EXCLUSIVE RIGHT TO USE "SPORTSWEAR", APART FROM THE MARK AS SHOWN.

THE MARK CONSISTS OF THE WORDS "HIGH FIVE SPORTSWEAR" AND AN OVAL DESIGN.

SN 78-595,235, FILED 3-25-2005.

MATTHEW KLINE, EXAMINING ATTORNEY



David J. Kappas

Director of the United States Patent and Trademark Office

United States of America

United States Patent and Trademark Office



Reg. No. 4,068,007

Registered Dec. 6, 2011

Int. Cl.: 3

TRADEMARK

PRINCIPAL REGISTER

FOAMIX LTD. (ISRAEL CORPORATION)
2 HOLZMAN STREET P.O.BOX 4038
NES ZIONA, ISRAEL 74140

FOR: FORMULATIONS FOR DELIVERY OF NON-PRESCRIPTION COSMETIC AGENTS FOR TOPICAL AND MUCOSAL USE, NAMELY, NON-MEDICATED SKIN OR MUCOSAL CARE FORMULATIONS FOR SKIN OR MUCOSAL HYDRATION, INCLUDING MOISTURE BARRIERS, AND MOISTURIZERS, NON-MEDICATED INFANT AND CHILD SKIN CARE PREPARATIONS, SUNSCREENS, SKIN CLEANSERS, SKIN CONDITIONERS, AND SKIN CREAMS, HAIR CARE PREPARATIONS INCLUDING HAIR CLEANSER FORMULATIONS; TOILETRIES AND COSMETICS FOR PERSONAL SKIN CARE; FORMULATIONS FOR PERSONAL HYGIENE, NAMELY, EMOLLIENTS, PERFUMED EMOLLIENTS, HAIR LOTIONS, TANNING AND SKIN CLEANSING FOAMS, MOUSSES, CREAMS AND LOTIONS, IN CLASS 3 (U.S. CLS. 1, 4, 6, 50, 51 AND 52).

FIRST USE 11-15-2010; IN COMMERCE 11-15-2010.

OWNER OF U.S. REG. NO. 3,555,212.

THE MARK CONSISTS OF THE COMBINATION OF A HAND WITH THREE FINGERS, THE WORD "FOAMIX", AND THE NUMBER "24", WITHOUT A SPACE IN BETWEEN THE WORDS, WHERE THE INSIDE OF THE HAND AND FINGERS, THE OUTSIDE OF THE WORD AND THE LEFT HAND SIDE OF THE NUMBERS ARE A LIGHT GREY SCALE AND THE INSIDE OF THE WORD, THE MAIN PART OF THE NUMBER AND THE LEFT AND LOWER EDGES OF THE HAND AND THE LEFT EDGE OF THE FURTHEST FINGER ARE BLACK.

SN 78-605,572, FILED 4-10-2005.

DAYNA BROWNE, EXAMINING ATTORNEY



David J. Kyros

Director of the United States Patent and Trademark Office

United States of America

United States Patent and Trademark Office

foamix 24

Reg. No. 4,068,008

Registered Dec. 6, 2011

Int. Cl.: 3

TRADEMARK

PRINCIPAL REGISTER

FOAMIX LTD. (ISRAEL CORPORATION)
2 HOLZMAN STREET P.O. BOX 4038
NES ZIONA, ISRAEL 74140

FOR: FORMULATIONS FOR DELIVERY OF NON-PRESCRIPTION COSMETIC AGENTS FOR TOPICAL AND MUCOSAL USE, NAMELY, NON-MEDICATED SKIN OR MUCOSAL CARE FORMULATIONS FOR SKIN OR MUCOSAL HYDRATION, INCLUDING MOISTURE BARRIERS, AND MOISTURIZERS, NON-MEDICATED INFANT AND CHILD SKIN CARE PREPARATIONS, SUNSCREENS, SKIN CLEANSERS, SKIN CONDITIONERS, AND SKIN CREAMS, HAIR CARE PREPARATIONS INCLUDING HAIR CLEANSER FORMULATIONS; TOILETRIES AND COSMETICS FOR PERSONAL SKIN CARE; FORMULATIONS FOR PERSONAL HYGIENE, NAMELY, EMOLLIENTS, PERFUMED EMOLLIENTS, HAIR LOTIONS, TANNING AND SKIN CLEANSING FOAMS, MOUSSES, CREAMS AND LOTIONS, IN CLASS 3 (U.S. CLS. 1, 4, 6, 50, 51 AND 52).

FIRST USE 11-15-2010; IN COMMERCE 11-15-2010.

THE MARK CONSISTS OF STANDARD CHARACTERS WITHOUT CLAIM TO ANY PARTICULAR FONT, STYLE, SIZE, OR COLOR.

OWNER OF U.S. REG. NO. 3,555,212.

NO CLAIM IS MADE TO THE EXCLUSIVE RIGHT TO USE "24", APART FROM THE MARK AS SHOWN.

SN 78-605,573, FILED 4-10-2005.

DAYNA BROWNE, EXAMINING ATTORNEY



David J. Kypos

Director of the United States Patent and Trademark Office

United States of America

United States Patent and Trademark Office

EPIC

Reg. No. 4,068,009

Registered Dec. 6, 2011

Int. Cl.: 28

TRADEMARK

PRINCIPAL REGISTER

ICON IP, INC. (DELAWARE CORPORATION)
1500 SOUTH 1000 WEST
LOGAN, UT 84321

FOR: EXERCISE MACHINES, IN CLASS 28 (U.S. CLS. 22, 23, 38 AND 50).

FIRST USE 2-0-2003; IN COMMERCE 2-0-2003.

THE MARK CONSISTS OF STANDARD CHARACTERS WITHOUT CLAIM TO ANY PARTICULAR FONT, STYLE, SIZE, OR COLOR.

OWNER OF U.S. REG. NOS. 2,940,801 AND 2,961,998.

SN 78-652,456, FILED 6-16-2005.

LINDA MICKLEBURGH, EXAMINING ATTORNEY



David J. Kybas

Director of the United States Patent and Trademark Office

United States of America

United States Patent and Trademark Office

Alcatraz Landing

Reg. No. 4,068,010

HORNBLOWER GROUP, LLC (CALIFORNIA LTD LIAB JT ST CO)
PIER 3, THE EMBARCADERO
SAN FRANCISCO, CA 94111

Registered Dec. 6, 2011

Int. Cl.: 35

FOR: RETAIL STORE SERVICES WITH AN ALCATRAZ THEME FEATURING CLOTHING, CONVENIENCE STORE ITEMS, KIOSK FOOD SERVICE FOR CRUISE LINE PASSENGERS, IN CLASS 35 (U.S. CLS. 100, 101 AND 102).

SERVICE MARK

FIRST USE 9-30-2006; IN COMMERCE 9-30-2006.

PRINCIPAL REGISTER

THE MARK CONSISTS OF STANDARD CHARACTERS WITHOUT CLAIM TO ANY PARTICULAR FONT, STYLE, SIZE, OR COLOR.

NO CLAIM IS MADE TO THE EXCLUSIVE RIGHT TO USE "ALCATRAZ", APART FROM THE MARK AS SHOWN.

SN 78-654,438, FILED 6-20-2005.

JENNIFER MARTIN, EXAMINING ATTORNEY



David J. Kyros

Director of the United States Patent and Trademark Office

United States of America

United States Patent and Trademark Office

ON THE GO

Reg. No. 4,068,011

Registered Dec. 6, 2011

Int. Cl.: 21

TRADEMARK

PRINCIPAL REGISTER

NEW WINCUP HOLDINGS, INC. (DELAWARE CORPORATION)
4640 LEWIS ROAD
STONE MOUNTAIN, GA 30083

FOR: DISPOSABLE CUPS AND LIDS THEREFOR; DISPOSABLE BOWLS AND CONTAINERS FOR FOOD AND BEVERAGES AND LIDS THEREFOR, IN CLASS 21 (U.S. CLS. 2, 13, 23, 29, 30, 33, 40 AND 50).

FIRST USE 3-0-1997; IN COMMERCE 3-0-1997.

THE MARK CONSISTS OF STANDARD CHARACTERS WITHOUT CLAIM TO ANY PARTICULAR FONT, STYLE, SIZE, OR COLOR.

OWNER OF U.S. REG. NO. 1,768,085.

SN 78-824,406, FILED 2-27-2006.

MELISSA VALLILLO, EXAMINING ATTORNEY



David J. Kyffers

Director of the United States Patent and Trademark Office

United States of America

United States Patent and Trademark Office

HABLA SIN BARRERAS

Reg. No. 4,068,012

Registered Dec. 6, 2011

Int. Cl.: 38

SERVICE MARK

PRINCIPAL REGISTER

ZONANA, MOSES (UNITED STATES INDIVIDUAL)
258 HARVARD STREET #322
BROOKLINE, MA 02446

FOR: TELECOMMUNICATIONS SERVICES, NAMELY, TRANSMISSION OF VOICE, DATA, IMAGES, AUDIO, VIDEO, AND INFORMATION VIA TELEPHONE, CELLULAR TELEPHONES OR THE INTERNET; PERSONAL COMMUNICATIONS SERVICES; PAGER SERVICES; ELECTRONIC MAIL SERVICES; TRANSMISSION OR BROADCAST OF NEWS AND INFORMATION FOR OTHERS VIA TELEPHONE, CELLULAR TELEPHONES OR THE INTERNET, IN CLASS 38 (U.S. CLS. 100, 101 AND 104).

FIRST USE 8-29-2011; IN COMMERCE 8-29-2011.

THE MARK CONSISTS OF STANDARD CHARACTERS WITHOUT CLAIM TO ANY PARTICULAR FONT, STYLE, SIZE, OR COLOR.

NO CLAIM IS MADE TO THE EXCLUSIVE RIGHT TO USE "HABLA", APART FROM THE MARK AS SHOWN.

THE FOREIGN WORDING IN THE MARK TRANSLATES INTO ENGLISH AS TALK WITHOUT BARRIERS.

SN 78-843,871, FILED 3-22-2006.

JAMES MACFARLANE, EXAMINING ATTORNEY



David J. Kyros

Director of the United States Patent and Trademark Office

United States of America

United States Patent and Trademark Office

LLAMA SIN BARRERAS

Reg. No. 4,068,013

Registered Dec. 6, 2011

Int. Cl.: 38

SERVICE MARK

PRINCIPAL REGISTER

ZONANA, MOSES (UNITED STATES INDIVIDUAL)
258 HARVARD STREET #322
BROOKLINE, MA 02446

FOR: TELECOMMUNICATIONS SERVICES, NAMELY, TRANSMISSION OF VOICE, DATA, IMAGES, AUDIO, VIDEO, AND INFORMATION VIA TELEPHONE, CELLULAR TELEPHONES OR THE INTERNET; PERSONAL COMMUNICATIONS SERVICES; PAGER SERVICES; ELECTRONIC MAIL SERVICES; TRANSMISSION OR BROADCAST OF NEWS AND INFORMATION FOR OTHERS VIA TELEPHONE, CELLULAR TELEPHONES OR THE INTERNET, IN CLASS 38 (U.S. CLS. 100, 101 AND 104).

FIRST USE 8-29-2011; IN COMMERCE 8-29-2011.

THE MARK CONSISTS OF STANDARD CHARACTERS WITHOUT CLAIM TO ANY PARTICULAR FONT, STYLE, SIZE, OR COLOR.

NO CLAIM IS MADE TO THE EXCLUSIVE RIGHT TO USE "LLAMA", APART FROM THE MARK AS SHOWN.

THE FOREIGN WORDING IN THE MARK TRANSLATES INTO ENGLISH AS CALL WITHOUT BARRIERS.

SN 78-843,875, FILED 3-22-2006.

JAMES MACFARLANE, EXAMINING ATTORNEY



David J. Kyros

Director of the United States Patent and Trademark Office

United States of America

United States Patent and Trademark Office

WOODSTOCK

Reg. No. 4,068,014

Registered Dec. 6, 2011

Int. Cl.: 25

TRADEMARK

PRINCIPAL REGISTER

WOODSTOCK VENTURES, LC (WYOMING LIMITED LIABILITY COMPANY)
106 CENTRAL PARK SOUTH, SUITE 3G
NEW YORK, NY 10019

FOR: CLOTHING, NAMELY, TOPS, SHIRTS, T-SHIRTS, POLO SHIRTS, KNIT TOPS, SWEATSHIRTS, WARM-UP SUITS, BOTTOMS, SHORTS, PANTS, JEANS, DRESSES, LOUNGEWEAR, SLEEPWEAR, INFANTWEAR, UNDERWEAR, IN CLASS 25 (U.S. CLS. 22 AND 39).

FIRST USE 0-0-1969; IN COMMERCE 0-0-1969.

THE MARK CONSISTS OF STANDARD CHARACTERS WITHOUT CLAIM TO ANY PARTICULAR FONT, STYLE, SIZE, OR COLOR.

OWNER OF U.S. REG. NO. 2,872,375.

SN 78-945,208, FILED 8-4-2006.

TASNEEM HUSSAIN, EXAMINING ATTORNEY



David J. Kybas

Director of the United States Patent and Trademark Office

United States of America

United States Patent and Trademark Office



Reg. No. 4,068,015

Registered Dec. 6, 2011

Int. Cls.: 16, 21, 25, and 28

TRADEMARK

PRINCIPAL REGISTER

AMPELMANN GMBH (FED REP GERMANY GMBH)
ROSENTHALER STRASSE 40
BERLIN, FED REP GERMANY 10178

FOR: TOWELS OF PAPER; KITCHEN TOWELS OF PAPER; CARDBOARD AND GOODS MADE FROM PAPER AND CARDBOARD, NAMELY, BAGS OF PAPER FOR PACKAGING NOT INCLUDED IN OTHER CLASSES; PLASTIC MATERIALS FOR PACKAGING, NAMELY, PLASTIC BAGS; BAGS OF PLASTICS FOR PACKAGING NOT INCLUDED IN OTHER CLASSES, NAMELY, GARBAGE BAGS OF PAPER OR OF PLASTICS; PLASTIC OR PAPER BAGS; POSTCARDS, NAMELY, SHEET OF POSTCARDS; STATIONERY; BOOK MARKERS OF PAPER; POSTERS; STICKERS; BOOKENDS; SELF-ADHESIVE NOTE PADS; CALENDARS, NAMELY, TEAR-OFF CALENDARS; WRITING PADS; MAGNET PENS; PENCILS, IN CLASS 16 (U.S. CLS. 2, 5, 22, 23, 29, 37, 38 AND 50).

FIRST USE 0-0-1997; IN COMMERCE 0-0-2007.

FOR: ICE CUBE MOLDS, IN CLASS 21 (U.S. CLS. 2, 13, 23, 29, 30, 33, 40 AND 50).

FIRST USE 0-0-2002; IN COMMERCE 0-0-2007.

FOR: HEADGEAR FOR WEAR, NAMELY, HATS AND CAPS; CLOTHING, NAMELY, TEE-SHIRTS, SHIRTS, AND JACKETS; CLOTHES FOR CHILDREN, NAMELY, TEE-SHIRTS, SHIRTS, AND JACKETS; CYCLISTS' CLOTHING, NAMELY, TEE-SHIRTS AND JACKETS; MOTORISTS' CLOTHING, NAMELY, JACKETS, IN CLASS 25 (U.S. CLS. 22 AND 39).

FIRST USE 0-0-2002; IN COMMERCE 0-0-2007.

FOR: PLUSH TOYS; BALLS, NAMELY, FOOTBALLS; PLAYING CARDS; CARD GAMES, NAMELY, MEMORY CARD DECKS; BAGS ESPECIALLY DESIGNED FOR SKIS AND SURFBOARDS, IN CLASS 28 (U.S. CLS. 22, 23, 38 AND 50).

FIRST USE 0-0-2004; IN COMMERCE 0-0-2007.

THE MARK CONSISTS OF A STYLIZED DEPICTION OF A FRONT VIEW SILHOUETTE OF A HUMAN BEING STANDING WITH ITS ARMS OUTSTRETCHED.

SN 78-953,880, FILED 8-16-2006.



David J. Kybas

Director of the United States Patent and Trademark Office

Reg. No. 4,068,015 YAT SYE, LEE, EXAMINING ATTORNEY

United States of America

United States Patent and Trademark Office

VISION NEEDLE

Reg. No. 4,068,016

Registered Dec. 6, 2011

Int. Cl.: 16

TRADEMARK

PRINCIPAL REGISTER

MITSUBISHI PENCIL CO., LTD. (JAPAN CORPORATION)
5-23-37, HIGASHI-OHI
SHINAGAWA-KU, JAPAN

FOR: WRITING INSTRUMENTS, IN CLASS 16 (U.S. CLS. 2, 5, 22, 23, 29, 37, 38 AND 50).

FIRST USE 2-1-2007; IN COMMERCE 3-1-2007.

OWNER OF U.S. REG. NOS. 1,991,977, 2,371,661, AND 2,725,249.

SN 78-963,217, FILED 8-29-2006.

KATHERINE E. HALMEN, EXAMINING ATTORNEY



David J. Kybas

Director of the United States Patent and Trademark Office

United States of America

United States Patent and Trademark Office

ENERGO

Reg. No. 4,068,017

Registered Dec. 6, 2011

Int. Cl.: 32

STEINSSON, JON (ICELAND INDIVIDUAL)
C/O NATALIE JONSSON
20946 BRYANT ST. #26.
CANOGA PARK, CA 91316

FOR: ENERGY DRINKS, IN CLASS 32 (U.S. CLS. 45, 46 AND 48).

TRADEMARK

FIRST USE 1-1-2009; IN COMMERCE 10-1-2011.

PRINCIPAL REGISTER

THE MARK CONSISTS OF STANDARD CHARACTERS WITHOUT CLAIM TO ANY PARTICULAR FONT, STYLE, SIZE, OR COLOR.

SN 78-966,392, FILED 9-1-2006.

EMILY CHUO, EXAMINING ATTORNEY



David J. Kybas

Director of the United States Patent and Trademark Office

United States of America

United States Patent and Trademark Office

SURGICEL SNOW

Reg. No. 4,068,018

JOHNSON & JOHNSON (NEW JERSEY CORPORATION)
ONE JOHNSON & JOHNSON PLAZA
NEW BRUNSWICK, NJ 089337001

Registered Dec. 6, 2011

Int. Cl.: 5

FOR: BIO-ABSORBABLE HEMOSTAT IN THE NATURE OF MEDICAL AND SURGICAL DRESSINGS, IN CLASS 5 (U.S. CLS. 6, 18, 44, 46, 51 AND 52).

TRADEMARK

FIRST USE 11-17-2010; IN COMMERCE 11-17-2010.

PRINCIPAL REGISTER

THE MARK CONSISTS OF STANDARD CHARACTERS WITHOUT CLAIM TO ANY PARTICULAR FONT, STYLE, SIZE, OR COLOR.

OWNER OF U.S. REG. NO. 682,773.

"SNOW" APPEARING IN THE MARK HAS NO SIGNIFICANCE IN THE RELEVANT TRADE OR INDUSTRY OR AS APPLIED TO THE GOODS/SERVICES LISTED IN THE APPLICATION, OR ANY GEOGRAPHICAL SIGNIFICANCE.

SN 85-000,459, FILED 3-29-2010.

CIMMERIAN COLEMAN, EXAMINING ATTORNEY



David J. Kyffers

Director of the United States Patent and Trademark Office

United States of America

United States Patent and Trademark Office

CONNEX

Reg. No. 4,068,019

Registered Dec. 6, 2011

Int. Cl.: 20

TRADEMARK

PRINCIPAL REGISTER

DSI INDUSTRIES INC. (CANADA CORPORATION)
115 CIDERMILL AVENUE
CONCORD, CANADA L4K4G5

FOR: OFFICE FURNITURE, IN CLASS 20 (U.S. CLS. 2, 13, 22, 25, 32 AND 50).

FIRST USE 4-1-2011; IN COMMERCE 4-1-2011.

THE MARK CONSISTS OF STANDARD CHARACTERS WITHOUT CLAIM TO ANY PARTICULAR FONT, STYLE, SIZE, OR COLOR.

SN 85-000,667, FILED 3-29-2010.

JEFF DEFORD, EXAMINING ATTORNEY



David J. Kybas

Director of the United States Patent and Trademark Office

United States of America

United States Patent and Trademark Office

DREAM MACHINE

Reg. No. 4,068,020

Registered Dec. 6, 2011

Int. Cl.: 40

SERVICE MARK

PRINCIPAL REGISTER

VYMAC CORP. (WISCONSIN CORPORATION)
201 N. MAIN STREET
FORT ATKINSON, WI 53538

FOR: CUSTOM FABRICATION AND PRODUCTION OF PILLOWS TO CUSTOMER SPECIFICATIONS AT IN-STORE KIOSK AT WHICH PILLOWS ARE STUFFED AND LABELLED WITH A REQUESTED EMBROIDERED MESSAGE; EMBROIDERY SERVICES, IN CLASS 40 (U.S. CLS. 100, 103 AND 106).

FIRST USE 8-5-2010; IN COMMERCE 4-10-2011.

THE MARK CONSISTS OF STANDARD CHARACTERS WITHOUT CLAIM TO ANY PARTICULAR FONT, STYLE, SIZE, OR COLOR.

NO CLAIM IS MADE TO THE EXCLUSIVE RIGHT TO USE "MACHINE", APART FROM THE MARK AS SHOWN.

SN 85-001,025, FILED 3-29-2010.

MICHAEL WEBSTER, EXAMINING ATTORNEY



David J. Kyfos

Director of the United States Patent and Trademark Office

United States of America

United States Patent and Trademark Office

COOLHAUS

Reg. No. 4,068,021

Registered Dec. 6, 2011

Int. Cl.: 35

SERVICE MARK

PRINCIPAL REGISTER

MORTON, NATHAN (UNITED STATES INDIVIDUAL)
2350 NEWPORT AVENUE
CARDIFF, CA 92007

FOR: ON-LINE RETAIL STORE SERVICES FEATURING HEALTH FOODS, BICYCLING ACCESSORIES, CLOTHING AND PUBLICATIONS IN THE FIELD OF ART, ARCHITECTURE AND DESIGN, IN CLASS 35 (U.S. CLS. 100, 101 AND 102).

FIRST USE 12-0-2009; IN COMMERCE 10-5-2011.

THE MARK CONSISTS OF STANDARD CHARACTERS WITHOUT CLAIM TO ANY PARTICULAR FONT, STYLE, SIZE, OR COLOR.

OWNER OF U.S. REG. NO. 3,237,290.

SN 85-001,083, FILED 3-29-2010.

MATTHEW MCDOWELL, EXAMINING ATTORNEY



David J. Kyffers

Director of the United States Patent and Trademark Office

United States of America

United States Patent and Trademark Office

ANCHOR-RITE

Reg. No. 4,068,022

Registered Dec. 6, 2011

Int. Cl.: 11

TRADEMARK

PRINCIPAL REGISTER

SEVERN TRENT WATER PURIFICATION, INC. (PENNSYLVANIA CORPORATION)
3000 ADVANCE LANE
COLMAR, PA 18915

FOR: WATER FILTERING APPARATUS, NAMELY, UNDERDRAIN BLOCKS, IN CLASS 11
(U.S. CLS. 13, 21, 23, 31 AND 34).

FIRST USE 2-1-2011; IN COMMERCE 2-1-2011.

THE MARK CONSISTS OF STANDARD CHARACTERS WITHOUT CLAIM TO ANY PARTICULAR FONT, STYLE, SIZE, OR COLOR.

SN 85-001,110, FILED 3-29-2010.

KATHERINE M. DUBRAY, EXAMINING ATTORNEY



David J. Kybas

Director of the United States Patent and Trademark Office

United States of America

United States Patent and Trademark Office

In the Beauty of Holiness Creative Arts Worship Series

Reg. No. 4,068,023

Registered Dec. 6, 2011

Int. Cls.: 9 and 41

TRADEMARK

SERVICE MARK

PRINCIPAL REGISTER

W.I.N.D. OF THE SPIRIT MINISTRIES (MINNESOTA CORPORATION)
8971 GARLAND COURT
EDEN PRAIRIE, MN 55347

FOR: DIGITAL MATERIALS, NAMELY, DVDS FEATURING RELIGION, IN CLASS 9 (U.S. CLS. 21, 23, 26, 36 AND 38).

FIRST USE 3-2-2011; IN COMMERCE 3-2-2011.

FOR: EDUCATION SERVICES, NAMELY, PROVIDING SEMINARS AND WORKSHOPS IN THE FIELD OF RELIGION, IN CLASS 41 (U.S. CLS. 100, 101 AND 107).

FIRST USE 3-2-2011; IN COMMERCE 3-2-2011.

THE MARK CONSISTS OF STANDARD CHARACTERS WITHOUT CLAIM TO ANY PARTICULAR FONT, STYLE, SIZE, OR COLOR.

NO CLAIM IS MADE TO THE EXCLUSIVE RIGHT TO USE "CREATIVE ARTS WORSHIP SERIES", APART FROM THE MARK AS SHOWN.

SN 85-001,793, FILED 3-30-2010.

SANJEEV VOHRA, EXAMINING ATTORNEY



David J. Kyros

Director of the United States Patent and Trademark Office

United States of America

United States Patent and Trademark Office



Reg. No. 4,068,024

Registered Dec. 6, 2011

Int. Cls.: 35 and 42

SERVICE MARK

PRINCIPAL REGISTER

101107853 SASKATCHEWAN LTD. (CANADA CORPORATION)
1, 1622 ONTARIO AVENUE, SASKATOON
SASKATCHEWA S7K 1S8, CANADA

FOR: PROVIDING AN ON-LINE SEARCHABLE DATABASE FEATURING TRADE INFORMATION IN THE FIELD OF AUTOMOBILE PARTS, IN CLASS 35 (U.S. CLS. 100, 101 AND 102).

FIRST USE 3-0-2006; IN COMMERCE 10-5-2007.

FOR: COMPUTER SERVICES, NAMELY, PROVIDING SEARCH ENGINES FOR OBTAINING AUTOMOBILE PARTS DATA ON A GLOBAL COMPUTER NETWORK, IN CLASS 42 (U.S. CLS. 100 AND 101).

FIRST USE 3-0-2006; IN COMMERCE 10-5-2007.

THE MARK CONSISTS OF THE STYLIZED WORD "PARTPAL" WITH THE WORDS "LIST IT, MATCH IT, SELL IT" UNDERNEATH, WITH WHAT APPEARS TO BE A DESIGN OF A WRENCH INSIDE OF A DIAMOND SHAPED BORDER.

SN 85-001,925, FILED 3-30-2010.

H. M. FISHER, EXAMINING ATTORNEY



David J. Kybas

Director of the United States Patent and Trademark Office

United States of America

United States Patent and Trademark Office



Reg. No. 4,068,025

Registered Dec. 6, 2011

Int. Cl.: 24

TRADEMARK

PRINCIPAL REGISTER

PETROS, JOIE NOELLE (UNITED STATES INDIVIDUAL)
97 TOWN WOODS ROAD
LYME, CT 06371

FOR: TABLE LINEN, IN CLASS 24 (U.S. CLS. 42 AND 50).

FIRST USE 3-1-2010; IN COMMERCE 6-1-2011.

NO CLAIM IS MADE TO THE EXCLUSIVE RIGHT TO USE "COUTURE", APART FROM THE MARK AS SHOWN.

THE MARK CONSISTS OF THE WORDING "JOIE DU JOUR COUTURE" WHERE THE LETTER "C" IN "COUTURE" IS MUCH LARGER IN SIZE THAN THE REMAINDER OF THE WORDING.

THE ENGLISH TRANSLATION OF "JOIE DU JOUR" IN THE MARK IS "JOY OF THE DAY".

SN 85-002,499, FILED 3-30-2010.

MARY I. SPARROW, EXAMINING ATTORNEY



David J. Kyros

Director of the United States Patent and Trademark Office

United States of America

United States Patent and Trademark Office

OMECHOL

Reg. No. 4,068,026

Registered Dec. 6, 2011

Int. Cl.: 5

TRADEMARK

PRINCIPAL REGISTER

VITAL HEALTH PHARMACEUTICALS, INC. (NEVADA CORPORATION)
SUITE 700
101 CONVENTION CENTER DRIVE
LAS VEGAS, NV 89109

FOR: NON-PRESCRIPTION VITAMIN AND DIETARY SUPPLEMENTS, EXCLUDING VITAMIN AND DIETARY SUPPLEMENTS FOR THE PROMOTION OF OPHTHALMIC AND OCULAR HEALTH OR FOR THE TREATMENT OF OPHTHALMIC, OCULAR OR EYE-RELATED DISEASES, IN CLASS 5 (U.S. CLS. 6, 18, 44, 46, 51 AND 52).

FIRST USE 1-18-2011; IN COMMERCE 1-18-2011.

THE MARK CONSISTS OF STANDARD CHARACTERS WITHOUT CLAIM TO ANY PARTICULAR FONT, STYLE, SIZE, OR COLOR.

SN 85-002,937, FILED 3-31-2010.

LAURA HAMMEL, EXAMINING ATTORNEY



David J. Kybas

Director of the United States Patent and Trademark Office

United States of America

United States Patent and Trademark Office

E-TAMIN

Reg. No. 4,068,027

Registered Dec. 6, 2011

Int. Cl.: 5

TRADEMARK

PRINCIPAL REGISTER

VITAL HEALTH PHARMACEUTICALS, INC. (NEVADA CORPORATION)
SUITE 700
101 CONVENTION CENTER DRIVE
LAS VEGAS, NV 89109

FOR: VITAMIN AND DIETARY SUPPLEMENTS CONTAINING VITAMIN E, IN CLASS 5
(U.S. CLS. 6, 18, 44, 46, 51 AND 52).

FIRST USE 1-18-2011; IN COMMERCE 1-18-2011.

THE MARK CONSISTS OF STANDARD CHARACTERS WITHOUT CLAIM TO ANY PARTICULAR FONT, STYLE, SIZE, OR COLOR.

SN 85-002,948, FILED 3-31-2010.

LAURA HAMMEL, EXAMINING ATTORNEY



David J. Kybas

Director of the United States Patent and Trademark Office

United States of America

United States Patent and Trademark Office

B-TAMIN

Reg. No. 4,068,028

Registered Dec. 6, 2011

Int. Cl.: 5

TRADEMARK

PRINCIPAL REGISTER

VITAL HEALTH PHARMACEUTICALS, INC. (NEVADA CORPORATION)
SUITE 700
101 CONVENTION CENTER DRIVE
LAS VEGAS, NV 89109

FOR: VITAMIN AND DIETARY SUPPLEMENTS CONTAINING VITAMIN B, IN CLASS 5
(U.S. CLS. 6, 18, 44, 46, 51 AND 52).

FIRST USE 1-18-2011; IN COMMERCE 1-18-2011.

THE MARK CONSISTS OF STANDARD CHARACTERS WITHOUT CLAIM TO ANY PARTICULAR FONT, STYLE, SIZE, OR COLOR.

SN 85-002,978, FILED 3-31-2010.

LAURA HAMMEL, EXAMINING ATTORNEY



David J. Kybas

Director of the United States Patent and Trademark Office

United States of America

United States Patent and Trademark Office



Reg. No. 4,068,029

Registered Dec. 6, 2011

Int. Cl.: 18

TRADEMARK

PRINCIPAL REGISTER

COMMUNITIES IN SCHOOLS, INC. (GEORGIA CORPORATION)
SUITE 801
2345 CRYSTAL DRIVE
ARLINGTON, VA 22201

FOR: TOTE BAGS, DUFFLE BAGS, BACKPACKS, SPORTS BAGS, AND UMBRELLAS, IN CLASS 18 (U.S. CLS. 1, 2, 3, 22 AND 41).

FIRST USE 9-0-2011; IN COMMERCE 9-0-2011.

THE MARK CONSISTS OF A HUMAN FIGURE LEAPING ACROSS THE FRONT BUILDING WITH A FLAG ON IT.

SN 85-003,123, FILED 3-31-2010.

LEIGH CAROLINE CASE, EXAMINING ATTORNEY



David J. Kybas

Director of the United States Patent and Trademark Office

United States of America

United States Patent and Trademark Office



Reg. No. 4,068,030

Registered Dec. 6, 2011

Int. Cl.: 35

SERVICE MARK

PRINCIPAL REGISTER

COMMUNITIES IN SCHOOLS, INC. (GEORGIA CORPORATION)
SUITE 801
2345 CRYSTAL DRIVE
ARLINGTON, VA 22201

FOR: PROVIDING INFORMATION VIA A GLOBAL COMMUNICATIONS NETWORK IN THE FIELD OF PROMOTING CHILDREN AND YOUTH TO STAY IN SCHOOL; PROMOTING PUBLIC AWARENESS OF THE NEED FOR CHILDREN AND YOUTH TO STAY IN SCHOOL VIA THE DEVELOPMENT AND DISSEMINATION OF INFORMATIONAL MATERIALS TO THE PUBLIC IN THE FIELD OF PROMOTING CHILDREN AND YOUTH TO STAY IN SCHOOL; PRODUCTION AND DISTRIBUTION OF PUBLIC SERVICE ANNOUNCEMENTS VIA A GLOBAL COMMUNICATIONS NETWORK IN THE FIELDS OF EDUCATION AND PROMOTING CHILDREN AND YOUTH TO STAY IN SCHOOL; ASSOCIATION SERVICES, NAMELY, PROMOTING THE INTERESTS OF YOUTH AND PUBLIC AWARENESS OF THE NEED FOR HEALTHY, SAFE, EDUCATED, AND MARKETABLE YOUTH, AND THE NEED FOR ADULT MENTORS OF YOUTH; ONLINE RETAIL STORE SERVICES FEATURING CLOTHING, CAPS, DESK ACCESSORIES, WRITING INSTRUMENTS, LAPEL PINS, MUGS, CUPS, TOTE BAGS, DUFFEL BAGS, BACKPACKS, SPORTS BAGS, AND UMBRELLAS; PROMOTING PUBLIC AWARENESS OF THE NEED FOR VOLUNTEERISM AND COMMUNITY SERVICE TO PROMOTE EDUCATION AND TO ENCOURAGE CHILDREN AND YOUTH TO STAY IN SCHOOL, IN CLASS 35 (U.S. CLS. 100, 101 AND 102).

FIRST USE 8-0-2011; IN COMMERCE 8-0-2011.

THE MARK CONSISTS OF A HUMAN FIGURE LEAPING ACROSS THE FRONT BUILDING WITH A FLAG ON IT.

SN 85-003,135, FILED 3-31-2010.

LEIGH CAROLINE CASE, EXAMINING ATTORNEY



David J. Kyros

Director of the United States Patent and Trademark Office

United States of America

United States Patent and Trademark Office

IEShineon.com

Reg. No. 4,068,031

Registered Dec. 6, 2011

Int. Cl.: 35

SERVICE MARK

PRINCIPAL REGISTER

PAK, SU (UNITED STATES INDIVIDUAL)
610 S. MAIN STREET
LOS ANGELES, CA 90014

FOR: PROVIDING A WEBSITE FEATURING AN ONLINE CITY GUIDE IN THE NATURE OF A BUSINESS AND RESTAURANT DIRECTORY FOR THE INLAND EMPIRE; PROVIDING AN INTERACTIVE WEBSITE OBTAINING USER COMMENTS CONCERNING BUSINESS ORGANIZATIONS, SERVICE PROVIDERS, AND OTHER RESOURCES IN THE INLAND EMPIRE; PROVIDING BUSINESS INFORMATION, ALSO VIA THE INTERNET, THE CABLE NETWORK, OR OTHER FORMS OF DATA TRANSFER, NAMELY, COMPILATIONS, RANKINGS, RATINGS, REVIEWS, REFERRALS, AND RECOMMENDATIONS RELATING TO BUSINESS ORGANIZATIONS, SERVICE PROVIDERS, AND OTHER RESOURCES IN THE INLAND EMPIRE, IN CLASS 35 (U.S. CLS. 100, 101 AND 102).

FIRST USE 9-23-2011; IN COMMERCE 9-23-2011.

THE MARK CONSISTS OF STANDARD CHARACTERS WITHOUT CLAIM TO ANY PARTICULAR FONT, STYLE, SIZE, OR COLOR.

SN 85-003,518, FILED 3-31-2010.

MARILYN IZZI, EXAMINING ATTORNEY



David J. Kyffers

Director of the United States Patent and Trademark Office

United States of America

United States Patent and Trademark Office

LUPO

Reg. No. 4,068,032

Registered Dec. 6, 2011

Int. Cl.: 25

TRADEMARK

PRINCIPAL REGISTER

LUPO S.A. (BRAZIL LIMITED LIABILITY COMPANY)
RODOVIA WASHINGTON LUIZ, S/N-KM 276.5
ARARAQUARA/SP, BRAZIL

FOR: CLOTHING, NAMELY, BREECHES FOR WEAR, CAPS, SHIRTS, T-SHIRTS, JACKETS, UNDERPANTS, CORSELETS, SOCK SUSPENDERS, SOCKS, STOCKINGS, STOCKING SUSPENDERS, CAMISOLES, TIGHTS, BRASSIERES, BABY-DOLL PAJAMAS, SWIMSUITS, JERSEYS, AND CLOTHING FOR GYMNASTICS, NAMELY, LEOTARDS, AND KNITWEAR, NAMELY, KNIT SHIRTS, KNIT PANTS, KNIT LEGGINGS, KNIT TOPS, KNIT BLOUSES, KNIT JACKETS, IN CLASS 25 (U.S. CLS. 22 AND 39).

FIRST USE 0-0-1921; IN COMMERCE 4-0-2010.

OWNER OF U.S. REG. NO. 2,971,865.

THE MARK CONSISTS OF THE STYLIZED WORD "LUPO".

THE ENGLISH TRANSLATION OF "LUPO" IN THE MARK IS "WOLF".

SN 85-004,025, FILED 4-1-2010.

LEIGH LOWRY, EXAMINING ATTORNEY



David J. Kyfos

Director of the United States Patent and Trademark Office

United States of America

United States Patent and Trademark Office

BEAUTIFUL CONFIDENCE AT YOUR CORE

Reg. No. 4,068,033

Registered Dec. 6, 2011

Int. Cl.: 41

SERVICE MARK

PRINCIPAL REGISTER

MIRIAM E FRANCO, PC (PENNSYLVANIA CORPORATION)
106 JEFFORDS CT.
PHOENIXVILLE, PA 19460

FOR: EDUCATIONAL SERVICES, NAMELY, CONDUCTING TRAINING COURSES, CLASSES, SEMINARS, CONFERENCES, AND WORKSHOPS IN THE FIELD OF STRESS REDUCTION AND GUIDED IMAGERY SERVICES AND PERSONAL AND PROFESSIONAL DEVELOPMENT, MOTIVATIONAL IMPROVEMENTS, AND SELF-IMAGE IMPROVEMENT AND THE DISTRIBUTION OF COURSE AND TRAINING MATERIALS IN CONNECTION THEREWITH, IN CLASS 41 (U.S. CLS. 100, 101 AND 107).

FIRST USE 8-17-2010; IN COMMERCE 12-6-2010.

THE MARK CONSISTS OF STANDARD CHARACTERS WITHOUT CLAIM TO ANY PARTICULAR FONT, STYLE, SIZE, OR COLOR.

SN 85-004,959, FILED 4-2-2010.

LINDA ORNDORFF, EXAMINING ATTORNEY



David J. Kybas

Director of the United States Patent and Trademark Office

United States of America

United States Patent and Trademark Office

This Game is My Life

Reg. No. 4,068,034

MAZZOTTA, MICHAEL (UNITED STATES INDIVIDUAL)
3535 MONROE AVE. UNIT 16
SAN DIEGO, CA 92116

Registered Dec. 6, 2011

Int. Cl.: 25

FOR: CLOTHING, NAMELY, SHIRTS, T-SHIRTS, SWEATSHIRTS, JACKETS, SHORTS, CAPS, HATS, IN CLASS 25 (U.S. CLS. 22 AND 39).

TRADEMARK

FIRST USE 1-1-2005; IN COMMERCE 12-1-2008.

PRINCIPAL REGISTER

THE MARK CONSISTS OF STANDARD CHARACTERS WITHOUT CLAIM TO ANY PARTICULAR FONT, STYLE, SIZE, OR COLOR.

SN 85-004,992, FILED 4-2-2010.

TIMOTHY FINNEGAN, EXAMINING ATTORNEY



David J. Kyros

Director of the United States Patent and Trademark Office

United States of America

United States Patent and Trademark Office

ABI

Reg. No. 4,068,035

Registered Dec. 6, 2011

Int. Cl.: 6

TRADEMARK

PRINCIPAL REGISTER

ALLIED BOLT PRODUCTS LLC (NEW YORK LIMITED LIABILITY COMPANY)
1000 AXINN AVENUE
GARDEN CITY, NY 11530

FOR: METAL SQUARE HEAD BOLTS FOR USE IN UTILITY POLES, IN CLASS 6 (U.S. CLS. 2, 12, 13, 14, 23, 25 AND 50).

FIRST USE 4-0-2011; IN COMMERCE 4-0-2011.

THE MARK CONSISTS OF STANDARD CHARACTERS WITHOUT CLAIM TO ANY PARTICULAR FONT, STYLE, SIZE, OR COLOR.

SN 85-005,269, FILED 4-2-2010.

KELLY TRUSILO, EXAMINING ATTORNEY



David J. Kyffers

Director of the United States Patent and Trademark Office

United States of America

United States Patent and Trademark Office

OVERLAND ADVISORS

Reg. No. 4,068,036

Registered Dec. 6, 2011

Int. Cl.: 36

SERVICE MARK

PRINCIPAL REGISTER

WELLS FARGO & COMPANY (DELAWARE CORPORATION)
1700 WELLS FARGO CENTER
MAC N9305-176, SIXTH AND MARQUETTE
MINNEAPOLIS, MN 55479

FOR: FINANCIAL AND INVESTMENT SERVICES, NAMELY, INVESTMENT ADVICE, INVESTMENT MANAGEMENT, AND INVESTMENT CONSULTATION; HEDGE FUND INVESTMENT SERVICES; FUNDS INVESTMENT, IN CLASS 36 (U.S. CLS. 100, 101 AND 102).

FIRST USE 1-15-2010; IN COMMERCE 1-15-2010.

THE MARK CONSISTS OF STANDARD CHARACTERS WITHOUT CLAIM TO ANY PARTICULAR FONT, STYLE, SIZE, OR COLOR.

OWNER OF U.S. REG. NOS. 2,036,713, 2,832,832, AND OTHERS.

NO CLAIM IS MADE TO THE EXCLUSIVE RIGHT TO USE "ADVISORS", APART FROM THE MARK AS SHOWN.

SN 85-005,720, FILED 4-3-2010.

KIM MONINGHOFF, EXAMINING ATTORNEY



David J. Kybas

Director of the United States Patent and Trademark Office

United States of America

United States Patent and Trademark Office

M2MWorks

Reg. No. 4,068,037

Registered Dec. 6, 2011

Int. Cl.: 9

TRADEMARK

PRINCIPAL REGISTER

SMARTIBYTES INFORMATION TECHNOLOGY CHINA INC. (CHINA CORPORATION),
AKA SMARTIBYTES CHINA, INC.,
WWW.SMARTIBYTES.COM
ZHENJIANG, CHINA 212000

FOR: WIRELESS COMMUNICATION DEVICES FOR VOICE, DATA OR IMAGE TRANSMISSION, IN CLASS 9 (U.S. CLS. 21, 23, 26, 36 AND 38).

FIRST USE 11-1-2010; IN COMMERCE 3-1-2011.

THE MARK CONSISTS OF STANDARD CHARACTERS WITHOUT CLAIM TO ANY PARTICULAR FONT, STYLE, SIZE, OR COLOR.

SN 85-005,913, FILED 4-5-2010.

JAMES GRIFFIN, EXAMINING ATTORNEY



David J. Kyffers

Director of the United States Patent and Trademark Office

United States of America

United States Patent and Trademark Office

4.0 Magazine

Reg. No. 4,068,038

Registered Dec. 6, 2011

Int. Cl.: 41

SERVICE MARK

PRINCIPAL REGISTER

4.0 MEDIA (D.C. LIMITED LIABILITY COMPANY)
4213 BROOKS ST. NE SUITE 204
WASHINGTON, DC 20019

FOR: ACADEMIC ENRICHMENT PROGRAMS IN THE FIELD(S) OF JOURNALISM, GRAPHIC DESIGN, FILM AND ALL UNDERGRADUATE STUDIES, IN CLASS 41 (U.S. CLS. 100, 101 AND 107).

FIRST USE 3-15-2006; IN COMMERCE 4-1-2010.

THE MARK CONSISTS OF STANDARD CHARACTERS WITHOUT CLAIM TO ANY PARTICULAR FONT, STYLE, SIZE, OR COLOR.

SN 85-006,088, FILED 4-5-2010.

ANNE E. GUSTASON, EXAMINING ATTORNEY



David J. Kyffers

Director of the United States Patent and Trademark Office

United States of America

United States Patent and Trademark Office

SCALP SHIELD

Reg. No. 4,068,039

Registered Dec. 6, 2011

Int. Cl.: 3

TRADEMARK

PRINCIPAL REGISTER

NIOXIN RESEARCH LABORATORIES, INC. (GEORGIA CORPORATION)
2124 SKYVIEW DRIVE
LITHIA SPRINGS, GA 30122

FOR: NON-MEDICATED SUN PROTECTION PREPARATIONS FOR USE ON SKIN, SCALP,
AND HAIR, IN CLASS 3 (U.S. CLS. 1, 4, 6, 50, 51 AND 52).

FIRST USE 7-1-2011; IN COMMERCE 7-1-2011.

THE MARK CONSISTS OF STANDARD CHARACTERS WITHOUT CLAIM TO ANY PAR-
TICULAR FONT, STYLE, SIZE, OR COLOR.

NO CLAIM IS MADE TO THE EXCLUSIVE RIGHT TO USE "SCALP", APART FROM THE
MARK AS SHOWN.

SN 85-006,981, FILED 4-6-2010.

ELLEN PERKINS, EXAMINING ATTORNEY



David J. Kyros

Director of the United States Patent and Trademark Office

United States of America

United States Patent and Trademark Office



Reg. No. 4,068,040

Registered Dec. 6, 2011

Int. Cl.: 25

TRADEMARK

PRINCIPAL REGISTER

DREAM BRANDS LLC (TEXAS LIMITED LIABILITY COMPANY)
3100 S. GESSNER RD., SUITE 115
HOUSTON, TX 77063

FOR: CLOTHING, NAMELY, SHIRTS, T-SHIRTS, PANTS, IN CLASS 25 (U.S. CLS. 22 AND 39).

FIRST USE 12-11-2010; IN COMMERCE 1-9-2011.

THE MARK CONSISTS OF A STYLIZED LOWER CASE LETTER "D" HAVING ITS VERTICAL LEG FORMED BY A DOUBLE STRIPE, WITH THE LITERAL ELEMENT OF THE MARK, "DR34M", APPEARING PROXIMATE THERETO.

SN 85-007,084, FILED 4-6-2010.

RON FAIRBANKS, EXAMINING ATTORNEY



David J. Kybas

Director of the United States Patent and Trademark Office

United States of America

United States Patent and Trademark Office

**SPORTS
LEGENDS**

Reg. No. 4,068,041

INFINITE VISIONS, LLC (NEW JERSEY LIMITED LIABILITY COMPANY)
45 ENTERPRISE AVE. N.
SECAUCUS, NJ 07094

Registered Dec. 6, 2011

Int. Cl.: 25

FOR: CLOTHING, NAMELY, SHIRTS, T-SHIRTS, JACKETS, SWEATSHIRTS, DRESSES, SKIRTS, TANK-TOPS, PANTS, SHORTS, CAPS, HATS, IN CLASS 25 (U.S. CLS. 22 AND 39).

TRADEMARK

FIRST USE 11-18-2008; IN COMMERCE 11-18-2008.

PRINCIPAL REGISTER

NO CLAIM IS MADE TO THE EXCLUSIVE RIGHT TO USE "SPORTS", APART FROM THE MARK AS SHOWN.

THE MARK CONSISTS OF THE WORD "SPORTS" ON TOP OF THE 3 LINES AND WORD "LEGENDS" DIRECTLY UNDERNEATH BOTH IN STYLIZED FORM.

SN 85-007,298, FILED 4-6-2010.

JACLYN KIDWELL WALKER, EXAMINING ATTORNEY



David J. Kybas

Director of the United States Patent and Trademark Office

United States of America

United States Patent and Trademark Office

EVERYTHING SPORTS

Reg. No. 4,068,042

INFINITE VISIONS, LLC (NEW JERSEY LIMITED LIABILITY COMPANY)
45 ENTERPRISE AVE. N.
SECAUCUS, NJ 07094

Registered Dec. 6, 2011

Int. Cl.: 25

FOR: CLOTHING, NAMELY, SHIRTS, T-SHIRTS, JACKETS, SWEATSHIRTS, DRESSES, SKIRTS, TANK-TOPS, PANTS, SHORTS, CAPS, HATS, IN CLASS 25 (U.S. CLS. 22 AND 39).

TRADEMARK

FIRST USE 11-18-2008; IN COMMERCE 11-18-2008.

PRINCIPAL REGISTER

NO CLAIM IS MADE TO THE EXCLUSIVE RIGHT TO USE "SPORTS", APART FROM THE MARK AS SHOWN.

THE MARK CONSISTS OF THE WORD "EVERYTHING" ON TOP OF THE WORD "SPORTS". THE WORDS ARE CAPITALIZED.

SN 85-007,303, FILED 4-6-2010.

JACLYN KIDWELL WALKER, EXAMINING ATTORNEY



David J. Kybas

Director of the United States Patent and Trademark Office

United States of America

United States Patent and Trademark Office

FRANKIE COOKS AND YOU CAN TOO!

Reg. No. 4,068,043

Registered Dec. 6, 2011

Int. Cl.: 41

SERVICE MARK

PRINCIPAL REGISTER

FRANK V. CELENZA (UNITED STATES INDIVIDUAL)
49 GREENE STREET, APT. 5E
NEW YORK, NY 10013

FOR: ENTERTAINMENT SERVICES, NAMELY, TELEVISION PERFORMANCES AND TELEVISION PROGRAMS RELATING TO COOKING, FOOD AND CULTURE, IN CLASS 41 (U.S. CLS. 100, 101 AND 107).

FIRST USE 7-20-2011; IN COMMERCE 7-20-2011.

THE MARK CONSISTS OF STANDARD CHARACTERS WITHOUT CLAIM TO ANY PARTICULAR FONT, STYLE, SIZE, OR COLOR.

SN 85-007,661, FILED 4-6-2010.

DOMINICK J. SALEMI, EXAMINING ATTORNEY



David J. Kybas

Director of the United States Patent and Trademark Office

United States of America

United States Patent and Trademark Office

GIM-ME-MOR

Reg. No. 4,068,044

DEBRUYN PRODUCE COMPANY (MICHIGAN CORPORATION)
26 N. FM 491
LA VILLA, TX 78562

Registered Dec. 6, 2011

Int. Cl.: 31

FOR: FRESH ONIONS, IN CLASS 31 (U.S. CLS. 1 AND 46).

TRADEMARK

FIRST USE 0-0-2000; IN COMMERCE 0-0-2000.

PRINCIPAL REGISTER

THE MARK CONSISTS OF STANDARD CHARACTERS WITHOUT CLAIM TO ANY PARTICULAR FONT, STYLE, SIZE, OR COLOR.

SN 85-007,696, FILED 4-6-2010.

MARY CRAWFORD, EXAMINING ATTORNEY



David J. Kyffers

Director of the United States Patent and Trademark Office

United States of America

United States Patent and Trademark Office

AND YOU CAN TOO

Reg. No. 4,068,045

Registered Dec. 6, 2011

Int. Cl.: 41

SERVICE MARK

PRINCIPAL REGISTER

FRANK V. CELENZA (UNITED STATES INDIVIDUAL)
49 GREENE STREET, APT. 5E
NEW YORK, NY 10013

FOR: ENTERTAINMENT SERVICES, NAMELY, ONLINE SHOWS AND TELEVISION PERFORMANCES AND TELEVISION PROGRAMS RELATING TO COOKING, FOOD AND CULTURE, IN CLASS 41 (U.S. CLS. 100, 101 AND 107).

FIRST USE 4-20-2009; IN COMMERCE 4-20-2009.

THE MARK CONSISTS OF STANDARD CHARACTERS WITHOUT CLAIM TO ANY PARTICULAR FONT, STYLE, SIZE, OR COLOR.

SN 85-007,708, FILED 4-6-2010.

DOMINICK J. SALEMI, EXAMINING ATTORNEY



David J. Kybas

Director of the United States Patent and Trademark Office

United States of America

United States Patent and Trademark Office

CONNECT K

Reg. No. 4,068,046

Registered Dec. 6, 2011

Int. Cl.: 36

SERVICE MARK

PRINCIPAL REGISTER

WELLS FARGO & COMPANY (DELAWARE CORPORATION)
1700 WELLS FARGO CENTER; MAC N9305-176
SIXTH AND MARQUETTE
MINNEAPOLIS, MN 55479

FOR: INVESTMENT MANAGEMENT SERVICES FOR FUNDING RETIREMENT, NAMELY, PROVIDING AND ADMINISTERING RETIREMENT PLANS; CONSULTING SERVICES IN THE FIELD OF RETIREMENT PLAN ADMINISTRATION AND FIDUCIARY COMPLIANCE; FINANCIAL INFORMATION PROVIDED BY ELECTRONIC MEANS, NAMELY, PROVIDING AN INTERNET WEBSITE PORTAL FEATURING RETIREMENT PLAN AND PARTICIPANT INFORMATION, IN CLASS 36 (U.S. CLS. 100, 101 AND 102).

FIRST USE 3-1-2010; IN COMMERCE 3-1-2010.

THE MARK CONSISTS OF STANDARD CHARACTERS WITHOUT CLAIM TO ANY PARTICULAR FONT, STYLE, SIZE, OR COLOR.

OWNER OF U.S. REG. NO. 3,382,462.

SN 85-008,513, FILED 4-7-2010.

KIM MONINGHOFF, EXAMINING ATTORNEY



David J. Kybas

Director of the United States Patent and Trademark Office

United States of America

United States Patent and Trademark Office

iMR

Reg. No. 4,068,047

Registered Dec. 6, 2011

Int. Cl.: 11

TRADEMARK

PRINCIPAL REGISTER

MSI-SSL INC. (FLORIDA LIMITED LIABILITY COMPANY)
1342 SOUTH POWERLINE ROAD
DEERFIELD BEACH, FL 33442

FOR: LED LIGHT BULBS, IN CLASS 11 (U.S. CLS. 13, 21, 23, 31 AND 34).

FIRST USE 11-1-2010; IN COMMERCE 5-1-2011.

THE MARK CONSISTS OF STANDARD CHARACTERS WITHOUT CLAIM TO ANY PARTICULAR FONT, STYLE, SIZE, OR COLOR.

SN 85-008,974, FILED 4-7-2010.

WILLIAM VERHOSEK, EXAMINING ATTORNEY



David J. Kybas

Director of the United States Patent and Trademark Office

United States of America

United States Patent and Trademark Office

SLEEK SOLUTIONS

Reg. No. 4,068,048

Registered Dec. 6, 2011

Int. Cl.: 25

TRADEMARK

PRINCIPAL REGISTER

BIFLEX INTIMATES GROUP, LTD. (DELAWARE LIMITED LIABILITY COMPANY)
180 MADISON AVENUE
FLOOR 6
NEW YORK, NY 10016

FOR: INTIMATE APPAREL, NAMELY, LINGERIE; SHAPEWEAR, NAMELY, BRAS, GIRDLES, HIGH BODY SHAPERS, BODY SUITS, ALL-IN-ONES, IN CLASS 25 (U.S. CLS. 22 AND 39).

FIRST USE 10-13-2011; IN COMMERCE 10-13-2011.

THE MARK CONSISTS OF STANDARD CHARACTERS WITHOUT CLAIM TO ANY PARTICULAR FONT, STYLE, SIZE, OR COLOR.

SN 85-009,539, FILED 4-8-2010.

MARK SPARACINO, EXAMINING ATTORNEY



David J. Kybas

Director of the United States Patent and Trademark Office

United States of America

United States Patent and Trademark Office

WHOLESOME LANE

Reg. No. 4,068,049

DRIVER DIGITAL, LLC (DELAWARE LIMITED LIABILITY COMPANY)
115 WEST 27TH STREET, 12TH FLOOR
NEW YORK, NY 10001

Registered Dec. 6, 2011

Int. Cl.: 38

FOR: BROADCASTING OF VIDEO AND AUDIO PROGRAMMING OVER THE INTERNET,
IN CLASS 38 (U.S. CLS. 100, 101 AND 104).

SERVICE MARK

FIRST USE 8-18-2011; IN COMMERCE 8-18-2011.

PRINCIPAL REGISTER

THE MARK CONSISTS OF STANDARD CHARACTERS WITHOUT CLAIM TO ANY PARTICULAR FONT, STYLE, SIZE, OR COLOR.

SN 85-010,073, FILED 4-9-2010.

MATTHEW KLINE, EXAMINING ATTORNEY



David J. Kappas

Director of the United States Patent and Trademark Office

United States of America

United States Patent and Trademark Office

HAPPY HORSE

Reg. No. 4,068,050

Registered Dec. 6, 2011

Int. Cl.: 31

TRADEMARK

PRINCIPAL REGISTER

ANDERSON, HARLAN R. (UNITED STATES INDIVIDUAL), DBA IDLE ACRES FARM,
2379 QUIMBY AVENUE S. W.
COKATO, MN 55321

FOR: FOOD FOR HORSES, IN CLASS 31 (U.S. CLS. 1 AND 46).

FIRST USE 3-1-2008; IN COMMERCE 3-1-2008.

THE MARK CONSISTS OF STANDARD CHARACTERS WITHOUT CLAIM TO ANY PARTICULAR FONT, STYLE, SIZE, OR COLOR.

NO CLAIM IS MADE TO THE EXCLUSIVE RIGHT TO USE "HORSE", APART FROM THE MARK AS SHOWN.

SN 85-010,174, FILED 4-9-2010.

DANIEL CAPSHAW, EXAMINING ATTORNEY



David J. Kybas

Director of the United States Patent and Trademark Office

United States of America

United States Patent and Trademark Office

Monarch Moon Studio

Reg. No. 4,068,051

Registered Dec. 6, 2011

Int. Cl.: 16

TRADEMARK

PRINCIPAL REGISTER

SILVERS, LINDA E. (UNITED STATES INDIVIDUAL), DBA MONARCH MOON STUDIO,
P.O. BOX 34889
BETHESDA, MD 20827

FOR: ART PRINTS ON CANVAS; CALENDARS; COLOR PRINTS; ENVELOPES; NOTE
CARDS; PAPER STATIONERY; PHOTOGRAPHIC PRINTS; PHOTOGRAPHS; PICTURES;
UNMOUNTED AND MOUNTED PHOTOGRAPHS; BOOKMARKS; PHOTOGRAPHS THAT
HAVE BEEN COMPUTER MANIPULATED AND ENHANCED TO LOOK LIKE PAINTINGS;
PICTURE BOOKS; PICTURE CARDS; PICTURE POSTCARDS; POST CARDS; POSTERS, IN
CLASS 16 (U.S. CLS. 2, 5, 22, 23, 29, 37, 38 AND 50).

FIRST USE 8-18-2009; IN COMMERCE 8-18-2009.

THE MARK CONSISTS OF STANDARD CHARACTERS WITHOUT CLAIM TO ANY PAR-
TICULAR FONT, STYLE, SIZE, OR COLOR.

NO CLAIM IS MADE TO THE EXCLUSIVE RIGHT TO USE "STUDIO", APART FROM THE
MARK AS SHOWN.

SN 85-011,164, FILED 4-10-2010.

MARTHA FROMM, EXAMINING ATTORNEY



David J. Kyffers

Director of the United States Patent and Trademark Office

United States of America

United States Patent and Trademark Office



Reg. No. 4,068,052

Registered Dec. 6, 2011

Int. Cl.: 16

TRADEMARK

PRINCIPAL REGISTER

SILVERS, LINDA, E. (UNITED STATES INDIVIDUAL), DBA MONARCH MOON STUDIO,
P.O. BOX 34889
BETHESDA, MD 20827

FOR: ART PRINTS ON CANVAS; CALENDARS; COLOR PRINTS; ENVELOPES; NOTE CARDS; PAPER STATIONERY; PHOTOGRAPHIC PRINTS; PHOTOGRAPHS; PICTURES; STATIONERY; UNMOUNTED AND MOUNTED PHOTOGRAPHS BOOKMARKS; PHOTOGRAPHS THAT HAVE BEEN COMPUTER MANIPULATED AND ENHANCED TO LOOK LIKE PAINTINGS; PICTURE BOOKS; PICTURE CARDS; PICTURE POSTCARDS; POSTCARDS; POSTERS, IN CLASS 16 (U.S. CLS. 2, 5, 22, 23, 29, 37, 38 AND 50).

FIRST USE 3-12-2011; IN COMMERCE 3-12-2011.

NO CLAIM IS MADE TO THE EXCLUSIVE RIGHT TO USE "STUDIO", APART FROM THE MARK AS SHOWN.

THE MARK CONSISTS OF THE SIDE VIEW OF A "MONARCH" BUTTERFLY STANDING ON THE UPPER LEFT PORTION OF THE MOON, AND THE WORDS "MONARCH MOON STUDIO" ARE WRAPPED IN A CURVED FASHION ALONG THE BOTTOM OF THE MOON.

SN 85-011,298, FILED 4-11-2010.

MARTHA FROMM, EXAMINING ATTORNEY



David J. Kybas

Director of the United States Patent and Trademark Office

United States of America

United States Patent and Trademark Office



Reg. No. 4,068,053

Registered Dec. 6, 2011

Int. Cl.: 39

SERVICE MARK

PRINCIPAL REGISTER

HYUNDAI LOGIEM CO., LTD. (REPUBLIC OF KOREA CORPORATION)
HYUNDAI GROUP B/D, 1-7
YEONJI-DONG, JONGNO-GU
SEOUL, REPUBLIC OF KOREA

FOR: TRANSPORT OF GOODS, NAMELY, DOCUMENTS, PACKAGES AND HOUSEHOLD GOODS; TRUCK HAULING; TRANSPORT OF TRAVELLERS; BOAT TRANSPORT; PARCEL DELIVERY; PASSENGER TRANSPORT; PROVIDING TRANSPORTATION INFORMATION; RAILWAY TRANSPORT; FREIGHT FORWARDING AGENCY SERVICES; AIR TRANSPORT AGENCY; AIR TRANSPORT; HARBOUR CRANE UNLOADING; FREIGHT FORWARDING; SHIPPING OF GOODS; FREIGHT TRANSPORTATION BY TRUCK, SHIPS, AIRCRAFT; REFRIGERATED WAREHOUSING; STORAGE OF GOODS; PROVIDING STORAGE INFORMATION; GENERAL WAREHOUSING, IN CLASS 39 (U.S. CLS. 100 AND 105).

FIRST USE 5-1-2011; IN COMMERCE 5-1-2011.

NO CLAIM IS MADE TO THE EXCLUSIVE RIGHT TO USE "CO., LTD.", APART FROM THE MARK AS SHOWN.

THE COLOR(S) RED AND BLUE IS/ARE CLAIMED AS A FEATURE OF THE MARK.

THE MARK CONSISTS OF THE LETTERS "HLC" APPEARING IN BLUE, TO THE LEFT OF A THREE CURVED BAND DESIGN WITH THE TOP BAND IN THE COLOR BLUE AND THE BOTTOM TWO BANDS IN RED, ALL APPEARING ABOVE THE WORDING "HYUNDAI LOGIEM CO., LTD." APPEARING IN BLUE.

THE ENGLISH TRANSLATION OF "HYUNDAI" IN THE MARK IS "MODERN".

SN 85-011,426, FILED 4-12-2010.

KELLY TRUSILO, EXAMINING ATTORNEY



David J. Kyros

Director of the United States Patent and Trademark Office

United States of America

United States Patent and Trademark Office



Reg. No. 4,068,054

Registered Dec. 6, 2011

Int. Cl.: 39

SERVICE MARK

PRINCIPAL REGISTER

HYUNDAI LOGIEM CO., LTD. (REPUBLIC OF KOREA CORPORATION)
HYUNDAI GROUP B/D, 1-7
YEONJI-DONG, JONGNO-GU
SEOUL, REPUBLIC OF KOREA

FOR: TRANSPORT OF GOODS, NAMELY, DOCUMENTS, PACKAGES AND HOUSEHOLD GOODS; TRUCK HAULING; TRANSPORT OF TRAVELLERS; BOAT TRANSPORT; PARCEL DELIVERY; PASSENGER TRANSPORT; PROVIDING TRANSPORTATION INFORMATION; RAILWAY TRANSPORT; FREIGHT FORWARDING AGENCY SERVICES; AIR TRANSPORT AGENCY; AIR TRANSPORT; HARBOUR CRANE UNLOADING; FREIGHT FORWARDING; SHIPPING OF GOODS; FREIGHT TRANSPORTATION BY TRUCK, SHIPS, AIRCRAFT; REFRIGERATED WAREHOUSING; STORAGE OF GOODS; PROVIDING STORAGE INFORMATION; GENERAL WAREHOUSING, IN CLASS 39 (U.S. CLS. 100 AND 105).

FIRST USE 5-1-2011; IN COMMERCE 5-1-2011.

THE MARK CONSISTS OF A GREEN SHADED TRIANGLE WITH A YELLOW SHADOW APPEARING TO THE LEFT OF THE WORDING "HYUNDAI LOGIEM" APPEARING IN BLUE.

THE COLOR(S) GREEN, YELLOW AND BLUE IS/ARE CLAIMED AS A FEATURE OF THE MARK.

THE ENGLISH TRANSLATION OF "HYUNDAI" IN THE MARK IS "MODERN".

SN 85-011,430, FILED 4-12-2010.

KELLY TRUSILO, EXAMINING ATTORNEY



David J. Kybas

Director of the United States Patent and Trademark Office

United States of America

United States Patent and Trademark Office

LULU'S ESSENTIAL GRANOLA

Reg. No. 4,068,055

Registered Dec. 6, 2011

Int. Cl.: 30

TRADEMARK

PRINCIPAL REGISTER

JANSEN, ALICIA (UNITED STATES INDIVIDUAL)
1050 LARRABEE AVENUE N, SUITE 104-814
BELLINGHAM, WA 98225

FOR: GRANOLA; GRANOLA SNACKS; GRANOLA-BASED SNACK BARS, IN CLASS 30
(U.S. CL. 46).

FIRST USE 9-21-2010; IN COMMERCE 6-1-2011.

THE MARK CONSISTS OF STANDARD CHARACTERS WITHOUT CLAIM TO ANY PARTICULAR FONT, STYLE, SIZE, OR COLOR.

NO CLAIM IS MADE TO THE EXCLUSIVE RIGHT TO USE "GRANOLA", APART FROM THE MARK AS SHOWN.

SN 85-011,863, FILED 4-12-2010.

JACLYN KIDWELL WALKER, EXAMINING ATTORNEY



David J. Kybas

Director of the United States Patent and Trademark Office

United States of America

United States Patent and Trademark Office

THE HEALTHY INTIMACY CONVERSATION

Reg. No. 4,068,056

Registered Dec. 6, 2011

Int. Cl.: 44

SERVICE MARK

PRINCIPAL REGISTER

JOHNSON & JOHNSON (NEW JERSEY CORPORATION)
ONE JOHNSON & JOHNSON PLAZA
NEW BRUNSWICK, NJ 089337001

FOR: PROVIDING INFORMATION ON HEALTH CARE TOPICS, IN CLASS 44 (U.S. CLS. 100 AND 101).

FIRST USE 5-31-2010; IN COMMERCE 5-31-2010.

THE MARK CONSISTS OF STANDARD CHARACTERS WITHOUT CLAIM TO ANY PARTICULAR FONT, STYLE, SIZE, OR COLOR.

SN 85-012,655, FILED 4-13-2010.

BARBARA GAYNOR, EXAMINING ATTORNEY



David J. Kybas

Director of the United States Patent and Trademark Office

United States of America

United States Patent and Trademark Office

KREMLEVKA

Reg. No. 4,068,057

Registered Dec. 6, 2011

Int. Cl.: 33

TRADEMARK

PRINCIPAL REGISTER

LIMITED LIABILITY COMPANY "SOYUZPRODEXPORT" (RUSSIAN FED. LIMITED LIABILITY COMPANY)
D. 7, UL. OLENIY VAL
MOSCOW, RUSSIAN FED. 107076

FOR: VODKA, IN CLASS 33 (U.S. CLS. 47 AND 49).

FIRST USE 0-0-2007; IN COMMERCE 1-0-2011.

THE MARK CONSISTS OF STANDARD CHARACTERS WITHOUT CLAIM TO ANY PARTICULAR FONT, STYLE, SIZE, OR COLOR.

OWNER OF U.S. REG. NO. 3,294,180.

SN 85-012,851, FILED 4-13-2010.

KATINA MISTER, EXAMINING ATTORNEY



David J. Kybas

Director of the United States Patent and Trademark Office

United States of America

United States Patent and Trademark Office

POLAR BEAR FOREST

Reg. No. 4,068,058

Registered Dec. 6, 2011

Int. Cls.: 35 and 42

SERVICE MARK

PRINCIPAL REGISTER

POLAR BEARS INTERNATIONAL (CALIFORNIA NON-PROFIT CORPORATION)
P. O. BOX 3008
BOZEMAN, MT 59772

FOR: PROMOTING PUBLIC AWARENESS OF ENVIRONMENTAL ISSUES, NAMELY, ON HOW PLANTING TREES CAN REDUCE CARBON EMISSIONS AND HELP SAVE POLAR BEAR HABITAT AND BENEFIT COMMUNITIES, IN CLASS 35 (U.S. CLS. 100, 101 AND 102).

FIRST USE 7-31-2010; IN COMMERCE 7-31-2010.

FOR: PROVIDING A WEBSITE FEATURING ENVIRONMENTAL INFORMATION ABOUT CLIMATE CHANGE, NAMELY, INFORMATION AND MATERIAL ON HOW PLANTING TREES CAN REDUCE CARBON EMISSIONS AND HELP SAVE POLAR BEAR HABITAT AND BENEFIT COMMUNITIES, IN CLASS 42 (U.S. CLS. 100 AND 101).

FIRST USE 7-31-2010; IN COMMERCE 7-31-2010.

THE MARK CONSISTS OF STANDARD CHARACTERS WITHOUT CLAIM TO ANY PARTICULAR FONT, STYLE, SIZE, OR COLOR.

NO CLAIM IS MADE TO THE EXCLUSIVE RIGHT TO USE "POLAR BEAR", APART FROM THE MARK AS SHOWN.

SN 85-013,359, FILED 4-14-2010.

MARK SPARACINO, EXAMINING ATTORNEY



David J. Kypos

Director of the United States Patent and Trademark Office

United States of America

United States Patent and Trademark Office

TUNDRA CONNECTIONS

Reg. No. 4,068,059

Registered Dec. 6, 2011

Int. Cls.: 35 and 41

SERVICE MARK

PRINCIPAL REGISTER

POLAR BEARS INTERNATIONAL (CALIFORNIA NON-PROFIT CORPORATION)
P. O. BOX 3008
BOZEMAN, MT 59772

FOR: PROMOTING PUBLIC AWARENESS OF ENVIRONMENTAL ISSUES AND PROMOTING PUBLIC AWARENESS OF ENVIRONMENTAL ISSUES CONCERNING ARCTIC ECOSYSTEMS AND POLAR BEARS, IN CLASS 35 (U.S. CLS. 100, 101 AND 102).

FIRST USE 9-30-2009; IN COMMERCE 9-30-2009.

FOR: EDUCATIONAL SERVICES, NAMELY, PROVIDING SEMINARS IN THE FIELD OF ARCTIC ECOSYSTEMS AND POLAR BEARS, IN CLASS 41 (U.S. CLS. 100, 101 AND 107).

FIRST USE 9-30-2009; IN COMMERCE 9-30-2009.

THE MARK CONSISTS OF STANDARD CHARACTERS WITHOUT CLAIM TO ANY PARTICULAR FONT, STYLE, SIZE, OR COLOR.

NO CLAIM IS MADE TO THE EXCLUSIVE RIGHT TO USE "TUNDRA", APART FROM THE MARK AS SHOWN.

SN 85-013,361, FILED 4-14-2010.

MARK SPARACINO, EXAMINING ATTORNEY



David J. Kypos

Director of the United States Patent and Trademark Office

United States of America

United States Patent and Trademark Office

SPOT'S A SPOILED DOG INC

Reg. No. 4,068,060

Registered Dec. 6, 2011

Int. Cl.: 20

TRADEMARK

PRINCIPAL REGISTER

SPOT'S A SPOILED DOG, INC. (WYOMING CORPORATION)
3616 BIG HORN AVE
CODY, WY 82414

FOR: FURNITURE, NAMELY, DRESSERS AND ENTERTAINMENT CENTERS, ALL WITH DOG KENNELS BUILT INTO THEM; FURNITURE, NAMELY, DRESSERS AND ENTERTAINMENT CENTERS, IN CLASS 20 (U.S. CLS. 2, 13, 22, 25, 32 AND 50).

FIRST USE 10-28-2011; IN COMMERCE 10-28-2011.

THE MARK CONSISTS OF STANDARD CHARACTERS WITHOUT CLAIM TO ANY PARTICULAR FONT, STYLE, SIZE, OR COLOR.

NO CLAIM IS MADE TO THE EXCLUSIVE RIGHT TO USE "INC", APART FROM THE MARK AS SHOWN.

SN 85-013,567, FILED 4-14-2010.

ELI HELLMAN, EXAMINING ATTORNEY



David J. Kyffers

Director of the United States Patent and Trademark Office

United States of America

United States Patent and Trademark Office

DOC IT

Reg. No. 4,068,061

Registered Dec. 6, 2011

Int. Cl.: 7

TRADEMARK

PRINCIPAL REGISTER

CANA-VAC SYSTEMS INC. (CANADA CORPORATION)
P.O. BOX 910
2795 3RD AVENUE EAST
OWEN SOUND, CANADA N4K6H6

FOR: VACUUM CLEANER HOSE MANAGEMENT SYSTEM FOR HOSES, ATTACHMENTS AND TOOLS USED IN CONJUNCTION WITH A CENTRAL VACUUM SYSTEM, NAMELY, A HOSE CONTAINER INSTALLED INSIDE TYPICAL WALL CONSTRUCTION, A RETRACTOR MECHANISM AND VACUUM CLEANER ATTACHMENTS, IN CLASS 7 (U.S. CLS. 13, 19, 21, 23, 31, 34 AND 35).

FIRST USE 2-0-2011; IN COMMERCE 2-0-2011.

THE MARK CONSISTS OF STANDARD CHARACTERS WITHOUT CLAIM TO ANY PARTICULAR FONT, STYLE, SIZE, OR COLOR.

PRIORITY CLAIMED UNDER SEC. 44(D) ON CANADA APPLICATION NO. TM50,181, FILED 2-5-2010.

SN 85-013,763, FILED 4-14-2010.

MIDGE BUTLER, EXAMINING ATTORNEY



David J. Kyros

Director of the United States Patent and Trademark Office

United States of America

United States Patent and Trademark Office

CLOUD9

Reg. No. 4,068,062

Registered Dec. 6, 2011

Int. Cl.: 34

TRADEMARK

PRINCIPAL REGISTER

UNITABAC, LLC (NEW JERSEY LIMITED LIABILITY COMPANY)
114 RICHARDS AVENUE
DOVER, NJ 07801

FOR: CIGARILLOS; CIGARS, IN CLASS 34 (U.S. CLS. 2, 8, 9 AND 17).

FIRST USE 7-28-2010; IN COMMERCE 7-28-2010.

THE MARK CONSISTS OF STANDARD CHARACTERS WITHOUT CLAIM TO ANY PARTICULAR FONT, STYLE, SIZE, OR COLOR.

SN 85-014,077, FILED 4-14-2010.

ANDREW LEASER, EXAMINING ATTORNEY



David J. Kybas

Director of the United States Patent and Trademark Office

United States of America

United States Patent and Trademark Office



Reg. No. 4,068,063

Registered Dec. 6, 2011

Int. Cl.: 20

TRADEMARK

PRINCIPAL REGISTER

SPOT'S A SPOILED DOG, INC. (WYOMING CORPORATION)
3616 BIG HORN AVE
CODY, WY 82414

FOR: FURNITURE, NAMELY, DRESSERS AND ENTERTAINMENT CENTERS, ALL WITH DOG KENNELS BUILT INTO THEM; FURNITURE, NAMELY, DRESSERS AND ENTERTAINMENT CENTERS, IN CLASS 20 (U.S. CLS. 2, 13, 22, 25, 32 AND 50).

FIRST USE 10-28-2011; IN COMMERCE 10-28-2011.

NO CLAIM IS MADE TO THE EXCLUSIVE RIGHT TO USE "INC", APART FROM THE MARK AS SHOWN.

THE MARK CONSISTS OF THE WORDS "SPOT'S" OVER AND "A SPOILED DOG INC" UNDER A LINE DRAWING OF A DOG.

SN 85-014,304, FILED 4-14-2010.

ELI HELLMAN, EXAMINING ATTORNEY



David J. Kybas

Director of the United States Patent and Trademark Office

United States of America

United States Patent and Trademark Office

THE WORMHOLE COFFEE

Reg. No. 4,068,064

Registered Dec. 6, 2011

Int. Cl.: 30

TRADEMARK

PRINCIPAL REGISTER

TIME BANDITS, LLC (ILLINOIS LIMITED LIABILITY COMPANY)
1330 W. ROSEDALE AVE.
CHICAGO, IL 60660

FOR: COFFEE BASED BEVERAGES; PREPARED COFFEE AND COFFEE-BASED BEVERAGES, IN CLASS 30 (U.S. CL. 46).

FIRST USE 9-5-2011; IN COMMERCE 9-5-2011.

THE MARK CONSISTS OF STANDARD CHARACTERS WITHOUT CLAIM TO ANY PARTICULAR FONT, STYLE, SIZE, OR COLOR.

NO CLAIM IS MADE TO THE EXCLUSIVE RIGHT TO USE "COFFEE", APART FROM THE MARK AS SHOWN.

SN 85-014,493, FILED 4-15-2010.

CHRISTINA SOBRAL, EXAMINING ATTORNEY



David J. Kybas

Director of the United States Patent and Trademark Office

United States of America

United States Patent and Trademark Office

ALIGN

Reg. No. 4,068,065

Registered Dec. 6, 2011

Int. Cl.: 5

TRADEMARK

PRINCIPAL REGISTER

ARYSTA LIFESCIENCE NORTH AMERICA, LLC (CALIFORNIA LIMITED LIABILITY COMPANY)
15401 WESTON PARKWAY, SUITE 150
CARY, NC 27513

FOR: HERBICIDES FOR USE IN TURF AND ORNAMENTAL CARE, IN CLASS 5 (U.S. CLS. 6, 18, 44, 46, 51 AND 52).

FIRST USE 8-0-2011; IN COMMERCE 8-0-2011.

THE MARK CONSISTS OF STANDARD CHARACTERS WITHOUT CLAIM TO ANY PARTICULAR FONT, STYLE, SIZE, OR COLOR.

SN 85-015,109, FILED 4-15-2010.

NICHOLAS ALTREE, EXAMINING ATTORNEY



David J. Kybas

Director of the United States Patent and Trademark Office

United States of America

United States Patent and Trademark Office

DJ'S BAKLAVA

Reg. No. 4,068,066

Registered Dec. 6, 2011

Int. Cl.: 30

TRADEMARK

PRINCIPAL REGISTER

MOURAS, DONNA (UNITED STATES INDIVIDUAL)
23 WINDHAM DRIVE
EASTAMPTON, NJ 08060

FOR: PASTRIES, IN CLASS 30 (U.S. CL. 46).

FIRST USE 9-7-2010; IN COMMERCE 9-7-2010.

THE MARK CONSISTS OF STANDARD CHARACTERS WITHOUT CLAIM TO ANY PARTICULAR FONT, STYLE, SIZE, OR COLOR.

NO CLAIM IS MADE TO THE EXCLUSIVE RIGHT TO USE "BAKLAVA", APART FROM THE MARK AS SHOWN.

SN 85-015,804, FILED 4-16-2010.

MARIA-VICTORIA SUAREZ, EXAMINING ATTORNEY



David J. Kybas

Director of the United States Patent and Trademark Office

United States of America

United States Patent and Trademark Office



Reg. No. 4,068,067

Registered Dec. 6, 2011

Int. Cl.: 35

SERVICE MARK

PRINCIPAL REGISTER

AMERICAN ASSOCIATION OF FAMILY & CONSUMER SCIENCES (D.C. CORPORATION)
SUITE 202
400 N. COLUMBUS STREET
ALEXANDRIA, VA 22314

FOR: ASSOCIATION SERVICES, NAMELY, PROMOTING THE INTERESTS OF THOSE INVOLVED IN IMPROVING THE QUALITY OF INDIVIDUAL, FAMILY AND COMMUNITY LIFE, IN CLASS 35 (U.S. CLS. 100, 101 AND 102).

FIRST USE 6-24-2010; IN COMMERCE 6-24-2010.

OWNER OF U.S. REG. NO. 2,106,699.

THE COLOR(S) BURGUNDY AND NAVY IS/ARE CLAIMED AS A FEATURE OF THE MARK.

NO CLAIM IS MADE TO THE EXCLUSIVE RIGHT TO USE "AMERICAN ASSOCIATION OF FAMILY & CONSUMER SCIENCES", APART FROM THE MARK AS SHOWN.

THE MARK CONSISTS OF A BURGUNDY AND NAVY BETTY LAMP NEXT TO THE LETTERS "AA" IN NAVY AND "FCS" IN BURGUNDY ABOVE THE WORDS "AMERICAN ASSOCIATION OF FAMILY & CONSUMER SCIENCES" IN NAVY.

SN 85-017,194, FILED 4-19-2010.

JEFFREY LOOK, EXAMINING ATTORNEY



David J. Kybas

Director of the United States Patent and Trademark Office

United States of America

United States Patent and Trademark Office

FLEX

Reg. No. 4,068,068

Registered Dec. 6, 2011

Int. Cls.: 35 and 45

SERVICE MARK

PRINCIPAL REGISTER

FENWICK & WEST LLP (CALIFORNIA LIMITED LIABILITY PARTNERSHIP)
801 CALIFORNIA STREET
SILICON VALLEY CENTER
MOUNTAIN VIEW, CA 94041

FOR: LEGAL OUTSOURCING SERVICES, LEGAL INSOURCING SERVICES, IN CLASS 35
(U.S. CLS. 100, 101 AND 102).

FIRST USE 3-0-2010; IN COMMERCE 3-0-2010.

FOR: LEGAL SERVICES, IN CLASS 45 (U.S. CLS. 100 AND 101).

FIRST USE 3-0-2010; IN COMMERCE 3-0-2010.

THE MARK CONSISTS OF STANDARD CHARACTERS WITHOUT CLAIM TO ANY PARTICULAR FONT, STYLE, SIZE, OR COLOR.

SN 85-017,624, FILED 4-19-2010.

JANET LEE, EXAMINING ATTORNEY



David J. Kybas

Director of the United States Patent and Trademark Office

United States of America

United States Patent and Trademark Office

HEALTHSTAGE

Reg. No. 4,068,069

Registered Dec. 6, 2011

Int. Cl.: 35

SERVICE MARK

PRINCIPAL REGISTER

MEDCO HEALTH SOLUTIONS, INC. (DELAWARE CORPORATION)
100 PARSONS POND DRIVE
FRANKLIN LAKES, NJ 07417

FOR: A SERVICE PROVIDING ANALYSIS OF THE ATTRIBUTES OF PRESCRIPTION BENEFIT PLAN MEMBERS TO FACILITATE CUSTOMIZATION OF MATERIALS AND COMMUNICATIONS DIRECTED TO SUCH MEMBERS, IN CLASS 35 (U.S. CLS. 100, 101 AND 102).

FIRST USE 4-27-2011; IN COMMERCE 4-27-2011.

THE MARK CONSISTS OF STANDARD CHARACTERS WITHOUT CLAIM TO ANY PARTICULAR FONT, STYLE, SIZE, OR COLOR.

SN 85-017,882, FILED 4-20-2010.

MICHAEL ENGEL, EXAMINING ATTORNEY



David J. Kyros

Director of the United States Patent and Trademark Office

United States of America
United States Patent and Trademark Office

AQUATRAC

Reg. No. 4,068,070

EXPANDED TECHNOLOGIES CORP (WISCONSIN CORPORATION)
6520 46TH STREET
KENOSHA, WI 53144

Registered Dec. 6, 2011

Int. Cl.: 27

FOR: FLOOR COVERINGS, IN CLASS 27 (U.S. CLS. 19, 20, 37, 42 AND 50).

TRADEMARK

FIRST USE 5-31-2010; IN COMMERCE 5-31-2010.

PRINCIPAL REGISTER

THE MARK CONSISTS OF STANDARD CHARACTERS WITHOUT CLAIM TO ANY PARTICULAR FONT, STYLE, SIZE, OR COLOR.

SN 85-018,402, FILED 4-20-2010.

SIMON TENG, EXAMINING ATTORNEY



David J. Kybas

Director of the United States Patent and Trademark Office

United States of America

United States Patent and Trademark Office

LONG RANGE

Reg. No. 4,068,071

Registered Dec. 6, 2011

Int. Cl.: 25

TRADEMARK

PRINCIPAL REGISTER

ROCKY BRANDS WHOLESALE LLC (DELAWARE LIMITED LIABILITY COMPANY)
39 EAST CANAL STREET
NELSONVILLE, OH 45764

FOR: FOOTWEAR AND APPAREL, NAMELY, T-SHIRTS, PANTS, JEANS, SHIRTS, SWEATSHIRTS, HEADWEAR, BANDANNAS, PARKAS, COVERALLS, WADERS, VESTS, GLOVES, COATS, BIB OVERALLS, RAINWEAR, JACKETS, PULLOVERS; BELTS AND SOCKS, IN CLASS 25 (U.S. CLS. 22 AND 39).

FIRST USE 10-26-2010; IN COMMERCE 10-26-2010.

THE MARK CONSISTS OF STANDARD CHARACTERS WITHOUT CLAIM TO ANY PARTICULAR FONT, STYLE, SIZE, OR COLOR.

SN 85-018,903, FILED 4-20-2010.

SHAUNIA CARLYLE, EXAMINING ATTORNEY



David J. Kybas

Director of the United States Patent and Trademark Office

United States of America

United States Patent and Trademark Office

Forsaken Truth

Reg. No. 4,068,072

Registered Dec. 6, 2011

Int. Cl.: 25

TRADEMARK

PRINCIPAL REGISTER

STANO, JENNIFER (UNITED STATES INDIVIDUAL)
P.O BOX 2909
BEVERLY HILLS, CA 90213

FOR: APPAREL FOR DANCERS, NAMELY, TEE SHIRTS, SWEATSHIRTS, PANTS, LEGGINGS, SHORTS AND JACKETS; BATHING SUITS FOR MEN; BEACH COVER-UPS; BEACH COVERUPS; BEACH FOOTWEAR; BEACH SHOES; BEACHWEAR; BELTS; BERMUDA SHORTS; BOARD SHORTS; BOTTOMS; BOXER SHORTS; CLOTHING FOR ATHLETIC USE, NAMELY, PADDED SHORTS; CLOTHING, NAMELY, ARM WARMERS; CLOTHING, NAMELY, KNEE WARMERS; CLOTHING, NAMELY, WRAP-AROUNDS; FOOTWEAR FOR MEN AND WOMEN; GLOVES AS CLOTHING; GYM SHORTS; HEAD WEAR; HEADBANDS FOR CLOTHING; HOODS; JACKETS; JERSEYS; LEATHER BELTS; LINGERIE ACCESSORIES, NAMELY, REMOVABLE SILICONE BREAST ENHANCER PADS USED IN A BRA; MEN'S AND WOMEN'S JACKETS, COATS, TROUSERS, VESTS; MEN'S UNDERWEAR; PANTIES, SHORTS AND BRIEFS; SANDALS AND BEACH SHOES; SHIRTS AND SHORT-SLEEVED SHIRTS; SHORT SETS; SHORT-SLEEVED OR LONG-SLEEVED T-SHIRTS; SHORT-SLEEVED SHIRTS; SHORTS; SURF WEAR; SWIM WEAR; SWIM WEAR FOR GENTLEMEN AND LADIES; SWIMWEAR; TIES; TOPS; UNDERWEAR, NAMELY, BOY SHORTS, IN CLASS 25 (U.S. CLS. 22 AND 39).

FIRST USE 8-1-2011; IN COMMERCE 9-1-2011.

THE MARK CONSISTS OF STANDARD CHARACTERS WITHOUT CLAIM TO ANY PARTICULAR FONT, STYLE, SIZE, OR COLOR.

SN 85-018,956, FILED 4-21-2010.

LINDA ESTRADA, EXAMINING ATTORNEY



David J. Kyros

Director of the United States Patent and Trademark Office

United States of America

United States Patent and Trademark Office

J. BOUCHON

Reg. No. 4,068,073

Registered Dec. 6, 2011

Int. Cl.: 33

TRADEMARK

PRINCIPAL REGISTER

J. BOUCHON COMPANIA LIMITADA (CHILE CORPORATION)
OFICINA 23
EVARISTO LILLO 178
LAS CONDES, SANTIAGO, CHILE

FOR: WINE, IN CLASS 33 (U.S. CLS. 47 AND 49).

FIRST USE 12-0-2010; IN COMMERCE 12-0-2010.

THE MARK CONSISTS OF STANDARD CHARACTERS WITHOUT CLAIM TO ANY PARTICULAR FONT, STYLE, SIZE, OR COLOR.

THE NAME "J. BOUCHON" IDENTIFIES A LIVING INDIVIDUAL WHOSE CONSENT IS OF RECORD.

THE ENGLISH TRANSLATION OF THE WORD "BOUCHON" IN THE MARK IS CORK, STOPPER, OR PLUG.

SN 85-020,729, FILED 4-22-2010.

MAYUR VAGHANI, EXAMINING ATTORNEY



David J. Kybas

Director of the United States Patent and Trademark Office

United States of America

United States Patent and Trademark Office

Chemin de Fer

Reg. No. 4,068,074

Registered Dec. 6, 2011

Int. Cl.: 33

TRADEMARK

PRINCIPAL REGISTER

JOHN A. LASSETER AND NANCY T. LASSETER, TRUSTEES OF THE LASSETER LIVING TRUST (CALIFORNIA TRUST)
ONE VINTAGE LANE
GLEN ELLEN, CA 95442

FOR: WINES, IN CLASS 33 (U.S. CLS. 47 AND 49).

FIRST USE 3-10-2011; IN COMMERCE 3-10-2011.

THE MARK CONSISTS OF STANDARD CHARACTERS WITHOUT CLAIM TO ANY PARTICULAR FONT, STYLE, SIZE, OR COLOR.

THE ENGLISH TRANSLATION OF "CHEMIN DE FER" IN THE MARK IS "RAILWAY".

SN 85-021,250, FILED 4-22-2010.

TRACY CROSS, EXAMINING ATTORNEY



David J. Kyros

Director of the United States Patent and Trademark Office

United States of America

United States Patent and Trademark Office

PRESIDENTIAL RESERVE SUITE

Reg. No. 4,068,075

WYNDHAM TM CORP. (DELAWARE CORPORATION)
10750 WEST CHARLESTON BLVD., SUITE 130
LAS VEGAS, NV 89135

Registered Dec. 6, 2011

Int. Cl.: 36

FOR: VACATION REAL ESTATE TIMESHARE SERVICES, IN CLASS 36 (U.S. CLS. 100, 101 AND 102).

SERVICE MARK

FIRST USE 7-1-2010; IN COMMERCE 7-1-2010.

PRINCIPAL REGISTER

THE MARK CONSISTS OF STANDARD CHARACTERS WITHOUT CLAIM TO ANY PARTICULAR FONT, STYLE, SIZE, OR COLOR.

OWNER OF U.S. REG. NO. 3,658,789.

NO CLAIM IS MADE TO THE EXCLUSIVE RIGHT TO USE "SUITE", APART FROM THE MARK AS SHOWN.

SN 85-021,703, FILED 4-23-2010.

JANET LEE, EXAMINING ATTORNEY



David J. Kybas

Director of the United States Patent and Trademark Office

United States of America

United States Patent and Trademark Office

We want you well.

Reg. No. 4,068,076

Registered Dec. 6, 2011

Int. Cl.: 44

SERVICE MARK

PRINCIPAL REGISTER

AMERICAN MULTISPECIALTY GROUP, INC. (MISSOURI CORPORATION), DBA ESSE
HEALTH,
12655 OLIVE BLVD., 4TH FLOOR
ST. LOUIS, MO 63141

FOR: MEDICAL SERVICES, IN CLASS 44 (U.S. CLS. 100 AND 101).

FIRST USE 9-1-2010; IN COMMERCE 9-1-2010.

NO CLAIM IS MADE TO THE EXCLUSIVE RIGHT TO USE "WE WANT YOU WELL",
APART FROM THE MARK AS SHOWN.

THE COLOR(S) WHITE AND TEAL IS/ARE CLAIMED AS A FEATURE OF THE MARK.

THE MARK CONSISTS OF THE WORDING "WE WANT YOU WELL." IN A STYLIZED
TEAL FONT.

SN 85-022,052, FILED 4-23-2010.

ELLEN PERKINS, EXAMINING ATTORNEY



David J. Kybas

Director of the United States Patent and Trademark Office

United States of America

United States Patent and Trademark Office



Reg. No. 4,068,077

Registered Dec. 6, 2011

Int. Cl.: 5

TRADEMARK

PRINCIPAL REGISTER

TAIWAN SUNPAN BIOTECHNOLOGY DEVELOPMENT CO., LTD. (TAIWAN CORPORATION)
7F.-5, NO. 1071, CHUNG-CHENG RD.
TAUYUAN, TAIWAN

FOR: MEDICINAL HERBAL PREPARATIONS, NAMELY, GALENICALS; ORAL ANALGESICS; ANTI-INFLAMMATORY DRUGS; PRESCRIPTION SYNTHETIC AND EXTRACTED NARCOTICS; ANTI-CARCINOGEN PREPARATION; ANTI-DIABETES PREPARATION, NAMELY, PHARMACEUTICAL PREPARATIONS FOR TREATING DIABETES; CHOLESTEROL LOWERING DRUGS; ANTIDIARRHEAL PREPARATIONS, NAMELY, DIARRHEA MEDICATION; ANTINEOPLASTIC AGENTS, NAMELY, PHARMACEUTICAL PREPARATIONS FOR USE IN CHEMOTHERAPY AND IN CURING TUMORS AND CANCER; ANTI-HYPERTENSION DRUGS; WESTERN PHARMACEUTICAL PREPARATIONS FOR USE IN OR AS ANTIDEPRESSANTS, ANTICOAGULANTS, ANTI-CANCER DRUGS; CHINESE HERBAL PHARMACEUTICAL PREPARATIONS, NAMELY, MEDICINAL HERBAL PREPARATIONS; MEDICINE AND PHARMACEUTICAL PREPARATIONS FOR CENTRAL NERVOUS SYSTEM; CARDIOVASCULAR AGENTS, NAMELY, CARDIOVASCULAR TREATMENT PREPARATIONS AND CARDIOVASCULAR PHARMACEUTICALS; PHARMACEUTICAL PREPARATIONS FOR PREVENTING AND CURING HYPERTENSION AND CIRCULATORY SYSTEM DISEASES; MEDICINE AND PHARMACEUTICAL PREPARATIONS FOR HUMAN USE, NAMELY, SEDATIVES, ANTIALLERGIC MEDICINES, PHARMACEUTICAL PREPARATIONS, NAMELY, SYNTHETIC OR EXTRACTED PHARMACEUTICAL PREPARATIONS FOR ORAL OR INJECTION ADMINISTRATION TO CURE CANCER, TUMORS, AND DISEASES, ANTI-CONVULSION PREPARATIONS, MEDICINES FOR THE HUMAN BRAIN; ANTIVIRAL AGENTS; ANTISPASMODICS, NAMELY, PHARMACEUTICAL PREPARATIONS TO RELIEVE CRAMPS OR SPASMS OF THE STOMACH, INTESTINES, AND BLADDER, IN CLASS 5 (U.S. CLS. 6, 18, 44, 46, 51 AND 52).

FIRST USE 10-1-2011; IN COMMERCE 10-1-2011.

THE MARK CONSISTS OF THE LETTERS "TSB" HAVING A BROKEN LINE GOING THROUGH THE BOTTOM OF THE LETTERS AND FIVE CIRCLES WITH LIGHT SPOTS IN THE UPPER LEFT HAND CORNER STARTING NEXT TO THE LETTER "T" AND CONTINUING ABOVE THE LETTERS "TSB" AND GETTING SMALLER IN SIZE AND ENDING TO THE RIGHT OF THE LETTER "B".



David J. Kappas

Director of the United States Patent and Trademark Office

SN 85-022,695, FILED 4-26-2010.

Reg. No. 4,068,077 LINDSEY RUBIN, EXAMINING ATTORNEY

United States of America

United States Patent and Trademark Office

PACKAGING EXPERTISE

Reg. No. 4,068,078

Registered Dec. 6, 2011

Int. Cls.: 40 and 42

SERVICE MARK

PRINCIPAL REGISTER

INTERNATIONAL PAPER COMPANY (NEW YORK CORPORATION)
6400 POPLAR AVENUE
MEMPHIS, TN 38197

FOR: COATING, PRINTING, FINISHING, CUSTOM MANUFACTURING AND CONVERTING OF PAPER AND PAPERBOARD INTO CONSUMER AND INDUSTRIAL SHIPPING AND DISPLAY PACKAGING FOR OTHERS, IN CLASS 40 (U.S. CLS. 100, 103 AND 106).

FIRST USE 4-30-2010; IN COMMERCE 4-30-2010.

FOR: DESIGN OF CONSUMER AND INDUSTRIAL SHIPPING AND DISPLAY PACKAGING FOR OTHERS, IN CLASS 42 (U.S. CLS. 100 AND 101).

FIRST USE 4-30-2010; IN COMMERCE 4-30-2010.

THE MARK CONSISTS OF STANDARD CHARACTERS WITHOUT CLAIM TO ANY PARTICULAR FONT, STYLE, SIZE, OR COLOR.

NO CLAIM IS MADE TO THE EXCLUSIVE RIGHT TO USE "PACKAGING", APART FROM THE MARK AS SHOWN.

SN 85-022,707, FILED 4-26-2010.

PAULA MAHONEY, EXAMINING ATTORNEY



David J. Kybas

Director of the United States Patent and Trademark Office

United States of America

United States Patent and Trademark Office

three
Springs

Reg. No. 4,068,079

Registered Dec. 6, 2011

Int. Cl.: 44

SERVICE MARK

PRINCIPAL REGISTER

GERMAN AMERICAN CAPITAL CORPORATION (MARYLAND CORPORATION)
60 WALL STREET
NEW YORK, NY 10005

FOR: DAY SPA SERVICES, NAMELY, NAIL CARE, MANICURES, PEDICURES AND NAIL ENHANCEMENTS; HEALTH SPA SERVICES FOR HEALTH AND WELLNESS OF THE BODY AND SPIRIT OFFERED AT A HEALTH RESORT; HEALTH SPA SERVICES FOR HEALTH AND WELLNESS OF THE BODY AND SPIRIT, NAMELY, PROVIDING MASSAGE, FACIAL AND BODY TREATMENT SERVICES, COSMETIC BODY CARE SERVICES, IN CLASS 44 (U.S. CLS. 100 AND 101).

FIRST USE 3-1-2010; IN COMMERCE 6-1-2010.

THE MARK CONSISTS OF THE WORD "THREE" WHICH IS IN LOWER CASE LETTERS ABOVE THE LETTER "P" AND "R" OF THE WORD "SPRINGS". THE "G" IN "SPRINGS" IS A SQUIGGLY LINE LARGER THAN THE REMAINDER OF THE WORD "SPRINGS".

SN 85-023,167, FILED 4-26-2010.

KELLY BOULTON, EXAMINING ATTORNEY



David J. Kybas

Director of the United States Patent and Trademark Office

United States of America

United States Patent and Trademark Office

BIOLAMINA

Reg. No. 4,068,080

BIOLAMINA AB (SWEDEN CORPORATION)
SCHEELES VÄG 2
SOLNA, SWEDEN 17165

Registered Dec. 6, 2011

Int. Cls.: 1, 9, 41, and 42

FOR: CHEMICAL BUFFERS, CHEMICAL REAGENTS AND OTHER CHEMICALS FOR USE WITHIN CELL BIOLOGICAL, MOLECULAR BIOLOGICAL AND BIOCHEMICAL RESEARCH WITHIN ACADEMIA AND INDUSTRY, IN CLASS 1 (U.S. CLS. 1, 5, 6, 10, 26 AND 46).

TRADEMARK

FIRST USE 12-0-2009; IN COMMERCE 12-0-2009.

SERVICE MARK

FOR: LABORATORY KITS FOR THE ANALYSIS OF CELLS, PROTEINS AND MOLECULES CONSISTING OF PURIFICATION APPARATUS, NAMELY, CELL SORTING AND SEPARATING APPARATUS, PREPARATIVE CARTRIDGES AND CELL CULTURE DISHES, CHROMATOGRAPHY COLUMNS, CHEMICAL BUFFERS AND CHEMICAL REAGENTS FOR SCIENTIFIC AND INDUSTRIAL USE, AND NOT FOR MEDICAL USE, IN CLASS 9 (U.S. CLS. 21, 23, 26, 36 AND 38).

PRINCIPAL REGISTER

FIRST USE 12-0-2009; IN COMMERCE 12-0-2009.

FOR: EDUCATIONAL SERVICES, NAMELY, PROVIDING TRAINING IN THE AREAS OF CELLULAR BIOLOGY, MOLECULAR BIOLOGY, BIOCHEMISTRY, REPRODUCTIVE SCIENCE, HUMAN GENETICS AND STEM CELL RESEARCH, IN CLASS 41 (U.S. CLS. 100, 101 AND 107).

FIRST USE 1-0-2009; IN COMMERCE 1-0-2009.

FOR: SCIENTIFIC RESEARCH IN THE FIELDS OF CELLULAR BIOLOGY, MOLECULAR BIOLOGY, BIOCHEMISTRY, REPRODUCTIVE SCIENCE, HUMAN GENETICS AND STEM CELLS, NAMELY, CLINICAL TRIALS FOR RESEARCH PURPOSES, GENETIC TESTING FOR RESEARCH PURPOSES, RESEARCH LABORATORY TESTING, DIAGNOSTIC TESTING FOR RESEARCH PURPOSES, CONDUCTING CLINICAL TRIALS; SCIENTIFIC RESEARCH IN THE FIELDS OF CELLULAR BIOLOGY, MOLECULAR BIOLOGY, BIOCHEMISTRY, REPRODUCTIVE SCIENCE, HUMAN GENETICS AND STEM CELLS, IN CLASS 42 (U.S. CLS. 100 AND 101).

FIRST USE 1-0-2009; IN COMMERCE 1-0-2009.



David J. Kyjars

Director of the United States Patent and Trademark Office

Reg. No. 4,068,080 THE MARK CONSISTS OF STANDARD CHARACTERS WITHOUT CLAIM TO ANY PARTICULAR FONT, STYLE, SIZE, OR COLOR.

SN 85-024,389, FILED 4-27-2010.

LINDSEY RUBIN, EXAMINING ATTORNEY

United States of America

United States Patent and Trademark Office

Piccolo Composite

Reg. No. 4,068,081

Registered Dec. 6, 2011

Int. Cl.: 10

TRADEMARK

PRINCIPAL REGISTER

N.M.B MEDICAL APPLICATIONS LTD. (ISRAEL CORPORATION)
11 HA'HOSHLIM ST.
HERZELIA, ISRAEL 46724

FOR: BONE IMPLANTS COMPOSED OF ARTIFICIAL MATERIALS; BONE SCREWS; IN-TRAMEDULLARY NAILS; MEDICAL AND SURGICAL APPARATUS AND INSTRUMENTS, NAMELY, ORTHOPEDIC FIXATION DEVICE USED IN ORTHOPEDIC TRANSPLANT AND/OR IMPLANT SURGERY; MEDICAL, SURGICAL AND ORTHOPAEDIC IMPLANTS MADE OF ARTIFICIAL MATERIALS; SURGICAL IMPLANTS COMPRISING ARTIFICIAL MATERIAL; SURGICAL IMPLANTS COMPRISING ARTIFICIAL MATERIAL AND ASSOCIATED SURGICAL INSTRUMENT SETS, IN CLASS 10 (U.S. CLS. 26, 39 AND 44).

FIRST USE 5-5-2010; IN COMMERCE 5-24-2010.

THE MARK CONSISTS OF STANDARD CHARACTERS WITHOUT CLAIM TO ANY PARTICULAR FONT, STYLE, SIZE, OR COLOR.

NO CLAIM IS MADE TO THE EXCLUSIVE RIGHT TO USE "COMPOSITE", APART FROM THE MARK AS SHOWN.

SN 85-024,876, FILED 4-28-2010.

ELIZABETH KAJUBI, EXAMINING ATTORNEY



David J. Kypos

Director of the United States Patent and Trademark Office

United States of America

United States Patent and Trademark Office

SPORTEX

Reg. No. 4,068,082

DIVERSIFIED PRODUCTS, INC. (PENNSYLVANIA CORPORATION)
4 BLUE HERON DRIVE
COLLEGEVILLE, PA 19426

Registered Dec. 6, 2011

Int. Cl.: 9

FOR: NON-PRESCRIPTION READING GLASSES, IN CLASS 9 (U.S. CLS. 21, 23, 26, 36 AND 38).

TRADEMARK

FIRST USE 2-17-2010; IN COMMERCE 2-17-2010.

PRINCIPAL REGISTER

THE MARK CONSISTS OF STANDARD CHARACTERS WITHOUT CLAIM TO ANY PARTICULAR FONT, STYLE, SIZE, OR COLOR.

SN 85-024,946, FILED 4-28-2010.

MARK RADEMACHER, EXAMINING ATTORNEY



David J. Kybas

Director of the United States Patent and Trademark Office

United States of America

United States Patent and Trademark Office

SYNDUET

Reg. No. 4,068,083

WYETH LLC (DELAWARE LIMITED LIABILITY COMPANY)
FIVE GIRALDA FARMS
MADISON, NJ 07940

Registered Dec. 6, 2011

Int. Cl.: 5

FOR: PROBIOTIC NUTRITIONAL SUPPLEMENT FOR HUMANS, IN CLASS 5 (U.S. CLS. 6, 18, 44, 46, 51 AND 52).

TRADEMARK

FIRST USE 9-1-2011; IN COMMERCE 9-1-2011.

PRINCIPAL REGISTER

THE MARK CONSISTS OF STANDARD CHARACTERS WITHOUT CLAIM TO ANY PARTICULAR FONT, STYLE, SIZE, OR COLOR.

SN 85-025,516, FILED 4-28-2010.

JENNIFER VASQUEZ, EXAMINING ATTORNEY



David J. Kybas

Director of the United States Patent and Trademark Office

United States of America

United States Patent and Trademark Office

DBLOGIC

Reg. No. 4,068,084

Registered Dec. 6, 2011

Int. Cl.: 40

SERVICE MARK

PRINCIPAL REGISTER

MWM MOBILE PRODUCTS, LLC (INDIANA LIMITED LIABILITY COMPANY)
6602 E. 75TH STREET, SUITE 520
INDIANAPOLIS, IN 46250

FOR: CUSTOM MANUFACTURE OF AUDIO CONDUIT, AMPLIFICATION AND MONITORING DEVICES AND ACOUSTIC SEPARATION DEVICES, IN CLASS 40 (U.S. CLS. 100, 103 AND 106).

FIRST USE 9-30-2010; IN COMMERCE 9-30-2010.

THE MARK CONSISTS OF STANDARD CHARACTERS WITHOUT CLAIM TO ANY PARTICULAR FONT, STYLE, SIZE, OR COLOR.

SN 85-026,317, FILED 4-29-2010.

VERNA BETH RIRIE, EXAMINING ATTORNEY



David J. Kyros

Director of the United States Patent and Trademark Office

United States of America

United States Patent and Trademark Office

We Make Websites Easy

Reg. No. 4,068,085

Registered Dec. 6, 2011

**Int. Cls.: 9, 35, 39, 42,
and 45**

GODADDY.COM, INC. (ARIZONA CORPORATION)
14455 N. HAYDEN ROAD, SUITE 219
SCOTTSDALE, AZ 85260

FOR: WEB SITE DEVELOPMENT SOFTWARE, IN CLASS 9 (U.S. CLS. 21, 23, 26, 36 AND 38).

FIRST USE 5-30-2010; IN COMMERCE 5-30-2010.

TRADEMARK

SERVICE MARK

FOR: ONLINE AUCTION SERVICES; AUCTION MANAGEMENT SERVICES PROVIDED TO OTHERS OVER AN ON-LINE WEB SITE ACCESSED THROUGH A GLOBAL COMPUTER NETWORK, IN CLASS 35 (U.S. CLS. 100, 101 AND 102).

PRINCIPAL REGISTER

FIRST USE 5-30-2010; IN COMMERCE 5-30-2010.

FOR: PARKING DOMAIN NAMES FOR OTHERS, NAMELY, PROVIDING COMPUTER SERVERS FOR FACILITATION OF THE STORAGE OF DOMAIN NAME ADDRESSES, IN CLASS 39 (U.S. CLS. 100 AND 105).

FIRST USE 5-30-2010; IN COMMERCE 5-30-2010.

FOR: DESIGN, CREATION, HOSTING, MAINTENANCE OF WEBSITES FOR OTHERS; WEBSITE DEVELOPMENT FOR OTHERS; COMPUTER SERVICES, NAMELY, CREATING AND MAINTAINING WEB SITES FOR OTHERS; COMPUTER SERVICES, NAMELY, DESIGNING AND IMPLEMENTING WEB SITES FOR OTHERS; CREATING OR MAINTAINING WEB SITES FOR OTHERS; HOSTING THE WEB SITES OF OTHERS ON A COMPUTER SERVER FOR A GLOBAL COMPUTER NETWORK; WEB SITE HOSTING SERVICES, IN CLASS 42 (U.S. CLS. 100 AND 101).

FIRST USE 5-30-2010; IN COMMERCE 5-30-2010.

FOR: REGISTRATION OF DOMAIN NAMES FOR IDENTIFICATION OF USERS ON A GLOBAL COMPUTER NETWORK, IN CLASS 45 (U.S. CLS. 100 AND 101).

FIRST USE 5-30-2010; IN COMMERCE 5-30-2010.



David J. Kybas

Director of the United States Patent and Trademark Office

Reg. No. 4,068,085 THE MARK CONSISTS OF STANDARD CHARACTERS WITHOUT CLAIM TO ANY PARTICULAR FONT, STYLE, SIZE, OR COLOR.

SN 85-026,324, FILED 4-29-2010.

KAREN K. BUSH, EXAMINING ATTORNEY

United States of America

United States Patent and Trademark Office



Reg. No. 4,068,086

Registered Dec. 6, 2011

Int. Cl.: 30

TRADEMARK

PRINCIPAL REGISTER

TYSON FOODS, INC. (DELAWARE CORPORATION)
2200 DON TYSON PARKWAY
SPRINGDALE, AR 72762

FOR: TORTILLAS, IN CLASS 30 (U.S. CL. 46).

FIRST USE 1-0-1997; IN COMMERCE 1-0-1997.

OWNER OF U.S. REG. NO. 3,178,826.

NO CLAIM IS MADE TO THE EXCLUSIVE RIGHT TO USE "ORIGINAL WRAPS" , APART FROM THE MARK AS SHOWN.

THE MARK CONSISTS OF THE WORDS "ORIGINAL WRAPS" WITH A SWIRL ON THE "W" FORMING THE "O" IN "ORIGINAL" WITH SWIRLY LINES SURROUNDING THE WORDS.

SN 85-027,007, FILED 4-30-2010.

JOHN GARTNER, EXAMINING ATTORNEY



David J. Kybas

Director of the United States Patent and Trademark Office

United States of America

United States Patent and Trademark Office

DELIMEX

Reg. No. 4,068,087

Registered Dec. 6, 2011

Int. Cls.: 29 and 30

TRADEMARK

PRINCIPAL REGISTER

H. J. HEINZ FINANCE COMPANY (DELAWARE CORPORATION)
ONE PPG PLACE, SUITE 3100
PITTSBURGH, PA 15222

FOR: FROZEN, PREPARED OR PACKAGED MEALS, ENTREES OR APPETIZERS CONSISTING OF MEAT, FISH, POULTRY, BEANS, VEGETABLES OR CHEESE, IN CLASS 29 (U.S. CL. 46).

FIRST USE 8-31-2010; IN COMMERCE 8-31-2010.

FOR: FROZEN, PREPARED OR PACKAGED MEALS, ENTREES OR APPETIZERS CONSISTING OF RICE, IN CLASS 30 (U.S. CL. 46).

FIRST USE 8-31-2010; IN COMMERCE 8-31-2010.

THE MARK CONSISTS OF STANDARD CHARACTERS WITHOUT CLAIM TO ANY PARTICULAR FONT, STYLE, SIZE, OR COLOR.

OWNER OF U.S. REG. NOS. 1,658,372, 3,507,244, AND OTHERS.

SN 85-027,031, FILED 4-30-2010.

SUSAN RICHARDS, EXAMINING ATTORNEY



David J. Kybas

Director of the United States Patent and Trademark Office

United States of America

United States Patent and Trademark Office



Reg. No. 4,068,088

Registered Dec. 6, 2011

Int. Cl.: 25

TRADEMARK

PRINCIPAL REGISTER

LEONISA S.A. (COLOMBIA CORPORATION)
CARRERA 51 NO. 13-158
MEDELLIN, COLOMBIA

FOR: CLOTHING FOR MEN, WOMEN AND CHILDREN, NAMELY, UNDERWEAR, LINGERIE, KNICKERS, BRASSIERES, VESTS, BRIEFS, BOXERS, STOCKINGS, SOCKS, TIGHTS, LEGGINGS, GARTERS, PYJAMAS, SLEEP SHIRTS, ROBES, BEACHWEAR AND SWIMWEAR, INCLUDING SWIMMING COSTUMES, SWIM SHORTS, BEACH COVER UPS, IN CLASS 25 (U.S. CLS. 22 AND 39).

FIRST USE 7-28-2010; IN COMMERCE 11-22-2010.

OWNER OF U.S. REG. NOS. 2,352,263 AND 2,467,355.

THE COLOR(S) PINK AND WHITE IS/ARE CLAIMED AS A FEATURE OF THE MARK.

THE MARK CONSISTS OF STYLIZED WORDING "T.Q.M BY LEONISA" IN PINK WITH A WHITE HEART IN THE CENTER OF THE LETTER "Q".

SN 85-027,605, FILED 4-30-2010.

KATHY DE JONGE, EXAMINING ATTORNEY



David J. Kyffers

Director of the United States Patent and Trademark Office

United States of America

United States Patent and Trademark Office

jupiter oil

Reg. No. 4,068,089

ALICIA ALONZO LLC (LOUISIANA LIMITED LIABILITY COMPANY)
1101 TCHOUPITOULAS
NEW ORLEANS, LA 70130

Registered Dec. 6, 2011

Int. Cl.: 3

FOR: BODY AND BEAUTY CARE COSMETICS, IN CLASS 3 (U.S. CLS. 1, 4, 6, 50, 51 AND 52).

TRADEMARK

FIRST USE 11-13-2010; IN COMMERCE 3-5-2011.

PRINCIPAL REGISTER

THE MARK CONSISTS OF STANDARD CHARACTERS WITHOUT CLAIM TO ANY PARTICULAR FONT, STYLE, SIZE, OR COLOR.

SN 85-027,813, FILED 4-30-2010.

DOMINIC J. FERRAIUOLO, EXAMINING ATTORNEY



David J. Kybas

Director of the United States Patent and Trademark Office

United States of America

United States Patent and Trademark Office

Family Financial Hospice

Reg. No. 4,068,090

Registered Dec. 6, 2011

Int. Cl.: 36

SERVICE MARK

PRINCIPAL REGISTER

EVANS FINANCIAL GROUP (LOUISIANA CORPORATION)
7600 FERN AVENUE
#1200
SHREVEPORT, LA 71105

FOR: INSURANCE AND FINANCIAL PLANNING SERVICES, NAMELY, INSURANCE BROKERAGE SERVICES, FINANCIAL PLANNING SERVICES, AND INSURANCE AND FINANCIAL PLANNING CONSULTING SERVICES, IN CLASS 36 (U.S. CLS. 100, 101 AND 102).

FIRST USE 1-25-2011; IN COMMERCE 1-25-2011.

THE MARK CONSISTS OF STANDARD CHARACTERS WITHOUT CLAIM TO ANY PARTICULAR FONT, STYLE, SIZE, OR COLOR.

NO CLAIM IS MADE TO THE EXCLUSIVE RIGHT TO USE "FAMILY FINANCIAL", APART FROM THE MARK AS SHOWN.

SN 85-028,814, FILED 5-3-2010.

DOMINICK J. SALEMI, EXAMINING ATTORNEY



David J. Kybas

Director of the United States Patent and Trademark Office

United States of America

United States Patent and Trademark Office

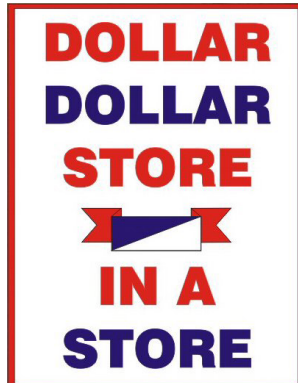

Reg. No. 4,068,091

Registered Dec. 6, 2011

Int. Cl.: 35

SERVICE MARK

PRINCIPAL REGISTER

JOE D. REYNOLDS (UNITED STATES INDIVIDUAL)
P.O. BOX 339
POSEYVILLE, IN 47633

FOR: BUSINESS CONSULTATION IN THE FIELD OF RETAIL STORES; RETAIL STORE SERVICES FEATURING GENERAL CONSUMER MERCHANDISE, IN CLASS 35 (U.S. CLS. 100, 101 AND 102).

FIRST USE 5-17-2011; IN COMMERCE 10-10-2011.

NO CLAIM IS MADE TO THE EXCLUSIVE RIGHT TO USE "DOLLAR, DOLLAR STORE AND STORE", APART FROM THE MARK AS SHOWN.

THE COLOR(S) RED, WHITE AND BLUE IS/ARE CLAIMED AS A FEATURE OF THE MARK.

THE MARK CONSISTS OF A RED RECTANGULAR BORDER WITH A WHITE INTERIOR; THE WORD "DOLLAR" IS AT THE TOP IN RED; BELOW THIS IS THE WORD "DOLLAR" IN BLUE; BELOW THIS IS THE WORD "STORE" IN RED; BELOW THIS IS A BANNER THAT IS RED AT EACH END WITH A RECTANGLE IN THE CENTER THAT IS DIVIDED INTO A BLUE TRIANGULAR SHAPE AT THE TOP AND A WHITE TRIANGULAR SHAPE AT THE BOTTOM; BELOW THIS ARE THE WORDS "IN A" IN RED; BELOW THIS IS THE WORD "STORE" IN BLUE.

SN 85-028,862, FILED 5-3-2010.

MARY CRAWFORD, EXAMINING ATTORNEY



David J. Kybas

Director of the United States Patent and Trademark Office

United States of America

United States Patent and Trademark Office

What do you want to
happen, when what's going
to happen, happens?

Reg. No. 4,068,092

Registered Dec. 6, 2011

Int. Cl.: 36

SERVICE MARK

PRINCIPAL REGISTER

EVANS FINANCIAL GROUP (LOUISIANA CORPORATION)
7600 FERN AVENUE
#1200
SHREVEPORT, LA 71105

FOR: INSURANCE AND FINANCIAL PLANNING SERVICES, NAMELY, INSURANCE BROKERAGE SERVICES, FINANCIAL PLANNING SERVICES, AND INSURANCE AND FINANCIAL PLANNING CONSULTING SERVICES, IN CLASS 36 (U.S. CLS. 100, 101 AND 102).

FIRST USE 1-25-2011; IN COMMERCE 1-25-2011.

THE MARK CONSISTS OF STANDARD CHARACTERS WITHOUT CLAIM TO ANY PARTICULAR FONT, STYLE, SIZE, OR COLOR.

SN 85-028,887, FILED 5-3-2010.

DOMINICK J. SALEMI, EXAMINING ATTORNEY



David J. Kybas

Director of the United States Patent and Trademark Office

United States of America

United States Patent and Trademark Office



Reg. No. 4,068,093

Registered Dec. 6, 2011

Int. Cl.: 43

SERVICE MARK

PRINCIPAL REGISTER

CROOKED PINT, LLC (MINNESOTA LIMITED LIABILITY COMPANY)
1342 GRAND AVENUE
ST. PAUL, MN 55105

FOR: RESTAURANT AND BAR SERVICES, IN CLASS 43 (U.S. CLS. 100 AND 101).

FIRST USE 9-10-2011; IN COMMERCE 9-10-2011.

NO CLAIM IS MADE TO THE EXCLUSIVE RIGHT TO USE "ALE HOUSE", APART FROM THE MARK AS SHOWN.

THE COLOR(S) BLACK, WHITE, AND YELLOW IS/ARE CLAIMED AS A FEATURE OF THE MARK.

THE MARK CONSISTS OF AN IMAGE DEPICTING A GLASS FILLED WITH ALE, THE GLASS IS THE COLOR WHITE, OUTLINED IN THE COLOR BLACK, THE GLASS IS FILLED WITH THE COLOR YELLOW, DEPICTING ALE. THE WORDS "CROOKED PINT", IN THE COLOR BLACK, FORM A HALF CIRCLE SURROUNDING THE TOP OF THE GLASS, AND THE WORDS "ALE HOUSE", IN THE COLOR BLACK, FORM A HALF CIRCLE AROUND THE BOTTOM PORTION OF THE GLASS. THERE IS A SMALL DESIGN, IN THE FORM OF 5 FLOWER PETALS, SIMILAR TO AN ASTERISK, PRECEDING THE WORD CROOKED AND FOLLOWING THE WORD PINT.

SN 85-029,333, FILED 5-4-2010.

KELLY TRUSILO, EXAMINING ATTORNEY



David J. Kybas

Director of the United States Patent and Trademark Office

United States of America

United States Patent and Trademark Office



Reg. No. 4,068,094

Registered Dec. 6, 2011

Int. Cl.: 25

TRADEMARK

PRINCIPAL REGISTER

BILLY BUOY SPORTSWEAR INC. (CANADA CORPORATION)
414 HERKIMER STREET
HAMILTON, ONTARIO, CANADA L8P2J3

FOR: CLOTHING, NAMELY, SHIRTS AND HATS; GOLF WEAR IN THE NATURE OF JACKETS, RAINWEAR; AND SPORTS CLOTHING, NAMELY, FISHING TACKLE VESTS, IN CLASS 25 (U.S. CLS. 22 AND 39).

FIRST USE 1-1-1996; IN COMMERCE 5-24-2010.

THE MARK CONSISTS OF THE MARK CONSISTS OF THE STYLIZED WORDING "BILLY BUOY". BOTH WORDS SHARE A LETTER "B" WHICH INCLUDES A STYLIZED FISHING HOOK AT THE TOP AND A FISH AT THE BOTTOM, THE EYE OF WHICH FISH DOUBLES AS A GOLF BALL. THE VERTICAL LINE OF THE LETTER "B" IS COMPRISED OF A GOLF HOLE AND FLAG. THE LETTER "I" CONTAINS A GOLF BALL AS THE DOT. THE LETTERS "L" ARE BOTH FISH STANDING ON THEIR TAILS. THE EYE OF BOTH OF THESE FISH ARE GOLF BALLS. THE TAILS OF BOTH LETTERS "Y" ARE FISHING HOOKS.

SN 85-029,799, FILED 5-4-2010.

TARAH HARDY, EXAMINING ATTORNEY



David J. Kyffers

Director of the United States Patent and Trademark Office

United States of America

United States Patent and Trademark Office

FLOSS & GLOSS TIRE GLAZE

Reg. No. 4,068,095

Registered Dec. 6, 2011

Int. Cl.: 3

TRADEMARK

PRINCIPAL REGISTER

WRIGHT TOUCH HAND CAR WASH & DETAILING (INDIANA LIMITED LIABILITY COMPANY)
4989 BROADWAY
GARY, IN 46409

FOR: TIRE DRESSINGS, NAMELY, TIRE GEL THAT ENHANCES THE LOOK AND PROTECTION OF AN AUTOMOBILE'S TIRES, IN CLASS 3 (U.S. CLS. 1, 4, 6, 50, 51 AND 52).

FIRST USE 10-11-2010; IN COMMERCE 10-15-2010.

THE MARK CONSISTS OF STANDARD CHARACTERS WITHOUT CLAIM TO ANY PARTICULAR FONT, STYLE, SIZE, OR COLOR.

NO CLAIM IS MADE TO THE EXCLUSIVE RIGHT TO USE "TIRE GLAZE", APART FROM THE MARK AS SHOWN.

SN 85-030,503, FILED 5-5-2010.

LINDSEY RUBIN, EXAMINING ATTORNEY



David J. Kyros

Director of the United States Patent and Trademark Office

United States of America

United States Patent and Trademark Office



Reg. No. 4,068,096

Registered Dec. 6, 2011

Int. Cl.: 43

SERVICE MARK

PRINCIPAL REGISTER

SODEXO OPERATIONS, LLC (DELAWARE LIMITED LIABILITY COMPANY)
9801 WASHINGTONIAN BOULEVARD
GAITHERSBURG, MD 20878

FOR: CONTRACT FOOD SERVICES, IN CLASS 43 (U.S. CLS. 100 AND 101).

FIRST USE 10-4-2011; IN COMMERCE 10-4-2011.

NO CLAIM IS MADE TO THE EXCLUSIVE RIGHT TO USE "FRESH MEXICAN GRILL",
APART FROM THE MARK AS SHOWN.

THE COLOR(S) BLACK, WHITE, RED, ORANGE AND YELLOW IS/ARE CLAIMED AS A
FEATURE OF THE MARK.

THE MARK CONSISTS OF THE WORDS "CON FLAVOR" ON A BLACK RECTANGULAR
BACKGROUND, WITH "CON" SHOWN IN WHITE AND "FLAVOR" SHOWN IN A SERIES
OF HORIZONTALLY ORIENTED STRIATIONS OF RED, ORANGE, YELLOW AND BLACK
WHICH FORM THE LETTERS, AND THE WORDING "FRESH MEXICAN GRILL" SHOWN
BENEATH.

THE ENGLISH TRANSLATION OF "CON" IN THE MARK IS "WITH".

SN 85-030,597, FILED 5-5-2010.

ANNE E. GUSTASON, EXAMINING ATTORNEY



David J. Kybas

Director of the United States Patent and Trademark Office

United States of America

United States Patent and Trademark Office



Reg. No. 4,068,097

Registered Dec. 6, 2011

Int. Cl.: 36

SERVICE MARK

PRINCIPAL REGISTER

21ST CENTURY INSURANCE AND FINANCIAL SERVICES, INC. (DELAWARE CORPORATION)
3 BEAVER VALLEY ROAD
WILMINGTON, DE 19803

FOR: INSURANCE UNDERWRITING SERVICES IN THE FIELD OF PROPERTY AND CASUALTY, AUTOMOBILE, BOAT, FLOOD, RENTERS, TOWNHOUSE, CONDOMINIUMS, HOMEOWNERS, RECREATIONAL VEHICLES, AND BUSINESS AND COMMERCIAL INSURANCE; INSURANCE ADMINISTRATION; INSURANCE CLAIMS PROCESSING, INSURANCE CLAIMS ADMINISTRATION, AND INSURANCE AGENCY SERVICES; PROVIDING INFORMATION IN INSURANCE MATTERS, IN CLASS 36 (U.S. CLS. 100, 101 AND 102).

FIRST USE 5-17-2010; IN COMMERCE 5-17-2010.

OWNER OF U.S. REG. NO. 3,275,078.

THE MARK CONSISTS OF TWO SEMI-CIRCULAR ARCS BESIDE AND ABOVE "21ST".

SN 85-031,492, FILED 5-6-2010.

JOHN WILKE, EXAMINING ATTORNEY



David J. Kybas

Director of the United States Patent and Trademark Office

United States of America

United States Patent and Trademark Office



UMANS BROADCASTING COMPANY

Reg. No. 4,068,098

SINGH, NEIL SANJAY (UNITED STATES INDIVIDUAL)
3 HOLLY COURT
MIDDLE ISLAND, NY 11953

Registered Dec. 6, 2011

Int. Cl.: 38

FOR: BROADCASTING OF RADIO AND TELEVISION PROGRAMMES; BROADCASTING PROGRAMS VIA A GLOBAL COMPUTER NETWORK, IN CLASS 38 (U.S. CLS. 100, 101 AND 104).

SERVICE MARK

FIRST USE 5-6-2010; IN COMMERCE 5-6-2010.

PRINCIPAL REGISTER

NO CLAIM IS MADE TO THE EXCLUSIVE RIGHT TO USE "BROADCASTING COMPANY", APART FROM THE MARK AS SHOWN.

THE MARK CONSISTS OF A DEPICTION OF A STICK PERSON WITH THE BODY IN THE SHAPE OF AN "H" AND, IN SMALLER FONT, "UMANS BROADCASTING COMPANY" IMMEDIATELY FOLLOWING.

SN 85-032,999, FILED 5-7-2010.

MAYUR VAGHANI, EXAMINING ATTORNEY



David J. Kybas

Director of the United States Patent and Trademark Office

United States of America

United States Patent and Trademark Office

FROM THE HIGHCHAIR TO THE LUNCHBOX

Reg. No. 4,068,099

Registered Dec. 6, 2011

Int. Cl.: 29

TRADEMARK

PRINCIPAL REGISTER

THE NEST COLLECTIVE, INC. (DELAWARE CORPORATION)
1485 PARK AVENUE, SUITE 200
EMERYVILLE, CA 94608

FOR: PROTEIN BASED NUTRIENT-DENSE SNACK BARS; PRESERVED, DRIED, AND COOKED FRUITS AND VEGETABLES; APPLESAUCE; PREPARED MEALS, PROCESSED MEALS, DRIED MEALS AND COOKED MEALS CONSISTING PRIMARILY OF MEAT, IN CLASS 29 (U.S. CL. 46).

FIRST USE 9-1-2010; IN COMMERCE 9-1-2010.

THE MARK CONSISTS OF STANDARD CHARACTERS WITHOUT CLAIM TO ANY PARTICULAR FONT, STYLE, SIZE, OR COLOR.

SN 85-033,453, FILED 5-7-2010.

KATINA MISTER, EXAMINING ATTORNEY



David J. Kyffers

Director of the United States Patent and Trademark Office

United States of America

United States Patent and Trademark Office

EbonyOpal

Reg. No. 4,068,100

Registered Dec. 6, 2011

Int. Cl.: 14

TRADEMARK

PRINCIPAL REGISTER

PATRICK, DENNIS (UNITED STATES INDIVIDUAL)
16520 JOHNSON LANE
NORTH FT. MYERS, FL 33917

FOR: JEWELRY, IN CLASS 14 (U.S. CLS. 2, 27, 28 AND 50).

FIRST USE 7-31-2010; IN COMMERCE 7-31-2010.

THE MARK CONSISTS OF STANDARD CHARACTERS WITHOUT CLAIM TO ANY PARTICULAR FONT, STYLE, SIZE, OR COLOR.

SN 85-034,092, FILED 5-10-2010.

ZACHARY BELLO, EXAMINING ATTORNEY



David J. Kyffers

Director of the United States Patent and Trademark Office

United States of America

United States Patent and Trademark Office

ACCUBLADE

Reg. No. 4,068,101

Registered Dec. 6, 2011

Int. Cl.: 8

TRADEMARK

PRINCIPAL REGISTER

EVEREADY BATTERY COMPANY, INC. (DELAWARE CORPORATION)
SWS LEGAL TRADEMARKS, 533 MARYVILLE
UNIVERSITY, DRIVE
ST. LOUIS, MO 63141

FOR: RAZORS AND RAZOR BLADES, IN CLASS 8 (U.S. CLS. 23, 28 AND 44).

FIRST USE 7-31-2011; IN COMMERCE 7-31-2011.

THE MARK CONSISTS OF STANDARD CHARACTERS WITHOUT CLAIM TO ANY PARTICULAR FONT, STYLE, SIZE, OR COLOR.

SN 85-034,310, FILED 5-10-2010.

CARYN GLASSER, EXAMINING ATTORNEY



David J. Kybas

Director of the United States Patent and Trademark Office

United States of America

United States Patent and Trademark Office

PAINT IT!

Reg. No. 4,068,102

Registered Dec. 6, 2011

Int. Cl.: 9

TRADEMARK

PRINCIPAL REGISTER

COREL CORPORATION (CANADA CORPORATION)
1600 CARLING AVENUE
OTTAWA, ONTARIO, CANADA K1Z8R7

FOR: COMPUTER SOFTWARE FOR COLLECTING, CREATING, AUTHORING, EDITING, ORGANIZING, MANIPULATING, ANIMATING, PROCESSING, MANAGING, RECEIVING, TRANSMITTING, STORING, ARCHIVING, SHARING AND VIEWING AUDIO-VISUAL DATA AND INFORMATION; COMPUTER SOFTWARE FOR COLLECTING, CREATING, AUTHORING, EDITING, ORGANIZING, MANIPULATING, ANIMATING, PROCESSING, MANAGING, RECEIVING, TRANSMITTING, STORING, ARCHIVING, SHARING AND VIEWING AUDIO-VISUAL DATA AND INFORMATION THAT MAY BE DOWNLOADED FROM A GLOBAL COMPUTER NETWORK; OPERATING AND USER INSTRUCTIONS IN DIGITAL FORM FOR COMPUTERS, TABLET BASED COMPUTERS AND COMPUTER SOFTWARE, STORED ON PHYSICAL MEDIA OR DOWNLOADABLE FROM A GLOBAL COMPUTER NETWORK; OPERATING AND USER INSTRUCTIONS IN DIGITAL FORM FOR PERSONAL DIGITAL ASSISTANTS, CELLULAR TELEPHONES, SMART PHONES, DIGITAL CAMERAS, DIGITAL VIDEO RECORDERS, AUDIO-VISUAL MEDIA PLAYERS, AND GAMING CONSOLES, STORED ON PHYSICAL MEDIA OR DOWNLOADABLE FROM A GLOBAL COMPUTER NETWORK; DOWNLOADABLE ELECTRONIC PUBLICATIONS IN THE NATURE OF USER GUIDES, COMPUTER MANUAL, AND HELP GUIDES IN THE FIELD OF GRAPHICS IMAGE PROCESSING, IN CLASS 9 (U.S. CLS. 21, 23, 26, 36 AND 38).

FIRST USE 5-10-2011; IN COMMERCE 5-10-2011.

THE MARK CONSISTS OF STANDARD CHARACTERS WITHOUT CLAIM TO ANY PARTICULAR FONT, STYLE, SIZE, OR COLOR.

SN 85-034,948, FILED 5-11-2010.

DAYNA BROWNE, EXAMINING ATTORNEY



David J. Kyros

Director of the United States Patent and Trademark Office

United States of America

United States Patent and Trademark Office

HOMEROOM

Reg. No. 4,068,103

Registered Dec. 6, 2011

Int. Cl.: 9

TRADEMARK

PRINCIPAL REGISTER

R & A SOLUTIONS, INC. (TENNESSEE CORPORATION), DBA RANDA SOLUTIONS,
722 RUNDLE AVENUE
NASHVILLE, TN 37210

FOR: COMPUTER SOFTWARE FOR THE FIELD OF EDUCATIONAL TESTING, TO MANAGE
TRANSACTIONAL DATA, PROVIDE STATISTICAL ANALYSIS, AND PRODUCE NOTIFIC-
ATIONS AND REPORTS, IN CLASS 9 (U.S. CLS. 21, 23, 26, 36 AND 38).

FIRST USE 11-12-2009; IN COMMERCE 11-12-2009.

THE MARK CONSISTS OF STANDARD CHARACTERS WITHOUT CLAIM TO ANY PAR-
TICULAR FONT, STYLE, SIZE, OR COLOR.

SN 85-035,067, FILED 5-11-2010.

JESSICA A. POWERS, EXAMINING ATTORNEY



David J. Kyjars

Director of the United States Patent and Trademark Office

United States of America

United States Patent and Trademark Office

ProMed  **Xpress**
PRODUCTS

Moving you forward in Physical Therapy

Reg. No. 4,068,104

Registered Dec. 6, 2011

Int. Cl.: 35

SERVICE MARK

PRINCIPAL REGISTER

SCRIP, INC. (ILLINOIS CORPORATION)
360 VETERANS PARKWAY, SUITE 115
BOLINGBROOK, IL 60440

FOR: MAIL ORDER CATALOG AND ONLINE RETAIL STORE SERVICES FEATURING PHYSICAL THERAPY AND REHABILITATION PRODUCTS, EQUIPMENT AND SUPPLIES, IN CLASS 35 (U.S. CLS. 100, 101 AND 102).

FIRST USE 5-0-2010; IN COMMERCE 5-0-2010.

OWNER OF U.S. REG. NO. 2,729,160.

NO CLAIM IS MADE TO THE EXCLUSIVE RIGHT TO USE "PRODUCTS" AND "EXPRESS" AND "PHYSICAL THERAPY", APART FROM THE MARK AS SHOWN.

THE MARK CONSISTS OF THE WORD "PROMED" STACKED ON TOP OF THE WORD "PRODUCTS"; IN THE CENTER IS A STYLIZED DESIGN OF A CREST OF A WAVE AND TO THE RIGHT OF THE DESIGN IS THE WORD "XPRESS"; A HORIZONTAL BLACK LINE APPEARS UNDERNEATH AND BELOW THE LINE IS THE TAG LINE "MOVING YOU FORWARD IN PHYSICAL THERAPY".

SN 85-037,039, FILED 5-12-2010.

BRIAN CALLAGHAN, EXAMINING ATTORNEY



David J. Kyjars

Director of the United States Patent and Trademark Office

United States of America

United States Patent and Trademark Office

Domainable

Reg. No. 4,068,105

Registered Dec. 6, 2011

Int. Cl.: 45

SERVICE MARK

PRINCIPAL REGISTER

DOMAINABLE, INC. (CALIFORNIA CORPORATION)
#566 PMB
56925 YUCCA TRAIL
YUCCA VALLEY, CA 92284

FOR: DOMAIN NAME REGISTRATION SERVICES, NAMELY, PROVIDING AN INTERNET WEB SITE WHICH ALLOWS ON-LINE BUYERS AND ON-LINE SELLERS TO SEARCH, REGISTER, MANAGE, TRACK AND TRANSFER DOMAIN NAMES FOR USE ON A GLOBAL COMPUTER NETWORK, IN CLASS 45 (U.S. CLS. 100 AND 101).

FIRST USE 12-14-2009; IN COMMERCE 8-26-2010.

THE MARK CONSISTS OF STANDARD CHARACTERS WITHOUT CLAIM TO ANY PARTICULAR FONT, STYLE, SIZE, OR COLOR.

SN 85-037,471, FILED 5-13-2010.

JOSETTE BEVERLY, EXAMINING ATTORNEY



David J. Kybas

Director of the United States Patent and Trademark Office

United States of America

United States Patent and Trademark Office

ALL-NAIL

Reg. No. 4,068,106

Registered Dec. 6, 2011

Int. Cls.: 6 and 20

TRADEMARK

PRINCIPAL REGISTER

COOPER TECHNOLOGIES COMPANY (DELAWARE CORPORATION)
600 TRAVIS, SUITE 5600
HOUSTON, TX 77002

FOR: BAR HANGERS AND PARTS AND FITTINGS THEREFOR MADE OF METAL FOR LIGHTING FIXTURES; BAR HANGERS AND PARTS AND FITTINGS THEREFOR MADE OF METAL FOR ELECTRICAL FIXTURES AND HOUSINGS; BAR HANGER SYSTEMS CONSISTING PRIMARILY OF METAL BAR HANGERS FOR USE IN ELECTRICAL LIGHTING FIXTURES AND HOUSING INSTALLATIONS, IN CLASS 6 (U.S. CLS. 2, 12, 13, 14, 23, 25 AND 50).

FIRST USE 4-30-2008; IN COMMERCE 4-30-2008.

FOR: NON-METAL BAR HANGERS AND PARTS AND FITTINGS THEREFOR FOR LIGHTING FIXTURES; NON-METAL BAR HANGERS AND PARTS AND FITTINGS THEREFOR FOR ELECTRICAL FIXTURES AND HOUSINGS; BAR HANGER SYSTEMS CONSISTING PRIMARILY OF NON-METAL BAR HANGERS FOR USE IN ELECTRICAL LIGHTING FIXTURES AND HOUSING INSTALLATIONS, IN CLASS 20 (U.S. CLS. 2, 13, 22, 25, 32 AND 50).

FIRST USE 4-30-2008; IN COMMERCE 4-30-2008.

THE MARK CONSISTS OF STANDARD CHARACTERS WITHOUT CLAIM TO ANY PARTICULAR FONT, STYLE, SIZE, OR COLOR.

SN 85-037,758, FILED 5-13-2010.

JAY BESCH, EXAMINING ATTORNEY



David J. Kyros

Director of the United States Patent and Trademark Office

United States of America
United States Patent and Trademark Office

UNIREC

Reg. No. 4,068,107

NOVATEX ITALIA S.P.A. (ITALY CORPORATION)
VIA PER DOLZAGO, 37
OGGIONO (LC), ITALY 23848

Registered Dec. 6, 2011

Int. Cl.: 22

FOR: NETS FOR AGRICULTURAL USES, NAMELY, ROUND BALE NETWRAP, NETS FOR FODDER, HAY, SILAGE, STRAW, IN CLASS 22 (U.S. CLS. 1, 2, 7, 19, 22, 42 AND 50).

TRADEMARK

FIRST USE 12-0-1992; IN COMMERCE 5-1-2011.

PRINCIPAL REGISTER

THE MARK CONSISTS OF THE WORD "UNIREC" WRITTEN IN BLUE STYLIZED CHARACTERS.

THE COLOR(S) BLUE IS/ARE CLAIMED AS A FEATURE OF THE MARK.

SN 85-037,872, FILED 5-13-2010.

KARANENDRA S. CHHINA, EXAMINING ATTORNEY



David J. Kybas

Director of the United States Patent and Trademark Office

United States of America

United States Patent and Trademark Office

WONDER COVER

Reg. No. 4,068,108

Registered Dec. 6, 2011

Int. Cl.: 25

TRADEMARK

PRINCIPAL REGISTER

INFANTINO, LLC (CALIFORNIA LIMITED LIABILITY COMPANY)
SUITE 200
4920 CARROLL CANYON RD.
SAN DIEGO, CA 92121

FOR: BIBS NOT MADE OF PAPER, IN CLASS 25 (U.S. CLS. 22 AND 39).

FIRST USE 8-20-2010; IN COMMERCE 8-20-2010.

THE MARK CONSISTS OF STANDARD CHARACTERS WITHOUT CLAIM TO ANY PARTICULAR FONT, STYLE, SIZE, OR COLOR.

NO CLAIM IS MADE TO THE EXCLUSIVE RIGHT TO USE "COVER", APART FROM THE MARK AS SHOWN.

SN 85-038,256, FILED 5-13-2010.

COURTNEY ALVAREZ, EXAMINING ATTORNEY



David J. Kyffers

Director of the United States Patent and Trademark Office

United States of America

United States Patent and Trademark Office

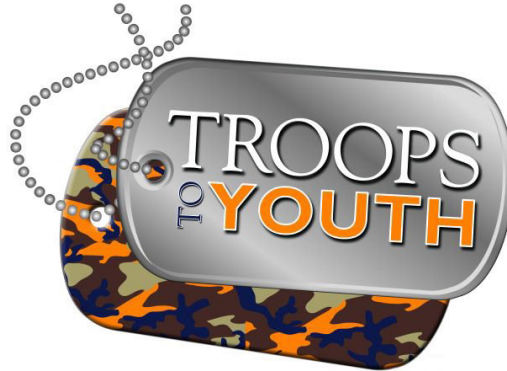

Reg. No. 4,068,109

Registered Dec. 6, 2011

Int. Cl.: 35

SERVICE MARK

PRINCIPAL REGISTER

YOUTH MATTER INC. (VIRGINIA CORPORATION), AKA YOUTH MATTER AMERICA,
P.O. BOX 396
PORTSMOUTH, VA 23705

FOR: CHARITABLE SERVICES, NAMELY, ORGANIZING YOUTH GROUPS TO UNDERTAKE PROJECTS TO BENEFIT THE NEEDY AND THE COMMUNITY TO ENCOURAGE LEADERSHIP, CHARACTER, COMPASSION, AND GOOD CITIZENSHIP, IN CLASS 35 (U.S. CLS. 100, 101 AND 102).

FIRST USE 6-1-2010; IN COMMERCE 6-1-2010.

NO CLAIM IS MADE TO THE EXCLUSIVE RIGHT TO USE "YOUTH", APART FROM THE MARK AS SHOWN.

THE COLOR(S) GRAY, ORANGE, GREEN, BROWN, BLUE AND WHITE IS/ARE CLAIMED AS A FEATURE OF THE MARK.

THE MARK CONSISTS OF A SYMBOL OF 2 DOG TAGS WITH THE FIRST TAG HAVING A BACKGROUND OF GRAY WITH THE WORD "TROOPS" IN WHITE, WRITTEN OVER THE WORD "TO" IN DARKER GRAY, AND "YOUTH" IN ORANGE OUTLINED WITH WHITE, THE SECOND TAG, SHOWN UNDERNEATH THE FIRST, HAS A CAMOUFLAGE COLOR SCHEME CONSISTING OF ORANGE, BROWN, BLUE AND GREEN; AND THERE IS CHAIN IN GRAY CONNECTING THE TWO DOG TAGS.

SN 85-038,708, FILED 5-14-2010.

BENJAMIN OKEKE, EXAMINING ATTORNEY



David J. Kyffers

Director of the United States Patent and Trademark Office

United States of America

United States Patent and Trademark Office



Reg. No. 4,068,110

Registered Dec. 6, 2011

Int. Cl.: 30

TRADEMARK

PRINCIPAL REGISTER

GRANNY LALA INC (WASHINGTON CORPORATION)
PO BOX 818
SPANAWAY, WA 98387

FOR: BREAD AND PASTRY, IN CLASS 30 (U.S. CL. 46).

FIRST USE 9-26-2008; IN COMMERCE 5-1-2009.

NO CLAIM IS MADE TO THE EXCLUSIVE RIGHT TO USE "INC.", APART FROM THE MARK AS SHOWN.

THE COLOR(S) LIGHT BLUE, DARK BLUE AND PURPLE IS/ARE CLAIMED AS A FEATURE OF THE MARK.

THE NAME(S), PORTRAIT(S), AND/OR SIGNATURE(S) SHOWN IN THE MARK IDENTIFIES "GRANNY LALA", AKA LARA WEIHS, WHOSE CONSENT(S) TO REGISTER IS MADE OF RECORD.

THE MARK CONSISTS OF A LIGHT BLUE, DARK BLUE AND PURPLE APRON WITH A PURPLE POCKET. THE APRON TIES STRETCH OUT TO EITHER SIDE OF THE APRON. TO THE RIGHT OF THE APRON, THE WORDS "GRANNY LALA'S, INC." ARE FEATURED IN PURPLE (OUTLINED IN DARK BLUE).

SN 85-039,089, FILED 5-14-2010.

SUSAN LESLIE DUBOIS, EXAMINING ATTORNEY



David J. Kybas

Director of the United States Patent and Trademark Office

United States of America

United States Patent and Trademark Office

iMs Connexis

Reg. No. 4,068,111

Registered Dec. 6, 2011

Int. Cl.: 9

TRADEMARK

PRINCIPAL REGISTER

INTEGRATED MANAGEMENT SOLUTIONS (TENNESSEE), INC. (DELAWARE CORPORATION)
4900 BRADFORD DRIVE NW
HUNTSVILLE, AL 35805

FOR: COMPUTER PROGRAMS FOR COURT CASE MANAGEMENT AND THERAPEUTIC CASE MANAGEMENT, NAMELY, COMPUTER PROGRAMS UTILIZED BY TREATMENT PROVIDERS, CASE MANAGERS, DRUG COURTS, DUI COURTS, MENTAL HEALTH COURTS, FAMILY COURTS, OR JUVENILE COURTS TO MANAGE INFORMATION AND INDIVIDUALS MAINTAINED BY SUCH SPECIALTY COURTS AND THEIR RELATED THERAPEUTIC PARTNERS, IN CLASS 9 (U.S. CLS. 21, 23, 26, 36 AND 38).

FIRST USE 6-30-2010; IN COMMERCE 6-30-2010.

THE MARK CONSISTS OF STYLIZED LETTERS "IMS CONNEXIS".

SN 85-039,141, FILED 5-14-2010.

KATHERINE E. HALMEN, EXAMINING ATTORNEY



David J. Kybas

Director of the United States Patent and Trademark Office

United States of America

United States Patent and Trademark Office

DYAD

Reg. No. 4,068,112

Registered Dec. 6, 2011

Int. Cl.: 12

TRADEMARK

PRINCIPAL REGISTER

FOX FACTORY, INC. (CALIFORNIA CORPORATION)
130 HANGAR WAY
WATSONVILLE, CA 95076

FOR: BICYCLE PARTS, NAMELY, SHOCK ABSORBERS, IN CLASS 12 (U.S. CLS. 19, 21, 23, 31, 35 AND 44).

FIRST USE 6-2-2010; IN COMMERCE 6-2-2010.

THE MARK CONSISTS OF STANDARD CHARACTERS WITHOUT CLAIM TO ANY PARTICULAR FONT, STYLE, SIZE, OR COLOR.

SN 85-039,828, FILED 5-17-2010.

MICHAEL WIENER, EXAMINING ATTORNEY



David J. Kybas

Director of the United States Patent and Trademark Office

United States of America

United States Patent and Trademark Office

DYAD RT2

Reg. No. 4,068,113

Registered Dec. 6, 2011

Int. Cl.: 12

TRADEMARK

PRINCIPAL REGISTER

FOX FACTORY, INC. (CALIFORNIA CORPORATION)
130 HANGAR WAY
WATSONVILLE, CA 95076

FOR: BICYCLE PARTS, NAMELY, SHOCK ABSORBERS, IN CLASS 12 (U.S. CLS. 19, 21, 23, 31, 35 AND 44).

FIRST USE 6-2-2010; IN COMMERCE 6-2-2010.

THE MARK CONSISTS OF STANDARD CHARACTERS WITHOUT CLAIM TO ANY PARTICULAR FONT, STYLE, SIZE, OR COLOR.

SN 85-039,829, FILED 5-17-2010.

MICHAEL WIENER, EXAMINING ATTORNEY



David J. Kybas

Director of the United States Patent and Trademark Office

United States of America

United States Patent and Trademark Office

ONTHE GLOW

Reg. No. 4,068,114

Registered Dec. 6, 2011

Int. Cl.: 9

TRADEMARK

PRINCIPAL REGISTER

MARDEL, INC. (OKLAHOMA CORPORATION)
7727 SW 44TH STREET
OKLAHOMA CITY, OK 73179

FOR: MAGNIFYING GLASSES, IN CLASS 9 (U.S. CLS. 21, 23, 26, 36 AND 38).

FIRST USE 12-29-2010; IN COMMERCE 12-29-2010.

THE MARK CONSISTS OF STANDARD CHARACTERS WITHOUT CLAIM TO ANY PARTICULAR FONT, STYLE, SIZE, OR COLOR.

NO CLAIM IS MADE TO THE EXCLUSIVE RIGHT TO USE "MAGNIFIER", APART FROM THE MARK AS SHOWN.

SN 85-040,374, FILED 5-17-2010.

TRACY WHITTAKER-BROWN, EXAMINING ATTORNEY



David J. Kyfos

Director of the United States Patent and Trademark Office

United States of America
United States Patent and Trademark Office

BLOXSUN

Reg. No. 4,068,115

Registered Dec. 6, 2011

Int. Cl.: 25

TRADEMARK

PRINCIPAL REGISTER

BLOXSUN SG IP, LLC (FLORIDA LIMITED LIABILITY COMPANY)
650 CURTISWOOD DRIVE
KEY BISCAYNE, FL 33149

FOR: GLOVES, IN CLASS 25 (U.S. CLS. 22 AND 39).

FIRST USE 10-3-2011; IN COMMERCE 10-3-2011.

THE MARK CONSISTS OF STANDARD CHARACTERS WITHOUT CLAIM TO ANY PARTICULAR FONT, STYLE, SIZE, OR COLOR.

SN 85-040,474, FILED 5-17-2010.

SALLY SHIH, EXAMINING ATTORNEY



David J. Kybas

Director of the United States Patent and Trademark Office

United States of America

United States Patent and Trademark Office



Reg. No. 4,068,116

Registered Dec. 6, 2011

Int. Cl.: 28

TRADEMARK

PRINCIPAL REGISTER

TOMY COMPANY, LTD. (JAPAN CORPORATION)
7-9-10 TATEISHI, KATSUSHIKA-KU
TOKYO, JAPAN

FOR: TOYS AND GAMES, NAMELY, DIE CAST MINIATURE CARS, TOY VEHICLES, TOY ROADWAYS, TOY ROAD SETS, TOY VEHICLE ACCESSORIES, TOY TRAINS, TOY TRAIN TRACKWAYS, TOY ACTION TRAIN STATIONS FOR TOY TRACKWAYS, AND PLAYSETS FOR TOY VEHICLES, NAMELY, SIMULATED ENVIRONMENTAL AREAS AND ACCESSORIES THEREFOR, NAMELY, MODEL BUILDINGS, MODEL SIGNS, MODEL TREES, MODEL BRIDGES, IN CLASS 28 (U.S. CLS. 22, 23, 38 AND 50).

FIRST USE 7-0-2010; IN COMMERCE 9-0-2010.

OWNER OF U.S. REG. NOS. 2,412,830 AND 2,923,732.

THE MARK CONSISTS OF "TOMICA" (STYLIZED LETTERING) IN DARK BACKGROUND.

SN 85-040,760, FILED 5-17-2010.

SAMUEL E. SHARPER JR., EXAMINING ATTORNEY



David J. Kyros

Director of the United States Patent and Trademark Office

United States of America

United States Patent and Trademark Office

FIREFINGERS

Reg. No. 4,068,117

Registered Dec. 6, 2011

Int. Cl.: 8

TRADEMARK

PRINCIPAL REGISTER

PIERCE, ALBERT L. (UNITED STATES INDIVIDUAL)
4648 N. VERSAILLES AVENUE
DALLAS, TX 75209

FOR: FIREPLACE TOOL USED FOR ADDING OR REARRANGING LOGS IN AN INDOOR
FIREPLACE, IN CLASS 8 (U.S. CLS. 23, 28 AND 44).

FIRST USE 9-0-2010; IN COMMERCE 9-0-2010.

THE MARK CONSISTS OF STANDARD CHARACTERS WITHOUT CLAIM TO ANY PAR-
TICULAR FONT, STYLE, SIZE, OR COLOR.

SN 85-040,879, FILED 5-17-2010.

JEFF DEFORD, EXAMINING ATTORNEY



David J. Kybas

Director of the United States Patent and Trademark Office

United States of America

United States Patent and Trademark Office

CAGE FIGHTER

Reg. No. 4,068,118

Registered Dec. 6, 2011

Int. Cl.: 14

TRADEMARK

PRINCIPAL REGISTER

TREO HOLDINGS, LLC (OHIO LIMITED LIABILITY COMPANY)
576 GEORGESVILLE ROAD
COLUMBUS, OH 43215

FOR: JEWELRY; TIMEPIECES; AND WATCHES, IN CLASS 14 (U.S. CLS. 2, 27, 28 AND 50).

FIRST USE 8-1-2011; IN COMMERCE 8-1-2011.

THE MARK CONSISTS OF STANDARD CHARACTERS WITHOUT CLAIM TO ANY PARTICULAR FONT, STYLE, SIZE, OR COLOR.

OWNER OF U.S. REG. NO. 3,451,558.

SN 85-040,880, FILED 5-17-2010.

ALEXANDER L. POWERS, EXAMINING ATTORNEY



David J. Kyros

Director of the United States Patent and Trademark Office

United States of America

United States Patent and Trademark Office

CAGE FIGHTER

Reg. No. 4,068,119

Registered Dec. 6, 2011

Int. Cl.: 14

TRADEMARK

PRINCIPAL REGISTER

TREO HOLDINGS, LLC (OHIO LIMITED LIABILITY COMPANY)
576 GEORGESVILLE ROAD
COLUMBUS, OH 43215

FOR: JEWELRY; TIMEPIECES; AND WATCHES, IN CLASS 14 (U.S. CLS. 2, 27, 28 AND 50).

FIRST USE 8-1-2011; IN COMMERCE 8-1-2011.

OWNER OF U.S. REG. NO. 3,451,558.

THE MARK CONSISTS OF THE WORDING "CAGE FIGHTER" IN STYLIZED FONT. THE COLORS BLACK, WHITE AND GRAY REPRESENT OUTLINING AND SHADING AND ARE NOT PART OF THE MARK.

SN 85-040,894, FILED 5-17-2010.

ALEXANDER L. POWERS, EXAMINING ATTORNEY



David J. Kyros

Director of the United States Patent and Trademark Office

United States of America

United States Patent and Trademark Office

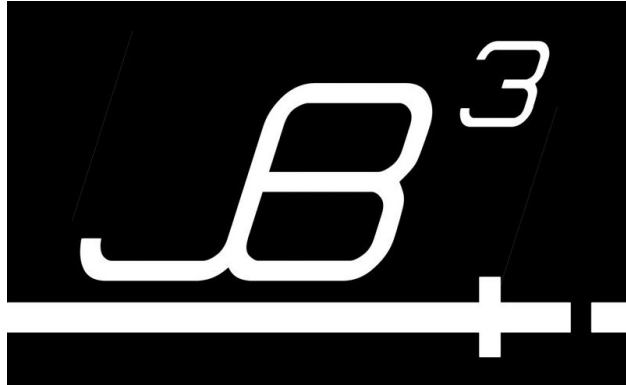

Reg. No. 4,068,120

Registered Dec. 6, 2011

Int. Cl.: 28

TRADEMARK

PRINCIPAL REGISTER

BENDER, JONATHAN R. (UNITED STATES INDIVIDUAL)
3919 FALLSBROOK CT.
SUGAR LAND, TX 774793371

FOR: MANUALLY OPERATED EXERCISE EQUIPMENT FOR THE DEVELOPMENT OF THE LOWER BODY, IN CLASS 28 (U.S. CLS. 22, 23, 38 AND 50).

FIRST USE 6-21-2011; IN COMMERCE 6-21-2011.

THE MARK CONSISTS OF THE CHARACTERS "JB3" IN A STYLIZED FONT, AND A FRAGMENTED LINE THAT INCLUDES A PLUS SYMBOL BELOW THE SAME.

SN 85-041,144, FILED 5-18-2010.

LOURDES AYALA, EXAMINING ATTORNEY



David J. Kybas

Director of the United States Patent and Trademark Office

United States of America

United States Patent and Trademark Office

Truly
FRAMELESS

Reg. No. 4,068,121

Registered Dec. 6, 2011

Int. Cl.: 11

TRADEMARK

PRINCIPAL REGISTER

SNYDER PAUL E. (UNITED STATES INDIVIDUAL)
10065 SW 77CT.
MIAMI, FL 33156

FOR: SHOWER ENCLOSURES, IN CLASS 11 (U.S. CLS. 13, 21, 23, 31 AND 34).

FIRST USE 1-4-2011; IN COMMERCE 1-4-2011.

NO CLAIM IS MADE TO THE EXCLUSIVE RIGHT TO USE "FRAMELESS", APART FROM THE MARK AS SHOWN.

THE MARK CONSISTS OF THE TERM "TRULY" WITH A HALO AROUND THE TOP PORTION, ABOVE THE TERM "FRAMELESS".

SN 85-042,331, FILED 5-19-2010.

TARA PATE, EXAMINING ATTORNEY



David J. Kyffers

Director of the United States Patent and Trademark Office

United States of America

United States Patent and Trademark Office

eat da babies

Reg. No. 4,068,122

Registered Dec. 6, 2011

Int. Cl.: 41

SERVICE MARK

PRINCIPAL REGISTER

HONORE, KELVIN (UNITED STATES INDIVIDUAL)
APT. 50
10822 MAGNOLIA BLVD
LOS ANGELES, CA 91601

FOR: MULTIMEDIA ENTERTAINMENT SERVICES IN THE NATURE OF RECORDING, PRODUCTION AND POST-PRODUCTION SERVICES IN THE FIELDS OF MUSIC, VIDEO, AND FILMS, IN CLASS 41 (U.S. CLS. 100, 101 AND 107).

FIRST USE 2-9-2003; IN COMMERCE 2-9-2005.

THE MARK CONSISTS OF STANDARD CHARACTERS WITHOUT CLAIM TO ANY PARTICULAR FONT, STYLE, SIZE, OR COLOR.

SN 85-043,616, FILED 5-20-2010.

MICHAEL WIENER, EXAMINING ATTORNEY



David J. Kyros

Director of the United States Patent and Trademark Office

United States of America

United States Patent and Trademark Office

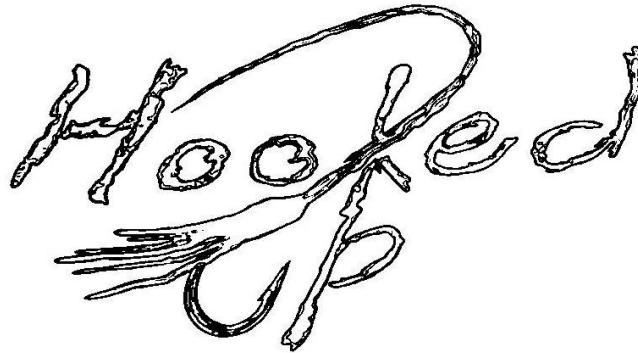

Reg. No. 4,068,123

Registered Dec. 6, 2011

Int. Cl.: 25

TRADEMARK

PRINCIPAL REGISTER

JARRELL & SHAW, LLC (FLORIDA LIMITED LIABILITY COMPANY)
4975 SE 38TH STREET
OCALA, FL 34480

FOR: HATS AND SHIRTS, ALL SPECIFICALLY DESIGNED FOR FISHING ENTHUSIASTS,
IN CLASS 25 (U.S. CLS. 22 AND 39).

FIRST USE 6-1-2010; IN COMMERCE 7-5-2010.

THE MARK CONSISTS OF THE LETTERS "HOOKED UP", WITH THE "U" DESIGNED INTO
A FISHING JIG WITH FISHING LINE GOING THROUGH THE "K".

SN 85-045,536, FILED 5-21-2010.

KELLY TRUSILO, EXAMINING ATTORNEY



David J. Kyros

Director of the United States Patent and Trademark Office

United States of America

United States Patent and Trademark Office

HEALTHWAYS | BLUE ZONES VITALITY CITY

Reg. No. 4,068,124

Registered Dec. 6, 2011

Int. Cls.: 35 and 44

SERVICE MARK

PRINCIPAL REGISTER

HEALTHWAYS, INC. (DELAWARE CORPORATION)
701 COOL SPRINGS BLVD.
FRANKLIN, TN 37067 AND

BLUE ZONES, LLC (DELAWARE LIMITED LIABILITY COMPANY)
BLUE ZONES
724 NORTH 1ST STREET
MINNEAPOLIS, MN 55401

FOR: PROMOTING PUBLIC AWARENESS OF PUBLIC HEALTH INITIATIVES AND PROJECTS THAT IMPROVE HEALTH AND LONGEVITY, IN CLASS 35 (U.S. CLS. 100, 101 AND 102).

FIRST USE 3-0-2010; IN COMMERCE 3-0-2010.

FOR: HEALTH CARE SERVICES, NAMELY, WELLNESS PROGRAMS; HEALTH CARE SERVICES, NAMELY, PLANNING, ADMINISTERING AND MANAGING PUBLIC HEALTH INITIATIVES AND PROJECTS IN THE NATURE OF WELLNESS PROGRAMS THAT IMPROVE HEALTH AND LONGEVITY, IN CLASS 44 (U.S. CLS. 100 AND 101).

FIRST USE 3-0-2010; IN COMMERCE 3-0-2010.

THE MARK CONSISTS OF STANDARD CHARACTERS WITHOUT CLAIM TO ANY PARTICULAR FONT, STYLE, SIZE, OR COLOR.

OWNER OF U.S. REG. NOS. 3,226,699, 3,294,917, AND OTHERS.

SN 85-046,354, FILED 5-24-2010.

JAMES LOVELACE, EXAMINING ATTORNEY



David J. Kyros

Director of the United States Patent and Trademark Office

United States of America

United States Patent and Trademark Office

PHYTOKINETIC

Reg. No. 4,068,125

RAINBOW LIGHT NUTRITIONAL SYSTEMS, INC. (DELAWARE CORPORATION)
125 MCPHERSON ST.
SANTA CRUZ, CA 95060

Registered Dec. 6, 2011

Int. Cl.: 5

FOR: DIETARY AND NUTRITIONAL SUPPLEMENTS; VITAMINS, IN CLASS 5 (U.S. CLS. 6, 18, 44, 46, 51 AND 52).

TRADEMARK

FIRST USE 9-19-2010; IN COMMERCE 9-19-2010.

PRINCIPAL REGISTER

THE MARK CONSISTS OF STANDARD CHARACTERS WITHOUT CLAIM TO ANY PARTICULAR FONT, STYLE, SIZE, OR COLOR.

SN 85-047,160, FILED 5-25-2010.

MYRIAH HABEEB, EXAMINING ATTORNEY



David J. Kybas

Director of the United States Patent and Trademark Office

United States of America

United States Patent and Trademark Office



Reg. No. 4,068,126

Registered Dec. 6, 2011

Int. Cl.: 24

TRADEMARK

PRINCIPAL REGISTER

MICHAELSON, ANDREA (UNITED STATES INDIVIDUAL), DBA ANDREA MICHAELSON DESIGN,
1196 SUMMIT DRIVE
BEVERLY HILLS, CA 90210

FOR: FURNISHING AND UPHOLSTERY FABRICS, IN CLASS 24 (U.S. CLS. 42 AND 50).

FIRST USE 4-1-2010; IN COMMERCE 5-1-2010.

THE MARK CONSISTS OF THE STYLIZED LETTERS "AMD" WITH GRAPH MARKINGS SUPERIMPOSED OVER THE LETTER "D".

SN 85-047,762, FILED 5-25-2010.

JOSETTE BEVERLY, EXAMINING ATTORNEY



David J. Kybas

Director of the United States Patent and Trademark Office

United States of America

United States Patent and Trademark Office

NUTRA CARB

Reg. No. 4,068,127

Registered Dec. 6, 2011

Int. Cls.: 1 and 5

TRADEMARK

PRINCIPAL REGISTER

IMERYS PIGMENTS, INC. (GEORGIA CORPORATION)
100 MANSELL COURT, SUITE 300
ROSWELL, GA 30076

FOR: CALCIUM CARBONATE; CHEMICALS FOR USE IN AGRICULTURE EXCEPT FUNGICIDES, HERBICIDES, INSECTICIDES, AND PARASITICIDES, IN CLASS 1 (U.S. CLS. 1, 5, 6, 10, 26 AND 46).

FIRST USE 10-31-2010; IN COMMERCE 10-31-2010.

FOR: CALCIUM SUPPLEMENTS; ANIMAL FEED SUPPLEMENTS, IN CLASS 5 (U.S. CLS. 6, 18, 44, 46, 51 AND 52).

FIRST USE 10-31-2010; IN COMMERCE 10-31-2010.

THE MARK CONSISTS OF STANDARD CHARACTERS WITHOUT CLAIM TO ANY PARTICULAR FONT, STYLE, SIZE, OR COLOR.

NO CLAIM IS MADE TO THE EXCLUSIVE RIGHT TO USE "CARB", APART FROM THE MARK AS SHOWN.

SN 85-047,917, FILED 5-26-2010.

MARGARET POWER, EXAMINING ATTORNEY



David J. Kyros

Director of the United States Patent and Trademark Office

United States of America

United States Patent and Trademark Office

Great  Heron

Reg. No. 4,068,128

ORESCH LLC (FLORIDA LIMITED LIABILITY COMPANY)
5811 SW 164 TERRACE
SOUTHWEST RANCHES, FL 33331

Registered Dec. 6, 2011

Int. Cl.: 4

FOR: WOOD CHIPS FOR USE AS FUEL, CHARCOAL, SPLINTS, NAMELY, WOOD FOR USE AS FUEL, IN CLASS 4 (U.S. CLS. 1, 6 AND 15).

TRADEMARK

FIRST USE 8-31-2011; IN COMMERCE 8-31-2011.

PRINCIPAL REGISTER

THE MARK CONSISTS OF THE WORD "GREAT" AND "HERON" IN A STYLIZED SCRIPT FONT WITH A BIRD STANDING IN GRASS WITHIN A CIRCLE BETWEEN THE TWO WORDS.

SN 85-047,995, FILED 5-26-2010.

DANNEAN HETZEL, EXAMINING ATTORNEY



David J. Kyros

Director of the United States Patent and Trademark Office

United States of America

United States Patent and Trademark Office



Reg. No. 4,068,129

Registered Dec. 6, 2011

Int. Cl.: 25

TRADEMARK

PRINCIPAL REGISTER

C-MRK, INC. (CALIFORNIA CORPORATION)
4510 LOMA VISTA AVE.
VERNON, CA 90058

FOR: BELTS; FOOTWEAR; HATS; JACKETS; PANTS; SHIRTS; SHORTS; TOPS, IN CLASS
25 (U.S. CLS. 22 AND 39).

FIRST USE 4-1-2011; IN COMMERCE 4-1-2011.

THE MARK CONSISTS OF THE WORD "DIVISION" SET WITHIN A TRIANGLE.

SN 85-048,363, FILED 5-26-2010.

KELLY BOULTON, EXAMINING ATTORNEY



David J. Kybas

Director of the United States Patent and Trademark Office

United States of America

United States Patent and Trademark Office

h é l o
ILLUMINATION

Reg. No. 4,068,130

Registered Dec. 6, 2011

Int. Cls.: 9 and 11

TRADEMARK

PRINCIPAL REGISTER

YEH-CHIANG TECHNOLOGY CORP. (TAIWAN CORPORATION)
7F.,NO.19-13,SANCHONG RD.,NANGANG DIST.
TAIPEI CITY, TAIWAN

FOR: ELECTRONIC PUBLICATIONS, NAMELY, MAGAZINES FEATURING COMPUTER AND TECHNOLOGY INFORMATION RECORDED ON COMPUTER MEDIA; COMPUTER HARDWARE; COMPUTER SOFTWARE FOR USE IN NETWORK COMMUNICATION; INTERFACES FOR COMPUTERS; COMPUTER CURSOR CONTROL DEVICES, NAMELY, TOUCH PADS; ELECTRONIC NOTE BOOK COMPUTERS; ELECTRONIC BOOK READER; PERSONAL DIGITAL ASSISTANTS; HAND-HELD ELECTRONIC DICTIONARIES; COMPUTER BAGS; VIDEO GAME CARTRIDGES AND CASSETTES; COMPUTER GAME PROGRAMS RECORDED ON MAGNETIC DISKS AND STORAGE MEDIA; COMPUTER GAME PROGRAMS RECORDED ON OPTICAL DISKS AND STORAGE MEDIA; COMPUTER GAME PROGRAM CARTRIDGES AND CASSETTES; VIDEO GAME SOFTWARE; COMPUTER GAME PROGRAMS DOWNLOADABLE VIA THE INTERNET; VIDEO CAMERAS; SLIDE PROJECTORS; FILM CAMERAS; VIDEO CASSETTE RECORDERS; TELEVISIONS; PERSONAL STEREOS; VIDEO GAME MACHINES FOR USE WITH TELEVISIONS; FLUORESCENT LAMP BALLAST FOR ELECTRIC LIGHTS; BATTERIES; ACCUMULATOR JARS; TELEPHONES; FACSIMILE MACHINES; MONITORS, NAMELY, COMPUTER MONITORS AND VIDEO MONITORS; LIQUID CRYSTAL DISPLAYS; SATELLITE NAVIGATIONAL SYSTEM, NAMELY, A GLOBAL POSITIONING SYSTEM (GPS); LIGHT EMITTING DIODES; LIGHT EMITTING DIODE DISPLAYS; GLOBAL POSITIONING SYSTEM (GPS) CONSISTING OF COMPUTERS, COMPUTER SOFTWARE, TRANSMITTERS, RECEIVERS, AND NETWORK INTERFACE DEVICES; DISCHARGE TUBES, ELECTRIC, OTHER THAN FOR LIGHTING; TELEPHONE RECEIVERS; TELEPHONE TRANSMITTERS; WIRELESS TELEVISION SET FOR PROVIDING VIDEO CONFERENCING AND TELEPHONE SERVICE OVER THE INTERNET; INTEROPERABLE COMMUNICATION SYSTEM DESIGNED TO PROVIDE RADIO, STREAMING VIDEO, WIRELESS INTERNET, AND VOIP PHONE; NAVIGATION APPARATUS FOR VEHICLES IN THE NATURE OF ON-BOARD COMPUTERS; SOUND TRANSMITTING APPARATUS; COMPUTER CHIPS; SEMICONDUCTORS; INTEGRATED CIRCUITS; LIGHTING BALLASTS; ELECTRICAL INDUCTORS; BATTERY CHARGERS; LIGHTING CONTROLS; ELECTRICAL CONDUCTORS, IN CLASS 9 (U.S. CLS. 21, 23, 26, 36 AND 38).



David J. Kappas

Director of the United States Patent and Trademark Office

FIRST USE 9-8-2011; IN COMMERCE 9-15-2011.

FOR: LANTERNS; LIGHT BULBS; LIGHTING FIXTURES; LIGHTING APPARATUS FOR VEHICLES; ELECTRIC KETTLES; ELECTRIC COFFEE PERCOLATORS; ELECTRIC COFFEE

Reg. No. 4,068,130 POTS; COFFEE FILTERS NOT OF PAPER BEING PART OF ELECTRIC COFFEE MAKERS; ELECTRIC FANS; WATER FOUNTAINS; WATER STERILIZERS AND STERILIZERS NOT FOR INDUSTRY PURPOSES; AIR CONDITIONING INSTALLATIONS; SOLAR ENERGY RECEIVERS, IN CLASS 11 (U.S. CLS. 13, 21, 23, 31 AND 34).

FIRST USE 9-8-2011; IN COMMERCE 9-15-2011.

NO CLAIM IS MADE TO THE EXCLUSIVE RIGHT TO USE "ILLUMINATION", APART FROM THE MARK AS SHOWN.

THE MARK CONSISTS OF THE WORD "HÉLO", WITH AN AURA SURROUNDING THE LETTER "O" ABOVE THE CAPITALIZED WORD "ILLUMINATION".

SN 85-048,365, FILED 5-26-2010.

KELLY BOULTON, EXAMINING ATTORNEY

United States of America

United States Patent and Trademark Office

MAKO

Reg. No. 4,068,131

Registered Dec. 6, 2011

Int. Cl.: 9

TRADEMARK

PRINCIPAL REGISTER

ALLSO INTERNATIONAL MARKETING PTY. LIMITED (AUSTRALIA CORPORATION)
P.O. BOX 195
CAMPSIE, NSW, AUSTRALIA 2194

FOR: OPTICAL GOODS, NAMELY, SPECTACLES, SPECTACLE CASES, SUNGLASSES, OPTICAL FRAMES, ACCESSORIES THEREFOR, NAMELY, CHAINS AND CORDS FOR HOLDING SPECTACLES AND SUNGLASSES, IN CLASS 9 (U.S. CLS. 21, 23, 26, 36 AND 38).

FIRST USE 5-31-1991; IN COMMERCE 8-31-2010.

THE MARK CONSISTS OF STANDARD CHARACTERS WITHOUT CLAIM TO ANY PARTICULAR FONT, STYLE, SIZE, OR COLOR.

SN 85-050,566, FILED 5-28-2010.

MAYUR VAGHANI, EXAMINING ATTORNEY



David J. Kyros

Director of the United States Patent and Trademark Office

United States of America

United States Patent and Trademark Office

KEEP LIFE MOVING

Reg. No. 4,068,132

Registered Dec. 6, 2011

Int. Cls.: 35 and 40

SERVICE MARK

PRINCIPAL REGISTER

WALGREEN CO. (ILLINOIS CORPORATION)
200 WILMOT ROAD
DEERFIELD, IL 60015

FOR: RETAIL PHARMACY AND GENERAL MERCHANDISE STORE SERVICES, IN CLASS 35 (U.S. CLS. 100, 101 AND 102).

FIRST USE 6-2-2010; IN COMMERCE 6-2-2010.

FOR: FILM PROCESSING AND PHOTO FINISHING SERVICES, IN CLASS 40 (U.S. CLS. 100, 103 AND 106).

FIRST USE 6-2-2010; IN COMMERCE 6-2-2010.

THE MARK CONSISTS OF STANDARD CHARACTERS WITHOUT CLAIM TO ANY PARTICULAR FONT, STYLE, SIZE, OR COLOR.

SN 85-051,426, FILED 6-1-2010.

KATINA MISTER, EXAMINING ATTORNEY



David J. Kybas

Director of the United States Patent and Trademark Office

United States of America

United States Patent and Trademark Office

A·OR 第一原手

Reg. No. 4,068,133

Registered Dec. 6, 2011

Int. Cl.: 44

SERVICE MARK

PRINCIPAL REGISTER

GAO, HONG D. (CHINA INDIVIDUAL)
33-25 81 ST., APT. 1F
JACKSON HEIGHTS, NY 11372

FOR: FACIAL TREATMENT SERVICES, NAMELY, COSMETIC PEELS; HEALTH SPA SERVICES FOR HEALTH AND WELLNESS OF THE BODY AND SPIRIT, NAMELY, PROVIDING MASSAGE, FACIAL AND BODY TREATMENT SERVICES, COSMETIC BODY CARE SERVICES; HEALTH SPA SERVICES, NAMELY, LASER TREATMENTS FOR ACNE, REJUVENATION, SCARS, TATTOO REMOVAL AND FOR FACIALS AND MASSAGE; SALON SERVICES, NAMELY, FACIALS, MANICURES AND MESSAGES THAT ARE PROVIDED IN A TRAILER OUTFITTED WITH CHAIR, TABLE AND SINK ACCESSORIES; SKIN TREATMENT, NAMELY, THE INJECTION OF DERMAL FILLERS TO REDUCE THE APPEARANCE OF FACIAL FINE LINES; SKIN TREATMENTS, NAMELY, THE INJECTION OF DERMAL FILLING AGENTS AND NEUROMUSCULAR BLOCKING AGENTS TO REDUCE THE APPEARANCE OF FACIAL LINES AND WRINKLES, IN CLASS 44 (U.S. CLS. 100 AND 101).

FIRST USE 6-1-2011; IN COMMERCE 6-1-2011.

NO CLAIM IS MADE TO THE EXCLUSIVE RIGHT TO USE THE NON-LATIN CHARACTERS THAT TRANSLITERATE TO DI YI YUAN SHOU, APART FROM THE MARK AS SHOWN.

THE MARK CONSISTS OF A TERM "A-OR" AND NON-LATIN CHARACTERS THAT TRANSLITERATE AS DI, YI, YUAN, SHOU AND THAT TRANSLATE TO THE 1ST AND ORIGINAL HAND MASSAGE TECHNIQUES FOR FACIAL AND BODY SKIN TREATMENT IN ENGLISH.

THE ENGLISH TRANSLITERATION OF THE NON-LATIN CHARACTERS IN THE MARK IS DI YI YUAN SHOU AND THIS TRANSLATES AS THE 1ST AND ORIGINAL HAND MASSAGE TECHNIQUES FOR FACIAL AND BODY SKIN TREATMENT.

SN 85-052,029, FILED 6-1-2010.

CHRIS WELLS, EXAMINING ATTORNEY



David J. Kyjars

Director of the United States Patent and Trademark Office

United States of America

United States Patent and Trademark Office

THE HOPEFULL GIFT PACK

Reg. No. 4,068,134

Registered Dec. 6, 2011

Int. Cl.: 21

TRADEMARK

PRINCIPAL REGISTER

THE HOPEFULL COMPANY, INC. (MINNESOTA CORPORATION)
4354 BRIARWOOD LANE
MINNETONKA, MN 55343

FOR: KITS FOR MAKING MEAL POPS COMPRISED PRIMARILY OF MOLDS FOR MAKING THE FROZEN MEALS, WOOD STICKS, RECIPE CARDS AND COOLER BAGS FOR HOT OR COLD FOOD OR BEVERAGES, IN CLASS 21 (U.S. CLS. 2, 13, 23, 29, 30, 33, 40 AND 50).

FIRST USE 11-18-2010; IN COMMERCE 11-18-2010.

THE MARK CONSISTS OF STANDARD CHARACTERS WITHOUT CLAIM TO ANY PARTICULAR FONT, STYLE, SIZE, OR COLOR.

NO CLAIM IS MADE TO THE EXCLUSIVE RIGHT TO USE "GIFT PACK", APART FROM THE MARK AS SHOWN.

SN 85-054,154, FILED 6-3-2010.

ELIZABETH KAJUBI, EXAMINING ATTORNEY



David J. Kyros

Director of the United States Patent and Trademark Office

United States of America

United States Patent and Trademark Office

TRUE POMEGRANATE

Reg. No. 4,068,135

Registered Dec. 6, 2011

Int. Cl.: 5

TRADEMARK

PRINCIPAL REGISTER

STIEBS, LLC (CALIFORNIA LIMITED LIABILITY COMPANY)
11767 ROAD 27 1/2
MADERA, CA 93637

FOR: POMEGRANATE DERIVATIVES SOLD AS COMPONENTS IN NUTRACEUTICALS, PHARMACEUTICALS, DIETARY SUPPLEMENTS, AND NUTRITIONAL SUPPLEMENTS; POMEGRANATE EXTRACT, POMEGRANATE SEED OIL, POMEGRANATE SEED OIL EXTRACT, POMEGRANATE PUMICE, POMEGRANATE PEEL EXTRACT, AND POMEGRANATE JUICE POWDER, EACH SOLD AS COMPONENTS IN NUTRACEUTICALS, PHARMACEUTICALS, DIETARY SUPPLEMENTS, AND NUTRITIONAL SUPPLEMENTS, IN CLASS 5 (U.S. CLS. 6, 18, 44, 46, 51 AND 52).

FIRST USE 2-1-2011; IN COMMERCE 2-1-2011.

THE MARK CONSISTS OF STANDARD CHARACTERS WITHOUT CLAIM TO ANY PARTICULAR FONT, STYLE, SIZE, OR COLOR.

NO CLAIM IS MADE TO THE EXCLUSIVE RIGHT TO USE "POMEGRANATE" , APART FROM THE MARK AS SHOWN.

SN 85-054,982, FILED 6-4-2010.

DAVID TAYLOR, EXAMINING ATTORNEY



David J. Kyros

Director of the United States Patent and Trademark Office

United States of America

United States Patent and Trademark Office



Reg. No. 4,068,136

Registered Dec. 6, 2011

Int. Cl.: 11

TRADEMARK

PRINCIPAL REGISTER

HNO GREEN FUELS, INC. (NEVADA CORPORATION)
32947 COZY WAY
TEMECULA, CA 92592 AND

OWENS, DONALD W (UNITED STATES INDIVIDUAL)
32947 COZY WAY
TEMECULA, CA 92592

FOR: HYDROGEN-GENERATION EQUIPMENT AND COMPONENTS, NAMELY, HYDROGEN GENERATORS, HYDROGEN PURIFIERS, HYDROGEN PURIFICATION MEMBRANES, FUEL PROCESSORS, AND STEAM REFORMERS, IN CLASS 11 (U.S. CLS. 13, 21, 23, 31 AND 34).

FIRST USE 5-1-2010; IN COMMERCE 7-5-2011.

NO CLAIM IS MADE TO THE EXCLUSIVE RIGHT TO USE "GREEN FUELS INC" AND "ENERGY", APART FROM THE MARK AS SHOWN.

THE COLOR(S) BLUE, GREEN, YELLOW, ORANGE AND WHITE IS/ARE CLAIMED AS A FEATURE OF THE MARK.

THE MARK CONSISTS OF A BLUE STYLIZED LETTER "H" WITH A WATER DROP IN THE MIDDLE OF THE "H" IN THE COLOR BLUE AND THE LETTER "O" IN THE COLOR BLUE WITH THE COLOR WHITE IN THE CENTER OF THE "O", AN ORANGE AND YELLOW STYLIZED LETTER "N" WITH AN EXTENDED CRESCENT SHAPE THAT EXTENDS OVER THE LETTER "H", THE WORDING "GREEN FUELS" IN THE COLOR GREEN, AND THE WORDING "ENERGY IN ABUNDANCE" AND "INC" IN THE COLOR ORANGE.

THE WORDING "HNO" HAS NO MEANING IN A FOREIGN LANGUAGE.

SN 85-055,563, FILED 6-5-2010.

ANNE E. GUSTASON, EXAMINING ATTORNEY



David J. Kyffers

Director of the United States Patent and Trademark Office

United States of America

United States Patent and Trademark Office

WINDCHILL SOCIALLINK

Reg. No. 4,068,137

Registered Dec. 6, 2011

Int. Cls.: 9, 41, and 42

TRADEMARK

SERVICE MARK

PRINCIPAL REGISTER

PARAMETRIC TECHNOLOGY CORPORATION (MASSACHUSETTS CORPORATION)
140 KENDRICK STREET
NEEDHAM, MA 02494

FOR: COMPUTER SOFTWARE FOR THE MANAGEMENT OF THE PRODUCT DEVELOPMENT PROCESS, NAMELY, SOFTWARE FOR COMPUTER AIDED DESIGN (CAD), PRODUCT DATA MANAGEMENT (PDM), PRODUCT VISUALIZATION AND PRODUCT DOCUMENT CREATION; SOFTWARE FOR AUTOMATION OF WORKFLOWS, PRODUCTION PROCESSES, CONFIGURATION/CHANGE MANAGEMENT REQUIREMENTS MANAGEMENT, AND MANUFACTURING PLANNING FOR THE PURPOSES OF PRODUCT LIFECYCLE MANAGEMENT (PLM); AND SOFTWARE FOR COLLABORATION AND SHARED WORKSPACES UTILIZING SOCIAL COMPUTING CAPABILITIES; ACCOMPANYING USED GUIDES SOLD WITH SUCH SOFTWARE AS A UNIT, IN CLASS 9 (U.S. CLS. 21, 23, 26, 36 AND 38).

FIRST USE 12-24-2010; IN COMMERCE 12-24-2010.

FOR: COMPUTER EDUCATION TRAINING CLASSES, IN CLASS 41 (U.S. CLS. 100, 101 AND 107).

FIRST USE 11-1-2010; IN COMMERCE 11-1-2010.

FOR: TECHNICAL SUPPORT SERVICES, NAMELY, TROUBLESHOOTING OF COMPUTER SOFTWARE PROBLEMS VIA TELEPHONE; UPDATING OF COMPUTER SOFTWARE FOR OTHERS; MAINTENANCE OF COMPUTER SOFTWARE, NAMELY, MAINTENANCE AND ERROR CORRECTION SERVICES FOR COMPUTER SOFTWARE; COMPUTER CONSULTATION; PRODUCT DEVELOPMENT FOR OTHERS; CONSULTING SERVICES IN THE FIELD OF PRODUCT DEVELOPMENT; AND REPAIR OF COMPUTER SOFTWARE, IN CLASS 42 (U.S. CLS. 100 AND 101).

FIRST USE 12-24-2010; IN COMMERCE 12-24-2010.

THE MARK CONSISTS OF STANDARD CHARACTERS WITHOUT CLAIM TO ANY PARTICULAR FONT, STYLE, SIZE, OR COLOR.

OWNER OF U.S. REG. NOS. 2,267,669, 3,521,064, AND OTHERS.



David J. Kyjars

Director of the United States Patent and Trademark Office

Reg. No. 4,068,137 NO CLAIM IS MADE TO THE EXCLUSIVE RIGHT TO USE "SOCIALLINK", APART FROM THE MARK AS SHOWN.

SN 85-055,941, FILED 6-7-2010.

PAUL F. GAST, EXAMINING ATTORNEY

United States of America

United States Patent and Trademark Office

FACIAL FUEL TRANSFORMER

Reg. No. 4,068,138

Registered Dec. 6, 2011

Int. Cl.: 3

TRADEMARK

PRINCIPAL REGISTER

L'OREAL USA CREATIVE, INC. (DELAWARE CORPORATION)
575 FIFTH AVENUE
NEW YORK, NY 10017

FOR: FACIAL MOISTURIZER, IN CLASS 3 (U.S. CLS. 1, 4, 6, 50, 51 AND 52).

FIRST USE 5-0-2011; IN COMMERCE 5-0-2011.

THE MARK CONSISTS OF STANDARD CHARACTERS WITHOUT CLAIM TO ANY PARTICULAR FONT, STYLE, SIZE, OR COLOR.

OWNER OF U.S. REG. NO. 2,974,622.

SN 85-055,970, FILED 6-7-2010.

JOHN HWANG, EXAMINING ATTORNEY



David J. Kyffers

Director of the United States Patent and Trademark Office

United States of America

United States Patent and Trademark Office

COLOR FLARE

Reg. No. 4,068,139

Registered Dec. 6, 2011

Int. Cl.: 17

TRADEMARK

PRINCIPAL REGISTER

NEW PENDULUM CORP. (DELAWARE CORPORATION)
1105 N. MARKET STREET, SUITE 1300
WILMINGTON, DE 19801

FOR: SORBENT PRODUCTS, NAMELY, ARTICLES FOR ABSORBING AND, BY MEANS OF A CHANGE IN COLOR, INDICATING THE PRESENCE OF SPILLED OR LEAKED FLUIDS, NAMELY, BOOMS, PADS, PILLOWS, MATS, AND SOCKS FOR INDUSTRIAL, COMMERCIAL AND RESIDENTIAL USE, IN CLASS 17 (U.S. CLS. 1, 5, 12, 13, 35 AND 50).

FIRST USE 3-9-2011; IN COMMERCE 3-9-2011.

THE MARK CONSISTS OF STANDARD CHARACTERS WITHOUT CLAIM TO ANY PARTICULAR FONT, STYLE, SIZE, OR COLOR.

NO CLAIM IS MADE TO THE EXCLUSIVE RIGHT TO USE "COLOR", APART FROM THE MARK AS SHOWN.

SN 85-056,108, FILED 6-7-2010.

MAYUR VAGHANI, EXAMINING ATTORNEY



David J. Kyros

Director of the United States Patent and Trademark Office

United States of America
United States Patent and Trademark Office

SIDEARM

Reg. No. 4,068,140

SIDEARMPRO LLC (COLORADO LIMITED LIABILITY COMPANY)
P.O. BOX 3282
CENTENNIAL, CO 801613282

Registered Dec. 6, 2011

Int. Cl.: 16

FOR: PAINT TRAYS; PAINT TRAY LINERS OF PAPER OR PLASTIC, IN CLASS 16 (U.S. CLS. 2, 5, 22, 23, 29, 37, 38 AND 50).

TRADEMARK

FIRST USE 2-0-2011; IN COMMERCE 2-0-2011.

PRINCIPAL REGISTER

THE MARK CONSISTS OF STANDARD CHARACTERS WITHOUT CLAIM TO ANY PARTICULAR FONT, STYLE, SIZE, OR COLOR.

SN 85-056,687, FILED 6-7-2010.

BILL DAWE, EXAMINING ATTORNEY



David J. Kybas

Director of the United States Patent and Trademark Office

United States of America

United States Patent and Trademark Office

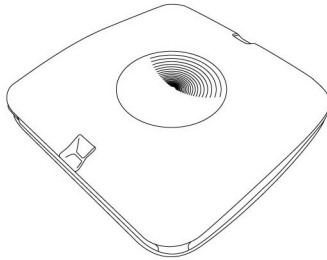

Reg. No. 4,068,141

Registered Dec. 6, 2011

Int. Cl.: 30

TRADEMARK

PRINCIPAL REGISTER

SWEET TEC GMBH (FED REP GERMANY LIMITED LIABILITY COMPANY)
LINDHORST 4
BOIZENBURG, FED REP GERMANY 19258

FOR: CANDY, IN CLASS 30 (U.S. CL. 46).

FIRST USE 6-14-2011; IN COMMERCE 6-14-2011.

THE MARK CONSISTS OF A CONFIGURATION OF A CONTAINER FOR MINTS WITH TWO SLIDING HALVES AND A ROUND INDENTATION IN THE CENTER.

SN 85-058,229, FILED 6-9-2010.

JANET LEE, EXAMINING ATTORNEY



David J. Kybas

Director of the United States Patent and Trademark Office

United States of America

United States Patent and Trademark Office

AROMATABS

Reg. No. 4,068,142

BEEKLEY CORPORATION (CONNECTICUT CORPORATION)
ONE PRESTIGE LANE
BRISTOL, CT 06010

Registered Dec. 6, 2011

Int. Cl.: 3

FOR: SINGLE-USE ADHESIVE-BACKED PACKAGE CONTAINING AROMATHERAPY OIL FOR RELEASING A SCENT OF THE OIL, IN CLASS 3 (U.S. CLS. 1, 4, 6, 50, 51 AND 52).

TRADEMARK

FIRST USE 10-11-2010; IN COMMERCE 10-11-2010.

PRINCIPAL REGISTER

THE MARK CONSISTS OF STANDARD CHARACTERS WITHOUT CLAIM TO ANY PARTICULAR FONT, STYLE, SIZE, OR COLOR.

SN 85-058,813, FILED 6-9-2010.

ROSELLE HERRERA, EXAMINING ATTORNEY



David J. Kybas

Director of the United States Patent and Trademark Office

United States of America

United States Patent and Trademark Office

Matrix

Reg. No. 4,068,143

Registered Dec. 6, 2011

Int. Cl.: 5

TRADEMARK

PRINCIPAL REGISTER

SEPRO CORPORATION (INDIANA CORPORATION)
STE. 600
11550 N. MERIDIAN STREET
CARMEL, IN 46032

FOR: AQUATIC HERBICIDES, IN CLASS 5 (U.S. CLS. 6, 18, 44, 46, 51 AND 52).

FIRST USE 9-30-2010; IN COMMERCE 9-30-2010.

THE MARK CONSISTS OF STANDARD CHARACTERS WITHOUT CLAIM TO ANY PARTICULAR FONT, STYLE, SIZE, OR COLOR.

SN 85-059,144, FILED 6-10-2010.

JESSICA A. POWERS, EXAMINING ATTORNEY



David J. Kybas

Director of the United States Patent and Trademark Office

United States of America

United States Patent and Trademark Office

PEGASUS

Reg. No. 4,068,144

Registered Dec. 6, 2011

Int. Cl.: 1

TRADEMARK

PRINCIPAL REGISTER

THE MOSAIC COMPANY (DELAWARE CORPORATION)
SUITE E490
3033 CAMPUS DRIVE
PLYMOUTH, MN 55441

FOR: FERTILIZER FOR AGRICULTURAL USE SOLD IN BULK NON-PACKAGED FORM,
IN CLASS 1 (U.S. CLS. 1, 5, 6, 10, 26 AND 46).

FIRST USE 12-31-2010; IN COMMERCE 12-31-2010.

THE MARK CONSISTS OF STANDARD CHARACTERS WITHOUT CLAIM TO ANY PAR-
TICULAR FONT, STYLE, SIZE, OR COLOR.

SN 85-059,291, FILED 6-10-2010.

BARBARA RUTLAND, EXAMINING ATTORNEY



David J. Kybas

Director of the United States Patent and Trademark Office

United States of America

United States Patent and Trademark Office

AromaTabs

Reg. No. 4,068,145

Registered Dec. 6, 2011

Int. Cl.: 3

TRADEMARK

PRINCIPAL REGISTER

BEEKLEY CORPORATION (CONNECTICUT CORPORATION)
ONE PRESTIGE LANE
BRISTOL, CT 06010

FOR: SINGLE-USE ADHESIVE-BACKED PACKAGE CONTAINING AROMATHERAPY OIL
FOR RELEASING A SCENT OF THE OIL, IN CLASS 3 (U.S. CLS. 1, 4, 6, 50, 51 AND 52).

FIRST USE 10-11-2010; IN COMMERCE 10-11-2010.

THE MARK CONSISTS OF THE WORD "AROMATABS" IN STYLIZED FONT WITH LARGER
"A" AND "T" LETTERS.

SN 85-059,576, FILED 6-10-2010.

ROSELLE HERRERA, EXAMINING ATTORNEY



David J. Kybas

Director of the United States Patent and Trademark Office

United States of America

United States Patent and Trademark Office



Reg. No. 4,068,146

D&W FINE PACK LLC (DELAWARE LIMITED LIABILITY COMPANY)
1372 N. OLD LAURENS ROAD
FOUNTAIN INN, SC 29644

Registered Dec. 6, 2011

**Int. Cls.: 6, 8, 16, 20, 21,
and 42**

FOR: METAL FOIL FOR USE IN FOOD SERVICE; METAL FOOD CONTAINERS FOR COMMERCIAL USE, IN CLASS 6 (U.S. CLS. 2, 12, 13, 14, 23, 25 AND 50).

FIRST USE 10-10-2011; IN COMMERCE 10-10-2011.

TRADEMARK

FOR: DISPOSABLE PRODUCTS FOR THE FOOD SERVICE INDUSTRY, NAMELY, CUTLERY, NAMELY, KNIVES, FORKS AND SPOONS; DISPOSABLE PRODUCTS FOR THE FOOD SERVICE INDUSTRY, NAMELY, DINNER KITS CONSISTING PRIMARILY OF PRE-PACKAGED CUTLERY COMPRISING, KNIVES, FORKS AND SPOONS, INCLUDING A NAPKIN, CONDIMENTS AND PACKETS OF SKIN CLEANSER WIPES, IN CLASS 8 (U.S. CLS. 23, 28 AND 44).

SERVICE MARK

FIRST USE 10-10-2011; IN COMMERCE 10-10-2011.

PRINCIPAL REGISTER

FOR: DISPOSABLE PRODUCTS FOR THE FOOD SERVICE INDUSTRY, NAMELY, PAPER BAKING PAN LINERS AND PAPER AND CARDBOARD FOOD CONTAINERS FOR TAKE-OUT AND MADE TO ORDER FOODS; DISPOSABLE, BIODEGRADABLE FIBER PULP PRODUCTS FOR THE FOOD SERVICE INDUSTRY, NAMELY, CONTAINERS; DISPOSABLE PRODUCTS FOR USE WITH COFFEE BEVERAGES, NAMELY, PAPER NAPKINS, IN CLASS 16 (U.S. CLS. 2, 5, 22, 23, 29, 37, 38 AND 50).

FIRST USE 10-10-2011; IN COMMERCE 10-10-2011.



David J. Kybas

Director of the United States Patent and Trademark Office

FOR: PLASTIC CONTAINERS FOR COMMERCIAL USE, NAMELY, FOR STORING AND DISPENSING BULK FOODS; PLASTIC CONTAINERS AND COVERS FOR COMMERCIAL USE, NAMELY, FOR THE FOOD INDUSTRY; PLASTIC CONTAINERS AND COVERS SOLD AS A UNIT TO THE FOOD INDUSTRY FOR MADE TO ORDER FOOD PRODUCTS; DISPOSABLE PRODUCTS FOR THE FOOD SERVICE INDUSTRY, NAMELY, DRINKING STRAWS AND PIZZA SAVERS, NAMELY, SPACERS MADE OF PLASTIC FOR USE IN PREVENTING FOOD CONTAINERS FROM CONTACTING OR CRUSHING FOOD; COMMERCIAL PACKAGING MATERIALS, NAMELY, DISPOSABLE PRODUCTS FOR THE FOOD SERVICE INDUSTRY, NAMELY, FOAM CONTAINERS FOR TAKE-OUT AND MADE TO ORDER FOODS; PLASTIC BOXES; DISPOSABLE PRODUCTS FOR THE FOOD SERVICE INDUSTRY,

Reg. No. 4,068,146 NAMELY, FOAM CONTAINERS FOR COMMERCIAL USE; DISPOSABLE PRODUCTS FOR THE FOOD SERVICE INDUSTRY, NAMELY, PLASTIC FOOD CONTAINERS FOR TAKE-OUT AND MADE TO ORDER FOODS, IN CLASS 20 (U.S. CLS. 2, 13, 22, 25, 32 AND 50).

FIRST USE 10-10-2011; IN COMMERCE 10-10-2011.

FOR: DISPOSABLE FOAM FOOD SERVING TRAYS; DISPOSABLE FOAM FOOD SERVING TRAYS SOLD IN COMBINATION WITH DISPOSABLE TABLEWARE, NAMELY, SPORKS, FORKS, SPOONS, KNIVES, DRINKING STRAWS, AND/OR PAPER NAPKINS; DISPOSABLE, BIODEGRADABLE PRODUCTS FOR THE FOOD SERVICE INDUSTRY, NAMELY, PLATES, BOWLS, TRAYS; DISPOSABLE FOAM TABLEWARE, NAMELY, PLATES, CUPS, BOWLS AND SERVING TRAYS; DISPOSABLE PRODUCTS FOR USE WITH COFFEE BEVERAGES, NAMELY, BEVERAGE STIRRERS; DISPOSABLE PRODUCTS FOR THE FOOD SERVICE INDUSTRY, NAMELY, FOAM PLATES, BOWLS AND TRAYS; DISPOSABLE PRODUCTS FOR THE FOOD SERVICE INDUSTRY, NAMELY, PLATES, BOWLS AND TRAYS; DISPOSABLE, BIODEGRADABLE FIBER PULP PRODUCTS FOR THE FOOD SERVICE INDUSTRY, NAMELY, PLATES, BOWLS AND TRAYS; COMMERCIAL PACKAGING MATERIALS, NAMELY, DISPOSABLE PRODUCTS FOR THE FOOD SERVICE INDUSTRY, NAMELY, PLATES, BOWLS AND TRAYS FOR TAKE-OUT AND MADE TO ORDER FOODS, IN CLASS 21 (U.S. CLS. 2, 13, 23, 29, 30, 33, 40 AND 50).

FIRST USE 10-10-2011; IN COMMERCE 10-10-2011.

FOR: DESIGN OF PLASTIC FOOD SERVICE CONTAINERS, PLATES, BOWLS, TRAYS, DRINKING STRAWS, AND CUTLERY; DESIGN OF PREPACKAGED KITS OF CUTLERY, CONDIMENTS, BEVERAGE STIRRERS, CLEANSER WIPES AND NAPKINS; DESIGN OF METAL FOIL FOR USE WITH FOOD; DESIGN OF METAL FOOD SERVICE CONTAINERS, PLATES, BOWLS, AND TRAYS; DESIGN OF FIBER PULP FOOD SERVICE CONTAINERS, PLATES, BOWLS, AND TRAYS, IN CLASS 42 (U.S. CLS. 100 AND 101).

FIRST USE 10-10-2011; IN COMMERCE 10-10-2011.

NO CLAIM IS MADE TO THE EXCLUSIVE RIGHT TO USE "PACK" , APART FROM THE MARK AS SHOWN.

THE MARK CONSISTS OF THE LETTERS "D&W" AND BENEATH SAME, THE WORDS "FINE PACK", ALL WITHIN AN OVAL.

SN 85-059,874, FILED 6-10-2010.

MATTHEW PAPPAS, EXAMINING ATTORNEY

United States of America

United States Patent and Trademark Office

Where value meets values.

Reg. No. 4,068,147

Registered Dec. 6, 2011

Int. Cl.: 35

SERVICE MARK

PRINCIPAL REGISTER

GIVE SOMETHING BACK INC (CALIFORNIA CORPORATION), DBA GIVE SOMETHING
BACK BUSINESS PRODUCTS,
7730 PARDEE LANE
OAKLAND, CA 94621

FOR: WHOLESALE STORE SERVICES FEATURING OFFICE PRODUCTS, FURNITURE,
AND OFFICE EQUIPMENT; PROCUREMENT, NAMELY, PURCHASING OFFICE SUPPLIES
FOR OTHERS, IN CLASS 35 (U.S. CLS. 100, 101 AND 102).

FIRST USE 7-1-2010; IN COMMERCE 7-1-2010.

THE MARK CONSISTS OF STANDARD CHARACTERS WITHOUT CLAIM TO ANY PAR-
TICULAR FONT, STYLE, SIZE, OR COLOR.

SN 85-060,349, FILED 6-11-2010.

SCOTT BIBB, EXAMINING ATTORNEY



David J. Kyffers

Director of the United States Patent and Trademark Office

United States of America

United States Patent and Trademark Office

WONDERBEADS

Reg. No. 4,068,148

INTERNATIONAL PLAYTHINGS LLC (DELAWARE LIMITED LIABILITY COMPANY)
75D LACKAWANNA AVENUE
PARSIPPANY, NJ 07054

Registered Dec. 6, 2011

Int. Cl.: 26

FOR: CHILDREN'S ARTS AND CRAFT KITS COMPRISED OF BEADS AND TEMPLATES
FOR HANDICRAFT WORK, IN CLASS 26 (U.S. CLS. 37, 39, 40, 42 AND 50).

TRADEMARK

FIRST USE 1-31-2011; IN COMMERCE 1-31-2011.

PRINCIPAL REGISTER

THE MARK CONSISTS OF STANDARD CHARACTERS WITHOUT CLAIM TO ANY PAR-
TICULAR FONT, STYLE, SIZE, OR COLOR.

SN 85-060,465, FILED 6-11-2010.

JASON TURNER, EXAMINING ATTORNEY



David J. Kybas

Director of the United States Patent and Trademark Office

United States of America

United States Patent and Trademark Office

OZ QUADRA SMARTIUM

Reg. No. 4,068,149

Registered Dec. 6, 2011

Int. Cl.: 39

SERVICE MARK

PRINCIPAL REGISTER

ASIANA AIRLINES, INC. (REPUBLIC OF KOREA CORPORATION)
ASIANA TOWN #47, OSAE-DONG, KANGSEO-KU
SEOUL, REPUBLIC OF KOREA

FOR: AIR TRANSPORT; INTERNATIONAL COMPLEX AIR TRANSPORTATION; PASSENGER TRANSPORT; TRANSPORTATION OF TRAVELERS; TRANSPORT RESERVATION; MAKING TRAVEL RESERVATIONS, NAMELY, MAKING RESERVATIONS FOR TRANSPORTATION; BOOKING OF SEATS FOR TRAVEL; AIRLINE TRANSPORTATION SERVICES, IN CLASS 39 (U.S. CLS. 100 AND 105).

FIRST USE 6-7-2010; IN COMMERCE 6-7-2010.

THE MARK CONSISTS OF STANDARD CHARACTERS WITHOUT CLAIM TO ANY PARTICULAR FONT, STYLE, SIZE, OR COLOR.

SN 85-060,641, FILED 6-11-2010.

KELLY BOULTON, EXAMINING ATTORNEY



David J. Kybas

Director of the United States Patent and Trademark Office

United States of America

United States Patent and Trademark Office

Marca Future

Reg. No. 4,068,150

Registered Dec. 6, 2011

Int. Cl.: 9

TRADEMARK

PRINCIPAL REGISTER

MARCA INDUSTRIES, INC. (ILLINOIS CORPORATION)
5501 W. 79TH STREET
SUITE 400
BURBANK, IL 60459

FOR: COMPUTER PROGRAMS FOR USE IN THE MEDICAL FIELD FOR PROCESSING REIMBURSEMENTS FOR HEALTHCARE PROVIDERS, IN CLASS 9 (U.S. CLS. 21, 23, 26, 36 AND 38).

FIRST USE 5-2-2011; IN COMMERCE 5-2-2011.

THE MARK CONSISTS OF STANDARD CHARACTERS WITHOUT CLAIM TO ANY PARTICULAR FONT, STYLE, SIZE, OR COLOR.

OWNER OF U.S. REG. NO. 1,763,189.

THE ENGLISH TRANSLATION OF THE WORD "MARCA" IN THE MARK IS "MARK".

SN 85-060,843, FILED 6-11-2010.

MARY CRAWFORD, EXAMINING ATTORNEY



David J. Kybas

Director of the United States Patent and Trademark Office

United States of America

United States Patent and Trademark Office

drink smart, drink Neuro

Reg. No. 4,068,151

Registered Dec. 6, 2011

Int. Cls.: 5 and 32

TRADEMARK

PRINCIPAL REGISTER

NEUROBRANDS LLC (CALIFORNIA LIMITED LIABILITY COMPANY)
510 SANTA MONICA BLVD.
2ND FLOOR
SANTA MONICA, CA 90401

FOR: DIETARY SUPPLEMENTAL DRINKS; NUTRITIONALLY FORTIFIED BEVERAGES;
VITAMIN FORTIFIED BEVERAGES, IN CLASS 5 (U.S. CLS. 6, 18, 44, 46, 51 AND 52).

FIRST USE 6-4-2010; IN COMMERCE 10-10-2010.

FOR: NON-ALCOHOLIC BEVERAGES, NAMELY, FRUIT DRINKS, ENERGY DRINKS,
FRUIT FLAVORED DRINKS, HERBAL JUICES AND ISOTONIC DRINKS, IN CLASS 32 (U.S.
CLS. 45, 46 AND 48).

FIRST USE 6-4-2010; IN COMMERCE 10-10-2010.

THE MARK CONSISTS OF STANDARD CHARACTERS WITHOUT CLAIM TO ANY PAR-
TICULAR FONT, STYLE, SIZE, OR COLOR.

OWNER OF U.S. REG. NOS. 3,814,258, 3,923,701, AND OTHERS.

SN 85-061,283, FILED 6-11-2010.

MARGARET POWER, EXAMINING ATTORNEY



David J. Kyros

Director of the United States Patent and Trademark Office

United States of America

United States Patent and Trademark Office

LIVE YOUR SPORT FOG FREE

Reg. No. 4,068,152

Registered Dec. 6, 2011

Int. Cls.: 3 and 21

TRADEMARK

PRINCIPAL REGISTER

BAUSCH & LOMB INCORPORATED (NEW YORK CORPORATION)
LAW DEPARTMENT
ONE BAUSCH & LOMB PLACE
ROCHESTER, NY 146042701

FOR: OPTICAL LENS CLEANING PRODUCTS, NAMELY, LENS CLEANING SOLUTIONS FOR SPECTACLE LENSES, EYEGLASSES, SAFETY GOGGLES AND EYEWEAR USED IN ATHLETICS AND IMPREGNATED CLEANING CLOTHS FOR OPTICAL AND SPECTACLE LENSES, EYEGLASSES AND SAFETY GOGGLES AND EYEWEAR USED IN ATHLETICS, IN CLASS 3 (U.S. CLS. 1, 4, 6, 50, 51 AND 52).

FIRST USE 11-0-2009; IN COMMERCE 11-0-2009.

FOR: OPTICAL LENS CLEANING PRODUCTS, NAMELY, CLEANING CLOTHS FOR OPTICAL AND SPECTACLE LENSES, EYEGLASSES, SAFETY GOGGLES AND EYEWEAR USED IN ATHLETICS, IN CLASS 21 (U.S. CLS. 2, 13, 23, 29, 30, 33, 40 AND 50).

FIRST USE 11-0-2009; IN COMMERCE 11-0-2009.

THE MARK CONSISTS OF STANDARD CHARACTERS WITHOUT CLAIM TO ANY PARTICULAR FONT, STYLE, SIZE, OR COLOR.

SN 85-061,850, FILED 6-14-2010.

JULIE WATSON, EXAMINING ATTORNEY



David J. Kyffers

Director of the United States Patent and Trademark Office

United States of America

United States Patent and Trademark Office

ZOKU

Reg. No. 4,068,153

Registered Dec. 6, 2011

Int. Cl.: 16

TRADEMARK

PRINCIPAL REGISTER

ZOKU, LLC (NEW JERSEY LIMITED LIABILITY COMPANY)
SUITE C405
720 MONROE ST
HOBOKEN, NJ 07030

FOR: COOK BOOKS, IN CLASS 16 (U.S. CLS. 2, 5, 22, 23, 29, 37, 38 AND 50).

FIRST USE 11-15-2010; IN COMMERCE 11-15-2010.

THE MARK CONSISTS OF STANDARD CHARACTERS WITHOUT CLAIM TO ANY PARTICULAR FONT, STYLE, SIZE, OR COLOR.

OWNER OF U.S. REG. NO. 3,803,008.

THE WORDING "ZOKU" HAS NO MEANING IN A FOREIGN LANGUAGE.

SN 85-063,355, FILED 6-15-2010.

JAMES STEIN, EXAMINING ATTORNEY



David J. Kybas

Director of the United States Patent and Trademark Office

United States of America

United States Patent and Trademark Office

RELEASE THE KRAKEN

Reg. No. 4,068,154

Registered Dec. 6, 2011

Int. Cl.: 33

TRADEMARK

PRINCIPAL REGISTER

PROXIMO SPIRITS, INC. (DELAWARE CORPORATION)
333 WASHINGTON STREET
JERSEY CITY, NJ 07302

FOR: RUM, IN CLASS 33 (U.S. CLS. 47 AND 49).

FIRST USE 9-19-2011; IN COMMERCE 9-19-2011.

THE MARK CONSISTS OF STANDARD CHARACTERS WITHOUT CLAIM TO ANY PARTICULAR FONT, STYLE, SIZE, OR COLOR.

SN 85-063,419, FILED 6-15-2010.

NICHOLAS ALTREE, EXAMINING ATTORNEY



David J. Kybas

Director of the United States Patent and Trademark Office

United States of America

United States Patent and Trademark Office

Pegasus

Reg. No. 4,068,155

Registered Dec. 6, 2011

Int. Cl.: 1

TRADEMARK

PRINCIPAL REGISTER

THE MOSAIC COMPANY (DELAWARE CORPORATION)
SUITE E490
3033 CAMPUS DRIVE
PLYMOUTH, MN 55441

FOR: FERTILIZER FOR AGRICULTURAL USE SOLD IN BULK NON-PACKAGED FORM,
IN CLASS 1 (U.S. CLS. 1, 5, 6, 10, 26 AND 46).

FIRST USE 12-31-2010; IN COMMERCE 12-31-2010.

THE MARK CONSISTS OF SHAPE OF A WING IS LATTERLY DISPOSED TO THE LEFT
OF THE WORD "PEGASUS".

SN 85-064,574, FILED 6-16-2010.

BARBARA RUTLAND, EXAMINING ATTORNEY



David J. Kybas

Director of the United States Patent and Trademark Office

United States of America

United States Patent and Trademark Office

CARING REALTY

Reg. No. 4,068,156

Registered Dec. 6, 2011

Int. Cl.: 36

SERVICE MARK

PRINCIPAL REGISTER

HOUSE HUNTERS (CALIFORNIA SOLE PROPRIETORSHIP)
PO BOX 15664
LONG BEACH, CA 90815

FOR: FINANCIAL EVALUATION FOR INSURANCE PURPOSES; FINANCIAL EVALUATION OF REAL ESTATE; BANKING; REAL ESTATE BROKERAGE, IN CLASS 36 (U.S. CLS. 100, 101 AND 102).

FIRST USE 6-12-2011; IN COMMERCE 6-12-2011.

THE MARK CONSISTS OF STANDARD CHARACTERS WITHOUT CLAIM TO ANY PARTICULAR FONT, STYLE, SIZE, OR COLOR.

NO CLAIM IS MADE TO THE EXCLUSIVE RIGHT TO USE "REALTY", APART FROM THE MARK AS SHOWN.

SN 85-065,998, FILED 6-18-2010.

JENNIFER MARTIN, EXAMINING ATTORNEY



David J. Kyros

Director of the United States Patent and Trademark Office

United States of America

United States Patent and Trademark Office

PM REALTY ADVISORS

Reg. No. 4,068,157

Registered Dec. 6, 2011

Int. Cls.: 36 and 37

SERVICE MARK

PRINCIPAL REGISTER

PM REALTY GROUP, L.P. (TEXAS LIMITED PARTNERSHIP)
SUITE 2400
1000 MAIN
HOUSTON, TX 77027

FOR: REAL ESTATE SERVICES, NAMELY, LEASING, PROPERTY MANAGEMENT, AND FACILITY MANAGEMENT FOR OTHERS IN THE FIELD OF COMMERCIAL REAL ESTATE, NAMELY, OFFICE, MEDICAL OFFICE, INDUSTRIAL, RETAIL, MIXED USE, RESIDENTIAL, DISTRIBUTION, HEALTHCARE, STUDENT HOUSING, AND RECEIVERSHIP REO PROPERTIES; FINANCIAL AND INVESTMENT SERVICES IN THE NATURE OF PURCHASING AND SELLING REAL ESTATE FOR OTHERS; REAL ESTATE BROKERAGE; FINANCIAL DUE DILIGENCE SERVICES IN THE FIELD OF REAL ESTATE, IN CLASS 36 (U.S. CLS. 100, 101 AND 102).

FIRST USE 10-19-2011; IN COMMERCE 10-19-2011.

FOR: REAL ESTATE DEVELOPMENT IN THE FIELD OF COMMERCIAL REAL ESTATE, NAMELY, OFFICE, MEDICAL OFFICE, INDUSTRIAL, RETAIL, MIXED USE, RESIDENTIAL, DISTRIBUTION, HEALTHCARE, STUDENT HOUSING, AND RECEIVERSHIP REO PROPERTIES; REAL ESTATE CONSTRUCTION PROJECT MANAGEMENT, IN CLASS 37 (U.S. CLS. 100, 103 AND 106).

FIRST USE 10-19-2011; IN COMMERCE 10-19-2011.

THE MARK CONSISTS OF STANDARD CHARACTERS WITHOUT CLAIM TO ANY PARTICULAR FONT, STYLE, SIZE, OR COLOR.

OWNER OF U.S. REG. NOS. 3,840,108, 3,843,889, AND OTHERS.

NO CLAIM IS MADE TO THE EXCLUSIVE RIGHT TO USE "REALTY ADVISORS", APART FROM THE MARK AS SHOWN.

SN 85-066,279, FILED 6-18-2010.

DAVID TOOLEY, EXAMINING ATTORNEY



David J. Kyffers

Director of the United States Patent and Trademark Office

United States of America

United States Patent and Trademark Office

EDUCATORSTUDIO

Reg. No. 4,068,158

Registered Dec. 6, 2011

Int. Cls.: 38 and 41

SERVICE MARK

PRINCIPAL REGISTER

FULL SAIL, LLC (FLORIDA LIMITED LIABILITY COMPANY)
3300 UNIVERSITY BOULEVARD
WINTER PARK, FL 32792

FOR: PROVIDING ON-LINE FORUMS AND ELECTRONIC BULLETIN BOARDS FOR TRANSMISSION OF MESSAGES AMONG USERS FOR USE IN PROVIDING EDUCATORS WITH INFORMATION AND INSTRUCTIONS IN DEVELOPING AND IMPROVING EDUCATION, STUDENT PERFORMANCE, CLASSROOM INSTRUCTIONAL PROGRAMS, CURRICULA AND THE USE OF TECHNOLOGY IN CONNECTION WITH SAME, IN CLASS 38 (U.S. CLS. 100, 101 AND 104).

FIRST USE 10-5-2011; IN COMMERCE 10-5-2011.

FOR: ON-LINE JOURNALS, NAMELY, BLOGS, FOR USE IN PROVIDING EDUCATORS INFORMATION AND INSTRUCTIONS IN DEVELOPING AND IMPROVING EDUCATION, STUDENT PERFORMANCE, CLASSROOM INSTRUCTIONAL PROGRAMS, CURRICULA AND THE USE OF TECHNOLOGY IN CONNECTION WITH SAME; EDUCATIONAL SERVICES, NAMELY, PROVIDING ON-LINE INSTRUCTION TO EDUCATORS IN THE DEVELOPMENT AND IMPROVEMENT OF EDUCATION, STUDENT PERFORMANCE, CLASSROOM INSTRUCTIONAL PROGRAMS, CURRICULA AND THE USE OF TECHNOLOGY IN CONNECTION WITH SAME, IN CLASS 41 (U.S. CLS. 100, 101 AND 107).

FIRST USE 10-5-2011; IN COMMERCE 10-5-2011.

THE MARK CONSISTS OF STANDARD CHARACTERS WITHOUT CLAIM TO ANY PARTICULAR FONT, STYLE, SIZE, OR COLOR.

SN 85-068,773, FILED 6-22-2010.

THOMAS MANOR, EXAMINING ATTORNEY



David J. Kyros

Director of the United States Patent and Trademark Office

United States of America

United States Patent and Trademark Office

MARKETINGZEUS

Reg. No. 4,068,159

Registered Dec. 6, 2011

Int. Cls.: 38 and 41

SERVICE MARK

PRINCIPAL REGISTER

FULL SAIL, LLC (FLORIDA LIMITED LIABILITY COMPANY)
3300 UNIVERSITY BOULEVARD
WINTER PARK, FL 32792

FOR: PROVIDING ON-LINE FORUMS AND ELECTRONIC BULLETIN BOARDS FOR TRANSMISSION OF MESSAGES AMONG USERS FEATURING ARTICLES, COLUMNS, INTERVIEWS AND INFORMATION IN THE FIELD OF INTERNET MARKETING, IN CLASS 38 (U.S. CLS. 100, 101 AND 104).

FIRST USE 10-5-2011; IN COMMERCE 10-5-2011.

FOR: ON-LINE JOURNALS, NAMELY, BLOGS, FEATURING ARTICLES, COLUMNS, INTERVIEWS AND INFORMATION IN THE FIELD OF INTERNET MARKETING, IN CLASS 41 (U.S. CLS. 100, 101 AND 107).

FIRST USE 10-5-2011; IN COMMERCE 10-5-2011.

THE MARK CONSISTS OF STANDARD CHARACTERS WITHOUT CLAIM TO ANY PARTICULAR FONT, STYLE, SIZE, OR COLOR.

SN 85-068,795, FILED 6-22-2010.

THOMAS MANOR, EXAMINING ATTORNEY



David J. Kyros

Director of the United States Patent and Trademark Office

United States of America
United States Patent and Trademark Office

Hadley
TABLE

Reg. No. 4,068,160

Registered Dec. 6, 2011

Int. Cls.: 21 and 24

TRADEMARK

PRINCIPAL REGISTER

HADLEY LLC (DELAWARE LIMITED LIABILITY COMPANY)
4617 TOWNES CIR
EDINA, MN 55424

FOR: COASTERS, NOT OF PAPER AND OTHER THAN TABLE LINEN, IN CLASS 21 (U.S. CLS. 2, 13, 23, 29, 30, 33, 40 AND 50).

FIRST USE 3-1-2011; IN COMMERCE 6-1-2011.

FOR: PLACE MATS, NOT OF PAPER; PLASTIC PLACE MATS; TABLE LINEN, NAMELY, COTTON AND LINEN NAPKINS; TABLE MATS NOT OF PAPER, IN CLASS 24 (U.S. CLS. 42 AND 50).

FIRST USE 3-1-2011; IN COMMERCE 6-1-2011.

NO CLAIM IS MADE TO THE EXCLUSIVE RIGHT TO USE "TABLE", APART FROM THE MARK AS SHOWN.

THE MARK CONSISTS OF THE WORD "HADLEY" IN BICKHAM SCRIPT PRO FONT WITH THE WORD "TABLE" IN CAPS UNDER THE WORD "HADLEY" IN A SMALLER SIZE IN THE MYRIAD PRO SCRIPT FONT.

SN 85-068,844, FILED 6-22-2010.

DAVID TAYLOR, EXAMINING ATTORNEY



David J. Kyros

Director of the United States Patent and Trademark Office

United States of America

United States Patent and Trademark Office

IRHEMA

Reg. No. 4,068,161

Registered Dec. 6, 2011

Int. Cl.: 9

TRADEMARK

PRINCIPAL REGISTER

MITCHELL, TYRA K. (UNITED STATES INDIVIDUAL)
213 BEAVER CREEK DRIVE
COLUMBIA, SC 29223

FOR: COMPUTER SOFTWARE FOR USE IN THE ENCRYPTION AND DECRYPTION OF DIGITAL FILES, INCLUDING AUDIO, VIDEO, TEXT, BINARY, STILL IMAGES, GRAPHICS AND MULTIMEDIA FILES; COMPUTER SOFTWARE FOR USE IN AUTHORIZING, DOWNLOADING, TRANSMITTING, RECEIVING, EDITING, EXTRACTING, ENCODING, DECODING, PLAYING, STORING, AND ORGANIZING AUDIO DATA, IN CLASS 9 (U.S. CLS. 21, 23, 26, 36 AND 38).

FIRST USE 10-15-2009; IN COMMERCE 7-3-2010.

THE MARK CONSISTS OF STANDARD CHARACTERS WITHOUT CLAIM TO ANY PARTICULAR FONT, STYLE, SIZE, OR COLOR.

SN 85-069,646, FILED 6-23-2010.

TRACY CROSS, EXAMINING ATTORNEY



David J. Kypos

Director of the United States Patent and Trademark Office

United States of America

United States Patent and Trademark Office

ISIMPLE

Reg. No. 4,068,162

Registered Dec. 6, 2011

Int. Cl.: 9

TRADEMARK

PRINCIPAL REGISTER

AAMP OF FLORIDA, INC. (FLORIDA CORPORATION)
13190 56TH COURT SUITE 401
13190 56TH COURT
CLEARWATER, FL 33760

FOR: AUDIO DEVICES, NAMELY, AMPLIFIER INTEGRATION INTERFACES, AUDIO CABLES, AUDIO EQUALIZERS, AUDIO INTERFACES, AUDIO SIGNAL AMPLIFIERS, AUDIO SIGNAL SWITCHERS, AUXILIARY INPUT DEVICES FOR AUTOMOTIVE RADIOS, BAND-PASS FILTERS FOR USE WITH AUDIO CIRCUITS AND SPEAKER ENCLOSURES, BASS BLOCKERS IN THE NATURE OF A HIGH PASS FILTER THAT ATTENUATES LOWER FREQUENCIES; CD CHANGER INTERFACES, FLOATING GROUND ADAPTERS, FM MODULATED AUDIO RECEIVERS, FM MODULATED AUDIO TRANSMITTERS, HIGH-PASS FILTERS; LINE OUTPUT CONVERTERS, LOWPASS FILTERS, POWER RESISTORS, RADIO FREQUENCY AUDIO RECEIVERS, RADIO FREQUENCY AUDIO TRANSMITTERS, RADIO INSTALLATION INTERFACES, RCA LEVEL ATTENUATORS, RCA LEVEL CONTROLLER, RCA SWITCHER SATELLITE, RADIO INTERFACES, VOLUME CONTROLS; NOISE CONTROL, NAMELY, ANTENNA GROUND LOOP ISOLATORS, CHOKE FILTERS, FILTERING CAPACITORS, POWER LEAD FILTERS; CELL PHONE DEVICES, NAMELY, CELL PHONE INTERFACES, CHARGE CORDS, DOORLOCK INTERFACES; PORTABLE ELECTRONIC INTERFACES, NAMELY, PDA INTERFACES, PORTABLE VIDEO PLAYER INTERFACES; DVD CHANGER INTERFACES, DVD INTERFACES, GAME SYSTEM INTERFACES, IN-CAR ENTERTAINMENT SYSTEM INTERFACES, LCD VIDEO MONITORING INTERFACES, NAVIGATION AUDIO AND RADIO INTERFACES, NAVIGATION SYSTEM INTERFACES, RADIO FREQUENCY AUDIO/VIDEO RECEIVERS, RADIO FREQUENCY AUDIO/VIDEO TRANSMITTERS, RADIO FREQUENCY VIDEO RECEIVERS, RADIO FREQUENCY TRANSMITTERS, VIDEO CABLES, VIDEO SIGNAL AMPLIFIERS, VIDEO SIGNAL SWITCHERS; TIMERS; AUDIO SIGNAL DISTRIBUTION PRODUCTS NAMELY, SIGNAL PROCESSORS, CABLES FOR AUDIO SIGNAL TRANSMISSION; DIGITAL SIGNAL PROCESSORS, AUDIO DEVICES, NAMELY, LINE DRIVERS; SECURITY DEVICES, NAMELY, INDUSTRIAL AUTOMATION AND PROCESS CONTROL SIGNAL TRANSMISSION CABLE DOORLOCK INTERFACES, KEYLESS ENTRY SYSTEMS, NAMELY, ELECTRONIC PROGRAMMABLE KEYLESS ACTIVATION UNLOCKING SYSTEM COMPRISED OF A MICRO-PROCESSOR, SIGNAL DETECTOR AND SIGNAL EMITTER; SHORT RANGE RADIO INTERFACES FOR MOBILE DEVICES; MP3 PLAYER ACCESSORIES AND MP3 PLAYER INTERFACE KITS COMPRISING PLAYER ELECTRICAL POWER CORD AND PLAYER TRANSMITTERS; AUDIOVISUAL DEVICES, NAMELY, VIDEO PROCESSORS; VIDEO SIGNAL DISTRIBUTION PRODUCTS, NAMELY, VIDEO TRANSMISSION APPARATUS;



David J. Kybas

Director of the United States Patent and Trademark Office

Reg. No. 4,068,162 COMPUTER OPERATING SYSTEMS, LOUDSPEAKER SYSTEMS; INTERFACES FOR INDUSTRIAL AUTOMATION AND PROCESS CONTROL SIGNAL TRANSMISSION CABLES; INFRARED CAMERA REPEATERS; INFRARED CAMERA TRANSMITTERS; PULSE GENERATORS FOR TESTING ELECTRIC CURRENT; AND DEVICES FOR HANDS-FREE USE OF MOBILE PHONES, IN CLASS 9 (U.S. CLS. 21, 23, 26, 36 AND 38).

FIRST USE 9-15-2006; IN COMMERCE 9-15-2006.

THE MARK CONSISTS OF STANDARD CHARACTERS WITHOUT CLAIM TO ANY PARTICULAR FONT, STYLE, SIZE, OR COLOR.

OWNER OF U.S. REG. NO. 3,386,693.

SN 85-069,748, FILED 6-23-2010.

KELLY BOULTON, EXAMINING ATTORNEY

United States of America

United States Patent and Trademark Office

iNeed a Great Story 

Reg. No. 4,068,163

Registered Dec. 6, 2011

Int. Cl.: 35

SERVICE MARK

PRINCIPAL REGISTER

FM ACQUISITION CORP. (DELAWARE CORPORATION)
SUITE 101
4410 N. RAVENSWOOD AVENUE
CHICAGO, IL 60540

FOR: ONLINE RETAIL STORE SERVICES FEATURING, ARTICLES, INFO-GRAPHICS AND VIDEOS PRODUCED BY OTHERS, IN CLASS 35 (U.S. CLS. 100, 101 AND 102).

FIRST USE 7-5-2010; IN COMMERCE 7-5-2010.

THE MARK CONSISTS OF THE WORDS "I NEED A GREAT STORY" WITH A LIGHTED LAMP NEXT TO THE WORDS.

SN 85-069,932, FILED 6-23-2010.

WILLIAM ROSSMAN, EXAMINING ATTORNEY



David J. Kyros

Director of the United States Patent and Trademark Office

United States of America

United States Patent and Trademark Office

BRIDGE THE BREAK

Reg. No. 4,068,164

Registered Dec. 6, 2011

Int. Cl.: 35

SERVICE MARK

PRINCIPAL REGISTER

BRIDGE THE BREAK, LLC (NEW YORK LIMITED LIABILITY COMPANY)
P.O. BOX 340572
JAMAICA, NY 11434

FOR: ADVERTISING SERVICES, NAMELY, PROVIDING AN ON-LINE DIRECTORY INFORMATION SERVICE FEATURING INFORMATION REGARDING CHURCH BASED PROGRAMS, EVENTS AND ACTIVITIES AVAILABLE TO THE PUBLIC; PROVIDING AN INTERNET WEB SITE TO PROMOTE CHRISTIAN ARTISTS AND PERFORMERS BY MEANS OF AN ON LINE EVENTS CALENDAR, IN CLASS 35 (U.S. CLS. 100, 101 AND 102).

FIRST USE 4-3-2011; IN COMMERCE 4-3-2011.

THE MARK CONSISTS OF STANDARD CHARACTERS WITHOUT CLAIM TO ANY PARTICULAR FONT, STYLE, SIZE, OR COLOR.

SN 85-071,629, FILED 6-25-2010.

AMEEN IMAM, EXAMINING ATTORNEY



David J. Kybas

Director of the United States Patent and Trademark Office

United States of America

United States Patent and Trademark Office

Good Earth Minerals

Reg. No. 4,068,165

Registered Dec. 6, 2011

Int. Cl.: 1

TRADEMARK

PRINCIPAL REGISTER

GOOD EARTH MINERALS (COLORADO LIMITED LIABILITY COMPANY)
600 17TH ST. STE. 2800 SOUTH
DENVER, CO 80202

FOR: SELENITE AND GYPSUM ADDITIVES IN THE NATURE OF CHEMICALS, CHEMICAL ADDITIVES, CHEMICAL PREPARATIONS, CATALYSTS, POLYMERS AND POLYMERIC ADDITIVES ALL FOR USE IN THE MANUFACTURE OF PHARMACEUTICALS, FOOD, FERTILIZERS, SOIL ADDITIVES, WATER TREATMENT CHEMICALS, PLASTICS, RUBBER, PAPER, VARNISHES, PAINTS, INKS, ADHESIVES, SEALANTS, CAULKS, CHEMICALS, ADSORBENTS AND FRICTION MATERIALS FOR USE IN BRAKE LININGS AND CLUTCH FACINGS, IN CLASS 1 (U.S. CLS. 1, 5, 6, 10, 26 AND 46).

FIRST USE 6-29-2010; IN COMMERCE 7-3-2010.

THE MARK CONSISTS OF STANDARD CHARACTERS WITHOUT CLAIM TO ANY PARTICULAR FONT, STYLE, SIZE, OR COLOR.

NO CLAIM IS MADE TO THE EXCLUSIVE RIGHT TO USE "MINERALS", APART FROM THE MARK AS SHOWN.

SN 85-071,887, FILED 6-25-2010.

CHARISMA HAMPTON, EXAMINING ATTORNEY



David J. Kyros

Director of the United States Patent and Trademark Office

United States of America

United States Patent and Trademark Office

NOT A FAN

Reg. No. 4,068,166

Registered Dec. 6, 2011

Int. Cl.: 14

TRADEMARK

PRINCIPAL REGISTER

CITY ON A HILL STUDIO, LLC (KENTUCKY LIMITED LIABILITY COMPANY)
13149 MIDDLETOWN INDUSTRIAL BLVD.
LOUISVILLE, KY 40223

FOR: JEWELRY, ORNAMENTAL PINS, IN CLASS 14 (U.S. CLS. 2, 27, 28 AND 50).

FIRST USE 9-1-2009; IN COMMERCE 9-1-2010.

THE MARK CONSISTS OF STANDARD CHARACTERS WITHOUT CLAIM TO ANY PARTICULAR FONT, STYLE, SIZE, OR COLOR.

OWNER OF U.S. REG. NOS. 4,032,495, 4,032,497, AND OTHERS.

SN 85-071,910, FILED 6-25-2010.

ANNE MADDEN, EXAMINING ATTORNEY



David J. Kyffers

Director of the United States Patent and Trademark Office

United States of America

United States Patent and Trademark Office



Reg. No. 4,068,167

Registered Dec. 6, 2011

Int. Cl.: 9

TRADEMARK

PRINCIPAL REGISTER

TIER 2 SALES (CALIFORNIA CORPORATION)
2062 HAVENHURST WAY
UPLAND, CA 91784

FOR: WATERPROOF AND AIR TIGHT INJECTION MOLDED CASES WITH FOAM INSERTS USED TO SHIP AND STORE COMPUTER DATA MEDIA, IT SERVERS, PRO AUDIO VIDEO TAPES, COMPUTER HARD DRIVES, CDS AND DVDS , IN CLASS 9 (U.S. CLS. 21, 23, 26, 36 AND 38).

FIRST USE 10-1-2010; IN COMMERCE 2-10-2011.

NO CLAIM IS MADE TO THE EXCLUSIVE RIGHT TO USE "CASES", APART FROM THE MARK AS SHOWN.

THE MARK CONSISTS OF THE WORDS "ALLIGATOR CASES" AND AN ALLIGATOR HEAD SILHOUETTE.

SN 85-072,194, FILED 6-25-2010.

KHANH LE, EXAMINING ATTORNEY



David J. Kyffers

Director of the United States Patent and Trademark Office

United States of America

United States Patent and Trademark Office

BRINGING THE WORLD HOME TO YOU

Reg. No. 4,068,168

Registered Dec. 6, 2011

Int. Cl.: 35

SERVICE MARK

PRINCIPAL REGISTER

HOME SOURCE INTERNATIONAL (GEORGIA CORPORATION)
SUITE 120
1100 WESTLAKE PARKWAY
ATLANTA, GA 30336

FOR: RETAIL STORE SERVICES FEATURING CLOTHING, FURNISHINGS, BEDROOM
AND BATHROOM ACCESSORIES, IN CLASS 35 (U.S. CLS. 100, 101 AND 102).

FIRST USE 8-1-2011; IN COMMERCE 8-1-2011.

THE MARK CONSISTS OF STANDARD CHARACTERS WITHOUT CLAIM TO ANY PAR-
TICULAR FONT, STYLE, SIZE, OR COLOR.

SN 85-072,376, FILED 6-26-2010.

DAVID COLLIER, EXAMINING ATTORNEY



David J. Kyffers

Director of the United States Patent and Trademark Office

United States of America

United States Patent and Trademark Office

TOAKLAND

Reg. No. 4,068,169

Registered Dec. 6, 2011

Int. Cl.: 25

TRADEMARK

PRINCIPAL REGISTER

HERCKT, SPENCER (UNITED STATES INDIVIDUAL)
25185 MANZANITA
DANA POINT, CA 92629

FOR: CLOTHING, NAMELY, JEANS, PANTS, SHORTS, DRESSES, SKIRTS, SHIRTS, T-SHIRTS, LONG-SLEEVED SHIRTS, DRESS SHIRTS, SWEATSHIRTS, HOODED SWEATSHIRTS, JACKETS, COATS, BELTS, HATS, SOCKS, GLOVES, SHOES, SCARVES, WRISTBANDS, UNDERWEAR, BATHING SUITS, SUITS, TIGHTS, FOOTWEAR, AND HEADWEAR, IN CLASS 25 (U.S. CLS. 22 AND 39).

FIRST USE 7-1-2010; IN COMMERCE 1-12-2011.

THE MARK CONSISTS OF STANDARD CHARACTERS WITHOUT CLAIM TO ANY PARTICULAR FONT, STYLE, SIZE, OR COLOR.

SN 85-072,568, FILED 6-28-2010.

KATHERINE M. DUBRAY, EXAMINING ATTORNEY



David J. Kyffers

Director of the United States Patent and Trademark Office

United States of America

United States Patent and Trademark Office



Reg. No. 4,068,170

Registered Dec. 6, 2011

Int. Cls.: 9, 36, and 38

AMERICAN EXPRESS MARKETING & DEVELOPMENT CORP. (DELAWARE CORPORATION)

ATTN. DIANNE CAHILL (014912)

200 VESEY STREET

NEW YORK, NY 10285

TRADEMARK

FOR: APPARATUS FOR PROCESSING POINT-OF-SALE TRANSACTIONS , IN CLASS 9 (U.S. CLS. 21, 23, 26, 36 AND 38).

SERVICE MARK

FIRST USE 3-28-2011; IN COMMERCE 3-28-2011.

PRINCIPAL REGISTER

FOR: CHARGE CARD, CREDIT CARD AND STORED VALUE CARD SERVICES; PAYMENT CARD TRANSACTION PROCESSING SERVICES; PROVIDING ELECTRONIC PAYMENTS; ELECTRONIC PROCESSING, VERIFICATION, AND SETTLEMENT OF ONLINE PAYMENTS; PAYMENT CARD TRANSACTION VERIFICATION AND SETTLEMENT SERVICES; ELECTRONIC PAYMENT PROCESSING OF PAYMENT CARDS AND ONLINE ACCOUNT PAYMENT DATA; DEBIT CARD SERVICES; PROVIDING FINANCIAL INFORMATION VIA A GLOBAL COMPUTER NETWORK; CONSULTATION SERVICES RELATED TO THE FOREGOING, IN CLASS 36 (U.S. CLS. 100, 101 AND 102).

FIRST USE 3-28-2011; IN COMMERCE 3-28-2011.

FOR: PROVIDING ELECTRONIC TRANSMISSION OF PAYMENT CARD AND ONLINE ACCOUNT PAYMENT DATA, IN CLASS 38 (U.S. CLS. 100, 101 AND 104).

FIRST USE 3-28-2011; IN COMMERCE 3-28-2011.

THE MARK CONSISTS OF A DESIGN OF DIAMOND FORMED BY FOUR LETTERS "P"S, IN PURPLE, LIGHT BLUE, GREEN AND TEAL.

THE COLOR(S) PURPLE, LIGHT BLUE, GREEN, AND TEAL IS/ARE CLAIMED AS A FEATURE OF THE MARK.

SN 85-072,698, FILED 6-28-2010.

KAREN K. BUSH, EXAMINING ATTORNEY

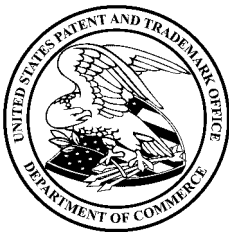

David J. Kybas

Director of the United States Patent and Trademark Office

United States of America
United States Patent and Trademark Office

LAZERON

Reg. No. 4,068,171

WAEI KABBANI (SAUDI ARABIA INDIVIDUAL)
P.O. BOX 14901
SAN FRANCISCO, CA 941140901

Registered Dec. 6, 2011

Int. Cl.: 41

FOR: ENTERTAINMENT SERVICES, NAMELY, PROVIDING A WEBSITE FEATURING CARTOONS, COMIC BOOK CHARACTERS AND NON-DOWNLOADABLE INTERACTIVE GAMES, IN CLASS 41 (U.S. CLS. 100, 101 AND 107).

SERVICE MARK

FIRST USE 9-14-2011; IN COMMERCE 9-14-2011.

PRINCIPAL REGISTER

THE MARK CONSISTS OF STANDARD CHARACTERS WITHOUT CLAIM TO ANY PARTICULAR FONT, STYLE, SIZE, OR COLOR.

SN 85-072,813, FILED 6-28-2010.

KIM MONINGHOFF, EXAMINING ATTORNEY



David J. Kybas

Director of the United States Patent and Trademark Office

United States of America

United States Patent and Trademark Office

SUUTHE

Reg. No. 4,068,172

Registered Dec. 6, 2011

Int. Cl.: 3

TRADEMARK

PRINCIPAL REGISTER

MARI CARLIN DART (UNITED STATES INDIVIDUAL)
2657 HUGHS DRIVE
ERIE, CO 80516

FOR: BATH POWDER; BATH SALTS; BODY BUTTER; BODY OILS; BUBBLE BATH; COSMETICS; ESSENTIAL OILS; ESSENTIAL OILS FOR USE IN AROMATHERAPY; FACE AND BODY CREAMS; HAIR CONDITIONERS; LIP BALM; LIQUID SOAPS; LOTIONS FOR FACE AND BODY; MASSAGE OILS; MOUTHWASH; NON-MEDICATED HERBAL BODY CARE PRODUCTS, NAMELY, BODY OILS, SALVES, AND LIP BALMS; NON-MEDICATED TOILETRIES; SHAMPOOS; SKIN MOISTURIZER; SOAPS FOR BODY CARE; SOAPS FOR PERSONAL USE; SUNSCREEN CREAMS; TOOTH GEL; TOOTH PASTE, IN CLASS 3 (U.S. CLS. 1, 4, 6, 50, 51 AND 52).

FIRST USE 5-0-2011; IN COMMERCE 5-0-2011.

THE MARK CONSISTS OF STANDARD CHARACTERS WITHOUT CLAIM TO ANY PARTICULAR FONT, STYLE, SIZE, OR COLOR.

SN 85-073,412, FILED 6-28-2010.

JAY FLOWERS, EXAMINING ATTORNEY



David J. Kypos

Director of the United States Patent and Trademark Office

United States of America

United States Patent and Trademark Office

SUUTHE BY MARI

Reg. No. 4,068,173

Registered Dec. 6, 2011

Int. Cl.: 3

TRADEMARK

PRINCIPAL REGISTER

MARI CARLIN DART (UNITED STATES INDIVIDUAL)
2657 HUGHS DRIVE
ERIE, CO 80516

FOR: BATH POWDER; BATH SALTS; BODY BUTTER; BODY OILS; BUBBLE BATH; COSMETICS; ESSENTIAL OILS; ESSENTIAL OILS FOR USE IN AROMATHERAPY; FACE AND BODY CREAMS; HAIR CONDITIONERS; LIP BALM; LIQUID SOAPS; LOTIONS FOR FACE AND BODY; MASSAGE OILS; MOUTHWASH; NON-MEDICATED HERBAL BODY CARE PRODUCTS, NAMELY, BODY OILS, SALVES, AND LIP BALMS; NON-MEDICATED TOILETRIES; SHAMPOOS; SKIN MOISTURIZER; SOAPS FOR BODY CARE; SOAPS FOR PERSONAL USE; SUNSCREEN CREAMS; TOOTH GEL; TOOTH PASTE, IN CLASS 3 (U.S. CLS. 1, 4, 6, 50, 51 AND 52).

FIRST USE 5-0-2011; IN COMMERCE 5-0-2011.

THE MARK CONSISTS OF STANDARD CHARACTERS WITHOUT CLAIM TO ANY PARTICULAR FONT, STYLE, SIZE, OR COLOR.

THE NAME "MARI" IDENTIFIES A LIVING INDIVIDUAL WHOSE CONSENT IS OF RECORD.

SN 85-073,415, FILED 6-28-2010.

JAY FLOWERS, EXAMINING ATTORNEY



David J. Kyros

Director of the United States Patent and Trademark Office

United States of America

United States Patent and Trademark Office



نعمه
Nehme

Reg. No. 4,068,174

Registered Dec. 6, 2011

Int. Cl.: 7

TRADEMARK

PRINCIPAL REGISTER

ALEXANDER NEHME (LEBANON INDIVIDUAL)
P.O. BOX 99
DOHA, QATAR

FOR: HEAT EXCHANGERS BEING PARTS OF ENGINES NOT FOR LAND VEHICLES;
HEAT EXCHANGERS BEING PARTS OF MACHINES, IN CLASS 7 (U.S. CLS. 13, 19, 21, 23,
31, 34 AND 35).

FIRST USE 2-17-2008; IN COMMERCE 2-17-2008.

THE MARK CONSISTS OF TWO BLUE CIRCULAR OBJECTS INTERTWINED WITH A
BLUE DOT ABOVE THE RIGHT CIRCULAR OBJECT. DIRECTLY TO THE RIGHT OF THE
BLUE CIRCULAR OBJECTS IN ARABIC, GRAY FONT IS THE WORD "NEHMEH". DIR-
ECTLY BELOW THE ARABIC VERSION IS THE ACTUAL WORD "NEHMEH" TRANSLATED
TO ENGLISH IN GRAY STYLIZED FONT.

THE COLOR(S) GRAY AND BLUE IS/ARE CLAIMED AS A FEATURE OF THE MARK.

THE NON-LATIN CHARACTERS IN THE MARK TRANSLITERATE TO "NEHMEH" AND
THIS HAS NO MEANING IN A FOREIGN LANGUAGE.

SN 85-073,774, FILED 6-29-2010.

JAMES A. RAUEN, EXAMINING ATTORNEY



David J. Kybas

Director of the United States Patent and Trademark Office

United States of America

United States Patent and Trademark Office

KEYNETIC

Reg. No. 4,068,175

Registered Dec. 6, 2011

Int. Cls.: 6 and 9

TRADEMARK

PRINCIPAL REGISTER

ROCKWELL SECURITY INC. (NORTH CAROLINA CORPORATION)
UNIT 513
400 NORTH CHURCH STREET
CHARLOTTE, NC 28202

FOR: METAL MECHANICAL LOCKS, IN CLASS 6 (U.S. CLS. 2, 12, 13, 14, 23, 25 AND 50).

FIRST USE 5-15-2002; IN COMMERCE 8-15-2002.

FOR: ELECTRIC LOCKS, IN CLASS 9 (U.S. CLS. 21, 23, 26, 36 AND 38).

FIRST USE 9-30-2011; IN COMMERCE 9-30-2011.

THE MARK CONSISTS OF STANDARD CHARACTERS WITHOUT CLAIM TO ANY PARTICULAR FONT, STYLE, SIZE, OR COLOR.

SN 85-074,076, FILED 6-29-2010.

GENE MACIOL, EXAMINING ATTORNEY



David J. Kybas

Director of the United States Patent and Trademark Office

United States of America
United States Patent and Trademark Office

COINBOX

Reg. No. 4,068,176

Registered Dec. 6, 2011

Int. Cl.: 36

KASH N' KARRY FOOD STORES, INC. (DELAWARE CORPORATION), DBA SWEETBAY
SUPERMARKET,
LEGAL DEPARTMENT
145 PLEASANT HILL ROAD
SCARBOROUGH, ME 04074

SERVICE MARK

FOR: AUTOMATED COIN COUNTING, SORTING AND CONVERTING SERVICES, NAMELY,
PROVIDING FOR THE CONVERSION OF COINS TO DOLLAR BILLS, IN CLASS 36 (U.S.
CLS. 100, 101 AND 102).

PRINCIPAL REGISTER

FIRST USE 10-10-2010; IN COMMERCE 10-10-2010.

THE MARK CONSISTS OF STANDARD CHARACTERS WITHOUT CLAIM TO ANY PAR-
TICULAR FONT, STYLE, SIZE, OR COLOR.

SN 85-076,318, FILED 7-1-2010.

LINDA POWELL, EXAMINING ATTORNEY



David J. Kyffers

Director of the United States Patent and Trademark Office

United States of America

United States Patent and Trademark Office

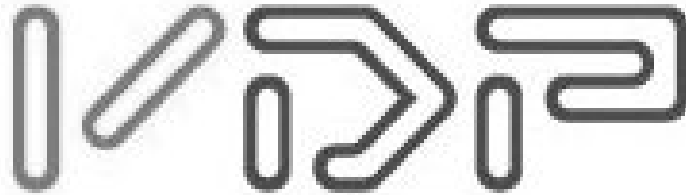

VASCULAR DEVICE PARTNERS

Reg. No. 4,068,177

Registered Dec. 6, 2011

Int. Cl.: 35

SERVICE MARK

PRINCIPAL REGISTER

VASCULAR DEVICE PARTNERS LLC (FLORIDA LIMITED LIABILITY COMPANY)
1501 SOUTH MIAMI AVENUE
MIAMI, FL 33129

FOR: PROVIDING TECHNICAL CONSULTING SERVICES AND INFORMATION MANAGEMENT SERVICES, NAMELY, CLINICAL DATA AND REGULATORY SUBMISSION MANAGEMENT, TO MEDICAL, BIOPHARMACEUTICAL AND BIOTECHNOLOGY COMPANIES TO ASSIST THEM WITH CLINICAL RESEARCH, CLINICAL TRIALS AND APPLICATIONS FOR REGULATORY APPROVAL, IN CLASS 35 (U.S. CLS. 100, 101 AND 102).

FIRST USE 7-1-2008; IN COMMERCE 7-1-2008.

NO CLAIM IS MADE TO THE EXCLUSIVE RIGHT TO USE "VASCULAR DEVICE PARTNERS", APART FROM THE MARK AS SHOWN.

THE MARK CONSISTS OF THE STYLISTICALLY DRAWN LETTERS "VDP", WITH "VASCULAR DEVICE PARTNERS" UNDERNEATH.

SN 85-076,730, FILED 7-2-2010.

MARC LEIPZIG, EXAMINING ATTORNEY



David J. Kyffers

Director of the United States Patent and Trademark Office

United States of America

United States Patent and Trademark Office

MOKKA

Reg. No. 4,068,178

Registered Dec. 6, 2011

Int. Cls.: 14 and 25

TRADEMARK

PRINCIPAL REGISTER

URBAN INTERNATIONAL LLC (CALIFORNIA LIMITED LIABILITY COMPANY)
11750 NATIONAL BLVD. STE. 17
LOS ANGELES, CA 90064

FOR: ANKLE BRACELETS; BRACELETS; BRACELETS; CHRONOGRAPHS AS WATCHES; DRESS WATCHES; INEXPENSIVE NON-JEWELRY WATCHES; MECHANICAL AND AUTOMATIC WATCHES; RUBBER OR SILICON WRISTBANDS IN THE NATURE OF A BRACELET; SPORTS WATCHES; STOP WATCHES; WATCH BANDS AND STRAPS; WATCH BRACELETS; WATCH CASES; WATCH STRAPS; WATCHES; WRIST WATCHES, IN CLASS 14 (U.S. CLS. 2, 27, 28 AND 50).

FIRST USE 6-1-2010; IN COMMERCE 2-1-2011.

FOR: A-SHIRTS; ANKLE SOCKS; ATHLETIC APPAREL, NAMELY, SHIRTS, PANTS, JACKETS, FOOTWEAR, HATS AND CAPS, ATHLETIC UNIFORMS; ATHLETIC FOOTWEAR; BASEBALL CAPS AND HATS; BEACH FOOTWEAR; BEACH SHOES; BELTS; BELTS OF TEXTILE; BERMUDA SHORTS; BOTTOMS; BOXER SHORTS; BRIEFS; BUTTON-FRONT ALOHA SHIRTS; CAPS; DENIMS; DRESS SHIRTS; DRESSES; EYESHADES; FLIP FLOPS; FOOTWEAR; GLOVES; HAT BANDS; HATS; HEADBANDS; HEELS; HOODED PULLOVERS; HOODED SWEAT SHIRTS; HOODS; JACKETS; JEANS; LONG-SLEEVED SHIRTS; PANTS; PIQUE SHIRTS; POLO KNIT TOPS; POLO SHIRTS; PULLOVERS; SANDALS AND BEACH SHOES; SHIRTS AND SHORT-SLEEVED SHIRTS; SHOES; SHORT-SLEEVED OR LONG-SLEEVED T-SHIRTS; SKI WEAR; SKULL CAPS; SLEEPING GARMENTS; SNEAKERS; SNOW PANTS; SOCKS; SPORTS CAPS AND HATS; STRETCH PANTS; SURF WEAR; SWEAT PANTS; SWEAT SHIRTS; SWEATERS; SWIM WEAR; T-SHIRTS; TEE SHIRTS; TENNIS WEAR; THONGS; TIES; TOPS; UNDERWEAR; WEARABLE GARMENTS AND CLOTHING, NAMELY, SHIRTS, IN CLASS 25 (U.S. CLS. 22 AND 39).

FIRST USE 6-1-2010; IN COMMERCE 2-1-2011.

THE MARK CONSISTS OF STANDARD CHARACTERS WITHOUT CLAIM TO ANY PARTICULAR FONT, STYLE, SIZE, OR COLOR.

SN 85-078,037, FILED 7-5-2010.

KATINA MISTER, EXAMINING ATTORNEY



David J. Kypos

Director of the United States Patent and Trademark Office

United States of America

United States Patent and Trademark Office

NUMENTUM

Reg. No. 4,068,179

DECKERS OUTDOOR CORPORATION (DELAWARE CORPORATION)
495-A S. FAIRVIEW AVENUE
GOLETA, CA 93117

Registered Dec. 6, 2011

Int. Cl.: 25

FOR: MIDSOLES SOLD AS AN INTEGRAL COMPONENT OF FOOTWEAR, IN CLASS 25 (U.S. CLS. 22 AND 39).

TRADEMARK

FIRST USE 6-29-2010; IN COMMERCE 1-0-2011.

PRINCIPAL REGISTER

THE MARK CONSISTS OF STANDARD CHARACTERS WITHOUT CLAIM TO ANY PARTICULAR FONT, STYLE, SIZE, OR COLOR.

SN 85-078,466, FILED 7-6-2010.

HENRY S. ZAK, EXAMINING ATTORNEY



David J. Kybas

Director of the United States Patent and Trademark Office

United States of America

United States Patent and Trademark Office



Reg. No. 4,068,180

Registered Dec. 6, 2011

Int. Cl.: 44

SERVICE MARK

PRINCIPAL REGISTER

CHILDREN'S MEDICAL CENTER OF DALLAS (TEXAS CORPORATION)
1935 MEDICAL DISTRICT DRIVE
DALLAS, TX 75235

FOR: PEDIATRIC PRIMARY MEDICAL CARE SERVICES, IN CLASS 44 (U.S. CLS. 100 AND 101).

FIRST USE 10-12-2010; IN COMMERCE 10-12-2010.

OWNER OF U.S. REG. NOS. 3,152,584, 3,161,365, AND OTHERS.

THE COLOR(S) YELLOW, RED, WHITE AND BLUE IS/ARE CLAIMED AS A FEATURE OF THE MARK.

SEC. 2(F) AS TO "CHILDREN'S".

THE MARK CONSISTS OF A SINGLE WORD AND STYLIZED DESIGN, WITH THE LETTERS "MY" IN BLUE AGAINST A YELLOW RECTANGLE TILTED TO THE LEFT, FOLLOWED BY THE WORDING "CHILDREN'S" IN WHITE WITH THE LETTER "I" REPLACED WITH A RED BALLOON WITH A WHITE HIGHLIGHT ON A WHITE STRING, ALL AGAINST A BLUE BACKGROUND RECTANGLE.

SN 85-079,369, FILED 7-7-2010.

COLLEEN KEARNEY, EXAMINING ATTORNEY



David J. Kybas

Director of the United States Patent and Trademark Office

United States of America

United States Patent and Trademark Office

VELOSTER

Reg. No. 4,068,181

Registered Dec. 6, 2011

Int. Cl.: 12

TRADEMARK

PRINCIPAL REGISTER

HYUNDAI MOTOR AMERICA (CALIFORNIA CORPORATION)
10550 TALBERT AVENUE
FOUNTAIN VALLEY, CA 92728

FOR: AUTOMOBILES, IN CLASS 12 (U.S. CLS. 19, 21, 23, 31, 35 AND 44).

FIRST USE 9-1-2011; IN COMMERCE 9-1-2011.

THE MARK CONSISTS OF STANDARD CHARACTERS WITHOUT CLAIM TO ANY PARTICULAR FONT, STYLE, SIZE, OR COLOR.

SN 85-079,608, FILED 7-7-2010.

ANTHONY RINKER, EXAMINING ATTORNEY



David J. Kybas

Director of the United States Patent and Trademark Office

United States of America

United States Patent and Trademark Office



Reg. No. 4,068,182

Registered Dec. 6, 2011

Int. Cl.: 41

SERVICE MARK

PRINCIPAL REGISTER

THE GENERAL COUNCIL OF THE ASSEMBLIES OF GOD (MISSOURI CORPORATION)
1445 NORTH BOONVILLE AVENUE
SPRINGFIELD, MO 65802

FOR: MULTIMEDIA PUBLISHING OF BOOKS, MAGAZINES, JOURNALS, SOFTWARE, GAMES, MUSIC, AND ELECTRONIC PUBLICATIONS, ALL IN THE FIELD OF RELIGION AND SPECIFICALLY EXCLUDING THE LEGAL AND BUSINESS FIELDS; EDUCATIONAL AND ENTERTAINMENT SERVICES, NAMELY, PROVIDING MOTIVATIONAL AND EDUCATIONAL SPEAKERS IN THE FIELD OF RELIGIOUS AND SPIRITUAL MOTIVATION, IN CLASS 41 (U.S. CLS. 100, 101 AND 107).

FIRST USE 7-0-2011; IN COMMERCE 7-0-2011.

THE MARK CONSISTS OF CIRCLES FORMING A STARBURST DESIGN WITH FOUR LINES EMANATING FROM THE CENTER CIRCLE TO THE OTHER FOUR CIRCLES, ALL TO THE LEFT OF THE WORD "INFLUENCE".

SN 85-080,011, FILED 7-8-2010.

LINDA POWELL, EXAMINING ATTORNEY



David J. Kyros

Director of the United States Patent and Trademark Office

United States of America

United States Patent and Trademark Office

SWISSBRAND

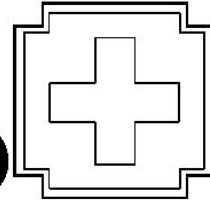

Reg. No. 4,068,183

Registered Dec. 6, 2011

Int. Cls.: 18 and 25

TRADEMARK

PRINCIPAL REGISTER

SWISS BRAND LIMITED INC (PANAMA CORPORATION)
CALLE D, EL CANGREJO, NO.14
EDIFICIO GLENDALE, PLANTA BAJA
PANAMA, PANAMA

FOR: LEATHER AND IMITATIONS OF LEATHER; ANIMAL SKINS AND HIDES; TRUNKS AND TRAVELLING BAGS; UMBRELLAS, PARASOLS AND WALKING STICKS; WHIPS, HARNESS AND SADDLERY, IN CLASS 18 (U.S. CLS. 1, 2, 3, 22 AND 41).

FIRST USE 9-8-2008; IN COMMERCE 9-9-2011.

FOR: CLOTHES, NAMELY, SHOES FOR WOMEN, MEN AND CHILDREN, SHORTS, T-SHIRTS, PANTS, JACKETS, PANTS FOR EXERCISES, SOCKS, SLIPPERS, DRESSES, HATS, ATHLETIC FOOTWEAR, SWEAT SHIRTS, IN CLASS 25 (U.S. CLS. 22 AND 39).

FIRST USE 9-8-2008; IN COMMERCE 9-9-2011.

THE MARK CONSISTS OF THE WORD "SWISSBRAND" NEXT TO A BOX WITH A CROSS IN IT.

SN 85-081,005, FILED 7-9-2010.

JANICE L. MCMORROW, EXAMINING ATTORNEY



David J. Kybas

Director of the United States Patent and Trademark Office

United States of America

United States Patent and Trademark Office

IASIS CENTER FOR THE ADVANCEMENT OF RESEARCH AND EDUCATION

Reg. No. 4,068,184

Registered Dec. 6, 2011

Int. Cls.: 41 and 42

SERVICE MARK

PRINCIPAL REGISTER

IASIS HEALTHCARE CORPORATION (DELAWARE CORPORATION)
DOVER CENTER, BUILDING E
117 SEABOARD LANE
FRANKLIN, TN 380672855

FOR: PROVIDING CLINICAL RESEARCH EDUCATION TO HEALTHCARE PROFESSIONALS, IN CLASS 41 (U.S. CLS. 100, 101 AND 107).

FIRST USE 9-7-2010; IN COMMERCE 9-7-2010.

FOR: PROVIDING ON-LINE, NON-DOWNLOADABLE SOFTWARE FOR SUBMITTING, TRACKING MANAGING AND CONTROLLING RESEARCH STUDIES AND CLINICAL TRIALS IN THE FIELD OF HEALTHCARE; PROVIDING ONLINE, NON-DOWNLOADABLE SOFTWARE USED TO PROVIDE AND ARCHIVE AVAILABLE PROTOCOLS FOR RESEARCH AND CLINICAL TRIALS IN THE FIELD OF HEALTHCARE, IN CLASS 42 (U.S. CLS. 100 AND 101).

FIRST USE 9-7-2010; IN COMMERCE 9-7-2010.

THE MARK CONSISTS OF STANDARD CHARACTERS WITHOUT CLAIM TO ANY PARTICULAR FONT, STYLE, SIZE, OR COLOR.

OWNER OF U.S. REG. NOS. 2,384,034 AND 2,384,093.

NO CLAIM IS MADE TO THE EXCLUSIVE RIGHT TO USE "CENTER FOR THE ADVANCEMENT OF RESEARCH AND EDUCATION", APART FROM THE MARK AS SHOWN.

SN 85-081,660, FILED 7-9-2010.

JANICE L. MCMORROW, EXAMINING ATTORNEY



David J. Kybas

Director of the United States Patent and Trademark Office

United States of America

United States Patent and Trademark Office

Dr. S

Reg. No. 4,068,185

Registered Dec. 6, 2011

Int. Cl.: 41

SERVICE MARK

PRINCIPAL REGISTER

SCHWARZ, EITAN D. (UNITED STATES INDIVIDUAL)
1500 SHERIDAN RD #TF
WILMETTE, IL 60091

FOR: EDUCATION SERVICES, NAMELY, PROVIDING ONLINE COGNITIVE ASSESSMENTS AND TRAINING PROGRAMS THAT HELP GUIDE PARENTS AND CHILDREN IN MANAGING THE CHILDREN'S USE OF TECHNOLOGY; EDUCATIONAL COUNSELING SERVICES TO ASSIST PARENTS AND CHILDREN IN MANAGING CHILDREN'S USE OF TECHNOLOGY; PROVIDING PARENTING SKILLS TRAINING IN THE FIELD OF CHILD PSYCHOLOGY AND MANAGING CHILDREN'S USE OF TECHNOLOGY; ENTERTAINMENT AND EDUCATIONAL SERVICES, NAMELY, PROVIDING A WEBSITE THAT DISPLAYS VARIOUS REQUESTS, REVIEWS, RECOMMENDATIONS, RANKINGS, TRACKINGS, VOTES, AND INFORMATION FOR THE PURPOSE OF TRAINING PARENTS AND CHILDREN IN MANAGING CHILDREN'S USE OF TECHNOLOGY; ON-LINE JOURNALS, NAMELY, BLOGS FEATURING GUIDING PARENTS AND CHILDREN IN MANAGING CHILDREN'S USE OF TECHNOLOGY; AN ON-GOING TELEVISION PROGRAM IN THE FIELD OF CHILD PSYCHOLOGY, SPECIFICALLY, MANAGING CHILDREN'S USE OF TECHNOLOGY; AND EDUCATIONAL AND ENTERTAINMENT SERVICES, NAMELY, A CONTINUING PROGRAM ABOUT CHILD PSYCHOLOGY, SPECIFICALLY, MANAGING CHILDREN'S USE OF TECHNOLOGY ACCESSIBLE BY RADIO, TELEVISION, SATELLITE, AUDIO, VIDEO AND COMPUTER NETWORKS, IN CLASS 41 (U.S. CLS. 100, 101 AND 107).

FIRST USE 6-1-2011; IN COMMERCE 6-1-2011.

THE MARK CONSISTS OF STANDARD CHARACTERS WITHOUT CLAIM TO ANY PARTICULAR FONT, STYLE, SIZE, OR COLOR.

SN 85-082,436, FILED 7-12-2010.

KAREN K. BUSH, EXAMINING ATTORNEY



David J. Kyjars

Director of the United States Patent and Trademark Office

United States of America

United States Patent and Trademark Office

M-POD

Reg. No. 4,068,186

Registered Dec. 6, 2011

Int. Cl.: 6

TRADEMARK

PRINCIPAL REGISTER

MID-PARK, INC. (KENTUCKY CORPORATION)
P.O. BOX 326, 1021 SALT RIVER ROAD
LEITCHFIELD, KY 42755

FOR: METAL BREAKAWAY POST ASSEMBLIES FOR ROADWAY SIGNS; METAL MOUNTING STRUCTURES FOR ROADWAY SIGNS, IN CLASS 6 (U.S. CLS. 2, 12, 13, 14, 23, 25 AND 50).

FIRST USE 3-31-2010; IN COMMERCE 3-31-2010.

THE MARK CONSISTS OF STANDARD CHARACTERS WITHOUT CLAIM TO ANY PARTICULAR FONT, STYLE, SIZE, OR COLOR.

SN 85-082,540, FILED 7-12-2010.

DAVID C. REIHNER, EXAMINING ATTORNEY



David J. Kyffers

Director of the United States Patent and Trademark Office

United States of America

United States Patent and Trademark Office



Reg. No. 4,068,187

Registered Dec. 6, 2011

Int. Cl.: 9

TRADEMARK

PRINCIPAL REGISTER

TRAVEL TOT, LLC (NEW JERSEY LIMITED LIABILITY COMPANY)
12 GARDNER ROAD
DENVER, NJ 07834

FOR: CHILD SAFETY PRODUCTS, NAMELY, A TEMPORARY CHILDPROOFING KIT, COMPRISED OF ELECTRICAL OUTLET COVERS, A BATH THERMOMETER, ADHESIVE BANDAGES AND FOREHEAD THERMOMETER STRIP, CORNER COVERS, DOOR KNOB COVERS, PINCH GUARDS FOR DOORS, CLOSET LOCKS, CORD WRAPS, BATH TUB SAFETY TREAD, ALL SOLD WITH TEMPORARY ADHESIVES AND ALL OF THE AFOREMENTIONED BEING SOLD AS A UNIT, IN CLASS 9 (U.S. CLS. 21, 23, 26, 36 AND 38).

FIRST USE 3-1-2010; IN COMMERCE 7-1-2010.

THE MARK CONSISTS OF THE STYLIZED WORDING "TRAVEL-TOT" APPEARING ON A BANNER DESIGN; BENEATH THE BANNER APPEARS THE SILHOUETTE OF A SEATED BABY PLAYING WITH THE FIRST LETTER "T" IN "TOT"; THE AFOREMENTIONED WORDING AND DESIGNS APPEAR ON A BACKGROUND IN THE SHAPE OF THE OUTLINE OF A SUITCASE.

SN 85-083,723, FILED 7-13-2010.

KEVIN CORWIN, EXAMINING ATTORNEY



David J. Kybas

Director of the United States Patent and Trademark Office

United States of America

United States Patent and Trademark Office



PALMETTO
READER

Reg. No. 4,068,188

Registered Dec. 6, 2011

Int. Cls.: 35 and 41

SERVICE MARK

PRINCIPAL REGISTER

PALMETTO READER, LLC (SOUTH CAROLINA LIMITED LIABILITY COMPANY)
SUITE 203
2231 DEVINE STREET
COLUMBIA, SC 29205

FOR: CUSTOM PUBLISHING SERVICES, NAMELY, THE PUBLICATION OF ADVERTISING AND PROMOTIONAL TEXTS AND ADVERTISING AND PROMOTIONAL TEXTS FOR PERIODICALS, IN CLASS 35 (U.S. CLS. 100, 101 AND 102).

FIRST USE 7-23-2010; IN COMMERCE 7-23-2010.

FOR: CUSTOM PUBLISHING SERVICES, NAMELY, THE PUBLICATION OF BOOKS, MAGAZINES, BROCHURES, AND PAMPHLETS, IN CLASS 41 (U.S. CLS. 100, 101 AND 107).

FIRST USE 7-23-2010; IN COMMERCE 7-23-2010.

NO CLAIM IS MADE TO THE EXCLUSIVE RIGHT TO USE "READER", APART FROM THE MARK AS SHOWN.

THE MARK CONSISTS OF AN OPEN BOOK SITTING ATOP A BOOKSTAND, WHICH MERGE TO FORM THE IMAGE OF A PALMETTO WITH THE WORDS "PALMETTO" AND "READER" BELOW; THE "O" IN THE "PALMETTO" IS A DESIGN OF A CRESCENT MOON WITH THE OPENING OF THE MOON FACING TOWARD THE SECOND "T" IN "PALMETTO".

SN 85-084,100, FILED 7-14-2010.

MAYUR VAGHANI, EXAMINING ATTORNEY



David J. Kybas

Director of the United States Patent and Trademark Office

United States of America

United States Patent and Trademark Office

MyChildren's

Reg. No. 4,068,189

Registered Dec. 6, 2011

Int. Cl.: 44

SERVICE MARK

PRINCIPAL REGISTER

CHILDREN'S MEDICAL CENTER OF DALLAS (TEXAS CORPORATION)
1935 MEDICAL DISTRICT DRIVE
DALLAS, TX 75235

FOR: PEDIATRIC PRIMARY MEDICAL CARE SERVICES, IN CLASS 44 (U.S. CLS. 100 AND 101).

FIRST USE 10-12-2010; IN COMMERCE 10-12-2010.

THE MARK CONSISTS OF STANDARD CHARACTERS WITHOUT CLAIM TO ANY PARTICULAR FONT, STYLE, SIZE, OR COLOR.

OWNER OF U.S. REG. NOS. 3,152,584, 3,161,365, AND OTHERS.

SN 85-084,338, FILED 7-14-2010.

COLLEEN KEARNEY, EXAMINING ATTORNEY



David J. Kyros

Director of the United States Patent and Trademark Office

United States of America

United States Patent and Trademark Office

NEWSF33D

Reg. No. 4,068,190

ICONOCLAST PRODUCTIONS, LLC (OHIO LIMITED LIABILITY COMPANY)
8425 KUGLER MILL RD.
CINCINNATI, OH 45243

Registered Dec. 6, 2011

Int. Cl.: 35

FOR: PROVIDING A WEBSITE FEATURING AN ONLINE NEWS CLIPPING SERVICE, IN CLASS 35 (U.S. CLS. 100, 101 AND 102).

SERVICE MARK

FIRST USE 10-20-2011; IN COMMERCE 10-20-2011.

PRINCIPAL REGISTER

THE MARK CONSISTS OF STANDARD CHARACTERS WITHOUT CLAIM TO ANY PARTICULAR FONT, STYLE, SIZE, OR COLOR.

SN 85-084,380, FILED 7-14-2010.

JEFFREY LOOK, EXAMINING ATTORNEY



David J. Kyffers

Director of the United States Patent and Trademark Office

United States of America

United States Patent and Trademark Office

Dog Scout Cookies

Reg. No. 4,068,191

Registered Dec. 6, 2011

Int. Cl.: 31

TRADEMARK

PRINCIPAL REGISTER

WILDER, KRISTIE L. (UNITED STATES INDIVIDUAL), DBA LIFE IS LABS RESCUE,
1485 OLD DRAKETOWN TRAIL
TEMPLE, GA 30179

FOR: DOG TREATS, IN CLASS 31 (U.S. CLS. 1 AND 46).

FIRST USE 7-14-2010; IN COMMERCE 8-16-2010.

THE MARK CONSISTS OF STANDARD CHARACTERS WITHOUT CLAIM TO ANY PARTICULAR FONT, STYLE, SIZE, OR COLOR.

NO CLAIM IS MADE TO THE EXCLUSIVE RIGHT TO USE "DOG" AND "COOKIES", APART FROM THE MARK AS SHOWN.

SN 85-084,638, FILED 7-14-2010.

KAPIL BHANOT, EXAMINING ATTORNEY



David J. Kybas

Director of the United States Patent and Trademark Office

United States of America

United States Patent and Trademark Office

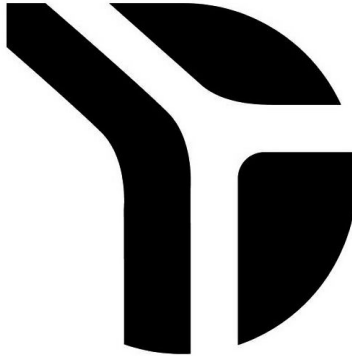

Reg. No. 4,068,192

Registered Dec. 6, 2011

Int. Cl.: 20

TRADEMARK

PRINCIPAL REGISTER

BUSH INDUSTRIES, INC. (DELAWARE CORPORATION)
ONE MASON DRIVE, P.O. BOX 460
JAMESTOWN, NY 147020460

FOR: FURNITURE, IN CLASS 20 (U.S. CLS. 2, 13, 22, 25, 32 AND 50).

FIRST USE 6-0-2010; IN COMMERCE 6-0-2010.

THE MARK CONSISTS OF A GRAPHIC RENDITION OF A WORKPLACE.

SN 85-085,345, FILED 7-15-2010.

NAPOLEON SHARMA, EXAMINING ATTORNEY



David J. Kyffers

Director of the United States Patent and Trademark Office

United States of America

United States Patent and Trademark Office

Teaming Document

Reg. No. 4,068,193

Registered Dec. 6, 2011

Int. Cl.: 42

SERVICE MARK

PRINCIPAL REGISTER

ESEIS, INC. (DELAWARE CORPORATION)
12012 WICKCHESTER LN, STE 600
HOUSTON, TX 77079

FOR: CONSULTING SERVICES IN THE FIELD OF GEOLOGY, GEOPHYSICS, ENGINEERING, AND SEISMOLOGY FOR THE OIL, GAS, AND MINING INDUSTRIES, IN CLASS 42 (U.S. CLS. 100 AND 101).

FIRST USE 10-18-2011; IN COMMERCE 10-18-2011.

THE MARK CONSISTS OF STANDARD CHARACTERS WITHOUT CLAIM TO ANY PARTICULAR FONT, STYLE, SIZE, OR COLOR.

SN 85-087,468, FILED 7-19-2010.

MICHAEL SOUDERS, EXAMINING ATTORNEY



David J. Kybas

Director of the United States Patent and Trademark Office

United States of America

United States Patent and Trademark Office

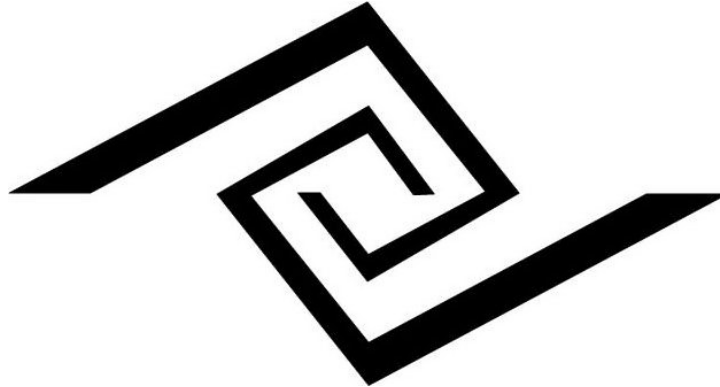

Reg. No. 4,068,194

Registered Dec. 6, 2011

Int. Cls.: 25 and 28

TRADEMARK

PRINCIPAL REGISTER

KNIPP, CHAD (UNITED STATES INDIVIDUAL)
2601 SOUTH ROANOKE ST.
GILBERT, AZ 85295 AND

KNIPP, LISA (UNITED STATES INDIVIDUAL)
2601 SOUTH ROANOKE ST.
GILBERT, AZ 85295

FOR: ATHLETIC APPAREL, NAMELY, SHIRTS, PANTS, JACKETS, FOOTWEAR, HATS AND CAPS, ATHLETIC UNIFORMS, SWEAT BANDS, GLOVES, VISORS, SWIMSUITS, IN CLASS 25 (U.S. CLS. 22 AND 39).

FIRST USE 10-5-2011; IN COMMERCE 10-5-2011.

FOR: SPORTING GOODS, NAMELY, ARM BANDS FOR DESIGNATING TEAM MEMBER POSITIONS IN SPORTS ACTIVITIES, ARTICLES OF CLOTHING FOR TOYS, BAGS ESPECIALLY DESIGNED FOR SURFBOARDS, BAGS FOR CLIMBERS SPECIALLY ADAPTED FOR HOLDING CLIMBING EQUIPMENT, BAGS FOR SKATEBOARDS, BAGS SPECIALLY ADAPTED FOR SPORTS EQUIPMENT, BAGS SPECIALLY ADAPTED TO CARRY YOGA EQUIPMENT, BALLS FOR SPORTS, BASEBALL BAT BAGS, STRAPS USED FOR YOGA AND OTHER FITNESS ACTIVITIES AND FOR CARRYING A YOGA MAT, SKI BAGS, CARRIERS SPECIALLY ADAPTED FOR SPORT BALLS, TENNIS RACKET COVERS, TELESCOPING CADDY FOR BUCKET FOR CARRYING, STORING AND TRANSPORTING TENNIS BALLS AND OTHER SPORTS EQUIPMENT, STRESS RELIEF BALLS FOR HAND EXERCISE, TROLLEY BAGS FOR GOLF EQUIPMENT, TROLLEY BAGS SPECIALLY ADAPTED FOR SPORTS EQUIPMENT, TROLLEY BAGS SPECIALLY ADAPTED FOR FOOTBALL EQUIPMENT, TROLLEY BAGS SPECIALLY ADAPTED FOR SOCCER EQUIPMENT, TROLLEY BAGS SPECIALLY ADAPTED FOR RUGBY EQUIPMENT, AND VOLLEYBALL TUBE BAGS, IN CLASS 28 (U.S. CLS. 22, 23, 38 AND 50).

FIRST USE 10-5-2011; IN COMMERCE 10-5-2011.

THE MARK CONSISTS OF AN IRREGULAR POLYGONAL SPIRAL DESIGN.

SN 85-088,060, FILED 7-19-2010.

REBECCA POVARCHUK, EXAMINING ATTORNEY



David J. Kyros

Director of the United States Patent and Trademark Office

United States of America

United States Patent and Trademark Office

★SafetyMAXX★

Reg. No. 4,068,195

Registered Dec. 6, 2011

Int. Cls.: 3 and 25

TRADEMARK

PRINCIPAL REGISTER

FSI, INC (TENNESSEE CORPORATION)
2140 DAYTON AVENUE
NASHVILLE, TN 37210

FOR: PERSONAL DEODORANTS; TOOTHPASTE; SOAP; HAIR SHAMPOO, IN CLASS 3
(U.S. CLS. 1, 4, 6, 50, 51 AND 52).

FIRST USE 6-30-2010; IN COMMERCE 10-1-2010.

FOR: CLOTHING, NAMELY, SHIRTS, PANTS, UNDERWEAR, COATS, SOCKS, FOOTWEAR,
SANDALS, TENNIS SHOES, DECK SHOES, BOOTS, IN CLASS 25 (U.S. CLS. 22 AND 39).

FIRST USE 6-30-2010; IN COMMERCE 10-1-2010.

THE MARK CONSISTS OF THE STYLIZED TEXT "SAFETYMAXX" WITH TWO STARS;
ONE AT THE BEGINNING AND ONE AT THE END.

SN 85-089,068, FILED 7-20-2010.

MATTHEW KLINE, EXAMINING ATTORNEY



David J. Kyros

Director of the United States Patent and Trademark Office

United States of America

United States Patent and Trademark Office

WISH

Reg. No. 4,068,196

Registered Dec. 6, 2011

Int. Cl.: 10

TRADEMARK

PRINCIPAL REGISTER

SYNOIA LTD. (ISRAEL CORPORATION)
PO BOX 698
NES ZIONA, ISRAEL 74106

FOR: MEDICAL COSMETIC DEVICES FOR HOME USE USING RF (RADIO FREQUENCY), MICRODERMABRASION, OR MICRO-CURRENT FOR THE TREATMENT OF ACNE, WRINKLE PREVENTION, AND THE TREATMENT OF DULL AND LIFELESS SKIN , IN CLASS 10 (U.S. CLS. 26, 39 AND 44).

FIRST USE 11-30-2010; IN COMMERCE 4-30-2011.

THE MARK CONSISTS OF STANDARD CHARACTERS WITHOUT CLAIM TO ANY PARTICULAR FONT, STYLE, SIZE, OR COLOR.

SN 85-089,228, FILED 7-21-2010.

MAYUR VAGHANI, EXAMINING ATTORNEY



David J. Kybas

Director of the United States Patent and Trademark Office

United States of America

United States Patent and Trademark Office

PURE HEART PURE MIND PURE BODY

Reg. No. 4,068,197

KNIPP, CHAD (UNITED STATES INDIVIDUAL)
2601 SOUTH ROANOKE ST.
GILBERT, AZ 85295 AND

Registered Dec. 6, 2011

Int. Cl.: 25

KNIPP, LISA (UNITED STATES INDIVIDUAL)
2601 SOUTH ROANOKE ST.
GILBERT, AZ 85295

TRADEMARK

PRINCIPAL REGISTER

FOR: ATHLETIC APPAREL, NAMELY, SHIRTS, PANTS, JACKETS, FOOTWEAR, HATS AND CAPS, ATHLETIC UNIFORMS, SWEAT BANDS, GLOVES, VISORS, SWIMSUITS, IN CLASS 25 (U.S. CLS. 22 AND 39).

FIRST USE 6-25-2011; IN COMMERCE 10-3-2011.

THE MARK CONSISTS OF STANDARD CHARACTERS WITHOUT CLAIM TO ANY PARTICULAR FONT, STYLE, SIZE, OR COLOR.

SN 85-089,776, FILED 7-21-2010.

REBECCA POVARCHUK, EXAMINING ATTORNEY



David J. Kyros

Director of the United States Patent and Trademark Office

United States of America

United States Patent and Trademark Office

NANO GATE

Reg. No. 4,068,198

Registered Dec. 6, 2011

Int. Cl.: 9

TRADEMARK

PRINCIPAL REGISTER

CHECKPOINT SYSTEMS, INC. (PENNSYLVANIA CORPORATION)
101 WOLF DRIVE
THOROFARE, NJ 080862243

FOR: AUTOMATED SECURITY GATES USED AT RETAIL STORES TO DETECT ELECTRONIC ARTICLE SURVEILLANCE DEVICES AND PREVENT THEFT OF RETAIL MERCHANDISE, IN CLASS 9 (U.S. CLS. 21, 23, 26, 36 AND 38).

FIRST USE 9-30-2010; IN COMMERCE 9-30-2010.

THE MARK CONSISTS OF STANDARD CHARACTERS WITHOUT CLAIM TO ANY PARTICULAR FONT, STYLE, SIZE, OR COLOR.

SN 85-090,876, FILED 7-22-2010.

LINDA M. KING, EXAMINING ATTORNEY



David J. Kyros

Director of the United States Patent and Trademark Office

United States of America

United States Patent and Trademark Office

EXPANDING VISUAL HORIZONS

Reg. No. 4,068,199

Registered Dec. 6, 2011

Int. Cl.: 9

TRADEMARK

PRINCIPAL REGISTER

DIMENSIONAL OPTICS, INC. (CALIFORNIA CORPORATION)
3590 SACRAMENTO DRIVE, SUITE 130
SAN LUIS OBISPO, CA 93401

FOR: EYEGLASSES; EYEWEAR, NAMELY, EYEGLASSES, IN CLASS 9 (U.S. CLS. 21, 23, 26, 36 AND 38).

FIRST USE 8-31-2011; IN COMMERCE 8-31-2011.

THE MARK CONSISTS OF STANDARD CHARACTERS WITHOUT CLAIM TO ANY PARTICULAR FONT, STYLE, SIZE, OR COLOR.

SN 85-091,184, FILED 7-23-2010.

KAREN K. BUSH, EXAMINING ATTORNEY



David J. Kybas

Director of the United States Patent and Trademark Office

United States of America

United States Patent and Trademark Office

CARIFLEX

Reg. No. 4,068,200

Registered Dec. 6, 2011

Int. Cl.: 17

TRADEMARK

PRINCIPAL REGISTER

KRATON POLYMERS U.S. LLC (DELAWARE LIMITED LIABILITY COMPANY)
16400 PARK ROW
HOUSTON, TX 770845015

FOR: RUBBER AND RUBBER LATEX FOR USE IN MANUFACTURING IN A WIDE VARIETY OF INDUSTRIES NOT FOR USE IN MANUFACTURING IMPACT RESISTANT ARMOR AND SHIELDING GOODS, EQUIPMENT AND MATERIALS USED FOR BALLISTIC PROTECTION AND PROTECTION FROM PROJECTILES, IN CLASS 17 (U.S. CLS. 1, 5, 12, 13, 35 AND 50).

FIRST USE 1-19-2011; IN COMMERCE 1-19-2011.

THE MARK CONSISTS OF STANDARD CHARACTERS WITHOUT CLAIM TO ANY PARTICULAR FONT, STYLE, SIZE, OR COLOR.

SN 85-091,642, FILED 7-23-2010.

TRACY WHITTAKER-BROWN, EXAMINING ATTORNEY



David J. Kyffers

Director of the United States Patent and Trademark Office

United States of America

United States Patent and Trademark Office

MTab

Reg. No. 4,068,201

Registered Dec. 6, 2011

Int. Cl.: 16

TRADEMARK

PRINCIPAL REGISTER

M CLIP CO. (DELAWARE CORPORATION)
1835 NEWPORT BOULEVARD, SUITE A-109
COSTA MESA, CA 92627

FOR: OFFICE SUPPLIES, NAMELY, INDEX CARDS, NOTE CARDS, CLIPS FOR DOCUMENTS, IN CLASS 16 (U.S. CLS. 2, 5, 22, 23, 29, 37, 38 AND 50).

FIRST USE 8-15-2011; IN COMMERCE 8-15-2011.

THE MARK CONSISTS OF STANDARD CHARACTERS WITHOUT CLAIM TO ANY PARTICULAR FONT, STYLE, SIZE, OR COLOR.

SN 85-091,909, FILED 7-23-2010.

JACLYN KIDWELL WALKER, EXAMINING ATTORNEY



David J. Kybas

Director of the United States Patent and Trademark Office

United States of America

United States Patent and Trademark Office

TRENDY CHARLIE

Reg. No. 4,068,202

FOURS P'S (OHIO LIMITED LIABILITY COMPANY)
193 LAKE BLUFF DR
COLUMBUS, OH 43235

Registered Dec. 6, 2011

Int. Cl.: 25

FOR: BATHING SUITS; HATS; JACKETS; PANTS; SHIRTS; SHOES; SHORTS; SOCKS;
UNDERWEAR, IN CLASS 25 (U.S. CLS. 22 AND 39).

TRADEMARK

FIRST USE 5-21-2010; IN COMMERCE 8-1-2011.

PRINCIPAL REGISTER

THE MARK CONSISTS OF STANDARD CHARACTERS WITHOUT CLAIM TO ANY PARTICULAR FONT, STYLE, SIZE, OR COLOR.

SN 85-094,177, FILED 7-27-2010.

ANDREA BUTLER, EXAMINING ATTORNEY



David J. Kybas

Director of the United States Patent and Trademark Office

United States of America

United States Patent and Trademark Office

StraightARM

Reg. No. 4,068,203

LAFLIN, SEAN L. (CALIFORNIA CORPORATION), DBA BANG! CREATIVE, INC.,
2395 CAMINO VIDA ROBLE, SUITE 107
CARLSBAD, CA 92011

Registered Dec. 6, 2011

Int. Cl.: 10

FOR: MANUALLY-OPERATED EXERCISE EQUIPMENT FOR PHYSICAL THERAPY PURPOSES, IN CLASS 10 (U.S. CLS. 26, 39 AND 44).

TRADEMARK

FIRST USE 7-23-2010; IN COMMERCE 8-8-2011.

PRINCIPAL REGISTER

THE MARK CONSISTS OF STANDARD CHARACTERS WITHOUT CLAIM TO ANY PARTICULAR FONT, STYLE, SIZE, OR COLOR.

SN 85-094,241, FILED 7-27-2010.

ANGELA M. MICHELI, EXAMINING ATTORNEY



David J. Kyros

Director of the United States Patent and Trademark Office

United States of America

United States Patent and Trademark Office

When Two Become One

Reg. No. 4,068,204

Registered Dec. 6, 2011

Int. Cl.: 14

TRADEMARK

PRINCIPAL REGISTER

A. JAFFE, INC. (NEW YORK CORPORATION)
154 WEST 14TH STREET
NEW YORK, NY 10011

FOR: JEWELRY, IN CLASS 14 (U.S. CLS. 2, 27, 28 AND 50).

FIRST USE 10-24-2011; IN COMMERCE 10-24-2011.

THE MARK CONSISTS OF STANDARD CHARACTERS WITHOUT CLAIM TO ANY PARTICULAR FONT, STYLE, SIZE, OR COLOR.

SN 85-094,569, FILED 7-28-2010.

TASNEEM HUSSAIN, EXAMINING ATTORNEY



David J. Kyffers

Director of the United States Patent and Trademark Office

United States of America

United States Patent and Trademark Office



Reg. No. 4,068,205

Registered Dec. 6, 2011

Int. Cl.: 28

TRADEMARK

PRINCIPAL REGISTER

CARNOLOGY, INC. (CALIFORNIA CORPORATION), DBA CARNOLOGY, INC.,
3545 DOVE HOLLOW ROAD
OLIVENHAIN, CA 92024

FOR: BOARD GAMES, IN CLASS 28 (U.S. CLS. 22, 23, 38 AND 50).

FIRST USE 8-1-2011; IN COMMERCE 8-15-2011.

NO CLAIM IS MADE TO THE EXCLUSIVE RIGHT TO USE "THE CAR IDENTIFICATION GAME", APART FROM THE MARK AS SHOWN.

THE COLOR(S) RED, BLACK AND WHITE IS/ARE CLAIMED AS A FEATURE OF THE MARK.

THE MARK CONSISTS OF A BLACK MAGNIFYING GLASS WITH A WHITE INTERIOR, WHICH ENCOMPASSES A CAR IMAGE IN BLACK AND WHITE; TO THE RIGHT OF THIS DESIGN IS THE WORDING "CARNOLOGY" WITH THE LETTERS "CAR" IN RED AND "NOLOGY" IN BLACK; UNDER THIS TERM IS THE PHRASE "THE CAR IDENTIFICATION GAME" IN BLACK.

SN 85-094,650, FILED 7-28-2010.

TINA L. SNAPP, EXAMINING ATTORNEY



David J. Kyffers

Director of the United States Patent and Trademark Office

United States of America

United States Patent and Trademark Office

Meshin

Reg. No. 4,068,206

Registered Dec. 6, 2011

Int. Cl.: 9

TRADEMARK

PRINCIPAL REGISTER

PALO ALTO RESEARCH CENTER, INC. (DELAWARE CORPORATION)
3333 COYOTE HILL ROAD
PALO ALTO, CA 94304

FOR: COMPUTER SOFTWARE FOR USE IN TRANSMISSION AND MANAGEMENT OF DATA ON COMPUTER NETWORKS; SOFTWARE FOR DATABASE MANAGEMENT; SOFTWARE FOR WORKFLOW MANAGEMENT; SOFTWARE FOR CREATING, FACILITATING, AND MANAGING REMOTE ACCESS TO AND COMMUNICATION WITH LOCAL AREA NETWORKS; SOFTWARE FOR ACCESSING INFORMATION DIRECTORIES ON INTERNET AND INTRANET COMPUTER NETWORKS, FOR MANAGEMENT OF COMPUTER NETWORKS INTERCONNECTING APPLICATIONS, FOR DATA MERGING AND MINING; SOFTWARE FOR ELECTRONIC FILE LOCATING, REFERENCING, DATA EXTRACTING, LINKING, INTEGRATING, TRANSFORMING THE INFORMATION; COMPUTER SOFTWARE FOR ELECTRONIC DATA PROCESSING OF STRUCTURED AND UNSTRUCTURED INFORMATION FOR PURPOSES OF RECOGNITION, CLASSIFICATION, AND RETRIEVAL, AS WELL AS INTELLIGENT CONTENT IDENTIFICATION AND MATCHING; COMPUTER SOFTWARE FOR USE IN THE MANAGEMENT OF WEB SITE CONTENT; COMPUTER SOFTWARE FOR USE IN BUSINESS PROCESS MANAGEMENT, NAMELY, COMMUNICATION STREAMS; COMPUTER SOFTWARE FOR USE MANAGING METADATA IN NETWORK SERVERS, COMPUTER WEBSITES AND COMPUTER PROGRAMS, IN CLASS 9 (U.S. CLS. 21, 23, 26, 36 AND 38).

FIRST USE 8-23-2010; IN COMMERCE 8-23-2010.

THE MARK CONSISTS OF STANDARD CHARACTERS WITHOUT CLAIM TO ANY PARTICULAR FONT, STYLE, SIZE, OR COLOR.

SN 85-095,019, FILED 7-28-2010.

HOWARD B. LEVINE, EXAMINING ATTORNEY



David J. Kyros

Director of the United States Patent and Trademark Office

United States of America

United States Patent and Trademark Office



Reg. No. 4,068,207

Registered Dec. 6, 2011

Int. Cl.: 9

TRADEMARK

PRINCIPAL REGISTER

FLUKE CORPORATION (WASHINGTON CORPORATION)
6920 SEAWAY BOULEVARD
EVERETT, WA 98203

FOR: CLAMP METERS AND ACCESSORIES SOLD AS A UNIT; CLAMP METER ACCESSORIES, IN CLASS 9 (U.S. CLS. 21, 23, 26, 36 AND 38).

FIRST USE 9-1-2010; IN COMMERCE 9-1-2010.

THE MARK CONSISTS OF A SOLID CIRCLE INSIDE A CONCENTRIC, INCOMPLETE CIRCLE WITH A STYLIZED "Y" AT THE BOTTOM OF THE INCOMPLETE CIRCLE.

SN 85-095,289, FILED 7-28-2010.

SUSAN STIGLITZ, EXAMINING ATTORNEY



David J. Kybas

Director of the United States Patent and Trademark Office

United States of America

United States Patent and Trademark Office

REED BETWEEN THE LINES

Reg. No. 4,068,208

Registered Dec. 6, 2011

Int. Cl.: 41

SERVICE MARK

PRINCIPAL REGISTER

BLACK ENTERTAINMENT TELEVISION LLC (D.C. LIMITED LIABILITY COMPANY),
AKA BET,
ONE BET PLAZA, 1235 W STREET, N.E.
BUSINESS & LEGAL AFFAIRS
WASHINGTON, DC 20018

FOR: ENTERTAINMENT SERVICES, NAMELY, AN ON-GOING SERIES FEATURING SCRIPTED MATERIAL IN THE NATURE OF A COMBINATION OF COMEDY AND DRAMA PROVIDED THROUGH TELEVISION, CABLE, SATELLITE SYSTEMS, GLOBAL COMMUNICATIONS NETWORKS AND WIRELESS COMMUNICATION DEVICES; ENTERTAINMENT, NAMELY, A CONTINUING SCRIPTED SHOW IN THE NATURE OF A COMBINATION OF COMEDY AND DRAMA BROADCAST OVER TELEVISION, CABLE, SATELLITE SYSTEMS, GLOBAL COMMUNICATIONS NETWORKS AND WIRELESS COMMUNICATION DEVICES, IN CLASS 41 (U.S. CLS. 100, 101 AND 107).

FIRST USE 10-11-2011; IN COMMERCE 10-11-2011.

THE MARK CONSISTS OF STANDARD CHARACTERS WITHOUT CLAIM TO ANY PARTICULAR FONT, STYLE, SIZE, OR COLOR.

SN 85-096,173, FILED 7-29-2010.

DAVID COLLIER, EXAMINING ATTORNEY



David J. Kyros

Director of the United States Patent and Trademark Office

United States of America

United States Patent and Trademark Office

THINK OUTSIDE THE TOUR

Reg. No. 4,068,209

Registered Dec. 6, 2011

Int. Cls.: 39 and 41

SERVICE MARK

PRINCIPAL REGISTER

ELDERHOSTEL, INC. (MASSACHUSETTS CORPORATION)
11 AVENUE DE LAFAYETTE
BOSTON, MA 021111746

FOR: ARRANGING TRAVEL TOURS, IN CLASS 39 (U.S. CLS. 100 AND 105).

FIRST USE 8-0-2010; IN COMMERCE 8-0-2010.

FOR: EDUCATIONAL SERVICES, NAMELY, PROVIDING CONFERENCES, WORKSHOPS, SEMINARS, AND CLASSES THROUGH EXPERIENTIAL OR CLASSROOM LEARNING IN THE FIELDS OF HISTORY, NATURE, CULTURES, SCIENCE, ENTERTAINMENT, ART, SELF-IMPROVEMENT, AND POLITICS, IN CLASS 41 (U.S. CLS. 100, 101 AND 107).

FIRST USE 8-0-2010; IN COMMERCE 8-0-2010.

THE MARK CONSISTS OF STANDARD CHARACTERS WITHOUT CLAIM TO ANY PARTICULAR FONT, STYLE, SIZE, OR COLOR.

OWNER OF U.S. REG. NO. 2,877,979.

SN 85-096,514, FILED 7-30-2010.

MEGHAN REINHART, EXAMINING ATTORNEY



David J. Kyros

Director of the United States Patent and Trademark Office

United States of America

United States Patent and Trademark Office



Reg. No. 4,068,210

Registered Dec. 6, 2011

Int. Cl.: 12

TRADEMARK

PRINCIPAL REGISTER

DEXTER AXLE COMPANY (DELAWARE CORPORATION)
2900 INDUSTRIAL PARKWAY EAST
ELKHART, IN 46515

FOR: AIR RIDE SUSPENSION AXLES, IN CLASS 12 (U.S. CLS. 19, 21, 23, 31, 35 AND 44).

FIRST USE 9-12-2011; IN COMMERCE 9-12-2011.

OWNER OF U.S. REG. NOS. 3,312,324 AND 3,317,908.

THE MARK CONSISTS OF BLACK SLANTED SQUARE WITH WAVY WHITE LINE RUNNING THROUGH THE SQUARE, THE SQUARE BEING LOCATED IMMEDIATELY PRECEDING THE STYLIZED WORD "AIRFLEX".

SN 85-096,648, FILED 7-30-2010.

PAUL F. GAST, EXAMINING ATTORNEY



David J. Kyffers

Director of the United States Patent and Trademark Office

United States of America

United States Patent and Trademark Office

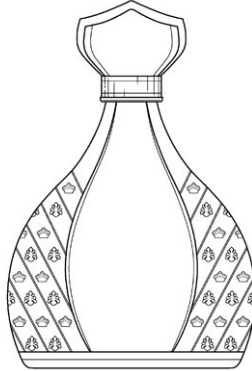

Reg. No. 4,068,211

Registered Dec. 6, 2011

Int. Cl.: 33

TRADEMARK

PRINCIPAL REGISTER

DIAGEO NORTH AMERICA, INC. (CONNECTICUT CORPORATION)
801 MAIN AVENUE
NORWALK, CT 06851

FOR: ALCOHOLIC BEVERAGES EXCEPT BEERS, IN CLASS 33 (U.S. CLS. 47 AND 49).

FIRST USE 6-30-2011; IN COMMERCE 6-30-2011.

THE MARK CONSISTS OF PRODUCT PACKAGING FOR THE GOODS, CONSISTING OF A THREE-DIMENSIONAL, PEAR-SHAPED BULBOUS BOTTLE, WITH A FRONT-EMBOSSSED FLAT ENGRAVED PANEL, WITH CARVED FACETS ALONG THE EDGES OF THE BOTTLE, SIDE EMBOSSED PANELS AND NECK AND, WITH A CIRCULAR SHAPE ON TOP OF THE NECK WITH A BOTTLE STOPPER THAT IS CROWN-LIKE IN SHAPE.

SN 85-096,816, FILED 7-30-2010.

JAY BESCH, EXAMINING ATTORNEY



David J. Kyffers

Director of the United States Patent and Trademark Office

United States of America

United States Patent and Trademark Office

DENTALGUARD ALLIANCE

Reg. No. 4,068,212

THE GUARDIAN LIFE INSURANCE COMPANY OF AMERICA (NEW YORK CORPORATION)
7 HANOVER SQUARE
NEW YORK, NY 10004

Registered Dec. 6, 2011

Int. Cl.: 36

FOR: INSURANCE SERVICES, NAMELY, INSURANCE UNDERWRITING IN THE FIELD OF GROUP DENTAL HEALTH INSURANCE, IN CLASS 36 (U.S. CLS. 100, 101 AND 102).

SERVICE MARK

FIRST USE 7-0-2010; IN COMMERCE 7-0-2010.

PRINCIPAL REGISTER

THE MARK CONSISTS OF STANDARD CHARACTERS WITHOUT CLAIM TO ANY PARTICULAR FONT, STYLE, SIZE, OR COLOR.

OWNER OF U.S. REG. NOS. 1,795,250, 2,103,285, AND 2,103,286.

NO CLAIM IS MADE TO THE EXCLUSIVE RIGHT TO USE "ALLIANCE", APART FROM THE MARK AS SHOWN.

SN 85-096,955, FILED 7-30-2010.

WON TEAK OH, EXAMINING ATTORNEY



David J. Kybas

Director of the United States Patent and Trademark Office

United States of America

United States Patent and Trademark Office

Wagner's Meat

Reg. No. 4,068,213

Registered Dec. 6, 2011

Int. Cl.: 35

SERVICE MARK

PRINCIPAL REGISTER

SCOTT GERARD WOLFE SR. (UNITED STATES INDIVIDUAL)
4817 PRYTANIA STREET
NEW ORLEANS, LA 70115

FOR: RETAIL STORE SERVICES FEATURING A WIDE VARIETY OF CONSUMER GOODS OF OTHERS; RETAIL STORE SERVICES FEATURING CONVENIENCE STORE ITEMS AND GASOLINE, IN CLASS 35 (U.S. CLS. 100, 101 AND 102).

FIRST USE 12-31-1987; IN COMMERCE 12-31-1987.

THE MARK CONSISTS OF STANDARD CHARACTERS WITHOUT CLAIM TO ANY PARTICULAR FONT, STYLE, SIZE, OR COLOR.

SEC. 2(F).

OWNER OF U.S. REG. NOS. 2,779,471 AND 2,964,520.

NO CLAIM IS MADE TO THE EXCLUSIVE RIGHT TO USE "MEAT", APART FROM THE MARK AS SHOWN.

SN 85-097,167, FILED 7-30-2010.

JACQUELINE A. LAVINE, EXAMINING ATTORNEY



David J. Kybas

Director of the United States Patent and Trademark Office

United States of America

United States Patent and Trademark Office



Reg. No. 4,068,214

Registered Dec. 6, 2011

Int. Cl.: 35

SERVICE MARK

PRINCIPAL REGISTER

NATIONAL ASSOCIATION OF EMERGENCY MEDICAL TECHNICIANS (MASSACHUSETTS CORPORATION)
PO BOX 1400
CLINTON, MS 39060

FOR: PUBLIC ADVOCACY TO PROMOTE AWARENESS OF EMERGENCY MEDICAL SERVICES, IN CLASS 35 (U.S. CLS. 100, 101 AND 102).

FIRST USE 1-1-2010; IN COMMERCE 1-1-2010.

NO CLAIM IS MADE TO THE EXCLUSIVE RIGHT TO USE "EMS" OR THE STAR OF LIFE AND CADUCEUS EMBLEM, APART FROM THE MARK AS SHOWN.

THE COLOR(S) BLACK, WHITE, ROYAL BLUE AND TEAL IS/ARE CLAIMED AS A FEATURE OF THE MARK.

THE MARK CONSISTS OF AN IMAGE OF A WHITE CAPITOL DOME OUTLINED IN BLACK WITH A STAR OF LIFE AND CADUCEUS SYMBOL CENTERED OVER IT IN THE COLORS ROYAL BLUE AND WHITE. A SEMI-CIRCLE IN TEAL IS DIRECTLY BELOW THE DOME IMAGE WITH THE LETTERS "EMS" APPEARING CENTERED ON IT IN THE COLOR WHITE. AT THE BOTTOM OF THE MARK IS THE WORDING "ON THE HILL DAY" AND "BE THERE FOR EMS" WRITTEN IN THE COLOR ROYAL BLUE.

SN 85-097,914, FILED 8-2-2010.

ALLISON SCHRODY, EXAMINING ATTORNEY



David J. Kyffers

Director of the United States Patent and Trademark Office

United States of America

United States Patent and Trademark Office

ABUNDANCE PORTAL

Reg. No. 4,068,215

Registered Dec. 6, 2011

Int. Cl.: 41

SERVICE MARK

PRINCIPAL REGISTER

KIMBERLY GEORGE (UNITED STATES INDIVIDUAL)
119 EDDYWOOD STREET
SPRINGFIELD, MA 01118

FOR: EDUCATION SERVICES, NAMELY, PROVIDING TRAINING IN THE FIELD OF BUSINESS AND ACHIEVING PERSONAL SUCCESS; PERSONAL AND LIFE COACHING SERVICES IN THE FIELD OF BUSINESS AND ACHIEVING PERSONAL SUCCESS; ARRANGING AND CONDUCTING CONVENTIONS, CONGRESSES, CONFERENCES, SEMINARS AND SYMPOSIUMS ALL IN THE FIELD OF PERSONAL AND LIFE COACHING; ORGANIZATION OF EXHIBITIONS FOR EDUCATIONAL, CULTURAL AND ENTERTAINMENT PURPOSES IN THE FIELDS OF BUSINESS AND LIFE COACHING; ORGANIZING AND CONDUCTING TRAINING CLASSES, SEMINARS AND WORKSHOPS IN THE FIELD OF BUSINESS AND LIFE COACHING, IN CLASS 41 (U.S. CLS. 100, 101 AND 107).

FIRST USE 10-15-2011; IN COMMERCE 10-15-2011.

THE MARK CONSISTS OF STANDARD CHARACTERS WITHOUT CLAIM TO ANY PARTICULAR FONT, STYLE, SIZE, OR COLOR.

SN 85-098,036, FILED 8-2-2010.

JOHN DWYER, EXAMINING ATTORNEY



David J. Kyfos

Director of the United States Patent and Trademark Office

United States of America

United States Patent and Trademark Office



Reg. No. 4,068,216

Registered Dec. 6, 2011

Int. Cls.: 38 and 42

SERVICE MARK

PRINCIPAL REGISTER

JIMMYGOOD, LLC (MISSOURI LIMITED LIABILITY COMPANY)
6705 N. CYPRESS AVE.
KANSAS CITY, MO 64119

FOR: BROADCAST COMMUNICATION SERVICES, NAMELY, TRANSMITTING DATA, CONTENT, TEXT MESSAGES, PHOTOGRAPHS, IMAGES, VIDEO RECORDINGS AND AUDIO RECORDINGS FROM SMART PHONES, PERSONAL DIGITAL ASSISTANTS, AND HANDHELD ELECTRONIC DEVICES FOR OTHERS OVER THE INTERNET; TRANSMISSION OF DATA, CONTENT, TEXT MESSAGES, PHOTOGRAPHS, IMAGES, VIDEO RECORDINGS AND AUDIO RECORDINGS FROM SMART PHONES, PERSONAL DIGITAL ASSISTANTS, AND HANDHELD ELECTRONIC DEVICES FOR OTHERS VIA PUBLIC AND PRIVATE WIRELESS NETWORKS FOR DISPLAY ON TELEVISIONS, COMPUTER MONITORS, ELECTRONIC SCOREBOARDS, AND OTHER ELECTRONIC DISPLAYS; ELECTRONIC TRANSMISSION OF MESSAGES AMONG USERS OF COMPUTERS, SMART PHONES, PERSONAL DIGITAL ASSISTANTS AND HANDHELD ELECTRONIC DEVICES; ELECTRONIC TRANSMISSION OF DATA, CONTENT, TEXT MESSAGES, PHOTOGRAPHS, IMAGES, VIDEO RECORDINGS AND AUDIO RECORDINGS TO SOCIAL NETWORKS AND BLOG WEBSITES, IN CLASS 38 (U.S. CLS. 100, 101 AND 104).

FIRST USE 6-1-2010; IN COMMERCE 6-1-2010.



FOR: PROVIDING TEMPORARY USE OF ON-LINE NON-DOWNLOADABLE SOFTWARE THAT ALLOWS USERS TO TRANSMIT DATA, CONTENT, TEXT MESSAGES, PHOTOGRAPHS, IMAGES, VIDEO RECORDINGS AND AUDIO RECORDINGS TO SOCIAL NETWORKING AND BLOG WEBSITES; PROVIDING TEMPORARY USE OF ON-LINE NON-DOWNLOADABLE SOFTWARE THAT ALLOWS USERS TO MONITOR, SHARE, COMMENT AND RESPOND TO TEXTUAL COMMUNICATIONS, PROVIDING A WEBSITE FEATURING TEMPORARY USE OF NON-DOWNLOADABLE SOFTWARE THAT ALLOWS USERS TO POST, SEARCH, WATCH, MONITOR, RESPOND TO, SHARE, CRITIQUE, RATE AND COMMENT ON TEXTUAL COMMUNICATIONS, IN CLASS 42 (U.S. CLS. 100 AND 101).

FIRST USE 6-1-2010; IN COMMERCE 6-1-2010.

David J. Kybas

THE MARK CONSISTS OF THE LETTER "C" AND TWO LOWER CASE "I"'S WITHIN TWO CONCENTRIC CIRCLES.

SN 85-098,395, FILED 8-2-2010.

Reg. No. 4,068,216 JAMES LOVELACE, EXAMINING ATTORNEY

United States of America

United States Patent and Trademark Office

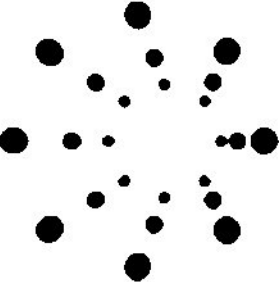
infusion  two

Reg. No. 4,068,217

Registered Dec. 6, 2011

Int. Cl.: 3

TRADEMARK

PRINCIPAL REGISTER

PYLANT VILLAGE PHARMACY, INC. (TEXAS CORPORATION)
SUITE 100
975 CORBINDALE ROAD
HOUSTON, TX 77024

FOR: COSMETIC CREAMS FOR SKIN CARE, IN CLASS 3 (U.S. CLS. 1, 4, 6, 50, 51 AND 52).

FIRST USE 5-16-2011; IN COMMERCE 10-1-2011.

THE MARK CONSISTS OF A SPHERICAL BURST IN BETWEEN THE WORDS "INFUSION" AND "TWO".

SN 85-098,530, FILED 8-2-2010.

APRIL ROACH, EXAMINING ATTORNEY



David J. Kyffers

Director of the United States Patent and Trademark Office

United States of America

United States Patent and Trademark Office

ASIST-AT

Reg. No. 4,068,218

Registered Dec. 6, 2011

Int. Cl.: 9

TRADEMARK

PRINCIPAL REGISTER

CHI SYSTEMS INC. (PENNSYLVANIA CORPORATION)
1035 VIRGINIA DRIVE, SUITE 300
FORT WASHINGTON, PA 19034

FOR: ARTIFICIAL INTELLIGENCE SOFTWARE FOR THE DEFENSE, AEROSPACE, SECURITY, ENERGY AND TRANSPORTATION INDUSTRIES USED TO TRAIN INDIVIDUALS AND TEAMS USING SIMULATIONS OF USER TASK ENVIRONMENTS, IN CLASS 9 (U.S. CLS. 21, 23, 26, 36 AND 38).

FIRST USE 6-24-2011; IN COMMERCE 6-24-2011.

THE MARK CONSISTS OF STANDARD CHARACTERS WITHOUT CLAIM TO ANY PARTICULAR FONT, STYLE, SIZE, OR COLOR.

SN 85-098,881, FILED 8-3-2010.

AMEEN IMAM, EXAMINING ATTORNEY



David J. Kybas

Director of the United States Patent and Trademark Office

United States of America

United States Patent and Trademark Office

MailPieceTracker

Reg. No. 4,068,219

Registered Dec. 6, 2011

Int. Cl.: 42

SERVICE MARK

PRINCIPAL REGISTER

TEC SOFTWARE, LLC (WISCONSIN LIMITED LIABILITY COMPANY)
SUITE 201
804 LIBERTY BOULEVARD
SUN PRAIRIE, WI 53590

FOR: SOFTWARE AS A SERVICE (SAAS), NAMELY, PROVIDING WEB-BASED NON-DOWNLOADABLE SOFTWARE FOR USE BY OTHERS FOR MANAGING AND TRACKING TIMELY AND ACCURATE DELIVERY OF MAILINGS, IN CLASS 42 (U.S. CLS. 100 AND 101).

FIRST USE 3-8-2010; IN COMMERCE 3-8-2010.

NO CLAIM IS MADE TO THE EXCLUSIVE RIGHT TO USE "MAIL PIECE TRACKER", APART FROM THE MARK AS SHOWN.

THE MARK CONSISTS OF THE WORDS "MAILPIECETRACKER" WITH THE "A" IN "MAIL" BEING FORMED BY A FIGURE OF A MAN.

SN 85-099,088, FILED 8-3-2010.

COURTNEY ALVAREZ, EXAMINING ATTORNEY



David J. Kybas

Director of the United States Patent and Trademark Office

United States of America

United States Patent and Trademark Office



Reg. No. 4,068,220

Registered Dec. 6, 2011

Int. Cl.: 45

SERVICE MARK

PRINCIPAL REGISTER

GAINES ROBERT (US VIRGIN ISLANDS SOLE PROPRIETORSHIP), DBA STOP SNOOPING,
ROOM 1A
2715 WEST OAKDALE STREET
PHILADELPHIA, PA 191323125

FOR: ELECTRONIC MONITORING SERVICES FOR SECURITY PURPOSES IN THE FIELD
OF TRACKING AND LOCATING CELLULAR OR MOBILE PHONES, IN CLASS 45 (U.S.
CLS. 100 AND 101).

FIRST USE 5-10-2011; IN COMMERCE 5-10-2011.

THE MARK CONSISTS OF THE WORDING "STOP SNOOPING" IN RED WRITTEN ON A
WALL CONSISTING OF WHITE BRICKS OUTLINED IN BLACK WITH A MAN'S FACE
PEERING OVER THE TOP OF THE WALL IN WHITE ALSO OUTLINED IN BLACK AND
HIS HANDS HOLDING THE WALL ALSO IN WHITE OUTLINED IN BLACK; AT THE
BOTTOM RIGHT OF THE WALL IS A PAIR OF SHOES ALSO IN WHITE OUTLINED IN
BLACK

THE COLOR(S) BLACK, WHITE AND RED IS/ARE CLAIMED AS A FEATURE OF THE
MARK.

SN 85-099,157, FILED 8-3-2010.

BENJAMIN OKEKE, EXAMINING ATTORNEY



David J. Kyffers

Director of the United States Patent and Trademark Office

United States of America

United States Patent and Trademark Office

MobileCAT

Reg. No. 4,068,221

Registered Dec. 6, 2011

Int. Cl.: 9

TRADEMARK

PRINCIPAL REGISTER

ALCHEMY3, LLC (GEORGIA LIMITED LIABILITY COMPANY)
SUITE 425
3480 PRESTON RIDGE RD
ALPHARETTA, GA 30005

FOR: DOWNLOADABLE COMPUTER APPLICATION SOFTWARE FOR MOBILE PHONES, NAMELY, SOFTWARE FOR PLAYING LOTTERY AND PROMOTIONAL GAMES, IN CLASS 9 (U.S. CLS. 21, 23, 26, 36 AND 38).

FIRST USE 8-9-2009; IN COMMERCE 4-15-2010.

THE MARK CONSISTS OF STANDARD CHARACTERS WITHOUT CLAIM TO ANY PARTICULAR FONT, STYLE, SIZE, OR COLOR.

SN 85-099,296, FILED 8-3-2010.

ELISSA GARBER KON, EXAMINING ATTORNEY



David J. Kyffers

Director of the United States Patent and Trademark Office

United States of America

United States Patent and Trademark Office

e-i-e-i-grow

Reg. No. 4,068,222

Registered Dec. 6, 2011

Int. Cl.: 24

TRADEMARK

PRINCIPAL REGISTER

ACCURSO, KIM R. (UNITED STATES INDIVIDUAL), DBA E-I-E-I-GROW,
P.O. BOX 375, WORLAND, WY 82401
3000 SOUTH SWEET 16
WORLAND, WY 82401

FOR: EARLY CHILDHOOD DEVELOPMENT PRODUCTS, NAMELY, BABY BLANKETS,
IN CLASS 24 (U.S. CLS. 42 AND 50).

FIRST USE 4-1-2010; IN COMMERCE 8-1-2011.

THE MARK CONSISTS OF STANDARD CHARACTERS WITHOUT CLAIM TO ANY PAR-
TICULAR FONT, STYLE, SIZE, OR COLOR.

SN 85-099,350, FILED 8-3-2010.

KAREN K. BUSH, EXAMINING ATTORNEY



David J. Kyros

Director of the United States Patent and Trademark Office

United States of America

United States Patent and Trademark Office



Reg. No. 4,068,223

Registered Dec. 6, 2011

Int. Cl.: 9

TRADEMARK

PRINCIPAL REGISTER

UBIQUITI NETWORKS, INC. (DELAWARE CORPORATION), DBA UBIQUITI NETWORKS, INC., A DELAWARE CORPORATION,
91 E. TASMAN DRIVE
SAN JOSE, CA 95035

FOR: ELECTRONIC TRANSMITTERS AND RECEIVERS FOR ENTERPRISE WIRELESS NETWORKS, NAMELY, TRANSMITTERS AND RECEIVERS OF ELECTRONIC SIGNALS, IN CLASS 9 (U.S. CLS. 21, 23, 26, 36 AND 38).

FIRST USE 1-15-2011; IN COMMERCE 1-15-2011.

THE MARK CONSISTS OF THE WORD "UNIFI" WITH A DESIGN OF SOUND WAVES EXTENDING FROM THE DOT OF THE FIRST "I" OVER THE TOP OF THE "NI" LETTERS.

SN 85-100,397, FILED 8-4-2010.

TARA PATE, EXAMINING ATTORNEY



David J. Kybas

Director of the United States Patent and Trademark Office

United States of America

United States Patent and Trademark Office

DELTADIODE

Reg. No. 4,068,224

Registered Dec. 6, 2011

Int. Cl.: 9

TRADEMARK

PRINCIPAL REGISTER

HORIBA JOBIN YVON INC. (DELAWARE CORPORATION)
3880 PARK AVENUE
EDISON, NJ 08820

FOR: SCIENTIFIC APPARATUS AND INSTRUMENTS FOR OPTICAL ANALYSIS, NAMELY, SPECTROMETERS, PHOTOLUMINESCENCE AND FLUORESCENCE SPECTROMETERS. APPARATUS AND INSTRUMENTS FOR PHOTOLUMINESCENCE LIFETIME MEASUREMENT AND SPECTROGRAPHS; MICROSCOPES; SCANNERS; AND RELATED COMPONENTS THEREOF, NAMELY, LIGHT-CONDUCTING FILAMENTS, ELECTRIC POWER CABLES, INTERFACE BETWEEN ELECTRICAL POWER CONNECTORS, DIFFRACTION GRATING, OPTICAL LENSES, OPTICAL MIRRORS AND OPTICAL FILTERS; COMPUTER SOFTWARE FOR OPTICAL ANALYSIS AND DATA ACQUISITION AND PROCESSING FOR USE IN ASSOCIATION WITH SPECTROMETERS, IN CLASS 9 (U.S. CLS. 21, 23, 26, 36 AND 38).

FIRST USE 2-1-2011; IN COMMERCE 2-1-2011.

THE MARK CONSISTS OF STANDARD CHARACTERS WITHOUT CLAIM TO ANY PARTICULAR FONT, STYLE, SIZE, OR COLOR.

SN 85-101,702, FILED 8-6-2010.

MICHELLE DUBOIS, EXAMINING ATTORNEY



David J. Kyros

Director of the United States Patent and Trademark Office

United States of America

United States Patent and Trademark Office



Reg. No. 4,068,225

Registered Dec. 6, 2011

Int. Cl.: 42

SERVICE MARK

PRINCIPAL REGISTER

SMART HOUSE CALLS, LLC (GEORGIA LIMITED LIABILITY COMPANY)
1540 GOBER ROAD
BISHOP, GA 30621

FOR: PROVIDING ON-LINE NON-DOWNLOADABLE SOFTWARE FOR ENABLING INTERNET CONFERENCES AND ONLINE MEETINGS FOR PHYSICIANS AND OTHER PROVIDERS OF HEALTHCARE-RELATED SERVICES, IN CLASS 42 (U.S. CLS. 100 AND 101).

FIRST USE 11-15-2010; IN COMMERCE 11-15-2010.

NO CLAIM IS MADE TO THE EXCLUSIVE RIGHT TO USE "HOUSE CALLS", APART FROM THE MARK AS SHOWN.

THE COLOR(S) BLUE AND GREEN IS/ARE CLAIMED AS A FEATURE OF THE MARK.

THE MARK CONSISTS OF LOWER-CASE WORD "SMART" IN GREEN WITH IMAGE OF HOUSE IN BLUE TO THE RIGHT WITH MEDICAL PLUS SYMBOL IN GREEN ON CHIMNEY AND BLUE HEART/APPLE SHAPED DOOR OUTLINE ON THE HOUSE; LOWER CASE WORDS "HOUSE" IN BLUE AND "CALLS" IN GREEN FROM LEFT TO RIGHT UNDERNEATH THE WORD "SMART" AND THE IMAGE DESCRIBED ABOVE.

SN 85-101,872, FILED 8-6-2010.

KATHERINE E. HALMEN, EXAMINING ATTORNEY



David J. Kybas

Director of the United States Patent and Trademark Office

United States of America

United States Patent and Trademark Office

FABRIC FIRST AID

Reg. No. 4,068,226

Registered Dec. 6, 2011

Int. Cl.: 3

TRADEMARK

PRINCIPAL REGISTER

VALSPAR SOURCING, INC. (MINNESOTA CORPORATION)
P.O. BOX 1461
MINNEAPOLIS, MN 55440

FOR: STAIN REMOVERS, IN CLASS 3 (U.S. CLS. 1, 4, 6, 50, 51 AND 52).

FIRST USE 3-1-2011; IN COMMERCE 3-1-2011.

THE MARK CONSISTS OF STANDARD CHARACTERS WITHOUT CLAIM TO ANY PARTICULAR FONT, STYLE, SIZE, OR COLOR.

NO CLAIM IS MADE TO THE EXCLUSIVE RIGHT TO USE "FABRIC", APART FROM THE MARK AS SHOWN.

SN 85-102,025, FILED 8-6-2010.

MATTHEW EINSTEIN, EXAMINING ATTORNEY



David J. Kyffers

Director of the United States Patent and Trademark Office

United States of America

United States Patent and Trademark Office

JSC SURFSIDE SEAFOOD

Reg. No. 4,068,227

Registered Dec. 6, 2011

Int. Cl.: 29

TRADEMARK

PRINCIPAL REGISTER

JENNY SERVICE COMPANY (NEVADA CORPORATION)
SUITE 101
150 EAST GREG STREET
SPARKS, NV 89431

FOR: SEAFOOD, NAMELY, MACKEREL; JACK MACKEREL; MACKEREL FILLETS; LIGHT TUNA; SARDINES; KIPPER; SALMON; CRAB MEAT; SMOKED BABY CLAMS; SMOKED OYSTERS; FISH STEAK; OCTOPUS; TINY SHRIMP; SMOKED SCALLOPS; SMOKED MUSSELS; SMOKED CLAMS; ALBACORE TUNA; TALAPIA FILLETS, IN CLASS 29 (U.S. CL. 46).

FIRST USE 7-15-2010; IN COMMERCE 7-15-2010.

THE MARK CONSISTS OF STANDARD CHARACTERS WITHOUT CLAIM TO ANY PARTICULAR FONT, STYLE, SIZE, OR COLOR.

NO CLAIM IS MADE TO THE EXCLUSIVE RIGHT TO USE "SEAFOOD", APART FROM THE MARK AS SHOWN.

SN 85-102,382, FILED 8-6-2010.

LINDA MICKLEBURGH, EXAMINING ATTORNEY



David J. Kyros

Director of the United States Patent and Trademark Office

United States of America

United States Patent and Trademark Office

EVOLVING LIGHT

Reg. No. 4,068,228

Registered Dec. 6, 2011

Int. Cl.: 35

SERVICE MARK

PRINCIPAL REGISTER

ELECTRONIC THEATRE CONTROLS, INC. (WISCONSIN CORPORATION)
3031 PLEASANT VIEW ROAD
PO BOX 620979
MIDDLETON, WI 535620979

FOR: SALES PROMOTION AND ADVERTISING OF ENTERTAINMENT AND ARCHITECTURAL LIGHTING SYSTEMS AND COMPONENTS, IN CLASS 35 (U.S. CLS. 100, 101 AND 102).

FIRST USE 9-12-2010; IN COMMERCE 9-12-2010.

THE MARK CONSISTS OF STANDARD CHARACTERS WITHOUT CLAIM TO ANY PARTICULAR FONT, STYLE, SIZE, OR COLOR.

NO CLAIM IS MADE TO THE EXCLUSIVE RIGHT TO USE "LIGHT", APART FROM THE MARK AS SHOWN.

SN 85-102,832, FILED 8-9-2010.

JAY FLOWERS, EXAMINING ATTORNEY



David J. Kyros

Director of the United States Patent and Trademark Office

United States of America

United States Patent and Trademark Office

ENLIGHTENED MEDICINE CONSCIOUS LIVING - COMPASSIONATE HEALING

Reg. No. 4,068,229

KHALSA, SORAM, M.D. (UNITED STATES INDIVIDUAL)
436 NORTH BEDFORD DR., SUITE 308
BEVERLY HILLS, CA 90210

Registered Dec. 6, 2011

Int. Cl.: 44

FOR: PROVIDING A WEBSITE FEATURING INFORMATION CONCERNING HEALTH AND NUTRITION; MEDICAL SERVICES, NAMELY, INTEGRATIVE AND COMPLEMENTARY MEDICAL SERVICES; PROVIDING MEDICAL INFORMATION AND CONSULTANCY SERVICES, IN CLASS 44 (U.S. CLS. 100 AND 101).

SERVICE MARK

PRINCIPAL REGISTER

FIRST USE 1-6-2010; IN COMMERCE 1-6-2010.

THE MARK CONSISTS OF STANDARD CHARACTERS WITHOUT CLAIM TO ANY PARTICULAR FONT, STYLE, SIZE, OR COLOR.

NO CLAIM IS MADE TO THE EXCLUSIVE RIGHT TO USE "MEDICINE", APART FROM THE MARK AS SHOWN.

SN 85-103,029, FILED 8-9-2010.

KATHRYN COWARD, EXAMINING ATTORNEY



David J. Kyros

Director of the United States Patent and Trademark Office

United States of America

United States Patent and Trademark Office

FEEL LIFE

Reg. No. 4,068,230

Registered Dec. 6, 2011

Int. Cl.: 32

TRADEMARK

PRINCIPAL REGISTER

GS (FLORIDA PARTNERSHIP), DBA GS WATERS,
11003 NW 33ST
DORAL, FL 33172

FOR: NON-ALCOHOLIC DRINKING WATER; DRINKING WATER; DRINKING WATER WITH VITAMINS; DRINKING WATER WITH VITAMINS AND NATURAL FLAVORS; FLAVORED WATER; WATER WITH NATURAL FLAVORS; DRINKING FLAVORED WATER; DRINKING WATER WITH NATURAL FLAVORS; DRINKING FLAVORED WATER WITH VITAMINS; DRINKING WATER WITH NATURAL FLAVORS AND VITAMINS, IN CLASS 32 (U.S. CLS. 45, 46 AND 48).

FIRST USE 10-4-2011; IN COMMERCE 10-4-2011.

THE MARK CONSISTS OF STANDARD CHARACTERS WITHOUT CLAIM TO ANY PARTICULAR FONT, STYLE, SIZE, OR COLOR.

SN 85-103,581, FILED 8-9-2010.

TINA MAI, EXAMINING ATTORNEY



David J. Kyros

Director of the United States Patent and Trademark Office

United States of America

United States Patent and Trademark Office



Reg. No. 4,068,231

Registered Dec. 6, 2011

Int. Cl.: 7

TRADEMARK

PRINCIPAL REGISTER

PHG ENERGY, LLC (TENNESSEE LIMITED LIABILITY COMPANY)
1245 BRIDGESTONE PARKWAY
LA VERGNE, TN 37086

FOR: GASIFIERS FOR GENERATING RENEWABLE ENERGY THROUGH GASIFICATION OF BIOMASS PRODUCTS AND REPLACEMENT PARTS THEREOF; GASIFIERS FOR PRODUCING CLEAN GAS FROM CARBON-BASED MATERIALS AND REPLACEMENT PARTS THEREOF, IN CLASS 7 (U.S. CLS. 13, 19, 21, 23, 31, 34 AND 35).

FIRST USE 9-0-2011; IN COMMERCE 9-0-2011.

THE MARK CONSISTS OF A FLAME DESIGN APPEARING IMMEDIATELY ABOVE THE LETTERS "PHG".

SN 85-104,702, FILED 8-11-2010.

BRENDAN MCCAULEY, EXAMINING ATTORNEY



David J. Kybas

Director of the United States Patent and Trademark Office

United States of America

United States Patent and Trademark Office

INFANT REFLUX SLEEP AID

Reg. No. 4,068,232

SCERBO, JENNIFER (UNITED STATES INDIVIDUAL)
431 DUNLIN PLAZA
SECAUCUS, NJ 07094

Registered Dec. 6, 2011

Int. Cl.: 9

FOR: DIGITAL MATERIALS, NAMELY, CDS AND DOWNLOADABLE AUDIO FILES FEATURING COMMON HOUSEHOLD SOUND RECORDINGS; PRE-RECORDED CDS FEATURING HOUSEHOLD SOUND RECORDINGS, IN CLASS 9 (U.S. CLS. 21, 23, 26, 36 AND 38).

TRADEMARK

PRINCIPAL REGISTER

FIRST USE 9-27-2011; IN COMMERCE 9-27-2011.

THE MARK CONSISTS OF STANDARD CHARACTERS WITHOUT CLAIM TO ANY PARTICULAR FONT, STYLE, SIZE, OR COLOR.

SN 85-104,967, FILED 8-11-2010.

KAELIE KUNG, EXAMINING ATTORNEY



David J. Kyffers

Director of the United States Patent and Trademark Office

United States of America

United States Patent and Trademark Office



Reg. No. 4,068,233

Registered Dec. 6, 2011

Int. Cl.: 21

TRADEMARK

PRINCIPAL REGISTER

YET-SHANG ENTERPRISES, LLC (NEW JERSEY LIMITED LIABILITY COMPANY)
P.O. BOX 24108
JERSEY CITY, NJ 07304

FOR: CRUETS; CRUETS NOT OF PRECIOUS METAL; SALT AND PEPPER SHAKERS;
VINEGAR CRUETS, IN CLASS 21 (U.S. CLS. 2, 13, 23, 29, 30, 33, 40 AND 50).

FIRST USE 12-20-2010; IN COMMERCE 12-20-2010.

THE MARK CONSISTS OF A CITY SCENE WITH 2 FLAGGED TOWERS AND BACK-
GROUND BUILDINGS NEXT TO A RIVER REPRESENTED BY 3 CURVES. IN THE SKY IS
A CLOUD AND A CRESCENT MOON. THE WORDS "SHAKING THE CITY" IS UNDER-
NEATH THE SCENE.

SN 85-105,057, FILED 8-11-2010.

MARILYN IZZI, EXAMINING ATTORNEY



David J. Kybas

Director of the United States Patent and Trademark Office

United States of America

United States Patent and Trademark Office

BILLY VANILLY

Reg. No. 4,068,234

Registered Dec. 6, 2011

Int. Cl.: 35

SERVICE MARK

PRINCIPAL REGISTER

BILLY VANILLY LLC (KANSAS LIMITED LIABILITY COMPANY)
105 NW COURTLAND
TOPEKA, KS 66606

FOR: RETAIL STORE SERVICES FEATURING BAKED AND DECORATED CUPCAKES, BAKED AND DECORATED ROUND CAKES, AND BAKED AND DECORATED SHEET CAKES, IN CLASS 35 (U.S. CLS. 100, 101 AND 102).

FIRST USE 2-1-2011; IN COMMERCE 2-1-2011.

THE MARK CONSISTS OF STANDARD CHARACTERS WITHOUT CLAIM TO ANY PARTICULAR FONT, STYLE, SIZE, OR COLOR.

THE NAME "BILLY VANILLY" DOES NOT IDENTIFY A LIVING INDIVIDUAL.

SN 85-105,526, FILED 8-11-2010.

JENNIFER MARTIN, EXAMINING ATTORNEY



David J. Kyros

Director of the United States Patent and Trademark Office

United States of America

United States Patent and Trademark Office

HUGG
the
WORLD

Reg. No. 4,068,235

Registered Dec. 6, 2011

Int. Cl.: 25

TRADEMARK

PRINCIPAL REGISTER

HUGG THE WORLD (INDIANA LIMITED LIABILITY COMPANY)
11220 SAINT JOE ROAD
FORT WAYNE, IN 46835

FOR: HATS; HOODED SWEAT SHIRTS; SHIRTS; SWEAT SHIRTS; T-SHIRTS, IN CLASS
25 (U.S. CLS. 22 AND 39).

FIRST USE 8-2-2010; IN COMMERCE 11-10-2010.

THE MARK CONSISTS OF THE STYLIZED TEXT "HUGG THE W(O)RLD".

SN 85-105,883, FILED 8-12-2010.

INGRID C. EULIN, EXAMINING ATTORNEY



David J. Kyffers

Director of the United States Patent and Trademark Office

United States of America

United States Patent and Trademark Office

COOL BAR

Reg. No. 4,068,236

Registered Dec. 6, 2011

Int. Cl.: 9

TRADEMARK

PRINCIPAL REGISTER

WHEELED COACH INDUSTRIES (FLORIDA CORPORATION)
2778 NORTH FORSYTH ROAD
WINTER PARK, FL 32792

FOR: COMBINATION EMERGENCY WARNING LIGHT ASSEMBLY INCORPORATING AIR CONDITIONER GAS CONDENSER, FANS, AND WARNING LIGHTS FOR USE ON EMERGENCY RESPONSE VEHICLES, IN CLASS 9 (U.S. CLS. 21, 23, 26, 36 AND 38).

FIRST USE 8-26-2010; IN COMMERCE 8-26-2010.

THE MARK CONSISTS OF STANDARD CHARACTERS WITHOUT CLAIM TO ANY PARTICULAR FONT, STYLE, SIZE, OR COLOR.

NO CLAIM IS MADE TO THE EXCLUSIVE RIGHT TO USE "BAR", APART FROM THE MARK AS SHOWN.

SN 85-105,962, FILED 8-12-2010.

B. PARADEWELAI, EXAMINING ATTORNEY



David J. Kyffers

Director of the United States Patent and Trademark Office

United States of America

United States Patent and Trademark Office



Reg. No. 4,068,237

Registered Dec. 6, 2011

Int. Cl.: 14

TRADEMARK

PRINCIPAL REGISTER

POWER CORE USA, LLC (FLORIDA LIMITED LIABILITY COMPANY)
2531 CLEVELAND AVENUE
FORT MYERS, FL 33901

FOR: BRACELETS AND JEWELRY FEATURING ELECTRONIC CHIPS FOR ATTRACTING ENERGY TO THE BODY WHEREIN THE ELECTRONIC CHIPS INCREASE IN POWER IN THE PRESENCE OF ELECTROMAGNETIC FIELDS, FOR THE PURPOSE OF RE-BALANCING THE HUMAN ENERGY FIELD, IN CLASS 14 (U.S. CLS. 2, 27, 28 AND 50).

FIRST USE 4-21-2011; IN COMMERCE 4-21-2011.

THE MARK CONSISTS OF A DEPICTION OF A COMPUTER MONITOR POWER BUTTON WITHIN A CIRCLE WITH THE WORDS "POWER CORE" IN UPPERCASE STYLIZED FONT REPEATING FIVE TIMES AROUND THE CIRCLE AND SEPARATED BY RAISED DOTS.

SN 85-106,231, FILED 8-12-2010.

ALYSSA STEEL, EXAMINING ATTORNEY



David J. Kybas

Director of the United States Patent and Trademark Office

United States of America

United States Patent and Trademark Office

CANOE

Reg. No. 4,068,238

Registered Dec. 6, 2011

Int. Cl.: 5

TRADEMARK

PRINCIPAL REGISTER

REGAL CHEMICAL COMPANY (GEORGIA CORPORATION)
P.O. BOX 900
ALPHARETTA, GA 30239

FOR: HERBICIDES FOR AGRICULTURAL, COMMERCIAL AND DOMESTIC USE, IN CLASS 5 (U.S. CLS. 6, 18, 44, 46, 51 AND 52).

FIRST USE 4-0-2011; IN COMMERCE 4-0-2011.

THE MARK CONSISTS OF STANDARD CHARACTERS WITHOUT CLAIM TO ANY PARTICULAR FONT, STYLE, SIZE, OR COLOR.

SN 85-106,424, FILED 8-12-2010.

C. DIONNE CLYBURN, EXAMINING ATTORNEY



David J. Kyfos

Director of the United States Patent and Trademark Office

United States of America

United States Patent and Trademark Office

IT-ASSIST

Reg. No. 4,068,239

Registered Dec. 6, 2011

Int. Cl.: 42

SERVICE MARK

PRINCIPAL REGISTER

RURBANC DATA SERVICES, INC. (OHIO CORPORATION)
7622 ST. RT. 66 N.
DEFIANCE, OH 43512

FOR: COMPUTER SERVICES, NAMELY, REMOTE AND ON-SITE MANAGEMENT OF THE INFORMATION TECHNOLOGY (IT) CLOUD COMPUTING SYSTEMS OF OTHERS; COMPUTER SERVICES, NAMELY, REMOTE AND ON-SITE MANAGEMENT OF THE INFORMATION TECHNOLOGY (IT) SYSTEMS OF OTHERS; INFORMATION TECHNOLOGY CONSULTATION, IN CLASS 42 (U.S. CLS. 100 AND 101).

FIRST USE 10-4-2011; IN COMMERCE 10-4-2011.

THE MARK CONSISTS OF STANDARD CHARACTERS WITHOUT CLAIM TO ANY PARTICULAR FONT, STYLE, SIZE, OR COLOR.

SN 85-106,751, FILED 8-13-2010.

BARBARA BROWN, EXAMINING ATTORNEY



David J. Kyros

Director of the United States Patent and Trademark Office

United States of America

United States Patent and Trademark Office

TAKE 1

Reg. No. 4,068,240

Registered Dec. 6, 2011

Int. Cl.: 9

TRADEMARK

PRINCIPAL REGISTER

ELITE BRANDS INC. (NEW YORK CORPORATION)
NORTH TOWER, 17TH FLOOR
499 SEVENTH AVENUE
NEW YORK, NY 10118

FOR: DIGITAL VIDEO AND STILL CAMERAS, EXPRESSLY EXCLUDING ALL COMPUTER AND VIDEO GAME PROGRAMS AND SOFTWARE, IN CLASS 9 (U.S. CLS. 21, 23, 26, 36 AND 38).

FIRST USE 10-29-2010; IN COMMERCE 11-11-2010.

THE MARK CONSISTS OF STANDARD CHARACTERS WITHOUT CLAIM TO ANY PARTICULAR FONT, STYLE, SIZE, OR COLOR.

SN 85-107,222, FILED 8-13-2010.

MAYUR VAGHANI, EXAMINING ATTORNEY



David J. Kyros

Director of the United States Patent and Trademark Office

United States of America

United States Patent and Trademark Office

AVANZ

Reg. No. 4,068,241

Registered Dec. 6, 2011

Int. Cl.: 36

SERVICE MARK

PRINCIPAL REGISTER

AVANZ CAPITAL PARTNERS (CAYMAN ISLANDS LIMITED LIABILITY COMPANY)
STUARTS CORPORATE SERVICES LTD.
36A DR ROY'S DRIVE
GEORGE TOWN, CAYMAN ISLANDS KY1-1104

FOR: ADVICE RELATING TO INVESTMENTS, IN CLASS 36 (U.S. CLS. 100, 101 AND 102).

FIRST USE 6-29-2010; IN COMMERCE 6-29-2010.

THE MARK CONSISTS OF STANDARD CHARACTERS WITHOUT CLAIM TO ANY PARTICULAR FONT, STYLE, SIZE, OR COLOR.

SN 85-107,231, FILED 8-13-2010.

RENEE SERVANCE, EXAMINING ATTORNEY



David J. Kybas

Director of the United States Patent and Trademark Office

United States of America

United States Patent and Trademark Office

MY REAL WEDDING

Reg. No. 4,068,242

Registered Dec. 6, 2011

Int. Cl.: 42

SERVICE MARK

PRINCIPAL REGISTER

XO GROUP INC. (DELAWARE CORPORATION)
462 BROADWAY, 6TH FLOOR
NEW YORK, NY 10013

FOR: PROVIDING AN ON-LINE WEB SITE THAT GIVES MULTIPLE COMPUTER USERS THE ABILITY TO UPLOAD, RATE, AND COMMENT UPON PHOTOGRAPHS, VIDEOS AND/OR INFORMATION ABOUT THEIR WEDDINGS AND THE WEDDINGS OF OTHERS, IN CLASS 42 (U.S. CLS. 100 AND 101).

FIRST USE 6-30-2010; IN COMMERCE 6-30-2010.

THE MARK CONSISTS OF STANDARD CHARACTERS WITHOUT CLAIM TO ANY PARTICULAR FONT, STYLE, SIZE, OR COLOR.

NO CLAIM IS MADE TO THE EXCLUSIVE RIGHT TO USE "WEDDING", APART FROM THE MARK AS SHOWN.

SN 85-107,265, FILED 8-13-2010.

MIDGE BUTLER, EXAMINING ATTORNEY



David J. Kyros

Director of the United States Patent and Trademark Office

United States of America

United States Patent and Trademark Office

COSMIC CORNER

Reg. No. 4,068,243

Registered Dec. 6, 2011

Int. Cl.: 35

SERVICE MARK

PRINCIPAL REGISTER

MAINSTREAM, LLC (WISCONSIN LIMITED LIABILITY COMPANY), DBA COSMIC CORNER,
1200 N MAIN STREET LOWER
RACINE, WI 53402

FOR: ONLINE RETAIL STORE AND RETAIL STORE SERVICES FEATURING TOBACCO PRODUCTS AND RELATED ACCESSORIES; ONLINE RETAIL STORE AND RETAIL STORE SERVICES FEATURING CLOTHING AND RELATED ACCESSORIES, IN CLASS 35 (U.S. CLS. 100, 101 AND 102).

FIRST USE 7-1-2007; IN COMMERCE 7-1-2007.

THE MARK CONSISTS OF STANDARD CHARACTERS WITHOUT CLAIM TO ANY PARTICULAR FONT, STYLE, SIZE, OR COLOR.

SN 85-107,784, FILED 8-15-2010.

LOURDES AYALA, EXAMINING ATTORNEY



David J. Kyros

Director of the United States Patent and Trademark Office

United States of America

United States Patent and Trademark Office

LANDGURU

Reg. No. 4,068,244

Registered Dec. 6, 2011

Int. Cl.: 35

SERVICE MARK

PRINCIPAL REGISTER

MITH MANAGEMENT, LLC (TEXAS LIMITED LIABILITY COMPANY)
P. O. BOX 878
HOWE, TX 75459

FOR: ADVERTISING SERVICES, NAMELY, PROMOTING RURAL PROPERTIES FOR SALE OR LEASE BY OWNERS OR BY AGENTS VIA THE INTERNET; PROVIDING A WEBSITE FOR CONNECTING SELLERS WITH BUYERS, IN CLASS 35 (U.S. CLS. 100, 101 AND 102).

FIRST USE 5-31-2011; IN COMMERCE 5-31-2011.

THE MARK CONSISTS OF STANDARD CHARACTERS WITHOUT CLAIM TO ANY PARTICULAR FONT, STYLE, SIZE, OR COLOR.

NO CLAIM IS MADE TO THE EXCLUSIVE RIGHT TO USE "LAND", APART FROM THE MARK AS SHOWN.

SN 85-108,368, FILED 8-16-2010.

ANDREW RHIM, EXAMINING ATTORNEY



David J. Kybas

Director of the United States Patent and Trademark Office

United States of America

United States Patent and Trademark Office

THE DREAMING TREE

Reg. No. 4,068,245

Registered Dec. 6, 2011

Int. Cl.: 33

TRADEMARK

PRINCIPAL REGISTER

CONSTELLATION WINES U.S., INC. (NEW YORK CORPORATION)
235 NORTH BLOOMFIELD ROAD
CANANDAIGUA, NY 14424

FOR: WINE, IN CLASS 33 (U.S. CLS. 47 AND 49).

FIRST USE 8-19-2011; IN COMMERCE 8-19-2011.

THE MARK CONSISTS OF STANDARD CHARACTERS WITHOUT CLAIM TO ANY PARTICULAR FONT, STYLE, SIZE, OR COLOR.

SN 85-108,617, FILED 8-16-2010.

PRISCILLA MILTON, EXAMINING ATTORNEY



David J. Kybas

Director of the United States Patent and Trademark Office

United States of America

United States Patent and Trademark Office



Reg. No. 4,068,246
Registered Dec. 6, 2011
Int. Cls.: 14 and 35

VEDANTA USA, LLC (CALIFORNIA LIMITED LIABILITY COMPANY)
SUITE 888
1482 EAST VALLEY RD
SANTA BARBARA, CA 93108

TRADEMARK

FOR: PRECIOUS METALS AND THEIR ALLOYS; GOODS IN PRECIOUS METALS AND THEIR ALLOYS OR COATED THEREWITH, NAMELY, JEWELRY, PRECIOUS STONES; HOROLOGICAL AND CHRONOMETRIC INSTRUMENTS, IN CLASS 14 (U.S. CLS. 2, 27, 28 AND 50).

SERVICE MARK

FIRST USE 5-4-2011; IN COMMERCE 5-4-2011.

PRINCIPAL REGISTER

FOR: RETAIL STORES AND ONLINE RETAIL STORES FEATURING PRECIOUS METALS AND THEIR ALLOYS AND GOODS IN PRECIOUS METALS OR COATED THEREWITH, JEWELRY, PRECIOUS STONES, AND HOROLOGICAL AND CHRONOMETRIC INSTRUMENTS; WHOLESALE DISTRIBUTORSHIPS FEATURING PRECIOUS METALS AND THEIR ALLOYS AND GOODS IN PRECIOUS METALS OR COATED THEREWITH, JEWELRY, PRECIOUS STONES, AND HOROLOGICAL AND CHRONOMETRIC INSTRUMENTS, IN CLASS 35 (U.S. CLS. 100, 101 AND 102).

FIRST USE 5-4-2011; IN COMMERCE 5-4-2011.

THE MARK CONSISTS OF A STYLIZED LETTER "U" IN GRAY (PANTONE 7544C) WITH THREE COLORED DOTS ABOVE IT IN BLUE (PANTONE 634C), RED (PANTONE 207C) AND GREEN (PANTONE 390C) AND A DOT TO THE RIGHT IN ORANGE (PANTONE 158C).

THE COLOR(S) GRAY, BLUE, RED, GREEN AND ORANGE IS/ARE CLAIMED AS A FEATURE OF THE MARK.

SN 85-109,339, FILED 8-17-2010.

MARK RADEMACHER, EXAMINING ATTORNEY



David J. Kyjars

Director of the United States Patent and Trademark Office

United States of America

United States Patent and Trademark Office

CVS SELECT

Reg. No. 4,068,247

Registered Dec. 6, 2011

Int. Cl.: 35

SERVICE MARK

PRINCIPAL REGISTER

CVS PHARMACY, INC. (RHODE ISLAND CORPORATION)
ONE CVS DRIVE
WOONSOCKET, RI 02895

FOR: PRE-PAID GIFT CARD SERVICES, NAMELY, ISSUING GIFT CARDS THAT MAY BE REDEEMED FOR GOODS OR SERVICES, IN CLASS 35 (U.S. CLS. 100, 101 AND 102).

FIRST USE 3-28-2011; IN COMMERCE 3-28-2011.

THE MARK CONSISTS OF STANDARD CHARACTERS WITHOUT CLAIM TO ANY PARTICULAR FONT, STYLE, SIZE, OR COLOR.

OWNER OF U.S. REG. NOS. 919,941, 2,048,916, AND OTHERS.

NO CLAIM IS MADE TO THE EXCLUSIVE RIGHT TO USE "SELECT", APART FROM THE MARK AS SHOWN.

SN 85-109,975, FILED 8-18-2010.

KIMBERLY FRYE, EXAMINING ATTORNEY



David J. Kybas

Director of the United States Patent and Trademark Office

United States of America

United States Patent and Trademark Office

ASPECT

Reg. No. 4,068,248

Registered Dec. 6, 2011

Int. Cl.: 9

TRADEMARK

PRINCIPAL REGISTER

HOYA CORPORATION (JAPAN CORPORATION)
SHINJUKU-KU
7-5, NAKA-OCHIAI 2-CHOME
TOKYO, JAPAN 161-0032

FOR: SPECTACLE LENSES, IN CLASS 9 (U.S. CLS. 21, 23, 26, 36 AND 38).

FIRST USE 6-0-2011; IN COMMERCE 6-0-2011.

THE MARK CONSISTS OF STANDARD CHARACTERS WITHOUT CLAIM TO ANY PARTICULAR FONT, STYLE, SIZE, OR COLOR.

SN 85-110,371, FILED 8-18-2010.

H. M. FISHER, EXAMINING ATTORNEY



David J. Kybas

Director of the United States Patent and Trademark Office

United States of America

United States Patent and Trademark Office

REFLECTIONS AND REVELATIONS

Reg. No. 4,068,249

Registered Dec. 6, 2011

Int. Cl.: 20

TRADEMARK

PRINCIPAL REGISTER

VALLEY, DOROTHY ANNE (UNITED STATES INDIVIDUAL)
11 VALLEY STREET
WEST GARDINER, ME 04345

FOR: WORKS OF ART MADE PRIMARILY FROM WOOD AND FABRICS, IN CLASS 20
(U.S. CLS. 2, 13, 22, 25, 32 AND 50).

FIRST USE 9-13-2011; IN COMMERCE 9-13-2011.

THE MARK CONSISTS OF STANDARD CHARACTERS WITHOUT CLAIM TO ANY PARTICULAR FONT, STYLE, SIZE, OR COLOR.

SN 85-111,085, FILED 8-19-2010.

CHRISTOPHER LAW, EXAMINING ATTORNEY



David J. Kybas

Director of the United States Patent and Trademark Office

United States of America

United States Patent and Trademark Office

MILESTONES AND MANTRAS

Reg. No. 4,068,250

VALLEY, DOROTHY ANNE (UNITED STATES INDIVIDUAL)
11 VALLEY STREET
WEST GARDINER, ME 04345

Registered Dec. 6, 2011

Int. Cl.: 20

FOR: WORKS OF ART MADE PRIMARILY FROM WOOD AND FABRICS, IN CLASS 20
(U.S. CLS. 2, 13, 22, 25, 32 AND 50).

TRADEMARK

FIRST USE 9-13-2011; IN COMMERCE 9-13-2011.

PRINCIPAL REGISTER

THE MARK CONSISTS OF STANDARD CHARACTERS WITHOUT CLAIM TO ANY PARTICULAR FONT, STYLE, SIZE, OR COLOR.

SN 85-111,089, FILED 8-19-2010.

CHRISTOPHER LAW, EXAMINING ATTORNEY



David J. Kybas

Director of the United States Patent and Trademark Office

United States of America

United States Patent and Trademark Office



Reg. No. 4,068,251

Registered Dec. 6, 2011

Int. Cl.: 7

TRADEMARK

PRINCIPAL REGISTER

CTJ MANAGEMENT, INC. (FLORIDA CORPORATION), DBA SPRAYER DEPOT,
12235 SW 128TH STREET, #205
MIAMI, FL 33186

FOR: MACHINE PARTS, NAMELY, NOZZLES WHICH ARE PARTS OF POWER-OPERATED SPRAYERS; POWER TOOL PARTS, NAMELY, GARDEN AND AGRICULTURAL TOOLS FOR THE SPRAYING OF LIQUIDS, SOLIDS AND GASES.; POWER-OPERATED SPRAYERS, IN CLASS 7 (U.S. CLS. 13, 19, 21, 23, 31, 34 AND 35).

FIRST USE 8-19-2010; IN COMMERCE 8-19-2010.

OWNER OF U.S. REG. NO. 1,746,173.

THE COLOR(S) DARK BLUE, GREEN, WHITE AND LIGHT BLUE IS/ARE CLAIMED AS A FEATURE OF THE MARK.

NO CLAIM IS MADE TO THE EXCLUSIVE RIGHT TO USE "SPRAYER DEPOT SPRAY EQUIPMENT, PARTS & ACCESSORIES", APART FROM THE MARK AS SHOWN.

THE MARK CONSISTS OF THE WORDS "SPRAYER DEPOT" ARE IN CAPITAL LETTERS AND FORM SOMEWHAT OF A BOX. THE WORD "SPRAYER" IS IN DARK BLUE AND ABOVE THE WORD "DEPOT", WHICH IS IN GREEN. TO THE LEFT OF THE WORD "DEPOT", THERE IS A BOX IN DARK BLUE, WHITE, GREEN AND LIGHT BLUE WHICH RESEMBLES WATER, IN DARK BLUE AND LIGHT BLUE, FROM THE BOTTOM LEFT TO THE TOP RIGHT AND GRASS, IN GREEN AND WHITE, FROM THE TOP RIGHT TO THE BOTTOM LEFT. UNDER THE WORD "DEPOT" ARE THE WORDS "SPRAY EQUIPMENT, PARTS & ACCESSORIES", IN GREEN AND INITIAL CASE.

SN 85-111,227, FILED 8-19-2010.

JOHN HWANG, EXAMINING ATTORNEY



David J. Kyros

Director of the United States Patent and Trademark Office

United States of America

United States Patent and Trademark Office

IPUB

Reg. No. 4,068,252

Registered Dec. 6, 2011

Int. Cls.: 9, 16, and 44

TRADEMARK

SERVICE MARK

PRINCIPAL REGISTER

INTELLISPHERE LLC (NEW JERSEY LIMITED LIABILITY COMPANY)
666 PLAINSBORO ROAD, SUITE 300
PLAINSBORO, NJ 08536

FOR: ELECTRONIC DOWNLOADABLE PUBLICATION, IN THE NATURE OF ARTICLES, COMMENTARY, AND NEWS RELATING TO MEDICINE, HEALTHCARE AND THE MEDICAL COMMUNITY, IN CLASS 9 (U.S. CLS. 21, 23, 26, 36 AND 38).

FIRST USE 10-12-2011; IN COMMERCE 10-12-2011.

FOR: PRINTED PUBLICATIONS, NAMELY, A MAGAZINE IN THE FIELDS OF MEDICINE, HEALTHCARE AND THE MEDICAL COMMUNITY, IN CLASS 16 (U.S. CLS. 2, 5, 22, 23, 29, 37, 38 AND 50).

FIRST USE 12-10-2010; IN COMMERCE 12-10-2010.

FOR: PROVIDING AN INTERNET WEBSITE PORTAL FEATURING MEDICAL AND HEALTHCARE INFORMATION IN THE FORM OF AUDIO AND VIDEO INTERVIEWS, ARTICLES, AND OTHER MATERIALS, IN CLASS 44 (U.S. CLS. 100 AND 101).

FIRST USE 12-10-2010; IN COMMERCE 12-10-2010.

THE MARK CONSISTS OF STANDARD CHARACTERS WITHOUT CLAIM TO ANY PARTICULAR FONT, STYLE, SIZE, OR COLOR.

SN 85-111,489, FILED 8-19-2010.

LINDA MICKLEBURGH, EXAMINING ATTORNEY



David J. Kyros

Director of the United States Patent and Trademark Office

United States of America

United States Patent and Trademark Office

CS

Reg. No. 4,068,253

Registered Dec. 6, 2011

Int. Cl.: 10

TRADEMARK

PRINCIPAL REGISTER

RYMED TECHNOLOGIES, INC. (DELAWARE CORPORATION)
137 THIRD AVENUE NORTH
FRANKLIN, TN 37064

FOR: MEDICAL DEVICES, NAMELY, INTRAVENOUS CONNECTORS, IN CLASS 10 (U.S. CLS. 26, 39 AND 44).

FIRST USE 11-30-2010; IN COMMERCE 11-30-2010.

THE MARK CONSISTS OF STANDARD CHARACTERS WITHOUT CLAIM TO ANY PARTICULAR FONT, STYLE, SIZE, OR COLOR.

SN 85-111,721, FILED 8-19-2010.

AMEEN IMAM, EXAMINING ATTORNEY



David J. Kybas

Director of the United States Patent and Trademark Office

United States of America

United States Patent and Trademark Office

DICK VAN PATTEN'S NATURAL BALANCE SYNERGY

Reg. No. 4,068,254

Registered Dec. 6, 2011

Int. Cl.: 31

TRADEMARK

PRINCIPAL REGISTER

NATURAL BALANCE PET FOODS, INC. (CALIFORNIA CORPORATION)
12924 PIERCE STREET
PACOIMA, CA 91331

FOR: DOG FOOD, DOG TREATS, CAT FOOD AND CAT TREATS, IN CLASS 31 (U.S. CLS. 1 AND 46).

FIRST USE 10-0-2010; IN COMMERCE 10-0-2010.

THE MARK CONSISTS OF STANDARD CHARACTERS WITHOUT CLAIM TO ANY PARTICULAR FONT, STYLE, SIZE, OR COLOR.

OWNER OF U.S. REG. NOS. 2,452,855, 3,044,178, AND OTHERS.

THE NAME(S), PORTRAIT(S), AND/OR SIGNATURE(S) SHOWN IN THE MARK IDENTIFIES "DICK VAN PATTEN", WHOSE CONSENT(S) TO REGISTER IS MADE OF RECORD.

SN 85-111,750, FILED 8-19-2010.

DEIRDRE ROBERTSON, EXAMINING ATTORNEY



David J. Kybas

Director of the United States Patent and Trademark Office

United States of America

United States Patent and Trademark Office

Sudden Savasana

Reg. No. 4,068,255

CYNTHIA L. GUSTAFSON (UNITED STATES INDIVIDUAL)
P.O. BOX 835634
RICHARDSON, TX 75083

Registered Dec. 6, 2011

Int. Cl.: 25

FOR: CLOTHING, NAMELY, SHIRTS AND HEAD WEAR, IN CLASS 25 (U.S. CLS. 22 AND 39).

TRADEMARK

FIRST USE 11-15-2010; IN COMMERCE 11-15-2010.

PRINCIPAL REGISTER

THE MARK CONSISTS OF STANDARD CHARACTERS WITHOUT CLAIM TO ANY PARTICULAR FONT, STYLE, SIZE, OR COLOR.

THE ENGLISH TRANSLATION OF "SAVASANA" IN THE MARK IS "CORPSE POSE".

SN 85-111,756, FILED 8-19-2010.

MICHAEL WIENER, EXAMINING ATTORNEY



David J. Kybas

Director of the United States Patent and Trademark Office

United States of America

United States Patent and Trademark Office

ESTUN

Reg. No. 4,068,256

Registered Dec. 6, 2011

Int. Cls.: 7 and 9

TRADEMARK

PRINCIPAL REGISTER

NANJING ESTUN DIGITAL TECHNOLOGY CO., LTD. (CHINA CORPORATION)
155 JIANGJUN ROAD, ECON&TECH DEVELOP
ZONE
JIANGNING, CHINA AND

ESTUN AUTOMATION TECHNOLOGY CO., LIMITED (CHINA CORPORATION)
155 JIANGJUN ROAD, ECON&TECH DEVELOP
ZONE
JIANGNING, CHINA

FOR: AC VARIABLE FREQUENCY DRIVES THAT ARE USED TO CONTROL SMALL AND MEDIUM-SIZED MOTORS IN APPLICATIONS SUCH AS MANUFACTURING PROCESSES, HVAC AND PUMPS; BENDING MACHINES; ELECTRIC MOTORS FOR MACHINES WITH A DIGITAL SERVO DRIVE CONTROLLER; INDUSTRIAL ROBOTS; MECHANICAL PRESSES; NUMERICALLY CONTROLLED MACHINES AND MACHINE TOOLS USED FOR MACHINING PARTS; PACKAGING MACHINES; SERVO MOTORS; SERVO MOTORS FOR SEWING MACHINES; SERVO-DRIVES FOR MOTORS , IN CLASS 7 (U.S. CLS. 13, 19, 21, 23, 31, 34 AND 35).

FIRST USE 8-20-2010; IN COMMERCE 8-20-2010.

FOR: COMPUTER CONTROLS FOR THE OPERATION OF MACHINE TOOLS; COMPUTER HARDWARE AND PERIPHERAL DEVICES; COMPUTER SOFTWARE TO MONITOR AND CONTROL FACTORY MANUFACTURING PROCESSES; ELECTRIC CONTROL PANELS; ELECTRICAL CONTROLLERS; ELECTRONIC APPARATUS AND INSTRUMENTS FOR CONTROLLING, ADJUSTING AND TESTING OF DRIVES AND MOTORS; ELECTRONIC CONTROL SYSTEMS FOR MACHINES; ELECTRONIC CONTROLS FOR MOTORS; ELECTRONIC SERVO MOTOR CONTROLLERS; INDUSTRIAL AUTOMATION CONTROLS, IN CLASS 9 (U.S. CLS. 21, 23, 26, 36 AND 38).

FIRST USE 8-20-2010; IN COMMERCE 8-20-2010.

THE MARK CONSISTS OF THE STYLIZED WORD "ESTUN" WITH THREE SMALL BLACK DOTS ABOVE THE WORD.

THE WORDING "ESTUN" HAS NO MEANING IN A FOREIGN LANGUAGE.



David J. Kybas

Director of the United States Patent and Trademark Office

Reg. No. 4,068,256 SN 85-111,927, FILED 8-20-2010.

MAYUR VAGHANI, EXAMINING ATTORNEY

United States of America

United States Patent and Trademark Office

DEAN & DEREK

Reg. No. 4,068,257

Registered Dec. 6, 2011

Int. Cls.: 37 and 41

SERVICE MARK

PRINCIPAL REGISTER

MARSICO, DEAN (UNITED STATES INDIVIDUAL)
550 WASHINGTON STREET
BRAintree, MA 02184 AND

STEARNS, DEREK (UNITED STATES INDIVIDUAL)
49 WOODSIDE PATH
WEYMOUTH, MA 02189

FOR: PROVIDING ONLINE INFORMATION IN THE FIELD OF MASONRY CONSTRUCTION METHODS, IN CLASS 37 (U.S. CLS. 100, 103 AND 106).

FIRST USE 12-0-2010; IN COMMERCE 10-25-2011.

FOR: EDUCATIONAL SERVICES, NAMELY, CONDUCTING DEMONSTRATIONS, WORKSHOPS AND ONLINE SEMINARS IN THE FIELD OF MASONRY CONSTRUCTION; ENTERTAINMENT SERVICES, NAMELY, PROVIDING ONLINE JOURNAL IN THE NATURE OF A BLOG IN THE FIELD OF MASONRY CONSTRUCTION, IN CLASS 41 (U.S. CLS. 100, 101 AND 107).

FIRST USE 12-0-2010; IN COMMERCE 10-25-2011.

THE MARK CONSISTS OF STANDARD CHARACTERS WITHOUT CLAIM TO ANY PARTICULAR FONT, STYLE, SIZE, OR COLOR.

SN 85-112,313, FILED 8-20-2010.

NELSON SNYDER, EXAMINING ATTORNEY



David J. Kybas

Director of the United States Patent and Trademark Office

United States of America

United States Patent and Trademark Office

1001 inventions

Reg. No. 4,068,258

Registered Dec. 6, 2011

Int. Cls.: 9, 16, and 41

FSTC LTD FOUNDATION FOR SCIENCE TECHNOLOGY AND CIVILISATION (UNITED KINGDOM LIMITED LIABILITY COMPANY)
CLYDESDALE HOUSE
27 TURNER STREET
MANCHESTER, UNITED KINGDOM M141DY

TRADEMARK

SERVICE MARK

PRINCIPAL REGISTER

FOR: SCIENTIFIC APPARATUS, NAMELY, COMPASSES; PRE-RECORDED ELECTRONIC MEDIA FEATURING MATERIALS RELATING TO THE HISTORY OF MUSLIM CIVILIZATION'S SCIENCE AND INVENTIONS; PRE-RECORDED CDS AND DVDS FEATURING MATERIALS RELATING TO THE HISTORY OF MUSLIM CIVILIZATION'S SCIENCE AND INVENTIONS; DOWNLOADABLE PUBLICATIONS, NAMELY, WORKBOOKS, BOOKLETS AND REPORTS IN THE FIELD OF THE HISTORY OF MUSLIM CIVILIZATION'S SCIENCE AND INVENTIONS; COMPUTER SOFTWARE FOR STUDYING AND LEARNING THE HISTORY OF MUSLIM CIVILIZATION'S SCIENCE AND INVENTIONS; MOTION PICTURE FILMS RELATING TO THE HISTORY OF MUSLIM CIVILIZATION'S SCIENCE AND INVENTIONS, IN CLASS 9 (U.S. CLS. 21, 23, 26, 36 AND 38).

FIRST USE 11-0-2009; IN COMMERCE 11-0-2009.

FOR: EDUCATIONAL MATERIALS, NAMELY, BOOKS, POSTERS, PAINTINGS AND MAPS RELATING TO THE HISTORY OF MUSLIM CIVILIZATION'S SCIENCE AND INVENTIONS, IN CLASS 16 (U.S. CLS. 2, 5, 22, 23, 29, 37, 38 AND 50).

FIRST USE 11-0-2009; IN COMMERCE 11-0-2009.

FOR: EDUCATIONAL SERVICES, NAMELY, CURRICULUM ENRICHMENT PROGRAMS, TRAINING WORKSHOPS AND SEMINARS IN THE FIELD OF THE HISTORY OF MUSLIM CIVILIZATION'S SCIENCE AND INVENTIONS; ORGANIZATION OF EXHIBITIONS FOR CULTURAL PURPOSES; ACADEMIC ENRICHMENT PROGRAMS IN THE FIELD OF THE HISTORY OF MUSLIM CIVILIZATION'S SCIENCE AND INVENTIONS; PROVIDING EDUCATIONAL INFORMATION AND ADVICE IN THE ACADEMIC FIELD OF THE HISTORY OF MUSLIM CIVILIZATION'S SCIENCE AND INVENTIONS; CONDUCTING A TRAVELLING EDUCATIONAL EXHIBITION RELATING TO THE HISTORY OF MUSLIM CIVILIZATION'S SCIENCE AND INVENTIONS, IN CLASS 41 (U.S. CLS. 100, 101 AND 107).

FIRST USE 11-0-2009; IN COMMERCE 11-0-2009.



David J. Kappas

Director of the United States Patent and Trademark Office

Reg. No. 4,068,258 THE MARK CONSISTS OF STANDARD CHARACTERS WITHOUT CLAIM TO ANY PARTICULAR FONT, STYLE, SIZE, OR COLOR.

NO CLAIM IS MADE TO THE EXCLUSIVE RIGHT TO USE "INVENTIONS", APART FROM THE MARK AS SHOWN.

SN 85-112,802, FILED 8-20-2010.

JULIE GUTTADAURO, EXAMINING ATTORNEY

United States of America

United States Patent and Trademark Office

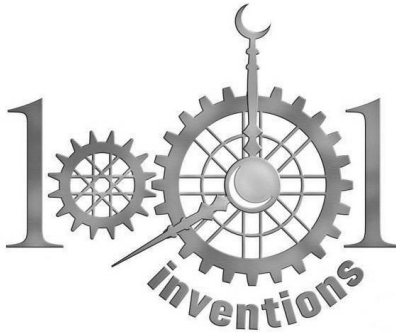

Reg. No. 4,068,259
Registered Dec. 6, 2011
Int. Cls.: 9, 16, and 41

TRADEMARK

SERVICE MARK

PRINCIPAL REGISTER

FSTC LTD FOUNDATION FOR SCIENCE TECHNOLOGY AND CIVILISATION (UNITED KINGDOM LIMITED COMPANY (LTD.))
CLYDESDALE HOUSE, 27 TURNER STREET
MANCHESTER, UNITED KINGDOM M141DY

FOR: SCIENTIFIC APPARATUS, NAMELY, COMPASSES; PRE-RECORDED ELECTRONIC MEDIA FEATURING MATERIALS RELATING TO THE HISTORY OF MUSLIM CIVILIZATION'S SCIENCE AND INVENTIONS; PRE-RECORDED CDS AND DVDS FEATURING MATERIALS RELATING TO THE HISTORY OF MUSLIM CIVILIZATION'S SCIENCE AND INVENTIONS; DOWNLOADABLE PUBLICATIONS, NAMELY, WORKBOOKS, BOOKLETS AND REPORTS IN THE FIELD OF THE HISTORY OF MUSLIM CIVILIZATION'S SCIENCE AND INVENTIONS; COMPUTER SOFTWARE FOR STUDYING AND LEARNING THE HISTORY OF MUSLIM CIVILIZATION'S SCIENCE AND INVENTIONS; MOTION PICTURE FILMS RELATING TO THE HISTORY OF MUSLIM CIVILIZATION'S SCIENCE AND INVENTIONS, IN CLASS 9 (U.S. CLS. 21, 23, 26, 36 AND 38).

FIRST USE 11-0-2009; IN COMMERCE 11-0-2009.

FOR: EDUCATIONAL MATERIALS, NAMELY, BOOKS, POSTERS, PAINTINGS AND MAPS RELATING TO THE HISTORY OF MUSLIM CIVILIZATION'S SCIENCE AND INVENTIONS, IN CLASS 16 (U.S. CLS. 2, 5, 22, 23, 29, 37, 38 AND 50).

FIRST USE 11-0-2009; IN COMMERCE 11-0-2009.

FOR: EDUCATIONAL SERVICES, NAMELY, CURRICULUM ENRICHMENT PROGRAMS, TRAINING WORKSHOPS AND SEMINARS IN THE FIELD OF THE HISTORY OF MUSLIM CIVILIZATION'S SCIENCE AND INVENTIONS; ORGANIZATION OF EXHIBITIONS FOR CULTURAL PURPOSES; ACADEMIC ENRICHMENT PROGRAMS IN THE FIELD OF THE HISTORY OF MUSLIM CIVILIZATION'S SCIENCE AND INVENTIONS; PROVIDING EDUCATIONAL INFORMATION AND ADVICE IN THE ACADEMIC FIELD OF THE HISTORY OF MUSLIM CIVILIZATION'S SCIENCE AND INVENTIONS; CONDUCTING A TRAVELLING EDUCATIONAL EXHIBITION RELATING TO THE HISTORY OF MUSLIM CIVILIZATION'S SCIENCE AND INVENTIONS, IN CLASS 41 (U.S. CLS. 100, 101 AND 107).

FIRST USE 11-0-2009; IN COMMERCE 11-0-2009.



David J. Kappas

Director of the United States Patent and Trademark Office

Reg. No. 4,068,259 NO CLAIM IS MADE TO THE EXCLUSIVE RIGHT TO USE "INVENTIONS", APART FROM THE MARK AS SHOWN.

THE MARK CONSISTS OF THE NUMERAL "1001" STYLIZED WITH GEARS IN PLACE OF "00" AND THE WORD "INVENTIONS" BENEATH THE "1001".

SN 85-112,811, FILED 8-20-2010.

JULIE GUTTADAURO, EXAMINING ATTORNEY

United States of America

United States Patent and Trademark Office

CCTUBES

Reg. No. 4,068,260

Registered Dec. 6, 2011

Int. Cls.: 9 and 42

TRADEMARK

SERVICE MARK

PRINCIPAL REGISTER

CCTUBES LLC (ARIZONA LIMITED LIABILITY COMPANY)
STE 105-299
9121 E. TANQUE VERDE
TUCSON, AZ 85749

FOR: ELECTRICAL APPARATUS, NAMELY, A VIDEO PLAYER THAT INCORPORATES CLOSED CAPTIONING FOR INTERNET VIDEOS, IN CLASS 9 (U.S. CLS. 21, 23, 26, 36 AND 38).

FIRST USE 7-1-2010; IN COMMERCE 7-1-2010.

FOR: COMPUTER AND TECHNOLOGICAL PROFESSIONAL SERVICES, NAMELY, A VIDEO WEBSITE THAT PLAYS CLOSED CAPTIONED INTERNET VIDEOS, IN CLASS 42 (U.S. CLS. 100 AND 101).

FIRST USE 7-1-2010; IN COMMERCE 7-1-2010.

THE MARK CONSISTS OF STANDARD CHARACTERS WITHOUT CLAIM TO ANY PARTICULAR FONT, STYLE, SIZE, OR COLOR.

SN 85-112,853, FILED 8-21-2010.

PAUL F. GAST, EXAMINING ATTORNEY



David J. Kyros

Director of the United States Patent and Trademark Office

United States of America

United States Patent and Trademark Office

2COOL

Reg. No. 4,068,261

Registered Dec. 6, 2011

Int. Cl.: 9

TRADEMARK

PRINCIPAL REGISTER

RTA PRODUCTS, LLC (FLORIDA LIMITED LIABILITY COMPANY)
3900 EXECUTIVE WAY
MIRAMAR, FL 33025

FOR: COMPUTER STANDS SPECIALLY DESIGNED FOR HOLDING A COMPUTER;
NOTEBOOK COMPUTER COOLING PADS; AND STANDS FOR PERSONAL DIGITAL
ELECTRONIC DEVICES, IN CLASS 9 (U.S. CLS. 21, 23, 26, 36 AND 38).

FIRST USE 1-0-2011; IN COMMERCE 2-0-2011.

THE MARK CONSISTS OF STANDARD CHARACTERS WITHOUT CLAIM TO ANY PAR-
TICULAR FONT, STYLE, SIZE, OR COLOR.

SN 85-113,608, FILED 8-23-2010.

VERNA BETH RIRIE, EXAMINING ATTORNEY



David J. Kybas

Director of the United States Patent and Trademark Office

United States of America

United States Patent and Trademark Office

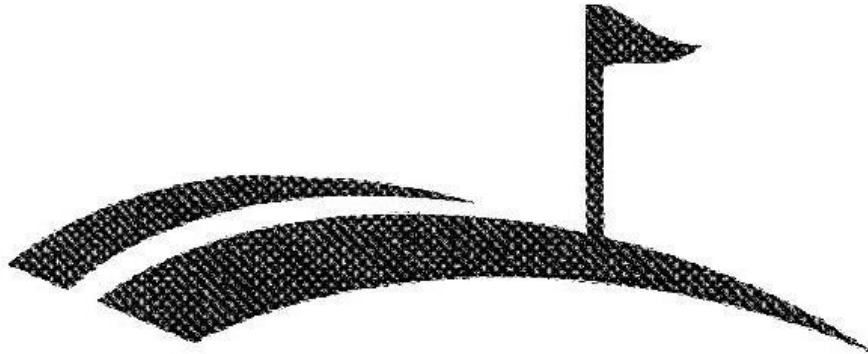

Reg. No. 4,068,262

Registered Dec. 6, 2011

Int. Cl.: 41

SERVICE MARK

PRINCIPAL REGISTER

RSM MCGLADREY, INC. (DELAWARE CORPORATION)
THIRD FLOOR
3600 AMERICAN BLVD. WEST
WEST BLOOMINGTON, MN 55431

FOR: ORGANIZING AND CONDUCTING GOLF TOURNAMENTS, IN CLASS 41 (U.S. CLS. 100, 101 AND 107).

FIRST USE 3-1-2010; IN COMMERCE 3-1-2010.

THE MARK CONSISTS OF TWO CURVED LINES WITH A FLAG ON TOP OF THE LOWER LINE.

SN 85-113,773, FILED 8-23-2010.

DOMINIC J. FERRAIUOLO, EXAMINING ATTORNEY



David J. Kybas

Director of the United States Patent and Trademark Office

United States of America

United States Patent and Trademark Office

WHAT DO YOU WANT?

Reg. No. 4,068,263

Registered Dec. 6, 2011

Int. Cl.: 28

TRADEMARK

PRINCIPAL REGISTER

RAPPORT INNOVATIONS, INC. (HAWAII CORPORATION)
#1607
NUUANU AVE.
HONOLULU, HI 96817

FOR: CARD GAMES, IN CLASS 28 (U.S. CLS. 22, 23, 38 AND 50).

FIRST USE 11-20-2010; IN COMMERCE 11-20-2010.

THE MARK CONSISTS OF STANDARD CHARACTERS WITHOUT CLAIM TO ANY PARTICULAR FONT, STYLE, SIZE, OR COLOR.

SN 85-114,491, FILED 8-24-2010.

ARETHA SOMERVILLE, EXAMINING ATTORNEY



David J. Kybas

Director of the United States Patent and Trademark Office

United States of America

United States Patent and Trademark Office

Wombat

Reg. No. 4,068,264

Registered Dec. 6, 2011

Int. Cl.: 11

TRADEMARK

PRINCIPAL REGISTER

APRICUS SOLAR CO., LTD. (CHINA LIMITED COMPANY (LTD.))
19 PUSI RD PUKOU NEW & HIGH TECH DEV. ZN
NANJING, CHINA 210061

FOR: BATH FITTINGS, NAMELY, SOLAR ASSISTED COMBINATION HOT WATER AND SPACE HEATING SYSTEM COMPRISED OF HOT WATER STORAGE TANK, HEAT EXCHANGERS AND CONTROLS; HOT AIR APPARATUS IN THE NATURE OF HOT AIR BLOWERS; HOT AIR SPACE HEATING APPARATUS; RADIANT AND FORCED AIR HEATING EQUIPMENT, NAMELY, RADIANT AND FORCED AIR HEATING SYSTEMS, IN CLASS 11 (U.S. CLS. 13, 21, 23, 31 AND 34).

FIRST USE 10-1-2011; IN COMMERCE 10-1-2011.

THE MARK CONSISTS OF STANDARD CHARACTERS WITHOUT CLAIM TO ANY PARTICULAR FONT, STYLE, SIZE, OR COLOR.

SN 85-114,517, FILED 8-24-2010.

JORDAN BAKER, EXAMINING ATTORNEY



David J. Kyros

Director of the United States Patent and Trademark Office

United States of America

United States Patent and Trademark Office

HARVEST DELIGHT

Reg. No. 4,068,265

MANNA PRO PRODUCTS, LLC (MISSOURI LIMITED LIABILITY COMPANY)
707 SPIRIT 40 PARK DRIVE, SUITE 150
ST. LOUIS, MO 63005

Registered Dec. 6, 2011

Int. Cl.: 31

FOR: ANIMAL FEED, NAMELY, TREATS FOR POULTRY, IN CLASS 31 (U.S. CLS. 1 AND 46).

TRADEMARK

FIRST USE 1-0-2011; IN COMMERCE 1-0-2011.

PRINCIPAL REGISTER

THE MARK CONSISTS OF STANDARD CHARACTERS WITHOUT CLAIM TO ANY PARTICULAR FONT, STYLE, SIZE, OR COLOR.

SN 85-115,240, FILED 8-25-2010.

JEFF DEFORD, EXAMINING ATTORNEY



David J. Kybas

Director of the United States Patent and Trademark Office

United States of America

United States Patent and Trademark Office



Reg. No. 4,068,266
Registered Dec. 6, 2011

FERGEN, PAUL (UNITED STATES INDIVIDUAL)
10501 LAKESIDE BLVD.
PARKER, AZ 85344

Int. Cl.: 16

FOR: DECALS, IN CLASS 16 (U.S. CLS. 2, 5, 22, 23, 29, 37, 38 AND 50).

TRADEMARK

FIRST USE 9-30-2011; IN COMMERCE 9-30-2011.

PRINCIPAL REGISTER

THE MARK CONSISTS OF THE WORD "MOTOR" ABOVE THE WORD "MEN", ENCLOSED IN STYLIZED DESIGN BOX.

SN 85-115,261, FILED 8-25-2010.

FONG HSU, EXAMINING ATTORNEY



David J. Kybas

Director of the United States Patent and Trademark Office

United States of America

United States Patent and Trademark Office



Reg. No. 4,068,267

Registered Dec. 6, 2011

Int. Cl.: 41

SERVICE MARK

PRINCIPAL REGISTER

SIATECH, INC. (CALIFORNIA CORPORATION)
2611 TEMPLE HEIGHTS DRIVE, SUITE A
OCEANSIDE, CA 92056

FOR: EDUCATIONAL SERVICES, NAMELY, PROVIDING A COURSE OF INSTRUCTION FOR SECONDARY STUDENTS, IN CLASS 41 (U.S. CLS. 100, 101 AND 107).

FIRST USE 1-5-2011; IN COMMERCE 1-5-2011.

NO CLAIM IS MADE TO THE EXCLUSIVE RIGHT TO USE "MICROSCHOOL", APART FROM THE MARK AS SHOWN.

THE MARK CONSISTS OF THE WORD "MYCROSCHOOL" WITH CAPITAL LETTERS "MY" AND "S", AND ALL REMAINING LETTERS IN LOWER CASE ON THE FIRST LINE. THE FIRST "O" HAS A WIDER OUTER CIRCLE AND TWO SMALLER CIRCLES INSIDE, WITH A SHAPE OF A PERSON'S HEAD AND UPPER BODY WITH AN OPEN BOOK BELOW THE FIGURE. ON THE SECOND LINE LOCATED TO THE RIGHT SIDE UNDER THE WORDS "SCHOOL" ARE THE WORDS "MY SCHOOL, MY WAY".

SN 85-115,910, FILED 8-25-2010.

LINDA MICKLEBURGH, EXAMINING ATTORNEY



David J. Kyffers

Director of the United States Patent and Trademark Office

United States of America

United States Patent and Trademark Office



Reg. No. 4,068,268

Registered Dec. 6, 2011

Int. Cl.: 41

SERVICE MARK

PRINCIPAL REGISTER

SIATECH, INC. (CALIFORNIA CORPORATION)
2611 TEMPLE HEIGHTS DRIVE, SUITE A
OCEANSIDE, CA 92056

FOR: EDUCATIONAL SERVICES, NAMELY, PROVIDING A COURSE OF INSTRUCTION FOR SECONDARY STUDENTS, IN CLASS 41 (U.S. CLS. 100, 101 AND 107).

FIRST USE 1-5-2011; IN COMMERCE 1-5-2011.

NO CLAIM IS MADE TO THE EXCLUSIVE RIGHT TO USE "MICROSCHOOL", APART FROM THE MARK AS SHOWN.

THE COLOR(S) GREY AND BROWN IS/ARE CLAIMED AS A FEATURE OF THE MARK.

THE MARK CONSISTS OF THE WORD "MYCROSCHOOL" IN GREY LETTERING WITH CAPITAL LETTERS "MY" AND "S", AND ALL REMAINING LETTERS IN LOWER CASE ON THE FIRST LINE. THE FIRST "O" HAS A GREY WIDER OUTER CIRCLE AND TWO BROWN SMALLER CIRCLES INSIDE, WITH A SHAPE OF A PERSON'S HEAD AND UPPER BODY WITH AN OPEN BOOK BELOW THE FIGURE ALSO IN THE COLOR BROWN. ON THE SECOND LINE LOCATED TO THE RIGHT SIDE UNDER THE WORDS "SCHOOL" ARE THE WORDS "MY SCHOOL, MY WAY" IN BROWN.

SN 85-115,964, FILED 8-25-2010.

LINDA MICKLEBURGH, EXAMINING ATTORNEY



David J. Kyjars

Director of the United States Patent and Trademark Office

United States of America

United States Patent and Trademark Office



Reg. No. 4,068,269
Registered Dec. 6, 2011
Int. Cls.: 35 and 42

SERVICE MARK

PRINCIPAL REGISTER

INSITE PRODUCTIONS, LLC (TEXAS LIMITED LIABILITY COMPANY), DBA INSITE INTERACTIVE,
4311 OAK LAWN, STE. 100
DALLAS, TX 75219

FOR: ADVERTISING, MARKETING AND PROMOTIONAL SERVICES, NAMELY, CREATING, MANAGING, AND EXECUTING ONLINE MARKETING CAMPAIGNS, SOCIAL MEDIA CAMPAIGNS, SEARCH ENGINE MARKETING, STRATEGIC PAY-PER-CLICK CAMPAIGNS, E-MAIL BLAST CAMPAIGNS, BANNER ADS, FLASH AND VIDEO PRESENTATIONS, AND DIGITAL TRADESHOW PRESENTATIONS; BUSINESS MONITORING AND CONSULTING SERVICES, NAMELY, MARKET RESEARCH, AND WEBSITE ANALYTICS AND REPORTING, IN CLASS 35 (U.S. CLS. 100, 101 AND 102).

FIRST USE 7-15-2011; IN COMMERCE 8-1-2011.

FOR: COMPUTER AND CONSULTATION SERVICES, NAMELY, SEARCH ENGINE OPTIMIZATION (SEO), USABILITY STUDIES AND USABILITY DESIGN, SERVER MIGRATION, DATA MANAGEMENT AND REPORTING TOOLS, COMPUTER AND WEB-BASED TRAINING TOOLS, TECHNICAL SUPPORT SERVICES, AND IMPLEMENTATION AND CUSTOMIZATION OF CONTENT MANAGEMENT SYSTEMS; PLANNING, DESIGN, DEVELOPMENT, MAINTENANCE, OPTIMIZATION AND HOSTING OF ONLINE WEBSITES FOR THIRD PARTIES; DESIGNING, CREATING, MAINTAINING AND HOSTING ONLINE RETAIL AND ELECTRONIC COMMERCE WEBSITES FOR OTHERS; CUSTOM WEB APPLICATION DEVELOPMENT, IN CLASS 42 (U.S. CLS. 100 AND 101).

FIRST USE 7-15-2011; IN COMMERCE 8-1-2011.

THE MARK CONSISTS OF FIVE ALTERNATING CONCENTRIC INCOMPLETE CIRCLES SURROUNDING A SOLID WHITE CIRCLE ALL ADJACENT TO THE WORD "INSITE".

SN 85-116,157, FILED 8-26-2010.

MICHAEL ENGEL, EXAMINING ATTORNEY



David J. Kybas

Director of the United States Patent and Trademark Office

United States of America

United States Patent and Trademark Office

LNO

Reg. No. 4,068,270

ALABY, LLC (TENNESSEE LIMITED LIABILITY COMPANY)
7105 IMERIAL DRIVE
KNOXVILLE, TN 37918

Registered Dec. 6, 2011

Int. Cl.: 33

FOR: ALCOHOLIC BEVERAGES EXCEPT BEERS; PREPARED ALCOHOLIC COCKTAILS,
IN CLASS 33 (U.S. CLS. 47 AND 49).

TRADEMARK

FIRST USE 4-28-2010; IN COMMERCE 4-28-2010.

PRINCIPAL REGISTER

THE MARK CONSISTS OF THE STYLIZED LETTERS "LNO" HAVING A STYLIZED DIAMOND-SHAPED DESIGN BETWEEN THE LETTER "L" AND THE LETTER "N" AND WHEREIN THE LETTER "O" APPEARS AS A STYLIZED SLICE OF LEMON OR LIME.

SN 85-116,286, FILED 8-26-2010.

MARK RADEMACHER, EXAMINING ATTORNEY



David J. Kyffers

Director of the United States Patent and Trademark Office

United States of America

United States Patent and Trademark Office

OAKHEART

Reg. No. 4,068,271

BACARDI & COMPANY LIMITED (LIECHTENSTEIN CORPORATION)
AEULESTRASSE 5
VADUZ, LIECHTENSTEIN FL-9490

Registered Dec. 6, 2011

Int. Cl.: 33

FOR: RUM, RUM-BASED BEVERAGES, FLAVORED RUMS, COCKTAILS FLAVORED WITH RUM, IN CLASS 33 (U.S. CLS. 47 AND 49).

TRADEMARK

FIRST USE 7-11-2011; IN COMMERCE 7-11-2011.

PRINCIPAL REGISTER

THE MARK CONSISTS OF STANDARD CHARACTERS WITHOUT CLAIM TO ANY PARTICULAR FONT, STYLE, SIZE, OR COLOR.

PRIORITY CLAIMED UNDER SEC. 44(D) ON LIECHTENSTEIN APPLICATION NO. 2010-602, FILED 8-12-2010.

SN 85-116,395, FILED 8-26-2010.

KIM MONINGHOFF, EXAMINING ATTORNEY



David J. Kybas

Director of the United States Patent and Trademark Office

United States of America

United States Patent and Trademark Office

ITALIAN GOLD

Reg. No. 4,068,272

Registered Dec. 6, 2011

Int. Cl.: 3

TRADEMARK

PRINCIPAL REGISTER

ALOXXI INTERNATIONAL CORPORATION (CALIFORNIA CORPORATION)
14144 VENTURA BOULEVARD, SUITE 110
SHERMAN OAKS, CA 91423

FOR: HAIR BLEACHING PREPARATIONS, NON-MEDICATED HAIR PREPARATIONS, HAIR CLEANING PREPARATIONS, HAIR COLOR REMOVERS, HAIR COLORING SOLUTIONS, HAIR LIGHTENERS, HAIR COLORING RINSE, HAIR LIGHTENING BLEACH, HAIR RINSES, HAIR COLOR FORMULATIONS, ALL IN THE FORM OF LIQUID, GEL AND CREAM, IN CLASS 3 (U.S. CLS. 1, 4, 6, 50, 51 AND 52).

FIRST USE 1-15-2011; IN COMMERCE 1-15-2011.

THE MARK CONSISTS OF STANDARD CHARACTERS WITHOUT CLAIM TO ANY PARTICULAR FONT, STYLE, SIZE, OR COLOR.

NO CLAIM IS MADE TO THE EXCLUSIVE RIGHT TO USE "GOLD", APART FROM THE MARK AS SHOWN.

SN 85-116,535, FILED 8-26-2010.

KELLEY WELLS, EXAMINING ATTORNEY



David J. Kyros

Director of the United States Patent and Trademark Office

United States of America

United States Patent and Trademark Office

ExecProtectGuard

Reg. No. 4,068,273

Registered Dec. 6, 2011

Int. Cl.: 36

SERVICE MARK

PRINCIPAL REGISTER

WILLIS NORTH AMERICA, INC (DELAWARE CORPORATION)
26 CENTURY BLVD, 7S
NASHVILLE, TN 37214

FOR: INSURANCE AGENCY SERVICES; INSURANCE BROKERAGE SERVICES; INSURANCE AGENCY/BROKERAGE SERVICES OF PRIVATE COMMERCIAL INSURANCE AND INSURANCE FOR THE ACTIONS OF NON-PROFIT DIRECTORS AND OFFICERS IN THE FIELDS OF MANAGEMENT LIABILITY RELATING TO EMPLOYMENT PRACTICES, CRIME, FIDUCIARY DUTIES, KIDNAP AND RANSOM, WORKPLACE VIOLENCE AND EMPLOYED LAWYERS, IN CLASS 36 (U.S. CLS. 100, 101 AND 102).

FIRST USE 3-9-2011; IN COMMERCE 3-9-2011.

THE MARK CONSISTS OF STANDARD CHARACTERS WITHOUT CLAIM TO ANY PARTICULAR FONT, STYLE, SIZE, OR COLOR.

SN 85-116,606, FILED 8-26-2010.

LINDA MICKLEBURGH, EXAMINING ATTORNEY



David J. Kyros

Director of the United States Patent and Trademark Office

United States of America

United States Patent and Trademark Office



Reg. No. 4,068,274

Registered Dec. 6, 2011

Int. Cl.: 18

CONCEPT SIX LLC (NEW YORK LIMITED LIABILITY COMPANY), DBA BLUE MARLIN
LIMITED LIABILITY COMPANY,
3RD FLOOR
119 WEST 40TH STREET
NEW YORK, NY 10018

TRADEMARK

PRINCIPAL REGISTER

FOR: HANDBAGS, SHOULDER BAGS, MESSENGER BAGS, TRAVEL CASES, ALL PURPOSE ATHLETIC BAGS, ALL PURPOSE SPORTS BAGS, BACK PACKS, BEACH BAGS, BRIEFCASES AND ATTACHE CASES, LUGGAGE, COSMETIC CASES SOLD EMPTY, DIAPER BAGS, PURSES, FANNY PACKS, OVERNIGHT BAGS, UMBRELLAS, WALLETS, SUITCASES, IN CLASS 18 (U.S. CLS. 1, 2, 3, 22 AND 41).

FIRST USE 7-15-2011; IN COMMERCE 7-15-2011.

OWNER OF U.S. REG. NOS. 2,354,501 AND 2,408,486.

THE MARK CONSISTS OF THE STYLIZED WORDS "BLUE MARLIN" FEATURED INSIDE A SHADED CIRCLE.

SN 85-116,819, FILED 8-26-2010.

BRIAN PINO, EXAMINING ATTORNEY



David J. Kyffers

Director of the United States Patent and Trademark Office

United States of America

United States Patent and Trademark Office

BLUE MARLIN

Reg. No. 4,068,275

Registered Dec. 6, 2011

Int. Cl.: 18

CONCEPT SIX LLC (NEW YORK LIMITED LIABILITY COMPANY), DBA BLUE MARLIN
LIMITED LIABILITY COMPANY,
3RD FLOOR
119 WEST 40TH STREET
NEW YORK, NY 10018

TRADEMARK

PRINCIPAL REGISTER

FOR: HANDBAGS, SHOULDER BAGS, MESSENGER BAGS, TRAVEL CASES, ALL PURPOSE ATHLETIC BAGS, ALL PURPOSE SPORTS BAGS, BACK PACKS, BEACH BAGS, BRIEFCASES AND ATTACHE CASES, LUGGAGE, COSMETIC CASES SOLD EMPTY, DIAPER BAGS, PURSES, FANNY PACKS, OVERNIGHT BAGS, UMBRELLAS, WALLETS, SUITCASES, IN CLASS 18 (U.S. CLS. 1, 2, 3, 22 AND 41).

FIRST USE 7-15-2011; IN COMMERCE 7-15-2011.

THE MARK CONSISTS OF STANDARD CHARACTERS WITHOUT CLAIM TO ANY PARTICULAR FONT, STYLE, SIZE, OR COLOR.

OWNER OF U.S. REG. NOS. 2,354,501 AND 2,408,486.

SN 85-116,821, FILED 8-26-2010.

BRIAN PINO, EXAMINING ATTORNEY



David J. Kyffers

Director of the United States Patent and Trademark Office

United States of America

United States Patent and Trademark Office



Reg. No. 4,068,276

Registered Dec. 6, 2011

Int. Cl.: 25

TRADEMARK

PRINCIPAL REGISTER

PATEL, MANISH (UNITED STATES INDIVIDUAL)
23385 FOLEY STREET
HAYWARD, CA 94545

FOR: APRONS; CAPS; HEADWEAR; JACKETS; SHIRTS; SWEAT SHIRTS; TOPS, IN CLASS 25 (U.S. CLS. 22 AND 39).

FIRST USE 3-1-2006; IN COMMERCE 3-1-2006.

NO CLAIM IS MADE TO THE EXCLUSIVE RIGHT TO USE "AK", APART FROM THE MARK AS SHOWN.

THE MARK CONSISTS OF THE LETTER "I", FOLLOWED BY THE IMAGE OF A STYLIZED HEART, FOLLOWED BY THE LETTERS "AK" UNDERNEATH THE FOREGOING.

SN 85-117,123, FILED 8-27-2010.

MAYUR VAGHANI, EXAMINING ATTORNEY



David J. Kybas

Director of the United States Patent and Trademark Office

United States of America

United States Patent and Trademark Office

RENEW YOURSELF IN STYLE

Reg. No. 4,068,277

Registered Dec. 6, 2011

Int. Cl.: 10

TRADEMARK

PRINCIPAL REGISTER

REJUVAHEALTH, LLC (CALIFORNIA LIMITED LIABILITY COMPANY)
22792 CENTRE DRIVE, SUITE 115
LAKE FOREST, CA 92630

FOR: MEDICAL COMPRESSION CLOTHING, NAMELY, MEDICAL COMPRESSION STOCKINGS, TIGHTS, HOSIERY, SOCKS, ARM SLEEVES AND GLOVES, IN CLASS 10 (U.S. CLS. 26, 39 AND 44).

FIRST USE 1-31-2011; IN COMMERCE 1-31-2011.

THE MARK CONSISTS OF STANDARD CHARACTERS WITHOUT CLAIM TO ANY PARTICULAR FONT, STYLE, SIZE, OR COLOR.

SN 85-117,329, FILED 8-27-2010.

JEFFREY LOOK, EXAMINING ATTORNEY



David J. Kybas

Director of the United States Patent and Trademark Office

United States of America

United States Patent and Trademark Office

TRANSFORMING THE PATIENT'S REHAB EXPERIENCE

Reg. No. 4,068,278

Registered Dec. 6, 2011

Int. Cl.: 44

SERVICE MARK

PRINCIPAL REGISTER

GENESIS REHABILITATION SERVICES, INC. (PENNSYLVANIA CORPORATION)
101 EAST STATE STREET
KENNETT SQUARE, PA 19348

FOR: PHYSICAL REHABILITATION SERVICES, IN CLASS 44 (U.S. CLS. 100 AND 101).

FIRST USE 5-0-2011; IN COMMERCE 5-0-2011.

THE MARK CONSISTS OF STANDARD CHARACTERS WITHOUT CLAIM TO ANY PARTICULAR FONT, STYLE, SIZE, OR COLOR.

SN 85-117,564, FILED 8-27-2010.

CHERYL CLAYTON, EXAMINING ATTORNEY



David J. Kybas

Director of the United States Patent and Trademark Office

United States of America

United States Patent and Trademark Office



Reg. No. 4,068,279

Registered Dec. 6, 2011

Int. Cl.: 35

SERVICE MARK

PRINCIPAL REGISTER

LB BRANDS, LLC (MAINE LIMITED LIABILITY COMPANY)
PO BOX 239
PORT CLYDE, ME 04855

FOR: WHOLESALE AND RETAIL STORE SERVICES FEATURING LOBSTER, SHELLFISH, SEAFOOD, HOUSEHOLD GIFT ITEMS; RETAIL MOBILE VENDING SERVICES FEATURING FOOD AND NOVELTY GIFTS, IN CLASS 35 (U.S. CLS. 100, 101 AND 102).

FIRST USE 12-31-2010; IN COMMERCE 12-31-2010.

OWNER OF U.S. REG. NOS. 3,590,573, 3,870,939, AND OTHERS.

NO CLAIM IS MADE TO THE EXCLUSIVE RIGHT TO USE "MAINE LOBSTER" AND A REPRESENTATION OF A LOBSTER, APART FROM THE MARK AS SHOWN.

THE NAME "LINDA BEAN" IDENTIFIES A LIVING INDIVIDUAL WHOSE CONSENT IS OF RECORD.

THE MARK CONSISTS OF A FANCIFUL DEPICTION OF A LOBSTER WITHIN A FANCIFUL DESIGN CIRCLE WITHIN TWO CIRCLES BETWEEN WHICH ARE THE WORDS "LINDA BEAN'S MAINE LOBSTER" WITH TWO SMALL CIRCLES/DOTS, ONE BETWEEN "MAINE" AND "LINDA" AND ONE BETWEEN "LOBSTER" AND "BEAN'S".

SN 85-118,073, FILED 8-28-2010.

CHRISTINE COOPER, EXAMINING ATTORNEY



David J. Kybas

Director of the United States Patent and Trademark Office

United States of America

United States Patent and Trademark Office

VIA DEL GUSTO

Reg. No. 4,068,280

ARTHUR SCHUMAN INC. (NEW JERSEY CORPORATION)
40 NEW DUTCH LANE
FAIRFIELD, NJ 07004

Registered Dec. 6, 2011

Int. Cl.: 29

FOR: CHEESE; MEAT, IN CLASS 29 (U.S. CL. 46).

TRADEMARK

FIRST USE 10-29-2010; IN COMMERCE 10-29-2010.

PRINCIPAL REGISTER

THE MARK CONSISTS OF STANDARD CHARACTERS WITHOUT CLAIM TO ANY PARTICULAR FONT, STYLE, SIZE, OR COLOR.

THE ENGLISH TRANSLATION OF "VIA DEL GUSTO" IN THE MARK IS WAY OF TASTE.

SN 85-118,304, FILED 8-30-2010.

KIMBERLY PERRY, EXAMINING ATTORNEY



David J. Kybas

Director of the United States Patent and Trademark Office

United States of America

United States Patent and Trademark Office

HELLHOUND

Reg. No. 4,068,281

Registered Dec. 6, 2011

Int. Cl.: 13

TRADEMARK

PRINCIPAL REGISTER

I.O., INC. (NORTH CAROLINA CORPORATION)
P.O. BOX 847
MONROE, NC 281110847

FOR: FIREARMS, IN CLASS 13 (U.S. CLS. 2 AND 9).

FIRST USE 3-0-2011; IN COMMERCE 3-0-2011.

THE MARK CONSISTS OF STANDARD CHARACTERS WITHOUT CLAIM TO ANY PARTICULAR FONT, STYLE, SIZE, OR COLOR.

SN 85-118,373, FILED 8-30-2010.

BARNEY CHARLON, EXAMINING ATTORNEY



David J. Kyfos

Director of the United States Patent and Trademark Office

United States of America

United States Patent and Trademark Office

Art-rithmetic

Reg. No. 4,068,282

Registered Dec. 6, 2011

Int. Cl.: 16

TRADEMARK

PRINCIPAL REGISTER

STRIKER, SUSAN (UNITED STATES INDIVIDUAL)
520 JUDD ROAD
EASTON, CT 06612

FOR: EDUCATIONAL PUBLICATIONS, NAMELY, BOOKS, HAND-OUTS AND WORKBOOKS
IN THE FIELD OF THE CORRELATION BETWEEN ART AND MATH, IN CLASS 16 (U.S.
CLS. 2, 5, 22, 23, 29, 37, 38 AND 50).

FIRST USE 9-1-2009; IN COMMERCE 9-1-2009.

THE MARK CONSISTS OF STANDARD CHARACTERS WITHOUT CLAIM TO ANY PAR-
TICULAR FONT, STYLE, SIZE, OR COLOR.

SN 85-118,531, FILED 8-30-2010.

TINA MAI, EXAMINING ATTORNEY



David J. Kyffers

Director of the United States Patent and Trademark Office

United States of America

United States Patent and Trademark Office

SAFE. EXCEPTIONAL.
EXPERIENCED.

Reg. No. 4,068,283

GREATBATCH INC. (NEW YORK CORPORATION)
10,000 WEHRLE DRIVE
CLARENCE, NY 14031

Registered Dec. 6, 2011

Int. Cls.: 40 and 42

FOR: MANUFACTURE OF BATTERIES AND BATTERY PACKS, WIRELESS SENSORS AND SYSTEMS, PRESSURE SENSORS, FLOW SENSORS, AND TEMPERATURE SENSORS TO ORDER AND/OR SPECIFICATION OF OTHERS, IN CLASS 40 (U.S. CLS. 100, 103 AND 106).

SERVICE MARK

PRINCIPAL REGISTER

FIRST USE 8-1-2011; IN COMMERCE 8-1-2011.

FOR: ENGINEERING SERVICES, NAMELY, ENGINEERING OF BATTERIES AND BATTERY PACKS, WIRELESS SENSORS AND SYSTEMS, PRESSURE SENSORS, FLOW SENSORS, AND TEMPERATURE SENSORS FOR OTHERS; DESIGN AND DEVELOPMENT SERVICES, NAMELY, DESIGN AND DEVELOPMENT OF BATTERIES AND BATTERY PACKS, WIRELESS SENSORS AND SYSTEMS, PRESSURE SENSORS, FLOW SENSORS, AND TEMPERATURE SENSORS FOR OTHERS, IN CLASS 42 (U.S. CLS. 100 AND 101).

FIRST USE 8-1-2011; IN COMMERCE 8-1-2011.

THE MARK CONSISTS OF STANDARD CHARACTERS WITHOUT CLAIM TO ANY PARTICULAR FONT, STYLE, SIZE, OR COLOR.

SN 85-118,854, FILED 8-30-2010.

BENJAMIN OKEKE, EXAMINING ATTORNEY



David J. Kyros

Director of the United States Patent and Trademark Office

United States of America

United States Patent and Trademark Office

SERIOUS POWER FOR SERIOUS MISSIONS

Reg. No. 4,068,284

Registered Dec. 6, 2011

Int. Cls.: 40 and 42

SERVICE MARK

PRINCIPAL REGISTER

GREATBATCH INC. (NEW YORK CORPORATION)
10,000 WEHRLE DRIVE
CLARENCE, NY 14031

FOR: MANUFACTURING OF BATTERIES AND BATTERY PACKS TO ORDER AND/OR SPECIFICATION OF OTHERS, IN CLASS 40 (U.S. CLS. 100, 103 AND 106).

FIRST USE 8-1-2011; IN COMMERCE 8-1-2011.

FOR: ENGINEERING SERVICES, NAMELY, ENGINEERING OF BATTERIES AND BATTERY PACKS FOR OTHERS; DESIGN AND DEVELOPMENT SERVICES, NAMELY, DESIGN AND DEVELOPMENT OF BATTERIES AND BATTERY PACKS FOR OTHERS, IN CLASS 42 (U.S. CLS. 100 AND 101).

FIRST USE 8-1-2011; IN COMMERCE 8-1-2011.

THE MARK CONSISTS OF STANDARD CHARACTERS WITHOUT CLAIM TO ANY PARTICULAR FONT, STYLE, SIZE, OR COLOR.

SN 85-118,887, FILED 8-30-2010.

BENJAMIN OKEKE, EXAMINING ATTORNEY



David J. Kybas

Director of the United States Patent and Trademark Office

United States of America

United States Patent and Trademark Office

ONE HOUSE, ONE FAMILY, ONE DAY

Reg. No. 4,068,285

Registered Dec. 6, 2011

Int. Cl.: 42

SERVICE MARK

PRINCIPAL REGISTER

BSB DESIGN, INC. (IOWA CORPORATION), AKA BLOODGOOD GROUP, INC.,
6601 WESTOWN PARKWAY, SUITE 240
WEST DES MOINES, IA 50266

FOR: ARCHITECTURAL DESIGN; LAND USE PLANNING SERVICES; LANDSCAPE AR-
CHITECTURAL DESIGN, IN CLASS 42 (U.S. CLS. 100 AND 101).

FIRST USE 8-10-2011; IN COMMERCE 8-10-2011.

THE MARK CONSISTS OF STANDARD CHARACTERS WITHOUT CLAIM TO ANY PAR-
TICULAR FONT, STYLE, SIZE, OR COLOR.

SN 85-118,985, FILED 8-30-2010.

CHARLES L. JENKINS, EXAMINING ATTORNEY



David J. Kybas

Director of the United States Patent and Trademark Office

United States of America

United States Patent and Trademark Office



Reg. No. 4,068,286

Registered Dec. 6, 2011

Int. Cl.: 25

TRADEMARK

PRINCIPAL REGISTER

SUITS YOUR BELLY, LLC (WISCONSIN LIMITED LIABILITY COMPANY)
4899 SPRINGBROOK ROAD
PLEASANT PRAIRIE, WI 53158

FOR: CUSTOM MADE TO MEASURE SUITS FOR MEN AND WOMEN; DRESS SUITS;
LADIES' SUITS, IN CLASS 25 (U.S. CLS. 22 AND 39).

FIRST USE 9-20-2011; IN COMMERCE 9-20-2011.

THE MARK CONSISTS OF A PROFILE LINE DRAWING OF A PREGNANT WOMAN
HOLDING A CASE LEANING UP AGAINST THE LETTER "B" IN THE WORD "BELLY".
TO THE RIGHT OF THE DESIGN IS THE WORDING "SUITS YOUR BELLY".

SN 85-119,360, FILED 8-31-2010.

KATHERINE E. HALMEN, EXAMINING ATTORNEY



David J. Kybas

Director of the United States Patent and Trademark Office

United States of America

United States Patent and Trademark Office

UNIGEL

Reg. No. 4,068,287

Registered Dec. 6, 2011

Int. Cl.: 5

TRADEMARK

PRINCIPAL REGISTER

SOFGEN PHARMACEUTICALS, LLC (FLORIDA LIMITED LIABILITY COMPANY), DBA
SOFGEN,
1301 SAWGRASS CORPORATE PARKWAY
SUNRISE, FL 33323

FOR: A MULTI-COMPARTMENT ORAL DELIVERY SYSTEM THAT COMBINES TWO OR MORE COMPOUNDS IN THE FORMS OF TABLETS, HARD OR SOFT GEL CAPSULES, GRANULES AND MICRO GRANULES INTO A SINGLE DOSAGE SOFT-GEL UNIT FOR THE IMMEDIATE OR MODIFIED RELEASE OF A WIDE VARIETY OF PHARMACEUTICAL OR NUTRITIONAL AGENTS, IN CLASS 5 (U.S. CLS. 6, 18, 44, 46, 51 AND 52).

FIRST USE 4-30-2010; IN COMMERCE 8-15-2011.

THE MARK CONSISTS OF STANDARD CHARACTERS WITHOUT CLAIM TO ANY PARTICULAR FONT, STYLE, SIZE, OR COLOR.

SN 85-119,390, FILED 8-31-2010.

TOBY BULLOFF, EXAMINING ATTORNEY



David J. Kyffers

Director of the United States Patent and Trademark Office

United States of America

United States Patent and Trademark Office



Reg. No. 4,068,288

Registered Dec. 6, 2011

Int. Cl.: 1

TRADEMARK

PRINCIPAL REGISTER

ZHANG HONGHAO (CHINA INDIVIDUAL)
#1, 223 PRINCETON AVE
BUFFALO, NY 14226

FOR: REAGENTS FOR SCIENTIFIC OR MEDICAL RESEARCH USE, IN CLASS 1 (U.S. CLS. 1, 5, 6, 10, 26 AND 46).

FIRST USE 5-20-2009; IN COMMERCE 9-28-2009.

THE MARK CONSISTS OF THE STYLIZED WORDING "PUEX", WITH THE LETTER "P" IN WHITE ON A BLUE ANGLED OVAL AND THE LETTERS "UEX" IN BLUE WITH GRAY BACKGROUND SHADOWING.

THE COLOR(S) WHITE, BLUE, GREY IS/ARE CLAIMED AS A FEATURE OF THE MARK.

SN 85-119,445, FILED 8-31-2010.

JEAN IM, EXAMINING ATTORNEY



David J. Kybas

Director of the United States Patent and Trademark Office

United States of America

United States Patent and Trademark Office

RUNNING OUT LOUD

Reg. No. 4,068,289

Registered Dec. 6, 2011

Int. Cl.: 25

TRADEMARK

PRINCIPAL REGISTER

RUNNING OUT LOUD LLC (NEVADA LIMITED LIABILITY COMPANY)
3014 ST. JOHN'S AVENUE
JACKSONVILLE, FL 32205

FOR: APRONS; ATHLETIC TIGHTS; CHEF'S COATS; CLOTHING, NAMELY, ATHLETIC SLEEVES; HATS; HEADBANDS; LONG-SLEEVED SHIRTS; SCARVES; SCRUBS NOT FOR MEDICAL PURPOSES; SHORT-SLEEVED OR LONG-SLEEVED T-SHIRTS; SHORT-SLEEVED SHIRTS; SHORTS; SWEATBANDS; TANK TOPS, IN CLASS 25 (U.S. CLS. 22 AND 39).

FIRST USE 9-24-2010; IN COMMERCE 11-2-2010.

THE MARK CONSISTS OF STANDARD CHARACTERS WITHOUT CLAIM TO ANY PARTICULAR FONT, STYLE, SIZE, OR COLOR.

SN 85-119,498, FILED 8-31-2010.

KATHERINE E. HALMEN, EXAMINING ATTORNEY



David J. Kybas

Director of the United States Patent and Trademark Office

United States of America

United States Patent and Trademark Office

MOONSHINE

Reg. No. 4,068,290

Registered Dec. 6, 2011

Int. Cl.: 2

TRADEMARK

PRINCIPAL REGISTER

GLASSFLAKE LIMITED (UNITED KINGDOM CORPORATION)
FORSTER STREET
LEEDS, UNITED KINGDOM LS101PW

FOR: COLOR PIGMENTS; INORGANIC PIGMENTS; ORGANIC PIGMENTS; PIGMENTS,
IN CLASS 2 (U.S. CLS. 6, 11 AND 16).

FIRST USE 11-29-2010; IN COMMERCE 11-29-2010.

THE MARK CONSISTS OF STANDARD CHARACTERS WITHOUT CLAIM TO ANY PAR-
TICULAR FONT, STYLE, SIZE, OR COLOR.

SN 85-119,593, FILED 8-31-2010.

DAVID H. STINE, EXAMINING ATTORNEY



David J. Kyffers

Director of the United States Patent and Trademark Office

United States of America

United States Patent and Trademark Office

ADVANCED SKIN CARE BY MAX

Reg. No. 4,068,291

Registered Dec. 6, 2011

Int. Cl.: 3

TRADEMARK

PRINCIPAL REGISTER

MAX INTERNATIONAL, LLC (UTAH LIMITED LIABILITY COMPANY)
7090 SOUTH UNION PARK AVENUE, SUITE 500
SALT LAKE CITY, UT 84047

FOR: FACE AND BODY CREAMS; MOISTURIZING CREAMS; NON-MEDICATED SKIN CARE CREAMS AND LOTIONS, IN CLASS 3 (U.S. CLS. 1, 4, 6, 50, 51 AND 52).

FIRST USE 1-0-2011; IN COMMERCE 1-0-2011.

THE MARK CONSISTS OF STANDARD CHARACTERS WITHOUT CLAIM TO ANY PARTICULAR FONT, STYLE, SIZE, OR COLOR.

NO CLAIM IS MADE TO THE EXCLUSIVE RIGHT TO USE "ADVANCED SKIN CARE", APART FROM THE MARK AS SHOWN.

SN 85-119,753, FILED 8-31-2010.

ANDREW RHIM, EXAMINING ATTORNEY



David J. Kybas

Director of the United States Patent and Trademark Office

United States of America
United States Patent and Trademark Office

GCHYDRO

Reg. No. 4,068,292

Registered Dec. 6, 2011

Int. Cl.: 35

SERVICE MARK

PRINCIPAL REGISTER

GCH, INC. (CALIFORNIA CORPORATION)
3439 GONDAR AVENUE
LONG BEACH, CA 90808

FOR: ON-LINE RETAIL STORE SERVICES FEATURING HYDROPONICS SUPPLIES AND EQUIPMENT, IN CLASS 35 (U.S. CLS. 100, 101 AND 102).

FIRST USE 7-1-2010; IN COMMERCE 7-1-2010.

THE MARK CONSISTS OF STANDARD CHARACTERS WITHOUT CLAIM TO ANY PARTICULAR FONT, STYLE, SIZE, OR COLOR.

SN 85-119,773, FILED 8-31-2010.

ANTHONY RINKER, EXAMINING ATTORNEY



David J. Kybas

Director of the United States Patent and Trademark Office

United States of America

United States Patent and Trademark Office

POSITIVITY GIRL

Reg. No. 4,068,293

Registered Dec. 6, 2011

Int. Cls.: 9 and 45

TRADEMARK

SERVICE MARK

PRINCIPAL REGISTER

POSITIVITY GIRL, LLC (PENNSYLVANIA LIMITED LIABILITY COMPANY)
1232 RESACA PLACE
PITTSBURGH, PA 15212

FOR: DOWNLOADABLE COMPUTER SOFTWARE FOR PROVIDING ELECTRONIC MEDIA AND/OR INFORMATION VIA COMMUNICATION NETWORKS; COMPUTER APPLICATION SOFTWARE FOR MOBILE PHONES, NAMELY, SOFTWARE FOR PROVIDING ELECTRONIC MEDIA AND/OR INFORMATION VIA COMMUNICATION NETWORKS; ALL IN THE FIELDS OF INSPIRATION, ENCOURAGEMENT AND WELLNESS, IN CLASS 9 (U.S. CLS. 21, 23, 26, 36 AND 38).

FIRST USE 10-0-2010; IN COMMERCE 10-0-2010.

FOR: PROVIDING A WEBSITE FEATURING INFORMATION, STORIES FOR INSPIRATION AND ENCOURAGEMENT AND CONTENT IN THE FIELDS OF PERSONAL RELATIONSHIPS, PERSONAL GROWTH AND MOTIVATION AND SELF-FULFILLMENT, IN CLASS 45 (U.S. CLS. 100 AND 101).

FIRST USE 10-0-2010; IN COMMERCE 10-0-2010.

THE MARK CONSISTS OF STANDARD CHARACTERS WITHOUT CLAIM TO ANY PARTICULAR FONT, STYLE, SIZE, OR COLOR.

SN 85-119,823, FILED 8-31-2010.

KATHERINE STOIDES, EXAMINING ATTORNEY



David J. Kyros

Director of the United States Patent and Trademark Office

United States of America

United States Patent and Trademark Office



Reg. No. 4,068,294

Registered Dec. 6, 2011

Int. Cls.: 9 and 45

TRADEMARK

SERVICE MARK

PRINCIPAL REGISTER

POSITIVITY GIRL, LLC (PENNSYLVANIA LIMITED LIABILITY COMPANY)
1232 RESACA PLACE
PITTSBURGH, PA 15212

FOR: DOWNLOADABLE COMPUTER SOFTWARE FOR PROVIDING ELECTRONIC MEDIA AND/OR INFORMATION VIA COMMUNICATION NETWORKS; COMPUTER APPLICATION SOFTWARE FOR MOBILE PHONES, NAMELY, SOFTWARE FOR PROVIDING ELECTRONIC MEDIA AND/OR INFORMATION VIA COMMUNICATION NETWORKS; ALL IN THE FIELDS OF INSPIRATION, ENCOURAGEMENT AND WELLNESS, IN CLASS 9 (U.S. CLS. 21, 23, 26, 36 AND 38).

FIRST USE 10-0-2010; IN COMMERCE 10-0-2010.

FOR: PROVIDING A WEBSITE FEATURING INFORMATION, STORIES FOR INSPIRATION AND ENCOURAGEMENT AND CONTENT IN THE FIELDS OF PERSONAL RELATIONSHIPS, PERSONAL GROWTH AND MOTIVATION AND SELF-FULFILLMENT, IN CLASS 45 (U.S. CLS. 100 AND 101).

FIRST USE 10-0-2010; IN COMMERCE 10-0-2010.

THE MARK CONSISTS OF THE TERM "POSITIVITY" CENTERED ABOVE THE TERM "GIRL" IN FRONT OF A DOUBLE-LINED CIRCLE.

SN 85-119,827, FILED 8-31-2010.

KATHERINE STOIDES, EXAMINING ATTORNEY



David J. Kyros

Director of the United States Patent and Trademark Office

United States of America

United States Patent and Trademark Office

PREMIER NOTES

Reg. No. 4,068,295

Registered Dec. 6, 2011

Int. Cl.: 36

SERVICE MARK

PRINCIPAL REGISTER

DUKE ENERGY CORPORATION (DELAWARE CORPORATION)
526 SOUTH CHURCH STREET
CHARLOTTE, NC 28202

FOR: FINANCIAL SERVICES, NAMELY, AN INTEREST BEARING DEPOSIT ACCOUNT WITH CHECKWRITING AND WITHDRAWAL PRIVILEGES, IN CLASS 36 (U.S. CLS. 100, 101 AND 102).

FIRST USE 4-4-2011; IN COMMERCE 4-4-2011.

THE MARK CONSISTS OF STANDARD CHARACTERS WITHOUT CLAIM TO ANY PARTICULAR FONT, STYLE, SIZE, OR COLOR.

NO CLAIM IS MADE TO THE EXCLUSIVE RIGHT TO USE "NOTES", APART FROM THE MARK AS SHOWN.

SN 85-119,839, FILED 8-31-2010.

MICHAEL SOUDERS, EXAMINING ATTORNEY



David J. Kybas

Director of the United States Patent and Trademark Office

United States of America

United States Patent and Trademark Office



Reg. No. 4,068,296

Registered Dec. 6, 2011

Int. Cls.: 9 and 45

TRADEMARK

SERVICE MARK

PRINCIPAL REGISTER

POSITIVITY GIRL, LLC (PENNSYLVANIA LIMITED LIABILITY COMPANY)
1232 RESACA PLACE
PITTSBURGH, PA 15212

FOR: DOWNLOADABLE COMPUTER SOFTWARE FOR PROVIDING ELECTRONIC MEDIA AND/OR INFORMATION VIA COMMUNICATION NETWORKS; COMPUTER APPLICATION SOFTWARE FOR MOBILE PHONES, NAMELY, SOFTWARE FOR PROVIDING ELECTRONIC MEDIA AND/OR INFORMATION VIA COMMUNICATION NETWORKS; ALL IN THE FIELDS OF INSPIRATION, ENCOURAGEMENT AND WELLNESS, IN CLASS 9 (U.S. CLS. 21, 23, 26, 36 AND 38).

FIRST USE 10-0-2010; IN COMMERCE 10-0-2010.

FOR: PROVIDING A WEBSITE FEATURING INFORMATION, STORIES FOR INSPIRATION AND ENCOURAGEMENT AND CONTENT IN THE FIELDS OF PERSONAL RELATIONSHIPS, PERSONAL GROWTH AND MOTIVATION AND SELF-FULFILLMENT, IN CLASS 45 (U.S. CLS. 100 AND 101).

FIRST USE 10-0-2010; IN COMMERCE 10-0-2010.

THE MARK CONSISTS OF A DESIGN OF A FACE OF AN ANIMATED GIRL.

SN 85-119,843, FILED 8-31-2010.

KATHERINE STOIDES, EXAMINING ATTORNEY



David J. Kyros

Director of the United States Patent and Trademark Office

United States of America

United States Patent and Trademark Office

BRILLIANT AS YOUR LOVE

Reg. No. 4,068,297

Registered Dec. 6, 2011

Int. Cl.: 14

TRADEMARK

PRINCIPAL REGISTER

WAL-MART STORES, INC. (DELAWARE CORPORATION)
702 SW 8TH STREET
BENTONVILLE, AR 727160520

FOR: JEWELRY, IN CLASS 14 (U.S. CLS. 2, 27, 28 AND 50).

FIRST USE 10-31-2010; IN COMMERCE 10-31-2010.

THE MARK CONSISTS OF STANDARD CHARACTERS WITHOUT CLAIM TO ANY PARTICULAR FONT, STYLE, SIZE, OR COLOR.

SN 85-120,094, FILED 8-31-2010.

KEVON CHISOLM, EXAMINING ATTORNEY



David J. Kyffers

Director of the United States Patent and Trademark Office

United States of America

United States Patent and Trademark Office

CHALKTALK

Reg. No. 4,068,298

Registered Dec. 6, 2011

Int. Cl.: 17

TRADEMARK

PRINCIPAL REGISTER

R TAPE CORPORATION (NEW JERSEY CORPORATION)
6 INGERSOLL ROAD
SOUTH PLAINFIELD, NJ 07080

FOR: FLEXIBLE PLASTIC FILM WITH ADHESIVE BACKING USED FOR MARKING WITH CHALK, IN CLASS 17 (U.S. CLS. 1, 5, 12, 13, 35 AND 50).

FIRST USE 2-1-2011; IN COMMERCE 2-1-2011.

THE MARK CONSISTS OF STANDARD CHARACTERS WITHOUT CLAIM TO ANY PARTICULAR FONT, STYLE, SIZE, OR COLOR.

SN 85-120,115, FILED 8-31-2010.

MELISSA VALLILLO, EXAMINING ATTORNEY



David J. Kyffers

Director of the United States Patent and Trademark Office

United States of America

United States Patent and Trademark Office

HOMESTYLE HAM

Reg. No. 4,068,299

Registered Dec. 6, 2011

Int. Cl.: 31

TRADEMARK

PRINCIPAL REGISTER

WAGGIN' TRAIN, LLC (DELAWARE LIMITED LIABILITY COMPANY)
P.O. BOX 5687
ANDERSON, SC 29623

FOR: EDIBLE PET TREAT, IN CLASS 31 (U.S. CLS. 1 AND 46).

FIRST USE 12-20-2010; IN COMMERCE 12-20-2010.

THE MARK CONSISTS OF STANDARD CHARACTERS WITHOUT CLAIM TO ANY PARTICULAR FONT, STYLE, SIZE, OR COLOR.

NO CLAIM IS MADE TO THE EXCLUSIVE RIGHT TO USE "HAM", APART FROM THE MARK AS SHOWN.

SN 85-120,288, FILED 8-31-2010.

JESSICA A. POWERS, EXAMINING ATTORNEY



David J. Kyffers

Director of the United States Patent and Trademark Office

United States of America

United States Patent and Trademark Office

RED SENTIENT STRIKE

Reg. No. 4,068,300

Registered Dec. 6, 2011

Int. Cl.: 41

SERVICE MARK

PRINCIPAL REGISTER

MATTEL, INC. (DELAWARE CORPORATION)
M1-1518
333 CONTINENTAL BOULEVARD
EL SEGUNDO, CA 90245

FOR: ENTERTAINMENT SERVICES, NAMELY, PROVIDING ON-LINE COMPUTER GAMES,
IN CLASS 41 (U.S. CLS. 100, 101 AND 107).

FIRST USE 9-30-2010; IN COMMERCE 9-30-2010.

THE MARK CONSISTS OF STANDARD CHARACTERS WITHOUT CLAIM TO ANY PAR-
TICULAR FONT, STYLE, SIZE, OR COLOR.

SN 85-120,648, FILED 9-1-2010.

ROBIN CHOSID, EXAMINING ATTORNEY



David J. Kybas

Director of the United States Patent and Trademark Office

United States of America

United States Patent and Trademark Office



Rewards right around the corner

Reg. No. 4,068,301

Registered Dec. 6, 2011

Int. Cls.: 35 and 43

SERVICE MARK

PRINCIPAL REGISTER

WYNDHAM TM CORP. (DELAWARE CORPORATION)
10750 WEST CHARLESTON BLVD.
SUITE 100
LAS VEGAS, NV 89135

FOR: PROMOTING THE GOODS AND SERVICES OF OTHERS BY AWARDING PURCHASE POINTS FOR MEMBERSHIP CARD AND MEMBERSHIP NUMBER USE; DEVELOPING AND ADMINISTERING A MEMBERSHIP REWARDS PROGRAM FOR LODGING GUESTS TO OBTAIN DISCOUNTS ON GOODS AND SERVICES, IN CLASS 35 (U.S. CLS. 100, 101 AND 102).

FIRST USE 9-0-2010; IN COMMERCE 9-0-2010.

FOR: HOTEL SERVICES FEATURING FREQUENT GUEST REWARD PROGRAM SERVICES WITH ADDED FEATURES WHICH ALLOW PARTICIPANTS TO EARN FREE LODGING AND OTHER TRAVEL-RELATED BENEFITS, AND ACQUIRE POINTS REDEEMABLE FOR CONSUMER PRODUCTS AND SERVICES, IN CLASS 43 (U.S. CLS. 100 AND 101).

FIRST USE 9-0-2010; IN COMMERCE 9-0-2010.

OWNER OF U.S. REG. NOS. 3,485,726, 3,690,444, AND OTHERS.

THE COLOR(S) BLUE AND GREY IS/ARE CLAIMED AS A FEATURE OF THE MARK.

NO CLAIM IS MADE TO THE EXCLUSIVE RIGHT TO USE "REWARDS", APART FROM THE MARK AS SHOWN.

THE MARK CONSISTS OF A SWOOSH IN THE COLOR GREY APPEARS ABOVE AND TO THE LEFT OF THE WORD "WYNDHAM" WHICH IS IN THE COLOR BLUE. THE WORD "REWARDS" APPEAR IN THE COLOR GREY BELOW THE WORD "WYNDHAM". BELOW THE WORD REWARDS APPEARS "REWARDS RIGHT AROUND THE CORNER" IN THE COLOR BLUE.

SN 85-120,713, FILED 9-1-2010.

MICHAEL ENGEL, EXAMINING ATTORNEY



David J. Kyros

Director of the United States Patent and Trademark Office

United States of America

United States Patent and Trademark Office

READY MATCH

Reg. No. 4,068,302

Registered Dec. 6, 2011

Int. Cl.: 2

TRADEMARK

PRINCIPAL REGISTER

THE SHERWIN-WILLIAMS COMPANY (OHIO CORPORATION)
101 W. PROSPECT AVENUE
CLEVELAND, OH 441151075

FOR: PAINTS, IN CLASS 2 (U.S. CLS. 6, 11 AND 16).

FIRST USE 5-6-2011; IN COMMERCE 5-6-2011.

THE MARK CONSISTS OF STANDARD CHARACTERS WITHOUT CLAIM TO ANY PARTICULAR FONT, STYLE, SIZE, OR COLOR.

SN 85-120,720, FILED 9-1-2010.

JANET LEE, EXAMINING ATTORNEY



David J. Kybas

Director of the United States Patent and Trademark Office

United States of America

United States Patent and Trademark Office



DiscipleWay
7 Disciplines for Maturing in Christ

Reg. No. 4,068,303

Registered Dec. 6, 2011

Int. Cl.: 9

TRADEMARK

PRINCIPAL REGISTER

LIFEWORD BROADCAST MINISTRIES, INC. (ARKANSAS NON-PROFIT CORPORATION)
611 LOCUST AVENUE
CONWAY, AR 72033

FOR: DIGITAL MEDIA, NAMELY, CDS AND DVDS FEATURING DISCUSSIONS OF DIS-
CIPLESHIP, IN CLASS 9 (U.S. CLS. 21, 23, 26, 36 AND 38).

FIRST USE 9-28-2009; IN COMMERCE 9-28-2009.

THE MARK CONSISTS OF THE WORDS "DISCIPLEWAY" ORIENTED DIRECTLY BELOW
A COMPASS IN THE FORM OF POCKET WATCH. UNDERNEATH THE WORDS "DISCIPLE-
WAY" ARE THE WORDS "7 DISCIPLINES FOR MATURING IN CHRIST".

SN 85-120,915, FILED 9-1-2010.

ARETHA SOMERVILLE, EXAMINING ATTORNEY



David J. Kybas

Director of the United States Patent and Trademark Office

United States of America

United States Patent and Trademark Office

DARING DIVA

Reg. No. 4,068,304

Registered Dec. 6, 2011

Int. Cls.: 9 and 41

TRADEMARK

SERVICE MARK

PRINCIPAL REGISTER

DEBORAH KERN, LLC (TEXAS LIMITED LIABILITY COMPANY)
140 CANTERBURY DRIVE
AUSTIN, TX 78737

FOR: DIGITAL MEDIA, NAMELY, DVDS FEATURING WORKOUT ROUTINES, FITNESS INSTRUCTION, YOGA INSTRUCTION, PILATES INSTRUCTION AND MEDITATION INSTRUCTION, IN CLASS 9 (U.S. CLS. 21, 23, 26, 36 AND 38).

FIRST USE 9-0-2011; IN COMMERCE 9-0-2011.

FOR: EDUCATION SERVICES, NAMELY, PROVIDING WORKSHOPS, CLASSES AND RETREATS IN THE FIELDS OF FITNESS, WELLNESS, AND LIFESTYLE; MEDITATION TRAINING; PHYSICAL FITNESS TRAINING SERVICES; PROVIDING FITNESS AND EXERCISE STUDIO SERVICES, NAMELY, PILATES INSTRUCTION AND TRAINING; YOGA INSTRUCTION, IN CLASS 41 (U.S. CLS. 100, 101 AND 107).

FIRST USE 9-0-2011; IN COMMERCE 9-0-2011.

THE MARK CONSISTS OF STANDARD CHARACTERS WITHOUT CLAIM TO ANY PARTICULAR FONT, STYLE, SIZE, OR COLOR.

SN 85-121,350, FILED 9-1-2010.

CHRISTOPHER BUONGIORNO, EXAMINING ATTORNEY



David J. Kybas

Director of the United States Patent and Trademark Office

United States of America

United States Patent and Trademark Office

PAW ACADEMY

Reg. No. 4,068,305

Registered Dec. 6, 2011

Int. Cl.: 44

SERVICE MARK

PRINCIPAL REGISTER

CARNAHAN, MELISSA (UNITED STATES INDIVIDUAL)
1220 IRONSMITH DRIVE
302
CELEBRATION, FL 34747

FOR: PET CARE SERVICES, NAMELY, DOG WALKING, DOG BATHING, NON-MEDICATED PET GROOMING AND IN-HOME MEDICAL CARE, IN CLASS 44 (U.S. CLS. 100 AND 101).

FIRST USE 10-1-2010; IN COMMERCE 10-1-2010.

THE MARK CONSISTS OF STANDARD CHARACTERS WITHOUT CLAIM TO ANY PARTICULAR FONT, STYLE, SIZE, OR COLOR.

SN 85-121,629, FILED 9-2-2010.

SUSAN STIGLITZ, EXAMINING ATTORNEY



David J. Kybas

Director of the United States Patent and Trademark Office

United States of America

United States Patent and Trademark Office

JUST PAUSE IT

Reg. No. 4,068,306

Registered Dec. 6, 2011

Int. Cl.: 35

SERVICE MARK

PRINCIPAL REGISTER

LCAIP, LLC (NEW YORK LIMITED LIABILITY COMPANY)
1950 MONROE AVE
BELLMORE, NY 11710

FOR: ON-LINE RETAIL STORE SERVICES FEATURING DOWNLOADABLE SOFTWARE, HARDWARE AND MOBILE PHONE AND COMPUTER ACCESSORIES, IN CLASS 35 (U.S. CLS. 100, 101 AND 102).

FIRST USE 12-1-2010; IN COMMERCE 12-1-2010.

THE MARK CONSISTS OF STANDARD CHARACTERS WITHOUT CLAIM TO ANY PARTICULAR FONT, STYLE, SIZE, OR COLOR.

SN 85-122,345, FILED 9-2-2010.

MARGARET POWER, EXAMINING ATTORNEY



David J. Kyffers

Director of the United States Patent and Trademark Office

United States of America

United States Patent and Trademark Office



Reg. No. 4,068,307

Registered Dec. 6, 2011

Int. Cl.: 37

SERVICE MARK

PRINCIPAL REGISTER

CANEZ, IVONNE R. (MEXICO INDIVIDUAL)
#121
13423 BLANCO RD
SAN ANTONIO, TX 78216

FOR: CLEANING OF OFFICES AND BUILDING; CLEANING OF RESIDENTIAL HOUSES; CLEANING OF INDUSTRIAL PREMISES; WINDOW CLEANING; CARPET AND RUG CLEANING; CLEANING OF CLOTHING; EVENT CLEAN-UP SERVICES, IN CLASS 37 (U.S. CLS. 100, 103 AND 106).

FIRST USE 9-1-2010; IN COMMERCE 9-28-2010.

NO CLAIM IS MADE TO THE EXCLUSIVE RIGHT TO USE "MAID" AND "MESS" AND "TEXAS", APART FROM THE MARK AS SHOWN.

THE COLOR(S) RED, BLACK, PINK, AND GRAY IS/ARE CLAIMED AS A FEATURE OF THE MARK.

THE MARK CONSISTS OF THE STYLIZED WORDING "MAID SQUAD NO MESS IN TEXAS" WITH A MAID WEARING AN APRON AND HOLDING A DUSTER WITH HER RIGHT HAND. THE COLOR RED IS IN THE WORDING "NO MESS IN TEXAS" AND IN THE MAID'S HAIR ORNAMENT, DRESS, APRON, AND SHOES. THE COLOR BLACK IS IN THE WORDING "MAID SQUAD", IN THE MAID'S DRESS AND HAIR, AND IN THE DUSTER. THE COLOR PINK IS IN THE MAID'S FACE, ARMS, AND LEGS. THE COLOR GRAY IS IN THE DUSTER.

SN 85-122,348, FILED 9-2-2010.

MARGARET POWER, EXAMINING ATTORNEY



David J. Kyros

Director of the United States Patent and Trademark Office

United States of America

United States Patent and Trademark Office

TRAVELAID

Reg. No. 4,068,308

Registered Dec. 6, 2011

Int. Cls.: 18 and 21

TRADEMARK

PRINCIPAL REGISTER

ROGER YANG (UNITED STATES INDIVIDUAL)
13280 TEMPLE AVENUE
CITY OF INDUSTRY, CA 91746

FOR: LUGGAGE; ALL-PURPOSE CARRYING BAGS; BOOK BAGS; BACKPACKS; ALL-PURPOSE SPORTING BAGS; DUFFLE BAGS; CARRY-ON BAGS; TOILETRY BAGS SOLD EMPTY; ROLLING LUGGAGE, IN CLASS 18 (U.S. CLS. 1, 2, 3, 22 AND 41).

FIRST USE 7-29-2011; IN COMMERCE 7-29-2011.

FOR: PORTABLE COOLERS, IN CLASS 21 (U.S. CLS. 2, 13, 23, 29, 30, 33, 40 AND 50).

FIRST USE 8-3-2011; IN COMMERCE 8-3-2011.

THE MARK CONSISTS OF STANDARD CHARACTERS WITHOUT CLAIM TO ANY PARTICULAR FONT, STYLE, SIZE, OR COLOR.

SN 85-122,773, FILED 9-3-2010.

SUNG IN, EXAMINING ATTORNEY



David J. Kypos

Director of the United States Patent and Trademark Office

United States of America

United States Patent and Trademark Office



Reg. No. 4,068,309

Registered Dec. 6, 2011

Int. Cl.: 41

SERVICE MARK

PRINCIPAL REGISTER

SEAWORLD PARKS & ENTERTAINMENT LLC (DELAWARE LIMITED LIABILITY COMPANY)
SUITE 400
9205 SOUTH PARK CENTER LOOP
ORLANDO, FL 32819

FOR: AMUSEMENT PARKS; RECREATIONAL CAMPS AND EDUCATIONAL SERVICES, NAMELY, CONDUCTING CAMPS IN THE FIELD OF ANIMALS, ZOO KEEPING, SCIENCE, ECOLOGY, WILDLIFE CONSERVATION, RESCUE AND REHABILITATION, AND ANIMAL CARE, IN CLASS 41 (U.S. CLS. 100, 101 AND 107).

FIRST USE 1-0-2011; IN COMMERCE 1-0-2011.

THE MARK CONSISTS OF A LION JUMPING THROUGH GRASS OR FIELDS.

SN 85-122,798, FILED 9-3-2010.

THEODORE MCBRIDE, EXAMINING ATTORNEY



David J. Kyffers

Director of the United States Patent and Trademark Office

United States of America

United States Patent and Trademark Office

Candlewood Investment Group

Reg. No. 4,068,310

Registered Dec. 6, 2011

Int. Cl.: 36

SERVICE MARK

PRINCIPAL REGISTER

CANDLEWOOD INVESTMENT GROUP, LP (DELAWARE LIMITED PARTNERSHIP)
777 THIRD AVENUE
19TH FLOOR
NEW YORK, NY 10017

FOR: INVESTMENT ADVISORY SERVICES, IN CLASS 36 (U.S. CLS. 100, 101 AND 102).

FIRST USE 10-1-2010; IN COMMERCE 10-1-2010.

THE MARK CONSISTS OF STANDARD CHARACTERS WITHOUT CLAIM TO ANY PARTICULAR FONT, STYLE, SIZE, OR COLOR.

NO CLAIM IS MADE TO THE EXCLUSIVE RIGHT TO USE "INVESTMENT GROUP", APART FROM THE MARK AS SHOWN.

SN 85-122,827, FILED 9-3-2010.

ODESSA BIBBINS, EXAMINING ATTORNEY



David J. Kybas

Director of the United States Patent and Trademark Office

United States of America

United States Patent and Trademark Office



Reg. No. 4,068,311

Registered Dec. 6, 2011

Int. Cl.: 41

SERVICE MARK

PRINCIPAL REGISTER

SEAWORLD PARKS & ENTERTAINMENT LLC (DELAWARE LIMITED LIABILITY COMPANY)
SUITE 400
9205 SOUTH PARK CENTER LOOP
ORLANDO, FL 32819

FOR: AMUSEMENT PARKS; RECREATIONAL CAMPS AND EDUCATIONAL SERVICES, NAMELY, CONDUCTING CAMPS IN THE FIELD OF ANIMALS, ZOO KEEPING, SCIENCE, ECOLOGY, WILDLIFE CONSERVATION, RESCUE AND REHABILITATION, AND ANIMAL CARE, IN CLASS 41 (U.S. CLS. 100, 101 AND 107).

FIRST USE 1-0-2011; IN COMMERCE 1-0-2011.

THE MARK CONSISTS OF A WHALE JUMPING WITH THE SUN BEHIND IT.

SN 85-123,052, FILED 9-3-2010.

THEODORE MCBRIDE, EXAMINING ATTORNEY



David J. Kyffers

Director of the United States Patent and Trademark Office

United States of America

United States Patent and Trademark Office

MyMomIsMeanerThanYourMom

Reg. No. 4,068,312

Registered Dec. 6, 2011

Int. Cl.: 21

TRADEMARK

PRINCIPAL REGISTER

CARRIE SNOW (UNITED STATES INDIVIDUAL)
3649 1/2 REGAL PLACE
LOS ANGELES, CA 90068

FOR: COFFEE CUPS, TEA CUPS AND MUGS; COFFEE MUGS; CUPS AND MUGS;
EARTHENWARE MUGS; MUGS; MUGS, NOT OF PRECIOUS METAL; PORCELAIN MUGS,
IN CLASS 21 (U.S. CLS. 2, 13, 23, 29, 30, 33, 40 AND 50).

FIRST USE 10-1-2011; IN COMMERCE 10-1-2011.

THE MARK CONSISTS OF STANDARD CHARACTERS WITHOUT CLAIM TO ANY PAR-
TICULAR FONT, STYLE, SIZE, OR COLOR.

SN 85-123,317, FILED 9-4-2010.

JOHN GARTNER, EXAMINING ATTORNEY



David J. Kyfos

Director of the United States Patent and Trademark Office

United States of America

United States Patent and Trademark Office



Reg. No. 4,068,313
Registered Dec. 6, 2011
Int. Cl.: 41

SEAWORLD PARKS & ENTERTAINMENT LLC (DELAWARE LIMITED LIABILITY COMPANY)
SUITE 400
9205 SOUTH PARK CENTER LOOP
ORLANDO, FL 32819

SERVICE MARK
PRINCIPAL REGISTER

FOR: AMUSEMENT PARKS; RECREATIONAL CAMPS AND EDUCATIONAL SERVICES, NAMELY, CONDUCTING CAMPS IN THE FIELD OF ANIMALS, ZOO KEEPING, SCIENCE, ECOLOGY, WILDLIFE CONSERVATION, RESCUE AND REHABILITATION, AND ANIMAL CARE, IN CLASS 41 (U.S. CLS. 100, 101 AND 107).

FIRST USE 1-0-2011; IN COMMERCE 1-0-2011.

THE MARK CONSISTS OF A WHALE JUMPING OVER A LION, WITH THE SUN BEHIND THE WHALE AND THE GRASS BENEATH THE LION, ALTOGETHER FORMING A BROKEN CIRCLE.

SN 85-123,361, FILED 9-4-2010.

THEODORE MCBRIDE, EXAMINING ATTORNEY



David J. Kybas

Director of the United States Patent and Trademark Office

United States of America

United States Patent and Trademark Office

Danzforia

Reg. No. 4,068,314

Registered Dec. 6, 2011

Int. Cl.: 25

TRADEMARK

PRINCIPAL REGISTER

E.K. CLOTHING, LLC (CALIFORNIA LIMITED LIABILITY COMPANY)
2815 GARDENA AVE
SIGNAL HILL, CA 90755

FOR: WEARABLE GARMENTS AND CLOTHING, NAMELY, DANCE WEAR AND CLUB-WEAR, NAMELY, SKIRTS, PANTS, FLARE PANTS, HALTER DRESSES, DRESSES INCORPORATING STRETCH BLENDS OF POLYESTER AND SPANDEX PARTICULARLY DESIGNED FOR BALLROOM, SWING, TANGO, JAZZ, AND LATIN DANCE, AND FLAMENCO FASHION; DANCE SHOES, IN CLASS 25 (U.S. CLS. 22 AND 39).

FIRST USE 8-25-2010; IN COMMERCE 1-23-2011.

THE MARK CONSISTS OF STANDARD CHARACTERS WITHOUT CLAIM TO ANY PARTICULAR FONT, STYLE, SIZE, OR COLOR.

SN 85-123,408, FILED 9-5-2010.

JESSICA A. POWERS, EXAMINING ATTORNEY



David J. Kybas

Director of the United States Patent and Trademark Office

United States of America

United States Patent and Trademark Office

L'Austin Space

Reg. No. 4,068,315

Registered Dec. 6, 2011

Int. Cls.: 41 and 43

SERVICE MARK

PRINCIPAL REGISTER

L'AUSTIN SPACE, LLC (TEXAS LIMITED LIABILITY COMPANY)
815-A BRAZOS ST. #332
AUSTIN, TX 78701

FOR: SOCIAL CLUB SERVICES, NAMELY, ARRANGING, ORGANIZING, AND HOSTING SOCIAL EVENTS, GATHERINGS, GET-TOGETHERS, AND PARTIES FOR CLUB MEMBERS, IN CLASS 41 (U.S. CLS. 100, 101 AND 107).

FIRST USE 8-21-2010; IN COMMERCE 8-21-2010.

FOR: RESTAURANT AND BAR SERVICES, IN CLASS 43 (U.S. CLS. 100 AND 101).

FIRST USE 8-21-2010; IN COMMERCE 12-31-2010.

THE MARK CONSISTS OF STANDARD CHARACTERS WITHOUT CLAIM TO ANY PARTICULAR FONT, STYLE, SIZE, OR COLOR.

SN 85-124,346, FILED 9-7-2010.

JUSTINE D. PARKER, EXAMINING ATTORNEY



David J. Kyros

Director of the United States Patent and Trademark Office

United States of America

United States Patent and Trademark Office

Lead Differently

Reg. No. 4,068,316

Registered Dec. 6, 2011

Int. Cls.: 16 and 41

TRADEMARK

SERVICE MARK

PRINCIPAL REGISTER

THE ANGELA FLETCHER COMPANY (GEORGIA LIMITED LIABILITY COMPANY)
SUITE 1500
400 GALLERIA PARKWAY
ATLANTA, GA 30339

FOR: A SERIES OF BOOKS, WRITTEN ARTICLES, HANDOUTS AND WORKSHEETS IN THE FIELD OF HUMAN CAPITAL TO INCLUDE LEADERSHIP DEVELOPMENT; CALENDARS; BOOKMARKERS; MOTIVATIONAL CARDS, IN CLASS 16 (U.S. CLS. 2, 5, 22, 23, 29, 37, 38 AND 50).

FIRST USE 6-15-2010; IN COMMERCE 8-17-2010.

FOR: TRAINING SERVICES IN THE FIELD OF HUMAN CAPITAL TO INCLUDE LEADERSHIP DEVELOPMENT; PROVIDING COACHING AND LEARNING FORUMS IN THE FIELD OF HUMAN CAPITAL TO INCLUDE LEADERSHIP DEVELOPMENT; PROVIDING ON-LINE TRAINING COURSES, SEMINARS, WORKSHOPS, WEBINARS, CLASSES IN THE FIELD OF HUMAN CAPITAL, LEADERSHIP DEVELOPMENT; EDUCATIONAL SERVICES, NAMELY, CONDUCTING COURSES, SEMINARS, WORKSHOPS, WEBINARS, CLASSES IN THE FIELD OF HUMAN CAPITAL TO INCLUDE LEADERSHIP DEVELOPMENT AND DISTRIBUTION OF COURSE MATERIAL IN CONNECTION THEREWITH, IN CLASS 41 (U.S. CLS. 100, 101 AND 107).

FIRST USE 6-15-2010; IN COMMERCE 8-17-2010.

THE MARK CONSISTS OF STANDARD CHARACTERS WITHOUT CLAIM TO ANY PARTICULAR FONT, STYLE, SIZE, OR COLOR.

SN 85-124,444, FILED 9-7-2010.

ELIZABETH HUGHITT, EXAMINING ATTORNEY



David J. Kypos

Director of the United States Patent and Trademark Office

United States of America
United States Patent and Trademark Office

nutri-fx

Reg. No. 4,068,317

Registered Dec. 6, 2011

Int. Cl.: 1

TRADEMARK

PRINCIPAL REGISTER

SHONIKER, TIMOTHY (CANADA INDIVIDUAL)
3370 GREENWOOD ROAD
GREENWOOD, ONTARIO, CANADA L0H1H0

FOR: PLANT FOOD, IN CLASS 1 (U.S. CLS. 1, 5, 6, 10, 26 AND 46).

FIRST USE 5-1-2011; IN COMMERCE 5-1-2011.

THE MARK CONSISTS OF STANDARD CHARACTERS WITHOUT CLAIM TO ANY PARTICULAR FONT, STYLE, SIZE, OR COLOR.

SN 85-124,646, FILED 9-8-2010.

SUNG IN, EXAMINING ATTORNEY



David J. Kyffers

Director of the United States Patent and Trademark Office

United States of America

United States Patent and Trademark Office

LANRIC

Reg. No. 4,068,318

Registered Dec. 6, 2011

Int. Cls.: 6, 9, and 19

TRADEMARK

PRINCIPAL REGISTER

SYARIKAT LAN-RIC INDUSTRIES SDN BHD (41948-V) (MALAYSIA CORPORATION)
PLOT 171, HALA PERUSAHAAN MENGLEMBU 1
FALIM
IPOH, PERAK, MALAYSIA 30200

FOR: METAL CABLE TRAYS USED IN BUILDING CONSTRUCTION; CABLE TRUNKING, CABLE TRAY, CABLE LADDER, UNDERFLOOR TRUNKING, RAISED FLOOR TRUNKING, FLUSH FLOOR TRUNKING AND ACCESSORIES THEREFOR ALL OF WHICH IS MADE OF METAL, AND NOT FOR ELECTRICAL INSTALLATIONS AND INSTEAD USED TO HOLD CABLES, IN CLASS 6 (U.S. CLS. 2, 12, 13, 14, 23, 25 AND 50).

FIRST USE 10-9-2010; IN COMMERCE 10-9-2010.

FOR: PLASTIC CONDUIT FOR ELECTRICAL USE; ELECTRICAL RACK SYSTEM CONSISTING OF ELECTRICAL CABLES, SHELVING, AND COOLING AND VENTILATION SYSTEMS FOR HOUSING, ORGANIZING AND PROTECTING ELECTRICAL COMPONENTS; BOXES ADAPTED FOR HOUSING ELECTRIC INSTRUMENTS AND ELECTRIC CABLE BOXES, NAMELY, JUNCTION BOXES; ELECTRICITY CONDUITS IN THE NATURE OF CABLE TRUNKING, CABLE TRAY, CABLE LADDER, UNDERFLOOR TRUNKING, RAISED FLOOR TRUNKING, FLUSH FLOOR TRUNKING AND ACCESSORIES THEREFOR ALL OF WHICH IS MADE OF METAL AND PLASTIC, IN CLASS 9 (U.S. CLS. 21, 23, 26, 36 AND 38).

FIRST USE 10-9-2010; IN COMMERCE 10-9-2010.

FOR: NONMETAL CABLE TRAYS USED IN BUILDING CONSTRUCTION; CABLE TRUNKING, CABLE TRAY, CABLE LADDER, UNDERFLOOR TRUNKING, RAISED FLOOR TRUNKING, FLUSH FLOOR TRUNKING AND ACCESSORIES THEREFOR ALL OF WHICH IS MADE OF PLASTIC AND NOT FOR ELECTRICAL INSTALLATIONS AND INSTEAD USED TO HOLD CABLES, IN CLASS 19 (U.S. CLS. 1, 12, 33 AND 50).

FIRST USE 10-9-2010; IN COMMERCE 10-9-2010.

THE MARK CONSISTS OF STANDARD CHARACTERS WITHOUT CLAIM TO ANY PARTICULAR FONT, STYLE, SIZE, OR COLOR.

SN 85-124,661, FILED 9-8-2010.



David J. Kyros

Director of the United States Patent and Trademark Office

Reg. No. 4,068,318 ERIN FALK, EXAMINING ATTORNEY

United States of America

United States Patent and Trademark Office



Reg. No. 4,068,319

Registered Dec. 6, 2011

Int. Cl.: 25

TRADEMARK

PRINCIPAL REGISTER

ROMPEROOS, LLC (NEW YORK LIMITED LIABILITY COMPANY)
APT. N3L
535 WEST 23RD ST.
NEW YORK, NY 10011

FOR: HATS; PANTS; SHIRTS; SHOES; SHORTS; SWEAT SHIRTS; UNDERWEAR, IN CLASS 25 (U.S. CLS. 22 AND 39).

FIRST USE 9-0-2011; IN COMMERCE 9-0-2011.

THE MARK CONSISTS OF "ROMPEROOS" IN NAVY STYLIZED FONT WITH A NAVY OUTLINE FLAG STRING; THE FIRST FLAG IS RED, THE SECOND, BLUE AND WHITE STRIPPED, THE THIRD, WHITE WITH RED POLKA DOTS AND THE LAST ONE IS BLUE.

THE COLOR(S) NAVY, BLUE, RED AND WHITE IS/ARE CLAIMED AS A FEATURE OF THE MARK.

SN 85-124,666, FILED 9-8-2010.

ERIN FALK, EXAMINING ATTORNEY



David J. Kybas

Director of the United States Patent and Trademark Office

United States of America

United States Patent and Trademark Office

ERMENEGILDO ZEGNA DUO

Reg. No. 4,068,320

Registered Dec. 6, 2011

Int. Cl.: 25

TRADEMARK

PRINCIPAL REGISTER

ERMENEGILDO ZEGNA CORPORATION (NEW YORK CORPORATION)
UNIT A
100 WEST FOREST AVENUE
ENGLEWOOD, NJ 07631

FOR: CLOTHING, NAMELY, SUITS, JACKETS, IN CLASS 25 (U.S. CLS. 22 AND 39).

FIRST USE 6-0-2010; IN COMMERCE 6-0-2010.

THE MARK CONSISTS OF STANDARD CHARACTERS WITHOUT CLAIM TO ANY PARTICULAR FONT, STYLE, SIZE, OR COLOR.

OWNER OF U.S. REG. NOS. 1,077,923, 3,130,777, AND OTHERS.

THE NAME(S), PORTRAIT(S), AND/OR SIGNATURE(S) SHOWN IN THE MARK DOES NOT IDENTIFY A PARTICULAR LIVING INDIVIDUAL.

SN 85-124,768, FILED 9-8-2010.

ANGELA M. MICHELI, EXAMINING ATTORNEY



David J. Kybas

Director of the United States Patent and Trademark Office

United States of America

United States Patent and Trademark Office

MAMMO MEDIA

Reg. No. 4,068,321

Registered Dec. 6, 2011

Int. Cl.: 35

SERVICE MARK

PRINCIPAL REGISTER

MAMMO MEDIA, LLC (TEXAS LIMITED LIABILITY COMPANY)
200 KAYLA LANE
LONGVIEW, TX 75602

FOR: BUSINESS CONSULTING, BUSINESS MANAGEMENT AND PROVIDING INFORMATION IN THE BUSINESS FIELDS OF MUSIC, FILM, AND TELEVISION, IN CLASS 35 (U.S. CLS. 100, 101 AND 102).

FIRST USE 5-20-2011; IN COMMERCE 5-20-2011.

THE MARK CONSISTS OF STANDARD CHARACTERS WITHOUT CLAIM TO ANY PARTICULAR FONT, STYLE, SIZE, OR COLOR.

NO CLAIM IS MADE TO THE EXCLUSIVE RIGHT TO USE "MEDIA", APART FROM THE MARK AS SHOWN.

SN 85-124,808, FILED 9-8-2010.

MICHAEL WIENER, EXAMINING ATTORNEY



David J. Kyros

Director of the United States Patent and Trademark Office

United States of America

United States Patent and Trademark Office

DARK RITUALS

Reg. No. 4,068,322

Registered Dec. 6, 2011

Int. Cl.: 34

TRADEMARK

PRINCIPAL REGISTER

EPC IP CO. LLC (FLORIDA LIMITED LIABILITY COMPANY)
984 S.W. 1ST STREET
MIAMI, FL 33130

FOR: CIGARS, IN CLASS 34 (U.S. CLS. 2, 8, 9 AND 17).

FIRST USE 10-5-2011; IN COMMERCE 10-5-2011.

THE MARK CONSISTS OF STANDARD CHARACTERS WITHOUT CLAIM TO ANY PARTICULAR FONT, STYLE, SIZE, OR COLOR.

SN 85-124,932, FILED 9-8-2010.

CHARISMA HAMPTON, EXAMINING ATTORNEY



David J. Kyffers

Director of the United States Patent and Trademark Office

United States of America

United States Patent and Trademark Office

CODE PLUS HOME

Reg. No. 4,068,323

Registered Dec. 6, 2011

Int. Cl.: 42

SERVICE MARK

PRINCIPAL REGISTER

APA-THE ENGINEERED WOOD ASSOCIATION (WASHINGTON NON-PROFIT CORPORATION)
7011 SOUTH 19TH STREET
TACOMA, WA 98466

FOR: PROVIDING RESIDENTIAL BUILDING DESIGN FOR OTHERS TO ASSIST IN THE CONSTRUCTION OF BUILDINGS MEETING OR SURPASSING THE BUILDING AND ENERGY CODES, IN CLASS 42 (U.S. CLS. 100 AND 101).

FIRST USE 12-31-1990; IN COMMERCE 12-31-1990.

THE MARK CONSISTS OF STANDARD CHARACTERS WITHOUT CLAIM TO ANY PARTICULAR FONT, STYLE, SIZE, OR COLOR.

NO CLAIM IS MADE TO THE EXCLUSIVE RIGHT TO USE "CODE" AND "HOME", APART FROM THE MARK AS SHOWN.

SN 85-125,182, FILED 9-8-2010.

RENEE MCCRAY, EXAMINING ATTORNEY



David J. Kybas

Director of the United States Patent and Trademark Office

United States of America

United States Patent and Trademark Office

el extremo

Reg. No. 4,068,324

Registered Dec. 6, 2011

Int. Cl.: 30

TRADEMARK

PRINCIPAL REGISTER

FOSTER POULTRY FARMS (CALIFORNIA CORPORATION)
1000 DAVIS STREET
LIVINGSTON, CA 95334

FOR: BURRITOS; CHIMICHANGAS, IN CLASS 30 (U.S. CL. 46).

FIRST USE 10-0-1999; IN COMMERCE 10-0-1999.

OWNER OF U.S. REG. NO. 2,426,450.

THE MARK CONSISTS OF THE WORDING "EL EXTREMO" IN STYLIZED LETTERING.

THE ENGLISH TRANSLATION OF "EL EXTREMO" IS "THE EXTREME".

SN 85-125,333, FILED 9-8-2010.

AISHA SALEM, EXAMINING ATTORNEY



David J. Kyffers

Director of the United States Patent and Trademark Office

United States of America

United States Patent and Trademark Office

ColorReports

Reg. No. 4,068,325

Registered Dec. 6, 2011

Int. Cl.: 9

TRADEMARK

PRINCIPAL REGISTER

SURETINT SYSTEMS, LLC (ILLINOIS LIMITED LIABILITY COMPANY)
500 SKOKIE BLVD., SUITE 280
NORTHBROOK, IL 60062

FOR: SOFTWARE FOR GENERATING SALES, INVENTORY AND USAGE REPORTS ON SALON ACTIVITIES, SALON AND PERSONAL CARE PRODUCTS, SALON AND PERSONAL CARE SERVICES AND MATERIALS USED IN SALONS, IN CLASS 9 (U.S. CLS. 21, 23, 26, 36 AND 38).

FIRST USE 9-27-2011; IN COMMERCE 9-27-2011.

THE MARK CONSISTS OF STANDARD CHARACTERS WITHOUT CLAIM TO ANY PARTICULAR FONT, STYLE, SIZE, OR COLOR.

SN 85-125,784, FILED 9-9-2010.

KELLEY WELLS, EXAMINING ATTORNEY



David J. Kyffers

Director of the United States Patent and Trademark Office

United States of America

United States Patent and Trademark Office

ColorRx

Reg. No. 4,068,326

Registered Dec. 6, 2011

Int. Cl.: 9

TRADEMARK

PRINCIPAL REGISTER

SURETINT SYSTEMS, LLC (ILLINOIS LIMITED LIABILITY COMPANY)
500 SKOKIE BLVD., SUITE 280
NORTHBROOK, IL 60062

FOR: SOFTWARE WHICH ANALYZES AN INDIVIDUAL'S HAIR AND PURCHASES FOR RECOMMENDING SALON PRODUCTS, PERSONAL CARE PRODUCTS, AND HAIR AND PERSONAL CARE SERVICES, IN CLASS 9 (U.S. CLS. 21, 23, 26, 36 AND 38).

FIRST USE 9-27-2011; IN COMMERCE 9-27-2011.

THE MARK CONSISTS OF STANDARD CHARACTERS WITHOUT CLAIM TO ANY PARTICULAR FONT, STYLE, SIZE, OR COLOR.

SN 85-125,815, FILED 9-9-2010.

KELLEY WELLS, EXAMINING ATTORNEY



David J. Kybas

Director of the United States Patent and Trademark Office

United States of America

United States Patent and Trademark Office

Scooter* *Vision

Reg. No. 4,068,327

GLOBAL OUTDOOR CONCEPTS, INC. (NEVADA CORPORATION)
10620 SOUTHERN HIGHLANDS PKWY., #110-424
LAS VEGAS, NV 89141

Registered Dec. 6, 2011

Int. Cl.: 35

FOR: ADVERTISING AND PROMOTIONAL SERVICES, IN CLASS 35 (U.S. CLS. 100, 101 AND 102).

SERVICE MARK

FIRST USE 8-17-2010; IN COMMERCE 9-1-2010.

PRINCIPAL REGISTER

THE MARK CONSISTS OF THE WORDING "SCOOTER" IN BLACK LETTERING WITH BLACK-TO-WHITE FADING LINES ABOVE THE LETTERS "COO" AND "ER" IN "SCOOTER", THE WORDING "VISION" IN RED LETTERING WITH A RED-TO-WHITE FADING LINE BELOW THE LETTERS "ISION" IN "VISION".

THE COLOR(S) BLACK AND RED IS/ARE CLAIMED AS A FEATURE OF THE MARK.

SN 85-125,968, FILED 9-9-2010.

KEVON CHISOLM, EXAMINING ATTORNEY



David J. Kyffers

Director of the United States Patent and Trademark Office

United States of America

United States Patent and Trademark Office

REMBRANDT

Reg. No. 4,068,328

GUARDIAN BUILDING PRODUCTS DISTRIBUTION, INC. (GEORGIA CORPORATION)
P.O. BOX 528
GREENVILLE, SC 29602

Registered Dec. 6, 2011

Int. Cl.: 19

FOR: NON-METALLIC COMPOSITE BOARDS FOR DECKING, IN CLASS 19 (U.S. CLS. 1, 12, 33 AND 50).

TRADEMARK

FIRST USE 12-0-2010; IN COMMERCE 12-0-2010.

PRINCIPAL REGISTER

THE MARK CONSISTS OF STANDARD CHARACTERS WITHOUT CLAIM TO ANY PARTICULAR FONT, STYLE, SIZE, OR COLOR.

SN 85-126,154, FILED 9-9-2010.

SUSAN RICHARDS, EXAMINING ATTORNEY



David J. Kyffers

Director of the United States Patent and Trademark Office

United States of America

United States Patent and Trademark Office

Young Aston

Reg. No. 4,068,329

Registered Dec. 6, 2011

Int. Cl.: 41

SERVICE MARK

PRINCIPAL REGISTER

BEAUDOUIN, MARLON (UNITED STATES INDIVIDUAL)
PH
1400 BROADWAY
NEW HYDE PARK, NY 11040

FOR: ENTERTAINMENT SERVICES IN THE NATURE OF LIVE MUSICAL PERFORMANCES;
ENTERTAINMENT SERVICES, NAMELY, LIVE, TELEVISED AND MOVIE APPEARANCES
BY A PROFESSIONAL ENTERTAINER, IN CLASS 41 (U.S. CLS. 100, 101 AND 107).

FIRST USE 9-0-2011; IN COMMERCE 9-0-2011.

THE MARK CONSISTS OF STANDARD CHARACTERS WITHOUT CLAIM TO ANY PARTICULAR FONT, STYLE, SIZE, OR COLOR.

THE NAME(S), PORTRAIT(S), AND/OR SIGNATURE(S) SHOWN IN THE MARK IDENTIFIES MARLON BEAUDOUIN, WHOSE CONSENT(S) TO REGISTER IS MADE OF RECORD.

SN 85-126,241, FILED 9-9-2010.

LINDA POWELL, EXAMINING ATTORNEY



David J. Kyros

Director of the United States Patent and Trademark Office

United States of America

United States Patent and Trademark Office

GREEN FIT

Reg. No. 4,068,330

FUNCTIONAL FOODS INC (CALIFORNIA CORPORATION)
35 LA VERNE AVE.
LONG BEACH, CA 90803

Registered Dec. 6, 2011

Int. Cl.: 5

FOR: NUTRITIONAL FORTIFIED BEVERAGES, IN CLASS 5 (U.S. CLS. 6, 18, 44, 46, 51 AND 52).

TRADEMARK

FIRST USE 7-9-2009; IN COMMERCE 7-28-2010.

PRINCIPAL REGISTER

THE MARK CONSISTS OF STANDARD CHARACTERS WITHOUT CLAIM TO ANY PARTICULAR FONT, STYLE, SIZE, OR COLOR.

NO CLAIM IS MADE TO THE EXCLUSIVE RIGHT TO USE "GREEN", APART FROM THE MARK AS SHOWN.

SN 85-126,247, FILED 9-9-2010.

LINDA POWELL, EXAMINING ATTORNEY



David J. Kybas

Director of the United States Patent and Trademark Office

United States of America
United States Patent and Trademark Office

bobble

Reg. No. 4,068,331

Registered Dec. 6, 2011

Int. Cls.: 11 and 21

TRADEMARK

PRINCIPAL REGISTER

MOVE COLLECTIVE LLC (DELAWARE LIMITED LIABILITY COMPANY)
319 LAFAYETTE STREET #210
NEW YORK, NY 10012

FOR: WATER FILTERING UNITS FOR REFILLABLE, REUSABLE PLASTIC WATER BOTTLES, FILTERS FOR DRINKING WATER, IN CLASS 11 (U.S. CLS. 13, 21, 23, 31 AND 34).

FIRST USE 9-15-2009; IN COMMERCE 2-19-2010.

FOR: BOTTLES, SOLD EMPTY; PLASTIC WATER BOTTLES SOLD EMPTY; SPORTS BOTTLES SOLD EMPTY; SQUEEZE BOTTLE SOLD EMPTY, IN CLASS 21 (U.S. CLS. 2, 13, 23, 29, 30, 33, 40 AND 50).

FIRST USE 9-15-2009; IN COMMERCE 2-19-2010.

OWNER OF U.S. REG. NO. 3,851,514.

THE MARK CONSISTS OF THE WORD "BOBBLE" IN STYLIZED FONT.

SN 85-126,254, FILED 9-9-2010.

ELI HELLMAN, EXAMINING ATTORNEY



David J. Kyffers

Director of the United States Patent and Trademark Office

United States of America

United States Patent and Trademark Office

KOOL N FUN

Reg. No. 4,068,332

Registered Dec. 6, 2011

Int. Cl.: 9

TRADEMARK

PRINCIPAL REGISTER

MARK BRIC INC. (VIRGINIA CORPORATION)
4740 CHUDOBA PARKWAY
PRINCE GEORGE, VA 23875

FOR: COMPUTER STORAGE DEVICES, NAMELY, BLANK FLASH DRIVES, IN CLASS 9
(U.S. CLS. 21, 23, 26, 36 AND 38).

FIRST USE 9-10-2010; IN COMMERCE 9-10-2010.

THE MARK CONSISTS OF STANDARD CHARACTERS WITHOUT CLAIM TO ANY PARTICULAR FONT, STYLE, SIZE, OR COLOR.

SN 85-126,475, FILED 9-9-2010.

TRACY FLETCHER, EXAMINING ATTORNEY



David J. Kybas

Director of the United States Patent and Trademark Office

United States of America

United States Patent and Trademark Office

TRANS SEASONAL

Reg. No. 4,068,333

GARCIA GROUP, INC. (GEORGIA CORPORATION)
5154 PEACHTREE INDUSTRIAL BLVD.
ATLANTA, GA 30341

Registered Dec. 6, 2011

Int. Cls.: 4 and 21

FOR: CANDLES, IN CLASS 4 (U.S. CLS. 1, 6 AND 15).

TRADEMARK

FIRST USE 9-16-2011; IN COMMERCE 9-16-2011.

PRINCIPAL REGISTER

FOR: VASES , IN CLASS 21 (U.S. CLS. 2, 13, 23, 29, 30, 33, 40 AND 50).

FIRST USE 9-16-2011; IN COMMERCE 9-16-2011.

THE MARK CONSISTS OF STANDARD CHARACTERS WITHOUT CLAIM TO ANY PARTICULAR FONT, STYLE, SIZE, OR COLOR.

SN 85-126,649, FILED 9-10-2010.

CHRIS WELLS, EXAMINING ATTORNEY



David J. Kybas

Director of the United States Patent and Trademark Office

United States of America

United States Patent and Trademark Office

LIN DANTO

Reg. No. 4,068,334

Registered Dec. 6, 2011

Int. Cl.: 18

TRADEMARK

PRINCIPAL REGISTER

LIN DANTO LLC (ARIZONA LIMITED LIABILITY COMPANY)
21215 N 75TH ST.
LIN DANTO
SCOTTSDALE, AZ 85255

FOR: HANDBAGS, PURSES AND WALLETS; LEATHER HANDBAGS, IN CLASS 18 (U.S. CLS. 1, 2, 3, 22 AND 41).

FIRST USE 5-0-2011; IN COMMERCE 5-0-2011.

THE MARK CONSISTS OF STANDARD CHARACTERS WITHOUT CLAIM TO ANY PARTICULAR FONT, STYLE, SIZE, OR COLOR.

THE NAME(S), PORTRAIT(S), AND/OR SIGNATURE(S) SHOWN IN THE MARK IDENTIFIES THE NICKNAME OF "LINDSAY DANTO", WHOSE CONSENT(S) TO REGISTER IS MADE OF RECORD.

SN 85-127,332, FILED 9-10-2010.

CIMMERIAN COLEMAN, EXAMINING ATTORNEY



David J. Kyros

Director of the United States Patent and Trademark Office

United States of America

United States Patent and Trademark Office

Hadpro

Reg. No. 4,068,335

Registered Dec. 6, 2011

Int. Cl.: 37

SERVICE MARK

PRINCIPAL REGISTER

WHITE GLOVE RESTAURANT SERVICES, LLC (DELAWARE LIMITED LIABILITY COMPANY)
4725A EISENHOWER AVENUE
ALEXANDRIA, VA 22304

FOR: KITCHEN EXHAUST CLEANING SERVICES; MAINTENANCE OF KITCHEN EXHAUST SYSTEMS; MAINTENANCE SERVICES FOR COMMERCIAL KITCHENS, NAMELY, FILTER REPLACEMENT SERVICES, IN CLASS 37 (U.S. CLS. 100, 103 AND 106).

FIRST USE 7-1-2011; IN COMMERCE 7-1-2011.

THE MARK CONSISTS OF STANDARD CHARACTERS WITHOUT CLAIM TO ANY PARTICULAR FONT, STYLE, SIZE, OR COLOR.

SN 85-128,068, FILED 9-13-2010.

INGRID C. EULIN, EXAMINING ATTORNEY



David J. Kybas

Director of the United States Patent and Trademark Office

United States of America

United States Patent and Trademark Office



Reg. No. 4,068,336

SABINSA CORPORATION (NEW JERSEY CORPORATION)
20 LAKE DRIVE
EAST WINDSOR, NJ 08520

Registered Dec. 6, 2011

Int. Cl.: 5

FOR: PROBIOTICS, NAMELY, LACTOBACILLUS SPOROGENES SPORES POWDER, IN CLASS 5 (U.S. CLS. 6, 18, 44, 46, 51 AND 52).

TRADEMARK

FIRST USE 9-15-2010; IN COMMERCE 9-15-2010.

PRINCIPAL REGISTER

OWNER OF U.S. REG. NO. 1,701,366.

THE COLOR(S) GRAY, PURPLE AND WHITE IS/ARE CLAIMED AS A FEATURE OF THE MARK.

NO CLAIM IS MADE TO THE EXCLUSIVE RIGHT TO USE "STABLE PROBIOTIC", APART FROM THE MARK AS SHOWN.

THE MARK CONSISTS OF STYLIZED LETTERS "L" (UPPER CASE) "ACTO" (LOWER CASE) IN GRAY FONT AND THE LETTERS "S"(UPPER CASE) "PORE" (LOWER CASE) IN PURPLE FONT; WITH THE WORD "SPORE" ENCLOSED IN PARENTHESIS APPEARING AT AN ANGLE OPENING ABOVE THE "S" AND CLOSING BELOW THE "E", AND WITH THE OPENING PARENTHESIS CONTAINING THE WORD "STABLE" IN WHITE FONT AND THE CLOSING PARENTHESIS CONTAINING THE WORD "PROBIOTIC" IN WHITE FONT.



SN 85-128,093, FILED 9-13-2010.

RONALD AIKENS, EXAMINING ATTORNEY

David J. Kybas

Director of the United States Patent and Trademark Office

United States of America

United States Patent and Trademark Office



Reg. No. 4,068,337

Registered Dec. 6, 2011

Int. Cl.: 5

TRADEMARK

PRINCIPAL REGISTER

SABINSA CORPORATION (NEW JERSEY CORPORATION)
20 LAKE DRIVE
EAST WINDSOR, NJ 08520

FOR: MIXTURE OF GARCINOL AND HYDROXYCITRIC ACID EXTRACTED FROM THE FRUIT RIND OF GARCINIA CAMBOGIA, FOR USE AS AN INGREDIENT IN NUTRITIONAL SUPPLEMENTS AND TOPICAL FORMULATIONS, IN CLASS 5 (U.S. CLS. 6, 18, 44, 46, 51 AND 52).

FIRST USE 9-15-2010; IN COMMERCE 9-15-2010.

OWNER OF U.S. REG. NO. 2,681,877.

THE COLOR(S) GREEN AND BURNT ORANGE IS/ARE CLAIMED AS A FEATURE OF THE MARK.

THE MARK CONSISTS OF STYLIZED LETTERS "G" (UPPER CASE) "AR" (LOWER CASE) IN GREEN FONT, AND THE LETTERS "C"(UPPER CASE) AND "ITRIN" (LOWER CASE) IN BURNT ORANGE, WITH A STYLIZED STICK FIGURE APPEARING ON THE LETTER "C", WITH THE LEFT SIDE OF THE BODY COLORED IN GREEN, AND THE RIGHT SIDE AND HEAD COLORED IN BURNT ORANGE.

SN 85-128,128, FILED 9-13-2010.

RONALD AIKENS, EXAMINING ATTORNEY



David J. Kybas

Director of the United States Patent and Trademark Office

United States of America

United States Patent and Trademark Office

BRIDGING THE GAP BETWEEN FASHION AND FINE

Reg. No. 4,068,338

Registered Dec. 6, 2011

Int. Cl.: 14

TRADEMARK

PRINCIPAL REGISTER

JUDITH BRIGHT, LLC (TENNESSEE LIMITED LIABILITY COMPANY)
607 CANTRELL AVENUE
NASHVILLE, TN 37215

FOR: JEWELRY, IN CLASS 14 (U.S. CLS. 2, 27, 28 AND 50).

FIRST USE 9-1-2010; IN COMMERCE 9-1-2010.

THE MARK CONSISTS OF STANDARD CHARACTERS WITHOUT CLAIM TO ANY PARTICULAR FONT, STYLE, SIZE, OR COLOR.

SN 85-128,458, FILED 9-13-2010.

JUDITH HELFMAN, EXAMINING ATTORNEY



David J. Kybas

Director of the United States Patent and Trademark Office

United States of America

United States Patent and Trademark Office

SANICONDENS

Reg. No. 4,068,339

SOCIETE FRANCAISE D'ASSAINISSEMENT-SFA (FRANCE SOCIÉTÉ ANONYME (SA))
8, RUE D'ABOUKIR
PARIS, FRANCE F-75002

Registered Dec. 6, 2011

Int. Cl.: 7

FOR: PUMPS BEING PARTS OF MACHINES, IN CLASS 7 (U.S. CLS. 13, 19, 21, 23, 31, 34 AND 35).

TRADEMARK

FIRST USE 1-0-2011; IN COMMERCE 7-0-2011.

PRINCIPAL REGISTER

THE MARK CONSISTS OF STANDARD CHARACTERS WITHOUT CLAIM TO ANY PARTICULAR FONT, STYLE, SIZE, OR COLOR.

SN 85-128,503, FILED 9-13-2010.

JASON TURNER, EXAMINING ATTORNEY



David J. Kybas

Director of the United States Patent and Trademark Office

United States of America
United States Patent and Trademark Office

SCORE
RESTORE

Reg. No. 4,068,340

SPORTABLE SCOREBOARDS, INC. (KENTUCKY CORPORATION)
106 MAX HURT DRIVE
MURRAY, KY 42071

Registered Dec. 6, 2011

Int. Cls.: 9 and 37

FOR: ELECTRONIC SCOREBOARDS, IN CLASS 9 (U.S. CLS. 21, 23, 26, 36 AND 38).

TRADEMARK

FIRST USE 8-0-2010; IN COMMERCE 8-0-2010.

SERVICE MARK

FOR: INSTALLATION AND MAINTENANCE OF ELECTRONIC SCOREBOARDS, IN CLASS 37 (U.S. CLS. 100, 103 AND 106).

PRINCIPAL REGISTER

FIRST USE 8-0-2010; IN COMMERCE 8-0-2010.

THE MARK CONSISTS OF THE RAGGED WORD "SCORE" WITH THE WORD "RESTORE" UNDERNEATH SUPERIMPOSED OVER A RECTANGULAR BOX.

SN 85-128,687, FILED 9-13-2010.

MAYUR VAGHANI, EXAMINING ATTORNEY



David J. Kybas

Director of the United States Patent and Trademark Office

United States of America

United States Patent and Trademark Office



Reg. No. 4,068,341

Registered Dec. 6, 2011

Int. Cl.: 9

TRADEMARK

PRINCIPAL REGISTER

PLASTOFORM INDUSTRIES LIMITED (HONG KONG LIMITED COMPANY (LTD.))
UNITS 6A-12, 15/F., MITA CENTRE
552-566 CASTLE PEAK ROAD
KWAI CHUNG, N.T., HONG KONG

FOR: APPARATUS FOR RECORDING, TRANSMISSION, PROCESSING AND REPRODUCTION OF SOUND, IMAGES OR DATA; AUDIO AMPLIFIERS; CABINETS FOR LOUDSPEAKERS; COMPUTER HARDWARE AND PERIPHERALS; COMPUTERS; LOUDSPEAKERS, IN CLASS 9 (U.S. CLS. 21, 23, 26, 36 AND 38).

FIRST USE 10-13-2010; IN COMMERCE 10-13-2010.

THE MARK CONSISTS OF THE WORD "IUI" WITH A SQUARE BORDER.

THE WORDING "IUI" HAS NO MEANING IN A FOREIGN LANGUAGE.

SN 85-128,726, FILED 9-14-2010.

JOHN E. MICHOS, EXAMINING ATTORNEY



David J. Kybas

Director of the United States Patent and Trademark Office

United States of America

United States Patent and Trademark Office

HERSHEY'S IS HALLOWEEN

Reg. No. 4,068,342

Registered Dec. 6, 2011

Int. Cl.: 30

TRADEMARK

PRINCIPAL REGISTER

HERSHEY CHOCOLATE & CONFECTIONERY CORPORATION (DELAWARE CORPORATION)
SUITE 204
4860 ROBB STREET
WHEAT RIDGE, CO 80033

FOR: CANDY; CHOCOLATE, IN CLASS 30 (U.S. CL. 46).

FIRST USE 9-30-2011; IN COMMERCE 9-30-2011.

THE MARK CONSISTS OF STANDARD CHARACTERS WITHOUT CLAIM TO ANY PARTICULAR FONT, STYLE, SIZE, OR COLOR.

OWNER OF U.S. REG. NOS. 54,041, 1,367,943, AND OTHERS.

NO CLAIM IS MADE TO THE EXCLUSIVE RIGHT TO USE "HALLOWEEN", APART FROM THE MARK AS SHOWN.

SN 85-128,854, FILED 9-14-2010.

ZHALEH DELANEY, EXAMINING ATTORNEY



David J. Kyffers

Director of the United States Patent and Trademark Office

United States of America

United States Patent and Trademark Office

HUB GRAPPLER

Reg. No. 4,068,343

Registered Dec. 6, 2011

Int. Cl.: 8

TRADEMARK

PRINCIPAL REGISTER

SPX CORPORATION (DELAWARE CORPORATION)
13515 BALLANTYNE CORPORATE PLACE
CHARLOTTE, NC 20036

FOR: HAND TOOLS, NAMELY, VEHICLE HUB PULLERS, IN CLASS 8 (U.S. CLS. 23, 28 AND 44).

FIRST USE 9-20-2010; IN COMMERCE 9-20-2010.

THE MARK CONSISTS OF STANDARD CHARACTERS WITHOUT CLAIM TO ANY PARTICULAR FONT, STYLE, SIZE, OR COLOR.

NO CLAIM IS MADE TO THE EXCLUSIVE RIGHT TO USE "HUB", APART FROM THE MARK AS SHOWN.

SN 85-128,920, FILED 9-14-2010.

JOHN GARTNER, EXAMINING ATTORNEY



David J. Kyffers

Director of the United States Patent and Trademark Office

United States of America

United States Patent and Trademark Office

IAGNOSIS

Reg. No. 4,068,344

Registered Dec. 6, 2011

Int. Cl.: 44

SERVICE MARK

PRINCIPAL REGISTER

IAGNOSIS, INC. (PENNSYLVANIA CORPORATION)
222 EAST MCMURRAY ROAD
MCMURRAY, PA 15317

FOR: MEDICAL SERVICES, NAMELY, ASSESSMENT AND TREATMENT OF DERMATOLOGICAL CONDITIONS, IN CLASS 44 (U.S. CLS. 100 AND 101).

FIRST USE 12-20-2010; IN COMMERCE 12-20-2010.

THE MARK CONSISTS OF STANDARD CHARACTERS WITHOUT CLAIM TO ANY PARTICULAR FONT, STYLE, SIZE, OR COLOR.

SN 85-129,059, FILED 9-14-2010.

BRENDAN MCCAULEY, EXAMINING ATTORNEY



David J. Kybas

Director of the United States Patent and Trademark Office

United States of America

United States Patent and Trademark Office

PERFECT BY NATURE PORTABLE BY DESIGN

Reg. No. 4,068,345

RAINIER FRUIT COMPANY (WASHINGTON CORPORATION)
P.O. BOX 189
SELAH, WA 98942

Registered Dec. 6, 2011

Int. Cl.: 31

FOR: FRESH FRUITS; UNPROCESSED APPLES; UNPROCESSED PEARS, IN CLASS 31 (U.S. CLS. 1 AND 46).

TRADEMARK

FIRST USE 10-31-2010; IN COMMERCE 10-31-2010.

PRINCIPAL REGISTER

THE MARK CONSISTS OF STANDARD CHARACTERS WITHOUT CLAIM TO ANY PARTICULAR FONT, STYLE, SIZE, OR COLOR.

SN 85-129,064, FILED 9-14-2010.

JOHN GARTNER, EXAMINING ATTORNEY



David J. Kybas

Director of the United States Patent and Trademark Office

United States of America

United States Patent and Trademark Office

PIPER DOWN

Reg. No. 4,068,346

Registered Dec. 6, 2011

Int. Cl.: 32

TRADEMARK

PRINCIPAL REGISTER

HOME BREW MART, INC. (CALIFORNIA CORPORATION)
10051 OLD GROVE ROAD, SUITE B
SAN DIEGO, CA 92131

FOR: BEER, IN CLASS 32 (U.S. CLS. 45, 46 AND 48).

FIRST USE 10-6-2009; IN COMMERCE 10-6-2009.

THE MARK CONSISTS OF STANDARD CHARACTERS WITHOUT CLAIM TO ANY PARTICULAR FONT, STYLE, SIZE, OR COLOR.

SN 85-129,520, FILED 9-14-2010.

ERIN FALK, EXAMINING ATTORNEY



David J. Kybas

Director of the United States Patent and Trademark Office

United States of America

United States Patent and Trademark Office



Reg. No. 4,068,347

Registered Dec. 6, 2011

Int. Cl.: 41

SERVICE MARK

PRINCIPAL REGISTER

FERDINAND, JANEEN (UNITED STATES INDIVIDUAL)
P.O. BOX 67
TEMPLE CITY, CA 91780

FOR: ENTERTAINMENT SERVICES IN THE NATURE OF LIVE MUSICAL PERFORMANCES; MUSIC COMPOSITION FOR OTHERS; MUSIC PRODUCTION SERVICES; MUSIC PUBLISHING SERVICES; PRODUCTION OF SOUND RECORDINGS, IN CLASS 41 (U.S. CLS. 100, 101 AND 107).

FIRST USE 10-10-2011; IN COMMERCE 10-10-2011.

NO CLAIM IS MADE TO THE EXCLUSIVE RIGHT TO USE "PUBLISHING HOUSE", APART FROM THE MARK AS SHOWN.

THE MARK CONSISTS OF A HOUSE ON THE OUTSIDE COMPRISED OF A MOTHER AND FATHER FIGURE. BOTH CHARACTERS ARE TOUCHING HANDS OVER THE CHILDREN INSIDE THE HOUSE REPRESENTING THE COVER; OR HOUSE. THE SISTER AND BROTHER ARE INSIDE THE HOUSE HOLDING HANDS ENCLOSED IN A HEART. "THE BLESSING" AND "PUBLISHING HOUSE" ARE BOTH PRINTED BELOW THE HOUSE, WITH "PUBLISHING HOUSE" IN CAPITAL LETTERS.

SN 85-130,170, FILED 9-15-2010.

BARBARA GAYNOR, EXAMINING ATTORNEY



David J. Kyros

Director of the United States Patent and Trademark Office

United States of America

United States Patent and Trademark Office

SERALITY

Reg. No. 4,068,348

Registered Dec. 6, 2011

Int. Cl.: 42

SERVICE MARK

PRINCIPAL REGISTER

SERALITY, INC. (DELAWARE CORPORATION)
225 WINTER STREET
HOPKINTON, MA 01748

FOR: SOFTWARE AS A SERVICE (SAAS) FEATURING SOFTWARE IN THE FIELD OF PERSONAL SUPPORT SERVICES FOR MEDICAL INSURERS, EMPLOYEE ASSISTANCE PLANS, SERVICE PROVIDERS, AND CAREGIVERS OF THE ELDERLY, ILL AND/OR DISABLED, AND FEATURING BILLING, TIMEKEEPING, CASE MANAGEMENT, TASK MANAGEMENT AND PLANNING, SCHEDULING, CALENDAR, CONTENT CREATION, AND ELECTRONIC COMMUNICATION FUNCTIONS, AND FEATURING E-COMMERCE SOFTWARE TO ALLOW USERS TO PERFORM ELECTRONIC BUSINESS TRANSACTIONS VIA A GLOBAL COMPUTER NETWORK; APPLICATION SERVICE PROVIDER FEATURING APPLICATION PROGRAMMING INTERFACE (API) SOFTWARE FOR USE IN BUILDING SOFTWARE APPLICATIONS; ALL OF THE ABOVE IN THE FIELD OF PROVIDING PERSONAL AND MEDICAL ASSISTANCE TO THE ELDERLY, ILL, AND/OR DISABLED AND THEIR CAREGIVERS, AND ECONOMIC, SOCIAL, AND POLITICAL ISSUES RELATED TO SAME, IN CLASS 42 (U.S. CLS. 100 AND 101).

FIRST USE 4-27-2011; IN COMMERCE 4-27-2011.

THE MARK CONSISTS OF STANDARD CHARACTERS WITHOUT CLAIM TO ANY PARTICULAR FONT, STYLE, SIZE, OR COLOR.

SN 85-130,258, FILED 9-15-2010.

MARLENE BELL, EXAMINING ATTORNEY



David J. Kyros

Director of the United States Patent and Trademark Office

United States of America

United States Patent and Trademark Office

ATOMIC BAKERY

Reg. No. 4,068,349

PENNINGTON, BRANDON (UNITED STATES INDIVIDUAL)
890 DORAL PLACE
ABINGDON, VA 24211

Registered Dec. 6, 2011

Int. Cl.: 40

FOR: BAKERY SERVICES, NAMELY, THE MANUFACTURE OF BAKERY PRODUCTS TO ORDER AND/OR SPECIFICATION OF OTHERS, IN CLASS 40 (U.S. CLS. 100, 103 AND 106).

SERVICE MARK

FIRST USE 4-30-2011; IN COMMERCE 4-30-2011.

PRINCIPAL REGISTER

THE MARK CONSISTS OF STANDARD CHARACTERS WITHOUT CLAIM TO ANY PARTICULAR FONT, STYLE, SIZE, OR COLOR.

NO CLAIM IS MADE TO THE EXCLUSIVE RIGHT TO USE "BAKERY", APART FROM THE MARK AS SHOWN.

SN 85-130,261, FILED 9-15-2010.

MARLENE BELL, EXAMINING ATTORNEY



David J. Kyfos

Director of the United States Patent and Trademark Office

United States of America

United States Patent and Trademark Office

QMIX

Reg. No. 4,068,350

Registered Dec. 6, 2011

Int. Cl.: 5

TRADEMARK

PRINCIPAL REGISTER

DENTSPLY INTERNATIONAL INC. (DELAWARE CORPORATION)
221 WEST PHILADELPHIA STREET
YORK, PA 174050872

FOR: DENTAL COMPOUNDS USED IN ENDODONTIC PROCEDURES, IN CLASS 5 (U.S. CLS. 6, 18, 44, 46, 51 AND 52).

FIRST USE 4-14-2011; IN COMMERCE 4-14-2011.

THE MARK CONSISTS OF STANDARD CHARACTERS WITHOUT CLAIM TO ANY PARTICULAR FONT, STYLE, SIZE, OR COLOR.

SN 85-130,283, FILED 9-15-2010.

DOMINICK J. SALEMI, EXAMINING ATTORNEY



David J. Kybas

Director of the United States Patent and Trademark Office

United States of America

United States Patent and Trademark Office

BeSave!

Reg. No. 4,068,351

Registered Dec. 6, 2011

Int. Cl.: 3

TRADEMARK

PRINCIPAL REGISTER

SOCIETE ACTIVE A VOCATION ECOLOGIQUE (FRANCE SOCIÉTÉ PRIVÉE À
RESPONSABILITÉ LIMITÉE (SPRL))
SA LES BASTIDES BLANCHES
SAINTE TULLE, FRANCE 04220

FOR: COSMETICS, IN CLASS 3 (U.S. CLS. 1, 4, 6, 50, 51 AND 52).

FIRST USE 6-15-2011; IN COMMERCE 6-15-2011.

THE MARK CONSISTS OF STANDARD CHARACTERS WITHOUT CLAIM TO ANY PAR-
TICULAR FONT, STYLE, SIZE, OR COLOR.

SN 85-130,299, FILED 9-15-2010.

MARK PILARO, EXAMINING ATTORNEY



David J. Kybas

Director of the United States Patent and Trademark Office

United States of America

United States Patent and Trademark Office

Eastern Sun Nutraceuticals

Reg. No. 4,068,352

Registered Dec. 6, 2011

Int. Cl.: 5

TRADEMARK

PRINCIPAL REGISTER

EASTERN SUN NUTRACEUTICALS, LLC (MASSACHUSETTS LIMITED LIABILITY COMPANY)
20 LESLIE ROAD
WINCHESTER, MA 01890

FOR: NUTRACEUTICALS FOR USE AS A DIETARY SUPPLEMENT, IN CLASS 5 (U.S. CLS. 6, 18, 44, 46, 51 AND 52).

FIRST USE 4-13-2011; IN COMMERCE 4-13-2011.

THE MARK CONSISTS OF STANDARD CHARACTERS WITHOUT CLAIM TO ANY PARTICULAR FONT, STYLE, SIZE, OR COLOR.

NO CLAIM IS MADE TO THE EXCLUSIVE RIGHT TO USE "NUTRACEUTICALS", APART FROM THE MARK AS SHOWN.

SN 85-130,761, FILED 9-16-2010.

ANNE E. GUSTASON, EXAMINING ATTORNEY



David J. Kybas

Director of the United States Patent and Trademark Office

United States of America

United States Patent and Trademark Office

SUB ZERO

Reg. No. 4,068,353

Registered Dec. 6, 2011

Int. Cl.: 11

TRADEMARK

PRINCIPAL REGISTER

MIRTEL XXI, S.L. (SPAIN SOCIEDAD DE RESPONSABILIDAD LIMITADA (SL))
MUNTANER 425, 2.2.
MIRTEL XXI, S. L.
BARCELONA, SPAIN 08022

FOR: FLASHLIGHTS, IN CLASS 11 (U.S. CLS. 13, 21, 23, 31 AND 34).

FIRST USE 12-31-2010; IN COMMERCE 12-31-2010.

THE MARK CONSISTS OF STANDARD CHARACTERS WITHOUT CLAIM TO ANY PARTICULAR FONT, STYLE, SIZE, OR COLOR.

SN 85-130,796, FILED 9-16-2010.

KIM SAITO, EXAMINING ATTORNEY



David J. Kybas

Director of the United States Patent and Trademark Office

United States of America

United States Patent and Trademark Office

CHAIR-IOT

Reg. No. 4,068,354

STEPHANIE SAIA (UNITED STATES INDIVIDUAL)
46460 STRATHMORE COURT
PLYMOUTH, MI 48170

Registered Dec. 6, 2011

Int. Cl.: 12

FOR: CARTS, NAMELY, WHEELED, COLLAPSIBLE, CANVAS CARTS FOR TRANSPORTING AND HAULING OBJECTS, IN CLASS 12 (U.S. CLS. 19, 21, 23, 31, 35 AND 44).

TRADEMARK

FIRST USE 6-1-2011; IN COMMERCE 6-1-2011.

PRINCIPAL REGISTER

THE MARK CONSISTS OF STANDARD CHARACTERS WITHOUT CLAIM TO ANY PARTICULAR FONT, STYLE, SIZE, OR COLOR.

SN 85-130,842, FILED 9-16-2010.

FLORENTINA BLANDU, EXAMINING ATTORNEY



David J. Kybas

Director of the United States Patent and Trademark Office

United States of America

United States Patent and Trademark Office



Reg. No. 4,068,355

Registered Dec. 6, 2011

Int. Cl.: 25

TRADEMARK

PRINCIPAL REGISTER

ESPENUSA PRODUCTS OF CALIFORNIA, LLC (CALIFORNIA LIMITED LIABILITY COMPANY)
SUITE #B190
ALISO VIEJO, CA 92656

FOR: CLOTHING, NAMELY, SHIRTS, JACKETS, COATS, PANTS, TIGHTS, SOCKS, SKIRTS, SHORTS, T-SHIRTS, SHOES, LEG WARMERS, ARM WARMERS, HATS, TIES, BOOTS, GLOVES, MITTENS, BELTS, VESTS, IN CLASS 25 (U.S. CLS. 22 AND 39).

FIRST USE 5-1-2011; IN COMMERCE 5-1-2011.

THE MARK CONSISTS OF A DEPICTION OF A DUCK LYING ON ITS BACK WITH ITS FEET IN THE AIR.

SN 85-131,035, FILED 9-16-2010.

TIMOTHY FINNEGAN, EXAMINING ATTORNEY



David J. Kybas

Director of the United States Patent and Trademark Office

United States of America

United States Patent and Trademark Office

STYLE MATCHES

Reg. No. 4,068,356

Registered Dec. 6, 2011

Int. Cls.: 35 and 36

SERVICE MARK

PRINCIPAL REGISTER

ALLIANCE DATA SYSTEMS CORPORATION (DELAWARE CORPORATION)
7500 DALLAS PARKWAY, SUITE 700
PLANO, TX 75024

FOR: CLUB SERVICES, NAMELY, PROMOTING THE INTERESTS OF RETAIL STORES AND RETAIL STORE CONSUMERS; CUSTOMER LOYALTY SERVICES AND CUSTOMER CLUB SERVICES, FOR COMMERCIAL, PROMOTIONAL AND/OR ADVERTISING PURPOSES; MEMBERSHIP CLUB SERVICES PROVIDING DISCOUNTS AND PROCESSING REBATES FOR THE SERVICES OF OTHERS; PROMOTING THE GOODS OF OTHERS, NAMELY, PROVIDING COUPONS, REBATES AND VOUCHERS FOR THE GOODS OF OTHERS; PROMOTING THE GOODS OF OTHERS, NAMELY, PROVIDING INFORMATION REGARDING DISCOUNTS, COUPONS, REBATES, VOUCHERS AND SPECIAL OFFERS FOR THE GOODS OF OTHERS, IN CLASS 35 (U.S. CLS. 100, 101 AND 102).

FIRST USE 10-31-2010; IN COMMERCE 10-31-2010.

FOR: LOYALTY PROGRAM PAYMENT PROCESSING SERVICES; PROVIDING CASH AND OTHER REBATES FOR CREDIT CARD USE AS PART OF A CUSTOMER LOYALTY PROGRAM, IN CLASS 36 (U.S. CLS. 100, 101 AND 102).

FIRST USE 10-31-2010; IN COMMERCE 10-31-2010.

THE MARK CONSISTS OF STANDARD CHARACTERS WITHOUT CLAIM TO ANY PARTICULAR FONT, STYLE, SIZE, OR COLOR.

SN 85-131,216, FILED 9-16-2010.

REBECCA POVARCHUK, EXAMINING ATTORNEY



David J. Kybas

Director of the United States Patent and Trademark Office

United States of America

United States Patent and Trademark Office

ABANDON SHIP

Reg. No. 4,068,357

Registered Dec. 6, 2011

Int. Cl.: 32

TRADEMARK

PRINCIPAL REGISTER

HOME BREW MART, INC. (CALIFORNIA CORPORATION)
10051 OLD GROVE ROAD, SUITE B
SAN DIEGO, CA 92131

FOR: BEER, IN CLASS 32 (U.S. CLS. 45, 46 AND 48).

FIRST USE 6-20-2006; IN COMMERCE 6-20-2006.

THE MARK CONSISTS OF STANDARD CHARACTERS WITHOUT CLAIM TO ANY PARTICULAR FONT, STYLE, SIZE, OR COLOR.

SN 85-132,013, FILED 9-17-2010.

ERIN FALK, EXAMINING ATTORNEY



David J. Kybas

Director of the United States Patent and Trademark Office

United States of America

United States Patent and Trademark Office

PRESERVA

Reg. No. 4,068,358

Registered Dec. 6, 2011

Int. Cl.: 11

TRADEMARK

PRINCIPAL REGISTER

WHIRLPOOL PROPERTIES, INC. (MICHIGAN CORPORATION)
SUITE 101
500 RENAISSANCE DRIVE
ST. JOSEPH, MI 49085

FOR: REFRIGERATORS, IN CLASS 11 (U.S. CLS. 13, 21, 23, 31 AND 34).

FIRST USE 9-17-2011; IN COMMERCE 9-17-2011.

THE MARK CONSISTS OF STANDARD CHARACTERS WITHOUT CLAIM TO ANY PARTICULAR FONT, STYLE, SIZE, OR COLOR.

THE ENGLISH TRANSLATION OF THE WORD "PRESERVA" IN THE MARK IS "PRESERVES".

SN 85-132,024, FILED 9-17-2010.

CHERYL CLAYTON, EXAMINING ATTORNEY



David J. Kybas

Director of the United States Patent and Trademark Office

United States of America

United States Patent and Trademark Office

EVEN KEEL

Reg. No. 4,068,359

Registered Dec. 6, 2011

Int. Cl.: 32

TRADEMARK

PRINCIPAL REGISTER

HOME BREW MART, INC. (CALIFORNIA CORPORATION)
10051 OLD GROVE ROAD, SUITE B
SAN DIEGO, CA 92131

FOR: BEER, IN CLASS 32 (U.S. CLS. 45, 46 AND 48).

FIRST USE 4-3-2006; IN COMMERCE 4-3-2006.

THE MARK CONSISTS OF STANDARD CHARACTERS WITHOUT CLAIM TO ANY PARTICULAR FONT, STYLE, SIZE, OR COLOR.

SN 85-132,026, FILED 9-17-2010.

ERIN FALK, EXAMINING ATTORNEY



David J. Kybas

Director of the United States Patent and Trademark Office

United States of America

United States Patent and Trademark Office

OPENFEINT

Reg. No. 4,068,360

Registered Dec. 6, 2011

Int. Cls.: 9, 38, and 42

TRADEMARK

SERVICE MARK

PRINCIPAL REGISTER

OPENFEINT INC. (DELAWARE CORPORATION)
330 PRIMROSE ROAD, SUITE 515
BURLINGAME, CA 94010

FOR: COMPUTER SOFTWARE DEVELOPMENT TOOLS; COMPUTER SOFTWARE PLATFORMS FOR ELECTRONIC GAMES, IN CLASS 9 (U.S. CLS. 21, 23, 26, 36 AND 38).

FIRST USE 2-17-2009; IN COMMERCE 2-17-2009.

FOR: PROVIDING ONLINE CHAT ROOMS AND ELECTRONIC BULLETIN BOARDS; PROVIDING ONLINE FORUMS FOR COMMUNICATION IN THE FIELD OF ELECTRONIC GAMES, IN CLASS 38 (U.S. CLS. 100, 101 AND 104).

FIRST USE 12-0-2009; IN COMMERCE 12-0-2009.

FOR: PROVIDING TEMPORARY USE OF ON-LINE NON-DOWNLOADABLE SOFTWARE DEVELOPMENT TOOLS IN THE FIELD OF ELECTRONIC GAMES; PROVIDING TEMPORARY USE OF NON-DOWNLOADABLE SOFTWARE APPLICATIONS FOR SOCIAL NETWORKING, CREATING A VIRTUAL COMMUNITY, AND TRANSMISSION OF AUDIO, VIDEO, PHOTOGRAPHIC IMAGES, TEXT, GRAPHICS AND DATA IN THE FIELD OF ELECTRONIC GAMES; PLATFORM AS A SERVICE (PAAS) FEATURING COMPUTER SOFTWARE PLATFORMS FOR SOCIAL NETWORKING, CREATING A VIRTUAL COMMUNITY, AND TRANSMISSION OF AUDIO, VIDEO, PHOTOGRAPHIC IMAGES, TEXT, GRAPHICS AND DATA IN THE FIELD OF ELECTRONIC GAMES, IN CLASS 42 (U.S. CLS. 100 AND 101).

FIRST USE 2-17-2009; IN COMMERCE 2-17-2009.

THE MARK CONSISTS OF STANDARD CHARACTERS WITHOUT CLAIM TO ANY PARTICULAR FONT, STYLE, SIZE, OR COLOR.

SN 85-132,430, FILED 9-17-2010.

KELLEY WELLS, EXAMINING ATTORNEY



David J. Kyros

Director of the United States Patent and Trademark Office

United States of America

United States Patent and Trademark Office

BRAIN-STAINS

Reg. No. 4,068,361

Registered Dec. 6, 2011

Int. Cl.: 25

TRADEMARK

PRINCIPAL REGISTER

RIST, JOHN (UNITED STATES INDIVIDUAL)
28 MIDDLELINE HWY
SOUTHAMPTON, NY 11968

FOR: CLOTHING, NAMELY, T-SHIRTS, HATS, SHIRTS, POLO SHIRTS, SWEATSHIRTS, HOODED SWEATSHIRTS, JACKETS, AND SWEATERS, IN CLASS 25 (U.S. CLS. 22 AND 39).

FIRST USE 9-1-2010; IN COMMERCE 3-1-2011.

THE MARK CONSISTS OF STANDARD CHARACTERS WITHOUT CLAIM TO ANY PARTICULAR FONT, STYLE, SIZE, OR COLOR.

SN 85-132,740, FILED 9-18-2010.

MARK PILARO, EXAMINING ATTORNEY



David J. Kybas

Director of the United States Patent and Trademark Office

United States of America

United States Patent and Trademark Office

REFLEX EDGE

Reg. No. 4,068,362

Registered Dec. 6, 2011

Int. Cl.: 13

TRADEMARK

PRINCIPAL REGISTER

WILLIAM D. MARCONI (UNITED STATES INDIVIDUAL)
2831 TUSCARORA ROAD
ERIEVILLE, NY 13061

FOR: CARTRIDGE CASES; EXPLOSIVE CARTRIDGES; INCENDIARY CARTRIDGES;
MACHINE GUN CARTRIDGES; RELEASING APPARATUS FOR GRENADES, BOMBS, AND
THE LIKE; RIFLE CARTRIDGES, IN CLASS 13 (U.S. CLS. 2 AND 9).

FIRST USE 10-25-2011; IN COMMERCE 10-25-2011.

THE MARK CONSISTS OF STANDARD CHARACTERS WITHOUT CLAIM TO ANY PAR-
TICULAR FONT, STYLE, SIZE, OR COLOR.

SN 85-132,827, FILED 9-18-2010.

LAURIE MAYES, EXAMINING ATTORNEY



David J. Kybas

Director of the United States Patent and Trademark Office

United States of America

United States Patent and Trademark Office

PUX

Reg. No. 4,068,363

Registered Dec. 6, 2011

Int. Cl.: 10

TRADEMARK

PRINCIPAL REGISTER

LOGAN, BRENT ELLIS (UNITED STATES INDIVIDUAL)
1100 NEZ PERCE DRIVE
MOUNT VERNON, WA 98273

FOR: ORTHOPEDIC FOOTWEAR, IN CLASS 10 (U.S. CLS. 26, 39 AND 44).

FIRST USE 4-8-2011; IN COMMERCE 6-14-2011.

THE MARK CONSISTS OF STANDARD CHARACTERS WITHOUT CLAIM TO ANY PARTICULAR FONT, STYLE, SIZE, OR COLOR.

SN 85-132,854, FILED 9-18-2010.

MARK PILARO, EXAMINING ATTORNEY



David J. Kybas

Director of the United States Patent and Trademark Office

United States of America

United States Patent and Trademark Office

TOUCH THE EARTH

Reg. No. 4,068,364

Registered Dec. 6, 2011

Int. Cl.: 10

TRADEMARK

PRINCIPAL REGISTER

BRENT ELLIS LOGAN (UNITED STATES INDIVIDUAL)
1100 NEZ PERCE DRIVE
MOUNT VERNON, WA 98273

FOR: ORTHOPEDIC FOOTWEAR, IN CLASS 10 (U.S. CLS. 26, 39 AND 44).

FIRST USE 4-8-2011; IN COMMERCE 6-14-2011.

THE MARK CONSISTS OF STANDARD CHARACTERS WITHOUT CLAIM TO ANY PARTICULAR FONT, STYLE, SIZE, OR COLOR.

SN 85-132,858, FILED 9-18-2010.

ODESSA BIBBINS, EXAMINING ATTORNEY



David J. Kyffers

Director of the United States Patent and Trademark Office

United States of America

United States Patent and Trademark Office

RejuvenAir

Reg. No. 4,068,365

LK LIFESTYLE PRODUCTS LLC (CALIFORNIA LIMITED LIABILITY COMPANY)
33782 SHAMROCK LANE
SAN JUAN CAPISTRANO, CA 92675

Registered Dec. 6, 2011

Int. Cl.: 11

FOR: ELECTRIC FANS; PORTABLE ELECTRIC FANS, IN CLASS 11 (U.S. CLS. 13, 21, 23, 31 AND 34).

TRADEMARK

FIRST USE 9-8-2011; IN COMMERCE 9-8-2011.

PRINCIPAL REGISTER

THE MARK CONSISTS OF STANDARD CHARACTERS WITHOUT CLAIM TO ANY PARTICULAR FONT, STYLE, SIZE, OR COLOR.

SN 85-132,891, FILED 9-18-2010.

MARCIE MILONE, EXAMINING ATTORNEY



David J. Kybas

Director of the United States Patent and Trademark Office

United States of America

United States Patent and Trademark Office

The DailyAlly

Reg. No. 4,068,366

Registered Dec. 6, 2011

Int. Cls.: 42 and 44

SERVICE MARK

PRINCIPAL REGISTER

HEALTHALLY, LLC (GEORGIA LIMITED LIABILITY COMPANY)
#323
8343 ROSWELL ROAD
ATLANTA, GA 30350

FOR: APPLICATION SERVICE PROVIDER (ASP) FEATURING SOFTWARE FOR CREATING SEARCHABLE DATABASES OF INFORMATION AND DATA, FOR ORGANIZING AND VIEWING DIGITAL IMAGES AND PHOTOGRAPHS, FOR CONTROLLING AND MANAGING PATIENT MEDICAL INFORMATION, FOR PROVIDING PERSONALIZED HEALTHCARE, WELLNESS, DIET, EXERCISE TOOLS AND FOR MANAGING INCENTIVE AND REWARD PROGRAMS BY PUBLIC HEALTH, PRIVATE HEALTH, PRIVATE ENTERPRISES AND INDIVIDUALS, IN CLASS 42 (U.S. CLS. 100 AND 101).

FIRST USE 9-0-2011; IN COMMERCE 9-0-2011.

FOR: MAINTAINING HEALTH INFORMATION, FILES AND PERSONAL HEALTH MEDICAL RECORDS FOR PATIENTS AND HEALTHCARE PROVIDERS; WELLNESS SERVICES, NAMELY, PERSONAL ASSESSMENTS, PERSONALIZED ROUTINES, MAINTENANCE SCHEDULES, AND COUNSELING, IN CLASS 44 (U.S. CLS. 100 AND 101).

FIRST USE 9-0-2011; IN COMMERCE 9-0-2011.

THE MARK CONSISTS OF STANDARD CHARACTERS WITHOUT CLAIM TO ANY PARTICULAR FONT, STYLE, SIZE, OR COLOR.

SN 85-133,147, FILED 9-20-2010.

HOWARD B. LEVINE, EXAMINING ATTORNEY



David J. Kyros

Director of the United States Patent and Trademark Office

United States of America

United States Patent and Trademark Office

TOSPRESSO

Reg. No. 4,068,367

Registered Dec. 6, 2011

Int. Cl.: 11

TRADEMARK

PRINCIPAL REGISTER

TOSPRESSO INC. (CANADA CORPORATION)
5285 DECARIE, OFFICE 100
MONTREAL, CANADA H3W3C2

FOR: COFFEE FILTERS NOT OF PAPER BEING PART OF ELECTRIC COFFEE MAKERS; COFFEE ROASTERS; COFFEE ROASTING OVENS; ELECTRIC APPARATUS FOR MAKING COFFEE; ELECTRIC COFFEE BREWERS; ELECTRIC COFFEE MACHINES; ELECTRIC COFFEE MAKERS; ELECTRIC COFFEE PERCOLATORS; ELECTRIC COFFEE POTS; ELECTRIC COFFEE URNS; POWERED COFFEE, SEED AND COCOA BEAN ROASTERS, IN CLASS 11 (U.S. CLS. 13, 21, 23, 31 AND 34).

FIRST USE 10-1-2011; IN COMMERCE 10-1-2011.

THE MARK CONSISTS OF STANDARD CHARACTERS WITHOUT CLAIM TO ANY PARTICULAR FONT, STYLE, SIZE, OR COLOR.

SN 85-133,190, FILED 9-20-2010.

JENNIFER VASQUEZ, EXAMINING ATTORNEY



David J. Kyros

Director of the United States Patent and Trademark Office

United States of America

United States Patent and Trademark Office

The Legend of the Dark Imperial

Reg. No. 4,068,368

Registered Dec. 6, 2011

Int. Cl.: 16

TRADEMARK

PRINCIPAL REGISTER

MARQUES ARAUJO, THADEU (BRAZIL INDIVIDUAL)
CONDOMIO MARAMBAIA
RUA BARRETOS 461
VINHEDO, BRAZIL 13280-000

FOR: SERIES OF FICTION WORKS, NAMELY, NOVELS AND BOOKS, IN CLASS 16 (U.S. CLS. 2, 5, 22, 23, 29, 37, 38 AND 50).

FIRST USE 3-1-2011; IN COMMERCE 3-1-2011.

THE MARK CONSISTS OF STANDARD CHARACTERS WITHOUT CLAIM TO ANY PARTICULAR FONT, STYLE, SIZE, OR COLOR.

SN 85-133,310, FILED 9-20-2010.

KELLY TRUSILO, EXAMINING ATTORNEY



David J. Kybas

Director of the United States Patent and Trademark Office

United States of America

United States Patent and Trademark Office

Huitante-Cinq Limited Edition

Reg. No. 4,068,369

Registered Dec. 6, 2011

Int. Cl.: 18

MARQUES ARAUJO, THADEU (BRAZIL INDIVIDUAL)
CONDOMIO MARAMBAIA
RUA BARRETOS 461
VINHEDO, BRAZIL 13280-000

FOR: HANDBAGS; PURSES; WALLETS, IN CLASS 18 (U.S. CLS. 1, 2, 3, 22 AND 41).

TRADEMARK

FIRST USE 3-1-2011; IN COMMERCE 3-1-2011.

PRINCIPAL REGISTER

THE MARK CONSISTS OF STANDARD CHARACTERS WITHOUT CLAIM TO ANY PARTICULAR FONT, STYLE, SIZE, OR COLOR.

NO CLAIM IS MADE TO THE EXCLUSIVE RIGHT TO USE "LIMITED EDITION", APART FROM THE MARK AS SHOWN.

THE ENGLISH TRANSLATION OF "HUITANTE-CINQ" IN THE MARK IS "EIGHTY FIVE".

SN 85-133,350, FILED 9-20-2010.

KELLY TRUSILO, EXAMINING ATTORNEY



David J. Kybas

Director of the United States Patent and Trademark Office

United States of America

United States Patent and Trademark Office



Reg. No. 4,068,370

Registered Dec. 6, 2011

Int. Cl.: 30

TRADEMARK

PRINCIPAL REGISTER

ERIC DOMINGUEZ AYASO (CALIFORNIA SOLE PROPRIETORSHIP), DBA CORNBREAD DADDY,
2714 FIRST AVE.
SAN DIEGO, CA 92103

FOR: FOOD PACKAGE COMBINATIONS CONSISTING PRIMARILY OF BREAD, CRACKERS AND/OR COOKIES; MIXES FOR MAKING BREADING, IN CLASS 30 (U.S. CL. 46).

FIRST USE 10-10-2010; IN COMMERCE 11-1-2010.

NO CLAIM IS MADE TO THE EXCLUSIVE RIGHT TO USE "SPECIALTY CORNBREADS", APART FROM THE MARK AS SHOWN.

THE COLOR(S) BLACK, WHITE, YELLOW, GREEN, MEDIUM BROWN, ORANGE-YELLOW, LIGHT-BROWN AND LIGHT-GREEN IS/ARE CLAIMED AS A FEATURE OF THE MARK.

THE MARK CONSISTS OF A WHITE BACKGROUND, A SKILLET WITH A MEDIUM BROWN OUTER BODY, LIGHT BROWN INNER SKILLET, ON TOP OF WHICH IS AN EAR OF CORN WITH GREEN AND LIGHT-GREEN HUSKS, YELLOW AND ORANGE-YELLOW CORN KERNELS, BLACK LINES THAT DEFINE CORN HUSKS; ABOVE THE SKILLET ARE THE WORDS "CORNBREAD DADDY" IN YELLOW AND BELOW THE SKILLET HANDLE ARE THE WORDS "SPECIALTY CORNBREADS" IN BROWN.

SN 85-134,163, FILED 9-21-2010.

LINDA MICKLEBURGH, EXAMINING ATTORNEY



David J. Kybas

Director of the United States Patent and Trademark Office

United States of America

United States Patent and Trademark Office

TEMO

Reg. No. 4,068,371

Registered Dec. 6, 2011

Int. Cl.: 35

SERVICE MARK

PRINCIPAL REGISTER

TEMO INDUSTRIAL LIMITED LIABILITY COMPANY (WISCONSIN LIMITED LIABILITY COMPANY)
1046 CANARY LANE
ONALASKA, WI 54650

FOR: ONLINE, TELEPHONE, CATALOG, AND WHOLESALE ORDERING SERVICES FEATURING TOOLS, MACHINERY, SAFETY EQUIPMENT, AND AUTOMOTIVE EQUIPMENT, INCLUDING: POWER TOOLS FOR DRILLING, NAMELY, DRILLS, BITS FOR POWER DRILLS, COUNTERSINKS, SCREW EXTRACTORS, POWER TOOLS FOR REAMING, NAMELY, REAMERS, POWER TOOLS FOR THREADING, NAMELY, TAPS, DIES, THREADING MACHINES, POWER TOOLS FOR CUTTING, NAMELY, POWER-OPERATED SAWS, BLADES FOR POWER SAWS, HOLE SAWS, CUTTING WHEELS, POWER TOOLS FOR MILLING, NAMELY, MILLING CUTTERS, END MILLS, AND SHELL MILLS, POWER TOOLS FOR SANDING, GRINDING, DEBURRING, AND POLISHING, NAMELY, GRINDERS, ABRASIVE AND POLISHING DISKS, ABRASIVE AND POLISHING WHEELS, ABRASIVE AND POLISHING BELTS, ABRASIVE AND POLISHING DRUMS, ABRASIVE AND POLISHING PADS, ABRASIVE AND POLISHING SHEETS, GRINDSTONES, FILES, RASPS, BURRS, ABRASIVE AND POLISHING BRUSHES, POWER-OPERATED SCREWDRIVERS, TURNING TOOLS FOR LATHES, POWER TOOL PARTS AND WORKPIECE HOLDERS, NAMELY, COLLETS AND MANDRELS, HIGH-PRESSURE WASHERS, AIR-POWERED TOOLS, NAMELY, WRENCHES, SCREWDRIVERS, HAMMERS, SAWS, DRILLS, GRINDERS, SANDERS AIR COMPRESSORS, HAND TOOLS, NAMELY, HAMMERS, PLIERS, WRENCHES, TAP WRENCHES, TWIST SOCKETS, SNIPS, KNIVES, SAWS, SCREWDRIVERS, CABLE STRIPPERS, CHISELS, GRINDERS, SANDERS, PUNCHES, FILES, VISES, MANUALLY-OPERATED HYDRAULIC JACKS, CHAIN BLOCKS, PULLERS, MANUALLY OPERATED GREASE GUNS, CUTTING TORCHES, MANUALLY-OPERATED PACKING PRESSES, MEASURING TOOLS, NAMELY, MEASURING CALIPERS, MICROMETERS, SQUARES, TAPE MEASURES, MEASURING WHEELS, LEVEL INDICATORS, LENGTH-MEASURING GAUGES, DIAL GAUGES AND MAGNETIC STANDS THEREFOR, METERS FOR ELECTRICAL MEASUREMENTS, MAGNIFYING LENSES, SHARPENING STONES, POLISHING, SCOURING AND ABRASIVE PREPARATIONS, STORAGE EQUIPMENT FOR TOOLS, NAMELY, TOOLBOXES, TOOL CHESTS, ROLLER CABINETS, AND STORAGE BINS, PERSONAL PROTECTION EQUIPMENT, NAMELY, SAFETY GLASSES, SAFETY HELMETS, FOOTGUARDS, FALL PROTECTION HARNESSSES, SAFETY MARKERS, ELECTRIC SOLDERING DEVICES, HEAT GUNS, HOSE CLIPS, CABLE TIES, ELECTRICALLY INSULATING GLOVES, SHOES, AND ADHESIVE TAPE, IN CLASS 35 (U.S. CLS. 100, 101 AND 102).



David J. Kybas

Director of the United States Patent and Trademark Office

Reg. No. 4,068,371 FIRST USE 9-28-2011; IN COMMERCE 9-28-2011.

THE MARK CONSISTS OF STANDARD CHARACTERS WITHOUT CLAIM TO ANY PARTICULAR FONT, STYLE, SIZE, OR COLOR.

SN 85-134,226, FILED 9-21-2010.

PAM WILLIS, EXAMINING ATTORNEY

United States of America

United States Patent and Trademark Office

AMARA

Reg. No. 4,068,372

Registered Dec. 6, 2011

Int. Cl.: 14

TRADEMARK

PRINCIPAL REGISTER

HALLMARK SWEET, INC. (RHODE ISLAND CORPORATION)
49 PEARL STREET
ATTLEBORO, MA 02703

FOR: BEADS FOR USE IN THE MANUFACTURE OF JEWELRY; JEWELLERY CHAIN OF PRECIOUS METAL FOR BRACELETS; JEWELRY; JEWELRY CHAINS; JEWELRY FINDINGS; METAL WIRE FOR USE IN THE MAKING OF JEWELRY, NAMELY, JEWELRY CABLE; PRECIOUS METAL ALLOYS; PRECIOUS METALS; PROCESSED OR SEMI-PROCESSED PRECIOUS METALS; SHEET METAL OF PRECIOUS METAL; SHEETS OF PRECIOUS METAL, IN CLASS 14 (U.S. CLS. 2, 27, 28 AND 50).

FIRST USE 4-0-2010; IN COMMERCE 7-0-2010.

THE MARK CONSISTS OF STANDARD CHARACTERS WITHOUT CLAIM TO ANY PARTICULAR FONT, STYLE, SIZE, OR COLOR.

SN 85-134,398, FILED 9-21-2010.

ALEXANDER L. POWERS, EXAMINING ATTORNEY



David J. Kypos

Director of the United States Patent and Trademark Office

United States of America

United States Patent and Trademark Office

SUNSACTIONS

Reg. No. 4,068,373

Registered Dec. 6, 2011

Int. Cls.: 3 and 5

TRADEMARK

PRINCIPAL REGISTER

ALLIANCE PACKAGING GROUP, INC. (WISCONSIN CORPORATION)
420 TECHNOLOGY WAY
SAUKVILLE, WI 53080

FOR: SUN CARE PRODUCTS COMPRISING SUNSCREEN LIP BALM, SUNSCREEN LOTIONS, SUNSCREEN SPRAYS, SUNSCREEN STICKS, SUNSCREEN GELS; AFTER-SUN BALMS, LOTIONS AND GELS FOR USE AFTER SUN EXPOSURE; BALMS, LOTIONS AND GELS CONTAINING ALOE VERA FOR COSMETIC PURPOSES, IN CLASS 3 (U.S. CLS. 1, 4, 6, 50, 51 AND 52).

FIRST USE 9-26-2011; IN COMMERCE 9-26-2011.

FOR: BALMS, LOTIONS AND GELS CONTAINING ALOE VERA FOR THERAPEUTIC PURPOSES, IN CLASS 5 (U.S. CLS. 6, 18, 44, 46, 51 AND 52).

FIRST USE 9-26-2011; IN COMMERCE 9-26-2011.

THE MARK CONSISTS OF STANDARD CHARACTERS WITHOUT CLAIM TO ANY PARTICULAR FONT, STYLE, SIZE, OR COLOR.

SN 85-134,651, FILED 9-21-2010.

DAVID ELTON, EXAMINING ATTORNEY



David J. Kypos

Director of the United States Patent and Trademark Office

United States of America

United States Patent and Trademark Office



HealthyPerks

Reg. No. 4,068,374

Registered Dec. 6, 2011

Int. Cl.: 30

TRADEMARK

PRINCIPAL REGISTER

BERRES BROTHERS, INC. (WISCONSIN CORPORATION)
202 AIR PARK DRIVE
WATERTOWN, WI 53094

FOR: CAFFEINE-FREE COFFEE; COFFEE; COFFEE BEANS; GROUND COFFEE BEANS;
ROASTED COFFEE BEANS, IN CLASS 30 (U.S. CL. 46).

FIRST USE 9-20-2011; IN COMMERCE 9-20-2011.

NO CLAIM IS MADE TO THE EXCLUSIVE RIGHT TO USE "HEALTHY", APART FROM
THE MARK AS SHOWN.

THE MARK CONSISTS OF THE WORDS "HEALTHY PERKS" SET BELOW A STYLIZED
COFFEE CUP COMPRISED OF A HANDLE, A SWIRL PATTERN FOR THE TOP OF THE
CUP AND A LEAF PATTERN FOR THE SIDE OF THE CUP.

SN 85-134,877, FILED 9-21-2010.

ANDREA K. NADELMAN, EXAMINING ATTORNEY



David J. Kybas

Director of the United States Patent and Trademark Office

United States of America

United States Patent and Trademark Office

CREATIVE DESTRUCTION

Reg. No. 4,068,375

ROSS, JR., CHARLES H. (UNITED STATES INDIVIDUAL)
530 SEVENTH AVENUE, SUITE 1008
NEW YORK, NY 10018

Registered Dec. 6, 2011

Int. Cl.: 25

FOR: CLOTHING, NAMELY, MEN'S AND BOYS' SHIRTS AND T-SHIRTS, IN CLASS 25
(U.S. CLS. 22 AND 39).

TRADEMARK

FIRST USE 8-31-2011; IN COMMERCE 8-31-2011.

PRINCIPAL REGISTER

THE MARK CONSISTS OF STANDARD CHARACTERS WITHOUT CLAIM TO ANY PARTICULAR FONT, STYLE, SIZE, OR COLOR.

SN 85-135,226, FILED 9-22-2010.

ALYSSA STEEL, EXAMINING ATTORNEY



David J. Kybas

Director of the United States Patent and Trademark Office

United States of America

United States Patent and Trademark Office

MAD MONKEY KUNG FU

Reg. No. 4,068,376

ROSS, JR., CHARLES H. (UNITED STATES INDIVIDUAL)
530 SEVENTH AVENUE, SUITE 1008
NEW YORK, NY 10018

Registered Dec. 6, 2011

Int. Cl.: 25

FOR: CLOTHING, NAMELY, MEN'S AND BOYS' SHIRTS AND T-SHIRTS, IN CLASS 25
(U.S. CLS. 22 AND 39).

TRADEMARK

FIRST USE 1-15-2011; IN COMMERCE 1-15-2011.

PRINCIPAL REGISTER

THE MARK CONSISTS OF STANDARD CHARACTERS WITHOUT CLAIM TO ANY PARTICULAR FONT, STYLE, SIZE, OR COLOR.

SN 85-135,239, FILED 9-22-2010.

ALYSSA STEEL, EXAMINING ATTORNEY



David J. Kyros

Director of the United States Patent and Trademark Office

United States of America

United States Patent and Trademark Office

SHIRT SCAN

Reg. No. 4,068,377

ANVIL KNITWEAR, INC. (DELAWARE CORPORATION)
521 FIFTH AVENUE, 9TH FLOOR
NEW YORK, NY 10175

Registered Dec. 6, 2011

Int. Cl.: 9

FOR: COMPUTER APPLICATION SOFTWARE FOR MOBILE PHONES, NAMELY, SOFTWARE FOR USE IN PROVIDING INFORMATIONAL AND OTHER DIGITAL CONTENT IN THE FIELD OF CLOTHING, THE MANUFACTURING OF CLOTHING, AND THE SUPPLY CHAIN FOR CLOTHING, IN CLASS 9 (U.S. CLS. 21, 23, 26, 36 AND 38).

TRADEMARK

PRINCIPAL REGISTER

FIRST USE 12-21-2010; IN COMMERCE 12-21-2010.

THE MARK CONSISTS OF STANDARD CHARACTERS WITHOUT CLAIM TO ANY PARTICULAR FONT, STYLE, SIZE, OR COLOR.

SN 85-135,267, FILED 9-22-2010.

ROSELLE HERRERA, EXAMINING ATTORNEY



David J. Kybas

Director of the United States Patent and Trademark Office

United States of America

United States Patent and Trademark Office

NANOGENESIS

Reg. No. 4,068,378

Registered Dec. 6, 2011

Int. Cl.: 42

SERVICE MARK

PRINCIPAL REGISTER

AEGIS TECHNOLOGIES GROUP, INC. (ALABAMA CORPORATION)
410 JAN DAVIS DRIVE
HUNTSVILLE, AL 35806

FOR: SCIENTIFIC AND TECHNOLOGICAL SERVICES, NAMELY, PRODUCT DESIGN AND DEVELOPMENT, MATERIALS TESTING, AND MICROSYSTEM PRODUCT DESIGN AND DEVELOPMENT SERVICES IN THE FIELDS OF MICRO-OPTICS AND MICRO-ELECTRONICS; MATERIALS RESEARCH FOR EXPOSURE SURVIVABILITY TO HIGH ENERGY LASERS; PHYSICS-BASED MODELING AND SIMULATION SERVICES; TECHNICAL CONSULTANCY SERVICES AND TECHNICAL RESEARCH IN THE FIELDS OF OPTICS, PHOTONICS, LASER SCIENCES, PLASMONICS, AND ARTIFICIAL MATERIALS ENGINEERED TO HAVE PROPERTIES THAT MAY NOT BE FOUND IN NATURE; AND TEST INSTRUMENTATION SERVICES AND ANALYSIS, NAMELY, DIAGNOSTIC INSTRUMENTATION SERVICES FOR LASER SYSTEMS, IN CLASS 42 (U.S. CLS. 100 AND 101).

FIRST USE 8-31-2010; IN COMMERCE 8-31-2010.

THE MARK CONSISTS OF STANDARD CHARACTERS WITHOUT CLAIM TO ANY PARTICULAR FONT, STYLE, SIZE, OR COLOR.

SN 85-136,307, FILED 9-23-2010.

RAUL CORDOVA, EXAMINING ATTORNEY



David J. Kyros

Director of the United States Patent and Trademark Office

United States of America

United States Patent and Trademark Office



Developing Life Changing Technologies
nanogenesis
A Division of AEGIS Technologies

Reg. No. 4,068,379

Registered Dec. 6, 2011

Int. Cl.: 42

SERVICE MARK

PRINCIPAL REGISTER

AEGIS TECHNOLOGIES GROUP, INC. (ALABAMA CORPORATION)
410 JAN DAVIS DRIVE
HUNTSVILLE, AL 35806

FOR: SCIENTIFIC AND TECHNOLOGICAL SERVICES, NAMELY, PRODUCT DESIGN AND DEVELOPMENT, MATERIALS TESTING, AND MICROSYSTEM PRODUCT DESIGN AND DEVELOPMENT SERVICES IN THE FIELDS OF MICRO-OPTICS AND MICRO-ELECTRONICS; MATERIALS RESEARCH FOR EXPOSURE SURVIVABILITY TO HIGH ENERGY LASERS; PHYSICS-BASED MODELING AND SIMULATION SERVICES; TECHNICAL CONSULTANCY SERVICES AND TECHNICAL RESEARCH IN THE FIELDS OF OPTICS, PHOTONICS, LASER SCIENCES, PLASMONICS, AND ARTIFICIAL MATERIALS ENGINEERED TO HAVE PROPERTIES THAT MAY NOT BE FOUND IN NATURE; AND TEST INSTRUMENTATION SERVICES AND ANALYSIS, NAMELY, DIAGNOSTIC INSTRUMENTATION SERVICES FOR LASER SYSTEMS, IN CLASS 42 (U.S. CLS. 100 AND 101).

FIRST USE 8-31-2010; IN COMMERCE 8-31-2010.

OWNER OF U.S. REG. NOS. 2,360,512 AND 2,436,906.

THE COLOR(S) ORANGE, GRAY AND BLACK IS/ARE CLAIMED AS A FEATURE OF THE MARK.

NO CLAIM IS MADE TO THE EXCLUSIVE RIGHT TO USE "DIVISION" AND "TECHNOLOGIES", APART FROM THE MARK AS SHOWN.

THE MARK CONSISTS OF A DESIGN OF THREE MOLECULE RINGS IN THE COLOR ORANGE, AND TO THE RIGHT THE WORDS, "DEVELOPING LIFE CHANGING TECHNOLOGIES" IN THE COLOR GRAY, AND BELOW THAT THE STYLIZED WORD, "NANOGENESIS" WITH THE "NANO" PORTION IN BLACK, AND THE "GENESIS" PORTION IN GRAY, AND BELOW THAT THE WORDS, "A DIVISION OF AEGIS TECHNOLOGIES", ALSO IN GRAY.

SN 85-136,312, FILED 9-23-2010.

RAUL CORDOVA, EXAMINING ATTORNEY



David J. Kyppas

Director of the United States Patent and Trademark Office

United States of America

United States Patent and Trademark Office

IT'S NOT BOTTLED ... IT'S
BETTER!

Reg. No. 4,068,380

UNIVERSAL WATER SYSTEMS, LLC (NEW MEXICO LIMITED LIABILITY COMPANY)
8532 PASEO ALAMEDA ST., NE
ALBUQUERQUE, NM 87113

Registered Dec. 6, 2011

Int. Cl.: 21

FOR: DRINKING VESSELS; PORTABLE BEVERAGE COOLERS; PORTABLE BEVERAGE DISPENSERS, IN CLASS 21 (U.S. CLS. 2, 13, 23, 29, 30, 33, 40 AND 50).

TRADEMARK

FIRST USE 5-15-2011; IN COMMERCE 5-15-2011.

PRINCIPAL REGISTER

THE MARK CONSISTS OF STANDARD CHARACTERS WITHOUT CLAIM TO ANY PARTICULAR FONT, STYLE, SIZE, OR COLOR.

SN 85-136,982, FILED 9-23-2010.

JENNIFER VASQUEZ, EXAMINING ATTORNEY



David J. Kybas

Director of the United States Patent and Trademark Office

United States of America

United States Patent and Trademark Office

FORTUNE FESTIVAL

Reg. No. 4,068,381

Registered Dec. 6, 2011

Int. Cl.: 9

TRADEMARK

PRINCIPAL REGISTER

ARUZE GAMING AMERICA, INC. (NEVADA CORPORATION)
745 GRIER DRIVE
LAS VEGAS, NV 89119

FOR: COMPONENTS FOR GAMING MACHINES THAT GENERATE OR DISPLAY WAGER OUTCOMES, NAMELY, CONTROLLERS, DISPLAYS, BUTTON PANELS, BOLSTERS, ELECTRICAL WIRING, AND COMPUTER HARDWARE AND SOFTWARE ASSOCIATED THEREWITH; COMPUTER GAME SOFTWARE FOR GAMING MACHINES INCLUDING SLOT MACHINES OR VIDEO LOTTERY TERMINALS; COMPUTER SOFTWARE AND FIRMWARE FOR GAMES OF CHANCE ON ANY COMPUTERIZED PLATFORM, INCLUDING DEDICATED GAMING CONSOLES, VIDEO BASED SLOT MACHINES, REEL BASED SLOT MACHINES, AND VIDEO LOTTERY TERMINALS; ELECTRONIC COMPONENTS FOR SLOT MACHINES; ELECTRONIC GAMING MACHINES, NAMELY, DEVICES WHICH ACCEPT A WAGER; GAMING MACHINES; GAMING MACHINES INCLUDING SLOT MACHINES OR VIDEO LOTTERY TERMINALS; GAMING MACHINES THAT GENERATE OR DISPLAY WAGER OUTCOMES; GAMING MACHINES, NAMELY, DEVICES WHICH ACCEPT A WAGER; GAMING SOFTWARE THAT GENERATES OR DISPLAYS WAGER OUTCOMES OF GAMING MACHINES; MACHINES FOR PLAYING GAMES OF CHANCE; SLOT MACHINES, IN CLASS 9 (U.S. CLS. 21, 23, 26, 36 AND 38).

FIRST USE 10-4-2011; IN COMMERCE 10-4-2011.

THE MARK CONSISTS OF STANDARD CHARACTERS WITHOUT CLAIM TO ANY PARTICULAR FONT, STYLE, SIZE, OR COLOR.

SN 85-137,108, FILED 9-23-2010.

GINA FINK, EXAMINING ATTORNEY



David J. Kybas

Director of the United States Patent and Trademark Office

United States of America

United States Patent and Trademark Office

CERAKOTE

Reg. No. 4,068,382

Registered Dec. 6, 2011

Int. Cls.: 1 and 2

TRADEMARK

PRINCIPAL REGISTER

NIC INDUSTRIES, INC. (OREGON CORPORATION)
7050 SIXTH STREET
WHITE CITY, OR 97503

FOR: INORGANIC POLYMERIC COMPOSITION FOR INDUSTRIAL METAL SUBSTRATES; POLYMER COMPOSITIONS USED IN THE MANUFACTURE OF COMMERCIAL AND INDUSTRIAL GOODS; POLYMER RESINS USED IN THE MANUFACTURE OF RESIN OR FIBER COMPOSITES, IN CLASS 1 (U.S. CLS. 1, 5, 6, 10, 26 AND 46).

FIRST USE 4-1-2003; IN COMMERCE 7-16-2003.

FOR: CERAMIC BASED SEALANTS AND COATINGS FOR USE ON FIREARMS, SCOPES AND RELATED FIREARM ACCESSORIES, IN CLASS 2 (U.S. CLS. 6, 11 AND 16).

FIRST USE 4-1-2003; IN COMMERCE 7-16-2003.

THE MARK CONSISTS OF STANDARD CHARACTERS WITHOUT CLAIM TO ANY PARTICULAR FONT, STYLE, SIZE, OR COLOR.

SN 85-137,700, FILED 9-24-2010.

ROBIN MITTLER, EXAMINING ATTORNEY



David J. Kybas

Director of the United States Patent and Trademark Office

United States of America

United States Patent and Trademark Office

BIG TECH BRAIN

Reg. No. 4,068,383

Registered Dec. 6, 2011

Int. Cls.: 37 and 42

SERVICE MARK

PRINCIPAL REGISTER

TIGERDIRECT INC. (FLORIDA CORPORATION)
7795 WEST FLAGLER STREET, SUITE 35
MIAMI, FL 33144

FOR: MAINTENANCE AND REPAIR OF COMPUTER HARDWARE, IN CLASS 37 (U.S. CLS. 100, 103 AND 106).

FIRST USE 9-28-2010; IN COMMERCE 9-28-2010.

FOR: MAINTENANCE, INSTALLATION AND REPAIR OF COMPUTER SOFTWARE, IN CLASS 42 (U.S. CLS. 100 AND 101).

FIRST USE 9-28-2010; IN COMMERCE 9-28-2010.

THE MARK CONSISTS OF STANDARD CHARACTERS WITHOUT CLAIM TO ANY PARTICULAR FONT, STYLE, SIZE, OR COLOR.

NO CLAIM IS MADE TO THE EXCLUSIVE RIGHT TO USE "TECH", APART FROM THE MARK AS SHOWN.

SN 85-137,918, FILED 9-24-2010.

CAROLINE WOOD, EXAMINING ATTORNEY



David J. Kyros

Director of the United States Patent and Trademark Office

United States of America

United States Patent and Trademark Office

Fauxchet

Reg. No. 4,068,384

PRYCE, KATHY S. (UNITED STATES INDIVIDUAL)
217 LOGTOWN RD.
EAST CALAIS, VT 05650

Registered Dec. 6, 2011

Int. Cl.: 26

FOR: KNITTING IMPLEMENTS, NAMELY, YARN BOBBINS, IN CLASS 26 (U.S. CLS. 37, 39, 40, 42 AND 50).

TRADEMARK

FIRST USE 7-1-2011; IN COMMERCE 9-1-2011.

PRINCIPAL REGISTER

THE MARK CONSISTS OF STANDARD CHARACTERS WITHOUT CLAIM TO ANY PARTICULAR FONT, STYLE, SIZE, OR COLOR.

SN 85-138,348, FILED 9-26-2010.

ZHALEH DELANEY, EXAMINING ATTORNEY



David J. Kybas

Director of the United States Patent and Trademark Office

United States of America

United States Patent and Trademark Office

Dayton Triangles

Reg. No. 4,068,385

Registered Dec. 6, 2011

Int. Cl.: 25

TRADEMARK

PRINCIPAL REGISTER

DAYTON HISTORY (OHIO NON-PROFIT CORPORATION)
1000 CARILLON BLVD.
DAYTON, OH 45409

FOR: CLOTHING, NAMELY, SWEATERS, JERSEYS, SHIRTS, SHORTS, CAPS, PANTS, SWEATSHIRTS, SWEATPANTS, AND OUTERWEAR, NAMELY, JACKETS, COATS AND PARKAS, IN CLASS 25 (U.S. CLS. 22 AND 39).

FIRST USE 9-27-2011; IN COMMERCE 9-27-2011.

THE MARK CONSISTS OF STANDARD CHARACTERS WITHOUT CLAIM TO ANY PARTICULAR FONT, STYLE, SIZE, OR COLOR.

NO CLAIM IS MADE TO THE EXCLUSIVE RIGHT TO USE "DAYTON", APART FROM THE MARK AS SHOWN.

SN 85-138,775, FILED 9-27-2010.

CARYN GLASSER, EXAMINING ATTORNEY



David J. Kybas

Director of the United States Patent and Trademark Office

United States of America

United States Patent and Trademark Office

VELCRO

Reg. No. 4,068,386

Registered Dec. 6, 2011

Int. Cl.: 22

TRADEMARK

PRINCIPAL REGISTER

VELCRO INDUSTRIES B.V. (NETHERLANDS ANTILLES LIMITED LIABILITY COMPANY)
CASTORWEG 22-24
CURACAO, NETHERLANDS ANTILLES

FOR: ALL-PURPOSE STRAPS ALSO INCLUDING HOOK AND LOOP FASTENERS, ALL
SOLD AS A UNIT, IN CLASS 22 (U.S. CLS. 1, 2, 7, 19, 22, 42 AND 50).

FIRST USE 3-1-1992; IN COMMERCE 3-1-1992.

THE MARK CONSISTS OF STANDARD CHARACTERS WITHOUT CLAIM TO ANY PAR-
TICULAR FONT, STYLE, SIZE, OR COLOR.

OWNER OF U.S. REG. NOS. 1,846,829, 2,225,651, AND OTHERS.

SN 85-139,072, FILED 9-27-2010.

JAMES STEIN, EXAMINING ATTORNEY



David J. Kybas

Director of the United States Patent and Trademark Office

United States of America

United States Patent and Trademark Office

INVADERS! PLANET MOOLAH

Reg. No. 4,068,387

Registered Dec. 6, 2011

Int. Cl.: 9

TRADEMARK

PRINCIPAL REGISTER

WMS GAMING INC. (DELAWARE CORPORATION)
800 SOUTH NORTHPOINT BOULEVARD
WAUKEGAN, IL 60085

FOR: COMPONENTS FOR GAMING MACHINES THAT GENERATE OR DISPLAY WAGER OUTCOMES, NAMELY, CONTROLLERS, DISPLAYS, BUTTON PANELS, BOLSTERS, ELECTRICAL WIRING, AND COMPUTER HARDWARE AND SOFTWARE ASSOCIATED THEREWITH; GAMING MACHINES, NAMELY, DEVICES WHICH ACCEPT A WAGER; GAMING SOFTWARE THAT GENERATES OR DISPLAYS WAGER OUTCOMES OF GAMING MACHINES, IN CLASS 9 (U.S. CLS. 21, 23, 26, 36 AND 38).

FIRST USE 11-16-2010; IN COMMERCE 11-16-2010.

THE MARK CONSISTS OF STANDARD CHARACTERS WITHOUT CLAIM TO ANY PARTICULAR FONT, STYLE, SIZE, OR COLOR.

OWNER OF U.S. REG. NO. 3,428,511.

SN 85-139,088, FILED 9-27-2010.

LESLIE RICHARDS, EXAMINING ATTORNEY



David J. Kyffers

Director of the United States Patent and Trademark Office

United States of America

United States Patent and Trademark Office

Doing Well By Doing Good

Reg. No. 4,068,388

Registered Dec. 6, 2011

Int. Cl.: 45

SERVICE MARK

PRINCIPAL REGISTER

DISABILITY GROUP, INC. (CALIFORNIA CORPORATION)
6033 W CENTURY BLVD., STE. 1000
LOS ANGELES, CA 90045

FOR: REPRESENTATION OF PERSONS FOR SOCIAL SECURITY AND DISABILITY RELATED CLAIMS, IN CLASS 45 (U.S. CLS. 100 AND 101).

FIRST USE 8-3-2011; IN COMMERCE 8-3-2011.

THE MARK CONSISTS OF STANDARD CHARACTERS WITHOUT CLAIM TO ANY PARTICULAR FONT, STYLE, SIZE, OR COLOR.

SN 85-139,383, FILED 9-27-2010.

THEODORE MCBRIDE, EXAMINING ATTORNEY



David J. Kyros

Director of the United States Patent and Trademark Office

United States of America

United States Patent and Trademark Office



Reg. No. 4,068,389

Registered Dec. 6, 2011

Int. Cl.: 28

TRADEMARK

PRINCIPAL REGISTER

VISIONARY ARCHERY (CALIFORNIA LIMITED LIABILITY COMPANY)
12024 BANK BEAVER COURT
MANASSAS, VA 20112

FOR: ARCHERY EQUIPMENT, NAMELY, CUSTOM BUILT RECURVE BOWS AND LONG BOWS, IN CLASS 28 (U.S. CLS. 22, 23, 38 AND 50).

FIRST USE 9-30-2011; IN COMMERCE 9-30-2011.

NO CLAIM IS MADE TO THE EXCLUSIVE RIGHT TO USE "ARCHERY", APART FROM THE MARK AS SHOWN.

THE MARK CONSISTS OF THE WORDS "VISIONARY ARCHERY" WITH STYLIZED LETTERS "V" AND "A" BETWEEN THE WORDS AND INTERLOCKED TO FORM AN X-SHAPE.

SN 85-139,719, FILED 9-28-2010.

LINDSEY RUBIN, EXAMINING ATTORNEY



David J. Kybas

Director of the United States Patent and Trademark Office

United States of America

United States Patent and Trademark Office



Reg. No. 4,068,390

Registered Dec. 6, 2011

Int. Cls.: 41 and 44

SERVICE MARK

PRINCIPAL REGISTER

BERRIOS-FERNANDEZ, MYRNA (PUERTO RICO INDIVIDUAL)
N12 MARGARITA ST. PARQ. MARIA
SAN JUAN, PUERTO RICO 00927

FOR: EDUCATIONAL SERVICES, NAMELY, PROVIDING CLASSES, WORKSHOPS IN THE FIELDS OF NUTRITION, DIET AND FOODS, IN CLASS 41 (U.S. CLS. 100, 101 AND 107).

FIRST USE 10-11-2011; IN COMMERCE 10-11-2011.

FOR: DIETARY AND NUTRITIONAL GUIDANCE; DIETITIAN SERVICE; FOOD NUTRITION CONSULTATION; NUTRITION COUNSELING, IN CLASS 44 (U.S. CLS. 100 AND 101).

FIRST USE 10-11-2011; IN COMMERCE 10-11-2011.

NO CLAIM IS MADE TO THE EXCLUSIVE RIGHT TO USE "EATS", APART FROM THE MARK AS SHOWN.

THE COLOR(S) RED AND GREEN IS/ARE CLAIMED AS A FEATURE OF THE MARK.

THE MARK CONSISTS OF A RED APPLE WITH A GREEN STEM AND LEAF WITH THE WORD "GOOD" DISPLAYED IN GREEN IN THE MIDDLE OF THE APPLE, THE WORD "EATZ" IS DISPLAYED IN RED LOCATED LEFT OF THE APPLE.

SN 85-139,742, FILED 9-28-2010.

DANIEL CAPSHAW, EXAMINING ATTORNEY



David J. Kybas

Director of the United States Patent and Trademark Office

United States of America

United States Patent and Trademark Office



Reg. No. 4,068,391

ORIENTAL PACKING CO., INC. (FLORIDA CORPORATION)
14855 SW 137 ST.
MIAMI, FL 33156

Registered Dec. 6, 2011

Int. Cl.: 30

FOR: CURRY POWDER; FOOD SEASONINGS; SEASONINGS; DRY COMPLETE SEASONING MIXES FOR FISH, MEAT, CHICKEN, OXTAIL, JERK SEASONING; MIXED SPICES FEATURING ALLSPICE, PROCESSED GARLIC, PROCESSED SCALLIONS, AND SEASONING MIXES FOR COCK SOUP, IN CLASS 30 (U.S. CL. 46).

TRADEMARK

PRINCIPAL REGISTER

FIRST USE 9-30-2011; IN COMMERCE 9-30-2011.

NO CLAIM IS MADE TO THE EXCLUSIVE RIGHT TO USE "JAMAICAN", APART FROM THE MARK AS SHOWN.

THE COLOR(S) WHITE, RED, GREEN, LIGHT GREEN, LIGHT YELLOW, YELLOW, GRAY AND BLACK IS/ARE CLAIMED AS A FEATURE OF THE MARK.

THE MARK CONSISTS OF THE STYLIZED WORDING "SIMPLY JAMAICAN". THE WORD "SIMPLY" IN RED CURSIVE WRITING OUTLINED IN BLACK AND WHITE ON THE TOP OF THE WORD "JAMAICAN" OUTLINED IN BLACK AND WHITE IN BLOCK LETTERS APPEARING WITH GREEN TO LIGHT GREEN AT THE TOP, FADING FROM LIGHT YELLOW TO YELLOW IN THE MIDDLE AND FINALLY GRAY AND BLACK AT THE BOTTOM.

SN 85-139,846, FILED 9-28-2010.

LOURDES AYALA, EXAMINING ATTORNEY



David J. Kyros

Director of the United States Patent and Trademark Office

United States of America

United States Patent and Trademark Office

ULTRA3

Reg. No. 4,068,392

HERRMANN ULTRASONICS, INC. (ILLINOIS CORPORATION)
1261 HARDT CIRCLE
BARTLETT, IL 60103

Registered Dec. 6, 2011

Int. Cl.: 7

FOR: ULTRASONIC WELDING AND CUTTING MACHINES AND STRUCTURAL PARTS THEREOF, IN CLASS 7 (U.S. CLS. 13, 19, 21, 23, 31, 34 AND 35).

TRADEMARK

FIRST USE 7-31-2011; IN COMMERCE 7-31-2011.

PRINCIPAL REGISTER

THE MARK CONSISTS OF STANDARD CHARACTERS WITHOUT CLAIM TO ANY PARTICULAR FONT, STYLE, SIZE, OR COLOR.

SN 85-140,071, FILED 9-28-2010.

EMILY CHUO, EXAMINING ATTORNEY



David J. Kybas

Director of the United States Patent and Trademark Office

United States of America

United States Patent and Trademark Office

MIGHTY MAC

Reg. No. 4,068,393

Registered Dec. 6, 2011

Int. Cl.: 7

TRADEMARK

PRINCIPAL REGISTER

PARAGON TECHNOLOGIES, INC. (DELAWARE CORPORATION)
600 KUEBLER ROAD
EASTON, PA 18040

FOR: AUTOMATED ORDER PICKING AND DISPENSING MACHINERY WHICH AUTOMATICALLY SELECTS ARTICLES FROM STORAGE CHANNELS AND DISPENSES THEM INTO A CARTON OR TOTE BEING TRANSPORTED BY AN ADJACENT CONVEYOR IN FRONT OF THE DISPENSER LOCATIONS, IN CLASS 7 (U.S. CLS. 13, 19, 21, 23, 31, 34 AND 35).

FIRST USE 3-0-2011; IN COMMERCE 3-0-2011.

THE MARK CONSISTS OF STANDARD CHARACTERS WITHOUT CLAIM TO ANY PARTICULAR FONT, STYLE, SIZE, OR COLOR.

SN 85-140,089, FILED 9-28-2010.

JAMES A. RAUEN, EXAMINING ATTORNEY



David J. Kybas

Director of the United States Patent and Trademark Office

United States of America

United States Patent and Trademark Office



Reg. No. 4,068,394

Registered Dec. 6, 2011

**Int. Cls.: 9, 38, 39, 42,
and 45**

TRADEMARK

SERVICE MARK

PRINCIPAL REGISTER

LOOKOUT, INC. (CALIFORNIA CORPORATION)
500 THIRD STREET, SUITE 455
SAN FRANCISCO, CA 94107

FOR: SOFTWARE FOR SCANNING MOBILE COMMUNICATION DEVICES, AND FOR ASSESSING, REPORTING, AND PREVENTING SECURITY RISKS AND PRIVACY RISKS ON MOBILE COMMUNICATION DEVICES; SOFTWARE FOR ASSESSING, REPORTING, AND PREVENTING THE SECURITY RISKS AND PRIVACY RISKS OF INSTALLING SOFTWARE DESIGNED FOR MOBILE COMMUNICATION DEVICES THAT IS AVAILABLE ON WEBSITES AND SOFTWARE REPOSITORIES, AND FOR ASSESSING, REPORTING, AND PREVENTING THE SECURITY RISKS AND PRIVACY RISKS OF SOFTWARE AFTER INSTALLATION OF THE SOFTWARE ON MOBILE COMMUNICATION DEVICES; MOBILE COMMUNICATION DEVICE ANTI-VIRUS SOFTWARE; INTERNET SECURITY SOFTWARE, NAMELY, MOBILE COMMUNICATION DEVICE FIREWALL, AND INTRUSION PREVENTION, AND ANTI-PHISHING SOFTWARE; SOFTWARE FOR IMPLEMENTING SECURITY POLICY, SPYWARE POLICY AND PRIVACY POLICY ON A MOBILE COMMUNICATION DEVICE; SOFTWARE FOR PREVENTING INSTALLATION OF UNDESIRE SOFTWARE ON A MOBILE COMMUNICATION DEVICE; SOFTWARE FOR MONITORING, BACKING UP, PRESERVING, AND RESTORING MOBILE COMMUNICATIONS DEVICES AND MOBILE COMMUNICATIONS DEVICE DATA; SOFTWARE FOR LOCATING, RECOVERING, SECURING, AND DISABLING A USER'S MISSING, STOLEN, OR LOST MOBILE COMMUNICATION DEVICE; SOFTWARE FOR REMOTELY MANAGING MOBILE COMMUNICATIONS DEVICES, IN CLASS 9 (U.S. CLS. 21, 23, 26, 36 AND 38).

FIRST USE 11-30-2009; IN COMMERCE 11-30-2009.

FOR: PROVIDING REMOTE USER INTERNET ACCESS TO ARCHIVED DATA FOR MOBILE COMMUNICATION DEVICES; PROVIDING REMOTE USER INTERNET ACCESS TO MOBILE COMMUNICATION DEVICE FUNCTIONALITY, IN CLASS 38 (U.S. CLS. 100, 101 AND 104).

FIRST USE 11-30-2009; IN COMMERCE 11-30-2009.

FOR: STORAGE SERVICES FOR STORING AND ARCHIVING ELECTRONIC USER DATA, IN CLASS 39 (U.S. CLS. 100 AND 105).

FIRST USE 11-30-2009; IN COMMERCE 11-30-2009.



David J. Kybas

Director of the United States Patent and Trademark Office

Reg. No. 4,068,394 FOR: COMPUTER SERVICES FOR OTHERS IN THE FIELDS OF MOBILE COMMUNICATION DEVICE DATA, NETWORK DATA, NETWORK SECURITY, AND PRIVACY, SECURITY RISKS, AND PRIVACY RISKS, NAMELY, SOFTWARE DEVELOPMENT AND MAINTENANCE FOR MANAGING MOBILE COMMUNICATION DEVICE DATA, SECURITY RISKS, AND PRIVACY RISKS; SERVICES FOR OTHERS IN THE FIELDS OF MOBILE COMMUNICATION DEVICE DATA, SECURITY RISKS, AND PRIVACY RISKS, NAMELY, TROUBLESHOOTING MOBILE COMMUNICATION DEVICE SOFTWARE PROBLEMS AND DIAGNOSING MOBILE COMMUNICATION DEVICE HARDWARE PROBLEMS; APPLICATION SERVICE PROVIDER FEATURING SOFTWARE FOR THE DETECTION, MONITORING, AND REMOVAL OF SECURITY RISKS AND PRIVACY RISKS, FOR MONITORING, PROTECTING, AND SECURING MOBILE COMMUNICATION DEVICES, NETWORKS, IN CLASS 42 (U.S. CLS. 100 AND 101).

FIRST USE 11-30-2009; IN COMMERCE 11-30-2009.

FOR: MONITORING OF MOBILE COMMUNICATION DEVICES FOR SECURITY PURPOSES, NAMELY, FOR SECURITY AND PRIVACY RISKS, IN CLASS 45 (U.S. CLS. 100 AND 101).

FIRST USE 11-30-2009; IN COMMERCE 11-30-2009.

THE MARK CONSISTS OF A STYLIZED IMAGE OF A SHIELD IN THE COLOR GREEN.

THE COLOR(S) GREEN IS/ARE CLAIMED AS A FEATURE OF THE MARK.

SN 85-140,410, FILED 9-28-2010.

CHRISTINE COOPER, EXAMINING ATTORNEY

United States of America

United States Patent and Trademark Office

HIGHLIGHT

Reg. No. 4,068,395

Registered Dec. 6, 2011

Int. Cl.: 41

SERVICE MARK

PRINCIPAL REGISTER

T-MOBILE USA, INC. (DELAWARE CORPORATION)
12920 S.E. 38TH STREET
BELLEVUE, WA 98006

FOR: ENTERTAINMENT SERVICES, NAMELY, PROVIDING INFORMATION TO MOBILE TELECOMMUNICATIONS DEVICES IN THE FIELDS OF NEWS, ENTERTAINMENT, MOVIES, TELEVISION, MUSIC, SPORTS, CELEBRITY PERSONALITIES, CURRENT EVENTS AND SOCIAL COMMENTARY ON ENTERTAINMENT, IN CLASS 41 (U.S. CLS. 100, 101 AND 107).

FIRST USE 2-18-2011; IN COMMERCE 2-18-2011.

THE MARK CONSISTS OF STANDARD CHARACTERS WITHOUT CLAIM TO ANY PARTICULAR FONT, STYLE, SIZE, OR COLOR.

SN 85-141,426, FILED 9-29-2010.

DAVID HOFFMAN, EXAMINING ATTORNEY



David J. Kyffers

Director of the United States Patent and Trademark Office

United States of America

United States Patent and Trademark Office

UBERRY BLAST

Reg. No. 4,068,396

Registered Dec. 6, 2011

Int. Cl.: 30

TRADEMARK

PRINCIPAL REGISTER

UFOOD RESTAURANT GROUP, INC. (NEVADA CORPORATION)
255 WASHINGTON STREET #100
NEWTON, MA 02458

FOR: FROZEN YOGURT, IN CLASS 30 (U.S. CL. 46).

FIRST USE 6-0-2009; IN COMMERCE 6-0-2009.

THE MARK CONSISTS OF STANDARD CHARACTERS WITHOUT CLAIM TO ANY PARTICULAR FONT, STYLE, SIZE, OR COLOR.

OWNER OF U.S. REG. NO. 3,528,967.

SN 85-141,847, FILED 9-30-2010.

KIM SAITO, EXAMINING ATTORNEY



David J. Kyffers

Director of the United States Patent and Trademark Office

United States of America

United States Patent and Trademark Office

ANALEMMA

Reg. No. 4,068,397

ANALEMMA WINES LLC (OREGON LIMITED LIABILITY COMPANY)
23 MOSIER CREEK PLACE
MOSIER, OR 97040

Registered Dec. 6, 2011

Int. Cl.: 33

FOR: ALCOHOLIC BEVERAGES EXCEPT BEERS; WINES, IN CLASS 33 (U.S. CLS. 47 AND 49).

TRADEMARK

FIRST USE 8-17-2011; IN COMMERCE 10-1-2011.

PRINCIPAL REGISTER

THE MARK CONSISTS OF STANDARD CHARACTERS WITHOUT CLAIM TO ANY PARTICULAR FONT, STYLE, SIZE, OR COLOR.

SN 85-141,911, FILED 9-30-2010.

GENE MACIOL, EXAMINING ATTORNEY



David J. Kybas

Director of the United States Patent and Trademark Office

United States of America

United States Patent and Trademark Office

Pound Sand Industry

Reg. No. 4,068,398

CHASE-CHARNAW, JENNIFER (UNITED STATES INDIVIDUAL)
4676 FILLY LN.
RIVERSIDE, CA 92509

Registered Dec. 6, 2011

Int. Cl.: 25

FOR: SHIRTS, IN CLASS 25 (U.S. CLS. 22 AND 39).

TRADEMARK

FIRST USE 3-3-2011; IN COMMERCE 3-3-2011.

PRINCIPAL REGISTER

THE MARK CONSISTS OF STANDARD CHARACTERS WITHOUT CLAIM TO ANY PARTICULAR FONT, STYLE, SIZE, OR COLOR.

SN 85-142,070, FILED 9-30-2010.

JANICE L. MCMORROW, EXAMINING ATTORNEY



David J. Kyffers

Director of the United States Patent and Trademark Office

United States of America

United States Patent and Trademark Office

GuardSpec

Reg. No. 4,068,399

Registered Dec. 6, 2011

Int. Cl.: 9

TRADEMARK

PRINCIPAL REGISTER

ARXAN TECHNOLOGIES, INC. (DELAWARE CORPORATION)
SUITE 910
6903 ROCKLEDGE DRIVE
BETHESDA, MD 20817

FOR: COMPUTER PROGRAMS FEATURING MODULES USED FOR ANTI-TAMPER SOFTWARE PROTECTION, FOR SOFTWARE COPY PROTECTION AND FOR COMPUTER SECURITY, IN CLASS 9 (U.S. CLS. 21, 23, 26, 36 AND 38).

FIRST USE 11-30-2010; IN COMMERCE 11-30-2010.

THE MARK CONSISTS OF STANDARD CHARACTERS WITHOUT CLAIM TO ANY PARTICULAR FONT, STYLE, SIZE, OR COLOR.

OWNER OF U.S. REG. NO. 3,450,304.

SN 85-142,921, FILED 10-1-2010.

ANDREA HACK, EXAMINING ATTORNEY



David J. Kybas

Director of the United States Patent and Trademark Office

United States of America

United States Patent and Trademark Office

BOTE

Reg. No. 4,068,400

Registered Dec. 6, 2011

Int. Cls.: 35 and 42

SERVICE MARK

PRINCIPAL REGISTER

GLOBAL MARITIME TRANSPORTATION SERVICES, INC. (FLORIDA CORPORATION)
12450 WEST ATLANTIC BLVD.
CORAL SPRINGS, FL 33071

FOR: PROVIDING BUSINESS INFORMATION IN THE FIELD OF IMPORT/EXPORT VIA THE INTERNET; PROVIDING A WEBSITE FEATURING BUSINESS INFORMATION IN THE FIELD OF IMPORT/EXPORT AND TARIFFS; PROVIDING A DATABASE FEATURING COMMODITY TAX INFORMATION, IN CLASS 35 (U.S. CLS. 100, 101 AND 102).

FIRST USE 10-1-2011; IN COMMERCE 10-1-2011.

FOR: PROVIDING TEMPORARY USE OF NON-DOWNLOADABLE COMPUTER SOFTWARE FOR PUBLISHING AND MANAGING SERVICE CONTRACTS, IN CLASS 42 (U.S. CLS. 100 AND 101).

FIRST USE 10-1-2011; IN COMMERCE 10-1-2011.

THE MARK CONSISTS OF STANDARD CHARACTERS WITHOUT CLAIM TO ANY PARTICULAR FONT, STYLE, SIZE, OR COLOR.

SN 85-142,986, FILED 10-1-2010.

KEVIN DINALLO, EXAMINING ATTORNEY



David J. Kybas

Director of the United States Patent and Trademark Office

United States of America

United States Patent and Trademark Office

ECHOTIP PROCORE

Reg. No. 4,068,401

Registered Dec. 6, 2011

Int. Cl.: 10

TRADEMARK

PRINCIPAL REGISTER

VANCE PRODUCTS INCORPORATED (INDIANA CORPORATION), DBA COOK
UROLOGICAL INCORPORATED,
P.O. BOX 227
1100 WEST MORGAN STREET
SPENCER, IN 47460

FOR: MEDICAL NEEDLES, IN CLASS 10 (U.S. CLS. 26, 39 AND 44).

FIRST USE 12-22-2010; IN COMMERCE 12-22-2010.

THE MARK CONSISTS OF STANDARD CHARACTERS WITHOUT CLAIM TO ANY PARTICULAR FONT, STYLE, SIZE, OR COLOR.

OWNER OF U.S. REG. NOS. 1,477,548, 1,759,708, AND 2,224,796.

SN 85-143,414, FILED 10-1-2010.

ANDREA K. NADELMAN, EXAMINING ATTORNEY



David J. Kybas

Director of the United States Patent and Trademark Office

United States of America

United States Patent and Trademark Office

MERRY-OKEE

Reg. No. 4,068,402

Registered Dec. 6, 2011

Int. Cl.: 9

TRADEMARK

PRINCIPAL REGISTER

HALLMARK LICENSING, INC. (DELAWARE CORPORATION)
MD 339
2440 PERSHING ROAD
KANSAS CITY, MO 64108

FOR: MICROPHONES, IN CLASS 9 (U.S. CLS. 21, 23, 26, 36 AND 38).

FIRST USE 10-8-2011; IN COMMERCE 10-8-2011.

THE MARK CONSISTS OF STANDARD CHARACTERS WITHOUT CLAIM TO ANY PARTICULAR FONT, STYLE, SIZE, OR COLOR.

SN 85-143,467, FILED 10-1-2010.

DAVID COLLIER, EXAMINING ATTORNEY



David J. Kyffers

Director of the United States Patent and Trademark Office

United States of America

United States Patent and Trademark Office

ROOM IT UP

Reg. No. 4,068,403

Registered Dec. 6, 2011

Int. Cl.: 16

TRADEMARK

PRINCIPAL REGISTER

PRIME SOURCE ACCESSORIES, INC. (FLORIDA CORPORATION)
2416 NW FORK ROAD
STUART, FL 34994

FOR: HOME, OFFICE, SCHOOL AND ORGANIZATIONAL SUPPLIES, NAMELY, CALENDARS, PERSONAL ORGANIZERS, FILE FOLDERS, FILE FOLDER CARRIERS, ADHESIVE NOTE PADS, NOTE PADS, NOTE CARDS, DRY ERASE WRITING BOARDS, BLANK JOURNALS, CLIP BOARDS, POCKET FOLDERS FOR STATIONERY USE, DESKTOP MAGAZINE ORGANIZERS, POCKET NOTEBOOKS, DESK TOP NOTE PAD AND PENCIL HOLDER SETS, DOOR HANGER NOTE PAD AND PENCIL HOLDER SETS, CLIP-ON NOTEPADS, NOTEBOOKS; PAPER PRODUCTS, NAMELY, GIFT BAGS, PAPER GIFT WRAPPING, BLANK LABELS, GIFT CARDS, IN CLASS 16 (U.S. CLS. 2, 5, 22, 23, 29, 37, 38 AND 50).

FIRST USE 3-24-2010; IN COMMERCE 3-24-2010.

THE MARK CONSISTS OF STANDARD CHARACTERS WITHOUT CLAIM TO ANY PARTICULAR FONT, STYLE, SIZE, OR COLOR.

OWNER OF U.S. REG. NOS. 3,335,987 AND 3,567,343.

SN 85-143,485, FILED 10-1-2010.

CAROLINE WOOD, EXAMINING ATTORNEY



David J. Kyros

Director of the United States Patent and Trademark Office

United States of America

United States Patent and Trademark Office

CAPTAIN FIZZY

Reg. No. 4,068,404

SEARLES, ANDREW N. (UNITED STATES INDIVIDUAL)
14 ZAHLER STREET, P.O. BOX 325
YEMASSEE, SC 29945

Registered Dec. 6, 2011

Int. Cl.: 20

FOR: NON-METAL CAPS FOR CARBONATED BEVERAGE CONTAINERS, IN CLASS 20
(U.S. CLS. 2, 13, 22, 25, 32 AND 50).

TRADEMARK

FIRST USE 1-20-2011; IN COMMERCE 1-20-2011.

PRINCIPAL REGISTER

THE MARK CONSISTS OF STANDARD CHARACTERS WITHOUT CLAIM TO ANY PARTICULAR FONT, STYLE, SIZE, OR COLOR.

SN 85-144,132, FILED 10-4-2010.

WILLIAM VERHOSEK, EXAMINING ATTORNEY



David J. Kybas

Director of the United States Patent and Trademark Office

United States of America

United States Patent and Trademark Office

Artonox

Reg. No. 4,068,405

Registered Dec. 6, 2011

Int. Cl.: 3

TRADEMARK

PRINCIPAL REGISTER

SABINSA CORPORATION (NEW JERSEY CORPORATION)
20 LAKE DRIVE
EAST WINDSOR, NJ 08520

FOR: COSMETIC COMPOSITIONS COMPRISING A NATURAL EXTRACT OF ARTOCARPUS LAKOOCHA, IN CLASS 3 (U.S. CLS. 1, 4, 6, 50, 51 AND 52).

FIRST USE 10-30-2010; IN COMMERCE 10-30-2010.

THE MARK CONSISTS OF STANDARD CHARACTERS WITHOUT CLAIM TO ANY PARTICULAR FONT, STYLE, SIZE, OR COLOR.

SN 85-144,296, FILED 10-4-2010.

RONALD AIKENS, EXAMINING ATTORNEY



David J. Kyffers

Director of the United States Patent and Trademark Office

United States of America

United States Patent and Trademark Office

ColorConnect

Reg. No. 4,068,406

Registered Dec. 6, 2011

Int. Cl.: 9

TRADEMARK

PRINCIPAL REGISTER

SURETINT SYSTEMS, LLC (ILLINOIS LIMITED LIABILITY COMPANY)
500 SKOKIE BLVD., SUITE 280
NORTHBROOK, IL 60062

FOR: SOFTWARE FOR PROVIDING REMOTE INTERNET ACCESS INTO BEAUTY SALONS AND STORES FOR REVIEWING AND GENERATING REPORTS ON SALON OPERATING STATISTICS AND FOR MANAGING SALON MANAGEMENT EQUIPMENT; SOFTWARE FOR PROVIDING ON-LINE ORDERING OF PERSONAL CARE PRODUCTS FROM SALONS AND BEAUTY SUPPLY; AND SOFTWARE FOR ACCESSING ON-LINE TECHNICAL SOFTWARE AND HARDWARE SUPPORT AND FEEDBACK, AND ACCESSING SOFTWARE UPDATES, IN CLASS 9 (U.S. CLS. 21, 23, 26, 36 AND 38).

FIRST USE 9-27-2011; IN COMMERCE 9-27-2011.

THE MARK CONSISTS OF STANDARD CHARACTERS WITHOUT CLAIM TO ANY PARTICULAR FONT, STYLE, SIZE, OR COLOR.

SN 85-145,054, FILED 10-5-2010.

KELLEY WELLS, EXAMINING ATTORNEY



David J. Kypos

Director of the United States Patent and Trademark Office

United States of America

United States Patent and Trademark Office



Reg. No. 4,068,407

Registered Dec. 6, 2011

Int. Cl.: 3

TRADEMARK

PRINCIPAL REGISTER

LEVLAD, LLC (CALIFORNIA LIMITED LIABILITY COMPANY)
9200 MASON AVENUE
CHATSWORTH, CA 91311

FOR: AFTER-BATH BODY SPLASH; ANTI-AGING CREAMS; BABY CARE PRODUCTS, NAMELY, BABY LOTIONS, SKIN CARE PREPARATIONS, NAMELY, BODY BALMS FOR BABIES, BABY OILS, BABY POWDERS, BABY WIPES, BABY HAIR CONDITIONER, BABY BODY WASH, SUN BLOCK PREPARATIONS FOR BABIES; BAR SOAPS; BATH AND SHOWER PRODUCTS, NAMELY, BATH AND SHOWER FOAM AND GEL; BATH GEL; BATH LOTION; BODY LOTION; BODY OILS; BODY SCRUBS; DEODORANTS FOR BODY CARE IN ROLL-ON, WIPE, AND SPRAY FORM; FACIAL SCRUBS; FACIAL MASKS; FACE WASH; FRAGRANCES FOR PERSONAL USE; HAIR DYES; HAIR OILS; HAIR RINSE; HAIR STYLING PREPARATIONS; NON-MEDICATED SKIN LOTIONS FOR FOOT CARE, HAND CARE, SKIN CARE, AND FACIAL CARE; NON-MEDICATED ACNE TREATMENT PREPARATIONS FOR THE FACE, NAMELY, SALICYLIC ACID CLEANSER, CALMING TONER, AND SALICYLIC ACID CONTROLLING LOTION; NON-MEDICATED SKIN CARE PREPARATIONS, NAMELY, WRINKLE REMOVING SKIN CARE PREPARATIONS, AND COSMETIC PREPARATIONS FOR SKIN RENEWAL; NON-MEDICATED SCALP TREATMENT CREAM; NON-MEDICATED PREPARATIONS FOR SCALP CARE; PERFUME; NON-MEDICATED SUN CARE PREPARATIONS; ORAL CARE PRODUCTS, NAMELY, MOUTHWASH, BREATH FRESHENING MOUTH SPRAYS, AND LIP BALMS; PERFUMES; SELF TANNING PREPARATIONS AND CREAMS; SKIN CREAM; SKIN MOISTURIZERS CONTAINING COSMETICS TO MATCH SKIN COLOR; NON-MEDICATED SUN CARE PREPARATIONS IN THE NATURE OF SUN BLOCK SPRAYS AND SUN BLOCK STICKS, IN CLASS 3 (U.S. CLS. 1, 4, 6, 50, 51 AND 52).



FIRST USE 5-1-2008; IN COMMERCE 8-0-2008.

THE MARK CONSISTS OF A RING ENCLOSING A DEPICTION OF A WATER WAVE WITH THE PHRASE "SUPPORT CLEAN WATER FOR ALL" SUPERIMPOSED ON THE RING.

SN 85-145,434, FILED 10-5-2010.

KATHERINE E. HALMEN, EXAMINING ATTORNEY

David J. Kyros

Director of the United States Patent and Trademark Office

United States of America

United States Patent and Trademark Office



Reg. No. 4,068,408

Registered Dec. 6, 2011

Int. Cl.: 41

SERVICE MARK

PRINCIPAL REGISTER

CABLE NEWS NETWORK, INC. (DELAWARE CORPORATION)
ONE CNN CENTER
ATLANTA, GA 30303

FOR: ENTERTAINMENT SERVICES, NAMELY, PROVISION OF ON-GOING MULTIMEDIA PROGRAMS IN THE FIELD OF NEWS AND CURRENT EVENTS DISTRIBUTED VIA VARIOUS PLATFORMS ACROSS MULTIPLE FORMS OF TRANSMISSION MEDIA, IN CLASS 41 (U.S. CLS. 100, 101 AND 107).

FIRST USE 11-22-2010; IN COMMERCE 11-22-2010.

THE MARK CONSISTS OF SPLIT LINE LETTERS "CNN" WITH SPLIT LINE SUPERScript TILDE.

SN 85-145,457, FILED 10-5-2010.

WENDY JUN, EXAMINING ATTORNEY



David J. Kyffers

Director of the United States Patent and Trademark Office

United States of America

United States Patent and Trademark Office



Reg. No. 4,068,409

Registered Dec. 6, 2011

Int. Cl.: 38

SERVICE MARK

PRINCIPAL REGISTER

CABLE NEWS NETWORK, INC. (DELAWARE CORPORATION)
ONE CNN CENTER
ATLANTA, GA 30303

FOR: CABLE TELEVISION AND SATELLITE BROADCASTING SERVICES; RADIO BROADCASTING SERVICES; STREAMING OF AUDIO, VIDEO AND AUDIO/VIDEO MATERIALS OVER THE INTERNET, IN CLASS 38 (U.S. CLS. 100, 101 AND 104).

FIRST USE 11-22-2010; IN COMMERCE 11-22-2010.

THE MARK CONSISTS OF SPLIT LINE LETTERS "CNN" WITH SPLIT LINE SUPERScript TILDE.

SN 85-145,464, FILED 10-5-2010.

WENDY JUN, EXAMINING ATTORNEY



David J. Kyffers

Director of the United States Patent and Trademark Office

United States of America

United States Patent and Trademark Office

HOLD OUT

Reg. No. 4,068,410

Registered Dec. 6, 2011

Int. Cl.: 8

TRADEMARK

PRINCIPAL REGISTER

COLD STEEL, INC. (CALIFORNIA CORPORATION)
3036-A SEABORG AVENUE
VENTURA, CA 93003

FOR: HUNTING KNIVES; SPORT KNIVES; UTILITY KNIVES, IN CLASS 8 (U.S. CLS. 23, 28 AND 44).

FIRST USE 1-0-2011; IN COMMERCE 1-0-2011.

THE MARK CONSISTS OF STANDARD CHARACTERS WITHOUT CLAIM TO ANY PARTICULAR FONT, STYLE, SIZE, OR COLOR.

SN 85-145,718, FILED 10-5-2010.

JORDAN BAKER, EXAMINING ATTORNEY



David J. Kybas

Director of the United States Patent and Trademark Office

United States of America

United States Patent and Trademark Office

CULTURE POP

Reg. No. 4,068,411

Registered Dec. 6, 2011

Int. Cl.: 28

TRADEMARK

PRINCIPAL REGISTER

FOX, DAVID WILLIAM (UNITED STATES INDIVIDUAL)
6343 BLUE HERON LANE
WARRENTON, VA 20187

FOR: PARTY GAMES, IN CLASS 28 (U.S. CLS. 22, 23, 38 AND 50).

FIRST USE 7-15-2009; IN COMMERCE 10-30-2010.

THE MARK CONSISTS OF STANDARD CHARACTERS WITHOUT CLAIM TO ANY PARTICULAR FONT, STYLE, SIZE, OR COLOR.

SN 85-145,898, FILED 10-6-2010.

KRISTINA MORRIS, EXAMINING ATTORNEY



David J. Kyffers

Director of the United States Patent and Trademark Office

United States of America

United States Patent and Trademark Office

Salmo Guard

Reg. No. 4,068,412

AGRI LABORATORIES, LTD. (DELAWARE CORPORATION)
20927 STATE ROUTE K
ST. JOSEPH, MO 64505

Registered Dec. 6, 2011

Int. Cl.: 5

FOR: ANIMAL VACCINE, NAMELY, VACCINE FOR USE IN CATTLE AS AN AID IN THE PREVENTION OF SALMONELLOSIS, IN CLASS 5 (U.S. CLS. 6, 18, 44, 46, 51 AND 52).

TRADEMARK

FIRST USE 9-20-2011; IN COMMERCE 9-20-2011.

PRINCIPAL REGISTER

THE MARK CONSISTS OF STANDARD CHARACTERS WITHOUT CLAIM TO ANY PARTICULAR FONT, STYLE, SIZE, OR COLOR.

NO CLAIM IS MADE TO THE EXCLUSIVE RIGHT TO USE "SALMO", APART FROM THE MARK AS SHOWN.

SN 85-146,140, FILED 10-6-2010.

ALICE BENMAMAN, EXAMINING ATTORNEY



David J. Kyffers

Director of the United States Patent and Trademark Office

United States of America

United States Patent and Trademark Office

Monkey
Brains
Gone
Bananas

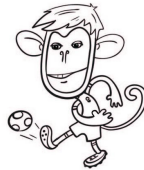

Reg. No. 4,068,413

Registered Dec. 6, 2011

Int. Cl.: 3

TRADEMARK

PRINCIPAL REGISTER

GOLDEN SUN, INC. (CALIFORNIA CORPORATION)
26529 RUETHNER AVENUE
SANTA CLARITA, CA 91350

FOR: WATERLESS FOAM SHAMPOO FOR USE AS A HAIR REFRESHER, IN CLASS 3 (U.S. CLS. 1, 4, 6, 50, 51 AND 52).

FIRST USE 1-18-2011; IN COMMERCE 1-18-2011.

THE MARK CONSISTS OF THE STYLIZED WORDING "MONKEY BRAINS" AND "GONE BANANAS" APPEARING ABOVE THE STYLIZED DESIGN OF A MONKEY IN A SOCCER SHIRT, SHORTS, SOCKS AND SHOES, KICKING A SOCCER BALL WITH HIS RIGHT FOOT.

SN 85-146,584, FILED 10-6-2010.

AMY KERTGATE, EXAMINING ATTORNEY



David J. Kybas

Director of the United States Patent and Trademark Office

United States of America

United States Patent and Trademark Office



WEAPONS GRADE

Reg. No. 4,068,414

MARANKIE, GREG (UNITED STATES INDIVIDUAL), DBA WEAPONS GRADE,
707 DANVERS CIRCLE
NEWBURY PARK, CA 91320

Registered Dec. 6, 2011

Int. Cl.: 12

FOR: AUTOMOBILE BUMPERS; AUTOMOBILE ROOF RACKS; AUTOMOTIVE CARGO RACK, IN CLASS 12 (U.S. CLS. 19, 21, 23, 31, 35 AND 44).

TRADEMARK

FIRST USE 6-10-2010; IN COMMERCE 7-10-2011.

PRINCIPAL REGISTER

THE MARK CONSISTS OF STANDARD CHARACTERS WITHOUT CLAIM TO ANY PARTICULAR FONT, STYLE, SIZE, OR COLOR.

SN 85-146,870, FILED 10-6-2010.

CHRIS WELLS, EXAMINING ATTORNEY



David J. Kybas

Director of the United States Patent and Trademark Office

United States of America

United States Patent and Trademark Office

NATURE'S FAVORITE

Reg. No. 4,068,415

SENECA FOODS CORPORATION (NEW YORK CORPORATION)
3736 SOUTH MAIN STREET
MARION, NY 14505

Registered Dec. 6, 2011

Int. Cl.: 30

FOR: OATMEAL-BASED SNACK FOODS ALSO CONTAINING FRUIT, IN CLASS 30 (U.S. CL. 46).

TRADEMARK

FIRST USE 3-31-2011; IN COMMERCE 3-31-2011.

PRINCIPAL REGISTER

THE MARK CONSISTS OF STANDARD CHARACTERS WITHOUT CLAIM TO ANY PARTICULAR FONT, STYLE, SIZE, OR COLOR.

OWNER OF U.S. REG. NOS. 1,493,344 AND 1,509,393.

SN 85-147,104, FILED 10-7-2010.

LIEF MARTIN, EXAMINING ATTORNEY



David J. Kybas

Director of the United States Patent and Trademark Office

United States of America

United States Patent and Trademark Office

UME

Reg. No. 4,068,416

Registered Dec. 6, 2011

Int. Cl.: 36

SERVICE MARK

PRINCIPAL REGISTER

UME FEDERAL CREDIT UNION (UNITED STATES FEDERALLY CHARTERED CREDIT UNION), AKA BURBANK COMMUNITY FEDERAL CREDIT UNION, 3000 WEST MAGNOLIA BLVD. BURBANK, CA 91510

FOR: FINANCIAL SERVICES, NAMELY, CREDIT UNION SERVICES, SAVINGS AND YOUTH SAVINGS ACCOUNTS, CHECKING ACCOUNTS, MONEY MARKET ACCOUNTS, CERTIFICATES OF DEPOSIT, IRAS, DEFERRED COMPENSATION ACCOUNTS, LOAN PROGRAMS, NAMELY, VEHICLE, CREDIT CARDS, LINES OF CREDIT, COMPUTER LOANS, REAL ESTATE LOANS, MORTGAGES, HOME EQUITY LOANS, ONLINE BANKING SERVICES, AUTOMATED TELLER MACHINE SERVICES, HOME BANKING, BILL PAY, ELECTRONIC DEPOSITS, ATM ACCESS SERVICES; INVESTMENT SERVICES, NAMELY, INVESTMENT ADVICE SERVICES, FUND TRANSFER AND TRANSACTION SERVICES; AND BANKING SERVICES PROVIDED BY TELEPHONE CONNECTIONS, IN CLASS 36 (U.S. CLS. 100, 101 AND 102).

FIRST USE 1-19-2011; IN COMMERCE 1-19-2011.

THE MARK CONSISTS OF STANDARD CHARACTERS WITHOUT CLAIM TO ANY PARTICULAR FONT, STYLE, SIZE, OR COLOR.

SN 85-147,778, FILED 10-7-2010.

INGRID C. EULIN, EXAMINING ATTORNEY



David J. Kyffers

Director of the United States Patent and Trademark Office

United States of America

United States Patent and Trademark Office

CUP ON REQUEST

Reg. No. 4,068,417

KRUPS GMBH (FED REP GERMANY GMBH)
29, HERESBACHSTRASSE
SOLINGEN, FED REP GERMANY D-42719

Registered Dec. 6, 2011

Int. Cl.: 11

FOR: ELECTRIC COFFEE MAKERS, IN CLASS 11 (U.S. CLS. 13, 21, 23, 31 AND 34).

TRADEMARK

FIRST USE 10-0-2010; IN COMMERCE 10-0-2010.

PRINCIPAL REGISTER

THE MARK CONSISTS OF STANDARD CHARACTERS WITHOUT CLAIM TO ANY PARTICULAR FONT, STYLE, SIZE, OR COLOR.

NO CLAIM IS MADE TO THE EXCLUSIVE RIGHT TO USE "CUP", APART FROM THE MARK AS SHOWN.

SN 85-147,998, FILED 10-7-2010.

JOHN GARTNER, EXAMINING ATTORNEY



David J. Kybas

Director of the United States Patent and Trademark Office

United States of America

United States Patent and Trademark Office

Tuck n' Throw

Reg. No. 4,068,418

Registered Dec. 6, 2011

Int. Cl.: 24

TRADEMARK

PRINCIPAL REGISTER

U.N.I.C. DESIGN, INC. (NEW YORK CORPORATION)
60 MADISON AVE.
SUITE #1026
NEW YORK, NY 10010

FOR: BED THROWS; BLANKET THROWS; THROWS, IN CLASS 24 (U.S. CLS. 42 AND 50).

FIRST USE 10-11-2011; IN COMMERCE 10-11-2011.

THE MARK CONSISTS OF STANDARD CHARACTERS WITHOUT CLAIM TO ANY PARTICULAR FONT, STYLE, SIZE, OR COLOR.

NO CLAIM IS MADE TO THE EXCLUSIVE RIGHT TO USE "THROW", APART FROM THE MARK AS SHOWN.

SN 85-148,489, FILED 10-8-2010.

MARK PILARO, EXAMINING ATTORNEY



David J. Kybas

Director of the United States Patent and Trademark Office

United States of America

United States Patent and Trademark Office



Reg. No. 4,068,419
Registered Dec. 6, 2011

TEQUILERA RH, SA DE CV (MEXICO CORPORATION), DBA TEQUILERA RH, SA DE CV,
COLMENA 1224, COLONIA MERCADO DE ABASTOS
GUADALAJARA, JALISCO, MEXICO 44530

Int. Cl.: 33

FOR: TEQUILA, IN CLASS 33 (U.S. CLS. 47 AND 49).

TRADEMARK

FIRST USE 6-1-2011; IN COMMERCE 6-20-2011.

PRINCIPAL REGISTER

NO CLAIM IS MADE TO THE EXCLUSIVE RIGHT TO USE "COLLECTION", APART FROM
THE MARK AS SHOWN.

THE MARK CONSISTS OF TWO LEAVES OF AN AGAVE PLANT SURROUNDING THE
NAME "R&H COLLECTION".

SN 85-148,629, FILED 10-8-2010.

JUSTINE D. PARKER, EXAMINING ATTORNEY



David J. Kyffers

Director of the United States Patent and Trademark Office

United States of America

United States Patent and Trademark Office

LOADED WITH VALUE!

Reg. No. 4,068,420

Registered Dec. 6, 2011

Int. Cl.: 3

TRADEMARK

PRINCIPAL REGISTER

PURE & NATURAL COMPANY (ARIZONA CORPORATION)
MS 04.50
19001 NORTH SCOTTSDALE ROAD
SCOTTSDALE, AZ 85255

FOR: LAUNDRY DETERGENTS, IN CLASS 3 (U.S. CLS. 1, 4, 6, 50, 51 AND 52).

FIRST USE 4-13-2011; IN COMMERCE 4-13-2011.

THE MARK CONSISTS OF STANDARD CHARACTERS WITHOUT CLAIM TO ANY PARTICULAR FONT, STYLE, SIZE, OR COLOR.

SN 85-148,711, FILED 10-8-2010.

JORDAN BAKER, EXAMINING ATTORNEY



David J. Kyffers

Director of the United States Patent and Trademark Office

United States of America

United States Patent and Trademark Office

G-SPEED

Reg. No. 4,068,421

Registered Dec. 6, 2011

Int. Cl.: 9

TRADEMARK

PRINCIPAL REGISTER

HITACHI GLOBAL STORAGE TECHNOLOGIES NETHERLANDS B.V. (NETHERLANDS PRIVATE LIMITED LIABILITY COMPANY)
LOCATELLIKADE 1
AMSTERDAM, NETHERLANDS 1076AZ

FOR: HARD DISK DRIVES AND PORTABLE HARD DISK DRIVES AND INSTRUCTION MANUALS SOLD AS A UNIT; HARD DISK DRIVES AND PORTABLE HARD DISK DRIVES, IN CLASS 9 (U.S. CLS. 21, 23, 26, 36 AND 38).

FIRST USE 8-26-2006; IN COMMERCE 8-26-2006.

THE MARK CONSISTS OF STANDARD CHARACTERS WITHOUT CLAIM TO ANY PARTICULAR FONT, STYLE, SIZE, OR COLOR.

SN 85-148,714, FILED 10-8-2010.

CHRISTOPHER BUONGIORNO, EXAMINING ATTORNEY



David J. Kybas

Director of the United States Patent and Trademark Office

United States of America

United States Patent and Trademark Office



Reg. No. 4,068,422

Registered Dec. 6, 2011

Int. Cl.: 9

TRADEMARK

PRINCIPAL REGISTER

TSC AUTO ID TECHNOLOGY CO., LTD. (TAIWAN CORPORATION)
8F., NO.563
SEC. 4, ZHONGXIAO E. RD., XINYI DIST.
TAIPEI CITY 110, TAIWAN

FOR: BAR CODE PRINTERS AND PARTS AND ACCESSORIES THEREFOR, NAMELY, BAR CODE LABEL CUTTERS, BAR CODE PRINTER KEYBOARD, AND INK-TRANSFER RIBBONS FOR USE WITH BAR CODE PRINTERS, SOLD AS UNIT THEREWITH; THERMAL PRINTERS; SCANNERS; MOBILE COMPUTERS, IN CLASS 9 (U.S. CLS. 21, 23, 26, 36 AND 38).

FIRST USE 2-15-2003; IN COMMERCE 2-15-2003.

OWNER OF U.S. REG. NO. 2,878,868.

THE MARK CONSISTS OF THE STYLIZED LETTERS "TSC" POSITIONED ABOVE THE WORDS "CONNECTING YOUR THERMAL PRINTING NEEDS.".

SN 85-149,037, FILED 10-9-2010.

DEZMONA MIZELLE, EXAMINING ATTORNEY



David J. Kyfos

Director of the United States Patent and Trademark Office

United States of America
United States Patent and Trademark Office

TROCCER

Reg. No. 4,068,423

Registered Dec. 6, 2011

Int. Cl.: 3

TRADEMARK

PRINCIPAL REGISTER

P/N TECHNOLOGY AND DESIGN LLC (INDIANA LIMITED LIABILITY COMPANY)
3500 CYPRESS LANE
LAFAYETTE, IN 47905

FOR: BEAUTY CREAMS; BEAUTY GELS; BEAUTY LOTIONS; HAIR CREAMS; HAIR GELS;
HAIR LOTIONS; NAIL CREAM; SKIN CREAMS; SKIN LOTIONS, IN CLASS 3 (U.S. CLS.
1, 4, 6, 50, 51 AND 52).

FIRST USE 6-23-2011; IN COMMERCE 6-23-2011.

THE MARK CONSISTS OF STANDARD CHARACTERS WITHOUT CLAIM TO ANY PAR-
TICULAR FONT, STYLE, SIZE, OR COLOR.

SN 85-149,582, FILED 10-11-2010.

MARK SPARACINO, EXAMINING ATTORNEY



David J. Kybas

Director of the United States Patent and Trademark Office

United States of America

United States Patent and Trademark Office

NATURALLY NORMAL

Reg. No. 4,068,424

Registered Dec. 6, 2011

Int. Cl.: 3

TRADEMARK

PRINCIPAL REGISTER

C.B. FLEET INVESTMENT CORPORATION (DELAWARE CORPORATION)
SUITE 202
103 FOULK ROAD
WILMINGTON, DE 19803

FOR: FEMININE HYGIENE CLEANSING SOLUTIONS, NAMELY, NON-MEDICATED DOUCHES AND NON-MEDICATED FEMININE HYGIENE WASH FOR EXTERNAL FEMININE HYGIENE; CLOTHS IMPREGNATED WITH A CLEANSING SOLUTION USED FOR EXTERNAL FEMININE HYGIENE CLEANSING; AND FEMININE HYGIENE CLEANSING TOWELETTES, IN CLASS 3 (U.S. CLS. 1, 4, 6, 50, 51 AND 52).

FIRST USE 5-31-2011; IN COMMERCE 5-31-2011.

THE MARK CONSISTS OF STANDARD CHARACTERS WITHOUT CLAIM TO ANY PARTICULAR FONT, STYLE, SIZE, OR COLOR.

SN 85-149,708, FILED 10-11-2010.

BRIAN PINO, EXAMINING ATTORNEY



David J. Kybas

Director of the United States Patent and Trademark Office

United States of America

United States Patent and Trademark Office



Simplee Delicious

Delicious food made simple

Reg. No. 4,068,425

Registered Dec. 6, 2011

Int. Cls.: 29 and 30

TRADEMARK

PRINCIPAL REGISTER

SIMPLEE DELICIOUS, INC. (ILLINOIS CORPORATION)
7454 TIMBER RIDGE ROAD
ROSCOE, IL 61073

FOR: APPLE BUTTER; DIP MIXES; GARLIC-BASED SPREAD; JELLIES AND JAMS; LEMON CURD; OLIVE OILS; PICKLES; PROCESSED NUTS; SNACK MIX CONSISTING OF PRIMARILY OF PROCESSED NUTS, SEEDS, DRIED FRUIT AND ALSO INCLUDING CHOCOLATE; SOUP MIXES; SOUPS, IN CLASS 29 (U.S. CL. 46).

FIRST USE 5-18-2011; IN COMMERCE 5-18-2011.

FOR: BAGEL CHIPS; BAKERY GOODS AND DESSERT ITEMS, NAMELY, CHEESECAKES FOR RETAIL AND WHOLESALE DISTRIBUTION AND CONSUMPTION ON OR OFF THE PREMISES; BARBECUE SAUCE; BISCOTTI; BREAD MIXES; BROWNIE MIXES; CAKE MIXES; CANDY; CARAMEL POPCORN; CARAMEL TOPPING FOR ICE CREAM; CARAMELS; CHOCOLATE CANDIES; CHOCOLATE COVERED FRUIT; CHOCOLATE COVERED NUTS; CHOCOLATE COVERED POPCORN; CHOCOLATE COVERED PRETZELS; CHOCOLATE COVERED RAISINS; CHOCOLATE COVERED ROASTED COFFEE BEANS; CHOCOLATE TOPPING; CHOCOLATE TRUFFLES; CHOCOLATES AND CHOCOLATE BASED READY TO EAT CANDIES AND SNACKS; CHUTNEYS; COCOA MIXES; COFFEE BEANS; COOKIE MIXES; COOKIES; DONUTS; DRY SPICE RUB FOR MEATS AND FISH; FROZEN DESSERT CONSISTING OF FRUIT AND CREAM OR CREAM SUBSTITUTES; GROUND COFFEE BEANS; GUMMY CANDIES; HONEY; MEAL KITS CONSISTING PRIMARILY OF NOODLES; MIXES FOR BAKERY GOODS; MUFFIN MIXES; MUSTARD; NON-DAIRY FROZEN CONFECTIONS; PANCAKE MIXES; PEANUT BRITTLE; PICKLE RELISH; PITA CHIPS; POPCORN; SALAD DRESSINGS; SAUCES; STEAK SAUCE; STUFFING MIXES CONTAINING BREAD; TEA FOR INFUSIONS; TOPPING SYRUP, IN CLASS 30 (U.S. CL. 46).

FIRST USE 6-1-2011; IN COMMERCE 6-1-2011.

NO CLAIM IS MADE TO THE EXCLUSIVE RIGHT TO USE "DELICIOUS", APART FROM THE MARK AS SHOWN.

THE MARK CONSISTS OF THE WORDS "SIMPLEE DELICIOUS" WITH THE LETTERS "SD" VISUALLY OFFSET IN A DIAMOND-SHAPED BACKGROUND ABOVE, A DOWNWARDLY CURVED DESIGN BELOW, AND THE WORDS "DELICIOUS FOOD MADE



David J. Kybas

Director of the United States Patent and Trademark Office

Reg. No. 4,068,425 SIMPLE" BETWEEN THE RIGHT SIDE OF THE CURVED DESIGN AND THE "SIMPLEE DELICIOUS" WORDS.

SN 85-149,774, FILED 10-11-2010.

JESSICA A. POWERS, EXAMINING ATTORNEY

United States of America

United States Patent and Trademark Office

GLABBER

Reg. No. 4,068,426

Registered Dec. 6, 2011

Int. Cl.: 45

SERVICE MARK

PRINCIPAL REGISTER

GLABBER, INC. (DELAWARE CORPORATION)
113 BARKSDALE PROFESSIONAL CENTER
NEWARK, DE 19711

FOR: INTERNET BASED SOCIAL NETWORKING SERVICES; PROVIDING ONLINE SEARCHABLE COMPUTER DATABASES IN THE FIELD OF SOCIAL NETWORKING, IN CLASS 45 (U.S. CLS. 100 AND 101).

FIRST USE 9-23-2009; IN COMMERCE 9-23-2009.

THE MARK CONSISTS OF STANDARD CHARACTERS WITHOUT CLAIM TO ANY PARTICULAR FONT, STYLE, SIZE, OR COLOR.

SN 85-149,886, FILED 10-11-2010.

JAMES LOVELACE, EXAMINING ATTORNEY



David J. Kyros

Director of the United States Patent and Trademark Office

United States of America

United States Patent and Trademark Office

CAMP + KING

Reg. No. 4,068,427

CAMP + KING, LLC (DELAWARE LIMITED LIABILITY COMPANY)
1355 SANSOME STREET
SAN FRANCISCO, CA 94111

Registered Dec. 6, 2011

Int. Cl.: 35

FOR: ADVERTISING AGENCY SERVICES AND ADVERTISING CONSULTING SERVICES,
IN CLASS 35 (U.S. CLS. 100, 101 AND 102).

SERVICE MARK

FIRST USE 1-5-2011; IN COMMERCE 1-5-2011.

PRINCIPAL REGISTER

THE MARK CONSISTS OF STANDARD CHARACTERS WITHOUT CLAIM TO ANY PARTICULAR FONT, STYLE, SIZE, OR COLOR.

SN 85-149,988, FILED 10-11-2010.

KATHERINE CONNOLLY, EXAMINING ATTORNEY



David J. Kybas

Director of the United States Patent and Trademark Office

United States of America

United States Patent and Trademark Office

COWBOY MILITIA COCK YOUR HAMMER

Reg. No. 4,068,428

Registered Dec. 6, 2011

Int. Cl.: 25

TRADEMARK

PRINCIPAL REGISTER

TROSPER, JASON (UNITED STATES INDIVIDUAL)
P.O. BOX 68
PONDER, TX 76258

FOR: HATS; SHIRTS; T-SHIRTS, IN CLASS 25 (U.S. CLS. 22 AND 39).

FIRST USE 4-8-2010; IN COMMERCE 4-8-2010.

THE MARK CONSISTS OF STANDARD CHARACTERS WITHOUT CLAIM TO ANY PARTICULAR FONT, STYLE, SIZE, OR COLOR.

OWNER OF U.S. REG. NO. 3,553,830.

SN 85-150,053, FILED 10-11-2010.

WILLIAM P. SHANAHAN, EXAMINING ATTORNEY



David J. Kyros

Director of the United States Patent and Trademark Office

United States of America

United States Patent and Trademark Office

COWGIRL MILITIA COCK YOUR HAMMER

Reg. No. 4,068,429

Registered Dec. 6, 2011

Int. Cl.: 25

TRADEMARK

PRINCIPAL REGISTER

TROSPER, JASON (UNITED STATES INDIVIDUAL)
P.O. BOX 68
PONDER, TX 76258

FOR: HATS; SHIRTS; T-SHIRTS, IN CLASS 25 (U.S. CLS. 22 AND 39).

FIRST USE 4-8-2010; IN COMMERCE 4-8-2010.

THE MARK CONSISTS OF STANDARD CHARACTERS WITHOUT CLAIM TO ANY PARTICULAR FONT, STYLE, SIZE, OR COLOR.

OWNER OF U.S. REG. NO. 3,553,830.

SN 85-150,060, FILED 10-11-2010.

WILLIAM P. SHANAHAN, EXAMINING ATTORNEY



David J. Kybas

Director of the United States Patent and Trademark Office

United States of America

United States Patent and Trademark Office

SAY GOOD NIGHT TO SNORING

Reg. No. 4,068,430

RANIR, LLC (DELAWARE LIMITED LIABILITY COMPANY)
4701 EAST PARIS AVENUE S.E.
GRAND RAPIDS, MI 49512

Registered Dec. 6, 2011

Int. Cl.: 10

FOR: THERAPEUTIC MOUTHPIECES FOR THE PREVENTION OF SNORING, IN CLASS 10 (U.S. CLS. 26, 39 AND 44).

TRADEMARK

FIRST USE 8-5-2011; IN COMMERCE 8-5-2011.

PRINCIPAL REGISTER

THE MARK CONSISTS OF STANDARD CHARACTERS WITHOUT CLAIM TO ANY PARTICULAR FONT, STYLE, SIZE, OR COLOR.

SN 85-150,242, FILED 10-12-2010.

DORITT L. CARROLL, EXAMINING ATTORNEY



David J. Kyffers

Director of the United States Patent and Trademark Office

United States of America

United States Patent and Trademark Office

CYCLE FLY'R

Reg. No. 4,068,431

BISHOP, MIKE (UNITED STATES INDIVIDUAL)
21 BURKESIDE AVE
BROCKTON, MA 02301

Registered Dec. 6, 2011

Int. Cl.: 28

FOR: PLAYGROUND EQUIPMENT, NAMELY, ROTATING SWINGS POWERED BY PED-
ALLING, IN CLASS 28 (U.S. CLS. 22, 23, 38 AND 50).

TRADEMARK

FIRST USE 11-4-2010; IN COMMERCE 10-19-2011.

PRINCIPAL REGISTER

THE MARK CONSISTS OF STANDARD CHARACTERS WITHOUT CLAIM TO ANY PAR-
TICULAR FONT, STYLE, SIZE, OR COLOR.

SN 85-150,341, FILED 10-12-2010.

FRED CARL, EXAMINING ATTORNEY



David J. Kyros

Director of the United States Patent and Trademark Office

United States of America

United States Patent and Trademark Office

PROTECT. OPTIMIZE. EMPOWER.

Reg. No. 4,068,432

MAX INTERNATIONAL, LLC (UTAH LIMITED LIABILITY COMPANY)
7090 S. UNION PARK AVE., SUITE 500
SALT LAKE CITY, UT 84047

Registered Dec. 6, 2011

Int. Cl.: 5

FOR: DIETARY AND NUTRITIONAL SUPPLEMENTS, IN CLASS 5 (U.S. CLS. 6, 18, 44, 46, 51 AND 52).

TRADEMARK

FIRST USE 10-0-2010; IN COMMERCE 10-0-2010.

PRINCIPAL REGISTER

THE MARK CONSISTS OF STANDARD CHARACTERS WITHOUT CLAIM TO ANY PARTICULAR FONT, STYLE, SIZE, OR COLOR.

SN 85-150,586, FILED 10-12-2010.

ANDREW RHIM, EXAMINING ATTORNEY



David J. Kyffers

Director of the United States Patent and Trademark Office

United States of America

United States Patent and Trademark Office

CORNERSTONES4CARE

Reg. No. 4,068,433

NOVO NORDISK A/S (DENMARK CORPORATION)

Registered Dec. 6, 2011

NOVO ALLÉ
DK-2880 BAGSVAERD, DENMARK

Int. Cl.: 44

FOR: PROVIDING INFORMATION IN THE FIELD OF DIABETES; AND PROVIDING A WEBSITE THAT FEATURES INFORMATION IN THE FIELD OF DIABETES, IN CLASS 44 (U.S. CLS. 100 AND 101).

SERVICE MARK

FIRST USE 11-9-2010; IN COMMERCE 11-9-2010.

PRINCIPAL REGISTER

THE MARK CONSISTS OF STANDARD CHARACTERS WITHOUT CLAIM TO ANY PARTICULAR FONT, STYLE, SIZE, OR COLOR.

SN 85-151,224, FILED 10-13-2010.

JAMES MACFARLANE, EXAMINING ATTORNEY



David J. Kybas

Director of the United States Patent and Trademark Office

United States of America

United States Patent and Trademark Office

MAKE YOURSELF HAPPY

Reg. No. 4,068,434

Registered Dec. 6, 2011

Int. Cl.: 43

SERVICE MARK

PRINCIPAL REGISTER

YOBLENDZ INTERNATIONAL, LLC (FLORIDA LIMITED LIABILITY COMPANY)
2893 EXECUTIVE PARK DRIVE, SUITE 202
WESTON, FL 33326

FOR: RESTAURANT SERVICES, IN CLASS 43 (U.S. CLS. 100 AND 101).

FIRST USE 12-1-2010; IN COMMERCE 12-1-2010.

THE MARK CONSISTS OF STANDARD CHARACTERS WITHOUT CLAIM TO ANY PARTICULAR FONT, STYLE, SIZE, OR COLOR.

SN 85-151,741, FILED 10-13-2010.

HELENE LIWINSKI, EXAMINING ATTORNEY



David J. Kybas

Director of the United States Patent and Trademark Office

United States of America

United States Patent and Trademark Office



Reg. No. 4,068,435

Registered Dec. 6, 2011

Int. Cl.: 5

TRADEMARK

PRINCIPAL REGISTER

MAX INTERNATIONAL, LLC (UTAH LIMITED LIABILITY COMPANY)
7090 S. UNION PARK AVE., SUITE 500
SALT LAKE CITY, UT 84047

FOR: DIETARY AND NUTRITIONAL SUPPLEMENTS, IN CLASS 5 (U.S. CLS. 6, 18, 44, 46, 51 AND 52).

FIRST USE 10-0-2010; IN COMMERCE 10-0-2010.

THE MARK CONSISTS OF THE WORDS "POWERED BY RIBOCEINE" AND AN HOURGLASS SHAPE AND A CIRCLE.

THE WORDING "RIBOCEINE" HAS NO MEANING IN A FOREIGN LANGUAGE.

SN 85-151,835, FILED 10-13-2010.

ANDREW RHIM, EXAMINING ATTORNEY



David J. Kybas

Director of the United States Patent and Trademark Office

United States of America

United States Patent and Trademark Office

Mustang Monument

Reg. No. 4,068,436

Registered Dec. 6, 2011

Int. Cl.: 41

SERVICE MARK

PRINCIPAL REGISTER

SAVING AMERICA'S MUSTANGS (NEVADA CORPORATION)
2683 VIA DE LA VALLE, #G313
DEL MAR, CA 92014

FOR: PROVIDING AN ANIMAL SANCTUARY FOR HORSES IN THE NATURE OF A PERMANENT REFUGE WHERE THE HORSES CAN BE VIEWED IN THEIR NATURAL HABITAT BY MEMBERS OF THE PUBLIC, IN CLASS 41 (U.S. CLS. 100, 101 AND 107).

FIRST USE 8-1-2010; IN COMMERCE 9-17-2010.

THE MARK CONSISTS OF STANDARD CHARACTERS WITHOUT CLAIM TO ANY PARTICULAR FONT, STYLE, SIZE, OR COLOR.

NO CLAIM IS MADE TO THE EXCLUSIVE RIGHT TO USE "MUSTANG", APART FROM THE MARK AS SHOWN.

SN 85-153,348, FILED 10-15-2010.

WILLIAM ROSSMAN, EXAMINING ATTORNEY



David J. Kyros

Director of the United States Patent and Trademark Office

United States of America

United States Patent and Trademark Office



Reg. No. 4,068,437

Registered Dec. 6, 2011

Int. Cl.: 41

SERVICE MARK

PRINCIPAL REGISTER

CAPE FEAR COMMUNITY COLLEGE FOUNDATION, INCORPORATED (NORTH CAROLINA
NON-PROFIT CORPORATION)
411 NORTH FRONT STREET
WILMINGTON, NC 28401

FOR: ENTERTAINMENT SERVICES, NAMELY, CONDUCTING COLLEGE LEVEL
SPORTING EVENTS, IN CLASS 41 (U.S. CLS. 100, 101 AND 107).

FIRST USE 9-1-2010; IN COMMERCE 9-1-2010.

OWNER OF U.S. REG. NOS. 3,847,718, 3,847,751, AND 3,849,900.

NO CLAIM IS MADE TO THE EXCLUSIVE RIGHT TO USE "CAPE FEAR COMMUNITY
COLLEGE", APART FROM THE MARK AS SHOWN.

THE MARK CONSISTS OF LITERAL ELEMENTS "CAPE FEAR COMMUNITY COLLEGE"
BELOW THE LITERAL ELEMENTS "SEA DEVILS" ALL BELOW THE IMAGE OF A STING
RAY.

SN 85-153,868, FILED 10-15-2010.

MICHAEL WEBSTER, EXAMINING ATTORNEY



David J. Kyffers

Director of the United States Patent and Trademark Office

United States of America

United States Patent and Trademark Office

REAL PEOPLE, REAL TALENT, REAL MATTERS

Reg. No. 4,068,438

Registered Dec. 6, 2011

Int. Cl.: 35

SERVICE MARK

PRINCIPAL REGISTER

ROSS RECRUITING, INC. (MICHIGAN CORPORATION), DBA JBL RESOURCES,
7064 VERDE VISTA DRIVE NE
ROCKFORD, MI 49341

FOR: JOB AND PERSONNEL PLACEMENT SERVICES, IN CLASS 35 (U.S. CLS. 100, 101
AND 102).

FIRST USE 8-26-2011; IN COMMERCE 8-26-2011.

THE MARK CONSISTS OF STANDARD CHARACTERS WITHOUT CLAIM TO ANY PAR-
TICULAR FONT, STYLE, SIZE, OR COLOR.

SN 85-153,874, FILED 10-15-2010.

DORITT L. CARROLL, EXAMINING ATTORNEY



David J. Kyros

Director of the United States Patent and Trademark Office

United States of America

United States Patent and Trademark Office

PLACING TALENT FOR YOUR CALLING

Reg. No. 4,068,439

Registered Dec. 6, 2011

Int. Cl.: 35

SERVICE MARK

PRINCIPAL REGISTER

ROSS RECRUITING, INC. (MICHIGAN CORPORATION), DBA JBL RESOURCES,
7064 VERDE VISTA DRIVE NE
ROCKFORD, MI 49341

FOR: JOB AND PERSONNEL PLACEMENT SERVICES, IN CLASS 35 (U.S. CLS. 100, 101
AND 102).

FIRST USE 8-26-2011; IN COMMERCE 8-26-2011.

THE MARK CONSISTS OF STANDARD CHARACTERS WITHOUT CLAIM TO ANY PAR-
TICULAR FONT, STYLE, SIZE, OR COLOR.

SN 85-153,881, FILED 10-15-2010.

DORITT L. CARROLL, EXAMINING ATTORNEY



David J. Kyros

Director of the United States Patent and Trademark Office

United States of America
United States Patent and Trademark Office

MAGIC LOOFAH

神奇絲瓜絡

Reg. No. 4,068,440

HUANG, CHUN (CANADA INDIVIDUAL)
7305 WOODBINE AVE., UNIT 157
MARKHAM, ON., CANADA L3R3V7

Registered Dec. 6, 2011

Int. Cl.: 21

FOR: BATH PRODUCTS, NAMELY, LOOFAH SPONGES; LOOFAHS FOR HOUSEHOLD PURPOSES, IN CLASS 21 (U.S. CLS. 2, 13, 23, 29, 30, 33, 40 AND 50).

TRADEMARK

FIRST USE 10-15-2010; IN COMMERCE 10-15-2010.

PRINCIPAL REGISTER

NO CLAIM IS MADE TO THE EXCLUSIVE RIGHT TO USE NON-LATIN CHARACTERS THAT TRANSLITERATE TO SI GUA LUO AND THE WORDING "LOOFAH", APART FROM THE MARK AS SHOWN.

THE NON-LATIN CHARACTERS IN THE MARK TRANSLITERATE TO SHEN QI SI GUA LUO AND THIS MEANS "MAGIC LOOFAH" IN ENGLISH.

THE MARK CONSISTS OF LETTERS OF "MAGIC LOOFAH", AND FIVE CHINESE CHARACTERS IN THE MEANING OF "MAGIC LOOFAH".

THE ENGLISH TRANSLATION OF "SHEN QI SI GUA LUO" IN THE MARK IS "MAGIC LOOFAH".

SN 85-153,972, FILED 10-15-2010.

ALEX KEAM, EXAMINING ATTORNEY



David J. Kappas

Director of the United States Patent and Trademark Office

United States of America

United States Patent and Trademark Office

Kerazyme

Reg. No. 4,068,441

ACTIVE CONCEPTS LLC (NEW JERSEY LIMITED LIABILITY COMPANY)
107 TECHNOLOGY DRIVE
LINCOLNTON, NC 28092

Registered Dec. 6, 2011

Int. Cl.: 1

FOR: CHEMICAL ADDITIVES FOR USE IN THE MANUFACTURE OF COSMETIC, IN CLASS 1 (U.S. CLS. 1, 5, 6, 10, 26 AND 46).

TRADEMARK

FIRST USE 1-13-2011; IN COMMERCE 9-15-2011.

PRINCIPAL REGISTER

THE MARK CONSISTS OF STANDARD CHARACTERS WITHOUT CLAIM TO ANY PARTICULAR FONT, STYLE, SIZE, OR COLOR.

SN 85-154,015, FILED 10-15-2010.

CYNTHIA TRIPI, EXAMINING ATTORNEY



David J. Kyros

Director of the United States Patent and Trademark Office

United States of America

United States Patent and Trademark Office

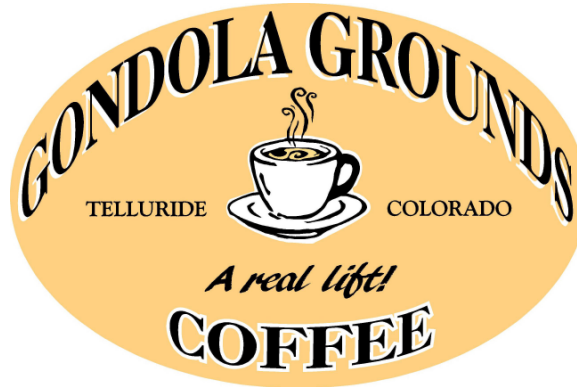

Reg. No. 4,068,442

Registered Dec. 6, 2011

Int. Cl.: 43

SERVICE MARK

PRINCIPAL REGISTER

GONDOLA GROUNDS COFFEE, LLC (COLORADO LIMITED LIABILITY COMPANY), DBA
GONDOLA GROUNDS COFFEE,
106 POLECAT LANE
MOUNTAINVILLAGE, CO 81435

FOR: COFFEE AND JUICE BAR SERVICES; COFFEE AND TEA BARS; COFFEE SHOPS, IN
CLASS 43 (U.S. CLS. 100 AND 101).

FIRST USE 9-1-2010; IN COMMERCE 10-1-2011.

NO CLAIM IS MADE TO THE EXCLUSIVE RIGHT TO USE "COFFEE" AND "TELLURIDE
COLORADO", APART FROM THE MARK AS SHOWN.

THE COLOR(S) BLACK, WHITE, BROWN AND TAN IS/ARE CLAIMED AS A FEATURE
OF THE MARK.

THE MARK CONSISTS OF A TAN OVAL WITH THE BLACK AND WHITE TEXT "GONDOLA
GROUNDS COFFEE". IN THE MIDDLE OF THE OVAL IS A WHITE, BLACK AND TAN
IMAGE OF A STEAMING COFFEE CUP, BETWEEN THE WORDS "TELLURIDE" AND
"COLORADO" IN BROWN. BELOW THE COFFEE CUP IS THE SLOGAN "A REAL LIFT"
IN BROWN.

SN 85-154,388, FILED 10-16-2010.

REBECCA EISINGER, EXAMINING ATTORNEY



David J. Kybas

Director of the United States Patent and Trademark Office

United States of America

United States Patent and Trademark Office

Lashfresh

Reg. No. 4,068,443

LASH OUT (CALIFORNIA LIMITED LIABILITY COMPANY)
7760 FAY AVE. STE. N
LA JOLLA, CA 92037

Registered Dec. 6, 2011

Int. Cl.: 3

FOR: COSMETIC PREPARATIONS FOR EYE LASHES, IN CLASS 3 (U.S. CLS. 1, 4, 6, 50, 51 AND 52).

TRADEMARK

FIRST USE 4-6-2011; IN COMMERCE 4-6-2011.

PRINCIPAL REGISTER

THE MARK CONSISTS OF STANDARD CHARACTERS WITHOUT CLAIM TO ANY PARTICULAR FONT, STYLE, SIZE, OR COLOR.

SN 85-154,402, FILED 10-16-2010.

REBECCA EISINGER, EXAMINING ATTORNEY



David J. Kybas

Director of the United States Patent and Trademark Office

United States of America

United States Patent and Trademark Office

Antartic

Reg. No. 4,068,444

Registered Dec. 6, 2011

Int. Cl.: 29

TRADEMARK

PRINCIPAL REGISTER

PESQUERA TRANS ANTARTIC S.A. (CHILE CORPORATION)
SANTA ADELA NO. 10.301 MAIPU
SANTIAGO, CHILE

FOR: TINNED SEAFOOD, IN CLASS 29 (U.S. CL. 46).

FIRST USE 10-20-2010; IN COMMERCE 1-31-2011.

THE MARK CONSISTS OF "ANTARTIC" UNDERLINED BY A SWEEPING DUAL ENDED
ARROW DESIGN.

SN 85-155,271, FILED 10-18-2010.

SUSAN LESLIE DUBOIS, EXAMINING ATTORNEY



David J. Kyffers

Director of the United States Patent and Trademark Office

United States of America

United States Patent and Trademark Office

POWERFUL CLEAN. GENTLE ON
SKIN.

Reg. No. 4,068,445

Registered Dec. 6, 2011

Int. Cl.: 3

TRADEMARK

PRINCIPAL REGISTER

THE SUN PRODUCTS CORPORATION (DELAWARE CORPORATION)
60 DANBURY ROAD
WILTON, CT 06897

FOR: LAUNDRY DETERGENT, IN CLASS 3 (U.S. CLS. 1, 4, 6, 50, 51 AND 52).

FIRST USE 5-0-2009; IN COMMERCE 5-0-2009.

THE MARK CONSISTS OF STANDARD CHARACTERS WITHOUT CLAIM TO ANY PARTICULAR FONT, STYLE, SIZE, OR COLOR.

SN 85-155,381, FILED 10-18-2010.

ANDREA HACK, EXAMINING ATTORNEY



David J. Kyffers

Director of the United States Patent and Trademark Office

United States of America

United States Patent and Trademark Office

MADE IN HEAVEN INTIMATES

Reg. No. 4,068,446

Registered Dec. 6, 2011

Int. Cl.: 25

TRADEMARK

PRINCIPAL REGISTER

SAEDI, SAMAN (UNITED STATES INDIVIDUAL)
C/O GAY HARWIN, SUITE 707
9454 WILSHIRE BOULEVARD
BEVERLY HILLS, CA 90212

FOR: LINGERIE; ROBES; SLIPPERS, IN CLASS 25 (U.S. CLS. 22 AND 39).

FIRST USE 9-30-2011; IN COMMERCE 9-30-2011.

THE MARK CONSISTS OF STANDARD CHARACTERS WITHOUT CLAIM TO ANY PARTICULAR FONT, STYLE, SIZE, OR COLOR.

OWNER OF U.S. REG. NO. 3,076,501.

NO CLAIM IS MADE TO THE EXCLUSIVE RIGHT TO USE "INTIMATES", APART FROM THE MARK AS SHOWN.

SN 85-155,773, FILED 10-19-2010.

REBECCA GILBERT, EXAMINING ATTORNEY



David J. Kybas

Director of the United States Patent and Trademark Office

United States of America

United States Patent and Trademark Office



Reg. No. 4,068,447

Registered Dec. 6, 2011

Int. Cl.: 35

SERVICE MARK

PRINCIPAL REGISTER

GOOD ENTERPRISES, LTD. (PENNSYLVANIA CORPORATION)
3518 OLD PHILADELPHIA PIKE
P.O. BOX 419
INTERCOURSE, PA 175340419

FOR: RETAIL STORE SERVICES FEATURING FOOD, COOKWARE, GLASSWARE, UTENSILS, COOKBOOKS, DVDS AND KITCHEN TEXTILE PRODUCTS, IN CLASS 35 (U.S. CLS. 100, 101 AND 102).

FIRST USE 11-26-2010; IN COMMERCE 11-26-2010.

NO CLAIM IS MADE TO THE EXCLUSIVE RIGHT TO USE "COOKING STORE", APART FROM THE MARK AS SHOWN.

THE MARK CONSISTS OF THE WORDS "THE GOOD COOKING STORE" AND THE DESIGN OF A POT WITHIN A LINE DESIGN.

SN 85-156,030, FILED 10-19-2010.

DANNEAN HETZEL, EXAMINING ATTORNEY



David J. Kybas

Director of the United States Patent and Trademark Office

United States of America

United States Patent and Trademark Office

MYPROFESSIONPROFILE THE PLACE TO CONNECT WITH PEOPLE YOU KNOW AND PEOPLE IN THE KNOW

Reg. No. 4,068,448

Registered Dec. 6, 2011

Int. Cl.: 42

SERVICE MARK

PRINCIPAL REGISTER

MYPROFESSIONPROFILE, INC. (DELAWARE CORPORATION)
P.O. BOX 423
WORTHINGTON, OH 43085

FOR: COMPUTER SERVICES, NAMELY, HOSTING ONLINE WEB FACILITIES FOR OTHERS TO ORGANIZE AND CONDUCT ONLINE MEETINGS, GATHERINGS, ORGANIZE GROUPS EVENTS, ENGAGE IN SOCIAL NETWORKING AND COMMUNITY NETWORKING; COMPUTER SERVICES IN THE NATURE OF CUSTOMIZED WEB PAGES FEATURING USER DEFINED INFORMATION AND PERSONAL PROFILES; COMPUTER SERVICES, NAMELY, CREATING AN ONLINE PROFESSION COMMUNITY FOR REGISTERED USERS TO PARTICIPATE IN DISCUSSIONS, GET FEEDBACK FROM THEIR PEERS, GET FEEDBACK FROM EMPLOYERS AND RECRUITERS, FORM VIRTUAL COMMUNITIES, AND ENGAGE IN PROFESSION NETWORKING; PEER TO PEER BROWSER PHOTO SHARING SERVICES NAMELY, PROVIDING A WEBSITE FEATURING TECHNOLOGY ENABLING USERS TO UPLOAD, VIEW, INTERACT AND DOWNLOAD DIGITAL PHOTOS, IN CLASS 42 (U.S. CLS. 100 AND 101).

FIRST USE 9-2-2011; IN COMMERCE 9-2-2011.

THE MARK CONSISTS OF STANDARD CHARACTERS WITHOUT CLAIM TO ANY PARTICULAR FONT, STYLE, SIZE, OR COLOR.

SN 85-159,059, FILED 10-22-2010.

BILL DAWE, EXAMINING ATTORNEY



David J. Kyffers

Director of the United States Patent and Trademark Office

United States of America

United States Patent and Trademark Office

NGT

Reg. No. 4,068,449

Registered Dec. 6, 2011

Int. Cl.: 3

TRADEMARK

PRINCIPAL REGISTER

QWR, INC. (CALIFORNIA CORPORATION)
3062 N LIMA ST
BURBANK, CA 91504

FOR: BODY AND BEAUTY CARE COSMETICS, IN CLASS 3 (U.S. CLS. 1, 4, 6, 50, 51 AND 52).

FIRST USE 4-22-2010; IN COMMERCE 1-17-2011.

THE MARK CONSISTS OF STANDARD CHARACTERS WITHOUT CLAIM TO ANY PARTICULAR FONT, STYLE, SIZE, OR COLOR.

SN 85-160,857, FILED 10-25-2010.

BRIDGETT SMITH, EXAMINING ATTORNEY



David J. Kybas

Director of the United States Patent and Trademark Office

United States of America

United States Patent and Trademark Office

BUILT FOR BATTLE

Reg. No. 4,068,450

Registered Dec. 6, 2011

Int. Cl.: 27

TRADEMARK

PRINCIPAL REGISTER

SHAW CONTRACT FLOORING SERVICES, INC. (GEORGIA CORPORATION)
616 EAST WALNUT AVENUE, P.O. DRAWER 2128
DALTON, GA 307222128

FOR: ARTIFICIAL TURF, IN CLASS 27 (U.S. CLS. 19, 20, 37, 42 AND 50).

FIRST USE 1-31-2011; IN COMMERCE 1-31-2011.

THE MARK CONSISTS OF STANDARD CHARACTERS WITHOUT CLAIM TO ANY PARTICULAR FONT, STYLE, SIZE, OR COLOR.

SN 85-161,234, FILED 10-26-2010.

PAULA MAHONEY, EXAMINING ATTORNEY



David J. Kybas

Director of the United States Patent and Trademark Office

United States of America

United States Patent and Trademark Office

BLOOM

Reg. No. 4,068,451

Registered Dec. 6, 2011

Int. Cl.: 35

SERVICE MARK

PRINCIPAL REGISTER

BLOOM HEALTH CORPORATION (DELAWARE CORPORATION)
10 SOUTH FIFTH STREET, SUITE 645
MINNEAPOLIS, MN 55402

FOR: CUSTOMER SERVICE IN THE FIELD OF HEALTH AND WELLNESS, HEALTH INSURANCE COVERAGE, EMPLOYEE PERSONAL HEALTH ACCOUNTS, HEALTH CARE PLANS, HEALTH CARE BENEFITS, AND EMPLOYEE WELFARE BENEFIT PLANS, IN CLASS 35 (U.S. CLS. 100, 101 AND 102).

FIRST USE 10-20-2011; IN COMMERCE 10-20-2011.

THE MARK CONSISTS OF STANDARD CHARACTERS WITHOUT CLAIM TO ANY PARTICULAR FONT, STYLE, SIZE, OR COLOR.

SN 85-161,309, FILED 10-26-2010.

SIMON TENG, EXAMINING ATTORNEY



David J. Kybas

Director of the United States Patent and Trademark Office

United States of America

United States Patent and Trademark Office

BEAUTY THROUGHOUT THE YEAR

Reg. No. 4,068,452

GARCIA GROUP, INC. (GEORGIA CORPORATION)
5154 PEACHTREE INDUSTRIAL BLVD.
ATLANTA, GA 30341

Registered Dec. 6, 2011

Int. Cls.: 4 and 21

FOR: CANDLES, IN CLASS 4 (U.S. CLS. 1, 6 AND 15).

TRADEMARK

FIRST USE 9-16-2011; IN COMMERCE 9-16-2011.

PRINCIPAL REGISTER

FOR: VASES , IN CLASS 21 (U.S. CLS. 2, 13, 23, 29, 30, 33, 40 AND 50).

FIRST USE 9-16-2011; IN COMMERCE 9-16-2011.

THE MARK CONSISTS OF STANDARD CHARACTERS WITHOUT CLAIM TO ANY PARTICULAR FONT, STYLE, SIZE, OR COLOR.

SN 85-161,375, FILED 10-26-2010.

CHRIS WELLS, EXAMINING ATTORNEY



David J. Kybas

Director of the United States Patent and Trademark Office

United States of America

United States Patent and Trademark Office

MARIA MERCEDES

Reg. No. 4,068,453

Registered Dec. 6, 2011

Int. Cls.: 9 and 41

TRADEMARK

SERVICE MARK

PRINCIPAL REGISTER

VIDEOSERPEL, LTD. (SWITZERLAND CORPORATION)
DAMMSTRASSE 19
ZUG, SWITZERLAND CH-6300

FOR: PRE-RECORDED DIGITAL AND ELECTRONIC MEDIA FEATURING TELEVISIONS SHOWS, IN CLASS 9 (U.S. CLS. 21, 23, 26, 36 AND 38).

FIRST USE 7-22-2008; IN COMMERCE 7-22-2008.

FOR: ENTERTAINMENT SERVICES IN THE NATURE OF A CONTINUING DRAMATIC SHOW BROADCAST OVER THE INTERNET AND AN ONGOING DRAMATIC TELEVISION PROGRAM, IN CLASS 41 (U.S. CLS. 100, 101 AND 107).

FIRST USE 9-14-1992; IN COMMERCE 8-29-2011.

THE MARK CONSISTS OF STANDARD CHARACTERS WITHOUT CLAIM TO ANY PARTICULAR FONT, STYLE, SIZE, OR COLOR.

THE NAME "MARIA MERCEDES" DOES NOT IDENTIFY A KNOWN LIVING INDIVIDUAL.

THE WORDING "MARIA MERCEDES" HAS NO MEANING IN A FOREIGN LANGUAGE.

SN 85-161,680, FILED 10-26-2010.

LEIGH CAROLINE CASE, EXAMINING ATTORNEY



David J. Kybas

Director of the United States Patent and Trademark Office

United States of America

United States Patent and Trademark Office



Reg. No. 4,068,454

Registered Dec. 6, 2011

Int. Cl.: 28

TRADEMARK

PRINCIPAL REGISTER

HUMPHREYS' H & H LURE COMPANY, INC (LOUISIANA CORPORATION)
10874 NORTH DUAL STREET
BATON ROUGE, LA 70814

FOR: FISHING HOOKS; FISHING LURES; FISHING REELS; FISHING SPINNERS; FISHING TACKLE, IN CLASS 28 (U.S. CLS. 22, 23, 38 AND 50).

FIRST USE 10-31-2010; IN COMMERCE 10-31-2010.

NO CLAIM IS MADE TO THE EXCLUSIVE RIGHT TO USE "LURE COMPANY", APART FROM THE MARK AS SHOWN.

THE COLOR(S) RED, BLACK AND YELLOW IS/ARE CLAIMED AS A FEATURE OF THE MARK.

THE MARK CONSISTS OF THE WORDING "H&H LURE COMPANY" IN STYLIZED LETTERING AND INTEGRATED DESIGN ELEMENTS. THE WORDING "H&H LURE COMPANY" APPEARS IN RED LETTERING OUTLINED IN BLACK. THE DESIGN ELEMENTS ARE A BLACK LURE THAT IS A FANCIFUL REPRESENTATION OF A FISH THAT IS INTEGRATED WITH THE TOP PORTION OF THE CIRCUMFERENCE OF A YELLOW OVAL THAT IS BORDERED IN BLACK. THE GILLS OF THE FISH ARE ON THE INSIDE OF THE LURE AND APPEAR IN RED, WHILE THE FISH FIN AND TAIL APPEAR IN BLACK AND ARE OUTSIDE OF THE OVAL.

SN 85-161,970, FILED 10-27-2010.

JUDITH HELFMAN, EXAMINING ATTORNEY



David J. Kyros

Director of the United States Patent and Trademark Office

United States of America

United States Patent and Trademark Office

The Gas Monkey

Reg. No. 4,068,455

LEGACY PRODUCTS, LLC (NEW YORK LIMITED LIABILITY COMPANY)
74 EAGLE CREST ROAD
PORT JERVIS, NY 12771

Registered Dec. 6, 2011

Int. Cl.: 20

FOR: NON-METAL CLIPS FOR USE WITH GAS PUMP FUEL NOZZLES, IN CLASS 20 (U.S. CLS. 2, 13, 22, 25, 32 AND 50).

TRADEMARK

FIRST USE 1-1-2011; IN COMMERCE 5-1-2011.

PRINCIPAL REGISTER

THE MARK CONSISTS OF STANDARD CHARACTERS WITHOUT CLAIM TO ANY PARTICULAR FONT, STYLE, SIZE, OR COLOR.

NO CLAIM IS MADE TO THE EXCLUSIVE RIGHT TO USE "GAS", APART FROM THE MARK AS SHOWN.

SN 85-162,047, FILED 10-27-2010.

MICHAEL WEBSTER, EXAMINING ATTORNEY



David J. Kybas

Director of the United States Patent and Trademark Office

United States of America

United States Patent and Trademark Office



Reg. No. 4,068,456

Registered Dec. 6, 2011

Int. Cl.: 30

TRADEMARK

PRINCIPAL REGISTER

LOUISIANA SUGAR REFINING, LLC (DELAWARE LIMITED LIABILITY COMPANY)
1230 S. FIFTH AVENUE - BOX 625
GRAMERCY, LA 70052

FOR: SUGAR PRODUCTS, NAMELY, WHITE REFINED SUGAR, LIQUID SUGAR, BROWN SUGAR AND MOLASSES, IN CLASS 30 (U.S. CL. 46).

FIRST USE 3-1-2011; IN COMMERCE 3-1-2011.

NO CLAIM IS MADE TO THE EXCLUSIVE RIGHT TO USE THE OUTLINE OF THE STATE OF LOUISIANA AND "LOUISIANA SUGAR REFINING, LLC", APART FROM THE MARK AS SHOWN.

THE MARK CONSISTS OF THE LETTERS "LSR" IMPOSED OVER THE OUTLINE OF THE STATE OF LOUISIANA WITH THE NAME OF THE COMPANY, "LOUISIANA SUGAR REFINING, LLC", IN A BLOCK BELOW THE LETTERS.

SN 85-163,023, FILED 10-27-2010.

DAVID I, EXAMINING ATTORNEY



David J. Kypos

Director of the United States Patent and Trademark Office

United States of America

United States Patent and Trademark Office

CAREERBLISS

Reg. No. 4,068,457

Registered Dec. 6, 2011

Int. Cls.: 35, 38, and 41

SERVICE MARK

PRINCIPAL REGISTER

CYBERCODERS, INC. (CALIFORNIA CORPORATION)
6591 IRVINE CENTER DRIVE
SUITE 200
IRVINE, CA 92618

FOR: PROVIDING ON-LINE EMPLOYMENT INFORMATION IN THE FIELDS OF CAREERS, PERSONAL ISSUES RELATED TO CAREER ADVANCEMENT AND RECRUITMENT, BALANCING CAREER ADVANCEMENT AND WORK LIFE, EDUCATIONAL REQUIREMENTS AS THEY PERTAIN TO CAREER ADVANCEMENT, COMPARATIVE SALARY OPPORTUNITIES, COMPARATIVE CORPORATE JOB OPPORTUNITIES, JOB RESOURCES AND LISTINGS, AND RESUMES; PROVIDING ON-LINE CAREER INFORMATION AND RELATED SERVICES, NAMELY, PROVIDING INFORMATION REGARDING EMPLOYMENT OPPORTUNITIES, RESUME REVIEW, CRITIQUE AND PREPARATION SERVICES, AND PROVIDING EMPLOYMENT-RELATED SALARY INFORMATION, COMPANY REVIEWS AND INDUSTRY REVIEWS, IN CLASS 35 (U.S. CLS. 100, 101 AND 102).

FIRST USE 6-0-2009; IN COMMERCE 6-0-2009.

FOR: PROVIDING ONLINE FORUMS FOR TRANSMISSION OF MESSAGES AMONG COMPUTER USERS CONCERNING CAREER INFORMATION AND JOB LISTINGS IN THE NATURE OF SALARY INFORMATION, COMPANY INFORMATION FOR JOB SEEKERS, AND INDUSTRY-SPECIFIC AND JOB INFORMATION AND REVIEWS FOR JOB SEEKERS, IN CLASS 38 (U.S. CLS. 100, 101 AND 104).

FIRST USE 6-0-2009; IN COMMERCE 6-0-2009.

FOR: CAREER COUNSELING IN THE NATURE OF PROVIDING ADVICE CONCERNING EDUCATION OPTIONS, IN CLASS 41 (U.S. CLS. 100, 101 AND 107).

FIRST USE 6-0-2009; IN COMMERCE 6-0-2009.

THE MARK CONSISTS OF STANDARD CHARACTERS WITHOUT CLAIM TO ANY PARTICULAR FONT, STYLE, SIZE, OR COLOR.

SN 85-163,616, FILED 10-28-2010.

MARC LEIPZIG, EXAMINING ATTORNEY



David J. Kyppas

Director of the United States Patent and Trademark Office

United States of America

United States Patent and Trademark Office

COZYTHERM

Reg. No. 4,068,458

DUCHATEAU, GARY (UNITED STATES INDIVIDUAL)
220 12TH ST SW #105
LOVELAND, CO 80537

Registered Dec. 6, 2011

Int. Cl.: 11

FOR: APPARATUS FOR ENVIRONMENTAL CONTROL, NAMELY, SOLAR COLLECTOR FOR DIRECT AIR HEATING, IN CLASS 11 (U.S. CLS. 13, 21, 23, 31 AND 34).

TRADEMARK

FIRST USE 4-8-2011; IN COMMERCE 4-8-2011.

PRINCIPAL REGISTER

THE MARK CONSISTS OF STANDARD CHARACTERS WITHOUT CLAIM TO ANY PARTICULAR FONT, STYLE, SIZE, OR COLOR.

SN 85-164,364, FILED 10-29-2010.

BERYL GARDNER, EXAMINING ATTORNEY



David J. Kyffers

Director of the United States Patent and Trademark Office

United States of America

United States Patent and Trademark Office

KAIKU

Reg. No. 4,068,459

Registered Dec. 6, 2011

Int. Cl.: 36

SERVICE MARK

PRINCIPAL REGISTER

KAIKU FINANCE LLC (DELAWARE LIMITED LIABILITY COMPANY)
SUITE 218
660 HAMPSHIRE ROAD
WESTLAKE VILLAGE, CA 91361

FOR: CREDIT, DEBIT, ELECTRONIC PREPAID AND STORED VALUE CARD TRANSACTION PROCESSING SERVICES; CREDIT, DEBIT, ELECTRONIC PREPAID AND STORED VALUE CARD SERVICES; CONSUMER LENDING SERVICES; PROVIDING TEMPORARY LOANS; BANKING SERVICES, IN CLASS 36 (U.S. CLS. 100, 101 AND 102).

FIRST USE 9-0-2010; IN COMMERCE 9-0-2011.

THE MARK CONSISTS OF STANDARD CHARACTERS WITHOUT CLAIM TO ANY PARTICULAR FONT, STYLE, SIZE, OR COLOR.

THE ENGLISH TRANSLATION OF THE WORD "KAIKU" IN THE MARK IS "REVERB".

SN 85-164,676, FILED 10-29-2010.

JAY BESCH, EXAMINING ATTORNEY



David J. Kybas

Director of the United States Patent and Trademark Office

United States of America

United States Patent and Trademark Office

CRAMMED WITH JOY

Reg. No. 4,068,460

Registered Dec. 6, 2011

Int. Cl.: 30

TRADEMARK

PRINCIPAL REGISTER

KRAFT FOODS GLOBAL BRANDS LLC (DELAWARE LIMITED LIABILITY COMPANY)
THREE LAKES DRIVE
NORTHFIELD, IL 60093

FOR: COOKIES, IN CLASS 30 (U.S. CL. 46).

FIRST USE 1-31-2011; IN COMMERCE 1-31-2011.

THE MARK CONSISTS OF STANDARD CHARACTERS WITHOUT CLAIM TO ANY PARTICULAR FONT, STYLE, SIZE, OR COLOR.

SN 85-164,737, FILED 10-29-2010.

ANNE MADDEN, EXAMINING ATTORNEY



David J. Kybas

Director of the United States Patent and Trademark Office

United States of America

United States Patent and Trademark Office

ProFiller

Reg. No. 4,068,461

Registered Dec. 6, 2011

Int. Cl.: 7

TRADEMARK

PRINCIPAL REGISTER

TORPAC (NEW JERSEY CORPORATION)
333 B ROUTE 46 WEST
FAIRFIELD, NJ 07446

FOR: MACHINE FOR ORIENTING, SEPARATING, FILLING AND LOCKING TWO PIECE CAPSULES WITH ELECTRICALLY ASSISTED VIBRATION, IN CLASS 7 (U.S. CLS. 13, 19, 21, 23, 31, 34 AND 35).

FIRST USE 9-30-2011; IN COMMERCE 9-30-2011.

THE MARK CONSISTS OF STANDARD CHARACTERS WITHOUT CLAIM TO ANY PARTICULAR FONT, STYLE, SIZE, OR COLOR.

SN 85-166,665, FILED 11-1-2010.

TARAH HARDY, EXAMINING ATTORNEY



David J. Kybas

Director of the United States Patent and Trademark Office

United States of America

United States Patent and Trademark Office

Moo Chew

Reg. No. 4,068,462

Registered Dec. 6, 2011

Int. Cl.: 29

TRADEMARK

PRINCIPAL REGISTER

WILLIAMS AND CONNER, LLC (TEXAS LIMITED LIABILITY COMPANY)
20 LOU STROUP DRIVE
UVALDE, TX 78801

FOR: BEEF JERKY, IN CLASS 29 (U.S. CL. 46).

FIRST USE 7-15-2011; IN COMMERCE 7-15-2011.

THE MARK CONSISTS OF STANDARD CHARACTERS WITHOUT CLAIM TO ANY PARTICULAR FONT, STYLE, SIZE, OR COLOR.

SN 85-166,923, FILED 11-2-2010.

ESTHER A. BORSUK, EXAMINING ATTORNEY



David J. Kybas

Director of the United States Patent and Trademark Office

United States of America

United States Patent and Trademark Office

SierraLeaf Productions

Reg. No. 4,068,463

Registered Dec. 6, 2011

Int. Cl.: 41

SERVICE MARK

PRINCIPAL REGISTER

MARY ENGLEMAN (UNITED STATES INDIVIDUAL)
535 KNOTTY PINE DRIVE
INCLINE VILLAGE, NV 89451

FOR: EDUCATIONAL SERVICES, NAMELY, CONDUCTING CLASSES AND SEMINARS IN THE FIELD OF VIDEO AND PHOTO EDITING AND TRAVEL DOCUMENTATION; PRODUCTION OF DVDS FEATURING PHOTOS AND/OR VIDEOS IN THE FIELD OF PERSONAL HISTORIES AND EXPERIENCES, IN CLASS 41 (U.S. CLS. 100, 101 AND 107).

FIRST USE 8-1-2011; IN COMMERCE 8-1-2011.

THE MARK CONSISTS OF STANDARD CHARACTERS WITHOUT CLAIM TO ANY PARTICULAR FONT, STYLE, SIZE, OR COLOR.

NO CLAIM IS MADE TO THE EXCLUSIVE RIGHT TO USE "PRODUCTIONS", APART FROM THE MARK AS SHOWN.

SN 85-167,053, FILED 11-2-2010.

COLLEEN DOMBROW, EXAMINING ATTORNEY



David J. Kybas

Director of the United States Patent and Trademark Office

United States of America

United States Patent and Trademark Office

Krimson & Klover

Reg. No. 4,068,464

Registered Dec. 6, 2011

Int. Cl.: 25

TRADEMARK

PRINCIPAL REGISTER

RS DESIGN, LLC (COLORADO LIMITED LIABILITY COMPANY)
PO BOX 214
BOULDER, CO 80306

FOR: ATHLETIC APPAREL, NAMELY, SHIRTS, PANTS, JACKETS, FOOTWEAR, HATS AND CAPS, ATHLETIC UNIFORMS; CHILDREN'S AND INFANT'S APPAREL, NAMELY, JUMPERS, OVERALL SLEEPWEAR, PAJAMAS, ROMPERS AND ONE-PIECE GARMENTS; CHILDREN'S HEADWEAR; CREW NECK SWEATERS; GLOVES; HATS FOR INFANTS, BABIES, TODDLERS AND CHILDREN; KNIT BOTTOMS; KNIT DRESSES; KNIT JACKETS; KNIT SHIRTS; KNIT SKIRTS; KNIT TOPS; KNITTED CAPS; KNITTED GLOVES; KNITTED UNDERWEAR; MITTENS; MOCK TURTLE-NECK SWEATERS; POLO KNIT TOPS; RAIN-PROOF JACKETS; SCARVES; SWEATERS; TURTLENECK SWEATERS; V-NECK SWEATERS, IN CLASS 25 (U.S. CLS. 22 AND 39).

FIRST USE 1-15-2010; IN COMMERCE 11-15-2010.

THE MARK CONSISTS OF STANDARD CHARACTERS WITHOUT CLAIM TO ANY PARTICULAR FONT, STYLE, SIZE, OR COLOR.

SN 85-167,382, FILED 11-2-2010.

KAREN K. BUSH, EXAMINING ATTORNEY



David J. Kyros

Director of the United States Patent and Trademark Office

United States of America

United States Patent and Trademark Office

Omaha Flame

Reg. No. 4,068,465

Registered Dec. 6, 2011

Int. Cl.: 41

SERVICE MARK

PRINCIPAL REGISTER

FAST BALL SPORTS, LLC (NEBRASKA LIMITED LIABILITY COMPANY)
5414 CENTER STREET
OMAHA, NE 58106

FOR: ENTERTAINMENT IN THE NATURE OF BASEBALL GAMES; ENTERTAINMENT, NAMELY, A CONTINUING BASEBALL GAME PRESENTATION SHOW BROADCAST OVER TELEVISION, RADIO, AND VIA INTERNET; ORGANIZING EXHIBITIONS FOR BASEBALL GAMES BEFORE LIVE AUDIENCES, IN CLASS 41 (U.S. CLS. 100, 101 AND 107).

FIRST USE 9-30-2010; IN COMMERCE 9-30-2010.

THE MARK CONSISTS OF STANDARD CHARACTERS WITHOUT CLAIM TO ANY PARTICULAR FONT, STYLE, SIZE, OR COLOR.

NO CLAIM IS MADE TO THE EXCLUSIVE RIGHT TO USE "OMAHA", APART FROM THE MARK AS SHOWN.

SN 85-167,976, FILED 11-3-2010.

MICHELLE DUBOIS, EXAMINING ATTORNEY



David J. Kyffers

Director of the United States Patent and Trademark Office

United States of America

United States Patent and Trademark Office

NORTH SKY CAPITAL

Reg. No. 4,068,466

Registered Dec. 6, 2011

Int. Cl.: 36

SERVICE MARK

PRINCIPAL REGISTER

NORTH SKY CAPITAL, LLC (DELAWARE LIMITED LIABILITY COMPANY)
C/O PIPER JAFFRAY PRIVATE CAPITAL, LLC
800 NICOLLET MALL, J13N04
MINNEAPOLIS, MN 55402

FOR: FINANCIAL SERVICES, NAMELY, INVESTMENT ADVISORY AND INVESTMENT MANAGEMENT SERVICES FOR INVESTMENT FUNDS AND INVESTMENTS, AND FINANCIAL SPONSORSHIP OF THE FORMATION OF INVESTMENT FUNDS; FINANCIAL SERVICES, NAMELY, FINANCIAL PORTFOLIO MANAGEMENT OF INVESTMENT FUNDS FOR OTHERS AND FINANCIAL INVESTMENTS FOR OTHERS, IN CLASS 36 (U.S. CLS. 100, 101 AND 102).

FIRST USE 12-1-2010; IN COMMERCE 12-1-2010.

THE MARK CONSISTS OF STANDARD CHARACTERS WITHOUT CLAIM TO ANY PARTICULAR FONT, STYLE, SIZE, OR COLOR.

NO CLAIM IS MADE TO THE EXCLUSIVE RIGHT TO USE "CAPITAL", APART FROM THE MARK AS SHOWN.

SN 85-168,605, FILED 11-3-2010.

CYNTHIA TRIPI, EXAMINING ATTORNEY



David J. Kybas

Director of the United States Patent and Trademark Office

United States of America

United States Patent and Trademark Office

EXPEDITION IMPOSSIBLE

Reg. No. 4,068,467

Registered Dec. 6, 2011

Int. Cl.: 41

SERVICE MARK

PRINCIPAL REGISTER

ONE THREE, INC. (CALIFORNIA CORPORATION)
SUITE 2520, BUILDING 1
3000 OLYMPIC BOULEVARD
SANTA MONICA, CA 904045073

FOR: ARRANGING AND CONDUCTING LIVE, INTERACTIVE GAMING ADVENTURES IN WHICH PARTICIPANTS TAKE PART IN PHYSICAL CHALLENGES AND/OR PROBLEM-SOLVING CHALLENGES; ENTERTAINMENT SERVICES IN THE NATURE OF AN ON-GOING REALITY BASED TELEVISION PROGRAM; ENTERTAINMENT SERVICES, NAMELY, PROVIDING ON-GOING TELEVISION PROGRAMS IN THE FIELD OF AN ADVENTURE SERIES VIA A GLOBAL COMPUTER NETWORK; ENTERTAINMENT SERVICES, NAMELY, AN ON-GOING REALITY BASED PROGRAM BROADCAST OVER TELEVISION AND VIA SATELLITE, AUDIOVISUAL MEDIA AND/OR WIRELESS NETWORKS, IN CLASS 41 (U.S. CLS. 100, 101 AND 107).

FIRST USE 6-23-2011; IN COMMERCE 6-23-2011.

THE MARK CONSISTS OF STANDARD CHARACTERS WITHOUT CLAIM TO ANY PARTICULAR FONT, STYLE, SIZE, OR COLOR.

OWNER OF U.S. REG. NO. 3,783,009.

SN 85-168,665, FILED 11-3-2010.

DAYNA BROWNE, EXAMINING ATTORNEY



David J. Kyros

Director of the United States Patent and Trademark Office

United States of America

United States Patent and Trademark Office

SOCIAL SECURITY TIMING

Reg. No. 4,068,468

Registered Dec. 6, 2011

Int. Cls.: 36 and 42

SERVICE MARK

PRINCIPAL REGISTER

SENIOR MARKET SALES, INC. (NEBRASKA CORPORATION)
8420 W. DODGE RD., 5TH FLOOR
OMAHA, NE 68114

FOR: INSURANCE AND FINANCIAL PLANNING CONSULTATION SERVICES IN THE FIELD OF RETIREMENT PLANNING, IN CLASS 36 (U.S. CLS. 100, 101 AND 102).

FIRST USE 10-0-2010; IN COMMERCE 10-0-2010.

FOR: PROVIDING TEMPORARY USE OF NON-DOWNLOADABLE COMPUTER SOFTWARE FOR FINANCIAL PLANNING, IN CLASS 42 (U.S. CLS. 100 AND 101).

FIRST USE 1-25-2011; IN COMMERCE 1-25-2011.

THE MARK CONSISTS OF STANDARD CHARACTERS WITHOUT CLAIM TO ANY PARTICULAR FONT, STYLE, SIZE, OR COLOR.

NO CLAIM IS MADE TO THE EXCLUSIVE RIGHT TO USE "SOCIAL SECURITY", APART FROM THE MARK AS SHOWN.

SN 85-170,434, FILED 11-5-2010.

KAREN K. BUSH, EXAMINING ATTORNEY



David J. Kyjars

Director of the United States Patent and Trademark Office

United States of America

United States Patent and Trademark Office



Reg. No. 4,068,469

Registered Dec. 6, 2011

Int. Cls.: 36 and 42

SERVICE MARK

PRINCIPAL REGISTER

SENIOR MARKET SALES, INC. (NEBRASKA CORPORATION)
8420 W. DODGE RD., 5TH FLOOR
OMAHA, NE 68114

FOR: INSURANCE AND FINANCIAL PLANNING CONSULTATION SERVICES IN THE FIELD OF RETIREMENT PLANNING, IN CLASS 36 (U.S. CLS. 100, 101 AND 102).

FIRST USE 10-0-2010; IN COMMERCE 10-0-2010.

FOR: PROVIDING TEMPORARY USE OF NON-DOWNLOADABLE COMPUTER SOFTWARE FOR FINANCIAL PLANNING, IN CLASS 42 (U.S. CLS. 100 AND 101).

FIRST USE 1-25-2011; IN COMMERCE 1-25-2011.

NO CLAIM IS MADE TO THE EXCLUSIVE RIGHT TO USE "SOCIAL SECURITY", APART FROM THE MARK AS SHOWN.

THE MARK CONSISTS OF THE WORDS "SOCIAL SECURITY TIMING" AND AN ARROW DESIGN.

SN 85-170,457, FILED 11-5-2010.

KAREN K. BUSH, EXAMINING ATTORNEY



David J. Kybas

Director of the United States Patent and Trademark Office

United States of America
United States Patent and Trademark Office

ONETAQ

Reg. No. 4,068,470

Registered Dec. 6, 2011

Int. Cl.: 1

TRADEMARK

PRINCIPAL REGISTER

NEW ENGLAND BIOLABS, INC. (MASSACHUSETTS CORPORATION)
240 COUNTY ROAD
ATTN: HARRIET STRIMPEL
IPSWICH, MA 01938

FOR: REAGENTS FOR RESEARCH USE; DIAGNOSTIC REAGENTS FOR CLINICAL OR
MEDICAL LABORATORY USE, IN CLASS 1 (U.S. CLS. 1, 5, 6, 10, 26 AND 46).

FIRST USE 2-9-2011; IN COMMERCE 2-9-2011.

THE MARK CONSISTS OF STANDARD CHARACTERS WITHOUT CLAIM TO ANY PAR-
TICULAR FONT, STYLE, SIZE, OR COLOR.

SN 85-170,460, FILED 11-5-2010.

ANDREA K. NADELMAN, EXAMINING ATTORNEY



David J. Kyjars

Director of the United States Patent and Trademark Office

United States of America

United States Patent and Trademark Office

SCRATCHIN' HOT

Reg. No. 4,068,471

Registered Dec. 6, 2011

Int. Cl.: 16

TRADEMARK

PRINCIPAL REGISTER

MELISSA & DOUG, LLC (DELAWARE LIMITED LIABILITY COMPANY)
141 DANBURY ROAD
WILTON, CT 068974411

FOR: ARTS AND CRAFT KITS CONSISTING OF FLUORESCENT COLORED SHEETS COVERED WITH INK AND A STYLUS, IN CLASS 16 (U.S. CLS. 2, 5, 22, 23, 29, 37, 38 AND 50).

FIRST USE 5-31-2011; IN COMMERCE 5-31-2011.

THE MARK CONSISTS OF STANDARD CHARACTERS WITHOUT CLAIM TO ANY PARTICULAR FONT, STYLE, SIZE, OR COLOR.

OWNER OF U.S. REG. NOS. 3,366,376, 3,412,076, AND 3,648,711.

SN 85-170,726, FILED 11-5-2010.

MATTHEW KLINE, EXAMINING ATTORNEY



David J. Kypas

Director of the United States Patent and Trademark Office

United States of America

United States Patent and Trademark Office

DUAL SAW

Reg. No. 4,068,472

Registered Dec. 6, 2011

Int. Cl.: 7

TRADEMARK

PRINCIPAL REGISTER

INFUSION BRANDS, INC. (NEVADA CORPORATION)
14375 MYER LAKE CIRCLE
CLEARWATER, FL 33760

FOR: POWER TOOLS, NAMELY, POWER SAWS, DRILLS, POWER-DRIVEN SCREW-DRIVERS, SANDERS, GRINDERS, IN CLASS 7 (U.S. CLS. 13, 19, 21, 23, 31, 34 AND 35).

FIRST USE 11-1-2008; IN COMMERCE 11-1-2008.

THE MARK CONSISTS OF STANDARD CHARACTERS WITHOUT CLAIM TO ANY PARTICULAR FONT, STYLE, SIZE, OR COLOR.

SEC. 2(F).

OWNER OF U.S. REG. NO. 3,898,459.

NO CLAIM IS MADE TO THE EXCLUSIVE RIGHT TO USE "SAW", APART FROM THE MARK AS SHOWN.

SN 85-171,478, FILED 11-8-2010.

JENNY PARK, EXAMINING ATTORNEY



David J. Kybas

Director of the United States Patent and Trademark Office

United States of America

United States Patent and Trademark Office

ZERO EGOS

Reg. No. 4,068,473

SEATOWN HULL LLC (MASSACHUSETTS LIMITED LIABILITY COMPANY)
105 MANOMET AVENUE
HULL, MA 02045

Registered Dec. 6, 2011

Int. Cl.: 25

FOR: HOODED SWEATSHIRTS; SHORT-SLEEVED AND LONG-SLEEVED T-SHIRTS;
SWEATSHIRTS; T-SHIRTS, IN CLASS 25 (U.S. CLS. 22 AND 39).

TRADEMARK

FIRST USE 10-7-2011; IN COMMERCE 10-7-2011.

PRINCIPAL REGISTER

THE MARK CONSISTS OF STANDARD CHARACTERS WITHOUT CLAIM TO ANY PARTICULAR FONT, STYLE, SIZE, OR COLOR.

SN 85-171,603, FILED 11-8-2010.

SAIMA MAKHDOOM, EXAMINING ATTORNEY



David J. Kybas

Director of the United States Patent and Trademark Office

United States of America

United States Patent and Trademark Office

Race for the Family

Reg. No. 4,068,474

Registered Dec. 6, 2011

Int. Cls.: 36 and 41

SERVICE MARK

PRINCIPAL REGISTER

HAMMOND, CAMILLE TC (UNITED STATES INDIVIDUAL), AKA CAMILLE T.C.
HAMMOND,
622 CHURCH RD
REISTERSTOWN, MD 21136

FOR: CHARITABLE FUNDRAISING SERVICES BY MEANS OF RUNNING AND WALKING
EVENTS, IN CLASS 36 (U.S. CLS. 100, 101 AND 102).

FIRST USE 3-1-2006; IN COMMERCE 7-1-2006.

FOR: ATHLETIC AND SPORTS EVENT SERVICES, NAMELY, ARRANGING, ORGANIZING,
OPERATING AND CONDUCTING MARATHON RACES, IN CLASS 41 (U.S. CLS. 100, 101
AND 107).

FIRST USE 3-1-2006; IN COMMERCE 7-1-2006.

THE MARK CONSISTS OF STANDARD CHARACTERS WITHOUT CLAIM TO ANY PAR-
TICULAR FONT, STYLE, SIZE, OR COLOR.

NO CLAIM IS MADE TO THE EXCLUSIVE RIGHT TO USE "RACE", APART FROM THE
MARK AS SHOWN.

SN 85-171,897, FILED 11-8-2010.

JORDAN BAKER, EXAMINING ATTORNEY



David J. Kybas

Director of the United States Patent and Trademark Office

United States of America
United States Patent and Trademark Office

YOUCELEB

Reg. No. 4,068,475

Registered Dec. 6, 2011

Int. Cl.: 35

SERVICE MARK

PRINCIPAL REGISTER

YOUCELEB, LLC (FLORIDA LIMITED LIABILITY COMPANY)
SUITE #1830
350 SE 2ND STREET
FORT LAUDERDALE, FL 33301

FOR: ON-LINE RETAIL STORE SERVICES FEATURING APPAREL, FOOTWEAR, JEWELRY, ACCESSORIES, AND PRE-RECORDED MUSIC AND VIDEO PRODUCTS , IN CLASS 35 (U.S. CLS. 100, 101 AND 102).

FIRST USE 7-24-2010; IN COMMERCE 7-24-2010.

THE MARK CONSISTS OF STANDARD CHARACTERS WITHOUT CLAIM TO ANY PARTICULAR FONT, STYLE, SIZE, OR COLOR.

SN 85-172,166, FILED 11-9-2010.

HELENE LIWINSKI, EXAMINING ATTORNEY



David J. Kyros

Director of the United States Patent and Trademark Office

United States of America

United States Patent and Trademark Office

PERSONALLY CONNECTED

Reg. No. 4,068,476

Registered Dec. 6, 2011

Int. Cls.: 35 and 36

SERVICE MARK

PRINCIPAL REGISTER

CETERA FINANCIAL HOLDINGS, INC. (DELAWARE CORPORATION)
SUITE 1200
200 N. SEPULVEDA BLVD.
EL SEGUNDO, CA 902455670

FOR: BUSINESS MANAGEMENT SERVICES, NAMELY, PROVIDING ON-LINE FACILITIES FEATURING TRANSACTION ORDER ENTRY AND ORDER CONFIRMATION SERVICES; BUSINESS MANAGEMENT SERVICES, NAMELY, BUSINESS CONSULTATION SERVICES IN THE FIELD OF REGULATION COMPLIANCE FOR INVESTMENT BROKERAGE, FINANCIAL BROKERAGE, AND INSURANCE BROKERAGE; BUSINESS MANAGEMENT SERVICES, NAMELY, ADVICE IN THE FIELD OF MARKETING, MARKETING ACTIVITIES AND LAUNCHING OF NEW PRODUCTS; PROVIDING OFFICE SUPPORT STAFF SERVICES FOR FEE-BASED FINANCIAL PLANNING PROGRAMS; BUSINESS ADMINISTRATION AND MANAGEMENT, NAMELY, COMMERCIAL ADMINISTRATION OF INSURANCE LICENSING FOR STATES AND SECURITY REGISTRATION BROKERAGE FIRMS AND ADVISORS, IN CLASS 35 (U.S. CLS. 100, 101 AND 102).

FIRST USE 2-0-2011; IN COMMERCE 2-0-2011.

FOR: FINANCIAL SERVICES, NAMELY, SECURITIES BROKERAGE SERVICES, FEE-BASED FINANCIAL PLANNING SERVICES, FINANCIAL AND INVESTMENT ADVISORY SERVICES FOR INDEPENDENT FINANCIAL PROFESSIONALS, FINANCIAL CONSULTATION, AND ESTATE PLANNING; FINANCIAL SERVICES WITH RESPECT TO SECURITIES AND OTHER FINANCIAL INSTRUMENTS AND PRODUCTS, NAMELY, TRADING OF AND INVESTMENTS IN SECURITIES AND FINANCIAL INSTRUMENTS AND PRODUCTS FOR OTHERS; INVESTMENT SERVICES, NAMELY, INVESTMENT MANAGEMENT, FINANCIAL INVESTMENT PORTFOLIO ANALYSIS, AND ADVICE RELATING TO INVESTMENTS; INSURANCE SERVICES, NAMELY, INSURANCE BROKERAGES AND INSURANCE AGENCY SERVICES; INVESTMENT CONSULTANCY, NAMELY, CONDUCTING RESEARCH AND DUE DILIGENCE ON INVESTMENT STRATEGIES, COMPANIES, OFFERORS AND INTERMEDIARIES AND THEIR PRODUCTS IN FURTHERANCE OF INVESTMENT ADVISORY AND CONSULTANCY SERVICES; REGULATORY COMPLIANCE CONSULTING IN THE FIELD OF INVESTMENT BROKERAGE, FINANCIAL BROKERAGE, AND INSURANCE BROKERAGE, IN CLASS 36 (U.S. CLS. 100, 101 AND 102).

FIRST USE 2-0-2011; IN COMMERCE 2-0-2011.



David J. Kyjars

Director of the United States Patent and Trademark Office

Reg. No. 4,068,476 THE MARK CONSISTS OF STANDARD CHARACTERS WITHOUT CLAIM TO ANY PARTICULAR FONT, STYLE, SIZE, OR COLOR.

SN 85-172,710, FILED 11-9-2010.

SANDRA BUJA, EXAMINING ATTORNEY

United States of America

United States Patent and Trademark Office

DURUSWORKS

Reg. No. 4,068,477

Registered Dec. 6, 2011

Int. Cl.: 9

TRADEMARK

PRINCIPAL REGISTER

CORPORATION FOR NATIONAL RESEARCH INITIATIVES (D.C. CORPORATION)
1895 PRESTON WHITE DRIVE
RESTON, VA 22091

FOR: DOWNLOADABLE SOFTWARE FOR MANAGING AND PRESENTING DATA, IN CLASS 9 (U.S. CLS. 21, 23, 26, 36 AND 38).

FIRST USE 8-17-2011; IN COMMERCE 8-17-2011.

THE MARK CONSISTS OF STANDARD CHARACTERS WITHOUT CLAIM TO ANY PARTICULAR FONT, STYLE, SIZE, OR COLOR.

SN 85-173,047, FILED 11-9-2010.

COURTNEY ALVAREZ, EXAMINING ATTORNEY



David J. Kybas

Director of the United States Patent and Trademark Office

United States of America

United States Patent and Trademark Office

SHUTTLEBED

Reg. No. 4,068,478

Registered Dec. 6, 2011

Int. Cl.: 20

TRADEMARK

PRINCIPAL REGISTER

POLLARD, RONALD (UNITED STATES INDIVIDUAL)
97 ALLISON RD.
BREVARD, NC 28712

FOR: FOLDING BEDS, IN CLASS 20 (U.S. CLS. 2, 13, 22, 25, 32 AND 50).

FIRST USE 6-1-2010; IN COMMERCE 3-7-2011.

THE MARK CONSISTS OF STANDARD CHARACTERS WITHOUT CLAIM TO ANY PARTICULAR FONT, STYLE, SIZE, OR COLOR.

SN 85-173,112, FILED 11-10-2010.

SETH A. RAPPAPORT, EXAMINING ATTORNEY



David J. Kybas

Director of the United States Patent and Trademark Office

United States of America

United States Patent and Trademark Office



Reg. No. 4,068,479

Registered Dec. 6, 2011

Int. Cl.: 40

SERVICE MARK

PRINCIPAL REGISTER

INTAI TECHNOLOGY CORP. (TAIWAN CORPORATION)
26, 34TH RD.
TAICHUNG INDUSTRIAL DISTRICT
TAICHUNG CITY, TAIWAN

FOR: APPLYING FINISH TO STAINLESS STEEL SHEETS AND COILS; CUSTOM MANUFACTURE OF MOLDS FOR USE IN INDUSTRY; CUSTOM MANUFACTURE OF GENERAL PRODUCT LINES IN THE FIELD OF STEEL PIPE AND TUBING; ENGRAVING; ETCHING OF METAL; MACHINE SHOP SERVICES, NAMELY, MACHINING PARTS FOR OTHERS; MANUFACTURE OF GENERAL PRODUCT LINES IN THE FIELD OF METAL TO THE ORDER AND SPECIFICATION OF OTHERS; METAL FABRICATION AND FINISHING SERVICES; METAL STAMPING, IN CLASS 40 (U.S. CLS. 100, 103 AND 106).

FIRST USE 10-0-2010; IN COMMERCE 10-0-2010.

NO CLAIM IS MADE TO THE EXCLUSIVE RIGHT TO USE "RECESSING", APART FROM THE MARK AS SHOWN.

THE MARK CONSISTS OF THE ACRONYM "SFR" ABOVE THE WORDS "STRESS FREE RECESSING" ABOVE AND TO THE LEFT OF A THREE DASHED WEDGE DESIGNS.

SN 85-173,291, FILED 11-10-2010.

JOHN DALIER, EXAMINING ATTORNEY



David J. Kybas

Director of the United States Patent and Trademark Office

United States of America

United States Patent and Trademark Office

GEL-FLOW

Reg. No. 4,068,480

Registered Dec. 6, 2011

Int. Cl.: 2

TRADEMARK

PRINCIPAL REGISTER

AKZO NOBEL COATINGS INTERNATIONAL B.V. (NETHERLANDS LIMITED LIABILITY COMPANY)
VELPERWEG 76
ARNHEM, NETHERLANDS 6824BM

FOR: PAINT ADDITIVES FOR PAINTS FOR INTERIOR AND EXTERIOR SURFACES, IN CLASS 2 (U.S. CLS. 6, 11 AND 16).

FIRST USE 6-30-2011; IN COMMERCE 6-30-2011.

THE MARK CONSISTS OF STANDARD CHARACTERS WITHOUT CLAIM TO ANY PARTICULAR FONT, STYLE, SIZE, OR COLOR.

SN 85-173,387, FILED 11-10-2010.

FLORENTINA BLANDU, EXAMINING ATTORNEY



David J. Kybas

Director of the United States Patent and Trademark Office

United States of America

United States Patent and Trademark Office



Reg. No. 4,068,481

DOWNTOWN DENTAL DESIGNS (CALIFORNIA CORPORATION)
717 UNION STREET
SAN DIEGO, CA 92101

Registered Dec. 6, 2011

Int. Cl.: 42

FOR: COMPUTER AIDED DESIGN FOR OTHERS IN THE FIELD OF COSMETIC DENTAL RESTORATIONS, IN CLASS 42 (U.S. CLS. 100 AND 101).

SERVICE MARK

FIRST USE 8-28-2009; IN COMMERCE 10-15-2009.

PRINCIPAL REGISTER

THE MARK CONSISTS OF THE STYLIZED WORD "CAD" IN GRAY AND "SMILES" IN YELLOW WITH A GRAY OCTAGON TO THE RIGHT HAVING A WHITE LINE TRACING THE INTERIOR OF MOST OF THE OCTAGON, WITH THE FINAL SEGMENT OF THE LINE POINTED AT A DOWNWARD ANGLE.

THE COLOR(S) GRAY, WHITE AND YELLOW IS/ARE CLAIMED AS A FEATURE OF THE MARK.

SN 85-173,444, FILED 11-10-2010.

ANDREA HACK, EXAMINING ATTORNEY



David J. Kybas

Director of the United States Patent and Trademark Office

United States of America

United States Patent and Trademark Office

Natroba

Reg. No. 4,068,482

Registered Dec. 6, 2011

Int. Cl.: 5

TRADEMARK

PRINCIPAL REGISTER

PARAPRO, LLC (INDIANA LIMITED LIABILITY COMPANY)
STE.400
11550 N. MERIDIAN STREET
CARMEL, IN 46032

FOR: LICE TREATMENT PREPARATIONS, IN CLASS 5 (U.S. CLS. 6, 18, 44, 46, 51 AND 52).

FIRST USE 8-1-2011; IN COMMERCE 8-1-2011.

THE MARK CONSISTS OF STANDARD CHARACTERS WITHOUT CLAIM TO ANY PARTICULAR FONT, STYLE, SIZE, OR COLOR.

SN 85-173,746, FILED 11-10-2010.

BRIDGETT SMITH, EXAMINING ATTORNEY



David J. Kybas

Director of the United States Patent and Trademark Office

United States of America

United States Patent and Trademark Office



Reg. No. 4,068,483

Registered Dec. 6, 2011

Int. Cl.: 5

TRADEMARK

PRINCIPAL REGISTER

GREENSTONE LLC (DELAWARE LIMITED LIABILITY COMPANY)
100 ROUTE 206 NORTH
PEAPACK, NJ 07977

FOR: PHARMACEUTICAL PREPARATIONS, NAMELY, A HOUSEMARK FOR A FULL LINE OF PHARMACEUTICAL PREPARATIONS, IN CLASS 5 (U.S. CLS. 6, 18, 44, 46, 51 AND 52).

FIRST USE 8-15-2011; IN COMMERCE 8-15-2011.

OWNER OF U.S. REG. NOS. 1,867,430 AND 3,144,656.

THE MARK CONSISTS OF THE LETTER "G" INSIDE OF A SQUARE.

SN 85-173,750, FILED 11-10-2010.

BRIDGETT SMITH, EXAMINING ATTORNEY



David J. Kybas

Director of the United States Patent and Trademark Office

United States of America

United States Patent and Trademark Office

SINGLE TRACK

Reg. No. 4,068,484

SINGLE TRACK LLC (OREGON LIMITED LIABILITY COMPANY)
26000 NW BUMP RD.
NORTH PLAINS, OR 97133

Registered Dec. 6, 2011

Int. Cl.: 7

FOR: EARTH MOVING MACHINES AND POWER TOOLS, NAMELY, DOZERS AND EXCAVATORS, IN CLASS 7 (U.S. CLS. 13, 19, 21, 23, 31, 34 AND 35).

TRADEMARK

FIRST USE 8-1-2005; IN COMMERCE 12-15-2010.

PRINCIPAL REGISTER

THE MARK CONSISTS OF STANDARD CHARACTERS WITHOUT CLAIM TO ANY PARTICULAR FONT, STYLE, SIZE, OR COLOR.

SN 85-174,559, FILED 11-11-2010.

LINDA E. BLOHM, EXAMINING ATTORNEY



David J. Kybas

Director of the United States Patent and Trademark Office

United States of America

United States Patent and Trademark Office

BRASH

Reg. No. 4,068,485

Registered Dec. 6, 2011

Int. Cl.: 14

TRADEMARK

PRINCIPAL REGISTER

PAYLESS SHOESOURCE WORLDWIDE, INC. (KANSAS CORPORATION)
JAYHAWK TOWERS, 700 SW JACKSON, SUITE 20
TOPEKA, KS 66603

FOR: JEWELRY; COSTUME JEWELRY, IN CLASS 14 (U.S. CLS. 2, 27, 28 AND 50).

FIRST USE 6-0-2011; IN COMMERCE 6-0-2011.

THE MARK CONSISTS OF STANDARD CHARACTERS WITHOUT CLAIM TO ANY PARTICULAR FONT, STYLE, SIZE, OR COLOR.

SN 85-174,862, FILED 11-11-2010.

ROBERT C. CLARK JR., EXAMINING ATTORNEY



David J. Kybas

Director of the United States Patent and Trademark Office

United States of America

United States Patent and Trademark Office

TRACERPIX

Reg. No. 4,068,486

Registered Dec. 6, 2011

Int. Cl.: 40

SERVICE MARK

PRINCIPAL REGISTER

TRACER IMAGING LLC (DELAWARE LIMITED LIABILITY COMPANY)
18 GLENN STREET
WHITE PLAINS, NY 10603

FOR: PRINTING SERVICES, NAMELY, CUSTOM PRINTING OF LENTICULAR PRODUCTS;
LENTICULAR PRINTING SERVICES; PHOTOGRAPHY AND PRINTING SERVICES, IN
CLASS 40 (U.S. CLS. 100, 103 AND 106).

FIRST USE 8-24-2011; IN COMMERCE 8-24-2011.

THE MARK CONSISTS OF STANDARD CHARACTERS WITHOUT CLAIM TO ANY PAR-
TICULAR FONT, STYLE, SIZE, OR COLOR.

SN 85-175,509, FILED 11-12-2010.

SOPHIA S. KIM, EXAMINING ATTORNEY



David J. Kybas

Director of the United States Patent and Trademark Office

United States of America

United States Patent and Trademark Office

INFLECTION

Reg. No. 4,068,487

CASS NEW YORK INC. (NEW YORK CORPORATION)
231 WEST 39TH STREET, ROOM 914
NEW YORK, NY 10018

Registered Dec. 6, 2011

Int. Cl.: 25

FOR: BLOUSES; COATS; DRESSES; JACKETS; PANTS; SHIRTS; SKIRTS; SUITS; SWEATERS, IN CLASS 25 (U.S. CLS. 22 AND 39).

TRADEMARK

FIRST USE 9-8-2011; IN COMMERCE 9-8-2011.

PRINCIPAL REGISTER

THE MARK CONSISTS OF STANDARD CHARACTERS WITHOUT CLAIM TO ANY PARTICULAR FONT, STYLE, SIZE, OR COLOR.

SN 85-175,577, FILED 11-12-2010.

SUNG IN, EXAMINING ATTORNEY



David J. Kyffers

Director of the United States Patent and Trademark Office

United States of America

United States Patent and Trademark Office

COMMIT TO YOUR WELLNESS

Reg. No. 4,068,488

Registered Dec. 6, 2011

Int. Cl.: 41

SERVICE MARK

PRINCIPAL REGISTER

POWER WELLNESS MANAGEMENT, LLC (ILLINOIS LIMITED LIABILITY COMPANY)
#124
2055 W. ARMY TRAIL ROAD
ADDISON, IL 60101

FOR: HEALTH CLUB SERVICES, NAMELY, PROVIDING INSTRUCTION AND EQUIPMENT
IN THE FIELD OF PHYSICAL EXERCISE; PROVIDING FITNESS AND EXERCISE FACIL-
ITIES, IN CLASS 41 (U.S. CLS. 100, 101 AND 107).

FIRST USE 1-1-2011; IN COMMERCE 1-1-2011.

THE MARK CONSISTS OF STANDARD CHARACTERS WITHOUT CLAIM TO ANY PAR-
TICULAR FONT, STYLE, SIZE, OR COLOR.

SN 85-176,292, FILED 11-14-2010.

JEFFERY COWARD, EXAMINING ATTORNEY



David J. Kybas

Director of the United States Patent and Trademark Office

United States of America

United States Patent and Trademark Office

EXPERIENCE THE MEDICAL FITNESS DIFFERENCE

Reg. No. 4,068,489

Registered Dec. 6, 2011

Int. Cl.: 41

SERVICE MARK

PRINCIPAL REGISTER

POWER WELLNESS MANAGEMENT, LLC (ILLINOIS LIMITED LIABILITY COMPANY)
#124
2055 W. ARMY TRAIL ROAD
ADDISON, IL 60101

FOR: HEALTH CLUB SERVICES, NAMELY, PROVIDING INSTRUCTION AND EQUIPMENT
IN THE FIELD OF PHYSICAL EXERCISE; PROVIDING FITNESS AND EXERCISE FACIL-
ITIES, IN CLASS 41 (U.S. CLS. 100, 101 AND 107).

FIRST USE 1-1-2011; IN COMMERCE 1-1-2011.

THE MARK CONSISTS OF STANDARD CHARACTERS WITHOUT CLAIM TO ANY PAR-
TICULAR FONT, STYLE, SIZE, OR COLOR.

SN 85-176,294, FILED 11-14-2010.

JEFFERY COWARD, EXAMINING ATTORNEY



David J. Kyros

Director of the United States Patent and Trademark Office

United States of America

United States Patent and Trademark Office

STONE ACADEMY

Reg. No. 4,068,490

Registered Dec. 6, 2011

Int. Cl.: 41

SERVICE MARK

PRINCIPAL REGISTER

THE STONE ACADEMY, INC. (GEORGIA NON-PROFIT CORPORATION)
391 MONROE STREET
MACON, GA 31201

FOR: EDUCATION SERVICES, NAMELY, PROVIDING AFTER SCHOOL EDUCATIONAL AND CHILD DEVELOPMENT PROGRAMS IN THE FIELDS OF SCIENCE, TECHNOLOGY, ENGINEERING, AND MATH AND IN THE FIELDS OF SPIRITUAL AND RELIGIOUS-BASED CHRISTIAN TEACHINGS AND BELIEFS, FOR CHILDREN IN ELEMENTARY, MIDDLE AND HIGH SCHOOL GRADES, IN CLASS 41 (U.S. CLS. 100, 101 AND 107).

FIRST USE 10-18-2010; IN COMMERCE 10-18-2010.

THE MARK CONSISTS OF STANDARD CHARACTERS WITHOUT CLAIM TO ANY PARTICULAR FONT, STYLE, SIZE, OR COLOR.

NO CLAIM IS MADE TO THE EXCLUSIVE RIGHT TO USE "ACADEMY", APART FROM THE MARK AS SHOWN.

SN 85-176,948, FILED 11-15-2010.

KATHERINE STOIDES, EXAMINING ATTORNEY



David J. Kyros

Director of the United States Patent and Trademark Office

United States of America

United States Patent and Trademark Office

MC2

Reg. No. 4,068,491

Registered Dec. 6, 2011

Int. Cl.: 42

SERVICE MARK

PRINCIPAL REGISTER

GENERAL DYNAMICS LAND SYSTEMS INC. (DELAWARE CORPORATION)
38500 MOUND ROAD
STERLING HEIGHTS, MI 48310

FOR: RESEARCH AND DEVELOPMENT OF NEW PRODUCTS CONDUCTED IN PHYSICAL LABORATORIES, DEMONSTRATION AREAS AND COLLABORATIVE FACILITIES; PROVIDING AN INTERNET WEBSITE PORTAL IN THE FIELDS OF TECHNOLOGY FOR USE BY MEMBER ORGANIZATIONS COMPRISED OF CORPORATIONS, GOVERNMENT AGENCIES AND ACADEMIC INSTITUTIONS, TO COLLABORATE, CREATE, DEVELOP, DESIGN, AND INTEGRATE TECHNOLOGY OF VEHICLES USED BY WAR FIGHTERS OR OTHER TACTICAL TEAMS, IN CLASS 42 (U.S. CLS. 100 AND 101).

FIRST USE 10-15-2010; IN COMMERCE 10-15-2010.

THE MARK CONSISTS OF STANDARD CHARACTERS WITHOUT CLAIM TO ANY PARTICULAR FONT, STYLE, SIZE, OR COLOR.

SN 85-177,172, FILED 11-15-2010.

ERIN FALK, EXAMINING ATTORNEY



David J. Kyros

Director of the United States Patent and Trademark Office

United States of America

United States Patent and Trademark Office



Reg. No. 4,068,492

Registered Dec. 6, 2011

Int. Cl.: 32

TRADEMARK

PRINCIPAL REGISTER

CONTRERAS, SANTOS (UNITED STATES INDIVIDUAL)
8108 ALMEDA GENOA
HOUSTON, TX 77075

FOR: NON-ALCOHOLIC BEVERAGES, NAMELY, CARBONATED BEVERAGES, IN CLASS 32 (U.S. CLS. 45, 46 AND 48).

FIRST USE 2-1-2011; IN COMMERCE 2-1-2011.

THE STIPLING IS FOR SHADING PURPOSES ONLY.

THE MARK CONSISTS OF A WAVING FLAG WITH THE TEXT "RIO LEMPA" ACROSS THE CENTER OF IT.

THE ENGLISH TRANSLATION OF RIO IN THE MARK IS RIVER.

SN 85-177,266, FILED 11-15-2010.

DORITT L. CARROLL, EXAMINING ATTORNEY



David J. Kybas

Director of the United States Patent and Trademark Office

United States of America

United States Patent and Trademark Office

MD2CR

Reg. No. 4,068,493

SHUFFLE MASTER INC (MINNESOTA CORPORATION)
1106 PALMS AIRPORT DRIVE
LAS VEGAS, NV 89119

Registered Dec. 6, 2011

Int. Cl.: 28

FOR: CASINO TABLE GAME EQUIPMENT, NAMELY, PLAYING CARD SHUFFLING DEVICES AND PARTS THEREFOR, IN CLASS 28 (U.S. CLS. 22, 23, 38 AND 50).

TRADEMARK

FIRST USE 4-23-2011; IN COMMERCE 4-23-2011.

PRINCIPAL REGISTER

THE MARK CONSISTS OF STANDARD CHARACTERS WITHOUT CLAIM TO ANY PARTICULAR FONT, STYLE, SIZE, OR COLOR.

SN 85-177,304, FILED 11-15-2010.

ALICE BENMAMAN, EXAMINING ATTORNEY



David J. Kybas

Director of the United States Patent and Trademark Office

United States of America

United States Patent and Trademark Office



Reg. No. 4,068,494

Registered Dec. 6, 2011

Int. Cl.: 25

TRADEMARK

PRINCIPAL REGISTER

MAN AT LEISURE, LLC (ARIZONA LIMITED LIABILITY COMPANY)
P.O. BOX 2221
PRESCOTT, AZ 863022221

FOR: CLOTHING, NAMELY, SHIRTS, SHORTS, PANTS, SWEATSHIRTS, SWEATERS, JACKETS, TIES, BELTS, IN CLASS 25 (U.S. CLS. 22 AND 39).

FIRST USE 11-18-2010; IN COMMERCE 11-18-2010.

THE MARK CONSISTS OF A DESIGN OF A YELLOW DIAMOND-SHAPED STREET SIGN WITH THE WORDS "MAN AT LEISURE" IN BLACK IN THE CENTER AND A BORDER THAT ALTERNATES BLACK, YELLOW AND THEN BLACK.

THE COLOR(S) BLACK AND YELLOW IS/ARE CLAIMED AS A FEATURE OF THE MARK.

SN 85-177,933, FILED 11-16-2010.

FRED CARL, EXAMINING ATTORNEY



David J. Kybas

Director of the United States Patent and Trademark Office

United States of America

United States Patent and Trademark Office



Reg. No. 4,068,495

Registered Dec. 6, 2011

Int. Cl.: 35

SERVICE MARK

PRINCIPAL REGISTER

MAN AT LEISURE, LLC (ARIZONA LIMITED LIABILITY COMPANY)
P.O. BOX 2221
PRESCOTT, AZ 863022221

FOR: RETAIL STORE AND ONLINE RETAIL STORE SERVICES FEATURING CLOTHING,
IN CLASS 35 (U.S. CLS. 100, 101 AND 102).

FIRST USE 11-18-2010; IN COMMERCE 11-18-2010.

THE MARK CONSISTS OF A DESIGN OF A YELLOW DIAMOND-SHAPED STREET SIGN
WITH THE WORDS "MAN AT LEISURE" IN BLACK IN THE CENTER AND A BORDER
THAT ALTERNATES BLACK, YELLOW AND THEN BLACK.

THE COLOR(S) BLACK AND YELLOW IS/ARE CLAIMED AS A FEATURE OF THE MARK.

SN 85-177,944, FILED 11-16-2010.

FRED CARL, EXAMINING ATTORNEY



David J. Kybas

Director of the United States Patent and Trademark Office

United States of America

United States Patent and Trademark Office

eleveneleven

Reg. No. 4,068,496

Registered Dec. 6, 2011

Int. Cls.: 9 and 41

TRADEMARK

SERVICE MARK

PRINCIPAL REGISTER

BARRY CLEVELAND (UNITED STATES INDIVIDUAL)
C/O L. MAXWELL TAYLOR, P.O. BOX 611
16 CREEK ROAD
MIDDLEBURY, VT 05753

FOR: MUSICAL SOUND RECORDINGS; AUDIOVISUAL RECORDINGS FEATURING MUSIC AND MUSICAL BASED ENTERTAINMENT; DOWNLOADABLE MUSICAL SOUND AND DOWNLOADABLE AUDIOVISUAL RECORDINGS FEATURING MUSIC AND MUSICAL BASED ENTERTAINMENT; DOWNLOADABLE RINGTONES, GRAPHICS AND MUSIC VIA A GLOBAL COMPUTER NETWORK AND WIRELESS DEVICES, IN CLASS 9 (U.S. CLS. 21, 23, 26, 36 AND 38).

FIRST USE 10-25-2010, THE MARK WAS FIRST USED ANYWHERE IN A DIFFERENT FORM OTHER THAN THAT SOUGHT TO BE REGISTERED AT LEAST AS EARLY AS 00/00/1986.; IN COMMERCE 10-25-2010, THE MARK WAS FIRST USED IN COMMERCE IN A DIFFERENT FORM OTHER THAN THAT SOUGHT TO BE REGISTERED AT LEAST AS EARLY AS 00/00/1986..

FOR: ENTERTAINMENT SERVICES IN THE NATURE OF RECORDING, PRODUCTION AND POST-PRODUCTION OF MUSIC AND MUSIC VIDEOS; MUSIC PUBLISHING; NON-DOWNLOADABLE PRE-RECORDED MUSIC; PRESENTATION OF LIVE MUSICAL PERFORMANCES, IN CLASS 41 (U.S. CLS. 100, 101 AND 107).

FIRST USE 5-26-2010, THE MARK WAS FIRST USED ANYWHERE IN A DIFFERENT FORM OTHER THAN THAT SOUGHT TO BE REGISTERED AT LEAST AS EARLY AS 00/00/1986. ; IN COMMERCE 5-26-2010, THE MARK WAS FIRST USED IN COMMERCE IN A DIFFERENT FORM OTHER THAN THAT SOUGHT TO BE REGISTERED AT LEAST AS EARLY AS 00/00/1986..

THE MARK CONSISTS OF STANDARD CHARACTERS WITHOUT CLAIM TO ANY PARTICULAR FONT, STYLE, SIZE, OR COLOR.

SN 85-178,462, FILED 11-16-2010.

CAROLYN CATALDO, EXAMINING ATTORNEY



David J. Kypos

Director of the United States Patent and Trademark Office

United States of America

United States Patent and Trademark Office



Reg. No. 4,068,497

Registered Dec. 6, 2011

Int. Cls.: 16, 35, and 41

TRADEMARK

SERVICE MARK

PRINCIPAL REGISTER

NATIONAL FIRE PROTECTION ASSOCIATION, INC. (MASSACHUSETTS CORPORATION)
ONE BATTERYMARCH PARK
QUINCY, MA 02169

FOR: BROCHURES ABOUT FIRE SAFETY; PRINTED GUIDES FOR USE IN EDUCATING CHILDREN ABOUT FIRE SAFETY, IN CLASS 16 (U.S. CLS. 2, 5, 22, 23, 29, 37, 38 AND 50).

FIRST USE 6-0-2011; IN COMMERCE 6-0-2011.

FOR: PROMOTING PUBLIC AWARENESS OF FIRE SAFETY ISSUES, IN CLASS 35 (U.S. CLS. 100, 101 AND 102).

FIRST USE 6-0-2011; IN COMMERCE 6-0-2011.

FOR: PROVIDING A WEB SITE FOR EDUCATIONAL AND ENTERTAINMENT PURPOSES IN THE FIELD OF FIRE SAFETY; ENTERTAINMENT SERVICES, NAMELY, PROVIDING ONLINE COMPUTER GAMES; PROVIDING ONLINE NON-DOWNLOADABLE COMIC BOOKS; PROVIDING NON-DOWNLOADABLE ANIMATED CARTOONS AND EDUCATIONAL VIDEOS; ENTERTAINMENT SERVICES IN THE NATURE OF LIVE PERFORMANCES BY A COSTUMED CHARACTER, IN CLASS 41 (U.S. CLS. 100, 101 AND 107).

FIRST USE 6-0-2011; IN COMMERCE 6-0-2011.

OWNER OF U.S. REG. NOS. 1,580,754, 1,585,147, AND 2,970,373.

THE MARK CONSISTS OF THE DESIGN OF THE HEAD OF A DOG WEARING A FIRE HELMET HAVING A RAISED VISOR, WITH THE WORD "SPARKY" ON THE HELMET, AND ALSO WEARING A JACKET OF WHICH THE COLLAR AND A PORTION OF THE SHOULDER ARE VISIBLE.

SN 85-178,725, FILED 11-17-2010.

KATHLEEN LORENZO, EXAMINING ATTORNEY



David J. Kybas

Director of the United States Patent and Trademark Office

United States of America

United States Patent and Trademark Office



Reg. No. 4,068,498

Registered Dec. 6, 2011

Int. Cl.: 43

SERVICE MARK

PRINCIPAL REGISTER

JOHN MURPHY (UNITED STATES INDIVIDUAL)
FOURTEENTH FLOOR
620 NEWPORT CENTER DRIVE
NEWPORT BEACH, CA 92660

FOR: HOTEL SERVICES, IN CLASS 43 (U.S. CLS. 100 AND 101).

FIRST USE 12-1-2010; IN COMMERCE 1-24-2011.

NO CLAIM IS MADE TO THE EXCLUSIVE RIGHT TO USE "HOSPITALITY", APART FROM THE MARK AS SHOWN.

THE MARK CONSISTS OF THE STYLIZED BOLD FONT "EVOLUTION" CENTERED ABOVE A LIGHTER WEIGHT FONT "HOSPITALITY", BOTH WORDS SPACED TO OCCUPY THE SAME WIDTH, WITH A STYLIZED NAUTILUS SHELL TO THE RIGHT AND ABOVE THE "N" IN "EVOLUTION".

SN 85-179,379, FILED 11-17-2010.

KATHERINE CONNOLLY, EXAMINING ATTORNEY



David J. Kybas

Director of the United States Patent and Trademark Office

United States of America

United States Patent and Trademark Office



Reg. No. 4,068,499

Registered Dec. 6, 2011

Int. Cl.: 43

SERVICE MARK

PRINCIPAL REGISTER

COCOYOGURT, INC. (FLORIDA CORPORATION)
5097 NORTH DIXIE HIGHWAY
DEERFIELD BEACH, FL 33064

FOR: FROZEN YOGURT SHOP SERVICES IN THE NATURE OF A RESTAURANT; RESTAURANT SERVICES FEATURING FROZEN YOGURT, IN CLASS 43 (U.S. CLS. 100 AND 101).

FIRST USE 2-25-2011; IN COMMERCE 2-25-2011.

NO CLAIM IS MADE TO THE EXCLUSIVE RIGHT TO USE "COCO YOGURT SELF-SERVE FROZEN YOGURT", APART FROM THE MARK AS SHOWN.

THE COLOR(S) GREEN, BROWN AND PURPLE IS/ARE CLAIMED AS A FEATURE OF THE MARK.

THE MARK CONSISTS OF THE WORDING "COCOYOGURT" WITH "COCO" APPEARING IN BROWN AND "YOGURT" APPEARING IN PURPLE WITH THE STYLIZED DESIGN OF A BROWN AND GREEN COCONUT APPEARING AROUND THE BEGINNING OF THE TERM "COCO" AND GREEN LEAVES APPEARING NEXT TO THE "T", ALL ABOVE A PURPLE OVAL CONTAINING THE WORDING "SELF-SERVE FROZEN YOGURT". THE COLOR WHITE IN THE MARK APPEARS FOR BACKGROUND PURPOSES ONLY AND IS NOT CLAIMED AS A FEATURE OF THE MARK.

SN 85-179,734, FILED 11-18-2010.

DAYNA BROWNE, EXAMINING ATTORNEY



David J. Kybas

Director of the United States Patent and Trademark Office

United States of America

United States Patent and Trademark Office

INTERAXION

Reg. No. 4,068,500

Registered Dec. 6, 2011

Int. Cl.: 28

TRADEMARK

PRINCIPAL REGISTER

MIRACLE RECREATION EQUIPMENT COMPANY (IOWA CORPORATION)
878 EAST U.S. HIGHWAY 60
MONETT, MO 65708

FOR: PLAYGROUND EQUIPMENT, NAMELY, STAND-ALONE PLAYGROUND STRUCTURES COMPRISED OF ONE OR MORE OF A CLIMBER, A BRIDGE, A BALANCING ELEMENT AND A GLIDE , IN CLASS 28 (U.S. CLS. 22, 23, 38 AND 50).

FIRST USE 6-23-2011; IN COMMERCE 6-23-2011.

THE MARK CONSISTS OF STANDARD CHARACTERS WITHOUT CLAIM TO ANY PARTICULAR FONT, STYLE, SIZE, OR COLOR.

SN 85-180,788, FILED 11-19-2010.

SHAUNIA CARLYLE, EXAMINING ATTORNEY



David J. Kyffers

Director of the United States Patent and Trademark Office

United States of America

United States Patent and Trademark Office

WELLNESS BANKING

Reg. No. 4,068,501

Registered Dec. 6, 2011

Int. Cls.: 39 and 40

SERVICE MARK

PRINCIPAL REGISTER

RENOVOCYTE, LLC (INDIANA LIMITED LIABILITY COMPANY)
1102 INDIANA AVENUE
INDIANAPOLIS, IN 46202

FOR: STORAGE OF BIOLOGICAL CELLS AND TISSUES OF HUMANS AND ANIMALS FOR VETERINARY AND MEDICAL PURPOSES, IN CLASS 39 (U.S. CLS. 100 AND 105).

FIRST USE 1-29-2011; IN COMMERCE 2-20-2011.

FOR: PRESERVATION OF BIOLOGICAL CELLS AND TISSUES OF HUMANS AND ANIMALS FOR VETERINARY AND MEDICAL PURPOSES, IN CLASS 40 (U.S. CLS. 100, 103 AND 106).

FIRST USE 1-29-2011; IN COMMERCE 2-20-2011.

THE MARK CONSISTS OF STANDARD CHARACTERS WITHOUT CLAIM TO ANY PARTICULAR FONT, STYLE, SIZE, OR COLOR.

NO CLAIM IS MADE TO THE EXCLUSIVE RIGHT TO USE "BANKING", APART FROM THE MARK AS SHOWN.

SN 85-181,036, FILED 11-19-2010.

BARBARA RUTLAND, EXAMINING ATTORNEY



David J. Kyjars

Director of the United States Patent and Trademark Office

United States of America

United States Patent and Trademark Office

S.O.N.G.

Reg. No. 4,068,502

Registered Dec. 6, 2011

Int. Cl.: 25

TRADEMARK

PRINCIPAL REGISTER

IT JEANS, INC. (CALIFORNIA CORPORATION)
5251 S. SANTE FE AVENUE
VERNON, CA 90058

FOR: FOOTWEAR, SLEEPWEAR, UNDERWEAR, LOUNGE WEAR, HOSIERY, SOCKS, JACKETS, T-SHIRTS, SHIRTS, JEANS, SHORTS AND SKIRTS, IN CLASS 25 (U.S. CLS. 22 AND 39).

FIRST USE 1-14-2011; IN COMMERCE 1-14-2011.

THE MARK CONSISTS OF STANDARD CHARACTERS WITHOUT CLAIM TO ANY PARTICULAR FONT, STYLE, SIZE, OR COLOR.

OWNER OF U.S. REG. NO. 3,848,910.

SN 85-181,137, FILED 11-19-2010.

JUDITH HELFMAN, EXAMINING ATTORNEY



David J. Kybas

Director of the United States Patent and Trademark Office

United States of America

United States Patent and Trademark Office

PISCO PORTON THE AUTHENTIC PERUVIAN PISCO

Reg. No. 4,068,503

Registered Dec. 6, 2011

Int. Cl.: 33

TRADEMARK

PRINCIPAL REGISTER

PISCO PORTON, LLC (NEVADA LIMITED LIABILITY COMPANY)
13430 NW FREEWAY, HWY 290, SUITE 800
HOUSTON, TX 77040

FOR: DISTILLED SPIRITS; BRANDY; PISCO, IN CLASS 33 (U.S. CLS. 47 AND 49).

FIRST USE 3-15-2011; IN COMMERCE 3-15-2011.

THE MARK CONSISTS OF STANDARD CHARACTERS WITHOUT CLAIM TO ANY PARTICULAR FONT, STYLE, SIZE, OR COLOR.

NO CLAIM IS MADE TO THE EXCLUSIVE RIGHT TO USE "PISCO" AND "THE AUTHENTIC PERUVIAN PISCO", APART FROM THE MARK AS SHOWN.

THE ENGLISH TRANSLATION OF "PORTON" IN THE MARK IS GATE.

SN 85-181,224, FILED 11-19-2010.

JOHN LINCOSKI, EXAMINING ATTORNEY



David J. Kybas

Director of the United States Patent and Trademark Office

United States of America

United States Patent and Trademark Office

ANCHOR-CD

Reg. No. 4,068,504

Registered Dec. 6, 2011

Int. Cl.: 42

SERVICE MARK

PRINCIPAL REGISTER

IPSEN PHARMA S.A.S. (FRANCE SOCIÉTÉ PAR ACTIONS SIMPLIFIÉE (SAS))
65, QUAI GEORGES GORSE
BOULOGNE BILLANCOURT, FRANCE 92650

FOR: PROGRAM OF MEDICAL AND SCIENTIFIC STUDIES, NAMELY, SCIENTIFIC INVESTIGATIONS FOR MEDICAL PURPOSES; MEDICAL AND SCIENTIFIC RESEARCH, NAMELY, CONDUCTING CLINICAL TRIALS, STUDIES AND ANALYSES; MEDICAL AND SCIENTIFIC RESEARCH, IN CLASS 42 (U.S. CLS. 100 AND 101).

FIRST USE 4-27-2011; IN COMMERCE 4-27-2011.

THE MARK CONSISTS OF STANDARD CHARACTERS WITHOUT CLAIM TO ANY PARTICULAR FONT, STYLE, SIZE, OR COLOR.

SN 85-181,354, FILED 11-19-2010.

JAMES LOVELACE, EXAMINING ATTORNEY



David J. Kyros

Director of the United States Patent and Trademark Office

United States of America

United States Patent and Trademark Office

IYQ

Reg. No. 4,068,505

Registered Dec. 6, 2011

Int. Cls.: 14 and 25

TRADEMARK

PRINCIPAL REGISTER

CYRUS, EILEEN (UNITED STATES INDIVIDUAL)
4309 HUNTING BOW TRAIL
MYRTLE BEACH, SC 29579

FOR: PRECIOUS METALS AND THEIR ALLOYS; JEWELRY, IN CLASS 14 (U.S. CLS. 2, 27, 28 AND 50).

FIRST USE 1-16-2011; IN COMMERCE 9-1-2011.

FOR: CLOTHING, NAMELY, TOPS, BOTTOMS, HATS, SHIRTS, SHORTS, PANTS, SWEATERS, OUTERWEAR, NAMELY, COATS AND JACKETS AND UNDERWEAR, IN CLASS 25 (U.S. CLS. 22 AND 39).

FIRST USE 1-16-2011; IN COMMERCE 9-1-2011.

THE MARK CONSISTS OF STANDARD CHARACTERS WITHOUT CLAIM TO ANY PARTICULAR FONT, STYLE, SIZE, OR COLOR.

SN 85-181,791, FILED 11-20-2010.

CHERYL CLAYTON, EXAMINING ATTORNEY



David J. Kybas

Director of the United States Patent and Trademark Office

United States of America

United States Patent and Trademark Office



Reg. No. 4,068,506

Registered Dec. 6, 2011

Int. Cl.: 1

TRADEMARK

PRINCIPAL REGISTER

OREGON RESOURCES CORPORATION (OREGON CORPORATION)
920 SW SIXTH AVENUE, SUITE 250
PORTLAND, OR 97204

FOR: FOUNDRY SAND, IN CLASS 1 (U.S. CLS. 1, 5, 6, 10, 26 AND 46).

FIRST USE 7-28-2011; IN COMMERCE 7-28-2011.

THE MARK CONSISTS OF THE WORD "SPHERICHROME" APPEARING OVER THE TOP OF A CIRCLE, WITH A STAR DESIGN APPEARING AS THE DOT ON THE LETTER "I".

SN 85-182,574, FILED 11-22-2010.

WILLIAM BRECKENFELD, EXAMINING ATTORNEY



David J. Kybas

Director of the United States Patent and Trademark Office

United States of America

United States Patent and Trademark Office

K-9 KOOLEE

Reg. No. 4,068,507

Registered Dec. 6, 2011

Int. Cl.: 20

TRADEMARK

PRINCIPAL REGISTER

B ANTHONY CORE GROUP, LLC (FLORIDA LIMITED LIABILITY COMPANY)
11625 FOX CREEK DR
TAMPA, FL 33635

FOR: PORTABLE BEDS FOR PETS, IN CLASS 20 (U.S. CLS. 2, 13, 22, 25, 32 AND 50).

FIRST USE 10-16-2011; IN COMMERCE 10-16-2011.

THE MARK CONSISTS OF STANDARD CHARACTERS WITHOUT CLAIM TO ANY PARTICULAR FONT, STYLE, SIZE, OR COLOR.

NO CLAIM IS MADE TO THE EXCLUSIVE RIGHT TO USE "CANINE", APART FROM THE MARK AS SHOWN.

SN 85-184,387, FILED 11-24-2010.

KATHLEEN LORENZO, EXAMINING ATTORNEY



David J. Kyffers

Director of the United States Patent and Trademark Office

United States of America

United States Patent and Trademark Office

EDIBLE TO GO

Reg. No. 4,068,508

Registered Dec. 6, 2011

Int. Cls.: 29, 30, and 32

TRADEMARK

PRINCIPAL REGISTER

EDIBLE ARRANGEMENTS, LLC (CONNECTICUT LIMITED LIABILITY COMPANY)
95 BARNES ROAD
WALLINGFORD, CT 064921800

FOR: FRUIT SALADS; FRUIT SALAD WITH YOGURT; FRESH FRUIT COMPRISED PRIMARILY OF FRUIT CUT INTO SHAPES; CUT FRESH FRUIT WITH EDIBLE TOPPINGS COMPRISED PRIMARILY OF GRANOLA AND DRIED FRUIT; FRESH FRUIT CUT INTO FLOWER SHAPES AND ARRANGED IN CONTAINERS AS FLORAL DESIGNS; ARRANGEMENTS MADE OF FRESH PROCESSED FRUIT, IN CLASS 29 (U.S. CL. 46).

FIRST USE 1-1-2011; IN COMMERCE 1-1-2011.

FOR: FRESH FRUIT COMPRISED PRIMARILY OF FRUIT CUT INTO SHAPES AND AT LEAST PARTIALLY COATED WITH AN EDIBLE TOPPING, NAMELY, CHOCOLATE; CUT FRESH FRUIT COATED WITH AN EDIBLE TOPPING, WHICH IS COMPRISED PRIMARILY OF CHOCOLATE WITH COCONUT, CINNAMON AND NUT BASED TOPPINGS; FRESH FRUIT COMPRISED PRIMARILY OF FRUIT CUT INTO SHAPES AND AT LEAST PARTIALLY COATED WITH AN EDIBLE TOPPING, WHICH IS COMPRISED PRIMARILY OF CHOCOLATE WITH COCONUT, CINNAMON AND NUT BASED TOPPINGS; FRESH FRUIT CUT INTO FLOWER SHAPES AND COATED WITH CHOCOLATE; FRESH PROCESSED FRUITS COATED WITH CHOCOLATE; ARRANGEMENTS MADE OF FRESH OR PROCESSED FRUIT COATED WITH CHOCOLATE; ARRANGEMENTS MADE OF FRESH OR PROCESSED FRUIT AT LEAST PARTIALLY COATED WITH AN EDIBLE TOPPING, NAMELY, CHOCOLATE, CHOCOLATE WITH COCONUT, CINNAMON AND NUT BASED TOPPINGS, IN CLASS 30 (U.S. CL. 46).

FIRST USE 1-1-2011; IN COMMERCE 1-1-2011.

FOR: SMOOTHIES; FRUIT SMOOTHIES; VEGETABLE SMOOTHIES; FRUIT BEVERAGES; FRUIT JUICES, IN CLASS 32 (U.S. CLS. 45, 46 AND 48).

FIRST USE 1-1-2011; IN COMMERCE 1-1-2011.

THE MARK CONSISTS OF STANDARD CHARACTERS WITHOUT CLAIM TO ANY PARTICULAR FONT, STYLE, SIZE, OR COLOR.



David J. Kyffers

Director of the United States Patent and Trademark Office

Reg. No. 4,068,508 NO CLAIM IS MADE TO THE EXCLUSIVE RIGHT TO USE "EDIBLE" , APART FROM THE MARK AS SHOWN.

SN 85-184,524, FILED 11-24-2010.

CIMMERIAN COLEMAN, EXAMINING ATTORNEY

United States of America

United States Patent and Trademark Office

SHOE SHRINK

Reg. No. 4,068,509

Registered Dec. 6, 2011

Int. Cl.: 41

SERVICE MARK

PRINCIPAL REGISTER

BENCHMARK BRANDS, INC. (TENNESSEE CORPORATION)
SUITE 200
5250 TRIANGLE PARKWAY
NORCROSS, GA 30092

FOR: ONLINE JOURNAL, NAMELY, BLOGS IN THE FIELD OF HEALTH AND WELLNESS;
ENTERTAINMENT SERVICES, NAMELY, PROVIDING PODCASTS AND VIDEO PODCASTS
IN THE FIELD OF HEALTH AND WELLNESS, IN CLASS 41 (U.S. CLS. 100, 101 AND 107).

FIRST USE 11-24-2010; IN COMMERCE 1-2-2011.

THE MARK CONSISTS OF STANDARD CHARACTERS WITHOUT CLAIM TO ANY PAR-
TICULAR FONT, STYLE, SIZE, OR COLOR.

NO CLAIM IS MADE TO THE EXCLUSIVE RIGHT TO USE "SHOE", APART FROM THE
MARK AS SHOWN.

SN 85-184,782, FILED 11-24-2010.

JAMES GRIFFIN, EXAMINING ATTORNEY



David J. Kyffers

Director of the United States Patent and Trademark Office

United States of America

United States Patent and Trademark Office

NASSP LEADING SCHOOLS

Reg. No. 4,068,510

Registered Dec. 6, 2011

Int. Cls.: 35 and 41

SERVICE MARK

**COLLECTIVE
MEMBERSHIP**

PRINCIPAL REGISTER

NATIONAL ASSOCIATION OF SECONDARY SCHOOL PRINCIPALS, INC. (D.C. CORPORATION)
1904 ASSOCIATION DRIVE
RESTON, VA 20191

FOR: ASSOCIATION SERVICES, NAMELY, PROMOTING THE INTERESTS OF ALL SCHOOL LEADERS, STUDENT COUNCILS, AND SCHOOL PROFESSIONALS AND ADMINISTRATORS, IN CLASS 35 (U.S. CLS. 100, 101 AND 102).

FIRST USE 2-25-2011; IN COMMERCE 2-25-2011.

FOR: EDUCATIONAL SERVICES, NAMELY, PROVIDING INCENTIVES TO ALL SCHOOL LEADERS, STUDENTS, FACULTY, AND SCHOOL ADMINISTRATORS WHO DEMONSTRATE EXCELLENCE IN THE FIELDS OF SOCIAL STUDIES, LANGUAGE, MATHEMATICS, SCIENCE AND/OR OTHER TRADITIONAL OR CORE ACADEMIC DISCIPLINES THAT ARE COMMONLY TAUGHT IN MIDDLE LEVEL SCHOOLS, THROUGH THE ISSUANCE OF AWARDS; EDUCATIONAL SERVICES, NAMELY, PROVIDING INCENTIVES TO ALL SCHOOL LEADERS, STUDENTS, TEACHERS, FACULTY ADVISORS AND EDUCATORS TO DEMONSTRATE EXCELLENCE IN THE FIELD OF ACADEMIC LEADERSHIP; PROVIDING RECOGNITION AND INCENTIVES BY THE WAY OF AWARDS TO DEMONSTRATE EXCELLENCE IN THE FIELD OF SCHOOL LEADERSHIP; EDUCATIONAL AND TRAINING SERVICES, NAMELY, PROVIDING CLASSES AND WORKSHOPS FOR ALL SCHOOL LEADERS, MIDDLE LEVEL SECONDARY SCHOOL STUDENTS, AND FACULTY IN THE FIELD OF LEADERSHIP; EDUCATIONAL SERVICES, NAMELY, PROVIDING CLASSES, SEMINARS AND WORKSHOPS IN THE FIELD OF SCHOOL LEADERSHIP AND SKILLS; EDUCATIONAL SERVICES, NAMELY, CONDUCTING CLASSES, SEMINARS, CONFERENCES AND WORKSHOPS IN THE FIELD OF SCHOOL LEADERSHIP, STUDENT COUNCILS, AND LEADERSHIP INFORMATION AND DISTRIBUTION OF COURSE MATERIAL IN CONNECTION THEREWITH; EDUCATIONAL SERVICES, NAMELY, CONDUCTING CLASSES, SEMINARS, CONFERENCES AND WORKSHOPS AS PART OF EDUCATIONAL AND VOCATIONAL PROGRAMS IN THE FIELDS OF EDUCATION AND SCHOOL LEADERSHIP; EDUCATIONAL SERVICES, NAMELY, PROVIDING CLASSES, WORKSHOP, SEMINARS AND CONFERENCES AS PART OF EDUCATIONAL AND VOCATIONAL PROGRAMS TO SCHOOL LEADERS, SECONDARY SCHOOL STUDENTS, AND FACULTY IN THE FIELDS OF EDUCATION AND SCHOOL LEADERSHIP AND SECONDARY SCHOOL LEVEL EDUCATION; EDUCATIONAL SERVICES, NAMELY, PROVIDING CLASSES, WORKSHOPS, SEMINARS AND CONFERENCES FOR SCHOOL LEADERS, MIDDLE LEVEL



David J. Kyros

Director of the United States Patent and Trademark Office

Reg. No. 4,068,510 AND HIGH SCHOOL STUDENT LEADERS, FACULTY ADVISERS AND EDUCATORS IN THE FIELD OF LEADERSHIP TRAINING, AND PROVIDING CLASSES, WORKSHOPS, SEMINARS AND CONFERENCES FOR SCHOOL LEADERS, MIDDLE LEVEL AND HIGH SCHOOL STUDENT LEADERS, FACULTY ADVISERS AND EDUCATORS IN THE FIELD OF HOW TO CONDUCT STUDIES OR SURVEYS THAT MEASURE AND EVALUATE THE QUALITY OF ACADEMIC INSTRUCTION AND LEARNING; EDUCATIONAL SERVICES, NAMELY, PROVIDING CLASSES, SEMINARS, AND WORKSHOPS THAT PROVIDE TRAINING FOR ASSISTING SCHOOL LEADERS AND ADMINISTRATORS IN THE FIELD OF SCHOOL REFORM; ARRANGING AND CONDUCTING ACADEMIC COMPETITIONS IN THE FIELD OF STUDENT LEADERSHIP; PROVIDING NEWSLETTERS IN THE FIELD OF SCHOOL LEADERSHIP, STUDENT COUNCILS, AND LEADERSHIP INFORMATION VIA E-MAIL; AND CONSULTATION IN THE FIELD OF K-12 EDUCATIONAL SYSTEMS, IN CLASS 41 (U.S. CLS. 100, 101 AND 107).

FIRST USE 2-25-2011; IN COMMERCE 2-25-2011.

FOR: INDICATING MEMBERSHIP IN AN EDUCATIONAL ASSOCIATION OF SCHOOL LEADERS; INDICATING MEMBERSHIP IN AN EDUCATIONAL ASSOCIATION OF PROFESSIONALS AND ADMINISTRATORS; INDICATING MEMBERSHIP IN A SCHOLASTIC SOCIETY OF SECONDARY SCHOOL STUDENTS, IN CLASS 200 (U.S. CL. 200).

FIRST USE 2-25-2011; IN COMMERCE 2-25-2011.

THE MARK CONSISTS OF STANDARD CHARACTERS WITHOUT CLAIM TO ANY PARTICULAR FONT, STYLE, SIZE, OR COLOR.

OWNER OF U.S. REG. NOS. 2,182,009 AND 2,193,238.

NO CLAIM IS MADE TO THE EXCLUSIVE RIGHT TO USE "LEADING SCHOOLS", APART FROM THE MARK AS SHOWN.

SN 85-184,992, FILED 11-24-2010.

NAPOLEON SHARMA, EXAMINING ATTORNEY

United States of America

United States Patent and Trademark Office



Reg. No. 4,068,511

Registered Dec. 6, 2011

Int. Cls.: 35 and 41

SERVICE MARK

**COLLECTIVE
MEMBERSHIP**

PRINCIPAL REGISTER

NATIONAL ASSOCIATION OF SECONDARY SCHOOL PRINCIPALS, INC. (D.C. CORPORATION)
1904 ASSOCIATION DRIVE
RESTON, VA 20191

FOR: ASSOCIATION SERVICES, NAMELY, PROMOTING THE INTERESTS OF ALL SCHOOL LEADERS, STUDENT COUNCILS, AND SCHOOL PROFESSIONALS AND ADMINISTRATORS, IN CLASS 35 (U.S. CLS. 100, 101 AND 102).

FIRST USE 2-25-2011; IN COMMERCE 2-25-2011.

FOR: EDUCATIONAL SERVICES, NAMELY, PROVIDING INCENTIVES TO ALL SCHOOL LEADERS, STUDENTS, FACULTY, AND SCHOOL ADMINISTRATORS WHO DEMONSTRATE EXCELLENCE IN THE FIELDS OF SOCIAL STUDIES, LANGUAGE, MATHEMATICS, SCIENCE AND/OR OTHER TRADITIONAL OR CORE ACADEMIC DISCIPLINES THAT ARE COMMONLY TAUGHT IN MIDDLE LEVEL SCHOOLS, THROUGH THE ISSUANCE OF AWARDS; EDUCATIONAL SERVICES, NAMELY, PROVIDING INCENTIVES TO ALL SCHOOL LEADERS, STUDENTS, TEACHERS, FACULTY ADVISORS AND EDUCATORS TO DEMONSTRATE EXCELLENCE IN THE FIELD OF ACADEMIC LEADERSHIP; PROVIDING RECOGNITION AND INCENTIVES BY THE WAY OF AWARDS TO DEMONSTRATE EXCELLENCE IN THE FIELD OF SCHOOL LEADERSHIP; EDUCATIONAL AND TRAINING SERVICES, NAMELY, PROVIDING CLASSES AND WORKSHOPS FOR ALL SCHOOL LEADERS, MIDDLE LEVEL SECONDARY SCHOOL STUDENTS, AND FACULTY IN THE FIELD OF LEADERSHIP; EDUCATIONAL SERVICES, NAMELY, PROVIDING CLASSES, SEMINARS AND WORKSHOPS IN THE FIELD OF SCHOOL LEADERSHIP AND SKILLS; EDUCATIONAL SERVICES, NAMELY, CONDUCTING CLASSES, SEMINARS, CONFERENCES AND WORKSHOPS IN THE FIELD OF SCHOOL LEADERSHIP, STUDENT COUNCILS, AND LEADERSHIP INFORMATION AND DISTRIBUTION OF COURSE MATERIAL IN CONNECTION THEREWITH; EDUCATIONAL SERVICES, NAMELY, CONDUCTING CLASSES, SEMINARS, CONFERENCES AND WORKSHOPS AS PART OF EDUCATIONAL AND VOCATIONAL PROGRAMS IN THE FIELDS OF EDUCATION AND SCHOOL LEADERSHIP; EDUCATIONAL SERVICES, NAMELY, PROVIDING CLASSES, WORKSHOP, SEMINARS AND CONFERENCES AS PART OF EDUCATIONAL AND VOCATIONAL PROGRAMS TO SCHOOL LEADERS, SECONDARY SCHOOL STUDENTS, AND FACULTY IN THE FIELDS OF EDUCATION AND SCHOOL LEADERSHIP AND SECONDARY SCHOOL LEVEL EDUCATION; EDUCATIONAL SERVICES, NAMELY, PROVIDING CLASSES, WORKSHOPS, SEMINARS AND CONFERENCES FOR SCHOOL LEADERS, MIDDLE LEVEL

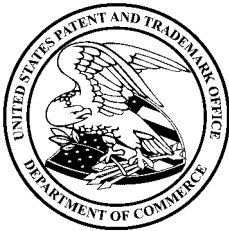

David J. Kyjars

Director of the United States Patent and Trademark Office

Reg. No. 4,068,511 AND HIGH SCHOOL STUDENT LEADERS, FACULTY ADVISERS AND EDUCATORS IN THE FIELD OF LEADERSHIP TRAINING, AND PROVIDING CLASSES, WORKSHOPS, SEMINARS AND CONFERENCES FOR SCHOOL LEADERS, MIDDLE LEVEL AND HIGH SCHOOL STUDENT LEADERS, FACULTY ADVISERS AND EDUCATORS IN THE FIELD OF HOW TO CONDUCT STUDIES OR SURVEYS THAT MEASURE AND EVALUATE THE QUALITY OF ACADEMIC INSTRUCTION AND LEARNING; EDUCATIONAL SERVICES, NAMELY, PROVIDING CLASSES, SEMINARS, AND WORKSHOPS THAT PROVIDE TRAINING FOR ASSISTING SCHOOL LEADERS AND ADMINISTRATORS IN THE FIELD OF SCHOOL REFORM; ARRANGING AND CONDUCTING ACADEMIC COMPETITIONS IN THE FIELD OF STUDENT LEADERSHIP; PROVIDING NEWSLETTERS IN THE FIELD OF SCHOOL LEADERSHIP, STUDENT COUNCILS, AND LEADERSHIP INFORMATION VIA E-MAIL; AND CONSULTATION IN THE FIELD OF K-12 EDUCATIONAL SYSTEMS, IN CLASS 41 (U.S. CLS. 100, 101 AND 107).

FIRST USE 2-25-2011; IN COMMERCE 2-25-2011.

FOR: INDICATING MEMBERSHIP IN AN EDUCATIONAL ASSOCIATION OF SCHOOL LEADERS; INDICATING MEMBERSHIP IN AN EDUCATIONAL ASSOCIATION OF PROFESSIONALS AND ADMINISTRATORS; INDICATING MEMBERSHIP IN A SCHOLASTIC SOCIETY OF SECONDARY SCHOOL STUDENTS, IN CLASS 200 (U.S. CL. 200).

FIRST USE 2-25-2011; IN COMMERCE 2-25-2011.

OWNER OF U.S. REG. NOS. 2,182,009, 2,193,238, AND 2,600,418.

THE COLOR(S) RED AND GRAY IS/ARE CLAIMED AS A FEATURE OF THE MARK.

NO CLAIM IS MADE TO THE EXCLUSIVE RIGHT TO USE "LEADING SCHOOLS", APART FROM THE MARK AS SHOWN.

THE MARK CONSISTS OF A STYLIZED TORCH FLAME IN RED, WITH THE TOP OF THE BASE BENEATH IT IN GRAY, AND THE LOWERCASE WORD "NASSP" IN RED TO ITS RIGHT, WITH THE LOWERCASE WORDS "LEADING SCHOOLS" DIRECTLY BENEATH "NASSP" IN GRAY.

SN 85-184,998, FILED 11-24-2010.

NAPOLEON SHARMA, EXAMINING ATTORNEY

United States of America

United States Patent and Trademark Office

RHODIOLA RECHARGE

Reg. No. 4,068,512

RAINBOW LIGHT NUTRITIONAL SYSTEMS, INC. (DELAWARE CORPORATION)
125 MCPHERSON ST.
SANTA CRUZ, CA 95060

Registered Dec. 6, 2011

Int. Cl.: 5

FOR: DIETARY AND NUTRITIONAL SUPPLEMENTS CONTAINING RHODIOLA; VITAMINS CONTAINING RHODIOLA, IN CLASS 5 (U.S. CLS. 6, 18, 44, 46, 51 AND 52).

TRADEMARK

FIRST USE 5-10-2011; IN COMMERCE 5-10-2011.

PRINCIPAL REGISTER

THE MARK CONSISTS OF STANDARD CHARACTERS WITHOUT CLAIM TO ANY PARTICULAR FONT, STYLE, SIZE, OR COLOR.

NO CLAIM IS MADE TO THE EXCLUSIVE RIGHT TO USE "RHODIOLA", APART FROM THE MARK AS SHOWN.

SN 85-186,119, FILED 11-29-2010.

IRA J. GOODSaid, EXAMINING ATTORNEY



David J. Kyros

Director of the United States Patent and Trademark Office

United States of America

United States Patent and Trademark Office

OUT FOX THE BULL AND THE BEAR!

Reg. No. 4,068,513

Registered Dec. 6, 2011

Int. Cl.: 36

SERVICE MARK

PRINCIPAL REGISTER

PALLOTTA, DAX (UNITED STATES INDIVIDUAL)
2712 CHECKER DRIVE
CEDAR PARK, TX 78613

FOR: FINANCIAL SERVICES, NAMELY, PROVIDING FINANCIAL ADVICE IN THE FIELD OF STOCK PICK RECOMMENDATIONS FOR REGISTERED USERS, IN CLASS 36 (U.S. CLS. 100, 101 AND 102).

FIRST USE 1-1-2011; IN COMMERCE 7-1-2011.

THE MARK CONSISTS OF STANDARD CHARACTERS WITHOUT CLAIM TO ANY PARTICULAR FONT, STYLE, SIZE, OR COLOR.

SN 85-186,835, FILED 11-30-2010.

KATHERINE E. HALMEN, EXAMINING ATTORNEY



David J. Kybas

Director of the United States Patent and Trademark Office

United States of America

United States Patent and Trademark Office

LAMAR FAMILY ESTATES

Reg. No. 4,068,514

Registered Dec. 6, 2011

Int. Cl.: 33

TRADEMARK

PRINCIPAL REGISTER

STRAPP, LADON (UNITED STATES INDIVIDUAL)
934 CHISHOLM TRAIL
GALT, CA 95632 AND

STRAPP, MARLENE (UNITED STATES INDIVIDUAL)
934 CHISHOLM TRAIL
GALT, CA 95632

FOR: WINES, IN CLASS 33 (U.S. CLS. 47 AND 49).

FIRST USE 8-1-2011; IN COMMERCE 8-29-2011.

THE MARK CONSISTS OF STANDARD CHARACTERS WITHOUT CLAIM TO ANY PARTICULAR FONT, STYLE, SIZE, OR COLOR.

NO CLAIM IS MADE TO THE EXCLUSIVE RIGHT TO USE "FAMILY ESTATES", APART FROM THE MARK AS SHOWN.

SN 85-186,840, FILED 11-30-2010.

KATHERINE E. HALMEN, EXAMINING ATTORNEY



David J. Kyros

Director of the United States Patent and Trademark Office

United States of America

United States Patent and Trademark Office

POTTYPALOOZA

Reg. No. 4,068,515

Registered Dec. 6, 2011

Int. Cl.: 44

SERVICE MARK

PRINCIPAL REGISTER

THE PROCTER & GAMBLE COMPANY (OHIO CORPORATION)
ONE PROCTER & GAMBLE PLAZA
CINCINNATI, OH 45202

FOR: PROVIDING PORTABLE TOILET SERVICES THROUGH THE USE OF TOILETS ON A TRUCK, IN CLASS 44 (U.S. CLS. 100 AND 101).

FIRST USE 3-31-2003; IN COMMERCE 3-31-2003.

THE MARK CONSISTS OF STANDARD CHARACTERS WITHOUT CLAIM TO ANY PARTICULAR FONT, STYLE, SIZE, OR COLOR.

NO CLAIM IS MADE TO THE EXCLUSIVE RIGHT TO USE "POTTY", APART FROM THE MARK AS SHOWN.

SN 85-186,858, FILED 11-30-2010.

MICHAEL SOUDERS, EXAMINING ATTORNEY



David J. Kybas

Director of the United States Patent and Trademark Office

United States of America
United States Patent and Trademark Office

HyperDrive

Reg. No. 4,068,516

Registered Dec. 6, 2011

Int. Cl.: 7

TRADEMARK

PRINCIPAL REGISTER

EXCEL INDUSTRIES, INC. (KANSAS CORPORATION)
P.O. BOX 7000
HESSTON, KS 67062

FOR: LAWN MOWERS, IN CLASS 7 (U.S. CLS. 13, 19, 21, 23, 31, 34 AND 35).

FIRST USE 6-13-2011; IN COMMERCE 6-13-2011.

THE MARK CONSISTS OF STANDARD CHARACTERS WITHOUT CLAIM TO ANY PARTICULAR FONT, STYLE, SIZE, OR COLOR.

SN 85-187,475, FILED 11-30-2010.

WILLIAM VERHOSEK, EXAMINING ATTORNEY



David J. Kybas

Director of the United States Patent and Trademark Office

United States of America
United States Patent and Trademark Office

GENEKEY

Reg. No. 4,068,517

Registered Dec. 6, 2011

Int. Cl.: 44

SERVICE MARK

PRINCIPAL REGISTER

GENEKEY CORPORATION (DELAWARE CORPORATION)
1340 CENTRE STREET, SUITE 207
NEWTON, MA 02459

FOR: MEDICAL CONSULTING SERVICES IN THE FIELD OF CANCER, NAMELY, RESEARCH, DATA COLLECTION, DATA ANALYSIS AND IDENTIFICATION OF PERSONAL THERAPIES FOR MEDICAL TREATMENT IN THE FIELD OF CANCER, IN CLASS 44 (U.S. CLS. 100 AND 101).

FIRST USE 4-13-2011; IN COMMERCE 4-13-2011.

THE MARK CONSISTS OF STANDARD CHARACTERS WITHOUT CLAIM TO ANY PARTICULAR FONT, STYLE, SIZE, OR COLOR.

SN 85-187,657, FILED 11-30-2010.

KEVON CHISOLM, EXAMINING ATTORNEY



David J. Kyros

Director of the United States Patent and Trademark Office

United States of America

United States Patent and Trademark Office

EZ FLEX

Reg. No. 4,068,518

NATIONAL DENTEX CORPORATION (MASSACHUSETTS CORPORATION)
2 VISION DRIVE
NATICK, MA 01760

Registered Dec. 6, 2011

Int. Cl.: 10

FOR: DENTAL PROSTHETIC APPLIANCES, DENTURES, PARTIAL DENTURES, IN CLASS 10 (U.S. CLS. 26, 39 AND 44).

TRADEMARK

FIRST USE 7-31-2010; IN COMMERCE 7-31-2010.

PRINCIPAL REGISTER

THE MARK CONSISTS OF STANDARD CHARACTERS WITHOUT CLAIM TO ANY PARTICULAR FONT, STYLE, SIZE, OR COLOR.

NO CLAIM IS MADE TO THE EXCLUSIVE RIGHT TO USE "FLEX", APART FROM THE MARK AS SHOWN.

SN 85-188,958, FILED 12-2-2010.

EDWARD NELSON, EXAMINING ATTORNEY



David J. Kyros

Director of the United States Patent and Trademark Office

United States of America

United States Patent and Trademark Office

ALWAYS LITES

Reg. No. 4,068,519

Registered Dec. 6, 2011

Int. Cl.: 5

TRADEMARK

PRINCIPAL REGISTER

THE PROCTER & GAMBLE COMPANY (OHIO CORPORATION)
ONE PROCTER & GAMBLE PLAZA
CINCINNATI, OH 45202

FOR: PANTY LINERS, IN CLASS 5 (U.S. CLS. 6, 18, 44, 46, 51 AND 52).

FIRST USE 7-31-2011; IN COMMERCE 7-31-2011.

THE MARK CONSISTS OF STANDARD CHARACTERS WITHOUT CLAIM TO ANY PARTICULAR FONT, STYLE, SIZE, OR COLOR.

OWNER OF U.S. REG. NOS. 1,867,440 AND 2,875,665.

SN 85-189,156, FILED 12-2-2010.

MICHAEL SOUDERS, EXAMINING ATTORNEY



David J. Kyros

Director of the United States Patent and Trademark Office

United States of America

United States Patent and Trademark Office

TOUS CÉLÈBRES ICI

Reg. No. 4,068,520

Registered Dec. 6, 2011

Int. Cl.: 43

SERVICE MARK

PRINCIPAL REGISTER

AZUR LIMITED (UNITED KINGDOM LIMITED LIABILITY COMPANY)
54 BROOKS MEWS
LONDON, UNITED KINGDOM W1K4EG

FOR: RESTAURANT AND BAR SERVICES, IN CLASS 43 (U.S. CLS. 100 AND 101).

FIRST USE 6-0-2007; IN COMMERCE 12-6-2010.

THE MARK CONSISTS OF STANDARD CHARACTERS WITHOUT CLAIM TO ANY PARTICULAR FONT, STYLE, SIZE, OR COLOR.

THE ENGLISH TRANSLATION OF "TOUS CÉLÈBRES ICI" IN THE MARK IS "ALL ARE FAMOUS (OR CELEBRATE) HERE".

SN 85-189,432, FILED 12-2-2010.

TARAH HARDY, EXAMINING ATTORNEY



David J. Kyros

Director of the United States Patent and Trademark Office

United States of America

United States Patent and Trademark Office

ALLERGINO

Reg. No. 4,068,521

Registered Dec. 6, 2011

Int. Cl.: 30

TRADEMARK

PRINCIPAL REGISTER

ALLERGINO BAKERY, LLC (COLORADO LIMITED LIABILITY COMPANY), TA
ALLERGINO,
P.O. BOX 533
LAFAYETTE, CO 80026

FOR: BREAD MIXES; CAKE MIXES; CANDY BARS; CANDY COATED APPLES; CANDY DECORATIONS FOR CAKES; CEREAL-BASED SNACK FOODS; CHOCOLATE CANDIES; CHOCOLATE COVERED FRUIT; CHOCOLATE COVERED PRETZELS; CHOCOLATE SYRUP; COOKIE MIXES; COOKIES AND CRACKERS; COTTON CANDY; ICING MIXES; PANCAKE MIXES; PASTRY MIXES; PIZZA CRUST MIXES, IN CLASS 30 (U.S. CL. 46).

FIRST USE 10-1-2010; IN COMMERCE 8-13-2011.

THE MARK CONSISTS OF STANDARD CHARACTERS WITHOUT CLAIM TO ANY PARTICULAR FONT, STYLE, SIZE, OR COLOR.

THE WORDING "ALLERGINO" HAS NO MEANING IN A FOREIGN LANGUAGE.

SN 85-189,576, FILED 12-2-2010.

ANDREA K. NADELMAN, EXAMINING ATTORNEY



David J. Kyros

Director of the United States Patent and Trademark Office

United States of America

United States Patent and Trademark Office

LIVER LONGEVITY

Reg. No. 4,068,522

RAINBOW LIGHT NUTRITIONAL SYSTEMS, INC. (DELAWARE CORPORATION)
125 MCPHERSON ST
SANTA CRUZ, CA 95060

Registered Dec. 6, 2011

Int. Cl.: 5

FOR: DIETARY AND NUTRITIONAL SUPPLEMENTS; VITAMINS, IN CLASS 5 (U.S. CLS. 6, 18, 44, 46, 51 AND 52).

TRADEMARK

FIRST USE 7-26-2011; IN COMMERCE 7-26-2011.

PRINCIPAL REGISTER

THE MARK CONSISTS OF STANDARD CHARACTERS WITHOUT CLAIM TO ANY PARTICULAR FONT, STYLE, SIZE, OR COLOR.

NO CLAIM IS MADE TO THE EXCLUSIVE RIGHT TO USE "LIVER", APART FROM THE MARK AS SHOWN.

SN 85-190,657, FILED 12-3-2010.

IRA J. GOODSaid, EXAMINING ATTORNEY



David J. Kyffers

Director of the United States Patent and Trademark Office

United States of America

United States Patent and Trademark Office

COMFORTBLEND

Reg. No. 4,068,523

Registered Dec. 6, 2011

Int. Cl.: 25

TRADEMARK

PRINCIPAL REGISTER

HBI BRANDED APPAREL LIMITED, INC. (DELAWARE CORPORATION)
1000 EAST HANES MILL ROAD
WINSTON-SALEM, NC 27105

FOR: UNDERWEAR, IN CLASS 25 (U.S. CLS. 22 AND 39).

FIRST USE 7-1-2011; IN COMMERCE 7-1-2011.

THE MARK CONSISTS OF STANDARD CHARACTERS WITHOUT CLAIM TO ANY PARTICULAR FONT, STYLE, SIZE, OR COLOR.

OWNER OF U.S. REG. NO. 2,109,989.

SN 85-191,086, FILED 12-6-2010.

LINDSEY RUBIN, EXAMINING ATTORNEY



David J. Kybas

Director of the United States Patent and Trademark Office

United States of America

United States Patent and Trademark Office

FOUR SEASONS PICP COLLECTION

Reg. No. 4,068,524

Registered Dec. 6, 2011

Int. Cl.: 19

TRADEMARK

PRINCIPAL REGISTER

INTERLOCK PAVING SYSTEMS, INC. (VIRGINIA CORPORATION)
802 W. PEMBROKE AVENUE
HAMPTON, VA 23669

FOR: PERMEABLE INTERLOCKING CONCRETE PAVERS FOR USE WHERE PERMEABLE SYSTEMS OR SURFACE TREATMENTS ARE CALLED FOR, IN CLASS 19 (U.S. CLS. 1, 12, 33 AND 50).

FIRST USE 10-1-2011; IN COMMERCE 10-1-2011.

THE MARK CONSISTS OF STANDARD CHARACTERS WITHOUT CLAIM TO ANY PARTICULAR FONT, STYLE, SIZE, OR COLOR.

NO CLAIM IS MADE TO THE EXCLUSIVE RIGHT TO USE "PICP COLLECTION", APART FROM THE MARK AS SHOWN.

SN 85-191,997, FILED 12-7-2010.

MARK RADEMACHER, EXAMINING ATTORNEY



David J. Kybas

Director of the United States Patent and Trademark Office

United States of America

United States Patent and Trademark Office

Alaskan Built

Reg. No. 4,068,525

Registered Dec. 6, 2011

Int. Cl.: 25

TRADEMARK

PRINCIPAL REGISTER

BENCHMARK CONSTRUCTION, INC. (ALASKA CORPORATION)
2903 TANGLEWOOD DRIVE
ANCHORAGE, AK 99517

FOR: JACKETS; SHIRTS, IN CLASS 25 (U.S. CLS. 22 AND 39).

FIRST USE 10-24-2010; IN COMMERCE 12-20-2010.

NO CLAIM IS MADE TO THE EXCLUSIVE RIGHT TO USE "ALASKAN" , APART FROM THE MARK AS SHOWN.

THE MARK CONSISTS OF THE STYLIZED TEXT "ALASKAN BUILT" INSIDE A ROUNDED RECTANGLE, WITH THE "N" IN "ALASKAN" AND THE "U" IN "BUILT" HAVING SCREWS ON THE INSIDE OF THE LETTERS.

SN 85-192,507, FILED 12-7-2010.

DEZMONA MIZELLE, EXAMINING ATTORNEY



David J. Kybas

Director of the United States Patent and Trademark Office

United States of America

United States Patent and Trademark Office

ARCH PACIFIC

Reg. No. 4,068,526

Registered Dec. 6, 2011

Int. Cl.: 36

SERVICE MARK

PRINCIPAL REGISTER

ESTES, SUSAN (UNITED STATES INDIVIDUAL)
1524 HEATHER OAKS LANE
WESTLAKE VILLAGE, CA 91361

FOR: FINANCIAL AND INVESTMENT SERVICES, NAMELY, MANAGEMENT AND BROKERAGE IN THE FIELDS OF STOCKS, BONDS, OPTIONS, COMMODITIES, FUTURES AND OTHER SECURITIES, AND THE INVESTMENT OF FUNDS OF OTHERS, IN CLASS 36 (U.S. CLS. 100, 101 AND 102).

FIRST USE 9-1-2009; IN COMMERCE 9-1-2009.

THE MARK CONSISTS OF STANDARD CHARACTERS WITHOUT CLAIM TO ANY PARTICULAR FONT, STYLE, SIZE, OR COLOR.

SN 85-192,817, FILED 12-8-2010.

NAPOLEON SHARMA, EXAMINING ATTORNEY



David J. Kyffers

Director of the United States Patent and Trademark Office

United States of America

United States Patent and Trademark Office



Reg. No. 4,068,527

Registered Dec. 6, 2011

Int. Cls.: 39 and 43

SERVICE MARK

PRINCIPAL REGISTER

FLIGHT CENTRE LIMITED (AUSTRALIA LIMITED COMPANY (LTD.))
LEVEL 2, 545 QUEEN STREET
BRISBANE, QLD, AUSTRALIA 4000

FOR: TRAVEL SERVICES BEING SERVICES OFFERED BY TRAVEL AGENTS, NAMELY, PASSENGER TRANSPORT SERVICES; AIR TRAVEL SERVICES, NAMELY, ARRANGING AIR TRANSPORTATION; CAR HIRE SERVICES, NAMELY, ARRANGING CAR TRANSPORT AND RENTAL OF CARS; ROAD TRANSPORT SERVICES, NAMELY, ARRANGING BUS TRANSPORT AND BUS CHARTERING; RAILWAY TRANSPORT SERVICES; SEA TRANSPORT SERVICES, NAMELY, ARRANGING BOAT CRUISES, BOAT CHARTERING, PASSENGER SHIP TRANSPORT, FERRY-BOAT TRANSPORT AND RENTAL OF BOATS; TRAVEL AGENCY SERVICES, NAMELY, MAKING RESERVATIONS AND BOOKINGS FOR TRANSPORTATION; TRAVEL AND TOUR TICKET RESERVATION SERVICES; TOURIST AGENCY SERVICES, NAMELY, PROVIDING TRAVEL AND TOUR INFORMATION; ORGANIZING SIGHTSEEING TOUR AND CRUISE ARRANGING SERVICES; ARRANGING TRAVEL TOURS, CAR RENTAL, TOURS AND CRUISES FOR HOLIDAY PACKAGES; AIR TRANSPORT SERVICES; TRAVEL AND TOURIST AGENCY SERVICES, NAMELY, PROVIDING AN ONLINE SEARCHABLE COMPUTER DATABASE FEATURING INFORMATION ON TRAVEL, AND MAKING ONLINE RESERVATIONS AND BOOKINGS FOR TRANSPORTATION; TRAVEL AND TOUR INFORMATION SERVICES, IN CLASS 39 (U.S. CLS. 100 AND 105).



FIRST USE 0-0-1998; IN COMMERCE 9-15-2011.

FOR: TRAVEL AND TOURIST AGENCY SERVICES, NAMELY, MAKING ONLINE RESERVATIONS AND BOOKINGS FOR TEMPORARY LODGING; TRAVEL AGENCY SERVICES, NAMELY, ARRANGING TEMPORARY HOUSING ACCOMMODATIONS FOR HOLIDAY PACKAGES; PROVIDING TRAVEL LODGING INFORMATION SERVICES AND TRAVEL LODGING BOOKING AGENCY SERVICES FOR TRAVELERS, IN CLASS 43 (U.S. CLS. 100 AND 101).

FIRST USE 0-0-1998; IN COMMERCE 9-15-2011.

NO CLAIM IS MADE TO THE EXCLUSIVE RIGHT TO USE "TRAVEL ASSOCIATES", APART FROM THE MARK AS SHOWN.

THE COLOR(S) BLUE, RED AND WHITE IS/ARE CLAIMED AS A FEATURE OF THE MARK.

David J. Kyros

Director of the United States Patent and Trademark Office

Reg. No. 4,068,527 THE MARK CONSISTS OF A BLUE OVAL WITH A RED BORDER WITH THE WORDS "TRAVEL ASSOCIATES" IN WHITE STACKED AND CENTERED IN THE OVAL SUPERIMPOSED OVER THE STYLIZED INITIALS "TA" IN BLUE.

SN 85-192,895, FILED 12-8-2010.

KEVON CHISOLM, EXAMINING ATTORNEY

United States of America

United States Patent and Trademark Office



Reg. No. 4,068,528

Registered Dec. 6, 2011

Int. Cl.: 35

SERVICE MARK

PRINCIPAL REGISTER

THE TOMORROW PROJECT, LLC (NEVADA LIMITED LIABILITY COMPANY)
PO BOX 10059
ZEPHYR COVE, NV 89448

FOR: ARRANGING AND CONDUCTING BUSINESS CONFERENCES IN THE FIELDS OF
BRANDING AND MARKETING, IN CLASS 35 (U.S. CLS. 100, 101 AND 102).

FIRST USE 9-22-2011; IN COMMERCE 9-22-2011.

THE MARK CONSISTS OF A STYLIZED LETTER "I" WITHIN A SQUARE, TWO LINES
BELOW THE STYLIZED LETTER "I" AND AN OVAL SHAPE AROUND THE DOT AND
TOP PORTION OF THE LETTER "I".

SN 85-193,026, FILED 12-8-2010.

ALLISON SCHRODY, EXAMINING ATTORNEY



David J. Kybas

Director of the United States Patent and Trademark Office

United States of America

United States Patent and Trademark Office

BIOH FUSION

Reg. No. 4,068,529

Registered Dec. 6, 2011

Int. Cl.: 1

TRADEMARK

PRINCIPAL REGISTER

CARGILL, INCORPORATED (DELAWARE CORPORATION)
15407 MCGINTY ROAD WEST
WAYZATA, MN 55391

FOR: NON-PETROLEUM BASED POLYMER USED FOR MANUFACTURING FOAM, COATINGS INCLUDING PAINT, ADHESIVES, SEALANT, ELASTOMERS, INSULATION AND RESINS, AND UNPROCESSED PLASTICS, IN CLASS 1 (U.S. CLS. 1, 5, 6, 10, 26 AND 46).

FIRST USE 3-1-2011; IN COMMERCE 3-1-2011.

THE MARK CONSISTS OF STANDARD CHARACTERS WITHOUT CLAIM TO ANY PARTICULAR FONT, STYLE, SIZE, OR COLOR.

OWNER OF U.S. REG. NOS. 3,458,625 AND 3,459,599.

SN 85-193,321, FILED 12-8-2010.

JOHN HWANG, EXAMINING ATTORNEY



David J. Kybas

Director of the United States Patent and Trademark Office

United States of America

United States Patent and Trademark Office

MORNING'S BEST

Reg. No. 4,068,530

Registered Dec. 6, 2011

Int. Cl.: 29

TRADEMARK

PRINCIPAL REGISTER

CARGILL, INCORPORATED (DELAWARE CORPORATION)
15407 MCGINTY ROAD WEST
WAYZATA, MN 55391

FOR: EGG PRODUCT, IN CLASS 29 (U.S. CL. 46).

FIRST USE 7-21-2011; IN COMMERCE 7-21-2011.

THE MARK CONSISTS OF STANDARD CHARACTERS WITHOUT CLAIM TO ANY PARTICULAR FONT, STYLE, SIZE, OR COLOR.

SN 85-193,326, FILED 12-8-2010.

JOHN HWANG, EXAMINING ATTORNEY



David J. Kybas

Director of the United States Patent and Trademark Office

United States of America

United States Patent and Trademark Office

SWISH-ROD

Reg. No. 4,068,531

Registered Dec. 6, 2011

Int. Cl.: 28

TRADEMARK

PRINCIPAL REGISTER

HANDI-SHOP INDUSTRIES, INCORPORATED (WISCONSIN CORPORATION)
1411 N. SUPERIOR AVENUE
TOMAH, WI 54660

FOR: ICE FISHING POLES, IN CLASS 28 (U.S. CLS. 22, 23, 38 AND 50).

FIRST USE 2-25-2011; IN COMMERCE 2-25-2011.

THE MARK CONSISTS OF STANDARD CHARACTERS WITHOUT CLAIM TO ANY PARTICULAR FONT, STYLE, SIZE, OR COLOR.

SN 85-194,024, FILED 12-9-2010.

SOPHIA S. KIM, EXAMINING ATTORNEY



David J. Kybas

Director of the United States Patent and Trademark Office

United States of America

United States Patent and Trademark Office



Reg. No. 4,068,532

Registered Dec. 6, 2011

Int. Cl.: 32

TRADEMARK

PRINCIPAL REGISTER

SUN KING BREWING COMPANY, LLC (INDIANA LIMITED LIABILITY COMPANY)
135 NORTH COLLEGE AVENUE
INDIANAPOLIS, IN 46202

FOR: ALES, IN CLASS 32 (U.S. CLS. 45, 46 AND 48).

FIRST USE 7-1-2009; IN COMMERCE 7-1-2009.

NO CLAIM IS MADE TO THE EXCLUSIVE RIGHT TO USE "BITTER", "ESB" OR "BREWERY", APART FROM THE MARK AS SHOWN.

THE MARK CONSISTS OF THE STYLIZED WORDS "SUN KING BREWERY" APPEARING ACROSS A HANDLE OF A MEDIEVAL-TYPE SWORD, ITSELF ON TOP OF A STYLIZED CELTIC-TYPE CROSS WITH A WOVEN PATTERN. BENEATH THE TOP PORTION OF THE CROSS IS A METALLIC CIRCULAR SHIELD. BEHIND THE CIRCULAR SHIELD IS A QUADRILATERAL WITH A CURVED TOP THAT CONTINUES BEHIND THE OTHER DESIGN FEATURES TO A THINNER BOTTOM JUST BEFORE THE END OF THE SWORD. THERE ARE DECORATIVE FLOURISH LINES ON AND IMMEDIATELY TO EACH SIDE OF THE QUADRILATERAL. ON THE CROSS BEAM OF THE CROSS IS THE STYLIZED WORD "BITTER" AND AT THE BOTTOM OF THE CROSS BEAM AND BOTTOM OF THE SHIELD IS A CIRCULAR CARVING OF A CENTRAL AMERICAN SUN GOD'S FACE. BELOW THE CARVING AND SHIELD, AND JUST ABOVE THE END OF THE SWORD, APPEARS THE STYLIZED WORD "DRUID" AND BELOW THE WORD "DRUID" APPEAR THE STYLIZED LETTERS "ESB", WITH A LEAF FLOURISH DESIGN ON EITHER SIDE OF THE "ESB". THE SMALL STYLIZED LETTERS "SB" APPEAR TO THE BOTTOM RIGHT OF THE RIGHT-SIDE FLOURISH. THE ENTIRE MARK APPEARS ON A SHADED RECTANGULAR BACKGROUND.



SN 85-194,105, FILED 12-9-2010.

ANDREA HACK, EXAMINING ATTORNEY

David J. Kyjars

Director of the United States Patent and Trademark Office

United States of America

United States Patent and Trademark Office

IR™

Reg. No. 4,068,533

Registered Dec. 6, 2011

Int. Cls.: 9 and 16

TRADEMARK

PRINCIPAL REGISTER

PICMG-PCI INDUSTRIAL COMPUTER MANUFACTURERS GROUP, INC. (DELAWARE CORPORATION)
SUITE 600
C/O 401 EDGEWATER PLACE
WAKEFIELD, MA 01880

FOR: COMPUTER HARDWARE AND PERIPHERALS FOR THE TELECOMMUNICATIONS AND INDUSTRIAL COMPUTING APPLICATIONS INDUSTRIES; DOWNLOADABLE ELECTRONIC PUBLICATIONS IN THE NATURE OF SPECIFICATIONS, MANUALS, GUIDES, DATA SHEETS, AND WHITE PAPERS PERTAINING TO THE INTEROPERABILITY OF COMMUNICATIONS AND INDUSTRIAL COMPUTING APPLICATIONS AND THE DEVELOPMENT AND IMPLEMENTATION OF TECHNICAL STANDARDS AND SPECIFICATIONS THEREFOR, IN CLASS 9 (U.S. CLS. 21, 23, 26, 36 AND 38).

FIRST USE 3-9-2010; IN COMMERCE 1-11-2011.

FOR: PRINTED MATTER IN THE NATURE OF SPECIFICATIONS, MANUALS, GUIDES, DATA SHEETS, AND WHITE PAPERS PERTAINING TO THE INTEROPERABILITY OF TELECOMMUNICATIONS AND INDUSTRIAL COMPUTING APPLICATIONS AND THE DEVELOPMENT AND IMPLEMENTATION OF TECHNICAL STANDARDS AND SPECIFICATIONS THEREFOR, IN CLASS 16 (U.S. CLS. 2, 5, 22, 23, 29, 37, 38 AND 50).

FIRST USE 3-9-2010; IN COMMERCE 1-11-2011.

THE MARK CONSISTS OF STANDARD CHARACTERS WITHOUT CLAIM TO ANY PARTICULAR FONT, STYLE, SIZE, OR COLOR.

SN 85-194,119, FILED 12-9-2010.

ANGELA M. MICHELI, EXAMINING ATTORNEY



David J. Kybas

Director of the United States Patent and Trademark Office

United States of America

United States Patent and Trademark Office

ADKU

Reg. No. 4,068,534

Registered Dec. 6, 2011

Int. Cl.: 42

SERVICE MARK

PRINCIPAL REGISTER

NOVOSTARK, INC. (DELAWARE CORPORATION)
255 KING STREET
SUITE 1409
SAN FRANCISCO, CA 94017

FOR: SOFTWARE AS A SERVICE (SAAS) FEATURING COMPUTER SOFTWARE TO GATHER AND ANALYZE REAL-TIME DATA IN THE NATURE OF WEATHER, NEWS, TRENDS AND THE ACTIONS AND INTERESTS OF CONSUMERS, AND THEN DYNAMICALLY CHANGE DIGITAL CONTENT IN THE NATURE OF WEB, MOBILE, TV BASED UPON RESULTS OF DATA ANALYSIS, IN CLASS 42 (U.S. CLS. 100 AND 101).

FIRST USE 3-1-2011; IN COMMERCE 3-1-2011.

THE MARK CONSISTS OF STANDARD CHARACTERS WITHOUT CLAIM TO ANY PARTICULAR FONT, STYLE, SIZE, OR COLOR.

SN 85-194,368, FILED 12-9-2010.

INGRID C. EULIN, EXAMINING ATTORNEY



David J. Kyros

Director of the United States Patent and Trademark Office

United States of America

United States Patent and Trademark Office

SYLATRON

Reg. No. 4,068,535

Registered Dec. 6, 2011

Int. Cl.: 5

TRADEMARK

PRINCIPAL REGISTER

SCHERING CORPORATION (NEW JERSEY CORPORATION)
2000 GALLOPING HILL ROAD
KENILWORTH, NJ 07033

FOR: PHARMACEUTICAL PREPARATIONS FOR THE TREATMENT OF CANCER, IN CLASS
5 (U.S. CLS. 6, 18, 44, 46, 51 AND 52).

FIRST USE 4-26-2011; IN COMMERCE 4-26-2011.

THE MARK CONSISTS OF STANDARD CHARACTERS WITHOUT CLAIM TO ANY PAR-
TICULAR FONT, STYLE, SIZE, OR COLOR.

SN 85-195,152, FILED 12-10-2010.

JOHN WILKE, EXAMINING ATTORNEY



David J. Kybas

Director of the United States Patent and Trademark Office

United States of America

United States Patent and Trademark Office

INFUZION

Reg. No. 4,068,536

Registered Dec. 6, 2011

Int. Cl.: 35

SERVICE MARK

PRINCIPAL REGISTER

DI-FI SOLUTIONS LLC (TENNESSEE LIMITED LIABILITY COMPANY)
357 MALLARD BAYE
RUTLEDGE, TN 37861

FOR: BUSINESS SERVICES, NAMELY, PROVIDING CONSULTATION IN RELATION TO RESOURCE PLANNING FOR THE ALCOHOLIC BEVERAGE WHOLESALE INDUSTRY, IN CLASS 35 (U.S. CLS. 100, 101 AND 102).

FIRST USE 4-1-2011; IN COMMERCE 4-1-2011.

THE MARK CONSISTS OF STANDARD CHARACTERS WITHOUT CLAIM TO ANY PARTICULAR FONT, STYLE, SIZE, OR COLOR.

SN 85-195,210, FILED 12-10-2010.

WANDA KAY PRICE, EXAMINING ATTORNEY



David J. Kybas

Director of the United States Patent and Trademark Office

United States of America

United States Patent and Trademark Office

BlingFinder

Reg. No. 4,068,537

Registered Dec. 6, 2011

Int. Cl.: 35

SERVICE MARK

PRINCIPAL REGISTER

JONES, DARROW (ARKANSAS SOLE PROPRIETORSHIP), DBA JONES & SON FINE
JEWELRY,
11121 RODNEY PARHAM ROAD
LITTLE ROCK, AR 72212

FOR: ON-LINE WHOLESALE AND RETAIL STORE SERVICES FEATURING JEWELRY, IN
CLASS 35 (U.S. CLS. 100, 101 AND 102).

FIRST USE 8-29-2011; IN COMMERCE 8-29-2011.

THE MARK CONSISTS OF STANDARD CHARACTERS WITHOUT CLAIM TO ANY PAR-
TICULAR FONT, STYLE, SIZE, OR COLOR.

SN 85-196,125, FILED 12-13-2010.

ROBIN CHOSID, EXAMINING ATTORNEY



David J. Kyffers

Director of the United States Patent and Trademark Office

United States of America

United States Patent and Trademark Office

LAZANDA

Reg. No. 4,068,538

Registered Dec. 6, 2011

Int. Cl.: 5

TRADEMARK

PRINCIPAL REGISTER

ARCHIMEDES DEVELOPMENT LIMITED (ENGLAND COMPANY)
ALBERT EINSTEIN CENTER
NOTTINGHAM SCI & TECH PARK, UNIV BLVD
NOTTINGHAM, UNITED KINGDOM NG72TN

FOR: PHARMACEUTICAL PREPARATIONS FOR THE TREATMENT OF PAIN, IN CLASS
5 (U.S. CLS. 6, 18, 44, 46, 51 AND 52).

FIRST USE 10-1-2011; IN COMMERCE 10-1-2011.

THE MARK CONSISTS OF STANDARD CHARACTERS WITHOUT CLAIM TO ANY PAR-
TICULAR FONT, STYLE, SIZE, OR COLOR.

THE WORDING "LAZANDA" HAS NO MEANING IN A FOREIGN LANGUAGE.

SN 85-196,378, FILED 12-13-2010.

MAYUR VAGHANI, EXAMINING ATTORNEY



David J. Kyros

Director of the United States Patent and Trademark Office

United States of America

United States Patent and Trademark Office

AMERICA'S NATIONAL TREASURES

Reg. No. 4,068,539

Registered Dec. 6, 2011

Int. Cl.: 42

SERVICE MARK

PRINCIPAL REGISTER

NUMISMATIC GUARANTY CORPORATION OF AMERICA (NEW JERSEY CORPORATION)
5501 COMMUNICATIONS PARKWAY
SARASOTA, FL 34240

FOR: COIN GRADING SERVICES AND COIN AUTHENTICATION SERVICES FEATURING
COIN ENCAPSULATION, NAMELY, ENCLOSING AUTHENTICATED, GRADED COINS IN
A PROTECTIVE HOLDER, IN CLASS 42 (U.S. CLS. 100 AND 101).

FIRST USE 1-8-2011; IN COMMERCE 1-8-2011.

THE MARK CONSISTS OF STANDARD CHARACTERS WITHOUT CLAIM TO ANY PAR-
TICULAR FONT, STYLE, SIZE, OR COLOR.

NO CLAIM IS MADE TO THE EXCLUSIVE RIGHT TO USE "AMERICA'S", APART FROM
THE MARK AS SHOWN.

SN 85-197,170, FILED 12-14-2010.

AISHA SALEM, EXAMINING ATTORNEY



David J. Kybas

Director of the United States Patent and Trademark Office

United States of America

United States Patent and Trademark Office

SMARTSCHEDULE

Reg. No. 4,068,540

Registered Dec. 6, 2011

Int. Cl.: 9

TRADEMARK

PRINCIPAL REGISTER

PATIENT INNOVATIONS, LLC (NEW YORK LIMITED LIABILITY COMPANY)
SUITE #100
125 KENNEDY DRIVE
HAUPPAUGE, NY 117884017

FOR: COMPUTER HARDWARE AND SOFTWARE, FOR USE WITH MEDICAL PATIENT MONITORING EQUIPMENT, FOR RECEIVING, PROCESSING, TRANSMITTING AND DISPLAYING DATA; COMPUTER PROGRAMMES FOR DOCUMENT MANAGEMENT; COMPUTER SOFTWARE FOR CONTROLLING AND MANAGING PATIENT MEDICAL INFORMATION; COMPUTER SOFTWARE FOR THE COLLECTION, EDITING, ORGANIZING, MODIFYING, BOOK MARKING, TRANSMISSION, STORAGE AND SHARING OF DATA AND INFORMATION; MEDICAL SOFTWARE FOR WEB BASED APPLICATIONS TO ENABLE HOSPITALS TO CONTACT PATIENTS, FAMILY AND FRIENDS WITH SAFE, SECURE, PORTABLE AND CURRENT ELECTRONIC MEDICAL RECORDS, IN CLASS 9 (U.S. CLS. 21, 23, 26, 36 AND 38).

FIRST USE 1-31-2011; IN COMMERCE 1-31-2011.

THE MARK CONSISTS OF STANDARD CHARACTERS WITHOUT CLAIM TO ANY PARTICULAR FONT, STYLE, SIZE, OR COLOR.

SN 85-197,183, FILED 12-14-2010.

DORITT L. CARROLL, EXAMINING ATTORNEY



David J. Kyros

Director of the United States Patent and Trademark Office

United States of America

United States Patent and Trademark Office

The Song Painters

Reg. No. 4,068,541

STEPHENSON, CARL FREDRICK (UNITED STATES INDIVIDUAL)
2525 EAST 29TH AVE. SUITE 10B-254
SPOKANE, WA 99223

Registered Dec. 6, 2011

Int. Cl.: 9

FOR: AUDIO AND VIDEO RECORDINGS FEATURING MUSIC AND ARTISTIC PERFORMANCES, IN CLASS 9 (U.S. CLS. 21, 23, 26, 36 AND 38).

TRADEMARK

FIRST USE 9-12-2011; IN COMMERCE 9-12-2011.

PRINCIPAL REGISTER

THE MARK CONSISTS OF STANDARD CHARACTERS WITHOUT CLAIM TO ANY PARTICULAR FONT, STYLE, SIZE, OR COLOR.

NO CLAIM IS MADE TO THE EXCLUSIVE RIGHT TO USE "SONG", APART FROM THE MARK AS SHOWN.

SN 85-197,914, FILED 12-14-2010.

WENDY JUN, EXAMINING ATTORNEY



David J. Kybas

Director of the United States Patent and Trademark Office

United States of America
United States Patent and Trademark Office

BIOREDOR

Reg. No. 4,068,542

MINNTECH CORPORATION (MINNESOTA CORPORATION)
14605 28TH AVENUE NORTH
MINNEAPOLIS, MN 55447

Registered Dec. 6, 2011

Int. Cl.: 40

FOR: BIO-HAZARD BIOLOGICAL DECONTAMINATION SERVICES, IN CLASS 40 (U.S. CLS. 100, 103 AND 106).

SERVICE MARK

FIRST USE 6-29-2011; IN COMMERCE 6-29-2011.

PRINCIPAL REGISTER

THE MARK CONSISTS OF STANDARD CHARACTERS WITHOUT CLAIM TO ANY PARTICULAR FONT, STYLE, SIZE, OR COLOR.

SN 85-198,048, FILED 12-15-2010.

GENE MACIOL, EXAMINING ATTORNEY



David J. Kybas

Director of the United States Patent and Trademark Office

United States of America

United States Patent and Trademark Office

TMX

Reg. No. 4,068,543

Registered Dec. 6, 2011

Int. Cl.: 35

SERVICE MARK

PRINCIPAL REGISTER

INTERNATIONAL DATA GROUP, INC. (MASSACHUSETTS CORPORATION)
5 SPEEN STREET
FRAMINGHAM, MA 01821

FOR: INTERNET ADVERTISING SERVICES; MANAGING A PLATFORM FOR THE BUYING AND SELLING OF INTERNET BASED ADVERTISING; PROVIDING ONLINE EXCHANGES AND ONLINE AUCTIONS FOR BUYING AND SELLING DIGITAL ADVERTISING; ADVERTISING SERVICES FOR MATCHING BUYERS AND SELLERS OF ADVERTISING, FOR TRACKING ADVERTISING PERFORMANCE, FOR MANAGING, DISTRIBUTING AND SERVING ADVERTISING, FOR ANALYZING ADVERTISING DATA, FOR REPORTING ADVERTISING DATA, AND FOR OPTIMIZING ADVERTISING PERFORMANCE; ENABLING AND CONTRACTING WITH DEMAND SITE PLATFORMS (DSPS), REAL TIME BIDDING PLATFORMS (RTBS), AGENCY TRADING DESKS (ATDS), AND OTHER ADVERTISING AGGREGATION AND BUYING PLATFORMS TO BID ON AND PURCHASE ONLINE AD SPACE, ENABLING THEM TO USE DATA AND OTHER INVENTORY TARGETING TECHNOLOGIES TO BUY SPECIFIC INVENTORY; ENABLING AND CONTRACTING WITH INTERNET WEBSITES, INTERNET AD NETWORKS, PUBLISHER NETWORKS, SYNDICATION NETWORKS, SUPPLY SIDE PLATFORMS (SSPS), ONLINE AD EXCHANGES, AND OTHER SOURCES OF INTERNET AD INVENTORY TO HAVE ADVERTISING BUYERS BID AND PURCHASE THEIR INTERNET INVENTORY THROUGH AN EXCHANGE PLATFORM, IN CLASS 35 (U.S. CLS. 100, 101 AND 102).

FIRST USE 3-31-2011; IN COMMERCE 3-31-2011.

THE MARK CONSISTS OF STANDARD CHARACTERS WITHOUT CLAIM TO ANY PARTICULAR FONT, STYLE, SIZE, OR COLOR.

SN 85-198,089, FILED 12-15-2010.

JANICE L. MCMORROW, EXAMINING ATTORNEY



David J. Kyros

Director of the United States Patent and Trademark Office

United States of America

United States Patent and Trademark Office

COCOA PUFFS BROWNIE CRUNCH

Reg. No. 4,068,544

GENERAL MILLS IP HOLDINGS II, LLC (DELAWARE LIMITED LIABILITY COMPANY)
NUMBER ONE GENERAL MILLS BLVD.
MINNEAPOLIS, MN 55426

Registered Dec. 6, 2011

Int. Cl.: 30

FOR: PROCESSED CEREAL-BASED FOOD TO BE USED AS A BREAKFAST FOOD, SNACK
FOOD OR INGREDIENT FOR MAKING OTHER FOODS, IN CLASS 30 (U.S. CL. 46).

TRADEMARK

FIRST USE 5-23-2011; IN COMMERCE 5-23-2011.

PRINCIPAL REGISTER

THE MARK CONSISTS OF STANDARD CHARACTERS WITHOUT CLAIM TO ANY PAR-
TICULAR FONT, STYLE, SIZE, OR COLOR.

SEC. 2(F) AS TO "COCOA PUFFS".

OWNER OF U.S. REG. NOS. 1,488,728, 3,537,012, AND OTHERS.

NO CLAIM IS MADE TO THE EXCLUSIVE RIGHT TO USE "BROWNIE CRUNCH", APART
FROM THE MARK AS SHOWN.

SN 85-198,602, FILED 12-15-2010.

MATTHEW MCDOWELL, EXAMINING ATTORNEY



David J. Kyros

Director of the United States Patent and Trademark Office

United States of America

United States Patent and Trademark Office

The Piano Duet Paradigm

Reg. No. 4,068,545

Registered Dec. 6, 2011

**Int. Cls.: 9, 35, 41, 44,
and 45**

TRADEMARK

SERVICE MARK

PRINCIPAL REGISTER

ROEMISCHER, JESSICA (UNITED STATES INDIVIDUAL)
P.O. BOX 1318
STOCKBRIDGE, MA 01262

FOR: DOWNLOADABLE MP3 FILES, MP3 RECORDINGS, ON-LINE DISCUSSION BOARDS, WEBCASTS, WEBINARS AND PODCASTS IN THE FIELD OF SELF-AWARENESS, AUDIO BOOKS IN THE FIELD OF SELF-AWARENESS, IN CLASS 9 (U.S. CLS. 21, 23, 26, 36 AND 38).

FIRST USE 3-1-2011; IN COMMERCE 3-1-2011.

FOR: BUSINESS CONSULTING SERVICE THAT PROVIDES TRANSFORMATIONAL STRATEGIES TO PROFESSIONALS, LEADERS, AND COMPANIES USING MUSIC, NAMELY, TO DEVELOP COMMUNICATION SKILLS, VALUES, CREATIVITY, AND LEADERSHIP DEVELOPMENT, IN CLASS 35 (U.S. CLS. 100, 101 AND 102).

FIRST USE 3-1-2011; IN COMMERCE 3-1-2011.

FOR: EDUCATION SERVICES, NAMELY, PROVIDING TEACHING, COACHING, SEMINARS, WORKSHOPS, TELESEMINARS AND TELECLASSES IN THE FIELD OF SELF-AWARENESS; DEVELOPING EDUCATIONAL MANUALS, TRAINING SYSTEMS AND METHODOLOGIES FOR OTHERS IN THE FIELD OF SELF-AWARENESS; ON-LINE JOURNALS, NAMELY, BLOGS FEATURING SELF-AWARENESS, IN CLASS 41 (U.S. CLS. 100, 101 AND 107).

FIRST USE 3-1-2011; IN COMMERCE 3-1-2011.

FOR: MUSIC THERAPY FOR PHYSICAL, PSYCHOLOGICAL AND COGNITIVE PURPOSES, IN CLASS 44 (U.S. CLS. 100 AND 101).

FIRST USE 3-1-2011; IN COMMERCE 3-1-2011.

FOR: COUNSELING USING MUSIC FOR PERSONAL DEVELOPMENT, NAMELY, SELF-IMPROVEMENT, SELF-FULFILLMENT, AND INTERPERSONAL COMMUNICATION; PROVIDING INFORMATION USING MUSIC IN THE FIELD OF PERSONAL DEVELOPMENT; PROVIDING A RESOURCE WEBSITE TO PROVIDE INFORMATION THAT USES MUSIC IN THE FIELD OF PERSONAL DEVELOPMENT, IN CLASS 45 (U.S. CLS. 100 AND 101).



David J. Kybas

Director of the United States Patent and Trademark Office

Reg. No. 4,068,545 FIRST USE 3-1-2011; IN COMMERCE 3-1-2011.

THE MARK CONSISTS OF STANDARD CHARACTERS WITHOUT CLAIM TO ANY PARTICULAR FONT, STYLE, SIZE, OR COLOR.

NO CLAIM IS MADE TO THE EXCLUSIVE RIGHT TO USE "PIANO DUET", APART FROM THE MARK AS SHOWN.

SN 85-198,630, FILED 12-15-2010.

NATALIE POLZER, EXAMINING ATTORNEY

United States of America

United States Patent and Trademark Office

Jah Coffee

Reg. No. 4,068,546

JASON SEIFERT (UNITED STATES INDIVIDUAL)
12472 LAKE UNDERHILL ROAD #250
ORLANDO, FL 32828

Registered Dec. 6, 2011

Int. Cls.: 25, 30, and 35

FOR: APRONS; BASEBALL CAPS AND HATS; GOLF SHIRTS; HATS; HOODED SWEAT SHIRTS; JACKETS; KNIT SHIRTS; SWEAT SHIRTS; T-SHIRTS, IN CLASS 25 (U.S. CLS. 22 AND 39).

TRADEMARK

FIRST USE 12-15-2010; IN COMMERCE 8-24-2011.

SERVICE MARK

FOR: BEVERAGES MADE OF COFFEE; COFFEE; COFFEE; COFFEE BASED BEVERAGES; COFFEE BEANS; COFFEE FLAVORED SYRUP USED IN MAKING FOOD BEVERAGES; ESPRESSO; ESPRESSO DRINKS; FLAVORING SYRUP; GROUND COFFEE BEANS; PREPARED COFFEE AND COFFEE-BASED BEVERAGES; ROASTED COFFEE BEANS, IN CLASS 30 (U.S. CL. 46).

PRINCIPAL REGISTER

FIRST USE 12-15-2010; IN COMMERCE 8-24-2011.

FOR: ON-LINE RETAIL STORE SERVICES FEATURING GROUND AND WHOLE BEAN COFFEE, COFFEE AND ESPRESSO BEVERAGES AND BEVERAGES MADE WITH A BASE OF COFFEE, ESPRESSO, POWDERED FLAVORINGS, FLAVORING SYRUPS, ELECTRIC APPLIANCES, NAMELY, KETTLES, COFFEE MAKERS, ESPRESSO MAKERS AND COFFEE GRINDERS, HOUSEWARES, NON-ELECTRIC APPLIANCES AND RELATED ITEMS, NAMELY, HAND-OPERATED COFFEE GRINDERS AND COFFEE MILLS, INSULATED COFFEE AND BEVERAGE CUPS, COFFEE CUPS AND MUGS, GLASSWARE, STORAGE CANISTERS, NON-ELECTRIC COFFEE MAKERS, COFFEE FILTERS, HATS, CLOTHING, NAMELY, T-SHIRTS, SWEATSHIRTS, JACKETS, APRONS AND TANK TOPS, BOOKS, MAGNETS, CDS AND DVDS, IN CLASS 35 (U.S. CLS. 100, 101 AND 102).

FIRST USE 12-15-2010; IN COMMERCE 8-24-2011.

THE MARK CONSISTS OF STANDARD CHARACTERS WITHOUT CLAIM TO ANY PARTICULAR FONT, STYLE, SIZE, OR COLOR.

NO CLAIM IS MADE TO THE EXCLUSIVE RIGHT TO USE "COFFEE", APART FROM THE MARK AS SHOWN.



David J. Kyros

Director of the United States Patent and Trademark Office

Reg. No. 4,068,546 SN 85-198,792, FILED 12-15-2010.

EVELYN BRADLEY, EXAMINING ATTORNEY

United States of America

United States Patent and Trademark Office

DIAMOND GUTTER SHIELD PRO

Reg. No. 4,068,547

AMERIMAX HOME PRODUCTS, INC. (DELAWARE CORPORATION)
4455 RIVER GREEN PARKWAY
DULUTH, GA 30096

Registered Dec. 6, 2011

Int. Cl.: 6

FOR: METAL DEBRIS GUARDS FOR GUTTERS, IN CLASS 6 (U.S. CLS. 2, 12, 13, 14, 23, 25 AND 50).

TRADEMARK

FIRST USE 5-31-2011; IN COMMERCE 5-31-2011.

PRINCIPAL REGISTER

THE MARK CONSISTS OF STANDARD CHARACTERS WITHOUT CLAIM TO ANY PARTICULAR FONT, STYLE, SIZE, OR COLOR.

OWNER OF U.S. REG. NOS. 3,839,108 AND 3,846,499.

NO CLAIM IS MADE TO THE EXCLUSIVE RIGHT TO USE "GUTTER SHIELD", APART FROM THE MARK AS SHOWN.

SN 85-201,158, FILED 12-17-2010.

KAREN BRACEY, EXAMINING ATTORNEY



David J. Kybas

Director of the United States Patent and Trademark Office

United States of America

United States Patent and Trademark Office

Breezette

Reg. No. 4,068,548

Registered Dec. 6, 2011

Int. Cl.: 33

TRADEMARK

PRINCIPAL REGISTER

ALGAN, AYLIN (CANADA INDIVIDUAL)
450 WEST 17TH STREET, APT. 903
NEW YORK, NY 10011

FOR: STILL WINES, IN CLASS 33 (U.S. CLS. 47 AND 49).

FIRST USE 4-15-2011; IN COMMERCE 4-15-2011.

THE MARK CONSISTS OF STANDARD CHARACTERS WITHOUT CLAIM TO ANY PARTICULAR FONT, STYLE, SIZE, OR COLOR.

SN 85-201,460, FILED 12-19-2010.

TINA L. SNAPP, EXAMINING ATTORNEY



David J. Kybas

Director of the United States Patent and Trademark Office

United States of America

United States Patent and Trademark Office

GET ACTION WAX

Reg. No. 4,068,549

L'OREAL USA CREATIVE, INC. (DELAWARE CORPORATION)
575 FIFTH AVENUE
NEW YORK, NY 10017

Registered Dec. 6, 2011

Int. Cl.: 3

FOR: HAIR STYLING PREPARATION, IN CLASS 3 (U.S. CLS. 1, 4, 6, 50, 51 AND 52).

TRADEMARK

FIRST USE 8-1-2011; IN COMMERCE 8-1-2011.

PRINCIPAL REGISTER

THE MARK CONSISTS OF STANDARD CHARACTERS WITHOUT CLAIM TO ANY PARTICULAR FONT, STYLE, SIZE, OR COLOR.

NO CLAIM IS MADE TO THE EXCLUSIVE RIGHT TO USE "WAX", APART FROM THE MARK AS SHOWN.

SN 85-201,539, FILED 12-20-2010.

JOHN HWANG, EXAMINING ATTORNEY



David J. Kyffers

Director of the United States Patent and Trademark Office

United States of America

United States Patent and Trademark Office

escara

Reg. No. 4,068,550

Registered Dec. 6, 2011

Int. Cl.: 26

TRADEMARK

PRINCIPAL REGISTER

MIDWAY INTERNATIONAL, INC. (CALIFORNIA CORPORATION)
13131 EAST 166TH STREET
CERRITOS, CA 90703

FOR: CLAM CLIPS FOR HAIR; FALSE HAIR; HAIR ACCESSORIES, NAMELY, CLAW CLIPS; HAIR ACCESSORIES, NAMELY, JAW CLIPS; HAIR ACCESSORIES, NAMELY, SNAP CLIPS; HAIR ACCESSORIES, NAMELY, TWISTERS; HAIR BANDS; HAIR BARRETTES; HAIR BOWS; HAIR CHOPSTICKS; HAIR CLAMPS; HAIR CLIPS; HAIR CURL CLIPS; HAIR ELASTICS; HAIR EXTENSIONS; HAIR GRIPS; HAIR NETS; HAIR NETTING; HAIR ORNAMENTS; HAIR PINS; HAIR PINS AND GRIPS; HAIR TASSEL ORNAMENTS FOR JAPANESE HAIR STYLING (NEGAKE); ORIENTAL HAIR PINS; WIGS, HAIRPIECES, AND ADD-IN AND ADD-ON HAIR ACCESSORIES CONSTRUCTED PRIMARILY OF SYNTHETIC AND/OR HUMAN HAIR, IN CLASS 26 (U.S. CLS. 37, 39, 40, 42 AND 50).

FIRST USE 5-1-2011; IN COMMERCE 5-1-2011.

THE MARK CONSISTS OF STANDARD CHARACTERS WITHOUT CLAIM TO ANY PARTICULAR FONT, STYLE, SIZE, OR COLOR.

SN 85-202,043, FILED 12-20-2010.

KEVON CHISOLM, EXAMINING ATTORNEY



David J. Kybas

Director of the United States Patent and Trademark Office

United States of America

United States Patent and Trademark Office

MAKING PARADISE POSSIBLE

Reg. No. 4,068,551

Registered Dec. 6, 2011

Int. Cls.: 41 and 45

SERVICE MARK

PRINCIPAL REGISTER

SEA STAR CONCIERGE, LLC (SOUTH CAROLINA LIMITED LIABILITY COMPANY)
SUITE 100
4 DUNMORE COURT
HILTON HEAD ISLAND, SC 29926

FOR: CONSULTATION IN THE FIELD OF SPECIAL EVENT PLANNING FOR SOCIAL ENTERTAINMENT PURPOSES; SPECIAL EVENT PLANNING FOR SOCIAL ENTERTAINMENT PURPOSES, IN CLASS 41 (U.S. CLS. 100, 101 AND 107).

FIRST USE 9-26-2011; IN COMMERCE 9-26-2011.

FOR: PERSONAL CONCIERGE SERVICES FOR OTHERS COMPRISING MAKING REQUESTED PERSONAL ARRANGEMENTS AND RESERVATIONS, RUNNING ERRANDS AND PROVIDING CUSTOMER SPECIFIC INFORMATION TO MEET INDIVIDUAL NEEDS, ALL RENDERED IN BUSINESS ESTABLISHMENTS, OFFICE BUILDINGS, HOTELS, RESIDENTIAL COMPLEXES AND HOMES, IN CLASS 45 (U.S. CLS. 100 AND 101).

FIRST USE 9-26-2011; IN COMMERCE 9-26-2011.

THE MARK CONSISTS OF STANDARD CHARACTERS WITHOUT CLAIM TO ANY PARTICULAR FONT, STYLE, SIZE, OR COLOR.

SN 85-202,549, FILED 12-21-2010.

KAELIE KUNG, EXAMINING ATTORNEY



David J. Kybas

Director of the United States Patent and Trademark Office

United States of America
United States Patent and Trademark Office

GROROOF

Reg. No. 4,068,552

Registered Dec. 6, 2011

Int. Cl.: 31

TRADEMARK

PRINCIPAL REGISTER

METRO GREEN VISIONS, INC. (NEW YORK CORPORATION)
140 HALF HOLLOW ROAD
DIX HILLS, NY 11746

FOR: HYBRID MODULAR GREEN ROOF KIT FOR GROWING PLANTS CONSISTING OF LIVE PLANTS, EMPTY PLANTER TRAYS FOR PLANTS, MESH-WOVEN GEOTEXTILE FABRICS, AND GROWING MEDIA FOR PLANTS , IN CLASS 31 (U.S. CLS. 1 AND 46).

FIRST USE 9-1-2011; IN COMMERCE 9-1-2011.

THE MARK CONSISTS OF STANDARD CHARACTERS WITHOUT CLAIM TO ANY PARTICULAR FONT, STYLE, SIZE, OR COLOR.

SN 85-202,619, FILED 12-21-2010.

BARBARA BROWN, EXAMINING ATTORNEY



David J. Kybas

Director of the United States Patent and Trademark Office

United States of America

United States Patent and Trademark Office

Lipsavvy! By Je' Ane

Reg. No. 4,068,553

JE'ANE, LLC (LOUISIANA LIMITED LIABILITY COMPANY)
336 MID LAKE LANE
LEESVILLE, LA 71446

Registered Dec. 6, 2011

Int. Cl.: 3

FOR: COSMETICS, NAMELY, COMPACTS; COSMETICS, NAMELY, LIP PRIMER; COSMETICS, NAMELY, LIP REPAIRERS, IN CLASS 3 (U.S. CLS. 1, 4, 6, 50, 51 AND 52).

TRADEMARK

FIRST USE 5-5-2009; IN COMMERCE 6-14-2011.

PRINCIPAL REGISTER

THE MARK CONSISTS OF STANDARD CHARACTERS WITHOUT CLAIM TO ANY PARTICULAR FONT, STYLE, SIZE, OR COLOR.

SN 85-203,801, FILED 12-22-2010.

CHRISTOPHER BUONGIORNO, EXAMINING ATTORNEY



David J. Kybas

Director of the United States Patent and Trademark Office

United States of America

United States Patent and Trademark Office



European Service at Home

Reg. No. 4,068,554

EUROPEAN SERVICE AT HOME INC. (ILLINOIS CORPORATION)
49 W. SLADE STREET
PALATINE, IL 60067

Registered Dec. 6, 2011

Int. Cls.: 35, 39, and 45

FOR: TRANSPORTATION LOGISTICS SERVICES, NAMELY, ARRANGING THE TRANSPORTATION OF GOODS FOR OTHERS; TRANSPORTATION MANAGEMENT SERVICES, NAMELY, PLANNING AND COORDINATING TRANSPORTATION OF PEOPLE FOR OTHERS, IN CLASS 35 (U.S. CLS. 100, 101 AND 102).

SERVICE MARK

PRINCIPAL REGISTER

FIRST USE 5-18-2003; IN COMMERCE 5-18-2003.

FOR: TRANSPORTATION OF PASSENGERS AND PASSENGERS' LUGGAGE; TRANSPORTATION OF PASSENGERS AND/OR GOODS BY BUS, CAR; TRANSPORTATION SERVICES, NAMELY, PROVIDING SHUTTLE SERVICES BY BUS, CAR, IN CLASS 39 (U.S. CLS. 100 AND 105).

FIRST USE 5-18-2003; IN COMMERCE 5-18-2003.

FOR: PERSONAL CARE ASSISTANCE OF ACTIVITIES OF DAILY LIVING, SUCH AS BATHING, GROOMING AND PERSONAL MOBILITY FOR MENTALLY OR PHYSICALLY CHALLENGED PEOPLE, IN CLASS 45 (U.S. CLS. 100 AND 101).

FIRST USE 5-18-2003; IN COMMERCE 5-18-2003.

NO CLAIM IS MADE TO THE EXCLUSIVE RIGHT TO USE "SERVICE AT HOME", APART FROM THE MARK AS SHOWN.

THE COLOR(S) RED, WHITE, AND BLUE IS/ARE CLAIMED AS A FEATURE OF THE MARK.

THE MARK CONSISTS OF A HEART WITH A CROSS AND LITERAL ELEMENT "EUROPEAN SERVICE AT HOME". THE HEART IS PRESENTED IN RED VERTICAL STRIPES WHERE THERE IS THE CROSS ON THE RIGHT SIDE OF THE HEART. ONE PART OF THE CROSS IS ON A TOP OF THE HEART AND IS IN WHITE. THE OTHER PART OF THE CROSS IS OUTSIDE OF THE HEART AND IS IN RED VERTICAL STRIPES. THERE IS ALSO A WORDING "EUROPEAN SERVICE AT HOME" THAT APPEARS TO THE RIGHT OF THE HEART, AND IS WRITTEN IN BLUE.



David J. Kybas

Director of the United States Patent and Trademark Office

Reg. No. 4,068,554 SN 85-204,638, FILED 12-23-2010.

MAYUR VAGHANI, EXAMINING ATTORNEY

United States of America

United States Patent and Trademark Office

ERRRTHANG

Reg. No. 4,068,555

MORRIS, WILLIE (UNITED STATES INDIVIDUAL)
P.O. BOX 1571
HYANNIS, MA 02673

Registered Dec. 6, 2011

Int. Cl.: 41

FOR: ENTERTAINMENT SERVICES IN THE NATURE OF RECORDING, PRODUCTION AND POST-PRODUCTION SERVICES IN THE FIELD OF MUSIC, IN CLASS 41 (U.S. CLS. 100, 101 AND 107).

SERVICE MARK

FIRST USE 9-22-2010; IN COMMERCE 9-22-2010.

PRINCIPAL REGISTER

THE MARK CONSISTS OF STANDARD CHARACTERS WITHOUT CLAIM TO ANY PARTICULAR FONT, STYLE, SIZE, OR COLOR.

SN 85-204,854, FILED 12-23-2010.

LINDSEY RUBIN, EXAMINING ATTORNEY



David J. Kybas

Director of the United States Patent and Trademark Office

United States of America

United States Patent and Trademark Office



Reg. No. 4,068,556

Registered Dec. 6, 2011

Int. Cl.: 35

SERVICE MARK

PRINCIPAL REGISTER

AGDATA, LP (DELAWARE LIMITED LIABILITY COMPANY)
2100 REXFORD ROAD, SUITE 300
CHARLOTTE, NC 28211

FOR: PROVIDING A SUBSCRIPTION-BASED ONLINE REPORT FOR MANUFACTURERS AND DISTRIBUTORS OF PRODUCTS FOR THE AGRICULTURAL INDUSTRY COMPILING SUBSCRIBER MARKET DATA , IN CLASS 35 (U.S. CLS. 100, 101 AND 102).

FIRST USE 7-6-2011; IN COMMERCE 7-6-2011.

THE MARK CONSISTS OF A STYLIZED DEPICTION OF A MAGNIFYING GLASS WITH A LEAF IN THE UPPER RIGHT SIDE OF THE MAGNIFYING GLASS.

SN 85-205,130, FILED 12-23-2010.

JENNY PARK, EXAMINING ATTORNEY



David J. Kybas

Director of the United States Patent and Trademark Office

United States of America

United States Patent and Trademark Office

Chilly Fillmore's

Reg. No. 4,068,557

Registered Dec. 6, 2011

Int. Cl.: 43

SERVICE MARK

PRINCIPAL REGISTER

CHILLY HORSEMAN, LLC (TEXAS LIMITED LIABILITY COMPANY)
2023 NORTH STREET, SUITE 101
NACOGDOCHES, TX 75965

FOR: FROZEN YOGURT SHOP SERVICES IN THE NATURE OF A RESTAURANT, IN CLASS
43 (U.S. CLS. 100 AND 101).

FIRST USE 6-4-2011; IN COMMERCE 6-4-2011.

THE MARK CONSISTS OF STANDARD CHARACTERS WITHOUT CLAIM TO ANY PAR-
TICULAR FONT, STYLE, SIZE, OR COLOR.

SN 85-205,833, FILED 12-27-2010.

KRISTIN CARLSON, EXAMINING ATTORNEY



David J. Kybas

Director of the United States Patent and Trademark Office

United States of America

United States Patent and Trademark Office

SNAP 'N SNACK

Reg. No. 4,068,558

Registered Dec. 6, 2011

Int. Cl.: 21

TRADEMARK

PRINCIPAL REGISTER

EVRIHOLDER PRODUCTS LLC (INDIANA LIMITED LIABILITY COMPANY)
1500 SOUTH LEWIS STREET
ANAHEIM, CA 92805

FOR: PLASTIC PLATES, IN CLASS 21 (U.S. CLS. 2, 13, 23, 29, 30, 33, 40 AND 50).

FIRST USE 1-24-2011; IN COMMERCE 2-23-2011.

THE MARK CONSISTS OF STANDARD CHARACTERS WITHOUT CLAIM TO ANY PARTICULAR FONT, STYLE, SIZE, OR COLOR.

SN 85-206,479, FILED 12-28-2010.

KAREN BRACEY, EXAMINING ATTORNEY



David J. Kybas

Director of the United States Patent and Trademark Office

United States of America

United States Patent and Trademark Office

VERTERRA

Reg. No. 4,068,559

Registered Dec. 6, 2011

Int. Cl.: 33

TRADEMARK

PRINCIPAL REGISTER

CHAOS VINTNERS, LLC (MICHIGAN LIMITED LIABILITY COMPANY)
8080 N SWEDE RD
NORTHPORT, MI 49670

FOR: WINES, IN CLASS 33 (U.S. CLS. 47 AND 49).

FIRST USE 2-1-2011; IN COMMERCE 6-29-2011.

THE MARK CONSISTS OF STANDARD CHARACTERS WITHOUT CLAIM TO ANY PARTICULAR FONT, STYLE, SIZE, OR COLOR.

THE ENGLISH TRANSLATION OF "VERTERRA" IN THE MARK IS "TRUE TO LAND".

SN 85-206,561, FILED 12-28-2010.

JIM RINGLE, EXAMINING ATTORNEY



David J. Kybas

Director of the United States Patent and Trademark Office

United States of America

United States Patent and Trademark Office

Agents Of Progress

Reg. No. 4,068,560

Registered Dec. 6, 2011

Int. Cl.: 41

SERVICE MARK

PRINCIPAL REGISTER

WADE, TERENCE C. (UNITED STATES INDIVIDUAL)
1188 BISHOP STREET, SUITE 3205
HONOLULU, HI 96813

FOR: EDUCATION SERVICES, NAMELY, PROVIDING LIVE AND ON-LINE CLASSES, SEMINARS, CONFERENCES AND WORKSHOPS IN THE FIELD OF MARKETING AND SALES, IN CLASS 41 (U.S. CLS. 100, 101 AND 107).

FIRST USE 1-26-2011; IN COMMERCE 1-26-2011.

THE MARK CONSISTS OF STANDARD CHARACTERS WITHOUT CLAIM TO ANY PARTICULAR FONT, STYLE, SIZE, OR COLOR.

SN 85-206,904, FILED 12-28-2010.

JOSETTE BEVERLY, EXAMINING ATTORNEY



David J. Kyffers

Director of the United States Patent and Trademark Office

United States of America

United States Patent and Trademark Office

SUGARLEAF

Reg. No. 4,068,561

Registered Dec. 6, 2011

Int. Cl.: 30

TRADEMARK

PRINCIPAL REGISTER

UNITED AMERICAN INDUSTRIES, INC. (ARIZONA CORPORATION)
1203 WEST SAN PEDRO STREET
GILBERT, AZ 85233

FOR: NATURAL SWEETENERS; SUGAR SUBSTITUTES; SUGAR FREE SWEETS; SUGAR-LESS SWEETS; EXTRACTS USED AS FLAVORING; FLAVOR ENHANCERS USED IN FOOD AND BEVERAGE PRODUCTS; FLAVORING ADDITIVES FOR NON-NUTRITIONAL PURPOSES; FLAVORINGS FOR BEVERAGES; FLAVORINGS FOR FOODS; FLAVORINGS, OTHER THAN ESSENTIAL OILS, FOR CAKES; FLAVORING SYRUP; FOOD ADDITIVES FOR NON-NUTRITIONAL PURPOSES FOR USE AS A FLAVORING; HONEY SUBSTITUTES; TOPPING SYRUP, IN CLASS 30 (U.S. CL. 46).

FIRST USE 7-15-2011; IN COMMERCE 7-15-2011.

THE MARK CONSISTS OF STANDARD CHARACTERS WITHOUT CLAIM TO ANY PARTICULAR FONT, STYLE, SIZE, OR COLOR.

OWNER OF U.S. REG. NO. 3,701,042.

SN 85-207,527, FILED 12-29-2010.

JOHN DALIER, EXAMINING ATTORNEY



David J. Kyffers

Director of the United States Patent and Trademark Office

United States of America

United States Patent and Trademark Office

RIVER NORTH

Reg. No. 4,068,562

Registered Dec. 6, 2011

Int. Cl.: 20

TRADEMARK

PRINCIPAL REGISTER

FOLDCRAFT CO. (MINNESOTA CORPORATION), AKA FOLDCRAFT COMPANY,
615 CENTENNIAL DRIVE
KENYON, MN 55946

FOR: OUTDOOR FURNITURE, NAMELY, ATTACHED SEATS AND TABLES AND THEIR PARTS, CHAIRS AND THEIR PARTS, TABLES AND THEIR PARTS, IN CLASS 20 (U.S. CLS. 2, 13, 22, 25, 32 AND 50).

FIRST USE 4-12-2011; IN COMMERCE 4-12-2011.

THE MARK CONSISTS OF STANDARD CHARACTERS WITHOUT CLAIM TO ANY PARTICULAR FONT, STYLE, SIZE, OR COLOR.

SN 85-208,067, FILED 12-30-2010.

KATHERINE CONNOLLY, EXAMINING ATTORNEY



David J. Kyffers

Director of the United States Patent and Trademark Office

United States of America

United States Patent and Trademark Office

Harvest More

Reg. No. 4,068,563

Registered Dec. 6, 2011

Int. Cl.: 20

TRADEMARK

PRINCIPAL REGISTER

GALEN HECKATHORN (UNITED STATES INDIVIDUAL)
1106 GADDIS CT
SANTA ROSA, CA 95404 AND

IVAN HANDELSMAN (UNITED STATES INDIVIDUAL)
407 GORDON CT
WINDSOR, CA 95492

FOR: CONTAINERS, NOT OF METAL FOR COMMERCIAL USE; NON-METAL BINS , IN CLASS 20 (U.S. CLS. 2, 13, 22, 25, 32 AND 50).

FIRST USE 7-14-2011; IN COMMERCE 9-1-2011.

THE MARK CONSISTS OF STANDARD CHARACTERS WITHOUT CLAIM TO ANY PARTICULAR FONT, STYLE, SIZE, OR COLOR.

SN 85-208,092, FILED 12-30-2010.

BILL DAWE, EXAMINING ATTORNEY



David J. Kyros

Director of the United States Patent and Trademark Office

United States of America

United States Patent and Trademark Office

ATTACK SKOPE

Reg. No. 4,068,564

ATTACK PRODUCTS, LLC (ILLINOIS LIMITED LIABILITY COMPANY)
2641 W. HARRISON
CHICAGO, IL 60612

Registered Dec. 6, 2011

Int. Cl.: 28

FOR: ARM BAND FOR AIDING BASKETBALL PLAYER'S SHOOTING TECHNIQUE AND CONTROL, IN CLASS 28 (U.S. CLS. 22, 23, 38 AND 50).

TRADEMARK

FIRST USE 6-0-2011; IN COMMERCE 6-0-2011.

PRINCIPAL REGISTER

THE MARK CONSISTS OF STANDARD CHARACTERS WITHOUT CLAIM TO ANY PARTICULAR FONT, STYLE, SIZE, OR COLOR.

SN 85-209,413, FILED 1-3-2011.

KEVIN CORWIN, EXAMINING ATTORNEY



David J. Kyros

Director of the United States Patent and Trademark Office

United States of America

United States Patent and Trademark Office

CAPTAIN'S CATCH

Reg. No. 4,068,565

Registered Dec. 6, 2011

Int. Cl.: 31

TRADEMARK

PRINCIPAL REGISTER

MARS, INCORPORATED (DELAWARE CORPORATION)
6885 ELM STREET
MCLEAN, VA 221013883

FOR: PET FOOD, IN CLASS 31 (U.S. CLS. 1 AND 46).

FIRST USE 5-3-2011; IN COMMERCE 5-3-2011.

THE MARK CONSISTS OF STANDARD CHARACTERS WITHOUT CLAIM TO ANY PARTICULAR FONT, STYLE, SIZE, OR COLOR.

SN 85-210,318, FILED 1-4-2011.

AISHA SALEM, EXAMINING ATTORNEY



David J. Kybas

Director of the United States Patent and Trademark Office

United States of America

United States Patent and Trademark Office

BONA DEEP CLEAN SOLUTION

Reg. No. 4,068,566

Registered Dec. 6, 2011

Int. Cl.: 3

TRADEMARK

PRINCIPAL REGISTER

BONA AB (SWEDEN CORPORATION)
P.O. BOX 21074, MURMANSGATAN 130
SE-200 21 MALMÖ, SWEDEN

FOR: WOOD FLOOR CLEANERS, IN CLASS 3 (U.S. CLS. 1, 4, 6, 50, 51 AND 52).

FIRST USE 4-30-2011; IN COMMERCE 4-30-2011.

THE MARK CONSISTS OF STANDARD CHARACTERS WITHOUT CLAIM TO ANY PARTICULAR FONT, STYLE, SIZE, OR COLOR.

OWNER OF U.S. REG. NOS. 1,640,991, 3,457,098, AND OTHERS.

NO CLAIM IS MADE TO THE EXCLUSIVE RIGHT TO USE "DEEP CLEAN SOLUTION", APART FROM THE MARK AS SHOWN.

SN 85-210,354, FILED 1-4-2011.

JULIE WATSON, EXAMINING ATTORNEY



David J. Kybas

Director of the United States Patent and Trademark Office

United States of America

United States Patent and Trademark Office

AMERICA WORKS HERE

Reg. No. 4,068,567

Registered Dec. 6, 2011

Int. Cl.: 35

SERVICE MARK

PRINCIPAL REGISTER

NATIONAL RESTAURANT ASSOCIATION (ILLINOIS CORPORATION)
1200 17TH STREET, NW
WASHINGTON, DC 200363097

FOR: LOBBYING SERVICES, NAMELY, PROMOTING THE INTERESTS OF THE RESTAURANT AND HOSPITALITY INDUSTRIES IN THE FIELDS OF LEGISLATION AND REGULATION, IN CLASS 35 (U.S. CLS. 100, 101 AND 102).

FIRST USE 1-20-2011; IN COMMERCE 1-20-2011.

THE MARK CONSISTS OF STANDARD CHARACTERS WITHOUT CLAIM TO ANY PARTICULAR FONT, STYLE, SIZE, OR COLOR.

SN 85-210,560, FILED 1-5-2011.

TINA L. SNAPP, EXAMINING ATTORNEY



David J. Kybas

Director of the United States Patent and Trademark Office

United States of America

United States Patent and Trademark Office

SmartStandby

Reg. No. 4,068,568

Registered Dec. 6, 2011

Int. Cl.: 9

TRADEMARK

PRINCIPAL REGISTER

PATIENT INNOVATIONS, LLC (NEW YORK LIMITED LIABILITY COMPANY)
SUITE #100
125 KENNEDY DRIVE
HAUPPAUGE, NY 117884017

FOR: COMPUTER HARDWARE AND SOFTWARE, FOR USE WITH MEDICAL PATIENT MONITORING EQUIPMENT, FOR RECEIVING, PROCESSING, TRANSMITTING AND DISPLAYING DATA; COMPUTER PROGRAMMES FOR DOCUMENT MANAGEMENT; COMPUTER SOFTWARE FOR CONTROLLING AND MANAGING PATIENT MEDICAL INFORMATION; COMPUTER SOFTWARE FOR THE COLLECTION, EDITING, ORGANIZING, MODIFYING, BOOK MARKING, TRANSMISSION, STORAGE AND SHARING OF DATA AND INFORMATION; MEDICAL SOFTWARE FOR WEB BASED APPLICATIONS TO ENABLE HOSPITALS TO CONTACT PATIENTS, FAMILY AND FRIENDS WITH SAFE, SECURE, PORTABLE AND CURRENT ELECTRONIC MEDICAL RECORDS, IN CLASS 9 (U.S. CLS. 21, 23, 26, 36 AND 38).

FIRST USE 1-31-2011; IN COMMERCE 1-31-2011.

THE MARK CONSISTS OF STANDARD CHARACTERS WITHOUT CLAIM TO ANY PARTICULAR FONT, STYLE, SIZE, OR COLOR.

SN 85-210,627, FILED 1-5-2011.

DORITT L. CARROLL, EXAMINING ATTORNEY



David J. Kyros

Director of the United States Patent and Trademark Office

United States of America

United States Patent and Trademark Office

Rhorie Drey Brand - Strength Leadership Focus

Reg. No. 4,068,569

BEMBRIDGE, RORY (UNITED STATES INDIVIDUAL)
20 ROSEDALE AVENUE FLOOR 2
MONTCLAIR, NJ 070423308

Registered Dec. 6, 2011

Int. Cl.: 25

FOR: BELTS; GLOVES; HATS; JACKETS; PANTS; SCARVES; SHIRTS; SHOES, IN CLASS 25 (U.S. CLS. 22 AND 39).

TRADEMARK

FIRST USE 7-1-2011; IN COMMERCE 8-1-2011.

PRINCIPAL REGISTER

THE MARK CONSISTS OF STANDARD CHARACTERS WITHOUT CLAIM TO ANY PARTICULAR FONT, STYLE, SIZE, OR COLOR.

NO CLAIM IS MADE TO THE EXCLUSIVE RIGHT TO USE "BRAND", APART FROM THE MARK AS SHOWN.

THE NAME(S), PORTRAIT(S), AND/OR SIGNATURE(S) SHOWN IN THE MARK IDENTIFIES RORY ANDRE BEMBRIDGE, WHOSE CONSENT(S) TO REGISTER IS MADE OF RECORD.

SN 85-211,349, FILED 1-5-2011.

MICHELE SWAIN, EXAMINING ATTORNEY



David J. Kyros

Director of the United States Patent and Trademark Office

United States of America

United States Patent and Trademark Office

GOOD LUCK CELLARS

Reg. No. 4,068,570

Registered Dec. 6, 2011

Int. Cl.: 33

TRADEMARK

PRINCIPAL REGISTER

KROP FARMS, LLC (VIRGINIA LIMITED LIABILITY COMPANY)
1863 DUKE OF YORK QUAY
VIRGINIA BEACH, VA 23454

FOR: WINE, IN CLASS 33 (U.S. CLS. 47 AND 49).

FIRST USE 7-23-2011; IN COMMERCE 7-23-2011.

THE MARK CONSISTS OF STANDARD CHARACTERS WITHOUT CLAIM TO ANY PARTICULAR FONT, STYLE, SIZE, OR COLOR.

NO CLAIM IS MADE TO THE EXCLUSIVE RIGHT TO USE "CELLARS", APART FROM THE MARK AS SHOWN.

SN 85-211,559, FILED 1-6-2011.

STEVEN JACKSON, EXAMINING ATTORNEY



David J. Kyros

Director of the United States Patent and Trademark Office

United States of America

United States Patent and Trademark Office

JUICY RIDDLE

Reg. No. 4,068,571

Registered Dec. 6, 2011

Int. Cl.: 30

TRADEMARK

PRINCIPAL REGISTER

WM. WRIGLEY JR. COMPANY (DELAWARE CORPORATION)
410 NORTH MICHIGAN AVENUE
CHICAGO, IL 60611

FOR: CHEWING GUM, IN CLASS 30 (U.S. CL. 46).

FIRST USE 7-1-2011; IN COMMERCE 7-1-2011.

THE MARK CONSISTS OF STANDARD CHARACTERS WITHOUT CLAIM TO ANY PARTICULAR FONT, STYLE, SIZE, OR COLOR.

SN 85-211,679, FILED 1-6-2011.

CHARLES L. JENKINS, EXAMINING ATTORNEY



David J. Kybas

Director of the United States Patent and Trademark Office

United States of America

United States Patent and Trademark Office

KEYSTONE CARDS

Reg. No. 4,068,572

HEALING HEARTS CONSULTANTS, LLC (GEORGIA LIMITED LIABILITY COMPANY)
1198 OAK KNOLL COURT
LITHONIA, GA 30058

Registered Dec. 6, 2011

Int. Cl.: 16

FOR: BOOKMARKS; CALENDARS; DAY PLANNERS; GREETING CARDS; MOTIVATIONAL CARDS; POSTCARDS; POSTERS, IN CLASS 16 (U.S. CLS. 2, 5, 22, 23, 29, 37, 38 AND 50).

TRADEMARK

FIRST USE 10-14-2011; IN COMMERCE 10-14-2011.

PRINCIPAL REGISTER

THE MARK CONSISTS OF STANDARD CHARACTERS WITHOUT CLAIM TO ANY PARTICULAR FONT, STYLE, SIZE, OR COLOR.

NO CLAIM IS MADE TO THE EXCLUSIVE RIGHT TO USE "CARDS", APART FROM THE MARK AS SHOWN.

SN 85-212,596, FILED 1-7-2011.

JORDAN BAKER, EXAMINING ATTORNEY



David J. Kybas

Director of the United States Patent and Trademark Office

United States of America
United States Patent and Trademark Office

BLOCKLITE

Reg. No. 4,068,573

Registered Dec. 6, 2011

Int. Cl.: 11

TRADEMARK

PRINCIPAL REGISTER

SUNWAY PRODUCTS LIMITED (HONG KONG LIMITED COMPANY (LTD.))
ROOM 2304, 23/F, FU FAI COMMERCIAL EET
CTR.HILLIER STR. SHEUNG WAN
HONG KONG, HONG KONG

FOR: FLASHLIGHTS, IN CLASS 11 (U.S. CLS. 13, 21, 23, 31 AND 34).

FIRST USE 5-30-2011; IN COMMERCE 5-30-2011.

THE MARK CONSISTS OF STANDARD CHARACTERS WITHOUT CLAIM TO ANY PARTICULAR FONT, STYLE, SIZE, OR COLOR.

SN 85-213,416, FILED 1-8-2011.

DANNEAN HETZEL, EXAMINING ATTORNEY



David J. Kybas

Director of the United States Patent and Trademark Office

United States of America

United States Patent and Trademark Office

N-COUNTER

Reg. No. 4,068,574

Registered Dec. 6, 2011

Int. Cl.: 43

SERVICE MARK

PRINCIPAL REGISTER

CART-MAC, LLC (ARIZONA LIMITED LIABILITY COMPANY)
1335 E. LOS ARBOLES DR.
TEMPE, AZ 85284

FOR: RESTAURANTS, IN CLASS 43 (U.S. CLS. 100 AND 101).

FIRST USE 8-6-2011; IN COMMERCE 8-6-2011.

THE MARK CONSISTS OF STANDARD CHARACTERS WITHOUT CLAIM TO ANY PARTICULAR FONT, STYLE, SIZE, OR COLOR.

SN 85-214,256, FILED 1-10-2011.

HANNO RITTNER, EXAMINING ATTORNEY



David J. Kyffers

Director of the United States Patent and Trademark Office

United States of America

United States Patent and Trademark Office



Reg. No. 4,068,575

Registered Dec. 6, 2011

Int. Cl.: 35

SERVICE MARK

PRINCIPAL REGISTER

KHORSANDI, JACK (UNITED STATES INDIVIDUAL)
SUITE 350
1258 N HIGHLAND AVE.
LOS ANGELES, CA 90038

FOR: PROMOTING THE GOODS AND SERVICES OF OTHERS THROUGH A WEBSITE BY PROVIDING COUPONS, REBATES AND VOUCHERS, ALLOWING GREATER MARKETING, BETTER PRICES AND CROSS-MARKETING OPPORTUNITIES BETWEEN MEMBERS, IN CLASS 35 (U.S. CLS. 100, 101 AND 102).

FIRST USE 8-3-2011; IN COMMERCE 9-9-2011.

THE MARK CONSISTS OF A PORTION OF A SCISSORS WITH THE HANDLE PORTION BEING COMPRISED OF A STYLIZED LETTER "D" CUTTING ALONG THE PERFORATED LINES, WITH THE WORD "DEALNERO" UNDERNEATH.

SN 85-215,235, FILED 1-11-2011.

MICHAEL KEATING, EXAMINING ATTORNEY



David J. Kybas

Director of the United States Patent and Trademark Office

United States of America

United States Patent and Trademark Office



Reg. No. 4,068,576

Registered Dec. 6, 2011

Int. Cl.: 35

SERVICE MARK

PRINCIPAL REGISTER

1-800-FLOWERS.COM, INC. (DELAWARE CORPORATION)
ONE OLD COUNTRY ROAD, SUITE 500
CARLE PLACE, NY 11514

FOR: ONLINE STORE SERVICES AVAILABLE BY TELEPHONE, AND THROUGH INTERACTIVE TELEVISION AND COMPUTER COMMUNICATIONS, ALL OF THE FOREGOING FEATURING FRESH CUT FLOWERS, FLORAL BOUQUETS AND ARRANGEMENTS, GIFTS, GOURMET FOODS, ARRANGEMENTS MADE OF CANDY, CHOCOLATE, HOME DECORATING ITEMS AND ACCESSORIES, COLLECTIBLES, PLUSH TOYS AND ANIMALS, BOOKS, PRE-RECORDED AUDIO AND/OR VIDEOTAPES AND DISKS, PICTURE FRAMES, PHOTO ALBUMS, AND GENERAL MERCHANDISE, IN CLASS 35 (U.S. CLS. 100, 101 AND 102).

FIRST USE 9-2-2010; IN COMMERCE 9-2-2010.

THE MARK CONSISTS OF A SMILEY FACE AND THE WORDS "100% SMILE GUARANTEE" ENCLOSED WITHIN A CIRCLE HAVING A SCALLOPED EDGE.

SN 85-215,240, FILED 1-11-2011.

ANNE E. GUSTASON, EXAMINING ATTORNEY



David J. Kyjars

Director of the United States Patent and Trademark Office

United States of America

United States Patent and Trademark Office

SMOKIN GRILLE

Reg. No. 4,068,577

Registered Dec. 6, 2011

Int. Cl.: 28

TRADEMARK

PRINCIPAL REGISTER

MATTEL, INC. (DELAWARE CORPORATION)
M1-1518
333 CONTINENTAL BOULEVARD
EL SEGUNDO, CA 90245

FOR: TOY VEHICLE AND ACCESSORIES THEREFOR, IN CLASS 28 (U.S. CLS. 22, 23, 38 AND 50).

FIRST USE 10-21-2011; IN COMMERCE 10-21-2011.

THE MARK CONSISTS OF STANDARD CHARACTERS WITHOUT CLAIM TO ANY PARTICULAR FONT, STYLE, SIZE, OR COLOR.

SN 85-215,691, FILED 1-12-2011.

HENRY S. ZAK, EXAMINING ATTORNEY



David J. Kybas

Director of the United States Patent and Trademark Office

United States of America
United States Patent and Trademark Office

h 寒布仕
ampsheer

Reg. No. 4,068,578

Registered Dec. 6, 2011

Int. Cl.: 25

TRADEMARK

PRINCIPAL REGISTER

SHANGHAI HAMPSHEER GARMENTS CO., LTD. (CHINA LIMITED COMPANY (LTD.))
NO.885, QIUXING ROAD, NICHENG TOWN
PUDONG NEW DISTRICT
SHANGHAI CITY, CHINA

FOR: DOWN JACKETS; JACKETS; KNIT TOPS; OVERALLS; SKIRTS; SUITS; TOPCOATS;
UNDERWEAR; UNIFORMS; WIND RESISTANT JACKETS, IN CLASS 25 (U.S. CLS. 22 AND
39).

FIRST USE 1-10-2007; IN COMMERCE 9-20-2008.

NO CLAIM IS MADE TO THE EXCLUSIVE RIGHT TO USE THE NON-LATIN CHARACTERS
THAT TRANSLITERATE TO "BU", APART FROM THE MARK AS SHOWN.

THE NON-LATIN CHARACTERS IN THE MARK TRANSLITERATE TO HAN; BU; SHI AND
THIS MEANS COLD; CLOTH; OFFICIAL CAREER IN ENGLISH.

THE MARK CONSISTS OF THE STYLIZED WORD "HAMPSHEER" AND 3 CHINESE
CHARACTERS ABOVE THE CHARACTERS "AMPSHEER".

THE WORDING HAMPSHEER HAS NO MEANING IN A FOREIGN LANGUAGE.

SN 85-216,509, FILED 1-13-2011.

DANIEL CAPSHAW, EXAMINING ATTORNEY



David J. Kyros

Director of the United States Patent and Trademark Office

United States of America

United States Patent and Trademark Office

DRIVEFLEX

Reg. No. 4,068,579

Registered Dec. 6, 2011

Int. Cl.: 9

TRADEMARK

PRINCIPAL REGISTER

FRIEDRICH LUTZE GMBH & CO. (FED REP GERMANY LIMITED LIABILITY JOINT STOCK COMPANY)
BRUCKWIESENSTRASSE 17-19 71384
WEINSTADT, FED REP GERMANY

FOR: ELECTRICAL CABLES FOR MACHINES, ELECTRICAL MOTORS AND ELECTRICAL CONNECTIONS, IN CLASS 9 (U.S. CLS. 21, 23, 26, 36 AND 38).

FIRST USE 2-8-2011; IN COMMERCE 2-8-2011.

THE MARK CONSISTS OF STANDARD CHARACTERS WITHOUT CLAIM TO ANY PARTICULAR FONT, STYLE, SIZE, OR COLOR.

SN 85-216,545, FILED 1-13-2011.

MARK SPARACINO, EXAMINING ATTORNEY



David J. Kybas

Director of the United States Patent and Trademark Office

United States of America

United States Patent and Trademark Office

INTELLICURE

Reg. No. 4,068,580

Registered Dec. 6, 2011

Int. Cl.: 9

TRADEMARK

PRINCIPAL REGISTER

FLIR SYSTEMS, INC. (OREGON CORPORATION)
27700 SW PARKWAY AVE
WILSONVILLE, OR 97070

FOR: ELECTRONIC APPARATUS PROVIDING A TEMPERATURE CONTROLLED ENVIRONMENT FOR CURING CONCRETE, IN CLASS 9 (U.S. CLS. 21, 23, 26, 36 AND 38).

FIRST USE 1-1-2011; IN COMMERCE 1-1-2011.

THE MARK CONSISTS OF STANDARD CHARACTERS WITHOUT CLAIM TO ANY PARTICULAR FONT, STYLE, SIZE, OR COLOR.

SN 85-217,185, FILED 1-13-2011.

MICHAEL ENGEL, EXAMINING ATTORNEY



David J. Kybas

Director of the United States Patent and Trademark Office

United States of America

United States Patent and Trademark Office

REFORMATION COUNSELING

Reg. No. 4,068,581

Registered Dec. 6, 2011

Int. Cl.: 44

SERVICE MARK

PRINCIPAL REGISTER

BOICE, NANJI S. (UNITED STATES INDIVIDUAL)
3839 BEE CAVE ROAD
SUITE 201
WEST LAKE HILLS, TX 78746

FOR: PSYCHOTHERAPY AND PSYCHOTHERAPY COUNSELING FOR CHILDREN AND ADULTS IN INDIVIDUAL AND FAMILY SESSIONS, IN CLASS 44 (U.S. CLS. 100 AND 101).

FIRST USE 4-1-2011; IN COMMERCE 4-1-2011.

THE MARK CONSISTS OF STANDARD CHARACTERS WITHOUT CLAIM TO ANY PARTICULAR FONT, STYLE, SIZE, OR COLOR.

NO CLAIM IS MADE TO THE EXCLUSIVE RIGHT TO USE "COUNSELING", APART FROM THE MARK AS SHOWN.

SN 85-218,097, FILED 1-14-2011.

DAVID I, EXAMINING ATTORNEY



David J. Kyffers

Director of the United States Patent and Trademark Office

United States of America
United States Patent and Trademark Office

PROTEIOS

Reg. No. 4,068,582

DURAN GARIBI, JOSE (MEXICO INDIVIDUAL)
LAS PALMAS 404, ARBIDE
LEON, MEXICO

Registered Dec. 6, 2011

Int. Cl.: 3

FOR: COSMETICS; HAIR LOTIONS; PERFUMERY; SOAPS FOR BODY CARE, IN CLASS 3 (U.S. CLS. 1, 4, 6, 50, 51 AND 52).

TRADEMARK

FIRST USE 8-19-2011; IN COMMERCE 8-19-2011.

PRINCIPAL REGISTER

THE MARK CONSISTS OF STANDARD CHARACTERS WITHOUT CLAIM TO ANY PARTICULAR FONT, STYLE, SIZE, OR COLOR.

OWNER OF MEXICO REG. NO. 1126070, DATED 10-16-2009, EXPIRES 8-28-2019.

SN 85-218,243, FILED 1-14-2011.

NAAKWAMA ANKRAH, EXAMINING ATTORNEY



David J. Kyros

Director of the United States Patent and Trademark Office

United States of America

United States Patent and Trademark Office

Handy Post

Reg. No. 4,068,583

Registered Dec. 6, 2011

Int. Cl.: 19

TRADEMARK

PRINCIPAL REGISTER

COOK PRODUCTS (OHIO LIMITED LIABILITY COMPANY)
11884 JURY ROAD
GREENFIELD, OH 45123

FOR: CEMENT POSTS; NON-METAL FENCE POSTS; NON-METAL POSTS; PLASTIC BOUNDARY MARKING POSTS; PLASTIC POSTS WITH REFLECTIVE UV COATED DISCS ATTACHED; WOOD POSTS, IN CLASS 19 (U.S. CLS. 1, 12, 33 AND 50).

FIRST USE 11-25-2010; IN COMMERCE 4-19-2011.

THE MARK CONSISTS OF STANDARD CHARACTERS WITHOUT CLAIM TO ANY PARTICULAR FONT, STYLE, SIZE, OR COLOR.

NO CLAIM IS MADE TO THE EXCLUSIVE RIGHT TO USE "POST", APART FROM THE MARK AS SHOWN.

SN 85-218,811, FILED 1-16-2011.

APRIL ROACH, EXAMINING ATTORNEY



David J. Kyros

Director of the United States Patent and Trademark Office

United States of America

United States Patent and Trademark Office

Mind Your Body

Reg. No. 4,068,584

Registered Dec. 6, 2011

Int. Cls.: 41 and 44

SERVICE MARK

PRINCIPAL REGISTER

ROTH, STEPHANIE C. (UNITED STATES INDIVIDUAL), AKA STEPHANIE STEPHENS,
31255 PALMA DRIVE
LAGUNA NIGUEL, CA 92677

FOR: ON-LINE JOURNALS, NAMELY, BLOGS FEATURING PHYSICAL AND MENTAL HEALTH; ENTERTAINMENT IN THE NATURE OF AN ON-GOING SPECIAL VARIETY, NEWS, MUSIC OR COMEDY SHOW FEATURING PHYSICAL AND MENTAL HEALTH BROADCAST OVER TELEVISION, SATELLITE, AUDIO, AND VIDEO MEDIA; PROVIDING A WEBSITE FEATURING BLOGS AND NON-DOWNLOADABLE PUBLICATIONS IN THE NATURE OF ARTICLES IN THE FIELD OF PHYSICAL AND MENTAL HEALTH, IN CLASS 41 (U.S. CLS. 100, 101 AND 107).

FIRST USE 8-11-2010; IN COMMERCE 12-15-2010.

FOR: PROVIDING A WEB SITE FEATURING INFORMATION IN THE FIELD OF MENTAL HEALTH AND PHYSICAL HEALTH, INCLUDING LIVING A HEALTHY AND DISEASE FREE LIFE; PROVIDING A WEB SITE FEATURING INFORMATION IN THE FIELD OF MENTAL HEALTH AND WELLNESS; PROVIDING A WEBSITE FEATURING CONTENT REGARDING HEALTHY LIVING AND LIFESTYLE WELLNESS; PROVIDING A WEBSITE FEATURING INFORMATION ABOUT HEALTH, WELLNESS AND NUTRITION; PROVIDING A WEBSITE FEATURING INFORMATION CONCERNING ALTERNATIVE HEALTH AND HEALING, IN CLASS 44 (U.S. CLS. 100 AND 101).

FIRST USE 4-1-2011; IN COMMERCE 8-21-2011.

THE MARK CONSISTS OF STANDARD CHARACTERS WITHOUT CLAIM TO ANY PARTICULAR FONT, STYLE, SIZE, OR COLOR.

SN 85-218,829, FILED 1-16-2011.

JOHN GARTNER, EXAMINING ATTORNEY



David J. Kyros

Director of the United States Patent and Trademark Office

United States of America

United States Patent and Trademark Office



Reg. No. 4,068,585

Registered Dec. 6, 2011

Int. Cl.: 33

TRADEMARK

PRINCIPAL REGISTER

PISCO PORTON, LLC (NEVADA LIMITED LIABILITY COMPANY)
13430 NW FREEWAY, HWY 290, SUITE 800
HOUSTON, TX 77040

FOR: DISTILLED SPIRITS; BRANDY; PISCO, IN CLASS 33 (U.S. CLS. 47 AND 49).

FIRST USE 3-15-2011; IN COMMERCE 3-15-2011.

THE MARK CONSISTS OF A STYLIZED OLD FASHIONED SPANISH-STYLE GATE.

SN 85-219,235, FILED 1-17-2011.

JOHN LINCOSKI, EXAMINING ATTORNEY



David J. Kyffers

Director of the United States Patent and Trademark Office

United States of America

United States Patent and Trademark Office

**Advance
Auto Parts
Professional** 

Service is our best part.

Reg. No. 4,068,586

Registered Dec. 6, 2011

Int. Cls.: 35 and 39

SERVICE MARK

PRINCIPAL REGISTER

ADVANCE AUTO INNOVATIONS, LLC (VIRGINIA LIMITED LIABILITY COMPANY)
5008 AIRPORT ROAD
ROANOKE, VA 24012

FOR: RETAIL STORE SERVICES FOR COMMERCIAL CUSTOMERS FEATURING TOOLS, HARDWARE, BATTERIES, VEHICLE AND AUTO PARTS AND ACCESSORIES; ONLINE RETAIL STORE SERVICES FOR COMMERCIAL CUSTOMERS FEATURING TOOLS, HARDWARE, BATTERIES, VEHICLE AND AUTO PARTS AND ACCESSORIES, IN CLASS 35 (U.S. CLS. 100, 101 AND 102).

FIRST USE 1-31-2011; IN COMMERCE 1-31-2011.

FOR: DELIVERY SERVICES TO CUSTOMERS IN THE FIELD OF VEHICLE AND AUTO PARTS AND ACCESSORIES, IN CLASS 39 (U.S. CLS. 100 AND 105).

FIRST USE 1-31-2011; IN COMMERCE 1-31-2011.

OWNER OF U.S. REG. NOS. 1,815,267, 3,628,525, AND OTHERS.

NO CLAIM IS MADE TO THE EXCLUSIVE RIGHT TO USE "AUTO PARTS PROFESSIONAL" AND "SERVICE", APART FROM THE MARK AS SHOWN.

THE MARK CONSISTS OF THE WORDING "ADVANCE AUTO PARTS PROFESSIONAL" IN LARGE STYLIZED LETTERS IN STACKED FORMAT TO THE LEFT OF A FLAG DESIGN COMPRISING SHADED AND UNSHADED SQUARES, WITH "SERVICE IS OUR BEST PART." UNDERNEATH AND TO THE RIGHT.

SN 85-219,367, FILED 1-17-2011.

ODESSA BIBBINS, EXAMINING ATTORNEY



David J. Kybas

Director of the United States Patent and Trademark Office

United States of America

United States Patent and Trademark Office



Reg. No. 4,068,587

Registered Dec. 6, 2011

Int. Cls.: 28 and 31

TRADEMARK

PRINCIPAL REGISTER

T.F.H. PUBLICATIONS, INC. (DELAWARE CORPORATION)
ONE TFH PLAZA, THIRD AND UNION AVENUES
NEPTUNE CITY, NJ 07753

FOR: NON-EDIBLE PET CHEW TOYS, IN CLASS 28 (U.S. CLS. 22, 23, 38 AND 50).

FIRST USE 6-7-2011; IN COMMERCE 6-7-2011.

FOR: EDIBLE PET CHEWS, IN CLASS 31 (U.S. CLS. 1 AND 46).

FIRST USE 6-7-2011; IN COMMERCE 6-7-2011.

OWNER OF U.S. REG. NOS. 3,645,175 AND 3,737,683.

NO CLAIM IS MADE TO THE EXCLUSIVE RIGHT TO USE "VETERINARIAN RECOMMENDED" AND "CHEW", APART FROM THE MARK AS SHOWN.

THE MARK CONSISTS OF THE WORDING "VETERINARIAN RECOMMENDED" AND "CHEW PLAY THRIVE" IN A CIRCULAR PATTERN WITH CARATS BETWEEN THE WORDS "CHEW" AND "VETERINARIAN" AND "RECOMMENDED" AND "THRIVE", AND DOTS BETWEEN THE WORDS "CHEW", "PLAY", AND "THRIVE", ALL OUTSIDE A CIRCULAR DESIGN THAT CONTAINS A CADUCEUS SYMBOL INSIDE A TRIANGLE CARRIER WITH THREE ARROWS SURROUNDING THE CADUCEUS SYMBOL.

SN 85-219,535, FILED 1-18-2011.

NICHOLAS COLEMAN, EXAMINING ATTORNEY



David J. Kybas

Director of the United States Patent and Trademark Office

United States of America

United States Patent and Trademark Office

LAMBDA

Reg. No. 4,068,588

Registered Dec. 6, 2011

Int. Cls.: 35 and 36

SERVICE MARK

PRINCIPAL REGISTER

AON RISK SERVICES COMPANIES, INC. (MARYLAND CORPORATION)
200 E. RANDOLPH STREET
CHICAGO, IL 60601

FOR: LITIGATION COST MANAGEMENT, IN CLASS 35 (U.S. CLS. 100, 101 AND 102).

FIRST USE 1-31-2011; IN COMMERCE 2-28-2011.

FOR: ACTUARIAL SERVICES, ACTUARIAL RESEARCH SERVICES, IN CLASS 36 (U.S. CLS. 100, 101 AND 102).

FIRST USE 1-31-2011; IN COMMERCE 2-28-2011.

THE MARK CONSISTS OF STANDARD CHARACTERS WITHOUT CLAIM TO ANY PARTICULAR FONT, STYLE, SIZE, OR COLOR.

SN 85-220,054, FILED 1-18-2011.

ALEX KEAM, EXAMINING ATTORNEY



David J. Kybas

Director of the United States Patent and Trademark Office

United States of America

United States Patent and Trademark Office



Reg. No. 4,068,589

Registered Dec. 6, 2011

Int. Cl.: 45

SERVICE MARK

PRINCIPAL REGISTER

JEVRA, LLC (NEW YORK LIMITED LIABILITY COMPANY)
3963 49TH STREET
SUNNYSIDE, NY 11104

FOR: ON-LINE SOCIAL NETWORKING SERVICES, IN CLASS 45 (U.S. CLS. 100 AND 101).

FIRST USE 3-18-2011; IN COMMERCE 3-18-2011.

THE MARK CONSISTS OF A SMILING DEVIL WITH A GOATEE AND HORNS, WEARING BOXER SHORTS, LEANING ON THE "B" IN "BURN AND ROT IN HELL!". THE LETTERS ARE ALL CAPITAL LETTERS AND ARE OUTLINED. THE WORDS ARE ON TWO LINES, I.E. "BURN AND" AND "ROT IN HELL!".

SN 85-220,934, FILED 1-19-2011.

COLLEEN DOMBROW, EXAMINING ATTORNEY



David J. Kybas

Director of the United States Patent and Trademark Office

United States of America

United States Patent and Trademark Office

ROADSIDE ANGELS

Reg. No. 4,068,590

Registered Dec. 6, 2011

Int. Cl.: 45

SERVICE MARK

PRINCIPAL REGISTER

ROADSIDE ANGELS, INC. (VIRGINIA CORPORATION)
300 E. MAIN STREET
SUITE 1400
NORFOLK, VA 23514

FOR: CHARITABLE SERVICES, NAMELY, PROVIDING A WEB SITE FOR POSTING TRIBUTES TO DECEASED INDIVIDUALS AND INFORMATION TO AND ABOUT THEIR FAMILIES AND FRIENDS, IN CLASS 45 (U.S. CLS. 100 AND 101).

FIRST USE 2-6-2011; IN COMMERCE 6-30-2011.

THE MARK CONSISTS OF STANDARD CHARACTERS WITHOUT CLAIM TO ANY PARTICULAR FONT, STYLE, SIZE, OR COLOR.

SN 85-221,030, FILED 1-19-2011.

DAVID C. REIHNER, EXAMINING ATTORNEY



David J. Kybas

Director of the United States Patent and Trademark Office

United States of America

United States Patent and Trademark Office

GROUPONLIVE

Reg. No. 4,068,591

Registered Dec. 6, 2011

Int. Cl.: 35

SERVICE MARK

PRINCIPAL REGISTER

GROUPON, INC. (DELAWARE CORPORATION)
600 WEST CHICAGO AVENUE
CHICAGO, IL 60654

FOR: PROMOTING THE GOODS AND SERVICES OF OTHERS BY PROVIDING A WEB SITE FEATURING COUPONS, REBATES, PRICE-COMPARISON INFORMATION, PRODUCT REVIEWS, LINKS TO THE RETAIL WEB SITES OF OTHERS, AND DISCOUNT INFORMATION, IN CLASS 35 (U.S. CLS. 100, 101 AND 102).

FIRST USE 5-9-2011; IN COMMERCE 5-9-2011.

THE MARK CONSISTS OF STANDARD CHARACTERS WITHOUT CLAIM TO ANY PARTICULAR FONT, STYLE, SIZE, OR COLOR.

OWNER OF U.S. REG. NOS. 3,513,882 AND 3,685,954.

SN 85-222,076, FILED 1-20-2011.

MARK SHINER, EXAMINING ATTORNEY



David J. Kybas

Director of the United States Patent and Trademark Office

United States of America

United States Patent and Trademark Office

MONARCH OF THE GLEN

Reg. No. 4,068,592

Registered Dec. 6, 2011

Int. Cl.: 33

TRADEMARK

PRINCIPAL REGISTER

WILLIAM GRANT & SONS LIMITED (UNITED KINGDOM LIMITED LIABILITY COMPANY)
THE GLENFIDDICH DISTILLERY
DUFFTOWN, BANFFSHIRE
SCOTLAND, UNITED KINGDOM

FOR: ALCOHOLIC BEVERAGES EXCEPT BEERS, IN CLASS 33 (U.S. CLS. 47 AND 49).

FIRST USE 1-7-2011; IN COMMERCE 1-7-2011.

THE MARK CONSISTS OF STANDARD CHARACTERS WITHOUT CLAIM TO ANY PARTICULAR FONT, STYLE, SIZE, OR COLOR.

THE WORDING "MONARCH OF THE GLEN" DOES NOT IDENTIFY A LIVING INDIVIDUAL.

SN 85-222,306, FILED 1-20-2011.

ANDREW RHIM, EXAMINING ATTORNEY



David J. Kybas

Director of the United States Patent and Trademark Office

United States of America

United States Patent and Trademark Office

MULU

Reg. No. 4,068,593

Registered Dec. 6, 2011

Int. Cl.: 42

SERVICE MARK

PRINCIPAL REGISTER

MULU, INC. (DELAWARE CORPORATION)
15850 CRABBS BRANCH WAY, SUITE 130
ROCKVILLE, MD 20855

FOR: PROVIDING AN ONLINE, SECURE, PRIVATE, CUSTOMIZABLE AND SEARCHABLE INTERFACE THAT ALLOWS USERS IN A PASSWORD PROTECTED ENVIRONMENT TO STORE AND ORGANIZE DIGITAL FILES, TO STORE, ORGANIZE, AND TRACK CONTACT INFORMATION AND PREFERENCES RELATED TO SUCH FILES, TO SEND FILES TO NAMED INDIVIDUAL RECIPIENTS, TO CREATE AND ORGANIZE MESSAGES RELATED TO SUCH FILES AND TO PROCESS ORDERS RELATED TO SUCH FILES, IN CLASS 42 (U.S. CLS. 100 AND 101).

FIRST USE 4-1-2011; IN COMMERCE 4-1-2011.

THE MARK CONSISTS OF STANDARD CHARACTERS WITHOUT CLAIM TO ANY PARTICULAR FONT, STYLE, SIZE, OR COLOR.

THE ENGLISH TRANSLATION OF "MULU" IN THE MARK IS "CATALOGUE" IN CHINESE.

SN 85-222,451, FILED 1-20-2011.

NATALIE POLZER, EXAMINING ATTORNEY



David J. Kypos

Director of the United States Patent and Trademark Office

United States of America

United States Patent and Trademark Office

CURLSDEFINEHER

Reg. No. 4,068,594

Registered Dec. 6, 2011

Int. Cl.: 3

TRADEMARK

PRINCIPAL REGISTER

GK WORLD HOLDING LLC (FLORIDA LIMITED LIABILITY COMPANY)
SUITE 16B
5555 ANGLERS AVENUE
FORT LAUDERDALE, FL 33312

FOR: HAIR CONDITIONERS, IN CLASS 3 (U.S. CLS. 1, 4, 6, 50, 51 AND 52).

FIRST USE 8-10-2011; IN COMMERCE 8-10-2011.

THE MARK CONSISTS OF STANDARD CHARACTERS WITHOUT CLAIM TO ANY PARTICULAR FONT, STYLE, SIZE, OR COLOR.

SN 85-222,508, FILED 1-20-2011.

SUE LAWRENCE, EXAMINING ATTORNEY



David J. Kyffers

Director of the United States Patent and Trademark Office

United States of America

United States Patent and Trademark Office

newbarista

Reg. No. 4,068,595

Registered Dec. 6, 2011

Int. Cl.: 41

SERVICE MARK

PRINCIPAL REGISTER

NEWBARISTA LLC (WASHINGTON LIMITED LIABILITY COMPANY)
PO BOX 583
SNOHOMISH, WA 98291

FOR: PROVIDING ONLINE TRAINING COURSES AND SEMINARS ALL IN THE FIELD OF JOB TRAINING AND BEVERAGE MAKING FOR SPECIALTY COFFEE AND ESPRESSO RELATED BUSINESSES; PROVIDING TRAINING COURSES FEATURING LIVE CLASSROOM INSTRUCTION IN THE FIELD OF JOB TRAINING AND BEVERAGE MAKING FOR SPECIALTY COFFEE AND ESPRESSO RELATED BUSINESSES, IN CLASS 41 (U.S. CLS. 100, 101 AND 107).

FIRST USE 5-24-2011; IN COMMERCE 5-24-2011.

THE MARK CONSISTS OF STANDARD CHARACTERS WITHOUT CLAIM TO ANY PARTICULAR FONT, STYLE, SIZE, OR COLOR.

SN 85-222,836, FILED 1-21-2011.

BERYL GARDNER, EXAMINING ATTORNEY



David J. Kybas

Director of the United States Patent and Trademark Office

United States of America

United States Patent and Trademark Office

RXRNA

Reg. No. 4,068,596

Registered Dec. 6, 2011

Int. Cl.: 1

TRADEMARK

PRINCIPAL REGISTER

RXI PHARMACEUTICALS CORPORATION (DELAWARE CORPORATION)
60 PRESCOTT STREET
WORCESTER, MA 01605

FOR: REAGENTS FOR RESEARCH PURPOSES, IN CLASS 1 (U.S. CLS. 1, 5, 6, 10, 26 AND 46).

FIRST USE 9-0-2011; IN COMMERCE 9-0-2011.

THE MARK CONSISTS OF STANDARD CHARACTERS WITHOUT CLAIM TO ANY PARTICULAR FONT, STYLE, SIZE, OR COLOR.

OWNER OF U.S. REG. NO. 3,932,105.

SN 85-223,046, FILED 1-21-2011.

BRENDAN REGAN, EXAMINING ATTORNEY



David J. Kybas

Director of the United States Patent and Trademark Office

United States of America

United States Patent and Trademark Office

Real Music Real Variety

Reg. No. 4,068,597

Registered Dec. 6, 2011

Int. Cl.: 38

SINCLAIR TELECABLE, INC. (VIRGINIA CORPORATION), DBA SINCLAIR
COMMUNICATIONS,
500 DOMINION TOWER
999 WATERSIDE DRIVE
NORFOLK, VA 23510

SERVICE MARK

FOR: INTERNET RADIO BROADCASTING SERVICES; RADIO BROADCASTING, IN CLASS
38 (U.S. CLS. 100, 101 AND 104).

PRINCIPAL REGISTER

FIRST USE 7-1-2011; IN COMMERCE 7-1-2011.

THE MARK CONSISTS OF STANDARD CHARACTERS WITHOUT CLAIM TO ANY PAR-
TICULAR FONT, STYLE, SIZE, OR COLOR.

NO CLAIM IS MADE TO THE EXCLUSIVE RIGHT TO USE "MUSIC", APART FROM THE
MARK AS SHOWN.

SN 85-223,397, FILED 1-21-2011.

SUNG IN, EXAMINING ATTORNEY



David J. Kyros

Director of the United States Patent and Trademark Office

United States of America

United States Patent and Trademark Office



Reg. No. 4,068,598

Registered Dec. 6, 2011

Int. Cl.: 19

TRADEMARK

PRINCIPAL REGISTER

AMERIMAX HOME PRODUCTS, INC. (DELAWARE CORPORATION)
4455 RIVER GREEN PARKWAY
DULUTH, GA 30096

FOR: PLASTIC CONDUIT FOR DRAINAGE, NON-METAL DOWNSPOUT EXTENSIONS, LOW PROFILE PLASTIC WATER CONDUIT TO CONVEY WATER FROM A DOWNSPOUT TO A REMOTE LOCATION, IN CLASS 19 (U.S. CLS. 1, 12, 33 AND 50).

FIRST USE 6-14-2011; IN COMMERCE 6-14-2011.

NO CLAIM IS MADE TO THE EXCLUSIVE RIGHT TO USE "LOW PROFILE DRAINAGE SYSTEM" OR THE PICTORIAL REPRESENTATION OF THE SPOUT AND EXTENSION DESIGN, APART FROM THE MARK AS SHOWN.

THE MARK CONSISTS OF THE WORDS "EXTEND-A-SPOUT LOW PROFILE DRAINAGE SYSTEM" POSITIONED TO THE RIGHT OF A BUILDING HAVING A DOWNSPOUT CONNECTED TO THE LOW PROFILE DRAINAGE SYSTEM PRODUCT WITH WATER DISCHARGING FROM THE END THEREOF, AND POSITIONED ABOVE A REPRESENTATION OF GRASS ABOVE A BED OF STONES THROUGH WHICH THE LOW PROFILE DRAINAGE SYSTEM PRODUCT EXTENDS.

SN 85-223,801, FILED 1-22-2011.

JAMES LOVELACE, EXAMINING ATTORNEY



David J. Kyros

Director of the United States Patent and Trademark Office

United States of America

United States Patent and Trademark Office

ArterioFlow

Reg. No. 4,068,599

Registered Dec. 6, 2011

Int. Cl.: 10

OAKWELL DISTRIBUTION, INC. (PENNSYLVANIA CORPORATION), DBA DEVON
MEDICAL PRODUCTS,
1100 FIRST AVENUE
SUITE 100
KING OF PRUSSIA, PA 19406

TRADEMARK

PRINCIPAL REGISTER

FOR: MEDICAL APPARATUS FOR IMPROVEMENT OF BLOOD CIRCULATION IN THE
LOWER EXTREMITIES THROUGH AN APPLICATION OF INTERMITTENT COMPRESSION
TO THE FOOT AND LOWER LEG AND HAVING A PUMP, TUBING AND INFLATABLE
GARMENT, IN CLASS 10 (U.S. CLS. 26, 39 AND 44).

FIRST USE 1-31-2011; IN COMMERCE 2-28-2011.

THE MARK CONSISTS OF STANDARD CHARACTERS WITHOUT CLAIM TO ANY PAR-
TICULAR FONT, STYLE, SIZE, OR COLOR.

SN 85-223,809, FILED 1-22-2011.

JORDAN BAKER, EXAMINING ATTORNEY



David J. Kyffers

Director of the United States Patent and Trademark Office

United States of America

United States Patent and Trademark Office

FUZZY FINGERS

Reg. No. 4,068,600

EVRIHOLDER PRODUCTS LLC (INDIANA LIMITED LIABILITY COMPANY)
1500 SOUTH LEWIS STREET
ANAHEIM, CA 92805

Registered Dec. 6, 2011

Int. Cl.: 21

FOR: CLEANING MITTS OF FABRIC, IN CLASS 21 (U.S. CLS. 2, 13, 23, 29, 30, 33, 40 AND 50).

TRADEMARK

FIRST USE 9-22-2008; IN COMMERCE 10-28-2008.

PRINCIPAL REGISTER

THE MARK CONSISTS OF STANDARD CHARACTERS WITHOUT CLAIM TO ANY PARTICULAR FONT, STYLE, SIZE, OR COLOR.

SN 85-223,910, FILED 1-23-2011.

KAREN BRACEY, EXAMINING ATTORNEY



David J. Kybas

Director of the United States Patent and Trademark Office

United States of America

United States Patent and Trademark Office

MEETDATEMATE

Reg. No. 4,068,601

Registered Dec. 6, 2011

Int. Cl.: 45

SERVICE MARK

PRINCIPAL REGISTER

WATSON, MICHAEL (UNITED STATES INDIVIDUAL)
270 KNOLLCREST RD.
MOUNTAINSIDE, NJ 07092

FOR: INTERNET BASED SOCIAL NETWORKING, INTRODUCTION, AND DATING SERVICES; PROVIDING A WEB SITE FEATURING INFORMATION ON LOVE, ROMANCE AND INTERPERSONAL RELATIONSHIPS, IN CLASS 45 (U.S. CLS. 100 AND 101).

FIRST USE 9-14-2011; IN COMMERCE 9-14-2011.

THE MARK CONSISTS OF STANDARD CHARACTERS WITHOUT CLAIM TO ANY PARTICULAR FONT, STYLE, SIZE, OR COLOR.

SN 85-224,030, FILED 1-23-2011.

WILLIAM VERHOSEK, EXAMINING ATTORNEY



David J. Kyros

Director of the United States Patent and Trademark Office

United States of America

United States Patent and Trademark Office

TVID

Reg. No. 4,068,602

Registered Dec. 6, 2011

Int. Cl.: 20

TRADEMARK

PRINCIPAL REGISTER

ROBERN INC. (PENNSYLVANIA CORPORATION)
701 NORTH WILSON AVENUE
BRISTOL, PA 19007

FOR: BATHROOM CABINETS; BATHROOM MIRRORS, IN CLASS 20 (U.S. CLS. 2, 13, 22, 25, 32 AND 50).

FIRST USE 4-30-2011; IN COMMERCE 4-30-2011.

THE MARK CONSISTS OF STANDARD CHARACTERS WITHOUT CLAIM TO ANY PARTICULAR FONT, STYLE, SIZE, OR COLOR.

SN 85-224,831, FILED 1-24-2011.

ODESSA BIBBINS, EXAMINING ATTORNEY



David J. Kybas

Director of the United States Patent and Trademark Office

United States of America

United States Patent and Trademark Office

VDX

Reg. No. 4,068,603

BROCADE COMMUNICATIONS SYSTEMS, INC. (DELAWARE CORPORATION)
130 HOLGER WAY
SAN JOSE, CA 95134

Registered Dec. 6, 2011

Int. Cl.: 9

FOR: COMPUTER NETWORKING HARDWARE, IN CLASS 9 (U.S. CLS. 21, 23, 26, 36 AND 38).

TRADEMARK

FIRST USE 11-1-2010; IN COMMERCE 11-1-2010.

PRINCIPAL REGISTER

THE MARK CONSISTS OF STANDARD CHARACTERS WITHOUT CLAIM TO ANY PARTICULAR FONT, STYLE, SIZE, OR COLOR.

SN 85-224,834, FILED 1-24-2011.

DORITT L. CARROLL, EXAMINING ATTORNEY



David J. Kybas

Director of the United States Patent and Trademark Office

United States of America

United States Patent and Trademark Office



Reg. No. 4,068,604

Registered Dec. 6, 2011

Int. Cl.: 31

TRADEMARK

PRINCIPAL REGISTER

SWEET ROSE FARM LLC (VIRGINIA LIMITED LIABILITY COMPANY)
2024 WILLOW BRANCH COURT
VIENNA, VA 22181

FOR: FRESH FRUIT AND VEGETABLES, IN CLASS 31 (U.S. CLS. 1 AND 46).

FIRST USE 6-1-2010; IN COMMERCE 8-27-2011.

NO CLAIM IS MADE TO THE EXCLUSIVE RIGHT TO USE "FARM LLC" OR "BLUE GRASS, VA USA", APART FROM THE MARK AS SHOWN.

THE COLOR(S) YELLOW AND GREEN IS/ARE CLAIMED AS A FEATURE OF THE MARK.

THE MARK CONSISTS OF THE NAME OF THE FARM IN GREEN INK, "SWEET ROSE FARM LLC" ON THE TOP OF A YELLOW BACKGROUND IN THE SHAPE OF AN OVAL. THE SLOGAN, IN GREEN INK "IT'S NATURAL TO EAT" IS CENTERED IN THE CENTER OF THE OVAL ON YELLOW BACKGROUND. THE CITY, STATE AND COUNTRY IS IN GREEN INK ON THE BOTTOM OF THE OVAL ON YELLOW BACKGROUND, "BLUE GRASS, VA USA".

SN 85-224,898, FILED 1-24-2011.

JOHN E. MICHOS, EXAMINING ATTORNEY



David J. Kyffers

Director of the United States Patent and Trademark Office

United States of America

United States Patent and Trademark Office

Happy to be here.

Reg. No. 4,068,605

Registered Dec. 6, 2011

Int. Cl.: 25

TRADEMARK

PRINCIPAL REGISTER

KAHN, VICTOR J. (UNITED STATES INDIVIDUAL)
112 HIDDEN VALLEY CT.
PITTSBURGH, PA 15237

FOR: A-SHIRTS; APPAREL FOR DANCERS, NAMELY, TEE SHIRTS, SWEATSHIRTS, PANTS, LEGGINGS, SHORTS AND JACKETS; ATHLETIC APPAREL, NAMELY, SHIRTS, PANTS, JACKETS, FOOTWEAR, HATS AND CAPS, ATHLETIC UNIFORMS; BODY SHIRTS; BUTTON DOWN SHIRTS; BUTTON-FRONT ALOHA SHIRTS; CAMOUFLAGE SHIRTS; CAMP SHIRTS; CLOTHING FOR ATHLETIC USE, NAMELY, PADDED SHIRTS; CLOTHING FOR BABIES, TODDLERS AND CHILDREN, TREATED WITH FIRE AND HEAT RETARDANTS, NAMELY, PAJAMAS, JACKETS, SHIRTS, PANTS, JUMPERS; CLOTHING SHIELDS, NAMELY, PADS APPLIED TO THE UNDERARMS OF SHIRTS, BLOUSES AND SWEATERS; COLLARED SHIRTS; DRESS SHIRTS; FISHING SHIRTS; GOLF PANTS, SHIRTS AND SKIRTS; GOLF SHIRTS; HOODED SWEAT SHIRTS; HUNTING SHIRTS; KNIT SHIRTS; LEATHER SHIRTS; LONG-SLEEVED SHIRTS; MOISTURE-WICKING SPORTS SHIRTS; NIGHT SHIRTS; OPEN-NECKED SHIRTS; OVER SHIRTS; PIQUE SHIRTS; POLO SHIRTS; RUGBY SHIRTS; SCIENTIFIC AND TECHNOLOGICAL APPAREL, NAMELY, SHIRTS, PANTS, JACKETS, FOOTWEAR, HATS AND CAPS, UNIFORMS; SHIRT FRONTS; SHIRT INSERTS, NAMELY, DICKIES; SHIRT YOKES; SHIRTS; SHIRTS AND SHORT-SLEEVED SHIRTS; SHIRTS AND SLIPS; SHIRTS FOR INFANTS, BABIES, TODDLERS AND CHILDREN; SHIRTS FOR SUITS; SHORT-SLEEVED OR LONG-SLEEVED T-SHIRTS; SHORT-SLEEVED SHIRTS; SLEEP SHIRTS; SLEEVES WORN SEPARATE AND APART FROM BLOUSES, SHIRTS AND OTHER TOPS; SPORT SHIRTS; SPORTS SHIRTS; SPORTS SHIRTS WITH SHORT SLEEVES; SWEAT SHIRTS; T-SHIRTS; TEE SHIRTS; TRIATHLON CLOTHING, NAMELY, TRIATHLON TIGHTS, TRIATHLON SHORTS, TRIATHLON SINGLET, TRIATHLON SHIRTS, TRIATHLON SUITS; TURTLE NECK SHIRTS; WEARABLE GARMENTS AND CLOTHING, NAMELY, SHIRTS; WIND SHIRTS; YOGA SHIRTS, IN CLASS 25 (U.S. CLS. 22 AND 39).



FIRST USE 1-25-2011; IN COMMERCE 3-18-2011.

THE MARK CONSISTS OF STANDARD CHARACTERS WITHOUT CLAIM TO ANY PARTICULAR FONT, STYLE, SIZE, OR COLOR.

SN 85-225,192, FILED 1-25-2011.

HENRY S. ZAK, EXAMINING ATTORNEY

David J. Kyros

Director of the United States Patent and Trademark Office

United States of America

United States Patent and Trademark Office

BLK

Reg. No. 4,068,606

Registered Dec. 6, 2011

Int. Cl.: 34

TRADEMARK

PRINCIPAL REGISTER

SWISHER INTERNATIONAL, INC. (DELAWARE CORPORATION)
459 EAST 16TH STREET
JACKSONVILLE, FL 32206

FOR: CIGARS, IN CLASS 34 (U.S. CLS. 2, 8, 9 AND 17).

FIRST USE 4-30-2011; IN COMMERCE 4-30-2011.

THE MARK CONSISTS OF STANDARD CHARACTERS WITHOUT CLAIM TO ANY PARTICULAR FONT, STYLE, SIZE, OR COLOR.

SN 85-225,672, FILED 1-25-2011.

FRED CARL, EXAMINING ATTORNEY



David J. Kyffers

Director of the United States Patent and Trademark Office

United States of America

United States Patent and Trademark Office

MYECATERING

Reg. No. 4,068,607

MORRISON MANAGEMENT SPECIALISTS, INC. (GEORGIA CORPORATION)
5801 PEACHTREE DUNWOODY ROAD
ATLANTA, GA 30342

Registered Dec. 6, 2011

Int. Cl.: 35

FOR: WEB BASED BUSINESS MANAGEMENT SERVICES FOR USE IN THE FOOD SERVICE INDUSTRY, IN CLASS 35 (U.S. CLS. 100, 101 AND 102).

SERVICE MARK

FIRST USE 8-4-2011; IN COMMERCE 8-4-2011.

PRINCIPAL REGISTER

THE MARK CONSISTS OF STANDARD CHARACTERS WITHOUT CLAIM TO ANY PARTICULAR FONT, STYLE, SIZE, OR COLOR.

SN 85-227,417, FILED 1-27-2011.

HELENE LIWINSKI, EXAMINING ATTORNEY



David J. Kybas

Director of the United States Patent and Trademark Office

United States of America

United States Patent and Trademark Office

IAMS SIMPLE & NATURAL

Reg. No. 4,068,608

Registered Dec. 6, 2011

Int. Cl.: 31

TRADEMARK

PRINCIPAL REGISTER

THE IAMS COMPANY (OHIO CORPORATION)
ONE PROCTER & GAMBLE PLAZA
CINCINNATI, OH 45202

FOR: PET FOOD, IN CLASS 31 (U.S. CLS. 1 AND 46).

FIRST USE 6-6-2011; IN COMMERCE 6-6-2011.

THE MARK CONSISTS OF STANDARD CHARACTERS WITHOUT CLAIM TO ANY PARTICULAR FONT, STYLE, SIZE, OR COLOR.

OWNER OF U.S. REG. NOS. 1,317,225, 3,676,446, AND OTHERS.

NO CLAIM IS MADE TO THE EXCLUSIVE RIGHT TO USE "NATURAL", APART FROM THE MARK AS SHOWN.

SN 85-227,783, FILED 1-27-2011.

ROBERT C. CLARK JR., EXAMINING ATTORNEY



David J. Kyffers

Director of the United States Patent and Trademark Office

United States of America

United States Patent and Trademark Office

SUCK IT UP

Reg. No. 4,068,609

Registered Dec. 6, 2011

Int. Cl.: 28

TRADEMARK

PRINCIPAL REGISTER

JIMMY JEWELL (UNITED STATES INDIVIDUAL)
42078 N. RIVER DRIVE
SWEET HOME, OR 97386

FOR: ARTIFICIAL FISHING LURES, IN CLASS 28 (U.S. CLS. 22, 23, 38 AND 50).

FIRST USE 5-31-2011; IN COMMERCE 5-31-2011.

THE MARK CONSISTS OF STANDARD CHARACTERS WITHOUT CLAIM TO ANY PARTICULAR FONT, STYLE, SIZE, OR COLOR.

SN 85-228,135, FILED 1-27-2011.

JAMES STEIN, EXAMINING ATTORNEY



David J. Kybas

Director of the United States Patent and Trademark Office

United States of America

United States Patent and Trademark Office

4 SERIES

Reg. No. 4,068,610

Registered Dec. 6, 2011

Int. Cl.: 28

TRADEMARK

PRINCIPAL REGISTER

KARSTEN MANUFACTURING CORPORATION (ARIZONA CORPORATION)
2201 WEST DESERT COVE
PHOENIX, AZ 85029

FOR: GOLF BAGS, IN CLASS 28 (U.S. CLS. 22, 23, 38 AND 50).

FIRST USE 10-19-2011; IN COMMERCE 10-19-2011.

THE MARK CONSISTS OF STANDARD CHARACTERS WITHOUT CLAIM TO ANY PARTICULAR FONT, STYLE, SIZE, OR COLOR.

NO CLAIM IS MADE TO THE EXCLUSIVE RIGHT TO USE "SERIES", APART FROM THE MARK AS SHOWN.

SN 85-229,079, FILED 1-28-2011.

ELI HELLMAN, EXAMINING ATTORNEY



David J. Kyffers

Director of the United States Patent and Trademark Office

United States of America

United States Patent and Trademark Office

TEN GALLON HAT

Reg. No. 4,068,611

NIHON SHURUI HANBAI CO., LTD. (JAPAN CORPORATION)
25-4, SHINKAWA 1-CHOME, CHUO-KU
TOKYO, JAPAN

Registered Dec. 6, 2011

Int. Cl.: 33

FOR: ALCOHOLIC BEVERAGES EXCEPT BEERS, IN CLASS 33 (U.S. CLS. 47 AND 49).

TRADEMARK

FIRST USE 12-27-2010; IN COMMERCE 12-27-2010.

PRINCIPAL REGISTER

THE MARK CONSISTS OF STANDARD CHARACTERS WITHOUT CLAIM TO ANY PARTICULAR FONT, STYLE, SIZE, OR COLOR.

SN 85-230,212, FILED 1-31-2011.

MICHAEL KEATING, EXAMINING ATTORNEY



David J. Kybas

Director of the United States Patent and Trademark Office

United States of America

United States Patent and Trademark Office

CIGNA GLOBAL HEALTH OPTIONS

Reg. No. 4,068,612

Registered Dec. 6, 2011

Int. Cls.: 36 and 44

SERVICE MARK

PRINCIPAL REGISTER

CIGNA INTELLECTUAL PROPERTY, INC. (DELAWARE CORPORATION)
300 BELLEVUE PARKWAY
WILMINGTON, DE 19809

FOR: INSURANCE SERVICES, NAMELY, INSURANCE ADMINISTRATION IN THE FIELDS OF MEDICAL, DENTAL, VISION, EVACUATION AND WELLNESS INSURANCE; INSURANCE SERVICES, NAMELY, UNDERWRITING IN THE FIELDS OF MEDICAL, DENTAL, VISION, EVACUATION AND WELLNESS INSURANCE; ADMINISTRATION OF EMPLOYEE BENEFIT PLANS CONCERNING HEALTH INSURANCE; INSURANCE SERVICES, NAMELY, UNDERWRITING, ISSUANCE AND ADMINISTRATION OF HEALTH, DENTAL, VISION, EVACUATION AND REPATRIATION INSURANCE FOR EXPATRIATES, IN CLASS 36 (U.S. CLS. 100, 101 AND 102).

FIRST USE 12-9-2010; IN COMMERCE 12-9-2010.

FOR: HEALTH AND WELLNESS ASSESSMENT SERVICES, NAMELY, PROVIDING AN ONLINE INTERACTIVE HEALTH AND WELLNESS QUESTIONNAIRE TO BE USED TO EVALUATE AN INDIVIDUAL'S HEALTH HABITS AND LIFESTYLE, AND RECOMMEND IMPROVEMENTS; HEALTH AND WELLNESS COUNSELING AND CONSULTING SERVICES; HEALTH COACHING SERVICES, NAMELY, SELF-DIRECTED, ONLINE INTERACTIVE NUTRITIONAL, PHYSICAL ACTIVITY, SLEEP HABITS AND STRESS MANAGEMENT PROGRAMS, IN CLASS 44 (U.S. CLS. 100 AND 101).

FIRST USE 12-9-2010; IN COMMERCE 12-9-2010.

THE MARK CONSISTS OF STANDARD CHARACTERS WITHOUT CLAIM TO ANY PARTICULAR FONT, STYLE, SIZE, OR COLOR.

OWNER OF U.S. REG. NOS. 1,270,224, 2,563,544, AND OTHERS.

NO CLAIM IS MADE TO THE EXCLUSIVE RIGHT TO USE "GLOBAL HEALTH OPTIONS", APART FROM THE MARK AS SHOWN.

SN 85-230,895, FILED 2-1-2011.

JAY FLOWERS, EXAMINING ATTORNEY



David J. Kyros

Director of the United States Patent and Trademark Office

United States of America

United States Patent and Trademark Office



Reg. No. 4,068,613

Registered Dec. 6, 2011

Int. Cl.: 43

SERVICE MARK

PRINCIPAL REGISTER

CART-MAC, LLC (ARIZONA LIMITED LIABILITY COMPANY)
1335 E. LOS ARBOLES DR.
TEMPE, AZ 85284

FOR: RESTAURANTS, IN CLASS 43 (U.S. CLS. 100 AND 101).

FIRST USE 8-6-2011; IN COMMERCE 8-6-2011.

THE MARK CONSISTS OF THE LETTER "N" IN BLACK, ON AN ORANGE SQUARE WITH ROUNDED CORNERS.

THE COLOR(S) ORANGE AND BLACK IS/ARE CLAIMED AS A FEATURE OF THE MARK.

SN 85-231,727, FILED 2-1-2011.

HANNO RITTNER, EXAMINING ATTORNEY



David J. Kyffers

Director of the United States Patent and Trademark Office

United States of America

United States Patent and Trademark Office

VENTURE TELECOM

Reg. No. 4,068,614

VENTURE TELECOM (NEVADA LIMITED LIABILITY COMPANY)
4894 SPARKS BLVD
SPARKS, NV 89436

Registered Dec. 6, 2011

Int. Cl.: 38

FOR: PROVIDING LOCAL AND LONG DISTANCE TELEPHONE SERVICES, IN CLASS 38
(U.S. CLS. 100, 101 AND 104).

SERVICE MARK

FIRST USE 11-20-2010; IN COMMERCE 5-1-2011.

PRINCIPAL REGISTER

THE MARK CONSISTS OF STANDARD CHARACTERS WITHOUT CLAIM TO ANY PARTICULAR FONT, STYLE, SIZE, OR COLOR.

NO CLAIM IS MADE TO THE EXCLUSIVE RIGHT TO USE "TELECOM", APART FROM THE MARK AS SHOWN.

SN 85-232,763, FILED 2-2-2011.

PAUL F. GAST, EXAMINING ATTORNEY



David J. Kyros

Director of the United States Patent and Trademark Office

United States of America

United States Patent and Trademark Office

Rock Flow Dynamics

Reg. No. 4,068,615

Registered Dec. 6, 2011

Int. Cl.: 9

TRADEMARK

PRINCIPAL REGISTER

ROCK FLOW DYNAMICS, INC. (DELAWARE CORPORATION)
393 WEST 49TH STREET
5AA
NEW YORK, NY 10019

FOR: SOFTWARE TO SIMULATE FLUID AND GAS FILTRATION DYNAMICS OF HYDRO-CARBON UNDERGROUND RESERVOIRS; SOFTWARE, NAMELY, INTEGRATED MODELING AND DATA ANALYSIS SOFTWARE FOR USE IN THE OIL AND GAS INDUSTRY, IN CLASS 9 (U.S. CLS. 21, 23, 26, 36 AND 38).

FIRST USE 7-18-2011; IN COMMERCE 7-18-2011.

THE MARK CONSISTS OF STANDARD CHARACTERS WITHOUT CLAIM TO ANY PARTICULAR FONT, STYLE, SIZE, OR COLOR.

NO CLAIM IS MADE TO THE EXCLUSIVE RIGHT TO USE "FLOW DYNAMICS", APART FROM THE MARK AS SHOWN.

SN 85-233,586, FILED 2-3-2011.

KAREN SEVERSON, EXAMINING ATTORNEY



David J. Kyros

Director of the United States Patent and Trademark Office

United States of America

United States Patent and Trademark Office



Reg. No. 4,068,616

Registered Dec. 6, 2011

Int. Cl.: 9

TRADEMARK

PRINCIPAL REGISTER

ROCK FLOW DYNAMICS, INC. (DELAWARE CORPORATION)
393 WEST 49TH STREET
5AA
NEW YORK, NY 10019

FOR: SOFTWARE TO SIMULATE FLUID AND GAS FILTRATION DYNAMICS OF HYDRO-CARBON UNDERGROUND RESERVOIRS; SOFTWARE, NAMELY, INTEGRATED MODELING AND DATA ANALYSIS SOFTWARE FOR USE IN THE OIL AND GAS INDUSTRY, IN CLASS 9 (U.S. CLS. 21, 23, 26, 36 AND 38).

FIRST USE 7-11-2011; IN COMMERCE 7-11-2011.

NO CLAIM IS MADE TO THE EXCLUSIVE RIGHT TO USE "FLOW DYNAMICS", APART FROM THE MARK AS SHOWN.

THE MARK CONSISTS OF THE STYLIZED LETTERS "RFD" ABOVE 4 SQUARES FOLLOWED BY THE WORDS "ROCK FLOW DYNAMICS".

SN 85-233,618, FILED 2-3-2011.

KAREN SEVERSON, EXAMINING ATTORNEY



David J. Kybas

Director of the United States Patent and Trademark Office

United States of America

United States Patent and Trademark Office

tNavigator

Reg. No. 4,068,617

Registered Dec. 6, 2011

Int. Cl.: 9

TRADEMARK

PRINCIPAL REGISTER

ROCK FLOW DYNAMICS, INC. (DELAWARE CORPORATION)
393 WEST 49TH STREET
5AA
NEW YORK, NY 10019

FOR: SOFTWARE TO SIMULATE FLUID AND GAS FILTRATION DYNAMICS OF HYDRO-CARBON UNDERGROUND RESERVOIRS; SOFTWARE, NAMELY, INTEGRATED MODELING AND DATA ANALYSIS SOFTWARE FOR USE IN THE OIL AND GAS INDUSTRY, IN CLASS 9 (U.S. CLS. 21, 23, 26, 36 AND 38).

FIRST USE 7-18-2011; IN COMMERCE 7-18-2011.

THE MARK CONSISTS OF STANDARD CHARACTERS WITHOUT CLAIM TO ANY PARTICULAR FONT, STYLE, SIZE, OR COLOR.

SN 85-233,661, FILED 2-3-2011.

KAREN SEVERSON, EXAMINING ATTORNEY



David J. Kybas

Director of the United States Patent and Trademark Office

United States of America

United States Patent and Trademark Office

Swiss Altima

Reg. No. 4,068,618

ORCA BEVERAGE, INC. (WASHINGTON CORPORATION)
11903 CYRUS WAY, #5
MUKILTEO, WA 98275

Registered Dec. 6, 2011

Int. Cl.: 32

FOR: CONCENTRATES, SYRUPS OR POWDERS USED IN THE PREPARATION OF SOFT DRINKS; SOFT DRINKS, IN CLASS 32 (U.S. CLS. 45, 46 AND 48).

TRADEMARK

FIRST USE 10-14-2011; IN COMMERCE 10-14-2011.

PRINCIPAL REGISTER

THE MARK CONSISTS OF STANDARD CHARACTERS WITHOUT CLAIM TO ANY PARTICULAR FONT, STYLE, SIZE, OR COLOR.

SN 85-235,417, FILED 2-7-2011.

LEIGH CAROLINE CASE, EXAMINING ATTORNEY



David J. Kybas

Director of the United States Patent and Trademark Office

United States of America

United States Patent and Trademark Office

GALPALGREET.COM

Reg. No. 4,068,619

Registered Dec. 6, 2011

Int. Cl.: 45

SERVICE MARK

PRINCIPAL REGISTER

ROGERS, MARA (UNITED STATES INDIVIDUAL)
APT 76
965 MAGNOLIA AVENUE
LARKSPUR, CA 94939

FOR: ON-LINE SOCIAL NETWORKING SERVICES; ONLINE SOCIAL NETWORKING SERVICES PROVIDED THROUGH A COMMUNITY WEBSITE, IN CLASS 45 (U.S. CLS. 100 AND 101).

FIRST USE 9-26-2011; IN COMMERCE 9-26-2011.

THE MARK CONSISTS OF STANDARD CHARACTERS WITHOUT CLAIM TO ANY PARTICULAR FONT, STYLE, SIZE, OR COLOR.

SN 85-235,425, FILED 2-7-2011.

PAUL MORENO, EXAMINING ATTORNEY



David J. Kybas

Director of the United States Patent and Trademark Office

United States of America

United States Patent and Trademark Office

LES BELLES COLLINES

Reg. No. 4,068,620

Registered Dec. 6, 2011

Int. Cl.: 33

TRADEMARK

PRINCIPAL REGISTER

PAN-PACIFIC CELLARS LLC (CALIFORNIA LIMITED LIABILITY COMPANY)
310 MAIN ST., STE 33C
SAN FRANCISCO, CA 94105

FOR: WINES AND LIQUEURS, IN CLASS 33 (U.S. CLS. 47 AND 49).

FIRST USE 6-2-2011; IN COMMERCE 8-8-2011.

THE MARK CONSISTS OF STANDARD CHARACTERS WITHOUT CLAIM TO ANY PARTICULAR FONT, STYLE, SIZE, OR COLOR.

THE ENGLISH TRANSLATION OF "LES BELLES COLLINES" IN THE MARK IS "THE BEAUTIFUL HILLS".

SN 85-235,928, FILED 2-7-2011.

KAPIL BHANOT, EXAMINING ATTORNEY



David J. Kyffers

Director of the United States Patent and Trademark Office

United States of America

United States Patent and Trademark Office

THE WINDOW

Reg. No. 4,068,621

BARNEY'S, INC. (NEW YORK CORPORATION)
575 FIFTH AVENUE; 11TH FLOOR
NEW YORK, NY 10017

Registered Dec. 6, 2011

Int. Cl.: 45

FOR: WEB SITE CONTAINING INFORMATION AND PHOTOGRAPHS RELATING TO FASHION, STYLE, AND CULTURE, IN CLASS 45 (U.S. CLS. 100 AND 101).

SERVICE MARK

FIRST USE 2-7-2011; IN COMMERCE 2-7-2011.

PRINCIPAL REGISTER

THE MARK CONSISTS OF STANDARD CHARACTERS WITHOUT CLAIM TO ANY PARTICULAR FONT, STYLE, SIZE, OR COLOR.

SN 85-236,974, FILED 2-8-2011.

JAMES A. RAUEN, EXAMINING ATTORNEY



David J. Kybas

Director of the United States Patent and Trademark Office

United States of America

United States Patent and Trademark Office

SUNDAY BAY

Reg. No. 4,068,622

Registered Dec. 6, 2011

Int. Cl.: 33

TRADEMARK

PRINCIPAL REGISTER

TUSSOCK JUMPER WINES LIMITED (NEW ZEALAND LIMITED LIABILITY COMPANY)
76 HIGH STREET
BLENHEIM, MARLBOROUGH, NEW ZEALAND 7201

FOR: WINES, IN CLASS 33 (U.S. CLS. 47 AND 49).

FIRST USE 3-14-2011; IN COMMERCE 3-14-2011.

THE MARK CONSISTS OF STANDARD CHARACTERS WITHOUT CLAIM TO ANY PARTICULAR FONT, STYLE, SIZE, OR COLOR.

SN 85-237,157, FILED 2-8-2011.

MICHELE SWAIN, EXAMINING ATTORNEY



David J. Kybas

Director of the United States Patent and Trademark Office

United States of America

United States Patent and Trademark Office

ROPIX

Reg. No. 4,068,623

DWYER, DENNIS (UNITED STATES INDIVIDUAL)
225 EAST 57TH STREET
NEW YORK, NY 10022

Registered Dec. 6, 2011

Int. Cl.: 25

FOR: FOOTWEAR, IN CLASS 25 (U.S. CLS. 22 AND 39).

TRADEMARK

FIRST USE 7-27-2011; IN COMMERCE 7-27-2011.

PRINCIPAL REGISTER

THE MARK CONSISTS OF THE WORD "ROPIX" WITH A HUMAN FORM WITHIN THE LETTER "O".

SN 85-237,672, FILED 2-9-2011.

NATALIE POLZER, EXAMINING ATTORNEY



David J. Kybas

Director of the United States Patent and Trademark Office

United States of America

United States Patent and Trademark Office

SPLYTTER

Reg. No. 4,068,624

ATTACK PRODUCTS, LLC (ILLINOIS LIMITED LIABILITY COMPANY)
2641 W. HARRISON STREET
CHICAGO, IL 60612

Registered Dec. 6, 2011

Int. Cl.: 28

FOR: FINGER PLACEMENT DEVICE FOR AIDING BASKETBALL PLAYER'S SHOOTING
TECHNIQUE AND CONTROL, IN CLASS 28 (U.S. CLS. 22, 23, 38 AND 50).

TRADEMARK

FIRST USE 6-0-2011; IN COMMERCE 6-0-2011.

PRINCIPAL REGISTER

THE MARK CONSISTS OF STANDARD CHARACTERS WITHOUT CLAIM TO ANY PAR-
TICULAR FONT, STYLE, SIZE, OR COLOR.

SN 85-237,719, FILED 2-9-2011.

KEVIN CORWIN, EXAMINING ATTORNEY



David J. Kybas

Director of the United States Patent and Trademark Office

United States of America

United States Patent and Trademark Office

BARRICAGE

Reg. No. 4,068,625

Registered Dec. 6, 2011

Int. Cl.: 6

TRADEMARK

PRINCIPAL REGISTER

LANDMARK EARTH SOLUTIONS, INC. (NEVADA CORPORATION)
NO. 1 LEGGETT ROAD
CARTHAGE, MO 64836

FOR: WELDED-WIRE GABIONS CONSISTING PRIMARILY OF METAL FOR EARTH RETENTION AND STABILIZATION, EROSION AND FLOOD CONTROL, AND ARCHITECTURAL APPLICATIONS; CAGE STRUCTURES AND MULTI-COMPARTMENTAL CAGE STRUCTURES CONSISTING PRIMARILY OF METAL FOR FORMING GABIONS; METALLIC FASTENERS FOR INTERCONNECTING COMPONENT PARTS OF GABION STRUCTURES; CONTAINERIZED GABIONS CONSISTING PRIMARILY OF METAL; METAL COMPONENT PARTS OF ALL THE AFORESAID GOODS, IN CLASS 6 (U.S. CLS. 2, 12, 13, 14, 23, 25 AND 50).

FIRST USE 2-0-2010; IN COMMERCE 9-9-2011.

THE MARK CONSISTS OF STANDARD CHARACTERS WITHOUT CLAIM TO ANY PARTICULAR FONT, STYLE, SIZE, OR COLOR.

SN 85-238,081, FILED 2-9-2011.

SUSAN RICHARDS, EXAMINING ATTORNEY



David J. Kyros

Director of the United States Patent and Trademark Office

United States of America

United States Patent and Trademark Office

KOMODO

Reg. No. 4,068,626

OKUMA FISHING TACKLE (CALIFORNIA CORPORATION)
2310 EAST LOCUST COURT
ONTARIO, CA 91761

Registered Dec. 6, 2011

Int. Cl.: 28

FOR: FISHING TACKLE; FISHING REELS; FISHING RODS, IN CLASS 28 (U.S. CLS. 22, 23, 38 AND 50).

TRADEMARK

FIRST USE 6-1-2011; IN COMMERCE 7-15-2011.

PRINCIPAL REGISTER

THE MARK CONSISTS OF STANDARD CHARACTERS WITHOUT CLAIM TO ANY PARTICULAR FONT, STYLE, SIZE, OR COLOR.

SN 85-238,558, FILED 2-10-2011.

VERNA BETH RIRIE, EXAMINING ATTORNEY



David J. Kybas

Director of the United States Patent and Trademark Office

United States of America

United States Patent and Trademark Office

cozi

Reg. No. 4,068,627

Registered Dec. 6, 2011

Int. Cl.: 33

TRADEMARK

PRINCIPAL REGISTER

VISION WINE & SPIRITS LLC (NEW JERSEY LIMITED LIABILITY COMPANY)
2ND FLOOR
700 PLAZA DRIVE
SECAUCUS, NJ 07094

FOR: WINES, IN CLASS 33 (U.S. CLS. 47 AND 49).

FIRST USE 6-1-2011; IN COMMERCE 6-1-2011.

THE MARK CONSISTS OF SMALL "CO" WITH A LARGE "Z" AND A SMALL "I" ALL IN ITALICS.

SN 85-238,685, FILED 2-10-2011.

JAMES A. RAUEN, EXAMINING ATTORNEY



David J. Kybas

Director of the United States Patent and Trademark Office

United States of America
United States Patent and Trademark Office

GEO WALL

Reg. No. 4,068,628

Registered Dec. 6, 2011

Int. Cl.: 19

TRADEMARK

PRINCIPAL REGISTER

PACIFIC COAST BUILDING PRODUCTS, INC. (CALIFORNIA CORPORATION)
10600 WHITE ROCK ROAD, SUITE 100
RANCHO CORDOVA, CA 95670

FOR: CONCRETE BLOCKS USED TO FORM RETAINING WALLS FOR STRUCTURAL AND LANDSCAPING PURPOSES, IN CLASS 19 (U.S. CLS. 1, 12, 33 AND 50).

FIRST USE 9-23-2011; IN COMMERCE 9-23-2011.

THE MARK CONSISTS OF STANDARD CHARACTERS WITHOUT CLAIM TO ANY PARTICULAR FONT, STYLE, SIZE, OR COLOR.

SN 85-238,892, FILED 2-10-2011.

LOURDES AYALA, EXAMINING ATTORNEY



David J. Kybas

Director of the United States Patent and Trademark Office

United States of America

United States Patent and Trademark Office

CELEBRATING GRACE

Reg. No. 4,068,629

CELEBRATING GRACE LLC (CALIFORNIA LIMITED LIABILITY COMPANY)
5515 DOYLE STREET, #4
EMERYVILLE, CA 94608

Registered Dec. 6, 2011

Int. Cl.: 25

FOR: CLOTHING, NAMELY, PANTS, TOPS, T-SHIRTS, SHIRTS, DRESSES, SKIRTS,
JACKETS, IN CLASS 25 (U.S. CLS. 22 AND 39).

TRADEMARK

FIRST USE 8-8-2011; IN COMMERCE 8-8-2011.

PRINCIPAL REGISTER

THE MARK CONSISTS OF STANDARD CHARACTERS WITHOUT CLAIM TO ANY PAR-
TICULAR FONT, STYLE, SIZE, OR COLOR.

SN 85-239,994, FILED 2-11-2011.

BENJAMIN OKEKE, EXAMINING ATTORNEY



David J. Kybas

Director of the United States Patent and Trademark Office

United States of America

United States Patent and Trademark Office

KAVITA

Reg. No. 4,068,630

Registered Dec. 6, 2011

Int. Cl.: 11

TRADEMARK

PRINCIPAL REGISTER

KAVITA CANADA INC. (CANADA CORPORATION)
06436.000
360 YORK RD, UNIT 3 & 4
NIAGARA O/T LAKE, ON, CANADA L0S1J0

FOR: CULTIVATION LAMPS, LIGHTS AND THEIR COMPONENTS, NAMELY, HIGH PRESSURE SODIUM (HPS), METAL HALIDE, PLASMA, AND LIGHT EMITTING DIODE (LED), IN CLASS 11 (U.S. CLS. 13, 21, 23, 31 AND 34).

FIRST USE 8-14-2002; IN COMMERCE 8-14-2002.

THE MARK CONSISTS OF STANDARD CHARACTERS WITHOUT CLAIM TO ANY PARTICULAR FONT, STYLE, SIZE, OR COLOR.

SN 85-240,137, FILED 2-11-2011.

THEODORE MCBRIDE, EXAMINING ATTORNEY



David J. Kybas

Director of the United States Patent and Trademark Office

United States of America

United States Patent and Trademark Office



Reg. No. 4,068,631

Registered Dec. 6, 2011

Int. Cl.: 41

SERVICE MARK

PRINCIPAL REGISTER

TROJNAR, WAYNE (UNITED STATES INDIVIDUAL)
1415 W. ALGONQUIN RD.
ALGONQUIN, IL 60102

FOR: ENTERTAINMENT IN THE NATURE OF LIVE PERFORMANCES BY THE FICTIONAL CHARACTER RANDY RAGE; ENTERTAINMENT SERVICES, NAMELY, THE PROVISION OF CONTINUING PROGRAMS, SEGMENTS, INTERVIEWS, AND AUDIENCE CALL-IN SHOWS FEATURING THE FICTIONAL CHARACTER RANDY RAGE AND THE SUBJECTS OF DRIVING, PUBLIC SAFETY, AND PREVENTION OF ROAD RAGE DELIVERED BY RADIO BROADCASTS, CABLE TELEVISION, WEBCASTS, AND OTHER PUBLIC MEDIA, IN CLASS 41 (U.S. CLS. 100, 101 AND 107).

FIRST USE 3-1-2011; IN COMMERCE 3-1-2011.

THE MARK CONSISTS OF THE CAPITALIZED LETTERS: "RANDY RAGE" IN GOLD OUTLINE FONT, NEXT TO THE GRAPHIC IMAGE (IN BLACK AND WHITE OUTLINE) OF A MAN WALKING WITH HIS RIGHT HAND EXTENDED IN FRIENDSHIP, SUPERIMPOSED ONTO A GLOBE (IN BLACK AND WHITE OUTLINE).

THE COLOR(S) GOLD, BLACK AND WHITE IS/ARE CLAIMED AS A FEATURE OF THE MARK.

SN 85-240,289, FILED 2-11-2011.

BARBARA RUTLAND, EXAMINING ATTORNEY



David J. Kyjars

Director of the United States Patent and Trademark Office

United States of America

United States Patent and Trademark Office

Powered By MARTIN'S POINT HEALTH CARE

Reg. No. 4,068,632

Registered Dec. 6, 2011

Int. Cl.: 36

SERVICE MARK

PRINCIPAL REGISTER

MARTIN'S POINT HEALTH CARE, INC. (MAINE NON-PROFIT CORPORATION)
891 WASHINGTON AVENUE
PORTLAND, ME 04103

FOR: INSURANCE SERVICES, NAMELY, UNDERWRITING, ISSUANCE AND ADMINISTRATION OF HEALTH INSURANCE, IN CLASS 36 (U.S. CLS. 100, 101 AND 102).

FIRST USE 2-11-2011; IN COMMERCE 2-11-2011.

THE MARK CONSISTS OF STANDARD CHARACTERS WITHOUT CLAIM TO ANY PARTICULAR FONT, STYLE, SIZE, OR COLOR.

OWNER OF U.S. REG. NOS. 2,600,269, 3,772,992, AND OTHERS.

NO CLAIM IS MADE TO THE EXCLUSIVE RIGHT TO USE "HEALTH CARE", APART FROM THE MARK AS SHOWN.

SN 85-241,253, FILED 2-14-2011.

ANDREA K. NADELMAN, EXAMINING ATTORNEY



David J. Kybas

Director of the United States Patent and Trademark Office

United States of America

United States Patent and Trademark Office



Reg. No. 4,068,633

Registered Dec. 6, 2011

Int. Cl.: 40

SERVICE MARK

PRINCIPAL REGISTER

GOLDBERG, NEIL (UNITED STATES INDIVIDUAL)
829 MENDOCINO AVENUE
BERKELEY, CA 94707

FOR: CUSTOM MANUFACTURE OF CERAMIC TILES, PORCELAIN PLAQUES AND PANELS TO THE ORDER AND SPECIFICATION OF OTHERS, IN CLASS 40 (U.S. CLS. 100, 103 AND 106).

FIRST USE 8-1-2011; IN COMMERCE 8-1-2011.

NO CLAIM IS MADE TO THE EXCLUSIVE RIGHT TO USE "TILES", APART FROM THE MARK AS SHOWN.

THE MARK CONSISTS OF A RECTANGULAR BLOCK, WITH A STYLIZED AMPERSAND EXTENDING FROM THE LOWER RIGHT CORNER OF THE BLOCK. THE STYLIZED TEXT "TILES" IS INSIDE THE BLOCK.

SN 85-242,029, FILED 2-14-2011.

SHAUNIA CARLYLE, EXAMINING ATTORNEY



David J. Kybas

Director of the United States Patent and Trademark Office

United States of America

United States Patent and Trademark Office



Reg. No. 4,068,634

Registered Dec. 6, 2011

Int. Cl.: 35

SERVICE MARK

PRINCIPAL REGISTER

SPECIALTY MEDICAL PRODUCTS, INC. (GEORGIA CORPORATION)
SUITE 130
507 HICKORY RIDGE TRAIL
WOODSTOCK, GA 30188

FOR: ORDER FULFILLMENT SERVICES, IN CLASS 35 (U.S. CLS. 100, 101 AND 102).

FIRST USE 3-8-2011; IN COMMERCE 3-8-2011.

NO CLAIM IS MADE TO THE EXCLUSIVE RIGHT TO USE "FULFILLMENT", APART FROM THE MARK AS SHOWN.

THE STIPPLING IS FOR SHADING PURPOSES ONLY.

THE MARK CONSISTS OF THE LETTERS "NM" AND A 3-D IMAGE OF A CUBE OVER THE WORD "FULFILLMENT".

SN 85-242,800, FILED 2-15-2011.

LEIGH CAROLINE CASE, EXAMINING ATTORNEY



David J. Kyros

Director of the United States Patent and Trademark Office

United States of America

United States Patent and Trademark Office

BARE NUGGETS

Reg. No. 4,068,635

Registered Dec. 6, 2011

Int. Cl.: 29

TRADEMARK

PRINCIPAL REGISTER

LIFE CHOICES NATURAL FOOD CORP. (CANADA CORPORATION)
178 ST. GEORGE ST.
TORONTO, ONTARIO, CANADA M5R2M7

FOR: CHICKEN NUGGETS, IN CLASS 29 (U.S. CL. 46).

FIRST USE 8-29-2011; IN COMMERCE 8-29-2011.

THE MARK CONSISTS OF STANDARD CHARACTERS WITHOUT CLAIM TO ANY PARTICULAR FONT, STYLE, SIZE, OR COLOR.

NO CLAIM IS MADE TO THE EXCLUSIVE RIGHT TO USE "NUGGETS", APART FROM THE MARK AS SHOWN.

SN 85-243,388, FILED 2-16-2011.

BENJAMIN OKEKE, EXAMINING ATTORNEY



David J. Kyros

Director of the United States Patent and Trademark Office

United States of America

United States Patent and Trademark Office

PILARIS MAX

Reg. No. 4,068,636

Registered Dec. 6, 2011

Int. Cl.: 3

TRADEMARK

PRINCIPAL REGISTER

PILARIS LABS LLC (FLORIDA LIMITED LIABILITY COMPANY)
SUITE 3015
11030 RCA CENTER DRIVE
PALM BEACH GARDENS, FL 33410

FOR: NON-MEDICATED HAIR CARE PREPARATIONS, NAMELY, HAIR LOTIONS, HAIR FOAM, HAIR CREAMS, HAIR GELS, CONDITIONERS AND SHAMPOOS, ALL TO PREVENT HAIR LOSS, IN CLASS 3 (U.S. CLS. 1, 4, 6, 50, 51 AND 52).

FIRST USE 8-1-2011; IN COMMERCE 8-4-2011.

THE MARK CONSISTS OF STANDARD CHARACTERS WITHOUT CLAIM TO ANY PARTICULAR FONT, STYLE, SIZE, OR COLOR.

SN 85-245,223, FILED 2-17-2011.

LINDA ESTRADA, EXAMINING ATTORNEY



David J. Kyffers

Director of the United States Patent and Trademark Office

United States of America

United States Patent and Trademark Office

WE'RE BIGGER BECAUSE WE'RE
BETTER.

Reg. No. 4,068,637

Registered Dec. 6, 2011

Int. Cl.: 36

SERVICE MARK

PRINCIPAL REGISTER

TWO JINN, INC. (CALIFORNIA CORPORATION)
SUITE 200
1959 PALOMAR OAKS WAY
CARLSBAD, CA 92011

FOR: BAIL BONDING, IN CLASS 36 (U.S. CLS. 100, 101 AND 102).

FIRST USE 8-0-2011; IN COMMERCE 8-0-2011.

THE MARK CONSISTS OF STANDARD CHARACTERS WITHOUT CLAIM TO ANY PARTICULAR FONT, STYLE, SIZE, OR COLOR.

SN 85-246,335, FILED 2-18-2011.

DORITT L. CARROLL, EXAMINING ATTORNEY



David J. Kybas

Director of the United States Patent and Trademark Office

United States of America

United States Patent and Trademark Office

Littoo Potatoes

Reg. No. 4,068,638

Registered Dec. 6, 2011

Int. Cl.: 25

TRADEMARK

PRINCIPAL REGISTER

G AND J SPORTS CORPORATION (CALIFORNIA CORPORATION), DBA G AND J SPORTS CORPORATION,
1142 WALL ST. #104
LOS ANGELES, CA 90015

FOR: ATHLETIC APPAREL, NAMELY, SHIRTS, PANTS, JACKETS, FOOTWEAR, HATS AND CAPS, ATHLETIC UNIFORMS; CHILDREN'S AND INFANT'S APPAREL, NAMELY, JUMPERS, OVERALL SLEEPWEAR, PAJAMAS, ROMPERS AND ONE-PIECE GARMENTS; CHILDREN'S AND INFANTS' APPAREL TREATED WITH FIRE AND HEAT RETARDANTS, NAMELY, JUMPERS, OVERALL SLEEPWEAR, PAJAMAS, ROMPERS AND ONE-PIECE GARMENTS; CLOTHING FOR BABIES, TODDLERS AND CHILDREN, TREATED WITH FIRE AND HEAT RETARDANTS, NAMELY, PAJAMAS, JACKETS, SHIRTS, PANTS, JUMPERS; HEAVY JACKETS; INFANT AND TODDLER ONE PIECE CLOTHING; JACKETS; JEANS; JEGGINGS, NAMELY, PANTS THAT ARE PARTIALLY JEANS AND PARTIALLY LEGGINGS; KNIT BOTTOMS; KNIT DRESSES; KNIT JACKETS; KNIT SHIRTS; KNIT SKIRTS; KNIT TOPS; KNITTED UNDERWEAR; LEGGINGS; LEGGINS; ONE PIECE GARMENT FOR INFANTS AND TODDLERS; POLO KNIT TOPS; POLO SHIRTS; RAINPROOF JACKETS; REVERSIBLE JACKETS; SHELL JACKETS; SHIRTS FOR INFANTS, BABIES, TODDLERS AND CHILDREN; SKIRTS AND DRESSES; SLEEVED OR SLEEVELESS JACKETS; SPORTS JACKETS; SWEAT JACKETS; TRACK JACKETS; WATERPROOF JACKETS AND PANTS; WOVEN BOTTOMS; WOVEN DRESSES; WOVEN SKIRTS; WOVEN TOPS, IN CLASS 25 (U.S. CLS. 22 AND 39).

FIRST USE 9-15-2011; IN COMMERCE 9-15-2011.

THE MARK CONSISTS OF STANDARD CHARACTERS WITHOUT CLAIM TO ANY PARTICULAR FONT, STYLE, SIZE, OR COLOR.

SN 85-246,648, FILED 2-18-2011.

ANNE E. GUSTASON, EXAMINING ATTORNEY



David J. Kyros

Director of the United States Patent and Trademark Office

United States of America

United States Patent and Trademark Office

SOSH

Reg. No. 4,068,639

Registered Dec. 6, 2011

Int. Cl.: 35

SERVICE MARK

PRINCIPAL REGISTER

CORPORATE IDENTITY SOLUTIONS, INC. (WISCONSIN CORPORATION)
6561 WASHINGTON CIRCLE
WAUWATOSA, WI 53213

FOR: SOCIAL MEDIA STRATEGY AND MARKETING CONSULTANCY FOCUSING ON HELPING CLIENTS CREATE AND EXTEND THEIR PRODUCT AND BRAND STRATEGIES BY BUILDING VIRALLY ENGAGING MARKETING SOLUTIONS, IN CLASS 35 (U.S. CLS. 100, 101 AND 102).

FIRST USE 2-1-2011; IN COMMERCE 3-1-2011.

THE MARK CONSISTS OF STANDARD CHARACTERS WITHOUT CLAIM TO ANY PARTICULAR FONT, STYLE, SIZE, OR COLOR.

SN 85-247,102, FILED 2-20-2011.

ASMAT KHAN, EXAMINING ATTORNEY



David J. Kybas

Director of the United States Patent and Trademark Office

United States of America

United States Patent and Trademark Office

RAPID FORCE STAY STRONG.
MOVE ON.

Reg. No. 4,068,640

PERFECT CROSS, LLC (WISCONSIN LIMITED LIABILITY COMPANY)
W332 N6011 HWY. C
NASHOTAH, WI 53058

Registered Dec. 6, 2011

Int. Cl.: 5

FOR: ADHESIVE APPLIANCES OF VARIOUS SHAPES AND CONFIGURATIONS FOR MEDICAL PURPOSES, NAMELY, FOR MUSCLE SUPPORT AND PAIN REDUCTION , IN CLASS 5 (U.S. CLS. 6, 18, 44, 46, 51 AND 52).

TRADEMARK

FIRST USE 1-0-2011; IN COMMERCE 4-0-2011.

PRINCIPAL REGISTER

THE MARK CONSISTS OF STANDARD CHARACTERS WITHOUT CLAIM TO ANY PARTICULAR FONT, STYLE, SIZE, OR COLOR.

SN 85-247,261, FILED 2-21-2011.

KATHERINE M. DUBRAY, EXAMINING ATTORNEY



David J. Kyros

Director of the United States Patent and Trademark Office

United States of America

United States Patent and Trademark Office

≠ lucity

Reg. No. 4,068,641

Registered Dec. 6, 2011

Int. Cl.: 9

TRADEMARK

PRINCIPAL REGISTER

GBA MASTER SERIES, INC. (KANSAS CORPORATION)
10561 BARKLEY STREET STE. 500
OVERLAND PARK, KS 66212

FOR: COMPUTER SOFTWARE THAT FACILITATES MAINTENANCE AND MANAGEMENT OF ASSETS FOR UTILITY COMPANIES AND RAILROAD COMPANIES, IN CLASS 9 (U.S. CLS. 21, 23, 26, 36 AND 38).

FIRST USE 5-31-2011; IN COMMERCE 5-31-2011.

THE MARK CONSISTS OF THE FANCIFUL COINED WORD "LUCITY" PRECEDED BY A CROSS FORMED FROM FOUR MUTUALLY FACING LINE CORNERS.

SN 85-247,644, FILED 2-21-2011.

KATHLEEN LORENZO, EXAMINING ATTORNEY



David J. Kyros

Director of the United States Patent and Trademark Office

United States of America

United States Patent and Trademark Office

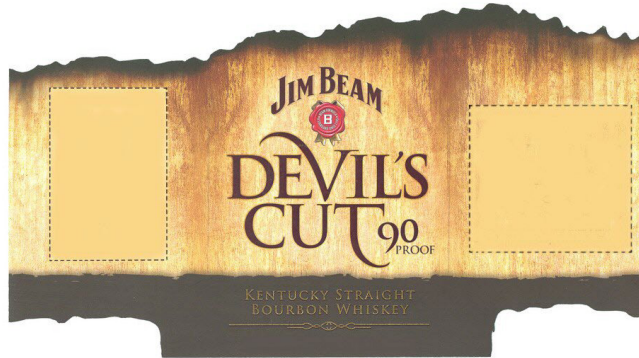

Reg. No. 4,068,642

Registered Dec. 6, 2011

Int. Cl.: 33

TRADEMARK

PRINCIPAL REGISTER

JIM BEAM BRANDS CO. (DELAWARE CORPORATION)
510 LAKE COOK ROAD
DEERFIELD, IL 60015

FOR: ALCOHOLIC BEVERAGES, NAMELY, WHISKEY, IN CLASS 33 (U.S. CLS. 47 AND 49).

FIRST USE 5-4-2011; IN COMMERCE 5-4-2011.

OWNER OF U.S. REG. NOS. 544,365 AND 2,522,294.

THE COLOR(S) BLACK, RED, WHITE, GOLD, AND BROWN IS/ARE CLAIMED AS A FEATURE OF THE MARK.

NO CLAIM IS MADE TO THE EXCLUSIVE RIGHT TO USE "90 PROOF" AND "KENTUCKY STRAIGHT BOURBON WHISKEY" AND "SINCE 1795", APART FROM THE MARK AS SHOWN.

THE MARK CONSISTS OF A GENERALLY RECTANGULAR SHAPED LABEL WITH A GRADIENT BROWN BACKGROUND WITH THE WORDS "JIM BEAM" IN BLACK AND IN AN ARC ABOVE A RED MEDALLION ON GOLD RIBBON WITH A CENTRAL WHITE LETTER "B" AND WITH THE WHITE WORDS "BEAM FORMULA" AND "A STANDARD SINCE 1795" IN WHITE IN A CIRCULAR MANNER ON THE UPPER AND LOWER HALVES OF THE MEDALLION. BELOW THE MEDALLION ARE THE WORDS "DEVIL'S CUT" WITH SMALLER WORDING "90 PROOF" IN BLACK TO THE LOWER LEFT OF THE WORD "CUT," ALL ABOVE THE WORDS "KENTUCKY STRAIGHT BOURBON WHISKEY" IN GOLD AND ON TWO LINES ABOVE A DECORATIVE HORIZONTAL GOLD LATTICE DESIGN AT BOTTOM CENTER. THE TOP AND BOTTOM EDGES OF THE LABEL ARE JAGGED AS IF CHARRED WOOD IN GRADIENT BLACK AND BROWN ON THE TOP EDGE AND WITH THE BOTTOM EDGE IN JAGGED BLACK. THE DOTTED LINES ON THE DRAWING ARE USED TO INDICATE AN AREA OF THE LABEL WITH NON-MARK MATTER.



SN 85-249,810, FILED 2-23-2011.

David J. Kyros

LINDA POWELL, EXAMINING ATTORNEY

United States of America

United States Patent and Trademark Office



Reg. No. 4,068,643

Registered Dec. 6, 2011

Int. Cl.: 33

TRADEMARK

PRINCIPAL REGISTER

PAN-PACIFIC CELLARS LLC (CALIFORNIA LIMITED LIABILITY COMPANY)
301 MAIN STREET, STE. 33C
SAN FRANCISCO, CA 94105

FOR: WINES AND LIQUEURS, IN CLASS 33 (U.S. CLS. 47 AND 49).

FIRST USE 6-2-2011; IN COMMERCE 8-8-2011.

THE MARK CONSISTS OF A CIRCULAR BORDER CONTAINING A PATTERN OF 6 REPEATED WINE BOTTLES AND 4 WINE GLASSES IN AN OPTICAL ILLUSION, WHERE A CHEVRON SHAPE EXISTS AT THE PLACE WHERE THE BOTTLE AND GLASS OVERLAP AND THE WINE INSIDE THE GLASS APPEARS TO BE IN MOTION.

SN 85-250,082, FILED 2-23-2011.

KAPIL BHANOT, EXAMINING ATTORNEY



David J. Kybas

Director of the United States Patent and Trademark Office

United States of America

United States Patent and Trademark Office



Reg. No. 4,068,644

Registered Dec. 6, 2011

Int. Cl.: 39

SERVICE MARK

PRINCIPAL REGISTER

CREDIT UNION SERVICES INC. (DELAWARE CORPORATION)
8131 LBJ FREEWAY, SUITE 400
DALLAS, TX 75251

FOR: MOTOR VEHICLE LEASING SERVICES, IN CLASS 39 (U.S. CLS. 100 AND 105).

FIRST USE 6-1-2011; IN COMMERCE 6-1-2011.

OWNER OF U.S. REG. NO. 2,588,144.

THE MARK CONSISTS OF A TALK BUBBLE CONTAINING THE LETTERS "L" (FACING FORWARD) AND "F" (TURNED BACKWARDS TO FACE THE "L"). THE NEGATIVE SPACE BETWEEN THESE TWO LETTERS FORMS THE SHAPE OF A HUMAN IN AN AUTOMOBILE DRIVER'S SEAT FACING TO THE RIGHT. THE TALK BUBBLE IS ROTATED COUNTER-CLOCKWISE 90 DEGREES SO THAT ITS POINT FACES THE TERM "FAIRLEASE".

SN 85-250,540, FILED 2-24-2011.

SUZANNE BLANE, EXAMINING ATTORNEY



David J. Kybas

Director of the United States Patent and Trademark Office

United States of America

United States Patent and Trademark Office

GENERATION WEB

Reg. No. 4,068,645

Registered Dec. 6, 2011

Int. Cl.: 35

SERVICE MARK

PRINCIPAL REGISTER

OPTIMUM WEB MARKETING, INC. (MONTANA CORPORATION)
10984 CHURCHILL ROAD
MANHATTAN, MT 59741

FOR: ON-LINE INTERNET ADVERTISING AND MARKETING SERVICES; SOCIAL MEDIA STRATEGY AND MARKETING CONSULTANCY, IN CLASS 35 (U.S. CLS. 100, 101 AND 102).

FIRST USE 4-1-2011; IN COMMERCE 4-1-2011.

THE MARK CONSISTS OF STANDARD CHARACTERS WITHOUT CLAIM TO ANY PARTICULAR FONT, STYLE, SIZE, OR COLOR.

NO CLAIM IS MADE TO THE EXCLUSIVE RIGHT TO USE "WEB", APART FROM THE MARK AS SHOWN.

SN 85-250,941, FILED 2-24-2011.

JOHN WILKE, EXAMINING ATTORNEY



David J. Kyros

Director of the United States Patent and Trademark Office

United States of America

United States Patent and Trademark Office

TROPICAL HIDEAWAY

Reg. No. 4,068,646

AGS, LLC (DELAWARE LIMITED LIABILITY COMPANY)
6680 AMELIA EARHART COURT
LAS VEGAS, NV 89119

Registered Dec. 6, 2011

Int. Cl.: 9

FOR: GAMING MACHINES; GAMING MACHINES, NAMELY, DEVICES THAT ACCEPT A WAGER; GAMING MACHINES, NAMELY, SLOT MACHINES AND VIDEO GAMING TERMINALS; AND MACHINES FOR PLAYING GAMES OF CHANCE, IN CLASS 9 (U.S. CLS. 21, 23, 26, 36 AND 38).

TRADEMARK

PRINCIPAL REGISTER

FIRST USE 10-3-2011; IN COMMERCE 10-3-2011.

THE MARK CONSISTS OF STANDARD CHARACTERS WITHOUT CLAIM TO ANY PARTICULAR FONT, STYLE, SIZE, OR COLOR.

SN 85-251,107, FILED 2-24-2011.

JOHN GARTNER, EXAMINING ATTORNEY



David J. Kybas

Director of the United States Patent and Trademark Office

United States of America

United States Patent and Trademark Office

GOLDEN PANDA

Reg. No. 4,068,647

AGS, LLC (DELAWARE LIMITED LIABILITY COMPANY)
6680 AMEILIA EARHART COURT
LAS VEGAS, NV 89119

Registered Dec. 6, 2011

Int. Cl.: 9

FOR: GAMING MACHINES; GAMING MACHINES, NAMELY, DEVICES THAT ACCEPT A WAGER; GAMING MACHINES, NAMELY, SLOT MACHINES AND VIDEO GAMING TERMINALS; AND MACHINES FOR PLAYING GAMES OF CHANCE, IN CLASS 9 (U.S. CLS. 21, 23, 26, 36 AND 38).

TRADEMARK

PRINCIPAL REGISTER

FIRST USE 10-3-2011; IN COMMERCE 10-3-2011.

THE MARK CONSISTS OF STANDARD CHARACTERS WITHOUT CLAIM TO ANY PARTICULAR FONT, STYLE, SIZE, OR COLOR.

SN 85-251,116, FILED 2-24-2011.

JOHN GARTNER, EXAMINING ATTORNEY



David J. Kyffers

Director of the United States Patent and Trademark Office

United States of America

United States Patent and Trademark Office

EVENING IN PARIS

Reg. No. 4,068,648

Registered Dec. 6, 2011

Int. Cl.: 9

TRADEMARK

PRINCIPAL REGISTER

AGS, LLC (DELAWARE LIMITED LIABILITY COMPANY)
6680 AMEILIA EARHART COURT
LAS VEGAS, NV 89119

FOR: GAMING MACHINES; GAMING MACHINES, NAMELY, DEVICES THAT ACCEPT A WAGER; GAMING MACHINES, NAMELY, SLOT MACHINES AND VIDEO GAMING TERMINALS; AND MACHINES FOR PLAYING GAMES OF CHANCE, IN CLASS 9 (U.S. CLS. 21, 23, 26, 36 AND 38).

FIRST USE 10-3-2011; IN COMMERCE 10-3-2011.

THE MARK CONSISTS OF STANDARD CHARACTERS WITHOUT CLAIM TO ANY PARTICULAR FONT, STYLE, SIZE, OR COLOR.

SN 85-251,121, FILED 2-24-2011.

JOHN GARTNER, EXAMINING ATTORNEY



David J. Kyffers

Director of the United States Patent and Trademark Office

United States of America

United States Patent and Trademark Office

Printer Patrol

Reg. No. 4,068,649

Registered Dec. 6, 2011

Int. Cls.: 35, 37, and 42

SERVICE MARK

PRINCIPAL REGISTER

A&B BUSINESS, INC. (SOUTH DAKOTA CORPORATION)
1600 NORTH A AVENUE
SIOUX FALLS, SD 57104

FOR: IMAGING AND OUTPUT MANAGEMENT SERVICES, NAMELY, BUSINESS MANAGEMENT OF DOCUMENT REPRODUCTION FOR OTHERS; ASSESSMENT SERVICES RELATING TO OFFICE DOCUMENT WORKFLOW PROCESSES; BUSINESS ADVISORY SERVICES RELATING TO BUSINESS PRODUCTION OPERATIONS; LEASING, HIRE AND RENTAL OF COPIERS, PRINTERS, SCANNERS AND OTHER OFFICE MACHINES AND APPARATUS; CONSULTANT AND ADVISORY SERVICES RELATING TO COPIERS, PRINTERS, SCANNERS AND OTHER OFFICE MACHINES; SERVICES IN THE MANAGEMENT OF DOCUMENT AND IMAGE PROCESSING AND PRODUCTION; DOCUMENT REPRODUCTION; PHOTOCOPYING SERVICES; CONSULTANCY AND ADVISORY SERVICES RELATING TO RENTAL OF OFFICE MACHINES AND OFFICE EQUIPMENT; BUSINESS SERVICES IN THE NATURE OF DOCUMENT REPRODUCTION, DOCUMENT ORGANIZATION AND DOCUMENT MANAGEMENT, IN CLASS 35 (U.S. CLS. 100, 101 AND 102).

FIRST USE 7-1-2011; IN COMMERCE 7-1-2011.

FOR: INSTALLATION, MAINTENANCE AND REPAIR OF OFFICE MACHINES AND APPARATUS, NAMELY, PRINTERS, PHOTOCOPYING MACHINES, PLOTTERS, SCANNERS, FACSIMILE RECEIVING AND TRANSMITTING EQUIPMENT AND MULTIFUNCTIONAL DEVICES WHICH SERVE AS ANY COMBINATION OF A COPIER, FACSIMILE, SCANNER AND/OR PRINTER; INSTALLATION, MAINTENANCE AND REPAIR OF COPYING APPARATUS, NAMELY, PHOTOCOPYING MACHINES, SCANNERS, PLOTTERS, TYPEWRITERS, WORD PROCESSORS, MODEMS, COMPUTERS, DISC DRIVES, PRINTERS, FACSIMILE TRANSMITTING AND RECEIVING APPARATUS, CALCULATORS AND OF DOCUMENT HANDLING APPARATUS, IN CLASS 37 (U.S. CLS. 100, 103 AND 106).

FIRST USE 7-1-2011; IN COMMERCE 7-1-2011.

FOR: PRINT MANAGEMENT SERVICES, NAMELY, REMOTE MONITORING OF PRINTERS FOR OTHERS; COMPUTER SOFTWARE AND HARDWARE CONSULTING SERVICES IN THE AREA OF PRINTING; TECHNOLOGICAL ADVISORY AND CONSULTING SERVICES IN PRINT MANAGEMENT AND PRINT COSTS, IN FILE CONVERSION, IN DATA STORAGE MANAGEMENT, IN COMPUTER NETWORK INTEGRATION AND MANAGEMENT;



David J. Kybas

Director of the United States Patent and Trademark Office

Reg. No. 4,068,649 COMPUTER SERVICES, NAMELY, PROVIDING SEARCH PLATFORMS TO ALLOW USERS TO REQUEST CONTENT FROM AND RECEIVE CONTENT FROM COMPUTER DATABASES; LEASING OF IMAGE AND PHOTO COPYING EQUIPMENT; INSTALLATION, MAINTENANCE, AND REPAIR OF SOFTWARE, IN CLASS 42 (U.S. CLS. 100 AND 101).

FIRST USE 7-1-2011; IN COMMERCE 7-1-2011.

THE MARK CONSISTS OF STANDARD CHARACTERS WITHOUT CLAIM TO ANY PARTICULAR FONT, STYLE, SIZE, OR COLOR.

NO CLAIM IS MADE TO THE EXCLUSIVE RIGHT TO USE "PRINTER", APART FROM THE MARK AS SHOWN.

SN 85-251,468, FILED 2-25-2011.

CIMMERIAN COLEMAN, EXAMINING ATTORNEY

United States of America

United States Patent and Trademark Office

Noorani

Reg. No. 4,068,650

Registered Dec. 6, 2011

Int. Cl.: 30

TRADEMARK

PRINCIPAL REGISTER

NOORANI-ZAMAROD PRODUCTS CORP. (CANADA CORPORATION)
4 RACINE ROAD, UNIT # 5
TORONTO, ON, CANADA M9W5W7

FOR: RICE, IN CLASS 30 (U.S. CL. 46).

FIRST USE 10-1-2010; IN COMMERCE 10-1-2010.

THE MARK CONSISTS OF STANDARD CHARACTERS WITHOUT CLAIM TO ANY PARTICULAR FONT, STYLE, SIZE, OR COLOR.

THE ENGLISH TRANSLATION OF "NOORANI" IN THE MARK IS "FULL OF LIGHT".

SN 85-251,661, FILED 2-25-2011.

WENDY JUN, EXAMINING ATTORNEY



David J. Kybas

Director of the United States Patent and Trademark Office

United States of America

United States Patent and Trademark Office

SKYWARD CREDIT SOLUTIONS

Reg. No. 4,068,651

Registered Dec. 6, 2011

Int. Cl.: 36

SERVICE MARK

PRINCIPAL REGISTER

SKYWARD CREDIT SOLUTIONS, LLC (DELAWARE LIMITED LIABILITY COMPANY)
121 CONTINENTAL DRIVE
SUITE 108
NEWARK, DE 19713

FOR: CONSUMER CREDIT CONSULTATION, IN CLASS 36 (U.S. CLS. 100, 101 AND 102).

FIRST USE 4-1-2011; IN COMMERCE 6-15-2011.

THE MARK CONSISTS OF STANDARD CHARACTERS WITHOUT CLAIM TO ANY PARTICULAR FONT, STYLE, SIZE, OR COLOR.

NO CLAIM IS MADE TO THE EXCLUSIVE RIGHT TO USE "CREDIT SOLUTIONS", APART FROM THE MARK AS SHOWN.

SN 85-252,117, FILED 2-25-2011.

SUNG IN, EXAMINING ATTORNEY



David J. Kyfos

Director of the United States Patent and Trademark Office

United States of America

United States Patent and Trademark Office

TYLT

Reg. No. 4,068,652

Registered Dec. 6, 2011

Int. Cl.: 9

TRADEMARK

PRINCIPAL REGISTER

FOREIGN TRADE CORPORATION (CALIFORNIA CORPORATION)
130 W. COCHRAN ST.
SIMI VALLEY, CA 93065

FOR: CELLULAR TELEPHONES AND CELLULAR TELEPHONE ACCESSORIES, NAMELY, ANTENNAS, BATTERIES, TELEPHONE CORDS, CHARGERS, CASES, HOLSTERS, AND ELECTRICAL CONNECTORS, IN CLASS 9 (U.S. CLS. 21, 23, 26, 36 AND 38).

FIRST USE 5-26-2011; IN COMMERCE 5-26-2011.

THE MARK CONSISTS OF STANDARD CHARACTERS WITHOUT CLAIM TO ANY PARTICULAR FONT, STYLE, SIZE, OR COLOR.

SN 85-252,838, FILED 2-27-2011.

FLORENTINA BLANDU, EXAMINING ATTORNEY



David J. Kyros

Director of the United States Patent and Trademark Office

United States of America

United States Patent and Trademark Office

WE KNOW APPLES

Reg. No. 4,068,653

Registered Dec. 6, 2011

Int. Cl.: 29

TRADEMARK

PRINCIPAL REGISTER

AGROINDUSTRIAL SURFRUT LIMITADA (CHILE LIMITED COMPANY (LTD.))
HERNANDO DE AGUIRRE 1915, PROVIDENCIA
SANTIAGO, CHILE

FOR: FRUIT-BASED SNACK FOOD, IN CLASS 29 (U.S. CL. 46).

FIRST USE 9-9-2011; IN COMMERCE 9-9-2011.

THE MARK CONSISTS OF STANDARD CHARACTERS WITHOUT CLAIM TO ANY PARTICULAR FONT, STYLE, SIZE, OR COLOR.

SN 85-253,442, FILED 2-28-2011.

KRISTIN CARLSON, EXAMINING ATTORNEY



David J. Kybas

Director of the United States Patent and Trademark Office

United States of America

United States Patent and Trademark Office

GREEN-FIT

Reg. No. 4,068,654

Registered Dec. 6, 2011

Int. Cl.: 37

SERVICE MARK

PRINCIPAL REGISTER

COMAU, INC. (MICHIGAN CORPORATION)
21000 TELEGRAPH ROAD
SOUTHFIELD, MI 48033

FOR: IMPLEMENTATION OF TOOLS AND MODIFICATIONS FOR IMPROVING ENERGY EFFICIENCY, NAMELY, INSTALLATION OF SENSORS AND COMPUTER SYSTEMS TO MONITOR AND MEASURE ENERGY EFFICIENCY, MODIFICATION OF COMMERCIAL, INDUSTRIAL AND INSTITUTIONAL ELECTRICAL APPARATUS TO IMPROVE ENERGY EFFICIENCY, IN CLASS 37 (U.S. CLS. 100, 103 AND 106).

FIRST USE 11-10-2010; IN COMMERCE 3-31-2011.

THE MARK CONSISTS OF STANDARD CHARACTERS WITHOUT CLAIM TO ANY PARTICULAR FONT, STYLE, SIZE, OR COLOR.

SN 85-253,540, FILED 2-28-2011.

ANDREW LEASER, EXAMINING ATTORNEY



David J. Kyros

Director of the United States Patent and Trademark Office

United States of America

United States Patent and Trademark Office



Reg. No. 4,068,655

Registered Dec. 6, 2011

Int. Cl.: 9

TRADEMARK

PRINCIPAL REGISTER

SCM TECHNOLOGIES (OHIO LIMITED LIABILITY COMPANY)
P.O. BOX 33157
CLEVELAND, OH 44133

FOR: CELLULAR PHONE MODULES THAT ACCEPT ANY STANDARD GSM SIM CARD THAT, WHEN THE MODULE IS ACTIVATED AND PROGRAMMED, CAN ACCEPT CELLULAR PHONE CALLS OR SMS MESSAGES TO PERFORM ANY NUMBER OF FUNCTIONS REMOTELY CONNECTED TO THE MODULES, WHILE ALSO MONITORING BOTH DIGITAL AND ANALOG INPUTS AND SIGNALS AND RELAYS THE STATUS OF THESE INPUTS VIA A SMS MESS, IN CLASS 9 (U.S. CLS. 21, 23, 26, 36 AND 38).

FIRST USE 7-29-2011; IN COMMERCE 8-15-2011.

NO CLAIM IS MADE TO THE EXCLUSIVE RIGHT TO USE "CELL", APART FROM THE MARK AS SHOWN.

THE MARK CONSISTS OF THE WORD "CELL SWITCH" WITH BROADCAST WAVES OVER THE TWO "LS" IN "CELL" AND NEXT TO TWO CURVED BANDS THAT GIVE THE IMPRESSION OF A "C" AND AN "S".

SN 85-253,928, FILED 2-28-2011.

FRANK LATTUCA, EXAMINING ATTORNEY



David J. Kyros

Director of the United States Patent and Trademark Office

United States of America

United States Patent and Trademark Office

TESTTRACKS

Reg. No. 4,068,656

Registered Dec. 6, 2011

Int. Cl.: 41

SERVICE MARK

PRINCIPAL REGISTER

CONTINENTAL PRESS, INC. (PENNSYLVANIA CORPORATION)
520 EAST BAINBRIDGE STREET
ELIZABETHTOWN, PA 17022

FOR: EDUCATIONAL TESTING AND ASSESSMENT SERVICES, NAMELY, PROVIDING ONLINE TESTING, PRACTICE, AND DIAGNOSTIC REPORTING FOR ASSESSING STUDENT PROFICIENCY RELATIVE TO STATE AND NATIONAL STANDARDS IN ACADEMIC SUBJECTS FOR CHILDREN IN GRADES 1 TO 12; PROVIDING ONLINE INFORMATION TO TEACHERS FOR ENHANCING STUDENT PROFICIENCY OF STATE AND NATIONAL STANDARDS FOR CHILDREN IN GRADES 1 TO 12 BY RECOMMENDING PRINT RESOURCES FOR INSTRUCTIONAL LESSONS FOR STUDENTS; PROVIDING ONLINE NON-DOWNLOADABLE COMPUTER GAMES AS A POST-PRACTICE REWARD SYSTEM FOR STUDENTS IN GRADES 1 TO 12; PROVIDING ONLINE RESOURCES IN THE NATURE OF QUESTIONS/ANSWERS ARRANGED BY STATE AND NATIONAL STANDARDS TO ASSIST TEACHERS, SCHOOLS, AND DISTRICTS IN CREATING BENCHMARK TESTS FOR ASSESSING STUDENT KNOWLEDGE OF STATE AND NATIONAL STANDARDS, IN CLASS 41 (U.S. CLS. 100, 101 AND 107).

FIRST USE 5-25-2011; IN COMMERCE 5-25-2011.

THE MARK CONSISTS OF STANDARD CHARACTERS WITHOUT CLAIM TO ANY PARTICULAR FONT, STYLE, SIZE, OR COLOR.

SN 85-254,187, FILED 3-1-2011.

HEATHER THOMPSON, EXAMINING ATTORNEY



David J. Kybas

Director of the United States Patent and Trademark Office

United States of America

United States Patent and Trademark Office

UBATUBA

Reg. No. 4,068,657

UBATUBA BEVERAGE COMPANY, LLC (UTAH LIMITED LIABILITY COMPANY)
7370 S. CREEK ROAD, STE 101
SANDY, UT 84093

Registered Dec. 6, 2011

Int. Cl.: 32

FOR: NON ALCOHOLIC CARBONATED AND NON CARBONATED BEVERAGES, IN CLASS 32 (U.S. CLS. 45, 46 AND 48).

TRADEMARK

FIRST USE 2-24-2011; IN COMMERCE 8-31-2011.

PRINCIPAL REGISTER

THE MARK CONSISTS OF STANDARD CHARACTERS WITHOUT CLAIM TO ANY PARTICULAR FONT, STYLE, SIZE, OR COLOR.

SN 85-254,418, FILED 3-1-2011.

DAVID COLLIER, EXAMINING ATTORNEY



David J. Kyros

Director of the United States Patent and Trademark Office

United States of America

United States Patent and Trademark Office

X20

Reg. No. 4,068,658

Registered Dec. 6, 2011

Int. Cl.: 7

TRADEMARK

PRINCIPAL REGISTER

TAP WORLDWIDE, LLC (DELAWARE LIMITED LIABILITY COMPANY)
400 WEST ARTESIA BOULEVARD
COMPTON, CA 90220

FOR: WINCHES, IN CLASS 7 (U.S. CLS. 13, 19, 21, 23, 31, 34 AND 35).

FIRST USE 10-1-2010; IN COMMERCE 11-1-2010.

THE MARK CONSISTS OF STANDARD CHARACTERS WITHOUT CLAIM TO ANY PARTICULAR FONT, STYLE, SIZE, OR COLOR.

SN 85-254,730, FILED 3-1-2011.

ZHALEH DELANEY, EXAMINING ATTORNEY



David J. Kybas

Director of the United States Patent and Trademark Office

United States of America

United States Patent and Trademark Office

NO! ON TEXT! OR YOU'LL BE
NEXT!

Reg. No. 4,068,659

WILSON SEELEY DESIGNS, LLC (MONTANA LIMITED LIABILITY COMPANY)
P.O. BOX 1403
FLORENCE, MT 59833

Registered Dec. 6, 2011

Int. Cl.: 16

FOR: BUMPER STICKERS; DECALS; MAGNETIC BUMPER STICKERS; STICKERS;
STICKERS AND TRANSFERS, IN CLASS 16 (U.S. CLS. 2, 5, 22, 23, 29, 37, 38 AND 50).

TRADEMARK

FIRST USE 5-26-2011; IN COMMERCE 5-26-2011.

PRINCIPAL REGISTER

THE MARK CONSISTS OF STANDARD CHARACTERS WITHOUT CLAIM TO ANY PAR-
TICULAR FONT, STYLE, SIZE, OR COLOR.

SN 85-254,764, FILED 3-1-2011.

SUE LAWRENCE, EXAMINING ATTORNEY



David J. Kybas

Director of the United States Patent and Trademark Office

United States of America

United States Patent and Trademark Office



**HOME
ENERGY
CONSULTANTS**

Reg. No. 4,068,660

Registered Dec. 6, 2011

Int. Cl.: 35

SERVICE MARK

PRINCIPAL REGISTER

PARR, GARY (UNITED STATES INDIVIDUAL)
P.O. BOX 1145
BROOKSHIRE, TX 77423

FOR: CONSULTING SERVICES IN THE FIELDS OF ENERGY CONSUMPTION AND USAGE CONSERVATION TO IMPROVE ENERGY EFFICIENCY, IN CLASS 35 (U.S. CLS. 100, 101 AND 102).

FIRST USE 7-1-2011; IN COMMERCE 7-1-2011.

NO CLAIM IS MADE TO THE EXCLUSIVE RIGHT TO USE "HOME ENERGY CONSULTANTS", APART FROM THE MARK AS SHOWN.

THE MARK CONSISTS OF AN ABSTRACT DESIGN CONSISTING OF FOUR JIGSAW PUZZLE PIECES FORMING A HOUSE TO THE LEFT OF THE TEXT "HOME ENERGY CONSULTANTS", AND THE TEXT IS IN A STACKED FORMATION.

SN 85-255,167, FILED 3-1-2011.

APRIL HESIK, EXAMINING ATTORNEY



David J. Kyros

Director of the United States Patent and Trademark Office

United States of America

United States Patent and Trademark Office

PROJECTPOD

Reg. No. 4,068,661

Registered Dec. 6, 2011

Int. Cl.: 42

SERVICE MARK

PRINCIPAL REGISTER

SUCCESSQUEST INTERNATIONAL LLC (DELAWARE CORPORATION)
15750 VENTURE LANE
EDEN PRAIRIE, MN 55344

FOR: PROVIDING TEMPORARY USE OF A WEB-BASED SOFTWARE APPLICATION FOR PLANNING, MANAGEMENT, AND MONITORING OF COMPANY COMMITMENTS AND EMPLOYEE RESPONSIBILITIES, IN CLASS 42 (U.S. CLS. 100 AND 101).

FIRST USE 5-31-2011; IN COMMERCE 5-31-2011.

THE MARK CONSISTS OF STANDARD CHARACTERS WITHOUT CLAIM TO ANY PARTICULAR FONT, STYLE, SIZE, OR COLOR.

SN 85-255,581, FILED 3-2-2011.

HANNO RITTNER, EXAMINING ATTORNEY



David J. Kyffers

Director of the United States Patent and Trademark Office

United States of America

United States Patent and Trademark Office

REFERRALPOD

Reg. No. 4,068,662

Registered Dec. 6, 2011

Int. Cl.: 42

SERVICE MARK

PRINCIPAL REGISTER

SUCCESSQUEST INTERNATIONAL LLC (DELAWARE CORPORATION)
15750 VENTURE LANE
EDEN PRAIRIE, MN 55344

FOR: PROVIDING TEMPORARY USE OF A WEB-BASED SOFTWARE APPLICATION FOR ESTABLISHING, TRACKING, AND RECORDING COMMUNICATIONS RELATED TO REFERRALS, IN CLASS 42 (U.S. CLS. 100 AND 101).

FIRST USE 3-7-2011; IN COMMERCE 3-7-2011.

THE MARK CONSISTS OF STANDARD CHARACTERS WITHOUT CLAIM TO ANY PARTICULAR FONT, STYLE, SIZE, OR COLOR.

SN 85-255,582, FILED 3-2-2011.

HANNO RITTNER, EXAMINING ATTORNEY



David J. Kyffers

Director of the United States Patent and Trademark Office

United States of America

United States Patent and Trademark Office

SUCCESSQUEST

Reg. No. 4,068,663

Registered Dec. 6, 2011

Int. Cl.: 42

SERVICE MARK

PRINCIPAL REGISTER

SUCCESSQUEST INTERNATIONAL LLC (DELAWARE CORPORATION)
15750 VENTURE LANE
EDEN PRAIRIE, MN 55344

FOR: PROVIDING TEMPORARY USE OF A WEB-BASED SOFTWARE APPLICATION FOR ANALYSIS, ASSESSMENT, AND MANAGEMENT OF PERSONAL AND CORPORATE PRODUCTIVITY, IN CLASS 42 (U.S. CLS. 100 AND 101).

FIRST USE 3-7-2011; IN COMMERCE 3-7-2011.

THE MARK CONSISTS OF STANDARD CHARACTERS WITHOUT CLAIM TO ANY PARTICULAR FONT, STYLE, SIZE, OR COLOR.

SN 85-255,585, FILED 3-2-2011.

HANNO RITTNER, EXAMINING ATTORNEY



David J. Kyros

Director of the United States Patent and Trademark Office

United States of America

United States Patent and Trademark Office



Reg. No. 4,068,664

Registered Dec. 6, 2011

Int. Cl.: 41

SERVICE MARK

PRINCIPAL REGISTER

BRANNON, DATHAN E. (UNITED STATES INDIVIDUAL)
392 SULPHUR SPRINGS ROAD
ASHEVILLE, NC 28806

FOR: MUSIC PUBLISHING SERVICES; ONLINE ELECTRONIC PUBLISHING OF MUSIC,
IN CLASS 41 (U.S. CLS. 100, 101 AND 107).

FIRST USE 6-21-2011; IN COMMERCE 6-21-2011.

THE MARK CONSISTS OF THREE NON-OVERLAPPING OVALS STACKED ONE ABOVE
THE OTHER AND INCREASING IN SIZE FROM BOTTOM TO TOP REPRESENTING SOUND
WAVES, AND A REPRESENTATION OF A FLAME IN THREE SEGMENTS BEGINNING
GENERALLY WITHIN THE TOP OVAL.

SN 85-255,873, FILED 3-2-2011.

KEVON CHISOLM, EXAMINING ATTORNEY



David J. Kybas

Director of the United States Patent and Trademark Office

United States of America

United States Patent and Trademark Office

ACID ARMOR

Reg. No. 4,068,665

Registered Dec. 6, 2011

Int. Cl.: 5

TRADEMARK

PRINCIPAL REGISTER

ARTHUR ANDREW MEDICAL, INC. (ARIZONA CORPORATION)
8350 E. RAIN TREE DR. #101
SCOTTSDALE, AZ 85260

FOR: NUTRITIONAL SUPPLEMENTS; DIETARY SUPPLEMENTS; CAPSULES FOR PHARMACEUTICALS AND NUTRACEUTICALS, IN CLASS 5 (U.S. CLS. 6, 18, 44, 46, 51 AND 52).

FIRST USE 6-22-2011; IN COMMERCE 6-22-2011.

THE MARK CONSISTS OF STANDARD CHARACTERS WITHOUT CLAIM TO ANY PARTICULAR FONT, STYLE, SIZE, OR COLOR.

SN 85-255,876, FILED 3-2-2011.

JAY FLOWERS, EXAMINING ATTORNEY



David J. Kyffers

Director of the United States Patent and Trademark Office

United States of America

United States Patent and Trademark Office

BEING SEXY

Reg. No. 4,068,666

Registered Dec. 6, 2011

Int. Cl.: 25

TRADEMARK

PRINCIPAL REGISTER

ACHATTI MARKETING, INC. (FLORIDA CORPORATION)
BAY 24
6993 NW 82 AVENUE
MIAMI, FL 33166

FOR: BATHING SUITS; BODY SHAPERS; JEANS; LADIES' UNDERWEAR; LINGERIE; SHAPEWEAR, NAMELY, GIRDLES; SHIRTS; UNDERWEAR; WOMEN'S CLOTHING, NAMELY, SHIRTS, DRESSES, SKIRTS, BLOUSES, IN CLASS 25 (U.S. CLS. 22 AND 39).

FIRST USE 9-1-2011; IN COMMERCE 9-1-2011.

THE MARK CONSISTS OF STANDARD CHARACTERS WITHOUT CLAIM TO ANY PARTICULAR FONT, STYLE, SIZE, OR COLOR.

SN 85-256,187, FILED 3-2-2011.

COLLEEN DOMBROW, EXAMINING ATTORNEY



David J. Kyros

Director of the United States Patent and Trademark Office

United States of America

United States Patent and Trademark Office

PENNYBANDZ

Reg. No. 4,068,667

PENNYBANDZ LLC (TEXAS LIMITED LIABILITY COMPANY)
312 FORESTCREST LANE
COPPELL, TX 75019

Registered Dec. 6, 2011

Int. Cl.: 14

FOR: RUBBER OR SILICON WRISTBANDS IN THE NATURE OF A BRACELET, IN CLASS 14 (U.S. CLS. 2, 27, 28 AND 50).

TRADEMARK

FIRST USE 6-16-2011; IN COMMERCE 6-16-2011.

PRINCIPAL REGISTER

THE MARK CONSISTS OF STANDARD CHARACTERS WITHOUT CLAIM TO ANY PARTICULAR FONT, STYLE, SIZE, OR COLOR.

SN 85-256,243, FILED 3-2-2011.

TASNEEM HUSSAIN, EXAMINING ATTORNEY



David J. Kyros

Director of the United States Patent and Trademark Office

United States of America

United States Patent and Trademark Office

MURKED

Reg. No. 4,068,668

PALACIOS, ALVIN (UNITED STATES INDIVIDUAL)
142 E BONITA AVE # 187
SAN DIMAS, CA 91773

Registered Dec. 6, 2011

Int. Cl.: 25

FOR: CLOTHING, NAMELY, T-SHIRTS, CAPS, HOODED PULLOVERS, HOODED SWEATSHIRTS, SWEATSHIRTS, JACKETS, TANK TOPS, SHORTS, PANTS, BANDANAS, SOCKS, HATS, HEAD WEAR, IN CLASS 25 (U.S. CLS. 22 AND 39).

TRADEMARK

FIRST USE 7-2-2011; IN COMMERCE 7-2-2011.

PRINCIPAL REGISTER

THE MARK CONSISTS OF STANDARD CHARACTERS WITHOUT CLAIM TO ANY PARTICULAR FONT, STYLE, SIZE, OR COLOR.

SN 85-256,427, FILED 3-3-2011.

JOHN KELLY, EXAMINING ATTORNEY



David J. Kyffers

Director of the United States Patent and Trademark Office

United States of America

United States Patent and Trademark Office



Reg. No. 4,068,669

Registered Dec. 6, 2011

Int. Cls.: 35 and 36

SERVICE MARK

PRINCIPAL REGISTER

CLARFELD FINANCIAL ADVISORS, INC. (NEW YORK CORPORATION)
560 WHITE PLAINS ROAD
TARRYTOWN, NY 10591

FOR: TAX PLANNING AND PREPARATION, IN CLASS 35 (U.S. CLS. 100, 101 AND 102).

FIRST USE 9-1-2010; IN COMMERCE 9-1-2010.

FOR: PERSONAL FINANCIAL PLANNING SERVICES, INVESTMENT ADVISORY SERVICES, WEALTH MANAGEMENT SERVICES, FINANCIAL PLANNING FOR RETIREMENT, ESTATE PLANNING SERVICES, LIFE INSURANCE BROKERAGE SERVICES; ESTATE TRUST MANAGEMENT; FINANCIAL TRUST OPERATIONS; FINANCIAL RISK MANAGEMENT SERVICES; EXECUTIVE BILL PAYING SERVICES, IN CLASS 36 (U.S. CLS. 100, 101 AND 102).

FIRST USE 9-1-2011; IN COMMERCE 9-1-2011.

NO CLAIM IS MADE TO THE EXCLUSIVE RIGHT TO USE "WEALTH STRATEGISTS & FINANCIAL", APART FROM THE MARK AS SHOWN.

THE COLOR(S) GREEN, WHITE AND GRAY IS/ARE CLAIMED AS A FEATURE OF THE MARK.

THE MARK CONSISTS OF A STYLIZED WHITE DIAMOND SHAPED BOX WITH GRAY AND GREEN SHADING TO THE LEFT OF THE GREEN WORDING "CLARFELD" WRITTEN IN ALL CAPITAL LETTERS, ABOVE A THIN GREEN LINE, ABOVE THE GRAY WORDING "WEALTH STRATEGISTS & FINANCIAL CONFIDANTES". THE REMAINING WHITE REPRESENTS BACKGROUND AND DOES NOT FORM PART OF THE MARK.

SN 85-256,530, FILED 3-3-2011.

TRACY FLETCHER, EXAMINING ATTORNEY



David J. Kyjars

Director of the United States Patent and Trademark Office

United States of America

United States Patent and Trademark Office

CHEFS FEED

Reg. No. 4,068,670

Registered Dec. 6, 2011

Int. Cl.: 9

TRADEMARK

PRINCIPAL REGISTER

CREDIBLE, INC. (CALIFORNIA CORPORATION)
4TH FLOOR
11 TILLMAN PLACE
SAN FRANCISCO, CA 94108

FOR: COMPUTER APPLICATION SOFTWARE FOR MOBILE PHONES, NAMELY, SOFTWARE FOR USE IN A MOBILE DEVICE APPLICATION FOR PROVIDING RECOMMENDATIONS TO CONSUMERS REGARDING RESTAURANTS AND CUISINE, IN CLASS 9 (U.S. CLS. 21, 23, 26, 36 AND 38).

FIRST USE 1-26-2011; IN COMMERCE 9-28-2011.

THE MARK CONSISTS OF STANDARD CHARACTERS WITHOUT CLAIM TO ANY PARTICULAR FONT, STYLE, SIZE, OR COLOR.

NO CLAIM IS MADE TO THE EXCLUSIVE RIGHT TO USE "CHEFS", APART FROM THE MARK AS SHOWN.

SN 85-257,580, FILED 3-3-2011.

LINDA ESTRADA, EXAMINING ATTORNEY



David J. Kyros

Director of the United States Patent and Trademark Office

United States of America

United States Patent and Trademark Office



Reg. No. 4,068,671

Registered Dec. 6, 2011

Int. Cl.: 3

TRADEMARK

PRINCIPAL REGISTER

DE LA CRUZ G., JUAN A. (DOMINICAN REP INDIVIDUAL)
C/ 2 # 12B EL MILLÓN
SANTO DOMINGO, DOMINICAN REP 10149

FOR: COLORING PREPARATIONS FOR COSMETIC PURPOSES; COSMETIC CREAMS; HAIR COLOR REMOVERS; HAIR COLORANTS; HAIR CONDITIONERS; HAIR DYES; LOTIONS FOR COSMETIC PURPOSES; PERFUMES; SHAMPOOS, IN CLASS 3 (U.S. CLS. 1, 4, 6, 50, 51 AND 52).

FIRST USE 11-1-2007; IN COMMERCE 11-1-2007.

NO CLAIM IS MADE TO THE EXCLUSIVE RIGHT TO USE "LINE", APART FROM THE MARK AS SHOWN.

THE COLOR(S) RED, WHITE, GREEN IS/ARE CLAIMED AS A FEATURE OF THE MARK.

THE MARK CONSISTS OF THE WORD "VITALIA", IN A STYLIZED RAISED WHITE FONT; WITH A WHITE ARC EXTENDING OFF THE TOP OF THE LEADING EDGE OF THE "V"; ATTACHING TO A STYLIZED GREEN LEAF, APPEARING BEHIND THE LETTERS, "I" AND "C"; WITH A WHITE UNDERLINE OF THE "VITALIA" WORD, INTERRUPTED BY THE WORD "LINE", IN A WHITE, ITALICIZED, CURSIVE FONT ALL ON A RED BACKGROUND.

SN 85-257,724, FILED 3-4-2011.

KIMBERLY PERRY, EXAMINING ATTORNEY



David J. Kyros

Director of the United States Patent and Trademark Office

United States of America

United States Patent and Trademark Office

ZarpZ

Reg. No. 4,068,672

Registered Dec. 6, 2011

Int. Cls.: 38 and 39

SERVICE MARK

PRINCIPAL REGISTER

ZARPZ, LLC (MICHIGAN LIMITED LIABILITY COMPANY)
10326 SPRING VALLEY DRIVE
ALTO, MI 49302

FOR: DELIVERY OF MESSAGES BY ELECTRONIC TRANSMISSION; ELECTRONIC MESSAGE SENDING; ELECTRONIC TRANSMISSION OF MESSAGES; ELECTRONIC TRANSMISSION OF MESSAGES AND DATA; MESSAGE COLLECTION AND TRANSMISSION; MESSAGE SENDING AND RECEIVING SERVICES; MESSAGE SENDING VIA A WEBSITE; MESSAGE SENDING, RECEIVING AND FORWARDING; ON-LINE SERVICES, NAMELY, MESSAGE SENDING; TRANSMISSION OF MESSAGES; TRANSMISSION OF MESSAGES OVER ELECTRONIC MEDIA; WEB MESSAGING, IN CLASS 38 (U.S. CLS. 100, 101 AND 104).

FIRST USE 7-27-2011; IN COMMERCE 7-27-2011.

FOR: ELECTRONIC STORAGE OF FILES AND DOCUMENTS; ELECTRONIC STORAGE OF PRE-RECORDED MESSAGES.; MESSAGE DELIVERY; PROVIDING A WEB SITE FOR THE ELECTRONIC STORAGE OF DIGITAL PHOTOGRAPHS AND VIDEOS; STORAGE OF ELECTRONIC MEDIA, NAMELY, IMAGES, TEXT AND AUDIO DATA, IN CLASS 39 (U.S. CLS. 100 AND 105).

FIRST USE 7-27-2011; IN COMMERCE 7-27-2011.

THE MARK CONSISTS OF STANDARD CHARACTERS WITHOUT CLAIM TO ANY PARTICULAR FONT, STYLE, SIZE, OR COLOR.

SN 85-258,073, FILED 3-4-2011.

CHRISTOPHER LAW, EXAMINING ATTORNEY



David J. Kyros

Director of the United States Patent and Trademark Office

United States of America

United States Patent and Trademark Office

sasq(wash)

Reg. No. 4,068,673

Registered Dec. 6, 2011

Int. Cl.: 3

TRADEMARK

PRINCIPAL REGISTER

THERAPY SYSTEMS, INC. (TENNESSEE CORPORATION)
GENERAL COUNSEL
4015 HILLSBORO PIKE, SUITE 202
NASHVILLE, TN 37215

FOR: BODY WASH; HAIR SHAMPOOS AND CONDITIONERS; SHOWER GEL, IN CLASS
3 (U.S. CLS. 1, 4, 6, 50, 51 AND 52).

FIRST USE 9-9-2011; IN COMMERCE 9-9-2011.

THE MARK CONSISTS OF STANDARD CHARACTERS WITHOUT CLAIM TO ANY PAR-
TICULAR FONT, STYLE, SIZE, OR COLOR.

SN 85-258,479, FILED 3-4-2011.

MARILYN IZZI, EXAMINING ATTORNEY



David J. Kyffers

Director of the United States Patent and Trademark Office

United States of America

United States Patent and Trademark Office

grit happens

Reg. No. 4,068,674

Registered Dec. 6, 2011

Int. Cl.: 3

TRADEMARK

PRINCIPAL REGISTER

THERAPY SYSTEMS, INC. (TENNESSEE CORPORATION)
GENERAL COUNSEL
4015 HILLSBORO PIKE, SUITE 202
NASHVILLE, TN 37215

FOR: BODY WASH; SHOWER GEL, IN CLASS 3 (U.S. CLS. 1, 4, 6, 50, 51 AND 52).

FIRST USE 9-9-2011; IN COMMERCE 9-9-2011.

THE MARK CONSISTS OF STANDARD CHARACTERS WITHOUT CLAIM TO ANY PARTICULAR FONT, STYLE, SIZE, OR COLOR.

SN 85-258,489, FILED 3-4-2011.

MARILYN IZZI, EXAMINING ATTORNEY



David J. Kybas

Director of the United States Patent and Trademark Office

United States of America

United States Patent and Trademark Office

INCIVEK

Reg. No. 4,068,675

VERTEX PHARMACEUTICALS INCORPORATED (MASSACHUSETTS CORPORATION)
130 WAVERLY STREET
CAMBRIDGE, MA 02139

Registered Dec. 6, 2011

Int. Cl.: 5

FOR: PHARMACEUTICAL PREPARATIONS FOR THE TREATMENT OF VIRAL DISEASES,
IN CLASS 5 (U.S. CLS. 6, 18, 44, 46, 51 AND 52).

TRADEMARK

FIRST USE 5-23-2011; IN COMMERCE 5-23-2011.

PRINCIPAL REGISTER

THE MARK CONSISTS OF STANDARD CHARACTERS WITHOUT CLAIM TO ANY PAR-
TICULAR FONT, STYLE, SIZE, OR COLOR.

SN 85-259,126, FILED 3-6-2011.

SEAN CROWLEY, EXAMINING ATTORNEY



David J. Kybas

Director of the United States Patent and Trademark Office

United States of America

United States Patent and Trademark Office

TEA OF THE SEA

Reg. No. 4,068,676

Registered Dec. 6, 2011

Int. Cl.: 30

TRADEMARK

PRINCIPAL REGISTER

TEA OF THE SEA (CALIFORNIA LIMITED LIABILITY COMPANY)
315 S. COAST HWY. 101 SUITE #277
ENCINITAS, CA 92024

FOR: TEA, IN CLASS 30 (U.S. CL. 46).

FIRST USE 2-1-2010; IN COMMERCE 6-14-2011.

THE MARK CONSISTS OF STANDARD CHARACTERS WITHOUT CLAIM TO ANY PARTICULAR FONT, STYLE, SIZE, OR COLOR.

NO CLAIM IS MADE TO THE EXCLUSIVE RIGHT TO USE "TEA", APART FROM THE MARK AS SHOWN.

SN 85-259,852, FILED 3-7-2011.

JEFFREY LOOK, EXAMINING ATTORNEY



David J. Kybas

Director of the United States Patent and Trademark Office

United States of America

United States Patent and Trademark Office

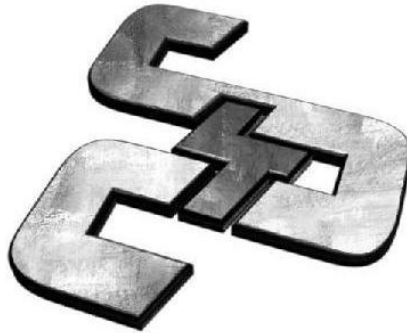

Reg. No. 4,068,677

Registered Dec. 6, 2011

Int. Cl.: 42

SERVICE MARK

PRINCIPAL REGISTER

STIX FOR CHIX, LLC (DELAWARE LIMITED LIABILITY COMPANY)
1 QUEEN ANNE LANE
HINGHAM, MA 02043

FOR: GRAPHIC ARTWORK DESIGN SERVICES IN THE FIELD OF ATHLETIC EQUIPMENT,
IN CLASS 42 (U.S. CLS. 100 AND 101).

FIRST USE 3-11-2011; IN COMMERCE 9-25-2011.

THE MARK CONSISTS OF A SERIES OF STRAIGHT AND CURVED BARS THAT ARE
CONNECTED IN THE MIDDLE WITH A GROUP OF CONNECTED ANGLES.

SN 85-260,799, FILED 3-8-2011.

HOWARD B. LEVINE, EXAMINING ATTORNEY



David J. Kybas

Director of the United States Patent and Trademark Office

United States of America

United States Patent and Trademark Office

CALL + RESPONSE

Reg. No. 4,068,678

Registered Dec. 6, 2011

Int. Cls.: 9 and 35

TRADEMARK

SERVICE MARK

PRINCIPAL REGISTER

FAIR TRADE FUND, INC. (CALIFORNIA CORPORATION)
1349 POWELL STREET
EMERYVILLE, CA 946082523

FOR: DIGITAL MATERIALS, NAMELY, DVDS, CDS, AND DOWNLOADABLE DIGITAL FILES, FEATURING INFORMATION IN THE FIELD OF HUMAN RIGHTS; MOTION PICTURE FILMS ABOUT HUMAN RIGHTS, IN CLASS 9 (U.S. CLS. 21, 23, 26, 36 AND 38).

FIRST USE 7-0-2010; IN COMMERCE 9-0-2011.

FOR: CHARITABLE SERVICES, NAMELY, ORGANIZING AND DEVELOPING PROJECTS TO PROMOTE GLOBAL AWARENESS ABOUT HUMAN RIGHTS, SLAVERY, AND HUMAN TRAFFICKING; INFORMATION SERVICES, NAMELY, PROVIDING A WEB SITE FEATURING AUDIO, VIDEO, PHOTOGRAPHIC AND TEXT PRESENTATIONS FEATURING INFORMATION PROMOTING AWARENESS OF HUMAN RIGHTS, SLAVERY AND HUMAN TRAFFICKING, IN CLASS 35 (U.S. CLS. 100, 101 AND 102).

FIRST USE 10-0-2008; IN COMMERCE 9-0-2011.

THE MARK CONSISTS OF STANDARD CHARACTERS WITHOUT CLAIM TO ANY PARTICULAR FONT, STYLE, SIZE, OR COLOR.

SN 85-260,927, FILED 3-8-2011.

MARK SHINER, EXAMINING ATTORNEY



David J. Kybas

Director of the United States Patent and Trademark Office

United States of America

United States Patent and Trademark Office

Webtec Insurance Services

Reg. No. 4,068,679

Registered Dec. 6, 2011

Int. Cl.: 36

SERVICE MARK

PRINCIPAL REGISTER

WEBTEC INSURANCE SERVICES, INC. (COLORADO CORPORATION)
P.O. BOX 3355
CAMARILLO, CA 93011

FOR: INSURANCE AGENCY SERVICES, IN CLASS 36 (U.S. CLS. 100, 101 AND 102).

FIRST USE 9-13-2011; IN COMMERCE 9-13-2011.

THE MARK CONSISTS OF STANDARD CHARACTERS WITHOUT CLAIM TO ANY PARTICULAR FONT, STYLE, SIZE, OR COLOR.

NO CLAIM IS MADE TO THE EXCLUSIVE RIGHT TO USE "INSURANCE SERVICES", APART FROM THE MARK AS SHOWN.

SN 85-260,988, FILED 3-8-2011.

KATHERINE E. HALMEN, EXAMINING ATTORNEY



David J. Kybas

Director of the United States Patent and Trademark Office

United States of America

United States Patent and Trademark Office



Reg. No. 4,068,680

KURAMO CAPITAL MANAGEMENT (DELAWARE LIMITED LIABILITY COMPANY)
500 FIFTH AVENUE, 44TH FLOOR
NEW YORK, NY 10110

Registered Dec. 6, 2011

Int. Cl.: 36

FOR: FINANCIAL ADVISORY AND CONSULTANCY SERVICES; FUNDS INVESTMENT;
INVESTMENT MANAGEMENT, IN CLASS 36 (U.S. CLS. 100, 101 AND 102).

SERVICE MARK

FIRST USE 7-1-2011; IN COMMERCE 10-4-2011.

PRINCIPAL REGISTER

NO CLAIM IS MADE TO THE EXCLUSIVE RIGHT TO USE "CAPITAL MANAGEMENT",
APART FROM THE MARK AS SHOWN.

THE MARK CONSISTS OF THE WORDING "KURAMO" PLACED ABOVE THE WORDING
"CAPITAL MANAGEMENT" IN A STYLIZED FONT. TO THE LEFT OF THE WORDING IS
A DESIGN THAT CONSISTS OF A WAVE IMAGE WITH 3 PEAKS.

THE WORDING "KURAMO" HAS NO SIGNIFICANCE OTHER THAN TRADEMARK SIGNI-
FICANCE.

SN 85-261,234, FILED 3-8-2011.

RENEE MCCRAY, EXAMINING ATTORNEY



David J. Kybas

Director of the United States Patent and Trademark Office

United States of America

United States Patent and Trademark Office

SPREEBIRD

Reg. No. 4,068,681

Registered Dec. 6, 2011

Int. Cls.: 35 and 42

SERVICE MARK

PRINCIPAL REGISTER

LOCAL.COM CORPORATION (DELAWARE CORPORATION)
7555 IRVINE CENTER DRIVE
IRVINE, CA 92618

FOR: ADVERTISING AND PROMOTIONAL SERVICES; PROMOTING THE GOODS AND SERVICES OF OTHERS BY PROVIDING A WEBSITE FEATURING DEALS, DISCOUNTS, COUPONS, REBATES, VOUCHERS, AND SPECIAL OFFERS; PROMOTING THE GOODS AND SERVICES OF OTHERS, NAMELY, COLLECTING, COMPILING, AND DISSEMINATING INFORMATION REGARDING DEALS, DISCOUNTS, COUPONS, REBATES, VOUCHERS, AND SPECIAL OFFERS FOR THE GOODS AND SERVICES OF OTHERS, IN CLASS 35 (U.S. CLS. 100, 101 AND 102).

FIRST USE 5-2-2011; IN COMMERCE 8-2-2011.

FOR: COMPUTER SERVICES, NAMELY, CREATING AN ON-LINE COMMUNITY FOR USERS TO ORGANIZE AND PARTICIPATE IN DISCUSSIONS, GET FEEDBACK FROM THEIR PEERS, AND PROVIDE RATINGS AND REVIEWS OF GOODS AND SERVICES FOR PEERS, FORM VIRTUAL COMMUNITIES, AND ENGAGE IN SOCIAL NETWORKING, IN CLASS 42 (U.S. CLS. 100 AND 101).

FIRST USE 5-2-2011; IN COMMERCE 8-2-2011.

THE MARK CONSISTS OF STANDARD CHARACTERS WITHOUT CLAIM TO ANY PARTICULAR FONT, STYLE, SIZE, OR COLOR.

SN 85-261,391, FILED 3-8-2011.

RON FAIRBANKS, EXAMINING ATTORNEY



David J. Kyros

Director of the United States Patent and Trademark Office

United States of America

United States Patent and Trademark Office

ESOL

Reg. No. 4,068,682

Registered Dec. 6, 2011

Int. Cl.: 26

TRADEMARK

PRINCIPAL REGISTER

BRAND I.D., LLC (CALIFORNIA LIMITED LIABILITY COMPANY)
3198 F AIRPORT LOOP DRIVE
COSTA MESA, CA 92626

FOR: ZIPPERS, IN CLASS 26 (U.S. CLS. 37, 39, 40, 42 AND 50).

FIRST USE 7-0-2011; IN COMMERCE 9-8-2011.

THE MARK CONSISTS OF STANDARD CHARACTERS WITHOUT CLAIM TO ANY PARTICULAR FONT, STYLE, SIZE, OR COLOR.

THE WORDING "ESOL" HAS NO MEANING IN A FOREIGN LANGUAGE.

SN 85-261,404, FILED 3-8-2011.

JOHN DWYER, EXAMINING ATTORNEY



David J. Kybas

Director of the United States Patent and Trademark Office

United States of America

United States Patent and Trademark Office

HEART OF POMEGRANATE COUNTRY

Reg. No. 4,068,683

Registered Dec. 6, 2011

Int. Cl.: 35

SERVICE MARK

PRINCIPAL REGISTER

MADERA DISTRICT CHAMBER OF COMMERCE (CALIFORNIA CORPORATION)
120 NORTH E STREET
MADERA, CA 93638

FOR: CHAMBER OF COMMERCE SERVICES, NAMELY, PROMOTING BUSINESS AND TOURISM IN THE MADERA COUNTY, CALIFORNIA AREA, IN CLASS 35 (U.S. CLS. 100, 101 AND 102).

FIRST USE 5-17-2011; IN COMMERCE 5-17-2011.

THE MARK CONSISTS OF STANDARD CHARACTERS WITHOUT CLAIM TO ANY PARTICULAR FONT, STYLE, SIZE, OR COLOR.

SN 85-261,569, FILED 3-8-2011.

DOUGLAS LEE, EXAMINING ATTORNEY



David J. Kyffers

Director of the United States Patent and Trademark Office

United States of America

United States Patent and Trademark Office



Reg. No. 4,068,684

Registered Dec. 6, 2011

Int. Cl.: 12

TRADEMARK

PRINCIPAL REGISTER

TUF RACK INC. (CANADA CORPORATION)
29-775 PACIFIC ROAD
OAKVILLE, ONTARIO, CANADA L6L6M4

FOR: BICYCLE CARRIERS FOR VEHICLES AND PARTS THEREOF, IN CLASS 12 (U.S. CLS. 19, 21, 23, 31, 35 AND 44).

FIRST USE 6-8-2011; IN COMMERCE 6-8-2011.

THE MARK CONSISTS OF THE INITIALS "T R", WITH THE LETTER "T" BEING FORMED BY A DEPICTION OF A MALLET. THE INITIALS ARE SURROUNDED BY A CIRCLE FORMED BY DASHED LINES.

SN 85-261,791, FILED 3-9-2011.

JOHN WILKE, EXAMINING ATTORNEY



David J. Kybas

Director of the United States Patent and Trademark Office

United States of America

United States Patent and Trademark Office

PRO ROTO

Reg. No. 4,068,685

Registered Dec. 6, 2011

Int. Cl.: 37

SERVICE MARK

PRINCIPAL REGISTER

PRO ROTO, INC. (CALIFORNIA CORPORATION)
704 CASSIA
REDWOOD CITY, CA 94063

FOR: PLUMBING CONTRACTOR SERVICES, IN CLASS 37 (U.S. CLS. 100, 103 AND 106).

FIRST USE 5-9-2009; IN COMMERCE 5-9-2009.

THE MARK CONSISTS OF STANDARD CHARACTERS WITHOUT CLAIM TO ANY PARTICULAR FONT, STYLE, SIZE, OR COLOR.

SN 85-261,957, FILED 3-9-2011.

DOMINIC J. FERRAIUOLO, EXAMINING ATTORNEY



David J. Kyffers

Director of the United States Patent and Trademark Office

United States of America

United States Patent and Trademark Office

OCEAN BURST

Reg. No. 4,068,686

Registered Dec. 6, 2011

Int. Cl.: 3

TRADEMARK

PRINCIPAL REGISTER

BEIERSDORF AG (FED REP GERMANY JOINT STOCK COMPANY)
UNNASTRASSE 48
HAMBURG, FED REP GERMANY 20253

FOR: COSMETIC HAIR AND BODY WASH, IN CLASS 3 (U.S. CLS. 1, 4, 6, 50, 51 AND 52).

FIRST USE 1-0-2011; IN COMMERCE 1-0-2011.

THE MARK CONSISTS OF STANDARD CHARACTERS WITHOUT CLAIM TO ANY PARTICULAR FONT, STYLE, SIZE, OR COLOR.

SN 85-262,420, FILED 3-9-2011.

JACQUELINE A. LAVINE, EXAMINING ATTORNEY



David J. Kybas

Director of the United States Patent and Trademark Office

United States of America

United States Patent and Trademark Office

HILLYARD CONNECT

Reg. No. 4,068,687

Registered Dec. 6, 2011

Int. Cl.: 21

TRADEMARK

PRINCIPAL REGISTER

HILLYARD ENTERPRISES, INC. (MISSOURI CORPORATION)
302 NORTH FOURTH STREET
SAINT JOSEPH, MO 64502

FOR: MANUALLY ACTUATED PUMP DISPENSERS FOR ATTACHMENT TO CONTAINERS FOR USE IN DILUTING AND DISPENSING LIQUIDS, IN CLASS 21 (U.S. CLS. 2, 13, 23, 29, 30, 33, 40 AND 50).

FIRST USE 7-14-2011; IN COMMERCE 7-14-2011.

THE MARK CONSISTS OF STANDARD CHARACTERS WITHOUT CLAIM TO ANY PARTICULAR FONT, STYLE, SIZE, OR COLOR.

SN 85-262,640, FILED 3-9-2011.

CYNTHIA TRIPI, EXAMINING ATTORNEY



David J. Kyros

Director of the United States Patent and Trademark Office

United States of America

United States Patent and Trademark Office

The Middle class Movement Financial Education for the Rest of Us

Reg. No. 4,068,688

Registered Dec. 6, 2011

Int. Cl.: 41

SERVICE MARK

PRINCIPAL REGISTER

BF8TH HOLDINGS, INC (CALIFORNIA CORPORATION)
10940 TRINITY PARKWAY SUITE C-153
STOCKTON, CA 95219

FOR: EDUCATION SERVICES, NAMELY, PROVIDING SEMINARS, WORKSHOPS, AND WEBINARS IN THE FIELD OF FINANCIAL LITERACY; EDUCATIONAL SERVICES, NAMELY, PROVIDING EDUCATIONAL SPEAKERS IN THE FIELD OF FINANCIAL LITERACY; ENTERTAINMENT, NAMELY, A CONTINUING NEWS SHOW BROADCAST OVER TELEVISION, RADIO, AND INTERNET, IN CLASS 41 (U.S. CLS. 100, 101 AND 107).

FIRST USE 7-23-2009; IN COMMERCE 7-23-2009.

THE MARK CONSISTS OF STANDARD CHARACTERS WITHOUT CLAIM TO ANY PARTICULAR FONT, STYLE, SIZE, OR COLOR.

SN 85-262,761, FILED 3-9-2011.

CHRISTINE COOPER, EXAMINING ATTORNEY



David J. Kybas

Director of the United States Patent and Trademark Office

United States of America

United States Patent and Trademark Office

Laser Show Dynamic

Reg. No. 4,068,689

SCHOTT, SAMUEL (UNITED STATES INDIVIDUAL)
822 OAK TREE DR.
CHATTANOOGA, TN 37415

Registered Dec. 6, 2011

Int. Cl.: 41

FOR: ENTERTAINMENT IN THE NATURE OF LASER SHOWS, IN CLASS 41 (U.S. CLS. 100, 101 AND 107).

SERVICE MARK

FIRST USE 11-15-2009; IN COMMERCE 11-20-2009.

PRINCIPAL REGISTER

THE MARK CONSISTS OF STANDARD CHARACTERS WITHOUT CLAIM TO ANY PARTICULAR FONT, STYLE, SIZE, OR COLOR.

NO CLAIM IS MADE TO THE EXCLUSIVE RIGHT TO USE "LASER SHOW", APART FROM THE MARK AS SHOWN.

SN 85-262,821, FILED 3-9-2011.

MARIA-VICTORIA SUAREZ, EXAMINING ATTORNEY



David J. Kybas

Director of the United States Patent and Trademark Office

United States of America

United States Patent and Trademark Office

FOCAL POINT

Reg. No. 4,068,690

Registered Dec. 6, 2011

Int. Cl.: 5

TRADEMARK

PRINCIPAL REGISTER

HEALTHY DIRECTIONS, LLC (DELAWARE LIMITED LIABILITY COMPANY)
7811 MONTROSE ROAD
POTOMAC, MD 20854

FOR: NUTRITIONAL SUPPLEMENTS, IN CLASS 5 (U.S. CLS. 6, 18, 44, 46, 51 AND 52).

FIRST USE 1-1-2011; IN COMMERCE 1-1-2011.

THE MARK CONSISTS OF STANDARD CHARACTERS WITHOUT CLAIM TO ANY PARTICULAR FONT, STYLE, SIZE, OR COLOR.

SN 85-263,575, FILED 3-10-2011.

STEVEN JACKSON, EXAMINING ATTORNEY



David J. Kybas

Director of the United States Patent and Trademark Office

United States of America

United States Patent and Trademark Office

LIBERTY BURGER

Reg. No. 4,068,691

LIBERTY BURGERS, INC. (TEXAS CORPORATION)
3604 OAK LAWN
DALLAS, TX 75219

Registered Dec. 6, 2011

Int. Cl.: 43

FOR: RESTAURANT AND BAR SERVICES, INCLUDING RESTAURANT CARRYOUT SERVICES, IN CLASS 43 (U.S. CLS. 100 AND 101).

SERVICE MARK

FIRST USE 7-1-2010; IN COMMERCE 3-10-2011.

PRINCIPAL REGISTER

THE MARK CONSISTS OF STANDARD CHARACTERS WITHOUT CLAIM TO ANY PARTICULAR FONT, STYLE, SIZE, OR COLOR.

NO CLAIM IS MADE TO THE EXCLUSIVE RIGHT TO USE "BURGER", APART FROM THE MARK AS SHOWN.

SN 85-263,584, FILED 3-10-2011.

WANDA KAY PRICE, EXAMINING ATTORNEY



David J. Kybas

Director of the United States Patent and Trademark Office

United States of America

United States Patent and Trademark Office



Reg. No. 4,068,692

Registered Dec. 6, 2011

Int. Cl.: 25

TRADEMARK

PRINCIPAL REGISTER

ASICS CORPORATION (JAPAN CORPORATION)
1-1, MINATOJIMA-NAKAMACHI 7-CHOME
CHUO-KU, KOBE, JAPAN 650-8555

FOR: FOOTWEAR, IN CLASS 25 (U.S. CLS. 22 AND 39).

FIRST USE 7-1-2011; IN COMMERCE 7-1-2011.

OWNER OF U.S. REG. NOS. 1,768,724, 3,305,197, AND OTHERS.

THE MARK CONSISTS OF THE STYLIZED NUMBER "33" WITH THE WORDING "BY ASICS".

SN 85-263,684, FILED 3-10-2011.

DANNEAN HETZEL, EXAMINING ATTORNEY



David J. Kyros

Director of the United States Patent and Trademark Office

United States of America

United States Patent and Trademark Office

A Playground For Your Brain

Reg. No. 4,068,693

Registered Dec. 6, 2011

Int. Cl.: 41

SERVICE MARK

PRINCIPAL REGISTER

CHILDRENS MUSEUM OF SANTA BARBARA (CALIFORNIA CORPORATION)
410 ALAMEDA PADRE SERRA
SANTA BARBARA, CA 93103

FOR: MUSEUMS, IN CLASS 41 (U.S. CLS. 100, 101 AND 107).

FIRST USE 8-1-2010; IN COMMERCE 8-1-2010.

THE MARK CONSISTS OF STANDARD CHARACTERS WITHOUT CLAIM TO ANY PARTICULAR FONT, STYLE, SIZE, OR COLOR.

SN 85-264,805, FILED 3-11-2011.

WENDY JUN, EXAMINING ATTORNEY



David J. Kybas

Director of the United States Patent and Trademark Office

United States of America

United States Patent and Trademark Office

BLANKZ

Reg. No. 4,068,694

Registered Dec. 6, 2011

Int. Cl.: 28

TRADEMARK

PRINCIPAL REGISTER

ALWAYS BEEN CREATIVE, INC. (NEW YORK CORPORATION)
17 WILDWOOD GARDENS / SUITE 1A
PORT WASHINGTON, NY 11050

FOR: CHILDREN'S MULTIPLE ACTIVITY TOYS; DRAWING TOYS; FANTASY CHARACTER TOYS; PARTY FAVORS IN THE NATURE OF SMALL TOYS; PLUSH TOYS; PRINTING TOYS; STUFFED AND PLUSH TOYS; STUFFED TOY ANIMALS; STUFFED TOY BEARS; STUFFED TOYS; TOYS, NAMELY, PUPPETS AND ACCESSORIES THEREFOR, IN CLASS 28 (U.S. CLS. 22, 23, 38 AND 50).

FIRST USE 1-20-2011; IN COMMERCE 3-1-2011.

THE MARK CONSISTS OF STANDARD CHARACTERS WITHOUT CLAIM TO ANY PARTICULAR FONT, STYLE, SIZE, OR COLOR.

SN 85-264,907, FILED 3-11-2011.

MAYUR VAGHANI, EXAMINING ATTORNEY



David J. Kybas

Director of the United States Patent and Trademark Office

United States of America
United States Patent and Trademark Office

CARAVAN

Reg. No. 4,068,695

Registered Dec. 6, 2011

Int. Cl.: 11

TRADEMARK

PRINCIPAL REGISTER

KOHLER CO. (WISCONSIN CORPORATION)
444 HIGHLAND DRIVE
KOHLER, WI 53044

FOR: LAVATORIES, IN CLASS 11 (U.S. CLS. 13, 21, 23, 31 AND 34).

FIRST USE 4-30-2011; IN COMMERCE 4-30-2011.

THE MARK CONSISTS OF STANDARD CHARACTERS WITHOUT CLAIM TO ANY PARTICULAR FONT, STYLE, SIZE, OR COLOR.

SN 85-265,780, FILED 3-14-2011.

STEVEN JACKSON, EXAMINING ATTORNEY



David J. Kybas

Director of the United States Patent and Trademark Office

United States of America

United States Patent and Trademark Office

THE RIGHT REASONS

Reg. No. 4,068,696

Registered Dec. 6, 2011

Int. Cl.: 41

SERVICE MARK

PRINCIPAL REGISTER

ADAM COZZINI (UNITED STATES INDIVIDUAL)
3400 NORTH LAKE SHORE DRIVE, SUITE 5A
CHICAGO, IL 60657

FOR: ENTERTAINMENT, NAMELY, LIVE PERFORMANCES BY MUSICAL BANDS, IN CLASS 41 (U.S. CLS. 100, 101 AND 107).

FIRST USE 9-16-2011; IN COMMERCE 9-16-2011.

THE MARK CONSISTS OF STANDARD CHARACTERS WITHOUT CLAIM TO ANY PARTICULAR FONT, STYLE, SIZE, OR COLOR.

SN 85-266,378, FILED 3-14-2011.

LINDA ESTRADA, EXAMINING ATTORNEY



David J. Kybas

Director of the United States Patent and Trademark Office

United States of America

United States Patent and Trademark Office

WE SPEAK SUCCESS

Reg. No. 4,068,697

Registered Dec. 6, 2011

Int. Cl.: 43

SERVICE MARK

PRINCIPAL REGISTER

HLT DOMESTIC IP LLC (DELAWARE LIMITED LIABILITY COMPANY)
7930 JONES BRANCH DRIVE, SUITE 1100
MCLEAN, VA 22102

FOR: HOTEL SERVICES, IN CLASS 43 (U.S. CLS. 100 AND 101).

FIRST USE 6-30-2011; IN COMMERCE 6-30-2011.

THE MARK CONSISTS OF STANDARD CHARACTERS WITHOUT CLAIM TO ANY PARTICULAR FONT, STYLE, SIZE, OR COLOR.

SN 85-266,566, FILED 3-14-2011.

ANGELA DUONG, EXAMINING ATTORNEY



David J. Kybas

Director of the United States Patent and Trademark Office

United States of America

United States Patent and Trademark Office

LA BELLE VIE COSMETIC SURGERY CENTERS

Reg. No. 4,068,698

Registered Dec. 6, 2011

Int. Cl.: 44

SERVICE MARK

PRINCIPAL REGISTER

TOTAL HEALTH MEDICAL INSTITUTE LLC (WASHINGTON LIMITED LIABILITY COMPANY)
16400 SOUTHCENTER PKWY, SUITE 101
TUKWILA, WA 98188

FOR: COSMETIC AND PLASTIC SURGERY, IN CLASS 44 (U.S. CLS. 100 AND 101).

FIRST USE 4-0-2011; IN COMMERCE 4-0-2011.

THE MARK CONSISTS OF STANDARD CHARACTERS WITHOUT CLAIM TO ANY PARTICULAR FONT, STYLE, SIZE, OR COLOR.

NO CLAIM IS MADE TO THE EXCLUSIVE RIGHT TO USE "COSMETIC SURGERY CENTERS", APART FROM THE MARK AS SHOWN.

THE ENGLISH TRANSLATION OF "LA BELLE VIE" IN THE MARK IS "BEAUTIFUL LIFE".

SN 85-266,956, FILED 3-15-2011.

IRA J. GOODSID, EXAMINING ATTORNEY



David J. Kyros

Director of the United States Patent and Trademark Office

United States of America

United States Patent and Trademark Office

State Farm Nation Rewards

Reg. No. 4,068,699

Registered Dec. 6, 2011

Int. Cl.: 35

SERVICE MARK

PRINCIPAL REGISTER

STATE FARM MUTUAL AUTOMOBILE INSURANCE COMPANY (ILLINOIS CORPORATION)

A-3
ONE STATE FARM PLAZA
BLOOMINGTON, IL 61710

FOR: PROVIDING AN INCENTIVE AWARD PROGRAM FOR CUSTOMERS OF INSURANCE AND FINANCIAL SERVICES THAT ENABLES PARTICIPANTS TO OBTAIN DISCOUNTS ON GOODS OR SERVICES OF OTHERS, IN CLASS 35 (U.S. CLS. 100, 101 AND 102).

FIRST USE 3-29-2011; IN COMMERCE 3-29-2011.

THE MARK CONSISTS OF STANDARD CHARACTERS WITHOUT CLAIM TO ANY PARTICULAR FONT, STYLE, SIZE, OR COLOR.

OWNER OF U.S. REG. NOS. 2,198,246, 3,945,538, AND OTHERS.

NO CLAIM IS MADE TO THE EXCLUSIVE RIGHT TO USE "REWARDS", APART FROM THE MARK AS SHOWN.

SN 85-267,058, FILED 3-15-2011.

ELISSA GARBER KON, EXAMINING ATTORNEY



David J. Kybas

Director of the United States Patent and Trademark Office

United States of America

United States Patent and Trademark Office

Ecomaniacs

Reg. No. 4,068,700

Registered Dec. 6, 2011

Int. Cls.: 9, 16, and 40

TRADEMARK

SERVICE MARK

PRINCIPAL REGISTER

MILLENNIUM RECYCLING, INC. (SOUTH DAKOTA CORPORATION)
305 E 50TH STREET NORTH
SIOUX FALLS, SD 57104

FOR: ELECTRONIC DOWNLOADABLE PUBLICATIONS, NAMELY, MAGAZINES, NEWSLETTERS, BROCHURES AND PAMPHLETS ENCOURAGING RECYCLING, IN CLASS 9 (U.S. CLS. 21, 23, 26, 36 AND 38).

FIRST USE 5-1-2011; IN COMMERCE 5-1-2011.

FOR: PROVIDING PRINTED MATERIALS IN THE NATURE OF MAGAZINES, NEWSLETTERS, BROCHURES AND PAMPHLETS ENCOURAGING RECYCLING, IN CLASS 16 (U.S. CLS. 2, 5, 22, 23, 29, 37, 38 AND 50).

FIRST USE 5-1-2011; IN COMMERCE 5-1-2011.

FOR: PROVIDING A WEBSITE FEATURING INFORMATION ENCOURAGING RECYCLING, IN CLASS 40 (U.S. CLS. 100, 103 AND 106).

FIRST USE 5-1-2011; IN COMMERCE 5-1-2011.

THE MARK CONSISTS OF STANDARD CHARACTERS WITHOUT CLAIM TO ANY PARTICULAR FONT, STYLE, SIZE, OR COLOR.

SN 85-267,059, FILED 3-15-2011.

MIDGE BUTLER, EXAMINING ATTORNEY



David J. Kypos

Director of the United States Patent and Trademark Office

United States of America

United States Patent and Trademark Office

Zip Tanz

Reg. No. 4,068,701

POYE FLORIDA (FLORIDA CORPORATION)
8950 FONTANA DEL SOL #100
NAPLES, FL 34109

Registered Dec. 6, 2011

Int. Cl.: 44

FOR: TANNING SALONS, IN CLASS 44 (U.S. CLS. 100 AND 101).

SERVICE MARK

FIRST USE 9-1-2011; IN COMMERCE 9-10-2011.

PRINCIPAL REGISTER

THE MARK CONSISTS OF STANDARD CHARACTERS WITHOUT CLAIM TO ANY PARTICULAR FONT, STYLE, SIZE, OR COLOR.

NO CLAIM IS MADE TO THE EXCLUSIVE RIGHT TO USE "TANS", APART FROM THE MARK AS SHOWN.

SN 85-268,329, FILED 3-16-2011.

AISHA SALEM, EXAMINING ATTORNEY



David J. Kyros

Director of the United States Patent and Trademark Office

United States of America

United States Patent and Trademark Office



Reg. No. 4,068,702

Registered Dec. 6, 2011

Int. Cl.: 19

TRADEMARK

PRINCIPAL REGISTER

SINGH, GURJEET (MALAYSIA INDIVIDUAL)
LEVEL 8, WISMA GENERAL LUMBER, BLOCK D
SHAH ALAM, SELANGOR, MALAYSIA 40150

FOR: ENGINEERED HARDWOOD FLOORING; PARQUET WOOD FLOORING; WOODEN FLOORING, IN CLASS 19 (U.S. CLS. 1, 12, 33 AND 50).

FIRST USE 4-12-2009; IN COMMERCE 4-12-2009.

NO CLAIM IS MADE TO THE EXCLUSIVE RIGHT TO USE "PARQUETRY", APART FROM THE MARK AS SHOWN.

THE COLOR(S) BROWN, WHITE, AND BLACK IS/ARE CLAIMED AS A FEATURE OF THE MARK.

THE MARK CONSISTS OF THE WORD, "WOODLINE", NEXT TO AND STAGGERED ABOVE THE WORD, "PARQUETRY", BOTH IN WHITE STYLISTIC LETTERS; ABOVE GROUPINGS OF BROWN VERTICAL PARALLEL LINES APPEARING THROUGH THE TOP OF "WOODLINE" AND THROUGH THE BOTTOM OF "PARQUETRY"; WITH MIRROR IMAGES OF STYLISTIC BROWN SEA SHELLS; ALL AGAINST A BLACK BACKGROUND.

SN 85-269,128, FILED 3-17-2011.

JOHN DWYER, EXAMINING ATTORNEY



David J. Kyros

Director of the United States Patent and Trademark Office

United States of America

United States Patent and Trademark Office

FLUSH. AND DONE.

Reg. No. 4,068,703

Registered Dec. 6, 2011

Int. Cl.: 11

TRADEMARK

PRINCIPAL REGISTER

KOHLER CO. (WISCONSIN CORPORATION)
444 HIGHLAND DRIVE
KOHLER, WI 53044

FOR: TOILETS, IN CLASS 11 (U.S. CLS. 13, 21, 23, 31 AND 34).

FIRST USE 9-30-2011; IN COMMERCE 9-30-2011.

THE MARK CONSISTS OF STANDARD CHARACTERS WITHOUT CLAIM TO ANY PARTICULAR FONT, STYLE, SIZE, OR COLOR.

SN 85-269,257, FILED 3-17-2011.

ANNE FARRELL, EXAMINING ATTORNEY



David J. Kybas

Director of the United States Patent and Trademark Office

United States of America

United States Patent and Trademark Office

"Chase The Cure"

Reg. No. 4,068,704

Registered Dec. 6, 2011

Int. Cl.: 25

TRADEMARK

PRINCIPAL REGISTER

IKE GOURDINE (UNITED STATES INDIVIDUAL)
33 W. PRICE ST.
LINDEN, NJ 07036

FOR: T-SHIRTS, HATS, CAPS, SWEATERS, SWEAT JACKETS, UNDER GARMENTS, SOCKS, HOODED SWEAT SHIRTS, BRAS, HEADBANDS, WRISTBANDS, JEANS, TIGHTS, STOCKINGS AND LEGGINGS, IN CLASS 25 (U.S. CLS. 22 AND 39).

FIRST USE 2-6-1997; IN COMMERCE 3-17-1997.

THE MARK CONSISTS OF STANDARD CHARACTERS WITHOUT CLAIM TO ANY PARTICULAR FONT, STYLE, SIZE, OR COLOR.

SN 85-269,292, FILED 3-17-2011.

BRENDAN MCCAULEY, EXAMINING ATTORNEY



David J. Kyros

Director of the United States Patent and Trademark Office

United States of America

United States Patent and Trademark Office

Me & My Money

Reg. No. 4,068,705

MYFINANCE, LLC (MINNESOTA LIMITED LIABILITY COMPANY)
5049 GREEN FARMS RD
EDINA, MN 55435

Registered Dec. 6, 2011

Int. Cls.: 36, 41, and 42

FOR: FINANCIAL CONSULTATION IN THE FIELD OF PERSONAL FINANCIAL MANAGEMENT AND MONETARY AFFAIRS EDUCATION; FINANCIAL COUNSELING SERVICES, NAMELY, HELPING OTHERS BUILD A BETTER WORKING RELATIONSHIP WITH THEIR MONEY, IN CLASS 36 (U.S. CLS. 100, 101 AND 102).

SERVICE MARK

PRINCIPAL REGISTER

FIRST USE 9-13-2011; IN COMMERCE 9-13-2011.

FOR: EDUCATIONAL SERVICES, NAMELY, CONDUCTING ON LINE AND TELEPHONIC INSTRUCTION AND COURSES IN THE FIELD PERSONAL FINANCIAL MANAGEMENT, PERSONAL FINANCIAL PRODUCTS, AND PERSONAL FINANCIAL SERVICES; INSTRUCTION IN THE FIELD OF PERSONAL FINANCIAL MANAGEMENT, PERSONAL FINANCIAL PRODUCTS, AND PERSONAL FINANCIAL SERVICES; PERSONAL COACHING SERVICES IN THE FIELD OF PERSONAL FINANCIAL MANAGEMENT, PERSONAL FINANCIAL PRODUCTS, AND PERSONAL FINANCIAL SERVICES, IN CLASS 41 (U.S. CLS. 100, 101 AND 107).

FIRST USE 9-13-2011; IN COMMERCE 9-13-2011.

FOR: PROVIDING A WEBSITE FEATURING RESOURCES, NAMELY, NON-DOWNLOADABLE SOFTWARE FOR EDUCATION AND COACHING RELATED TO PERSONAL FINANCIAL MANAGEMENT, PERSONAL FINANCIAL PRODUCTS, AND PERSONAL FINANCIAL SERVICES, IN CLASS 42 (U.S. CLS. 100 AND 101).

FIRST USE 9-13-2011; IN COMMERCE 9-13-2011.

THE MARK CONSISTS OF STANDARD CHARACTERS WITHOUT CLAIM TO ANY PARTICULAR FONT, STYLE, SIZE, OR COLOR.

NO CLAIM IS MADE TO THE EXCLUSIVE RIGHT TO USE "MONEY", APART FROM THE MARK AS SHOWN.

SN 85-269,807, FILED 3-17-2011.



David J. Kyros

Director of the United States Patent and Trademark Office

Reg. No. 4,068,705 PAUL F. GAST, EXAMINING ATTORNEY

United States of America

United States Patent and Trademark Office

BrainyHistory

Reg. No. 4,068,706

Registered Dec. 6, 2011

Int. Cl.: 9

TRADEMARK

PRINCIPAL REGISTER

XPLORE, INC (DELAWARE CORPORATION)
4409 KNIGHTSBRIDGE DRIVE
MCKINNEY, TX 75070

FOR: PROVIDING AN ONLINE COMPUTER DATABASE IN THE FIELD OF EDUCATION AND ENTERTAINMENT FEATURING HISTORICAL INFORMATION AND BIRTHDATES, IN CLASS 9 (U.S. CLS. 21, 23, 26, 36 AND 38).

FIRST USE 12-1-2001; IN COMMERCE 12-1-2001.

THE MARK CONSISTS OF STANDARD CHARACTERS WITHOUT CLAIM TO ANY PARTICULAR FONT, STYLE, SIZE, OR COLOR.

SN 85-270,032, FILED 3-17-2011.

LAURA KOVALSKY, EXAMINING ATTORNEY



David J. Kybas

Director of the United States Patent and Trademark Office

United States of America

United States Patent and Trademark Office

SOY - WHAT FOOD GETS FED

Reg. No. 4,068,707

ILLINOIS SOYBEAN ASSOCIATION (ILLINOIS CORPORATION)
1605 COMMERCE PARKWAY
BLOOMINGTON, IL 61704

Registered Dec. 6, 2011

Int. Cl.: 35

FOR: PROMOTING PUBLIC AWARENESS OF THE ROLE OF SOYBEANS IN FOOD PRODUCTION, IN CLASS 35 (U.S. CLS. 100, 101 AND 102).

SERVICE MARK

FIRST USE 6-21-2011; IN COMMERCE 10-13-2011.

PRINCIPAL REGISTER

THE MARK CONSISTS OF STANDARD CHARACTERS WITHOUT CLAIM TO ANY PARTICULAR FONT, STYLE, SIZE, OR COLOR.

NO CLAIM IS MADE TO THE EXCLUSIVE RIGHT TO USE "SOY", APART FROM THE MARK AS SHOWN.

SN 85-270,898, FILED 3-18-2011.

COLLEEN KEARNEY, EXAMINING ATTORNEY



David J. Kybas

Director of the United States Patent and Trademark Office

United States of America

United States Patent and Trademark Office

LEGALHUB.COM

Reg. No. 4,068,708

Registered Dec. 6, 2011

Int. Cls.: 35, 42, and 45

SERVICE MARK

PRINCIPAL REGISTER

LEGAL HUB, LLC (NORTH CAROLINA LIMITED LIABILITY COMPANY)
3201 B NORTH DAVIDSON STREET
CHARLOTTE, NC 28205

FOR: PROVIDING AN ONLINE SEARCHABLE AND INTERACTIVE DATABASE OF BUSINESS CONTACTS IN THE FIELD OF LAW, FOR USE BY ATTORNEYS, THEIR CLIENTS AND PROSPECTIVE CLIENTS; PROVIDING AN ONLINE SEARCHABLE AND INTERACTIVE DATABASE OF BUSINESS CONTACTS IN THE FIELD OF LAW, FOR USE BY ATTORNEYS, THEIR CLIENTS AND PROSPECTIVE CLIENTS, WHICH ALLOWS PROSPECTIVE CLIENTS TO SEARCH FOR ATTORNEYS BASED ON PARTICULAR CRITERIA; PROVIDING A WEBSITE WHERE USERS CAN POST RATINGS, REVIEWS AND RECOMMENDATIONS ON COMMERCIAL LEGAL SERVICES; PROVIDING ONLINE LAWYER REFERRALS; PROVIDING ON-LINE PROFESSIONAL NETWORKING OPPORTUNITIES FOR LAWYERS; PROVIDING AN ONLINE DIRECTORY OF LAWYERS FOR USE BY PEERS, CLIENTS AND PROSPECTIVE CLIENTS, IN CLASS 35 (U.S. CLS. 100, 101 AND 102).

FIRST USE 5-25-2010; IN COMMERCE 6-15-2010.

FOR: CREATING AN ON-LINE COMMUNITY FOR LAWYERS, CLIENTS AND PROSPECTIVE CLIENTS TO PARTICIPATE IN DISCUSSIONS, GIVING AND RECEIVING ADVICE AND RECOMMENDATIONS, REFERRALS AND RATINGS; COMPUTER SERVICES, NAMELY, CREATING AN ONLINE COMMUNITY FOR REGISTERED USERS TO EXCHANGE INFORMATION AND ENGAGE IN SOCIAL NETWORKING; PROVIDING A WEBSITE FOR LAWYERS FEATURING TECHNOLOGY THAT ENABLES USERS TO SHARE PRACTICE MANAGEMENT TOOLS IN THE NATURE OF CALENDARS IN THE FIELD OF LAW; PROVIDING AN INTERACTIVE WEBSITE FEATURING TECHNOLOGY THAT ALLOWS ATTORNEY USERS TO SHARE WORK PRODUCT, CASE RESULTS, CASE ACTIVITY ADVICE, OPINIONS, CASE STATUS UPDATES, AND BIOGRAPHICAL DATA WITH OTHER LAWYERS, CLIENTS AND PROSPECTIVE CLIENTS, IN CLASS 42 (U.S. CLS. 100 AND 101).

FIRST USE 5-25-2010; IN COMMERCE 6-15-2010.

FOR: PROVIDING A SOCIAL NETWORKING WEBSITE FOR LAWYERS, IN CLASS 45 (U.S. CLS. 100 AND 101).

FIRST USE 5-25-2010; IN COMMERCE 6-15-2010.



David J. Kyjars

Director of the United States Patent and Trademark Office

Reg. No. 4,068,708 THE MARK CONSISTS OF STANDARD CHARACTERS WITHOUT CLAIM TO ANY PARTICULAR FONT, STYLE, SIZE, OR COLOR.

SN 85-271,038, FILED 3-18-2011.

COLLEEN KEARNEY, EXAMINING ATTORNEY

United States of America

United States Patent and Trademark Office

ADVANCE AUTO PARTS

Reg. No. 4,068,709

Registered Dec. 6, 2011

Int. Cl.: 4

TRADEMARK

PRINCIPAL REGISTER

ADVANCE AUTO INNOVATIONS LLC (VIRGINIA LIMITED LIABILITY COMPANY)
5008 AIRPORT ROAD
ROANOKE, VA 24012

FOR: LUBRICATING OILS AND GREASES, IN CLASS 4 (U.S. CLS. 1, 6 AND 15).

FIRST USE 9-0-2011; IN COMMERCE 9-0-2011.

THE MARK CONSISTS OF STANDARD CHARACTERS WITHOUT CLAIM TO ANY PARTICULAR FONT, STYLE, SIZE, OR COLOR.

OWNER OF U.S. REG. NOS. 1,815,267, 3,628,525, AND OTHERS.

NO CLAIM IS MADE TO THE EXCLUSIVE RIGHT TO USE "AUTO PARTS", APART FROM THE MARK AS SHOWN.

SN 85-272,327, FILED 3-21-2011.

ANDREA HACK, EXAMINING ATTORNEY



David J. Kybas

Director of the United States Patent and Trademark Office

United States of America

United States Patent and Trademark Office

RED HEART SUPER TWEED

Reg. No. 4,068,710

Registered Dec. 6, 2011

Int. Cl.: 23

TRADEMARK

PRINCIPAL REGISTER

J. & P. COATS, LIMITED (UNITED KINGDOM COMPANY)
1 GEORGE SQUARE
GLASGOW, SCOTLAND G21AL

FOR: YARNS FOR KNITTING AND CROCHETING, IN CLASS 23 (U.S. CL. 43).

FIRST USE 6-6-2011; IN COMMERCE 6-6-2011.

THE MARK CONSISTS OF STANDARD CHARACTERS WITHOUT CLAIM TO ANY PARTICULAR FONT, STYLE, SIZE, OR COLOR.

NO CLAIM IS MADE TO THE EXCLUSIVE RIGHT TO USE "TWEED", APART FROM THE MARK AS SHOWN.

SN 85-273,037, FILED 3-22-2011.

KEVON CHISOLM, EXAMINING ATTORNEY



David J. Kyffers

Director of the United States Patent and Trademark Office

United States of America

United States Patent and Trademark Office



Reg. No. 4,068,711

Registered Dec. 6, 2011

Int. Cl.: 24

TRADEMARK

PRINCIPAL REGISTER

ECOCLEAN (DELAWARE CORPORATION)
14 HORSEMAN COURT
RANDALLSTOWN, MD 21133

FOR: FABRIC TOILET SEAT LINERS, IN CLASS 24 (U.S. CLS. 42 AND 50).

FIRST USE 5-25-2011; IN COMMERCE 5-25-2011.

THE MARK CONSISTS OF AN IMAGE OF A YOUNG GIRL WITH BEIGE COMPLEXION, BLACK MEDIUM LENGTH HAIR, BLUE EYES, WEARING GREEN CLOTHING, WHITE SOCKS, AND BLACK SHOES. SHE IS SITTING ON A WHITE TOILET WITH BLACK OUTLINE HOLDING A BROWN TEDDY BEAR. THE WORDING "SEATPAL" TO THE RIGHT OF THE DESIGN HAS THE "SEAT" PORTION OF THE WORD IN LOWERCASE GREEN FONT; AND THE "PAL" PORTION OF THE WORD IN CAPITALIZED BLACK FONT; WITH THE WORDING "NO MORE SQUATTING" IN SMALLER BLACK FONT BELOW IT.

THE COLOR(S) GREEN, BLACK, WHITE, BEIGE, BROWN AND BLUE IS/ARE CLAIMED AS A FEATURE OF THE MARK.

SN 85-273,958, FILED 3-22-2011.

MICHAEL ENGEL, EXAMINING ATTORNEY



David J. Kyffers

Director of the United States Patent and Trademark Office

United States of America

United States Patent and Trademark Office

CIGNA PROSOURCE

Reg. No. 4,068,712

Registered Dec. 6, 2011

Int. Cl.: 42

SERVICE MARK

PRINCIPAL REGISTER

CIGNA INTELLECTUAL PROPERTY, INC. (DELAWARE CORPORATION)
300 BELLEVUE PARKWAY
WILMINGTON, DE 19809

FOR: PROVIDING A WEB-BASED SYSTEM AND ONLINE PORTAL FOR SUPPLIERS AND VENDORS TO VIEW BUSINESS REQUIREMENTS, SUBMIT PROPOSALS AND NEGOTIATE CONTRACTS, AND EXCHANGE, MANAGE, MODIFY AND TRACK INFORMATION REGARDING REQUIREMENTS, PROPOSALS, NEGOTIATIONS, CONTRACTS AND TRANSACTIONS, IN CLASS 42 (U.S. CLS. 100 AND 101).

FIRST USE 6-20-2011; IN COMMERCE 6-20-2011.

THE MARK CONSISTS OF STANDARD CHARACTERS WITHOUT CLAIM TO ANY PARTICULAR FONT, STYLE, SIZE, OR COLOR.

SN 85-274,182, FILED 3-23-2011.

JAY FLOWERS, EXAMINING ATTORNEY



David J. Kybas

Director of the United States Patent and Trademark Office

United States of America

United States Patent and Trademark Office

ARCADIA

Reg. No. 4,068,713

Registered Dec. 6, 2011

Int. Cl.: 9

TRADEMARK

PRINCIPAL REGISTER

ALVANTAGE INC. (CALIFORNIA CORPORATION)
46715 FREMONT BLVD.
FREMONT, CA 94538

FOR: CARRYING CASES FOR CELL PHONES; CASES FOR MOBILE PHONES; CELL PHONE CASES; PROTECTIVE COVERS AND CASES FOR CELL PHONES, CELL PHONE BATTERIES, AND TABLET COMPUTERS; CELL PHONE AND MOBILE PHONE BATTERY CHARGERS; CELL PHONE BATTERY CHARGERS FOR USE IN VEHICLES; EXTERNAL BATTERIES FOR CELLULAR PHONES AND MOBILE PHONES; MOBILE TELEPHONE BATTERIES; CAMERA CASES, CAMERA BATTERIES AND CAMERA ACCESSORIES, NAMELY, CAMERA FILTERS, CAMERA TRIPODS, AND FISH-EYE CONVERSION LENSES FOR CAMERAS, IN CLASS 9 (U.S. CLS. 21, 23, 26, 36 AND 38).

FIRST USE 10-1-2011; IN COMMERCE 10-1-2011.

THE MARK CONSISTS OF STANDARD CHARACTERS WITHOUT CLAIM TO ANY PARTICULAR FONT, STYLE, SIZE, OR COLOR.

SN 85-274,354, FILED 3-23-2011.

MARK SHINER, EXAMINING ATTORNEY



David J. Kyros

Director of the United States Patent and Trademark Office

United States of America

United States Patent and Trademark Office

Utility Recon

Reg. No. 4,068,714

ENERGY MANAGEMENT SOLUTIONS (INDIANA LIMITED LIABILITY COMPANY)
3000 TECHNOLOGY AVENUE
NEW ALBANY, IN 47150

Registered Dec. 6, 2011

Int. Cl.: 9

FOR: COMPUTER HARDWARE AND SOFTWARE SYSTEMS FOR MANAGING AND REPORTING UTILITY DATA, IN CLASS 9 (U.S. CLS. 21, 23, 26, 36 AND 38).

TRADEMARK

FIRST USE 3-23-2011; IN COMMERCE 3-23-2011.

PRINCIPAL REGISTER

THE MARK CONSISTS OF STANDARD CHARACTERS WITHOUT CLAIM TO ANY PARTICULAR FONT, STYLE, SIZE, OR COLOR.

NO CLAIM IS MADE TO THE EXCLUSIVE RIGHT TO USE "UTILITY", APART FROM THE MARK AS SHOWN.

SN 85-274,982, FILED 3-23-2011.

SUSAN RICHARDS, EXAMINING ATTORNEY



David J. Kyffers

Director of the United States Patent and Trademark Office

United States of America

United States Patent and Trademark Office

MOMMY'S

Reg. No. 4,068,715

Registered Dec. 6, 2011

Int. Cl.: 33

TRADEMARK

PRINCIPAL REGISTER

SELECTIVE WINE ESTATES, INC. (NEW JERSEY CORPORATION)
9 TANGLEWOOD DRIVE
EAST HANOVER, NJ 07936

FOR: WINES, IN CLASS 33 (U.S. CLS. 47 AND 49).

FIRST USE 3-3-2006; IN COMMERCE 3-3-2006.

THE MARK CONSISTS OF STANDARD CHARACTERS WITHOUT CLAIM TO ANY PARTICULAR FONT, STYLE, SIZE, OR COLOR.

OWNER OF U.S. REG. NO. 3,218,976.

SN 85-275,430, FILED 3-24-2011.

DEIRDRE ROBERTSON, EXAMINING ATTORNEY



David J. Kybas

Director of the United States Patent and Trademark Office

United States of America

United States Patent and Trademark Office

eDebris

Reg. No. 4,068,716

Registered Dec. 6, 2011

Int. Cl.: 40

SERVICE MARK

PRINCIPAL REGISTER

DANIELE M. SAFONTE (UNITED STATES INDIVIDUAL)
EDEBRIS INC
467 16TH ST 3R
BROOKLYN, NY 11215

FOR: SORTING OF WASTE AND RECYCLABLE MATERIAL, IN CLASS 40 (U.S. CLS. 100, 103 AND 106).

FIRST USE 3-6-2011; IN COMMERCE 3-6-2011.

THE MARK CONSISTS OF STANDARD CHARACTERS WITHOUT CLAIM TO ANY PARTICULAR FONT, STYLE, SIZE, OR COLOR.

SN 85-275,434, FILED 3-24-2011.

DEIRDRE ROBERTSON, EXAMINING ATTORNEY



David J. Kybas

Director of the United States Patent and Trademark Office

United States of America

United States Patent and Trademark Office

STRAPables

Reg. No. 4,068,717

EDISON, JENNIFER L (UNITED STATES INDIVIDUAL)
43422 WEST OAKS DR # 254
NOVI, MI 48377

Registered Dec. 6, 2011

Int. Cl.: 25

FOR: REMOVABLE STRAPS THAT ATTACH TO CLOTHING, TOPS, DRESSES, BRAS AND SWIMSUITS, IN CLASS 25 (U.S. CLS. 22 AND 39).

TRADEMARK

FIRST USE 5-1-2011; IN COMMERCE 9-1-2011.

PRINCIPAL REGISTER

THE MARK CONSISTS OF STANDARD CHARACTERS WITHOUT CLAIM TO ANY PARTICULAR FONT, STYLE, SIZE, OR COLOR.

SN 85-277,692, FILED 3-25-2011.

HEATHER THOMPSON, EXAMINING ATTORNEY



David J. Kybas

Director of the United States Patent and Trademark Office

United States of America

United States Patent and Trademark Office

MEDFLOOR

Reg. No. 4,068,718

Registered Dec. 6, 2011

Int. Cl.: 27

TRADEMARK

PRINCIPAL REGISTER

TANDUS US, LLC (DELAWARE LIMITED LIABILITY COMPANY)
311 SMITH INDUSTRIAL BOULEVARD
DALTON, GA 30721

FOR: CARPET BACKING, IN CLASS 27 (U.S. CLS. 19, 20, 37, 42 AND 50).

FIRST USE 3-31-2011; IN COMMERCE 4-30-2011.

THE MARK CONSISTS OF STANDARD CHARACTERS WITHOUT CLAIM TO ANY PARTICULAR FONT, STYLE, SIZE, OR COLOR.

SN 85-278,607, FILED 3-28-2011.

DAVID I, EXAMINING ATTORNEY



David J. Kyfos

Director of the United States Patent and Trademark Office

United States of America

United States Patent and Trademark Office



REVERE BEACH National Sand Sculpting FESTIVAL

Reg. No. 4,068,719

Registered Dec. 6, 2011

Int. Cl.: 41

SERVICE MARK

PRINCIPAL REGISTER

REVERE BEACH PARTNERSHIP, INC. (MASSACHUSETTS CORPORATION)
150 BEACH STREET
REVERE, MA 02151

FOR: CONDUCTING ENTERTAINMENT EXHIBITIONS IN THE NATURE OF SAND SCULPTING CONTESTS, IN CLASS 41 (U.S. CLS. 100, 101 AND 107).

FIRST USE 7-14-2011; IN COMMERCE 7-14-2011.

NO CLAIM IS MADE TO THE EXCLUSIVE RIGHT TO USE "REVERE BEACH NATIONAL SAND SCULPTING FESTIVAL", APART FROM THE MARK AS SHOWN.

THE MARK CONSISTS OF AN IMAGE OF A GAZEBO PLACED OVER AN IMAGE OF A WAVE, WITH THE WORDS "REVERE BEACH NATIONAL SAND SCULPTING FESTIVAL" TO THE RIGHT.

SN 85-281,192, FILED 3-30-2011.

SCOTT BIBB, EXAMINING ATTORNEY



David J. Kybas

Director of the United States Patent and Trademark Office

United States of America

United States Patent and Trademark Office

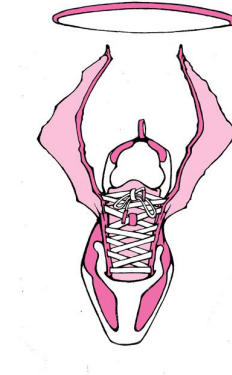

Reg. No. 4,068,720

Registered Dec. 6, 2011

Int. Cl.: 25

TRADEMARK

PRINCIPAL REGISTER

IKE GOURDINE (UNITED STATES INDIVIDUAL)
33 W. PRICE ST.
LINDEN, NJ 07036

FOR: T-SHIRTS, SOCKS, HATS, CAPS, SWEAT SHIRTS, SWEAT PANTS, UNDER GARMENTS, HOODED SWEAT SHIRTS, WRIST BANDS, HEADBANDS, TANK TOPS, STOCKINGS, GLOVES, PANTS, SHORTS, SKORTS, PAJAMAS AND CAPRIS , IN CLASS 25 (U.S. CLS. 22 AND 39).

FIRST USE 2-6-2011; IN COMMERCE 3-17-2011.

THE MARK CONSISTS OF A PINK, LIGHT PINK, BLACK AND WHITE SNEAKER WITH LIGHT PINK AND PINK WINGS WITH A BLACK AND PINK HALO ABOVE THE WINGS.

THE COLOR(S) PINK, LIGHT PINK, WHITE AND BLACK IS/ARE CLAIMED AS A FEATURE OF THE MARK.

SN 85-281,540, FILED 3-30-2011.

BRENDAN MCCAULEY, EXAMINING ATTORNEY



David J. Kybas

Director of the United States Patent and Trademark Office

United States of America

United States Patent and Trademark Office



INTRALINE

Reg. No. 4,068,721

Registered Dec. 6, 2011

Int. Cl.: 36

SERVICE MARK

PRINCIPAL REGISTER

LONGHORN CAPITAL MANAGEMENT, LLC (DELAWARE LIMITED LIABILITY COMPANY)
427 N. TATNALL ST. #52811
WILMINGTON, DE 198012230

FOR: FINANCIAL ASSET MANAGEMENT; INVESTMENT ADVISORY SERVICES, IN CLASS 36 (U.S. CLS. 100, 101 AND 102).

FIRST USE 3-29-2011; IN COMMERCE 3-29-2011.

NO CLAIM IS MADE TO THE EXCLUSIVE RIGHT TO USE "AM", APART FROM THE MARK AS SHOWN.

THE MARK CONSISTS OF THE STYLIZED LETTERS "A" AND "M" WITHIN THE OUTLINE OF A RECTANGLE WITH ROUNDED CORNERS CENTERED OVER THE TERM "INTRALINE" WITH THE LETTERS "A" AND "M" BEING INTERRUPTED BY A SERIES OF PARALLEL VERTICAL LINES, SAID VERTICAL LINES AND SAID OUTLINE BEING BROKEN WHERE THE VERTICAL LINES CROSS THE TOP OF THE OUTLINE.

SN 85-282,006, FILED 3-31-2011.

BENJAMIN OKEKE, EXAMINING ATTORNEY



David J. Kyfos

Director of the United States Patent and Trademark Office

United States of America

United States Patent and Trademark Office

glubbs

Reg. No. 4,068,722

Registered Dec. 6, 2011

Int. Cl.: 28

TRADEMARK

PRINCIPAL REGISTER

LONG, ROBERT (UNITED STATES INDIVIDUAL)
1111 E. SUNRISE BLVD
UNIT 803
FT LAUDERDALE, FL 33304

FOR: WORK-OUT GLOVES, NAMELY, SILICON MOLDED GLOVES USED TO PROTECT AND COMFORT HANDS DURING GRIPPING AND LIFTING, IN CLASS 28 (U.S. CLS. 22, 23, 38 AND 50).

FIRST USE 5-27-2011; IN COMMERCE 10-5-2011.

THE MARK CONSISTS OF STANDARD CHARACTERS WITHOUT CLAIM TO ANY PARTICULAR FONT, STYLE, SIZE, OR COLOR.

SN 85-282,234, FILED 3-31-2011.

GINA FINK, EXAMINING ATTORNEY



David J. Kybas

Director of the United States Patent and Trademark Office

United States of America

United States Patent and Trademark Office

POLAR NITE

Reg. No. 4,068,723

Registered Dec. 6, 2011

Int. Cl.: 21

TRADEMARK

PRINCIPAL REGISTER

THE TRANZONIC COMPANIES (OHIO CORPORATION)
SUITE 200
26301 CURTISS-WRIGHT PARKWAY
CLEVELAND, OH 44143

FOR: DISPOSABLE NITRILE GLOVES FOR GENERAL USE, IN CLASS 21 (U.S. CLS. 2, 13, 23, 29, 30, 33, 40 AND 50).

FIRST USE 6-15-2011; IN COMMERCE 6-15-2011.

THE MARK CONSISTS OF STANDARD CHARACTERS WITHOUT CLAIM TO ANY PARTICULAR FONT, STYLE, SIZE, OR COLOR.

SN 85-285,018, FILED 4-4-2011.

SUNG IN, EXAMINING ATTORNEY



David J. Kyfos

Director of the United States Patent and Trademark Office

United States of America

United States Patent and Trademark Office

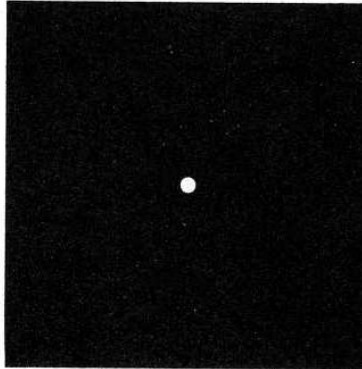

Reg. No. 4,068,724

Registered Dec. 6, 2011

Int. Cl.: 41

SERVICE MARK

PRINCIPAL REGISTER

SIMON, NICHOLAS RALPH (UNITED STATES INDIVIDUAL), DBA NICHOLAS SIMON
PHOTOGRAPHY,
3612 CHRISTINE DRIVE
LANSING, MI 48911

FOR: AERIAL PHOTOGRAPHY; DIGITAL IMAGING SERVICES; PHOTOGRAPHY; PHOTOGRAPHY SERVICES; PORTRAIT PHOTOGRAPHY; WEDDING PHOTOGRAPHY SERVICES, IN CLASS 41 (U.S. CLS. 100, 101 AND 107).

FIRST USE 1-1-1992; IN COMMERCE 1-1-1992.

THE MARK CONSISTS OF BLACK SQUARE WITH A SMALL WHITE DOT IN THE MIDDLE.

THE COLOR(S) BLACK AND WHITE IS/ARE CLAIMED AS A FEATURE OF THE MARK.

SN 85-285,388, FILED 4-4-2011.

GISELLE AGOSTO, EXAMINING ATTORNEY



David J. Kybas

Director of the United States Patent and Trademark Office

United States of America

United States Patent and Trademark Office

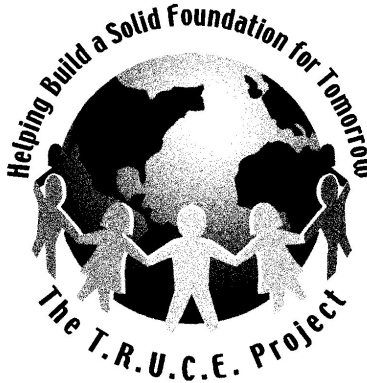

Reg. No. 4,068,725

Registered Dec. 6, 2011

Int. Cl.: 16

TRADEMARK

PRINCIPAL REGISTER

ENRIQUEZ, MICHAEL (UNITED STATES INDIVIDUAL)
BUILDING #211
2325 PALOS VERDES DRIVE WEST
PALOS VERDES ESTATES, CA 90274

FOR: EDUCATIONAL PUBLICATIONS, NAMELY, EDUCATIONAL ACTIVITY CARDS, WORKBOOKS, TEXTBOOKS, ACTIVITY BOOKS, STORY BOOKS, TEACHER GUIDES, MANUALS, POSTERS AND EDUCATIONAL BOOKLETS IN THE FIELD OF PSYCHO-EDUCATION, THERAPY, COUNSELING, MEDIATION, PEACE-BUILDING, AND CONFLICT RESOLUTION, IN CLASS 16 (U.S. CLS. 2, 5, 22, 23, 29, 37, 38 AND 50).

FIRST USE 6-19-2008; IN COMMERCE 7-19-2011.

THE STIPPLING IS FOR SHADING PURPOSES ONLY.

THE MARK CONSISTS OF A HALF CIRCLE OF SEVEN CHILDREN HOLDING HANDS AROUND A GLOBE. SEVERAL CONTINENTS ARE DISPLAYED ON THE GLOBE. THE WORDS "HELPING BUILD A SOLID FOUNDATION FOR TOMORROW" ARCH ACROSS THE TOP OF THE GLOBE, AND THE WORDS "THE T.R.U.C.E. PROJECT" CURVE AROUND THE BOTTOM OF THE GLOBE.

SN 85-285,898, FILED 4-4-2011.

BRIDGETT SMITH, EXAMINING ATTORNEY



David J. Kyjars

Director of the United States Patent and Trademark Office

United States of America

United States Patent and Trademark Office

MINI-Calc

Reg. No. 4,068,726

Registered Dec. 6, 2011

Int. Cl.: 10

TRADEMARK

PRINCIPAL REGISTER

ACUMED LLC (OREGON LIMITED LIABILITY COMPANY)
5885 NW CORNELIUS PASS ROAD
HILLSBORO, OR 97124

FOR: IMPLANTS CONSISTING OF ARTIFICIAL MATERIALS; MEDICAL, SURGICAL AND ORTHOPEDIC IMPLANTS MADE OF ARTIFICIAL MATERIALS; ORTHOPEDIC DEVICES, NAMELY, ARTIFICIAL BONE PLATES FOR IMPLANTATION AND BONE PLATE FASTENERS IN THE NATURE OF BONE SCREWS; SURGICAL AND MEDICAL APPARATUS AND INSTRUMENTS FOR USE IN ORTHOPEDIC SURGERY, IN CLASS 10 (U.S. CLS. 26, 39 AND 44).

FIRST USE 5-10-2011; IN COMMERCE 5-10-2011.

THE MARK CONSISTS OF STANDARD CHARACTERS WITHOUT CLAIM TO ANY PARTICULAR FONT, STYLE, SIZE, OR COLOR.

SN 85-286,249, FILED 4-5-2011.

CHRISTINA SOBRAL, EXAMINING ATTORNEY



David J. Kyjars

Director of the United States Patent and Trademark Office

United States of America

United States Patent and Trademark Office



Reg. No. 4,068,727

Registered Dec. 6, 2011

Int. Cl.: 9

TRADEMARK

PRINCIPAL REGISTER

CISCO TECHNOLOGY, INC. (CALIFORNIA CORPORATION)
170 WEST TASMAN DRIVE
SAN JOSE, CA 95134

FOR: VPN (VIRTUAL PRIVATE NETWORK) OPERATING SOFTWARE; SOFTWARE FOR SECURE REMOTE ACCESS TO PRIVATE COMPUTER NETWORKS VIA THE INTERNET; COMPUTER APPLICATION SOFTWARE FOR MOBILE DEVICES, NAMELY, SOFTWARE FOR CONTROLLING SECURE WIRELESS AND WIRED NETWORK ACCESS, IN CLASS 9 (U.S. CLS. 21, 23, 26, 36 AND 38).

FIRST USE 6-2-2011; IN COMMERCE 6-2-2011.

THE MARK CONSISTS OF A SPHERE CONTAINING THICK, CURVED U-SHAPED LINES THAT INTERSECT IN TWO PLACES, RESEMBLING INTERLOCKING CHAIN LINKS. THE LINES APPEAR PROMINENTLY ON THE FRONT OF THE SPHERE AND CONTINUE AS A SHADOW AROUND THE BACK OF THE SPHERE WHERE THEY INTERSECT AGAIN. THE SPHERE IS WHITE, WITH A GRAY SHADOW APPEARING AROUND THE BOTTOM AND EDGE OF THE SPHERE AND A BRIGHTER WHITE OVAL HIGHLIGHT ON THE TOP HALF OF THE SPHERE. THE THICK CURVED LINES APPEARING ON THE FRONT OF THE SPHERE ARE GREEN ON ONE END AND GRADUALLY CHANGE TO BLUE ON THE OTHER END. THE LINES APPEARING AS A SHADOW AT THE BACK OF THE SPHERE ARE GRAY.

THE COLOR(S) WHITE, GREEN, BLUE, AND GRAY IS/ARE CLAIMED AS A FEATURE OF THE MARK.

SN 85-287,045, FILED 4-5-2011.

JOHN SCHUYLER YARD, EXAMINING ATTORNEY



David J. Kyros

Director of the United States Patent and Trademark Office

United States of America

United States Patent and Trademark Office

I Am Woman

Reg. No. 4,068,728

Registered Dec. 6, 2011

Int. Cl.: 45

SERVICE MARK

PRINCIPAL REGISTER

HOWARD, VICTORIA (UNITED STATES INDIVIDUAL)
#1
5140- SABAL GARDENS LANE
BOCA RATON, FL 33487

FOR: CONSULTING IN THE FIELD OF PERSONAL RELATIONSHIPS; ORGANIZING AND CONDUCTING SUPPORT GROUPS IN THE FIELD OF WOMAN'S EMPOWERMENT, IN CLASS 45 (U.S. CLS. 100 AND 101).

FIRST USE 1-1-2011; IN COMMERCE 1-1-2011.

THE MARK CONSISTS OF STANDARD CHARACTERS WITHOUT CLAIM TO ANY PARTICULAR FONT, STYLE, SIZE, OR COLOR.

SN 85-289,485, FILED 4-7-2011.

MARK SPARACINO, EXAMINING ATTORNEY



David J. Kybas

Director of the United States Patent and Trademark Office

United States of America

United States Patent and Trademark Office

LEXARCHAEOLOGY

Reg. No. 4,068,729

Registered Dec. 6, 2011

Int. Cl.: 36

SERVICE MARK

PRINCIPAL REGISTER

AKITA, INC. (DELAWARE CORPORATION)
SUITE 400
2711 CENTERVILLE AVENUE
WILMINGTON, DE 19808

FOR: INSURANCE UNDERWRITING IN THE FIELD OF BUSINESS INTERRUPTION,
BUSINESS INCOME LOSS AND GENERAL LIABILITY INSURANCE, IN CLASS 36 (U.S.
CLS. 100, 101 AND 102).

FIRST USE 7-14-2011; IN COMMERCE 7-14-2011.

THE MARK CONSISTS OF STANDARD CHARACTERS WITHOUT CLAIM TO ANY PAR-
TICULAR FONT, STYLE, SIZE, OR COLOR.

SN 85-291,478, FILED 4-11-2011.

SUSAN RICHARDS, EXAMINING ATTORNEY



David J. Kyjars

Director of the United States Patent and Trademark Office

United States of America

United States Patent and Trademark Office

PURESANA

Reg. No. 4,068,730

Registered Dec. 6, 2011

Int. Cl.: 20

TRADEMARK

PRINCIPAL REGISTER

PGS-PARAGON GLOBAL SOURCING, INC. (TEXAS CORPORATION)
405 S NOLEN DRIVE, STE 600
SOUTHLAKE, TX 76092

FOR: BEAUTY SALON FURNITURE, IN CLASS 20 (U.S. CLS. 2, 13, 22, 25, 32 AND 50).

FIRST USE 6-26-2011; IN COMMERCE 7-20-2011.

THE MARK CONSISTS OF STANDARD CHARACTERS WITHOUT CLAIM TO ANY PARTICULAR FONT, STYLE, SIZE, OR COLOR.

SN 85-291,637, FILED 4-11-2011.

ANDREW LEASER, EXAMINING ATTORNEY



David J. Kyffers

Director of the United States Patent and Trademark Office

United States of America

United States Patent and Trademark Office

PROMINENCE

Reg. No. 4,068,731

Registered Dec. 6, 2011

Int. Cl.: 33

TRADEMARK

PRINCIPAL REGISTER

TERRAVANT WINE COMPANY, LLC (CALIFORNIA LIMITED LIABILITY COMPANY),
DBA PROMINENCE WINES,
C/O KOENIG & ASSOCIATES
920 GARDEN STREET, SUITE A
SANTA BARBARA, CA 93101

FOR: WINE; WINES, IN CLASS 33 (U.S. CLS. 47 AND 49).

FIRST USE 8-12-2011; IN COMMERCE 8-12-2011.

THE MARK CONSISTS OF STANDARD CHARACTERS WITHOUT CLAIM TO ANY PARTICULAR FONT, STYLE, SIZE, OR COLOR.

SN 85-293,476, FILED 4-12-2011.

MARIA-VICTORIA SUAREZ, EXAMINING ATTORNEY



David J. Kybas

Director of the United States Patent and Trademark Office

United States of America

United States Patent and Trademark Office



Reg. No. 4,068,732

Registered Dec. 6, 2011

Int. Cls.: 38, 41, and 45

SERVICE MARK

PRINCIPAL REGISTER

BODYFLASHWORLD, LLC (FLORIDA LIMITED LIABILITY COMPANY)
1395 BRICKELL AVE. SUITE 800
MIAMI, FL 33131

FOR: COMMUNICATIONS SERVICES, NAMELY, TRANSMITTING STREAMED SOUND AND AUDIOVISUAL RECORDINGS VIA THE INTERNET; STREAMING OF AUDIO, VISUAL AND AUDIOVISUAL MATERIAL VIA A GLOBAL COMPUTER NETWORK; STREAMING OF VIDEO MATERIAL ON THE INTERNET; VIDEO BROADCASTING SERVICES OVER THE INTERNET OR OTHER COMMUNICATIONS NETWORK FEATURING THE UPLOADED, POSTED AND TAGGED VIDEOS OF OTHERS, IN CLASS 38 (U.S. CLS. 100, 101 AND 104).

FIRST USE 10-1-2011; IN COMMERCE 10-1-2011.

FOR: ENTERTAINMENT SERVICES, NAMELY, PROVIDING A WEB SITE FEATURING NON-DOWNLOADABLE ADULT-THEMED PHOTOGRAPHS AND VIDEOS; ENTERTAINMENT SERVICES, NAMELY, PROVIDING VIRTUAL ENVIRONMENTS IN WHICH USERS CAN INTERACT FOR RECREATIONAL, LEISURE OR ENTERTAINMENT PURPOSES, IN CLASS 41 (U.S. CLS. 100, 101 AND 107).

FIRST USE 10-1-2011; IN COMMERCE 10-1-2011.

FOR: PROVIDING A SOCIAL NETWORKING WEBSITE FOR ENTERTAINMENT PURPOSES, IN CLASS 45 (U.S. CLS. 100 AND 101).

FIRST USE 10-1-2011; IN COMMERCE 10-1-2011.



David J. Kybas

Director of the United States Patent and Trademark Office

THE MARK CONSISTS OF A BLACK RECTANGULAR BACKGROUND AGAINST WHICH APPEARS A KEYHOLE-SHAPED BORDER IN SHADES OF SILVER, BLACK, GREY, WHITE, TEAL AND TURQUOISE WITH A STARBURST LIGHT EFFECT APPEARING AT UPPER-LEFT, WITHIN WHICH THERE IS A CERISE AND PURPLE COLOR BACKGROUND ON WHICH APPEAR THE UPPER-CASE LETTERS "B", "F", AND "W" IN VERTICAL ORDER RUNNING FROM "B" AT THE TOP TO "W" AT THE BOTTOM (THE UPPER LEFT AND RIGHT CORNERS OF THE W ARE PARTIALLY OBSCURED BY THE BORDER), AND UNDER THE "W" A STYLIZED VERSION OF THE LOWER TORSO AND LEGS OF A FEMALE WEARING HIGH HEELS.

Reg. No. 4,068,732 THE COLOR(S) SILVER, BLACK, GREY, WHITE, TURQUOISE, TEAL, PURPLE, AND CERISE IS/ARE CLAIMED AS A FEATURE OF THE MARK.

SN 85-293,963, FILED 4-13-2011.

BRENDAN REGAN, EXAMINING ATTORNEY

United States of America

United States Patent and Trademark Office



Reg. No. 4,068,733

Registered Dec. 6, 2011

Int. Cl.: 43

SERVICE MARK

PRINCIPAL REGISTER

BIG JUAN, LLC (TEXAS LIMITED LIABILITY COMPANY)
BOX 128
DALHART, TX 79022

FOR: RESTAURANT SERVICES, INCLUDING SIT-DOWN SERVICE OF FOOD AND TAKE-OUT RESTAURANT SERVICES, IN CLASS 43 (U.S. CLS. 100 AND 101).

FIRST USE 3-3-2011; IN COMMERCE 3-3-2011.

NO CLAIM IS MADE TO THE EXCLUSIVE RIGHT TO USE "MEXICAN GRILLE", APART FROM THE MARK AS SHOWN.

THE COLOR(S) DARK GREEN, LIGHT GREEN, RED, YELLOW, PURPLE, BROWN, TAN, BLACK AND WHITE IS/ARE CLAIMED AS A FEATURE OF THE MARK.

THE NAME "JUAN BURRITO" DOES NOT IDENTIFY A LIVING INDIVIDUAL.

THE MARK CONSISTS OF A DARK GREEN BANNER WITH A LIGHT GREEN BORDER AND THE WORDS "MEXICAN GRILLE" INSCRIBED IN STYLIZED RED UPPER-CASE LETTERS WITH WHITE BORDERS. ABOVE THE BANNER, THE WORDS "JUAN BURRITO'S" ARE INSCRIBED IN LARGER, STYLIZED LOWER-CASE BLOCK LETTERS EXCEPT FOR THE FIRST LETTER OF EACH WORD, WHICH IS UPPER CASE. THE LETTERS IN THE WORDS "JUAN BURRITO'S" ARE RED AT THE TOP, FADING TO YELLOW AND WITH PURPLE BORDERS. BENEATH THE BANNER IS A PURPLE DISK, UPON WHICH IS A CARICATURE OF A MAN WITH BLACK HAIR, A TAN FACE, BLACK AND WHITE EYES, A LARGE BLACK HANDLEBAR MOUSTACHE, AND A RED MOUTH, WEARING A WHITE SHIRT, A LARGE YELLOW SOMBRERO WITH A RED, YELLOW, PURPLE AND GREEN SERRATED DESIGN ON ITS EDGE, TWO CROSSED BROWN BANDOLIERS AND A BROWN BELT. THE CARICATURE IS HOLDING A WHITE BURRITO WITH RED, GREEN AND YELLOW CONTENTS IN EACH TAN HAND, WITH ARMS EXTENDED SO THAT THE BURRITOS EXTEND BEYOND THE PURPLE DISK.

SN 85-294,022, FILED 4-13-2011.

JAMES A. RAUEN, EXAMINING ATTORNEY



David J. Kyros

Director of the United States Patent and Trademark Office

United States of America

United States Patent and Trademark Office



Reg. No. 4,068,734

Registered Dec. 6, 2011

Int. Cl.: 30

TRADEMARK

PRINCIPAL REGISTER

LANCE MFG. LLC (NORTH CAROLINA LIMITED LIABILITY COMPANY)
ATTN: LEGAL DEPT.
13024 BALLANTYNE CORP. PL., STE. 900
CHARLOTTE, NC 28277

FOR: COOKIES, IN CLASS 30 (U.S. CL. 46).

FIRST USE 10-13-2011; IN COMMERCE 10-13-2011.

OWNER OF U.S. REG. NOS. 1,668,706, 1,671,959, AND 2,452,523.

NO CLAIM IS MADE TO THE EXCLUSIVE RIGHT TO USE "HOMESTYLE COOKIES",
APART FROM THE MARK AS SHOWN.

THE MARK CONSISTS OF AN OBLONG DESIGN, FLAT ON EACH END AND ROUNDED
ON TOP AND BOTTOM, WITH THE WORD "ARCHWAY" IN LARGER FONT CENTERED
INSIDE, THE WORD "HOMESTYLE" IN SMALLER FONT ON TOP INSIDE AND THE WORD
"COOKIES" IN SMALLER FONT ON BOTTOM INSIDE.

SN 85-305,104, FILED 4-26-2011.

ROBERT C. CLARK JR., EXAMINING ATTORNEY



David J. Kybas

Director of the United States Patent and Trademark Office

United States of America

United States Patent and Trademark Office

ACETADRYL

Reg. No. 4,068,735

Registered Dec. 6, 2011

Int. Cl.: 5

TRADEMARK

PRINCIPAL REGISTER

PHYSICIAN'S SCIENCE & NATURE, INC. (CALIFORNIA CORPORATION)
220 NEWPORT CENTER DRIVE SUITE 11-634
NEWPORT BEACH, CA 92660

FOR: ANALGESIC SLEEPING AID, IN CLASS 5 (U.S. CLS. 6, 18, 44, 46, 51 AND 52).

FIRST USE 4-14-2011; IN COMMERCE 8-19-2011.

THE MARK CONSISTS OF STANDARD CHARACTERS WITHOUT CLAIM TO ANY PARTICULAR FONT, STYLE, SIZE, OR COLOR.

SN 85-305,374, FILED 4-26-2011.

KAREN K. BUSH, EXAMINING ATTORNEY



David J. Kyffers

Director of the United States Patent and Trademark Office

United States of America

United States Patent and Trademark Office

Art That Pops

Reg. No. 4,068,736

Registered Dec. 6, 2011

Int. Cl.: 35

SERVICE MARK

PRINCIPAL REGISTER

ILLUSTRATION GALLERY INC. (NEW YORK CORPORATION)
25M
1675 YORK AVENUE
NEW YORK, NY 10128

FOR: ON-LINE ART GALLERIES, IN CLASS 35 (U.S. CLS. 100, 101 AND 102).

FIRST USE 6-23-2011; IN COMMERCE 6-23-2011.

THE MARK CONSISTS OF STANDARD CHARACTERS WITHOUT CLAIM TO ANY PARTICULAR FONT, STYLE, SIZE, OR COLOR.

NO CLAIM IS MADE TO THE EXCLUSIVE RIGHT TO USE "ART", APART FROM THE MARK AS SHOWN.

SN 85-306,890, FILED 4-28-2011.

DAYNA BROWNE, EXAMINING ATTORNEY



David J. Kyffers

Director of the United States Patent and Trademark Office

United States of America

United States Patent and Trademark Office

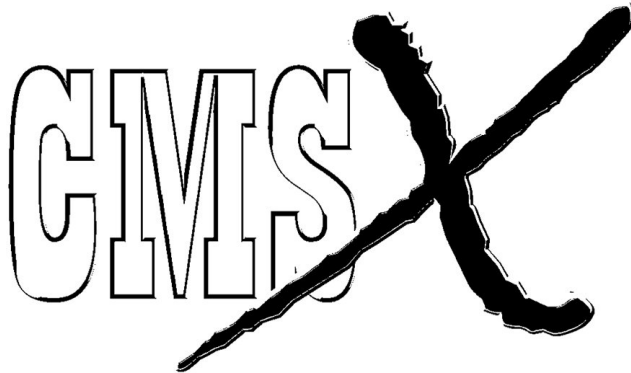

Reg. No. 4,068,737

Registered Dec. 6, 2011

Int. Cl.: 5

TRADEMARK

PRINCIPAL REGISTER

CMS INNOVATIVE TECHNOLOGIES, INC. (DELAWARE CORPORATION)
11 LAKE AVENUE EXTENSION
DANBURY, CT 06811

FOR: ANTIMICROBIAL PREPARATIONS FOR THE TREATMENT OF WOUNDS, INFECTIONS AND INFLAMMATIONS; ANTIMICROBIAL PREPARATIONS FOR THE TREATMENT OF ANIMALS, IN CLASS 5 (U.S. CLS. 6, 18, 44, 46, 51 AND 52).

FIRST USE 1-1-2011; IN COMMERCE 5-6-2011.

THE MARK CONSISTS OF THE LETTERS "C", "M" AND "S", FOLLOWED BY A STYLIZED "X".

SN 85-307,638, FILED 4-28-2011.

HEATHER BIDDULPH, EXAMINING ATTORNEY



David J. Kyjars

Director of the United States Patent and Trademark Office

United States of America
United States Patent and Trademark Office

HOMEKIST

Reg. No. 4,068,738

Registered Dec. 6, 2011

Int. Cl.: 30

TRADEMARK

PRINCIPAL REGISTER

LANCE MFG. LLC (NORTH CAROLINA LIMITED LIABILITY COMPANY)
ATTN: LEGAL DEPT.
13024 BALLANTYNE CORP. PL., STE. 900
CHARLOTTE, NC 28277

FOR: COOKIES, IN CLASS 30 (U.S. CL. 46).

FIRST USE 10-17-2011; IN COMMERCE 10-17-2011.

THE MARK CONSISTS OF STANDARD CHARACTERS WITHOUT CLAIM TO ANY PARTICULAR FONT, STYLE, SIZE, OR COLOR.

OWNER OF U.S. REG. NO. 2,337,901.

SN 85-308,464, FILED 4-29-2011.

ROBERT C. CLARK JR., EXAMINING ATTORNEY



David J. Kybas

Director of the United States Patent and Trademark Office

United States of America

United States Patent and Trademark Office

RED PRO

Reg. No. 4,068,739

Registered Dec. 6, 2011

Int. Cls.: 9 and 11

TRADEMARK

PRINCIPAL REGISTER

KISS NAIL PRODUCTS, INC. (NEW YORK CORPORATION)
57 SEAVIEW BOULEVARD
PORT WASHINGTON, NY 11050

FOR: ELECTRIC FLAT IRONS AND ELECTRIC CURLING IRONS FOR HAIR, IN CLASS 9
(U.S. CLS. 21, 23, 26, 36 AND 38).

FIRST USE 10-0-2010; IN COMMERCE 10-0-2010.

FOR: ELECTRIC BLOW DRYERS FOR HAIR, IN CLASS 11 (U.S. CLS. 13, 21, 23, 31 AND
34).

FIRST USE 8-0-2011; IN COMMERCE 8-0-2011.

THE MARK CONSISTS OF STANDARD CHARACTERS WITHOUT CLAIM TO ANY PAR-
TICULAR FONT, STYLE, SIZE, OR COLOR.

OWNER OF U.S. REG. NO. 3,807,817.

SN 85-315,393, FILED 5-9-2011.

CAROLINE WOOD, EXAMINING ATTORNEY



David J. Kyros

Director of the United States Patent and Trademark Office

United States of America

United States Patent and Trademark Office

GRID ONE SOLUTIONS

Reg. No. 4,068,740

Registered Dec. 6, 2011

Int. Cls.: 35, 37, and 42

SERVICE MARK

PRINCIPAL REGISTER

ASPLUNDH INVESTMENTS, INC. (DELAWARE CORPORATION)
1105 MARKET STREET
SUITE 1300
WILMINGTON, DE 19801

FOR: MANAGEMENT OF CALL CENTERS FOR OTHERS, IN CLASS 35 (U.S. CLS. 100, 101 AND 102).

FIRST USE 8-12-2011; IN COMMERCE 8-12-2011.

FOR: AUTOMATIC METER INSTALLATION SERVICES AND PROJECT MANAGEMENT RELATED THERETO; METER RETROFITTING SERVICES, IN CLASS 37 (U.S. CLS. 100, 103 AND 106).

FIRST USE 8-12-2011; IN COMMERCE 8-12-2011.

FOR: RESIDENTIAL, COMMERCIAL, AND INDUSTRIAL UTILITY METER SERVICES, NAMELY, ELECTRIC, GAS AND WATER METER READING SERVICES, IN CLASS 42 (U.S. CLS. 100 AND 101).

FIRST USE 8-12-2011; IN COMMERCE 8-12-2011.

THE MARK CONSISTS OF STANDARD CHARACTERS WITHOUT CLAIM TO ANY PARTICULAR FONT, STYLE, SIZE, OR COLOR.

NO CLAIM IS MADE TO THE EXCLUSIVE RIGHT TO USE "SOLUTIONS", APART FROM THE MARK AS SHOWN.

SN 85-315,397, FILED 5-9-2011.

NICHOLAS ALTREE, EXAMINING ATTORNEY



David J. Kyffers

Director of the United States Patent and Trademark Office

United States of America

United States Patent and Trademark Office

LET US STAY WITH YOU

Reg. No. 4,068,741

Registered Dec. 6, 2011

Int. Cl.: 43

SERVICE MARK

PRINCIPAL REGISTER

THE RITZ-CARLTON HOTEL COMPANY, L.L.C. (MARYLAND LIMITED LIABILITY COMPANY)
10400 FERNWOOD ROAD
BETHESDA, MD 20817

FOR: HOTEL SERVICES; RESTAURANT, CATERING, BAR AND COCKTAIL LOUNGE SERVICES; RESORT LODGING SERVICES; PROVISION OF GENERAL-PURPOSE FACILITIES FOR MEETINGS, CONFERENCES AND EXHIBITIONS; PROVISION OF BANQUET AND SOCIAL FUNCTION FACILITIES FOR SPECIAL OCCASIONS; RESERVATION SERVICES FOR HOTEL ACCOMMODATIONS FOR OTHERS; HOTEL SERVICES FEATURING AN INCENTIVE AWARD PROGRAM, IN CLASS 43 (U.S. CLS. 100 AND 101).

FIRST USE 9-15-2011; IN COMMERCE 9-15-2011.

THE MARK CONSISTS OF STANDARD CHARACTERS WITHOUT CLAIM TO ANY PARTICULAR FONT, STYLE, SIZE, OR COLOR.

SN 85-320,619, FILED 5-13-2011.

NAAKWAMA ANKRAH, EXAMINING ATTORNEY



David J. Kyros

Director of the United States Patent and Trademark Office

United States of America

United States Patent and Trademark Office



Reg. No. 4,068,742

Registered Dec. 6, 2011

Int. Cl.: 40

SERVICE MARK

PRINCIPAL REGISTER

JOHNSON, ARRON (UNITED STATES INDIVIDUAL)
19055 ORANGE AVE.
SONOMA, CA 95476

FOR: CUSTOM BUILDING OF MOTORCYCLES, IN CLASS 40 (U.S. CLS. 100, 103 AND 106).

FIRST USE 4-1-2011; IN COMMERCE 4-1-2011.

NO CLAIM IS MADE TO THE EXCLUSIVE RIGHT TO USE "V-TWIN", APART FROM THE MARK AS SHOWN.

THE MARK CONSISTS OF AN IMAGE OF A COMMON AMERICAN MADE V-TWIN MOTORCYCLE ENGINE, SHOWING THE UPPER CYLINDERS AND HEADS WITH A CARBURATOR IN THE MIDDLE WITH SMALL LETTERS ON IT SAYING "BAD ASS V-TWIN". ALONG SIDE EACH CYLINDER, FACING TO THE FRONT AND REAR ARE SIDE VIEWS OF SKULLS, ONE FACING LEFT, THE OTHER FACING RIGHT. GOING ACROSS THE LOWER SIDE OF THE V TWIN ENGINE IMAGE IS A FLAMED BANNER WITH LARGER WORDS "BAD ASS" INSIDE IT WITH THE FLAME TIPS INTERTWINING OUT FROM BEHIND THE IMAGE. BELOW THE BANNER IMAGE, BUT STILL ATTACHED, IS A TATTERED LOOKING HUMAN SKULL WITH FEATHERED WINGS STRETCHING OUTWARD FROM THE TEMPLE AREA OF THE SKULL THAT GO BEHIND THE FLAMED BANNER CONTAINING THE LARGE "BAD ASS" WORDS. BEHIND THE ENTIRE IMAGE ARE CLASSIC LOOKING FLAMES THAT STRETCH-OUT FROM THE SIDES AND ABOVE THE V TWIN ENGINE AND CYLINDERS. UNDERNEATH THE IMAGE AND SEPARATED FROM THE IMAGE ARE THE WORDS "V-TWIN".



SN 85-321,740, FILED 5-16-2011.

SANDRA BUJA, EXAMINING ATTORNEY

David J. Kypos

Director of the United States Patent and Trademark Office

United States of America

United States Patent and Trademark Office

Bad Ass Choppers

Reg. No. 4,068,743

JOHNSON, ARRON (UNITED STATES INDIVIDUAL)
19055 ORANGE AVE.
SONOMA, CA 95476

Registered Dec. 6, 2011

Int. Cl.: 37

FOR: MOTORCYCLE CUSTOMIZATION SERVICES; REPAIR AND MAINTENANCE OF VEHICLES, IN CLASS 37 (U.S. CLS. 100, 103 AND 106).

SERVICE MARK

FIRST USE 5-30-2011; IN COMMERCE 5-30-2011.

PRINCIPAL REGISTER

THE MARK CONSISTS OF STANDARD CHARACTERS WITHOUT CLAIM TO ANY PARTICULAR FONT, STYLE, SIZE, OR COLOR.

NO CLAIM IS MADE TO THE EXCLUSIVE RIGHT TO USE "CHOPPERS", APART FROM THE MARK AS SHOWN.

SN 85-344,960, FILED 6-13-2011.

SANDRA BUJA, EXAMINING ATTORNEY



David J. Kybas

Director of the United States Patent and Trademark Office

United States of America

United States Patent and Trademark Office

THE WEST IS DEAD

Reg. No. 4,068,744

Registered Dec. 6, 2011

Int. Cl.: 25

TRADEMARK

PRINCIPAL REGISTER

MCCRANE, INC. (CALIFORNIA CORPORATION), DBA HARBINGER,
801 CHADBOURNE ROAD, SUITE 103
FAIRFIELD, CA 94534

FOR: BEANIES; CAPS; COATS; COATS OF DENIM; DENIM JACKETS; GLOVES; GLOVES AS CLOTHING; GLOVES FOR APPAREL; HATS; HEADWEAR; JACKETS; JEANS; KNITTED CAPS; OUTDOOR GLOVES; OVER COATS; PANTS; SHIRTS; SHORT-SLEEVED OR LONG-SLEEVED T-SHIRTS; SWEAT SHIRTS; TEE SHIRTS, IN CLASS 25 (U.S. CLS. 22 AND 39).

FIRST USE 10-6-2010; IN COMMERCE 10-6-2010.

THE MARK CONSISTS OF STANDARD CHARACTERS WITHOUT CLAIM TO ANY PARTICULAR FONT, STYLE, SIZE, OR COLOR.

SN 85-975,553, FILED 3-31-2010.

GEORGE LORENZO, EXAMINING ATTORNEY



David J. Kypos

Director of the United States Patent and Trademark Office

United States of America
United States Patent and Trademark Office

NEXTERA
ENERGY 

CAPITAL
HOLDINGS

Reg. No. 4,068,745

Registered Dec. 6, 2011

Int. Cl.: 36

SERVICE MARK

PRINCIPAL REGISTER

NEXTERA ENERGY, INC. (FLORIDA CORPORATION)
700 UNIVERSE BLVD.
JUNO BEACH, FL 33408

FOR: FUNDING, FINANCING AND FINANCIAL SPONSORSHIP OF ENERGY GENERATION PROJECTS; FINANCIAL INVESTMENT IN THE FIELD OF ENERGY, ENERGY TECHNOLOGIES AND ENERGY SOURCES; FINANCING ENERGY PROJECTS, PLANTS AND SYSTEMS FOR OTHERS, INCLUDING RENEWABLE ENERGY PROJECTS, PLANTS AND SYSTEMS, ENERGY EFFICIENCY PROJECTS AND ENERGY CONSERVATION PROJECTS, IN CLASS 36 (U.S. CLS. 100, 101 AND 102).

FIRST USE 12-1-2010; IN COMMERCE 12-1-2010.

OWNER OF U.S. REG. NOS. 2,755,510, 3,750,687, AND OTHERS.

NO CLAIM IS MADE TO THE EXCLUSIVE RIGHT TO USE "ENERGY" AND "CAPITAL HOLDINGS", APART FROM THE MARK AS SHOWN.

THE MARK CONSISTS OF THE WORDS "NEXTERA ENERGY" APPEARING ABOVE A CURVED LINE. A FULLY SHADED INCOMPLETE CIRCLE OVER WHICH AN UNSHADED ZIGZAG LINE IS SUPERIMPOSED APPEARS TO THE RIGHT OF THE WORD "ENERGY" AND TOUCHES THE CURVED LINE. THE WORD "CAPITAL HOLDINGS" APPEARS BELOW THE CURVED LINE AND CIRCLE.

SN 85-975,580, FILED 10-19-2010.

MICHELE SWAIN, EXAMINING ATTORNEY



David J. Kyros

Director of the United States Patent and Trademark Office

United States of America

United States Patent and Trademark Office

FEW SPIRITS

Reg. No. 4,068,746

FEW SPIRITS, LLC (ILLINOIS LIMITED LIABILITY COMPANY)
918 CHICAGO AVE
EVANSTON, IL 60202

Registered Dec. 6, 2011

Int. Cl.: 33

FOR: DISTILLED SPIRITS; GIN; LIQUOR; SPIRITS; SPIRITS AND LIQUEURS; WHISKEY,
IN CLASS 33 (U.S. CLS. 47 AND 49).

TRADEMARK

FIRST USE 7-15-2011; IN COMMERCE 7-15-2011.

PRINCIPAL REGISTER

THE MARK CONSISTS OF STANDARD CHARACTERS WITHOUT CLAIM TO ANY PARTICULAR FONT, STYLE, SIZE, OR COLOR.

NO CLAIM IS MADE TO THE EXCLUSIVE RIGHT TO USE "SPIRITS", APART FROM THE MARK AS SHOWN.

SN 85-975,657, FILED 12-10-2010.

BENJAMIN OKEKE, EXAMINING ATTORNEY



David J. Kybas

Director of the United States Patent and Trademark Office

United States of America

United States Patent and Trademark Office

COOL-CORE

Reg. No. 4,068,747

Registered Dec. 6, 2011

Int. Cl.: 25

TRADEMARK

PRINCIPAL REGISTER

PARKER SYNERGIES LLC (FLORIDA LIMITED LIABILITY COMPANY)
10670 RIVERSIDE DR. EAST
WINDSOR, ONTARIO, CANADA N8P1A4

FOR: JACKETS; MOTORCYCLE JACKETS, IN CLASS 25 (U.S. CLS. 22 AND 39).

FIRST USE 2-0-2011; IN COMMERCE 2-0-2011.

THE MARK CONSISTS OF STANDARD CHARACTERS WITHOUT CLAIM TO ANY PARTICULAR FONT, STYLE, SIZE, OR COLOR.

SN 85-975,730, FILED 9-22-2010.

ALICE BENMAMAN, EXAMINING ATTORNEY



David J. Kybas

Director of the United States Patent and Trademark Office

United States of America

United States Patent and Trademark Office

MY VINEYARD

Reg. No. 4,068,748

Registered Dec. 6, 2011

Int. Cl.: 41

SERVICE MARK

PRINCIPAL REGISTER

PLAYDOM, INC. (DELAWARE CORPORATION)
395 PAGE MILL ROAD SUITE 200
PALO ALTO, CA 94306

FOR: ENTERTAINMENT SERVICES, NAMELY, PROVIDING TEMPORARY USE OF NON-DOWNLOADABLE INTERACTIVE GAMES COMPRISED OF COMPUTER SOFTWARE THAT MAY BE ACCESSED VIA THE INTERNET AND COMPUTERS, IN CLASS 41 (U.S. CLS. 100, 101 AND 107).

FIRST USE 4-1-2010; IN COMMERCE 4-1-2010.

THE MARK CONSISTS OF STANDARD CHARACTERS WITHOUT CLAIM TO ANY PARTICULAR FONT, STYLE, SIZE, OR COLOR.

SN 85-975,804, FILED 4-7-2010.

AMEEN IMAM, EXAMINING ATTORNEY



David J. Kybas

Director of the United States Patent and Trademark Office

United States of America

United States Patent and Trademark Office

BILLIONAIRE BOYFRIEND

Reg. No. 4,068,749

Registered Dec. 6, 2011

Int. Cl.: 3

TRADEMARK

PRINCIPAL REGISTER

KITTY LIKES TO SCRATCH PRODUCTIONS, INC. (CALIFORNIA CORPORATION)
10866 WILSHIRE BLVD
C/O KITTY LIKES TO SCRATCH/TMBG 10TH FL
LOS ANGELES, CA 90024

FOR: COSMETICS, NAMELY, FRAGRANCES, PERFUMES, AND NON-MEDICATED FACE CARE PREPARATIONS, IN CLASS 3 (U.S. CLS. 1, 4, 6, 50, 51 AND 52).

FIRST USE 9-23-2011; IN COMMERCE 9-23-2011.

THE MARK CONSISTS OF STANDARD CHARACTERS WITHOUT CLAIM TO ANY PARTICULAR FONT, STYLE, SIZE, OR COLOR.

OWNER OF U.S. REG. NO. 3,867,964.

SN 85-975,811, FILED 11-19-2010.

BRIDGETT SMITH, EXAMINING ATTORNEY



David J. Kyros

Director of the United States Patent and Trademark Office

United States of America

United States Patent and Trademark Office



Reg. No. 4,068,750
Registered Dec. 6, 2011
Int. Cls.: 16, 20, 21, 25,
and 42

TRADEMARK

SERVICE MARK

PRINCIPAL REGISTER

QUEENS COLLEGE (NEW YORK CITY UNIVERSITY OF NEW YORK SYSTEM, A NEW YORK GOVERNING BODY)
65-30 KISSENA BLVD
FLUSHING, NY 11367

FOR: PAPER GOODS, PAPER ARTICLES AND PRINTED MATTER, NAMELY, 3-RING BINDERS, APPOINTMENT BOOKS, BINDER FOLDERS, BINDERS, BUMPER STICKERS, DESKTOP BUSINESS CARD HOLDERS, CALENDARS, DATE BOOKS, DECALS, DESK PADS, DESK SETS, FOLDERS, LOOSELEAF BINDERS, NOTEBOOKS, PENCILS, PENS, PORTFOLIO NOTEBOOKS, STICKERS, WIREBOUND NOTEBOOKS; PRINTED MATERIALS, NAMELY, BOOKS, BULLETINS, CATALOGUES, CLASS ALBUMS, GUIDE BOOKS, JOURNALS, MAGAZINES, NEWSLETTERS, NEWSPAPERS, PAMPHLETS, PROGRAMS, REGISTERS, SCHEDULES, YEARBOOKS, ALL RELATING TO GENERAL NEWS, BUSINESS, POLITICAL, EDUCATIONAL, ARTS AND ENTERTAINMENT, SPORTS, TRAVEL, ALUMNI, FACULTY, STUDENTS AND OTHER QUEENS COLLEGE RELATED EVENTS, AFFAIRS AND NEWS-RELATED ITEMS, IN CLASS 16 (U.S. CLS. 2, 5, 22, 23, 29, 37, 38 AND 50).

FIRST USE 6-15-2009; IN COMMERCE 6-15-2009.

FOR: PICTURE FRAMES NOT OF PRECIOUS METAL, PICTURE FRAMES OF PRECIOUS METAL, PICTURE AND PHOTOGRAPH FRAMES, NON-METAL KEY CHAINS, NON-LEATHER KEY CHAINS, PLASTIC KEY CHAINS, PLASTIC KEY CHAIN TAGS, IN CLASS 20 (U.S. CLS. 2, 13, 22, 25, 32 AND 50).

FIRST USE 6-15-2009; IN COMMERCE 6-15-2009.

FOR: HOUSEWARES, EARTHENWARE AND GLASS ARTICLES, NAMELY, COFFEE CUPS, CUPS, DRINKING GLASSES, MUGS, PLASTIC WATER BOTTLES SOLD EMPTY, ALUMINUM WATER BOTTLES SOLD EMPTY, STAINLESS STEEL WATER BOTTLES SOLD EMPTY, IN CLASS 21 (U.S. CLS. 2, 13, 23, 29, 30, 33, 40 AND 50).

FIRST USE 6-15-2009; IN COMMERCE 6-15-2009.

FOR: CLOTHING FOR MEN, WOMEN AND CHILDREN, NAMELY, BASEBALL CAPS, FLEECE JACKETS, FLEECE TOPS, GLOVES, GOLF SHIRTS, HATS, HEADWEAR, INFANT CREEPERS, INFANTWEAR, JACKETS, KNIT SHIRTS, LOUNGEWEAR, ONE PIECE GARMENTS FOR INFANTS AND TODDLERS, PAJAMAS, PANTS, POLO SHIRTS, SCARVES,



David J. Kybas

Director of the United States Patent and Trademark Office

Reg. No. 4,068,750 SWEAT SHIRTS, SWEATPANTS, T-SHIRTS, WARM-UP PANTS, WARM-UP TOPS, WOOL HATS, IN CLASS 25 (U.S. CLS. 22 AND 39).

FIRST USE 6-15-2009; IN COMMERCE 6-15-2009.

FOR: COMPUTER SERVICES, NAMELY, PROVIDING TEMPORARY USE OF ON-LINE NON-DOWNLOADABLE COMPUTER SOFTWARE VIA THE INTERNET FOR VIEWING AND/OR LISTENING TO TELEVISION HIGHLIGHTS, INTERACTIVE TELEVISION HIGHLIGHTS, VIDEO RECORDINGS, VIDEO STREAM RECORDINGS, INTERACTIVE VIDEO HIGHLIGHT SELECTIONS, RADIO PROGRAMS, RADIO HIGHLIGHTS AND AUDIO RECORDINGS IN THE FIELD OF EDUCATION; COMPUTER SERVICES, NAMELY, CREATING AN ON-LINE COMMUNITY FOR REGISTERED USERS TO PARTICIPATE IN COMPETITIONS, SHOWCASE THEIR SKILLS, GET FEEDBACK FROM THEIR PEERS, FORM VIRTUAL COMMUNITIES, ENGAGE IN SOCIAL NETWORKING AND IMPROVE THEIR TALENT; COMPUTER SERVICES, NAMELY, HOSTING ON-LINE INTERACTIVE PUBLIC CALENDARS THAT ALLOW MULTIPLE PARTICIPANTS TO SHARE EVENT SCHEDULES AND FACILITY RESERVATIONS; COMPUTER SERVICES, NAMELY, INTERACTIVE HOSTING SERVICES WHICH ALLOW THE USER TO PUBLISH AND SHARE THEIR OWN CONTENT AND IMAGES ON-LINE, IN CLASS 42 (U.S. CLS. 100 AND 101).

FIRST USE 6-15-2009; IN COMMERCE 6-15-2009.

THE MARK CONSISTS OF A STYLIZED UPPERCASE LETTER "Q" WITH THE "TAIL" OF THE LETTER PLACED DIAGONALLY BELOW THE CIRCLE OF THE "Q" AND ENDING IN (OR TAPERING TO) A POINT ON THE RIGHT SIDE OF THE LETTER, PLUS AN ADDITIONAL STRIPE (OR BAR), PLACED IN PARALLEL AND ABOVE THE "TAIL" OF THE LETTER AND ALSO ENDING IN (OR TAPERING TO) A POINT ON THE RIGHT SIDE OF THE LETTER.

SN 85-975,827, FILED 4-25-2010.

CHRISTINA SOBRAL, EXAMINING ATTORNEY

United States of America
United States Patent and Trademark Office

HOOZA

Reg. No. 4,068,751

Registered Dec. 6, 2011

Int. Cls.: 38 and 42

SERVICE MARK

PRINCIPAL REGISTER

HOOZA, LLC (CALIFORNIA LIMITED LIABILITY COMPANY)
2029 VILLAGE LANE, SUITE 101
SOLVANG, CA 93463

FOR: ELECTRONIC MAIL, IN CLASS 38 (U.S. CLS. 100, 101 AND 104).

FIRST USE 10-15-2010; IN COMMERCE 10-6-2011.

FOR: COMPUTER AND INTERNET SERVICES, NAMELY, ONLINE NON-DOWNLOADABLE SOFTWARE THAT ALLOWS USERS TO DESIGN AND CONSTRUCT WEBSITES; MAINTENANCE AND HOSTING OF WEBSITES FOR OTHERS, INCLUDING HOSTING DATA, IMAGES, AUDIO AND VIDEO CONTENT FOR OTHERS ON A GLOBAL COMPUTER NETWORK; CONSULTATION, TECHNICAL SUPPORT AND ADVICE PROVIDED TO OTHERS REGARDING WEB SITE DESIGN, WEB SITE CONSTRUCTION, WEB SITE MAINTENANCE, SEARCH ENGINE OPTIMIZATION, AND REGARDING THE CREATION OF PERSONAL INTERNET WEBSITE PORTALS; PROVIDING TEMPORARY USE OF ONLINE NON-DOWNLOADABLE SOFTWARE FOR USE BY OTHERS TO DESIGN AND BUILD WEB SITES THAT FEATURE MEDIA, CONTENT AND FORMS, AND THAT ENABLE ELECTRONIC COMMERCE TRANSACTIONS, ONLINE SHOPPING CARTS AND OTHER ELECTRONIC PAYMENT MECHANISMS FOR OTHERS TO ACCEPT PAYMENT FOR THE SALE OF GOODS OR SERVICES, IN CLASS 42 (U.S. CLS. 100 AND 101).

FIRST USE 10-15-2010; IN COMMERCE 10-6-2011.

THE MARK CONSISTS OF STANDARD CHARACTERS WITHOUT CLAIM TO ANY PARTICULAR FONT, STYLE, SIZE, OR COLOR.

SN 85-975,844, FILED 2-17-2011.

COURTNEY ALVAREZ, EXAMINING ATTORNEY



David J. Kyros

Director of the United States Patent and Trademark Office

United States of America

United States Patent and Trademark Office

PEOPLE DRIVEN ARCHITECTURE

Reg. No. 4,068,752

Registered Dec. 6, 2011

Int. Cl.: 42

SERVICE MARK

PRINCIPAL REGISTER

BAROMETER INC. (MINNESOTA CORPORATION)
1331 TYLER STREET NE, SUITE 100
MINNEAPOLIS, MN 55413

FOR: CONSULTING IN THE FIELD OF INFORMATION TECHNOLOGY; SOFTWARE AS A SERVICE (SAAS) SERVICES FEATURING SOFTWARE FOR USE IN SEARCHING AND ORGANIZING INFORMATION IN THE FIELD OF INFORMATION TECHNOLOGY, IN CLASS 42 (U.S. CLS. 100 AND 101).

FIRST USE 10-13-2011; IN COMMERCE 10-13-2011.

THE MARK CONSISTS OF STANDARD CHARACTERS WITHOUT CLAIM TO ANY PARTICULAR FONT, STYLE, SIZE, OR COLOR.

SN 85-975,868, FILED 11-2-2010.

KAREN BRACEY, EXAMINING ATTORNEY



David J. Kyffers

Director of the United States Patent and Trademark Office

United States of America

United States Patent and Trademark Office

VIRTUAL PIGGY

Reg. No. 4,068,753

Registered Dec. 6, 2011

Int. Cl.: 36

SERVICE MARK

PRINCIPAL REGISTER

VIRTUAL PIGGY, INC. (DELAWARE CORPORATION)
15 WEST HIGHLAND AVENUE
PHILADELPHIA, PA 19118

FOR: ELECTRONIC COMMERCE PAYMENT SERVICES, NAMELY, ESTABLISHING AND ADMINISTERING ONLINE SPENDING PROFILES THAT ARE LINKED TO FUNDED ACCOUNTS OR CREDIT, DEBIT OR OTHER PAYMENT CARDS THAT CONTROL, FACILITATE AND ADMINISTER APPROVED PAYMENTS USED TO PURCHASE GOODS AND SERVICES ON THE INTERNET; PROVIDING ON-LINE PAYMENT PROCESSING AND MANAGEMENT OF CREDIT, DEBIT OR OTHER PAYMENT CARD TRANSACTIONS, IN CLASS 36 (U.S. CLS. 100, 101 AND 102).

FIRST USE 9-0-2011; IN COMMERCE 9-0-2011.

THE MARK CONSISTS OF STANDARD CHARACTERS WITHOUT CLAIM TO ANY PARTICULAR FONT, STYLE, SIZE, OR COLOR.

NO CLAIM IS MADE TO THE EXCLUSIVE RIGHT TO USE "VIRTUAL" , APART FROM THE MARK AS SHOWN.

SN 85-975,888, FILED 10-7-2010.

KAREN BRACEY, EXAMINING ATTORNEY



David J. Kyros

Director of the United States Patent and Trademark Office

United States of America
United States Patent and Trademark Office

Ferme

Reg. No. 4,068,754

Registered Dec. 6, 2011

Int. Cls.: 29 and 30

TRADEMARK

SUPPLEMENTAL REGISTER

SAHADI FINE FOODS, INC. (NEW YORK CORPORATION)
4215 FIRST AVENUE
BROOKLYN, NY 11232

FOR: SNACKS MIX CONSISTING OF PROCESSED NUTS, SEEDS, DRIED FRUITS AND RAISINS; NUT AND SEED BASED SNACK BARS; CANDIED FRUIT SNACKS; DRIED FRUIT BASED BARS, IN CLASS 29 (U.S. CL. 46).

FIRST USE 2-3-2007; IN COMMERCE 2-3-2007.

FOR: PROCESSED GRAINS, IN CLASS 30 (U.S. CL. 46).

FIRST USE 2-3-2007; IN COMMERCE 2-3-2007.

THE MARK CONSISTS OF STANDARD CHARACTERS WITHOUT CLAIM TO ANY PARTICULAR FONT, STYLE, SIZE, OR COLOR.

THE ENGLISH TRANSLATION OF "FERME" IN THE MARK IS "FARM".

SER. NO. 76-704,765, FILED P.R. 10-4-2010; AM. S.R. 7-22-2011.

KATHERINE E. HALMEN, EXAMINING ATTORNEY



David J. Kyros

Director of the United States Patent and Trademark Office

United States of America

United States Patent and Trademark Office

Piquant

Reg. No. 4,068,755

SAHADI FINE FOODS, INC. (NEW YORK CORPORATION)
4215 FIRST AVENUE
BROOKLYN, NY 11232

Registered Dec. 6, 2011

Int. Cl.: 29

FOR: CANNED AND JARRED FRUITS AND VEGETABLES, IN CLASS 29 (U.S. CL. 46).

TRADEMARK

FIRST USE 7-1-2004; IN COMMERCE 7-1-2004.

SUPPLEMENTAL REGISTER

THE MARK CONSISTS OF STANDARD CHARACTERS WITHOUT CLAIM TO ANY PARTICULAR FONT, STYLE, SIZE, OR COLOR.

SER. NO. 76-704,766, FILED P.R. 10-4-2010; AM. S.R. 7-22-2011.

KATHERINE E. HALMEN, EXAMINING ATTORNEY



David J. Kybas

Director of the United States Patent and Trademark Office

United States of America

United States Patent and Trademark Office

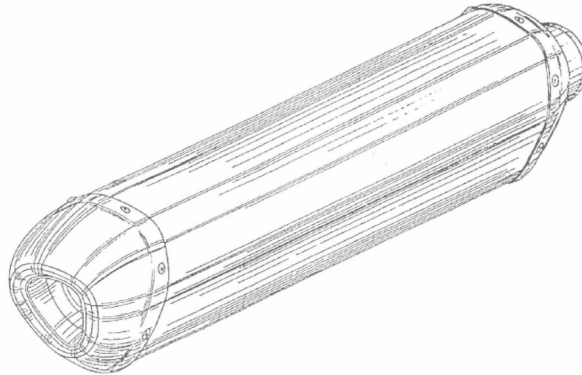

Reg. No. 4,068,756

Registered Dec. 6, 2011

Int. Cl.: 7

TRADEMARK

SUPPLEMENTAL REGISTER

IGOR AKRAPOVIC (SLOVENIA INDIVIDUAL)
ROZNA DOLINA C. VIII/10 A
SI-1000 LJUBLJANA, SLOVENIA

FOR: MUFFLERS FOR MOTORS OR ENGINES, IN CLASS 7 (U.S. CLS. 13, 19, 21, 23, 31, 34 AND 35).

FIRST USE 3-31-2006; IN COMMERCE 3-31-2006.

THE STIPPLING IS FOR SHADING PURPOSES.

THE MARK CONSISTS OF A THREE-DIMENSIONAL CONFIGURATION OF THE GOODS IN THE FORM OF A MUFFLER HAVING A MAIN BODY AND TWO ENDS. THE MAIN BODY INCLUDES A SLEEVE HAVING AN OUTER GENERALLY HEXAGONAL CROSS-SECTIONAL SHAPE. THE FIRST END OF THE MUFFLER HAS A HOLLOW GENERALLY CIRCULAR CYLINDRICAL PROJECTION. THE SECOND END HAS AN ANGLED PROJECTION HAVING A CURVILINEAR CROSS-SECTIONAL OPENING. THE ANGLED PROJECTION OF THE SECOND END PROTRUDES A GREATER DISTANCE FROM THE TOP OF THE MAIN BODY THAN IT DOES FROM THE BOTTOM OF THE MAIN BODY. THE CURVILINEAR CROSS-SECTIONAL OPENING OF THE SECOND END IS WIDER NEARER THE TOP OF THE MAIN BODY AND NARROWER NEAR THE BOTTOM OF THE MAIN BODY, AND IS GENERALLY A FOUR-SIDED DIAMOND-SHAPE. SURROUNDING THE MAIN BODY PROXIMATE TO THE FIRST END IS A FIRST BAND SECURED TO THE MAIN BODY. SURROUNDING THE MAIN BODY PROXIMATE TO THE SECOND END IS A SECOND BAND SECURED TO THE MAIN BODY. THE ENTIRE DRAWING COMPRISES THE MARK.



SER. NO. 76-705,529, FILED 12-1-2010.

KATHRYN COWARD, EXAMINING ATTORNEY

David J. Kybas

Director of the United States Patent and Trademark Office

United States of America

United States Patent and Trademark Office

PANEL BAR

Reg. No. 4,068,757

Registered Dec. 6, 2011

Int. Cl.: 9

TRADEMARK

SUPPLEMENTAL REGISTER

NEW ENGLAND ELECTRICAL CONTRACTORS, INC. (CONNECTICUT CORPORATION)
112 BEAVER BROOK ROAD
DANBURY, CT 06810

FOR: ELECTRIC SWITCH BOXES AND RELATED COMPONENTS, NAMELY, CABLE STACKING MEMBERS AND CABLE FASTENING MEMBERS, IN CLASS 9 (U.S. CLS. 21, 23, 26, 36 AND 38).

FIRST USE 7-12-2010; IN COMMERCE 5-4-2011.

THE MARK CONSISTS OF STANDARD CHARACTERS WITHOUT CLAIM TO ANY PARTICULAR FONT, STYLE, SIZE, OR COLOR.

SER. NO. 77-090,985, FILED P.R. 1-25-2007; AM. S.R. 10-18-2011.

LAURA KOVALSKY, EXAMINING ATTORNEY



David J. Kyffers

Director of the United States Patent and Trademark Office

United States of America

United States Patent and Trademark Office

DRINK THIS NOT THAT

Reg. No. 4,068,758

Registered Dec. 6, 2011

Int. Cl.: 16

TRADEMARK

SUPPLEMENTAL REGISTER

RODALE INC. (PENNSYLVANIA CORPORATION)
33 EAST MINOR STREET
EMMAUS, PA 180980099

FOR: MAGAZINE FEATURES, COLUMNS, SECTIONS, ARTICLES IN THE FIELDS OF HEALTH, FITNESS, DIET, EXERCISE AND LIFESTYLE, IN CLASS 16 (U.S. CLS. 2, 5, 22, 23, 29, 37, 38 AND 50).

FIRST USE 6-0-2010; IN COMMERCE 6-0-2010.

THE MARK CONSISTS OF STANDARD CHARACTERS WITHOUT CLAIM TO ANY PARTICULAR FONT, STYLE, SIZE, OR COLOR.

OWNER OF U.S. REG. NO. 3,033,225.

SER. NO. 77-369,870, FILED P.R. 1-11-2008; AM. S.R. 8-11-2011.

BARBARA RUTLAND, EXAMINING ATTORNEY



David J. Kybas

Director of the United States Patent and Trademark Office

United States of America

United States Patent and Trademark Office

THE RURAL CHANNEL

Reg. No. 4,068,759

AG-COM PRODUCTIONS LTD. (CANADA LIMITED PARTNERSHIP)
19 MCLEOD ROAD
EMERALD PARK, CANADA S4L1B7

Registered Dec. 6, 2011

Int. Cls.: 38 and 41

FOR: TELEVISION BROADCASTING, IN CLASS 38 (U.S. CLS. 100, 101 AND 104).

SERVICE MARK

FOR: DISTRIBUTION OF TELEVISION PROGRAMS FOR OTHERS; PRODUCTION OF TELEVISION PROGRAMS, IN CLASS 41 (U.S. CLS. 100, 101 AND 107).

SUPPLEMENTAL REGISTER

THE MARK CONSISTS OF STANDARD CHARACTERS WITHOUT CLAIM TO ANY PARTICULAR FONT, STYLE, SIZE, OR COLOR.

PRIORITY CLAIMED UNDER SEC. 44(D) ON CANADA APPLICATION NO. 1397598, FILED 5-30-2008, REG. NO. TMA797504, DATED 5-13-2011, EXPIRES 5-13-2026.

NO CLAIM IS MADE TO THE EXCLUSIVE RIGHT TO USE "CHANNEL", APART FROM THE MARK AS SHOWN.

SER. NO. 77-492,966, FILED P.R. 6-6-2008; AM. S.R. 10-19-2011.

KHANH LE, EXAMINING ATTORNEY



David J. Kyros

Director of the United States Patent and Trademark Office

United States of America

United States Patent and Trademark Office

GREEN CHOICE

Reg. No. 4,068,760

DENVER MATTRESS CO., LLC (COLORADO LIMITED LIABILITY COMPANY)
5641 N. BROADWAY
DENVER, CO 80216

Registered Dec. 6, 2011

Int. Cls.: 20, 24, and 35

FOR: MATTRESSES; BEDS; MATTRESS FOUNDATIONS; FURNITURE; PILLOWS, IN CLASS 20 (U.S. CLS. 2, 13, 22, 25, 32 AND 50).

TRADEMARK

FIRST USE 1-26-2011; IN COMMERCE 1-26-2011.

SERVICE MARK

FOR: COMFORTERS, DUVETS, PILLOW SHAMS, COVERLETS, BEDSPREADS, BED SHEETS, BED SKIRTS, BED BLANKETS, LAP BLANKETS, BLANKET THROWS, IN CLASS 24 (U.S. CLS. 42 AND 50).

SUPPLEMENTAL REGISTER

FIRST USE 1-26-2011; IN COMMERCE 1-26-2011.

FOR: RETAIL STORE SERVICES FEATURING BEDROOM FURNITURE, MATTRESSES, BEDDING AND PILLOWS; ONLINE RETAIL STORE SERVICES FEATURING BEDROOM FURNITURE, MATTRESSES, BEDDING AND PILLOWS, IN CLASS 35 (U.S. CLS. 100, 101 AND 102).

FIRST USE 1-26-2011; IN COMMERCE 1-26-2011.

THE MARK CONSISTS OF STANDARD CHARACTERS WITHOUT CLAIM TO ANY PARTICULAR FONT, STYLE, SIZE, OR COLOR.

SER. NO. 77-540,739, FILED P.R. 8-6-2008; AM. S.R. 1-28-2011.

KELLY CHOE, EXAMINING ATTORNEY



David J. Kybas

Director of the United States Patent and Trademark Office

United States of America

United States Patent and Trademark Office

LAS VEGAS MUSEUM OF ORGANIZED CRIME AND LAW ENFORCEMENT

Reg. No. 4,068,761

Registered Dec. 6, 2011

Int. Cl.: 41

SERVICE MARK

SUPPLEMENTAL REGISTER

300 STEWART AVENUE CORPORATION (NEVADA NON-PROFIT CORPORATION)
300 S. 4TH STREET
SUITE 1400
LAS VEGAS, NV 89101

FOR: MUSEUMS; GUIDED TOURS OF MUSEUMS; ENTERTAINMENT SERVICES, NAMELY, LIVE HISTORICAL SKITS; EDUCATIONAL SERVICES, NAMELY, SEMINARS ABOUT LAW ENFORCEMENT AGAINST ORGANIZED CRIME AND HISTORICAL EVENTS, IN CLASS 41 (U.S. CLS. 100, 101 AND 107).

FIRST USE 3-17-2011; IN COMMERCE 3-17-2011.

THE MARK CONSISTS OF STANDARD CHARACTERS WITHOUT CLAIM TO ANY PARTICULAR FONT, STYLE, SIZE, OR COLOR.

NO CLAIM IS MADE TO THE EXCLUSIVE RIGHT TO USE "MUSEUM", APART FROM THE MARK AS SHOWN.

SER. NO. 77-600,292, FILED P.R. 10-24-2008; AM. S.R. 10-5-2011.

FRED CARL, EXAMINING ATTORNEY



David J. Kyffers

Director of the United States Patent and Trademark Office

United States of America

United States Patent and Trademark Office

MUSCLE MEALS

Reg. No. 4,068,762

IRON MAN MAGAZINE (CALIFORNIA PARTNERSHIP)
1701 IVES AVENUE
OXNARD, CA 93033

Registered Dec. 6, 2011

Int. Cl.: 5

FOR: NUTRITIONAL DRINKS USED AS A MEAL REPLACEMENT, IN CLASS 5 (U.S. CLS. 6, 18, 44, 46, 51 AND 52).

TRADEMARK

FIRST USE 0-0-1998; IN COMMERCE 0-0-1998.

SUPPLEMENTAL REGISTER

THE MARK CONSISTS OF STANDARD CHARACTERS WITHOUT CLAIM TO ANY PARTICULAR FONT, STYLE, SIZE, OR COLOR.

NO CLAIM IS MADE TO THE EXCLUSIVE RIGHT TO USE "MEALS", APART FROM THE MARK AS SHOWN.

SER. NO. 77-736,966, FILED P.R. 5-14-2009; AM. S.R. 10-26-2011.

ANDREW LEASER, EXAMINING ATTORNEY



David J. Kybas

Director of the United States Patent and Trademark Office

United States of America

United States Patent and Trademark Office

PowerHub

Reg. No. 4,068,763

POWER DISTRIBUTION, INC (VIRGINIA CORPORATION)
4200 OAKLEYS CT.
RICHMOND, VA 23223

Registered Dec. 6, 2011

Int. Cl.: 9

FOR: ELECTRICAL POWER DISTRIBUTION UNITS EQUIPPED TO INDIVIDUALLY MONITOR AND DISPLAY PERFORMANCE OF EACH INPUT FEED AND EACH BRANCH CIRCUIT, FOR POWER RANGING FROM 150KVA TO 750KVA; ELECTRICAL POWER DISTRIBUTION UNITS, IN CLASS 9 (U.S. CLS. 21, 23, 26, 36 AND 38).

TRADEMARK

SUPPLEMENTAL REGISTER FIRST USE 3-31-2008; IN COMMERCE 3-31-2008.

THE MARK CONSISTS OF STANDARD CHARACTERS WITHOUT CLAIM TO ANY PARTICULAR FONT, STYLE, SIZE, OR COLOR.

SER. NO. 77-768,932, FILED P.R. 6-26-2009; AM. S.R. 10-24-2011.

CHRISTINE COOPER, EXAMINING ATTORNEY



David J. Kybas

Director of the United States Patent and Trademark Office

United States of America

United States Patent and Trademark Office

COOKING CHANNEL

Reg. No. 4,068,764

COOKING CHANNEL, LLC (DELAWARE LIMITED LIABILITY COMPANY)
312 WALNUT STREET, SUITE 1800
CINCINNATI, OH 45202

Registered Dec. 6, 2011

Int. Cl.: 38

FOR: TELEVISION BROADCASTING; STREAMING OF VIDEO PROGRAMS VIA THE INTERNET, IN CLASS 38 (U.S. CLS. 100, 101 AND 104).

SERVICE MARK

FIRST USE 5-31-2010; IN COMMERCE 5-31-2010.

SUPPLEMENTAL REGISTER

THE MARK CONSISTS OF STANDARD CHARACTERS WITHOUT CLAIM TO ANY PARTICULAR FONT, STYLE, SIZE, OR COLOR.

NO CLAIM IS MADE TO THE EXCLUSIVE RIGHT TO USE "CHANNEL", APART FROM THE MARK AS SHOWN.

SER. NO. 77-844,566, FILED P.R. 10-8-2009; AM. S.R. 10-25-2011.

CORY BOONE, EXAMINING ATTORNEY



David J. Kybas

Director of the United States Patent and Trademark Office

United States of America

United States Patent and Trademark Office

COOKING CHANNEL

Reg. No. 4,068,765

COOKING CHANNEL, LLC (DELAWARE LIMITED LIABILITY COMPANY)
312 WALNUT STREET, SUITE 1800
CINCINNATI, OH 45202

Registered Dec. 6, 2011

Int. Cl.: 41

FOR: EDUCATIONAL AND ENTERTAINMENT SERVICES, NAMELY, AN ON-GOING AUDIO AND VISUAL PROGRAM IN THE FIELD OF CULINARY ARTS DISTRIBUTED OVER TELEVISION, SATELLITE, WIRELESS, AUDIO AND VIDEO MEDIA, FIBER OPTICS, CABLE AND THE INTERNET, IN CLASS 41 (U.S. CLS. 100, 101 AND 107).

SERVICE MARK

SUPPLEMENTAL REGISTER FIRST USE 5-31-2010; IN COMMERCE 5-31-2010.

THE MARK CONSISTS OF STANDARD CHARACTERS WITHOUT CLAIM TO ANY PARTICULAR FONT, STYLE, SIZE, OR COLOR.

NO CLAIM IS MADE TO THE EXCLUSIVE RIGHT TO USE "CHANNEL", APART FROM THE MARK AS SHOWN.

SER. NO. 77-844,580, FILED P.R. 10-8-2009; AM. S.R. 10-25-2011.

CORY BOONE, EXAMINING ATTORNEY



David J. Kyffers

Director of the United States Patent and Trademark Office

United States of America

United States Patent and Trademark Office

WINGNUTS

Reg. No. 4,068,766

Registered Dec. 6, 2011

Int. Cl.: 41

SERVICE MARK

SUPPLEMENTAL REGISTER

AVLON, JOHN P. (UNITED STATES INDIVIDUAL)
5TH FLOOR
29 BROADWAY
NEW YORK, NY 10006

FOR: ENTERTAINMENT SERVICES, NAMELY, A CONTINUING COMMENTARY NEWS SEGMENT BROADCAST ON CABLE TELEVISION AND OTHER MEDIA; COMPUTER SERVICES, NAMELY, PROVIDING A COLUMN IN AN ONLINE MAGAZINE IN THE FIELD OF NEWS, MEDIA, SOCIAL ISSUES AND PUBLIC AFFAIRS, IN CLASS 41 (U.S. CLS. 100, 101 AND 107).

FIRST USE 5-0-2009; IN COMMERCE 5-0-2009.

THE MARK CONSISTS OF STANDARD CHARACTERS WITHOUT CLAIM TO ANY PARTICULAR FONT, STYLE, SIZE, OR COLOR.

SER. NO. 77-855,407, FILED P.R. 10-22-2009; AM. S.R. 2-22-2011.

NELSON SNYDER, EXAMINING ATTORNEY



David J. Kyffers

Director of the United States Patent and Trademark Office

United States of America

United States Patent and Trademark Office

WINGNUT

Reg. No. 4,068,767

Registered Dec. 6, 2011

Int. Cl.: 41

SERVICE MARK

SUPPLEMENTAL REGISTER

AVLON, JOHN P. (UNITED STATES INDIVIDUAL)
5TH FLOOR
29 BROADWAY
NEW YORK, NY 10006

FOR: ENTERTAINMENT SERVICES, NAMELY, A CONTINUING COMMENTARY NEWS SEGMENT BROADCAST ON CABLE TELEVISION AND OTHER MEDIA; COMPUTER SERVICES, NAMELY, PROVIDING A COLUMN IN AN ONLINE MAGAZINE IN THE FIELD OF NEWS, MEDIA, SOCIAL ISSUES AND PUBLIC AFFAIRS, IN CLASS 41 (U.S. CLS. 100, 101 AND 107).

FIRST USE 5-0-2009; IN COMMERCE 5-0-2009.

THE MARK CONSISTS OF STANDARD CHARACTERS WITHOUT CLAIM TO ANY PARTICULAR FONT, STYLE, SIZE, OR COLOR.

SER. NO. 77-855,409, FILED P.R. 10-22-2009; AM. S.R. 2-22-2011.

NELSON SNYDER, EXAMINING ATTORNEY



David J. Kybas

Director of the United States Patent and Trademark Office

United States of America

United States Patent and Trademark Office

YOYO.COM

Reg. No. 4,068,768

Registered Dec. 6, 2011

Int. Cl.: 35

SERVICE MARK

SUPPLEMENTAL REGISTER

QUIDSI, INC. (DELAWARE CORPORATION)
10 EXCHANGE PLACE, 25TH FLOOR
JERSEY CITY, NJ 07302

FOR: ON-LINE RETAIL STORE SERVICES FEATURING ACTION FIGURES, DOLLS AND ACCESSORIES THEREFOR, STUFFED TOYS, RUBBER ANIMALS, PLASTIC ANIMALS, PLAYING CARDS, GAMES, COMPUTER GAMES, ART SUPPLIES, PUZZLES, TOY MUSICAL INSTRUMENTS, BOOKS, STICKERS, BICYCLES, TRICYCLES, BALLS, CDS, DVDS, AUDIO AND VIDEO CASSETTES, SPORTING GOODS, TOY VEHICLES, INFLATABLE POOLS, YARD TOYS, CONSTRUCTION BLOCKS, TOY SCIENCE KITS, KITES, COSTUMES, MODEL AIRPLANES, TOY BINOCULARS, SQUIRT GUNS, HOBBY CRAFT SETS, BATH TOYS, KALEIDOSCOPIES, HOLIDAY DECORATIONS, TOY JEWELRY, TOY DINNERWARE AND TEA SETS, WALKIE-TALKIES, ROBOTS, POOL TOYS, ROLE PLAYING GAMES, AND ELECTRONICS, IN CLASS 35 (U.S. CLS. 100, 101 AND 102).

FIRST USE 9-20-2011; IN COMMERCE 9-20-2011.

THE MARK CONSISTS OF STANDARD CHARACTERS WITHOUT CLAIM TO ANY PARTICULAR FONT, STYLE, SIZE, OR COLOR.

SER. NO. 77-871,602, FILED P.R. 11-12-2009; AM. S.R. 10-7-2011.

MEGHAN REINHART, EXAMINING ATTORNEY



David J. Kyros

Director of the United States Patent and Trademark Office

United States of America

United States Patent and Trademark Office

MONOLITHIC ARRAY

Reg. No. 4,068,769

Registered Dec. 6, 2011

Int. Cl.: 9

TRADEMARK

SUPPLEMENTAL REGISTER

GRABER, CURTIS E. (UNITED STATES INDIVIDUAL)
9301 ROBERTS ROAD
WOODBURN, IN 46797

FOR: COMMUNICATION SYSTEMS, NAMELY, APPARATUS FOR TRANSMITTING AND REPRODUCING SOUND FOR USE IN COMMUNICATIONS; LONG RANGE COMMUNICATION APPARATUS IN THE NATURE OF LOUDSPEAKERS; HIGH OUTPUT ELECTRO-ACOUSTICAL DEVICES AND SYSTEMS, NAMELY, AUDIO SPEAKER, AUDIO AMPLIFIER AND LOUDSPEAKER FOR USE IN COMMUNICATIONS, IN CLASS 9 (U.S. CLS. 21, 23, 26, 36 AND 38).

FIRST USE 11-19-2009; IN COMMERCE 11-19-2009.

THE MARK CONSISTS OF STANDARD CHARACTERS WITHOUT CLAIM TO ANY PARTICULAR FONT, STYLE, SIZE, OR COLOR.

SER. NO. 77-877,497, FILED P.R. 11-20-2009; AM. S.R. 9-22-2011.

GRETCHEN ULRICH, EXAMINING ATTORNEY



David J. Kyfos

Director of the United States Patent and Trademark Office

United States of America

United States Patent and Trademark Office

nano-interface cooling

Reg. No. 4,068,770

Registered Dec. 6, 2011

Int. Cl.: 11

TRADEMARK

SUPPLEMENTAL REGISTER

LG ELECTRONICS INC. (REPUBLIC OF KOREA CORPORATION)
20, YEOUIDO-DONG, YEONGDEUNGPO-GU
SEOUL, REPUBLIC OF KOREA 150-721

FOR: STREET LAMPS; SAFETY LAMPS FOR UNDERGROUND USE; NEON LAMPS; LANTERNS; VEHICLE DYNAMO LAMPS; INCANDESCENT LAMPS; ULTRAVIOLET RAY LAMPS, NOT FOR MEDICAL PURPOSES; CHANDELIERS; MERCURY LAMPS; AQUARIUM LIGHTS; SPOTLIGHTS; ARC LAMPS; SAFETY LAMPS FOR UNDERGROUND USE; DIVING LIGHTS; DECORATIVE LAMPS; INFRARED LAMPS; ELECTRIC TORCHES FOR LIGHTING; LED UNDERWATER FISH GATHERING LAMP; CEILING LIGHTS; ELECTRIC LIGHT DECORATIVE STRINGS, NAMELY, FAIRY LIGHTS FOR FESTIVE DECORATION; ELECTRIC LIGHTS FOR CHRISTMAS TREES; LAMPS; SEARCHLIGHTS; FLOODLIGHTS; FLUORESCENT LAMPS; FLASHLIGHTS; LIGHTS FOR MOTORCYCLES; LIGHTS FOR AUTOMOBILES; REFLECTORS FOR AUTOMOBILES; VEHICLE TURN-SIGNAL LIGHT BULBS; DEFROSTING APPARATUS FOR VEHICLES; AIR CONDITIONERS FOR AUTOMOBILES; HEADLIGHTS FOR AUTOMOBILES; HEATERS FOR AUTOMOBILES, IN CLASS 11 (U.S. CLS. 13, 21, 23, 31 AND 34).

THE MARK CONSISTS OF STANDARD CHARACTERS WITHOUT CLAIM TO ANY PARTICULAR FONT, STYLE, SIZE, OR COLOR.

PRIORITY CLAIMED UNDER SEC. 44(D) ON REPUBLIC OF KOREA APPLICATION NO. 2009-0056683, FILED 11-17-2009, REG. NO. 0852626, DATED 2-9-2011, EXPIRES 2-9-2021.

NO CLAIM IS MADE TO THE EXCLUSIVE RIGHT TO USE "COOLING", APART FROM THE MARK AS SHOWN.

SER. NO. 77-884,264, FILED P.R. 12-2-2009; AM. S.R. 3-28-2011.

ESTHER A. BORSUK, EXAMINING ATTORNEY



David J. Kybas

Director of the United States Patent and Trademark Office

United States of America

United States Patent and Trademark Office



Reg. No. 4,068,771

Registered Dec. 6, 2011

Int. Cl.: 41

SERVICE MARK

SUPPLEMENTAL REGISTER FIRST USE 6-0-2002; IN COMMERCE 6-0-2002.

JOHN AMATUCCI (UNITED STATES INDIVIDUAL), DBA GOTHAM SPORTS,
UNIT 6
5397 COCHRAN STREET
SIMI VALLEY, CA 93063

FOR: PROVIDING A WEBSITE FEATURING INFORMATION ABOUT PROFESSIONAL AND AMATEUR SPORTS, AND SPORTS NEWS, SCORES AND STATISTICS NOT INCLUDING HORSE RACING, IN CLASS 41 (U.S. CLS. 100, 101 AND 107).

NO CLAIM IS MADE TO THE EXCLUSIVE RIGHT TO USE "SPORTS", APART FROM THE MARK AS SHOWN.

THE MARK CONSISTS OF THE WORDING "GOTHAM SPORTS" IN STYLIZED FONT ACROSS THE CENTER OF A SERIES OF THREE CONCENTRIC CIRCLES. THE OUTERMOST CIRCLE HAS THE WORDS "NEW YORK SPORTS" IN UPPERCASE STYLIZED FONT WRITTEN INSIDE THE TOP OF THE CIRCLE, AND THE WORDS "NEWS ON THE GO" IN UPPERCASE STYLIZED FONT WRITTEN INSIDE THE BOTTOM OF THE CIRCLE.

SER. NO. 77-940,185, FILED P.R. 2-19-2010; AM. S.R. 12-1-2010.

KAREN SEVERSON, EXAMINING ATTORNEY



David J. Kybas

Director of the United States Patent and Trademark Office

United States of America
United States Patent and Trademark Office

mail.com

Reg. No. 4,068,772

Registered Dec. 6, 2011

Int. Cl.: 38

SERVICE MARK

SUPPLEMENTAL REGISTER FIRST USE 9-1-2009; IN COMMERCE 9-1-2009.

GMX INTERNET SERVICES, INC. (DELAWARE CORPORATION)
1 & 1 INTERNET AG
ELGENDORFER STR. 57
MONTABAUER, FED REP GERMANY 56410

FOR: PROVIDING ELECTRONIC TRANSMISSION OF MAIL AND MESSAGES, PROVIDING
ONLINE COMMUNICATIONS LINKS WHICH TRANSFER THE USER TO OTHER LOCAL
AND GLOBAL PAGES, IN CLASS 38 (U.S. CLS. 100, 101 AND 104).

OWNER OF U.S. REG. NO. 3,694,632.

THE MARK CONSISTS OF THE STYLIZED WORDS "MAIL.COM" WITH THE LETTER "M"
ENCASED IN A MISCELLANEOUS DESIGN.

SER. NO. 77-940,456, FILED P.R. 2-19-2010; AM. S.R. 9-21-2011.

NAAKWAMA ANKRAH, EXAMINING ATTORNEY



David J. Kyffers

Director of the United States Patent and Trademark Office

United States of America

United States Patent and Trademark Office



Reg. No. 4,068,773

Registered Dec. 6, 2011

Int. Cl.: 21

TRADEMARK

SUPPLEMENTAL REGISTER

ECO-PRODUCTS, INC. (COLORADO CORPORATION)
3640 WALNUT STREET
BOULDER, CO 80301

FOR: COMPOSTABLE HOT CUPS, IN CLASS 21 (U.S. CLS. 2, 13, 23, 29, 30, 33, 40 AND 50).

FIRST USE 10-31-2007; IN COMMERCE 1-31-2008.

THE MARK CONSISTS OF A STYLIZED MAP OF THE EASTERN HEMISPHERE.

SER. NO. 77-951,044, FILED P.R. 3-4-2010; AM. S.R. 10-19-2011.

STEVEN JACKSON, EXAMINING ATTORNEY



David J. Kyffers

Director of the United States Patent and Trademark Office

United States of America

United States Patent and Trademark Office



Reg. No. 4,068,774

STEPHEN GERRARD DYE (UNITED STATES INDIVIDUAL)
1288 CHANNELL PARK
MARIETTA, GA 30064

Registered Dec. 6, 2011

Int. Cls.: 16 and 25

FOR: COMIC BOOKS; POSTERS MADE OF PAPER, IN CLASS 16 (U.S. CLS. 2, 5, 22, 23, 29, 37, 38 AND 50).

TRADEMARK

FIRST USE 8-31-2011; IN COMMERCE 8-31-2011.

SUPPLEMENTAL REGISTER

FOR: T-SHIRTS, IN CLASS 25 (U.S. CLS. 22 AND 39).

FIRST USE 8-31-2011; IN COMMERCE 8-31-2011.

THE MARK CONSISTS OF STYLIZED LETTERS TO CREATE THE WORD "ENTOMIANS".

SER. NO. 77-955,066, FILED P.R. 3-10-2010; AM. S.R. 10-28-2011.

CORY BOONE, EXAMINING ATTORNEY



David J. Kybas

Director of the United States Patent and Trademark Office

United States of America

United States Patent and Trademark Office

15 MINUTE TACTICAL

Reg. No. 4,068,775

Registered Dec. 6, 2011

Int. Cls.: 35, 36, and 42

MARQUETTE REAL ESTATE HOLDINGS, LLC (MINNESOTA LIMITED LIABILITY COMPANY), DBA UNITED PROPERTIES, SUITE 200
3500 AMERICAN BOULEVARD WEST
MINNEAPOLIS, MN 55431

SERVICE MARK

FOR: BUSINESS CONSULTING IN THE FIELD OF COMMERCIAL REAL PROPERTY PARTICULARLY SPECIALIZING IN THE USE OF ANALYTIC MODELS FOR THE UNDERSTANDING AND PREDICTING OF BUSINESS AND RETAIL MARKET TRENDS IN THE FIELD OF COMMERCIAL REAL PROPERTY, IN CLASS 35 (U.S. CLS. 100, 101 AND 102).

SUPPLEMENTAL REGISTER

FIRST USE 7-1-2009; IN COMMERCE 7-1-2009.

FOR: INFORMATION SERVICES PROVIDED TO BUSINESSES, NAMELY, GATHERING AND REPORTING INFORMATION REGARDING COMMERCIAL REAL ESTATE, IN CLASS 36 (U.S. CLS. 100, 101 AND 102).

FIRST USE 7-1-2009; IN COMMERCE 7-1-2009.

FOR: SOFTWARE AS A SERVICE (SAAS) SERVICES, NAMELY, HOSTING SOFTWARE FOR USE BY OTHERS IN THE FIELD OF COMMERCIAL REAL PROPERTY RESEARCH, IN CLASS 42 (U.S. CLS. 100 AND 101).

FIRST USE 7-1-2009; IN COMMERCE 7-1-2009.

THE MARK CONSISTS OF STANDARD CHARACTERS WITHOUT CLAIM TO ANY PARTICULAR FONT, STYLE, SIZE, OR COLOR.

SER. NO. 85-010,833, FILED P.R. 4-9-2010; AM. S.R. 10-11-2011.

KEVIN DINALLO, EXAMINING ATTORNEY



David J. Kypos

Director of the United States Patent and Trademark Office

United States of America
United States Patent and Trademark Office

MODEL
CHICAGO
MAGAZINE

Reg. No. 4,068,776

Registered Dec. 6, 2011

Int. Cl.: 16

TRADEMARK

SUPPLEMENTAL REGISTER

LIPKA, BRANDON D. (ILLINOIS SOLE PROPRIETORSHIP)
517 W. OAKDALE #106
CHICAGO, IL 60657

FOR: COMIC STRIPS APPEARING IN BLACK AND WHITE, COLOR; FILE BOXES FOR STORAGE OF MAGAZINES; GENERAL FEATURE MAGAZINE IN THE FIELD OF FASHION; GENERAL FEATURE MAGAZINES; MAGAZINE COLUMNS ABOUT FASHION, TRAVEL, BUSINESS, SPORTS, POLITICS; MAGAZINE DEPARTMENTS IN THE FIELD OF FASHION, TRAVEL, BUSINESS, SPORTS, POLITICS; MAGAZINE PAPER; MAGAZINE SECTIONS IN THE FIELD OF FASHION, TRAVEL, BUSINESS, SPORTS, POLITICS; MAGAZINE SUPPLEMENTS TO NEWSPAPERS IN THE FIELD OF FASHION, TRAVEL, BUSINESS, SPORTS, POLITICS; MAGAZINES FEATURING MODELS, DESIGNER CLOTHING, DESIGNER ACCESSORIES, BUSINESSES, CITY OF CHICAGO, CHICAGO SUBURBS, PROFESSIONALS; MAGAZINES IN THE FIELD OF FASHION, IN CLASS 16 (U.S. CLS. 2, 5, 22, 23, 29, 37, 38 AND 50).

FIRST USE 11-10-2010; IN COMMERCE 11-10-2010.

NO CLAIM IS MADE TO THE EXCLUSIVE RIGHT TO USE "MAGAZINE", APART FROM THE MARK AS SHOWN.

THE MARK CONSISTS OF THE WORDS "MODEL CHICAGO MAGAZINE" WRITTEN IN GARAMOND FONT, WITH CUSTOMIZATION IN, RESPECTIVELY, THE FIRST "D", SECOND "C", AND THIRD "A".

SER. NO. 85-014,328, FILED P.R. 4-14-2010; AM. S.R. 10-12-2011.

ROBERT C. CLARK JR., EXAMINING ATTORNEY



David J. Kyros

Director of the United States Patent and Trademark Office

United States of America

United States Patent and Trademark Office

Harlem Quartet

Reg. No. 4,068,777

Registered Dec. 6, 2011

Int. Cl.: 41

SERVICE MARK

SUPPLEMENTAL REGISTER

THE SPHINX ORGANIZATION, INC. (MICHIGAN CORPORATION)
SUITE 2550
400 RENAISSANCE CENTER
DETROIT, MI 48243

FOR: ENTERTAINMENT SERVICES, NAMELY, MUSIC PRODUCTION, RECORDING SERVICES AND LIVE PERFORMANCES BY A CLASSICAL MUSIC QUARTET CONSISTING OF LAUREATES OF THE SPHINX COMPETITION, IN CLASS 41 (U.S. CLS. 100, 101 AND 107).

FIRST USE 7-1-2006; IN COMMERCE 7-1-2006.

THE MARK CONSISTS OF STANDARD CHARACTERS WITHOUT CLAIM TO ANY PARTICULAR FONT, STYLE, SIZE, OR COLOR.

NO CLAIM IS MADE TO THE EXCLUSIVE RIGHT TO USE "QUARTET", APART FROM THE MARK AS SHOWN.

SER. NO. 85-019,576, FILED P.R. 4-21-2010; AM. S.R. 10-4-2011.

SANI KHOURI, EXAMINING ATTORNEY



David J. Kybas

Director of the United States Patent and Trademark Office

United States of America

United States Patent and Trademark Office

THE POND SHOP

Reg. No. 4,068,778

Registered Dec. 6, 2011

Int. Cl.: 35

SERVICE MARK

SUPPLEMENTAL REGISTER

THE POND SHOP (MICHIGAN LIMITED LIABILITY COMPANY)
58145 CARBINE
WASHINGTON, MI 48094

FOR: ON-LINE RETAIL STORE SERVICES, FEATURING POND CHEMICALS, ALGAECIDES AND HERBICIDES, FLOATING FOUNTAINS, FOUNTAIN LIGHTING, AERATION SYSTEMS IN THE NATURE OF BUBBLERS, LIFE SAVING DEVICES, ALL OF THE ABOVE FOR USE IN "EARTHEN" MAN MADE PONDS AND NATURALLY OCCURRING BODIES OF WATER, IN CLASS 35 (U.S. CLS. 100, 101 AND 102).

FIRST USE 10-31-2010; IN COMMERCE 10-31-2010.

THE MARK CONSISTS OF STANDARD CHARACTERS WITHOUT CLAIM TO ANY PARTICULAR FONT, STYLE, SIZE, OR COLOR.

SER. NO. 85-024,688, FILED P.R. 4-27-2010; AM. S.R. 10-27-2011.

ANDREA HACK, EXAMINING ATTORNEY



David J. Kyros

Director of the United States Patent and Trademark Office

United States of America

United States Patent and Trademark Office

HEALTH COMMUNITY XCHANGE

Reg. No. 4,068,779

DIANE WASILISIAN (UNITED STATES INDIVIDUAL)
18 ROBIN HOOD ROAD
WINDHAM, NH 03087

Registered Dec. 6, 2011

Int. Cl.: 42

FOR: COMPUTER SERVICES, NAMELY, CREATING AN ON-LINE COMMUNITY FOR REGISTERED USERS TO PARTICIPATE IN DISCUSSIONS, GET FEEDBACK FROM THEIR PEERS, FORM VIRTUAL COMMUNITIES, AND ENGAGE IN SOCIAL NETWORKING ABOUT THE FIELD OF HEALTHCARE, IN CLASS 42 (U.S. CLS. 100 AND 101).

SERVICE MARK

SUPPLEMENTAL REGISTER FIRST USE 9-30-2010; IN COMMERCE 9-30-2010.

THE MARK CONSISTS OF STANDARD CHARACTERS WITHOUT CLAIM TO ANY PARTICULAR FONT, STYLE, SIZE, OR COLOR.

SER. NO. 85-033,422, FILED P.R. 5-7-2010; AM. S.R. 10-21-2011.

JULIE GUTTADAURO, EXAMINING ATTORNEY



David J. Kyros

Director of the United States Patent and Trademark Office

United States of America

United States Patent and Trademark Office

FLAXSTALK

Reg. No. 4,068,780

SCHWEITZER-MAUDUIT INTERNATIONAL, INC. (DELAWARE CORPORATION)
100 NORTH POINT CENTER EAST, SUITE 600
ALPHARETTA, GA 30022

Registered Dec. 6, 2011

Int. Cl.: 22

FOR: PROCESSED FLAX FIBRES FOR USE IN BIOCOMPOSITE APPLICATIONS, IN CLASS 22 (U.S. CLS. 1, 2, 7, 19, 22, 42 AND 50).

TRADEMARK

FIRST USE 9-23-2011; IN COMMERCE 9-23-2011.

SUPPLEMENTAL REGISTER

THE MARK CONSISTS OF STANDARD CHARACTERS WITHOUT CLAIM TO ANY PARTICULAR FONT, STYLE, SIZE, OR COLOR.

SER. NO. 85-041,791, FILED P.R. 5-18-2010; AM. S.R. 9-28-2011.

VERNA BETH RIRIE, EXAMINING ATTORNEY



David J. Kyffers

Director of the United States Patent and Trademark Office

United States of America

United States Patent and Trademark Office

Dynamic Video

Reg. No. 4,068,781

DYNAMIC VIDEO, LLC (DELAWARE LIMITED LIABILITY COMPANY)
71 WEST 23RD STREET, 17TH FLOOR
NEW YORK, NY 10010

Registered Dec. 6, 2011

Int. Cls.: 35 and 41

FOR: PROVIDING ONLINE BASED SERVICES IN THE FIELD OF MARKETING AND ADVERTISING, IN CLASS 35 (U.S. CLS. 100, 101 AND 102).

SERVICE MARK

FIRST USE 2-11-2010; IN COMMERCE 2-11-2010.

SUPPLEMENTAL REGISTER

FOR: ENTERTAINMENT SERVICES, NAMELY, PROVIDING A WEBSITE FEATURING PHOTOGRAPHIC, AUDIO, VIDEO AND PROSE PRESENTATIONS FEATURING ADVERTISING MULTIMEDIA; ENTERTAINMENT SERVICES, NAMELY, A CONTINUING PROGRAM ABOUT ADVERTISING ACCESSIBLE BY COMPUTER NETWORKS; ENTERTAINMENT SERVICES, NAMELY, PROVIDING A RADIO PROGRAM IN THE FIELD OF ADVERTISING MULTIMEDIA VIA A GLOBAL COMPUTER NETWORK; ENTERTAINMENT SERVICES, NAMELY, PROVIDING A WEB SITE FEATURING MUSICAL PERFORMANCES, MUSICAL VIDEOS, RELATED FILM CLIPS, PHOTOGRAPHS, AND OTHER MULTIMEDIA MATERIALS FEATURING ADVERTISING CONTENT; MULTIMEDIA ENTERTAINMENT SERVICES IN THE NATURE OF RECORDING, PRODUCTION AND POST-PRODUCTION SERVICES IN THE FIELDS OF MUSIC, VIDEO, AND FILMS; MULTIMEDIA ENTERTAINMENT SOFTWARE PRODUCTION SERVICES; PROVIDING A WEB SITE WHERE USERS CAN POST RATINGS, REVIEWS AND RECOMMENDATIONS ON EVENTS AND ACTIVITIES IN THE FIELD OF ENTERTAINMENT AND EDUCATION; PROVIDING INFORMATION IN THE FIELD OF ENTERTAINMENT, FEATURING ANIMATION RENDERED BY MEANS OF A GLOBAL COMPUTER NETWORK; PROVIDING INFORMATION, NEWS AND COMMENTARY IN THE FIELD OF ENTERTAINMENT; TRAINING COURSES IN STRATEGIC PLANNING RELATING TO ADVERTISING, PROMOTION, MARKETING AND BUSINESS; TRAINING IN THE FIELD OF DESIGN, ADVERTISING AND COMMUNICATION TECHNOLOGIES, IN CLASS 41 (U.S. CLS. 100, 101 AND 107).



FIRST USE 2-11-2010; IN COMMERCE 2-11-2010.

THE MARK CONSISTS OF STANDARD CHARACTERS WITHOUT CLAIM TO ANY PARTICULAR FONT, STYLE, SIZE, OR COLOR.

David J. Kyffers

NO CLAIM IS MADE TO THE EXCLUSIVE RIGHT TO USE "VIDEO", APART FROM THE MARK AS SHOWN.

Director of the United States Patent and Trademark Office

Reg. No. 4,068,781 SER. NO. 85-044,921, FILED P.R. 5-21-2010; AM. S.R. 10-6-2011.

ALEXANDER L. POWERS, EXAMINING ATTORNEY

United States of America

United States Patent and Trademark Office

SaaSIT

Reg. No. 4,068,782

Registered Dec. 6, 2011

Int. Cl.: 42

SERVICE MARK

SUPPLEMENTAL REGISTER

FRONTRANGE SOLUTIONS USA INC. (COLORADO CORPORATION)
5675 GIBRALTAR DRIVE
PLEASANTON, CA 94588

FOR: CLOUD COMPUTING TO CUSTOMIZE, CONFIGURE, MANAGE AND AUTOMATE OPERATIONS AND PROCESSES IN THE FIELDS OF IT SERVICE MANAGEMENT, IT ASSET MANAGEMENT, CUSTOMER SERVICE MANAGEMENT, CUSTOMER RELATIONSHIP MANAGEMENT, AND CUSTOMER SERVICE SOLUTIONS, IN CLASS 42 (U.S. CLS. 100 AND 101).

FIRST USE 11-30-2010; IN COMMERCE 11-30-2010.

THE MARK CONSISTS OF STANDARD CHARACTERS WITHOUT CLAIM TO ANY PARTICULAR FONT, STYLE, SIZE, OR COLOR.

SER. NO. 85-052,159, FILED P.R. 6-1-2010; AM. S.R. 10-7-2011.

JENNIFER MARTIN, EXAMINING ATTORNEY



David J. Kybas

Director of the United States Patent and Trademark Office

United States of America

United States Patent and Trademark Office

UNIVERSAL

Reg. No. 4,068,783

Registered Dec. 6, 2011

Int. Cl.: 9

TRADEMARK

SUPPLEMENTAL REGISTER

X6D LIMITED (CYPRUS PRIVATE LIMITED COMPANY)
199 ARCH. MAKARIOUS
3030 LIMASSOL
NEOCLEOUS HOUSE, CYPRUS

FOR: STEREOSCOPIC EQUIPMENT CONSISTING PRIMARILY OF 3D EYE-GLASSES FOR 3D VIEWING, IN CLASS 9 (U.S. CLS. 21, 23, 26, 36 AND 38).

FIRST USE 11-0-2010; IN COMMERCE 11-0-2010.

THE MARK CONSISTS OF STANDARD CHARACTERS WITHOUT CLAIM TO ANY PARTICULAR FONT, STYLE, SIZE, OR COLOR.

SER. NO. 85-054,004, FILED P.R. 6-3-2010; AM. S.R. 8-17-2011.

DAWN HAN, EXAMINING ATTORNEY



David J. Kyros

Director of the United States Patent and Trademark Office

United States of America

United States Patent and Trademark Office

PeriPort

Reg. No. 4,068,784

CORMEDICS CORPORATION (TEXAS CORPORATION)
709 COUNTRY LANE
HOUSTON, TX 77024

Registered Dec. 6, 2011

Int. Cl.: 10

FOR: SURGICAL INSTRUMENTS AND APPARATUS, IN CLASS 10 (U.S. CLS. 26, 39 AND 44).

TRADEMARK

FIRST USE 3-1-2009; IN COMMERCE 6-13-2011.

SUPPLEMENTAL REGISTER

THE MARK CONSISTS OF STANDARD CHARACTERS WITHOUT CLAIM TO ANY PARTICULAR FONT, STYLE, SIZE, OR COLOR.

SER. NO. 85-055,948, FILED P.R. 6-7-2010; AM. S.R. 11-2-2011.

TRICIA SONNEBORN, EXAMINING ATTORNEY



David J. Kybas

Director of the United States Patent and Trademark Office

United States of America

United States Patent and Trademark Office

COMPLETE

Reg. No. 4,068,785

Registered Dec. 6, 2011

Int. Cl.: 5

TRADEMARK

SUPPLEMENTAL REGISTER

PBM PRODUCTS, LLC (DELAWARE LIMITED LIABILITY COMPANY)
204 NORTH MAIN STREET
GORDONSVILLE, VA 22942

FOR: INFANT FORMULA, IN CLASS 5 (U.S. CLS. 6, 18, 44, 46, 51 AND 52).

FIRST USE 7-16-2010; IN COMMERCE 7-16-2010.

THE MARK CONSISTS OF STANDARD CHARACTERS WITHOUT CLAIM TO ANY PARTICULAR FONT, STYLE, SIZE, OR COLOR.

SER. NO. 85-057,190, FILED P.R. 6-8-2010; AM. S.R. 10-11-2011.

STEVEN PEREZ, EXAMINING ATTORNEY



David J. Kybas

Director of the United States Patent and Trademark Office

United States of America

United States Patent and Trademark Office

DemocraTea Party

Reg. No. 4,068,786

COSTELLO, KATHLEEN F. (UNITED STATES INDIVIDUAL)
P.O. BOX 1185
BOWIE, MD 20718

Registered Dec. 6, 2011

Int. Cls.: 18 and 25

FOR: TOTE BAGS, IN CLASS 18 (U.S. CLS. 1, 2, 3, 22 AND 41).

TRADEMARK

FIRST USE 6-9-2010; IN COMMERCE 8-31-2010.

SUPPLEMENTAL REGISTER

FOR: T-SHIRTS, IN CLASS 25 (U.S. CLS. 22 AND 39).

FIRST USE 6-9-2010; IN COMMERCE 8-31-2010.

THE MARK CONSISTS OF STANDARD CHARACTERS WITHOUT CLAIM TO ANY PARTICULAR FONT, STYLE, SIZE, OR COLOR.

SER. NO. 85-058,344, FILED P.R. 6-9-2010; AM. S.R. 10-5-2011.

KATHRYN COWARD, EXAMINING ATTORNEY



David J. Kybas

Director of the United States Patent and Trademark Office

United States of America

United States Patent and Trademark Office

ORAL TWIN PACK

Reg. No. 4,068,787

Registered Dec. 6, 2011

Int. Cl.: 5

TRADEMARK

SUPPLEMENTAL REGISTER

W.H.P.M., INC. (CALIFORNIA CORPORATION)
5358 IRWINDALE AVE.,
IRWINDALE, CA 91706, CA 91706

FOR: SALIVA DRUG TEST KIT FOR DIAGNOSING MULTIPLE ILLICIT DRUGS THROUGH ORAL FLUIDS; PHARMACOLOGICAL TESTING KITS COMPRISED OF CLINICAL DIAGNOSTIC REAGENTS FOR THE DETECTION OF ELEVATED LEVELS OF ILLICIT DRUGS PRESENT IN BODILY FLUIDS OF HUMAN SUBJECTS FOR FORENSIC USE, IN CLASS 5 (U.S. CLS. 6, 18, 44, 46, 51 AND 52).

FIRST USE 3-18-2011; IN COMMERCE 3-18-2011.

THE MARK CONSISTS OF STANDARD CHARACTERS WITHOUT CLAIM TO ANY PARTICULAR FONT, STYLE, SIZE, OR COLOR.

NO CLAIM IS MADE TO THE EXCLUSIVE RIGHT TO USE "ORAL" AND "PACK", APART FROM THE MARK AS SHOWN.

SER. NO. 85-058,972, FILED P.R. 6-9-2010; AM. S.R. 3-25-2011.

JOHN DALIER, EXAMINING ATTORNEY



David J. Kyros

Director of the United States Patent and Trademark Office

United States of America

United States Patent and Trademark Office

FOOD SYSTEMS SOLUTIONS

Reg. No. 4,068,788

FOOD SYSTEMS SOLUTIONS LLC (NEW YORK LIMITED LIABILITY COMPANY)
42 W. 13TH STREET #6E
NEW YORK, NY 10011

Registered Dec. 6, 2011

Int. Cls.: 35 and 43

FOR: BUSINESS CONSULTING SERVICES IN THE FIELD OF ORGANIZATIONAL CHANGE MANAGEMENT, IN CLASS 35 (U.S. CLS. 100, 101 AND 102).

SERVICE MARK

FIRST USE 2-13-2006; IN COMMERCE 2-13-2006.

SUPPLEMENTAL REGISTER

FOR: CONSULTING SERVICES IN THE FIELD OF CULINARY ARTS, IN CLASS 43 (U.S. CLS. 100 AND 101).

FIRST USE 2-13-2006; IN COMMERCE 2-13-2006.

THE MARK CONSISTS OF STANDARD CHARACTERS WITHOUT CLAIM TO ANY PARTICULAR FONT, STYLE, SIZE, OR COLOR.

SER. NO. 85-061,519, FILED P.R. 6-13-2010; AM. S.R. 10-12-2011.

LINDA M. KING, EXAMINING ATTORNEY



David J. Kyros

Director of the United States Patent and Trademark Office

United States of America

United States Patent and Trademark Office

INTELLIGENT BONUSING

Reg. No. 4,068,789

IGT (NEVADA CORPORATION)
9295 PROTOTYPE DRIVE
RENO, NV 895218986

Registered Dec. 6, 2011

Int. Cl.: 9

FOR: COMPUTER SOFTWARE FOR ADMINISTRATION OF BONUS AWARDS TO CASINO PATRONS, IN CLASS 9 (U.S. CLS. 21, 23, 26, 36 AND 38).

TRADEMARK

FIRST USE 6-22-2011; IN COMMERCE 6-22-2011.

SUPPLEMENTAL REGISTER

THE MARK CONSISTS OF STANDARD CHARACTERS WITHOUT CLAIM TO ANY PARTICULAR FONT, STYLE, SIZE, OR COLOR.

OWNER OF U.S. REG. NO. 3,518,494.

SER. NO. 85-063,746, FILED P.R. 6-15-2010; AM. S.R. 9-29-2011.

JUDITH HELFMAN, EXAMINING ATTORNEY



David J. Kybas

Director of the United States Patent and Trademark Office

United States of America

United States Patent and Trademark Office

HAZMATID

Reg. No. 4,068,790

Registered Dec. 6, 2011

Int. Cl.: 9

TRADEMARK

SUPPLEMENTAL REGISTER

SMITHS DETECTION INC. (NEVADA CORPORATION)
21 COMMERCE DRIVE
DANBURY, CT 06810

FOR: APPARATUS AND INSTRUMENTS FOR DETECTION AND/OR ANALYSIS OF CHEMICAL AND TOXIC SUBSTANCES AND BIOLOGICAL MATERIAL AND PARTS AND FITTINGS THEREFOR, ALL NOT FOR MEDICAL USE; ELECTRONIC DATABASE FOR USE IN DETECTING AND ANALYZING CHEMICAL AND TOXIC SUBSTANCES AND BIOLOGICAL MATERIAL FOR USE IN THE FIELD OF SECURITY AND THREAT DETECTION RECORDED ON COMPUTER MEDIA, IN CLASS 9 (U.S. CLS. 21, 23, 26, 36 AND 38).

FIRST USE 8-5-2003; IN COMMERCE 8-5-2003.

THE MARK CONSISTS OF STANDARD CHARACTERS WITHOUT CLAIM TO ANY PARTICULAR FONT, STYLE, SIZE, OR COLOR.

SER. NO. 85-066,610, FILED P.R. 6-18-2010; AM. S.R. 9-29-2011.

MARY ROSSMAN, EXAMINING ATTORNEY



David J. Kyffers

Director of the United States Patent and Trademark Office

United States of America

United States Patent and Trademark Office

WHO'S WHO IN BLACK ALABAMA

Reg. No. 4,068,791

Registered Dec. 6, 2011

Int. Cl.: 16

TRADEMARK

SUPPLEMENTAL REGISTER

REAL TIMES, INC. OF ILLINOIS (ILLINOIS CORPORATION)
535 GRISWOLD STREET, SUITE 1300
DETROIT, MI 48226

FOR: SERIES OF PRINTED DIRECTORIES FEATURING LISTINGS HAVING INFORMATION ABOUT AFRICAN-AMERICANS IN ALABAMA, IN CLASS 16 (U.S. CLS. 2, 5, 22, 23, 29, 37, 38 AND 50).

FIRST USE 5-14-2011; IN COMMERCE 5-14-2011.

THE MARK CONSISTS OF STANDARD CHARACTERS WITHOUT CLAIM TO ANY PARTICULAR FONT, STYLE, SIZE, OR COLOR.

OWNER OF U.S. REG. NOS. 2,958,736, 3,030,839, AND OTHERS.

NO CLAIM IS MADE TO THE EXCLUSIVE RIGHT TO USE "WHO'S WHO", APART FROM THE MARK AS SHOWN.

SER. NO. 85-069,336, FILED P.R. 6-23-2010; AM. S.R. 10-17-2011.

KIM SAITO, EXAMINING ATTORNEY



David J. Kyros

Director of the United States Patent and Trademark Office

United States of America
United States Patent and Trademark Office

CHRYSA LIS

Reg. No. 4,068,792

ROBERT BAXTER ASSOCIATES, INC. (RHODE ISLAND CORPORATION)
200 JEFFERSON BLVD.
WARWICK, RI 02888

Registered Dec. 6, 2011

Int. Cl.: 14

FOR: JEWELRY, IN CLASS 14 (U.S. CLS. 2, 27, 28 AND 50).

TRADEMARK

FIRST USE 4-10-2010; IN COMMERCE 4-10-2010.

SUPPLEMENTAL REGISTER

THE MARK CONSISTS OF STANDARD CHARACTERS WITHOUT CLAIM TO ANY PARTICULAR FONT, STYLE, SIZE, OR COLOR.

SER. NO. 85-069,434, FILED P.R. 6-23-2010; AM. S.R. 9-19-2011.

WON TEAK OH, EXAMINING ATTORNEY



David J. Kybas

Director of the United States Patent and Trademark Office

United States of America

United States Patent and Trademark Office

CLASS BUILDER

Reg. No. 4,068,793

Registered Dec. 6, 2011

Int. Cl.: 9

TRADEMARK

SUPPLEMENTAL REGISTER

NACEY, GENE (UNITED STATES INDIVIDUAL)
2809 LEECHBURG ROAD
LOWER BURRELL, PA 15068

FOR: DOWNLOADABLE SOFTWARE FOR USE IN BOTH COMPUTERS AND MOBILE DEVICES, WHICH ENABLES THE USER TO CREATE CUSTOMIZED INDOOR CYCLING CLASSES, IN CLASS 9 (U.S. CLS. 21, 23, 26, 36 AND 38).

FIRST USE 8-15-2011; IN COMMERCE 8-15-2011.

THE MARK CONSISTS OF STANDARD CHARACTERS WITHOUT CLAIM TO ANY PARTICULAR FONT, STYLE, SIZE, OR COLOR.

SER. NO. 85-076,341, FILED P.R. 7-1-2010; AM. S.R. 9-16-2011.

AISHA SALEM, EXAMINING ATTORNEY



David J. Kybas

Director of the United States Patent and Trademark Office

United States of America

United States Patent and Trademark Office

POOL PUZZLES

Reg. No. 4,068,794

FUNDEX GAMES, LTD. (NEVADA CORPORATION)

Registered Dec. 6, 2011

P.O. BOX 421309
INDIANAPOLIS, IN 46242

Int. Cl.: 28

FOR: GAMES FEATURING PUZZLES, IN CLASS 28 (U.S. CLS. 22, 23, 38 AND 50).

TRADEMARK

FIRST USE 2-18-2011; IN COMMERCE 2-18-2011.

SUPPLEMENTAL REGISTER

THE MARK CONSISTS OF STANDARD CHARACTERS WITHOUT CLAIM TO ANY PARTICULAR FONT, STYLE, SIZE, OR COLOR.

NO CLAIM IS MADE TO THE EXCLUSIVE RIGHT TO USE "PUZZLES", APART FROM THE MARK AS SHOWN.

SER. NO. 85-077,136, FILED P.R. 7-2-2010; AM. S.R. 9-20-2011.

JORDAN BAKER, EXAMINING ATTORNEY



David J. Kyffers

Director of the United States Patent and Trademark Office

United States of America

United States Patent and Trademark Office

THE FELLOWSHIP INITIATIVE

Reg. No. 4,068,795

JPMORGAN CHASE & CO. (DELAWARE CORPORATION)
270 PARK AVENUE
NEW YORK, NY 10017

Registered Dec. 6, 2011

Int. Cl.: 41

FOR: NON-PROFIT EDUCATIONAL SERVICES, NAMELY CONDUCTING CLASSES, SEMINARS, CONFERENCES, WORKSHOPS AND EDUCATIONAL TRIPS, IN THE FIELDS OF TEAM BUILDING, PERSONAL AND PROFESSIONAL CHARACTER DEVELOPMENT, YOUTH LEADERSHIP, READING, MATHEMATICS, COLLEGE PREPARATION AND CAREER PREPARATION; PROVIDING CAREER GUIDANCE AND PROVIDING GROUP COACHING IN THE FIELD OF LEADERSHIP DEVELOPMENT TO BLACK, LATINO AND OTHER YOUNG MEN OF COLOR, IN CLASS 41 (U.S. CLS. 100, 101 AND 107).

SERVICE MARK

SUPPLEMENTAL REGISTER

FIRST USE 1-27-2010; IN COMMERCE 1-27-2010.

THE MARK CONSISTS OF STANDARD CHARACTERS WITHOUT CLAIM TO ANY PARTICULAR FONT, STYLE, SIZE, OR COLOR.

SER. NO. 85-080,037, FILED P.R. 7-8-2010; AM. S.R. 3-11-2011.

SALLY SHIH, EXAMINING ATTORNEY



David J. Kyros

Director of the United States Patent and Trademark Office

United States of America

United States Patent and Trademark Office

tbyb

Reg. No. 4,068,796

NORMA KAMALI, INC. (NEW YORK CORPORATION)
11 WEST 56TH STREET
NEW YORK, NY 10019

Registered Dec. 6, 2011

Int. Cl.: 35

FOR: OPERATING AN ON-LINE SHOPPING WEBSITE IN THE FIELD OF CLOTHING AND EYEWEAR; ON-LINE RETAIL STORE SERVICES FEATURING CLOTHING AND EYEWEAR, IN CLASS 35 (U.S. CLS. 100, 101 AND 102).

SERVICE MARK

FIRST USE 5-27-2010; IN COMMERCE 5-27-2010.

SUPPLEMENTAL REGISTER

THE MARK CONSISTS OF THE LETTERS "TBYB".

SER. NO. 85-085,655, FILED P.R. 7-15-2010; AM. S.R. 10-12-2011.

NATALIE POLZER, EXAMINING ATTORNEY



David J. Kybas

Director of the United States Patent and Trademark Office

United States of America

United States Patent and Trademark Office

CURBEPPEAL

Reg. No. 4,068,797

EXTERIOR ELEVATIONS, LLC (DELAWARE LIMITED LIABILITY COMPANY)
6825 N. LINCOLN AVE
LINCOLNWOOD, IL 60712

Registered Dec. 6, 2011

Int. Cl.: 37

FOR: CUSTOM CONSTRUCTION AND BUILDING RENOVATION; RENOVATION IN THE FIELD OF BUILDINGS, NAMELY SPECIALIZED EXTERIOR RENOVATIONS OF HOMES, IN CLASS 37 (U.S. CLS. 100, 103 AND 106).

SERVICE MARK

FIRST USE 3-1-2010; IN COMMERCE 3-1-2010.

SUPPLEMENTAL REGISTER

THE MARK CONSISTS OF STANDARD CHARACTERS WITHOUT CLAIM TO ANY PARTICULAR FONT, STYLE, SIZE, OR COLOR.

SER. NO. 85-087,524, FILED P.R. 7-19-2010; AM. S.R. 10-6-2011.

LINDA ORNDORFF, EXAMINING ATTORNEY



David J. Kyffers

Director of the United States Patent and Trademark Office

United States of America

United States Patent and Trademark Office

1-800-POPCORN

Reg. No. 4,068,798

BLACKSTONE, DAVID (CANADA INDIVIDUAL)

Registered Dec. 6, 2011

7601 BATHURST ST. # 102

THORNHILL, CANADA L4J4H5

Int. Cl.: 35

FOR: ONLINE AND TELEPHONIC WHOLESALE AND RETAIL STORE SERVICES FEATURING POPPED AND UN-POPPED POPCORN, MICROWAVE POPCORN, POPCORN PRODUCTS, POPCORN GIFTS; ONLINE AND TELEPHONIC ORDERING SERVICES IN THE FIELD OF POPCORN PRODUCTS; AND ONLINE AND TELEPHONIC CATALOGUE ORDERING SERVICES IN THE FIELD OF POPCORN PRODUCTS, IN CLASS 35 (U.S. CLS. 100, 101 AND 102).

SERVICE MARK

SUPPLEMENTAL REGISTER

FIRST USE 3-0-2002; IN COMMERCE 3-0-2002.

THE MARK CONSISTS OF STANDARD CHARACTERS WITHOUT CLAIM TO ANY PARTICULAR FONT, STYLE, SIZE, OR COLOR.

OWNER OF U.S. REG. NOS. 2,994,383 AND 3,332,922.

SER. NO. 85-101,633, FILED P.R. 8-6-2010; AM. S.R. 9-28-2011.

TRACY WHITTAKER-BROWN, EXAMINING ATTORNEY



David J. Kybas

Director of the United States Patent and Trademark Office

United States of America

United States Patent and Trademark Office

Property Fax

Reg. No. 4,068,799

Registered Dec. 6, 2011

Int. Cl.: 36

SERVICE MARK

SUPPLEMENTAL REGISTER

STEPHEN PIEGARI (UNITED STATES INDIVIDUAL), DBA PROPERTY FAX,
WWW.PROPERTYFAX.US.COM
19715 NE 11TH CT
MIAMI, FL 33179

FOR: PROVIDING INFORMATION IN THE FIELD OF REAL ESTATE VIA THE INTERNET,
IN CLASS 36 (U.S. CLS. 100, 101 AND 102).

FIRST USE 8-1-2009; IN COMMERCE 8-1-2009.

THE MARK CONSISTS OF STANDARD CHARACTERS WITHOUT CLAIM TO ANY PAR-
TICULAR FONT, STYLE, SIZE, OR COLOR.

NO CLAIM IS MADE TO THE EXCLUSIVE RIGHT TO USE "PROPERTY", APART FROM
THE MARK AS SHOWN.

SER. NO. 85-101,856, FILED P.R. 8-6-2010; AM. S.R. 5-31-2011.

BENJAMIN OKEKE, EXAMINING ATTORNEY



David J. Kyffers

Director of the United States Patent and Trademark Office

United States of America

United States Patent and Trademark Office

.SECURE

Reg. No. 4,068,800

ASIF (WISCONSIN LIMITED LIABILITY COMPANY)
2658 ABERDEEN COURT
FITCHBURG, WI 53711

Registered Dec. 6, 2011

Int. Cl.: 45

FOR: DOMAIN NAME REGISTRATION SERVICES, IN CLASS 45 (U.S. CLS. 100 AND 101).

SERVICE MARK

FIRST USE 2-4-2011; IN COMMERCE 10-18-2011.

SUPPLEMENTAL REGISTER

THE MARK CONSISTS OF STANDARD CHARACTERS WITHOUT CLAIM TO ANY PARTICULAR FONT, STYLE, SIZE, OR COLOR.

SER. NO. 85-103,038, FILED P.R. 8-9-2010; AM. S.R. 10-21-2011.

SETH A. RAPPAPORT, EXAMINING ATTORNEY



David J. Kybas

Director of the United States Patent and Trademark Office

United States of America

United States Patent and Trademark Office

Georgia Toffee Company

Reg. No. 4,068,801

Registered Dec. 6, 2011

Int. Cl.: 35

SERVICE MARK

SUPPLEMENTAL REGISTER

GEORGIA TOFFEE COMPANY (GEORGIA LIMITED LIABILITY COMPANY)
414 COLLEY LANE
SAINT SIMONS ISLAND, GA 31522

FOR: WHOLESALE AND RETAIL STORE SERVICES AND ON-LINE RETAIL AND WHOLESALE STORE SERVICES FEATURING TOFFEE, TOFFEE DIPPED IN VARIOUS CHOCOLATES, TOFFEE WITH VARIOUS NUTS, TOFFEE WITH VARIOUS SPICES, TOFFEE CRUMBLD PIECES, TOFFEE DIPPED PRETZELS, TOFFEE DIPPED CARAMEL APPLES, TOFFEE COVERED DRIED FRUITS, SUGAR-FREE VERSIONS OF OUR TOFFEE PRODUCTS, TOFFEE COOKIES, IN CLASS 35 (U.S. CLS. 100, 101 AND 102).

FIRST USE 9-1-2011; IN COMMERCE 9-1-2011.

THE MARK CONSISTS OF STANDARD CHARACTERS WITHOUT CLAIM TO ANY PARTICULAR FONT, STYLE, SIZE, OR COLOR.

NO CLAIM IS MADE TO THE EXCLUSIVE RIGHT TO USE "TOFFEE COMPANY", APART FROM THE MARK AS SHOWN.

SER. NO. 85-103,502, FILED P.R. 8-9-2010; AM. S.R. 10-20-2011.

MARGERIE A. TIERNEY, EXAMINING ATTORNEY



David J. Kybas

Director of the United States Patent and Trademark Office

United States of America

United States Patent and Trademark Office

Myths & Masks

Reg. No. 4,068,802

CLIPMAN, WILLIAM HENRY IV (UNITED STATES INDIVIDUAL)
3698 W. GORET RD.
TUCSON, AZ 85745

Registered Dec. 6, 2011

Int. Cl.: 41

FOR: EDUCATION SERVICES, NAMELY, PROVIDING CLASSES, SEMINARS AND WORKSHOPS FEATURING CREATIVE WRITING, MASK MAKING AND MUSIC IN THE FIELD OF LITERATURE AND ART; ENTERTAINMENT IN THE NATURE OF LIVE STAGE PERFORMANCES IN THE NATURE OF ONE MAN PLAYS OR LECTURE FOR HIRE IN THE FIELD OF MYTHIC PERSONAS BY AN INDIVIDUAL, IN CLASS 41 (U.S. CLS. 100, 101 AND 107).

SERVICE MARK

SUPPLEMENTAL REGISTER

FIRST USE 3-3-1993; IN COMMERCE 3-3-1993.

THE MARK CONSISTS OF STANDARD CHARACTERS WITHOUT CLAIM TO ANY PARTICULAR FONT, STYLE, SIZE, OR COLOR.

SER. NO. 85-106,219, FILED P.R. 8-12-2010; AM. S.R. 10-18-2011.

PATRICIA EVANKO, EXAMINING ATTORNEY



David J. Kybas

Director of the United States Patent and Trademark Office

United States of America

United States Patent and Trademark Office

Wellness eXchange

Reg. No. 4,068,803

Registered Dec. 6, 2011

Int. Cls.: 35, 42, and 44

SERVICE MARK

SUPPLEMENTAL REGISTER

HEALTHALLY, LLC (GEORGIA LIMITED LIABILITY COMPANY)
#323
8343 ROSWELL ROAD
ATLANTA, GA 30350

FOR: DATABASE MANAGEMENT SERVICES FOR GENERATING, MAINTAINING AND MANAGING PERSONAL HEALTH MEDICAL RECORDS FOR PATIENTS AND HEALTHCARE PROVIDERS; PROVIDING ASSISTANCE, FITNESS EVALUATION AND CONSULTATION TO CORPORATE AND INDIVIDUAL CLIENTS TO HELP EMPLOYEES AND INDIVIDUALS MAKE HEALTH, WELLNESS AND NUTRITIONAL CHANGES IN THEIR DAILY LIVING TO INCREASE PRODUCTIVITY AND LOWER HEALTH CARE COSTS, IN CLASS 35 (U.S. CLS. 100, 101 AND 102).

FIRST USE 7-0-2011; IN COMMERCE 7-0-2011.

FOR: APPLICATION SERVICE PROVIDER (ASP) FEATURING SOFTWARE FOR CREATING SEARCHABLE DATABASES OF INFORMATION AND DATA, FOR ORGANIZING AND VIEWING DIGITAL IMAGES AND PHOTOGRAPHS, FOR CONTROLLING AND MANAGING PATIENT MEDICAL INFORMATION, FOR PROVIDING PERSONALIZED HEALTHCARE, WELLNESS, DIET, EXERCISE TOOLS AND FOR MANAGING INCENTIVE AND REWARD PROGRAMS BY PUBLIC HEALTH, PRIVATE HEALTH, PRIVATE ENTERPRISES AND INDIVIDUALS, IN CLASS 42 (U.S. CLS. 100 AND 101).

FIRST USE 7-0-2011; IN COMMERCE 7-0-2011.

FOR: MAINTAINING HEALTH INFORMATION, FILES AND PERSONAL HEALTH MEDICAL RECORDS FOR PATIENTS AND HEALTHCARE PROVIDERS; NUTRITION COUNSELING; HEALTH CARE SERVICES, NAMELY, WELLNESS PROGRAMS; WELLNESS SERVICES, NAMELY, PERSONAL ASSESSMENTS, PERSONALIZED ROUTINES, MAINTENANCE SCHEDULES, AND COUNSELING, IN CLASS 44 (U.S. CLS. 100 AND 101).

FIRST USE 7-0-2011; IN COMMERCE 7-0-2011.

NO CLAIM IS MADE TO THE EXCLUSIVE RIGHT TO USE "WELLNESS", APART FROM THE MARK AS SHOWN.

THE COLOR(S) GREEN AND ORANGE IS/ARE CLAIMED AS A FEATURE OF THE MARK.



David J. Kyjars

Director of the United States Patent and Trademark Office

Reg. No. 4,068,803 THE MARK CONSISTS OF THE STYLIZED WORD "WELLNESS" IN GREEN FOLLOWED BY THE STYLIZED WORD "EXCHANGE" IN ORANGE.

SER. NO. 85-133,142, FILED P.R. 9-20-2010; AM. S.R. 10-1-2011.

HOWARD B. LEVINE, EXAMINING ATTORNEY

United States of America

United States Patent and Trademark Office

World Justice Project

Reg. No. 4,068,804

THE WORLD JUSTICE PROJECT (WASHINGTON NON-PROFIT CORPORATION)
740 15TH STREET, NW
WASHINGTON, DC 20005

Registered Dec. 6, 2011

Int. Cls.: 41 and 45

FOR: EDUCATION SERVICES, NAMELY, CONDUCTING CONFERENCES IN THE FIELD OF LAW, IN CLASS 41 (U.S. CLS. 100, 101 AND 107).

SERVICE MARK

FIRST USE 6-1-2007; IN COMMERCE 6-1-2007.

SUPPLEMENTAL REGISTER

FOR: PROVIDING INFORMATION RELATING TO THE RULE OF LAW, IN CLASS 45 (U.S. CLS. 100 AND 101).

FIRST USE 6-1-2007; IN COMMERCE 6-1-2007.

THE MARK CONSISTS OF STANDARD CHARACTERS WITHOUT CLAIM TO ANY PARTICULAR FONT, STYLE, SIZE, OR COLOR.

SER. NO. 85-135,069, FILED P.R. 9-21-2010; AM. S.R. 10-3-2011.

MARIA-VICTORIA SUAREZ, EXAMINING ATTORNEY



David J. Kybas

Director of the United States Patent and Trademark Office

United States of America

United States Patent and Trademark Office

DYNAMIC DISPERSION

Reg. No. 4,068,805

MOXI ENTERPRISES, LLC (MISSOURI LIMITED LIABILITY COMPANY)
1939 S. VANDEVENTER AVE.
SAINT LOUIS, MO 63110

Registered Dec. 6, 2011

Int. Cl.: 10

FOR: AIR MATTRESSES FOR MEDICAL PURPOSES; MEDICAL PRODUCTS, NAMELY, THERAPEUTIC MATTRESS SUPPORT; MEDICAL PRODUCTS, NAMELY, THERAPEUTIC MATTRESSES, BEDS, SEATS AND CUSHIONS; SUPPORT MATTRESSES FOR MEDICAL USE, IN CLASS 10 (U.S. CLS. 26, 39 AND 44).

TRADEMARK

SUPPLEMENTAL REGISTER FIRST USE 8-1-2010; IN COMMERCE 8-1-2010.

THE MARK CONSISTS OF STANDARD CHARACTERS WITHOUT CLAIM TO ANY PARTICULAR FONT, STYLE, SIZE, OR COLOR.

SER. NO. 85-139,145, FILED P.R. 9-27-2010; AM. S.R. 9-13-2011.

ELIZABETH HUGHITT, EXAMINING ATTORNEY

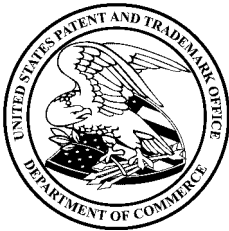

David J. Kybas

Director of the United States Patent and Trademark Office

United States of America

United States Patent and Trademark Office

Laboratory Institute of Merchandising Fashion Education Foundation

Reg. No. 4,068,806

Registered Dec. 6, 2011

Int. Cl.: 36

LABORATORY INSTITUTE OF MERCHANDISING FASHION EDUCATION FOUNDATION
(NEW YORK NON-PROFIT CORPORATION), AKA LIM FASHION EDUCATION
FOUNDATION,
12 EAST 53RD STREET
NEW YORK, NY 10022

SERVICE MARK

FOR: CHARITABLE FUNDRAISING FOR SCHOLARSHIPS, PROMOTING RESEARCH AND
EDUCATIONAL ENHANCEMENTS TO BENEFIT UNIVERSITY LEVEL STUDENTS IN THE
FIELD OF FASHION, IN CLASS 36 (U.S. CLS. 100, 101 AND 102).

SUPPLEMENTAL REGISTER

FIRST USE 10-17-2009; IN COMMERCE 10-17-2009.

THE MARK CONSISTS OF STANDARD CHARACTERS WITHOUT CLAIM TO ANY PAR-
TICULAR FONT, STYLE, SIZE, OR COLOR.

NO CLAIM IS MADE TO THE EXCLUSIVE RIGHT TO USE "EDUCATION FOUNDATION",
APART FROM THE MARK AS SHOWN.

SER. NO. 85-148,431, FILED P.R. 10-8-2010; AM. S.R. 6-20-2011.

JAMES A. RAUEN, EXAMINING ATTORNEY



David J. Kyros

Director of the United States Patent and Trademark Office

United States of America

United States Patent and Trademark Office

WORKFLOW DATA SYSTEMS

Reg. No. 4,068,807

Registered Dec. 6, 2011

Int. Cl.: 42

SERVICE MARK

SUPPLEMENTAL REGISTER

WORKFLOW DATA SYSTEMS, LLC (OHIO LIMITED LIABILITY COMPANY)
92 MONTROSE AVE
DELAWARE, OH 43015

FOR: CONSULTING SERVICES IN THE FIELD OF OFFICE AND WORKPLACE AUTOMATION; DATA CONVERSION OF ELECTRONIC INFORMATION; DESIGN OF INFORMATION GRAPHICS AND DATA VISUALIZATION MATERIALS; RECORDING DATA FOR OTHERS ON OPTICAL, DIGITAL AND MAGNETIC MEDIA FOR ELECTRONIC STORAGE; WRITING OF DATA PROCESSING PROGRAMS, IN CLASS 42 (U.S. CLS. 100 AND 101).

FIRST USE 0-0-1998; IN COMMERCE 0-0-1998.

THE MARK CONSISTS OF STANDARD CHARACTERS WITHOUT CLAIM TO ANY PARTICULAR FONT, STYLE, SIZE, OR COLOR.

NO CLAIM IS MADE TO THE EXCLUSIVE RIGHT TO USE "DATA SYSTEMS", APART FROM THE MARK AS SHOWN.

SER. NO. 85-157,771, FILED 10-21-2010.

MAYUR VAGHANI, EXAMINING ATTORNEY



David J. Kyros

Director of the United States Patent and Trademark Office

United States of America

United States Patent and Trademark Office

The Music Mentor

Reg. No. 4,068,808

Registered Dec. 6, 2011

Int. Cl.: 41

SERVICE MARK

SUPPLEMENTAL REGISTER

DENISE MARSA PRODUCTIONS, LLC (NEW JERSEY LIMITED LIABILITY COMPANY),
DBA THE MUSIC MENTOR,
22 SAND HILL ROAD
MORRISTOWN, NJ 07960

FOR: ENTERTAINMENT IN THE NATURE OF VISUAL AND AUDIO PERFORMANCES BY
MUSICAL ARTISTS, IN CLASS 41 (U.S. CLS. 100, 101 AND 107).

FIRST USE 7-24-2010; IN COMMERCE 7-24-2010.

THE MARK CONSISTS OF STANDARD CHARACTERS WITHOUT CLAIM TO ANY PAR-
TICULAR FONT, STYLE, SIZE, OR COLOR.

NO CLAIM IS MADE TO THE EXCLUSIVE RIGHT TO USE "MUSIC", APART FROM THE
MARK AS SHOWN.

SER. NO. 85-158,105, FILED P.R. 10-21-2010; AM. S.R. 10-4-2011.

DAVID YONTEF, EXAMINING ATTORNEY



David J. Kyfos

Director of the United States Patent and Trademark Office

United States of America
United States Patent and Trademark Office

ISHEETPILE

Reg. No. 4,068,809

Registered Dec. 6, 2011

Int. Cls.: 35 and 42

SERVICE MARK

SUPPLEMENTAL REGISTER

PILEPRO, LLC (DELAWARE LIMITED LIABILITY COMPANY)
1101 MUSIC LANE #340
AUSTIN, TX 78704

FOR: ONLINE RETAIL STORE SERVICES FOR ENGINEERS FEATURING SHEET PILE COMPONENTS FOR WALLS, PROVIDED VIA A WEB SITE, IN CLASS 35 (U.S. CLS. 100, 101 AND 102).

FIRST USE 11-5-2010; IN COMMERCE 11-5-2010.

FOR: PROVIDING ONLINE, NON-DOWNLOADABLE SOFTWARE FOR USE BY ENGINEERS TO DESIGN SHEET PILE WALLS, PROVIDED VIA A WEBSITE, IN CLASS 42 (U.S. CLS. 100 AND 101).

FIRST USE 11-5-2010; IN COMMERCE 11-5-2010.

THE MARK CONSISTS OF STANDARD CHARACTERS WITHOUT CLAIM TO ANY PARTICULAR FONT, STYLE, SIZE, OR COLOR.

SER. NO. 85-160,963, FILED P.R. 10-26-2010; AM. S.R. 7-7-2011.

JASON BLAIR, EXAMINING ATTORNEY



David J. Kybas

Director of the United States Patent and Trademark Office

United States of America

United States Patent and Trademark Office

nani bikini

Reg. No. 4,068,810

MEYER, MICHAEL E (UNITED STATES INDIVIDUAL)
944 LAURELWOOD ST
CARLSBAD, CA 92011

Registered Dec. 6, 2011

Int. Cl.: 25

FOR: SWIMWEAR, IN CLASS 25 (U.S. CLS. 22 AND 39).

TRADEMARK

FIRST USE 12-2-2009; IN COMMERCE 7-7-2010.

SUPPLEMENTAL REGISTER

THE MARK CONSISTS OF STANDARD CHARACTERS WITHOUT CLAIM TO ANY PARTICULAR FONT, STYLE, SIZE, OR COLOR.

NO CLAIM IS MADE TO THE EXCLUSIVE RIGHT TO USE "BIKINI", APART FROM THE MARK AS SHOWN.

SER. NO. 85-167,189, FILED P.R. 11-2-2010; AM. S.R. 4-14-2011.

KATHRYN COWARD, EXAMINING ATTORNEY



David J. Kybas

Director of the United States Patent and Trademark Office

United States of America

United States Patent and Trademark Office

THE ULTIMATE TOY FOR KIDS

Reg. No. 4,068,811

CAPRIOLA CORP. (FLORIDA CORPORATION)
4374 SOUTH LOCKWOOD RIDGE ROAD
SARASOTA, FL 34231

Registered Dec. 6, 2011

Int. Cl.: 28

FOR: EDUCATIONAL TOY CONSTRUCTION SETS FOR CONSTRUCTING TRACTORS, DUNE BUGGIES AND INSECTS FEATURING TRANSLUCENT BLOCKS WHICH LIGHT UP WHEN PLUGGED INTO AN ELECTRICAL OUTLET, IN CLASS 28 (U.S. CLS. 22, 23, 38 AND 50).

TRADEMARK

SUPPLEMENTAL REGISTER FIRST USE 6-0-2011; IN COMMERCE 6-0-2011.

THE MARK CONSISTS OF STANDARD CHARACTERS WITHOUT CLAIM TO ANY PARTICULAR FONT, STYLE, SIZE, OR COLOR.

SER. NO. 85-171,758, FILED P.R. 11-8-2010; AM. S.R. 9-28-2011.

EDWARD NELSON, EXAMINING ATTORNEY

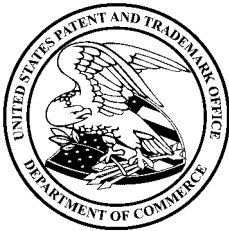

David J. Kyffers

Director of the United States Patent and Trademark Office

United States of America

United States Patent and Trademark Office

INDUSTRIAL AND COMMERCIAL BANK OF CHINA LIMITED

Reg. No. 4,068,812

Registered Dec. 6, 2011

Int. Cl.: 36

SERVICE MARK

SUPPLEMENTAL REGISTER

INDUSTRIAL AND COMMERCIAL BANK OF CHINA LIMITED (CHINA CORPORATION)
55 FUXINGMENNEI AVENUE
BEIJING, CHINA

FOR: BANKING SERVICES; CAPITAL INVESTMENT SERVICES; EXCHANGING MONEY; ISSUING OF TRAVELLERS' CHECKS; FINANCIAL CLEARING SERVICES; LOAN FINANCING; FINANCIAL EVALUATION IN THE FIELD OF INSURANCE, BANKING, AND REAL ESTATE; FINANCING SERVICES; FINANCIAL MANAGEMENT; FINANCIAL CONSULTANCY; CREDIT CARD SERVICES; DEBIT CARD SERVICES; ELECTRONIC FUNDS TRANSFER; FINANCIAL INFORMATION SERVICES; ISSUANCE OF CREDIT CARDS; BUSINESS LIQUIDATION SERVICES IN THE FIELD OF FINANCING, IN CLASS 36 (U.S. CLS. 100, 101 AND 102).

THE MARK CONSISTS OF STANDARD CHARACTERS WITHOUT CLAIM TO ANY PARTICULAR FONT, STYLE, SIZE, OR COLOR.

OWNER OF CHINA REG. NO. 5851623, DATED 2-14-2010, EXPIRES 2-13-2020.

NO CLAIM IS MADE TO THE EXCLUSIVE RIGHT TO USE "BANK" AND "LIMITED", APART FROM THE MARK AS SHOWN.

SER. NO. 85-178,251, FILED P.R. 11-16-2010; AM. S.R. 10-24-2011.

ANTHONY RINKER, EXAMINING ATTORNEY



David J. Kypos

Director of the United States Patent and Trademark Office

United States of America

United States Patent and Trademark Office

NATIONAL LATINO FAMILY EXPO

Reg. No. 4,068,813

Registered Dec. 6, 2011

Int. Cls.: 35 and 41

SERVICE MARK

SUPPLEMENTAL REGISTER

NATIONAL COUNCIL OF LA RAZA (ARIZONA NON-PROFIT CORPORATION)
1126 16TH STREET, N.W.
WASHINGTON, DC 20036

FOR: ORGANIZING AND PROMOTING TRADE SHOWS RELATING TO PRODUCTS, SERVICES, AND PROGRAMS OF INTEREST TO MEMBERS OF THE LATINO-AMERICAN COMMUNITY; PUBLIC RELATIONS; PUBLICITY SERVICES; PROMOTING EDUCATIONAL EXHIBITION AND CONSUMER FAIRS OF PARTICULAR INTEREST TO MEMBERS OF THE LATINO-AMERICAN COMMUNITY ABOUT HEALTH, EDUCATION, AND PERSONAL FINANCE; CONDUCTING CONSUMER TRADE FAIRS OF PARTICULAR INTEREST TO MEMBERS OF THE LATINO-AMERICAN COMMUNITY ABOUT HEALTH, EDUCATION, AND PERSONAL FINANCE, IN CLASS 35 (U.S. CLS. 100, 101 AND 102).

FIRST USE 3-0-2010; IN COMMERCE 3-0-2010.

FOR: ORGANIZING AND CONDUCTING EDUCATIONAL EXHIBITION AND CONSUMER FAIRS OF PARTICULAR INTEREST TO MEMBERS OF THE LATINO-AMERICAN COMMUNITY ABOUT HEALTH, EDUCATION, AND PERSONAL FINANCE; ENTERTAINMENT SERVICES, NAMELY, ARRANGING AND PRESENTING PUBLIC PERFORMANCES OF MUSIC, DANCE AND DRAMA IN THE NATURE OF PLAYS; ARRANGING AND PROVIDING EDUCATIONAL SESSIONS IN THE FIELD OF LATINO-AMERICAN CULTURE, HERITAGE, AND ACHIEVEMENTS; PROVIDING INFORMATION VIA A WEBSITE REGARDING EDUCATIONAL EXHIBITION AND CONSUMER FAIRS OF INTEREST TO LATINO-AMERICANS, IN CLASS 41 (U.S. CLS. 100, 101 AND 107).

FIRST USE 3-0-2010; IN COMMERCE 3-0-2010.

THE MARK CONSISTS OF STANDARD CHARACTERS WITHOUT CLAIM TO ANY PARTICULAR FONT, STYLE, SIZE, OR COLOR.

OWNER OF U.S. REG. NO. 3,024,335.

NO CLAIM IS MADE TO THE EXCLUSIVE RIGHT TO USE "EXPO", APART FROM THE MARK AS SHOWN.

SER. NO. 85-181,540, FILED P.R. 11-19-2010; AM. S.R. 9-9-2011.



David J. Kybas

Director of the United States Patent and Trademark Office

Reg. No. 4,068,813 ALLISON SCHRODY, EXAMINING ATTORNEY

United States of America

United States Patent and Trademark Office

PALM SPRINGS RESTAURANT WEEK

Reg. No. 4,068,814

Registered Dec. 6, 2011

Int. Cl.: 35

SERVICE MARK

SUPPLEMENTAL REGISTER FIRST USE 1-0-2008; IN COMMERCE 1-0-2008.

PALM SPRINGS DESERT RESORT RESTAURANT ASSOCIATION (CALIFORNIA CORPORATION)
P.O. BOX 6558
LA QUINTA, CA 92248

FOR: PROMOTING THE RESTAURANT SERVICES OF OTHERS, NAMELY, PROMOTING DINING AT RESTAURANTS IN THE PALM SPRINGS AREA, IN CLASS 35 (U.S. CLS. 100, 101 AND 102).

THE MARK CONSISTS OF STANDARD CHARACTERS WITHOUT CLAIM TO ANY PARTICULAR FONT, STYLE, SIZE, OR COLOR.

NO CLAIM IS MADE TO THE EXCLUSIVE RIGHT TO USE "RESTAURANT WEEK", APART FROM THE MARK AS SHOWN.

SER. NO. 85-183,320, FILED P.R. 11-23-2010; AM. S.R. 9-12-2011.

STEVEN R. FINE, EXAMINING ATTORNEY



David J. Kyros

Director of the United States Patent and Trademark Office

United States of America

United States Patent and Trademark Office

RADIOLOGY CLOUD EXCHANGE

Reg. No. 4,068,815

Registered Dec. 6, 2011

Int. Cl.: 42

SERVICE MARK

SUPPLEMENTAL REGISTER

SMITH, DOUGLAS (UNITED STATES INDIVIDUAL)
101 BRETTFORD COURT
SAN ANTONIO, TX 78230

FOR: PROVIDING SUBSCRIPTION BASED ONLINE NON-DOWNLOADABLE SOFTWARE THAT PROVIDES INTEROPERABILITY OF MEDICAL IMAGING STUDIES AND SENSITIVE ELECTRONIC HEALTH INFORMATION USING SECURITY METHODOLOGIES IN THE FIELD OF TELERADIOLOGY FOR MEDICAL PRACTITIONERS, IN CLASS 42 (U.S. CLS. 100 AND 101).

FIRST USE 7-1-2010; IN COMMERCE 7-1-2010.

THE MARK CONSISTS OF STANDARD CHARACTERS WITHOUT CLAIM TO ANY PARTICULAR FONT, STYLE, SIZE, OR COLOR.

SER. NO. 85-184,296, FILED P.R. 11-24-2010; AM. S.R. 9-23-2011.

JAMES LOVELACE, EXAMINING ATTORNEY



David J. Kyros

Director of the United States Patent and Trademark Office

United States of America

United States Patent and Trademark Office

MOTORCYCLE HISTORY REPORTS

Reg. No. 4,068,816

SPECIALTY REPORTS, INC. (NEVADA CORPORATION)
375 N STEPHANIE STREET, SUITE 1411
HENDERSON, NV 890148909

Registered Dec. 6, 2011

Int. Cl.: 35

FOR: PROVIDING BUSINESS AND CONSUMER INFORMATION IN THE FIELD OF MOTOR VEHICLE HISTORY INFORMATION, IN CLASS 35 (U.S. CLS. 100, 101 AND 102).

SERVICE MARK

FIRST USE 4-5-2007; IN COMMERCE 4-5-2007.

SUPPLEMENTAL REGISTER

THE MARK CONSISTS OF STANDARD CHARACTERS WITHOUT CLAIM TO ANY PARTICULAR FONT, STYLE, SIZE, OR COLOR.

NO CLAIM IS MADE TO THE EXCLUSIVE RIGHT TO USE "REPORTS", APART FROM THE MARK AS SHOWN.

SER. NO. 85-184,359, FILED P.R. 11-24-2010; AM. S.R. 9-12-2011.

MARK PILARO, EXAMINING ATTORNEY



David J. Kyffers

Director of the United States Patent and Trademark Office

United States of America

United States Patent and Trademark Office

SAN DIEGO JEWELRY BUYERS

Reg. No. 4,068,817

Registered Dec. 6, 2011

Int. Cls.: 35 and 36

SERVICE MARK

SUPPLEMENTAL REGISTER

SAN DIEGO JEWELRY BUYERS, LLC (CALIFORNIA LIMITED LIABILITY COMPANY)
907 6TH AVE
SAN DIEGO, CA 92101

FOR: SECOND HAND DEALERSHIPS FEATURING GOLD, DIAMONDS, WATCHES, JEWELRY, HANDBAGS, PURSES, FURNITURE, ARTWORK, AND DECORATIVE OBJECTS , IN CLASS 35 (U.S. CLS. 100, 101 AND 102).

FIRST USE 1-1-1996; IN COMMERCE 1-1-1996.

FOR: PAWN BROKERAGE, IN CLASS 36 (U.S. CLS. 100, 101 AND 102).

FIRST USE 1-1-1996; IN COMMERCE 1-1-1996.

THE MARK CONSISTS OF STANDARD CHARACTERS WITHOUT CLAIM TO ANY PARTICULAR FONT, STYLE, SIZE, OR COLOR.

NO CLAIM IS MADE TO THE EXCLUSIVE RIGHT TO USE "JEWELRY BUYERS", APART FROM THE MARK AS SHOWN.

SER. NO. 85-186,831, FILED P.R. 11-30-2010; AM. S.R. 9-7-2011.

SCOTT BIBB, EXAMINING ATTORNEY



David J. Kybas

Director of the United States Patent and Trademark Office

United States of America

United States Patent and Trademark Office

GREATVETS

Reg. No. 4,068,818

Registered Dec. 6, 2011

Int. Cl.: 35

SERVICE MARK

SUPPLEMENTAL REGISTER

GREATVETS, INC. (DELAWARE CORPORATION)
199 SOUTH LOS ROBLES AVENUE, SUITE 200
PASADENA, CA 91101

FOR: PROVIDING COMPARISONS OF FEES OF PET CARE PROVIDERS; VETERINARIAN REFERRALS; PROVIDING PRICE QUOTATIONS FOR PET CARE SERVICES; PRICE COMPARISON OF PET CARE SERVICES; BIDDING QUOTATION FOR PET CARE SERVICES; CONDUCTING AUCTION SALES IN THE FIELD OF PET CARE SERVICES; MANAGEMENT OF COMPUTERIZED DATABASES IN THE FIELD OF ANIMAL CARE AND PET CARE; BUSINESS ADVISORY SERVICES IN THE NATURE OF SEARCHING ADVICE FOR THE BEST PRICES FOR CONSUMERS OF ANIMAL GROOMING, VETERINARY SERVICES, EMERGENCY VETERINARY SERVICES AND GENERAL PET CARE SERVICES IN THE NATURE OF PET WALKING, SUPERVISED PET PLAY AND PET FEEDING ORGANIZED BY GEOGRAPHIC AREA, PROVIDER LOCATION, PROVIDER AFFILIATION AND PROVIDER NAME; COOPERATIVE MARKETING AND DISTRIBUTORSHIP SERVICES IN THE FIELD OF VETERINARY MEDICINE AND ANIMAL HEALTH FOR VETERINARIANS, ANIMAL HOSPITALS, INDIVIDUALS AND ORGANIZATIONS IN THE ANIMAL HEALTH AND WELFARE INDUSTRIES; ASSOCIATION SERVICES, NAMELY, PROMOTING THE INTERESTS OF VETERINARY CARE PROVIDERS AND VETERINARY PROFESSIONALS; PROVIDING INFORMATION IN THE NATURE OF CONSUMER EVALUATIONS OF VETERINARY HOSPITALS, IN CLASS 35 (U.S. CLS. 100, 101 AND 102).

FIRST USE 10-31-2010; IN COMMERCE 10-31-2010.

THE MARK CONSISTS OF STANDARD CHARACTERS WITHOUT CLAIM TO ANY PARTICULAR FONT, STYLE, SIZE, OR COLOR.

SER. NO. 85-187,143, FILED P.R. 11-30-2010; AM. S.R. 9-12-2011.

VIVIAN MICZNIK FIRST, EXAMINING ATTORNEY



David J. Kypos

Director of the United States Patent and Trademark Office

United States of America

United States Patent and Trademark Office

JUNIOR & WILLIE

Reg. No. 4,068,819

LOUISIANA SWAMPERS, LLC (LOUISIANA LIMITED LIABILITY COMPANY)
38815 HIGHWAY 75
PLAQUEMINE, LA 70764

Registered Dec. 6, 2011

Int. Cl.: 25

FOR: CLOTHING, NAMELY, SHIRTS AND HATS, IN CLASS 25 (U.S. CLS. 22 AND 39).

TRADEMARK

FIRST USE 12-22-2010; IN COMMERCE 12-22-2010.

SUPPLEMENTAL REGISTER

THE MARK CONSISTS OF STANDARD CHARACTERS WITHOUT CLAIM TO ANY PARTICULAR FONT, STYLE, SIZE, OR COLOR.

SER. NO. 85-187,961, FILED P.R. 12-1-2010; AM. S.R. 9-28-2011.

MAYUR VAGHANI, EXAMINING ATTORNEY



David J. Kybas

Director of the United States Patent and Trademark Office

United States of America

United States Patent and Trademark Office

RESULTS ANALYZER

Reg. No. 4,068,820

NCS PEARSON, INC. (MINNESOTA CORPORATION)
5601 GREEN VALLEY DRIVE
BLOOMINGTON, MN 55437

Registered Dec. 6, 2011

Int. Cl.: 42

FOR: APPLICATION SERVICE PROVIDER (ASP) FEATURING SOFTWARE FOR USE BY EDUCATOR PREPARATION INSTITUTIONS AND STATE AGENCIES IN VIEWING, ORGANIZING, COMPARING, AND EXAMINING DATA FROM TEACHER LICENSURE TESTS AND TESTING PROGRAMS, IN CLASS 42 (U.S. CLS. 100 AND 101).

SERVICE MARK

SUPPLEMENTAL REGISTER FIRST USE 1-26-2010; IN COMMERCE 1-26-2010.

THE MARK CONSISTS OF STANDARD CHARACTERS WITHOUT CLAIM TO ANY PARTICULAR FONT, STYLE, SIZE, OR COLOR.

SER. NO. 85-189,189, FILED P.R. 12-2-2010; AM. S.R. 10-4-2011.

PATRICIA EVANKO, EXAMINING ATTORNEY



David J. Kyjars

Director of the United States Patent and Trademark Office

United States of America

United States Patent and Trademark Office

FURRYHEAD

Reg. No. 4,068,821

ABBE, WILLIAM J (UNITED STATES INDIVIDUAL), DBA FURRYHEAD,
23283 SAGEBRUSH
NOVI, MI 48375

Registered Dec. 6, 2011

Int. Cl.: 9

FOR: MICROPHONE BOOM POLES; MICROPHONE MOUNTS; MICROPHONE WIND-SHIELDS, IN CLASS 9 (U.S. CLS. 21, 23, 26, 36 AND 38).

TRADEMARK

FIRST USE 7-30-2010; IN COMMERCE 7-30-2010.

SUPPLEMENTAL REGISTER

THE MARK CONSISTS OF STANDARD CHARACTERS WITHOUT CLAIM TO ANY PARTICULAR FONT, STYLE, SIZE, OR COLOR.

SER. NO. 85-192,843, FILED P.R. 12-8-2010; AM. S.R. 9-29-2011.

BARBARA A. GOLD, EXAMINING ATTORNEY



David J. Kyros

Director of the United States Patent and Trademark Office

United States of America

United States Patent and Trademark Office

Data Leak Intelligence

Reg. No. 4,068,822

HIJAZI, KARIM R (UNITED STATES INDIVIDUAL)
3475 OAK VALLEY ROAD NE STE 2740
ATLANTA, GA 30326

Registered Dec. 6, 2011

Int. Cl.: 42

FOR: RESEARCH IN THE FIELD OF INTELLIGENCE AND SECURITY TECHNOLOGY FEATURING PAST, PRESENT AND PERSISTENT DATA EX-FILTRATION, FRAUD, THEFT AND ESPIONAGE, TO REDUCE THE TIME BETWEEN IDENTIFICATION OF COMPROMISE AND ACTUAL REMEDIATION, IN CLASS 42 (U.S. CLS. 100 AND 101).

SERVICE MARK

SUPPLEMENTAL REGISTER FIRST USE 8-1-2010; IN COMMERCE 8-1-2010.

THE MARK CONSISTS OF STANDARD CHARACTERS WITHOUT CLAIM TO ANY PARTICULAR FONT, STYLE, SIZE, OR COLOR.

SER. NO. 85-195,895, FILED P.R. 12-11-2010; AM. S.R. 9-12-2011.

DAWN HAN, EXAMINING ATTORNEY



David J. Kybas

Director of the United States Patent and Trademark Office

United States of America

United States Patent and Trademark Office

Structural Mechanics Corporation

Reg. No. 4,068,823

Registered Dec. 6, 2011

Int. Cl.: 42

STRUCTURAL MECHANICS CORPORATION (CALIFORNIA CORPORATION), DBA
STRUCTURAL MECHANICS CORPORATION,
811 N. CATALINA AVE
SUITE 2106
REDONDO BEACH, CA 90277

SERVICE MARK

SUPPLEMENTAL REGISTER

FOR: COMPUTER-AIDED ENGINEERING SERVICES FOR OTHERS; CONSULTATION AND RESEARCH IN THE FIELD OF AEROSPACE ENGINEERING; CONSULTING IN THE FIELD OF STRUCTURAL ENGINEERING; CONSULTING IN THE FIELDS OF ENGINEERING AND ARCHITECTURE; CONSULTING SERVICES IN THE FIELD OF INDUSTRIAL ENGINEERING; ENGINEERING; MECHANICAL ENGINEERING; PRODUCT DEVELOPMENT AND ENGINEERING SERVICES FOR OTHERS; RESEARCH RELATING TO MECHANICAL ENGINEERING; STRUCTURAL ENGINEERING DESIGN SERVICES; TECHNOLOGY CONSULTATION AND RESEARCH IN THE FIELD OF AEROSPACE ENGINEERING, IN CLASS 42 (U.S. CLS. 100 AND 101).

FIRST USE 3-31-2010; IN COMMERCE 3-31-2010.

THE MARK CONSISTS OF STANDARD CHARACTERS WITHOUT CLAIM TO ANY PARTICULAR FONT, STYLE, SIZE, OR COLOR.

NO CLAIM IS MADE TO THE EXCLUSIVE RIGHT TO USE "CORPORATION", APART FROM THE MARK AS SHOWN.

SER. NO. 85-197,428, FILED P.R. 12-14-2010; AM. S.R. 9-22-2011.

LINDA M. KING, EXAMINING ATTORNEY



David J. Kybas

Director of the United States Patent and Trademark Office

United States of America
United States Patent and Trademark Office

DIETJOE

Reg. No. 4,068,824

ISIS FITNESS, LLC (NEW YORK LIMITED LIABILITY COMPANY)
18 SUZETTE DR.
CHEEKTOWAGA, NY 14227

Registered Dec. 6, 2011

Int. Cl.: 30

FOR: GROUND COFFEE BEANS, IN CLASS 30 (U.S. CL. 46).

TRADEMARK

FIRST USE 7-0-2010; IN COMMERCE 11-1-2010.

SUPPLEMENTAL REGISTER

THE MARK CONSISTS OF STANDARD CHARACTERS WITHOUT CLAIM TO ANY PARTICULAR FONT, STYLE, SIZE, OR COLOR.

SER. NO. 85-198,583, FILED P.R. 12-15-2010; AM. S.R. 10-24-2011.

DAVID HOFFMAN, EXAMINING ATTORNEY



David J. Kyfos

Director of the United States Patent and Trademark Office

United States of America

United States Patent and Trademark Office

Smokehouse Subs

Reg. No. 4,068,825

Registered Dec. 6, 2011

Int. Cl.: 43

SERVICE MARK

SUPPLEMENTAL REGISTER

SMOKEHOUSE SUBS, LLC (ARIZONA LIMITED LIABILITY COMPANY)
15607 E CHAPARRAL WAY
FOUNTAIN HILLS, AZ 85268

FOR: RESTAURANT; RESTAURANT SERVICES FEATURING SANDWICHES; RESTAURANT SERVICES, NAMELY, PROVIDING OF FOOD AND BEVERAGES FOR CONSUMPTION ON AND OFF THE PREMISES, IN CLASS 43 (U.S. CLS. 100 AND 101).

FIRST USE 8-1-2011; IN COMMERCE 8-1-2011.

THE MARK CONSISTS OF STANDARD CHARACTERS WITHOUT CLAIM TO ANY PARTICULAR FONT, STYLE, SIZE, OR COLOR.

NO CLAIM IS MADE TO THE EXCLUSIVE RIGHT TO USE "SUBS", APART FROM THE MARK AS SHOWN.

SER. NO. 85-200,240, FILED P.R. 12-17-2010; AM. S.R. 9-14-2011.

APRIL ROACH, EXAMINING ATTORNEY



David J. Kyros

Director of the United States Patent and Trademark Office

United States of America

United States Patent and Trademark Office

QAO CERTIFIED

Reg. No. 4,068,826

OAC MANAGEMENT INCORPORATED (COLORADO CORPORATION)

Registered Dec. 6, 2011

P.O. BOX 2399
EDWARDS, CO 81632

Int. Cl.: 45

FOR: BUILDING CONSTRUCTION SERVICES, NAMELY, QUALITY ASSURANCE OBSERVATION, PROCESS MANAGEMENT, AND QUALITY CONTROL, IN CLASS B (U.S. CL. B).

CERTIFICATION MARK

FIRST USE 9-21-2010; IN COMMERCE 9-21-2010.

SERVICES

THE MARK CONSISTS OF STANDARD CHARACTERS WITHOUT CLAIM TO ANY PARTICULAR FONT, STYLE, SIZE, OR COLOR.

SUPPLEMENTAL REGISTER

NO CLAIM IS MADE TO THE EXCLUSIVE RIGHT TO USE "CERTIFIED", APART FROM THE MARK AS SHOWN.

THE CERTIFICATION MARK, AS USED BY AUTHORIZED PERSONS, CERTIFIES THE CERTIFICATION MARK, AS USED BY AUTHORIZED PERSONS CERTIFIES THAT THE SERVICE PROVIDER HAS ATTAINED A LEVEL OF QUALITY IN ITS PROCESS OF CONSTRUCTION, MANAGEMENT AND QUALITY CONTROL AND VERIFIES THAT PROTOCOLS HAVE BEEN FOLLOWED THROUGHOUT THE COMPLETION OF A PROJECT.

SER. NO. 85-203,546, FILED P.R. 12-22-2010; AM. S.R. 9-22-2011.

SHAUNIA CARLYLE, EXAMINING ATTORNEY



David J. Kybas

Director of the United States Patent and Trademark Office

United States of America

United States Patent and Trademark Office

BestSalon

Reg. No. 4,068,827

Registered Dec. 6, 2011

Int. Cls.: 11 and 20

TRADEMARK

SUPPLEMENTAL REGISTER

FACTORY DIRECT WHOLESALE, LLC (GEORGIA LIMITED LIABILITY COMPANY)
2351 BUTTON GWINNETT DR, #800
DORAVILLE, GA 30340

FOR: SHAMPOO BASINS FOR BARBERS' SHOP USE, IN CLASS 11 (U.S. CLS. 13, 21, 23, 31 AND 34).

FIRST USE 10-11-2010; IN COMMERCE 12-16-2010.

FOR: BARBERS' CHAIRS; FREE-STANDING DRAWER UNIT FOR ORGANIZING ITEMS USED IN BRAIDING SHOPS, BARBER SHOPS, AND STYLING SHOPS, IN CLASS 20 (U.S. CLS. 2, 13, 22, 25, 32 AND 50).

FIRST USE 4-7-2010; IN COMMERCE 6-2-2010.

THE MARK CONSISTS OF STANDARD CHARACTERS WITHOUT CLAIM TO ANY PARTICULAR FONT, STYLE, SIZE, OR COLOR.

SER. NO. 85-204,915, FILED P.R. 12-23-2010; AM. S.R. 12-23-2010.

KATHERINE CHANG, EXAMINING ATTORNEY



David J. Kyros

Director of the United States Patent and Trademark Office

United States of America

United States Patent and Trademark Office

WEDNET

Reg. No. 4,068,828

Registered Dec. 6, 2011

Int. Cl.: 9

TRADEMARK

SUPPLEMENTAL REGISTER

WEDNET LLC (WASHINGTON LIMITED LIABILITY COMPANY)
18603 NORTHEAST 194TH STREET
WOODINVILLE, WA 98077

FOR: ELECTRONIC DOWNLOADABLE PUBLICATIONS, NAMELY, ARTICLES ABOUT WEDDING INVITATIONS, STATIONARY, POSTCARDS, WEDDING PHOTO ALBUMS, WEDDINGS, WEDDING CAKES, WEDDING PLANNING, WEDDING PHOTOGRAPHS, WEDDING RINGS, WEDDING FLOWERS, WEDDING MUSIC, WEDDING RECEPTIONS, HAIR STYLES FOR WEDDINGS AND WEDDING RECEPTIONS, HONEYMOONS, SPEECHES FOR WEDDING OCCASIONS, WEDDING AND WEDDING RECEPTION LOCATIONS, WEDDING CEREMONIES, WEDDING GIFTS, AND WEDDING CLOTHING, IN CLASS 9 (U.S. CLS. 21, 23, 26, 36 AND 38).

FIRST USE 9-6-1995; IN COMMERCE 9-6-1995.

THE MARK CONSISTS OF STANDARD CHARACTERS WITHOUT CLAIM TO ANY PARTICULAR FONT, STYLE, SIZE, OR COLOR.

SER. NO. 85-205,994, FILED P.R. 12-27-2010; AM. S.R. 9-23-2011.

DEZMONA MIZELLE, EXAMINING ATTORNEY



David J. Kypos

Director of the United States Patent and Trademark Office

United States of America

United States Patent and Trademark Office

WEDNET

Reg. No. 4,068,829

Registered Dec. 6, 2011

Int. Cl.: 35

SERVICE MARK

SUPPLEMENTAL REGISTER

WEDNET LLC (WASHINGTON LIMITED LIABILITY COMPANY)
18603 NORTHEAST 194TH STREET
WOODINVILLE, WA 98077

FOR: ONLINE BUSINESS DIRECTORY OF VENDORS FOR WEDDING SERVICES AND GOODS; PROMOTING, ADVERTISING, AND MARKETING THE GOODS AND SERVICES OF OTHERS RELATED TO WEDDING PLANNING, WEDDING CLOTHING, WEDDING RINGS, WEDDING RELATED PARTIES AND GATHERINGS, WEDDING FLOWERS, WEDDING MUSIC, WEDDING PHOTOGRAPHS, WEDDING CEREMONIES, WEDDING CAKES, WEDDING RECEPTIONS, WEDDING GIFTS, SPEECHES FOR WEDDING OCCASIONS, HONEYMOONS, AND WEDDING ANNIVERSARIES, IN CLASS 35 (U.S. CLS. 100, 101 AND 102).

FIRST USE 9-6-1995; IN COMMERCE 9-6-1995.

THE MARK CONSISTS OF STANDARD CHARACTERS WITHOUT CLAIM TO ANY PARTICULAR FONT, STYLE, SIZE, OR COLOR.

SER. NO. 85-205,997, FILED P.R. 12-27-2010; AM. S.R. 9-23-2011.

DEZMONA MIZELLE, EXAMINING ATTORNEY



David J. Kypos

Director of the United States Patent and Trademark Office

United States of America

United States Patent and Trademark Office

MARGARITA COLE SLAW

Reg. No. 4,068,830

OCEAN HARVEST MARKET, LLC (FLORIDA LIMITED LIABILITY COMPANY)
5718 MANATEE AVENUE WEST
BRADENTON, FL 34209

Registered Dec. 6, 2011

Int. Cl.: 29

FOR: COLE SLAW, IN CLASS 29 (U.S. CL. 46).

TRADEMARK

FIRST USE 4-1-2010; IN COMMERCE 4-1-2010.

SUPPLEMENTAL REGISTER

THE MARK CONSISTS OF STANDARD CHARACTERS WITHOUT CLAIM TO ANY PARTICULAR FONT, STYLE, SIZE, OR COLOR.

NO CLAIM IS MADE TO THE EXCLUSIVE RIGHT TO USE "COLE SLAW", APART FROM THE MARK AS SHOWN.

SER. NO. 85-208,141, FILED P.R. 12-30-2010; AM. S.R. 10-3-2011.

MARCIE MILONE, EXAMINING ATTORNEY



David J. Kybas

Director of the United States Patent and Trademark Office

United States of America

United States Patent and Trademark Office

Atlanta Computer Solutions

Reg. No. 4,068,831

BRIAN BENNETT (UNITED STATES INDIVIDUAL)
1850 SCENIC HWY. N. SUITE 135
SNELLVILLE, GA 30078

Registered Dec. 6, 2011

Int. Cls.: 35, 37, and 42

FOR: RETAIL STORE SERVICES IN THE FIELD OF COMPUTER SOFTWARE AND COMPUTER HARDWARE, IN CLASS 35 (U.S. CLS. 100, 101 AND 102).

SERVICE MARK

FIRST USE 3-15-2001; IN COMMERCE 3-15-2001.

SUPPLEMENTAL REGISTER

FOR: INSTALLATION, MAINTENANCE, AND REPAIR OF COMPUTER HARDWARE; TECHNICAL SUPPORT SERVICES, NAMELY, TROUBLESHOOTING IN THE NATURE OF THE REPAIR OF COMPUTER HARDWARE AND COMPUTERS, IN CLASS 37 (U.S. CLS. 100, 103 AND 106).

FIRST USE 3-15-2001; IN COMMERCE 3-15-2001.

FOR: INSTALLATION, MAINTENANCE, AND REPAIR OF COMPUTER SOFTWARE; COMPUTER CONSULTATION; COMPUTER CONSULTATION IN THE FIELD OF NETWORKING; TECHNICAL SUPPORT SERVICES, NAMELY, TROUBLESHOOTING OF COMPUTER SOFTWARE PROBLEMS, IN CLASS 42 (U.S. CLS. 100 AND 101).

FIRST USE 3-15-2001; IN COMMERCE 3-15-2001.

THE MARK CONSISTS OF STANDARD CHARACTERS WITHOUT CLAIM TO ANY PARTICULAR FONT, STYLE, SIZE, OR COLOR.

SER. NO. 85-208,744, FILED P.R. 12-31-2010; AM. S.R. 9-25-2011.

ELLEN B. AWRICH, EXAMINING ATTORNEY



David J. Kyros

Director of the United States Patent and Trademark Office

United States of America

United States Patent and Trademark Office

www.usassetrealty.com

Reg. No. 4,068,832

US ASSET REALTY, LLC (CONNECTICUT LIMITED LIABILITY COMPANY)
611 ACCESS ROAD
STRATFORD, CT 06615

Registered Dec. 6, 2011

Int. Cl.: 45

FOR: DOMAIN NAME REGISTRATION SERVICES, IN CLASS 45 (U.S. CLS. 100 AND 101).

SERVICE MARK

FIRST USE 12-6-2010; IN COMMERCE 12-6-2010.

SUPPLEMENTAL REGISTER

THE MARK CONSISTS OF STANDARD CHARACTERS WITHOUT CLAIM TO ANY PARTICULAR FONT, STYLE, SIZE, OR COLOR.

SER. NO. 85-210,207, FILED P.R. 1-4-2011; AM. S.R. 9-29-2011.

SUSAN RICHARDS, EXAMINING ATTORNEY



David J. Kyffers

Director of the United States Patent and Trademark Office

United States of America

United States Patent and Trademark Office

Furniture Balls

Reg. No. 4,068,833

Registered Dec. 6, 2011

Int. Cl.: 20

TRADEMARK

SUPPLEMENTAL REGISTER

THE GLIDE STORE, L.C. (LOUISIANA LIMITED LIABILITY COMPANY)
402 ZACHARY STREET
SCOTT, LA 70583

FOR: FITTED FURNITURE LEG COVERS FOR FLOOR PROTECTION PURPOSES, NAMELY, PRE-CUT BALLS USED AS PADS ON THE LEGS OF CHAIRS, STOOLS, ADULT WALKERS, TABLES, AND DESKS, IN CLASS 20 (U.S. CLS. 2, 13, 22, 25, 32 AND 50).

FIRST USE 5-15-2010; IN COMMERCE 5-15-2010.

THE MARK CONSISTS OF STANDARD CHARACTERS WITHOUT CLAIM TO ANY PARTICULAR FONT, STYLE, SIZE, OR COLOR.

NO CLAIM IS MADE TO THE EXCLUSIVE RIGHT TO USE "BALLS", APART FROM THE MARK AS SHOWN.

SER. NO. 85-211,397, FILED P.R. 1-5-2011; AM. S.R. 9-28-2011.

GEOFFREY FOSDICK, EXAMINING ATTORNEY



David J. Kyros

Director of the United States Patent and Trademark Office

United States of America

United States Patent and Trademark Office

SILVIES VALLEY RANCH

Reg. No. 4,068,834

SILVIES VALLEY RANCH, LLC (OREGON LIMITED LIABILITY COMPANY)
7610 SE 162ND AVENUE
PORTLAND, OR 97236

Registered Dec. 6, 2011

Int. Cl.: 29

FOR: BEEF; MEAT, IN CLASS 29 (U.S. CL. 46).

TRADEMARK

FIRST USE 7-1-2010; IN COMMERCE 7-1-2010.

SUPPLEMENTAL REGISTER

THE MARK CONSISTS OF STANDARD CHARACTERS WITHOUT CLAIM TO ANY PARTICULAR FONT, STYLE, SIZE, OR COLOR.

SER. NO. 85-213,228, FILED P.R. 1-7-2011; AM. S.R. 9-21-2011.

ALEX KEAM, EXAMINING ATTORNEY



David J. Kybas

Director of the United States Patent and Trademark Office

United States of America

United States Patent and Trademark Office

SILVIES VALLEY RANCH

Reg. No. 4,068,835

SILVIES VALLEY RANCH, LLC (OREGON LIMITED LIABILITY COMPANY)
7610 SE 162ND AVENUE
PORTLAND, OR 97236

Registered Dec. 6, 2011

Int. Cl.: 31

FOR: HAY, IN CLASS 31 (U.S. CLS. 1 AND 46).

TRADEMARK

FIRST USE 7-1-2010; IN COMMERCE 7-1-2010.

SUPPLEMENTAL REGISTER

THE MARK CONSISTS OF STANDARD CHARACTERS WITHOUT CLAIM TO ANY PARTICULAR FONT, STYLE, SIZE, OR COLOR.

SER. NO. 85-213,238, FILED P.R. 1-7-2011; AM. S.R. 9-21-2011.

ALEX KEAM, EXAMINING ATTORNEY



David J. Kybas

Director of the United States Patent and Trademark Office

United States of America

United States Patent and Trademark Office

DUTCHCRAFT

Reg. No. 4,068,836

ARCADIA IMPORTS LLC (CONNECTICUT LIMITED LIABILITY COMPANY)
3 RIDGEWOOD ROAD
BURLINGTON, CT 06013

Registered Dec. 6, 2011

Int. Cl.: 33

FOR: DISTILLED SPIRITS; ALCOHOLIC BEVERAGES, NAMELY, VODKA, IN CLASS 33
(U.S. CLS. 47 AND 49).

TRADEMARK

FIRST USE 12-22-2010; IN COMMERCE 12-22-2010.

SUPPLEMENTAL REGISTER

THE MARK CONSISTS OF STANDARD CHARACTERS WITHOUT CLAIM TO ANY PARTICULAR FONT, STYLE, SIZE, OR COLOR.

SER. NO. 85-214,135, FILED P.R. 1-10-2011; AM. S.R. 10-4-2011.

STEVEN JACKSON, EXAMINING ATTORNEY



David J. Kyros

Director of the United States Patent and Trademark Office

United States of America

United States Patent and Trademark Office

RETAILGIS

Reg. No. 4,068,837

RETAILGIS, LLC (DELAWARE LIMITED LIABILITY COMPANY)
3300 FERNBROOK LANE NORTH, STE 200
PLYMOUTH, MN 55447

Registered Dec. 6, 2011

Int. Cl.: 35

FOR: BUSINESS SERVICES, NAMELY, PROVIDING INVENTORY MANAGEMENT SERVICES TO RETAIL STORES, IN CLASS 35 (U.S. CLS. 100, 101 AND 102).

SERVICE MARK

FIRST USE 12-19-2008; IN COMMERCE 12-19-2008.

SUPPLEMENTAL REGISTER

THE MARK CONSISTS OF STANDARD CHARACTERS WITHOUT CLAIM TO ANY PARTICULAR FONT, STYLE, SIZE, OR COLOR.

SER. NO. 85-218,122, FILED P.R. 1-14-2011; AM. S.R. 9-23-2011.

JAMES LOVELACE, EXAMINING ATTORNEY



David J. Kyros

Director of the United States Patent and Trademark Office

United States of America

United States Patent and Trademark Office

JOE TO PRO

Reg. No. 4,068,838

STREGE, PAUL (UNITED STATES INDIVIDUAL)
401 NELI COURT
DEERFIELD, WI 53531

Registered Dec. 6, 2011

Int. Cl.: 16

FOR: PRINTED WRITTEN ARTICLES, NAMELY, BIOGRAPHICAL, ADVICE, INSTRUCTIONAL, AND INSPIRATIONAL ARTICLES FOR ASPIRING PROFESSIONAL FISHERMEN AND ATHLETES, IN CLASS 16 (U.S. CLS. 2, 5, 22, 23, 29, 37, 38 AND 50).

TRADEMARK

FIRST USE 2-17-2008; IN COMMERCE 5-1-2008.

SUPPLEMENTAL REGISTER

THE MARK CONSISTS OF STANDARD CHARACTERS WITHOUT CLAIM TO ANY PARTICULAR FONT, STYLE, SIZE, OR COLOR.

SER. NO. 85-219,490, FILED P.R. 1-18-2011; AM. S.R. 9-20-2011.

B. PARADEWELAI, EXAMINING ATTORNEY



David J. Kyffers

Director of the United States Patent and Trademark Office

United States of America

United States Patent and Trademark Office

POPPED PIMPLE RELIEF

Reg. No. 4,068,839

JOHNSON & JOHNSON (NEW JERSEY CORPORATION)
ONE JOHNSON & JOHNSON PLAZA
NEW BRUNSWICK, NJ 089337001

Registered Dec. 6, 2011

Int. Cl.: 5

FOR: ACNE TREATMENT PREPARATIONS, IN CLASS 5 (U.S. CLS. 6, 18, 44, 46, 51 AND 52).

TRADEMARK

FIRST USE 12-19-2010; IN COMMERCE 12-19-2010.

SUPPLEMENTAL REGISTER

THE MARK CONSISTS OF STANDARD CHARACTERS WITHOUT CLAIM TO ANY PARTICULAR FONT, STYLE, SIZE, OR COLOR.

NO CLAIM IS MADE TO THE EXCLUSIVE RIGHT TO USE "POPPED PIMPLE RELIEF", APART FROM THE MARK AS SHOWN.

SER. NO. 85-221,750, FILED P.R. 1-20-2011; AM. S.R. 10-3-2011.

ANTHONY RINKER, EXAMINING ATTORNEY



David J. Kybas

Director of the United States Patent and Trademark Office

United States of America

United States Patent and Trademark Office

WORKSHIFTING.COM

Reg. No. 4,068,840

Registered Dec. 6, 2011

Int. Cl.: 41

SERVICE MARK

SUPPLEMENTAL REGISTER FIRST USE 5-12-2009; IN COMMERCE 5-12-2009.

CITRIX ONLINE LLC (DELAWARE LIMITED LIABILITY COMPANY)
7414 HOLLISTER AVENUE
GOLETA, CA 93117

FOR: PROVIDING A WEB SITE FEATURING ON-LINE PUBLICATIONS, BLOGS AND INTERACTIVE FORUMS IN THE FIELDS OF REMOTE ACCESS, DISTANCE LEARNING, BUSINESS COMMUNICATIONS, LIFESTYLE MANAGEMENT AND TELECOMMUTING, IN CLASS 41 (U.S. CLS. 100, 101 AND 107).

THE MARK CONSISTS OF STANDARD CHARACTERS WITHOUT CLAIM TO ANY PARTICULAR FONT, STYLE, SIZE, OR COLOR.

SER. NO. 85-225,677, FILED P.R. 1-25-2011; AM. S.R. 9-29-2011.

NAKIA HENRY, EXAMINING ATTORNEY

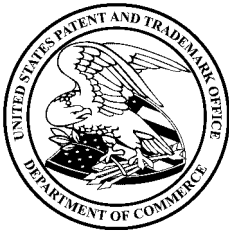

David J. Kyffers

Director of the United States Patent and Trademark Office

United States of America

United States Patent and Trademark Office

WORKSHIFTING

Reg. No. 4,068,841

CITRIX ONLINE LLC (DELAWARE LIMITED LIABILITY COMPANY)
7414 HOLLISTER AVENUE
GOLETA, CA 93117

Registered Dec. 6, 2011

Int. Cl.: 41

FOR: PROVIDING A WEB SITE FEATURING ON-LINE PUBLICATIONS, BLOGS AND INTERACTIVE FORUMS IN THE FIELDS OF REMOTE ACCESS, DISTANCE LEARNING, BUSINESS COMMUNICATIONS, LIFESTYLE MANAGEMENT AND TELECOMMUTING, IN CLASS 41 (U.S. CLS. 100, 101 AND 107).

SERVICE MARK

SUPPLEMENTAL REGISTER FIRST USE 5-12-2009; IN COMMERCE 5-12-2009.

THE MARK CONSISTS OF STANDARD CHARACTERS WITHOUT CLAIM TO ANY PARTICULAR FONT, STYLE, SIZE, OR COLOR.

SER. NO. 85-225,685, FILED P.R. 1-25-2011; AM. S.R. 9-29-2011.

NAKIA HENRY, EXAMINING ATTORNEY



David J. Kyffers

Director of the United States Patent and Trademark Office

United States of America

United States Patent and Trademark Office

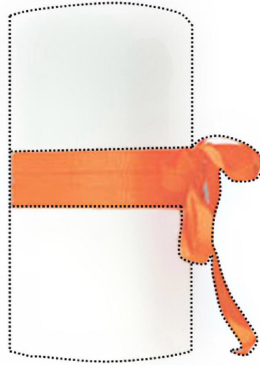

Reg. No. 4,068,842

Registered Dec. 6, 2011

Int. Cl.: 37

SERVICE MARK

SUPPLEMENTAL REGISTER

ANA VALENZUELA INC. (NEW MEXICO CORPORATION)
377 CALLE LOMA NORTE
SANTA FE, NM 87501

FOR: JANITORIAL SERVICES; RESIDENTIAL AND VACATION RENTAL CLEANING SERVICES, IN CLASS 37 (U.S. CLS. 100, 103 AND 106).

FIRST USE 10-31-2006; IN COMMERCE 10-31-2006.

THE MARK CONSISTS OF THE COLOR ORANGE AS APPLIED TO A RIBBON SURROUNDING A ROLL OF PAPER TOWELS USED AS A PROMOTIONAL ITEM FOR THE SERVICES. THE DOTTED LINES ARE USED TO SHOW PLACEMENT OF THE MARK ON THE GOODS AND ARE NOT CLAIMED AS PART OF THE MARK.

THE COLOR(S) ORANGE IS/ARE CLAIMED AS A FEATURE OF THE MARK.

SER. NO. 85-226,272, FILED 1-26-2011.

VERNA BETH RIRIE, EXAMINING ATTORNEY



David J. Kybas

Director of the United States Patent and Trademark Office

United States of America

United States Patent and Trademark Office

CLASSIC PINK 12" CRUISER

Reg. No. 4,068,843

RADIO FLYER, INC. (ILLINOIS CORPORATION)
6515 WEST GRAND AVENUE
CHICAGO, IL 60707

Registered Dec. 6, 2011

Int. Cl.: 12

FOR: BICYCLES, IN CLASS 12 (U.S. CLS. 19, 21, 23, 31, 35 AND 44).

TRADEMARK

FIRST USE 1-0-2011; IN COMMERCE 1-0-2011.

SUPPLEMENTAL REGISTER

THE MARK CONSISTS OF STANDARD CHARACTERS WITHOUT CLAIM TO ANY PARTICULAR FONT, STYLE, SIZE, OR COLOR.

SER. NO. 85-230,950, FILED P.R. 2-1-2011; AM. S.R. 10-3-2011.

JOHN DWYER, EXAMINING ATTORNEY



David J. Kybas

Director of the United States Patent and Trademark Office

United States of America

United States Patent and Trademark Office

QUE 4 KIDS

Reg. No. 4,068,844

SMOKERISE BBQ, INC. (GEORGIA CORPORATION)
376 DUNAHOO ROAD
WINDER, GA 30680

Registered Dec. 6, 2011

Int. Cl.: 36

FOR: CHARITABLE FUNDRAISING, IN CLASS 36 (U.S. CLS. 100, 101 AND 102).

SERVICE MARK

FIRST USE 10-29-2008; IN COMMERCE 10-29-2008.

SUPPLEMENTAL REGISTER

THE MARK CONSISTS OF STANDARD CHARACTERS WITHOUT CLAIM TO ANY PARTICULAR FONT, STYLE, SIZE, OR COLOR.

SER. NO. 85-236,728, FILED P.R. 2-8-2011; AM. S.R. 9-29-2011.

SETH A. RAPPAPORT, EXAMINING ATTORNEY



David J. Kyros

Director of the United States Patent and Trademark Office

United States of America

United States Patent and Trademark Office

The Chemistry Channel

Reg. No. 4,068,845

Registered Dec. 6, 2011

Int. Cl.: 42

SERVICE MARK

SUPPLEMENTAL REGISTER

SPECTRUM LABORATORIES, INC. (CALIFORNIA CORPORATION)
18617 S BROADWICK ST.
RANCHO DOMINGUEZ, CA 90220

FOR: INFORMATION SERVICES, NAMELY, PROVIDING A WEB SITE FEATURING AUDIO, VIDEO, PHOTOGRAPHIC AND PROSE PRESENTATIONS FEATURING BIOCHEMISTRY, IN CLASS 42 (U.S. CLS. 100 AND 101).

FIRST USE 9-21-2011; IN COMMERCE 9-21-2011.

THE MARK CONSISTS OF STANDARD CHARACTERS WITHOUT CLAIM TO ANY PARTICULAR FONT, STYLE, SIZE, OR COLOR.

NO CLAIM IS MADE TO THE EXCLUSIVE RIGHT TO USE "CHANNEL", APART FROM THE MARK AS SHOWN.

SER. NO. 85-238,915, FILED P.R. 2-10-2011; AM. S.R. 10-28-2011.

ELLEN BURNS, EXAMINING ATTORNEY



David J. Kybas

Director of the United States Patent and Trademark Office

United States of America

United States Patent and Trademark Office

SUSTAINABLE QUALITY

Reg. No. 4,068,846

OAC MANAGEMENT INCORPORATED (COLORADO CORPORATION)
P.O. BOX 2399
EDWARDS, CO 81632

Registered Dec. 6, 2011

Int. Cl.: 42

FOR: QUALITY MANAGEMENT SERVICES, NAMELY, QUALITY EVALUATION AND ANALYSIS, QUALITY ASSURANCE, QUALITY CONTROL FOR THE PURPOSE OF CERTIFICATION IN THE FIELD OF REAL ESTATE CONSTRUCTION AND ENGINEERING DEVELOPMENT, IN CLASS 42 (U.S. CLS. 100 AND 101).

SERVICE MARK

SUPPLEMENTAL REGISTER FIRST USE 11-30-2010; IN COMMERCE 11-30-2010.

THE MARK CONSISTS OF STANDARD CHARACTERS WITHOUT CLAIM TO ANY PARTICULAR FONT, STYLE, SIZE, OR COLOR.

SER. NO. 85-242,201, FILED P.R. 2-15-2011; AM. S.R. 9-22-2011.

SHAUNIA CARLYLE, EXAMINING ATTORNEY



David J. Kybas

Director of the United States Patent and Trademark Office

United States of America

United States Patent and Trademark Office

Clean·Treat·Heal

Reg. No. 4,068,847

Registered Dec. 6, 2011

Int. Cl.: 5

TRADEMARK

SUPPLEMENTAL REGISTER

INNOVACYN, INC. (CALIFORNIA CORPORATION)
3546 N. RIVERSIDE AVENUE
RIALTO, CA 92377

FOR: ALL PURPOSE DISINFECTANTS; ANTISEPTIC PREPARATIONS; ANTISEPTICS;
MEDICAL CLEANSERS FOR SKIN AND WOUNDS; VETERINARY PREPARATIONS FOR
ANIMAL WOUNDS AND INFECTIONS, IN CLASS 5 (U.S. CLS. 6, 18, 44, 46, 51 AND 52).

FIRST USE 4-0-2009; IN COMMERCE 4-0-2009.

THE MARK CONSISTS OF THE WORDS "CLEAN TREAT HEAL" WITH DOTS IN BETWEEN
THE WORDS.

SER. NO. 85-244,974, FILED P.R. 2-17-2011; AM. S.R. 10-7-2011.

CURTIS FRENCH, EXAMINING ATTORNEY



David J. Kyros

Director of the United States Patent and Trademark Office

United States of America

United States Patent and Trademark Office

drugrecalls.com

Reg. No. 4,068,848

TASCHNER, DANA B. (UNITED STATES INDIVIDUAL)
2049 CENTURY PARK EAST, STE. 1940
LOS ANGELES, CA 90067

Registered Dec. 6, 2011

Int. Cl.: 45

FOR: LEGAL SERVICES, ADVICE AND REPRESENTATION OF PROSPECTIVE CLIENTS,
IN CLASS 45 (U.S. CLS. 100 AND 101).

SERVICE MARK

FIRST USE 6-1-1997; IN COMMERCE 6-1-1997.

SUPPLEMENTAL REGISTER

THE MARK CONSISTS OF STANDARD CHARACTERS WITHOUT CLAIM TO ANY PARTICULAR FONT, STYLE, SIZE, OR COLOR.

SER. NO. 85-258,474, FILED P.R. 3-4-2011; AM. S.R. 10-4-2011.

CIMMERIAN COLEMAN, EXAMINING ATTORNEY



David J. Kybas

Director of the United States Patent and Trademark Office

United States of America

United States Patent and Trademark Office



Reg. No. 4,068,849

Registered Dec. 6, 2011

Int. Cl.: 25

TRADEMARK

SUPPLEMENTAL REGISTER

HAYES HITZEMAN FOUNDATION (VIRGINIA CHARITABLE TRUST), DBA HAYES FOUNDATION,
P.O. BOX 7248
RICHMOND, VA 23221

FOR: INFANT AND TODDLER ONE PIECE CLOTHING, IN CLASS 25 (U.S. CLS. 22 AND 39).

FIRST USE 11-1-2004; IN COMMERCE 11-15-2004.

THE MARK CONSISTS OF THE DESIGN OF A SLEEPING BABY WITH THE DESIGN OF A FIVE-POINT STAR, QUARTER-MOON, AND CIRCLE FEATURED TO THE LEFT OF THE BABY'S HEAD, ALL APPEARING IN THE COLOR LIGHT GREEN EXCEPT THE QUARTER-MOON WHICH APPEARS IN THE COLOR DARK GREEN AND THE WORDING "THIS SIDE UP... WHILE SLEEPING" APPEARING TO THE LEFT AND UNDERNEATH THE DESIGN OF THE SLEEPING BABY ALL IN THE COLOR DARK GREEN, EXCEPT THE WORD "SIDE" APPEARS IN THE COLOR LIGHT GREEN.

THE COLOR(S) DARK GREEN AND LIGHT GREEN IS/ARE CLAIMED AS A FEATURE OF THE MARK.

SER. NO. 85-259,692, FILED P.R. 3-7-2011; AM. S.R. 9-20-2011.

CHARISMA HAMPTON, EXAMINING ATTORNEY



David J. Kybas

Director of the United States Patent and Trademark Office

United States of America
United States Patent and Trademark Office

LOOPCLIP

Reg. No. 4,068,850

LOOPROPE, LLC (OREGON LIMITED LIABILITY COMPANY)
P.O. BOX 1665
MEDFORD, OR 97501

Registered Dec. 6, 2011

Int. Cl.: 6

FOR: METAL HARDWARE, NAMELY, CARABINERS OF METAL, IN CLASS 6 (U.S. CLS. 2, 12, 13, 14, 23, 25 AND 50).

TRADEMARK

FIRST USE 9-28-2011; IN COMMERCE 9-28-2011.

SUPPLEMENTAL REGISTER

THE MARK CONSISTS OF STANDARD CHARACTERS WITHOUT CLAIM TO ANY PARTICULAR FONT, STYLE, SIZE, OR COLOR.

SER. NO. 85-263,040, FILED P.R. 3-10-2011; AM. S.R. 10-6-2011.

LINDA M. KING, EXAMINING ATTORNEY



David J. Kybas

Director of the United States Patent and Trademark Office

United States of America

United States Patent and Trademark Office

National Repository of Reverse Mortgage Banks

Reg. No. 4,068,851

MCCONNELL, SHELLY (UNITED STATES INDIVIDUAL)
1942 HUBBARD TERRACE
JACKSONVILLE, FL 32206

Registered Dec. 6, 2011

Int. Cl.: 35

FOR: PROVIDING DEMAND CREATION AND LEAD GENERATION ACTIVITIES AND SERVICES; MATCHING BORROWERS WITH POTENTIAL LENDERS IN THE FIELD OF CONSUMER AND MORTGAGE LENDING, IN CLASS 35 (U.S. CLS. 100, 101 AND 102).

SERVICE MARK

FIRST USE 9-28-2011; IN COMMERCE 9-28-2011.

SUPPLEMENTAL REGISTER

THE MARK CONSISTS OF STANDARD CHARACTERS WITHOUT CLAIM TO ANY PARTICULAR FONT, STYLE, SIZE, OR COLOR.

SER. NO. 85-273,730, FILED P.R. 3-22-2011; AM. S.R. 10-4-2011.

KIMBERLY PERRY, EXAMINING ATTORNEY



David J. Kybas

Director of the United States Patent and Trademark Office

United States of America

United States Patent and Trademark Office

TATE

Reg. No. 4,068,852

Registered Dec. 6, 2011

**Int. Cls.: 9, 20, 37, and
42**

THE BOARD OF TRUSTEES OF THE TATE GALLERY (UNITED KINGDOM A BODY CORPORATE ESTABLISHED UNDER THE MUSEUMS AND GALLERIES ACT 1992, ORGANIZED UNDER THE LAWS OF ENGLAND AND WALES)
MILLBANK
LONDON SW1P 4RG, UNITED KINGDOM

FOR: OPTICAL APPARATUS FOR MEASURING THE LIGHT-FASTNESS OF PIGMENTS AND DYES, IN CLASS 9 (U.S. CLS. 21, 23, 26, 36 AND 38).

TRADEMARK

FOR: FRAMES FOR PICTURES AND WORKS OF ART; ANOXIC AND HYPOXIC FRAMES FOR PICTURES AND WORKS OF ART; CABINETS AND CASES FOR THE DISPLAY OF PICTURES AND WORKS OF ART; ANOXIC AND HYPOXIC CABINETS AND CASES FOR THE DISPLAY OF PICTURES AND WORKS OF ART, IN CLASS 20 (U.S. CLS. 2, 13, 22, 25, 32 AND 50).

SERVICE MARK

SUPPLEMENTAL REGISTER

FOR: CONSERVATION, RESTORATION, MAINTENANCE AND REPAIR OF PICTURES AND WORKS OF ART, IN CLASS 37 (U.S. CLS. 100, 103 AND 106).

FOR: LABORATORY SERVICES, NAMELY, PIGMENT AND COLOR ANALYSIS; LABORATORY TESTING OF MATERIALS, IN CLASS 42 (U.S. CLS. 100 AND 101).

THE MARK CONSISTS OF STANDARD CHARACTERS WITHOUT CLAIM TO ANY PARTICULAR FONT, STYLE, SIZE, OR COLOR.

PRIORITY CLAIMED UNDER SEC. 44(D) ON ERPN CMNTY TM OFC APPLICATION NO. 009691346, FILED 1-27-2011, REG. NO. 009691346, DATED 7-5-2011, EXPIRES 1-27-2021.

OWNER OF U.S. REG. NOS. 2,374,154 AND 3,548,462.

SER. NO. 85-281,007, FILED P.R. 3-30-2011; AM. S.R. 10-20-2011.

LINDA ORNDORFF, EXAMINING ATTORNEY



David J. Kybas

Director of the United States Patent and Trademark Office

United States of America

United States Patent and Trademark Office

KILNCOAT

Reg. No. 4,068,853

Registered Dec. 6, 2011

Int. Cl.: 2

TRADEMARK

SUPPLEMENTAL REGISTER

REFRACTORY ANCHORS, INC. (OKLAHOMA CORPORATION)
9836 SOUTH 219TH EAST AVENUE
BROKEN ARROW, OK 74014

FOR: CORROSION INHIBITORS IN THE NATURE OF A COATING, NAMELY, WATER-BASED CERAMIC COATING FORMULATED FOR APPLICATION ON INTERNAL STEEL SURFACES OF HIGH TEMPERATURE PROCESS EQUIPMENT FOR PROTECTION AGAINST OXIDATION AND CORROSION; ABRASION RESISTANT COATING COMPOSITIONS, NAMELY, WATER-BASED CERAMIC COATING FORMULATED FOR APPLICATION ON INTERNAL STEEL SURFACES OF HIGH TEMPERATURE PROCESS EQUIPMENT FOR PROTECTION AGAINST ABRASION, IN CLASS 2 (U.S. CLS. 6, 11 AND 16).

FIRST USE 3-1-2010; IN COMMERCE 3-1-2010.

THE MARK CONSISTS OF STANDARD CHARACTERS WITHOUT CLAIM TO ANY PARTICULAR FONT, STYLE, SIZE, OR COLOR.

SER. NO. 85-284,124, FILED P.R. 4-1-2011; AM. S.R. 10-4-2011.

MARK SPARACINO, EXAMINING ATTORNEY



David J. Kyffers

Director of the United States Patent and Trademark Office

United States of America

United States Patent and Trademark Office

THE CLEANING INDUSTRY EXPERTS

Reg. No. 4,068,854

Registered Dec. 6, 2011

Int. Cl.: 35

SERVICE MARK

SUPPLEMENTAL REGISTER

AMERICAN INSTITUTE FOR CLEANING SCIENCES, LLC (COLORADO LIMITED LIABILITY COMPANY)
2432 E. TERRARIDGE DR.
HIGHLANDS RANCH, CO 80126

FOR: BUSINESS CONSULTATION IN THE FIELD OF THE CLEANING INDUSTRY, IN CLASS 35 (U.S. CLS. 100, 101 AND 102).

FIRST USE 3-17-2011; IN COMMERCE 3-17-2011.

THE MARK CONSISTS OF STANDARD CHARACTERS WITHOUT CLAIM TO ANY PARTICULAR FONT, STYLE, SIZE, OR COLOR.

SER. NO. 85-291,488, FILED P.R. 4-11-2011; AM. S.R. 9-9-2011.

SHARON MEIER, EXAMINING ATTORNEY



David J. Kyffers

Director of the United States Patent and Trademark Office

United States of America

United States Patent and Trademark Office

The Guild of Carillonneurs in North America

Reg. No. 4,068,855

THE GUILD OF CARILLONNEURS IN NORTH AMERICA (CALIFORNIA CORPORATION)
6671 GIRVIN DR
OAKLAND, CA 946111629

Registered Dec. 6, 2011

Int. Cl.: 16

FOR: SHEET MUSIC, IN CLASS 16 (U.S. CLS. 2, 5, 22, 23, 29, 37, 38 AND 50).

TRADEMARK

FIRST USE 9-30-1936; IN COMMERCE 7-1-1950.

SUPPLEMENTAL REGISTER

THE MARK CONSISTS OF STANDARD CHARACTERS WITHOUT CLAIM TO ANY PARTICULAR FONT, STYLE, SIZE, OR COLOR.

SER. NO. 85-292,215, FILED P.R. 4-11-2011; AM. S.R. 9-13-2011.

JUSTINE D. PARKER, EXAMINING ATTORNEY



David J. Kybas

Director of the United States Patent and Trademark Office

United States of America

United States Patent and Trademark Office

CHECKDIRECT

Reg. No. 4,068,856

INTERMEX WIRE TRANSFER, LLC (FLORIDA LIMITED LIABILITY COMPANY)
9480 S. DIXIE HIGHWAY
MIAMI, FL 33156

Registered Dec. 6, 2011

Int. Cls.: 9 and 36

FOR: COMPUTER SOFTWARE FOR USE IN PROCESSING ELECTRONIC REMOTE CHECK DEPOSITS, IN CLASS 9 (U.S. CLS. 21, 23, 26, 36 AND 38).

TRADEMARK

FIRST USE 2-0-2011; IN COMMERCE 2-0-2011.

SERVICE MARK

FOR: FINANCIAL SERVICES, NAMELY, ELECTRONIC REMOTE CHECK DEPOSIT SERVICES, IN CLASS 36 (U.S. CLS. 100, 101 AND 102).

SUPPLEMENTAL REGISTER

FIRST USE 2-0-2011; IN COMMERCE 2-0-2011.

THE MARK CONSISTS OF STANDARD CHARACTERS WITHOUT CLAIM TO ANY PARTICULAR FONT, STYLE, SIZE, OR COLOR.

SER. NO. 85-293,752, FILED P.R. 4-13-2011; AM. S.R. 9-14-2011.

TEJBIR SINGH, EXAMINING ATTORNEY



David J. Kyros

Director of the United States Patent and Trademark Office

United States of America

United States Patent and Trademark Office

STAWSKI

Reg. No. 4,068,857

STANLEY STAWSKI DISTRIBUTING COMPANY, INC. (ILLINOIS CORPORATION)
2017 NORTH MENDELL STREET
CHICAGO, IL 60614

Registered Dec. 6, 2011

Int. Cl.: 33

FOR: SPIRITS AND LIQUEURS, IN CLASS 33 (U.S. CLS. 47 AND 49).

TRADEMARK

FIRST USE 6-1-1962; IN COMMERCE 6-1-1962.

SUPPLEMENTAL REGISTER

THE MARK CONSISTS OF STANDARD CHARACTERS WITHOUT CLAIM TO ANY PARTICULAR FONT, STYLE, SIZE, OR COLOR.

OWNER OF U.S. REG. NOS. 3,214,227 AND 3,702,481.

SER. NO. 85-295,458, FILED P.R. 4-14-2011; AM. S.R. 10-13-2011.

JOHN DWYER, EXAMINING ATTORNEY



David J. Kyros

Director of the United States Patent and Trademark Office

United States of America

United States Patent and Trademark Office



Reg. No. 4,068,858

Registered Dec. 6, 2011

Int. Cl.: 7

TRADEMARK

SUPPLEMENTAL REGISTER

THANE INTERNATIONAL, INC. (DELAWARE CORPORATION)
78-140 CALLE TAMPICO
LA QUINTA, CA 92253

FOR: STEAM CLEANING MACHINES, IN CLASS 7 (U.S. CLS. 13, 19, 21, 23, 31, 34 AND 35).

FIRST USE 12-4-2010; IN COMMERCE 1-28-2011.

THE MARK CONSISTS OF THE COLORS GREEN, BLACK AND WHITE USED ON THE BODY OF STEAM CLEANING MACHINES WITH DETACHABLE TRIANGULAR HEADS CONNECTED BY A SWIVEL JOINT TO A CYLINDRICAL BODY WITH A DETACHABLE EXTENSION HANDLE AND DETACHABLE CURVED HANDLE; AND THE COLOR GREEN APPEARS ON THE TRIANGULAR HEAD, THE CYLINDRICAL BODY, THE EXTENSION HANDLE AND TO THE TOP HALF OF THE CURVED HANDLE; THE COLOR BLACK APPEARS ON THE SWIVEL JOINT OF THE TRIANGULAR HEAD; THE COLOR WHITE APPLIED TO THE WATER TANK. THE MATTER SHOWN IN BROKEN LINES IS NOT PART OF THE MARK AND SERVES ONLY TO SHOW THE POSITION OR PLACEMENT OF THE MARK AND NEITHER THE MATTER SHOWN IN BROKEN LINES NOR THE CONFIGURATION OF THE STEAM CLEANING MACHINES ARE CLAIMED AS A FEATURE OF THE MARK.

THE COLOR(S) GREEN, WHITE AND BLACK IS/ARE CLAIMED AS A FEATURE OF THE MARK.

SER. NO. 85-302,088, FILED P.R. 4-22-2011; AM. S.R. 8-24-2011.

MYRIAH HABEEB, EXAMINING ATTORNEY



David J. Kyros

Director of the United States Patent and Trademark Office

United States of America

United States Patent and Trademark Office

GREEN OXYGEN

Reg. No. 4,068,859

RAMIREZ MORELES, SELOMITH (MEXICO INDIVIDUAL)
ALVARO OBREGON 145 CENTRO
IRAPUATO, MEXICO

Registered Dec. 6, 2011

Int. Cl.: 5

FOR: GREEN DIETARY AND NUTRITIONAL SUPPLEMENTS; AND OXYGEN DIETARY AND NUTRITIONAL SUPPLEMENTS, IN CLASS 5 (U.S. CLS. 6, 18, 44, 46, 51 AND 52).

TRADEMARK

FIRST USE 1-2-2006; IN COMMERCE 10-5-2008.

SUPPLEMENTAL REGISTER

THE MARK CONSISTS OF STANDARD CHARACTERS WITHOUT CLAIM TO ANY PARTICULAR FONT, STYLE, SIZE, OR COLOR.

OWNER OF U.S. REG. NO. 3,895,115.

SER. NO. 85-307,278, FILED P.R. 4-28-2011; AM. S.R. 9-30-2011.

EMILY CARLSEN, EXAMINING ATTORNEY



David J. Kybas

Director of the United States Patent and Trademark Office

United States of America

United States Patent and Trademark Office

DAVENPORT TRACTOR

Reg. No. 4,068,860

Registered Dec. 6, 2011

Int. Cl.: 35

SERVICE MARK

SUPPLEMENTAL REGISTER

DAVENPORT TRACTOR, INC. (ILLINOIS CORPORATION)
11115 KNOXVILLE ROAD
MILAN, IL 61264

FOR: PROVIDING A WEBSITE USED TO PLACE ON-LINE COMMERCIAL ORDERS IN THE FIELD OF TRACTOR PARTS AND RELATED MANUALS AND MEMORABILIA, IN CLASS 35 (U.S. CLS. 100, 101 AND 102).

FIRST USE 2-14-2011; IN COMMERCE 2-14-2011.

THE MARK CONSISTS OF STANDARD CHARACTERS WITHOUT CLAIM TO ANY PARTICULAR FONT, STYLE, SIZE, OR COLOR.

NO CLAIM IS MADE TO THE EXCLUSIVE RIGHT TO USE "TRACTOR", APART FROM THE MARK AS SHOWN.

SER. NO. 85-308,555, FILED P.R. 4-29-2011; AM. S.R. 9-29-2011.

KYLE PEETE, EXAMINING ATTORNEY



David J. Kyros

Director of the United States Patent and Trademark Office

United States of America

United States Patent and Trademark Office

High Performance Board

Reg. No. 4,068,861

Registered Dec. 6, 2011

Int. Cl.: 35

SERVICE MARK

SUPPLEMENTAL REGISTER

BECKROERVIG.COM,LLC (NEW YORK LIMITED LIABILITY COMPANY), AKA BECK
GLOBAL CONSULTING,
102 WEST 75TH ST
NEW YORK, NY 10023

FOR: BUSINESS MANAGEMENT, IN CLASS 35 (U.S. CLS. 100, 101 AND 102).

FIRST USE 1-1-2011; IN COMMERCE 1-1-2011.

THE MARK CONSISTS OF STANDARD CHARACTERS WITHOUT CLAIM TO ANY PAR-
TICULAR FONT, STYLE, SIZE, OR COLOR.

SER. NO. 85-309,211, FILED P.R. 4-30-2011; AM. S.R. 9-21-2011.

ELLEN B. AWRICH, EXAMINING ATTORNEY



David J. Kybas

Director of the United States Patent and Trademark Office

United States of America

United States Patent and Trademark Office

NEVADA VODKA

Reg. No. 4,068,862

Registered Dec. 6, 2011

Int. Cl.: 33

TRADEMARK

SUPPLEMENTAL REGISTER

LAS VEGAS DISTILLERY, LLC (NEVADA LIMITED LIABILITY COMPANY)
SUITE 100
7330 EASTGATE RD
HENDERSON, NV 89011

FOR: ALCOHOLIC BEVERAGES, NAMELY, VODKA; DISTILLED SPIRITS; SPIRITS, IN CLASS 33 (U.S. CLS. 47 AND 49).

FIRST USE 7-20-2011; IN COMMERCE 7-27-2011.

THE MARK CONSISTS OF STANDARD CHARACTERS WITHOUT CLAIM TO ANY PARTICULAR FONT, STYLE, SIZE, OR COLOR.

NO CLAIM IS MADE TO THE EXCLUSIVE RIGHT TO USE "VODKA", APART FROM THE MARK AS SHOWN.

SER. NO. 85-309,392, FILED P.R. 5-2-2011; AM. S.R. 10-23-2011.

JILL C. ALT, EXAMINING ATTORNEY



David J. Kyros

Director of the United States Patent and Trademark Office

United States of America

United States Patent and Trademark Office

AMERICA'S TANK TRAILER SUPERSTORE

Reg. No. 4,068,863

Registered Dec. 6, 2011

Int. Cl.: 12

TRADEMARK

SUPPLEMENTAL REGISTER

PARAGON ENTERPRISES, LLC (WISCONSIN LIMITED LIABILITY COMPANY)
400 E. WISCONSIN AVE., SUITE 300
MILWAUKEE, WI 53202

FOR: TANK TRAILERS; TANK TRUCK EQUIPMENT FOR DISCHARGING LIQUID OR BULK MATERIALS FROM TANK TRAILERS, IN CLASS 12 (U.S. CLS. 19, 21, 23, 31, 35 AND 44).

FIRST USE 12-31-2006; IN COMMERCE 12-31-2006.

THE MARK CONSISTS OF STANDARD CHARACTERS WITHOUT CLAIM TO ANY PARTICULAR FONT, STYLE, SIZE, OR COLOR.

NO CLAIM IS MADE TO THE EXCLUSIVE RIGHT TO USE "TANK TRAILER SUPERSTORE", APART FROM THE MARK AS SHOWN.

SER. NO. 85-309,537, FILED P.R. 5-2-2011; AM. S.R. 10-3-2011.

KATINA MISTER, EXAMINING ATTORNEY



David J. Kybas

Director of the United States Patent and Trademark Office

United States of America

United States Patent and Trademark Office

FIRST BOSTON

Reg. No. 4,068,864

Registered Dec. 6, 2011

Int. Cls.: 35 and 36

SERVICE MARK

SUPPLEMENTAL REGISTER

DOMINANT BRANDS LLC (NEW YORK LIMITED LIABILITY COMPANY)
28-42 210TH STREET
BAYSIDE, NY 11360

FOR: COMMERCIAL BUSINESS MANAGEMENT, BUSINESS ADMINISTRATION CONSULTANCY, CONSULTING IN THE FIELDS OF BUSINESS ORGANIZATION AND MANAGEMENT, BUSINESS INTERMEDIARY SERVICES AND ADVISORY SERVICES IN THE FIELD OF SELLING PRODUCTS AND RENDERING SERVICES; ACCOUNTING FOR THIRD PARTIES; ECONOMIC FORECASTING AND ANALYSIS; PROVIDING BUSINESS INFORMATION, DATA, STATISTICS, AND INDICES FOR OTHERS; PROVIDING STATISTICAL INFORMATION FOR BUSINESSES; PROVIDING TRADE AND BUSINESS PRICE INFORMATION FOR BUSINESSES; PERSONNEL MANAGEMENT, HUMAN CAPITAL MANAGEMENT OUTSOURCING, ORGANIZING AND CONDUCTING TRADE FAIRS AND EXHIBITIONS FOR ECONOMIC AND ADVERTISING PURPOSES, ARRANGING AND CONDUCTING AUCTION SALES, IN CLASS 35 (U.S. CLS. 100, 101 AND 102).

FIRST USE 5-17-2011; IN COMMERCE 5-17-2001.

FOR: INVESTMENT BANKING SERVICES, FINANCIAL ADVISORY SERVICES, FINANCIAL MANAGEMENT, AND INVESTMENT ADVISORY SERVICES AND SECURITIES BROKERAGE SERVICES, IN CLASS 36 (U.S. CLS. 100, 101 AND 102).

FIRST USE 5-17-2011; IN COMMERCE 5-17-2011.

THE MARK CONSISTS OF STANDARD CHARACTERS WITHOUT CLAIM TO ANY PARTICULAR FONT, STYLE, SIZE, OR COLOR.

SER. NO. 85-310,103, FILED P.R. 5-2-2011; AM. S.R. 7-29-2011.

THOMAS MANOR, EXAMINING ATTORNEY



David J. Kypos

Director of the United States Patent and Trademark Office

United States of America

United States Patent and Trademark Office

Funky Brothers

Reg. No. 4,068,865

FUNKY BROTHERS (CALIFORNIA CORPORATION)
453 SOUTH SPRING STREET, SUITE 839
LOS ANGELES, CA 90013

Registered Dec. 6, 2011

Int. Cl.: 25

FOR: T-SHIRTS, IN CLASS 25 (U.S. CLS. 22 AND 39).

TRADEMARK

FIRST USE 1-8-2008; IN COMMERCE 1-8-2008.

SUPPLEMENTAL REGISTER

THE MARK CONSISTS OF STANDARD CHARACTERS WITHOUT CLAIM TO ANY PARTICULAR FONT, STYLE, SIZE, OR COLOR.

NO CLAIM IS MADE TO THE EXCLUSIVE RIGHT TO USE "BROTHERS", APART FROM THE MARK AS SHOWN.

SER. NO. 85-321,283, FILED P.R. 5-15-2011; AM. S.R. 9-13-2011.

BRENDAN REGAN, EXAMINING ATTORNEY



David J. Kybas

Director of the United States Patent and Trademark Office

United States of America

United States Patent and Trademark Office



**Funky
Brothers**

Reg. No. 4,068,866

Registered Dec. 6, 2011

Int. Cl.: 25

TRADEMARK

SUPPLEMENTAL REGISTER

FUNKY BROTHERS (CALIFORNIA CORPORATION)
453 SOUTH SPRING STREET, SUITE 839
LOS ANGELES, CA 90013

FOR: T-SHIRTS, IN CLASS 25 (U.S. CLS. 22 AND 39).

FIRST USE 1-8-2008; IN COMMERCE 1-8-2008.

NO CLAIM IS MADE TO THE EXCLUSIVE RIGHT TO USE "BROTHERS" , APART FROM THE MARK AS SHOWN.

THE COLOR(S) DARK BROWN, BROWN, AND MUSTARD IS/ARE CLAIMED AS A FEATURE OF THE MARK.

THE MARK CONSISTS OF A DARK-BROWN SQUARE-SHAPED BACKGROUND FEATURING A MAN'S HEAD IN BROWN WITH A MUSTARD-COLORED OUTLINE, WEARING A MUSTARD-COLORED HAT WITH THE MAN CHEWING MUSTARD-COLORED HAY AND THE WORDS "FUNKY BROTHERS" BENEATH HIM, "FUNKY" BEING IN BROWN AND "BROTHERS" BEING IN DARK BROWN.

SER. NO. 85-321,288, FILED P.R. 5-15-2011; AM. S.R. 9-13-2011.

BRENDAN REGAN, EXAMINING ATTORNEY



David J. Kybas

Director of the United States Patent and Trademark Office

United States of America

United States Patent and Trademark Office

THE COMMUNITY TAP

Reg. No. 4,068,867

Registered Dec. 6, 2011

Int. Cl.: 35

SERVICE MARK

SUPPLEMENTAL REGISTER

THE COMMUNITY TAP, INC. (SOUTH CAROLINA CORPORATION)
205 WADE HAMPTON BOULEVARD
GREENVILLE, SC 29609

FOR: RETAIL STORE SERVICES FEATURING BEER, WINE, REFILLABLE GROWLERS AND BOTTLES, TOTE BAGS FOR GROWLERS, GLASSWARE, CHOCOLATES, T-SHIRTS, CORKSCREWS AND WINE STOPPERS, IN CLASS 35 (U.S. CLS. 100, 101 AND 102).

FIRST USE 7-1-2010; IN COMMERCE 7-1-2010.

THE MARK CONSISTS OF STANDARD CHARACTERS WITHOUT CLAIM TO ANY PARTICULAR FONT, STYLE, SIZE, OR COLOR.

NO CLAIM IS MADE TO THE EXCLUSIVE RIGHT TO USE "TAP", APART FROM THE MARK AS SHOWN.

SER. NO. 85-324,816, FILED P.R. 5-19-2011; AM. S.R. 9-21-2011.

JOHN KELLY, EXAMINING ATTORNEY



David J. Kyffers

Director of the United States Patent and Trademark Office

United States of America

United States Patent and Trademark Office

SCHOOL LOUNGE MAKEOVER

Reg. No. 4,068,868

Registered Dec. 6, 2011

Int. Cl.: 41

SERVICE MARK

SUPPLEMENTAL REGISTER

CALIFORNIA CASUALTY MANAGEMENT COMPANY (CALIFORNIA CORPORATION)
1900 ALAMEDA DE LAS PULGAS
SAN MATEO, CA 94403

FOR: ENTERTAINMENT SERVICES, NAMELY, CONDUCTING CONTESTS AND SWEEPSTAKES THROUGH WHICH MEMBERS OF DESIGNATED EDUCATIONAL ASSOCIATIONS, ORGANIZATION AND GROUPS CAN WIN FOR THE SCHOOL BY WHICH THEY ARE EMPLOYED A SCHOOL LOUNGE MAKEOVER NOT TO EXCEED A SPECIFIED DOLLAR AMOUNT, IN CLASS 41 (U.S. CLS. 100, 101 AND 107).

FIRST USE 11-23-2010; IN COMMERCE 11-23-2010.

THE MARK CONSISTS OF STANDARD CHARACTERS WITHOUT CLAIM TO ANY PARTICULAR FONT, STYLE, SIZE, OR COLOR.

SER. NO. 85-324,852, FILED P.R. 5-19-2011; AM. S.R. 9-23-2011.

JULIE WATSON, EXAMINING ATTORNEY



David J. Kyffers

Director of the United States Patent and Trademark Office

United States of America

United States Patent and Trademark Office

PROCESSED-FREE

Reg. No. 4,068,869

Registered Dec. 6, 2011

Int. Cl.: 16

TRADEMARK

SUPPLEMENTAL REGISTER FIRST USE 10-17-2006; IN COMMERCE 1-18-2007.

CENTER FOR PROCESSED-FREE LIVING (ARIZONA CORPORATION)
P.O. BOX 27564
TEMPE, AZ 85285

FOR: PAPER AND GOODS MADE FROM PAPER, NAMELY, PUBLICATIONS AND DOCUMENTATION IN THE NATURE OF BROCHURES, NEWSLETTERS AND MAGAZINES IN THE FIELDS OF NUTRITION, DIET, HEALTH AND WELLNESS, IN CLASS 16 (U.S. CLS. 2, 5, 22, 23, 29, 37, 38 AND 50).

THE MARK CONSISTS OF STANDARD CHARACTERS WITHOUT CLAIM TO ANY PARTICULAR FONT, STYLE, SIZE, OR COLOR.

SER. NO. 85-325,298, FILED P.R. 5-19-2011; AM. S.R. 9-20-2011.

KATHERINE CHANG, EXAMINING ATTORNEY



David J. Kybas

Director of the United States Patent and Trademark Office

United States of America

United States Patent and Trademark Office

Northwest Local

Reg. No. 4,068,870

NINKASI BREWERY, LLC (OREGON LIMITED LIABILITY COMPANY)
272 VAN BUREN ST.
EUGENE, OR 97402

Registered Dec. 6, 2011

Int. Cl.: 32

FOR: BEER, IN CLASS 32 (U.S. CLS. 45, 46 AND 48).

TRADEMARK

FIRST USE 6-1-2010; IN COMMERCE 6-1-2010.

SUPPLEMENTAL REGISTER

THE MARK CONSISTS OF STANDARD CHARACTERS WITHOUT CLAIM TO ANY PARTICULAR FONT, STYLE, SIZE, OR COLOR.

SER. NO. 85-327,799, FILED P.R. 5-23-2011; AM. S.R. 9-29-2011.

PATRICIA EVANKO, EXAMINING ATTORNEY



David J. Kybas

Director of the United States Patent and Trademark Office

United States of America

United States Patent and Trademark Office

SQUEEZABLE FRUIT

Reg. No. 4,068,871

DEL MONTE CORPORATION (DELAWARE CORPORATION)
PO BOX 193575
SAN FRANCISCO, CA 94111

Registered Dec. 6, 2011

Int. Cl.: 29

FOR: FRUIT PUREES; PROCESSED FRUITS, IN CLASS 29 (U.S. CL. 46).

TRADEMARK

FIRST USE 9-6-2011; IN COMMERCE 9-6-2011.

SUPPLEMENTAL REGISTER

THE MARK CONSISTS OF STANDARD CHARACTERS WITHOUT CLAIM TO ANY PARTICULAR FONT, STYLE, SIZE, OR COLOR.

NO CLAIM IS MADE TO THE EXCLUSIVE RIGHT TO USE "FRUIT", APART FROM THE MARK AS SHOWN.

SER. NO. 85-328,660, FILED P.R. 5-24-2011; AM. S.R. 9-27-2011.

DAVID COLLIER, EXAMINING ATTORNEY



David J. Kyros

Director of the United States Patent and Trademark Office

United States of America

United States Patent and Trademark Office

Concerns Based Systems International

Reg. No. 4,068,872

Registered Dec. 6, 2011

Int. Cl.: 35

SERVICE MARK

SUPPLEMENTAL REGISTER

HALL, GENE E. (UNITED STATES INDIVIDUAL), DBA GENE HALL,
2759 S. MILLER LANE
LAS VEGAS, NV 891172602

FOR: BUSINESS ADMINISTRATION CONSULTANCY; BUSINESS CONSULTING SERVICES
IN THE FIELD OF ORGANIZATIONAL CHANGE MANAGEMENT; BUSINESS MANAGE-
MENT CONSULTATION; BUSINESS MANAGEMENT CONSULTATION IN THE FIELD OF
EXECUTIVE AND LEADERSHIP DEVELOPMENT; BUSINESS MANAGEMENT CONSULT-
ING; BUSINESS ORGANIZATIONAL CONSULTATION, IN CLASS 35 (U.S. CLS. 100, 101
AND 102).

FIRST USE 6-19-1980; IN COMMERCE 5-20-1986.

THE MARK CONSISTS OF STANDARD CHARACTERS WITHOUT CLAIM TO ANY PAR-
TICULAR FONT, STYLE, SIZE, OR COLOR.

SER. NO. 85-331,581, FILED P.R. 5-26-2011; AM. S.R. 9-26-2011.

DAVID I, EXAMINING ATTORNEY



David J. Kyfos

Director of the United States Patent and Trademark Office

United States of America

United States Patent and Trademark Office

Brielle Dog Boutique

Reg. No. 4,068,873

K&D DOG ENTERPRISE LLC (NEW JERSEY LIMITED LIABILITY COMPANY)
501 UNION AVE.
BRIELLE, NJ 08730

Registered Dec. 6, 2011

Int. Cl.: 35

FOR: RETAIL STORE SERVICES FEATURING A WIDE VARIETY OF PET PRODUCTS OF OTHERS, IN CLASS 35 (U.S. CLS. 100, 101 AND 102).

SERVICE MARK

FIRST USE 3-1-2011; IN COMMERCE 3-1-2011.

SUPPLEMENTAL REGISTER

THE MARK CONSISTS OF STANDARD CHARACTERS WITHOUT CLAIM TO ANY PARTICULAR FONT, STYLE, SIZE, OR COLOR.

NO CLAIM IS MADE TO THE EXCLUSIVE RIGHT TO USE "DOG BOUTIQUE", APART FROM THE MARK AS SHOWN.

SER. NO. 85-333,053, FILED P.R. 5-28-2011; AM. S.R. 9-16-2011.

CURTIS FRENCH, EXAMINING ATTORNEY



David J. Kyros

Director of the United States Patent and Trademark Office

United States of America

United States Patent and Trademark Office

Social Goals

Reg. No. 4,068,874

Registered Dec. 6, 2011

Int. Cl.: 42

SERVICE MARK

SUPPLEMENTAL REGISTER

WORKSIMPLE, INC (DELAWARE CORPORATION)
UNIT B
3043 22ND STREET
SAN FRANCISCO, CA 94110

FOR: PROVIDING TEMPORARY USE OF A WEB-BASED SOFTWARE APPLICATION FOR PROVIDING WORKPLACE MANAGEMENT AND VIRTUAL SOCIAL COMMUNITY AMONG PEOPLE MANAGERS, EMPLOYEES, AND CO-WORKERS, IN CLASS 42 (U.S. CLS. 100 AND 101).

FIRST USE 3-1-2010; IN COMMERCE 4-0-2010.

THE MARK CONSISTS OF STANDARD CHARACTERS WITHOUT CLAIM TO ANY PARTICULAR FONT, STYLE, SIZE, OR COLOR.

SER. NO. 85-333,056, FILED P.R. 5-28-2011; AM. S.R. 9-21-2011.

BRENDAN REGAN, EXAMINING ATTORNEY



David J. Kybas

Director of the United States Patent and Trademark Office

United States of America

United States Patent and Trademark Office

DIY Business Improvement

Reg. No. 4,068,875

Registered Dec. 6, 2011

Int. Cl.: 35

SERVICE MARK

SUPPLEMENTAL REGISTER

OPSDOG, INC. (DELAWARE CORPORATION)
1502 AUGUSTA DRIVE, SUITE 312
HOUSTON, TX 77057

FOR: PROVIDING A WEBSITE FEATURING INFORMATION ON THE SUBJECT OF DO-IT-YOURSELF BUSINESS OPERATION AND MANAGEMENT IMPROVEMENT INFORMATION AND METHODS, IN CLASS 35 (U.S. CLS. 100, 101 AND 102).

FIRST USE 4-22-2011; IN COMMERCE 4-22-2011.

THE MARK CONSISTS OF STANDARD CHARACTERS WITHOUT CLAIM TO ANY PARTICULAR FONT, STYLE, SIZE, OR COLOR.

SER. NO. 85-333,587, FILED P.R. 5-31-2011; AM. S.R. 10-3-2011.

CHARLOTTE CORWIN, EXAMINING ATTORNEY



David J. Kybas

Director of the United States Patent and Trademark Office

United States of America

United States Patent and Trademark Office

BIKINI 'N A BAG

Reg. No. 4,068,876

LM WEB AND DESIGN, INC. (NEW YORK CORPORATION)
2 BRYANT DRIVE
HUNTINGTON, NY 11743

Registered Dec. 6, 2011

Int. Cl.: 18

FOR: CLUTCH PURSES, IN CLASS 18 (U.S. CLS. 1, 2, 3, 22 AND 41).

TRADEMARK

FIRST USE 6-2-2011; IN COMMERCE 6-2-2011.

SUPPLEMENTAL REGISTER

THE MARK CONSISTS OF STANDARD CHARACTERS WITHOUT CLAIM TO ANY PARTICULAR FONT, STYLE, SIZE, OR COLOR.

NO CLAIM IS MADE TO THE EXCLUSIVE RIGHT TO USE "BAG", APART FROM THE MARK AS SHOWN.

SER. NO. 85-337,676, FILED P.R. 6-3-2011; AM. S.R. 9-20-2011.

ADA HAN, EXAMINING ATTORNEY



David J. Kyffers

Director of the United States Patent and Trademark Office

United States of America

United States Patent and Trademark Office

BIKINI 'N A BAG

Reg. No. 4,068,877

LM WEB AND DESIGN, INC. (NEW YORK CORPORATION)
2 BRYANT DRIVE
HUNTINGTON, NY 11743

Registered Dec. 6, 2011

Int. Cl.: 25

FOR: BIKINIS, IN CLASS 25 (U.S. CLS. 22 AND 39).

TRADEMARK

FIRST USE 6-2-2011; IN COMMERCE 6-2-2011.

SUPPLEMENTAL REGISTER

THE MARK CONSISTS OF STANDARD CHARACTERS WITHOUT CLAIM TO ANY PARTICULAR FONT, STYLE, SIZE, OR COLOR.

NO CLAIM IS MADE TO THE EXCLUSIVE RIGHT TO USE "BIKINI", APART FROM THE MARK AS SHOWN.

SER. NO. 85-337,688, FILED P.R. 6-3-2011; AM. S.R. 9-20-2011.

ADA HAN, EXAMINING ATTORNEY



David J. Kyffers

Director of the United States Patent and Trademark Office

United States of America

United States Patent and Trademark Office

American Academy of Teaching

Reg. No. 4,068,878

Registered Dec. 6, 2011

Int. Cl.: 41

SERVICE MARK

SUPPLEMENTAL REGISTER

ATLANTIC RESEARCH PARTNERS, INC. (FLORIDA CORPORATION)
SUITE 113-256
13820 OLD ST. AUGUSTINE RD
JACKSONVILLE, FL 32258

FOR: EDUCATIONAL SERVICES, NAMELY, PROFESSIONAL COACHING OF TEACHERS IN THE FIELD OF TEACHING METHODS PROVIDED ON A REAL-TIME BASIS DURING CLASSROOM INSTRUCTION; EDUCATIONAL SERVICES, NAMELY, TEACHER TRAINING IN THE FIELD OF TEACHING METHODS PROVIDED ON A REAL-TIME BASIS DURING CLASSROOM INSTRUCTION, IN CLASS 41 (U.S. CLS. 100, 101 AND 107).

FIRST USE 3-12-2011; IN COMMERCE 3-12-2011.

THE MARK CONSISTS OF STANDARD CHARACTERS WITHOUT CLAIM TO ANY PARTICULAR FONT, STYLE, SIZE, OR COLOR.

NO CLAIM IS MADE TO THE EXCLUSIVE RIGHT TO USE "ACADEMY OF TEACHING", APART FROM THE MARK AS SHOWN.

SER. NO. 85-338,365, FILED P.R. 6-5-2011; AM. S.R. 9-30-2011.

LAURIE KAUFMAN, EXAMINING ATTORNEY



David J. Kyjars

Director of the United States Patent and Trademark Office

United States of America

United States Patent and Trademark Office

Job Channel Network

Reg. No. 4,068,879

Registered Dec. 6, 2011

Int. Cls.: 35 and 38

SERVICE MARK

SUPPLEMENTAL REGISTER

JASPER MEDIA, INC. (DELAWARE CORPORATION)
15 BIRCH COURT
OSSINING, NY 10562

FOR: ADVERTISEMENT AND PUBLICITY SERVICES BY TELEVISION, RADIO, MAIL; PRODUCTION AND DISTRIBUTION OF RADIO AND TELEVISION COMMERCIALS; PRODUCTION OF FILM AND TELEVISION ADVERTISING; PROMOTING THE GOODS AND SERVICES OF OTHERS THROUGH INFOMERCIALS PLAYED ON CUSTOMER POINT OF PURCHASE TELEVISION MONITORS IN RETAIL STORES; PROVIDING ADVERTISING, MARKETING AND PROMOTIONAL SERVICES, NAMELY, DEVELOPMENT OF ADVERTISING CAMPAIGNS PROVIDED THROUGH CABLE TELEVISION BROADCAST, WEB CASTS, RADIO BROADCASTS, NEWSPAPERS, MAGAZINES, ONLINE BANNERS, OUTDOOR BILLBOARDS, WILD POSTINGS, BUS AND SUBWAY ADS; PROVIDING TELEVISION ADVERTISING FOR OTHERS, IN CLASS 35 (U.S. CLS. 100, 101 AND 102).

FIRST USE 9-30-2010; IN COMMERCE 10-20-2010.

FOR: BROADCAST OF CABLE TELEVISION PROGRAMMES; BROADCASTING OF RADIO AND TELEVISION PROGRAMMES; BROADCASTING OF TELEVISION PROGRAMMES; BROADCASTING SERVICES AND PROVISION OF TELECOMMUNICATION ACCESS TO FILMS AND TELEVISION PROGRAMMES PROVIDED VIA A VIDEO-ON-DEMAND SERVICE; CABLE TELEVISION BROADCASTING; CABLE TELEVISION BROADCASTING SERVICES; CABLE TELEVISION TRANSMISSION; COMMUNICATION VIA RADIO, TELEGRAPH, TELEPHONE AND TELEVISION TRANSMISSIONS; COMMUNICATIONS BY TELEVISION FOR MEETING; ELECTRONIC TRANSMISSION OF VOICE, DATA AND IMAGES BY TELEVISION AND VIDEO BROADCASTING; INTERNET PROTOCOL TELEVISION (IPTV) TRANSMISSION SERVICES; RADIO AND TELEVISION BROADCASTING SERVICES; RADIO AND TELEVISION PROGRAMME BROADCASTING; SIMULCASTING BROADCAST TELEVISION OVER GLOBAL COMMUNICATION NETWORKS, THE INTERNET AND WIRELESS NETWORKS; SUBSCRIPTION TELEVISION BROADCASTING; TELEVISION AND RADIO BROADCASTING SERVICES; TELEVISION BROADCASTING; TELEVISION PROGRAMME BROADCASTING; TELEVISION PROGRAMME BROADCASTING VIA CABLE, IN CLASS 38 (U.S. CLS. 100, 101 AND 104).

FIRST USE 9-30-2010; IN COMMERCE 10-20-2010.



David J. Kyjars

Director of the United States Patent and Trademark Office

Reg. No. 4,068,879 THE MARK CONSISTS OF STANDARD CHARACTERS WITHOUT CLAIM TO ANY PARTICULAR FONT, STYLE, SIZE, OR COLOR.

NO CLAIM IS MADE TO THE EXCLUSIVE RIGHT TO USE "CHANNEL NETWORK", APART FROM THE MARK AS SHOWN.

SER. NO. 85-338,491, FILED P.R. 6-6-2011; AM. S.R. 9-27-2011.

TOBY BULLOFF, EXAMINING ATTORNEY

United States of America

United States Patent and Trademark Office

beauty media network

Reg. No. 4,068,880

Registered Dec. 6, 2011

Int. Cl.: 35

SERVICE MARK

SUPPLEMENTAL REGISTER

BRAND MEDIA LLC (GEORGIA LIMITED LIABILITY COMPANY)
2963 LOOKOUT PLACE NE
ATLANTA, GA 30305

FOR: ADVERTISING AND BUSINESS MANAGEMENT CONSULTANCY; ADVERTISING AND MARKETING; ADVERTISING AND MARKETING CONSULTANCY; ADVERTISING AND MARKETING SERVICES, NAMELY, PROMOTING THE GOODS AND SERVICES OF OTHERS; ADVERTISING AND PROMOTIONAL SERVICES; ADVERTISING AND PUBLICITY SERVICES, NAMELY, PROMOTING THE GOODS, SERVICES, BRAND IDENTITY AND COMMERCIAL INFORMATION AND NEWS OF THIRD PARTIES THROUGH PRINT, AUDIO, VIDEO, DIGITAL AND ON-LINE MEDIUM; ADVERTISING SERVICES; ADVERTISING SERVICES, NAMELY, PROMOTING AND MARKETING THE GOODS AND SERVICES OF OTHERS THROUGH ALL PUBLIC COMMUNICATION MEANS; DIRECT MARKETING ADVERTISING FOR OTHERS; PLACING ADVERTISEMENTS FOR OTHERS, IN CLASS 35 (U.S. CLS. 100, 101 AND 102).

FIRST USE 1-2-2011; IN COMMERCE 1-2-2011.

THE MARK CONSISTS OF STANDARD CHARACTERS WITHOUT CLAIM TO ANY PARTICULAR FONT, STYLE, SIZE, OR COLOR.

SER. NO. 85-339,384, FILED P.R. 6-6-2011; AM. S.R. 9-29-2011.

DAVID TOOLEY, EXAMINING ATTORNEY



David J. Kyffers

Director of the United States Patent and Trademark Office

United States of America

United States Patent and Trademark Office

Science of Energy Flow

Reg. No. 4,068,881

Registered Dec. 6, 2011

Int. Cl.: 41

SERVICE MARK

SUPPLEMENTAL REGISTER FIRST USE 5-1-2011; IN COMMERCE 5-1-2011.

MARTHA MATHEWS LIBSTER (UNITED STATES INDIVIDUAL), DBA GOLDEN APPLE
HEALING ARTS,
4304 WEST CHURCH ST
FARMVILLE, NC 27828

FOR: EDUCATIONAL SERVICES, NAMELY, PROVIDING CONTINUING PROFESSIONAL
EDUCATION COURSES IN THE FIELD OF FOOT REFLEXOLOGY, IN CLASS 41 (U.S. CLS.
100, 101 AND 107).

THE MARK CONSISTS OF STANDARD CHARACTERS WITHOUT CLAIM TO ANY PAR-
TICULAR FONT, STYLE, SIZE, OR COLOR.

SER. NO. 85-340,139, FILED P.R. 6-7-2011; AM. S.R. 9-27-2011.

SANI KHOURI, EXAMINING ATTORNEY



David J. Kyffers

Director of the United States Patent and Trademark Office

United States of America

United States Patent and Trademark Office

Westport Reflexology

Reg. No. 4,068,882

Registered Dec. 6, 2011

Int. Cl.: 44

MIELE, ANNIE GRAHAM (UNITED STATES INDIVIDUAL), DBA WESTPORT
REFLEXOLOGY,
26 HICKORY DRIVE
WESTPORT, CT 06880

FOR: REFLEXOLOGY SERVICES, IN CLASS 44 (U.S. CLS. 100 AND 101).

SERVICE MARK

FIRST USE 11-1-2006; IN COMMERCE 11-1-2006.

SUPPLEMENTAL REGISTER

THE MARK CONSISTS OF STANDARD CHARACTERS WITHOUT CLAIM TO ANY PARTICULAR FONT, STYLE, SIZE, OR COLOR.

NO CLAIM IS MADE TO THE EXCLUSIVE RIGHT TO USE "REFLEXOLOGY", APART FROM THE MARK AS SHOWN.

SER. NO. 85-341,203, FILED 6-8-2011.

MATTHEW KLINE, EXAMINING ATTORNEY



David J. Kypas

Director of the United States Patent and Trademark Office

United States of America

United States Patent and Trademark Office

MASKIN MEIBUM EXPRESSOR

Reg. No. 4,068,883

MGD INNOVATIONS, LLC (FLORIDA LIMITED LIABILITY COMPANY)
3001 SWANN AVENUE
TAMPA, FL 33609

Registered Dec. 6, 2011

Int. Cl.: 10

FOR: MEDICAL DEVICE FOR REMOVAL OF SECRETION FROM OIL GLANDS, IN CLASS 10 (U.S. CLS. 26, 39 AND 44).

TRADEMARK

FIRST USE 7-27-2011; IN COMMERCE 7-27-2011.

SUPPLEMENTAL REGISTER

THE MARK CONSISTS OF STANDARD CHARACTERS WITHOUT CLAIM TO ANY PARTICULAR FONT, STYLE, SIZE, OR COLOR.

OWNER OF U.S. REG. NO. 3,956,143.

NO CLAIM IS MADE TO THE EXCLUSIVE RIGHT TO USE "MEIBUM EXPRESSOR", APART FROM THE MARK AS SHOWN.

SER. NO. 85-341,620, FILED P.R. 6-8-2011; AM. S.R. 9-30-2011.

KRISTIN CARLSON, EXAMINING ATTORNEY



David J. Kybas

Director of the United States Patent and Trademark Office

United States of America

United States Patent and Trademark Office

VALIDATION WEEK

Reg. No. 4,068,884

Registered Dec. 6, 2011

Int. Cl.: 41

SERVICE MARK

SUPPLEMENTAL REGISTER

ADVANSTAR COMMUNICATIONS INC. (NEW YORK CORPORATION)
131 WEST FIRST STREET
DULUTH, MN 55802

FOR: PROVIDING EDUCATIONAL CONFERENCES FOR EXECUTIVES AND MANAGERS IN THE PHARMACEUTICAL, BIOTECH AND MEDICAL DEVICE FIELDS REGARDING THE ESTABLISHMENT OF INDUSTRY STANDARDS AND PROCESSES FOR TESTING SYSTEMS AND EQUIPMENT TO VERIFY THAT THEY CONSISTENTLY MEET PRE-DETERMINED STANDARDS AND REGULATORY REQUIREMENTS, IN CLASS 41 (U.S. CLS. 100, 101 AND 107).

FIRST USE 10-0-2007; IN COMMERCE 10-0-2007.

THE MARK CONSISTS OF STANDARD CHARACTERS WITHOUT CLAIM TO ANY PARTICULAR FONT, STYLE, SIZE, OR COLOR.

SER. NO. 85-342,291, FILED P.R. 6-9-2011; AM. S.R. 10-3-2011.

HEATHER THOMPSON, EXAMINING ATTORNEY



David J. Kybas

Director of the United States Patent and Trademark Office

United States of America

United States Patent and Trademark Office

URBAN INDOOR GARDEN STORE

Reg. No. 4,068,885

URBAN INDOOR GARDEN STORE, INC. (WYOMING CORPORATION)
8044 SE HAROLD STREET
PORTLAND, OR 97206

Registered Dec. 6, 2011

Int. Cl.: 35

FOR: RETAIL LAWN, GARDEN AND NURSERY STORES, IN CLASS 35 (U.S. CLS. 100, 101 AND 102).

SERVICE MARK

FIRST USE 3-31-2011; IN COMMERCE 3-31-2011.

SUPPLEMENTAL REGISTER

THE MARK CONSISTS OF STANDARD CHARACTERS WITHOUT CLAIM TO ANY PARTICULAR FONT, STYLE, SIZE, OR COLOR.

NO CLAIM IS MADE TO THE EXCLUSIVE RIGHT TO USE "GARDEN STORE", APART FROM THE MARK AS SHOWN.

SER. NO. 85-342,780, FILED P.R. 6-10-2011; AM. S.R. 9-23-2011.

JAMES LOVELACE, EXAMINING ATTORNEY



David J. Kyffers

Director of the United States Patent and Trademark Office

United States of America

United States Patent and Trademark Office

Pleasure Beach Carousel

Reg. No. 4,068,886

Registered Dec. 6, 2011

Int. Cl.: 16

TRADEMARK

SUPPLEMENTAL REGISTER

ZARIFF, GEORGE A. (UNITED STATES INDIVIDUAL)
815 CLINTON AVE.
BRIDGEPORT, CT 06604

FOR: A SERIES OF BOOKS, WRITTEN ARTICLES, HANDOUTS AND WORKSHEETS IN THE FIELD OF CAROUSELS; ADDRESS LABELS; BOOKS IN THE FIELD OF CAROUSELS; CALENDARS; ENVELOPES FOR STATIONERY USE; GREETING CARDS; MEMO PADS; NOTE PADS; NOTE PAPER; PAPER STATIONERY; PHOTOGRAPHIC PRINTS; PHOTOGRAPHS; PICTURE BOOKS; PICTURE POSTCARDS; POSTERS; STATIONERY WRITING PAPER AND ENVELOPES; IRON-ON TRANSFERS, IN CLASS 16 (U.S. CLS. 2, 5, 22, 23, 29, 37, 38 AND 50).

FIRST USE 4-1-2011; IN COMMERCE 4-1-2011.

THE MARK CONSISTS OF STANDARD CHARACTERS WITHOUT CLAIM TO ANY PARTICULAR FONT, STYLE, SIZE, OR COLOR.

SER. NO. 85-344,108, FILED P.R. 6-12-2011; AM. S.R. 6-12-2011.

MICHELLE DUBOIS, EXAMINING ATTORNEY



David J. Kyffers

Director of the United States Patent and Trademark Office

United States of America

United States Patent and Trademark Office

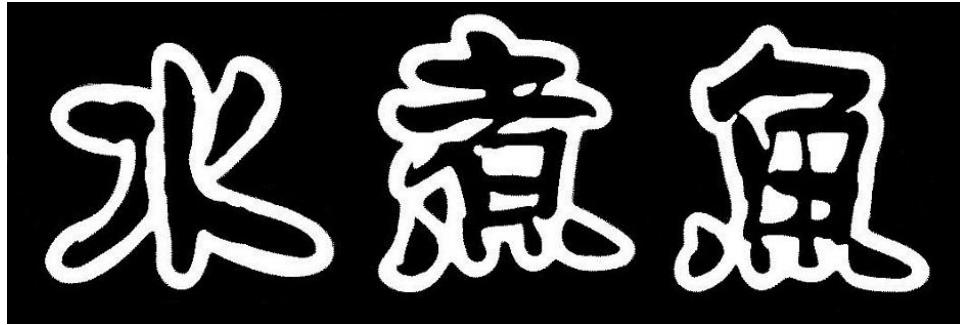

Reg. No. 4,068,887

SICHUAN CUISINE RESTAURANT INC. (NEW YORK CORPORATION)
C/O WILLIAM X. ZOU, 136-20 38 AVE, #10D
FLUSHING, NY 11354

Registered Dec. 6, 2011

Int. Cl.: 43

FOR: RESTAURANT, IN CLASS 43 (U.S. CLS. 100 AND 101).

SERVICE MARK

FIRST USE 4-1-2011; IN COMMERCE 4-1-2011.

SUPPLEMENTAL REGISTER

THE MARK CONSISTS OF CHINESE CHARACTERS. THE SHADED RECTANGLE IS FOR BACKGROUND PURPOSES ONLY.

SER. NO. 85-345,899, FILED P.R. 6-14-2011; AM. S.R. 9-26-2011.

EVELYN BRADLEY, EXAMINING ATTORNEY



David J. Kybas

Director of the United States Patent and Trademark Office

United States of America

United States Patent and Trademark Office

TAKEMOTO

Reg. No. 4,068,888

Registered Dec. 6, 2011

Int. Cl.: 8

TRADEMARK

SUPPLEMENTAL REGISTER

PACIFIC SOLUTION MARKETING INC. (CALIFORNIA CORPORATION)
1220 E. BELMONT ST
ONTARIO, CA 91761

FOR: FOLDING KNIVES; HUNTING KNIVES; JAPANESE SWORDS; KNIVES; KNIVES FOR HOBBY USE; SABRES; SPORT KNIVES; SWORDS; THROWING KNIVES, IN CLASS 8 (U.S. CLS. 23, 28 AND 44).

FIRST USE 11-14-2007; IN COMMERCE 11-14-2007.

THE MARK CONSISTS OF STANDARD CHARACTERS WITHOUT CLAIM TO ANY PARTICULAR FONT, STYLE, SIZE, OR COLOR.

SER. NO. 85-346,874, FILED P.R. 6-15-2011; AM. S.R. 9-24-2011.

ESTHER A. BORSUK, EXAMINING ATTORNEY



David J. Kyffers

Director of the United States Patent and Trademark Office

United States of America

United States Patent and Trademark Office

Dealer GraphiX

Reg. No. 4,068,889

Registered Dec. 6, 2011

Int. Cl.: 40

SERVICE MARK

SUPPLEMENTAL REGISTER

COHEN, PHILIP (UNITED STATES INDIVIDUAL)
11924 FOREST HILL BLVD SUITE 22-103
WELLINGTON, FL 33414

FOR: CUSTOM MANUFACTURE OF SIGNS, BANNERS, VINYL VEHICLE WRAPS, AND DECALS TO THE ORDER AND SPECIFICATION OF AUTOMOTIVE DEALERS , IN CLASS 40 (U.S. CLS. 100, 103 AND 106).

FIRST USE 8-1-2011; IN COMMERCE 8-1-2011.

THE MARK CONSISTS OF STANDARD CHARACTERS WITHOUT CLAIM TO ANY PARTICULAR FONT, STYLE, SIZE, OR COLOR.

SER. NO. 85-347,778, FILED P.R. 6-16-2011; AM. S.R. 10-16-2011.

JENNIFER VASQUEZ, EXAMINING ATTORNEY



David J. Kybas

Director of the United States Patent and Trademark Office

United States of America

United States Patent and Trademark Office

RENTAL TRENDS

Reg. No. 4,068,890

Registered Dec. 6, 2011

Int. Cl.: 9

TRADEMARK

SUPPLEMENTAL REGISTER

MEYERS BUILDER ADVISORS, MEYERS LLC (CALIFORNIA LIMITED LIABILITY COMPANY)
2712 EAST PACIFIC COAST HIGHWAY, #101
CORONA DEL MAR, CA 92625

FOR: DOWNLOADABLE ELECTRONIC NEWSLETTERS DELIVERED BY E-MAIL IN THE FIELD OF MULTI FAMILY HOUSING; DOWNLOADABLE ELECTRONIC NEWSLETTERS IN THE FIELD OF MULTI FAMILY HOUSING, IN CLASS 9 (U.S. CLS. 21, 23, 26, 36 AND 38).

FIRST USE 6-15-2011; IN COMMERCE 6-15-2011.

THE MARK CONSISTS OF STANDARD CHARACTERS WITHOUT CLAIM TO ANY PARTICULAR FONT, STYLE, SIZE, OR COLOR.

SER. NO. 85-348,590, FILED P.R. 6-16-2011; AM. S.R. 10-4-2011.

JAY FLOWERS, EXAMINING ATTORNEY



David J. Kyffers

Director of the United States Patent and Trademark Office

United States of America

United States Patent and Trademark Office

1-800-MEDIGAP

Reg. No. 4,068,891

Registered Dec. 6, 2011

Int. Cl.: 36

SERVICE MARK

SUPPLEMENTAL REGISTER FIRST USE 4-11-2011; IN COMMERCE 4-11-2011.

POLICY STORE INC. (TEXAS CORPORATION)
1100
2860 STATE HIGHWAY 66
ROCKWALL, TX 75087

FOR: INSURANCE CONSULTATION, ADMINISTRATION AND BROKERAGE IN THE FIELD OF SUPPLEMENTAL INSURANCE AND MEDIGAP PLANS FOR OTHERS, IN CLASS 36 (U.S. CLS. 100, 101 AND 102).

THE MARK CONSISTS OF STANDARD CHARACTERS WITHOUT CLAIM TO ANY PARTICULAR FONT, STYLE, SIZE, OR COLOR.

SER. NO. 85-348,591, FILED P.R. 6-16-2011; AM. S.R. 10-4-2011.

JAY FLOWERS, EXAMINING ATTORNEY



David J. Kybas

Director of the United States Patent and Trademark Office

United States of America

United States Patent and Trademark Office

UNCONDITIONAL



Reg. No. 4,068,892

MELANIE ZYSK (UNITED STATES INDIVIDUAL), DBA A SPOT ON PRODUCTIONS,
5804 SW WOODHAM STREET
PALM CITY, FL 34990

Registered Dec. 6, 2011

Int. Cl.: 16

FOR: APPLIQUES IN THE FORM OF DECALS; DECALS; DECORATIVE DECALS FOR
VEHICLE WINDOWS, IN CLASS 16 (U.S. CLS. 2, 5, 22, 23, 29, 37, 38 AND 50).

TRADEMARK

FIRST USE 1-1-2011; IN COMMERCE 1-1-2011.

SUPPLEMENTAL REGISTER

THE MARK CONSISTS OF "UNCONDITIONAL LOVE" DECAL HAS TWO PAW PRINTS
ON EITHER SIDE OF THE DECAL.

SER. NO. 85-348,796, FILED P.R. 6-17-2011; AM. S.R. 10-3-2011.

DOMINICK J. SALEMI, EXAMINING ATTORNEY



David J. Kybas

Director of the United States Patent and Trademark Office

United States of America

United States Patent and Trademark Office

NAPLES FLATBREAD

Reg. No. 4,068,893

Registered Dec. 6, 2011

Int. Cl.: 43

SERVICE MARK

SUPPLEMENTAL REGISTER

NAPLES FLATBREAD ORIGINAL LLC (FLORIDA LIMITED LIABILITY COMPANY)
SUITE 408
6434 NAPLES BOULEVARD
NAPLES, FL 34109

FOR: RESTAURANT, BAR AND CATERING SERVICES, IN CLASS 43 (U.S. CLS. 100 AND 101).

FIRST USE 2-18-2009; IN COMMERCE 2-18-2009.

THE MARK CONSISTS OF STANDARD CHARACTERS WITHOUT CLAIM TO ANY PARTICULAR FONT, STYLE, SIZE, OR COLOR.

SER. NO. 85-349,446, FILED P.R. 6-17-2011; AM. S.R. 9-28-2011.

ELLEN B. AWRICH, EXAMINING ATTORNEY



David J. Kyros

Director of the United States Patent and Trademark Office

United States of America

United States Patent and Trademark Office

COLD HANDS AND FEET SUPPORT

Reg. No. 4,068,894

HEALTHY DIRECTIONS, LLC (DELAWARE LIMITED LIABILITY COMPANY)
7811 MONTROSE ROAD
POTOMAC, MD 20854

Registered Dec. 6, 2011

Int. Cl.: 5

FOR: NUTRITIONAL SUPPLEMENTS, IN CLASS 5 (U.S. CLS. 6, 18, 44, 46, 51 AND 52).

TRADEMARK

FIRST USE 9-0-2011; IN COMMERCE 9-0-2011.

SUPPLEMENTAL REGISTER

THE MARK CONSISTS OF STANDARD CHARACTERS WITHOUT CLAIM TO ANY PARTICULAR FONT, STYLE, SIZE, OR COLOR.

SER. NO. 85-350,189, FILED P.R. 6-20-2011; AM. S.R. 10-26-2011.

LOURDES AYALA, EXAMINING ATTORNEY



David J. Kybas

Director of the United States Patent and Trademark Office

United States of America
United States Patent and Trademark Office

CANAPÉS

Reg. No. 4,068,895

DI VINO BROS, INC. (CALIFORNIA CORPORATION)
1553 BRIGHTON GLEN ROAD
SAN MARCOS, CA 92078

Registered Dec. 6, 2011

Int. Cl.: 43

FOR: RESTAURANT, BAR AND CATERING SERVICES, IN CLASS 43 (U.S. CLS. 100 AND 101).

SERVICE MARK

FIRST USE 11-1-2009; IN COMMERCE 11-1-2009.

SUPPLEMENTAL REGISTER

THE MARK CONSISTS OF STANDARD CHARACTERS WITHOUT CLAIM TO ANY PARTICULAR FONT, STYLE, SIZE, OR COLOR.

SER. NO. 85-350,356, FILED P.R. 6-20-2011; AM. S.R. 9-30-2011.

ALYSSA STEEL, EXAMINING ATTORNEY



David J. Kybas

Director of the United States Patent and Trademark Office

United States of America

United States Patent and Trademark Office

ECO GOWN

Reg. No. 4,068,896

Registered Dec. 6, 2011

Int. Cl.: 25

APHRODITE SOLUTIONS LIMITED (HONG KONG LIMITED LIABILITY COMPANY)
ROOM C1D 6/F
14 HING YIP STREET
KOWLOON, HONG KONG

FOR: GOWNS, IN CLASS 25 (U.S. CLS. 22 AND 39).

TRADEMARK

FIRST USE 11-10-2010; IN COMMERCE 11-10-2010.

SUPPLEMENTAL REGISTER

THE MARK CONSISTS OF STANDARD CHARACTERS WITHOUT CLAIM TO ANY PARTICULAR FONT, STYLE, SIZE, OR COLOR.

NO CLAIM IS MADE TO THE EXCLUSIVE RIGHT TO USE "GOWN", APART FROM THE MARK AS SHOWN.

SER. NO. 85-351,370, FILED P.R. 6-21-2011; AM. S.R. 10-3-2011.

ANDREW RHIM, EXAMINING ATTORNEY



David J. Kybas

Director of the United States Patent and Trademark Office

United States of America

United States Patent and Trademark Office

AFE FOUNDATION

Reg. No. 4,068,897

Registered Dec. 6, 2011

Int. Cl.: 36

SERVICE MARK

SUPPLEMENTAL REGISTER

AMNIOTIC FLUID EMBOLISM FOUNDATION. (CALIFORNIA CORPORATION)
1611 S. MELROSE DR. #152
VISTA, CA 92081

FOR: CHARITABLE FUNDRAISING AND FINANCING RESEARCH FOR AMNIOTIC FLUID EMBOLISM; CHARITABLE FUNDRAISING SERVICES; CHARITABLE FOUNDATION SERVICES, NAMELY, PROVIDING FUNDRAISING ACTIVITIES TO SUPPORT MEDICAL RESEARCH AND PROCEDURES FOR THOSE IN NEED; ACCEPTING AND ADMINISTERING MONETARY CHARITABLE CONTRIBUTIONS TO FUND MEDICAL RESEARCH; CHARITABLE FUNDRAISING SERVICES FOR PROMOTING RESEARCH, EDUCATION, COUNSELING AND OTHER ACTIVITIES RELATING TO AMNIOTIC FLUID EMBOLISM; CHARITABLE FUNDRAISING SERVICES, NAMELY, ORGANIZING AND CONDUCTING EVENTS TO PROMOTE AWARENESS OF AMNIOTIC FLUID EMBOLISM, IN CLASS 36 (U.S. CLS. 100, 101 AND 102).

FIRST USE 7-14-2008; IN COMMERCE 7-14-2008.

THE MARK CONSISTS OF STANDARD CHARACTERS WITHOUT CLAIM TO ANY PARTICULAR FONT, STYLE, SIZE, OR COLOR.

NO CLAIM IS MADE TO THE EXCLUSIVE RIGHT TO USE "FOUNDATION", APART FROM THE MARK AS SHOWN.

SER. NO. 85-351,591, FILED P.R. 6-21-2011; AM. S.R. 9-30-2011.

ALLISON SCHRODY, EXAMINING ATTORNEY



David J. Kybas

Director of the United States Patent and Trademark Office

United States of America

United States Patent and Trademark Office

CelebrityPress

Reg. No. 4,068,898

Registered Dec. 6, 2011

Int. Cl.: 41

SERVICE MARK

SUPPLEMENTAL REGISTER

D&N IPROPERTIES LLC (FLORIDA LIMITED LIABILITY COMPANY)
#2
520 N. ORLANDO AVENUE
WINTER PARK, FL 32789

FOR: BOOK PUBLISHING, IN CLASS 41 (U.S. CLS. 100, 101 AND 107).

FIRST USE 1-1-2010; IN COMMERCE 1-1-2010.

THE MARK CONSISTS OF STANDARD CHARACTERS WITHOUT CLAIM TO ANY PARTICULAR FONT, STYLE, SIZE, OR COLOR.

SER. NO. 85-352,081, FILED P.R. 6-21-2011; AM. S.R. 9-29-2011.

WENDY GOODMAN, EXAMINING ATTORNEY



David J. Kybas

Director of the United States Patent and Trademark Office

United States of America

United States Patent and Trademark Office

PUGILIST

Reg. No. 4,068,899

Registered Dec. 6, 2011

Int. Cl.: 25

TRADEMARK

SUPPLEMENTAL REGISTER

PUGILIST LLC (CALIFORNIA LIMITED LIABILITY COMPANY), DBA PUGILIST,
360 E. FIRST STREET 459
TUSTIN, CA 92780

FOR: MEN'S, WOMEN'S AND CHILDREN'S CLOTHING, NAMELY, SWEATSHIRTS, SWEATPANTS, SHIRTS, JEANS, JACKETS, COATS, SLACKS, SHORTPANTS, OVERALLS, SUITS, HATS, HEAD AND WRISTBANDS, DRESSES, SKIRTS, ROMPERS, BLOUSES, SCARVES, GLOVES, SOCKS, BELTS, NECKTIES, UNDERGARMENTS, T-SHIRTS, DRESS SHIRTS, COLLARED SHIRTS, RUGBY SHIRTS, POLO SHIRTS, KNIT SHIRTS, AND JERSEYS; SPORTS CAPS, NAMELY, BASEBALL CAPS, KNIT CAPS, SKULL CAPS AND VISOR CAPS; SHOES, NAMELY, SNEAKERS, BOOTS AND SANDALS, WITH ALL OF THE ABOVE IN ALL FABRICATIONS AND WEIGHTS, IN CLASS 25 (U.S. CLS. 22 AND 39).

FIRST USE 11-18-1995; IN COMMERCE 11-18-1995.

THE MARK CONSISTS OF STANDARD CHARACTERS WITHOUT CLAIM TO ANY PARTICULAR FONT, STYLE, SIZE, OR COLOR.

OWNER OF U.S. REG. NOS. 2,899,536 AND 3,608,018.

SER. NO. 85-352,723, FILED 6-22-2011.

ANDREW LEASER, EXAMINING ATTORNEY



David J. Kyros

Director of the United States Patent and Trademark Office

United States of America

United States Patent and Trademark Office

Overcoming Addictions

Reg. No. 4,068,900

REID K. HESTER, PH.D. (UNITED STATES INDIVIDUAL)
9426 INDIAN SCHOOL RD NE STE 1
ALBUQUERQUE, NM 87112

Registered Dec. 6, 2011

Int. Cl.: 9

FOR: COMPUTER SOFTWARE FOR USE IN HEALTHCARE TREATMENT IN THE FIELD OF ADDICTIONS, IN CLASS 9 (U.S. CLS. 21, 23, 26, 36 AND 38).

TRADEMARK

FIRST USE 6-1-2006; IN COMMERCE 6-1-2006.

SUPPLEMENTAL REGISTER

THE MARK CONSISTS OF STANDARD CHARACTERS WITHOUT CLAIM TO ANY PARTICULAR FONT, STYLE, SIZE, OR COLOR.

SER. NO. 85-352,796, FILED P.R. 6-22-2011; AM. S.R. 10-5-2011.

KAPIL BHANOT, EXAMINING ATTORNEY



David J. Kyffers

Director of the United States Patent and Trademark Office

United States of America

United States Patent and Trademark Office

HIP HOP BACKDROPS

Reg. No. 4,068,901

Registered Dec. 6, 2011

Int. Cl.: 24

TRADEMARK

SUPPLEMENTAL REGISTER

BLOODHOUND LLC (ARKANSAS LIMITED LIABILITY COMPANY), DBA BACKDROP CITY,
1704 W. 19TH ST.
LITTLE ROCK, AR 72202

FOR: CANVAS AND MUSLIN BACKDROPS FOR USE IN PHOTOGRAPHIC AND VIDEO PRODUCTION, IN CLASS 24 (U.S. CLS. 42 AND 50).

FIRST USE 3-31-2007; IN COMMERCE 3-31-2007.

THE MARK CONSISTS OF STANDARD CHARACTERS WITHOUT CLAIM TO ANY PARTICULAR FONT, STYLE, SIZE, OR COLOR.

NO CLAIM IS MADE TO THE EXCLUSIVE RIGHT TO USE "BACKDROPS", APART FROM THE MARK AS SHOWN.

SER. NO. 85-353,564, FILED 6-22-2011.

MARGARET POWER, EXAMINING ATTORNEY



David J. Kybas

Director of the United States Patent and Trademark Office

United States of America

United States Patent and Trademark Office

HIP HOP BACKGROUNDS

Reg. No. 4,068,902

Registered Dec. 6, 2011

Int. Cl.: 24

TRADEMARK

SUPPLEMENTAL REGISTER

BLOODHOUND LLC (ARKANSAS LIMITED LIABILITY COMPANY), DBA BACKDROP CITY,
1704 W. 19TH ST.
LITTLE ROCK, AR 72202

FOR: CANVAS AND MUSLIN BACKDROPS FOR USE IN PHOTOGRAPHIC AND VIDEO PRODUCTION, IN CLASS 24 (U.S. CLS. 42 AND 50).

FIRST USE 3-31-2007; IN COMMERCE 3-31-2007.

THE MARK CONSISTS OF STANDARD CHARACTERS WITHOUT CLAIM TO ANY PARTICULAR FONT, STYLE, SIZE, OR COLOR.

NO CLAIM IS MADE TO THE EXCLUSIVE RIGHT TO USE "BACKGROUNDS", APART FROM THE MARK AS SHOWN.

SER. NO. 85-353,567, FILED 6-22-2011.

MARGARET POWER, EXAMINING ATTORNEY



David J. Kybas

Director of the United States Patent and Trademark Office

United States of America

United States Patent and Trademark Office

ECO · HEALTHY · FAST

Reg. No. 4,068,903

Registered Dec. 6, 2011

Int. Cl.: 43

SERVICE MARK

SUPPLEMENTAL REGISTER

GREEN DAY HOLDINGS LLC. (FLORIDA LIMITED LIABILITY COMPANY), DBA GREEN DAY CAFE,
PO BOX 1356
WINTER PARK, FL 32790

FOR: FAST-FOOD RESTAURANT SERVICES FEATURING NUTRITIOUS AND ENVIRONMENTALLY-FRIENDLY FOOD OPTIONS, IN CLASS 43 (U.S. CLS. 100 AND 101).

FIRST USE 8-8-2008; IN COMMERCE 8-8-2008.

THE MARK CONSISTS OF STANDARD CHARACTERS WITHOUT CLAIM TO ANY PARTICULAR FONT, STYLE, SIZE, OR COLOR.

SER. NO. 85-353,783, FILED P.R. 6-23-2011; AM. S.R. 10-13-2011.

ALYSSA STEEL, EXAMINING ATTORNEY



David J. Kyros

Director of the United States Patent and Trademark Office

United States of America

United States Patent and Trademark Office

HEALTH AND WELLNESS CHANNEL

Reg. No. 4,068,904

HEALTH AND WELLNESS CHANNEL, LLC (FLORIDA LIMITED LIABILITY COMPANY)
7217 GULF BLVD., #14139
ST. PETE BEACH, FL 33706

Registered Dec. 6, 2011

Int. Cl.: 38

FOR: CABLE TELEVISION BROADCASTING, IN CLASS 38 (U.S. CLS. 100, 101 AND 104).

SERVICE MARK

FIRST USE 3-14-2011; IN COMMERCE 3-14-2011.

SUPPLEMENTAL REGISTER

THE MARK CONSISTS OF STANDARD CHARACTERS WITHOUT CLAIM TO ANY PARTICULAR FONT, STYLE, SIZE, OR COLOR.

NO CLAIM IS MADE TO THE EXCLUSIVE RIGHT TO USE "CHANNEL", APART FROM THE MARK AS SHOWN.

SER. NO. 85-357,983, FILED 6-28-2011.

DAVID I, EXAMINING ATTORNEY



David J. Kyros

Director of the United States Patent and Trademark Office

United States of America

United States Patent and Trademark Office

National Association of State Technology Directors

Reg. No. 4,068,905

Registered Dec. 6, 2011

Int. Cl.: 35

SERVICE MARK

SUPPLEMENTAL REGISTER

NATIONAL ASSOCIATION OF STATE TECHNOLOGY DIRECTORS (DELAWARE CORPORATION)
2760 RESEARCH PARK DR.
LEXINGTON, KY 40511

FOR: ASSOCIATION SERVICES, NAMELY, PROMOTING THE INTERESTS OF STATE TECHNOLOGY DIRECTORS THROUGH THE EFFECTIVE USE OF INFORMATION TECHNOLOGY TO FACILITATE OPERATIONAL EFFICIENCIES IN STATE GOVERNMENT, IN CLASS 35 (U.S. CLS. 100, 101 AND 102).

FIRST USE 1-15-2007; IN COMMERCE 1-15-2007.

THE MARK CONSISTS OF STANDARD CHARACTERS WITHOUT CLAIM TO ANY PARTICULAR FONT, STYLE, SIZE, OR COLOR.

SER. NO. 85-360,676, FILED P.R. 6-30-2011; AM. S.R. 10-21-2011.

TEJBIR SINGH, EXAMINING ATTORNEY



David J. Kybas

Director of the United States Patent and Trademark Office

United States of America

United States Patent and Trademark Office

Cossatot River RV Park-Cabins

Reg. No. 4,068,906

Registered Dec. 6, 2011

Int. Cl.: 41

SERVICE MARK

SUPPLEMENTAL REGISTER

COSSATOT RIVER RV PARK-CABINS LLC (ARKANSAS LIMITED LIABILITY COMPANY)
P.O. BOX 167
1435 HWY 278 EAST
WICKES, AR 71973

FOR: RECREATIONAL PARK SERVICES, IN CLASS 41 (U.S. CLS. 100, 101 AND 107).

FIRST USE 4-1-2011; IN COMMERCE 4-1-2011.

THE MARK CONSISTS OF STANDARD CHARACTERS WITHOUT CLAIM TO ANY PARTICULAR FONT, STYLE, SIZE, OR COLOR.

NO CLAIM IS MADE TO THE EXCLUSIVE RIGHT TO USE "RV PARK CABINS", APART FROM THE MARK AS SHOWN.

SER. NO. 85-362,823, FILED P.R. 7-5-2011; AM. S.R. 10-26-2011.

TARAH HARDY, EXAMINING ATTORNEY



David J. Kyffers

Director of the United States Patent and Trademark Office

United States of America

United States Patent and Trademark Office

ResortForaDay

Reg. No. 4,068,907

PINKY'S UP INC. (NEW YORK CORPORATION)
23 FARMINGTON LANE
MELVILLE, NY 11747

Registered Dec. 6, 2011

Int. Cl.: 39

FOR: ARRANGING EXCURSIONS FOR TOURISTS, IN CLASS 39 (U.S. CLS. 100 AND 105).

SERVICE MARK

FIRST USE 5-15-2010; IN COMMERCE 5-15-2010.

SUPPLEMENTAL REGISTER

THE MARK CONSISTS OF STANDARD CHARACTERS WITHOUT CLAIM TO ANY PARTICULAR FONT, STYLE, SIZE, OR COLOR.

SER. NO. 85-363,793, FILED P.R. 7-6-2011; AM. S.R. 10-26-2011.

ELISSA GARBER KON, EXAMINING ATTORNEY



David J. Kybas

Director of the United States Patent and Trademark Office

United States of America

United States Patent and Trademark Office

JamaicaForaDay

Reg. No. 4,068,908

PINKY'S UP INC. (NEW YORK CORPORATION)
23 FARMINGTON LANE
MELVILLE, NY 11747

Registered Dec. 6, 2011

Int. Cl.: 39

FOR: ARRANGING EXCURSIONS FOR TOURISTS, IN CLASS 39 (U.S. CLS. 100 AND 105).

SERVICE MARK

FIRST USE 6-15-2009; IN COMMERCE 6-15-2009.

SUPPLEMENTAL REGISTER

THE MARK CONSISTS OF STANDARD CHARACTERS WITHOUT CLAIM TO ANY PARTICULAR FONT, STYLE, SIZE, OR COLOR.

SER. NO. 85-363,795, FILED P.R. 7-6-2011; AM. S.R. 10-26-2011.

ELISSA GARBER KON, EXAMINING ATTORNEY



David J. Kybas

Director of the United States Patent and Trademark Office

United States of America

United States Patent and Trademark Office

CozumelForaDay

Reg. No. 4,068,909

PINKY'S UP INC. (NEW YORK CORPORATION)
23 FARMINGTON LANE
MELVILLE, NY 11747

Registered Dec. 6, 2011

Int. Cl.: 39

FOR: ARRANGING EXCURSIONS FOR TOURISTS, IN CLASS 39 (U.S. CLS. 100 AND 105).

SERVICE MARK

FIRST USE 5-1-2011; IN COMMERCE 5-1-2011.

SUPPLEMENTAL REGISTER

THE MARK CONSISTS OF STANDARD CHARACTERS WITHOUT CLAIM TO ANY PARTICULAR FONT, STYLE, SIZE, OR COLOR.

SER. NO. 85-363,796, FILED P.R. 7-6-2011; AM. S.R. 10-26-2011.

ELISSA GARBER KON, EXAMINING ATTORNEY



David J. Kyffers

Director of the United States Patent and Trademark Office

United States of America

United States Patent and Trademark Office

Livin' Like a... Carolina Girl!

Reg. No. 4,068,910

SUCCESS CENTRE INTERNATIONAL, INC. (SOUTH CAROLINA CORPORATION)
556 KIMBALL POND ROAD
AIKEN, SC 29803

Registered Dec. 6, 2011

Int. Cl.: 25

FOR: HOODED SWEATSHIRTS; T-SHIRTS; TANK-TOPS, IN CLASS 25 (U.S. CLS. 22 AND 39).

TRADEMARK

FIRST USE 2-1-2010; IN COMMERCE 2-1-2010.

SUPPLEMENTAL REGISTER

THE MARK CONSISTS OF STANDARD CHARACTERS WITHOUT CLAIM TO ANY PARTICULAR FONT, STYLE, SIZE, OR COLOR.

SER. NO. 85-365,181, FILED 7-7-2011.

LOURDES AYALA, EXAMINING ATTORNEY



David J. Kyffers

Director of the United States Patent and Trademark Office

United States of America

United States Patent and Trademark Office

SOUNDS OF THE GAME

Reg. No. 4,068,911

TWENTIETH CENTURY FOX FILM CORPORATION (DELAWARE CORPORATION)
10201 WEST PICO BOULEVARD
LOS ANGELES, CA 90035

Registered Dec. 6, 2011

Int. Cl.: 41

FOR: ENTERTAINMENT SERVICES IN THE NATURE OF AN ON-GOING TELEVISION SEGMENT FEATURING SPORTS, IN CLASS 41 (U.S. CLS. 100, 101 AND 107).

SERVICE MARK

FIRST USE 12-31-1997; IN COMMERCE 12-31-1997.

SUPPLEMENTAL REGISTER

THE MARK CONSISTS OF STANDARD CHARACTERS WITHOUT CLAIM TO ANY PARTICULAR FONT, STYLE, SIZE, OR COLOR.

OWNER OF U.S. REG. NO. 3,023,447.

NO CLAIM IS MADE TO THE EXCLUSIVE RIGHT TO USE "GAME", APART FROM THE MARK AS SHOWN.

SER. NO. 85-388,489, FILED P.R. 8-3-2011; AM. S.R. 9-27-2011.

TRACY WHITTAKER-BROWN, EXAMINING ATTORNEY



David J. Kybas

Director of the United States Patent and Trademark Office

United States of America

United States Patent and Trademark Office

FAST LANE

Reg. No. 4,068,912

CEDAR FAIR, L.P. (DELAWARE LIMITED PARTNERSHIP)
ONE CEDAR POINT DRIVE
SANDUSKY, OH 44870

Registered Dec. 6, 2011

Int. Cl.: 41

FOR: AMUSEMENT PARK SERVICES; TICKET RESERVATION SYSTEM FOR AMUSEMENT PARK ATTRACTIONS, IN CLASS 41 (U.S. CLS. 100, 101 AND 107).

SERVICE MARK

FIRST USE 7-19-2011; IN COMMERCE 7-19-2011.

SUPPLEMENTAL REGISTER

THE MARK CONSISTS OF STANDARD CHARACTERS WITHOUT CLAIM TO ANY PARTICULAR FONT, STYLE, SIZE, OR COLOR.

SER. NO. 85-394,424, FILED P.R. 8-10-2011; AM. S.R. 10-3-2011.

DOMINIC FATHY, EXAMINING ATTORNEY



David J. Kyros

Director of the United States Patent and Trademark Office

United States of America

United States Patent and Trademark Office

Cupcake Pen

Reg. No. 4,068,913

ICI-USA LLC (WASHINGTON LIMITED LIABILITY COMPANY), DBA TOVOLO,
2815 EAST LAKE AVE. E., STE 150
SEATTLE, WA 98102

Registered Dec. 6, 2011

Int. Cl.: 21

FOR: COOKING UTENSIL, NAMELY, BATTER DISPENSER, IN CLASS 21 (U.S. CLS. 2, 13,
23, 29, 30, 33, 40 AND 50).

TRADEMARK

FIRST USE 9-1-2010; IN COMMERCE 10-1-2010.

SUPPLEMENTAL REGISTER

THE MARK CONSISTS OF STANDARD CHARACTERS WITHOUT CLAIM TO ANY PAR-
TICULAR FONT, STYLE, SIZE, OR COLOR.

SER. NO. 85-424,989, FILED 9-16-2011.

LUCY ARANT, EXAMINING ATTORNEY



David J. Kyros

Director of the United States Patent and Trademark Office

United States of America

United States Patent and Trademark Office

THE INDIAN UNIVERSITY OF NORTH AMERICA

Reg. No. 4,068,914

Registered Dec. 6, 2011

Int. Cl.: 41

SERVICE MARK

SUPPLEMENTAL REGISTER FIRST USE 6-0-2011; IN COMMERCE 6-0-2011.

THE CRAZY HORSE MEMORIAL FOUNDATION (SOUTH DAKOTA NON-PROFIT CORPORATION)
12151 AVENUE OF THE CHIEFS
CRAZY HORSE, SD 577308900

FOR: EDUCATION SERVICES, NAMELY, CONDUCTING COURSES, LECTURES, WORKSHOPS, SEMINARS AND CONFERENCES AT THE UNIVERSITY LEVEL, IN CLASS 41 (U.S. CLS. 100, 101 AND 107).

THE MARK CONSISTS OF STANDARD CHARACTERS WITHOUT CLAIM TO ANY PARTICULAR FONT, STYLE, SIZE, OR COLOR.

OWNER OF U.S. REG. NO. 2,316,708.

NO CLAIM IS MADE TO THE EXCLUSIVE RIGHT TO USE "UNIVERSITY", APART FROM THE MARK AS SHOWN.

SER. NO. 85-431,726, FILED P.R. 9-26-2011; AM. S.R. 10-4-2011.

KATHLEEN M. VANSTON, EXAMINING ATTORNEY



David J. Kybas

Director of the United States Patent and Trademark Office

United States of America

United States Patent and Trademark Office

COLLECTION LAW REPORTER

Reg. No. 4,068,915

COOK COLLECTION ATTORNEYS, P.L.C. (CALIFORNIA CORPORATION)
165 FELL STREET
SAN FRANCISCO, CA 94102

Registered Dec. 6, 2011

Int. Cl.: 41

FOR: ONLINE JOURNALS IN THE FIELD OF LEGAL SERVICES, IN CLASS 41 (U.S. CLS. 100, 101 AND 107).

SERVICE MARK

FIRST USE 12-16-2010; IN COMMERCE 12-16-2010.

SUPPLEMENTAL REGISTER

THE MARK CONSISTS OF STANDARD CHARACTERS WITHOUT CLAIM TO ANY PARTICULAR FONT, STYLE, SIZE, OR COLOR.

NO CLAIM IS MADE TO THE EXCLUSIVE RIGHT TO USE "REPORTER", APART FROM THE MARK AS SHOWN.

SER. NO. 85-975,654, FILED P.R. 12-17-2010; AM. S.R. 9-22-2011.

SUE LAWRENCE, EXAMINING ATTORNEY



David J. Kybas

Director of the United States Patent and Trademark Office