

United States of America

United States Patent and Trademark Office

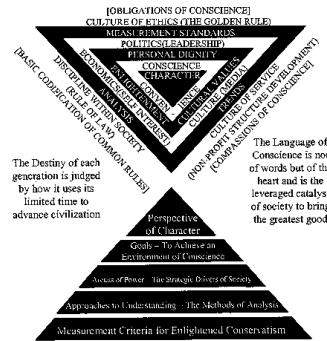

Reg. No. 4,107,121

Registered Mar. 6, 2012

Int. Cl.: 41

SERVICE MARK

PRINCIPAL REGISTER

TEXAS PEACEMAKER PUBLICATIONS, L.L.C. (TEXAS LIMITED LIABILITY COMPANY)
2211 SOUTH DAY STREET, SUITE 401
BRENHAM, TX 77833

FOR: EDUCATIONAL SERVICES, NAMELY, CONDUCTING CLASSES, WORKSHOPS, AND SEMINARS IN THE FIELD OF PERSONAL, SPIRITUAL AND SOCIAL GROWTH, IN CLASS 41 (U.S. CLS. 100, 101 AND 107).

FIRST USE 8-17-2002; IN COMMERCE 2-25-2005.

OWNER OF U.S. REG. NO. 3,196,388.

THE MARK CONSISTS OF TWO TRIANGLES AND THE WORDING "OBLIGATIONS OF CONSCIENCE CULTURE OF ETHICS (THE GOLDEN RULE) MEASUREMENT STANDARDS POLITICS (LEADERSHIP) PERSONAL DIGNITY CONSCIENCE CHARACTER CONVENIENCE ENLIGHTENMENT CULTURAL VALUES ECONOMICS (SELF INTEREST) CULTURE (MEDIA) ANALYSIS TRENDS DISCIPLINE WITHIN SOCIETY CULTURE OF SERVICE (RULE OF LAW) (NON-PROFIT STRUCTURE DEVELOPMENT) BASIC CODIFICATION OF COMMON RULES COMPASSIONS OF CONSCIENCE THE DESTINY OF EACH GENERATION IS JUDGED BY HOW IT USES ITS LIMITED TIME TO ADVANCE CIVILIZATION THE LANGUAGE OF CONSCIENCE IS NOT OF WORDS BUT OF THE HEART AND IS THE LEVERAGED CATALYST OF SOCIETY TO BRING THE GREATEST GOOD PERSPECTIVE OF CHARACTER GOALS - TO ACHIEVE AN ENVIRONMENT OF CONSCIENCE ARENAS OF POWER - THE STRATEGIC DRIVERS OF SOCIETY APPROACHES TO UNDERSTANDING - THE METHODS OF ANALYSIS MEASUREMENT CRITERIA FOR ENLIGHTENED CONSERVATISM".

SER. NO. 76-670,418, FILED 12-15-2006.

FLORENTINA BLANDU, EXAMINING ATTORNEY



David J. Kyros

Director of the United States Patent and Trademark Office

United States of America

United States Patent and Trademark Office

APPLIED ADVANTAGE

Reg. No. 4,107,122

Registered Mar. 6, 2012

Int. Cl.: 35

SERVICE MARK

PRINCIPAL REGISTER

APPLIED CARD SYSTEMS, INC. (DELAWARE CORPORATION)
5401 BROKEN SOUND BLVD. NW
BOCA RATON, FL 33487

FOR: CREDIT CARD SERVICES, NAMELY, A DISCOUNT PROGRAM OFFERED AS A COMPONENT OF A CREDIT CARD THAT PROVIDES DISCOUNTS ON THE GOODS AND SERVICES OF OTHERS, IN CLASS 35 (U.S. CLS. 100, 101 AND 102).

FIRST USE 6-10-1998; IN COMMERCE 6-10-1998.

THE MARK CONSISTS OF STANDARD CHARACTERS WITHOUT CLAIM TO ANY PARTICULAR FONT, STYLE, SIZE, OR COLOR.

OWNER OF U.S. REG. NOS. 2,699,666 AND 2,752,332.

SER. NO. 76-675,725, FILED 4-19-2007.

LEIGH CAROLINE CASE, EXAMINING ATTORNEY



David J. Kybas

Director of the United States Patent and Trademark Office

United States of America

United States Patent and Trademark Office

TALKBOOK

Reg. No. 4,107,123

Registered Mar. 6, 2012

Int. Cl.: 38

SERVICE MARK

PRINCIPAL REGISTER

EVERCLEAR COMMUNICATIONS INC. (CANADA CORPORATION)
117 GIRTON BLVD.
WINNIPEG, MANITOBA, CANADA R3P 0A4

FOR: COMMUNICATION SERVICES VIA THE INTERNET, NAMELY, THE TRANSMISSION OF AUDIO, DATA, IMAGE AND VOICE INFORMATION AND RECORDINGS IN THE FORM OF VOICE OVER INTERNET PROTOCOL (VOIP) TELEPHONY COMMUNICATION SERVICES, ALL OF THE FOREGOING EXCLUDING SOCIAL NETWORKING SERVICES, IN CLASS 38 (U.S. CLS. 100, 101 AND 104).

FIRST USE 1-31-2008; IN COMMERCE 1-31-2008.

THE MARK CONSISTS OF STANDARD CHARACTERS WITHOUT CLAIM TO ANY PARTICULAR FONT, STYLE, SIZE, OR COLOR.

SER. NO. 76-693,743, FILED 10-22-2008.

JASON LOTT, EXAMINING ATTORNEY



David J. Kybas

Director of the United States Patent and Trademark Office

United States of America

United States Patent and Trademark Office

SUPERSTAR TEACHING MODEL

Reg. No. 4,107,124

AMERICAN FUTURE SYSTEMS, INC. (PENNSYLVANIA CORPORATION)
370 TECHNOLOGY DRIVE
MALVERN, PA 19355

Registered Mar. 6, 2012

Int. Cl.: 41

FOR: EDUCATIONAL SERVICES, NAMELY, PROFESSIONAL BUSINESS EDUCATION PROGRAMS AND COURSES, IN CLASS 41 (U.S. CLS. 100, 101 AND 107).

SERVICE MARK

FIRST USE 3-0-2010; IN COMMERCE 3-0-2010.

PRINCIPAL REGISTER

THE MARK CONSISTS OF STANDARD CHARACTERS WITHOUT CLAIM TO ANY PARTICULAR FONT, STYLE, SIZE, OR COLOR.

NO CLAIM IS MADE TO THE EXCLUSIVE RIGHT TO USE "TEACHING MODEL", APART FROM THE MARK AS SHOWN.

SER. NO. 76-703,229, FILED 6-3-2010.

MYRIAH HABEEB, EXAMINING ATTORNEY



David J. Kybas

Director of the United States Patent and Trademark Office

United States of America

United States Patent and Trademark Office

FIV5PM

FIVE | POST MERIDIEM

Reg. No. 4,107,125

TRENDY APPAREL, INC (GEORGIA CORPORATION)
5910 SHILOH RD E. # 112
ALPHARETTA, GA 30005

Registered Mar. 6, 2012

Int. Cl.: 25

FOR: JEANS, PANTS, SKIRTS, SHIRTS, T-SHIRTS, DRESSES, BLOUSES, JACKETS, SHORTS, COATS, IN CLASS 25 (U.S. CLS. 22 AND 39).

TRADEMARK

FIRST USE 0-0-2010; IN COMMERCE 1-2-2011.

PRINCIPAL REGISTER

THE MARK CONSISTS OF THE STYLIZED WORDING "FIV5PM FIVE POST MERIDIEM" WITH "FIV5PM" APPEARING OVER THE SMALLER WORDING "FIVE POST MERIDIEM". IN BETWEEN "FIVE" AND "POST" IS A VERTICAL LINE.

SER. NO. 76-704,374, FILED 9-7-2010.

JERI J. FICKES, EXAMINING ATTORNEY



David J. Kyros

Director of the United States Patent and Trademark Office

United States of America

United States Patent and Trademark Office

CadréNET

Reg. No. 4,107,126

Registered Mar. 6, 2012

Int. Cl.: 36

SERVICE MARK

PRINCIPAL REGISTER

CADRÉNET (NEW YORK CORPORATION)
1110 SOUTH AVENUE
SECOND FLOOR
STATEN ISLAND, NY 10314

FOR: SERVICE CONTRACTS FOR COMPUTER NETWORKS, NAMELY, EXTENDED WARRANTY SERVICES IN THE NATURE OF SERVICE CONTRACTS, IN CLASS 36 (U.S. CLS. 100, 101 AND 102).

FIRST USE 4-12-2004; IN COMMERCE 4-12-2004.

THE MARK CONSISTS OF STANDARD CHARACTERS WITHOUT CLAIM TO ANY PARTICULAR FONT, STYLE, SIZE, OR COLOR.

SER. NO. 76-704,846, FILED 10-12-2010.

JAMES STEIN, EXAMINING ATTORNEY



David J. Kybas

Director of the United States Patent and Trademark Office

United States of America

United States Patent and Trademark Office

TEN PALMS RESTAURANT

Reg. No. 4,107,127

MI DEVELOPMENTS INVESTMENTS INC. (DELAWARE CORPORATION)
455 MAGNA DRIVE
AURORA, ONTARIO, CANADA L4G 7A9

Registered Mar. 6, 2012

Int. Cls.: 41 and 43

FOR: ENTERTAINMENT SERVICES, NAMELY, IN THE NATURE OF CONDUCTING HORSE RACES; AND CASINO GAMING SERVICES, IN CLASS 41 (U.S. CLS. 100, 101 AND 107).

SERVICE MARK

FIRST USE 2-1-2006; IN COMMERCE 2-1-2006.

PRINCIPAL REGISTER

FOR: RESTAURANT SERVICES, IN CLASS 43 (U.S. CLS. 100 AND 101).

FIRST USE 2-1-2006; IN COMMERCE 2-1-2006.

THE MARK CONSISTS OF STANDARD CHARACTERS WITHOUT CLAIM TO ANY PARTICULAR FONT, STYLE, SIZE, OR COLOR.

NO CLAIM IS MADE TO THE EXCLUSIVE RIGHT TO USE "RESTAURANT", APART FROM THE MARK AS SHOWN.

SER. NO. 76-705,015, FILED 10-22-2010.

GINA HAYES, EXAMINING ATTORNEY



David J. Kyffers

Director of the United States Patent and Trademark Office

United States of America

United States Patent and Trademark Office



Reg. No. 4,107,128

Registered Mar. 6, 2012

Int. Cl.: 35

SERVICE MARK

PRINCIPAL REGISTER

FARMER'S NATIONAL COMPANY (NEBRASKA CORPORATION)
11516 NICHOLAS STREET, SUITE 100
OMAHA, NE 68154

FOR: FORESTRY MANAGEMENT SERVICES, NAMELY, MANAGING HUNTING AND FISHING LEASES AND PRESERVES; AND BUSINESS MANAGEMENT SERVICES IN THE FIELD OF CONSERVING AND PRESERVING LAND AND NATURAL RESOURCES FOR HUNTING AND FISHING, IN CLASS 35 (U.S. CLS. 100, 101 AND 102).

FIRST USE 8-16-2010; IN COMMERCE 8-16-2010.

OWNER OF U.S. REG. NOS. 2,980,170, 3,052,505, AND 3,968,181.

NO CLAIM IS MADE TO THE EXCLUSIVE RIGHT TO USE "HUNTING LEASE NETWORK", APART FROM THE MARK AS SHOWN.

SER. NO. 76-705,143, FILED 10-29-2010.

BERYL GARDNER, EXAMINING ATTORNEY



David J. Kybas

Director of the United States Patent and Trademark Office

United States of America

United States Patent and Trademark Office

NEPHEW TOMMY

Reg. No. 4,107,129

Registered Mar. 6, 2012

Int. Cl.: 41

SERVICE MARK

PRINCIPAL REGISTER

THE STEVE HARVEY RADIO NETWORK, INC. (TEXAS CORPORATION)
7322 S. W. FRWY., STE. 2010
HOUSTON, TX 77074

FOR: RADIO ENTERTAINMENT SERVICES, NAMELY, RADIO PROGRAMS FEATURING PERFORMANCES BY A FICTIONAL COMEDIC CHARACTER; ENTERTAINMENT SERVICES, NAMELY, PERSONAL APPEARANCES BY A RADIO PERSONALITY; ENTERTAINMENT SERVICES, NAMELY, LIVE, TELEVISED AND MOVIE APPEARANCES BY A PROFESSIONAL ENTERTAINER; ALL OF THE AFOREMENTIONED SERVICES PROVIDED BY A COMEDIC CHARACTER FROM A RADIO PROGRAM, IN CLASS 41 (U.S. CLS. 100, 101 AND 107).

FIRST USE 3-10-2001; IN COMMERCE 3-10-2001.

THE MARK CONSISTS OF STANDARD CHARACTERS WITHOUT CLAIM TO ANY PARTICULAR FONT, STYLE, SIZE, OR COLOR.

THE NAME "NEPHEW TOMMY" IDENTIFIES THE STAGE NAME OF THOMAS MILES, A LIVING INDIVIDUAL WHOSE CONSENT IS OF RECORD.

SER. NO. 76-705,918, FILED 1-6-2011.

KIM SAITO, EXAMINING ATTORNEY



David J. Kyffers

Director of the United States Patent and Trademark Office

United States of America

United States Patent and Trademark Office

INTERNET EYES

Reg. No. 4,107,130

Registered Mar. 6, 2012

Int. Cls.: 38 and 45

SERVICE MARK

PRINCIPAL REGISTER

MORGAN, ANTHONY CLIVE (UNITED KINGDOM INDIVIDUAL)
LAMMAS PARK HOUSE
3 PRIORITY ROAD
DAWLISH, DEVON EX79JF, UNITED KINGDOM

FOR: INTERNET-BASED COMMUNICATION SERVICES, NAMELY, PROVIDING ACCESS TO CCTV (CLOSED CIRCUIT TELEVISION) SECURITY VIDEO AT A REMOTE STATION; TRANSMISSION OF CCTV (CLOSED CIRCUIT TELEVISION) SECURITY VIDEO, IN CLASS 38 (U.S. CLS. 100, 101 AND 104).

FOR: SECURITY SERVICES FOR BUSINESS ESTABLISHMENTS, NAMELY, MONITORING OF ALARMS AND SECURITY SYSTEMS; SECURITY SERVICES FOR RETAIL PREMISES, NAMELY, BUILDING SECURITY ADVISORY AND CONSULTANCY SERVICES; REMOTE BUILDING SECURITY MONITORING THROUGH CCTV (CLOSED CIRCUIT TELEVISION); ELECTRONIC MONITORING SERVICES FOR SECURITY OF RETAIL PREMISES, NAMELY, MONITORING OF INTERIOR AND EXTERIOR PERIMETERS OF BUSINESSES, MONITORING OF ALARMS AND SECURITY SYSTEMS, IN CLASS 45 (U.S. CLS. 100 AND 101).

THE MARK CONSISTS OF STANDARD CHARACTERS WITHOUT CLAIM TO ANY PARTICULAR FONT, STYLE, SIZE, OR COLOR.

OWNER OF UNITED KINGDOM REG. NO. 2456622, DATED 11-30-2007, EXPIRES 5-25-2017.

NO CLAIM IS MADE TO THE EXCLUSIVE RIGHT TO USE "INTERNET", APART FROM THE MARK AS SHOWN.

SER. NO. 76-706,086, FILED 1-21-2011.

ELI HELLMAN, EXAMINING ATTORNEY



David J. Kypos

Director of the United States Patent and Trademark Office

United States of America

United States Patent and Trademark Office



Reg. No. 4,107,131

Registered Mar. 6, 2012

Int. Cl.: 18

TRADEMARK

PRINCIPAL REGISTER

RIGGS, GAIL S. (UNITED STATES INDIVIDUAL)
43 EAST BOULEVARD
ROCHESTER, NY 14610

FOR: BROOCHES ATTACHED TO HANDBAGS AND PURSES, AND BROOCHES FOR PERSONAL WEAR, IN CLASS 18 (U.S. CLS. 1, 2, 3, 22 AND 41).

FIRST USE 11-0-2001; IN COMMERCE 11-0-2001.

THE NAME "ABIGAIL RIGGS" IDENTIFIES A LIVING INDIVIDUAL WHOSE CONSENT IS OF RECORD.

THE MARK CONSISTS OF A NAME "ABIGAIL RIGGS", A SLOGAN "EVERY BEE NEEDS A PURSE OF HER OWN TO BECOME A QUEEN", AND A DESIGN OF A BEE WITH A CROWN, ALL WITHIN A SURROUNDING CIRCLE. THE NAME "ABIGAIL RIGGS" IS AT THE BOTTOM OF THE CIRCLE. THE SLOGAN "EVERY BEE NEEDS A PURSE OF HER OWN TO BECOME A QUEEN" EXTENDS CLOCKWISE FROM LOWER LEFT TO LOWER RIGHT AROUND THE BEE. IN THE MIDDLE OF THE MARK IS A BEE WITH A CROWN ON TOP OF IT.

SER. NO. 76-706,101, FILED 1-24-2011.

DAWN FELDMAN, EXAMINING ATTORNEY



David J. Kyffers

Director of the United States Patent and Trademark Office

United States of America

United States Patent and Trademark Office



Reg. No. 4,107,132

Registered Mar. 6, 2012

Int. Cl.: 5

TRADEMARK

PRINCIPAL REGISTER

C-5 BIOTECHNOLOGIES, LLC (DELAWARE LIMITED LIABILITY COMPANY)
11516 PERPETUAL DRIVE
ODESSA, FL 33556

FOR: MEDICATED SKIN PREPARATIONS, NAMELY, CREAMS, LOTIONS, GELS AND SOLUTIONS FOR THE TREATMENT OF MINOR INJURIES, INSECT BITES, SUNBURN, AND SKIN BLEMISHES, IN CLASS 5 (U.S. CLS. 6, 18, 44, 46, 51 AND 52).

FIRST USE 12-1-2010; IN COMMERCE 12-1-2010.

THE MARK CONSISTS OF THE STYLIZED WORD "POWERED" SURROUNDED BY AN INCOMPLETE CIRCLE; WITHIN THE CIRCLE IS A CURVED BAND TO THE LEFT OF THE STYLIZED TEXT "BY" ATOP OF "C5".

SER. NO. 76-706,397, FILED 2-14-2011.

JULIE GUTTADAURO, EXAMINING ATTORNEY



David J. Kybas

Director of the United States Patent and Trademark Office

United States of America

United States Patent and Trademark Office

KIDS GARDEN NEWS

Reg. No. 4,107,133

Registered Mar. 6, 2012

Int. Cls.: 9 and 41

TRADEMARK

SERVICE MARK

PRINCIPAL REGISTER

NATIONAL GARDENING ASSOCIATION, INC. (VERMONT CORPORATION)
1100 DORSET STREET
SOUTH BURLINGTON, VT 05403

FOR: DOWNLOADABLE ELECTRONIC NEWSLETTERS DELIVERED BY E-MAIL TO EDUCATORS AND PARENTS IN THE FIELD OF PLANT BASED EDUCATION, IN CLASS 9 (U.S. CLS. 21, 23, 26, 36 AND 38).

FIRST USE 2-1-2005; IN COMMERCE 2-1-2005.

FOR: ON-LINE NON-DOWNLOADABLE NEWSLETTERS DELIVERED ELECTRONICALLY TO EDUCATORS AND PARENT SIN THE FIELD OF PLANT BASED EDUCATION, IN CLASS 41 (U.S. CLS. 100, 101 AND 107).

FIRST USE 2-1-2005; IN COMMERCE 2-1-2005.

THE MARK CONSISTS OF STANDARD CHARACTERS WITHOUT CLAIM TO ANY PARTICULAR FONT, STYLE, SIZE, OR COLOR.

NO CLAIM IS MADE TO THE EXCLUSIVE RIGHT TO USE "NEWS" , APART FROM THE MARK AS SHOWN.

SEC. 2(F).

SER. NO. 76-706,546, FILED 2-24-2011.

KATHERINE E. HALMEN, EXAMINING ATTORNEY



David J. Kybas

Director of the United States Patent and Trademark Office

United States of America

United States Patent and Trademark Office

TRACK OFFICIALZ

Reg. No. 4,107,134

Registered Mar. 6, 2012

Int. Cl.: 41

SERVICE MARK

PRINCIPAL REGISTER

FLAGG, STEVEN (UNITED STATES INDIVIDUAL)
578 SELFMASTER PARKWAY
UNION, NJ 070839027

FOR: MUSIC PRODUCTION, IN CLASS 41 (U.S. CLS. 100, 101 AND 107).

FIRST USE 2-18-2011; IN COMMERCE 2-18-2011.

THE MARK CONSISTS OF STANDARD CHARACTERS WITHOUT CLAIM TO ANY PARTICULAR FONT, STYLE, SIZE, OR COLOR.

SER. NO. 76-706,955, FILED 3-24-2011.

LIEF MARTIN, EXAMINING ATTORNEY



David J. Kybas

Director of the United States Patent and Trademark Office

United States of America

United States Patent and Trademark Office

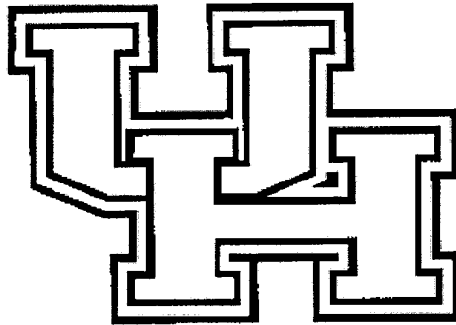

Reg. No. 4,107,135

Registered Mar. 6, 2012

Int. Cl.: 41

SERVICE MARK

PRINCIPAL REGISTER

THE UNIVERSITY OF HOUSTON SYSTEM (TEXAS A PUBLIC INSITUION OF HIGHER EDUCATION OF THE STATE OF TEXAS)
4800 CALHOUN ROAD
HOUSTON, TX 77204

FOR: EDUCATIONAL SERVICES, NAMELY, PROVIDING COLLEGE AND GRADUATE LEVEL COURSES OF INSTRUCTION, CONTINUING EDUCATION COURSES AND SEMINARS IN THE FIELDS OF BUSINESS, ACCOUNTING, ENGINEERING, SCIENCE, LEGAL, MEDICAL, HEALTH SCIENCE, LITERATURE, HISTORY, AND MATH FIELDS; EDUCATIONAL SERVICES, NAMELY, PROVIDING OPPORTUNITIES FOR STUDENTS TO PARTICIPATE IN EDUCATIONAL RESEARCH PROGRAMS; ENTERTAINMENT SERVICES, NAMELY, PROVIDING COLLEGE ATHLETIC AND SPORTING EVENTS IN THE FIELDS OF FOOTBALL, BASKETBALL, SOCCER, HOCKEY, TENNIS, VOLLEYBALL, TRACK AND FIELD, AND BASEBALL; ENTERTAINMENT SERVICES, NAMELY, LIVE PERFORMANCES OF DRAMATIC WORKS AND LIVE MUSICAL PERFORMANCES, IN CLASS 41 (U.S. CLS. 100, 101 AND 107).

FIRST USE 8-0-1997; IN COMMERCE 8-0-1997.

OWNER OF U.S. REG. NOS. 917,683, 3,866,209 AND OTHERS.

THE MARK CONSISTS OF THE STYLIZED LETTERS "'U" AND "H", WHICH ARE INTERLOCKING AND OUTLINED.

SER. NO. 76-707,261, FILED 4-14-2011.

JANET LEE, EXAMINING ATTORNEY



David J. Kyffers

Director of the United States Patent and Trademark Office

United States of America

United States Patent and Trademark Office



Reg. No. 4,107,136

Registered Mar. 6, 2012

Int. Cl.: 41

SERVICE MARK

PRINCIPAL REGISTER

THE UNIVERSITY OF HOUSTON SYSTEM (TEXAS A PUBLIC INSTITUTION OF HIGHER EDUCATION OF THE STATE OF TEXAS)
4800 CALHOUN ROAD
HOUSTON, TX 77204

FOR: EDUCATIONAL SERVICES, NAMELY, PROVIDING COLLEGE AND GRADUATE LEVEL COURSES OF INSTRUCTION, CONTINUING EDUCATION COURSES AND SEMINARS IN THE FIELDS OF BUSINESS, ACCOUNTING, ENGINEERING, SCIENCE, LEGAL, MEDICAL, HEALTH SCIENCE, LITERATURE, HISTORY, AND MATH FIELDS; EDUCATIONAL SERVICES, NAMELY, PROVIDING OPPORTUNITIES FOR STUDENTS TO PARTICIPATE IN EDUCATIONAL RESEARCH PROGRAMS; ENTERTAINMENT SERVICES, NAMELY, PROVIDING COLLEGE ATHLETIC AND SPORTING EVENTS IN THE FIELDS OF FOOTBALL, BASKETBALL, SOCCER, HOCKEY, TENNIS, VOLLEYBALL, TRACK AND FIELD, AND BASEBALL; ENTERTAINMENT SERVICES, NAMELY, LIVE PERFORMANCES OF DRAMATIC WORKS AND LIVE MUSICAL PERFORMANCES, IN CLASS 41 (U.S. CLS. 100, 101 AND 107).

FIRST USE 8-0-2003; IN COMMERCE 8-0-2003.

OWNER OF U.S. REG. NOS. 3,025,462, 3,697,389 AND OTHERS.

THE MARK CONSISTS OF A STYLIZED COUGAR HEAD WITH AN OPEN SNARLING MOUTH.

SER. NO. 76-707,285, FILED 4-15-2011.

JANET LEE, EXAMINING ATTORNEY



David J. Kyffers

Director of the United States Patent and Trademark Office

United States of America

United States Patent and Trademark Office

MISS HALLADAY

Reg. No. 4,107,137

VIBES BASE GROUP CORP. (CALIFORNIA CORPORATION)
9328 TELSTAR AVENUE
EL MONTE, CA 91731

Registered Mar. 6, 2012

Int. Cl.: 25

FOR: WOMEN'S CLOTHING, NAMELY, LADIES' DENIM JEANS AND SPORTSWEAR IN THE NATURE OF PANTS, SHORTS, SHIRTS, IN CLASS 25 (U.S. CLS. 22 AND 39).

TRADEMARK

FIRST USE 1-10-2011; IN COMMERCE 1-10-2011.

PRINCIPAL REGISTER

THE NAME "MISS HALLADAY" DOES NOT IDENTIFY A LIVING INDIVIDUAL.

SER. NO. 76-707,739, FILED 5-24-2011.

TRACY FLETCHER, EXAMINING ATTORNEY



David J. Kybas

Director of the United States Patent and Trademark Office

United States of America

United States Patent and Trademark Office

OPTISOURCE INTERNATIONAL

Reg. No. 4,107,138

Registered Mar. 6, 2012

Int. Cl.: 35

SERVICE MARK

PRINCIPAL REGISTER

OPTISOURCE INTERNATIONAL INC. (NEW YORK CORPORATION)
13515 N. STEMMONS FRWY.
DALLAS, TX 75234

FOR: ON-LINE STORE SERVICES AND MAIL ORDER CATALOG SERVICES FEATURING EYE CARE PRODUCTS, NAMELY, LENS CLEANERS, LENS CLEANING KITS, SCRATCH PROTECTANTS, LEAP PADS, BLOCKING PADS, LENS CLEANING CLOTHS, PRE-MOISTENED LENS WIPES, NOSE PADS FOR EYE GLASSES, LENS COATINGS FOR ULTRAVIOLET AND SCRATCH PROTECTION, COLOR DYES AND TINTS FOR LENSES, LENS CARE KITS CONTAINING CLEANERS AND WIPE CLOTHS, EYEGLASS CASES, EYEGLASS CHAINS AND HOLDERS, CLIP-ON FRAMES AND LENSES, POLARIZED LENSES AND SUNGLASSES, NON-PRESCRIPTION MAGNIFIER GLASSES, EYE PATCHES, CONTACT LENS STORAGE CASE AND VIALS, IN CLASS 35 (U.S. CLS. 100, 101 AND 102).

FIRST USE 11-1-2001; IN COMMERCE 11-1-2001.

THE MARK CONSISTS OF STANDARD CHARACTERS WITHOUT CLAIM TO ANY PARTICULAR FONT, STYLE, SIZE, OR COLOR.

NO CLAIM IS MADE TO THE EXCLUSIVE RIGHT TO USE "INTERNATIONAL", APART FROM THE MARK AS SHOWN.

SER. NO. 76-707,841, FILED 6-6-2011.

TINA BROWN, EXAMINING ATTORNEY



David J. Kybas

Director of the United States Patent and Trademark Office

United States of America

United States Patent and Trademark Office

MTN PASS COFFEE

Reg. No. 4,107,139

MOUNTAIN PASS COFFEE COMPANY, L.P. (TEXAS LIMITED PARTNERSHIP)
8411 LOCKHEED, SUITE 2
EL PASO, TX 79925

Registered Mar. 6, 2012

Int. Cl.: 43

FOR: SERVICES FOR PROVIDING COFFEE AND BEVERAGES, NAMELY, COFFEE SUPPLY SERVICE FOR BUSINESSES, IN CLASS 43 (U.S. CLS. 100 AND 101).

SERVICE MARK

FIRST USE 4-25-2006; IN COMMERCE 4-25-2006.

PRINCIPAL REGISTER

THE MARK CONSISTS OF STANDARD CHARACTERS WITHOUT CLAIM TO ANY PARTICULAR FONT, STYLE, SIZE, OR COLOR.

NO CLAIM IS MADE TO THE EXCLUSIVE RIGHT TO USE "COFFEE", APART FROM THE MARK AS SHOWN.

SER. NO. 76-707,952, FILED 6-13-2011.

BENJAMIN OKEKE, EXAMINING ATTORNEY



David J. Kybas

Director of the United States Patent and Trademark Office

United States of America

United States Patent and Trademark Office

WONDER BABY.ORG

Reg. No. 4,107,140

Registered Mar. 6, 2012

Int. Cls.: 35 and 41

SERVICE MARK

PRINCIPAL REGISTER

PERKINS SCHOOL FOR THE BLIND (MASSACHUSETTS NON-PROFIT CORPORATION)
175 NORTH BEACON STREET
WATERTOWN, MA 02472

FOR: PROVIDING AN ONLINE DATABASE IN THE FIELD OF CONSUMER PRODUCT REVIEWS REGARDING NEW PRODUCTS FOR PARENTS AND CAREGIVERS OF BLIND AND DISABLED CHILDREN, IN CLASS 35 (U.S. CLS. 100, 101 AND 102).

FIRST USE 12-1-2005; IN COMMERCE 12-1-2005.

FOR: PROVIDING ONLINE PUBLICATIONS IN THE NATURE OF RESOURCE GUIDES FOR PARENTS AND CAREGIVERS OF BLIND AND DISABLED CHILDREN IN THE FIELDS OF HEALTH, SAFETY, EDUCATION AND RECREATION, IN CLASS 41 (U.S. CLS. 100, 101 AND 107).

FIRST USE 12-1-2005; IN COMMERCE 12-1-2005.

THE MARK CONSISTS OF STANDARD CHARACTERS WITHOUT CLAIM TO ANY PARTICULAR FONT, STYLE, SIZE, OR COLOR.

SER. NO. 76-708,009, FILED 6-15-2011.

INGRID C. EULIN, EXAMINING ATTORNEY



David J. Kybas

Director of the United States Patent and Trademark Office

United States of America

United States Patent and Trademark Office

SYNDRAULIC

Reg. No. 4,107,141

Registered Mar. 6, 2012

Int. Cl.: 4

TRADEMARK

PRINCIPAL REGISTER

ROYAL PURPLE, INC. (TEXAS CORPORATION)
1 ROYAL PURPLE LANE
PORTER, TX 77396

FOR: HYDRAULIC OIL, IN CLASS 4 (U.S. CLS. 1, 6 AND 15).

FIRST USE 5-0-1988; IN COMMERCE 5-0-1988.

THE MARK CONSISTS OF STANDARD CHARACTERS WITHOUT CLAIM TO ANY PARTICULAR FONT, STYLE, SIZE, OR COLOR.

SER. NO. 76-708,116, FILED 6-23-2011.

JAMES GRIFFIN, EXAMINING ATTORNEY



David J. Kyffers

Director of the United States Patent and Trademark Office

United States of America

United States Patent and Trademark Office

MAXIMIZE YOUR STRENGTH

Reg. No. 4,107,142

Registered Mar. 6, 2012

Int. Cl.: 41

SERVICE MARK

PRINCIPAL REGISTER

THE AYERS FOUNDATION (TENNESSEE CORPORATION)
450 TENNESSEE AVENUE SOUTH
SUITE 101
PARSONS, TN 38363

FOR: EDUCATIONAL SERVICES, NAMELY, CONDUCTING CLASSES, SEMINARS, CONFERENCES AND WORKSHOPS IN THE FIELD OF SELF-RESPECT, PROBLEM-SOLVING SKILLS AND GOAL-SETTING FOR YOUNG MEN, IN CLASS 41 (U.S. CLS. 100, 101 AND 107).

FIRST USE 3-24-2011; IN COMMERCE 4-12-2011.

THE MARK CONSISTS OF STANDARD CHARACTERS WITHOUT CLAIM TO ANY PARTICULAR FONT, STYLE, SIZE, OR COLOR.

SER. NO. 76-708,329, FILED 7-14-2011.

DAVID YONTEF, EXAMINING ATTORNEY



David J. Kyffers

Director of the United States Patent and Trademark Office

United States of America

United States Patent and Trademark Office

LEARN-GROW-SUCCEED

Reg. No. 4,107,143

Registered Mar. 6, 2012

Int. Cl.: 41

SERVICE MARK

PRINCIPAL REGISTER

THE AYERS FOUNDATION (TENNESSEE CORPORATION)
450 TENNESSEE AVENUE SOUTH
SUITE 101
PARSONS, TN 38363

FOR: EDUCATIONAL COUNSELING SERVICES TO ASSIST STUDENTS IN PLANNING AND PREPARING FOR FURTHER EDUCATION; EDUCATIONAL SERVICES, NAMELY, CONDUCTING CLASSES, SEMINARS, CONFERENCES AND WORKSHOPS IN THE FIELD OF COLLEGE SCHEDULING AND ADMISSIONS, IN CLASS 41 (U.S. CLS. 100, 101 AND 107).

FIRST USE 3-30-2009; IN COMMERCE 6-18-2009.

THE MARK CONSISTS OF STANDARD CHARACTERS WITHOUT CLAIM TO ANY PARTICULAR FONT, STYLE, SIZE, OR COLOR.

SER. NO. 76-708,332, FILED 7-14-2011.

DAVID YONTEF, EXAMINING ATTORNEY



David J. Kyffers

Director of the United States Patent and Trademark Office

United States of America

United States Patent and Trademark Office



Reg. No. 4,107,144

Registered Mar. 6, 2012

Int. Cl.: 41

SERVICE MARK

PRINCIPAL REGISTER

THE AYERS FOUNDATION (TENNESSEE CORPORATION)
450 TENNESSEE AVENUE SOUTH
SUITE 101
PARSONS, TN 38363

FOR: EDUCATIONAL SERVICES, NAMELY, CONDUCTING CLASSES, SEMINARS, CONFERENCES AND WORKSHOPS IN THE FIELD OF SELF-RESPECT, PROBLEM-SOLVING SKILLS AND GOAL-SETTING FOR YOUNG MEN, IN CLASS 41 (U.S. CLS. 100, 101 AND 107).

FIRST USE 3-28-2011; IN COMMERCE 4-12-2011.

NO CLAIM IS MADE TO THE EXCLUSIVE RIGHT TO USE "A SUMMIT FOR YOUNG MEN", APART FROM THE MARK AS SHOWN.

THE MARK CONSISTS OF THE WORDS "MAXIMIZE YOUR STRENGTH" IN STYLIZED FONT PARTIALLY AGAINST AN INCOMPLETE RECTANGLE WHEREBY THE SECOND LETTER "T" IN THE WORD "STRENGTH" IS REPRESENTED BY A STYLIZED TORCH DESIGN COMPRISED OF A COLUMN AND FLAME AND THE WORDS "A SUMMIT FOR YOUNG MEN" SHOWN IN STYLIZED CURSIVE LETTERING.

SER. NO. 76-708,333, FILED 7-14-2011.

DAVID YONTEF, EXAMINING ATTORNEY



David J. Kyffers

Director of the United States Patent and Trademark Office

United States of America

United States Patent and Trademark Office

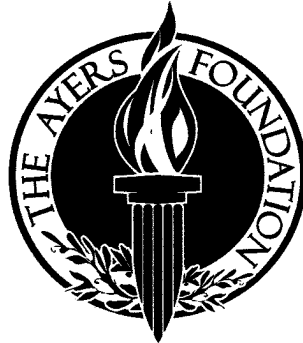

Reg. No. 4,107,145

Registered Mar. 6, 2012

Int. Cl.: 41

SERVICE MARK

PRINCIPAL REGISTER

THE AYERS FOUNDATION (TENNESSEE CORPORATION)
450 TENNESSEE AVENUE SOUTH
SUITE 101
PARSONS, TN 38363

FOR: EDUCATIONAL COUNSELING SERVICES TO ASSIST STUDENTS IN PLANNING AND PREPARING FOR FURTHER EDUCATION; EDUCATIONAL SERVICES, NAMELY, CONDUCTING CLASSES, SEMINARS, CONFERENCES AND WORKSHOPS IN THE FIELD OF COLLEGE SCHEDULING AND ADMISSIONS, IN CLASS 41 (U.S. CLS. 100, 101 AND 107).

FIRST USE 3-30-2009; IN COMMERCE 6-18-2009.

NO CLAIM IS MADE TO THE EXCLUSIVE RIGHT TO USE "FOUNDATION", APART FROM THE MARK AS SHOWN.

THE MARK CONSISTS OF THE WORDS "THE AYERS FOUNDATION" IN STYLIZED FONT POSITIONED IN-BETWEEN TWO CONCENTRIC CIRCLES AND A STYLIZED TORCH DESIGN COMPRISED OF A COLUMN AND FLAME FEATURING A PLANT DESIGN AROUND THE BOTTOM SUPERIMPOSED OVER THE CIRCLES.

SER. NO. 76-708,337, FILED 7-14-2011.

DAVID YONTEF, EXAMINING ATTORNEY



David J. Kybas

Director of the United States Patent and Trademark Office

United States of America

United States Patent and Trademark Office

Sentinel

Reg. No. 4,107,146

Registered Mar. 6, 2012

Int. Cl.: 5

TRADEMARK

PRINCIPAL REGISTER

ACTION LABS, INC. (CALIFORNIA CORPORATION)
35258 MOORBROOK RD.
PALM DESERT, CA 92211

FOR: DIETARY AND NUTRITIONAL SUPPLEMENTS FOR HUMAN CONSUMPTION, IN CLASS 5 (U.S. CLS. 6, 18, 44, 46, 51 AND 52).

FIRST USE 9-0-1987; IN COMMERCE 9-0-1987.

THE MARK CONSISTS OF STANDARD CHARACTERS WITHOUT CLAIM TO ANY PARTICULAR FONT, STYLE, SIZE, OR COLOR.

SER. NO. 76-708,389, FILED 7-18-2011.

ALICE BENMAMAN, EXAMINING ATTORNEY



David J. Kybas

Director of the United States Patent and Trademark Office

United States of America

United States Patent and Trademark Office

THEWINEBUZZ

Reg. No. 4,107,147

Registered Mar. 6, 2012

Int. Cl.: 16

TRADEMARK

PRINCIPAL REGISTER

THE WINE BUZZ, LTD. (OHIO CORPORATION)
3105 LINCOLN BLVD.
CLEVELAND HTS., OH 44118

FOR: PERIODICAL PUBLICATIONS, NAMELY, MAGAZINES RELATED TO WINE AND ITS ASSOCIATED PRODUCTS AND SERVICES, IN CLASS 16 (U.S. CLS. 2, 5, 22, 23, 29, 37, 38 AND 50).

FIRST USE 9-0-2003; IN COMMERCE 9-0-2003.

THE MARK CONSISTS OF STANDARD CHARACTERS WITHOUT CLAIM TO ANY PARTICULAR FONT, STYLE, SIZE, OR COLOR.

OWNER OF U.S. REG. NO. 2,905,947.

SER. NO. 76-708,416, FILED 7-20-2011.

JULIE WATSON, EXAMINING ATTORNEY



David J. Kybas

Director of the United States Patent and Trademark Office

United States of America

United States Patent and Trademark Office

POWERADVOCATE

Reg. No. 4,107,148

Registered Mar. 6, 2012

Int. Cl.: 42

SERVICE MARK

PRINCIPAL REGISTER

POWER ADVOCATE, INC. (DELAWARE CORPORATION)
179 LINCOLN STREET
BOSTON, MA 02111

FOR: SOFTWARE AS A SERVICE (SAAS) SERVICES FEATURING SOFTWARE FOR USE IN FACILITY AND PROJECT RESOURCE MANAGEMENT, PLANNING AND PROCUREMENT ACTIVITIES FOR THE ENERGY INDUSTRY , IN CLASS 42 (U.S. CLS. 100 AND 101).

FIRST USE 2-4-2001; IN COMMERCE 2-4-2001.

THE MARK CONSISTS OF STANDARD CHARACTERS WITHOUT CLAIM TO ANY PARTICULAR FONT, STYLE, SIZE, OR COLOR.

OWNER OF U.S. REG. NOS. 3,687,906 AND 3,690,917.

SER. NO. 76-708,429, FILED 7-21-2011.

JOHN GARTNER, EXAMINING ATTORNEY



David J. Kybas

Director of the United States Patent and Trademark Office

United States of America

United States Patent and Trademark Office



Reg. No. 4,107,149

Registered Mar. 6, 2012

Int. Cl.: 42

SERVICE MARK

PRINCIPAL REGISTER

POWER ADVOCATE, INC. (DELAWARE CORPORATION)
179 LINCOLN STREET
BOSTON, MA 02111

FOR: SOFTWARE AS A SERVICE (SAAS) SERVICES FEATURING SOFTWARE FOR USE IN FACILITY AND PROJECT RESOURCE MANAGEMENT, PLANNING AND PROCUREMENT ACTIVITIES FOR THE ENERGY INDUSTRY , IN CLASS 42 (U.S. CLS. 100 AND 101).

FIRST USE 12-0-2005; IN COMMERCE 12-0-2005.

OWNER OF U.S. REG. NOS. 3,687,906 AND 3,690,917.

SER. NO. 76-708,435, FILED 7-21-2011.

JOHN GARTNER, EXAMINING ATTORNEY



David J. Kybas

Director of the United States Patent and Trademark Office

United States of America

United States Patent and Trademark Office

FINCA VENTA DE DON QUIJOTE

Reg. No. 4,107,150

Registered Mar. 6, 2012

Int. Cl.: 33

TRADEMARK

PRINCIPAL REGISTER

FINCA VENTA DE DON QUIJOTE (SPAIN CORPORATION)
CTRA NATIONAL 301, KM 131
45820 EL TOBOSO
TOLEDO, SPAIN

FOR: WINE, IN CLASS 33 (U.S. CLS. 47 AND 49).

FIRST USE 6-0-2000; IN COMMERCE 10-9-2006.

THE MARK CONSISTS OF STANDARD CHARACTERS WITHOUT CLAIM TO ANY PARTICULAR FONT, STYLE, SIZE, OR COLOR.

THE NAME DON QUIJOTE DOES NOT IDENTIFY A LIVING INDIVIDUAL.

THE ENGLISH TRANSLATION OF FINCA VENTA DE DON QUIJOTE IS THE ESTATE SALE OF DON QUIJOTE.

SER. NO. 76-708,504, FILED 7-27-2011.

BERYL GARDNER, EXAMINING ATTORNEY



David J. Kyffers

Director of the United States Patent and Trademark Office

United States of America
United States Patent and Trademark Office

IMPERIAN

Reg. No. 4,107,151

GORAN STOSOVIC (UNITED STATES INDIVIDUAL)
5720 KEENEY STREET
MORTON GROVE, IL 60053

Registered Mar. 6, 2012

Int. Cl.: 33

FOR: BRANDY, IN CLASS 33 (U.S. CLS. 47 AND 49).

TRADEMARK

FIRST USE 3-0-2007; IN COMMERCE 3-0-2007.

PRINCIPAL REGISTER

THE MARK CONSISTS OF STANDARD CHARACTERS WITHOUT CLAIM TO ANY PARTICULAR FONT, STYLE, SIZE, OR COLOR.

SER. NO. 77-070,650, FILED 12-22-2006.

MICHAEL KEATING, EXAMINING ATTORNEY



David J. Kybas

Director of the United States Patent and Trademark Office

United States of America

United States Patent and Trademark Office

BASLAC

Reg. No. 4,107,152

Registered Mar. 6, 2012

Int. Cls.: 1 and 2

TRADEMARK

PRINCIPAL REGISTER

BASF COATINGS GMBH (FED REP GERMANY LIMITED LIABILITY COMPANY)
GLASURITSTRASSE 1
MUNSTER, FED REP GERMANY 48165

FOR: AUTOMOTIVE AND INDUSTRIAL BODY REPAIR PUTTIES, IN CLASS 1 (U.S. CLS. 1, 5, 6, 10, 26 AND 46).

FOR: PAINTS; LACQUERS; SURFACERS, NAMELY, UNDERCOATING FOR SURFACES TO BE PAINTED AND PAINT USED TO REPAIR VEHICLES PRIOR TO APPLICATION OF COLOR FINISHES; PRIMERS, NAMELY, AUTOMOTIVE PAINT PRIMER, COATINGS IN THE NATURE OF AUTOMOTIVE PRIMER AND PRIMER FOR PREPARING SURFACES TO BE PAINTED; PREPARATIONS AGAINST RUST, NAMELY, RUST PREVENTATIVES IN THE NATURE OF A COATING AND RUST PRESERVATIVES IN THE NATURE OF A COATING; PAINT HARDENER, NAMELY, VARNISHES; THINNERS FOR PAINTS, NAMELY, PAINT THINNER; CLEAR COATINGS USED IN THE NATURE OF AUTOMOTIVE REFINISHING PAINTS, IN CLASS 2 (U.S. CLS. 6, 11 AND 16).

THE MARK CONSISTS OF STANDARD CHARACTERS WITHOUT CLAIM TO ANY PARTICULAR FONT, STYLE, SIZE, OR COLOR.

OWNER OF FED REP GERMANY REG. NO. 30641864, DATED 7-5-2006, EXPIRES 7-31-2016.

SER. NO. 77-089,966, FILED 1-24-2007.

WILLIAM ROSSMAN, EXAMINING ATTORNEY



David J. Kybas

Director of the United States Patent and Trademark Office

United States of America

United States Patent and Trademark Office

WILDLIFE WARRIORS

Reg. No. 4,107,153

Registered Mar. 6, 2012

**Int. Cls.: 9, 16, 25, 30, 32,
35, 41 and 42**

TRADEMARK

SERVICE MARK

PRINCIPAL REGISTER

AUSTRALIA ZOO WILDLIFE WARRIORS WORLDWIDE LTD (AUSTRALIA LIMITED COMPANY)

STEVE IRWIN WAY, BEERWAH
QUEENSLAND, AUSTRALIA 4519

FOR: (BASED ON 44(E) PURSUANT TO AUSTRALIAN REGISTRATION NUMBER 972356) MOTION PICTURE FILMS FEATURING CONTENT RELATED TO WILDLIFE, THE ENVIRONMENT, CONSERVATION, BIODIVERSITY, SUSTAINABILITY, REHABILITATION, ZOOLOGY, BOTANY, ANIMAL WELFARE, VETERINARY PRACTICE, ENTERTAINMENT, SPORTS, MUSIC, DANCING AND SINGING PERFORMANCES, EXERCISE, FITNESS, HEALTH, AND/OR AUDIO AND/OR VISUAL CONTENT CAPTURING EXPERIENCES OF VISITORS TO ZOOS, ANIMAL PARKS AND AMUSEMENT PARKS AND OF ATTENDEES AT LIVE SHOWS; PRE-RECORDED AUDIO AND VIDEO TAPES FEATURING CONTENT RELATING TO WILDLIFE, THE ENVIRONMENT, CONSERVATION, BIODIVERSITY, SUSTAINABILITY, REHABILITATION, ZOOLOGY, BOTANY, ANIMAL WELFARE, VETERINARY PRACTICE, ENTERTAINMENT, SPORTS, MUSIC, DANCING AND SINGING PERFORMANCES, EXERCISE, FITNESS, HEALTH, AND/OR AUDIO AND/OR VISUAL CONTENT CAPTURING EXPERIENCES OF VISITORS TO ZOOS, ANIMAL PARKS AND AMUSEMENT PARKS AND OF ATTENDEES AT LIVE SHOWS; AUDIO AND VIDEO DISCS FEATURING CONTENT RELATING TO WILDLIFE, THE ENVIRONMENT, CONSERVATION, BIODIVERSITY, SUSTAINABILITY, REHABILITATION, ZOOLOGY, BOTANY, ANIMAL WELFARE, VETERINARY PRACTICE, ENTERTAINMENT, SPORTS, MUSIC, DANCING AND SINGING PERFORMANCES, EXERCISE, FITNESS, HEALTH, AND/OR AUDIO AND/OR VISUAL CONTENT CAPTURING EXPERIENCES OF VISITORS TO ZOOS, ANIMAL PARKS AND AMUSEMENT PARKS AND OF ATTENDEES AT LIVE SHOWS; COMPACT DISCS FEATURING CONTENT RELATING TO WILDLIFE, THE ENVIRONMENT, CONSERVATION, BIODIVERSITY, SUSTAINABILITY, REHABILITATION, ZOOLOGY, BOTANY, ANIMAL WELFARE, VETERINARY PRACTICE, ENTERTAINMENT, SPORTS, MUSIC, DANCING AND SINGING PERFORMANCES, EXERCISE, FITNESS, HEALTH, AND/OR AUDIO AND/OR VISUAL CONTENT CAPTURING EXPERIENCES OF VISITORS TO ZOOS, ANIMAL PARKS AND AMUSEMENT PARKS AND OF ATTENDEES AT LIVE SHOWS; COMPUTER SOFTWARE FOR EDUCATION AND ENTERTAINMENT IN THE FIELD OF WILDLIFE, THE ENVIRONMENT, CONSERVATION, BIODIVERSITY, SUSTAINABILITY, REHABILITATION, ZOOLOGY, ZOOLOGICAL PARKS, BOTANY, ANIMAL WELFARE, VETERINARY PRACTICE, ENTERTAINMENT, SPORTS, MUSIC, DANCING, SINGING, EXERCISE, FITNESS AND HEALTH; COMPUTER GAME HARDWARE AND SOFTWARE; CASSETTES FEATURING CONTENT RELATED TO WILDLIFE, THE ENVIRONMENT, CONSERVATION,



David J. Kyros

Director of the United States Patent and Trademark Office

Reg. No. 4,107,153 BIODIVERSITY, SUSTAINABILITY, REHABILITATION, ZOOLOGY, BOTANY, ANIMAL WELFARE, VETERINARY PRACTICE, ENTERTAINMENT, SPORTS, MUSIC, DANCING AND SINGING PERFORMANCES, EXERCISE, FITNESS, HEALTH, AND/OR AUDIO AND/OR VISUAL CONTENT CAPTURING EXPERIENCES OF VISITORS TO ZOOS, ANIMAL PARKS AND AMUSEMENT PARKS AND OF ATTENDEES AT LIVE SHOWS; COMPUTER DISCS FEATURING CONTENT RELATED TO WILDLIFE, THE ENVIRONMENT, CONSERVATION, BIODIVERSITY, SUSTAINABILITY, REHABILITATION, ZOOLOGY, BOTANY, ANIMAL WELFARE, VETERINARY PRACTICE, ENTERTAINMENT, SPORTS, MUSIC, DANCING AND SINGING PERFORMANCES, EXERCISE, FITNESS, HEALTH, AND/OR AUDIO AND/OR VISUAL CONTENT CAPTURING EXPERIENCES OF VISITORS TO ZOOS, ANIMAL PARKS AND AMUSEMENT PARKS AND OF ATTENDEES AT LIVE SHOWS; CD-ROMS FEATURING CONTENT RELATED TO WILDLIFE, THE ENVIRONMENT, CONSERVATION, BIODIVERSITY, SUSTAINABILITY, REHABILITATION, ZOOLOGY, BOTANY, ANIMAL WELFARE, VETERINARY PRACTICE, ENTERTAINMENT, SPORTS, MUSIC, DANCING AND SINGING PERFORMANCES, EXERCISE, FITNESS, HEALTH, AND/OR AUDIO AND/OR VISUAL CONTENT CAPTURING EXPERIENCES OF VISITORS TO ZOOS, ANIMAL PARKS AND AMUSEMENT PARKS AND OF ATTENDEES AT LIVE SHOWS; INTERACTIVE MULTIMEDIA SOFTWARE PROGRAMS FOR EDUCATION AND ENTERTAINMENT AND INTERACTIVE MULTIMEDIA SOFTWARE FOR PLAYING GAMES, IN CLASS 9 (U.S. CLS. 21, 23, 26, 36 AND 38).

FOR: (BASED ON 44(E) PURSUANT TO AUSTRALIAN REGISTRATION NUMBER 972356) PRINTED PUBLICATIONS, NAMELY, MAGAZINES, NEWSLETTERS, NEWSPAPERS, PERIODICALS, FLYERS, BOOKS, BOOKLETS, HANDBOOKS, GUIDES, PAMPHLETS, COMIC BOOKS, ACTIVITY BOOKS, CHILDREN'S BOOKS, RELATING TO NATURE, ANIMALS, WILDLIFE, THE ENVIRONMENT, CONSERVATION, BIO DIVERSITY, SUSTAINABILITY, REHABILITATION, WILDLIFE PARKS, ZOOLOGY, BOTANY, ENTERTAINMENT, DANCING, SINGING, SPORTS, WELL KNOWN PERSONS, BIOGRAPHIES, MUSIC, EXERCISE, FITNESS, HEALTH, ANIMAL WELFARE, VETERINARY PRACTICE AND/OR WILDLIFE PARKS; STATIONERY; ALBUMS FOR PHOTOGRAPHS, STICKERS, STAMPS, AUTOGRAPHS, COINS AND PICTURES; GARBAGE BAGS MADE OF PAPER OR PLASTIC; BINDERS; BOOKMARKS; BOXES MADE OF PAPER OR CARDBOARD; CALENDARS; CARDS, NAMELY, TRADING CARDS, TRADING CARDS BEARING PICTURES OF WILDLIFE, PICTURE CARDS, ILLUSTRATED CARDS, DISCOUNT CARDS OTHER THAN ENCODED OR MAGNETIC DISCOUNT CARDS, VALUE CARDS OTHER THAN MACHINE READABLE OR MAGNETIC VALUE CARDS, CASH CARDS OTHER THAN MACHINE READABLE OR MAGNETIC VALUE CARDS, GREETING CARDS, THANK YOU CARDS, CONGRATULATORY CARDS, CORRESPONDENCE CARDS, UNCODED TELEPHONE CARDS, WRITING CARDS, BIRTHDAY CARDS, ANNOUNCEMENT CARDS, CHRISTMAS CARDS, SONG LYRIC CARDS, REFERENCE CARDS, PLASTIC CARDS OTHER THAN MAGNETIC OR ENCODED CARDS, PLACE CARDS, NOTE CARDS, VISITING CARDS, WEDDING CARDS; CATALOGUES AND CHARTS IN THE FIELD OF ANIMALS INCLUDING WILDLIFE, THE ENVIRONMENT, CONSERVATION, BIODIVERSITY, SUSTAINABILITY, REHABILITATION, WILDLIFE PARKS, ZOOLOGY, BOTANY, ENTERTAINMENT, DANCING, SINGING, SPORTS, WELL KNOWN PERSONS, BIOGRAPHIES AND/OR MUSIC; CLIPBOARDS; ENVELOPES; FOLDERS; MAPS; NEWSPAPERS; NOTE BOOKS; PADS OF PAPER FOR WRITING, DRAWING AND INVITATIONS TO EVENTS; ADVERTISING PAMPHLETS AS GOODS IN TRADE; PAPER; PENS; PENCILS; POSTERS; STICKERS; PRINTED HANDBOOKS, REPORTS, MANUALS AND TRAINING MANUALS, RELATING TO NATURE, ANIMALS INCLUDING WILDLIFE, THE ENVIRONMENT, CONSERVATION, BIODIVERSITY, SUSTAINABILITY, REHABILITATION, WILDLIFE PARKS, ZOOLOGY, BOTANY, ENTERTAINMENT, DANCING, SINGING, SPORTS AND/OR MUSIC, IN CLASS 16 (U.S. CLS. 2, 5, 22, 23, 29, 37, 38 AND 50).

FOR: (BASED ON 44(E) PURSUANT TO AUSTRALIAN REGISTRATION NUMBER 972356) CLOTHING, FOOTWEAR AND HEADGEAR, NAMELY, CAPS, HATS, BEANIES, VISORS, HEADBANDS, SHOWER CAPS, BATHING CAPS, BOOTS, RUBBER BOOTS, SHOES, SLIPPERS, HIGH HEELED SHOES, FLIP FLOPS, SANDALS, SOCKS, LEG WARMERS,

Reg. No. 4,107,153 HOSIERY, TIGHTS, PANTS, JEANS, SHORTS, SKIRTS, GLOVES, MITTENS, WRISTBANDS, BELTS, MONEY BELTS, SUSPENDERS, BEACHWEAR, SWIMWEAR, SWIMSUITS, DRESSES, OVERALLS, COVERALLS, T-SHIRTS, SHIRTS, JUMPERS, PULLOVERS, JERSEYS, CARDIGANS, PARKAS, JACKETS, CLOSE-FITTING GARMENTS FOR WIND PROTECTION, NAMELY, WIND RESISTANT JACKETS, OUTDOOR CLOTHING, NAMELY, OVERCOATS, RAIN PONCHOS, COVERALLS, COATS WATERPROOF CLOTHING, NAMELY, WATERPROOF SHIRTS, PANTS, JACKETS AND SUITS AND RAINCOATS, IN CLASS 25 (U.S. CLS. 22 AND 39).

FOR: (BASED ON 44(E) PURSUANT TO AUSTRALIAN REGISTRATION NUMBER 1160863) CONFECTIONERY, NAMELY, CANDY, LOLLIPOPS, COATED NUTS, CARAMELS, FRUIT JELLIES, NAMELY, FRUIT JELLY CANDY, MARSHMALLOWS, NON-MEDICATED LOZENGES, SHERBETS, MINTS, PASTILLES, TRUFFLES, BOILED CONFECTIONERY, NAMELY, HARD CANDY, TOFFEES, PEANUT CONFECTIONERY, MACADAMIA CONFECTIONERY, ALMOND CONFECTIONERY, FUDGE, CHOCOLATE BARS; BEVERAGES IN THIS CLASS, NAMELY, BEVERAGES MADE FROM OR CONSISTING PRINCIPALLY OF CHOCOLATE, COCOA, COFFEE AND/OR TEA; BISCUITS; BREADS; CAKES; CHEWING GUM, BUBBLE GUM; CHOCOLATE; COCOA PRODUCTS, NAMELY, POWDERED PREPARATIONS CONTAINING COCOA FOR USE IN MAKING BEVERAGES; ICE CONFECTIONS, NAMELY, FLAVORED ICES, FREEZABLE LIQUID FOR USE IN MAKING FROZEN CONFECTIONS, FROZEN CUSTARDS, FRUIT ICE, ICE CREAM, ICE CREAM BARS, ICE CREAM CONES, ICE CREAM SUBSTITUTE, ICE MILK, MILKSHAKES, PARFAITS, SHAKES; EDIBLE FRUIT ICES, EDIBLE DAIRY ICES; FROZEN YOGHURT; ICED TEA; FRUIT JELLIES; LIQUORICE; PASTRIES; PIES; PANCAKES; PIZZAS; POPCORN; PRALINES; PUDDINGS; QUICHES; PASTA; SALAD DRESSINGS; SAUCES; SANDWICHES; SHERBETS; SORBETS; SUSHI; WAFFLES, IN CLASS 30 (U.S. CL. 46).

FOR: (BASED ON 44(E) PURSUANT TO AUSTRALIAN REGISTRATION NUMBER 1160863) AERATED WATER; NON-ALCOHOLIC BEVERAGES, NAMELY, NON-ALCOHOLIC COCKTAILS, NON-ALCOHOLIC APERITIFS, NON-ALCOHOLIC BEER, NON-ALCOHOLIC CIDER, NON-ALCOHOLIC MIXER BEVERAGES, PART-FROZEN SLUSH DRINKS, HONEY BASED BEVERAGES, PUNCHES, ISOTONIC BEVERAGES, ELECTROLYTE REPLACEMENT BEVERAGES, SHERBETS, SORBETS, SMOOTHIES WITH FRUIT PREDOMINATING, CRUSHES, CORDIALS AND SQUASHES; NON-ALCOHOLIC FRUIT EXTRACTS USED IN THE PREPARATION OF BEVERAGES; FRUIT JUICES; FRUIT DRINKS; NON-ALCOHOLIC FRUIT NECTARS; SOFT DRINKS; MINERAL WATER; SODA WATER; TABLE WATERS, IN CLASS 32 (U.S. CLS. 45, 46 AND 48).

FOR: (BASED ON 44(E) PURSUANT TO AUSTRALIAN REGISTRATION NUMBER 972356) LOBBYING SERVICES, NAMELY, PROMOTING THE PRESERVATION AND PROTECTION OF BIODIVERSITY, WILDLIFE, WILDLIFE HABITATS AND THE ENVIRONMENT IN THE FIELDS OF LEGISLATION, REGULATION AND RAISING PUBLIC AWARENESS, IN CLASS 35 (U.S. CLS. 100, 101 AND 102).

FOR: (BASED ON 44(E) PURSUANT TO AUSTRALIAN REGISTRATION NUMBER 972356) EDUCATION AND TRAINING SERVICES, NAMELY, ORGANIZATION OF WORKSHOPS, SEMINARS, CONFERENCES, TRAINING COURSES, CORRESPONDENCE COURSES, LECTURES, DEMONSTRATIONS, INTERACTIVE DEMONSTRATIONS, CLASSES, SYMPOSIUMS, CONGRESSES AND EXHIBITIONS AND DISSEMINATING PRE-RECORDED LECTURES, LECTURE NOTES, INFORMATION SHEETS, PRE-RECORDED CD-ROMS, PRE-RECORDED DVDS, EDUCATIONAL MATERIAL, E-MAIL, EDUCATIONAL RESOURCES, TRAINING MATERIAL AND TRAINING RESOURCES, IN THE FIELDS OF THE ENVIRONMENT, ENVIRONMENTAL PROTECTION, CONSERVATION, BIODIVERSITY, SUSTAINABILITY, ZOOLOGY, ZOOLOGICAL PARKS, WILDLIFE, WILDLIFE MANAGEMENT, ANIMAL WELFARE, VETERINARY PRACTICE, SPECIES EXTINCTION, REHABILITATION OF ANIMALS, RESTORATION OF HABITATS, HABITAT MANAGEMENT, POLLUTION, CLIMATE CHANGE, BOTANY, GEOLOGY, ENTERTAINMENT, MUSIC, DANCING, SINGING, EXERCISE, FITNESS AND HEALTH; ENTERTAINMENT SERVICES,

Reg. No. 4,107,153 NAMELY, WILDLIFE PARK, AMUSEMENT PARK AND THEME PARK ENTERTAINMENT; ENTERTAINMENT SERVICES, NAMELY, ONGOING FREE-TO-AIR TELEVISION, CABLE TELEVISION, PAY-PER-VIEW TELEVISION AND RADIO PROGRAMS ALL IN THE FIELD OF ENVIRONMENT, ENVIRONMENTAL PROTECTION, CONSERVATION, BIODIVERSITY, SUSTAINABILITY, ZOOLOGY, ZOOLOGICAL PARKS, WILDLIFE, WILDLIFE MANAGEMENT, ANIMAL WELFARE, VETERINARY PRACTICE, SPECIES EXTINCTION, REHABILITATION OF ANIMALS, RESTORATION OF HABITATS, HABITAT MANAGEMENT, POLLUTION, CLIMATE CHANGE, BOTANY, GEOLOGY, ENTERTAINMENT, MUSIC, DANCING, SINGING, EXERCISE, FITNESS AND HEALTH; ENTERTAINMENT SERVICES, NAMELY, ONLINE AND WIRELESS ENTERTAINMENT, NAMELY, A WEB SITE FEATURING ARTICLES AND BLOG ENTRIES IN THE FIELDS OF THE ENVIRONMENT, ENVIRONMENTAL PROTECTION, CONSERVATION, BIODIVERSITY, SUSTAINABILITY, ZOOLOGY, ZOOLOGICAL PARKS, WILDLIFE, WILDLIFE MANAGEMENT, ANIMAL WELFARE, VETERINARY PRACTICE, SPECIES EXTINCTION, REHABILITATION OF ANIMALS, RESTORATION OF HABITATS, HABITAT MANAGEMENT, POLLUTION, CLIMATE CHANGE, BOTANY, GEOLOGY, ENTERTAINMENT, MUSIC, DANCING, SINGING, EXERCISE, FITNESS AND HEALTH; ENTERTAINMENT SERVICES, NAMELY, PROVIDING NON-DOWNLOADABLE RING TONES AND PRE-RECORDED FOR MOBILE COMMUNICATION DEVICES; ENTERTAINMENT SERVICES, NAMELY, PRODUCTION, RENTAL AND DISTRIBUTION, OTHER THAN TRANSPORTATION, OF TELEVISION PROGRAMS, RADIO PROGRAMS, FILMS AND PRE-RECORDED MEDIA FEATURING ENTERTAINMENT, SINGING PERFORMANCES, DANCING PERFORMANCES, HUMANS INTERACTING WITH ANIMALS, ANIMAL RESCUES, VETERINARY PRACTICES, ANIMALS AT ZOOLOGICAL PARKS, ANIMAL REHABILITATION AND/OR ANIMALS IN THEIR NATURAL HABITATS; ENTERTAINMENT SERVICES, NAMELY, LIVE AND MUSICAL THEATRICAL AND EDUCATIONAL PERFORMANCES IN THE FIELD OF ENVIRONMENT, ENVIRONMENTAL PROTECTION, CONSERVATION, BIODIVERSITY, SUSTAINABILITY, ZOOLOGY, ZOOLOGICAL PARKS, WILDLIFE, WILDLIFE MANAGEMENT, ANIMAL WELFARE, VETERINARY PRACTICE, SPECIES EXTINCTION, REHABILITATION OF ANIMALS, RESTORATION OF HABITATS, HABITAT MANAGEMENT, POLLUTION, CLIMATE CHANGE, BOTANY, GEOLOGY, ENTERTAINMENT, MUSIC, DANCING, SINGING, EXERCISE, FITNESS AND HEALTH ; ENTERTAINMENT SERVICES, NAMELY, ARRANGING LIVE PERSONAL APPEARANCES BY CELEBRITIES AND ANIMALS; ENTERTAINMENT SERVICES, NAMELY, ARRANGING AND CONDUCTING OF EXHIBITIONS, SHOWS, CONFERENCES, SEMINARS, COMPETITIONS AND CONTESTS FOR ENTERTAINMENT; AND ENTERTAINMENT SERVICES, NAMELY, PROVISION OF ONLINE BLOGS FEATURING THE ENVIRONMENT, ENVIRONMENTAL PROTECTION, CONSERVATION, BIODIVERSITY, SUSTAINABILITY, ZOOLOGY, ZOOLOGICAL PARKS, WILDLIFE, WILDLIFE MANAGEMENT, ANIMAL WELFARE, VETERINARY PRACTICE, SPECIES EXTINCTION, REHABILITATION OF ANIMALS, RESTORATION OF HABITATS, HABITAT MANAGEMENT, POLLUTION, CLIMATE CHANGE, BOTANY, GEOLOGY, ENTERTAINMENT, MUSIC, DANCING, SINGING, EXERCISE, FITNESS AND HEALTH, IN CLASS 41 (U.S. CLS. 100, 101 AND 107).

FOR: (BASED ON 44(E) PURSUANT TO AUSTRALIAN REGISTRATION NUMBER 972356) ADVISORY SERVICES IN THE FIELDS OF RESEARCH ON ENVIRONMENTAL PROTECTION, ENVIRONMENTAL CONSERVATION, ENVIRONMENTAL POLLUTION, ENVIRONMENTAL PROTECTION, HABITAT POLLUTION, HABITAT MANAGEMENT, WILDLIFE PROTECTION, AND WILDLIFE MANAGEMENT; COMPILATION OF INFORMATION ABOUT THE ENVIRONMENT, CONSERVATION, ENVIRONMENTAL POLLUTION, ENVIRONMENTAL PROTECTION, HABITAT POLLUTION, HABITAT MANAGEMENT, WILDLIFE PROTECTION, AND WILDLIFE MANAGEMENT; PROVIDING AND DISSEMINATING INFORMATION ABOUT THE ENVIRONMENT, CONSERVATION, ENVIRONMENTAL POLLUTION, ENVIRONMENTAL PROTECTION, HABITAT POLLUTION, HABITAT MANAGEMENT, WILDLIFE PROTECTION, AND WILDLIFE MANAGEMENT; ENVIRONMENTAL MONITORING SERVICES TO MEASURE IMPACTS ON THE ENVIRONMENT; ENVIRONMENTAL TESTING SERVICES; CONDUCTING RESEARCH RELATING TO THE ENVIRONMENT, CONSERVATION, ENVIRONMENTAL POLLUTION, ENVIRONMENTAL PROTECTION, HABITAT POLLUTION, HABITAT MANAGEMENT, WILDLIFE PROTECTION, AND

Reg. No. 4,107,153 WILDLIFE MANAGEMENT NAMELY, RESEARCHING ANIMAL BREEDING, RESEARCHING PLANT BREEDING, CONDUCTING FIELD STUDIES OF FAUNA, FLORA AND HABITATS, MEASURING WILDLIFE NUMBERS, MONITORING WILDLIFE BEHAVIOR, CONDUCTING TRIALS, CONDUCTING CLINICAL TRIALS; PROVIDING A WEB SITE ON A GLOBAL COMPUTER NETWORK FEATURING INFORMATION RELATING TO THE ENVIRONMENT, ENVIRONMENTAL PROTECTION, CONSERVATION, BIODIVERSITY, SUSTAINABILITY, ZOOLOGY, ZOOLOGICAL PARKS, ECOSYSTEMS, ANIMALS, WILDLIFE, ANIMAL WELFARE, VETERINARY PRACTICE, SPECIES EXTINCTION, REHABILITATION OF ANIMALS, RESTORATION OF HABITATS, POLLUTION, CLIMATE CHANGE, BOTANY, AND GEOLOGY, IN CLASS 42 (U.S. CLS. 100 AND 101).

THE MARK CONSISTS OF STANDARD CHARACTERS WITHOUT CLAIM TO ANY PARTICULAR FONT, STYLE, SIZE, OR COLOR.

OWNER OF AUSTRALIA REG. NO. 1160863, DATED 2-13-2007, EXPIRES 2-13-2017.

OWNER OF AUSTRALIA REG. NO. 972356, DATED 9-29-2003, EXPIRES 9-29-2013.

NO CLAIM IS MADE TO THE EXCLUSIVE RIGHT TO USE "WILDLIFE", APART FROM THE MARK AS SHOWN.

SER. NO. 77-184,061, FILED 5-17-2007.

FRANK LATTUCA, EXAMINING ATTORNEY

United States of America

United States Patent and Trademark Office

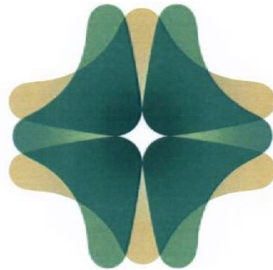

Reg. No. 4,107,154

Registered Mar. 6, 2012

Int. Cl.: 36

SERVICE MARK

PRINCIPAL REGISTER

THE ISLAMIC BANK OF ASIA LIMITED (SINGAPORE CORPORATION)
#01-01/02 DBS BUILDING
6 SHENTON WAY
SINGAPORE, SINGAPORE 068809

FOR: INSURANCE AGENCIES; FINANCIAL CONSULTATION; MONETARY EXCHANGE; REAL ESTATE BROKERAGE; BANKING SERVICES; INVESTMENT CONSULTATION; INVESTMENT MANAGEMENT; CREDIT CONSULTATION; CREDIT CARD SERVICES; SAFE DEPOSIT BOX SERVICES; SECURITY BROKERAGE; INSURANCE UNDERWRITING SERVICES FOR ALL TYPES OF INSURANCE; FINANCIAL CLEARING HOUSES; FIDUCIARY REPRESENTATIVE SERVICES; FINANCING SERVICES; BROKERAGE IN THE FIELD OF SECURITIES AND COMMODITIES; ESTATE TRUST MANAGEMENT; BUSINESS FINANCE PROCUREMENT SERVICES; VENTURE CAPITAL FUNDING SERVICES TO EMERGING AND START UP COMPANIES; ADMINISTRATION OF EMPLOYEE PENSION PLANS; TAX PAYMENT PROCESSING SERVICES; FINANCIAL CONSULTATION SERVICES; APPRAISALS OF REAL ESTATE; FINANCIAL MANAGEMENT; STOCK BROKERAGE; MUTUAL FUND BROKERAGE; INVESTMENT BROKERAGE; CREDIT CONSULTATION; CREDIT CARD SERVICES; FINANCIAL ANALYSIS AND CONSULTATION; FINANCIAL EVALUATION FOR INSURANCE PURPOSES; BANKING SERVICES; REAL ESTATE FINANCING SERVICES; REAL ESTATE AGENCIES; FINANCIAL EXCHANGE SERVICES; MANAGEMENT OF CAPITAL INVESTMENT FUNDS; FINANCIAL GUARANTEE SERVICES; PROVIDING INFORMATION IN THE FIELD OF FINANCE; FUNDS INVESTMENT; MORTGAGE, COMMERCIAL AND CONSUMER FINANCING SERVICES; INSURANCE SERVICES IN THE NATURE OF LOSS CONTROL MANAGEMENT FOR OTHERS; FINANCIAL MANAGEMENT SERVICES; FINANCIAL AND INVESTMENT SERVICES, NAMELY, MANAGEMENT AND BROKERAGE IN THE FIELDS OF STOCKS, BONDS, OPTIONS, COMMODITIES, FUTURES AND OTHER SECURITIES, AND INVESTMENT OF FUNDS FOR OTHERS; PROVIDING INFORMATION IN THE FIELD OF FINANCIAL MARKETS; INVESTMENT MANAGEMENT, NAMELY, REAL ESTATE AND FINANCIAL TRUSTEE SERVICES; FINANCIAL PLANNING SERVICES; FINANCIAL PORTFOLIO MANAGEMENT; FINANCIAL RESEARCH; FINANCIAL PLANNING, NAMELY, THE CREATION OF PERSONALIZED STRATEGIES TO ACHIEVE FINANCIAL INDEPENDENCE; FINANCIAL MANAGEMENT SERVICES; ESTATE TRUST MANAGEMENT; FINANCIAL VALUATIONS OF PERSONAL PROPERTY AND REAL ESTATE; INVESTMENT BANKING, NAMELY, FINANCING OF ASSET ACQUISITIONS; FINANCING SERVICES; INVESTMENT OF FUNDS FOR OTHERS VIA THE INTERNET; INVESTMENT ADVICE; INVESTMENT SERVICES, NAMELY, ASSET MANAGEMENT SERVICES; INVESTMENT BANKING; INVESTMENT BROKERAGE;



David J. Kappas

Director of the United States Patent and Trademark Office

Reg. No. 4,107,154 INVESTMENT MANAGEMENT; ACQUISITION AND TRANSFER OF MONETARY CLAIMS; MONETARY EXCHANGE SERVICES; CASH AND FOREIGN EXCHANGE TRANSACTIONS; MONEY ORDER SERVICES; MONEY TRANSFER SERVICES; MONEY ORDER SERVICES; MONEY TRANSFER SERVICES; ELECTRONIC FUNDS TRANSFER; CURRENCY EXCHANGE; BANKING VIA THE GLOBAL COMMUNICATIONS NETWORK; HOME BANKING; AUTOMATED TELLER MACHINE SERVICES; DEBIT CARD SERVICES; CREDIT CARD TRANSACTION PROCESSING SERVICES; FINANCIAL AND INVESTMENT ADVISORY SERVICES; FINANCIAL ADMINISTRATION OF RETIREMENT PLANS; BANKING SERVICES, NAMELY, ADMINISTRATION OF BANK ACCOUNTS; INSURANCE CLAIMS ADMINISTRATION ISSUANCE AND ADMINISTRATION OF ANNUITIES; AND FINANCIAL ADVICE, IN CLASS 36 (U.S. CLS. 100, 101 AND 102).

PRIORITY CLAIMED UNDER SEC. 44(D) ON SINGAPORE APPLICATION NO. T0711723D, FILED 5-29-2007.

THE COLOR(S) GREEN AND GOLD IS/ARE CLAIMED AS A FEATURE OF THE MARK.

OWNER OF SINGAPORE REG. NO. T0711723D, DATED 5-29-2007, EXPIRES 5-29-2017.

THE MARK CONSISTS OF A QUATREFOIL ARROWHEAD DESIGN WITH TRANSPARENT ELEMENTS APPEARING IN GOLD AND GREEN.

SER. NO. 77-207,179, FILED 6-15-2007.

ROBERT C. CLARK JR., EXAMINING ATTORNEY

United States of America

United States Patent and Trademark Office

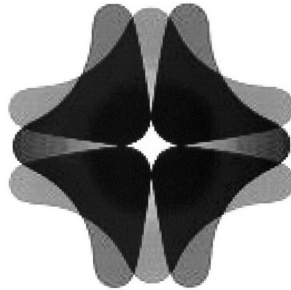

Reg. No. 4,107,155

Registered Mar. 6, 2012

Int. Cl.: 36

SERVICE MARK

PRINCIPAL REGISTER

THE ISLAMIC BANK OF ASIA LIMITED (SINGAPORE CORPORATION)
#01-01/02 DBS BUILDING
6 SHENTON WAY
SINGAPORE, SINGAPORE 068809

FOR: INSURANCE AGENCIES; FINANCIAL CONSULTATION; MONETARY EXCHANGE; REAL ESTATE BROKERAGE; BANKING SERVICES; INVESTMENT CONSULTATION; INVESTMENT MANAGEMENT; CREDIT CONSULTATION; CREDIT CARD SERVICES; SAFE DEPOSIT BOX SERVICES; SECURITY BROKERAGE; INSURANCE UNDERWRITING SERVICES FOR ALL TYPES OF INSURANCE; FINANCIAL CLEARING HOUSES; FIDUCIARY REPRESENTATIVE SERVICES; FINANCING SERVICES; BROKERAGE IN THE FIELD OF SECURITIES AND COMMODITIES; ESTATE TRUST MANAGEMENT; BUSINESS FINANCE PROCUREMENT SERVICES; VENTURE CAPITAL FUNDING SERVICES TO EMERGING AND START UP COMPANIES; ADMINISTRATION OF EMPLOYEE PENSION PLANS; TAX PAYMENT PROCESSING SERVICES; FINANCIAL CONSULTATION SERVICES; APPRAISALS OF REAL ESTATE; FINANCIAL MANAGEMENT; STOCK BROKERAGE; MUTUAL FUND BROKERAGE; INVESTMENT BROKERAGE; CREDIT CONSULTATION; CREDIT CARD SERVICES; FINANCIAL ANALYSIS AND CONSULTATION; FINANCIAL EVALUATION FOR INSURANCE PURPOSES; BANKING SERVICES; REAL ESTATE FINANCING SERVICES; REAL ESTATE AGENCIES; FINANCIAL EXCHANGE SERVICES; MANAGEMENT OF CAPITAL INVESTMENT FUNDS; FINANCIAL GUARANTEE SERVICES; PROVIDING INFORMATION IN THE FIELD OF FINANCE; FUNDS INVESTMENT; MORTGAGE, COMMERCIAL AND CONSUMER FINANCING SERVICES; INSURANCE SERVICES IN THE NATURE OF LOSS CONTROL MANAGEMENT FOR OTHERS; FINANCIAL MANAGEMENT SERVICES; FINANCIAL AND INVESTMENT SERVICES, NAMELY, MANAGEMENT AND BROKERAGE IN THE FIELDS OF STOCKS, BONDS, OPTIONS, COMMODITIES, FUTURES AND OTHER SECURITIES, AND INVESTMENT OF FUNDS FOR OTHERS; PROVIDING INFORMATION IN THE FIELD OF FINANCIAL MARKETS; INVESTMENT MANAGEMENT, NAMELY, REAL ESTATE AND FINANCIAL TRUSTEE SERVICES; FINANCIAL PLANNING SERVICES; FINANCIAL PORTFOLIO MANAGEMENT; FINANCIAL RESEARCH; FINANCIAL PLANNING, NAMELY, THE CREATION OF PERSONALIZED STRATEGIES TO ACHIEVE FINANCIAL INDEPENDENCE; FINANCIAL MANAGEMENT SERVICES; ESTATE TRUST MANAGEMENT; FINANCIAL VALUATIONS OF PERSONAL PROPERTY AND REAL ESTATE; INVESTMENT BANKING, NAMELY, FINANCING OF ASSET ACQUISITIONS; FINANCING SERVICES; INVESTMENT OF FUNDS FOR OTHERS VIA THE INTERNET; INVESTMENT ADVICE; INVESTMENT SERVICES, NAMELY, ASSET MANAGEMENT SERVICES; INVESTMENT BANKING; INVESTMENT BROKERAGE;



David J. Kybas

Director of the United States Patent and Trademark Office

Reg. No. 4,107,155 INVESTMENT MANAGEMENT; ACQUISITION AND TRANSFER OF MONETARY CLAIMS; MONETARY EXCHANGE SERVICES; CASH AND FOREIGN EXCHANGE TRANSACTIONS; MONEY ORDER SERVICES; MONEY TRANSFER SERVICES; MONEY ORDER SERVICES; MONEY TRANSFER SERVICES; ELECTRONIC FUNDS TRANSFER; CURRENCY EXCHANGE; BANKING VIA THE GLOBAL COMMUNICATIONS NETWORK; HOME BANKING; AUTOMATED TELLER MACHINE SERVICES; DEBIT CARD SERVICES; CREDIT CARD TRANSACTION PROCESSING SERVICES; FINANCIAL AND INVESTMENT ADVISORY SERVICES; FINANCIAL ADMINISTRATION OF RETIREMENT PLANS; BANKING SERVICES, NAMELY, ADMINISTRATION OF BANK ACCOUNTS; INSURANCE CLAIMS ADMINISTRATION ISSUANCE AND ADMINISTRATION OF ANNUITIES; AND FINANCIAL ADVICE, IN CLASS 36 (U.S. CLS. 100, 101 AND 102).

PRIORITY CLAIMED UNDER SEC. 44(D) ON SINGAPORE APPLICATION NO. T0711723D, FILED 5-29-2007.

OWNER OF SINGAPORE REG. NO. T0711723D, DATED 5-29-2007, EXPIRES 5-29-2017.

THE MARK CONSISTS OF A QUATREFOIL ARROWHEAD DESIGN WITH TRANSPARENT ELEMENTS.

SER. NO. 77-228,880, FILED 7-13-2007.

ROBERT C. CLARK JR., EXAMINING ATTORNEY

United States of America

United States Patent and Trademark Office

NOW HOUSE

Reg. No. 4,107,156

Registered Mar. 6, 2012

**Int. Cls.: 16, 35, 37, 41
and 42**

TRADEMARK

SERVICE MARK

PRINCIPAL REGISTER

NOW HOUSE PROJECT INC., THE (CANADA CORPORATION)
882 QUEEN STREET WEST
TORONTO, CANADA M6J1G3

FOR: WRITTEN MATERIALS AND PRINTED PUBLICATIONS, NAMELY, MANUALS, GUIDES, AND REPORTS IN THE FIELDS OF SUSTAINABLE HOUSING DEVELOPMENT AND DESIGN, RESOURCE EFFICIENCY, ENERGY EFFICIENCY, AND ENVIRONMENTAL RESPONSIBILITY; EDUCATIONAL PUBLICATIONS, NAMELY, MANUALS, BINDERS, AND GUIDES IN THE FIELDS OF SUSTAINABLE HOUSING, SUSTAINABLE HOUSING DEVELOPMENT AND DESIGN, RESOURCE EFFICIENCY, ENERGY EFFICIENCY, AND ENVIRONMENTAL RESPONSIBILITY, IN CLASS 16 (U.S. CLS. 2, 5, 22, 23, 29, 37, 38 AND 50).

FOR: CONSULTING SERVICES IN THE FIELDS OF RESOURCE EFFICIENCY AND ENERGY EFFICIENCY; DISSEMINATING INFORMATION TO THE PUBLIC AND PROVIDING AN ELECTRONIC DATABASE WITH INFORMATION RELATING TO RESOURCE EFFICIENCY AND ENERGY EFFICIENCY; ADVERTISING SERVICES, NAMELY, PROVIDING ADVERTISING SPACE VIA THE GLOBAL COMPUTER NETWORK, NAMELY, THE INTERNET; PROMOTING THE GOODS AND SERVICES OF OTHERS OVER THE INTERNET THROUGH THE PLACEMENT OF THIRD-PARTY ADVERTISEMENTS AND CLASSIFIED ADS ON A WEBSITE; HOME ENERGY AUDITS, IN CLASS 35 (U.S. CLS. 100, 101 AND 102).

FOR: CONSULTING SERVICES IN THE FIELD OF SUSTAINABLE HOUSING DEVELOPMENT; DISSEMINATING INFORMATION TO THE PUBLIC AND PROVIDING AN ELECTRONIC DATABASE WITH INFORMATION RELATING TO SUSTAINABLE HOUSING DEVELOPMENT; REMODELING OF HOMES AND BUILDINGS; CONSTRUCTION SERVICES, NAMELY, PLANNING AND CONSTRUCTING HOUSING AND BUILDINGS FOR THE PURPOSE OF INCREASING AND OPTIMIZING ENERGY EFFICIENCY AND SUSTAINABILITY; ENERGY RETROFITTING OF EXISTING HOMES AND BUILDINGS, IN CLASS 37 (U.S. CLS. 100, 103 AND 106).

FOR: ARRANGING AND CONDUCTING WORKSHOPS, SEMINARS AND EDUCATIONAL DEMONSTRATIONS IN THE FIELDS OF SUSTAINABLE HOUSING DEVELOPMENT, RESOURCE EFFICIENCY, ENERGY EFFICIENCY, AND ENVIRONMENTAL RESPONSIBILITY; PROVIDING EDUCATIONAL AND TRAINING PROGRAMS IN THE FIELDS OF SUSTAINABLE HOUSING DEVELOPMENT, SUSTAINABLE HOUSING DESIGN, RESOURCE EFFI-



David J. Kyjars

Director of the United States Patent and Trademark Office

Reg. No. 4,107,156 CIENCY, ENERGY EFFICIENCY, AND ENVIRONMENTAL RESPONSIBILITY, IN CLASS 41 (U.S. CLS. 100, 101 AND 107).

FOR: CONSULTING SERVICES IN THE FIELD OF SUSTAINABLE HOUSING DESIGN AND ENVIRONMENTALLY RESPONSIBLE HOUSING AND BUILDING DESIGN; DISSEMINATING INFORMATION TO THE PUBLIC AND PROVIDING AN ELECTRONIC DATABASE WITH INFORMATION RELATING TO SUSTAINABLE HOUSING DESIGN AND ENVIRONMENTALLY RESPONSIBLE HOUSING AND BUILDING DESIGN; DESIGNING HOUSING AND BUILDINGS FOR THE PURPOSE OF INCREASING AND OPTIMIZING ENERGY EFFICIENCY AND SUSTAINABILITY; DESIGNING THE RETROFIT OF EXISTING HOMES AND BUILDINGS; RESEARCH AND DEVELOPMENT IN THE FIELD OF SUSTAINABLE HOUSING, SUSTAINABLE HOUSING DEVELOPMENT, RESOURCE EFFICIENCY, ENERGY EFFICIENCY, AND ENVIRONMENTALLY RESPONSIBLE HOUSING AND BUILDING DESIGN, IN CLASS 42 (U.S. CLS. 100 AND 101).

THE MARK CONSISTS OF STANDARD CHARACTERS WITHOUT CLAIM TO ANY PARTICULAR FONT, STYLE, SIZE, OR COLOR.

PRIORITY CLAIMED UNDER SEC. 44(D) ON CANADA APPLICATION NO. 1334941, FILED 2-12-2007, REG. NO. 768459, DATED 6-2-2010, EXPIRES 6-2-2025.

NO CLAIM IS MADE TO THE EXCLUSIVE RIGHT TO USE "HOUSE", APART FROM THE MARK AS SHOWN.

SER. NO. 77-248,152, FILED 8-6-2007.

LINDSEY RUBIN, EXAMINING ATTORNEY

United States of America

United States Patent and Trademark Office

GWYNEDDS

Reg. No. 4,107,157

Registered Mar. 6, 2012

**Int. Cls.: 9, 14, 18, 25
and 28**

TRADEMARK

PRINCIPAL REGISTER

APPAREL UNITED EUROPE GMBH (FED REP GERMANY GERMAN LIMITED LIABILITY)
GOTTLIEB-DAIMLER-STR. 1
LANGENSELBOLD, FED REP GERMANY D-63505

FOR: EYEWEAR, NAMELY SPECTACLES, SPECTACLE CASES, OPHTHALMIC FRAMES, GLASSES FRAMES, LENSES FOR EYEGLASSES, SHADES, NAMELY SUNGLASSES, SPECTACLES FOR SPORTS, BINOCULARS, TELESCOPES, CINE-CAMERAS, NAMELY CINEMATOGRAPHIC CAMERAS, OPTICAL AND SPECTACLE LENSES, OPTICAL GOODS, NAMELY, GLASSES AND SUNGLASSES, HELMETS FOR HORSE RIDING, DIVING EQUIPMENT, NAMELY FACE MASKS FOR DIVING, GOGGLES, SKIN DIVING MASKS, AND HELMETS, IN CLASS 9 (U.S. CLS. 21, 23, 26, 36 AND 38).

FOR: PRECIOUS METALS AND THEIR ALLOYS AND GOODS MADE OF PRECIOUS METALS OR COATED THEREWITH, NOT INCLUDED IN OTHER CLASSES, NAMELY JEWELRY AND ORNAMENTS; PRECIOUS STONES; HOROLOGICAL AND CHRONOMETRIC INSTRUMENTS, IN PARTICULAR CLOCKS AND JEWELRY, NAMELY WATCHES, IN CLASS 14 (U.S. CLS. 2, 27, 28 AND 50).

FOR: GOODS MADE OF LEATHER AND SYNTHETIC LEATHER, NAMELY BRIEFCASES, ATTACHE CASES, IDENTITY CARD HOLDERS, ON-BOARD CASES, NAMELY LUGGAGE, LEATHER CHEST POUCHES, PURSES (NOT OF PRECIOUS METAL), PURSES, SUITCASES, GARMENT BAGS FOR TRAVEL, CASES, NAMELY UNFITTED VANITY CASES SOLD EMPTY AND PILOT CARRYING CASES FOR PILOTS, TOILET BAGS SOLD EMPTY, RUCKSACKS, INCLUDING RUCKSACKS FOR MOUNTAIN CLIMBERS, CHEQUE CARD HOLDERS, KEY CASES, SATCHELS, WALLETS, BAGS, NAMELY, BAGS FOR SCHOOL, BATHING BAGS, NAMELY BEACH BAGS, BAGS FOR CAMPERS, NAMELY BACKPACKS, WOMEN'S AND MEN'S BAGS, NAMELY ALL PURPOSE CARRYING BAGS, BELT BAGS, HANDBAGS, HUNTING BAGS, HOLDALLS, SLING BAGS, HAVERSACKS, KITBAGS, SPORTS BAGS, INCLUDING GOLF BAGS, AND TENNIS BAGS; ANIMAL SKINS AND HIDES; RIDING CROPS; PADS FOR HORSE RIDING SADDLES, IN CLASS 18 (U.S. CLS. 1, 2, 3, 22 AND 41).

FOR: ARTICLES OF CLOTHING IN THE NATURE OF OUTER CLOTHING NAMELY, BLOUSES, SHIRTS, JUMPERS, TROUSERS, JACKETS, IN PARTICULAR ALL-ROUND JACKETS, ALL-DAY JACKETS, OUTDOOR JACKETS OF VARIOUS MATERIALS, INCLUDING NYLON AND/OR DOWN, FUNCTIONAL JACKETS, RAIN SLICKERS, TREKKING JACKETS, HIKING JACKETS, WATERPROOF JACKETS, AND HEAVY JACKETS, DRESSES,



David J. Kyros

Director of the United States Patent and Trademark Office

Reg. No. 4,107,157 COATS, SKIRTS, WAISTCOATS; GYMNASTIC AND SPORTS CLOTHING, NAMELY SHORTS, JERSEYS, LEOTARDS, AND UNDERSHIRTS; BELTS; MONEY BELTS; GLOVES; HEADGEAR, IN PARTICULAR HEADSCARVES, HATS, SUN HATS; FOOTWEAR; SHOES, IN PARTICULAR FOOTBALL BOOTS, GYMNASTIC SHOES, MEN'S, WOMEN'S AND CHILDREN'S SHOES, JOGGING SHOES, OUTDOOR SHOES, SPORTS SHOES, RIDING BOOTS; UNDERWEAR, IN CLASS 25 (U.S. CLS. 22 AND 39).

FOR: GAMES AND PLAYTHINGS, NAMELY, BOARD GAMES, PLAYING CARDS AND CARD GAMES, PARTY GAMES; GYMNASTIC AND SPORTING ARTICLES NOT INCLUDED IN OTHER CLASSES, NAMELY GYMNASTIC APPARATUS, HORIZONTAL BARS, PARALLEL BARS, TRAINING STOOLS, AND VAULTING HORSES ALL FOR GYMNASTICS AND SPRING BOARDS AND SPORTS BALLS, IN CLASS 28 (U.S. CLS. 22, 23, 38 AND 50).

THE MARK CONSISTS OF STANDARD CHARACTERS WITHOUT CLAIM TO ANY PARTICULAR FONT, STYLE, SIZE, OR COLOR.

OWNER OF ERPN CMNTY TM OFC REG. NO. 005637939, DATED 1-9-2008, EXPIRES 1-24-2017.

SER. NO. 77-257,124, FILED 8-16-2007.

RONALD DELGIZZI, EXAMINING ATTORNEY

United States of America

United States Patent and Trademark Office

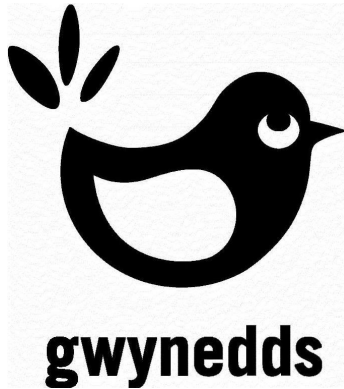

Reg. No. 4,107,158

Registered Mar. 6, 2012

**Int. Cls.: 9, 14, 18, 25
and 28**

TRADEMARK

PRINCIPAL REGISTER

APPAREL UNITED EUROPE GMBH (FED REP GERMANY GERMAN LIMITED LIABILITY)
GOTTLIEB-DAIMLER-STR. 1
LANGENSELBOLD, FED REP GERMANY D-63505

FOR: EYEWEAR, NAMELY SPECTACLES, SPECTACLE CASES, OPHTHALMIC FRAMES, GLASSES FRAMES, LENSES FOR EYEGASSES, SHADES, NAMELY SUNGLASSES, SPECTACLES FOR SPORTS, BINOCULARS, TELESCOPES, CINE-CAMERAS, NAMELY CINEMATOGRAPHIC CAMERAS, OPTICAL AND SPECTACLE LENSES, OPTICAL GOODS, NAMELY, GLASSES AND SUNGLASSES, HELMETS FOR HORSE RIDING, DIVING EQUIPMENT, NAMELY FACE MASKS FOR DIVING, GOGGLES, SKIN DIVING MASKS, AND HELMETS, IN CLASS 9 (U.S. CLS. 21, 23, 26, 36 AND 38).

FOR: PRECIOUS METALS AND THEIR ALLOYS AND GOODS MADE OF PRECIOUS METALS OR COATED THEREWITH, NOT INCLUDED IN OTHER CLASSES, NAMELY JEWELRY AND ORNAMENTS; PRECIOUS STONES; HOROLOGICAL AND CHRONOMETRIC INSTRUMENTS, IN PARTICULAR CLOCKS AND JEWELRY, NAMELY WATCHES, IN CLASS 14 (U.S. CLS. 2, 27, 28 AND 50).

FOR: GOODS MADE OF LEATHER AND SYNTHETIC LEATHER, NAMELY BRIEFCASES, ATTACHE CASES, IDENTITY CARD HOLDERS, ON-BOARD CASES, NAMELY LUGGAGE, LEATHER CHEST POUCHES, PURSES (NOT OF PRECIOUS METAL), PURSES, SUITCASES, GARMENT BAGS FOR TRAVEL, CASES, NAMELY UNFITTED VANITY CASES SOLD EMPTY AND PILOT CARRYING CASES FOR PILOTS, TOILET BAGS SOLD EMPTY, RUCKSACKS, INCLUDING RUCKSACKS FOR MOUNTAIN CLIMBERS, CHEQUE CARD HOLDERS, KEY CASES, SATCHELS, WALLETS, BAGS, NAMELY, BAGS FOR SCHOOL, BATHING BAGS, NAMELY BEACH BAGS, BAGS FOR CAMPERS, NAMELY BACKPACKS, WOMEN'S AND MEN'S BAGS, NAMELY ALL PURPOSE CARRYING BAGS, BELT BAGS, HANDBAGS, HUNTING BAGS, HOLDALLS, SLING BAGS, HAVERSACKS, KIT BAGS, SPORTS BAGS, INCLUDING GOLF BAGS, AND TENNIS BAGS; ANIMAL SKINS AND HIDES; RIDING CROPS; PADS FOR HORSE RIDING SADDLES, IN CLASS 18 (U.S. CLS. 1, 2, 3, 22 AND 41).

FOR: ARTICLES OF CLOTHING IN THE NATURE OF OUTER CLOTHING NAMELY BLOUSES, SHIRTS, JUMPERS, TROUSERS, JACKETS, IN PARTICULAR ALL-ROUND JACKETS, ALL-DAY JACKETS, OUTDOOR JACKETS OF VARIOUS MATERIALS, INCLUDING NYLON AND/OR DOWN, FUNCTIONAL JACKETS, RAIN SLICKERS, TREKKING JACKETS, HIKING JACKETS, WATERPROOF JACKETS, AND HEAVY JACKETS, DRESSES,



David J. Kybas

Director of the United States Patent and Trademark Office

Reg. No. 4,107,158 COATS, SKIRTS, WAISTCOATS; GYMNASTIC AND SPORTS CLOTHING, NAMELY SHORTS, JERSEYS, LEOTARDS, AND UNDERSHIRTS; BELTS; MONEY BELTS; GLOVES; HEADGEAR, IN PARTICULAR HEADSCARVES, HATS, SUN HATS; FOOTWEAR; SHOES, IN PARTICULAR FOOTBALL BOOTS, GYMNASTIC SHOES, MEN'S, WOMEN'S AND CHILDREN'S SHOES, JOGGING SHOES, OUTDOOR SHOES, SPORTS SHOES, RIDING BOOTS; UNDERWEAR, IN CLASS 25 (U.S. CLS. 22 AND 39).

FOR: GAMES AND PLAYTHINGS, NAMELY, BOARD GAMES, PLAYING CARDS AND CARD GAMES, PARTY GAMES; GYMNASTIC AND SPORTING ARTICLES NOT INCLUDED IN OTHER CLASSES, NAMELY GYMNASTIC APPARATUS, HORIZONTAL BARS, PARALLEL BARS, TRAINING STOOLS, AND VAULTING HORSES ALL FOR GYMNASTICS AND SPRING BOARDS AND SPORTS BALLS, IN CLASS 28 (U.S. CLS. 22, 23, 38 AND 50).

OWNER OF FED REP GERMANY REG. NO. 005638648, DATED 12-13-2007, EXPIRES 1-24-2017.

SER. NO. 77-257,237, FILED 8-16-2007.

DAVID HOFFMAN, EXAMINING ATTORNEY

United States of America

United States Patent and Trademark Office

Gold Diggers Closet

Reg. No. 4,107,159

CHOATE, LINDA JO (UNITED STATES INDIVIDUAL)
980 C.R. 1121

Registered Mar. 6, 2012

FARMERSVILLE, TX 75442 AND

Int. Cls.: 25 and 35

CHOATE, EARL WAYNE JR. (UNITED STATES INDIVIDUAL)
980 C.R. 1121
FARMERSVILLE, TX 75442

TRADEMARK

SERVICE MARK

PRINCIPAL REGISTER

FOR: BELTS; CAPS; CLOTHING, NAMELY, WRAP-AROUNDS; CORSETS; DUSTERS; HOODS; JERSEYS; LEATHER BELTS; MANTLES; MUFFLERS; SHIFTS; SHORT SETS; SHOULDER WRAPS; TIES; TOPS; WRAPS; LINGERIE; DRESS SHIRTS; DRESS SUITS; DRESSES; DRESSING GOWNS; EVENING DRESSES; SKIRTS AND DRESSES; WEDDING DRESSES; WOMEN'S CEREMONIAL DRESSES; BATHING SUITS; BATHING SUITS FOR MEN; BODY SUITS; GYM SUITS; JOGGING SUITS; LADIES' SUITS; MEN'S SUITS; MEN'S SUITS, WOMEN'S SUITS; ONE-PIECE PLAY SUITS; PARTS OF CLOTHING, NAMELY, GUSSETS FOR TIGHTS, GUSSETS FOR STOCKINGS, GUSSETS FOR BATHING SUITS, GUSSETS FOR UNDERWEAR, GUSSETS FOR LEOTARDS AND GUSSETS FOR FOOTLETS; PLAY SUITS; SHIRTS FOR SUITS; SKI SUITS; SKIRT SUITS; SNOW SUITS; SUIT COATS; SUITS; SUITS OF LEATHER; SWEAT SUITS; TRACK SUITS; TRAINING SUITS; VESTED SUITS; WARM UP SUITS; BRIEFS; LADIES' UNDERWEAR; THONGS; UNDERWEAR; UNDERWEAR, NAMELY, BOY SHORTS; WOMEN'S UNDERWEAR; BODY STOCKINGS; KNEE-HIGH STOCKINGS; SOCKS AND STOCKINGS; STOCKINGS; BRAS; FITTED SWIMMING COSTUMES WITH BRA CUPS; SHAPEWEAR, NAMELY, GIRDLES, BRAS, PANTYHOSE, PANTIES; SPORTS BRA; SPORTS BRAS; STRAPLESS BRAS; GARTER BELTS; GARTERS; SWIMWEAR; HATS; SHOES; PAJAMA BOTTOMS; PAJAMAS; DENIM JACKETS; DOWN JACKETS; FUR COATS AND JACKETS; FUR JACKETS; HEAVY JACKETS; JACKETS; LEATHER JACKETS; LONG JACKETS; MEN AND WOMEN JACKETS, COATS, TROUSERS, VESTS; RAIN JACKETS; SKI JACKETS; GLOVES; EVENING GOWNS; GOWNS; NIGHT GOWNS; WEDDING GOWNS; ROBES; SWIM WEAR; SWIM WEAR FOR GENTLEMEN AND LADIES; TENNIS WEAR, IN CLASS 25 (U.S. CLS. 22 AND 39).



FIRST USE 10-19-2007; IN COMMERCE 10-19-2007.

David J. Kypos

FOR: RETAIL CLOTHING BOUTIQUES; RETAIL CLOTHING STORES; RETAIL STORES FEATURING CLOTHING, LINGERIE, COSMETICS, DRESSES, SUITS, FRAGRANCES, JEWELRY, CLOTHING ACCESSORIES, GIFTS; RETAIL APPAREL STORES, IN CLASS 35 (U.S. CLS. 100, 101 AND 102).

Director of the United States Patent and Trademark Office

Reg. No. 4,107,159 FIRST USE 10-19-2007; IN COMMERCE 10-19-2007.

THE MARK CONSISTS OF STANDARD CHARACTERS WITHOUT CLAIM TO ANY PARTICULAR FONT, STYLE, SIZE, OR COLOR.

SER. NO. 77-339,547, FILED 11-29-2007.

KYLE PEETE, EXAMINING ATTORNEY

United States of America

United States Patent and Trademark Office

WOUNDTRAKKER

Reg. No. 4,107,160

Registered Mar. 6, 2012

Int. Cl.: 9

TRADEMARK

PRINCIPAL REGISTER

RECOVERCARE, LLC (PENNSYLVANIA LIMITED LIABILITY COMPANY)
FIVE RADNOR CORPORATE CENTER, SUITE 500
100 MATSONFORD ROAD
RADNOR, PA 19087

FOR: DOWNLOADABLE COMPUTER SOFTWARE FOR MONITORING AND MEASURING MEDICAL WOUNDS, AND FOR ASSESSING, TRACKING AND MONITORING CLINICAL OUTCOMES, IN CLASS 9 (U.S. CLS. 21, 23, 26, 36 AND 38).

FIRST USE 12-0-2005; IN COMMERCE 12-0-2005.

THE MARK CONSISTS OF STANDARD CHARACTERS WITHOUT CLAIM TO ANY PARTICULAR FONT, STYLE, SIZE, OR COLOR.

OWNER OF U.S. REG. NO. 2,942,179.

SER. NO. 77-429,792, FILED 3-24-2008.

KAREN SEVERSON, EXAMINING ATTORNEY



David J. Kyffers

Director of the United States Patent and Trademark Office

United States of America

United States Patent and Trademark Office

THE GREAT TRAITS OF CHAMPIONS

Reg. No. 4,107,161

Registered Mar. 6, 2012

Int. Cls.: 9, 16, 35 and 41

TRADEMARK

SERVICE MARK

PRINCIPAL REGISTER

GREAT TRAITS INC. (CANADA CORPORATION)
8 STRATHWOOD BAY SW
CALGARY, CANADA T3H1V6

FOR: PRE-RECORDED AUDIO CASSETTES, AUDIO TAPES, VIDEO CASSETTES, VIDEO TAPES, DIGITAL VIDEO DISCS, DIGITAL AUDIO DISCS, AUDIO COMPACT DISCS, CD-ROMS, CDS AND DVDS FEATURING INSPIRATIONAL AND MOTIVATIONAL TEACHINGS, INFORMATION, SEMINARS, SPEAKING AND DOCUMENTARIES ON FACING LIFE'S CHALLENGES, ACHIEVING PEAK PERFORMANCE, SETTING AND ACHIEVING GOALS, PERSONAL DEVELOPMENT, EXECUTIVE COACHING, STRESS MANAGEMENT, PERSONAL ACHIEVEMENT, LEADERSHIP, COMMUNITY INVOLVEMENT, BUILDING TEAMWORK, MAINTAINING A HEALTHY LIFESTYLE, SELF-AWARENESS AND PERSONAL IMPROVEMENT, AND IN THE FIELDS OF PERSONAL, MENTAL, EMOTIONAL AND PHYSICAL IMPROVEMENT AND WELL-BEING, MOTIVATION AND MANAGEMENT TRAINING, SELF-MOTIVATION, SELF-IMPROVEMENT AND PERSONAL AND PROFESSIONAL SUCCESS, IN CLASS 9 (U.S. CLS. 21, 23, 26, 36 AND 38).

FOR: PRINTED MATTER, NAMELY, BOOKS, PAMPHLETS, NEWSLETTERS, NEWSPAPERS, BROCHURES, WRITTEN ARTICLES, WORKBOOKS, PHOTOGRAPHS, POSTERS, CALENDARS, JOURNALS, GREETING CARDS AND MAGAZINES CONTAINING INSPIRATIONAL AND MOTIVATIONAL TEACHINGS, INFORMATION, SEMINARS, SPEAKING AND DOCUMENTARIES ON FACING LIFE'S CHALLENGES, ACHIEVING PEAK PERFORMANCE, SETTING AND ACHIEVING GOALS, PERSONAL DEVELOPMENT, EXECUTIVE COACHING, STRESS MANAGEMENT, PERSONAL ACHIEVEMENT, LEADERSHIP, COMMUNITY INVOLVEMENT, BUILDING TEAMWORK, MAINTAINING A HEALTHY LIFESTYLE, SELF-AWARENESS AND PERSONAL IMPROVEMENT, AND IN THE FIELDS OF PERSONAL, MENTAL, EMOTIONAL AND PHYSICAL IMPROVEMENT AND WELL-BEING, MOTIVATION AND MANAGEMENT TRAINING, SELF-MOTIVATION, SELF-IMPROVEMENT AND PERSONAL AND PROFESSIONAL SUCCESS, IN CLASS 16 (U.S. CLS. 2, 5, 22, 23, 29, 37, 38 AND 50).

FOR: ONLINE RETAIL STORE SERVICES FEATURING BOOKS, CD'S AND DVD'S ON FACING LIFE'S CHALLENGES, ACHIEVING PEAK PERFORMANCE, SETTING AND ACHIEVING GOALS, PERSONAL DEVELOPMENT, EXECUTIVE COACHING, STRESS MANAGEMENT, PERSONAL ACHIEVEMENT, LEADERSHIP, COMMUNITY INVOLVEMENT, BUILDING TEAMWORK, MAINTAINING A HEALTHY LIFESTYLE, SELF-AWARENESS AND PERSONAL IMPROVEMENT, AND IN THE FIELDS OF MENTAL,



David J. Kyjars

Director of the United States Patent and Trademark Office

Reg. No. 4,107,161 EMOTIONAL AND PHYSICAL IMPROVEMENT AND WELL-BEING, MOTIVATION AND MANAGEMENT TRAINING, SELF-MOTIVATION, SELF-IMPROVEMENT AND PERSONAL AND PROFESSIONAL SUCCESS, IN CLASS 35 (U.S. CLS. 100, 101 AND 102).

FOR: ORGANIZING, ARRANGING, CONDUCTING, DELIVERING AND PROVIDING SEMINARS, CONFERENCES, SPEECHES, PRESENTATIONS, WORKSHOPS AND RETREATS ON FACING LIFE'S CHALLENGES, ACHIEVING PEAK PERFORMANCE, PERSONAL DEVELOPMENT, COMMUNITY INVOLVEMENT, BUILDING TEAMWORK, AND MAINTAINING A HEALTHY LIFESTYLE; EDUCATIONAL AND ENTERTAINMENT SERVICES, NAMELY, PROVIDING MOTIVATIONAL AND EDUCATIONAL SPEAKERS IN THE FIELD OF SELF AND PERSONAL IMPROVEMENT; PROVIDING GROUP COACHING AND LEARNING FORUMS IN THE FIELD OF LEADERSHIP DEVELOPMENT, IN CLASS 41 (U.S. CLS. 100, 101 AND 107).

THE MARK CONSISTS OF STANDARD CHARACTERS WITHOUT CLAIM TO ANY PARTICULAR FONT, STYLE, SIZE, OR COLOR.

PRIORITY CLAIMED UNDER SEC. 44(D) ON CANADA APPLICATION NO. 1367329, FILED 10-12-2007, REG. NO. TMA779302, DATED 10-6-2010, EXPIRES 1-6-2025.

SER. NO. 77-447,232, FILED 4-14-2008.

JOHN HWANG, EXAMINING ATTORNEY

United States of America

United States Patent and Trademark Office

FUNDAMENTALS FOR ACHIEVERS, LEADERS AND LEGACY LEAVERS

Reg. No. 4,107,162

Registered Mar. 6, 2012

Int. Cls.: 9, 16, 35 and 41

TRADEMARK

SERVICE MARK

PRINCIPAL REGISTER

GREAT TRAITS INC. (CANADA CORPORATION)
8 STRATHWOOD BAY SW
CALGARY, CANADA T3H1V6

FOR: PRE-RECORDED AUDIO CASSETTES, AUDIO TAPES, VIDEO CASSETTES, VIDEO TAPES, DIGITAL VIDEO DISCS, DIGITAL AUDIO DISCS, AUDIO COMPACT DISCS, CD-ROMS, CDS AND DVDS FEATURING INSPIRATIONAL AND MOTIVATIONAL TEACHINGS, INFORMATION, SEMINARS, SPEAKING AND DOCUMENTARIES ON FACING LIFE'S CHALLENGES, ACHIEVING PEAK PERFORMANCE, SETTING AND ACHIEVING GOALS, PERSONAL DEVELOPMENT, EXECUTIVE COACHING, STRESS MANAGEMENT, PERSONAL ACHIEVEMENT, LEADERSHIP, COMMUNITY INVOLVEMENT, BUILDING TEAMWORK, MAINTAINING A HEALTHY LIFESTYLE, SELF-AWARENESS AND PERSONAL IMPROVEMENT, AND IN THE FIELDS OF PERSONAL, MENTAL, EMOTIONAL AND PHYSICAL IMPROVEMENT AND WELL-BEING, MOTIVATION AND MANAGEMENT TRAINING, SELF-MOTIVATION, SELF-IMPROVEMENT AND PERSONAL AND PROFESSIONAL SUCCESS, IN CLASS 9 (U.S. CLS. 21, 23, 26, 36 AND 38).

FOR: PRINTED MATTER, NAMELY, BOOKS, PAMPHLETS, NEWSLETTERS, NEWSPAPERS, BROCHURES, WRITTEN ARTICLES, WORKBOOKS, PHOTOGRAPHS, POSTERS, CALENDARS, JOURNALS, GREETING CARDS AND MAGAZINES CONTAINING INSPIRATIONAL AND MOTIVATIONAL TEACHINGS, INFORMATION, SEMINARS, SPEAKING AND DOCUMENTARIES ON FACING LIFE'S CHALLENGES, ACHIEVING PEAK PERFORMANCE, SETTING AND ACHIEVING GOALS, PERSONAL DEVELOPMENT, EXECUTIVE COACHING, STRESS MANAGEMENT, PERSONAL ACHIEVEMENT, LEADERSHIP, COMMUNITY INVOLVEMENT, BUILDING TEAMWORK, MAINTAINING A HEALTHY LIFESTYLE, SELF-AWARENESS AND PERSONAL IMPROVEMENT, AND IN THE FIELDS OF PERSONAL, MENTAL, EMOTIONAL AND PHYSICAL IMPROVEMENT AND WELL-BEING, MOTIVATION AND MANAGEMENT TRAINING, SELF-MOTIVATION, SELF-IMPROVEMENT AND PERSONAL AND PROFESSIONAL SUCCESS, IN CLASS 16 (U.S. CLS. 2, 5, 22, 23, 29, 37, 38 AND 50).

FOR: ONLINE RETAIL STORE SERVICES FEATURING BOOKS, CD'S AND DVD'S ON FACING LIFE'S CHALLENGES, ACHIEVING PEAK PERFORMANCE, SETTING AND ACHIEVING GOALS, PERSONAL DEVELOPMENT, EXECUTIVE COACHING, STRESS MANAGEMENT, PERSONAL ACHIEVEMENT, LEADERSHIP, COMMUNITY INVOLVEMENT, BUILDING TEAMWORK, MAINTAINING A HEALTHY LIFESTYLE, SELF-AWARENESS AND PERSONAL IMPROVEMENT, AND IN THE FIELDS OF MENTAL,



David J. Kappas

Director of the United States Patent and Trademark Office

Reg. No. 4,107,162 EMOTIONAL AND PHYSICAL IMPROVEMENT AND WELL-BEING, MOTIVATION AND MANAGEMENT TRAINING, SELF-MOTIVATION, SELF-IMPROVEMENT AND PERSONAL AND PROFESSIONAL SUCCESS, IN CLASS 35 (U.S. CLS. 100, 101 AND 102).

FOR: ORGANIZING, ARRANGING, CONDUCTING, DELIVERING AND PROVIDING SEMINARS, CONFERENCES, SPEECHES, PRESENTATIONS, WORKSHOPS AND RETREATS ON FACING LIFE'S CHALLENGES, ACHIEVING PEAK PERFORMANCE, PERSONAL DEVELOPMENT, COMMUNITY INVOLVEMENT, BUILDING TEAMWORK, AND MAINTAINING A HEALTHY LIFESTYLE; EDUCATIONAL AND ENTERTAINMENT SERVICES, NAMELY, PROVIDING MOTIVATIONAL AND EDUCATIONAL SPEAKERS IN THE FIELD OF SELF AND PERSONAL IMPROVEMENT; PROVIDING GROUP COACHING AND LEARNING FORUMS IN THE FIELD OF LEADERSHIP DEVELOPMENT, IN CLASS 41 (U.S. CLS. 100, 101 AND 107).

THE MARK CONSISTS OF STANDARD CHARACTERS WITHOUT CLAIM TO ANY PARTICULAR FONT, STYLE, SIZE, OR COLOR.

PRIORITY CLAIMED UNDER SEC. 44(D) ON CANADA APPLICATION NO. 1367330, FILED 10-12-2007, REG. NO. TMA779583, DATED 10-12-2010, EXPIRES 10-12-2025.

SER. NO. 77-447,345, FILED 4-14-2008.

JOHN HWANG, EXAMINING ATTORNEY

United States of America

United States Patent and Trademark Office



Reg. No. 4,107,163

Registered Mar. 6, 2012

Int. Cl.: 33

TRADEMARK

PRINCIPAL REGISTER

ASSEMBLED INVESTMENTS (PROPRIETARY) LIMITED (SOUTH AFRICA PROPRIETARY LIMITED COMPANY (P/L OR PTY. LTD.))
WATERFORD FARM, BLAAUKLIPPEN ROAD
STELLENBOSCH CAPE TOWN, SOUTH AFRICA

FOR: WINES, IN CLASS 33 (U.S. CLS. 47 AND 49).

FIRST USE 7-22-2004; IN COMMERCE 11-0-2004.

NO CLAIM IS MADE TO THE EXCLUSIVE RIGHT TO USE "ESTATE" AND "STELLENBOSCH", APART FROM THE MARK AS SHOWN.

THE MARK CONSISTS OF THE WORDS "WATERFORD ESTATE" ABOVE THE STYLIZED LETTER "W", AND THE WORD "STELLENBOSCH" JUST BELOW THE LETTER "W". ALL OF THE AFOREMENTIONED ARE WITHIN A RECTANGULAR DESIGN.

SER. NO. 77-473,401, FILED 5-13-2008.

DAVID COLLIER, EXAMINING ATTORNEY



David J. Kybas

Director of the United States Patent and Trademark Office

United States of America

United States Patent and Trademark Office

DAR'TUA

Reg. No. 4,107,164

Registered Mar. 6, 2012

Int. Cls.: 3 and 5

TRADEMARK

PRINCIPAL REGISTER

DARTUA PRODUCTS INC. (CANADA CORPORATION)
3041 CONNAUGHT AVENUE
NORTH VANCOUVER, CANADA

FOR: FACIAL CARE PRODUCTS, NAMELY, FACIAL MOISTURIZER, FACIAL EXFOLIATING SCRUB, FACIAL TONER, EYE GEL/CREAM, NON-MEDICATED FACIAL SERUM, FACIAL CLEANSER AND FACIAL MASKS; BODY CARE PRODUCTS, NAMELY, BODY MOISTURIZING LOTION, MASSAGE OIL, BODY EXFOLIATING SCRUB, CELLULITE REDUCING CREAM, BAR SOAP, LIQUID SOAP, SHAMPOO, CONDITIONER, BATH OIL, NON-MEDICATED BATH SALTS AND NON-MEDICATED FOOT BALM, IN CLASS 3 (U.S. CLS. 1, 4, 6, 50, 51 AND 52).

FOR: MEAL REPLACEMENT NUTRITIONAL DRINKS IN POWDER AND LIQUID FORM; NUTRITIONAL ENERGY BARS FOR USE AS A MEAL SUBSTITUTE, IN CLASS 5 (U.S. CLS. 6, 18, 44, 46, 51 AND 52).

THE MARK CONSISTS OF STANDARD CHARACTERS WITHOUT CLAIM TO ANY PARTICULAR FONT, STYLE, SIZE, OR COLOR.

PRIORITY CLAIMED UNDER SEC. 44(D) ON CANADA APPLICATION NO. 1375290, FILED 12-7-2007, REG. NO. TMA807,515, DATED 9-26-2011, EXPIRES 9-26-2026.

THE WORDING "DAR'TUA" HAS NO MEANING IN A FOREIGN LANGUAGE.

SER. NO. 77-492,311, FILED 6-5-2008.

SALLY SHIH, EXAMINING ATTORNEY



David J. Kypos

Director of the United States Patent and Trademark Office

United States of America

United States Patent and Trademark Office

MAX COCOS ISLAND TROTTERS

Reg. No. 4,107,165

Registered Mar. 6, 2012

Int. Cls.: 18 and 25

TRADEMARK

PRINCIPAL REGISTER

EFFIGI INC. (CANADA CORPORATION)
1155 AUTOROUTE 13
LAVAL, QUEBEC, CANADA H7W5J8

FOR: BAGS, NAMELY, SPORTS BAGS, GYM BAGS, BEACH BAGS, DIAPER BAGS, BACKPACKS, HANDBAGS, TRAVEL BAGS, SCHOOL BAGS, SHOE BAGS FOR TRAVEL, FANNY PACKS, HIKING BAGS, SHOULDER BAGS, TOTE BAGS, BABY CARRIERS WORN ON THE BODY, IN CLASS 18 (U.S. CLS. 1, 2, 3, 22 AND 41).

FOR: CLOTHING, NAMELY, SWEATERS, T-SHIRTS, CAMISOLES, VESTS, CARDIGANS, TURTLENECKS, DRESSES, UNDERWEAR, CULOTTES, MIDRIFF TOPS, SLIPS, PANTS, JEANS, JACKETS, BERMUDA SHORTS, SHORTS, SKIRTS, SUITS, JUMPSUITS, OVERALLS, BLOUSES, BLAZERS, SKI SUITS, OVERCOATS, PARKAS, ANORAKS, RAINCOATS, RAIN SLICKERS, SWEATSHIRTS, HOODED SWEATSHIRTS, JERSEYS, JOGGING OUTFITS, MITTENS, GLOVES, PAJAMAS, NIGHTGOWNS, BABY DOLLS, NIGHTIES, DRESSING GOWNS, BATHROBES, SLEEPING GARMENTS, BABY BIBS NOT OF PAPER, BEACHWEAR, SWIM SUITS, LEOTARDS, COATS, SLIPOVERS, POLO SHIRTS, BOXER SHORTS; HEADWEAR, NAMELY, HATS, SKULL CAPS, BERETS, HEADBANDS, KERCHIEFS, EAR MUFFS, TOQUES, CAPS; FASHION ACCESSORIES, NAMELY, BELTS, SUSPENDERS, NECKTIES, SCARVES, BANDANNAS, IN CLASS 25 (U.S. CLS. 22 AND 39).

THE MARK CONSISTS OF STANDARD CHARACTERS WITHOUT CLAIM TO ANY PARTICULAR FONT, STYLE, SIZE, OR COLOR.

PRIORITY CLAIMED UNDER SEC. 44(D) ON CANADA APPLICATION NO. 1393337, FILED 4-29-2008, REG. NO. TMA797553, DATED 5-13-2011, EXPIRES 5-13-2026.

THE NAME(S), PORTRAIT(S), AND/OR SIGNATURE(S) SHOWN IN THE MARK DOES NOT IDENTIFY A PARTICULAR LIVING INDIVIDUAL.

SER. NO. 77-568,509, FILED 9-12-2008.

SHAILA SETTLES, EXAMINING ATTORNEY



David J. Kyros

Director of the United States Patent and Trademark Office

United States of America

United States Patent and Trademark Office



HUSTLE UP

Reg. No. 4,107,166

Registered Mar. 6, 2012

**Int. Cls.: 9, 16, 18, 20, 21
and 25**

BRAD PATTISON ENTERTAINMENT CORPORATION (CANADA CORPORATION)
1160 BERNARD AVENUE, #210
KELOWNA, CANADA V1Y6R2

FOR: DOG TRAINING DVD'S AND DOWNLOADABLE PODCASTS IN THE FIELD OF DOG TRAINING, IN CLASS 9 (U.S. CLS. 21, 23, 26, 36 AND 38).

FOR: DOG TRAINING BOOKS AND PLASTIC BAGS FOR DISPOSING OF PET WASTE, IN CLASS 16 (U.S. CLS. 2, 5, 22, 23, 29, 37, 38 AND 50).

TRADEMARK

PRINCIPAL REGISTER

FOR: DOG LEASHES AND COLLARS, IN CLASS 18 (U.S. CLS. 1, 2, 3, 22 AND 41).

FOR: DOG BEDS, IN CLASS 20 (U.S. CLS. 2, 13, 22, 25, 32 AND 50).

FOR: WATER BOWLS AND EMPTY WATER BOTTLES FOR HUMANS, IN CLASS 21 (U.S. CLS. 2, 13, 23, 29, 30, 33, 40 AND 50).

FOR: CLOTHING FOR MEN AND WOMEN, NAMELY, SHIRTS AND JACKETS, IN CLASS 25 (U.S. CLS. 22 AND 39).

PRIORITY CLAIMED UNDER SEC. 44(D) ON CANADA APPLICATION NO. 1411461, FILED 9-19-2008, REG. NO. TMA808,358, DATED 10-5-2011, EXPIRES 10-5-2026.

THE MARK CONSISTS OF THE WORDS "HUSTLE UP" WITH A HUMAN FOOTPRINT AND AN ANIMAL PAW PRINT.

SER. NO. 77-578,267, FILED 9-24-2008.

BRIAN NEVILLE, EXAMINING ATTORNEY



David J. Kybas

Director of the United States Patent and Trademark Office

United States of America

United States Patent and Trademark Office

dPals

Reg. No. 4,107,167

Registered Mar. 6, 2012

Int. Cl.: 9

TRADEMARK

PRINCIPAL REGISTER

DPALS LIMITED (UNITED KINGDOM LIMITED COMPANY (LTD.))
HELLABY INDUSTRIAL ESTATE
2 DENBY WAY
ROTHERHAM, UNITED KINGDOM S668HR

FOR: COMPUTER GAME SOFTWARE, COMPUTER SOFTWARE TO PROVIDE ACCESS TO A GLOBAL COMMUNICATIONS NETWORK, ALL DOWNLOADABLE FROM THE INTERNET; COMPUTER GAME SOFTWARE; COMPUTER GAME SOFTWARE TO PROVIDE ACCESS TO A GLOBAL TELECOMMUNICATIONS NETWORK; COMPUTER GAME SOFTWARE TO PROVIDE ACCESS TO A COMPUTER-GENERATED ENVIRONMENT; COMPUTER GAME SOFTWARE TO PROVIDE ACCESS TO A COMPUTER-GENERATED ENVIRONMENT VIA A GLOBAL TELECOMMUNICATIONS NETWORK; COMPUTER GAME SOFTWARE FOR MULTI-ACCESS USE AND INTERACTION WITH A VIRTUAL REALITY COMPUTER-GENERATED ENVIRONMENT; COMPUTER SOFTWARE DOWNLOADABLE FROM THE INTERNET THAT ENABLES END USERS TO ACCESS AND INTERACT WITHIN A COMPUTER-GENERATED ENVIRONMENT, ALLOWING USERS VIA A GLOBAL TELECOMMUNICATIONS NETWORK TO EXPLORE, COLLABORATE AND INTERACT WITH OTHER USERS, OBJECTS AND THE VIRTUAL WORLD AROUND THEM; COMPUTER SOFTWARE THAT ENABLES USERS TO CREATE, EDIT, MAINTAIN AND PUBLISH THREE DIMENSIONAL AVATARS ON A COMPUTER, AND TO ACCESS AND USE THOSE THREE DIMENSIONAL AVATARS ON A COMPUTER, OVER COMPUTER NETWORKS AND VIA A GLOBAL TELECOMMUNICATIONS NETWORK TO ALLOW USERS TO EXPLORE, COLLABORATE AND INTERACT WITH OTHER USERS, AVATARS, OBJECTS AND WITHIN A COMPUTER-GENERATED VIRTUAL ENVIRONMENT; ELECTRONIC DATA AND ELECTRONIC CODE FILES IN THE FIELDS OF SPORT, ELECTRONIC MEDIA, ENTERTAINMENT, CARTOONS AND CULTURAL ACTIVITIES; DIGITAL MUSIC DOWNLOADABLE FROM THE INTERNET; IMAGES DOWNLOADABLE FROM THE INTERNET, NAMELY, IN THE FIELDS OF SPORT, CHILDREN'S TOYS, ANIMALS, INCLUDING PETS, CLOTHES, MUSICAL INSTRUMENTS, CARTOONS AND CULTURAL ACTIVITIES; DOWNLOADABLE ELECTRONIC INFORMATION IN THE FORM OF ELECTRONIC PUBLICATIONS, NAMELY, MAGAZINES, BROCHURES AND BOOKS IN THE FIELDS OF SPORTS, CHILDREN'S TOYS, ANIMALS, INCLUDING PETS, CLOTHES, MUSICAL INSTRUMENTS, CARTOONS AND CULTURAL ACTIVITIES; RING-TONES DOWNLOADABLE FROM THE INTERNET; DIGITAL AUDIO FILES FEATURING MUSICAL SOUNDS DOWNLOADABLE FROM THE INTERNET; TEXT FILES DOWNLOADABLE FROM THE INTERNET IN THE FIELDS OF SPORTS, CHILDREN'S TOYS, ANIMALS, INCLUDING PETS, CLOTHES, MUSICAL INSTRUMENTS, CARTOONS AND CULTURAL ACTIVITIES;



David J. Kybas

Director of the United States Patent and Trademark Office

Reg. No. 4,107,167 ELECTRONIC PUBLICATIONS DOWNLOADABLE FROM THE INTERNET IN THE NATURE OF MAGAZINES, BROCHURES AND BOOKS IN THE FIELDS OF SPORTS, CHILDREN'S TOYS, ANIMALS, INCLUDING PETS, CLOTHES, MUSICAL INSTRUMENTS, CARTOONS AND CULTURAL ACTIVITIES; COMPUTER GAME SOFTWARE DOWNLOADABLE FROM THE INTERNET; MAGNETS; DECORATIVE FRIDGE MAGNETS; MAGNETIC DISPLAY CARDS; MAGNETIC CARDS FOR USE IN GAMES; MOUSE MATS; MOBILE PHONE ACCESSORIES, NAMELY, MOBILE PHONE COVERS, MOBILE PHONE CHARMS AND MOBILE PHONE STRAPS , IN CLASS 9 (U.S. CLS. 21, 23, 26, 36 AND 38).

THE MARK CONSISTS OF STANDARD CHARACTERS WITHOUT CLAIM TO ANY PARTICULAR FONT, STYLE, SIZE, OR COLOR.

OWNER OF ERPN CMNTY TM OFC REG. NO. 006345128, DATED 6-10-2009, EXPIRES 10-9-2017.

SER. NO. 77-604,272, FILED 10-30-2008.

SHAILA SETTLES, EXAMINING ATTORNEY

United States of America

United States Patent and Trademark Office

GLOW Mobile Spray Tanning

Reg. No. 4,107,168

Registered Mar. 6, 2012

Int. Cl.: 44

SERVICE MARK

PRINCIPAL REGISTER

GLOW MOBILE SPRAY TANNING (FLORIDA LIMITED LIABILITY COMPANY)
1404-1 PINE ST.
TALLAHASSEE, FL 32303

FOR: MOBILE SKIN TANNING SERVICE, IN CLASS 44 (U.S. CLS. 100 AND 101).

FIRST USE 8-0-2008; IN COMMERCE 10-0-2008.

THE MARK CONSISTS OF STANDARD CHARACTERS WITHOUT CLAIM TO ANY PARTICULAR FONT, STYLE, SIZE, OR COLOR.

NO CLAIM IS MADE TO THE EXCLUSIVE RIGHT TO USE "MOBILE SPRAY TANNING", APART FROM THE MARK AS SHOWN.

SER. NO. 77-606,060, FILED 11-3-2008.

ODESSA BIBBINS, EXAMINING ATTORNEY



David J. Kyffers

Director of the United States Patent and Trademark Office

United States of America

United States Patent and Trademark Office



Reg. No. 4,107,169

Registered Mar. 6, 2012

Int. Cls.: 41 and 45

SERVICE MARK

PRINCIPAL REGISTER

ANGHA, NADER (UNITED STATES INDIVIDUAL)
P. O. BOX 151135
SAN RAFAEL, CA 94915

FOR: EDUCATION SERVICES, NAMELY, RELIGIOUS INSTRUCTION SERVICES; PROVIDING CLASSES AND SEMINARS IN THE FIELDS OF RELIGION, ISLAM, AND SUFISM, IN CLASS 41 (U.S. CLS. 100, 101 AND 107).

FOR: CONDUCTING RELIGIOUS PRAYER SERVICES; ORGANIZATION OF RELIGIOUS EVENTS, NAMELY, OPERATING PLACES OF ASSEMBLY IN THE NATURE OF PROVIDING FACILITIES FOR PRAYER AND WORSHIP; MINISTERIAL SERVICES AND COUNSELING SERVICES IN THE FIELDS OF RELIGION, ISLAM AND SUFISM; PROVIDING INFORMATION IN THE FIELDS OF RELIGION, ISLAM, AND SUFISM; PROVIDING AN INTERNET WEB SITE WITH INFORMATION IN THE FIELDS OF RELIGION, ISLAM, AND SUFISM, IN CLASS 45 (U.S. CLS. 100 AND 101).

OWNER OF FED REP GERMANY REG. NO. 302008071775, DATED 2-24-2009, EXPIRES 11-30-2018.

THE PORTRAIT SHOWN IN THE MARK IDENTIFIES NADER ANGHA, WHOSE CONSENT TO REGISTER IS MADE OF RECORD.

THE MARK CONSISTS OF AN INDIVIDUAL DEPICTED IN A BODILY POSTURE IN PRAYER.

SER. NO. 77-606,369, FILED 11-3-2008.

MARIAM MAHMOUDI, EXAMINING ATTORNEY



David J. Kybas

Director of the United States Patent and Trademark Office

United States of America

United States Patent and Trademark Office

MED IN SWITZERLAND

Reg. No. 4,107,170

Registered Mar. 6, 2012

Int. Cls.: 9, 10 and 16

TRADEMARK

PRINCIPAL REGISTER

KARL STORZ GMBH & CO. KG (FED REP GERMANY LIMITED PARTNERSHIP)
MITTELSTRASSE 8
TUTTLINGEN, FED REP GERMANY D-78532

FOR: ENDOSCOPES FOR TECHNICAL AND SCIENTIFIC USE AND STRUCTURAL PARTS THEREOF; ILLUMINATION APPARATUS, NAMELY, LIGHTS AS PARTS OF TECHNICAL AND SCIENTIFIC ENDOSCOPES FOR ALL NON-MEDICAL PURPOSES; CAMERAS, NAMELY, CCD CAMERAS FOR USE IN NON-MEDICAL, TECHNICAL ENDOSCOPY FOR SCIENTIFIC AND INDUSTRIAL PURPOSES; MICROSCOPES; ADAPTERS AND CABLES FOR CONNECTING CAMERAS TO ENDOSCOPES; COMPUTER HARDWARE, SOFTWARE, AND PERIPHERALS USED TO REPRODUCE AND RECORD IMAGES, FOR USE IN SCIENTIFIC AND TECHNICAL ENDOSCOPY; HIGH-FREQUENCY AND ULTRA-SONIC POWER SUPPLIES FOR NON-MEDICAL ENDOSCOPES; HIGH-FREQUENCY AND ULTRA-SONIC INSTRUMENTS USED TO GENERATE HIGH-FREQUENCY AND ULTRA-SONIC WAVES FOR USE IN SCIENTIFIC AND TECHNICAL ENDOSCOPIES; COMPUTER HARDWARE, SOFTWARE AND PERIPHERALS USED FOR TRAINING ON THE USE OF INDUSTRIAL ENDOSCOPES AND ENDOSCOPIC EQUIPMENT; ELECTRONIC TEST AND CHECK DEVICES FOR EXAMINING, TESTING AND CHECKING THE MECHANICAL FUNCTION, OPTICAL FUNCTION, MAGNETO-ELECTRICAL FUNCTION, POLARIZATION, AND FREQUENCY OF ENDOSCOPES AND ENDOSCOPIC EQUIPMENT; TRANSPORT RECEPTACLES, NAMELY, BOXES, CASES AND PACKAGES DESIGNED SPECIFICALLY FOR USE IN STORING AND TRANSPORTING THE EQUIPMENT LISTED ABOVE; DATA PROCESSORS; BLANK DATA MEDIA, NAMELY, OPTICAL DISKS, TAPES, AND MAGNETIC DATA CARRIERS AND COMPUTER HARDWARE, SOFTWARE AND PERIPHERALS FOR STORING AND CONVERTING AND DISPLAYING INFORMATION OBTAINED FROM TECHNICAL AND SCIENTIFIC ENDOSCOPES; REMOTE CONTROLS FOR ENDOSCOPE AND ENDOSCOPIC EQUIPMENT; COMPUTER HARDWARE FOR USE IN COMPUTER NETWORKS, COMPUTER SOFTWARE USED FOR OPERATING AND NETWORKING ENDOSCOPES AND ENDOSCOPIC EQUIPMENT; DOWNLOADABLE ELECTRONIC PUBLICATIONS, NAMELY, BROCHURES AND INFORMATION SHEETS RELATING TO MEDICAL INSTRUMENTS AND APPARATUS, IN CLASS 9 (U.S. CLS. 21, 23, 26, 36 AND 38).



David J. Kyjars

Director of the United States Patent and Trademark Office

FOR: SURGICAL AND MEDICAL APPARATUS AND INSTRUMENTS FOR USE IN OPEN AND ENDOSCOPIC SURGERY; CAMERAS, NAMELY, CCD ENDOSCOPY CAMERAS, FOR USE IN MEDICAL ENDOSCOPY; TRANSPORT RECEPTACLES, NAMELY, BOXES, CASES, AND PACKAGES DESIGNED SPECIFICALLY FOR USE IN STORING AND TRANSPORTING THE EQUIPMENT LISTED ABOVE, IN CLASS 10 (U.S. CLS. 26, 39 AND 44).

Reg. No. 4,107,170 FOR: PRINTED MATERIALS, NAMELY, BROCHURES AND INFORMATION SHEETS IN THE FIELD OF MEDICAL TECHNOLOGY, IN CLASS 16 (U.S. CLS. 2, 5, 22, 23, 29, 37, 38 AND 50).

THE MARK CONSISTS OF STANDARD CHARACTERS WITHOUT CLAIM TO ANY PARTICULAR FONT, STYLE, SIZE, OR COLOR.

PRIORITY CLAIMED UNDER SEC. 44(D) ON FED REP GERMANY APPLICATION NO. 302008034091, FILED 5-26-2008, REG. NO. 302008034091, DATED 10-12-2010, EXPIRES 5-31-2018.

NO CLAIM IS MADE TO THE EXCLUSIVE RIGHT TO USE "SWITZERLAND", APART FROM THE MARK AS SHOWN.

SER. NO. 77-621,215, FILED 11-25-2008.

MEGHAN REINHART, EXAMINING ATTORNEY

United States of America

United States Patent and Trademark Office

SOLABS

Reg. No. 4,107,171

Registered Mar. 6, 2012

Int. Cls.: 9, 41 and 42

TRADEMARK

SERVICE MARK

PRINCIPAL REGISTER

NORSOFT TECHNOLOGIES INC. (CANADA CORPORATION)
777 DE LA COMMUNE, SUITE 330
MONTREAL, QUEBEC, CANADA H3C1Y1

FOR: COMPUTER SOFTWARE TO CONTROL AND MANAGE DOCUMENTS, WORKFLOW, TRAINING AND QUALITY IN THE LIFE SCIENCES, HEALTHCARE, FOOD AGRICULTURAL AND MANUFACTURING INDUSTRIES, IN CLASS 9 (U.S. CLS. 21, 23, 26, 36 AND 38).

FOR: TRAINING IN THE USE AND OPERATION OF SOFTWARE TO CONTROL AND MANAGE DOCUMENTS, WORKFLOW, TRAINING AND QUALITY IN THE LIFE SCIENCES, HEALTHCARE, FOOD, AGRICULTURE AND MANUFACTURING INDUSTRIES, IN CLASS 41 (U.S. CLS. 100, 101 AND 107).

FOR: TECHNICAL SUPPORT SERVICES, NAMELY, TROUBLESHOOTING OF COMPUTER SOFTWARE FOR TO CONTROL AND MANAGE DOCUMENTS, WORKFLOW, TRAINING AND QUALITY IN THE LIFE SCIENCES, HEALTHCARE, FOOD, AGRICULTURE AND MANUFACTURING INDUSTRIES; DESIGN, PROGRAMMING, INSTALLATION AND MAINTENANCE OF SOFTWARE AND DATABASES TO CONTROL AND MANAGE DOCUMENTS, WORKFLOW, TRAINING AND QUALITY IN THE LIFE SCIENCES, HEALTHCARE, FOOD, AGRICULTURE AND MANUFACTURING INDUSTRIES; PROVIDING TEMPORARY USE OF ONLINE NON-DOWNLOADABLE SOFTWARE TO CONTROL AND MANAGE DOCUMENTS, WORKFLOW, TRAINING AND QUALITY IN THE LIFE SCIENCES, HEALTHCARE, FOOD, AGRICULTURE AND MANUFACTURING INDUSTRIES, IN CLASS 42 (U.S. CLS. 100 AND 101).



THE MARK CONSISTS OF STANDARD CHARACTERS WITHOUT CLAIM TO ANY PARTICULAR FONT, STYLE, SIZE, OR COLOR.

PRIORITY CLAIMED UNDER SEC. 44(D) ON CANADA APPLICATION NO. 1415482, FILED 10-22-2008, REG. NO. TMA808,450, DATED 10-6-2011, EXPIRES 10-6-2026.

SER. NO. 77-631,516, FILED 12-11-2008.

RICHARD WHITE, EXAMINING ATTORNEY

David J. Kyros

Director of the United States Patent and Trademark Office

United States of America

United States Patent and Trademark Office

FRESH GARDEN PICK

Reg. No. 4,107,172

PFF BRANDS, LLC (FLORIDA LIMITED LIABILITY COMPANY)
14095 N. STATE ROAD 7
DELRAY BEACH, FL 33446

Registered Mar. 6, 2012

Int. Cl.: 31

FOR: FRESH FRUIT AND VEGETABLES, IN CLASS 31 (U.S. CLS. 1 AND 46).

TRADEMARK

FIRST USE 4-21-2010; IN COMMERCE 4-21-2010.

PRINCIPAL REGISTER

THE MARK CONSISTS OF STANDARD CHARACTERS WITHOUT CLAIM TO ANY PARTICULAR FONT, STYLE, SIZE, OR COLOR.

NO CLAIM IS MADE TO THE EXCLUSIVE RIGHT TO USE "FRESH", APART FROM THE MARK AS SHOWN.

SER. NO. 77-632,029, FILED 12-12-2008.

DAVID C. REIHNER, EXAMINING ATTORNEY



David J. Kyffers

Director of the United States Patent and Trademark Office

United States of America

United States Patent and Trademark Office

SPIT DECISIONS

Reg. No. 4,107,173

Registered Mar. 6, 2012

Int. Cls.: 21, 25, 33 and 35

TRADEMARK

SERVICE MARK

PRINCIPAL REGISTER

JOEY TOMATO'S (CANADA) INC. (CANADA CORPORATION)
505 BURRARD STREET, SUITE 950
VANCOUVER, CANADA V7X1M4

FOR: WINE GLASSES; WINE CORKSCREWS; COFFEE MUGS , IN CLASS 21 (U.S. CLS. 2, 13, 23, 29, 30, 33, 40 AND 50).

FOR: WEARING APPAREL, NAMELY, HATS, SHIRTS, T-SHIRTS, POLO SHIRTS, TANK TOPS, JACKETS, SWEATERS, SWEAT SHIRTS, SWEAT PANTS, COATS, AND VESTS, IN CLASS 25 (U.S. CLS. 22 AND 39).

FOR: WINE, IN CLASS 33 (U.S. CLS. 47 AND 49).

FOR: PROCUREMENT SERVICES, NAMELY, PURCHASING OF WINE FOR OTHERS; WHOLESALE, RETAIL, AND ONLINE STORE SERVICES FEATURING WINE AND WINE ACCESSORIES SUCH AS WINE BOTTLES, WINE GLASSES, WINE CORKSCREWS, AND WINE STORAGE AND SHIPPING DEVICES; GROUP BUYING CLUB SERVICES; ADVERTISING SERVICES, NAMELY, PROMOTING THE WINES OF OTHERS; ORGANIZATION AND OPERATION OF CLUB SERVICES, NAMELY, PROMOTING THE INTERESTS OF WINE ENTHUSIASTS, IN CLASS 35 (U.S. CLS. 100, 101 AND 102).

THE MARK CONSISTS OF STANDARD CHARACTERS WITHOUT CLAIM TO ANY PARTICULAR FONT, STYLE, SIZE, OR COLOR.

PRIORITY CLAIMED UNDER SEC. 44(D) ON CANADA APPLICATION NO. 1400959, FILED 6-25-2008, REG. NO. TMA776033, DATED 9-1-2010, EXPIRES 9-1-2025.

SER. NO. 77-635,433, FILED 12-17-2008.

MARK SPARACINO, EXAMINING ATTORNEY



David J. Kybas

Director of the United States Patent and Trademark Office

United States of America

United States Patent and Trademark Office

ABLEPLANET

Reg. No. 4,107,174

Registered Mar. 6, 2012

Int. Cl.: 9

TRADEMARK

PRINCIPAL REGISTER

ABLE PLANET, INC. (DELAWARE CORPORATION)
BUILDING B-102
9500 WEST 49TH AVENUE
WHEAT RIDGE, CO 80033

FOR: AUDIO AND COMMUNICATION DEVICES FOR IMPROVING ACOUSTIC CLARITY AND AUDIO TRANSMISSION AND RECEPTION FOR ASSISTING PERSONS WITH SENSORY OR COGNITIVE IMPAIRMENTS AND TO PRESERVE HEARING LEVELS, NAMELY, WIRED AND WIRELESS ADAPTED HEADPHONES AND HEADSETS FOR USE IN AUDIO, CELLULAR VOICE OVER INTERNET PROTOCOL AND TELECOMMUNICATIONS; AND CORDED AND CORDLESS ADAPTED TELEPHONES, IN CLASS 9 (U.S. CLS. 21, 23, 26, 36 AND 38).

FIRST USE 10-5-2005; IN COMMERCE 10-5-2005.

THE MARK CONSISTS OF STANDARD CHARACTERS WITHOUT CLAIM TO ANY PARTICULAR FONT, STYLE, SIZE, OR COLOR.

OWNER OF U.S. REG. NOS. 3,563,428 AND 3,563,429.

SER. NO. 77-647,014, FILED 1-9-2009.

SEAN CROWLEY, EXAMINING ATTORNEY



David J. Kyros

Director of the United States Patent and Trademark Office

United States of America

United States Patent and Trademark Office

ElectroVox

Reg. No. 4,107,175

Registered Mar. 6, 2012

Int. Cl.: 9

TRADEMARK

PRINCIPAL REGISTER

TRANSONO INC. (REPUBLIC OF KOREA CORPORATION)
17 HAENDANG-DONG SEONGDONG-GU
605, 6TH FLOOR, FUSION TECH CENTER
SEOUL, REPUBLIC OF KOREA 133-791

FOR: COMPUTER APPLICATION SOFTWARE FOR MOBILE PHONES; COMPUTER SOFTWARE FOR COMMUNICATING WITH USERS OF HAND-HELD COMPUTERS; DIGITAL TELEPHONE PLATFORMS AND SOFTWARE; COMPUTER HARDWARE AND SOFTWARE USED FOR THE CONTROL OF VOICE CONTROLLED INFORMATION AND COMMUNICATION DEVICES; DIGITAL SIGNAL PROCESSORS; SOFTWARE TO CONTROL AND IMPROVE AUDIO EQUIPMENT SOUND QUALITY; COMPUTER SOFTWARE TO CONTROL AND IMPROVE COMPUTER AND AUDIO EQUIPMENT SOUND QUALITY; COMPUTER TELEPHONY SOFTWARE; COMPUTER HARDWARE AND COMPUTER SOFTWARE PROGRAMS FOR THE INTEGRATION OF TEXT, AUDIO, GRAPHICS, STILL IMAGES AND MOVING PICTURES INTO AN INTERACTIVE DELIVERY FOR MULTIMEDIA APPLICATIONS; COMPUTER HARDWARE AND SOFTWARE FOR PROCESSING DIGITAL MUSIC FILES; COMPUTER SOFTWARE FOR PROCESSING DIGITAL MUSIC FILES; COMPUTER SOFTWARE FOR WIRELESS CONTENT DELIVERY; PATTERN RECOGNITION SYSTEMS COMPOSED OF COMPUTER CHIPS, COMPUTER HARDWARE AND SOFTWARE, IN CLASS 9 (U.S. CLS. 21, 23, 26, 36 AND 38).

THE MARK CONSISTS OF STANDARD CHARACTERS WITHOUT CLAIM TO ANY PARTICULAR FONT, STYLE, SIZE, OR COLOR.

PRIORITY CLAIMED UNDER SEC. 44(D) ON REPUBLIC OF KOREA APPLICATION NO. 40-2008-0057, FILED 12-9-2008, REG. NO. 40-0823844, DATED 5-20-2010, EXPIRES 5-20-2020.

SER. NO. 77-654,285, FILED 1-22-2009.

JAY BESCH, EXAMINING ATTORNEY



David J. Kypos

Director of the United States Patent and Trademark Office

United States of America
United States Patent and Trademark Office

TOOTSIES

Reg. No. 4,107,176

Registered Mar. 6, 2012

Int. Cl.: 43

SERVICE MARK

PRINCIPAL REGISTER

TOOTSIE'S ENTERTAINMENT, LLC (TENNESSEE LIMITED LIABILITY COMPANY)
422 BROADWAY
NASHVILLE, TN 37203

FOR: BAR AND RESTAURANT SERVICES, IN CLASS 43 (U.S. CLS. 100 AND 101).

FIRST USE 12-1-1960; IN COMMERCE 12-1-1995.

THE MARK CONSISTS OF STANDARD CHARACTERS WITHOUT CLAIM TO ANY PARTICULAR FONT, STYLE, SIZE, OR COLOR.

SER. NO. 77-668,168, FILED 2-11-2009.

GENE MACIOL, EXAMINING ATTORNEY



David J. Kybas

Director of the United States Patent and Trademark Office

United States of America
United States Patent and Trademark Office

TOOTSIES

Reg. No. 4,107,177

Registered Mar. 6, 2012

Int. Cl.: 41

SERVICE MARK

PRINCIPAL REGISTER

TOOTSIE'S ENTERTAINMENT, LLC (TENNESSEE LIMITED LIABILITY COMPANY)
422 BROADWAY
NASHVILLE, TN 37203

FOR: ARRANGING AND CONDUCTING NIGHTCLUB ENTERTAINMENT EVENTS; ENTERTAINMENT, NAMELY, LIVE MUSIC CONCERTS; ENTERTAINMENT, NAMELY, LIVE PERFORMANCES BY MUSICAL BANDS, IN CLASS 41 (U.S. CLS. 100, 101 AND 107).

FIRST USE 12-1-1960; IN COMMERCE 12-1-1995.

THE MARK CONSISTS OF STANDARD CHARACTERS WITHOUT CLAIM TO ANY PARTICULAR FONT, STYLE, SIZE, OR COLOR.

SER. NO. 77-668,180, FILED 2-11-2009.

GENE MACIOL, EXAMINING ATTORNEY



David J. Kyffers

Director of the United States Patent and Trademark Office

United States of America

United States Patent and Trademark Office

LEGG MASON GLOBAL ASSET MANAGEMENT

Reg. No. 4,107,178

Registered Mar. 6, 2012

Int. Cl.: 36

SERVICE MARK

PRINCIPAL REGISTER

LEGG MASON & CO., LLC (MARYLAND LIMITED LIABILITY COMPANY)
100 INTERNATIONAL DRIVE
BALTIMORE, MD 21202

FOR: FINANCIAL SERVICES, NAMELY, ASSET MANAGEMENT SERVICES, IN CLASS 36
(U.S. CLS. 100, 101 AND 102).

FIRST USE 6-0-2008; IN COMMERCE 6-0-2008.

THE MARK CONSISTS OF STANDARD CHARACTERS WITHOUT CLAIM TO ANY PARTICULAR FONT, STYLE, SIZE, OR COLOR.

OWNER OF U.S. REG. NOS. 1,850,422 AND 3,049,354.

NO CLAIM IS MADE TO THE EXCLUSIVE RIGHT TO USE "GLOBAL ASSET MANAGEMENT", APART FROM THE MARK AS SHOWN.

SER. NO. 77-676,259, FILED 2-23-2009.

KATHERINE CHANG, EXAMINING ATTORNEY



David J. Kybas

Director of the United States Patent and Trademark Office

United States of America

United States Patent and Trademark Office

SCIENTIFIC WIZARD

Reg. No. 4,107,179

Registered Mar. 6, 2012

Int. Cls.: 35, 40, 41 and 42

SERVICE MARK

PRINCIPAL REGISTER

SCIENTIFIC WIZARD LTD. (ISRAEL LIMITED COMPANY (LTD.))
38 YONI NETANYAHU STREET
GIVAT SHMUEL, ISRAEL

FOR: MARKETING RESEARCH IN THE FIELDS OF ELECTRO-OPTICS, PHOTONICS, NANO-TECHNOLOGY, BIO-TECHNOLOGY, PHYSICS, CHEMISTRY, ENERGY, SENSORS, TELECOMMUNICATION, ROBOTICS, MIND-MACHINE INTERFACE, NANO-ROBOTICS, IMAGING AND MATHEMATICS; MARKETING RESEARCH IN THE FIELD OF THEORETICAL MODELS AND SIMULATIONS FOR ANALYSIS AND OPTIMIZATION OF PROBLEMS, COMPONENTS, DEVICES, SYSTEMS, PRODUCTS AND PROCESSES; MARKETING RESEARCH IN THE FIELD OF ALGORITHMS AND THEIR IMPLEMENTATION AS SOFTWARE AND COMPUTATION; PRODUCT MARKETING IN THE FIELD MEDICAL EQUIPMENT, DEVICES, EXAMINATION AND TREATMENT; MARKETING RESEARCH IN THE FIELD OF ALGORITHMS AND THEIR IMPLEMENTATION AS SOFTWARE AND COMPUTATION; MARKETING RESEARCH IN THE FIELD MEDICAL EQUIPMENT, DEVICES, EXAMINATION AND TREATMENT; MARKETING RESEARCH IN THE FIELDS OF MICRO/NANO DESIGN AND CONSTRUCTION OF MICRO/NANO DEVICES AND MICRO/NANO MATERIALS; OUTSOURCING SERVICES FOR OTHERS IN THE FIELDS OF ELECTRO-OPTICS, PHOTONICS, NANO-TECHNOLOGY, BIO-TECHNOLOGY, PHYSICS, CHEMISTRY, ENERGY, SENSORS, TELECOMMUNICATION, ROBOTICS, MIND-MACHINE INTERFACE, NANO-ROBOTICS, IMAGING AND MATHEMATICS; OUTSOURCING SERVICES FOR OTHERS IN THE FIELD OF THEORETICAL MODELS AND SIMULATIONS FOR ANALYSIS AND OPTIMIZATION OF PROBLEMS, COMPONENTS, DEVICES, SYSTEMS, PRODUCTS AND PROCESSES; OUTSOURCING SERVICES FOR OTHERS IN THE FIELD OF ALGORITHMS AND THEIR IMPLEMENTATION AS SOFTWARE AND COMPUTATION; OUTSOURCING SERVICES FOR OTHERS IN THE FIELD OF MEDICAL EQUIPMENT, DEVICES, EXAMINATION AND TREATMENT; OUTSOURCING SERVICES FOR OTHERS IN THE FIELDS OF MICRO/NANO DESIGN AND CONSTRUCTION OF MICRO/NANO DEVICES AND MICRO/NANO MATERIALS, IN CLASS 35 (U.S. CLS. 100, 101 AND 102).



David J. Kyffers

Director of the United States Patent and Trademark Office

FOR: CUSTOM MANUFACTURING OF PRODUCTS IN THE FIELDS OF ELECTRO-OPTICS, PHOTONICS, NANO-TECHNOLOGY, BIO-TECHNOLOGY, PHYSICS, CHEMISTRY, ENERGY, SENSORS, TELECOMMUNICATION, ROBOTICS, MIND-MACHINE INTERFACE, NANO-ROBOTICS, IMAGING AND MATHEMATICS; CUSTOM MANUFACTURING OF PRODUCTS IN THE FIELD OF THEORETICAL MODELS AND SIMULATIONS FOR ANALYSIS AND OPTIMIZATION OF PROBLEMS, COMPONENTS, DEVICES, SYSTEMS, PRODUCTS AND PROCESSES; CUSTOM MANUFACTURING OF PRODUCTS IN THE FIELD

Reg. No. 4,107,179 OF ALGORITHMS AND THEIR IMPLEMENTATION AS SOFTWARE AND COMPUTATION; CUSTOM MANUFACTURING OF PRODUCTS IN THE FIELD MEDICAL EQUIPMENT, DEVICES, EXAMINATION AND TREATMENT; CUSTOM MANUFACTURING OF PRODUCTS IN THE FIELD OF ALGORITHMS AND THEIR IMPLEMENTATION AS SOFTWARE AND COMPUTATION; MANUFACTURING AND MARKETING IN THE FIELD MEDICAL EQUIPMENT, DEVICES, EXAMINATION AND TREATMENT; CUSTOM MANUFACTURING OF PRODUCTS IN THE FIELDS OF MICRO/NANO DESIGN AND CONSTRUCTION OF MICRO/NANO DEVICES AND MICRO/NANO MATERIALS; CUSTOM MANUFACTURING OF PRODUCTS IN THE FIELD MEDICAL EQUIPMENT, DEVICES, EXAMINATION AND TREATMENT, IN CLASS 40 (U.S. CLS. 100, 103 AND 106).

FOR: PUBLICATION OF BOOKS, JOURNALS AND INTERNET WEBSITES IN THE FIELD OF SCIENTIFIC AND TECHNICAL MATERIAL, IN CLASS 41 (U.S. CLS. 100, 101 AND 107).

FOR: SCIENTIFIC RESEARCH; RESEARCH AND DEVELOPMENT OF TECHNOLOGY IN THE FIELD OF THEORETICAL MODELS AND SIMULATIONS FOR ANALYSIS AND OPTIMIZATION OF PROBLEMS, COMPONENTS, DEVICES, SYSTEMS, PRODUCTS AND PROCESSES; RESEARCH AND DEVELOPMENT OF TECHNOLOGY IN THE FIELD OF ALGORITHMS AND THEIR IMPLEMENTATION AS SOFTWARE AND COMPUTATION; RESEARCH AND DEVELOPMENT OF TECHNOLOGY IN THE FIELD OF MEDICAL EQUIPMENT, DEVICES, EXAMINATION AND TREATMENT; RESEARCH AND DEVELOPMENT OF TECHNOLOGY IN THE FIELDS OF MICRO/NANO DESIGN AND CONSTRUCTION OF MICRO/NANO DEVICES AND MICRO/NANO MATERIALS; CONSULTING SERVICES FOR THE DEVELOPMENT OF KNOWLEDGE BASES; PRODUCT DEVELOPMENT IN THE FIELDS OF ELECTRO-OPTICS, PHOTONICS, NANO-TECHNOLOGY, BIO-TECHNOLOGY, PHYSICS, CHEMISTRY, ENERGY, SENSORS, TELECOMMUNICATION, ROBOTICS, MIND-MACHINE INTERFACE, NANO-ROBOTICS, IMAGING AND MATHEMATICS; PRODUCT DEVELOPMENT IN THE FIELDS OF THEORETICAL MODELS AND SIMULATIONS FOR ANALYSIS AND OPTIMIZATION OF PROBLEMS, COMPONENTS, DEVICES, SYSTEMS, PRODUCTS AND PROCESSES; PRODUCT DEVELOPMENT IN THE FIELD OF ALGORITHMS AND THEIR IMPLEMENTATION AS SOFTWARE AND COMPUTATION; PRODUCT DEVELOPMENT IN THE FIELD MEDICAL EQUIPMENT, DEVICES, EXAMINATION AND TREATMENT; PRODUCT DEVELOPMENT IN THE FIELDS OF MICRO/NANO DESIGN AND CONSTRUCTION OF MICRO/NANO DEVICES AND MICRO/NANO MATERIALS; SCIENTIFIC AND TECHNOLOGICAL CONSULTING SERVICES FOR OTHERS IN THE FIELDS OF ELECTRO-OPTICS, PHOTONICS, NANO-TECHNOLOGY, BIO-TECHNOLOGY, PHYSICS, CHEMISTRY, ENERGY, SENSORS, TELECOMMUNICATION, ROBOTICS, MIND-MACHINE INTERFACE, NANO-ROBOTICS, IMAGING AND MATHEMATICS; SCIENTIFIC AND TECHNOLOGICAL CONSULTING SERVICES FOR OTHERS IN THE FIELD OF THEORETICAL MODELS AND SIMULATIONS FOR ANALYSIS AND OPTIMIZATION OF PROBLEMS, COMPONENTS, DEVICES, SYSTEMS, PRODUCTS AND PROCESSES; SCIENTIFIC AND TECHNOLOGICAL CONSULTING SERVICES FOR OTHERS IN THE FIELD OF ALGORITHMS AND THEIR IMPLEMENTATION AS SOFTWARE AND COMPUTATION; SCIENTIFIC AND TECHNOLOGICAL CONSULTING SERVICES FOR OTHERS IN THE FIELD OF MEDICAL EQUIPMENT, DEVICES, EXAMINATION AND TREATMENT; SCIENTIFIC AND TECHNOLOGICAL CONSULTING SERVICES FOR OTHERS IN THE FIELDS OF MICRO/NANO DESIGN AND CONSTRUCTION OF MICRO/NANO DEVICES AND MICRO/NANO MATERIALS; SCIENTIFIC AND TECHNOLOGICAL OUTSOURCING SERVICES FOR OTHERS IN THE FIELDS OF ELECTRO-OPTICS, PHOTONICS, NANO-TECHNOLOGY, BIO-TECHNOLOGY, PHYSICS, CHEMISTRY, ENERGY, SENSORS, TELECOMMUNICATION, ROBOTICS, MIND-MACHINE INTERFACE, NANO-ROBOTICS, IMAGING AND MATHEMATICS; PRODUCT DEVELOPMENT IN THE FIELD MEDICAL EQUIPMENT, DEVICES, EXAMINATION AND TREATMENT , IN CLASS 42 (U.S. CLS. 100 AND 101).

THE MARK CONSISTS OF STANDARD CHARACTERS WITHOUT CLAIM TO ANY PARTICULAR FONT, STYLE, SIZE, OR COLOR.

OWNER OF ISRAEL REG. NO. 219294, DATED 12-5-2010, EXPIRES 3-5-2019.

Reg. No. 4,107,179 NO CLAIM IS MADE TO THE EXCLUSIVE RIGHT TO USE "SCIENTIFIC", APART FROM THE MARK AS SHOWN.

SER. NO. 77-686,594, FILED 3-9-2009.

NAAKWAMA ANKRAH, EXAMINING ATTORNEY

United States of America

United States Patent and Trademark Office

ADINA

Reg. No. 4,107,180

Registered Mar. 6, 2012

Int. Cl.: 14

TRADEMARK

PRINCIPAL REGISTER

FAIRFIELD INVESTMENTS PTY LIMITED (AUSTRALIA CORPORATION)
11 HOLDEN STREET, WOOLLOONGABBA
QUEENSLAND, 4102, AUSTRALIA

FOR: MEN'S AND WOMEN'S WATCHES, WATCH BANDS AND CLOCKS, IN CLASS 14
(U.S. CLS. 2, 27, 28 AND 50).

THE MARK CONSISTS OF STANDARD CHARACTERS WITHOUT CLAIM TO ANY PAR-
TICULAR FONT, STYLE, SIZE, OR COLOR.

OWNER OF AUSTRALIA REG. NO. 282597, DATED 10-18-1974, EXPIRES 10-18-2019.

SER. NO. 77-688,191, FILED 3-11-2009.

JOHN HWANG, EXAMINING ATTORNEY



David J. Kybas

Director of the United States Patent and Trademark Office

United States of America

United States Patent and Trademark Office

THE DIABETES DTOUR DIET

Reg. No. 4,107,181

RODALE INC. (PENNSYLVANIA CORPORATION)
33 EAST MINOR STREET
EMMAUS, PA 180980099

Registered Mar. 6, 2012

Int. Cl.: 16

FOR: SERIES OF BOOKS IN THE FIELD OF HEALTH, IN CLASS 16 (U.S. CLS. 2, 5, 22, 23, 29, 37, 38 AND 50).

TRADEMARK

FIRST USE 2-0-2009; IN COMMERCE 2-0-2009.

PRINCIPAL REGISTER

THE MARK CONSISTS OF STANDARD CHARACTERS WITHOUT CLAIM TO ANY PARTICULAR FONT, STYLE, SIZE, OR COLOR.

NO CLAIM IS MADE TO THE EXCLUSIVE RIGHT TO USE "DIABETES" AND "DIET", APART FROM THE MARK AS SHOWN.

SER. NO. 77-695,722, FILED 3-20-2009.

WILLIAM VERHOSEK, EXAMINING ATTORNEY



David J. Kybas

Director of the United States Patent and Trademark Office

United States of America

United States Patent and Trademark Office

Diabetes DTOUR Powered by Prevention

Reg. No. 4,107,182

Registered Mar. 6, 2012

Int. Cls.: 9, 41 and 44

TRADEMARK

SERVICE MARK

PRINCIPAL REGISTER

RODALE INC. (PENNSYLVANIA CORPORATION)
33 EAST MINOR STREET
EMMAUS, PA 180980099

FOR: DVD AND BOOK PACKAGED TOGETHER AND SOLD AS A UNIT IN THE FIELDS OF DIET, HEALTH AND NUTRITION, IN CLASS 9 (U.S. CLS. 21, 23, 26, 36 AND 38).

FIRST USE 3-2-2009; IN COMMERCE 3-2-2009.

FOR: PROVIDING A WEB SITE FEATURING ONLINE JOURNALS, NAMELY, BLOGS, IN THE FIELDS OF DIET, HEALTH AND NUTRITION; PROVIDING ONLINE NEWSLETTERS IN THE FIELDS OF HEALTH, DIET AND NUTRITION, IN CLASS 41 (U.S. CLS. 100, 101 AND 107).

FIRST USE 3-2-2009; IN COMMERCE 3-2-2009.

FOR: PROVIDING A WEB SITE FEATURING INFORMATION ON DIET, HEALTH AND NUTRITION; PROVIDING ONLINE VIDEOS CONTAINING INFORMATION IN THE FIELDS OF DIET, HEALTH AND NUTRITION; WEIGHT REDUCTION DIET PLANNING AND SUPERVISION FOR ASSISTANCE IN THE MANAGEMENT AND MOTIVATION THEREOF; PROVIDING WEIGHT LOSS PROGRAM SERVICES; PROVIDING INFORMATION ON MAINTAINING A HEALTHY LIFESTYLE AND LOSING WEIGHT; PROVIDING AN ONLINE COMPUTER DATABASE FEATURING INFORMATION IN THE FIELDS OF DIET, HEALTH, AND NUTRITION; PROVIDING HEALTHCARE INFORMATION VIA TELEPHONE AND THE INTERNET; AND PROVIDING HEALTH INFORMATION, IN CLASS 44 (U.S. CLS. 100 AND 101).

FIRST USE 3-2-2009; IN COMMERCE 3-2-2009.

THE MARK CONSISTS OF STANDARD CHARACTERS WITHOUT CLAIM TO ANY PARTICULAR FONT, STYLE, SIZE, OR COLOR.

OWNER OF U.S. REG. NOS. 2,643,325, 3,569,622 AND OTHERS.

NO CLAIM IS MADE TO THE EXCLUSIVE RIGHT TO USE "DIABETES", APART FROM THE MARK AS SHOWN.



David J. Kyjars

Director of the United States Patent and Trademark Office

Reg. No. 4,107,182 SER. NO. 77-704,528, FILED 4-1-2009.

WILLIAM VERHOSEK, EXAMINING ATTORNEY

United States of America

United States Patent and Trademark Office

TRADEWINDS

Reg. No. 4,107,183

Registered Mar. 6, 2012

Int. Cl.: 33

TRADEMARK

PRINCIPAL REGISTER

MANSFIELD, RICHARD L. (UNITED STATES INDIVIDUAL)
P.O. BOX 839
1291 CONN VALLEY RD.
SAINT HELENA, CA 94574 AND

MANSFIELD, LESLIE (UNITED STATES INDIVIDUAL)
P.O. BOX 839
1291 CONN VALLEY RD.
SAINT HELENA, CA 94574

FOR: WINE , IN CLASS 33 (U.S. CLS. 47 AND 49).

FIRST USE 6-12-2007; IN COMMERCE 6-12-2007.

THE MARK CONSISTS OF STANDARD CHARACTERS WITHOUT CLAIM TO ANY PARTICULAR FONT, STYLE, SIZE, OR COLOR.

SER. NO. 77-733,081, FILED 5-8-2009.

BERYL GARDNER, EXAMINING ATTORNEY



David J. Kyros

Director of the United States Patent and Trademark Office

United States of America

United States Patent and Trademark Office

RENDERING CONFIDENCE

Reg. No. 4,107,184

Registered Mar. 6, 2012

Int. Cls.: 9, 10 and 42

TRADEMARK

SERVICE MARK

PRINCIPAL REGISTER

DOG MICROSYSTEMS INC. (CANADA CORPORATION)
116, PRINCIPALE, SUITE 200
GRANBY, QUEBEC, CANADA J2G2V2

FOR: DIGITAL DATA PROCESSING SYSTEM COMPRISED PRIMARILY OF COMPUTER SOFTWARE AND COMPUTER HARDWARE FOR USE IN VIRTUAL IMAGING AND MULTI-DIMENSIONAL DIAGNOSTIC IMAGING USING GRAPHICAL PARAMETERS; DIGITAL DATA PROCESSING SYSTEM COMPRISED PRIMARILY OF COMPUTER SOFTWARE AND COMPUTER HARDWARE FOR USE IN TRANSMITTING DATA ELECTRONICALLY VIA THE INTERNET AND CORPORATE INTRANETS; DIGITAL DATA PROCESSING SYSTEM COMPRISED PRIMARILY OF COMPUTER SOFTWARE AND COMPUTER HARDWARE FOR USERS TO INTERACT AND EXCHANGE DATA ELECTRONICALLY VIA THE INTERNET AND CORPORATE INTRANETS IN REAL-TIME; DIGITAL DATA PROCESSING SYSTEM CONSISTING PRIMARILY OF COMPUTER SOFTWARE AND COMPUTER HARDWARE FOR USE IN CAPTURING, STORING, RETRIEVING, READING, PROCESSING, MANIPULATING AND ANALYZING DIGITAL DATA, IN CLASS 9 (U.S. CLS. 21, 23, 26, 36 AND 38).

FOR: DIGITAL DATA PROCESSING SYSTEM USED AS A PATIENT AIDED DIAGNOSTIC APPARATUS CONSISTING PRIMARILY OF COMPUTER SOFTWARE AND COMPUTER HARDWARE FOR USE IN CAPTURING, STORING, RETRIEVING, READING, PROCESSING, MANIPULATING AND ANALYZING MEDICAL DATA FOR PATIENTS AND GENERATING COMPUTER AIDED DIAGNOSTIC INFORMATION FOR USE IN TREATING MEDICAL CONDITIONS AND PREPARING IMAGES FOR SURGERY; DIGITAL DATA PROCESSING SYSTEMS USED AS A PATIENT AIDED DIAGNOSTIC APPARATUS CONSISTING PRIMARILY OF COMPUTER SOFTWARE AND COMPUTER HARDWARE FOR USE IN PERFORMING VIRTUAL COLONOSCOPIES, VIRTUAL BRONCHOSCOPIES, VIRTUAL NEURONENDOSCOPIES, VIRTUAL ENDOSCOPIES, VIRTUAL BREAST CANCER IMAGING, AND VIRTUAL IMAGING IN THE DIAGNOSES OF CANCER, IN CLASS 10 (U.S. CLS. 26, 39 AND 44).

FOR: INSTALLATION OF COMPUTER SOFTWARE FOR USE IN VIRTUAL IMAGING AND MULTI-DIMENSIONAL DIAGNOSTIC IMAGING USING GRAPHICAL PARAMETERS; INSTALLATION OF COMPUTER SOFTWARE FOR USE IN GENERATING IMAGES FOR VIRTUAL COLONOSCOPIES, VIRTUAL BRONCHOSCOPIES, VIRTUAL NEURON-ENDOSCOPIES, VIRTUAL ENDOSCOPIES, VIRTUAL BREAST CANCER, AND VIRTUAL DIAGNOSES OF CANCER, IN CLASS 42 (U.S. CLS. 100 AND 101).



David J. Kybas

Director of the United States Patent and Trademark Office

Reg. No. 4,107,184 THE MARK CONSISTS OF STANDARD CHARACTERS WITHOUT CLAIM TO ANY PARTICULAR FONT, STYLE, SIZE, OR COLOR.

PRIORITY CLAIMED UNDER SEC. 44(D) ON CANADA APPLICATION NO. 1418925, FILED 11-20-2008, REG. NO. TMA776,475, DATED 9-8-2010, EXPIRES 9-8-2025.

SER. NO. 77-740,405, FILED 5-19-2009.

BERYL GARDNER, EXAMINING ATTORNEY

United States of America

United States Patent and Trademark Office

XTENDNET

Reg. No. 4,107,185

Registered Mar. 6, 2012

Int. Cl.: 9

TRADEMARK

PRINCIPAL REGISTER

GIGLE NETWORKS INC. (DELAWARE CORPORATION)
275 SHORELINE DRIVE, SUITE 530
REDWOOD CITY, CA 94065

FOR: SEMICONDUCTOR PROCESSORS; SEMICONDUCTOR PROCESSOR CHIPS; INTEGRATED CIRCUIT CHIPS; SEMICONDUCTORS; AND INTEGRATED CIRCUITS; ALL THE FOREGOING EXCLUDING RF RADIO MODEMS, IN CLASS 9 (U.S. CLS. 21, 23, 26, 36 AND 38).

THE MARK CONSISTS OF STANDARD CHARACTERS WITHOUT CLAIM TO ANY PARTICULAR FONT, STYLE, SIZE, OR COLOR.

PRIORITY CLAIMED UNDER SEC. 44(D) ON ERPN CMNTY TM OFC APPLICATION NO. 8334443, FILED 6-2-2009, REG. NO. 8334443, DATED 1-28-2010, EXPIRES 6-2-2020.

SER. NO. 77-755,125, FILED 6-9-2009.

ANDREA HACK, EXAMINING ATTORNEY



David J. Kybas

Director of the United States Patent and Trademark Office

United States of America

United States Patent and Trademark Office

D&F

Reg. No. 4,107,186

Registered Mar. 6, 2012

Int. Cl.: 9

TRADEMARK

PRINCIPAL REGISTER

NEOPLE, INC. (REPUBLIC OF KOREA CORPORATION)
2F, JBK BLDG. 108-6 SAMSEONG-DONG
GANGNAM-GU
SEOUL, REPUBLIC OF KOREA

FOR: RECORDED COMPUTER SOFTWARE FOR ON-LINE GAMES, RECORDED COMPUTER SOFTWARE FOR COMPUTER GAMES, COMPUTER SOFTWARE FOR ON-LINE GAMES, COMPUTER SOFTWARE FOR COMPUTER GAMES, DOWNLOADABLE ELECTRONIC PUBLICATIONS IN THE NATURE OF A SERIES OF BOOKS, MAGAZINES, AND MANUALS RECORDED ON COMPUTER MEDIA IN THE FIELD OF COMPUTER GAMES, IN CLASS 9 (U.S. CLS. 21, 23, 26, 36 AND 38).

THE MARK CONSISTS OF STANDARD CHARACTERS WITHOUT CLAIM TO ANY PARTICULAR FONT, STYLE, SIZE, OR COLOR.

PRIORITY CLAIMED UNDER SEC. 44(D) ON REPUBLIC OF KOREA APPLICATION NO. 2009-0025984, FILED 6-4-2009, REG. NO. 847073, DATED 12-20-2010, EXPIRES 12-20-2020.

SER. NO. 77-763,747, FILED 6-19-2009.

SIMON TENG, EXAMINING ATTORNEY



David J. Kybas

Director of the United States Patent and Trademark Office

United States of America

United States Patent and Trademark Office



Reg. No. 4,107,187

Registered Mar. 6, 2012

Int. Cl.: 35

SERVICE MARK

PRINCIPAL REGISTER

WILSEY WOLF, LLC (NEW YORK LIMITED LIABILITY COMPANY), DBA GREENHOUSE
SUITE 9G
ONE HANSON PLACE
BROOKLYN, NY 11243

FOR: RETAIL STORE AND ON-LINE RETAIL STORE SERVICES FEATURING FURNITURE,
HOME FURNISHINGS, TABLEWARE, BEDDING, BATH PRODUCTS AND HOME AC-
CESSORIES, IN CLASS 35 (U.S. CLS. 100, 101 AND 102).

FIRST USE 9-16-2008; IN COMMERCE 9-16-2008.

THE MARK CONSISTS OF LIGHT GREEN TREE BRANCHES SHAPED IN THE FORM OF
A HOUSE WITH THE WORDS "GREENHOUSE" IN DARK GREEN AND "ECO-FRIENDLY
LIVING" IN LIGHT GREEN UNDERNEATH THE HOUSE. THE SPACES BETWEEN THE
TREE BRANCHES ARE TRANSPARENT AREAS AND ARE NOT PART OF THE MARK.

THE COLOR(S) LIGHT GREEN AND DARK GREEN IS/ARE CLAIMED AS A FEATURE OF
THE MARK.

SER. NO. 77-772,732, FILED 7-1-2009.

TEJBIR SINGH, EXAMINING ATTORNEY



David J. Kybas

Director of the United States Patent and Trademark Office

United States of America

United States Patent and Trademark Office

WATERSAVER

Reg. No. 4,107,188

WATERSAVER FAUCET CO. (ILLINOIS CORPORATION)
701 WEST ERIE STREET
CHICAGO, IL 60610

Registered Mar. 6, 2012

Int. Cls.: 6, 9, 11, 19 and 20

FOR: MANUALLY OPERATED METAL VALVES; ALUMINUM CLAMPS; ALUMINUM LATTICE RODS AND STAINLESS STEEL LATTICE RODS, NAMELY, METAL LATTICES; METAL CLAMPS, IN CLASS 6 (U.S. CLS. 2, 12, 13, 14, 23, 25 AND 50).

TRADEMARK

FIRST USE 8-1-1925; IN COMMERCE 8-1-1925.

PRINCIPAL REGISTER

FOR: AUTOMATIC VALVES; CONTROL VALVES FOR REGULATING THE FLOW OF GASES AND LIQUIDS; ELECTRONIC VALVES FOR CONTROLLING GAS OR FLUIDS; FUME HOOD OUTLETS, NAMELY, VENTILATION HOODS, IN CLASS 9 (U.S. CLS. 21, 23, 26, 36 AND 38).

FIRST USE 8-1-1925; IN COMMERCE 8-1-1925.

FOR: MANUALLY OPERATED PLUMBING VALVES; PRESSURE REGULATORS FOR WATER, GAS AND SANITARY INSTALLATIONS; STEAM VALVES; SINK PEDESTALS, IN CLASS 11 (U.S. CLS. 13, 21, 23, 31 AND 34).

FIRST USE 8-1-1925; IN COMMERCE 8-1-1925.

FOR: FIBERGLASS LATTICE RODS, NAMELY, NON-METAL LATTICES, IN CLASS 19 (U.S. CLS. 1, 12, 33 AND 50).

FIRST USE 1-1-1963; IN COMMERCE 1-1-1963.

FOR: NON-METAL CLAMPS, IN CLASS 20 (U.S. CLS. 2, 13, 22, 25, 32 AND 50).

FIRST USE 1-1-1963; IN COMMERCE 1-1-1963.

THE MARK CONSISTS OF STANDARD CHARACTERS WITHOUT CLAIM TO ANY PARTICULAR FONT, STYLE, SIZE, OR COLOR.

OWNER OF U.S. REG. NOS. 3,956,478 AND 3,987,628.



David J. Kyros

Director of the United States Patent and Trademark Office

Reg. No. 4,107,188 SEC. 2(F).

SER. NO. 77-789,983, FILED 7-27-2009.

JOHN DWYER, EXAMINING ATTORNEY

United States of America

United States Patent and Trademark Office

Medley

Reg. No. 4,107,189

Registered Mar. 6, 2012

Int. Cls.: 35 and 42

SERVICE MARK

PRINCIPAL REGISTER

VARIOUS, INC. (CALIFORNIA CORPORATION)
220 HUMBOLDT COURT
SUNNYVALE, CA 94089

FOR: ADVERTISING AND PROMOTING THE GOODS AND SERVICES OF OTHERS; RENTAL OF ADVERTISING SPACE ON INTERNET WEBSITES; RENDERING OF SALES PROMOTION ADVICE TO OTHERS; PLANNING OF ADVERTISING CAMPAIGNS FOR OTHERS; DESIGN OF ADVERTISING MATERIALS FOR OTHERS; PRODUCTION OF ADVERTISING MATERIALS FOR OTHERS; ANALYSIS OF ADVERTISING CAMPAIGNS FOR OTHERS, IN CLASS 35 (U.S. CLS. 100, 101 AND 102).

FIRST USE 7-0-2004; IN COMMERCE 11-0-2004.

FOR: CREATING INTERNET OR INTRANET BASED ANALYTICAL TOOLS IN THE FORM OF SOFTWARE APPLICATIONS THAT CREATE AND INCORPORATE DYNAMIC AD OPTIMIZATION TO ENHANCE ADVERTISERS' BUSINESS, SALES AND ADVERTISING PLANNING AND STRATEGIES, AND FACILITATE THE TRACKING ANALYSIS, ADMINISTRATION, BILLING, AND REPORTING OF INTERNET WEBSITE OR WEBPAGE BASED ADVERTISING, IN CLASS 42 (U.S. CLS. 100 AND 101).

FIRST USE 7-0-2004; IN COMMERCE 11-0-2004.

THE MARK CONSISTS OF STANDARD CHARACTERS WITHOUT CLAIM TO ANY PARTICULAR FONT, STYLE, SIZE, OR COLOR.

SER. NO. 77-796,408, FILED 8-4-2009.

KATHLEEN M. VANSTON, EXAMINING ATTORNEY



David J. Kybas

Director of the United States Patent and Trademark Office

United States of America
United States Patent and Trademark Office

VOMARIS

Reg. No. 4,107,190

Registered Mar. 6, 2012

Int. Cl.: 5

TRADEMARK

PRINCIPAL REGISTER

VOMARIS INNOVATIONS, INC. (DELAWARE CORPORATION)
3100 W. RAY ROAD, SUITE 148
CHANDLER, AZ 85226

FOR: ADHESIVE BANDAGES; ADHESIVE FOR BANDAGES FOR SKIN WOUNDS; ANALGESICS FOR THE TREATMENT OF WOUNDS AND SKIN DISORDERS; ANESTHETICS FOR NON-SURGICAL USE FOR THE TREATMENT OF WOUNDS AND SKIN DISORDERS; ANTI-DERMOINFECTIVES; AND ANTI-INFECTIVES FOR THE TREATMENT OF WOUNDS AND SKIN DISORDERS; ANTI-INFLAMMATORIES FOR THE TREATMENT OF WOUNDS AND SKIN DISORDERS; ANTIBACTERIAL SUBSTANCES FOR THE TREATMENT OF WOUNDS AND SKIN DISORDERS; ANTIMICROBIAL COATINGS TO TREAT THE GROWTH OF MOLD, MILDEW, BACTERIA AND FUNGUS ON VARIOUS SURFACES; ANTIMICROBIALS FOR DERMATOLOGIC USE; ANTIVIRALS; BANDAGES FOR DRESSINGS; BANDAGES FOR SKIN WOUNDS; BURN DRESSINGS; DERMATOLOGICALS; DRESSINGS FOR WOUNDS, BURNS AND SURGERY; SURGICAL BANDAGES; SURGICAL DRESSINGS; TOPICAL ANALGESICS FOR THE TREATMENT OF WOUNDS AND SKIN DISORDERS; WOUND DRESSINGS, IN CLASS 5 (U.S. CLS. 6, 18, 44, 46, 51 AND 52).

FIRST USE 3-16-2009; IN COMMERCE 3-16-2009.

THE MARK CONSISTS OF STANDARD CHARACTERS WITHOUT CLAIM TO ANY PARTICULAR FONT, STYLE, SIZE, OR COLOR.

SER. NO. 77-811,864, FILED 8-25-2009.

MARC LEIPZIG, EXAMINING ATTORNEY



David J. Kypos

Director of the United States Patent and Trademark Office

United States of America

United States Patent and Trademark Office

TAO DE FRUIT

Reg. No. 4,107,191

Registered Mar. 6, 2012

Int. Cl.: 30

TRADEMARK

PRINCIPAL REGISTER

TEAVANA CORPORATION (GEORGIA CORPORATION)
SUITE 860
3475 LENOX ROAD
ATLANTA, GA 30326

FOR: TEA, IN CLASS 30 (U.S. CL. 46).

FIRST USE 9-1-2009; IN COMMERCE 9-1-2009.

THE MARK CONSISTS OF STANDARD CHARACTERS WITHOUT CLAIM TO ANY PARTICULAR FONT, STYLE, SIZE, OR COLOR.

NO CLAIM IS MADE TO THE EXCLUSIVE RIGHT TO USE "FRUIT", APART FROM THE MARK AS SHOWN.

THE ENGLISH TRANSLATION OF "TAO DE" IN THE MARK IS THE WAY OR METHOD OF.

SER. NO. 77-818,126, FILED 9-2-2009.

KIM SAITO, EXAMINING ATTORNEY



David J. Kyffers

Director of the United States Patent and Trademark Office

United States of America

United States Patent and Trademark Office

MAIGRET

Reg. No. 4,107,192

Registered Mar. 6, 2012

Int. Cls.: 9, 16, 28 and 41

TRADEMARK

SERVICE MARK

PRINCIPAL REGISTER

GEORGES SIMENON LIMITED (UNITED KINGDOM CORPORATION)
4TH FLOOR, ALDWYCH HOUSE 81 ALDWYCH
LONDON WC2B 4HN, UNITED KINGDOM

FOR: AUDIO RECORDINGS IN THE FORM OF DISCS, TAPES, MAGNETIC AND/OR DIGITAL DATA CARRIERS INCLUDING MP3 FILES FEATURING MYSTERY AND DETECTIVE STORIES; AUDIO BOOKS FEATURING MYSTERY AND DETECTIVE STORIES; RECORDINGS IN THE FORM OF DISCS, VIDEOS, TAPES, MAGNETIC AND/OR DIGITAL DATA CARRIERS INCLUDING MP4 FILES FEATURING MYSTERY AND DETECTIVE STORIES; DOWNLOADABLE ELECTRONIC PUBLICATIONS IN THE NATURE OF BOOKS, JOURNALS AND MAGAZINES FEATURING MYSTERY AND DETECTIVE STORIES; COMPUTER GAME SOFTWARE; BLANK RECORDABLE CD-ROMS; TELEPHONES; MOBILE PHONES; CELL PHONES; DOWNLOADABLE AUDIO AND VIDEO RECORDINGS, AND SOFTWARE SUPPLIED ON-LINE FROM A COMPUTER DATABASE OR THE INTERNET FEATURING MYSTERY AND DETECTIVE STORIES; DOWNLOADABLE PUBLICATIONS IN THE NATURE OF BOOKS, JOURNALS AND MAGAZINES FEATURING MYSTERY AND DETECTIVE STORIES; FILMS FEATURING MYSTERY AND DETECTIVE STORIES; EYEGLASSES; SPECTACLES; SUNGLASSES; EYEGGLASS CASES, EYEGGLASS CHAINS, IN CLASS 9 (U.S. CLS. 21, 23, 26, 36 AND 38).

FOR: PRINTED MATTER, NAMELY, A SERIES OF MYSTERY AND DETECTIVE BOOKS, MAGAZINES, CATALOGS, THEATRE PROGRAMS AND GUIDES, JOURNALS, PAMPHLETS, BROCHURES, BOOKLETS, GUIDES, NEWSLETTERS, AND NEWSPAPERS FEATURING INFORMATION OF INTEREST TO MYSTERY READERS; BOOKMARKS; POSTERS; PHOTOGRAPHS; PART WORK PUBLICATIONS, NAMELY, MAGAZINES AND BOOKS IN THE FIELD MYSTERY AND DETECTIVE FICTION; PAPER, CARDBOARD, ARTICLES MADE OF PAPER OR CARDBOARD NOT INCLUDED IN OTHER CLASSES, NAMELY, COASTERS OF PAPER, DECALS, INDEX CARDS, WRITING PAPER AND WRITING PADS, TABLE MATS OF PAPER, PAPER TOWELS, NOTE CARDS; STATIONERY; GIFT CARDS, GREETING CARDS, TRADING CARDS AND TRIVIA CARDS, ANNOUNCEMENT CARDS; PENS, PENCILS; CALENDARS; DRAWING MATERIALS, NAMELY, WRITING INSTRUMENTS, PADS AND PAPER; EMBROIDERY DESIGN PATTERNS; ENVELOPES; LOOSE LEAF BINDERS; PAPER NAPKINS; NOTEBOOKS; GIFT WRAPPING PAPER; LOOSE LEAF PAPER; PEN CASES; PENCIL HOLDERS; PENCIL SHARPENERS; PAPER PLACE MATS; PAPER HANDKERCHIEFS; POSTCARDS; BOOK COVERS, IN CLASS 16 (U.S. CLS. 2, 5, 22, 23, 29, 37, 38 AND 50).



David J. Kyjars

Director of the United States Patent and Trademark Office

Reg. No. 4,107,192 FOR: JIGSAW PUZZLES; BOARD GAMES; BOARD GAMES FOR INTERACTIVE USE; TOY FIGURES; CARD GAMES; PLAYING CARDS, IN CLASS 28 (U.S. CLS. 22, 23, 38 AND 50).

FOR: PUBLICATION OF BOOKS, JOURNALS AND MAGAZINES; PRODUCTION OF TELEVISION SHOWS AND FILMS; RENTAL OF MOTION PICTURES, SOUND RECORDINGS, AUDIO BOOKS; ARRANGING AND ORGANIZING LIVE EVENTS IN THE FIELD OF MYSTERY AND DETECTIVE FICTION; PROVIDING ENTERTAINMENT INFORMATION; ENTERTAINMENT IN THE NATURE OF THEATER PRODUCTIONS; PRODUCTION OF RADIO AND TELEVISION PROGRAMS AND SHOWS; PROVIDING ON-LINE ELECTRONIC PUBLICATION FEATURING BOOKS, MAGAZINES AND PERIODICALS IN THE FIELD OF MYSTERY AND DETECTIVE FICTION, IN CLASS 41 (U.S. CLS. 100, 101 AND 107).

THE MARK CONSISTS OF STANDARD CHARACTERS WITHOUT CLAIM TO ANY PARTICULAR FONT, STYLE, SIZE, OR COLOR.

OWNER OF ERPN CMNTY TM OFC REG. NO. 003818903, DATED 10-7-2005, EXPIRES 5-5-2014.

OWNER OF U.S. REG. NO. 1,793,622.

THE WORDING "MAIGRET" HAS NO MEANING IN A FOREIGN LANGUAGE.

SER. NO. 77-827,882, FILED 9-16-2009.

RAUL CORDOVA, EXAMINING ATTORNEY

United States of America

United States Patent and Trademark Office

LIGHTING AFRICA

Reg. No. 4,107,193

Registered Mar. 6, 2012

**Int. Cls.: 16, 35, 41 and
42**

TRADEMARK

SERVICE MARK

PRINCIPAL REGISTER

INTERNATIONAL FINANCE CORPORATION (STATELESS INTERGOVERNMENTAL AND SPECIALIZED AGENCY OF THE UNITED NATIONS)
2121 PENNSYLVANIA AVENUE, NW
WASHINGTON, DC 20433

FOR: PUBLICATIONS, NAMELY, BROCHURES, BOOKLETS, ARTICLES, FLYERS, ANNOUNCEMENTS, NEWSLETTERS, PRESENTATIONS, REPORTS AND TEACHING MATERIALS IN THE FIELD OF AFRICAN OFF-GRID LIGHTING MARKET, IN CLASS 16 (U.S. CLS. 2, 5, 22, 23, 29, 37, 38 AND 50).

FIRST USE 9-7-2007; IN COMMERCE 9-7-2007.

FOR: PROVIDING BUSINESS INTELLIGENCE AND CONSULTING SERVICES TO COMPANIES, ORGANIZATIONS, AND CONSUMERS REGARDING THE AFRICAN OFF-GRID LIGHTING MARKET; PROVIDING INFORMATION TO BUSINESSES AND CONSUMERS REGARDING PURCHASING OFF-GRID LIGHTING IN AFRICA; PROMOTING PUBLIC AWARENESS OF THE NEED FOR DEVELOPING AFFORDABLE, CLEAN, AND EFFICIENT MODERN LIGHTING AND ENERGY SOLUTIONS FOR AFRICANS AND FOR THE NEED TO ADDRESS POLICY AND REGULATORY BARRIERS TO THE DEVELOPMENT OF AFFORDABLE, CLEAN AND EFFICIENT MODERN LIGHTING AND ENERGY SOLUTIONS IN AFRICA; PROVIDING ONLINE BUSINESS NETWORKING SERVICES REGARDING THE OFF-GRID LIGHTING MARKET; AND CONTESTS AND AWARD PROGRAMS TO PROMOTE THE SALE OF PRODUCTS AND SERVICES OF OTHERS WITH RESPECT TO THE AFRICAN OFF-GRID LIGHTING MARKET; PROVIDING BUSINESS, MARKETING AND CONSUMER INFORMATION VIA THE INTERNET IN THE FIELD OF OFF-GRID LIGHTING AND OFF-GRID LIGHTING RESOURCES; PROVIDING MARKETING INFORMATION FOR OFF-GRID LIGHTING PROVIDERS, IN CLASS 35 (U.S. CLS. 100, 101 AND 102).

FIRST USE 9-7-2007; IN COMMERCE 9-7-2007.

FOR: EDUCATIONAL SERVICES, NAMELY, CONDUCTING CLASSES, SEMINARS, LECTURES, CONFERENCES, WORKSHOPS IN THE FIELD OF THE AFRICAN OFF-GRID LIGHTING MARKET AND DISTRIBUTION OF EDUCATIONAL MATERIALS IN CONNECTION THEREWITH, IN CLASS 41 (U.S. CLS. 100, 101 AND 107).

FIRST USE 9-7-2007; IN COMMERCE 9-7-2007.



David J. Kyffers

Director of the United States Patent and Trademark Office

Reg. No. 4,107,193 FOR: PROVIDING QUALITY ASSURANCE AND TECHNICAL INFORMATION VIA THE INTERNET IN THE FIELD OF OFF-GRID LIGHTING MARKET, OFF-GRID LIGHTING RESOURCES AND NON-DOWNLOADABLE SOFTWARE TOOLS FOR USE BY BUSINESSES CONCERNING THE AFRICAN OFF-GRID LIGHTING MARKET, IN CLASS 42 (U.S. CLS. 100 AND 101).

FIRST USE 9-7-2007; IN COMMERCE 9-7-2007.

THE MARK CONSISTS OF STANDARD CHARACTERS WITHOUT CLAIM TO ANY PARTICULAR FONT, STYLE, SIZE, OR COLOR.

SEC. 2(F).

SER. NO. 77-834,338, FILED 9-24-2009.

MIDGE BUTLER, EXAMINING ATTORNEY

United States of America

United States Patent and Trademark Office

IVIVVA

Reg. No. 4,107,194

Registered Mar. 6, 2012

Int. Cl.: 25

TRADEMARK

PRINCIPAL REGISTER

LULULEMON ATHLETICA CANADA INC. (CANADA CORPORATION)
2113 WEST FOURTH AVENUE
VANCOUVER, BC, CANADA V6K1N6

FOR: BANDANAS; BELTS; BERETS; BODY SUITS; BOOTS; CAPS; COATS; COVERUPS; DANCE SHOES; DRESSES; EAR MUFFS; FOOTWEAR, NAMELY, CASUAL SHOES; GAITERS; GLOVES; HATS; HEADBANDS; HEADWEAR; JACKETS; JERSEYS; JUMPERS; LEG WARMERS; LEGGINGS; LEOTARDS; PAJAMAS; PANTS; ROBES; SANDALS; SCARVES; SHAWLS; SHIRTS; SPORTS SHOES; SHORTS; SHOULDER WRAPS; SKIRTS; SLIPPERS; SOCKS; SWEAT PANTS; SWEAT SHIRTS; SWEATERS; T-SHIRTS; TANK TOPS; TIGHTS; TOQUES; UNDERWEAR; UNITARDS; VESTS; VISORS; WARM UP SUITS, IN CLASS 25 (U.S. CLS. 22 AND 39).

THE MARK CONSISTS OF STANDARD CHARACTERS WITHOUT CLAIM TO ANY PARTICULAR FONT, STYLE, SIZE, OR COLOR.

OWNER OF CANADA REG. NO. TMA775365, DATED 8-24-2010, EXPIRES 8-24-2025.

SER. NO. 77-838,971, FILED 10-1-2009.

SHANNON TWOHIG, EXAMINING ATTORNEY



David J. Kyros

Director of the United States Patent and Trademark Office

United States of America

United States Patent and Trademark Office

SMART PLAN

Reg. No. 4,107,195

SEARS BRANDS, LLC (ILLINOIS LIMITED LIABILITY COMPANY)
3333 BEVERLY ROAD
HOFFMAN ESTATES, IL 60179

Registered Mar. 6, 2012

Int. Cl.: 36

FOR: EXTENDED WARRANTY SERVICES, NAMELY, SERVICE CONTRACTS THAT PROVIDE FOR THE REPAIR AND/OR REPLACEMENT OF APPLIANCES AND PARTS THEREOF THAT INCUR ELECTRICAL OR MECHANICAL FAILURE, IN CLASS 36 (U.S. CLS. 100, 101 AND 102).

SERVICE MARK

PRINCIPAL REGISTER

FIRST USE 11-1-1996; IN COMMERCE 11-1-1996.

THE MARK CONSISTS OF STANDARD CHARACTERS WITHOUT CLAIM TO ANY PARTICULAR FONT, STYLE, SIZE, OR COLOR.

NO CLAIM IS MADE TO THE EXCLUSIVE RIGHT TO USE "PLAN", APART FROM THE MARK AS SHOWN.

SER. NO. 77-843,134, FILED 10-7-2009.

ODESSA BIBBINS, EXAMINING ATTORNEY



David J. Kyros

Director of the United States Patent and Trademark Office

United States of America

United States Patent and Trademark Office

ACTIVEAGENT

Reg. No. 4,107,196

Registered Mar. 6, 2012

Int. Cl.: 42

SERVICE MARK

PRINCIPAL REGISTER

THE GOHOME NETWORKS, INC. (OREGON CORPORATION)
SUITE 150
1600 SW WESTERN BLVD
CORVALLIS, OR 97333

FOR: COMPUTER SERVICES, NAMELY, DESIGNING AND IMPLEMENTING WEB SITES AND WEB SITE COMPUTER SOFTWARE FOR USE BY OTHERS IN THE REAL ESTATE SALES INDUSTRY, IN CLASS 42 (U.S. CLS. 100 AND 101).

FIRST USE 7-15-1997; IN COMMERCE 11-14-1997.

THE MARK CONSISTS OF STANDARD CHARACTERS WITHOUT CLAIM TO ANY PARTICULAR FONT, STYLE, SIZE, OR COLOR.

SER. NO. 77-843,909, FILED 10-7-2009.

SUSAN LESLIE DUBOIS, EXAMINING ATTORNEY



David J. Kyffers

Director of the United States Patent and Trademark Office

United States of America

United States Patent and Trademark Office



Reg. No. 4,107,197

Registered Mar. 6, 2012

Int. Cls.: 35, 36 and 42

SERVICE MARK

PRINCIPAL REGISTER

WAUGH INFRASTRUCTURE MANAGEMENT LIMITED (NEW ZEALAND CORPORATION)
LEVEL 2, 18 WOOLLCOOMBE STREET
TIMARU, NEW ZEALAND 7910

FOR: BUSINESS ADMINISTRATION, MANAGEMENT, AND STATISTICAL SERVICES IN THE NATURE OF COMPILATION OF STATISTICS FOR BUSINESS PURPOSES; ECONOMIC FORECASTING; INFRASTRUCTURE MANAGEMENT IN THE NATURE OF ADVISORY SERVICES RELATING TO BUSINESS MANAGEMENT AND BUSINESS OPERATIONS; BUSINESS ASSET MANAGEMENT PLANNING AND SERVICES; ASSET SYSTEMS IMPLEMENTATION IN THE NATURE OF COMMERCIAL ASSISTANCE RELATING TO SYSTEM DEVELOPMENT, IMPLEMENTATION AND MAINTENANCE; BUSINESS RISK MANAGEMENT; BUSINESS OPERATION MANAGEMENT FOR OTHERS; BUSINESS ACTIVITY MANAGEMENT PLANNING FOR OTHERS; BUSINESS PROCESS INTEGRATION AND REPORTING SERVICES FOR OTHERS; CONSULTATION IN THE FIELD OF ENERGY EFFICIENCY, IN CLASS 35 (U.S. CLS. 100, 101 AND 102).

FOR: FINANCIAL VALUATION SERVICES; FINANCIAL ASSET MANAGEMENT PLANNING AND SERVICES; FINANCIAL RISK MANAGEMENT, IN CLASS 36 (U.S. CLS. 100, 101 AND 102).

FOR: ENGINEERING, DRAFTING AND ARCHITECTURAL SERVICES; RESEARCH RELATING TO ENVIRONMENTAL PROTECTION AND SERVICES IN THE NATURE OF CONSULTING SERVICES IN THE FIELD OF ENVIRONMENTAL ASSESSMENT AND PLANNING; INDUSTRIAL DESIGN CONSULTANCY, ANALYSIS AND RESEARCH; GEOLOGICAL RESEARCH AND SURVEYS INCLUDING LAND SURVEYING; TECHNICAL PROJECT STUDIES AND SURVEYS IN THE NATURE OF CONDUCTING ENGINEERING SURVEYS AND INFRASTRUCTURE ASSET SURVEYS, IN CLASS 42 (U.S. CLS. 100 AND 101).

OWNER OF NEW ZEALAND REG. NO. 798225, DATED 10-29-2008, EXPIRES 10-29-2018.

THE MARK CONSISTS OF THE WORD "WAUGH" WITH A CIRCLE WITH INTERSECTING LINES.

SER. NO. 77-847,923, FILED 10-13-2009.

BRIDGETT SMITH, EXAMINING ATTORNEY



David J. Kyjars

Director of the United States Patent and Trademark Office

United States of America

United States Patent and Trademark Office

CROWDSENSE

Reg. No. 4,107,198

Registered Mar. 6, 2012

Int. Cl.: 35

SERVICE MARK

PRINCIPAL REGISTER

CARDINAL PATH HOLDING COMPANY (DELAWARE CORPORATION)
16 RAMSHEAD ROAD, SUITE 100
MEDFORD, MA 02155

FOR: MARKETING ANALYSIS SERVICES, NAMELY, CONDUCTING CONSUMER TRACKING BEHAVIOR RESEARCH AND CONSUMER TREND ANALYSIS THROUGH THE USE OF WEB-BASED ANALYTICAL TOOLS IN THE FIELD OF WEBSITE AND MARKET ANALYSIS, MARKETING DATA AND STATISTICS RELATING TO SEARCH ENGINE OPTIMIZATION AND MARKETING, IN CLASS 35 (U.S. CLS. 100, 101 AND 102).

THE MARK CONSISTS OF STANDARD CHARACTERS WITHOUT CLAIM TO ANY PARTICULAR FONT, STYLE, SIZE, OR COLOR.

PRIORITY CLAIMED UNDER SEC. 44(D) ON CANADA APPLICATION NO. 1435155, FILED 4-20-2009, REG. NO. TMA769,154, DATED 6-8-2010, EXPIRES 6-8-2025.

SER. NO. 77-853,230, FILED 10-20-2009.

JULIE GUTTADAURO, EXAMINING ATTORNEY



David J. Kybas

Director of the United States Patent and Trademark Office

United States of America

United States Patent and Trademark Office



Reg. No. 4,107,199

Registered Mar. 6, 2012

Int. Cls.: 9 and 35

TRADEMARK

SERVICE MARK

PRINCIPAL REGISTER

CUSTOM PROTECT EAR INC. (CANADA CORPORATION)
681-7789 134TH STREET, SURREY
BRITISH COLUMBIA, CANADA V3W9E9

FOR: HEARING PROTECTORS, NAMELY, HEARING PROTECTION EARPIECES AND HEADSETS NOT FOR MEDICAL USE AND EAR PLUGS FOR SOUNDPROOFING; HEADSETS FOR CELLULAR PHONES, COMMUNICATION RADIOS OR OTHER COMMUNICATIONS NETWORK TRANSCEIVERS AND COMPONENTS THEREFOR, IN CLASS 9 (U.S. CLS. 21, 23, 26, 36 AND 38).

FIRST USE 6-0-2008; IN COMMERCE 6-0-2008.

FOR: RETAIL SALES, NAMELY, RETAIL SERVICES THROUGH DIRECT SOLICITATION BY SALESPERSONS AND DISTRIBUTORS DIRECTED TO END-USERS FEATURING HEARING PROTECTORS AND HEADSETS FOR CELLULAR PHONES, COMMUNICATION RADIOS OR OTHER COMMUNICATIONS NETWORK TRANSCEIVERS AND COMPONENTS THEREFOR; ONLINE RETAIL SERVICES THROUGH DIRECT SOLICITATION BY SALESPERSONS AND DISTRIBUTORS DIRECTED TO END-USERS FEATURING HEARING PROTECTORS AND HEADSETS FOR CELLULAR PHONES, COMMUNICATION RADIOS OR OTHER COMMUNICATIONS NETWORK TRANSCEIVERS AND COMPONENTS THEREFOR; COMPUTERIZED ON-LINE ORDERING SERVICES AND COMPUTERIZED ON-LINE RETAIL STORE SERVICES IN THE FIELD OF HEARING PROTECTORS AND HEADSETS FOR CELLULAR PHONES, COMMUNICATION RADIOS OR OTHER COMMUNICATIONS NETWORK TRANSCEIVERS AND COMPONENTS THEREFOR; OPERATING AN ON-LINE MARKETPLACE FEATURING HEARING PROTECTORS AND HEADSETS FOR CELLULAR PHONES, COMMUNICATION RADIOS OR OTHER COMMUNICATIONS NETWORK TRANSCEIVERS AND COMPONENTS THEREFOR, IN CLASS 35 (U.S. CLS. 100, 101 AND 102).

FIRST USE 6-0-2008; IN COMMERCE 6-0-2008.

PRIORITY CLAIMED UNDER SEC. 44(D) ON CANADA APPLICATION NO. 1455471, FILED 10-15-2009, REG. NO. TMA782741, DATED 11-17-2010, EXPIRES 11-17-2025.

NO CLAIM IS MADE TO THE EXCLUSIVE RIGHT TO USE "DB" AND "COM", APART FROM THE MARK AS SHOWN.



David J. Kyjars

Director of the United States Patent and Trademark Office

Reg. No. 4,107,199 THE MARK CONSISTS OF STYLIZED HUMAN EAR, A CURVED LINE REPRESENTING A SOUND WAVE, THE LETTER "DB" APPEARING UPON THE EAR AND THE LETTERS "COM".

SER. NO. 77-857,846, FILED 10-26-2009.

EDWARD NELSON, EXAMINING ATTORNEY

United States of America

United States Patent and Trademark Office

THE WAXED BAT

Reg. No. 4,107,200

Registered Mar. 6, 2012

Int. Cl.: 33

TRADEMARK

PRINCIPAL REGISTER

DIRECT WINES LTD (UNITED KINGDOM LIMITED LIABILITY COMPANY)
EXETER WAY, THEALE NEW AQUITAINE HOUSE
READING, BERKSHIRE, UNITED KINGDOM RG74PL

FOR: ALCOHOLIC BEVERAGES EXCEPT BEERS; WINES; SHERRY, IN CLASS 33 (U.S. CLS. 47 AND 49).

THE MARK CONSISTS OF STANDARD CHARACTERS WITHOUT CLAIM TO ANY PARTICULAR FONT, STYLE, SIZE, OR COLOR.

OWNER OF ERPN CMNTY TM OFC REG. NO. 8565591, DATED 6-18-2010, EXPIRES 6-18-2020.

SER. NO. 77-858,250, FILED 10-27-2009.

PATRICIA EVANKO, EXAMINING ATTORNEY



David J. Kybas

Director of the United States Patent and Trademark Office

United States of America

United States Patent and Trademark Office



Swiss PrivateAviation

Reg. No. 4,107,201

Registered Mar. 6, 2012

**Int. Cls.: 35, 36, 37, 39
and 41**

SERVICE MARK

PRINCIPAL REGISTER

SWISS INTERNATIONAL AIR LINES AG (SWITZERLAND CORPORATION)
MALZGASSE 15
BASEL, SWITZERLAND 4052

FOR: BUSINESS MANAGEMENT CONSULTANCY, SPONSORSHIP SEARCH, ADVERTISING AND MARKETING, RENTING-OUT OF ADVERTISING SPACES AND RENTAL OF ADVERTISING SPACE ON VEHICLES, IN CLASS 35 (U.S. CLS. 100, 101 AND 102).

FOR: RENTING-OUT OF OFFICES; FINANCIAL SPONSORSHIP OF SPORTING, CULTURAL AND CIVIC EVENTS, IN CLASS 36 (U.S. CLS. 100, 101 AND 102).

FOR: REPAIR AND MAINTENANCE SERVICES; NAMELY, AIRPLANE MAINTENANCE, REPAIR, OVERHAUL AND CLEANING SERVICES, IN CLASS 37 (U.S. CLS. 100, 103 AND 106).

FOR: PACKAGING; STORING AND TRANSPORTING GOODS; TRANSPORTING PERSONS; TOUR OPERATING; RENTAL OF AIRCRAFT AND VEHICLES; RENTING-OUT OF GARAGES AND AIRCRAFT HANGARS; BOOKING TRAVEL ARRANGEMENTS, NAMELY, ARRANGING TRAVEL TOURS, CHARTER TRAVEL AND ORGANIZATION OF SIGHTSEEING TOURS, HOLIDAYS AND TRAVEL; PROVIDING TRAVEL AND TRANSPORT-RELATED INFORMATION, IN CLASS 39 (U.S. CLS. 100 AND 105).

FOR: INITIAL AND FURTHER TRAINING IN THE USE AND OPERATION OF IT COMPUTER HARDWARE AND SOFTWARE IN THE FIELDS OF AVIATION MAINTENANCE, SCHEDULING AND AIRLINE OPERATIONS; ORGANIZING COMMUNITY SPORTING AND CULTURAL EVENTS; PROVISION OF INFORMATION RELATING TO THE ORGANIZING OF EDUCATIONAL, CULTURAL, SPORTING AND ENTERTAINMENT EXHIBITIONS, IN CLASS 41 (U.S. CLS. 100, 101 AND 107).

OWNER OF SWITZERLAND REG. NO. 580932, DATED 12-23-2008, EXPIRES 6-26-2018.

NO CLAIM IS MADE TO THE EXCLUSIVE RIGHT TO USE "SWISS" WITH RESPECT TO INTERNATIONAL CLASSES 35, 36, 37, 41, 42, AND 43; "SWISS PRIVATE AVIATION" WITH RESPECT TO INTERNATIONAL CLASSES 35, 36, 37, 41, 42, AND 43; AND "PRIVATE AVIATION" WITH RESPECT TO INTERNATIONAL CLASS 39, APART FROM THE MARK AS SHOWN.



David J. Kybas

Director of the United States Patent and Trademark Office

Reg. No. 4,107,201 THE MARK CONSISTS OF THE WORD "SWISS" SHOWN IN A SQUARE CENTERED AT THE TOP, WITH A CROSS SHOWN AT THE BOTTOM RIGHT, ALL TO THE LEFT OF THE WORDS "SWISS PRIVATEAVIATION".

SEC. 2(F) AS TO "SWISS" FOR INTERNATIONAL CLASS 39..

SER. NO. 77-860,058, FILED 10-29-2009.

SUNG IN, EXAMINING ATTORNEY

United States of America

United States Patent and Trademark Office



Reg. No. 4,107,202

Registered Mar. 6, 2012

Int. Cls.: 9, 38 and 42

TRADEMARK

SERVICE MARK

PRINCIPAL REGISTER

EON CORPORATION (DELAWARE CORPORATION)
SUITE 900
360 HERNDON PARKWAY
HERNDON, VA 20170

FOR: TRANSMITTERS, NAMELY, CABLE TELEVISION TRANSMITTERS, RF TRANSMITTERS AND DIGITAL TRANSMITTERS; RECEIVERS, NAMELY, RF RECEIVERS, DIGITAL RECEIVERS; COMMUNICATION EQUIPMENT, NAMELY, ANTENNAS AND TRANSCEIVERS; COMPUTER HARDWARE AND SOFTWARE FOR SETTING UP, CONFIGURING, AND ADMINISTRATION OF WIRELESS COMMUNICATION NETWORKS AND WIRELINE NETWORKS; COMPUTER NETWORK ADAPTERS, COMPUTER NETWORK SERVERS; MODEMS, AND ELECTRONIC TRANSDUCERS; COMPUTER CONTROLLED TELEVISION SYSTEMS COMPRISING COMPUTERS AND TELEVISION RECEIVERS INTERCONNECTED BY COMPUTER PROGRAMS WITH MANUAL INTERVENTION INSTRUMENTS FOR INTERACTIVE CONTROL, NAMELY, TOUCH SCREENS, REMOTE CONTROLS FOR TELEVISIONS; TELEVISION CONTROL SOFTWARE FOR USE IN INTERACTIVE CONTROL OF TELEVISION RECEIVERS AND BIDIRECTIONAL COMMUNICATION IN A NETWORK OF SUBSCRIBERS; COMMUNICATION SYSTEMS COMPRISING COMMUNICATION ROUTING EQUIPMENT, NAMELY, COMPUTER NETWORK ROUTERS, AUTOMATIC NETWORK SWITCHING CENTERS, NETWORK ELECTRONIC CONTROLLERS, NETWORK SERVERS, FOR RELAYING MESSAGES BETWEEN PARTICIPANTS IN A BIDIRECTIONAL COMMUNICATION NETWORK, NAMELY, INTERACTIVE MEDIA COMPUTER SOFTWARE APPLICATIONS; INTERCONNECTION NETWORKS COMPRISING RADIO, CABLE AND SATELLITE RECEIVERS AND TRANSMITTER COUPLES TO COMMUNICATE BETWEEN TWO REMOTE POINTS; COMPUTER HARDWARE AND SOFTWARE APPLICATIONS FOR CAPTURING, TRANSPORTING, STORING, ANALYZING AND DELIVERING DATA, IN CLASS 9 (U.S. CLS. 21, 23, 26, 36 AND 38).

FIRST USE 3-26-2008; IN COMMERCE 3-26-2008.

FOR: WIRELESS COMMUNICATION TECHNOLOGY AND MESSAGING SERVICES, NAMELY, TECHNOLOGY FOR TWO-WAY, INTERACTIVE COMMUNICATIONS TECHNOLOGY FOR TELEPHONES, COMPUTERS, TABLETS, SMART PHONES, MOBILE AND PORTABLE COMMUNICATIONS DEVICES, FOR CELLULAR ADVANCED ELECTRONIC MESSAGING SYSTEMS, MOBILE TELEVISION STREAMING AND BROADCASTING SERVICES OF AUDIO, VISUAL, AND AUDIOVISUAL MATERIAL, BIDIRECTIONAL RADIO AND TELEVISION COMMUNICATION SYSTEMS AND WIRELESS BROADBAND COM-



David J. Kybas

Director of the United States Patent and Trademark Office

Reg. No. 4,107,202 MUNICATION SERVICES; WIRELESS COMMUNICATION SERVICES, NAMELY, WIRELESS COMMUNICATION TECHNOLOGY AND MESSAGING SERVICES, NAMELY, TECHNOLOGY FOR TWO-WAY, INTERACTIVE COMMUNICATIONS TECHNOLOGY, FOR TELEPHONES, COMPUTERS, TABLETS, SMART PHONES, MOBILE AND PORTABLE COMMUNICATIONS DEVICES FOR CELLULAR ADVANCED ELECTRONIC MESSAGING SYSTEMS, MOBILE TELEVISION STREAMING AND BROADCASTING SERVICES OF AUDIO, VISUAL, AND AUDIOVISUAL MATERIAL, BIDIRECTIONAL RADIO AND TELEVISION COMMUNICATION SYSTEMS AND WIRELESS BROADBAND COMMUNICATION SERVICES, IN CLASS 38 (U.S. CLS. 100, 101 AND 104).

FIRST USE 3-26-2008; IN COMMERCE 3-26-2008.

FOR: RESEARCH AND DEVELOPMENT OF NEW PRODUCTS OR SERVICES IN THE FIELD OF TELECOMMUNICATIONS, IN CLASS 42 (U.S. CLS. 100 AND 101).

FIRST USE 3-26-2008; IN COMMERCE 3-26-2008.

NO CLAIM IS MADE TO THE EXCLUSIVE RIGHT TO USE "CORP", APART FROM THE MARK AS SHOWN.

THE MARK CONSISTS OF TWO ADJACENT QUADRILATERALS WITH THE WORD "EON" IN ONE AND "CORP" IN THE OTHER.

SER. NO. 77-862,577, FILED 11-2-2009.

ANGELA DUONG, EXAMINING ATTORNEY

United States of America

United States Patent and Trademark Office

Alta Financial Services

Reg. No. 4,107,203

Registered Mar. 6, 2012

Int. Cl.: 36

SERVICE MARK

PRINCIPAL REGISTER

ALTA EQUIPMENT COMPANY, INC. (MICHIGAN CORPORATION)
28775 BECK ROAD
WIXOM, MI 483933416

FOR: FACILITATING AND ARRANGING FOR THE FINANCING OF LIFT TRUCKS AND PARTS, MATERIALS HANDLING EQUIPMENT AND OTHER CONSTRUCTION EQUIPMENT, IN CLASS 36 (U.S. CLS. 100, 101 AND 102).

FIRST USE 11-1-2010; IN COMMERCE 11-1-2010.

THE MARK CONSISTS OF STANDARD CHARACTERS WITHOUT CLAIM TO ANY PARTICULAR FONT, STYLE, SIZE, OR COLOR.

REGISTRATION LIMITED TO THE AREA COMPRISING ALABAMA, ARKANSAS, CONNECTICUT, DELAWARE, FLORIDA, GEORGIA, ILLINOIS, IOWA, KANSAS, KENTUCKY, LOUISIANA, MAINE, MARYLAND, MASSACHUSETTS, MICHIGAN, MINNESOTA, MISSISSIPPI, MISSOURI, NEBRASKA, NEW HAMPSHIRE, NEW JERSEY, NEW YORK, NORTH CAROLINA, NORTH DAKOTA, OHIO, OKLAHOMA, PENNSYLVANIA, RHODE ISLAND, SOUTH CAROLINA, SOUTH DAKOTA, TENNESSEE, VERMONT, VIRGINIA, WEST VIRGINIA AND WISCONSIN PURSUANT TO CONCURRENT USE PROCEEDING NO. 94002315. CONCURRENT USE WITH REGISTRATION NO. 3662246.

OWNER OF U.S. REG. NOS. 2,598,846 AND 2,705,077.

NO CLAIM IS MADE TO THE EXCLUSIVE RIGHT TO USE "FINANCIAL SERVICES", APART FROM THE MARK AS SHOWN.

THE ENGLISH TRANSLATION OF "ALTA" IN THE MARK IS "HIGH".

SER. NO. 77-873,987, FILED 11-17-2009.

CHRISTOPHER BUONGIORNO, EXAMINING ATTORNEY



David J. Kyros

Director of the United States Patent and Trademark Office

United States of America

United States Patent and Trademark Office

Surf Slider

Reg. No. 4,107,204

Registered Mar. 6, 2012

Int. Cl.: 9

TRADEMARK

PRINCIPAL REGISTER

SONY CORPORATION (JAPAN CORPORATION)
1-7-1 KONAN, MINATO-KU
TOKYO, JAPAN

FOR: MOBILE PHONES, PERSONAL COMPUTERS, IN CLASS 9 (U.S. CLS. 21, 23, 26, 36 AND 38).

THE MARK CONSISTS OF STANDARD CHARACTERS WITHOUT CLAIM TO ANY PARTICULAR FONT, STYLE, SIZE, OR COLOR.

OWNER OF JAPAN REG. NO. 5325631, DATED 5-28-2010, EXPIRES 5-28-2020.

SER. NO. 77-875,060, FILED 11-18-2009.

KRISTIN DAHLING, EXAMINING ATTORNEY



David J. Kybas

Director of the United States Patent and Trademark Office

United States of America

United States Patent and Trademark Office

TOLLGATE

Reg. No. 4,107,205

STRATUS VINEYARDS LIMITED (CANADA CORPORATION)
1150 FLINT ROAD
TORONTO ONTARIO M3J2J5, CANADA

Registered Mar. 6, 2012

Int. Cl.: 33

FOR: WINES, IN CLASS 33 (U.S. CLS. 47 AND 49).

TRADEMARK

THE MARK CONSISTS OF STANDARD CHARACTERS WITHOUT CLAIM TO ANY PARTICULAR FONT, STYLE, SIZE, OR COLOR.

PRINCIPAL REGISTER

PRIORITY CLAIMED UNDER SEC. 44(D) ON CANADA APPLICATION NO. 1439721, FILED 5-29-2009, REG. NO. TMA790352, DATED 2-10-2011, EXPIRES 2-10-2026.

SER. NO. 77-880,884, FILED 11-25-2009.

KRISTIN CARLSON, EXAMINING ATTORNEY



David J. Kybas

Director of the United States Patent and Trademark Office

United States of America

United States Patent and Trademark Office

BoldBioTech

Reg. No. 4,107,206

Registered Mar. 6, 2012

Int. Cl.: 9

TRADEMARK

PRINCIPAL REGISTER

JAMES C. TIMMONS (UNITED STATES INDIVIDUAL)
96044 CARIBBEAN COURT
FERNANDINA BEACH, FL 32034 AND

THURMAN TOM W. (UNITED STATES INDIVIDUAL)
19 CRENSHAW STREET
AMARILLO, TX 79124

FOR: ASEPTIC LIQUID SAMPLE COLLECTION DEVICES, NAMELY, A STERILE TWO LITER PLASTIC BAG WITH A TUBE ATTACHED THAT IS CONNECTED VIA AN ATTACHED LUERLOK CONNECTOR TO LINE CARRYING MILK OR OTHER BEVERAGES, STERILE 60CC SYRINGES WITH ATTACHED NEEDLES FOR SAMPLING OF LIQUID, SANITARY GASKETS WITH HOLES IN THEM FOR THE NEEDLE TO ACCESS LIQUIDS, AND STERILE NEEDLES WITH ATTACHED VALVES, ALL FOR QUALITY CONTROL TESTS IN THE DAIRY AND CHEESE INDUSTRIES, IN CLASS 9 (U.S. CLS. 21, 23, 26, 36 AND 38).

FIRST USE 2-1-2008; IN COMMERCE 4-27-2009.

THE MARK CONSISTS OF STANDARD CHARACTERS WITHOUT CLAIM TO ANY PARTICULAR FONT, STYLE, SIZE, OR COLOR.

SER. NO. 77-881,362, FILED 11-26-2009.

TINA L. SNAPP, EXAMINING ATTORNEY



David J. Kybas

Director of the United States Patent and Trademark Office

United States of America

United States Patent and Trademark Office



Reg. No. 4,107,207

Registered Mar. 6, 2012

Int. Cl.: 25

TRADEMARK

PRINCIPAL REGISTER

APPLESAMY GROUP INC. (NORTH CAROLINA CORPORATION)
101 COLLINGTON PL
MADISON, AL 35758

FOR: HATS; HEADWEAR; SHIRTS; SWEAT SHIRTS; T-SHIRTS; TOPS, IN CLASS 25 (U.S. CLS. 22 AND 39).

FIRST USE 8-0-2006; IN COMMERCE 8-0-2006.

THE MARK CONSISTS OF A SHIELD WITH THE IMAGE OF A WARRIOR'S HELMET WITHIN THE SHIELD. BELOW THE HELMET IS THE NUMBER "3". THERE ARE TWO CROSSES TO THE RIGHT AND LEFT OF THE HELMET AND ONE ABOVE THE HELMET. WITHIN THE SHIELD AT THE TOP IS THE NON-LATIN LETTERING FOR THE TERMS "KILL FACTORY". THE WORDING "KILL FACTORY" APPEARS ABOVE THE SHIELD. THE WORDING "VIOLENCE IS OUR GIFT" APPEARS BELOW THE SHIELD.

THE NON-LATIN CHARACTERS IN THE MARK TRANSLITERATE TO "KILL FACTORY" AND THIS MEANS KILL FACTORY IN ENGLISH.

SEC. 2(F).

SER. NO. 77-885,905, FILED 12-3-2009.

PAULA MAHONEY, EXAMINING ATTORNEY



David J. Kyffers

Director of the United States Patent and Trademark Office

United States of America

United States Patent and Trademark Office



Reg. No. 4,107,208

Registered Mar. 6, 2012

Int. Cls.: 29 and 30

TRADEMARK

PRINCIPAL REGISTER

HYPERAMA PLC (UNITED KINGDOM PUBLIC LIMITED COMPANY (PLC))
LENTON INDUSTRIAL ESTATE
HYPERAMA BUILDINGS; BULL CLOSE ROAD
NOTTINGHAM, UNITED KINGDOM NG72UT

FOR: MEAT, FISH, POULTRY AND GAME; MEAT EXTRACTS; PRESERVED, DRIED, COOKED AND FROZEN FRUITS AND VEGETABLES; JELLIES, JAMS; FRUIT SAUCES, NAMELY, APPLE SAUCE AND CRANBERRY SAUCE; PUREE FRUIT SAUCES, NAMELY, APPLE SAUCE AND CRANBERRY SAUCE; FRUIT PUREES; COMPOTES; EGGS; MILK; MILK PRODUCTS EXCLUDING ICE CREAM, ICE MILK AND FROZEN YOGURT; EDIBLE OILS AND FATS; CHEESE; MEAT IN SAVOURY SAUCES; FISH AND SEAFOOD; FROZEN FISH AND SEAFOOD; FROZEN FOODS, NAMELY, FROZEN MEAT, POULTRY AND GAME; SESAME OIL; GROUND NUT OIL; PRESERVED BLACK BEANS; DRIED AND PRESERVED PULSES; DRIED AND PRESERVED BEANS, PEAS AND LENTILS; PICKLES; PREPARATIONS FOR MAKING SAUCES CONSISTING PREDOMINANTLY OF MEAT, FISH, POULTRY OR VEGETABLE; TOMATO CONCENTRATES AND PUREES; TOMATO JUICES FOR COOKING; TOMATO PASTE; TOMATO PUREE; CANNED AND BOTTLED FRUIT; CANNED AND BOTTLED VEGETABLES; PREPARED MEALS AND SNACKS CONSISTING PRIMARILY OF MEAT, FISH, POULTRY OR VEGETABLES; FROZEN PREPARED MEALS AND SNACKS CONSISTING PRIMARILY OF MEAT, FISH, POULTRY OR VEGETABLES; COOKED MEALS AND SNACKS CONSISTING PRIMARILY OF MEAT, FISH, POULTRY OR VEGETABLES; SALADS EXCEPT MACARONI, RICE, AND PASTA SALAD; FRUIT SALADS; VEGETABLE SALADS; GARDEN SALADS; SOUPS; POTATO CRISPS; PREPARED APPETIZERS AND ENTREES CONSISTING PREDOMINANTLY OF MEAT, FISH, POULTRY OR VEGETABLES, IN CLASS 29 (U.S. CL. 46).



David J. Kappas

Director of the United States Patent and Trademark Office

FOR: COFFEE; TEA; COCOA; SUGAR; RICE; LONG GRAIN RICE; TAPIOCA; SAGO; ARTIFICIAL COFFEE; FLOUR AND PREPARATIONS MADE FROM CEREALS, NAMELY, BREAKFAST CEREALS, CEREAL-BASED SNACK FOODS AND CEREAL BASED ENERGY BARS; PREPARATIONS MADE FROM BREAD, NAMELY, BUNS, BREAD BASES, BISCUITS, BREAD ROLLS, BREAD STICKS, FRUIT BREADS, GARLIC BREAD, PITA BREAD, NAAN BREAD, CHAPATTIS, POPPADOMS, PARATHAS, UNLEAVENED BREAD, WHOLEMEAL BREAD, BAGUETTES, CROISSANTS, SANDWICHES, BAGELS AND WRAPS; PREPARATIONS MADE FROM PASTRY, NAMELY, PASTRIES, MACAROONS, PASTIES; CONFECTIONERY, NAMELY, SWEETS AND CHOCOLATES; ICES; HONEY; TREACLE; YEAST, BAKING-POWDER; SALT, MUSTARD; VINEGAR, SAUCES; SPICES; ICE; SANDWICHES; PIES; SOY SAUCE; BLACK BEAN SAUCE; HOI SIN SAUCE; CURRY SPICES; CURRY

Reg. No. 4,107,208 MIXES; CURRY PASTE; CURRY POWDER; CURRY SAUCES; SEASONINGS; SAUCES; FRUIT SAUCES, NAMELY, PLUM SAUCE, STRAWBERRY SAUCE AND RASPBERRY SAUCE, BUT EXCLUDING APPLE SAUCE AND CRANBERRY SAUCE; PUREE FRUIT SAUCES, EXCLUDING APPLE SAUCE AND CRANBERRY SAUCE; PREPARED SAUCES; CANNED SAUCES; SAUCES FOR FISH; BARBECUE SAUCE; BROWN SAUCE; COOKING SAUCES; FOOD DRESSINGS, NAMELY, SALAD DRESSINGS AND COLE SLAW DRESSING; TOMATO KETCHUP; TOMATO SAUCE; SAUCE MIXES AND POWDERS; SAUCES FOR MEAT, FISH, SEAFOOD, POULTRY, GAME, VEGETABLES, AND PASTA; SAVOURY SAUCES; PREPARED SAUCES; MAYONNAISE; CHUTNEY; PREPARED MEALS AND SNACKS CONSISTING PRIMARILY OF PASTA, NOODLES AND RICE; PREPARED SNACKS IN THE FORM OF RICE, PASTA AND NOODLE DISHES; COOKED MEALS AND SNACKS CONSISTING PRIMARILY OF PASTA, NOODLES AND RICE; FROZEN PREPARED MEALS AND SNACKS CONSISTING PRIMARILY OF PASTA, NOODLES AND RICE; FROZEN, PREPARED AND PACKAGED PASTRY STUFFED WITH FISH, SEAFOOD AND VEGETABLES; RICE-BASED DISHES, NAMELY, FROZEN, PREPARED AND PACKAGED RICE-BASED DISHES; PIZZAS; FROZEN PIZZAS; PASTAS AND PREPARED PASTA-BASED DISHES. PASTA AND NOODLES; SPAGHETTI AND SPAGHETTI-BASED DISHES; CANNED SPAGHETTI IN TOMATO SAUCE; ICE CREAM; BAKERY DESSERTS; DESSERT PUDDINGS; PUDDINGS; BISCUITS; BREAD; CAKES; BEVERAGES MADE OF TEA; BEVERAGES MADE OF COFFEE; BEVERAGES WITH A CHOCOLATE BASE; CRACKERS; RICE CRACKERS; PRAWN CRACKERS; FISH CRACKERS; CHUTNEY; DESSERTS, NAMELY, INSTANT DESSERT PUDDINGS, INSTANT PUDDING MIXES, RICE PUDDING, RICE-BASED PUDDING DESSERTS, FLAVOURED ICES, FRUIT ICES, COOKIES, FORTUNE COOKIES, RICE DOUGH, FRITTERS, NAMELY, APPLE, BANANA, CORN AND PINEAPPLE FRITTERS, DESSERT MOUSSE, PANCAKES AND PANCAKE MIXES, KULFI IN THE NATURE OF FROZEN CONFECTIONERY SIMILAR TO ICE CREAM, AND TOFFEE, IN CLASS 30 (U.S. CL. 46).

PRIORITY CLAIMED UNDER SEC. 44(D) ON UNITED KINGDOM APPLICATION NO. 2524958, FILED 8-26-2009, REG. NO. 2524958, DATED 2-26-2010, EXPIRES 8-26-2019.

THE MARK CONSISTS OF THE WORDS "TRAVELER'S CHOICE" AND THE DESIGN OF THE PLANET EARTH.

SER. NO. 77-889,421, FILED 12-9-2009.

GINA FINK, EXAMINING ATTORNEY

United States of America

United States Patent and Trademark Office

Discover the freedom

Reg. No. 4,107,209

Registered Mar. 6, 2012

Int. Cl.: 9

TRADEMARK

PRINCIPAL REGISTER

LG ELECTRONICS INC. (REPUBLIC OF KOREA CORPORATION)
20, YEUIDO-DONG, YEONGDEUNGPO-GU
SEOUL, REPUBLIC OF KOREA 150-721

FOR: TELEVISION RECEIVERS; TELEVISION REMOTE CONTROLLERS; MICROCHIPS FOR IMPROVEMENT OF TELEVISION IMAGE QUALITY, IN CLASS 9 (U.S. CLS. 21, 23, 26, 36 AND 38).

THE MARK CONSISTS OF STANDARD CHARACTERS WITHOUT CLAIM TO ANY PARTICULAR FONT, STYLE, SIZE, OR COLOR.

PRIORITY CLAIMED UNDER SEC. 44(D) ON REPUBLIC OF KOREA APPLICATION NO. 402009006078, FILED 12-9-2009.

OWNER OF ERPN CMNTY TM OFC REG. NO. 008748899, DATED 6-11-2010, EXPIRES 12-11-2019.

SER. NO. 77-890,329, FILED 12-10-2009.

DEZMONA MIZELLE, EXAMINING ATTORNEY



David J. Kyffers

Director of the United States Patent and Trademark Office

United States of America

United States Patent and Trademark Office

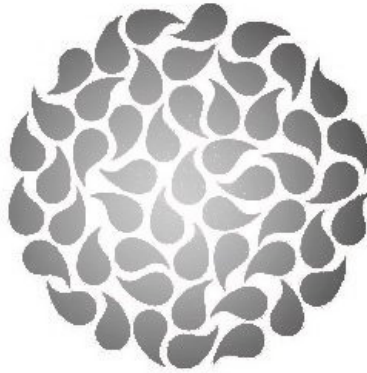

Reg. No. 4,107,210

Registered Mar. 6, 2012

Int. Cls.: 35, 36 and 41

SERVICE MARK

PRINCIPAL REGISTER

CAREGGI PUBLISHING LIMITED (BR. VIRGIN ISLANDS COMPANY)
P.O. BOX 3162
WOODBOURNE HALL
ROAD TOWN, TORTOLA, BR. VIRGIN ISLANDS

FOR: BUSINESS APPRAISALS; BUSINESS INFORMATION IN THE FIELDS OF MUSIC, THE ARTS AND THE MEDIA; ASSISTANCE WITH BUSINESS MANAGEMENT AND PLANNING; ADVISORY SERVICES RELATING TO BUSINESS RISK MANAGEMENT; BUSINESS ADVISORY SERVICES IN THE FIELD OF BUSINESS PERFORMANCE; BUSINESS PROJECT MANAGEMENT; COMMERCIAL EXPLOITATION OF THE GOODS AND SERVICES OF OTHERS, NAMELY, PROMOTING THE GOODS AND SERVICES OF OTHERS THROUGH SEARCH ENGINE REFERRAL TRAFFIC ANALYSIS AND REPORTING; PROJECT STUDIES FOR BUSINESSES, NAMELY, CONDUCTING FEASIBILITY STUDIES FOR BUSINESS PURPOSES; WRITING OF BUSINESS PROJECT REPORTS AND STUDIES, NAMELY, PREPARING BUSINESS REPORTS; BUSINESS EVALUATION SERVICES, NAMELY, BUSINESS APPRAISALS AND EVALUATIONS IN BUSINESS MATTERS; EVALUATION OF BUSINESS OPPORTUNITIES, NAMELY, BUSINESS INVESTIGATIONS, EVALUATIONS, EXPERT APPRAISALS, INFORMATION AND RESEARCH; COMPUTERIZED ACCOUNTING SERVICES, NAMELY, DRAWING UP OF STATEMENTS OF ACCOUNTS; BUSINESS INVESTIGATIONS; BUSINESS RESEARCH; COMMERCIAL OR INDUSTRIAL MANAGEMENT ASSISTANCE; COMPILATION OF STATISTICS; SPONSORSHIP SEARCH; PREPARING FINANCIAL REPORTS FOR OTHERS, IN CLASS 35 (U.S. CLS. 100, 101 AND 102).

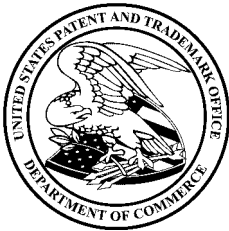

David J. Kybas

Director of the United States Patent and Trademark Office

FOR: CAPITAL INVESTMENT SERVICES; PROVIDING FINANCIAL INFORMATION; INVESTMENT SERVICES IN THE NATURE OF FUNDING DEVELOPMENT PROJECTS, NAMELY, DEVELOPING FUND RAISING CAMPAIGNS FOR OTHERS; INVESTMENT MANAGEMENT SERVICES, NAMELY, MANAGEMENT AND ADMINISTRATION OF INVESTMENT FUNDS FOR CHARITABLE AND PHILANTHROPIC PURPOSES; FINANCIAL GRANT SERVICES, NAMELY, PROVIDING GRANTS TO INDIVIDUALS AS INCENTIVES TO DEMONSTRATE EXCELLENCE IN THE ARTS AND ENCOURAGING FREEDOM OF EXPRESSION IN THE ARTS AND THE MEDIA; FINANCIAL GRANT SERVICES IN THE FIELDS OF EDUCATION, ENTREPRENEURSHIP AND COMMUNITY DEVELOPMENT, NAMELY, PROVIDING PROJECT GRANTS FOR RAISING AWARENESS OF SOCIAL AND HUMANITARIAN ISSUES AND THE PROMOTION OF HUMAN RIGHTS AND FREEDOM OF EXPRESSION; FINANCIAL GRANT SERVICES, NAMELY, PROVIDING GRANTS TO MULTILATERAL OR BILATERAL AGENCIES, NON-GOVERNMENTAL ORGANIZATIONS,

Reg. No. 4,107,210 ACADEMIC INSTITUTIONS, PUBLIC COMPANIES, AND PRIVATE BUSINESSES; FINANCIAL SERVICES, NAMELY, PROVIDING FINANCIAL SPONSORSHIP OF MUSIC, ART, CULTURAL AND EDUCATIONAL ACTIVITIES; FINANCIAL SERVICES, NAMELY, PROVIDING PROJECT GRANTS FOR CULTURAL AND EDUCATIONAL PROGRAMS TO RAISE AWARENESS OF SOCIAL AND HUMANITARIAN ISSUES AND PROMOTE HUMAN RIGHTS AND FREEDOM OF EXPRESSION; VENTURE CAPITAL SERVICES, NAMELY, PROVIDING DEVELOPMENT FINANCING TO COMMUNITIES; FINANCIAL MANAGEMENT OF FUNDS TO FINANCE DEVELOPMENT PROJECTS; FINANCIAL ANALYSIS; INVESTMENT MANAGEMENT SERVICES, NAMELY, ARRANGING OF INVESTMENTS FOR THE GROWTH AND BENEFIT OF COMMUNITIES; INVESTMENT MANAGEMENT SERVICES, NAMELY, INVESTMENT PERFORMANCE MONITORING; INVESTMENT RESEARCH; FINANCIAL RESEARCH SERVICES RELATING TO INVESTMENT, NAMELY, RESEARCH AND DEVELOPMENT OF INVESTMENT METHODS FOR FUNDING DEVELOPMENT PROJECTS; CAPITAL INVESTMENT IN SMALL, INDEPENDENT, AND SEED ENTERPRISES IN COMMUNITIES; VENTURE CAPITAL SERVICES, NAMELY, PROVIDING FINANCING TO SMALL, INDEPENDENT, AND SEED ENTERPRISES IN COMMUNITIES, IN CLASS 36 (U.S. CLS. 100, 101 AND 102).

FOR: ARRANGING AND CONDUCTING OF ARTISTIC PRIZE COMPETITIONS RELATING TO THE PROMOTION OF SOCIAL DEVELOPMENT, HUMAN RIGHTS AND FREEDOM OF EXPRESSION; ORGANIZATION OF EXHIBITIONS FOR CULTURAL OR EDUCATIONAL PURPOSES; PRESENTATION OF LIVE SHOW PERFORMANCES; PUBLICATION OF BOOKS; PUBLICATION OF BOOKS, MAGAZINES, JOURNALS, PERIODICALS AND OTHER PRINTED MATTER; ELECTRONIC PUBLISHING SERVICES, NAMELY, PUBLICATION OF TEXT AND GRAPHIC WORKS OF OTHERS ON VIDEO DISCS, VIDEO TAPES, COMPACT DISCS, CD-ROMS AND DVDS FEATURING INFORMATION AND TOPICS IN THE FIELD OF THE ARTS TO PROMOTE CREATIVE EXPRESSION FOR HUMAN DEVELOPMENT INCLUDING EMPOWERMENT OF WOMEN, TO BUILD STRONG FOUNDATIONS FOR ECONOMIC, POLITICAL AND CULTURAL DEVELOPMENT FOR PEACE AND PROSPERITY; PROVIDING RECOGNITION AND INCENTIVES BY THE WAY OF AWARDS AND CONTESTS TO DEMONSTRATE EXCELLENCE IN THE FIELD OF THE ARTS AND THE MEDIA RELATING TO THE PROMOTION OF SOCIAL DEVELOPMENT, HUMAN RIGHTS AND FREEDOM OF EXPRESSION; FILM PRODUCTION; PRODUCTION OF RADIO AND TELEVISION PROGRAMS; VIDEO TAPE FILM PRODUCTION; EDUCATIONAL SERVICES, NAMELY, ARRANGING AND CONDUCTING CONFERENCES, CONGRESSES, SEMINARS AND SYMPOSIUMS IN THE FIELD OF THE ARTS AND THE MEDIA AND USE OF THE ARTS AND THE MEDIA FOR THE PROMOTION OF SOCIAL DEVELOPMENT, HUMAN RIGHTS AND FREEDOM OF EXPRESSION; EDUCATIONAL SERVICES, NAMELY, PROVIDING INCENTIVES TO INDIVIDUALS TO DEMONSTRATE EXCELLENCE IN THE FIELD OF THE ARTS AND ENCOURAGE FREEDOM OF EXPRESSION IN THE ARTS AND THE MEDIA; INSTRUCTION SERVICES, NAMELY, INSTRUCTION IN THE FIELD OF THE ARTS AND THE MEDIA AND THE USE OF THE ARTS AND THE MEDIA FOR THE PROMOTION OF FREEDOM OF EXPRESSION; EDUCATION SERVICES, NAMELY, PROVIDING CONFERENCES, CONGRESSES, SEMINARS, SYMPOSIUMS, COLLOQUIUMS, AND WORKSHOPS IN THE FIELD OF THE ARTS AND THE MEDIA AND THE USE OF THE ARTS AND THE MEDIA FOR THE PROMOTION OF SOCIAL DEVELOPMENT, HUMAN RIGHTS AND FREEDOM OF EXPRESSION; INSTRUCTION SERVICES FOR THE ADMINISTRATION AND MANAGEMENT OF EDUCATIONAL, ENTREPRENEURIAL AND SOCIAL DEVELOPMENT PROJECTS, NAMELY, INSTRUCTION IN THE FIELD THE ARTS AND THE MEDIA AND USE OF THE ARTS AND THE MEDIA FOR THE PROMOTION OF SOCIAL DEVELOPMENT, HUMAN RIGHTS AND FREEDOM OF EXPRESSION; EDUCATIONAL SERVICES, NAMELY, ARRANGING AND CONDUCTING OF COLLOQUIUMS, SEMINARS, AND WORKSHOPS IN THE FIELD OF ADMINISTRATION AND MANAGEMENT OF EDUCATIONAL, ENTREPRENEURIAL AND SOCIAL DEVELOPMENT PROJECTS; EDUCATIONAL SERVICES, NAMELY, ARRANGING AND CONDUCTING CONFERENCES, CONGRESSES, SEMINARS AND SYMPOSIUMS IN THE FIELD OF OPERATION AND IMPLEMENTATION OF EDUCATIONAL, ENTREPRENEURIAL AND SOCIAL DEVELOPMENT PROJECTS, IN CLASS 41 (U.S. CLS. 100, 101 AND 107).

Reg. No. 4,107,210 OWNER OF SINGAPORE REG. NO. T0913050E, DATED 11-12-2009, EXPIRES 11-12-2019.

THE MARK CONSISTS OF NUMEROUS CURVED TEARDROP SHAPES GROUPED TOGETHER IN A CIRCULAR PATTERN.

SER. NO. 77-891,506, FILED 12-11-2009.

CIMMERIAN COLEMAN, EXAMINING ATTORNEY

United States of America

United States Patent and Trademark Office

GAZZELLE CIAMPI

Reg. No. 4,107,211

GAZZELLE CHAMPY (UNITED STATES INDIVIDUAL)
120 EAST MAIN ST.
RAMSEY, NJ 07446

Registered Mar. 6, 2012

Int. Cl.: 25

FOR: WEARABLE GARMENTS AND CLOTHING, NAMELY, SHIRTS, IN CLASS 25 (U.S. CLS. 22 AND 39).

TRADEMARK

FIRST USE 6-1-1994; IN COMMERCE 6-1-1994.

PRINCIPAL REGISTER

THE MARK CONSISTS OF STANDARD CHARACTERS WITHOUT CLAIM TO ANY PARTICULAR FONT, STYLE, SIZE, OR COLOR.

OWNER OF U.S. REG. NO. 1,927,931.

THE NAME(S), PORTRAIT(S), AND/OR SIGNATURE(S) SHOWN IN THE MARK IDENTIFIES GAZZELLE CHAMPY, WHOSE CONSENT(S) TO REGISTER IS MADE OF RECORD.

THE ENGLISH TRANSLATION OF "GAZZELLE CIAMPI" IN THE MARK IS "GAZZELLE CIAMPI". THE WORDING "GAZZELLE CIAMPI" HAS NO MEANING IN A FOREIGN LANGUAGE.

SER. NO. 77-891,710, FILED 12-11-2009.

TRACY CROSS, EXAMINING ATTORNEY



David J. Kyros

Director of the United States Patent and Trademark Office

United States of America

United States Patent and Trademark Office

SNOW COUNTRY

Reg. No. 4,107,212

HOBBS BONDED FIBERS, INC. (TEXAS CORPORATION)
200 COMMERCE DRIVE
WACO, TX 76710

Registered Mar. 6, 2012

Int. Cl.: 22

FOR: POLYESTER BATTING; POLYESTER FIBERS; POLYESTER STUFFING FIBERS, IN CLASS 22 (U.S. CLS. 1, 2, 7, 19, 22, 42 AND 50).

TRADEMARK

FIRST USE 1-31-2002; IN COMMERCE 1-31-2002.

PRINCIPAL REGISTER

THE MARK CONSISTS OF STANDARD CHARACTERS WITHOUT CLAIM TO ANY PARTICULAR FONT, STYLE, SIZE, OR COLOR.

SER. NO. 77-893,007, FILED 12-14-2009.

JOHN SCHUYLER YARD, EXAMINING ATTORNEY



David J. Kybas

Director of the United States Patent and Trademark Office

United States of America

United States Patent and Trademark Office

LEDON

Reg. No. 4,107,213

Registered Mar. 6, 2012

Int. Cls.: 9 and 11

TRADEMARK

PRINCIPAL REGISTER

ZUMTOBEL AG (AUSTRIA AKTIENGESELLSCHAFT)
HÖCHSTER STRASSE 8
DORNBIRN, AUSTRIA

FOR: ELECTRIC AND ELECTRONIC EQUIPMENT FOR THE OPERATION OF LIGHT EMITTING DIODES AND ELECTROLUMINESCENT FILMS; ELECTRONIC REGULATING AND CONTROL DEVICES FOR THE OPERATION OF LIGHT EMITTING DIODES; FLASHLIGHTS WITH LIGHT EMITTING DIODES FOR PHOTOGRAPHICAL USE; LIGHT EMITTING DIODES, IN CLASS 9 (U.S. CLS. 21, 23, 26, 36 AND 38).

FOR: ELECTRIC LAMPS, IN PARTICULAR RETROFIT LAMPS WITH LIGHT EMITTING DIODES AS THE MEANS OF LIGHTING; LIGHT MODULES AND LIGHTS WITH LIGHT EMITTING DIODES AS THE MEANS OF LIGHTING, NAMELY, SPOTLIGHTS, DOWN-LIGHTS, CEILING RECESSED LIGHT MODULES, FLOODLIGHT MODULES, BATTENS, TRUNKING LIGHT MODULES, FLOOR RECESSED LIGHT MODULES, FREE STANDING LIGHT MODULES, SURFACE MOUNTED AND RECESSED LIGHT MODULES, SURFACE MOUNTED AND SUSPENDED LIGHT MODULES, SUSPENDED LIGHT MODULES, TOP-MOUNTED LIGHT MODULES, WALL MOUNTED LIGHT MODULES, WALL RECESSED LIGHT MODULES; SOURCES OF LIGHT, NAMELY, LIGHT EMITTING DIODES LIGHTING FIXTURES, IN CLASS 11 (U.S. CLS. 13, 21, 23, 31 AND 34).

THE MARK CONSISTS OF STANDARD CHARACTERS WITHOUT CLAIM TO ANY PARTICULAR FONT, STYLE, SIZE, OR COLOR.

PRIORITY CLAIMED UNDER SEC. 44(D) ON AUSTRIA APPLICATION NO. AM4171/2009, FILED 7-10-2009, REG. NO. 253487, DATED 10-14-2009, EXPIRES 10-31-2019.

OWNER OF U.S. REG. NO. 3,245,187.

SER. NO. 77-895,468, FILED 12-17-2009.

KATHERINE STOIDES, EXAMINING ATTORNEY



David J. Kyffers

Director of the United States Patent and Trademark Office

United States of America

United States Patent and Trademark Office

A NEW BEGINNING

Reg. No. 4,107,214

Registered Mar. 6, 2012

Int. Cl.: 16

TRADEMARK

PRINCIPAL REGISTER

GOLDEN SHELTERS PRIVATE LIMITED (INDIA COMPANY)
33, SHAFEE MOHAMMED ROAD
4TH FLOOR, RUTLAND TOWERS
CHENNAI, TAMIL NADU, INDIA 600006

FOR: PAPER, CARDBOARD AND OTHER OFFICE SUPPLY MATERIALS, NAMELY, PENS, PENCILS, STAPLERS, PAPER HOLE PUNCHERS, ADHESIVE TAPE FOR HOUSEHOLD OR STATIONERY USE AND ADHESIVE TAPE DISPENSERS, RUBBER BANDS AND STATIONERY, IN CLASS 16 (U.S. CLS. 2, 5, 22, 23, 29, 37, 38 AND 50).

THE MARK CONSISTS OF STANDARD CHARACTERS WITHOUT CLAIM TO ANY PARTICULAR FONT, STYLE, SIZE, OR COLOR.

PRIORITY CLAIMED UNDER SEC. 44(D) ON ERPN CMNTY TM OFC APPLICATION NO. 008763161, FILED 12-16-2009, REG. NO. 008763161, DATED 6-15-2010, EXPIRES 12-16-2019.

SER. NO. 77-895,530, FILED 12-17-2009.

PAM WILLIS, EXAMINING ATTORNEY



David J. Kyffers

Director of the United States Patent and Trademark Office

United States of America

United States Patent and Trademark Office

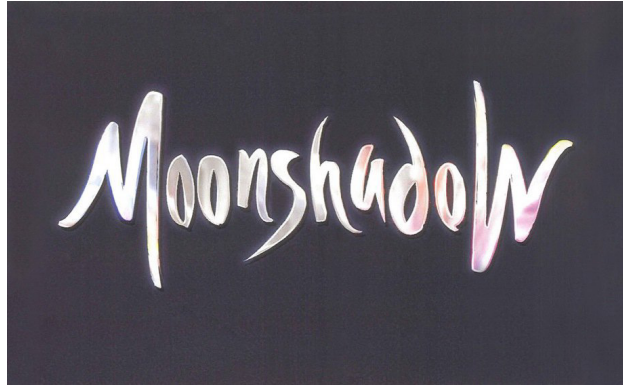

Reg. No. 4,107,215

Registered Mar. 6, 2012

Int. Cls.: 9, 16, 25 and 41

TRADEMARK

SERVICE MARK

PRINCIPAL REGISTER

MOONSHADOW FZ LLC (UNITED ARAB EMIR. LIMITED LIABILITY COMPANY)
C/O 131 SALUSBURY ROAD
LONDON, UNITED KINGDOM NW66RN

FOR: FILMS, VIDEOS, CASSETTES, RECORDS, COMPACT DISCS, DISCS, ALL FEATURING MUSIC OR FILMS ABOUT OR FEATURING, MUSICAL PERFORMANCE AND ARTISTS, MUSICAL PERFORMANCES AND DRAMA; SOFTWARE FOR LISTENING TO MUSIC OR WATCHING FILMS OR FOR PLAYING AMUSEMENT GAMES FOR ENTERTAINMENT; MUSICAL SOUND AND VIDEO RECORDINGS; PRE-RECORDED AUDIO AND VIDEO MEDIA, NAMELY, PRE-RECORDED COMPACT DISCS, AUDIO CASSETTES, PRE-RECORDED VIDEOCASSETTES, DVDS AND PHONOGRAPH RECORDS FEATURING MUSIC; PRE-RECORDED AUDIO AND VIDEO MEDIA IN MP3 DIGITAL FORMATS, NAMELY, MUSICAL DATA IN DIGITAL FORM DOWNLOADED FROM A GLOBAL COMPUTER NETWORK AND RECORDED ON MAGNETIC MEDIA; CD BAGS MADE FROM PAPER OR PLASTIC, IN CLASS 9 (U.S. CLS. 21, 23, 26, 36 AND 38).

FOR: STATIONERY; PRINTED MATTER, NAMELY, BOOKS, NEWSPAPERS, NEWSLETTERS, PAMPHLETS, PERIODICALS, CATALOGS, BROCHURES, AND PROGRAMS, ALL ABOUT ENTERTAINMENT, MUSIC AND MUSIC ARTISTS; MAGAZINES IN THE FIELD OF ENTERTAINMENT AND MUSIC; STICKERS; PHOTOGRAPHS; POSTERS; PAPER BAGS; ART PRINTS; PHOTOGRAPH ALBUMS; NOTE CARDS, IN CLASS 16 (U.S. CLS. 2, 5, 22, 23, 29, 37, 38 AND 50).

FOR: T-SHIRTS; CLOTHING ACCESSORIES, NAMELY, WRIST BANDS; BELTS; SCARVES; JACKETS; HOODED TOPS; FOOTWEAR; HATS AND HEADWEAR; NONE BEING SKI WEAR OR FOR USE IN WINTER SPORTS, IN CLASS 25 (U.S. CLS. 22 AND 39).

FOR: FILM PRODUCTION; PRESENTATION OF LIVE MUSICAL, SINGING, DANCE, DRAMATIC AND VARIETY PERFORMANCES; PUBLISHING OF BOOKS AND MAGAZINES; SOUND RECORDING PRODUCTION SERVICES; LIVE PERFORMANCES OF MUSIC AND SINGING; AUDIO VISUAL PERFORMANCES; ENTERTAINMENT SERVICES, NAMELY, PERSONAL PERFORMANCES BY MUSICAL ARTISTS; PROVIDING MUSIC AND MUSIC-RELATED INFORMATION VIA THE INTERNET; ORGANIZING CULTURAL EVENTS, IN CLASS 41 (U.S. CLS. 100, 101 AND 107).

PRIORITY CLAIMED UNDER SEC. 44(D) ON ERPN CMNTY TM OFC APPLICATION NO. 008766651, FILED 12-17-2009, REG. NO. 008766651, DATED 6-11-2010, EXPIRES 12-17-2019.



David J. Kyros

Director of the United States Patent and Trademark Office

Reg. No. 4,107,215 THE COLOR(S) BLACK, WHITE, GRAY, SILVER, PINK, PURPLE, YELLOW AND BROWN IS/ARE CLAIMED AS A FEATURE OF THE MARK.

THE MARK CONSISTS OF THE WORD "MOONSHADOW"; BLACK APPEARS IN THE BACKGROUND OF THE MARK, THE LETTERS ARE WHITE, GRAY AND SILVER; PINK APPEARS IN THE "W" AND THE "D", TRACES OF PURPLE APPEAR IN THE "M" AND THE "W", TRACES OF YELLOW AND BROWN APPEAR IN "ADO".

SER. NO. 77-896,416, FILED 12-18-2009.

HEATHER THOMPSON, EXAMINING ATTORNEY

United States of America

United States Patent and Trademark Office

PEOPLEPOND

Reg. No. 4,107,216

Registered Mar. 6, 2012

Int. Cl.: 35

SERVICE MARK

PRINCIPAL REGISTER

PEOPLEPOND, LLC (WASHINGTON LIMITED LIABILITY COMPANY)
6220 PORTAL WAY
FERNDALE, WA 98248

FOR: PROVIDING AN ONLINE DIRECTORY INFORMATION SERVICE FEATURING PERSONAL PROFILE AND BUSINESS INFORMATION ABOUT INDIVIDUALS; PROVIDING ONLINE BUSINESS AND MARKETING STRATEGIES FOCUSED ON HELPING BUSINESSES CREATE, EXTEND, AND MANAGE THEIR BRANDS AND CREATE GREATER VISIBILITY FOR THEIR SOCIAL MEDIA, SOCIAL NETWORKING, AND OTHER ONLINE RESOURCES, IN CLASS 35 (U.S. CLS. 100, 101 AND 102).

FIRST USE 3-4-2009; IN COMMERCE 3-4-2009.

THE MARK CONSISTS OF STANDARD CHARACTERS WITHOUT CLAIM TO ANY PARTICULAR FONT, STYLE, SIZE, OR COLOR.

SER. NO. 77-897,330, FILED 12-18-2009.

CHRISIE B. KING, EXAMINING ATTORNEY



David J. Kybas

Director of the United States Patent and Trademark Office

United States of America

United States Patent and Trademark Office



LA GARDE

Reg. No. 4,107,217

Registered Mar. 6, 2012

Int. Cl.: 6

TRADEMARK

PRINCIPAL REGISTER

SML GROUPE ACIER INOXYDABLE (CANADA CORPORATION)
5170 RIDEAU STREET
QUEBEC, CANADA G2E5S4

FOR: VATS OF STAINLESS STEEL AND OF METAL FOR WINEMAKING, IN CLASS 6 (U.S. CLS. 2, 12, 13, 14, 23, 25 AND 50).

PRIORITY CLAIMED UNDER SEC. 44(D) ON CANADA APPLICATION NO. 1444228, FILED 7-9-2009, REG. NO. TMA808135, DATED 10-3-2011, EXPIRES 10-3-2026.

THE MARK CONSISTS OF A THREE-HEADED BIRD POSITIONED ABOVE THE WORDS "LA GARDE".

THE ENGLISH TRANSLATION OF "LA GARDE" IN THE MARK IS THE GUARD.

SER. NO. 77-898,367, FILED 12-21-2009.

REBECCA EISINGER, EXAMINING ATTORNEY



David J. Kybas

Director of the United States Patent and Trademark Office

United States of America

United States Patent and Trademark Office

Cléd'Or

Reg. No. 4,107,218

Registered Mar. 6, 2012

Int. Cl.: 30

TRADEMARK

PRINCIPAL REGISTER

BINGGRAE CO., LTD. (REPUBLIC OF KOREA CORPORATION)
344-3, DONONG-DONG, NAMYANGJU-SHI
KYUNGGI-DO, REPUBLIC OF KOREA 472-711

FOR: ICE CREAM; ICE CANDIES; ICED CAKES; ICE SHERBETS; CONES FOR ICE CREAM; ICE CREAM MIXES; ICED TEA; EDIBLE ICES; ICE BLOCKS; PROCESSED CEREALS; CEREAL-BASED SNACK FOODS; FRUIT ICE; FRUIT JELLIES; FROZEN YOGURT CONFECTIONS; GREEN TEA; TEA SUBSTITUTES; ARTIFICIAL COFFEE; MILK CHOCOLATE; COFFEE BEVERAGES WITH MILK; COCOA BEVERAGES WITH MILK; CHEWING GUM, NOT FOR MEDICAL PURPOSES; BREAD; SAUCES; TEA; TEA-BASED BEVERAGES; CHOCOLATE; CHOCOLATE BARS; CHOCOLATE CANDIES; CHOCOLATE PASTES; CANDY; COFFEE; COFFEE BASED BEVERAGES; CAKES; COOKIES; CRACKERS; PASTA; PIES; PANCAKES; PIZZA; PEPPER, IN CLASS 30 (U.S. CL. 46).

PRIORITY CLAIMED UNDER SEC. 44(D) ON REPUBLIC OF KOREA APPLICATION NO. 40-2009-0062, FILED 12-16-2009, REG. NO. 0851890, DATED 2-1-2011, EXPIRES 2-1-2021.

THE MARK CONSISTS OF THE STYLIZED WORDING "CLÉD'OR".

THE ENGLISH TRANSLATION OF "CLÉD'OR" IN THE MARK IS "GOLDEN KEY".

SER. NO. 77-898,905, FILED 12-22-2009.

DOMINIC FATHY, EXAMINING ATTORNEY



David J. Kyffers

Director of the United States Patent and Trademark Office

United States of America

United States Patent and Trademark Office

Casanova Cowboy

Reg. No. 4,107,219

Registered Mar. 6, 2012

Int. Cl.: 41

SERVICE MARK

PRINCIPAL REGISTER

DANIEL CASANOVA COWBOY HAMILL (UNITED STATES INDIVIDUAL), AKA
CASANOVA COWBOY OR DANIEL O HAMILL
2301 HERRING AVE
WACO, TX 76708

FOR: ENTERTAINMENT IN THE NATURE OF LIVE PERFORMANCES BY READING ORIGINAL POETRY, POEM WRITING AND SINGING ORIGINAL SONGS; ENTERTAINMENT IN THE NATURE OF POETRY READING; ENTERTAINMENT SERVICES, NAMELY, PROVIDING A WEB SITE FEATURING PHOTOGRAPHIC AND PROSE PRESENTATIONS FEATURING ORIGINAL WORKS OF POETRY AND SONGS BY CASANOVA COWBOY, IN CLASS 41 (U.S. CLS. 100, 101 AND 107).

FIRST USE 5-7-1981; IN COMMERCE 7-2-1981.

THE MARK CONSISTS OF STANDARD CHARACTERS WITHOUT CLAIM TO ANY PARTICULAR FONT, STYLE, SIZE, OR COLOR.

THE NAME "CASANOVA COWBOY" IDENTIFIES A LIVING INDIVIDUAL WHOSE CONSENT IS OF RECORD. "CASANOVA COWBOY" IS THE STAGE NAME OF DANIEL CASANOVA COWBOY HAMILL, A LIVING INDIVIDUAL WHOSE CONSENT IS OF RECORD.

SER. NO. 77-898,954, FILED 12-22-2009.

ANTHONY RINKER, EXAMINING ATTORNEY



David J. Kybas

Director of the United States Patent and Trademark Office

United States of America

United States Patent and Trademark Office

LITTLE MISS AND MISTER GLITZ PAGEANTS

Reg. No. 4,107,220

Registered Mar. 6, 2012

Int. Cl.: 41

SERVICE MARK

PRINCIPAL REGISTER

SIMS, STEPHANIE O. (UNITED STATES INDIVIDUAL)
#160
4377 N. COMMERCIAL WAY, #160
SPRING HILL, FL 34606

FOR: ENTERTAINMENT IN THE NATURE OF BEAUTY PAGEANTS, IN CLASS 41 (U.S. CLS. 100, 101 AND 107).

FIRST USE 12-1-2006; IN COMMERCE 12-1-2006.

THE MARK CONSISTS OF STANDARD CHARACTERS WITHOUT CLAIM TO ANY PARTICULAR FONT, STYLE, SIZE, OR COLOR.

NO CLAIM IS MADE TO THE EXCLUSIVE RIGHT TO USE PAGEANTS, APART FROM THE MARK AS SHOWN.

SER. NO. 77-901,108, FILED 12-26-2009.

YAT SYE, LEE, EXAMINING ATTORNEY



David J. Kyffers

Director of the United States Patent and Trademark Office

United States of America

United States Patent and Trademark Office

SHOCKFRAC

Reg. No. 4,107,221

Registered Mar. 6, 2012

Int. Cl.: 7

TRADEMARK

PRINCIPAL REGISTER

SANJEL LIMITED PARTNERSHIP (CANADA PARTNERSHIP)
200, 505 2 STREET S.W.
CALGARY, ALBERTA, CANADA T2P1N8

FOR: A DOWNHOLE TOOL USED FOR THE PURPOSE OF TREATMENT FORMATIONS
IN WELLBORES, IN CLASS 7 (U.S. CLS. 13, 19, 21, 23, 31, 34 AND 35).

THE MARK CONSISTS OF STANDARD CHARACTERS WITHOUT CLAIM TO ANY PAR-
TICULAR FONT, STYLE, SIZE, OR COLOR.

PRIORITY CLAIMED UNDER SEC. 44(D) ON CANADA APPLICATION NO. 1463937, FILED
12-22-2009, REG. NO. TMA804762, DATED 8-18-2011, EXPIRES 8-18-2026.

SER. NO. 77-902,727, FILED 12-30-2009.

DANNEAN HETZEL, EXAMINING ATTORNEY



David J. Kybas

Director of the United States Patent and Trademark Office

United States of America

United States Patent and Trademark Office

Wii Relax

Reg. No. 4,107,222

Registered Mar. 6, 2012

Int. Cl.: 9

TRADEMARK

PRINCIPAL REGISTER

NINTENDO OF AMERICA INC. (WASHINGTON CORPORATION)
4600 150TH AVENUE NE
REDMOND, WA 98052

FOR: CONSUMER VIDEO GAME APPARATUS, ADAPTED FOR USE WITH TV RECEIVERS ONLY; COMPUTER PROGRAMS FOR CONSUMER VIDEO GAME APPARATUS; ELECTRONIC CIRCUITS RECORDED WITH PROGRAMS FOR CONSUMER VIDEO GAME APPARATUS; OPTICAL DISKS RECORDED WITH PROGRAMS FOR CONSUMER VIDEO GAME APPARATUS; CD-ROMS RECORDED WITH PROGRAMS FOR CONSUMER VIDEO GAME APPARATUS; DVD-ROMS RECORDED WITH PROGRAMS FOR CONSUMER VIDEO GAME APPARATUS; STORAGE MEDIA, NAMELY FLASH MEMORY, RECORDED WITH PROGRAMS FOR CONSUMER VIDEO GAME APPARATUS; PRE-RECORDED MEMORY CARDS FEATURING GAMES FOR CONSUMER VIDEO GAME APPARATUS, ADAPTED FOR USE WITH TV RECEIVERS ONLY; MICROPHONES FOR CONSUMER VIDEO GAME APPARATUS, ADAPTED FOR USE WITH TV RECEIVERS ONLY; EARPHONES FOR CONSUMER VIDEO GAME APPARATUS, ADAPTED FOR USE WITH TV RECEIVERS ONLY; CDS FEATURING COMPUTER GAMES; DVDS FEATURING COMPUTER GAMES; SENSORS FOR CONSUMER VIDEO GAME APPARATUS, ADAPTED FOR USE WITH TV RECEIVERS ONLY; PULSE-MEASURING SENSORS FOR CONSUMER VIDEO GAME APPARATUS AND NOT FOR MEDICAL USE; PARTS AND ACCESSORIES FOR CONSUMER VIDEO GAME APPARATUS, NAMELY, JOYSTICKS, CONTROLLERS, POWER SUPPLIES, TRANSFORMERS, CONNECTORS FOR CONNECTING TO OTHER VIDEO GAME MACHINES; PRE-RECORDED COMPACT DISCS AND OPTICAL DISCS FEATURING ENTERTAINMENT, EDUCATIONAL AND INFORMATIONAL CONTENT PERTAINING TO VIDEO AND COMPUTER GAMES, PUZZLES, MUSIC, STORIES AND WELLNESS; COMPUTER GAME DISCS; COMPUTER GAME PROGRAMS; COMPUTER GAME SOFTWARE; ELECTRONIC GAME DISCS; ELECTRONIC GAME PROGRAMS; ELECTRONIC GAME SOFTWARE; INTERACTIVE ELECTRONIC GAME DISCS; INTERACTIVE ELECTRONIC GAME PROGRAMS; INTERACTIVE ELECTRONIC GAME SOFTWARE; INTERACTIVE VIDEO GAME DISCS; INTERACTIVE VIDEO GAME PROGRAMS; INTERACTIVE VIDEO GAME SOFTWARE; VIDEO GAME DISCS; VIDEO GAME PROGRAMS; VIDEO GAME SOFTWARE; DOWNLOADABLE COMPUTER GAME SOFTWARE; DOWNLOADABLE VIDEO GAME SOFTWARE; DOWNLOADABLE COMPUTER GAME PROGRAMS; DOWNLOADABLE VIDEO GAME PROGRAMS, IN CLASS 9 (U.S. CLS. 21, 23, 26, 36 AND 38).



David J. Kyros

Director of the United States Patent and Trademark Office

THE MARK CONSISTS OF STANDARD CHARACTERS WITHOUT CLAIM TO ANY PARTICULAR FONT, STYLE, SIZE, OR COLOR.

Reg. No. 4,107,222 PRIORITY CLAIMED UNDER SEC. 44(D) ON REPUBLIC OF KOREA APPLICATION NO. 45-2009-0002, FILED 7-7-2009.

OWNER OF JAPAN REG. NO. 5391881, DATED 2-18-2011, EXPIRES 2-18-2021.

SER. NO. 77-905,859, FILED 1-6-2010.

ANDREA HACK, EXAMINING ATTORNEY

United States of America

United States Patent and Trademark Office

GREAT MEALS GET STAR- TED WITH STAR

Reg. No. 4,107,223

Registered Mar. 6, 2012

Int. Cl.: 29

TRADEMARK

PRINCIPAL REGISTER

BORGES USA, INC. (DELAWARE CORPORATION)
2680 W. SHAW AVENUE
FRESNO, CA 93711

FOR: GRAPESEED OIL; FLAVORED OLIVE OILS; SOUP; SUN DRIED TOMATOES; TAPENADE MADE FROM OLIVES OR GARLIC; ONION PUREE; COCKTAIL ONIONS; MARINATED ARTICHOKE; PROCESSED ARTICHOKE; PROCESSED PIMENTOS; MARASCHINO CHERRIES; PROCESSED OLIVES; PROCESSED SPANISH STYLE OLIVES; PROCESSED ANCHOVIES; ANCHOVY PASTE; MARINATED VEGETABLES, NAMELY, CARROTS, ASPARAGUS, ONIONS, SWEET CHERRY PEPPERS, ITALIAN PEPPERS, GOLDEN PEPPERS, WAX PEPPERS, JALAPENO PEPPERS, CASABELLA PEPPERS, PEPPERONCINI, CELERY, MUSHROOMS, BRUSSELS SPROUTS, CAULIFLOWER; PICKLES; AND GARLIC PUREE USED AS A VEGETABLE AND SPREAD, IN CLASS 29 (U.S. CL. 46).

FIRST USE 12-15-2009; IN COMMERCE 12-15-2009.

THE MARK CONSISTS OF STANDARD CHARACTERS WITHOUT CLAIM TO ANY PARTICULAR FONT, STYLE, SIZE, OR COLOR.

OWNER OF U.S. REG. NOS. 2,294,487, 3,177,109 AND OTHERS.

SER. NO. 77-915,880, FILED 1-20-2010.

DORITT L. CARROLL, EXAMINING ATTORNEY



David J. Kyros

Director of the United States Patent and Trademark Office

United States of America

United States Patent and Trademark Office



Reg. No. 4,107,224

Registered Mar. 6, 2012

Int. Cls.: 35, 42 and 45

SERVICE MARK

PRINCIPAL REGISTER

KSJ & ASSOCIATES, INC. (VIRGINIA CORPORATION)
SUITE 901
5203 LEESBURG PIKE
FALLS CHURCH, VA 22041

FOR: BUSINESS PORTFOLIO MANAGEMENT, NAMELY, DEVELOPMENT OF PROCESSES FOR THE ANALYSIS AND THE IMPLEMENTATION OF STRATEGY PLANS AND MANAGEMENT PROJECTS; BUSINESS RISK MANAGEMENT; CONDUCTING BUSINESS STUDIES AND ANALYSIS OF BUSINESS PROCESSES TO PROVIDE ASSISTANCE ON BUSINESS PROCESS RE-ENGINEERING, BALANCING PROCESS PERFORMANCE WITH COST AND RISK OF PROCESS SUCCESS AND EFFICIENCY OF PROCESSES; COST ANALYSIS, COST ASSESSMENT AND BUSINESS RISK ANALYSIS AND ASSESSMENT FEATURING COST, BENEFIT AND RISK MODELING AND ANALYSIS, RISK-ADJUSTED ESTIMATION OF COST, BENEFIT AND RETURN-ON-INVESTMENT, ANALYSIS OF COST ALTERNATIVES, TOTAL OWNERSHIP COST ANALYSIS, BUDGET PREPARATION, BUDGET JUSTIFICATION AND BUDGET EXECUTION TRACKING, IN CLASS 35 (U.S. CLS. 100, 101 AND 102).

FIRST USE 11-16-2009; IN COMMERCE 11-16-2009.

FOR: CONDUCTING SYSTEMS ENGINEERING, ENTERPRISE ARCHITECTURE, IT STRATEGIC PLANNING AND ENGINEERING CONSULTING STUDIES AND PROVIDING ANALYSIS IN REGARD TO THE EFFICIENCY AND USAGE OF OTHER'S INFORMATION TECHNOLOGY SOFTWARE AND SYSTEMS SPANNING THE COMPLETE IT LIFECYCLE, IN CLASS 42 (U.S. CLS. 100 AND 101).

FIRST USE 11-16-2009; IN COMMERCE 11-16-2009.

FOR: REVIEWING STANDARDS AND PRACTICES TO ASSURE COMPLIANCE WITH INFORMATION TECHNOLOGY ACQUISITION AND COMPLIANCE LAWS AND REGULATIONS THROUGHOUT ALL PHASES OF THE ACQUISITION LIFECYCLE, IN CLASS 45 (U.S. CLS. 100 AND 101).

FIRST USE 11-16-2009; IN COMMERCE 11-16-2009.

THE MARK CONSISTS OF A SHADED SQUARE DESIGN WITH THREE VERTICAL LINES WHICH SLANT DOWN TO THE RIGHT INSIDE THE SQUARE AND ONE CURVED LINE



David J. Kyjars

Director of the United States Patent and Trademark Office

Reg. No. 4,107,224 CROSSING OVER THE OTHER LINES AND SLANTING UP TO THE RIGHT INSIDE THE SQUARE WITH THE STYLIZED LETTERS "KSJ" NEXT TO THE SQUARE AND THE WORDING "YOUR MISSION" "OUR TEAM" "ONE SOLUTION" IN STYLIZED LETTERS WITH RAISED DOTS BETWEEN EACH PHRASE BENEATH THE DESIGN AND "KSJ".

SER. NO. 77-922,291, FILED 1-28-2010.

KELLEY WELLS, EXAMINING ATTORNEY

United States of America

United States Patent and Trademark Office



Reg. No. 4,107,225

Registered Mar. 6, 2012

Int. Cl.: 20

TRADEMARK

PRINCIPAL REGISTER

HYGIE CANADA INC. (CANADA CORPORATION)
2760, CHEMIN DU LAC
LONGUEUIL (QUEBEC), CANADA J4N1B8

FOR: PLASTIC FRAME TO SUPPORT AND ACCOMMODATE BAGS CONTAINING BIOLOGICAL LIQUIDS, IN CLASS 20 (U.S. CLS. 2, 13, 22, 25, 32 AND 50).

PRIORITY CLAIMED UNDER SEC. 44(D) ON CANADA APPLICATION NO. 1453150, FILED 9-25-2009, REG. NO. TMA785132, DATED 12-15-2010, EXPIRES 12-15-2025.

THE COLOR(S) GREEN AND GREY IS/ARE CLAIMED AS A FEATURE OF THE MARK.

THE MARK CONSISTS OF THE FRONT OF THE RIBBON IN GREEN TO THE LEFT OF THE LETTERS "HY" IN GREY AND NUMBER "21" IN GREEN AND "BY HYGIE" IN GREY; THE INSIDE OF THE RIBBON IS GREY.

SER. NO. 77-932,907, FILED 2-10-2010.

TRACY CROSS, EXAMINING ATTORNEY



David J. Kybas

Director of the United States Patent and Trademark Office

United States of America

United States Patent and Trademark Office

Alta Rents

Reg. No. 4,107,226

Registered Mar. 6, 2012

Int. Cl.: 39

SERVICE MARK

PRINCIPAL REGISTER

ALTA EQUIPMENT COMPANY, INC. (MICHIGAN CORPORATION)
28775 BECK ROAD
WIXOM, MI 483933416

FOR: LEASING OF TRUCKS, IN CLASS 39 (U.S. CLS. 100 AND 105).

FIRST USE 11-1-2010; IN COMMERCE 11-1-2010.

THE MARK CONSISTS OF STANDARD CHARACTERS WITHOUT CLAIM TO ANY PARTICULAR FONT, STYLE, SIZE, OR COLOR.

REGISTRATION LIMITED TO THE AREA COMPRISING ALABAMA, ARKANSAS, CONNECTICUT, DELAWARE, FLORIDA, GEORGIA, ILLINOIS, IOWA, KANSAS, KENTUCKY, LOUISIANA, MAINE, MARYLAND, MASSACHUSETTS, MICHIGAN, MINNESOTA, MISSISSIPPI, MISSOURI, NEBRASKA, NEW HAMPSHIRE, NEW JERSEY, NEW YORK, NORTH CAROLINA, NORTH DAKOTA, OHIO, OKLAHOMA, PENNSYLVANIA, RHODE ISLAND, SOUTH CAROLINA, SOUTH DAKOTA, TENNESSEE, VERMONT, VIRGINIA, WEST VIRGINIA AND WISCONSIN PURSUANT TO CONCURRENT USE PROCEEDING NO. 94002315. CONCURRENT USE WITH REGISTRATION NO. 3662246.

OWNER OF U.S. REG. NOS. 2,598,846 AND 2,705,077.

NO CLAIM IS MADE TO THE EXCLUSIVE RIGHT TO USE "RENTS", APART FROM THE MARK AS SHOWN.

THE ENGLISH TRANSLATION OF "ALTA" IN THE MARK IS HIGH.

SER. NO. 77-933,306, FILED 2-11-2010.

CHRISTOPHER BUONGIORNO, EXAMINING ATTORNEY



David J. Kyffers

Director of the United States Patent and Trademark Office

United States of America

United States Patent and Trademark Office

Alta Construction Equipment

Reg. No. 4,107,227

ALTA EQUIPMENT COMPANY, INC. (MICHIGAN CORPORATION)
28775 BECK ROAD
WIXOM, MI 483933416

Registered Mar. 6, 2012

Int. Cls.: 35, 37 and 39

FOR: LOCATING PRE-OWNED VEHICLES AVAILABLE FOR PURCHASE OR LEASE, IN CLASS 35 (U.S. CLS. 100, 101 AND 102).

SERVICE MARK

FIRST USE 11-1-2010; IN COMMERCE 11-1-2010.

PRINCIPAL REGISTER

FOR: LEASING OF CONSTRUCTION EQUIPMENT, IN CLASS 37 (U.S. CLS. 100, 103 AND 106).

FIRST USE 11-1-2010; IN COMMERCE 11-1-2010.

FOR: LEASING OF VEHICLES, IN CLASS 39 (U.S. CLS. 100 AND 105).

FIRST USE 11-1-2010; IN COMMERCE 11-1-2010.

THE MARK CONSISTS OF STANDARD CHARACTERS WITHOUT CLAIM TO ANY PARTICULAR FONT, STYLE, SIZE, OR COLOR.

REGISTRATION LIMITED TO THE AREA COMPRISING ALABAMA, ARKANSAS, CONNECTICUT, DELAWARE, FLORIDA, GEORGIA, ILLINOIS, IOWA, KANSAS, KENTUCKY, LOUISIANA, MAINE, MARYLAND, MASSACHUSETTS, MICHIGAN, MINNESOTA, MISSISSIPPI, MISSOURI, NEBRASKA, NEW HAMPSHIRE, NEW JERSEY, NEW YORK, NORTH CAROLINA, NORTH DAKOTA, OHIO, OKLAHOMA, PENNSYLVANIA, RHODE ISLAND, SOUTH CAROLINA, SOUTH DAKOTA, TENNESSEE, VERMONT, VIRGINIA, WEST VIRGINIA AND WISCONSIN PURSUANT TO CONCURRENT USE PROCEEDING NO. 94002315. CONCURRENT USE WITH REGISTRATION NO. 3662246.

OWNER OF U.S. REG. NOS. 2,598,846 AND 2,705,077.

NO CLAIM IS MADE TO THE EXCLUSIVE RIGHT TO USE "CONSTRUCTION EQUIPMENT", APART FROM THE MARK AS SHOWN.

THE ENGLISH TRANSLATION OF "ALTA" IN THE MARK IS HIGH.



David J. Kybas

Director of the United States Patent and Trademark Office

Reg. No. 4,107,227 SER. NO. 77-933,361, FILED 2-11-2010.

CHRISTOPHER BUONGIORNO, EXAMINING ATTORNEY

United States of America

United States Patent and Trademark Office

Alta Industrial Equipment

Reg. No. 4,107,228

Registered Mar. 6, 2012

Int. Cls.: 37 and 39

SERVICE MARK

PRINCIPAL REGISTER

ALTA EQUIPMENT COMPANY, INC. (MICHIGAN CORPORATION)
28775 BECK ROAD
WIXOM, MI 483933416

FOR: LEASING OF CONSTRUCTION EQUIPMENT, IN CLASS 37 (U.S. CLS. 100, 103 AND 106).

FIRST USE 11-1-2010; IN COMMERCE 11-1-2010.

FOR: LEASING OF TRUCKS , IN CLASS 39 (U.S. CLS. 100 AND 105).

FIRST USE 11-1-2010; IN COMMERCE 11-1-2010.

THE MARK CONSISTS OF STANDARD CHARACTERS WITHOUT CLAIM TO ANY PARTICULAR FONT, STYLE, SIZE, OR COLOR.

REGISTRATION LIMITED TO THE AREA COMPRISING ALABAMA, ARKANSAS, CONNECTICUT, DELAWARE, FLORIDA, GEORGIA, ILLINOIS, IOWA, KANSAS, KENTUCKY, LOUISIANA, MAINE, MARYLAND, MASSACHUSETTS, MICHIGAN, MINNESOTA, MISSISSIPPI, MISSOURI, NEBRASKA, NEW HAMPSHIRE, NEW JERSEY, NEW YORK, NORTH CAROLINA, NORTH DAKOTA, OHIO, OKLAHOMA, PENNSYLVANIA, RHODE ISLAND, SOUTH CAROLINA, SOUTH DAKOTA, TENNESSEE, VERMONT, VIRGINIA, WEST VIRGINIA AND WISCONSIN PURSUANT TO CONCURRENT USE PROCEEDING NO. 94002315. CONCURRENT USE WITH REGISTRATION NO. 3662246.

OWNER OF U.S. REG. NOS. 2,598,846 AND 2,705,077.

NO CLAIM IS MADE TO THE EXCLUSIVE RIGHT TO USE "INDUSTRIAL EQUIPMENT", APART FROM THE MARK AS SHOWN.

THE ENGLISH TRANSLATION OF "ALTA" IN THE MARK IS "HIGH".

SER. NO. 77-933,393, FILED 2-11-2010.

CHRISTOPHER BUONGIORNO, EXAMINING ATTORNEY



David J. Kyfos

Director of the United States Patent and Trademark Office

United States of America

United States Patent and Trademark Office

OTSC

Reg. No. 4,107,229

Registered Mar. 6, 2012

Int. Cl.: 10

TRADEMARK

PRINCIPAL REGISTER

OVESCO ENDOSCOPY AG (FED REP GERMANY INCORPORATED STOCK COMPANY)
DORFACKERSTRASSE 26
TUBINGEN, FED REP GERMANY 72074

FOR: ENDOSCOPIC EQUIPMENT, NAMELY, SUTURE MATERIAL ESPECIALLY SUPER-ELASTIC NITINOL DEVICES (CLIPS) FOR COMPRESSION AND APPROXIMATION OF TISSUES IN THE HUMAN DIGESTIVE TRACT ONLY, EXCLUDING SAME FOR ANY KIND OF USE IN RELATION TO TREATING OR DIAGNOSING OTOSCLEROSIS, IN CLASS 10 (U.S. CLS. 26, 39 AND 44).

THE MARK CONSISTS OF STANDARD CHARACTERS WITHOUT CLAIM TO ANY PARTICULAR FONT, STYLE, SIZE, OR COLOR.

OWNER OF FED REP GERMANY REG. NO. 30410165, DATED 9-20-2004, EXPIRES 2-28-2014.

SER. NO. 77-934,927, FILED 2-12-2010.

DAVID I, EXAMINING ATTORNEY



David J. Kyfos

Director of the United States Patent and Trademark Office

United States of America

United States Patent and Trademark Office

PLEASANT HEARTH

Reg. No. 4,107,230

Registered Mar. 6, 2012

Int. Cls.: 6, 8, 11 and 18

TRADEMARK

PRINCIPAL REGISTER

GHP GROUP, INC. (ILLINOIS CORPORATION)
8280 N. AUSTIN AVENUE
MORTON GROVE, IL 60053

FOR: ACCESSORIES FOR FIREPLACES, NAMELY, FIRE SCREENS CONSISTING PRIMARILY OF A METAL FRAME WITH A METAL MESH, IN CLASS 6 (U.S. CLS. 2, 12, 13, 14, 23, 25 AND 50).

FIRST USE 6-0-2004; IN COMMERCE 6-0-2004.

FOR: FIREPLACE TOOLS AND ACCESSORIES SOLD INDIVIDUALLY AND AS UNITS, NAMELY, SHOVELS, TONGS, POKERS AND BELLOWS, IN CLASS 8 (U.S. CLS. 23, 28 AND 44).

FIRST USE 6-0-2004; IN COMMERCE 6-0-2004.

FOR: HEARTH PRODUCTS, NAMELY, FIREPLACE DOORS, ELECTRIC FIREPLACES, AND FIREPLACE INSERTS, COMPRISED OF ARTIFICIAL LOGS POWERED BY ELECTRICITY, IN CLASS 11 (U.S. CLS. 13, 21, 23, 31 AND 34).

FIRST USE 6-0-2004; IN COMMERCE 6-0-2004.

FOR: LOG TOTE BAGS, NAMELY, CANVAS WOOD CARRIERS, IN CLASS 18 (U.S. CLS. 1, 2, 3, 22 AND 41).

FIRST USE 6-0-2004; IN COMMERCE 6-0-2004.

THE MARK CONSISTS OF STANDARD CHARACTERS WITHOUT CLAIM TO ANY PARTICULAR FONT, STYLE, SIZE, OR COLOR.

NO CLAIM IS MADE TO THE EXCLUSIVE RIGHT TO USE "HEARTH", APART FROM THE MARK AS SHOWN.

SER. NO. 77-936,892, FILED 2-16-2010.

TRACY CROSS, EXAMINING ATTORNEY



David J. Kyffers

Director of the United States Patent and Trademark Office

United States of America

United States Patent and Trademark Office

C3 COLOR MATCHING SYSTEM

Reg. No. 4,107,231

3FORM, INC. (UTAH CORPORATION)

Registered Mar. 6, 2012

2300 SOUTH 2300 WEST
SALT LAKE CITY, UT 84119

Int. Cl.: 19

FOR: BUILDING MATERIALS, NAMELY, NONMETAL PANELS TO BE CUSTOMIZED IN THE SHAPE OF BENT PATTERNS, WOVEN PATTERNS, CURVED PATTERNS OR OTHER CONFIGURATIONS FOR INTERIOR AND EXTERIOR USE, IN CLASS 19 (U.S. CLS. 1, 12, 33 AND 50).

TRADEMARK

PRINCIPAL REGISTER

FIRST USE 10-1-2008; IN COMMERCE 10-1-2008.

THE MARK CONSISTS OF STANDARD CHARACTERS WITHOUT CLAIM TO ANY PARTICULAR FONT, STYLE, SIZE, OR COLOR.

OWNER OF U.S. REG. NO. 3,731,363.

NO CLAIM IS MADE TO THE EXCLUSIVE RIGHT TO USE "COLOR MATCHING SYSTEM", APART FROM THE MARK AS SHOWN.

SER. NO. 77-937,808, FILED 2-17-2010.

DOMINIC J. FERRAIUOLO, EXAMINING ATTORNEY



David J. Kybas

Director of the United States Patent and Trademark Office

United States of America

United States Patent and Trademark Office

ROOT SHOOTERS

Reg. No. 4,107,232

ADVANCED NUTRIENTS LTD. (CANADA CORPORATION)

Registered Mar. 6, 2012

#102 - 32526 GEORGE FERGUSON WAY
ABBOTSFORD, BC, CANADA V2T4Y1

Int. Cl.: 1

FOR: PLANT NUTRIENT PREPARATIONS, IN CLASS 1 (U.S. CLS. 1, 5, 6, 10, 26 AND 46).

TRADEMARK

THE MARK CONSISTS OF STANDARD CHARACTERS WITHOUT CLAIM TO ANY PARTICULAR FONT, STYLE, SIZE, OR COLOR.

PRINCIPAL REGISTER

PRIORITY CLAIMED UNDER SEC. 44(D) ON CANADA APPLICATION NO. 1471638, FILED 3-3-2010, REG. NO. TMA802,908, DATED 7-25-2011, EXPIRES 7-25-2026.

NO CLAIM IS MADE TO THE EXCLUSIVE RIGHT TO USE "ROOT", APART FROM THE MARK AS SHOWN.

SER. NO. 77-950,569, FILED 3-4-2010.

HEATHER BIDDULPH, EXAMINING ATTORNEY



David J. Kybas

Director of the United States Patent and Trademark Office

United States of America

United States Patent and Trademark Office



Reg. No. 4,107,233

Registered Mar. 6, 2012

Int. Cl.: 42

SERVICE MARK

PRINCIPAL REGISTER

INDUSTRIAL AND FINANCIAL SYSTEMS, IFS AB (SWEDEN LIMITED LIABILITY COMPANY)
BOX 1545
TEKNIKRINGEN 5
LINKÖPING, SWEDEN 58115

FOR: COMPUTER SOFTWARE SERVICES, NAMELY, MAINTENANCE AND IMPLEMENTATION OF ENTERPRISE RESOURCE PLANNING COMPUTER PROGRAMS FOR USERS; COMPUTER SOFTWARE TECHNICAL SUPPORT SERVICES IN THE NATURE OF TROUBLESHOOTING ENTERPRISE RESOURCE PLANNING COMPUTER SOFTWARE PROBLEMS FOR USERS, IN CLASS 42 (U.S. CLS. 100 AND 101).

FIRST USE 8-1-1987; IN COMMERCE 8-1-1987.

THE MARK CONSISTS OF THE LETTERS "IFS" SHOWN IN A DIAGONAL FORM INSIDE A SQUARE BOX.

SER. NO. 77-953,062, FILED 3-8-2010.

GRETCHEN ULRICH, EXAMINING ATTORNEY



David J. Kyffers

Director of the United States Patent and Trademark Office

United States of America

United States Patent and Trademark Office



Reg. No. 4,107,234

Registered Mar. 6, 2012

Int. Cl.: 35

SERVICE MARK

PRINCIPAL REGISTER

US SMOKE & FIRE CURTAIN LLC (VIRGINIA LIMITED LIABILITY COMPANY)
SUITE 301
12310 PINECREST ROAD
RESTON, VA 20191

FOR: IMPORT AGENCY SERVICES FEATURING SMOKE AND FIRE CURTAIN PRODUCTS AND SYSTEMS; RETAIL STORE SERVICES FEATURING SMOKE AND FIRE CURTAIN PRODUCTS AND SYSTEMS; DISTRIBUTORSHIPS FEATURING SMOKE AND FIRE CURTAIN PRODUCTS AND SYSTEMS, IN CLASS 35 (U.S. CLS. 100, 101 AND 102).

FIRST USE 4-29-2009; IN COMMERCE 4-29-2009.

NO CLAIM IS MADE TO THE EXCLUSIVE RIGHT TO USE "US" AND "SMOKE & FIRE CURTAIN", APART FROM THE MARK AS SHOWN.

THE COLOR(S) YELLOW AND GRAY IS/ARE CLAIMED AS A FEATURE OF THE MARK.

THE MARK CONSISTS OF THE WORDING "US" IN YELLOW, "SMOKE&FIRECURTAIN" AND "LIFE" "SAFETY", "ACCESSIBILITY", "DESIGN FREEDOM" IN GRAY WITH THE DOTS OF THE I'S IN "FIRE" AND "CURTAIN" IN YELLOW.

SER. NO. 77-957,241, FILED 3-12-2010.

AMY HELLA, EXAMINING ATTORNEY



David J. Kybas

Director of the United States Patent and Trademark Office

United States of America

United States Patent and Trademark Office

PureContact

Reg. No. 4,107,235

Registered Mar. 6, 2012

Int. Cl.: 12

TRADEMARK

PRINCIPAL REGISTER

CONTINENTAL REIFEN DEUTSCHLAND GMBH (FED REP GERMANY GESELLSCHAFT
MIT BESCHRÄNKTER HAFTUNG (GMBH))
VAHRENWALDER STRASSE 9
HANNOVER, FED REP GERMANY D-30165

FOR: VEHICLE TIRES, IN CLASS 12 (U.S. CLS. 19, 21, 23, 31, 35 AND 44).

THE MARK CONSISTS OF STANDARD CHARACTERS WITHOUT CLAIM TO ANY PARTICULAR FONT, STYLE, SIZE, OR COLOR.

PRIORITY CLAIMED UNDER SEC. 44(D) ON ERPN CMNTY TM OFC APPLICATION NO. 008953267, FILED 3-15-2010, REG. NO. 008953267, DATED 8-2-2010, EXPIRES 3-15-2020.

SER. NO. 77-960,174, FILED 3-16-2010.

DAVID MURRAY, EXAMINING ATTORNEY



David J. Kyfos

Director of the United States Patent and Trademark Office

United States of America

United States Patent and Trademark Office



Reg. No. 4,107,236

Registered Mar. 6, 2012

Int. Cl.: 12

TRADEMARK

PRINCIPAL REGISTER

TRADE UNION INTERNATIONAL, INC. (CALIFORNIA CORPORATION)
4651 STATE STREET
MONTCLAIR, CA 91763

FOR: LUG NUTS FOR VEHICLE WHEELS; TIRES; VEHICLE WHEEL RIMS AND STRUCTURAL PARTS THEREFOR; VEHICLE WHEELS; WHEEL COVERS, IN CLASS 12 (U.S. CLS. 19, 21, 23, 31, 35 AND 44).

FIRST USE 3-1-2011; IN COMMERCE 3-1-2011.

THE MARK CONSISTS OF A LARGE STYLIZED "V" WITH A SMALLER "ROCK" ADJACENT THERETO, WHERE THE TERM "ROCK" IS UNDERLINED.

SER. NO. 77-960,495, FILED 3-16-2010.

LAURIE MAYES, EXAMINING ATTORNEY



David J. Kybas

Director of the United States Patent and Trademark Office

United States of America

United States Patent and Trademark Office



Reg. No. 4,107,237

Registered Mar. 6, 2012

Int. Cl.: 36

SERVICE MARK

PRINCIPAL REGISTER

DRIVETIME SALES AND FINANCE CORPORATION (ARIZONA CORPORATION)
4020 EAST INDIAN SCHOOL ROAD
PHOENIX, AZ 85018

FOR: AUTOMOBILE FINANCING SERVICES, IN CLASS 36 (U.S. CLS. 100, 101 AND 102).

FIRST USE 11-1-2009; IN COMMERCE 11-1-2009.

OWNER OF U.S. REG. NOS. 2,779,062, 2,792,416, AND 3,698,633.

THE MARK CONSISTS OF THE WORD "APPROVED" IN A RECTANGLE, SET ON THE DIAGONAL, HAVING THE APPEARANCE OF A RUBBER STAMP WITH THE WORDS "DRIVETIME.COM" IN THE LOWER RIGHT CORNER.

SER. NO. 77-960,688, FILED 3-17-2010.

C. DIONNE CLYBURN, EXAMINING ATTORNEY



David J. Kyffers

Director of the United States Patent and Trademark Office

United States of America

United States Patent and Trademark Office



Reg. No. 4,107,238

Registered Mar. 6, 2012

CERTIFICATION MARK

PRINCIPAL REGISTER

ISLAMIC FOOD AND NUTRITION COUNCIL OF AMERICA (ILLINOIS CORPORATION)
5901 N. CICERO AVENUE
SUITE 309
CHICAGO, IL 60646

FOR: FOOD PRODUCTS, NAMELY, MEAT, POULTRY, BREADS, CEREALS, COOKIES, BAKED GOODS, MILK PRODUCTS, CANDY, SPICES, KETCHUP, SAUCES AND DIETARY SUPPLEMENTS, IN CLASS A (U.S. CL. A).

FIRST USE 0-0-1990; IN COMMERCE 0-0-1990.

NO CLAIM IS MADE TO THE EXCLUSIVE RIGHT TO USE "COUNCIL", "CERTIFIED HALAL", AND THE NON-LATIN CHARACTERS THAT TRANSLITERATE TO "HALAL", APART FROM THE MARK AS SHOWN.

THE NON-LATIN CHARACTERS IN THE MARK TRANSLITERATE TO "HALAL" AND THIS MEANS PERMITTED IN ENGLISH.

THE MARK CONSISTS OF THE LETTER "M" INSIDE A CRESCENT CIRCLE DESIGN WITH THE PHRASE "CERTIFIED HALAL ISLAMIC FOOD AND NUTRITION COUNCIL OF AMERICA" AND THE ARABIC SYMBOL FOR "HALAL" CONTAINED WITHIN A RECTANGULAR BOX.

THE ENGLISH TRANSLATION OF THE WORD "HALAL" IN THE MARK IS PERMITTED.

THE CERTIFICATION MARK CERTIFIES THAT FOOD PRODUCTS MEET ISLAMIC HALAL GUIDELINES.

SEC. 2(F) AS TO "ISLAMIC FOOD AND NUTRITION COUNCIL OF AMERICA".

SER. NO. 77-962,615, FILED 3-18-2010.

HEATHER THOMPSON, EXAMINING ATTORNEY



David J. Kybas

Director of the United States Patent and Trademark Office

United States of America

United States Patent and Trademark Office

KRÖNAN

Reg. No. 4,107,239

SWEDISH MATCH NORTH EUROPE AB (SWEDEN JOINT STOCK COMPANY)
SE-118 85

Registered Mar. 6, 2012

STOCKHOLM, SWEDEN

Int. Cl.: 34

FOR: TOBACCO SUBSTITUTES NOT FOR MEDICAL PURPOSES; SNUFF AND TOBACCO ALTERNATIVES IN THE FORM OF PRODUCTS BASED ON VEGETABLE FIBERS, FOR ORAL USE NOT FOR CONSUMPTION; SNUFF; TOBACCO FREE SNUFF; HERBAL SNUFF, IN CLASS 34 (U.S. CLS. 2, 8, 9 AND 17).

TRADEMARK

PRINCIPAL REGISTER

OWNER OF SWEDEN REG. NO. 411471, DATED 6-4-2010, EXPIRES 6-4-2020.

THE MARK CONSISTS OF THE WORD "KRONAN" WITH A THREE-POINTED CROWN DESIGN OVER THE LETTER "O".

THE ENGLISH TRANSLATION OF "KRONAN" IN THE MARK IS THE CROWN.

SER. NO. 77-969,916, FILED 3-26-2010.

KATHERINE STOIDES, EXAMINING ATTORNEY



David J. Kyffers

Director of the United States Patent and Trademark Office

United States of America

United States Patent and Trademark Office

OPEN TEXT THE CONTENT EXPERTS

Reg. No. 4,107,240

Registered Mar. 6, 2012

Int. Cls.: 9 and 42

TRADEMARK

SERVICE MARK

PRINCIPAL REGISTER

OPEN TEXT SA (LUXEMBOURG PUBLIC LIMITED LIABILITY COMPANY)
26, BOULEVARD ROYAL
L-2449, LUXEMBOURG

FOR: COMPUTER SOFTWARE FOR THE COLLECTION, EDITING, ORGANIZING, MODIFYING, BOOK MARKING, TRANSMISSION, STORAGE AND SHARING OF DATA AND INFORMATION; DATABASE MANAGEMENT SOFTWARE; COMPUTER SOFTWARE TO AUTOMATE DATA WAREHOUSING; COMPUTER SOFTWARE FOR ARCHIVING DATABASES, IMAGES AND OTHER ELECTRONIC DATA; COMPUTER SOFTWARE FOR BUSINESS PROCESS MANAGEMENT; COMPUTER SOFTWARE FOR DIGITAL ASSET MANAGEMENT; COMPUTER SOFTWARE FOR E-MAIL MANAGEMENT; COMPUTER SOFTWARE FOR DOCUMENT PROCESSING; COMPUTER SOFTWARE FOR ORGANIZING AND VIEWING DIGITAL IMAGES AND PHOTOGRAPHS; COMPUTER SOFTWARE FOR ACCESSING, SEARCHING, INDEXING, AND RETRIEVING DATA FROM NETWORKED COMPUTERS; COMPUTER SOFTWARE FOR SHARING AND DISTRIBUTING DATA, DOCUMENTS AND INFORMATION; COMPUTER SOFTWARE THAT FACILITATES COLLABORATION THROUGH THE SHARING AND DISTRIBUTING DATA, DOCUMENTS AND INFORMATION; COMPUTER SOFTWARE FOR USE IN PROVIDING A DOCUMENT RETRIEVAL SYSTEM FOR BUSINESSES; COMPUTER SOFTWARE USED BY BUSINESSES TO FACILITATE COMPLIANCE WITH LAWS AND REGULATIONS; AND COMPUTER SOFTWARE USED BY BUSINESSES TO FACILITATE COMPLIANCE WITH INTERNAL GOVERNANCE REQUIREMENTS, IN CLASS 9 (U.S. CLS. 21, 23, 26, 36 AND 38).

FIRST USE 11-1-2007; IN COMMERCE 11-1-2007.



David J. Kyjars

Director of the United States Patent and Trademark Office

FOR: COMPUTER SOFTWARE CONSULTATION; CONSULTATION SERVICES IN THE FIELDS OF SELECTION, IMPLEMENTATION AND USE OF COMPUTER HARDWARE AND SOFTWARE SYSTEMS FOR OTHERS; COMPUTER CONSULTATION; COMPUTER CONSULTATION IN THE FIELD OF COMPUTER SECURITY; CUSTOMIZATION OF COMPUTER HARDWARE AND SOFTWARE; DESIGN, DEVELOPMENT, IMPLEMENTATION, UPDATING AND MAINTENANCE OF SOFTWARE; TECHNICAL SUPPORT SERVICES, NAMELY, TROUBLESHOOTING OF COMPUTER SOFTWARE PROBLEMS; COMPUTER SERVICE, NAMELY, ACTING AS AN APPLICATION SERVICE PROVIDER IN THE FIELD OF KNOWLEDGE MANAGEMENT TO HOST COMPUTER APPLICATION SOFTWARE FOR CREATING SEARCHABLE DATABASES OF INFORMATION AND DATA AND FOR SEARCHING AND RETRIEVING INFORMATION FROM DATABASES AND COMPUTER NETWORKS, AND FOR THE COLLECTION, EDITING, ORGANIZING, MODIFYING, BOOK

Reg. No. 4,107,240 MARKING, TRANSMISSION, STORAGE AND SHARING OF DATA AND INFORMATION; COMPUTER SERVICES, NAMELY, REMOTE MANAGEMENT OF COMPUTER APPLICATIONS FOR OTHERS; APPLICATION SERVICE PROVIDER (ASP) FEATURING SOFTWARE FOR THE COLLECTION, EDITING, ORGANIZING, MODIFYING, BOOKMARKING, TRANSMISSION, STORAGE AND SHARING OF DATA AND INFORMATION; APPLICATION SERVICE PROVIDER (ASP) FEATURING DATABASE MANAGEMENT SOFTWARE; APPLICATION SERVICE PROVIDER (ASP) FEATURING SOFTWARE TO AUTOMATE DATA WAREHOUSING; APPLICATION SERVICE PROVIDER (ASP) FEATURING SOFTWARE FOR ARCHIVING DATABASES, IMAGES AND OTHER ELECTRONIC DATA, APPLICATION SERVICE PROVIDER (ASP) FEATURING SOFTWARE FOR BUSINESS PROCESS MANAGEMENT; APPLICATION SERVICE PROVIDER (ASP) FEATURING SOFTWARE FOR DIGITAL ASSET MANAGEMENT; APPLICATION SERVICE PROVIDER (ASP) FEATURING SOFTWARE FOR E-MAIL MANAGEMENT; APPLICATION SERVICE PROVIDER (ASP) FEATURING SOFTWARE FOR DOCUMENT PROCESSING; APPLICATION SERVICE PROVIDER (ASP) FEATURING SOFTWARE FOR ORGANIZING AND VIEWING DIGITAL IMAGES AND PHOTOGRAPHS; APPLICATION SERVICE PROVIDER (ASP) FEATURING SOFTWARE FOR ACCESSING, SEARCHING, INDEXING, AND RETRIEVING DATA FROM NETWORKED COMPUTERS; APPLICATION SERVICE PROVIDER (ASP) FEATURING SOFTWARE FOR SHARING AND DISTRIBUTING DATA, DOCUMENTS AND INFORMATION; APPLICATION SERVICE PROVIDER (ASP) FEATURING SOFTWARE THAT FACILITATES COLLABORATION THROUGH THE SHARING AND DISTRIBUTING DATA, DOCUMENTS AND INFORMATION; APPLICATION SERVICE PROVIDER (ASP) FEATURING SOFTWARE FOR USE IN PROVIDING A DOCUMENT RETRIEVAL SYSTEM FOR BUSINESSES; APPLICATION SERVICE PROVIDER (ASP) FEATURING SOFTWARE USED BY BUSINESSES TO FACILITATE COMPLIANCE WITH LAWS AND REGULATIONS; AND APPLICATION SERVICE PROVIDER (ASP) FEATURING SOFTWARE USED BY BUSINESSES TO FACILITATE COMPLIANCE WITH INTERNAL GOVERNANCE REQUIREMENTS, IN CLASS 42 (U.S. CLS. 100 AND 101).

FIRST USE 11-1-2007; IN COMMERCE 11-1-2007.

THE MARK CONSISTS OF STANDARD CHARACTERS WITHOUT CLAIM TO ANY PARTICULAR FONT, STYLE, SIZE, OR COLOR.

OWNER OF U.S. REG. NOS. 1,773,909 AND 2,685,043.

NO CLAIM IS MADE TO THE EXCLUSIVE RIGHT TO USE "CONTENT" AS TO THE CLASS 9 GOODS, AND "THE CONTENT EXPERTS" AS TO THE CLASS 42 SERVICES, APART FROM THE MARK AS SHOWN.

SEC. 2(F).

SER. NO. 77-982,368, FILED 3-23-2010.

LAURA KOVALSKY, EXAMINING ATTORNEY

United States of America

United States Patent and Trademark Office

KERAGEL

Reg. No. 4,107,241

KERAPLAST TECHNOLOGIES, LLC (TEXAS LIMITED LIABILITY COMPANY)
19210 HUEBNER RD.
SAN ANTONIO, TX 78258

Registered Mar. 6, 2012

Int. Cl.: 5

FOR: TOPICAL WOUND DRESSINGS AND SURGICAL DRESSINGS; SANITARY PREPARATION FOR MEDICAL USE, IN CLASS 5 (U.S. CLS. 6, 18, 44, 46, 51 AND 52).

TRADEMARK

FIRST USE 7-0-2007; IN COMMERCE 7-0-2007.

PRINCIPAL REGISTER

THE MARK CONSISTS OF STANDARD CHARACTERS WITHOUT CLAIM TO ANY PARTICULAR FONT, STYLE, SIZE, OR COLOR.

SER. NO. 77-982,772, FILED 11-4-2009.

JAY BESCH, EXAMINING ATTORNEY



David J. Kyffers

Director of the United States Patent and Trademark Office

United States of America

United States Patent and Trademark Office

SPY

Reg. No. 4,107,242

Registered Mar. 6, 2012

Int. Cl.: 25

TRADEMARK

PRINCIPAL REGISTER

HOUSE ON F STREET, LLC., THE (DELAWARE LIMITED LIABILITY JOINT STOCK COMPANY)
SUITE 800, 1660 WEST SECOND STREET
CLEVELAND, OH 44113

FOR: CLOTHING, NAMELY, SHIRTS, HATS, AND CAPS OFFERED OR SOLD THROUGH MUSEUMS, MUSEUM STORES, SOUVENIR STORES, NOVELTY STORES, GIFT STORES, GIFT SHOPS, AIRPORT STORES, SELF-STANDING KIOSKS AND CARTS, AND CATALOGS AND WEBSITES AFFILIATED WITH MUSEUMS, MUSEUM STORES, SOUVENIR STORES, NOVELTY STORES, GIFT STORES, GIFT SHOPS AND AIRPORT STORES, IN CLASS 25 (U.S. CLS. 22 AND 39).

FIRST USE 7-19-2002; IN COMMERCE 7-19-2002.

SEC. 2(F).

SER. NO. 78-189,970, FILED 12-1-2002.

MICHELE SWAIN, EXAMINING ATTORNEY



David J. Kyffers

Director of the United States Patent and Trademark Office

United States of America

United States Patent and Trademark Office

DB SIGNATURE

Reg. No. 4,107,243

Registered Mar. 6, 2012

Int. Cl.: 14

TRADEMARK

PRINCIPAL REGISTER

DE BEERS LV LTD (UNITED KINGDOM CORPORATION)
1 SILK STREET
LONDON, UNITED KINGDOM EC2Y 8HQ

FOR: PRECIOUS METALS AND THEIR ALLOYS, NAMELY, JEWELRY, IMITATION JEWELRY, GEMSTONES; PRECIOUS STONES; SEMI-PRECIOUS STONES, DIAMONDS, HOROLOGICAL AND CHRONOMETRIC INSTRUMENTS, NAMELY, WATCHES AND CLOCKS AND PARTS THEREOF FOR ALL THE AFOREMENTIONED GOODS, IN CLASS 14 (U.S. CLS. 2, 27, 28 AND 50).

PRIORITY CLAIMED UNDER SEC. 44(D) ON UNITED KINGDOM APPLICATION NO. 2315056, FILED 11-5-2002, REG. NO. 2315056, DATED 11-5-2002, EXPIRES 11-5-2012.

SER. NO. 78-245,210, FILED 5-2-2003.

MARY I. SPARROW, EXAMINING ATTORNEY



David J. Kybas

Director of the United States Patent and Trademark Office

United States of America

United States Patent and Trademark Office

DB LOGO

Reg. No. 4,107,244

Registered Mar. 6, 2012

Int. Cl.: 14

TRADEMARK

PRINCIPAL REGISTER

DE BEERS LV LTD (UNITED KINGDOM CORPORATION)
1 SILK STREET
LONDON, UNITED KINGDOM EC2Y 8HQ

FOR: PRECIOUS METALS AND THEIR ALLOYS AND GOODS IN PRECIOUS METALS OR COATED THEREWITH NOT INCLUDED IN OTHER CLASSES; NAMELY BEVERAGEWARE AND DISHES OF PRECIOUS METAL, CANDLE SNUFFERS AND CANDLESTICKS OF PRECIOUS METAL, NAPKIN RINGS OF PRECIOUS METAL, VASES OF PRECIOUS METAL, JEWEL CASES OF PRECIOUS METAL, STATUES OF PRECIOUS METAL, RINGS, NECKLACES, BRACELETS, EARRINGS, BROOCHES, DIADEMS MADE OF PRECIOUS METALS OR COATED THEREWITH, JEWELRY AND IMITATION JEWELRY, GEMSTONES; PRECIOUS STONES, SEMI-PRECIOUS STONES; DIAMONDS; WATCHES, CLOCKS; HOROLOGICAL AND CHRONOMETRIC INSTRUMENTS, NAMELY, CHRONOMETERS, CHRONOGRAPHS FOR USE AS WATCHES, WATCH BRACELETS, WATCH CASES, POCKET WATCHES, WRISTWATCHES, WATCH MOVEMENTS; REPLACEMENT PARTS FOR ALL THE AFORESAID GOODS, IN CLASS 14 (U.S. CLS. 2, 27, 28 AND 50).

PRIORITY CLAIMED UNDER SEC. 44(D) ON UNITED KINGDOM APPLICATION NO. 2315054, FILED 11-5-2002, REG. NO. 2315054, DATED 11-5-2002, EXPIRES 11-5-2012.

SER. NO. 78-245,219, FILED 5-2-2003.

NAAKWAMA ANKRAH, EXAMINING ATTORNEY



David J. Kyros

Director of the United States Patent and Trademark Office

United States of America

United States Patent and Trademark Office



Reg. No. 4,107,245

Registered Mar. 6, 2012

Int. Cls.: 4, 6, 8, 9, 11, 16, 18, 20, 21, 22, 24 and 27

CANADIAN HOME PUBLISHERS (CANADA LIMITED PARTNERSHIP)
511 KING STREET WEST, SUITE 120
TORONTO, CANADA M5V 2Z4

FOR: CANDLES, IN CLASS 4 (U.S. CLS. 1, 6 AND 15).

FOR: METAL STEP LADDERS, IN CLASS 6 (U.S. CLS. 2, 12, 13, 14, 23, 25 AND 50).

TRADEMARK

FOR: FLATWARE, IN CLASS 8 (U.S. CLS. 23, 28 AND 44).

PRINCIPAL REGISTER

FOR: ELECTRIC IRONS, IN CLASS 9 (U.S. CLS. 21, 23, 26, 36 AND 38).

FOR: ELECTRIC LANTERNS; OIL LANTERNS, IN CLASS 11 (U.S. CLS. 13, 21, 23, 31 AND 34).

FOR: BULLETIN BOARDS; CORK BOARDS, IN CLASS 16 (U.S. CLS. 2, 5, 22, 23, 29, 37, 38 AND 50).

FOR: UMBRELLAS; PATIO UMBRELLAS, IN CLASS 18 (U.S. CLS. 1, 2, 3, 22 AND 41).

FOR: FURNITURE, BEDS, SOFAS, DINING TABLES; DECORATIVE PILLOWS; PICTURE FRAMES; OUTDOOR FURNITURE AND ACCESSORIES, NAMELY, TABLES, CHAIRS, FOOTSTOOLS, LOUNGE CHAIRS, PILLOWS, CHAIR PADS; HAMPERS; NON-METAL HOOKS; CHAIRS AND CHAIRS FOR USE IN IRONING; NON-METAL STEP STOOLS; MAGAZINE HOLDERS, IN CLASS 20 (U.S. CLS. 2, 13, 22, 25, 32 AND 50).

FOR: PIE SERVERS, CAKE SERVERS, SERVING SPOONS, SERVING FORKS, SERVING TONGS; SOAP DISPENSERS, TOOTHBRUSH HOLDERS, SOAP DISHES; DINNER PLATES, CUPS, SAUCERS, MUGS, DRINKING GLASSES, BEVERAGE GLASSWARE, BEVERAGEWARE; GLASS BEVERAGEWARE; BEVERAGEWARE, NAMELY, STEMWARE; TEAPOTS, NOT OF PRECIOUS METAL, CREAMERS, SERVING PLATTERS, BOWLS; IRONING BOARDS; CANDLE HOLDERS, NOT OF PRECIOUS METAL; VASES; LAUNDRY BASKETS OF WICKER; SERVING TRAYS, PITCHERS; TOILET PAPER HOLDERS, TOWEL BARS, AND CUP HOLDERS; DISH DRYING RACKS, DISH DRYING RACKS; WINE BOTTLE CRADLES, BOTTLE HOLDERS, NAMELY, WINE BUCKETS; COOLERS FOR WINE IN THE SHAPE OF CUBES; LAUNDRY HAMPERS; CANVAS BINS FOR LAUNDRY, IN CLASS 21 (U.S. CLS. 2, 13, 23, 29, 30, 33, 40 AND 50).



David J. Kybas

Director of the United States Patent and Trademark Office

Reg. No. 4,107,245 FOR: LAUNDRY BAGS, IN CLASS 22 (U.S. CLS. 1, 2, 7, 19, 22, 42 AND 50).

FOR: COMPLETE BED SETS, NAMELY, BED SHEETS, BED SHEETS IN STAND ALONE COLORS, COMFORTERS, PILLOWCASES, IN CLASS 24 (U.S. CLS. 42 AND 50).

FOR: BATH MATS, IN CLASS 27 (U.S. CLS. 19, 20, 37, 42 AND 50).

PRIORITY CLAIMED UNDER SEC. 44(D) ON CANADA APPLICATION NO. 1224898, FILED 7-21-2004.

OWNER OF CANADA REG. NO. 798523, DATED 5-25-2011, EXPIRES 5-25-2026.

OWNER OF U.S. REG. NO. 2,661,212.

THE MARK CONSISTS OF A SQUARE DESIGN BEHIND THE TERM "H&H".

SER. NO. 78-505,884, FILED 10-26-2004.

ANDREW RHIM, EXAMINING ATTORNEY

United States of America

United States Patent and Trademark Office

XAP

Reg. No. 4,107,246

Registered Mar. 6, 2012

Int. Cls.: 9, 40 and 42

TRADEMARK

SERVICE MARK

PRINCIPAL REGISTER

CAMBRIDGE CONSULTANTS LIMITED (UNITED KINGDOM CORPORATION)
SCIENCE PARK, MILTON ROAD
CAMBRIDGE, UNITED KINGDOM CB4 ODW

FOR: ELECTRONIC GOODS FOR MICROPROCESSOR CORES EMBEDDED WITHIN INTEGRATED CIRCUITS, NAMELY, COMPUTER PERIPHERAL EQUIPMENT AND COMPUTER SOFTWARE FOR THE DESIGN, SIMULATION, PROGRAMMING, PRODUCTION AND TESTING OF MICROPROCESSOR CORES EMBEDDED WITHIN INTEGRATED CIRCUITS; ELECTRONIC GOODS FOR MICROPROCESSOR CORES EMBEDDED WITHIN INTEGRATED CIRCUITS, NAMELY, DOWNLOADABLE SCHEMATIC DIAGRAMS FOR BUILDING MICROPROCESSOR CORES TO BE EMBEDDED IN COMPUTER CIRCUITS, IN CLASS 9 (U.S. CLS. 21, 23, 26, 36 AND 38).

FOR: PROFESSIONAL CONSULTANCY SERVICES IN THE FIELD OF THE CUSTOM MANUFACTURE OF EMBEDDED MICROPROCESSOR CORES AND ELECTRONIC INTEGRATED CIRCUITS HAVING EMBEDDED MICROPROCESSOR CORES, IN CLASS 40 (U.S. CLS. 100, 103 AND 106).

FOR: PROFESSIONAL CONSULTANCY SERVICES IN THE FIELD OF DESIGN FOR OTHERS, COMPUTER PROGRAMMING AND PRODUCT TESTING, ALL IN THE FIELD OF EMBEDDED MICROPROCESSOR CORES AND ELECTRONIC INTEGRATED CIRCUITS HAVING EMBEDDED MICROPROCESSOR CORES; RENTAL OF COMPUTER HARDWARE, SOFTWARE AND PERIPHERAL EQUIPMENT IN THE FIELD OF DESIGN, SIMULATION, PROGRAMMING, PRODUCTION AND TESTING OF EMBEDDED MICROPROCESSOR CORES AND INTEGRATED CIRCUITS HAVING EMBEDDED MICROPROCESSOR CORES, IN CLASS 42 (U.S. CLS. 100 AND 101).

THE MARK CONSISTS OF STANDARD CHARACTERS WITHOUT CLAIM TO ANY PARTICULAR FONT, STYLE, SIZE, OR COLOR.

PRIORITY CLAIMED UNDER SEC. 44(D) ON ERPN CMNTY TM OFC APPLICATION NO. 004633723, FILED 9-14-2005, REG. NO. 004633723, DATED 11-5-2010, EXPIRES 9-14-2015.

SER. NO. 78-817,892, FILED 2-17-2006.

DAWN HAN, EXAMINING ATTORNEY



David J. Kyffers

Director of the United States Patent and Trademark Office

United States of America

United States Patent and Trademark Office

HEARTSPEAK

Reg. No. 4,107,247

HEARTSPEAK PRODUCTIONS INC. (CANADA CORPORATION)
1475 ISLINGTON AVENUE
ETOBICOKE, CANADA M9A 3L4

Registered Mar. 6, 2012

**Int. Cls.: 6, 9, 14, 16, 18,
21, 25, 32, 38, 41, 44 and
45**

FOR: PROMOTIONAL ITEMS, NAMELY, METAL KEY CHAINS, IN CLASS 6 (U.S. CLS. 2, 12, 13, 14, 23, 25 AND 50).

TRADEMARK

SERVICE MARK

PRINCIPAL REGISTER

FOR: PRE-RECORDED FILMS, AUDIO AND VIDEO TAPES, DVDS, AND CD-ROMS FEATURING EDUCATIONAL INFORMATION AND VIDEO FOOTAGE REGARDING ISSUES AFFECTING CHILDREN, YOUTH, TEENS, AND YOUNG ADULTS; ELECTRONIC PUBLICATIONS, NAMELY, NEWSLETTERS, MAGAZINES AND BULLETINS RECORDED ON COMPUTER AND DIGITAL MEDIA REGARDING ISSUES AFFECTING CHILDREN, YOUTH, TEENS, AND YOUNG ADULTS; ELECTRONIC INSTRUCTIONAL, EDUCATIONAL AND TEACHING MATERIALS, NAMELY, FORMS, GUIDES, MANUALS, WORK BOOKS, BROCHURES, FLYERS, BOOKS, NEWSLETTERS, JOURNALS, AND BULLETINS REGARDING ISSUES AFFECTING CHILDREN, YOUTH, TEENS, AND YOUNG ADULTS; CHILDREN'S EDUCATIONAL SOFTWARE; DOWNLOADABLE ELECTRONIC PUBLICATIONS IN THE NATURE OF NEWSLETTERS, BULLETINS, AND MAGAZINES REGARDING ISSUES AFFECTING CHILDREN, YOUTH, TEENS, AND YOUNG ADULTS; PROMOTIONAL ITEMS, NAMELY, MOUSE PADS, DECORATIVE MAGNETS, SUNGLASSES, IN CLASS 9 (U.S. CLS. 21, 23, 26, 36 AND 38).

FOR: BRACELETS; PROMOTIONAL ITEMS, NAMELY, KEY CHAINS OF PRECIOUS METAL AND COSTUME JEWELRY, NAMELY, NECKLACES, EARRINGS, ANKLETS, BELLY RINGS, RINGS, AND TOE RINGS, IN CLASS 14 (U.S. CLS. 2, 27, 28 AND 50).



David J. Kyros

Director of the United States Patent and Trademark Office

FOR: PRINTED INSTRUCTIONAL, EDUCATIONAL AND TEACHING MATERIALS IN THE FIELD OF ISSUES AFFECTING CHILDREN, YOUTH, TEENS, AND YOUNG ADULTS; PRINTED FORMS, GUIDES, MANUALS, WORK BOOKS, BROCHURES, FLYERS, BOOKS, NEWSLETTERS, JOURNALS, AND BULLETINS ALL FEATURING INFORMATION ABOUT ISSUES AFFECTING CHILDREN, YOUTH, TEENS, AND YOUNG ADULTS; SYNDICATED NEWSPAPER COLUMNS DEALING WITH ADVICE ; BULLETINS, NEWSLETTERS, AND MAGAZINES ABOUT ISSUES AFFECTING CHILDREN, YOUTH, TEENS, AND YOUNG ADULTS; PRINTED PUBLICATIONS, NAMELY, NEWSLETTERS AND BULLETINS ABOUT ISSUES AFFECTING CHILDREN, YOUTH, TEENS, AND YOUNG ADULTS; PENS, POSTERS, FOLDERS, PENCILS, DECALS, AND STICKERS; PRINTED VISUALS IN THE NATURE OF PROMOTIONAL MATERIALS; PROMOTIONAL ITEMS, NAMELY, BOOK MARKS, MEMO

Reg. No. 4,107,247 PADS, DIARIES, NOTE PADS, CALENDARS, NOTEBOOKS, HIGH LIGHTERS AND MARKERS, PEN AND PENCIL HOLDERS AND CASES, DRAWING RULERS; SYNDICATED PRINT ADVICE COLUMNS IN THE FIELD OF ISSUES AFFECTING CHILDREN, YOUTH, TEENS, AND YOUNG ADULTS, IN CLASS 16 (U.S. CLS. 2, 5, 22, 23, 29, 37, 38 AND 50).

FOR: PROMOTIONAL ITEMS, NAMELY, LEATHER KEY CHAINS, HANDBAGS, DUFFEL BAGS, WALLETS, AND CHANGE PURSES, IN CLASS 18 (U.S. CLS. 1, 2, 3, 22 AND 41).

FOR: PROMOTIONAL ITEMS, NAMELY, INSULATED MUGS, CUPS AND GLASSES, DRINKING GLASSES, WATER AND BEVERAGE BOTTLES, COASTERS NOT OF PAPER AND NOT BEING TABLE LINEN, LEATHER COASTERS, PLASTIC COASTERS, IN CLASS 21 (U.S. CLS. 2, 13, 23, 29, 30, 33, 40 AND 50).

FOR: HATS, BASE BALL HATS, AND SUN VISORS; CLOTHING, NAMELY, T-SHIRTS, SWEATERS, SWEATSHIRTS, SWEATPANTS, JOGGING SUITS, PANTS, SOCKS, SHORTS, JACKETS, VESTS, TANK TOPS, SCARVES, TOQUES, WRIST BANDS, HEAD BANDS, IN CLASS 25 (U.S. CLS. 22 AND 39).

FOR: PROMOTIONAL ITEMS, NAMELY, BOTTLED DRINKING WATER, IN CLASS 32 (U.S. CLS. 45, 46 AND 48).

FOR: WEBCASTING SERVICES; VIDEO ON DEMAND TRANSMISSION SERVICES; ENTERTAINMENT SERVICES, NAMELY, TRANSMISSION AND BROADCASTING OF TELEVISION SHOWS VIA TELEVISION, AN INTERNET WEBSITE, PORTABLE MEDIA PLAYERS, CELLULAR PHONES AND PERSONAL DIGITAL ASSISTANTS (PDAS) IN THE FIELD OF ISSUES AFFECTING CHILDREN, YOUTH, TEENS, AND YOUNG ADULTS, IN CLASS 38 (U.S. CLS. 100, 101 AND 104).

FOR: EDUCATIONAL SERVICES, NAMELY, CONDUCTING CLASSES, SEMINARS, COURSES AND WORKSHOPS CONCERNING ISSUES AFFECTING CHILDREN, YOUTH, TEENS, AND YOUNG ADULTS; CONDUCTING ON-LINE TUTORIALS AND SEMINARS CONCERNING ISSUES AFFECTING CHILDREN, YOUTH, TEENS, AND YOUNG ADULTS; ENTERTAINMENT SERVICES, NAMELY, CONTINUING RADIO AND TELEVISION PROGRAMS ABOUT ISSUES AFFECTING CHILDREN, YOUTH, TEENS, AND YOUNG ADULTS; PROVIDING A WEBSITE FEATURING INFORMATION CONCERNING ISSUES AFFECTING CHILDREN, YOUTH, TEENS, AND YOUNG ADULTS IN THE FIELDS OF THE IMPORTANCE OF EDUCATION; PRODUCTION OF TELEVISION PROGRAMS, WEBCAST AUDIO AND VIDEO PROGRAMS, AND AUDIO BROADCAST PROGRAMS; PROVISION OF NON-DOWNLOADABLE FILMS AND TV PROGRAMS VIA A VIDEO-ON-DEMAND SERVICE; ENTERTAINMENT IN THE NATURE OF LIVE MUSICAL AND THEATRICAL PERFORMANCES; ENTERTAINMENT SERVICES IN THE NATURE OF TALK SHOWS DISTRIBUTED BY RADIO OR TELEVISION BROADCAST, PODCAST, VIA A GLOBAL COMPUTER NETWORK, OR BROADCAST TO PORTABLE MEDIA PLAYERS, CELLULAR PHONES AND PERSONAL DIGITAL ASSISTANTS (PDAS); ENTERTAINMENT SERVICES, NAMELY, PROVIDING A TELEVISION PROGRAM IN THE FIELD OF INFORMATION CONCERNING ISSUES AFFECTING CHILDREN, YOUTH, TEENS, AND YOUNG ADULTS VIA A GLOBAL COMPUTER NETWORK; ENTERTAINMENT SERVICES, NAMELY, PROVIDING A WEBSITE FEATURING PHOTOGRAPHIC, AUDIO, VIDEO AND PROSE PRESENTATIONS FEATURING ISSUES AFFECTING CHILDREN, YOUTH, TEENS, AND YOUNG ADULTS; EDUCATIONAL SERVICES, NAMELY, CONDUCTING INFORMAL ON-LINE PROGRAMS AND DISCUSSION FORUMS IN THE FIELDS OF ISSUES AFFECTING CHILDREN, YOUTH, TEENS, AND YOUNG ADULTS; EDUCATIONAL SERVICES, NAMELY, CONDUCTING INFORMAL PROGRAMS IN THE FIELDS OF ISSUES AFFECTING CHILDREN, YOUTH, TEENS, AND YOUNG ADULTS, USING ON-LINE ACTIVITIES AND INTERACTIVE EXHIBITS; DEVELOPMENT AND DISSEMINATION OF EDUCATIONAL MATERIALS, INFORMATION, AND PRE-RECORDED OR LIVE VIDEO FOOTAGE VIA AN INTERNET WEBSITE AND WEBCASTS IN THE FIELD OF ISSUES AFFECTING CHILDREN, YOUTH, TEENS, AND YOUNG ADULTS; EDUCATIONAL CONSULTING SERVICES IN THE FIELDS OF ISSUES AFFECT-

Reg. No. 4,107,247 ING CHILDREN, YOUTH, TEENS, AND YOUNG ADULTS; ENTERTAINMENT SERVICES, NAMELY, DEVELOPMENT, PRODUCTION AND DISTRIBUTION, TRANSMISSION, AND BROADCASTING OF TELEVISION SHOWS VIA TELEVISION, AN INTERNET WEBSITE, PORTABLE MEDIA PLAYERS, CELLULAR PHONES AND PERSONAL DIGITAL ASSISTANTS (PDAS) IN THE FIELD OF ISSUES AFFECTING CHILDREN, YOUTH, TEENS, AND YOUNG ADULTS; PROVIDING COURSES OF INSTRUCTION IN REGARDS TO ISSUES AFFECTING CHILDREN, YOUTH, TEENS, AND YOUNG ADULTS; ARRANGING AND CONDUCTING LIVE AND ON LINE SEMINARS, TUTORIALS, CLASSES AND INTERACTIVE WORKSHOPS AND DISCUSSION FORUMS IN REGARDS TO ISSUES AFFECTING CHILDREN, YOUTH, TEENS, AND YOUNG ADULTS; PROVIDING ONLINE COLUMNS AND BLOGS IN THE FIELD OF ISSUES AFFECTING CHILDREN, YOUTH, TEENS, AND YOUNG ADULTS; MENTORING SERVICES IN THE FIELDS OF ISSUES AFFECTING CHILDREN, YOUTH, TEENS, AND YOUNG ADULTS IN THE FIELDS OF SELF- AND PERSON IMPROVEMENT, FAMILY LIFE, RELATIONSHIPS, EDUCATION, COMMUNITY INITIATIVES, SOCIOLOGY, EMOTIONS, ADDICTION, MENTAL HEALTH AND DISORDERS, VICTIM SERVICES, CRIMINAL JUSTICE, BULLYING, PHYSICAL HEALTH AND DISORDERS, LEARNING DISABILITIES, AND LIFESTYLE, IN CLASS 41 (U.S. CLS. 100, 101 AND 107).

FOR: COUNSELING SERVICES IN THE FIELDS OF ISSUES AFFECTING CHILDREN, YOUTH, TEENS, AND YOUNG ADULTS IN THE FIELDS OF SELF- AND PERSON IMPROVEMENT, FAMILY LIFE, RELATIONSHIPS, EDUCATION, COMMUNITY INITIATIVES, SOCIOLOGY, EMOTIONS, ADDICTION, MENTAL HEALTH AND DISORDERS, VICTIM SERVICES, CRIMINAL JUSTICE, BULLYING, PHYSICAL HEALTH AND DISORDERS, LEARNING DISABILITIES, AND LIFESTYLE; PROVIDING COUNSELING AND REFERRAL SERVICES TO CHILDREN, YOUTH, TEENS, YOUNG ADULTS, PARENTS, AND CAREGIVERS VIA A HELP LINE ACCESSIBLE BY TELEPHONE, CELLULAR PHONE OR VIA AN INTERNET WEBSITE; PROVIDING A WEBSITE FEATURING INFORMATION CONCERNING ISSUES AFFECTING CHILDREN, YOUTH, TEENS, AND YOUNG ADULTS IN THE FIELDS OF ADDICTION, MENTAL HEALTH AND DISORDERS, PHYSICAL HEALTH AND DISORDERS, AND LEARNING DISABILITIES, IN CLASS 44 (U.S. CLS. 100 AND 101).

FOR: PROVIDING A WEBSITE FEATURING INFORMATION CONCERNING ISSUES AFFECTING CHILDREN, YOUTH, TEENS, AND YOUNG ADULTS IN THE FIELDS OF SELF AND PERSONAL IMPROVEMENT, PERSONAL RELATIONSHIPS, EMOTIONAL COUNSELING AND EMOTIONAL SUPPORT, HOW TO DEAL WITH AND PROCESS PERSONAL EMOTIONS, CRIME VICTIMS, CRIMINAL JUSTICE, AND LIFESTYLE; PROVIDING A WEBSITE FEATURING EDUCATIONAL INFORMATION CONCERNING ISSUES AFFECTING CHILDREN, YOUTH, TEENS, AND YOUNG ADULTS IN THE FIELDS OF FAMILY LIFE, COMMUNITY INITIATIVES, SOCIOLOGY AND BULLYING, IN CLASS 45 (U.S. CLS. 100 AND 101).

THE MARK CONSISTS OF STANDARD CHARACTERS WITHOUT CLAIM TO ANY PARTICULAR FONT, STYLE, SIZE, OR COLOR.

PRIORITY CLAIMED UNDER SEC. 44(D) ON CANADA APPLICATION NO. 1281425, FILED 11-30-2005, REG. NO. TMA771182, DATED 7-5-2010, EXPIRES 7-5-2025.

SER. NO. 78-884,002, FILED 5-15-2006.

LESLIE RICHARDS, EXAMINING ATTORNEY

United States of America

United States Patent and Trademark Office

UNO

Reg. No. 4,107,248

Registered Mar. 6, 2012

Int. Cl.: 20

TRADEMARK

PRINCIPAL REGISTER

STEELCASE INC. (MICHIGAN CORPORATION)
901 44TH STREET SE
PO BOX 1967
GRAND RAPIDS, MI 49501

FOR: OFFICE FURNITURE, NAMELY, SEATING, IN CLASS 20 (U.S. CLS. 2, 13, 22, 25, 32 AND 50).

FIRST USE 11-0-1999; IN COMMERCE 11-0-1999.

THE MARK CONSISTS OF STANDARD CHARACTERS WITHOUT CLAIM TO ANY PARTICULAR FONT, STYLE, SIZE, OR COLOR.

THE ENGLISH TRANSLATION OF THE WORD "UNO" IN THE MARK IS "ONE".

SER. NO. 78-921,767, FILED 7-3-2006.

SARA BENJAMIN, EXAMINING ATTORNEY



David J. Kybas

Director of the United States Patent and Trademark Office

United States of America

United States Patent and Trademark Office

ABBY LINGVO

Reg. No. 4,107,249

Registered Mar. 6, 2012

Int. Cl.: 9

TRADEMARK

PRINCIPAL REGISTER

ABBY SOFTWARE LTD. (CYPRUS LIMITED LIABILITY COMPANY)
STASIKRATOUS 29
OFFICE 202; CY-1065 NICOSIA
CYPRUS

FOR: LANGUAGE TRANSLATION AND EDUCATIONAL SOFTWARE, FACILITATING AND ENABLING COMMUNICATION, THE FEATURES OF WHICH ARE AUDIO PRONUNCIATIONS IN THE NATURE OF TEXT TO SPEECH CAPABILITY, DETAILED DEFINITIONS OF WORDS AND WORD COMBINATIONS, SYNONYMS AND ANTONYMS, PRONUNCIATION KEYS, SEMANTICS, MORPHOLOGY, SYNTAX, PHONOLOGY, GRAMMAR, SPELLING, AND USAGE EXAMPLES FROM REAL SOURCES SUCH AS BOOKS, NEWSPAPERS AND OTHER PUBLICATIONS, IN CLASS 9 (U.S. CLS. 21, 23, 26, 36 AND 38).

THE MARK CONSISTS OF STANDARD CHARACTERS WITHOUT CLAIM TO ANY PARTICULAR FONT, STYLE, SIZE, OR COLOR.

PRIORITY DATE OF 4-24-2007 IS CLAIMED.

OWNER OF INTERNATIONAL REGISTRATION 0953958 DATED 10-1-2007, EXPIRES 10-1-2017.

OWNER OF U.S. REG. NOS. 2,646,419, 3,325,716, AND 3,346,919.

SER. NO. 79-050,166, FILED 10-1-2007.

SARA BENJAMIN, EXAMINING ATTORNEY



David J. Kyffers

Director of the United States Patent and Trademark Office

United States of America

United States Patent and Trademark Office

iFind

Reg. No. 4,107,250

Registered Mar. 6, 2012

Int. Cls.: 35 and 38

SERVICE MARK

PRINCIPAL REGISTER

DW CAPITAL GMBH (FED REP GERMANY LIMITED LIABILITY COMPANY)
VOGELSANGER STRASSE 66
50823 COLOGNE
FED REP GERMANY

FOR: ADVERTISING AND ADVERTISEMENT SERVICES; PROCUREMENT SERVICES FOR OTHERS, NAMELY, PROCURING GOODS FROM DIFFERENT COUNTRIES, NAMELY, PROCURING LEISURE, HEALTH AND WELLNESS AS WELL AS FASHION AND TEXTILE GOODS, NAMELY, EQUIPMENT FOR SPORTS AND TECHNOLOGY, BEACH AND CASUAL CLOTHING, AND SOUVENIRS; PRESENTATION OF GOODS ON COMMUNICATION MEDIA, FOR RETAIL PURPOSES; RENTAL OF ADVERTISING SPACE; DEMONSTRATION OF GOODS BY ELECTRONIC MEANS, ALSO FOR THE BENEFIT OF THE SO-CALLED TEleshopping AND HOME SHOPPING SERVICES; PROVIDING SPACE AT A WEB SITE FOR THE ADVERTISEMENT OF THE GOODS AND SERVICES OF OTHERS; SALES PROMOTION FOR OTHERS PROVIDED THROUGH THE DISTRIBUTION AND THE ADMINISTRATION OF PRIVILEGED USER CARDS; COST PRICE ANALYSIS; AUCTIONEERING; COMMERCIAL INFORMATION AND ADVICE FOR CONSUMERS; COMPUTERIZED FILE MANAGEMENT; MARKETING STUDIES; CONDUCTING MARKETING RESEARCH, PUBLIC OPINION POLLING; SYSTEMIZATION OF INFORMATION INTO COMPUTER DATABASES; DISSEMINATION OF ADVERTISING MATTER, IN CLASS 35 (U.S. CLS. 100, 101 AND 102).



FOR: COMMUNICATIONS BY COMPUTER TERMINALS, PROVIDING INTERNET CHAT-ROOMS; ELECTRONIC MESSAGE TRANSMISSION; ELECTRONIC TRANSMISSION OF MESSAGES AND DATA; ELECTRONIC TRANSMISSION OF DATA AND DOCUMENTS VIA COMPUTER TERMINALS; ELECTRONIC TRANSMISSION OF IMAGES VIA A GLOBAL COMPUTER NETWORK; ELECTRONIC BULLETIN BOARD SERVICES FOR TRANSMISSION OF MESSAGES AMONG COMPUTER USERS CONCERNING POLITICS, ECONOMICS, SPORTS, CULTURE, TECHNOLOGY; PROVIDING TELECOMMUNICATIONS CONNECTIONS TO A GLOBAL COMPUTER NETWORK; ELECTRONIC MAIL; PROVIDING ON-LINE FORUMS FOR TRANSMISSION OF MESSAGES AMONG COMPUTER USERS CONCERNING POLITICS, ECONOMICS, SPORTS, CULTURE, TECHNOLOGY, IN CLASS 38 (U.S. CLS. 100, 101 AND 104).

David J. Kyros

THE MARK CONSISTS OF STANDARD CHARACTERS WITHOUT CLAIM TO ANY PARTICULAR FONT, STYLE, SIZE, OR COLOR.

Reg. No. 4,107,250 PRIORITY DATE OF 5-14-2007 IS CLAIMED.

OWNER OF INTERNATIONAL REGISTRATION 0965927 DATED 10-19-2007, EXPIRES 10-19-2017.

SER. NO. 79-054,473, FILED 10-19-2007.

SHAUNIA CARLYLE, EXAMINING ATTORNEY

United States of America

United States Patent and Trademark Office

STAR PIXEL

Reg. No. 4,107,251

Registered Mar. 6, 2012

Int. Cls.: 2, 9, 16 and 41

TRADEMARK

SERVICE MARK

PRINCIPAL REGISTER

DAGMAR WOYDE-KÖHLER (FED REP GERMANY INDIVIDUAL)
ROONSTRASSE 23
76137 KARLSRUHE
FED REP GERMANY

FOR: PAINTS, VARNISHES, LACQUERS; COLORANTS; MORDANTS FOR USE IN THE FIELD OF ARTWORK; RAW NATURAL RESINS; METALS IN FOIL AND POWDER FORM FOR PAINTERS, DECORATORS, PRINTERS AND ARTISTS, IN CLASS 2 (U.S. CLS. 6, 11 AND 16).

FOR: MACHINE-READABLE DATA MEDIA EQUIPPED WITH PROGRAMS, NAMELY, COMPUTER PROGRAMS RECORDED ON MEDIA FOR CREATING, VIEWING, MANIPULATING, EDITING, MANAGING, INDEXING, CATALOGUING, SORTING, ORGANIZING, STORING, TRANSFERRING, SYNCHRONIZING, PRINTING, AND EXCHANGING DIGITAL PHOTOGRAPHS, DIGITAL AND GRAPHIC IMAGES, DATA, TEXT, AUDIO, VIDEO, MULTIMEDIA AND INTERACTIVE DOCUMENTS AND WORKS, TEXT DOCUMENTS, AND RECORDED INFORMATION; COMPUTER PROGRAMS AND SOFTWARE FOR CREATING, VIEWING, MANIPULATING, EDITING, MANAGING, INDEXING, CATALOGUING, SORTING, ORGANIZING, STORING, TRANSFERRING, SYNCHRONIZING, PRINTING, AND EXCHANGING DIGITAL PHOTOGRAPHS, DIGITAL AND GRAPHIC IMAGES, DATA, TEXT, AUDIO, VIDEO, MULTIMEDIA AND INTERACTIVE DOCUMENTS AND WORKS, TEXT DOCUMENTS, AND RECORDED INFORMATION, IN CLASS 9 (U.S. CLS. 21, 23, 26, 36 AND 38).

FOR: PAPER AND CARDBOARD; PAPER AND CARDBOARD GOODS, NAMELY, CANVAS PANELS FOR ARTISTIC PURPOSES; PRINTED MATTER, NAMELY, EXHIBITION CATALOGS IN THE NATURE OF EVENT PROGRAMS; PHOTOGRAPHS; STATIONERY; ARTISTS' MATERIALS, NAMELY, ARTISTS' PENS; PAINT BRUSHES, IN CLASS 16 (U.S. CLS. 2, 5, 22, 23, 29, 37, 38 AND 50).

FOR: PUBLIC PRESENTATIONS OF ARTWORK AND LITERATURE FOR CULTURAL AND EDUCATIONAL PURPOSES, IN CLASS 41 (U.S. CLS. 100, 101 AND 107).

THE MARK CONSISTS OF STANDARD CHARACTERS WITHOUT CLAIM TO ANY PARTICULAR FONT, STYLE, SIZE, OR COLOR.



David J. Kyjars

Director of the United States Patent and Trademark Office

Reg. No. 4,107,251 OWNER OF INTERNATIONAL REGISTRATION 0973549 DATED 5-28-2008, EXPIRES 5-28-2018.

SER. NO. 79-057,434, FILED 5-28-2008.

REBECCA POVARCHUK, EXAMINING ATTORNEY

United States of America
United States Patent and Trademark Office

EcoBallast

Reg. No. 4,107,252

Registered Mar. 6, 2012

Int. Cl.: 11

HYUNDAI HEAVY INDUSTRIES CO., LTD. (REPUBLIC OF KOREA CORPORATION OF
REPUBLIC OF KOREA)
1, JEONHA-DONG, DONG-KU
ULSAN, 682-792
REPUBLIC OF KOREA

TRADEMARK

PRINCIPAL REGISTER

FOR: SEA WATER PURIFYING APPARATUS FOR SHIPS; SEA WATER PURIFYING AP-
PARATUS FOR INDUSTRIAL PURPOSES RELATED TO SHIPS; SEA WATER STERILIZERS
FOR SHIPS; SEA WATER PURIFICATION INSTALLATIONS FOR SHIPS; SEA WATER
PURIFYING APPARATUS FOR SHIPS; SEA WATER PURIFYING APPARATUS AND MA-
CHINES FOR SHIPS; SEA WATER PURIFICATION UNITS FOR SHIPS; SEA WATER
PURIFICATION INSTALLATIONS FOR WASTE WATER AND SEWAGE ON SHIPS, IN
CLASS 11 (U.S. CLS. 13, 21, 23, 31 AND 34).

THE MARK CONSISTS OF THE WORDING "ECOBALLAST" IN BLUE.

OWNER OF INTERNATIONAL REGISTRATION 0979641 DATED 7-24-2008, EXPIRES 7-24-
2018.

THE COLOR(S) BLUE IS/ARE CLAIMED AS A FEATURE OF THE MARK.

SER. NO. 79-059,873, FILED 7-24-2008.

JACLYN KIDWELL WALKER, EXAMINING ATTORNEY



David J. Kyffers

Director of the United States Patent and Trademark Office

United States of America
United States Patent and Trademark Office

JETT

Reg. No. 4,107,253

Registered Mar. 6, 2012

Int. Cl.: 25

TRADEMARK

PRINCIPAL REGISTER

ABE SPORT GROUP SRL (ITALY SOCIETÀ A RESPONSABILITÀ LIMITATA)
VIA DELL'INDUSTRIA, 31
I-31041 CORNUDA (TREVISO)
ITALY

FOR: BOOTS FOR MOTORCYCLISTS, IN CLASS 25 (U.S. CLS. 22 AND 39).

PRIORITY DATE OF 4-9-2009 IS CLAIMED.

OWNER OF INTERNATIONAL REGISTRATION 1002969 DATED 5-11-2009, EXPIRES 5-11-2019.

SER. NO. 79-068,917, FILED 5-11-2009.

TOBY BULLOFF, EXAMINING ATTORNEY



David J. Kybas

Director of the United States Patent and Trademark Office

United States of America

United States Patent and Trademark Office



Reg. No. 4,107,254

Registered Mar. 6, 2012

Int. Cls.: 5, 10, 16 and 41

KONINKLIJKE PHILIPS ELECTRONICS N.V. (NETHERLANDS LIMITED LIABILITY COMPANY)
GROENEWOUDSEWEG 1
NL-5621 BA EINDHOVEN
NETHERLANDS

TRADEMARK

FOR: DIETETIC SUBSTANCES ADAPTED FOR MEDICAL USE, NAMELY, SUCROSE SOLUTIONS, FOOD FOR BABIES; MEDICAL DRESSINGS; MEDICAL PLASTERS; WIPES FOR MEDICAL PURPOSES, NAMELY, MEDICATED PRE-MOISTENED WIPES, IN CLASS 5 (U.S. CLS. 6, 18, 44, 46, 51 AND 52).

SERVICE MARK

PRINCIPAL REGISTER

FOR: SURGICAL, MEDICAL AND DENTAL APPARATUS AND INSTRUMENTS, NAMELY, NASAL ASPIRATORS, APNEA MONITORS, HEART RATE AND RESPIRATION MONITORS, NEONATAL AND PEDIATRIC ELECTRODES, BLOOD TESTERS; LIGHT THERAPY AND PHOTOTHERAPY APPARATUS AND PROTECTIVE MASKS THEREFORE SOLD AS A UNIT THEREWITH; DOSIMETERS FOR ASSESSING THERAPEUTIC DOSES OF RADIATION DELIVERED TO PATIENTS; ORTHOPEDIC ARTICLES, NAMELY, ORTHOPEDIC SUPPORTS, CONTOURED ORTHOPEDIC CUSHIONS AND BUMPERS FOR MEDICAL USE; MEDICAL POSITIONING AIDS IN THE NATURE OF CUSHIONS AND FOAM WEDGES FOR STABILIZING PATIENTS; CUSHIONS AND PILLOWS FOR MEDICAL USE; FITTED COVERS FOR BABY INCUBATORS; PACIFIERS, TEATS, BABY BOTTLES AND NIPPLES; INFANT HEEL WARMERS FOR MEDICAL USE, MEDICAL MATTRESSES; TEMPERATURE STRIPS IN THE NATURE OF THERMOMETERS FOR MONITORING PATIENTS THERMOREGULATION; ENTERAL FEEDING SETS COMPRISED OF FEEDING TUBES, ENTERAL FEEDING PUMPS AND PUMP BAGS; ORAL AND ENTERAL MEDICAL SYRINGES; TRIFURCATED EXTENSION SETS COMPRISED OF IMPLANTABLE MEDICATION PORT, BACK FLOW PREVENTION VALVE AND A FILTERED LINE; TRANSILLUMINATORS IN THE NATURE OF A LIGHT EMITTING DIODE (LED) DEVICE FOR LOCATION OF VEINS AND THERMOREGULATION PRODUCTS, NAMELY, INCUBATORS AND INFANT WARMERS, IN CLASS 10 (U.S. CLS. 26, 39 AND 44).



David J. Kyros

FOR: PRINTED INSTRUCTIONAL AND TEACHING MATERIAL, EXCEPT APPARATUS, IN THE FIELD OF CHILD AND INFANT EDUCATION, CARE AND DEVELOPMENT; DISPOSABLE DIAPERS AND PAPER DIAPERS FOR BABIES, IN CLASS 16 (U.S. CLS. 2, 5, 22, 23, 29, 37, 38 AND 50).

Reg. No. 4,107,254 FOR: EDUCATION SERVICES, NAMELY, EDUCATIONAL INSTRUCTION AND WORKSHOPS ON INFANT HANDLING AND CHILD CARE; PROVIDING TRAINING SERVICES IN THE FIELD OF MEDICAL PROCESS IMPROVEMENT AND MEDICAL CONSULTING; TRAINING OF NEONATAL INTENSIVE-CARE UNIT MEDICAL PROFESSIONALS AND OCCUPATIONAL THERAPISTS, IN CLASS 41 (U.S. CLS. 100, 101 AND 107).

THE MARK CONSISTS OF THE DESIGN OF A HEART THAT IS PARTIALLY FILLED IN.

PRIORITY DATE OF 6-17-2009 IS CLAIMED.

OWNER OF INTERNATIONAL REGISTRATION 1027708 DATED 12-16-2009, EXPIRES 12-16-2019.

SER. NO. 79-078,488, FILED 12-16-2009.

ELLEN PERKINS, EXAMINING ATTORNEY

United States of America

United States Patent and Trademark Office

CP

Reg. No. 4,107,255

Registered Mar. 6, 2012

Int. Cl.: 8

TRADEMARK

PRINCIPAL REGISTER

EXEL INDUSTRIES (FRANCE SOCIÉTÉ ANONYME)
54 RUE MARCEL PAUL
F-51200 EPERNAY, FRANCE

FOR: SMALL DEVICES FOR AGRICULTURAL PURPOSES, SPARE PARTS AND ACCESSORIES, NAMELY, HAND-OPERATED TOOLS AND INSTRUMENTS IN THE NATURE OF SPADES, FORKS AND DIBBLES, WITH THE EXCEPTION OF AND NOT INCLUDING PNEUMATIC IMPACT WRENCHES, SCREWDRIVERS, COMPRESSION TOOLS, NAMELY, AIR COMPRESSORS, HYDRAULIC AND PNEUMATIC RIVETERS, HYDRAULIC AND PNEUMATIC PRESSURE UNITS, AND HYDRAULIC AND PNEUMATIC PUNCHES, DRILLS, ABRASIVE TOOLS, NAMELY, PNEUMATIC DIE GRINDERS, ANGLE AND VERTICAL GRINDERS AND SANDERS, AND HORIZONTAL GRINDERS AND SANDERS, HAMMERS, DEMOLITION TOOLS, NAMELY, CONCRETE BREAKERS, SINKER DRILLS, CLAY DIGGERS AND SCALING HAMMERS, ROCK DRILLS, TAMPERS, VIBRATORS, PUMPS, HOISTS, BALANCERS AND WINCHES, STATIONARY MOTORS FOR USE WITH SCREW JACKS, STRAPPING MACHINERY, DOOR AND VALVE ACTUATORS, AND AGITATOR/MIXING EQUIPMENT AND AIR LINES, BUILDING MATERIALS, BUILDING SUPPLIES, CONSTRUCTION TOOLS, POWER TOOLS, NAMELY, TORQUED CONTROLLED WRENCHES, HIGH POWER AND STANDARD ELECTRIC SCREWDRIVERS, PISTOL GRIP NUTRUNNERS, IN-LINE NUTRUNNERS, ANGLE HEAD NUTRUNNERS, FIXTURE SPINDLES, SOCKETS, NAMELY, PNEUMATIC OPERATED SOCKET WRENCHES AND SOCKETS; HAND-OPERATED AGRICULTURAL IMPLEMENTS AND HAND-OPERATED HAND TOOLS FOR GARDENING IN THE NATURE OF HOES, GARDENING TROWELS, CULTIVATORS; APPLICATORS IN THE NATURE OF HAND-OPERATED SPRAYERS FOR INSECTICIDES, FUNGICIDES, HERBICIDES AND OTHER CHEMICAL, BIOLOGICAL AND PHYTOSANITARY PRODUCTS; HAND TOOLS, NAMELY, SPRAY GUNS FOR PAINTING, ENAMELING AND TREATING OF HERBICIDES, INSECTICIDES AND FUNGICIDES APPLICATIONS; NOZZLES FOR HANDHELD, HAND-OPERATED SPRAY GUNS; HAND-OPERATED SPRAY GUNS FOR PAINT; HAND-OPERATED HAND TOOLS AND IMPLEMENTS IN THE NATURE OF HAND OPERATED ATOMIZERS, VAPORIZERS, SPRAYERS, SPRAY GUNS FOR TREATING SURFACES BEFORE PAINTING; ABRASIVE WHEELS IN THE NATURE OF MANUALLY-OPERATED GRINDING WHEELS; HAND-HELD, HAND-OPERATED SPRAY GUNS FOR ELECTROSTATIC ENAMELING; HAND-HELD, HAND-OPERATED SPRAY GUNS FOR ELECTROSTATIC DUSTING; HAND-HELD, HAND-OPERATED SPRAY GUNS USED FOR LIQUID PAINT OR VARNISHES, IN CLASS 8 (U.S. CLS. 23, 28 AND 44).



David J. Kypos

Director of the United States Patent and Trademark Office

Reg. No. 4,107,255 THE MARK CONSISTS OF STANDARD CHARACTERS WITHOUT CLAIM TO ANY PARTICULAR FONT, STYLE, SIZE, OR COLOR.

PRIORITY DATE OF 6-29-2009 IS CLAIMED.

OWNER OF INTERNATIONAL REGISTRATION 1031577 DATED 12-15-2009, EXPIRES 12-15-2019.

SER. NO. 79-079,950, FILED 12-15-2009.

TINA BROWN, EXAMINING ATTORNEY

United States of America

United States Patent and Trademark Office

ECO-ACTIV

Reg. No. 4,107,256

Registered Mar. 6, 2012

Int. Cls.: 17 and 19

TRADEMARK

PRINCIPAL REGISTER

ICOPAL SAS (FRANCE SOCIÉTÉ PAR ACTIONS SIMPLIFIÉE)
12 RUE DE LA RENAISSANCE
F-92184 ANTONY CEDEX, FRANCE

FOR: RUBBER, GUTTA-PERCHA, GUM RUBBER, ASBESTOS, MICA AND GOODS MADE OF RUBBER, GUTTA-PERCHA, GUM, ASBESTOS, AND MICA, NOT INCLUDED IN OTHER CLASSES, NAMELY, RUBBER THREAD, NOT FOR TEXTILE USE; WATERTIGHT RINGS FOR PLUMBING PIPES, INSULATING TAPE, WEATHERSTRIPPING FOR USE IN DEPOLLUTING MEMBRANES, INSULATING GLOVES, WATERTIGHT PACKING MATERIAL FOR FORMING SEALS; FLOATING ANTI-POLLUTION BARRIERS; PLASTICS IN EXTRUDED FORM OF BARS, BLOCKS, PELLETS, RODS, SHEETS AND TUBES FOR USE IN MANUFACTURE; PACKING AND INSULATING MATERIALS; RUBBER STOPPERS FOR INDUSTRIAL PACKAGING CONTAINERS; FLEXIBLE PIPES, NOT OF METAL; ANTI-POLLUTION WEATHERIZING MEMBRANES BARRIERS, IN CLASS 17 (U.S. CLS. 1, 5, 12, 13, 35 AND 50).

FOR: NON-METALLIC BUILDING MATERIALS, NAMELY, DEPOLLUTING MEMBRANES FOR WATERPROOF ROOFING WHICH CONTAINS THE DEPOLLUTING ELEMENT TITANIUM OXIDE; NON-METALLIC RIGID PIPES FOR BUILDING; ASPHALT, PITCH AND BITUMEN; NON-METALLIC TRANSPORTABLE BUILDINGS; NON-METALLIC MONUMENTS, IN CLASS 19 (U.S. CLS. 1, 12, 33 AND 50).

THE MARK CONSISTS OF STANDARD CHARACTERS WITHOUT CLAIM TO ANY PARTICULAR FONT, STYLE, SIZE, OR COLOR.

PRIORITY DATE OF 6-24-2009 IS CLAIMED.

OWNER OF INTERNATIONAL REGISTRATION 1036040 DATED 12-24-2009, EXPIRES 12-24-2019.

SER. NO. 79-081,603, FILED 12-24-2009.

WARREN L. OLANDRIA, EXAMINING ATTORNEY



David J. Kyffers

Director of the United States Patent and Trademark Office

United States of America

United States Patent and Trademark Office



Reg. No. 4,107,257

Registered Mar. 6, 2012

Int. Cl.: 33

TRADEMARK

PRINCIPAL REGISTER

MARIE BRIZARD ET ROGER INTERNATIONAL (FRANCE SOCIÉTÉ PAR ACTIONS SIMPLIFIÉE)
19 BOULEVARD PAUL VAILLANT COUTURIER
F-94200 IVRY SUR SEINE
FRANCE

FOR: ALCOHOLIC BEVERAGES EXCEPT BEERS, IN CLASS 33 (U.S. CLS. 47 AND 49).

OWNER OF U.S. REG. NOS. 1,696,309 AND 2,883,798.

PRIORITY DATE OF 10-5-2009 IS CLAIMED.

OWNER OF INTERNATIONAL REGISTRATION 1037194 DATED 3-16-2010, EXPIRES 3-16-2020.

THE COLOR(S) ORANGE, WHITE AND BLACK IS/ARE CLAIMED AS A FEATURE OF THE MARK.

NO CLAIM IS MADE TO THE EXCLUSIVE RIGHT TO USE "BORDEAUX FRANCE", "ORANGE LIQUEUR", "DEPUIS 1755", "DELICIEUSE GOURMANDICE", "LIQUEUR D'ECORCES D'ORANGES" AND "COGNAC", APART FROM THE MARK AS SHOWN.

THE NAME "MARIE BRIZARD" DOES NOT IDENTIFY A LIVING INDIVIDUAL.



David J. Kybas

Director of the United States Patent and Trademark Office

THE MARK CONSISTS OF A THREE DIMENSIONAL SHAPE OF AN ORANGE COLORED BOTTLE HAVING A TAPERED MID PORTION. ON THE NECK BELOW THE CAP APPEARS A STYLIZED "MARIE BRIZARD AND ROGER" WITH A DESIGN ELEMENT IN WHITE. BELOW WHICH IS A CREST FEATURING AN ORANGE LION HOLDING A WHITE SHIELD. THE WORDS "MARIE BRIZARD BORDEAUX FRANCE" FORM A CIRCLE AROUND THE LION IN ORANGE. THE LETTERS "MB" APPEAR IN ORANGE ON THE WHITE SHIELD. THE UPPER PORTION OF THE BOTTLE FEATURES A RELIEF OF AN ORANGE SLICE. ABOUT THE MID SECTION OF THE BOTTLE FEATURES THE WORDING "GRAND ORANGE" IN WHITE, WITH THE "O" IN "ORANGE" APPEARING AS A STYLIZED ORANGE. BELOW WHICH IS A STYLIZED VINE DESIGN FEATURING A WOMAN FLANKED BY TWO CHERUBS IN BLACK. IN THE LOWER PORTION OF THE BOTTLE, THE WORDING "LIQUEUR ORANGE DELICIEUSE GOURMANDISE, D'UNE DOUCE LIQUEUR D'ECORCES D'ORANGES. AROME DELICATEMENT BOISÉS ET VIRILE VOLUPTÉ D'UN COGNAC

Reg. No. 4,107,257 D'EXCELLENCE" APPEARS IN WHITE. AT THE BOTTOM OF THE BOTTLE, THERE IS A STYLIZED "MARIE BRIZARD AND ROGER" WITH A DESIGN ELEMENT IN BLACK. THE WORDING "MARIE BRIZARD DEPUIS 1755" APPEARS IN WHITE AT THE LOWEST PORTION OF THE BOTTLE.

THE ENGLISH TRANSLATION OF "DELICIEUSE GOURMANDISE, D'UNE DOUCE LIQUEUR D'ECORCES D'ORANGES. AROME DELICATEMENT BOISÉS ET VIRILE VOLUPTÉ D'UN COGNAC D'EXCELLENCE; DEPUIS" IN THE MARK IS A DELICIOUS TREAT, A SWEET LIQUEUR MADE OF ORANGE PEELS. A COGNAC OF DISTINCTION WITH A DELICATE WOODY AROMA THAT IS STRONG AND SENSUAL; SINCE.

SER. NO. 79-082,034, FILED 3-16-2010.

WILLIAM BRECKENFELD, EXAMINING ATTORNEY

United States of America
United States Patent and Trademark Office

ALFA TCT

Reg. No. 4,107,258

Registered Mar. 6, 2012

Int. Cl.: 12

TRADEMARK

PRINCIPAL REGISTER

FIAT GROUP AUTOMOBILES S.P.A. (ITALY JOINT STOCK COMPANY)
CORSO GIOVANNI AGNELLI, 200
I-10135 TORINO
ITALY

FOR: AUTOMOTIVE GEARS FOR MOTOR VEHICLES, NAMELY, CLUTCH TRANSMISSION,
IN CLASS 12 (U.S. CLS. 19, 21, 23, 31, 35 AND 44).

THE MARK CONSISTS OF STANDARD CHARACTERS WITHOUT CLAIM TO ANY PAR-
TICULAR FONT, STYLE, SIZE, OR COLOR.

PRIORITY DATE OF 3-4-2010 IS CLAIMED.

OWNER OF INTERNATIONAL REGISTRATION 1040541 DATED 4-8-2010, EXPIRES 4-8-
2020.

OWNER OF U.S. REG. NOS. 3,011,575 AND 3,148,964.

SER. NO. 79-083,205, FILED 4-8-2010.

CHARISMA HAMPTON, EXAMINING ATTORNEY



David J. Kybas

Director of the United States Patent and Trademark Office

United States of America

United States Patent and Trademark Office

LeanOrder

Reg. No. 4,107,259

Registered Mar. 6, 2012

Int. Cls.: 9, 39, 42 and 45

TRADEMARK

SERVICE MARK

PRINCIPAL REGISTER

INTELLION AG (SWITZERLAND SOCIÉTÉ ANONYME)
SCHUPPISSTRASSE 8
CH-9016 ST. GALLEN
SWITZERLAND

FOR: TESTING APPARATUS NOT FOR MEDICAL PURPOSES, NAMELY, TESTING EQUIPMENT FOR MEASURING THE POSITION, LOCATION, SPEED, TEMPERATURE AND FORM OF ITEMS IN THE FIELDS OF MANUFACTURING, DISTRIBUTION AND SALES; ANTENNAE; ELECTRIC AND MAGNETIC INDICATORS FOR SENSING, SENDING AND ACTIVATING OF ELECTRONIC AND RADIO FREQUENCY SIGNALS; DEVICES ENABLING WIRELESS CONNECTIONS BETWEEN PORTABLE ELECTRONIC APPARATUS, NAMELY, WIRELESS COMMUNICATION DEVICES FOR VOICE, DATA OR IMAGE TRANSMISSION; DISTANCE RECORDING APPARATUS, NAMELY, LASER DISTANCE METERS AND OPTICAL DISTANCE METERS; ELECTRIC OR ELECTRONIC SENSORS FOR THE DETECTION OF RADIO WAVES, MAGNETIC FIELDS, ACCELERATION AND WEIGHT DETECTION, NAMELY, RADIO FREQUENCY IDENTIFICATION (RFID) TAGS, SCALES, PRESSURE PLATES, ACCELEROMETERS AND OPTICAL SENSORS; DIAGNOSTIC APPARATUS NOT FOR MEDICAL PURPOSES, NAMELY, DIAGNOSTIC SENSORS FOR USE IN MANUFACTURING, DISTRIBUTION AND SALES AND CALIBRATION DEVICES FOR RFID TAGS, SCALES, PRESSURE PLATES, ACCELEROMETERS AND OPTICAL SENSORS; ELECTRONIC NOTICE BOARDS; DISTANCE MEASURING APPARATUS; INTERFACES FOR COMPUTERS; DISC DRIVES FOR COMPUTERS; MEASURING INSTRUMENTS FOR MEASURING RADIO, MAGNETIC FIELDS, ACCELERATION AND WEIGHT; COORDINATE MEASURING MACHINES AND INSTRUMENTS FOR MEASURING LENGTH AND TIME OF FLIGHT; ELECTRIC INSTRUMENTS FOR NAVIGATION; SOUND-LOCATING INSTRUMENTS, NAMELY, SOUND SENSORS USED FOR LOCATING GOODS AND CARRIERS AS WELL AS FOR TRANSPORT ASSISTANCE; ELECTRONIC SIGNAL TRANSMITTERS; MECHANICAL OR LUMINOUS SIGNS; ELECTRICAL MONITORING APPARATUS, NAMELY, HARDWARE AND COMMUNICATIONS DEVICES FOR PLANNING, SCHEDULING, CONTROLLING, MONITORING AND PROVIDING INFORMATION ON TRANSPORTATION ASSETS AND PARTS THEREOF COMPRISED OF RFID TAGS, SENSORS, TRANSMITTERS, RECEIVERS AND GLOBAL POSITIONING SATELLITE RECEIVERS, IN CLASS 9 (U.S. CLS. 21, 23, 26, 36 AND 38).



David J. Kappas

Director of the United States Patent and Trademark Office

FOR: TRANSPORTATION INFORMATION; STORAGE INFORMATION; COURIER SERVICES, NAMELY, MESSAGES OR MERCHANDISE; STORAGE OF DATA OR DOCUMENT MEDIA; TRANSPORT SERVICES, NAMELY, LOGISTICAL SERVICES FOR THE REPLENISHMENT

Reg. No. 4,107,259 OF GOODS IN STORAGE OR AT MANUFACTURING SITES, NAMELY, STORAGE, TRANSPORTATION AND DELIVERY OF GOODS FOR OTHERS BY AIR, RAIL, SHIP OR TRUCK; PROVIDING TRANSPORTATION SERVICES FOR THE TRANSPORT OF BOXES IN STERILE ENVIRONMENTS, NAMELY, TRANSPORT OF GOODS, IN CLASS 39 (U.S. CLS. 100 AND 105).

FOR: COMPUTER CONSULTANCY SERVICES; COMPUTER SYSTEM ANALYSIS; ONLINE MONITORING, NAMELY, ANALYSIS OF ACCESS TO COMPUTER NETWORKS, NAMELY, MONITORING THE COMPUTER NETWORKS OF OTHERS USING WIRELESS AND LOCALIZATION TECHNOLOGIES SUCH AS GPS, GRPS AND UMTS, IN CLASS 42 (U.S. CLS. 100 AND 101).

FOR: GRANTING OF INDUSTRIAL PROPERTY LICENSES, NAMELY, LICENSING OF INTELLECTUAL PROPERTY, IN CLASS 45 (U.S. CLS. 100 AND 101).

THE MARK CONSISTS OF STANDARD CHARACTERS WITHOUT CLAIM TO ANY PARTICULAR FONT, STYLE, SIZE, OR COLOR.

OWNER OF INTERNATIONAL REGISTRATION 0995783 DATED 12-5-2008, EXPIRES 12-5-2018.

SER. NO. 79-084,660, FILED 6-17-2010.

SCOTT BIBB, EXAMINING ATTORNEY

United States of America

United States Patent and Trademark Office



Reg. No. 4,107,260

Registered Mar. 6, 2012

Int. Cl.: 6

TRADEMARK

PRINCIPAL REGISTER

DEMAC S.R.L. (ITALY SOCIÉTÉ RESPONSABILITÉ LIMITÉE)
VIA R. MURRI, 14
I-20013 MAGENTA (MI)
ITALY

FOR: HAND-OPERATED METAL CABLE REELS, NON-MECHANICAL; NON-MECHANICAL METAL STORAGE SPOOLS FOR FLEXIBLE TUBES; HAND-OPERATED AND AUTO RETRACTABLE NON-MECHANICAL METAL SPOOLS FOR REELING FLEXIBLE TUBES OF METAL; NON-MECHANICAL METAL STORAGE SPOOLS FOR FLEXIBLE TUBES AND FOR CABLES OF METAL, ESPECIALLY FOR CONDUCTING GAS, LIQUIDS OR ELECTRICITY IN VERTICAL AND TURNING CONDUITS, ESPECIALLY FOR INSTALLING IN ELECTRICAL EQUIPMENT; REELING SYSTEMS FOR FLEXIBLE TUBES AND FOR CABLES OF METAL, COMPRISING, HAND-OPERATED METAL REELS FOR FLEXIBLE TUBES AND METAL CABLES ESPECIALLY FOR CONDUCTING GAS, LIQUIDS OR ELECTRICITY IN VERTICAL AND TURNING CONDUITS, ESPECIALLY FOR INSTALLING IN ELECTRICAL EQUIPMENT; METALLIC PIPING SYSTEMS COMPRISING, METAL PIPES, METAL PIPE FITTINGS; METAL SLEEVES FOR TUBES OF METAL; TUBE COUPLINGS OF METAL, METAL COUPLINGS FOR USE WITH HYDRAULIC AND PNEUMATIC SYSTEMS FOR LUBRICATION, MANUALLY OPERATED METAL VALVES FOR WATER PIPES OF METAL; MANUALLY OPERATED METAL VALVES FOR DRAINAGE TUBES; COMMON METALS, UNWROUGHT, FOR FURTHER MANUFACTURE; SHEET METAL; METAL LICENSE PLATES, METAL NAME PLATES AND METAL STORAGE SPOOLS; SEMI-FINISHED STEEL SHEETS AND THEIR ALLOYS; ANCHORS; ANVILS; METAL BELLS; CAST AND LAMINATED METAL CONSTRUCTION MATERIALS, NAMELY, METAL SOFFITS; METAL KEY RINGS; METAL RAILS, AND OTHER METAL MATERIALS FOR RAILWAYS, NAMELY, METALLIC MATERIALS FOR RAILWAY TRACKS; METAL CHAINS EXCEPT THOSE FOR VEHICLES; NON-ELECTRIC CABLES AND WIRES OF COMMON METAL; METAL LOCKS; PIPES OF METAL; METAL SAFES; STEEL SPHERES; NAILS AND METAL SCREWS; METAL GOODS NOT INCLUDED IN OTHER CLASSES, NAMELY, ANDIRONS, IN CLASS 6 (U.S. CLS. 2, 12, 13, 14, 23, 25 AND 50).



David J. Kyros

Director of the United States Patent and Trademark Office

THE TRADEMARK HAS A COMPLEX STRUCTURE COMPOSED OF GRAPHIC AND WRITTEN ELEMENTS; INSIDE A RECTANGLE WITH ROUNDED CORNERS IS THE WORD "DEMAC" IN SPECIAL FONT; TO THE LEFT OF THIS WORD AND INSIDE THE RECTANGLE WITH ROUNDED CORNERS IS A STYLISED LETTER "D", LIGHTLY DOUBLED.

PRIORITY DATE OF 5-13-2010 IS CLAIMED.

Reg. No. 4,107,260 OWNER OF INTERNATIONAL REGISTRATION 1045909 DATED 5-27-2010, EXPIRES 5-27-2020.

SER. NO. 79-085,390, FILED 5-27-2010.

LEIGH LOWRY, EXAMINING ATTORNEY

United States of America

United States Patent and Trademark Office

NEWTREE SUPERFRUIT

Reg. No. 4,107,261

Registered Mar. 6, 2012

Int. Cl.: 30

TRADEMARK

PRINCIPAL REGISTER

NEWTREE SA (BELGIUM SOCIÉTÉ ANONYME)
BD. DU SOUVERAIN, 207- BOÎTE 3
B-1160 BRUXELLES
BELGIUM

FOR: COCOA, COCOA PRODUCTS, NAMELY, COCOA POWDER, COCOA BEANS; NON MEDICATED CHOCOLATE, CHOCOLATE LOZENGE TABLETS AND CHOCOLATE PASTILLES, PRALINES AND CHOCOLATE TRUFFLES; CHOCOLATE AND COCOA-BASED BEVERAGES, NON DAIRY PRODUCTS BASED OR VEGETABLE BASED, IN CLASS 30 (U.S. CL. 46).

THE MARK CONSISTS OF STANDARD CHARACTERS WITHOUT CLAIM TO ANY PARTICULAR FONT, STYLE, SIZE, OR COLOR.

PRIORITY DATE OF 12-2-2009 IS CLAIMED.

OWNER OF INTERNATIONAL REGISTRATION 1046037 DATED 6-2-2010, EXPIRES 6-2-2020.

OWNER OF U.S. REG. NO. 3,119,587.

NO CLAIM IS MADE TO THE EXCLUSIVE RIGHT TO USE "SUPERFRUIT", APART FROM THE MARK AS SHOWN.

SER. NO. 79-085,451, FILED 6-2-2010.

WILLIAM ROSSMAN, EXAMINING ATTORNEY



David J. Kybas

Director of the United States Patent and Trademark Office

United States of America

United States Patent and Trademark Office



Reg. No. 4,107,262

Registered Mar. 6, 2012

Int. Cls.: 35, 36 and 41

SERVICE MARK

PRINCIPAL REGISTER

BANCA CÍVICA, S.A.
PZA. DE SAN FRANCISCO, 1
E-41004 SEVILLA
SPAIN

FOR: ADVERTISING SERVICES; BUSINESS MANAGEMENT; BUSINESS MANAGEMENT AND ORGANIZATION CONSULTANCY; BUSINESS ADMINISTRATION; PROVIDING OFFICE FUNCTIONS; MARKET RESEARCH AND STUDIES; COMPILATION OF STATISTICAL INFORMATION; COMPILATION OF STATISTICS IN THE FIELD OF BUSINESS AND COMMERCIAL INDUSTRY; IMPORT-EXPORT AGENCY SERVICES; ADVISORY AND CONSULTANCY SERVICES RELATING TO EXPORT, EXPORT SERVICES AND EXPORT PROMOTION INFORMATION SERVICES; COMPUTERIZED FILE MANAGEMENT AND DATABASE MANAGEMENT; ORGANIZATION OF EXHIBITIONS FOR COMMERCIAL OR ADVERTISING PURPOSES; RENTAL OF ADVERTISING SPACE, IN CLASS 35 (U.S. CLS. 100, 101 AND 102).

FOR: FINANCING SERVICES, CREDIT AND INVESTMENT SERVICES, NAMELY, CREDIT AND INVESTMENT CONSULTATION, CREDIT BUREAUS, ISSUING CREDIT CARDS, INVESTMENT ADVICE, INVESTMENT BROKERAGE, AND INVESTMENT MANAGEMENT, FINANCIAL INVESTMENTS IN THE FIELD OF SECURITIES, BONDS, DEBENTURES, MORTGAGE BOND HOLDINGS, NEGOTIABLE SECURITIES AND NEGOTIABLE SECURITIES THAT INCLUDE OPTIONS TO PURCHASE, TO SUBSCRIBE OR TO SELL THE UNDERLYING ASSETS, MAINTAINING INVESTMENT ESCROW ACCOUNTS AND MONEY DEPOSIT ACCOUNTS; REAL ESTATE SERVICES, NAMELY, REAL ESTATE ACQUISITION SERVICES, REAL ESTATE ESCROW SERVICES, REAL ESTATE INVESTMENT, AND REAL ESTATE MANAGEMENT; MORTGAGES, NAMELY, MORTGAGE LENDING, MORTGAGE BANKING AND MAINTAINING MORTGAGE ESCROW ACCOUNTS; LOANS, NAMELY, LOAN FINANCING, AND SAVINGS AND LOAN SERVICES; INSURANCE SERVICES, NAMELY, INSURANCE AGENCIES, INSURANCE CONSULTATION, INSURANCE BROKERAGE, AND INSURANCE ADMINISTRATION; COMPUTERIZED FILE MANAGEMENT AND DATABASE SERVICES IN THE FIELD OF FINANCIAL SERVICES, IN CLASS 36 (U.S. CLS. 100, 101 AND 102).



David J. Kybas

Director of the United States Patent and Trademark Office

FOR: EDUCATION SERVICES, NAMELY, PROVIDING CONTINUING PROFESSIONAL EDUCATIONAL COURSES IN THE FIELD OF BANKING, FINANCE, ECONOMICS, INVESTMENTS, AND MONEY MANAGEMENT; TRAINING SERVICES THE FIELD OF IN BANKING, FINANCE, ECONOMICS, INVESTMENTS, AND MONEY MANAGEMENT; ORGANIZATION

Reg. No. 4,107,262 OF SEMINARS, COLLOQUIUMS, SYMPOSIUMS AND CONGRESSES IN THE FIELD OF BANKING, FINANCE, ECONOMICS, INVESTMENTS, AND MONEY MANAGEMENT; PROVIDING NON-DOWNLOADABLE ELECTRONIC PUBLICATIONS, NAMELY, MAGAZINES AND BLOGS IN THE FIELD OF BANKING, FINANCE, ECONOMICS, INVESTMENTS, AND MONEY MANAGEMENT; ORGANIZING COMMUNITY SPORTING AND CULTURAL EVENTS, IN CLASS 41 (U.S. CLS. 100, 101 AND 107).

OWNER OF U.S. REG. NO. 3,922,147.

PRIORITY DATE OF 6-4-2010 IS CLAIMED.

OWNER OF INTERNATIONAL REGISTRATION 1046125 DATED 6-14-2010, EXPIRES 6-14-2020.

NO CLAIM IS MADE TO THE EXCLUSIVE RIGHT TO USE "BANKING", APART FROM THE MARK AS SHOWN.

THE MARK CONSISTS OF THE WORDING "CIVIC BANKING" IN STYLIZED FONT WITH A TREE BRANCH WITH LEAVES IN BETWEEN THE TWO WORDS.

SER. NO. 79-085,482, FILED 6-14-2010.

WILLIAM ROSSMAN, EXAMINING ATTORNEY

United States of America

United States Patent and Trademark Office

JOURNEY TO DEEP GREEN

Reg. No. 4,107,263

Registered Mar. 6, 2012

**Int. Cls.: 6, 19, 36, 37, 41
and 42**

TRADEMARK

SERVICE MARK

PRINCIPAL REGISTER

SKANSKA AB (SWEDEN AKTIEBOLAG (AB))
BOX 1195
SE-169 83 SOLNA
SWEDEN

FOR: REINFORCING MATERIALS, OF METAL, FOR CONCRETE FOR BUILDING PURPOSES; REINFORCING MATERIALS OF METAL FOR BUILDING; BUILDINGS, TRANSPORTABLE, OF METAL; COMMON METALS, UNWROUGHT OR SEMI-WROUGHT FOR FURTHER MANUFACTURE; ALL OF THE ABOVE FOR USE IN GREEN CONSTRUCTION, IN CLASS 6 (U.S. CLS. 2, 12, 13, 14, 23, 25 AND 50).

FOR: NON-METALLIC BUILDING MATERIALS, NAMELY, SOFFITS, SEMIWORKED WOODS, BUILDING STONE, ARTIFICIAL STONE, GRAVEL, CONCRETE, CEMENT MIXES, CERAMIC TILES, RUBBER COVE BASES, RUBBER FLOOR TILES, RUBBER FLOORING, PLASTIC CONDUIT FOR DRAINAGE AND IRRIGATION, PLASTIC FLOORBOARDS, PLASTIC TILES, PLASTIC WALLBOARDS, PLASTIC WATER CONDUITS FOR ROOFS AND BALCONIES, WOOD BEAMS, WOOD BLOCKS, WOOD DOOR FRAMES, WOOD JOINTS, WOOD JOISTS, WOOD MOLDINGS, WOOD PANELING, WOOD POLES FOR UTILITIES OR POWER LINES, WOOD POSTS, WOOD RAFTERS, WOOD SIDING, WOOD TILE FLOORS, WOOD TRIM, WOOD VENEER, WOOD WINDOW FRAMES, WOOD-FIBER REINFORCED CEMENT BOARDS IN THE NATURE OF CEMENT EXCELSIOR BOARDS, PLASTER, LIGHTWEIGHT AGGREGATED CONCRETE FOR USE AS SCREED, CLAY PIPES AND CONDUITS, CLAY TILES, ASPHALT, PITCH AND BITUMEN ASPHALT; NON-METALLIC RIGID PIPES FOR BUILDINGS; NON-METALLIC TRANSPORTABLE BUILDINGS; ALL OF THE ABOVE FOR USE IN GREEN CONSTRUCTION, IN CLASS 19 (U.S. CLS. 1, 12, 33 AND 50).

FOR: REAL ESTATE AGENCIES, RENTAL OF HOMES, REAL ESTATE BROKERAGE, REAL ESTATE APPRAISAL, ACCOMMODATION BUREAUX, NAMELY, REAL ESTATE MANAGEMENT SERVICES, RENTING OF FLATS, LEASING OF REAL ESTATE, ALL THE FOREGOING RELATING TO GREEN CONSTRUCTION, IN CLASS 36 (U.S. CLS. 100, 101 AND 102).

FOR: CONSTRUCTION INFORMATION IN THE FIELD OF BUILDING CONSTRUCTION, ROAD CONSTRUCTION, INSTALLATION OF VEHICULAR AND PEDESTRIAN BRIDGES, RESIDENTIAL CONSTRUCTION, AND CONSTRUCTION AND CONSTRUCTION MANAGEMENT OF TUNNELS AND UNDERGROUND STRUCTURES; BUILDING CONSTRUCTION;



David J. Kyros

Director of the United States Patent and Trademark Office

Reg. No. 4,107,263 RENTAL OF CONSTRUCTION EQUIPMENT; DEMOLITION OF BUILDINGS; CLEANING OF BUILDINGS' INTERIORS; CLEANING OF BUILDINGS' EXTERIOR SURFACES; INSTALLATION OF BUILDING INSULATION; BUILDING SEALING SERVICES; ASPHALTING; BUILDING CONSTRUCTION SUPERVISION; SCAFFOLDING CONSTRUCTION; ELECTRIC APPLIANCE INSTALLATION AND REPAIR; INSTALLATION OF DOORS AND WINDOWS; ALL OF THE ABOVE IN THE FIELD OF GREEN CONSTRUCTION, IN CLASS 37 (U.S. CLS. 100, 103 AND 106).

FOR: ARRANGING AND CONDUCTING OF EDUCATIONAL CONFERENCES; ARRANGING AND CONDUCTING OF EDUCATIONAL CONGRESSES; ARRANGING AND CONDUCTING OF SEMINARS IN THE FIELD OF PROPERTY DEVELOPMENT, SUSTAINABLE ECONOMIC DEVELOPMENT, AND INTERNATIONAL PROJECT DEVELOPMENT; EDUCATIONAL SERVICES, NAMELY, SEMINARS IN THE FIELD OF ECONOMIC DEVELOPMENT FOR COMPANIES, CITIES, AND REGIONS; PRACTICAL TRAINING BEING EDUCATIONAL DEMONSTRATIONS, IN CLASS 41 (U.S. CLS. 100, 101 AND 107).

FOR: ARCHITECTURAL CONSULTATION; ARCHITECTURE, NAMELY, ARCHITECTURAL DESIGN, ARCHITECTURAL RESEARCH; CONSTRUCTION DRAFTING; SURVEYING; LAND SURVEYING; ENGINEERING; TECHNICAL PROJECT STUDIES IN THE NATURE OF FEASIBILITY STUDIES; TECHNICAL RESEARCH IN THE FIELD OF PROPERTY DEVELOPMENT; DESIGN OF INTERIOR DÉCOR , IN CLASS 42 (U.S. CLS. 100 AND 101).

NO CLAIM IS MADE TO THE EXCLUSIVE RIGHT TO USE "GREEN", APART FROM THE MARK AS SHOWN.

PRIORITY DATE OF 6-11-2010 IS CLAIMED.

OWNER OF INTERNATIONAL REGISTRATION 1046518 DATED 7-6-2010, EXPIRES 7-6-2020.

SER. NO. 79-085,620, FILED 7-6-2010.

ANDREA HACK, EXAMINING ATTORNEY

United States of America

United States Patent and Trademark Office

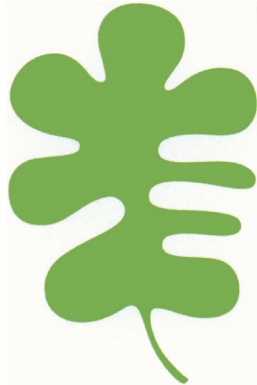

Reg. No. 4,107,264

Registered Mar. 6, 2012

**Int. Cls.: 6, 19, 35, 36, 37,
41 and 42**

SKANSKA AB (SWEDEN AKTIEBOLAG (AB))
BOX 1195
SE-169 83 SOLNA
SWEDEN

FOR: REINFORCING MATERIALS, OF METAL, FOR CONCRETE FOR BUILDING PURPOSES; REINFORCING MATERIALS OF METAL FOR BUILDING; BUILDINGS, TRANSPORTABLE, OF METAL; COMMON METALS, UNWROUGHT OR SEMI-WROUGHT FOR FURTHER MANUFACTURE, IN CLASS 6 (U.S. CLS. 2, 12, 13, 14, 23, 25 AND 50).

TRADEMARK

SERVICE MARK

PRINCIPAL REGISTER

FOR: NON-METALLIC BUILDING MATERIALS, NAMELY, SOFFITS, SEMIWORKED WOODS, BUILDING STONE, ARTIFICIAL STONE, GRAVEL, CONCRETE, CEMENT MIXES, CERAMIC TILES, RUBBER COVE BASES, RUBBER FLOOR TILES, RUBBER FLOORING, PLASTIC CONDUIT FOR DRAINAGE AND IRRIGATION, PLASTIC FLOORBOARDS, PLASTIC TILES, PLASTIC WALLBOARDS, PLASTIC WATER CONDUITS FOR ROOFS AND BALCONIES, WOOD BEAMS, WOOD BLOCKS, WOOD DOOR FRAMES, WOOD JOINTS, WOOD JOISTS, WOOD MOLDINGS, WOOD PANELING, WOOD POLES FOR UTILITIES OR POWER LINES, WOOD POSTS, WOOD RAFTERS, WOOD SIDING, WOOD TILE FLOORS, WOOD TRIM, WOOD VENEER, WOOD WINDOW FRAMES, WOOD-FIBER REINFORCED CEMENT BOARDS IN THE NATURE OF CEMENT EXCELSIOR BOARDS, PLASTER, LIGHTWEIGHT AGGREGATED CONCRETE FOR USE AS SCREED, CLAY PIPES AND CONDUITS, CLAY TILES, ASPHALT, PITCH AND BITUMEN ASPHALT; NON-METALLIC RIGID PIPES FOR BUILDINGS; NON-METALLIC TRANSPORTABLE BUILDINGS, IN CLASS 19 (U.S. CLS. 1, 12, 33 AND 50).



FOR: BUSINESS APPRAISALS; COMMERCIAL OR INDUSTRIAL MANAGEMENT ASSISTANCE; BUSINESS INVESTIGATIONS; ECONOMIC FORECASTING; ADVERTISING; ADMINISTRATIVE PROCESSING OF PURCHASE ORDERS; DRAWING UP OF STATEMENTS OF ACCOUNTS BEING ADMINISTRATIVE ACCOUNTING SERVICES; COMPUTERIZED FILE MANAGEMENT; COMPILATION OF INFORMATION INTO COMPUTER DATABASES; SYSTEMIZATION OF INFORMATION INTO COMPUTER DATABASES; COMPILATION OF STATISTICS; PROFESSIONAL BUSINESS CONSULTANCY; PROCUREMENT SERVICES FOR OTHERS, NAMELY, PURCHASING RESIDENTIAL AND COMMERCIAL PROPERTIES FOR OTHER BUSINESSES, NAMELY, REAL ESTATE SALES MANAGEMENT, IN CLASS 35 (U.S. CLS. 100, 101 AND 102).

David J. Kyros

Director of the United States Patent and Trademark Office

Reg. No. 4,107,264 FOR: REAL ESTATE AGENCIES; RENTAL OF HOMES; REAL ESTATE MANAGEMENT SERVICES; REAL ESTATE BROKERAGE; REAL ESTATE APPRAISAL; ACCOMMODATION BUREAUX, NAMELY, REAL ESTATE MANAGEMENT SERVICES; RENTING OF FLATS; LEASING OF REAL ESTATE; FINANCIAL EVALUATION FOR INSURANCE, BANKING, AND REAL ESTATE PURPOSES; FINANCIAL ANALYSIS; FINANCIAL CONSULTANCY; FINANCIAL INFORMATION; INSURANCE INFORMATION; INSURANCE CONSULTANCY, IN CLASS 36 (U.S. CLS. 100, 101 AND 102).

FOR: CONSTRUCTION INFORMATION IN THE FIELD OF BUILDING CONSTRUCTION, ROAD CONSTRUCTION, INSTALLATION OF VEHICULAR AND PEDESTRIAN BRIDGES, RESIDENTIAL CONSTRUCTION, AND CONSTRUCTION AND CONSTRUCTION MANAGEMENT OF TUNNELS AND UNDERGROUND STRUCTURES; BUILDING CONSTRUCTION; RENTAL OF CONSTRUCTION EQUIPMENT; DEMOLITION OF BUILDINGS; CLEANING OF BUILDINGS' INTERIORS; CLEANING OF BUILDINGS' EXTERIOR SURFACES; INSTALLATION OF BUILDING INSULATION; BUILDING SEALING SERVICES; ASPHALTING; BUILDING CONSTRUCTION SUPERVISION; SCAFFOLDING CONSTRUCTION; ELECTRIC APPLIANCE INSTALLATION AND REPAIR; INSTALLATION OF DOORS AND WINDOWS, IN CLASS 37 (U.S. CLS. 100, 103 AND 106).

FOR: ARRANGING AND CONDUCTING OF EDUCATIONAL CONFERENCES; ARRANGING AND CONDUCTING OF EDUCATIONAL CONGRESSES; ARRANGING AND CONDUCTING OF SEMINARS IN THE FIELD OF PROPERTY DEVELOPMENT, SUSTAINABLE ECONOMIC DEVELOPMENT, AND INTERNATIONAL PROJECT DEVELOPMENT; EDUCATIONAL SERVICES, NAMELY, SEMINARS IN THE FIELD OF ECONOMIC DEVELOPMENT FOR COMPANIES, CITIES, AND REGIONS; PRACTICAL TRAINING BEING EDUCATIONAL DEMONSTRATIONS, IN CLASS 41 (U.S. CLS. 100, 101 AND 107).

FOR: ARCHITECTURAL CONSULTATION; ARCHITECTURE, NAMELY, ARCHITECTURAL DESIGN, ARCHITECTURAL RESEARCH; CONSTRUCTION DRAFTING; SURVEYING; LAND SURVEYING; ENGINEERING; TECHNICAL PROJECT STUDIES IN THE NATURE OF FEASIBILITY STUDIES; TECHNICAL RESEARCH IN THE FIELD OF PROPERTY DEVELOPMENT; DESIGN OF INTERIOR DÉCOR, IN CLASS 42 (U.S. CLS. 100 AND 101).

THE MARK CONSISTS OF AN ASYMMETRICAL GREEN LEAF, HAVING A STEM AT ITS BOTTOM, THREE BULGES ON ITS LEFT SIDE, ONE ON ITS TOP, AND FOUR ON ITS RIGHT SIDE.

PRIORITY DATE OF 3-19-2010 IS CLAIMED.

OWNER OF INTERNATIONAL REGISTRATION 1046519 DATED 7-6-2010, EXPIRES 7-6-2020.

THE COLOR(S) GREEN IS/ARE CLAIMED AS A FEATURE OF THE MARK.

SER. NO. 79-085,621, FILED 7-6-2010.

ANDREA HACK, EXAMINING ATTORNEY

United States of America

United States Patent and Trademark Office

CHOMARAT

Reg. No. 4,107,265

Registered Mar. 6, 2012

**Int. Cls.: 17, 19, 21, 22,
23, 24 and 25**

TRADEMARK

PRINCIPAL REGISTER

COMPAGNIE CHOMARAT (FRANCE SOCIÉTÉ EN COMMANDITE PAR ACTIONS)
29 BOULEVARD DES ITALIENS
F-75002 PARIS
FRANCE

FOR: SEMI-WORKED GOODS IN THE NATURE OF INSULATING FABRICS OF TEXTILE AND SYNTHETIC MATERIAL FOR REINFORCING SEMI-FINISHED PLASTIC GOODS; SEMI-WORKED GOODS IN THE NATURE OF INSULATING PLASTIC YARNS, THREADS AND FIBERS NOT FOR TEXTILE USE FOR REINFORCING SEMI-FINISHED PLASTIC GOODS; SEMI-WORKED GOODS IN THE NATURE OF PLASTIC FIBERS NOT FOR TEXTILE USE FOR REINFORCING SEMI-FINISHED PLASTIC GOODS; FIBERGLASS AND FIBERGLASS FABRICS FOR INSULATING PURPOSES PARTICULARLY SOUND-PROOFING MATERIALS, SHOCK-INSULATING MATERIALS; SEMI-FINISHED INSULATING GOODS, NAMELY, FABRICS AND MATERIALS; SEALANTS FOR WATERPROOF TEXTILE COMPLEXES; FLAMEPROOF AND FLAME-RESISTANT REINFORCEMENT MATERIAL FOR THERMAL INSULATION AND FIRE PROTECTION, NAMELY, FIRE-RESISTANT COMPOSITE PANELS MADE OF ARAMID, GLASS CARBON AND CERAMIC FIBERS; FLEXIBLE TUBES, NOT OF METAL, NAMELY, PLASTIC, ARAMID, GLASS, CARBON AND CERAMIC FIBERS TUBES FOR INDUSTRIAL AND COMMERCIAL USE; FIBERGLASS FABRICS AND SEMI-WORKED GOODS IN THE FORM OF WOVEN MESHING, FOR INSULATING AND REINFORCING PLASTIC MATERIALS OR COMPOSITES, IN CLASS 17 (U.S. CLS. 1, 5, 12, 13, 35 AND 50).

FOR: CONSTRUCTION MATERIALS, NOT OF METAL, NAMELY, MATERIAL FOR ROAD CONSTRUCTION AND MAINTENANCE, NAMELY, SHEETS, BLOCKS, SLABS, FLOORS, ROOFING, SIDING, SANDWICH PANELS, PROFILES, MULTILAYER PANELS AND PARTITION WALLS; MATERIAL FOR REINFORCEMENT AND INSULATION OF FLOORING, ROOFS, CEILINGS, NAMELY, SHEETS, BLOCKS, SLABS, FLOORS, ROOFING, SIDING, SANDWICH PANELS, PROFILES, MULTILAYER PANELS AND PARTITION WALLS; RIGID PIPES NOT OF METAL, IN CLASS 19 (U.S. CLS. 1, 12, 33 AND 50).

FOR: FIBERGLASS FOR INDUSTRIAL AND COMMERCIAL USE, FIBERGLASS NOT FOR TEXTILE USE, GLASS WOOL OTHER THAN FOR INSULATION, FIBERGLASS THREAD, NOT FOR TEXTILE USE, ALL FOR THE REINFORCEMENT OF PLASTIC MATERIALS OR FOR MAKING COMPOSITE MATERIALS, NOT FOR TEXTILE USE, IN CLASS 21 (U.S. CLS. 2, 13, 23, 29, 30, 33, 40 AND 50).



David J. Kyjars

Director of the United States Patent and Trademark Office

Reg. No. 4,107,265 FOR: RAW FIBROUS TEXTILE MATERIALS; RAW FIBERS, NAMELY, LINEN, HEMP, JUTE, SISAL, RAMIE, KENAF AND COTTON FOR REINFORCING PLASTIC MATERIALS OR FOR MAKING COMPOSITE MATERIALS, IN CLASS 22 (U.S. CLS. 1, 2, 7, 19, 22, 42 AND 50).

FOR: YARNS AND THREADS FOR TEXTILE USE, IN CLASS 23 (U.S. CL. 43).

FOR: FABRICS, TEXTILE FABRICS, AND TEXTILE COMPLEXES PARTICULARLY FOR THE REINFORCEMENT OF PLASTIC MATERIALS OR COMPOSITES; VELVET, TEXTILE FOR TECHNICAL APPLICATIONS, NAMELY, FOR USE IN STRENGTHENING INDUSTRIAL AND ARCHITECTURAL COMPOSITE PARTS AND MATERIALS IN BUILDINGS, WALL PANELS, SWIMMING POOLS AND WINDMILLS; TEXTILE FOR CLOTHING; WOVEN OR NON-WOVEN TEXTILE MESH, IN CLASS 24 (U.S. CLS. 42 AND 50).

FOR: CLOTHING, NAMELY, DRESSING GOWNS, NON-PAPER BABY BIBS, HOSIERY, SOCKS, SHIRTS, SHORT-SLEEVED SHIRTS, DRESSES, SKIRTS, SLACKS, PANTIES AND UNDERPANTS, GLOVES, VESTS, LAYETTES, COATS, JACKETS, PAJAMAS, PULLOVERS, UNDERCLOTHING, FOOTWEAR EXCEPT ORTHOPEDIC SHOES, NAMELY, SPORTS FOOTWEAR, SLIPPERS, BOOTS, ANKLE BOOTS, SLIPPERS, SANDALS, HEADGEAR, NAMELY, HATS, CAPS, VISORS, IN CLASS 25 (U.S. CLS. 22 AND 39).

THE MARK CONSISTS OF STANDARD CHARACTERS WITHOUT CLAIM TO ANY PARTICULAR FONT, STYLE, SIZE, OR COLOR.

PRIORITY DATE OF 10-8-2009 IS CLAIMED.

OWNER OF INTERNATIONAL REGISTRATION 1046714 DATED 3-25-2010, EXPIRES 3-25-2020.

SER. NO. 79-085,733, FILED 3-25-2010.

RON FAIRBANKS, EXAMINING ATTORNEY

United States of America

United States Patent and Trademark Office

CELESSENCE

Reg. No. 4,107,266

Registered Mar. 6, 2012

**Int. Cls.: 3, 5, 16, 20, 24,
25 and 40**

TRADEMARK

SERVICE MARK

PRINCIPAL REGISTER

CELESSENCE INTERNATIONAL LIMITED (ENGLAND LIMITED COMPANY)
UNIT 3, ARDEN BUSINESS PARK
ENTERPRISE CLOSE,; MEDWAY CITY ESTATE; ROCHESTER, KENT ME2 4LY
UNITED KINGDOM

FOR: BLEACHING PREPARATIONS AND OTHER SUBSTANCES FOR LAUNDRY USE, NAMELY, FABRIC SOFTENERS, LAUNDRY BLEACH, LAUNDRY DETERGENT, LAUNDRY PRE-SOAK, LAUNDRY SOAP, AND LAUNDRY STARCH; CLEANING, POLISHING, SCOURING AND ABRASIVE PREPARATIONS; SOAPS FOR HYGIENIC, SANITARY AND BEAUTY PURPOSES; PERFUMERY; ESSENTIAL OILS; COSMETICS; HAIR LOTIONS; DENTIFRICES; DEODORANTS FOR PERSONAL USE; COSMETIC GOODS, NAMELY, SKIN-CARE CREAMS, LOTIONS, TALCUM POWDERS, PERFUMES, LIPSTICKS, FINGER-NAIL AND TOE NAIL POLISH, EYE AND FACIAL MAKEUP, HAIR COLORS, HAIR SPRAYS AND GELS, DEODORANTS FOR PERSONAL USE, BABY PRODUCTS IN THE NATURE OF BATH OILS, BUBBLE BATHS, BATH SALTS, BODY BUTTERS, ALL OF THE FOREGOING COSMETIC GOODS BEING MADE WITH ENCAPSULATED AND MICROENCAPSULATED FRAGRANCES, MOISTURIZERS, ANTI-OXIDANTS, SKIN SOOTHING PRODUCTS, OR SKIN AND BODY CONDITIONING PRODUCTS, IN CLASS 3 (U.S. CLS. 1, 4, 6, 50, 51 AND 52).

FOR: AIR PERFUMING PREPARATIONS, NAMELY, AIR FRESHENERS, AIR DEODORIZERS, AIR SANITIZING AGENTS FOR HOUSEHOLD USE, USE IN PUBLIC RESTROOMS OR OTHER PUBLIC AND COMMERCIAL LOCATIONS, AIR DISINFECTANTS, IN CLASS 5 (U.S. CLS. 6, 18, 44, 46, 51 AND 52).



David J. Kyros

Director of the United States Patent and Trademark Office

FOR: PAPER, CARDBOARD AND GOODS MADE FROM THESE MATERIALS, NAMELY, STATIONERY WRITING PAPER, BOXES OF PAPER OR CARDBOARD, CARDBOARD PACKAGING, PACKING PAPER, HANG TAGS, NOTE PAPER, ENVELOPES, ALL OF THE FOREGOING ITEMS BEING MADE WITH OR WITHOUT ENCAPSULATED AND MICROENCAPSULATED FRAGRANCES; PRINTED MATTER IN THE FIELDS OF EDUCATION AND ENTERTAINMENT, NAMELY, BOOKS, MAGAZINES, JOURNALS, NEWSLETTERS AND MANUALS, ALL OF THE FOREGOING ITEMS BEING MADE WITH OR WITHOUT ENCAPSULATED AND MICROENCAPSULATED FRAGRANCES; NEWSPAPERS; BOOK BINDING MATERIAL; PHOTOGRAPHS; STATIONERY; ADHESIVES FOR STATIONERY OR HOUSEHOLD PURPOSES; ARTISTS' MATERIALS, NAMELY, ARTISTS' PENS, ARTISTS' BRUSHES, ARTISTS' PASTELS; PAINT BRUSHES; TYPEWRITERS; PACKAGING MATERIALS, NAMELY, PAPER, CARDBOARD, PROTECTIVE PACKAGING IN THE NATURE OF

Reg. No. 4,107,266 PLASTIC BUBBLE PACKS FOR WRAPPING OR PACKAGING, ENVELOPES, PAPER AND CARDBOARD BOXES; PRINTERS' TYPE; PRINTING BLOCKS; DISPOSABLE NAPPIES OF PAPER FOR BABIES; PRINTED PUBLICATIONS IN THE FIELDS OF EDUCATION AND ENTERTAINMENT, NAMELY, BOOKS, MAGAZINES, JOURNALS, AND NEWSLETTERS; PAINT BOXES FOR CHILDREN; CHECK BOOK HOLDERS, IN CLASS 16 (U.S. CLS. 2, 5, 22, 23, 29, 37, 38 AND 50).

FOR: FURNITURE; MIRRORS; PICTURE FRAMES; ARTICLES MADE OF WOOD, CORK, REED, CANE, WICKER, HORN, BONE, IVORY, WHALEBONE, SHELL, AMBER, MOTHER-OF-PEARL, MEERSCHAUM OR PLASTIC WHICH ARE NOT INCLUDED IN OTHER CLASSES, NAMELY, WOOD BOXES, CORKS, DRAWER PULLS, STOPPERS, REEDS, ANIMAL HORNS, STATUES, SCULPTURES, FIGURINES, BUSTS, IVORY, WHALEBONES, SEA SHELLS, RAW MOTHER OF PEARL, MEERSCHAUM, PLASTIC DOORKNOBS, ORNAMENTS NOT INCLUDING CHRISTMAS TREE ORNAMENTS; GARDEN FURNITURE; SOFT FURNISHINGS, NAMELY, PILLOWS, CUSHIONS, ALL OF THE FOREGOING ITEMS BEING MADE WITH OR WITHOUT ENCAPSULATED AND MICROENCAPSULATED FRAGRANCES AND DEODORIZERS, IN CLASS 20 (U.S. CLS. 2, 13, 22, 25, 32 AND 50).

FOR: TEXTILES AND TEXTILE GOODS, NAMELY, WAVY FIBER TEXTILES, VINYL AND CLOTH TEXTILES FOR USE IN THE MANUFACTURE OF CLOTHING AND SOFT FURNISHINGS, TEXTILES FOR DYE-SUBLIMATION PRINTING, TEXTILE WALL HANGINGS, TEXTILE USED AS LINING FOR CLOTHING, TEXTILE LABELS, TAPESTRIES OF TEXTILE, FELT AND NON-WOVEN TEXTILE FABRICS, TEXTILE NAPKINS, TEXTILE PLACE MATS, LINEN, COTTON FABRIC, WOOL BASED MIXED FABRICS, SILK CLOTH, JUTE CLOTH, HEMP CLOTH, POLYESTER FABRIC, ACRYLIC, NAMELY, POLYESTER FABRIC, THROWS, BED BLANKETS, ALL OF THE FOREGOING ITEMS BEING MADE WITH OR WITHOUT ENCAPSULATED AND MICROENCAPSULATED FRAGRANCES, MOISTURIZERS, ANTI-OXIDANTS, SKIN SOOTHING PRODUCTS AND SKIN AND BODY CONDITIONING PRODUCTS; BED COVERS AND TABLE CLOTHS OF TEXTILE; TRAVELERS' RUGS; TEXTILE FABRICS FOR MAKING ARTICLES OF CLOTHING, ALL OF THE FOREGOING ITEMS BEING MADE WITH OR WITHOUT ENCAPSULATED AND MICROENCAPSULATED FRAGRANCES, MOISTURIZERS, ANTI-OXIDANTS, SKIN SOOTHING PRODUCTS AND SKIN AND BODY CONDITIONING PRODUCTS; CURTAINS BEING MADE WITH OR WITHOUT ENCAPSULATED AND MICROENCAPSULATED FRAGRANCES AND DEODORIZERS; PARTS AND FITTINGS FOR ALL OF THE AFORESAID GOODS, NAMELY, CURTAIN LOOPS OF TEXTILE MATERIAL, SHOWER CURTAIN LINERS, TEXTILE SUIT LININGS, IN CLASS 24 (U.S. CLS. 42 AND 50).

FOR: CLOTHING AND HEADGEAR, NAMELY, SHIRTS, PANTS, BELTS, JACKETS, DRESSES, SOCKS, UNDERWEAR, LINGERIE, SCARVES, GLOVES, T-SHIRTS, JUMPERS, TROUSERS, HATS AND CAPS; FOOTWEAR; ALL OF THE FOREGOING ITEMS BEING MADE WITH OR WITHOUT ENCAPSULATED AND MICROENCAPSULATED FRAGRANCES, MOISTURIZERS, ANTI-OXIDANTS, SKIN SOOTHING PRODUCTS, SKIN AND BODY CONDITIONING PRODUCTS OR COOLING PRODUCTS; PARTS AND FITTINGS FOR ALL OF THE AFORESAID GOODS SOLD AS A UNIT THEREWITH, NAMELY, ZIPPERS, BUTTONS, LACES, HOOKS AND EYES, THREAD, CLASPS, IN CLASS 25 (U.S. CLS. 22 AND 39).

FOR: TREATMENT OF MATERIALS, NAMELY, TREATMENT OF MATERIALS BY APPLYING AND IMPREGNATING ENCAPSULATED AND MICROENCAPSULATED FRAGRANCES, MOISTURIZERS, ANTI-OXIDANTS, SKIN SOOTHING PRODUCTS AND SKIN AND BODY CONDITIONING PRODUCTS; TREATMENT OF MATERIALS, NAMELY, TEXTILES, WOVEN AND NON-WOVEN, PAPER PRODUCTS, PLASTICS, WOOD AND LEATHER WITH MICROENCAPSULATED AND ENCAPSULATED FRAGRANCES; TREATMENT OF MATERIALS WITH ENCAPSULATED AND MICROENCAPSULATED COOLING PRODUCTS; TREATMENT OF MATERIALS WITH ENCAPSULATED AND MICROENCAPSULATED MOISTURIZERS; TREATMENT OF MATERIALS WITH ENCAPSULATED AND MICROENCAPSULATED ANTI-OXIDANTS; TREATMENT OF MATERIALS WITH ENCAPSULATED

Reg. No. 4,107,266 AND MICROENCAPSULATED SKIN SOOTHING PRODUCTS; TREATMENT OF MATERIALS WITH ENCAPSULATED AND MICROENCAPSULATED SKIN AND BODY CONDITIONING PRODUCTS; ADVISORY SERVICES IN RELATION TO TREATMENT OF MATERIALS BY APPLYING ENCAPSULATED AND MICROENCAPSULATED FRAGRANCES, MOISTURIZERS, ANTI-OXIDANTS, SKIN SOOTHING PRODUCTS AND SKIN AND BODY CONDITIONING PRODUCTS, IN CLASS 40 (U.S. CLS. 100, 103 AND 106).

THE MARK CONSISTS OF STANDARD CHARACTERS WITHOUT CLAIM TO ANY PARTICULAR FONT, STYLE, SIZE, OR COLOR.

OWNER OF INTERNATIONAL REGISTRATION 1047884 DATED 3-19-2010, EXPIRES 3-19-2020.

THE WORDING CELESSENCE HAS NO MEANING IN A FOREIGN LANGUAGE.

SER. NO. 79-086,151, FILED 3-19-2010.

JESSICA A. POWERS, EXAMINING ATTORNEY

United States of America
United States Patent and Trademark Office

PATHFINDER

Reg. No. 4,107,267

Registered Mar. 6, 2012

Int. Cl.: 12

TRADEMARK

PRINCIPAL REGISTER

SHANGHAI JILONG ECONOMY DEVELOPMENT CO., LTD. (CHINA CORPORATION)
NO. 520, LANXUE ROAD
HUANGLOU TOWN, PUDONG NEW DISTRICT
SHANGHAI, CHINA

FOR: BOATS, NAMELY, KAYAKS; OARS; SCULLS; PADDLES FOR CANOES, IN CLASS
12 (U.S. CLS. 19, 21, 23, 31, 35 AND 44).

OWNER OF INTERNATIONAL REGISTRATION 1048369 DATED 5-11-2010, EXPIRES 5-11-
2020.

SER. NO. 79-086,330, FILED 5-11-2010.

KRISTINA MORRIS, EXAMINING ATTORNEY



David J. Kybas

Director of the United States Patent and Trademark Office

United States of America

United States Patent and Trademark Office

unióñsuiza

Reg. No. 4,107,268

UNION SUIZA, S.A. (SPAIN SOCIEDAD ANONIMA)

Registered Mar. 6, 2012

VÍA AUGUSTA, 1
E-08006 BARCELONA, SPAIN

**Int. Cls.: 9, 14, 16, 18, 20,
25 and 35**

FOR: SCIENTIFIC, NAUTICAL, SURVEYING, PHOTOGRAPHIC, CINEMATOGRAPHIC, OPTICAL, WEIGHING, MEASURING, SIGNALING, CHECKING (SUPERVISION), LIFE-SAVING AND TEACHING APPARATUS AND INSTRUMENTS, NAMELY, COMPASS, CAMERAS, TAPE RECORDERS, MEASURING RULES, SCALES, LAMPS, TRAYS, TANKS, CASES; ELECTRIC CONDUCTORS; ELECTRIC SWITCHES; ELECTRIC TRANSFORMERS; ELECTRIC ACCUMULATORS; ELECTRIC CONTROLLERS; VOLTAGE REGULATORS FOR ELECTRIC POWER; DIGITAL MEDIA, NAMELY, PRE-RECORDED DIGITAL VIDEO DISCS, DIGITAL VERSATILE DISCS, DVDS AND HIGH DEFINITION DIGITAL DISCS FEATURING JEWELRY; APPARATUS FOR RECORDING, TRANSMISSION OR REPRODUCTION OF SOUND OR IMAGES; MAGNETIC DATA CARRIERS; AUTOMATIC VENDING MACHINES AND MECHANISMS FOR COIN-OPERATED APPARATUS; CASH REGISTERS, CALCULATING MACHINES, DATA PROCESSING EQUIPMENT AND COMPUTERS, IN CLASS 9 (U.S. CLS. 21, 23, 26, 36 AND 38).

TRADEMARK

SERVICE MARK

PRINCIPAL REGISTER

FOR: PRECIOUS METALS AND THEIR ALLOYS; JEWELRY; PRECIOUS STONES; TIMEPIECES AND CHRONOMETRIC INSTRUMENTS, IN CLASS 14 (U.S. CLS. 2, 27, 28 AND 50).



FOR: PRINTED MATTER, NAMELY, PAPER, CARDBOARD; PHOTOGRAPHS; STATIONERY; ADHESIVES (GLUES) FOR STATIONERY OR HOUSEHOLD PURPOSES; PAINTBRUSHES; TYPEWRITERS; PRINTING TYPE; PRINTING BLOCKS; MATERIALS FOR BOOK BINDING; ARTIST MATERIALS, NAMELY, PENCILS, PENS, PASTELS, PAINTBRUSHES; OFFICE REQUISITES, NAMELY, STAPLERS, PUNCHES, PLASTIC OR PAPER BAGS FOR MERCHANDISE PACKAGING IN THE NATURE OF ENVELOPES AND POUCHES; CLIPS FOR OFFICES; INK; POSTAGE STAMPS, SEALING MACHINES FOR OFFICES; PRINTED INSTRUCTIONAL AND TEACHING MATERIALS IN THE FIELD OF JEWELRY; PLASTIC BAGS FOR PACKAGING JEWELS, IN CLASS 16 (U.S. CLS. 2, 5, 22, 23, 29, 37, 38 AND 50).

David J. Kyros

FOR: LEATHER AND IMITATIONS FOR LEATHER; ANIMAL SKINS; TRUNKS AND TRAVELING BAGS; UMBRELLAS, PARASOLS AND WALKING STICKS; WHIPS; SADDLERY, IN CLASS 18 (U.S. CLS. 1, 2, 3, 22 AND 41).

Reg. No. 4,107,268 FOR: FURNITURE, MIRRORS, PICTURE FRAMES, CHAIRS, BAG CLOSURES IN THE NATURE OF AN ELASTIC BAND; STATUETTES OF BONE, IVORY, PLASTER, PLASTIC, WAX, WOOD; FURNITURE, NAMELY, SCREENS; PLASTIC BOXES FOR PACKAGING CONSUMER AND RETAIL ITEMS; NONMETAL CONTAINERS FOR USE IN TRANSPORT OF PRECIOUS METALS AND THEIR ALLOYS, JEWELRY, PRECIOUS STONES, TIMEPIECES AND CHRONOMETRIC INSTRUMENTS FOR COMMERCIAL OR INDUSTRIAL USE, SCULPTURES OF WOOD, CORK, REED, CANE, WICKER, HORN, BONE, IVORY, WHALEBONE, SHELL, AMBER, MOTHER-OF-PEARL, MEERSCHAUM AND SUBSTITUTES FOR ALL THESE MATERIALS OR OF PLASTICS, IN CLASS 20 (U.S. CLS. 2, 13, 22, 25, 32 AND 50).

FOR: CLOTHING, NAMELY, SHIRTS, PANTS, SHORTS, SKIRTS, DRESSES, COATS, SCARVES, FOOTWEAR, HEADWEAR, IN CLASS 25 (U.S. CLS. 22 AND 39).

FOR: ADVERTISING; BUSINESS MANAGEMENT; BUSINESS ADMINISTRATION; OFFICE FUNCTIONS, IN CLASS 35 (U.S. CLS. 100, 101 AND 102).

THE MARK CONSISTS OF THE STYLIZED WORDING "UNIONSUIZA" WITH A SOLID DIAMOND DESIGN OVER THE "O" IN "UNION".

PRIORITY DATE OF 6-7-2010 IS CLAIMED.

OWNER OF INTERNATIONAL REGISTRATION 1048608 DATED 7-27-2010, EXPIRES 7-27-2020.

THE ENGLISH TRANSLATION OF "UNION SUIZA" IN THE MARK IS "SWISS UNION".

SER. NO. 79-086,435, FILED 7-27-2010.

REBECCA SMITH, EXAMINING ATTORNEY

United States of America

United States Patent and Trademark Office



IDEX

Reg. No. 4,107,269

Registered Mar. 6, 2012

Int. Cls.: 9, 16 and 42

TRADEMARK

SERVICE MARK

PRINCIPAL REGISTER

IDEX ASA (NORWAY PLC)
ROLFSBUKTVEIEN 17
N-1364 FORNEBU, NORWAY

FOR: COMPUTER HARDWARE AND PORTABLE ELECTRONIC DEVICES, NAMELY, PERSONAL COMPUTERS, PERSONAL DIGITAL ASSISTANTS, MOBILE TELEPHONES AND REMOTE CONTROLS WITH FINGERPRINT RECOGNITION APPARATUS, NAMELY, DEVICES BASED ON BIOMETRIC TECHNOLOGY FOR IDENTIFICATION AND IDENTITY VERIFICATION AND POINTING, AND FOR USE ON TOUCH SCREENS; MAGNETIC ENCODED CARD READERS; MICROPROCESSORS, NOTEBOOK COMPUTERS, COMPUTER OPERATING SYSTEMS, MAGNETICALLY ENCODED IDENTIFICATION CARDS ALL CARRYING INTEGRATED CIRCUITRY FOR IDENTIFYING THE BEARER OF THE CARD; ENCODED SMART CARDS CONTAINING PROGRAMMING USED TO MAKE ELECTRONIC PAYMENTS; OPTICAL CHARACTER RECOGNITION APPARATUS; ELECTRICAL APPARATUS, NAMELY, SENSORS, AND COMPONENTS, NAMELY, ELECTRICAL RECODING MACHINES FOR IDENTITY CONTROL, ADMISSION CONTROL, HUMAN FINGERPRINT SIMULATING AND RECOGNITION APPARATUS; COMPUTER SOFTWARE, NAMELY, FOR USE IN DATABASE MANAGEMENT, AND USE IN ELECTRONIC STORAGE OF DATA; FINGERPRINT IMAGING SYSTEMS COMPRISED OF FINGERPRINT SENSORS, FINGERPRINT VERIFICATION SOFTWARE AND HARDWARE; DEVICES BASED ON BIOMETRIC TECHNOLOGY FOR IDENTIFICATION AND IDENTITY VERIFICATION, NAMELY, ELECTRONIC AND OPTICAL CHARACTER RECOGNITION APPARATUS FOR IDENTIFICATION AND VERIFICATION OF THE IDENTITY OF PEOPLE, TOKENS AND OTHER DATA CARRIERS BASED ON BIOMETRIC IDENTIFICATION AND IDENTITY VERIFICATION. THE ABOVE MENTIONED GOODS DO NOT INCLUDE GOODS FOR VETERINARY PURPOSES OR WATER OR DAIRY TESTING PURPOSES, IN CLASS 9 (U.S. CLS. 21, 23, 26, 36 AND 38).

FOR: MANUALS IN THE AREAS OF COMPUTER PROGRAMMING, SOFTWARE AND HARDWARE FOR FINGERPRINT RECOGNITION APPARATUS AND FINGERPRINT VERIFICATION, PRINTED INSTRUCTIONAL AND EDUCATIONAL BOOKS IN THE AREAS OF COMPUTER PROGRAMMING, SOFTWARE AND HARDWARE FOR FINGERPRINT RECOGNITION APPARATUS AND FINGERPRINT VERIFICATION, IN CLASS 16 (U.S. CLS. 2, 5, 22, 23, 29, 37, 38 AND 50).

FOR: COMPUTER PROGRAMMING FOR OTHERS, UPDATING OF COMPUTER SOFTWARE FOR OTHERS AND MAINTENANCE OF COMPUTER SOFTWARE; SCIENTIFIC AND IN-



David J. Kyjars

Director of the United States Patent and Trademark Office

Reg. No. 4,107,269 INDUSTRIAL RESEARCH IN THE FIELD OF CONTROL OF IDENTITY AND ADMISSION BASED ON FINGERPRINT RECOGNITION; TECHNOLOGICAL CONSULTATION SERVICES IN THE TECHNOLOGY FIELD OF CONTROL OF IDENTITY AND ADMISSION BASED ON FINGERPRINT RECOGNITION; RESEARCH AND DEVELOPMENT OF NEW PRODUCTS FOR OTHERS IN THE FIELD OF CONTROL OF IDENTITY AND ADMISSION BASED ON FINGERPRINT RECOGNITION. THE ABOVE MENTIONED SERVICES DO NOT INCLUDE GOODS FOR VETERINARY PURPOSES OR FOR WATER OR DAIRY TESTING PURPOSES, IN CLASS 42 (U.S. CLS. 100 AND 101).

THE MARK CONSISTS OF THE WORDING "IDEX" IN STYLIZED FONT WITH THE DESIGN OF A FINGERPRINT IN A SEPARATED RECTANGLE.

PRIORITY DATE OF 4-14-2009 IS CLAIMED.

OWNER OF INTERNATIONAL REGISTRATION 1048876 DATED 10-14-2009, EXPIRES 10-14-2019.

SER. NO. 79-086,524, FILED 10-14-2009.

WILLIAM ROSSMAN, EXAMINING ATTORNEY

United States of America

United States Patent and Trademark Office

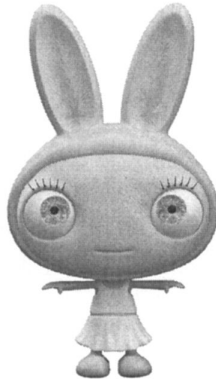

Reg. No. 4,107,270

Registered Mar. 6, 2012

**Int. Cls.: 9, 16, 25, 28, 38
and 41**

TRADEMARK

SERVICE MARK

PRINCIPAL REGISTER

ZODIAK RIGHTS LIMITED (UNITED KINGDOM LIMITED COMPANY)
THE GLOUCESTER BUILDING
KENSINGTON VILLAGE, AVONMORE ROAD, LONDON W14 8RF
UNITED KINGDOM

FOR: SCIENTIFIC, NAUTICAL, SURVEYING, PHOTOGRAPHIC, CINEMATOGRAPHIC, OPTICAL, WEIGHING, MEASURING, SIGNALING, CHECKING, LIFE-SAVING AND TEACHING APPARATUS AND INSTRUMENTS, NAMELY, CAMERAS AND DIGITAL VIDEO RECORDERS; APPARATUS AND INSTRUMENTS FOR CONDUCTING, SWITCHING, TRANSFORMING, ACCUMULATING, REGULATING OR CONTROLLING ELECTRICITY, NAMELY, TRANSFORMERS, ELECTRICAL SWITCHES, AND VOLTAGE REGULATORS; APPARATUS FOR RECORDING, TRANSMISSION OR REPRODUCTION OF SOUND OR IMAGES, NAMELY, VIDEO RECORDERS, CASSETTE PLAYERS, CASSETTE RECORDERS, VIDEO PLAYERS, MUSIC AMPLIFIERS, TAPE PLAYERS, VIDEO CAMERAS, AND MUSIC RECORDING APPARATUS IN THE NATURE OF TAPE RECORDERS, CD RECORDERS, DVD RECORDERS, MP3 RECORDERS AND DIGITAL AUDIO FILE RECORDERS; MAGNETIC DATA CARRIERS, RECORDING DISCS, VIDEOS, CDS, CD ROMS, DVDS, MINIDISKS, AUDIO, VIDEO AND AUDIO-VISUAL RECORDINGS AND CINEMATOGRAPHICAL FILMS FEATURING CHILDREN'S TELEVISION PROGRAMMES, SERIALS, MOVIES AND CARTOONS; AUDIO RECORDINGS FEATURING MUSIC; DATA PROCESSING EQUIPMENT AND COMPUTERS, NAMELY, PERSONAL COMPUTERS AND DATA PROCESSORS; COMPUTER FIRMWARE FOR USE IN DATABASE MANAGEMENT; SOFTWARE AND DOWNLOADABLE SOFTWARE IN RELATION TO CHILDREN'S GAMES AND ENTERTAINMENT; COMPACT DISCS FEATURING MUSIC; DOWNLOADABLE MUSIC VIA THE INTERNET; TELECOMMUNICATIONS APPARATUS, NAMELY, TELEPHONES, MOBILE PHONES AND CELL PHONES; COMPUTER GAMES EQUIPMENT ADAPTED FOR USE WITH TV RECEIVERS, NAMELY, JOYSTICKS AND CONSOLES; ELECTRONIC GAMES SOFTWARE, HAND HELD ELECTRONIC GAME DEVICES AND PORTABLE GAME CONSOLE DEVICES FOR USE WITH AN EXTERNAL MONITOR; APPARATUS FOR USE IN BROADCASTING, TRANSMISSION, RECEIVING, PROCESSING, REPRODUCING, ENCODING AND DECODING OF RADIO AND TELEVISION PROGRAMMES AND DATA, NAMELY, DECODER SOFTWARE, TRANSMITTERS, AND ANTENNAE; DOWNLOADABLE COMPUTER GAMES SOFTWARE; COMPUTER GAMES SOFTWARE; HANDHELD COMPUTER GAMES FOR USE WITH TELEVISION RECEIVERS; DOWNLOADABLE ELECTRONIC PUBLICATIONS AVAILABLE VIA THE INTERNET OR DATABASES IN THE NATURE OF MAGAZINES, PERIODICALS, BOOKS OR NEWSLETTERS IN THE FIELD OF CHILDREN'S ENTERTAINMENT; COMMUNICATIONS SOFTWARE USED IN CONNECTING COMPUTERS



David J. Kyros

Director of the United States Patent and Trademark Office

Reg. No. 4,107,270 TO DATABASES AND THE INTERNET; TELECOMMUNICATIONS APPARATUS TO ENABLE CONNECTION TO DATABASES AND THE INTERNET, NAMELY, MODEMS; DOWNLOADABLE DIGITAL MUSIC AND MP3 MUSIC FILES; BINOCULARS; MAGNETS; SUNGLASSES; SUNGLASS CASES; AUTOMATIC VENDING MACHINES, NAMELY, TICKET VENDING MACHINES AND DISPENSERS; PARTS AND FITTINGS FOR THE AFORESAID GOODS, IN CLASS 9 (U.S. CLS. 21, 23, 26, 36 AND 38).

FOR: PRINTED PUBLICATIONS, NAMELY, FORMS AND CHARTS; BOOKS, MAGAZINES, AND JOURNALS IN THE FIELD OF CHILDREN'S ENTERTAINMENT, ART AND COOKERY; POSTERS; PHOTOGRAPHS; OFFICE AND CHILDREN'S STATIONERY; CALENDARS; GUIDE BOOKS FEATURING CHILDREN'S ENTERTAINMENT; PAPER BAGS; PRINTED SHOW PROGRAMMES RELATED TO CHILDREN'S ENTERTAINMENT; GUIDE BOOKS IN THE FIELD OF ENTERTAINMENT; BROCHURES AND LEAFLETS ABOUT THE ENTERTAINMENT INDUSTRY; PRINTED FORMS FEATURING THE SCHEDULES OF PLAYS AND TELEVISION PROGRAMMING; BOOKS FEATURING TELEVISION AND MOVIE SCRIPTS, MUSIC, AND SONG LYRICS; MUSIC SHEETS; PRINTED INSTRUCTIONAL AND TEACHING MATERIAL IN THE FIELD OF CHILDREN'S ENTERTAINMENT, ART, COOKERY, MATHEMATICS, ENGLISH, READING AND WRITING; WRITING INSTRUMENTS, NAMELY, PENS, PENCILS, CRAYONS; ERASERS; DRAWING RULERS; PENCIL SHARPENERS; PENCIL BOXES AND CASES; PENCIL HOLDERS; PHOTOGRAPH ALBUMS; RING BINDERS; FOLDERS; NOTEBOOKS; NOTEPADS; DIARIES; CALENDARS; POSTCARDS; DRAWINGS; STICKERS; TRANSFERS; STENCILS; SEAT AND ADMISSION TICKETS FOR SPORTING, CULTURAL, EDUCATIONAL AND ARTISTIC EVENTS, MOTION PICTURES, MUSICAL CONCERTS, TELEVISION SHOWS AND OTHER ENTERTAINMENT EVENTS, IN CLASS 16 (U.S. CLS. 2, 5, 22, 23, 29, 37, 38 AND 50).

FOR: CLOTHING, NAMELY, T-SHIRTS, SHIRTS, TANK TOPS, JUMPERS, SWEATERS, TROUSERS, SHORTS, SKIRTS, COATS, RAINCOATS, JACKETS, DRESSES, JEANS, LEGGINGS, JOGGING SUITS, SPORTS WEAR, NAMELY, DRESS SUITS, GYM SUITS, SWEAT SUITS AND TRACK SUITS, OVERALLS, BODYSUITS, ROMPER SUITS, NIGHTWEAR, ROBES, DRESSING GOWNS, PYJAMAS, SHORTS, SLEEP SUITS, SWIMWEAR, BOOTS, SHOES, SLIPPERS, SANDALS, RUNNING SHOES, SNEAKERS, SOCKS, HOSIERY, HATS, CAPS, BERETS, SCARVES, GLOVES, MITTENS, BOOTIES, CLOTH BIBS, APRONS, UNDERWEAR, BELTS, BRACES, IN CLASS 25 (U.S. CLS. 22 AND 39).

FOR: GAMES, TOYS AND PLAYTHINGS, NAMELY, ACTION FIGURES AND DOLLS; BEACH AND WATER TOYS, NAMELY, BEACH BALLS, SAND TOYS, BEACH BUCKETS AND SHOVELS, AIR MATTRESSES FOR RECREATIONAL USE, FLYING DISKS, AND WATER PISTOLS; PLAYMATS FOR INFANTS WITH TOYS ATTACHED; GYMNASTIC AND SPORTING ARTICLES, NAMELY, SKITTLES; HAND-HELD ELECTRONIC GAME DEVICES AND PORTABLE GAME CONSOLE DEVICES OTHER THAN THOSE FOR USE WITH AN EXTERNAL MONITOR; ELECTRONIC TOYS AND GAMES, NAMELY, ELECTRONIC ACTION TOYS AND ELECTRONIC BOARD GAMES OTHER THAN THOSE FOR USE WITH AN EXTERNAL MONITOR; DOLLS AND DOLLS' CLOTHING; ACCESSORIES FOR DOLLS; DOLLS' HOUSES; DOLLS' FURNITURE; DOLLS' FURNITURE ACCESSORIES; TEDDY BEARS; TOY ACTION FIGURES; TOY VEHICLES; SCALE MODEL VEHICLES; TOY BUILDING STRUCTURES AND TOY VEHICLE TRACKS; SOFT TOYS, NAMELY, STUFFED ANIMALS AND STUFFED CHARACTER FIGURES; PLUSH TOYS; PLAY SETS AND PLAY CASES, NAMELY, CHESS SETS AND CHECKER SETS AND CASES THEREFOR AND CHILDREN'S BOARD GAMES RELATING TO CHILDREN'S TELEVISION PROGRAMMES; BALLOONS; PLAYING CARDS; NOVELTY JOKES AND NOVELTIES FOR PARTIES, NAMELY, TOY MASKS AND FACE MASKS, PLASTIC TOY VEHICLES, PLASTIC TOY MODELS OF FIGURES, DIE CAST VEHICLES, DIE CAST FIGURES; PUZZLES; COSTUME MASKS; DECORATIONS FOR CHRISTMAS TREES; SKATEBOARDS; ICE SKATES AND ROLLER SKATES; SKATING BOOTS WITH SKATES ATTACHED; SPORTS BAG ADAPTED FOR CARRYING SPORTS ARTICLES; GOLF GLOVES; SOFTBALL AND BASEBALLS GLOVES; PUPPETS; MARIONETTES; KITES; MARBLES; BASKETBALLS, BASEBALLS, TENNIS BALLS, SOFT BALLS, CRICKET BALLS, GOLF BALLS; BASEBALL

Reg. No. 4,107,270 BATS, CRICKET BATS, SOFT BALL BAT, GOLF CLUBS, IN CLASS 28 (U.S. CLS. 22, 23, 38 AND 50).

FOR: PROVIDING ACCESS TO TELECOMMUNICATIONS NETWORKS; TELECOMMUNICATIONS SERVICES, NAMELY, PROVIDING E-MAIL SERVICES AND ACCESS TO THE INTERNET; PROVIDING USER ACCESS TO THE INTERNET; INTERNET BROADCASTING SERVICES; WEBCASTING SERVICES; INFORMATION TRANSMISSION VIA ELECTRONIC COMMUNICATION NETWORKS; TRANSMISSION OF MESSAGES, DATA AND CONTENT VIA THE INTERNET AND OTHER COMPUTER AND COMMUNICATIONS NETWORKS; PROVIDING ACCESS TO DATABASES; PROVIDING ONLINE FORUMS, CHAT ROOMS AND LIST SERVERS FOR THE TRANSMISSION OF MESSAGES, COMMENTS AND MULTIMEDIA CONTENT AMONG USERS IN THE FIELD OF ENTERTAINMENT; TRANSMISSION OF ELECTRONIC MEDIA, MULTIMEDIA CONTENT, VIDEOS, MOVIES, PICTURES, IMAGES, TEXT, PHOTOS, GAMES, USER-GENERATED CONTENT, AUDIO CONTENT, AND INFORMATION VIA THE INTERNET AND OTHER COMPUTER AND COMMUNICATIONS NETWORKS, IN CLASS 38 (U.S. CLS. 100, 101 AND 104).

FOR: PROVIDING ON-LINE JOURNALS, NAMELY, BLOGS IN THE FIELD OF ENTERTAINMENT; EDUCATIONAL SERVICES, NAMELY, PROVIDING CLASSES IN THE FIELD OF ENTERTAINMENT, MATHEMATICS, ENGLISH, READING AND WRITING; ENTERTAINMENT SERVICES, NAMELY, ORGANIZING COMMUNITY AND CULTURAL EVENTS AND PUTTING ON RADIO AND STAGE SHOWS FOR CHILDREN FOR THE PURPOSE OF ENTERTAINMENT; ENTERTAINMENT SERVICES, NAMELY, PROVIDING ONLINE COMPUTER GAMES; PRODUCTION OF RADIO PROGRAMMES, AUDIO RECORDINGS, LIVE SHOWS, STAGE PLAYS AND DRAMAS, AND CONCERTS; PRESENTATION OF MUSICAL AND LIVE PERFORMANCES; RENTAL OF FILMS, DVDS, COMPUTER GAMES AND VIDEO GAMES; THEATRICAL, MUSICAL, AND RADIO ENTERTAINMENT SERVICES, NAMELY, PROVIDING CHILDREN'S ENTERTAINMENT; PROVIDING THEATRE AND CINEMA FACILITIES; PRESENTATION OF LIVE PERFORMANCES; RECORDING STUDIO SERVICES; RENTAL OF EQUIPMENT, APPARATUS AND STAGE SCENERY FOR THEATRICAL SETS OR TELEVISION STUDIOS; RENTAL OF SOUND RECORDINGS AND VIDEO RECORDINGS; PROVIDING ENTERTAINMENT INFORMATION; ENTERTAINMENT TICKET AGENCY SERVICES; PROVIDING OF TRAINING AND EDUCATION IN THE NATURE OF CLASSES, SEMINARS AND WORKSHOPS RELATING TO THEATRICAL, MUSICAL, TELEVISION, RADIO AND CINEMATIC SHOWS TELEVISION AND RADIO ENTERTAINMENT; THEATRE PRODUCTION; PUBLICATION OF PRINTED MATTER, NAMELY, BOOKS, MAGAZINES, JOURNALS, PERIODICALS, REPORTS, MANUALS, AND TEXT; PROVIDING ONLINE ELECTRONIC NON-DOWNLOADABLE PUBLICATIONS IN THE NATURE OF BOOKS AND JOURNALS IN THE FIELD OF ENTERTAINMENT; PROVIDING NEWS INFORMATION IN THE FIELD OF ENTERTAINMENT; ENTERTAINMENT SERVICES, NAMELY, PROVIDING NON-DOWNLOADABLE DIGITAL MUSIC AND INFORMATION IN THE FIELD OF MUSIC AND ENTERTAINMENT VIA A COMPUTER DATABASE AND THE INTERNET, IN CLASS 41 (U.S. CLS. 100, 101 AND 107).

THE MARK CONSISTS OF A STYLIZED DEPICTION OF A RABBIT WITH A LARGE HEAD, TWO ARMS, TWO EYES, A MOUTH, EARS, AND A DRESS.

PRIORITY DATE OF 10-29-2009 IS CLAIMED.

OWNER OF INTERNATIONAL REGISTRATION 1049211 DATED 4-7-2010, EXPIRES 4-7-2020.

SER. NO. 79-086,651, FILED 4-7-2010.

LEIGH CAROLINE CASE, EXAMINING ATTORNEY

United States of America

United States Patent and Trademark Office



Reg. No. 4,107,271

Registered Mar. 6, 2012

**Int. Cls.: 9, 16, 25, 28, 38
and 41**

TRADEMARK

SERVICE MARK

PRINCIPAL REGISTER

ZODIAK RIGHTS LIMITED (UNITED KINGDOM LIMITED COMPANY)
THE GLOUCESTER BUILDING
KENSINGTON VILLAGE, AVONMORE ROAD, LONDON W14 8RF
UNITED KINGDOM

FOR: SCIENTIFIC, NAUTICAL, SURVEYING, PHOTOGRAPHIC, CINEMATOGRAPHIC, OPTICAL, WEIGHING, MEASURING, SIGNALING, CHECKING, LIFE-SAVING AND TEACHING APPARATUS AND INSTRUMENTS, NAMELY, CAMERAS AND DIGITAL VIDEO RECORDERS; APPARATUS AND INSTRUMENTS FOR CONDUCTING, SWITCHING, TRANSFORMING, ACCUMULATING, REGULATING OR CONTROLLING ELECTRICITY, NAMELY, TRANSFORMERS, ELECTRICAL SWITCHES, AND VOLTAGE REGULATORS; APPARATUS FOR RECORDING, TRANSMISSION OR REPRODUCTION OF SOUND OR IMAGES, NAMELY, VIDEO RECORDERS, CASSETTE PLAYERS, CASSETTE RECORDERS, VIDEO PLAYERS, MUSIC AMPLIFIERS, TAPE PLAYERS, VIDEO CAMERAS, AND MUSIC RECORDING APPARATUS IN THE NATURE OF TAPE RECORDERS, CD RECORDERS, DVD RECORDERS, MP3 RECORDERS AND DIGITAL AUDIO FILE RECORDERS; MAGNETIC DATA CARRIERS, RECORDING DISCS, VIDEOS, CDS, CD ROMS, DVDS, MINIDISKS, AUDIO, VIDEO AND AUDIO-VISUAL RECORDINGS AND CINEMATOGRAPHICAL FILMS FEATURING CHILDREN'S TELEVISION PROGRAMMES, SERIALS, MOVIES AND CARTOONS; AUDIO RECORDINGS FEATURING MUSIC; DATA PROCESSING EQUIPMENT AND COMPUTERS, NAMELY, PERSONAL COMPUTERS AND DATA PROCESSORS; COMPUTER FIRMWARE FOR USE IN DATABASE MANAGEMENT; SOFTWARE AND DOWNLOADABLE SOFTWARE IN RELATION TO CHILDREN'S GAMES AND ENTERTAINMENT; COMPACT DISCS FEATURING MUSIC; DOWNLOADABLE MUSIC VIA THE INTERNET; TELECOMMUNICATIONS APPARATUS, NAMELY, TELEPHONES, MOBILE PHONES AND CELL PHONES; COMPUTER GAMES EQUIPMENT ADAPTED FOR USE WITH TV RECEIVERS, NAMELY, JOYSTICKS AND CONSOLES; ELECTRONIC GAMES SOFTWARE, HAND HELD ELECTRONIC GAME DEVICES AND PORTABLE GAME CONSOLE DEVICES FOR USE WITH AN EXTERNAL MONITOR; APPARATUS FOR USE IN BROADCASTING, TRANSMISSION, RECEIVING, PROCESSING, REPRODUCING, ENCODING AND DECODING OF RADIO AND TELEVISION PROGRAMMES AND DATA, NAMELY, DECODER SOFTWARE, TRANSMITTERS, AND ANTENNAE; DOWNLOADABLE COMPUTER GAMES SOFTWARE; COMPUTER GAMES SOFTWARE; HANDHELD COMPUTER GAMES FOR USE WITH TELEVISION RECEIVERS; DOWNLOADABLE ELECTRONIC PUBLICATIONS AVAILABLE VIA THE INTERNET OR DATABASES IN THE NATURE OF MAGAZINES, PERIODICALS, BOOKS OR NEWSLETTERS IN THE FIELD OF CHILDREN'S ENTERTAINMENT; COMMUNICATIONS SOFTWARE USED IN CONNECTING COMPUTERS



David J. Kybas

Director of the United States Patent and Trademark Office

Reg. No. 4,107,271 TO DATABASES AND THE INTERNET; TELECOMMUNICATIONS APPARATUS TO ENABLE CONNECTION TO DATABASES AND THE INTERNET, NAMELY, MODEMS; DOWNLOADABLE DIGITAL MUSIC AND MP3 MUSIC FILES; BINOCULARS; MAGNETS; SUNGLASSES; SUNGLASS CASES; AUTOMATIC VENDING MACHINES, NAMELY, TICKET VENDING MACHINES AND DISPENSERS; PARTS AND FITTINGS FOR THE AFORESAID GOODS, IN CLASS 9 (U.S. CLS. 21, 23, 26, 36 AND 38).

FOR: PRINTED PUBLICATIONS, NAMELY, FORMS AND CHARTS; BOOKS, MAGAZINES, AND JOURNALS IN THE FIELD OF CHILDREN'S ENTERTAINMENT, ART AND COOKERY; POSTERS; PHOTOGRAPHS; OFFICE AND CHILDREN'S STATIONERY; CALENDARS; GUIDE BOOKS FEATURING CHILDREN'S ENTERTAINMENT; PAPER BAGS; PRINTED SHOW PROGRAMMES RELATED TO CHILDREN'S ENTERTAINMENT; GUIDE BOOKS IN THE FIELD OF ENTERTAINMENT; BROCHURES AND LEAFLETS ABOUT THE ENTERTAINMENT INDUSTRY; PRINTED FORMS FEATURING THE SCHEDULES OF PLAYS AND TELEVISION PROGRAMMING; BOOKS FEATURING TELEVISION AND MOVIE SCRIPTS, MUSIC, AND SONG LYRICS; MUSIC SHEETS; PRINTED INSTRUCTIONAL AND TEACHING MATERIAL IN THE FIELD OF CHILDREN'S ENTERTAINMENT, ART, COOKERY, MATHEMATICS, ENGLISH, READING AND WRITING; WRITING INSTRUMENTS, NAMELY, PENS, PENCILS, CRAYONS; ERASERS; DRAWING RULERS; PENCIL SHARPENERS; PENCIL BOXES AND CASES; PENCIL HOLDERS; PHOTOGRAPH ALBUMS; RING BINDERS; FOLDERS; NOTEBOOKS; NOTEPADS; DIARIES; CALENDARS; POSTCARDS; DRAWINGS; STICKERS; TRANSFERS; STENCILS; SEAT AND ADMISSION TICKETS FOR SPORTING, CULTURAL, EDUCATIONAL AND ARTISTIC EVENTS, MOTION PICTURES, MUSICAL CONCERTS, TELEVISION SHOWS AND OTHER ENTERTAINMENT EVENTS, IN CLASS 16 (U.S. CLS. 2, 5, 22, 23, 29, 37, 38 AND 50).

FOR: CLOTHING, NAMELY, T-SHIRTS, SHIRTS, TANK TOPS, JUMPERS, SWEATERS, TROUSERS, SHORTS, SKIRTS, COATS, RAINCOATS, JACKETS, DRESSES, JEANS, LEGGINGS, JOGGING SUITS, SPORTS WEAR, NAMELY, DRESS SUITS, GYM SUITS, SWEAT SUITS AND TRACK SUITS, OVERALLS, BODYSUITS, ROMPER SUITS, NIGHTWEAR, ROBES, DRESSING GOWNS, PYJAMAS, SHORTS, SLEEP SUITS, SWIMWEAR, BOOTS, SHOES, SLIPPERS, SANDALS, RUNNING SHOES, SNEAKERS, SOCKS, HOSIERY, HATS, CAPS, BERETS, SCARVES, GLOVES, MITTENS, BOOTIES, CLOTH BIBS, APRONS, UNDERWEAR, BELTS, BRACES, IN CLASS 25 (U.S. CLS. 22 AND 39).

FOR: GAMES, TOYS AND PLAYTHINGS, NAMELY, ACTION FIGURES AND DOLLS; BEACH AND WATER TOYS, NAMELY, BEACH BALLS, SAND TOYS, BEACH BUCKETS AND SHOVELS, AIR MATTRESSES FOR RECREATIONAL USE, FLYING DISKS, AND WATER PISTOLS; PLAYMATS FOR INFANTS WITH TOYS ATTACHED; GYMNASTIC AND SPORTING ARTICLES, NAMELY, SKITTLES; HAND-HELD ELECTRONIC GAME DEVICES AND PORTABLE GAME CONSOLE DEVICES OTHER THAN THOSE FOR USE WITH AN EXTERNAL MONITOR; ELECTRONIC TOYS AND GAMES, NAMELY, ELECTRONIC ACTION TOYS AND ELECTRONIC BOARD GAMES OTHER THAN THOSE FOR USE WITH AN EXTERNAL MONITOR; DOLLS AND DOLLS' CLOTHING; ACCESSORIES FOR DOLLS; DOLLS' HOUSES; DOLLS' FURNITURE; DOLLS' FURNITURE ACCESSORIES; TEDDY BEARS; TOY ACTION FIGURES; TOY VEHICLES; SCALE MODEL VEHICLES; TOY BUILDING STRUCTURES AND TOY VEHICLE TRACKS; SOFT TOYS, NAMELY, STUFFED ANIMALS AND STUFFED CHARACTER FIGURES; PLUSH TOYS; PLAY SETS AND PLAY CASES, NAMELY, CHESS SETS AND CHECKER SETS AND CASES THEREFOR AND CHILDREN'S BOARD GAMES RELATING TO CHILDREN'S TELEVISION PROGRAMMES; BALLOONS; PLAYING CARDS; NOVELTY JOKES AND NOVELTIES FOR PARTIES, NAMELY, TOY MASKS AND FACE MASKS, PLASTIC TOY VEHICLES, PLASTIC TOY MODELS OF FIGURES, DIE CAST VEHICLES, DIE CAST FIGURES; PUZZLES; COSTUME MASKS; DECORATIONS FOR CHRISTMAS TREES; SKATEBOARDS; ICE SKATES AND ROLLER SKATES; SKATING BOOTS WITH SKATES ATTACHED; SPORTS BAG ADAPTED FOR CARRYING SPORTS ARTICLES; GOLF GLOVES; SOFTBALL AND BASEBALLS GLOVES; PUPPETS; MARIONETTES; KITES; MARBLES; BASKETBALLS, BASEBALLS, TENNIS BALLS, SOFT BALLS, CRICKET BALLS, GOLF BALLS; BASEBALL

Reg. No. 4,107,271 BATS, CRICKET BATS, SOFT BALL BAT, GOLF CLUBS, IN CLASS 28 (U.S. CLS. 22, 23, 38 AND 50).

FOR: PROVIDING ACCESS TO TELECOMMUNICATIONS NETWORKS; TELECOMMUNICATIONS SERVICES, NAMELY, PROVIDING E-MAIL SERVICES AND ACCESS TO THE INTERNET; PROVIDING USER ACCESS TO THE INTERNET; INTERNET BROADCASTING SERVICES; WEBCASTING SERVICES; INFORMATION TRANSMISSION VIA ELECTRONIC COMMUNICATION NETWORKS; TRANSMISSION OF MESSAGES, DATA AND CONTENT VIA THE INTERNET AND OTHER COMPUTER AND COMMUNICATIONS NETWORKS; PROVIDING ACCESS TO DATABASES; PROVIDING ONLINE FORUMS, CHAT ROOMS AND LIST SERVERS FOR THE TRANSMISSION OF MESSAGES, COMMENTS AND MULTIMEDIA CONTENT AMONG USERS IN THE FIELD OF ENTERTAINMENT; TRANSMISSION OF ELECTRONIC MEDIA, MULTIMEDIA CONTENT, VIDEOS, MOVIES, PICTURES, IMAGES, TEXT, PHOTOS, GAMES, USER-GENERATED CONTENT, AUDIO CONTENT, AND INFORMATION VIA THE INTERNET AND OTHER COMPUTER AND COMMUNICATIONS NETWORKS, IN CLASS 38 (U.S. CLS. 100, 101 AND 104).

FOR: PROVIDING ON-LINE JOURNALS, NAMELY, BLOGS IN THE FIELD OF ENTERTAINMENT; EDUCATIONAL SERVICES, NAMELY, PROVIDING CLASSES IN THE FIELD OF ENTERTAINMENT, MATHEMATICS, ENGLISH, READING AND WRITING; ENTERTAINMENT SERVICES, NAMELY, ORGANIZING COMMUNITY AND CULTURAL EVENTS AND PUTTING ON RADIO AND STAGE SHOWS FOR CHILDREN FOR THE PURPOSE OF ENTERTAINMENT; ENTERTAINMENT SERVICES, NAMELY, PROVIDING ONLINE COMPUTER GAMES; PRODUCTION OF RADIO PROGRAMMES, AUDIO RECORDINGS, LIVE SHOWS, STAGE PLAYS AND DRAMAS, AND CONCERTS; PRESENTATION OF MUSICAL AND LIVE PERFORMANCES; RENTAL OF FILMS, DVDS, COMPUTER GAMES AND VIDEO GAMES; THEATRICAL, MUSICAL, AND RADIO ENTERTAINMENT SERVICES, NAMELY, PROVIDING CHILDREN'S ENTERTAINMENT; PROVIDING THEATRE AND CINEMA FACILITIES; PRESENTATION OF LIVE PERFORMANCES; RECORDING STUDIO SERVICES; RENTAL OF EQUIPMENT, APPARATUS AND STAGE SCENERY FOR THEATRICAL SETS OR TELEVISION STUDIOS; RENTAL OF SOUND RECORDINGS AND VIDEO RECORDINGS; PROVIDING ENTERTAINMENT INFORMATION; ENTERTAINMENT TICKET AGENCY SERVICES; PROVIDING OF TRAINING AND EDUCATION IN THE NATURE OF CLASSES, SEMINARS AND WORKSHOPS RELATING TO THEATRICAL, MUSICAL, TELEVISION, RADIO AND CINEMATIC SHOWS TELEVISION AND RADIO ENTERTAINMENT; THEATRE PRODUCTION; PUBLICATION OF PRINTED MATTER, NAMELY, BOOKS, MAGAZINES, JOURNALS, PERIODICALS, REPORTS, MANUALS, AND TEXT; PROVIDING ONLINE ELECTRONIC NON-DOWNLOADABLE PUBLICATIONS IN THE NATURE OF BOOKS AND JOURNALS IN THE FIELD OF ENTERTAINMENT; PROVIDING NEWS INFORMATION IN THE FIELD OF ENTERTAINMENT; ENTERTAINMENT SERVICES, NAMELY, PROVIDING NON-DOWNLOADABLE DIGITAL MUSIC AND INFORMATION IN THE FIELD OF MUSIC AND ENTERTAINMENT VIA A COMPUTER DATABASE, AND THE INTERNET, IN CLASS 41 (U.S. CLS. 100, 101 AND 107).

THE MARK CONSISTS OF A CREATURE WITH A LARGE HEAD AND EARS, TWO ARMS, TWO EYES, AND A MOUTH WITH FOUR STRANDS OF HAIR ON THE SIDE OF ITS HEAD.

PRIORITY DATE OF 10-29-2009 IS CLAIMED.

OWNER OF INTERNATIONAL REGISTRATION 1049212 DATED 4-7-2010, EXPIRES 4-7-2020.

SER. NO. 79-086,652, FILED 4-7-2010.

LEIGH CAROLINE CASE, EXAMINING ATTORNEY

United States of America

United States Patent and Trademark Office



Reg. No. 4,107,272

Registered Mar. 6, 2012

**Int. Cls.: 9, 16, 25, 28, 38
and 41**

TRADEMARK

SERVICE MARK

PRINCIPAL REGISTER

ZODIAK RIGHTS LIMITED (UNITED KINGDOM LIMITED COMPANY)
THE GLOUCESTER BUILDING
KENSINGTON VILLAGE, AVONMORE ROAD, LONDON W14 8RF
UNITED KINGDOM

FOR: SCIENTIFIC, NAUTICAL, SURVEYING, PHOTOGRAPHIC, CINEMATOGRAPHIC, OPTICAL, WEIGHING, MEASURING, SIGNALING, CHECKING, LIFE-SAVING AND TEACHING APPARATUS AND INSTRUMENTS, NAMELY, CAMERAS AND DIGITAL VIDEO RECORDERS; APPARATUS AND INSTRUMENTS FOR CONDUCTING, SWITCHING, TRANSFORMING, ACCUMULATING, REGULATING OR CONTROLLING ELECTRICITY, NAMELY, TRANSFORMERS, ELECTRICAL SWITCHES, AND VOLTAGE REGULATORS; APPARATUS FOR RECORDING, TRANSMISSION OR REPRODUCTION OF SOUND OR IMAGES, NAMELY, VIDEO RECORDERS, CASSETTE PLAYERS, CASSETTE RECORDERS, VIDEO PLAYERS, MUSIC AMPLIFIERS, TAPE PLAYERS, VIDEO CAMERAS, AND MUSIC RECORDING APPARATUS IN THE NATURE OF TAPE RECORDERS, CD RECORDERS, DVD RECORDERS, MP3 RECORDERS AND DIGITAL AUDIO FILE RECORDERS; MAGNETIC DATA CARRIERS, RECORDING DISCS, VIDEOS, CDS, CD ROMS, DVDS, MINIDISKS, AUDIO, VIDEO AND AUDIO-VISUAL RECORDINGS AND CINEMATOGRAPHICAL FILMS FEATURING CHILDREN'S TELEVISION PROGRAMMES, SERIALS, MOVIES AND CARTOONS; AUDIO RECORDINGS FEATURING MUSIC; DATA PROCESSING EQUIPMENT AND COMPUTERS, NAMELY, PERSONAL COMPUTERS AND DATA PROCESSORS; COMPUTER FIRMWARE FOR USE IN DATABASE MANAGEMENT; SOFTWARE AND DOWNLOADABLE SOFTWARE IN RELATION TO CHILDREN'S GAMES AND ENTERTAINMENT; COMPACT DISCS FEATURING MUSIC; DOWNLOADABLE MUSIC VIA THE INTERNET; TELECOMMUNICATIONS APPARATUS, NAMELY, TELEPHONES, MOBILE PHONES AND CELL PHONES; COMPUTER GAMES EQUIPMENT ADAPTED FOR USE WITH TV RECEIVERS, NAMELY, JOYSTICKS AND CONSOLES; ELECTRONIC GAMES SOFTWARE, HAND HELD ELECTRONIC GAME DEVICES AND PORTABLE GAME CONSOLE DEVICES FOR USE WITH AN EXTERNAL MONITOR; APPARATUS FOR USE IN BROADCASTING, TRANSMISSION, RECEIVING, PROCESSING, REPRODUCING, ENCODING AND DECODING OF RADIO AND TELEVISION PROGRAMMES AND DATA, NAMELY, DECODER SOFTWARE, TRANSMITTERS, AND ANTENNAE; DOWNLOADABLE COMPUTER GAMES SOFTWARE; COMPUTER GAMES SOFTWARE; HANDHELD COMPUTER GAMES FOR USE WITH TELEVISION RECEIVERS; DOWNLOADABLE ELECTRONIC PUBLICATIONS AVAILABLE VIA THE INTERNET OR DATABASES IN THE NATURE OF MAGAZINES, PERIODICALS, BOOKS OR NEWSLETTERS IN THE FIELD OF CHILDREN'S ENTERTAINMENT; COMMUNICATIONS SOFTWARE USED IN CONNECTING COMPUTERS



David J. Kybas

Director of the United States Patent and Trademark Office

Reg. No. 4,107,272 TO DATABASES AND THE INTERNET; TELECOMMUNICATIONS APPARATUS TO ENABLE CONNECTION TO DATABASES AND THE INTERNET, NAMELY, MODEMS; DOWNLOADABLE DIGITAL MUSIC AND MP3 MUSIC FILES; BINOCULARS; MAGNETS; SUNGLASSES; SUNGLASS CASES; AUTOMATIC VENDING MACHINES, NAMELY, TICKET VENDING MACHINES AND DISPENSERS; PARTS AND FITTINGS FOR THE AFORESAID GOODS, IN CLASS 9 (U.S. CLS. 21, 23, 26, 36 AND 38).

FOR: PRINTED PUBLICATIONS, NAMELY, FORMS AND CHARTS; BOOKS, MAGAZINES, AND JOURNALS IN THE FIELD OF CHILDREN'S ENTERTAINMENT, ART AND COOKERY; POSTERS; PHOTOGRAPHS; OFFICE AND CHILDREN'S STATIONERY; CALENDARS; GUIDE BOOKS FEATURING CHILDREN'S ENTERTAINMENT; PAPER BAGS; PRINTED SHOW PROGRAMMES RELATED TO CHILDREN'S ENTERTAINMENT; GUIDE BOOKS IN THE FIELD OF ENTERTAINMENT; BROCHURES AND LEAFLETS ABOUT THE ENTERTAINMENT INDUSTRY; PRINTED FORMS FEATURING THE SCHEDULES OF PLAYS AND TELEVISION PROGRAMMING; BOOKS FEATURING TELEVISION AND MOVIE SCRIPTS, MUSIC, AND SONG LYRICS; MUSIC SHEETS; PRINTED INSTRUCTIONAL AND TEACHING MATERIAL IN THE FIELD OF CHILDREN'S ENTERTAINMENT, ART, COOKERY, MATHEMATICS, ENGLISH, READING AND WRITING; WRITING INSTRUMENTS, NAMELY, PENS, PENCILS, CRAYONS; ERASERS; DRAWING RULERS; PENCIL SHARPENERS; PENCIL BOXES AND CASES; PENCIL HOLDERS; PHOTOGRAPH ALBUMS; RING BINDERS; FOLDERS; NOTEBOOKS; NOTEPADS; DIARIES; CALENDARS; POSTCARDS; DRAWINGS; STICKERS; TRANSFERS; STENCILS; SEAT AND ADMISSION TICKETS FOR SPORTING, CULTURAL, EDUCATIONAL AND ARTISTIC EVENTS, MOTION PICTURES, MUSICAL CONCERTS, TELEVISION SHOWS AND OTHER ENTERTAINMENT EVENTS, IN CLASS 16 (U.S. CLS. 2, 5, 22, 23, 29, 37, 38 AND 50).

FOR: CLOTHING, NAMELY, T-SHIRTS, SHIRTS, TANK TOPS, JUMPERS, SWEATERS, TROUSERS, SHORTS, SKIRTS, COATS, RAINCOATS, JACKETS, DRESSES, JEANS, LEGGINGS, JOGGING SUITS, SPORTS WEAR, NAMELY, DRESS SUITS, GYM SUITS, SWEAT SUITS AND TRACK SUITS, OVERALLS, BODYSUITS, ROMPER SUITS, NIGHTWEAR, ROBES, DRESSING GOWNS, PYJAMAS, SHORTS, SLEEP SUITS, SWIMWEAR, BOOTS, SHOES, SLIPPERS, SANDALS, RUNNING SHOES, SNEAKERS, SOCKS, HOSIERY, HATS, CAPS, BERETS, SCARVES, GLOVES, MITTENS, BOOTIES, CLOTH BIBS, APRONS, UNDERWEAR, BELTS, BRACES, IN CLASS 25 (U.S. CLS. 22 AND 39).

FOR: GAMES, TOYS AND PLAYTHINGS, NAMELY, ACTION FIGURES AND DOLLS; BEACH AND WATER TOYS, NAMELY, BEACH BALLS, SAND TOYS, BEACH BUCKETS AND SHOVELS, AIR MATTRESSES FOR RECREATIONAL USE, FLYING DISKS, AND WATER PISTOLS; PLAYMATS FOR INFANTS WITH TOYS ATTACHED; GYMNASTIC AND SPORTING ARTICLES, NAMELY, SKITTLES; HAND-HELD ELECTRONIC GAME DEVICES AND PORTABLE GAME CONSOLE DEVICES OTHER THAN THOSE FOR USE WITH AN EXTERNAL MONITOR; ELECTRONIC TOYS AND GAMES, NAMELY, ELECTRONIC ACTION TOYS AND ELECTRONIC BOARD GAMES OTHER THAN THOSE FOR USE WITH AN EXTERNAL MONITOR; DOLLS AND DOLLS' CLOTHING; ACCESSORIES FOR DOLLS; DOLLS' HOUSES; DOLLS' FURNITURE; DOLLS' FURNITURE ACCESSORIES; TEDDY BEARS; TOY ACTION FIGURES; TOY VEHICLES; SCALE MODEL VEHICLES; TOY BUILDING STRUCTURES AND TOY VEHICLE TRACKS; SOFT TOYS, NAMELY, STUFFED ANIMALS AND STUFFED CHARACTER FIGURES; PLUSH TOYS; PLAY SETS AND PLAY CASES, NAMELY, CHESS SETS AND CHECKER SETS AND CASES THEREFOR AND CHILDREN'S BOARD GAMES RELATING TO CHILDREN'S TELEVISION PROGRAMMES; BALLOONS; PLAYING CARDS; NOVELTY JOKES AND NOVELTIES FOR PARTIES, NAMELY, TOY MASKS AND FACE MASKS, PLASTIC TOY VEHICLES, PLASTIC TOY MODELS OF FIGURES, DIE CAST VEHICLES, DIE CAST FIGURES; PUZZLES; COSTUME MASKS; DECORATIONS FOR CHRISTMAS TREES; SKATEBOARDS; ICE SKATES AND ROLLER SKATES; SKATING BOOTS WITH SKATES ATTACHED; SPORTS BAG ADAPTED FOR CARRYING SPORTS ARTICLES; GOLF GLOVES; SOFTBALL AND BASEBALLS GLOVES; PUPPETS; MARIONETTES; KITES; MARBLES; BASKETBALLS, BASEBALLS, TENNIS BALLS, SOFT BALLS, CRICKET BALLS, GOLF BALLS; BASEBALL

Reg. No. 4,107,272 BATS, CRICKET BATS, SOFT BALL BAT, GOLF CLUBS, IN CLASS 28 (U.S. CLS. 22, 23, 38 AND 50).

FOR: PROVIDING ACCESS TO TELECOMMUNICATIONS NETWORKS; TELECOMMUNICATIONS SERVICES, NAMELY, PROVIDING E-MAIL SERVICES AND ACCESS TO THE INTERNET; PROVIDING USER ACCESS TO THE INTERNET; INTERNET BROADCASTING SERVICES; WEBCASTING SERVICES; INFORMATION TRANSMISSION VIA ELECTRONIC COMMUNICATION NETWORKS; TRANSMISSION OF MESSAGES, DATA AND CONTENT VIA THE INTERNET AND OTHER COMPUTER AND COMMUNICATIONS NETWORKS; PROVIDING ACCESS TO DATABASES; PROVIDING ONLINE FORUMS, CHAT ROOMS AND LIST SERVERS FOR THE TRANSMISSION OF MESSAGES, COMMENTS AND MULTIMEDIA CONTENT AMONG USERS IN THE FIELD OF ENTERTAINMENT; TRANSMISSION OF ELECTRONIC MEDIA, MULTIMEDIA CONTENT, VIDEOS, MOVIES, PICTURES, IMAGES, TEXT, PHOTOS, GAMES, USER-GENERATED CONTENT, AUDIO CONTENT, AND INFORMATION VIA THE INTERNET AND OTHER COMPUTER AND COMMUNICATIONS NETWORKS, IN CLASS 38 (U.S. CLS. 100, 101 AND 104).

FOR: PROVIDING ON-LINE JOURNALS, NAMELY, BLOGS IN THE FIELD OF ENTERTAINMENT; EDUCATIONAL SERVICES, NAMELY, PROVIDING CLASSES IN THE FIELD OF ENTERTAINMENT, MATHEMATICS, ENGLISH, READING AND WRITING; ENTERTAINMENT SERVICES, NAMELY, ORGANIZING COMMUNITY AND CULTURAL EVENTS AND PUTTING ON RADIO AND STAGE SHOWS FOR CHILDREN FOR THE PURPOSE OF ENTERTAINMENT; ENTERTAINMENT SERVICES, NAMELY, PROVIDING ONLINE COMPUTER GAMES; PRODUCTION OF RADIO PROGRAMMES, AUDIO RECORDINGS, LIVE SHOWS, STAGE PLAYS AND DRAMAS, AND CONCERTS; PRESENTATION OF MUSICAL AND LIVE PERFORMANCES; RENTAL OF FILMS, DVDS, COMPUTER GAMES AND VIDEO GAMES; THEATRICAL, MUSICAL, AND RADIO ENTERTAINMENT SERVICES, NAMELY, PROVIDING CHILDREN'S ENTERTAINMENT; PROVIDING THEATRE AND CINEMA FACILITIES; PRESENTATION OF LIVE PERFORMANCES; RECORDING STUDIO SERVICES; RENTAL OF EQUIPMENT, APPARATUS AND STAGE SCENERY FOR THEATRICAL SETS OR TELEVISION STUDIOS; RENTAL OF SOUND RECORDINGS AND VIDEO RECORDINGS; PROVIDING ENTERTAINMENT INFORMATION; ENTERTAINMENT TICKET AGENCY SERVICES; PROVIDING OF TRAINING AND EDUCATION IN THE NATURE OF CLASSES, SEMINARS AND WORKSHOPS RELATING TO THEATRICAL, MUSICAL, TELEVISION, RADIO AND CINEMATIC SHOWS TELEVISION AND RADIO ENTERTAINMENT; THEATRE PRODUCTION; PUBLICATION OF PRINTED MATTER, NAMELY, BOOKS, MAGAZINES, JOURNALS, PERIODICALS, REPORTS, MANUALS, AND TEXT; PROVIDING ONLINE ELECTRONIC NON-DOWNLOADABLE PUBLICATIONS IN THE NATURE OF BOOKS AND JOURNALS IN THE FIELD OF ENTERTAINMENT; PROVIDING NEWS INFORMATION IN THE FIELD OF ENTERTAINMENT; ENTERTAINMENT SERVICES, NAMELY, PROVIDING NON-DOWNLOADABLE DIGITAL MUSIC AND INFORMATION IN THE FIELD OF MUSIC AND ENTERTAINMENT VIA A COMPUTER DATABASE, AND THE INTERNET, IN CLASS 41 (U.S. CLS. 100, 101 AND 107).

THE MARK CONSISTS OF CREATURE WITH A LARGE HEAD, TWO ARMS, TWO EYES AND A MOUTH WITH FIVE STRANDS OF HAIR STANDING VERTICALLY BETWEEN ITS EARS.

PRIORITY DATE OF 10-29-2009 IS CLAIMED.

OWNER OF INTERNATIONAL REGISTRATION 1049213 DATED 4-7-2010, EXPIRES 4-7-2020.

SER. NO. 79-086,653, FILED 4-7-2010.

LEIGH CAROLINE CASE, EXAMINING ATTORNEY

United States of America

United States Patent and Trademark Office

CAPTIVE DE CARTIER

Reg. No. 4,107,273

Registered Mar. 6, 2012

Int. Cl.: 14

TRADEMARK

PRINCIPAL REGISTER

CARTIER INTERNATIONAL AG (SWITZERLAND AKTIENGESELLSCHAFT)
HINTERBERGSTRASSE 22
POSTFACH 61
STEINHAUSEN, SWITZERLAND CH6312

FOR: CUFFLINKS, TIE CLIPS, RINGS, BRACELETS, EARRINGS, NECKLACES, BROOCHES, KEY HOLDERS OF PRECIOUS METAL, WATCHES, CHRONOMETERS, CLOCKS, WATCH STRAPS, BOXES MADE OF PRECIOUS METAL FOR WATCHES AND JEWELRY, IN CLASS 14 (U.S. CLS. 2, 27, 28 AND 50).

THE MARK CONSISTS OF STANDARD CHARACTERS WITHOUT CLAIM TO ANY PARTICULAR FONT, STYLE, SIZE, OR COLOR.

PRIORITY DATE OF 3-5-2010 IS CLAIMED.

OWNER OF INTERNATIONAL REGISTRATION 1049250 DATED 8-23-2010, EXPIRES 8-23-2020.

OWNER OF U.S. REG. NOS. 411,240, 759,202, AND 1,474,214.

THE ENGLISH TRANSLATION OF "CAPTIVE DE" IN THE MARK IS CAPTIVE OF.

SER. NO. 79-086,663, FILED 8-23-2010.

CAROLYN CATALDO, EXAMINING ATTORNEY



David J. Kybas

Director of the United States Patent and Trademark Office

United States of America

United States Patent and Trademark Office

Homefit

Reg. No. 4,107,274

Registered Mar. 6, 2012

Int. Cls.: 9 and 16

TRADEMARK

PRINCIPAL REGISTER

HINKLER BOOKS PTY LTD (AUSTRALIA CORPORATION)
45-55 FAIRCHILD STREET
HEATHERTON, AUSTRALIA VIC 3202

FOR: CDS, CASSETTES, PHONOGRAPH RECORDS, DVDS, AUDIO AND VIDEO TAPES FEATURING MUSIC AND INSTRUCTIONAL IMAGES, PRESENTATIONS AND DIALOGUE IN THE FIELD OF FITNESS, WEIGHT LOSS, HEALTH, EXERCISE, MASSAGE, MEDITATION, SPORTS, YOGA AND PILATES; MAGNETIC DATA CARRIERS FEATURING MUSIC AND INSTRUCTIONAL IMAGES, PRESENTATIONS AND DIALOGUE IN THE FIELD OF FITNESS, WEIGHT LOSS, HEALTH, EXERCISE, MASSAGE, MEDITATION, SPORTS, YOGA AND PILATES; AUDIO AND VIDEO RECORDINGS FEATURING MUSIC AND INSTRUCTIONAL IMAGES, PRESENTATIONS AND DIALOGUE IN THE FIELD OF FITNESS, WEIGHT LOSS, HEALTH, EXERCISE, MASSAGE, MEDITATION, SPORTS, YOGA AND PILATES; CINEMATOGRAPHIC FILMS FEATURING MUSIC AND INSTRUCTIONAL IMAGES, PRESENTATIONS AND DIALOGUE IN THE FIELD OF FITNESS, WEIGHT LOSS, HEALTH, EXERCISE, MASSAGE, MEDITATION, SPORTS, YOGA AND PILATES; COMPUTER AND VIDEO GAMES; COMPUTER AND VIDEO GAME PROGRAMS AND SOFTWARE, IN CLASS 9 (U.S. CLS. 21, 23, 26, 36 AND 38).

FOR: BOOKS, MAGAZINES AND ALBUMS FEATURING FITNESS, LIFESTYLE, FITNESS, WEIGHT LOSS, HEALTH, EXERCISE, MASSAGE, MEDITATION, SPORTS, YOGA AND PILATES EDUCATION AND ENTERTAINMENT IN THE FIELD OF FITNESS, WEIGHT LOSS, HEALTH, EXERCISE, MASSAGE, MEDITATION, SPORTS, YOGA AND PILATES; SCRAPBOOKS; COLOURING BOOKS, NOTEBOOKS, ADDRESS BOOKS, DATE BOOKS, AUTOGRAPH BOOKS, DIARIES, REMINDER BOOKS, GUIDE BOOKS FEATURING FITNESS, LIFESTYLE, FITNESS, WEIGHT LOSS, HEALTH, EXERCISE, MASSAGE, MEDITATION, SPORTS, YOGA AND PILATES EDUCATION AND ENTERTAINMENT IN THE FIELD OF FITNESS, WEIGHT LOSS, HEALTH, EXERCISE, MASSAGE, MEDITATION, SPORTS, YOGA AND PILATES; PRINTED MATTER, NAMELY, BOOKLETS AND LEAFLETS IN THE FIELD OF FITNESS, LIFESTYLE, FITNESS, WEIGHT LOSS, HEALTH, EXERCISE, MASSAGE, MEDITATION, SPORTS, YOGA AND PILATES EDUCATION AND ENTERTAINMENT IN THE FIELD OF FITNESS, WEIGHT LOSS, HEALTH, EXERCISE, MASSAGE, MEDITATION, SPORTS, YOGA AND PILATES; BOOKBINDING MATERIALS; PHOTOGRAPHS; STATIONERY; PLASTIC MATERIALS FOR PACKAGING, NAMELY, PLASTIC BAGS FOR PACKAGING AND PLASTIC BUBBLE PACKS FOR PACKAGING; POSTERS; PAPER PLACEMATS; COASTERS OF PAPER; PAPER; CARDBOARD; GOODS MADE FROM PAPER OR CARDBOARD, NAMELY, CARDBOARD BOXES; STICKERS, SEALS AND



David J. Kappas

Director of the United States Patent and Trademark Office

Reg. No. 4,107,274 TRANSFERS; WRITING INSTRUMENTS, PENS AND PENCILS; WRITING PAPER, NOTE PAPER; PAPER PARTY FAVORS AND DECORATIONS, BOOKS FEATURING GAMES; RULE BOOKS FOR GAMES; SCORE CARDS AND SCORE PADS; PAPER PARTY DECORATIONS FOR WALLS AND DOORS, IN CLASS 16 (U.S. CLS. 2, 5, 22, 23, 29, 37, 38 AND 50).

THE MARK CONSISTS OF THE WORDING "HOMEFIT" WITH THE SILHOUETTES OF FIVE PEOPLE TO THE RIGHT OF THE WORDING. FROM LEFT TO RIGHT, THE FIRST PERSON IS SITTING, THE SECOND IS LUNGING WITH ARMS RAISED AND LEANING BACK, THE THIRD IS LUNGING WITH ARMS RAISED AND BACK STRAIGHT UP, THE FOURTH IS STANDING WITH LEGS SPREAD APART AND ARMS OUTSTRETCHED TO THE SIDE, AND THE FIFTH IS STANDING WITH LEGS SPREAD APART AND ARMS RAISED STRAIGHT UP.

PRIORITY DATE OF 6-21-2010 IS CLAIMED.

OWNER OF INTERNATIONAL REGISTRATION 1049555 DATED 7-13-2010, EXPIRES 7-13-2020.

SER. NO. 79-086,769, FILED 7-13-2010.

JASON BLAIR, EXAMINING ATTORNEY

United States of America

United States Patent and Trademark Office

MONTE SCHIAVO

Reg. No. 4,107,275

Registered Mar. 6, 2012

Int. Cls.: 3, 29 and 33

TRADEMARK

PRINCIPAL REGISTER

LA VITE S.P.A. (ITALY JOINT STOCK COMPANY)
VIA VIVAIO
I-60030 MAIOLATI SPONTINI (AN), ITALY

FOR: SOAPS; PERFUMERY, COSMETICS, IN CLASS 3 (U.S. CLS. 1, 4, 6, 50, 51 AND 52).

FOR: MEAT, FISH, POULTRY AND GAME; MEAT EXTRACTS; PRESERVED, FROZEN, DRIED AND COOKED FRUITS AND VEGETABLES; JELLIES, JAMS, COMPOTES; EGGS, MILK AND MILK PRODUCTS EXCLUDING ICE CREAM, ICE MILK AND FROZEN YOGURT; EDIBLE OILS AND FATS, IN CLASS 29 (U.S. CL. 46).

FOR: ALCOHOLIC BEVERAGES EXCEPT BEERS, IN CLASS 33 (U.S. CLS. 47 AND 49).

THE MARK CONSISTS OF STANDARD CHARACTERS WITHOUT CLAIM TO ANY PARTICULAR FONT, STYLE, SIZE, OR COLOR.

PRIORITY DATE OF 6-30-2010 IS CLAIMED.

OWNER OF INTERNATIONAL REGISTRATION 1049604 DATED 7-6-2010, EXPIRES 7-6-2020.

THE ENGLISH TRANSLATION OF "MONTE SCHIAVO" IN THE MARK IS "MOUNTAIN SLAVE".

SER. NO. 79-086,822, FILED 7-6-2010.

SOPHIA S. KIM, EXAMINING ATTORNEY



David J. Kybas

Director of the United States Patent and Trademark Office

United States of America

United States Patent and Trademark Office

HOME FIT

Reg. No. 4,107,276

Registered Mar. 6, 2012

Int. Cls.: 9 and 16

TRADEMARK

PRINCIPAL REGISTER

HINKLER BOOKS PTY LTD (AUSTRALIA CORPORATION)
45-55 FAIRCHILD STREET
HEATHERTON, AUSTRALIA VIC 3202

FOR: CDS, CASSETTES, PHONOGRAPH RECORDS, DVDS, AUDIO AND VIDEO TAPES FEATURING MUSIC AND INSTRUCTIONAL IMAGES, PRESENTATIONS AND DIALOGUE IN THE FIELD OF FITNESS, WEIGHT LOSS, HEALTH, EXERCISE, MASSAGE, MEDITATION, SPORTS, YOGA AND PILATES; MAGNETIC DATA CARRIERS FEATURING MUSIC AND INSTRUCTIONAL IMAGES, PRESENTATIONS AND DIALOGUE IN THE FIELD OF FITNESS, WEIGHT LOSS, HEALTH, EXERCISE, MASSAGE, MEDITATION, SPORTS, YOGA AND PILATES; AUDIO AND VIDEO RECORDINGS FEATURING MUSIC AND INSTRUCTIONAL IMAGES, PRESENTATIONS AND DIALOGUE IN THE FIELD OF FITNESS, WEIGHT LOSS, HEALTH, EXERCISE, MASSAGE, MEDITATION, SPORTS, YOGA AND PILATES; CINEMATOGRAPHIC FILMS FEATURING MUSIC AND INSTRUCTIONAL IMAGES, PRESENTATIONS AND DIALOGUE IN THE FIELD OF FITNESS, WEIGHT LOSS, HEALTH, EXERCISE, MASSAGE, MEDITATION, SPORTS, YOGA AND PILATES; COMPUTER AND VIDEO GAMES; COMPUTER AND VIDEO GAME PROGRAMS AND SOFTWARE, IN CLASS 9 (U.S. CLS. 21, 23, 26, 36 AND 38).

FOR: BOOKS, MAGAZINES AND ALBUMS FEATURING FITNESS, LIFESTYLE, FITNESS, WEIGHT LOSS, HEALTH, EXERCISE, MASSAGE, MEDITATION, SPORTS, YOGA AND PILATES EDUCATION AND ENTERTAINMENT IN THE FIELD OF FITNESS, WEIGHT LOSS, HEALTH, EXERCISE, MASSAGE, MEDITATION, SPORTS, YOGA AND PILATES; SCRAPBOOKS; COLOURING BOOKS, NOTEBOOKS, ADDRESS BOOKS, DATE BOOKS, AUTOGRAPH BOOKS, DIARIES, REMINDER BOOKS, GUIDE BOOKS FEATURING FITNESS, LIFESTYLE, FITNESS, WEIGHT LOSS, HEALTH, EXERCISE, MASSAGE, MEDITATION, SPORTS, YOGA AND PILATES EDUCATION AND ENTERTAINMENT IN THE FIELD OF FITNESS, WEIGHT LOSS, HEALTH, EXERCISE, MASSAGE, MEDITATION, SPORTS, YOGA AND PILATES; PRINTED MATTER, NAMELY, BOOKLETS AND LEAFLETS IN THE FIELD OF FITNESS, LIFESTYLE, FITNESS, WEIGHT LOSS, HEALTH, EXERCISE, MASSAGE, MEDITATION, SPORTS, YOGA AND PILATES EDUCATION AND ENTERTAINMENT IN THE FIELD OF FITNESS, WEIGHT LOSS, HEALTH, EXERCISE, MASSAGE, MEDITATION, SPORTS, YOGA AND PILATES; BOOKBINDING MATERIALS; PHOTOGRAPHS; STATIONERY; PLASTIC MATERIALS FOR PACKAGING, NAMELY, PLASTIC BAGS FOR PACKAGING AND PLASTIC BUBBLE PACKS FOR PACKAGING; POSTERS; PAPER PLACEMATS; COASTERS OF PAPER; PAPER; CARDBOARD; GOODS MADE FROM PAPER OR CARDBOARD, NAMELY, CARDBOARD BOXES; STICKERS, SEALS AND



David J. Kyros

Director of the United States Patent and Trademark Office

Reg. No. 4,107,276 TRANSFERS; WRITING INSTRUMENTS, PENS AND PENCILS; WRITING PAPER, NOTE PAPER; PAPER PARTY FAVORS AND DECORATIONS, BOOKS FEATURING GAMES; RULE BOOKS FOR GAMES; SCORE CARDS AND SCORE PADS; PAPER PARTY DECORATIONS FOR WALLS AND DOORS, IN CLASS 16 (U.S. CLS. 2, 5, 22, 23, 29, 37, 38 AND 50).

THE MARK CONSISTS OF STANDARD CHARACTERS WITHOUT CLAIM TO ANY PARTICULAR FONT, STYLE, SIZE, OR COLOR.

PRIORITY DATE OF 6-21-2010 IS CLAIMED.

OWNER OF INTERNATIONAL REGISTRATION 1049669 DATED 7-13-2010, EXPIRES 7-13-2020.

NO CLAIM IS MADE TO THE EXCLUSIVE RIGHT TO USE "FIT", APART FROM THE MARK AS SHOWN.

SER. NO. 79-086,845, FILED 7-13-2010.

JASON BLAIR, EXAMINING ATTORNEY

United States of America

United States Patent and Trademark Office



Reg. No. 4,107,277

Registered Mar. 6, 2012

Int. Cls.: 16, 38 and 41

TRADEMARK

SERVICE MARK

PRINCIPAL REGISTER

CLAUDE BRUHIN (FRANCE INDIVIDUAL)
PRÉ DES PALMIERS
F-83400 PORQUEROLLES, FRANCE

FOR: PAPER, CARDBOARD; PRINTED MATTER, NAMELY, NEWSPAPERS, PHOTOGRAPHS, MAGAZINES, BOOKS, PRINTED PERIODICALS, NEWSLETTERS, AND BROCHURES ALL IN THE FIELDS OF ART, SPORT, HISTORY, SCIENCE, LANGUAGE, GEOGRAPHY, ECONOMY, HUMAN SCIENCES; NEWSPAPERS FOR GENERAL CIRCULATION, PHOTOGRAPHS, GENERAL FEATURE MAGAZINES; BOOKBINDING MATERIAL; PHOTOGRAPHS; STATIONERY; ADHESIVES GLUES FOR STATIONERY OR HOUSEHOLD PURPOSES; PAINTBRUSHES; PRINTED INSTRUCTIONAL AND TEACHING MATERIAL IN THE FIELD OF ART, SPORT, HISTORY, SCIENCE, LANGUAGE, GEOGRAPHY, ECONOMY, HUMAN SCIENCES; PLASTIC MATERIALS FOR PACKAGING, NAMELY, BAGS, SMALL BAGS, FILMS AND SHEETS; PRINTING TYPE; PRINTING BLOCKS, IN CLASS 16 (U.S. CLS. 2, 5, 22, 23, 29, 37, 38 AND 50).

FOR: TELECOMMUNICATIONS, NEWS AND PRESS AGENCIES, NAMELY, NEWS AGENCY SERVICES FOR ELECTRONIC TRANSMISSION; COMMUNICATIONS BY RADIO, SENDING TELEGRAMS, TELEVISION PROGRAMME BROADCASTING, RADIO PROGRAMMES BROADCASTS, TELEVISION PROGRAMMES BROADCASTS, INTERACTIVE TELEVISION PROGRAMMES BROADCASTS, RADIO BROADCASTING, RENTAL OF APPARATUS FOR TRANSMITTING MESSAGES AND TELECOMMUNICATIONS; PROVIDING TELECOMMUNICATION CONNECTIVITY SERVICES FOR DOWNLOADING AUDIOVISUAL PROGRAMMES AND COMPUTER SOFTWARE, BROADCASTING AUDIOVISUAL PROGRAMMES, INTERACTIVE OR NOT, OVER THE INTERNET, ELECTRONIC TRANSMISSION OF DATA, IMAGES AND SOUND, IN CLASS 38 (U.S. CLS. 100, 101 AND 104).

FOR: EDUCATION, NAMELY, PROVIDING TRAINING SERVICES IN THE FIELDS OF ART, SPORTS, HISTORY, SCIENCE, LANGUAGE, GEOGRAPHY, ECONOMY, HUMAN SCIENCES; ENTERTAINMENT, NAMELY, ORGANIZING COMMUNITY SPORTING AND CULTURAL ACTIVITIES; ARRANGING AND CONDUCTING COLLOQUIUMS, EDUCATIONAL CONFERENCES, CONGRESSES, SEMINARS AND SYMPOSIUMS IN THE FIELDS OF ART, SPORTS, HISTORY, SCIENCE, LANGUAGE, GEOGRAPHY, ECONOMY, HUMAN SCIENCES; PRACTICAL TRAINING IN THE FIELDS OF ART, HISTORY, SCIENCE, LANGUAGE, GEOGRAPHY, ECONOMY, HUMAN SCIENCES; PUBLISHING SERVICES FOR BOOKS AND DOCUMENTS IN THE FIELDS OF ART, SPORTS, HISTORY, SCIENCE, LANGUAGE, GEOGRAPHY, ECONOMY, HUMAN SCIENCES; RENTAL OF SOUND RECORDINGS,



David J. Kybas

Director of the United States Patent and Trademark Office

Reg. No. 4,107,277 CINEMATOGRAPHIC FILMS AND VIDEO TAPES; RADIO AND TELEVISION PROGRAMME PRODUCTION AND EDITING; ORGANIZATION OF EXHIBITIONS FOR CULTURAL OR EDUCATIONAL PURPOSES; ORGANIZATION OF SPORTS COMPETITIONS FOR ENTERTAINMENT PURPOSES; LENDING LIBRARIES; EDITING AND PRODUCTION OF FILMS ON VIDEOTAPES, AUDIOVISUAL AND MULTIMEDIA PROGRAMMES; EDITING OF TEXTS, FIXED OR ANIMATED IMAGES, AND/OR MUSICAL SOUNDS VIA A COMPUTER FOR INTERACTIVE USE; ORGANIZING, PRODUCING AND PRESENTATION OF LIVE PERFORMANCES; RECORDING STUDIO SERVICES; MOVIE STUDIOS; RADIO AND TELEVISION ENTERTAINMENT, NAMELY, PROVIDING AN ON-GOING RADIO AND TELEVISION PROGRAM IN THE FIELDS OF ART, SPORTS, HISTORY, SCIENCE, LANGUAGE, GEOGRAPHY, ECONOMY, HUMAN SCIENCES; PARTY PLANNING, IN CLASS 41 (U.S. CLS. 100, 101 AND 107).

THE MARK CONSISTS OF AN INCOMPLETE BLUE CIRCLE WITH THE TERMS "GLOBAL SOCIETY" IN THE MIDDLE IN BLUE AND A STYLIZED DEPICTION OF A BIRD WITH THE LEFT WING BLUE AND THE RIGHT WING GREEN ABOVE THE LETTERS "GLO" IN "GLOBAL".

OWNER OF INTERNATIONAL REGISTRATION 1051135 DATED 7-20-2010, EXPIRES 7-20-2020.

THE COLOR(S) BLUE AND GREEN IS/ARE CLAIMED AS A FEATURE OF THE MARK.

SER. NO. 79-087,368, FILED 7-20-2010.

CHERYL CLAYTON, EXAMINING ATTORNEY

United States of America

United States Patent and Trademark Office

ARMANI JUNIOR

Reg. No. 4,107,278

Registered Mar. 6, 2012

**Int. Cls.: 10, 14, 21 and
24**

TRADEMARK

PRINCIPAL REGISTER

GIORGIO ARMANI S.P.A., MILAN, SWISS BRANCH MENDRISIO (SWITZERLAND JOINT STOCK COMPANY)
VIA PENATE 4
CH-6850 MENDRISIO, SWITZERLAND

FOR: SURGICAL, MEDICAL, DENTAL AND VETERINARY APPARATUS AND INSTRUMENTS, NAMELY, GLOVES FOR MEDICAL PURPOSES, IN CLASS 10 (U.S. CLS. 26, 39 AND 44).

FOR: PRECIOUS METALS AND THEIR ALLOYS AND GOODS MADE OF OR COATED WITH THESE MATERIALS, NAMELY, EARRINGS, BRACELETS, NECKLACES, RINGS, PENDANTS, BROOCHES, JEWELRY CHAINS, PINS BEING JEWELRY, MEDALLIONS, CUFFLINKS, TIE CLIPS; WATCH STRAPS; JEWELRY AND WATCH CASES MADE OF PRECIOUS METALS; KEY RINGS OF PRECIOUS METALS; JEWELRY, PRECIOUS STONES; HOROLOGICAL AND CHRONOMETRIC INSTRUMENTS, IN CLASS 14 (U.S. CLS. 2, 27, 28 AND 50).

FOR: HOUSEHOLD OR KITCHEN UTENSILS AND CONTAINERS NOT OF PRECIOUS METAL OR COATED THEREWITH, NAMELY, EMPTY PERFUME ATOMIZERS, PLASTIC BATH RACKS, SOAP BOXES, SOAP DISPENSERS, PAPER TOWEL DISPENSERS, SHAVING BRUSHES, SHAVING BRUSH STANDS, FOOTWEAR BRUSHES, COSMETIC BRUSHES, HAIRBRUSHES, ELECTRIC AND NONELECTRIC TOOTH BRUSHES, COMBS AND SPONGES, NAMELY, FACIAL SPONGES, CLEANING SPONGES, COMB CASES, HAIR COMBS, MATERIAL FOR MAKING BRUSHES, SPONGE HOLDERS, TOILET TISSUE HOLDERS, HOUSEHOLD SPONGES, CONFECTIONER'S DECORATING BAGS, SERVING SPOONS, SLOTTED SPOONS, BASTING SPOONS, MIXING SPOONS, CUTTING BOARDS, BREAD BOXES, CAKE SERVERS, CASSEROLES, STRAINERS, SIEVES AND COLANDERS FOR HOUSEHOLD USE, COOKERY MOLDS, COOKIE CUTTERS, CORN COB HOLDERS, CRUETS NOT OF PRECIOUS METALS FOR OIL AND VINEGAR, GARLIC PRESSES, PEPPER GRINDERS, NON-ELECTRIC GRIDDLES, GRATERS FOR HOUSEHOLD PURPOSES, HOUSEHOLD UTENSILS, NAMELY, SPATULAS, TURNERS, WHISKS, ICE-CUBE MOLDS FOR REFRIGERATORS, KITCHEN LADLES, LEMON SQUEEZERS, SCOOPS, SALT AND PEPPER SHAKERS, BASINS FOR HOLDING AND STORING FOOD ITEMS AND BEVERAGES, BOWLS, CANISTER SETS, CHINA ORNAMENTS, HOUSEHOLD CONTAINERS FOR FOOD, INSULATING JARS, PITCHERS, POTS, VASES NOT OF PRECIOUS METAL, GRAVY BOATS, COVERS FOR DISHES AND POTS, BUTTER DISHES, NAPKIN HOLDERS, TOOTHPICK HOLDERS, NON-ELECTRIC KETTLES, NON-ELECTRIC PRESSURE COOKERS,



David J. Kybas

Director of the United States Patent and Trademark Office

Reg. No. 4,107,278 PANS, PLATES, SERVING PLATTERS, SAUCEPANS, SAUCERS, SOUP TUREENS, CAVIAR COOLERS, DECANTERS, BEVERAGE STIRRERS, SWIZZLE STICKS, WINE TASTERS, NAMELY, SIPHONS, BOTTLE OPENERS, ICE BUCKETS, CUPS, CORK SCREWS, JUGS, MUGS, DRINKING GLASSES, DRINKING VESSELS, REAMERS FOR FRUIT JUICES, NON-ELECTRIC JUICERS, TEA AND COFFEE SERVICES, NOT OF PRECIOUS METAL, COFFEE STIRRERS, HAND OPERATED COFFEE GRINDERS, DOMESTIC COFFEE MEASURERS, NON-ELECTRIC COFFEE PERCOLATORS AND POTS NOT OF PRECIOUS METAL, TEA BALLS NOT OF PRECIOUS METALS, TEA INFUSERS AND TEA POTS NOT OF PRECIOUS METALS, TEA CADDIES; CLEANING CLOTHS, STEEL WOOL FOR CLEANING; NON-ELECTRIC CARPET BEATERS AND CARPET CLEANERS, WASTEPAPER BASKETS, DUSTBINS, DECORATIVE BOXES MADE OF GLASS OR PORCELAIN, DECORATIVE PLATES, CLOTHES BRUSHES, CRUMB BRUSHES, DISHWASHING BRUSHES, FLOWER POTS, FLOWER POT HOLDERS; UNWORKED OR SEMI-WORKED GLASS EXCEPT BUILDING GLASS; PORCELAIN OR EARTHENWARE DOORKNOBS, ALL PURPOSE PORTABLE HOUSEHOLD CONTAINERS, ENAMELLED GLASS, OPALINE GLASS, STAINED GLASS, UNWROUGHT GLASS, GLASS TUBES FOR NON-SCIENTIFIC PURPOSES, CINDER SIFTERS FOR HOUSEHOLD USE, COAL SCUTTLES, DUTCH OVENS, PLASTIC COASTERS, DECORATIVE CRYSTAL PRISMS, PORCELAIN EGGS; PORCELAIN AND EARTHENWARE VASES, BOWLS, MUGS, CUPS, DISHES, PITCHERS, SERVING TRAYS; PORCELAIN FIGURES, PAILS, IN CLASS 21 (U.S. CLS. 2, 13, 23, 29, 30, 33, 40 AND 50).

FOR: FABRICS FOR TEXTILE USE; FABRIC FOR UPHOLSTERY; TEXTILE FABRICS FOR THE MANUFACTURE OF CLOTHING; TEXTILE GOODS, NAMELY, BED AND TABLE COVERS NOT OF PAPER, BED SPREADS, BED SHEETS, COMFORTERS, DUVETS, DUVET COVERS, BED BLANKETS; LINEN AND CLOTH TABLE NAPKINS AND PLACE MATS, CURTAINS, IN CLASS 24 (U.S. CLS. 42 AND 50).

THE MARK CONSISTS OF STANDARD CHARACTERS WITHOUT CLAIM TO ANY PARTICULAR FONT, STYLE, SIZE, OR COLOR.

PRIORITY DATE OF 5-20-2010 IS CLAIMED.

OWNER OF INTERNATIONAL REGISTRATION 1053193 DATED 9-16-2010, EXPIRES 9-16-2020.

OWNER OF U.S. REG. NOS. 2,009,673, 2,998,352 AND OTHERS.

NO CLAIM IS MADE TO THE EXCLUSIVE RIGHT TO USE "JUNIOR", APART FROM THE MARK AS SHOWN.

THE NAME "ARMANI" IDENTIFIES A LIVING INDIVIDUAL WHOSE CONSENT IS OF RECORD.

SER. NO. 79-088,103, FILED 9-16-2010.

JESSICA FATHY, EXAMINING ATTORNEY

United States of America
United States Patent and Trademark Office

ELESTA

Reg. No. 4,107,279

Registered Mar. 6, 2012

Int. Cls.: 9 and 42

TRADEMARK

SERVICE MARK

PRINCIPAL REGISTER

ELESTA RELAYS GMBH (SWITZERLAND LIMITED LIABILITY COMPANY)
HEUTEILSTRASSE 18
CH-7310 BAD RAGAZ
SWITZERLAND

FOR: OPTICAL, MEASURING, SIGNALING, CHECKING SUPERVISION APPARATUS AND INSTRUMENTS, NAMELY, OPTICAL, MAGNETIC, SONIC, ULTRASONIC AND INFRARED SENSORS FOR SENSING THE POSITION OF OBJECTS; APPARATUS AND INSTRUMENTS FOR CONDUCTING AND SWITCHING ELECTRICITY, NAMELY, ELECTRIC RELAYS, INCLUDING, SAFETY RELAYS AND RELAYS WITH FORCIBLY GUIDED CONTACTS; ENCODERS, IN CLASS 9 (U.S. CLS. 21, 23, 26, 36 AND 38).

FOR: SCIENTIFIC AND TECHNOLOGICAL SERVICES AND RESEARCH AND DESIGN RELATING TO THE DESIGN AND MANUFACTURE OF OPTICAL, MAGNETIC, SONIC, ULTRASONIC AND INFRARED SENSORS, RELAYS AND ENCODERS, NAMELY, SCIENTIFIC RESEARCH, DESIGN AND DEVELOPMENT OF NEW PRODUCTS, TECHNOLOGY SUPERVISION AND INSPECTION IN THE FIELD OF PRODUCT QUALITY CONTROL; TECHNOLOGICAL CONSULTING RELATING TO THE DEVELOPMENT AND DESIGN OF ELECTROMECHANICAL AND ELECTRONIC APPARATUS AND COMPONENTS; DEVELOPMENT OF ELECTROMECHANICAL AND ELECTRONIC APPARATUS AND COMPONENTS FOR OTHERS, IN CLASS 42 (U.S. CLS. 100 AND 101).

THE MARK CONSISTS OF STANDARD CHARACTERS WITHOUT CLAIM TO ANY PARTICULAR FONT, STYLE, SIZE, OR COLOR.

PRIORITY DATE OF 4-21-2010 IS CLAIMED.

OWNER OF INTERNATIONAL REGISTRATION 1055099 DATED 9-20-2010, EXPIRES 9-20-2020.

OWNER OF U.S. REG. NO. 2,581,620.

THE WORDING "ELESTA" HAS NO MEANING IN A FOREIGN LANGUAGE.

SER. NO. 79-088,791, FILED 9-20-2010.

TINA BROWN, EXAMINING ATTORNEY



David J. Kyffers

Director of the United States Patent and Trademark Office

United States of America

United States Patent and Trademark Office



Reg. No. 4,107,280

Registered Mar. 6, 2012

Int. Cls.: 31, 35 and 38

TRADEMARK

SERVICE MARK

PRINCIPAL REGISTER

AGRICULTURE BUSINESS INVESTMENTS INC. (PANAMA INCORPORATE)
PLAZA 2000, PISO 16, CALLE 50,
P.O. BOX 0816-01098; PANAMÁ
PANAMA

FOR: AGRICULTURAL, HORTICULTURAL AND FORESTRY PRODUCTS AND GRAINS NOT INCLUDED IN OTHER CLASSES, NAMELY, LIVE ANIMALS; FRESH FRUITS AND VEGETABLES; SEEDS, FOR AGRICULTURAL PURPOSES AND FOR FLOWERS; NATURAL PLANTS, LIVE; PLANTS AND FLOWERS; FOODSTUFFS FOR ANIMALS, MALT FOR BREWING AND DISTILLING PURPOSES; UNPROCESSED EDIBLE NATURAL FLOWERS; EDIBLE NATURAL PLANTS, NAMELY, FRESH FRUITS; FLOWER BULBS; WREATHS OF FRESH FLOWERS; ORNAMENTAL DRIED FLOWERS, IN CLASS 31 (U.S. CLS. 1 AND 46).

FOR: ADVERTISING RELATING TO FLOWERS; BUSINESS INTERMEDIARY SERVICES RELATING TO FLOWERS IN THE NATURE OF BRINGING TOGETHER A VARIETY OF GOODS AND SERVICES FOR THE BENEFIT OF OTHERS, ENABLING CUSTOMERS TO CONVENIENTLY VIEW AND PURCHASE THE ABOVE-MENTIONED GOODS AND SERVICES ON-LINE IN THE FIELD OF FLOWERS AND INFORMATION REGARDING ALL ABOVE-MENTIONED SERVICES; MARKETING AND RETAIL STORE SERVICES FEATURING FLOWERS AND INFORMATION THERETO, IN CLASS 35 (U.S. CLS. 100, 101 AND 102).

FOR: TELECOMMUNICATIONS, NAMELY, TRANSMISSION OF VOICE, DATA, GRAPHICS, SOUND AND VIDEO MEANS OF BROADBAND POWER LINE OR WIRELESS NETWORK; PROVIDING ACCESS TO DATABASES, NAMELY, PROVIDING ACCESS TO INTERCONNECTED COMPUTER NETWORK FOR ORGANIZATION AND MANAGEMENT OF INTERCONNECTED MEETINGS, GATHERINGS, INTERACTIVE DISCUSSIONS, CHATROOMS, VIRTUAL SOCIETY AND BUILDING OF SOCIAL NETWORK; PROVIDING ACCESS TO CUSTOMER ADAPTED WEBSITES WITH USER DEFINED INFORMATION, PERSONAL PROFILES AND INFORMATION; PROVIDING ACCESS TO SERVICES REGARDING DATA TRANSMISSION AND INSTANT MESSAGES, IN CLASS 38 (U.S. CLS. 100, 101 AND 104).

THE MARK CONSISTS OF A DESIGN OF A PURPLE ROSE HIGHLIGHTED IN WHITE WITH A GREEN STYLIZED LEAF SCROLLING BENEATH IT. BENEATH THE DESIGN IS THE WORDING "ILOVEROSES.COM" IN PURPLE.

PRIORITY DATE OF 7-12-2010 IS CLAIMED.



David J. Kyros

Director of the United States Patent and Trademark Office

Reg. No. 4,107,280 OWNER OF INTERNATIONAL REGISTRATION 1055295 DATED 7-12-2010, EXPIRES 7-12-2020.

THE COLOR(S) PURPLE, GREEN AND WHITE IS/ARE CLAIMED AS A FEATURE OF THE MARK.

SER. NO. 79-088,853, FILED 7-12-2010.

MARILYN IZZI, EXAMINING ATTORNEY

United States of America

United States Patent and Trademark Office

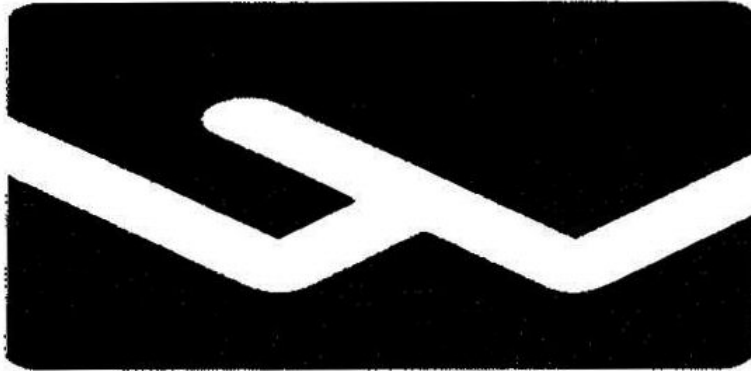

Reg. No. 4,107,281

Registered Mar. 6, 2012

**Int. Cls.: 12, 14, 18, 20,
25, 28 and 42**

TRADEMARK

SERVICE MARK

PRINCIPAL REGISTER

WOLLSDORF LEDER SCHMIDT & CO. GES.M.B.H. (AUSTRIA PRIVATE LIMITED COMPANY)
WOLLSDORF 80
A-8181 WOLLSDORF
AUSTRIA

FOR: INTERIOR FITTINGS OF LEATHER FOR LAND, WATER AND AIR VEHICLES, NAMELY, STEERING WHEELS, STEERING WHEEL COVERS, GEAR KNOBS AND GEAR SHIFT COLLARS, GEAR SHIFTS, GRIPS FOR HAND BRAKES, NAMELY, BICYCLE HANDLEBAR GRIPS FOR HAND BRAKES AND MOTORCYCLE HANDLEBAR GRIPS FOR HAND BRAKES, SEAT COVERS FOR VEHICLES, INTERIOR LININGS MADE OF LEATHER FOR VEHICLE SEATS, VEHICLE ROOFS AND DOORS, HAND BRAKE LEVER COVERS AND GEAR SHIFT LEVEL COVERS, SIDE MOULDINGS FOR DOORS, LEATHER-COATED SWITCHBOARDS, PILLARS, SEAT-BELT PADS, SHOULDER/HEAD SUPPORT CUSHIONS, ALL THE AFORESAID GOODS BEING VEHICLE ACCESSORIES; VEHICLES AND APPARATUS FOR LOCOMOTION BY LAND, AIR OR WATER, NAMELY, CARS, TRAINS, MOTORBIKES, BICYCLES, AIRCRAFTS, HELICOPTERS; AND STRUCTURAL PARTS AND FITTINGS FOR ALL THE AFORESAID GOODS, IN CLASS 12 (U.S. CLS. 19, 21, 23, 31, 35 AND 44).

FOR: WATCH STRAPS, CASES FOR CLOCKS AND WATCHES, PRESENTATION CASES FOR CLOCKS AND WATCHES, JEWELRY, TRINKET BOXES COVERED IN LEATHER, KEY RINGS OF PRECIOUS METAL, BRACELETS, WATCH BANDS AND STRAPS, IN CLASS 14 (U.S. CLS. 2, 27, 28 AND 50).



FOR: LEATHER, IN PARTICULAR FOR CLOTHING, FURNITURE AND INTERIOR FITTINGS FOR LAND, WATER AND AIR VEHICLES, IN PARTICULAR FOR SEAT COVERS OR STITCHED SEAT COVERS, COVERS, LINING PARTS OF ALL KINDS, SIDE MOULDINGS FOR DOORS, SWITCHBOARDS, PILLARS, COVERINGS AND FOR SCREENS OF ALL KINDS; CATTLE SKINS; ANIMAL SKINS, HIDES; CURRIED SKINS; TRUNKS AND TRAVELING BAGS; BAGS, NAMELY, SADDLE BAGS, ALL-PURPOSE CARRYING BAGS, GARMENT BAGS FOR TRAVEL MADE OF LEATHER, KEY BAGS, LEATHER BAGS AND WALLETS, TRAVELING BAGS; STRAPS, NAMELY, LEATHER STRAPS, STRAPS FOR HANDBAGS; SADDLERY; BRIEFCASES; DOCUMENTS WALLETS; WALLETS; LEATHER SOLD IN BULK FOR USE AS A COATING MATERIAL FOR COMPONENT AND LINING PARTS, IN PARTICULAR FOR COMPUTERS, MOBILE TELEPHONES AND GAMES CONSOLES, AND UNWORKED OR SEMI-WORKED LEATHER FOR USE AS COMPONENT AND

David J. Kyros

Director of the United States Patent and Trademark Office

Reg. No. 4,107,281 LINING PARTS FOR COMPUTERS, MOBILE TELEPHONES AND GAMES CONSOLES, IN CLASS 18 (U.S. CLS. 1, 2, 3, 22 AND 41).

FOR: FURNITURE OF LEATHER, IN CLASS 20 (U.S. CLS. 2, 13, 22, 25, 32 AND 50).

FOR: SHOES, SANDALS, BOOTS, BOOTS FOR SPORTS, CLOTHING IN THE NATURE OF BELTS, GLOVES, DRIVING GLOVES, FOOTWEAR UPPERS, TIPS FOR FOOTWEAR, INNER SOLES, IN CLASS 25 (U.S. CLS. 22 AND 39).

FOR: GOLF GLOVES, SPORTS GLOVES FOR GOLF; GYMNASTIC APPARATUS, BALLS FOR GAMES, IN CLASS 28 (U.S. CLS. 22, 23, 38 AND 50).

FOR: SCIENTIFIC RESEARCH, DESIGN AND DEVELOPMENT OF NEW TECHNOLOGIES ALL IN THE FIELD OF ALTERNATIVE PRODUCTION TECHNOLOGIES OF LEATHER AND GOODS OF LEATHER, IN PARTICULAR CLOTHING, FURNITURE, INTERIOR FITTINGS FOR LAND, WATER AND AIR VEHICLES, IN PARTICULAR SEAT COVERS, COVERS, LINING PARTS OF ALL KINDS, PILLARS, SIDE MOULDINGS FOR DOORS, SWITCHBOARDS, COVERINGS AND SCREENS OF ALL KINDS, IN CLASS 42 (U.S. CLS. 100 AND 101).

THE MARK CONSISTS OF A STYLIZED LETTER "W" ON A SHADED RECTANGLE.

PRIORITY DATE OF 4-21-2010 IS CLAIMED.

OWNER OF INTERNATIONAL REGISTRATION 1055793 DATED 10-5-2010, EXPIRES 10-5-2020.

SER. NO. 79-089,029, FILED 10-5-2010.

COLLEEN DOMBROW, EXAMINING ATTORNEY

United States of America

United States Patent and Trademark Office



WOLLSDORF

Reg. No. 4,107,282

Registered Mar. 6, 2012

**Int. Cls.: 12, 14, 18, 20,
25, 28 and 42**

TRADEMARK

SERVICE MARK

PRINCIPAL REGISTER

WOLLSDORF LEDER SCHMIDT & CO. GES.M.B.H. (AUSTRIA PRIVATE LIMITED COMPANY)
WOLLSDORF 80
A-8181 WOLLSDORF
AUSTRIA

FOR: INTERIOR FITTINGS OF LEATHER FOR LAND, WATER AND AIR VEHICLES, NAMELY, STEERING WHEELS, STEERING WHEEL COVERS, GEAR KNOBS AND GEAR SHIFT COLLARS, GEAR SHIFTS, GRIPS FOR HAND BRAKES, NAMELY, BICYCLE HANDLEBAR GRIPS FOR HAND BRAKES AND MOTORCYCLE HANDLEBAR GRIPS FOR HAND BRAKES, SEAT COVERS FOR VEHICLES, INTERIOR LININGS MADE OF LEATHER FOR VEHICLE SEATS, VEHICLE ROOFS AND DOORS, HAND BRAKE LEVER COVERS AND GEAR SHIFT LEVEL COVERS, SIDE MOULDINGS FOR DOORS, LEATHER-COATED SWITCHBOARDS, PILLARS, SEAT-BELT PADS, SHOULDER/HEAD SUPPORT CUSHIONS, ALL THE AFORESAID GOODS BEING VEHICLE ACCESSORIES; VEHICLES AND APPARATUS FOR LOCOMOTION BY LAND, AIR OR WATER, NAMELY, CARS, TRAINS, MOTORBIKES, BICYCLES, AIRCRAFTS, HELICOPTERS; AND STRUCTURAL PARTS AND FITTINGS FOR ALL THE AFORESAID GOODS, IN CLASS 12 (U.S. CLS. 19, 21, 23, 31, 35 AND 44).

FOR: WATCH STRAPS, CASES FOR CLOCKS AND WATCHES, PRESENTATION CASES FOR CLOCKS AND WATCHES, JEWELRY, TRINKET BOXES COVERED IN LEATHER, KEY RINGS OF PRECIOUS METAL, BRACELETS, WATCH BANDS AND STRAPS, IN CLASS 14 (U.S. CLS. 2, 27, 28 AND 50).



FOR: LEATHER, IN PARTICULAR FOR CLOTHING, FURNITURE AND INTERIOR FITTINGS FOR LAND, WATER AND AIR VEHICLES, IN PARTICULAR FOR SEAT COVERS OR STITCHED SEAT COVERS, COVERS, LINING PARTS OF ALL KINDS, SIDE MOULDINGS FOR DOORS, SWITCHBOARDS, PILLARS, COVERINGS AND FOR SCREENS OF ALL KINDS; CATTLE SKINS; ANIMAL SKINS, HIDES; CURRIED SKINS; TRUNKS AND TRAVELING BAGS; BAGS, NAMELY, SADDLE BAGS, ALL-PURPOSE CARRYING BAGS, GARMENT BAGS FOR TRAVEL MADE OF LEATHER, KEY BAGS, LEATHER BAGS AND WALLETS, TRAVELING BAGS; STRAPS, NAMELY, LEATHER STRAPS, STRAPS FOR HANDBAGS; SADDLERY; BRIEFCASES; DOCUMENTS WALLETS; WALLETS; LEATHER SOLD IN BULK FOR USE AS A COATING MATERIAL FOR COMPONENT AND LINING PARTS, IN PARTICULAR FOR COMPUTERS, MOBILE TELEPHONES AND GAMES CONSOLES, AND UNWORKED OR SEMI-WORKED LEATHER FOR USE AS COMPONENT AND

David J. Kybas

Director of the United States Patent and Trademark Office

Reg. No. 4,107,282 LINING PARTS FOR COMPUTERS, MOBILE TELEPHONES AND GAMES CONSOLES, IN CLASS 18 (U.S. CLS. 1, 2, 3, 22 AND 41).

FOR: FURNITURE OF LEATHER, IN CLASS 20 (U.S. CLS. 2, 13, 22, 25, 32 AND 50).

FOR: SHOES, SANDALS, BOOTS, BOOTS FOR SPORTS, CLOTHING IN THE NATURE OF BELTS, GLOVES, DRIVING GLOVES, FOOTWEAR UPPERS, TIPS FOR FOOTWEAR, INNER SOLES, IN CLASS 25 (U.S. CLS. 22 AND 39).

FOR: GOLF GLOVES, SPORTS GLOVES FOR GOLF; GYMNASTIC APPARATUS, BALLS FOR GAMES, IN CLASS 28 (U.S. CLS. 22, 23, 38 AND 50).

FOR: SCIENTIFIC RESEARCH, DESIGN AND DEVELOPMENT OF NEW TECHNOLOGIES ALL IN THE FIELD OF ALTERNATIVE PRODUCTION TECHNOLOGIES OF LEATHER AND GOODS OF LEATHER, IN PARTICULAR CLOTHING, FURNITURE, INTERIOR FITTINGS FOR LAND, WATER AND AIR VEHICLES, IN PARTICULAR SEAT COVERS, COVERS, LINING PARTS OF ALL KINDS, PILLARS, SIDE MOULDINGS FOR DOORS, SWITCHBOARDS, COVERINGS AND SCREENS OF ALL KINDS, IN CLASS 42 (U.S. CLS. 100 AND 101).

NO CLAIM IS MADE TO THE EXCLUSIVE RIGHT TO USE "WOLLSDORF", APART FROM THE MARK AS SHOWN.

PRIORITY DATE OF 4-21-2010 IS CLAIMED.

OWNER OF INTERNATIONAL REGISTRATION 1056647 DATED 10-5-2010, EXPIRES 10-5-2020.

THE MARK CONSISTS OF A STYLIZED LETTER "W" ON A SHADED RECTANGLE COMBINED WITH THE WORDING "WOLLSDORF".

SER. NO. 79-089,335, FILED 10-5-2010.

COLLEEN DOMBROW, EXAMINING ATTORNEY

United States of America

United States Patent and Trademark Office

Lean SMC

Reg. No. 4,107,283

Registered Mar. 6, 2012

Int. Cl.: 7

TRADEMARK

PRINCIPAL REGISTER

SCHMIDT & HEINZMANN GMBH & CO. KG (FED REP GERMANY GMBH & CO. KG)
VICHYSTRASSE 12
BRUCHSAL, FED REP GERMANY 76646

FOR: MACHINES FOR MANUFACTURING, PROCESSING, TREATMENT OF SYNTHETIC MATERIAL AND SEMIFINISHED PRODUCTS, IN CLASS 7 (U.S. CLS. 13, 19, 21, 23, 31, 34 AND 35).

THE MARK CONSISTS OF STANDARD CHARACTERS WITHOUT CLAIM TO ANY PARTICULAR FONT, STYLE, SIZE, OR COLOR.

PRIORITY DATE OF 12-14-2009 IS CLAIMED.

OWNER OF INTERNATIONAL REGISTRATION 1058738 DATED 6-14-2010, EXPIRES 6-14-2020.

NO CLAIM IS MADE TO THE EXCLUSIVE RIGHT TO USE "SMC", APART FROM THE MARK AS SHOWN.

SER. NO. 79-090,139, FILED 6-14-2010.

SCOTT BIBB, EXAMINING ATTORNEY



David J. Kyffers

Director of the United States Patent and Trademark Office

United States of America

United States Patent and Trademark Office

TOUCH WOOD

Reg. No. 4,107,284

Registered Mar. 6, 2012

Int. Cl.: 9

TRADEMARK

PRINCIPAL REGISTER

RIGHTNING, INC. (JAPAN CORPORATION)
11-1-1103, TORANOMON 5-CHOME
MINATO-KU; TOKYO 105-0001
JAPAN

FOR: EAR PLUGS NOT FOR MEDICAL PURPOSES; ELECTRIC WELDING APPARATUS, NAMELY, ELECTRIC WELDING ELECTRODES; OZONATORS, NAMELY, OZONISERS; ELECTROLYTIC CELLS, NAMELY, ELECTROLYSERS; EGG-CANDLERS; BLUEPRINT APPARATUS, NAMELY, KEYBOARD AND PRINT OUT APPARATUS FOR USE WITH COMPUTERS; CASH REGISTERS; COIN COUNTING OR SORTING MACHINES; ELECTRIC SIGN BOARDS FOR DISPLAYING TARGET FIGURES CURRENT OUTPUTS, NAMELY, ELECTRONIC SIGNS; PHOTOCOPYING MACHINES; TIME AND DATE STAMPING MACHINES; TIME RECORDING DEVICES, PUNCHED CARD OFFICE MACHINES, NAMELY, PUNCH CLOCKS; VOTING MACHINES; POSTAGE STAMP CHECKING APPARATUS, NAMELY, POSTAGE STAMP METERS; VENDING MACHINES; METERED GASOLINE PUMPS FOR SERVICE STATIONS; COIN-OPERATED GATES FOR CAR PARKING FACILITIES; LIFE SAVING APPARATUS AND EQUIPMENT, NAMELY, LIFE SAVING RAFTS; FIRE EXTINGUISHERS; FIRE HOSE NOZZLES; SPRINKLER SYSTEMS FOR FIRE PROTECTION; FIRE ALARMS, GAS ALARMS, NAMELY, GAS APPLIANCE ALARM TIMER FOR DETECTING AND ALERTING THE PRESENCE OF GAS FLOW AFTER A PRESCRIBED PERIOD OF TIME; ANTI-THEFT WARNING APPARATUS FOR BURGLAR ALARMS; PROTECTIVE HELMETS; RAILWAY SIGNAL APPARATUS, LUMINOUS OR MECHANICAL, NAMELY, RAILWAY SIGNALS; VEHICLE BREAKDOWN WARNING TRIANGLES; LUMINOUS OR MECHANICAL ROAD SIGNS; DIVERS' APPARATUS, NAMELY, WEIGHT BELTS FOR DIVERS; ARCADE GAMES APPARATUS FOR USE WITH AN EXTERNAL DISPLAY SCREEN OR MONITOR, NAMELY, JOYSTICKS; ELECTRIC DOOR OPENERS; SIMULATORS FOR THE STEERING AND CONTROL OF VEHICLES, NAMELY, VEHICLE DRIVE TRAINING SIMULATORS; SPORTS TRAINING SIMULATORS, NAMELY, SIMULATORS FOR DRIVING OR CONTROL OF VEHICLES; LABORATORY APPARATUS AND INSTRUMENTS, NAMELY, CENTRIFUGES; PHOTOGRAPHIC INSTRUMENTS AND APPARATUS, NAMELY, ANALYSIS INSTRUMENTS FOR PHOTOGRAMMETRIC PURPOSES; CINEMATOGRAPHIC INSTRUMENTS AND APPARATUS, NAMELY, CINEMATOGRAPHIC PROJECTORS; OPTICAL APPARATUS AND INSTRUMENTS, NAMELY, FILTERS FOR OPTICAL DEVICES; MEASURING OR TESTING MACHINES AND INSTRUMENTS, NAMELY, LEVEL MEASURING MACHINES; POWER DISTRIBUTION OR CONTROL MACHINES AND APPARATUS, NAMELY, ELECTRICAL POWER DISTRIBUTION UNITS; ROTARY CONVERTERS; PHASE MODIFIERS, NAMELY, OPTICAL PHASE SHIFTER; ELECTRICAL BATTERIES



David J. Kyros

Director of the United States Patent and Trademark Office

Reg. No. 4,107,284 AND CELLS; ELECTRIC OR MAGNETIC METERS AND TESTERS, NAMELY, CONTINUITY TEST APPARATUS FOR ELECTRICAL CIRCUITS; ELECTRIC WIRES AND CABLES; ELECTRIC FLAT IRONS; ELECTRIC HAIR-CURLERS; ELECTRIC BUZZERS; TELECOMMUNICATION DEVICES AND APPARATUS, NAMELY, FIBER OPTIC REPEATERS, TELEPHONES, MOBILE PHONES AND CORDLESS PHONES; ELECTRONIC MACHINES, APPARATUS AND THEIR PARTS, NAMELY, ELECTROPLATING MACHINES, COMPUTERS; MAGNETIC CORES; RESISTANCE WIRES; ELECTRODES; FIRE BOATS; FIRE ENGINES; CIGAR LIGHTERS FOR AUTOMOBILES; GLOVES FOR PROTECTION AGAINST ACCIDENTS; DUST MASKS; GAS MASKS; WELDING MASKS; FIREPROOF GARMENTS; EYEGLASSES AND GOGGLES, NAMELY, SAFETY GOGGLES; CONSUMER GAMES APPARATUS FOR USE WITH AN EXTERNAL DISPLAY SCREEN OR MONITOR, NAMELY, JOYSTICKS; ELECTRONIC CIRCUITS AND CD-ROMS RECORDED WITH PROGRAMS FOR HAND-HELD GAMING DEVICES WITH LIQUID CRYSTAL DISPLAYS; WEIGHT BELTS FOR SCUBA DIVING; INFLATABLE SWIMMING FLOATS FOR SAFETY PURPOSES; PROTECTIVE HELMETS FOR SPORTS; AIR TANKS FOR SCUBA DIVING; REGULATORS FOR SCUBA DIVING; PHONOGRAPH RECORDS FEATURING JAZZ MUSIC; METRONOMES; DOWNLOADABLE MUSIC SOUND RECORDINGS; EXPOSED CINEMATOGRAPHIC FILMS; EXPOSED SLIDE FILMS; SLIDE FILM MOUNTS; ALL THE AFOREMENTIONED GOODS CONTAIN WOOD IN WHOLE OR IN PART, IN CLASS 9 (U.S. CLS. 21, 23, 26, 36 AND 38).

NO CLAIM IS MADE TO THE EXCLUSIVE RIGHT TO USE "WOOD", APART FROM THE MARK AS SHOWN.

PRIORITY DATE OF 5-14-2010 IS CLAIMED.

OWNER OF INTERNATIONAL REGISTRATION 1060098 DATED 7-14-2010, EXPIRES 7-14-2020.

SER. NO. 79-090,608, FILED 7-14-2010.

JAMES STEIN, EXAMINING ATTORNEY

United States of America

United States Patent and Trademark Office

Château Dutruch Grand Poujeaux Moulis-en-Médoc Appellation Moulis contrôlée

Reg. No. 4,107,285

Registered Mar. 6, 2012

Int. Cl.: 33

TRADEMARK

PRINCIPAL REGISTER

CORDONNIER JEAN-BAPTISTE (FRANCE INDIVIDUAL)
CHÂTEAU ANTHONIC
MOULIS EN MEDOC, FRANCE F33480 AND

CORDONNIER NATHALIE (BELGIUM INDIVIDUAL)
CHÂTEAU ANTHONIC
MOULIS EN MEDOC, FRANCE F33480

FOR: WINE WITH PROTECTED APPELLATION OF ORIGIN, NAMELY, FROM THE WINE-
MAKING ESTATE CALLED CHÂTEAU DUTRUCH GRAND POUJEAUX, IN CLASS 33 (U.S.
CLS. 47 AND 49).

NO CLAIM IS MADE TO THE EXCLUSIVE RIGHT TO USE "MOULIS EN MEDOC APPEL-
LATION MOULIS CONTROLEE", APART FROM THE MARK AS SHOWN.

OWNER OF INTERNATIONAL REGISTRATION 1061173 DATED 11-3-2010, EXPIRES 11-
3-2020.

THE ENGLISH TRANSLATION OF "CHATEAU DUTRUCH GRAND POUJEAUX MOULIS
EN MEDOC APPELLATION MOULIS CONTROLEE" IN THE MARK IS "CHATEAU
DUTRUCH GRAND POUJEAUX MOULIS EN MEDOC" CONTROLLED "APPELLATION
MOULIS".

SER. NO. 79-091,028, FILED 11-3-2010.

LOURDES AYALA, EXAMINING ATTORNEY



David J. Kyros

Director of the United States Patent and Trademark Office

United States of America

United States Patent and Trademark Office



Reg. No. 4,107,286

Registered Mar. 6, 2012

Int. Cl.: 12

TRADEMARK

PRINCIPAL REGISTER

BF GERMANY GMBH (FED REP GERMANY GESELLSCHAFT MIT BESCHRÄNKTER HAFTUNG)
LEHENFELD 22
ASPERG, FED REP GERMANY 71679

FOR: LAND VEHICLE PARTS, NAMELY, GEARBOXES FOR LAND VEHICLES, PISTON RODS, TRANSMISSIONS FOR LAND VEHICLES, DRIVE BELTS, DRIVE GEARS, AND AXLES; LAND VEHICLE SUSPENSION PARTS, NAMELY, TORSION/SWAY BARS, LEAF SPRINGS AND EQUALIZERS, IN CLASS 12 (U.S. CLS. 19, 21, 23, 31, 35 AND 44).

NO CLAIM IS MADE TO THE EXCLUSIVE RIGHT TO USE "GERMANY", APART FROM THE MARK AS SHOWN.

OWNER OF INTERNATIONAL REGISTRATION 0837999 DATED 8-26-2004, EXPIRES 8-26-2014.

THE COLOR(S) BLUE, BLACK AND WHITE IS/ARE CLAIMED AS A FEATURE OF THE MARK.

THE MARK CONSISTS OF THE LETTERS "BF" IN BLUE WITH A BLACK BORDER, A BLUE OVAL AND "GERMANY" IN WHITE UPON A BLACK RECTANGLE.

SER. NO. 79-091,082, FILED 9-22-2009.

EDWARD NELSON, EXAMINING ATTORNEY



David J. Kyffers

Director of the United States Patent and Trademark Office

United States of America

United States Patent and Trademark Office



Reg. No. 4,107,287

Registered Mar. 6, 2012

Int. Cl.: 12

TRADEMARK

PRINCIPAL REGISTER

MAI INTERNATIONAL S.R.L. (ITALY LIMITED LIABILITY COMPANY)
VIA CONCHE, 1151
I-37050 I
SOLA RIZZA (VERONA), ITALY AND

MAI S.P.A. (ITALY JOINT STOCK COMPANY)
VIA CONCHE, 1103
I-37050
ISOLA RIZZA (VR), ITALY

FOR: VEHICLE TIRES; RUBBER TREADS FOR RETREADING VEHICLE TIRES; VEHICLE WHEELS; PREMOULDED TIRE TREADS OF RUBBER FOR RETREADING TIRES; TIRES FOR VEHICLE WHEELS, IN CLASS 12 (U.S. CLS. 19, 21, 23, 31, 35 AND 44).

THE MARK CONSISTS OF THE FANTASY WORD "MAXAM", WRITTEN IN CAPITAL LETTERS, WHERE THE LETTER "X" IS WRITTEN IN A LARGER CHARACTER WITH A CIRCLE OVER IT, FORMING THE DESIGN OF A PERSON WITH OUTSTRETCHED ARMS.

OWNER OF INTERNATIONAL REGISTRATION 0977849 DATED 7-15-2008, EXPIRES 7-15-2018.

THE WORD "MAXAM" HAS NO MEANING IN A FOREIGN LANGUAGE.

SER. NO. 79-091,102, FILED 11-15-2010.

GILBERT SWIFT, EXAMINING ATTORNEY



David J. Kyffers

Director of the United States Patent and Trademark Office

United States of America
United States Patent and Trademark Office

UNIGLIDE

Reg. No. 4,107,288

Registered Mar. 6, 2012

Int. Cl.: 10

TRADEMARK

PRINCIPAL REGISTER

CORIN LIMITED (UNITED KINGDOM LIMITED COMPANY)
THE CORINIUM CENTRE
CIRENCESTER, GLOUCESTERSHIRE, UNITED KINGDOM GL7 1YJ

FOR: SURGICAL AND MEDICAL APPARATUS, NAMELY, ORTHOPAEDIC KNEE IMPLANTS MADE OF ARTIFICIAL MATERIALS, AND INSTRUMENTS FOR THE FITTING AND FIXING OF SUCH GOODS; ORTHOPAEDIC KNEE PROSTHESES; ORTHOPAEDIC KNEE ENDOPROSTHESES; REPLACEMENT PARTS FOR ALL THE AFORESAID GOODS, IN CLASS 10 (U.S. CLS. 26, 39 AND 44).

THE MARK CONSISTS OF STANDARD CHARACTERS WITHOUT CLAIM TO ANY PARTICULAR FONT, STYLE, SIZE, OR COLOR.

OWNER OF INTERNATIONAL REGISTRATION 1061520 DATED 11-30-2010, EXPIRES 11-30-2020.

SER. NO. 79-091,202, FILED 11-30-2010.

DOMINICK J. SALEMI, EXAMINING ATTORNEY



David J. Kyffers

Director of the United States Patent and Trademark Office

United States of America

United States Patent and Trademark Office



Reg. No. 4,107,289

Registered Mar. 6, 2012

Int. Cl.: 3

TRADEMARK

PRINCIPAL REGISTER

MARGARET MIRSALINA CLAYTON AS TRUSTEE FOR THE IRS HOLDINGS UNIT TRUST
(AUSTRALIA TRUST)
160 WEATHERALL ROAD
CHELTENHAM, AUSTRALIA VIC 3192 AND

CRAIG ANDREW DELMO AS TRUSTEE FOR THE IRS HOLDINGS UNIT TRUST
(AUSTRALIA TRUST)
C/- 22 ROCKLEA DRIVE
PORT MELBOURNE, AUSTRALIA VIC 3207

FOR: SHAMPOOS; HAIR MOUSSE, HAIR SPRAY AND HAIR WAX; HAIR GEL; HAIR MOUSSE; HAIR SPRAY; HAIR STYLING WAXES; CONDITIONERS FOR USE ON THE HAIR; BLEACHES FOR USE ON THE HAIR; COLOUR RINSES (FOR THE HAIR); COSMETICS FOR THE USE ON THE HAIR; CREAMS FOR THE HAIR; DYES FOR THE HAIR; GELS FOR USE ON THE HAIR; HAIR CLEANING PREPARATIONS; HAIR COLOURS; HAIR COSMETICS; HAIR FINISHING RINSES; HAIR FIXERS; HAIR GEL; HAIR GROOMING PREPARATIONS; HAIR LACQUER; HAIR LOTIONS; HAIR MOISTURISERS; HAIR MOUSSE; HAIR OIL; HAIR SETTING LOTION; HAIR TINTS; COSMETIC PREPARATIONS FOR THE HAIR; WAX TREATMENTS FOR THE HAIR, IN CLASS 3 (U.S. CLS. 1, 4, 6, 50, 51 AND 52).

NO CLAIM IS MADE TO THE EXCLUSIVE RIGHT TO USE "HAIR", APART FROM THE MARK AS SHOWN.

PRIORITY DATE OF 9-20-2010 IS CLAIMED.

OWNER OF INTERNATIONAL REGISTRATION 1061954 DATED 9-22-2010, EXPIRES 9-22-2020.

THE MARK CONSISTS OF A STYLIZED LETTER "R" MADE FROM HAIR. AT THE BOTTOM OF THE LETTER "R" IS THE WORD "RESPECT" IN STYLIZED FONT. BENEATH THE LETTER "R" IS THE WORD "HAIR" IN STYLIZED FONT.

SER. NO. 79-091,361, FILED 9-22-2010.

MARILYN IZZI, EXAMINING ATTORNEY



David J. Kyros

Director of the United States Patent and Trademark Office

United States of America

United States Patent and Trademark Office

TOOLREX

Swiss Precision Fluids

Reg. No. 4,107,290

Registered Mar. 6, 2012

Int. Cls.: 1, 2 and 4

TRADEMARK

PRINCIPAL REGISTER

BUCHER AG LANGENTHAL (SWITZERLAND SOCIÉTÉ ANONYME (SA))
BERN-ZÜRICH-STRASSE 31
CH-4900 LANGENTHAL
SWITZERLAND

FOR: CHEMICALS USED IN INDUSTRY, IN PARTICULAR ANTIFREEZE AND BRAKE FLUIDS, MOLD-RELEASE AGENTS, ALL AFOREMENTIONED GOODS OF SWISS ORIGIN, IN CLASS 1 (U.S. CLS. 1, 5, 6, 10, 26 AND 46).

FOR: CHEMICO-TECHNICAL PREPARATIONS, NAMELY, COLOR PIGMENTS, LACQUERS AND THINNERS FOR COLORS AND FOR PAINT, ANTI-CORROSIVE COATINGS, ANTI-RUST OILS AND GREASES, COATINGS IN THE NATURE OF RUST TRANSFORMERS AND RUST CONVERTERS FOR THE TREATMENT OF RUSTED SURFACES, RUST PRESERVATIVES IN THE NATURE OF A COATING, ALL AFOREMENTIONED GOODS OF SWISS ORIGIN, IN CLASS 2 (U.S. CLS. 6, 11 AND 16).

FOR: MINERAL AND NON-MINERAL OILS AND GREASES FOR INDUSTRIAL PURPOSES, CUTTING OILS, INDUSTRIAL LUBRICANTS FOR COOLING PURPOSES, INDUSTRIAL LUBRICANTS FOR THE TREATMENT OF METALS; AND HYDRAULIC OILS, ALL AFOREMENTIONED GOODS OF SWISS ORIGIN, IN CLASS 4 (U.S. CLS. 1, 6 AND 15).

NO CLAIM IS MADE TO THE EXCLUSIVE RIGHT TO USE "SWISS" AND "FLUIDS", APART FROM THE MARK AS SHOWN.

PRIORITY DATE OF 6-11-2010 IS CLAIMED.

OWNER OF INTERNATIONAL REGISTRATION 1062451 DATED 11-8-2010, EXPIRES 11-8-2020.

SER. NO. 79-091,601, FILED 11-8-2010.

TEJBIR SINGH, EXAMINING ATTORNEY



David J. Kybas

Director of the United States Patent and Trademark Office

United States of America
United States Patent and Trademark Office

Luxin

Reg. No. 4,107,291

Registered Mar. 6, 2012

Int. Cl.: 42

SERVICE MARK

PRINCIPAL REGISTER

LUXIN (GREEN PLANET) AG WATER MANAGEMENT
BRAMBERGSTR. 18
CH-6004 LUZERN
SWITZERLAND

FOR: RESEARCH IN THE FIELD OF ENVIRONMENTAL PROTECTION; ENVIRONMENTAL IMPACT ASSESSMENT IN THE NATURE OF FEASIBILITY STUDIES; CONSULTING SERVICES IN THE FIELD OF CONCEPTUAL PLANNING OF ENVIRONMENTAL PROJECTS AS THEY RELATE TO ENVIRONMENTAL ENGINEERING AND ENVIRONMENTAL COMPLIANCE; CONSULTING SERVICES IN THE FIELD OF ENVIRONMENTAL ASSESSMENT AND PLANNING; GEOLOGICAL RESEARCH; PROVIDING GEOLOGICAL REPORTS PROVIDING INFORMATION PERTAINING TO GEOLOGICAL RESEARCH; CONSULTING SERVICES IN THE FIELD OF ENERGY EFFICIENCY; AND ENVIRONMENTAL CONSULTING IN THE FIELD OF ENVIRONMENTAL ENGINEERING, IN CLASS 42 (U.S. CLS. 100 AND 101).

THE MARK CONSISTS OF STANDARD CHARACTERS WITHOUT CLAIM TO ANY PARTICULAR FONT, STYLE, SIZE, OR COLOR.

PRIORITY DATE OF 3-5-2010 IS CLAIMED.

OWNER OF INTERNATIONAL REGISTRATION 1063357 DATED 9-2-2010, EXPIRES 9-2-2020.

SER. NO. 79-091,921, FILED 9-2-2010.

KAREN SEVERSON, EXAMINING ATTORNEY



David J. Kybas

Director of the United States Patent and Trademark Office

United States of America
United States Patent and Trademark Office

PEFAKIT

Reg. No. 4,107,292

Registered Mar. 6, 2012

Int. Cls.: 1 and 5

TRADEMARK

PRINCIPAL REGISTER

DSM IP ASSETS B.V. (NETHERLANDS BESLOTEN VENNOOTSCHAP)
HET OVERLOON 1
NL-6411 TE HEERLEN
NETHERLANDS

FOR: CHEMICAL PREPARATIONS FOR PHARMACEUTICAL OR MEDICAL PURPOSES, NAMELY, FOR THE DETECTION OF FIBRINOGEN POLYMERIZATION DISORDERS, DETERMINATION OF INITIAL THROMBIN FORMATION BY INTRINSIC ACTIVATION, DETERMINATION OF FACTOR XA AND FACTOR LLA INHIBITORS AND DETERMINATION OF RESISTANCE OF FACTOR VA TO INACTIVATION BY ACTIVATED PROTEIN C, NAMELY, APC, CAUSED BY THE FACTOR V LEIDEN MUTATION, NAMELY, FV: Q506; DIAGNOSTIC PREPARATIONS FOR MEDICAL PURPOSES, IN CLASS 1 (U.S. CLS. 1, 5, 6, 10, 26 AND 46).

FOR: CHEMICAL PREPARATIONS FOR PHARMACEUTICAL OR MEDICAL PURPOSES, NAMELY, FOR THE DETECTION OF FIBRINOGEN POLYMERIZATION DISORDERS, DETERMINATION OF INITIAL THROMBIN FORMATION BY INTRINSIC ACTIVATION, DETERMINATION OF FACTOR XA AND FACTOR LLA INHIBITORS AND DETERMINATION OF RESISTANCE OF FACTOR VA TO INACTIVATION BY ACTIVATED PROTEIN C (APC) CAUSED BY THE FACTOR V LEIDEN MUTATION (FV:Q506); DIAGNOSTIC PREPARATIONS FOR MEDICAL PURPOSES, IN CLASS 5 (U.S. CLS. 6, 18, 44, 46, 51 AND 52).

THE MARK CONSISTS OF STANDARD CHARACTERS WITHOUT CLAIM TO ANY PARTICULAR FONT, STYLE, SIZE, OR COLOR.

OWNER OF INTERNATIONAL REGISTRATION 0712218 DATED 5-11-1999, EXPIRES 5-11-2019.

OWNER OF U.S. REG. NO. 2,395,142.

SER. NO. 79-091,943, FILED 9-17-2010.

TIMOTHY FINNEGAN, EXAMINING ATTORNEY



David J. Kyros

Director of the United States Patent and Trademark Office

United States of America
United States Patent and Trademark Office

REFOREN

Reg. No. 4,107,293

Registered Mar. 6, 2012

Int. Cls.: 1, 2 and 17

TRADEMARK

PRINCIPAL REGISTER

SOLVAY SA (BELGIUM SOCIÉTÉ ANONYME)
RUE DU PRINCE ALBERT 33
B-1050 BRUXELLES
BELGIUM

FOR: CHEMICALS USED IN INDUSTRY AND SCIENCE; UNPROCESSED ARTIFICIAL RESINS, UNPROCESSED PLASTICS; FIRE EXTINGUISHING COMPOSITIONS; ADHESIVES FOR INDUSTRIAL PURPOSES; CHEMICAL SUBSTANCES FOR PRESERVING FOODSTUFFS, IN CLASS 1 (U.S. CLS. 1, 5, 6, 10, 26 AND 46).

FOR: PAINTS, VARNISHES, LACQUERS, COATINGS, NAMELY, MEMBRANE COATINGS, METAL ANTI-STICK COATINGS, PROTECTIVE COATINGS FOR WIRES, CABLES, TUBING, AND GASKETS, AND ANTI-RUST GREASE, IN CLASS 2 (U.S. CLS. 6, 11 AND 16).

FOR: PLASTICS IN EXTRUDED FORM FOR USE IN MANUFACTURE; PACKING, STOPPING AND INSULATING MATERIALS; NON-METAL FLEXIBLE TUBES, NAMELY, RUBBER TUBES, SYNTHETIC RUBBER TUBES, AND TUBES MADE OF PLASTIC OR ELASTOMERS; NON-METAL GASKETS FOR INDUSTRIAL APPLICATIONS, IN CLASS 17 (U.S. CLS. 1, 5, 12, 13, 35 AND 50).

THE MARK CONSISTS OF STANDARD CHARACTERS WITHOUT CLAIM TO ANY PARTICULAR FONT, STYLE, SIZE, OR COLOR.

PRIORITY DATE OF 8-9-2010 IS CLAIMED.

OWNER OF INTERNATIONAL REGISTRATION 1063936 DATED 12-6-2010, EXPIRES 12-6-2020.

THE WORDING "REFOREN" HAS NO MEANING IN A FOREIGN LANGUAGE.

SER. NO. 79-092,139, FILED 12-6-2010.

ALLISON SCHRODY, EXAMINING ATTORNEY



David J. Kyffers

Director of the United States Patent and Trademark Office

United States of America

United States Patent and Trademark Office

CAMPAGNE DECORATION

Reg. No. 4,107,294

Registered Mar. 6, 2012

Int. Cl.: 24

TRADEMARK

PRINCIPAL REGISTER

HACHETTE FILIPACCHI PRESSE (FRANCE SOCIÉTÉ ANONYME)
149 RUE ANATOLE FRANCE
F-92534 LEVALLOIS-PERRET
FRANCE

FOR: TEXTILES AND TEXTILE GOODS NOT INCLUDED IN OTHER CLASSES, NAMELY, BED AND TABLE COVERS IN THE NATURE OF TEXTILE TABLE CLOTHS, BATH LINEN, BED LINEN, BED COVERS OF PAPER, PILLOW COVERS; TRAVELLING RUGS; SLEEPING BAGS, NAMELY, QUILTS AND TRAVELLING BLANKETS, DUVETS, EIDERDOWNS, SHEETS, NAMELY, SHEET SETS, EIDERDOWN COVERS, PILLOWCASES, HOUSEHOLD LINEN, BATHROOM AND TOILET LINEN, LINEN MADE OF TOWELING AND BEACH TOWELS OF TOWELING; HANDKERCHIEFS, TEXTILE NAPKINS FOR REMOVING MAKE-UP; MOSQUITO NETS; SHOWER CURTAINS OF TEXTILE OR OF PLASTICS, CURTAINS OF TEXTILE OR OF PLASTICS, BLINDS OF TEXTILE, NAMELY, DRAPERIES, CURTAINS, NET CURTAINS, HOUSEHOLD FABRICS, NAMELY, TEXTILE FABRICS FOR MAKING HOUSEHOLD FURNISHINGS, UPHOLSTERY FABRICS, COVERS FOR CUSHIONS, MATTRESS COVERS, COVERINGS FOR FURNITURE OF PLASTICS, FABRIC FOR FURNITURE, UNFITTED FURNITURE COVERS OF TEXTILE, DOILIES, NOT OF PAPER, TEXTILE FACE TOWELS, TOWELS OF TEXTILE, TABLE NAPKINS OF TEXTILE, WALL HANGINGS OF TEXTILE, TEXTILE POCKET HANDKERCHIEFS, TABLECLOTHS, IN CLASS 24 (U.S. CLS. 42 AND 50).

NO CLAIM IS MADE TO THE EXCLUSIVE RIGHT TO USE "DECORATION", APART FROM THE MARK AS SHOWN.

OWNER OF INTERNATIONAL REGISTRATION 1064078 DATED 12-6-2010, EXPIRES 12-6-2020.

THE ENGLISH TRANSLATION OF "CAMPAGNE" IN THE MARK IS COUNTRY.

SER. NO. 79-092,197, FILED 12-6-2010.

ALLISON SCHRODY, EXAMINING ATTORNEY



David J. Kyffers

Director of the United States Patent and Trademark Office

United States of America

United States Patent and Trademark Office



HOROMETER

Reg. No. 4,107,295

Registered Mar. 6, 2012

Int. Cl.: 9

TRADEMARK

PRINCIPAL REGISTER

SYNSINFORG KFT. (HUNGARY LIMITED LIABILITY COMPANY)
HALLER U. 23-25
H-1096 BUDAPEST
HUNGARY

FOR: CALIBRATION DEVICES FOR CALIBRATING TIME MEASURING APPARATUS, IN CLASS 9 (U.S. CLS. 21, 23, 26, 36 AND 38).

NO CLAIM IS MADE TO THE EXCLUSIVE RIGHT TO USE "HOROMETER", APART FROM THE MARK AS SHOWN.

PRIORITY DATE OF 7-14-2010 IS CLAIMED.

OWNER OF INTERNATIONAL REGISTRATION 1064130 DATED 7-21-2010, EXPIRES 7-21-2020.

THE MARK CONSISTS OF AN ELECTRONIC PULSE SHAPE (TIK) OF A MEASURED HOUR, INSIDE A SHADED CIRCLE. TO THE RIGHT IS THE TERM "HOROMETER".

SER. NO. 79-092,223, FILED 7-21-2010.

MICHAEL WIENER, EXAMINING ATTORNEY



David J. Kyros

Director of the United States Patent and Trademark Office

United States of America

United States Patent and Trademark Office



Reg. No. 4,107,296

Registered Mar. 6, 2012

**Int. Cls.: 9, 16, 38, 41
and 45**

TRADEMARK

SERVICE MARK

PRINCIPAL REGISTER

KEY DEVELOPMENTAL ASSETS, LLC
40E DIVISION STREET,
SUITE ADOVER DE 19901
UNITED STATES

FOR: ELECTRONIC PUBLICATIONS, NAMELY, TEXTS, BOOKS, TEXTBOOKS, JOURNALS, BROCHURES, PERIODICALS, MAGAZINES, NEWSLETTERS, NEWSPAPERS, AND WORKSHEETS IN THE FIELDS OF FOSTER CARE, CHILD CARE, ADULT CARE, RESIDENTIAL CARE, SHELTERED HOUSING, RESPITE CARE, CHILD PLACEMENT, ADULT PLACEMENT, CHILD DAY CARE SERVICES, ADULT DAY CARE SERVICES, ADULT DOMICILIARY CARE SERVICES, CHILD DOMICILIARY CARE SERVICES, PARENTING, PSYCHOLOGY, PSYCHOTHERAPY, NUTRITION, EMPLOYMENT PLACEMENT, SOCIAL POLICY, SOCIAL SCIENCE, COUNSELING SERVICES, NURSING, HEALTH CARE, AND MENTAL HEALTH; DOWNLOADABLE SOUND FILES, DOWNLOADABLE IMAGE FILES, DOWNLOADABLE TEXT AND INFORMATION FILES, ALL CONTAINING INFORMATION ON THE SUBJECTS OF FOSTER CARE, CHILD CARE, ADULT CARE, RESIDENTIAL CARE, SHELTERED HOUSING, RESPITE CARE, CHILD PLACEMENT, ADULT PLACEMENT, CHILD DAY CARE SERVICES, ADULT DAY CARE SERVICES, ADULT DOMICILIARY CARE SERVICES, CHILD DOMICILIARY CARE SERVICES, PARENTING, PSYCHOLOGY, PSYCHOTHERAPY, NUTRITION, EMPLOYMENT PLACEMENT, SOCIAL POLICY, SOCIAL SCIENCE, COUNSELING SERVICES, NURSING, HEALTH CARE, AND MENTAL HEALTH PROVIDED ELECTRONICALLY, BY TELECOMMUNICATIONS NETWORKS, BY ONLINE DELIVERY, BY WAY OF THE INTERNET OR WORLD WIDE WEB; ELECTRONIC DATABASES PROVIDING INFORMATION IN THE FIELDS OF FOSTER CARE, CHILD CARE, ADULT CARE, RESIDENTIAL CARE, SHELTERED HOUSING, RESPITE CARE, CHILD PLACEMENT, ADULT PLACEMENT, CHILD DAY CARE SERVICES, ADULT DAY CARE SERVICES, ADULT DOMICILIARY CARE SERVICES, CHILD DOMICILIARY CARE SERVICES, PARENTING, PSYCHOLOGY, PSYCHOTHERAPY, NUTRITION, EMPLOYMENT PLACEMENT, SOCIAL POLICY, SOCIAL SCIENCE, COUNSELING SERVICES, NURSING, HEALTH CARE, AND MENTAL HEALTH RECORDED ON COMPUTER MEDIA; COMPACT DISCS, FLOPPY DISCS, CD-ROMS, DVDS, DVD-ROMS, CASSETTE TAPES, VIDEO TAPES, RECORDS, CINEMATOGRAPHIC FILMS, SLIDE FILMS, AND RECORDED VIDEO DISCS, MAGNETIC AND OPTICAL DISCS FEATURING INFORMATION ON THE SUBJECTS OF FOSTER CARE, CHILD CARE, ADULT CARE, RESIDENTIAL CARE, SHELTERED HOUSING, RESPITE CARE, CHILD PLACEMENT, ADULT PLACEMENT, CHILD DAY CARE SERVICES, ADULT DAY CARE SERVICES, ADULT DOMICILIARY CARE SERVICES, CHILD DOMICILIARY CARE SERVICES, PARENTING, PSYCHOLOGY, PSYCHOTHERAPY, NUTRITION,



David J. Kyjars

Director of the United States Patent and Trademark Office

Reg. No. 4,107,296 EMPLOYMENT PLACEMENT, SOCIAL POLICY, SOCIAL SCIENCE, COUNSELING SERVICES, NURSING, HEALTH CARE, AND MENTAL HEALTH; COMPUTER SOFTWARE, INCLUDING SOFTWARE DOWNLOADABLE FROM THE INTERNET, FOR COMPILING ANALYZING, AND PROCESSING INFORMATION AND DATA IN THE FIELDS OF FOSTERING SERVICES, FOSTER CARE SERVICES, CHILD CARE SERVICES, ADULT CARE SERVICES, RESIDENTIAL CARE SERVICES, SHELTERED HOUSING SERVICES, RESPITE CARE SERVICES, CHILD PLACEMENT SERVICES, ADULT PLACEMENT SERVICES, CHILD DAY CARE SERVICES, ADULT DAY CARE SERVICES, ADULT DOMICILIARY CARE SERVICES, CHILD DOMICILIARY CARE SERVICES, PARENTING SERVICES, PSYCHOLOGY SERVICES, PSYCHOTHERAPY SERVICES, NUTRITION SERVICES, EMPLOYMENT PLACEMENT SERVICES, SOCIAL POLICY SERVICES, SOCIAL SCIENCE SERVICES, COUNSELING SERVICES, NURSING SERVICES, HEALTHCARE SERVICES, AND MENTAL HEALTH SERVICES; SOFTWARE, FOR THE CREATION, MANAGEMENT, UPDATING, AND OPERATING OF DATABASES; ELECTRONIC PUBLICATIONS, NAMELY, ELECTRONIC TEXTS, BOOKS, TEXTBOOKS, BROCHURES, SYLLABI, MAGAZINES, JOURNALS, AND NEWSPAPERS, FEATURING INFORMATION ON THE SUBJECTS OF FOSTER CARE, CHILD CARE, ADULT CARE, RESIDENTIAL CARE, SHELTERED HOUSING, RESPITE CARE, CHILD PLACEMENT, ADULT PLACEMENT, CHILD DAY CARE SERVICES, ADULT DAY CARE SERVICES, ADULT DOMICILIARY CARE SERVICES, CHILD DOMICILIARY CARE SERVICES, PARENTING, PSYCHOLOGY, PSYCHOTHERAPY, NUTRITION, EMPLOYMENT PLACEMENT, SOCIAL POLICY, SOCIAL SCIENCE, COUNSELING SERVICES, NURSING, HEALTH CARE, AND MENTAL HEALTH, ALL BEING DOWNLOADABLE FROM AN ONLINE DATABASE OR FROM A GLOBAL COMPUTER NETWORK, IN CLASS 9 (U.S. CLS. 21, 23, 26, 36 AND 38).

FOR: PAPER, PRINTED MATTER AND PUBLICATIONS, NAMELY, INSTRUCTIONAL MATERIALS AND TEACHING MATERIALS IN THE FIELDS OF FOSTER CARE, CHILD CARE, ADULT CARE, RESIDENTIAL CARE, SHELTERED HOUSING, RESPITE CARE, CHILD PLACEMENT, ADULT PLACEMENT, CHILD DAY CARE SERVICES, ADULT DAY CARE SERVICES, ADULT DOMICILIARY CARE SERVICES, CHILD DOMICILIARY CARE SERVICES, PARENTING, PSYCHOLOGY, PSYCHOTHERAPY, NUTRITION, EMPLOYMENT PLACEMENT, SOCIAL POLICY, SOCIAL SCIENCE, COUNSELING SERVICES, NURSING, HEALTH CARE, AND MENTAL HEALTH; BOOKS, JOURNALS, PERIODICALS, MAGAZINES, LEAFLETS, PAMPHLETS, NEWSLETTERS, AND WORKSHEETS ON THE SUBJECTS OF FOSTER CARE, CHILD CARE, ADULT CARE, RESIDENTIAL CARE, SHELTERED HOUSING, RESPITE CARE, CHILD PLACEMENT, ADULT PLACEMENT, CHILD DAY CARE SERVICES, ADULT DAY CARE SERVICES, ADULT DOMICILIARY CARE SERVICES, CHILD DOMICILIARY CARE SERVICES, PARENTING, PSYCHOLOGY, PSYCHOTHERAPY, NUTRITION, EMPLOYMENT PLACEMENT, SOCIAL POLICY, SOCIAL SCIENCE, COUNSELING SERVICES, NURSING, HEALTHCARE, AND MENTAL HEALTH; GREETING CARDS; POSTCARDS; PHOTOGRAPHS; FOLDERS, FOLIOS; DOCUMENT FOLDERS, STICKERS; DECALCOMANIAS; MAPS; POSTERS; CALENDARS AND DIARIES; STATIONERY; PENS, PENCILS, CRAYONS; CREDIT, DEBIT AND CHARGE CARDS NEITHER MAGNETIC NOR ENCODED; CHEQUE BOOKS, IN CLASS 16 (U.S. CLS. 2, 5, 22, 23, 29, 37, 38 AND 50).

FOR: RENTAL OF TELECOMMUNICATION FACILITIES AND EQUIPMENT FOR TRAINING, TEACHING, ACADEMIC, EDUCATION, INSTRUCTION, EXAMINATION, TESTING, AND ASSESSMENT PURPOSES; TELECOMMUNICATION SERVICES, NAMELY, COMPUTER-AIDED TRANSMISSION OF INFORMATION AND IMAGES, NAMELY, THE TRANSMISSION OF ELECTRONIC PUBLICATIONS AND COMMUNICATIONS IN ELECTRONIC FORM SUPPLIED ONLINE, FROM DATABASES OR FROM FACILITIES PROVIDED ON THE INTERNET; PROVISION OF ACCESS TO DATA OR DOCUMENTS STORED ELECTRONICALLY IN CENTRAL FILES FOR REMOTE CONSULTATION; PROVIDING MULTIPLE USER ACCESS TO GLOBAL COMPUTER INFORMATION NETWORKS; PROVISION OF ONLINE FORUMS IN THE NATURE OF CHAT ROOMS; PROVISION OF ONLINE BULLETIN BOARDS AND CHAT ROOM SERVICES FOR TRANSMISSION OF MESSAGES AMONG COMPUTER USERS ON THE SUBJECT OF FOSTER CARE, CHILD CARE, ADULT CARE, RESIDENTIAL

Reg. No. 4,107,296 CARE, SHELTERED HOUSING, RESPITE CARE, CHILD PLACEMENT, ADULT PLACEMENT, CHILD DAY CARE SERVICES, ADULT DAY CARE SERVICES, ADULT DOMICILIARY CARE SERVICES, CHILD DOMICILIARY CARE SERVICES, PARENTING, PSYCHOLOGY, PSYCHOTHERAPY, NUTRITION, EMPLOYMENT PLACEMENT, SOCIAL POLICY, SOCIAL SCIENCE, COUNSELING SERVICES, NURSING, HEALTHCARE, AND MENTAL HEALTH; TRANSMISSION OF EDUCATIONAL FILMS, TELEVISION PROGRAMS AND VIDEO RECORDINGS VIA THE INTERNET, AND BROADCAST OVER TELEVISION AND RADIO; PROVIDING INFORMATION, ADVISORY, AND CONSULTANCY SERVICES RELATING TO ALL OF THE AFORESAID, IN CLASS 38 (U.S. CLS. 100, 101 AND 104).

FOR: EDUCATION SERVICES, NAMELY, TRAINING, TEACHING AND INSTRUCTION ON THE SUBJECTS OF FOSTER CARE, CHILD CARE, ADULT CARE, RESIDENTIAL CARE, SHELTERED HOUSING, RESPITE CARE, CHILD PLACEMENT, ADULT PLACEMENT, CHILD DAY CARE SERVICES, ADULT DAY CARE SERVICES, ADULT DOMICILIARY CARE SERVICES, CHILD DOMICILIARY CARE SERVICES, PARENTING, PSYCHOLOGY, PSYCHOTHERAPY, NUTRITION, EMPLOYMENT PLACEMENT, SOCIAL POLICY, SOCIAL SCIENCE, COUNSELING SERVICES, NURSING, HEALTHCARE, AND MENTAL HEALTH; EDUCATIONAL EXAMINATION, EDUCATIONAL TESTING, AND EDUCATIONAL ASSESSMENT SERVICES; PROVISION OF TRAINING, TEACHING, AND INSTRUCTION ON THE SUBJECTS OF FOSTER CARE, CHILD CARE, ADULT CARE, RESIDENTIAL CARE, SHELTERED HOUSING, RESPITE CARE, CHILD PLACEMENT, ADULT PLACEMENT, CHILD DAY CARE SERVICES, ADULT DAY CARE SERVICES, ADULT DOMICILIARY CARE SERVICES, CHILD DOMICILIARY CARE SERVICES, PARENTING, PSYCHOLOGY, PSYCHOTHERAPY, NUTRITION, EMPLOYMENT PLACEMENT, SOCIAL POLICY, SOCIAL SCIENCE, COUNSELING SERVICES, NURSING, HEALTHCARE, AND MENTAL HEALTH, OFFERED ELECTRONICALLY, BY MEANS OF TELECOMMUNICATIONS NETWORKS, BY ONLINE DELIVERY, BY WAY OF THE INTERNET OR WORLD WIDE WEB; EDUCATIONAL EXAMINATION, EDUCATIONAL TESTING, AND EDUCATIONAL ASSESSMENT SERVICES OFFERED ELECTRONICALLY BY MEANS OF TELECOMMUNICATIONS NETWORKS, BY ONLINE DELIVERY, BY WAY OF THE INTERNET OR WORLD WIDE WEB; PUBLICATION OF INSTRUCTION, TEACHING, TRAINING, EXAMINATION, TESTING, AND ASSESSMENT MATERIAL; PUBLICATION OF TEXTS, BOOKS, TEXTBOOKS, BROCHURES, MAGAZINES, JOURNALS, AND NEWSPAPERS; ELECTRONIC DESKTOP PUBLISHING; ONLINE PUBLICATION OF ELECTRONIC TEXTS, BOOKS, TEXTBOOKS, BROCHURES, MAGAZINES, JOURNALS, AND NEWSPAPERS; PUBLICATION OF ELECTRONIC TEXTS, BOOKS, TEXTBOOKS, BROCHURES, MAGAZINES, JOURNALS AND NEWSPAPERS, ALL BEING DOWNLOADABLE FROM AN ONLINE DATABASE OR FROM A GLOBAL COMPUTER NETWORK; EDUCATIONAL ASSESSMENT SERVICES; DISTANCE LEARNING IN THE FIELDS OF FOSTER CARE, CHILD CARE, ADULT CARE, RESIDENTIAL CARE, SHELTERED HOUSING, RESPITE CARE, CHILD PLACEMENT, ADULT PLACEMENT, CHILD DAY CARE SERVICES, ADULT DAY CARE SERVICES, ADULT DOMICILIARY CARE SERVICES, CHILD DOMICILIARY CARE SERVICES, PARENTING, PSYCHOLOGY, PSYCHOTHERAPY, NUTRITION, EMPLOYMENT PLACEMENT, SOCIAL POLICY, SOCIAL SCIENCE, COUNSELING SERVICES, NURSING, HEALTHCARE, AND MENTAL HEALTH; ORGANIZATION AND PROVISION OF COURSES, ASSESSMENT, TEACHING, AND TRAINING IN THE FIELDS OF FOSTER CARE, CHILD CARE, ADULT CARE, RESIDENTIAL CARE, SHELTERED HOUSING, RESPITE CARE, CHILD PLACEMENT, ADULT PLACEMENT, CHILD DAY CARE SERVICES, ADULT DAY CARE SERVICES, ADULT DOMICILIARY CARE SERVICES, CHILD DOMICILIARY CARE SERVICES, PARENTING, PSYCHOLOGY, PSYCHOTHERAPY, NUTRITION, EMPLOYMENT PLACEMENT, SOCIAL POLICY, SOCIAL SCIENCE, COUNSELING SERVICES, NURSING, HEALTHCARE, AND MENTAL HEALTH; RESEARCH IN THE FIELD OF EDUCATION; PROVISION OF CORRESPONDENCE COURSES IN THE FIELDS OF FOSTER CARE, CHILD CARE, ADULT CARE, RESIDENTIAL CARE, SHELTERED HOUSING, RESPITE CARE, CHILD PLACEMENT, ADULT PLACEMENT, CHILD DAY CARE SERVICES, ADULT DAY CARE SERVICES, ADULT DOMICILIARY CARE SERVICES, CHILD DOMICILIARY CARE SERVICES, PARENTING, PSYCHOLOGY, PSYCHOTHERAPY, NUTRITION, EMPLOYMENT PLACEMENT, SOCIAL POLICY, SOCIAL SCIENCE, COUNSELING SERVICES, NURSING, HEALTHCARE,

Reg. No. 4,107,296 AND MENTAL HEALTH; ARRANGING, ORGANIZING, AND CONDUCTING COURSES, SEMINARS, SYMPOSIUMS, CONFERENCES, CONGRESSES, AND EXHIBITIONS IN THE FIELDS OF FOSTER CARE, CHILD CARE, ADULT CARE, RESIDENTIAL CARE, SHELTERED HOUSING, RESPITE CARE, CHILD PLACEMENT, ADULT PLACEMENT, CHILD DAY CARE SERVICES, ADULT DAY CARE SERVICES, ADULT DOMICILIARY CARE SERVICES, CHILD DOMICILIARY CARE SERVICES, PARENTING, PSYCHOLOGY, PSYCHOTHERAPY, NUTRITION, EMPLOYMENT PLACEMENT, SOCIAL POLICY, SOCIAL SCIENCE, COUNSELING SERVICES, NURSING, HEALTHCARE, AND MENTAL HEALTH; PROVISION OF EDUCATIONAL EXAMINATIONS; CAREERS COUNSELING; EDUCATION LIAISON SERVICES, NAMELY, TUTORING AND CONSULTING SERVICES REGARDING EDUCATIONAL PLACEMENT FOR THE STUDY OF FOSTER CARE, CHILD CARE, ADULT CARE, RESIDENTIAL CARE, SHELTERED HOUSING, RESPITE CARE, CHILD PLACEMENT, ADULT PLACEMENT, CHILD DAY CARE SERVICES, ADULT DAY CARE SERVICES, ADULT DOMICILIARY CARE SERVICES, CHILD DOMICILIARY CARE SERVICES, PARENTING, PSYCHOLOGY, PSYCHOTHERAPY, NUTRITION, EMPLOYMENT PLACEMENT, SOCIAL POLICY, SOCIAL SCIENCE, COUNSELING SERVICES, NURSING, HEALTHCARE, AND MENTAL HEALTH; TRAINING AND EDUCATIONAL ASSESSMENT OF FOSTER CARE PROVIDERS; PARENTING SKILLS TRAINING; PRODUCTION AND DISTRIBUTION OF EDUCATIONAL FILMS, TELEVISION PROGRAMS, AND VIDEO RECORDINGS FOR DISPLAY OVER THE INTERNET, TELEVISION, AND RADIO; PROVIDING INFORMATION, ADVISORY, AND CONSULTANCY SERVICES RELATING TO ALL OF THE AFORESAID SERVICES, IN CLASS 41 (U.S. CLS. 100, 101 AND 107).

FOR: SOCIAL WORK SERVICES, NAMELY, THE COORDINATION AND ORGANIZATION OF LEGAL SERVICES, SOCIAL SERVICES, FOSTER CARE SERVICES, NURSING SERVICES, HEALTHCARE AND MENTAL HEALTH RESIDENTIAL CARE SERVICES, RESPITE CARE SERVICES, PSYCHOLOGY SERVICES, PSYCHOTHERAPY SERVICES AND COUNSELING SERVICES FOR ADULTS, CHILDREN, AND FAMILIES; FOSTER CARE SERVICES; FOSTER CARE SERVICES, NAMELY, FOSTERING OF MOTHERS AND BABIES; FOSTER CARE SERVICES, NAMELY, FOSTERING OF CHILDREN; PERSONAL AND SOCIAL SERVICES RENDERED BY OTHERS, NAMELY, FOSTER PLACEMENT OF CHILDREN AND YOUNG PEOPLE; PROVISION OF SUPPORT SERVICES, NAMELY, PROVIDING EMOTIONAL GUIDANCE, EMOTIONAL THERAPY, COUNSELLING AND EMOTIONAL ADVICE TO FOSTER CARERS; PROVISION OF SUPPORT SERVICES FOR YOUNG PEOPLE AND CHILDREN, NAMELY, PROVIDING REHOMING SERVICES, IN THE NATURE OF FOSTER CARE, EMOTIONAL GUIDANCE, EMOTIONAL COUNSELING, EMOTIONAL THERAPY, AND EMOTIONAL ADVICE, ADVICE IN RESPECT OF BEING FOSTERED AND FOSTERING AND ADVICE TO IMPROVE SOCIAL SKILLS TO YOUNG PEOPLE AND CHILDREN; FOSTER CARE SERVICES IN THE NATURE OF FOSTER CARE ASSESSMENT SERVICES RELATING TO FOSTER CARERS, NAMELY, CONDUCTING RESEARCH ON FOSTER CARERS, INVESTIGATIONS ON FOSTER CARERS, AND DRUG SCREENING, ALCOHOL SCREENING AND DNA SCREENING OF FOSTER CARERS, TO ENSURE THEIR CONTINUED STABILITY TO PERFORM THEIR ROLE; CARRYING OUT CHECKS AND COMPILING REPORTS ON FOSTER CARERS, NAMELY, CONDUCTING RESEARCH ON FOSTER CARERS, BACKGROUND INVESTIGATIONS ON FOSTER CARERS, EMPLOYEE MISCONDUCT INVESTIGATIONS ON FOSTER CARERS, PERSONAL BACKGROUND INVESTIGATIONS ON FOSTER CARERS, PUBLIC RECORD INVESTIGATIONS ON FOSTER CARERS TO ENSURE THEIR CONTINUED STABILITY TO PERFORM THEIR ROLE; EMPLOYMENT SCREENING SERVICES, NAMELY, CONDUCTING BACKGROUND RESEARCH ON FOSTER CARERS, BACKGROUND INVESTIGATIONS ON FOSTER CARERS AND PRE-EMPLOYMENT BACKGROUND SCREENING SERVICES ON FOSTER CARERS; LIAISON SERVICES WITH LOCAL AUTHORITIES RELATING TO FOSTER CARE, NAMELY, ACTING AS A LIAISON BETWEEN FOSTER CARE PROVIDERS AND LOCAL AUTHORITIES TO ADDRESS THE LEGAL AND PERSONAL SUPPORT NEEDS OF FOSTER CARE PROVIDERS AND INDIVIDUALS RESIDING IN FOSTER CARE; PROVIDING INFORMATION, CONSULTANCY, AND ADVISORY SERVICES RELATING TO ALL OF THE AFORESAID SERVICES, IN CLASS 45 (U.S. CLS. 100 AND 101).

Reg. No. 4,107,296 THE MARK CONSISTS OF THE WORDING "KDA" ABOVE THE WORDING "KEY DEVELOPMENTAL ASSETS" ALL AGAINST A BACKGROUND OF MULTIPLE WAVY LINES.

PRIORITY DATE OF 3-19-2010 IS CLAIMED.

OWNER OF INTERNATIONAL REGISTRATION 1064827 DATED 9-9-2010, EXPIRES 9-9-2020.

SER. NO. 79-092,456, FILED 9-9-2010.

ANDREA HACK, EXAMINING ATTORNEY

United States of America

United States Patent and Trademark Office

U MARINE

Reg. No. 4,107,297

Registered Mar. 6, 2012

**Int. Cls.: 12, 17, 19 and
37**

TRADEMARK

SERVICE MARK

PRINCIPAL REGISTER

SAINT-GOBAIN ISOVER (FRANCE SOCIÉTÉ ANONYME)
"LES MIROIRS"
18 AVENUE D'ALSACE
F-92400 COURBEVOIE, FRANCE

FOR: VEHICLES FOR LOCOMOTION BY WATER AND APPARATUS FOR LOCOMOTION BY SEA, NAMELY, BOATS, SHIPS, LAUNCHES, IN CLASS 12 (U.S. CLS. 19, 21, 23, 31, 35 AND 44).

FOR: PACKING AND INSULATING MATERIALS AND STOPPING MATERIALS, NAMELY, RUBBER STOPPERS; INSULATING MATERIALS MADE OF MINERAL WOOL OR MINERAL FIBRES IN THE FORM OF LOOSE, WOOL, TAPES, MATS, FELTS, BATTS, PLATES, SLABS, ROLLS, WRAPS, PIPES, CYLINDRICAL AND MOLDED SECTIONS DESIGNED FOR THERMAL AND ACOUSTICAL INSULATION AND FOR ROOFING; FACED INSULATING MATERIAL, IN CLASS 17 (U.S. CLS. 1, 5, 12, 13, 35 AND 50).

FOR: CONSTRUCTION MATERIALS NOT OF METAL, NAMELY, FIBERGLASS PANELS; BITUMINOUS ROOF COATINGS, FRAMEWORK NOT OF METAL FOR USE IN CONSTRUCTION, NAMELY, NON-METAL WINDOW FRAMES; FASTENING DEVICES, NAMELY, SASH FASTENERS FOR WINDOWS NOT OF METAL FOR USE IN CONSTRUCTION; NON-METAL FIRE-RESISTANT BOARDS, PLATES, ROLLERS FOR CONSTRUCTION, WITH OR WITHOUT SURFACE FINISHING, FOR HEAT AND SOUND INSULATION AND PROTECTION AGAINST HUMIDITY AND FIRE USED IN THE BUILDING OF WALLS, PARTITIONS, CEILINGS, FALSE CEILINGS, FLOORING, ROOFING, FALSE ROOFS, FACINGS AND WATERPROOF INSULATION STRUCTURES, IN CLASS 19 (U.S. CLS. 1, 12, 33 AND 50).

FOR: UPKEEP, NAMELY, MAINTENANCE AND REFURBISHMENT OF BUILDINGS, INSULATION SERVICES, NAMELY, INSTALLATION OF BUILDING INSULATION, IN CLASS 37 (U.S. CLS. 100, 103 AND 106).

OWNER OF U.S. REG. NO. 3,683,385.

PRIORITY DATE OF 7-20-2010 IS CLAIMED.

OWNER OF INTERNATIONAL REGISTRATION 1064986 DATED 12-3-2010, EXPIRES 12-3-2020.



David J. Kyffers

Director of the United States Patent and Trademark Office

Reg. No. 4,107,297 NO CLAIM IS MADE TO THE EXCLUSIVE RIGHT TO USE "MARINE", APART FROM THE MARK AS SHOWN.

THE MARK CONSISTS OF THE WORDING "U MARINE" IN STYLIZED FONT.

SER. NO. 79-092,521, FILED 12-3-2010.

TASNEEM HUSSAIN, EXAMINING ATTORNEY

United States of America

United States Patent and Trademark Office

SLIDTUNE

Reg. No. 4,107,298

Registered Mar. 6, 2012

Int. Cls.: 9 and 15

TRADEMARK

PRINCIPAL REGISTER

RYTHMES & SONS (FRANCE SOCIÉTÉ À RESPONSABILITÉ LIMITÉE)
18, RUE DU COR DE CHASSE
F-67400 ILLKIRCH-GRAFFENSTADEN
FRANCE

FOR: APPARATUS FOR REGULATING, TRANSMISSION AND MANIPULATION OF SOUND,
IN CLASS 9 (U.S. CLS. 21, 23, 26, 36 AND 38).

FOR: TUNERS AND ELECTROMECHANICAL TUNERS FOR MUSICAL INSTRUMENTS;
PERCUSSION INSTRUMENTS, IN CLASS 15 (U.S. CLS. 2, 21 AND 36).

THE MARK CONSISTS OF STANDARD CHARACTERS WITHOUT CLAIM TO ANY PAR-
TICULAR FONT, STYLE, SIZE, OR COLOR.

PRIORITY DATE OF 7-20-2010 IS CLAIMED.

OWNER OF INTERNATIONAL REGISTRATION 1065532 DATED 1-13-2011, EXPIRES 1-13-
2021.

SER. NO. 79-092,701, FILED 1-13-2011.

KAREN SEVERSON, EXAMINING ATTORNEY



David J. Kyfos

Director of the United States Patent and Trademark Office

United States of America

United States Patent and Trademark Office

Anyservice

Reg. No. 4,107,299

Registered Mar. 6, 2012

Int. Cl.: 9

TRADEMARK

PRINCIPAL REGISTER

ZTE CORPORATION (CHINA CORPORATION)
ZTE PLAZA, KEJI ROAD SOUTH
HI-TECH INDUSTRIAL PARK; NANSHAN DISTRICT
SHENZHEN, CHINA

FOR: DATA PROCESSING APPARATUS; BLANK SMART CARDS, NAMELY, INTEGRATED CIRCUIT CARDS; DATA PROCESSING EQUIPMENT, NAMELY, COUPLERS; COMPUTER SOFTWARE FOR USE IN MOBILE PHONES, NAMELY, USE IN DATABASE MANAGEMENT, USE AS A SPREADSHEET, WORD PROCESSING; DOWNLOADABLE COMPUTER PROGRAMS FOR USE IN MOBILE PHONES, NAMELY, USE IN DATABASE MANAGEMENT, USE AS A SPREADSHEET, WORD PROCESSING; STORED PROGRAM CONTROLLED TELEPHONE SWITCHING SYSTEM, NAMELY, DIGITAL TELEPHONE SWITCHING APPARATUS; COMPUTER CHIPS, NAMELY, INTEGRATED CIRCUITS; LOW-VOLTAGE POWER SUPPLY; CENTRAL PROCESSING UNITS, IN CLASS 9 (U.S. CLS. 21, 23, 26, 36 AND 38).

THE MARK CONSISTS OF THE STYLIZED WORDING "ANYSERVICE".

OWNER OF INTERNATIONAL REGISTRATION 1066781 DATED 1-21-2011, EXPIRES 1-21-2021.

SER. NO. 79-093,192, FILED 1-21-2011.

DAVID HOFFMAN, EXAMINING ATTORNEY



David J. Kyfos

Director of the United States Patent and Trademark Office

United States of America

United States Patent and Trademark Office

NOKIAN KUUTUA

Reg. No. 4,107,300

Registered Mar. 6, 2012

Int. Cl.: 12

TRADEMARK

PRINCIPAL REGISTER

NOKIAN TYRES PLC (FINLAND JOINT STOCK COMPANY)
PIRKKALAISTIE
FI-37100 NOKIA
FINLAND

FOR: VEHICLE WHEEL TIRES, IN CLASS 12 (U.S. CLS. 19, 21, 23, 31, 35 AND 44).

THE MARK CONSISTS OF STANDARD CHARACTERS WITHOUT CLAIM TO ANY PARTICULAR FONT, STYLE, SIZE, OR COLOR.

PRIORITY DATE OF 12-8-2010 IS CLAIMED.

OWNER OF INTERNATIONAL REGISTRATION 1066946 DATED 12-28-2010, EXPIRES 12-28-2020.

OWNER OF U.S. REG. NOS. 2,962,873, 3,086,419 AND OTHERS.

THE WORDING "KUUTUA" HAS NO MEANING IN A FOREIGN LANGUAGE.

SER. NO. 79-093,269, FILED 12-28-2010.

LANA PHAM, EXAMINING ATTORNEY



David J. Kyros

Director of the United States Patent and Trademark Office

United States of America
United States Patent and Trademark Office

Daniusoft

Reg. No. 4,107,301

Registered Mar. 6, 2012

Int. Cl.: 9

WONDERSHARE SOFTWARE CO., LTD. (CHINA CORPORATION)

A901, 9/F, BLOCK A

TCL BUILDING,; GAOXIN AVE. 1.S.; NANSHANDISTRICT; SHENZHEN, GUANGDONG PROVINCE

CHINA

TRADEMARK

PRINCIPAL REGISTER

FOR: DATA PROCESSING APPARATUS, NAMELY, DATA PROCESSORS; COMPUTER MEMORIES; COMPUTER OPERATING PROGRAMS, RECORDED; COMPUTER SOFTWARE TO ENHANCE THE AUDIO-VISUAL CAPABILITIES OF MULTIMEDIA APPLICATIONS, NAMELY, FOR THE INTEGRATION OF TEXT, AUDIO, GRAPHIC, STILL IMAGES AND MOVING PICTURES; ELECTRONIC PUBLICATIONS, NAMELY, A MAGAZINE FEATURING INFORMATION ABOUT ELECTRONICS RECORDED ON COMPUTER MEDIA; DOWNLOADABLE COMPUTER SOFTWARE FOR USE AS A SPREADSHEET, WORD PROCESSING; PRE-RECORDED OPTICAL DISCS FEATURING MUSIC, VIDEO GAMES, STILL IMAGES; COMPUTER PERIPHERAL DEVICES; RECORDED COMPUTER SOFTWARE FOR DATABASE MANAGEMENT; COMPUTERS, IN CLASS 9 (U.S. CLS. 21, 23, 26, 36 AND 38).

THE MARK CONSISTS OF THE STYLIZED WORD "DANIUSOFT".

OWNER OF INTERNATIONAL REGISTRATION 1067187 DATED 1-4-2011, EXPIRES 1-4-2021.

SER. NO. 79-093,416, FILED 1-4-2011.

LANA PHAM, EXAMINING ATTORNEY



David J. Kybas

Director of the United States Patent and Trademark Office

United States of America

United States Patent and Trademark Office



Reg. No. 4,107,302

Registered Mar. 6, 2012

Int. Cl.: 11

TRADEMARK

PRINCIPAL REGISTER

ZHEJIANG HUANRI SANITATION CO., LTD. (CHINA CORPORATION)
XUANMEN INDUSTRIAL ZONE
LUPU TOWN., YUHUAN; ZHEJIANG PROVINCE
CHINA

FOR: THERMOSTATIC VALVES AS PARTS OF HEATING INSTALLATIONS; BATH FITTINGS, NAMELY, FLEXIBLE PIPES BEING AS PARTS OF BATH PLUMBING INSTALLATION; SANITARY APPARATUS AND INSTALLATIONS, NAMELY, STEAM ROOMS; SHOWER CUBICLES; SHOWER ENCLOSURES, IN CLASS 11 (U.S. CLS. 13, 21, 23, 31 AND 34).

NO CLAIM IS MADE TO THE EXCLUSIVE RIGHT TO USE "SANITATION", APART FROM THE MARK AS SHOWN.

OWNER OF INTERNATIONAL REGISTRATION 1067617 DATED 1-4-2011, EXPIRES 1-4-2021.

THE MARK CONSISTS OF THE STYLIZED WORDING, "HUANRI SANITATION" AND A WAVY LINE FROM THE LETTER "U" EXTENDING BACKWARDS TO THE LETTER "H" AND A WAVY LINE EXTENDING FROM THE LETTER "A" TO THE LETTER "I" IN THE WORD, "HUANRI".

THE WORDING "HUANRI" HAS NO MEANING IN A FOREIGN LANGUAGE.

SER. NO. 79-093,750, FILED 1-4-2011.

LANA PHAM, EXAMINING ATTORNEY



David J. Kybas

Director of the United States Patent and Trademark Office

United States of America

United States Patent and Trademark Office

FOOTY FRIDGE

Reg. No. 4,107,303

Registered Mar. 6, 2012

Int. Cl.: 11

TRADEMARK

PRINCIPAL REGISTER

CREATIVE INSTORE SOLUTIONS PTY LTD (AUSTRALIA CORPORATION)
1 TEPKO ROAD
TERREY HILLS NSW 2084
AUSTRALIA

FOR: APPARATUS FOR COOLING AND FREEZING, NAMELY, REFRIGERATORS; FREEZERS; REFRIGERATORS AND FREEZERS, SOLD AS A UNIT, REFRIGERATORS ENCASED IN A FIBREGLASS SURROUND THAT HOLDS SPORTING MEMORABILIA, REFRIGERATING CABINETS; PORTABLE ELECTRIC ICE BOXES; THERMOELECTRIC COOLER FOR FOOD AND BEVERAGES, IN CLASS 11 (U.S. CLS. 13, 21, 23, 31 AND 34).

THE MARK CONSISTS OF STANDARD CHARACTERS WITHOUT CLAIM TO ANY PARTICULAR FONT, STYLE, SIZE, OR COLOR.

PRIORITY DATE OF 8-25-2010 IS CLAIMED.

OWNER OF INTERNATIONAL REGISTRATION 1067811 DATED 1-31-2011, EXPIRES 1-31-2021.

NO CLAIM IS MADE TO THE EXCLUSIVE RIGHT TO USE "FRIDGE" , APART FROM THE MARK AS SHOWN.

SER. NO. 79-093,832, FILED 1-31-2011.

MARC LEIPZIG, EXAMINING ATTORNEY



David J. Kyffers

Director of the United States Patent and Trademark Office

United States of America
United States Patent and Trademark Office

大阪王将

Reg. No. 4,107,304

Registered Mar. 6, 2012

Int. Cl.: 43

SERVICE MARK

PRINCIPAL REGISTER

EAT&CO., LTD. (JAPAN CORPORATION)
1-5, MINAMIKYUHOJI-MACHI 2-CHOME
CHUO-KU, OSAKA-SHI
OSAKA, JAPAN 5410058

FOR: RESTAURANT SERVICES FEATURING ASIAN CUISINE INCLUDING CHINESE CUISINE, IN CLASS 43 (U.S. CLS. 100 AND 101).

OWNER OF INTERNATIONAL REGISTRATION 1068102 DATED 1-4-2011, EXPIRES 1-4-2021.

THE NON-LATIN CHARACTERS IN THE MARK TRANSLITERATE TO OSAKAHSHO AND THIS HAS NO MEANING IN A FOREIGN LANGUAGE.

SER. NO. 79-093,925, FILED 1-4-2011.

BARBARA RUTLAND, EXAMINING ATTORNEY



David J. Kyros

Director of the United States Patent and Trademark Office

United States of America

United States Patent and Trademark Office

SiteHunt

Reg. No. 4,107,305

Registered Mar. 6, 2012

Int. Cls.: 36 and 42

SERVICE MARK

PRINCIPAL REGISTER

VESTAS WIND SYSTEMS A/S (DENMARK PUBLIC LIMITED COMPANY)
ALSVEJ 21
DK-8940 RANDERS SV
DENMARK

FOR: FINANCIAL SERVICES, NAMELY, PROVIDING INFORMATION, EVALUATION AND ASSESSMENT IN THE FIELD OF WIND ENERGY PROJECTS AND WIND POWER PROJECTS FOR WIND FARMS IN THE NATURE OF LIFETIME FINANCIAL ANALYSES AND CALCULATIONS RELATED TO THE USE OF SPECIFIC WIND TURBINES AND WIND FARM PROJECTS AT DIFFERENT LOCATIONS AND PROVIDING REPORTS IN RELATION THERETO, IN CLASS 36 (U.S. CLS. 100, 101 AND 102).

FOR: SCIENTIFIC AND TECHNOLOGICAL SERVICES, NAMELY, RESEARCH, ANALYSES, ASSESSMENTS AND TESTING OF WIND ENERGY AND WIND TURBINE PROJECTS, NAMELY, TECHNICAL ANALYSES, CALCULATIONS AND ASSESSMENTS OF SPECIFIC WIND FARM PROJECTS AND PREPARATION OF ANALYSES REGARDING OPTIMAL ENERGY PRODUCTION, GRID INTEGRATION AND LONG-TERM OPERATION SOLUTIONS; CARTOGRAPHY SERVICES, NAMELY, PREPARATION OF TOPOGRAPHICAL MAPS AND DESCRIPTIONS REGARDING OPTIMIZED TURBINE SELECTION AND PLACEMENT OF WIND TURBINES WITHIN A CERTAIN GEOGRAPHICAL AREA; PROVIDING METEOROLOGICAL INFORMATION, NAMELY, CLIMATE, WEATHER AND WIND ANALYSES AND CALCULATIONS; PREPARATION OF WIND RESOURCE MAPS THAT TAKE WIND CONDITIONS SUCH AS TEMPERATURE, WIND SPEED, WIND DIRECTION, ALTITUDE AND TOPOGRAPHY INTO CONSIDERATION; PREPARATION OF GRID MAPS; PREPARING GEOPHYSICAL REPORTS AND MAPS SIMULATING WIND CONDITIONS THAT ARE LIKELY TO BE EXPERIENCED BY TURBINES IN A GIVEN AREA; PROVIDING TECHNICAL ASSISTANCE AND CONSULTANCY REGARDING CHOICE, NAMELY, TECHNOLOGICAL CHOICES AND DESIGN CHOICES OF WIND TURBINE AND MICROSITING OF WIND TURBINES FOR A SPECIFIC WIND ENERGY PROJECT, IN CLASS 42 (U.S. CLS. 100 AND 101).



David J. Kyjars

Director of the United States Patent and Trademark Office

THE MARK CONSISTS OF STANDARD CHARACTERS WITHOUT CLAIM TO ANY PARTICULAR FONT, STYLE, SIZE, OR COLOR.

PRIORITY DATE OF 2-18-2010 IS CLAIMED.

Reg. No. 4,107,305 OWNER OF INTERNATIONAL REGISTRATION 1068276 DATED 8-18-2010, EXPIRES 8-18-2020.

SER. NO. 79-094,021, FILED 8-18-2010.

KAREN BRACEY, EXAMINING ATTORNEY

United States of America

United States Patent and Trademark Office

MORATECH

Reg. No. 4,107,306

Registered Mar. 6, 2012

Int. Cls.: 7 and 9

TRADEMARK

PRINCIPAL REGISTER

MORA ALESSANDRO (ITALY INDIVIDUAL)
VIA FERRARI, 20
I-43029 TRAVERSETOLO (PR)
ITALY

FOR: MACHINES AND MACHINE TOOLS IN THE FIELD OF AUTOMOTIVE AND VEHICLE REPAIR, NAMELY, MACHINES FOR WASHING THE EXTERIOR SURFACE OF AN AUTOMOBILE VEHICLE AND VACUUMING THE INTERIOR OF SUCH VEHICLE, WHERE THE EQUIPMENT IS MANUALLY-OPERATED BY THE USER, CAR LIFTS, MOTORS EXCEPT FOR LAND VEHICLES; MACHINE COUPLING AND TRANSMISSION COMPONENTS EXCEPT FOR LAND VEHICLES, IN CLASS 7 (U.S. CLS. 13, 19, 21, 23, 31, 34 AND 35).

FOR: WEIGHING APPARATUS AND INSTRUMENTS; CAR AIR CONDITIONING SYSTEMS CONTROLLERS AND REPAIR DEVICES; DIAGNOSTIC APPARATUS AND INSTRUMENTS NOT FOR MEDICAL PURPOSES AND ELECTRIC OR ELECTRONIC INSTRUMENTS OR CONTROL SUPERVISION INSTRUMENTS PARTICULARLY FOR VEHICLE REPAIR AND VEHICLE SERVICING WORKSHOPS, SUCH AS ABS BRAKING SYSTEM ANALYZERS, BRAKE TESTING BENCHES, SUSPENSION AND VEHICLE BATTERY TESTING, OPACIMETERS, HEADLIGHT TESTERS, CAR ENGINE EXHAUST GAS ANALYZERS, LAMBDA SENSOR SYSTEMS ANALYZERS, ENGINE REVOLUTION COUNTERS FOR VEHICLE SERVICING SYSTEMS, VEHICLE SPEED CHECKING APPARATUS AND INSTRUMENTS, VEHICLE ELECTRONIC CONTROL UNIT DIAGNOSIS EQUIPMENT, DIALOG TOOLS FOR ELECTRONIC CONTROL UNITS, APPLICATIONS AND DIAGNOSTIC SOFTWARE PACKAGES, REGISTERED PROGRAMS, FOR VEHICLE REPAIR AND VEHICLE SERVICING WORKSHOPS, IN CLASS 9 (U.S. CLS. 21, 23, 26, 36 AND 38).

THE MARK CONSISTS OF STANDARD CHARACTERS WITHOUT CLAIM TO ANY PARTICULAR FONT, STYLE, SIZE, OR COLOR.

PRIORITY DATE OF 7-28-2010 IS CLAIMED.

OWNER OF INTERNATIONAL REGISTRATION 1068441 DATED 12-14-2010, EXPIRES 12-14-2020.

THE ENGLISH TRANSLATION OF THE WORD "MORA" IN THE MARK IS BLACKBERRY OR BRUNETTE OR DELAY.



David J. Kyjars

Director of the United States Patent and Trademark Office

Reg. No. 4,107,306 SER. NO. 79-094,079, FILED 12-14-2010.

WARREN L. OLANDRIA, EXAMINING ATTORNEY

United States of America

United States Patent and Trademark Office

CEPEX

Reg. No. 4,107,307

Registered Mar. 6, 2012

Int. Cls.: 20 and 35

TRADEMARK

SERVICE MARK

PRINCIPAL REGISTER

FLUIDRA COMMERCIAL, S.A.U. (SPAIN SOCIEDAD ANÓNIMA UNIPERSONAL)
AV. FRANCESC MACIÀ, 38, PLANTA 15ª
E-08208 SABADELL (BARCELONA)
SPAIN

FOR: BOTTLES OF POLYESTER FOR WATER, NAMELY, BIODEGRADABLE PLASTIC BASED CONTAINERS FOR COMMERCIAL PACKAGING; TANKS OF POLYETHYLENE FOR WATER, FOR HOUSEHOLD, INDUSTRIAL, AND AGRICULTURAL PURPOSES; PLASTIC VALVES FOR WATER PIPES, IN CLASS 20 (U.S. CLS. 2, 13, 22, 25, 32 AND 50).

FOR: BUSINESS MANAGEMENT FOR MANUFACTURING AND MARKETING OF PRODUCTS FOR SWIMMING POOLS AND WATERING PRODUCTS FOR CONDUCTING, PUMPING, FILTERING, TREATING AND PURIFYING WATER, IN CLASS 35 (U.S. CLS. 100, 101 AND 102).

THE MARK CONSISTS OF STANDARD CHARACTERS WITHOUT CLAIM TO ANY PARTICULAR FONT, STYLE, SIZE, OR COLOR.

OWNER OF INTERNATIONAL REGISTRATION 1069102 DATED 1-24-2011, EXPIRES 1-24-2021.

OWNER OF U.S. REG. NOS. 2,565,482 AND 2,701,981.

SER. NO. 79-094,345, FILED 1-24-2011.

RUDY R. SINGLETON, EXAMINING ATTORNEY



David J. Kypos

Director of the United States Patent and Trademark Office

United States of America

United States Patent and Trademark Office



Reg. No. 4,107,308

Registered Mar. 6, 2012

Int. Cls.: 30 and 33

TRADEMARK

PRINCIPAL REGISTER

PETRA WALDHERR-MERK (FED REP GERMANY INDIVIDUAL)
BERGWEG 12
83661 LENGGRIES, FED REP GERMANY

FOR: COFFEE; TEA; COCOA; CHOCOLATE DRINKS, NAMELY, BEVERAGES WITH A CHOCOLATE BASE, HOT CHOCOLATE, CHOCOLATE-BASED BEVERAGES WITH MILK, CHOCOLATE FOOD BEVERAGES NOT BEING DAIRY-BASED OR VEGETABLE-BASED, IN CLASS 30 (U.S. CL. 46).

FOR: LIQUEUR; SPIRITS; ALCOHOLIC BEVERAGES EXCEPT BEERS; ALCOHOLIC BEVERAGES, NAMELY, COFFEE, TEA, COCOA, CHOCOLATE DRINKS, EACH CONTAINING ALCOHOLIC BEVERAGES, IN PARTICULAR, HERBAL LIQUEUR AND ALCOHOLIC FRUIT DRINKS, IN CLASS 33 (U.S. CLS. 47 AND 49).

OWNER OF U.S. REG. NOS. 3,913,239 AND 3,922,174.

PRIORITY DATE OF 8-19-2010 IS CLAIMED.

OWNER OF INTERNATIONAL REGISTRATION 1069362 DATED 12-31-2010, EXPIRES 12-31-2020.

THE COLOR(S) RED, YELLOW, AND WHITE IS/ARE CLAIMED AS A FEATURE OF THE MARK.



David J. Kybas

Director of the United States Patent and Trademark Office

THE MARK CONSISTS OF A DESIGN OF TWO WHITE DEER FACING EACH OTHER AND TOUCHING NOSE-TO-NOSE AND ANTLERS-TO-ANTLERS, WHERE THE ANTLERS AND NOSES FORM A HEART INSIDE A CIRCLE WITH A RED BACKGROUND, A YELLOW SINGLE LINE INNER BORDER, A WHITE SINGLE LINE BORDER OUTSIDE OF THE INNER BORDER, A YELLOW WIDER SINGLE LINE BORDER FOLLOWING THE WHITE BORDER, ANOTHER WHITE SINGLE LINE BORDER OUTSIDE OF THE YELLOW WIDER BORDER AND A RED SINGLE LINE OUTER BORDER. INSIDE THE SOLID RED INNER CIRCLE AND CENTERED BELOW THE HEART, THERE IS A WHITE CUP ON A WHITE SAUCER WITH WHITE STEAM RISING FROM THE CENTER OF THE CUP BETWEEN THE NOSES OF THE DEER. THE WORDING "HIRSCHKUSS" APPEARS IN RED STYLIZED FONT CENTERED ABOVE THE CIRCLES. THERE ARE TWO RED LEAVES EXTENDING FROM THE SINGLE LINE OUTER BORDER, ONE ON THE LEFT SIDE OF THE LETTER "H" IN "HIRSCHKUSS" AND THE OTHER ON THE RIGHT SIDE OF THE FINAL LETTER "S" IN

Reg. No. 4,107,308 THE WORD "HIRSCHKUSS". THERE IS A RED RECTANGULAR SHAPE CONNECTED TO AND CENTERED BELOW THE CIRCLE WITH THE WORD "HEISSMACHER" IN WHITE STYLIZED FONT CENTERED IN THE MIDDLE OF THE RECTANGLE.

THE ENGLISH TRANSLATION OF "HIRSCHKUSS" AND "HEISSMACHER" IN THE MARK IS "DEER KISS" AND "MAKING HOT".

SER. NO. 79-094,433, FILED 12-31-2010.

TINA BROWN, EXAMINING ATTORNEY

United States of America

United States Patent and Trademark Office

navington

Reg. No. 4,107,309

Registered Mar. 6, 2012

Int. Cls.: 12, 18 and 20

TRADEMARK

PRINCIPAL REGISTER

"DELTIM" MACHURA, MACHURA SPÓLKA JAWNA (POLAND GENERAL PARTNERSHIP)
UL. LOURDYJSKA 5
PL-42-200 CZESTOCHOWA
POLAND

FOR: PRAMS AND PUSHCHAIRS, CAR SAFETY SEATS FOR CHILDREN, ACCESSORIES FOR PRAMS AND PUSHCHAIRS, NAMELY, SLEEPING BAGS THAT ARE AFFIXED TO PRAMS AND PUSHCHAIRS, RAIN COVERS FOR PRAMS AND PUSHCHAIRS, COVERS FOR PRAMS AND PUSHCHAIRS, IN CLASS 12 (U.S. CLS. 19, 21, 23, 31, 35 AND 44).

FOR: BABY CARRIERS WORN ON THE BODY, IN AND OUT CARRIERS, NAMELY, SLING CARRIERS FOR INFANTS, INFANT CARRIERS ENABLING A BABY TO LIE FLAT, NAMELY, INFANT CARRYING BAGS, BACKPACKS, PARASOLS, TEXTILE SHOPPING BAGS, WHEELED LUGGAGE, WAIST BAGS, TRAVEL BAGS, IN CLASS 18 (U.S. CLS. 1, 2, 3, 22 AND 41).

FOR: HIGH CHAIRS, COTS, TRAVEL COTS, DECKCHAIRS, IN CLASS 20 (U.S. CLS. 2, 13, 22, 25, 32 AND 50).

OWNER OF INTERNATIONAL REGISTRATION 1069470 DATED 1-3-2011, EXPIRES 1-3-2021.

THE COLOR(S) DARK BLUE (PANTONE 2965C) IS/ARE CLAIMED AS A FEATURE OF THE MARK.

INSCRIPTION "NAVINGTON" WRITTEN WITH SMALL LETTERS - COLOR DARK BLEU (PANTONE 2965C).

SER. NO. 79-094,470, FILED 1-3-2011.

KAELIE KUNG, EXAMINING ATTORNEY



David J. Kybas

Director of the United States Patent and Trademark Office

United States of America

United States Patent and Trademark Office



Reg. No. 4,107,310

Registered Mar. 6, 2012

Int. Cls.: 5 and 30

TRADEMARK

PRINCIPAL REGISTER

WANG XIU (CHINA INDIVIDUAL)
ROOM 1703, BUILDING 10
HUI MIN YUAN, TONG HUI JIA YUAN, SI HUI EAST.; CHAO YANG DISTRICT; 100025
BEIJING, CHINA

FOR: MEDICINAL HERBS; LIQUORICE FOR PHARMACEUTICAL PURPOSES, NAMELY, FOR USE AS A NUTRITIONAL SUPPLEMENT; STICK LIQUORICE FOR PHARMACEUTICAL PURPOSES, NAMELY, FOR USE AS A NUTRITIONAL SUPPLEMENT; HERBS TEAS FOR MEDICINAL PURPOSES; MEDICINAL ROOTS; MEDICATED ALCOHOL FOR MEDICAL USE; RAW MATERIAL MEDICINE, NAMELY, GELATIN CAPSULES SOLD EMPTY FOR PHARMACEUTICALS; MEDICINES FOR HUMAN PURPOSES FOR THE TREATMENT OF GASTROINTESTINAL DISEASE; MINERAL BATH SALTS FOR MEDICAL PURPOSES, IN CLASS 5 (U.S. CLS. 6, 18, 44, 46, 51 AND 52).

FOR: TEA SUBSTITUTE; ICED TEA; TEA-BASED BEVERAGES; NON-MEDICAL NUTRIENT SOLUTION, NAMELY, LIQUID MIXTURES OF COFFEE AND CHICORY CONTAINING NUTRIENTS; NON-MEDICAL NUTRIENT POWDER, NAMELY, CHOCOLATES CONTAINING NUTRIENTS IN POWDER FORM; NON-MEDICAL NUTRIENT CAPSULE, NAMELY, COFFEE CAPSULES CONTAINING COFFEE AND NUTRIENTS FOR BREWING; SEASONINGS; RELISH; GINGER BASED CONDIMENT FOR INSTANT BOILED MUTTON; MEAT GRAVIES, IN CLASS 30 (U.S. CL. 46).

THE MARK CONSISTS OF TWO CRISSCROSSING BRANCHES, ONE IN RED AND ONE IN GREEN APPEARING ABOVE FOUR BLACK CHINESE CHARACTERS AND THE STYLIZED BLACK WORDING "BA DAN JI LIN".

OWNER OF INTERNATIONAL REGISTRATION 1069635 DATED 11-3-2010, EXPIRES 11-3-2020.

THE COLOR(S) GREEN, RED AND BLACK IS/ARE CLAIMED AS A FEATURE OF THE MARK.

THE TRANSLITERATION OF THE NON-LATIN CHARACTERS IN THE MARK IS "BA DAN JI LIN".

THE ENGLISH TRANSLATION "BA" IS "HOPE EARNESTLY". THE ENGLISH TRANSLATION OF "DAN" IS "RED". THE ENGLISH TRANSLATION OF "JI" IS "LUCKY". THE



David J. Kybas

Director of the United States Patent and Trademark Office

Reg. No. 4,107,310 ENGLISH TRANSLATION OF "LIN" IS "FOREST". "BA DAN JI LIN" HAS NO MEANING
IN A FOREIGN LANGUAGE.

SER. NO. 79-094,555, FILED 11-3-2010.

ALYSSA STEEL, EXAMINING ATTORNEY

United States of America

United States Patent and Trademark Office



Reg. No. 4,107,311

Registered Mar. 6, 2012

Int. Cls.: 1, 2 and 17

TRADEMARK

PRINCIPAL REGISTER

WACKER CHEMIE AG (FED REP GERMANY AKTIENGESELLSCHAFT)
HANNS-SEIDEL-PLATZ 4
MÜNCHEN, FED REP GERMANY 81737

FOR: CHEMICAL PRODUCTS USED IN INDUSTRY AND SCIENCE, NAMELY, UNPROCESSED PLASTICS; INDUSTRIAL CHEMICAL COMPOUNDS THAT CROSSLINK TO FORM PLASTICS; UNPROCESSED PLASTICS IN THE FORM OF PLASTIC CONTAINING POWDERS, SOLUTIONS, DISPERSIONS AND GRANULES; CHEMICAL RAW MATERIALS, AUXILIARIES, ADDITIVES AND CATALYSTS USED IN PLASTICS PRODUCTION; SILANES; SILICIC-ACID ESTERS; SILICONES; CARBOSILANES; SILICONE ELASTOMERS; INDUSTRIAL CHEMICAL COMPOUNDS THAT CROSSLINK TO FORM SILICONE ELASTOMERS; EMBEDDING COMPOUNDS, NOT FOR DENTAL OR MEDICAL PURPOSES; MOULDING COMPOUNDS, NOT FOR DENTAL OR MEDICAL PURPOSES; AGENTS FOR IMPREGNATING, BINDING OR COATING OF TEXTILES, FURS AND LEATHER, NON-WOVENS AND FABRICS; ANTIFOAM AGENTS; SOFTENERS FOR TEXTILES; CHEMICAL RELEASE AGENTS; ANTICAKING AGENTS; THICKENING AND THIXOTROPIC AGENTS; CHEMICAL IMPREGNATING AGENTS FOR BUILDING MATERIALS, WOOD, ARTIFICIAL AND NATURAL STONE, MORTAR, CEMENT, CONCRETE, GAS CONCRETE, GYPSUM, MASONRY AND FACADES; CHEMICAL STONE STRENGTHENERS; POLYMER COATING AGENTS FOR PAPER, MINERAL MATERIALS, FILLERS AND PIGMENTS; BINDERS FOR GLUES, ADHESIVES AND FOR CHEMICALS USED IN THE BUILDING INDUSTRY; CHEMICAL ADDITIVES FOR COSMETIC PREPARATIONS; PLASTICISERS FOR PLASTICS; ADHESION PROMOTERS; ANTISTATIC AGENTS; ACTIVE SUBSTANCES, RAW MATERIALS AND AUXILIARIES FOR THE MANUFACTURE OF PHARMACEUTICALS, IN CLASS 1 (U.S. CLS. 1, 5, 6, 10, 26 AND 46).



FOR: PAINTS, VARNISHES, LACQUERS, WOOD PRESERVATIVES, ANTI-RUST AGENTS; RAW MATERIALS FOR LACQUERS, LACQUER ADDITIVES AND AUXILIARIES; PIGMENTS; FLOW CONTROL AGENTS; BACTERICIDAL, FIREPROOF AND HAMMER FINISH ADDITIVES FOR LACQUERS, INCLUDED IN THIS CLASS; LACQUERS FOR COATING ELECTRICAL AND ELECTRONIC PARTS AND COMPONENTS; BINDERS FOR LACQUERS AND PAINTS, IN CLASS 2 (U.S. CLS. 6, 11 AND 16).

David J. Kybas

Director of the United States Patent and Trademark Office

FOR: SEMI-PROCESSED PLASTICS AND PLASTIC GOODS, NAMELY, SEALING, PACKING AND INSULATING MATERIAL; SEMI-PROCESSED PLASTICS IN THE FORM OF BLOCKS, EXTRUDATES, SHEETS, FILMS, RODS, FLEXIBLE PIPES, FIBRES, NOT FOR TEXTILE USE, AND MOULDED BODIES; SEMI-PROCESSED THERMOPLASTIC SYNTHETIC RESINS;

Reg. No. 4,107,311 SEALANTS FOR JOINTS; INSULATING PAINTS AND LACQUERS; INSULATING OILS; PLASTIC GASKETS; YARNS, FIBRES AND THREADS, NOT FOR TEXTILE USE, IN CLASS 17 (U.S. CLS. 1, 5, 12, 13, 35 AND 50).

THE MARK CONSISTS OF A DESIGN CONSISTING OF THE GREEK LETTER ALPHA SUPERIMPOSED UPON A DIAMOND BACKGROUND WHICH IN TURN IS BORDERED BY ANOTHER DIAMOND BACKGROUND.

PRIORITY DATE OF 4-14-2010 IS CLAIMED.

OWNER OF INTERNATIONAL REGISTRATION 1069694 DATED 10-13-2010, EXPIRES 10-13-2020.

THE TRANSLITERATION OF THE NON-LATIN CHARACTERS IN THE MARK IS: ALPHA.

SER. NO. 79-094,576, FILED 10-13-2010.

RONALD DELGIZZI, EXAMINING ATTORNEY

United States of America

United States Patent and Trademark Office

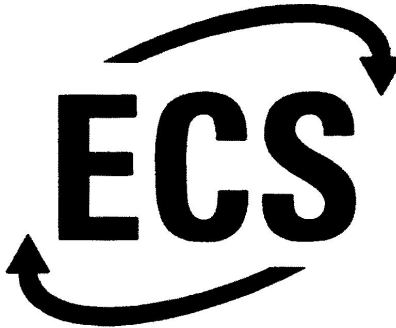

EcoCost Cleaning Solutions

Reg. No. 4,107,312

Registered Mar. 6, 2012

Int. Cl.: 7

TRADEMARK

PRINCIPAL REGISTER

IP CLEANING S.P.A. (ITALY JOINT STOCK COMPANY)
VIALE TREVISO, 63
I-30026 SUMMAGA DI PORTOGRUARO (VE)
ITALY

FOR: FLOOR CLEANING MACHINES; CLEANING APPLIANCES UTILIZING STEAM, NAMELY, STEAM CLEANING MACHINES AND MULTI-PURPOSE STEAM CLEANERS; HOT AND COLD WATER CLEANING MACHINES FOR CLEANING SURFACES USING HIGH PRESSURE WATER; SAND-BLASTING MACHINES; HYDRO-SAND-BLASTING MACHINES; MOTORIZED ELECTRIC FLOOR SWEEPERS; AUTOMATIC ELECTRIC MOTORIZED FLOOR SCRUBBERS FOR CLEANING ALL TYPES OF HARD AND SOFT SURFACES; ELECTRIC AND MANUAL TRACTION FLOOR SCRUBBING AND DRYING MACHINES FOR CLEANING ALL TYPES OF HARD AND SOFT SURFACES; CARPET AND ARMCHAIR CLEANING MACHINES; DRY VACUUM CLEANERS; WET VACUUM CLEANERS; SINGLE DISC FLOOR CLEANING MACHINES; FLOOR POLISHERS; STRUCTURAL PARTS AND REPLACEMENT PARTS FOR ALL AFOREMENTIONED MACHINES, NAMELY, VACUUM CLEANER MOTORS, BOILERS BEING PARTS OF STEAM ENGINES NOT FOR LAND VEHICLES, PRESSURE ADAPTERS, EJECTORS TO ASPIRATE DETERGENT SOLUTION, SOLUTION AND WATER TANKS, DUMP TRAYS FOR CLEARING DEBRIS, REMOVABLE AND TRANSPORTABLE SOLUTION AND WATER RECOVERY TANKS, ANTI-FOAM HEAD ATTACHMENTS FOR CLEANING MACHINES, DETERGENT MIXING MACHINES AND POWER-OPERATED DETERGENT DISPENSERS FOR MACHINES, VACUUM CLEANER HOSES, DISCHARGING HOSES, HIGH AND LOW PRESSURE WASHING MACHINE HOSES, FLEXIBLE HOSE COUPLINGS FOR MACHINES, LANCES FOR PRESSURE WASHING MACHINES, POWER-OPERATED SPRAY GUNS FOR PRESSURE WASHING MACHINES, CONTAINERS FOR HOLDING CLEARED DEBRIS, EMULSION OIL SQUEEGEE BLADES, WHEELS AND NON-MARKING WHEELS, BRUSHES, CIRCULAR AND CYLINDRICAL BRUSHES, ROTARY BRUSHES, ROLLER BRUSHES, SQUEEGEE BLADES, ROTARY MACHINE HEADS FOR MACHINES, SELF-ADJUSTING AND LEVELING WASHING AND SWEEPING HEADS, POLISHING DISKS FOR CLEANING AND DEWAXING, PAD HOLDERS, POWER-OPERATED MECHANICAL HOSE REELS FOR FLEXIBLE HOSES, FILTERS, INLET AND OUTLET FILTERS, SELF-CLEANING FILTERS, FILTER BAGS MADE OF POLYESTER, FABRIC FILTERS, CARTRIDGE FILTERS AND PAPER FILTERS; ALL OF THE FOREGOING, EXCLUDING MECHANICAL SHAFT SEALS FOR INDUSTRIAL MACHINERY, IN CLASS 7 (U.S. CLS. 13, 19, 21, 23, 31, 34 AND 35).



David J. Kyjars

Director of the United States Patent and Trademark Office

Reg. No. 4,107,312 NO CLAIM IS MADE TO THE EXCLUSIVE RIGHT TO USE "CLEANING SOLUTIONS",
APART FROM THE MARK AS SHOWN.

PRIORITY DATE OF 12-23-2010 IS CLAIMED.

OWNER OF INTERNATIONAL REGISTRATION 1069698 DATED 12-31-2010, EXPIRES 12-31-2020.

THE MARK CONSISTS OF THE LETTERS "ECS" IN STYLIZED FONT SURROUNDED BY TWO ARROWS ALL ABOVE THE STYLIZED WORDS "ECOCOST CLEANING SOLUTIONS".

SER. NO. 79-094,578, FILED 12-31-2010.

DAVID YONTEF, EXAMINING ATTORNEY

United States of America

United States Patent and Trademark Office

GISPHUB

Reg. No. 4,107,313

Registered Mar. 6, 2012

Int. Cls.: 9, 35 and 42

TRADEMARK

SERVICE MARK

PRINCIPAL REGISTER

GIS PARTNER AS (NORWAY AKSJESELSKAP)
P.O. BOX 8034
N-4068 STAVANGER
NORWAY

FOR: DATA PROCESSING EQUIPMENT, NAMELY, DATA PROCESSORS, COMPUTER PROGRAMS FOR USE IN DATABASE MANAGEMENT; COMPUTERS; COMPUTER OPERATING SOFTWARE FOR NETWORK ROUTERS, COMPUTER NETWORK HUBS AND COMPUTER SERVERS, IN CLASS 9 (U.S. CLS. 21, 23, 26, 36 AND 38).

FOR: COMPILATION AND SYSTEMIZATION OF INFORMATION INTO COMPUTER DATABASES, IN CLASS 35 (U.S. CLS. 100, 101 AND 102).

FOR: DESIGN AND DEVELOPMENT OF COMPUTER HARDWARE AND SOFTWARE; INSTALLATION, UPDATING AND MAINTENANCE OF COMPUTER SOFTWARE; RENTAL OF COMPUTERS, COMPUTER SOFTWARE AND WEB SERVERS; CREATING AND MAINTAINING WEB SITES FOR OTHERS; HOSTING COMPUTER SITES, NAMELY, HOSTING WEB SITES FOR OTHERS, IN CLASS 42 (U.S. CLS. 100 AND 101).

THE MARK CONSISTS OF STANDARD CHARACTERS WITHOUT CLAIM TO ANY PARTICULAR FONT, STYLE, SIZE, OR COLOR.

PRIORITY DATE OF 6-15-2010 IS CLAIMED.

OWNER OF INTERNATIONAL REGISTRATION 1069960 DATED 12-14-2010, EXPIRES 12-14-2020.

SER. NO. 79-094,672, FILED 12-14-2010.

JERI J. FICKES, EXAMINING ATTORNEY



David J. Kyjars

Director of the United States Patent and Trademark Office

United States of America

United States Patent and Trademark Office

FLEXPOL

Reg. No. 4,107,314

Registered Mar. 6, 2012

Int. Cls.: 7, 9 and 42

TRADEMARK

SERVICE MARK

PRINCIPAL REGISTER

ASML NETHERLANDS B.V. (NETHERLANDS BESLOTEN VENNOOTSCHAP)
DE RUN 6501
NL-5504 DR VELDHOENEN
NETHERLANDS

FOR: MACHINES FOR MICRO-LITHOGRAPHY, NAMELY, MACHINES FOR MANUFACTURING SEMICONDUCTORS; MACHINES NOT INCLUDED IN OTHER CLASSES, FOR USE IN THE FIELD OF ELECTRONICS, INTEGRATED CIRCUITS, SEMI-CONDUCTORS, MAGNETIC DOMAIN MEMORY AND INTEGRATED OPTICAL SYSTEMS, NAMELY, MACHINES FOR MANUFACTURING INTEGRATED CIRCUITS, SEMI-CONDUCTORS, MAGNETIC DOMAIN MEMORIES AND OPTICAL DEVICES; PARTS OF ALL OF THE AFOREMENTIONED GOODS IN THE FORM OF MIRROR AND LENS ASSEMBLIES FOR POLARIZATION PURPOSES, NAMELY, ETCHING LASERS FOR SEMICONDUCTOR MANUFACTURING MACHINES, IN CLASS 7 (U.S. CLS. 13, 19, 21, 23, 31, 34 AND 35).

FOR: MICRO-LITHOGRAPHY APPLIANCES, NAMELY, ELECTRONIC PRODUCTS FOR MEASURING SILICON WAFERS; ELECTRONIC APPARATUS AND INSTRUMENTS FOR USE IN THE FIELD OF MICRO-LITHOGRAPHY, SEMI-CONDUCTORS, INTEGRATED CIRCUITS, MAGNETIC DOMAIN MEMORY AND INTEGRATED OPTICAL SYSTEMS NOT INCLUDED IN OTHER CLASSES NAMELY, OPTICAL APPARATUS FOR INSPECTION AND TESTING FOR SEMICONDUCTOR WAFERS AND PHOTOMASKS; PARTS OF ALL THE AFOREMENTIONED GOODS, NAMELY, MIRRORS AND LENSES FOR POLARIZATION PURPOSES; SOFTWARE FOR USE IN THE FIELD OF ELECTRONICS, MICRO-LITHOGRAPHY, SEMI-CONDUCTORS, INTEGRATED CIRCUITS, MAGNETIC DOMAIN MEMORY AND INTEGRATED OPTICAL SYSTEMS, NAMELY, COMPUTER SOFTWARE FOR MEASUREMENT AND CONTROL OF LIGHT SOURCES AND LIGHT POLARIZATION PROCESSES; COMPUTER SOFTWARE FOR USE IN THE DESIGN, TESTING AND MANUFACTURING OF PHOTOLITHOGRAPHIC MASKS; SEMI-CONDUCTORS; INTEGRATED CIRCUITS; PHOTO-LITHOGRAPHIC MASKS; MAGNETIC HEADS, NAMELY, ELECTRIC AND MAGNETIC CONTACTS FOR INTEGRATED CIRCUIT TESTERS; SEMICONDUCTOR CHIPS AND GENE CHIPS; LCDS AND DISPLAY SCREENS, NAMELY, LCD LARGE SCREEN DISPLAYS; MAGNETIC DOMAIN MEMORIES FOR USE WITH COMPUTERS; INTEGRATED OPTICAL SYSTEMS CONSISTING OF BLANK RECORDABLE OPTICAL DISCS, IN CLASS 9 (U.S. CLS. 21, 23, 26, 36 AND 38).



David J. Kyros

Director of the United States Patent and Trademark Office

FOR: TECHNICAL CONSULTANCY INVOLVING THE SERVICES OF ENGINEERS IN THE FIELD OF ENGINEERING OF MACHINES, APPARATUS AND INSTRUMENTS FOR USE

Reg. No. 4,107,314 IN ELECTRONICS, MICRO-LITHOGRAPHY, SEMI-CONDUCTORS, INTEGRATED CIRCUITS, MAGNETIC DOMAIN MEMORIES AND INTEGRATED OPTICAL SYSTEMS INDUSTRIES; DESIGN, MAINTENANCE AND DEVELOPMENT OF COMPUTER SOFTWARE FOR USE IN THE FIELD OF ELECTRONICS, MICRO-LITHOGRAPHY, SEMI-CONDUCTORS, INTEGRATED CIRCUITS, MAGNETIC DOMAIN MEMORIES AND INTEGRATED OPTICAL SYSTEMS INDUSTRIES AND FOR THE DESIGN, TESTING AND MANUFACTURE OF PHOTO-LITHOGRAPHIC MASKS, IN CLASS 42 (U.S. CLS. 100 AND 101).

THE MARK CONSISTS OF STANDARD CHARACTERS WITHOUT CLAIM TO ANY PARTICULAR FONT, STYLE, SIZE, OR COLOR.

PRIORITY DATE OF 1-27-2011 IS CLAIMED.

OWNER OF INTERNATIONAL REGISTRATION 1070002 DATED 1-27-2011, EXPIRES 1-27-2021.

SER. NO. 79-094,688, FILED 1-27-2011.

RENEE MCCRAY, EXAMINING ATTORNEY

United States of America

United States Patent and Trademark Office

UBE POLYOXAMIDE

Reg. No. 4,107,315

Registered Mar. 6, 2012

Int. Cl.: 1

TRADEMARK

PRINCIPAL REGISTER

UBE INDUSTRIES, LTD. (JAPAN CORPORATION)
1978-96 O-AZA KOGUSHI
UBE-SHI, YAMAGUCHI-KEN 755-8633
JAPAN

FOR: UNPROCESSED PLASTICS, IN CLASS 1 (U.S. CLS. 1, 5, 6, 10, 26 AND 46).

OWNER OF U.S. REG. NOS. 1,316,347, 3,818,541, AND 3,831,939.

PRIORITY DATE OF 10-8-2010 IS CLAIMED.

OWNER OF INTERNATIONAL REGISTRATION 1070063 DATED 2-17-2011, EXPIRES 2-17-2021.

NO CLAIM IS MADE TO THE EXCLUSIVE RIGHT TO USE "POLYOXAMIDE", APART FROM THE MARK AS SHOWN.

THE MARK CONSISTS OF THE STYLIZED WORDS "UBE POLYOXAMIDE".

SER. NO. 79-094,707, FILED 2-17-2011.

SIMON TENG, EXAMINING ATTORNEY



David J. Kyffers

Director of the United States Patent and Trademark Office

United States of America

United States Patent and Trademark Office



Reg. No. 4,107,316

Registered Mar. 6, 2012

Int. Cl.: 36

SERVICE MARK

PRINCIPAL REGISTER

COLLINSON GROUP (TRADEMARKS) LIMITED (GIBRALTAR COMPANY)
SUITE 1, INTERNATIONAL HOUSE
16 BELL LANE; GIBRALTAR
GIBRALTAR

FOR: INSURANCE AGENCIES; INSURANCE AGENCY AND BROKERAGE IN THE FIELDS OF TRAVEL INSURANCE, HOLIDAY INSURANCE, MOTOR INSURANCE, HOME INSURANCE, MORTGAGE PAYMENT PROTECTION INSURANCE, HEALTH INSURANCE AND PET INSURANCE; INSURANCE SERVICES NAMELY, UNDERWRITING AND ISSUING ADMINISTRATION OF TRAVEL INSURANCE, HOLIDAY INSURANCE, MEDICAL INSURANCE, MOTOR INSURANCE, VEHICLE INSURANCE, HOME INSURANCE, HOME CONTENTS INSURANCE, MORTGAGE PAYMENT PROTECTION INSURANCE, HEALTH INSURANCE, LIFE INSURANCE, PET INSURANCE; INSURANCE BROKERAGE IN THE FIELD OF TRAVEL INSURANCE, HOLIDAY INSURANCE, MEDICAL INSURANCE, MOTOR INSURANCE, VEHICLE INSURANCE, HOME INSURANCE, HOME CONTENTS INSURANCE, NAMELY, FIRE INSURANCE UNDERWRITING; MAINTAINING MORTGAGE ESCROW ACCOUNTS; MORTGAGE PAYMENT PROTECTION INSURANCE, HEALTH INSURANCE, LIFE INSURANCE, PET INSURANCE; MEDICAL INSURANCE UNDERWRITING; INSURANCE BROKERAGE IN THE FIELD OF AUTOMOBILE AND MOTOR HOME INSURANCE; INSURANCE CONSULTATION SERVICES, INSURANCE CONSULTANCY AND INSURANCE CLAIMS ADMINISTRATION AND PROCESSING IN THE FIELDS OF TRAVEL INSURANCE, HOLIDAY INSURANCE, MOTOR INSURANCE, HOME INSURANCE, MORTGAGE PAYMENT PROTECTION INSURANCE, HEALTH INSURANCE AND PET INSURANCE; PROVISION OF ADVISORY, INFORMATION AND CONSULTANCY SERVICES IN RELATION TO ALL OF THE AFORESAID, IN CLASS 36 (U.S. CLS. 100, 101 AND 102).



THE MARK CONSISTS OF THE FOLLOWING: A DOG WITH BLACK EYES, BROWN NOSE, WITH BROWN AND WHITE FUR WITH A BROWN AND GRAY BARREL AROUND ITS NECK AND HOLDING A BLUE AND GREEN GLOBE OF THE EARTH.

OWNER OF INTERNATIONAL REGISTRATION 1070076 DATED 1-10-2011, EXPIRES 1-10-2021.

David J. Kyros

THE COLOR(S) BROWN, WHITE, BLACK, BLUE, GREEN, AND GRAY IS/ARE CLAIMED AS A FEATURE OF THE MARK.

SER. NO. 79-094,713, FILED 1-10-2011.

Reg. No. 4,107,316 LINDA M. KING, EXAMINING ATTORNEY

United States of America

United States Patent and Trademark Office

GHOST LUMINOUS

Reg. No. 4,107,317

Registered Mar. 6, 2012

Int. Cl.: 3

PROCTER & GAMBLE INTERNATIONAL OPERATIONS SA (SWITZERLAND SOCIÉTÉ ANONYME (SA))
47, ROUTE DE SAINT-GEORGES
CH-1213 PETIT-LANCY
SWITZERLAND

TRADEMARK

FOR: PERFUME, BATH GEL, SHOWER GEL, BATH FOAMS AND DEODORANTS FOR PERSONAL USE, IN CLASS 3 (U.S. CLS. 1, 4, 6, 50, 51 AND 52).

PRINCIPAL REGISTER

THE MARK CONSISTS OF STANDARD CHARACTERS WITHOUT CLAIM TO ANY PARTICULAR FONT, STYLE, SIZE, OR COLOR.

PRIORITY DATE OF 9-15-2010 IS CLAIMED.

OWNER OF INTERNATIONAL REGISTRATION 1070141 DATED 2-21-2011, EXPIRES 2-21-2021.

SER. NO. 79-094,741, FILED 2-21-2011.

HEATHER BIDDULPH, EXAMINING ATTORNEY



David J. Kyffers

Director of the United States Patent and Trademark Office

United States of America

United States Patent and Trademark Office

Rheosorbilact

Reg. No. 4,107,318

Registered Mar. 6, 2012

Int. Cl.: 5

ASSOCIATION LIMITED "MEDICAL CENTER "M.T.K."" (UKRAINE LIMITED LIABILITY COMPANY)
10, MYKOLA AMOSOV STR. 680
KYIV 03680
UKRAINE

TRADEMARK

PRINCIPAL REGISTER

FOR: PHARMACEUTICAL PREPARATIONS FOR IMPROVING CAPILLARY CIRCULATION, FOR PREVENTION AND TREATMENT OF TRAUMATIC, OPERATIVE, HEMOLYTIC, TOXIC AND BURN SHOCK, ACUTE BLOOD LOSSES, BURN DISEASE, FOR PREVENTION AND TREATMENT OF INTOXICATION CAUSED BY CONTAGIOUS DISEASES, AGGRAVATION OF CHRONIC HEPATITIS, SEPSIS, FOR PREVENTION AND TREATMENT OF DEHYDRATION, FOR PREVENTION AND TREATMENT OF WATER-ELECTROLYTE IMBALANCE DURING PRE-OPERATIVE AND POST-OPERATIVE PERIODS, FOR IMPROVING ARTERIAL AND VENOUS CIRCULATION TO PREVENT THROMBOSIS, THROMBOPHLEBITIS, ENDARTERITIS, RAYNAUD SYNDROME; VACCINES; VITAMIN PREPARATIONS; MEDICINAL COSMETICS, IN CLASS 5 (U.S. CLS. 6, 18, 44, 46, 51 AND 52).

PRIORITY DATE OF 11-11-2010 IS CLAIMED.

OWNER OF INTERNATIONAL REGISTRATION 1070159 DATED 2-10-2011, EXPIRES 2-10-2021.

SER. NO. 79-094,745, FILED 2-10-2011.

HELENE LIWINSKI, EXAMINING ATTORNEY



David J. Kyffers

Director of the United States Patent and Trademark Office

United States of America

United States Patent and Trademark Office



Reg. No. 4,107,319

Registered Mar. 6, 2012

Int. Cls.: 7, 9, 11 and 16

TRADEMARK

PRINCIPAL REGISTER

GREE ELECTRIC APPLIANCES, INC. OF ZHUHAI (CHINA CORPORATION)
JINJI WEST ROAD
QIANSHAN ZHUHAI; GUANGDONG
CHINA

FOR: AGRICULTURAL MACHINES, NAMELY, REAPERS, SEED PLANTING MACHINES, CULTIVATORS, COMBINES, SEEDERS MOWERS; AERATING PUMPS FOR AQUARIA; FODDER PRESSES; MILKING MACHINES; HAIR CLIPPING MACHINES FOR ANIMALS; MORTISING MACHINES; PAPER REELING MACHINES; SANITARY TOWEL PRODUCTION EQUIPMENT, NAMELY PAPER REELING MACHINES AND PAPER MAKING MACHINES; TYPE-SETTING MACHINES USED FOR PRINTING; COTTON GINS; SIZING MACHINES FOR THE MANUFACTURE OF TEXTILES; DEBLOCKING MACHINES USED IN THE TEA INDUSTRY; TOBACCO PROCESSING MACHINES; EMBOSsing MACHINES; BICYCLE ASSEMBLING MACHINES; BATTERY MAKING MACHINES; PROCESSING MACHINES FOR LOCAL PRODUCTS AND SUNDRY GOODS IN THE NATURE OF FOLDING, CUTTING, PRESSING, MOLDING, CARVING, KNEADING, MIXING AND GRATING MACHINES; ENAMEL PRODUCTION MACHINERY, NAMELY, MISSING MACHINES; BULB PRODUCTION MACHINERY, NAMELY, GRINDING AND POLISHING MACHINES; SEALING MACHINES FOR INDUSTRIAL PURPOSES NOT BEING HEAT SEALING MACHINES; BRIQUETTE MAKING MACHINES; ELECTRIC WASHING MACHINES FOR CLOTHES; PRESSURE MOLDING MACHINES; GLASS WORKING MACHINES; PETROCHEMICAL APPARATUS, NAMELY, DRILLING RIGS, OIL REFINING MACHINES; INDUSTRIAL MACHINE PRESSES; MOLDING EQUIPMENT, NAMELY, PLASTIC JET MOLDING MACHINES; STEAM ENGINES; IGNITING DEVICES FOR INTERNAL COMBUSTION ENGINES; WATER POWERED EQUIPMENT, NAMELY, WATER AERATION SYSTEMS COMPRISING WATER PUMPS, AIR COMPRESSORS AND AIR BLOWERS; NEEDLE MAKING MACHINES; ZIPPER MAKING MACHINES; BLADE SHARPENING MACHINES; WIRE DRAWING MACHINES; HAND-HELD TOOLS, OTHER THAN HAND OPERATED, NAMELY, ELECTRIC SCISSORS, HYDRAULIC PRESSURE ELECTRIC SCREWDRIVERS; ELECTRONIC INDUSTRY DEVICES, NAMELY, STATIC ELIMINATING MACHINES; GAS SEPARATING EQUIPMENT, NAMELY, SEPARATING MACHINES; PAINT SPRAYING MACHINES, NAMELY PAINT SPRAYERS; ALTERNATORS, NAMELY, AC GENERATORS, STARTER ALTERNATORS; DRIVING MOTORS OTHER THAN FOR LAND VEHICLES; CENTRIFUGAL PUMPS; VALVES BEING PARTS OF MACHINES; COMPRESSED AIR MACHINES; BEARINGS BEING PARTS OF MACHINES; BELTS FOR MACHINES; ACETYLENE CLEANING APPARATUS, NAMELY, COMPRESSORS CLEANING MACHINES; ELECTRIC MACHINES AND APPARATUS FOR CLEANING, NAMELY, CARPET CLEANING MACHINES; FILTER-



David J. Kybas

Director of the United States Patent and Trademark Office

Reg. No. 4,107,319 ING MACHINES BEING PARTS OF AIR CONDITIONERS; VACUUM CLEANERS; COMPRESSORS FOR MACHINES; DIRECT CURRENT MOTORS; ALTERNATING CURRENT SERVO MOTORS; ELECTRIC MOTORS WITH PLASTIC COVER; ELECTRIC MOTORS WITH IRON COVER; DISH WASHERS; AIR FILTERS FOR PURIFYING AND COOLING VEHICLE ENGINES, IN CLASS 7 (U.S. CLS. 13, 19, 21, 23, 31, 34 AND 35).

FOR: COMPUTERS; TIME RECORDING APPARATUS; POSTAGE STAMPING METERS; CASH REGISTERS; VENDING MACHINES; FUEL DISPENSING PUMPS FOR SERVICE STATIONS; PLOTTERS; FACSIMILE MACHINES; WEIGHING APPARATUS AND INSTRUMENTS; MEASURING INSTRUMENTS, NAMELY, RULERS; SIGNAL LANTERNS; TELEPHONE SETS; RADIOS; CINEMATOGRAPHIC CAMERAS; COUNTERS, NAMELY, GEIGER COUNTERS; GAS METERS; MILEAGE RECORDERS FOR VEHICLES, NAMELY, ODOMETERS; THERMOSTATS; AUDIOVISUAL TEACHING APPARATUS; GALVANOMETERS; SATELLITES FOR SCIENTIFIC PURPOSES; TELESCOPES; MATERIAL FOR ELECTRICITY MAINS, NAMELY, WIRES AND CABLES; SEMICONDUCTORS; INTEGRATED CIRCUITS; ELECTRIC COILS; ELECTRIC SWITCHES; FLUORESCENT SCREENS; REMOTE CONTROLLERS FOR RADIOS, TELEVISIONS, STEREOS, AND AIR CONDITIONERS; LIGHT CONDUCTING FILAMENTS, NAMELY, OPTICAL FIBERS; ELEVATOR OPERATION APPARATUS, NAMELY, ELECTRONIC CONTROLLERS TO MANAGE THE POWER MOVEMENT AND FUNCTION OF AN ELEVATOR; LIGHTING CONDUCTORS; ELECTROPLATING APPARATUS FOR ELECTROPLATING PURPOSES; FIRE EXTINGUISHERS; ELECTRIC WELDING APPARATUS, NAMELY, WELDING TORCHES; RADIOLOGICAL APPARATUS FOR INDUSTRIAL PURPOSES; PROTECTION DEVICES FOR PERSONAL USE AGAINST ACCIDENTS, NAMELY, PROTECTIVE WORK GLOVES; ELECTRIC ALARM BELLS, NAMELY, BURGLAR ALARMS; CONTACT LENSES; GALVANIC CELLS BEING BATTERIES; VIDEO DISKS AND VIDEO TAPES WITH RECORDED ANIMATED CARTOONS; ELECTRIC FLAT IRONS; ENAMELED WIRES; CAPACITORS; INTEGRATED CIRCUITS OF ELECTRIC COMPONENTS; ELECTRIC RESISTERS FOR TELECOMMUNICATIONS PURPOSES; ELECTROMAGNETIC COILS, IN CLASS 9 (U.S. CLS. 21, 23, 26, 36 AND 38).

FOR: AIR CONDITIONERS; REFRIGERATORS; REFRIGERATING APPLIANCES AND INSTALLATIONS; WHIRLPOOL BATH HEATERS; ELECTRIC STERILIZERS FOR DISHES; FRICTION LIGHTERS FOR IGNITING GAS; GAS BURNERS; MICRO-WAVE OVENS FOR KITCHEN USE; LIGHTING INSTALLATIONS; LIGHTS FOR VEHICLES; ACETYLENE GENERATORS; GAS LIGHTERS; COOKING RANGES AND OVENS; LAVA ROCKS FOR USE IN BARBEQUE GRILLS; REFRIGERATING APPLIANCES AND INSTALLATIONS; ELECTRIC HAIR DRYERS; HEATING APPARATUS, NAMELY, ELECTRIC SPACE HEATERS, AND ELECTRIC HEATING FANS; HYDRANTS; DRIP IRRIGATION EMITTERS, NAMELY, IRRIGATION FITTINGS; SANITARY APPARATUS AND INSTALLATIONS, NAMELY, BATH TUBS, AND SHOWERS; DISINFECTANT APPARATUS FOR TOILETS; DISPOSABLE STERILIZATION POUCHES NOT FOR MEDICAL USE; ELECTRIC RADIATORS; GAS LIGHTERS FOR LIGHTING GRILLS, FIREPLACES AND CANDLES; NUCLEAR REACTORS; ELECTRIC FANS; ELECTRIC RICE COOKERS; ELECTROMAGNETIC INDUCTION COOKERS FOR HOUSEHOLD PURPOSES; ELECTRIC COOKING POTS FOR HOUSEHOLD PURPOSES; ELECTRIC COOLING APPARATUS FOR DISPENSING DRINKING WATER; ELECTRIC KETTLES; HUMIDIFIERS; SOLAR WATER HEATERS; EXTRACTOR HOODS FOR KITCHENS; HEATERS FOR BATHS; EXHAUST HOODS FOR KITCHENS; AIR PURIFYING UNITS; ELECTRIC PRESSURE COOKERS; WATER PURIFICATION INSTALLATIONS; ELECTRIC WATER HEATERS; GAS WATER HEATERS; ELECTRIC EGG BOILERS; ELECTRIC COFFEE MACHINES; ELECTRIC BAKERS' OVENS; ELECTRIC SLOW COOKERS; AIR HUMIDIFIERS; STEAM FACIAL APPARATUS FOR SAUNAS; FILTERS FOR DRINKING WATER; ELECTRIC LAUNDRY DRYERS, IN CLASS 11 (U.S. CLS. 13, 21, 23, 31 AND 34).

FOR: PAPER; STATIONERY, NAMELY, COPYING PAPER; TOILET PAPER; BOXES OF CARDBOARD, CARDBOARD PACKAGING; PRINTED MATTER, NAMELY, PRINTED CALENDARS, NAMELY, PRINTED CALENDARS, PRINTED AWARDS, POSTCARDS, PRINTED FORMS, PRINTED INVITATIONS; STATUETTES OF PAPER; PRINTED PUBLICATIONS, NAMELY, NEWSPAPERS, BOOKS AND MAGAZINES FEATURING ELECTRICAL

Reg. No. 4,107,319 APPLIANCES, POSTERS, PRINTED INSTRUCTION BOOKS IN THE FIELD OF ELECTRICAL APPLIANCES; PRINTED PERIODICALS IN THE FIELD OF ELECTRICAL APPLIANCES; PICTURES; PACKING PAPER; STAPLES FOR OFFICES; STATIONERY; WRITING INK; STAMPS, NAMELY, INK STAMPS; WRITING INSTRUMENTS; GUMMED TAPE FOR STATIONERY OR HOUSEHOLD USE; SQUARE RULERS; DRAWING MATERIALS FOR BLACKBOARDS; INKING RIBBONS; PRINTED MATHEMATICAL TEACHING MATERIAL; ARCHITECTS' MODELS; CHAPLETS, IN CLASS 16 (U.S. CLS. 2, 5, 22, 23, 29, 37, 38 AND 50).

OWNER OF U.S. REG. NOS. 2,026,479, 3,774,914 AND OTHERS.

OWNER OF INTERNATIONAL REGISTRATION 1070175 DATED 10-8-2010, EXPIRES 10-8-2020.

THE TRANSLITERATION OF THE NON-LATIN CHARACTERS IN THE MARK IS: "GE LI".

THE MARK CONSISTS OF AN INCOMPLETE CIRCLE AND CHEVRON WHICH FORMS A STYLIZED CAPITALIZED LETTER "G", THE LETTERS "G", "R", "E", "E" AND CHINESE CHARACTERS WHICH TRANSLITERATE TO "GE LI".

THE ENGLISH TRANSLATION OF THE FOREIGN WORD(S) IN THE MARK IS: IN ENGLISH, "GE" MEANS "GRID" AND "LI" MEANS STRENGTH; AS A COMBINATION OF THE CHINESE CHARACTERS OF "GE" AND "LI", THIS MARK HAS NO SPECIFIC MEANING IN TRADE OR GEOGRAPHY.

SER. NO. 79-094,749, FILED 10-8-2010.

EDWARD NELSON, EXAMINING ATTORNEY

United States of America

United States Patent and Trademark Office



THE CHIA CO

Reg. No. 4,107,320

Registered Mar. 6, 2012

**Int. Cls.: 3, 5, 29, 30, 31
and 32**

TRADEMARK

PRINCIPAL REGISTER

CHIA AUSTRALIA PTY LTD (AUSTRALIA AN AUSTRALIAN PROPRIETARY COMPANY LIMITED BY SHARES)
262-276 LORIMER STREET
PORT MELBOURNE VIC 3207
AUSTRALIA

FOR: NON-MEDICATED SKIN CARE AND HAIR CARE PREPARATIONS; COSMETICS; MAKE-UP KITS COMPRISED OF LIPSTICK, LIP GLOSS, LIP LINER, FOUNDATION, FACIAL POWDER, EYE SHADOW, MASCARA AND EYE LINER; ESSENTIAL OILS; OILS FOR COSMETIC PURPOSES; ALL OF THE AFORESAID CONTAINING CHIA OR INGREDIENTS DERIVED FROM CHIA, IN CLASS 3 (U.S. CLS. 1, 4, 6, 50, 51 AND 52).

FOR: FOOD FOR BABIES; NUTRITIONAL ADDITIVES FOR MEDICAL PURPOSES USED IN FOODS AND DIETARY SUPPLEMENTS FOR HUMAN CONSUMPTION; MEDICINAL OILS; DIETETIC FOODS AND BEVERAGES ADAPTED FOR MEDICAL USE; ALL OF THE AFORESAID CONTAINING CHIA OR INGREDIENTS DERIVED FROM CHIA, IN CLASS 5 (U.S. CLS. 6, 18, 44, 46, 51 AND 52).

FOR: DAIRY PRODUCTS EXCLUDING ICE CREAM, ICE MILK AND FROZEN YOGURT; YOGHURT; MILK; FLAVOURED MILK; MILK PRODUCTS, NAMELY, EVAPORATED MILK, MILK PROTEINS AND SOLIDS; DAIRY SMOOTHIES; CHEESE; EDIBLE OILS; MARGARINE; PROCESSED EDIBLE SEEDS; ALL OF THE AFORESAID CONTAINING CHIA OR INGREDIENTS DERIVED FROM CHIA, IN CLASS 29 (U.S. CL. 46).

FOR: BREAD AND BREAD PRODUCTS, NAMELY, BREADSTICKS, BREADS, BUNS, BAGELS, WRAPS, FLAT BREADS, PITA BREADS; CONFECTIONARY, NAMELY, SUGAR CONFECTIONARY, CHOCOLATE CONFECTIONARY, NAMELY, CANDIES; BAKERY PRODUCTS; BISCUITS, CRACKERS, BAGEL CHIPS, PITA CHIPS, FLOUR-BASED AND GRAIN-BASED CHIPS; CEREAL AND CEREAL PRODUCTS, NAMELY, ROLLED OATS, GRANOLA, READY-TO-EAT CEREAL-DERIVED FOOD BARS, FLOUR, PROCESSED BRAN; BEVERAGES CONTAINING TEA, COFFEE AND COCOA, NAMELY, BEVERAGES MADE OF TEA, BEVERAGES WITH A TEA BASE, COFFEE BASED BEVERAGES, PREPARED COFFEE AND COFFEE-BASED BEVERAGES, COCOA-BASED BEVERAGES; FLOUR FOR FOOD; SNACK FOODS, NAMELY, BAGEL CHIPS, PITA CHIPS, TACO CHIPS, TORTILLA CHIPS, FROZEN PREPARED MEALS CONSISTING PRIMARILY OF PASTA OR RICE; SAUCES, NAMELY, TOMATO-BASED SAUCES, VEGETABLE BASED SAUCES, LENTIL-BASED SAUCES, SOYA SAUCES, TERIYAKI SAUCES, STIR FRY SAUCES, BLACK BEAN



David J. Kybas

Director of the United States Patent and Trademark Office

Reg. No. 4,107,320 SAUCES, BARBEQUE SAUCES, SEAFOOD BASED SAUCES, POULTRY BASED SAUCES, MEAT BASED SAUCES, PORK BASED SAUCES, CHEESE SAUCES, MARINADE SAUCES; SPICES; ICE; ALL OF THE AFORESAID CONTAINING CHIA OR INGREDIENTS DERIVED FROM CHIA, IN CLASS 30 (U.S. CL. 46).

FOR: PET FOOD; SEEDS, NAMELY, GRASS SEEDS, BIRD SEEDS; ADDITIVES FOR FODDER, NOT FOR MEDICAL PURPOSES; FOODSTUFFS FOR ANIMALS; ALL OF THE AFORESAID CONTAINING CHIA OR INGREDIENTS DERIVED FROM CHIA, IN CLASS 31 (U.S. CLS. 1 AND 46).

FOR: FLAVOURED WATER, NON-FLAVOURED STILL AND SPARKLING WATER; BEER; VEGETABLE JUICES; FRUIT JUICE BEVERAGES; ALL OF THE AFORESAID CONTAINING CHIA OR INGREDIENTS DERIVED FROM CHIA, IN CLASS 32 (U.S. CLS. 45, 46 AND 48).

NO CLAIM IS MADE TO THE EXCLUSIVE RIGHT TO USE "CHIA CO", APART FROM THE MARK AS SHOWN.

OWNER OF INTERNATIONAL REGISTRATION 1070195 DATED 11-26-2010, EXPIRES 11-26-2020.

THE MARK CONSISTS OF THE STYLIZED WORDING "THE CHIA CO" WITH THE DESIGN OF THREE ABSTRACT FLOWER PETALS ABOVE.

SER. NO. 79-094,752, FILED 11-26-2010.

ADA HAN, EXAMINING ATTORNEY

United States of America

United States Patent and Trademark Office

ER&M

Reg. No. 4,107,321

Registered Mar. 6, 2012

Int. Cls.: 9, 37 and 41

REICHLÉ & DE-MASSARI HOLDING AG (SWITZERLAND SOCIÉTÉ ANONYME (JOINT STOCK COMPANY))
BINZSTRASSE 31
CH-8620 WETZIKON
SWITZERLAND

TRADEMARK

SERVICE MARK

PRINCIPAL REGISTER

FOR: ELECTRIC, ELECTRONIC, MEASURING, SIGNALING, CHECKING, AND SUPERVISION APPARATUS, INSTRUMENTS AND INSTALLATIONS, NAMELY, SWITCHES, SWITCH BOARDS, ELECTRIC SWITCH BLADES, COMPUTER CABLES, ELECTRICAL CABLES, ETHER NET CABLES; ELECTRIC SOCKETS AND PLUGS; COAXIAL CABLES; ELECTRICAL DUCTS AND DUCTS FOR FIBER OPTIC CABLES, NAMELY, FLEX DUCTS AND ON-FLOOR DUCTS; FIBER OPTIC SPLICE CLOSURES; TELECOMMUNICATIONS EQUIPMENT, NAMELY, CROSS CONNECTION CABINETS, DISTRIBUTION HOUSINGS, DISTRIBUTION FRAMES, MOUNTING CHANNELS, SPLICE TRAYS, BAYS, RACKS, AND PATCH PANELS ALL FOR USE IN ELECTRONIC AND FIBER OPTIC HARDWARE INSTALLATIONS; FIBER OPTIC TERMINALS; TERMINALS FOR COPPER ELECTRIC WIRES; FIBER OPTIC TERMINAL HOUSINGS, FIBER OPTIC CABLE GUIDES AND ELECTRICAL WALL OUTLETS; COPPER WIRE AND CABLE FOR TRANSMISSION OF ELECTRICITY; TELECOMMUNICATIONS CABLES; ANTI-TANGLING DEVICES FOR CABLES, FIBER OPTICS, FIBER OPTIC CABLES, FIBER OPTIC CONNECTORS, FIBER OPTIC COUPLINGS; TELEPHONE CONNECTORS, TELEPHONE DISTRIBUTION FRAMES, TELEPHONE WIRING; ELECTRONIC TEST EQUIPMENT FOR ELECTRICAL AND TELECOMMUNICATIONS SYSTEMS, NAMELY, CABLE TESTERS; COMPUTER INTERFACE CONNECTORS; ELECTRICAL SWITCHBOARDS, PRINTED SWITCHBOARDS, ELECTRICAL SWITCHES, SWITCH BOXES FOR ELECTRICITY; MOUNTING STANDS, RACKS AND TOWERS FOR ELECTRONIC AND FIBER OPTIC HARDWARE INSTALLATIONS; ELECTRIC AND FIBER OPTIC CABLES, ELECTRICITY CONDUITS, IDENTIFICATION THREADS AND SHEATHS FOR ELECTRIC WIRES, ELECTRICITY WIRE CONNECTORS, JUNCTION AND DISTRIBUTION SLEEVES FOR ELECTRIC AND FIBER OPTIC CABLES; SOCKETS, PLUGS AND OTHER CONTACTS FOR ELECTRIC CONNECTIONS, ELECTRICITY JUNCTION BOXES, ELECTRICITY DISTRIBUTION BOXES, ELECTRICITY PLUGS AND FIBER OPTIC CONNECTIONS; COPPER COMPONENTS FOR ELECTRICAL WIRING AND OPTICAL FIBER SYSTEM, NAMELY, CONNECTION AND DISCONNECTION TERMINAL BLOCKS FOR CABLING SYSTEMS, ELECTRICAL WIRES AND OPTICAL FIBER CABLES; PROTECTION EQUIPMENT FOR CABLING SYSTEMS, NAMELY, DISCONNECTION MODULES, OVER VOLTAGE PROTECTION MODULES, OVER CURRENT PROTECTION MODULES; PATCH AND TEST CORDS; CABLES FOR THE TRANSFER OF VOICE, DATA, AND VIDEO SIGNALS, NAMELY,



David J. Kyros

Director of the United States Patent and Trademark Office

Reg. No. 4,107,321 COMPUTER AND TELEPHONE CABLES AND COMPUTER AND TELEPHONE INTERFACE CONNECTORS FOR VOICE, DATA AND VIDEO APPLICATIONS; COMPUTER CABLES AND COMPUTER INTERFACE CONNECTORS FOR COMPUTER NETWORKS, IN CLASS 9 (U.S. CLS. 21, 23, 26, 36 AND 38).

FOR: REPAIR, INSTALLATION, MAINTENANCE AND SERVICING OF ELECTRIC, ELECTRONIC, MEASURING, SIGNALING AND CHECKING AND SUPERVISION APPARATUS AND INSTRUMENTS AND THEIR PARTS AND FITTINGS, NAMELY, SWITCHES, SWITCH BOARDS, ELECTRIC SWITCH BLADES, CABLES, SOCKETS AND PLUGS, COAXIAL CABLES, FIBRE PROTECTION AND ELECTRIC INSTALLATION MATERIALS, COPPER WIRE; TELECOMMUNICATIONS CABLES, VOICE AND DATA TELECOM, ANTI-TANGLING DEVICE FOR CABLES, FIBRE-OPTICS COMPONENTS, COPPER COMPONENTS, PLATFORMS FOR TELEPHONE SYSTEMS, TELEPHONE CONNECTORS, TELEPHONE DISTRIBUTION FRAMES, TELEPHONE WIRING, CABLE TESTING EQUIPMENT, FIBRE OPTIC CABLES; COMPUTER INSTALLATIONS COMPRISING COMPUTER CONNECTIONS TO TELEPHONE CABLES AND COMPUTER CABLES AND PART AND FITTINGS; COMPUTER NETWORKS COMPRISING COMPUTER CABLING NETWORK; COMPUTER INTERFACES COMPRISING COMPUTER INTERFACE CONNECTORS; ELECTRICAL SWITCHBOARDS, PRINTED SWITCHBOARDS, ELECTRICAL SWITCHES, SWITCH BOXES FOR ELECTRICITY, STANDS AND RACKS, NAMELY, TOWELS FOR ELECTRONIC AND FIBRE OPTIC INSTALLATIONS; ELECTRIC AND FIBRE OPTIC CABLES, ELECTRICITY CONDUITS, IDENTIFICATION THREADS AND SHEATHS FOR ELECTRIC WIRES, ELECTRICITY WIRE CONNECTORS, SHEETS FOR ELECTRIC AND FIBRE OPTIC CABLES; JUNCTION AND DISTRIBUTION SLEEVES FOR ELECTRIC AND FIBRE OPTIC CABLES; SOCKETS, PLUGS AND OTHER CONTACTS FOR ELECTRIC CONNECTIONS, ELECTRICITY JUNCTION BOXES, ELECTRICITY DISTRIBUTION BOXES, ELECTRICITY PLUGS, AND FIBRE OPTIC CONNECTIONS, IN CLASS 37 (U.S. CLS. 100, 103 AND 106).

FOR: PROVIDING OF TRAINING, ARRANGING AND CONDUCTING OF TRAINING COURSES, SEMINARS AND WORKSHOPS, IN PARTICULAR, FOR PLANNING, INSTALLING AND DISTRIBUTING ELECTRIC, ELECTRONIC AND TELECOMMUNICATION APPARATUS AND NETWORKS AND THEIR PARTS AND FITTINGS, AND COMPUTER NETWORKS AND THEIR PARTS AND FITTINGS, IN CLASS 41 (U.S. CLS. 100, 101 AND 107).

OWNER OF U.S. REG. NO. 2,781,028.

OWNER OF INTERNATIONAL REGISTRATION 0740760 DATED 5-29-2000, EXPIRES 5-29-2020.

THE MARK CONSISTS OF THREE HORIZONTAL BARS STACKED ON TOP OF ONE ANOTHER WITH THE STYLIZED LETTERING "R&M" TO THE RIGHT OF THE BARS.

SER. NO. 79-094,777, FILED 2-1-2011.

MARILYN IZZI, EXAMINING ATTORNEY

United States of America
United States Patent and Trademark Office

BALBÁS

Reg. No. 4,107,322

Registered Mar. 6, 2012

Int. Cl.: 33

TRADEMARK

PRINCIPAL REGISTER

BODEGAS BALBAS, S.L. (SPAIN SOCIEDAD LIMITADA)
LA MAJADA, S/N.
E-09442 LA HORRA (BURGOS)
SPAIN

FOR: WINE, IN CLASS 33 (U.S. CLS. 47 AND 49).

THE MARK CONSISTS OF STANDARD CHARACTERS WITHOUT CLAIM TO ANY PARTICULAR FONT, STYLE, SIZE, OR COLOR.

PRIORITY DATE OF 10-1-2010 IS CLAIMED.

OWNER OF INTERNATIONAL REGISTRATION 1070336 DATED 11-4-2010, EXPIRES 11-4-2020.

SER. NO. 79-094,819, FILED 11-4-2010.

APRIL ROACH, EXAMINING ATTORNEY



David J. Kyffers

Director of the United States Patent and Trademark Office

United States of America

United States Patent and Trademark Office



Reg. No. 4,107,323

Registered Mar. 6, 2012

Int. Cls.: 7 and 9

TRADEMARK

PRINCIPAL REGISTER

MAINA ORGANI DI TRASMISSIONE S.P.A. (ITALY CORPORATION)
PIAZZA CARLO EMANUELE II, 13
I-10123 TORINO
ITALY

FOR: GEAR COUPLINGS FOR MACHINES AND POWER TRANSMISSION EQUIPMENTS EXCEPT FOR LAND VEHICLES, NAMELY, POWER TRANSMISSIONS AND GEARING FOR MACHINES, IN CLASS 7 (U.S. CLS. 13, 19, 21, 23, 31, 34 AND 35).

FOR: ELECTRONIC DEVICE TO MONITOR THE TORQUE, NAMELY, TORQUE MEASUREMENT PRODUCTS IN THE NATURE OF DIGITAL TORQUE GAUGES IN THE FIELD OF ROTARY TORQUE TRANSMISSION, INSTALLED IN ROLLING MILL PLANTS, REFINERY PLANTS, POWER ENERGY PLANTS, SHIPBUILDING INDUSTRIES, CEMENT INDUSTRIES, PAPER FACTORIES, FOOD PROCESSING INDUSTRY, RUBBER PRODUCTION PLANTS, OIL AND GAS PRODUCTION PLANTS, TEXTILE INDUSTRIES, HOSTING DEVICES AND MINING INDUSTRIES, IN CLASS 9 (U.S. CLS. 21, 23, 26, 36 AND 38).

NO CLAIM IS MADE TO THE EXCLUSIVE RIGHT TO USE "ORGANI DI TRASMISSIONE" AND "ASTI ITALY", APART FROM THE MARK AS SHOWN.

OWNER OF INTERNATIONAL REGISTRATION 1070366 DATED 1-5-2011, EXPIRES 1-5-2021.



THE MARK CONSISTS OF A CIRCULAR CARRIED WITH A HORIZONTAL BAR IN THE MIDDLE. THE WORD "TORQVISION" APPEARS IN THE TOP HALF OF THE CIRCULAR CARRIER. THE WORDING "ASTI - ITALY" APPEARS IN THE BOTTOM HALF OF THE CIRCULAR CARRIER. THE LETTERS FORMING THE WORD "MAINA" APPEAR IN INDIVIDUAL SQUARES FORMING A HORIZONTAL BREAK IN THE MIDDLE OF THE CIRCULAR CARRIER. THE WORDING "ORGANI DI TRASMISSIONE" APPEARS IN A HORIZONTAL BAR PLACED ACROSS THE MIDDLE OF THE CARRIER AND IN FRONT OF THE WORD "MAINA".

THE ENGLISH TRANSLATION OF "ORGANI DI TRASMISSIONE" IS "POWER TRANSMISSION EQUIPMENT". THE WORDING "MAINA" HAS NO MEANING IN A FOREIGN LANGUAGE.

David J. Kyros

Director of the United States Patent and Trademark Office

SER. NO. 79-094,830, FILED 1-5-2011.

Reg. No. 4,107,323 KATHERINE E. HALMEN, EXAMINING ATTORNEY

United States of America

United States Patent and Trademark Office

BEASSY

Reg. No. 4,107,324

Registered Mar. 6, 2012

Int. Cl.: 28

DELUXE BILILARD KORLÁTOLT FELELOSSÉGU TÁRSASÁG (HUNGARY LIMITED LIABILITY COMPANY)
MÓRA U. 14. 11 EM. 4/A
H-6725 SZEGED
HUNGARY

TRADEMARK

FOR: BILLIARD EQUIPMENT, NAMELY, BILLIARD TABLES, BILLIARD CUES, BILLIARD CUE TIPS, BILLIARD MARKERS, IN CLASS 28 (U.S. CLS. 22, 23, 38 AND 50).

PRINCIPAL REGISTER

THE MARK CONSISTS OF THE WORD "BEASSY" IN STYLIZED FONT. TO THE LEFT OF THE WORD IS A DESIGN OF A CROWN AND A VERTICAL LINE.

OWNER OF INTERNATIONAL REGISTRATION 1070410 DATED 2-3-2011, EXPIRES 2-3-2021.

SER. NO. 79-094,842, FILED 2-3-2011.

ERNEST SHOSHO, EXAMINING ATTORNEY



David J. Kyffers

Director of the United States Patent and Trademark Office

United States of America
United States Patent and Trademark Office

weedit

Reg. No. 4,107,325

Registered Mar. 6, 2012

Int. Cls.: 7 and 9

TRADEMARK

PRINCIPAL REGISTER

ROMETRON AGRICULTURAL B.V. (NETHERLANDS BESLOTEN VENNOOTSCHAP (B.V.))
ROLANDSECK 87
NL-6865 AD DOORWERTH
NETHERLANDS

FOR: MACHINES, NAMELY, MACHINES FOR APPLYING LIQUID CHEMICALS TO A LAND SURFACE; AGRICULTURAL MACHINES, NAMELY, CULTIVATORS, SPRAYERS, HARVESTORS, DISK HARROWS, SEEDERS, IN CLASS 7 (U.S. CLS. 13, 19, 21, 23, 31, 34 AND 35).

FOR: SCIENTIFIC INSTRUMENTS, NAMELY, OPTICAL SENSORS, PHOTOELECTRIC SENSORS, INFRARED SENSORS, ALL FOR USE WITHIN AGRICULTURAL IMPLEMENTS, IN CLASS 9 (U.S. CLS. 21, 23, 26, 36 AND 38).

THE MARK CONSISTS OF STANDARD CHARACTERS WITHOUT CLAIM TO ANY PARTICULAR FONT, STYLE, SIZE, OR COLOR.

PRIORITY DATE OF 10-20-2010 IS CLAIMED.

OWNER OF INTERNATIONAL REGISTRATION 1070414 DATED 2-18-2011, EXPIRES 2-18-2021.

SER. NO. 79-094,843, FILED 2-18-2011.

CURTIS FRENCH, EXAMINING ATTORNEY



David J. Kyffers

Director of the United States Patent and Trademark Office

United States of America
United States Patent and Trademark Office

APPTOON

Reg. No. 4,107,326

Registered Mar. 6, 2012

Int. Cl.: 9

TRADEMARK

PRINCIPAL REGISTER

LEEON IPL CO., LTD (REPUBLIC OF KOREA CORPORATION)
316 KOLON SCIENCE VALLEY 2CHA
811 GURO-DONG, GURO-GU
SEOUL, REPUBLIC OF KOREA

FOR: DOWNLOADABLE ELECTRONIC PUBLICATION IN THE NATURE OF BOOKS IN THE FIELD OF CARTOONS; RECORDED COMPUTER SOFTWARE FOR USE IN SHOWING ELECTRONIC PUBLICATION IN THE NATURE OF BOOKS IN THE FIELD OF CARTOONS; COMPUTER SOFTWARE FOR WIRELESS CONTENT DELIVERY, IN CLASS 9 (U.S. CLS. 21, 23, 26, 36 AND 38).

PRIORITY DATE OF 10-15-2010 IS CLAIMED.

OWNER OF INTERNATIONAL REGISTRATION 1070433 DATED 1-17-2011, EXPIRES 1-17-2021.

SER. NO. 79-094,852, FILED 1-17-2011.

JOHN DWYER, EXAMINING ATTORNEY



David J. Kyros

Director of the United States Patent and Trademark Office

United States of America

United States Patent and Trademark Office

UNISG

Reg. No. 4,107,327

Registered Mar. 6, 2012

**Int. Cls.: 9, 16, 35, 38, 41
and 42**

UNIVERSITÄT ST. GALLEN HOCHSCHULE FÜR WIRTSCHAFTS-, RECHTS- UND
SOZIALWISSENSCHAFTEN (HSG) (SWITZERLAND INSTITUTION UNDER THE PUBLIC
LAW OF THE CANTON ST. GALLEN (SWITZERLAND), WITH ITS OWN LEGAL
PERSONALITY AND THE RIGHT TO SELF-ADMINISTRATION)
DUFOURSTRASSE 50
CH-9000 ST. GALLEN
SWITZERLAND

TRADEMARK

SERVICE MARK

PRINCIPAL REGISTER

FOR: EDUCATIONAL AND ADMINISTRATIVE COMPUTER SOFTWARE FROM
SWITZERLAND FEATURING INSTRUCTION IN ECONOMICS, BUSINESS, LAW AND
POLITICS; COMPACT DISKS AND MULTIMEDIA SOFTWARE RECORDED ON CD-ROM
FROM SWITZERLAND FEATURING INSTRUCTION AND ADMINISTRATION IN ECONOM-
ICS, BUSINESS, LAW AND POLITICS, IN CLASS 9 (U.S. CLS. 21, 23, 26, 36 AND 38).

FOR: PRINTED INSTRUCTIONAL OR TEACHING MATERIALS IN THE FIELD OF ECO-
NOMICS, BUSINESS, LAW AND POLITICS; BOOKS, BROCHURES, NEWSPAPERS AND
PRINTED PERIODICALS IN THE FIELD OF ECONOMICS, BUSINESS, LAW AND POLITICS;
ALL ABOVEMENTIONED GOODS FROM SWITZERLAND, IN CLASS 16 (U.S. CLS. 2, 5,
22, 23, 29, 37, 38 AND 50).

FOR: BUSINESS CONSULTING FOR COMPANIES, IN CLASS 35 (U.S. CLS. 100, 101 AND
102).

FOR: ONLINE INFORMATION ACCESS SERVICES, NAMELY, PROVIDING ACCESS TO
COMPUTER NETWORKS, INTERNET PLATFORMS AND DATABASES; PROVIDING AC-
CESS TIME TO THE INTERNET, IN CLASS 38 (U.S. CLS. 100, 101 AND 104).

FOR: PROVIDING OF TRAINING AND CONTINUOUS TRAINING IN THE FIELD OF ECO-
NOMICS, BUSINESS, LAW AND POLITICS; ARRANGING AND CONDUCTING EDUCA-
TIONAL SEMINARS IN THE FIELD OF ECONOMICS, BUSINESS, LAW AND POLITICS;
PUBLICATION OF TEXTS, PUBLICATION OF PRINTED MATTER, IN CLASS 41 (U.S. CLS.
100, 101 AND 107).

FOR: SCIENTIFIC RESEARCH AND INDUSTRIAL RESEARCH IN THE FIELD OF BUSINESS
MANAGEMENT, ECONOMICS, LAW, SOCIAL SCIENCES AND INTERNATIONAL AFFAIRS;
PROFESSIONAL CONSULTING, NAMELY, COMPUTER CONSULTING FOR THE FIELDS
OF MANAGEMENT, ECONOMICS, LAW, SOCIAL SCIENCES AND INTERNATIONAL



David J. Kybas

Director of the United States Patent and Trademark Office

Reg. No. 4,107,327 AFFAIRS; TECHNICAL AND SCIENTIFIC APPRAISALS, NAMELY, IN THE FIELD OF DATA PROCESSING TECHNOLOGY AND ENERGY-SAVING; COMPUTER PROGRAMMING IN THE FIELD OF MANAGEMENT, ECONOMICS, LAW, SOCIAL SCIENCES AND INTERNATIONAL AFFAIRS, IN CLASS 42 (U.S. CLS. 100 AND 101).

THE MARK CONSISTS OF STANDARD CHARACTERS WITHOUT CLAIM TO ANY PARTICULAR FONT, STYLE, SIZE, OR COLOR.

PRIORITY DATE OF 8-26-2010 IS CLAIMED.

OWNER OF INTERNATIONAL REGISTRATION 1070455 DATED 1-28-2011, EXPIRES 1-28-2021.

SER. NO. 79-094,865, FILED 1-28-2011.

NATALIE POLZER, EXAMINING ATTORNEY

United States of America

United States Patent and Trademark Office

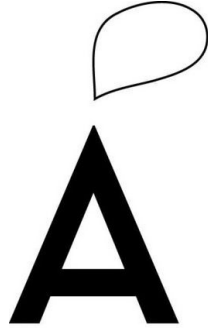

AGAPE CASA

Reg. No. 4,107,328

Registered Mar. 6, 2012

Int. Cls.: 11, 20 and 21

TRADEMARK

PRINCIPAL REGISTER

AGAPE S.R.L. (ITALY JOINT STOCK COMPANY WITH LIMITED LIABILITY)
VIA PO BARNA, 69-70
FRAZIONE CORREGGIO MICHELI
BAGNOLO SAN VITO (MN), ITALY

FOR: APPARATUS FOR LIGHTING, NAMELY, WALL MOUNTED LIGHTS AND CEILING MOUNTED LIGHTS AND PARTS THEREOF, NAMELY, LIGHT BULBS; APPARATUS FOR WATER SUPPLY, NAMELY, FAUCETS, MIXER FAUCET TAPS, WATER FAUCET SPOUTS, SHOWER MIXER FAUCETS, SHOWER MIXER FAUCET TAPS, HAND-HELD SHOWERS; BATHTUBS, TOILETS, SHOWER BASES, SHOWER DOORS, BIDETS, HOT TUBS, SINKS, TOILET BOWLS, TOILET SEATS; DISINFECTANT DISPENSERS FOR TOILETS, IN CLASS 11 (U.S. CLS. 13, 21, 23, 31 AND 34).

FOR: FURNITURE, MIRRORS, PICTURE FRAMES; GOODS NOT INCLUDED IN OTHER CLASSES OF WOOD, CORK, REED, CANE, WICKER, HORN, BONE, IVORY, WHALEBONE, SHELL, AMBER, MOTHER-OF-PEARL, MEERSCHAUM AND SUBSTITUTES FOR ALL THESE MATERIALS OR OF PLASTICS, NAMELY, BOOKCASES, SHELVING UNITS, MODULAR STORAGE UNITS, STORAGE CHESTS, STORAGE TROLLEYS, NAMELY, SERVING TROLLEYS WITH FOOD STORAGE, SHELF CONTAINERS FOR STORAGE OR TRANSPORT, MIRRORED CABINETS, CLOTHES HOOKS, MAGAZINE HOLDERS, UNDER MIRROR SHELVES, CORNER SHELVES, MIRROR SUPPORTS, DOOR STOPS, STOOLS, STORAGE STOOLS, WICKER SLEEPING MATS, REED SLEEPING MATS, ALL OF THE AFOREMENTIONED GOODS NOT MADE OF METAL OR RUBBER, IN CLASS 20 (U.S. CLS. 2, 13, 22, 25, 32 AND 50).

FOR: HOUSEHOLD AND KITCHEN UTENSILS AND CONTAINERS NOT OF PRECIOUS METAL OR COATED THEREWITH, NAMELY, CERAMIC STORAGE CONTAINERS, GLASS STORAGE CONTAINERS; COMBS; SPONGES, NAMELY, BATH SPONGES, BODY SPONGES, LOOFAH SPONGES, ABRASIVE SPONGES, TOILET SPONGES, SPONGES FOR HOUSEHOLD PURPOSES; BRUSHES, EXCEPT PAINT BRUSHES, NAMELY, HAIR BRUSHES, TOILET BRUSHES, BATH BRUSHES; BRUSH-MAKING MATERIALS, NAMELY, BRUSH SCOURING SPONGES, SCRUB SPONGES; STEEL WOOL FOR CLEANING PURPOSES; UN-WORKED OR SEMI-WORKED GLASS NOT FOR BUILDING; BEVERAGE GLASSWARE; PORCELAIN AND EARTHENWARE NOT INCLUDED IN OTHER CLASSES, NAMELY, WASH BASINS, SOAP HOLDERS, SOAP DISHES, SPONGE HOLDERS, TOOTHBRUSH HOLDERS, TOOTHPASTE HOLDERS, STORAGE CONTAINERS, STORAGE DISHES, STORAGE BOWLS, STORAGE CUPS, FREE STANDING TOWEL HOLDERS, TOILET ROLL HOLDER, FREE



David J. Kybas

Director of the United States Patent and Trademark Office

Reg. No. 4,107,328 STANDING PAPER TOWEL HOLDERS, TOILET BRUSH HOLDERS, LIQUID SOAP DISPENSERS, WASTEPAPER BASKETS, SERVING TRAYS, IN CLASS 21 (U.S. CLS. 2, 13, 23, 29, 30, 33, 40 AND 50).

OWNER OF U.S. REG. NO. 3,032,500.

OWNER OF INTERNATIONAL REGISTRATION 1070530 DATED 12-9-2010, EXPIRES 12-9-2020.

THE MARK CONSISTS OF THE DENOMINATION "A AGAPECASA" IN PARTICULAR BLOCK CHARACTERS. THE FIRST LETTER "A" IS BIGGER THAN THE OTHER PART OF THE DENOMINATION AND IS OVERTOPPED BY A CURVILINEAR, CLOSED SHAPE THAT REPRESENTS A STYLIZED DROP.

SER. NO. 79-094,885, FILED 12-9-2010.

KRISTIN DAHLING, EXAMINING ATTORNEY

United States of America

United States Patent and Trademark Office



Reg. No. 4,107,329

Registered Mar. 6, 2012

Int. Cls.: 29, 33 and 35

TRADEMARK

SERVICE MARK

PRINCIPAL REGISTER

DANIELA MIRETTI (ITALY INDIVIDUAL)
CORSO ORBASSANO 255/D
I-10137 TORINO
ITALY

FOR: MEAT, FISH, POULTRY AND GAME; MEAT EXTRACTS; PRESERVED, DRIED AND COOKED FRUITS AND VEGETABLES; JELLIES, JAMS, COMPOTES, EGGS, MILK AND MILK PRODUCTS EXCLUDING ICE CREAM, ICE MILK, AND FROZEN YOGURT; EDIBLE OILS AND FATS, IN CLASS 29 (U.S. CL. 46).

FOR: ALCOHOLIC BEVERAGES EXCEPT BEERS, IN CLASS 33 (U.S. CLS. 47 AND 49).

FOR: WHOLESALE AND RETAIL STORE SERVICES FOR MEAT, FISH, POULTRY AND GAME, MEAT EXTRACTS, PRESERVED, FROZEN, DRIED AND COOKED FRUITS AND VEGETABLES, JELLIES, JAMS, COMPOTES, EGGS, MILK AND MILK PRODUCTS, EDIBLE OILS AND FATS, AND ALCOHOLIC BEVERAGES EXCEPT BEERS, IN CLASS 35 (U.S. CLS. 100, 101 AND 102).

NO CLAIM IS MADE TO THE EXCLUSIVE RIGHT TO USE "ENOTECA", APART FROM THE MARK AS SHOWN.

PRIORITY DATE OF 1-4-2011 IS CLAIMED.

OWNER OF INTERNATIONAL REGISTRATION 1070733 DATED 2-9-2011, EXPIRES 2-9-2021.

THE MARK CONSISTS OF THE WORDING "ENOTECA PROPERZIO" UNDER A CASTLE DESIGN.

THE ENGLISH TRANSLATION OF THE FOREIGN WORD(S) IN THE MARK IS "PROPERZIO WINE SHOP".

SER. NO. 79-094,971, FILED 2-9-2011.

MATTHEW EINSTEIN, EXAMINING ATTORNEY



David J. Kyros

Director of the United States Patent and Trademark Office

United States of America

United States Patent and Trademark Office

PROTOS

Reg. No. 4,107,330

Registered Mar. 6, 2012

Int. Cl.: 9

TRADEMARK

PRINCIPAL REGISTER

ANTON PFANNER (AUSTRIA INDIVIDUAL)
SCHLOSSBERGSTRASSE 15
A-6845 HOHENEMS
AUSTRIA

FOR: GLOVES FOR PROTECTION AGAINST ACCIDENTS; GARMENTS FOR PROTECTION AGAINST BODILY HARM AND BLUNT FORCE TRAUMA FOR FORESTRY WORKERS AND FORESTRY SUPERVISORS; PROTECTIVE GARMENTS FOR WORKING WITH SAWS; HELMETS, NAMELY, HELMETS FOR LIFESAVING SERVICES IN THE NATURE OF HELMETS FOR MOUNTAIN RESCUE WORKERS; HELMETS FOR CONSTRUCTION WORKERS AND FOR FORESTRY WORKERS; PROTECTIVE GARMENTS FOR WORK FOR PROTECTION AGAINST ACCIDENTS; PROTECTIVE MASKS FOR WORKERS, IN CLASS 9 (U.S. CLS. 21, 23, 26, 36 AND 38).

THE MARK CONSISTS OF STANDARD CHARACTERS WITHOUT CLAIM TO ANY PARTICULAR FONT, STYLE, SIZE, OR COLOR.

PRIORITY DATE OF 6-9-2010 IS CLAIMED.

OWNER OF INTERNATIONAL REGISTRATION 1071078 DATED 11-30-2010, EXPIRES 11-30-2020.

SER. NO. 79-095,097, FILED 11-30-2010.

LIEF MARTIN, EXAMINING ATTORNEY



David J. Kyffers

Director of the United States Patent and Trademark Office

United States of America

United States Patent and Trademark Office

MiniOmni

Reg. No. 4,107,331

Registered Mar. 6, 2012

Int. Cl.: 10

TRADEMARK

PRINCIPAL REGISTER

BEAM-MED LTD. (ISRAEL CORPORATION)
8 HALAPID ST
P.O.B. 7520
PETACH TIKVA, ISRAEL

FOR: ULTRASOUND DIAGNOSTIC APPARATUS FOR MEDICAL USE; ULTRASOUND IMAGING DEVICES FOR MEDICAL USE; MEDICAL APPARATUS FOR THE PROCESSING OF DATA, NAMELY, ULTRASONIC BONE DENSITOMETER WITH USB-PORT CONNECTIVITY FOR MEDICAL DIAGNOSTIC USE TO MONITOR AND SCREEN FOR BONE FRACTURE RISK AND OSTEOPOROSIS; MEDICAL APPARATUS, NAMELY, BONE DETECTORS FOR THE MEASUREMENT OF BONE MINERAL CONTENT; MEDICAL DEVICES, NAMELY, SENSORS TO MONITOR THE BONE DENSITY OF PATIENTS; TRANSDUCERS ADAPTED FOR USE IN PATIENT MONITORING SYSTEMS; APPARATUS FOR ULTRASONIC DIAGNOSIS; ULTRASONIC APPARATUS FOR MEDICAL USE; ULTRASONIC APPARATUS FOR MEDICAL USE IN DIAGNOSIS; ULTRASONIC APPARATUS FOR MEDICAL USE IN SCANNING THE BODY; ULTRASONIC DIAGNOSTIC APPARATUS FOR MEDICAL USE; ULTRASONIC DIAGNOSTIC INSTRUMENTS FOR MEDICAL USE; ULTRASONIC SENSORS FOR MEDICAL USE; ULTRASONIC TESTING APPARATUS FOR MEDICAL USE, IN CLASS 10 (U.S. CLS. 26, 39 AND 44).

THE MARK CONSISTS OF STANDARD CHARACTERS WITHOUT CLAIM TO ANY PARTICULAR FONT, STYLE, SIZE, OR COLOR.

PRIORITY DATE OF 5-3-2010 IS CLAIMED.

OWNER OF INTERNATIONAL REGISTRATION 1071090 DATED 11-3-2010, EXPIRES 11-3-2020.

OWNER OF U.S. REG. NOS. 2,820,594 AND 3,913,465.

SER. NO. 79-095,102, FILED 11-3-2010.

JORDAN BAKER, EXAMINING ATTORNEY



David J. Kyffers

Director of the United States Patent and Trademark Office

United States of America
United States Patent and Trademark Office

TESTIGO

Reg. No. 4,107,332

Registered Mar. 6, 2012

Int. Cl.: 33

TRADEMARK

PRINCIPAL REGISTER

BODEGAS ROMERO DE AVILA SALCEDO, S.L. (SPAIN LIMITED LIABILITY COMPANY)
AVDA. DE LA CONSTITUCIÓN, 4
LA SOLANA
CIUDAD REAL, SPAIN E13240

FOR: ALCOHOLIC BEVERAGES EXCEPT BEER, IN CLASS 33 (U.S. CLS. 47 AND 49).

THE MARK CONSISTS OF STANDARD CHARACTERS WITHOUT CLAIM TO ANY PARTICULAR FONT, STYLE, SIZE, OR COLOR.

OWNER OF INTERNATIONAL REGISTRATION 1071126 DATED 11-4-2010, EXPIRES 11-4-2020.

THE ENGLISH TRANSLATION OF "TESTIGO" IN THE MARK IS WITNESS.

SER. NO. 79-095,112, FILED 11-4-2010.

DAVID YONTEF, EXAMINING ATTORNEY



David J. Kyffers

Director of the United States Patent and Trademark Office

United States of America

United States Patent and Trademark Office

MemoTrans

Reg. No. 4,107,333

Registered Mar. 6, 2012

Int. Cl.: 9

KNICK ELEKTRONISCHE MESSGERÄTE GMBH & CO. KG (FED REP GERMANY GMBH & CO. KG)
BEUCKESTRAßE 22
14163 BERLIN
FED REP GERMANY

TRADEMARK

PRINCIPAL REGISTER

FOR: ELECTRIC, ELECTRONIC AND ELECTROCHEMICAL APPARATUS AND INSTRUMENTS, IN PARTICULAR ELECTRIC MEASURING AND CONTROL DEVICES, NAMELY, ELECTRICAL CONTROLLERS, ELECTRO-OPTICAL INSTRUMENTS FOR USE IN INSPECTION AND MEASUREMENT OF INDUSTRIAL COMPONENTS AND MEASURING DEVICES AND FITTINGS FOR ANALYZING LIQUIDS, NAMELY, LIQUID ANALYZERS, ISOLATION AMPLIFIER, LIQUID LEVEL SENSORS; PARTS OF THE ABOVE-MENTIONED GOODS, ALL ABOVE-MENTIONED GOODS INCLUDED IN THIS CLASS, IN CLASS 9 (U.S. CLS. 21, 23, 26, 36 AND 38).

THE MARK CONSISTS OF STANDARD CHARACTERS WITHOUT CLAIM TO ANY PARTICULAR FONT, STYLE, SIZE, OR COLOR.

PRIORITY DATE OF 8-19-2010 IS CLAIMED.

OWNER OF INTERNATIONAL REGISTRATION 1071185 DATED 2-7-2011, EXPIRES 2-7-2021.

SER. NO. 79-095,130, FILED 2-7-2011.

APRIL HESIK, EXAMINING ATTORNEY



David J. Kyffers

Director of the United States Patent and Trademark Office

United States of America

United States Patent and Trademark Office

ICEPIPE

Reg. No. 4,107,334

Registered Mar. 6, 2012

Int. Cl.: 11

TRADEMARK

PRINCIPAL REGISTER

ZAONZI CO.,LTD. (REPUBLIC OF KOREA CORPORATION)
SUITE 1310
BYUCKSAN DIGITAL VALLEY 6-CHA., 481-4 GASAN-DONG, GEUMCHEON-GU; SEOUL
153-803
REPUBLIC OF KOREA

FOR: LIGHT EMITTING DIODES (LED) LIGHT BULBS, IN CLASS 11 (U.S. CLS. 13, 21, 23,
31 AND 34).

THE MARK CONSISTS OF THE WORDING "ICEPIPE" IN STYLIZED BLUE FONT.

OWNER OF INTERNATIONAL REGISTRATION 1071403 DATED 11-29-2010, EXPIRES 11-
29-2020.

THE COLOR(S) BLUE IS/ARE CLAIMED AS A FEATURE OF THE MARK.

SER. NO. 79-095,191, FILED 11-29-2010.

LIEF MARTIN, EXAMINING ATTORNEY



David J. Kyros

Director of the United States Patent and Trademark Office

United States of America
United States Patent and Trademark Office

CANTEO

Reg. No. 4,107,335

Registered Mar. 6, 2012

Int. Cl.: 10

TRADEMARK

PRINCIPAL REGISTER

BERNAFON AG (SWITZERLAND SOCIÉTÉ ANONYME (SA) / INCORPORATED COMPANY
UNDER THE LAWS OF SWITZERLAND)
MORGENSTRASSE 131
CH-3018 BERN
SWITZERLAND

FOR: HEARING AIDS, IN CLASS 10 (U.S. CLS. 26, 39 AND 44).

THE MARK CONSISTS OF STANDARD CHARACTERS WITHOUT CLAIM TO ANY PARTICULAR FONT, STYLE, SIZE, OR COLOR.

PRIORITY DATE OF 9-22-2010 IS CLAIMED.

OWNER OF INTERNATIONAL REGISTRATION 1071710 DATED 3-15-2011, EXPIRES 3-15-2021.

SER. NO. 79-095,279, FILED 3-15-2011.

ELIZABETH KAJUBI, EXAMINING ATTORNEY



David J. Kybas

Director of the United States Patent and Trademark Office

United States of America

United States Patent and Trademark Office

TCHERNOVAUDIO

Reg. No. 4,107,336

Registered Mar. 6, 2012

Int. Cls.: 9 and 35

TRADEMARK

SERVICE MARK

PRINCIPAL REGISTER

OBCHTCHESTVO S OGRANITCHENNOI OTVETSTVENNOSTYOU "TCHERNOV AODIO"
(RUSSIAN FED. OBSCHESTVO S OGRANICHENNOY OTVESTSTVENNOSTYU (OOO))
STR. 2, D. 30, OUL. 3-YA MAGISTRALNAYA
RU-123007 MOSKVA
RUSSIAN FED.

FOR: DVD PLAYERS; SOUND TRANSMITTING APPARATUS; SOCKETS, PLUGS AND OTHER CONTACTS, NAMELY ELECTRICAL SOCKETS AND PLUGS AND ELECTRIC CONTACTS; LOUDSPEAKERS; COAXIAL CABLES; FIBER OPTIC CABLES; CABLES, ELECTRIC; CONTACTS, ELECTRIC; CONTACTS, ELECTRIC, OF PRECIOUS METAL; CABINETS FOR LOUDSPEAKERS; SHEATHS FOR ELECTRIC CABLES; IDENTIFICATION SHEATHS FOR ELECTRIC WIRES; COMPACT DISC PLAYERS; CONVERTERS, ELECTRIC; AUDIO- AND VIDEO-RECEIVERS; WIRES, ELECTRIC; CONDUCTORS, ELECTRIC; COPPER WIRE, INSULATED; RECORD PLAYERS; PROCESSORS IN THE NATURE OF CENTRAL PROCESSING UNITS; COUPLINGS, ELECTRIC; ELECTRONIC TRANSISTORS; AMPLIFIERS; SOUND REPRODUCTION APPARATUS; ANTI-INTERFERENCE DEVICES, NAMELY, CONDUCTIVE SILICONE PACKING FOR ELECTRO-MAGNETIC INTERFERENCE; ELECTRONIC CHIPS FOR THE MANUFACTURE OF INTEGRATED CIRCUITS; ELECTRICAL DUCTS, IN CLASS 9 (U.S. CLS. 21, 23, 26, 36 AND 38).

FOR: DEMONSTRATION OF GOODS; COMMERCIAL INFORMATION AND ADVICE FOR CONSUMERS; PROFESSIONAL BUSINESS CONSULTANCY; LAYOUT SERVICES FOR ADVERTISING PURPOSES; ORGANIZATION OF EXHIBITIONS FOR COMMERCIAL OR ADVERTISING PURPOSES; PRESENTATION OF GOODS ON COMMUNICATION MEDIA, FOR RETAIL PURPOSES; AUCTIONEERING; SALES PROMOTION FOR OTHERS; PUBLICITY MATERIAL RENTAL; DISTRIBUTION OF SAMPLES; DISSEMINATION OF ADVERTISING MATTER; ADVERTISING SERVICES; ONLINE ADVERTISING ON A COMPUTER NETWORK; ADMINISTRATIVE PROCESSING OF PURCHASE ORDERS; PROCUREMENT SERVICES FOR OTHERS IN THE NATURE OF PURCHASING GOODS AND SERVICES FOR OTHER BUSINESSES, IN CLASS 35 (U.S. CLS. 100, 101 AND 102).



THE MARK CONSISTS OF THE WORDING "TCHERNOVAUDIO" IN STYLIZED FONT.

PRIORITY DATE OF 5-28-2010 IS CLAIMED.

OWNER OF INTERNATIONAL REGISTRATION 1072527 DATED 11-8-2010, EXPIRES 11-8-2020.

David J. Kyjars

Director of the United States Patent and Trademark Office

Reg. No. 4,107,336 THE WORDING "TCHERNOVAUDIO" HAS NO MEANING IN A FOREIGN LANGUAGE.

SER. NO. 79-095,561, FILED 11-8-2010.

KAREN SEVERSON, EXAMINING ATTORNEY

United States of America

United States Patent and Trademark Office

INSTANTILE

Reg. No. 4,107,337

Registered Mar. 6, 2012

Int. Cls.: 17 and 19

TRADEMARK

PRINCIPAL REGISTER

GRUPPO CONCORDE SPA (ITALY JOINT STOCK COMPANY)
VIA CANALETTO, 141
I-41042 SPEZZANO DI FIORANO (MO)
ITALY

FOR: INSULATING MATERIALS, INSULATING FLOOR COVERINGS, FLOOR TILE JOINT PRODUCTS CONSISTING OF RUBBER STRIPS TO PLACE BETWEEN FLOOR TILES, PLASTIC TILE SPACER FOR LAYING FLOOR, IN CLASS 17 (U.S. CLS. 1, 5, 12, 13, 35 AND 50).

FOR: NON-METALLIC RIGID PIPES FOR BUILDING; ASPHALT, PITCH AND BITUMEN; NON-METALLIC TRANSPORTABLE BUILDINGS; MONUMENTS, NOT OF METAL; NON-METAL TILES FOR FLOORS AND CLADDING; NON-METAL SWIMMING POOLS, IN CLASS 19 (U.S. CLS. 1, 12, 33 AND 50).

THE MARK CONSISTS OF STANDARD CHARACTERS WITHOUT CLAIM TO ANY PARTICULAR FONT, STYLE, SIZE, OR COLOR.

PRIORITY DATE OF 1-10-2011 IS CLAIMED.

OWNER OF INTERNATIONAL REGISTRATION 1072806 DATED 1-26-2011, EXPIRES 1-26-2021.

SER. NO. 79-095,687, FILED 1-26-2011.

MICHAEL WIENER, EXAMINING ATTORNEY



David J. Kyffers

Director of the United States Patent and Trademark Office

United States of America

United States Patent and Trademark Office



Reg. No. 4,107,338

Registered Mar. 6, 2012

Int. Cls.: 5, 29, 30 and 32

TRADEMARK

PRINCIPAL REGISTER

DAESANG CORPORATION (REPUBLIC OF KOREA CORPORATION)
96-48, SINSUL-DONG
DONGDAEMUN-KU, SEOUL
REPUBLIC OF KOREA

FOR: FOOD FOR BABIES EXCEPT FOR LACTEAL POWDER; DIETETIC FOODS ADAPTED FOR MEDICAL USE; DIETETIC BEVERAGES ADAPTED FOR MEDICAL USE; VITAMIN PREPARATIONS; MINERAL FOOD-SUPPLEMENTS, IN CLASS 5 (U.S. CLS. 6, 18, 44, 46, 51 AND 52).

FOR: PRESERVED VEGETABLES; COOKED VEGETABLES; DRIED VEGETABLES; TOFU; PRESERVED BEANS; MEAT; EGGS; PRESERVED MEAT; SAUSAGES; HAM; CANNED COOKED MEAT; CHEESE; MILK PRODUCTS EXCLUDING ICE CREAM, ICE MILK, AND FROZEN YOGURT; EDIBLE OILS; SOYBEAN OIL FOR FOOD; MAIZE OIL FOR FOOD; SESAME OIL FOR FOOD; OLIVE OIL FOR FOOD; FISH AND SHELLFISH, NOT LIVE, FOR FOOD; PROCESSED EDIBLE BROWN SEAWEED; TOASTED LAVENDER; PROCESSED ALGAE FOR HUMAN CONSUMPTION, NAMELY, CHLORELLA; PRESERVED FISH AND SHELLFISH FOR FOOD; PREPARED ENTREES CONSISTING PRIMARILY OF FISH; FERMENTED VEGETABLE FOODS, NAMELY, KIMCHI; WHITE-RADISH PICKLES HEAVILY SPICED WITH PEPPER AND GARLIC; JAMS; BACON; PREPARED ENTREES CONSISTING PRIMARILY OF MEAT; PROCESSED GINSENG FOR USE AS VEGETABLES; PREPARED WALNUT; SLICED VEGETABLES PRESERVED IN SOY SAUCE OR SOYBEAN PASTE; PRESERVED FISH, NAMELY, SALTED FISH; PICKLED RADISH; PREPARED ENTREES CONSISTING PRIMARILY OF VEGETABLES; FOOD PRODUCTS MADE FROM FRUITS, NAMELY, CRYSTALLIZED FRUIT, FROSTED FRUIT, STEWED FRUIT AND TINNED FRUIT; PORK CUTLETS; SOUPS, IN CLASS 29 (U.S. CL. 46).

FOR: FLOUR FOR FOOD; CORN STARCH FOR FOOD; SAGO PALM STARCH FOR FOOD; UNCOOKED ARTIFICIAL RICE; HUSKED BARLEY; CEREAL-BASED SNACK FOOD; NOODLES; PIZZAS; PASTA; CONFECTIONERY, NAMELY, PASTILLES AND CHIPS FOR BAKING; BREAD; CANDY FOR FOOD; CHOCOLATE; CAKES; SUGAR; HONEY; RICE CAKES; FERMENTED SOYBEAN PASTE FOR USE AS A CONDIMENT, NAMELY, KNOWN AS 'DOYN-JANG'; CHINESE SOYBEAN PASTE FOR USE AS A CONDIMENT, NAMELY, KNOWN AS 'CHUN-JANG'; SOYA SAUCE; FERMENTED HOT PEPPER PASTE FOR USE AS A CONDIMENT, NAMELY, KNOWN AS 'GOCHU-JANG'; FERMENTED SOYBEAN PASTE FOR USE AS A CONDIMENT, NAMELY, KNOWN AS 'CHONGGUG-JANG'; CHEMICAL SEASONINGS; MONOSODIUM GLUTAMATE AS A FLAVOR ENHANCER



David J. Kyjars

Director of the United States Patent and Trademark Office

Reg. No. 4,107,338 FOR FOOD; NUCLEIC ACID SEASONING; MAYONNAISE; VINEGAR; SAUCES, NAMELY, CONDIMENTS CONSISTING OF CHILI SAUCE, BACON SAUCE, SPAGHETTI SAUCE, STEAK SAUCE, OYSTER SAUCE, PORK CUTLETS SAUCE, SALAD SAUCES, AND MUSTARD DIPPING SAUCES; KETCHUP SAUCE; STARCH SYRUP FOR FOOD; RED PEPPER POWDER FOR USE AS A SEASONING; CURRY POWDER FOR USE AS A SPICE; GINGER FOR USE AS A SPICE; FLAVORINGS, OTHER THAN ESSENTIAL OILS; SEASONING SALT; COOKING SALT; TEA; COFFEE; TEA-BASED BEVERAGES; SALAD DRESSINGS; MUSTARD; DUMPLINGS; HOT DOG SANDWICHES; BARLEY TEA; COFFEE FLAVORED SYRUP USED IN MAKING FOOD BEVERAGES; PEPPER POWDER FOR USE AS A SPICE; RICE BASED SNACK FOOD; ICE CREAM; BISCUITS; INSTANT NOODLES; DRY CAKES; CHINESE NOODLES, UNCOOKED, NAMELY, KNOWN AS 'DANG-MYUN'; PREPARATIONS MADE FROM CEREALS, NAMELY, WHEAT BREAD; PROCESSED CEREALS; CEREAL-BASED PROCESSED PRODUCTS, NAMELY, SNACK FOODS AND ENERGY BARS; SPICES, IN CLASS 30 (U.S. CL. 46).

FOR: NON-ALCOHOLIC FRUIT JUICE BEVERAGES; NON-ALCOHOLIC FRUIT EXTRACTS USED IN THE PREPARATION OF BEVERAGES; APPLE JUICES FOR BEVERAGES; TOMATO JUICES FOR BEVERAGES; VEGETABLE JUICES FOR BEVERAGES; MINERAL WATER; DRINKING WATER FOR BEVERAGES; SYRUPS FOR BEVERAGES; NON-ALCOHOLIC BEVERAGES, NAMELY, VINEGAR FOR BEVERAGES; VEGETABLE OR FRUIT PROCESSED BEVERAGES, IN CLASS 32 (U.S. CLS. 45, 46 AND 48).

THE MARK CONSISTS OF THE WORD "DAESANG" IN GOLD TO THE RIGHT OF A DESIGN CONSISTING OF TWO GOLD TRIANGLES WITH ROUNDED SIDES. THE BACKGROUND OF THE MARK IS TRANSPARENT.

PRIORITY DATE OF 10-8-2010 IS CLAIMED.

OWNER OF INTERNATIONAL REGISTRATION 1072823 DATED 10-25-2010, EXPIRES 10-25-2020.

THE COLOR(S) GOLD IS/ARE CLAIMED AS A FEATURE OF THE MARK.

THE ENGLISH TRANSLATION OF "DAESANG" IN THE MARK IS "BIG ELEPHANT".

SER. NO. 79-095,692, FILED 10-25-2010.

ANDREA HACK, EXAMINING ATTORNEY

United States of America

United States Patent and Trademark Office

GREENSIDE

Reg. No. 4,107,339

Registered Mar. 6, 2012

Int. Cls.: 7 and 42

TRADEMARK

SERVICE MARK

PRINCIPAL REGISTER

WFL MILITURN TECHNOLOGIES GMBH & CO. KG (AUSTRIA LIMITED PARTNERSHIP)
WAHRINGERSTRASSE 36
A-4030 LINZ
AUSTRIA

FOR: MACHINES AND MACHINE TOOLS, AS WELL AS THEIR PARTS FOR CUTTING AND FORMING OF MATERIALS; MILLING, TURNING, AND DRILLING MACHINE AND CENTRES AND PARTS THEREOF; GRINDING MACHINES; MILLING-DRILLING MACHINES; LATHE CENTRES; MILLING CUTTERS; METALWORKING MACHINE TOOLS; MACHINES AND MACHINE TOOLS WITH REDUCED AND/OR OPTIMIZED ENERGY CONSUMPTION FOR CUTTING AND FORMING OF MATERIALS, IN CLASS 7 (U.S. CLS. 13, 19, 21, 23, 31, 34 AND 35).

FOR: COMPUTER PROGRAMMING FOR THE OPERATION AND THE FUNCTIONING OF MACHINES AND MACHINE TOOLS, ESPECIALLY ACCOUNTING FOR ASPECTS OF A REDUCED AND/OR OPTIMIZED ENERGY CONSUMPTION; SCIENTIFIC RESEARCH, AND TECHNOLOGICAL CONSULTING AND RESEARCH IN THE FIELD OF OPTIMIZING AND/OR REDUCTION OF THE CONSUMPTION OF ENERGY WITH MACHINES AND MACHINE TOOLS, IN CLASS 42 (U.S. CLS. 100 AND 101).

THE MARK CONSISTS OF STANDARD CHARACTERS WITHOUT CLAIM TO ANY PARTICULAR FONT, STYLE, SIZE, OR COLOR.

PRIORITY DATE OF 7-9-2010 IS CLAIMED.

OWNER OF INTERNATIONAL REGISTRATION 1072957 DATED 1-7-2011, EXPIRES 1-7-2021.

SER. NO. 79-095,755, FILED 1-7-2011.

CARYN GLASSER, EXAMINING ATTORNEY



David J. Kyffers

Director of the United States Patent and Trademark Office

United States of America

United States Patent and Trademark Office



Reg. No. 4,107,340

Registered Mar. 6, 2012

Int. Cl.: 30

TRADEMARK

PRINCIPAL REGISTER

LA MAISON DU CHOCOLAT (FRANCE SOCIÉTÉ PAR ACTIONS SIMPLIFIÉE)
41/43 RUE PAUL LESCOPI
F-92000 NANTERRE
FRANCE

FOR: COFFEE; COCOA; ARTIFICIAL COFFEE; PASTRY; CONFECTIONERY, NAMELY, CHOCOLATES AND CANDY; EDIBLE ICES; COOKIES; CAKES; RUSKS; SUGAR CONFECTIONERY; CHOCOLATE; CHOCOLATE PRODUCTS, NAMELY, CHOCOLATE BARS AND CHOCOLATE CANDIES; COCOA-BASED BEVERAGES, COFFEE-BASED BEVERAGES, CHOCOLATE FOOD BEVERAGES NOT BEING DAIRY-BASED OR VEGETABLE BASED, IN CLASS 30 (U.S. CL. 46).

OWNER OF U.S. REG. NOS. 1,302,946, 2,326,518, AND 2,928,665.

PRIORITY DATE OF 9-13-2010 IS CLAIMED.

OWNER OF INTERNATIONAL REGISTRATION 1073357 DATED 3-8-2011, EXPIRES 3-8-2021.

NO CLAIM IS MADE TO THE EXCLUSIVE RIGHT TO USE "CHOCOLAT", APART FROM THE MARK AS SHOWN.

THE MARK CONSISTS OF AN ELONGATED SOLID RECTANGLE WITH A DESIGN OF A METATE FOLLOWED BY THE WORDING "LA MAISON DU CHOCOLAT," FOLLOWED BY ANOTHER METATE, FOLLOWED BY THE WORDING "LA MAISON DU CHOCOLAT," FOLLOWED BY ANOTHER METATE.

THE ENGLISH TRANSLATION OF "LA MAISON DU CHOCOLAT" IN THE MARK IS "THE HOUSE OF CHOCOLATE".

SER. NO. 79-095,890, FILED 3-8-2011.

COLLEEN KEARNEY, EXAMINING ATTORNEY



David J. Kyffers

Director of the United States Patent and Trademark Office

United States of America

United States Patent and Trademark Office



Reg. No. 4,107,341

Registered Mar. 6, 2012

Int. Cls.: 18 and 28

TRADEMARK

PRINCIPAL REGISTER

SUNBUM TECHNOLOGIES PTY LTD (AUSTRALIA CORPORATION)
5-7 BY THE SEA ROAD
MONA VALE NSW 2103
AUSTRALIA

FOR: LUGGAGE AND BAGS, NAMELY, TRAVEL BAGS, OVERNIGHT BAGS, SACHELS, COMPUTERS BAGS, BEACH BAGS AND SHOULDER BAGS; BACKPACKS AND RUCK-SACKS; WALLETS, NAMELY, WALLETS FOR MONEY; PURSES; COSMETIC BAGS AND CASES SOLD EMPTY; UMBRELLAS, IN CLASS 18 (U.S. CLS. 1, 2, 3, 22 AND 41).

FOR: SPORTING APPARATUS AND EQUIPMENT, NAMELY, APPARATUS AND EQUIPMENT FOR WATER SPORTS, SNOW SPORTS AND SKATE SPORTS, NAMELY, SURFBOARDS, SURF SKIS, WATER SKIS, SAILBOARDS, SNOW SKIS, SNOWBOARDS AND SKATEBOARDS; PARTS AND ACCESSORIES FOR SURFBOARDS, SURF SKIS, WATER SKIS AND SAILBOARDS, NAMELY, WAX COMBS, FIN PLUG KEYS FOR SECURING FINS TO FIN PLUGS, WALLETS ESPECIALLY DESIGNED FOR SURFBOARD FINS, LEASHES FOR SURFBOARDS AND COVERS FOR SURFBOARDS, SURF SKIS, WATER SKIS AND SAILBOARDS; FINS AND FIN ATTACHMENT DEVICES FOR SURFBOARDS, SURF SKIS, WATER SKIS AND SAILBOARDS; GRIP MATERIAL FOR SURFING, SAILING, SAILBOARDING AND BOATING PURPOSES, NAMELY, WAX FOR SURFBOARDS AND SAILBOARDS AND DECK GRIP FOR SURFBOARDS AND SAILBOARDS; BAGS ESPECIALLY DESIGNED FOR SURFBOARDS, SURF SKIS, WATER SKIS, BODY BOARDS, SAILBOARDS, SNOW SKIS AND SAILBOARDS, IN CLASS 28 (U.S. CLS. 22, 23, 38 AND 50).

THE MARK CONSISTS OF A PENTAGON ENCOMPASSING THREE CIRCLES IN A TRIANGULAR FORMATION.

PRIORITY DATE OF 11-23-2010 IS CLAIMED.

OWNER OF INTERNATIONAL REGISTRATION 1073528 DATED 12-17-2010, EXPIRES 12-17-2020.

SER. NO. 79-095,988, FILED 12-17-2010.

TASNEEM HUSSAIN, EXAMINING ATTORNEY



David J. Kyros

Director of the United States Patent and Trademark Office

United States of America
United States Patent and Trademark Office

Rollermate

Reg. No. 4,107,342

Registered Mar. 6, 2012

Int. Cl.: 10

TRADEMARK

PRINCIPAL REGISTER

JESPER SIGBJÖRNSSON (SWEDEN INDIVIDUAL)
KUNGSGATAN 20
VÄNNÄS, SWEDEN SE911 32

FOR: CRUTCHES; WALKING AIDS FOR MEDICAL PURPOSES; INVALID WALKERS, IN CLASS 10 (U.S. CLS. 26, 39 AND 44).

THE MARK CONSISTS OF STANDARD CHARACTERS WITHOUT CLAIM TO ANY PARTICULAR FONT, STYLE, SIZE, OR COLOR.

OWNER OF INTERNATIONAL REGISTRATION 1073790 DATED 3-23-2011, EXPIRES 3-23-2021.

SER. NO. 79-096,112, FILED 3-23-2011.

DAVID HOFFMAN, EXAMINING ATTORNEY



David J. Kyfos

Director of the United States Patent and Trademark Office

United States of America

United States Patent and Trademark Office

結

Reg. No. 4,107,343

Registered Mar. 6, 2012

Int. Cl.: 33

TRADEMARK

PRINCIPAL REGISTER

TSUJIMOTO KENZO (JAPAN INDIVIDUAL)
2-15, EGANOSHO 5-CHOME
HABIKINO-SHI; OSAKA 583-0886
JAPAN

FOR: ROSE WINE; WINE; ALCOHOLIC FRUIT BEVERAGES; WESTERN LIQUORS IN GENERAL, IN CLASS 33 (U.S. CLS. 47 AND 49).

PRIORITY DATE OF 8-9-2010 IS CLAIMED.

OWNER OF INTERNATIONAL REGISTRATION 1074154 DATED 2-7-2011, EXPIRES 2-7-2021.

THE NON-LATIN CHARACTERS IN THE MARK TRANSLITERATE TO "YUI" AND THIS MEANS SUCH AS "DOING ONE'S (OR SOMEONE'S) HAIR", "TYING", "BINDING", OR "CONNECTION" IN ENGLISH.

SER. NO. 79-096,268, FILED 2-7-2011.

DEBRA LEE, EXAMINING ATTORNEY



David J. Kybas

Director of the United States Patent and Trademark Office

United States of America

United States Patent and Trademark Office



Reg. No. 4,107,344

Registered Mar. 6, 2012

Int. Cls.: 19 and 37

TRADEMARK

SERVICE MARK

PRINCIPAL REGISTER

LA FABBRICA S.P.A. (ITALY JOINT STOCK COMPANY)
VIA EMILIA PONENTE, 925
I-48014 CASTEL BOLOGNESE (RA)
ITALY

FOR: CERAMIC TILES, MAJOLICA TILE, PORCELAIN TILES; STONEWARE TILES FOR FLOORING AND WALL TILES; CERAMIC TILES AND PANELS FOR URBAN DEVELOPMENT; CERAMIC TILES AND PANELS FOR WOOD AND MARBLE FURNITURE, IN CLASS 19 (U.S. CLS. 1, 12, 33 AND 50).

FOR: BUILDING CONSTRUCTION AND REPAIR; INSTALLATION OF TILE, IN CLASS 37 (U.S. CLS. 100, 103 AND 106).

NO CLAIM IS MADE TO THE EXCLUSIVE RIGHT TO USE "LA FABBRICA", "CERAMICHE" AND "S.P.A.", APART FROM THE MARK AS SHOWN.

PRIORITY DATE OF 2-15-2011 IS CLAIMED.

OWNER OF INTERNATIONAL REGISTRATION 1074627 DATED 2-22-2011, EXPIRES 2-22-2021.

THE MARK CONSISTS OF THE STYLIZED WORDING "LA FABBRICA CERAMICHE S.P.A." APPEARING ON A STYLIZED STREET SIGN DESIGN.

THE ENGLISH TRANSLATION OF "LA FABBRICA CERAMICHE" IN THE MARK IS THE CERAMIC FACTORY.

SER. NO. 79-096,454, FILED 2-22-2011.

ELI HELLMAN, EXAMINING ATTORNEY



David J. Kybas

Director of the United States Patent and Trademark Office

United States of America

United States Patent and Trademark Office

人头马

Reg. No. 4,107,345

Registered Mar. 6, 2012

Int. Cl.: 33

TRADEMARK

PRINCIPAL REGISTER

E. REMY MARTIN & C° (FRANCE SOCIETE PAR ACTIONS SIMPLIFIEE)
20, RUE DE LA SOCIÉTÉ VINICOLE
F-16100 COGNAC
FRANCE

FOR: ALCOHOLIC BEVERAGES, EXCEPT BEER, IN CLASS 33 (U.S. CLS. 47 AND 49).

PRIORITY DATE OF 2-10-2011 IS CLAIMED.

OWNER OF INTERNATIONAL REGISTRATION 1075081 DATED 3-30-2011, EXPIRES 3-30-2021.

THE NON-LATIN CHARACTERS IN THE MARK TRANSLITERATE TO REN TOU MA AND THIS MEANS "CENTAUR" IN ENGLISH.

SER. NO. 79-096,651, FILED 3-30-2011.

LIEF MARTIN, EXAMINING ATTORNEY



David J. Kyros

Director of the United States Patent and Trademark Office

United States of America
United States Patent and Trademark Office

ABDS

Reg. No. 4,107,346

Registered Mar. 6, 2012

Int. Cls.: 6, 12, 13 and 17

TRADEMARK

PRINCIPAL REGISTER

KONINKLIJKE TEN CATE N.V. (NETHERLANDS NAAMLOZE VENNOOTSCHAP)
WIERDENSESTRAAT 40
NL-7607 GJ ALMELO
NETHERLANDS

FOR: ARMOUR PLATE; ARMOUR PLATING, IN CLASS 6 (U.S. CLS. 2, 12, 13, 14, 23, 25 AND 50).

FOR: LAND VEHICLES, IN CLASS 12 (U.S. CLS. 19, 21, 23, 31, 35 AND 44).

FOR: FIREARMS; AMMUNITION AND PROJECTILES; EXPLOSIVES; FIREWORKS, IN CLASS 13 (U.S. CLS. 2 AND 9).

FOR: SEMI-FINISHED PRODUCTS, NAMELY, PLATES, SHIELDS, SHEETS AND PANELS MADE OF PLASTIC COMPOSITE MATERIALS OR PLASTIC FIBERS FOR USE IN MANUFACTURE AND ARMOURING, NOT INCLUDED IN OTHER CLASSES, IN CLASS 17 (U.S. CLS. 1, 5, 12, 13, 35 AND 50).

THE MARK CONSISTS OF STANDARD CHARACTERS WITHOUT CLAIM TO ANY PARTICULAR FONT, STYLE, SIZE, OR COLOR.

PRIORITY DATE OF 9-23-2010 IS CLAIMED.

OWNER OF INTERNATIONAL REGISTRATION 1075214 DATED 3-17-2011, EXPIRES 3-17-2021.

THE WORDING "ABDS" HAS NO MEANING IN A FOREIGN LANGUAGE.

SER. NO. 79-096,701, FILED 3-17-2011.

DORITT L. CARROLL, EXAMINING ATTORNEY



David J. Kypos

Director of the United States Patent and Trademark Office

United States of America

United States Patent and Trademark Office

Sustain4

Reg. No. 4,107,347

Registered Mar. 6, 2012

Int. Cls.: 9, 38 and 42

UNIT4 BUSINESS SOFTWARE HOLDING B.V. (NETHERLANDS LIMITED LIABILITY COMPANY)
STATIONSPARK 1000
NL-3364 DA SLIEDRECHT
NETHERLANDS

TRADEMARK

SERVICE MARK

PRINCIPAL REGISTER

FOR: COMPUTER PROGRAMS RECORDED ON DATA MEDIA DESIGNED FOR USE IN BUSINESS FOR GIVING INSIGHT IN ENVIRONMENTAL PERFORMANCE AND IMPACT IN THE ORGANIZATION'S SUPPLY CHAIN AROUND SPECIFICALLY GREENHOUSE GAS EMISSIONS, AIR POLLUTANTS, NATURAL RESOURCE USAGE, WATER CONSUMPTION, WASTE AND LAND AND WATER POLLUTANTS; BLANK MAGNETIC DATA CARRIERS, PRERECORDED MAGNETIC DATA CARRIERS FEATURING ENTERPRISE RESOURCE PLANNING SOFTWARE, IN CLASS 9 (U.S. CLS. 21, 23, 26, 36 AND 38).

FOR: TELECOMMUNICATION SERVICES, NAMELY, ELECTRONIC TRANSMISSION AND RETRIEVAL OF DATA, IMAGES, AUDIO, VIDEO AND DOCUMENTS, AS WELL AS ELECTRONIC TRANSMISSION OF COMPUTER SOFTWARE, OVER LOCAL OR GLOBAL COMMUNICATIONS NETWORKS, INCLUDING THE INTERNET, INTRANETS, EXTRANETS, TELEVISION, MOBILE COMMUNICATION, CELLULAR AND SATELLITE NETWORKS, IN CLASS 38 (U.S. CLS. 100, 101 AND 104).

FOR: COMPUTERIZATION SERVICES, NAMELY, COMPUTER PROGRAMMING; DESIGNING AND WRITING OF COMPUTER SOFTWARE; CONSULTANCY ON COMPUTERIZATION AND COMPUTER PROGRAMMING; INSTALLATION, IMPLEMENTATION AND MAINTENANCE OF COMPUTER SOFTWARE, IN CLASS 42 (U.S. CLS. 100 AND 101).

THE MARK CONSISTS OF STANDARD CHARACTERS WITHOUT CLAIM TO ANY PARTICULAR FONT, STYLE, SIZE, OR COLOR.

PRIORITY DATE OF 7-5-2010 IS CLAIMED.

OWNER OF INTERNATIONAL REGISTRATION 1075531 DATED 10-14-2010, EXPIRES 10-14-2020.

SER. NO. 79-096,816, FILED 10-14-2010.

BRIAN PINO, EXAMINING ATTORNEY



David J. Kyros

Director of the United States Patent and Trademark Office

United States of America

United States Patent and Trademark Office

INFALOK

Reg. No. 4,107,348

Registered Mar. 6, 2012

Int. Cl.: 6

AVDEL UK LIMITED (UNITED KINGDOM LIMITED COMPANY (LTD.))
PACIFIC HOUSE, 2 SWIFTFIELDS
WATCHMEAD INDUSTRIAL ESTATE., WELWYN GARDEN CITY; HERTFORDSHIRE AL7
ILY
UNITED KINGDOM

TRADEMARK

PRINCIPAL REGISTER

FOR: BOLTING DEVICES CONSISTING OF PINS, STUMPS AND COLLARS, ALL OF COMMON METAL; PEGS AND RIVETS OF COMMON METAL; FASTENERS MADE PRE-DOMINANTLY OF COMMON METALS AND PARTS THEREOF, NAMELY, THREADED FASTENERS, THREADED INSERTS, ANCHORS, BOLTS, PINS, PIVOTS, RIVETS, SCREWS, WASHERS, BUSHES; FASTENINGS, NAMELY, PIN AND SWAGED COLLAR LOCKBOLT METAL FASTENERS; FASTENING DEVICES WHOLLY OR PRINCIPALLY OF METAL, IN THE FORM OF RIVETS, BOLTS AND SCREWS AS WELL AS PARTS THEREOF; BOLTS, PINS, RIVETS, HOLLOW RIVETS, SCREWS, NUTS FOR THE FIXED OR RELEASABLE CONNECTION BETWEEN PLATES AND STRUCTURAL PARTS ALL OF METAL; LOCKING BOLTS, COLLARS FOR USE ON THREADED FASTENERS, COLLARS FOR USE ON BOLTS AND SCREWS, PLATES BEING PIECES OF METAL THAT ARE SWAGED TOGETHER BY THE AFOREMENTIONED FASTENING DEVICE, LOCK WASHERS, SLEEVES FOR USE ON THREADED FASTENERS, SLEEVES FOR USE ON BOLTS AND SCREWS, PIVOT OR SCREW RINGS, PIN AND COLLAR LOCKBOLT FASTENERS, ALL AFOREMENTIONED GOODS MADE FROM STEEL OR METAL, IN CLASS 6 (U.S. CLS. 2, 12, 13, 14, 23, 25 AND 50).

THE MARK CONSISTS OF STANDARD CHARACTERS WITHOUT CLAIM TO ANY PARTICULAR FONT, STYLE, SIZE, OR COLOR.

PRIORITY DATE OF 11-24-2010 IS CLAIMED.

OWNER OF INTERNATIONAL REGISTRATION 1075704 DATED 1-14-2011, EXPIRES 1-14-2021.

SER. NO. 79-096,873, FILED 1-14-2011.

APRIL ROACH, EXAMINING ATTORNEY



David J. Kyros

Director of the United States Patent and Trademark Office

United States of America

United States Patent and Trademark Office

EMPERTECH

Reg. No. 4,107,349

Registered Mar. 6, 2012

Int. Cl.: 9

LIFE SAFETY A/V (GUANGZHOU) CO., LTD (CHINA LIMITED COMPANY)
FLOOR 1 & 2, THE THIRD BUILDING, #257,
JUNYE ROAD, EAST SECTION, GUANGZHOU; ECONOMIC AND TECHNOLOGY
DEVELOPMENT; DISTRICT, GUANGZHOU; 510000 GUANGDONG PROVINCE
CHINA

TRADEMARK

PRINCIPAL REGISTER

FOR: ACOUSTIC CONDUITS; CABINETS FOR LOUDSPEAKERS; DIAPHRAGMS FOR ACOUSTICS, NAMELY, AUDIO SPEAKERS; MICROPHONES; HORNS FOR LOUDSPEAKERS; SOUND TRANSMITTING APPARATUS; ACOUSTIC COUPLERS; ELECTRONIC TRANSISTORS, NAMELY, TRANSISTORS; INTEGRATED CIRCUITS; LIGHT DIMMERS, ELECTRIC, NAMELY, ELECTRIC LIGHT DIMMERS, IN CLASS 9 (U.S. CLS. 21, 23, 26, 36 AND 38).

PRIORITY DATE OF 10-28-2010 IS CLAIMED.

OWNER OF INTERNATIONAL REGISTRATION 1075733 DATED 4-11-2011, EXPIRES 4-11-2021.

SER. NO. 79-096,883, FILED 4-11-2011.

MATTHEW EINSTEIN, EXAMINING ATTORNEY



David J. Kyfos

Director of the United States Patent and Trademark Office

United States of America

United States Patent and Trademark Office

ITALIAN KISS

Reg. No. 4,107,350

Registered Mar. 6, 2012

Int. Cl.: 33

CONSORZIO COOPERATIVE RIUNITE D'ABRUZZO - SOCIETA' COOPERATIVA (ITALY
COOPERATIVE SOCIETY ITALY)
CONTRADA CUCULLO
I-66026 ORTONA (CH)
ITALY

TRADEMARK

FOR: WINES AND ALCOHOLIC BEVERAGES EXCEPT BEERS, IN CLASS 33 (U.S. CLS. 47
AND 49).

PRINCIPAL REGISTER

THE MARK CONSISTS OF STANDARD CHARACTERS WITHOUT CLAIM TO ANY PAR-
TICULAR FONT, STYLE, SIZE, OR COLOR.

PRIORITY DATE OF 3-8-2011 IS CLAIMED.

OWNER OF INTERNATIONAL REGISTRATION 1075778 DATED 3-25-2011, EXPIRES 3-25-
2021.

NO CLAIM IS MADE TO THE EXCLUSIVE RIGHT TO USE "ITALIAN", APART FROM THE
MARK AS SHOWN.

SER. NO. 79-096,896, FILED 3-25-2011.

ALICE BENMAMAN, EXAMINING ATTORNEY



David J. Kyffers

Director of the United States Patent and Trademark Office

United States of America

United States Patent and Trademark Office



CANTINA
NOVELLI

Reg. No. 4,107,351

Registered Mar. 6, 2012

Int. Cls.: 33 and 43

TRADEMARK

SERVICE MARK

PRINCIPAL REGISTER

CANTINE NOVELLI S.R.L. (ITALY S.R.L.)
VIA DEL COMMERCIO 32
TERNI, ITALY I05100 05

FOR: ALCOHOLIC BEVERAGES EXCEPT BEERS, IN CLASS 33 (U.S. CLS. 47 AND 49).

FOR: PROVIDING OF FOOD AND DRINK, IN CLASS 43 (U.S. CLS. 100 AND 101).

NO CLAIM IS MADE TO THE EXCLUSIVE RIGHT TO USE "CANTINA", APART FROM THE MARK AS SHOWN.

OWNER OF INTERNATIONAL REGISTRATION 1075849 DATED 10-25-2010, EXPIRES 10-25-2020.

THE MARK CONSISTS OF THE WORDING "CANTINA NOVELLI" STYLIZED WITH TWO INVERTED CURVED LINES ABOVE.

THE ENGLISH TRANSLATION OF "CANTINA" IN THE MARK IS WINERY.

SER. NO. 79-096,919, FILED 10-25-2010.

ALICE BENMAMAN, EXAMINING ATTORNEY



David J. Kybas

Director of the United States Patent and Trademark Office

United States of America

United States Patent and Trademark Office



Reg. No. 4,107,352

Registered Mar. 6, 2012

Int. Cls.: 29 and 30

TRADEMARK

PRINCIPAL REGISTER

I.F.F. SPA (ITALIAN FRESH FOODS) (ITALY S.P.A.)
VIA NOVARA, 160
I-28062 CAMERI (NO)
ITALY

FOR: DAIRY PRODUCTS EXCLUDING ICE CREAM, ICE MILK AND FROZEN YOGURT; CHEESE; EGGS; FOODSTUFFS IN WHICH DAIRY PRODUCTS AND/OR CHEESE AND/OR EGGS PREDOMINATE, NAMELY, DAIRY-BASED SNACK FOODS EXCLUDING ICE CREAM, ICE MILK AND FROZEN YOGURT, IN CLASS 29 (U.S. CL. 46).

FOR: PASTRY; CONFECTIONERY, NAMELY, PASTILLES, CHOCOLATE CONFECTIONS, FROZEN CONFECTIONS, CONFECTIONERY MADE OF SUGAR, ICE CREAM, ICE MILK AND FROZEN YOGURT; EDIBLE ICES, IN CLASS 30 (U.S. CL. 46).

NO CLAIM IS MADE TO THE EXCLUSIVE RIGHT TO USE "CLASSICI DESSERT ITALINI AND DOLCE AND ITALIA" , APART FROM THE MARK AS SHOWN.

OWNER OF INTERNATIONAL REGISTRATION 0673092 DATED 4-7-1997, EXPIRES 4-7-2017.

THE MARK CONSISTS OF AN OVAL AROUND THE WORDING "DOLCE ITALIA CLASSICI DESSERT ITALIANI", TO THE RIGHT OF WHICH ARE THREE, SLANTED RECTANGLES.

THE ENGLISH TRANSLATION OF "CLASSICI DESSERT ITALINI, DOLCE, ITALIA" IN THE MARK IS CLASSIC ITALIAN DESSERT, SWEET, ITALY.

SER. NO. 79-096,966, FILED 2-4-2011.

NAPOLEON SHARMA, EXAMINING ATTORNEY



David J. Kybas

Director of the United States Patent and Trademark Office

United States of America

United States Patent and Trademark Office

PSB

Reg. No. 4,107,353

Registered Mar. 6, 2012

Int. Cl.: 10

TRADEMARK

PRINCIPAL REGISTER

NEA INTERNATIONAL B.V. (NETHERLANDS BESLOTEN VENNOOTSCHAP (B.V.))
EUROPALAAN 31
AB MAASTRICHT, NETHERLANDS NL6199

FOR: ORTHOPAEDIC ARTICLES, NAMELY, ORTHOPEDIC KNEE AND WRIST BANDAGES, ORTHOPEDIC CUSHIONS AND PADDINGS, AND ORTHOPEDIC SOLES; ORTHOSES, NAMELY, ORTHOTICS FOR THE FEET, BACK SUPPORTS FOR MEDICAL PURPOSES; BANDAGES, NAMELY, ORTHOPEDIC SUPPORT BANDAGES; ORTHOPAEDIC BANDAGES, NAMELY, COMPRESSION AND SUPPORT BANDAGES; BANDS FOR MEDICAL USE, NAMELY, ORTHOPAEDIC KNEE SUPPORT BANDS; ELASTIC BANDAGES; ARTIFICIAL LIMBS, EYES AND TEETH, IN CLASS 10 (U.S. CLS. 26, 39 AND 44).

OWNER OF U.S. REG. NO. 2,608,797.

OWNER OF INTERNATIONAL REGISTRATION 0745772 DATED 8-18-2000, EXPIRES 8-18-2020.

SER. NO. 79-096,967, FILED 9-16-2010.

APRIL ROACH, EXAMINING ATTORNEY



David J. Kyffers

Director of the United States Patent and Trademark Office

United States of America

United States Patent and Trademark Office



Ramatuelle

Reg. No. 4,107,354

Registered Mar. 6, 2012

Int. Cls.: 21, 24 and 25

TRADEMARK

PRINCIPAL REGISTER

VEDA BEHEER B.V. (NETHERLANDS BESLOTEN VENNOOTSCHAP)
LISSERDIJK 48
BUITENKAAG, NETHERLANDS NL2158 LV

FOR: HOUSEHOLD OR KITCHEN UTENSILS, NAMELY, CREAM AND SUGAR SETS, SALT AND PEPPER MILLS, AND PLASTIC STORAGE CONTAINERS FOR FOOD FOR HOUSEHOLD USE; EARTHENWARE AND PORCELAIN DINNERWARE AND CHINAWARE, NAMELY, PLATES, CUPS AND SAUCERS, CREAM AND SUGAR SETS, SALT AND PEPPER SETS, TEA POTS, AND STORAGE CONTAINERS FOR FOOD FOR HOUSEHOLD USE, IN CLASS 21 (U.S. CLS. 2, 13, 23, 29, 30, 33, 40 AND 50).

FOR: TEXTILES, NAMELY, TEXTILE PLACEMATS, TEXTILE TABLECLOTHS, NAPKINS, THROWS, PILLOWCOVERS, IN CLASS 24 (U.S. CLS. 42 AND 50).

FOR: CLOTHING, NAMELY, DRESSES, TEE SHIRTS, BIKINIS, SWIM TRUNKS, SWEAT-SHIRTS; FOOTWEAR, NAMELY, SLIPPERS, SANDALS, IN CLASS 25 (U.S. CLS. 22 AND 39).

THE MARK CONSISTS OF THE STYLIZED WORDING "RAMATUELLE" UNDER FIVE FIVE-POINTED STARS.

PRIORITY DATE OF 11-2-2010 IS CLAIMED.

OWNER OF INTERNATIONAL REGISTRATION 1076214 DATED 3-24-2011, EXPIRES 3-24-2021.

SER. NO. 79-097,044, FILED 3-24-2011.

TASNEEM HUSSAIN, EXAMINING ATTORNEY



David J. Kybas

Director of the United States Patent and Trademark Office

United States of America

United States Patent and Trademark Office

ZAPAPA

Reg. No. 4,107,355

Registered Mar. 6, 2012

Int. Cls.: 9 and 41

TRADEMARK

SERVICE MARK

PRINCIPAL REGISTER

SPIL GAMES INTANGIBLES B.V. (NETHERLANDS BV)
ARENDSSTRAAT 23
RE HILVERSUM, NETHERLANDS NL1223

FOR: COMPUTERS AND PERIPHERAL EQUIPMENT THEREFOR, AUXILIARY EQUIPMENT AND ACCESSORIES, NAMELY, MONITORS, DISK DRIVES, PRINTERS, WRITERS, RECORDERS, DRAWING TABLETS, KEYBOARDS AND REMOTE CONTROL EQUIPMENT, NAMELY, INTERACTIVE CONTROL FLOOR PADS OR MATS, COMPUTER GAME INTERACTIVE REMOTE CONTROL UNITS, COMPUTER GAME INTERACTIVE HAND HELD REMOTE CONTROLS FOR PLAYING ELECTRONIC GAMES; REGISTERED PRE-RECORDED COMPUTER PROGRAMS, NAMELY, COMPUTER PROGRAMS AND SOFTWARE FOR GAMES AND GAMING, THAT MAY BE DOWNLOADED VIA COMPUTER NETWORKS AND ELECTRONIC SOCIAL NETWORKS; DATA CARRIERS, IMAGE AND SOUND CARRIERS FEATURING COMPUTER VIDEO GAMES; CD-ROM PRE-RECORDED REGISTERED SOFTWARE FOR COMPUTER GAMES; COMPUTER GAMING DEVICES, NAMELY, CD ROM COMPUTER GAME HARDWARE AND CONTROLLING AND OPERATING PANELS THEREFOR; APPARATUS FOR RECORDING, TRANSMITTING OR REPRODUCING SOUND OR IMAGES; PRE-RECORDED ELECTRONIC, OPTICAL AND MAGNETIC DATA CARRIERS, AND RECORDING DISCS FEATURING COMPUTER GAMES; AUTOMATIC VENDING MACHINES AND MECHANISMS FOR COIN-OPERATED APPARATUS; CALCULATORS, DATA PROCESSING EQUIPMENT AND COMPUTERS; VIDEO GAMES SOFTWARE FOR PERSONAL USE; BLANK ELECTRONIC DATA CARRIERS, OPTICAL DATA CARRIERS, MAGNETIC DISCS AND ROM CASSETTES FOR THE STORAGE OF VIDEO GAMES; COMPUTER PROGRAMS FOR PLAYING ELECTRONIC GAMES FOR PERSONAL USE; JOYSTICKS AND PARTS OF COMPUTER GAME CONSOLES, NAMELY, CONTROLLERS, DISPLAYS, BUTTON PANELS, BOLSTERS, ELECTRICAL WIRING, AND COMPUTER HARDWARE AND OPERATING SOFTWARE ASSOCIATED THEREWITH; PORTABLE HAND-HELD GAMING UNITS FOR PLAYING GAMES ADAPTED FOR USE ON LCD SCREENS; BLANK ROM CASSETTES FOR THE RECORDING OF PROGRAMS AND OTHER PERIPHERAL DEVICES FOR PORTABLE GAMING APPARATUS FOR USE ON LCD, NAMELY, CONTROLLERS, DISPLAYS, BUTTON PANELS, BOLSTERS, ELECTRICAL WIRING, AND COMPUTER HARDWARE AND OPERATING SOFTWARE ASSOCIATED THEREWITH; GAMING DEVICES, NAMELY, VIDEO GAME CARTRIDGES AND DISCS AND CASSETTES, VIDEO GAME CONSOLES FOR USE WITH AN EXTERNAL DISPLAY SCREEN OR MONITOR, VIDEO GAME DISCS, VIDEO GAME INTERACTIVE CONTROL FLOOR PADS OR MATS, VIDEO GAME INTERACTIVE REMOTE CONTROL UNITS, VIDEO GAME INTERACTIVE HAND HELD REMOTE CONTROLS FOR PLAYING ELECTRONIC



David J. Kyffers

Director of the United States Patent and Trademark Office

Reg. No. 4,107,355 GAMES, VIDEO GAME JOYSTICKS, VIDEO GAME MACHINES FOR USE WITH TELEVISIONS, VIDEO GAME MACHINES FOR USE WITH EXTERNAL DISPLAY SCREEN OR MONITOR, IN CLASS 9 (U.S. CLS. 21, 23, 26, 36 AND 38).

FOR: ENTERTAINMENT, NAMELY, ENTERTAINMENT VIA INTERNET AND SOCIAL NETWORKS AVAILABLE ON INTERNET, NAMELY, PROVIDING NON-DOWNLOADABLE GAMES FOR ONLINE GAMING AND ENTERTAINMENT SERVICES CONSISTING OF PROVIDING TEMPORARY USE OF NON-DOWNLOADABLE INTERACTIVE GAMES; ONLINE SERVICES FOR GAMES AND GAMING, NAMELY, PROVIDING ONLINE COMPUTER GAMES AND ONLINE CASINO GAMING; ONLINE ENTERTAINMENT SERVICES, NAMELY, ARRANGING AND CONDUCTING TOURNAMENTS, CHAMPIONSHIPS, VIRTUAL REALITY SPORTS AND COMPETITION OF GAMES, WHERE PLAYERS PLAY AGAINST EACH OTHER ONLINE, IN CLASS 41 (U.S. CLS. 100, 101 AND 107).

THE MARK CONSISTS OF STANDARD CHARACTERS WITHOUT CLAIM TO ANY PARTICULAR FONT, STYLE, SIZE, OR COLOR.

OWNER OF INTERNATIONAL REGISTRATION 1076579 DATED 8-12-2010, EXPIRES 8-12-2020.

THE WORDING "ZAPAPA" HAS NO MEANING IN A FOREIGN LANGUAGE.

SER. NO. 79-097,170, FILED 8-12-2010.

TRACY CROSS, EXAMINING ATTORNEY

United States of America

United States Patent and Trademark Office



CNYD

Reg. No. 4,107,356

Registered Mar. 6, 2012

Int. Cl.: 37

SHENYANG YUANDA ALUMINIUM INDUSTRY ENGINEERING CO., LTD (CHINA CORPORATION)
NO. 20, 13TH STREET
SHENYANG ECONOMIC & TECHNOLOGICAL; DEVELOPMENT AREA; LIAONING PROVINCE
CHINA

SERVICE MARK

PRINCIPAL REGISTER

FOR: CONSTRUCTION OF BUILDINGS; CONSTRUCTION OF HOUSES; INSTALLATION OF BUILDING INSULATION; PIPELINE CONSTRUCTION AND MAINTENANCE; MACHINERY INSTALLATION, MAINTENANCE AND REPAIR; DECORATIVE PAINTING SERVICES; ELEVATOR INSTALLATION AND REPAIR; BUILDING CONSTRUCTION SUPERVISION; INSTALLATION OF DOORS AND WINDOWS; UPHOLSTERY REPAIR; DRILLING OF WELLS, IN CLASS 37 (U.S. CLS. 100, 103 AND 106).

OWNER OF U.S. REG. NOS. 3,580,562 AND 3,845,908.

OWNER OF INTERNATIONAL REGISTRATION 1077161 DATED 4-27-2011, EXPIRES 4-27-2021.

THE MARK CONSISTS OF THE WORDING "CNYD" UNDER A DESIGN OF SHADED QUADRILATERALS THAT FORM A "V" LIKE SHAPE.

SER. NO. 79-097,388, FILED 4-27-2011.

LAURA HAMMEL, EXAMINING ATTORNEY



David J. Kyffers

Director of the United States Patent and Trademark Office

United States of America

United States Patent and Trademark Office

ADEMPIERE

Reg. No. 4,107,357

Registered Mar. 6, 2012

Int. Cls.: 9, 35, 41 and 42

ADEMPIERE DEUTSCHLAND E.V. (FED REP GERMANY UNINCORPORATED ASSOCIATION, CLUB)
NAHMITZER DAMM 32
12277 BERLIN
FED REP GERMANY

TRADEMARK

FOR: SOFTWARE FOR USE IN ENTERPRISE RESOURCE PLANNING , IN CLASS 9 (U.S. CLS. 21, 23, 26, 36 AND 38).

SERVICE MARK

FOR: BUSINESS MANAGEMENT AND ORGANIZATION CONSULTANCY SERVICES, IN THE FIELD OF ENTERPRISE RESOURCE PLANNING; COMPUTERIZED FILE MANAGING; BUSINESS MANAGEMENT ASSISTANCE TO COMMERCIAL OR INDUSTRIAL FIRMS IN THE CONDUCT OF THEIR BUSINESS IN THE FIELD OF ENTERPRISE RESOURCE PLANNING; ORGANIZATION OF JOB FAIRS OR ADVERTISING-RELATED FAIRS; ORGANIZATION OF FAIRS AND EXHIBITIONS FOR COMMERCIAL OR ADVERTISING PURPOSES IN THE FIELD OF ENTERPRISE RESOURCE PLANNING, IN CLASS 35 (U.S. CLS. 100, 101 AND 102).

PRINCIPAL REGISTER

FOR: ARRANGING AND CONDUCTING OF EDUCATIONAL CONFERENCES IN THE FIELD OF ENTERPRISE RESOURCE PLANNING AND OPEN SOURCE SOFTWARE; ARRANGING AND CONDUCTING OF EDUCATIONAL CONGRESSES IN THE FIELD OF ENTERPRISE RESOURCE PLANNING AND OPEN SOURCE SOFTWARE; ONLINE PUBLISHING OF ELECTRONIC BOOKS AND PERIODICALS IN THE FIELD OF ENTERPRISE RESOURCE PLANNING; ARRANGING AND CONDUCTING OF SEMINARS IN THE FIELD OF ENTERPRISE RESOURCE PLANNING AND OPEN SOURCE SOFTWARE; PROVIDING OF TRAINING, INCLUDING THROUGH INTERNATIONAL COMPUTER NETWORKS IN THE FIELD OF ENTERPRISE RESOURCE PLANNING; WRITING OF TEXTS, OTHER THAN PUBLICITY TEXTS IN THE FIELD OF ENTERPRISE RESOURCE PLANNING AND OPEN SOURCE SOFTWARE; ARRANGING AND CONDUCTING OF WORKSHOPS FOR TRAINING PURPOSES IN THE FIELD OF ENTERPRISE RESOURCE PLANNING AND OPEN SOURCE SOFTWARE, IN CLASS 41 (U.S. CLS. 100, 101 AND 107).



David J. Kyros

Director of the United States Patent and Trademark Office

FOR: UPDATING OF COMPUTER SOFTWARE; COMPUTER SOFTWARE CONSULTING IN THE FIELD OF ENTERPRISE RESOURCE PLANNING; COMPUTER SOFTWARE DESIGN, IN THE FIELD OF ENTERPRISE RESOURCE PLANNING; COMPUTER SOFTWARE RENTAL, IN THE FIELD OF ENTERPRISE RESOURCE PLANNING; RESTORATION OF COMPUTER DATA, NAMELY, DATA RECOVERY SERVICES; COMPUTER SYSTEMS

Reg. No. 4,107,357 ANALYSES; COMPUTER PROGRAMMING IN THE FIELD OF ENTERPRISE RESOURCE PLANNING; TECHNOLOGY RESEARCH IN THE FIELD OF ENTERPRISE RESOURCE PLANNING AND OPEN SOURCE SOFTWARE, IN CLASS 42 (U.S. CLS. 100 AND 101).

THE MARK CONSISTS OF STANDARD CHARACTERS WITHOUT CLAIM TO ANY PARTICULAR FONT, STYLE, SIZE, OR COLOR.

OWNER OF INTERNATIONAL REGISTRATION 1077493 DATED 4-11-2011, EXPIRES 4-11-2021.

THE ENGLISH TRANSLATION OF "ADEMPIERE" IN THE MARK IS "TO CARRY OUT / FULFILL".

SER. NO. 79-097,509, FILED 4-11-2011.

DANIEL CAPSHAW, EXAMINING ATTORNEY

United States of America
United States Patent and Trademark Office

UNISOL

Reg. No. 4,107,358

Registered Mar. 6, 2012

Int. Cls.: 7 and 12

TRADEMARK

PRINCIPAL REGISTER

USHIO INDUSTRIES, LTD. (JAPAN CORPORATION)
1-18, SENTAN-DORI 3-CHOME
NADA-KU,; KOBE-SHI;
HYOGO 657-0056, JAPAN

FOR: GEARING NOT FOR LAND VEHICLES, NAMELY, GEARING FOR MACHINES; POWER TRANSMISSION BELTS NOT FOR LAND VEHICLES; TIMING BELTS NOT FOR LAND VEHICLES, NAMELY, TIMING BELTS FOR MACHINES; V-RIBBED BELTS NOT FOR LAND VEHICLES, NAMELY, V-RIBBED BELTS FOR MACHINES; V BELTS NOT FOR LAND VEHICLES, NAMELY, V BELTS FOR MACHINES; COGGED BELTS NOT FOR LAND VEHICLES, NAMELY, COGGED BELTS FOR MACHINES; FAN BELTS FOR MOTORS AND ENGINES, NOT FOR LAND VEHICLES; DYNAMO BELTS NOT FOR LAND VEHICLES; TIMING BELTS FOR ENGINES FOR LAND VEHICLES; FAN BELTS FOR MOTORS AND ENGINES FOR LAND VEHICLES; DYNAMO BELTS FOR LAND VEHICLES , IN CLASS 7 (U.S. CLS. 13, 19, 21, 23, 31, 34 AND 35).

FOR: GEARING FOR LAND VEHICLES, NAMELY, TRANSMISSION GEARS; POWER TRANSMISSION BELTS FOR LAND VEHICLES; V-RIBBED BELTS FOR TRANSMISSIONS FOR LAND VEHICLES; V BELTS FOR TRANSMISSIONS FOR LAND VEHICLES; COGGED BELTS FOR TRANSMISSIONS FOR LAND VEHICLES, IN CLASS 12 (U.S. CLS. 19, 21, 23, 31, 35 AND 44).

PRIORITY DATE OF 8-23-2010 IS CLAIMED.

OWNER OF INTERNATIONAL REGISTRATION 1077752 DATED 2-22-2011, EXPIRES 2-22-2021.

SER. NO. 79-097,600, FILED 2-22-2011.

BERNICE MIDDLETON, EXAMINING ATTORNEY



David J. Kyffers

Director of the United States Patent and Trademark Office

United States of America

United States Patent and Trademark Office

La Barre Infernale

Reg. No. 4,107,359

PRALUS FRANÇOIS (FRANCE INDIVIDUAL)
8, RUE CHARLES DE GAULLE
ROANNE, FRANCE F42300

Registered Mar. 6, 2012

Int. Cl.: 30

FOR: CHOCOLATE, COCOA, CHOCOLATE BARS, PASTRIES, IN CLASS 30 (U.S. CL. 46).

TRADEMARK

NO CLAIM IS MADE TO THE EXCLUSIVE RIGHT TO USE "LA BARRE", APART FROM THE MARK AS SHOWN.

PRINCIPAL REGISTER

OWNER OF INTERNATIONAL REGISTRATION 1077800 DATED 4-13-2011, EXPIRES 4-13-2021.

THE ENGLISH TRANSLATION OF "LA BARRE INFERNALE" IN THE MARK IS THE INFERNAL BAR.

SER. NO. 79-097,613, FILED 4-13-2011.

TOBY BULLOFF, EXAMINING ATTORNEY



David J. Kyros

Director of the United States Patent and Trademark Office

United States of America

United States Patent and Trademark Office



Reg. No. 4,107,360

Registered Mar. 6, 2012

Int. Cl.: 6

TRADEMARK

PRINCIPAL REGISTER

GAO LIDENG (CHINA INDIVIDUAL)
GAONAN VILLAGE
GAOBIAN, DALI TOWN,; NANHAI CITY; 528200GUANGDONG
CHINA

FOR: STEEL ALLOYS; COMMON METALS, UNWROUGHT OR SEMI-WROUGHT, NAMELY, COMMON METALS, UNWROUGHT AND SEMI-WORKED, FOR FURTHER MANUFACTURE; METAL LATHS; SHEETS AND PLATES OF COMMON METAL, NAMELY, LAMINATED METAL SHEETS AND PLATES FOR FURTHER MANUFACTURE; PREFABRICATED METAL PLATFORMS; BUILDING MATERIALS OF METAL, NAMELY, COMPOSITE PANELS COMPOSED PRIMARILY OF METAL; FRAMEWORK OF METAL FOR BUILDING, IN CLASS 6 (U.S. CLS. 2, 12, 13, 14, 23, 25 AND 50).

THE MARK CONSISTS OF THE DESIGN OF A GLOBE WITH OUTLINES OF THE CONTINENTS AND MERIDIANS AND PARALLELS. THERE ARE TWO QUADRILATERALS TRANSPosed OVER THE CENTER PORTION OF THE GLOBE WITH DIAGONAL LINES ACROSS THE QUADRILATERALS. THERE IS A LETTER "Y" CENTERED ON THE LEFT QUADRILATERAL AND A LETTER "X" CENTERED ON THE RIGHT QUADRILATERAL. TWO NON-LATIN CHARACTERS MEANING "XINGQIU" ARE CENTERED BELOW THE QUADRILATERALS AND GLOBE.

OWNER OF INTERNATIONAL REGISTRATION 1078061 DATED 1-4-2011, EXPIRES 1-4-2021.

THE NON-LATIN CHARACTERS IN THE MARK TRANSLITERATE TO "XINGQIU" AND THIS MEANS "PLANET" IN ENGLISH.

SER. NO. 79-097,681, FILED 1-4-2011.

TINA BROWN, EXAMINING ATTORNEY



David J. Kyros

Director of the United States Patent and Trademark Office

United States of America

United States Patent and Trademark Office



Reg. No. 4,107,361

Registered Mar. 6, 2012

Int. Cl.: 24

TRADEMARK

PRINCIPAL REGISTER

CHANGSHU ZHONGWANG WARP & WEFT KNITTING CO., LTD. (CHINA CORPORATION)
FUMA VILLAGE,
MEILI TOWN,; CHANGSHU CITY; JIANGSU PROVINCE
CHINA

FOR: CLOTH, NAMELY, JUTE CLOTH, COTTON CLOTH, LINEN CLOTH, WOOLLEN CLOTH, SILK CLOTH; FABRICS FOR TEXTILE USE; NON-WOVEN FABRICS; WALL HANGINGS, OF TEXTILE; TOWELS OF TEXTILE; BED COVERS; BED SPREADS; BED SHEETS; FURNITURE COVERINGS OF TEXTILE, NAMELY, UNFITTED FABRIC FURNITURE COVERS; WASHING MITTS; BED LINEN, IN CLASS 24 (U.S. CLS. 42 AND 50).

THE MARK CONSISTS OF THREE CHINESE CHARACTERS, A COINED LATIN WORD "BORAULEN" AND A STYLIZED "BOL" LOGO.

OWNER OF INTERNATIONAL REGISTRATION 1078097 DATED 4-14-2011, EXPIRES 4-14-2021.

THE TRANSLITERATION OF THE NON-LATIN CHARACTERS IN THE MARK IS: BO OU LUN.

THE ENGLISH TRANSLATION OF THE FOREIGN WORD(S) IN THE MARK IS: THE FIRST CHARACTER MEANS "ABUNDANT"; THE SECOND CHARACTER IS A SURNAME; THE TRANSLATION OF THE THIRD CHARACTER IS "ORDER"; THE THREE CHINESE CHARACTERS AS A WHOLE HAVE NO MEANING; THE LATIN CHARACTERS HAVE NO SIGNIFICANCE IN THE RELEVANT TRADE OR INDUSTRY, OR ANY GEOGRAPHICAL SIGNIFICANCE, OR ANY MEANING IN A FOREIGN LANGUAGE.

SER. NO. 79-097,697, FILED 4-14-2011.

ELIZABETH KAJUBI, EXAMINING ATTORNEY



David J. Kybas

Director of the United States Patent and Trademark Office

United States of America

United States Patent and Trademark Office

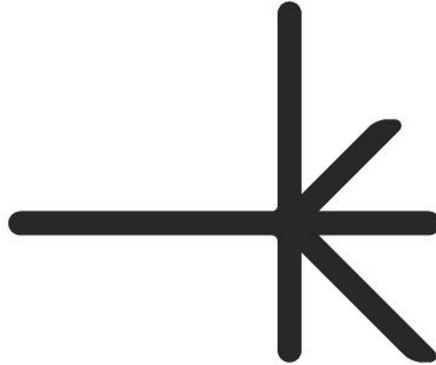

Reg. No. 4,107,362

Registered Mar. 6, 2012

Int. Cl.: 10

TRADEMARK

PRINCIPAL REGISTER

SPINEART SA (SWITZERLAND SOCIÉTÉ ANONYME (SA); CORPORATION)
20 ROUTE DE PRÉ BOIS
MEYRIN, SWITZERLAND CH1217

FOR: SURGICAL APPARATUS AND INSTRUMENTS; SURGICAL IMPLANTS COMPRISING ARTIFICIAL MATERIAL; ARTIFICIAL LIMBS, IN CLASS 10 (U.S. CLS. 26, 39 AND 44).

THE MARK CONSISTS OF HORIZONTAL LINE; ON THE RIGHT PORTION OF THE LINE IS A VERTICAL LINE, GOING THROUGH THE HORIZONTAL LINE, AT THE MEETING OF POINT OF THE LINES ARE DIAGONAL LINE POINTED TO THE UPPER RIGHT AND A DIAGONAL TO THE LOWER RIGHT.

PRIORITY DATE OF 11-24-2010 IS CLAIMED.

OWNER OF INTERNATIONAL REGISTRATION 1078645 DATED 5-5-2011, EXPIRES 5-5-2021.

SER. NO. 79-097,873, FILED 5-5-2011.

SCOTT BIBB, EXAMINING ATTORNEY



David J. Kybas

Director of the United States Patent and Trademark Office

United States of America

United States Patent and Trademark Office



Reg. No. 4,107,363

Registered Mar. 6, 2012

Int. Cl.: 10

TRADEMARK

PRINCIPAL REGISTER

AGSA GOMMA SRL (ITALY SOCIETA' A RESPONSABILITA' LIMITATA)
VIA ORLANDI, 7
I-40068 SAN LAZZARO DI SAVENA (BO), ITALY

FOR: GLOVES FOR MEDICAL USE, GLOVES FOR USE IN HOSPITAL, MEDICAL EXAMINATION GLOVES, PROTECTIVE GLOVES FOR MEDICAL USE, SURGICAL GLOVES, IN CLASS 10 (U.S. CLS. 26, 39 AND 44).

NO CLAIM IS MADE TO THE EXCLUSIVE RIGHT TO USE "GOMMA", APART FROM THE MARK AS SHOWN.

OWNER OF INTERNATIONAL REGISTRATION 1078664 DATED 5-6-2011, EXPIRES 5-6-2021.

THE MARK CONSISTS OF THE WORDING "AGSA GOMMA" TO THE RIGHT OF A GLOVE DESIGN HAVING IMPOSED THEREON A PLUS SYMBOL WITHIN A CIRCLE.

THE ENGLISH TRANSLATION OF "GOMMA" IN THE MARK IS "RUBBER". THE WORDING "AGSA" HAS NO MEANING IN A FOREIGN LANGUAGE.

SER. NO. 79-097,881, FILED 5-6-2011.

RUDY R. SINGLETON, EXAMINING ATTORNEY



David J. Kybas

Director of the United States Patent and Trademark Office

United States of America

United States Patent and Trademark Office

W o A

Reg. No. 4,107,364

Registered Mar. 6, 2012

Int. Cls.: 9 and 41

TRADEMARK

SERVICE MARK

PRINCIPAL REGISTER

NEOWIZ GAMES CO., LTD. (REPUBLIC OF KOREA CORPORATION)
NEOWIZ TOWER, 192-2, GUMI-DONG,
BUNDANG-GU, SEONGNAM-SI.; GYEONGGI-DO, 463-500
REPUBLIC OF KOREA AND

NJINTERACTIVE CO., LTD. (REPUBLIC OF KOREA CORPORATION)
5F CHANWOO
1580-3 SEOCHO-DONG.; SEOCHO-GU; SEOUL 137-070
REPUBLIC OF KOREA

FOR: COMPUTER GAME PROGRAMS, RECORDED; DOWNLOADABLE GAME SOFTWARE;
DOWNLOADABLE COMPUTER GAME PROGRAMS; COMPUTER GAME CONSOLES FOR
USE WITH AN EXTERNAL DISPLAY SCREEN OR MONITOR; HAND-HELD UNITS FOR
PLAYING ELECTRONIC GAMES FOR USE WITH EXTERNAL DISPLAY SCREEN OR
MONITOR; VIDEO GAME CONSOLES FOR USE WITH AN EXTERNAL DISPLAY SCREEN
OR MONITOR; VIDEO OUTPUT GAME MACHINES FOR USE WITH EXTERNAL DISPLAY
SCREEN OR MONITOR; COMPUTER GAME SOFTWARE FOR USE ON MOBILE AND
CELLULAR PHONES, IN CLASS 9 (U.S. CLS. 21, 23, 26, 36 AND 38).

FOR: GAME SERVICES PROVIDED ON-LINE FROM A COMPUTER NETWORK; ELEC-
TRONIC GAME SERVICES PROVIDED BY MEANS OF THE INTERNET; PROVISION OF
COMPUTER GAME SERVICES VIA THE INTERNET, IN CLASS 41 (U.S. CLS. 100, 101 AND
107).

THE MARK CONSISTS OF STANDARD CHARACTERS WITHOUT CLAIM TO ANY PAR-
TICULAR FONT, STYLE, SIZE, OR COLOR.

PRIORITY DATE OF 12-3-2010 IS CLAIMED.

OWNER OF INTERNATIONAL REGISTRATION 1078969 DATED 3-9-2011, EXPIRES 3-9-
2021.

SER. NO. 79-097,973, FILED 3-9-2011.

KAELIE KUNG, EXAMINING ATTORNEY



David J. Kappas

Director of the United States Patent and Trademark Office

United States of America
United States Patent and Trademark Office

nRFgo

Reg. No. 4,107,365

Registered Mar. 6, 2012

Int. Cl.: 9

TRADEMARK

PRINCIPAL REGISTER

NORDIC SEMICONDUCTOR ASA (NORWAY PUBLIC LIMITED LIABILITY COMPANY)
OTTO NIELSENS VEG 12
N-7004 TRONDHEIM
NORWAY

FOR: APPARATUS AND INSTRUMENTS FOR CONDUCTING, SWITCHING, TRANSFORMING, ACCUMULATING, REGULATING OR CONTROLLING ELECTRICITY; APPARATUS FOR RECORDING, TRANSMISSION OR REPRODUCTION OF SOUND OR IMAGES; SEMICONDUCTORS, ELECTRONIC CIRCUITS, RADIO RECEIVERS AND TRANSMITTERS, IN CLASS 9 (U.S. CLS. 21, 23, 26, 36 AND 38).

THE MARK CONSISTS OF STANDARD CHARACTERS WITHOUT CLAIM TO ANY PARTICULAR FONT, STYLE, SIZE, OR COLOR.

OWNER OF INTERNATIONAL REGISTRATION 1079179 DATED 3-25-2011, EXPIRES 3-25-2021.

SER. NO. 79-098,045, FILED 3-25-2011.

KATHY DE JONGE, EXAMINING ATTORNEY



David J. Kyffers

Director of the United States Patent and Trademark Office

United States of America

United States Patent and Trademark Office

nRFready

Reg. No. 4,107,366

Registered Mar. 6, 2012

Int. Cl.: 9

TRADEMARK

PRINCIPAL REGISTER

NORDIC SEMICONDUCTOR ASA (NORWAY PUBLIC LIMITED LIABILITY COMPANY)
OTTO NIELSENS VEG 12
N-7004 TRONDHEIM
NORWAY

FOR: APPARATUS AND INSTRUMENTS FOR CONDUCTING, SWITCHING, TRANSFORMING, ACCUMULATING, REGULATING OR CONTROLLING ELECTRICITY; APPARATUS FOR RECORDING, TRANSMISSION OR REPRODUCTION OF SOUND OR IMAGES; SEMICONDUCTORS, ELECTRONIC CIRCUITS, RADIO RECEIVERS AND TRANSMITTERS, IN CLASS 9 (U.S. CLS. 21, 23, 26, 36 AND 38).

THE MARK CONSISTS OF STANDARD CHARACTERS WITHOUT CLAIM TO ANY PARTICULAR FONT, STYLE, SIZE, OR COLOR.

OWNER OF INTERNATIONAL REGISTRATION 1079180 DATED 3-25-2011, EXPIRES 3-25-2021.

SER. NO. 79-098,046, FILED 3-25-2011.

KATHY DE JONGE, EXAMINING ATTORNEY



David J. Kyffers

Director of the United States Patent and Trademark Office

United States of America
United States Patent and Trademark Office

TRIX

Reg. No. 4,107,367

Registered Mar. 6, 2012

Int. Cl.: 17

TRADEMARK

PRINCIPAL REGISTER

CONTITECH SCHLAUCH GMBH (FED REP GERMANY COMPANY WITH LIMITED LIABILITY)
VAHRENWALDER STR. 9
HANNOVER, FED REP GERMANY 30165

FOR: HOSES MADE OF RUBBER AND RUBBER HOSES REINFORCED WITH CARBIDE, NAMELY, WATER HOSES FOR AGRICULTURAL, INDUSTRIAL, COMMERCIAL AND CIVIL USE; HYDRAULIC HOSES MADE OF RUBBER; HOSES MADE OF RUBBER AND RUBBER HOSES REINFORCED WITH CARBIDE, NAMELY, GAS HOSES, AIR HOSES, HOSES FOR USE IN THE OIL DRILLING, MINING, EXCAVATION AND CONSTRUCTION INDUSTRIES; HOSES MADE OF RUBBER AND RUBBER HOSES REINFORCED WITH CARBIDE, NAMELY, HOSES FOR USE IN THE BEER AND WINE INDUSTRIES, HOSES FOR USE IN THE FOOD INDUSTRY, GASOLINE HOSES, PETROLEUM HOSES, HOSES FOR THE TRANSFER OF HOT TAR AND ASPHALT, INDUSTRIAL HOSES TO CARRY STEAM, VEHICLE RADIATOR CONNECTING HOSES, HOSES USED TO CARRY WINDSHIELD WIPER FLUID TO WINDSHIELD WIPERS, HOSES USED IN CONNECTION WITH WELDING, IN CLASS 17 (U.S. CLS. 1, 5, 12, 13, 35 AND 50).

THE MARK CONSISTS OF STANDARD CHARACTERS WITHOUT CLAIM TO ANY PARTICULAR FONT, STYLE, SIZE, OR COLOR.

OWNER OF INTERNATIONAL REGISTRATION 0697764 DATED 7-16-1998, EXPIRES 7-16-2018.

SER. NO. 79-098,088, FILED 10-1-2010.

AMY HELLA, EXAMINING ATTORNEY



David J. Kyffers

Director of the United States Patent and Trademark Office

United States of America

United States Patent and Trademark Office



Reg. No. 4,107,368

Registered Mar. 6, 2012

Int. Cl.: 41

SERVICE MARK

PRINCIPAL REGISTER

ALI S.P.A. (ITALY JOINT STOCK COMPANY)
VIA CAMPERIO, 9
I-20123 MILANO, ITALY

FOR: TRAINING ACTIVITIES, NAMELY, COURSES, SEMINARS, LECTURES AND WORKSHOPS FOR ADMINISTRATORS OF COMMERCIAL BUSINESS IN THE FIELD OF ARTISANAL ICE-CREAM SHOPS AND PASTRY SHOPS; TRAINING ACTIVITIES, NAMELY, COURSES, SEMINARS, LECTURES AND WORKSHOPS FOR ICE-CREAM MAKERS AND CONFECTIONERS IN THE FIELD OF ICE CREAM MAKING; EDUCATIONAL SERVICES, NAMELY, PROVIDING COURSES FOR THE STARTING UP AND THE MANAGEMENT OF ENTREPRENEURIAL BUSINESSES IN THE FIELD OF ICE-CREAM SHOPS AND PASTRY SHOPS; EDUCATIONAL SERVICES, NAMELY, PROVIDING COURSES FOR THE LEARNING OF INGREDIENTS AND PRODUCTION TECHNIQUES IN THE FIELD OF ICE-CREAM SHOPS AND PASTRY SHOPS; PROVIDING EDUCATION AND TRAINING COURSES FOR THE MANAGEMENT AND CONDUCTING THE BUSINESS OF ICE-CREAM SHOPS AND PASTRY SHOPS, IN CLASS 41 (U.S. CLS. 100, 101 AND 107).

OWNER OF U.S. REG. NOS. 2,361,256, 2,608,379, AND 3,038,973.

PRIORITY DATE OF 2-28-2011 IS CLAIMED.

OWNER OF INTERNATIONAL REGISTRATION 1079686 DATED 3-25-2011, EXPIRES 3-25-2021.

NO CLAIM IS MADE TO THE EXCLUSIVE RIGHT TO USE "GELATO UNIVERSITY", APART FROM THE MARK AS SHOWN.

THE MARK CONSISTS OF A GRAPHIC OF A CLOUD-LIKE BANNER CONTAINING THE WORDS "GELATO UNIVERSITY" AND THE TERM "CARPIGIANI" APPEARING AS A BREAK IN THE BOTTOM BORDER OF THE BANNER.

THE ENGLISH TRANSLATION OF THE FOREIGN WORD(S) IN THE MARK IS "ICE CREAM UNIVERSITY CARPIGIANI". THE WORDING "CARPIGIANI" HAS NO MEANING IN A FOREIGN LANGUAGE.

SER. NO. 79-098,271, FILED 3-25-2011.



David J. Kybas

Director of the United States Patent and Trademark Office

Reg. No. 4,107,368 ALYSSA STEEL, EXAMINING ATTORNEY

United States of America

United States Patent and Trademark Office

SANTENBERG

Reg. No. 4,107,369

Registered Mar. 6, 2012

Int. Cls.: 7, 9, 35 and 37

IBEX PATENT AND BRAND ESTABLISHMENT (LIECHTENSTEIN LIMITED LIABILITY COMPANY)
POSTFACH 742
LANDSTRASSE 140; FL-9494 SCHAAN
LIECHTENSTEIN

TRADEMARK

SERVICE MARK

PRINCIPAL REGISTER

FOR: MACHINES AND MACHINE TOOLS, NAMELY, GRINDING MACHINES, LATHES, CUTTING MACHINES; MOTORS AND ENGINES NOT FOR LAND VEHICLES; MACHINE COUPLING AND TRANSMISSION COMPONENTS NOT FOR LAND VEHICLES; SPARE PARTS FOR ALL THE AFOREMENTIONED GOODS, NAMELY, REPLACEMENT PARTS, MACHINE TOOL HOLDERS, TOOL BITS FOR MACHINES, IN CLASS 7 (U.S. CLS. 13, 19, 21, 23, 31, 34 AND 35).

FOR: MEASURING APPARATUS, NAMELY, BEVELS, ANGLE FINDERS, DIGITIZERS, GRADUATED RULERS; COMPUTERS AND PROGRAMS FOR COMPUTER OPERATING SYSTEMS, DOCUMENT MANAGEMENT, EDITING IMAGES, SOUND AND VIDEO, IN CLASS 9 (U.S. CLS. 21, 23, 26, 36 AND 38).

FOR: ADVERTISING; BUSINESS MANAGEMENT; BUSINESS ADMINISTRATION; IMPORT AND EXPORT AGENCIES IN THE FIELDS OF MACHINES, MACHINE TOOLS AND MEASURING APPARATUS; RETAIL STORE SERVICES FEATURING MACHINES, MACHINE TOOLS AND MEASURING APPARATUS; NEGOTIATION AND SETTLEMENT OF COMMERCIAL TRANSACTIONS FOR THIRD PARTIES, IN CLASS 35 (U.S. CLS. 100, 101 AND 102).

FOR: REPAIR, MAINTENANCE AND INSTALLATION OF MACHINES AND MACHINE TOOLS, IN CLASS 37 (U.S. CLS. 100, 103 AND 106).

THE MARK CONSISTS OF STANDARD CHARACTERS WITHOUT CLAIM TO ANY PARTICULAR FONT, STYLE, SIZE, OR COLOR.

PRIORITY DATE OF 11-4-2010 IS CLAIMED.

OWNER OF INTERNATIONAL REGISTRATION 1079990 DATED 5-2-2011, EXPIRES 5-2-2021.

SER. NO. 79-098,402, FILED 5-2-2011.



David J. Kyros

Director of the United States Patent and Trademark Office

Reg. No. 4,107,369 ELLEN BURNS, EXAMINING ATTORNEY

United States of America

United States Patent and Trademark Office

OPALYS

Reg. No. 4,107,370

Registered Mar. 6, 2012

Int. Cl.: 30

TRADEMARK

PRINCIPAL REGISTER

SONAFI (FRANCE SOCIÉTÉ PAR ACTIONS SIMPLIFIÉE)
42 RUE RIEUSSEC
F-78220 VIROFLAY
FRANCE

FOR: COCOA; CHOCOLATE; CONFECTIONERY AND CHOCOLATE PRODUCTS, NAMELY, CANDY, CHOCOLATES, CHOCOLATE TOPPING, AND CHOCOLATE FOR TOPPINGS, IN CLASS 30 (U.S. CL. 46).

THE MARK CONSISTS OF STANDARD CHARACTERS WITHOUT CLAIM TO ANY PARTICULAR FONT, STYLE, SIZE, OR COLOR.

PRIORITY DATE OF 11-25-2010 IS CLAIMED.

OWNER OF INTERNATIONAL REGISTRATION 1079992 DATED 5-16-2011, EXPIRES 5-16-2021.

THE WORD(S) "OPALYS" HAS NO MEANING IN A FOREIGN LANGUAGE.

SER. NO. 79-098,404, FILED 5-16-2011.

LIEF MARTIN, EXAMINING ATTORNEY



David J. Kyffers

Director of the United States Patent and Trademark Office

United States of America

United States Patent and Trademark Office



Reg. No. 4,107,371

TRINITAE ANSTALT (LIECHTENSTEIN CORPORATION)
AM SCHRÄGEN WEG 2
FL-9490 VADUZ, LIECHTENSTEIN

Registered Mar. 6, 2012

Int. Cls.: 3, 16 and 35

FOR: BLEACHING PREPARATIONS AND OTHER SUBSTANCES, NAMELY, DETERGENT, FOR LAUNDRY USE; CLEANING, POLISHING, SCOURING AND ABRASIVE PREPARATIONS; SOAPS; PERFUMERY, ESSENTIAL OILS, COSMETICS, HAIR LOTIONS; DENTIFRICES, IN CLASS 3 (U.S. CLS. 1, 4, 6, 50, 51 AND 52).

TRADEMARK

SERVICE MARK

FOR: PAPER, CARDBOARD AND GOODS MADE FROM THESE MATERIALS, NOT INCLUDED IN OTHER CLASSES, NAMELY, BOXES AND CARTONS; PRINTED MATTER, NAMELY, PERIODICALS, NEWSLETTERS AND BROCHURES ALL IN THE FIELD OF COSMETICS; BOOKBINDING MATERIAL; PHOTOGRAPHS; STATIONERY; ADHESIVES FOR STATIONERY OR HOUSEHOLD PURPOSES; ARTISTS' MATERIALS, NAMELY, BRUSHES AND PENS; PAINT BRUSHES; TYPEWRITERS AND OFFICE REQUISITES, EXCEPT FURNITURE, NAMELY, STAPLERS AND PAPER TRIMMERS; PRINTED INSTRUCTIONAL AND TEACHING MATERIAL IN THE FIELD OF COSMETICS; PLASTIC MATERIALS FOR PACKAGING, NAMELY, BAGS AND BUBBLE PACKS; PRINTERS' TYPE; PRINTING BLOCKS, IN CLASS 16 (U.S. CLS. 2, 5, 22, 23, 29, 37, 38 AND 50).

PRINCIPAL REGISTER

FOR: ADVERTISING SERVICES; ADVERTISING AGENCIES; BUSINESS MANAGEMENT; BUSINESS ADMINISTRATION; PROVIDING OFFICE FUNCTIONS, IN CLASS 35 (U.S. CLS. 100, 101 AND 102).



THE MARK CONSISTS OF THE WORDING "TRINITAE" IN STYLIZED FONT, WITH THE FIRST "T" REPRESENTED BY A CLOVER AND STEM AND WITH THE "AE" REPRESENTED BY A CAPITAL "AE" LIGATURE. ALL OF THE AFOREMENTIONED APPEARS ABOVE THE WORDING "LOVE YOURSELF FIRST" IN STYLIZED FONT.

PRIORITY DATE OF 4-27-2011 IS CLAIMED.

OWNER OF INTERNATIONAL REGISTRATION 1080058 DATED 4-27-2011, EXPIRES 4-27-2021.

David J. Kyros

SER. NO. 79-098,428, FILED 4-27-2011.

KAREN SEVERSON, EXAMINING ATTORNEY

United States of America

United States Patent and Trademark Office

LARCORE

Reg. No. 4,107,372

Registered Mar. 6, 2012

Int. Cls.: 6, 7 and 9

TRADEMARK

PRINCIPAL REGISTER

ALUCOIL, S.A. (SPAIN SOCIEDAD ANÓNIMA)
POLIGONO INDUSTRIAL BAYAS -
C/IRCIO, PARCELAS R72-R77, E-09200 MIRANDA DE EBRO (BURGOS)
SPAIN

FOR: BUILDING MATERIAL, NAMELY, COMPOSITE PANELS OF STAINLESS STEEL, METAL FACADES FOR BUILDING, METAL ROOFING AND METAL PARTITIONS, IN CLASS 6 (U.S. CLS. 2, 12, 13, 14, 23, 25 AND 50).

FOR: METAL LINING FOR THE INTERIOR OF MACHINES, PRINCIPALLY MADE OF STAINLESS STEEL, ALUMINUM OR ALUMINUM ALLOYS, IN CLASS 7 (U.S. CLS. 13, 19, 21, 23, 31, 34 AND 35).

FOR: ELECTRIC SIGNALLING PANELS PRINCIPALLY MADE OF STAINLESS STEEL, ALUMINUM OR ALUMINUM ALLOYS, IN CLASS 9 (U.S. CLS. 21, 23, 26, 36 AND 38).

OWNER OF INTERNATIONAL REGISTRATION 0865125 DATED 8-10-2005, EXPIRES 8-10-2015.

SER. NO. 79-098,485, FILED 4-13-2011.

MIDGE BUTLER, EXAMINING ATTORNEY



David J. Kyffers

Director of the United States Patent and Trademark Office

United States of America

United States Patent and Trademark Office

SPIDER KING

Reg. No. 4,107,373

Registered Mar. 6, 2012

Int. Cl.: 18

TRADEMARK

PRINCIPAL REGISTER

SPIDER KING GROUP CO., LTD. (CHINA CORPORATION)
OUJIANG 3RD BRIDGE INDUSTRY
ZONE YONGJIA; 325000 ZHEJIANG
CHINA

FOR: PELTS; IMITATION LEATHER SOLD IN BULK; WALKING STICKS; LEATHER FOR FURNITURE; SCHOOL BAGS; PURSES; TRAVEL BAGS; HANDBAGS; VALISES; TRAVELING CASES OF LEATHER; UMBRELLAS, IN CLASS 18 (U.S. CLS. 1, 2, 3, 22 AND 41).

OWNER OF U.S. REG. NO. 3,055,705.

OWNER OF INTERNATIONAL REGISTRATION 1080334 DATED 4-11-2011, EXPIRES 4-11-2021.

THE MARK CONSISTS OF THE WORDING "SPIDER KING" IN STYLIZED FORM.

SER. NO. 79-098,548, FILED 4-11-2011.

NANCY CLARKE, EXAMINING ATTORNEY



David J. Kyffers

Director of the United States Patent and Trademark Office

United States of America

United States Patent and Trademark Office

PINEBERRY WHITE DREAM

Reg. No. 4,107,374

Registered Mar. 6, 2012

Int. Cl.: 31

TRADEMARK

PRINCIPAL REGISTER

VITRO BIO PLANT HOLLAND B.V. (NETHERLANDS BESLOTEN VENNOOTSCHAP (B.V.))
RIJKSWEG 30-A
NL-6744 WB EDERVEEN
NETHERLANDS

FOR: AGRICULTURAL, HORTICULTURAL AND FORESTRY PRODUCTS, NAMELY, PLANTS OF PLANT SPECIES STRAWBERRY; LIVE PLANTS AND FLOWERS AND PARTS THEREOF OF THE PLANT SPECIES STRAWBERRY; PROPAGATION MATERIAL, NAMELY, PLANT LEAVES, BUDS, CUTTINGS AND TISSUE CULTURE; ALL THE AFOREMENTIONED GOODS IN PARTICULAR CONCERNING VARIETIES OF THE PLANT SPECIES STRAWBERRY, IN CLASS 31 (U.S. CLS. 1 AND 46).

THE MARK CONSISTS OF STANDARD CHARACTERS WITHOUT CLAIM TO ANY PARTICULAR FONT, STYLE, SIZE, OR COLOR.

PRIORITY DATE OF 2-14-2011 IS CLAIMED.

OWNER OF INTERNATIONAL REGISTRATION 1080422 DATED 5-4-2011, EXPIRES 5-4-2021.

NO CLAIM IS MADE TO THE EXCLUSIVE RIGHT TO USE "PINEBERRY WHITE", APART FROM THE MARK AS SHOWN.

SER. NO. 79-098,578, FILED 5-4-2011.

DAVID HOFFMAN, EXAMINING ATTORNEY



David J. Kyfos

Director of the United States Patent and Trademark Office

United States of America

United States Patent and Trademark Office

CENTRICA ENERGY

Reg. No. 4,107,375

Registered Mar. 6, 2012

Int. Cls.: 4, 36, 39 and 40

TRADEMARK

SERVICE MARK

PRINCIPAL REGISTER

GB GAS HOLDINGS LIMITED (UNITED KINGDOM LIMITED COMPANY)
MILLSTREAM
MAIDENHEAD ROAD; WINDSOR, BERKSHIRE SL45GD
UNITED KINGDOM

FOR: INDUSTRIAL OILS AND GREASES; INDUSTRIAL LUBRICANTS; FUELS; GASOLINE; NATURAL GAS, LIQUEFIED NATURAL GAS, COMPRESSED NATURAL GAS; GASEOUS FUELS; OILS, NAMELY, CRUDE OIL, FUEL OIL, HEAVY OILS, MOTOR OIL; FOSSIL FUELS; ELECTRICAL ENERGY, IN CLASS 4 (U.S. CLS. 1, 6 AND 15).

FOR: FINANCIAL SERVICES, NAMELY, FINANCIAL ADVISORY SERVICES, FINANCIAL PLANNING, FINANCIAL INVESTMENT BROKERAGE, FINANCIAL RISK MANAGEMENT; BANKING; INSURANCE SERVICES, NAMELY, ADMINISTRATION OF HOME AND BUSINESS PLANS CONCERNING INSURANCE AND FINANCE, AND UNDERWRITING EXTENDED WARRANTY CONTRACTS IN THE FIELD OF HOME AND BUSINESS APPLIANCES, ENERGY, ELECTRICAL SYSTEMS, PLUMBING AND DRAINS; TRADING OF ENERGY-RELATED COMMODITIES, INCLUDING ELECTRICITY, GAS, OIL, PETROLEUM, AND OTHER FUELS FOR OTHERS; BROKERAGE OF ENERGY, NAMELY, GAS, OIL AND ELECTRICITY; ADVISORY, INFORMATION AND CONSULTANCY SERVICES RELATING TO ALL THE AFORESAID SERVICES, IN CLASS 36 (U.S. CLS. 100, 101 AND 102).

FOR: STORAGE, DISTRIBUTION, TRANSPORTATION AND DELIVERY OF GAS AND ELECTRICITY; TRANSMITTING AND SUPPLYING ELECTRICITY; TRANSMISSION AND SUPPLY OF GAS AND OIL; CONSULTANCY, INFORMATION AND ADVISORY SERVICES RELATING TO ALL THE AFORESAID SERVICES, IN CLASS 39 (U.S. CLS. 100 AND 105).

FOR: GENERATION OF ELECTRICITY; GENERATION OF POWER AND OF ELECTRICITY; GENERATION OF ENERGY FROM RENEWABLE SOURCES; PRODUCTION OF GAS AND OIL; CONSULTANCY, INFORMATION AND ADVISORY SERVICES RELATING TO ALL THE AFORESAID SERVICES, IN CLASS 40 (U.S. CLS. 100, 103 AND 106).

THE MARK CONSISTS OF STANDARD CHARACTERS WITHOUT CLAIM TO ANY PARTICULAR FONT, STYLE, SIZE, OR COLOR.

PRIORITY DATE OF 1-28-2011 IS CLAIMED.



David J. Kyros

Director of the United States Patent and Trademark Office

Reg. No. 4,107,375 OWNER OF INTERNATIONAL REGISTRATION 1080798 DATED 4-14-2011, EXPIRES 4-14-2021.

OWNER OF U.S. REG. NO. 2,706,111.

NO CLAIM IS MADE TO THE EXCLUSIVE RIGHT TO USE "ENERGY", APART FROM THE MARK AS SHOWN.

SER. NO. 79-098,673, FILED 4-14-2011.

KRISTIN CARLSON, EXAMINING ATTORNEY

United States of America

United States Patent and Trademark Office

ГАЙНОМАКС

Reg. No. 4,107,376

Registered Mar. 6, 2012

Int. Cl.: 5

TRADEMARK

PRINCIPAL REGISTER

EMBIL İLAÇ SANAYİ LIMITED SİRKETİ (TURKEY LIMITED COMPANY)
MASLAK MAHALLESİ SÜMER SOKAK AYAZAGA,
TİCARET MERKEZİ NO:3/1.; SISLI; İSTANBUL
TURKEY

FOR: MEDICINES FOR HUMAN AND VETERINARY PURPOSES FOR THE TREATMENT OF INFECTIOUS VULVOVAGINITIS , IN CLASS 5 (U.S. CLS. 6, 18, 44, 46, 51 AND 52).

THE MARK CONSISTS OF A SINGLE WORD WRITTEN IN STYLIZED CYRILLIC LETTERS.

OWNER OF INTERNATIONAL REGISTRATION 1080955 DATED 4-28-2011, EXPIRES 4-28-2021.

THE TRANSLITERATION OF THE NON-LATIN CHARACTERS IN THE MARK IS: GAYNOMAKS.

THE WORDING GAYNOMAKS HAS NO MEANING IN A FOREIGN LANGUAGE.

SER. NO. 79-098,748, FILED 4-28-2011.

SHAILA SETTLES, EXAMINING ATTORNEY



David J. Kypos

Director of the United States Patent and Trademark Office

United States of America

United States Patent and Trademark Office

COMFLOOR

Reg. No. 4,107,377

Registered Mar. 6, 2012

Int. Cl.: 11

TRADEMARK

PRINCIPAL REGISTER

AIREX AG (SWITZERLAND AKTIENGESELLSCHAFT)
INDUSTRIE NORD
CH-5643 SINS
SWITZERLAND

FOR: ELECTRICALLY HEATED CARPETS; DEFROSTER FOR VEHICLES; ELECTRIC BLANKETS NOT FOR MEDICAL PURPOSES; HEATING FILAMENT; ELECTRIC HEATING APPARATUS FOR INDOOR HEATING IN VEHICLES; FORCED CONVECTION AIR HEATING UNITS FOR INDUSTRIAL PURPOSES AS APPLICATION IN VEHICLES; HEATING PLATES FOR INDOOR HEATING IN VEHICLES; HEATING RADIATORS; HEATING INSTALLATIONS; HEATERS FOR VEHICLES; HOT WATER HEATING INSTALLATIONS; AIR CONDITIONING INSTALLATIONS FOR VEHICLES; AIR CONDITIONING APPARATUS; AIR REHEATERS; AIR FILTERS FOR INDUSTRIAL PURPOSES AND INSTALLATIONS; AIR FILTERING INSTALLATIONS; AIR COOLING APPARATUS; AIR CONDITIONING APPLIANCES; VENTILATION INSTALLATIONS FOR VEHICLES; VENTILATION APPARATUS FOR INDOOR COOLING IN VEHICLES; HEAT PUMPS; COILS AS PARTS OF DISTILLING; HEATING OR COOLING SYSTEMS; FANS FOR AIR-CONDITIONING APPARATUS; FANS FOR AIR-CONDITIONING INSTALLATIONS; VALVES AS PART OF HEATING INSTALLATIONS; HEAT REGENERATORS; HEAT ACCUMULATORS; HEAT EXCHANGERS FOR VEHICLES; HEATERS FOR VEHICLES IN THE FORM OF FLOORS, FALSE FLOORS; ROOFS AND WALLS FOR VEHICLES, NAMELY, FOR RAILWAY CARS AND MOTOR BUSES; HEATING APPARATUS FOR HEATING INTERIORS, NAMELY, FOR RAILWAY CARS AND MOTOR BUSES; INSTALLATION FOR AIR-CONDITIONING OF RAILWAY CARS AND MOTOR BUSES; HEATING PANELS FOR HEATERS IN RAILWAY CARS AND MOTOR BUSES; HEATING ELEMENTS IN THE FORM OF PLATES OR PANELS; HEATING ELEMENTS IN THE FORM OF PLATES OR PANELS FOR VEHICLES, NAMELY, RAILWAY CARS AND MOTOR BUSES, IN CLASS 11 (U.S. CLS. 13, 21, 23, 31 AND 34).



THE MARK CONSISTS OF STANDARD CHARACTERS WITHOUT CLAIM TO ANY PARTICULAR FONT, STYLE, SIZE, OR COLOR.

OWNER OF INTERNATIONAL REGISTRATION 1081269 DATED 5-19-2011, EXPIRES 5-19-2021.

SER. NO. 79-098,857, FILED 5-19-2011.

MICHAEL KEATING, EXAMINING ATTORNEY

David J. Kyros

Director of the United States Patent and Trademark Office

United States of America

United States Patent and Trademark Office



Reg. No. 4,107,378

Registered Mar. 6, 2012

Int. Cls.: 12 and 37

TRADEMARK

SERVICE MARK

PRINCIPAL REGISTER

BSG AUTO GLASS CO., LTD (CHINA CORPORATION)
QINSHI INDUSTRIAL ZONE,
SANZAO HI-TECH PARK; ZHUHAI CITY; 519000 GUANGDONG
CHINA

FOR: WINDSHIELDS; WINDSCREENS; WINDSHIELD WIPERS; WINDOWS FOR VEHICLES,
IN CLASS 12 (U.S. CLS. 19, 21, 23, 31, 35 AND 44).

FOR: INSTALLATION OF WINDSHIELDS FOR VEHICLES; INSTALLATION OF ANTI-
DAZZLE DEVICES FOR VEHICLES; CHANGING, MAINTAIN AND REPAIR OF WIND-
SHIELDS FOR VEHICLES; MOTOR VEHICLE MAINTENANCE AND REPAIR, IN CLASS
37 (U.S. CLS. 100, 103 AND 106).

OWNER OF U.S. REG. NO. 3,583,660.

OWNER OF INTERNATIONAL REGISTRATION 1081281 DATED 6-10-2011, EXPIRES 6-10-
2021.

THE MARK CONSISTS OF THE ENGLISH WORD "CSG" IN AN ELLIPSE.

SER. NO. 79-098,863, FILED 6-10-2011.

RON FAIRBANKS, EXAMINING ATTORNEY



David J. Kyros

Director of the United States Patent and Trademark Office

United States of America

United States Patent and Trademark Office



Reg. No. 4,107,379

Registered Mar. 6, 2012

Int. Cl.: 3

TRADEMARK

PRINCIPAL REGISTER

VOLKER SCHUSTER (FED REP GERMANY INDIVIDUAL)
23 BARKFIELD AVENUE
FORMBY L37 3JH
UNITED KINGDOM

FOR: COMPOSITIONS FOR REMOVING PAINT; PREPARATIONS FOR REMOVING PAINT; PREPARATIONS FOR STRIPPING PAINT; PAINT REMOVERS; PAINT REMOVING COMPOSITIONS; PAINT REMOVING PREPARATIONS; PAPER SHEETS SPECIFICALLY ADAPTED FOR USE IN PAINT REMOVING AND PAINT STRIPPING, IN CLASS 3 (U.S. CLS. 1, 4, 6, 50, 51 AND 52).

NO CLAIM IS MADE TO THE EXCLUSIVE RIGHT TO USE "YACHTSTRIP", APART FROM THE MARK AS SHOWN.

OWNER OF INTERNATIONAL REGISTRATION 1081671 DATED 2-2-2011, EXPIRES 2-2-2021.

THE COLOR(S) BLUE AND RED IS/ARE CLAIMED AS A FEATURE OF THE MARK.

THE MARK CONSISTS OF THE WORDING "YACHTSTRIP" IN BLUE WITHIN THE LOWER HALF OF A BOAT OUTLINE IN BLUE WITH A RED HULL.

SER. NO. 79-099,011, FILED 2-2-2011.

NICHOLAS COLEMAN, EXAMINING ATTORNEY



David J. Kyffers

Director of the United States Patent and Trademark Office

United States of America
United States Patent and Trademark Office

PURIFLOW

Reg. No. 4,107,380

Registered Mar. 6, 2012

Int. Cl.: 2

TRADEMARK

PRINCIPAL REGISTER

VOTTELER LACKFABRIK GMBH & CO. KG (FED REP GERMANY GMBH & CO. KG)
SCHWIEBERDINGER STRASSE 97 + 102
70825 KORNTAL-MÜNCHINGEN, FED REP GERMANY

FOR: LACQUERS; MORDANTS FOR USE IN THE WOOD INDUSTRY, IN CLASS 2 (U.S. CLS. 6, 11 AND 16).

THE MARK CONSISTS OF STANDARD CHARACTERS WITHOUT CLAIM TO ANY PARTICULAR FONT, STYLE, SIZE, OR COLOR.

OWNER OF INTERNATIONAL REGISTRATION 1082251 DATED 5-31-2011, EXPIRES 5-31-2021.

SER. NO. 79-099,208, FILED 5-31-2011.

CHRISIE B. KING, EXAMINING ATTORNEY



David J. Kybas

Director of the United States Patent and Trademark Office

United States of America

United States Patent and Trademark Office

ANGELINA BALLERINA

Reg. No. 4,107,381

Registered Mar. 6, 2012

Int. Cl.: 28

TRADEMARK

PRINCIPAL REGISTER

HIT ENTERTAINMENT LIMITED (UNITED KINGDOM PRIVATE LIMITED COMPANY)
149 TOTTENHAM COURT ROAD
5TH FLOOR, MAPLE HOUSE; LONDON, W1T 7NF
UNITED KINGDOM AND

KATHARINE HOLABIRD (UNITED KINGDOM INDIVIDUAL)
17 CORRINGHAM ROAD
LONDON NW11 7BS
UNITED KINGDOM AND

HELEN CRAIG (UNITED KINGDOM INDIVIDUAL)
21 CHURCH STREET
GREAT SHELFORD; CAMBRIDGE CB22 5EL
UNITED KINGDOM

FOR: PLUSH TOYS; TOY BUILDING BLOCKS; TOY FIRE TRUCKS; TOY VEHICLES; TOY CONSTRUCTION SETS; ELECTRONIC NOVELTY TOYS, NAMELY, TOYS FEATURING MUSIC, SOUND, LIGHT AND/OR MOVEMENT; ELECTRONIC LEARNING TOYS; WOODEN TOYS, NAMELY, TRAINS AND TRAIN ACCESSORIES; HANDHELD UNITS FOR PLAYING ELECTRONIC GAMES OTHER THAN THOSE ADAPTED FOR USE WITH AN EXTERNAL DISPLAY SCREEN OR MONITOR; PLAY SETS COMPRISED OF FIGURES AND ACCESSORIES WITH TOY BUILDINGS, LANDSCAPES, ENVIRONMENTS AND/OR SETTINGS; TOY DIECAST FIGURES; TOY PLASTIC FIGURES; TOY TRAINS; LEARNING TOYS, NAMELY, TOYS FOR TEACHING LANGUAGE, ALPHABET, NUMBERS, COLORS, SPATIAL RELATIONSHIPS, MANNERS, VOCABULARY, AND/OR MATH; BOARD GAMES; PLAYING CARDS; CARD GAMES; JIGSAW PUZZLES; MANIPULATIVE PUZZLES; CARDS FOR PLAYING A MATCHING CARD GAME; MULTIPLE ACTIVITY BABY TOYS; CRIB TOYS; CRIB MOBILES; BATH TOYS; BUBBLE MAKING TOYS; SAND TOYS; INFLATABLE TOYS; SPORTS EQUIPMENT, NAMELY, BASEBALL GLOVES, BASEBALL BATS, SPORTS BALLS, JUMP ROPES, ROLLER SKATES AND ATHLETIC PROTECTIVE PADS FOR ROLLER SKATING; PLAYGROUND BALLS; TOY SCOOTERS; PLAYHOUSES FOR CHILDREN; KITCHEN PLAY SETS COMPRISED OF PLASTIC TOY APPLIANCES, PLASTIC TOY UTENSILS, PLASTIC TOY PLATES, AND PLASTIC TOY FOOD; HOUSE CLEANING PLAY SETS COMPRISED OF PLASTIC TOY CLEANING EQUIPMENT AND TOY ACCESSORIES; COIN-OPERATED AMUSEMENT RIDES; RIDE-ON TOYS; PULL TOYS; BALLOONS; KITES; PIÑATAS; BABY RATTLES; POGO STICKS; CHRISTMAS STOCKINGS; HOLIDAY ORNAMENTS, NAMELY, CHRISTMAS TREE ORNAMENTS; DOLLS; BEAN BAG DOLLS; PUP-



David J. Kybas

Director of the United States Patent and Trademark Office

Reg. No. 4,107,381 PETS; SNOW GLOBES; TOY CHRISTMAS TREES; TOY MUSIC BOXES; WATER PISTOLS; KITS COMPRISING PRE-CUT MATERIALS FORMING PLAY SURFACES AND INTER-CHANGEABLE DESIGN STICKERS FOR ATTACHMENT TO THE PLAY SURFACES; PARTY FAVOURS IN THE NATURE OF CRACKERS AND NOISEMAKERS, IN CLASS 28 (U.S. CLS. 22, 23, 38 AND 50).

THE MARK CONSISTS OF STANDARD CHARACTERS WITHOUT CLAIM TO ANY PARTICULAR FONT, STYLE, SIZE, OR COLOR.

OWNER OF INTERNATIONAL REGISTRATION 1082871 DATED 5-13-2011, EXPIRES 5-13-2021.

OWNER OF U.S. REG. NOS. 2,752,592, 3,889,235, AND 3,889,236.

SER. NO. 79-099,468, FILED 5-13-2011.

EVELYN BRADLEY, EXAMINING ATTORNEY

United States of America

United States Patent and Trademark Office

WIKITUDE

Reg. No. 4,107,382

Registered Mar. 6, 2012

Int. Cls.: 9, 35, 38 and 42

TRADEMARK

SERVICE MARK

PRINCIPAL REGISTER

MOBILIZY GMBH (AUSTRIA LIMITED LIABILITY COMPANY)
GINZKEYPLATZ 11
A-5020 SALZBURG
AUSTRIA

FOR: DATA PROCESSING EQUIPMENT AND COMPUTERS, IN CLASS 9 (U.S. CLS. 21, 23, 26, 36 AND 38).

FOR: ADVERTISING , IN CLASS 35 (U.S. CLS. 100, 101 AND 102).

FOR: TELECOMMUNICATIONS SERVICES, NAMELY, TRANSMISSION OF DATA, GRAPHICS, SOUND AND VIDEO BY MEANS OF WIRELESS NETWORKS, IN CLASS 38 (U.S. CLS. 100, 101 AND 104).

FOR: SCIENTIFIC AND TECHNOLOGICAL SERVICES, NAMELY, RESEARCH AND DESIGN IN THE FIELD OF COMPUTER NETWORKING HARDWARE AND COMPUTER DATACENTER ARCHITECTURE, IN CLASS 42 (U.S. CLS. 100 AND 101).

THE MARK CONSISTS OF STANDARD CHARACTERS WITHOUT CLAIM TO ANY PARTICULAR FONT, STYLE, SIZE, OR COLOR.

OWNER OF INTERNATIONAL REGISTRATION 1082997 DATED 5-2-2011, EXPIRES 5-2-2021.

SER. NO. 79-099,531, FILED 5-2-2011.

PAUL E. FAHRENKOPF, EXAMINING ATTORNEY



David J. Kypos

Director of the United States Patent and Trademark Office

United States of America

United States Patent and Trademark Office

BAUME DU JARDINIER

Reg. No. 4,107,383

Registered Mar. 6, 2012

Int. Cl.: 3

TRADEMARK

PRINCIPAL REGISTER

L'OCCITANE INTERNATIONAL SA (LUXEMBOURG SOCIÉTÉ ANONYME)
1 RUE DU FORT RHEINSHEIM
L-2419 LUXEMBOURG
LUXEMBOURG

FOR: BODY AND BEAUTY CARE COSMETICS, IN CLASS 3 (U.S. CLS. 1, 4, 6, 50, 51 AND 52).

THE MARK CONSISTS OF STANDARD CHARACTERS WITHOUT CLAIM TO ANY PARTICULAR FONT, STYLE, SIZE, OR COLOR.

PRIORITY DATE OF 11-23-2010 IS CLAIMED.

OWNER OF INTERNATIONAL REGISTRATION 1083143 DATED 5-23-2011, EXPIRES 5-23-2021.

NO CLAIM IS MADE TO THE EXCLUSIVE RIGHT TO USE "BAUME", APART FROM THE MARK AS SHOWN.

THE ENGLISH TRANSLATION OF "BAUME DU JARDINIER" IN THE MARK IS GARDENER'S BALM.

SER. NO. 79-099,594, FILED 5-23-2011.

SUE LAWRENCE, EXAMINING ATTORNEY



David J. Kybas

Director of the United States Patent and Trademark Office

United States of America

United States Patent and Trademark Office

TOYAL POLYCA

Reg. No. 4,107,384

Registered Mar. 6, 2012

Int. Cl.: 9

TRADEMARK

PRINCIPAL REGISTER

TOYO ALUMINIUM KABUSHIKI KAISHA (JAPAN CORPORATION)
6-8, KYUTARO-MACHI 3-CHOME
CHUO-KU., OSAKA-SHI; OSAKA 541-0056
JAPAN

FOR: ANTENNA CIRCUITS FOR INTEGRATED CIRCUIT CARDS AND INTEGRATED CIRCUIT TAGS TO BE EMBEDDED THEREIN; CIRCUIT BOARDS; CONTROL BOARDS FOR ACCUMULATORS; ELECTRONIC TAGS FOR GOODS; ELECTRICAL CELLS AND BATTERIES; SOLAR PANELS FOR PRODUCTION OF ELECTRICITY; PLATES FOR BATTERIES; LOUDSPEAKERS; ANTENNAS FOR WIRELESS COMMUNICATIONS APPARATUS; MAGNETIC CORES; RESISTANCE WIRES; ELECTRODES, IN CLASS 9 (U.S. CLS. 21, 23, 26, 36 AND 38).

THE MARK CONSISTS OF STANDARD CHARACTERS WITHOUT CLAIM TO ANY PARTICULAR FONT, STYLE, SIZE, OR COLOR.

PRIORITY DATE OF 12-7-2010 IS CLAIMED.

OWNER OF INTERNATIONAL REGISTRATION 1083270 DATED 4-8-2011, EXPIRES 4-8-2021.

THE WORDING "TOYAL POLYCA" HAS NO MEANING IN A FOREIGN LANGUAGE.

SER. NO. 79-099,633, FILED 4-8-2011.

FRANK LATTUCA, EXAMINING ATTORNEY



David J. Kyffers

Director of the United States Patent and Trademark Office

United States of America

United States Patent and Trademark Office

ZEROPEX

Reg. No. 4,107,385

Registered Mar. 6, 2012

Int. Cl.: 35

SERVICE MARK

PRINCIPAL REGISTER

ENERGREEN AS (NORWAY AKSJESELSKAP)
ÅLGÅRDSVEIEN 170
N-4325 SANDNES
NORWAY

FOR: RETAIL STORE SERVICES AND ON-LINE RETAIL STORE SERVICES, BOTH FEATURING MACHINES AND MACHINE TOOLS, MOTORS AND ENGINES EXCEPT FOR LAND VEHICLES, MACHINE COUPLING AND TRANSMISSION COMPONENTS EXCEPT FOR LAND VEHICLES, PRESSURE REDUCTION VALVES, GENERATORS OF ELECTRICITY, TURBINES OTHER THAN FOR LAND VEHICLES, PRESSURE REGULATORS, SPEED GOVERNORS FOR MACHINES, ENGINES AND MOTORS, PUMPS, HYDRAULIC ENGINES AND MOTORS, HYDRAULIC TURBINES, SOLENOID VALVES, PRESSURE INDICATORS FOR VALVES, WATER DISTRIBUTION AND WATER SUPPLY INSTALLATIONS, GAS GENERATORS, REGULATING ACCESSORIES FOR WATER OR GAS APPARATUS AND FOR WATER OR GAS PIPES, AND WATER, OIL OR GAS PURIFYING APPARATUS AND MACHINES, AND PARTS AND ACCESSORIES FOR THE AFOREMENTIONED GOODS, IN CLASS 35 (U.S. CLS. 100, 101 AND 102).

THE MARK CONSISTS OF STANDARD CHARACTERS WITHOUT CLAIM TO ANY PARTICULAR FONT, STYLE, SIZE, OR COLOR.

OWNER OF INTERNATIONAL REGISTRATION 1083421 DATED 4-18-2011, EXPIRES 4-18-2021.

SER. NO. 79-099,741, FILED 4-18-2011.

SHAILA SETTLES, EXAMINING ATTORNEY



David J. Kyfos

Director of the United States Patent and Trademark Office

United States of America

United States Patent and Trademark Office



Reg. No. 4,107,386

Registered Mar. 6, 2012

Int. Cl.: 28

TRADEMARK

PRINCIPAL REGISTER

HIT ENTERTAINMENT LIMITED (UNITED KINGDOM PRIVATE LIMITED COMPANY)
149 TOTTENHAM COURT ROAD
5TH FLOOR, MAPLE HOUSE; LONDON, W1T 7NF
UNITED KINGDOM AND

KATHARINE HOLABIRD (UNITED KINGDOM INDIVIDUAL)
17 CORRINGHAM ROAD
LONDON NW11 7BS
UNITED KINGDOM AND

HELEN CRAIG (UNITED KINGDOM INDIVIDUAL)
21 CHURCH STREET
GREAT SHELFORD; CAMBRIDGE CB22 5EL
UNITED KINGDOM

FOR: PLUSH TOYS; TOY BUILDING BLOCKS; TOY FIRE TRUCKS; TOY VEHICLES; TOY CONSTRUCTION SETS; ELECTRONIC NOVELTY TOYS, NAMELY, TOYS FEATURING MUSIC, SOUND, LIGHT AND/OR MOVEMENT; ELECTRONIC LEARNING TOYS; WOODEN TOYS, NAMELY, TRAINS AND TRAIN ACCESSORIES; HANDHELD UNITS FOR PLAYING ELECTRONIC GAMES OTHER THAN THOSE ADAPTED FOR USE WITH AN EXTERNAL DISPLAY SCREEN OR MONITOR; PLAY SETS COMPRISED OF FIGURES AND ACCESSORIES WITH TOY BUILDINGS, LANDSCAPES, ENVIRONMENTS AND/OR SETTINGS; TOY DIECAST FIGURES; TOY PLASTIC FIGURES; TOY TRAINS; LEARNING TOYS, NAMELY, TOYS FOR TEACHING LANGUAGE, ALPHABET, NUMBERS, COLORS, SPATIAL RELATIONSHIPS, MANNERS, VOCABULARY, AND/OR MATH; BOARD GAMES; PLAYING CARDS; CARD GAMES; JIGSAW PUZZLES; MANIPULATIVE PUZZLES; CARDS FOR PLAYING A MATCHING CARD GAME; MULTIPLE ACTIVITY BABY TOYS; CRIB TOYS; CRIB MOBILES; BATH TOYS; BUBBLE MAKING TOYS; SAND TOYS; INFLATABLE TOYS; SPORTS EQUIPMENT, NAMELY, BASEBALL GLOVES, BASEBALL BATS, SPORTS BALLS, JUMP ROPES, ROLLER SKATES AND ATHLETIC PROTECTIVE PADS FOR ROLLER SKATING; PLAYGROUND BALLS; TOY SCOOTERS; PLAYHOUSES FOR CHILDREN; KITCHEN PLAY SETS COMPRISED OF PLASTIC TOY APPLIANCES, PLASTIC TOY UTENSILS, PLASTIC TOY PLATES, AND PLASTIC TOY FOOD; HOUSE CLEANING PLAY SETS COMPRISED OF PLASTIC TOY CLEANING EQUIPMENT AND TOY ACCESSORIES; COIN-OPERATED AMUSEMENT RIDES; RIDE-ON TOYS; PULL TOYS; BALLOONS; KITES; PIÑATAS; BABY RATTLES; POGO STICKS; CHRISTMAS STOCKINGS; HOLIDAY ORNAMENTS, NAMELY, CHRISTMAS TREE ORNAMENTS; DOLLS; BEAN BAG DOLLS; PUP-



David J. Kyros

Director of the United States Patent and Trademark Office

Reg. No. 4,107,386 PETS; SNOW GLOBES; TOY CHRISTMAS TREES; TOY MUSIC BOXES; WATER PISTOLS; KITS COMPRISING PRE-CUT MATERIALS FORMING PLAY SURFACES AND INTER-CHANGEABLE DESIGN STICKERS FOR ATTACHMENT TO THE PLAY SURFACES; PARTY FAVOURS IN THE NATURE OF CRACKERS AND NOISEMAKERS, IN CLASS 28 (U.S. CLS. 22, 23, 38 AND 50).

OWNER OF U.S. REG. NOS. 2,752,592, 3,889,235, AND 3,889,236.

PRIORITY DATE OF 12-24-2010 IS CLAIMED.

OWNER OF INTERNATIONAL REGISTRATION 1083776 DATED 5-13-2011, EXPIRES 5-13-2021.

THE COLOR(S) DARK PINK, LIGHT PINK, WHITE AND YELLOW IS/ARE CLAIMED AS A FEATURE OF THE MARK.

THE COLOR WHITE APPEARS IN THE WORD "ANGELINA", IN THE OUTER EDGES OF THE MISCELLANEOUS DESIGN WITH AN OVERALL OVAL SHAPE, AND IN THE TWO SMALL CIRCLES IN THE MISCELLANEOUS DESIGN. THE COLOR LIGHT PINK APPEARS IN THE WORD "BALLERINA". THE COLOR YELLOW APPEARS IN THE DEPICTION OF A STAR. THE COLOR DARK PINK APPEARS INSIDE AND IN THE OUTLINE OF THE MISCELLANEOUS DESIGN WITH AN OVERALL OVAL SHAPE.

SER. NO. 79-099,861, FILED 5-13-2011.

EVELYN BRADLEY, EXAMINING ATTORNEY

United States of America

United States Patent and Trademark Office



Reg. No. 4,107,387

Registered Mar. 6, 2012

Int. Cl.: 28

TRADEMARK

PRINCIPAL REGISTER

HIT ENTERTAINMENT LIMITED (UNITED KINGDOM PRIVATE LIMITED COMPANY)
149 TOTTENHAM COURT ROAD
5TH FLOOR, MAPLE HOUSE; LONDON, W1T 7NF
UNITED KINGDOM AND

KATHARINE HOLABIRD (UNITED KINGDOM INDIVIDUAL)
17 CORRINGHAM ROAD
LONDON NW11 7BS
UNITED KINGDOM AND

HELEN CRAIG (UNITED KINGDOM INDIVIDUAL)
21 CHURCH STREET
GREAT SHELFORD; CAMBRIDGE CB22 5EL
UNITED KINGDOM

FOR: PLUSH TOYS; TOY BUILDING BLOCKS; TOY FIRE TRUCKS; TOY VEHICLES; TOY CONSTRUCTION SETS; ELECTRONIC NOVELTY TOYS, NAMELY, TOYS FEATURING MUSIC, SOUND, LIGHT AND/OR MOVEMENT; ELECTRONIC LEARNING TOYS; WOODEN TOYS, NAMELY, TRAINS AND TRAIN ACCESSORIES; HANDHELD UNITS FOR PLAYING ELECTRONIC GAMES OTHER THAN THOSE ADAPTED FOR USE WITH AN EXTERNAL DISPLAY SCREEN OR MONITOR; PLAY SETS COMPRISED OF FIGURES AND ACCESSORIES WITH TOY BUILDINGS, LANDSCAPES, ENVIRONMENTS AND/OR SETTINGS; TOY DIECAST FIGURES; TOY PLASTIC FIGURES; TOY TRAINS; LEARNING TOYS, NAMELY, TOYS FOR TEACHING LANGUAGE, ALPHABET, NUMBERS, COLORS, SPATIAL RELATIONSHIPS, MANNERS, VOCABULARY, AND/OR MATH; BOARD GAMES; PLAYING CARDS; CARD GAMES; JIGSAW PUZZLES; MANIPULATIVE PUZZLES; CARDS FOR PLAYING A MATCHING CARD GAME; MULTIPLE ACTIVITY BABY TOYS; CRIB TOYS; CRIB MOBILES; BATH TOYS; BUBBLE MAKING TOYS; SAND TOYS; INFLATABLE TOYS; SPORTS EQUIPMENT, NAMELY, BASEBALL GLOVES, BASEBALL BATS, SPORTS BALLS, JUMP ROPES, ROLLER SKATES AND ATHLETIC PROTECTIVE PADS FOR ROLLER SKATING; PLAYGROUND BALLS; TOY SCOOTERS; PLAYHOUSES FOR CHILDREN; KITCHEN PLAY SETS COMPRISED OF PLASTIC TOY APPLIANCES, PLASTIC TOY UTENSILS, PLASTIC TOY PLATES, AND PLASTIC TOY FOOD; HOUSE CLEANING PLAY SETS COMPRISED OF PLASTIC TOY CLEANING EQUIPMENT AND TOY ACCESSORIES; COIN-OPERATED AMUSEMENT RIDES; RIDE-ON TOYS; PULL TOYS; BALLOONS; KITES; PIÑATAS; BABY RATTLES; POGO STICKS; CHRISTMAS STOCKINGS; HOLIDAY ORNAMENTS, NAMELY, CHRISTMAS TREE ORNAMENTS; DOLLS; BEAN BAG DOLLS; PUP-



David J. Kybas

Director of the United States Patent and Trademark Office

Reg. No. 4,107,387 PETS; SNOW GLOBES; TOY CHRISTMAS TREES; TOY MUSIC BOXES; WATER PISTOLS; KITS COMPRISING PRE-CUT MATERIALS FORMING PLAY SURFACES AND INTER-CHANGEABLE DESIGN STICKERS FOR ATTACHMENT TO THE PLAY SURFACES; PARTY FAVOURS IN THE NATURE OF CRACKERS AND NOISEMAKERS, IN CLASS 28 (U.S. CLS. 22, 23, 38 AND 50).

OWNER OF U.S. REG. NO. 3,899,293.

PRIORITY DATE OF 12-24-2010 IS CLAIMED.

OWNER OF INTERNATIONAL REGISTRATION 1083777 DATED 5-13-2011, EXPIRES 5-13-2021.

THE COLOR(S) PINK, LIGHT PINK, RED, BLACK AND WHITE IS/ARE CLAIMED AS A FEATURE OF THE MARK.

THE MARK CONSISTS OF A DESIGN OF A DANCING MOUSE. THE COLOR LIGHT PINK APPEARS IN THE BODY OF THE MOUSE. THE COLORS PINK AND LIGHT PINK APPEAR IN THE MOUSE'S DRESS. THE COLOR PINK APPEARS IN THE MOUSE'S SHOES. THE COLOR RED APPEARS IN THE FLOWER ON THE MOUSE'S DRESS. THE COLORS WHITE AND BLACK APPEAR IN THE MOUSE'S EYES.

SER. NO. 79-099,862, FILED 5-13-2011.

EVELYN BRADLEY, EXAMINING ATTORNEY

United States of America

United States Patent and Trademark Office

shave-lab

Reg. No. 4,107,388

Registered Mar. 6, 2012

Int. Cls.: 3, 8 and 21

TRADEMARK

PRINCIPAL REGISTER

ISOLUTIONS GMBH (FED REP GERMANY GMBH (GESELLSCHAFT MIT BESCHRÄNKTER HAFTUNG))
MANNHEIMERSTR. 7
80803 MÜNCHEN, FED REP GERMANY

FOR: BLEACHING PREPARATIONS FOR LAUNDRY USE; CLEANING, POLISHING, SCOURING AND ABRASIVE PREPARATIONS; SOAPS; PERFUMERY, ESSENTIAL OILS, COSMETICS, HAIR LOTIONS; DENTIFRICES; NON-MEDICATED PREPARATIONS FOR USE BEFORE, DURING AND AFTER SHAVING; SHAVING FOAM; SHAVING GELS; SHAVING CREAMS; SHAVING LOTIONS; SHAVING OILS; AFTERSHAVE; AFTER-SHAVE; SHAVING COSMETICS, IN CLASS 3 (U.S. CLS. 1, 4, 6, 50, 51 AND 52).

FOR: HAND TOOLS AND IMPLEMENTS, NAMELY, SHAVING SETS CONSISTING PRIMARILY OF ELECTRIC AND NON-ELECTRIC RAZORS, SHAVER HANDLES BEING STRUCTURAL PARTS OF RAZORS, AND SHAVING BLADES, INCLUDING THOSE SOLD IN CARTRIDGES, DISPENSERS, CASSETTES, HOLDERS AND RAZOR CASES; ELECTRIC AND NON-ELECTRIC RAZORS AND RAZOR BLADES; STRUCTURAL PARTS OF ELECTRIC AND NON-ELECTRIC SHAVERS, NAMELY, SHAVER HANDLES, INCLUDING THOSE FOR WET SHAVING, AND NON-ELECTRIC ADAPTERS FOR SHAVING HANDLES SPECIALLY FITTED FOR SHAVERS; SHAVING BLADES SOLD CONTAINED IN DISPENSERS, CASSETTES, HOLDERS AND CARTRIDGES; RAZOR CASES, IN CLASS 8 (U.S. CLS. 23, 28 AND 44).

FOR: COMBS; BRUSH-MAKING MATERIALS; STEEL WOOL; UNWORKED OR SEMI-WORKED GLASS NOT FOR USE IN BUILDING; GLASSWARE, PORCELAIN AND EARTHENWARE, NAMELY, SHAVING BRUSH HOLDERS, SHAVING DISHES, SHAVING POTS AND SHAVING BOWLS; SHAVING BRUSHES AND SHAVING BRUSH STANDS; HOLDERS FOR SHAVING APPARATUS, NAMELY, SHAVING BRUSH HOLDERS, SHAVING DISHES, SHAVING POTS, SHAVING BOWLS AND SHAVING DRIP STANDS FOR HOLDING SHAVERS AND RAZORS, IN CLASS 21 (U.S. CLS. 2, 13, 23, 29, 30, 33, 40 AND 50).

THE MARK CONSISTS OF STANDARD CHARACTERS WITHOUT CLAIM TO ANY PARTICULAR FONT, STYLE, SIZE, OR COLOR.

PRIORITY DATE OF 12-20-2010 IS CLAIMED.



David J. Kyffers

Director of the United States Patent and Trademark Office

Reg. No. 4,107,388 OWNER OF INTERNATIONAL REGISTRATION 1083849 DATED 4-18-2011, EXPIRES 4-18-2021.

SER. NO. 79-099,883, FILED 4-18-2011.

ZHALEH DELANEY, EXAMINING ATTORNEY

United States of America

United States Patent and Trademark Office

Elypso

Reg. No. 4,107,389

Registered Mar. 6, 2012

Int. Cls.: 9, 16 and 37

TRADEMARK

SERVICE MARK

PRINCIPAL REGISTER

EVOLIS (FRANCE SA)
ZI ANGERS BEAUCOUZE -
14 AVENUE DE LA FONTAINE
F-49070 BEAUCOUZE, FRANCE

FOR: COMPUTER PERIPHERAL DEVICES, NAMELY, PRINTER THAT ALSO FEATURE LAMINATING CAPABILITY AND ENCODER; COMPONENT PARTS SPECIALLY ADAPTED FOR USE WITH PRINTERS THAT ALSO FEATURE LAMINATING CAPABILITY, NAMELY, CHARGING UNITS, PRINT HEADS, LAMINATION MODULES, REJECT BINS, CARD REVERSAL MODULES, RIBBON SAVERS FOR PRINTING AND COMPONENT PARTS SPECIALLY ADAPTED FOR USE WITH ENCODERS, NAMELY, MAGNETIC TRACK ENCODING STATIONS, AND ELECTRONIC DOCKING STATIONS WITH CONTACT POINTS FOR INTEGRATED CIRCUIT CARDS IN THE NATURE OF SMART CARDS; INTEGRATED CIRCUIT CARDS IN THE NATURE OF SMART CARDS AND MAGNETIC ENCODED CARDS; PRINTERS FOR USE WITH CARDS MADE OF PLASTIC AND PAPER; COMPUTER PERIPHERAL, NAMELY, PRINT DRIVERS AND ENCODERS FOR USE WITH PLASTIC CARDS; COMPUTER SOFTWARE FOR PROCESSING, MANAGING AND CREATING CARDS, COMPUTER SOFTWARE FOR MANAGING PRINTERS, COMPUTER SOFTWARE FOR ENCODING MAGNETIC STRIPE CARDS AND INTEGRATED CIRCUIT CARDS IN THE NATURE OF SMART CARDS, IN CLASS 9 (U.S. CLS. 21, 23, 26, 36 AND 38).

FOR: COLOR AND MONOCHROME RIBBONS FOR USE WITH PRINTERS, ENCODING AND LAMINATING MACHINES; TRANSPARENT PROTECTIVE RIBBONS FOR USE WITH PRINTERS AND LAMINATION MACHINES; BLANK PLASTIC SMART CARDS; PLASTIC CASES SPECIALLY ADAPTED FOR HOLDING BADGES AND OTHER IDENTIFICATION CARDS; PAPER GIFT CARDS; PAPER BUSINESS CARDS; PAPER INDEX CARDS, IN CLASS 16 (U.S. CLS. 2, 5, 22, 23, 29, 37, 38 AND 50).

FOR: INSTALLATION OF PRINTING, ENCODING AND LAMINATION MACHINES NOT INCLUDING INSTALLATION OF COMPUTER SOFTWARE; MAINTAINING, SERVICING AND REPAIRING OF PRINTING, ENCODING AND LAMINATION MACHINES, IN CLASS 37 (U.S. CLS. 100, 103 AND 106).

THE WORDING "ELYPSO" HAS NO MEANING IN A FOREIGN LANGUAGE.

PRIORITY DATE OF 12-22-2010 IS CLAIMED.



David J. Kyffers

Director of the United States Patent and Trademark Office

Reg. No. 4,107,389 OWNER OF INTERNATIONAL REGISTRATION 1084010 DATED 4-21-2011, EXPIRES 4-21-2021.

SER. NO. 79-099,953, FILED 4-21-2011.

TRACY FLETCHER, EXAMINING ATTORNEY

United States of America

United States Patent and Trademark Office

ZENIUS

Reg. No. 4,107,390

Registered Mar. 6, 2012

Int. Cls.: 9, 16 and 37

TRADEMARK

SERVICE MARK

PRINCIPAL REGISTER

EVOLIS (FRANCE SA)
ZI ANGERS BEAUCOUZE -
14 AVENUE DE LA FONTAINE
F-49070 BEAUCOUZE, FRANCE

FOR: COMPUTER PERIPHERAL DEVICES, NAMELY, PRINTER THAT ALSO FEATURE LAMINATING CAPABILITY AND ENCODER; COMPONENT PARTS SPECIALLY ADAPTED FOR USE WITH PRINTERS THAT ALSO FEATURE LAMINATING CAPABILITY, NAMELY, CHARGING UNITS, PRINT HEADS, LAMINATION MODULES, REJECT BINS, CARD REVERSAL MODULES, RIBBON SAVERS FOR PRINTING AND COMPONENT PARTS SPECIALLY ADAPTED FOR USE WITH ENCODERS, NAMELY, MAGNETIC TRACK ENCODING STATIONS, AND ELECTRONIC DOCKING STATIONS WITH CONTACT POINTS FOR INTEGRATED CIRCUIT CARDS IN THE NATURE OF SMART CARDS; INTEGRATED CIRCUIT CARDS IN THE NATURE OF SMART CARDS AND MAGNETIC ENCODED CARDS; PRINTERS FOR USE WITH CARDS MADE OF PLASTIC AND PAPER; COMPUTER PERIPHERAL, NAMELY, PRINT DRIVERS AND ENCODERS FOR USE WITH PLASTIC CARDS; COMPUTER SOFTWARE FOR PROCESSING, MANAGING AND CREATING CARDS, COMPUTER SOFTWARE FOR MANAGING PRINTERS, COMPUTER SOFTWARE FOR ENCODING MAGNETIC STRIPE CARDS AND INTEGRATED CIRCUIT CARDS IN THE NATURE OF SMART CARDS, IN CLASS 9 (U.S. CLS. 21, 23, 26, 36 AND 38).

FOR: COLOR AND MONOCHROME RIBBONS FOR USE WITH PRINTERS, ENCODING AND LAMINATING MACHINES; TRANSPARENT PROTECTIVE RIBBONS FOR USE WITH PRINTERS AND LAMINATION MACHINES; BLANK PLASTIC SMART CARDS; PLASTIC CASES SPECIALLY ADAPTED FOR HOLDING BADGES AND OTHER IDENTIFICATION CARDS; PAPER GIFT CARDS; PAPER BUSINESS CARDS; PAPER INDEX CARDS, IN CLASS 16 (U.S. CLS. 2, 5, 22, 23, 29, 37, 38 AND 50).

FOR: INSTALLATION OF PRINTING, ENCODING AND LAMINATION MACHINES NOT INCLUDING INSTALLATION OF COMPUTER SOFTWARE; MAINTAINING, SERVICING AND REPAIRING OF PRINTING, ENCODING AND LAMINATION MACHINES, IN CLASS 37 (U.S. CLS. 100, 103 AND 106).

THE MARK CONSISTS OF STANDARD CHARACTERS WITHOUT CLAIM TO ANY PARTICULAR FONT, STYLE, SIZE, OR COLOR.

PRIORITY DATE OF 12-22-2010 IS CLAIMED.



David J. Kyros

Director of the United States Patent and Trademark Office

Reg. No. 4,107,390 OWNER OF INTERNATIONAL REGISTRATION 1084011 DATED 4-21-2011, EXPIRES 4-21-2021.

THE WORDING "ZENIUS" HAS NO MEANING IN A FOREIGN LANGUAGE.

SER. NO. 79-099,954, FILED 4-21-2011.

TRACY FLETCHER, EXAMINING ATTORNEY

United States of America

United States Patent and Trademark Office

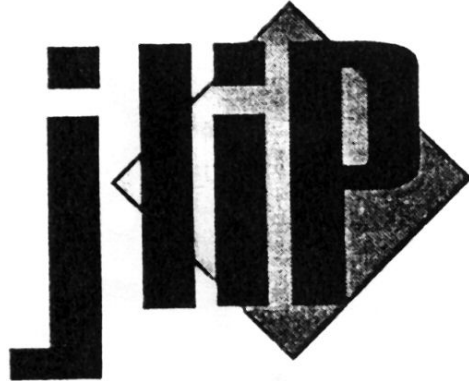

Reg. No. 4,107,391

Registered Mar. 6, 2012

Int. Cls.: 20 and 25

TRADEMARK

PRINCIPAL REGISTER

JLIP GROUP CO., LTD. (CHINA CORPORATION)
4-6 FLOOR
NO. 107, SHENGLI ROAD,; JIANGMEN; GUANGDONG
CHINA

FOR: FURNITURE; TRESTLE TABLES; INFANT WALKERS; WOVEN ARTICLES OF BAMBOO, NOT INCLUDING HATS, MATTINGS, OR MATTRESSES, NAMELY, BAMBOO BLINDS, BAMBOO CURTAINS; WOVEN ARTICLES OF RATTAN WHIP, NOT INCLUDING HATS, MATTINGS, OR MATTRESSES, NAMELY, BLINDS OF RATTAN, FIGURES OF RATTAN; WOVEN ARTICLES OF STRAW, NOT INCLUDING HATS, MATTINGS, OR MATTRESSES, NAMELY, STRAW CHAIRS, STRAW BLINDS; LACQUERWORK ARTWARE, NAMELY, WORKS OF ART OF WOOD PAINTED WITH LACQUER; WORKS OF ART, OF WOOD, WAX, PLASTER OR PLASTIC; SLEEPING BAGS; PORTABLE KENNELS FOR HOUSEHOLD PETS, IN CLASS 20 (U.S. CLS. 2, 13, 22, 25, 32 AND 50).

FOR: CLOTHING, NAMELY, SHIRTS, PANTS, JACKETS, COATS; UNDERPANTS; CHILDREN'S CLOTHING, NAMELY, BABIES' PANTS; BABY LAYETTES FOR CLOTHING; BABY BUNTING SNUGGLE SUITS; SHOES; HATS; HOSIERY; LEATHER BELTS AS CLOTHING, IN CLASS 25 (U.S. CLS. 22 AND 39).

THE STIPLING IS FOR SHADING PURPOSES ONLY.

OWNER OF INTERNATIONAL REGISTRATION 1084152 DATED 3-10-2011, EXPIRES 3-10-2021.

THE MARK CONSISTS OF THE TEXT "JLIP" WITH A PARTIALLY SHADED DIAMOND DESIGN BEHIND "LIP".

SER. NO. 79-099,999, FILED 3-10-2011.

CARYN GLASSER, EXAMINING ATTORNEY



David J. Kybas

Director of the United States Patent and Trademark Office

United States of America

United States Patent and Trademark Office

MYLAN DIGITAL PRINTING INKS

Original Quality. Alternative Price.

Reg. No. 4,107,392

Registered Mar. 6, 2012

Int. Cl.: 2

TRADEMARK

PRINCIPAL REGISTER

MYLAN GROUP (VIETNAM CORPORATION)
LONG DUC INDUSTRIAL PARK
TRA VINH CITY; TRA VINH PROVINCE
VIETNAM

FOR: PRINTING SOLVENT INKS; ECO-SOLVENT PRINTING INKS; WATER-BASED INKS, TONERS AND DYES FOR USE WITH OR ON TEXTILES AND FABRICS, GLASS, METAL, PLASTIC, BIOLOGICAL, NAMELY, FOOD, EGGS, MEDICINES, COATED AND UNCOATED SUBSTRATES; PRINTING INKS, COATING, PIGMENTS AND DISPERSIONS FOR USE ON CARTONS AND PACKAGING; PRINTING INKS, COATING, PIGMENTS AND DISPERSIONS, NAMELY, INDUSTRIAL GRADE, ECOFRIENDLY THERMAL INKS FOR POSTAL, ADDRESSING, PACKAGING, BARCODE, AND INDUSTRIAL PRINTING MARKETS; PRINTING INKS, NAMELY, LIGHTFAST INKS THAT SET THE INDUSTRY STANDARD ON THE WIDEST COLOR GAMUT FOR THE WIDE FORMAT, OUT-OF-HOME ADVERTISING MARKET, IN CLASS 2 (U.S. CLS. 6, 11 AND 16).

NO CLAIM IS MADE TO THE EXCLUSIVE RIGHT TO USE "DIGITAL PRINTING INKS, ORIGINAL QUALITY, PRICE", APART FROM THE MARK AS SHOWN.

PRIORITY DATE OF 4-8-2011 IS CLAIMED.

OWNER OF INTERNATIONAL REGISTRATION 1084224 DATED 4-28-2011, EXPIRES 4-28-2021.

THE COLOR(S) RED AND DARK BLUE IS/ARE CLAIMED AS A FEATURE OF THE MARK.

THE MARK CONSISTS OF THE STYLIZED WORDING "MYLAN DIGITAL PRINTING INKS ORIGINAL QUALITY. ALTERNATIVE PRICE." IN TWO LINES. THE WORDING "MYLAN DIGITAL PRINTING INKS" IS IN RED AND "ORIGINAL QUALITY. ALTERNATIVE PRICE." IS IN BLUE.

SER. NO. 79-100,039, FILED 4-28-2011.

LOURDES AYALA, EXAMINING ATTORNEY



David J. Kyffers

Director of the United States Patent and Trademark Office

United States of America

United States Patent and Trademark Office



Reg. No. 4,107,393

Registered Mar. 6, 2012

Int. Cl.: 16

TRADEMARK

PRINCIPAL REGISTER

OBCHTCHESTVO S OGRANITCHENNOI OTVETSTVENNOSTIOU "KORPORATSIA
"SIBIRSKOE ZDOROVIE" (RUSSIAN FED. SOCIÉTÉ À RESPONSABILITÉ LIMITÉE)
RU-630004 UL. LENINA, 48, NOVOSIBIRSK,
RUSSIAN FED.

FOR: POSTERS; ALMANACS; STATIONERY; STICKERS; PAMPHLETS IN THE FIELD OF PROMOTION OF ACTIVE DIETARY SUPPLEMENTS AND SKIN CARE PRODUCTS; CALENDARS; NOTE BOOKS; GREETING CARDS; POSTCARDS; CARDBOARD ARTICLES, NAMELY, CARD BOARD PACKAGING; CATALOGUES PROVIDING INFORMATION ABOUT ACTIVE DIETARY SUPPLEMENTS AND SKIN CARE PRODUCTS; NEWSLETTERS IN THE FIELD OF PROMOTION OF ACTIVE DIETARY SUPPLEMENTS AND SKIN CARE PRODUCTS; GRAPHIC PRINTS; SIGNBOARDS OF PAPER OR CARDBOARD; ENVELOPES; LABELS, NOT OF TEXTILE, NAMELY, ADHESIVE LABELS; FORMS, PRINTED; WRITING INSTRUMENTS; NEWSPAPERS; BOOKS IN THE FIELD OF HEALTH PROMOTION; BOOKLETS IN THE FIELD OF HEALTH PROMOTION; MANUALS IN THE FIELD OF USAGE OF ACTIVE DIETARY SUPPLEMENTS AND SKIN CARE PRODUCTS; WRITING CASED SETS COMPRISING WRITING INSTRUMENTS; PAPER; PERIODICALS IN THE FIELD OF HEALTH PROMOTION; PROSPECTUSES IN THE FIELD OF HEALTH PROMOTION; BAGS, ENVELOPES AND POUCHES OF PAPER OR PLASTICS, FOR PACKAGING, IN CLASS 16 (U.S. CLS. 2, 5, 22, 23, 29, 37, 38 AND 50).

THE MARK CONSISTS OF THE FOLLOWING: A LARGE FRUIT-BEARING APPLE TREE LINED IN LIGHT BROWN OVER WHITE.

OWNER OF INTERNATIONAL REGISTRATION 1084671 DATED 6-10-2011, EXPIRES 6-10-2021.

THE COLOR(S) LIGHT BROWN, WHITE IS/ARE CLAIMED AS A FEATURE OF THE MARK.

SER. NO. 79-100,213, FILED 6-10-2011.

RON FAIRBANKS, EXAMINING ATTORNEY



David J. Kyros

Director of the United States Patent and Trademark Office

United States of America
United States Patent and Trademark Office

UPE

Reg. No. 4,107,394

Registered Mar. 6, 2012

Int. Cl.: 2

TRADEMARK

PRINCIPAL REGISTER

VOTTELER LACKFABRIK GMBH & CO. KG (FED REP GERMANY GMBH & CO. KG)
SCHWIEBERDINGER STRASSE 97 + 102
70825 KORNTAL-MÜNCHINGEN, FED REP GERMANY

FOR: PAINTS, VARNISHES, LACQUERS; RUST PRESERVATIVES IN THE NATURE OF COATING; WOOD PRESERVATIVES FOR PREVENTING DETERIORATION OF WOOD; COLORANTS; MORDANTS FOR USE IN THE WOOD INDUSTRY, IN CLASS 2 (U.S. CLS. 6, 11 AND 16).

THE MARK CONSISTS OF STANDARD CHARACTERS WITHOUT CLAIM TO ANY PARTICULAR FONT, STYLE, SIZE, OR COLOR.

OWNER OF INTERNATIONAL REGISTRATION 0749477 DATED 12-13-2000, EXPIRES 12-13-2020.

SER. NO. 79-100,306, FILED 5-31-2011.

CHRISIE B. KING, EXAMINING ATTORNEY



David J. Kyffers

Director of the United States Patent and Trademark Office

United States of America

United States Patent and Trademark Office

SEEK

Reg. No. 4,107,395

Registered Mar. 6, 2012

Int. Cls.: 5, 44 and 45

TRADEMARK

SERVICE MARK

PRINCIPAL REGISTER

PEPTCELL LIMITED (UNITED KINGDOM LIMITED COMPANY)
100 FETTER LANE
LONDON EC4A 1BN
UNITED KINGDOM

FOR: PHARMACEUTICAL PREPARATIONS FOR USE IN THE TREATMENT OF INFLUENZA, HIV, HEPATITIS C, HEPATITIS B, MOSQUITO BORNE DISEASES, TUBERCULOSIS, RHEUMATOID ARTHRITIS, ROTAVIRUS, BLOOD DISORDERS, CANCER, CARDIOVASCULAR DISEASES, CENTRAL NERVOUS SYSTEM DISEASES AND DISORDERS, DIABETES, ENDOCRINE DISORDERS, GASTROINTESTINAL DISORDERS, HORMONAL DISEASES AND DISORDERS, INFLAMMATION AND INFLAMMATORY DISORDERS, MUSCULOSKELETAL DISORDERS, NEURODEGENERATIVE DISORDERS, NEUROLOGICAL DISORDERS, OBESITY, OPHTHALMOLOGIC CONDITIONS AND DISORDERS, SEXUAL DYSFUNCTION, UROLOGICAL DISORDERS, VIRAL, PROTOZOA AND BACTERIAL DISORDERS, DISEASES AND ILLNESSES; VETERINARY PREPARATIONS, NAMELY, AMINO ACIDS FOR VETERINARY PURPOSES, ANTI-INFECTION PRODUCTS FOR VETERINARY USE, BACTERIAL PREPARATIONS FOR VETERINARY PURPOSES, BIOCHEMICAL PREPARATIONS FOR USE IN THE TREATMENT OF INFLUENZA, HIV, HEPATITIS C, HEPATITIS B, MOSQUITO BORNE DISEASES, TUBERCULOSIS, RHEUMATOID ARTHRITIS, ROTAVIRUS, BLOOD DISORDERS, CANCER, CARDIOVASCULAR DISEASES, CENTRAL NERVOUS SYSTEM DISEASES AND DISORDERS, DIABETES, ENDOCRINE DISORDERS, GASTROINTESTINAL DISORDERS, HORMONAL DISEASES AND DISORDERS, INFLAMMATION AND INFLAMMATORY DISORDERS, MUSCULOSKELETAL DISORDERS, NEURODEGENERATIVE DISORDERS, NEUROLOGICAL DISORDERS, OBESITY, OPHTHALMOLOGIC CONDITIONS AND DISORDERS, SEXUAL DYSFUNCTION, UROLOGICAL DISORDERS, VIRAL, PROTOZOA AND BACTERIAL DISORDERS, DISEASES AND ILLNESSES, BLOOD SUBSTITUTE FOR VETERINARY USE, VETERINARY VACCINES, PAIN RELIEF MEDICATION FOR VETERINARY USE, VETERINARY PREPARATIONS FOR THE TREATMENT OF INTESTINAL BACTERIA, VETERINARY PARASITICIDES FOR LIVESTOCK USE; SANITARY STERILIZING PREPARATIONS; DIETETIC SUBSTANCES, NAMELY, FOODS ADAPTED FOR MEDICAL USE; MEDICAL PLASTERS, DISINFECTANTS FOR MEDICAL INSTRUMENTS AND SANITARY PURPOSES, FUNGICIDES, HERBICIDES, PREPARATIONS FOR DESTROYING VERMIN, PAIN RELIEF MEDICATIONS; NUTRITIONAL SUBSTANCES, NAMELY, NUTRITIONAL SUBSTANCES IN THE NATURE OF CAPSULES CONTAINING GLUCOSAMINE AND CHONDROITIN AND NUTRITIONAL SUPPLEMENTS, VITAMINS, MINERAL SUPPLEMENTS, AND NUTRITIONAL SUPPLEMENTS, NAMELY, GLUCOSAMINE AND CHONDROITIN; NUTRACEUTICALS FOR USE AS A DI-



David J. Kyros

Director of the United States Patent and Trademark Office

Reg. No. 4,107,395 ETARY SUPPLEMENT, NUTRITIONAL SUBSTANCES, NAMELY, INTRAVENOUS FLUIDS USED FOR NUTRITION; FOOD SUPPLEMENTS FOR MEDICAL PURPOSES, DIETETIC BEVERAGES AND DIETETIC FOODS ADAPTED FOR MEDICAL USE; MEDICAL USE AND NUTRITIONAL SUPPLEMENTS, VITAMINS, MINERAL SUPPLEMENTS, BACTERIOLOGICAL PREPARATIONS FOR MEDICAL OR VETERINARY PURPOSES; BIOLOGICAL PREPARATIONS FOR THE TREATMENT OF INFLUENZA, HIV, HEPATITIS C, HEPATITIS B, MOSQUITO BORNE DISEASES, TUBERCULOSIS, RHEUMATOID ARTHRITIS, ROTAVIRUS, BLOOD DISORDERS, CANCER, CARDIOVASCULAR DISEASES, CENTRAL NERVOUS SYSTEM DISEASES AND DISORDERS, DIABETES, ENDOCRINE DISORDERS, GASTROINTESTINAL DISORDERS, HORMONAL DISEASES AND DISORDERS, INFLAMMATION AND INFLAMMATORY DISORDERS, MUSCULOSKELETAL DISORDERS, NEURODEGENERATIVE DISORDERS, NEUROLOGICAL DISORDERS, OBESITY, OPHTHALMOLOGIC CONDITIONS AND DISORDERS, SEXUAL DYSFUNCTION, UROLOGICAL DISORDERS, VIRAL, PROTOZOA AND BACTERIAL DISORDERS, DISEASES AND ILLNESSES, DIAGNOSTIC PREPARATIONS FOR MEDICAL PURPOSES, CHEMICALS FOR USE IN THE MANUFACTURE OF PHARMACEUTICALS; VACCINES, IN CLASS 5 (U.S. CLS. 6, 18, 44, 46, 51 AND 52).

FOR: MEDICAL SERVICES, VETERINARY SERVICES, HYGIENIC CARE FOR HUMAN BEINGS; MEDICAL CLINICS, CONVALESCENT HOME SERVICES, DENTISTRY, HEALTHCARE SERVICES, NURSING HOMES, MIDWIFE SERVICES, OPTICIANS SERVICES, PHYSIOTHERAPY SERVICES, PSYCHOLOGY SERVICES, BLOOD BANK SERVICES, AGRICULTURAL SERVICES, NAMELY, AGRICULTURAL ADVICE, SPREADING OF FERTILIZERS AND OTHER AGRICULTURAL CHEMICALS; HORTICULTURAL SERVICES; FORESTRY SERVICES, NAMELY, PROVIDING ADVICE PERTAINING TO PEST CONTROL FOR FORESTRY; HOSPICE, HOSPITAL, MEDICAL ASSISTANCE, NURSING SERVICES, PHARMACEUTICAL ADVICE, AND REST HOME SERVICES; SURGERY, ASSISTANCE AND ADVICE IN THE FIELDS OF SANITARY, NUTRITIONAL, NATUROPATHIC, ALLOPATHIC, PHARMACEUTICAL, MEDICAL AND HEALTHCARE PRODUCTS AND SERVICES; INFORMATION AND ADVISORY SERVICES RELATING TO THE FOREGOING; INCLUDING THE PROVISION OF SUCH SERVICES VIA THE INTERNET, BY ONLINE MEANS AND/OR BY COMMUNICATIONS NETWORKS, PROVISION OF INFORMATION RELATING TO PHARMACEUTICALS, DRUG DELIVERY SYSTEMS, VACCINES, IN CLASS 44 (U.S. CLS. 100 AND 101).

FOR: LICENSING OF INTELLECTUAL PROPERTY; LICENSING OF TECHNOLOGIES IN RELATION TO MEDICAL AND SCIENTIFIC RESEARCH; REGULATORY COMPLIANCE CONSULTING IN THE FIELD OF PHARMACEUTICALS AND PHARMACEUTICAL COMPOUNDS; OFFICIAL REGULATORY ASSISTANCE AND ADVICE IN THE FIELDS OF CHEMICAL, SANITARY, FOOD, BEVERAGE, NUTRITIONAL, NATUROPATHIC, PHARMACEUTICAL, MEDICAL, VETERINARY AND HEALTHCARE PRODUCTS AND SERVICES, IN CLASS 45 (U.S. CLS. 100 AND 101).

THE MARK CONSISTS OF STANDARD CHARACTERS WITHOUT CLAIM TO ANY PARTICULAR FONT, STYLE, SIZE, OR COLOR.

PRIORITY DATE OF 11-25-2010 IS CLAIMED.

OWNER OF INTERNATIONAL REGISTRATION 1084903 DATED 3-21-2011, EXPIRES 3-21-2021.

SER. NO. 79-100,334, FILED 3-21-2011.

LINDA ORNDORFF, EXAMINING ATTORNEY

United States of America

United States Patent and Trademark Office



Reg. No. 4,107,396

Registered Mar. 6, 2012

Int. Cl.: 21

TRADEMARK

PRINCIPAL REGISTER

JOSEPH JOSEPH LIMITED (UNITED KINGDOM COMPANY)
TRADEMARK WORKS
LEVEL 29, CHIFLEY TOWER 2; CHIFLEY SQUARE
SYDNEY, AUSTRALIA NSW 2000

FOR: KITCHEN UTENSILS, NAMELY, CUTTING BOARDS FOR THE KITCHEN; KITCHEN BOARDS FOR CHOPPING; HOUSEHOLD UTENSILS, NAMELY, COLANDERS, HAND-OPERATED GRINDERS, ROLLING PINS, GRATERS FOR HOUSEHOLD PURPOSES, VEGETABLE MASHERS, SERVING TRAYS, GARLIC PRESSES, WHISKS, BAKING DISHES, DISH DRYING RACKS, DISH DRAINERS, BOWLS, CUTTING BOARDS, SERVING SPOONS, SLOTTED SPOONS, TURNERS, KITCHEN LADLES, SERVING LADLES, SPAGHETTI SERVERS, FOOD SERVERS, TRIVETS, TRAYS, AND NON-ELECTRIC JUICERS; CERAMICS FOR KITCHEN USE, NAMELY, CERAMIC HAND-OPERATED GRINDERS, CERAMIC ROLLING PINS, CERAMIC GRATERS FOR HOUSEHOLD PURPOSES, CERAMIC VEGETABLE MASHERS, CERAMIC SERVING TRAYS, CERAMIC GARLIC PRESSES, CERAMIC WHISKS; ARTICLES OF EARTHENWARE FOR KITCHEN USE, NAMELY, STORAGE JARS, MIXING BOWLS, SALAD BOWLS, SERVING TRAYS, BAKING DISHES, DISH DRYING RACKS, BOWLS, FOOD SERVERS, TRIVETS, TRAYS; ARTICLES OF GLASS FOR KITCHEN USE, NAMELY, MIXING BOWLS, SALAD BOWLS, SERVING TRAYS, BAKING DISHES, BOWLS, CUTTING BOARDS, TURNERS, KITCHEN LADLES, DRINKS SERVERS, IN CLASS 21 (U.S. CLS. 2, 13, 23, 29, 30, 33, 40 AND 50).

THE MARK CONSISTS OF STYLIZED DESIGNS OF A CUT OF MEAT, A STEAMING BOWL OF SOUP, A FISH AND A CARROT.

OWNER OF INTERNATIONAL REGISTRATION 1085613 DATED 5-16-2011, EXPIRES 5-16-2021.

SER. NO. 79-100,617, FILED 5-16-2011.

LIEF MARTIN, EXAMINING ATTORNEY



David J. Kyros

Director of the United States Patent and Trademark Office

United States of America

United States Patent and Trademark Office



Reg. No. 4,107,397

Registered Mar. 6, 2012

Int. Cl.: 11

XU HUI (CHINA INDIVIDUAL)
ROOM 1501, C4 BUILDING
PINGSHAFULI CHENG,; BAIYUN DISTRICT; GUANGZHOU CITY, GUANGDONG
PROVINCE; GUANGDONG PROVINCE
CHINA

TRADEMARK

PRINCIPAL REGISTER

FOR: LIGHTING APPARATUS, NAMELY, LIGHTING INSTALLATIONS; LIGHTING APPARATUS FOR THEATERS; STAGE LAMPS AND LANTERNS; AIR CONDITIONING INSTALLATIONS; COOKING APPARATUS AND INSTALLATIONS, NAMELY, COOKTOPS AND MICROWAVE OVENS; MULTI-PURPOSE, ELECTRIC COUNTERTOP FOOD PREPARATION APPARATUS FOR COOKING, BAKING, BROILING, ROASTING, TOASTING, SEARING, BROWNING, BARBECUING AND GRILLING FOOD; REFRIGERATING MACHINES AND INSTALLATIONS; BATH PLUMBING FIXTURES, NAMELY, SINK TRAPS, SINK SPRAYERS, SHOWER SPRAYERS AND SHOWER MIXERS; STAGE FOG MACHINE; ORNAMENTAL FOUNTAINS; LIGHTS FOR VEHICLES, IN CLASS 11 (U.S. CLS. 13, 21, 23, 31 AND 34).

THE MARK CONSISTS OF THE STYLIZED WORDING "DJPOWER", WHERE THE "O" IN POWER IS A SIX POINTED IMAGE WITH FOUR SHAPES WITHIN CREATING A CIRCLE.

OWNER OF INTERNATIONAL REGISTRATION 1086031 DATED 7-5-2011, EXPIRES 7-5-2021.

SER. NO. 79-100,774, FILED 7-5-2011.

JANICE KIM, EXAMINING ATTORNEY



David J. Kybas

Director of the United States Patent and Trademark Office

United States of America
United States Patent and Trademark Office

INARI

Reg. No. 4,107,398

Registered Mar. 6, 2012

Int. Cls.: 9, 40 and 42

TRADEMARK

SERVICE MARK

PRINCIPAL REGISTER

COMPAGNIE NATIONALE DU RHÔNE (FRANCE SOCIÉTÉ ANONYME)
2 RUE ANDRÉ BONIN
F-69004 LYON
FRANCE

FOR: SOFTWARE IN CONNECTION WITH OPERATING AND CONTROLLING HYDRO-ELECTRIC POWER STATIONS , IN CLASS 9 (U.S. CLS. 21, 23, 26, 36 AND 38).

FOR: SERVICES FOR PRODUCING ELECTRICAL, THERMAL, KINETIC, GEOTHERMAL, SOLAR, WIND, HYDRAULIC AND RENEWABLE ENERGY, IN CLASS 40 (U.S. CLS. 100, 103 AND 106).

FOR: SOFTWARE DESIGN AND DEVELOPMENT IN CONNECTION WITH OPERATING AND CONTROLLING HYDROELECTRIC POWER STATIONS; SOFTWARE INSTALLATION, UPDATING AND MAINTENANCE IN CONNECTION WITH OPERATING AND CONTROLLING HYDROELECTRIC POWER STATIONS; RENTAL OF COMPUTER SOFTWARE IN CONNECTION WITH OPERATING AND CONTROLLING HYDROELECTRIC POWER STATIONS, IN CLASS 42 (U.S. CLS. 100 AND 101).

THE MARK CONSISTS OF STANDARD CHARACTERS WITHOUT CLAIM TO ANY PARTICULAR FONT, STYLE, SIZE, OR COLOR.

OWNER OF INTERNATIONAL REGISTRATION 0984041 DATED 10-9-2008, EXPIRES 10-9-2018.

SER. NO. 79-101,172, FILED 7-18-2011.

DOUGLAS LEE, EXAMINING ATTORNEY



David J. Kypos

Director of the United States Patent and Trademark Office

United States of America

United States Patent and Trademark Office



CROSSPRO

Reg. No. 4,107,399

Registered Mar. 6, 2012

Int. Cl.: 25

TRADEMARK

PRINCIPAL REGISTER

OKAMOTO CORPORATION (JAPAN CORPORATION)
150-1 OAZA OTSUKA
KORYO-CHO, KITAKATSURAGI-GUN; NARA 635-8550
JAPAN

FOR: JOGGING PANTS; LEGGINGS; RAINCOATS; WIND RESISTANT JACKETS; UNDER-SHIRTS; TIGHTS; SOCKS FOR SPORTS; KNEE-HIGH SOCKS; SOCKS FOR SNEAKERS; SOCKS; LEG WARMERS; ARM WARMERS; GLOVES; MITTENS; THERMAL UNDERWEAR; MUFFLERS; EAR MUFFS; NECK WARMERS; HEADGEAR, NAMELY, HATS, CAPS; SOCCER SOCKS; RUNNING SOCKS; MOUNTAINEERING SOCKS; UNIFORMS; WRISTBANDS; SPATS, IN CLASS 25 (U.S. CLS. 22 AND 39).

OWNER OF U.S. REG. NO. 3,741,547.

PRIORITY DATE OF 5-27-2011 IS CLAIMED.

OWNER OF INTERNATIONAL REGISTRATION 1087203 DATED 6-6-2011, EXPIRES 6-6-2021.

THE MARK CONSISTS OF THE STYLIZED WORDING "CROSSPRO" BELOW A DESIGN OF A "CP" LINKED ON ITS SIDE.

SER. NO. 79-101,232, FILED 6-6-2011.

BERYL GARDNER, EXAMINING ATTORNEY



David J. Kybas

Director of the United States Patent and Trademark Office

United States of America

United States Patent and Trademark Office

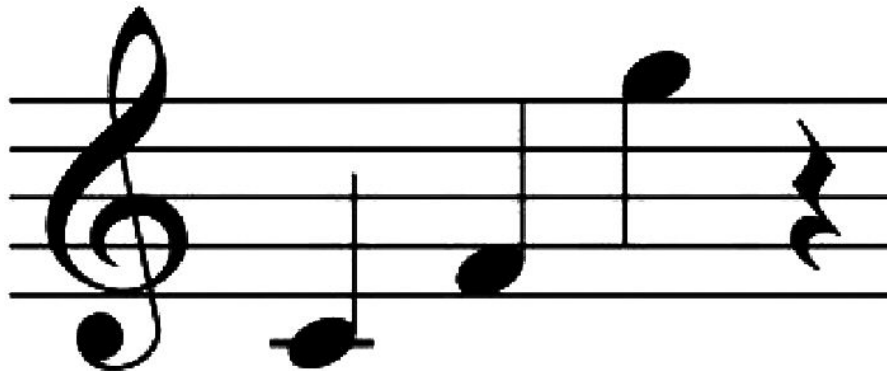

Reg. No. 4,107,400

Registered Mar. 6, 2012

Int. Cls.: 29, 33 and 43

VILLA CAMPESTRI SRL (ITALY LIMITED LIABILITY COMPANY)
VIA DEI CAMPESTRI, 19/22
I-50039 VICCHIO DI MUGELLO (FI)
ITALY

FOR: EDIBLE OILS, IN CLASS 29 (U.S. CL. 46).

TRADEMARK

FOR: WINES AND SPIRITS, IN CLASS 33 (U.S. CLS. 47 AND 49).

SERVICE MARK

FOR: SERVICES FOR PROVIDING FOOD AND DRINK; PROVIDING TEMPORARY ACCOMMODATION, IN CLASS 43 (U.S. CLS. 100 AND 101).

PRINCIPAL REGISTER

THE TRADEMARK CONSISTS OF A PENTAGRAM WITH, FROM LEFT TO RIGHT, A TREBLE CLEF, THREE MUSICAL NOTES AND A REST SIGN.

OWNER OF INTERNATIONAL REGISTRATION 1087556 DATED 7-26-2011, EXPIRES 7-26-2021.

SER. NO. 79-101,364, FILED 7-26-2011.

NATALIE POLZER, EXAMINING ATTORNEY



David J. Kyros

Director of the United States Patent and Trademark Office

United States of America

United States Patent and Trademark Office



Reg. No. 4,107,401

Registered Mar. 6, 2012

Int. Cls.: 7 and 9

TRADEMARK

PRINCIPAL REGISTER

HARTNER GMBH (FED REP GERMANY LIMITED LIABILITY COMPANY)
JAKOBSTR. 10
72458 ALBSTADT
FED REP GERMANY

FOR: SPIRAL DRILL, NAMELY, POWER DRILLS; GRINDING MACHINES FOR METAL-WORKING AND MILLING MACHINES, IN CLASS 7 (U.S. CLS. 13, 19, 21, 23, 31, 34 AND 35).

FOR: WEIGHING EQUIPMENT, NAMELY, BALANCES, IN CLASS 9 (U.S. CLS. 21, 23, 26, 36 AND 38).

THE NAME(S), PORTRAIT(S), AND/OR SIGNATURE(S) SHOWN IN THE MARK DOES NOT IDENTIFY A PARTICULAR LIVING INDIVIDUAL.

OWNER OF INTERNATIONAL REGISTRATION 0384560 DATED 11-17-1971, EXPIRES 11-17-2021.

THE MARK CONSISTS OF A DESIGN OF A CIRCLE WITH A STYLIZED "H" ON IT AND RESEMBLES A BASEBALL INSIDE OF AN INVERTED TRIANGLE. ABOVE THE DESIGN IS THE STYLIZED WORDING "HARTNER".

SER. NO. 79-101,445, FILED 2-15-2011.

INGRID C. EULIN, EXAMINING ATTORNEY



David J. Kyffers

Director of the United States Patent and Trademark Office

United States of America
United States Patent and Trademark Office

OSIRIS

Reg. No. 4,107,402

Registered Mar. 6, 2012

Int. Cls.: 9, 40 and 42

TRADEMARK

SERVICE MARK

PRINCIPAL REGISTER

COMPAGNIE NATIONALE DU RHÔNE (FRANCE SOCIÉTÉ ANONYME)
2 RUE ANDRÉ BONIN
F-69004 LYON
FRANCE

FOR: SOFTWARE IN CONNECTION WITH OPERATING AND CONTROLLING HYDRO-ELECTRIC POWER STATIONS , IN CLASS 9 (U.S. CLS. 21, 23, 26, 36 AND 38).

FOR: SERVICES FOR PRODUCING ELECTRICAL, THERMAL, KINETIC, GEOTHERMAL, SOLAR, WIND, HYDRAULIC AND RENEWABLE ENERGY, IN CLASS 40 (U.S. CLS. 100, 103 AND 106).

FOR: SOFTWARE DESIGN AND DEVELOPMENT IN CONNECTION WITH OPERATING AND CONTROLLING HYDROELECTRIC POWER STATIONS; SOFTWARE INSTALLATION, UPDATING AND MAINTENANCE IN CONNECTION WITH OPERATING AND CONTROLLING HYDROELECTRIC POWER STATIONS; RENTAL OF COMPUTER SOFTWARE IN CONNECTION WITH OPERATING AND CONTROLLING HYDROELECTRIC POWER STATIONS, IN CLASS 42 (U.S. CLS. 100 AND 101).

THE MARK CONSISTS OF STANDARD CHARACTERS WITHOUT CLAIM TO ANY PARTICULAR FONT, STYLE, SIZE, OR COLOR.

OWNER OF INTERNATIONAL REGISTRATION 0984253 DATED 10-9-2008, EXPIRES 10-9-2018.

SER. NO. 79-101,451, FILED 7-18-2011.

DOUGLAS LEE, EXAMINING ATTORNEY



David J. Kypos

Director of the United States Patent and Trademark Office

United States of America

United States Patent and Trademark Office

BUTTON LOCK

Reg. No. 4,107,403

Registered Mar. 6, 2012

Int. Cls.: 23 and 26

TRADEMARK

PRINCIPAL REGISTER

J. & P.COATS, LIMITED (UNITED KINGDOM COMPANY)
1 GEORGE SQUARE
GLASGOW G2 1AL
UNITED KINGDOM

FOR: YARNS AND THREADS, FOR TEXTILE USE, IN CLASS 23 (U.S. CL. 43).

FOR: LACE AND EMBROIDERY, RIBBONS AND BRAID; BUTTONS, HOOKS AND EYES, SEWING PINS AND NEEDLES; ARTIFICIAL FLOWERS, IN CLASS 26 (U.S. CLS. 37, 39, 40, 42 AND 50).

THE MARK CONSISTS OF STANDARD CHARACTERS WITHOUT CLAIM TO ANY PARTICULAR FONT, STYLE, SIZE, OR COLOR.

PRIORITY DATE OF 7-6-2011 IS CLAIMED.

OWNER OF INTERNATIONAL REGISTRATION 1088356 DATED 7-29-2011, EXPIRES 7-29-2021.

NO CLAIM IS MADE TO THE EXCLUSIVE RIGHT TO USE "BUTTON", APART FROM THE MARK AS SHOWN.

SER. NO. 79-101,690, FILED 7-29-2011.

NAAKWAMA ANKRAH, EXAMINING ATTORNEY



David J. Kyffers

Director of the United States Patent and Trademark Office

United States of America

United States Patent and Trademark Office

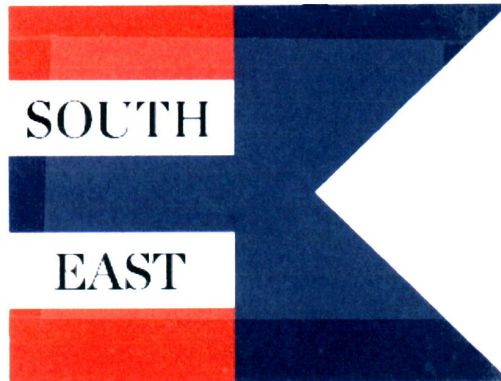

Reg. No. 4,107,404

Registered Mar. 6, 2012

Int. Cls.: 20, 24 and 25

TRADEMARK

PRINCIPAL REGISTER

SOUTH EAST COLLECTION AB ORG NR 556701-1282 (SWEDEN AKTIEBOLAG (AB))
HEIMDALSVÄGEN 17A
SE-182 63 DJURSHOLM
SWEDEN

FOR: BATHROOM FURNITURE; KIDS FURNITURE; BENCHES IN THE NATURE OF FURNITURE; TABLES IN THE NATURE OF FURNITURE; TOWEL CABINET IN THE NATURE OF FURNITURE; COAT RACKS IN THE NATURE OF FURNITURE; FURNITURE; HOME FURNITURE; MIRRORS; PICTURE FRAMES; BLINDS FOR INDOOR USE; SEATING FURNITURE; SCREENS IN THE NATURE OF FURNITURE; BEDROOM FURNITURE; UP-HOLSTERED FURNITURE; GARDEN FURNITURE; LIVING ROOM FURNITURE; KEY-BOARDS FOR HANGING KEYS, NAMELY, KEY CABINETS; BEDDING EXCEPT LINEN, NAMELY, BED PILLOWS, BED CUSHIONS; PILLOWS; CUSHIONS, IN CLASS 20 (U.S. CLS. 2, 13, 22, 25, 32 AND 50).

FOR: BATH LINEN EXCEPT CLOTHING; BED LINEN; BED LINEN AND TABLE CLOTHS OF TEXTILE; FABRIC FOR THE MANUFACTURE OF LINGERIE; BEDSPREADS; BED LINEN AND TABLE LINEN; BED AND LAP BLANKETS; BED COVERS; DUVETS; QUILTS, IN CLASS 24 (U.S. CLS. 42 AND 50).

FOR: CLOTHING, NAMELY, PANTS, SHIRTS, JERSEYS, SHORTS; EVENING CLOTHES, NAMELY, DRESSES, SUITS; BABY CLOTHES, NAMELY, PANTS, SHIRTS, SHORTS; LAYETTES IN THE NATURE OF CLOTHING; LINGERIE; APRONS IN THE NATURE OF CLOTHING; BRACES FOR CLOTHING; CLOTHING IMPREGNATED WITH A WATER-PROOFING SUBSTANCE, NAMELY, PANTS, SHORTS, SHIRTS; UNDERWEAR SETS INCLUDING BRAS AND PANTIES; CUFFS IN THE NATURE OF CLOTHING; NIGHTWEAR; HEADBANDS; RAINWEAR; SWIMWEAR; SPORTSWEAR, NAMELY, PANTS, SHORTS, SHIRTS; BEACHWEAR; UNDERWEAR; WATERPROOF CLOTHING, NAMELY, JACKETS, PANTS; OUTERWEAR, NAMELY, JACKETS, COATS; SWIM SHORTS; BABY PANTS; TROUSERS; SLACKS; SHORTS; TROUSERS; SKI PANTS; BASEBALL CAPS, IN CLASS 25 (U.S. CLS. 22 AND 39).



David J. Kybas

Director of the United States Patent and Trademark Office

THE MARK CONSISTS OF WORDING "SOUTH" AND "EAST" APPEARING IN BLACK WITH TWO RED RECTANGLES ABOVE AND BELOW THE WORDING, A BLUE RECTANGLE SEPARATING THE TWO WORDS, AND TWO JOINED TRIANGLES IN BLUE APPEARING TO THE RIGHT OF THE WORDING, ALL ON A WHITE BACKGROUND.

Reg. No. 4,107,404 PRIORITY DATE OF 9-27-2010 IS CLAIMED.

OWNER OF INTERNATIONAL REGISTRATION 1088504 DATED 1-7-2011, EXPIRES 1-7-2021.

THE COLOR(S) BLUE, RED, WHITE AND BLACK IS/ARE CLAIMED AS A FEATURE OF THE MARK.

SER. NO. 79-101,734, FILED 1-7-2011.

CARRIE GENOVESE, EXAMINING ATTORNEY

United States of America

United States Patent and Trademark Office

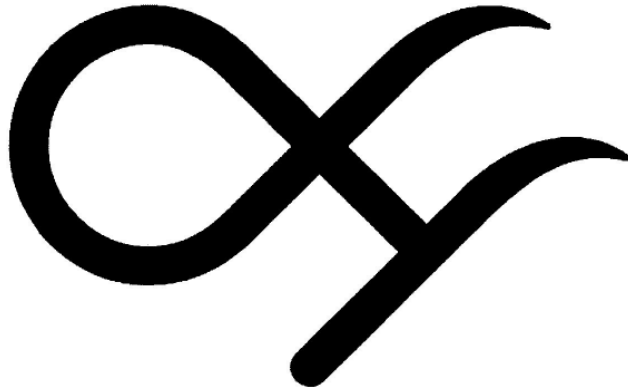

Reg. No. 4,107,405

OXYRIDE AS (NORWAY AS)
GURINESTUBBEN 9
N-0584 OSLO, NORWAY

Registered Mar. 6, 2012

Int. Cls.: 9, 25, 28 and 41

FOR: SPECTACLES; SPORTS SPECTACLES; SPECTACLE CASES; SPECTACLE GLASSES; BINOCULARS; OPTICAL REFLECTORS; REFLECTIVE DISCS TO BE WORN ON THE BODY FOR PREVENTION OF TRAFFIC ACCIDENTS; PROTECTIVE HELMETS, NAMELY, SKI HELMETS; HELMETS FOR SPORTS, IN CLASS 9 (U.S. CLS. 21, 23, 26, 36 AND 38).

TRADEMARK

SERVICE MARK

FOR: CLOTHING, NAMELY, SHIRTS, SHORTS, PANTS, COATS, DRESSES, JACKETS, T-SHIRTS, WET SUITS FOR WATER SPORTS; FOOTWEAR, NAMELY, SHOES, BOOTS, SLIPPERS; HEADGEAR, NAMELY, HATS, CAPS, HEADWEAR, IN CLASS 25 (U.S. CLS. 22 AND 39).

PRINCIPAL REGISTER

FOR: GAMES AND TOYS, NAMELY, BOARD GAMES, DOLLS, ACTION SKILL GAMES, ARCADE RACING GAME MACHINES, BATTERY-POWERED COMPUTER GAME WITH LCD SCREEN, BATH TOYS, COLLECTABLE TOY FIGURES, INFLATABLE RIDE-ON TOYS, RIDE-ON TOYS AND ACCESSORIES THEREFOR; GYMNAS TIC AND SPORTING ARTICLES, NAMELY, WATER SKIS, BOARDS USED IN THE PRACTICE OF WATER SPORTS, WATER BOARDS, COMBINED WATER AND SNOW BOARDS, SNOW SKIS, SNOW BOARDS, LEASHES FOR SNOW BOARDS AND WATER BOARDS AND FOR COMBINED WATER AND SNOW BOARDS, IN CLASS 28 (U.S. CLS. 22, 23, 38 AND 50).



FOR: TRAINING SERVICES, NAMELY, TEACHING SKI AND SNOW BOARD SKILLS AND TECHNIQUES, AND TRAINING IN THE FIELD OF WATER SPORTS AND SNOW SPORTS; PERSONAL TRAINING SERVICES, NAMELY, STRENGTH AND CONDITIONING TRAINING AND SPEED TRAINING; SPORTS TRAINING SERVICES; ENTERTAINMENT SERVICES, NAMELY, ARRANGING, ORGANIZING, CONDUCTING, AND HOSTING SOCIAL AND SPORTS ENTERTAINMENT EVENTS; ORGANIZING COMMUNITY SPORTING AND CULTURAL EVENTS, NAMELY, WATER SPORTS, SNOWBOARDING, SKIING, AND SLEDGING, IN CLASS 41 (U.S. CLS. 100, 101 AND 107).

THE MARK CONSISTS OF A STYLIZED "X" WITH A SLANTED LINE AT THE BOTTOM RIGHT HAND CORNER OF THE "X".

David J. Kybas

PRIORITY DATE OF 10-15-2010 IS CLAIMED.

Reg. No. 4,107,405 OWNER OF INTERNATIONAL REGISTRATION 1088546 DATED 4-15-2011, EXPIRES 4-15-2021.

SER. NO. 79-101,751, FILED 4-15-2011.

EMILY CHUO, EXAMINING ATTORNEY

United States of America

United States Patent and Trademark Office

Sternthaler

Reg. No. 4,107,406

Registered Mar. 6, 2012

Int. Cl.: 33

TRADEMARK

PRINCIPAL REGISTER

JOSEF DRATHEN GMBH & CO. KG WEIN- & SEKTKELLEREI SCHLOSS ARRAS (FED
REP GERMANY GMBH & CO. KG)
FLIEHBURGSTRASSE 23
56856 ZELL, FED REP GERMANY

FOR: WINES, SEMI-SPARKLING WINES, SPARKLING WINES, SPARKLING FRUIT WINE,
AND BEVERAGES CONTAINING WINE, NAMELY, HERBAL WINE, EXCLUDING VER-
MOUTH WINE, IN CLASS 33 (U.S. CLS. 47 AND 49).

THE MARK CONSISTS OF STANDARD CHARACTERS WITHOUT CLAIM TO ANY PAR-
TICULAR FONT, STYLE, SIZE, OR COLOR.

OWNER OF INTERNATIONAL REGISTRATION 1088911 DATED 3-5-2011, EXPIRES 3-5-
2021.

SER. NO. 79-101,888, FILED 3-5-2011.

PATRICIA EVANKO, EXAMINING ATTORNEY



David J. Kyffers

Director of the United States Patent and Trademark Office

United States of America

United States Patent and Trademark Office

U L M T

Reg. No. 4,107,407

Registered Mar. 6, 2012

Int. Cl.: 9

TRADEMARK

PRINCIPAL REGISTER

TOSHIBA MOBILE DISPLAY CO., LTD. (JAPAN CORPORATION)
1-9-2, HATARA-CHO
FUKAYA-SHI; SAITAMA 366-0032
JAPAN

FOR: LIQUID CRYSTAL DISPLAY DEVICES, IN CLASS 9 (U.S. CLS. 21, 23, 26, 36 AND 38).

THE MARK CONSISTS OF STANDARD CHARACTERS WITHOUT CLAIM TO ANY PARTICULAR FONT, STYLE, SIZE, OR COLOR.

OWNER OF INTERNATIONAL REGISTRATION 1089901 DATED 7-20-2011, EXPIRES 7-20-2021.

SER. NO. 79-102,245, FILED 7-20-2011.

TRACY FLETCHER, EXAMINING ATTORNEY



David J. Kyffers

Director of the United States Patent and Trademark Office

United States of America

United States Patent and Trademark Office



Reg. No. 4,107,408

Registered Mar. 6, 2012

Int. Cls.: 25 and 33

TRADEMARK

PRINCIPAL REGISTER

H P COMMUNICATIONS LTD (UNITED KINGDOM LIMITED LIABILITY COMPANY)
77 ST JOHN'S STREET
LONDON, UNITED KINGDOM EC1M 4NN

FOR: T-SHIRTS, SWEATSHIRTS, COATS, JACKETS, HATS, APRONS, IN CLASS 25 (U.S. CLS. 22 AND 39).

FOR: ALCOHOLIC SPIRITS AND DERIVATIVES THEREOF, NAMELY, ALCOHOLIC COCKTAIL MIXES CONTAINING ALCOHOLIC SPIRITS, IN CLASS 33 (U.S. CLS. 47 AND 49).

THE MARK CONSISTS OF A CIRCULAR DESIGN COMPOSED OF CONCENTRIC CIRCLES HOUSING A CROSS IN THE CENTRE, WHERE FLOURISHES AND BIRD'S TALONS EXTEND FROM THE INNERMOST CIRCLE, ADDITIONAL FLOURISHES APPEAR IN THE BACKGROUND, WHERE LINES RADIATE FROM TWO INNER CONCENTRIC CIRCLES; BELOW THE CIRCLE DESIGN ARE FIVE SMALL STARS; BELOW ALL DESIGN IS THE STYLIZED WORD "LEBERKLEISTER".

OWNER OF INTERNATIONAL REGISTRATION 1091126 DATED 4-27-2011, EXPIRES 4-27-2021.

THE ENGLISH TRANSLATION OF "LEBERKLEISTER" IN THE MARK IS LIVER PASTE.

SER. NO. 79-102,714, FILED 4-27-2011.

ADA HAN, EXAMINING ATTORNEY



David J. Kybas

Director of the United States Patent and Trademark Office

United States of America

United States Patent and Trademark Office

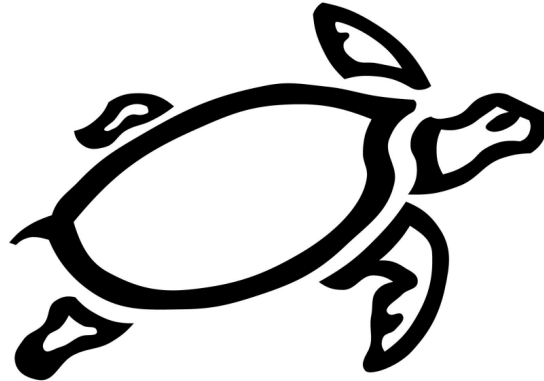

Reg. No. 4,107,409

Registered Mar. 6, 2012

Int. Cl.: 14

TRADEMARK

PRINCIPAL REGISTER

ILC INTERNATIONAL LUXURY COMPANY SA (SWITZERLAND SOCIÉTÉ ANONYME
(SA))
84, RUE DU RHÔNE
CH-1204 GENÈVE
SWITZERLAND

FOR: TIMEPIECES AND CHRONOMETRIC INSTRUMENTS, NAMELY WATCHES,
WRISTWATCHES, CHRONOMETERS, CLOCKS, TABLE CLOCKS, MOVEMENTS FOR
CLOCKS AND WATCHES; JEWELRY; PRECIOUS STONES, IN CLASS 14 (U.S. CLS. 2, 27,
28 AND 50).

PRIORITY DATE OF 4-21-2011 IS CLAIMED.

OWNER OF INTERNATIONAL REGISTRATION 1092167 DATED 8-30-2011, EXPIRES 8-30-
2021.

SER. NO. 79-103,088, FILED 8-30-2011.

MICHAEL WIENER, EXAMINING ATTORNEY



David J. Kyffers

Director of the United States Patent and Trademark Office

United States of America

United States Patent and Trademark Office

HELLBREED

Reg. No. 4,107,410

Registered Mar. 6, 2012

Int. Cls.: 9, 28 and 41

GAMEFORGE PRODUCTIONS GMBH (FED REP GERMANY A COMPANY WITH LIMITED LIABILITY ORGANIZED UNDER GERMAN LAW)
ALBERT-NESTLER-STRASSE 8
76131 KARLSRUHE
FED REP GERMANY

TRADEMARK

SERVICE MARK

PRINCIPAL REGISTER

FOR: COMPUTER GAMES AND VIDEO GAME SOFTWARE; COMPUTER GAME PROGRAMS AND COMPUTER GAME SOFTWARE FOR VIDEO, COMPUTER, AND INTERNET GAMES AND FOR ELECTRONIC AND VISUAL GAMES; COMPUTER GAME PROGRAMS AND COMPUTER GAME SOFTWARE FOR INTERACTIVE GAMES AND COMPUTER GAME PROGRAMS FOR MOBILE TELEPHONES AND WIRELESS COMMUNICATIONS APPARATUS, IN CLASS 9 (U.S. CLS. 21, 23, 26, 36 AND 38).

FOR: GAMES, NAMELY, ARCADE GAMES, COIN-OPERATED VIDEO GAMES, HAND-HELD UNITS FOR PLAYING VIDEO GAMES OTHER THAN THOSE ADAPTED FOR USE WITH AN EXTERNAL DISPLAY SCREEN OR MONITOR, LCD GAME MACHINES, STAND-ALONE VIDEO GAME MACHINES, PINBALL GAMES, ELECTRONIC GAMES OTHER THAN THOSE ADAPTED FOR USE WITH TELEVISION RECEIVERS ONLY, ROLE PLAYING GAMES, BOARD GAMES, CARD GAMES, IN CLASS 28 (U.S. CLS. 22, 23, 38 AND 50).

FOR: ONLINE GAMING SERVICES, NAMELY, PROVIDING ONLINE, NON-DOWNLOADABLE VIDEO GAMES, COMPUTER GAMES, AND COMPUTER GAME PROGRAMS FOR MOBILE TELEPHONES AND WIRELESS COMMUNICATIONS APPARATUS VIA THE INTERNET OR A GLOBAL NETWORK; ONLINE GAMING SERVICES, NAMELY, PROVIDING ONLINE, NON-DOWNLOADABLE INTERACTIVE GAMES, VIDEO GAMES, AND COMPUTER GAMES VIA THE INTERNET OR A GLOBAL NETWORK; PROVIDING ENTERTAINMENT INFORMATION IN THE FIELD OF COMPUTER GAMES AND VIDEO GAMES VIA THE INTERNET AND A GLOBAL NETWORK AND IN ELECTRONIC AND COMPUTER-AIDED FORM, IN CLASS 41 (U.S. CLS. 100, 101 AND 107).



THE MARK CONSISTS OF STANDARD CHARACTERS WITHOUT CLAIM TO ANY PARTICULAR FONT, STYLE, SIZE, OR COLOR.

PRIORITY DATE OF 3-1-2011 IS CLAIMED.

OWNER OF INTERNATIONAL REGISTRATION 1094397 DATED 7-22-2011, EXPIRES 7-22-2021.

David J. Kyros

Director of the United States Patent and Trademark Office

Reg. No. 4,107,410 SER. NO. 79-103,984, FILED 7-22-2011.

NAKIA HENRY, EXAMINING ATTORNEY

United States of America

United States Patent and Trademark Office

REXATROL

Reg. No. 4,107,411

Registered Mar. 6, 2012

Int. Cls.: 1, 3 and 5

TRADEMARK

PRINCIPAL REGISTER

INDENA SPA (ITALY CORPORATION)
VIALE ORTLES, 12
I-20139 MILANO
ITALY

FOR: CHEMICALS MADE FROM BOTANICAL EXTRACTS FOR USE IN THE PREPARATION OF PHARMACEUTICAL PRODUCTS, COSMETIC PRODUCTS, NUTRACEUTICALS AND FOODSTUFFS, IN CLASS 1 (U.S. CLS. 1, 5, 6, 10, 26 AND 46).

FOR: BOTANICAL EXTRACTS, NAMELY EXTRACTS FROM POLYGONUM CUSPIDATUM, USED IN COSMETICS SUCH AS FACE CREAMS, GELS, OINTMENTS, PRE-SUN BATH PRODUCTS, AFTER SUN BATH PRODUCTS, LIPSTICKS, IN CLASS 3 (U.S. CLS. 1, 4, 6, 50, 51 AND 52).

FOR: MEDICINAL PLANT EXTRACTS FOR PHARMACEUTICAL USE NAMELY FOR THE TREATMENT OF CARDIOVASCULAR SYSTEM DISEASES AND AS DIETARY SUPPLEMENTS, IN CLASS 5 (U.S. CLS. 6, 18, 44, 46, 51 AND 52).

THE MARK CONSISTS OF STANDARD CHARACTERS WITHOUT CLAIM TO ANY PARTICULAR FONT, STYLE, SIZE, OR COLOR.

PRIORITY DATE OF 6-29-2011 IS CLAIMED.

OWNER OF INTERNATIONAL REGISTRATION 1094952 DATED 7-8-2011, EXPIRES 7-8-2021.

SER. NO. 79-104,226, FILED 7-8-2011.

MAYUR VAGHANI, EXAMINING ATTORNEY



David J. Kypos

Director of the United States Patent and Trademark Office

United States of America
United States Patent and Trademark Office

ISPRITZ

Reg. No. 4,107,412

Registered Mar. 6, 2012

Int. Cl.: 33

TRADEMARK

PRINCIPAL REGISTER

CANTINE RIONDO S.P.A. (ITALY JOINT STOCK COMPANY)
VIA CAPPUCINI, 6
I-37032 MONTEFORTE D'ALPONE (VR)
ITALY

FOR: ALCOHOLIC APERITIFS, IN CLASS 33 (U.S. CLS. 47 AND 49).

THE MARK CONSISTS OF STANDARD CHARACTERS WITHOUT CLAIM TO ANY PARTICULAR FONT, STYLE, SIZE, OR COLOR.

OWNER OF INTERNATIONAL REGISTRATION 1095187 DATED 5-5-2011, EXPIRES 5-5-2021.

SER. NO. 79-104,297, FILED 5-5-2011.

SHANNON TWOHIG, EXAMINING ATTORNEY



David J. Kybas

Director of the United States Patent and Trademark Office

United States of America

United States Patent and Trademark Office

ALFA TCT

Reg. No. 4,107,413

Registered Mar. 6, 2012

Int. Cl.: 9

TRADEMARK

PRINCIPAL REGISTER

FIAT GROUP AUTOMOBILES S.P.A. (ITALY JOINT STOCK COMPANY)
CORSO GIOVANNI AGNELLI, 200
I-10135 TORINO
ITALY

FOR: ELECTRIC AND ELECTRONIC DRIVE CONTROLS, NAMELY, ELECTRONIC APPARATUS AND INSTRUMENTS FOR CONTROLLING, ADJUSTING AND TESTING OF DRIVES AND MOTORS; ELECTRIC MEASURING DEVICES, NAMELY, ACCELEROMETERS, SPEEDOMETERS, GASOMETERS FOR CAR GEARS, IN CLASS 9 (U.S. CLS. 21, 23, 26, 36 AND 38).

THE MARK CONSISTS OF STANDARD CHARACTERS WITHOUT CLAIM TO ANY PARTICULAR FONT, STYLE, SIZE, OR COLOR.

PRIORITY DATE OF 3-4-2010 IS CLAIMED.

OWNER OF INTERNATIONAL REGISTRATION 1040541 DATED 4-8-2010, EXPIRES 4-8-2020.

OWNER OF U.S. REG. NOS. 3,011,575 AND 3,148,964.

SER. NO. 79-975,199, FILED 4-8-2010.

CHARISMA HAMPTON, EXAMINING ATTORNEY



David J. Kyffers

Director of the United States Patent and Trademark Office

United States of America

United States Patent and Trademark Office

PerformanceBlade

Reg. No. 4,107,414

Registered Mar. 6, 2012

Int. Cl.: 27

TRADEMARK

PRINCIPAL REGISTER

DOC SPORTS SURFACE CONTRACTORS, LLC. (MARYLAND LIMITED LIABILITY COMPANY)
10905 INDIAN HEAD HWY
FORT WASHINGTON, MD 20744

FOR: ARTIFICIAL LAWN; ARTIFICIAL TURF; ARTIFICIAL TURF FOR LAYING ON THE SURFACES OF RECREATIONAL AREAS; SYNTHETIC GRASS, IN CLASS 27 (U.S. CLS. 19, 20, 37, 42 AND 50).

FIRST USE 6-2-2009; IN COMMERCE 6-2-2009.

THE MARK CONSISTS OF STANDARD CHARACTERS WITHOUT CLAIM TO ANY PARTICULAR FONT, STYLE, SIZE, OR COLOR.

SER. NO. 85-005,825, FILED 4-4-2010.

KEVIN DINALLO, EXAMINING ATTORNEY



David J. Kyffers

Director of the United States Patent and Trademark Office

United States of America

United States Patent and Trademark Office

FAST SLOW FOOD

Reg. No. 4,107,415

Registered Mar. 6, 2012

Int. Cl.: 43

SERVICE MARK

PRINCIPAL REGISTER

CIRIELLO, JOSEPH (UNITED STATES INDIVIDUAL)
APT B25
285 MOTT STREET
NEW YORK, NY 10012

FOR: CARRY-OUT RESTAURANTS; RESTAURANT SERVICES; RESTAURANT SERVICES
FEATURING CHICKEN, IN CLASS 43 (U.S. CLS. 100 AND 101).

FIRST USE 4-13-2006; IN COMMERCE 4-13-2006.

THE MARK CONSISTS OF STANDARD CHARACTERS WITHOUT CLAIM TO ANY PAR-
TICULAR FONT, STYLE, SIZE, OR COLOR.

NO CLAIM IS MADE TO THE EXCLUSIVE RIGHT TO USE "SLOW FOOD", APART FROM
THE MARK AS SHOWN.

SER. NO. 85-006,296, FILED 4-5-2010.

INGRID C. EULIN, EXAMINING ATTORNEY



David J. Kybas

Director of the United States Patent and Trademark Office

United States of America

United States Patent and Trademark Office

PROMOD

Reg. No. 4,107,416

Registered Mar. 6, 2012

Int. Cl.: 1

TRADEMARK

PRINCIPAL REGISTER

BIOCATALYSTS LIMITED (UNITED KINGDOM LIMITED COMPANY (LTD.))
CEFN COED, PARC NANTGARW
CARDIFF, UNITED KINGDOM CF157QQ

FOR: CHEMICAL SUBSTANCES FOR PRESERVING FOODSTUFFS; ENZYMES AND ENZYME PREPARATIONS FOR USE IN THE FOOD INDUSTRY; CHEMICAL OR ENZYMATIC PREPARATIONS FOR PRESERVING FOODSTUFFS; ENZYMES FOR FOOD OR DRINK, IN CLASS 1 (U.S. CLS. 1, 5, 6, 10, 26 AND 46).

THE MARK CONSISTS OF STANDARD CHARACTERS WITHOUT CLAIM TO ANY PARTICULAR FONT, STYLE, SIZE, OR COLOR.

PRIORITY CLAIMED UNDER SEC. 44(D) ON ERPN CMNTY TM OFC APPLICATION NO. 009004904, FILED 4-6-2010, REG. NO. 1264260, DATED 10-30-1987, EXPIRES 4-8-2017.

OWNER OF ERPN CMNTY TM OFC REG. NO. 009004904, DATED 3-25-2011, EXPIRES 6-4-2020.

SER. NO. 85-007,382, FILED 4-6-2010.

JOSETTE BEVERLY, EXAMINING ATTORNEY



David J. Kyffers

Director of the United States Patent and Trademark Office

United States of America

United States Patent and Trademark Office

CGV

Reg. No. 4,107,417

Registered Mar. 6, 2012

Int. Cl.: 41

SERVICE MARK

PRINCIPAL REGISTER

CJ CGV CO., LTD. (REPUBLIC OF KOREA CORPORATION)
1606, SANGAM-DONG, MAPO-GU
SEOUL, REPUBLIC OF KOREA

FOR: PRODUCTION OF RADIO AND TELEVISION PROGRAMS; PRESENTATION OF LIVE SHOW PERFORMANCES; PRESENTATION OF MUSICAL PERFORMANCE; IMPRESARIO SERVICES, NAMELY, ORGANIZATION OF LIVE SHOW PERFORMANCES IN THE FIELD OF MOVIES; ANIMATION PRODUCTION SERVICES; ENTERTAINMENT IN THE NATURE OF LIVE STAGE PERFORMANCES IN THE NATURE OF PLAYS AND CONCERTS; DISTRIBUTION OF MOTION PICTURE FILMS; CINEMA THEATERS; ENTERTAINMENT SERVICES, NAMELY, PLANNING AND CONDUCTING A SERIES OF FILM FESTIVALS; FILM PRODUCTION; MOVIE STUDIOS; RENTAL OF CINE-FILMS; PUBLICATION OF PERIODICALS; NIGHT CLUBS; VIDEOTAPING; NEWS REPORTERS SERVICES; PROVIDING AMUSEMENT FACILITIES; ARRANGING FOR TICKET RESERVATIONS FOR MOVIES; ARRANGING FOR TICKET RESERVATIONS FOR SHOWS AND OTHER ENTERTAINMENT EVENTS; PROVISION OF INFORMATION AND DATA CONCERNING MOVIES, IN CLASS 41 (U.S. CLS. 100, 101 AND 107).

THE MARK CONSISTS OF STANDARD CHARACTERS WITHOUT CLAIM TO ANY PARTICULAR FONT, STYLE, SIZE, OR COLOR.

PRIORITY CLAIMED UNDER SEC. 44(D) ON REPUBLIC OF KOREA APPLICATION NO. 41-2010-8400, FILED 4-2-2010, REG. NO. 0217453, DATED 9-20-2011, EXPIRES 9-20-2021.

OWNER OF REPUBLIC OF KOREA REG. NO. 185503, DATED 5-26-2009, EXPIRES 5-26-2019.

SER. NO. 85-009,689, FILED 4-8-2010.

JASON BLAIR, EXAMINING ATTORNEY



David J. Kypos

Director of the United States Patent and Trademark Office

United States of America
United States Patent and Trademark Office

Bio-MAX

Reg. No. 4,107,418

HARRELL'S (FLORIDA LIMITED LIABILITY COMPANY)
720 KRAFT RD
LAKELAND, FL 33815

Registered Mar. 6, 2012

Int. Cl.: 1

FOR: LIQUID NUTRITIONAL SUPPLEMENTS FOR PLANTS, IN CLASS 1 (U.S. CLS. 1, 5, 6, 10, 26 AND 46).

TRADEMARK

FIRST USE 4-14-2010; IN COMMERCE 4-14-2010.

PRINCIPAL REGISTER

SER. NO. 85-014,522, FILED 4-15-2010.

JOHN DWYER, EXAMINING ATTORNEY



David J. Kyfos

Director of the United States Patent and Trademark Office

United States of America

United States Patent and Trademark Office

SUPER RELAX

Reg. No. 4,107,419

Registered Mar. 6, 2012

Int. Cl.: 35

SERVICE MARK

PRINCIPAL REGISTER

SUPER RELAX, LLC (TEXAS LIMITED LIABILITY COMPANY)
SUITE 143-227
9211 WEST ROAD
HOUSTON, TX 77064

FOR: WHOLESALE AND RETAIL STORE SERVICES FEATURING MASSAGE APPARATUS AND MERCHANDISE FOR THE RELAXATION OF THE HUMAN BODY, IN CLASS 35 (U.S. CLS. 100, 101 AND 102).

FIRST USE 2-15-2010; IN COMMERCE 2-15-2010.

THE MARK CONSISTS OF STANDARD CHARACTERS WITHOUT CLAIM TO ANY PARTICULAR FONT, STYLE, SIZE, OR COLOR.

SER. NO. 85-015,015, FILED 4-15-2010.

KELLEY WELLS, EXAMINING ATTORNEY



David J. Kybas

Director of the United States Patent and Trademark Office

United States of America

United States Patent and Trademark Office



Reg. No. 4,107,420

Registered Mar. 6, 2012

Int. Cl.: 25

TRADEMARK

PRINCIPAL REGISTER

KEVIN H. RATHBURN (UNITED STATES INDIVIDUAL), DBA GLORY BOUND
#6308
28401 LOS ALISOS BLVD
MISSION VIEJO, CA 92692 AND

STEPHEN B. FIELD (UNITED STATES INDIVIDUAL), DBA GLORY BOUND
#6308
28401 LOS ALISOS BLVD
MISSION VIEJO, CA 92692

FOR: BELTS; BLOUSES; HATS; HOODED SWEAT SHIRTS; JACKETS; PANTS; SHIRTS;
SHORTS; SOCKS; SWEAT SHIRTS; SWEATERS; SWIMWEAR; T-SHIRTS; TANK-TOPS;
TOPS, IN CLASS 25 (U.S. CLS. 22 AND 39).

FIRST USE 6-0-2006; IN COMMERCE 6-0-2006.

THE MARK CONSISTS OF A STYLIZED HEXAGONAL IMAGE THAT INCORPORATES
THE LETTERS "G", "B". BELOW THE DESIGN ARE THE WORDS "GLORY BOUND" IN
UPPERCASE STYLIZED FONT.

SER. NO. 85-018,841, FILED 4-20-2010.

HELENE LIWINSKI, EXAMINING ATTORNEY



David J. Kyffers

Director of the United States Patent and Trademark Office

United States of America

United States Patent and Trademark Office

THE DRAMATICS

Reg. No. 4,107,421

Registered Mar. 6, 2012

Int. Cls.: 9 and 41

TRADEMARK

SERVICE MARK

PRINCIPAL REGISTER

BANKS, SANDRA (UNITED STATES INDIVIDUAL)
23401 PLUMBROOKE DRIVE
SOUTHVILLE, MI 48075

FOR: AUDIO AND VIDEO RECORDINGS FEATURING MUSIC AND ARTISTIC PERFORMANCES; DIGITAL MUSIC DOWNLOADABLE FROM THE INTERNET, IN CLASS 9 (U.S. CLS. 21, 23, 26, 36 AND 38).

FIRST USE 1-1-1962; IN COMMERCE 1-1-1962.

FOR: ENTERTAINMENT IN THE NATURE OF LIVE PERFORMANCES BY A MUSICAL GROUP, IN CLASS 41 (U.S. CLS. 100, 101 AND 107).

FIRST USE 1-1-1962; IN COMMERCE 1-1-1962.

THE MARK CONSISTS OF STANDARD CHARACTERS WITHOUT CLAIM TO ANY PARTICULAR FONT, STYLE, SIZE, OR COLOR.

SEC. 2(F).

SER. NO. 85-019,438, FILED 4-21-2010.

ROBERT C. CLARK JR., EXAMINING ATTORNEY



David J. Kyros

Director of the United States Patent and Trademark Office

United States of America

United States Patent and Trademark Office

ARCOS

Reg. No. 4,107,422

Registered Mar. 6, 2012

Int. Cls.: 3, 21 and 26

TRADEMARK

PRINCIPAL REGISTER

ARCOS DIE HAARPROFIS HANDELS GMBH (FED REP GERMANY LIMITED LIABILITY COMPANY)
AM WOLFSMANTEL 8
ERLANGEN, FED REP GERMANY 91058

FOR: HAIR CARE PRODUCTS, NAMELY, SHAMPOO, CONDITIONER, BALSAM, DE-TANGLING LOTION, REPAIR CRÈME; SPLIT END TREATMENT, NAMELY, HAIR LOTION; BONDING GLUE FOR TOUPEES, WIGS, HAIR EXTENSIONS, HAIRPIECES; SOLVENT, NAMELY, GLUE REMOVER FOR USE IN REMOVAL OF TOUPEE, WIG, HAIRPIECE AND HAIR EXTENSION BONDING GLUE, AND FOR USE IN CLEANSING THE SCALP, IN CLASS 3 (U.S. CLS. 1, 4, 6, 50, 51 AND 52).

FIRST USE 12-31-2003; IN COMMERCE 12-31-2003.

FOR: HAIR BRUSHES, IN CLASS 21 (U.S. CLS. 2, 13, 23, 29, 30, 33, 40 AND 50).

FIRST USE 12-31-2005; IN COMMERCE 12-31-2005.

FOR: TOUPEES, WIGS, HAIRPIECES, HAIR EXTENSIONS AND ADD-IN AND ADD-ON HAIR ACCESSORIES CONSTRUCTED PRIMARILY OF SYNTHETIC AND/OR HUMAN HAIR; ADHESIVE TAPE FOR AFFIXING HAIRPIECES, TOUPEES AND WIGS TO THE HEAD; ADHESIVE TAPE FOR HAIRPIECES, TOUPEES, WIGS AND HAIR EXTENSIONS, IN CLASS 26 (U.S. CLS. 37, 39, 40, 42 AND 50).

FIRST USE 12-31-2003; IN COMMERCE 12-31-2003.

THE MARK CONSISTS OF STANDARD CHARACTERS WITHOUT CLAIM TO ANY PARTICULAR FONT, STYLE, SIZE, OR COLOR.

OWNER OF U.S. REG. NO. 2,937,295.

SER. NO. 85-020,833, FILED 4-22-2010.

JOHN DWYER, EXAMINING ATTORNEY



David J. Kyffers

Director of the United States Patent and Trademark Office

United States of America

United States Patent and Trademark Office



Reg. No. 4,107,423

Registered Mar. 6, 2012

Int. Cls.: 35 and 42

SERVICE MARK

PRINCIPAL REGISTER

KRUPS GMBH (FED REP GERMANY GESELLSCHAFT MIT BESCHRÄNKTER HAFTUNG (GMBH))
HERESBACHSTRASSE 29
SOLINGEN, FED REP GERMANY 42719

FOR: ADVERTISING SERVICES; BUSINESS MANAGEMENT; BUSINESS ADMINISTRATION AND PROVIDING OFFICE FUNCTIONS, IN CLASS 35 (U.S. CLS. 100, 101 AND 102).

FOR: SCIENTIFIC AND TECHNOLOGICAL SERVICES AND RESEARCH AND DESIGN RELATING TO SMALL KITCHEN APPLIANCES; INDUSTRIAL ANALYSIS AND RESEARCH SERVICES IN THE FIELD OF SMALL KITCHEN APPLIANCES; DESIGN AND DEVELOPMENT OF COMPUTER HARDWARE AND SOFTWARE, IN CLASS 42 (U.S. CLS. 100 AND 101).

PRIORITY CLAIMED UNDER SEC. 44(D) ON FED REP GERMANY APPLICATION NO. 302009041531, FILED 10-27-2009, REG. NO. 302009041531, DATED 9-28-2009, EXPIRES 10-27-2019.

OWNER OF U.S. REG. NOS. 1,241,799 AND 2,070,984.

NO CLAIM IS MADE TO THE EXCLUSIVE RIGHT TO USE "EXCLUSIVE SERVICE" AND "CLUB", APART FROM THE MARK AS SHOWN.

THE MARK CONSISTS OF TWO CONCENTRIC CIRCLES WITH THE WORD "KRUPS" INSCRIBED IN THE INNER CIRCLE AND THE WORDS "CLUB EXCLUSIVE SERVICE" INSCRIBED IN THE OUTER CIRCLE.

SER. NO. 85-023,699, FILED 4-26-2010.

WILLIAM P. SHANAHAN, EXAMINING ATTORNEY



David J. Kyros

Director of the United States Patent and Trademark Office

United States of America

United States Patent and Trademark Office

ONICO

Reg. No. 4,107,424

SWEDISH MATCH NORTH EUROPE AB (SWEDEN JOINT STOCK COMPANY)
S-118 85

Registered Mar. 6, 2012

STOCKHOLM, SWEDEN

Int. Cl.: 34

FOR: TOBACCO; MATCHES; TOBACCO SUBSTITUTES NOT FOR MEDICAL PURPOSES; SNUFF AND TOBACCO ALTERNATIVES IN THE FORM OF PRODUCTS BASED ON VEGETABLE FIBERS, FOR ORAL USE NOT FOR CONSUMPTION; SNUFF; TOBACCO FREE SNUFF; HERBAL SNUFF, IN CLASS 34 (U.S. CLS. 2, 8, 9 AND 17).

TRADEMARK

PRINCIPAL REGISTER

THE MARK CONSISTS OF STANDARD CHARACTERS WITHOUT CLAIM TO ANY PARTICULAR FONT, STYLE, SIZE, OR COLOR.

OWNER OF ERPN CMNTY TM OFC REG. NO. 004821203, DATED 3-2-2007, EXPIRES 1-9-2016.

THE WORDING "ONICO" HAS NO MEANING IN A FOREIGN LANGUAGE.

SER. NO. 85-024,573, FILED 4-27-2010.

KATHERINE STOIDES, EXAMINING ATTORNEY



David J. Kybas

Director of the United States Patent and Trademark Office

United States of America

United States Patent and Trademark Office

MOWBI

Reg. No. 4,107,425

MOWBI, LLC (MAINE LIMITED LIABILITY COMPANY)
39 EXCHANGE STREET
PORTLAND, ME 04101

Registered Mar. 6, 2012

Int. Cl.: 42

FOR: COMPUTER SOFTWARE DEVELOPMENT IN THE FIELD OF MOBILE APPLICATIONS,
IN CLASS 42 (U.S. CLS. 100 AND 101).

SERVICE MARK

FIRST USE 5-3-2010; IN COMMERCE 5-3-2010.

PRINCIPAL REGISTER

THE MARK CONSISTS OF STANDARD CHARACTERS WITHOUT CLAIM TO ANY PAR-
TICULAR FONT, STYLE, SIZE, OR COLOR.

SER. NO. 85-029,306, FILED 5-4-2010.

ANGELA M. MICHELI, EXAMINING ATTORNEY



David J. Kybas

Director of the United States Patent and Trademark Office

United States of America

United States Patent and Trademark Office

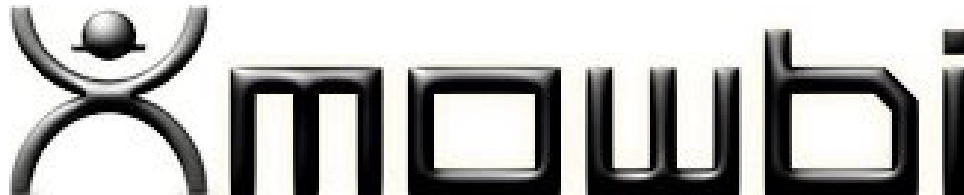

Reg. No. 4,107,426

MOWBI, LLC (MAINE LIMITED LIABILITY COMPANY)
39 EXCHANGE STREET
PORTLAND, ME 04101

Registered Mar. 6, 2012

Int. Cl.: 42

FOR: COMPUTER SOFTWARE DEVELOPMENT IN THE FIELD OF MOBILE APPLICATIONS,
IN CLASS 42 (U.S. CLS. 100 AND 101).

SERVICE MARK

FIRST USE 5-3-2010; IN COMMERCE 5-3-2010.

PRINCIPAL REGISTER

THE MARK CONSISTS OF A FANCIFUL DEPICTION OF A PERSON AND THE WORD
"MOWBI".

SER. NO. 85-029,308, FILED 5-4-2010.

ANGELA M. MICHELI, EXAMINING ATTORNEY



David J. Kybas

Director of the United States Patent and Trademark Office

United States of America

United States Patent and Trademark Office

TAOBAO

Reg. No. 4,107,427

Registered Mar. 6, 2012

**Int. Cls.: 9, 16, 35, 38, 41
and 42**

TRADEMARK

SERVICE MARK

PRINCIPAL REGISTER

ALIBABA GROUP HOLDING LIMITED (CAYMAN ISLANDS CORPORATION)
FOURTH FLOOR, ONE CAPITAL PLACE
P.O. BOX 847, GEORGE TOWN
GRAND CAYMAN, CAYMAN ISLANDS

FOR: SCIENTIFIC, NAUTICAL, SURVEYING, PHOTOGRAPHIC, CINEMATOGRAPHIC, OPTICAL, WEIGHING, MEASURING, SIGNALLING, CHECKING, LIFE-SAVING AND TEACHING APPARATUS AND INSTRUMENTS, NAMELY, TELEPHONES, PUNCH CLOCKS, TIME RECORDING DEVICES, NAMELY, TIME CLOCKS, SCALES AND BALANCES, SCALED RULERS, ELECTRONIC POCKET TRANSLATORS, NEON SIGNS, ELECTRONIC NOTICE BOARDS, TRANSPARENCY PROJECTION APPARATUS, KILOMETER RECORDERS FOR VEHICLES, TELESCOPES, MECHANISMS FOR COUNTER-OPERATED APPARATUS, NAMELY, POINT-OF-SALE TERMINALS, FIRE EXTINGUISHERS, ACOUSTIC ALARMS, NAMELY, SMOKE AND FIRE ALARMS, EYEGLASSES, BATTERIES, EXPOSED FILMS, NAMELY, EXPOSED CAMERA FILM; APPARATUS AND INSTRUMENTS FOR CONDUCTING, SWITCHING, TRANSFORMING, ACCUMULATING, REGULATING OR CONTROLLING ELECTRICITY, NAMELY, ELECTRIC WIRES; ELECTRIC SWITCHES; ELECTROPLATING APPARATUS, NAMELY, ELECTROPLATING MACHINES, ELECTRIC WELDING APPARATUS, NAMELY, TORCHES, ELECTRIFIED FENCES, NAMELY, ELECTRIC FENCES; APPARATUS FOR RECORDING, TRANSMISSION OR REPRODUCTION OF SOUND OR IMAGES; BLANK MAGNETIC DATA CARRIERS AND RECORDING DISCS; AUTOMATIC VENDING MACHINES AND MECHANISMS FOR COIN-OPERATED APPARATUS; CASH REGISTERS, CALCULATING MACHINES, DATA PROCESSING EQUIPMENT AND COMPUTERS; SOFTWARE FOR PROCESSING ELECTRONIC PAYMENTS TO AND FROM OTHERS; AUTHENTICATION SOFTWARE, NAMELY, SOFTWARE FOR AUTHENTICATING THE IDENTITY OF A PAYER; ON-LINE ELECTRONIC PUBLICATIONS DOWNLOADABLE FROM THE INTERNET OR A COMPUTER NETWORK OR A COMPUTER DATABASE IN THE NATURE OF MAGAZINES, ARTICLES, BROCHURES, LEAFLETS AND DATASHEETS CONTAINING INFORMATION OR INSTRUCTIONS IN THE FIELD OF BUSINESS AND E-COMMERCE; COMPUTER SOFTWARE FOR USE IN CONNECTION WITH THE PROVISION OF AN INTERACTIVE WEBSITE FOR THIRD PARTIES TO POST INFORMATION, CREATE ELECTRONIC PRODUCT CATALOGS, RESPOND TO REQUESTS AND PLACE AND FULFILL ORDERS FOR PRODUCTS, SERVICES AND BUSINESS OPPORTUNITIES VIA LOCAL AND GLOBAL COMPUTER NETWORKS; COMPUTER SOFTWARE FOR BUSINESS MANAGEMENT, CUSTOMER RELATIONSHIP MANAGEMENT (CRM), INVENTORY MANAGEMENT, SALES FORCE MANAGEMENT, PLANNING AND MANAGEMENT OF PERSONAL AND BUSINESS FINANCES, AND MARKETING INFORMATION MANAGEMENT, ALL IN THE



David J. Kyros

Director of the United States Patent and Trademark Office

Reg. No. 4,107,427 FIELD OF E-COMMERCE; COMPUTER SOFTWARE FOR PROCESSING ELECTRONIC PAYMENTS TO AND FROM OTHERS; COMPUTER SOFTWARE FOR USE IN THE SEARCH AND RETRIEVAL OF COMPUTERIZED INFORMATION ON HOBBIES, COLLECTIBLES, AUCTIONS AND PRODUCTS ACCESSED FROM GLOBAL INFORMATION NETWORKS AND NETWORK SYSTEMS; COMPUTER PERIPHERALS; NOTEBOOK COMPUTERS; LAPTOP COMPUTERS; PORTABLE COMPUTERS; HANDHELD COMPUTERS; PERSONAL DIGITAL ASSISTANTS; PERSONAL MEDIA PLAYERS, NAMELY, DIGITAL AND ANALOG AUDIO PLAYERS, DIGITAL AND ANALOG VIDEO PLAYERS; MOBILE TELEPHONES; SMART PHONES; DIGITAL CAMERAS; SERVERS, NAMELY, COMPUTER SERVERS; COMPUTER AND TELECOMMUNICATIONS NETWORKING COMPUTER HARDWARE; COMPUTER NETWORK ADAPTORS, SWITCHES, ROUTERS AND HUBS; WIRELESS AND WIRED MODEMS AND COMPUTER EQUIPMENT, NAMELY, WIRELESS CARDS; LAPTOP HOLDERS IN THE NATURE OF PROTECTIVE SLEEVES AND CARRYING CASES, COMPUTER BAGS; FIRE-EXTINGUISHING APPARATUS; BLANK COMPACT DISCS; DIGITAL MUSIC DOWNLOADABLE FROM THE INTERNET; TELECOMMUNICATIONS APPARATUS, NAMELY, NETWORK TELEPHONE, ELECTRONIC FACSIMILE APPARATUS, PORTABLE DEVICE FOR SENDING AND RECEIVING ELECTRONIC MAILS, AND INSTANT MESSAGING COMMUNICATION TOOL IN THE NATURE OF PORTABLE TELECOMMUNICATION INSTANT MESSAGING DEVICES; MOUSE PADS; MOBILE PHONE HANDSETS; MOBILE PHONE ACCESSORIES, NAMELY, BATTERY CHARGERS, CASES, COVERS, EAR PHONES AND DEVICES FOR HANDS-FREE USE OF MOBILE PHONES; DOWNLOADABLE GAMES, PICTURES, MOTION PICTURES, MOVIES AND MUSIC VIA THE INTERNET AND WIRELESS DEVICES; ALARM MONITORING SYSTEMS; SECURITY CAMERAS; MOBILE RADIO AND TELEVISION BROADCASTING UNITS; TELEVISION BROADCASTING EQUIPMENT, NAMELY, VIDEO CAMERAS, FILM CAMERAS, MONITORS, DISPLAYS, AUDIO MONITORS, AUDIO RECORDERS, VIDEO RECORDERS, SWITCHERS, CABLES, LIGHTING, LENSES, TRIPODS, CASES, VIDEOTAPE, AUDIO MIXING BOARDS, AND VIDEO EDITING CONSOLES; CAMERAS; VIDEO CAMERAS; HEADPHONES; EAR PIECES; SPEAKERS; GLOBAL POSITIONING SYSTEM (GPS) APPARATUS AND EQUIPMENT; COMPUTER, ELECTRONIC AND VIDEO GAMES PROGRAMS AND SOFTWARE INCLUDING SOFTWARE DOWNLOADABLE FROM THE INTERNET; LIQUID CRYSTAL DISPLAYS FOR TELECOMMUNICATIONS AND ELECTRONIC EQUIPMENT; SET TOP BOX; REMOTE CONTROL FOR TELEVISIONS, COMPUTERS, AUDIO SYSTEMS, AND VIDEO GAME SYSTEMS; DATA STORAGE PROGRAMS, NAMELY, COMPUTER SOFTWARE USED FOR THE STORAGE OF ELECTRONIC DATA AND DOCUMENTS; SPECTACLES AND SUNGLASSES; ENCODED OR MAGNETIC BANK CREDIT, DEBIT, CASH AND IDENTIFICATION CARDS; AUTOMATIC TELLER MACHINES, CASH DISPENSERS, IN CLASS 9 (U.S. CLS. 21, 23, 26, 36 AND 38).

FOR: NEWSPAPERS; MAGAZINES, NAMELY, GENERAL FEATURE MAGAZINES; JOURNALS, NAMELY, BLANK JOURNAL BOOKS, BLANK JOURNALS, BLANK WRITING JOURNALS, CUSTOMIZABLE JOURNAL BOOKS, JOURNALS CONCERNING BUSINESS AND ECOMMERCE, PERSONALIZED WRITING JOURNALS, TRADE JOURNALS IN THE FIELD OF BUSINESS AND ECOMMERCE, WRITING JOURNAL SHEETS; PAPER, CARDBOARD AND GOODS MADE FROM THESE MATERIALS, NOT INCLUDED IN OTHER CLASSES, NAMELY, COMPUTER PAPER AND CARDBOARD BOXES; PRINTED MATTER, NAMELY, CALENDARS AND PHOTOGRAPHS; PRINTED MATTER, NAMELY, PRINTED CHARTS, AND BOOKS IN THE FIELD OF ENTREPRENEURSHIP AND E-COMMERCE; STATIONERY; ADHESIVES FOR STATIONERY OR HOUSEHOLD PURPOSES; ARTISTS' MATERIALS, NAMELY, ARTISTS' BRUSHES, PASTELS, PENCILS, PENS, CANVAS PANELS, ELECTRICAL WOOD BURNING PENS, GESSO, NAMELY, PLASTERS, AND MOLDS FOR MODELING CLAYS; TYPEWRITERS; PRINTED INSTRUCTIONAL AND TEACHING MATERIAL, EXCEPT APPARATUS, IN THE FIELD OF MATHEMATICS, SCIENCE, LITERATURE, MUSIC, ART, AND WRITING; PLASTIC MATERIALS FOR PACKAGING NOT INCLUDED IN OTHER CLASSES, NAMELY, PLASTIC BAGS FOR PACKING AND PLASTIC BUBBLE PACKS FOR PACKAGING; PRINTERS' TYPE; PRINTING BLOCKS; BOOKS AND PAMPHLETS IN THE FIELD OF BUSINESS AND ECOMMERCE; POSTERS; PRINTED CARDS, NAMELY, PRINTED GREETING CARDS; CALENDARS; PRICE TAGS; PAPER

Reg. No. 4,107,427 PRICE LABELS; GENERAL PURPOSE BAGS OF PAPER, CARDBOARD AND PLASTIC; PRINTED TELEPHONE, FACSIMILE, ELECTRONIC MAIL AND WEB SITE DIRECTORIES; CARDS IN THE FORM OF DEBIT CARDS, CREDIT CARDS, CHARGE CARDS AND TELEPHONE CARDS OTHER THAN ENCODED AND MAGNETIC CARDS; MARKETING AND PROMOTIONAL MATERIALS, NAMELY, PRINTED VISUALS IN THE NATURE OF PROMOTIONAL MATERIALS; PRINTED ADVERTISEMENTS, NAMELY, ADVERTISING PAMPHLETS AND ADVERTISING SIGNS OF PAPER OR CARDBOARD; PRINTED USER MANUALS IN THE FIELD OF BUSINESS AND ECOMMERCE; PACKAGING MATERIALS, NAMELY, SYNTHETIC RESIN, PAPER, CARDBOARD, AND PLASTIC SHIPPING MATERIALS; FACIAL TISSUES; HANDKERCHIEFS MADE OF PAPER; MODELS AND FIGURINES MADE OF PAPER; PAPER PARTY BAGS; PAPER PARTY FAVORS; PAPER AND CARDBOARD SIGNBOARDS, IN CLASS 16 (U.S. CLS. 2, 5, 22, 23, 29, 37, 38 AND 50).

FOR: ADVERTISING; BUSINESS MANAGEMENT; BUSINESS ADMINISTRATION; PROVIDING OFFICE FUNCTIONS; ADVERTISING AGENCY SERVICES; ADVERTISING SERVICES PROVIDED FOR OTHERS; DATABASE MANAGEMENT; COMPILATION OF INFORMATION INTO COMPUTER DATABASES; MARKET RESEARCH AND BUSINESS CONSULTING SERVICES; BUSINESS CONSULTANCY SERVICES RELATING TO FACILITATING THE TRANSACTION OF BUSINESS VIA LOCAL AND GLOBAL COMPUTER NETWORKS BY LOCATING AND PROVIDING REFERRALS FOR THE DELIVERY OF A WIDE VARIETY OF BUSINESS AND CONSUMER PRODUCTS AND SERVICES; DISSEMINATION OF BUSINESS INFORMATION OF GOODS AND SERVICES OF OTHERS VIA LOCAL AND GLOBAL COMPUTER NETWORKS; BUSINESS CONSULTANCY SERVICES IN THE FIELD OF GLOBAL COMPUTER WEB SITES WHERE THIRD PARTIES CAN OFFER AND SOURCE GOODS AND SERVICES, PLACE, DETERMINE THE STATUS OF AND FULFILL TRADE LEADS AND ORDERS, ENTER INTO CONTRACTS AND TRANSACT BUSINESS; PROVIDING COMPUTERIZED ONLINE ORDERING SERVICES FEATURING A WIDE VARIETY OF GENERAL CONSUMER, BUSINESS, AND INDUSTRIAL PRODUCTS AND MERCHANDISE; ADVERTISING OF GOODS AND SERVICES OF OTHERS VIA LOCAL AND GLOBAL COMPUTER NETWORKS; INTERNATIONAL IMPORT AND EXPORT AGENCY SERVICES; RENTAL OF ADVERTISING SPACE ON COMMUNICATION MEDIA; ONLINE TRADING SERVICES RELATING TO ELECTRONIC AUCTIONEERING AND PROVIDING ONLINE BUSINESS EVALUATION RELATING THERETO; ONLINE RETAIL STORE SERVICES FEATURING A WIDE VARIETY OF GENERAL CONSUMER, BUSINESS, AND INDUSTRIAL PRODUCTS AND MERCHANDISE; PROVIDING AN ONLINE BUSINESS DIRECTORY OF THIRD PARTY WEB SITES TO FACILITATE BUSINESS TRANSACTIONS; BUSINESS CONSULTANCY SERVICES IN THE FIELD OF OPERATING AN ELECTRONIC MARKETPLACE FOR THE BUYERS AND SELLERS OF GOODS AND/OR SERVICES ON A GLOBAL COMPUTER NETWORK; BUSINESS ASSISTANCE FOR OTHERS IN THE FIELD OF FACILITATING BUSINESS TRANSACTION VIA LOCAL AND GLOBAL COMPUTER NETWORKS; CORPORATE BUSINESS MANAGEMENT CONSULTANCY SERVICES; MARKETING AND PROMOTION SERVICES; PUBLICATION OF PUBLICITY MATERIALS; REAL ESTATE MARKETING SERVICES, NAMELY, MARKETING OF VACANT PREMISES; DISSEMINATION OF ADVERTISING MATERIALS, UPDATING OF ADVERTISING MATERIALS, COMPILATION OF ADVERTISEMENTS FOR USE AS WEB PAGES ON THE INTERNET; RENTAL OF ADVERTISING SPACE; COMPUTER DATA PROCESSING; PROVIDING INFORMATION CONCERNING COMMERCIAL SALES, PROVIDING BUSINESS INFORMATION, PROMOTIONAL INFORMATION SERVICES, NAMELY, PROMOTING THE GOODS OF OTHER BY PROVIDING INFORMATION REGARDING DISCOUNTS, COUPONS, REBATES, VOUCHERS AND SPECIAL OFFERS FOR THE GOODS OF OTHERS; TELEPHONE ANSWERING SERVICE; AUCTIONEERING PROVIDED ON THE INTERNET; PERSONNEL MANAGEMENT; PROVISION OF COMMERCIAL SALES, BUSINESS INFORMATION, ADVERTISING AND COMMERCIAL INFORMATION THROUGH A GLOBAL COMPUTER NETWORK AND VIA THE INTERNET; PRESENTATION OF GOODS ON COMMUNICATION MEDIA FOR RETAIL PURPOSES; THE BRINGING TOGETHER, FOR THE BENEFIT OF OTHERS, OF A VARIETY OF GOODS, ENABLING CUSTOMERS TO CONVENIENTLY VIEW AND PURCHASE THOSE GOODS FROM A GENERAL MERCHANDISE INTERNET WEB SITE SPECIALIZING IN THE MARKETING OF THE SALE OF GOODS AND SERVICES

Reg. No. 4,107,427 OF OTHERS; RETAIL AND WHOLESALE STORE SERVICES FEATURING TELEPHONES, MOBILE PHONE HANDSETS, MOBILE PHONE ACCESSORIES, ELECTRONIC AND TELECOMMUNICATIONS GOODS, COMPUTER HARDWARE AND COMPUTER SOFTWARE, BATTERIES, BATTERY CHARGERS, APPARATUS AND INSTRUMENTS FOR RECORDING, RECEIVING, TRANSMITTING AND/OR REPRODUCING DATA, INFORMATION, PICTURES, IMAGES AND/OR SOUND, PRECIOUS METALS, JEWELLERY, PRECIOUS STONES, PRINTED MATTER, STATIONERY AND MAGNETIC AND NON MAGNETICALLY ENCODED CARDS, FURNITURE, PICTURE FRAMES, HOUSEHOLD AND KITCHEN UTENSILS, GLASSWARE, PORCELAIN AND EARTHENWARE, TEXTILES, CLOTHING, FOOTWEAR, HEADGEAR, LACES AND EMBROIDERY, BUTTONS, RIBBONS, PINS AND NEEDLES, ARTIFICIAL FLOWERS, CARPETS, RUGS, GAMES AND ELECTRONIC TOYS, CHEMICALS USED IN INDUSTRY, SCIENCE, PHOTOGRAPHY AND AGRICULTURE, PAINTS, VARNISHES AND LACQUERS, PERSONAL HYGIENE PRODUCTS, SOAPS, PERFUMERY, COSMETICS, HAIR AND BODY LOTIONS, ESSENTIAL OILS, CLEANING AND BLEACHING PREPARATIONS, LUBRICANTS, FUELS, CANDLES, PHARMACEUTICAL, VETERINARY AND SANITARY PREPARATIONS, IRONMONGERY AND SMALL ITEMS OF METAL HARDWARE, MACHINES AND MACHINE TOOLS, CUTLERY, RAZORS AND HAND TOOLS, COMPUTERS, CALCULATING MACHINES, ELECTRICAL, PHOTOGRAPHIC, CINEMATOGRAPHIC AND OPTICAL APPARATUS AND INSTRUMENTS, SPECTACLES AND SUN GLASSES, SURGICAL AND MEDICAL APPARATUS AND INSTRUMENTS, APPARATUS FOR LIGHTING, HEATING, STEAM GENERATING, COOKING, REFRIGERATING, DRYING, VENTILATING, WATER SUPPLY AND SANITARY PURPOSES, VEHICLES, FIREARMS, FIREWORKS, SILVERWARE, HOROLOGICAL AND CHRONOMETRIC INSTRUMENTS, MUSICAL INSTRUMENTS, MAGAZINE, CARDS, PAPER AND CARDBOARD PRODUCTS, PICTURE, TYPEWRITERS AND OFFICE REQUISITES, PACKAGING MATERIALS, RUBBER AND PLASTICS FOR MANUFACTURE USE, PACKING AND INSULATING MATERIALS, LEATHER AND IMITATIONS OF LEATHER AND GOODS MADE FROM THESE MATERIALS, HANDBAGS, PURSES, WALLETS, LEATHER HOLDERS, BAGS, LUGGAGE, UMBRELLAS, MIRRORS, ROPES, STRING, NETS, TENTS, YARNS AND THREADS FOR TEXTILE USE, COAT HANGERS, PLACE MATS, DRESSMAKER'S ARTICLES, BED AND TABLE COVERS, PLAYTHINGS AND SPORTING ARTICLES. FOODSTUFFS AND BEVERAGES, MEAT, FISH, POULTRY, PRESERVED, DRIED AND COOKED FRUITS AND VEGETABLES, JAMS AND FRUITS SAUCES, EGGS, MILK AND MILK PRODUCTS, EDIBLE OILS AND FATS, COFFEE, TEA, COCOA, SUGAR, RICE, FLOUR, BREAD AND CAKES, CONDIMENTS, FRESH FRUIT AND VEGETABLES, BEER, MINERAL WATER, FRUIT JUICES AND OTHER NON-ALCOHOLIC DRINKS, ALCOHOLIC BEVERAGES, FLORAL PRODUCTS, TOBACCO, SMOKERS' ARTICLES AND MATCHES; DIRECT MAIL ADVERTISING; BUYING AND SELLING AGENCY SERVICES, NAMELY, PURCHASING A WIDE VARIETY OF CONSUMER, BUSINESS AND INDUSTRIAL PRODUCTS AND SERVICES FOR OTHERS; SELECTION AND PROCUREMENT OF GOODS, NAMELY, PURCHASING OF A WIDE VARIETY OF CONSUMER, BUSINESS AND INDUSTRIAL PRODUCTS AND SERVICES FOR INDIVIDUALS AND BUSINESSES FOR INDIVIDUALS AND BUSINESSES; CATALOG AND ONLINE ORDERING SERVICES FEATURING A WIDE VARIETY OF CONSUMER GOODS OF OTHERS; DEPARTMENT STORE SERVICES; SUPERMARKET SERVICES; SECRETARIAL SERVICES; PROVIDING STATISTICAL INFORMATION; ORGANIZATION OF EXHIBITIONS FOR COMMERCIAL OR ADVERTISING PURPOSES; BUSINESS SERVICES, NAMELY, PREPARING MAILING LISTS; BUSINESS INVESTIGATION; BUSINESS ADMINISTRATION CONSULTATION SERVICES IN THE FIELD OF PROCESSING OF SALES MADE ON THE INTERNET; BUSINESS NETWORKING REFERRAL SERVICES AND PERSONNEL PLACEMENT; IMPORT-EXPORT AGENCIES; SUBSCRIPTIONS TO NEWSPAPERS; DOCUMENT REPRODUCTION; TRANSCRIPTION SERVICES, NAMELY, CONFERENCE CALL, MESSAGE AND STENOGRAPHIC TRANSCRIPTION; RENTAL OF OFFICE EQUIPMENT; CUSTOMER RELATIONSHIP MANAGEMENT; BUSINESS MANAGEMENT SERVICES RELATING TO ELECTRONIC COMMERCE; BUSINESS MANAGEMENT AND ADMINISTRATION SERVICES RELATING TO SPONSORSHIP PROGRAMS; ACCOUNTING SERVICES, CONSULTANCY, INFORMATION AND ADVISORY SERVICES RELATING TO THE AFORESAID SERVICES, IN CLASS 35 (U.S. CLS. 100, 101 AND 102).

Reg. No. 4,107,427 FOR: TELECOMMUNICATIONS SERVICES, NAMELY, PROVIDING TELEPHONE COMMUNICATION, INTERNET TELEPHONY SERVICES, NETWORK TELEPHONE, ELECTRONIC FACSIMILE, ELECTRONIC MAILS, AND INSTANT MESSAGING COMMUNICATION SERVICES; PROVISION OF TELECOMMUNICATION ACCESS AND LINKS TO COMPUTER DATABASE AND TO THE INTERNET; ELECTRONIC COMMUNICATION SERVICES; INTERACTIVE TELECOMMUNICATIONS SERVICES; TELECOMMUNICATIONS SERVICES, NAMELY, THE ELECTRONIC TRANSMISSION OF DATA AND DOCUMENTS; PROVIDING TELECOMMUNICATIONS CONNECTIONS TO THE INTERNET OR DATA BASES; PROVISION OF TELECOMMUNICATION ACCESS TO THE WORLD-WIDE WEB; COMMUNICATION BY COMPUTER TERMINALS; COMMUNICATION BY FIBER OPTIC NETWORKS; ELECTRONIC TRANSMISSION OF MESSAGES AND IMAGES BY COMPUTER; FACSIMILE TRANSMISSION; MESSAGE SENDING; PAGING SERVICES; RENTAL OF MODEMS; TRANSMISSION OF DATA BY ELECTRONIC MEANS; RENTAL OF TELECOMMUNICATION EQUIPMENT; ELECTRONIC MESSAGE SENDING, RECEIVING AND FORWARDING SERVICES; TRANSMISSION AND DELIVERY OF DATA BY ELECTRONIC MEANS; ELECTRONIC TRANSMISSION AND DELIVERY OF MAIL MESSAGES, STILL PICTURE AND/OR MOVING PICTURE INFORMATION SUCH AS CHARACTERS, MESSAGES, MUSIC AND IMAGES, TELEGRAMS, INFORMATION AND DATA BY ELECTRONIC, TELEPHONE, TELEGRAPH, CABLE, COMPUTER AND SATELLITE MEANS; TRANSMISSION, BROADCAST AND RECEPTION OF AUDIO, VIDEO, STILL AND MOVING IMAGES AND DATA WHETHER IN COMPRESSED OR UNCOMPRESSED FORM AND WHETHER IN REAL OR DELAYED TIME; ELECTRONIC MESSAGING SERVICES, TELEPHONE, VIDEO AND WEB CONFERENCING SERVICES AND ORDER-TRANSMISSION SERVICES; VIDEO CONFERENCING SERVICES; PROVIDING AN ELECTRONIC BULLETIN BOARD THAT ENABLES USERS TO PERFORM A REAL-TIME INTERACTIVE TALK BETWEEN A COMPUTER TERMINAL AND AN ELECTRONIC BULLETIN BOARD CONTAINING STILL PICTURE AND MOVING PICTURE INFORMATION AND VOICE INFORMATION SUCH AS CHARACTERS IN THE FIELD OF GENERAL INTEREST; PROVIDING ELECTRONIC BULLETIN BOARDS AND MESSAGE BOARDS FOR TRANSMISSION OF IN THE FIELD OF GENERAL INTEREST; PROVISION OF DISCUSSION FORUMS IN THE FIELD OF GENERAL INTEREST; TELEVISION BROADCASTING SERVICES; BROADCASTING AND TRANSMISSION OF RADIO AND TELEVISION PROGRAMS; MUSIC BROADCASTING; TRANSMISSION OF MUSIC, FILMS, INTERACTIVE PROGRAMS, VIDEOS, ELECTRONIC COMPUTER GAMES VIA A GLOBAL COMPUTER NETWORK OR THE INTERNET; ELECTRONIC TRANSMISSION OF INFORMATION IN THE FIELD OF ON-LINE SHOPPING AND GENERAL RETAIL SERVICES; VIDEO-ON-DEMAND TRANSMISSION SERVICES; NEWS AGENCY SERVICES, NAMELY, TRANSMISSION OF NEWS ITEMS TO NEWS REPORTING ORGANIZATIONS; PROVIDING ACCESS TO COMPUTER DATABASES ON THE GLOBAL COMPUTER NETWORK; PROVIDING CHAT ROOM SERVICES OR TRANSMISSION OF MESSAGES AMONG COMPUTER USERS CONCERNING BUSINESS AND ECOMMERCE; PROVIDING MULTIPLE USER ACCESS TO GLOBAL COMPUTER INFORMATION NETWORKS; PROVIDING ACCESS TO A WEBSITE ON A GLOBAL COMPUTER NETWORK BY WHICH THIRD PARTIES CAN OFFER GOODS AND SERVICES, PLACE AND FULFILL ORDERS, ENTER INTO CONTRACTS AND TRANSACT BUSINESS; PROVIDING ACCESS TO AN INTERACTIVE WEBSITE ON A GLOBAL COMPUTER NETWORK FOR THIRD PARTIES TO POST INFORMATION, RESPOND TO REQUESTS AND PLACE AND FULFILL ORDERS FOR PRODUCTS, SERVICES AND BUSINESS OPPORTUNITIES; COMMUNICATION SERVICES, NAMELY, TEXT AND NUMERIC WIRELESS DIGITAL MESSAGING SERVICES; TRANSMISSION OF INFORMATION AND DATA COMMUNICATIONS FOR ASSISTING DECISION MAKING; TRANSMISSION OF INFORMATION THROUGH VIDEO COMMUNICATION SYSTEMS; WEB CONFERENCING SERVICES; VIRTUAL CHATROOMS ESTABLISHED VIA TEXT MESSAGING; PROVIDING ELECTRONIC BULLETIN BOARDS FOR THE POSTING AND TRANSMISSION OF MESSAGES AMONG AND BETWEEN COMPUTER USERS CONCERNING CONSUMER PRODUCTS, SERVICES AND BUSINESS LEADS AND OPPORTUNITIES; PROVIDING AN ONLINE INTERACTIVE BULLETIN BOARD FOR THE POSTING, PROMOTION, SALE AND RESALE OF ITEMS VIA A GLOBAL COMPUTER NETWORK; PROVIDING ELECTRONIC MAIL AND ELECTRONIC MAIL FORWARDING SERVICES; AUDIO AND VIDEO COMMUNICATION VIA COMPUTERS AND COMPUTER NETWORKS, AND VIA

Reg. No. 4,107,427 A GLOBAL COMMUNICATIONS NETWORK; PROVIDING COMPUTER ACCESS TO ONLINE INTERACTIVE BULLETIN BOARDS AND DATABASES; PROVIDING ACCESS TO ELECTRONIC BULLETIN BOARDS FOR THE POSTING AND TRANSMISSION OF MESSAGES AMONG AND BETWEEN COMPUTER USERS CONCERNING PRODUCTS, SERVICES AND BUSINESS OPPORTUNITIES; PROVIDING ACCESS TO ELECTRONIC CALENDAR, ADDRESS BOOK AND NOTES FEATURE, VIA LOCAL AND GLOBAL COMPUTER NETWORKS; PROVIDING DISTANT VIDEO AND/OR TELEPHONE CONFERENCING ACCESS AND FACILITIES; CONSULTANCY, INFORMATION AND ADVISORY SERVICES RELATING TO THE AFORESAID SERVICES, IN CLASS 38 (U.S. CLS. 100, 101 AND 104).

FOR: PROVIDING OF TRAINING IN THE FIELD OF BUSINESS AND E-COMMERCE; ENTERTAINMENT, NAMELY, PROVIDING ON-LINE VIDEO GAMES, COMPUTER GAMES AND COMPUTER GAME CONTESTS; ORGANIZING SPORTING AND CULTURAL ACTIVITIES; PUBLICATION OF TEXTS, BOOKS AND JOURNALS OTHER THAN PUBLICITY TEXTS; PUBLICATION OF DIAGRAMS, IMAGES AND PHOTOGRAPHS; PUBLICATION OF NEWSPAPERS, MAGAZINES AND PERIODICALS; EDUCATION, NAMELY, TRAINING COURSES AND INSTRUCTIONAL CLASSES IN THE FIELD OF TELECOMMUNICATIONS HARDWARE AND SOFTWARE, OPERATION OF COMPUTERS, COMPUTER PROGRAMMING, WEB SITE DESIGN, E-COMMERCE, BUSINESS MANAGEMENT AND ADVERTISING; PROVIDING INFORMATION ABOUT EDUCATION, RECREATION, INSTRUCTION, TUITION AND TRAINING BOTH INTERACTIVE AND NON-INTERACTIVE; DESIGN OF EDUCATIONAL COURSES, NAMELY, DEVELOPMENT OF CURRICULUM AND EXAMINATIONS IN THE FIELD OF BUSINESS AND ECOMMERCE; ENTERTAINMENT PROVIDED VIA ELECTRONIC AND DIGITAL INTERACTIVE MEDIA, NAMELY, PROVIDING ON-LINE VIDEO GAMES, COMPUTER GAMES AND COMPUTER GAME CONTESTS; PROVISION OF INFORMATION ABOUT EDUCATION, ENTERTAINMENT INFORMATION, INFORMATION IN THE FIELD OF SPORTS AND SPORTING EVENTS, AND INFORMATION IN THE FIELD OF RECREATION AND LEISURE ACTIVITIES AND CULTURAL ACTIVITIES AND EXHIBITIONS; PROVIDING ONLINE ELECTRONIC PUBLICATIONS IN THE NATURE OF BOOKS, JOURNALS, NEWSLETTERS AND ARTICLES IN THE FIELD OF BUSINESS AND E-COMMERCE; ARRANGING, ORGANIZING, HOSTING AND CONDUCTING SINGING COMPETITIONS; ARRANGING, ORGANIZING, HOSTING AND CONDUCTING MUSICAL CONCERTS; ARRANGING, ORGANIZING, HOSTING AND CONDUCTING GAME SHOWS AND QUESTS; ENTERTAINMENT TICKET AGENCY SERVICES; ENTERTAINMENT INFORMATION AND INFORMATION ABOUT EDUCATION, PROVIDED ONLINE FROM A COMPUTER DATABASE OR THE INTERNET; PROVIDING NON-DOWNLOADABLE PRERECORDED DIGITAL MUSIC FROM THE INTERNET; PROVIDING NON-DOWNLOADABLE PRERECORDED DIGITAL MUSIC FROM MP3 INTERNET WEB SITES; ENTERTAINMENT AND EDUCATION SERVICES, NAMELY, CONDUCTING COURSES OF INSTRUCTION ABOUT PLANNING, PRODUCTION AND DISTRIBUTION OF SOUND, IMAGES, DIGITAL MUSIC, MOVIES AND LIVE OR RECORDED AUDIO, VISUAL OR AUDIOVISUAL MATERIAL FOR BROADCASTING ON TERRESTRIAL CABLE, SATELLITE CHANNELS, THE INTERNET, WIRELESS OR WIRELINK SYSTEMS AND OTHER MEANS OF COMMUNICATIONS; MUSIC ENTERTAINMENT SERVICES, NAMELY, LIVE MUSIC CONCERTS; RENTAL OF SOUND RECORDINGS; ENTERTAINMENT IN THE NATURE OF ON-GOING TELEVISION PROGRAMS IN THE FIELDS OF BUSINESS AND E-COMMERCE; RENTAL OF SOUND RECORDINGS; NEWS REPORTERS SERVICES; PROVIDING NEWS IN THE FIELD OF SPORTING OR CULTURAL EVENTS AND CURRENT EVENTS REPORTING PROVIDED BY SATELLITE TELEVISION, THE INTERNET OR RADIO; PRODUCTION OF TELEVISION AND RADIO PROGRAMS AND FILM PRODUCTION; GAME SERVICES PROVIDED ON-LINE FROM A COMPUTER NETWORK; PROVISION OF RECREATION ACTIVITY, SPORTING AND GYMNASIUM FACILITIES; LIVE PERFORMANCES BY MUSICAL BANDS; NIGHT CLUB SERVICES, DISCOTHEQUES, AND FASHION SHOWS; ARRANGING, CONDUCTING AND PROVISION OF CONFERENCES, CONVENTIONS, SEMINARS AND TRAINING WORKSHOPS IN THE FIELD OF BUSINESS AND E-COMMERCE; ART EXHIBITIONS; ART SERVICES, NAMELY, RENTAL OF ARTWORK; TRAINING SERVICES IN THE FIELD OF OCCUPATIONAL HEALTH AND SAFETY, AND ENVIRONMENTAL CONSERVATION; PROVISION OF CIGAR

Reg. No. 4,107,427 CLASSES, WINE TASTING CLASSES; ARRANGING, ORGANIZING, PLANNING AND RUNNING SEMINARS IN THE FIELD OF BUSINESS AND E-COMMERCE; ANIMAL TRAINING; DIRECTION IN PRODUCING BROADCASTING PROGRAMS, NAMELY, PRODUCTION OF TELEVISION AND RADIO PROGRAMS AND FILM PRODUCTION; INSTRUCTIONAL SERVICES, NAMELY, TRAINING IN THE OPERATION OF AUDIOVISUAL MACHINES AND EQUIPMENT USED FOR THE PRODUCTION OF BROADCASTING PROGRAMS; PROVIDING AUDIO AND VISUAL STUDIOS; PROVIDING SPORTS FACILITIES; PROVIDING FACILITIES FOR MOVIES, SHOWS, PLAYS, MUSIC OR EDUCATIONAL TRAINING; ENTERTAINMENT BOOKING AGENCIES, NAMELY, BOOKING OF SEATS FOR SHOWS AND SPORTS EVENTS; RENTAL OF MOTION PICTURES; RENTAL AND LEASING OF MUSICAL INSTRUMENTS; RENTAL AND LEASING OF RECORDED TELEVISION PROGRAMS; RENTAL AND LEASING OF TELEVISION SETS; LENDING LIBRARIES; ARCHIVE LIBRARY SERVICES; SUBTITLING SERVICES, NAMELY, PREPARING SUBTITLES FOR MOVIES; SIGN LANGUAGE INTERPRETATION SERVICES; RENTAL OF COMPUTER GAME SOFTWARE; PROVIDING ONLINE VIDEO GAMES, COMPUTER GAMES; PROVIDING ONLINE NONDOWNLOADABLE MUSIC AND MOVIES THROUGH THE INTERNET; PROVIDING ONLINE COMPUTER GAMES AND CONDUCTING CONTESTS; RENTAL OF PRE-RECORDED VIDEO TAPES; RENTAL AND LEASING OF GAME MACHINES; RENTAL OF ARCADE GAME EQUIPMENT; RENTAL OF MOTION PICTURES; PHOTOGRAPHY; TRANSLATION; LANGUAGE INTERPRETATION; EDUCATIONAL AND TRAINING PROGRAMS IN THE FIELD OF RISK MANAGEMENT; EDUCATIONAL AND TRAINING PROGRAMS RELATED TO THE CERTIFICATION OF BUYERS AND SELLERS ENGAGED IN ECOMMERCE; PROVISION OF NEWS IN THE NATURE OF CURRENT EVENT REPORTING; CONSULTANCY, INFORMATION AND ADVISORY SERVICES RELATING TO THE AFORESAID SERVICES; LOTTERY SERVICES, IN CLASS 41 (U.S. CLS. 100, 101 AND 107).

FOR: SCIENTIFIC AND TECHNOLOGICAL SERVICES AND RESEARCH AND DESIGN RELATING THERETO, IN THE FIELD OF TELECOMMUNICATIONS SOFTWARE AND HARDWARE DESIGN, INTERNET TECHNOLOGY, THE DESIGN OF WEBSITES FOR ADVERTISING, SOFTWARE DESIGN AND E-COMMERCE SOFTWARE AND HARDWARE DESIGN, AND INDUSTRIAL RESEARCH AND ANALYSIS SERVICES IN THE FIELD OF ECOMMERCE; DESIGN AND DEVELOPMENT OF COMPUTER HARDWARE AND SOFTWARE; COMPUTER SERVICE RELATING TO CREATING INDEXES OF INFORMATION, SITES AND RESOURCES ON COMPUTER NETWORKS; PROVIDING SEARCH ENGINES; DESIGN OF COMPUTERS, NOTEBOOK COMPUTERS, LAPTOP COMPUTERS, PORTABLE COMPUTERS AND HANDHELD COMPUTERS; DESIGN FOR OTHERS IN THE FIELD OF PERSONAL DIGITAL ASSISTANTS AND PERSONAL MEDIA PLAYERS; DESIGN FOR OTHERS IN THE FIELD OF MOBILE TELEPHONES AND SMART PHONES; DESIGN FOR OTHERS IN THE FIELD OF DIGITAL CAMERAS; COMPUTER SERVICES, NAMELY, CREATING, MAINTAINING AND HOSTING WEBSITES FOR OTHERS, COMPUTER SYSTEM ADMINISTRATION FOR OTHERS, HOSTING COMPUTER APPLICATION SOFTWARE FOR SEARCHING AND RETRIEVING INFORMATION FROM DATABASES AND COMPUTER NETWORKS, HOSTING SOFTWARE FOR CUSTOMIZED SEARCHING OF COMPUTER DATABASES AND WEBSITES, CREATING, MAINTAINING AND HOSTING WEBSITES FOR OTHERS, CREATING AN ON-LINE COMMUNITY FOR REGISTERED USERS TO DEVELOP AND COLLABORATE ON ADDRESS BOOKS AND CALENDARS, SOFTWARE DESIGN AND DEVELOPMENT FOR OTHERS, HOSTING ON-LINE INTERACTIVE PUBLIC CALENDARS, ADDRESS BOOKS AND NOTES THAT ALLOW MULTIPLE PARTICIPANTS TO SHARE EVENT SCHEDULES, FACILITY RESERVATIONS, AND TRANSPORTATION REQUESTS VIA LOCAL AND GLOBAL COMPUTER NETWORK, CUSTOMIZED SEARCHING OF COMPUTER DATABASES AND WEBSITES, NAMELY, PROVIDING CUSTOMIZED ONLINE WEB PAGES FEATURING USER-DEFINED INFORMATION WHICH INCLUDES ONLINE LINKS TO THIRD PARTY WEB SITES, AND PROVIDING SEARCH ENGINES FOR OBTAINING DATA FROM COMPUTER FILES ON A GLOBAL COMPUTER NETWORK; COMPUTER PROGRAMMING; COMPUTER SYSTEM SOFTWARE SERVICES, NAMELY, DESIGN AND DEVELOPMENT OF ON-LINE COMPUTER SOFTWARE SYSTEMS; COMPUTER PROGRAMMING IN RELATION TO THE DEFENSE AGAINST VIRUS, NAMELY,

Reg. No. 4,107,427 COMPUTER VIRUS PROTECTION SERVICES; COMPUTER INTEGRATION SERVICES, NAMELY, COMPUTER SYSTEMS INTEGRATION SERVICES, INTEGRATION OF COMPUTER SOFTWARE INTO MULTIPLE SYSTEMS AND NETWORKS, INTEGRATION OF COMPUTER SYSTEMS AND NETWORKS, AND IT INTEGRATION SERVICES; COMPUTER ANALYSIS SERVICES, NAMELY, COMPUTER SYSTEMS ANALYSIS; PROVIDING DIRECT CONNECTION SERVICES BETWEEN COMPUTER USERS FOR EXCHANGING DATA, NAMELY, PROVIDING TEMPORARY USE OF ONLINE NON-DOWNLOADABLE SOFTWARE FOR THE EXCHANGE OF DATA; COMPUTER SOFTWARE DESIGN; COMPUTER SYSTEM DESIGN; DESIGN AND DEVELOPMENT OF WEBPAGES; HOSTING WEBPAGES FOR OTHERS; HOSTING COMPUTER APPLICATION SOFTWARE OF OTHERS FOR USE IN SEARCHING AND RETRIEVING INFORMATION FROM DATABASES AND COMPUTER NETWORKS; PROVIDING TECHNICAL INFORMATION AT THE SPECIFIC REQUEST OF END-USERS BY MEANS OF TELEPHONE OR GLOBAL COMPUTER NETWORK; COMPUTER SERVICES RELATING TO CUSTOMIZED SEARCHING OF COMPUTER DATABASES AND WEBSITES, NAMELY, PROVIDING CUSTOMIZED ONLINE WEB PAGES FEATURING USER-DEFINED INFORMATION WHICH INCLUDES ONLINE LINKS TO THIRD PARTY WEB SITES; COMPUTER AND ELECTRONIC SIGNAL CODING AND DECODING; CONVERSION OF PHYSICAL DATA AND DOCUMENTS INTO ELECTRONIC MEDIA FORMAT; TESTING AND EVALUATION SERVICES OF THE GOODS AND SERVICES OF OTHERS; ARCHITECTURAL AND DESIGN SERVICES; INTERIOR DESIGNS OF BUILDINGS, OFFICES AND APARTMENTS; COMPUTER SECURITY CONSULTATION SERVICES FOR COMPUTER AND NETWORK INFORMATION SERVICES; COMPUTER SECURITY INFORMATION, KNOWLEDGE, AND TESTING SERVICES; TESTING, ANALYSIS AND EVALUATION OF THE GOODS AND SERVICES OF OTHERS FOR PURPOSES OF CERTIFICATION; AUTHENTICATION SERVICES IN THE FIELD OF ECOMMERCE; COMPUTER SECURITY SERVICES, NAMELY, ACCESS CONTROL TO COMPUTERS, ELECTRONIC NETWORKS AND DATABASES; SECURITY OF DATA TRANSMISSION AND OF TRANSACTIONS VIA COMPUTER NETWORKS; ON-LINE AUTHENTICATION OF ELECTRONIC SIGNATURES; CONSULTANCY IN THE FIELD OF DATA SECURITY; CONSULTANCY, INFORMATION AND ADVISORY SERVICES RELATING TO THE AFORESAID SERVICES, IN CLASS 42 (U.S. CLS. 100 AND 101).

THE MARK CONSISTS OF STANDARD CHARACTERS WITHOUT CLAIM TO ANY PARTICULAR FONT, STYLE, SIZE, OR COLOR.

PRIORITY CLAIMED UNDER SEC. 44(D) ON HONG KONG APPLICATION NO. 301603881, FILED 5-3-2010, REG. NO. 301603881, DATED 5-30-2010, EXPIRES 5-30-2020.

THE WORDING "TAOBAO" HAS NO ENGLISH TRANSLATION.

SER. NO. 85-032,223, FILED 5-6-2010.

KAREN K. BUSH, EXAMINING ATTORNEY

United States of America

United States Patent and Trademark Office

淘宝网

Reg. No. 4,107,428

Registered Mar. 6, 2012

**Int. Cls.: 9, 16, 35, 38, 41
and 42**

TRADEMARK

SERVICE MARK

PRINCIPAL REGISTER

ALIBABA GROUP HOLDING LIMITED (CAYMAN ISLANDS CORPORATION)
FOURTH FLOOR, ONE CAPITAL PLACE
P.O. BOX 847, GEORGE TOWN
GRAND CAYMAN, CAYMAN ISLANDS

FOR: SCIENTIFIC, NAUTICAL, SURVEYING, PHOTOGRAPHIC, CINEMATOGRAPHIC, OPTICAL, WEIGHING, MEASURING, SIGNALLING, CHECKING, LIFE-SAVING AND TEACHING APPARATUS AND INSTRUMENTS, NAMELY, TELEPHONES, PUNCH CLOCKS, TIME RECORDING DEVICES, NAMELY, TIME CLOCKS, SCALES AND BALANCES, SCALED RULERS, ELECTRONIC POCKET TRANSLATORS, NEON SIGNS, ELECTRONIC NOTICE BOARDS, TRANSPARENCY PROJECTION APPARATUS, KILOMETER RECORDERS FOR VEHICLES, TELESCOPES, MECHANISMS FOR COUNTER-OPERATED APPARATUS, NAMELY, POINT-OF-SALE TERMINALS, FIRE EXTINGUISHERS, ACOUSTIC ALARMS, NAMELY, SMOKE AND FIRE ALARMS, EYEGLASSES, BATTERIES, EXPOSED FILMS, NAMELY, EXPOSED CAMERA FILM; APPARATUS AND INSTRUMENTS FOR CONDUCTING, SWITCHING, TRANSFORMING, ACCUMULATING, REGULATING OR CONTROLLING ELECTRICITY, NAMELY, ELECTRIC WIRES; ELECTRIC SWITCHES; ELECTROPLATING APPARATUS, NAMELY, ELECTROPLATING MACHINES, ELECTRIC WELDING APPARATUS, NAMELY, TORCHES, ELECTRIFIED FENCES, NAMELY, ELECTRIC FENCES; APPARATUS FOR RECORDING, TRANSMISSION OR REPRODUCTION OF SOUND OR IMAGES; BLANK MAGNETIC DATA CARRIERS AND RECORDING DISCS; AUTOMATIC VENDING MACHINES AND MECHANISMS FOR COIN-OPERATED APPARATUS; CASH REGISTERS, CALCULATING MACHINES, DATA PROCESSING EQUIPMENT AND COMPUTERS; SOFTWARE FOR PROCESSING ELECTRONIC PAYMENTS TO AND FROM OTHERS; AUTHENTICATION SOFTWARE, NAMELY, SOFTWARE FOR AUTHENTICATING THE IDENTITY OF A PAYER; ON-LINE ELECTRONIC PUBLICATIONS DOWNLOADABLE FROM THE INTERNET OR A COMPUTER NETWORK OR A COMPUTER DATABASE IN THE NATURE OF MAGAZINES, ARTICLES, BROCHURES, LEAFLETS AND DATASHEETS CONTAINING INFORMATION OR INSTRUCTIONS IN THE FIELD OF BUSINESS AND E-COMMERCE; COMPUTER SOFTWARE FOR USE IN CONNECTION WITH THE PROVISION OF AN INTERACTIVE WEBSITE FOR THIRD PARTIES TO POST INFORMATION, CREATE ELECTRONIC PRODUCT CATALOGS, RESPOND TO REQUESTS AND PLACE AND FULFILL ORDERS FOR PRODUCTS, SERVICES AND BUSINESS OPPORTUNITIES VIA LOCAL AND GLOBAL COMPUTER NETWORKS; COMPUTER SOFTWARE FOR BUSINESS MANAGEMENT, CUSTOMER RELATIONSHIP MANAGEMENT (CRM), INVENTORY MANAGEMENT, SALES FORCE MANAGEMENT, PLANNING AND MANAGEMENT OF PERSONAL AND BUSINESS FINANCES, AND MARKETING INFORMATION MANAGEMENT, ALL IN THE



David J. Kyros

Director of the United States Patent and Trademark Office

Reg. No. 4,107,428 FIELD OF E-COMMERCE; COMPUTER SOFTWARE FOR PROCESSING ELECTRONIC PAYMENTS TO AND FROM OTHERS; COMPUTER SOFTWARE FOR USE IN THE SEARCH AND RETRIEVAL OF COMPUTERIZED INFORMATION ON HOBBIES, COLLECTIBLES, AUCTIONS AND PRODUCTS ACCESSED FROM GLOBAL INFORMATION NETWORKS AND NETWORK SYSTEMS; COMPUTER PERIPHERALS; NOTEBOOK COMPUTERS; LAPTOP COMPUTERS; PORTABLE COMPUTERS; HANDHELD COMPUTERS; PERSONAL DIGITAL ASSISTANTS; PERSONAL MEDIA PLAYERS, NAMELY, DIGITAL AND ANALOG AUDIO PLAYERS, DIGITAL AND ANALOG VIDEO PLAYERS; MOBILE TELEPHONES; SMART PHONES; DIGITAL CAMERAS; SERVERS, NAMELY, COMPUTER SERVERS; COMPUTER AND TELECOMMUNICATIONS NETWORKING COMPUTER HARDWARE; COMPUTER NETWORK ADAPTORS, SWITCHES, ROUTERS AND HUBS; WIRELESS AND WIRED MODEMS AND COMPUTER EQUIPMENT, NAMELY, WIRELESS CARDS; LAPTOP HOLDERS IN THE NATURE OF PROTECTIVE SLEEVES AND CARRYING CASES, COMPUTER BAGS; FIRE-EXTINGUISHING APPARATUS; BLANK COMPACT DISCS; DIGITAL MUSIC DOWNLOADABLE FROM THE INTERNET; TELECOMMUNICATIONS APPARATUS, NAMELY, NETWORK TELEPHONE, ELECTRONIC FACSIMILE APPARATUS, PORTABLE DEVICE FOR SENDING AND RECEIVING ELECTRONIC MAILED, AND INSTANT MESSAGING COMMUNICATION TOOL IN THE NATURE OF PORTABLE TELECOMMUNICATION INSTANT MESSAGING DEVICES; MOUSE PADS; MOBILE PHONE HANDSETS; MOBILE PHONE ACCESSORIES, NAMELY, BATTERY CHARGERS, CASES, COVERS, EAR PHONES AND DEVICES FOR HANDS-FREE USE OF MOBILE PHONES; DOWNLOADABLE GAMES, PICTURES, MOTION PICTURES, MOVIES AND MUSIC VIA THE INTERNET AND WIRELESS DEVICES; ALARM MONITORING SYSTEMS; SECURITY CAMERAS; MOBILE RADIO AND TELEVISION BROADCASTING UNITS; TELEVISION BROADCASTING EQUIPMENT, NAMELY, VIDEO CAMERAS, FILM CAMERAS, MONITORS, DISPLAYS, AUDIO MONITORS, AUDIO RECORDERS, VIDEO RECORDERS, SWITCHERS, CABLES, LIGHTING, LENSES, TRIPODS, CASES, VIDEOTAPE, AUDIO MIXING BOARDS, AND VIDEO EDITING CONSOLES; CAMERAS; VIDEO CAMERAS; HEADPHONES; EAR PIECES; SPEAKERS; GLOBAL POSITIONING SYSTEM (GPS) APPARATUS AND EQUIPMENT; COMPUTER, ELECTRONIC AND VIDEO GAMES PROGRAMS AND SOFTWARE INCLUDING SOFTWARE DOWNLOADABLE FROM THE INTERNET; LIQUID CRYSTAL DISPLAYS FOR TELECOMMUNICATIONS AND ELECTRONIC EQUIPMENT; SET TOP BOX; REMOTE CONTROL FOR TELEVISIONS, COMPUTERS, AUDIO SYSTEMS, AND VIDEO GAME SYSTEMS; DATA STORAGE PROGRAMS, NAMELY, COMPUTER SOFTWARE USED FOR THE STORAGE OF ELECTRONIC DATA AND DOCUMENTS; SPECTACLES AND SUNGLASSES; ENCODED OR MAGNETIC BANK CREDIT, DEBIT, CASH AND IDENTIFICATION CARDS; AUTOMATIC TELLER MACHINES, CASH DISPENSERS, IN CLASS 9 (U.S. CLS. 21, 23, 26, 36 AND 38).

FOR: NEWSPAPERS; MAGAZINES, NAMELY, GENERAL FEATURE MAGAZINES; JOURNALS, NAMELY, BLANK JOURNAL BOOKS, BLANK JOURNALS, BLANK WRITING JOURNALS, CUSTOMIZABLE JOURNAL BOOKS, JOURNALS CONCERNING BUSINESS AND ECOMMERCE, PERSONALIZED WRITING JOURNALS, TRADE JOURNALS IN THE FIELD OF BUSINESS AND ECOMMERCE, WRITING JOURNAL SHEETS; PAPER, CARDBOARD AND GOODS MADE FROM THESE MATERIALS, NOT INCLUDED IN OTHER CLASSES, NAMELY, COMPUTER PAPER AND CARDBOARD BOXES; PRINTED MATTER, NAMELY, CALENDARS AND PHOTOGRAPHS; PRINTED MATTER, NAMELY, PRINTED CHARTS, AND BOOKS IN THE FIELD OF ENTREPRENEURSHIP AND E-COMMERCE; STATIONERY; ADHESIVES FOR STATIONERY OR HOUSEHOLD PURPOSES; ARTISTS' MATERIALS, NAMELY, ARTISTS' BRUSHES, PASTELS, PENCILS, PENS, CANVAS PANELS, ELECTRICAL WOOD BURNING PENS, GESSO, NAMELY, PLASTERS, AND MOLDS FOR MODELING CLAYS; TYPEWRITERS; PRINTED INSTRUCTIONAL AND TEACHING MATERIAL, EXCEPT APPARATUS, IN THE FIELD OF MATHEMATICS, SCIENCE, LITERATURE, MUSIC, ART, AND WRITING; PLASTIC MATERIALS FOR PACKAGING NOT INCLUDED IN OTHER CLASSES, NAMELY, PLASTIC BAGS FOR PACKING AND PLASTIC BUBBLE PACKS FOR PACKAGING; PRINTERS' TYPE; PRINTING BLOCKS; BOOKS AND PAMPHLETS IN THE FIELD OF BUSINESS AND ECOMMERCE; POSTERS; PRINTED CARDS, NAMELY, PRINTED GREETING CARDS; CALENDARS; PRICE TAGS; PAPER

Reg. No. 4,107,428 PRICE LABELS; GENERAL PURPOSE BAGS OF PAPER, CARDBOARD AND PLASTIC; PRINTED TELEPHONE, FACSIMILE, ELECTRONIC MAIL AND WEB SITE DIRECTORIES; CARDS IN THE FORM OF DEBIT CARDS, CREDIT CARDS, CHARGE CARDS AND TELEPHONE CARDS OTHER THAN ENCODED AND MAGNETIC CARDS; MARKETING AND PROMOTIONAL MATERIALS, NAMELY, PRINTED VISUALS IN THE NATURE OF PROMOTIONAL MATERIALS; PRINTED ADVERTISEMENTS, NAMELY, ADVERTISING PAMPHLETS AND ADVERTISING SIGNS OF PAPER OR CARDBOARD; PRINTED USER MANUALS IN THE FIELD OF BUSINESS AND ECOMMERCE; PACKAGING MATERIALS, NAMELY, SYNTHETIC RESIN, PAPER, CARDBOARD, AND PLASTIC SHIPPING MATERIALS; FACIAL TISSUES; HANDKERCHIEFS MADE OF PAPER; MODELS AND FIGURINES MADE OF PAPER; PAPER PARTY BAGS; PAPER PARTY FAVORS; PAPER AND CARDBOARD SIGNBOARDS, IN CLASS 16 (U.S. CLS. 2, 5, 22, 23, 29, 37, 38 AND 50).

FOR: ADVERTISING; BUSINESS MANAGEMENT; BUSINESS ADMINISTRATION; PROVIDING OFFICE FUNCTIONS; ADVERTISING AGENCY SERVICES; ADVERTISING SERVICES PROVIDED FOR OTHERS; DATABASE MANAGEMENT; COMPILATION OF INFORMATION INTO COMPUTER DATABASES; MARKET RESEARCH AND BUSINESS CONSULTING SERVICES; BUSINESS CONSULTANCY SERVICES RELATING TO FACILITATING THE TRANSACTION OF BUSINESS VIA LOCAL AND GLOBAL COMPUTER NETWORKS BY LOCATING AND PROVIDING REFERRALS FOR THE DELIVERY OF A WIDE VARIETY OF BUSINESS AND CONSUMER PRODUCTS AND SERVICES; DISSEMINATION OF BUSINESS INFORMATION OF GOODS AND SERVICES OF OTHERS VIA LOCAL AND GLOBAL COMPUTER NETWORKS; BUSINESS CONSULTANCY SERVICES IN THE FIELD OF GLOBAL COMPUTER WEB SITES WHERE THIRD PARTIES CAN OFFER AND SOURCE GOODS AND SERVICES, PLACE, DETERMINE THE STATUS OF AND FULFILL TRADE LEADS AND ORDERS, ENTER INTO CONTRACTS AND TRANSACT BUSINESS; PROVIDING COMPUTERIZED ONLINE ORDERING SERVICES FEATURING A WIDE VARIETY OF GENERAL CONSUMER, BUSINESS, AND INDUSTRIAL PRODUCTS AND MERCHANDISE; ADVERTISING OF GOODS AND SERVICES OF OTHERS VIA LOCAL AND GLOBAL COMPUTER NETWORKS; INTERNATIONAL IMPORT AND EXPORT AGENCY SERVICES; RENTAL OF ADVERTISING SPACE ON COMMUNICATION MEDIA; ONLINE TRADING SERVICES RELATING TO ELECTRONIC AUCTIONEERING AND PROVIDING ONLINE BUSINESS EVALUATION RELATING THERETO; ONLINE RETAIL STORE SERVICES FEATURING A WIDE VARIETY OF GENERAL CONSUMER, BUSINESS, AND INDUSTRIAL PRODUCTS AND MERCHANDISE; PROVIDING AN ONLINE BUSINESS DIRECTORY OF THIRD PARTY WEB SITES TO FACILITATE BUSINESS TRANSACTIONS; BUSINESS CONSULTANCY SERVICES IN THE FIELD OF OPERATING AN ELECTRONIC MARKETPLACE FOR THE BUYERS AND SELLERS OF GOODS AND/OR SERVICES ON A GLOBAL COMPUTER NETWORK; BUSINESS ASSISTANCE FOR OTHERS IN THE FIELD OF FACILITATING BUSINESS TRANSACTION VIA LOCAL AND GLOBAL COMPUTER NETWORKS; CORPORATE BUSINESS MANAGEMENT CONSULTANCY SERVICES; MARKETING AND PROMOTION SERVICES; PUBLICATION OF PUBLICITY MATERIALS; REAL ESTATE MARKETING SERVICES, NAMELY, MARKETING OF VACANT PREMISES; DISSEMINATION OF ADVERTISING MATERIALS, UPDATING OF ADVERTISING MATERIALS, COMPILATION OF ADVERTISEMENTS FOR USE AS WEB PAGES ON THE INTERNET; RENTAL OF ADVERTISING SPACE; COMPUTER DATA PROCESSING; PROVIDING INFORMATION CONCERNING COMMERCIAL SALES, PROVIDING BUSINESS INFORMATION, PROMOTIONAL INFORMATION SERVICES, NAMELY, PROMOTING THE GOODS OF OTHER BY PROVIDING INFORMATION REGARDING DISCOUNTS, COUPONS, REBATES, VOUCHERS AND SPECIAL OFFERS FOR THE GOODS OF OTHERS; TELEPHONE ANSWERING SERVICE; AUCTIONEERING PROVIDED ON THE INTERNET; PERSONNEL MANAGEMENT; PROVISION OF COMMERCIAL SALES, BUSINESS INFORMATION, ADVERTISING AND COMMERCIAL INFORMATION THROUGH A GLOBAL COMPUTER NETWORK AND VIA THE INTERNET; PRESENTATION OF GOODS ON COMMUNICATION MEDIA FOR RETAIL PURPOSES; THE BRINGING TOGETHER, FOR THE BENEFIT OF OTHERS, OF A VARIETY OF GOODS, ENABLING CUSTOMERS TO CONVENIENTLY VIEW AND PURCHASE THOSE GOODS FROM A GENERAL MERCHANDISE INTERNET WEB SITE SPECIALIZING IN THE MARKETING OF THE SALE OF GOODS AND SERVICES

Reg. No. 4,107,428 OF OTHERS; RETAIL AND WHOLESALE STORE SERVICES FEATURING TELEPHONES, MOBILE PHONE HANDSETS, MOBILE PHONE ACCESSORIES, ELECTRONIC AND TELECOMMUNICATIONS GOODS, COMPUTER HARDWARE AND COMPUTER SOFTWARE, BATTERIES, BATTERY CHARGERS, APPARATUS AND INSTRUMENTS FOR RECORDING, RECEIVING, TRANSMITTING AND/OR REPRODUCING DATA, INFORMATION, PICTURES, IMAGES AND/OR SOUND, PRECIOUS METALS, JEWELLERY, PRECIOUS STONES, PRINTED MATTER, STATIONERY AND MAGNETIC AND NON MAGNETICALLY ENCODED CARDS, FURNITURE, PICTURE FRAMES, HOUSEHOLD AND KITCHEN UTENSILS, GLASSWARE, PORCELAIN AND EARTHENWARE, TEXTILES, CLOTHING, FOOTWEAR, HEADGEAR, LACES AND EMBROIDERY, BUTTONS, RIBBONS, PINS AND NEEDLES, ARTIFICIAL FLOWERS, CARPETS, RUGS, GAMES AND ELECTRONIC TOYS, CHEMICALS USED IN INDUSTRY, SCIENCE, PHOTOGRAPHY AND AGRICULTURE, PAINTS, VARNISHES AND LACQUERS, PERSONAL HYGIENE PRODUCTS, SOAPS, PERFUMERY, COSMETICS, HAIR AND BODY LOTIONS, ESSENTIAL OILS, CLEANING AND BLEACHING PREPARATIONS, LUBRICANTS, FUELS, CANDLES, PHARMACEUTICAL, VETERINARY AND SANITARY PREPARATIONS, IRONMONGERY AND SMALL ITEMS OF METAL HARDWARE, MACHINES AND MACHINE TOOLS, CUTLERY, RAZORS AND HAND TOOLS, COMPUTERS, CALCULATING MACHINES, ELECTRICAL, PHOTOGRAPHIC, CINEMATOGRAPHIC AND OPTICAL APPARATUS AND INSTRUMENTS, SPECTACLES AND SUN GLASSES, SURGICAL AND MEDICAL APPARATUS AND INSTRUMENTS, APPARATUS FOR LIGHTING, HEATING, STEAM GENERATING, COOKING, REFRIGERATING, DRYING, VENTILATING, WATER SUPPLY AND SANITARY PURPOSES, VEHICLES, FIREARMS, FIREWORKS, SILVERWARE, HOROLOGICAL AND CHRONOMETRIC INSTRUMENTS, MUSICAL INSTRUMENTS, MAGAZINE, CARDS, PAPER AND CARDBOARD PRODUCTS, PICTURE, TYPEWRITERS AND OFFICE REQUISITES, PACKAGING MATERIALS, RUBBER AND PLASTICS FOR MANUFACTURE USE, PACKING AND INSULATING MATERIALS, LEATHER AND IMITATIONS OF LEATHER AND GOODS MADE FROM THESE MATERIALS, HANDBAGS, PURSES, WALLETS, LEATHER HOLDERS, BAGS, LUGGAGE, UMBRELLAS, MIRRORS, ROPES, STRING, NETS, TENTS, YARNS AND THREADS FOR TEXTILE USE, COAT HANGERS, PLACE MATS, DRESSMAKER'S ARTICLES, BED AND TABLE COVERS, PLAYTHINGS AND SPORTING ARTICLES; FOODSTUFFS AND BEVERAGES, MEAT, FISH, POULTRY, PRESERVED, DRIED AND COOKED FRUITS AND VEGETABLES, JAMS AND FRUITS SAUCES, EGGS, MILK AND MILK PRODUCTS, EDIBLE OILS AND FATS, COFFEE, TEA, COCOA, SUGAR, RICE, FLOUR, BREAD AND CAKES, CONDIMENTS, FRESH FRUIT AND VEGETABLES, BEER, MINERAL WATER, FRUIT JUICES AND OTHER NON-ALCOHOLIC DRINKS, ALCOHOLIC BEVERAGES, FLORAL PRODUCTS, TOBACCO, SMOKERS' ARTICLES AND MATCHES; DIRECT MAIL ADVERTISING; BUYING AND SELLING AGENCY SERVICES, NAMELY, PURCHASING A WIDE VARIETY OF CONSUMER, BUSINESS AND INDUSTRIAL PRODUCTS AND SERVICES FOR OTHERS; SELECTION AND PROCUREMENT OF GOODS, NAMELY, PURCHASING OF A WIDE VARIETY OF CONSUMER, BUSINESS AND INDUSTRIAL PRODUCTS AND SERVICES FOR INDIVIDUALS AND BUSINESSES FOR INDIVIDUALS AND BUSINESSES; CATALOG AND ONLINE ORDERING SERVICES FEATURING A WIDE VARIETY OF CONSUMER GOODS OF OTHERS; DEPARTMENT STORE SERVICES; SUPERMARKET SERVICES; SECRETARIAL SERVICES; PROVIDING STATISTICAL INFORMATION; ORGANIZATION OF EXHIBITIONS FOR COMMERCIAL OR ADVERTISING PURPOSES; BUSINESS SERVICES, NAMELY, PREPARING MAILING LISTS; BUSINESS INVESTIGATION; BUSINESS ADMINISTRATION CONSULTATION SERVICES IN THE FIELD OF PROCESSING OF SALES MADE ON THE INTERNET; BUSINESS NETWORKING REFERRAL SERVICES AND PERSONNEL PLACEMENT; IMPORT-EXPORT AGENCIES; SUBSCRIPTIONS TO NEWSPAPERS; DOCUMENT REPRODUCTION; TRANSCRIPTION SERVICES, NAMELY, CONFERENCE CALL, MESSAGE AND STENOGRAPHIC TRANSCRIPTION; RENTAL OF OFFICE EQUIPMENT; CUSTOMER RELATIONSHIP MANAGEMENT; BUSINESS MANAGEMENT SERVICES RELATING TO ELECTRONIC COMMERCE; BUSINESS MANAGEMENT AND ADMINISTRATION SERVICES RELATING TO SPONSORSHIP PROGRAMS; ACCOUNTING SERVICES, CONSULTANCY, INFORMATION AND ADVISORY SERVICES RELATING TO THE AFORESAID SERVICES, IN CLASS 35 (U.S. CLS. 100, 101 AND 102).

Reg. No. 4,107,428 FOR: TELECOMMUNICATIONS SERVICES, NAMELY, PROVIDING TELEPHONE COMMUNICATION, INTERNET TELEPHONY SERVICES, NETWORK TELEPHONE, ELECTRONIC FACSIMILE, ELECTRONIC MAILS, AND INSTANT MESSAGING COMMUNICATION SERVICES; PROVISION OF TELECOMMUNICATION ACCESS AND LINKS TO COMPUTER DATABASE AND TO THE INTERNET; ELECTRONIC COMMUNICATION SERVICES; INTERACTIVE TELECOMMUNICATIONS SERVICES; TELECOMMUNICATIONS SERVICES, NAMELY, THE ELECTRONIC TRANSMISSION OF DATA AND DOCUMENTS; PROVIDING TELECOMMUNICATIONS CONNECTIONS TO THE INTERNET OR DATA BASES; PROVISION OF TELECOMMUNICATION ACCESS TO THE WORLD-WIDE WEB; COMMUNICATION BY COMPUTER TERMINALS; COMMUNICATION BY FIBER OPTIC NETWORKS; ELECTRONIC TRANSMISSION OF MESSAGES AND IMAGES BY COMPUTER; FACSIMILE TRANSMISSION; MESSAGE SENDING; PAGING SERVICES; RENTAL OF MODEMS; TRANSMISSION OF DATA BY ELECTRONIC MEANS; RENTAL OF TELECOMMUNICATION EQUIPMENT; ELECTRONIC MESSAGE SENDING, RECEIVING AND FORWARDING SERVICES; TRANSMISSION AND DELIVERY OF DATA BY ELECTRONIC MEANS; ELECTRONIC TRANSMISSION AND DELIVERY OF MAIL MESSAGES, STILL PICTURE AND/OR MOVING PICTURE INFORMATION SUCH AS CHARACTERS, MESSAGES, MUSIC AND IMAGES, TELEGRAMS, INFORMATION AND DATA BY ELECTRONIC, TELEPHONE, TELEGRAPH, CABLE, COMPUTER AND SATELLITE MEANS; TRANSMISSION, BROADCAST AND RECEPTION OF AUDIO, VIDEO, STILL AND MOVING IMAGES AND DATA WHETHER IN COMPRESSED OR UNCOMPRESSED FORM AND WHETHER IN REAL OR DELAYED TIME; ELECTRONIC MESSAGING SERVICES, TELEPHONE, VIDEO AND WEB CONFERENCING SERVICES AND ORDER-TRANSMISSION SERVICES; VIDEO CONFERENCING SERVICES; PROVIDING AN ELECTRONIC BULLETIN BOARD THAT ENABLES USERS TO PERFORM A REAL-TIME INTERACTIVE TALK BETWEEN A COMPUTER TERMINAL AND AN ELECTRONIC BULLETIN BOARD CONTAINING STILL PICTURE AND MOVING PICTURE INFORMATION AND VOICE INFORMATION SUCH AS CHARACTERS IN THE FIELD OF GENERAL INTEREST; PROVIDING ELECTRONIC BULLETIN BOARDS AND MESSAGE BOARDS FOR TRANSMISSION OF IN THE FIELD OF GENERAL INTEREST; PROVISION OF DISCUSSION FORUMS IN THE FIELD OF GENERAL INTEREST; TELEVISION BROADCASTING SERVICES; BROADCASTING AND TRANSMISSION OF RADIO AND TELEVISION PROGRAMS; MUSIC BROADCASTING; TRANSMISSION OF MUSIC, FILMS, INTERACTIVE PROGRAMS, VIDEOS, ELECTRONIC COMPUTER GAMES VIA A GLOBAL COMPUTER NETWORK OR THE INTERNET; ELECTRONIC TRANSMISSION OF INFORMATION IN THE FIELD OF ON-LINE SHOPPING AND GENERAL RETAIL SERVICES; VIDEO-ON-DEMAND TRANSMISSION SERVICES; NEWS AGENCY SERVICES, NAMELY, TRANSMISSION OF NEWS ITEMS TO NEWS REPORTING ORGANIZATIONS; PROVIDING ACCESS TO COMPUTER DATABASES ON THE GLOBAL COMPUTER NETWORK; PROVIDING CHAT ROOM SERVICES OR TRANSMISSION OF MESSAGES AMONG COMPUTER USERS CONCERNING BUSINESS AND ECOMMERCE; PROVIDING MULTIPLE USER ACCESS TO GLOBAL COMPUTER INFORMATION NETWORKS; PROVIDING ACCESS TO A WEBSITE ON A GLOBAL COMPUTER NETWORK BY WHICH THIRD PARTIES CAN OFFER GOODS AND SERVICES, PLACE AND FULFILL ORDERS, ENTER INTO CONTRACTS AND TRANSACT BUSINESS; PROVIDING ACCESS TO AN INTERACTIVE WEBSITE ON A GLOBAL COMPUTER NETWORK FOR THIRD PARTIES TO POST INFORMATION, RESPOND TO REQUESTS AND PLACE AND FULFILL ORDERS FOR PRODUCTS, SERVICES AND BUSINESS OPPORTUNITIES; COMMUNICATION SERVICES, NAMELY, TEXT AND NUMERIC WIRELESS DIGITAL MESSAGING SERVICES; TRANSMISSION OF INFORMATION AND DATA COMMUNICATIONS FOR ASSISTING DECISION MAKING; TRANSMISSION OF INFORMATION THROUGH VIDEO COMMUNICATION SYSTEMS; WEB CONFERENCING SERVICES; VIRTUAL CHATROOMS ESTABLISHED VIA TEXT MESSAGING; PROVIDING ELECTRONIC BULLETIN BOARDS FOR THE POSTING AND TRANSMISSION OF MESSAGES AMONG AND BETWEEN COMPUTER USERS CONCERNING CONSUMER PRODUCTS, SERVICES AND BUSINESS LEADS AND OPPORTUNITIES; PROVIDING AN ONLINE INTERACTIVE BULLETIN BOARD FOR THE POSTING, PROMOTION, SALE AND RESALE OF ITEMS VIA A GLOBAL COMPUTER NETWORK; PROVIDING ELECTRONIC MAIL AND ELECTRONIC MAIL FORWARDING SERVICES; AUDIO AND VIDEO COMMUNICATION VIA COMPUTERS AND COMPUTER NETWORKS, AND VIA

Reg. No. 4,107,428 A GLOBAL COMMUNICATIONS NETWORK; PROVIDING COMPUTER ACCESS TO ONLINE INTERACTIVE BULLETIN BOARDS AND DATABASES; PROVIDING ACCESS TO ELECTRONIC BULLETIN BOARDS FOR THE POSTING AND TRANSMISSION OF MESSAGES AMONG AND BETWEEN COMPUTER USERS CONCERNING PRODUCTS, SERVICES AND BUSINESS OPPORTUNITIES; PROVIDING ACCESS TO ELECTRONIC CALENDAR, ADDRESS BOOK AND NOTES FEATURE, VIA LOCAL AND GLOBAL COMPUTER NETWORKS; PROVIDING DISTANT VIDEO AND/OR TELEPHONE CONFERENCING ACCESS AND FACILITIES; CONSULTANCY, INFORMATION AND ADVISORY SERVICES RELATING TO THE AFORESAID SERVICES, IN CLASS 38 (U.S. CLS. 100, 101 AND 104).

FOR: PROVIDING OF TRAINING IN THE FIELD OF BUSINESS AND E-COMMERCE; ENTERTAINMENT, NAMELY, PROVIDING ON-LINE VIDEO GAMES, COMPUTER GAMES AND COMPUTER GAME CONTESTS; ORGANIZING SPORTING AND CULTURAL ACTIVITIES; PUBLICATION OF TEXTS, BOOKS AND JOURNALS OTHER THAN PUBLICITY TEXTS; PUBLICATION OF DIAGRAMS, IMAGES AND PHOTOGRAPHS; PUBLICATION OF NEWSPAPERS, MAGAZINES AND PERIODICALS; EDUCATION, NAMELY, TRAINING COURSES AND INSTRUCTIONAL CLASSES IN THE FIELD OF TELECOMMUNICATIONS HARDWARE AND SOFTWARE, OPERATION OF COMPUTERS, COMPUTER PROGRAMMING, WEB SITE DESIGN, E-COMMERCE, BUSINESS MANAGEMENT AND ADVERTISING; PROVIDING INFORMATION ABOUT EDUCATION, RECREATION, INSTRUCTION, TUITION AND TRAINING BOTH INTERACTIVE AND NON-INTERACTIVE; DESIGN OF EDUCATIONAL COURSES, NAMELY, DEVELOPMENT OF CURRICULUM AND EXAMINATIONS IN THE FIELD OF BUSINESS AND ECOMMERCE; ENTERTAINMENT PROVIDED VIA ELECTRONIC AND DIGITAL INTERACTIVE MEDIA, NAMELY, PROVIDING ON-LINE VIDEO GAMES, COMPUTER GAMES AND COMPUTER GAME CONTESTS; PROVISION OF INFORMATION ABOUT EDUCATION, ENTERTAINMENT INFORMATION, INFORMATION IN THE FIELD OF SPORTS AND SPORTING EVENTS, AND INFORMATION IN THE FIELD OF RECREATION AND LEISURE ACTIVITIES AND CULTURAL ACTIVITIES AND EXHIBITIONS; PROVIDING ONLINE ELECTRONIC PUBLICATIONS IN THE NATURE OF BOOKS, JOURNALS, NEWSLETTERS AND ARTICLES IN THE FIELD OF BUSINESS AND E-COMMERCE; ARRANGING, ORGANIZING, HOSTING AND CONDUCTING SINGING COMPETITIONS; ARRANGING, ORGANIZING, HOSTING AND CONDUCTING MUSICAL CONCERTS; ARRANGING, ORGANIZING, HOSTING AND CONDUCTING GAME SHOWS AND QUESTS; ENTERTAINMENT TICKET AGENCY SERVICES; ENTERTAINMENT INFORMATION AND INFORMATION ABOUT EDUCATION, PROVIDED ONLINE FROM A COMPUTER DATABASE OR THE INTERNET; PROVIDING NON-DOWNLOADABLE PRERECORDED DIGITAL MUSIC FROM THE INTERNET; PROVIDING NON-DOWNLOADABLE PRERECORDED DIGITAL MUSIC FROM MP3 INTERNET WEB SITES; ENTERTAINMENT AND EDUCATION SERVICES, NAMELY, CONDUCTING COURSES OF INSTRUCTION ABOUT PLANNING, PRODUCTION AND DISTRIBUTION OF SOUND, IMAGES, DIGITAL MUSIC, MOVIES AND LIVE OR RECORDED AUDIO, VISUAL OR AUDIOVISUAL MATERIAL FOR BROADCASTING ON TERRESTRIAL CABLE, SATELLITE CHANNELS, THE INTERNET, WIRELESS OR WIRELINK SYSTEMS AND OTHER MEANS OF COMMUNICATIONS; MUSIC ENTERTAINMENT SERVICES, NAMELY, LIVE MUSIC CONCERTS; RENTAL OF SOUND RECORDINGS; ENTERTAINMENT IN THE NATURE OF ON-GOING TELEVISION PROGRAMS IN THE FIELDS OF BUSINESS AND E-COMMERCE; RENTAL OF SOUND RECORDINGS; NEWS REPORTERS SERVICES; PROVIDING NEWS IN THE FIELD OF SPORTING OR CULTURAL EVENTS AND CURRENT EVENTS REPORTING PROVIDED BY SATELLITE TELEVISION, THE INTERNET OR RADIO; PRODUCTION OF TELEVISION AND RADIO PROGRAMS AND FILM PRODUCTION; GAME SERVICES PROVIDED ON-LINE FROM A COMPUTER NETWORK; PROVISION OF RECREATION ACTIVITY, SPORTING AND GYMNASIUM FACILITIES; LIVE PERFORMANCES BY MUSICAL BANDS; NIGHT CLUB SERVICES, DISCOTHEQUES, AND FASHION SHOWS; ARRANGING, CONDUCTING AND PROVISION OF CONFERENCES, CONVENTIONS, SEMINARS AND TRAINING WORKSHOPS IN THE FIELD OF BUSINESS AND E-COMMERCE; ART EXHIBITIONS; ART SERVICES, NAMELY, RENTAL OF ARTWORK; TRAINING SERVICES IN THE FIELD OF OCCUPATIONAL HEALTH AND SAFETY, AND ENVIRONMENTAL CONSERVATION; PROVISION OF CIGAR

Reg. No. 4,107,428 CLASSES, WINE TASTING CLASSES; ARRANGING, ORGANIZING, PLANNING AND RUNNING SEMINARS IN THE FIELD OF BUSINESS AND E-COMMERCE; ANIMAL TRAINING; DIRECTION IN PRODUCING BROADCASTING PROGRAMS, NAMELY, PRODUCTION OF TELEVISION AND RADIO PROGRAMS AND FILM PRODUCTION; INSTRUCTIONAL SERVICES, NAMELY, TRAINING IN THE OPERATION OF AUDIOVISUAL MACHINES AND EQUIPMENT USED FOR THE PRODUCTION OF BROADCASTING PROGRAMS; PROVIDING AUDIO AND VISUAL STUDIOS; PROVIDING SPORTS FACILITIES; PROVIDING FACILITIES FOR MOVIES, SHOWS, PLAYS, MUSIC OR EDUCATIONAL TRAINING; ENTERTAINMENT BOOKING AGENCIES, NAMELY, BOOKING OF SEATS FOR SHOWS AND SPORTS EVENTS; RENTAL OF MOTION PICTURES; RENTAL AND LEASING OF MUSICAL INSTRUMENTS; RENTAL AND LEASING OF RECORDED TELEVISION PROGRAMS; RENTAL AND LEASING OF TELEVISION SETS; LENDING LIBRARIES; ARCHIVE LIBRARY SERVICES; SUBTITLING SERVICES, NAMELY, PREPARING SUBTITLES FOR MOVIES; SIGN LANGUAGE INTERPRETATION SERVICES; RENTAL OF COMPUTER GAME SOFTWARE; PROVIDING ONLINE VIDEO GAMES, COMPUTER GAMES; PROVIDING ONLINE NONDOWNLOADABLE MUSIC AND MOVIES THROUGH THE INTERNET; PROVIDING ONLINE COMPUTER GAMES AND CONDUCTING CONTESTS; RENTAL OF PRE-RECORDED VIDEO TAPES; RENTAL AND LEASING OF GAME MACHINES; RENTAL OF ARCADE GAME EQUIPMENT; RENTAL OF MOTION PICTURES; PHOTOGRAPHY; TRANSLATION; LANGUAGE INTERPRETATION; EDUCATIONAL AND TRAINING PROGRAMS IN THE FIELD OF RISK MANAGEMENT; EDUCATIONAL AND TRAINING PROGRAMS RELATED TO THE CERTIFICATION OF BUYERS AND SELLERS ENGAGED IN ECOMMERCE; PROVISION OF NEWS IN THE NATURE OF CURRENT EVENT REPORTING; CONSULTANCY, INFORMATION AND ADVISORY SERVICES RELATING TO THE AFORESAID SERVICES; LOTTERY SERVICES, IN CLASS 41 (U.S. CLS. 100, 101 AND 107).

FOR: SCIENTIFIC AND TECHNOLOGICAL SERVICES AND RESEARCH AND DESIGN RELATING THERETO, IN THE FIELD OF TELECOMMUNICATIONS SOFTWARE AND HARDWARE DESIGN, INTERNET TECHNOLOGY, THE DESIGN OF WEBSITES FOR ADVERTISING, SOFTWARE DESIGN AND E-COMMERCE SOFTWARE AND HARDWARE DESIGN, AND INDUSTRIAL RESEARCH AND ANALYSIS SERVICES IN THE FIELD OF ECOMMERCE; DESIGN AND DEVELOPMENT OF COMPUTER HARDWARE AND SOFTWARE; COMPUTER SERVICE RELATING TO CREATING INDEXES OF INFORMATION, SITES AND RESOURCES ON COMPUTER NETWORKS; PROVIDING SEARCH ENGINES; DESIGN OF COMPUTERS, NOTEBOOK COMPUTERS, LAPTOP COMPUTERS, PORTABLE COMPUTERS AND HANDHELD COMPUTERS; DESIGN FOR OTHERS IN THE FIELD OF PERSONAL DIGITAL ASSISTANTS AND PERSONAL MEDIA PLAYERS; DESIGN FOR OTHERS IN THE FIELD OF MOBILE TELEPHONES AND SMART PHONES; DESIGN FOR OTHERS IN THE FIELD OF DIGITAL CAMERAS; COMPUTER SERVICES, NAMELY, CREATING, MAINTAINING AND HOSTING WEBSITES FOR OTHERS, COMPUTER SYSTEM ADMINISTRATION FOR OTHERS, HOSTING COMPUTER APPLICATION SOFTWARE FOR SEARCHING AND RETRIEVING INFORMATION FROM DATABASES AND COMPUTER NETWORKS, HOSTING SOFTWARE FOR CUSTOMIZED SEARCHING OF COMPUTER DATABASES AND WEBSITES, CREATING, MAINTAINING AND HOSTING WEBSITES FOR OTHERS, CREATING AN ON-LINE COMMUNITY FOR REGISTERED USERS TO DEVELOP AND COLLABORATE ON ADDRESS BOOKS AND CALENDARS, SOFTWARE DESIGN AND DEVELOPMENT FOR OTHERS, HOSTING ON-LINE INTERACTIVE PUBLIC CALENDARS, ADDRESS BOOKS AND NOTES THAT ALLOW MULTIPLE PARTICIPANTS TO SHARE EVENT SCHEDULES, FACILITY RESERVATIONS, AND TRANSPORTATION REQUESTS VIA LOCAL AND GLOBAL COMPUTER NETWORK, CUSTOMIZED SEARCHING OF COMPUTER DATABASES AND WEBSITES, NAMELY, PROVIDING CUSTOMIZED ONLINE WEB PAGES FEATURING USER-DEFINED INFORMATION WHICH INCLUDES ONLINE LINKS TO THIRD PARTY WEB SITES, AND PROVIDING SEARCH ENGINES FOR OBTAINING DATA FROM COMPUTER FILES ON A GLOBAL COMPUTER NETWORK; COMPUTER PROGRAMMING; COMPUTER SYSTEM SOFTWARE SERVICES, NAMELY, DESIGN AND DEVELOPMENT OF ON-LINE COMPUTER SOFTWARE SYSTEMS; COMPUTER PROGRAMMING IN RELATION TO THE DEFENSE AGAINST VIRUS, NAMELY,

Reg. No. 4,107,428 COMPUTER VIRUS PROTECTION SERVICES; COMPUTER INTEGRATION SERVICES, NAMELY, COMPUTER SYSTEMS INTEGRATION SERVICES, INTEGRATION OF COMPUTER SOFTWARE INTO MULTIPLE SYSTEMS AND NETWORKS, INTEGRATION OF COMPUTER SYSTEMS AND NETWORKS, AND IT INTEGRATION SERVICES; COMPUTER ANALYSIS SERVICES, NAMELY, COMPUTER SYSTEMS ANALYSIS; PROVIDING DIRECT CONNECTION SERVICES BETWEEN COMPUTER USERS FOR EXCHANGING DATA, NAMELY, PROVIDING TEMPORARY USE OF ONLINE NON-DOWNLOADABLE SOFTWARE FOR THE EXCHANGE OF DATA; COMPUTER SOFTWARE DESIGN; COMPUTER SYSTEM DESIGN; DESIGN AND DEVELOPMENT OF WEBPAGES; HOSTING WEBPAGES FOR OTHERS; HOSTING COMPUTER APPLICATION SOFTWARE OF OTHERS FOR USE IN SEARCHING AND RETRIEVING INFORMATION FROM DATABASES AND COMPUTER NETWORKS; PROVIDING TECHNICAL INFORMATION AT THE SPECIFIC REQUEST OF END-USERS BY MEANS OF TELEPHONE OR GLOBAL COMPUTER NETWORK; COMPUTER SERVICES RELATING TO CUSTOMIZED SEARCHING OF COMPUTER DATABASES AND WEBSITES, NAMELY, PROVIDING CUSTOMIZED ONLINE WEB PAGES FEATURING USER-DEFINED INFORMATION WHICH INCLUDES ONLINE LINKS TO THIRD PARTY WEB SITES; COMPUTER AND ELECTRONIC SIGNAL CODING AND DECODING; CONVERSION OF PHYSICAL DATA AND DOCUMENTS INTO ELECTRONIC MEDIA FORMAT; TESTING AND EVALUATION SERVICES OF THE GOODS AND SERVICES OF OTHERS; ARCHITECTURAL AND DESIGN SERVICES; INTERIOR DESIGNS OF BUILDINGS, OFFICES AND APARTMENTS; COMPUTER SECURITY CONSULTATION SERVICES FOR COMPUTER AND NETWORK INFORMATION SERVICES; COMPUTER SECURITY INFORMATION, KNOWLEDGE, AND TESTING SERVICES; TESTING, ANALYSIS AND EVALUATION OF THE GOODS AND SERVICES OF OTHERS FOR PURPOSES OF CERTIFICATION; AUTHENTICATION SERVICES IN THE FIELD OF ECOMMERCE; COMPUTER SECURITY SERVICES, NAMELY, ACCESS CONTROL TO COMPUTERS, ELECTRONIC NETWORKS AND DATABASES; SECURITY OF DATA TRANSMISSION AND OF TRANSACTIONS VIA COMPUTER NETWORKS; ON-LINE AUTHENTICATION OF ELECTRONIC SIGNATURES; CONSULTANCY IN THE FIELD OF DATA SECURITY; CONSULTANCY, INFORMATION AND ADVISORY SERVICES RELATING TO THE AFORESAID SERVICES, IN CLASS 42 (U.S. CLS. 100 AND 101).

PRIORITY CLAIMED UNDER SEC. 44(D) ON HONG KONG APPLICATION NO. 301603890, FILED 5-3-2010, REG. NO. 301603890, DATED 5-3-2010, EXPIRES 5-3-2020.

THE CHINESE CHARACTERS IN THE MARK TRANSLITERATE TO TAO BAO WANG AND HAS NO ENGLISH TRANSLATION.

THE MARK CONSISTS OF THE WORDS TAO BAO WANG IN CHINESE CHARACTERS.

SER. NO. 85-032,240, FILED 5-6-2010.

KAREN K. BUSH, EXAMINING ATTORNEY

United States of America

United States Patent and Trademark Office

ALPINOX

Reg. No. 4,107,429

Registered Mar. 6, 2012

Int. Cls.: 6, 7 and 10

TRADEMARK

PRINCIPAL REGISTER

LUXEMBOURG PATENT COMPANY S.A. (LUXEMBOURG SOCIÉTÉ ANONYME (SA))
24 ROUTE DE DIEKIRCH
LINTGEN, LUXEMBOURG L-7440

FOR: COMMON METALS AND THEIR ALLOYS; TRANSPORTABLE BUILDINGS OF METAL; MATERIALS OF METAL FOR RAILWAY TRACKS CONSTRUCTION; NON-ELECTRIC CABLES AND WIRES OF COMMON METAL; IRONMONGERY IN THE NATURE OF SMALL ITEMS OF METAL HARDWARE MATERIALS, NAMELY, VALVES OF BRASS OTHER THAN PARTS OF MACHINES; PIPES AND TUBES OF METAL; METAL SAFES; GOODS OF COMMON METAL NOT INCLUDED IN OTHER CLASSES, NAMELY, METAL NOT BEING PARTS OF MACHINES AND METAL PIPE COUPLINGS; VALVES OF METAL AND COUPLINGS OF METAL FOR USE IN WATER PIPES, IN DRAIN TRAPS, AND FOR USE WITH PIPES FOR THE DISTRIBUTION OF GASES OR LIQUIDS; METAL TAPS FOR GAS BOTTLES WITH INTEGRATED PRESSURE REDUCERS, IN CLASS 6 (U.S. CLS. 2, 12, 13, 14, 23, 25 AND 50).

FOR: MOTORS AND ENGINES EXCEPT FOR LAND VEHICLES; MACHINE COUPLING AND TRANSMISSION COMPONENTS EXCEPT FOR LAND VEHICLES; PRESSURE REDUCERS AS PARTS OF MACHINES; MACHINE TOOLS, NAMELY, TAPS; MACHINE TOOLS, NAMELY, TAPS WITH INTEGRATED PRESSURE REDUCERS, TO BE USED AS PARTS OF MACHINES; PRESSURE REGULATORS BEING PARTS OF MACHINES; PNEUMATIC CONTROLS FOR USE IN ENGINES OR MOTORS, NAMELY, PNEUMATICALLY CONTROLLED TAPS; PNEUMATIC CONTROLS FOR OPENING AND CLOSING TAPS OR FAUCETS, IN CLASS 7 (U.S. CLS. 13, 19, 21, 23, 31, 34 AND 35).

FOR: MEDICAL APPARATUS, NAMELY, THERAPEUTIC DEVICES FOR DELIVERING SPECIFICALLY ENGINEERED PRESSURE AND GAS MIXTURES FOR MEDICAL BENEFIT, IN CLASS 10 (U.S. CLS. 26, 39 AND 44).

THE MARK CONSISTS OF STANDARD CHARACTERS WITHOUT CLAIM TO ANY PARTICULAR FONT, STYLE, SIZE, OR COLOR.

PRIORITY CLAIMED UNDER SEC. 44(D) ON BENELUX APPLICATION NO. 1191770, FILED 11-10-2009, REG. NO. 0872062, DATED 2-10-2010, EXPIRES 11-10-2019.

THE WORDING "ALPINOX" HAS NO MEANING IN A FOREIGN LANGUAGE.



David J. Kybas

Director of the United States Patent and Trademark Office

Reg. No. 4,107,429 SER. NO. 85-033,029, FILED 5-7-2010.

ELLEN PERKINS, EXAMINING ATTORNEY

United States of America

United States Patent and Trademark Office

SNAP-IT!

Reg. No. 4,107,430

Registered Mar. 6, 2012

Int. Cl.: 10

TRADEMARK

PRINCIPAL REGISTER

DEN-MAT HOLDINGS, LLC (DELAWARE LIMITED LIABILITY COMPANY)
2727 SKYWAY DRIVE
SANTA MARIA, CA 93455

FOR: DENTAL APPLIANCE, NAMELY, HOLLOW TEETH IN THE FORM OF A DENTAL ARCH CORRESPONDING TO AND MOUNTABLE EITHER ON THE SURFACE OF A PERSON'S EXISTING TEETH OR PROXIMATE TEETH IN EDENTULOUS CASES, IN CLASS 10 (U.S. CLS. 26, 39 AND 44).

FIRST USE 5-7-2010; IN COMMERCE 5-7-2010.

THE MARK CONSISTS OF STANDARD CHARACTERS WITHOUT CLAIM TO ANY PARTICULAR FONT, STYLE, SIZE, OR COLOR.

SER. NO. 85-034,472, FILED 5-10-2010.

ALYSSA STEEL, EXAMINING ATTORNEY



David J. Kybas

Director of the United States Patent and Trademark Office

United States of America

United States Patent and Trademark Office

ADVENTURE WOMAN

Reg. No. 4,107,431

ADVENTURE WOMAN, LLC (OREGON LIMITED LIABILITY COMPANY)
636 WILD IRIS LN
ROSEBURG, OR 97470

Registered Mar. 6, 2012

Int. Cl.: 41

FOR: ENTERTAINMENT SERVICES, NAMELY, PROVIDING AN ON-GOING RADIO PROGRAM RELATING TO WOMEN ROLE MODELS, HISTORICAL FEMALE ACHIEVEMENT AND ENRICHMENT-RELATED ACTIVITIES IN THE FIELD OF SPORTS, MUSIC, AND ART; PROVIDING MOTIVATIONAL SPEAKING SERVICES IN THE FIELD OF PERSONAL FULFILLMENT AND EMPOWERMENT, IN CLASS 41 (U.S. CLS. 100, 101 AND 107).

SERVICE MARK

PRINCIPAL REGISTER

FIRST USE 5-0-2002; IN COMMERCE 5-0-2009.

THE MARK CONSISTS OF STANDARD CHARACTERS WITHOUT CLAIM TO ANY PARTICULAR FONT, STYLE, SIZE, OR COLOR.

SER. NO. 85-039,743, FILED 5-17-2010.

SHAILA SETTLES, EXAMINING ATTORNEY



David J. Kyffers

Director of the United States Patent and Trademark Office

United States of America

United States Patent and Trademark Office

ANBOTO

Reg. No. 4,107,432

Registered Mar. 6, 2012

Int. Cls.: 9, 25 and 42

TRADEMARK

SERVICE MARK

PRINCIPAL REGISTER

JIMENEZ, XABIER URIBE-ETXEBARRIA (SPAIN INDIVIDUAL)
RIBERA DE AXPE, 28, 1°
ERANDIO, SPAIN 48950

FOR: DOWNLOADABLE ELECTRONIC PUBLICATIONS IN THE FORM OF PERIODICALS, NEWSLETTERS, BLOGS, AND MICROBLOGS IN THE FIELDS OF SEMANTIC TECHNOLOGY, ARTIFICIAL INTELLIGENCE, AND COMPUTATIONAL LINGUISTICS; TECHNOLOGICAL DEVICES, NAMELY, COMPUTERS, COMPUTERS TERMINALS, COMPUTER HARDWARE AND OPERATING SOFTWARE, E-COMMERCE SOFTWARE FOR ALLOWING USERS TO BUY PRODUCTS OR SERVICES, GET INFORMATION OR PERFORM ELECTRONIC BUSINESS TRANSACTIONS VIA THE INTERNET, DIALOG SOFTWARE FOR ENABLING NATURAL LANGUAGE DIALOG BETWEEN A HUMAN USER AND A WEB SERVICE, DATA CENTER, WEBSITE CONTACT CENTER OR DIGITAL DEVICE, CUSTOMER SERVICE SOFTWARE FOR HELPDESK SUPPORT MANAGEMENT, DIGITAL PERSONAL ASSISTANCE SOFTWARE FOR OPERATING PERSONAL DIGITAL ASSISTANT DEVICES, AND SOFTWARE FOR CONSULTATION PURPOSES, NAMELY, A LIVE CHAT APPLICATION FOR COMPUTER USERS AND TECHNICAL SUPPORT ASSISTANCE OPERATIONS IN TROUBLESHOOTING OF COMPUTER HARDWARE AND SOFTWARE PROBLEMS, ALL OF THE FOREGOING WITH MULTIMEDIA AND INTERACTIVE FUNCTIONS; TELEPHONES, CORDLESS TELEPHONES, MOBILE TELEPHONES, PORTABLE DIGITAL ELECTRONIC DEVICES AND SOFTWARE RELATED THERETO FOR RECORDING, ORGANIZING, TRANSMITTING, MANIPULATING, AND REVIEWING AUDIO, TEXT, DATA, IMAGE, AND GRAPHICS FILES, HAND-HELD COMPUTERS, PERSONAL DIGITAL ASSISTANTS, ELECTRONIC ORGANIZERS, ELECTRONIC NOTEPADS, COMPUTER SOFTWARE FOR PERSONAL INFORMATION MANAGEMENT; ELECTRONIC HAND-HELD DEVICES FOR THE WIRELESS RECEIPT, STORAGE AND/OR TRANSMISSION OF DATA AND MESSAGES, AND HAND-HELD ELECTRONIC DEVICES FOR THE WIRELESS RECEIPT AND TRANSMISSION OF DATA THAT ENABLE THE USER TO KEEP TRACK OF OR MANAGE PERSONAL INFORMATION, IN CLASS 9 (U.S. CLS. 21, 23, 26, 36 AND 38).

FOR: CLOTHING, NAMELY, T-SHIRTS, SWEAT SHIRTS, JACKETS; HEADWEAR, IN CLASS 25 (U.S. CLS. 22 AND 39).

FOR: SOFTWARE DESIGN AND DEVELOPMENT, IN CLASS 42 (U.S. CLS. 100 AND 101).

THE MARK CONSISTS OF STANDARD CHARACTERS WITHOUT CLAIM TO ANY PARTICULAR FONT, STYLE, SIZE, OR COLOR.



David J. Kappas

Director of the United States Patent and Trademark Office

Reg. No. 4,107,432 PRIORITY CLAIMED UNDER SEC. 44(D) ON SPAIN APPLICATION NO. 2901362, FILED 11-18-2009, REG. NO. 2901362, DATED 2-22-2010, EXPIRES 11-18-2019.

THE WORDING "ANBOTO" HAS NO MEANING IN A FOREIGN LANGUAGE.

SER. NO. 85-040,034, FILED 5-17-2010.

MATTHEW PAPPAS, EXAMINING ATTORNEY

United States of America

United States Patent and Trademark Office



Reg. No. 4,107,433

Registered Mar. 6, 2012

Int. Cls.: 35 and 42

SERVICE MARK

PRINCIPAL REGISTER

CONSTRUCTION SOFTWARE TECHNOLOGIES, INC. (DELAWARE CORPORATION)
4500 LAKE FOREST DRIVE, SUITE 502
CINCINNATI, OH 45242

FOR: COMPUTERIZED DATABASE MANAGEMENT, NAMELY, MANAGING DATA IN THE FORM OF DRAWING PLANS, BLUEPRINTS, AND SPECIFICATIONS OF CONSTRUCTION COMPANIES, REAL ESTATE DEVELOPERS, ENGINEERS, ARCHITECTS, SUBCONTRACTORS AND FACILITIES MANAGERS VIA A GLOBAL COMPUTER NETWORK, IN CLASS 35 (U.S. CLS. 100, 101 AND 102).

FIRST USE 12-0-2009; IN COMMERCE 12-0-2009.

FOR: PROVIDING TEMPORARY USE OF ONLINE, NON-DOWNLOADABLE SOFTWARE FOR USE IN MANAGING DRAWING PLANS, BLUEPRINTS, AND SPECIFICATIONS OF CONSTRUCTION COMPANIES, REAL ESTATE DEVELOPERS, ENGINEERS, ARCHITECTS, SUBCONTRACTORS AND FACILITIES MANAGERS, IN CLASS 42 (U.S. CLS. 100 AND 101).

FIRST USE 12-0-2009; IN COMMERCE 12-0-2009.

OWNER OF U.S. REG. NO. 2,845,267.

THE MARK CONSISTS OF A STYLIZED, LOWER-CASE LETTER "I" INSIDE A SQUARE WITH A SECOND, SMALLER SQUARE LOCATED IN THE BOTTOM, RIGHT-HAND CORNER OF THE MAIN SQUARE.

SER. NO. 85-041,125, FILED 5-18-2010.

JOHN GARTNER, EXAMINING ATTORNEY



David J. Kybas

Director of the United States Patent and Trademark Office

United States of America

United States Patent and Trademark Office

IRON ANGEL ROADWEAR

Reg. No. 4,107,434

Registered Mar. 6, 2012

Int. Cls.: 25, 26 and 39

TRADEMARK

SERVICE MARK

PRINCIPAL REGISTER

TAVANI, JOANN (UNITED STATES INDIVIDUAL), DBA IRON ANGEL ROADWEAR
430 ALCANTAR CIRCLE
SACRAMENTO, CA 95834

FOR: ADULT NOVELTY GAG CLOTHING ITEM, NAMELY, SOCKS; ANKLE BOOTS; AP-
RONS; BABY DOLL PYJAMAS; BANDANAS; BASEBALL CAPS AND HATS; BATHING
SUITS; BATHROBES; BELTS; BELTS FOR CLOTHING; BELTS MADE OUT OF CLOTH;
BOMBER JACKETS; BOOTS; BOOTS FOR MOTORCYCLING; BOOTS FOR SPORT; BOXER
SHORTS; BUSTIERS; CAP VISORS; CAPS; CHAPS; CLOTHING, NAMELY, HAND-
WARMERS; CLOTHING, NAMELY, NECK TUBES; CLOTHING, NAMELY, WRAP-
AROUNDS; COATS FOR MEN AND WOMEN; COATS OF DENIM; CORSETS; CROP TOPS;
DENIM JACKETS; DENIMS; DRESS SHIRTS; EAR WARMERS; FOOTWEAR FOR WOMEN
AND MEN; FUR COATS AND JACKETS; GLOVES; GLOVES FOR APPAREL; GLOVES IN-
CLUDING THOSE MADE OF SKIN, HIDE OR FUR; HALTER TOPS; HEADBANDS FOR
CLOTHING; HEADGEAR, NAMELY, HATS AND CAPS; HEAVY JACKETS; HOODED
PULLOVERS; HOODED SWEAT SHIRTS; HOODS; JACKET LINERS; JACKETS; JEANS;
JERSEYS; KNITTED GLOVES; LACE BOOTS; LADIES' BOOTS; LEATHER BELTS;
LEATHER JACKETS; LEG WARMERS; LIGHT-REFLECTING JACKETS; LONG-SLEEVED
SHIRTS; MEN'S AND WOMEN'S JACKETS, TROUSERS, VESTS; MOCK TURTLE-NECK
SWEATERS; MOTORCYCLE GLOVES; MOTORCYCLE JACKETS; MOTORCYCLE RAIN
SUITS; MOTORCYCLIST BOOTS; MUSCLE TOPS; NECK BANDS; NECK GAITERS;
NECKWEAR; NIGHT SHIRTS; PADDED JACKETS; PANTIES, SHORTS AND BRIEFS; POLO
KNIT TOPS; RAIN JACKETS; RAINPROOF JACKETS; REVERSIBLE JACKETS; RIDING
BOOTS; RIDING GLOVES; SHIRTS; SHOES; SHORT SETS; SHORT-SLEEVED OR LONG-
SLEEVED T-SHIRTS; SKULL CAPS; SPORTS JACKETS; SUEDE JACKETS; SWEAT
JACKETS; SWEAT SHORTS; TANK TOPS; TOPS; TUBE TOPS; UNDER GARMENTS; UN-
DERCLOTHES; UNDERWEAR, NAMELY, BOY SHORTS; VESTS; WATER PROOF BOOTS;
WATER REPELLING BOOTS; WATER REPELLING LEATHER BOOTS; WATERPROOF
JACKETS AND PANTS; WIND RESISTANT JACKETS; WIND VESTS; WOMEN'S SHOES;
WOMEN'S TOPS, NAMELY, CAMIS; WORK SHOES AND BOOTS, IN CLASS 25 (U.S. CLS.
22 AND 39).



David J. Kyros

Director of the United States Patent and Trademark Office

FIRST USE 2-1-2007; IN COMMERCE 2-1-2007.

FOR: CHARMS FOR SHOES; CLOTH PATCHES FOR CLOTHING; EMBROIDERED PATCHES
FOR CLOTHING; EMBROIDERY FOR GARMENTS; FASTENERS FOR SHOES AND BOOTS;
ORNAMENTAL CLOTH PATCHES; ORNAMENTS FOR THE HAIR; PATCHES FOR

Reg. No. 4,107,434 CLOTHING MADE OF RUBBER, PLASTIC AND VINYL; PONYTAIL HOLDERS; HAIR RIBBONS; SHOE BUCKLES; SHOE ORNAMENTS NOT OF PRECIOUS METAL; ZIPPER FASTENERS; ZIPPER PULLS, IN CLASS 26 (U.S. CLS. 37, 39, 40, 42 AND 50).

FIRST USE 5-4-2010; IN COMMERCE 5-4-2010.

FOR: DELIVERY AND STORAGE OF GOODS; DELIVERY OF GIFT BASKETS WITH SELECTED ITEMS REGARDING A PARTICULAR OCCASION OR THEME; DELIVERY OF GOODS; DELIVERY OF GOODS AND MESSAGES ACCOMPANIED BY BALLOONS AND/OR NOVELTY PRESENTATIONS; DELIVERY OF GOODS BY MAIL, AIR, TRUCK OR SHIP; DELIVERY OF NEWSPAPERS, NAMELY, NEWSLETTERS; EXPRESS DELIVERY OF GOODS BY MAIL, AIR, TRUCK OR SHIP; FLOWER DELIVERY; ORGANIZATION OF EXCURSIONS; ORGANIZATION OF TRAVEL; ORGANIZATION OF TRIPS; PROVIDING INFORMATION, NEWS AND COMMENTARY IN THE FIELD OF TRAVEL; PROVIDING LINKS TO WEB SITES OF OTHERS FEATURING TRAVEL; SHIPPING OF GOODS, IN CLASS 39 (U.S. CLS. 100 AND 105).

FIRST USE 5-4-2010; IN COMMERCE 5-4-2010.

THE MARK CONSISTS OF STANDARD CHARACTERS WITHOUT CLAIM TO ANY PARTICULAR FONT, STYLE, SIZE, OR COLOR.

NO CLAIM IS MADE TO THE EXCLUSIVE RIGHT TO USE "ROADWEAR", APART FROM THE MARK AS SHOWN.

SER. NO. 85-042,055, FILED 5-18-2010.

ROBERT STRUCK, EXAMINING ATTORNEY

United States of America

United States Patent and Trademark Office

TRACKLESS

Reg. No. 4,107,435

Registered Mar. 6, 2012

Int. Cl.: 24

TRADEMARK

PRINCIPAL REGISTER

PHIFER INCORPORATED (ALABAMA CORPORATION)
4400 KAULOOSA AVENUE
TUSCALOOSA, AL 35401

FOR: EXTERIOR AND INTERIOR WOVEN SHADING FABRIC FOR USE IN ROLL-UP SHADES, PLEATED SHADES, FOLDING SHADES, DRAPES, SLIDING PANELS, AWNINGS AND OTHER WINDOW TREATMENT APPLICATIONS, IN CLASS 24 (U.S. CLS. 42 AND 50).

FIRST USE 5-12-2010; IN COMMERCE 5-12-2010.

THE MARK CONSISTS OF STANDARD CHARACTERS WITHOUT CLAIM TO ANY PARTICULAR FONT, STYLE, SIZE, OR COLOR.

SER. NO. 85-044,094, FILED 5-20-2010.

PAULA MAHONEY, EXAMINING ATTORNEY



David J. Kybas

Director of the United States Patent and Trademark Office

United States of America

United States Patent and Trademark Office

FRENCH MARKET DISTRICT EST. 1791

Reg. No. 4,107,436

FRENCH MARKET CORPORATION (LOUISIANA CORPORATION)
1008 N. PETERS ST.
NEW ORLEANS, LA 70116

Registered Mar. 6, 2012

Int. Cl.: 36

FOR: LEASING OF MALL SPACE, IN CLASS 36 (U.S. CLS. 100, 101 AND 102).

SERVICE MARK

FIRST USE 1-1-2004; IN COMMERCE 1-1-2004.

PRINCIPAL REGISTER

THE MARK CONSISTS OF STANDARD CHARACTERS WITHOUT CLAIM TO ANY PARTICULAR FONT, STYLE, SIZE, OR COLOR.

OWNER OF U.S. REG. NOS. 3,118,696, 3,200,041 AND OTHERS.

NO CLAIM IS MADE TO THE EXCLUSIVE RIGHT TO USE "MARKET DISTRICT EST. 1791", APART FROM THE MARK AS SHOWN.

SEC. 2(F).

SER. NO. 85-047,287, FILED 5-25-2010.

ROBERT STRUCK, EXAMINING ATTORNEY



David J. Kyffers

Director of the United States Patent and Trademark Office

United States of America

United States Patent and Trademark Office

How Ah Ya

Reg. No. 4,107,437

Registered Mar. 6, 2012

Int. Cl.: 25

TRADEMARK

PRINCIPAL REGISTER

PROCREATIONS PUBLISHING COMPANY (TEXAS CORPORATION)
1508 EDWARDS AVENUE, SUITE HH
NEW ORLEANS, LA 70123

FOR: CAMP SHIRTS, IN CLASS 25 (U.S. CLS. 22 AND 39).

FIRST USE 1-1-1981; IN COMMERCE 1-1-1981.

THE MARK CONSISTS OF STANDARD CHARACTERS WITHOUT CLAIM TO ANY PARTICULAR FONT, STYLE, SIZE, OR COLOR.

SER. NO. 85-048,665, FILED 5-26-2010.

JOHN SCHUYLER YARD, EXAMINING ATTORNEY



David J. Kybas

Director of the United States Patent and Trademark Office

United States of America

United States Patent and Trademark Office



Reg. No. 4,107,438

Registered Mar. 6, 2012

Int. Cl.: 25

TRADEMARK

PRINCIPAL REGISTER

PROCREATIONS PUBLISHING COMPANY (TEXAS CORPORATION)
1508 EDWARDS AVENUE, SUITE HH
NEW ORLEANS, LA 70123

FOR: CAMP SHIRTS, IN CLASS 25 (U.S. CLS. 22 AND 39).

FIRST USE 1-1-1981; IN COMMERCE 1-1-1981.

NO CLAIM IS MADE TO THE EXCLUSIVE RIGHT TO USE "BRAND SHIRT" , APART FROM THE MARK AS SHOWN.

THE MARK CONSISTS OF THE WORDS "HOW" "AH" "YA" IN STYLIZED FONT DISPLAYED WITHIN A RECTANGLE WITH SMALL CIRCLES FOLLOWING THE WORDS "HOW" AND "AH" WITH THE WORDS "BRAND SHIRT" DISPLAYED UNDER THE RECTANGLE.

SER. NO. 85-048,677, FILED 5-26-2010.

JOHN SCHUYLER YARD, EXAMINING ATTORNEY



David J. Kyros

Director of the United States Patent and Trademark Office

United States of America

United States Patent and Trademark Office



美國武術學院

Reg. No. 4,107,439

CHRISTOPHER PEI (UNITED STATES INDIVIDUAL)
10620 OAKLYN DRIVE
POTOMAC, MD 20854

Registered Mar. 6, 2012

Int. Cls.: 9, 18, 25 and 41

FOR: PRERECORDED AUDIO TAPES FEATURING MARTIAL ARTS, DOCUMENTARY TRAVELOGUES, INTERVIEWS, HEALTH ISSUES, MARTIAL ARTS COMPETITIONS, MARTIAL ARTS DEMONSTRATIONS AND LECTURES REGARDING MARTIAL ARTS; ATHLETIC PROTECTIVE HELMETS FOR THE MARTIAL ARTS; PROTECTIVE MARTIAL ARTS HELMETS, IN CLASS 9 (U.S. CLS. 21, 23, 26, 36 AND 38).

TRADEMARK

SERVICE MARK

PRINCIPAL REGISTER

FIRST USE 5-26-1998; IN COMMERCE 5-26-1998.

FOR: BACKPACKS; FANNY PACKS; GYM BAGS, IN CLASS 18 (U.S. CLS. 1, 2, 3, 22 AND 41).

FIRST USE 9-30-1992; IN COMMERCE 9-30-1992.

FOR: BANDANAS; HATS; SCARVES; SWEAT BANDS; SWEAT JACKETS; SWEAT PANTS; SWEAT SHIRTS; SWEAT SHORTS; SWEAT SUITS; T-SHIRTS; TANK TOPS; TEE SHIRTS; WRISTBANDS, IN CLASS 25 (U.S. CLS. 22 AND 39).

FIRST USE 6-1-1988; IN COMMERCE 6-1-1988.

FOR: ENTERTAINMENT SERVICES, NAMELY, ARRANGING AND CONDUCTING OF COMPETITIONS FOR ATHLETICS AND MARTIAL ARTS, CONDUCTING WORKSHOPS AND SEMINARS IN THE FIELDS OF MARTIAL ARTS; AND MARTIAL ARTS INSTRUCTION; MARTIAL ARTS INSTRUCTION, IN CLASS 41 (U.S. CLS. 100, 101 AND 107).

FIRST USE 6-1-1988; IN COMMERCE 6-1-1988.

NO CLAIM IS MADE TO THE EXCLUSIVE RIGHT TO USE "WUSHU ACADEMY" AND THE NON-LATIN CHARACTERS THAT TRANSLITERATE TO "MEI GUO WU SHU XUE YUAN", APART FROM THE MARK AS SHOWN.

THE NON-LATIN CHARACTERS IN THE MARK TRANSLITERATE TO "MEI GUO WU SHU XUE YUAN" AND THIS MEANS "UNITED STATES WUSHU ACADEMY"



David J. Kybas

Director of the United States Patent and Trademark Office

Reg. No. 4,107,439 THE MARK CONSISTS OF THE WORDING OF "UNITED STATES WUSHU ACADEMY" SHOWING WITHIN A CIRCLE WITH THE LETTERS OF "USWA" IN STYLIZED FORMAT IN THE CENTER OF THE CIRCLE, WITH A SMALL STAR BETWEEN "UNITED" AND "WUSHU" AND ANOTHER SMALL STAR BETWEEN "STATES" AND "ACADEMY", ALL SHOWN ABOUT SIX CHINESE CHARACTERS.

THE ENGLISH TRANSLATION OF "WUSHU" IN THE MARK IS "ART OF WAR"

SEC. 2(F) AS TO "UNITED STATES WUSHU ACADEMY".

SER. NO. 85-049,414, FILED 5-27-2010.

ANGELA DUONG, EXAMINING ATTORNEY

United States of America

United States Patent and Trademark Office

WATCH FOR MOTORCYCLES

Reg. No. 4,107,440

Registered Mar. 6, 2012

Int. Cls.: 41 and 45

SERVICE MARK

PRINCIPAL REGISTER

HUPY & ABRAHAM, S.C. (WISCONSIN CORPORATION)
SUITE 1110
100 EAST WISCONSIN AVENUE
MILWAUKEE, WI 53202

FOR: EDUCATION SERVICES, NAMELY, PROVIDING ON-LINE CLASSES, SEMINARS AND WORKSHOPS IN THE FIELDS OF MOTORCYCLE SAFETY AND MOTORCYCLIST LEGAL RIGHTS; ENTERTAINMENT SERVICES, NAMELY, PROVIDING VIDEO PODCASTS IN THE FIELDS OF MOTORCYCLE SAFETY AND MOTORCYCLIST LEGAL RIGHTS, IN CLASS 41 (U.S. CLS. 100, 101 AND 107).

FIRST USE 4-22-2007; IN COMMERCE 4-22-2007.

FOR: LEGAL SERVICES, IN CLASS 45 (U.S. CLS. 100 AND 101).

FIRST USE 4-22-2007; IN COMMERCE 4-22-2007.

THE MARK CONSISTS OF STANDARD CHARACTERS WITHOUT CLAIM TO ANY PARTICULAR FONT, STYLE, SIZE, OR COLOR.

NO CLAIM IS MADE TO THE EXCLUSIVE RIGHT TO USE "MOTORCYCLES" , APART FROM THE MARK AS SHOWN.

SER. NO. 85-052,750, FILED 6-2-2010.

CIMMERIAN COLEMAN, EXAMINING ATTORNEY



David J. Kyros

Director of the United States Patent and Trademark Office

United States of America

United States Patent and Trademark Office

WET PAINT

Reg. No. 4,107,441

DAWSON, SOPHIA S. (UNITED STATES INDIVIDUAL)
551 EAST 93 STREET
BROOKLYN, NY 11236

Registered Mar. 6, 2012

Int. Cl.: 41

SERVICE MARK

PRINCIPAL REGISTER

FOR: CONDUCTING ENTERTAINMENT EXHIBITIONS IN THE NATURE OF ART BY SOPHIA S. DAWSON; EDUCATIONAL AND ENTERTAINMENT SERVICES, NAMELY, A CONTINUING PROGRAM ABOUT ART BY SOPHIA S. DAWSON WHICH IS ACCESSIBLE BY RADIO, TELEVISION, SATELLITE, AUDIO, VIDEO AND COMPUTER NETWORKS; ENTERTAINMENT IN THE NATURE OF LASER SHOWS BY SOPHIA S. DAWSON; ENTERTAINMENT IN THE NATURE OF LIVE PERFORMANCES BY SOPHIA S. DAWSON; ENTERTAINMENT IN THE NATURE OF LIVE STAGE PERFORMANCES IN THE NATURE OF ART BY SOPHIA S. DAWSON OR LECTURE FOR HIRE IN THE FIELD OF ART BY SOPHIA S. DAWSON; ENTERTAINMENT SERVICES, NAMELY, ARRANGING AND CONDUCTING OF COMPETITIONS FOR ART BY SOPHIA S. DAWSON; ENTERTAINMENT SERVICES, NAMELY, PERSONAL APPEARANCES BY SOPHIA S. DAWSON; ENTERTAINMENT SERVICES, NAMELY, PRODUCTION OF SPECIAL EFFECTS INCLUDING MODEL-MAKING SERVICES BY SOPHIA S. DAWSON; ENTERTAINMENT SERVICES, NAMELY, PROVIDING A WEB SITE FEATURING PHOTOGRAPHIC, VIDEO AND PROSE PRESENTATIONS EXCLUSIVELY FEATURING ART BY SOPHIA S. DAWSON; ENTERTAINMENT SERVICES, NAMELY, PROVIDING ON-LINE, NON-DOWNLOADABLE VIRTUAL ART BY SOPHIA S. DAWSON FOR USE IN VIRTUAL ARTISTIC ENVIRONMENTS CREATED FOR ENTERTAINMENT PURPOSES; ENTERTAINMENT, NAMELY, A CONTINUING ART SHOW BY SOPHIA S. DAWSON, BROADCAST OVER TELEVISION, SATELLITE, AUDIO, AND VIDEO MEDIA; AND ORGANIZING AND ARRANGING ART EXHIBITIONS FOR ENTERTAINMENT PURPOSES BY SOPHIA S. DAWSON, IN CLASS 41 (U.S. CLS. 100, 101 AND 107).



FIRST USE 1-1-2005; IN COMMERCE 7-12-2005.

THE MARK CONSISTS OF THE STYLIZED WORDING "WET PAINT" IN RED.

THE COLOR(S) RED IS/ARE CLAIMED AS A FEATURE OF THE MARK.

SER. NO. 85-057,051, FILED 6-8-2010.

JENNIFER VASQUEZ, EXAMINING ATTORNEY

David J. Kyros

Director of the United States Patent and Trademark Office

United States of America

United States Patent and Trademark Office

TradeVision

Reg. No. 4,107,442

Registered Mar. 6, 2012

Int. Cl.: 9

TRADEMARK

PRINCIPAL REGISTER

MPOWER TRADING SYSTEMS, LLC (PENNSYLVANIA LIMITED LIABILITY COMPANY)
521 W. LANCASTER AVENUE
HAVERFORD, PA 19041

FOR: DOWNLOADABLE SOFTWARE FUNCTIONING AS AN AUTOMATED TRADING SYSTEM FOR PROFESSIONAL AND INSTITUTIONAL INVESTORS TO ANALYZE THE OVERALL INVESTMENT MARKET, INITIATE ORDERS, MANAGE POSITIONS, QUANTIFY RISK, AND EFFECTIVELY EXECUTE SIMULTANEOUS SOPHISTICATED ORDERS, IN CLASS 9 (U.S. CLS. 21, 23, 26, 36 AND 38).

FIRST USE 7-0-2008; IN COMMERCE 7-0-2008.

THE MARK CONSISTS OF CAPITAL LETTER "T" FOLLOWED BY LOWER CASE LETTERS "RADE" AND CAPITAL LETTER "V" FOLLOWED BY LOWER CASE LETTERS "ISION" TO FORM THE WORD "TRADEVISION".

SER. NO. 85-060,598, FILED 6-11-2010.

KATHLEEN M. VANSTON, EXAMINING ATTORNEY



David J. Kyjars

Director of the United States Patent and Trademark Office

United States of America

United States Patent and Trademark Office



Reg. No. 4,107,443

Registered Mar. 6, 2012

Int. Cl.: 43

SERVICE MARK

PRINCIPAL REGISTER

MR. BEEF ON HARLEM, LTD. (ILLINOIS CORPORATION)
3917 N. HARLEM AVENUE
CHICAGO, IL 60634

FOR: RESTAURANT AND CATERING SERVICES, IN CLASS 43 (U.S. CLS. 100 AND 101).

FIRST USE 12-1-1982; IN COMMERCE 12-1-1982.

NO CLAIM IS MADE TO THE EXCLUSIVE RIGHT TO USE "ON NORTH HARLEM", APART FROM THE MARK AS SHOWN.

THE MARK CONSISTS OF THE WORDS "MR. BEEF & PIZZA" INSIDE A STYLIZED CIRCLE, WITH THE WORDS "ON NORTH HARLEM" ALONG THE OUTSIDE BOTTOM CURVE OF THE CIRCLE.

SER. NO. 85-061,764, FILED 6-14-2010.

AMY ALFIERI, EXAMINING ATTORNEY



David J. Kyffers

Director of the United States Patent and Trademark Office

United States of America

United States Patent and Trademark Office

MR. BEEF & PIZZA ON NORTH HARLEM

Reg. No. 4,107,444

Registered Mar. 6, 2012

Int. Cl.: 43

SERVICE MARK

PRINCIPAL REGISTER

MR. BEEF ON HARLEM, LTD. (ILLINOIS CORPORATION)
3917 N. HARLEM AVENUE
CHICAGO, IL 60634

FOR: RESTAURANT AND CATERING SERVICES, IN CLASS 43 (U.S. CLS. 100 AND 101).

FIRST USE 12-1-1981; IN COMMERCE 12-1-1981.

THE MARK CONSISTS OF STANDARD CHARACTERS WITHOUT CLAIM TO ANY PARTICULAR FONT, STYLE, SIZE, OR COLOR.

NO CLAIM IS MADE TO THE EXCLUSIVE RIGHT TO USE "ON NORTH HARLEM", APART FROM THE MARK AS SHOWN.

SER. NO. 85-061,788, FILED 6-14-2010.

AMY ALFIERI, EXAMINING ATTORNEY



David J. Kybas

Director of the United States Patent and Trademark Office

United States of America

United States Patent and Trademark Office

MUELLNER GREEN ROOF

Reg. No. 4,107,445

Registered Mar. 6, 2012

Int. Cls.: 37 and 42

SERVICE MARK

PRINCIPAL REGISTER

REHBEIN ENVIRONMENTAL SOLUTIONS, INC. (NEVADA CORPORATION)
8651 NAPLES STREET, NE
MINNEAPOLIS, MN 554496724

FOR: INSTALLATION, INSTALLATION SUPERVISION, AND MAINTENANCE OF GREEN ROOFS; INSTALLATION AND MAINTENANCE SUPERVISION OF GREEN ROOFS , IN CLASS 37 (U.S. CLS. 100, 103 AND 106).

FIRST USE 7-31-2005; IN COMMERCE 7-31-2005.

FOR: ENGINEERING AND HYDROLOGICAL DESIGN OF GREEN ROOFS, IN CLASS 42 (U.S. CLS. 100 AND 101).

FIRST USE 7-31-2005; IN COMMERCE 7-31-2005.

THE MARK CONSISTS OF STANDARD CHARACTERS WITHOUT CLAIM TO ANY PARTICULAR FONT, STYLE, SIZE, OR COLOR.

NO CLAIM IS MADE TO THE EXCLUSIVE RIGHT TO USE "GREEN ROOF", APART FROM THE MARK AS SHOWN.

THE NAME(S), PORTRAIT(S), AND/OR SIGNATURE(S) SHOWN IN THE MARK IDENTIFIES DAVID L. "MUELLNER", WHOSE CONSENT(S) TO REGISTER IS MADE OF RECORD.

SEC. 2(F).

SER. NO. 85-062,523, FILED 6-14-2010.

SANI KHOURI, EXAMINING ATTORNEY



David J. Kybas

Director of the United States Patent and Trademark Office

United States of America

United States Patent and Trademark Office

MULTI-SAK

Reg. No. 4,107,446

Registered Mar. 6, 2012

Int. Cl.: 11

TRADEMARK

PRINCIPAL REGISTER

KOCH FILTER CORPORATION (KENTUCKY CORPORATION)
625 WEST HILL STREET
LOUISVILLE, KY 40208

FOR: AIR FILTRATION PRODUCTS FOR INDUSTRIAL USES, NAMELY, HEALTH FACILITY AIR CONDITIONING FILTERS, PAINT BOOTH AIR FILTERS, AIRCRAFT PASSENGER CABIN AIR VENTILATION FILTERS, CLEAN ROOM AIR FILTERS, CABIN AIR FILTERS FOR FILTERING POLLEN IN PASSENGER COMPARTMENTS OF A VEHICLE, INDUSTRIAL HEATING, VENTILATION AND AIR-CONDITIONING SYSTEM AIR FILTERS, IN CLASS 11 (U.S. CLS. 13, 21, 23, 31 AND 34).

FIRST USE 12-31-1975; IN COMMERCE 12-31-1975.

THE MARK CONSISTS OF STANDARD CHARACTERS WITHOUT CLAIM TO ANY PARTICULAR FONT, STYLE, SIZE, OR COLOR.

SER. NO. 85-064,381, FILED 6-16-2010.

ANTHONY RINKER, EXAMINING ATTORNEY



David J. Kyffers

Director of the United States Patent and Trademark Office

United States of America

United States Patent and Trademark Office

MULTI-FLO

Reg. No. 4,107,447

Registered Mar. 6, 2012

Int. Cl.: 11

TRADEMARK

PRINCIPAL REGISTER

KOCH FILTER CORPORATION (KENTUCKY CORPORATION)
625 WEST HILL STREET
LOUISVILLE, KY 40208

FOR: AIR FILTRATION PRODUCTS FOR INDUSTRIAL USES, NAMELY, HEALTH FACILITY AIR CONDITIONING FILTERS, PAINT BOOTH AIR FILTERS, AIRCRAFT PASSENGER CABIN AIR VENTILATION FILTERS, CLEAN ROOM AIR FILTERS, CABIN AIR FILTERS FOR FILTERING POLLEN IN PASSENGER COMPARTMENTS OF A VEHICLE, INDUSTRIAL HEATING, VENTILATION AND AIR-CONDITIONING SYSTEM AIR FILTERS, IN CLASS 11 (U.S. CLS. 13, 21, 23, 31 AND 34).

FIRST USE 12-31-1987; IN COMMERCE 12-31-1987.

THE MARK CONSISTS OF STANDARD CHARACTERS WITHOUT CLAIM TO ANY PARTICULAR FONT, STYLE, SIZE, OR COLOR.

SER. NO. 85-064,383, FILED 6-16-2010.

ANTHONY RINKER, EXAMINING ATTORNEY



David J. Kyffers

Director of the United States Patent and Trademark Office

United States of America

United States Patent and Trademark Office

MULTI-CELL

Reg. No. 4,107,448

Registered Mar. 6, 2012

Int. Cl.: 11

TRADEMARK

PRINCIPAL REGISTER

KOCH FILTER CORPORATION (KENTUCKY CORPORATION)
625 WEST HILL STREET
LOUISVILLE, KY 40208

FOR: AIR FILTRATION PRODUCTS FOR INDUSTRIAL USES, NAMELY, HEALTH FACILITY AIR CONDITIONING FILTERS, PAINT BOOTH AIR FILTERS, AIRCRAFT PASSENGER CABIN AIR VENTILATION FILTERS, CLEAN ROOM AIR FILTERS, CABIN AIR FILTERS FOR FILTERING POLLEN IN PASSENGER COMPARTMENTS OF A VEHICLE, INDUSTRIAL HEATING, VENTILATION AND AIR-CONDITIONING SYSTEM AIR FILTERS, IN CLASS 11 (U.S. CLS. 13, 21, 23, 31 AND 34).

FIRST USE 12-31-1987; IN COMMERCE 12-31-1987.

THE MARK CONSISTS OF STANDARD CHARACTERS WITHOUT CLAIM TO ANY PARTICULAR FONT, STYLE, SIZE, OR COLOR.

SER. NO. 85-064,395, FILED 6-16-2010.

ANTHONY RINKER, EXAMINING ATTORNEY



David J. Kyffers

Director of the United States Patent and Trademark Office

United States of America

United States Patent and Trademark Office

SAK CONSTRUCTION

Reg. No. 4,107,449

Registered Mar. 6, 2012

Int. Cl.: 37

SERVICE MARK

PRINCIPAL REGISTER

SAK CONSTRUCTION, LLC (MISSOURI LIMITED LIABILITY COMPANY)
103 NORTH COOL SPRINGS ROAD
O'FALLON, MO 633663492

FOR: REPAIR, RECONSTRUCTION AND REHABILITATION OF EXISTING CONDUITS, PIPELINES, POTABLE WATER PIPES AND PASSAGEWAYS, NAMELY, CURED-IN PLACE PIPE LINING AND REHABILITATION OF PIPES BY SHOTCRETING, SLIPLINING, GROUTING AND CRACK SEALING; TRENCHLESS INSTALLATIONS OF NEW PIPELINES VIA TUNNELING, IN CLASS 37 (U.S. CLS. 100, 103 AND 106).

FIRST USE 12-8-2008; IN COMMERCE 12-8-2008.

THE MARK CONSISTS OF STANDARD CHARACTERS WITHOUT CLAIM TO ANY PARTICULAR FONT, STYLE, SIZE, OR COLOR.

NO CLAIM IS MADE TO THE EXCLUSIVE RIGHT TO USE "CONSTRUCTION", APART FROM THE MARK AS SHOWN.

SER. NO. 85-064,701, FILED 6-16-2010.

JENNIFER VASQUEZ, EXAMINING ATTORNEY



David J. Kyros

Director of the United States Patent and Trademark Office

United States of America

United States Patent and Trademark Office



SAK
CONSTRUCTION

Reg. No. 4,107,450

Registered Mar. 6, 2012

Int. Cl.: 37

SERVICE MARK

PRINCIPAL REGISTER

SAK CONSTRUCTION, LLC (MISSOURI LIMITED LIABILITY COMPANY)
103 NORTH COOL SPRINGS ROAD
O'FALLON, MO 633663492

FOR: REPAIR, RECONSTRUCTION AND REHABILITATION OF EXISTING CONDUITS, PIPELINES, POTABLE WATER PIPES AND PASSAGeways, NAMELY, CURED-IN PLACE PIPE LINING AND REHABILITATION OF PIPES BY SHOTCRETING, SLIPLINING, GROUTING AND CRACK SEALING; TRENCHLESS INSTALLATIONS OF NEW PIPELINES VIA TUNNELING, IN CLASS 37 (U.S. CLS. 100, 103 AND 106).

FIRST USE 6-1-2009; IN COMMERCE 6-1-2009.

NO CLAIM IS MADE TO THE EXCLUSIVE RIGHT TO USE "CONSTRUCTION", APART FROM THE MARK AS SHOWN.

THE MARK CONSISTS OF AN INCOMPLETE CIRCLE WITH THREE CURVED, SHADED PORTIONS WHICH APPEAR AT THE TOP, THE MIDDLE, AND THE BOTTOM OF THE CIRCLE. THE WORD "SAK" APPEARS IN LARGE CAPITAL LETTERS TO THE RIGHT OF THE CIRCLE. THE WORD "CONSTRUCTION" APPEARS IN SMALLER CAPITAL LETTERS DIRECTLY BENEATH THE WORD "SAK".

SER. NO. 85-064,703, FILED 6-16-2010.

JENNIFER VASQUEZ, EXAMINING ATTORNEY



David J. Kybas

Director of the United States Patent and Trademark Office

United States of America

United States Patent and Trademark Office



Reg. No. 4,107,451

Registered Mar. 6, 2012

Int. Cls.: 35 and 39

SERVICE MARK

PRINCIPAL REGISTER

VINDEMIA INC. (NEW YORK CORPORATION), DBA WINE CELLARAGE
890 GARRISON AVENUE
BRONX, NY 10474

FOR: RETAIL STORE SERVICES FEATURING ALCOHOLIC BEVERAGES, IN CLASS 35 (U.S. CLS. 100, 101 AND 102).

FIRST USE 4-30-2009; IN COMMERCE 4-30-2009.

FOR: STORAGE SERVICES, NAMELY, STORAGE, DISTRIBUTION, PICK-UP, PACKING, AND SHIPPING OF ALCOHOLIC BEVERAGES; DISTRIBUTION SERVICES, NAMELY, TRANSPORTATION AND DELIVERY SERVICES OF ALCOHOLIC BEVERAGES, IN CLASS 39 (U.S. CLS. 100 AND 105).

FIRST USE 9-30-2002; IN COMMERCE 9-30-2002.

NO CLAIM IS MADE TO THE EXCLUSIVE RIGHT TO USE "THE WINE CELLARAGE 55°", APART FROM THE MARK AS SHOWN.

THE COLOR(S) BLACK, WHITE AND GOLD IS/ARE CLAIMED AS A FEATURE OF THE MARK.

THE MARK CONSISTS OF THE TEMPERATURE "55°" APPEARS IN GOLD ABOVE THE WORDS "THE WINE CELLARAGE" WRITTEN IN BLACK SURROUNDED BY A DECORATIVE DESIGN WHICH APPEARS IN GOLD ALL ON A WHITE BACKGROUND.

SER. NO. 85-065,638, FILED 6-17-2010.

JANET LEE, EXAMINING ATTORNEY



David J. Kybas

Director of the United States Patent and Trademark Office

United States of America

United States Patent and Trademark Office

SCRIPT OHIO

Reg. No. 4,107,452

Registered Mar. 6, 2012

Int. Cl.: 41

SERVICE MARK

PRINCIPAL REGISTER

THE OHIO STATE UNIVERSITY (OHIO STATE UNIVERSITY)
190 NORTH OVAL MALL
COLUMBUS, OH 43210

FOR: EDUCATIONAL SERVICES, NAMELY, PROVIDING COURSES OF INSTRUCTION AT THE COLLEGE LEVEL; ENTERTAINMENT SERVICES, NAMELY, LIVE PERFORMANCES BY A COLLEGIATE MARCHING BAND, IN CLASS 41 (U.S. CLS. 100, 101 AND 107).

FIRST USE 10-10-1936; IN COMMERCE 10-10-1936.

THE MARK CONSISTS OF STANDARD CHARACTERS WITHOUT CLAIM TO ANY PARTICULAR FONT, STYLE, SIZE, OR COLOR.

SEC. 2(F) AS TO "OHIO".

SER. NO. 85-065,788, FILED 6-17-2010.

KELLEY WELLS, EXAMINING ATTORNEY



David J. Kyffers

Director of the United States Patent and Trademark Office

United States of America

United States Patent and Trademark Office

LIFELINE ENERGY

Reg. No. 4,107,453

Registered Mar. 6, 2012

Int. Cl.: 35

SERVICE MARK

PRINCIPAL REGISTER

LIFELINE ENERGY FOUNDATION (DELAWARE NON-PROFIT CORPORATION)
120 BROADWAY-18TH FLOOR
NEW YORK, NY 10005

FOR: CHARITABLE SERVICES, NAMELY, COORDINATION OF THE PROCUREMENT AND DISTRIBUTION OF APPARATUS AND INSTRUMENTS FOR LIGHTING, WIND-UP APPARATUS AND INSTRUMENTS FOR LIGHTING, FLASHLIGHTS, RECHARGEABLE TORCHES, AND APPARATUS FOR USE IN RECORDING, PRODUCING, PRESENTING, BROADCASTING, TRANSMITTING, RECEIVING, PROCESSING, REPRODUCING, ENCODING AND DECODING OF RADIO AND TELEVISION PROGRAMS, INFORMATION AND DATA FOR THE PURPOSES OF HUMANITARIAN AID, IN CLASS 35 (U.S. CLS. 100, 101 AND 102).

FIRST USE 4-7-2010; IN COMMERCE 4-7-2010.

THE MARK CONSISTS OF STANDARD CHARACTERS WITHOUT CLAIM TO ANY PARTICULAR FONT, STYLE, SIZE, OR COLOR.

NO CLAIM IS MADE TO THE EXCLUSIVE RIGHT TO USE "ENERGY", APART FROM THE MARK AS SHOWN.

SER. NO. 85-065,845, FILED 6-17-2010.

ANNE E. GUSTASON, EXAMINING ATTORNEY



David J. Kyros

Director of the United States Patent and Trademark Office

United States of America

United States Patent and Trademark Office

KALIBER

Reg. No. 4,107,454

SWEDISH MATCH NORTH EUROPE AB (SWEDEN JOINT STOCK COMPANY)
SE-118 85

Registered Mar. 6, 2012

STOCKHOLM, SWEDEN

Int. Cl.: 34

FOR: TOBACCO; MATCHES; TOBACCO SUBSTITUTES NOT FOR MEDICAL PURPOSES; SNUFF AND TOBACCO ALTERNATIVES IN THE FORM OF PRODUCTS BASED ON VEGETABLE FIBERS, FOR ORAL USE NOT FOR CONSUMPTION; SNUFF; TOBACCO FREE SNUFF; HERBAL SNUFF, IN CLASS 34 (U.S. CLS. 2, 8, 9 AND 17).

TRADEMARK

PRINCIPAL REGISTER

THE MARK CONSISTS OF STANDARD CHARACTERS WITHOUT CLAIM TO ANY PARTICULAR FONT, STYLE, SIZE, OR COLOR.

OWNER OF SWEDEN REG. NO. 413176, DATED 10-1-2010, EXPIRES 10-1-2020.

THE ENGLISH TRANSLATION OF "KALIBER" IN THE MARK IS "CALIBRE".

SER. NO. 85-066,640, FILED 6-18-2010.

LANA PHAM, EXAMINING ATTORNEY



David J. Kyros

Director of the United States Patent and Trademark Office

United States of America

United States Patent and Trademark Office

EZ-AID

Reg. No. 4,107,455

Registered Mar. 6, 2012

Int. Cls.: 10 and 28

TRADEMARK

PRINCIPAL REGISTER

CONSUMER SALES NETWORK, INC. (MINNESOTA CORPORATION)
6527 CECILIA CIRCLE
BLOOMINGTON, MN 55439

FOR: INVALID WALKERS, MASSAGERS, NAMELY, ELECTRIC VIBRATING, WRIST, ARM AND LEG BRACES AND CRUTCHES ALL FOR MEDICAL USE; MANUALLY-OPERATED EXERCISE EQUIPMENT FOR PHYSICAL THERAPY PURPOSES, IN CLASS 10 (U.S. CLS. 26, 39 AND 44).

FIRST USE 1-1-2010; IN COMMERCE 1-1-2010.

FOR: EXERCISE EQUIPMENT, NAMELY, STATIONARY EXERCISE BICYCLE, PULL UP BARS, BAR BELLS AND WEIGHT LIFTING MACHINES, IN CLASS 28 (U.S. CLS. 22, 23, 38 AND 50).

FIRST USE 1-1-2010; IN COMMERCE 1-1-2010.

THE MARK CONSISTS OF STANDARD CHARACTERS WITHOUT CLAIM TO ANY PARTICULAR FONT, STYLE, SIZE, OR COLOR.

SER. NO. 85-066,944, FILED 6-18-2010.

MICHAEL WEBSTER, EXAMINING ATTORNEY



David J. Kybas

Director of the United States Patent and Trademark Office

United States of America

United States Patent and Trademark Office

UPTOWN COFFEE TEA SODA

Reg. No. 4,107,456

UPTOWN COFFEE TEA & SODA LLC (INDIANA LIMITED LIABILITY COMPANY)
579 CHEYENNE CT
WESTVILLE, IN 46391

Registered Mar. 6, 2012

Int. Cl.: 30

FOR: STAPLE FOOD PRODUCTS, NAMELY, COFFEE-BASED BEVERAGES FOR CONSUMERS, IN CLASS 30 (U.S. CL. 46).

TRADEMARK

FIRST USE 12-18-2009; IN COMMERCE 12-18-2009.

PRINCIPAL REGISTER

THE MARK CONSISTS OF STANDARD CHARACTERS WITHOUT CLAIM TO ANY PARTICULAR FONT, STYLE, SIZE, OR COLOR.

NO CLAIM IS MADE TO THE EXCLUSIVE RIGHT TO USE "COFFEE TEA SODA", APART FROM THE MARK AS SHOWN.

SER. NO. 85-068,211, FILED 6-22-2010.

JILL PRATER, EXAMINING ATTORNEY



David J. Kyros

Director of the United States Patent and Trademark Office

United States of America

United States Patent and Trademark Office

Glowing Your Business

Reg. No. 4,107,457

Registered Mar. 6, 2012

Int. Cl.: 35

SERVICE MARK

PRINCIPAL REGISTER

BRUCE W. BURTCH, INC. (CALIFORNIA CORPORATION)
340 KNIGHT DRIVE
SAN RAFAEL, CA 94901

FOR: BUSINESS MARKETING SERVICES, IN CLASS 35 (U.S. CLS. 100, 101 AND 102).

FIRST USE 6-18-2010; IN COMMERCE 6-18-2010.

THE MARK CONSISTS OF STANDARD CHARACTERS WITHOUT CLAIM TO ANY PARTICULAR FONT, STYLE, SIZE, OR COLOR.

NO CLAIM IS MADE TO THE EXCLUSIVE RIGHT TO USE "BUSINESS", APART FROM THE MARK AS SHOWN.

SER. NO. 85-069,006, FILED 6-22-2010.

PAUL F. GAST, EXAMINING ATTORNEY



David J. Kybas

Director of the United States Patent and Trademark Office

United States of America

United States Patent and Trademark Office

FUJIFILM

Reg. No. 4,107,458

Registered Mar. 6, 2012

**Int. Cls.: 1, 2, 3, 7, 9, 10,
16, 35, 40 and 42**

TRADEMARK

SERVICE MARK

PRINCIPAL REGISTER

FUJIFILM CORPORATION (JAPAN CORPORATION)
26-30, NISHIAZABU 2-CHOME, MINATO-KU
TOKYO, JAPAN

FOR: ORGANIC SOLVENT OR SOLVENT MIXTURES WHICH DISSOLVE EXPOSED OR UNEXPOSED PHOTSENSITIVE COMPOSITIONS; POLYIMIDE RESINS FOR USE IN THE MANUFACTURE OF SEMICONDUCTORS AND ELECTRONIC EQUIPMENT; AQUEOUS DEVELOPABLE POLYAMIC ACID POLYMER SOLUTIONS IN ORGANIC SOLVENTS USED FOR MANUFACTURE OF BUFFER COATS ON SEMICONDUCTOR DEVICES; ORGANIC POLYMER COATING FOR USE ON SEMICONDUCTOR UNITS; PHOTOLITHOGRAPHIC CHEMICALS IN THE NATURE OF NONPHOTOIMAGEABLE AND PHOTOIMAGEABLE ORGANIC COMPOUNDS AND POLYMERS, AND PHOTOIMAGEABLE MIXTURE OF ORGANIC COMPOUNDS, POLYMERS, PIGMENTS AND ORGANIC SOLVENTS; PHOTOLITHOGRAPHIC DEVELOPERS IN THE NATURE OF NEGATIVE PHOTORESIST DEVELOPER; REACTIVE SILICON COMPOUNDS FOR IMPROVING ADHESION OF POLYMER FILMS; DOPING COMPOUNDS FOR USE IN THE MANUFACTURE OF SEMICONDUCTORS; CHEMICALS IN THE NATURE OF THIN FILM CHEMICAL VAPOR DEPOSITION PRECURSORS AND POROGENS; LITHOGRAPHIC IMAGING CHEMICALS IN THE NATURE OF ELECTRON BEAM RESIST CHEMICALS; CHEMICALS IN THE NATURE OF AQUEOUS DEVELOPERS USED TO DEVELOP PHOTOLITHOGRAPHIC IMAGES; ETCHANTS FOR USE IN THE MANUFACTURE AND CLEANING OF SEMICONDUCTORS; ORGANIC SOLVENT STRIPPERS WHICH DISSOLVE PHOTSENSITIVE COMPOSITIONS; AQUEOUS BASED CLEANERS WHICH DISSOLVE PHOTSENSITIVE COMPOSITION RESIDUES, PHOTSENSITIVE COMPOSITION PLASMA ETCH RESIDUES AND POST CHEMICAL MECHANICAL POLISHING RESIDUES FROM SEMICONDUCTOR SUBSTRATES; ORGANIC SOLVENTS USED AS EDGE BEAD REMOVERS ON SEMICONDUCTOR WAFERS AFTER COATING; SCREEN PRINTING ADHESIVES; CHEMICALS USED IN THE PRINTING INDUSTRY FOR CLEANING AND OPTIMIZING THE ADHESION OF EMULSION TO MESH; UNEXPOSED GRAPHIC ARTS CAMERA FILM; CHEMICALS FOR USE IN THE PRINTING INDUSTRY; CHEMICAL PRESSROOM PRODUCTS, NAMELY, ANTI-STATIC SPRAY AND SPRAY ADHESIVE FOR USE ON ELECTRONIC EQUIPMENT; PHOTOGRAPHIC FILM PROCESSING CHEMICALS; CHEMICALS, POLYMER COATING AGENTS AND CHEMICAL ADDITIVES USED IN THE MANUFACTURE OF SPECIALIZED CHEMICALS, NAMELY, THOSE USED FOR THE LASER RADIATION IMAGING, MARKING AND CODING OF PLASTICS, PAPER, CARDBOARD, METAL, GLASS AND FOIL; PROCESSING CHEMICALS FOR MARKING AND ETCHING METAL PLATES; PHOTOGRAPHIC CHEMICALS FOR USE IN GRAPHIC ARTS AND PRESSROOM PROCESSING; SILICONE RESINS IN THE



David J. Kypas

Director of the United States Patent and Trademark Office

Reg. No. 4,107,458 NATURE OF DUPLEX FOULING RELEASE MATERIAL WHICH CONTAIN SILICONE BASED COATING TECHNOLOGY PROVIDING BIOFOULING ENVIRONMENTAL PROTECTION FOR THE MARINE AND POWER GENERATOR INDUSTRY; UNEXPOSED CAMERA FILM, NAMELY, PROFESSIONAL INSTANT COLOR FILM, BLACK AND WHITE FILM, COLOR REVERSAL FILM, PROFESSIONAL DUPLICATING FILM, PROFESSIONAL COLOR NEGATIVE FILM FOR SHORT AND LONG EXPOSURES, PROFESSIONAL COLOR NEGATIVE FILM FOR HIGH CONTRAST PORTRAITURE, PROFESSIONAL PORTRAIT FILM, INSTANT COLOR DAYLIGHT FILM AND PROFESSIONAL INSTANT COLOR FILM; CHEMICALLY-TREATED NON-MEDICAL TEST STRIPS IN THE FORM OF SENSITOMETRICALLY EXPOSED PAPER STRIPS FOR USE IN THE PRINTING INDUSTRY; UNEXPOSED CAMERA COLOR PRINT FILM; UNEXPOSED COLOR MICROFILM, UNEXPOSED CAMERA FILM FOR DIRECT DUPLICATING, UNEXPOSED CAMERA MINIPOSITIVE FILM, UNEXPOSED NEGATIVE MICROFILM FOR CAMERAS, UNEXPOSED CAMERA FILM FOR RECORDING DIGITAL DOCUMENTS, IN CLASS 1 (U.S. CLS. 1, 5, 6, 10, 26 AND 46).

FIRST USE 11-30-2008; IN COMMERCE 11-30-2008.

FOR: JETTABLE FOOD COLORING; PRINTING INK IN THE NATURE OF INKJET PRINTING LIQUIDS; INKJET PRINTING SOLVENTS, UV CURABLE AND WATER BASED INKS, SOLVENT SCREEN INKS, SCREEN PRINTING EMULSIONS, DIGITAL INKS, SCREEN INKS AND ROTARY SCREEN INKS AND PRINTING INK VARNISHES; COMMERCIAL INK JET PRINTER INK, IN CLASS 2 (U.S. CLS. 6, 11 AND 16).

FIRST USE 12-31-2007; IN COMMERCE 12-31-2007.

FOR: CHEMICAL PRESSROOM PRODUCTS, NAMELY, GLASS CLEANER AND CANNED PRESSURED AIR FOR DUSTING, IN CLASS 3 (U.S. CLS. 1, 4, 6, 50, 51 AND 52).

FIRST USE 3-31-2008; IN COMMERCE 3-31-2008.

FOR: PRE-SENSITIZED OFFSET PRINTING PLATES; LAMINATORS FOR INDUSTRIAL USE; COMPONENTS OF LITHOGRAPHIC PRESSES, NAMELY, CLOTH-BACKED RUBBER PRINTING BLANKETS; COMMERCIAL PLATESETTERS , IN CLASS 7 (U.S. CLS. 13, 19, 21, 23, 31, 34 AND 35).

FIRST USE 11-30-2009; IN COMMERCE 11-30-2009.

FOR: INDUSTRIAL INKJET PRINT CONTROLLERS; INKJET PRINTERS; DIGITAL PRINTERS; WIDE FORMAT INKJET PRINTERS; WIDE FORMAT DIGITAL PRINTERS AND PRINTER OPERATING SOFTWARE; PRINTHEADS FOR INDUSTRIAL PRINTING APPLICATIONS; OPERATING SOFTWARE FOR OPERATING RETAIL KIOSK AND DIGITAL IMAGE PROCESSING STANDS; SOFTWARE FOR DIGITAL IMAGE FULFILLMENT AND PRINTING; COMPUTER SOFTWARE FOR MANAGING WORKFLOW WITHIN PRINTING APPLICATIONS FOR THE PRINTING INDUSTRY; COMPUTER GRAPHIC IMAGE OPTIMIZATION SOFTWARE; COMPUTER SOFTWARE FOR ANALYZING PRINTING TRENDS IN THE FIELD OF COMMERCIAL PRINTING; COMPUTER SOFTWARE FOR PROVIDING TECHNICAL REAL-TIME SUPPORT FOR COMMERCIAL PRINTING AND INFORMATION TECHNOLOGY BY COMBINING TECHNICAL SUPPORT INFORMATION FROM VARIOUS DATABASES AND PRESENTING IT IN A USER FRIENDLY INTERFACE; BLANK STORAGE DISKS FOR FLOPPY DRIVES; BLANK STORAGE DISKS FOR CONDENSED DISK DRIVES; BLANK RECORDABLE VIDEOTAPE FOR 8MM, DIGITAL VIDEO DISCS AND VIDEO CAMCORDERS, BLANK RECORDABLE VIDEOTAPE FOR DIGITAL VIDEO RECORDERS, BLANK VIDEOCASSETTES, BLANK OPTICAL DISKS FOR DATA AND AUDIOWIDTH CAPACITY, BLANK COMMERCIAL DATA STORAGE TAPE, BLANK OPTICAL STORAGE DISK FOR OPTICAL DISK DRIVES, BLANK GLOBAL POSITIONING SYSTEM TRACKING DATA CARTRIDGE; DATA TAPE STORAGE RACK, BLANK VIDEOCASSETTES, BLANK COMPOSITE DIGITAL VIDEOCASSETTES, BLANK VIDEOCASSETTES, BLANK VIDEO HOME SYSTEM VIDEOCASSETTES, BLANK DIGITAL VIDEOCASSETTES, BLANK

Reg. No. 4,107,458 BROADCAST VIDEOCASSETTES; MEMORY CARDS; ANALOG ELECTRONIC DATA RECORDERS FOR RECORDING DIGITAL DOCUMENTS; DIGITAL PHOTO PRINTER FOR MAKING IDENTIFICATION PHOTOS; SOFTWARE FOR IMAGE PRESENTATION AND FOR ORDERING IMAGES IN THE FIELD OF PROFESSIONAL IMAGING; COMPUTER SOFTWARE FOR MANAGING COLOR PROFILES IN THE FIELD OF PROFESSIONAL IMAGING SERVICES; COMPUTER SOFTWARE FOR CREATING AND EDITING PHOTO DIGITAL TEMPLATES; PROFESSIONAL PHOTO EDITING SOFTWARE; COMPUTER SOFTWARE FOR MANAGING WORKFLOW IN PROFESSIONAL PHOTO LABS; CD DRIVES FOR COMPUTERS FOR USE IN THE PHOTOFINISHING INDUSTRY; DIGITAL CAMERAS; CAMERA ACCESSORIES, NAMELY, UNDERWATER CAMERA HOUSING; DIGITAL PHOTO STORAGE MEDIA, NAMELY MEMORY CARDS FOR PICTURES; CONSUMER INTERACTIVE TOUCH SCREEN PHOTO KIOSKS FOR PRINTING DIGITAL PHOTOS AND PLACING ORDERS FOR DIGITAL PHOTOS; INTERACTIVE COMPUTER PHOTO KIOSKS FOR PRINTING DIGITAL PHOTOS AND PLACING ORDERS FOR DIGITAL PHOTOS; ELECTROMECHANICAL CONTROLS HOUSED IN A CABINET FOR USE IN DELIVERING HIGH PURITY CHEMICALS TO POINT OF USE SEMICONDUCTOR EQUIPMENT, IN CLASS 9 (U.S. CLS. 21, 23, 26, 36 AND 38).

FIRST USE 12-31-2009; IN COMMERCE 12-31-2009.

FOR: MEDICAL CASSETTE BASED COMPUTED RADIOGRAPHY X-RAY IMAGE READER WITH SINGLE CASSETTE SLOT; MEDICAL CASSETTE BASED COMPUTER RADIOGRAPHY X-RAY IMAGE READER WITH MULTIPLE CASSETTE SLOTS; MEDICAL DIGITAL RADIOGRAPHY DETECTOR; MEDICAL RADIOGRAPHIC PATIENT AND X-RAY TABLE POSITIONING SYSTEM COMPRISING FILM PROCESSOR FOR PROCESSING X-RAY IMAGES; MAMMOGRAPHY X-RAY FILM, IN CLASS 10 (U.S. CLS. 26, 39 AND 44).

FIRST USE 12-31-2009; IN COMMERCE 12-31-2009.

FOR: PAPER AND POLYESTER MATERIAL FOR USE AS A PAPER SUBSTITUTE FOR PRINTING PHOTOS; PRINTING PAPER FOR DIGITAL PHOTOGRAPHS; THERMAL PHOTOGRAPHIC PAPER; INKJET PRINTING MATERIALS, NAMELY, CANVAS PRINTING BOARD, SEMI-GLOSS PRINTING BOARD, PHOTO PAPER, FINE ART PRINTING PAPER AND ROLL PAPER; BANNER PAPER FOR SPECIALTY PRINTING; PROOFING PAPER, IN CLASS 16 (U.S. CLS. 2, 5, 22, 23, 29, 37, 38 AND 50).

FIRST USE 6-30-2008; IN COMMERCE 6-30-2008.

FOR: PROVIDING BUSINESS CONSULTATION SERVICES TO THE INFORMATION TECHNOLOGY INDUSTRY AS IT PERTAINS TO INFORMATION TECHNOLOGY PROJECTS, NAMELY, PROVIDING DETAILED ASSESSMENT OF CURRENT BACKUP ENVIRONMENT AS TO POTENTIAL COST SAVINGS, MAXIMIZATION OF PERFORMANCE AND IDENTIFYING DEFECTIVE OR DEGRADING TAPE DRIVES AND MEDIA DELIVERABLE IN A DETAILED REPORT TO MAXIMIZE EXISTING BACKUP RESOURCES, AVOID UNNECESSARY EXPENDITURES ON EQUIPMENT, SAVE TIME, MEET COMPLIANCE REQUIREMENTS AND REDUCE THE RISK OF LOST DATA WHILE EXECUTING INFORMATION TECHNOLOGY PROJECTS; PROVIDING INCENTIVE AWARD PROGRAMS FOR CUSTOMERS THROUGH ISSUANCE AND PROCESSING OF LOYALTY POINTS FOR PURCHASE OF COMPANY'S GOODS AND SERVICES, IN CLASS 35 (U.S. CLS. 100, 101 AND 102).

FIRST USE 2-11-2010; IN COMMERCE 2-11-2010.

FOR: CONSULTATION SERVICES IN THE FIELD OF PRINTING, NAMELY, ALIGNING PRINT PRODUCTION DEVICES WITH PRINTING STANDARDS AND BUNDLING CUSTOMIZED PRINTING RELATED SERVICES TO MAINTAIN COLOR QUALITY IN PRE-PRESS, PROOFING AND PRESSROOM; PROVIDING ONLINE INFORMATION IN THE FIELD OF PRINTING, NAMELY PRINTING INFORMATION RELATED TO QUALITY CONTROL, AND

Reg. No. 4,107,458 CUSTOMIZED REPORTS WITH ANALYSIS ON TRENDS IN THE PRINTING FIELD, IN CLASS 40 (U.S. CLS. 100, 103 AND 106).

FIRST USE 12-31-2007; IN COMMERCE 12-31-2007.

FOR: COMPUTER SYSTEMS AND SYSTEMS INTEGRATION CONSULTATION AS IT PERTAINS TO PRINTING SYSTEMS COMPRISED OF PRINTHEADS, DIGITAL IMAGING AND INK JET TECHNOLOGIES AND OF CONTROL DEVICES, HARDWARE AND SOFTWARE RELATED TO PRINTING SYSTEMS, PRINTING PROCESSES, PRINTHEADS, DIGITAL IMAGING AND INK JET TECHNOLOGIES, AND THE COMPUTER SYSTEMS ENGINEERING, DESIGN AND DEVELOPMENT THEREOF; TECHNICAL SUPPORT, NAMELY, TROUBLESHOOTING COMPUTER HARDWARE AND SOFTWARE PROBLEMS PERTAINING TO PRINTING SYSTEMS COMPRISED OF COMPUTER OPERATED PRINTHEADS AND DIGITAL IMAGING AND INK JET CONTROL DEVICES; TECHNICAL CONSULTING AND ASSISTANCE WITH COMPUTER BASED INFORMATION SYSTEMS AND COMPONENTS USED IN THE PRINTING INDUSTRY FOR CUSTOM COLOR MATCHING TO BLEND INKS TO ACHIEVE A DESIRED COLOR; TECHNICAL CONSULTING AND ASSISTANCE IN THE FIELD OF COLOR MANAGEMENT IN THE PRE-PRESS, PROOFING AND PRINTING INDUSTRY; REAL TIME COMPUTER TECHNOLOGY SUPPORT SERVICES, NAMELY, HELP DESK SERVICES FOR THE COMMERCIAL PRINTING INDUSTRY, IN CLASS 42 (U.S. CLS. 100 AND 101).

FIRST USE 2-11-2010; IN COMMERCE 2-11-2010.

THE MARK CONSISTS OF STANDARD CHARACTERS WITHOUT CLAIM TO ANY PARTICULAR FONT, STYLE, SIZE, OR COLOR.

OWNER OF U.S. REG. NOS. 3,089,936, 3,092,797, AND 3,807,598.

SER. NO. 85-071,890, FILED 6-25-2010.

COLLEEN KEARNEY, EXAMINING ATTORNEY

United States of America

United States Patent and Trademark Office

KARDUS

Reg. No. 4,107,459

SWEDISH MATCH NORTH EUROPE AB (SWEDEN JOINT STOCK COMPANY)
SE-118 85

Registered Mar. 6, 2012

STOCKHOLM, SWEDEN

Int. Cl.: 34

FOR: TOBACCO; MATCHES; TOBACCO SUBSTITUTES NOT FOR MEDICAL PURPOSES; SNUFF AND TOBACCO ALTERNATIVES IN THE FORM OF PRODUCTS BASED ON VEGETABLE FIBERS, FOR ORAL USE NOT FOR CONSUMPTION; SNUFF; TOBACCO FREE SNUFF; HERBAL SNUFF, IN CLASS 34 (U.S. CLS. 2, 8, 9 AND 17).

TRADEMARK

PRINCIPAL REGISTER

OWNER OF ERPN CMNTY TM OFC REG. NO. 004545588, DATED 8-21-2006, EXPIRES 8-16-2015.

THE MARK CONSISTS OF THE WORD "KARDUS" WITH PARTS OF EACH LETTER MISSING.

THE ENGLISH TRANSLATION OF "KARDUS" IN THE MARK IS CARTOUCHE.

SER. NO. 85-076,166, FILED 7-1-2010.

LANA PHAM, EXAMINING ATTORNEY



David J. Kyjars

Director of the United States Patent and Trademark Office

United States of America

United States Patent and Trademark Office



Reg. No. 4,107,460

Registered Mar. 6, 2012

Int. Cl.: 33

TRADEMARK

PRINCIPAL REGISTER

CHUANKAI LIU (CHINA INDIVIDUAL)
NO.8 BUILDING 1,SINGLE DORM
WATER BUREAU THIRD FACTROY,SONGBAI TOWN
CHANGNING,HUNAN, CHINA

FOR: ALCOHOLIC BEVERAGES EXCEPT BEERS; ALCOHOLIC EXTRACTS; ARAK;
BRANDY; DISTILLED SPIRITS; FRUIT WINE; GRAPE WINE; SPIRITS AND LIQUEURS;
VODKA; WHISKY; WINES, IN CLASS 33 (U.S. CLS. 47 AND 49).

FIRST USE 4-2-2008; IN COMMERCE 4-2-2008.

THE MARK CONSISTS OF STYLIZED WORD "VINNOR", CAPITAL LETTER "V" AND A
KNIGHT ON A HORSE WITH A JAVELIN. THE LETTER "V" IS PLACED BEHIND THE
KNIGHT ON HORSEBACK.

SER. NO. 85-078,097, FILED 7-6-2010.

CURTIS FRENCH, EXAMINING ATTORNEY



David J. Kyros

Director of the United States Patent and Trademark Office

United States of America

United States Patent and Trademark Office

ZorbMax

Reg. No. 4,107,461

Registered Mar. 6, 2012

Int. Cl.: 5

TRADEMARK

PRINCIPAL REGISTER

LIVSMART 360, LLC (FLORIDA LIMITED LIABILITY COMPANY)
2829 CATTLEMEN ROAD
SARASOTA, FL 34232

FOR: NUTRITIONAL SUPPLEMENT INGREDIENT IN THE NATURE OF A BLEND OF ELECTROMAGNETICALLY CHARGED TRACE MINERAL ELEMENTS SOLD AS AN INTEGRAL COMPONENT OF MINERAL NUTRITIONAL SUPPLEMENTS, EXPRESSLY EXCLUDING NUTRITIONAL SUPPLEMENTS FOR GROWTH, NUTRITIONAL SUPPLEMENTS FOR THE TREATMENT OF GASTROENTEROLOGICAL DISEASES AND DISORDERS, HUMAN GROWTH HORMONE, RECOMBINANT GROWTH HORMONE, PHARMACEUTICAL PREPARATIONS FOR THE TREATMENT OF GROWTH HORMONE DISEASES AND DISORDERS, PHARMACEUTICAL PREPARATIONS FOR THE TREATMENT OF GASTROENTEROLOGICAL DISEASES AND DISORDERS, AND PHARMACEUTICAL PREPARATIONS FOR THE TREATMENT OF SHORT BOWEL SYNDROME, IN CLASS 5 (U.S. CLS. 6, 18, 44, 46, 51 AND 52).

FIRST USE 5-11-2010; IN COMMERCE 5-11-2010.

THE MARK CONSISTS OF STANDARD CHARACTERS WITHOUT CLAIM TO ANY PARTICULAR FONT, STYLE, SIZE, OR COLOR.

SER. NO. 85-079,347, FILED 7-7-2010.

JESSICA FATHY, EXAMINING ATTORNEY



David J. Kypos

Director of the United States Patent and Trademark Office

United States of America

United States Patent and Trademark Office

VICTUS

Reg. No. 4,107,462

Registered Mar. 6, 2012

Int. Cl.: 35

SERVICE MARK

PRINCIPAL REGISTER

VICTUS, INC. (FLORIDA CORPORATION)
4918 SOUTHWEST 74TH COURT
MIAMI, FL 33155

FOR: ON-LINE RETAIL STORE SERVICES FEATURING NUTRITIONAL PRODUCTS, IN CLASS 35 (U.S. CLS. 100, 101 AND 102).

FIRST USE 12-31-1996; IN COMMERCE 12-31-1996.

THE MARK CONSISTS OF STANDARD CHARACTERS WITHOUT CLAIM TO ANY PARTICULAR FONT, STYLE, SIZE, OR COLOR.

OWNER OF U.S. REG. NOS. 2,692,337 AND 3,061,807.

THE WORDING "VICTUS" HAS NO MEANING IN A FOREIGN LANGUAGE.

SER. NO. 85-079,560, FILED 7-7-2010.

FRED CARL, EXAMINING ATTORNEY



David J. Kyfos

Director of the United States Patent and Trademark Office

United States of America

United States Patent and Trademark Office

COTTON ISLAND

Reg. No. 4,107,463

NUAGE, INC. (TEXAS CORPORATION)
7115 HILL FOREST DR.
DALLAS, TX 75230

Registered Mar. 6, 2012

Int. Cl.: 35

FOR: ON-LINE RETAIL STORE SERVICES FEATURING CLOTHING; RETAIL CLOTHING STORES, IN CLASS 35 (U.S. CLS. 100, 101 AND 102).

SERVICE MARK

FIRST USE 3-6-1983; IN COMMERCE 3-6-1983.

PRINCIPAL REGISTER

THE MARK CONSISTS OF STANDARD CHARACTERS WITHOUT CLAIM TO ANY PARTICULAR FONT, STYLE, SIZE, OR COLOR.

NO CLAIM IS MADE TO THE EXCLUSIVE RIGHT TO USE "COTTON", APART FROM THE MARK AS SHOWN.

SER. NO. 85-079,666, FILED 7-7-2010.

VIVIAN MICZNIK FIRST, EXAMINING ATTORNEY



David J. Kybas

Director of the United States Patent and Trademark Office

United States of America

United States Patent and Trademark Office

BURNISHED VELVET

Reg. No. 4,107,464

Registered Mar. 6, 2012

Int. Cl.: 41

SERVICE MARK

PRINCIPAL REGISTER

CREATIVE MAKINGS ENTERPRISES (CANADA PARTNERSHIP)
19067 DEWDNEY TRUNK ROAD
PITT MEADOWS, BC, CANADA V3Y2R8

FOR: EDUCATIONAL SERVICES, NAMELY, CONDUCTING CLASSES AND TUTORIALS IN THE FIELDS OF CRAFTS, SCRAPBOOKING, PAPER CRAFT PROJECTS AND GLITTER CRAFT TECHNIQUES, AND DISTRIBUTION OF INSTRUCTIONAL AND TRAINING MATERIALS IN CONNECTION THEREWITH, IN CLASS 41 (U.S. CLS. 100, 101 AND 107).

THE MARK CONSISTS OF STANDARD CHARACTERS WITHOUT CLAIM TO ANY PARTICULAR FONT, STYLE, SIZE, OR COLOR.

PRIORITY CLAIMED UNDER SEC. 44(D) ON CANADA APPLICATION NO. 1,466,424, FILED 1-20-2010, REG. NO. TMA779,954, DATED 10-15-2010, EXPIRES 10-15-2025.

SER. NO. 85-080,416, FILED 7-8-2010.

HENRY S. ZAK, EXAMINING ATTORNEY



David J. Kybas

Director of the United States Patent and Trademark Office

United States of America

United States Patent and Trademark Office

MAXWELL'S

AT THE CLUB

Reg. No. 4,107,465

EAST BANC CLUB CORPORATION (ILLINOIS CORPORATION)
500 N. KINGSBURY STREET
CHICAGO, IL 60654

Registered Mar. 6, 2012

Int. Cl.: 43

FOR: PROVIDING CATERING AND RESTAURANT SERVICES, NAMELY, BAR, COCKTAIL, AND DINING FOR SPECIAL OCCASIONS, BREAKFAST, BRUNCH, LUNCH AND DINNER, IN CLASS 43 (U.S. CLS. 100 AND 101).

SERVICE MARK

FIRST USE 1-1-2009; IN COMMERCE 1-1-2009.

PRINCIPAL REGISTER

NO CLAIM IS MADE TO THE EXCLUSIVE RIGHT TO USE "CLUB", APART FROM THE MARK AS SHOWN.

SER. NO. 85-080,693, FILED 7-8-2010.

MARY CRAWFORD, EXAMINING ATTORNEY



David J. Kyffers

Director of the United States Patent and Trademark Office

United States of America

United States Patent and Trademark Office

BBright

Reg. No. 4,107,466

Registered Mar. 6, 2012

Int. Cls.: 12 and 25

TRADEMARK

PRINCIPAL REGISTER

VROOMEN/WHITE DESIGN INC. (CANADA CORPORATION)
15 LESWYN ROAD
TORONTO, ONTARIO, CANADA M6A1J8

FOR: BICYCLES; BICYCLE COMPONENTS, NAMELY, FRAMES, CRANK ARMS, SPINDLES, CRANK BEARINGS, BEARING CUPS AND BOTTOM BRACKET SHELL ASSEMBLIES CONTAINING CRANK ARMS, SPINDLES, CHAIN RINGS, CRANK BEARINGS, BOTTOM BRACKET BEARINGS AND BEARING CUPS, IN CLASS 12 (U.S. CLS. 19, 21, 23, 31, 35 AND 44).

FOR: T-SHIRTS, IN CLASS 25 (U.S. CLS. 22 AND 39).

THE MARK CONSISTS OF STANDARD CHARACTERS WITHOUT CLAIM TO ANY PARTICULAR FONT, STYLE, SIZE, OR COLOR.

PRIORITY CLAIMED UNDER SEC. 44(D) ON CANADA APPLICATION NO. 1488046, FILED 7-9-2010, REG. NO. TMA808115, DATED 10-3-2011, EXPIRES 10-3-2026.

SER. NO. 85-081,244, FILED 7-9-2010.

RAMONA ORTIGA, EXAMINING ATTORNEY



David J. Kypos

Director of the United States Patent and Trademark Office

United States of America

United States Patent and Trademark Office

KEYFEST

Reg. No. 4,107,467

MERRIAM MUSIC INC. (CANADA CORPORATION)
2359 BRISTOL CIRCLE

Registered Mar. 6, 2012

OAKVILLE, ONTARIO, CANADA L6H6P8

Int. Cls.: 35, 37 and 41

FOR: RETAIL STORE SERVICES FEATURING MUSICAL INSTRUMENTS, NAMELY, PIANOS, DIGITAL PIANOS, KEYBOARDS AND OTHER MUSICAL INSTRUMENTS AND ACCESSORIES AND BOOKS, IN CLASS 35 (U.S. CLS. 100, 101 AND 102).

SERVICE MARK

FOR: PIANO TUNING AND REPAIR, IN CLASS 37 (U.S. CLS. 100, 103 AND 106).

PRINCIPAL REGISTER

FOR: RENTING MUSICAL INSTRUMENTS, NAMELY, PIANOS, DIGITAL PIANOS, KEYBOARDS BRASS AND WOODWIND INSTRUMENTS AND PERCUSSION INSTRUMENTS, IN CLASS 41 (U.S. CLS. 100, 101 AND 107).

THE MARK CONSISTS OF STANDARD CHARACTERS WITHOUT CLAIM TO ANY PARTICULAR FONT, STYLE, SIZE, OR COLOR.

PRIORITY CLAIMED UNDER SEC. 44(D) ON CANADA APPLICATION NO. 1466507, FILED 1-20-2010, REG. NO. TMA795255, DATED 4-12-2011, EXPIRES 4-12-2026.

SER. NO. 85-088,274, FILED 7-20-2010.

EMILY CARLSEN, EXAMINING ATTORNEY



David J. Kyffers

Director of the United States Patent and Trademark Office

United States of America

United States Patent and Trademark Office



Reg. No. 4,107,468

Registered Mar. 6, 2012

Int. Cl.: 9

TRADEMARK

PRINCIPAL REGISTER

DA2 TECHNOLOGIES CORPORATION (TAIWAN CORPORATION)
4F., NO. 218, SEC. 3, DATONG ROAD
XIZHI CITY, TAIPEI, TAIWAN 221

FOR: TELEVISIONS; PROJECTORS, NAMELY, MOVIE PROJECTORS AND LIQUID CRYSTAL DISPLAY (LCD) PROJECTORS; PROJECTION SCREENS, NAMELY, SCREENS FOR MOVIE PROJECTORS AND LIQUID CRYSTAL DISPLAY (LCD) PROJECTORS; DVD DRIVES; TELEVISION CABLE CONVERTER BOXES; DIGITAL RADIO SIGNAL TUNERS; CD PLAYERS; AUDIO-VIDEO RECEIVERS; AUDIO SYSTEMS COMPRISED OF AUDIO SPEAKERS, AMPLIFIERS, STEREO RECEIVERS AND STEREO TRANSMITTERS; AND PERSONAL COMPUTERS, IN CLASS 9 (U.S. CLS. 21, 23, 26, 36 AND 38).

OWNER OF TAIWAN REG. NO. 01441354, DATED 12-1-2010, EXPIRES 11-30-2020.

THE MARK CONSISTS OF THE WORD "HORNCINEMA" IN STYLIZED FONT. THE LINE COMPRISING THE LEFT SIDE OF THE LETTER "H" APPEARS TO BE A CURVED HORN, WHILE THE LINE COMPRISING THE RIGHT SIDE OF THE LETTER "H" APPEARS TO BE A FLUTE. THE LETTER "C" IN "CINEMA" APPEARS TO BE A CURVED HORN.

SER. NO. 85-088,518, FILED 7-20-2010.

CHRISTOPHER BUONGIORNO, EXAMINING ATTORNEY



David J. Kyros

Director of the United States Patent and Trademark Office

United States of America
United States Patent and Trademark Office

BOO LA LA

Reg. No. 4,107,469

CAROL'S COSTUME CORNER LTD. (CANADA CORPORATION)
152 E. 2 STREET
NORTH VANCOUVER, BC, CANADA

Registered Mar. 6, 2012

Int. Cl.: 35

FOR: ONLINE RETAIL STORES AND RETAIL STORES FEATURING COSTUMES, WIGS
AND ACCESSORIES, IN CLASS 35 (U.S. CLS. 100, 101 AND 102).

SERVICE MARK

THE MARK CONSISTS OF STANDARD CHARACTERS WITHOUT CLAIM TO ANY PAR-
TICULAR FONT, STYLE, SIZE, OR COLOR.

PRINCIPAL REGISTER

OWNER OF CANADA REG. NO. TMA809475, DATED 10-19-2011, EXPIRES 10-19-2026.

SER. NO. 85-089,727, FILED 7-21-2010.

IRA J. GOODSaid, EXAMINING ATTORNEY



David J. Kyfos

Director of the United States Patent and Trademark Office

United States of America

United States Patent and Trademark Office

REPTISAND

Reg. No. 4,107,470

ZOO MED LABORATORIES, INC. (CALIFORNIA CORPORATION)
3650 SACRAMENTO DRIVE
SAN LUIS OBISPO, CA 93401

Registered Mar. 6, 2012

Int. Cl.: 31

FOR: PET LITTER FOR USE IN PET HABITATS, AQUARIUMS, TERRARIUMS AND CAGES,
IN CLASS 31 (U.S. CLS. 1 AND 46).

TRADEMARK

FIRST USE 4-1-1997; IN COMMERCE 4-1-1997.

PRINCIPAL REGISTER

THE MARK CONSISTS OF STANDARD CHARACTERS WITHOUT CLAIM TO ANY PAR-
TICULAR FONT, STYLE, SIZE, OR COLOR.

SER. NO. 85-090,137, FILED 7-22-2010.

KELLY TRUSILO, EXAMINING ATTORNEY



David J. Kybas

Director of the United States Patent and Trademark Office

United States of America

United States Patent and Trademark Office



Reg. No. 4,107,471

Registered Mar. 6, 2012

Int. Cl.: 35

OPTOMETRIC PHYSICIANS OF WASHINGTON (WASHINGTON NON-PROFIT CORPORATION)
SUITE 166
555 116TH AVE. NE
BELLEVUE, WA 98004

SERVICE MARK

PRINCIPAL REGISTER

FOR: ASSOCIATION SERVICES, NAMELY, PROMOTING THE INTERESTS OF MEMBERS OF THE OPTOMETRIC PROFESSION AND PROMOTING EYE CARE AND SAFETY TO MEMBERS OF THE ORGANIZATION AND TO THE GENERAL PUBLIC, IN CLASS 35 (U.S. CLS. 100, 101 AND 102).

FIRST USE 5-1-2002; IN COMMERCE 5-1-2002.

NO CLAIM IS MADE TO THE EXCLUSIVE RIGHT TO USE "OPTOMETRIC PHYSICIANS OF WASHINGTON", APART FROM THE MARK AS SHOWN.

THE COLOR(S) BLUE AND BLACK IS/ARE CLAIMED AS A FEATURE OF THE MARK.

THE MARK CONSISTS OF A STYLIZED BLUE HUMAN EYE UNDER A BLACK ARC TO THE LEFT OF THE WORDS "OPTOMETRIC PHYSICIANS OF WASHINGTON" IN BLACK.

SER. NO. 85-091,099, FILED 7-22-2010.

LAURIE KAUFMAN, EXAMINING ATTORNEY



David J. Kyffers

Director of the United States Patent and Trademark Office

United States of America

United States Patent and Trademark Office

DSP GOKYO FOOD&CHEMICAL

Reg. No. 4,107,472

Registered Mar. 6, 2012

Int. Cls.: 1 and 30

TRADEMARK

PRINCIPAL REGISTER

DAINIPPON SUMITOMO PHARMA CO., LTD. (JAPAN CORPORATION)
6-8, DOSHOMACHI 2-CHOME, CHUO-KU
OSAKA-SHI, OSAKA, JAPAN

FOR: STABILIZING AGENTS, NAMELY, SUSPENDING AGENTS, EMULSIFIERS AND ICE CRYSTAL STABILIZER FOR FOOD; GELATIN GLUE, NAMELY, GELATINIZING AGENTS FOR FOOD; FOOD PRESERVATIVE COMPOSITIONS; EMULSIFIERS FOR USE IN THE MANUFACTURE OF FOOD; SURFACTANTS FOR USE IN THE MANUFACTURE OF SYNTHETIC DETERGENTS; ORGANIC ACIDS AND THEIR SALTS, NAMELY, BENZOIC ACID, ACETIC ACID, TANNIC ACID; CHEMICAL AGENTS FOR PHOTORESISTS USED IN THE MANUFACTURE OF SEMICONDUCTORS; VISCOSITY MODIFIERS FOR PREPARING COSMETICS, NAMELY, POLYMERS AND POLYMERIC ADDITIVES FOR USE IN THE MANUFACTURE OF COSMETICS; PHYSICALITY MODIFIERS FOR PREPARING COSMETICS, NAMELY, POLYMERS AND POLYMERIC ADDITIVES FOR USE IN THE MANUFACTURE OF COSMETICS; ULTRAVIOLET ABSORBERS FOR PREPARING COSMETICS, NAMELY, POLYMERS AND POLYMERIC ADDITIVES FOR USE IN THE MANUFACTURE OF COSMETICS; MOISTURIZING AGENTS FOR PREPARING COSMETICS, NAMELY, POLYMERS AND POLYMERIC ADDITIVES FOR USE IN THE MANUFACTURE OF COSMETICS; OTHER CHEMICALS, NAMELY, CHEMICALS FOR USE IN INDUSTRY; ARTIFICIAL SWEETENERS; UNPROCESSED PLASTICS IN PRIMARY FORM; AND AROMATIC PREPARATIONS FOR USE IN THE MANUFACTURE OF FOOD, NOT FROM ESSENTIAL OILS; THICKENING AGENTS FOR USE IN INDUSTRIAL FOOD PROCESSING, NAMELY, FOOD POLYSACCHARIDES FOR USE AS FOOD THICKENERS FOR PROCESSING FOOD, IN CLASS 1 (U.S. CLS. 1, 5, 6, 10, 26 AND 46).

FOR: SEASONINGS; SPICES; HUSKED RICE; HUSKED OATS; HUSKED BARLEY; FLOUR FOR FOOD; GLUTEN FOR FOOD, IN CLASS 30 (U.S. CL. 46).

THE MARK CONSISTS OF STANDARD CHARACTERS WITHOUT CLAIM TO ANY PARTICULAR FONT, STYLE, SIZE, OR COLOR.

PRIORITY CLAIMED UNDER SEC. 44(D) ON JAPAN APPLICATION NO. 2010-005845, FILED 1-28-2010, REG. NO. 5440237, DATED 9-22-2011, EXPIRES 9-22-2021.

NO CLAIM IS MADE TO THE EXCLUSIVE RIGHT TO USE "FOOD & CHEMICAL", APART FROM THE MARK AS SHOWN.



David J. Kyjars

Director of the United States Patent and Trademark Office

Reg. No. 4,107,472 THE WORDING "GOKYO" HAS NO MEANING IN A FOREIGN LANGUAGE.

SER. NO. 85-091,495, FILED 7-23-2010.

BENJAMIN OKEKE, EXAMINING ATTORNEY

United States of America

United States Patent and Trademark Office

 redlambda

Reg. No. 4,107,473

Registered Mar. 6, 2012

Int. Cls.: 9 and 42

TRADEMARK

SERVICE MARK

PRINCIPAL REGISTER

RED LAMBDA, INC. (FLORIDA CORPORATION)
SUITE 6184
2180 WEST STATE ROAD 434
LONGWOOD, FL 32779

FOR: COMPUTER SOFTWARE FOR NETWORK SECURITY, IDENTITY MANAGEMENT, AND NETWORK MANAGEMENT; COMPUTER SOFTWARE FOR APPLICATION AND DATABASE INTEGRATION; COMPUTER SOFTWARE FOR CREATING SEARCHABLE DATABASES OF INFORMATION AND DATA; COMPUTER SOFTWARE PLATFORMS FOR NETWORK SECURITY; COMPUTER SOFTWARE FOR NETWORK TRAFFIC MANAGEMENT AND NETWORK-BASED STORAGE; ENTERPRISE SOFTWARE IN THE NATURE OF A DATABASE FOR NON-TRANSACTIONAL DATA AND A SEARCH ENGINE FOR DATABASE CONTENT; COMPUTER SOFTWARE FOR INFORMATION AND DATA CACHING AND INFORMATION AND DATA MANAGEMENT; COMPUTER SOFTWARE FOR GRID COMPUTING, NAMELY, PROVIDING SEAMLESS ACCESS TO COMPUTING POWER, MEMORY AND DATA STORAGE CAPACITY DISTRIBUTED ACROSS A MULTIPLE NETWORK-BASED COMPUTING DEVICES, IN CLASS 9 (U.S. CLS. 21, 23, 26, 36 AND 38).

FIRST USE 7-23-2010; IN COMMERCE 7-23-2010.

FOR: CLOUD COMPUTING SERVICES IN THE FIELD OF NETWORK SECURITY, IDENTITY MANAGEMENT, AND NETWORK MANAGEMENT; COMPUTER SERVICES FOR OTHERS, NAMELY, OPTIMIZATION OF SCALABILITY AND PERFORMANCE OF WEB SITES, REMOTE AND ON-SITE MANAGEMENT OF CLOUD COMPUTING SOFTWARE AND SYSTEMS, COMPUTER NETWORK CONFIGURATION, SOFTWARE MAINTENANCE; COMPUTER SOFTWARE DEVELOPMENT SERVICES FOR OTHERS IN THE FIELD OF NETWORK TRAFFIC MANAGEMENT; CONSULTING SERVICES IN THE FIELDS OF CLOUD COMPUTING AND NETWORK SECURITY; COMPUTER SOFTWARE DEVELOPMENT AND PROGRAMMING SERVICES FOR OTHERS IN THE NATURE OF NETWORK SECURITY PROGRAMMING AND DATABASE CONTENT PROGRAMMING; APPLICATION SERVICE PROVIDER (ASP) FEATURING NON-DOWNLOADABLE COMPUTER SOFTWARE FOR USE IN DATABASE MANAGEMENT, NETWORK MANAGEMENT AND NETWORK SECURITY; COMPUTER SOFTWARE AS A SERVICE (SAAS) FEATURING SOFTWARE IN THE FIELD OF NETWORK SECURITY AND NETWORK MANAGEMENT AND FOR USE IN DATABASE MANAGEMENT, IN CLASS 42 (U.S. CLS. 100 AND 101).

FIRST USE 7-23-2010; IN COMMERCE 7-23-2010.



David J. Kyjars

Director of the United States Patent and Trademark Office

Reg. No. 4,107,473 THE MARK CONSISTS OF THE GREEK SYMBOL "LAMBDA" WITH THE WORDS "RED LAMBDA".

SER. NO. 85-091,810, FILED 7-23-2010.

NAPOLEON SHARMA, EXAMINING ATTORNEY

United States of America

United States Patent and Trademark Office

HOUSE OF OXFORD

Reg. No. 4,107,474

GOLDMAN, ALEX (UNITED STATES INDIVIDUAL)
P.O. BOX 6030
SOMERSET, NJ 08875

Registered Mar. 6, 2012

Int. Cl.: 34

FOR: CIGARS, IN CLASS 34 (U.S. CLS. 2, 8, 9 AND 17).

TRADEMARK

FIRST USE 7-21-2010; IN COMMERCE 7-21-2010.

PRINCIPAL REGISTER

THE MARK CONSISTS OF STANDARD CHARACTERS WITHOUT CLAIM TO ANY PARTICULAR FONT, STYLE, SIZE, OR COLOR.

SER. NO. 85-091,859, FILED 7-23-2010.

JEFFERY COWARD, EXAMINING ATTORNEY



David J. Kybas

Director of the United States Patent and Trademark Office

United States of America

United States Patent and Trademark Office

STARTRADERS

Reg. No. 4,107,475

CALDERA LABS, INC. (DELAWARE CORPORATION)
6715 ELVERTON DRIVE
OAKLAND, CA 94611

Registered Mar. 6, 2012

Int. Cl.: 41

FOR: ENTERTAINMENT SERVICES, NAMELY, PROVIDING A SCIENCE-FICTION BASED MULTIPLAYER ONLINE ROLE-PLAYING GAME, IN CLASS 41 (U.S. CLS. 100, 101 AND 107).

SERVICE MARK

FIRST USE 6-3-2010; IN COMMERCE 6-3-2010.

PRINCIPAL REGISTER

THE MARK CONSISTS OF STANDARD CHARACTERS WITHOUT CLAIM TO ANY PARTICULAR FONT, STYLE, SIZE, OR COLOR.

SER. NO. 85-094,113, FILED 7-27-2010.

SARA BENJAMIN, EXAMINING ATTORNEY



David J. Kyffers

Director of the United States Patent and Trademark Office

United States of America

United States Patent and Trademark Office

SKINOMICS

Reg. No. 4,107,476

Registered Mar. 6, 2012

Int. Cl.: 3

TRADEMARK

PRINCIPAL REGISTER

AMOREPACIFIC CORPORATION (REPUBLIC OF KOREA CORPORATION)
181, 2GA, HANGANG-RO, YONGSAN-GU
SEOUL, REPUBLIC OF KOREA 140-777

FOR: COSMETICS; COSMETIC CREAMS; LOTIONS FOR COSMETIC PURPOSES; TOILET WATER; COSMETIC PREPARATIONS FOR SKIN CARE; CREAMY FOUNDATIONS; MAKE-UP POWDER; MASCARA; EYE SHADOWS; LIPSTICKS; BODY LOTIONS; HAIR SHAMPOOS; HAIR RINSE; HAIR CONDITIONER; HAIR CREAMS; HAIR LOTIONS; HAIR MOUSSE; HAIR CARE LOTIONS; HAIR CONDITIONING OIL; BATH OIL FOR HAIR CARE; HAIR NOURISHER; HAIR COLORANTS; HAIR TONIC; DENTIFRICES; DETERGENT FOR HOUSEHOLD USE; POLISHING WAX; FUMIGATION INCENSE; PET FRAGRANCE, IN CLASS 3 (U.S. CLS. 1, 4, 6, 50, 51 AND 52).

THE MARK CONSISTS OF STANDARD CHARACTERS WITHOUT CLAIM TO ANY PARTICULAR FONT, STYLE, SIZE, OR COLOR.

PRIORITY CLAIMED UNDER SEC. 44(D) ON REPUBLIC OF KOREA APPLICATION NO. 40-2010-0030, FILED 6-9-2010, REG. NO. TM1009547E, DATED 7-28-2010, EXPIRES 7-28-2020.

SER. NO. 85-094,840, FILED 7-28-2010.

LEIGH LOWRY, EXAMINING ATTORNEY



David J. Kyros

Director of the United States Patent and Trademark Office

United States of America

United States Patent and Trademark Office

gamutco

Reg. No. 4,107,477

Registered Mar. 6, 2012

Int. Cl.: 35

SERVICE MARK

PRINCIPAL REGISTER

GAMUTCO, LLC (COLORADO LIMITED LIABILITY COMPANY)
PO BOX 729
825 WHITEROCK AVE.
CRESTED BUTTE, CO 81224

FOR: BUSINESS SERVICES, NAMELY, BUSINESS CONSULTING AND PROJECT MANAGEMENT SERVICES FOR OTHERS FOR BUSINESS PURPOSES FOR INTERNATIONAL SPORTS EVENT AND LIVE SHOW INDUSTRIES, IN CLASS 35 (U.S. CLS. 100, 101 AND 102).

FIRST USE 7-14-2010; IN COMMERCE 7-14-2010.

THE MARK CONSISTS OF STANDARD CHARACTERS WITHOUT CLAIM TO ANY PARTICULAR FONT, STYLE, SIZE, OR COLOR.

THE WORDING "GAMUTCO" HAS NO MEANING IN A FOREIGN LANGUAGE.

SER. NO. 85-096,019, FILED 7-29-2010.

LINDA ESTRADA, EXAMINING ATTORNEY



David J. Kybas

Director of the United States Patent and Trademark Office

United States of America

United States Patent and Trademark Office



Reg. No. 4,107,478

Registered Mar. 6, 2012

Int. Cl.: 25

TRADEMARK

PRINCIPAL REGISTER

MAY L. ZAPATA (UNITED STATES INDIVIDUAL)
5143 NEWCOME DRIVE
SAN ANTONIO, TX 78229 AND

PATRICIA A. ZAPATA (UNITED STATES INDIVIDUAL)
5143 NEWCOME DRIVE
SAN ANTONIO, TX 78229

FOR: CLOTHING, NAMELY, JACKETS, BASEBALL CAPS, AND T-SHIRTS, IN CLASS 25
(U.S. CLS. 22 AND 39).

FIRST USE 3-1-2004; IN COMMERCE 3-1-2004.

THE MARK CONSISTS OF THE DESIGN OF A MOTION PICTURE CLAPBOARD IN BLACK AND WHITE COLORS. INSIDE THE BOARD ARE THE STYLIZED WORDINGS "TXTIF" IN RED AND "CREW" AND "PIONEERING TO NEW HEIGHTS" IN WHITE COLOR, AGAINST A BLACK BACKGROUND.

THE COLOR(S) BLACK, WHITE AND RED IS/ARE CLAIMED AS A FEATURE OF THE MARK.

SER. NO. 85-097,360, FILED 7-30-2010.

DAWN HAN, EXAMINING ATTORNEY



David J. Kybas

Director of the United States Patent and Trademark Office

United States of America

United States Patent and Trademark Office

THE 99

Reg. No. 4,107,479

TESHKEEL MEDIA GROUP, INC. (DELAWARE CORPORATION)
FIVE PENN PLAZA, SUITE 2337
NEW YORK, NY 10001

Registered Mar. 6, 2012

Int. Cl.: 28

FOR: TOY VEHICLES, STUFFED ANIMALS, BEACH BALLS, FLYING DISCS, IN CLASS 28 (U.S. CLS. 22, 23, 38 AND 50).

TRADEMARK

FIRST USE 3-15-2009; IN COMMERCE 3-15-2009.

PRINCIPAL REGISTER

THE MARK CONSISTS OF STANDARD CHARACTERS WITHOUT CLAIM TO ANY PARTICULAR FONT, STYLE, SIZE, OR COLOR.

OWNER OF U.S. REG. NOS. 3,370,631, 3,607,691 AND OTHERS.

SER. NO. 85-098,761, FILED 8-3-2010.

SUNG IN, EXAMINING ATTORNEY



David J. Kybas

Director of the United States Patent and Trademark Office

United States of America

United States Patent and Trademark Office

Absolute Action MMA

Reg. No. 4,107,480

Registered Mar. 6, 2012

Int. Cls.: 25 and 41

TRADEMARK

SERVICE MARK

PRINCIPAL REGISTER

PJP INVESTMENTS, LLC (KENTUCKY LIMITED LIABILITY COMPANY)
SUITE 201
330 THOMAS MORE PARKWAY
CRESTVIEW HILLS, KY 41017

FOR: T-SHIRTS, IN CLASS 25 (U.S. CLS. 22 AND 39).

FIRST USE 3-10-2010; IN COMMERCE 3-10-2010.

FOR: ENTERTAINMENT SERVICES IN THE NATURE OF LIVE MIXED MARTIAL ARTS (MMA) EVENTS; ORGANIZING LIVE MIXED MARTIAL ARTS EVENTS AND COMPETITIONS; PRESENTATION OF MIXED MARTIAL ARTS (MMA) EVENTS, IN CLASS 41 (U.S. CLS. 100, 101 AND 107).

FIRST USE 3-10-2010; IN COMMERCE 3-10-2010.

THE MARK CONSISTS OF STANDARD CHARACTERS WITHOUT CLAIM TO ANY PARTICULAR FONT, STYLE, SIZE, OR COLOR.

NO CLAIM IS MADE TO THE EXCLUSIVE RIGHT TO USE "ACTION MMA", APART FROM THE MARK AS SHOWN.

SER. NO. 85-099,819, FILED 8-4-2010.

DOMINIC J. FERRAIUOLO, EXAMINING ATTORNEY



David J. Kybas

Director of the United States Patent and Trademark Office

United States of America

United States Patent and Trademark Office

Yensid

Reg. No. 4,107,481

Registered Mar. 6, 2012

Int. Cl.: 41

SERVICE MARK

PRINCIPAL REGISTER

PIRK, STEPHEN EDWARD (UNITED STATES INDIVIDUAL)
3471 PERRY AVE NE
BREMERTON, WA 98310

FOR: PROVIDING AUDIO-VISUAL ENTERTAINMENT AND EDUCATIONAL SERVICES, NAMELY, NON-DOWNLOADABLE MOTION PICTURES IN THE FIELD OF TECHNOLOGY VIA A VIDEO-ON-DEMAND SERVICE; ONGOING RADIO PROGRAMS IN THE NATURE OF PODCASTS AND ONGOING VIDEO PRESENTATIONS IN THE NATURE OF PODCASTS IN THE FIELD OF TECHNOLOGY, ALL OF THE AFOREMENTIONED DELIVERED VIA GLOBAL COMPUTER NETWORKS; PROVIDING AUDIOVISUAL ENTERTAINMENT, NAMELY, NON-DOWNLOADABLE MOTION PICTURES IN THE FIELD OF SCIENCE FICTION VIA A VIDEO-ON-DEMAND SERVICE; ONGOING RADIO PROGRAMS IN THE NATURE OF PODCASTS AND ONGOING VIDEO PRESENTATIONS IN THE NATURE OF PODCASTS IN THE FIELD OF SCIENCE FICTION, ALL OF THE AFOREMENTIONED DELIVERED VIA A GLOBAL COMPUTER NETWORKS; PROVIDING EDUCATIONAL SERVICES IN THE FORM OF SEMINARS, CLASSROOM INSTRUCTION, AND TUTORING AT EDUCATIONAL INSTITUTIONS FOR ALL AGE LEVELS IN THE FIELD OF TECHNOLOGY, IN CLASS 41 (U.S. CLS. 100, 101 AND 107).

FIRST USE 6-22-1999; IN COMMERCE 6-22-1999.

THE MARK CONSISTS OF STANDARD CHARACTERS WITHOUT CLAIM TO ANY PARTICULAR FONT, STYLE, SIZE, OR COLOR.

THE WORDING "YENSID" HAS NO MEANING IN A FOREIGN LANGUAGE.

SER. NO. 85-100,429, FILED 8-4-2010.

CHRISTINA SOBRAL, EXAMINING ATTORNEY



David J. Kybas

Director of the United States Patent and Trademark Office

United States of America

United States Patent and Trademark Office



Reg. No. 4,107,482

Registered Mar. 6, 2012

Int. Cls.: 16 and 25

TRADEMARK

PRINCIPAL REGISTER

MARY L. ZAPATA (UNITED STATES INDIVIDUAL)
5143 NEWCOME DRIVE
SAN ANTONIO, TX 78229 AND

PATRICIA A. ZAPATA (UNITED STATES INDIVIDUAL)
5143 NEWCOME DRIVE
SAN ANTONIO, TX 78229

FOR: POSTERS, IN CLASS 16 (U.S. CLS. 2, 5, 22, 23, 29, 37, 38 AND 50).

FIRST USE 3-1-2004; IN COMMERCE 3-1-2004.

FOR: CLOTHING, JACKETS, BASEBALL CAPS, T-SHIRTS, SWEATSHIRTS, POLO SHIRTS,
IN CLASS 25 (U.S. CLS. 22 AND 39).

FIRST USE 3-1-2004; IN COMMERCE 3-1-2004.

THE MARK CONSISTS OF THE STYLIZED RED WORDING "TXTIF" APPEARING ON A MOVIE CLAPBOARD DESIGN IN THE COLORS OF BROWN, WHITE AND BLACK. THIS IS SUPERIMPOSED BY THE DESIGN OF A BANNER IN THE COLOR OF WHITE, OUTLINED IN GREY. THE WORDING "A FESTIVAL OF FILMS" IN GREY COLOR APPEARS ON THE BANNER. A DIAGONAL DESIGN RESEMBLING LIGHT RAYS IN THE COLORS OF BLUE, LIGHT BLUE, SILVER GRAY AND WHITE APPEARS ON THE TOP OF THE CLAPBOARD AND BANNER DESIGNS. THESE DESIGNS SIT ABOVE A RECTANGULAR LIGHT BLUE AND BLUE HORIZONTAL BAR DESIGN AND AGAINST A BLACK BACKGROUND.

THE COLOR(S) RED, WHITE, BROWN, GREY, BLACK, BLUE, SILVER GRAY AND LIGHT BLUE IS/ARE CLAIMED AS A FEATURE OF THE MARK.

SER. NO. 85-100,477, FILED 8-4-2010.

DAWN HAN, EXAMINING ATTORNEY



David J. Kybas

Director of the United States Patent and Trademark Office

United States of America

United States Patent and Trademark Office

PURO

Reg. No. 4,107,483

Registered Mar. 6, 2012

Int. Cls.: 8 and 21

TRADEMARK

PRINCIPAL REGISTER

GLOBAL ONE-PAK LIMITED (UNITED KINGDOM LIMITED COMPANY (LTD.))
HYDE PARK HOUSE
CARTWRIGHT STREET, NEWTON
HYDE, CHESHIRE, UNITED KINGDOM SK144EH

FOR: HAND-OPERATED SPRAYERS FOR USE WITH INDUSTRIAL LIQUIDS, SOLD EMPTY; REPLACEMENT PARTS AND FITTINGS THEREFORE, NAMELY, NOZZLES, SHROUDS, PUMP BODIES, PUMPS, HANDLES, ACTUATORS, TRIGGERS, SPRINGS, SEALS, O-RINGS, WADS, WAD ASSEMBLIES, CAP LINERS, CAP LINER ASSEMBLIES, CLOSURES, CLOSURE CAPS, DIP TUBES, CONTAINERS, BOTTLES, IN CLASS 8 (U.S. CLS. 23, 28 AND 44).

FOR: MANUALLY ACTUATED PUMP DISPENSERS FOR ATTACHMENT TO CONTAINERS FOR USE IN DISPENSING LIQUIDS, AND PLASTIC SPRAY NOZZLES AND BOTTLES, SOLD EMPTY; REPLACEMENT PARTS AND FITTINGS THEREFORE, NAMELY, NOZZLES, SHROUDS, PUMP BODIES, PUMPS, HANDLES, ACTUATORS, TRIGGERS, SPRINGS, SEALS, O-RINGS, WADS, WAD ASSEMBLIES, CAP LINERS, CAP LINER ASSEMBLIES, CLOSURES, CLOSURE CAPS, DIP TUBES, CONTAINERS, BOTTLES, IN CLASS 21 (U.S. CLS. 2, 13, 23, 29, 30, 33, 40 AND 50).

THE MARK CONSISTS OF STANDARD CHARACTERS WITHOUT CLAIM TO ANY PARTICULAR FONT, STYLE, SIZE, OR COLOR.

PRIORITY CLAIMED UNDER SEC. 44(D) ON ERPN CMNTY TM OFC APPLICATION NO. 9278185, FILED 7-28-2010, REG. NO. 009278185, DATED 1-18-2011, EXPIRES 7-28-2020.

THE ENGLISH TRANSLATION OF "PURO" IN THE MARK IS "PURE".

SER. NO. 85-100,917, FILED 8-5-2010.

ALLISON SCHRODY, EXAMINING ATTORNEY



David J. Kybas

Director of the United States Patent and Trademark Office

United States of America

United States Patent and Trademark Office

AMERIMAC

Reg. No. 4,107,484

AMERIMAC CAL-WEST FINANCIAL, INC. (CALIFORNIA CORPORATION)
1725 S. BASCOM AVENUE, SUITE 100
CAMPBELL, CA 95008

Registered Mar. 6, 2012

Int. Cl.: 36

FOR: FINANCIAL SERVICES, NAMELY, MORTGAGE BROKERAGE SERVICES, IN CLASS 36 (U.S. CLS. 100, 101 AND 102).

SERVICE MARK

FIRST USE 6-24-1988; IN COMMERCE 6-24-1988.

PRINCIPAL REGISTER

THE MARK CONSISTS OF STANDARD CHARACTERS WITHOUT CLAIM TO ANY PARTICULAR FONT, STYLE, SIZE, OR COLOR.

SER. NO. 85-106,279, FILED 8-12-2010.

PAUL E. FAHRENKOPF, EXAMINING ATTORNEY



David J. Kyffers

Director of the United States Patent and Trademark Office

United States of America

United States Patent and Trademark Office

casa

Reg. No. 4,107,485

Registered Mar. 6, 2012

Int. Cl.: 20

TRADEMARK

PRINCIPAL REGISTER

CASA OTURMA GRUPLARI MOBILYA IMALAT ITHALAT IHRACAT SANAYI VE TICARET
LIMITED SIRKETI (TURKEY LIMITED LIABILITY COMPANY)
CANKIRI BULVARI NO: 103 AKYURT
ANKARA, TURKEY

FOR: ARMCHAIRS, SOFAS, SETTEES, DIVANS, BENCHES, DECKCHAIRS, CHAIRS, SEATS,
STOOLS, BEDS, BED FRAMES, CUPBOARDS, WARDROBES, DRESSING TABLES, SIDE-
BOARDS, CABINETS, BOOKCASES, SHELVES, CHESTS OF DRAWERS, SWING ARM-
CHAIRS, BUNK BEDS, TABLES, COAT STANDS AND HANGER, AND FLOWER STANDS,
IN CLASS 20 (U.S. CLS. 2, 13, 22, 25, 32 AND 50).

OWNER OF TURKEY REG. NO. 200771342, DATED 10-16-2009, EXPIRES 10-16-2019.

OWNER OF U.S. REG. NO. 2,959,073.

THE MARK CONSISTS OF THE WORD "CASA" IN STYLIZED FORM.

SEC. 2(F).

SER. NO. 85-107,635, FILED 8-14-2010.

MELISSA VALLILLO, EXAMINING ATTORNEY



David J. Kyros

Director of the United States Patent and Trademark Office

United States of America

United States Patent and Trademark Office

ZIFF DAVIS

Reg. No. 4,107,486

Registered Mar. 6, 2012

Int. Cl.: 41

SERVICE MARK

PRINCIPAL REGISTER

ZIFF DAVIS, INC. (DELAWARE CORPORATION)
11TH FLOOR, LEGAL DEPT.
28 EAST 28TH STREET
NEW YORK, NY 10016

FOR: ONLINE PUBLICATIONS, NAMELY MAGAZINES IN THE FIELDS OF COMPUTERS, COMPUTING, COMPUTER NETWORKS AND NETWORKING, BUSINESS, TECHNOLOGY, INFORMATION TECHNOLOGY, COMMUNICATIONS, AND INTERACTIVE AND ONLINE SERVICES, IN CLASS 41 (U.S. CLS. 100, 101 AND 107).

FIRST USE 4-5-2000; IN COMMERCE 4-5-2000.

THE MARK CONSISTS OF STANDARD CHARACTERS WITHOUT CLAIM TO ANY PARTICULAR FONT, STYLE, SIZE, OR COLOR.

OWNER OF U.S. REG. NOS. 2,602,167, 3,094,281 AND OTHERS.

THE NAME(S), PORTRAIT(S), AND/OR SIGNATURE(S) SHOWN IN THE MARK DOES NOT IDENTIFY A PARTICULAR LIVING INDIVIDUAL.

SER. NO. 85-108,033, FILED 8-16-2010.

DEZMONA MIZELLE, EXAMINING ATTORNEY



David J. Kyffers

Director of the United States Patent and Trademark Office

United States of America

United States Patent and Trademark Office

Renfrew Tape

Reg. No. 4,107,487

Registered Mar. 6, 2012

Int. Cl.: 28

TRADEMARK

PRINCIPAL REGISTER

SCAPA NORTH AMERICA INC. (CONNECTICUT CORPORATION)
WWW.SCAPANA.COM
111 GREAT POND DRIVE
WINDSOR, CT 06095

FOR: ATHLETIC SPORTING GOODS, NAMELY, ADHESIVE TAPE FOR HOCKEY STICK AND UNIFORM SUPPORT, IN CLASS 28 (U.S. CLS. 22, 23, 38 AND 50).

FIRST USE 4-29-1997; IN COMMERCE 4-29-1997.

THE MARK CONSISTS OF STANDARD CHARACTERS WITHOUT CLAIM TO ANY PARTICULAR FONT, STYLE, SIZE, OR COLOR.

OWNER OF U.S. REG. NO. 3,701,484.

NO CLAIM IS MADE TO THE EXCLUSIVE RIGHT TO USE "TAPE", APART FROM THE MARK AS SHOWN.

SER. NO. 85-108,485, FILED 8-16-2010.

WENDY JUN, EXAMINING ATTORNEY



David J. Kyros

Director of the United States Patent and Trademark Office

United States of America

United States Patent and Trademark Office

RAYSURE

Reg. No. 4,107,488

Registered Mar. 6, 2012

Int. Cls.: 9, 42 and 45

TRADEMARK

SERVICE MARK

PRINCIPAL REGISTER

QINETIQ LIMITED (UNITED KINGDOM CORPORATION)
85 BUCKINGHAM GATE
LONDON, UNITED KINGDOM SW1E6PD

FOR: INSTRUMENTS AND APPARATUS FOR RECORDING, MEASURING, FORECASTING, MONITORING, WARNING OF AND DETECTING RADIATION LEVELS, EXPOSURE TO RADIATION AND RADIATION HAZARDS, INCLUDING THE AFORESAID FOR USE IN AIRCRAFT AND SPACE VEHICLES; RADIATION DOSIMETERS; COMPUTER SOFTWARE AND HARDWARE FOR EVALUATING AND FORECASTING RADIATION DATA, IN CLASS 9 (U.S. CLS. 21, 23, 26, 36 AND 38).

FOR: SCIENTIFIC ANALYSIS AND EVALUATION OF DATA RELATING TO RADIATION LEVELS, RADIATION HAZARDS AND EXPOSURE TO RADIATION, EXCLUDING SAFETY ANALYSIS AND EVALUATION; PREPARATION OF SCIENTIFIC REPORTS ON RADIATION LEVELS, RADIATION HAZARDS AND EXPOSURE TO RADIATION, EXCLUDING SAFETY REPORTS; PROVIDING SCIENTIFIC INFORMATION, CONSULTANCY AND ADVISORY SERVICES RELATING TO FORECASTING, DETECTION, MONITORING AND MEASURING OF RADIATION LEVELS, RADIATION HAZARDS AND EXPOSURE TO RADIATION, EXCLUDING RADIATION SAFETY, IN CLASS 42 (U.S. CLS. 100 AND 101).

FOR: SAFETY ANALYSIS AND EVALUATION OF DATA RELATING TO RADIATION LEVELS, RADIATION HAZARDS AND EXPOSURE TO RADIATION; PREPARATION OF SAFETY REPORTS ON RADIATION LEVELS, RADIATION HAZARDS AND EXPOSURE TO RADIATION; PROVIDING INFORMATION, CONSULTANCY AND ADVISORY SERVICES RELATING TO RADIATION SAFETY, NAMELY, FORECASTING, DETECTION, MONITORING AND MEASURING OF RADIATION LEVELS, RADIATION HAZARDS AND EXPOSURE TO RADIATION, IN CLASS 45 (U.S. CLS. 100 AND 101).

THE MARK CONSISTS OF STANDARD CHARACTERS WITHOUT CLAIM TO ANY PARTICULAR FONT, STYLE, SIZE, OR COLOR.

PRIORITY CLAIMED UNDER SEC. 44(D) ON ERPN CMNTY TM OFC APPLICATION NO. 008996902, FILED 3-31-2010, REG. NO. 008996902, DATED 9-20-2010, EXPIRES 3-31-2020.

SER. NO. 85-110,415, FILED 8-18-2010.

BRIAN PINO, EXAMINING ATTORNEY



David J. Kyffers

Director of the United States Patent and Trademark Office

United States of America

United States Patent and Trademark Office

Z CALC

Reg. No. 4,107,489

Registered Mar. 6, 2012

Int. Cl.: 9

TRADEMARK

PRINCIPAL REGISTER

CARL ZEISS MEDITEC AG (FED REP GERMANY CORPORATION)
GOESCHWITZER STRASSE 51-52
JENA, FED REP GERMANY 07745

FOR: SOFTWARE USED IN OPHTHALMIC SURGERY TO PROVIDE POST-OPERATIVE REFRACTION DATA, IN CLASS 9 (U.S. CLS. 21, 23, 26, 36 AND 38).

THE MARK CONSISTS OF STANDARD CHARACTERS WITHOUT CLAIM TO ANY PARTICULAR FONT, STYLE, SIZE, OR COLOR.

PRIORITY CLAIMED UNDER SEC. 44(D) ON FED REP GERMANY APPLICATION NO. 302010040790, FILED 7-2-2010, REG. NO. 302010040790, DATED 9-20-2010, EXPIRES 7-31-2020.

NO CLAIM IS MADE TO THE EXCLUSIVE RIGHT TO USE "CALC", APART FROM THE MARK AS SHOWN.

SER. NO. 85-110,507, FILED 8-18-2010.

DEIRDRE ROBERTSON, EXAMINING ATTORNEY



David J. Kybas

Director of the United States Patent and Trademark Office

United States of America

United States Patent and Trademark Office



Reg. No. 4,107,490

Registered Mar. 6, 2012

Int. Cl.: 35

SERVICE MARK

PRINCIPAL REGISTER

SEED OF SOLACE LLC (WASHINGTON LIMITED LIABILITY COMPANY)
HTTP://WWW.SEEDOF SOLACE.COM/
15411 SE 53RD PL
BELLEVUE, WA 98006

FOR: ON-LINE RETAIL STORE SERVICES FEATURING MESSENGER BAGS, SHOULDER BAGS, BACKPACKS, APPAREL AND CAMPING GEAR, IN CLASS 35 (U.S. CLS. 100, 101 AND 102).

FIRST USE 6-24-2010; IN COMMERCE 6-24-2010.

THE MARK CONSISTS OF A CIRCULAR OUTER-LAYER ENCOMPASSES THE CIRCULAR GRAPHIC IN THE MIDDLE. WITHIN THE CIRCULAR GRAPHIC, AT THE CENTER CONTAINS AN UPPER "S" SHAPED GRAPHIC AND A LOWER "S" SHAPED GRAPHIC CONNECTING TOGETHER.

SER. NO. 85-112,966, FILED 8-22-2010.

THOMAS MANOR, EXAMINING ATTORNEY



David J. Kybas

Director of the United States Patent and Trademark Office

United States of America

United States Patent and Trademark Office

SecureVid

Reg. No. 4,107,491

Registered Mar. 6, 2012

Int. Cls.: 16 and 17

TRADEMARK

PRINCIPAL REGISTER

SONY DADC CORPORATION (JAPAN CORPORATION)
5-1-12, KITA-SHINAGAWA, SHINAGAWA-KU
TOKYO, JAPAN

FOR: PRINTED HOLOGRAMS; PRINTED HOLOGRAMS, NAMELY, HOLOGRAM PRINTED PAPERS, HOLOGRAM PRINTED SEALS, HOLOGRAM PRINTED STICKERS, HOLOGRAM PRINTED PAPER TAGS, HOLOGRAM PRINTED PAPER LABELS, HOLOGRAM PRINTED TRADING CARDS AND HOLOGRAM PROCESSED PRINTS; PAPER; STATIONERY, IN CLASS 16 (U.S. CLS. 2, 5, 22, 23, 29, 37, 38 AND 50).

FOR: HOLOGRAPHIC FILMS AND PLASTIC, ACETATE FOIL AND NON-METAL FILMS, ALL USED TO CREATE AND APPLY HOLOGRAMS ON TO PRODUCTS, DOCUMENTS, AND PACKAGING FOR SECURITY AND AUTHENTICITY VERIFICATION; FOILS, NAMELY, SELF ADHESIVE PLASTIC FOILS AND FILMS, NON-SELF ADHESIVE PLASTIC FOILS AND FILMS, PLASTIC LAMINATES, AND EMBOSSED FILMS PREDOMINANTLY CONTAINING NEUTRALIZED PLASTIC, ALL FOR USE IN THE PRODUCTION OF DIFFRACTIVE OPTICALLY VARIABLE IMAGE DEVICES ("DOVIDS") AND REFLECTIVE SECURITY HOLOGRAMS, IN CLASS 17 (U.S. CLS. 1, 5, 12, 13, 35 AND 50).

THE MARK CONSISTS OF STANDARD CHARACTERS WITHOUT CLAIM TO ANY PARTICULAR FONT, STYLE, SIZE, OR COLOR.

PRIORITY CLAIMED UNDER SEC. 44(D) ON JAPAN APPLICATION NO. 2010-049418, FILED 6-22-2010, REG. NO. 5398027, DATED 3-11-2011, EXPIRES 3-11-2021.

SER. NO. 85-118,300, FILED 8-30-2010.

ANDREA BUTLER, EXAMINING ATTORNEY



David J. Kyros

Director of the United States Patent and Trademark Office

United States of America

United States Patent and Trademark Office



Reg. No. 4,107,492

SWEDISH MATCH NORTH EUROPE AB (SWEDEN CORPORATION)

Registered Mar. 6, 2012

SE-118 85
STOCKHOLM, SWEDEN

Int. Cl.: 34

FOR: TOBACCO; MATCHES; TOBACCO SUBSTITUTES NOT FOR MEDICAL PURPOSES; SNUFF AND TOBACCO ALTERNATIVES IN THE FORM OF PRODUCTS BASED ON VEGETABLE FIBERS, FOR ORAL USE NOT FOR CONSUMPTION; SNUFF; TOBACCO FREE SNUFF; HERBAL SNUFF, IN CLASS 34 (U.S. CLS. 2, 8, 9 AND 17).

TRADEMARK

PRINCIPAL REGISTER

PRIORITY CLAIMED UNDER SEC. 44(D) ON SWEDEN APPLICATION NO. 2010/03701, FILED 4-27-2010, REG. NO. 412335, DATED 8-27-2010, EXPIRES 8-27-2020.

THE MARK CONSISTS OF AN EIGHT-POINTED FLOWER DESIGN WHICH APPEAR DARKER IN THE MIDDLE AND GRADUALLY FADES OUTWARD. THE WORD "KARDUS" APPEARS ACROSS THE BOTTOM OF THE DESIGN WITH PARTS OF EACH LETTER MISSING.

THE ENGLISH TRANSLATION OF "KARDUS" IN THE MARK IS "CARTOUCHE".

SER. NO. 85-118,900, FILED 8-30-2010.

LANA PHAM, EXAMINING ATTORNEY



David J. Kyjars

Director of the United States Patent and Trademark Office

United States of America

United States Patent and Trademark Office

GRAN CAPITAN

Reg. No. 4,107,493

Registered Mar. 6, 2012

Int. Cl.: 29

TRADEMARK

PRINCIPAL REGISTER

PAMPLONA FOODS, INC. (FLORIDA CORPORATION)
9600 SW 122ND COURT
MIAMI, FL 33186

FOR: CANNED FISH, IN CLASS 29 (U.S. CL. 46).

FIRST USE 3-24-2004; IN COMMERCE 3-24-2004.

THE MARK CONSISTS OF STANDARD CHARACTERS WITHOUT CLAIM TO ANY PARTICULAR FONT, STYLE, SIZE, OR COLOR.

THE ENGLISH TRANSLATION OF GRAN CAPITAN IN THE MARK IS GRAND CAPTAIN.

SER. NO. 85-120,195, FILED 8-31-2010.

RONALD MCMORROW, EXAMINING ATTORNEY



David J. Kybas

Director of the United States Patent and Trademark Office

United States of America

United States Patent and Trademark Office

CONEX

Reg. No. 4,107,494

Registered Mar. 6, 2012

Int. Cl.: 6

TRADEMARK

PRINCIPAL REGISTER

ICB IPR REALISATIONS LIMITED (UNITED KINGDOM LIMITED COMPANY)
8 SALISBURY SQUARE
LONDON, UNITED KINGDOM EC4Y 8BB

FOR: METAL FITTINGS FOR CONNECTING PIPES AND TUBES, NAMELY, CLIPS, AND BRACKETS; METAL CONNECTORS, NAMELY, METAL PIPE CONNECTION FITTINGS FOR CONNECTING SECTIONS OF PIPES AND TUBES; METAL FITTINGS FOR CONNECTING PIPES AND TUBES, NAMELY, TEES, FLANGES, BENDS, ELBOWS FOR PIPES, PIPE CONNECTORS, COUPLERS, STOP ENDS AND BEND WASHERS; PIPES OF METAL; METAL VALVES NOT BEING PART OF MACHINES; NUTS OF METAL; METAL SEALS FOR USE IN PLUMBING AND HEATING APPLICATIONS, IN CLASS 6 (U.S. CLS. 2, 12, 13, 14, 23, 25 AND 50).

THE MARK CONSISTS OF STANDARD CHARACTERS WITHOUT CLAIM TO ANY PARTICULAR FONT, STYLE, SIZE, OR COLOR.

OWNER OF ERPN CMNTY TM OFC REG. NO. 95265, DATED 12-18-2000, EXPIRES 4-1-2016.

SER. NO. 85-126,705, FILED 9-10-2010.

HANNO RITTNER, EXAMINING ATTORNEY



David J. Kyffers

Director of the United States Patent and Trademark Office

United States of America

United States Patent and Trademark Office

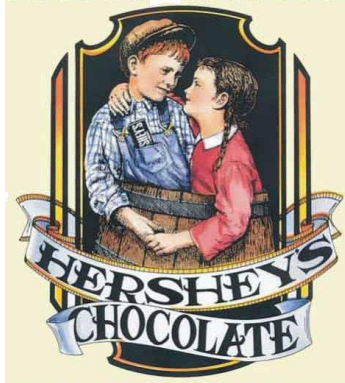

Reg. No. 4,107,495

Registered Mar. 6, 2012

Int. Cl.: 4

HERSHEY CHOCOLATE & CONFECTIONERY CORPORATION (DELAWARE CORPORATION)
SUITE 204
4860 ROBB STREET
WHEAT RIDGE, CO 80033

TRADEMARK

PRINCIPAL REGISTER

FOR: CANDLES, IN CLASS 4 (U.S. CLS. 1, 6 AND 15).

FIRST USE 4-30-2010; IN COMMERCE 4-30-2010.

OWNER OF U.S. REG. NOS. 54,041, 3,581,726 AND OTHERS.

THE COLOR(S) CREAM, BEIGE, BROWN, MAROON, SILVER, BLUE, WHITE, YELLOW, BLACK, GRAY, ORANGE AND RED IS/ARE CLAIMED AS A FEATURE OF THE MARK.

NO CLAIM IS MADE TO THE EXCLUSIVE RIGHT TO USE "CHOCOLATE", APART FROM THE MARK AS SHOWN.

THE NAME(S), PORTRAIT(S), AND/OR SIGNATURE(S) SHOWN IN THE MARK DOES NOT IDENTIFY A PARTICULAR LIVING INDIVIDUAL.

THE MARK CONSISTS OF A BOY WITH ORANGE HAIR, A BROWN CAP, A BEIGE FACE AND HANDS, BLACK EYES AND EYEBROWS, BLUE AND WHITE SHIRT, AND BLUE OVERALLS WITH A BROWN CHOCOLATE BAR IN THE POCKET WITH THE SILVER LETTERS "SHEY'S" HOLDING HANDS WITH BROWN HAIR, BEIGE FACE AND HANDS, BLACK EYES AND EYEBROWS, AND MAROON AND WHITE SHIRT. THE BOY AND GIRL ARE STANDING IN A BROWN AND GRAY BARREL. BELOW THE BARREL ARE WHITE BANNERS WITH BLACK STYLIZED WORDING "HERSHEY'S CHOCOLATE" AND YELLOW AND ORANGE BORDERS, ALL ON A SCALLOPED BLACK GEOMETRICAL SHAPE WITH ORANGE AND YELLOW BORDER TRIM. THE RECTANGULAR BACKGROUND IS CREAM.

SER. NO. 85-131,483, FILED 9-16-2010.

KRISTINA MORRIS, EXAMINING ATTORNEY



David J. Kyros

Director of the United States Patent and Trademark Office

United States of America

United States Patent and Trademark Office

TRANSFUSION

Reg. No. 4,107,496

AMERICAN ASSOCIATION OF BLOOD BANKS (ILLINOIS NON-PROFIT CORPORATION)
8101 GLENBROOK ROAD
BETHESDA, MD 20814

Registered Mar. 6, 2012

Int. Cl.: 16

FOR: PUBLICATIONS, NAMELY, PERIODIC JOURNAL IN THE FIELDS OF MEDICINE, CELLULAR AND GENE THERAPIES, AND TISSUE TRANSPLANTATION , IN CLASS 16 (U.S. CLS. 2, 5, 22, 23, 29, 37, 38 AND 50).

TRADEMARK

FIRST USE 7-0-1960; IN COMMERCE 7-0-1960.

PRINCIPAL REGISTER

THE MARK CONSISTS OF STANDARD CHARACTERS WITHOUT CLAIM TO ANY PARTICULAR FONT, STYLE, SIZE, OR COLOR.

SEC. 2(F).

SER. NO. 85-133,112, FILED 9-20-2010.

BILL DAWE, EXAMINING ATTORNEY



David J. Kybas

Director of the United States Patent and Trademark Office

United States of America

United States Patent and Trademark Office



Reg. No. 4,107,497

Registered Mar. 6, 2012

Int. Cls.: 35 and 45

SERVICE MARK

PRINCIPAL REGISTER

BLACK FLY OUTFITTERS, INC. (FLORIDA CORPORATION)
11702 BEACH BLVD., SUITE 103
JACKSONVILLE, FL 32246

FOR: RETAIL STORE SERVICES AND ON-LINE STORE SERVICES IN THE FIELD OF FISHING EQUIPMENT AND SUPPLIES, IN CLASS 35 (U.S. CLS. 100, 101 AND 102).

FIRST USE 1-1-1992; IN COMMERCE 1-1-1992.

FOR: LICENSING OF MARK FOR USE BY FISHING RESORTS, IN CLASS 45 (U.S. CLS. 100 AND 101).

FIRST USE 6-1-2010; IN COMMERCE 6-1-2010.

THE MARK CONSISTS OF THE SILHOUETTE OF A FISHING FLY.

SER. NO. 85-134,585, FILED 9-21-2010.

RAMONA ORTIGA, EXAMINING ATTORNEY



David J. Kybas

Director of the United States Patent and Trademark Office

United States of America

United States Patent and Trademark Office

ΔDELTA

Reg. No. 4,107,498

Registered Mar. 6, 2012

Int. Cl.: 9

TRADEMARK

PRINCIPAL REGISTER

OLYMPUS CORPORATION (JAPAN JOINT STOCK COMPANY)
43-2, HATAGAYA 2-CHOME, SHIBUYA-KU
TOKYO, JAPAN

FOR: HANDHELD X-RAY FLORESCENCE ANALYZERS FOR USE IN THE FIELDS OF METALLURGY, MINING, RECYCLING AND ENVIRONMENTAL SAFETY, IN CLASS 9 (U.S. CLS. 21, 23, 26, 36 AND 38).

FIRST USE 4-0-2010; IN COMMERCE 4-0-2010.

THE MARK CONSISTS OF THE STYLIZED WORD "DELTA" WITH A TRIANGLE TO THE LEFT OF THE WORD.

SER. NO. 85-134,754, FILED 9-21-2010.

CURTIS FRENCH, EXAMINING ATTORNEY



David J. Kybas

Director of the United States Patent and Trademark Office

United States of America

United States Patent and Trademark Office

AMDEC F.I.R.S.T.

Reg. No. 4,107,499

Registered Mar. 6, 2012

Int. Cls.: 35 and 42

SERVICE MARK

PRINCIPAL REGISTER

AMDEC, LLC (DELAWARE LIMITED LIABILITY COMPANY)
SUITE 1960
45 ROCKEFELLER PLAZA
NEW YORK, NY 10111

FOR: ONLINE RESOURCE FOR ACADEMIC RESEARCH INSTITUTIONS AND OTHERS INCLUDING BIO-TECH, PHARMACEUTICAL, AND BIO-MEDICAL RESEARCH COMPANIES, NAMELY, PROVIDING AN ONLINE DATABASE FEATURING ADVERTISING AND PROMOTIONAL INFORMATION REGARDING BIOMEDICAL RESEARCH FACILITIES AND SERVICES AND REGARDING COMMERCIAL PRODUCTS AND SERVICES USED IN BIOMEDICAL RESEARCH, ALL FOR THE BENEFIT AND ADVANCEMENT OF BIOMEDICAL RESEARCH, IN CLASS 35 (U.S. CLS. 100, 101 AND 102).

FIRST USE 7-0-2010; IN COMMERCE 7-0-2010.

FOR: ONLINE RESOURCE FOR ACADEMIC RESEARCH INSTITUTIONS AND OTHERS INCLUDING BIO-TECH, PHARMACEUTICAL, AND BIO-MEDICAL RESEARCH COMPANIES, NAMELY, PROVIDING AN ONLINE DATABASE FEATURING INFORMATION REGARDING BIOMEDICAL RESEARCH, ALL FOR THE BENEFIT AND ADVANCEMENT OF BIOMEDICAL RESEARCH, IN CLASS 42 (U.S. CLS. 100 AND 101).

FIRST USE 7-0-2010; IN COMMERCE 7-0-2010.

THE MARK CONSISTS OF STANDARD CHARACTERS WITHOUT CLAIM TO ANY PARTICULAR FONT, STYLE, SIZE, OR COLOR.

SER. NO. 85-134,755, FILED 9-21-2010.

MAUREEN DALL, EXAMINING ATTORNEY



David J. Kybas

Director of the United States Patent and Trademark Office

United States of America

United States Patent and Trademark Office

M3X

Reg. No. 4,107,500

Registered Mar. 6, 2012

Int. Cl.: 38

SERVICE MARK

PRINCIPAL REGISTER

M3X MEDIA, INC. (FLORIDA CORPORATION)
SUITE 102
350 SOUTH COUNTY ROAD
PALM BEACH, FL 33480

FOR: PROVIDING ACCESS TO TELECOMMUNICATION NETWORKS VIA SECURE WIRELESS AND HARD-WIRED TELECOMMUNICATIONS FOR THE PURPOSE OF ALLOWING SUBSCRIBERS TO COMMUNICATE USING PEER-TO-PEER TECHNOLOGY TO EXCHANGE DIGITAL CONTENT, DIGITAL MEDIA AND DIGITAL INFORMATION AND TO PURCHASE MEDIA PROGRAMMING INTERNET ACCESS, PRE-RECORDED VIDEO AND AUDIO; PROVIDING TELECOMMUNICATIONS SERVICES VIA A WEB PORTAL, NAMELY, PROVIDING TELEPHONE SERVICES OVER THE INTERNET IN THE NATURE OF VOICE OVER INTERNET (VOIP) AND SECURE VIRTUAL PRIVATE NETWORK SERVICES, IN CLASS 38 (U.S. CLS. 100, 101 AND 104).

FIRST USE 8-7-2006; IN COMMERCE 8-7-2006.

THE MARK CONSISTS OF STANDARD CHARACTERS WITHOUT CLAIM TO ANY PARTICULAR FONT, STYLE, SIZE, OR COLOR.

SER. NO. 85-134,843, FILED 9-21-2010.

SUSAN HAYASH, EXAMINING ATTORNEY



David J. Kyros

Director of the United States Patent and Trademark Office

United States of America

United States Patent and Trademark Office

LOLLIPOP CHAINSAW

Reg. No. 4,107,501

Registered Mar. 6, 2012

Int. Cl.: 9

TRADEMARK

PRINCIPAL REGISTER

KADOKAWA GAMES, LTD. (JAPAN CORPORATION)
13-3, FUJIMI 2-CHOME
CHIYODA-KU
TOKYO, JAPAN

FOR: DOWNLOADABLE COMPUTER, ELECTRONIC AND INTERACTIVE GAME PROGRAMS FOR USE WITH VIDEO GAME MACHINES FOR COMMERCIAL USE; DOWNLOADABLE COMPUTER, ELECTRONIC AND INTERACTIVE GAME SOFTWARE FOR USE WITH VIDEO GAME MACHINES FOR COMMERCIAL USE; COMPUTER, ELECTRONIC AND INTERACTIVE GAME PROGRAMS FOR USE WITH VIDEO GAME MACHINES FOR COMMERCIAL USE; GAME SOFTWARE FOR USE WITH VIDEO GAME MACHINES FOR COMMERCIAL USE; PRERECORDED ELECTRONIC CIRCUITS, CD-ROMS, DVDS, MAGNETIC TAPES, MAGNETIC DISCS, OPTICAL DISCS, CARTRIDGES, CASSETTES AND OTHER MEDIA, NAMELY, ELECTRONIC MEDIA ALL FEATURING COMPUTER, ELECTRONIC AND INTERACTIVE GAME PROGRAMS FOR USE WITH VIDEO GAME MACHINES FOR COMMERCIAL USE; PRERECORDED ELECTRONIC CIRCUIT, CD-ROMS, DVDS, MAGNETIC TAPES, MAGNETIC DISCS, OPTICAL DISCS, CARTRIDGES, CASSETTES AND OTHER MEDIA, NAMELY, ELECTRONIC MEDIA ALL FEATURING GAME SOFTWARE FOR USE WITH VIDEO GAME MACHINES FOR COMMERCIAL USE; VIDEO GAME MACHINES FOR USE WITH EXTERNAL DISPLAY SCREEN, MONITOR OR TELEVISIONS FOR COMMERCIAL USE; STRAPS FOR MOBILE PHONE; DOWNLOADABLE COMPUTER GAME PROGRAMS FOR USE WITH COMPUTER; DOWNLOADABLE GAME SOFTWARE FOR USE WITH COMPUTER; COMPUTER, ELECTRONIC AND INTERACTIVE GAME PROGRAMS FOR USE WITH COMPUTER; GAME SOFTWARE FOR USE WITH COMPUTER; PRERECORDED ELECTRONIC CIRCUIT, CD-ROMS, DVDS, MAGNETIC TAPES, MAGNETIC DISCS, OPTICAL DISCS, CARTRIDGES, CASSETTES AND OTHER MEDIA, NAMELY, ELECTRONIC MEDIA ALL FEATURING COMPUTER, ELECTRONIC AND INTERACTIVE GAME PROGRAMS FOR USE WITH COMPUTER; PRERECORDED ELECTRONIC CIRCUIT, CD-ROMS, DVDS, MAGNETIC TAPES, MAGNETIC DISCS, OPTICAL DISCS, CARTRIDGES, CASSETTES AND OTHER MEDIA, NAMELY, ELECTRONIC MEDIA ALL FEATURING GAME SOFTWARE FOR USE WITH COMPUTER; DOWNLOADABLE COMPUTER, ELECTRONIC AND INTERACTIVE GAME PROGRAMS FOR USE WITH MOBILE PHONE; DOWNLOADABLE GAME SOFTWARE FOR USE WITH MOBILE PHONE; COMPUTER, ELECTRONIC AND INTERACTIVE GAME PROGRAMS FOR USE WITH MOBILE PHONE; GAME SOFTWARE FOR USE WITH MOBILE PHONE; PRERECORDED ELECTRONIC CIRCUIT, CD-ROMS, DVDS, MAGNETIC TAPES, MAGNETIC DISCS, OPTICAL DISCS, CARTRIDGES, CASSETTES AND OTHER MEDIA, NAMELY, ELECTRONIC MEDIA ALL



David J. Kappas

Director of the United States Patent and Trademark Office

Reg. No. 4,107,501 FEATURING COMPUTER, ELECTRONIC AND INTERACTIVE GAME PROGRAMS FOR USE WITH MOBILE PHONE; PRERECORDED ELECTRONIC CIRCUIT, CD-ROMS, DVDS, MAGNETIC TAPES, MAGNETIC DISCS, OPTICAL DISCS, CARTRIDGES, CASSETTES AND OTHER MEDIA, NAMELY, ELECTRONIC MEDIA ALL FEATURING GAME SOFTWARE FOR USE WITH MOBILE PHONE; DOWNLOADABLE COMPUTER, ELECTRONIC AND INTERACTIVE GAME PROGRAMS FOR USE WITH VIDEO GAME MACHINES FOR DOMESTIC USE; DOWNLOADABLE GAME SOFTWARE FOR USE WITH VIDEO GAME MACHINES, FOR DOMESTIC USE; COMPUTER, ELECTRONIC AND INTERACTIVE GAME PROGRAMS FOR USE WITH VIDEO GAME MACHINES FOR DOMESTIC USE; GAME SOFTWARE FOR USE WITH VIDEO GAME MACHINES FOR DOMESTIC USE; PRERECORDED ELECTRONIC CIRCUIT, CD-ROMS, DVDS, MAGNETIC TAPES, MAGNETIC DISCS, OPTICAL DISCS, CARTRIDGES, CASSETTES AND OTHER MEDIA, NAMELY, ELECTRONIC MEDIA ALL FEATURING COMPUTER AND INTERACTIVE GAME PROGRAMS FOR USE WITH VIDEO GAME MACHINES FOR DOMESTIC USE; PRERECORDED ELECTRONIC CIRCUIT, CD-ROMS, DVDS, MAGNETIC TAPES, MAGNETIC DISCS, OPTICAL DISCS CARTRIDGES, CASSETTES AND OTHER MEDIA, NAMELY, ELECTRONIC MEDIA ALL FEATURING GAME SOFTWARE FOR USE WITH VIDEO GAME MACHINES FOR DOMESTIC USE; OTHER VIDEO GAMES, NAMELY, VIDEO GAME CARTRIDGES, VIDEO GAME DISCS AND VIDEO GAME SOFTWARE FOR DOMESTIC USE; DOWNLOADABLE COMPUTER, ELECTRONIC AND INTERACTIVE GAME PROGRAMS FOR USE WITH HAND-HELD GAMES WITH LIQUID CRYSTAL DISPLAYS; DOWNLOADABLE GAME SOFTWARE FOR USE WITH HAND-HELD GAMES WITH LIQUID CRYSTAL DISPLAYS; COMPUTER, ELECTRONIC AND INTERACTIVE GAME PROGRAMS FOR USE WITH HAND-HELD GAMES WITH LIQUID CRYSTAL DISPLAYS; COMPUTER, ELECTRONIC AND INTERACTIVE GAME SOFTWARE FOR USE WITH HAND-HELD GAMES WITH LIQUID CRYSTAL DISPLAYS; PRERECORDED ELECTRONIC CIRCUIT, CD-ROMS, DVDS, MAGNETIC TAPES, MAGNETIC DISCS, OPTICAL DISCS, CARTRIDGES CASSETTES AND OTHER MEDIA, NAMELY, ELECTRONIC MEDIA ALL FEATURING COMPUTER, ELECTRONIC AND INTERACTIVE GAME PROGRAMS FOR USE WITH HAND-HELD GAMES WITH LIQUID CRYSTAL DISPLAYS; PRERECORDED ELECTRONIC CIRCUIT, CD-ROMS, DVDS, MAGNETIC TAPES, MAGNETIC DISCS, OPTICAL DISCS, CARTRIDGES, CASSETTES AND OTHER MEDIA, NAMELY, ELECTRONIC MEDIA ALL FEATURING COMPUTER, ELECTRONIC AND INTERACTIVE GAME PROGRAMS FOR USE WITH HAND-HELD GAMES WITH LIQUID CRYSTAL DISPLAYS; PRERECORDED ELECTRONIC CIRCUIT, CD-ROMS, DVDS, MAGNETIC TAPES, MAGNETIC DISCS, OPTICAL DISCS, CARTRIDGES, CASSETTES AND OTHER MEDIA, NAMELY, ELECTRONIC MEDIA ALL FEATURING COMPUTER, ELECTRONIC AND INTERACTIVE GAME PROGRAMS FOR USE WITH HAND-HELD GAMES WITH LIQUID CRYSTAL DISPLAYS; PHONOGRAPH RECORDS FEATURING MUSIC, BGM OF VIDEO GAMES AND SOUND TRACKS; OTHER RECORDED MEDIA, NAMELY, PRERECORDED DIGITAL MEDIA FEATURING MUSIC, BGM OF VIDEO GAMES AND SOUND TRACKS; METRONOMES; ELECTRONIC CIRCUITS AND CD-ROMS RECORDED WITH AUTOMATIC PERFORMANCE PROGRAMS FOR ELECTRONIC MUSICAL INSTRUMENTS; DOWNLOADABLE MUSIC VIA THE INTERNET AND WIRELESS DEVICES; EXPOSED CINEMATOGRAPHIC FILMS; EXPOSED SLIDE FILMS; SLIDE FILM MOUNTS; DOWNLOADABLE IMAGE FILES CONTAINING MOVIES AND IMAGES OF VIDEO GAMES; PRERECORDED VIDEO DISCS, VIDEO TAPES, CD-ROMS, DVDS AND OTHER MEDIA, NAMELY, ELECTRONIC MEDIA ALL FEATURING MOVIES AND IMAGES OF VIDEO GAMES; DOWNLOADABLE ELECTRONIC PUBLICATIONS, NAMELY, MAGAZINES, NEWSPAPERS, MANUALS AND NOVELS IN THE FIELD OF ENTERTAINMENT INCLUDING VIDEO GAMES; DOWNLOADABLE MP3 FILES AND MP3 RECORDINGS FEATURING MUSIC AND SOUND; DOWNLOADABLE IMAGE FILES CONTAINING ANIMATED IMAGES AND STILL IMAGES IN THE FIELD OF SPORTS, ENTERTAINERS AND VIDEO GAMES, IN CLASS 9 (U.S. CLS. 21, 23, 26, 36 AND 38).

THE MARK CONSISTS OF STANDARD CHARACTERS WITHOUT CLAIM TO ANY PARTICULAR FONT, STYLE, SIZE, OR COLOR.

PRIORITY CLAIMED UNDER SEC. 44(D) ON JAPAN APPLICATION NO. 2010-25040, FILED 3-31-2010, REG. NO. 5359596, DATED 10-8-2010, EXPIRES 10-8-2020.

Reg. No. 4,107,501 SER. NO. 85-138,891, FILED 9-27-2010.

ELLEN PERKINS, EXAMINING ATTORNEY

United States of America

United States Patent and Trademark Office

RAW

Reg. No. 4,107,502

Registered Mar. 6, 2012

Int. Cl.: 5

TRADEMARK

PRINCIPAL REGISTER

ATRIUM INNOVATIONS INC. (CANADA CORPORATION)
1405 BOULEVARD DU PARC-TECHNOLOGIQUE
QUEBEC CITY, QUEBEC, CANADA G1P4P5

FOR: DIETARY AND NUTRITIONAL SUPPLEMENTS CONTAINING RAW INGREDIENTS,
IN CLASS 5 (U.S. CLS. 6, 18, 44, 46, 51 AND 52).

FIRST USE 12-15-2009; IN COMMERCE 12-15-2009.

OWNER OF U.S. REG. NO. 3,736,377.

NO CLAIM IS MADE TO THE EXCLUSIVE RIGHT TO USE "RAW", APART FROM THE
MARK AS SHOWN.

THE MARK CONSISTS OF THE LETTERS CAPITAL "R", CAPITAL DELTA, THE GREEK
LETTER FOR D, BUT THE LETTER "A" IS INFERRED AND CAPITAL "W". IT IS A STYLIZED
REPRESENTATION OF THE WORD "RAW".

SER. NO. 85-139,611, FILED 9-28-2010.

KATHLEEN LORENZO, EXAMINING ATTORNEY



David J. Kyros

Director of the United States Patent and Trademark Office

United States of America

United States Patent and Trademark Office

Notifam

Reg. No. 4,107,503

LIFESITENEWS.COM, INC. (PENNSYLVANIA CORPORATION)
4 FAMILY LIFE LANE
FRONT ROYAL, VA 22630

Registered Mar. 6, 2012

Int. Cl.: 16

FOR: NEWS BULLETINS, IN CLASS 16 (U.S. CLS. 2, 5, 22, 23, 29, 37, 38 AND 50).

TRADEMARK

FIRST USE 7-28-2010; IN COMMERCE 7-28-2010.

PRINCIPAL REGISTER

THE MARK CONSISTS OF STANDARD CHARACTERS WITHOUT CLAIM TO ANY PARTICULAR FONT, STYLE, SIZE, OR COLOR.

SER. NO. 85-139,672, FILED 9-28-2010.

SANJEEV VOHRA, EXAMINING ATTORNEY



David J. Kybas

Director of the United States Patent and Trademark Office

United States of America

United States Patent and Trademark Office



Reg. No. 4,107,504

Registered Mar. 6, 2012

Int. Cl.: 37

SERVICE MARK

PRINCIPAL REGISTER

SERVISTAR USA, LLC (VIRGINIA LIMITED LIABILITY COMPANY)
1384 INGLESIDE ROAD
NORFOLK, VA 23502

FOR: HOME SERVICES, NAMELY, HOUSE REPAIR SERVICES, HOUSE MAINTENANCE AND REPAIR SERVICES, AND GENERAL BUILDING CONTRACTOR SERVICES SPECIFICALLY FOR HOUSES, IN CLASS 37 (U.S. CLS. 100, 103 AND 106).

FIRST USE 2-8-2008; IN COMMERCE 1-1-2010.

OWNER OF U.S. REG. NO. 3,764,832.

THE COLOR(S) BLUE, WHITE, AND RED IS/ARE CLAIMED AS A FEATURE OF THE MARK.

NO CLAIM IS MADE TO THE EXCLUSIVE RIGHT TO USE "HOME SERVICE", APART FROM THE MARK AS SHOWN.

THE MARK CONSISTS OF "SERVISTAR" IN BLUE LETTERS WITH WHITE OUTLINE BORDER, A BLUE HOUSE ICON WITH A WHITE OUTLINE OF THE HOUSE ICON AND WHITE STAR INSIDE THE HOUSE ICON ON THE RIGHT TOP SIDE OF THE "SERVISTAR" NAME, THEN THE WORDING "THE HOME SERVICE PEOPLE" IN WHITE LETTERS BELOW THE "SERVISTAR" NAME. THE LETTERING AND HOUSE ICON ARE SURROUNDED BY AN EMBOSSED RED BACKGROUND THAT CONTOURS TO THE SHAPE OF THE LETTERING AND ICON.

SER. NO. 85-140,868, FILED 9-29-2010.

TEJBIR SINGH, EXAMINING ATTORNEY



David J. Kybas

Director of the United States Patent and Trademark Office

United States of America

United States Patent and Trademark Office

VINOGLASS

Reg. No. 4,107,505

CAVANOVA WINE, S.L. (SPAIN SOCIEDAD DE RESPONSABILIDAD LIMITADA (SL))
CRTA A-355 KM. 20 NAVE 13-14 MONDA
MALAGA, SPAIN 29110

Registered Mar. 6, 2012

Int. Cl.: 11

FOR: TEMPERATURE CONTROLLED BEVERAGE DISPENSERS, NAMELY, WINE DISPENSERS, IN CLASS 11 (U.S. CLS. 13, 21, 23, 31 AND 34).

TRADEMARK

FIRST USE 4-0-2010; IN COMMERCE 5-0-2011.

PRINCIPAL REGISTER

THE MARK CONSISTS OF STANDARD CHARACTERS WITHOUT CLAIM TO ANY PARTICULAR FONT, STYLE, SIZE, OR COLOR.

SER. NO. 85-147,620, FILED 10-7-2010.

ANDREA HACK, EXAMINING ATTORNEY



David J. Kybas

Director of the United States Patent and Trademark Office

United States of America

United States Patent and Trademark Office



Reg. No. 4,107,506

Registered Mar. 6, 2012

Int. Cl.: 25

TRADEMARK

PRINCIPAL REGISTER

TALI LEHAVI (UNITED STATES INDIVIDUAL), AKA TALI LEHAVI HAMER
13370 N. 91ST STREET
SCOTTSDALE, AZ 85260

FOR: APPAREL FOR DANCERS, NAMELY, TEE SHIRTS, SWEATSHIRTS, PANTS, LEGGINGS, SHORTS AND JACKETS; ATHLETIC APPAREL, NAMELY, SHIRTS, PANTS, JACKETS, FOOTWEAR, HATS AND CAPS, ATHLETIC UNIFORMS; CHILDREN'S AND INFANT'S APPAREL, NAMELY, JUMPERS, OVERALL SLEEPWEAR, PAJAMAS, ROMPERS AND ONE-PIECE GARMENTS; CHILDREN'S AND INFANTS' APPAREL TREATED WITH FIRE AND HEAT RETARDANTS, NAMELY, JUMPERS, OVERALL SLEEPWEAR, PAJAMAS, ROMPERS AND ONE-PIECE GARMENTS; GLOVES FOR APPAREL; NURSE'S APPAREL, NAMELY, SCRUBS; SCIENTIFIC AND TECHNOLOGICAL APPAREL, NAMELY, SHIRTS, PANTS, JACKETS, FOOTWEAR, HATS AND CAPS, UNIFORMS, IN CLASS 25 (U.S. CLS. 22 AND 39).

FIRST USE 6-0-2003; IN COMMERCE 5-0-2004.

THE MARK CONSISTS OF TWO HANDS JOINING TO MAKE A HEART BETWEEN THEM.

SER. NO. 85-148,037, FILED 10-8-2010.

ARETHA SOMERVILLE, EXAMINING ATTORNEY



David J. Kyros

Director of the United States Patent and Trademark Office

United States of America

United States Patent and Trademark Office

ARCA

Reg. No. 4,107,507

Registered Mar. 6, 2012

Int. Cls.: 9, 35, 36 and 37

TRADEMARK

SERVICE MARK

PRINCIPAL REGISTER

ARCA.TECH SYSTEMS (NORTH CAROLINA LIMITED LIABILITY COMPANY)
1403 S. 3RD STREET EXTENSION
MEBANE, NC 27302

FOR: AUTOMATED CASH HANDLING EQUIPMENT, NAMELY, CASH DISPENSERS, CASH RECYCLERS IN THE NATURE OF CASH SORTING MACHINES, ELECTRONIC COIN DISPENSERS; COMPUTER SOFTWARE FOR CURRENCY MANAGEMENT, NAMELY, OPERATING SOFTWARE FOR AUTOMATED CASH HANDLING EQUIPMENT; FINANCIAL TRANSACTION AUTOMATION EQUIPMENT IN THE NATURE OF COMPUTER HARDWARE AND MODEMS FOR USE IN FINANCIAL TRANSACTIONS NOT IN THE FIELD OF SECURITIES; COMPUTER SOFTWARE FOR CURRENCY MANAGEMENT, NAMELY, OPERATING SOFTWARE FOR FINANCIAL TRANSACTION AUTOMATION EQUIPMENT IN THE NATURE OF COMPUTER HARDWARE AND MODEMS FOR USE IN FINANCIAL TRANSACTIONS NOT IN THE FIELD OF SECURITIES, IN CLASS 9 (U.S. CLS. 21, 23, 26, 36 AND 38).

FIRST USE 4-21-2011; IN COMMERCE 4-21-2011.

FOR: RETAIL DISTRIBUTORSHIP SERVICES FEATURING ORIGINAL EQUIPMENT MANUFACTURER MONEY COUNTING AND HANDLING EQUIPMENT, IN CLASS 35 (U.S. CLS. 100, 101 AND 102).

FIRST USE 6-13-2010; IN COMMERCE 6-13-2010.

FOR: CASH TRANSFER SERVICES NOT IN THE FIELD OF SECURITIES; AUTOMATED COIN COUNTING, SORTING AND CONVERTING SERVICES, IN CLASS 36 (U.S. CLS. 100, 101 AND 102).

FIRST USE 6-13-2010; IN COMMERCE 6-13-2010.

FOR: INSTALLATION, MAINTENANCE AND REPAIR OF AUTOMATED CASH HANDLING EQUIPMENT; INSTALLATION, MAINTENANCE AND REPAIR OF CASH TRANSACTION AUTOMATION EQUIPMENT, IN CLASS 37 (U.S. CLS. 100, 103 AND 106).

FIRST USE 3-2-2011; IN COMMERCE 3-2-2011.



David J. Kyjars

Director of the United States Patent and Trademark Office

Reg. No. 4,107,507 THE MARK CONSISTS OF STANDARD CHARACTERS WITHOUT CLAIM TO ANY PARTICULAR FONT, STYLE, SIZE, OR COLOR.

OWNER OF U.S. REG. NO. 2,407,741.

THE ENGLISH TRANSLATION OF "ARCA" IN THE MARK IS "CHEST" OR "BOX".

SER. NO. 85-148,373, FILED 10-8-2010.

NELSON SNYDER, EXAMINING ATTORNEY

United States of America
United States Patent and Trademark Office

SootheMD

Reg. No. 4,107,508

BIOVALITY, LLC (UTAH LIMITED LIABILITY COMPANY)
695 VISTA VIEW LANE
NORTH SALT LAKE, UT 84054

Registered Mar. 6, 2012

Int. Cl.: 5

FOR: DIETARY SUPPLEMENTS IN THE NATURE OF POWDERED IMMUNE SUPPORT DRINK, IN CLASS 5 (U.S. CLS. 6, 18, 44, 46, 51 AND 52).

TRADEMARK

FIRST USE 8-1-2010; IN COMMERCE 9-15-2010.

PRINCIPAL REGISTER

THE MARK CONSISTS OF STANDARD CHARACTERS WITHOUT CLAIM TO ANY PARTICULAR FONT, STYLE, SIZE, OR COLOR.

SER. NO. 85-148,375, FILED 10-8-2010.

NELSON SNYDER, EXAMINING ATTORNEY



David J. Kybas

Director of the United States Patent and Trademark Office

United States of America

United States Patent and Trademark Office



Reg. No. 4,107,509

Registered Mar. 6, 2012

Int. Cls.: 9, 16 and 35

TRADEMARK

SERVICE MARK

PRINCIPAL REGISTER

TAXASSIST DIRECT LIMITED (UNITED KINGDOM PRIVATE LIMITED COMPANY)
TAXASSIST HOUSE
112-114 THORPE ROAD, NORWICH
NORFOLK NR1 1RT, UNITED KINGDOM

FOR: COMPUTER SOFTWARE, NAMELY, COMPUTER SOFTWARE FOR USE IN ACCOUNTING AND TAXATION; COMPUTER NETWORKS, NAMELY, COMPUTER HARDWARE AND SOFTWARE FOR SETTING UP AND CONFIGURING LOCAL AREA NETWORKS; COMPUTER SOFTWARE FOR USE IN ACCOUNTING; COMPUTER SOFTWARE FOR TAX MANAGEMENT; ONLINE DOWNLOADABLE ELECTRONIC PUBLICATIONS IN THE NATURE OF NEWSLETTERS, JOURNALS, MAGAZINES, BROCHURES, BOOKS, MANUALS, STATIONERY RELATING TO ACCOUNTING AND TAXATION, IN CLASS 9 (U.S. CLS. 21, 23, 26, 36 AND 38).

FOR: PRINTED MATTER IN THE NATURE OF NEWSLETTERS, JOURNALS, MAGAZINES, BROCHURES, BOOKS, MANUALS, STATIONERY RELATING TO ACCOUNTING AND TAXATION; MANUALS FOR USE IN ACCOUNTING; PRINTED INSTRUCTIONAL AND TEACHING MATERIALS RELATING TO ACCOUNTING AND TAXATION; PRE-PRINTED FORMS RELATING TO ACCOUNTING AND TAXATION, IN CLASS 16 (U.S. CLS. 2, 5, 22, 23, 29, 37, 38 AND 50).

FOR: ACCOUNTANCY SERVICES; CONSULTANCY SERVICES IN THE FIELD OF ACCOUNTING AND TAXATION; COMPILATION OF INFORMATION INTO COMPUTER DATABASES IN THE FIELD OF ACCOUNTING AND TAXATION; DATABASE MANAGEMENT SERVICES; BOOKKEEPING SERVICES; ACCOUNT AND BUSINESS AUDITING SERVICES; PROVISION OF TAX RELATED ADVICE; PROVIDING START-UP SUPPORT SERVICES FOR BUSINESSES OF OTHERS; PROVIDING ONLINE INFORMATION CONCERNING ACCOUNTING AND TAXATION, IN CLASS 35 (U.S. CLS. 100, 101 AND 102).

OWNER OF ERPN CMNTY TM OFC REG. NO. 005277629, DATED 1-14-2008, EXPIRES 5-12-2016.

NO CLAIM IS MADE TO THE EXCLUSIVE RIGHT TO USE "TAX ASSIST ACCOUNTANTS" AND "THE ACCOUNTANCY AND TAX SERVICE FOR SMALL BUSINESS", APART FROM THE MARK AS SHOWN.



David J. Kyjars

Director of the United States Patent and Trademark Office

Reg. No. 4,107,509 THE MARK CONSISTS OF A DOLLAR SIGN AND THE WORDING "TAXASSIST" "AC-COUNTANTS"; BELOW THAT APPEARS THE WORDING "THE ACCOUNTANCY AND TAX SERVICE FOR SMALL BUSINESS" WITHIN A RECTANGULAR SHAPE ATTACHED TO THE BOTTOM OF THE DOLLAR SIGN.

SER. NO. 85-149,494, FILED 10-11-2010.

KRISTIN CARLSON, EXAMINING ATTORNEY

United States of America

United States Patent and Trademark Office

FRATICELLI'S ITALIAN GRILL & LOUNGE

Reg. No. 4,107,510

TORTOISE RESTAURANT GROUP INC. (CANADA CORPORATION)
3370 SOUTH SERVICE ROAD
BURLINGTON, ONTARIO, CANADA L7N3M6

Registered Mar. 6, 2012

Int. Cl.: 43

FOR: RESTAURANT AND BAR SERVICES, IN CLASS 43 (U.S. CLS. 100 AND 101).

SERVICE MARK

THE MARK CONSISTS OF STANDARD CHARACTERS WITHOUT CLAIM TO ANY PARTICULAR FONT, STYLE, SIZE, OR COLOR.

PRINCIPAL REGISTER

OWNER OF CANADA REG. NO. TMA804508, DATED 8-16-2011, EXPIRES 8-16-2026.

NO CLAIM IS MADE TO THE EXCLUSIVE RIGHT TO USE "ITALIAN GRILL & LOUNGE", APART FROM THE MARK AS SHOWN.

SER. NO. 85-151,501, FILED 10-13-2010.

ANNE MADDEN, EXAMINING ATTORNEY



David J. Kyffers

Director of the United States Patent and Trademark Office

United States of America

United States Patent and Trademark Office

ZEEMA

Reg. No. 4,107,511

Registered Mar. 6, 2012

Int. Cl.: 31

TRADEMARK

PRINCIPAL REGISTER

MASTRONARDI PRODUCE LTD. (CANADA CORPORATION)
C/O KOENIG & ASSOCIATES
920 GARDEN STREET, SUITE A
SANTA BARBARA, CA 93101

FOR: FRESH TOMATOES; RAW TOMATOES; UNPROCESSED TOMATOES, IN CLASS 31
(U.S. CLS. 1 AND 46).

FIRST USE 1-10-2011; IN COMMERCE 1-10-2011.

THE MARK CONSISTS OF STANDARD CHARACTERS WITHOUT CLAIM TO ANY PARTICULAR FONT, STYLE, SIZE, OR COLOR.

PRIORITY CLAIMED UNDER SEC. 44(D) ON CANADA APPLICATION NO. 1497368, FILED 9-27-2010, REG. NO. TMA810787, DATED 11-1-2011, EXPIRES 11-1-2026.

SER. NO. 85-151,765, FILED 10-13-2010.

THEODORE MCBRIDE, EXAMINING ATTORNEY



David J. Kybas

Director of the United States Patent and Trademark Office

United States of America

United States Patent and Trademark Office

FOREVER YOUNG.MD

Reg. No. 4,107,512

Registered Mar. 6, 2012

Int. Cl.: 44

SERVICE MARK

PRINCIPAL REGISTER

TORRES-RAMOS, FRANCISCO M. (UNITED STATES INDIVIDUAL), DBA
FOREVERYOUNG.MD
3280 MCMULLEN BOOTH RD. STE. 240
CLEARWATER, FL 33761

FOR: CONSULTING SERVICES IN THE FIELD OF NUTRITION; CONSULTING SERVICES IN THE FIELDS OF HEALTH AND NUTRITION; COUNSELING SERVICES IN THE FIELDS OF HEALTH, NUTRITION AND LIFESTYLE WELLNESS; DIETARY AND NUTRITIONAL GUIDANCE; FOOD NUTRITION CONSULTATION; MEDICAL AND PHARMACEUTICAL CONSULTATION; MEDICAL CONSULTATIONS; MEDICAL TESTING OF URINE, BLOOD, AND BREATH; MEDICAL TESTING SERVICES, NAMELY, FITNESS EVALUATION; MEDICAL, PHYSICAL REHABILITATION; NUTRITION COUNSELING; NUTRITIONAL THERAPY SERVICES; PROVIDING ASSISTANCE, FITNESS EVALUATION AND CONSULTATION TO INDIVIDUALS TO HELP THEM MAKE HEALTH, WELLNESS AND NUTRITIONAL CHANGES IN THEIR DAILY LIVING TO IMPROVE HEALTH; PROVIDING HEALTHY LIFESTYLE AND NUTRITION SERVICES, NAMELY, PERSONAL ASSESSMENTS, PERSONALIZED ROUTINES, MAINTENANCE SCHEDULES, AND COUNSELING; PROVIDING INFORMATION ABOUT DIETARY SUPPLEMENTS AND NUTRITION, IN CLASS 44 (U.S. CLS. 100 AND 101).

FIRST USE 4-1-2010; IN COMMERCE 4-1-2010.

THE MARK CONSISTS OF THE WORDS "FOREVERYOUNG.MD", BEING THE LETTER "O" IN THE WORD "FOREVER" A CIRCULAR LOGO.

SER. NO. 85-152,567, FILED 10-14-2010.

ALICE BENMAMAN, EXAMINING ATTORNEY



David J. Kyffers

Director of the United States Patent and Trademark Office

United States of America

United States Patent and Trademark Office



Reg. No. 4,107,513

Registered Mar. 6, 2012

Int. Cl.: 36

SERVICE MARK

PRINCIPAL REGISTER

MVP HEALTH CARE, INC. (NEW YORK CORPORATION)
625 STATE STREET
SCHENECTADY, NY 12305

FOR: HEALTH INSURANCE SERVICES, NAMELY, UNDERWRITING AND ADMINISTRATION; THIRD PARTY ADMINISTRATION OF EMPLOYEE BENEFITS CONCERNING HEALTH INSURANCE, NAMELY, CLAIMS ADMINISTRATION AND CONSULTATION RELATED TO SUCH EMPLOYEE BENEFITS PLANS, IN CLASS 36 (U.S. CLS. 100, 101 AND 102).

FIRST USE 4-30-2009; IN COMMERCE 4-30-2009.

OWNER OF U.S. REG. NOS. 1,949,225, 2,684,587, AND 2,753,944.

NO CLAIM IS MADE TO THE EXCLUSIVE RIGHT TO USE "HEALTH CARE", APART FROM THE MARK AS SHOWN.

THE MARK CONSISTS OF A SHAPE SIMILAR TO A HALF OF A VERTICAL SLICE OF AN APPLE WITH A SMALL LEAF ATTACHED TO THE STEM PORTION OF THE SLICE. THE VERTICAL SLICE IS SHAPED AS A BACKWARDS LETTER C WITH A RHOMBUS SHAPE POSITIONED AT THE TOP END OF THE BACKWARDS C. THE WORDS "MVP HEALTH CARE" ARE POSITIONED ADJACENT TO THE BULBOUS PART OF THE BACKWARDS LETTER C.

SER. NO. 85-155,684, FILED 10-19-2010.

JEAN IM, EXAMINING ATTORNEY



David J. Kyros

Director of the United States Patent and Trademark Office

United States of America

United States Patent and Trademark Office



Reg. No. 4,107,514

Registered Mar. 6, 2012

Int. Cl.: 41

SERVICE MARK

PRINCIPAL REGISTER

BILLIE, WENDY A (UNITED STATES INDIVIDUAL)
324 COUNTY HWY 1
OTTERTAIL, MN 56571

FOR: CONDUCTING WORKSHOPS AND SEMINARS IN YOGA, MARTIAL ARTS, AND MIND AND BODY COACHING.; LIFE COACHING SERVICES IN THE FIELD OF MIND AND BODY WELLNESS.; MARTIAL ARTS INSTRUCTION; YOGA INSTRUCTION, IN CLASS 41 (U.S. CLS. 100, 101 AND 107).

FIRST USE 1-12-2009; IN COMMERCE 1-12-2009.

THE MARK CONSISTS OF A SWIRL OF RED CIRCLES AND ONE BLUE CIRCLE IN FRONT OF THE WORD "ADRENAZEN". THE TERM "ADRENA" IS A DEEP RED COLOR AND THE TERM "ZEN" IS A LIGHT BLUE COLOR. THE MARK ALSO INCLUDES THE WORDING "INTENSITY REFOCUSED" IN LIGHT BLUE BENEATH THE LETTERS "NAZEN" IN THE WORD "ADRENAZEN".

THE COLOR(S) DEEP RED AND LIGHT BLUE IS/ARE CLAIMED AS A FEATURE OF THE MARK.

SER. NO. 85-155,792, FILED 10-19-2010.

RUSS HERMAN, EXAMINING ATTORNEY



David J. Kyros

Director of the United States Patent and Trademark Office

United States of America

United States Patent and Trademark Office

COLDTRAC

Reg. No. 4,107,515

Registered Mar. 6, 2012

Int. Cls.: 9 and 42

TRADEMARK

SERVICE MARK

PRINCIPAL REGISTER

GENESIS MEDICAL IMAGING, INC. (ILLINOIS CORPORATION)
12031 SMITH DRIVE
HUNTLEY, IL 60142

FOR: DIAGNOSTIC APPARATUS FOR ACTIVE MONITORING OF OPERATIONAL PARAMETERS OF MEDICAL DIAGNOSTIC IMAGING, CLINICAL AND BIOMEDICAL EQUIPMENT, IN CLASS 9 (U.S. CLS. 21, 23, 26, 36 AND 38).

FIRST USE 10-1-2009; IN COMMERCE 11-1-2009.

FOR: REMOTE DIAGNOSIS OF MEDICAL DIAGNOSTIC IMAGING, CLINICAL AND BIOMEDICAL EQUIPMENT FOR DETERMINING THE NEED FOR REPAIR, IN CLASS 42 (U.S. CLS. 100 AND 101).

FIRST USE 10-1-2009; IN COMMERCE 11-1-2009.

THE MARK CONSISTS OF STANDARD CHARACTERS WITHOUT CLAIM TO ANY PARTICULAR FONT, STYLE, SIZE, OR COLOR.

SER. NO. 85-155,868, FILED 10-19-2010.

SHAUNIA CARLYLE, EXAMINING ATTORNEY



David J. Kybas

Director of the United States Patent and Trademark Office

United States of America

United States Patent and Trademark Office

NOVOCART

Reg. No. 4,107,516

Registered Mar. 6, 2012

Int. Cl.: 5

TRADEMARK

PRINCIPAL REGISTER

TETEC TISSUE ENGINEERING TECHNOLOGIES AG (FED REP GERMANY JOINT STOCK COMPANY (AKTIENGESELLSCHAFT))
ASPENHAUSTRASSE 25
REUTLINGEN, FED REP GERMANY 72770

FOR: BIOLOGICAL CELLS FOR MEDICAL PURPOSES, NAMELY, EXPANDED CELLS IN A CELL CULTURE SYSTEM, USED FOR THE REGENERATION OF ARTICULAR CARTILAGE OR COMBINED BONE AND CARTILAGE DEFECTS WITH OR WITHOUT SCAFFOLD, IN CLASS 5 (U.S. CLS. 6, 18, 44, 46, 51 AND 52).

THE MARK CONSISTS OF STANDARD CHARACTERS WITHOUT CLAIM TO ANY PARTICULAR FONT, STYLE, SIZE, OR COLOR.

OWNER OF FED REP GERMANY REG. NO. 30012956, DATED 8-16-2000, RENEWED AS REG. NO. 30012956, DATED 3-1-2010, EXPIRES 2-29-2020.

OWNER OF U.S. REG. NO. 3,093,469.

SER. NO. 85-156,719, FILED 10-20-2010.

NAAKWAMA ANKRAH, EXAMINING ATTORNEY



David J. Kyfos

Director of the United States Patent and Trademark Office

United States of America

United States Patent and Trademark Office



Reg. No. 4,107,517

Registered Mar. 6, 2012

Int. Cl.: 41

SERVICE MARK

PRINCIPAL REGISTER

HOT TOMATO RECORDS, LLC (NORTH CAROLINA LIMITED LIABILITY COMPANY)
652 NORTH DOHENY DRIVE
LOS ANGELES, CA 90069

FOR: AUDIO RECORDING AND PRODUCTION, IN CLASS 41 (U.S. CLS. 100, 101 AND 107).

FIRST USE 1-1-2002; IN COMMERCE 1-10-2002.

NO CLAIM IS MADE TO THE EXCLUSIVE RIGHT TO USE "RECORDS", APART FROM THE MARK AS SHOWN.

THE MARK CONSISTS OF THE DEPICTION OF A WOMAN'S BODY WITH A TOMATO FOR A HEAD, TRANPOSED OVER THE WORD "HOT" IN STYLIZED LETTERS STACKED ABOVE THE WORD "TOMATO" IN STYLIZED LETTER WITHIN A RECTANGLE STACKED ABOVE THE WORD "RECORDS" WITH EACH LETTER STYLIZED WITHIN A CIRCLE, TO THE RIGHT CENTER OF THE DESIGN IS A SMALL CIRCLE WHICH CONTAINS A SHOE AND THE WORDS "LITTLE FEAT".

SER. NO. 85-157,158, FILED 10-20-2010.

BRIAN PINO, EXAMINING ATTORNEY



David J. Kybas

Director of the United States Patent and Trademark Office

United States of America

United States Patent and Trademark Office

WATER FOR GROWTH

Reg. No. 4,107,518

GLOBAL GREEN STAR, LLC (UTAH LIMITED LIABILITY COMPANY)
PO BOX 911986
ST. GEORGE, UT 84791

Registered Mar. 6, 2012

Int. Cl.: 40

FOR: CONTINUOUS BIOLOGICAL WATER TREATMENT SERVICES; TREATMENT OF WASTE WATER; WASTE WATER REPROCESSING; WASTE WATER TREATMENT SERVICES, IN CLASS 40 (U.S. CLS. 100, 103 AND 106).

SERVICE MARK

FIRST USE 10-5-2010; IN COMMERCE 10-5-2010.

PRINCIPAL REGISTER

THE MARK CONSISTS OF STANDARD CHARACTERS WITHOUT CLAIM TO ANY PARTICULAR FONT, STYLE, SIZE, OR COLOR.

NO CLAIM IS MADE TO THE EXCLUSIVE RIGHT TO USE "WATER", APART FROM THE MARK AS SHOWN.

SER. NO. 85-159,163, FILED 10-22-2010.

NAAKWAMA ANKRAH, EXAMINING ATTORNEY



David J. Kyros

Director of the United States Patent and Trademark Office

United States of America

United States Patent and Trademark Office



Reg. No. 4,107,519

Registered Mar. 6, 2012

Int. Cl.: 43

SERVICE MARK

PRINCIPAL REGISTER

ROJO ONE, LLC (MICHIGAN LIMITED LIABILITY COMPANY)
42705 GRAND RIVER AVE
NOVI, MI 48375

FOR: BAR AND RESTAURANT SERVICES, IN CLASS 43 (U.S. CLS. 100 AND 101).

FIRST USE 11-3-2008; IN COMMERCE 11-12-2008.

OWNER OF U.S. REG. NO. 3,891,371.

NO CLAIM IS MADE TO THE EXCLUSIVE RIGHT TO USE "MEXICAN BISTRO", APART FROM THE MARK AS SHOWN.

THE MARK CONSISTS OF A CIRCULAR DESIGN LIKE AN AZTEC CALENDAR DESIGN, ABOVE THE WORD "ROJO" IN STYLIZED LETTERING, ABOVE A STRAIGHT HORIZONTAL LINE, WITH THE WORDS "MEXICAN BISTRO" APPEARING BELOW THE LINE, ALSO IN STYLIZED LETTERING.

THE ENGLISH TRANSLATION OF "ROJO" IN THE MARK IS "RED".

SER. NO. 85-160,509, FILED 10-25-2010.

LAKEISHA LEWIS, EXAMINING ATTORNEY



David J. Kybas

Director of the United States Patent and Trademark Office

United States of America

United States Patent and Trademark Office

PUTUMAYO

Reg. No. 4,107,520

ZOUK, LLC (NEW YORK LIMITED LIABILITY COMPANY)
411 LAFAYETTE STREET
NEW YORK, NY 10003

Registered Mar. 6, 2012

Int. Cl.: 41

FOR: ENTERTAINMENT IN THE NATURE OF LIVE PERFORMANCES BY A MUSICAL BAND, LIVE MUSIC CONCERTS, DANCE EVENTS AND CULTURAL FESTIVALS, IN CLASS 41 (U.S. CLS. 100, 101 AND 107).

SERVICE MARK

FIRST USE 8-7-1993; IN COMMERCE 8-7-1993.

PRINCIPAL REGISTER

THE MARK CONSISTS OF STANDARD CHARACTERS WITHOUT CLAIM TO ANY PARTICULAR FONT, STYLE, SIZE, OR COLOR.

OWNER OF U.S. REG. NOS. 2,479,926, 3,159,238 AND OTHERS.

SER. NO. 85-162,774, FILED 10-27-2010.

NANCY CLARKE, EXAMINING ATTORNEY



David J. Kybas

Director of the United States Patent and Trademark Office

United States of America

United States Patent and Trademark Office

ORBIS ACCESS

Reg. No. 4,107,521

Registered Mar. 6, 2012

Int. Cl.: 36

SERVICE MARK

PRINCIPAL REGISTER

ORBIS HOLDINGS LIMITED (BERMUDA CORPORATION)
ORBIS HOUSE, 25 FRONT STREET
HAMILTON, BERMUDA HM11

FOR: MANAGEMENT OF CAPITAL INVESTMENT FUND; CAPITAL INVESTMENT SERVICES; FINANCIAL INVESTMENT SERVICES IN THE FIELD OF MUTUAL FUNDS; FINANCIAL PORTFOLIO MANAGEMENT SERVICES; HEDGE FUND INVESTMENT MANAGEMENT AND ADMINISTRATION SERVICES; MUTUAL FUND BROKERAGE; MUTUAL FUND DISTRIBUTION; ESTABLISHING MUTUAL FUNDS FOR OTHERS; INVESTMENT ADVISORY SERVICES; BROKERAGE SERVICES IN THE FIELD OF INVESTMENT FUNDS; FINANCIAL MANAGEMENT AND ANALYSIS SERVICES; INFORMATION, ADVISORY AND CONSULTANCY SERVICES RELATING TO ALL THE AFORESAID FINANCIAL SERVICES; ALL OF THE ABOVE FINANCIAL SERVICES CAPABLE OF BEING PROVIDED ON-LINE FROM A COMPUTER DATABASE OR VIA THE INTERNET, IN CLASS 36 (U.S. CLS. 100, 101 AND 102).

THE MARK CONSISTS OF STANDARD CHARACTERS WITHOUT CLAIM TO ANY PARTICULAR FONT, STYLE, SIZE, OR COLOR.

PRIORITY CLAIMED UNDER SEC. 44(D) ON ERPN CMNTY TM OFC APPLICATION NO. 9478611, FILED 10-26-2010, REG. NO. 009478611, DATED 3-8-2011, EXPIRES 3-8-2021.

OWNER OF U.S. REG. NO. 1,971,216.

NO CLAIM IS MADE TO THE EXCLUSIVE RIGHT TO USE "ACCESS", APART FROM THE MARK AS SHOWN.

SER. NO. 85-162,925, FILED 10-27-2010.

ODESSA BIBBINS, EXAMINING ATTORNEY



David J. Kyffers

Director of the United States Patent and Trademark Office

United States of America

United States Patent and Trademark Office



Reg. No. 4,107,522

Registered Mar. 6, 2012

Int. Cls.: 9 and 25

TRADEMARK

PRINCIPAL REGISTER

KIMPEX INC. (CANADA CORPORATION)
5355 ST-ROCH
DRUMMONDVILLE, QUEBEC, CANADA J2B6V4

FOR: HELMETS, GOGGLES AND PROTECTION MASKS, IN CLASS 9 (U.S. CLS. 21, 23, 26, 36 AND 38).

FIRST USE 1-30-2004; IN COMMERCE 1-30-2004.

FOR: CLOTHING AND ACCESSORIES FOR SNOWMOBILE, MOTORCYCLE AND ATV, NAMELY, HATS, VISORS, BOOTS, JACKETS, COATS, PANTS, LEATHER OR NYLON JACKETS, GLOVES, GLOVE LINERS, MITTENS, HOODS, MASKS, HEADBANDS, UNDER STOCKINGS, UNDERWEAR, THERMAL UNDERWEAR, BASE LAYERS, SLEEVES, BELTS, SWEAT SUITS, IN CLASS 25 (U.S. CLS. 22 AND 39).

FIRST USE 1-30-2004; IN COMMERCE 1-30-2004.

THE MARK CONSISTS OF THE LETTERS "CKX" IN STYLIZED FORM WHEREIN THE LETTERS ARE DOUBLE-OUTLINED.

SER. NO. 85-164,723, FILED 10-29-2010.

TRACY WHITTAKER-BROWN, EXAMINING ATTORNEY



David J. Kybas

Director of the United States Patent and Trademark Office

United States of America

United States Patent and Trademark Office

ADEUNIS

Reg. No. 4,107,523

Registered Mar. 6, 2012

Int. Cl.: 9

TRADEMARK

PRINCIPAL REGISTER

ADEUNIS R F (FRANCE SOCIETE ANONYME A CONSEIL D'ADMINISTRATION)
PARC TECHNIQUE PRE ROUX
283 RUE LOUIS NEEL
CROLLES, FRANCE 38920

FOR: APPARATUS AND INSTRUMENTS FOR CONDUCTING, SWITCHING, TRANSFORMING, ACCUMULATING, REGULATING OR CONTROLLING ELECTRICITY FROM A DISTANCE; APPARATUS FOR RECORDING, TRANSMISSION OR REPRODUCTION OF SOUND OR IMAGES; ELECTRICAL, ELECTRONIC, COMPUTER, MULTI-USER AND HANDS FREE DEVICES INTENDED TO BE USED FOR TRANSMITTING AND REPRODUCING SOUNDS AND IMAGES FROM MOBILE RADIOS AT A DISTANCE PARTICULARLY IN NOISY ENVIRONMENTS; WIRELESS PRODUCTS, NAMELY, WIRELESS ACCESS CONTROL AND ALARM MONITORING SYSTEMS, HOME AND OFFICE AUTOMATION SYSTEMS COMPRISING WIRELESS AND WIRED CONTROLLERS, CONTROLLED DEVICES, AND SOFTWARE FOR LIGHTING, HVAC, SECURITY, SAFETY AND OTHER HOME AND OFFICE MONITORING AND CONTROL APPLICATIONS; DEVICES FOR WIRELESS RADIO TRANSMISSION, NAMELY, RADIO FREQUENCY APPARATUS AND INSTRUMENTS USED IN LONG RANGE COMMUNICATION FOR TRACKING AND MONITORING SOUND AND IMAGES; ELECTRONIC REMOTE CONTROL TRANSMITTERS FOR RADIO-CONTROLLED DEVICES AND BROADCASTING RADIO FREQUENCY SIGNALS; APPARATUS FOR TRANSMITTING AND REPRODUCING SOUNDS AND IMAGES FROM A DISTANCE; PARTS AND FITTINGS FOR APPARATUS FOR TRANSMITTING AND REPRODUCING SOUNDS AND IMAGES FROM A DISTANCE, NAMELY, TRANSMITTING SETS, RECEIVERS, FILTERS AND RESONATORS; WIRELESS COMMUNICATION DEVICES, NAMELY, WIRELESS TRANSMITTERS AND RECEIVERS ENABLING WIRELESS AUDIO AND VIDEO CONFERENCES; EQUIPMENT FOR DATA PROCESSING, SOFTWARE AND COMPUTER PROGRAMS FOR OPERATING AND USE OF WIRELESS ELECTRONIC SYSTEMS; WIRELESS ELECTRONIC SYSTEMS, NAMELY, WIRELESS ACCESS CONTROL AND ALARM MONITORING SYSTEMS, HOME AND OFFICE AUTOMATION SYSTEMS COMPRISING WIRELESS AND WIRED CONTROLLERS, CONTROLLED DEVICES, AND SOFTWARE FOR LIGHTING, HVAC, SECURITY, SAFETY AND OTHER HOME AND OFFICE MONITORING AND CONTROL APPLICATIONS; PROTECTION DEVICES FOR PERSONAL USE AGAINST ACCIDENTS, NAMELY, EMERGENCY REMOTE CONTROL DEVICES THAT COMMUNICATE WITH EMERGENCY FIRST RESPONDERS, IN CLASS 9 (U.S. CLS. 21, 23, 26, 36 AND 38).



David J. Kyjars

Director of the United States Patent and Trademark Office

Reg. No. 4,107,523 THE MARK CONSISTS OF STANDARD CHARACTERS WITHOUT CLAIM TO ANY PARTICULAR FONT, STYLE, SIZE, OR COLOR.

PRIORITY CLAIMED UNDER SEC. 44(D) ON FRANCE APPLICATION NO. 10/3754817, FILED 7-20-2010, REG. NO. 10/3754817, DATED 7-20-2010, EXPIRES 7-20-2020.

THE WORDING "ADEUNIS" HAS NO MEANING IN A FOREIGN LANGUAGE KNOWN TO APPLICANT.

SER. NO. 85-164,829, FILED 10-29-2010.

SKYE YOUNG, EXAMINING ATTORNEY

United States of America
United States Patent and Trademark Office

pervasa



Reg. No. 4,107,524

Registered Mar. 6, 2012

Int. Cl.: 9

TRADEMARK

PRINCIPAL REGISTER

PERVASA, INC. (FLORIDA CORPORATION)
SUITE 109
101 SE 2ND PLACE
GAINESVILLE, FL 32601

FOR: SENSOR NODES, NAMELY, ELECTRONIC DEVICES THAT CAN AUTOMATICALLY INTEGRATE AND CONNECT SENSORS FOR TEMPERATURE, PRESSURE, HUMIDITY, VIBRATION, PROXIMITY, CONTACT, MOTION, AND INFRARED, THAT ARE ABLE TO DO LOCAL PROCESSING, AND THAT ARE ABLE TO COMMUNICATE, NAMELY, USING, LOW-POWER WIRELESS COMMUNICATION TECHNOLOGY, ETHERNET, WIRELESS CABLE REPLACEMENT TECHNOLOGY, CELLULAR, SATELLITE AND WI-FI; SENSOR NODE MODULES, NAMELY, SENSOR INTERFACE MODULES FOR TEMPERATURE, PRESSURE, HUMIDITY, VIBRATION, PROXIMITY, CONTACT, MOTION, AND INFRARED, SENSOR PROCESSING MODULE FOR TEMPERATURE, PRESSURE, HUMIDITY, VIBRATION, PROXIMITY, CONTACT, MOTION, AND INFRARED, SENSOR COMMUNICATION MODULES FOR TEMPERATURE, PRESSURE, HUMIDITY, VIBRATION, PROXIMITY, CONTACT, MOTION, AND INFRARED FEATURING WI-FI, ETHERNET, CELLULAR, SATELLITE, AND LOW-POWER WIRELESS COMMUNICATION TECHNOLOGY; MIDDLEWARE, NAMELY, A COLLECTION OF FIRMWARE ON THE SENSOR NODES AND SOFTWARE ON A POWERFUL DEVICE THAT AUTOMATES AND MAINTAINS THE INTEGRATION OF A SENSOR, ACTUATOR OR A DEVICE INTO THE INTERNET OR THE INTRANET; KITS COMPRISED OF SEVERAL SENSOR NODES ALONG WITH SAMPLE SENSORS, NAMELY, TEMPERATURE, PHOTO, PRESSURE, HUMIDITY, VIBRATION, PROXIMITY, CONTACT, MOTION, AND INFRARED, ALONG WITH SAMPLE ACTUATORS, NAMELY, SERVO, POWER SWITCHES, SPEAKERS, AND LIGHT; KITS COMPRISED OF SENSORS ALONG WITH MIDDLEWARE AND SOFTWARE FOR INTERFACING WITH THE SENSORS THROUGH APPLICATION PROGRAMMATIC INTERFACES (API), NAMELY, COMPRISING A PATIENT MONITORING SENSORS AND ALARMS; KITS COMPRISED OF SENSORS ALONG WITH MIDDLEWARE AND SOFTWARE FOR INTERFACING WITH THE SENSORS THROUGH APPLICATION PROGRAMMATIC INTERFACES (API), NAMELY, COMPRISING A HEALTH MONITORS COMPRISING SENSOR THAT MONITOR THE HEALTH OF THE ELDERLY OR HANDICAPPED IN THEIR OWN HOMES; KITS COMPRISED OF SENSORS ALONG WITH MIDDLEWARE AND SOFTWARE FOR INTERFACING WITH THE SENSORS THROUGH APPLICATION PROGRAMMATIC INTERFACES (API), NAMELY, COMPRISING A VEHICLE TRACKING DEVICES COMPRISED OF SENSOR NODES, VARIETY OF SENSORS, NAMELY, HUMIDITY SENSORS, TEMPERATURE SENSORS, CONTACT SENSORS, FRESHNESS SENSORS, VIBRATION SENSORS, WEIGHT SENSORS,



David J. Kyjars

Director of the United States Patent and Trademark Office

Reg. No. 4,107,524 AND GLOBAL POSITIONING SATELLITE RECEIVERS, ALL FOR USE IN CONNECTION WITH VEHICLE TRACKING, VEHICLE MONITORING AND ANTI-SHRINKAGE VEHICLE ALARMS; KITS COMPRISED OF SENSORS ALONG WITH MIDDLEWARE AND SOFTWARE FOR INTERFACING WITH THE SENSORS THROUGH APPLICATION PROGRAMMATIC INTERFACES (API), NAMELY, COMPRISING A SITE ASSET AND TRACKING SYSTEM, CONSISTING OF A LARGE COLLECTION OF DEVICES, SENSORS, NAMELY, ACTIVE RADIO FREQUENCY IDENTIFICATION (RFID) TAGS, RADIO FREQUENCY IDENTIFICATION (RFID) TAGS, RFID READERS, CAMERAS, AREAL CAMERAS, NEAR FIELD COMMUNICATION TAGS, ALL FOR USE IN TRACKING ASSETS AND FOR ENFORCING SECURITY AND DETECTING SECURITY BREACHES, IN CLASS 9 (U.S. CLS. 21, 23, 26, 36 AND 38).

FIRST USE 6-30-2006; IN COMMERCE 9-21-2006.

THE MARK CONSISTS OF THE WORD "PERVASA", AND AT THE BASE OF THE "V" ARE SEVERAL WAVES RADIATING SOUTH EAST DIRECTION.

THE WORDING "PERVASA" HAS NO MEANING IN A FOREIGN LANGUAGE.

SER. NO. 85-165,393, FILED 10-29-2010.

WARREN L. OLANDRIA, EXAMINING ATTORNEY

United States of America

United States Patent and Trademark Office



Reg. No. 4,107,525

Registered Mar. 6, 2012

Int. Cl.: 19

TRADEMARK

PRINCIPAL REGISTER

CUSTOM BUILDING PRODUCTS, INC. (DELAWARE CORPORATION)
13001 SEAL BEACH BOULEVARD
SEAL BEACH, CA 90740

FOR: BUILDING MATERIALS, NAMELY, GROUTS, IN CLASS 19 (U.S. CLS. 1, 12, 33 AND 50).

FIRST USE 11-1-2010, THE MARK WAS FIRST USED ANYWHERE IN A DIFFERENT FORM OTHER THAN THAT SOUGHT TO BE REGISTERED AT LEAST AS EARLY AS 02/00/2006.; IN COMMERCE 1-31-2011, THE MARK WAS FIRST USED IN COMMERCE IN A DIFFERENT FORM OTHER THAN THAT SOUGHT TO BE REGISTERED AT LEAST AS EARLY AS 02/00/2006..

OWNER OF U.S. REG. NO. 1,604,678.

THE COLOR(S) BLUE, YELLOW, WHITE AND BLACK IS/ARE CLAIMED AS A FEATURE OF THE MARK.

NO CLAIM IS MADE TO THE EXCLUSIVE RIGHT TO USE "GROUT", APART FROM THE MARK AS SHOWN.

THE MARK CONSISTS OF TWO OVERLAPPING STARBURST DESIGNS, WITH ONE DESIGN INCORPORATING ALTERNATING BLUE AND WHITE COLORED LINES AND THE SECOND DESIGN INCORPORATING ALTERNATING YELLOW AND WHITE LINES, WITH THE WORDS "POLYBLEND AMERICA'S #1 GROUT" IN BLACK COLORED LETTERS SUPERIMPOSED OVER THE OVERLAPPING STARBURST DESIGNS.

SEC. 2(F) AS TO "AMERICA'S #1 GROUT".

SER. NO. 85-166,663, FILED 11-1-2010.

TARAH HARDY, EXAMINING ATTORNEY



David J. Kybas

Director of the United States Patent and Trademark Office

United States of America

United States Patent and Trademark Office

KYLO

Reg. No. 4,107,526

Registered Mar. 6, 2012

Int. Cl.: 3

TRADEMARK

PRINCIPAL REGISTER

RAGUNATH, SURESH JAYASEELAN (INDIA INDIVIDUAL)
NEW. NO. 3 (OLD NO.46)
BHEEMANNA GARDEN STREET, ABHIRAMAPURAM
CHENNAI, INDIA 600018

FOR: CLEANING, POLISHING, SCOURING AND ABRASIVE PREPARATIONS; DETERGENT SOAPS AND DETERGENT POWDERS FOR LAUNDRY AND DISHWASHING, IN CLASS 3 (U.S. CLS. 1, 4, 6, 50, 51 AND 52).

THE MARK CONSISTS OF STANDARD CHARACTERS WITHOUT CLAIM TO ANY PARTICULAR FONT, STYLE, SIZE, OR COLOR.

OWNER OF INDIA REG. NO. 885034, DATED 11-4-1999, EXPIRES 11-4-2016.

SER. NO. 85-168,112, FILED 11-3-2010.

NICHOLAS COLEMAN, EXAMINING ATTORNEY



David J. Kyffers

Director of the United States Patent and Trademark Office

United States of America

United States Patent and Trademark Office



Reg. No. 4,107,527

Registered Mar. 6, 2012

Int. Cls.: 35, 36 and 41

SERVICE MARK

PRINCIPAL REGISTER

BNP PARIBAS (FRANCE CORPORATION)
16, BOULEVARD DES ITALIENS
PARIS, FRANCE 75009

FOR: ASSISTANCE IN THE MANAGEMENT OF THE BUSINESS AFFAIRS OR COMMERCIAL FUNCTIONS OF AN INDUSTRIAL OR COMMERCIAL COMPANY; BUSINESS MANAGEMENT AND BUSINESS ORGANIZATION CONSULTANCY; PROFESSIONAL BUSINESS CONSULTANCY; EFFICIENCY EXPERTS; BUSINESS ADVICE AND INFORMATION; BUSINESS INFORMATION SERVICES IN THE NATURE OF PROVIDING INFORMATION ON BUSINESS OPPORTUNITIES; BUSINESS INFORMATION IN THE FIELD OF BANKING, FINANCIAL, MONETARY, INSURANCE AND REAL ESTATE SERVICES; BUSINESS INVESTIGATIONS; BUSINESS RESEARCH; BUSINESS INQUIRIES; DISSEMINATION OF ADVERTISING MATTER; COMMERCIAL OR INDUSTRIAL MANAGEMENT ASSISTANCE; BOOK-KEEPING; TAX PREPARATION; DIRECT MAIL ADVERTISING FEATURING TRACTS, PROSPECTUSES, PRINTED MATTER, SAMPLES; CONDUCTING MARKETING STUDIES; COMPILATION OF INFORMATION INTO COMPUTER DATABASES; COMPUTERIZED FILE MANAGEMENT; ECONOMIC FORECASTING; DRAWING UP OF STATEMENTS OF ACCOUNTS; ADVERTISING; ONLINE ADVERTISING ON COMPUTERIZED COMMUNICATIONS NETWORKS SUCH AS THE INTERNET AND INTRANET; DATA SEARCHES IN COMPUTERIZED FILES FOR OTHERS; RENTAL OF ADVERTISING TIME ON COMPUTERIZED COMMUNICATIONS NETWORKS SUCH AS THE INTERNET AND INTRANET; WRITING OF ELECTRONIC PUBLICITY COLUMNS PREPARATION; BUSINESS SERVICES, PROVIDING INFORMATION, CONSULTANCY AND ADMINISTRATIVE AND COMMERCIAL ASSISTANCE FOR THE ESTABLISHMENT OF SECURE PAYMENTS FOR ONLINE COMMERCE ON COMPUTERIZED COMMUNICATIONS NETWORKS SUCH AS THE INTERNET; BUSINESS APPRAISALS; MARKETING RESEARCH, COMPILATION OF STATISTICS, IN CLASS 35 (U.S. CLS. 100, 101 AND 102).



David J. Kyjars

Director of the United States Patent and Trademark Office

FOR: BANKING; FINANCIAL AFFAIRS, NAMELY, FINANCIAL INFORMATION, MANAGEMENT AND ANALYSIS SERVICES; FINANCIAL ANALYSIS, FINANCIAL CONSULTANCY, FINANCING SERVICES, DEBT COLLECTION AGENCIES, CREDIT BUREAUX; HIRE-PURCHASING FINANCING; REAL ESTATE AFFAIRS, NAMELY, REAL ESTATE APPRAISAL, REAL ESTATE LISTING; REAL ESTATE BROKERAGE, REAL ESTATE VALUATION, REAL ESTATE CONSULTANCY, FINANCIAL EVALUATION OF REAL ESTATE, PROVIDING REAL ESTATE INFORMATION, REAL ESTATE MANAGEMENT, RENT COLLECTION; INSURANCE SERVICES, NAMELY, INSURANCE SUBROGATION AND INSURANCE BROKERAGE; INSURANCE CONSULTANCY, INSURANCE INFORMATION,

Reg. No. 4,107,527 INSURANCE UNDERWRITING IN THE FIELD OF LIFE, HEALTH, ACCIDENT, FIRE; SURETY SERVICES, SAVINGS BANKS, FINANCIAL PLANNING FOR RETIREMENT SAVINGS; FINANCIAL EVALUATION OF INSURANCE, BANKING, AND REAL ESTATE; FINANCIAL INFORMATION; MUTUAL FUNDS SERVICES, NAMELY, MUTUAL FUND BROKERAGE AND MUTUAL FUND DISTRIBUTION; CAPITAL INVESTMENTS; MONETARY AFFAIRS, NAMELY, FINANCIAL INFORMATION, MANAGEMENT AND ANALYSIS SERVICES; ACTUARIAL SERVICES, FACTORING AGENCIES, STOCK EXCHANGE QUOTATIONS, SECURITIES BROKERAGE, SAVINGS BANKS, CAPITAL INVESTMENTS, CREDIT CARD SERVICES, DEBIT CARD SERVICES, EXCHANGING MONEY, CHEQUE VERIFICATION, ISSUING OF TRAVELLERS' CHEQUES, ISSUING OF BANK CHEQUES, SAFE DEPOSIT BOX SERVICES; FINANCIAL CLEARING HOUSES; INSURANCE BROKERAGE; DEPOSIT OF VALUABLES IN SAFETY DEPOSIT BOXES; ISSUE OF TOKENS OF VALUE, ISSUING OF CREDIT CARDS; FINANCIAL SERVICES, NAMELY, ISSUING OF LOYALTY CARDS AS PART OF A LOYALTY PROGRAM; FISCAL ASSESSMENTS, TRUSTEESHIP REPRESENTATIVES, ELECTRONIC FUNDS TRANSFER, APARTMENT HOUSE MANAGEMENT, FINANCIAL MANAGEMENT, LIFE INSURANCE BROKERAGE AND UNDERWRITING; MARINE INSURANCE UNDERWRITING, ACCIDENT INSURANCE UNDERWRITING, FIRE INSURANCE UNDERWRITING, HEALTH INSURANCE UNDERWRITING, HOME INSURANCE UNDERWRITING; INSURANCE AGAINST UNPAID RENT; APARTMENT RENTAL; REAL ESTATE SERVICES, NAMELY, RENTAL OF OFFICES; MORTGAGE BANKING, BANKING SERVICES, INSTALLMENT LOANS; FINANCIAL SPONSORSHIP OF CULTURAL EVENTS, ENTERTAINMENT EVENTS, SPORTING EVENTS, SPORTS TEAMS, COMMUNITY CENTERED EVENTS, PUBLIC INTEREST PROGRAMS AND ACTIVITIES, EDUCATIONAL PROGRAMS AND ACTIVITIES, CHARITABLE EVENTS AND CHARITIES; FINANCING OF LOANS; FINANCIAL TRANSACTIONS SERVICES, NAMELY, PROVIDING SECURE COMMERCIAL TRANSACTIONS AND PAYMENT OPTIONS; HOME BANKING; MUTUAL FUNDS SERVICES, NAMELY, MUTUAL FUND BROKERAGE AND MUTUAL FUND DISTRIBUTION; BANKING, FINANCE AND MONEY LENDING INFORMATION, CONSULTANCY AND ASSISTANCE; ONLINE BANKING, FINANCIAL, MONETARY, INSURANCE AND REAL ESTATE SERVICES, NAMELY, FINANCIAL SERVICES IN THE NATURE OF INVESTMENT SECURITY, MONETARY EXCHANGE SERVICES, INSURANCE BROKERAGE, AND REAL ESTATE CONSULTANCY ON TELECOMMUNICATIONS NETWORKS INCLUDING MOBILE TELEPHONES, DATA TRANSMISSION NETWORKS AND COMPUTERIZED COMMUNICATIONS NETWORKS SUCH AS THE INTERNET AND INTRANET, VIA ELECTRONIC SITES, IN CLASS 36 (U.S. CLS. 100, 101 AND 102).

FOR: ARRANGING AND CONDUCTING OF SEMINARS, COLLOQUIA, CONFERENCES AND CONGRESSES IN THE FIELD OF BANKING FINANCE, REAL ESTATE, INVESTMENT, BUSINESS MANAGEMENT AND INSURANCE; ORGANIZATION OF SPORTING EVENTS IN THE NATURE OF TENNIS, SOCCER, TRIATHLONS, CYCLING, RUNNING AND SPORTS COMPETITIONS; EDUCATION AND ENTERTAINMENT SERVICES, NAMELY, ORGANIZATION OF COMPETITIONS IN THE FIELD OF ATHLETICS; TEACHING AND PROVIDING OF TRAINING AT THE UNDERGRADUATE, GRADUATE AND POST-GRADUATE LEVEL; ENTERTAINMENT IN THE NATURE OF ORGANIZING COMMUNITY SPORTING AND CULTURAL EVENTS; ENTERTAINMENT IN THE NATURE OF MUSICAL GROUP, TELEVISION COMEDY SERIES, ETHNIC FESTIVAL; EDUCATION AND ENTERTAINMENT INFORMATION; EDUCATION ADVICE, NAMELY, CAREER COUNSELING; TRAINING ADVICE IN THE USE OF COMPUTERS AND IN THE FIELD OF BUSINESS TRAINING, BUSINESS, INDUSTRY AND INFORMATION TECHNOLOGY AND STRATEGIC PLANNING RELATING TO ADVERTISING, PROMOTION, MARKETING AND BUSINESS; ORGANIZATION OF EXHIBITIONS FOR CULTURAL OR EDUCATIONAL PURPOSES; COMPUTER GAMES SERVICES PROVIDED ON-LINE FROM A COMPUTER NETWORK; PUBLICATION OF BOOKS AND PERIODICALS; EDITING AND PUBLICATION OF TEXTS, OTHER THAN PUBLICITY TEXTS; MICRO PUBLISHING OF BOOKS, E-BOOKS, AUDIO BOOKS, MUSIC AND ILLUSTRATIONS; PUBLICATION OF ELECTRONIC BOOKS AND JOURNALS ONLINE; ORGANIZING SPORTING EVENTS AND CULTURAL EVENTS; PRODUCTION OF TELEVISION SHOWS AND FILMS, IN CLASS 41 (U.S. CLS. 100, 101 AND 107).

Reg. No. 4,107,527 PRIORITY CLAIMED UNDER SEC. 44(D) ON FRANCE APPLICATION NO. 10/3776332, FILED 10-21-2010, REG. NO. 103776332, DATED 10-21-2010, EXPIRES 10-21-2020.

THE COLOR(S) BLACK, GREEN AND WHITE IS/ARE CLAIMED AS A FEATURE OF THE MARK.

THE MARK CONSISTS OF THE WORDING "KEEP REACHING" SHOWN IN BLACK WITH A BLACK GEOMETRIC BORDER WITH A GREEN SQUARE INTERSECTING THE UPPER RIGHT CORNER OF THE BORDER. THE FOUR (4) STYLIZED WHITE STARS CONTAINED WITHIN THE GREEN SQUARE GIVE THE APPEARANCE OF MOVEMENT.

SER. NO. 85-168,277, FILED 11-3-2010.

WARREN L. OLANDRIA, EXAMINING ATTORNEY

United States of America

United States Patent and Trademark Office

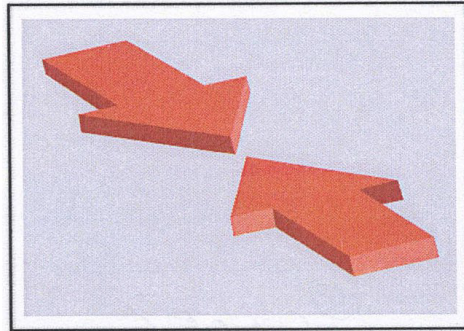

Reg. No. 4,107,528

Registered Mar. 6, 2012

Int. Cls.: 9, 16, 19 and 35

TRADEMARK

SERVICE MARK

PRINCIPAL REGISTER

FORIA GLOBAL S.A. (CHILE CORPORATION)
AV. TOMAS MORO 1075, OF. 1302
LAS CONDES, SANTIAGO, CHILE

FOR: LUMINOUS AND MECHANICAL SIGNALS, NAMELY, LUMINOUS SIGNALS FOR DOORS, ROADS AND EXITS; ELECTRICAL, SIGNALLING, CHECKING (SUPERVISION), LIFE-SAVING AND TEACHING APPARATUS AND INSTRUMENTS, NAMELY, LUMINOUS SIGNALS FOR TRAFFIC; APPARATUS FOR RECORDING, TRANSMISSION OR REPRODUCTION OF SOUND OR IMAGES, IN CLASS 9 (U.S. CLS. 21, 23, 26, 36 AND 38).

FOR: PRINTED INSTRUCTIONAL AND TEACHING MATERIAL IN THE FIELD OF PEDESTRIAN TRAFFIC; PAPER PRINTED SIGNALS; PLASTIC AND IRON-ON TRANSFERS; NEWSPAPERS AND SIGNS FOR BOOKS IN THE FIELD OF PEDESTRIAN TRAFFIC; PAPER, CARDBOARD; PRINTED MATTER, NAMELY, GUIDES, MANUALS, POSTERS AND EDUCATIONAL BOOKLETS IN THE FIELD OF PEDESTRIAN TRAFFIC; BOOKBINDING MATERIAL; PHOTOGRAPHS; STATIONERY; ADHESIVES FOR STATIONERY OR HOUSEHOLD PURPOSES; PRINTERS' TYPE; PRINTING BLOCKS, IN CLASS 16 (U.S. CLS. 2, 5, 22, 23, 29, 37, 38 AND 50).

FOR: NON-LUMINOUS, NON-MECHANICAL SIGNS NOT OF METAL, IN CLASS 19 (U.S. CLS. 1, 12, 33 AND 50).

FOR: ADVERTISING AND PUBLICITY SERVICES THROUGH RADIO AND TELEVISION; IMPORT AND EXPORT AGENCIES; PROMOTIONAL MARKETING AND REPRESENTATION SERVICES FOR SALES TO THE PUBLIC SECTOR FEATURING ALL KIND OF PRODUCTS AND ARTICLES; DISTRIBUTION OF SAMPLES FOR PUBLICITY PURPOSES; MARKETING AND ADVERTISING; MARKETING RESEARCH SERVICES, MARKETING CONSULTING; SERVICES CONSISTING OF THE REGISTRATION, COLLECTION, TRANSCRIPTION, COMPILATION AND SYSTEMIZATION OF WRITTEN COMMUNICATIONS AND DATA, IN CLASS 35 (U.S. CLS. 100, 101 AND 102).

PRIORITY CLAIMED UNDER SEC. 44(D) ON CHILE APPLICATION NO. 904.682, FILED 5-10-2010, REG. NO. 905.093, DATED 12-16-2010, EXPIRES 12-16-2020.

THE COLOR(S) RED, GRAY AND BLACK IS/ARE CLAIMED AS A FEATURE OF THE MARK.



David J. Kyjars

Director of the United States Patent and Trademark Office

Reg. No. 4,107,528 PRIORITY CLAIMED UNDER SEC. 44(D) ON CHILE APPLICATION NO. 904.681, FILED 5-10-2010, REG. NO. 907.464, DATED 1-12-2011, EXPIRES 1-12-2021.

THE MARK CONSISTS OF TWO RED ARROWS COMING ACROSS EACH OTHER IN DIAGONAL POSITION OVER A GRAY BACKGROUND. THE ENTIRE MARK IS ENCLOSED IN A BLACK SQUARE AND THE WHITE BORDER INSIDE THE SQUARE REPRESENTS BACKGROUND.

SER. NO. 85-170,054, FILED 11-5-2010.

NAAKWAMA ANKRAH, EXAMINING ATTORNEY

United States of America

United States Patent and Trademark Office

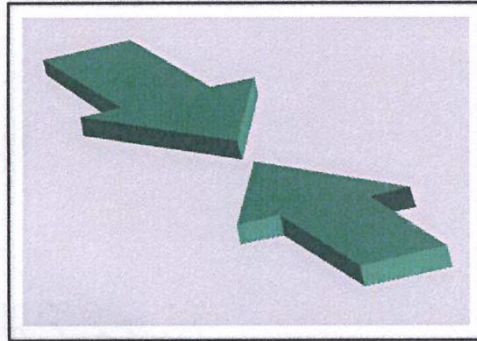

Reg. No. 4,107,529

Registered Mar. 6, 2012

Int. Cls.: 9, 16, 19 and 35

TRADEMARK

SERVICE MARK

PRINCIPAL REGISTER

FORIA GLOBAL S.A. (CHILE CORPORATION)
AV. TOMAS MORO 1075, OF. 1302
LAS CONDES, SANTIAGO, CHILE

FOR: LUMINOUS AND MECHANICAL SIGNALS, NAMELY, LUMINOUS SIGNALS FOR DOORS, ROADS AND EXITS; ELECTRICAL, SIGNALLING, CHECKING, SUPERVISION, LIFE-SAVING AND TEACHING APPARATUS AND INSTRUMENTS, NAMELY, LUMINOUS SIGNALS FOR TRAFFIC; APPARATUS FOR RECORDING, TRANSMISSION OR REPRODUCTION OF SOUND OR IMAGES, IN CLASS 9 (U.S. CLS. 21, 23, 26, 36 AND 38).

FOR: PRINTED INSTRUCTIONAL AND TEACHING MATERIAL IN THE FIELD OF PEDESTRIAN TRAFFIC; PAPER PRINTED SIGNALS; PLASTIC AND IRON-ON TRANSFERS; NEWSPAPERS AND SIGNS FOR BOOKS IN THE FIELD OF PEDESTRIAN TRAFFIC; PAPER CARDBOARD; PRINTED MATTER, NAMELY, GUIDES, MANUALS, POSTERS AND EDUCATIONAL BOOKLETS IN THE FIELD OF PEDESTRIAN TRAFFIC; BOOKBINDING MATERIAL; PHOTOGRAPHS; STATIONERY; ADHESIVES FOR STATIONERY OR HOUSEHOLD PURPOSES; PRINTERS' TYPE; PRINTING BLOCKS, IN CLASS 16 (U.S. CLS. 2, 5, 22, 23, 29, 37, 38 AND 50).

FOR: NON-LUMINOUS, NON-MECHANICAL SIGNS NOT OF METAL, IN CLASS 19 (U.S. CLS. 1, 12, 33 AND 50).

FOR: ADVERTISING AND PUBLICITY SERVICES THROUGH RADIO AND TELEVISION; IMPORT AND EXPORT AGENCIES; PROMOTIONAL MARKETING AND REPRESENTATION SERVICES FOR SALES TO THE PUBLIC SECTOR FEATURING ALL KIND OF PRODUCTS AND ARTICLES; DISTRIBUTION OF SAMPLES FOR PUBLICITY PURPOSES; MARKETING AND ADVERTISING; MARKETING RESEARCH SERVICES, MARKETING CONSULTING; SERVICES CONSISTING OF THE REGISTRATION, COLLECTION, TRANSCRIPTION, COMPILATION AND SYSTEMIZATION OF WRITTEN COMMUNICATIONS AND DATA, IN CLASS 35 (U.S. CLS. 100, 101 AND 102).

PRIORITY CLAIMED UNDER SEC. 44(D) ON CHILE APPLICATION NO. 904.288, FILED 5-6-2010, REG. NO. 905.090, DATED 12-16-2010, EXPIRES 12-16-2020.

THE COLOR(S) GREEN, GRAY AND BLACK IS/ARE CLAIMED AS A FEATURE OF THE MARK.



David J. Kyjars

Director of the United States Patent and Trademark Office

Reg. No. 4,107,529 PRIORITY CLAIMED UNDER SEC. 44(D) ON CHILE APPLICATION NO. 904.287, FILED 5-6-2010, REG. NO. 905.089, DATED 12-16-2010, EXPIRES 12-16-2020.

THE MARK CONSISTS OF TWO GREEN ARROWS COMING ACROSS EACH OTHER IN DIAGONAL POSITION OVER A GRAY BACKGROUND. THE ENTIRE MARK IS ENCLOSED IN A BLACK SQUARE AND THE WHITE BORDER INSIDE THE SQUARE REPRESENTS BACKGROUND.

SER. NO. 85-170,091, FILED 11-5-2010.

NAAKWAMA ANKRAH, EXAMINING ATTORNEY

United States of America

United States Patent and Trademark Office

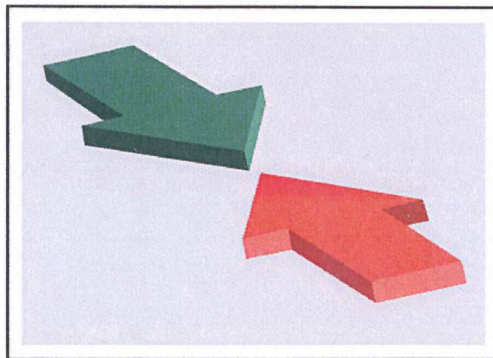

Reg. No. 4,107,530

Registered Mar. 6, 2012

Int. Cls.: 9, 16, 19 and 35

TRADEMARK

SERVICE MARK

PRINCIPAL REGISTER

FORIA GLOBAL S.A. (CHILE CORPORATION)
AV. TOMAS MORO 1075, OF. 1302
LAS CONDES, SANTIAGO, CHILE

FOR: LUMINOUS AND MECHANICAL SIGNALS, NAMELY, LUMINOUS SIGNALS FOR DOORS, ROADS AND EXITS; ELECTRICAL, SIGNALLING, CHECKING, SUPERVISION, LIFE-SAVING AND TEACHING APPARATUS AND INSTRUMENTS, NAMELY, LUMINOUS SIGNALS FOR TRAFFIC; APPARATUS FOR RECORDING, TRANSMISSION OR REPRODUCTION OF SOUND OR IMAGES, IN CLASS 9 (U.S. CLS. 21, 23, 26, 36 AND 38).

FOR: PRINTED INSTRUCTIONAL AND TEACHING MATERIAL IN THE FIELD OF PEDESTRIAN TRAFFIC; PAPER PRINTED SIGNALS; PLASTIC AND IRON-ON TRANSFERS; NEWSPAPERS AND SIGNS FOR BOOKS IN THE FIELD OF PEDESTRIAN TRAFFIC; PAPER, CARDBOARD; PRINTED MATTER, NAMELY, GUIDES, MANUALS, POSTERS AND EDUCATIONAL BOOKLETS IN THE FIELD OF PEDESTRIAN TRAFFIC; BOOKBINDING MATERIALS; PHOTOGRAPHS; STATIONERY; ADHESIVES FOR STATIONERY OR HOUSEHOLD PURPOSES; PRINTERS' TYPE; PRINTING BLOCKS, IN CLASS 16 (U.S. CLS. 2, 5, 22, 23, 29, 37, 38 AND 50).

FOR: NON-LUMINOUS, NON-MECHANICAL SIGNS NOT OF METAL, IN CLASS 19 (U.S. CLS. 1, 12, 33 AND 50).

FOR: ADVERTISING AND PUBLICITY SERVICES THROUGH RADIO AND TELEVISION; IMPORT AND EXPORT AGENCIES; PROMOTIONAL MARKETING AND REPRESENTATION SERVICES FOR SALES TO THE PUBLIC SECTOR FEATURING ALL KIND OF PRODUCTS AND ARTICLES; DISTRIBUTION OF SAMPLES FOR PUBLICITY PURPOSES; MARKETING AND ADVERTISING; MARKETING RESEARCH SERVICES, MARKETING CONSULTING; SERVICES CONSISTING OF THE REGISTRATION, COLLECTION, TRANSCRIPTION, COMPILATION AND SYSTEMIZATION OF WRITTEN COMMUNICATIONS AND DATA, IN CLASS 35 (U.S. CLS. 100, 101 AND 102).

PRIORITY CLAIMED UNDER SEC. 44(D) ON CHILE APPLICATION NO. 904.290, FILED 5-6-2010, REG. NO. 907.490, DATED 1-12-2010, EXPIRES 1-12-2020.

THE COLOR(S) RED, GREEN, GRAY AND BLACK IS/ARE CLAIMED AS A FEATURE OF THE MARK.



David J. Kappas

Director of the United States Patent and Trademark Office

Reg. No. 4,107,530 PRIORITY CLAIMED UNDER SEC. 44(D) ON CHILE APPLICATION NO. 904.289, FILED 5-6-2010, REG. NO. 905.091, DATED 12-16-2010, EXPIRES 12-16-2020.

THE MARK CONSISTS OF TWO ARROWS COMING ACROSS EACH OTHER IN DIAGONAL POSITION OVER A GRAY BACKGROUND. THE LEFT ARROW IS GREEN, WHILE THE RIGHT ARROW IS RED. THE ENTIRE MARK IS ENCLOSED IN A BLACK SQUARE AND THE WHITE BORDER INSIDE THE SQUARE REPRESENTS BACKGROUND.

SER. NO. 85-170,103, FILED 11-5-2010.

NAAKWAMA ANKRAH, EXAMINING ATTORNEY

United States of America

United States Patent and Trademark Office

NUWAY

Reg. No. 4,107,531

F.S.F. INC. (KANSAS CORPORATION)

Registered Mar. 6, 2012

3441 E. HARRY
WICHITA, KS 67218

Int. Cl.: 43

FOR: RESTAURANT SERVICES, IN CLASS 43 (U.S. CLS. 100 AND 101).

SERVICE MARK

FIRST USE 7-4-1930; IN COMMERCE 7-4-1930.

PRINCIPAL REGISTER

THE MARK CONSISTS OF STANDARD CHARACTERS WITHOUT CLAIM TO ANY PARTICULAR FONT, STYLE, SIZE, OR COLOR.

SER. NO. 85-170,285, FILED 11-5-2010.

RICHARD WHITE, EXAMINING ATTORNEY



David J. Kyfos

Director of the United States Patent and Trademark Office

United States of America

United States Patent and Trademark Office

NUWAY CRUMBLY BURGERS

Reg. No. 4,107,532

F.S.F., INC (KANSAS CORPORATION)

Registered Mar. 6, 2012

3441 E. HARRY
WICHITA, KS 67218

Int. Cl.: 43

FOR: RESTAURANT SERVICES, IN CLASS 43 (U.S. CLS. 100 AND 101).

SERVICE MARK

FIRST USE 11-4-2010; IN COMMERCE 11-4-2010.

PRINCIPAL REGISTER

THE MARK CONSISTS OF STANDARD CHARACTERS WITHOUT CLAIM TO ANY PARTICULAR FONT, STYLE, SIZE, OR COLOR.

NO CLAIM IS MADE TO THE EXCLUSIVE RIGHT TO USE "BURGERS", APART FROM THE MARK AS SHOWN.

SER. NO. 85-170,301, FILED 11-5-2010.

DANNEAN HETZEL, EXAMINING ATTORNEY



David J. Kyffers

Director of the United States Patent and Trademark Office

United States of America

United States Patent and Trademark Office



Reg. No. 4,107,533

Registered Mar. 6, 2012

Int. Cl.: 28

TRADEMARK

PRINCIPAL REGISTER

LES PRODUITS D'ACIER FAMONT INC. (CANADA CORPORATION)
6780 P.E. LAMARCHE
SAINT-LÉONARD, CANADA H1P1K1

FOR: PLAYGROUND EQUIPMENT, NAMELY, CLIMBING NETS, CLIMBING ROTATING NETS, SWINGS, TRAMPOLINES, BASKETBALL UNITS COMPRISED OF BASKETBALL GOALS, BASKETBALL HOOPS, BACKBOARDS FOR BASKETBALLS, IN CLASS 28 (U.S. CLS. 22, 23, 38 AND 50).

PRIORITY CLAIMED UNDER SEC. 44(D) ON CANADA APPLICATION NO. 1500641, FILED 10-21-2010, REG. NO. TMA809,248, DATED 10-17-2011, EXPIRES 10-17-2026.

THE MARK CONSISTS OF THE WORD "CLIMBINET" AND THE WORDS "REACHING THE TOP" BELOW WITH THE DESIGN OF A TRIANGLE CLIMBING NET ON TOP OF THE MARK.

SER. NO. 85-171,254, FILED 11-8-2010.

BERNICE MIDDLETON, EXAMINING ATTORNEY



David J. Kybas

Director of the United States Patent and Trademark Office

United States of America

United States Patent and Trademark Office

POWER STRIKE

48

Reg. No. 4,107,534

EASEBON SERVICES LIMITED (HONG KONG LIMITED CORPORATION)
151-153 HOI BUN RD STE 2 5/F
KWUN TONG, HONG KONG

Registered Mar. 6, 2012

Int. Cl.: 28

FOR: TOY GUNS AND TOY DARTS SOLD AS A SET; SOFT DART TOY SHOOTING GAMES,
IN CLASS 28 (U.S. CLS. 22, 23, 38 AND 50).

TRADEMARK

FIRST USE 8-21-2010; IN COMMERCE 8-21-2010.

PRINCIPAL REGISTER

THE MARK CONSISTS OF STANDARD CHARACTERS WITHOUT CLAIM TO ANY PAR-
TICULAR FONT, STYLE, SIZE, OR COLOR.

NO CLAIM IS MADE TO THE EXCLUSIVE RIGHT TO USE "48", APART FROM THE MARK
AS SHOWN.

SER. NO. 85-171,743, FILED 11-8-2010.

LAURA HAMMEL, EXAMINING ATTORNEY



David J. Kybas

Director of the United States Patent and Trademark Office

United States of America

United States Patent and Trademark Office

LEADING THE WAY TO GOOD HEALTH

Reg. No. 4,107,535

Registered Mar. 6, 2012

Int. Cl.: 44

SERVICE MARK

PRINCIPAL REGISTER

DRAYER PHYSICAL THERAPY INSTITUTE, LLC (PENNSYLVANIA LIMITED LIABILITY COMPANY)
2ND FLOOR
8205 PRESIDENTS DRIVE
HUMMELSTOWN, PA 17036

FOR: PHYSICAL REHABILITATION; PHYSICAL THERAPY; PROVIDING PHYSICAL REHABILITATION FACILITIES, IN CLASS 44 (U.S. CLS. 100 AND 101).

FIRST USE 10-1-2002; IN COMMERCE 10-1-2002.

THE MARK CONSISTS OF STANDARD CHARACTERS WITHOUT CLAIM TO ANY PARTICULAR FONT, STYLE, SIZE, OR COLOR.

SER. NO. 85-176,734, FILED 11-15-2010.

RAMONA ORTIGA, EXAMINING ATTORNEY



David J. Kyffers

Director of the United States Patent and Trademark Office

United States of America

United States Patent and Trademark Office

FEWER WASHES. FEWER WORRIES.

Reg. No. 4,107,536

Registered Mar. 6, 2012

Int. Cl.: 3

TRADEMARK

PRINCIPAL REGISTER

PUNCH INDUSTRIES (IRELAND COMPANY)
MACRO II, UNIT 4, PLATO BUSINESS PARK
DAMASTOWN
DUBLIN, IRELAND 15

FOR: SYNTHETIC CELLULOSE NON-WOVEN APERTURED SHEETS AND BAGS IMPREGNATED AND TREATED WITH WASHING, STAIN REMOVING AND DYE ABSORBING PROPERTIES USED IN A LAUNDRY WASH OR LAUNDRY DRYING CYCLE; LAUNDRY FABRIC CONDITIONERS; LAUNDRY FABRIC SOFTENERS; LAUNDRY FABRIC DIRT AND DYE ATTRACTERS IN THE NATURE OF IMPREGNATED SHEETS, BAGS OR SACHETS FOR LAUNDRY USE; STAIN REMOVERS; BLEACHING PREPARATIONS FOR LAUNDRY USE; CLEANING PREPARATIONS COMPOSED OF DYE ABSORBING SUBSTANCES FOR LAUNDRY USE; CLEANING PREPARATIONS; POLISHING PREPARATIONS; DEGREASING PREPARATIONS FOR LAUNDRY USE, IN CLASS 3 (U.S. CLS. 1, 4, 6, 50, 51 AND 52).

THE MARK CONSISTS OF STANDARD CHARACTERS WITHOUT CLAIM TO ANY PARTICULAR FONT, STYLE, SIZE, OR COLOR.

PRIORITY CLAIMED UNDER SEC. 44(D) ON IRELAND APPLICATION NO. 2010/00973, FILED 5-27-2010, REG. NO. 244342, DATED 5-27-2010, EXPIRES 5-27-2020.

SER. NO. 85-176,886, FILED 11-15-2010.

DANIEL CAPSHAW, EXAMINING ATTORNEY



David J. Kyffers

Director of the United States Patent and Trademark Office

United States of America

United States Patent and Trademark Office

LAWYER'S

STAFFING, INC.

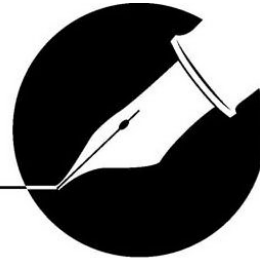

Reg. No. 4,107,537

Registered Mar. 6, 2012

Int. Cl.: 35

SERVICE MARK

PRINCIPAL REGISTER

LAWYER'S STAFFING, INC. (VIRGINIA CORPORATION)
6800 PARAGON PLACE, SUITE 501
RICHMOND, VA 23230

FOR: HUMAN RESOURCE ADVISORY SERVICES FOR THE LEGAL INDUSTRY INCLUDING LAW FIRMS, CORPORATE LEGAL DEPARTMENTS AND STATE AND LOCAL GOVERNMENT AGENCIES; PROFESSIONAL STAFFING AND RECRUITING SERVICES, NAMELY, PROVIDING SOURCING, RECRUITING, SCREENING AND PERSONNEL EVALUATION SERVICES FOR PERMANENT AND TEMPORARY EMPLOYMENT NEEDS; PROVIDING CONTRACT EMPLOYMENT STAFFING SERVICES FOR LEGAL PROJECTS INCLUDING DISCOVERY, E-DISCOVERY, DOCUMENT REVIEW AND CLAIMS PROCESSING; PROVIDING EMPLOYMENT PLACEMENT ADVISORY SERVICES FOR ATTORNEYS, PARALEGALS AND LEGAL SUPPORT PROFESSIONALS INCLUDING SEARCH STRATEGIES, RESUME PREPARATION, INTERVIEW PREPARATION AND EMPLOYMENT COUNSELING IN THE FIELD OF LAW, IN CLASS 35 (U.S. CLS. 100, 101 AND 102).

FIRST USE 1-1-1999; IN COMMERCE 1-1-1999.

NO CLAIM IS MADE TO THE EXCLUSIVE RIGHT TO USE "LAWYER'S STAFFING, INC.", APART FROM THE MARK AS SHOWN.

THE MARK CONSISTS OF THE WORD "LAWYER'S" OVER A LINE WITH THE WORDS "STAFFING, INC." UNDER THE LINE. THE LINE GOES TO THE RIGHT TO A CIRCLE, AND BECOMES THE OUTLINE OF A FOUNTAIN-PEN NIB SURROUNDED BY THE CIRCLE.

SER. NO. 85-176,926, FILED 11-15-2010.

LIEF MARTIN, EXAMINING ATTORNEY



David J. Kyjars

Director of the United States Patent and Trademark Office

United States of America

United States Patent and Trademark Office

Frés

Reg. No. 4,107,538

Registered Mar. 6, 2012

Int. Cl.: 30

TRADEMARK

PRINCIPAL REGISTER

FRESBAKERY, INC. (WASHINGTON CORPORATION)
606 COMMERCIAL AVE., STE. C
ANACORTES, WA 98221

FOR: STAPLE FOODS, NAMELY, ENERGY BARS, NON-MEDICINAL FOOD SUPPLEMENTS AND NON-MEDICINAL BEVERAGE SUPPLEMENTS MADE WITH COFFEE AND/OR CHOCOLATE BASE BUT NOT INCLUDING ENERGY DRINKS, FRUIT-FLAVORED BEVERAGES, TEA-BASED BEVERAGES, SPORTS DRINKS, RECOVERY DRINKS, CONCENTRATES AND POWDERS USED IN THE PREPARATION OF ENERGY DRINKS, FRUIT-FLAVORED BEVERAGES, TEA-BASED BEVERAGES, SPORTS DRINKS, RECOVERY DRINKS, IN CLASS 30 (U.S. CL. 46).

FIRST USE 12-9-2009; IN COMMERCE 12-9-2009.

THE MARK CONSISTS OF STANDARD CHARACTERS WITHOUT CLAIM TO ANY PARTICULAR FONT, STYLE, SIZE, OR COLOR.

THE WORDING "FRÉS" HAS NO MEANING IN A FOREIGN LANGUAGE.

SER. NO. 85-177,945, FILED 11-16-2010.

FRED CARL, EXAMINING ATTORNEY



David J. Kyros

Director of the United States Patent and Trademark Office

United States of America

United States Patent and Trademark Office

MultiMerge

Reg. No. 4,107,539

Registered Mar. 6, 2012

Int. Cl.: 9

TRADEMARK

PRINCIPAL REGISTER

DAVID V. DAY (UNITED STATES INDIVIDUAL)
34 EAST CENTENNIAL DRIVE
MEDFORD, NJ 08055

FOR: AUDIO ELECTRONIC COMPONENTS, NAMELY, SURROUND SOUND SYSTEMS; CONSUMER ELECTRONIC PRODUCTS, NAMELY, AUDIO AMPLIFIERS, AUDIO SPEAKERS, AUDIO RECEIVERS, ELECTRICAL AUDIO AND SPEAKER CABLES AND CONNECTORS, AUDIO DECODERS, VIDEO DECODERS, SPEAKERS, POWER CONVERSION DEVICES, POWER CONVERTERS, AND POWER INVERTERS; DIGITAL SIGNAL PROCESSORS; ELECTRONIC PRODUCTS FOR THE GENERATION, MEASUREMENT, AND ANALYSIS OF AUDIO SIGNALS, NAMELY, AUDIO ANALYZERS; ELECTRONIC PRODUCTS FOR THE MANIPULATION OF THE FREQUENCY, TIME, AND AMPLITUDE CHARACTERISTICS OF AUDIO SIGNALS, NAMELY, AUDIO PROCESSORS; ELECTRONIC SWITCHERS FOR AUDIO AND VIDEO SIGNALS, IN CLASS 9 (U.S. CLS. 21, 23, 26, 36 AND 38).

FIRST USE 9-30-2008; IN COMMERCE 4-12-2009.

THE MARK CONSISTS OF STANDARD CHARACTERS WITHOUT CLAIM TO ANY PARTICULAR FONT, STYLE, SIZE, OR COLOR.

OWNER OF U.S. REG. NO. 4,043,073.

SER. NO. 85-178,061, FILED 11-16-2010.

PAUL E. FAHRENKOPF, EXAMINING ATTORNEY



David J. Kyffers

Director of the United States Patent and Trademark Office

United States of America

United States Patent and Trademark Office

MEDIA CONTACTS

Reg. No. 4,107,540

Registered Mar. 6, 2012

Int. Cls.: 35 and 41

SERVICE MARK

PRINCIPAL REGISTER

MEDIA CONTACTS, S.A. (SPAIN CORPORATION)
AV. GENERAL PERON 38
28020 MADRID, SPAIN 28020

FOR: ADVERTISING SERVICES; INTERACTIVE AND DIGITAL ADVERTISING AND MARKETING SERVICES; COMMERCIAL BUSINESS MANAGEMENT; BUSINESS ADMINISTRATION SERVICES, IN CLASS 35 (U.S. CLS. 100, 101 AND 102).

FIRST USE 7-5-1999; IN COMMERCE 7-5-1999.

FOR: EDUCATIONAL SERVICES, NAMELY, PROVIDING SEMINARS, SYMPOSIUM, CONFERENCES, TRAINING SERVICES IN THE FIELD OF MARKETING AND PUBLICITY, IN CLASS 41 (U.S. CLS. 100, 101 AND 107).

FIRST USE 7-5-1999; IN COMMERCE 7-5-1999.

THE MARK CONSISTS OF STANDARD CHARACTERS WITHOUT CLAIM TO ANY PARTICULAR FONT, STYLE, SIZE, OR COLOR.

OWNER OF U.S. REG. NO. 3,754,803.

NO CLAIM IS MADE TO THE EXCLUSIVE RIGHT TO USE "MEDIA", APART FROM THE MARK AS SHOWN.

SEC. 2(F).

SER. NO. 85-179,278, FILED 11-17-2010.

DARRYL SPRUILL, EXAMINING ATTORNEY



David J. Kybas

Director of the United States Patent and Trademark Office

United States of America

United States Patent and Trademark Office

MOPHIE PULSE

Reg. No. 4,107,541

Registered Mar. 6, 2012

Int. Cl.: 9

TRADEMARK

PRINCIPAL REGISTER

MOPHIE, INC. (CALIFORNIA CORPORATION)
2850 RED HILL AVENUE, SUITE 128
SANTA ANA, CA 92705

FOR: COMPUTER DEVICES AND SYSTEMS, NAMELY, HAPTIC INTERFACES AND DEVICES FOR PROVIDING HAPTIC, FORCE AND TACTILE FEEDBACK WITH INTEGRATED AUDIO SPEAKERS FOR USE WITH MOBILE ELECTRONIC DEVICES, NAMELY, MOBILE PHONES, DIGITAL AUDIO AND VIDEO PLAYERS, HANDHELD COMPUTERS, PERSONAL DIGITAL ASSISTANTS, ELECTRONIC ORGANIZERS, ELECTRONIC NOTE-PADS, AND TABLET COMPUTERS; COMPUTER SOFTWARE USED TO GENERATE HAPTIC, FORCE AND TACTILE FEEDBACK FOR USE WITH SUCH DEVICES AND SYSTEMS; RECHARGEABLE BATTERIES INTEGRATED INTO A PROTECTIVE CASE OR HOUSING WITH AN ELECTRICAL CONNECTOR FOR USE WITH MOBILE ELECTRONIC DEVICES, NAMELY, MOBILE PHONES, DIGITAL AUDIO AND VIDEO PLAYERS, HANDHELD COMPUTERS, PERSONAL DIGITAL ASSISTANTS, ELECTRONIC ORGANIZERS, ELECTRONIC NOTEPADS; BATTERY CHARGERS, IN CLASS 9 (U.S. CLS. 21, 23, 26, 36 AND 38).

FIRST USE 9-19-2011; IN COMMERCE 9-19-2011.

THE MARK CONSISTS OF STANDARD CHARACTERS WITHOUT CLAIM TO ANY PARTICULAR FONT, STYLE, SIZE, OR COLOR.

OWNER OF U.S. REG. NOS. 3,227,723, 3,227,725, AND 3,949,983.

SER. NO. 85-180,162, FILED 11-18-2010.

DEZMONA MIZELLE, EXAMINING ATTORNEY



David J. Kyros

Director of the United States Patent and Trademark Office

United States of America

United States Patent and Trademark Office

Reuseit

Reg. No. 4,107,542

Registered Mar. 6, 2012

**Int. Cls.: 16, 18, 21, 22
and 24**

PONO PRODUCTS, INC. (ILLINOIS CORPORATION)
STE 6E
116 W ILLINOIS ST.
CHICAGO, IL 60654

FOR: SANDWICH BAGS; SNACK BAGS, IN CLASS 16 (U.S. CLS. 2, 5, 22, 23, 29, 37, 38 AND 50).

TRADEMARK

FIRST USE 9-15-2009; IN COMMERCE 9-15-2009.

PRINCIPAL REGISTER

FOR: REUSABLE FABRIC SHOPPING BAGS; ALL-PURPOSE FABRIC CARRYING BAGS; REUSABLE TEXTILE PRODUCE BAGS TO CARRY PRODUCE FROM GROCERY STORES AND FARMER'S MARKETS; NATURAL AND SYNTHETIC FIBER SHOPPING BAGS FOR PRODUCE NOT COMPRISED OF PLASTIC FILM, PAPER OR ALUMINUM, IN CLASS 18 (U.S. CLS. 1, 2, 3, 22 AND 41).

FIRST USE 9-15-2009; IN COMMERCE 9-15-2009.

FOR: EMPTY SPRAY BOTTLES; CLEANING CLOTHS, IN CLASS 21 (U.S. CLS. 2, 13, 23, 29, 30, 33, 40 AND 50).

FIRST USE 9-15-2009; IN COMMERCE 9-15-2009.

FOR: BAGS FOR STORAGE NOT COMPRISED OF PLASTIC FILM, PAPER OR ALUMINUM; CLOTH BAGS FOR STORAGE AND DISPENSING OF PLASTIC BAGS; FABRIC BAGS FOR STORAGE AND DISPENSING OF PLASTIC BAGS; CANVASS BAGS FOR STORAGE OF PRODUCE, IN CLASS 22 (U.S. CLS. 1, 2, 7, 19, 22, 42 AND 50).

FIRST USE 7-15-2010; IN COMMERCE 7-15-2010.

FOR: HAND TOWELS NOT COMPRISED OF PAPER; KITCHEN TOWELS NOT COMPRISED OF PAPER; TOWEL SETS NOT COMPRISED OF PAPER; TOWELS NOT COMPRISED OF PAPER; HANDKERCHIEFS; TABLE LINENS, NAMELY, NAPKINS, TEXTILE NAPKINS NOT COMPRISED OF PAPER, IN CLASS 24 (U.S. CLS. 42 AND 50).

FIRST USE 7-15-2010; IN COMMERCE 7-15-2010.



David J. Kybas

Director of the United States Patent and Trademark Office

Reg. No. 4,107,542 THE MARK CONSISTS OF STANDARD CHARACTERS WITHOUT CLAIM TO ANY PARTICULAR FONT, STYLE, SIZE, OR COLOR.

OWNER OF U.S. REG. NOS. 3,600,480 AND 3,763,753.

SER. NO. 85-180,205, FILED 11-18-2010.

ANGELA M. MICHELI, EXAMINING ATTORNEY

United States of America

United States Patent and Trademark Office

AWAKE VINTAGE

Reg. No. 4,107,543

AWAKE, INC. (CALIFORNIA CORPORATION)
459 PARK AVENUE
SAN FERNANDO, CA 91340

Registered Mar. 6, 2012

Int. Cl.: 25

FOR: PANTS; SHIRTS; SKIRTS; SWEAT SHIRTS; SWEATERS; TANK TOPS; TUNICS, IN CLASS 25 (U.S. CLS. 22 AND 39).

TRADEMARK

FIRST USE 11-10-2009; IN COMMERCE 11-10-2009.

PRINCIPAL REGISTER

THE MARK CONSISTS OF STANDARD CHARACTERS WITHOUT CLAIM TO ANY PARTICULAR FONT, STYLE, SIZE, OR COLOR.

OWNER OF U.S. REG. NOS. 3,725,298 AND 3,725,497.

NO CLAIM IS MADE TO THE EXCLUSIVE RIGHT TO USE "VINTAGE", APART FROM THE MARK AS SHOWN.

SER. NO. 85-180,382, FILED 11-18-2010.

GENE MACIOL, EXAMINING ATTORNEY



David J. Kybas

Director of the United States Patent and Trademark Office

United States of America

United States Patent and Trademark Office



Reg. No. 4,107,544

Registered Mar. 6, 2012

Int. Cl.: 25

TRADEMARK

PRINCIPAL REGISTER

ANGDERSON CORP USA INC. (ARIZONA CORPORATION)
2151 SOUTH COCONINO DR.
APACHE JUNCTION, AZ 85220

FOR: JACKETS; PULLOVERS; SHIRTS; SHORTS; SUNDRESSES; SWEATSHIRTS; T-SHIRTS,
IN CLASS 25 (U.S. CLS. 22 AND 39).

FIRST USE 10-28-2010; IN COMMERCE 10-28-2010.

NO CLAIM IS MADE TO THE EXCLUSIVE RIGHT TO USE "ARIZONA", APART FROM
THE MARK AS SHOWN.

THE MARK CONSISTS OF THE TERMS "ANGDERSON" AND "ARIZONA"; THERE ARE
KOKOPELLI FIGURES ON EITHER SIDE OF THE MARK; THERE ARE SEVEN SMALL
CIRCLES ON THE TOP OF THE MARK; THERE IS A PERIOD AFTER THE TERM "ARI-
ZONA".

SER. NO. 85-182,371, FILED 11-22-2010.

GINA HAYES, EXAMINING ATTORNEY



David J. Kybas

Director of the United States Patent and Trademark Office

United States of America

United States Patent and Trademark Office



Reg. No. 4,107,545

Registered Mar. 6, 2012

Int. Cl.: 41

SERVICE MARK

PRINCIPAL REGISTER

THE PROSPECT COLLEGIATE LEAGUE, LLC (OHIO LIMITED LIABILITY COMPANY)
59 NORTH PAINT STREET
CHILLICOTHE, OH 45601

FOR: ENTERTAINMENT IN THE NATURE OF BASEBALL GAMES, IN CLASS 41 (U.S. CLS. 100, 101 AND 107).

FIRST USE 1-1-2009; IN COMMERCE 1-1-2009.

NO CLAIM IS MADE TO THE EXCLUSIVE RIGHT TO USE "PROSPECT LEAGUE", APART FROM THE MARK AS SHOWN.

THE MARK CONSISTS OF A BASEBALL PLAYER THROWING A BASEBALL WITH A MOTION LINE AND STAR ABOVE THE BASEBALL AND A BASEBALL FIELD BEHIND THE PLAYER. THE STYLIZED TEXT "PROSPECT LEAGUE" APPEARS BELOW.

SER. NO. 85-183,311, FILED 11-23-2010.

MICHAEL SOUDERS, EXAMINING ATTORNEY



David J. Kybas

Director of the United States Patent and Trademark Office

United States of America

United States Patent and Trademark Office

ESSENTIAL GSH

Reg. No. 4,107,546

Registered Mar. 6, 2012

Int. Cl.: 5

TRADEMARK

PRINCIPAL REGISTER

ESSENTIAL NUTRACEUTICALS, LLC (ALABAMA LIMITED LIABILITY COMPANY)
3401 INDEPENDENCE DRIVE
BIRMINGHAM, AL 35209

FOR: DIETARY AND NUTRITIONAL SUPPLEMENTS CONTAINING GLUATHIONE; DIETARY FOOD SUPPLEMENTS CONTAINING GLUATHIONE; DIETARY SUPPLEMENTS CONTAINING GLUATHIONE; DIETARY SUPPLEMENTS CONTAINING GLUATHIONE FOR HUMAN CONSUMPTION; FOOD SUPPLEMENTS CONTAINING GLUATHIONE; FOOD SUPPLEMENTS, NAMELY, ANTI-OXIDANTS CONTAINING GLUATHIONE; HEALTH FOOD SUPPLEMENTS CONTAINING GLUATHIONE; HERBAL SUPPLEMENTS CONTAINING GLUATHIONE; NUTRACEUTICALS CONTAINING GLUATHIONE FOR USE AS A DIETARY SUPPLEMENT; NUTRITIONAL SUPPLEMENTS CONTAINING GLUATHIONE; VITAMIN AND MINERAL SUPPLEMENTS CONTAINING GLUATHIONE; VITAMIN SUPPLEMENTS CONTAINING GLUATHIONE, IN CLASS 5 (U.S. CLS. 6, 18, 44, 46, 51 AND 52).

FIRST USE 12-1-2005; IN COMMERCE 12-1-2005.

THE MARK CONSISTS OF STANDARD CHARACTERS WITHOUT CLAIM TO ANY PARTICULAR FONT, STYLE, SIZE, OR COLOR.

NO CLAIM IS MADE TO THE EXCLUSIVE RIGHT TO USE "GSH", APART FROM THE MARK AS SHOWN.

SEC. 2(F).

SER. NO. 85-184,880, FILED 11-24-2010.

SUZANNE BLANE, EXAMINING ATTORNEY



David J. Kyros

Director of the United States Patent and Trademark Office

United States of America

United States Patent and Trademark Office



Reg. No. 4,107,547

Registered Mar. 6, 2012

Int. Cl.: 28

TRADEMARK

PRINCIPAL REGISTER

ENVISOR LIMITED (UNITED KINGDOM LIMITED COMPANY (LTD.))
53 SLIPPER ROAD
EMSWORTH, HAMPSHIRE, UNITED KINGDOM PO10-8BS

FOR: SURFBOARDS; BODY BOARDS; SKIM BOARDS; WINDSURFERS; KITE BOARDS; STAND UP PADDLE BOARDS; SURF CRAFT, NAMELY, SURFBOARDS, STAND-UP SURF PADDLES, WAKEBOARDS; SPORTING ARTICLES, NAMELY, SURF SKIS, SURF FINS, SURF PADDLES; CASES ADAPTED FOR CARRYING THE AFORESAID GOODS; SWIMMING FINS; PARTS AND FITTINGS FOR ALL THE AFORESAID GOODS, NAMELY, LEASHES, FINS, PADDLES, DECK PADS, REPAIR PATCHES, AND WAX, IN CLASS 28 (U.S. CLS. 22, 23, 38 AND 50).

PRIORITY CLAIMED UNDER SEC. 44(D) ON UNITED KINGDOM APPLICATION NO. 25495665, FILED 6-4-2010, REG. NO. 25495665, DATED 9-17-2010, EXPIRES 6-4-2020.

THE MARK CONSISTS OF A STYLIZED WAVE LOGO COMPRISING A SET OF BARRELING WAVES OVERTOPPING A SET OF PEAKING WAVES. THE PERCEPTION OF MULTIPLE SETS OF WAVES AND A SIMPLISTIC DEPTH PERSPECTIVE TO THE WAVES ARE DEPICTED BY THE 2 ADDITIONAL CRESCENT SHAPES RADIATING FROM THE LARGER WAVES. THE WAVES ARE SET ON TOP OF A SOLID BOX WITH THE TRAILING EDGES OF THE WAVES EXTENDING BEYOND THE EDGE OF THE BOX, WITH THE WORDING "OGG" IN FONT DEPICTED CENTRALIZED BELOW MARK.

SER. NO. 85-185,443, FILED 11-26-2010.

JAY BESCH, EXAMINING ATTORNEY



David J. Kyros

Director of the United States Patent and Trademark Office

United States of America

United States Patent and Trademark Office

Gorilla Grabber

Reg. No. 4,107,548

Registered Mar. 6, 2012

Int. Cl.: 7

TRADEMARK

PRINCIPAL REGISTER

DAVIS, STEVEN R. (UNITED STATES INDIVIDUAL)
347 LORRAINE STREET
GLEN ELLYN, IL 60137

FOR: REPLACEABLE LIFT-BLADE ATTACHMENTS IN THE NATURE OF CARTON CLAMP PADS WITH REPLACEABLE GRIP STRIPS FOR INDUSTRIAL FORK LIFTS AND SIMILAR LOAD-LIFTING TRUCKS, IN CLASS 7 (U.S. CLS. 13, 19, 21, 23, 31, 34 AND 35).

FIRST USE 5-1-2003; IN COMMERCE 5-1-2003.

THE MARK CONSISTS OF STANDARD CHARACTERS WITHOUT CLAIM TO ANY PARTICULAR FONT, STYLE, SIZE, OR COLOR.

SER. NO. 85-186,613, FILED 11-29-2010.

SUNG IN, EXAMINING ATTORNEY



David J. Kyffers

Director of the United States Patent and Trademark Office

United States of America

United States Patent and Trademark Office

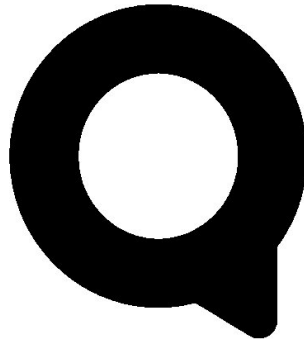

Reg. No. 4,107,549

Registered Mar. 6, 2012

Int. Cls.: 38, 41 and 42

SERVICE MARK

PRINCIPAL REGISTER

THE QUOJAX CORPORATION (NEW YORK CORPORATION)
125 TECH PARK DRIVE
ROCHESTER, NY 14623

FOR: TELECOMMUNICATION SERVICES, NAMELY, COMMUNICATIONS VIA TELECOMMUNICATION NETWORKS; TELECOMMUNICATIONS SERVICES, NAMELY, TELECOMMUNICATIONS ACCESS SERVICES; DATA TRANSMISSION AND RECEPTION SERVICES VIA TELECOMMUNICATION MEANS; ELECTRONIC EXCHANGE OF MESSAGES, INFORMATION, VOICE, DATA, AND GRAPHICS ACCESSIBLE VIA COMPUTER AND TELECOMMUNICATION NETWORKS; PROVIDING MULTIPLE-USER ACCESS TO A GLOBAL COMPUTER INFORMATION NETWORK; PROVIDING ONLINE FORUMS, DISCUSSION GROUPS, CHAT ROOMS, ELECTRONIC BULLETIN BOARDS, AND ONLINE WEB FACILITIES FOR TRANSMISSION OF MESSAGES, INFORMATION, VOICE, DATA, IMAGES AND GRAPHICS AMONG USERS IN FIELDS OF MUTUAL OR GENERAL INTEREST; ELECTRONIC MAIL SERVICES; WORKGROUP COMMUNICATIONS SERVICES OVER COMPUTER NETWORKS; INSTANT MESSAGING SERVICES; VOICE OVER IP SERVICES; COMMUNICATIONS BY COMPUTER TERMINALS; WIRELESS BROADBAND COMMUNICATION SERVICES; MOBILE PHONE COMMUNICATION SERVICES, IN CLASS 38 (U.S. CLS. 100, 101 AND 104).

FIRST USE 5-1-2009; IN COMMERCE 5-1-2009.

FOR: PROVIDING A WEBSITE FEATURING ONLINE JOURNALS AND BLOGS FEATURING TOPICS OF GENERAL INTEREST, IN CLASS 41 (U.S. CLS. 100, 101 AND 107).

FIRST USE 5-1-2009; IN COMMERCE 5-1-2009.

FOR: COMPUTER SECURITY SERVICES, NAMELY, PROVIDING USERS WITH A MEANS TO RESTRICT ACCESS TO INDIVIDUALS WHO ARE ABLE TO ACCESS THEIR MESSAGES, INFORMATION, DATA, IMAGES, GRAPHICS AND VOICE COMMUNICATION; COMPUTER SECURITY SERVICES, NAMELY, PROVIDING USERS WITH MEANS TO RESTRICT ACCESS TO INDIVIDUALS WHO ARE ABLE TO SEND THEM MESSAGES, INFORMATION, DATA, IMAGES, GRAPHICS AND VOICE COMMUNICATION; COMPUTER SERVICES, NAMELY, HOSTING ONLINE WEB FACILITIES FOR OTHERS FOR ORGANIZING AND CONDUCTING ONLINE MEETINGS, GATHERINGS, AND INTERACTIVE DISCUSSIONS; COMPUTER SERVICES IN THE NATURE OF CUSTOMIZED WEB PAGES FEATURING USER-DEFINED INFORMATION, PERSONAL PROFILES AND INFORMATION; COMPUTER SERVICES,



David J. Kybas

Director of the United States Patent and Trademark Office

Reg. No. 4,107,549 NAMELY, PROVIDING A WEBSITE FEATURING TECHNOLOGY ENABLING USERS TO UPLOAD, ADVERTISE, VIEW, SELL, EXCHANGE, BUY, DOWNLOAD, AND PRINT DIGITAL PHOTOS AND DIGITAL CONTENT; COMMERCIAL SERVICES, NAMELY, PROVIDING A WEBSITE FEATURING TECHNOLOGY ENABLING USERS TO ADVERTISE, SELL, EXCHANGE, AND BUY GOODS, INFORMATION, OTHER CONTENT AND SERVICES, IN CLASS 42 (U.S. CLS. 100 AND 101).

FIRST USE 5-1-2009; IN COMMERCE 5-1-2009.

THE MARK CONSISTS OF A STYLIZED "Q".

SER. NO. 85-186,632, FILED 11-29-2010.

ARETHA SOMERVILLE, EXAMINING ATTORNEY

United States of America

United States Patent and Trademark Office



Reg. No. 4,107,550

Registered Mar. 6, 2012

Int. Cl.: 39

SERVICE MARK

PRINCIPAL REGISTER

STEEL AND PIPE SUPPLY COMPANY, INC. (KANSAS CORPORATION)
555 POYNTZ AVENUE
MANHATTAN, KS 66502

FOR: SHIPPING, RECEIVING IN THE NATURE OF CARGO UNLOADING, STORAGE, AND CARGO HANDLING, AND TRANSPORTATION SERVICES OF STEEL PRODUCTS, NAMELY, COILS, PLATE, PIPES, SHEETS AND BEAMS, IN CLASS 39 (U.S. CLS. 100 AND 105).

FIRST USE 9-29-2010; IN COMMERCE 10-1-2010.

NO CLAIM IS MADE TO THE EXCLUSIVE RIGHT TO USE "STORAGE AND PROCESSORS INC.", APART FROM THE MARK AS SHOWN.

THE MARK CONSISTS OF THE LETTERS "S" AND "P" WITHIN A CIRCLE AND AN ORBITING RING, WITH THE WORD "STORAGE" APPEARING DIRECTLY TO THE RIGHT AND THE WORDS "AND PROCESSORS INC." APPEARING DIRECTLY BELOW "STORAGE".

SER. NO. 85-186,989, FILED 11-30-2010.

BRIDGETT SMITH, EXAMINING ATTORNEY



David J. Kybas

Director of the United States Patent and Trademark Office

United States of America

United States Patent and Trademark Office

EC+

Reg. No. 4,107,551

Registered Mar. 6, 2012

Int. Cl.: 9

TRADEMARK

PRINCIPAL REGISTER

DANFOSS DRIVES A/S (DENMARK CORPORATION)
ULSNAES 1
GRAASTEN 6300, DENMARK

FOR: SOFTWARE FEATURING AN ALGORITHM FOR CONTROLLING MOTORS; INVERTERS AND CONVERTERS, NONE OF THE AFORESAID GOODS RELATING TO THE AERONAUTICAL FIELD, AND IN PARTICULAR HELICOPTERS AND ROTORCRAFT, IN CLASS 9 (U.S. CLS. 21, 23, 26, 36 AND 38).

THE MARK CONSISTS OF STANDARD CHARACTERS WITHOUT CLAIM TO ANY PARTICULAR FONT, STYLE, SIZE, OR COLOR.

PRIORITY CLAIMED UNDER SEC. 44(D) ON ERPN CMNTY TM OFC APPLICATION NO. 009530239, FILED 11-17-2010, REG. NO. 009530239, DATED 4-27-2011, EXPIRES 11-17-2020.

SER. NO. 85-187,396, FILED 11-30-2010.

MARTHA FROMM, EXAMINING ATTORNEY



David J. Kyffers

Director of the United States Patent and Trademark Office

United States of America

United States Patent and Trademark Office

CELLOPHANE HOUSE

Reg. No. 4,107,552

KIERANTIMBERLAKE ASSOCIATES LLP (PENNSYLVANIA LIMITED PARTNERSHIP)
420 N. 20TH STREET
PHILADELPHIA, PA 19130

Registered Mar. 6, 2012

Int. Cls.: 19 and 42

FOR: MANUFACTURED HOMES; MODULAR HOMES; PRE-FABRICATED HOMES, IN CLASS 19 (U.S. CLS. 1, 12, 33 AND 50).

TRADEMARK

FIRST USE 7-20-2008; IN COMMERCE 7-20-2008.

SERVICE MARK

FOR: ARCHITECTURAL DESIGN, IN CLASS 42 (U.S. CLS. 100 AND 101).

PRINCIPAL REGISTER

FIRST USE 7-20-2008; IN COMMERCE 7-20-2008.

THE MARK CONSISTS OF STANDARD CHARACTERS WITHOUT CLAIM TO ANY PARTICULAR FONT, STYLE, SIZE, OR COLOR.

NO CLAIM IS MADE TO THE EXCLUSIVE RIGHT TO USE "HOUSE", APART FROM THE MARK AS SHOWN.

SER. NO. 85-188,028, FILED 12-1-2010.

EUGENIA MARTIN, EXAMINING ATTORNEY



David J. Kyffers

Director of the United States Patent and Trademark Office

United States of America

United States Patent and Trademark Office

PRONTAPRINT

Reg. No. 4,107,553

Registered Mar. 6, 2012

**Int. Cls.: 35, 38, 40, 41
and 42**

SERVICE MARK

PRINCIPAL REGISTER

PRONTAPRINT LIMITED (UNITED KINGDOM CORPORATION)
ARTEMIS
ODYSSEY BUSINESS PARK, WEST END ROAD
SOUTH RUISLIP, UNITED KINGDOM HA46QE

FOR: PHOTOCOPYING SERVICES; BUSINESS MANAGEMENT AND ADMINISTRATION SERVICES RELATING TO PRINTED MATTER, NAMELY, ADMINISTRATION OF THE BUSINESS AFFAIRS OF FRANCHISES AND ADMINISTRATION RELATING TO MARKETING AND BUSINESS ACCOUNTS MANAGEMENT; ADVERTISING SERVICES, NAMELY, DIRECT MAIL ADVERTISING SERVICES AND DISSEMINATION OF ADVERTISING MATTER; PERSONNEL RECRUITMENT SERVICES; CONSULTATION WITH REGARD TO RECRUITMENT OF PERSONNEL; PROVISION OF BUSINESS INFORMATION, NAMELY, PROVISION OF BUSINESS ADVERTISING AND MARKETING INFORMATION AND BUSINESS INFORMATION RELATING TO FRANCHISING AND JOINT VENTURES; BUSINESS MANAGEMENT AND ORGANIZATION CONSULTANCY; DOCUMENT REPRODUCTION; PUBLICATION OF PUBLICITY TEXTS; RENTAL OF PHOTOCOPYING MACHINES; DUPLICATION OF PRINTED MATTER; INFORMATION AND ADVISORY SERVICES, ALL RELATING TO THE AFORESAID SERVICES, IN CLASS 35 (U.S. CLS. 100, 101 AND 102).

FOR: COMMUNICATION VIA TELEPHONE AND RADIO TRANSMISSION; OR FACSIMILE TRANSMISSION SERVICES; EMAIL SERVICES; DELIVERY OF MESSAGES BY ELECTRONIC TRANSMISSION; RENTAL OF FACSIMILE APPARATUS; INFORMATION AND ADVISORY SERVICES, ALL RELATING TO THE AFORESAID SERVICES, IN CLASS 38 (U.S. CLS. 100, 101 AND 104).

FOR: PRINTING SERVICES; LITHOGRAPHIC PRINTING; OFFSET PRINTING; PHOTO COMPOSING SERVICES; BOOKBINDING; BINDERY SERVICES, NAMELY, COLLATING, FOLDING, STAPLING, PERFORATING, CUTTING AND BINDING OF PRINTED, PHOTOCOPIED AND TYPEWRITTEN MATERIAL; TYPESETTING; INFORMATION AND ADVISORY SERVICES, ALL RELATING TO THE AFORESAID SERVICES, IN CLASS 40 (U.S. CLS. 100, 103 AND 106).

FOR: ELECTRONIC DESKTOP PUBLISHING FOR OTHERS; DIGITAL IMAGING SERVICES; TEXT COMPOSITION SERVICES, NAMELY, CUSTOM WRITING SERVICES; PHOTOGRAPHY SERVICES; TEXT PROOFREADING SERVICES; INFORMATION AND ADVISORY



David J. Kybas

Director of the United States Patent and Trademark Office

Reg. No. 4,107,553 SERVICES, ALL RELATED TO THE AFORESAID SERVICES, IN CLASS 41 (U.S. CLS. 100, 101 AND 107).

FOR: CONVERSION OF DATA OR DOCUMENTS FROM PHYSICAL TO ELECTRONIC MEDIA; GRAPHICS COMPOSITION SERVICES, NAMELY, GRAPHIC DESIGN SERVICES; PACKAGING DESIGN FOR OTHERS; INFORMATION, ADVISORY AND CONSULTANCY SERVICES, ALL RELATED TO THE AFORESAID SERVICES, IN CLASS 42 (U.S. CLS. 100 AND 101).

THE MARK CONSISTS OF STANDARD CHARACTERS WITHOUT CLAIM TO ANY PARTICULAR FONT, STYLE, SIZE, OR COLOR.

OWNER OF ERPN CMNTY TM OFC REG. NO. 002777142, DATED 2-24-2004, EXPIRES 7-16-2012.

OWNER OF U.S. REG. NOS. 2,905,612 AND 3,016,654.

SER. NO. 85-188,438, FILED 12-1-2010.

SUE LAWRENCE, EXAMINING ATTORNEY

United States of America

United States Patent and Trademark Office

Source it!

Reg. No. 4,107,554

Registered Mar. 6, 2012

Int. Cls.: 16 and 35

TRADEMARK

SERVICE MARK

PRINCIPAL REGISTER

MESSE FRANKFURT EXHIBITION GMBH (FED REP GERMANY GESELLSCHAFT MIT BESCHRÄNKTER HAFTUNG (GMBH))
LUDWIG-ERHARD-ANLAGE 1
FRANKFURT AM MAIN, FED REP GERMANY 60327

FOR: PRINTED MATTER, NAMELY, NEWSPAPERS, PERIODICALS, MAGAZINES, CATALOGUES, PAMPHLETS, HANDBOOKS, AND PRINTED INSTRUCTIONAL TEACHING MATERIAL, ALL OF WHICH ARE IN THE FIELD OF FABRICS, TEXTILES, AND APPAREL; ADVERTISING PROSPECTUS PAMPHLETS; PAPER PLACARDS; PHOTOGRAPHS, IN CLASS 16 (U.S. CLS. 2, 5, 22, 23, 29, 37, 38 AND 50).

FOR: ADVERTISING; MARKETING RESEARCH; TELEMARKETING; ORGANIZING AND CONDUCTING OF TRADE FAIRS AND EXHIBITIONS FOR COMMERCIAL AND ADVERTISING PURPOSES; BUSINESS MANAGEMENT, PARTICULARLY IN RESPECT OF ORGANIZING AND CONDUCTING TRADE FAIRS AND EXHIBITIONS FOR COMMERCIAL AND ADVERTISING PURPOSES; ADVERTISING SERVICES, NAMELY, PRESENTATION OF BUSINESS COMPANIES AND THEIR PRODUCTS AND SERVICES, ALSO VIA THE INTERNET; ADVERTISING SERVICES, NAMELY, SALES PROMOTION FOR OTHERS; PRODUCT MERCHANDISING; DEMONSTRATION OF GOODS FOR PUBLICITY PURPOSES; ARRANGING CONTACTS BETWEEN COMMERCIAL PARTNERS IN TRADE AND INDUSTRY, ALSO VIA THE INTERNET; RENTAL OF ADVERTISING SPACE AND ADVERTISING MATERIAL; RENTAL OF BOOTHS FOR EXHIBITIONS AND TRADE FAIRS; BUSINESS MANAGEMENT CONSULTANCY, PARTICULARLY IN RESPECT OF ORGANIZING AND CONDUCTING TRADE FAIRS AND EXHIBITIONS FOR COMMERCIAL AND ADVERTISING PURPOSES; MANAGEMENT AND COMPILATION OF COMPUTER DATABASES, IN CLASS 35 (U.S. CLS. 100, 101 AND 102).



THE MARK CONSISTS OF STANDARD CHARACTERS WITHOUT CLAIM TO ANY PARTICULAR FONT, STYLE, SIZE, OR COLOR.

PRIORITY CLAIMED UNDER SEC. 44(D) ON FED REP GERMANY APPLICATION NO. 302010026998, FILED 6-25-2010, REG. NO. 302010026998, DATED 11-2-2010, EXPIRES 6-30-2020.

SER. NO. 85-188,719, FILED 12-1-2010.

MICHAEL ENGEL, EXAMINING ATTORNEY

David J. Kyros

Director of the United States Patent and Trademark Office

United States of America

United States Patent and Trademark Office

TESTOCREME

Reg. No. 4,107,555

Registered Mar. 6, 2012

Int. Cl.: 5

TRADEMARK

PRINCIPAL REGISTER

KRYGER, ABRAHAM, HARVEY (CALIFORNIA LIMITED LIABILITY COMPANY), DBA
TESTOCREME, LLC
32 ALISO ROAD
CARMEL VALLEY, CA 93924

FOR: DRUG DELIVERY AGENTS CONSISTING OF COMPOUNDS THAT FACILITATE
DELIVERY OF A WIDE RANGE OF PHARMACEUTICALS; HORMONE REPLACEMENT
THERAPY PREPARATIONS, IN CLASS 5 (U.S. CLS. 6, 18, 44, 46, 51 AND 52).

FIRST USE 1-1-1996; IN COMMERCE 3-15-1996.

THE MARK CONSISTS OF STANDARD CHARACTERS WITHOUT CLAIM TO ANY PAR-
TICULAR FONT, STYLE, SIZE, OR COLOR.

SER. NO. 85-189,260, FILED 12-2-2010.

HEATHER THOMPSON, EXAMINING ATTORNEY



David J. Kybas

Director of the United States Patent and Trademark Office

United States of America

United States Patent and Trademark Office

PRISA

Reg. No. 4,107,556

Registered Mar. 6, 2012

Int. Cl.: 42

SERVICE MARK

PRINCIPAL REGISTER

PROMOTORA DE INFORMACIONES, S.A. (SPAIN CORPORATION)
GRAN VÍA, 32 - SEXTA PLANTA
MADRID, SPAIN 28013

FOR: SCIENTIFIC AND TECHNOLOGICAL SERVICES AND RESEARCH, NAMELY, SCIENTIFIC RESEARCH, ANALYSIS AND TESTING, IN THE FIELD OF TELECOMMUNICATIONS AND AUDIOVISUAL EQUIPMENT AND MEDIA; DESIGN RELATING TO SCIENCE AND TECHNOLOGY, NAMELY, COMPUTER SITE DESIGN; DESIGN AND DEVELOPMENT OF COMPUTER HARDWARE AND SOFTWARE; ENGINEERING SERVICES, FEATURING EVALUATIONS, APPRAISALS, RESEARCH AND REPORTS IN VARIOUS SCIENTIFIC AND TECHNOLOGICAL FIELDS, IN CLASS 42 (U.S. CLS. 100 AND 101).

THE MARK CONSISTS OF STANDARD CHARACTERS WITHOUT CLAIM TO ANY PARTICULAR FONT, STYLE, SIZE, OR COLOR.

PRIORITY CLAIMED UNDER SEC. 44(D) ON SPAIN APPLICATION NO. 2950548, FILED 10-15-2010, REG. NO. 2950548, DATED 2-23-2011, EXPIRES 10-15-2020.

THE ENGLISH TRANSLATION OF "PRISA" IN THE MARK IS "HASTE".

SER. NO. 85-189,468, FILED 12-2-2010.

GILBERT SWIFT, EXAMINING ATTORNEY



David J. Kyffers

Director of the United States Patent and Trademark Office

United States of America

United States Patent and Trademark Office

ANTICATO

Reg. No. 4,107,557

Registered Mar. 6, 2012

Int. Cl.: 33

TRADEMARK

PRINCIPAL REGISTER

TERRAVANT WINE COMPANY, LLC (CALIFORNIA LIMITED LIABILITY COMPANY)
C/O KOENIG & ASSOCIATES
920 GARDEN STREET, SUITE A
SANTA BARBARA, CA 93101

FOR: WINE; WINES, IN CLASS 33 (U.S. CLS. 47 AND 49).

FIRST USE 9-12-2011; IN COMMERCE 9-12-2011.

THE MARK CONSISTS OF STANDARD CHARACTERS WITHOUT CLAIM TO ANY PARTICULAR FONT, STYLE, SIZE, OR COLOR.

THE ENGLISH TRANSLATION OF "ANTICATO" IN THE MARK IS OLD LOOKING.

SER. NO. 85-189,636, FILED 12-2-2010.

PRISCILLA MILTON, EXAMINING ATTORNEY



David J. Kybas

Director of the United States Patent and Trademark Office

United States of America

United States Patent and Trademark Office

WELLSPRING FAMILY SERVICES

Reg. No. 4,107,558

Registered Mar. 6, 2012

Int. Cls.: 35 and 41

SERVICE MARK

PRINCIPAL REGISTER

WELLSPRING FAMILY SERVICES (WASHINGTON NON-PROFIT CORPORATION)
1900 RAINIER AVENUE SOUTH
SEATTLE, WA 98144

FOR: EMPLOYEE ASSISTANCE SERVICES, NAMELY, SERVICES FOR COMPANIES TO HELP KEEP EMPLOYEES FUNCTIONING WELL AND BALANCE DEMANDS OF WORK AND LIFE, IN THE NATURE OF PROVIDING ASSISTANCE AND CONSULTATION TO CORPORATE CLIENTS TO HELP THEIR EMPLOYEES MAKE HEALTH AND WELLNESS CHANGES IN THEIR DAILY LIVING TO INCREASE PRODUCTIVITY AND LOWER HEALTH CARE COSTS; NONE OF THE AFOREMENTIONED INCLUDING, OR IN CONNECTION WITH, SERVICES RELATED TO WEIGHT LOSS, EATING DISORDERS, NUTRITION, OBESITY, OR EATING HABITS, IN CLASS 35 (U.S. CLS. 100, 101 AND 102).

FIRST USE 5-23-2005; IN COMMERCE 5-23-2005.

FOR: EMPLOYEE ASSISTANCE SERVICES, NAMELY, SERVICES FOR COMPANIES IN THE NATURE OF TRAINING SERVICES FOR EMPLOYEES IN THE FIELD OF BALANCING DEMANDS OF WORK AND LIFE, IN CLASS 41 (U.S. CLS. 100, 101 AND 107).

FIRST USE 5-23-2005; IN COMMERCE 5-23-2005.

THE MARK CONSISTS OF STANDARD CHARACTERS WITHOUT CLAIM TO ANY PARTICULAR FONT, STYLE, SIZE, OR COLOR.

NO CLAIM IS MADE TO THE EXCLUSIVE RIGHT TO USE "FAMILY SERVICES", APART FROM THE MARK AS SHOWN.

SER. NO. 85-189,692, FILED 12-2-2010.

AMY HELLA, EXAMINING ATTORNEY



David J. Kyjars

Director of the United States Patent and Trademark Office

United States of America

United States Patent and Trademark Office

COSTLESS OUTLET

Reg. No. 4,107,559

Registered Mar. 6, 2012

Int. Cl.: 35

SERVICE MARK

PRINCIPAL REGISTER

COSTLESS PARTNERS, LLC (SOUTH CAROLINA LIMITED LIABILITY COMPANY)
1031 LE GRAND BLVD.
CHARLESTON, SC 29492

FOR: RETAIL DISCOUNT STORE SERVICES IN THE FIELD OF GENERAL CONSUMER MERCHANDISE, EXCLUDING AUTOMOTIVE PARTS AND EQUIPMENT, CAR CARE PRODUCTS, AND TOOLS FOR SERVICING AND REPAIRING VEHICLES, IN CLASS 35 (U.S. CLS. 100, 101 AND 102).

FIRST USE 1-1-2009; IN COMMERCE 1-1-2009.

THE MARK CONSISTS OF STANDARD CHARACTERS WITHOUT CLAIM TO ANY PARTICULAR FONT, STYLE, SIZE, OR COLOR.

NO CLAIM IS MADE TO THE EXCLUSIVE RIGHT TO USE "OUTLET", APART FROM THE MARK AS SHOWN.

SER. NO. 85-190,328, FILED 12-3-2010.

ELI HELLMAN, EXAMINING ATTORNEY



David J. Kyffers

Director of the United States Patent and Trademark Office

United States of America

United States Patent and Trademark Office

NUTRITIOUS AMERICA

Reg. No. 4,107,560

Registered Mar. 6, 2012

Int. Cls.: 41 and 44

SERVICE MARK

PRINCIPAL REGISTER

NUTRITIOUS AMERICA (DELAWARE LIMITED LIABILITY COMPANY)
42 READ'S WAY
NEW CASTLE, DE 19720

FOR: EDUCATION SERVICES, NAMELY, PROVIDING CLASSES, SEMINARS, AND WORKSHOPS IN THE FIELDS OF HEALTH AND WELLNESS, IN CLASS 41 (U.S. CLS. 100, 101 AND 107).

FIRST USE 1-1-2008; IN COMMERCE 1-1-2008.

FOR: NUTRITION COUNSELING, IN CLASS 44 (U.S. CLS. 100 AND 101).

FIRST USE 1-1-2008; IN COMMERCE 1-1-2008.

THE MARK CONSISTS OF STANDARD CHARACTERS WITHOUT CLAIM TO ANY PARTICULAR FONT, STYLE, SIZE, OR COLOR.

NO CLAIM IS MADE TO THE EXCLUSIVE RIGHT TO USE "AMERICA", APART FROM THE MARK AS SHOWN.

SER. NO. 85-191,624, FILED 12-6-2010.

JENNY PARK, EXAMINING ATTORNEY



David J. Kybas

Director of the United States Patent and Trademark Office

United States of America

United States Patent and Trademark Office

ARIZONA TEACHING FELLOWS

Reg. No. 4,107,561

Registered Mar. 6, 2012

Int. Cls.: 35 and 41

SERVICE MARK

PRINCIPAL REGISTER

THE NEW TEACHER PROJECT, INC. (DELAWARE NON-PROFIT CORPORATION)
186 JORALEMON STREET, SUITE 300
BROOKLYN, NY 11201

FOR: EMPLOYMENT SERVICES, NAMELY, RECRUITING INDIVIDUALS TO TEACH CLASSES IN PRIMARY AND SECONDARY PUBLIC SCHOOLS IN THE FIELDS OF READING, WRITING, SPELLING, GRAMMAR, LANGUAGES, GEOGRAPHY, SOCIAL STUDIES, MATHEMATICS, SCIENCE, NUTRITION, HEALTH, PHYSICAL EDUCATION, COMPUTER AND INFORMATION TECHNOLOGY, MUSIC, ART AND LITERATURE, IN CLASS 35 (U.S. CLS. 100, 101 AND 102).

FIRST USE 8-2-2010; IN COMMERCE 8-2-2010.

FOR: EDUCATIONAL SERVICES, NAMELY, TRAINING INDIVIDUALS TO TEACH CLASSES IN PRIMARY AND SECONDARY PUBLIC SCHOOLS IN THE FIELDS OF READING, WRITING, SPELLING, GRAMMAR, LANGUAGES, GEOGRAPHY, SOCIAL STUDIES, MATHEMATICS, SCIENCE, NUTRITION, HEALTH, PHYSICAL EDUCATION, COMPUTER AND INFORMATION TECHNOLOGY, MUSIC, ART AND LITERATURE, IN CLASS 41 (U.S. CLS. 100, 101 AND 107).

FIRST USE 8-2-2010; IN COMMERCE 8-2-2010.

THE MARK CONSISTS OF STANDARD CHARACTERS WITHOUT CLAIM TO ANY PARTICULAR FONT, STYLE, SIZE, OR COLOR.

OWNER OF U.S. REG. NOS. 2,888,971, 3,126,125 AND OTHERS.

SEC. 2(F).

SER. NO. 85-191,860, FILED 12-7-2010.

THOMAS MANOR, EXAMINING ATTORNEY



David J. Kyffers

Director of the United States Patent and Trademark Office

United States of America

United States Patent and Trademark Office

AVDA

Reg. No. 4,107,562

AID TO VICTIMS OF DOMESTIC ABUSE, INC. (FLORIDA CORPORATION)
P.O. BOX 6161
DELRAY BEACH, FL 33482

Registered Mar. 6, 2012

Int. Cls.: 36 and 43

FOR: CHARITABLE FUNDRAISING SERVICES, NAMELY, RAISING FUNDS TO BENEFIT VICTIMS OF DOMESTIC ABUSE, IN CLASS 36 (U.S. CLS. 100, 101 AND 102).

SERVICE MARK

FIRST USE 1-31-1985; IN COMMERCE 2-9-1985.

PRINCIPAL REGISTER

FOR: CHILD AND FAMILY WELFARE SERVICES, NAMELY, PROVIDING TEMPORARY HOUSING ACCOMMODATIONS, AND ARRANGING TEMPORARY, INDEPENDENT HOUSING ACCOMMODATIONS; PROVIDING INFORMATION IN THE FIELD OF CHILD AND FAMILY WELFARE, NAMELY, PROVIDING INFORMATION ABOUT RESIDENTIAL HOMES AND HOUSING FOR CHILDREN AND FAMILIES, IN CLASS 43 (U.S. CLS. 100 AND 101).

FIRST USE 1-31-1985; IN COMMERCE 2-9-1985.

THE MARK CONSISTS OF STANDARD CHARACTERS WITHOUT CLAIM TO ANY PARTICULAR FONT, STYLE, SIZE, OR COLOR.

SER. NO. 85-191,981, FILED 12-7-2010.

NANCY CLARKE, EXAMINING ATTORNEY



David J. Kybas

Director of the United States Patent and Trademark Office

United States of America

United States Patent and Trademark Office

CHELSEA CHOWDER HOUSE & BAR

Reg. No. 4,107,563

Registered Mar. 6, 2012

Int. Cl.: 43

SERVICE MARK

PRINCIPAL REGISTER

CITY OF LONG BEACH (CALIFORNIA MUNICIPAL CORPORATION)
333 WEST OCEAN BOULEVARD
LONG BEACH, CA 90802

FOR: RESTAURANT AND BAR SERVICES, IN CLASS 43 (U.S. CLS. 100 AND 101).

FIRST USE 11-1-2010; IN COMMERCE 11-1-2010.

THE MARK CONSISTS OF STANDARD CHARACTERS WITHOUT CLAIM TO ANY PARTICULAR FONT, STYLE, SIZE, OR COLOR.

NO CLAIM IS MADE TO THE EXCLUSIVE RIGHT TO USE "CHOWDER HOUSE & BAR", APART FROM THE MARK AS SHOWN.

SER. NO. 85-193,565, FILED 12-8-2010.

H. M. FISHER, EXAMINING ATTORNEY



David J. Kybas

Director of the United States Patent and Trademark Office

United States of America

United States Patent and Trademark Office

Botani

Reg. No. 4,107,564

Registered Mar. 6, 2012

Int. Cl.: 3

TRADEMARK

PRINCIPAL REGISTER

BOTANI AUSTRALIA PTY LIMITED (AUSTRALIA CORPORATION)
16/306 ALBERT STREET
BRUNSWICK VIC3056, AUSTRALIA

FOR: NON-MEDICATED TOILET PREPARATIONS, NAMELY, TOILETRIES AND SOAPS FOR BODYCARE; COSMETICS; NON-MEDICATED PREPARATIONS AND SUBSTANCES ALL FOR THE CARE OF THE SKIN, FACE, LIPS, BODY, HAIR AND SCALP, NAMELY, SKIN CARE PREPARATIONS, HAIR CARE PREPARATIONS; SKINCARE PRODUCTS, NAMELY, COSMETIC PREPARATION FOR THE SKIN, BODY AND BEAUTY CARE COSMETICS, FOOT SCRUBS, LIP BALM, LOTIONS FOR FACE AND BODY CARE, SKIN CREAMS, EXFOLIANT CREAMS, BODY OILS, AND HAND CREAM; NATURAL SKINCARE PRODUCTS, NAMELY, COSMETIC PREPARATION FOR THE SKIN, BODY AND BEAUTY CARE COSMETICS, FOOT SCRUBS, LIP BALM, LOTIONS FOR FACE AND BODY CARE, SKIN CREAMS, EXFOLIANT CREAMS, BODY OILS, AND HAND CREAM; NON-MEDICATED SKINCARE PREPARATIONS; NON-MEDICATED NATURAL PREPARATIONS AND SUBSTANCES ALL FOR THE CARE OF THE SKIN, FACE, LIPS, BODY, HAIR AND SCALP, NAMELY, SKIN CARE PREPARATIONS, HAIR CARE PREPARATIONS; CREAMS AND LOTIONS FOR THE SKIN; NON-MEDICATED SKIN CARE PREPARATIONS CONTAINING BOTANICAL EXTRACTS; NON-MEDICATED COSMETIC SKIN CLEANSING, HYDRATING, MOISTURIZING, PROTECTING, FRESHENING, SOFTENING, SOOTHING, FIRMING AND TONING CREAMS, LOTIONS, GELS, BALMS, SERUMS, SCRUBS, WASHES, OILS AND MISTS; COSMETIC ESSENCES FOR SKIN CARE; SKIN EMOLLIENTS; MASSAGE PREPARATIONS, NAMELY, MASSAGE LOTIONS, OILS, CREAMS, AND SERUMS; AFTER-SHAVE; DEODORANTS FOR PERSONAL USE; ANTIPERSPIRANTS; HAIR SHAMPOOS AND CONDITIONERS; HAIR CARE TREATMENTS, NAMELY, NON-MEDICATED, HAIR PREPARATIONS FOR COSMETIC PURPOSES; EXFOLIANTS FOR BODY, FACE, SKIN, AND FEET; SCRUBS FOR BODY, FACE, SKIN, AND FEET; SALT SCRUBS FOR BODY, FACE, SKIN, AND FEET; FACIAL SCRUBS; BODY SCRUBS; FOOT SCRUBS; NON-MEDICATED BALMS FOR USE ON HAIR, SKIN, AND LIPS; NON-MEDICATED HAIR BALMS; NON-MEDICATED SKIN BALMS; LIP BALMS; NON-MEDICATED FOOT BALMS; BODY LOTIONS; BODY WASHES; COSMETIC EYE TREATMENTS, NAMELY, EYE CREAM, EYE LOTION, AND EYE SERUM, IN CLASS 3 (U.S. CLS. 1, 4, 6, 50, 51 AND 52).

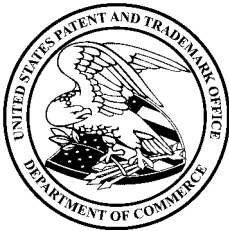

David J. Kappas

FIRST USE 10-20-2006; IN COMMERCE 10-20-2006.

Reg. No. 4,107,564 THE MARK CONSISTS OF THE WORD "BOTÁNI" WHICH IS PRONOUNCED VOH-TAH-NEE. THIS IS NOT A GREEK WORD BUT IS A COMBINATION OF GREEK ROMAN CHARACTERS.

THE WORDING "BOTANI" HAS NO MEANING IN A FOREIGN LANGUAGE.

SER. NO. 85-193,676, FILED 12-8-2010.

TARAH HARDY, EXAMINING ATTORNEY

United States of America

United States Patent and Trademark Office

Botani

Reg. No. 4,107,565

Registered Mar. 6, 2012

Int. Cl.: 5

TRADEMARK

PRINCIPAL REGISTER

BOTANI AUSTRALIA PTY LIMITED (AUSTRALIA CORPORATION)
16/306 ALBERT STREET
BRUNSWICK VIC 3056, AUSTRALIA

FOR: MEDICATED TOILET PREPARATIONS, NAMELY, MEDICATED BATH PREPARATIONS, MEDICATED SOAPS FOR BODYCARE, ANTIFUNGAL CREAMS FOR MEDICAL USE, ANTIFUNGAL PREPARATIONS, AND ACNE TREATMENT PREPARATIONS; MEDICATED PREPARATIONS AND SUBSTANCES ALL FOR THE CARE OF THE SKIN, FACE, LIPS, BODY, HAIR AND SCALP; MEDICATED SKINCARE PREPARATIONS; MEDICATED NATURAL PREPARATIONS AND SUBSTANCES ALL FOR THE CARE OF THE SKIN, FACE, LIPS, BODY, HAIR AND SCALP; PHARMACEUTICAL PREPARATIONS AND SUBSTANCES FOR THE TREATMENT OF DAMAGED SKIN AND TISSUE; DERMATOLOGICAL PHARMACEUTICAL PREPARATIONS FOR THE SKIN, HAIR AND SCALP; THERAPEUTIC SKIN LOTIONS AND CREAMS FOR TREATMENT OF ACNE, SKIN DRYNESS, FUNGAL INFECTIONS, OILINESS, CHAPPING, BLEMISHES AND IRRITATIONS; MEDICATED CREAMS AND LOTIONS FOR THE SKIN; MEDICATED PREPARATIONS FOR TOPICAL TREATMENT OF SKIN DRYNESS, OILINESS, CHAPPING, BLEMISHES AND IRRITATIONS; MEDICATED SKIN CARE AND TREATMENT PRODUCTS AND PREPARATIONS CONTAINING BOTANICAL EXTRACTS FOR TREATMENT OF ACNE, FUNGAL INFECTIONS, SKIN DRYNESS, SKIN OILINESS, SKIN CHAPPING, SKIN BLEMISHES AND IRRITATIONS; MEDICATED SKIN CLEANSING, HYDRATING, MOISTURIZING, PROTECTING, FRESHENING, SOFTENING, SOOTHING, FIRING AND TONING CREAMS, LOTIONS, GELS, BALMS, SERUMS, SCRUBS, WASHES, OILS AND MISTS; MEDICATED ESSENCES FOR SKIN CARE; MEDICATED SKIN EMOLLIENTS; MEDICATED HAIR CARE TREATMENTS; MEDICATED BALMS FOR TREATMENT OF ACNE, FUNGAL INFECTIONS, SKIN DRYNESS, SKIN OILINESS, SKIN CHAPPING, SKIN BLEMISHES AND IRRITATIONS; MEDICATED HAIR BALMS; MEDICATED SKIN BALMS; MEDICATED LIP BALMS; MEDICATED FOOT BALMS; MEDICATED BODY LOTIONS; MEDICATED BODY WASHES; MEDICATED EYE TREATMENTS FOR TREATMENT OF PUFFINESS, DARK CIRCLES, DRY SKIN, AND WRINKLES; BIOCIDES FOR DOMESTIC USE; ANTISEPTICS; BACTERIAL PREPARATIONS, NAMELY, CREAMS, LOTIONS, SERUMS FOR TREATMENT OF ACNE AND FUNGAL INFECTIONS; ALL PURPOSE DISINFECTANTS, IN CLASS 5 (U.S. CLS. 6, 18, 44, 46, 51 AND 52).



David J. Kappas

FIRST USE 10-20-2006; IN COMMERCE 10-20-2006.

Reg. No. 4,107,565 THE MARK CONSISTS OF THE WORD "BOTÁNI" WHICH IS PRONOUNCED VOH-TAH-NEE. THIS IS NOT A GREEK WORD BUT IS A COMBINATION OF GREEK ROMAN CHARACTERS.

THE WORDING "BOTANI" HAS NO MEANING IN A FOREIGN LANGUAGE.

SER. NO. 85-193,680, FILED 12-8-2010.

TARAH HARDY, EXAMINING ATTORNEY

United States of America

United States Patent and Trademark Office

FREEMONEE

Reg. No. 4,107,566

Registered Mar. 6, 2012

Int. Cl.: 35

SERVICE MARK

PRINCIPAL REGISTER

FREE MONEY NETWORK, INC. (DELAWARE CORPORATION)
411 BOREL AVENUE SUITE 310
SAN MATEO, CA 94402

FOR: MARKETING SERVICES, NAMELY, COMPUTER-ASSISTED MATCHING OF MERCHANT INCENTIVES TO PROSPECTIVE CONSUMERS BY CREATING DEFINITIONS OF MERCHANT INCENTIVES, ANALYZING CARD PURCHASE TRANSACTIONS TO MATCH INCENTIVES TO PROSPECTIVE CONSUMERS, FACILITATING DELIVERY OF INCENTIVES TO PROSPECTIVE CONSUMERS, AND PROVIDING CONSUMER NOTIFICATIONS ABOUT AVAILABLE INCENTIVES, IN CLASS 35 (U.S. CLS. 100, 101 AND 102).

FIRST USE 5-11-2011; IN COMMERCE 6-28-2011.

THE MARK CONSISTS OF STANDARD CHARACTERS WITHOUT CLAIM TO ANY PARTICULAR FONT, STYLE, SIZE, OR COLOR.

SER. NO. 85-193,756, FILED 12-8-2010.

PAUL E. FAHRENKOPF, EXAMINING ATTORNEY



David J. Kyffers

Director of the United States Patent and Trademark Office

United States of America

United States Patent and Trademark Office



Reg. No. 4,107,567

Registered Mar. 6, 2012

**Int. Cls.: 35, 39, 40, 41
and 42**

SERVICE MARK

PRINCIPAL REGISTER

GROUP360, INC. (DELAWARE CORPORATION)
1227 WASHINGTON AVE.
ST. LOUIS, MO 63103

FOR: DESIGN OF ADVERTISING MATERIALS FOR OTHERS; DESIGN OF ADVERTISING AND PROMOTIONAL MATERIALS FOR OTHERS FOR USE IN MARKETING CAMPAIGNS USED AT TRADE SHOWS, BUSINESS-TO-BUSINESS EVENTS, AND BUSINESS-TO-CONSUMER EVENTS; CREATING CORPORATE AND BRAND IDENTITY FOR OTHERS; BUSINESS MARKETING SERVICES, NAMELY, DESIGN AND IMPLEMENTATION OF SOCIAL MEDIA STRATEGIES FOR BUSINESSES FOR MARKETING PURPOSES, IN CLASS 35 (U.S. CLS. 100, 101 AND 102).

FIRST USE 11-0-2010; IN COMMERCE 11-0-2010.

FOR: IMAGE ASSET MANAGEMENT, NAMELY, STORAGE OF ELECTRONIC MEDIA IN THE NATURE OF DIGITAL IMAGES FOR OTHERS, IN CLASS 39 (U.S. CLS. 100 AND 105).

FIRST USE 11-0-2010; IN COMMERCE 11-0-2010.

FOR: PRINTING SERVICES, NAMELY, PRINTING ADVERTISING MATERIALS FOR OTHERS, IN CLASS 40 (U.S. CLS. 100, 103 AND 106).

FIRST USE 11-0-2010; IN COMMERCE 11-0-2010.

FOR: PHOTOGRAPHY SERVICES, IN CLASS 41 (U.S. CLS. 100, 101 AND 107).

FIRST USE 11-0-2010; IN COMMERCE 11-0-2010.

FOR: PACKAGING DESIGN FOR OTHERS; WEBSITE DESIGN AND DEVELOPMENT FOR OTHERS, IN CLASS 42 (U.S. CLS. 100 AND 101).

FIRST USE 11-0-2010; IN COMMERCE 11-0-2010.

OWNER OF U.S. REG. NOS. 2,743,286 AND 3,941,592.

NO CLAIM IS MADE TO THE EXCLUSIVE RIGHT TO USE "GROUP AND WORLDWIDE", APART FROM THE MARK AS SHOWN.



David J. Kyffers

Director of the United States Patent and Trademark Office

Reg. No. 4,107,567 THE MARK CONSISTS OF THE WORDS "GROUP" AND "WORLDWIDE" PRESENTED IN STYLIZED FONT. A DESIGN ELEMENT COMPRISED OF A CIRCLE CONTAINING THE NUMBER "360" IN STYLIZED FONT IS SITUATED BETWEEN "GROUP" AND "WORLDWIDE".

SER. NO. 85-194,330, FILED 12-9-2010.

GRETCHEN ULRICH, EXAMINING ATTORNEY

United States of America

United States Patent and Trademark Office

FREE  **MONEE**

Reg. No. 4,107,568

Registered Mar. 6, 2012

Int. Cl.: 35

SERVICE MARK

PRINCIPAL REGISTER

FREE MONEY NETWORK, INC. (DELAWARE CORPORATION)
411 BOREL AVENUE SUITE 310
SAN MATEO, CA 94404

FOR: MARKETING SERVICES, NAMELY, COMPUTER-ASSISTED MATCHING OF MERCHANT INCENTIVES TO PROSPECTIVE CONSUMERS BY CREATING DEFINITIONS OF MERCHANT INCENTIVES, ANALYZING CARD PURCHASE TRANSACTIONS TO MATCH INCENTIVES TO PROSPECTIVE CONSUMERS, FACILITATING DELIVERY OF INCENTIVES TO PROSPECTIVE CONSUMERS, AND PROVIDING CONSUMER NOTIFICATIONS ABOUT AVAILABLE INCENTIVES, IN CLASS 35 (U.S. CLS. 100, 101 AND 102).

FIRST USE 5-11-2011; IN COMMERCE 6-28-2011.

NO CLAIM IS MADE TO THE EXCLUSIVE RIGHT TO USE "MONEY", APART FROM THE MARK AS SHOWN.

THE MARK CONSISTS OF THE WORDS "FREE MONEE" AND A GRAPHICAL REPRESENTATION OF A BOX WITH A BOW.

SER. NO. 85-194,551, FILED 12-9-2010.

PAUL E. FAHRENKOPF, EXAMINING ATTORNEY



David J. Kybas

Director of the United States Patent and Trademark Office

United States of America

United States Patent and Trademark Office

TEK TOWEL

Reg. No. 4,107,569

Registered Mar. 6, 2012

Int. Cl.: 24

TRADEMARK

PRINCIPAL REGISTER

SEA TO SUMMIT PTY LTD (AUSTRALIA CORPORATION)
6-8 BROWN STREET
EAST PERTH WA 6004, AUSTRALIA

FOR: BATH TOWELS; BEACH TOWELS; FACE TOWELS OF TEXTILE; HAND TOWELS OF TEXTILE; TERRY TOWELS; TEXTILE FABRICS FOR USE IN THE MANUFACTURE OF TOWELS; TOWELS; TOWELS OF TEXTILE, IN CLASS 24 (U.S. CLS. 42 AND 50).

THE MARK CONSISTS OF STANDARD CHARACTERS WITHOUT CLAIM TO ANY PARTICULAR FONT, STYLE, SIZE, OR COLOR.

PRIORITY CLAIMED UNDER SEC. 44(D) ON AUSTRALIA APPLICATION NO. 1366221, FILED 6-10-2010, REG. NO. 1366221, DATED 6-10-2010, EXPIRES 6-10-2020.

NO CLAIM IS MADE TO THE EXCLUSIVE RIGHT TO USE "TOWEL", APART FROM THE MARK AS SHOWN.

SER. NO. 85-194,967, FILED 12-10-2010.

JESSICA A. POWERS, EXAMINING ATTORNEY



David J. Kyros

Director of the United States Patent and Trademark Office

United States of America

United States Patent and Trademark Office



Reg. No. 4,107,570

Registered Mar. 6, 2012

Int. Cl.: 43

SERVICE MARK

PRINCIPAL REGISTER

HUGH JASS BURGERS, LLC (KENTUCKY LIMITED LIABILITY COMPANY)
1385 PRIDEMORE COURT
LEXINGTON, KY 40505

FOR: RESTAURANT SERVICES, IN CLASS 43 (U.S. CLS. 100 AND 101).

FIRST USE 8-13-2010; IN COMMERCE 8-13-2010.

NO CLAIM IS MADE TO THE EXCLUSIVE RIGHT TO USE "BURGERS", APART FROM THE MARK AS SHOWN.

THE COLOR(S) RED, YELLOW, LIGHT GRAY, DARK GRAY, BLACK AND WHITE IS/ARE CLAIMED AS A FEATURE OF THE MARK.

THE NAME(S), PORTRAIT(S), AND/OR SIGNATURE(S) SHOWN IN THE MARK DOES NOT IDENTIFY A PARTICULAR LIVING INDIVIDUAL.

THE MARK CONSISTS OF A RED CIRCLE OUTLINED IN BLACK; INSIDE THE CIRCLE IS A DESIGN OF A DONKEY OUTLINED IN BLACK AND SHADED IN LIGHT GRAY AND DARK GRAY WITH WHITE TEETH, WHITE EYES WITH BLACK PUPILS, AND BLACK MANE, HOOVES AND TAIL. THE WORDS "HUGH JASS" APPEAR OVER THE DONKEY AND THE WORD "BURGERS" APPEARS UNDER THE DONKEY, ALL IN CURVED YELLOW LETTERS OUTLINED IN BLACK WITH BLACK DOTS SUGGESTING NAILS IN EACH LETTER. TO THE LEFT AND RIGHT OF THE DONKEY ARE YELLOW CIRCLES WITH WHITE SHADING OUTLINED IN BLACK, AND EACH CIRCLE HAS THREE CURVED BLACK LINES EXTENDING ABOVE AND BELOW THE CIRCLE. WHITE SPACE APPEARING AROUND THE OUTSIDE OF THE MARK IS BACKGROUND AND IS NOT A FEATURE OF THE MARK.

SER. NO. 85-195,276, FILED 12-10-2010.

MEGHAN REINHART, EXAMINING ATTORNEY



David J. Kybas

Director of the United States Patent and Trademark Office

United States of America

United States Patent and Trademark Office

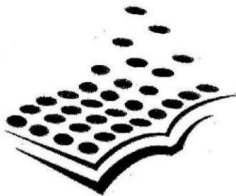

MOODYRADIO

Where you turn. For life.

Reg. No. 4,107,571

Registered Mar. 6, 2012

Int. Cls.: 38 and 41

SERVICE MARK

PRINCIPAL REGISTER

MOODY BIBLE INSTITUTE (ILLINOIS CORPORATION)
820 NORTH LASALLE BLVD.
CHICAGO, IL 60610

FOR: RADIO BROADCASTING SERVICES; INTERNET RADIO BROADCASTING SERVICES;
STREAMING OF AUDIO, VISUAL AND AUDIOVISUAL MATERIAL VIA A GLOBAL
COMPUTER NETWORK, IN CLASS 38 (U.S. CLS. 100, 101 AND 104).

FIRST USE 11-22-2008; IN COMMERCE 11-22-2008.

FOR: PRODUCTION AND DISTRIBUTION OF RADIO PROGRAMS, IN CLASS 41 (U.S. CLS.
100, 101 AND 107).

FIRST USE 11-22-2008; IN COMMERCE 11-22-2008.

OWNER OF U.S. REG. NO. 3,567,311.

NO CLAIM IS MADE TO THE EXCLUSIVE RIGHT TO USE "RADIO", APART FROM THE
MARK AS SHOWN.

THE MARK CONSISTS OF THE WORDS "MOODY RADIO" ABOVE THE WORDS "WHERE
YOU TURN. FOR LIFE." AND A BOOK THAT IS IN THE OPEN POSITION. THERE ARE
FOUR ROWS OF CIRCLES THAT ARE LOCATED WITHIN TWO CURVED LINES THAT
ARE THE PAGES OF THE BOOK.

SER. NO. 85-195,581, FILED 12-10-2010.

ROBERT C. CLARK JR., EXAMINING ATTORNEY



David J. Kybas

Director of the United States Patent and Trademark Office

United States of America

United States Patent and Trademark Office

rebusphinx

Reg. No. 4,107,572

Registered Mar. 6, 2012

Int. Cls.: 28 and 44

TRADEMARK

SERVICE MARK

PRINCIPAL REGISTER

BRENNEMAN, KURT, A (UNITED STATES INDIVIDUAL)
824 HEDGEWOOD DRIVE
LAFAYETTE, IN 47904

FOR: GAME EQUIPMENT SOLD AS A UNIT FOR PLAYING MIND-BODY EMOTIONAL AND PSYCHOLOGICAL GAMES FOR ADULT COUPLES AND INDIVIDUALS, IN CLASS 28 (U.S. CLS. 22, 23, 38 AND 50).

FIRST USE 12-8-2010; IN COMMERCE 12-8-2010.

FOR: ART THERAPY, IN CLASS 44 (U.S. CLS. 100 AND 101).

FIRST USE 12-8-2010; IN COMMERCE 12-8-2010.

THE MARK CONSISTS OF STANDARD CHARACTERS WITHOUT CLAIM TO ANY PARTICULAR FONT, STYLE, SIZE, OR COLOR.

SER. NO. 85-195,792, FILED 12-11-2010.

SKYE YOUNG, EXAMINING ATTORNEY



David J. Kybas

Director of the United States Patent and Trademark Office

United States of America

United States Patent and Trademark Office

BLUE ANT, INC.

Reg. No. 4,107,573

BLUE ANT, INC. (CALIFORNIA CORPORATION)
1507 7TH ST UNIT #225
SANTA MONICA, CA 90401

Registered Mar. 6, 2012

Int. Cl.: 37

FOR: CLEANING OF BUILDINGS; CLEANING OF COMMERCIAL PREMISES; CLEANING OF INDUSTRIAL PREMISES; CLEANING OF RESIDENTIAL HOUSES; CLEANING OF OFFICES, CARPETS, FLOORS, RESTROOMS, AND EXTERIOR AND INTERIOR OF BUILDINGS; JANITORIAL SERVICES, IN CLASS 37 (U.S. CLS. 100, 103 AND 106).

SERVICE MARK

PRINCIPAL REGISTER

FIRST USE 1-0-2002; IN COMMERCE 1-0-2002.

THE MARK CONSISTS OF STANDARD CHARACTERS WITHOUT CLAIM TO ANY PARTICULAR FONT, STYLE, SIZE, OR COLOR.

NO CLAIM IS MADE TO THE EXCLUSIVE RIGHT TO USE "INC.", APART FROM THE MARK AS SHOWN.

SER. NO. 85-195,908, FILED 12-11-2010.

LAKEISHA LEWIS, EXAMINING ATTORNEY



David J. Kyros

Director of the United States Patent and Trademark Office

United States of America

United States Patent and Trademark Office

NOURISH & FLOURISH

Reg. No. 4,107,574

Registered Mar. 6, 2012

Int. Cl.: 44

SERVICE MARK

PRINCIPAL REGISTER

BRIAN T. LUMB, D.C., P.S. INC. (NORTH CAROLINA CORPORATION)
SUITE 201
347 DEPOT STREET
ASHEVILLE, NC 28801

FOR: MEDICAL SERVICES, NAMELY, CHIROPRACTIC CARE FOCUSING ON NETWORK SPINAL ANALYSIS AND SOMATO RESPIRATORY INTEGRATION; WELLNESS AND HEALTH-RELATED CONSULTING SERVICES; PROVIDING A WEBSITE FEATURING INFORMATION ABOUT HEALTHY LIVING AND LIFESTYLE WELLNESS, IN CLASS 44 (U.S. CLS. 100 AND 101).

FIRST USE 8-13-2010; IN COMMERCE 8-13-2010.

THE MARK CONSISTS OF STANDARD CHARACTERS WITHOUT CLAIM TO ANY PARTICULAR FONT, STYLE, SIZE, OR COLOR.

SER. NO. 85-196,084, FILED 12-13-2010.

JORDAN BAKER, EXAMINING ATTORNEY



David J. Kybas

Director of the United States Patent and Trademark Office

United States of America
United States Patent and Trademark Office

Parade of Homes

Reg. No. 4,107,575

Registered Mar. 6, 2012

Int. Cl.: 35

SERVICE MARK

PRINCIPAL REGISTER

BUILDERS ASSOCIATION OF THE TWIN CITIES (MINNESOTA NON-PROFIT CORPORATION)
2960 CENTRE POINTE DRIVE
ROSEVILLE, MN 55113

FOR: PROMOTING THE GOODS AND SERVICES OF MEMBERS OF THE HOME BUILDING CONSTRUCTION INDUSTRY THROUGH THE PRESENTATION OF NEW AND REMODELED HOMES TO THE PUBLIC; AND PROMOTING THE SERVICES OF BUILDERS BY ORGANIZING AND ARRANGING HOME TOURS, IN CLASS 35 (U.S. CLS. 100, 101 AND 102).

FIRST USE 2-0-2002; IN COMMERCE 2-0-2002.

OWNER OF U.S. REG. NO. 1,639,919.

THE MARK CONSISTS OF TWO LINES OF TEXT OF EQUAL WIDTH, WITH THE WORDS "PARADE OF" ON THE FIRST LINE, AND THE WORD "HOMES" ON THE SECOND LINE WITH THE "S" UNDERLINING THE WORD "HOMES" TO THE LEFT OF THE LETTER "H".

SEC. 2(F).

SER. NO. 85-196,518, FILED 12-13-2010.

KELLY TRUSILO, EXAMINING ATTORNEY



David J. Kyffers

Director of the United States Patent and Trademark Office

United States of America

United States Patent and Trademark Office

PATIO GLOW

Reg. No. 4,107,576

Registered Mar. 6, 2012

Int. Cl.: 11

TRADEMARK

PRINCIPAL REGISTER

AGIO INTERNATIONAL COMPANY, LTD. (HONG KONG CORPORATION)
UNIT 1013 CHINACHEM GOLDEN PLAZA
77 MODY ROAD T.S.T. EAST
KOWLOON, HONG KONG

FOR: LP, NATURAL GAS, AND WOOD BURNING FREESTANDING PORTABLE FIRE-PLACES FOR OUTDOOR USE, IN CLASS 11 (U.S. CLS. 13, 21, 23, 31 AND 34).

FIRST USE 8-1-2004; IN COMMERCE 8-1-2004.

THE MARK CONSISTS OF STANDARD CHARACTERS WITHOUT CLAIM TO ANY PARTICULAR FONT, STYLE, SIZE, OR COLOR.

OWNER OF U.S. REG. NO. 3,015,503.

SER. NO. 85-197,107, FILED 12-14-2010.

NAAKWAMA ANKRAH, EXAMINING ATTORNEY



David J. Kyffers

Director of the United States Patent and Trademark Office

United States of America

United States Patent and Trademark Office

erotikaway

Reg. No. 4,107,577

Registered Mar. 6, 2012

Int. Cl.: 35

SERVICE MARK

PRINCIPAL REGISTER

IBIZA POLO CLUB, S.L. (SPAIN CORPORATION)
MUNTANER, 406, 40 2A
BARCELONA, SPAIN 08006

FOR: ADVERTISING; BUSINESS MANAGEMENT; FRANCHISE SERVICES, NAMELY, OFFERING BUSINESS MANAGEMENT ASSISTANCE IN THE ESTABLISHMENT AND OPERATION OF STORES AND ON LINE STORES FEATURING EROTIC GOODS, TOYS EQUIPMENT AND UNDERWEAR; IMPORT AND EXPORT AGENCY SERVICES IN THE FIELDS OF EROTIC GOODS, TOYS EQUIPMENT AND UNDERWEAR; RESELLER SERVICES, NAMELY, DISTRIBUTORSHIP SERVICES IN THE FIELDS OF EROTIC GOODS, TOYS AND EQUIPMENT AND ALSO UNDERWEAR; DISTRIBUTORSHIPS IN THE FIELDS OF EROTIC GOODS, TOYS AND EQUIPMENT AND ALSO UNDERWEAR; RETAIL STORE SERVICES AND ON LINE RETAIL STORE SERVICES FEATURING EROTIC GOODS, TOYS EQUIPMENT AND UNDERWEAR, IN CLASS 35 (U.S. CLS. 100, 101 AND 102).

OWNER OF ERPN CMNTY TM OFC REG. NO. 008992455, DATED 9-27-2010, EXPIRES 3-30-2020.

THE MARK CONSISTS OF THE WORDING "EROTIKAWAY" IN STYLIZED LETTERS IN STYLIZED FONT WITH AN UMLAT OVER THE LETTER "Y".

THE WORDING "EROTIKAWAY" HAS NO MEANING IN A FOREIGN LANGUAGE.

SER. NO. 85-197,133, FILED 12-14-2010.

LESLEY LAMOTHE, EXAMINING ATTORNEY



David J. Kybas

Director of the United States Patent and Trademark Office

United States of America

United States Patent and Trademark Office

Lightning Bolt

Reg. No. 4,107,578

Registered Mar. 6, 2012

Int. Cls.: 35 and 38

SERVICE MARK

PRINCIPAL REGISTER

LIGHTNING BOLT SOLUTIONS, INC. (DELAWARE CORPORATION)
433 AIRPORT BLVD., SUITE 319
BURLINGAME, CA 94010

FOR: MANAGEMENT ON BEHALF OF INDUSTRIAL AND COMMERCIAL ENTERPRISES; NAMELY, PROVIDING TEMPORARY OR CONTRACT APPOINTMENT STAFF SCHEDULING, HOSPITAL SCHEDULING, RESIDENT SCHEDULING, ON CALL SCHEDULING, SHIFT SCHEDULING, CIRCADIAN RHYTHM SCHEDULING, AND BLOCK SCHEDULING, IN CLASS 35 (U.S. CLS. 100, 101 AND 102).

FIRST USE 9-30-1999; IN COMMERCE 7-31-2002.

FOR: ELECTRONIC TRANSMISSION OF MESSAGES FROM ONE PERSON TO ANOTHER; NAMELY, TRANSMISSION OF MESSAGES FROM ONE PERSON TO ANOTHER IN CONNECTION WITH TEMPORARY OR CONTRACT STAFF SCHEDULING, HOSPITALIST SCHEDULING, RESIDENT SCHEDULING, ON CALL SCHEDULING, SHIFT SCHEDULING, CIRCADIAN RHYTHM SCHEDULING, AND BLOCK SCHEDULING, IN CLASS 38 (U.S. CLS. 100, 101 AND 104).

FIRST USE 9-30-1999; IN COMMERCE 7-31-2002.

THE MARK CONSISTS OF STANDARD CHARACTERS WITHOUT CLAIM TO ANY PARTICULAR FONT, STYLE, SIZE, OR COLOR.

SER. NO. 85-197,445, FILED 12-14-2010.

ALICE BENMAMAN, EXAMINING ATTORNEY



David J. Kyros

Director of the United States Patent and Trademark Office

United States of America

United States Patent and Trademark Office

COAST SPAS - THE WINNING EDGE

Reg. No. 4,107,579

COAST SPAS MANUFACTURING INC. (CANADA CORPORATION)
6315 202 STREET
LANGLEY, BC, CANADA V2Y1N1

Registered Mar. 6, 2012

Int. Cl.: 11

FOR: HOT TUBS, SPAS IN THE NATURE OF HEATED POOLS AND SWIM SPAS IN THE NATURE OF HEATED POOLS; HOT TUB ACCESSORIES, NAMELY, HOT TUB JETS, FITTED LINERS FOR HOT TUBS, AND FILTERS, HEATERS AND PUMPS SOLD IN COMBINATION FOR USE IN HOT TUBS, IN CLASS 11 (U.S. CLS. 13, 21, 23, 31 AND 34).

TRADEMARK

PRINCIPAL REGISTER

FIRST USE 11-3-2010; IN COMMERCE 11-3-2010.

THE MARK CONSISTS OF STANDARD CHARACTERS WITHOUT CLAIM TO ANY PARTICULAR FONT, STYLE, SIZE, OR COLOR.

OWNER OF U.S. REG. NOS. 2,405,059 AND 3,748,075.

NO CLAIM IS MADE TO THE EXCLUSIVE RIGHT TO USE "SPAS", APART FROM THE MARK AS SHOWN.

SER. NO. 85-197,795, FILED 12-14-2010.

ROBERT STRUCK, EXAMINING ATTORNEY



David J. Kybas

Director of the United States Patent and Trademark Office

United States of America

United States Patent and Trademark Office

CANDY ADDICT

Reg. No. 4,107,580

BRAINY ATOM, LLC (NORTH CAROLINA LIMITED LIABILITY COMPANY)
105 ANNAGREY CIRCLE
CARY, NC 27513

Registered Mar. 6, 2012

Int. Cl.: 35

FOR: PROVIDING A WEBSITE FEATURING REVIEWS OF CANDY PRODUCTS, NAMELY, CONSUMER INFORMATION IN THE FIELD OF CANDY, BUSINESS NEWS, NAMELY, CANDY INDUSTRY NEWS, PROVIDING LINKS TO THIRD PARTY ONLINE CANDY RETAILERS, IN CLASS 35 (U.S. CLS. 100, 101 AND 102).

SERVICE MARK

PRINCIPAL REGISTER

FIRST USE 10-2-2005; IN COMMERCE 10-2-2005.

THE MARK CONSISTS OF STANDARD CHARACTERS WITHOUT CLAIM TO ANY PARTICULAR FONT, STYLE, SIZE, OR COLOR.

NO CLAIM IS MADE TO THE EXCLUSIVE RIGHT TO USE "CANDY", APART FROM THE MARK AS SHOWN.

SER. NO. 85-198,240, FILED 12-15-2010.

MATTHEW EINSTEIN, EXAMINING ATTORNEY



David J. Kyros

Director of the United States Patent and Trademark Office

United States of America

United States Patent and Trademark Office

COUNT ON KONICA MINOLTA

Reg. No. 4,107,581

Registered Mar. 6, 2012

Int. Cl.: 9

TRADEMARK

PRINCIPAL REGISTER

KONICA MINOLTA HOLDINGS, INC. (JAPAN CORPORATION)
1-6-1, MARUNOUCHI
CHIYODA-KU, TOKYO, JAPAN

FOR: ELECTRO PHOTOGRAPHIC PRINTERS, PHOTO-COPYING MACHINES, FACSIMILE MACHINES, SCANNERS, AND MULTIFUNCTIONAL PRODUCTS, NAMELY, MACHINES WHICH OFFER COPYING, FACSIMILE, PRINTING AND SCANNING FUNCTIONS; PARTS AND ACCESSORIES FOR THE AFOREMENTIONED MACHINES; NAMELY, DOCUMENT FEEDERS, SORTERS, FINISHERS, PAPER FEED CASSETTES, AND MAINTENANCE SERVICE PARTS; COMPUTER OPERATING SOFTWARE FOR THE AFOREMENTIONED MACHINES, IN CLASS 9 (U.S. CLS. 21, 23, 26, 36 AND 38).

FIRST USE 1-1-2009; IN COMMERCE 1-1-2009.

THE MARK CONSISTS OF STANDARD CHARACTERS WITHOUT CLAIM TO ANY PARTICULAR FONT, STYLE, SIZE, OR COLOR.

OWNER OF U.S. REG. NOS. 3,490,699, 3,494,178, AND 3,600,435.

SER. NO. 85-198,834, FILED 12-15-2010.

FRED CARL, EXAMINING ATTORNEY



David J. Kyffers

Director of the United States Patent and Trademark Office

United States of America

United States Patent and Trademark Office

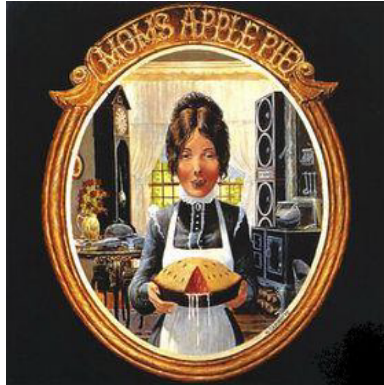

Reg. No. 4,107,582

Registered Mar. 6, 2012

Int. Cl.: 41

SERVICE MARK

PRINCIPAL REGISTER

MOMS APPLE PIE MUSIC INC (VIRGINIA CORPORATION)
24 WILLIAMSON PARK DR.
NEWPORT NEWS, VA 23608

FOR: MULTIMEDIA ENTERTAINMENT SERVICES IN THE NATURE OF RECORDING, PRODUCTION AND POST-PRODUCTION SERVICES IN THE FIELDS OF MUSIC, VIDEO, AND FILMS, IN CLASS 41 (U.S. CLS. 100, 101 AND 107).

FIRST USE 11-0-2010; IN COMMERCE 11-0-2010.

THE MARK CONSISTS OF THE LETTERS "MOM'S APPLE PIE" IN GOLD LETTERS CENTERED AT THE TOP OF A FANCY GOLD OVAL FRAME WITH A BEIGE OVAL OUTLINE INSIDE THE FRAME AROUND ARTWORK THAT CONSISTS OF A BROWN-HAIRED WOMAN WITH HAIR PARTED IN THE MIDDLE AND BUN IN A HIGH-COLLARED BLUE LONG-SLEEVED DRESS WITH WHITE LACE AROUND THE COLLAR AND ON THE SHOULDERS AND DOWN THE FRONT OF THE DRESS WITH A WHITE OVAL PIN AT THE NECKLINE ABOVE THREE, WHITE BUTTONS, WITH TWO WHITE BUTTONS UNDONE ON THE DRESS BEHIND A WHITE APRON THAT IS TIED AROUND HER NECK. THE WOMAN'S FACE AND HANDS ARE TAN. SHE IS HOLDING A PIE OOOZING WITH WHITE LIQUID FROM A RED FILLING THAT IS IN A TAN CRUST WITH AIR HOLES IN A TRIANGLE PATTERN WITH THE PIE CONTAINED IN A BLACK PIE PAN. THE WOMAN IS IN A KITCHEN IN FRONT OF A WINDOW WITH A GREEN AND BLUE BACKGROUND, BROWN WOODEN WINDOW PANE AND WHITE TRANSLUCENT CURTAINS TIED BACK WITH A TAN RUFFLE ON TOP, AND LIGHT BROWN WALLS. THERE IS A LARGE BROWN WOODEN CLOCK WITH NO HANDS ON THE BEIGE FACE OF THE CLOCK THAT STANDS ON THE LEFT SIDE OF THE PICTURE. ON THE RIGHT SIDE THERE ARE BLACK SPEAKERS TRIMMED IN BLUE AND SHOWING THREE AND ONE-HALF CIRCLES WHICH INDICATE THE SPEAKERS. THERE IS AN OLD-FASHIONED BLACK METAL STOVE NEXT TO THE SPEAKERS WITH A BLUE KETTLE ON IT AND BLUE SPOONS ABOVE IT, WITH BROWN STACKED LOGS UNDER THE STOVE AND A GRAY CONTAINER NEXT TO THE STOVE CONTAINING BLACK COAL. THERE IS A BROWN AND GOLD KITCHEN TABLE ON THE LEFT SIDE OF THE PICTURE WITH A GLASS TABLE TOP HOLDING A GOLD VASE WITH BLUE DESIGNS ON IT AND RED ROSES WITH GREEN STEMS AND LEAVES. THERE IS A PICTURE ON THE BLUE WALL BEHIND THE TABLE THAT HAS A GOLD SILHOUETTE OF A HEAD ON A WHITE BACKGROUND WITH THE FRAME IN GOLD. A SMALL RUG IN RED AND ORANGE IS ON THE FLOOR BEHIND THE TABLE,



David J. Kyros

Director of the United States Patent and Trademark Office

Reg. No. 4,107,582 AND THE HARDWOOD FLOOR IS BROWN. THE BLACK SQUARE IS FOR BACKGROUND AND IS NOT A FEATURE OF THE MARK.

THE COLOR(S) GOLD, BROWN, BLACK, BLUE, WHITE, BEIGE, TAN, GREEN, RED, ORANGE IS/ARE CLAIMED AS A FEATURE OF THE MARK.

SER. NO. 85-199,063, FILED 12-15-2010.

ROBIN CHOSID, EXAMINING ATTORNEY

United States of America

United States Patent and Trademark Office

PBVA

Reg. No. 4,107,583

Registered Mar. 6, 2012

Int. Cl.: 41

SERVICE MARK

PRINCIPAL REGISTER

KENT STEFFES (UNITED STATES INDIVIDUAL), TA PBVA
1536 WEST TWENTY FIFTH STREET #333
1536 WEST TWENTY FIFTH STREET #333
SAN PEDRO, CA 90732

FOR: AMATEUR YOUTH SPORTS SERVICES, NAMELY, ORGANIZING AND PROVIDING YOUTH SPORTS ACTIVITIES; ARRANGING AND CONDUCTING SPECIAL EVENTS FOR SOCIAL ENTERTAINMENT PURPOSES; ARRANGING FOR TICKET RESERVATIONS FOR SHOWS AND OTHER ENTERTAINMENT EVENTS; ARRANGING, ORGANIZING, CONDUCTING, AND HOSTING SOCIAL ENTERTAINMENT EVENTS; BOOKING OF SEATS FOR SHOWS AND SPORTS EVENTS; COACHING IN THE FIELD OF SPORTS; CONSULTATION IN THE FIELD OF SPECIAL EVENT PLANNING FOR SOCIAL ENTERTAINMENT PURPOSES; ENCOURAGING AMATEUR SPORTS AND PHYSICAL EDUCATION BY ORGANIZING, SANCTIONING, CONDUCTING, REGULATING AND GOVERNING AMATEUR ATHLETIC PROGRAMS AND ACTIVITIES; ENTERTAINMENT AND EDUCATIONAL SERVICES IN THE NATURE OF ON-LINE COMPETITIONS IN THE FIELD OF ENTERTAINMENT, EDUCATION, CULTURE, SPORTS, AND OTHER NON-BUSINESS AND NON-COMMERCIAL FIELDS; ENTERTAINMENT IN THE NATURE OF VOLLEYBALL GAMES; ENTERTAINMENT SERVICES IN THE NATURE OF FANTASY VOLLEYBALL LEAGUES; ENTERTAINMENT SERVICES, NAMELY, ORGANIZING AND CONDUCTING AN ARRAY OF ATHLETIC EVENTS RENDERED LIVE AND RECORDED FOR THE PURPOSE OF DISTRIBUTION THROUGH BROADCAST MEDIA; ENTERTAINMENT SERVICES, NAMELY, PARTICIPATION IN VOLLEYBALL TOURNAMENTS, EXHIBITIONS, LEAGUES, CONTESTS, CHAMPIONSHIPS, GAMES; ENTERTAINMENT SERVICES, NAMELY, PERSONAL APPEARANCES BY A PROFESSIONAL OR AMATEUR ATHLETE; MASTER OF CEREMONY SERVICES FOR PARTIES AND SPECIAL EVENTS; OFFICIATING AT SPORTS CONTESTS; ON-LINE ADMISSION TICKET AGENCY SERVICES FOR ENTERTAINMENT, EDUCATIONAL, SPORTING AND CULTURAL EVENTS; OPERATION OF SPORTS CAMPS; ORGANISATION OF SPORTS COMPETITIONS; ORGANIZING AND HOSTING OF EVENTS FOR CULTURAL PURPOSES; ORGANIZING COMMUNITY SPORTING AND CULTURAL EVENTS; ORGANIZING LIVE EXHIBITIONS AND CONFERENCES IN THE FIELDS OF EDUCATION, CULTURE, SPORTS AND ENTERTAINMENT FOR NON-BUSINESS AND NON-COMMERCIAL PURPOSES; ORGANIZING ON-LINE EXHIBITIONS AND CONFERENCES IN THE FIELDS OF EDUCATION, CULTURE, SPORTS AND ENTERTAINMENT FOR NON-BUSINESS AND NON-COMMERCIAL PURPOSES; ORGANIZING, ARRANGING, AND CONDUCTING VOLLEYBALL AND BEACH SPORTS EVENTS; PROVIDING A WEB SITE FEATURING INFORMATION ON YOUTH SPORTS; PROVIDING A WEB SITE FEATURING SPORTING



David J. Kyros

Director of the United States Patent and Trademark Office

Reg. No. 4,107,583 INFORMATION; PROVIDING A WEB SITE THAT PROVIDES SPORTS LEAGUE PLAYER STATISTICS; PROVIDING A WEB SITE WHERE USERS CAN POST RATINGS, REVIEWS AND RECOMMENDATIONS ON EVENTS AND ACTIVITIES IN THE FIELD OF ENTERTAINMENT AND EDUCATION; PROVIDING AN INTERNET WEBSITE PORTAL IN THE FIELD OF ENTERTAINMENT, CULTURAL AND SPORTING EVENTS; PROVIDING FACILITIES FOR VOLLEYBALL TOURNAMENTS; PROVIDING INFORMATION, NEWS AND COMMENTARY IN THE FIELD OF CURRENT EVENTS RELATING TO SPORTS; PROVIDING NEWS AND INFORMATION IN THE FIELD OF SPORTS; PROVIDING NEWS IN THE NATURE OF CURRENT EVENT REPORTING; PROVIDING VARIOUS FACILITIES FOR AN ARRAY OF SPORTING EVENTS, SPORTS AND ATHLETIC COMPETITIONS AND AWARDS PROGRAMMES; PROVISION OF INFORMATION RELATING TO EDUCATIONAL AND ENTERTAINMENT ACTIVITIES AND EVENTS FOR CHILDREN; PROVISION OF INFORMATION RELATING TO ORGANIZING COMMUNITY SPORTING AND CULTURAL ACTIVITIES, CONTESTS AND GAMES; PROVISION OF INFORMATION RELATING TO THE ORGANIZING OF EDUCATIONAL, CULTURAL, SPORTING, OR ENTERTAINMENT EXHIBITIONS; SPECIAL EVENT PLANNING FOR SOCIAL ENTERTAINMENT PURPOSES; SPORT CAMP SERVICES; SPORT CAMPS; SPORTS CAMP SERVICES; SPORTS INSTRUCTION SERVICES; SPORTS REFEREEING AND OFFICIATING; SPORTS TRAINING SERVICES; TICKET AGENCY SERVICES FOR ENTERTAINMENT EVENTS; TICKET RESERVATION AND BOOKING SERVICES FOR ENTERTAINMENT, SPORTING AND CULTURAL EVENTS, IN CLASS 41 (U.S. CLS. 100, 101 AND 107).

FIRST USE 3-1-2006; IN COMMERCE 3-1-2006.

THE MARK CONSISTS OF STANDARD CHARACTERS WITHOUT CLAIM TO ANY PARTICULAR FONT, STYLE, SIZE, OR COLOR.

SER. NO. 85-199,181, FILED 12-16-2010.

MATTHEW PAPPAS, EXAMINING ATTORNEY

United States of America

United States Patent and Trademark Office

DRUMMM

Reg. No. 4,107,584

Registered Mar. 6, 2012

Int. Cl.: 41

SERVICE MARK

PRINCIPAL REGISTER

DRUMMM RHYTHMIC EVENTS (CALIFORNIA SOLE PROPRIETORSHIP)
3012 HARRISON STREET, #5
OAKLAND, CA 94611

FOR: ENTERTAINMENT SERVICES IN THE NATURE OF LIVE INTERACTIVE DRUMMING PERFORMANCES; EDUCATIONAL SERVICES, NAMELY, PROVIDING TUTORIAL SESSIONS IN THE FIELD OF DRUMMING, IN CLASS 41 (U.S. CLS. 100, 101 AND 107).

FIRST USE 8-31-2000; IN COMMERCE 8-31-2000.

THE MARK CONSISTS OF STANDARD CHARACTERS WITHOUT CLAIM TO ANY PARTICULAR FONT, STYLE, SIZE, OR COLOR.

NO CLAIM IS MADE TO THE EXCLUSIVE RIGHT TO USE "DRUM", APART FROM THE MARK AS SHOWN.

SEC. 2(F).

SER. NO. 85-199,401, FILED 12-16-2010.

CHRISIE B. KING, EXAMINING ATTORNEY



David J. Kyffers

Director of the United States Patent and Trademark Office

United States of America

United States Patent and Trademark Office

SECURE360

Reg. No. 4,107,585

ST. JOHN'S MEDICAL RESEARCH INSTITUTE, INC. (MISSOURI CORPORATION)
1235 E. CHEROKEE STREET
SPRINGFIELD, MO 65804

Registered Mar. 6, 2012

Int. Cl.: 10

FOR: OPERATING ROOM EQUIPMENT, NAMELY, SURGICAL BEDS FOR INFANTS, IN CLASS 10 (U.S. CLS. 26, 39 AND 44).

TRADEMARK

FIRST USE 8-23-2010; IN COMMERCE 8-23-2010.

PRINCIPAL REGISTER

THE MARK CONSISTS OF STANDARD CHARACTERS WITHOUT CLAIM TO ANY PARTICULAR FONT, STYLE, SIZE, OR COLOR.

SER. NO. 85-199,762, FILED 12-16-2010.

COLLEEN DOMBROW, EXAMINING ATTORNEY



David J. Kybas

Director of the United States Patent and Trademark Office

United States of America

United States Patent and Trademark Office

Ongoing



Access To Cash

Reg. No. 4,107,586

Registered Mar. 6, 2012

Int. Cl.: 36

SERVICE MARK

PRINCIPAL REGISTER

MERCHANT REWARDS NETWORK, LLC (NEW YORK LIMITED LIABILITY COMPANY)
31355 OAK CREST DRIVE, STE 150
WESTLAKE VILLAGE, CA 91361

FOR: FINANCING SERVICES; PROVIDING WORKING CAPITAL FINANCING TO SMALL BUSINESSES AND SMALL BUSINESS OWNERS; CREDIT CARD FACTORING SERVICES; ACCOUNTS RECEIVABLES FINANCING, IN CLASS 36 (U.S. CLS. 100, 101 AND 102).

FIRST USE 5-30-2010; IN COMMERCE 5-30-2010.

NO CLAIM IS MADE TO THE EXCLUSIVE RIGHT TO USE "ONGOING ACCESS TO CASH", APART FROM THE MARK AS SHOWN.

THE COLOR(S) BLACK, BLUE AND WHITE IS/ARE CLAIMED AS A FEATURE OF THE MARK.

THE MARK CONSISTS OF THE WORDING "ONGOING ACCESS TO CASH" IN BLACK. THE WORD "ONGOING" IS POSITIONED ABOVE AND TO THE LEFT OF THE WORDING "ACCESS TO CASH". A BLACK LINE EXTENDS FROM THE END OF THE WORD "ONGOING" ABOVE THE WORDING "ACCESS TO CASH". A STYLIZED DEPICTION OF A BLUE CREDIT CARD IS POSITIONED TO THE LEFT OF THE WORDING "ACCESS TO CASH". WHITE LETTERS AND NUMBERS ARE DEPICTED ON THE CREDIT CARD. THE RIGHT SIDE OF THE CREDIT CARD EXTENDS TO FORM A BLUE AND WHITE DOLLAR SIGN. A SECOND BLACK LINE EXTENDS FROM THE END OF THE DOLLAR SIGN BELOW THE WORDING "ACCESS TO CASH".

SER. NO. 85-199,826, FILED 12-16-2010.

REGINA DRUMMOND, EXAMINING ATTORNEY



David J. Kybas

Director of the United States Patent and Trademark Office

United States of America

United States Patent and Trademark Office

BRANDCASTER

Reg. No. 4,107,587

Registered Mar. 6, 2012

Int. Cl.: 35

SERVICE MARK

PRINCIPAL REGISTER

COUPONS.COM, INC. (DELAWARE CORPORATION)
400 LOGUE DR.
MOUNTAIN VIEW, CA 94043

FOR: ADVERTISING AND MARKETING SERVICES, NAMELY, PROMOTING THE GOODS AND SERVICES OF OTHERS THROUGH AN ONLINE AFFILIATE PROGRAM FEATURING COUPONS, IN CLASS 35 (U.S. CLS. 100, 101 AND 102).

FIRST USE 5-14-2008; IN COMMERCE 5-14-2008.

THE MARK CONSISTS OF STANDARD CHARACTERS WITHOUT CLAIM TO ANY PARTICULAR FONT, STYLE, SIZE, OR COLOR.

SER. NO. 85-199,924, FILED 12-16-2010.

CHARLOTTE CORWIN, EXAMINING ATTORNEY



David J. Kybas

Director of the United States Patent and Trademark Office

United States of America

United States Patent and Trademark Office

Money Maestro

Reg. No. 4,107,588

Registered Mar. 6, 2012

Int. Cl.: 36

SERVICE MARK

PRINCIPAL REGISTER

MILLER, KRIS (UNITED STATES INDIVIDUAL)
33756 KEITH AVE
HEMET, CA 92545

FOR: FINANCIAL COUNSELING SERVICES, NAMELY, HELPING OTHERS BUILD A BETTER WORKING RELATIONSHIP WITH THEIR MONEY, IN CLASS 36 (U.S. CLS. 100, 101 AND 102).

FIRST USE 7-7-2009; IN COMMERCE 7-7-2009.

THE MARK CONSISTS OF STANDARD CHARACTERS WITHOUT CLAIM TO ANY PARTICULAR FONT, STYLE, SIZE, OR COLOR.

NO CLAIM IS MADE TO THE EXCLUSIVE RIGHT TO USE "MONEY", APART FROM THE MARK AS SHOWN.

SER. NO. 85-200,011, FILED 12-16-2010.

JESSICA A. POWERS, EXAMINING ATTORNEY



David J. Kybas

Director of the United States Patent and Trademark Office

United States of America

United States Patent and Trademark Office

BLACK SHEEP LODGE

Reg. No. 4,107,589

BLACK SHEEP LODGE LTD. (TEXAS LIMITED LIABILITY COMPANY)
2108 S LAMAR BLVD
AUSTIN, TX 78704

Registered Mar. 6, 2012

Int. Cl.: 43

FOR: RESTAURANT SERVICES, NAMELY, SERVICE OF FOOD, LIQUOR, BEER AND WINE, IN CLASS 43 (U.S. CLS. 100 AND 101).

SERVICE MARK

FIRST USE 11-1-2008; IN COMMERCE 5-15-2009.

PRINCIPAL REGISTER

THE MARK CONSISTS OF STANDARD CHARACTERS WITHOUT CLAIM TO ANY PARTICULAR FONT, STYLE, SIZE, OR COLOR.

NO CLAIM IS MADE TO THE EXCLUSIVE RIGHT TO USE "LODGE", APART FROM THE MARK AS SHOWN.

SER. NO. 85-200,188, FILED 12-17-2010.

DARRYL SPRUILL, EXAMINING ATTORNEY



David J. Kybas

Director of the United States Patent and Trademark Office

United States of America

United States Patent and Trademark Office

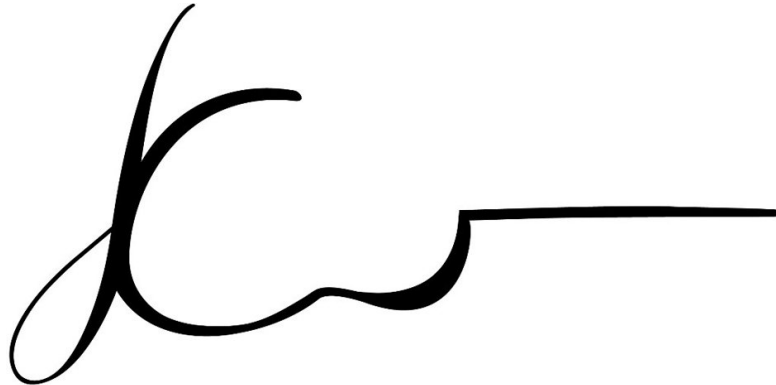

Reg. No. 4,107,590

Registered Mar. 6, 2012

Int. Cls.: 25 and 41

TRADEMARK

SERVICE MARK

PRINCIPAL REGISTER

CANELA, JENCARLOS (UNITED STATES INDIVIDUAL)
C/O UNION MUSIC RECORDS CO.
7435 WEST 18TH LANE
HIALEAH, FL 33014

FOR: CAPS; CHILDREN'S HEADWEAR; FLEECE PULLOVERS; HEADGEAR, NAMELY, MEN'S, WOMEN'S AND CHILDREN'S CAPS, HATS, AND VISORS; HEADWEAR; HOODED PULLOVERS; LONG SLEEVE PULLOVERS; MEN'S AND WOMEN'S JACKETS, COATS, TROUSERS, VESTS; PULLOVERS; SHORT-SLEEVED OR LONG-SLEEVED T-SHIRTS; T-SHIRTS; TURTLENECK PULLOVERS, IN CLASS 25 (U.S. CLS. 22 AND 39).

FIRST USE 1-28-2004; IN COMMERCE 1-28-2004.

FOR: COMPOSITION OF MUSIC FOR OTHERS; ENTERTAINMENT IN THE NATURE OF VISUAL AND AUDIO PERFORMANCES BY A MUSICAL PERFORMER; ENTERTAINMENT IN THE NATURE OF VISUAL AND AUDIO PERFORMANCES BY AN ACTOR; ENTERTAINMENT SERVICES BY A MUSICAL ARTIST AND PRODUCER, NAMELY, MUSICAL COMPOSITION FOR OTHERS AND PRODUCTION OF MUSICAL SOUND RECORDINGS; ENTERTAINMENT SERVICES IN THE NATURE OF LIVE MUSICAL PERFORMANCES; ENTERTAINMENT, NAMELY, LIVE MUSIC CONCERTS; ENTERTAINMENT, NAMELY, LIVE PERFORMANCES BY A MUSICAL BAND; LIVE PERFORMANCES BY A MUSICAL GROUP; PRODUCTION OF MUSICAL SOUND RECORDING, IN CLASS 41 (U.S. CLS. 100, 101 AND 107).

FIRST USE 1-28-2004; IN COMMERCE 1-28-2004.

THE MARK CONSISTS OF A STYLIZED "J" TO THE LEFT OF A SIDEWAYS GUITAR SILHOUETTE WITH THE NECK OF THE GUITAR POINTING TO THE RIGHT.

SER. NO. 85-200,361, FILED 12-17-2010.

CHRISTINE COOPER, EXAMINING ATTORNEY



David J. Kyros

Director of the United States Patent and Trademark Office

United States of America

United States Patent and Trademark Office

BD MICRO

Reg. No. 4,107,591

SECOB GMBH (FED REP GERMANY CORPORATION)
MADS-CLAUSEN-STRASSE 7
FLensburg, FED REP GERMANY D-24939

Registered Mar. 6, 2012

Int. Cls.: 7, 9 and 11

FOR: COMPRESSORS FOR MACHINES, IN CLASS 7 (U.S. CLS. 13, 19, 21, 23, 31, 34 AND 35).

TRADEMARK

FOR: ELECTRONIC CONTROLLERS FOR COMPRESSORS; SOFTWARE FOR ALLOWING CUSTOMERS TO SELECT AND CONFIGURE COMPONENTS AND CONTROLS NECESSARY TO BUILD COLD ROOMS AND MEET COLD-ROOM REQUIREMENTS, IN CLASS 9 (U.S. CLS. 21, 23, 26, 36 AND 38).

PRINCIPAL REGISTER

FOR: APPARATUS FOR REFRIGERATING, NAMELY, REFRIGERATING MACHINES, REFRIGERATING CABINETS, REFRIGERATING APPLIANCES AND INSTALLATIONS, REFRIGERATING DISPLAY CABINETS, AND REFRIGERATING SHOWCASES, IN CLASS 11 (U.S. CLS. 13, 21, 23, 31 AND 34).

THE MARK CONSISTS OF STANDARD CHARACTERS WITHOUT CLAIM TO ANY PARTICULAR FONT, STYLE, SIZE, OR COLOR.

PRIORITY CLAIMED UNDER SEC. 44(D) ON ERPN CMNTY TM OFC APPLICATION NO. 009196056, FILED 6-23-2010, REG. NO. 009196056, DATED 2-4-2011, EXPIRES 6-23-2020.

NO CLAIM IS MADE TO THE EXCLUSIVE RIGHT TO USE "MICRO", APART FROM THE MARK AS SHOWN.

SER. NO. 85-200,636, FILED 12-17-2010.

JERI J. FICKES, EXAMINING ATTORNEY



David J. Kybas

Director of the United States Patent and Trademark Office

United States of America

United States Patent and Trademark Office

BRONKITOSE

Reg. No. 4,107,592

Registered Mar. 6, 2012

Int. Cl.: 30

TRADEMARK

PRINCIPAL REGISTER

COMERCIALIZADORA MD, S.A. DE C.V. (MEXICO CORPORATION)
FRACCIONAMIENTO INDUSTRIAL ZAPOPAN NORTE
INDUSTRIA HULERA #97
ZAPOPAN, JALISCO, MEXICO C.P.45130

FOR: HONEY, MOLASSES, MOLASSES SYRUP, COFFEE, TEA, SUGAR, ROYAL JELLY
FOR FOOD PURPOSES, SALT, BREAD, CAKES, IN CLASS 30 (U.S. CL. 46).

THE MARK CONSISTS OF STANDARD CHARACTERS WITHOUT CLAIM TO ANY PAR-
TICULAR FONT, STYLE, SIZE, OR COLOR.

OWNER OF MEXICO REG. NO. 449791, DATED 10-19-1993, EXPIRES 10-19-2013.

SER. NO. 85-200,774, FILED 12-17-2010.

NAAKWAMA ANKRAH, EXAMINING ATTORNEY



David J. Kyfos

Director of the United States Patent and Trademark Office

United States of America
United States Patent and Trademark Office

VICKERY

Reg. No. 4,107,593

Registered Mar. 6, 2012

Int. Cl.: 37

SERVICE MARK

PRINCIPAL REGISTER

WELLS FARGO BANK, N. A. (UNITED STATES NATIONAL BANKING ASSOCIATION)
1525 WEST W.T. HARRIS BLVD.
CHARLOTTE, NC 28262

FOR: REAL ESTATE DEVELOPMENT SERVICES IN THE FIELD OF MIXED USE COMMUNITIES, NAMELY, COMMERCIAL, RETAIL, AND RESIDENTIAL PROPERTIES , IN CLASS 37 (U.S. CLS. 100, 103 AND 106).

FIRST USE 12-31-2003; IN COMMERCE 12-31-2003.

THE MARK CONSISTS OF STANDARD CHARACTERS WITHOUT CLAIM TO ANY PARTICULAR FONT, STYLE, SIZE, OR COLOR.

SEC. 2(F).

SER. NO. 85-200,792, FILED 12-17-2010.

ANTHONY RINKER, EXAMINING ATTORNEY



David J. Kybas

Director of the United States Patent and Trademark Office

United States of America
United States Patent and Trademark Office

VICKERY

Reg. No. 4,107,594

WELLS FARGO BANK, N. A. (UNITED STATES NATIONAL BANKING ASSOCIATION)
1525 WEST W.T. HARRIS BLVD.
CHARLOTTE, NC 28262

Registered Mar. 6, 2012

Int. Cl.: 37

FOR: REAL ESTATE DEVELOPMENT SERVICES IN THE FIELD OF MIXED USE COMMUNITIES, NAMELY, COMMERCIAL, RETAIL, AND RESIDENTIAL PROPERTIES , IN CLASS 37 (U.S. CLS. 100, 103 AND 106).

SERVICE MARK

FIRST USE 12-31-2003; IN COMMERCE 12-31-2003.

PRINCIPAL REGISTER

THE MARK CONSISTS OF STYLIZED SPELLING OF THE MARK "VICKERY".

SEC. 2(F).

SER. NO. 85-200,794, FILED 12-17-2010.

ANTHONY RINKER, EXAMINING ATTORNEY



David J. Kybas

Director of the United States Patent and Trademark Office

United States of America

United States Patent and Trademark Office



Reg. No. 4,107,595

Registered Mar. 6, 2012

Int. Cl.: 37

SERVICE MARK

PRINCIPAL REGISTER

WELLS FARGO BANK, N. A. (UNITED STATES NATIONAL BANKING ASSOCIATION)
1525 WEST W.T. HARRIS BLVD.
CHARLOTTE, NC 28262

FOR: REAL ESTATE DEVELOPMENT SERVICES IN THE FIELD OF MIXED USE COMMUNITIES, NAMELY, COMMERCIAL, RETAIL, AND RESIDENTIAL PROPERTIES , IN CLASS 37 (U.S. CLS. 100, 103 AND 106).

FIRST USE 12-31-2003; IN COMMERCE 12-31-2003.

THE MARK CONSISTS OF A CIRCLE WITH TWO CONCENTRIC RINGS WHICH CARRIES IN ITS CENTER A STYLIZED LETTER "V" WITH A BRANCH AND LEAVES PASSING THROUGH THE MIDDLE OF THE LETTER "V".

SER. NO. 85-200,795, FILED 12-17-2010.

ANTHONY RINKER, EXAMINING ATTORNEY



David J. Kybas

Director of the United States Patent and Trademark Office

United States of America

United States Patent and Trademark Office

HUMAN SHOCK ABSORBERS

Reg. No. 4,107,596

Registered Mar. 6, 2012

Int. Cl.: 10

TRADEMARK

PRINCIPAL REGISTER

STRUTZ, INC. (NEW JERSEY CORPORATION)
2 US EXECUTIVE CENTER
560 SYLVAN AVENUE
ENGLEWOOD CLIFFS, NJ 07632

FOR: ORTHOPEDIC FOOTWEAR NAMELY, ARCH SUPPORTS, IN CLASS 10 (U.S. CLS. 26, 39 AND 44).

FIRST USE 12-0-2009; IN COMMERCE 12-0-2009.

THE MARK CONSISTS OF STANDARD CHARACTERS WITHOUT CLAIM TO ANY PARTICULAR FONT, STYLE, SIZE, OR COLOR.

SER. NO. 85-201,083, FILED 12-17-2010.

HAI-LY LAM, EXAMINING ATTORNEY



David J. Kybas

Director of the United States Patent and Trademark Office

United States of America

United States Patent and Trademark Office



Reg. No. 4,107,597

W2007 ARIZONA CHARLIE'S PROPCO, L.P. (DELAWARE LIMITED PARTNERSHIP)
2000 LAS VEGAS BOULEVARD SOUTH
LAS VEGAS, NV 89104

Registered Mar. 6, 2012

Int. Cl.: 43

FOR: CATERING SERVICES; PROVIDING OF FOOD AND DRINK; RESTAURANT SERVICES,
IN CLASS 43 (U.S. CLS. 100 AND 101).

SERVICE MARK

FIRST USE 12-17-2010; IN COMMERCE 12-17-2010.

PRINCIPAL REGISTER

NO CLAIM IS MADE TO THE EXCLUSIVE RIGHT TO USE "STEAKHOUSE", APART FROM
THE MARK AS SHOWN.

THE MARK CONSISTS OF THE WORD "RON'S" SURROUNDED ON BOTH SIDES WITH
UP-TURNED, THINNING POINTED LINES POSITIONED ABOVE "STEAKHOUSE".

SER. NO. 85-201,116, FILED 12-17-2010.

GILBERT SWIFT, EXAMINING ATTORNEY



David J. Kybas

Director of the United States Patent and Trademark Office

United States of America

United States Patent and Trademark Office

NEVADA NEWS

Reg. No. 4,107,598

SEAN THOMPSON (UNITED STATES INDIVIDUAL)
4292 VENTURE PLACE
MERIDIAN, ID 83646

Registered Mar. 6, 2012

Int. Cls.: 35 and 41

FOR: PROMOTING THE GOODS AND SERVICES OF OTHERS BY PREPARING AND PLACING ADVERTISEMENTS ON A WEBSITE, IN ELECTRONIC MAGAZINES, AND IN EMAIL NEWSLETTERS ACCESSED THROUGH A GLOBAL COMPUTER NETWORK, IN CLASS 35 (U.S. CLS. 100, 101 AND 102).

SERVICE MARK

PRINCIPAL REGISTER

FIRST USE 2-20-1998; IN COMMERCE 2-20-1998.

FOR: NON-DOWNLOADABLE ELECTRONIC PUBLICATIONS IN THE NATURE OF ELECTRONIC MAGAZINES AND ELECTRONIC NEWSLETTERS ALL IN THE FIELD OF NEWS AND INFORMATION ABOUT THE STATE OF NEVADA, IN CLASS 41 (U.S. CLS. 100, 101 AND 107).

FIRST USE 2-20-1998; IN COMMERCE 2-20-1998.

THE MARK CONSISTS OF STANDARD CHARACTERS WITHOUT CLAIM TO ANY PARTICULAR FONT, STYLE, SIZE, OR COLOR.

OWNER OF U.S. REG. NO. 2,365,638.

NO CLAIM IS MADE TO THE EXCLUSIVE RIGHT TO USE "NEWS", APART FROM THE MARK AS SHOWN.

SEC. 2(F).

SER. NO. 85-201,517, FILED 12-20-2010.

SANJEEV VOHRA, EXAMINING ATTORNEY



David J. Kybas

Director of the United States Patent and Trademark Office

United States of America

United States Patent and Trademark Office

PlumeSIM

Reg. No. 4,107,599

Registered Mar. 6, 2012

Int. Cl.: 9

TRADEMARK

PRINCIPAL REGISTER

ARGON ELECTRONICS (UK) LIMITED (UNITED KINGDOM LIMITED COMPANY (LTD.))
16 RIBOCON WAY, PROGRESS BUSINESS PARK
LUTON, BEDFORDSHIRE, UNITED KINGDOM LU49UR

FOR: COMPUTER SOFTWARE FOR SIMULATING THE DETECTION OF HAZARDOUS MATERIALS AND GASES, AND FOR SIMULATING THE DISTRIBUTION OF GASES AND ENVIRONMENTAL CONTAMINANTS; COMPUTER SOFTWARE FOR TRAINING PERSONNEL IN THE DETECTION OF HAZARDOUS MATERIALS AND GASES AND FOR SIMULATING THE DISTRIBUTION OF GASES AND ENVIRONMENTAL CONTAMINANTS; ELECTRONIC PUBLICATIONS, NAMELY, BOOKS, MAGAZINES, AND MANUALS RELATING TO THE TEACHING OF THE DETECTION OF GASES AND HAZARDOUS MATERIALS AND THE DISTRIBUTION OF GASES AND ENVIRONMENTAL CONTAMINANTS, RECORDED ON COMPUTER MEDIA, IN CLASS 9 (U.S. CLS. 21, 23, 26, 36 AND 38).

THE MARK CONSISTS OF STANDARD CHARACTERS WITHOUT CLAIM TO ANY PARTICULAR FONT, STYLE, SIZE, OR COLOR.

PRIORITY CLAIMED UNDER SEC. 44(D) ON ERPN CMNTY TM OFC APPLICATION NO. 009606435, FILED 12-17-2010, REG. NO. 009606435, DATED 5-27-2011, EXPIRES 12-17-2020.

SER. NO. 85-201,859, FILED 12-20-2010.

ALICE BENMAMAN, EXAMINING ATTORNEY



David J. Kybas

Director of the United States Patent and Trademark Office

United States of America

United States Patent and Trademark Office

KorElement

Reg. No. 4,107,600

NELSON, NEIZKOR YISRAEL (UNITED STATES INDIVIDUAL)
PO BOX 403
SUCCASUNNA, NJ 07876

Registered Mar. 6, 2012

Int. Cls.: 9 and 41

FOR: DIGITAL MATERIALS, NAMELY, CDS, DVDS, DOWNLOADABLE AUDIO FILES
FEATURING MUSIC, IN CLASS 9 (U.S. CLS. 21, 23, 26, 36 AND 38).

TRADEMARK

FIRST USE 12-25-2009; IN COMMERCE 12-25-2009.

SERVICE MARK

FOR: ENTERTAINMENT SERVICES IN THE NATURE OF LIVE MUSICAL PERFORMANCES,
IN CLASS 41 (U.S. CLS. 100, 101 AND 107).

PRINCIPAL REGISTER

FIRST USE 12-25-2009; IN COMMERCE 12-25-2009.

THE MARK CONSISTS OF STANDARD CHARACTERS WITHOUT CLAIM TO ANY PAR-
TICULAR FONT, STYLE, SIZE, OR COLOR.

THE NAME "KORELEMENT" IDENTIFIES THE STAGE NAME OF NEIZKOR YISRAEL
NELSON, A LIVING INDIVIDUAL WHOSE CONSENT IS OF RECORD.

SER. NO. 85-202,034, FILED 12-20-2010.

RUDY R. SINGLETON, EXAMINING ATTORNEY



David J. Kybas

Director of the United States Patent and Trademark Office

United States of America

United States Patent and Trademark Office

COLDER FLOW

Reg. No. 4,107,601

Registered Mar. 6, 2012

Int. Cl.: 1

TRADEMARK

PRINCIPAL REGISTER

GREEN GRID PARTNERS GLOBAL, LLC (COLORADO LIMITED LIABILITY COMPANY)
SUITE 600
8400 E CRESCENT PARKWAY
GREENWOOD VILLAGE, CO 80111

FOR: CHEMICAL ADDITIVES FOR OILS, NAMELY, SYNTHETIC COMPOUNDS TO REMOVE OIL FOULING, LOWER REFRIGERANT EVAPORATING TEMPERATURE AND INCREASE COMPRESSOR OIL LUBRICITY IN HVAC SYSTEMS, IN CLASS 1 (U.S. CLS. 1, 5, 6, 10, 26 AND 46).

FIRST USE 9-1-2010; IN COMMERCE 9-13-2010.

THE MARK CONSISTS OF STANDARD CHARACTERS WITHOUT CLAIM TO ANY PARTICULAR FONT, STYLE, SIZE, OR COLOR.

SER. NO. 85-202,413, FILED 12-21-2010.

DORITT L. CARROLL, EXAMINING ATTORNEY



David J. Kybas

Director of the United States Patent and Trademark Office

United States of America

United States Patent and Trademark Office

HARRISON'S

Reg. No. 4,107,602

THE MCGRAW-HILL COMPANIES, INC. (NEW YORK CORPORATION)
1221 AVENUE OF THE AMERICAS
NEW YORK, NY 10020

Registered Mar. 6, 2012

Int. Cls.: 9, 16, 41 and 44

FOR: DVDS AND COMPUTER SOFTWARE CONTAINING EDUCATIONAL MATERIALS
IN THE FIELD OF MEDICINE , IN CLASS 9 (U.S. CLS. 21, 23, 26, 36 AND 38).

TRADEMARK

FIRST USE 0-0-2001; IN COMMERCE 0-0-2001.

SERVICE MARK

FOR: SERIES OF TEXTBOOKS IN THE FIELD OF MEDICINE, IN CLASS 16 (U.S. CLS. 2, 5,
22, 23, 29, 37, 38 AND 50).

PRINCIPAL REGISTER

FIRST USE 0-0-1966; IN COMMERCE 0-0-1966.

FOR: PROVIDING DOWNLOADABLE EDUCATIONAL E-BOOKS IN THE FIELD OF
MEDICINE, IN CLASS 41 (U.S. CLS. 100, 101 AND 107).

FIRST USE 0-0-1999; IN COMMERCE 0-0-1999.

FOR: PROVIDING A WEB SITE CONTAINING EDUCATIONAL INFORMATION IN THE
FIELD OF MEDICINE, IN CLASS 44 (U.S. CLS. 100 AND 101).

FIRST USE 0-0-1999; IN COMMERCE 0-0-1999.

THE MARK CONSISTS OF STANDARD CHARACTERS WITHOUT CLAIM TO ANY PAR-
TICULAR FONT, STYLE, SIZE, OR COLOR.

SER. NO. 85-202,718, FILED 12-21-2010.

SUNG IN, EXAMINING ATTORNEY



David J. Kypos

Director of the United States Patent and Trademark Office

United States of America

United States Patent and Trademark Office

WOODKINS

Reg. No. 4,107,603

SMALL WORLD TOYS ENTERPRISES LLC (DELAWARE LIMITED LIABILITY COMPANY)
1451 WEST KNOX STREET
TORRANCE, CA 90501

Registered Mar. 6, 2012

Int. Cl.: 28

FOR: TOYS AND PLAYTHINGS, NAMELY, WOODEN DRESS-UP DOLLS AND CLOTHING AND ACCESSORIES THEREFOR, IN CLASS 28 (U.S. CLS. 22, 23, 38 AND 50).

TRADEMARK

FIRST USE 0-0-1999; IN COMMERCE 0-0-1999.

PRINCIPAL REGISTER

THE MARK CONSISTS OF STANDARD CHARACTERS WITHOUT CLAIM TO ANY PARTICULAR FONT, STYLE, SIZE, OR COLOR.

SER. NO. 85-202,753, FILED 12-21-2010.

BENJAMIN OKEKE, EXAMINING ATTORNEY



David J. Kyffers

Director of the United States Patent and Trademark Office

United States of America

United States Patent and Trademark Office

General

Reg. No. 4,107,604

SWEDISH MATCH NORTH EUROPE AB (SWEDEN JOINT STOCK COMPANY)
SE-118 85

Registered Mar. 6, 2012

STOCKHOLM, SWEDEN

Int. Cl.: 34

FOR: TOBACCO; MATCHES; TOBACCO SUBSTITUTES NOT FOR MEDICAL PURPOSES; SNUFF AND TOBACCO ALTERNATIVES IN THE FORM OF PRODUCTS BASED ON VEGETABLE FIBERS, FOR ORAL USE, NOT FOR CONSUMPTION; SNUFF; TOBACCO FREE SNUFF; HERBAL SNUFF, IN CLASS 34 (U.S. CLS. 2, 8, 9 AND 17).

TRADEMARK

PRINCIPAL REGISTER

OWNER OF SWEDEN REG. NO. 400488, DATED 1-16-2009, EXPIRES 1-16-2019.

OWNER OF U.S. REG. NOS. 3,018,074, 3,725,636 AND OTHERS.

THE MARK CONSISTS OF A STYLIZED VERSION OF THE WORD "GENERAL".

SER. NO. 85-202,888, FILED 12-21-2010.

MARK PILARO, EXAMINING ATTORNEY



David J. Kyjars

Director of the United States Patent and Trademark Office

United States of America

United States Patent and Trademark Office

life is good onboard

Reg. No. 4,107,605

Registered Mar. 6, 2012

Int. Cl.: 42

SERVICE MARK

PRINCIPAL REGISTER

PLAUCHE', KRISHA (UNITED STATES INDIVIDUAL), DBA ONBOARD INTERIORS
P.O. BOX 1420, MARBLEHEAD, MA01945
1 CLARK LANE
MARBLEHEAD, MA 01945

FOR: INTERIOR DECORATING; INTERIOR DECORATION CONSULTATION; INTERIOR DESIGN SERVICES; INTERIOR DESIGN SERVICES INCLUDING SPACE PLANNING, FURNITURE SELECTION, MATERIAL AND SURFACE SELECTION; INTERIOR STYLING SERVICES, IN CLASS 42 (U.S. CLS. 100 AND 101).

FIRST USE 0-0-2004; IN COMMERCE 0-0-2004.

THE MARK CONSISTS OF STANDARD CHARACTERS WITHOUT CLAIM TO ANY PARTICULAR FONT, STYLE, SIZE, OR COLOR.

SER. NO. 85-203,933, FILED 12-22-2010.

BRIAN CALLAGHAN, EXAMINING ATTORNEY



David J. Kyffers

Director of the United States Patent and Trademark Office

United States of America

United States Patent and Trademark Office

The Wildflower Triathlon

Reg. No. 4,107,606

Registered Mar. 6, 2012

Int. Cl.: 41

SERVICE MARK

PRINCIPAL REGISTER

TRI-CALIFORNIA EVENTS, INC. (CALIFORNIA CORPORATION)
1284 ADOBE LANE
PACIFIC GROVE, CA 93950

FOR: ORGANIZING, ARRANGING, AND CONDUCTING TRIATHLON EVENTS, IN CLASS 41 (U.S. CLS. 100, 101 AND 107).

FIRST USE 1-1-1995; IN COMMERCE 1-1-1995.

THE MARK CONSISTS OF STANDARD CHARACTERS WITHOUT CLAIM TO ANY PARTICULAR FONT, STYLE, SIZE, OR COLOR.

NO CLAIM IS MADE TO THE EXCLUSIVE RIGHT TO USE "TRIATHLON", APART FROM THE MARK AS SHOWN.

SER. NO. 85-204,127, FILED 12-22-2010.

STEVEN R. FINE, EXAMINING ATTORNEY



David J. Kybas

Director of the United States Patent and Trademark Office

United States of America

United States Patent and Trademark Office

NINEFOLD

Reg. No. 4,107,607

Registered Mar. 6, 2012

Int. Cl.: 42

SERVICE MARK

PRINCIPAL REGISTER

MACQUARIE TELECOM PTY LIMITED (AUSTRALIA CORPORATION)
LEVEL 20, 2 MARKET STREET
SYDNEY, NSW, AUSTRALIA 2000

FOR: SCIENTIFIC AND TECHNOLOGICAL SERVICES, NAMELY, RESEARCH AND DESIGN IN THE FIELD OF COMPUTER SYSTEMS ARCHITECTURE, VIRTUAL COMPUTING ENVIRONMENTS, ELECTRONIC DATA STORAGE AND DATA RETRIEVAL AND ELECTRONIC DATA STORAGE SOLUTIONS; SCIENTIFIC AND TECHNOLOGICAL SERVICES, NAMELY, INDUSTRIAL ANALYSIS AND RESEARCH SERVICES IN THE FIELD OF COMPUTER SYSTEMS ARCHITECTURE, VIRTUAL COMPUTING ENVIRONMENTS, ELECTRONIC DATA STORAGE AND DATA RETRIEVAL AND ELECTRONIC DATA STORAGE SOLUTIONS; DESIGN AND DEVELOPMENT OF COMPUTER HARDWARE AND SOFTWARE IN THE FIELD OF COMPUTER SYSTEMS ARCHITECTURE, VIRTUAL COMPUTING ENVIRONMENTS, ELECTRONIC DATA STORAGE AND DATA RETRIEVAL AND ELECTRONIC DATA STORAGE SOLUTIONS; SCIENTIFIC AND TECHNOLOGICAL SERVICES, NAMELY, INSTALLATION AND MAINTENANCE OF SOFTWARE IN THE FIELD OF COMPUTER SYSTEMS ARCHITECTURE, VIRTUAL COMPUTING ENVIRONMENTS, ELECTRONIC DATA STORAGE AND DATA RETRIEVAL AND ELECTRONIC DATA STORAGE SOLUTIONS; DESIGN, CREATION, HOSTING, AND MAINTENANCE OF DATABASES FOR OTHERS; DESIGN, CREATION, HOSTING, AND MAINTENANCE OF WEBSITES FOR OTHERS; DESIGN, CREATION, HOSTING, AND MAINTENANCE OF WEB PORTAL SERVICES FOR OTHERS; HOSTING OF SOFTWARE AS A SERVICE, NAMELY, INFRASTRUCTURE AS A SERVICE (IAAS) SERVICES, NAMELY, REMOTE HOSTING OF OPERATING SYSTEMS AND COMPUTER APPLICATIONS THROUGH A VIRTUAL COMPUTING ENVIRONMENT ACCESSIBLE VIA A GLOBAL COMMUNICATIONS NETWORK FOR THE PURPOSE OF PROVISIONING COMPUTER SERVER CAPACITY AND RENTAL OF COMPUTING AND DATA STORAGE FACILITIES, NAMELY, DATABASE SERVERS, TO THIRD PARTIES; PROVIDING ACCESS TO HOSTED OPERATING SYSTEMS AND COMPUTER APPLICATIONS THROUGH A GLOBAL COMMUNICATIONS NETWORK; CONSULTING SERVICES IN THE FIELD OF SOFTWARE AS A SERVICE (SAAS), COMPUTER SYSTEMS ARCHITECTURE, VIRTUAL COMPUTING ENVIRONMENTS, ELECTRONIC DATA STORAGE AND DATA RETRIEVAL AND ELECTRONIC DATA STORAGE SOLUTIONS, IN CLASS 42 (U.S. CLS. 100 AND 101).



David J. Kyros

THE MARK CONSISTS OF STANDARD CHARACTERS WITHOUT CLAIM TO ANY PARTICULAR FONT, STYLE, SIZE, OR COLOR.

Reg. No. 4,107,607 PRIORITY CLAIMED UNDER SEC. 44(D) ON AUSTRALIA APPLICATION NO. 1402785,
FILED 12-23-2010, REG. NO. 1402785, DATED 1-4-2011, EXPIRES 1-4-2021.

SER. NO. 85-204,741, FILED 12-23-2010.

HOWARD SMIGA, EXAMINING ATTORNEY

United States of America

United States Patent and Trademark Office

9FOLD

Reg. No. 4,107,608

Registered Mar. 6, 2012

Int. Cl.: 42

SERVICE MARK

PRINCIPAL REGISTER

MACQUARIE TELECOM PTY LIMITED (AUSTRALIA CORPORATION)
LEVEL 20, 2 MARKET STREET
SYDNEY, NSW, AUSTRALIA 2000

FOR: SCIENTIFIC AND TECHNOLOGICAL SERVICES, NAMELY, RESEARCH AND DESIGN IN THE FIELD OF COMPUTER SYSTEMS ARCHITECTURE, VIRTUAL COMPUTING ENVIRONMENTS, ELECTRONIC DATA STORAGE AND DATA RETRIEVAL AND ELECTRONIC DATA STORAGE SOLUTIONS; SCIENTIFIC AND TECHNOLOGICAL SERVICES, NAMELY, INDUSTRIAL ANALYSIS AND RESEARCH SERVICES IN THE FIELD OF COMPUTER SYSTEMS ARCHITECTURE, VIRTUAL COMPUTING ENVIRONMENTS, ELECTRONIC DATA STORAGE AND DATA RETRIEVAL AND ELECTRONIC DATA STORAGE SOLUTIONS; DESIGN AND DEVELOPMENT OF COMPUTER HARDWARE AND SOFTWARE IN THE FIELD OF COMPUTER SYSTEMS ARCHITECTURE, VIRTUAL COMPUTING ENVIRONMENTS, ELECTRONIC DATA STORAGE AND DATA RETRIEVAL AND ELECTRONIC DATA STORAGE SOLUTIONS; SCIENTIFIC AND TECHNOLOGICAL SERVICES, NAMELY, INSTALLATION AND MAINTENANCE OF SOFTWARE IN THE FIELD OF COMPUTER SYSTEMS ARCHITECTURE, VIRTUAL COMPUTING ENVIRONMENTS, ELECTRONIC DATA STORAGE AND DATA RETRIEVAL AND ELECTRONIC DATA STORAGE SOLUTIONS; DESIGN, CREATION, HOSTING, AND MAINTENANCE OF DATABASES FOR OTHERS; DESIGN, CREATION, HOSTING, AND MAINTENANCE OF WEBSITES FOR OTHERS; DESIGN, CREATION, HOSTING, AND MAINTENANCE OF WEB PORTAL SERVICES FOR OTHERS; HOSTING OF SOFTWARE AS A SERVICE, NAMELY, INFRASTRUCTURE AS A SERVICE (IAAS) SERVICES, NAMELY, REMOTE HOSTING OF OPERATING SYSTEMS AND COMPUTER APPLICATIONS THROUGH A VIRTUAL COMPUTING ENVIRONMENT ACCESSIBLE VIA A GLOBAL COMMUNICATIONS NETWORK FOR THE PURPOSE OF PROVISIONING COMPUTER SERVER CAPACITY AND RENTAL OF COMPUTING AND DATA STORAGE FACILITIES, NAMELY, DATABASE SERVERS, TO THIRD PARTIES; PROVIDING ACCESS TO HOSTED OPERATING SYSTEMS AND COMPUTER APPLICATIONS THROUGH A GLOBAL COMMUNICATIONS NETWORK; CONSULTING SERVICES IN THE FIELD OF SOFTWARE AS A SERVICE (SAAS), COMPUTER SYSTEMS ARCHITECTURE, VIRTUAL COMPUTING ENVIRONMENTS, ELECTRONIC DATA STORAGE AND DATA RETRIEVAL AND ELECTRONIC DATA STORAGE SOLUTIONS, IN CLASS 42 (U.S. CLS. 100 AND 101).



David J. Kyros

THE MARK CONSISTS OF STANDARD CHARACTERS WITHOUT CLAIM TO ANY PARTICULAR FONT, STYLE, SIZE, OR COLOR.

Reg. No. 4,107,608 PRIORITY CLAIMED UNDER SEC. 44(D) ON AUSTRALIA APPLICATION NO. 1402799,
FILED 12-23-2010, REG. NO. 1402799, DATED 1-4-2011, EXPIRES 1-4-2021.

SER. NO. 85-204,753, FILED 12-23-2010.

HOWARD SMIGA, EXAMINING ATTORNEY

United States of America

United States Patent and Trademark Office



Reg. No. 4,107,609

MAG-NIF, INC. (OHIO CORPORATION)
8820 EAST AVE.
MENTOR, OH 44060

Registered Mar. 6, 2012

Int. Cl.: 28

FOR: 3 DIMENSIONAL PUZZLES, IN CLASS 28 (U.S. CLS. 22, 23, 38 AND 50).

TRADEMARK

FIRST USE 10-31-2010; IN COMMERCE 10-31-2010.

PRINCIPAL REGISTER

NO CLAIM IS MADE TO THE EXCLUSIVE RIGHT TO USE "THE BRAIN TEASERS" , APART FROM THE MARK AS SHOWN.

THE COLOR(S) PINK, GREEN, BLUE AND BLACK IS/ARE CLAIMED AS A FEATURE OF THE MARK.

THE MARK CONSISTS OF THE COLOR PINK APPEARS IN THE WORD "BRAIN", THE COLOR GREEN APPEARS IN "THE" AND "TEASERS" AND IN THE OUTLINE OF THE BLUE FIGURE, THE COLOR BLUE APPEARS IN THE CLOUD BUBBLE BACKGROUND, AND THE COLOR BLACK APPEARS AS THE SHADOW AND OUTLINE OF THE WORDING.

SER. NO. 85-205,093, FILED 12-23-2010.

ROSELLE HERRERA, EXAMINING ATTORNEY



David J. Kyros

Director of the United States Patent and Trademark Office

United States of America

United States Patent and Trademark Office



Reg. No. 4,107,610

BLUE-GRACE I.P. LLC (FLORIDA LIMITED LIABILITY COMPANY)
2846 S. FALKENBURG RD.
RIVERVIEW, FL 33578

Registered Mar. 6, 2012

Int. Cl.: 42

FOR: PROVIDING TEMPORARY USE OF NON-DOWNLOADABLE COMPUTER SOFTWARE FOR VIEWING AND DOWNLOADING DIGITAL SHIPPING AND DELIVERY DOCUMENTS OVER THE INTERNET AS IT RELATES TO THE LOGISTICS AND TRANSPORTING OF GOODS, IN CLASS 42 (U.S. CLS. 100 AND 101).

SERVICE MARK

PRINCIPAL REGISTER

FIRST USE 11-0-2010; IN COMMERCE 11-0-2010.

THE MARK CONSISTS OF THE WORDS "DOCK TO DOC" TO THE RIGHT OF TWO PARTIALLY OVERLAPPING STYLIZED SQUARES.

SER. NO. 85-205,191, FILED 12-23-2010.

TRICIA SONNEBORN, EXAMINING ATTORNEY



David J. Kyffers

Director of the United States Patent and Trademark Office

United States of America

United States Patent and Trademark Office

The Color of Film

Reg. No. 4,107,611

Registered Mar. 6, 2012

Int. Cl.: 41

SERVICE MARK

PRINCIPAL REGISTER

THE COLOR OF FILM COLLABORATIVE, INC. (MASSACHUSETTS NON-PROFIT CORPORATION)
19 CLIFFORD STREET
ROXBURY, MA 02119

FOR: ENTERTAINMENT SERVICES, NAMELY, PLANNING AND CONDUCTING A SERIES OF FILM FESTIVALS, DISPLAYING A SERIES OF FILMS, AND PROVIDING OTHER SERVICES TO PEOPLE OF COLOR IN FILM, VIDEO, THEATER AND OTHER MEDIA, NAMELY, CONTINUING PUBLIC SERVICE PROGRAMS ABOUT TELEVISION AND MOVIE PRODUCTION, PRODUCED AND DISTRIBUTED OVER THE INTERNET OR OTHER MEDIA, DISTRIBUTION OF FILMS, PROVIDING A WEBSITE FEATURING NON-DOWNLOADABLE FILM CLIPS ABOUT ENTERTAINMENT AND DOCUMENTARY FILMS AND PROVIDING INFORMATION IN THE FIELD OF FILM VIA A GLOBAL COMPUTER NETWORK, IN CLASS 41 (U.S. CLS. 100, 101 AND 107).

FIRST USE 11-15-1998; IN COMMERCE 11-15-1998.

THE MARK CONSISTS OF STANDARD CHARACTERS WITHOUT CLAIM TO ANY PARTICULAR FONT, STYLE, SIZE, OR COLOR.

NO CLAIM IS MADE TO THE EXCLUSIVE RIGHT TO USE "FILM", APART FROM THE MARK AS SHOWN.

SER. NO. 85-206,564, FILED 12-28-2010.

APRIL ROACH, EXAMINING ATTORNEY



David J. Kyros

Director of the United States Patent and Trademark Office

United States of America

United States Patent and Trademark Office

DESTINATION BRAND GROUP



Reg. No. 4,107,612

DESTINATION BRAND GROUP, LLC (ILLINOIS LIMITED LIABILITY COMPANY)
824 W. ARMITAGE, APT. 2A
CHICAGO, IL 60614

Registered Mar. 6, 2012

Int. Cl.: 35

FOR: BUSINESS CONSULTATION SERVICES, IN CLASS 35 (U.S. CLS. 100, 101 AND 102).

SERVICE MARK

FIRST USE 7-16-2009; IN COMMERCE 7-16-2009.

PRINCIPAL REGISTER

NO CLAIM IS MADE TO THE EXCLUSIVE RIGHT TO USE "BRAND GROUP", APART FROM THE MARK AS SHOWN.

THE MARK CONSISTS OF THE WORDING "DESTINATION BRAND GROUP" TO THE LEFT OF A TARGET DESIGN.

SER. NO. 85-207,134, FILED 12-29-2010.

ALICIA COLLINS, EXAMINING ATTORNEY



David J. Kybas

Director of the United States Patent and Trademark Office

United States of America

United States Patent and Trademark Office

WE LIVE IT

Reg. No. 4,107,613

Registered Mar. 6, 2012

Int. Cl.: 35

SERVICE MARK

PRINCIPAL REGISTER

DENNIS B. JARVIS, INC. (CALIFORNIA CORPORATION)
591 18TH STREET
HERMOSA BEACH, CA 90254

FOR: RETAIL STORE AND ON-LINE RETAIL STORE SERVICES IN THE FIELDS OF SURFING, SKIING, AND SKATEBOARDING FEATURING CLOTHING AND ACCESSORIES, AND SPORTING GOODS AND EQUIPMENT , IN CLASS 35 (U.S. CLS. 100, 101 AND 102).

FIRST USE 0-0-2008; IN COMMERCE 0-0-2008.

THE MARK CONSISTS OF STANDARD CHARACTERS WITHOUT CLAIM TO ANY PARTICULAR FONT, STYLE, SIZE, OR COLOR.

SER. NO. 85-207,181, FILED 12-29-2010.

JAMES GRIFFIN, EXAMINING ATTORNEY



David J. Kyffers

Director of the United States Patent and Trademark Office

United States of America

United States Patent and Trademark Office

Bier Baron

Reg. No. 4,107,614

FABRICE SOUCHAUD (FRANCE INDIVIDUAL)
1842 16TH STREET NW
WASHINGTON, DC 20009

Registered Mar. 6, 2012

Int. Cl.: 43

FOR: RESTAURANT, HOTEL, TOURIST INN AND TAVERN SERVICES, NAMELY, HOTEL AND RESTAURANT RESERVATION SERVICES; TOURIST INN SERVICES; HOSPITALITY SERVICES, NAMELY, MAKING RESERVATIONS AND BOOKINGS FOR OTHERS FOR HOTEL ACCOMMODATIONS, IN CLASS 43 (U.S. CLS. 100 AND 101).

SERVICE MARK

PRINCIPAL REGISTER

FIRST USE 12-29-2010; IN COMMERCE 12-29-2010.

THE MARK CONSISTS OF STANDARD CHARACTERS WITHOUT CLAIM TO ANY PARTICULAR FONT, STYLE, SIZE, OR COLOR.

THE NAME SHOWN IN THE MARK DOES NOT IDENTIFY A PARTICULAR LIVING INDIVIDUAL.

SER. NO. 85-207,366, FILED 12-29-2010.

TINA BROWN, EXAMINING ATTORNEY



David J. Kybas

Director of the United States Patent and Trademark Office

United States of America

United States Patent and Trademark Office

KUNLUN

Reg. No. 4,107,615

Registered Mar. 6, 2012

Int. Cl.: 41

SERVICE MARK

PRINCIPAL REGISTER

PRIMORDIAL ALCHEMIST LLC (WASHINGTON LIMITED LIABILITY COMPANY)
C/O EMORY LAW GROUP PC, SUITE 777
1 SW COLUMBIA
PORTLAND, OR 97258

FOR: EDUCATIONAL TRAINING IN THE FIELDS OF MEDITATION AND HEALING ARTS
IN THE NATURE OF PERSONAL ENERGIES DEVELOPMENT, INDIVIDUAL SELF-
AWAKENING, PERSONAL GROWTH AND HUMAN EMPOWERMENT FOR BODY, MIND,
AND SPIRIT, IN CLASS 41 (U.S. CLS. 100, 101 AND 107).

FIRST USE 1-1-2000; IN COMMERCE 1-1-2000.

THE MARK CONSISTS OF STANDARD CHARACTERS WITHOUT CLAIM TO ANY PAR-
TICULAR FONT, STYLE, SIZE, OR COLOR.

SER. NO. 85-207,505, FILED 12-29-2010.

TRACY WHITTAKER-BROWN, EXAMINING ATTORNEY



David J. Kybas

Director of the United States Patent and Trademark Office

United States of America

United States Patent and Trademark Office

LEAK STOPPER

Reg. No. 4,107,616

Registered Mar. 6, 2012

Int. Cl.: 19

TRADEMARK

PRINCIPAL REGISTER

GARDNER ASPHALT CORPORATION (DELAWARE CORPORATION)
P.O. BOX 5449
TAMPA, FL 33675

FOR: ASPHALT-BASED SEALANTS FOR USE ON ROOFS, ROOF PENETRATIONS, GUTTERS, WALLS AND FOUNDATIONS, IN CLASS 19 (U.S. CLS. 1, 12, 33 AND 50).

FIRST USE 4-1-1997; IN COMMERCE 4-1-1997.

THE MARK CONSISTS OF STANDARD CHARACTERS WITHOUT CLAIM TO ANY PARTICULAR FONT, STYLE, SIZE, OR COLOR.

OWNER OF U.S. REG. NOS. 2,414,834 AND 2,416,680.

NO CLAIM IS MADE TO THE EXCLUSIVE RIGHT TO USE "LEAK", APART FROM THE MARK AS SHOWN.

SEC. 2(F).

SER. NO. 85-207,669, FILED 12-29-2010.

BARNEY CHARLON, EXAMINING ATTORNEY



David J. Kyros

Director of the United States Patent and Trademark Office

United States of America

United States Patent and Trademark Office

LEAK STOPPER

Reg. No. 4,107,617

Registered Mar. 6, 2012

Int. Cl.: 17

TRADEMARK

PRINCIPAL REGISTER

GARDNER ASPHALT CORPORATION (DELAWARE CORPORATION)
P.O. BOX 5449
TAMPA, FL 33675

FOR: SEALANTS FOR BUILDINGS, IN CLASS 17 (U.S. CLS. 1, 5, 12, 13, 35 AND 50).

FIRST USE 4-1-1997; IN COMMERCE 4-1-1997.

THE MARK CONSISTS OF STANDARD CHARACTERS WITHOUT CLAIM TO ANY PARTICULAR FONT, STYLE, SIZE, OR COLOR.

OWNER OF U.S. REG. NOS. 2,414,834 AND 2,416,680.

NO CLAIM IS MADE TO THE EXCLUSIVE RIGHT TO USE "LEAK", APART FROM THE MARK AS SHOWN.

SEC. 2(F).

SER. NO. 85-207,670, FILED 12-29-2010.

BARNEY CHARLON, EXAMINING ATTORNEY



David J. Kyffers

Director of the United States Patent and Trademark Office

United States of America

United States Patent and Trademark Office

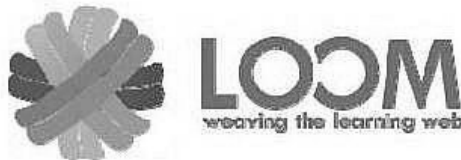

Reg. No. 4,107,618

Registered Mar. 6, 2012

Int. Cl.: 42

SERVICE MARK

PRINCIPAL REGISTER

LOOM, INC. (DELAWARE CORPORATION)
1526 REVERDY OAKS DRIVE
MATTHEWS, NC 28105

FOR: PROVIDING A WEBSITE FEATURING ON-LINE SUBSCRIPTION BASED SERVICES IN THE FIELD OF EDUCATION, NAMELY, NON-DOWNLOADABLE SOFTWARE USED FOR PROVIDING TECHNICAL SUPPORT, HELP DESK SUPPORT, CLOUD HOSTING, PROFESSIONAL SERVICES SUPPORT USING COMMUNICATION TOOLS, ACTIVITIES AND ASSESSMENT, PRODUCTIVITY TOOLS AND INSTRUCTIONAL STANDARDS COMPLIANCE ACCESSED VIA THE GLOBAL COMPUTER NETWORK, IN CLASS 42 (U.S. CLS. 100 AND 101).

FIRST USE 10-2-2009; IN COMMERCE 10-2-2009.

THE MARK CONSISTS OF A STYLIZED DESIGN DEPICTING A SKEIN OF YARN WITH THE WORDS "LOOM" AND "WEAVING THE LEARNING WEB" TO THE RIGHT OF THE DESIGN.

SER. NO. 85-207,767, FILED 12-30-2010.

JULIE GUTTADAURO, EXAMINING ATTORNEY



David J. Kybas

Director of the United States Patent and Trademark Office

United States of America

United States Patent and Trademark Office

H. C. Nutting

Reg. No. 4,107,619

Registered Mar. 6, 2012

Int. Cl.: 42

SERVICE MARK

PRINCIPAL REGISTER

TERRACON CONSULTANTS, INC. (DELAWARE CORPORATION)
SUITE 300
18001 W. 106TH STREET
OLATHE, KS 66061

FOR: ENGINEERING CONSULTING SERVICES, IN CLASS 42 (U.S. CLS. 100 AND 101).

FIRST USE 6-12-1931; IN COMMERCE 6-12-1931.

THE MARK CONSISTS OF STANDARD CHARACTERS WITHOUT CLAIM TO ANY PARTICULAR FONT, STYLE, SIZE, OR COLOR.

THE NAME "H. C. NUTTING" DOES NOT IDENTIFY A LIVING INDIVIDUAL.

SER. NO. 85-208,674, FILED 12-31-2010.

JILL PRATER, EXAMINING ATTORNEY



David J. Kybas

Director of the United States Patent and Trademark Office

United States of America

United States Patent and Trademark Office

05

Reg. No. 4,107,620

SWEDISH MATCH NORTH EUROPE AB (SWEDEN JOINT STOCK COMPANY)
SE-118 85

Registered Mar. 6, 2012

STOCKHOLM, SWEDEN

Int. Cl.: 34

FOR: SNUFF AND TOBACCO ALTERNATIVES IN THE FORM OF PRODUCTS BASED ON VEGETABLE FIBRES, FOR ORAL USE, NOT FOR CONSUMPTION; SNUFF; TOBACCO FREE SNUFF; HERBAL SNUFF, IN CLASS 34 (U.S. CLS. 2, 8, 9 AND 17).

TRADEMARK

THE MARK CONSISTS OF STANDARD CHARACTERS WITHOUT CLAIM TO ANY PARTICULAR FONT, STYLE, SIZE, OR COLOR.

PRINCIPAL REGISTER

OWNER OF SWEDEN REG. NO. 415871, DATED 1-21-2011, EXPIRES 1-21-2021.

SER. NO. 85-209,179, FILED 1-3-2011.

MARK PILARO, EXAMINING ATTORNEY



David J. Kyffers

Director of the United States Patent and Trademark Office

United States of America

United States Patent and Trademark Office

BALANI

Reg. No. 4,107,621

Registered Mar. 6, 2012

Int. Cls.: 25 and 35

TRADEMARK

SERVICE MARK

PRINCIPAL REGISTER

MEDOS CUSTOM TAILORS INC. (ILLINOIS CORPORATION)
SUITE 210
55 WEST MONROE
CHICAGO, IL 60603

FOR: CUSTOM AND READY MADE CLOTHING, NAMELY, SHIRTS, SUITS, SHOES, TIES, SLACKS, BLAZERS, SPORT-COATS, OVERCOATS, VESTS, LEATHER JACKETS, AND BELTS, IN CLASS 25 (U.S. CLS. 22 AND 39).

FIRST USE 2-1-2004; IN COMMERCE 2-1-2004.

FOR: RETAIL CLOTHING STORE SERVICES, IN CLASS 35 (U.S. CLS. 100, 101 AND 102).

FIRST USE 2-1-2006; IN COMMERCE 2-1-2006.

THE MARK CONSISTS OF STANDARD CHARACTERS WITHOUT CLAIM TO ANY PARTICULAR FONT, STYLE, SIZE, OR COLOR.

OWNER OF U.S. REG. NO. 3,108,315.

SER. NO. 85-209,332, FILED 1-3-2011.

KELLY CHOE, EXAMINING ATTORNEY



David J. Kybas

Director of the United States Patent and Trademark Office

United States of America

United States Patent and Trademark Office



Reg. No. 4,107,622

Registered Mar. 6, 2012

Int. Cl.: 20

TRADEMARK

PRINCIPAL REGISTER

KENSINGTON HOUSE MATTRESSES, INC. (CALIFORNIA CORPORATION)
3700 S. CAPITAL AVE.,
INDUSTRY, CA 90601

FOR: BEDROOM FURNITURE; BEDS; BEDS, MATTRESSES, PILLOWS AND BOLSTERS; CUSHIONS; FURNITURE; MATTRESS CUSHIONS; MATTRESS FOUNDATIONS; MATTRESS TOPPERS; MATTRESSES; MATTRESSES AND PILLOWS; SLEEP PRODUCTS, NAMELY, MATTRESSES, SPRING MATTRESSES, BOX SPRINGS AND MATTRESS FOUNDATIONS, IN CLASS 20 (U.S. CLS. 2, 13, 22, 25, 32 AND 50).

FIRST USE 5-0-2009; IN COMMERCE 5-0-2009.

NO CLAIM IS MADE TO THE EXCLUSIVE RIGHT TO USE "BEDDING", APART FROM THE MARK AS SHOWN.

THE COLOR(S) BLACK, RED, GOLD, AND BROWN IS/ARE CLAIMED AS A FEATURE OF THE MARK.

THE MARK CONSISTS OF THE FOLLOWING: A STYLIZED DESIGN OF A CROWN, SHIELD AND LIONS APPEAR IN GOLD, THE LETTER "KH" APPEAR IN RED, THE WORDS "KENNSINGTON HOUSE BEDDING" APPEAR IN BLACK AND THE BACKGROUND APPEARS IN BROWN.

SER. NO. 85-209,652, FILED 1-4-2011.

ANNE FARRELL, EXAMINING ATTORNEY



David J. Kybas

Director of the United States Patent and Trademark Office

United States of America

United States Patent and Trademark Office



Reg. No. 4,107,623

U.S. ASSET REALTY, LLC (CONNECTICUT LIMITED LIABILITY COMPANY)
611 ACCESS RD
STRATFORD, CT 06615

Registered Mar. 6, 2012

Int. Cl.: 36

FOR: REAL ESTATE AGENCIES; REAL ESTATE BROKERAGE, REAL ESTATE MANAGEMENT SERVICES, IN CLASS 36 (U.S. CLS. 100, 101 AND 102).

SERVICE MARK

FIRST USE 2-4-2010; IN COMMERCE 2-4-2010.

PRINCIPAL REGISTER

NO CLAIM IS MADE TO THE EXCLUSIVE RIGHT TO USE "U.S. ASSET REALTY", APART FROM THE MARK AS SHOWN.

THE COLOR(S) RED AND BLUE IS/ARE CLAIMED AS A FEATURE OF THE MARK.

THE MARK CONSISTS OF THE PHRASE "U.S. ASSET REALTY" WHEREIN THE WORDS "U.S." AND "REALTY" APPEAR IN BLUE COLOR AND "ASSET" IN RED COLOR, THE WORDS "ASSET REALTY" APPEARS WITHIN THE IMAGE OF A HOUSE WITH A BLUE OUTLINE AND AN OPENING ON THE LEFT AS SHOWN IN THE MARK AND THE WHITE BACKGROUND IS NOT CLAIMED AS A FEATURE OF THE MARK.

SER. NO. 85-209,661, FILED 1-4-2011.

SUSAN RICHARDS, EXAMINING ATTORNEY



David J. Kybas

Director of the United States Patent and Trademark Office

United States of America

United States Patent and Trademark Office

The Adventures of Hotep

Reg. No. 4,107,624

Registered Mar. 6, 2012

Int. Cl.: 16

TRADEMARK

PRINCIPAL REGISTER

ROACH, DAVID N. (UNITED STATES INDIVIDUAL), DBA THE ADVENTURES OF
HOTEP.COM
2123 EAST 30TH STREET
OAKLAND, CA 94606

FOR: EDUCATIONAL KITS SOLD AS A UNIT IN THE FIELD OF HEALTHY ECONOMICS
CONSISTING PRIMARILY OF EDUCATIONAL BOOKS AND ALSO INCLUDING DVDS
AND T-SHIRTS, IN CLASS 16 (U.S. CLS. 2, 5, 22, 23, 29, 37, 38 AND 50).

FIRST USE 6-1-1992; IN COMMERCE 9-1-1996.

THE MARK CONSISTS OF STANDARD CHARACTERS WITHOUT CLAIM TO ANY PAR-
TICULAR FONT, STYLE, SIZE, OR COLOR.

SER. NO. 85-209,709, FILED 1-4-2011.

STEPHANIE ALI, EXAMINING ATTORNEY



David J. Kyffers

Director of the United States Patent and Trademark Office

United States of America

United States Patent and Trademark Office

Taste World Travel

Reg. No. 4,107,625

Registered Mar. 6, 2012

Int. Cl.: 39

SERVICE MARK

PRINCIPAL REGISTER

BAIDOA CORPORATION (CALIFORNIA CORPORATION)
369-B THIRD STREET, SUITE 531
SAN RAFAEL, CA 94901

FOR: ARRANGING AND COORDINATING TRAVEL ARRANGEMENTS FOR INDIVIDUALS AND GROUPS, NAMELY, DESTINATIONS STAYS, HONEYMOONS, FAMILY VACATIONS, AND DESTINATION WEDDINGS; COORDINATING TRAVEL ARRANGEMENTS FOR INDIVIDUALS AND FOR GROUPS; PROVIDING A WEB SITE FEATURING TRAVEL INFORMATION AND COMMENTARY; PROVIDING AN ON-LINE COMPUTER DATABASE IN THE FIELD OF TRAVEL INFORMATION SERVICES; PROVIDING TRAVEL INFORMATION TO TRAVELERS REGARDING FARES, TIMETABLES AND PUBLIC TRANSPORT; TRAVEL AGENCY SERVICES, NAMELY, MAKING RESERVATIONS AND BOOKINGS FOR TRANSPORTATION; TRAVEL GUIDE AND TRAVEL INFORMATION SERVICES; TRAVEL INFORMATION SERVICES, IN CLASS 39 (U.S. CLS. 100 AND 105).

FIRST USE 5-15-2007; IN COMMERCE 5-15-2007.

THE MARK CONSISTS OF STANDARD CHARACTERS WITHOUT CLAIM TO ANY PARTICULAR FONT, STYLE, SIZE, OR COLOR.

NO CLAIM IS MADE TO THE EXCLUSIVE RIGHT TO USE "WORLD TRAVEL", APART FROM THE MARK AS SHOWN.

SER. NO. 85-210,042, FILED 1-4-2011.

NANCY CLARKE, EXAMINING ATTORNEY



David J. Kyffers

Director of the United States Patent and Trademark Office

United States of America

United States Patent and Trademark Office

MFX

Reg. No. 4,107,626

Registered Mar. 6, 2012

Int. Cl.: 9

TRADEMARK

PRINCIPAL REGISTER

SYNCSORT INCORPORATED (NEW JERSEY CORPORATION)
50 TICE BOULEVARD
WOODCLIFF LAKE, NJ 07677

FOR: COMPUTER SOFTWARE, NAMELY, COMPUTER SOFTWARE FOR PERFORMING OPERATIONS OF DATA INTEGRATION, DATA SORTING, INFORMATION MANAGEMENT, DATA CONVERSION AND REFORMATTING, AND PRODUCING RELATED REPORTS, AND COMPUTER SOFTWARE FOR PERFORMING THESE OPERATIONS IN PARALLEL, AND FOR PERFORMING THESE OPERATIONS IN PLACE OF SIMILAR FUNCTIONALITY NATIVELY PROVIDED WITHIN ITEMS OF APPLICATION SOFTWARE, IN CLASS 9 (U.S. CLS. 21, 23, 26, 36 AND 38).

FIRST USE 10-1-2010; IN COMMERCE 10-1-2010.

THE MARK CONSISTS OF STANDARD CHARACTERS WITHOUT CLAIM TO ANY PARTICULAR FONT, STYLE, SIZE, OR COLOR.

SER. NO. 85-210,091, FILED 1-4-2011.

KIM SAITO, EXAMINING ATTORNEY



David J. Kybas

Director of the United States Patent and Trademark Office

United States of America

United States Patent and Trademark Office

Dairy Balance

Reg. No. 4,107,627

Registered Mar. 6, 2012

Int. Cls.: 1 and 29

TRADEMARK

PRINCIPAL REGISTER

FOSTER DAIRY FARMS (CALIFORNIA CORPORATION)
525 KANSAS AVENUE
MODESTO, CA 95351

FOR: PROBIOTIC COMPOSITIONS FOR USE AS INGREDIENTS FOR FOOD AND BEVERAGES, NAMELY, PROBIOTIC BACTERIA AND PROBIOTIC BACTERIAL CULTURES, IN CLASS 1 (U.S. CLS. 1, 5, 6, 10, 26 AND 46).

FIRST USE 4-4-2011; IN COMMERCE 4-4-2011.

FOR: CHEESE; COTTAGE CHEESE; CREAM, BEING DAIRY PRODUCTS; DAIRY-BASED BEVERAGES; DAIRY-BASED FOOD BEVERAGES; DAIRY-BASED SPREADS; MILK; SOUR CREAM; YOGURT, IN CLASS 29 (U.S. CL. 46).

FIRST USE 4-4-2011; IN COMMERCE 4-4-2011.

THE MARK CONSISTS OF STANDARD CHARACTERS WITHOUT CLAIM TO ANY PARTICULAR FONT, STYLE, SIZE, OR COLOR.

NO CLAIM IS MADE TO THE EXCLUSIVE RIGHT TO USE "DAIRY", APART FROM THE MARK AS SHOWN.

SER. NO. 85-210,760, FILED 1-5-2011.

NATALIE POLZER, EXAMINING ATTORNEY



David J. Kyffers

Director of the United States Patent and Trademark Office

United States of America

United States Patent and Trademark Office

THE BIG PAYBACK

Reg. No. 4,107,628

Registered Mar. 6, 2012

Int. Cl.: 35

SERVICE MARK

PRINCIPAL REGISTER

GUITAR CENTER, INC. (DELAWARE CORPORATION)
5795 LINDERO CANYON ROAD
WESTLAKE VILLAGE, CA 91362

FOR: PROMOTING THE GOODS OF OTHERS, NAMELY, PROVIDING INFORMATION REGARDING DISCOUNTS AND COUPONS FOR THE GOODS OF OTHERS, IN CLASS 35 (U.S. CLS. 100, 101 AND 102).

FIRST USE 5-1-2010; IN COMMERCE 5-1-2010.

THE MARK CONSISTS OF STANDARD CHARACTERS WITHOUT CLAIM TO ANY PARTICULAR FONT, STYLE, SIZE, OR COLOR.

SER. NO. 85-210,884, FILED 1-5-2011.

ANNE E. GUSTASON, EXAMINING ATTORNEY



David J. Kyffers

Director of the United States Patent and Trademark Office

United States of America

United States Patent and Trademark Office



Reg. No. 4,107,629

GLO SCIENCE LLC (DELAWARE LIMITED LIABILITY COMPANY)
923 FIFTH AVENUE
NEW YORK, NY 10021

Registered Mar. 6, 2012

Int. Cl.: 10

FOR: INTRA-ORAL LIGHT SYSTEMS; INTRA-ORAL LIGHT AND HEAT SYSTEMS, IN CLASS 10 (U.S. CLS. 26, 39 AND 44).

TRADEMARK

FIRST USE 5-25-2010; IN COMMERCE 5-25-2010.

PRINCIPAL REGISTER

OWNER OF U.S. REG. NO. 3,873,849.

THE MARK CONSISTS OF THE FANCIFUL WORD "GLO" WHERE THE LETTER "G" APPEARS IN HIGHLY STYLIZED FORM.

SER. NO. 85-211,039, FILED 1-5-2011.

GISELLE AGOSTO, EXAMINING ATTORNEY



David J. Kybas

Director of the United States Patent and Trademark Office

United States of America

United States Patent and Trademark Office

WANDERING WINO

Reg. No. 4,107,630

BURGERT, SHAWN (UNITED STATES INDIVIDUAL), DBA WANDERING WINO
3014 COTTONWOOD COURT
NEWBURY, CA 91320

Registered Mar. 6, 2012

Int. Cl.: 43

FOR: PROVIDING A WEB SITE THAT PROVIDES REVIEWS OF THE WINES OF WINERIES AND WHERE USERS CAN POST RATINGS, REVIEWS AND RECOMMENDATIONS ON THE WINES OF WINERIES FOR WINE APPRECIATION PURPOSES, IN CLASS 43 (U.S. CLS. 100 AND 101).

SERVICE MARK

PRINCIPAL REGISTER

FIRST USE 12-22-2010; IN COMMERCE 12-22-2010.

THE MARK CONSISTS OF STANDARD CHARACTERS WITHOUT CLAIM TO ANY PARTICULAR FONT, STYLE, SIZE, OR COLOR.

SER. NO. 85-211,087, FILED 1-5-2011.

MICHAEL WEBSTER, EXAMINING ATTORNEY



David J. Kybas

Director of the United States Patent and Trademark Office

United States of America

United States Patent and Trademark Office



Reg. No. 4,107,631

Registered Mar. 6, 2012

Int. Cl.: 43

SERVICE MARK

PRINCIPAL REGISTER

PIZZA & ALE HOUSE FRANCHISING LLC (NEW YORK LIMITED LIABILITY COMPANY),
DBA AMHERST ALE HOUSE
1047 SWEENEY STREET
NORTH TONAWANDA, NY 14120

FOR: BAR AND RESTAURANT SERVICES, IN CLASS 43 (U.S. CLS. 100 AND 101).

FIRST USE 8-1-2004; IN COMMERCE 8-1-2004.

NO CLAIM IS MADE TO THE EXCLUSIVE RIGHT TO USE "AMHERST ALE HOUSE EST 2005", APART FROM THE MARK AS SHOWN.

THE COLOR(S) MAROON, DARK MAROON, WHITE, YELLOW-GOLD IS/ARE CLAIMED AS A FEATURE OF THE MARK.

THE MARK CONSISTS OF A MAROON RECTANGLE SHAPE WITH ROUNDED MIDDLE ON TOP AND BOTTOM. THE RECTANGULAR SHAPE IS OUTLINED IN A DARK MAROON. CENTERED INSIDE THE RECTANGLE ARE THE WORDS "AMHERST ALE HOUSE EST 2005" IN WHITE LETTERS WITH DARK MAROON OUTLINE. FIRST LINE IS "AMHERST" IN ALL CAPS. CENTERED UNDERNEATH "AMHERST" ARE THE WORDS "ALE HOUSE". THE "A" IN ALE IS CAPITALIZED. THE "H" IN HOUSE IS CAPITALIZED. UNDER "ALE HOUSE" IN THE BOTTOM ROUNDED PORTION OF RECTANGLE SHAPE ARE THE WORDS "EST 2005" THE "E" IN "EST" IS CAPITALIZED. BEHIND THE WORDS AND IN THE ROUNDED PORTION OF THE RECTANGLE ARE 10 WHEAT-LIKE SHAPES WITH THEIR TOPS EXTENDING TO THE TOP AND BOTTOM OF THE ROUNDED PORTION IN A "SPOKE-LIKE" MANNER. THE WHEAT SHAPES ARE A YELLOW-GOLD COLOR. THERE ARE 5 WHEAT SHAPES AT THE BOTTOM OF THE ROUNDED AREA AND FIVE AT THE TOP OF THE ROUNDED AREA.

SER. NO. 85-211,136, FILED 1-5-2011.

DAVID TOOLEY, EXAMINING ATTORNEY



David J. Kyffers

Director of the United States Patent and Trademark Office

United States of America

United States Patent and Trademark Office

FLING

Reg. No. 4,107,632

Registered Mar. 6, 2012

Int. Cl.: 9

TRADEMARK

PRINCIPAL REGISTER

TEN ONE DESIGN LLC (NEW JERSEY LIMITED LIABILITY COMPANY)
149 CHESTNUT STREET
MONTCLAIR, NJ 07042

FOR: INPUT DEVICES FOR HAND HELD, DESKTOP AND TABLET COMPUTERS; INPUT DEVICES IN THE NATURE OF COMPUTER GAME JOYSTICKS FOR USE WITH ELECTRONIC DEVICES, PERSONAL DIGITAL ASSISTANTS, ELECTRONIC ORGANIZERS, AND ELECTRONIC NOTEPADS; AND GAME CONTROLLERS FOR COMPUTER GAMES FOR USE WITH HAND HELD AND DESKTOP COMPUTERS AND ELECTRONIC DEVICES, TABLET COMPUTERS, PERSONAL DIGITAL ASSISTANTS, ELECTRONIC ORGANIZERS, AND ELECTRONIC NOTEPADS, IN CLASS 9 (U.S. CLS. 21, 23, 26, 36 AND 38).

FIRST USE 1-4-2010; IN COMMERCE 1-4-2010.

THE MARK CONSISTS OF STANDARD CHARACTERS WITHOUT CLAIM TO ANY PARTICULAR FONT, STYLE, SIZE, OR COLOR.

SER. NO. 85-211,160, FILED 1-5-2011.

NELSON SNYDER, EXAMINING ATTORNEY



David J. Kybas

Director of the United States Patent and Trademark Office

United States of America

United States Patent and Trademark Office

GLO Brilliant

Reg. No. 4,107,633

GLO SCIENCE LLC (DELAWARE LIMITED LIABILITY COMPANY)
923 FIFTH AVENUE
NEW YORK, NY 10021

Registered Mar. 6, 2012

Int. Cl.: 10

FOR: INTRA-ORAL LIGHT SYSTEMS; INTRA-ORAL LIGHT AND HEAT SYSTEMS, IN CLASS 10 (U.S. CLS. 26, 39 AND 44).

TRADEMARK

FIRST USE 5-25-2010; IN COMMERCE 5-25-2010.

PRINCIPAL REGISTER

THE MARK CONSISTS OF STANDARD CHARACTERS WITHOUT CLAIM TO ANY PARTICULAR FONT, STYLE, SIZE, OR COLOR.

OWNER OF U.S. REG. NO. 3,873,849.

SER. NO. 85-211,725, FILED 1-6-2011.

GISELLE AGOSTO, EXAMINING ATTORNEY



David J. Kyffers

Director of the United States Patent and Trademark Office

United States of America

United States Patent and Trademark Office

SocialLogic

Reg. No. 4,107,634

Registered Mar. 6, 2012

Int. Cl.: 35

SERVICE MARK

PRINCIPAL REGISTER

VANSICKLE, RICHARD, M. (UNITED STATES INDIVIDUAL)
PLAN B INC.
116 WEST ILLINOIS STREET
CHICAGO, IL 60654

FOR: ADVERTISEMENT AND PUBLICITY SERVICES BY TELEVISION, RADIO, MAIL; ADVERTISEMENT FOR OTHERS ON THE INTERNET; ADVERTISING AGENCIES, NAMELY, PROMOTING THE GOODS AND SERVICES OF OTHERS; ADVERTISING AND ADVERTISEMENT SERVICES; ADVERTISING AND MARKETING; ADVERTISING AND MARKETING CONSULTANCY; ADVERTISING AND MARKETING SERVICES PROVIDED BY MEANS OF INDIRECT METHODS OF MARKETING COMMUNICATIONS, NAMELY, SOCIAL MEDIA, SEARCH ENGINE MARKETING, INQUIRY MARKETING, INTERNET MARKETING, MOBILE MARKETING, BLOGGING AND OTHER FORMS OF PASSIVE, SHARABLE OR VIRAL COMMUNICATIONS CHANNELS; ADVERTISING AND MARKETING SERVICES, NAMELY, PROMOTING THE GOODS AND SERVICES OF OTHERS, IN CLASS 35 (U.S. CLS. 100, 101 AND 102).

FIRST USE 1-6-2011; IN COMMERCE 5-11-2011.

THE MARK CONSISTS OF STANDARD CHARACTERS WITHOUT CLAIM TO ANY PARTICULAR FONT, STYLE, SIZE, OR COLOR.

SER. NO. 85-211,757, FILED 1-6-2011.

JANET LEE, EXAMINING ATTORNEY



David J. Kybas

Director of the United States Patent and Trademark Office

United States of America

United States Patent and Trademark Office

INFACOL

Reg. No. 4,107,635

Registered Mar. 6, 2012

Int. Cl.: 5

FOREST LABORATORIES UK LIMITED (UNITED KINGDOM CORPORATION), FORMERLY
PHARMAX LIMITED
RIVERBRIDGE HOUSE
ANCHOR BLVD, CROSSWAYS BUSINESS PARK
DARTFORD, KENT, UNITED KINGDOM DA26SL

TRADEMARK

FOR: PHARMACEUTICAL PREPARATIONS FOR THE TREATMENT OF FLATULENCE ,
IN CLASS 5 (U.S. CLS. 6, 18, 44, 46, 51 AND 52).

PRINCIPAL REGISTER

THE MARK CONSISTS OF STANDARD CHARACTERS WITHOUT CLAIM TO ANY PAR-
TICULAR FONT, STYLE, SIZE, OR COLOR.

OWNER OF ERPN CMNTY TM OFC REG. NO. 00198739, DATED 6-27-2000, EXPIRES 4-1-
2016.

SER. NO. 85-211,987, FILED 1-6-2011.

SHAUNIA CARLYLE, EXAMINING ATTORNEY



David J. Kybas

Director of the United States Patent and Trademark Office

United States of America

United States Patent and Trademark Office



Reg. No. 4,107,636

Registered Mar. 6, 2012

Int. Cl.: 25

TRADEMARK

PRINCIPAL REGISTER

XAVIER UNIVERSITY CORPORATION (OHIO CORPORATION), DBA XAVIER UNIVERSITY
3800 VICTORY PARKWAY
CINCINNATI, OH 45207

FOR: ATHLETIC APPAREL, NAMELY, SHIRTS, PANTS, JACKETS, FOOTWEAR, HATS
AND CAPS, ATHLETIC UNIFORMS, IN CLASS 25 (U.S. CLS. 22 AND 39).

FIRST USE 10-1-2010; IN COMMERCE 10-1-2010.

THE MARK CONSISTS OF AN ATHLETIC MASCOT REFERRED TO AS THE BLUE BLOB
- A FURRY BLOB LIKE CREATURE WITH WHITE HANDS, EYES, AND NOSE, A BLUE
BODY, AND BLACK AND WHITE SHOES.

THE COLOR(S) BLUE, WHITE, AND BLACK IS/ARE CLAIMED AS A FEATURE OF THE
MARK.

SER. NO. 85-212,250, FILED 1-6-2011.

ANGELA M. MICHELI, EXAMINING ATTORNEY



David J. Kybas

Director of the United States Patent and Trademark Office

United States of America

United States Patent and Trademark Office

SECURE-MOUNT

Reg. No. 4,107,637

FOREMOST GROUPS, INC. (NEW JERSEY CORPORATION)
906 MURRAY ROAD
EAST HANOVER, NJ 07936

Registered Mar. 6, 2012

Int. Cl.: 20

FOR: WALL HANGING SYSTEM NOT OF METAL CONSISTING OF TWO INTERLOCKING AND LEVELING BEVELED RAILS AND SOLD AS AN INTEGRAL COMPONENT OF BATHROOM FURNITURE, NAMELY, CABINETS, MIRRORS OR SHELVING UNITS, IN CLASS 20 (U.S. CLS. 2, 13, 22, 25, 32 AND 50).

TRADEMARK

PRINCIPAL REGISTER

FIRST USE 5-1-2005; IN COMMERCE 8-1-2005.

THE MARK CONSISTS OF STANDARD CHARACTERS WITHOUT CLAIM TO ANY PARTICULAR FONT, STYLE, SIZE, OR COLOR.

SEC. 2(F).

SER. NO. 85-212,251, FILED 1-6-2011.

ANGELA M. MICHELI, EXAMINING ATTORNEY



David J. Kybas

Director of the United States Patent and Trademark Office

United States of America

United States Patent and Trademark Office



Reg. No. 4,107,638

ALICORP S.A.A. (PERU CORPORATION)
AV. ARGENTINA 4793, CALLAO
LIMA, PERU

Registered Mar. 6, 2012

Int. Cl.: 35

FOR: ADVERTISING; BUSINESS MANAGEMENT; BUSINESS ADMINISTRATION; OFFICE WORK, IN CLASS 35 (U.S. CLS. 100, 101 AND 102).

SERVICE MARK

OWNER OF PERU REG. NO. 00059670, DATED 12-4-2009, EXPIRES 12-4-2019.

PRINCIPAL REGISTER

THE COLOR(S) WARM GREY, GREEN AND RED IS/ARE CLAIMED AS A FEATURE OF THE MARK.

OWNER OF U.S. REG. NO. 2,969,021.

THE MARK CONSISTS OF THE WORDS "GRAN COCINA" APPEARING BENEATH THE WORD "ALICORP" IN A STYLIZED FONT, A DESIGN OF A CURVED SPOON UNDERNEATH THE LETTER "N" IN "GRAN" AND BELOW THE WORD "COCINA", A LEAF DESIGN ABOVE THE LETTER "A" IN "ALICORP", AND A DESIGN OF VAPOR RISING FROM THE SPOON TO THE RIGHT OF THE WORDS "ALICORP GRAN COCINA". THE LEAF AND SPOON DESIGNS ARE IN THE COLOR GREEN; THE VAPOR DESIGN AND WORDING "GRAN COCINA" ARE IN A WARM GREY COLOR; AND THE WORDING "ALICORP" IS IN THE COLOR RED.

THE ENGLISH TRANSLATION OF "GRAN COCINA" IN THE MARK IS "GREAT KITCHEN".

SER. NO. 85-212,555, FILED 1-7-2011.

STEVEN R. FINE, EXAMINING ATTORNEY



David J. Kyffers

Director of the United States Patent and Trademark Office

United States of America

United States Patent and Trademark Office

PUNCHTV

Reg. No. 4,107,639

Registered Mar. 6, 2012

Int. Cl.: 41

SERVICE MARK

PRINCIPAL REGISTER

PUNCH INTERNATIONAL PTY LIMITED (AUSTRALIA CORPORATION)
6/2 BISHOP STREET
ST. PETERS, AUSTRALIA NSW2044

FOR: TRAINING COURSES RELATED TO BOXING AND PERSONAL FITNESS TRAINING;
TELEVISION AND CABLE ENTERTAINMENT PROGRAMS IN THE NATURE OF BOXING
AND PERSONAL FITNESS TRAINING SHOWS, IN CLASS 41 (U.S. CLS. 100, 101 AND 107).

THE MARK CONSISTS OF STANDARD CHARACTERS WITHOUT CLAIM TO ANY PAR-
TICULAR FONT, STYLE, SIZE, OR COLOR.

OWNER OF AUSTRALIA REG. NO. 1286023, DATED 6-15-2010, EXPIRES 2-20-2019.

SER. NO. 85-212,565, FILED 1-7-2011.

KAPIL BHANOT, EXAMINING ATTORNEY



David J. Kybas

Director of the United States Patent and Trademark Office

United States of America

United States Patent and Trademark Office

B4U

Reg. No. 4,107,640

Registered Mar. 6, 2012

Int. Cl.: 25

TRADEMARK

PRINCIPAL REGISTER

LMB HOLDINGS LIMITED (ISLE OF MAN LIMITED COMPANY (LTD.))
FIRST FLOOR, MILLENNIUM HOUSE
VICTORIA ROAD
DOUGLAS, ISLE OF MAN IM24RW

FOR: DRESSES; HEADWEAR; JACKETS; TOPS, IN CLASS 25 (U.S. CLS. 22 AND 39).

FIRST USE 1-1-2000; IN COMMERCE 1-1-2000.

THE MARK CONSISTS OF STANDARD CHARACTERS WITHOUT CLAIM TO ANY PARTICULAR FONT, STYLE, SIZE, OR COLOR.

SER. NO. 85-212,711, FILED 1-7-2011.

KIMBERLY FRYE, EXAMINING ATTORNEY



David J. Kybas

Director of the United States Patent and Trademark Office

United States of America

United States Patent and Trademark Office

PANTHER

Reg. No. 4,107,641

PANTHER II TRANSPORTATION, INC. (OHIO CORPORATION)
4940 PANTHER PARKWAY
SEVILLE, OH 442738929

Registered Mar. 6, 2012

Int. Cl.: 39

FOR: PICK-UP, TRANSPORTATION, STORAGE AND DELIVERY OF DOCUMENTS,
PACKAGES AND FREIGHT BY LAND AND AIR, IN CLASS 39 (U.S. CLS. 100 AND 105).

SERVICE MARK

FIRST USE 12-30-1992; IN COMMERCE 12-30-1992.

PRINCIPAL REGISTER

THE MARK CONSISTS OF STANDARD CHARACTERS WITHOUT CLAIM TO ANY PAR-
TICULAR FONT, STYLE, SIZE, OR COLOR.

OWNER OF U.S. REG. NOS. 2,338,784, 3,235,775 AND OTHERS.

SER. NO. 85-212,886, FILED 1-7-2011.

MICHELLE DUBOIS, EXAMINING ATTORNEY



David J. Kybas

Director of the United States Patent and Trademark Office

United States of America

United States Patent and Trademark Office



Reg. No. 4,107,642

Registered Mar. 6, 2012

Int. Cls.: 25 and 36

TRADEMARK

SERVICE MARK

PRINCIPAL REGISTER

TRICIA'S TROOPS INC. (WISCONSIN CORPORATION)
120 E. WISCONSIN AVENUE
OCONOMOWOC, WI 53066

FOR: CLOTHING, NAMELY, T-SHIRTS AND SWEATSHIRTS, IN CLASS 25 (U.S. CLS. 22 AND 39).

FIRST USE 1-1-2011; IN COMMERCE 1-1-2011.

FOR: CHARITABLE FUNDRAISING SERVICES FOR PROMOTING RESEARCH, EDUCATION AND OTHER ACTIVITIES RELATING TO INDIVIDUALS DIAGNOSED WITH CANCER, IN CLASS 36 (U.S. CLS. 100, 101 AND 102).

FIRST USE 1-1-2011; IN COMMERCE 1-1-2011.

NO CLAIM IS MADE TO THE EXCLUSIVE RIGHT TO USE "CANCER", APART FROM THE MARK AS SHOWN.

THE MARK CONSISTS OF RIBBON WITH CROSS IN THE MIDDLE WITH THE WORD "TRICIA'S" APPEARING TO THE LEFT OF THE RIBBON AND THE WORD "TROOPS" APPEARING TO THE RIGHT OF THE RIBBON. BELOW THE RIBBON APPEARS THE WORDS "CANCER CONNECTION".

SER. NO. 85-213,139, FILED 1-7-2011.

GENE MACIOL, EXAMINING ATTORNEY



David J. Kyffers

Director of the United States Patent and Trademark Office

United States of America

United States Patent and Trademark Office

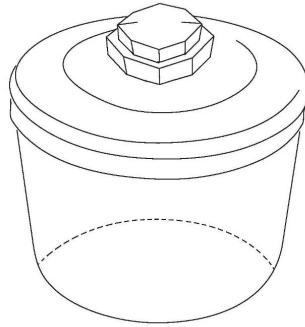

Reg. No. 4,107,643

Registered Mar. 6, 2012

Int. Cl.: 30

TRADEMARK

PRINCIPAL REGISTER

AMERICAN LICORICE CO. (DELAWARE CORPORATION)
2796 NW CLEARWATER DRIVE
BEND, OR 97701

FOR: CANDY, IN CLASS 30 (U.S. CL. 46).

FIRST USE 2-0-1983; IN COMMERCE 2-0-1983.

NO CLAIM IS MADE TO THE EXCLUSIVE RIGHT TO USE THE CYLINDRICAL JAR AND FLAT LID PORTIONS OF THE PACKAGING DESIGN, APART FROM THE MARK AS SHOWN.

THE MARK CONSISTS OF THREE-DIMENSIONAL CONFIGURATION OF THE CONTAINER FOR THE GOODS, NAMELY, A CYLINDRICAL JAR WITH A CYLINDRICAL LID HAVING A DOUBLE OCTAGON NUT-SHAPED HANDLE. THE BROKEN LINE IN THE BOTTOM OF THE CONTAINER IS NOT CLAIMED AS PART OF THE MARK AND IS INCLUDED MERELY TO SHOW THE POSITION OF THE CLAIMED PORTION OF THE MARK.

SEC. 2(F).

SER. NO. 85-213,220, FILED 1-7-2011.

KIM MONINGHOFF, EXAMINING ATTORNEY



David J. Kybas

Director of the United States Patent and Trademark Office

United States of America

United States Patent and Trademark Office

B4U

Reg. No. 4,107,644

Registered Mar. 6, 2012

Int. Cl.: 16

TRADEMARK

PRINCIPAL REGISTER

LMB HOLDINGS LIMITED (ISLE OF MAN LIMITED COMPANY (LTD.))
FIRST FLOOR, MILLENNIUM HOUSE
VICTORIA ROAD
DOUGLAS, ISLE OF MAN IM24RW

FOR: ADHESIVE LABELS; BINDERS; BOOK MARKS; ENVELOPES; FOLDERS; GREETING CARDS; INFORMATIONAL FLYERS FEATURING MUSIC AND FILMS; MAGAZINES IN THE FIELD OF MUSIC AND FILMS; PAPER; PAPER BAGS; PAPER LABELS; PEN AND PENCIL CASES; PEN AND PENCIL HOLDERS; PENCILS; PENS; PHOTOGRAPHS; PLASTIC SHOPPING BAGS; POSTERS; SCRAP BOOKS; SCRATCH PADS; STATIONERY; STICKERS; STICKERS AND TRANSFERS; WRITING PADS, IN CLASS 16 (U.S. CLS. 2, 5, 22, 23, 29, 37, 38 AND 50).

FIRST USE 1-1-2000; IN COMMERCE 1-1-2000.

THE MARK CONSISTS OF STANDARD CHARACTERS WITHOUT CLAIM TO ANY PARTICULAR FONT, STYLE, SIZE, OR COLOR.

SER. NO. 85-213,245, FILED 1-7-2011.

KIMBERLY FRYE, EXAMINING ATTORNEY



David J. Kybas

Director of the United States Patent and Trademark Office

United States of America

United States Patent and Trademark Office



Reg. No. 4,107,645

Registered Mar. 6, 2012

Int. Cl.: 43

SERVICE MARK

PRINCIPAL REGISTER

KUNJANI COFFEA LLC (COLORADO LIMITED LIABILITY COMPANY)
10009 SOUTH JORDAN ROAD
PARKER, CO 80134

FOR: COFFEE AND TEA BARS; COFFEE SHOPS, IN CLASS 43 (U.S. CLS. 100 AND 101).

FIRST USE 9-1-2008; IN COMMERCE 9-1-2008.

NO CLAIM IS MADE TO THE EXCLUSIVE RIGHT TO USE "COFFEA", APART FROM THE MARK AS SHOWN.

THE COLOR(S) BLACK, WHITE, AND BROWN IS/ARE CLAIMED AS A FEATURE OF THE MARK.

THE MARK CONSISTS OF THE WORD "KUNJANI" IN CAPITAL LETTERS, IN WHITE, WITH THE WORD "COFFEA" SMALL CASE LETTERS BELOW THE "KUNJANI" WORD, IN BROWN, AND A STYLIZED COFFEE AROMA SWIRL ABOVE THE WORD "KUNJANI", IN BROWN WITH A BLACK BACKGROUND.

THE ENGLISH TRANSLATION OF "KUNJANI" IN THE MARK IS "HOW ARE YOU".

SER. NO. 85-213,266, FILED 1-7-2011.

KRISTINA MORRIS, EXAMINING ATTORNEY



David J. Kybas

Director of the United States Patent and Trademark Office

United States of America

United States Patent and Trademark Office

NORTON DOLLARS

Reg. No. 4,107,646

RICHARD PETERSEN (UNITED STATES INDIVIDUAL), DBA NORTON DOLLARS
77 BELGRAVE
SAN FRANCISCO, CA 94117

Registered Mar. 6, 2012

Int. Cl.: 36

FOR: CURRENCY EXCHANGE SERVICES; CURRENCY TRADING; CURRENCY TRANSFER SERVICES, IN CLASS 36 (U.S. CLS. 100, 101 AND 102).

SERVICE MARK

FIRST USE 7-31-2010; IN COMMERCE 12-31-2010.

PRINCIPAL REGISTER

THE MARK CONSISTS OF STANDARD CHARACTERS WITHOUT CLAIM TO ANY PARTICULAR FONT, STYLE, SIZE, OR COLOR.

NO CLAIM IS MADE TO THE EXCLUSIVE RIGHT TO USE "DOLLARS", APART FROM THE MARK AS SHOWN.

SER. NO. 85-213,356, FILED 1-7-2011.

DAVID TAYLOR, EXAMINING ATTORNEY



David J. Kyffers

Director of the United States Patent and Trademark Office

United States of America

United States Patent and Trademark Office



Reg. No. 4,107,647

Registered Mar. 6, 2012

Int. Cl.: 30

HERSHEY CHOCOLATE & CONFECTIONERY CORPORATION (DELAWARE CORPORATION)
SUITE 204
4860 ROBB STREET
WHEAT RIDGE, CO 80033

TRADEMARK

PRINCIPAL REGISTER

FOR: CANDY, IN CLASS 30 (U.S. CL. 46).

FIRST USE 8-1-2010; IN COMMERCE 8-1-2010.

OWNER OF U.S. REG. NOS. 680,105, 4,011,567 AND OTHERS.

THE COLOR(S) WHITE, BLUE, RED, YELLOW, GREEN, AND PINK IS/ARE CLAIMED AS A FEATURE OF THE MARK.

NO CLAIM IS MADE TO THE EXCLUSIVE RIGHT TO USE "LOW FAT SNACK", "BITE SIZED", "BITES", "CHERRY ARTIFICIALLY FLAVORED" AND THE PICTORIAL REPRESENTATION OF THE CHERRIES AND THE PICTORIAL REPRESENTATION OF THE CANDY, APART FROM THE MARK AS SHOWN.

THE MARK CONSISTS OF A RECTANGULAR SHAPE BROKEN INTO THREE WAVY BANDS COLORED RED, WHITE AND PINK FROM TOP TO BOTTOM. THE COLOR WHITE IN THIS PORTION OF THE MARK IS A TRANSPARENT AREA AND IS NOT PART OF THE MARK. THE MATTER SHOWN IN DOTTED LINES SHOWS POSITIONING OF THE MARK AND IS NOT PART OF THE MARK. ON THE RECTANGULAR SHAPE IS THE WORD "TWIZZLERS" IN WHITE WITH A BLUE AND RED BORDER. ABOVE THE WORD IS A DESIGN OF RED CANDY WITH THE WORDS "BITE SIZED" AND AN ARROW DESIGN ALL IN WHITE. TO THE LEFT OF THE CANDY DESIGN ARE THE WORDS "LOW FAT" IN YELLOW AND "SNACK" IN WHITE. UNDERNEATH THE WORD "TWIZZLERS" IS THE WORD "BITES" IN YELLOW. AT THE BOTTOM OF THE RECTANGLE DESIGN IS A DESIGN OF RED CHERRIES WITH GREEN STEMS AND THE WORDS "CHERRY ARTIFICIALLY FLAVORED" IN WHITE.



David J. Kyros

SER. NO. 85-213,899, FILED 1-10-2011.

ERNEST SHOSHO, EXAMINING ATTORNEY

United States of America

United States Patent and Trademark Office

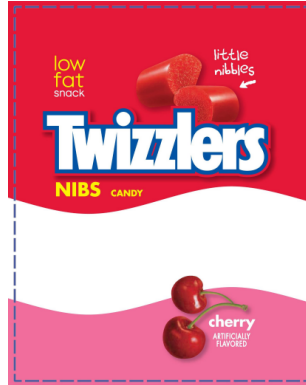

Reg. No. 4,107,648

Registered Mar. 6, 2012

Int. Cl.: 30

TRADEMARK

PRINCIPAL REGISTER

HERSHEY CHOCOLATE & CONFECTIONERY CORPORATION (DELAWARE CORPORATION)
CORPORATION)
SUITE 204
4860 ROBB STREET
WHEAT RIDGE, CO 80033

FOR: CANDY, IN CLASS 30 (U.S. CL. 46).

FIRST USE 8-1-2010; IN COMMERCE 8-1-2010.

OWNER OF U.S. REG. NOS. 680,105, 4,011,567 AND OTHERS.

THE COLOR(S) WHITE, BLUE, RED, YELLOW, GREEN, AND PINK IS/ARE CLAIMED AS A FEATURE OF THE MARK.

NO CLAIM IS MADE TO THE EXCLUSIVE RIGHT TO USE "LOW FAT SNACK", "LITTLE", "CANDY", "CHERRY ARTIFICIALLY FLAVORED" AND THE PICTORIAL REPRESENTATION OF THE CHERRIES AND THE PICTORIAL REPRESENTATION OF THE CANDY, APART FROM THE MARK AS SHOWN.

THE MARK CONSISTS OF A RECTANGULAR SHAPE BROKEN INTO THREE WAVY BANDS COLORED RED, WHITE AND PINK FROM TOP TO BOTTOM. THE COLOR WHITE IN THIS PORTION OF THE MARK IS A TRANSPARENT AREA AND IS NOT PART OF THE MARK. THE MATTER SHOWN IN DOTTED LINES SHOWS POSITIONING OF THE MARK AND IS NOT PART OF THE MARK. ON THE RECTANGULAR SHAPE IS THE WORD "TWIZZLERS" IN WHITE WITH A BLUE AND RED BORDER. ABOVE THE WORD IS A DESIGN OF RED CANDY WITH THE WORDS "LITTLE NIBBLES" AND AN ARROW DESIGN ALL IN WHITE. TO THE LEFT OF THE CANDY DESIGN ARE THE WORDS "LOW FAT" IN YELLOW AND "SNACK" IN WHITE. UNDERNEATH THE WORD "TWIZZLERS" ARE THE WORDS "NIBS CANDY" IN YELLOW. AT THE BOTTOM OF THE RECTANGLE DESIGN IS A DESIGN OF RED CHERRIES WITH GREEN STEMS AND THE WORDS "CHERRY ARTIFICIALLY FLAVORED" IN WHITE.



David J. Kypos

SER. NO. 85-213,921, FILED 1-10-2011.

ERNEST SHOSHO, EXAMINING ATTORNEY

United States of America

United States Patent and Trademark Office



Reg. No. 4,107,649

Registered Mar. 6, 2012

Int. Cls.: 35 and 39

SERVICE MARK

PRINCIPAL REGISTER

PANTHER II TRANSPORTATION, INC. (OHIO CORPORATION)
4940 PANTHER PARKWAY
SEVILLE, OH 442738929

FOR: SUPPLY CHAIN MANAGEMENT SERVICES AND TRANSPORTATION MANAGEMENT OF DOMESTIC AND INTERNATIONAL SHIPMENTS; AND CONSULTATION SERVICES IN THE FIELD OF TRANSPORTATION MANAGEMENT, SHIPMENT PLANNING, ADMINISTRATION FOR FREIGHT BILL AUDITING, PAYMENT INVOICING AND REPORTING, IN CLASS 35 (U.S. CLS. 100, 101 AND 102).

FIRST USE 8-31-2009; IN COMMERCE 8-31-2009.

FOR: PICK-UP, TRANSPORTATION, STORAGE AND DELIVERY OF DOCUMENTS, PACKAGES AND FREIGHT BY LAND AND AIR, IN CLASS 39 (U.S. CLS. 100 AND 105).

FIRST USE 8-31-2009; IN COMMERCE 8-31-2009.

OWNER OF U.S. REG. NOS. 2,338,784, 3,235,775 AND OTHERS.

NO CLAIM IS MADE TO THE EXCLUSIVE RIGHT TO USE "PREMIUM LOGISTICS", APART FROM THE MARK AS SHOWN.

THE MARK CONSISTS OF THE STYLIZED WORD "PANTHER" BETWEEN TWO STYLIZED PARTIAL PANTHERS WITH A LINE AND THE STYLIZED WORDS "PREMIUM LOGISTICS" BELOW.

SER. NO. 85-213,934, FILED 1-10-2011.

MICHELLE DUBOIS, EXAMINING ATTORNEY



David J. Kyjars

Director of the United States Patent and Trademark Office

United States of America

United States Patent and Trademark Office



Reg. No. 4,107,650

Registered Mar. 6, 2012

Int. Cl.: 30

TRADEMARK

PRINCIPAL REGISTER

HERSHEY CHOCOLATE & CONFECTIONERY CORPORATION (DELAWARE CORPORATION)
CORPORATION)
SUITE 204
4860 ROBB STREET
WHEAT RIDGE, CO 80033

FOR: CANDY, IN CLASS 30 (U.S. CL. 46).

FIRST USE 8-1-2010; IN COMMERCE 8-1-2010.

OWNER OF U.S. REG. NOS. 680,105, 4,011,567 AND OTHERS.

THE COLOR(S) WHITE, BLUE, RED, YELLOW AND GREEN IS/ARE CLAIMED AS A FEATURE OF THE MARK.

NO CLAIM IS MADE TO THE EXCLUSIVE RIGHT TO USE "LOW FAT SNACK", "STRAWBERRY ARTIFICIALLY FLAVORED", THE PICTORIAL REPRESENTATION OF THE STRAWBERRIES AND THE PICTORIAL REPRESENTATION OF THE CANDY, APART FROM THE MARK AS SHOWN.

THE MARK CONSISTS OF A RECTANGULAR SHAPE BROKEN INTO THREE WAVY BANDS COLORED RED, WHITE AND RED FROM TOP TO BOTTOM. THE COLOR WHITE IN THIS PORTION OF THE MARK IS A TRANSPARENT AREA AND IS NOT PART OF THE MARK. THE MATTER SHOWN IN DOTTED LINES SHOWS POSITIONING OF THE MARK AND IS NOT PART OF THE MARK. ON THE RECTANGULAR SHAPE IS THE WORD "TWIZZLERS" IN WHITE WITH A BLUE AND RED BORDER. ABOVE AND BELOW THE WORD IS A DESIGN OF RED CANDY WITH THE WORDS "TOTALLY TWISTED" AND AN ARROW DESIGN ALL IN WHITE AT THE TOP OF THE CANDY DESIGN. TO THE LEFT OF THE CANDY DESIGN ARE THE WORDS "LOW FAT" IN YELLOW AND "SNACK" IN WHITE. UNDERNEATH THE WORD "TWIZZLERS" IS THE WORD "TWISTS" IN YELLOW. AT THE BOTTOM OF THE RECTANGLE DESIGN IS A DESIGN OF RED AND YELLOW STRAWBERRIES WITH GREEN LEAVES AND THE WORDS "STRAWBERRY ARTIFICIALLY FLAVORED" IN WHITE.



David J. Kyros

Director of the United States Patent and Trademark Office

SER. NO. 85-213,935, FILED 1-10-2011.

ERNEST SHOSHO, EXAMINING ATTORNEY

United States of America

United States Patent and Trademark Office



Reg. No. 4,107,651

Registered Mar. 6, 2012

Int. Cl.: 30

TRADEMARK

PRINCIPAL REGISTER

HERSHEY CHOCOLATE & CONFECTIONERY CORPORATION (DELAWARE CORPORATION)
SUITE 204
4860 ROBB STREET
WHEAT RIDGE, CO 80033

FOR: CANDY, IN CLASS 30 (U.S. CL. 46).

FIRST USE 8-1-2010; IN COMMERCE 8-1-2010.

OWNER OF U.S. REG. NOS. 680,105, 4,011,567 AND OTHERS.

THE COLOR(S) WHITE, BLUE, RED, YELLOW, AND GREEN IS/ARE CLAIMED AS A FEATURE OF THE MARK.

NO CLAIM IS MADE TO THE EXCLUSIVE RIGHT TO USE "LOW FAT SNACK", "STRAWBERRY ARTIFICIALLY FLAVORED", THE PICTORIAL REPRESENTATION OF THE STRAWBERRIES AND THE PICTORIAL REPRESENTATION OF THE CANDY, APART FROM THE MARK AS SHOWN.

THE MARK CONSISTS OF A RECTANGULAR SHAPE BROKEN INTO THREE WAVY BANDS COLORED RED, WHITE AND RED FROM LEFT TO RIGHT. THE COLOR WHITE IN THIS PORTION OF THE MARK IS A TRANSPARENT AREA AND IS NOT PART OF THE MARK. THE MATTER SHOWN IN DOTTED LINES SHOWS POSITIONING OF THE MARK AND IS NOT PART OF THE MARK. ON THE RECTANGULAR SHAPE IS THE WORD "TWIZZLERS" IN WHITE WITH A BLUE AND RED BORDER. ABOVE AND BELOW THE WORD IS A DESIGN OF RED CANDY WITH THE WORDS "TOTALLY TWISTED" AND AN ARROW DESIGN ALL IN WHITE AT THE TOP OF THE CANDY DESIGN. TO THE LEFT OF THE CANDY DESIGN ARE THE WORDS "LOW FAT" IN YELLOW AND "SNACK" IN WHITE. UNDERNEATH THE WORD "TWIZZLERS" IS THE WORD "TWISTS" IN YELLOW. AT THE RIGHT OF THE RECTANGLE DESIGN IS A DESIGN OF RED AND YELLOW STRAWBERRIES WITH GREEN LEAVES AND THE WORDS "STRAWBERRY ARTIFICIALLY FLAVORED" IN WHITE.



David J. Kyffers

Director of the United States Patent and Trademark Office

SER. NO. 85-213,948, FILED 1-10-2011.

ERNEST SHOSHO, EXAMINING ATTORNEY

United States of America

United States Patent and Trademark Office

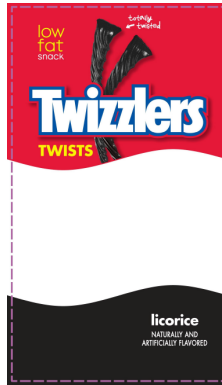

Reg. No. 4,107,652

Registered Mar. 6, 2012

Int. Cl.: 30

HERSHEY CHOCOLATE & CONFECTIONERY CORPORATION (DELAWARE CORPORATION)
CORPORATION)
SUITE 204
4860 ROBB STREET
WHEAT RIDGE, CO 80033

TRADEMARK

FOR: CANDY, IN CLASS 30 (U.S. CL. 46).

PRINCIPAL REGISTER

FIRST USE 8-1-2010; IN COMMERCE 8-1-2010.

OWNER OF U.S. REG. NOS. 680,105, 4,011,567 AND OTHERS.

THE COLOR(S) WHITE, BLUE, RED, YELLOW, AND BLACK IS/ARE CLAIMED AS A FEATURE OF THE MARK.

NO CLAIM IS MADE TO THE EXCLUSIVE RIGHT TO USE "LOW FAT SNACK", "LICORICE", "NATURALLY AND ARTIFICIALLY FLAVORED" AND THE PICTORIAL REPRESENTATION OF THE CANDY, APART FROM THE MARK AS SHOWN.

THE MARK CONSISTS OF A RECTANGULAR SHAPE BROKEN INTO THREE WAVY BANDS COLORED RED, WHITE AND BLACK FROM TOP TO BOTTOM. THE COLOR WHITE IN THIS PORTION OF THE MARK IS A TRANSPARENT AREA AND IS NOT PART OF THE MARK. THE MATTER SHOWN IN DOTTED LINES SHOWS POSITIONING OF THE MARK AND IS NOT PART OF THE MARK. ON THE RECTANGULAR SHAPE IS THE WORD "TWIZZLERS" IN WHITE WITH A BLUE AND RED BORDER. ABOVE AND BELOW THE WORD IS A DESIGN OF BLACK CANDY WITH THE WORDS "TOTALLY TWISTED" AND AN ARROW DESIGN ALL IN WHITE AT THE TOP OF THE CANDY DESIGN. TO THE LEFT OF THE CANDY DESIGN ARE THE WORDS "LOW FAT" IN YELLOW AND "SNACK" IN WHITE. UNDERNEATH THE WORD "TWIZZLERS" IS THE WORD "TWISTS" IN YELLOW. AT THE BOTTOM OF THE RECTANGLE DESIGN ARE THE WORDS "LICORICE NATURALLY AND ARTIFICIALLY FLAVORED" IN WHITE.



SER. NO. 85-213,967, FILED 1-10-2011.

David J. Kypos

ERNEST SHOSHO, EXAMINING ATTORNEY

United States of America

United States Patent and Trademark Office



Reg. No. 4,107,653

Registered Mar. 6, 2012

Int. Cl.: 30

TRADEMARK

PRINCIPAL REGISTER

HERSHEY CHOCOLATE & CONFECTIONERY CORPORATION (DELAWARE CORPORATION)
SUITE 204
4860 ROBB STREET
WHEAT RIDGE, CO 80033

FOR: CANDY, IN CLASS 30 (U.S. CL. 46).

FIRST USE 8-1-2010; IN COMMERCE 8-1-2010.

OWNER OF U.S. REG. NOS. 680,105, 4,011,567 AND OTHERS.

THE COLOR(S) WHITE, BLUE, RED, YELLOW, AND BLACK IS/ARE CLAIMED AS A FEATURE OF THE MARK.

NO CLAIM IS MADE TO THE EXCLUSIVE RIGHT TO USE "LOW FAT SNACK", "LICORICE", "NATURALLY AND ARTIFICIALLY FLAVORED" AND THE PICTORIAL REPRESENTATION OF THE CANDY, APART FROM THE MARK AS SHOWN.

THE MARK CONSISTS OF A RECTANGULAR SHAPE BROKEN INTO THREE WAVY BANDS COLORED RED, WHITE AND BLACK FROM LEFT TO RIGHT. THE COLOR WHITE IN THIS PORTION OF THE MARK IS A TRANSPARENT AREA AND IS NOT PART OF THE MARK. THE MATTER SHOWN IN DOTTED LINES SHOWS POSITIONING OF THE MARK AND IS NOT PART OF THE MARK. IN THE CENTER LEFT OF THE RECTANGULAR SHAPE IS THE PHRASE "TWIZZLERS TWISTS" REPEATED TWICE IN THE SAME COLOR SCHEME WHERE THE WORD "TWIZZLERS" IS IN WHITE WITH A RED AND BLUE BORDER AND THE WORD "TWISTS" IS IN YELLOW. ABOVE AND BELOW "TWIZZLERS TWISTS" IS A DESIGN OF BLACK CANDY WITH THE WORDS "TOTALLY TWISTED" AND AN ARROW DESIGN ALL IN WHITE AT THE TOP OF THE CANDY DESIGN. TO THE LEFT OF THE CANDY DESIGN ARE THE WORDS "LOW FAT" IN YELLOW AND "SNACK" IN WHITE. AT THE RIGHT OF THE RECTANGLE DESIGN ARE THE WORDS "LICORICE NATURALLY AND ARTIFICIALLY FLAVORED" IN WHITE REPEATED TWICE AT THE MIDDLE AND BOTTOM OF THE BLACK WAVY BAND.



David J. Kypos

Director of the United States Patent and Trademark Office

SER. NO. 85-213,979, FILED 1-10-2011.

ERNEST SHOSHO, EXAMINING ATTORNEY

United States of America

United States Patent and Trademark Office



Reg. No. 4,107,654

Registered Mar. 6, 2012

Int. Cls.: 9, 35 and 42

TRADEMARK

SERVICE MARK

PRINCIPAL REGISTER

K12 ENTERPRISE LLC (MARYLAND LIMITED LIABILITY COMPANY)
SUITE 514
1220-C EAST JOPPA ROAD
TOWSON, MD 21286

FOR: COMPUTER SOFTWARE FOR USE IN PERFORMING BUSINESS TRANSACTIONS, NAMELY, FINANCIAL MANAGEMENT, FINANCIAL TRANSACTIONS AND RECORD KEEPING, ACCOUNTING, HUMAN RELATIONS FUNCTIONS, HUMAN RESOURCES, PAYROLL PROCESSING AND MANAGEMENT, PROCUREMENT, AND STAFF MANAGEMENT FOR USE BY SCHOOL DISTRICTS AND SCHOOL SYSTEMS, IN CLASS 9 (U.S. CLS. 21, 23, 26, 36 AND 38).

FIRST USE 12-16-2010; IN COMMERCE 12-16-2010.

FOR: VALUE-ADDED RESELLER SERVICES, NAMELY, DISTRIBUTORSHIP SERVICES FEATURING COMPUTER SOFTWARE, IN CLASS 35 (U.S. CLS. 100, 101 AND 102).

FIRST USE 12-16-2010; IN COMMERCE 12-16-2010.

FOR: APPLICATION SERVICE PROVIDER (ASP) FEATURING SOFTWARE FOR USE IN THE HOSTING, MANAGING, DEVELOPING AND MAINTAINING OF APPLICATIONS, WEBSITES, AND DATABASES, ALL SOFTWARE BEING IN THE FIELD OF BUSINESS SYSTEMS FOR SCHOOL DISTRICTS AND SCHOOL SYSTEMS; INSTALLATION OF COMPUTER SOFTWARE FOR USE IN PERFORMING BUSINESS TRANSACTIONS RELATING TO FINANCIAL MANAGEMENT, FINANCIAL TRANSACTIONS AND RECORD KEEPING, ACCOUNTING, HUMAN RELATIONS FUNCTIONS, HUMAN RESOURCES, PAYROLL PROCESSING AND MANAGEMENT, PROCUREMENT, AND STAFF MANAGEMENT FOR USE BY SCHOOL DISTRICTS AND SCHOOL SYSTEMS, IN CLASS 42 (U.S. CLS. 100 AND 101).

FIRST USE 12-16-2010; IN COMMERCE 12-16-2010.

NO CLAIM IS MADE TO THE EXCLUSIVE RIGHT TO USE "K12 ENTERPRISE", APART FROM THE MARK AS SHOWN.

THE COLOR(S) ORANGE, GREEN, RED, LIGHT BLUE, AND DARK BLUE IS/ARE CLAIMED AS A FEATURE OF THE MARK.



David J. Kybas

Director of the United States Patent and Trademark Office

Reg. No. 4,107,654 THE MARK CONSISTS OF A DESIGN ELEMENT CONSISTING OF THREE COLUMNS OF GEOMETRIC SHAPES REPRESENTING HUMAN FIGURES. THE FIRST COLUMN CONSISTS OF A GREEN SQUARE WITH AN ORANGE CIRCLE ON TOP OF IT. THE SECOND COLUMN CONSISTS OF TWO DARK BLUE SQUARES WITH AN ORANGE CIRCLE ON TOP OF THEM. THE THIRD COLUMN CONSISTS OF THREE RED SQUARES WITH AN ORANGE CIRCLE ON TOP OF THEM. THE TERM "K12" APPEARS TO THE RIGHT OF THE DESIGN IN DARK BLUE. THE NUMBER "12" IS SMALLER IN SIZE THAN THE LETTER "K". THE WORD "ENTERPRISE" APPEARS UNDER THE DESIGN AND "K12" IN LIGHT BLUE. THE WHITE BACKGROUND IS NOT PART OF THE MARK.

SER. NO. 85-214,131, FILED 1-10-2011.

CHARLES L. JENKINS, EXAMINING ATTORNEY

United States of America

United States Patent and Trademark Office

FOURSIGHT

Reg. No. 4,107,655

Registered Mar. 6, 2012

Int. Cl.: 41

SERVICE MARK

PRINCIPAL REGISTER

FOURSIGHT GROUP, LLC (DELAWARE LIMITED LIABILITY COMPANY)
1809 CENTRAL STREET, SUITE 2E
EVANSTON, IL 60201

FOR: PUBLISHING OF RESEARCH-BASED PSYCHOLOGICAL TESTING AND ASSESSMENT, EDUCATION AND TRAINING MATERIALS, NAMELY, BOOKS, MANUALS, AND REPORTS, IN CLASS 41 (U.S. CLS. 100, 101 AND 107).

FIRST USE 1-1-2002; IN COMMERCE 1-1-2002.

THE MARK CONSISTS OF STANDARD CHARACTERS WITHOUT CLAIM TO ANY PARTICULAR FONT, STYLE, SIZE, OR COLOR.

SER. NO. 85-214,353, FILED 1-10-2011.

ELLEN BURNS, EXAMINING ATTORNEY



David J. Kyjars

Director of the United States Patent and Trademark Office

United States of America

United States Patent and Trademark Office

FOURSIGHT

Reg. No. 4,107,656

Registered Mar. 6, 2012

Int. Cl.: 16

TRADEMARK

PRINCIPAL REGISTER

FOURSIGHT GROUP, LLC (DELAWARE LIMITED LIABILITY COMPANY)
1809 CENTRAL STREET, SUITE 2E
EVANSTON, IL 60201

FOR: PRINTED MATTER, NAMELY, BOOKS, MANUALS, GUIDES, WORKBOOKS, CARDS, TEST AND ANSWER SHEETS, INTERPRETIVE REPORTS AND OTHER PUBLICATIONS IN THE NATURE OF ASSESSMENT REPORTS, ALL IN THE FIELD OF RESEARCH-BASED PSYCHOLOGICAL TESTING, ASSESSMENT, EDUCATION, TRAINING, CREATIVITY LEADERSHIP TRAINING, COUNSELING, AND TEAM BUILDING, IN CLASS 16 (U.S. CLS. 2, 5, 22, 23, 29, 37, 38 AND 50).

FIRST USE 1-1-2002; IN COMMERCE 1-1-2002.

THE MARK CONSISTS OF STANDARD CHARACTERS WITHOUT CLAIM TO ANY PARTICULAR FONT, STYLE, SIZE, OR COLOR.

SER. NO. 85-214,361, FILED 1-10-2011.

ELLEN BURNS, EXAMINING ATTORNEY



David J. Kyjars

Director of the United States Patent and Trademark Office

United States of America

United States Patent and Trademark Office



Reg. No. 4,107,657

Registered Mar. 6, 2012

Int. Cl.: 16

TRADEMARK

PRINCIPAL REGISTER

FOURSIGHT GROUP, LLC (DELAWARE LIMITED LIABILITY COMPANY)
1809 CENTRAL STREET, SUITE 2E
EVANSTON, IL 60201

FOR: PRINTED MATTER, NAMELY, BOOKS, MANUALS, GUIDES, WORKBOOKS, CARDS, TEST AND ANSWER SHEETS, INTERPRETIVE REPORTS AND OTHER PUBLICATIONS IN THE NATURE OF ASSESSMENT REPORTS, ALL IN THE FIELD OF RESEARCH-BASED PSYCHOLOGICAL TESTING, ASSESSMENT, EDUCATION, TRAINING, CREATIVITY LEADERSHIP TRAINING, COUNSELING, AND TEAM BUILDING, IN CLASS 16 (U.S. CLS. 2, 5, 22, 23, 29, 37, 38 AND 50).

FIRST USE 1-1-2002; IN COMMERCE 1-1-2002.

THE MARK CONSISTS OF A GRAPHIC OF TWO CURVED LINES, AROUND WHICH FOUR DOTS ARE PLACED IN A SQUARE FORMATION.

SER. NO. 85-214,376, FILED 1-10-2011.

ELLEN BURNS, EXAMINING ATTORNEY



David J. Kybas

Director of the United States Patent and Trademark Office

United States of America

United States Patent and Trademark Office



Reg. No. 4,107,658

Registered Mar. 6, 2012

Int. Cl.: 41

SERVICE MARK

PRINCIPAL REGISTER

FOURSIGHT GROUP, LLC (DELAWARE LIMITED LIABILITY COMPANY)
1809 CENTRAL STREET, SUITE 2E
EVANSTON, IL 60201

FOR: EDUCATION SERVICES, NAMELY, PROVIDING CLASSES, SEMINARS AND WORKSHOPS IN THE FIELD OF CREATIVITY LEADERSHIP TRAINING, COUNSELING AND TEAM BUILDING; AND PUBLISHING OF RESEARCH-BASED PSYCHOLOGICAL TESTING AND ASSESSMENT, EDUCATION AND TRAINING MATERIALS, NAMELY, BOOKS, MANUALS, AND REPORTS, IN CLASS 41 (U.S. CLS. 100, 101 AND 107).

FIRST USE 1-1-2002; IN COMMERCE 1-1-2002.

THE MARK CONSISTS OF A GRAPHIC OF TWO CURVED LINES, AROUND WHICH FOUR DOTS ARE PLACED IN A SQUARE FORMATION.

SER. NO. 85-214,389, FILED 1-10-2011.

ELLEN BURNS, EXAMINING ATTORNEY



David J. Kyffers

Director of the United States Patent and Trademark Office

United States of America

United States Patent and Trademark Office



Reg. No. 4,107,659

CITY OF ST. CLOUD, FLORIDA (FLORIDA STATE AGENCY)
1300 NORTH STREET
ST. CLOUD, FL 34769

Registered Mar. 6, 2012

Int. Cl.: 35

FOR: PROMOTING THE BUSINESS, COMMERCIAL, ENTERTAINMENT, AND RESIDENTIAL DEVELOPMENT OF THE CITY OF ST. CLOUD, IN CLASS 35 (U.S. CLS. 100, 101 AND 102).

SERVICE MARK

FIRST USE 4-16-2010; IN COMMERCE 4-16-2010.

PRINCIPAL REGISTER

OWNER OF U.S. REG. NO. 3,034,181.

THE COLOR(S) GREEN, BLUE, BLACK, AND WHITE IS/ARE CLAIMED AS A FEATURE OF THE MARK.

NO CLAIM IS MADE TO THE EXCLUSIVE RIGHT TO USE "ST. CLOUD FLORIDA" AND "COMMUNITY REDEVELOPMENT AGENCY DOWNTOWN CENTRAL WEST END", APART FROM THE MARK AS SHOWN.

THE MARK CONSISTS OF A DIAGONAL WHITE SASH BISECTING A GREEN SQUARE FROM THE LOWER LEFT CORNER TO THE UPPER RIGHT CORNER, SO THAT THE PRESENCE OF THE SASH ESSENTIALLY CREATES A GREEN TRIANGLE ABOVE THE SASH, AND A GREEN TRIANGLE BELOW THE SASH. THE WHITE SASH CONTAINS THE WORDS "ST. CLOUD" ABOVE THE WORD "FLORIDA" IN BLACK, IN ITALICIZED FONT. TO THE RIGHT OF THE GREEN SQUARE PORTION, IN BLUE, BLOCK FONT, ARE THE LETTERS "C", "R", AND "A", IN ALL CAPITAL LETTERS. BELOW THE "CRA" LETTERS, IN THE SAME BLUE FONT, ARE THE WORDS "COMMUNITY REDEVELOPMENT AGENCY". BELOW BOTH THE GREEN SQUARE PORTION OF THE MARK AND THE BLUE "COMMUNITY REDEVELOPMENT AGENCY" PORTION OF THE MARK IS A THIN BLACK LINE, BELOW WHICH ARE THE WORDS, "DOWNTOWN", "CENTRAL", AND "WEST END", IN BLACK COLOR. A SMALL BLACK CIRCLE SEPARATES THE WORDS "DOWNTOWN" AND "CENTRAL", AND "CENTRAL" AND "WEST END". BELOW THESE WORDS IS ANOTHER THIN BLACK LINE.



David J. Kyros

SER. NO. 85-214,620, FILED 1-11-2011.

FRANK LATTUCA, EXAMINING ATTORNEY

United States of America

United States Patent and Trademark Office



Reg. No. 4,107,660

Registered Mar. 6, 2012

Int. Cl.: 39

SERVICE MARK

PRINCIPAL REGISTER

PANTHER II TRANSPORTATION, INC. (OHIO CORPORATION)
4940 PANTHER PARKWAY
SEVILLE, OH 442738929

FOR: PICK-UP, TRANSPORTATION, STORAGE AND DELIVERY OF DOCUMENTS, PACKAGES AND FREIGHT BY LAND, OCEAN AND AIR, IN CLASS 39 (U.S. CLS. 100 AND 105).

FIRST USE 8-31-2009; IN COMMERCE 8-31-2009.

OWNER OF U.S. REG. NOS. 2,338,784, 3,235,775 AND OTHERS.

NO CLAIM IS MADE TO THE EXCLUSIVE RIGHT TO USE "GROUND AIR OCEAN LOGISTICS", APART FROM THE MARK AS SHOWN.

THE MARK CONSISTS OF THE STYLIZED WORD "PANTHER" IN THE MIDDLE OF TWO STYLIZED PARTIAL PANTHER BODIES WITH A LINE AND THE STYLIZED WORDS "GROUND AIR OCEAN LOGISTICS" BELOW.

SER. NO. 85-214,707, FILED 1-11-2011.

MICHELLE DUBOIS, EXAMINING ATTORNEY



David J. Kyjars

Director of the United States Patent and Trademark Office

United States of America

United States Patent and Trademark Office



Reg. No. 4,107,661

Registered Mar. 6, 2012

Int. Cl.: 39

SERVICE MARK

PRINCIPAL REGISTER

PANTHER II TRANSPORTATION, INC. (OHIO CORPORATION)
4940 PANTHER PARKWAY
SEVILLE, OH 442738929

FOR: PICK-UP, TRANSPORTATION, STORAGE AND DELIVERY OF DOCUMENTS, PACKAGES AND FREIGHT BY LAND, OCEAN AND AIR, IN CLASS 39 (U.S. CLS. 100 AND 105).

FIRST USE 12-30-1992; IN COMMERCE 12-30-1992.

OWNER OF U.S. REG. NOS. 2,338,784, 3,235,775 AND OTHERS.

THE MARK CONSISTS OF THE STYLIZED WORD "PANTHER" BETWEEN TWO STYLIZED PARTIAL PANTHER BODIES.

SER. NO. 85-215,136, FILED 1-11-2011.

MICHELLE DUBOIS, EXAMINING ATTORNEY



David J. Kybas

Director of the United States Patent and Trademark Office

United States of America

United States Patent and Trademark Office

MoBe

Reg. No. 4,107,662

Registered Mar. 6, 2012

Int. Cls.: 36 and 38

SERVICE MARK

PRINCIPAL REGISTER

PAY2GLOBAL LIMITED (UNITED KINGDOM LIMITED COMPANY (LTD.))
5 ST HELENS PLACE, BISHOPSGATE
LONDON, UNITED KINGDOM EC3A

FOR: FINANCIAL TRANSACTION SERVICES, NAMELY, PROVIDING SECURE COMMERCIAL TRANSACTIONS AND PAYMENT OPTIONS USING A MOBILE DEVICE AT A POINT OF SALE; FINANCIAL TRANSACTION SERVICES, NAMELY, PROVIDING SECURE COMMERCIAL TRANSACTIONS AND PAYMENT OPTIONS; FINANCIAL SERVICES, NAMELY, FUNDING ONLINE CASH ACCOUNTS FROM PREPAID CASH CARDS, BANK ACCOUNTS AND CREDIT CARD ACCOUNT; PROVIDING FINANCIAL INFORMATION; BANKING SERVICES; ELECTRONIC TRANSFER OF MONEY; ENABLING THE TRANSFER OF FUNDS TO FACILITATE THE PURCHASE OF PRODUCTS AND SERVICES OFFERED BY OTHERS, ALL VIA ELECTRONIC COMMUNICATION NETWORKS; BILL PAYMENT SERVICES; WIRELESS TELEPHONE PAYMENT SERVICES, NAMELY, WIRELESS MOBILE TELEPHONE RATE PLANS; CHARGE CARD AND CREDIT CARD SERVICES; FOREIGN EXCHANGE TRANSACTIONS; ISSUE OF TOKENS OF VALUE; CLEARING AND RECONCILING FINANCIAL TRANSACTIONS VIA A GLOBAL COMPUTER NETWORK; FINANCIAL CLEARING-HOUSE SERVICES; MAINTAINING ESCROW ACCOUNTS FOR INVESTMENTS; ON-LINE ESCROW SERVICE FOR EXCHANGE OF SERVICES; FRAUD REIMBURSEMENT SERVICES IN THE FIELD OF CREDIT CARD PURCHASES; CHARITABLE FUNDRAISING SERVICES, IN CLASS 36 (U.S. CLS. 100, 101 AND 102).



FOR: TELECOMMUNICATIONS SERVICES, NAMELY, WIRELESS TELEPHONY AND WIRELESS BROADBAND COMMUNICATIONS SERVICES FOR THE TRANSMISSION OF VOICE AND DATA; TELECOMMUNICATIONS SERVICES, NAMELY, PERSONAL COMMUNICATION SERVICES; TELECOMMUNICATIONS BY E-MAIL; INSTANT MESSAGING SERVICES; SMS MESSAGING SERVICES; TELECOMMUNICATION SERVICES, NAMELY, PROVIDING INTERNET ACCESS VIA BROADBAND OPTICAL OR WIRELESS NETWORKS; TELECOMMUNICATION SERVICES, NAMELY, TRANSMISSION OF PODCASTS OR WEBCASTS; VIRTUAL CHAT ROOMS ESTABLISHED VIA TEXT MESSAGING, IN CLASS 38 (U.S. CLS. 100, 101 AND 104).

THE MARK CONSISTS OF STANDARD CHARACTERS WITHOUT CLAIM TO ANY PARTICULAR FONT, STYLE, SIZE, OR COLOR.

David J. Kyjars

Director of the United States Patent and Trademark Office

PRIORITY CLAIMED UNDER SEC. 44(D) ON UNITED KINGDOM APPLICATION NO. 2563837, FILED 11-10-2010, REG. NO. 2563837, DATED 11-10-2010, EXPIRES 11-10-2020.

Reg. No. 4,107,662 SER. NO. 85-215,249, FILED 1-11-2011.

MICHAEL KEATING, EXAMINING ATTORNEY

United States of America

United States Patent and Trademark Office

DICENTRAL

Reg. No. 4,107,663

Registered Mar. 6, 2012

Int. Cl.: 42

SERVICE MARK

PRINCIPAL REGISTER

DICENTRAL CORPORATION (TEXAS CORPORATION)
1199 NASA PARKWAY
HOUSTON, TX 77058

FOR: DEVELOPMENT OF COMPUTER SOFTWARE FOR OTHERS IN THE FIELD OF ELECTRONIC DATA INTERCHANGE SOFTWARE; CONSULTING IN THE FIELD OF SOFTWARE DEVELOPMENT IN THE FIELD OF ELECTRONIC DATA INTERCHANGE SOFTWARE; CONSULTATION SERVICES IN THE FIELDS OF SELECTION AND IMPLEMENTATION OF COMPUTER SOFTWARE FOR OTHERS IN THE FIELD OF ELECTRONIC DATA INTERCHANGE; SOFTWARE AS A SERVICE (SAAS) SERVICES, NAMELY, HOSTING ELECTRONIC COMMERCE SOFTWARE FOR USE BY OTHERS FOR USE IN ALLOWING USERS TO PERFORM ELECTRONIC BUSINESS TRANSACTIONS VIA A GLOBAL COMPUTER NETWORK AND FOR USE IN ALLOWING USERS TO PERFORM THE ELECTRONIC EXCHANGE OF DOCUMENTS AND DATA, IN CLASS 42 (U.S. CLS. 100 AND 101).

FIRST USE 7-1-2000; IN COMMERCE 7-1-2000.

THE MARK CONSISTS OF STANDARD CHARACTERS WITHOUT CLAIM TO ANY PARTICULAR FONT, STYLE, SIZE, OR COLOR.

OWNER OF U.S. REG. NO. 3,364,856.

SER. NO. 85-216,636, FILED 1-13-2011.

B. PARADEWELAI, EXAMINING ATTORNEY



David J. Kyffers

Director of the United States Patent and Trademark Office

United States of America

United States Patent and Trademark Office



Reg. No. 4,107,664

Registered Mar. 6, 2012

Int. Cl.: 35

SERVICE MARK

PRINCIPAL REGISTER

C&K MARKET, INC. (OREGON CORPORATION)
LEGAL DEPARTMENT
615 5TH STREET
BROOKINGS, OR 97415

FOR: RETAIL AND WHOLESALE GROCERY STORE SERVICES, IN CLASS 35 (U.S. CLS. 100, 101 AND 102).

FIRST USE 0-0-1956; IN COMMERCE 0-0-1967.

OWNER OF U.S. REG. NOS. 3,864,247 AND 3,872,828.

NO CLAIM IS MADE TO THE EXCLUSIVE RIGHT TO USE "MARKET INC.", APART FROM THE MARK AS SHOWN.

THE MARK CONSISTS OF A SERIES OF THREE RECTANGULAR SHAPES, EACH OF WHOSE LENGTHWISE SIDES ARE PARABOLIC, WITH THE LITERAL ELEMENTS OF THE MARK, "C&K" AND "C&K MARKET, INC.", APPEARING IN THE INNERMOST RECTANGULAR SHAPE AND SEPARATED BY A HORIZONTAL LINE, AND WITH THE REMAINING TWO RECTANGULAR SHAPES FRAMING THE INNER RECTANGULAR SHAPE WITH THEIR BORDERS MERGED AND CENTERED ALONG THE LENGTHWISE SIDES.

SER. NO. 85-216,931, FILED 1-13-2011.

JAMES GRIFFIN, EXAMINING ATTORNEY



David J. Kyffers

Director of the United States Patent and Trademark Office

United States of America

United States Patent and Trademark Office

ENVIRONIC FOUNDATION INTERNATIONAL

Reg. No. 4,107,665

Registered Mar. 6, 2012

Int. Cl.: 35

SERVICE MARK

PRINCIPAL REGISTER

ENVIRONIC FOUNDATION INTERNATIONAL (INDIANA NON-PROFIT CORPORATION)
12035 STONEWICK PLACE
GLEN ALLEN, VA 230597152

FOR: PROMOTING PUBLIC AWARENESS IN THE FIELDS OF CONSTRUCTIVE SOCIAL AND ECONOMIC PRACTICES AND NATURAL RESOURCE MANAGEMENT AND CONSERVANCY; PROVIDING INFORMATION IN THE FIELD OF NATURAL RESOURCE MANAGEMENT AND PROMOTING SOCIETAL, ECOLOGICAL AND ECONOMIC BENEFITS FROM APPROPRIATE USES OF NATURAL RESOURCES WORLDWIDE, IN CLASS 35 (U.S. CLS. 100, 101 AND 102).

FIRST USE 12-31-1970; IN COMMERCE 12-31-1970.

THE MARK CONSISTS OF STANDARD CHARACTERS WITHOUT CLAIM TO ANY PARTICULAR FONT, STYLE, SIZE, OR COLOR.

NO CLAIM IS MADE TO THE EXCLUSIVE RIGHT TO USE "FOUNDATION INTERNATIONAL", APART FROM THE MARK AS SHOWN.

SER. NO. 85-217,013, FILED 1-13-2011.

ANDREA HACK, EXAMINING ATTORNEY



David J. Kyffers

Director of the United States Patent and Trademark Office

United States of America

United States Patent and Trademark Office

EFI

Reg. No. 4,107,666

Registered Mar. 6, 2012

Int. Cl.: 35

SERVICE MARK

PRINCIPAL REGISTER

ENVIRONIC FOUNDATION INTERNATIONAL (INDIANA NON-PROFIT CORPORATION)
12035 STONEWICK PLACE
GLEN ALLEN, VA 230597152

FOR: PROMOTING PUBLIC AWARENESS IN THE FIELDS OF CONSTRUCTIVE SOCIAL AND ECONOMIC PRACTICES AND NATURAL RESOURCE MANAGEMENT AND CONSERVANCY; PROVIDING INFORMATION IN THE FIELD OF NATURAL RESOURCE MANAGEMENT AND PROMOTING SOCIETAL, ECOLOGICAL AND ECONOMIC BENEFITS FROM APPROPRIATE USES OF NATURAL RESOURCES WORLDWIDE, IN CLASS 35 (U.S. CLS. 100, 101 AND 102).

FIRST USE 5-17-2001; IN COMMERCE 5-17-2001.

THE MARK CONSISTS OF STANDARD CHARACTERS WITHOUT CLAIM TO ANY PARTICULAR FONT, STYLE, SIZE, OR COLOR.

SER. NO. 85-217,019, FILED 1-13-2011.

ANDREA HACK, EXAMINING ATTORNEY



David J. Kybas

Director of the United States Patent and Trademark Office

United States of America

United States Patent and Trademark Office

Shoulder Works

Reg. No. 4,107,667

SAMUEL S. KOO (UNITED STATES INDIVIDUAL)
901 BOREN STREET, SUITE 800
SEATTLE, WA 98104

Registered Mar. 6, 2012

Int. Cl.: 44

FOR: MEDICAL CLINICS; MEDICAL CONSULTATIONS; MEDICAL SERVICES; PHYSICAL REHABILITATION; PHYSICIAN SERVICES; PROVIDING A WEB SITE FEATURING MEDICAL INFORMATION; PROVIDING MEDICAL INFORMATION; SURGERY, IN CLASS 44 (U.S. CLS. 100 AND 101).

SERVICE MARK

PRINCIPAL REGISTER

FIRST USE 9-30-2010; IN COMMERCE 9-30-2010.

THE MARK CONSISTS OF STANDARD CHARACTERS WITHOUT CLAIM TO ANY PARTICULAR FONT, STYLE, SIZE, OR COLOR.

SER. NO. 85-217,483, FILED 1-13-2011.

KRISTINA MORRIS, EXAMINING ATTORNEY



David J. Kyffers

Director of the United States Patent and Trademark Office

United States of America

United States Patent and Trademark Office

REEL STUNTS

Reg. No. 4,107,668

REEL EFX, INC. (CALIFORNIA CORPORATION)
5539 RIVERTON AVENUE
NORTH HOLLYWOOD, CA 91601

Registered Mar. 6, 2012

Int. Cl.: 41

FOR: ENTERTAINMENT SERVICES, NAMELY, THE CREATION AND PRODUCTION OF MECHANICAL AND COMPUTER GENERATED ACTION SEQUENCES, IN CLASS 41 (U.S. CLS. 100, 101 AND 107).

SERVICE MARK

FIRST USE 3-1-2011; IN COMMERCE 3-1-2011.

PRINCIPAL REGISTER

THE MARK CONSISTS OF STANDARD CHARACTERS WITHOUT CLAIM TO ANY PARTICULAR FONT, STYLE, SIZE, OR COLOR.

NO CLAIM IS MADE TO THE EXCLUSIVE RIGHT TO USE "STUNTS", APART FROM THE MARK AS SHOWN.

SER. NO. 85-217,686, FILED 1-14-2011.

TRICIA SONNEBORN, EXAMINING ATTORNEY



David J. Kyffers

Director of the United States Patent and Trademark Office

United States of America

United States Patent and Trademark Office



Reg. No. 4,107,669

Registered Mar. 6, 2012

CERTIFICATION MARK

PRINCIPAL REGISTER

NORTH AMERICAN BOARD OF CERTIFIED ENERGY PRACTITIONERS, INC. (NABCEP)
(NEVADA NON-PROFIT CORPORATION)
56 CLIFTON COUNTRY ROAD, SUITE 202
CLIFTON PARK, NY 12065

FOR: INSTALLATION AND MAINTENANCE OF SMALL WIND ENERGY SYSTEMS, IN CLASS B (U.S. CL. B).

FIRST USE 10-15-2010; IN COMMERCE 10-15-2010.

OWNER OF U.S. REG. NOS. 2,897,803, 2,971,642, AND 3,616,648.

THE COLOR(S) BLACK, ORANGE, AND GRAY IS/ARE CLAIMED AS A FEATURE OF THE MARK.

NO CLAIM IS MADE TO THE EXCLUSIVE RIGHT TO USE "NORTH AMERICAN BOARD OF CERTIFIED ENERGY PRACTITIONERS CERTIFIED SMALL WIND INSTALLER", APART FROM THE MARK AS SHOWN.

THE MARK CONSISTS OF THE WORDS "NORTH AMERICAN BOARD OF CERTIFIED ENERGY PRACTITIONERS CERTIFIED SMALL WIND INSTALLER," INCLUDING A REPRESENTATION OF THE SUN POSITIONED ON THE LEFT-SIDE OF THE MARK. THE WORDS "SMALL WIND" AND THE SUN ARE IN ORANGE. THE WORD "INSTALLER" IS IN GRAY. THE REMAINING WORDING APPEARS IN BLACK. THE WHITE SHOWN IN THE MARK REPRESENTS BACKGROUND ONLY AND IS NOT INTENDED AS A FEATURE OF THE MARK. THE WORDS "NORTH AMERICAN BOARD OF CERTIFIED ENERGY PRACTITIONERS" FORM A CIRCLE AROUND THE WORDS "CERTIFIED SMALL WIND INSTALLER".

THE CERTIFICATION MARK, AS USED BY AUTHORIZED PERSONS, CERTIFIES THAT THESE PERSONS, WHO ARE PERFORMING THE SERVICES IDENTIFIED ABOVE, HAVE DEMONSTRATED SATISFACTORY TECHNICAL KNOWLEDGE TO APPLY THE APPROPRIATE PROFESSIONAL SKILLS NECESSARY IN THE FIELD OF SMALL WIND TECHNOLOGY, IN ACCORDANCE WITH THE REQUIREMENTS ESTABLISHED BY THE CERTIFIER, INCLUDING THE COMPLETION OF EDUCATIONAL AND/OR OCCUPATIONAL REQUIREMENTS; APPROPRIATE PROFESSIONAL EXPERIENCE; AND, SUCCESSFUL COMPLETION OF A KNOWLEDGE-BASED EXAMINATION



David J. Kyjars

Director of the United States Patent and Trademark Office

Reg. No. 4,107,669 SER. NO. 85-218,009, FILED 1-14-2011.

WENDY JUN, EXAMINING ATTORNEY

United States of America

United States Patent and Trademark Office

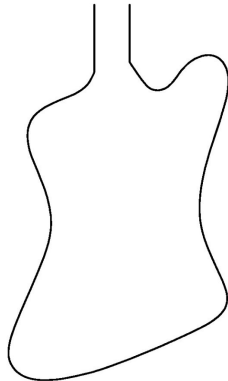

Reg. No. 4,107,670

Registered Mar. 6, 2012

Int. Cl.: 15

TRADEMARK

PRINCIPAL REGISTER

GIBSON GUITAR CORP. (DELAWARE CORPORATION)
309 PLUS PARK BLVD.
NASHVILLE, TN 37217

FOR: BASS GUITARS; ELECTRIC BASS GUITARS; ELECTRIC GUITARS; GUITARS, IN CLASS 15 (U.S. CLS. 2, 21 AND 36).

FIRST USE 12-31-1963; IN COMMERCE 12-31-1963.

THE MARK CONSISTS OF A THREE DIMENSIONAL CONFIGURATION OF A GUITAR BODY.

SEC. 2(F).

SER. NO. 85-218,173, FILED 1-14-2011.

FRANK LATTUCA, EXAMINING ATTORNEY



David J. Kybas

Director of the United States Patent and Trademark Office

United States of America

United States Patent and Trademark Office



HEILALA

Reg. No. 4,107,671

Registered Mar. 6, 2012

Int. Cl.: 30

TRADEMARK

PRINCIPAL REGISTER

REUNION FOOD COMPANY LIMITED (NEW ZEALAND COMPANY)
66 TE PUNA ROAD, RD 6
TAURANGA, NEW ZEALAND 3176

FOR: VANILLA ESSENCE NOT BEING ESSENTIAL OILS FOR USE AS FLAVOURING; VANILLA EXTRACT NOT BEING ESSENTIAL OILS FOR USE AS FLAVOURING; FLAVOURINGS IN THE NATURE OF VANILLA SEEDS AND PODS; VANILLA SYRUP FOR USE AS FLAVOURING; VANILLA PASTE FOR USE AS FLAVOURING; VANILLA SUGAR; VANILLA POWDER FOR USE AS FLAVOURING, IN CLASS 30 (U.S. CL. 46).

PRIORITY CLAIMED UNDER SEC. 44(D) ON NEW ZEALAND APPLICATION NO. 828540, FILED 8-9-2010, REG. NO. 828540, DATED 2-9-2011, EXPIRES 8-9-2017.

THE MARK CONSISTS OF THE STYLIZED WORDING "HEILALA" AND THE DESIGN OF A FLOWER.

SER. NO. 85-218,213, FILED 1-14-2011.

JEAN IM, EXAMINING ATTORNEY



David J. Kyffers

Director of the United States Patent and Trademark Office

United States of America

United States Patent and Trademark Office

FELIPE II

Reg. No. 4,107,672

Registered Mar. 6, 2012

Int. Cl.: 33

TRADEMARK

PRINCIPAL REGISTER

BODEGAS OSBORNE S.A.U. (SPAIN CORPORATION)
CALLE FERNAN CABALLERO NO. 7
11500 EL PUERTO DE SANTA MARIA
CADIZ, SPAIN

FOR: BRANDY, IN CLASS 33 (U.S. CLS. 47 AND 49).

FIRST USE 11-18-1935; IN COMMERCE 12-31-1953.

THE MARK CONSISTS OF STANDARD CHARACTERS WITHOUT CLAIM TO ANY PARTICULAR FONT, STYLE, SIZE, OR COLOR.

OWNER OF U.S. REG. NO. 839,357.

SER. NO. 85-218,214, FILED 1-14-2011.

ROBERT STRUCK, EXAMINING ATTORNEY



David J. Kyffers

Director of the United States Patent and Trademark Office

United States of America

United States Patent and Trademark Office

DACTrak

Reg. No. 4,107,673

Registered Mar. 6, 2012

Int. Cl.: 35

SERVICE MARK

PRINCIPAL REGISTER

DISABILITY ACCESS CONSULTANTS, INC. (NEVADA CORPORATION)
#220
720 W. CHEYENNE AVE
NORTH LAS VEGAS, NV 890307847

FOR: REVIEWING STANDARDS AND PRACTICES TO ASSURE COMPLIANCE WITH AMERICANS WITH DISABILITIES ACT, IN CLASS 35 (U.S. CLS. 100, 101 AND 102).

FIRST USE 1-11-2007; IN COMMERCE 1-11-2007.

THE MARK CONSISTS OF STANDARD CHARACTERS WITHOUT CLAIM TO ANY PARTICULAR FONT, STYLE, SIZE, OR COLOR.

SER. NO. 85-218,316, FILED 1-14-2011.

CHRIS WELLS, EXAMINING ATTORNEY



David J. Kyros

Director of the United States Patent and Trademark Office

United States of America

United States Patent and Trademark Office

SPARETIME MUSEUMS

Reg. No. 4,107,674

Registered Mar. 6, 2012

Int. Cl.: 41

SERVICE MARK

PRINCIPAL REGISTER

MICHAEL H. GLANTZ (UNITED STATES INDIVIDUAL)
1560 30TH STREET, CAMPUS BOX 450
CCB - INSTAAR - UNIVERSITY OF CO
BOULDER, CO 803090450

FOR: VIRTUAL MUSEUM TOURS, NAMELY, PROVIDING NON-DOWNLOADABLE ONLINE VIDEOS FEATURING TOURS OF MUSEUMS, IN CLASS 41 (U.S. CLS. 100, 101 AND 107).

FIRST USE 3-5-2010; IN COMMERCE 3-5-2010.

THE MARK CONSISTS OF STANDARD CHARACTERS WITHOUT CLAIM TO ANY PARTICULAR FONT, STYLE, SIZE, OR COLOR.

OWNER OF U.S. REG. NO. 3,866,968.

NO CLAIM IS MADE TO THE EXCLUSIVE RIGHT TO USE "MUSEUMS", APART FROM THE MARK AS SHOWN.

SER. NO. 85-218,437, FILED 1-14-2011.

MICHELLE DUBOIS, EXAMINING ATTORNEY



David J. Kybas

Director of the United States Patent and Trademark Office

United States of America

United States Patent and Trademark Office

ANTONINA

Reg. No. 4,107,675

Registered Mar. 6, 2012

Int. Cls.: 29, 30 and 32

TRADEMARK

PRINCIPAL REGISTER

E & S FOOD INC. (NEW JERSEY CORPORATION)
64 S. JEFFERSON ROAD
WHIPPANY, NJ 07981

FOR: CHEESE, CANNED, COOKED OR OTHERWISE PROCESSED TOMATOES, MUSHROOMS, PEPPER STRIPS, ROASTED PEPPERS, BLACK OLIVES, CHERRY PEPPERS, PEPPER HULLS, PEPPERONCINI, GREEN OLIVES, MIXED OLIVES, GIARDINIERA, BATTERED ONION RINGS, BREADED MUSHROOMS, BREADED ZUCCHINI STICKS, BREADED MOZZARELLA STICKS, JALAPENO CHEDDAR POPPERS, VEGETABLE OIL, OLIVE OIL, POMACE OIL, SOY BEAN OIL, PEANUT OIL, FROZEN MUSSELS, COOKED HAM, SLICED PEPPERONI, SWEET SAUSAGE, HOT SAUSAGE, STEAKS, COOKED MEATBALLS, RAW MEATBALLS, AND VEAL CUTLETS, IN CLASS 29 (U.S. CL. 46).

FIRST USE 9-0-1985; IN COMMERCE 9-0-1985.

FOR: VINEGAR, SALAD DRESSING, MAYONNAISE, ESPRESSO BEANS, PASTA SAUCE, PIZZA SAUCE, FLOUR, PASTA, PASTA SHEETS, SANDWICH WRAPS, FROZEN FETTUCCHINI, FILLED RAVIOLI, STUFFED JUMBO SHELLS, MANICOTTI, TORTELLINI STUFFED WITH CHEESE, LASAGNA, RIGATONI STUFFED WITH CHEESE, IN CLASS 30 (U.S. CL. 46).

FIRST USE 9-0-1985; IN COMMERCE 9-0-1985.

FOR: SPRING WATER, IN CLASS 32 (U.S. CLS. 45, 46 AND 48).

FIRST USE 9-0-1985; IN COMMERCE 9-0-1985.

THE MARK CONSISTS OF STANDARD CHARACTERS WITHOUT CLAIM TO ANY PARTICULAR FONT, STYLE, SIZE, OR COLOR.

SER. NO. 85-219,855, FILED 1-18-2011.

MICHAEL TANNER, EXAMINING ATTORNEY



David J. Kyros

Director of the United States Patent and Trademark Office

United States of America

United States Patent and Trademark Office

NextDocs

Reg. No. 4,107,676

Registered Mar. 6, 2012

Int. Cl.: 9

TRADEMARK

PRINCIPAL REGISTER

NEXTDOCS CORPORATION (PENNSYLVANIA CORPORATION), AKA BUSINESS AGILITY SYSTEMS
500 N GULPH ROAD STE 240
KING OF PRUSSIA, PA 19406

FOR: COMPUTER SOFTWARE FOR CONTROLLING AND MANAGING ACCESS SERVER APPLICATIONS, IN CLASS 9 (U.S. CLS. 21, 23, 26, 36 AND 38).

FIRST USE 1-1-2006; IN COMMERCE 1-1-2006.

THE MARK CONSISTS OF STANDARD CHARACTERS WITHOUT CLAIM TO ANY PARTICULAR FONT, STYLE, SIZE, OR COLOR.

SER. NO. 85-219,929, FILED 1-18-2011.

EDWARD NELSON, EXAMINING ATTORNEY



David J. Kybas

Director of the United States Patent and Trademark Office

United States of America

United States Patent and Trademark Office



Reg. No. 4,107,677

Registered Mar. 6, 2012

Int. Cls.: 29, 30 and 32

TRADEMARK

PRINCIPAL REGISTER

E & S FOOD INC. (NEW JERSEY CORPORATION)
64 S. JEFFERSON ROAD
WHIPPANY, NJ 07981

FOR: CHEESE, CANNED COOKED OR OTHERWISE PROCESSED TOMATOES, MUSHROOMS, PEPPER STRIPS, ROASTED PEPPERS, BLACK OLIVES, CHERRY PEPPERS, PEPPER HULLS, PEPPERONCINI, GREEN OLIVES, MIXED OLIVES, GIARDINIERA, BATTERED ONION RINGS, BREADED MUSHROOMS, BREADED ZUCCHINI STICKS, BREADED MOZZARELLA STICKS, JALAPENO CHEDDAR POPPERS, VEGETABLE OIL, OLIVE OIL, POMACE OIL, SOY BEAN OIL, PEANUT OIL, FROZEN MUSSELS, COOKED HAM, SLICED PEPPERONI, SWEET SAUSAGE, HOT SAUSAGE, STEAKS, COOKED MEATBALLS, RAW MEATBALLS, AND VEAL CUTLETS, IN CLASS 29 (U.S. CL. 46).

FIRST USE 9-0-1985; IN COMMERCE 9-0-1985.

FOR: VINEGAR, SALAD DRESSING, MAYONNAISE, ESPRESSO BEANS, PASTA SAUCE, PIZZA SAUCE, FLOUR, PASTA, PASTA SHEETS, SANDWICH WRAPS, FROZEN FETTUCCHINI, FILLED RAVIOLI, STUFFED JUMBO SHELLS, MANICOTTI, TORTELLINI STUFFED WITH CHEESE, LASAGNA, RIGATONI STUFFED WITH CHEESE, IN CLASS 30 (U.S. CL. 46).

FIRST USE 9-0-1985; IN COMMERCE 9-0-1985.

FOR: SPRING WATER, IN CLASS 32 (U.S. CLS. 45, 46 AND 48).

FIRST USE 9-0-1985; IN COMMERCE 9-0-1985.

THE MARK CONSISTS OF AN OVAL SURROUNDING THE DEPICTION OF A WOMAN DRESSED IN A TRADITIONAL ITALIAN FOLK COSTUME WEARING HOOP EARRINGS, A NECKLACE AND SHAWL AND CARRYING A BASKET. LOCATED BEHIND AND OVER THE LEFT SHOULDER OF THE WOMAN IS A STYLIZED REPRESENTATION OF A COLISEUM. LOCATED BEHIND AND OVER THE RIGHT SHOULDER OF THE WOMAN IS A STRUCTURE IN RUINS CONSISTING OF TWO STANDING COLUMNS.



David J. Kyros

Director of the United States Patent and Trademark Office

SER. NO. 85-220,045, FILED 1-18-2011.

MICHAEL TANNER, EXAMINING ATTORNEY

United States of America

United States Patent and Trademark Office

HELI POP

Reg. No. 4,107,678

Registered Mar. 6, 2012

Int. Cl.: 28

TRADEMARK

PRINCIPAL REGISTER

BAKER BRAND, INC. (CALIFORNIA CORPORATION)
13151 SHERMAN WAY UNIT F
NORTH HOLLYWOOD, CA 91605

FOR: SKATEBOARD DECKS, IN CLASS 28 (U.S. CLS. 22, 23, 38 AND 50).

FIRST USE 4-29-2010; IN COMMERCE 4-29-2010.

THE MARK CONSISTS OF STANDARD CHARACTERS WITHOUT CLAIM TO ANY PARTICULAR FONT, STYLE, SIZE, OR COLOR.

SER. NO. 85-220,387, FILED 1-18-2011.

GEORGE LORENZO, EXAMINING ATTORNEY



David J. Kybas

Director of the United States Patent and Trademark Office

United States of America

United States Patent and Trademark Office

HELI
POP

Reg. No. 4,107,679

Registered Mar. 6, 2012

Int. Cl.: 28

TRADEMARK

PRINCIPAL REGISTER

BAKER BRAND, INC. (CALIFORNIA CORPORATION)
13151 SHERMAN WAY UNIT F
NORTH HOLLYWOOD, CA 91605

FOR: SKATEBOARD DECKS, IN CLASS 28 (U.S. CLS. 22, 23, 38 AND 50).

FIRST USE 4-29-2010; IN COMMERCE 4-29-2010.

THE MARK CONSISTS OF THE WORD "HELI" WITH AN "X" FORMING THE DOT ABOVE THE LOWER CASE "I" AND THE WORD "POP" WITH FIGURATIVE EYES AND A MOUTH WITHIN THE "O".

SER. NO. 85-220,393, FILED 1-18-2011.

GEORGE LORENZO, EXAMINING ATTORNEY



David J. Kybas

Director of the United States Patent and Trademark Office

United States of America

United States Patent and Trademark Office

BE LUCKY

Reg. No. 4,107,680

Registered Mar. 6, 2012

**Int. Cls.: 14, 16, 18, 21
and 25**

TRADEMARK

PRINCIPAL REGISTER

LUCKY SURF SHOP, INC. (MARYLAND CORPORATION)
115 MONROE MANOR ROAD
STEVENSVILLE, MD 21666

FOR: JEWELRY, IN CLASS 14 (U.S. CLS. 2, 27, 28 AND 50).

FIRST USE 9-11-2010; IN COMMERCE 9-11-2010.

FOR: DECALS; PAPER STATIONERY; STICKERS, IN CLASS 16 (U.S. CLS. 2, 5, 22, 23, 29, 37, 38 AND 50).

FIRST USE 9-11-2010; IN COMMERCE 9-11-2010.

FOR: ALL-PURPOSE CARRYING BAGS, IN CLASS 18 (U.S. CLS. 1, 2, 3, 22 AND 41).

FIRST USE 9-11-2010; IN COMMERCE 9-11-2010.

FOR: CUPS AND MUGS, IN CLASS 21 (U.S. CLS. 2, 13, 23, 29, 30, 33, 40 AND 50).

FIRST USE 9-11-2010; IN COMMERCE 9-11-2010.

FOR: HATS; PANTS; PULLOVERS; SHIRTS; SHORTS, IN CLASS 25 (U.S. CLS. 22 AND 39).

FIRST USE 9-11-2010; IN COMMERCE 9-11-2010.

THE MARK CONSISTS OF STANDARD CHARACTERS WITHOUT CLAIM TO ANY PARTICULAR FONT, STYLE, SIZE, OR COLOR.

SER. NO. 85-220,547, FILED 1-19-2011.

TEJBIR SINGH, EXAMINING ATTORNEY



David J. Kybas

Director of the United States Patent and Trademark Office

United States of America

United States Patent and Trademark Office

PHILIP B.

Reg. No. 4,107,681

Registered Mar. 6, 2012

Int. Cls.: 3 and 21

TRADEMARK

PRINCIPAL REGISTER

PHILIP SCOTT, INC. (CALIFORNIA CORPORATION), DBA PHILIP B, INC.
2630 TOWNSGATE RD., STE. H
WESTLAKE VILLAGE, CA 91361

FOR: HAIR AND SCALP SHAMPOOS; HAIR CARE AND HAIR STYLING PRODUCTS, NAMELY, HAIR RINSES, HAIR STYLING GELS, HAIR SPRAY, HAIR TONICS, HAIR WAIVING LOTIONS, HAIR MOUSSE, HAIR STYLING OILS, STYLING CLAYS, FOAMS AND PASTES FOR HAIR; BODY WASH; BUBBLE BATH; BODY SPRAYS; HAND CREAM; AND BODY CREAM, IN CLASS 3 (U.S. CLS. 1, 4, 6, 50, 51 AND 52).

FIRST USE 11-5-1991; IN COMMERCE 11-5-1991.

FOR: HAIR BRUSHES, IN CLASS 21 (U.S. CLS. 2, 13, 23, 29, 30, 33, 40 AND 50).

FIRST USE 11-5-1991; IN COMMERCE 11-5-1991.

THE MARK CONSISTS OF STANDARD CHARACTERS WITHOUT CLAIM TO ANY PARTICULAR FONT, STYLE, SIZE, OR COLOR.

OWNER OF U.S. REG. NO. 1,783,787.

THE NAME(S), PORTRAIT(S), AND/OR SIGNATURE(S) SHOWN IN THE MARK IDENTIFIES "PHILIP BERKOVITZ", WHOSE CONSENT(S) TO REGISTER IS MADE OF RECORD.

SER. NO. 85-220,740, FILED 1-19-2011.

JEFFREY LOOK, EXAMINING ATTORNEY



David J. Kyros

Director of the United States Patent and Trademark Office

United States of America

United States Patent and Trademark Office

PMC

Reg. No. 4,107,682

Registered Mar. 6, 2012

Int. Cl.: 35

SERVICE MARK

PRINCIPAL REGISTER

PHARMED CONSULTANTS LLC (PENNSYLVANIA LIMITED LIABILITY COMPANY)
44-B MOUNTAIN AVENUE
MENDHAM, NJ 07945

FOR: CONSULTING SERVICES IN THE FIELD OF SALES METHODS, SALES MANAGEMENT, AND SALES IMPROVEMENT IN THE PHARMACEUTICAL, BIOTECH AND MEDICAL DEVICE/EQUIPMENT SECTORS, WITH THE AFOREMENTIONED CONSULTING SERVICES OFFERED TO PHARMACEUTICAL COMPANIES' SALES REPRESENTATIVES WHO MARKET PHARMACEUTICALS WITHIN THE HOSPITAL SETTING TO HOSPITALISTS, I.E., PHYSICIANS WHO PRACTICE THE SPECIALTY OF HOSPITAL MEDICINE, IN CLASS 35 (U.S. CLS. 100, 101 AND 102).

FIRST USE 10-31-2008; IN COMMERCE 10-31-2008.

THE MARK CONSISTS OF STANDARD CHARACTERS WITHOUT CLAIM TO ANY PARTICULAR FONT, STYLE, SIZE, OR COLOR.

SER. NO. 85-222,122, FILED 1-20-2011.

ELIZABETH HUGHITT, EXAMINING ATTORNEY



David J. Kyffers

Director of the United States Patent and Trademark Office

United States of America

United States Patent and Trademark Office

EPASS

Reg. No. 4,107,683

Registered Mar. 6, 2012

Int. Cl.: 42

SERVICE MARK

PRINCIPAL REGISTER

MEDASSURANT, INC. (DELAWARE CORPORATION)
4321 COLLINGTON ROAD
BOWIE, MD 20716

FOR: PROVIDING A SECURE WEB-BASED HEALTHCARE INFORMATION SYSTEM PROVIDING ON-LINE PRIMARILY NON-DOWNLOADABLE COMPUTER PROGRAMS THAT ALLOW ANALYSIS AND PROTOCOL SUPPORT FOR CLINICAL DECISION-MAKING AND REVIEWS PATIENT ENCOUNTER DATA CONCURRENTLY TO IDENTIFY AND IMPROVE REIMBURSEMENT OPPORTUNITIES, IN CLASS 42 (U.S. CLS. 100 AND 101).

FIRST USE 12-0-2008; IN COMMERCE 12-0-2008.

THE MARK CONSISTS OF STANDARD CHARACTERS WITHOUT CLAIM TO ANY PARTICULAR FONT, STYLE, SIZE, OR COLOR.

SER. NO. 85-222,267, FILED 1-20-2011.

JEAN IM, EXAMINING ATTORNEY



David J. Kybas

Director of the United States Patent and Trademark Office

United States of America

United States Patent and Trademark Office



Reg. No. 4,107,684

Registered Mar. 6, 2012

Int. Cl.: 35

LUMINOUS MANAGEMENT SERVICES LIMITED (UNITED KINGDOM PRIVATE LIMITED COMPANY)
2ND FLOOR, STELLA BUILDING
WHITEHILL WAY, SWINDON
WILTSHIRE, UNITED KINGDOM SN56NX

SERVICE MARK

PRINCIPAL REGISTER

FOR: ADVERTISING; BUSINESS MANAGEMENT; BUSINESS ADMINISTRATION; OFFICE FUNCTIONS; BUSINESS MANAGEMENT CONSULTANCY; ADVISORY SERVICES RELATING TO BUSINESS MANAGEMENT; BUSINESS CONSULTING AND INFORMATION SERVICES, NAMELY, ASSESSMENT ANALYSIS RELATING TO BUSINESS MANAGEMENT; BUSINESS MANAGEMENT ASSISTANCE; BUSINESS CONSULTANCY SERVICES RELATING TO THE SUPPLY OF QUALITY MANAGEMENT SYSTEMS; CONSULTANCY RELATING TO BUSINESS MANAGEMENT; BUSINESS MANAGEMENT ORGANISATION CONSULTANCY; BUSINESS MANAGEMENT SERVICES RELATING TO THE DEVELOPMENT OF BUSINESSES; COMMERCIAL BUSINESS MANAGEMENT; COMMERCIAL MANAGEMENT ADVISORY SERVICES; COMMERCIAL MANAGEMENT ASSISTANCE; COMMERCIAL MANAGEMENT CONSULTANCY; EVALUATIONS RELATING TO BUSINESS MANAGEMENT IN COMMERCIAL ENTERPRISES; EVALUATIONS RELATING TO BUSINESS MANAGEMENT IN PROFESSIONAL ENTERPRISES; MANAGEMENT ADVICE RELATING TO THE RECRUITMENT OF STAFF; MANAGEMENT ASSISTANCE FOR PROMOTING BUSINESS; MANAGEMENT ASSISTANCE IN BUSINESS AFFAIRS; MARKETING MANAGEMENT ADVICE; PERSONNEL MANAGEMENT; PERSONNEL MANAGEMENT ADVICE; PERSONNEL MANAGEMENT ASSISTANCE; PERSONNEL MANAGEMENT CONSULTANCY; PERSONNEL RESOURCES MANAGEMENT; BUSINESS STATISTICAL ANALYSIS; BUSINESS STRATEGIC PLANNING, IN CLASS 35 (U.S. CLS. 100, 101 AND 102).



PRIORITY CLAIMED UNDER SEC. 44(D) ON ERPN CMNTY TM OFC APPLICATION NO. 009586041, FILED 12-9-2010, REG. NO. 009586041, DATED 5-16-2011, EXPIRES 12-9-2020.

THE COLOR(S) GREEN, BLACK, AND WHITE IS/ARE CLAIMED AS A FEATURE OF THE MARK.

David J. Kybas

THE MARK CONSISTS OF THE WORD "APEX" APPEARING WITHIN A GREEN BOX, WITH THE LETTER "A" APPEARING IN BLACK, AND THE LETTERS "PEX" APPEARING IN WHITE.

Reg. No. 4,107,684 SER. NO. 85-222,413, FILED 1-20-2011.

ANDREW LEASER, EXAMINING ATTORNEY

United States of America

United States Patent and Trademark Office

FUNVILLE ON STAGE

Reg. No. 4,107,685

Registered Mar. 6, 2012

Int. Cl.: 28

TRADEMARK

PRINCIPAL REGISTER

FUNVILLE LIMITED (HONG KONG LIMITED LIABILITY COMPANY)
UNIT 1117-1120, 11TH FLOOR TOWER B
NEW MANDARIN PLAZA, 14 SCIENCE MUSEUM RD
TSIMSHATSUI E., KOWLOON, HONG KONG

FOR: TOY SING-ALONG AUDIO AND VIDEO PLAYERS AND RECORDERS WITH MICROPHONES; TOY MICROPHONES WITH RECORDED MUSIC, SONGS AND VIDEO AND WITH SING ALONG FUNCTIONS; TOY MICROPHONES, TOY DUET MICROPHONES, TOY MICROPHONE CLIPS, TOY MICROPHONE WIND SCREEN SOCKS, TOY MICROPHONE HOLDERS, TOY MICROPHONE STANDS, IN CLASS 28 (U.S. CLS. 22, 23, 38 AND 50).

THE MARK CONSISTS OF STANDARD CHARACTERS WITHOUT CLAIM TO ANY PARTICULAR FONT, STYLE, SIZE, OR COLOR.

OWNER OF HONG KONG REG. NO. 301670247, DATED 11-25-2010, EXPIRES 7-21-2020.

SER. NO. 85-222,447, FILED 1-20-2011.

TEJBIR SINGH, EXAMINING ATTORNEY



David J. Kyffers

Director of the United States Patent and Trademark Office

United States of America

United States Patent and Trademark Office



Reg. No. 4,107,686

Registered Mar. 6, 2012

Int. Cls.: 3 and 21

TRADEMARK

PRINCIPAL REGISTER

PHILIP SCOTT, INC. (CALIFORNIA CORPORATION), DBA PHILIP B, INC.
2630 TOWNSGATE RD., STE. H
WESTLAKE VILLAGE, CA 91361

FOR: HAIR AND SCALP SHAMPOOS; HAIR CARE AND HAIR STYLING PRODUCTS, NAMELY, HAIR OIL AND HAIR CONDITIONER, FINISHING RINSE, HAIR CREAMS, HAIR CARE PREPARATIONS, HAIR SPRAY, HAIR GEL, VOLUMIZING SPRAY, HAIR MASKS, STRAIGHTENING BALMS, SERUMS AND SHINE SPRAY; BODY WASH; BUBBLE BATH; BODY SPRAYS; HAND CREAM; AND BODY CREAM, IN CLASS 3 (U.S. CLS. 1, 4, 6, 50, 51 AND 52).

FIRST USE 3-0-2008; IN COMMERCE 3-0-2008.

FOR: HAIR BRUSHES, IN CLASS 21 (U.S. CLS. 2, 13, 23, 29, 30, 33, 40 AND 50).

FIRST USE 3-0-2008; IN COMMERCE 3-0-2008.

THE MARK CONSISTS OF AN UPSIDE DOWN BOUQUET OF FLOWERS WITH MIRROR IMAGES OF THE FLOWERS AND LEAVES ON THE LEFT AND RIGHT SIDES OF THE VERTICAL AXIS OF THE DESIGN. AN OBLONG BAND CONNECTS THE TWO LARGE PAIRS OF LEAVES NEAR THE TOP OF THE DESIGN.

SER. NO. 85-222,532, FILED 1-20-2011.

JEFFREY LOOK, EXAMINING ATTORNEY



David J. Kypos

Director of the United States Patent and Trademark Office

United States of America

United States Patent and Trademark Office

SEM MX

Reg. No. 4,107,687

SEMANTIC MARKETING SYSTEMS, INC. (DELAWARE CORPORATION)
15 MAPLE STREET
PAOLI, PA 19301

Registered Mar. 6, 2012

Int. Cls.: 35, 38 and 42

FOR: ADVERTISING SERVICES, NAMELY, PAY PER CLICK (PPC) ADVERTISING, IN CLASS 35 (U.S. CLS. 100, 101 AND 102).

SERVICE MARK

FIRST USE 10-17-2010; IN COMMERCE 10-17-2010.

PRINCIPAL REGISTER

FOR: PROVIDING ACCESS TO DATABASES, NAMELY, PROVIDING ACCESS TO A DATABASE OF INFORMATION PRODUCED BY ORTHOGONAL CORPUS INDEXING, FOR SEMANTIC SEARCH, SEMANTIC ANALYSIS, AND SEMANTIC TRANSFORMATION; PROVIDING ACCESS TO A DATABASE FOR DISCOVERY AND MANAGEMENT OF SEARCH-BASED KEYWORDS, IN CLASS 38 (U.S. CLS. 100, 101 AND 104).

FIRST USE 10-17-2010; IN COMMERCE 10-17-2010.

FOR: COMPUTER SERVICES, NAMELY, SEARCH ENGINE OPTIMIZATION, IN CLASS 42 (U.S. CLS. 100 AND 101).

FIRST USE 10-17-2010; IN COMMERCE 10-17-2010.

THE MARK CONSISTS OF THE WORD "SEMMX" PRINTED IN STYLIZED TYPE, WITH THE TOP OF THE LETTER "S" EXTENDING OVER THE TOPS OF THE LETTERS "E" AND "M".

SER. NO. 85-222,847, FILED 1-21-2011.

BENJAMIN OKEKE, EXAMINING ATTORNEY



David J. Kyros

Director of the United States Patent and Trademark Office

United States of America

United States Patent and Trademark Office

SPARQ

Reg. No. 4,107,688

Registered Mar. 6, 2012

Int. Cl.: 42

SERVICE MARK

PRINCIPAL REGISTER

VISION CRITICAL COMMUNICATIONS INC. (CANADA CORPORATION)
SUITE 700
858 BEATTY STREET
VANCOUVER, BC, CANADA V6B1C1

FOR: PROVIDING TEMPORARY USE OF ONLINE, NON-DOWNLOADABLE, SOFTWARE TO MANAGE, TRACK, ANALYZE, COLLECT AND REPORT ON DATA FROM RESPONDENTS IN THE FIELD OF MARKET RESEARCH, IN CLASS 42 (U.S. CLS. 100 AND 101).

FIRST USE 10-31-2008; IN COMMERCE 10-31-2008.

THE MARK CONSISTS OF STANDARD CHARACTERS WITHOUT CLAIM TO ANY PARTICULAR FONT, STYLE, SIZE, OR COLOR.

PRIORITY CLAIMED UNDER SEC. 44(D) ON CANADA APPLICATION NO. 1,511,742, FILED 1-18-2011.

SER. NO. 85-223,088, FILED 1-21-2011.

KAREN SEVERSON, EXAMINING ATTORNEY



David J. Kybas

Director of the United States Patent and Trademark Office

United States of America

United States Patent and Trademark Office

Q Interactive

Reg. No. 4,107,689

Registered Mar. 6, 2012

Int. Cl.: 35

SERVICE MARK

PRINCIPAL REGISTER

Q INTERACTIVE (DELAWARE LIMITED LIABILITY COMPANY)
1613 NW 136TH AVE
SUITE 100
SUNRISE, FL 33323

FOR: ADVERTISING SERVICES, IN CLASS 35 (U.S. CLS. 100, 101 AND 102).

FIRST USE 9-8-2005; IN COMMERCE 9-8-2005.

THE MARK CONSISTS OF STANDARD CHARACTERS WITHOUT CLAIM TO ANY PARTICULAR FONT, STYLE, SIZE, OR COLOR.

NO CLAIM IS MADE TO THE EXCLUSIVE RIGHT TO USE "INTERACTIVE", APART FROM THE MARK AS SHOWN.

SER. NO. 85-223,162, FILED 1-21-2011.

ANN E. SAPPENFIELD, EXAMINING ATTORNEY



David J. Kyros

Director of the United States Patent and Trademark Office

United States of America

United States Patent and Trademark Office

CLINICAL CONVERSATIONS

Reg. No. 4,107,690

Registered Mar. 6, 2012

Int. Cls.: 9 and 41

TRADEMARK

SERVICE MARK

PRINCIPAL REGISTER

THERAPEUTIC RESOURCES, INC. (WISCONSIN CORPORATION)
6613 SEYBOLD ROAD, SUITE D
MADISON, WI 53719

FOR: AUDIO RECORDINGS FEATURING CONTINUING EDUCATION COURSES IN THE FIELD OF OCCUPATIONAL THERAPY, IN CLASS 9 (U.S. CLS. 21, 23, 26, 36 AND 38).

FIRST USE 1-21-2011; IN COMMERCE 1-21-2011.

FOR: PROVIDING CONTINUING EDUCATION COURSES IN THE FIELD OF OCCUPATIONAL THERAPY, IN CLASS 41 (U.S. CLS. 100, 101 AND 107).

FIRST USE 1-21-2011; IN COMMERCE 1-21-2011.

THE MARK CONSISTS OF STANDARD CHARACTERS WITHOUT CLAIM TO ANY PARTICULAR FONT, STYLE, SIZE, OR COLOR.

NO CLAIM IS MADE TO THE EXCLUSIVE RIGHT TO USE "CLINICAL", APART FROM THE MARK AS SHOWN.

SER. NO. 85-223,307, FILED 1-21-2011.

CAROLYN CATALDO, EXAMINING ATTORNEY



David J. Kybas

Director of the United States Patent and Trademark Office

United States of America

United States Patent and Trademark Office

PAWS 4 MASSAGE

Reg. No. 4,107,691

KESTER, KYRA K (UNITED STATES INDIVIDUAL)
1235 BELLE AVENUE
LAKEWOOD, OH 44107

Registered Mar. 6, 2012

Int. Cl.: 44

FOR: MASSAGE, IN CLASS 44 (U.S. CLS. 100 AND 101).

SERVICE MARK

FIRST USE 4-9-2003; IN COMMERCE 4-9-2003.

PRINCIPAL REGISTER

NO CLAIM IS MADE TO THE EXCLUSIVE RIGHT TO USE "MASSAGE", APART FROM THE MARK AS SHOWN.

THE MARK CONSISTS OF THE WORDS "PAWS 4 MASSAGE" CONTAINING A PAW PRINT INSIDE THE NUMBER "4".

SER. NO. 85-223,442, FILED 1-21-2011.

FONG HSU, EXAMINING ATTORNEY



David J. Kybas

Director of the United States Patent and Trademark Office

United States of America

United States Patent and Trademark Office

SWM

Reg. No. 4,107,692

Registered Mar. 6, 2012

Int. Cl.: 25

TRADEMARK

PRINCIPAL REGISTER

SCHWEITZER-MAUDUIT INTERNATIONAL, INC. (DELAWARE CORPORATION)
100 NORTH POINT CENTER EAST, SUITE 600
ALPHARETTA, GA 30022

FOR: CLOTHING, NAMELY, SHIRTS, JACKETS, AND HATS, DISTRIBUTED FOR PROMOTIONAL PURPOSES TO THOSE INVOLVED IN THE SPECIALTY PAPER TRADE, IN CLASS 25 (U.S. CLS. 22 AND 39).

FIRST USE 12-0-2009; IN COMMERCE 12-0-2009.

THE MARK CONSISTS OF STANDARD CHARACTERS WITHOUT CLAIM TO ANY PARTICULAR FONT, STYLE, SIZE, OR COLOR.

SER. NO. 85-223,510, FILED 1-21-2011.

CHRISTINE COOPER, EXAMINING ATTORNEY



David J. Kybas

Director of the United States Patent and Trademark Office

United States of America

United States Patent and Trademark Office

AquaBundance

Reg. No. 4,107,693

Registered Mar. 6, 2012

Int. Cl.: 21

TRADEMARK

PRINCIPAL REGISTER

THE AQUAPONIC SOURCE, INC. (COLORADO CORPORATION)
SUITE 103-142
3980 BROADWAY
BOULDER, CO 803041329

FOR: AQUAPONICS KITS TO GROW PLANTS AND FISH TOGETHER FOR HOME USE, COMPRISED OF WATER TANKS, PLANTERS FOR FLOWERS AND PLANTS, PLANTER STANDS, WATER PUMPS, AND DRAIN COMPONENTS, IN CLASS 21 (U.S. CLS. 2, 13, 23, 29, 30, 33, 40 AND 50).

FIRST USE 9-15-2010; IN COMMERCE 9-15-2010.

THE MARK CONSISTS OF STANDARD CHARACTERS WITHOUT CLAIM TO ANY PARTICULAR FONT, STYLE, SIZE, OR COLOR.

SER. NO. 85-223,960, FILED 1-23-2011.

DOMINIC J. FERRAIUOLO, EXAMINING ATTORNEY



David J. Kyffers

Director of the United States Patent and Trademark Office

United States of America

United States Patent and Trademark Office

Travel Series

Reg. No. 4,107,694

Registered Mar. 6, 2012

Int. Cl.: 9

TRADEMARK

PRINCIPAL REGISTER

CAMMATE SYSTEMS, INC. (ARIZONA CORPORATION)
425 E. COMSTOCK
CHANDLER, AZ 85225

FOR: CAMERA ACCESSORIES, NAMELY, CAMERA CRANES, EXTENSIBLE CAMERA CRANES, CAMERA JIBS, CAMERA DOLLIES, CAMERA CRANE DOLLIES, TRIPODS, CAMERA HEADS, PEDESTAL LEVELERS, ELECTRONIC CRANE CONTROLLERS, CRANE REMOTE CONTROLLERS, AND ELECTRONIC CAMERA CONTROLLERS, IN CLASS 9 (U.S. CLS. 21, 23, 26, 36 AND 38).

FIRST USE 1-1-1999; IN COMMERCE 1-1-1999.

THE MARK CONSISTS OF STANDARD CHARACTERS WITHOUT CLAIM TO ANY PARTICULAR FONT, STYLE, SIZE, OR COLOR.

NO CLAIM IS MADE TO THE EXCLUSIVE RIGHT TO USE "SERIES", APART FROM THE MARK AS SHOWN.

SEC. 2(F).

SER. NO. 85-224,127, FILED 1-24-2011.

MARILYN IZZI, EXAMINING ATTORNEY



David J. Kyros

Director of the United States Patent and Trademark Office

United States of America

United States Patent and Trademark Office

PV

Reg. No. 4,107,695

Registered Mar. 6, 2012

Int. Cl.: 18

TRADEMARK

PRINCIPAL REGISTER

TYR TACTICAL, LLC (ARIZONA LIMITED LIABILITY COMPANY)
16661 N. 84TH AVENUE #110
PEORIA, AZ 85382

FOR: BALLISTIC RESISTANT FABRIC SOLD AS AN INTEGRAL COMPONENT OF MILITARY DUFFLE BAGS, TOTE BAGS, SHOULDER BAGS, BACKPACKS AND TEXTILE POUCHES, IN CLASS 18 (U.S. CLS. 1, 2, 3, 22 AND 41).

FIRST USE 1-24-2011; IN COMMERCE 1-24-2011.

THE MARK CONSISTS OF STANDARD CHARACTERS WITHOUT CLAIM TO ANY PARTICULAR FONT, STYLE, SIZE, OR COLOR.

SER. NO. 85-224,187, FILED 1-24-2011.

IRA J. GOODSaid, EXAMINING ATTORNEY



David J. Kybas

Director of the United States Patent and Trademark Office

United States of America

United States Patent and Trademark Office

CAPSALUS

Reg. No. 4,107,696

Registered Mar. 6, 2012

Int. Cl.: 36

SERVICE MARK

PRINCIPAL REGISTER

CAPSALUS CORP. (GEORGIA CORPORATION)
SUITE 100
2675 PACES FERRY ROAD
ATLANTA, GA 30339

FOR: INVESTMENT SERVICES, NAMELY, ASSET ACQUISITION, CONSULTATION, DEVELOPMENT AND MANAGEMENT SERVICES IN THE FIELD OF HEALTH AND WELLNESS, AND FINANCIAL ANALYSIS, FINANCIAL CONSULTATION, AND FINANCIAL CONTROL AND REPORTING SERVICES FOR ONE OR MORE HEALTH AND WELLNESS INSTITUTIONS, IN CLASS 36 (U.S. CLS. 100, 101 AND 102).

FIRST USE 8-31-2010; IN COMMERCE 8-31-2010.

THE MARK CONSISTS OF STANDARD CHARACTERS WITHOUT CLAIM TO ANY PARTICULAR FONT, STYLE, SIZE, OR COLOR.

SER. NO. 85-224,305, FILED 1-24-2011.

EDWARD FENNESSY, EXAMINING ATTORNEY



David J. Kyffers

Director of the United States Patent and Trademark Office

United States of America

United States Patent and Trademark Office

PERACIDIN

Reg. No. 4,107,697

ALCAVIS HDC LLC (MARYLAND LIMITED LIABILITY COMPANY)
8322 HELGERMAN COURT
GAITHERSBURG, MD 20877

Registered Mar. 6, 2012

Int. Cl.: 5

FOR: STERILANT AND DISINFECTANT FOR USE IN REPROCESSED DIALYZERS, IN CLASS 5 (U.S. CLS. 6, 18, 44, 46, 51 AND 52).

TRADEMARK

FIRST USE 7-1-1998; IN COMMERCE 10-5-1998.

PRINCIPAL REGISTER

THE MARK CONSISTS OF STANDARD CHARACTERS WITHOUT CLAIM TO ANY PARTICULAR FONT, STYLE, SIZE, OR COLOR.

SER. NO. 85-225,493, FILED 1-25-2011.

LINDA ORNDORFF, EXAMINING ATTORNEY



David J. Kybas

Director of the United States Patent and Trademark Office

United States of America

United States Patent and Trademark Office

Prayerlithic

Reg. No. 4,107,698

Registered Mar. 6, 2012

Int. Cl.: 20

TRADEMARK

PRINCIPAL REGISTER

PRAYER INDUSTRIES, LLC (INDIANA LIMITED LIABILITY COMPANY)
7617 FRANKLIN PARKE WOODS
INDIANAPOLIS, IN 46259

FOR: PERSONAL PRAYER ALTARS, IN CLASS 20 (U.S. CLS. 2, 13, 22, 25, 32 AND 50).

FIRST USE 7-1-2010; IN COMMERCE 7-1-2010.

THE MARK CONSISTS OF STANDARD CHARACTERS WITHOUT CLAIM TO ANY PARTICULAR FONT, STYLE, SIZE, OR COLOR.

SER. NO. 85-225,495, FILED 1-25-2011.

ANDREW LEASER, EXAMINING ATTORNEY



David J. Kybas

Director of the United States Patent and Trademark Office

United States of America

United States Patent and Trademark Office

Audio Note

Reg. No. 4,107,699

Registered Mar. 6, 2012

Int. Cl.: 9

TRADEMARK

PRINCIPAL REGISTER

AUDIO NOTE (UK) LTD (UNITED KINGDOM LIMITED COMPANY (LTD.))
25 MONTEFIORE ROAD, HOVE
EAST SUSSEX BN3 1RD, GREAT BRITAIN

FOR: AUDIO ELECTRONIC EQUIPMENT, NAMELY, ANALOG AND DIGITAL AMPLIFIERS, ANALOG AND DIGITAL PRE-AMPLIFIERS, SPEAKERS; ANALOG TURNTABLES, MC TRANSFORMERS, ELECTRICAL PHONOGRAPH RECORD TURNTABLE CARTRIDGES; TONE ARMS FOR RECORD PLAYERS; CD PLAYERS, NAMELY DIGITAL CD TRANSPORTS, CD PLAYERS, AND DIGITAL TO ANALOG CONVERTERS; CABLES FOR ALL OF THE AFOREMENTIONED GOODS, IN CLASS 9 (U.S. CLS. 21, 23, 26, 36 AND 38).

FIRST USE 6-1-1991; IN COMMERCE 11-1-1994.

THE MARK CONSISTS OF STANDARD CHARACTERS WITHOUT CLAIM TO ANY PARTICULAR FONT, STYLE, SIZE, OR COLOR.

OWNER OF U.S. REG. NO. 2,266,800.

NO CLAIM IS MADE TO THE EXCLUSIVE RIGHT TO USE "AUDIO", APART FROM THE MARK AS SHOWN.

SER. NO. 85-225,580, FILED 1-25-2011.

LOURDES AYALA, EXAMINING ATTORNEY



David J. Kybas

Director of the United States Patent and Trademark Office

United States of America

United States Patent and Trademark Office

STEM
CELL
THERAPY



Reg. No. 4,107,700

Registered Mar. 6, 2012

Int. Cl.: 3

TRADEMARK

PRINCIPAL REGISTER

FMC INTERNATIONAL, LTD. (DELAWARE CORPORATION), DBA BIOLOGIC SOLUTIONS
8 SLATER ROAD
PORT CHESTER, NY 10573

FOR: SKIN CREAM, IN CLASS 3 (U.S. CLS. 1, 4, 6, 50, 51 AND 52).

FIRST USE 5-1-2009; IN COMMERCE 5-1-2009.

NO CLAIM IS MADE TO THE EXCLUSIVE RIGHT TO USE "STEM CELL THERAPY" AND "BIOLOGIC", APART FROM THE MARK AS SHOWN.

THE MARK CONSISTS OF THE PHRASE "STEM CELL THERAPY BY BIOLOGIC" WITH THE WORD "CELL" WRITTEN VERTICALLY BETWEEN AND INDENTED RELATIVE TO THE WORDS "STEM" AND "THERAPY", THE WORDS "BY BIOLOGIC" APPEARING BELOW THE WORD "THERAPY", A STEM AND LEAVES ATTACHED THERETO APPEARING BETWEEN THE WORDS "BY" AND "BIOLOGIC", THE "S" OF "STEM" ENLARGED, THE "C" OF "CELL" ENLARGED, EACH "L" OF "CELL" HAVING AN ELONGATED VERTICAL PORTION, THE "T" OF "THERAPY" HAVING AN ELONGATED VERTICAL PORTION, AND THE LEFT VERTICAL PORTION OF THE "H" OF "THERAPY" ELONGATED.

SER. NO. 85-225,771, FILED 1-25-2011.

BRENDAN MCCAULEY, EXAMINING ATTORNEY



David J. Kyros

Director of the United States Patent and Trademark Office

United States of America

United States Patent and Trademark Office

SOZO LIFE

Reg. No. 4,107,701

SOZO GLOBAL, LLC (NEVADA LIMITED LIABILITY COMPANY)
811 BARTON SPRINGS ROAD, SUITE 400A
AUSTIN, TX 78704

Registered Mar. 6, 2012

Int. Cl.: 35

FOR: PROVIDING SERVICES TO INDEPENDENT SALES REPRESENTATIVES ENGAGED IN THE FIELD OF NUTRITIONAL, HEALTH, AND WELLNESS PRODUCTS, NAMELY, MARKETING, ADVERTISING, AND PROMOTIONAL SERVICES, IN CLASS 35 (U.S. CLS. 100, 101 AND 102).

SERVICE MARK

PRINCIPAL REGISTER

FIRST USE 11-6-2010; IN COMMERCE 11-6-2010.

THE MARK CONSISTS OF STANDARD CHARACTERS WITHOUT CLAIM TO ANY PARTICULAR FONT, STYLE, SIZE, OR COLOR.

OWNER OF U.S. REG. NO. 3,448,834.

THE ENGLISH TRANSLATION OF "SOZO" IN THE MARK IS "TO SAVE, KEEP SAFE AND SOUND, TO RESCUE FROM DANGER OR DESTRUCTION" OR "TO MAKE WELL, HEAL, RESTORE TO HEALTH".

SER. NO. 85-225,838, FILED 1-25-2011.

SALLY SHIH, EXAMINING ATTORNEY



David J. Kyffers

Director of the United States Patent and Trademark Office

United States of America

United States Patent and Trademark Office

LADDER-ADDER

Reg. No. 4,107,702

Registered Mar. 6, 2012

Int. Cl.: 20

TRADEMARK

PRINCIPAL REGISTER

MICHAEL DAVID POTTER (CANADA INDIVIDUAL), TA LADDER-ADDER
MANUFACTURING
221 BEECH HILL ROAD
HUNT'S POINT, NS, CANADA B0T1G0

FOR: STABILIZING DEVICE, NAMELY, A DEVICE COMPRISING LEG SUPPORTS AND BRACING THAT IS USED TO ENHANCE THE SAFE OPERATION OF AN EXTENSION LADDER, IN CLASS 20 (U.S. CLS. 2, 13, 22, 25, 32 AND 50).

FIRST USE 1-4-2010; IN COMMERCE 1-4-2010.

THE MARK CONSISTS OF STANDARD CHARACTERS WITHOUT CLAIM TO ANY PARTICULAR FONT, STYLE, SIZE, OR COLOR.

SER. NO. 85-225,881, FILED 1-25-2011.

INGA ERVIN, EXAMINING ATTORNEY



David J. Kyffers

Director of the United States Patent and Trademark Office

United States of America

United States Patent and Trademark Office

MUSCLE WIZ

Reg. No. 4,107,703

MUSCLE WIZ, INC. (CALIFORNIA CORPORATION)
10866 WASHINGTON BLVD. #608
CULVER CITY, CA 90232

Registered Mar. 6, 2012

Int. Cl.: 5

FOR: VITAMINS AND VITAMIN, MINERAL, DIETARY AND NUTRITIONAL SUPPLEMENTS, IN CLASS 5 (U.S. CLS. 6, 18, 44, 46, 51 AND 52).

TRADEMARK

FIRST USE 1-24-2011; IN COMMERCE 1-24-2011.

PRINCIPAL REGISTER

THE MARK CONSISTS OF STANDARD CHARACTERS WITHOUT CLAIM TO ANY PARTICULAR FONT, STYLE, SIZE, OR COLOR.

NO CLAIM IS MADE TO THE EXCLUSIVE RIGHT TO USE "MUSCLE", APART FROM THE MARK AS SHOWN.

SER. NO. 85-226,121, FILED 1-25-2011.

PAUL F. GAST, EXAMINING ATTORNEY



David J. Kyros

Director of the United States Patent and Trademark Office

United States of America

United States Patent and Trademark Office



Reg. No. 4,107,704

Registered Mar. 6, 2012

Int. Cl.: 36

SERVICE MARK

PRINCIPAL REGISTER

CAPSALUS CORP. (GEORGIA CORPORATION)
SUITE 100
2675 PACES FERRY ROAD
ATLANTA, GA 30339

FOR: INVESTMENT SERVICES, NAMELY, ASSET ACQUISITION, CONSULTATION, DEVELOPMENT AND MANAGEMENT SERVICES IN THE FIELD OF HEALTH AND WELLNESS, AND FINANCIAL ANALYSIS, FINANCIAL CONSULTATION, AND FINANCIAL CONTROL AND REPORTING SERVICES FOR ONE OR MORE HEALTH AND WELLNESS INSTITUTIONS, IN CLASS 36 (U.S. CLS. 100, 101 AND 102).

FIRST USE 8-31-2010; IN COMMERCE 8-31-2010.

THE MARK CONSISTS OF A LARGE GREEN LEAF-SHAPE WITH SMALLER YELLOW, ORANGE AND RED LEAF-SHAPES OVERLAPPING ON THE TOP AND A SMALLER BLUE LEAF-SHAPE OVERLAPPING ON THE BOTTOM.

THE COLOR(S) RED, GREEN, YELLOW, ORANGE AND BLUE IS/ARE CLAIMED AS A FEATURE OF THE MARK.

SER. NO. 85-226,217, FILED 1-26-2011.

EDWARD FENNESSY, EXAMINING ATTORNEY



David J. Kyjars

Director of the United States Patent and Trademark Office

United States of America

United States Patent and Trademark Office

CAFE DJANGO

Reg. No. 4,107,705

Registered Mar. 6, 2012

Int. Cl.: 43

SERVICE MARK

PRINCIPAL REGISTER

EVERSOLL, ADRIAN E (UNITED STATES INDIVIDUAL), DBA CAFE DJANGO
116 N GRANT ST.
BLOOMINGTON, IN 47408

FOR: BAR AND RESTAURANT SERVICES; CAFE AND RESTAURANT SERVICES; CAFE-RESTAURANTS; CARRY-OUT RESTAURANTS; RESTAURANT; RESTAURANT AND BAR SERVICES; RESTAURANT AND BAR SERVICES, INCLUDING RESTAURANT CARRYOUT SERVICES; RESTAURANT AND CAFE SERVICES; RESTAURANT SERVICES FEATURING INTERNATIONAL CUISINE; RESTAURANT SERVICES, INCLUDING SIT-DOWN SERVICE OF FOOD AND TAKE-OUT RESTAURANT SERVICES; RESTAURANT SERVICES, NAMELY, PROVIDING OF FOOD AND BEVERAGES FOR CONSUMPTION ON THE PREMISES; RESTAURANTS, IN CLASS 43 (U.S. CLS. 100 AND 101).

FIRST USE 5-1-1999; IN COMMERCE 5-1-1999.

THE MARK CONSISTS OF STANDARD CHARACTERS WITHOUT CLAIM TO ANY PARTICULAR FONT, STYLE, SIZE, OR COLOR.

NO CLAIM IS MADE TO THE EXCLUSIVE RIGHT TO USE "CAFE", APART FROM THE MARK AS SHOWN.

SER. NO. 85-226,489, FILED 1-26-2011.

SETH A. RAPPAPORT, EXAMINING ATTORNEY



David J. Kypos

Director of the United States Patent and Trademark Office

United States of America

United States Patent and Trademark Office

NORMAXAN

Reg. No. 4,107,706

BIOFARMA (FRANCE SOCIÉTÉ PAR ACTIONS SIMPLIFIÉE (SAS))
50, RUE CARNOT
SURESNES CEDEX, FRANCE 92284

Registered Mar. 6, 2012

Int. Cl.: 5

FOR: PHARMACEUTICAL PREPARATIONS FOR THE PREVENTION AND TREATMENT OF CENTRAL NERVOUS SYSTEM DISEASES; ANTI-DEPRESSANTS; PHARMACEUTICAL PREPARATIONS FOR THE PREVENTION AND TREATMENT OF ALZHEIMER DISEASE; PHARMACEUTICAL PREPARATIONS FOR THE PREVENTION OF PARKINSON DISEASE, IN CLASS 5 (U.S. CLS. 6, 18, 44, 46, 51 AND 52).

TRADEMARK

PRINCIPAL REGISTER

THE MARK CONSISTS OF STANDARD CHARACTERS WITHOUT CLAIM TO ANY PARTICULAR FONT, STYLE, SIZE, OR COLOR.

OWNER OF FRANCE REG. NO. 023161156, DATED 4-24-2002, EXPIRES 4-24-2012.

OWNER OF U.S. REG. NO. 3,073,673.

THE WORDING "NORMAXAN" HAS NO MEANING IN A FOREIGN LANGUAGE.

SER. NO. 85-226,509, FILED 1-26-2011.

MATTHEW PAPPAS, EXAMINING ATTORNEY



David J. Kyffers

Director of the United States Patent and Trademark Office

United States of America

United States Patent and Trademark Office

ARGUS Navigator

Reg. No. 4,107,707

Registered Mar. 6, 2012

Int. Cl.: 9

TRADEMARK

PRINCIPAL REGISTER

ARGUS SOFTWARE, INC. (DELAWARE CORPORATION)
3050 POST OAK BLVD., SUITE 900
HOUSTON, TX 77056

FOR: COMPUTER SOFTWARE PLATFORM FOR REAL ESTATE ASSET VALUATION; COMPUTER SOFTWARE FOR REAL ESTATE PORTFOLIO MANAGEMENT; COMPUTER SOFTWARE FOR FINANCIAL ANALYSIS AND BUDGETING OF REAL ESTATE INVESTMENTS; COMPUTER SOFTWARE FOR MANAGING DISCOUNTED CASH FLOW; COMPUTER SOFTWARE FOR ANALYSIS OF FINANCIAL ASSETS AND REAL ESTATE TRANSACTIONS; COMPUTER SOFTWARE FOR EVALUATION OF MARKET RISKS IN CONNECTION WITH THE MANAGEMENT OF REAL ESTATE INVESTMENT PORTFOLIOS; COMPUTER SOFTWARE FOR THE ANALYSIS AND CALCULATION OF FINANCIAL ASPECTS OF REAL ESTATE LEASING STRATEGIES, FOR FORECASTING REAL ESTATE ASSET AND REAL ESTATE PORTFOLIO CASH FLOWS, FOR CALCULATION OF REAL ESTATE INVESTMENT VALUES AND RETURNS AND FOR THE AGGREGATION OF MARKET AND REAL ESTATE ENTERPRISE DATA; COMPUTER SOFTWARE FOR USE IN DATA MINING AND DATA POOLING; DASHBOARD SOFTWARE FOR PROVIDING REAL TIME OPERATIONAL DATA IN CONNECTION WITH THE MANAGEMENT OF REAL ESTATE INVESTMENTS AND TRANSMITTING SUCH DATA BETWEEN AND AMONG USERS THEREOF, IN CLASS 9 (U.S. CLS. 21, 23, 26, 36 AND 38).

FIRST USE 1-1-2011; IN COMMERCE 1-1-2011.

THE MARK CONSISTS OF STANDARD CHARACTERS WITHOUT CLAIM TO ANY PARTICULAR FONT, STYLE, SIZE, OR COLOR.

SER. NO. 85-226,614, FILED 1-26-2011.

RUSS HERMAN, EXAMINING ATTORNEY



David J. Kyffers

Director of the United States Patent and Trademark Office

United States of America

United States Patent and Trademark Office

US SEEDS

Reg. No. 4,107,708

Registered Mar. 6, 2012

Int. Cl.: 31

TRADEMARK

PRINCIPAL REGISTER

U.S. SEEDS, INC. (TEXAS CORPORATION)
CROWN RIDGE
26 VENTANA PARKWAY
SAN ANTONIO, TX 78256

FOR: SEEDS FOR AGRICULTURAL PURPOSES, IN CLASS 31 (U.S. CLS. 1 AND 46).

FIRST USE 1-1-1984; IN COMMERCE 1-1-1984.

THE MARK CONSISTS OF STANDARD CHARACTERS WITHOUT CLAIM TO ANY PARTICULAR FONT, STYLE, SIZE, OR COLOR.

NO CLAIM IS MADE TO THE EXCLUSIVE RIGHT TO USE "SEEDS", APART FROM THE MARK AS SHOWN.

SEC. 2(F).

SER. NO. 85-226,690, FILED 1-26-2011.

JESSICA A. POWERS, EXAMINING ATTORNEY



David J. Kyffers

Director of the United States Patent and Trademark Office

United States of America

United States Patent and Trademark Office

WE'RE ROLLING PRETZEL COMPANY

Reg. No. 4,107,709

KRABILL, KEVIN A. (UNITED STATES INDIVIDUAL)
P.O. BOX 6106
ALLIANCE, OH 44601

Registered Mar. 6, 2012

Int. Cl.: 35

FOR: RETAIL OUTLETS FEATURING SNACK FOODS, NAMELY, PRETZELS, PRETZEL STICKS, AND RELATED PRODUCTS AND BEVERAGES, IN CLASS 35 (U.S. CLS. 100, 101 AND 102).

SERVICE MARK

FIRST USE 7-8-1999; IN COMMERCE 7-8-1999.

PRINCIPAL REGISTER

THE MARK CONSISTS OF STANDARD CHARACTERS WITHOUT CLAIM TO ANY PARTICULAR FONT, STYLE, SIZE, OR COLOR.

OWNER OF U.S. REG. NO. 2,333,828.

NO CLAIM IS MADE TO THE EXCLUSIVE RIGHT TO USE "PRETZEL COMPANY", APART FROM THE MARK AS SHOWN.

SER. NO. 85-226,729, FILED 1-26-2011.

KRISTINA MORRIS, EXAMINING ATTORNEY



David J. Kybas

Director of the United States Patent and Trademark Office

United States of America

United States Patent and Trademark Office

LANZATECH

Reg. No. 4,107,710

Registered Mar. 6, 2012

Int. Cls.: 1, 4 and 40

TRADEMARK

SERVICE MARK

PRINCIPAL REGISTER

LANZATECH NEW ZEALAND LIMITED (NEW ZEALAND LIMITED COMPANY (LTD.))
24 BALFOUR ROAD
PARNELL, AUCKLAND, NEW ZEALAND

FOR: CHEMICALS USED IN INDUSTRY; INDUSTRIAL CHEMICALS, NAMELY, 2, 3 BUTANEDIOL, ISOPRENE, METHYL ETHYL KETONE, I-BUTANOL, ISOPROPANAL, ACETONE, SUCCINIC ACID, ACRYLIC ACID, 2-BUTANOL, BIODIESEL AND FATTY ACID ETHYL ESTER; CHEMICAL ADDITIVES FOR FUELS AND LUBRICANTS; BACTERIA FOR USE IN FERMENTATION PROCESSES; BACTERIAL SUBSTANCES FOR INDUSTRIAL AND SCIENTIFIC USE, NAMELY, BACTERIAL SUBSTANCES AND PREPARATIONS, NAMELY, BACTERIA FOR USE IN FERMENTATION PROCESSES; PREPARATIONS AND CULTURES FOR MICROORGANISMS, NAMELY, ANAEROBIC PREPARATIONS AND CULTURES FOR USE IN FERMENTATION PROCESSES, IN CLASS 1 (U.S. CLS. 1, 5, 6, 10, 26 AND 46).

FOR: ALCOHOLS, NAMELY, ALCOHOL AND MIXED ALCOHOL FUEL; ALCOHOL FOR FUEL MANUFACTURE, NAMELY, FUELS WITH AN ALCOHOLIC BASE; ETHYL FUELS; GASEOUS FUELS; LIQUID FUELS; SOLID FUELS; SMOKELESS FUELS; LIQUID BIO-FUELS; GASEOUS BIO-FUELS; SOLID BIO-FUELS; SMOKELESS BIO-FUELS; BIO-DIESEL FUELS; NON CHEMICAL ADDITIVES FOR OILS AND FUELS, IN CLASS 4 (U.S. CLS. 1, 6 AND 15).

FOR: PRODUCTION OF ENERGY; RECYCLING; PRODUCTION, TREATMENT AND REFINEMENT OF MICROORGANISMS AND BACTERIA; PRODUCTION, TREATMENT AND REFINEMENT OF FUELS; PRODUCTION, TREATMENT AND REFINEMENT OF FUELS USING CARBON MONOXIDE COMPONENT OF WASTE FLUE GASES AS A FEED, IN CLASS 40 (U.S. CLS. 100, 103 AND 106).

THE MARK CONSISTS OF STANDARD CHARACTERS WITHOUT CLAIM TO ANY PARTICULAR FONT, STYLE, SIZE, OR COLOR.

OWNER OF NEW ZEALAND REG. NO. 827971, DATED 1-28-2011, EXPIRES 7-28-2020.

SER. NO. 85-227,015, FILED 1-26-2011.

LESLIE RICHARDS, EXAMINING ATTORNEY



David J. Kyros

Director of the United States Patent and Trademark Office

United States of America

United States Patent and Trademark Office

LanzaTech

Reg. No. 4,107,711

Registered Mar. 6, 2012

Int. Cls.: 1, 4 and 40

TRADEMARK

SERVICE MARK

PRINCIPAL REGISTER

LANZATECH NEW ZEALAND LIMITED (NEW ZEALAND LIMITED COMPANY (LTD.))
24 BALFOUR ROAD
PARNELL, AUCKLAND, NEW ZEALAND

FOR: CHEMICALS USED IN INDUSTRY; INDUSTRIAL CHEMICALS, NAMELY, 2, 3 BUTANEDIOL, ISOPRENE, METHYL ETHYL KETONE, I-BUTANOL, ISOPROPANAL, ACETONE, SUCCINIC ACID, ACRYLIC ACID, 2-BUTANOL, BIODIESEL AND FATTY ACID ETHYL ESTER; CHEMICAL ADDITIVES FOR FUELS AND LUBRICANTS; BACTERIA FOR USE IN FERMENTATION PROCESSES; BACTERIAL SUBSTANCES FOR INDUSTRIAL AND SCIENTIFIC USE, NAMELY, BACTERIAL SUBSTANCES AND PREPARATIONS, NAMELY, BACTERIA FOR USE IN FERMENTATION PROCESSES; PREPARATIONS AND CULTURES FOR MICROORGANISMS, NAMELY, ANAEROBIC PREPARATIONS AND CULTURES FOR USE IN FERMENTATION PROCESSES, IN CLASS 1 (U.S. CLS. 1, 5, 6, 10, 26 AND 46).

FOR: ALCOHOLS, NAMELY, ALCOHOL AND MIXED ALCOHOL FUEL; ALCOHOL FOR FUEL MANUFACTURE, NAMELY, FUELS WITH AN ALCOHOLIC BASE; ETHYL FUELS; GASEOUS FUELS; LIQUID FUELS; SOLID FUELS; SMOKELESS FUELS; LIQUID BIO-FUELS; GASEOUS BIO-FUELS; SOLID BIO-FUELS; SMOKELESS BIO-FUELS; BIO-DIESEL FUELS; NON CHEMICAL ADDITIVES FOR OILS AND FUELS, IN CLASS 4 (U.S. CLS. 1, 6 AND 15).

FOR: PRODUCTION OF ENERGY; RECYCLING; PRODUCTION, TREATMENT AND REFINEMENT OF MICROORGANISMS AND BACTERIA; PRODUCTION, TREATMENT AND REFINEMENT OF FUELS; PRODUCTION, TREATMENT AND REFINEMENT OF FUELS USING CARBON MONOXIDE COMPONENT OF WASTE FLUE GASES AS A FEED, IN CLASS 40 (U.S. CLS. 100, 103 AND 106).

OWNER OF NEW ZEALAND REG. NO. 827979, DATED 1-28-2011, EXPIRES 7-28-2020.

THE MARK CONSISTS OF THE WORD "LANZATECH" ON THE LEFT AND A DESIGN OF A FLAME ABOVE A DROPLET ON THE RIGHT.

SER. NO. 85-227,036, FILED 1-26-2011.

LESLIE RICHARDS, EXAMINING ATTORNEY



David J. Kyros

Director of the United States Patent and Trademark Office

United States of America

United States Patent and Trademark Office



Reg. No. 4,107,712

Registered Mar. 6, 2012

Int. Cls.: 1, 4 and 40

TRADEMARK

SERVICE MARK

PRINCIPAL REGISTER

LANZATECH NEW ZEALAND LIMITED (NEW ZEALAND LIMITED COMPANY (LTD.))
24 BALFOUR ROAD
PARNELL, AUCKLAND, NEW ZEALAND

FOR: CHEMICALS USED IN INDUSTRY; INDUSTRIAL CHEMICALS, NAMELY, 2, 3 BUTANEDIOL, ISOPRENE, METHYL ETHYL KETONE, I-BUTANOL, ISOPROPANAL, ACETONE, SUCCINIC ACID, ACRYLIC ACID, 2-BUTANOL, BIODIESEL AND FATTY ACID ETHYL ESTER; CHEMICAL ADDITIVES FOR FUELS AND LUBRICANTS; BACTERIA FOR USE IN FERMENTATION PROCESSES; BACTERIAL SUBSTANCES FOR INDUSTRIAL AND SCIENTIFIC USE, NAMELY, BACTERIAL SUBSTANCES AND PREPARATIONS, NAMELY, BACTERIA FOR USE IN FERMENTATION PROCESSES; PREPARATIONS AND CULTURES FOR MICROORGANISMS, NAMELY, ANAEROBIC PREPARATIONS AND CULTURES FOR USE IN FERMENTATION PROCESSES, IN CLASS 1 (U.S. CLS. 1, 5, 6, 10, 26 AND 46).

FOR: ALCOHOLS, NAMELY, ALCOHOL AND MIXED ALCOHOL FUEL; ALCOHOL FOR FUEL MANUFACTURE, NAMELY, FUELS WITH AN ALCOHOLIC BASE; ETHYL FUELS; GASEOUS FUELS; LIQUID FUELS; SOLID FUELS; SMOKELESS FUELS; LIQUID BIO-FUELS; GASEOUS BIO-FUELS; SOLID BIO-FUELS; SMOKELESS BIO-FUELS; BIO-DIESEL FUELS; NON CHEMICAL ADDITIVES FOR OILS AND FUELS, IN CLASS 4 (U.S. CLS. 1, 6 AND 15).

FOR: PRODUCTION OF ENERGY; RECYCLING; PRODUCTION, TREATMENT AND REFINEMENT OF MICROORGANISMS AND BACTERIA; PRODUCTION, TREATMENT AND REFINEMENT OF FUELS; PRODUCTION, TREATMENT AND REFINEMENT OF FUELS USING CARBON MONOXIDE COMPONENT OF WASTE FLUE GASES AS A FEED, IN CLASS 40 (U.S. CLS. 100, 103 AND 106).

OWNER OF NEW ZEALAND REG. NO. 827969, DATED 1-28-2011, EXPIRES 7-28-2020.

THE MARK CONSISTS OF A DESIGN OF A FLAME ABOVE A DROPLET.

SER. NO. 85-227,060, FILED 1-26-2011.

LESLIE RICHARDS, EXAMINING ATTORNEY



David J. Kybas

Director of the United States Patent and Trademark Office

United States of America

United States Patent and Trademark Office

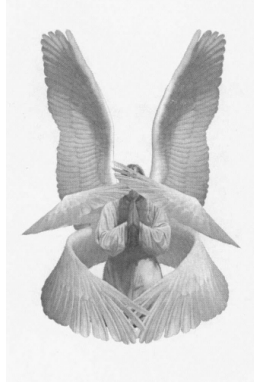

Reg. No. 4,107,713

Registered Mar. 6, 2012

Int. Cl.: 41

SERVICE MARK

PRINCIPAL REGISTER

BEATIFIC VISION (MISSOURI NON-PROFIT CORPORATION)
P.O. BOX 735
LEE'S SUMMIT, MO 640630735

FOR: PRODUCTION AND DISTRIBUTION OF TELEVISION SHOWS AND MOVIES, IN CLASS 41 (U.S. CLS. 100, 101 AND 107).

FIRST USE 4-19-2011; IN COMMERCE 4-19-2011.

THE MARK CONSISTS OF A MAN WEARING A ROBE WITH HANDS TOGETHER AT THE FRONT. THERE IS PAIR OF WINGS COMING FROM HIS BACK, A PAIR OF WINGS COVERING HIS FACE AND A PAIR OF WINGS CIRCLING AROUND HIS WAIST.

SER. NO. 85-227,197, FILED 1-26-2011.

MICHAEL WEBSTER, EXAMINING ATTORNEY



David J. Kyffers

Director of the United States Patent and Trademark Office

United States of America

United States Patent and Trademark Office

SKINFORMATION

Reg. No. 4,107,714

Registered Mar. 6, 2012

Int. Cls.: 16 and 41

TRADEMARK

SERVICE MARK

PRINCIPAL REGISTER

LINDSEY, CHERYL R. (UNITED STATES INDIVIDUAL)
942 WOODGATE DRIVE
PALM HARBOR, FL 34685

FOR: PUBLICATIONS, NAMELY, BOOKS, BOOKLETS, BROCHURES, MAGAZINES, JOURNALS, NEWSLETTERS, AND EDUCATIONAL MATERIALS IN THE FIELD OF PERSONAL AND SKIN CARE, IN CLASS 16 (U.S. CLS. 2, 5, 22, 23, 29, 37, 38 AND 50).

FIRST USE 9-10-2010; IN COMMERCE 9-30-2010.

FOR: PROVIDING A WEBSITE FEATURING BLOGS AND NON-DOWNLOADABLE PUBLICATIONS IN THE NATURE OF ARTICLES, NEWSLETTERS, EDUCATIONAL MATERIALS, AND INFORMATION ABOUT EVENTS IN THE FIELD OF PERSONAL AND SKIN CARE; NON-DOWNLOADABLE ELECTRONIC PUBLICATIONS IN THE NATURE OF BOOKS, BOOKLETS, BROCHURES, MAGAZINES, JOURNALS, NEWSLETTERS, AND EDUCATIONAL MATERIALS IN THE FIELD OF PERSONAL AND SKIN CARE; ON-LINE PUBLICATION OF BOOKS, BOOKLETS, BROCHURES, MAGAZINES, JOURNALS, NEWSLETTERS, AND EDUCATIONAL MATERIALS IN THE FIELD OF PERSONAL AND SKIN CARE; AND ON-LINE JOURNALS, NAMELY, BLOGS IN THE FIELD OF PERSONAL AND SKIN CARE, IN CLASS 41 (U.S. CLS. 100, 101 AND 107).

FIRST USE 9-10-2010; IN COMMERCE 9-30-2010.

THE MARK CONSISTS OF STANDARD CHARACTERS WITHOUT CLAIM TO ANY PARTICULAR FONT, STYLE, SIZE, OR COLOR.

SER. NO. 85-227,649, FILED 1-27-2011.

JORDAN BAKER, EXAMINING ATTORNEY



David J. Kyros

Director of the United States Patent and Trademark Office

United States of America

United States Patent and Trademark Office

51DEGREES

Reg. No. 4,107,715

Registered Mar. 6, 2012

Int. Cls.: 9, 35, 41 and 42

TRADEMARK

SERVICE MARK

PRINCIPAL REGISTER

51DEGREES.MOBI LIMITED (UNITED KINGDOM CORPORATION)
CAVERSHAM
5 CHARLOTTE CLOSE
READING, UNITED KINGDOM RG47BY

FOR: COMPUTER APPLICATION SOFTWARE FOR MOBILE PHONES, TABLET AND OTHER COMPUTER DEVICES AS WILL APPEAR FROM TIME TO TIME, NAMELY, SOFTWARE FOR THE OPTIMIZATION OF ELECTRONIC SERVICES TO OPERATE ON MOBILE OR SMALL DEVICES; COMPUTER SOFTWARE FOR WEBSITES FOR OPTIMIZING CONTENT AND SERVICES FOR OPERATION WITH MOBILE OR SMALL SCREEN DEVICES; COMPUTER SOFTWARE TO FACILITATE, IMPROVE, AID THE ACCESS TO WEBSITES OF MOBILE OR SMALL SCREEN DEVICES; COMPUTER SOFTWARE FOR THE CREATION OF MOBILE OR SMALL SCREEN DEVICE OPTIMIZED WEBSITES; COMPUTER SOFTWARE TO DETECT MOBILE OR SMALL SCREEN DEVICES ACCESSING WEBSITES; COMPUTER SOFTWARE TO REDIRECT MOBILE OR SMALL SCREEN DEVICES ACCESSING WEBSITES TO OTHER WEBSITES; COMPUTER SOFTWARE TO OPTIMIZE WEBSITES FOR MOBILE OR SMALL SCREEN DEVICES INCLUDING TAILORING ALL DATA TYPES FOR THE DATA CONNECTION IN USE AND THE CHARACTERISTICS OF THE REQUESTING MOBILE DEVICE; COMPUTER SOFTWARE TO OPTIMIZE MOBILE DEVICES FOR ACCESSING WEB SITE CONTENT VIA TYPES OF DATA CONNECTIONS, IN CLASS 9 (U.S. CLS. 21, 23, 26, 36 AND 38).

FIRST USE 4-0-2009; IN COMMERCE 4-0-2009.

FOR: BUSINESS CONSULTANCY IN RELATION TO COMPUTER SOFTWARE AND MOBILE DEVICES, IN CLASS 35 (U.S. CLS. 100, 101 AND 102).

FIRST USE 4-0-2009; IN COMMERCE 4-0-2009.

FOR: EDUCATION SERVICES, NAMELY, PROVIDING TUTORIAL SESSIONS IN THE USE AND OPERATION OF COMPUTER SOFTWARE AND MOBILE DEVICES; TRAINING IN THE USE AND OPERATION OF COMPUTER SOFTWARE AND MOBILE DEVICES, IN CLASS 41 (U.S. CLS. 100, 101 AND 107).

FIRST USE 4-0-2009; IN COMMERCE 4-0-2009.



David J. Kyjars

Director of the United States Patent and Trademark Office

Reg. No. 4,107,715 FOR: COMPUTER PROGRAMMING; COMPUTER SOFTWARE CONSULTANCY; COMPUTER SOFTWARE DESIGN ALL IN RELATION TO MOBILE OR SMALL SCREEN DEVICES, IN CLASS 42 (U.S. CLS. 100 AND 101).

FIRST USE 4-0-2009; IN COMMERCE 4-0-2009.

THE MARK CONSISTS OF STANDARD CHARACTERS WITHOUT CLAIM TO ANY PARTICULAR FONT, STYLE, SIZE, OR COLOR.

PRIORITY CLAIMED UNDER SEC. 44(D) ON UNITED KINGDOM APPLICATION NO. 009641812, FILED 1-5-2011, REG. NO. 009641812, DATED 7-13-2011, EXPIRES 1-5-2021.

SER. NO. 85-228,040, FILED 1-27-2011.

GEOFFREY FOSDICK, EXAMINING ATTORNEY

United States of America

United States Patent and Trademark Office



Reg. No. 4,107,716

COMPART ASIA PTE LTD. (SINGAPORE CORPORATION)
50 RAFFLES PLACE, #32-01
SINGAPORE LAND TOWER, SINGAPORE 04823

Registered Mar. 6, 2012

Int. Cl.: 6

FOR: TUBE AND CYLINDER FITTINGS OF METAL AND PLASTIC FOR USE PRIMARILY IN THE MEDICAL EQUIPMENT, SOLAR ENERGY, MILITARY, ROBOTIC, INDUSTRIAL AUTOMATION, PETRO CHEMICAL, SEMICONDUCTOR, AUTOMOTIVE AND DATA STORAGE INDUSTRIES, IN CLASS 6 (U.S. CLS. 2, 12, 13, 14, 23, 25 AND 50).

TRADEMARK

PRINCIPAL REGISTER

FIRST USE 12-0-2007; IN COMMERCE 12-0-2007.

THE MARK CONSISTS OF THE WORD "COMPART" WITH A PARTIAL OVAL ENCLOSING THE WORD.

SER. NO. 85-228,050, FILED 1-27-2011.

JILL C. ALT, EXAMINING ATTORNEY



David J. Kybas

Director of the United States Patent and Trademark Office

United States of America

United States Patent and Trademark Office

EnviroLytical

Reg. No. 4,107,717

Registered Mar. 6, 2012

Int. Cl.: 42

SERVICE MARK

PRINCIPAL REGISTER

ENVIROISSUES INC. (WASHINGTON CORPORATION)
SUITE 1200
101 STEWART ST
SEATTLE, WA 98101

FOR: APPLICATION SERVICE PROVIDER (ASP) FEATURING SOFTWARE TO MANAGE CONTACT INFORMATION, CORRESPONDENCE AND ACTIVITIES, AND DEVELOP PLANNING TOOLS THAT SUPPORT PUBLIC INVOLVEMENT, AS PART OF THE ENVIRONMENTAL ASSESSMENT AND PLANNING, DESIGN AND/OR CONSTRUCTION PHASES OF A PUBLIC OR PRIVATE PROJECT, IN CLASS 42 (U.S. CLS. 100 AND 101).

FIRST USE 5-10-2010; IN COMMERCE 5-10-2010.

THE MARK CONSISTS OF STANDARD CHARACTERS WITHOUT CLAIM TO ANY PARTICULAR FONT, STYLE, SIZE, OR COLOR.

SER. NO. 85-228,263, FILED 1-27-2011.

MARK SPARACINO, EXAMINING ATTORNEY



David J. Kyffers

Director of the United States Patent and Trademark Office

United States of America

United States Patent and Trademark Office



Reg. No. 4,107,718

Registered Mar. 6, 2012

Int. Cl.: 28

TRADEMARK

PRINCIPAL REGISTER

COMPASS INTERNATIONAL PICTURES (CALIFORNIA CORPORATION)
2021 PONTIUS
LOS ANGELES, CA 90025

FOR: TOYS, NAMELY, ACTION FIGURES AND MINI BUSTS IN THE NATURE OF ACTION FIGURES, NOT PERTAINING TO HALLOWEEN THE HOLIDAY, BUT PERTAINING TO CHARACTERS AND THEMES FROM A SERIES OF HORROR AND SUSPENSE MOVIES, IN CLASS 28 (U.S. CLS. 22, 23, 38 AND 50).

FIRST USE 10-1-1999; IN COMMERCE 10-1-1999.

THE MARK CONSISTS OF THE WORDS "HALLOWEEN" TO THE RIGHT OF A JACK-O-LANTERN WITH A FIST HOLDING A KNIFE NEXT TO THE JACK-O-LANTERN; THE RECTANGLE CARRIER IS NOT PART OF THE MARK BUT REPRESENTS TRANSPARENT BACKGROUND.

SER. NO. 85-228,711, FILED 1-28-2011.

APRIL HESIK, EXAMINING ATTORNEY



David J. Kyros

Director of the United States Patent and Trademark Office

United States of America

United States Patent and Trademark Office



Reg. No. 4,107,719

Registered Mar. 6, 2012

Int. Cl.: 42

SERVICE MARK

PRINCIPAL REGISTER

ENVIROISSUES INC. (WASHINGTON CORPORATION)
SUITE 1200
101 STEWART ST
SEATTLE, WA 98101

FOR: APPLICATION SERVICE PROVIDER (ASP) FEATURING SOFTWARE TO MANAGE CONTACT INFORMATION, CORRESPONDENCE AND ACTIVITIES, AND DEVELOP PLANNING TOOLS THAT SUPPORT PUBLIC INVOLVEMENT, AS PART OF THE ENVIRONMENTAL ASSESSMENT AND PLANNING, DESIGN AND/OR CONSTRUCTION PHASES OF A PUBLIC OR PRIVATE PROJECT, IN CLASS 42 (U.S. CLS. 100 AND 101).

FIRST USE 5-10-2010; IN COMMERCE 5-10-2010.

THE MARK CONSISTS OF A SERIES OF 6 DIFFERENT SIZED BOXES WITH DIFFERENT COLORS INCLUDING ORANGE, GRAY, AND BLUE ON THE LEFT HAND SIDE OF THE IMAGE. "ENVIROLYTICAL" IS TYPED OUT WITH "ENVIRO" BEING ORANGE AND "LYTICAL" THE COLOR BLUE.

THE COLOR(S) ORANGE, BLUE, AND GRAY IS/ARE CLAIMED AS A FEATURE OF THE MARK.

SER. NO. 85-228,721, FILED 1-28-2011.

MARK SPARACINO, EXAMINING ATTORNEY



David J. Kyjars

Director of the United States Patent and Trademark Office

United States of America

United States Patent and Trademark Office



Reg. No. 4,107,720

INTERTAPE POLYMER CORP. (DELAWARE CORPORATION)
3647 CORTEZ ROAD WEST
BRADENTON, FL 34210

Registered Mar. 6, 2012

Int. Cls.: 20, 22 and 24

FOR: PLASTIC INDUSTRIAL CONTAINERS, NAMELY, FLEXIBLE CONTAINERS FORMED FROM WOVEN POLYMERIC TAPES, IN CLASS 20 (U.S. CLS. 2, 13, 22, 25, 32 AND 50).

TRADEMARK

FIRST USE 8-31-1993; IN COMMERCE 8-31-1993.

PRINCIPAL REGISTER

FOR: FLEXIBLE INTERMEDIATE BULK CONTAINERS IN THE NATURE OF BAGS FOR THE TRANSPORTATION OR STORAGE OF MATERIALS IN BULK; WOVEN POLYPROPYLENE FABRIC INDUSTRIAL AND AGRICULTURAL BAGS FOR INTERMEDIATE-BULK HANDLING, IN CLASS 22 (U.S. CLS. 1, 2, 7, 19, 22, 42 AND 50).

FIRST USE 8-31-1993; IN COMMERCE 8-31-1993.

FOR: SYNTHETIC FABRICS WOVEN AND COATED AND UNCOATED, MADE FROM POLYMERIC MATERIALS, IN CLASS 24 (U.S. CLS. 42 AND 50).

FIRST USE 8-31-1993; IN COMMERCE 8-31-1993.

OWNER OF U.S. REG. NO. 3,870,684.

THE MARK CONSISTS OF THE LETTERS "IPG" WITHIN A CIRCLE.

SER. NO. 85-228,772, FILED 1-28-2011.

PRISCILLA MILTON, EXAMINING ATTORNEY



David J. Kybas

Director of the United States Patent and Trademark Office

United States of America

United States Patent and Trademark Office

NO-FED-BEAR

Reg. No. 4,107,721

UDAP INDUSTRIES, INC. (MONTANA CORPORATION)
13160 YONDER ROAD
BOZEMAN, MT 59718

Registered Mar. 6, 2012

Int. Cl.: 21

FOR: CONTAINERS FOR FOODS, NAMELY, PLASTIC FOOD STORAGE CONTAINERS FOR DOMESTIC USE, IN CLASS 21 (U.S. CLS. 2, 13, 23, 29, 30, 33, 40 AND 50).

TRADEMARK

FIRST USE 5-5-2010; IN COMMERCE 5-5-2010.

PRINCIPAL REGISTER

THE MARK CONSISTS OF STANDARD CHARACTERS WITHOUT CLAIM TO ANY PARTICULAR FONT, STYLE, SIZE, OR COLOR.

SER. NO. 85-228,944, FILED 1-28-2011.

LIEF MARTIN, EXAMINING ATTORNEY



David J. Kyffers

Director of the United States Patent and Trademark Office

United States of America

United States Patent and Trademark Office



Reg. No. 4,107,722

SHEK, JOANNA (UNITED STATES INDIVIDUAL)
13 STEPHENVILLE PARKWAY
EDISON, NJ 08820

Registered Mar. 6, 2012

Int. Cl.: 20

FOR: KITCHEN CABINETS; BATHROOM CABINETS, IN CLASS 20 (U.S. CLS. 2, 13, 22, 25, 32 AND 50).

TRADEMARK

FIRST USE 6-1-2005; IN COMMERCE 6-1-2005.

PRINCIPAL REGISTER

NO CLAIM IS MADE TO THE EXCLUSIVE RIGHT TO USE "GROUP, LLC", APART FROM THE MARK AS SHOWN.

THE COLOR(S) PURPLE AND DARK PURPLE IS/ARE CLAIMED AS A FEATURE OF THE MARK.

THE MARK CONSISTS OF THE LETTERS "TSG" IN PURPLE ABOVE THE WORDING "THE SHEKIA GROUP, LLC" IN DARK PURPLE WITH TWO DARK PURPLE HORIZONTAL LINES SEPARATING THE LETTERING FROM THE WORDING. TO THE LEFT OF THE LETTERING IS A STAR DESIGN IN DARK PURPLE. THE BACKGROUND OF THE MARK IS TRANSPARENT.

SER. NO. 85-229,403, FILED 1-29-2011.

ANDREA HACK, EXAMINING ATTORNEY



David J. Kybas

Director of the United States Patent and Trademark Office

United States of America

United States Patent and Trademark Office

CARDIOLEAF

Reg. No. 4,107,723

Registered Mar. 6, 2012

Int. Cl.: 10

TRADEMARK

PRINCIPAL REGISTER

CLEARBRIDGE VITALSIGNS PTE LTD (SINGAPORE LIMITED LIABILITY COMPANY)
20 AYER RAJAH CRESCENT, #08-03
TECHNOPRENEUR CENTRE, SINGAPORE 139964

FOR: APPARATUS FOR MEDICAL USE FOR MONITORING VITAL SIGNS OF PATIENTS; CARDIOGRAPHIC APPARATUS, NAMELY, CARDIAC ELECTRODES FOR RECORDING, MONITORING AND TRANSMISSION; MEDICAL INSTRUMENTS FOR RECORDING HEART ACTIVITY; ELECTROCARDIOGRAPHIC (ECG) RECORDERS AND ELECTROCARDIOGRAPHIC (ECG) DIGITAL PLASTERS; ELECTROCARDIOGRAPHS; MEDICAL APPARATUS AND INSTRUMENTS FOR MONITORING VITAL SIGNS, BLOOD PROPERTIES AND RESPIRATORY EVENTS, IN CLASS 10 (U.S. CLS. 26, 39 AND 44).

THE MARK CONSISTS OF STANDARD CHARACTERS WITHOUT CLAIM TO ANY PARTICULAR FONT, STYLE, SIZE, OR COLOR.

PRIORITY CLAIMED UNDER SEC. 44(D) ON SINGAPORE APPLICATION NO. T1100584D, FILED 1-14-2011, REG. NO. T1100584D, DATED 1-14-2011, EXPIRES 1-14-2021.

SER. NO. 85-230,215, FILED 1-31-2011.

B. PARADEWELAI, EXAMINING ATTORNEY



David J. Kyros

Director of the United States Patent and Trademark Office

United States of America

United States Patent and Trademark Office

MULTI-MC

Reg. No. 4,107,724

MCELROY MANUFACTURING, INC. (OKLAHOMA CORPORATION)
833 N. FULTON STREET
TULSA, OK 74115

Registered Mar. 6, 2012

Int. Cl.: 7

FOR: ELECTRIC PIPE FUSION HEATING MACHINES, IN CLASS 7 (U.S. CLS. 13, 19, 21, 23, 31, 34 AND 35).

TRADEMARK

FIRST USE 4-30-2002; IN COMMERCE 4-30-2002.

PRINCIPAL REGISTER

THE MARK CONSISTS OF STANDARD CHARACTERS WITHOUT CLAIM TO ANY PARTICULAR FONT, STYLE, SIZE, OR COLOR.

SER. NO. 85-230,329, FILED 1-31-2011.

JORDAN BAKER, EXAMINING ATTORNEY



David J. Kyffers

Director of the United States Patent and Trademark Office

United States of America

United States Patent and Trademark Office

SWITCHSTACK

Reg. No. 4,107,725

Registered Mar. 6, 2012

Int. Cl.: 42

SERVICE MARK

PRINCIPAL REGISTER

SWITCH COMMUNICATIONS GROUP LLC (NEVADA LIMITED LIABILITY COMPANY)
7135 S. DECATUR BLVD
LAS VEGAS, NV 89118

FOR: COMPUTER SERVICES, NAMELY, ACTING AS AN APPLICATION SERVICES PROVIDER FOR THIRD PARTIES FEATURING REMOTE HOSTING OF OPERATING SYSTEMS AND COMPUTER SOFTWARE APPLICATIONS OF OTHERS; CLOUD COMPUTING, NAMELY, PROVIDING VIRTUAL COMPUTER SYSTEMS AND VIRTUAL COMPUTER ENVIRONMENTS THROUGH CLOUD COMPUTING; COMPUTER SERVICES, NAMELY, PROVIDING A VIRTUAL COMPUTING ENVIRONMENT ACCESSIBLE VIA THE INTERNET FOR REGISTERED USERS FOR THE PURPOSE OF COMPUTING COMPUTER SERVER CAPACITY; RENTAL OF COMPUTING AND DATA STORAGE FACILITIES OF VARIABLE CAPACITY, NAMELY, DATABASE SERVERS, TO THIRD PARTIES; PROVIDING NON-DOWNLOADABLE SOFTWARE ACCESSIBLE OVER A GLOBAL COMPUTER NETWORK FOR USE IN MANAGING COMPUTER APPLICATIONS OF OTHERS, IN CLASS 42 (U.S. CLS. 100 AND 101).

FIRST USE 10-31-2010; IN COMMERCE 10-31-2010.

THE MARK CONSISTS OF STANDARD CHARACTERS WITHOUT CLAIM TO ANY PARTICULAR FONT, STYLE, SIZE, OR COLOR.

OWNER OF U.S. REG. NOS. 3,229,168, 3,946,128 AND OTHERS.

SER. NO. 85-231,144, FILED 2-1-2011.

JAY BESCH, EXAMINING ATTORNEY



David J. Kyros

Director of the United States Patent and Trademark Office

United States of America

United States Patent and Trademark Office

GOLD SYSTEMS

Reg. No. 4,107,726

Registered Mar. 6, 2012

Int. Cl.: 42

SERVICE MARK

PRINCIPAL REGISTER

GOLD SYSTEMS, INC. (DELAWARE CORPORATION)
4840 PEARL EAST CIRCLE STE 106
BOULDER, CO 80301

FOR: DESIGNING SOFTWARE FOR OTHERS IN THE FIELDS OF WIRELESS COMMUNICATIONS, TELECOMMUNICATIONS, TELEPHONY AND THE WORLDWIDE WEB, NAMELY, DESIGNING WIRELESS INTERFACE MIDDLEWARE FOR THE INTEGRATION OF SOFTWARE IN THESE AREAS INTO INTERACTIVE UNITS, IN CLASS 42 (U.S. CLS. 100 AND 101).

FIRST USE 6-21-1991; IN COMMERCE 6-21-1991.

THE MARK CONSISTS OF STANDARD CHARACTERS WITHOUT CLAIM TO ANY PARTICULAR FONT, STYLE, SIZE, OR COLOR.

NO CLAIM IS MADE TO THE EXCLUSIVE RIGHT TO USE "SYSTEMS", APART FROM THE MARK AS SHOWN.

SER. NO. 85-231,718, FILED 2-1-2011.

ERNEST SHOSHO, EXAMINING ATTORNEY



David J. Kyros

Director of the United States Patent and Trademark Office

United States of America

United States Patent and Trademark Office

GOLD SYSTEMS

Reg. No. 4,107,727

Registered Mar. 6, 2012

Int. Cl.: 9

TRADEMARK

PRINCIPAL REGISTER

GOLD SYSTEMS, INC. (DELAWARE CORPORATION)
4840 PEARL EAST CIRCLE STE 106
BOULDER, CO 80301

FOR: SOFTWARE FOR USE IN THE FIELDS OF SPEECH RECOGNITION, INTERACTIVE VOICE RESPONSE (IVR), WIRELESS COMMUNICATIONS, WEB INTERFACE AND COMPUTER TELEPHONY INTEGRATION ENVIRONMENTS, NAMELY, WIRELESS INTERFACE COMPUTER SOFTWARE FOR ALLOWING THE INTEGRATION OF SOFTWARE IN THESE AREAS INTO CUSTOMER'S EXISTING INTERACTIVE CALL CENTER SOFTWARE AND HARDWARE, IN CLASS 9 (U.S. CLS. 21, 23, 26, 36 AND 38).

FIRST USE 6-21-1991; IN COMMERCE 6-21-1991.

THE MARK CONSISTS OF STANDARD CHARACTERS WITHOUT CLAIM TO ANY PARTICULAR FONT, STYLE, SIZE, OR COLOR.

NO CLAIM IS MADE TO THE EXCLUSIVE RIGHT TO USE "SYSTEMS", APART FROM THE MARK AS SHOWN.

SER. NO. 85-231,739, FILED 2-1-2011.

ERNEST SHOSHO, EXAMINING ATTORNEY



David J. Kyffers

Director of the United States Patent and Trademark Office

United States of America

United States Patent and Trademark Office

BROADROCK RENEWABLES

Reg. No. 4,107,728

Registered Mar. 6, 2012

Int. Cls.: 37 and 40

SERVICE MARK

PRINCIPAL REGISTER

BROADROCK RENEWABLES LLC (DELAWARE LIMITED LIABILITY COMPANY)
14 PHILIPS PARKWAY
MONTVALE, NJ 076451811

FOR: INSTALLATION OF ENERGY GENERATION, ELECTRICITY GENERATION, AND STEAM GENERATION EQUIPMENT, NAMELY, ENGINES, TURBINES, AND HEAT EXCHANGERS; PLANT CONSTRUCTION, MAINTENANCE AND CONSTRUCTION PROJECT MANAGEMENT SERVICES FOR ENERGY GENERATION, ELECTRICITY GENERATION, AND STEAM GENERATION FACILITIES, AND FOR BUSINESSES IN THE ENERGY PRODUCTION AND ENERGY TRANSMISSION SECTOR, IN CLASS 37 (U.S. CLS. 100, 103 AND 106).

FIRST USE 1-18-2011; IN COMMERCE 1-18-2011.

FOR: GENERATION OF ENERGY, GENERATION OF STEAM ASSOCIATED WITH THE GENERATION OF ELECTRICITY, GENERATION OF ELECTRICITY; ENERGY RECYCLING SERVICES, NAMELY, CAPTURING AND CONVERSION OF WASTED ENERGY INTO ELECTRICITY AND USEFUL STEAM; PRODUCTION OF ENERGY, PRODUCTION OF STEAM, PRODUCTION OF ELECTRICITY, WASTE-TO-ENERGY GENERATION SERVICES, IN CLASS 40 (U.S. CLS. 100, 103 AND 106).

FIRST USE 1-18-2011; IN COMMERCE 1-18-2011.

THE MARK CONSISTS OF STANDARD CHARACTERS WITHOUT CLAIM TO ANY PARTICULAR FONT, STYLE, SIZE, OR COLOR.

NO CLAIM IS MADE TO THE EXCLUSIVE RIGHT TO USE "RENEWABLES", APART FROM THE MARK AS SHOWN.

SER. NO. 85-231,941, FILED 2-2-2011.

EDWARD FENNESSY, EXAMINING ATTORNEY



David J. Kyffers

Director of the United States Patent and Trademark Office

United States of America

United States Patent and Trademark Office



The Final Touch
CLEANING SERVICE INC.

Reg. No. 4,107,729

Registered Mar. 6, 2012

Int. Cl.: 37

SERVICE MARK

PRINCIPAL REGISTER

THE FINAL TOUCH CLEANING SERVICE INC. (WASHINGTON CORPORATION)
PO BOX 5927
BELLINGHAM, WA 98227

FOR: JANITORIAL SERVICES, IN CLASS 37 (U.S. CLS. 100, 103 AND 106).

FIRST USE 2-28-1995; IN COMMERCE 2-28-1995.

NO CLAIM IS MADE TO THE EXCLUSIVE RIGHT TO USE "CLEANING SERVICE INC.",
APART FROM THE MARK AS SHOWN.

THE MARK CONSISTS OF THE WORDING, "THE FINAL TOUCH CLEANING SERVICE
INC.", WITH A CARTOONED HOUSE. THE HOUSE HAS A FACE, ARMS, AND LEGS. THE
CARTOONED HOUSE IS HOLDING A BUCKET IN ONE HAND AND A MOP IN THE OTHER,
IT ALSO HAS A BROOM ATTACHED TO ITS CHIMNEY.

SER. NO. 85-232,309, FILED 2-2-2011.

KELLY BOULTON, EXAMINING ATTORNEY



David J. Kybas

Director of the United States Patent and Trademark Office

United States of America

United States Patent and Trademark Office



Reg. No. 4,107,730

Registered Mar. 6, 2012

Int. Cls.: 7, 11 and 32

TRADEMARK

PRINCIPAL REGISTER

NANOBREWING LIMITED (NEW ZEALAND LIMITED LIABILITY COMPANY)
2 KINGS ROAD, PANMURE
AUCKLAND, NEW ZEALAND 1072

FOR: BEER BREWING MACHINES AND STRUCTURAL PARTS AND FITTINGS THEREFOR;
BREWING MACHINES FOR MAKING ALCOHOLIC BEVERAGES AND STRUCTURAL
PARTS AND FITTINGS THEREFOR, IN CLASS 7 (U.S. CLS. 13, 19, 21, 23, 31, 34 AND 35).

FOR: DISTILLERS, IN CLASS 11 (U.S. CLS. 13, 21, 23, 31 AND 34).

FOR: BEERS; SYRUPS AND PREPARATIONS FOR MAKING ALCOHOLIC BEVERAGES;
PREPARATIONS FOR MAKING BEER, NAMELY, HOP AND MALT EXTRACTS AND
BREWING YEAST FOR MANUFACTURING BEER; BEER BREWING KITS FOR HOME USE
CONTAINING MALT EXTRACTS, BREWING YEAST, FRESH HOPS AND/OR HOP EX-
TRACTS, IN CLASS 32 (U.S. CLS. 45, 46 AND 48).

OWNER OF NEW ZEALAND REG. NO. 828259, DATED 8-3-2010, EXPIRES 8-3-2020.

THE MARK CONSISTS OF A CIRCLE WITH THREE CONCENTRIC RINGS ON THE INSIDE
EDGE OF THE CIRCLE, AND A STYLISTIC REPRESENTATION OF THE LETTER "W"
(WHICH LOOKS LIKE TWO BEER GLASSES SIDE BY SIDE) IN THE CENTER OF THE
CIRCLE.

SER. NO. 85-232,437, FILED 2-2-2011.

NAPOLEON SHARMA, EXAMINING ATTORNEY



David J. Kyjars

Director of the United States Patent and Trademark Office

United States of America

United States Patent and Trademark Office

Trex Transcend

Reg. No. 4,107,731

Registered Mar. 6, 2012

Int. Cl.: 19

TRADEMARK

PRINCIPAL REGISTER

TREX COMPANY, INC. (DELAWARE CORPORATION)
160 EXETER DRIVE
WINCHESTER, VA 22603

FOR: COMPOSITE BUILDING MATERIALS COMPRISING WOOD FIBER AND POLYMER, NAMELY, DECKING, RAILING AND PORCH PRODUCTS, IN CLASS 19 (U.S. CLS. 1, 12, 33 AND 50).

FIRST USE 11-11-2009; IN COMMERCE 11-11-2009.

OWNER OF U.S. REG. NOS. 1,938,516, 3,773,349 AND OTHERS.

THE MARK CONSISTS OF THE WORD "TREX" WITH A STYLIZED "X" AND THE WORD "TRANSCEND".

SER. NO. 85-232,998, FILED 2-3-2011.

TOBY BULLOFF, EXAMINING ATTORNEY



David J. Kyffers

Director of the United States Patent and Trademark Office

United States of America

United States Patent and Trademark Office



Reg. No. 4,107,732

Registered Mar. 6, 2012

Int. Cl.: 9

TRADEMARK

PRINCIPAL REGISTER

GOLD SYSTEMS, INC. (DELAWARE CORPORATION)
4840 PEARL EAST CIRCLE STE 106
BOULDER, CO 80301

FOR: SOFTWARE FOR USE IN THE FIELDS OF SPEECH RECOGNITION, INTERACTIVE VOICE RESPONSE (IVR), WIRELESS COMMUNICATIONS, WEB INTERFACE AND COMPUTER TELEPHONY INTEGRATION ENVIRONMENTS, NAMELY, WIRELESS INTERFACE COMPUTER SOFTWARE FOR ALLOWING THE INTEGRATION OF SOFTWARE IN THESE AREAS INTO CUSTOMER'S EXISTING INTERACTIVE CALL CENTER SOFTWARE AND HARDWARE, IN CLASS 9 (U.S. CLS. 21, 23, 26, 36 AND 38).

FIRST USE 12-1-1995; IN COMMERCE 12-1-1995.

THE MARK CONSISTS OF A SUBSTANTIALLY SQUARE AREA HAVING PORTIONS OF CONCENTRIC CIRCULAR ELEMENTS.

SER. NO. 85-233,093, FILED 2-3-2011.

ERNEST SHOSHO, EXAMINING ATTORNEY



David J. Kyffers

Director of the United States Patent and Trademark Office

United States of America

United States Patent and Trademark Office



GOLD SYSTEMS

Reg. No. 4,107,733

Registered Mar. 6, 2012

Int. Cl.: 42

SERVICE MARK

PRINCIPAL REGISTER

GOLD SYSTEMS, INC. (DELAWARE CORPORATION)
4840 PEARL EAST CIRCLE STE 106
BOULDER, CO 80301

FOR: DESIGNING SOFTWARE FOR OTHERS IN THE FIELDS OF WIRELESS COMMUNICATIONS, TELECOMMUNICATIONS, TELEPHONY AND THE WORLDWIDE WEB, NAMELY, DESIGNING WIRELESS INTERFACE MIDDLEWARE FOR THE INTEGRATION OF SOFTWARE IN THESE AREAS INTO INTERACTIVE UNITS, IN CLASS 42 (U.S. CLS. 100 AND 101).

FIRST USE 6-21-1991; IN COMMERCE 6-21-1991.

NO CLAIM IS MADE TO THE EXCLUSIVE RIGHT TO USE "SYSTEMS", APART FROM THE MARK AS SHOWN.

THE MARK CONSISTS OF A SUBSTANTIALLY SQUARE AREA HAVING PORTIONS OF CONCENTRIC CIRCULAR ELEMENTS WITH THE WORDS "GOLD SYSTEMS" POSITIONED ADJACENT THE SQUARE AREA.

SER. NO. 85-233,180, FILED 2-3-2011.

ERNEST SHOSHO, EXAMINING ATTORNEY



David J. Kyfos

Director of the United States Patent and Trademark Office

United States of America

United States Patent and Trademark Office



GOLD SYSTEMS

Reg. No. 4,107,734

Registered Mar. 6, 2012

Int. Cl.: 9

TRADEMARK

PRINCIPAL REGISTER

GOLD SYSTEMS, INC. (DELAWARE CORPORATION)
4840 PEARL EAST CIRCLE STE 106
BOULDER, CO 80301

FOR: SOFTWARE FOR USE IN THE FIELDS OF SPEECH RECOGNITION, INTERACTIVE VOICE RESPONSE (IVR), WIRELESS COMMUNICATIONS, WEB INTERFACE AND COMPUTER TELEPHONY INTEGRATION ENVIRONMENTS, NAMELY, WIRELESS INTERFACE COMPUTER SOFTWARE FOR ALLOWING THE INTEGRATION OF SOFTWARE IN THESE AREAS INTO CUSTOMER'S EXISTING INTERACTIVE CALL CENTER SOFTWARE AND HARDWARE, IN CLASS 9 (U.S. CLS. 21, 23, 26, 36 AND 38).

FIRST USE 6-21-1991; IN COMMERCE 6-21-1991.

NO CLAIM IS MADE TO THE EXCLUSIVE RIGHT TO USE "SYSTEMS", APART FROM THE MARK AS SHOWN.

THE MARK CONSISTS OF A SUBSTANTIALLY SQUARE AREA HAVING PORTIONS OF CONCENTRIC CIRCULAR ELEMENTS WITH THE WORDS "GOLD SYSTEMS" POSITIONED ADJACENT THE SQUARE AREA.

SER. NO. 85-233,282, FILED 2-3-2011.

ERNEST SHOSHO, EXAMINING ATTORNEY



David J. Kybas

Director of the United States Patent and Trademark Office

United States of America

United States Patent and Trademark Office

VONETIX

Reg. No. 4,107,735

Registered Mar. 6, 2012

Int. Cl.: 9

TRADEMARK

PRINCIPAL REGISTER

GOLD SYSTEMS, INC. (DELAWARE CORPORATION)
4840 PEARL EAST CIRCLE STE 106
BOULDER, CO 80301

FOR: SOFTWARE FOR INTEGRATING SPEECH RECOGNITION, INTERACTIVE VOICE RESPONSE (IVR), AND WIRELESS WEB TECHNOLOGIES WITH TRADITIONAL COMMUNICATIONS AND TELEPHONY INTERFACES, NAMELY, WIRELESS INTERFACE COMPUTER SOFTWARE WHICH CONNECTS DATABASES, ENTERPRISE SOFTWARE PACKAGES, SPEECH RECOGNITION SOFTWARE APPLICATIONS, WIRELESS MOBILE-COMMERCE SOFTWARE INTERFACES AND BOTH TRADITIONAL AND IP-BASED IVR PLATFORMS COMPRISED OF COMPUTER SOFTWARE AND HARDWARE, IN CLASS 9 (U.S. CLS. 21, 23, 26, 36 AND 38).

FIRST USE 5-0-2000; IN COMMERCE 5-0-2000.

THE MARK CONSISTS OF STANDARD CHARACTERS WITHOUT CLAIM TO ANY PARTICULAR FONT, STYLE, SIZE, OR COLOR.

SER. NO. 85-233,314, FILED 2-3-2011.

ERNEST SHOSHO, EXAMINING ATTORNEY



David J. Kypos

Director of the United States Patent and Trademark Office

United States of America

United States Patent and Trademark Office



ENVIRONIC FOUNDATION INTERNATIONAL

Reg. No. 4,107,736

Registered Mar. 6, 2012

Int. Cl.: 35

SERVICE MARK

PRINCIPAL REGISTER

ENVIRONIC FOUNDATION INTERNATIONAL (INDIANA NON-PROFIT CORPORATION)
12035 STONEWICK PLACE
GLEN ALLEN, VA 230597152

FOR: PROMOTING PUBLIC AWARENESS IN THE FIELDS OF CONSTRUCTIVE SOCIAL AND ECONOMIC PRACTICES AND NATURAL RESOURCE MANAGEMENT AND CONSERVANCY; PROVIDING INFORMATION IN THE FIELD OF NATURAL RESOURCE MANAGEMENT AND PROMOTING SOCIETAL, ECOLOGICAL AND ECONOMIC BENEFITS FROM APPROPRIATE USES OF NATURAL RESOURCES WORLDWIDE, IN CLASS 35 (U.S. CLS. 100, 101 AND 102).

FIRST USE 2-17-2003; IN COMMERCE 2-17-2003.

NO CLAIM IS MADE TO THE EXCLUSIVE RIGHT TO USE "FOUNDATION INTERNATIONAL", APART FROM THE MARK AS SHOWN.

THE MARK CONSISTS OF THE WORDS "ENVIRONIC FOUNDATION INTERNATIONAL" WITH TWO INTERSECTING SPHERES THROUGH THE WORD "FOUNDATION" WHERE THE SPHERES ARE MADE UP OF HORIZONTAL LINES.

SER. NO. 85-233,532, FILED 2-3-2011.

ANDREA HACK, EXAMINING ATTORNEY



David J. Kybas

Director of the United States Patent and Trademark Office

United States of America

United States Patent and Trademark Office

PALEOCEANOGRAPHY

Reg. No. 4,107,737

AMERICAN GEOPHYSICAL UNION (D.C. NON-PROFIT CORPORATION)
2000 FLORIDA AVENUE, N.W.
WASHINGTON, DC 20009

Registered Mar. 6, 2012

Int. Cls.: 16 and 41

FOR: PRINTED PUBLICATIONS, NAMELY, JOURNALS CONTAINING ARTICLES ON THE SUBJECT OF RECONSTRUCTIONS OF PAST CONDITIONS AND PROCESSES OF CHANGE AS RECORDED IN SEDIMENTS DEPOSITED IN WATER, IN CLASS 16 (U.S. CLS. 2, 5, 22, 23, 29, 37, 38 AND 50).

TRADEMARK

SERVICE MARK

FIRST USE 0-0-1986; IN COMMERCE 0-0-1986.

PRINCIPAL REGISTER

FOR: PROVIDING ONLINE PUBLICATIONS IN THE NATURE OF JOURNALS CONTAINING ARTICLES ON THE SUBJECT OF RECONSTRUCTIONS OF PAST CONDITIONS AND PROCESSES OF CHANGE AS RECORDED IN SEDIMENTS DEPOSITED IN WATER, IN CLASS 41 (U.S. CLS. 100, 101 AND 107).

FIRST USE 0-0-2002; IN COMMERCE 0-0-2002.

THE MARK CONSISTS OF STANDARD CHARACTERS WITHOUT CLAIM TO ANY PARTICULAR FONT, STYLE, SIZE, OR COLOR.

SEC. 2(F).

SER. NO. 85-233,705, FILED 2-3-2011.

DOMINICK J. SALEMI, EXAMINING ATTORNEY



David J. Kybas

Director of the United States Patent and Trademark Office

United States of America

United States Patent and Trademark Office

INTIMATE BASICS

Reg. No. 4,107,738

CALIFORNIA EXOTIC NOVELTIES, LLC (CALIFORNIA LIMITED LIABILITY COMPANY)
14235 RAMONA AVENUE
CHINO, CA 91710

Registered Mar. 6, 2012

Int. Cl.: 10

FOR: ADULT SEXUAL STIMULATION AIDS, NAMELY, VIBRATORS AND ARTIFICIAL PENISES, IN CLASS 10 (U.S. CLS. 26, 39 AND 44).

TRADEMARK

FIRST USE 8-1-2005; IN COMMERCE 8-1-2005.

PRINCIPAL REGISTER

THE MARK CONSISTS OF STANDARD CHARACTERS WITHOUT CLAIM TO ANY PARTICULAR FONT, STYLE, SIZE, OR COLOR.

SER. NO. 85-234,021, FILED 2-4-2011.

GILBERT SWIFT, EXAMINING ATTORNEY



David J. Kybas

Director of the United States Patent and Trademark Office

United States of America

United States Patent and Trademark Office

BRATOCYN

Reg. No. 4,107,739

CHIESI FARMACEUTICI S.P.A. (ITALY JOINT STOCK COMPANY)
VIA PALERMO, 26/A
43122 PARMA, ITALY

Registered Mar. 6, 2012

Int. Cl.: 5

FOR: PHARMACEUTICAL PREPARATIONS FOR THE TREATMENT OF RESPIRATORY DISEASES, IN CLASS 5 (U.S. CLS. 6, 18, 44, 46, 51 AND 52).

TRADEMARK

THE MARK CONSISTS OF STANDARD CHARACTERS WITHOUT CLAIM TO ANY PARTICULAR FONT, STYLE, SIZE, OR COLOR.

PRINCIPAL REGISTER

OWNER OF ITALY REG. NO. 0001009254, DATED 5-23-2006, EXPIRES 12-31-2014.

SER. NO. 85-234,049, FILED 2-4-2011.

TINA L. SNAPP, EXAMINING ATTORNEY



David J. Kyjars

Director of the United States Patent and Trademark Office

United States of America

United States Patent and Trademark Office

Sportrax

Reg. No. 4,107,740

Registered Mar. 6, 2012

Int. Cl.: 19

TRADEMARK

PRINCIPAL REGISTER

SWISSTRAX, INC. (CALIFORNIA CORPORATION)
UNIT A
82-579 FLEMING WAY
INDIO, CA 92201

FOR: FLOOR PANELS NOT OF METAL, IN CLASS 19 (U.S. CLS. 1, 12, 33 AND 50).

FIRST USE 6-1-2005; IN COMMERCE 6-1-2005.

THE MARK CONSISTS OF STANDARD CHARACTERS WITHOUT CLAIM TO ANY PARTICULAR FONT, STYLE, SIZE, OR COLOR.

SEC. 2(F).

SER. NO. 85-234,461, FILED 2-4-2011.

INGRID C. EULIN, EXAMINING ATTORNEY



David J. Kybas

Director of the United States Patent and Trademark Office

United States of America

United States Patent and Trademark Office



Reg. No. 4,107,741

Registered Mar. 6, 2012

Int. Cls.: 41 and 44

SERVICE MARK

PRINCIPAL REGISTER

LIVE OAK CANYON CHRISTMAS TREE FARM (CALIFORNIA SOLE PROPRIETORSHIP)
32335 LIVE OAK CANYON ROAD
REDLANDS, CA 92373

FOR: PROVIDING AMUSEMENT FACILITIES, IN CLASS 41 (U.S. CLS. 100, 101 AND 107).

FIRST USE 0-0-1982; IN COMMERCE 0-0-1982.

FOR: TREE CARE SERVICES, IN CLASS 44 (U.S. CLS. 100 AND 101).

FIRST USE 0-0-1982; IN COMMERCE 0-0-1982.

NO CLAIM IS MADE TO THE EXCLUSIVE RIGHT TO USE "LIVE OAK CANYON" AND "CHRISTMAS TREE FARM", APART FROM THE MARK AS SHOWN.

THE COLOR(S) RED AND WHITE IS/ARE CLAIMED AS A FEATURE OF THE MARK.

THE MARK CONSISTS OF A SILHOUETTED MAN, WOMAN AND CHILD CARRYING A CHRISTMAS TREE FRAMED IN AN ARCH WITH THE WORDS "LIVE OAK CANYON" ABOVE AND "CHRISTMAS TREE FARM" BELOW ALL IN WHITE ON A RED BACKGROUND.

SER. NO. 85-234,550, FILED 2-4-2011.

JENNIFER VASQUEZ, EXAMINING ATTORNEY



David J. Kybas

Director of the United States Patent and Trademark Office

United States of America

United States Patent and Trademark Office

FANTASTIC

Reg. No. 4,107,742

FANTASTIC ENERGY SOLUTIONS, INC. (NEW YORK CORPORATION)
3500 SUNRISE HIGHWAY, BDG. 200 SUITE 210
GREAT RIVER, NY 11739

Registered Mar. 6, 2012

Int. Cls.: 37 and 42

FOR: INSTALLATION, MAINTENANCE AND REPAIR SERVICES OF THERMAL EQUALIZATION ENERGY EFFICIENT FAN SYSTEMS, IN CLASS 37 (U.S. CLS. 100, 103 AND 106).

SERVICE MARK

FIRST USE 5-0-2010; IN COMMERCE 5-0-2010.

PRINCIPAL REGISTER

FOR: DESIGN OF THERMAL EQUALIZATION ENERGY EFFICIENT FAN SYSTEMS, IN CLASS 42 (U.S. CLS. 100 AND 101).

FIRST USE 5-0-2010; IN COMMERCE 5-0-2010.

THE MARK CONSISTS OF STANDARD CHARACTERS WITHOUT CLAIM TO ANY PARTICULAR FONT, STYLE, SIZE, OR COLOR.

SER. NO. 85-235,405, FILED 2-7-2011.

ROSELLE HERRERA, EXAMINING ATTORNEY



David J. Kyros

Director of the United States Patent and Trademark Office

United States of America

United States Patent and Trademark Office



Reg. No. 4,107,743

Registered Mar. 6, 2012

Int. Cl.: 35

SERVICE MARK

PRINCIPAL REGISTER

ELLIOTT GLASS COMPANY INC. (NEW JERSEY CORPORATION)
192 LACKAWANNA AVENUE
WOODLAND PARK, NJ 07424

FOR: RETAIL STORE SERVICES FEATURING WINDOWS, SHOWER DOORS, COMMON SHEET GLASS AND DOORS, IN CLASS 35 (U.S. CLS. 100, 101 AND 102).

FIRST USE 1-1-1964; IN COMMERCE 1-1-1964.

NO CLAIM IS MADE TO THE EXCLUSIVE RIGHT TO USE "GLASS", APART FROM THE MARK AS SHOWN.

THE NAME "ELLIOTT GLASS" DOES NOT IDENTIFY A LIVING INDIVIDUAL.

THE MARK CONSISTS OF THE STYLIZED WORDING "ELLIOTT" WITH A DESIGN OF A CROWN ABOVE IT. UNDERNEATH THIS WORDING AND BETWEEN TWO CHEVRON SHAPES IS THE STYLIZED WORDING "GLASS".

SER. NO. 85-235,760, FILED 2-7-2011.

HAI-LY LAM, EXAMINING ATTORNEY



David J. Kybas

Director of the United States Patent and Trademark Office

United States of America

United States Patent and Trademark Office

BALVAND

Reg. No. 4,107,744

Registered Mar. 6, 2012

Int. Cl.: 5

TRADEMARK

PRINCIPAL REGISTER

TAKEDA PHARMACEUTICAL COMPANY LIMITED (JAPAN CORPORATION)
1-1, DOSHOMACHI 4-CHOME
CHUO-KU, OSAKA, JAPAN

FOR: PHARMACEUTICAL PREPARATIONS FOR THE TREATMENT AND PREVENTION
OF DIABETIC DISEASES, IN CLASS 5 (U.S. CLS. 6, 18, 44, 46, 51 AND 52).

THE MARK CONSISTS OF STANDARD CHARACTERS WITHOUT CLAIM TO ANY PAR-
TICULAR FONT, STYLE, SIZE, OR COLOR.

PRIORITY CLAIMED UNDER SEC. 44(D) ON JAPAN APPLICATION NO. 2011-001703,
FILED 1-13-2011, REG. NO. 5419694, DATED 6-17-2011, EXPIRES 6-17-2021.

SER. NO. 85-235,778, FILED 2-7-2011.

ANTHONY RINKER, EXAMINING ATTORNEY



David J. Kybas

Director of the United States Patent and Trademark Office

United States of America

United States Patent and Trademark Office

INDEPENDENCEIT

Reg. No. 4,107,745

Registered Mar. 6, 2012

Int. Cl.: 42

SERVICE MARK

PRINCIPAL REGISTER

MRK NETWORKS, INC. (PENNSYLVANIA CORPORATION), DBA INDEPENDENCEIT
1011 BROOKSIDE ROAD, SUITE 120
ALLENTOWN, PA 18106

FOR: APPLICATION SERVICE PROVIDER, NAMELY, MANAGING APPLICATIONS AND SOFTWARE FOR OTHERS IN THE FIELD OF BUSINESS; COMPUTER SERVICES, NAMELY, REMOTE MANAGEMENT OF INFORMATION TECHNOLOGY INFRASTRUCTURES IN THE NATURE OF COMPUTER NETWORKS, DEDICATED VIRTUAL SERVERS, MULTI-PARTY VPN (VIRTUAL PRIVATE NETWORKS) FOR OTHER IN THE FIELD OF BUSINESS, IN CLASS 42 (U.S. CLS. 100 AND 101).

FIRST USE 6-15-2009; IN COMMERCE 6-15-2009.

THE MARK CONSISTS OF STANDARD CHARACTERS WITHOUT CLAIM TO ANY PARTICULAR FONT, STYLE, SIZE, OR COLOR.

SER. NO. 85-235,989, FILED 2-7-2011.

NICHOLAS COLEMAN, EXAMINING ATTORNEY



David J. Kyffers

Director of the United States Patent and Trademark Office

United States of America

United States Patent and Trademark Office

MACBOOK PRO

Reg. No. 4,107,746

Registered Mar. 6, 2012

Int. Cl.: 9

TRADEMARK

PRINCIPAL REGISTER

APPLE INC. (CALIFORNIA CORPORATION)
1 INFINITE LOOP
CUPERTINO, CA 95014

FOR: COMPUTERS; NOTEBOOK COMPUTERS; COMPUTER HARDWARE; COMPUTER OPERATING SYSTEM SOFTWARE; ELECTRICAL POWER ADAPTORS; ELECTRICAL POWER CORDS; COMPUTER BATTERIES; REMOTE CONTROLS FOR USE WITH COMPUTERS; CABLES AND CONNECTORS FOR USE WITH COMPUTERS AND COMPUTER PERIPHERALS; DOWNLOADABLE ELECTRONIC PUBLICATIONS IN THE NATURE OF INSTRUCTION MANUALS IN THE FIELD OF COMPUTERS, NOTEBOOK COMPUTERS, COMPUTER HARDWARE, COMPUTER OPERATING SYSTEM SOFTWARE, COMPUTER BATTERIES AND OTHER COMPUTER ACCESSORIES AND PERIPHERALS, IN CLASS 9 (U.S. CLS. 21, 23, 26, 36 AND 38).

FIRST USE 1-10-2006; IN COMMERCE 1-10-2006.

THE MARK CONSISTS OF STANDARD CHARACTERS WITHOUT CLAIM TO ANY PARTICULAR FONT, STYLE, SIZE, OR COLOR.

OWNER OF U.S. REG. NOS. 3,222,089, 3,420,541, AND 3,522,328.

SER. NO. 85-236,152, FILED 2-7-2011.

AMY C. KEAN, EXAMINING ATTORNEY



David J. Kappas

Director of the United States Patent and Trademark Office

United States of America

United States Patent and Trademark Office

Platica Tax

Reg. No. 4,107,747

Registered Mar. 6, 2012

Int. Cls.: 35 and 38

SERVICE MARK

PRINCIPAL REGISTER

LOPEZ, CARLOS C (UNITED STATES INDIVIDUAL)
1588 MOFFETT ST., SUITE F
SALINAS, CA 93905

FOR: PROVIDING A WEBSITE FEATURING INFORMATION ABOUT TAX FILING AND TAX PREPARATION, CONSISTING OF TAX QUESTIONS, TAX PROBLEMS AND SOLUTIONS; PROVIDING A WEBSITE FEATURING BUSINESS INFORMATION ABOUT TAX PROFESSIONALS; ALL THE FOREGOING PROVIDED FOR SPANISH SPEAKERS, IN CLASS 35 (U.S. CLS. 100, 101 AND 102).

FIRST USE 2-7-2011; IN COMMERCE 2-7-2011.

FOR: PROVIDING AN ON-LINE FORUM FOR SOCIAL NETWORKING FEATURING GENERAL TAX INFORMATION, AND PROFESSIONAL AND PUBLIC COMMENTARY; PROVIDING AN ON-LINE FORUM FOR TAX PROFESSIONALS; ALL THE FOREGOING PROVIDED FOR SPANISH SPEAKERS, IN CLASS 38 (U.S. CLS. 100, 101 AND 104).

FIRST USE 2-7-2011; IN COMMERCE 2-7-2011.

THE MARK CONSISTS OF STANDARD CHARACTERS WITHOUT CLAIM TO ANY PARTICULAR FONT, STYLE, SIZE, OR COLOR.

NO CLAIM IS MADE TO THE EXCLUSIVE RIGHT TO USE "TAX", APART FROM THE MARK AS SHOWN.

THE ENGLISH TRANSLATION OF "PLATICA" IN THE MARK IS "TALK".

SER. NO. 85-236,219, FILED 2-7-2011.

LIEF MARTIN, EXAMINING ATTORNEY



David J. Kyros

Director of the United States Patent and Trademark Office

United States of America

United States Patent and Trademark Office



Reg. No. 4,107,748

Registered Mar. 6, 2012

Int. Cl.: 9

TRADEMARK

PRINCIPAL REGISTER

CLINTON, WINSTON (UNITED STATES INDIVIDUAL)
5771 1/2 CORBETT ST
LOS ANGELES, CA 90016

FOR: MESSENGER BAG WITH A REMOVABLE STRAP SPECIFICALLY ADAPTED TO HOLD TABLET COMPUTERS, IN CLASS 9 (U.S. CLS. 21, 23, 26, 36 AND 38).

FIRST USE 6-3-2011; IN COMMERCE 6-3-2011.

THE MARK CONSISTS OF THE HIGHLY STYLIZED WORDING "TABSAC". THE LETTER "T" COMBINED WITH THE LETTER "A" APPEARS IN THE CENTER OF THE MARK. ON THE RIGHT HAND SIDE OF THE COMBINED LETTERS THERE IS A CIRCLE WITHIN THE LETTERS. THERE IS A LETTER "S" AT THE TOP, WITH THE LINE CONTINUING TO FORM THE CURVED PORTION OF THE LETTER "B" AND THE LETTER "C" AT THE BOTTOM.

SER. NO. 85-236,463, FILED 2-8-2011.

JEAN IM, EXAMINING ATTORNEY



David J. Kybas

Director of the United States Patent and Trademark Office

United States of America

United States Patent and Trademark Office

AlternaFISH

Reg. No. 4,107,749

Registered Mar. 6, 2012

Int. Cl.: 41

SERVICE MARK

PRINCIPAL REGISTER

SHAMROCKSTAR INC. (OHIO CORPORATION)
SUITE 635, 6000 LOMBARDO CENTER DRIVE
SEVEN HILLS, OH 44131

FOR: ENTERTAINMENT SERVICES, NAMELY, AN ON-GOING SERIES FEATURING MUSIC PROVIDED THROUGH RADIO BROADCASTS, INTERNET, AND WEBCASTS, IN CLASS 41 (U.S. CLS. 100, 101 AND 107).

FIRST USE 1-1-2009; IN COMMERCE 3-21-2009.

THE MARK CONSISTS OF STANDARD CHARACTERS WITHOUT CLAIM TO ANY PARTICULAR FONT, STYLE, SIZE, OR COLOR.

SER. NO. 85-236,501, FILED 2-8-2011.

RICHARD WHITE, EXAMINING ATTORNEY



David J. Kyfos

Director of the United States Patent and Trademark Office

United States of America
United States Patent and Trademark Office

SLINGSHOT

Reg. No. 4,107,750

AQUA-LUNG AMERICA, INC. (DELAWARE CORPORATION)
2340 COUSTEAU COURT
VISTA, CA 92081

Registered Mar. 6, 2012

Int. Cl.: 28

FOR: FLIPPERS FOR SWIMMING; FLIPPERS FOR USE IN SCUBA DIVING; SCUBA FINS;
SWIM FINS, IN CLASS 28 (U.S. CLS. 22, 23, 38 AND 50).

TRADEMARK

FIRST USE 12-31-2007; IN COMMERCE 12-31-2007.

PRINCIPAL REGISTER

THE MARK CONSISTS OF STANDARD CHARACTERS WITHOUT CLAIM TO ANY PAR-
TICULAR FONT, STYLE, SIZE, OR COLOR.

SER. NO. 85-236,892, FILED 2-8-2011.

ALICE BENMAMAN, EXAMINING ATTORNEY



David J. Kybas

Director of the United States Patent and Trademark Office

United States of America

United States Patent and Trademark Office

BINGHAM MCCUTCHEN

Reg. No. 4,107,751

Registered Mar. 6, 2012

Int. Cl.: 9

TRADEMARK

PRINCIPAL REGISTER

BINGHAM MCCUTCHEN LLP (MASSACHUSETTS LIMITED LIABILITY PARTNERSHIP)
ONE FEDERAL STREET
BOSTON, MA 02110

FOR: DOWNLOADABLE PUBLICATIONS, NAMELY, REPORTS, NEWSLETTERS, BOOK-
LETS, BROCHURES AND PAMPHLETS IN THE FIELD OF LAW, IN CLASS 9 (U.S. CLS. 21,
23, 26, 36 AND 38).

FIRST USE 7-1-2002; IN COMMERCE 7-1-2002.

THE MARK CONSISTS OF STANDARD CHARACTERS WITHOUT CLAIM TO ANY PAR-
TICULAR FONT, STYLE, SIZE, OR COLOR.

OWNER OF U.S. REG. NOS. 2,254,390, 2,873,938, AND 3,656,588.

SER. NO. 85-237,292, FILED 2-8-2011.

JENNIFER MARTIN, EXAMINING ATTORNEY



David J. Kybas

Director of the United States Patent and Trademark Office

United States of America

United States Patent and Trademark Office

ONEWAYHOME

Reg. No. 4,107,752

Registered Mar. 6, 2012

Int. Cls.: 9 and 41

TRADEMARK

SERVICE MARK

PRINCIPAL REGISTER

SMITH, RICHARD (UNITED STATES INDIVIDUAL)
12103 MILAM CIR
SANTA FE, TX 775107925

FOR: DIGITAL MATERIALS, NAMELY, PRERECORDED CDS, DVDS AND DOWNLOADABLE AUDIO AND VIDEO FILES FEATURING MUSIC, IN CLASS 9 (U.S. CLS. 21, 23, 26, 36 AND 38).

FIRST USE 11-19-2004; IN COMMERCE 5-10-2008.

FOR: ENTERTAINMENT, NAMELY, LIVE MUSIC CONCERTS, IN CLASS 41 (U.S. CLS. 100, 101 AND 107).

FIRST USE 11-19-2004; IN COMMERCE 11-19-2004.

THE MARK CONSISTS OF STANDARD CHARACTERS WITHOUT CLAIM TO ANY PARTICULAR FONT, STYLE, SIZE, OR COLOR.

OWNER OF U.S. REG. NO. 3,741,959.

SER. NO. 85-237,782, FILED 2-9-2011.

SUSAN LESLIE DUBOIS, EXAMINING ATTORNEY



David J. Kyffers

Director of the United States Patent and Trademark Office

United States of America

United States Patent and Trademark Office

Loyal Biscuit Co.

Reg. No. 4,107,753

LOYAL BISCUIT COMPANY (MAINE CORPORATION)
442 MAIN STREET
ROCKLAND, ME 04841

Registered Mar. 6, 2012

Int. Cl.: 35

FOR: RETAIL STORE SERVICES FEATURING PET SUPPLIES, IN CLASS 35 (U.S. CLS. 100, 101 AND 102).

SERVICE MARK

FIRST USE 1-19-2010; IN COMMERCE 1-19-2010.

PRINCIPAL REGISTER

THE MARK CONSISTS OF STANDARD CHARACTERS WITHOUT CLAIM TO ANY PARTICULAR FONT, STYLE, SIZE, OR COLOR.

NO CLAIM IS MADE TO THE EXCLUSIVE RIGHT TO USE "BISCUIT CO.", APART FROM THE MARK AS SHOWN.

SER. NO. 85-238,121, FILED 2-9-2011.

DARRYL SPRUILL, EXAMINING ATTORNEY



David J. Kybas

Director of the United States Patent and Trademark Office

United States of America

United States Patent and Trademark Office

RPM

Reg. No. 4,107,754

Registered Mar. 6, 2012

Int. Cl.: 42

SERVICE MARK

PRINCIPAL REGISTER

SUPPLY CHAIN SERVICES (FLORIDA LIMITED LIABILITY COMPANY)
THE LEGAL DEPARTMENT
TWO ALHAMBRA PLAZA, SUITE 500
CORAL GABLES, FL 33134

FOR: PROVIDING TEMPORARY USE OF ONLINE NON-DOWNLOADABLE SOFTWARE FOR USE IN DATABASE MANAGEMENT, SALES PROCESS ANALYSIS AND DATA COLLECTION IN THE FIELD OF RESTAURANT BUSINESS, IN CLASS 42 (U.S. CLS. 100 AND 101).

FIRST USE 8-1-2010; IN COMMERCE 8-1-2010.

THE MARK CONSISTS OF STANDARD CHARACTERS WITHOUT CLAIM TO ANY PARTICULAR FONT, STYLE, SIZE, OR COLOR.

SER. NO. 85-239,146, FILED 2-10-2011.

MELISSA VALLILLO, EXAMINING ATTORNEY



David J. Kybas

Director of the United States Patent and Trademark Office

United States of America

United States Patent and Trademark Office

IRON CROSS

Reg. No. 4,107,755

IRON CROSS AUTOMOTIVE, INC. (OKLAHOMA CORPORATION)
519 WEST DEWEY
SAPULPA, OK 74066

Registered Mar. 6, 2012

Int. Cl.: 12

FOR: AUTOMOBILE AND TRUCK AFTERMARKET ACCESSORIES, NAMELY, STEPS AND STEP PLATES FOR ATTACHMENT TO TRUCKS, RUNNING BOARDS, BUMPERS, AND GRILL GUARDS, IN CLASS 12 (U.S. CLS. 19, 21, 23, 31, 35 AND 44).

TRADEMARK

FIRST USE 11-1-2003; IN COMMERCE 11-1-2003.

PRINCIPAL REGISTER

THE MARK CONSISTS OF STANDARD CHARACTERS WITHOUT CLAIM TO ANY PARTICULAR FONT, STYLE, SIZE, OR COLOR.

SER. NO. 85-240,059, FILED 2-11-2011.

LINDA M. KING, EXAMINING ATTORNEY



David J. Kyros

Director of the United States Patent and Trademark Office

United States of America

United States Patent and Trademark Office

AT&T FOUNDRY

Reg. No. 4,107,756

Registered Mar. 6, 2012

Int. Cl.: 42

SERVICE MARK

PRINCIPAL REGISTER

AT&T INTELLECTUAL PROPERTY II, L.P. (NEVADA LIMITED PARTNERSHIP)
645 EAST PLUMB LANE
RENO, NV 89502

FOR: DESIGN, ENGINEERING, RESEARCH, DEVELOPMENT AND TESTING SERVICES OF NEW PRODUCTS AND TECHNOLOGY IN THE FIELD OF TELECOMMUNICATIONS; COMPUTER SERVICES, NAMELY, CREATING AN ONLINE COMMUNITY FOR REGISTERED USERS TO DEVELOP AND COLLABORATE ON NEW PRODUCTS AND TECHNOLOGY IN THE FIELD OF TELECOMMUNICATIONS; AND INNOVATIVE CONSULTING SERVICES, NAMELY, ADVISING OTHERS IN THE AREA OF PRODUCT DEVELOPMENT IN THE TELECOMMUNICATIONS FIELD, IN CLASS 42 (U.S. CLS. 100 AND 101).

FIRST USE 1-4-2011; IN COMMERCE 1-4-2011.

THE MARK CONSISTS OF STANDARD CHARACTERS WITHOUT CLAIM TO ANY PARTICULAR FONT, STYLE, SIZE, OR COLOR.

OWNER OF U.S. REG. NOS. 1,298,084, 3,068,918 AND OTHERS.

SER. NO. 85-240,360, FILED 2-11-2011.

HENRY S. ZAK, EXAMINING ATTORNEY



David J. Kyros

Director of the United States Patent and Trademark Office

United States of America

United States Patent and Trademark Office



Reg. No. 4,107,757

Registered Mar. 6, 2012

Int. Cl.: 25

TRADEMARK

PRINCIPAL REGISTER

BLAK APPAREL, LLC (ALABAMA LIMITED LIABILITY COMPANY)
75 RYAN CIRCLE
ODENVILLE, AL 35120

FOR: APPAREL FOR DANCERS, NAMELY, TEE SHIRTS, SWEATSHIRTS, PANTS, LEGGINGS, SHORTS AND JACKETS; BODY SHIRTS; BUTTON DOWN SHIRTS; COLLARED SHIRTS; DRESS SHIRTS; HOODED SWEAT SHIRTS; KNIT SHIRTS; LEATHER SHIRTS; LONG-SLEEVED SHIRTS; POLO SHIRTS; RUGBY SHIRTS; SHIRTS AND SHORT-SLEEVED SHIRTS; SHORT-SLEEVED OR LONG-SLEEVED T-SHIRTS; T-SHIRTS FOR WOMEN; WEARABLE GARMENTS AND CLOTHING, NAMELY, SHIRTS; WOMEN'S CLOTHING, NAMELY, SHIRTS, DRESSES, SKIRTS, BLOUSES, IN CLASS 25 (U.S. CLS. 22 AND 39).

FIRST USE 3-1-2010; IN COMMERCE 2-5-2011.

NO CLAIM IS MADE TO THE EXCLUSIVE RIGHT TO USE "BLACK RAGS", APART FROM THE MARK AS SHOWN.

THE MARK CONSISTS OF IMAGE OF A BACKWARDS "B" AND FORWARD "R" CONNECTED, WITH THE WORDS "BLAK RAGZ" WRITTEN IN CURSIVE UNDERNEATH.

SER. NO. 85-240,680, FILED 2-11-2011.

MICHELE SWAIN, EXAMINING ATTORNEY



David J. Kybas

Director of the United States Patent and Trademark Office

United States of America

United States Patent and Trademark Office



Reg. No. 4,107,758

Registered Mar. 6, 2012

Int. Cls.: 39 and 42

SERVICE MARK

PRINCIPAL REGISTER

NVISION GLOBAL TECHNOLOGY SOLUTIONS, INC. (GEORGIA CORPORATION)
1900 BRANNAN ROAD, SUITE 100
MCDONOUGH, GA 30253

FOR: CONSULTING SERVICES RELATING TO TRANSPORTATION LOGISTICS MANAGEMENT, IN CLASS 39 (U.S. CLS. 100 AND 105).

FIRST USE 1-1-2005; IN COMMERCE 1-1-2005.

FOR: PROVIDING A WEB SITE FEATURING NON-DOWNLOADABLE SOFTWARE FOR GLOBAL FREIGHT BILLING, AUDIT AND PAYMENT AND TRANSPORTATION LOGISTICS MANAGEMENT, IN CLASS 42 (U.S. CLS. 100 AND 101).

FIRST USE 1-1-2005; IN COMMERCE 1-1-2005.

OWNER OF U.S. REG. NO. 3,096,441.

NO CLAIM IS MADE TO THE EXCLUSIVE RIGHT TO USE "GLOBAL", APART FROM THE MARK AS SHOWN.

THE MARK CONSISTS OF THE WORD "NVISION" FEATURING A STYLIZED "V" COMPRISED OF A SLANTED RECTANGLE AND TRIANGLE AND A GLOBE APPEARING IN THE "O". UNDERNEATH THIS WORD APPEARS THE WORD "GLOBAL" APPEARING IN A RECTANGLE.

SER. NO. 85-241,185, FILED 2-14-2011.

KATHRYN COWARD, EXAMINING ATTORNEY



David J. Kybas

Director of the United States Patent and Trademark Office

United States of America

United States Patent and Trademark Office

NVISION GLOBAL

Reg. No. 4,107,759

Registered Mar. 6, 2012

Int. Cls.: 39 and 42

SERVICE MARK

PRINCIPAL REGISTER

NVISION GLOBAL TECHNOLOGY SOLUTIONS, INC. (GEORGIA CORPORATION)
1900 BRANNAN ROAD, SUITE 100
MCDONOUGH, GA 30253

FOR: CONSULTING SERVICES RELATING TO TRANSPORTATION LOGISTICS MANAGEMENT, IN CLASS 39 (U.S. CLS. 100 AND 105).

FIRST USE 1-1-2005; IN COMMERCE 1-1-2005.

FOR: PROVIDING A WEB SITE FEATURING NON-DOWNLOADABLE SOFTWARE FOR GLOBAL FREIGHT BILLING, AUDIT AND PAYMENT AND TRANSPORTATION LOGISTICS MANAGEMENT, IN CLASS 42 (U.S. CLS. 100 AND 101).

FIRST USE 1-1-2005; IN COMMERCE 1-1-2005.

THE MARK CONSISTS OF STANDARD CHARACTERS WITHOUT CLAIM TO ANY PARTICULAR FONT, STYLE, SIZE, OR COLOR.

OWNER OF U.S. REG. NO. 3,096,441.

NO CLAIM IS MADE TO THE EXCLUSIVE RIGHT TO USE "GLOBAL", APART FROM THE MARK AS SHOWN.

SER. NO. 85-241,187, FILED 2-14-2011.

KATHRYN COWARD, EXAMINING ATTORNEY



David J. Kyjars

Director of the United States Patent and Trademark Office

United States of America

United States Patent and Trademark Office

BiOM

Reg. No. 4,107,760

Registered Mar. 6, 2012

Int. Cl.: 10

TRADEMARK

PRINCIPAL REGISTER

IWALK, INC. (DELAWARE CORPORATION)
#3130
222 THIRD STREET
CAMBRIDGE, MA 02142

FOR: ROBOTIC PROSTHETIC DEVICES, NAMELY, ARTIFICIAL LIMBS, APPENDAGES AND JOINTS, IN CLASS 10 (U.S. CLS. 26, 39 AND 44).

FIRST USE 1-0-2011; IN COMMERCE 1-0-2011.

THE MARK CONSISTS OF THE LETTERS "B", "I", "O", AND "M"; THE "I" IS LOWERCASE AND IN MAROON; THE LETTERS "B", "O", AND "M" ARE CAPITALIZED AND IN GRAY. THERE IS A WHITE WAVE THAT RUNS ACROSS THE LETTERS FROM LEFT TO RIGHT.

THE COLOR(S) GRAY, MAROON AND WHITE IS/ARE CLAIMED AS A FEATURE OF THE MARK.

SER. NO. 85-241,759, FILED 2-14-2011.

FLORENTINA BLANDU, EXAMINING ATTORNEY



David J. Kybas

Director of the United States Patent and Trademark Office

United States of America

United States Patent and Trademark Office



Qwizzle
Simply. Real Estate

Reg. No. 4,107,761

QWIZZLE, LLC (COLORADO LIMITED LIABILITY COMPANY)
#9 WHITE FIR CT.
LITTLETON, CO 80127

Registered Mar. 6, 2012

Int. Cl.: 36

FOR: LEASING OF REAL ESTATE; REAL ESTATE AGENCIES; REAL ESTATE BROKERS;
REAL ESTATE MANAGEMENT; RENTAL OF OFFICES, IN CLASS 36 (U.S. CLS. 100, 101
AND 102).

SERVICE MARK

FIRST USE 6-1-2010; IN COMMERCE 9-1-2010.

PRINCIPAL REGISTER

NO CLAIM IS MADE TO THE EXCLUSIVE RIGHT TO USE "REAL ESTATE", APART FROM
THE MARK AS SHOWN.

THE MARK CONSISTS OF THE STYLIZED WORD "QWIZZLE". TO THE RIGHT OF THE
WORDING, A DESIGN OF A HOUSE WITH A WINDOW AND A ROOF APPEARS IN A
MAGNIFYING GLASS. THE MARK IS PRESENTED ON A WHITE BACKGROUND AND
WHITE IS NOT BEING CLAIMED AS A FEATURE OF THE MARK.

SER. NO. 85-242,206, FILED 2-15-2011.

MARILYN IZZI, EXAMINING ATTORNEY



David J. Kybas

Director of the United States Patent and Trademark Office

United States of America

United States Patent and Trademark Office

ARCTIC AVALANCHE

Reg. No. 4,107,762

Registered Mar. 6, 2012

Int. Cl.: 9

TRADEMARK

PRINCIPAL REGISTER

ARISTOCRAT TECHNOLOGIES AUSTRALIA PTY LTD (AUSTRALIA CORPORATION)
BUILDING A, PINNACLE OFFICE PARK
85 EPPING ROAD
NORTH RYDE, NSW, AUSTRALIA 2113

FOR: ELECTRONIC GAMING MACHINES, NAMELY, DEVICES WHICH ACCEPT A WAGER,
IN CLASS 9 (U.S. CLS. 21, 23, 26, 36 AND 38).

THE MARK CONSISTS OF STANDARD CHARACTERS WITHOUT CLAIM TO ANY PAR-
TICULAR FONT, STYLE, SIZE, OR COLOR.

PRIORITY CLAIMED UNDER SEC. 44(D) ON AUSTRALIA APPLICATION NO. 1399591,
FILED 12-21-2010, REG. NO. 1399591, DATED 12-21-2010, EXPIRES 12-21-2020.

SER. NO. 85-242,646, FILED 2-15-2011.

SUSAN STIGLITZ, EXAMINING ATTORNEY



David J. Kybas

Director of the United States Patent and Trademark Office

United States of America

United States Patent and Trademark Office

HEALTHCARE 21 BUSINESS COALITION

Reg. No. 4,107,763

Registered Mar. 6, 2012

Int. Cls.: 16 and 36

TRADEMARK

SERVICE MARK

PRINCIPAL REGISTER

HEALTHCARE 21 BUSINESS COALITION (TENNESSEE NON-STOCK CORPORATION)
625 MARKET STREET, SUITE 900
KNOXVILLE, TN 37902

FOR: PRINTED MATTER, NAMELY, ANNUAL GUIDES IN THE FIELDS OF THE HEALTHCARE PURCHASING PROCESS, HEALTHCARE BENEFITS AND HEALTHCARE NETWORKS, IN CLASS 16 (U.S. CLS. 2, 5, 22, 23, 29, 37, 38 AND 50).

FIRST USE 9-30-1997; IN COMMERCE 9-30-1997.

FOR: PROVIDING ASSISTANCE TO EMPLOYERS WITH REGARD TO EVALUATING HEALTH CARE BENEFIT PLANS AND HEALTH CARE NETWORKS, NAMELY, PROVIDING ADVICE TO EMPLOYERS IN THE SELECTION OF HEALTH CARE INSURANCE PLANS AND HEALTH CARE PROVIDERS BASED UPON PAST PERFORMANCE OF THE PLANS AND PROVIDERS, IN CLASS 36 (U.S. CLS. 100, 101 AND 102).

FIRST USE 9-30-1997; IN COMMERCE 9-30-1997.

THE MARK CONSISTS OF STANDARD CHARACTERS WITHOUT CLAIM TO ANY PARTICULAR FONT, STYLE, SIZE, OR COLOR.

NO CLAIM IS MADE TO THE EXCLUSIVE RIGHT TO USE "HEALTHCARE" OR "BUSINESS COALITION", APART FROM THE MARK AS SHOWN.

SER. NO. 85-242,862, FILED 2-15-2011.

BILL DAWE, EXAMINING ATTORNEY



David J. Kyros

Director of the United States Patent and Trademark Office

United States of America

United States Patent and Trademark Office

THE WATER ELIMINATOR

Reg. No. 4,107,764

Registered Mar. 6, 2012

Int. Cl.: 1

TRADEMARK

PRINCIPAL REGISTER

AMERICAN TRANSPORTATION TECHNOLOGY CORPORATION (CALIFORNIA CORPORATION)
P.O. BOX 3300
ASHLAND, OR 97520

FOR: PLASTIC CONTAINERS FILLED WITH A WATER-ABSORBENT CHEMICAL FOR REMOVING WATER FROM FUEL TANKS, IN CLASS 1 (U.S. CLS. 1, 5, 6, 10, 26 AND 46).

FIRST USE 5-1-1988; IN COMMERCE 5-1-1988.

THE MARK CONSISTS OF STANDARD CHARACTERS WITHOUT CLAIM TO ANY PARTICULAR FONT, STYLE, SIZE, OR COLOR.

SEC. 2(F).

SER. NO. 85-243,067, FILED 2-15-2011.

CAROLYN CATALDO, EXAMINING ATTORNEY



David J. Kyffers

Director of the United States Patent and Trademark Office

United States of America

United States Patent and Trademark Office

miir

Reg. No. 4,107,765

MIIR (WASHINGTON CORPORATION)
P.O BOX 3663
BELLEVUE, WA 98009

Registered Mar. 6, 2012

Int. Cls.: 6, 20 and 21

FOR: REUSABLE METAL BOTTLE CAPS FOR CLOSING THE BOTTLES SOLD EMPTY, IN CLASS 6 (U.S. CLS. 2, 12, 13, 14, 23, 25 AND 50).

TRADEMARK

FIRST USE 11-4-2009; IN COMMERCE 7-1-2010.

PRINCIPAL REGISTER

FOR: REUSABLE PLASTIC BOTTLE CAPS FOR CLOSING THE BOTTLES SOLD EMPTY, IN CLASS 20 (U.S. CLS. 2, 13, 22, 25, 32 AND 50).

FIRST USE 11-4-2009; IN COMMERCE 7-1-2010.

FOR: REUSABLE BOTTLES SOLD EMPTY; FITTED PLASTIC FILMS KNOWN AS SKINS FOR PERSONALIZING THE APPEARANCE OF THE BOTTLES SOLD EMPTY AND FOR PROVIDING A SCRATCH RESISTANT BARRIER FOR THE BOTTLES SOLD EMPTY; EACH SOLD SEPARATELY OR AS A UNIT, IN CLASS 21 (U.S. CLS. 2, 13, 23, 29, 30, 33, 40 AND 50).

FIRST USE 11-4-2009; IN COMMERCE 7-1-2010.

THE MARK CONSISTS OF STANDARD CHARACTERS WITHOUT CLAIM TO ANY PARTICULAR FONT, STYLE, SIZE, OR COLOR.

OWNER OF U.S. REG. NO. 3,810,273.

SER. NO. 85-244,220, FILED 2-16-2011.

DOMINICK J. SALEMI, EXAMINING ATTORNEY



David J. Kybas

Director of the United States Patent and Trademark Office

United States of America

United States Patent and Trademark Office

MOJOS
ESPRESSO

Reg. No. 4,107,766

CARDENAS, ALBERT (UNITED STATES INDIVIDUAL), DBA MOJOS ESPRESSO
1003 W YAKIMA AVE
YAKIMA, WA 98902 AND

Registered Mar. 6, 2012

Int. Cl.: 30

CARDENAS, VALERIA, S. (UNITED STATES INDIVIDUAL), DBA MOJOS ESPRESSO
1003 W YAKIMA AVE
YAKIMA, WA 98902 AND

TRADEMARK

PRINCIPAL REGISTER

ALVAREZ, ALBERTO (UNITED STATES INDIVIDUAL), DBA MOJOS ESPRESSO
1010S. 29TH AVE.
YAKIMA, WA 98902



David J. Kyros

Director of the United States Patent and Trademark Office

FOR: ARRANGEMENTS OF CUT FRUIT COMPRISED OF FRESH FRUITS CUT INTO FLOWER SHAPES AND AT LEAST PARTIALLY COATED WITH CHOCOLATE; ARTIFICIAL COFFEE; ARTIFICIAL COFFEE AND TEA; BEVERAGES MADE OF COFFEE; BEVERAGES MADE OF TEA; BEVERAGES WITH A CHOCOLATE BASE; BEVERAGES WITH A COFFEE BASE; BEVERAGES WITH A TEA BASE; BREAKFAST BURRITOS; BURRITOS; CAFFEINE-FREE COFFEE; CANDY CONTAINING ALCOHOLIC BEVERAGE CONTENT AND FLAVOR; CAPPUCCINO; CHEESEBURGER SANDWICHES; CHICORY AND CHICORY MIXTURES, ALL FOR USE AS SUBSTITUTES FOR COFFEE; CHICORY BASED COFFEE SUBSTITUTE; CHOCOLATE; CHOCOLATE AND CHOCOLATES; CHOCOLATE BARK CONTAINING GROUND COFFEE BEANS; CHOCOLATE BARS; CHOCOLATE CANDIES; CHOCOLATE CHIPS; CHOCOLATE CONFECTIONS; CHOCOLATE COVERED COCOA NIBS; CHOCOLATE COVERED COOKIES; CHOCOLATE COVERED FRUIT; CHOCOLATE COVERED NUTS; CHOCOLATE COVERED POPCORN; CHOCOLATE COVERED PRETZELS; CHOCOLATE COVERED RAISINS; CHOCOLATE COVERED ROASTED COFFEE BEANS; CHOCOLATE FONDUE; CHOCOLATE FOOD BEVERAGES NOT BEING DAIRY-BASED OR VEGETABLE BASED; CHOCOLATE FOR CONFECTIONERY AND BREAD; CHOCOLATE FOR TOPPINGS; CHOCOLATE MOUSSE; CHOCOLATE PASTES; CHOCOLATE POWDER; CHOCOLATE SAUCE; CHOCOLATE SYRUP; CHOCOLATE TOPPED PRETZELS; CHOCOLATE TOPPING; CHOCOLATE TRUFFLES; CHOCOLATE-BASED BEVERAGES WITH MILK; CHOCOLATE-BASED FILLINGS FOR CAKES AND PIES; CHOCOLATE-BASED READY-TO-EAT FOOD BARS; CHOCOLATE-COVERED POTATO CHIPS; CHOCOLATES AND CHOCOLATE BASED READY TO EAT CANDIES AND SNACKS; CHOCOLATES CONTAINING NUTRIENTS; COCOA BEVERAGES WITH MILK; COCOA-BASED BEVERAGES; COFFEE; COFFEE; COFFEE AND ARTIFICIAL COFFEE; COFFEE AND COFFEE SUBSTITUTES; COFFEE AND TEA; COFFEE BASED BEVERAGES; COFFEE BEANS; COFFEE BEVERAGES WITH MILK;

Reg. No. 4,107,766 COFFEE CAPSULES CONTAINING COFFEE FOR BREWING; COFFEE ESSENCES; COFFEE ESSENCES FOR USE AS SUBSTITUTES FOR COFFEE; COFFEE EXTRACTS; COFFEE EXTRACTS FOR USE AS SUBSTITUTES FOR COFFEE; COFFEE FLAVORED SYRUP USED IN MAKING FOOD BEVERAGES; COFFEE PODS; COFFEE SUBSTITUTES; COFFEE SUBSTITUTES; COFFEE-BASED BEVERAGE CONTAINING MILK; COFFEE-BASED BEVERAGES; CONFECTIONERIES, NAMELY, SNACK FOODS, NAMELY, CHOCOLATE; CORN STARCH BASED DRINK, IN THE NATURE OF A FOOD BEVERAGE CONSISTING PRIMARILY OF MAIZE AND PORRIDGE; ESPRESSO; ESPRESSO DRINKS; FERMENTED HOT PEPPER PASTE FOR USE AS A SEASONING; FILLED CHOCOLATE; FISH SANDWICHES; FLAVOR ENHANCERS USED IN FOOD AND BEVERAGE PRODUCTS; FLAVORINGS FOR BEVERAGES; FLAVORINGS FOR BEVERAGES, OTHER THAN ESSENTIAL OILS; FRANKFURTER SANDWICHES; FRESH FRUITS CUT INTO FLOWER SHAPES AND AT LEAST PARTIALLY COATED WITH CHOCOLATE; FROZEN FLOUR-FREE FOODS, NAMELY, PANCAKES, CREPES, SANDWICH WRAPS, MUFFINS AND GRIDDLE CAKE SANDWICHES WHICH ARE PROTEIN-ENRICHED; FROZEN FLOUR-FREE FOODS, NAMELY, WAFFLES, PANCAKES, CREPES, SANDWICH WRAPS, MUFFINS AND GRIDDLE CAKE SANDWICHES WHICH ARE PROTEIN-ENRICHED; GRAIN-BASED BEVERAGES; GRAIN-BASED FOOD BEVERAGES; GRASS-BASED FOOD BEVERAGES; GREEN COFFEE; GROUND COFFEE BEANS; HAMBURGER SANDWICHES; HERBAL FLAVOURINGS FOR MAKING BEVERAGES; HERBAL FOOD BEVERAGES; HOP EXTRACTS USED AS FLAVORING FOR FOODS AND BEVERAGES; HOT CHILI PEPPER SAUCE; HOT CHOCOLATE; HOT DOG SANDWICHES; HOT PEPPER POWDER; HOT SAUCE; ICE CREAM SANDWICHES; ICED COFFEE; INSTANT COFFEE; MILK CHOCOLATE; MIXES IN THE NATURE OF CONCENTRATES, SYRUPS OR POWDERS USED IN THE PREPARATION OF TEA BASED BEVERAGES; MIXTURES OF COFFEE AND CHICORY; PREPARED COCOA AND COCOA-BASED BEVERAGES; PREPARED COFFEE AND COFFEE-BASED BEVERAGES; ROASTED COFFEE BEANS; SANDWICH RELISH; SANDWICHES; SCENTED WATER FOR FLAVORING BEVERAGES; SNACK FOODS, NAMELY, CHOCOLATE-BASED SNACK FOODS; SOY BURGER SANDWICHES; SPREAD CONTAINING CHOCOLATE AND NUTS; SUGAR-COATED COFFEE BEANS; TEA-BASED BEVERAGES; TEA-BASED BEVERAGES WITH FRUIT FLAVORING; TURKEY BURGER SANDWICHES; UNROASTED COFFEE; VEGGIE BURGER SANDWICHES, IN CLASS 30 (U.S. CL. 46).

FIRST USE 1-1-1996; IN COMMERCE 1-1-1996.

NO CLAIM IS MADE TO THE EXCLUSIVE RIGHT TO USE "ESPRESSO", APART FROM THE MARK AS SHOWN.

THE MARK CONSISTS OF THE STYLIZED WORDING "MOJO'S ESPRESSO". THE TWO "OS" IN THE WORD "MOJO'S" ARE REPRESENTED BY COFFEE MUGS WITH COVERS, AND SMOKE EMANATING FROM THESE MUGS.

SER. NO. 85-244,464, FILED 2-16-2011.

EVELYN BRADLEY, EXAMINING ATTORNEY

United States of America

United States Patent and Trademark Office



Reg. No. 4,107,767

PERKINS, OWEN W (UNITED STATES INDIVIDUAL)
52 APPLETON ROAD
NANTUCKET, MA 02554

Registered Mar. 6, 2012

Int. Cl.: 18

FOR: HANDBAGS, IN CLASS 18 (U.S. CLS. 1, 2, 3, 22 AND 41).

TRADEMARK

FIRST USE 1-1-2003; IN COMMERCE 1-1-2003.

PRINCIPAL REGISTER

NO CLAIM IS MADE TO THE EXCLUSIVE RIGHT TO USE "NANTUCKET" , APART FROM THE MARK AS SHOWN.

THE NAME DOES NOT IDENTIFY A PARTICULAR LIVING INDIVIDUAL.

THE MARK CONSISTS OF "JUDY" IN ALL CAPITAL LETTERS ABOVE THE WORD "NANTUCKET" ALSO ALL IN CAPITAL LETTERS.

SER. NO. 85-244,521, FILED 2-17-2011.

JOHN E. MICHOS, EXAMINING ATTORNEY



David J. Kybas

Director of the United States Patent and Trademark Office

United States of America

United States Patent and Trademark Office

OM

Reg. No. 4,107,768

BISHOP, EMILY-KATE (UNITED STATES INDIVIDUAL), DBA OM BY MIQUETTE
292 GILBERT STUART ROAD
SAUNDERSTOWN, RI 02874

Registered Mar. 6, 2012

Int. Cl.: 20

FOR: FANTASY HUMANOID FIGURINES MADE OF POLYMER CLAY AND PLASTIC
BASED RESIN, IN CLASS 20 (U.S. CLS. 2, 13, 22, 25, 32 AND 50).

TRADEMARK

FIRST USE 7-1-2010; IN COMMERCE 7-6-2010.

PRINCIPAL REGISTER

THE MARK CONSISTS OF STANDARD CHARACTERS WITHOUT CLAIM TO ANY PAR-
TICULAR FONT, STYLE, SIZE, OR COLOR.

SER. NO. 85-244,544, FILED 2-17-2011.

TINA MAI, EXAMINING ATTORNEY



David J. Kybas

Director of the United States Patent and Trademark Office

United States of America

United States Patent and Trademark Office



Reg. No. 4,107,769

Registered Mar. 6, 2012

Int. Cl.: 38

SERVICE MARK

PRINCIPAL REGISTER

FARMERS TELEPHONE COOPERATIVE, INC. (SOUTH CAROLINA CORPORATION)
POST OFFICE BOX 588
KINGSTREE, SC 29556

FOR: TELECOMMUNICATION SERVICES, NAMELY, LOCAL AND LONG DISTANCE TRANSMISSION OF VOICE, DATA, GRAPHICS AND VIDEO BY MEANS OF BROADBAND, COPPER AND OPTICAL OR WIRELESS NETWORKS, IN CLASS 38 (U.S. CLS. 100, 101 AND 104).

FIRST USE 11-1-2007; IN COMMERCE 11-1-2007.

OWNER OF U.S. REG. NOS. 2,344,285, 3,634,013 AND OTHERS.

NO CLAIM IS MADE TO THE EXCLUSIVE RIGHT TO USE "DIVERSIFIED", APART FROM THE MARK AS SHOWN.

THE MARK CONSISTS OF THE WORDS "FTC DIVERSIFIED" WITH A PARTIALLY-SHADED OVAL DESIGN WITH MULTIPLE WAVY HORIZONTAL LINES TO THE LEFT OF THE WORDS.

SER. NO. 85-244,680, FILED 2-17-2011.

JULIE WATSON, EXAMINING ATTORNEY



David J. Kyffers

Director of the United States Patent and Trademark Office

United States of America

United States Patent and Trademark Office



Reg. No. 4,107,770

Registered Mar. 6, 2012

Int. Cl.: 9

TRADEMARK

PRINCIPAL REGISTER

PRO VISUAL, INC. (FLORIDA CORPORATION)
SUITE 123
3399 NW 72ND AVE.
MIAMI, FL 33122

FOR: SECURITY VIDEO CAMERAS, DIGITAL VIDEO RECORDERS, ACCESS CONTROL AND ALARM MONITORING SYSTEMS, SECURITY ALARMS, UTP VIDEO CONVERTERS AND EXPANDERS, AND COAXIAL CABLES AND ACCESSORIES, NAMELY, CABLE CONNECTORS, IN CLASS 9 (U.S. CLS. 21, 23, 26, 36 AND 38).

FIRST USE 8-31-2007; IN COMMERCE 8-31-2007.

OWNER OF U.S. REG. NO. 3,333,906.

THE COLOR(S) WHITE, LIGHT BLUE, AND DARK BLUE IS/ARE CLAIMED AS A FEATURE OF THE MARK.

THE MARK CONSISTS OF THE WORD "PROVISUAL" APPEARING IN THE FOREGROUND IN WHITE IN CAPITAL LETTERS, WITH THE TOP OF THE LETTER "V" EXTENDING OVER THE WORD TO THE LEFT AND THE RIGHT. THE BACKGROUND CONSISTS OF A DARK BLUE BACKGROUND WITH A LIGHT BLUE ARCH TOWARDS THE TOP.

SER. NO. 85-245,251, FILED 2-17-2011.

MATTHEW KLINE, EXAMINING ATTORNEY



David J. Kybas

Director of the United States Patent and Trademark Office

United States of America

United States Patent and Trademark Office



Reg. No. 4,107,771

Registered Mar. 6, 2012

Int. Cl.: 35

SERVICE MARK

PRINCIPAL REGISTER

HANNINGTON, MARY LEE (UNITED STATES INDIVIDUAL), DBA THE CUPID STUNT
748 SEMINOLE
DETROIT, MI 48214

FOR: ADVERTISING AGENCY SPECIALIZING IN THE DESIGN AND EXECUTION OF WORD OF MOUTH, VIRAL, BUZZ AND EXPERIENTIAL MARKETING PROGRAMS; CREATIVE MARKETING DESIGN SERVICES; DESIGN OF ADVERTISING BROCHURES FOR OTHERS; DESIGN OF ADVERTISING FLYERS FOR OTHERS; DESIGN OF ADVERTISING MATERIALS FOR OTHERS; DESIGN OF INTERNET ADVERTISING; ON-LINE RETAIL STORE SERVICES FEATURING PHYSICAL AND VIRTUAL MERCHANDISE FOR USE BY MEMBERS OF AN ONLINE COMMUNITY IN CONNECTION WITH A DESIGNATED WEBSITE FEATURING FICTIONAL CHARACTERS; PLANNING, DESIGN, DEVELOPMENT, MAINTENANCE, TRACKING AND REPORTING OF ONLINE MARKETING ACTIVITIES FOR THIRD PARTIES; PROMOTING THE GRAPHIC ARTS DESIGN SERVICES OF OTHERS BY MEANS OF A WEBSITE FEATURING GRAPHIC ARTWORK SUBMITTED BY GRAPHIC ART DESIGNERS; PROVIDING ADVERTISING SERVICES USING 3D AND ANIMATION DESIGNS; PROVIDING ADVERTISING, MARKETING AND PROMOTIONAL SERVICES, NAMELY, DEVELOPMENT OF ADVERTISING CAMPAIGNS FOR TELEVISION, PRINT, CD-ROM AND WEB DESIGN FOR CORPORATIONS, IN CLASS 35 (U.S. CLS. 100, 101 AND 102).

FIRST USE 2-16-2011; IN COMMERCE 2-16-2011.



THE MARK CONSISTS OF A DESIGN OF A NUDE PEACH OR FLESH COLORED CUPID FIGURE OUTLINED IN BLACK LAYING FACE DOWN WITH PURPLE SHADOWING. THE CUPID HAS AN ARROW WITH A YELLOW SHAFT AND A PINK VANE PUNCTURING HER HEAD. THE CUPID FIGURE HAS PALE BLUE WINGS OUTLINED IN BLACK WITH PURPLE STIPPLING AND SHADOWING. THE CUPID'S HAIR IS ORANGE WITH BLACK SHADOWING. THE STYLIZED WORDING "THE CUPID STUNT" APPEARS IN THE COLOR BLACK BELOW THE CUPID FIGURE.

THE COLOR(S) PEACH, BLACK, PURPLE, PALE BLUE, ORANGE, YELLOW, AND PINK IS/ARE CLAIMED AS A FEATURE OF THE MARK.

David J. Kyros

SER. NO. 85-245,901, FILED 2-18-2011.

ZHALEH DELANEY, EXAMINING ATTORNEY

United States of America

United States Patent and Trademark Office



Reg. No. 4,107,772

Registered Mar. 6, 2012

Int. Cl.: 30

TRADEMARK

PRINCIPAL REGISTER

GOLDEN HILL HOUSE, INC. (NEW YORK CORPORATION)
PO BOX 6
EAST DURHAM, NY 12423

FOR: BREAD MIXES, IN CLASS 30 (U.S. CL. 46).

FIRST USE 1-0-2011; IN COMMERCE 1-0-2011.

NO CLAIM IS MADE TO THE EXCLUSIVE RIGHT TO USE "IRISH BREAD MIX" AND "OLD TRADITIONAL IRISH RECIPE" , APART FROM THE MARK AS SHOWN.

THE COLOR(S) GREEN, WHITE, BLACK IS/ARE CLAIMED AS A FEATURE OF THE MARK.

THE NAME SHOWN IN THE MARK IDENTIFIES A LIVING INDIVIDUAL WHOSE CONSENT TO REGISTER IS OF RECORD.

THE MARK CONSISTS OF THE TERMS "NELLIE GAVIN'S IRISH BREAD MIX" IN A WHITE LETTERING, IN CLOSED IN A GREEN SHAMROCK. THE TERMS "NELLIE'S OLD TRADITIONAL RECIPE" APPEAR IN BLACK BELOW THE SHAMROCK.

SER. NO. 85-246,531, FILED 2-18-2011.

CAROLYN CATALDO, EXAMINING ATTORNEY



David J. Kybas

Director of the United States Patent and Trademark Office

United States of America

United States Patent and Trademark Office

METLIFE AUTO

Reg. No. 4,107,773

Registered Mar. 6, 2012

Int. Cl.: 36

SERVICE MARK

PRINCIPAL REGISTER

METROPOLITAN LIFE INSURANCE COMPANY (NEW YORK CORPORATION)
1095 AVENUE OF THE AMERICAS
NEW YORK, NY 10036

FOR: UNDERWRITING AND ADMINISTRATION OF AUTO, BOAT, RECREATIONAL VEHICLE, MOBILE HOME AND MOTORCYCLE INSURANCE COVERAGE, IN CLASS 36 (U.S. CLS. 100, 101 AND 102).

FIRST USE 1-1-2011; IN COMMERCE 1-1-2011.

THE MARK CONSISTS OF STANDARD CHARACTERS WITHOUT CLAIM TO ANY PARTICULAR FONT, STYLE, SIZE, OR COLOR.

OWNER OF U.S. REG. NOS. 2,599,438, 2,652,295 AND OTHERS.

NO CLAIM IS MADE TO THE EXCLUSIVE RIGHT TO USE "AUTO", APART FROM THE MARK AS SHOWN.

SER. NO. 85-246,690, FILED 2-18-2011.

MAUREEN DALL, EXAMINING ATTORNEY



David J. Kybas

Director of the United States Patent and Trademark Office

United States of America

United States Patent and Trademark Office

Uncle Grumpy

Reg. No. 4,107,774

HELD, MATHEW G (UNITED STATES INDIVIDUAL), DBA UNCLE GRUMPY
1059 CLEMENT ST APT 7
SAN FRANCISCO, CA 94118

Registered Mar. 6, 2012

Int. Cl.: 42

FOR: COMPUTER SERVICES, NAMELY, ELECTRONIC IMAGING OF ILLUSTRATION,
ARTWORK, DESIGN, IN CLASS 42 (U.S. CLS. 100 AND 101).

SERVICE MARK

FIRST USE 10-3-2001; IN COMMERCE 10-31-2010.

PRINCIPAL REGISTER

THE MARK CONSISTS OF STANDARD CHARACTERS WITHOUT CLAIM TO ANY PAR-
TICULAR FONT, STYLE, SIZE, OR COLOR.

THE NAME(S), PORTRAIT(S), AND/OR SIGNATURE(S) SHOWN IN THE MARK DOES NOT
IDENTIFY A PARTICULAR LIVING INDIVIDUAL.

SER. NO. 85-247,084, FILED 2-20-2011.

ALYSSA STEEL, EXAMINING ATTORNEY



David J. Kybas

Director of the United States Patent and Trademark Office

United States of America

United States Patent and Trademark Office



Reg. No. 4,107,775

EVERY1FIT, LLC (COLORADO LIMITED LIABILITY COMPANY)
6570 N. VILLAGE RD
PARKER, CO 80134

Registered Mar. 6, 2012

Int. Cl.: 44

FOR: COUNSELING SERVICES IN THE FIELDS OF HEALTH AND NUTRITION; PROVIDING A WEBSITE FEATURING INFORMATION, GUIDANCE, PLANS, VIDEOS, AUDIOS, AND WEBINARS IN THE FIELD OF HEALTH, NUTRITION, SPORT PSYCHOLOGY, AND PSYCHOLOGICAL ASSESSMENT SERVICES, IN CLASS 44 (U.S. CLS. 100 AND 101).

SERVICE MARK

PRINCIPAL REGISTER

FIRST USE 6-30-2009; IN COMMERCE 9-30-2009.

NO CLAIM IS MADE TO THE EXCLUSIVE RIGHT TO USE "FIT", APART FROM THE MARK AS SHOWN.

THE COLOR(S) BLUE, ORANGE AND WHITE IS/ARE CLAIMED AS A FEATURE OF THE MARK.

THE MARK CONSISTS OF THE LITERAL ELEMENTS "E 1 FIT", "PREPARE FOR AMAZING", WHEREIN THE NUMBER "1" IS SUPERIMPOSED ON A IMAGE OF EARTH IN BLUE COLOR, THERE IS A CIRCULAR SHAPE AROUND THE IMAGE OF EARTH CONNECTED TO THE LETTER "E" AND "F" IN WHICH THERE ARE SIX DIFFERENT TYPES OF BALLS USED IN VARIOUS SPORTS LIKE GOLF, BASKETBALL, BASEBALL, FOOTBALL, VOLLEYBALL AND A BALL RESEMBLING A TENNIS BALL, THREE IN THE UPPER HALF AND THREE IN THE LOWER HALF OF THE CIRCULAR SHAPE, IN ORANGE COLOR. THE WORDS "E" AND "FIT" IS IN BLUE COLOR, NUMBER "1" IS IN WHITE AND THE WORDS "PREPARE FOR AMAZING" IS IN ORANGE COLOR AS SHOWN IN THE MARK.



SER. NO. 85-247,395, FILED 2-21-2011.

ALEXANDER L. POWERS, EXAMINING ATTORNEY

David J. Kybas

Director of the United States Patent and Trademark Office

United States of America

United States Patent and Trademark Office

D-FEND

Reg. No. 4,107,776

Registered Mar. 6, 2012

Int. Cl.: 9

TRADEMARK

PRINCIPAL REGISTER

INTRINSIC AUDIO SOLUTIONS, INC. (MISSOURI CORPORATION)
1650 WEST JACKSON
OZARK, MO 65721

FOR: AUDIO CIRCUIT BOARDS; CIRCUIT BOARDS; LOUDSPEAKER SYSTEMS; SOUND SYSTEMS COMPRISING REMOTE CONTROLS, AMPLIFIERS, LOUDSPEAKERS AND COMPONENTS THEREFOR, IN CLASS 9 (U.S. CLS. 21, 23, 26, 36 AND 38).

FIRST USE 2-17-2011; IN COMMERCE 2-17-2011.

THE MARK CONSISTS OF STANDARD CHARACTERS WITHOUT CLAIM TO ANY PARTICULAR FONT, STYLE, SIZE, OR COLOR.

SER. NO. 85-247,540, FILED 2-21-2011.

SETH A. RAPPAPORT, EXAMINING ATTORNEY



David J. Kybas

Director of the United States Patent and Trademark Office

United States of America

United States Patent and Trademark Office

RESPERATE

Reg. No. 4,107,777

Registered Mar. 6, 2012

Int. Cls.: 10 and 44

TRADEMARK

SERVICE MARK

PRINCIPAL REGISTER

INTERCURE INC. (DELAWARE CORPORATION)
333 W. 39TH ST., #704
NEW YORK, NY 10018

FOR: INTERACTIVE RESPIRATORY MODULATING APPARATUS COMPRISING MEDICAL SENSORS AND MONITORS, ELECTRONIC CONTROLS, AND APPARATUS FOR TRANSMITTING AND REPRODUCING SOUND AND IMAGES, SOLD AS A UNIT, FOR USE IN IMPROVING MEDICAL, PHYSICAL, AND PSYCHOLOGICAL CONDITIONS, IN CLASS 10 (U.S. CLS. 26, 39 AND 44).

FIRST USE 0-0-2000; IN COMMERCE 2-0-2002.

FOR: PROVIDING A WEBSITE FOR CONDUCTING MEDICAL PHYSICAL EVALUATIONS AND ASSESSMENTS USING DATA PROVIDED BY PATIENTS ONLINE AND/OR THROUGH EMAIL; MEDICAL EVALUATION AND ASSESSMENT SERVICES, NAMELY, FUNCTIONAL ASSESSMENT PROGRAM FOR PATIENTS USING INTERACTIVE RESPIRATORY MODULATING APPARATUS FOR PURPOSES OF GUIDING TREATMENT AND ASSESSING PROGRAM EFFECTIVENESS, IN CLASS 44 (U.S. CLS. 100 AND 101).

FIRST USE 0-0-2000; IN COMMERCE 2-0-2002.

THE MARK CONSISTS OF STANDARD CHARACTERS WITHOUT CLAIM TO ANY PARTICULAR FONT, STYLE, SIZE, OR COLOR.

THE WORDING "RESPERATE" HAS NO MEANING OTHER THAN TRADEMARK SIGNIFICANCE.

SER. NO. 85-247,631, FILED 2-21-2011.

LINDA ORNDORFF, EXAMINING ATTORNEY



David J. Kyffers

Director of the United States Patent and Trademark Office

United States of America

United States Patent and Trademark Office



Reg. No. 4,107,778

Registered Mar. 6, 2012

Int. Cls.: 41 and 44

SERVICE MARK

PRINCIPAL REGISTER

RESCUE RIDERS, NFP (ILLINOIS CORPORATION)
UNIT A
40W148 CAMPTON CROSSINGS DR.
ST. CHARLES, IL 60175

FOR: EDUCATION SERVICES, NAMELY, PROVIDING TRAINING IN THE FIELDS OF ACCIDENT SCENE MANAGEMENT AND EMERGENCY MEDICAL RESPONSE SERVICES, IN CLASS 41 (U.S. CLS. 100, 101 AND 107).

FIRST USE 3-25-2006; IN COMMERCE 5-16-2007.

FOR: EMERGENCY MEDICAL RESPONSE SERVICES, IN CLASS 44 (U.S. CLS. 100 AND 101).

FIRST USE 3-25-2006; IN COMMERCE 5-16-2007.

NO CLAIM IS MADE TO THE EXCLUSIVE RIGHT TO USE THE CADUCEUS ON A SIX-POINT CROSS, APART FROM THE MARK AS SHOWN.

THE MARK CONSISTS OF A SHIELD BEARING THE WORDS "RESCUE RIDERS" ACROSS THE TOP, THE WORDS "RIDE FOR A REASON" IN THE MIDDLE, AND A DRAWING OF A CADUCEUS ON A SIX-POINT CROSS ON THE BOTTOM.

SER. NO. 85-247,693, FILED 2-21-2011.

LINDA MICKLEBURGH, EXAMINING ATTORNEY



David J. Kybas

Director of the United States Patent and Trademark Office

United States of America

United States Patent and Trademark Office



Reg. No. 4,107,779

Registered Mar. 6, 2012

Int. Cl.: 9

TRADEMARK

PRINCIPAL REGISTER

GOLD SYSTEMS, INC. (DELAWARE CORPORATION)
4840 PEARL EAST CIRCLE STE 106
BOULDER, CO 80301

FOR: SOFTWARE FOR INTEGRATING SPEECH RECOGNITION, INTERACTIVE VOICE RESPONSE (IVR), AND WIRELESS WEB TECHNOLOGIES WITH TRADITIONAL COMMUNICATIONS AND TELEPHONY INTERFACES, NAMELY, WIRELESS INTERFACE COMPUTER SOFTWARE WHICH CONNECTS DATABASES, ENTERPRISE SOFTWARE PACKAGES, SPEECH RECOGNITION SOFTWARE APPLICATIONS, WIRELESS MOBILE-COMMERCE SOFTWARE INTERFACES AND BOTH TRADITIONAL AND IP-BASED IVR PLATFORMS COMPRISED OF COMPUTER SOFTWARE AND HARDWARE, IN CLASS 9 (U.S. CLS. 21, 23, 26, 36 AND 38).

FIRST USE 4-3-2001; IN COMMERCE 4-3-2001.

THE MARK CONSISTS OF A STYLIZED V-SHAPE ENCLOSED IN A RECTANGLE BOX WITH THE WORD "VONETIX" POSITIONED ADJACENT THE RECTANGLE BOX.

SER. NO. 85-247,709, FILED 2-21-2011.

ERNEST SHOSHO, EXAMINING ATTORNEY



David J. Kypos

Director of the United States Patent and Trademark Office

United States of America

United States Patent and Trademark Office

NORTHERN LITE

Reg. No. 4,107,780

Registered Mar. 6, 2012

Int. Cl.: 30

TRADEMARK

PRINCIPAL REGISTER

ARABICA FUNDING, INC. (DELAWARE CORPORATION)
3900 LAKEBREEZE AVENUE NORTH
BROOKLYN CENTER, MN 55429

FOR: COFFEE-BASED BEVERAGES, IN CLASS 30 (U.S. CL. 46).

FIRST USE 12-31-1992; IN COMMERCE 9-18-1994.

THE MARK CONSISTS OF STANDARD CHARACTERS WITHOUT CLAIM TO ANY PARTICULAR FONT, STYLE, SIZE, OR COLOR.

SER. NO. 85-247,918, FILED 2-22-2011.

FRANK LATTUCA, EXAMINING ATTORNEY



David J. Kyffers

Director of the United States Patent and Trademark Office

United States of America

United States Patent and Trademark Office

LA COSECHA GOLDEN FOODS

Reg. No. 4,107,781

Registered Mar. 6, 2012

Int. Cl.: 30

TRADEMARK

PRINCIPAL REGISTER

CEREALES Y PASTAS, S.A. DE C.V. (MEXICO CORPORATION)
COL. CIUDAD INDUSTRIAL CELAYA
AVENIDA MEXICO JAPON NO. 400-A
CELAYA GUANAJUATO, MEXICO 38010

FOR: BREAKFAST CEREALS AND CEREAL BASED SNACK FOODS, IN CLASS 30 (U.S. CL. 46).

THE MARK CONSISTS OF STANDARD CHARACTERS WITHOUT CLAIM TO ANY PARTICULAR FONT, STYLE, SIZE, OR COLOR.

PRIORITY CLAIMED UNDER SEC. 44(D) ON MEXICO APPLICATION NO. 1154667, FILED 2-14-2011, REG. NO. 1223450, DATED 2-14-2011, EXPIRES 2-14-2021.

OWNER OF U.S. REG. NO. 3,666,019.

NO CLAIM IS MADE TO THE EXCLUSIVE RIGHT TO USE "FOODS", APART FROM THE MARK AS SHOWN.

THE ENGLISH TRANSLATION OF "LA COSECHA" IN THE MARK IS "THE HARVEST".

SER. NO. 85-247,959, FILED 2-22-2011.

MICHAEL KEATING, EXAMINING ATTORNEY



David J. Kybas

Director of the United States Patent and Trademark Office

United States of America

United States Patent and Trademark Office

Fast Tract Digestion

Reg. No. 4,107,782

Registered Mar. 6, 2012

Int. Cl.: 16

TRADEMARK

PRINCIPAL REGISTER

DIGESTIVE HEALTH INSTITUTE (MASSACHUSETTS CORPORATION), DBA DIGESTIVE HEALTH INSTITUTE
226 COMMON ST
WATERTOWN, MA 02472

FOR: A SERIES OF BOOKS, WRITTEN ARTICLES, HANDOUTS AND WORKSHEETS IN THE FIELD OF DIGESTIVE HEALTH, IN CLASS 16 (U.S. CLS. 2, 5, 22, 23, 29, 37, 38 AND 50).

FIRST USE 1-7-2010; IN COMMERCE 1-7-2010.

THE MARK CONSISTS OF STANDARD CHARACTERS WITHOUT CLAIM TO ANY PARTICULAR FONT, STYLE, SIZE, OR COLOR.

NO CLAIM IS MADE TO THE EXCLUSIVE RIGHT TO USE "DIGESTION", APART FROM THE MARK AS SHOWN.

SER. NO. 85-247,990, FILED 2-22-2011.

FLORENTINA BLANDU, EXAMINING ATTORNEY



David J. Kyjars

Director of the United States Patent and Trademark Office

United States of America

United States Patent and Trademark Office



irradiant

Reg. No. 4,107,783

Registered Mar. 6, 2012

Int. Cl.: 11

TRADEMARK

PRINCIPAL REGISTER

NEO-NEON LED LIGHTING INTERNATIONAL LTD. (HONG KONG CORPORATION)
TSIM SHA TSUI, KOWLOON NOS R1 & 8
2/F. 33 CANTON ROAD
HONG KONG, HONG KONG

FOR: LED (LIGHT EMITTING DIODES) LIGHTING FIXTURES FOR USE IN DISPLAY, COMMERCIAL, INDUSTRIAL, RESIDENTIAL, AND ARCHITECTURAL ACCENT LIGHTING APPLICATIONS, NAMELY, PAR CANS, LED PAR CANS, LED PIN SPOTS, LED EFFECT LIGHTS, LED WASHES, LED STAGES WASHES, LED LINEAR WASHES, LED WASH PANELS, LED BALLS AND CUBES, AND DISCHARGE LAMPS, IN CLASS 11 (U.S. CLS. 13, 21, 23, 31 AND 34).

FIRST USE 10-13-2010; IN COMMERCE 10-13-2010.

NO CLAIM IS MADE TO THE EXCLUSIVE RIGHT TO USE "IRRADIANT", APART FROM THE MARK AS SHOWN.

THE MARK CONSISTS OF THREE ROWS OF SOLID CIRCLES IN AN ARCH-SHAPE AND TO THE RIGHT IS ONE SOLID CIRCLE CENTERED TO THE ARCH. NEXT TO THE CIRCLES IS THE WORD "IRRADIANT". THE LETTER "N" IN "IRRADIANT" IS STYLIZED.

SER. NO. 85-248,878, FILED 2-22-2011.

CAROLINE WOOD, EXAMINING ATTORNEY



David J. Kybas

Director of the United States Patent and Trademark Office

United States of America

United States Patent and Trademark Office

EZ TAX REFUNDS

Reg. No. 4,107,784

EZ TAX REFUNDS, LLC (ALABAMA LIMITED LIABILITY COMPANY)
5411 HIGHLAND RD
MOBILE, AL 36693

Registered Mar. 6, 2012

Int. Cl.: 35

FOR: TAX PREPARATION, IN CLASS 35 (U.S. CLS. 100, 101 AND 102).

SERVICE MARK

FIRST USE 9-1-2010; IN COMMERCE 9-1-2010.

PRINCIPAL REGISTER

NO CLAIM IS MADE TO THE EXCLUSIVE RIGHT TO USE "TAX REFUNDS", APART FROM THE MARK AS SHOWN.

THE MARK CONSISTS OF THE STYLIZED TEXT "EZ TAX REFUNDS" WITH A LINE AT THE BOTTOM.

SER. NO. 85-248,911, FILED 2-22-2011.

REBECCA SMITH, EXAMINING ATTORNEY



David J. Kybas

Director of the United States Patent and Trademark Office

United States of America

United States Patent and Trademark Office

IN THRUST WE TRUST

Reg. No. 4,107,785

WHEEL PROS, LLC (DELAWARE LIMITED LIABILITY COMPANY)
44 UNION BLVD., SUITE 620
LAKEWOOD, CO 80228

Registered Mar. 6, 2012

Int. Cl.: 12

FOR: AUTOMOTIVE VEHICLE WHEELS, AND PARTS THEREOF, IN CLASS 12 (U.S. CLS. 19, 21, 23, 31, 35 AND 44).

TRADEMARK

FIRST USE 1-0-2007; IN COMMERCE 2-17-2011.

PRINCIPAL REGISTER

THE MARK CONSISTS OF STANDARD CHARACTERS WITHOUT CLAIM TO ANY PARTICULAR FONT, STYLE, SIZE, OR COLOR.

SER. NO. 85-249,345, FILED 2-23-2011.

JASON BLAIR, EXAMINING ATTORNEY



David J. Kyffers

Director of the United States Patent and Trademark Office

United States of America

United States Patent and Trademark Office



Reg. No. 4,107,786

Registered Mar. 6, 2012

Int. Cl.: 32

TRADEMARK

PRINCIPAL REGISTER

PACIFIC CAPITAL, LLC (ARIZONA LIMITED LIABILITY COMPANY)
P.O. BOX 85060
PHOENIX, AZ 85060

FOR: FRUIT FLAVORED DRINKS WITH 100% OF THE RECOMMENDED DAILY VALUE OF VITAMIN C; FRUIT FLAVOURED DRINKS WITH 100% OF THE RECOMMENDED DAILY VALUE OF VITAMIN C; FRUIT-BASED BEVERAGES WITH 100% OF THE RECOMMENDED DAILY VALUE OF VITAMIN C; FRUIT-FLAVORED BEVERAGES WITH 100% OF THE RECOMMENDED DAILY VALUE OF VITAMIN C; FRUIT-FLAVOURED BEVERAGES WITH 100% OF THE RECOMMENDED DAILY VALUE OF VITAMIN C; NON-ALCOHOLIC BEVERAGES CONTAINING FRUIT JUICES WITH 100% OF THE RECOMMENDED DAILY VALUE OF VITAMIN C, IN CLASS 32 (U.S. CLS. 45, 46 AND 48).

FIRST USE 2-1-2011; IN COMMERCE 2-1-2011.

NO CLAIM IS MADE TO THE EXCLUSIVE RIGHT TO USE "ORANGE CITRUS PUNCH" AND "100% VITAMIN C", APART FROM THE MARK AS SHOWN.

THE COLOR(S) WHITE, ORANGE, YELLOW, BLACK, GREEN, AND RED IS/ARE CLAIMED AS A FEATURE OF THE MARK.

THE MARK CONSISTS OF A CARTOON ORANGE IN ORANGE WITH EYES AND NOSE IN BLACK, AND LIPS IN RED BEING KISSED BY A CARTOON LEMON IN YELLOW WITH EYES IN BLACK, BOTH HANGING FROM A GREEN AND BLACK BRANCHES AND SURROUNDED BY GREEN AND BLACK LEAVES, AT THE TOP OF THE CARTOON ORANGE IS A WHITE FLOWER PARTIALLY OBSTRUCTED BY THE WORDING "LA GRANDE" IN THE UPPER LEFT PORTION OF THE MARK IS THE WORDING "LA GRANDE" IN ORANGE AND YELLOW OUTLINED IN WHITE, AT THE BOTTOM LEFT PORTION OF THE MARK IS THE WORDING "ORANGE CITRUS PUNCH" IN ORANGE OUTLINED IN WHITE, AT THE BOTTOM CENTER PORTION OF THE MARK IS A SEAL DESIGN IN ORANGE OUTLINED IN GREEN FEATURING TWO RED STARS AND THE WORDING "100% VITAMIN C" IN GREEN, BLACK AND WHITE WITH A BLACK OUTLINE, ALL IN FRONT OF A GREEN SQUARED BACKGROUND WITH CURVED CORNERS AND A SLIGHT ANGLE TO UPPER RIGHT PORTION OF THE SQUARE, THE BACKGROUND IS FADING TO LIGHT GREEN FROM TOP TO BOTTOM AND OUTLINED IN GREEN FADING TO DARK GREEN FROM TOP TO BOTTOM.



David J. Kyjars

Director of the United States Patent and Trademark Office

Reg. No. 4,107,786 THE ENGLISH TRANSLATION OF "LA GRANDE" IN THE MARK IS "THE GREAT".

SER. NO. 85-249,386, FILED 2-23-2011.

DEIRDRE ROBERTSON, EXAMINING ATTORNEY

United States of America

United States Patent and Trademark Office

TECTONICS

Reg. No. 4,107,787

AMERICAN GEOPHYSICAL UNION (D.C. NON-PROFIT CORPORATION)
2000 FLORIDA AVENUE, N.W.
WASHINGTON, DC 20009

Registered Mar. 6, 2012

Int. Cls.: 16 and 41

FOR: PRINTED PUBLICATIONS, NAMELY, JOURNALS CONTAINING ARTICLES ON THE SUBJECT OF ANALYTICAL, SYNTHETIC, AND INTEGRATIVE TECTONICS AND THE STRUCTURE AND EVOLUTION OF THE TERRESTRIAL LITHOSPHERE, IN CLASS 16 (U.S. CLS. 2, 5, 22, 23, 29, 37, 38 AND 50).

TRADEMARK

SERVICE MARK

FIRST USE 0-0-1982; IN COMMERCE 0-0-1982.

PRINCIPAL REGISTER

FOR: PROVIDING ONLINE PUBLICATIONS IN THE NATURE OF JOURNALS CONTAINING ARTICLES ON THE SUBJECT OF ANALYTICAL, SYNTHETIC, AND INTEGRATIVE TECTONICS AND THE STRUCTURE AND EVOLUTION OF THE TERRESTRIAL LITHOSPHERE, IN CLASS 41 (U.S. CLS. 100, 101 AND 107).

FIRST USE 0-0-2002; IN COMMERCE 0-0-2002.

THE MARK CONSISTS OF STANDARD CHARACTERS WITHOUT CLAIM TO ANY PARTICULAR FONT, STYLE, SIZE, OR COLOR.

SEC. 2(F).

SER. NO. 85-249,690, FILED 2-23-2011.

DOMINICK J. SALEMI, EXAMINING ATTORNEY



David J. Kyffers

Director of the United States Patent and Trademark Office

United States of America

United States Patent and Trademark Office

Bend it, Twist it, Shape
it... Wear it!

Reg. No. 4,107,788

CM EQUITY INVESTMENTS, INC. (NEVADA CORPORATION)
9701 W. PICO BOULEVARD, SUITE 110
LOS ANGELES, CA 90035

Registered Mar. 6, 2012

Int. Cl.: 14

FOR: COSTUME JEWELRY; JEWELRY; JEWELRY AND IMITATION JEWELRY; JEWELRY BROOCHES; JEWELRY CHAINS; JEWELRY FOR THE HEAD; JEWELRY IN THE NATURE OF ARMBANDS; JEWELRY, NAMELY, ANKLETS, IN CLASS 14 (U.S. CLS. 2, 27, 28 AND 50).

TRADEMARK

PRINCIPAL REGISTER

FIRST USE 12-2-2010; IN COMMERCE 1-23-2011.

THE MARK CONSISTS OF STANDARD CHARACTERS WITHOUT CLAIM TO ANY PARTICULAR FONT, STYLE, SIZE, OR COLOR.

SER. NO. 85-250,151, FILED 2-23-2011.

SETH A. RAPPAPORT, EXAMINING ATTORNEY



David J. Kybas

Director of the United States Patent and Trademark Office

United States of America

United States Patent and Trademark Office

enactor

Reg. No. 4,107,789

Registered Mar. 6, 2012

Int. Cls.: 9 and 42

TRADEMARK

SERVICE MARK

PRINCIPAL REGISTER

ENACTOR LIMITED (UNITED KINGDOM LIMITED LIABILITY COMPANY), TA ENACTOR LIMITED
CAMBRIDGE HOUSE
6 BLUECOATES AVENUE
HERTFORD, UNITED KINGDOM SG90HF

FOR: (BASED ON USE IN COMMERCE) (BASED ON 44(E)) COMPUTER APPLICATION SOFTWARE FOR BUSINESS SERVICES, NAMELY, SOFTWARE FOR POINT-OF-SALE, INVENTORY MANAGEMENT AND CUSTOMER RELATIONSHIP MANAGEMENT FOR RETAIL SYSTEMS; COMPUTER SOFTWARE DEVELOPMENT TOOLS, IN CLASS 9 (U.S. CLS. 21, 23, 26, 36 AND 38).

FIRST USE 12-1-2008; IN COMMERCE 12-1-2008.

FOR: ((BASED ON 44(E)) COMPUTER CONSULTATION; COMPUTER PROGRAMMING AND SOFTWARE DESIGN, IN CLASS 42 (U.S. CLS. 100 AND 101).

THE MARK CONSISTS OF STANDARD CHARACTERS WITHOUT CLAIM TO ANY PARTICULAR FONT, STYLE, SIZE, OR COLOR.

OWNER OF UNITED KINGDOM REG. NO. 2508094, DATED 2-6-2009, EXPIRES 2-6-2019.

SER. NO. 85-250,237, FILED 2-24-2011.

JOHN SCHUYLER YARD, EXAMINING ATTORNEY



David J. Kybas

Director of the United States Patent and Trademark Office

United States of America

United States Patent and Trademark Office

WATER RESOURCES RESEARCH

Reg. No. 4,107,790

AMERICAN GEOPHYSICAL UNION (D.C. NON-PROFIT CORPORATION)
2000 FLORIDA AVENUE, N.W.
WASHINGTON, DC 20009

Registered Mar. 6, 2012

Int. Cls.: 16 and 41

FOR: PRINTED PUBLICATIONS, NAMELY, JOURNALS CONTAINING ARTICLES ON THE SUBJECT OF THE SOCIAL AND NATURAL SCIENCES OF WATER, HYDROLOGY, THE PHYSICAL, CHEMICAL, AND BIOLOGICAL SCIENCES AND THE SOCIAL AND POLICY SCIENCES, IN CLASS 16 (U.S. CLS. 2, 5, 22, 23, 29, 37, 38 AND 50).

TRADEMARK

SERVICE MARK

FIRST USE 0-0-1965; IN COMMERCE 0-0-1965.

PRINCIPAL REGISTER

FOR: PROVIDING ONLINE PUBLICATIONS IN THE NATURE OF JOURNALS CONTAINING ARTICLES ON THE SUBJECT OF THE SOCIAL AND NATURAL SCIENCES OF WATER, HYDROLOGY, THE PHYSICAL, CHEMICAL, AND BIOLOGICAL SCIENCES AND THE SOCIAL AND POLICY SCIENCES, IN CLASS 41 (U.S. CLS. 100, 101 AND 107).

FIRST USE 0-0-2002; IN COMMERCE 0-0-2002.

THE MARK CONSISTS OF STANDARD CHARACTERS WITHOUT CLAIM TO ANY PARTICULAR FONT, STYLE, SIZE, OR COLOR.

SEC. 2(F).

SER. NO. 85-250,310, FILED 2-24-2011.

DOMINICK J. SALEMI, EXAMINING ATTORNEY



David J. Kybas

Director of the United States Patent and Trademark Office

United States of America

United States Patent and Trademark Office

ONE THOUGHT Institute

Reg. No. 4,107,791

MARA GLEASON (UNITED STATES INDIVIDUAL)
12 DESBROSSES ST
NEW YORK, NY 10013

Registered Mar. 6, 2012

Int. Cl.: 35

FOR: BUSINESS CONSULTING SERVICES, IN CLASS 35 (U.S. CLS. 100, 101 AND 102).

SERVICE MARK

FIRST USE 7-1-2010; IN COMMERCE 7-13-2010.

PRINCIPAL REGISTER

THE MARK CONSISTS OF STANDARD CHARACTERS WITHOUT CLAIM TO ANY PARTICULAR FONT, STYLE, SIZE, OR COLOR.

NO CLAIM IS MADE TO THE EXCLUSIVE RIGHT TO USE "INSTITUTE", APART FROM THE MARK AS SHOWN.

SER. NO. 85-250,639, FILED 2-24-2011.

DAVID TOOLEY, EXAMINING ATTORNEY



David J. Kyffers

Director of the United States Patent and Trademark Office

United States of America

United States Patent and Trademark Office

BathSimple

Reg. No. 4,107,792

BATH SIMPLE LLC (CALIFORNIA LIMITED LIABILITY COMPANY)
733 ALLSTON WAY
BERKELEY, CA 94710

Registered Mar. 6, 2012

Int. Cls.: 35, 37 and 42

FOR: WHOLESALE AND RETAIL STORE SERVICES AND ON-LINE RETAIL AND WHOLESALE STORE SERVICES FEATURING BATHROOM FIXTURES, FITTINGS, CABINETS AND APPLIANCES AND HOME REMODELING AND RENOVATION PRODUCTS, IN CLASS 35 (U.S. CLS. 100, 101 AND 102).

SERVICE MARK

PRINCIPAL REGISTER

FIRST USE 5-31-2010; IN COMMERCE 5-31-2010.

FOR: INSTALLATION OF BATHROOM FIXTURES, FITTINGS, CABINETS, APPLIANCES AND FINISHES; PROVIDING INFORMATION IN THE FIELD OF HOME REMODELING AND RENOVATION, AND INSTALLATION OF BATHROOM FIXTURES, FITTINGS, CABINETS, APPLIANCES AND FINISHES, IN CLASS 37 (U.S. CLS. 100, 103 AND 106).

FIRST USE 5-31-2010; IN COMMERCE 5-31-2010.

FOR: PROVIDING INFORMATION IN THE FIELD OF BATHROOM DESIGN, IN CLASS 42 (U.S. CLS. 100 AND 101).

FIRST USE 5-31-2010; IN COMMERCE 5-31-2010.

THE MARK CONSISTS OF STANDARD CHARACTERS WITHOUT CLAIM TO ANY PARTICULAR FONT, STYLE, SIZE, OR COLOR.

SER. NO. 85-251,106, FILED 2-24-2011.

LINDA ORNDORFF, EXAMINING ATTORNEY



David J. Kyros

Director of the United States Patent and Trademark Office

United States of America

United States Patent and Trademark Office

bathsimple

Reg. No. 4,107,793

Registered Mar. 6, 2012

Int. Cls.: 35, 37 and 42

SERVICE MARK

PRINCIPAL REGISTER

BATH SIMPLE LLC (CALIFORNIA LIMITED LIABILITY COMPANY)
733 ALLSTON WAY
BERKELEY, CA 94710

FOR: WHOLESALE AND RETAIL STORE SERVICES AND ON-LINE RETAIL AND WHOLESALE STORE SERVICES FEATURING BATHROOM FIXTURES, FITTINGS, CABINETS AND APPLIANCES AND HOME REMODELING AND RENOVATION PRODUCTS, IN CLASS 35 (U.S. CLS. 100, 101 AND 102).

FIRST USE 5-31-2010; IN COMMERCE 5-31-2010.

FOR: INSTALLATION OF BATHROOM FIXTURES, FITTINGS, CABINETS, APPLIANCES AND FINISHES; PROVIDING INFORMATION IN THE FIELD OF HOME REMODELING AND RENOVATION, AND INSTALLATION OF BATHROOM FIXTURES, FITTINGS, CABINETS, APPLIANCES AND FINISHES, IN CLASS 37 (U.S. CLS. 100, 103 AND 106).

FIRST USE 5-31-2010; IN COMMERCE 5-31-2010.

FOR: PROVIDING INFORMATION IN THE FIELD OF BATHROOM DESIGN, IN CLASS 42 (U.S. CLS. 100 AND 101).

FIRST USE 5-31-2010; IN COMMERCE 5-31-2010.

THE MARK CONSISTS OF THE WORD "BATH" IN BOLD TYPE, WITH A SUPERIMPOSED WAVE SHAPE THROUGH THE WORD, WITH THE LOWER HALF OF THE WAVE SHAPE A DARKER BOLD; IN THE CENTER OF THE LETTER "A" IN THE WORD "BATH" IS A TEARDROP SHAPE; FOLLOWED BY THE WORD "SIMPLE".

SER. NO. 85-251,519, FILED 2-25-2011.

LINDA ORNDORFF, EXAMINING ATTORNEY



David J. Kypos

Director of the United States Patent and Trademark Office

United States of America

United States Patent and Trademark Office

TUNE2FIT

Reg. No. 4,107,794

Registered Mar. 6, 2012

Int. Cl.: 9

TRADEMARK

PRINCIPAL REGISTER

BITWAVE PTE LTD (SINGAPORE LIMITED PRIVATE COMPANY)
159 SIN MING ROAD #04-05 AMTECH BUILDING
SINGAPORE, SINGAPORE 575625

FOR: HEARING ASSISTANCE AND ENHANCEMENT DEVICES, NAMELY, HEADPHONES WITH ACTIVE NOISE CONTROL FEATURES FOR CELLULAR AND MOBILE PHONES, INTERCOMS AND WALKIE-TALKIES; HEADSETS FOR MUSIC STREAMING FEATURES FOR JOGGERS, HIKERS, SPORTSMEN, CYCLISTS, BIKERS AND PASSENGERS; CAR MOUNTED UNIT INCORPORATING A MICROPHONE AND LOUDSPEAKER TO ENABLE HANDS-FREE USE OF MOBILE COMMUNICATION DEVICES, NAMELY, CELLULAR AND MOBILE PHONES WITH ACTIVE NOISE CONTROL FEATURES AND FEATURES FOR STREAMING OF MUSIC AND INTERCOMS, IN CLASS 9 (U.S. CLS. 21, 23, 26, 36 AND 38).

FIRST USE 1-6-2011; IN COMMERCE 1-6-2011.

THE MARK CONSISTS OF STANDARD CHARACTERS WITHOUT CLAIM TO ANY PARTICULAR FONT, STYLE, SIZE, OR COLOR.

SER. NO. 85-251,906, FILED 2-25-2011.

GINA HAYES, EXAMINING ATTORNEY



David J. Kyros

Director of the United States Patent and Trademark Office

United States of America

United States Patent and Trademark Office

WEBLOCK

Reg. No. 4,107,795

Registered Mar. 6, 2012

Int. Cls.: 19 and 37

TRADEMARK

SERVICE MARK

PRINCIPAL REGISTER

STRAD ENERGY SERVICES LTD. (CANADA CORPORATION)
1200, 440 - 2ND AVENUE SW
CALGARY, CANADA T2P5E9

FOR: INTERLOCKING EROSION CONTROL MATS, NOT PRIMARILY OF METAL, IN CLASS 19 (U.S. CLS. 1, 12, 33 AND 50).

FOR: RENTAL OF INTERLOCKING EROSION CONTROL MATS, IN CLASS 37 (U.S. CLS. 100, 103 AND 106).

THE MARK CONSISTS OF STANDARD CHARACTERS WITHOUT CLAIM TO ANY PARTICULAR FONT, STYLE, SIZE, OR COLOR.

PRIORITY CLAIMED UNDER SEC. 44(D) ON CANADA APPLICATION NO. 1494693, FILED 9-7-2010, REG. NO. TMA808,267, DATED 10-4-2011, EXPIRES 10-1-2026.

SER. NO. 85-252,576, FILED 2-26-2011.

JILL C. ALT, EXAMINING ATTORNEY



David J. Kybas

Director of the United States Patent and Trademark Office

United States of America

United States Patent and Trademark Office



Reg. No. 4,107,796

CUMMINS, JAMES (UNITED STATES INDIVIDUAL)
20 BRANDYWINE COURT
EASTON, PA 18040

Registered Mar. 6, 2012

Int. Cl.: 41

FOR: ENTERTAINMENT IN THE NATURE OF COMPETITIONS IN THE FIELD OF BICYCLE RACES, IN CLASS 41 (U.S. CLS. 100, 101 AND 107).

SERVICE MARK

FIRST USE 1-1-2011; IN COMMERCE 1-15-2011.

PRINCIPAL REGISTER

NO CLAIM IS MADE TO THE EXCLUSIVE RIGHT TO USE "200", APART FROM THE MARK AS SHOWN.

THE MARK CONSISTS OF TWO STALKS OF WHEAT DIRECTLY BELOW THE TEXT "DIRTY KANZA 200", CROSSED AT THE STEMS TO FORM AN "X". THE TEXT IS SURROUNDED BY A BICYCLE CHAINRING.

SER. NO. 85-252,672, FILED 2-26-2011.

KATHLEEN M. VANSTON, EXAMINING ATTORNEY



David J. Kybas

Director of the United States Patent and Trademark Office

United States of America

United States Patent and Trademark Office

Never Remember a Coupon Again

Reg. No. 4,107,797

Registered Mar. 6, 2012

Int. Cl.: 35

SERVICE MARK

PRINCIPAL REGISTER

ROBERT RAFF (UNITED STATES INDIVIDUAL)
5584 CLEMWOOD CT. SE
ADA, MI 49301

FOR: AN INTERACTIVE WEB SITE FOR USERS TO REVIEW AND RATE INTERNET CONTENT, PEOPLE, COMPANIES, PRODUCTS AND/OR SERVICES UTILIZING A SOFTWARE APPLICATION TO AWARD LOYALTY POINTS, PROMOTIONS, REBATES, COUPONS, SPECIAL OFFERS, AND DISCOUNTS ON GOOD AND SERVICES PROVIDED BY WEBSITE SPONSORS. PROMOTING THE GOODS AND SERVICES OF OTHERS BY PROVIDING A COMMUNITY-DRIVEN WEB SITE FEATURING USER-SUBMITTED CONTENT IN THE NATURE OF COUPONS, REBATES, PRICE-COMPARISON INFORMATION, PRODUCT REVIEWS, LINKS TO THE RETAIL WEB SITES OF OTHERS, AND DISCOUNT INFORMATION; PROMOTING THE GOODS AND SERVICES OF OTHERS BY PROVIDING A WEBSITE FEATURING COUPONS, REBATES, PRICE-COMPARISON INFORMATION, PRODUCT REVIEWS, LINKS TO THE RETAIL WEBSITES OF OTHERS, AND DISCOUNT INFORMATION; PROMOTING THE GOODS OF OTHERS, NAMELY, PROVIDING COUPONS, REBATES AND VOUCHERS FOR THE GOODS OF OTHERS; PROMOTING THE GOODS OF OTHERS, NAMELY, PROVIDING INFORMATION REGARDING DISCOUNTS, COUPONS, REBATES, VOUCHERS AND SPECIAL OFFERS FOR THE GOODS OF OTHERS; PROMOTING THE SALE OF GOODS AND SERVICES OF OTHERS BY AWARDING PURCHASE LOYALTY POINTS FOR CARD USE, DISTRIBUTING COUPONS, CONDUCTING PROMOTIONAL CONTESTS, PROMOTIONAL SERVICES, NAMELY, DISTRIBUTION OF ADVERTISING FLYERS, COUPONS, CATALOGS AND PROMOTIONAL ITEMS OF OTHERS; PROMOTIONAL SERVICES, NAMELY, PROMOTING THE GOODS OF OTHERS BY MEANS OF PROVIDING ONLINE COUPONS; PROVIDING INCENTIVE AWARD PROGRAMS FOR CUSTOMERS THROUGH THE ISSUANCE AND PROCESSING OF LOYALTY COUPONS FOR FREQUENT USE OF PARTICIPATING BUSINESSES, IN CLASS 35 (U.S. CLS. 100, 101 AND 102).



FIRST USE 4-1-2010; IN COMMERCE 8-1-2010.

THE MARK CONSISTS OF STANDARD CHARACTERS WITHOUT CLAIM TO ANY PARTICULAR FONT, STYLE, SIZE, OR COLOR.

SER. NO. 85-253,101, FILED 2-28-2011.

STEVEN JACKSON, EXAMINING ATTORNEY

David J. Kyros

Director of the United States Patent and Trademark Office

United States of America

United States Patent and Trademark Office

RUGBYTOWN USA

Reg. No. 4,107,798

Registered Mar. 6, 2012

Int. Cls.: 35 and 41

SERVICE MARK

PRINCIPAL REGISTER

CITY OF GLENDALE (COLORADO MUNICIPAL CORPORATION)
950 BIRCH STREET
GLENDALE, CO 80246

FOR: ENTERTAINMENT MARKETING SERVICES, NAMELY, PROMOTION OF RUGBY FOOTBALL COMPETITIONS AND RUGBY FOOTBALL TEAMS, IN CLASS 35 (U.S. CLS. 100, 101 AND 102).

FIRST USE 4-10-2010; IN COMMERCE 4-10-2010.

FOR: PROVIDING A WEBSITE CONTAINING INFORMATION RELATING TO THE SPORT OF RUGBY, INCLUDING TEAM INFORMATION, PLAYER STATISTICS AND NEWS; EDUCATIONAL SERVICES, NAMELY, CONDUCTING PROGRAMS IN THE FIELD OF RUGBY; EDUCATIONAL SERVICES, NAMELY, CONDUCTING ON-LINE EXHIBITIONS AND DISPLAYS AND INTERACTIVE EXHIBITS IN THE FIELD OF RUGBY; ENTERTAINMENT, NAMELY, PRODUCTION OF RUGBY FOOTBALL GAMES AND TOURNAMENTS; ENTERTAINMENT SERVICES IN THE NATURE OF HOSTING RUGBY GAMES; ENTERTAINMENT SERVICES, NAMELY, THE ORGANIZATION, PRODUCTION, AND PRESENTATION OF RUGBY FOOTBALL COMPETITIONS AND A RUGBY FOOTBALL TEAM, AND THE TEACHING OF RUGBY FOOTBALL; CONDUCTING EDUCATIONAL EXHIBITIONS IN THE NATURE OF RUGBY; CONDUCTING ENTERTAINMENT EXHIBITIONS IN THE NATURE OF RUGBY; MUSEUMS, IN CLASS 41 (U.S. CLS. 100, 101 AND 107).

FIRST USE 4-10-2010; IN COMMERCE 4-10-2010.

THE MARK CONSISTS OF STANDARD CHARACTERS WITHOUT CLAIM TO ANY PARTICULAR FONT, STYLE, SIZE, OR COLOR.

NO CLAIM IS MADE TO THE EXCLUSIVE RIGHT TO USE "USA", APART FROM THE MARK AS SHOWN.

SER. NO. 85-253,671, FILED 2-28-2011.

ANDREW LEASER, EXAMINING ATTORNEY



David J. Kyros

Director of the United States Patent and Trademark Office

United States of America

United States Patent and Trademark Office

EQUITYBUILDER

Reg. No. 4,107,799

Registered Mar. 6, 2012

Int. Cl.: 35

BUSINESS TRANSITIONS, LLC (OREGON LIMITED LIABILITY COMPANY), DBA FP
TRANSITIONS
SUITE 300
4900 MEADOWS
LAKE OSWEGO, OR 97305

SERVICE MARK

PRINCIPAL REGISTER

FOR: BUSINESS CONSULTATION IN THE FIELD OF BUSINESS ENTITY FORMATION;
BUSINESS CONSULTING SERVICES IN THE FIELD OF CONTINUITY AND SUCCESSION
PLANNING; BUSINESS MANAGEMENT SERVICES, NAMELY, PURCHASING OF AND
SELLING OF COMPANIES FOR OTHERS; BUSINESS MANAGEMENT CONSULTANCY IN
THE FIELD OF PURCHASES, NAMELY, ASSISTING BUSINESSES IN IMPROVEMENT OF
PURCHASING FUNCTIONS, IN CLASS 35 (U.S. CLS. 100, 101 AND 102).

FIRST USE 12-22-2008; IN COMMERCE 12-22-2008.

THE MARK CONSISTS OF STANDARD CHARACTERS WITHOUT CLAIM TO ANY PAR-
TICULAR FONT, STYLE, SIZE, OR COLOR.

SER. NO. 85-253,722, FILED 2-28-2011.

KIM SAITO, EXAMINING ATTORNEY



David J. Kyffers

Director of the United States Patent and Trademark Office

United States of America

United States Patent and Trademark Office

CHAT 'N' CHILL

Reg. No. 4,107,800

Registered Mar. 6, 2012

Int. Cl.: 25

TRADEMARK

PRINCIPAL REGISTER

CHAT 'N' CHILL, LTD. (BAHAMAS CORPORATION)
STOCKING ISLAND
P.O. BOX EX-29445
GEORGETOWN GREAT EXUMA, BAHAMAS

FOR: APRONS; BASEBALL CAPS AND HATS; LADIES' UNDERWEAR; MEN'S UNDERWEAR; SWEATPANTS; SWEATSHIRTS; T-SHIRTS; TANK TOPS, IN CLASS 25 (U.S. CLS. 22 AND 39).

FIRST USE 3-17-2006; IN COMMERCE 3-17-2006.

THE MARK CONSISTS OF STANDARD CHARACTERS WITHOUT CLAIM TO ANY PARTICULAR FONT, STYLE, SIZE, OR COLOR.

OWNER OF U.S. REG. NO. 4,028,736.

SER. NO. 85-254,057, FILED 2-28-2011.

GISELLE AGOSTO, EXAMINING ATTORNEY



David J. Kyffers

Director of the United States Patent and Trademark Office

United States of America

United States Patent and Trademark Office

UNLEASH YOUR PHOTOS

Reg. No. 4,107,801

Registered Mar. 6, 2012

Int. Cls.: 40 and 42

SERVICE MARK

PRINCIPAL REGISTER

POSTERDOG, LLC (COLORADO LIMITED LIABILITY COMPANY)
13333 EAST 37TH AVENUE
DENVER, CO 80239

FOR: PHOTOGRAPHIC FILM DEVELOPMENT; PHOTOGRAPHIC PRINTING; PHOTOGRAPHIC REPRODUCTION; PRINTING; INDIVIDUAL PRINTING OF POSTERS FROM ARTWORK SUPPLIED BY CUSTOMERS, IN CLASS 40 (U.S. CLS. 100, 103 AND 106).

FIRST USE 12-9-2010; IN COMMERCE 12-9-2010.

FOR: DIGITAL IMAGE MANIPULATION, NAMELY, DIGITAL CORRECTION, ENHANCEMENT AND RESTORATION OF PHOTOGRAPHS, IN CLASS 42 (U.S. CLS. 100 AND 101).

FIRST USE 12-9-2010; IN COMMERCE 12-9-2010.

THE MARK CONSISTS OF STANDARD CHARACTERS WITHOUT CLAIM TO ANY PARTICULAR FONT, STYLE, SIZE, OR COLOR.

NO CLAIM IS MADE TO THE EXCLUSIVE RIGHT TO USE "PHOTOS", APART FROM THE MARK AS SHOWN.

SER. NO. 85-254,699, FILED 3-1-2011.

REBECCA SMITH, EXAMINING ATTORNEY



David J. Kypos

Director of the United States Patent and Trademark Office

United States of America

United States Patent and Trademark Office

CHAT 'N' CHILL

Reg. No. 4,107,802

Registered Mar. 6, 2012

Int. Cl.: 21

TRADEMARK

PRINCIPAL REGISTER

CHAT 'N' CHILL, LTD. (BAHAMAS CORPORATION)
P.O. BOX EX-29445, STOCKING ISLAND
GEORGETOWN, GREAT EXUMA, BAHAMAS

FOR: COASTERS, NOT OF PAPER AND OTHER THAN TABLE LINEN; MUGS, IN CLASS
21 (U.S. CLS. 2, 13, 23, 29, 30, 33, 40 AND 50).

FIRST USE 3-17-2006; IN COMMERCE 3-17-2006.

THE MARK CONSISTS OF STANDARD CHARACTERS WITHOUT CLAIM TO ANY PAR-
TICULAR FONT, STYLE, SIZE, OR COLOR.

OWNER OF U.S. REG. NO. 4,028,736.

SER. NO. 85-255,412, FILED 3-2-2011.

GISELLE AGOSTO, EXAMINING ATTORNEY



David J. Kybas

Director of the United States Patent and Trademark Office

United States of America

United States Patent and Trademark Office

GODLIKE PRODUCTIONS

Reg. No. 4,107,803

Registered Mar. 6, 2012

Int. Cl.: 41

SERVICE MARK

PRINCIPAL REGISTER

ZERO POINT LTD. (JERSEY CORPORATION)
P.O. BOX 539
NO. 1, WESLEY STREET
ST. HELIER, JERSEY JE45UT

FOR: ON-LINE JOURNALS, NAMELY, BLOGS FEATURING DISCUSSIONS REGARDING CONSPIRACIES AND CURRENT EVENTS, IN CLASS 41 (U.S. CLS. 100, 101 AND 107).

FIRST USE 12-31-2004; IN COMMERCE 12-31-2004.

THE MARK CONSISTS OF STANDARD CHARACTERS WITHOUT CLAIM TO ANY PARTICULAR FONT, STYLE, SIZE, OR COLOR.

NO CLAIM IS MADE TO THE EXCLUSIVE RIGHT TO USE "PRODUCTIONS", APART FROM THE MARK AS SHOWN.

SER. NO. 85-256,568, FILED 3-3-2011.

DOMINIC J. FERRAIUOLO, EXAMINING ATTORNEY



David J. Kyffers

Director of the United States Patent and Trademark Office

United States of America

United States Patent and Trademark Office



Reg. No. 4,107,804

Registered Mar. 6, 2012

Int. Cls.: 38 and 44

SERVICE MARK

PRINCIPAL REGISTER

SHARECARE, INC. (DELAWARE CORPORATION)
SUITE 600
3280 PEACHTREE ROAD, NE
ATLANTA, GA 30305

FOR: COMMUNICATIONS SERVICES, NAMELY, TRANSMITTING STREAMED SOUND AND AUDIO-VISUAL RECORDINGS VIA THE INTERNET AND WIRELESS NETWORKS; AUDIO AND VIDEO BROADCASTING SERVICES OVER THE INTERNET; WEB CASTING SERVICES; AND MOBILE MEDIA SERVICES IN THE NATURE OF ELECTRONIC TRANSMISSION OF ENTERTAINMENT MEDIA CONTENT, IN CLASS 38 (U.S. CLS. 100, 101 AND 104).

FIRST USE 10-0-2010; IN COMMERCE 10-0-2010.

FOR: PROVIDING A WIDE RANGE OF INFORMATION IN THE FIELDS OF HEALTH, HEALTHCARE, MEDICAL TREATMENTS, AND MEDICINE VIA A GLOBAL COMPUTER NETWORK, IN CLASS 44 (U.S. CLS. 100 AND 101).

FIRST USE 10-0-2010; IN COMMERCE 10-0-2010.

THE MARK CONSISTS OF A HEART SHAPE SURROUNDED BY A MAGNIFYING GLASS DESIGN.

SER. NO. 85-256,874, FILED 3-3-2011.

INGA ERVIN, EXAMINING ATTORNEY



David J. Kybas

Director of the United States Patent and Trademark Office

United States of America

United States Patent and Trademark Office

GODLIKE PRODUCTIONS

Reg. No. 4,107,805

Registered Mar. 6, 2012

Int. Cl.: 38

SERVICE MARK

PRINCIPAL REGISTER

ZERO POINT LTD. (JERSEY CORPORATION)
P.O. BOX 539, NO. 1
WESLEY STREET
ST. HELIER, JERSEY JE45UT

FOR: PROVIDING INTERNET CHAT ROOMS; PROVIDING ON-LINE FORUMS FOR TRANSMISSION OF MESSAGES AMONG COMPUTER USERS; TELECOMMUNICATION SERVICES, NAMELY, TRANSMISSION OF PODCASTS, IN CLASS 38 (U.S. CLS. 100, 101 AND 104).

FIRST USE 1-1-2006; IN COMMERCE 1-1-2006.

THE MARK CONSISTS OF STANDARD CHARACTERS WITHOUT CLAIM TO ANY PARTICULAR FONT, STYLE, SIZE, OR COLOR.

NO CLAIM IS MADE TO THE EXCLUSIVE RIGHT TO USE "PRODUCTIONS", APART FROM THE MARK AS SHOWN.

SER. NO. 85-256,929, FILED 3-3-2011.

DOMINIC J. FERRAIUOLO, EXAMINING ATTORNEY



David J. Kyffers

Director of the United States Patent and Trademark Office

United States of America

United States Patent and Trademark Office



Reg. No. 4,107,806

DICENTRAL CORPORATION (TEXAS CORPORATION)
1199 NASA PARKWAY
HOUSTON, TX 77058

Registered Mar. 6, 2012

Int. Cls.: 35, 42 and 45

FOR: PROVIDING BUSINESS MANAGEMENT SERVICES, IN CLASS 35 (U.S. CLS. 100, 101 AND 102).

SERVICE MARK

FIRST USE 3-3-2011; IN COMMERCE 3-3-2011.

PRINCIPAL REGISTER

FOR: DEVELOPMENT OF COMPUTER SOFTWARE FOR OTHERS IN THE FIELD OF ELECTRONIC DATA INTERCHANGE SOFTWARE; CONSULTING IN THE FIELD OF SOFTWARE DEVELOPMENT IN THE FIELD OF ELECTRONIC DATA INTERCHANGE SOFTWARE; CONSULTATION SERVICES IN THE FIELDS OF SELECTION AND IMPLEMENTATION OF COMPUTER SOFTWARE FOR OTHERS IN THE FIELD OF ELECTRONIC DATA INTERCHANGE; PROVIDING TEMPORARY USE OF NON-DOWNLOADABLE ELECTRONIC COMMERCE SOFTWARE VIA A GLOBAL COMPUTER NETWORK FOR USE IN ELECTRONIC DATA INTERCHANGE, IN CLASS 42 (U.S. CLS. 100 AND 101).

FIRST USE 12-1-2006; IN COMMERCE 12-1-2006.

FOR: REGULATORY COMPLIANCE CONSULTING IN THE FIELD OF ELECTRONIC DATA INTERCHANGE TO ASSURE BUSINESS'S STANDARDS AND PRACTICES ARE IN COMPLIANCE WITH LAWS AND REGULATIONS, IN CLASS 45 (U.S. CLS. 100 AND 101).

FIRST USE 3-3-2011; IN COMMERCE 3-3-2011.

THE MARK CONSISTS OF "DI" SURROUNDED BY A SQUARE SHADOW BOX.

SER. NO. 85-257,082, FILED 3-3-2011.

B. PARADEWELAI, EXAMINING ATTORNEY



David J. Kyffers

Director of the United States Patent and Trademark Office

United States of America

United States Patent and Trademark Office

COOPER

Reg. No. 4,107,807

Registered Mar. 6, 2012

Int. Cl.: 28

TRADEMARK

PRINCIPAL REGISTER

HALLMARK LICENSING, INC. (DELAWARE CORPORATION)
MD 339
2440 PERSHING ROAD
KANSAS CITY, MO 64108

FOR: PLUSH TOYS SOLD AS A UNIT WITH BOOKS, IN CLASS 28 (U.S. CLS. 22, 23, 38 AND 50).

FIRST USE 12-31-2010; IN COMMERCE 12-31-2010.

THE MARK CONSISTS OF STANDARD CHARACTERS WITHOUT CLAIM TO ANY PARTICULAR FONT, STYLE, SIZE, OR COLOR.

THE NAME(S), PORTRAIT(S), AND/OR SIGNATURE(S) SHOWN IN THE MARK DOES NOT IDENTIFY A PARTICULAR LIVING INDIVIDUAL.

SER. NO. 85-258,358, FILED 3-4-2011.

ANDREA HACK, EXAMINING ATTORNEY



David J. Kybas

Director of the United States Patent and Trademark Office

United States of America

United States Patent and Trademark Office

RFTW

Reg. No. 4,107,808

Registered Mar. 6, 2012

Int. Cl.: 41

SERVICE MARK

PRINCIPAL REGISTER

TRIPLETT, WILLIE, EIRVAN (UNITED STATES INDIVIDUAL), DBA RFTW
2020 HOWELL MILL ROAD SUITE C-281
ATLANTA, GA 30318 AND

RILEY, MELVIN, CHARLES (UNITED STATES INDIVIDUAL), DBA RFTW
2020 HOWELL MILL ROAD SUITE C-281
ATLANTA, GA 30318 AND

VALENTINE, GERALD, ANDRE (UNITED STATES INDIVIDUAL), DBA RFTW
2020 HOWELL MILL ROAD SUITE C-281
ATLANTA, GA 30318

FOR: ENTERTAINMENT, NAMELY, LIVE PERFORMANCES BY A MUSICAL BAND, IN CLASS 41 (U.S. CLS. 100, 101 AND 107).

FIRST USE 2-1-1984; IN COMMERCE 2-1-1984.

THE MARK CONSISTS OF STANDARD CHARACTERS WITHOUT CLAIM TO ANY PARTICULAR FONT, STYLE, SIZE, OR COLOR.

SER. NO. 85-258,451, FILED 3-4-2011.

ARETHA SOMERVILLE, EXAMINING ATTORNEY



David J. Kyros

Director of the United States Patent and Trademark Office

United States of America

United States Patent and Trademark Office

PORCH PIES

Reg. No. 4,107,809

Registered Mar. 6, 2012

Int. Cl.: 30

TRADEMARK

PRINCIPAL REGISTER

PORCH PIES, LLC (CALIFORNIA LIMITED LIABILITY COMPANY)
6060 CENTER DRIVE, TENTH FLOOR
C/O FULWIDER PATTON LLP
LOS ANGELES, CA 90045

FOR: BAKERY GOODS; BAKERY DESSERTS; BAKERY PRODUCTS; BAKED GOODS, NAMELY, PIES, IN CLASS 30 (U.S. CL. 46).

FIRST USE 5-1-2005, THE MARK WAS FIRST USED ANYWHERE IN A DIFFERENT FORM OTHER THAN THAT SOUGHT TO BE REGISTERED AT LEAST AS EARLY AS 10/01/2002; IN COMMERCE 5-1-2005, THE MARK WAS FIRST USED IN COMMERCE IN A DIFFERENT FORM OTHER THAN THAT SOUGHT TO BE REGISTERED AT LEAST AS EARLY AS 10/01/2002.

THE MARK CONSISTS OF STANDARD CHARACTERS WITHOUT CLAIM TO ANY PARTICULAR FONT, STYLE, SIZE, OR COLOR.

NO CLAIM IS MADE TO THE EXCLUSIVE RIGHT TO USE "PIES", APART FROM THE MARK AS SHOWN.

SER. NO. 85-258,742, FILED 3-4-2011.

DORITT L. CARROLL, EXAMINING ATTORNEY



David J. Kyros

Director of the United States Patent and Trademark Office

United States of America

United States Patent and Trademark Office



Reg. No. 4,107,810

Registered Mar. 6, 2012

Int. Cl.: 30

TRADEMARK

PRINCIPAL REGISTER

AA USA TRADING INC (NEW JERSEY CORPORATION)
90 DAYTON AVENUE
PASSAIC, NJ 07055

FOR: FLAVOURINGS AND SEASONINGS; FOOD SEASONINGS; SEASONED COATING MIXTURES FOR FOODS; SEASONING MIXES; SEASONING MIXES FOR SOUPS; SEASONINGS, IN CLASS 30 (U.S. CL. 46).

FIRST USE 12-0-2006; IN COMMERCE 12-0-2006.

THE MARK CONSISTS OF GROUP OF CHINESE MALES AND FEMALES WEARING TRADITIONAL CHINESE CLOTHING CHATTING IN A FOOD MARKET. THE ENTIRE MARK IS IN BLACK AND WHITE, EXCEPT ON THE UPPER RIGHT CORNER OF THE MARK THERE IS A RED ANCIENT CHINESE CHARACTER THAT TRANSLITERATES INTO "YI".

THE COLOR(S) BLACK, WHITE AND RED IS/ARE CLAIMED AS A FEATURE OF THE MARK.

THE NON-LATIN CHARACTERS IN THE MARK TRANSLITERATE TO YI AND THIS HAS NO MEANING IN A FOREIGN LANGUAGE.

SER. NO. 85-260,133, FILED 3-7-2011.

DAVID HOFFMAN, EXAMINING ATTORNEY



David J. Kybas

Director of the United States Patent and Trademark Office

United States of America

United States Patent and Trademark Office

SCUFFMASTER

Reg. No. 4,107,811

Registered Mar. 6, 2012

Int. Cl.: 2

TRADEMARK

PRINCIPAL REGISTER

MASTER COATING TECHNOLOGIES, LLC (MINNESOTA LIMITED LIABILITY COMPANY)
2777 EAGANDALE ROAD
EAGAN, MN 55121

FOR: WATER-BASED POLYURETHANE AND ACRYLIC COATINGS FOR COMMERCIAL
AND RESIDENTIAL INTERIOR DECORATIVE FINISH USE, IN CLASS 2 (U.S. CLS. 6, 11
AND 16).

FIRST USE 2-28-1995; IN COMMERCE 2-28-1995.

THE MARK CONSISTS OF STANDARD CHARACTERS WITHOUT CLAIM TO ANY PAR-
TICULAR FONT, STYLE, SIZE, OR COLOR.

SER. NO. 85-260,293, FILED 3-7-2011.

SOPHIA S. KIM, EXAMINING ATTORNEY



David J. Kyffers

Director of the United States Patent and Trademark Office

United States of America

United States Patent and Trademark Office



Reg. No. 4,107,812

Registered Mar. 6, 2012

Int. Cl.: 9

TRADEMARK

PRINCIPAL REGISTER

WESTMONEY MUSIC GROUP INC (NEW YORK CORPORATION)
273A SHERIDAN ST
WESTBURY, NY 11590

FOR: AUDIO AND VIDEO RECORDINGS FEATURING MUSIC AND ARTISTIC PERFORMANCES; DIGITAL MUSIC DOWNLOADABLE FROM THE INTERNET; DOWNLOADABLE MUSICAL SOUND RECORDINGS; DOWNLOADABLE VIDEO RECORDINGS FEATURING MUSIC; MUSICAL RECORDINGS; MUSICAL SOUND RECORDINGS; MUSICAL VIDEO RECORDINGS; PHONOGRAPH RECORDS FEATURING MUSIC; PRE-RECORDED CDS, VIDEO TAPES, LASER DISKS AND DVDS FEATURING MUSIC; SOUND RECORDINGS FEATURING MUSIC; VIDEO RECORDERS AND VIDEO REPRODUCING APPARATUS, IN CLASS 9 (U.S. CLS. 21, 23, 26, 36 AND 38).

FIRST USE 12-12-2010; IN COMMERCE 12-12-2010.

NO CLAIM IS MADE TO THE EXCLUSIVE RIGHT TO USE "MUSIC GROUP", APART FROM THE MARK AS SHOWN.

THE COLOR(S) GREEN, YELLOW, RED, BLACK AND WHITE IS/ARE CLAIMED AS A FEATURE OF THE MARK.

THE MARK CONSISTS OF THE WORDING "WESTMONEY MUSIC GROUP" IN BOLD CAPITAL LETTERS WITH THE TOP OF "WESTMONEY" IN GREEN AND OUTLINED IN WHITE AND THE BOTTOM OF "WESTMONEY" IN YELLOW AND OUTLINED IN BLACK. THE WORDS "MUSIC GROUP" IS BELOW IN GREEN. ABOVE THE WORDING IS A YELLOW AND BLACK COIN WITH AN EAGLE INSIDE GRASPING OLIVE BRANCH AND ARROWS SURROUNDED BY STARS. THERE ARE DECORATIVE SCROLLS IN GREEN AND YELLOW BLEND AND OUTLINED IN BLACK AT THE TOP AND BOTTOM OF THE WORDING. THE MARK IS SURROUNDED BY A RED BACKGROUND.

SER. NO. 85-260,295, FILED 3-7-2011.

SOPHIA S. KIM, EXAMINING ATTORNEY



David J. Kyffers

Director of the United States Patent and Trademark Office

United States of America

United States Patent and Trademark Office

We Speak Diesel

Reg. No. 4,107,813

Registered Mar. 6, 2012

Int. Cls.: 7, 9 and 12

TRADEMARK

PRINCIPAL REGISTER

PREMIER PERFORMANCE, LLC (DELAWARE LIMITED LIABILITY COMPANY)
SUITE 530
1201 PEACHTREE STREET
ATLANTA, GA 30361

FOR: COMPONENTS FOR DIESEL ENGINES FOR LAND VEHICLES, NAMELY, ENGINE EXHAUST SYSTEMS COMPRISED OF CYLINDER HEADS, TURBOCHARGER SYSTEMS, EXHAUST MANIFOLDS, CATALYTIC CONVERTERS, DIESEL PARTICULATE TRAPS, MUFFLERS, AND EXHAUST PIPES; COMPONENTS FOR DIESEL ENGINES FOR LAND VEHICLES, NAMELY, AIR INTAKE SYSTEMS CONSISTING OF AIR-INTAKE TUBES AND FILTERS FOR AFTER-MARKET INSTALLATION; COMPONENTS FOR DIESEL ENGINES FOR LAND VEHICLES, NAMELY, FUEL INJECTORS, AIR FILTERS FOR AUTOMOBILE ENGINES, INTERCOOLERS, FUEL PUMPS, AND FUEL FILTERS; COMPONENTS FOR DIESEL ENGINES FOR LAND VEHICLES, NAMELY, COOLING SYSTEMS COMPRISED OF COOLING RADIATORS FOR ENGINES AND PUMPS FOR COOLING ENGINES, IN CLASS 7 (U.S. CLS. 13, 19, 21, 23, 31, 34 AND 35).

FIRST USE 12-7-2000; IN COMMERCE 1-1-2011.

FOR: COMPONENTS FOR DIESEL ENGINES FOR LAND VEHICLES, NAMELY, AUTOMOTIVE MEASURING INSTRUMENTS, NAMELY, FUEL GAUGES, PRESSURE GAUGES, WATER TEMPERATURE GAUGES, AIR/FUEL RATIO GAUGES, BOOST GAUGES, VACUUM GAUGES AND EXHAUST GAS TEMPERATURE GAUGES; COMPONENTS FOR DIESEL ENGINES FOR LAND VEHICLES, NAMELY, ELECTRONIC MOTOR VEHICLE IGNITION TUNING KITS COMPRISED OF AN ELECTRONIC CONTROL UNIT THAT MONITORS ENGINE PERFORMANCES AND DELIVERS RE-CALCULATED SENSOR VALUES TO THE ORIGINAL ENGINE CONTROL UNIT TO INCREASE ENGINE PERFORMANCE, IN CLASS 9 (U.S. CLS. 21, 23, 26, 36 AND 38).

FIRST USE 12-7-2000; IN COMMERCE 1-1-2001.

FOR: COMPONENTS FOR DIESEL ENGINES FOR LAND VEHICLES, NAMELY, SUSPENSION SYSTEMS, IN CLASS 12 (U.S. CLS. 19, 21, 23, 31, 35 AND 44).

FIRST USE 12-7-2000; IN COMMERCE 1-1-2001.



David J. Kyjars

Director of the United States Patent and Trademark Office

Reg. No. 4,107,813 THE MARK CONSISTS OF STANDARD CHARACTERS WITHOUT CLAIM TO ANY PARTICULAR FONT, STYLE, SIZE, OR COLOR.

NO CLAIM IS MADE TO THE EXCLUSIVE RIGHT TO USE "DIESEL", APART FROM THE MARK AS SHOWN.

SER. NO. 85-261,299, FILED 3-8-2011.

JANICE KIM, EXAMINING ATTORNEY

United States of America

United States Patent and Trademark Office



Reg. No. 4,107,814

Registered Mar. 6, 2012

Int. Cl.: 10

TRADEMARK

PRINCIPAL REGISTER

OWEN MUMFORD LIMITED (UNITED KINGDOM PRIVATE LIMITED COMPANY)
BROOK HILL
WOODSTOCK OXFORD, UNITED KINGDOM OX201TU

FOR: MEDICAL INJECTION DEVICES, NAMELY, PEN NEEDLES, AND PEN NEEDLE REMOVERS FOR USE WITH MEDICAL INJECTION DEVICES, IN CLASS 10 (U.S. CLS. 26, 39 AND 44).

PRIORITY CLAIMED UNDER SEC. 44(D) ON UNITED KINGDOM APPLICATION NO. 2573247, FILED 2-24-2011.

OWNER OF ERPN CMNTY TM OFC REG. NO. 009762683, DATED 9-16-2011, EXPIRES 2-24-2021.

NO CLAIM IS MADE TO THE EXCLUSIVE RIGHT TO USE "TECHNOLOGY", APART FROM THE MARK AS SHOWN.

THE MARK CONSISTS OF THE WORDS "WITH SAFELY-CLICK TECHNOLOGY" APPEARING IN THE CENTER AND THREE ARC-SHAPED LINES ON EACH SIDE.

SER. NO. 85-262,101, FILED 3-9-2011.

FLORENTINA BLANDU, EXAMINING ATTORNEY



David J. Kybas

Director of the United States Patent and Trademark Office

United States of America

United States Patent and Trademark Office

STAFFASSIST WORKFORCE MANAGEMENT

Reg. No. 4,107,815

Registered Mar. 6, 2012

Int. Cls.: 35 and 42

SERVICE MARK

PRINCIPAL REGISTER

MAXIM HEALTHCARE SERVICES, INC. (MARYLAND CORPORATION)
7227 LEE DEFOREST DRIVE
COLUMBIA, MD 21046

FOR: WORKFORCE MANAGEMENT SERVICES, NAMELY, MANAGING THE TEMPORARY AND PERMANENT STAFFING NEEDS OF THIRD PARTY BUSINESS ENTITIES THAT OFFER HEALTH CARE SERVICES, IN CLASS 35 (U.S. CLS. 100, 101 AND 102).

FIRST USE 8-31-2011; IN COMMERCE 8-31-2011.

FOR: SOFTWARE AS A SERVICE (SAAS) SERVICES FEATURING SOFTWARE THAT EN-ABLES OTHERS TO HAVE ALL OF THEIR STAFFING NEEDS MANAGED AND TRACKED THROUGH AN ONLINE SCHEDULING SYSTEM, IN CLASS 42 (U.S. CLS. 100 AND 101).

FIRST USE 8-31-2011; IN COMMERCE 8-31-2011.

THE MARK CONSISTS OF STANDARD CHARACTERS WITHOUT CLAIM TO ANY PAR-TICULAR FONT, STYLE, SIZE, OR COLOR.

NO CLAIM IS MADE TO THE EXCLUSIVE RIGHT TO USE "WORKFORCE MANAGEMENT", APART FROM THE MARK AS SHOWN.

SER. NO. 85-264,423, FILED 3-11-2011.

JULIE GUTTADAURO, EXAMINING ATTORNEY



David J. Kyros

Director of the United States Patent and Trademark Office

United States of America

United States Patent and Trademark Office

ELEVEN

Reg. No. 4,107,816

LOEW'S HOTELS, INC. (NEW YORK CORPORATION)
667 MADISON AVENUE
NEW YORK, NY 10065

Registered Mar. 6, 2012

Int. Cl.: 43

FOR: RESTAURANT SERVICES, IN CLASS 43 (U.S. CLS. 100 AND 101).

SERVICE MARK

FIRST USE 4-1-2010; IN COMMERCE 4-1-2010.

PRINCIPAL REGISTER

THE MARK CONSISTS OF STANDARD CHARACTERS WITHOUT CLAIM TO ANY PARTICULAR FONT, STYLE, SIZE, OR COLOR.

SER. NO. 85-266,387, FILED 3-14-2011.

DAVID C. REIHNER, EXAMINING ATTORNEY



David J. Kybas

Director of the United States Patent and Trademark Office

United States of America

United States Patent and Trademark Office

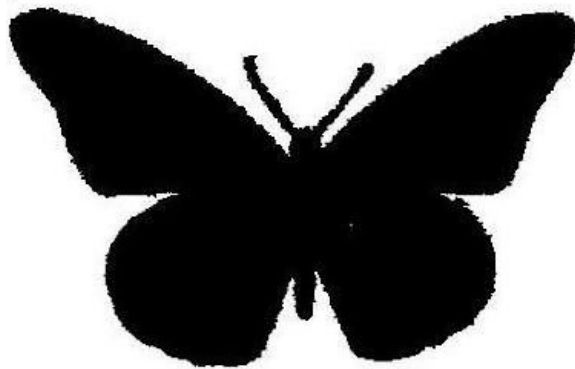

Reg. No. 4,107,817

Registered Mar. 6, 2012

Int. Cl.: 35

SERVICE MARK

PRINCIPAL REGISTER

THARPERROBBINS COMPANY, INC. (DELAWARE CORPORATION)
149 CRAWFORD ROAD
STATESVILLE, NC 28625

FOR: PROVIDING EMPLOYEE RECOGNITION PROGRAMS TO BUSINESSES TO PROMOTE AND REWARD JOB QUALITY, PRODUCTIVITY, LOYALTY AND LONGEVITY, IN CLASS 35 (U.S. CLS. 100, 101 AND 102).

FIRST USE 2-0-2007; IN COMMERCE 2-0-2007.

THE MARK CONSISTS OF IMAGE OF A BUTTERFLY.

SER. NO. 85-266,441, FILED 3-14-2011.

LAURIE MAYES, EXAMINING ATTORNEY



David J. Kyffers

Director of the United States Patent and Trademark Office

United States of America

United States Patent and Trademark Office

CORPORATE BOARDLINK

Reg. No. 4,107,818

Registered Mar. 6, 2012

Int. Cl.: 41

SERVICE MARK

PRINCIPAL REGISTER

NETWORK SEARCH INCORPORATED (ILLINOIS CORPORATION)
2530 WEST PALMER
CHICAGO, IL 60647

FOR: BUSINESS EDUCATION AND TRAINING SERVICES, NAMELY, DEVELOPING AND FACILITATING CUSTOMIZED LEADERSHIP AND EXECUTIVE DEVELOPMENT PROGRAMS, PROVIDING EXECUTIVE COACHING SERVICES, AND PROVIDING BUSINESS EDUCATION PROGRAMS TO EMPLOYEES AND EXECUTIVES, IN CLASS 41 (U.S. CLS. 100, 101 AND 107).

FIRST USE 9-1-2008; IN COMMERCE 9-1-2008.

THE MARK CONSISTS OF STANDARD CHARACTERS WITHOUT CLAIM TO ANY PARTICULAR FONT, STYLE, SIZE, OR COLOR.

NO CLAIM IS MADE TO THE EXCLUSIVE RIGHT TO USE "CORPORATE", APART FROM THE MARK AS SHOWN.

SER. NO. 85-268,497, FILED 3-16-2011.

PATRICIA EVANKO, EXAMINING ATTORNEY



David J. Kybas

Director of the United States Patent and Trademark Office

United States of America

United States Patent and Trademark Office



Reg. No. 4,107,819

Registered Mar. 6, 2012

Int. Cl.: 11

TRADEMARK

PRINCIPAL REGISTER

NEO-NEON LED LIGHTING INTERNATIONAL LTD. (HONG KONG CORPORATION)
TSIM SHA TSUI, KOWLOON NOS R1 & 8
2/F. 33 CANTON ROAD
HONG KONG, HONG KONG

FOR: LED (LIGHT EMITTING DIODES) LIGHTING FIXTURES FOR USE IN DISPLAY, COMMERCIAL, INDUSTRIAL, RESIDENTIAL, AND ARCHITECTURAL ACCENT LIGHTING APPLICATIONS, NAMELY, PAR CANS, LED PAR CANS, LED PIN SPOTS, LED EFFECT LIGHTS, LED WASHES, LED STAGES WASHES, LED LINEAR WASHES, LED WASH PANELS, LED BALLS AND CUBES, AND DISCHARGE LAMPS, IN CLASS 11 (U.S. CLS. 13, 21, 23, 31 AND 34).

FIRST USE 10-13-2010; IN COMMERCE 10-13-2010.

NO CLAIM IS MADE TO THE EXCLUSIVE RIGHT TO USE "ILLUMINATE", APART FROM THE MARK AS SHOWN.

THE MARK CONSISTS OF THE LETTERS "I" AND "L" INSIDE A SOLID RECTANGLE WITH A SOLID LINE TO THE RIGHT. THEN SLIGHTLY ABOVE THE LETTERS "IL" IS THE WORD "ILUMENITE" IN LARGE FONT.

SER. NO. 85-268,838, FILED 3-16-2011.

CAROLINE WOOD, EXAMINING ATTORNEY



David J. Kyjars

Director of the United States Patent and Trademark Office

United States of America

United States Patent and Trademark Office

WARMOUTH

Reg. No. 4,107,820

BIG BITE BAITs, INC. (ALABAMA CORPORATION)
P.O. BOX 1375
EUFAULA, AL 36072

Registered Mar. 6, 2012

Int. Cl.: 28

FOR: FISHING LURES, IN CLASS 28 (U.S. CLS. 22, 23, 38 AND 50).

TRADEMARK

FIRST USE 2-16-2011; IN COMMERCE 2-16-2011.

PRINCIPAL REGISTER

THE MARK CONSISTS OF STANDARD CHARACTERS WITHOUT CLAIM TO ANY PARTICULAR FONT, STYLE, SIZE, OR COLOR.

SER. NO. 85-269,313, FILED 3-17-2011.

KEVIN CORWIN, EXAMINING ATTORNEY



David J. Kybas

Director of the United States Patent and Trademark Office

United States of America

United States Patent and Trademark Office

La Quinta

Reg. No. 4,107,821

Registered Mar. 6, 2012

Int. Cl.: 43

SERVICE MARK

PRINCIPAL REGISTER

LA QUINTA WORLDWIDE, LLC (DELAWARE LIMITED LIABILITY COMPANY)
101 CONVENTION CENTER DRIVE, SUITE 850
LAS VEGAS, NV 89109

FOR: RESTAURANT SERVICES, IN CLASS 43 (U.S. CLS. 100 AND 101).

FIRST USE 1-1-1989; IN COMMERCE 1-1-1989.

THE MARK CONSISTS OF STANDARD CHARACTERS WITHOUT CLAIM TO ANY PARTICULAR FONT, STYLE, SIZE, OR COLOR.

CONCURRENT USE INFORMATION. REGISTRATION EXCLUDES THE AREA COMPRISING THE 37-MILE RADIUS AROUND THE MAIN LOBBY OF THE LA QUINTA RESORT AND CLUB IN LA QUINTA, CALIFORNIA, BUT INCLUDES THE AREAS WITHIN THE CITY LIMITS OF TWENTY NINE PALMS, BANNING, AND SAN JACINTO, CALIFORNIA, PURSUANT TO THE DECREE OF UNITED STATES DISTRICT COURT FOR THE CENTRAL DISTRICT OF CALIFORNIA, CASE NO. 03-9577DSF, FILED JANUARY 24, 2005. CONCURRENT REGISTRATION WITH CNL DESERT RESORT, LP, FORMERLY KNOWN AS KSL DESERT RESORTS, INC.; AND CNL RESORT RECREATION LP, FORMERLY KNOWN AS KSL RECREATION CORPORATION, 56-140 PGA BOULEVARD, LA QUINTA, CALIFORNIA, 92253, AS TO REGISTRATION NUMBERS 2342039, 2147965, 2397149; AND SERIAL NUMBER 78280589

OWNER OF U.S. REG. NOS. 875,802, 1,841,032 AND OTHERS.

THE ENGLISH TRANSLATION OF LA QUINTA IN THE MARK IS "COUNTRY HOUSE".

SER. NO. 85-269,548, FILED 3-17-2011.

CIMMERIAN COLEMAN, EXAMINING ATTORNEY



David J. Kyffers

Director of the United States Patent and Trademark Office

United States of America

United States Patent and Trademark Office

BE LEGENDARY: BE POSITIVE

Reg. No. 4,107,822

Registered Mar. 6, 2012

Int. Cls.: 1, 5 and 44

TRADEMARK

SERVICE MARK

PRINCIPAL REGISTER

BECKER-UNDERWOOD, INC. (DELAWARE CORPORATION)
801 DAYTON AVENUE
AMES, IA 50010

FOR: CHEMICAL PRODUCTS AND PREPARATIONS FOR USE IN AGRICULTURE AND HORTICULTURE, NAMELY, INOCULANTS AND PRE-INOCULANTS FOR USE IN THE TREATMENT OF SEEDS, SURFACTANTS FOR USE IN CONNECTION WITH AGRICULTURAL PESTICIDES AND SEED INOCULANTS, SEED COATINGS USED AS YIELD ENHANCING AGENTS FOR CROPS, AND SOIL SUPPLEMENTS FOR IMPROVED PLANT GROWTH; GROWTH ENHANCING AND GROWTH REGULATING PREPARATIONS FOR USE IN AGRICULTURE AND HORTICULTURE, NAMELY, BENEFICIAL BACTERIA, PLANT GROWTH ENHANCERS AND PLANT GROWTH REGULATORS; FERTILIZING PREPARATIONS; CULTURES OF MICROORGANISMS FOR USE IN AGRICULTURE, IN CLASS 1 (U.S. CLS. 1, 5, 6, 10, 26 AND 46).

FOR: HERBICIDES, FUNGICIDES AND PESTICIDES, IN CLASS 5 (U.S. CLS. 6, 18, 44, 46, 51 AND 52).

FOR: INFORMATION, ADVISORY AND CONSULTANCY SERVICES RELATING TO AGRICULTURE AND HORTICULTURE, IN CLASS 44 (U.S. CLS. 100 AND 101).

THE MARK CONSISTS OF STANDARD CHARACTERS WITHOUT CLAIM TO ANY PARTICULAR FONT, STYLE, SIZE, OR COLOR.

PRIORITY CLAIMED UNDER SEC. 44(D) ON ERPN CMNTY TM OFC APPLICATION NO. 009814054, FILED 3-16-2011, REG. NO. 009814054, DATED 8-29-2011, EXPIRES 3-16-2021.

SER. NO. 85-269,928, FILED 3-17-2011.

JASON TURNER, EXAMINING ATTORNEY



David J. Kybas

Director of the United States Patent and Trademark Office

United States of America

United States Patent and Trademark Office

Restless Nation

Reg. No. 4,107,823

WEARREN MICHAEL E (UNITED STATES INDIVIDUAL), DBA RESTLESS NATION
4640 ARIZONA ST SD CA 92116
SAN DIEGO, CA 92116

Registered Mar. 6, 2012

Int. Cl.: 25

FOR: CLOTHING, NAMELY, SWEAT SHIRTS, T-SHIRTS, FLEECE JACKETS, KNITTED PANTS, SHORTS, JEANS, WOVEN JACKETS, WOVEN SKIRTS, WOVEN OVERALLS, SWEATERS, CAPS, WINTER CAPS, WINTER COATS, HATS, TENNIS SHOES, SOCKS, BELTS, PANTS, AND SHOES, IN CLASS 25 (U.S. CLS. 22 AND 39).

TRADEMARK

PRINCIPAL REGISTER

FIRST USE 6-18-2001; IN COMMERCE 6-18-2001.

THE MARK CONSISTS OF STANDARD CHARACTERS WITHOUT CLAIM TO ANY PARTICULAR FONT, STYLE, SIZE, OR COLOR.

SER. NO. 85-270,218, FILED 3-17-2011.

JEFFERY COWARD, EXAMINING ATTORNEY



David J. Kyffers

Director of the United States Patent and Trademark Office

United States of America

United States Patent and Trademark Office



Reg. No. 4,107,824

Registered Mar. 6, 2012

Int. Cls.: 9 and 42

TRADEMARK

SERVICE MARK

PRINCIPAL REGISTER

MONTAGE TECHNOLOGY INC. (CALIFORNIA CORPORATION)
SUITE 320
4677 OLD IRONSIDES DRIVE,
SANTA CLARA, CA 95054

FOR: COMPUTER HARDWARE; COMPUTER SOFTWARE FOR USE IN DESIGNING INTEGRATED CIRCUITS; INTEGRATED CIRCUITS, PRINTED CIRCUITS, BLANK INTEGRATED CIRCUIT CARDS, BLANK SMART CARDS; ENCODED INTEGRATED CIRCUIT CARDS CONTAINING PROGRAMMING USED TO DESIGN INTEGRATED CIRCUITS, NOT FOR USE IN THE MUSIC INDUSTRY; ENCODED SMART CARDS CONTAINING PROGRAMMING USED TO DESIGN INTEGRATED CIRCUITS, NOT FOR USE IN THE MUSIC INDUSTRY; RECORDED SOFTWARE AND COMPUTER HARDWARE FOR USE IN DESIGNING INTEGRATED CIRCUITS; AUDIO AND VIDEO RECEIVERS, SEMICONDUCTOR APPARATUS, NAMELY, SEMICONDUCTORS; OPTICAL GOODS IN THE NATURE OF INTEGRATED CIRCUITS AND MEMORY EXPANSION MODULES, AND RADIO FREQUENCY OF INTEGRATED CIRCUITS, DIGITAL SIGNAL PROCESSING OF INTEGRATED CIRCUITS, AND MIXED-SIGNAL INTEGRATED CIRCUITS, PORTABLE TELEPHONES; APPARATUS AND INSTRUMENTS FOR CONDUCTING, SWITCHING, TRANSFORMING, ACCUMULATING, REGULATING OR CONTROLLING ELECTRICITY, NAMELY, INTEGRATED CIRCUITS AND MEMORY EXPANSION MODULES, AND RADIO FREQUENCY OF INTEGRATED CIRCUITS, DIGITAL SIGNAL PROCESSING OF INTEGRATED CIRCUITS, AND MIXED-SIGNAL INTEGRATED CIRCUITS; APPARATUS FOR RECORDING, TRANSMISSION, OR REPRODUCTION OF SOUND OR IMAGES; ENCODED MAGNETIC DATA CARRIERS CONTAINING PROGRAMMING USED TO DESIGN INTEGRATED CIRCUITS, NOT FOR USE IN THE MUSIC INDUSTRY; ENCODED RECORDING DISCS CONTAINING PROGRAMMING USED FOR DESIGNING INTEGRATED CIRCUITS, NOT FOR USE IN THE MUSIC INDUSTRY, IN CLASS 9 (U.S. CLS. 21, 23, 26, 36 AND 38).



FIRST USE 3-15-2004, THE MARK WAS FIRST USED ANYWHERE IN A DIFFERENT FORM OTHER THAN THAT SOUGHT TO BE REGISTERED AT LEAST AS EARLY AS 03/15/2004; IN COMMERCE 4-1-2004, THE MARK WAS FIRST USED IN COMMERCE IN A DIFFERENT FORM OTHER THAN THAT SOUGHT TO BE REGISTERED AT LEAST AS EARLY AS 04/01/2004.

David J. Kyffers

Director of the United States Patent and Trademark Office

FOR: SCIENTIFIC AND TECHNOLOGICAL SERVICES, NAMELY, SCIENTIFIC RESEARCH AND DEVELOPMENT AND TECHNOLOGICAL CONSULTATION IN THE FIELD OF SEMICONDUCTOR AND INTEGRATED CIRCUIT DESIGN FIELD AND RESEARCH AND

Reg. No. 4,107,824 DESIGN OF INTEGRATED CIRCUIT DESIGN FIELD RELATING THERETO; INDUSTRIAL ANALYSIS AND RESEARCH SERVICES IN THE FIELD OF INTEGRATED CIRCUIT DESIGN FIELD; DESIGN AND DEVELOPMENT OF COMPUTER HARDWARE AND SOFTWARE, NAMELY, OF HARDWARE AND SOFTWARE RELATING TO INTEGRATED CIRCUITS AND MEMORY MODULES, AND RADIO FREQUENCY, DIGITAL SIGNAL PROCESSING AND MIXED-SIGNAL INTEGRATED CIRCUITS FOR DIGITAL TELEVISION BROADCASTING; MATERIALS EVALUATION FOR ENGINEERING APPLICATIONS; SCIENTIFIC RESEARCH SERVICES FOR MEDICAL PURPOSES; ENGINEERING AND MATERIALS QUALITY CONTROL AND TESTING SERVICES; HOSTING WEBSITES; INDUSTRIAL DESIGN SERVICES, IN CLASS 42 (U.S. CLS. 100 AND 101).

FIRST USE 3-15-2004, THE MARK WAS FIRST USED ANYWHERE IN A DIFFERENT FORM OTHER THAN THAT SOUGHT TO BE REGISTERED AT LEAST AS EARLY AS 03/15/2004; IN COMMERCE 4-1-2004, THE MARK WAS FIRST USED IN COMMERCE IN A DIFFERENT FORM OTHER THAN THAT SOUGHT TO BE REGISTERED AT LEAST AS EARLY AS 04/01/2004.

THE MARK CONSISTS OF A STYLIZED LETTER "M" WITH A CURVE RUNNING THROUGH THE BOTTOM PART OF THE LETTER "M". THE APPLICANT IS NOT CLAIMING COLOR AS A FEATURE OF THE MARK.

SER. NO. 85-271,129, FILED 3-18-2011.

ANNE MADDEN, EXAMINING ATTORNEY

United States of America

United States Patent and Trademark Office

IDO LED

Reg. No. 4,107,825

Registered Mar. 6, 2012

Int. Cl.: 9

TRADEMARK

PRINCIPAL REGISTER

SEMILEDS OPTOELECTRONICS CO., LTD. (TAIWAN CORPORATION)
3F, NO. 11, KE JUNG RD. CHU-NAN
MIAO-LI COUNTY, TAIWAN 350

FOR: LIGHT EMITTING DIODES (LEDS), IN CLASS 9 (U.S. CLS. 21, 23, 26, 36 AND 38).

FIRST USE 1-1-2011; IN COMMERCE 1-3-2011.

THE MARK CONSISTS OF STANDARD CHARACTERS WITHOUT CLAIM TO ANY PARTICULAR FONT, STYLE, SIZE, OR COLOR.

NO CLAIM IS MADE TO THE EXCLUSIVE RIGHT TO USE "LED", APART FROM THE MARK AS SHOWN.

THE WORDING "IDO" HAS NO MEANING IN A FOREIGN LANGUAGE.

SER. NO. 85-271,583, FILED 3-19-2011.

H. M. FISHER, EXAMINING ATTORNEY



David J. Kybas

Director of the United States Patent and Trademark Office

United States of America

United States Patent and Trademark Office



Reg. No. 4,107,826

Registered Mar. 6, 2012

Int. Cls.: 29 and 30

TRADEMARK

PRINCIPAL REGISTER

VADILAL INTERNATIONAL PRIVATE LIMITED (INDIA CORPORATION)
VADILAL HOUSE, SHRIMALI SOCIETY
NR. NAVRANGPURA RAILWAY CROSSING
AHMEDABAD, GUJARAT, INDIA

FOR: READY-TO-EAT FOODS, NAMELY, FROZEN AND CANNED ENTREES AND SIDE DISHES CONSISTING PRIMARILY OF VEGETABLES; AND FROZEN AND CANNED FRUITS AND VEGETABLES, IN CLASS 29 (U.S. CL. 46).

FIRST USE 1-1-2002; IN COMMERCE 2-1-2002.

FOR: FROZEN DESSERTS, NAMELY, ICE CREAM; AND READY-TO-EAT FROZEN AND CANNED ENTREES AND SIDE DISHES CONSISTING PRIMARILY OF PASTA OR RICE, IN CLASS 30 (U.S. CL. 46).

FIRST USE 1-1-2002; IN COMMERCE 3-1-2002.

NO CLAIM IS MADE TO THE EXCLUSIVE RIGHT TO USE "TREAT", APART FROM THE MARK AS SHOWN.

THE MARK CONSISTS OF THE WORD "VADILAL" IN AN OVAL AND THE WORDS "QUICK TREAT" ON A DECORATIVE BACKGROUND.

SER. NO. 85-272,983, FILED 3-22-2011.

PAUL E. FAHRENKOPF, EXAMINING ATTORNEY



David J. Kyros

Director of the United States Patent and Trademark Office

United States of America

United States Patent and Trademark Office

TOPWORX

Reg. No. 4,107,827

Registered Mar. 6, 2012

Int. Cls.: 35 and 37

SERVICE MARK

PRINCIPAL REGISTER

GENERAL EQUIPMENT AND MANUFACTURING COMPANY, INC. (KENTUCKY CORPORATION)
3300 FERN VALLEY ROAD
LOUISVILLE, KY 40213

FOR: DISTRIBUTORSHIP SERVICES IN THE FIELD OF PROCESS CONTROL EQUIPMENT, NAMELY, VALVE CONTROL APPARATUS, RELATED MONITORING AND NETWORKING PRODUCTS AND OTHER EQUIPMENT FOR MONITORING AND CONTROL OF INDUSTRIAL MACHINERY AND INSTALLATIONS, IN CLASS 35 (U.S. CLS. 100, 101 AND 102).

FIRST USE 12-28-1998; IN COMMERCE 12-28-1998.

FOR: TECHNICAL CONSULTING RELATED TO THE INSTALLATION OF OIL AND GAS EQUIPMENT, CONTROL SYSTEMS, AND MACHINERY, IN CLASS 37 (U.S. CLS. 100, 103 AND 106).

FIRST USE 12-31-2007; IN COMMERCE 12-31-2007.

THE MARK CONSISTS OF STANDARD CHARACTERS WITHOUT CLAIM TO ANY PARTICULAR FONT, STYLE, SIZE, OR COLOR.

SER. NO. 85-273,103, FILED 3-22-2011.

STEVEN PEREZ, EXAMINING ATTORNEY



David J. Kypos

Director of the United States Patent and Trademark Office

United States of America

United States Patent and Trademark Office

PRESTO

Reg. No. 4,107,828

Registered Mar. 6, 2012

Int. Cl.: 6

TRADEMARK

PRINCIPAL REGISTER

HSU, JULIE (CALIFORNIA CORPORATION), DBA PRESTO
14764 YORBA COURT
CHINO, CA 91710

FOR: BUCKLES OF COMMON METAL; METAL HARDWARE, NAMELY, DOUBLE-END SWIVELS; METAL HOOKS; METAL SHACKLES AND HOOKS FOR LIFTING AND RIGGING, IN CLASS 6 (U.S. CLS. 2, 12, 13, 14, 23, 25 AND 50).

FIRST USE 1-1-2002; IN COMMERCE 1-1-2002.

THE MARK CONSISTS OF THE WORD "PRESTO" IN ALL CAPITAL LETTERS.

SER. NO. 85-273,784, FILED 3-22-2011.

JESSICA A. POWERS, EXAMINING ATTORNEY



David J. Kybas

Director of the United States Patent and Trademark Office

United States of America

United States Patent and Trademark Office

THE LEANING TOWER OF PIZZA

Reg. No. 4,107,829

Registered Mar. 6, 2012

Int. Cl.: 28

TRADEMARK

PRINCIPAL REGISTER

GENIE TOYS PLC (GREAT BRITAIN PRIVATE LIMITED COMPANY)
GENIE HOUSE
ST. JAMES SQUARE
CHELTENHAM GL50 3QG, GREAT BRITAIN

FOR: GAMES, NAMELY, TABLETOP GAMES, BOARD GAMES, CARD GAMES, IN CLASS
28 (U.S. CLS. 22, 23, 38 AND 50).

THE MARK CONSISTS OF STANDARD CHARACTERS WITHOUT CLAIM TO ANY PAR-
TICULAR FONT, STYLE, SIZE, OR COLOR.

OWNER OF GREAT BRITAIN REG. NO. 2571451, DATED 2-7-2011, EXPIRES 2-7-2021.

SER. NO. 85-274,152, FILED 3-23-2011.

HELENE LIWINSKI, EXAMINING ATTORNEY



David J. Kybas

Director of the United States Patent and Trademark Office

United States of America

United States Patent and Trademark Office

XP FIT PLUS

Reg. No. 4,107,830

SENKO ADVANCED COMPONENTS, INC. (MASSACHUSETTS CORPORATION)
450 DONALD LYNCH BLVD - D
MARLBOROUGH, MA 017524714

Registered Mar. 6, 2012

Int. Cl.: 9

FOR: FIBER OPTIC FIELD INSTALLABLE CONNECTORS; FIBER OPTIC CONNECTOR INSTALLATION KITS COMPRISED OF FIBER OPTIC CONNECTORS AND INSTALLATION TOOLS , IN CLASS 9 (U.S. CLS. 21, 23, 26, 36 AND 38).

TRADEMARK

FIRST USE 0-0-2008; IN COMMERCE 0-0-2008.

PRINCIPAL REGISTER

THE MARK CONSISTS OF STANDARD CHARACTERS WITHOUT CLAIM TO ANY PARTICULAR FONT, STYLE, SIZE, OR COLOR.

SER. NO. 85-274,493, FILED 3-23-2011.

GRETCHEN ULRICH, EXAMINING ATTORNEY



David J. Kyros

Director of the United States Patent and Trademark Office

United States of America

United States Patent and Trademark Office

TALLEY

Reg. No. 4,107,831

Registered Mar. 6, 2012

Int. Cl.: 13

TRADEMARK

PRINCIPAL REGISTER

TALLEY, DAVID E. (UNITED STATES INDIVIDUAL)
128 WATEREE DRIVE
SANTEE, SC 29142

FOR: FIREARM ACCESSORIES, NAMELY, SCOPE RINGS, SLING SWIVELS, CROSS BOLTS, BOLT KNOBS, AND NON-TELESCOPIC GUN SIGHTS, IN CLASS 13 (U.S. CLS. 2 AND 9).

FIRST USE 0-0-1979; IN COMMERCE 0-0-1979.

THE MARK CONSISTS OF STANDARD CHARACTERS WITHOUT CLAIM TO ANY PARTICULAR FONT, STYLE, SIZE, OR COLOR.

SEC. 2(F).

SER. NO. 85-276,071, FILED 3-24-2011.

GEOFFREY FOSDICK, EXAMINING ATTORNEY



David J. Kybas

Director of the United States Patent and Trademark Office

United States of America

United States Patent and Trademark Office

FACTORY CONNECTION

Reg. No. 4,107,832

Registered Mar. 6, 2012

Int. Cl.: 35

SERVICE MARK

PRINCIPAL REGISTER

FACTORY CONNECTION, LLC (DELAWARE LIMITED LIABILITY COMPANY)
701 RAILROAD AVENUE
ALBERTVILLE, AL 35951

FOR: RETAIL CLOTHING AND ACCESSORY STORES, IN CLASS 35 (U.S. CLS. 100, 101 AND 102).

FIRST USE 4-0-1984; IN COMMERCE 4-0-1984.

THE MARK CONSISTS OF STANDARD CHARACTERS WITHOUT CLAIM TO ANY PARTICULAR FONT, STYLE, SIZE, OR COLOR.

OWNER OF U.S. REG. NO. 1,487,941.

SEC. 2(F) FACTORY.

SER. NO. 85-276,677, FILED 3-25-2011.

JEAN IM, EXAMINING ATTORNEY



David J. Kybas

Director of the United States Patent and Trademark Office

United States of America

United States Patent and Trademark Office

EDIFIER IMAGE

Reg. No. 4,107,833

Registered Mar. 6, 2012

Int. Cl.: 9

TRADEMARK

PRINCIPAL REGISTER

EDIFIER INTERNATIONAL, LTD. (HONG KONG CORPORATION)
TOWER II, LIPPO CENTRE
89 QUEENSWAY, HONG KONG

FOR: LOUDSPEAKER SYSTEMS; ELECTRONIC DOCKING STATIONS; STANDS SPECIALLY DESIGNED FOR HOLDING PORTABLE AND HANDHELD DIGITAL ELECTRONIC DEVICES; BATTERY CHARGERS; BATTERY PACKS; ELECTRICAL CONNECTORS, WIRES, CABLES, AND ADAPTORS; WIRED AND WIRELESS REMOTE CONTROLS FOR PORTABLE AND HANDHELD DIGITAL ELECTRONIC DEVICES; STEREO AMPLIFIER AND SPEAKER BASE STATIONS; RADIO RECEIVERS; RADIO TRANSMITTERS; ACOUSTIC CONDUITS; ACOUSTIC MEMBRANES; AUDIO AMPLIFIERS; AUDIO MIXERS; LOUDSPEAKERS; SOUND MIXERS; STEREO AMPLIFIERS, IN CLASS 9 (U.S. CLS. 21, 23, 26, 36 AND 38).

FIRST USE 1-11-2007; IN COMMERCE 1-11-2007.

THE MARK CONSISTS OF STANDARD CHARACTERS WITHOUT CLAIM TO ANY PARTICULAR FONT, STYLE, SIZE, OR COLOR.

OWNER OF U.S. REG. NO. 2,783,259.

SER. NO. 85-276,719, FILED 3-25-2011.

LEIGH CAROLINE CASE, EXAMINING ATTORNEY



David J. Kyros

Director of the United States Patent and Trademark Office

United States of America

United States Patent and Trademark Office

EDIFIER MULTIMEDIA

Reg. No. 4,107,834

Registered Mar. 6, 2012

Int. Cl.: 9

TRADEMARK

PRINCIPAL REGISTER

EDIFIER INTERNATIONAL, LTD. (HONG KONG CORPORATION)
TOWER II, LIPPO CENTRE
89 QUEENSWAY, HONG KONG

FOR: LOUDSPEAKER SYSTEMS; ELECTRONIC DOCKING STATIONS; STANDS SPECIALLY DESIGNED FOR HOLDING PORTABLE AND HANDHELD DIGITAL ELECTRONIC DEVICES; BATTERY CHARGERS; BATTERY PACKS; ELECTRICAL CONNECTORS, WIRES, CABLES, AND ADAPTORS; WIRED AND WIRELESS REMOTE CONTROLS FOR PORTABLE AND HANDHELD DIGITAL ELECTRONIC DEVICES; STEREO AMPLIFIER AND SPEAKER BASE STATIONS; RADIO RECEIVERS; RADIO TRANSMITTERS; ACOUSTIC CONDUITS; ACOUSTIC MEMBRANES; AUDIO AMPLIFIERS; AUDIO MIXERS; LOUDSPEAKERS; SOUND MIXERS; STEREO AMPLIFIERS, IN CLASS 9 (U.S. CLS. 21, 23, 26, 36 AND 38).

FIRST USE 1-1-1998; IN COMMERCE 1-1-1998.

THE MARK CONSISTS OF STANDARD CHARACTERS WITHOUT CLAIM TO ANY PARTICULAR FONT, STYLE, SIZE, OR COLOR.

OWNER OF U.S. REG. NO. 2,783,259.

NO CLAIM IS MADE TO THE EXCLUSIVE RIGHT TO USE "MULTIMEDIA", APART FROM THE MARK AS SHOWN.

SER. NO. 85-276,725, FILED 3-25-2011.

LEIGH CAROLINE CASE, EXAMINING ATTORNEY



David J. Kypos

Director of the United States Patent and Trademark Office

United States of America

United States Patent and Trademark Office

PROFESSIONAL SERIES

Reg. No. 4,107,835

Registered Mar. 6, 2012

Int. Cl.: 20

TRADEMARK

PRINCIPAL REGISTER

FOUNDATIONS WORLDWIDE, INC. (OHIO CORPORATION)
7001 WOOSTER PIKE ROAD
MEDINA, OH 44256

FOR: CRIBS; CRIB MATTRESSES, IN CLASS 20 (U.S. CLS. 2, 13, 22, 25, 32 AND 50).

FIRST USE 2-23-2011; IN COMMERCE 2-23-2011.

THE MARK CONSISTS OF STANDARD CHARACTERS WITHOUT CLAIM TO ANY PARTICULAR FONT, STYLE, SIZE, OR COLOR.

NO CLAIM IS MADE TO THE EXCLUSIVE RIGHT TO USE "SERIES", APART FROM THE MARK AS SHOWN.

SER. NO. 85-278,077, FILED 3-27-2011.

JANET LEE, EXAMINING ATTORNEY



David J. Kybas

Director of the United States Patent and Trademark Office

United States of America

United States Patent and Trademark Office



Reg. No. 4,107,836

Registered Mar. 6, 2012

Int. Cl.: 41

SERVICE MARK

PRINCIPAL REGISTER

THE CHICKASAW NATION (UNITED STATES FEDERALLY-RECOGNIZED INDIAN TRIBE)
520 E. ARLINGTON BLVD.
ADA, OK 74820

FOR: BETTING SERVICES; CASINOS; CONDUCTING AND PROVIDING FACILITIES FOR SPECIAL EVENTS FEATURING CASINO AND GAMING CONTESTS AND TOURNAMENTS; ENTERTAINMENT IN THE NATURE OF BOXING CONTESTS; ENTERTAINMENT SERVICES IN THE NATURE OF LIVE MUSICAL PERFORMANCES; ENTERTAINMENT SERVICES IN THE NATURE OF PRESENTING LIVE MUSICAL PERFORMANCES; ENTERTAINMENT SERVICES, NAMELY, AN ON-GOING TELEVISION GAME SHOW AND GAMES OF CHANCE TO BE PLAYED AT A CASINO; ENTERTAINMENT SERVICES, NAMELY, CASINO GAMING; ENTERTAINMENT SERVICES, NAMELY, CONDUCTING LIVE BLACKJACK CARD GAME TOURNAMENTS; ENTERTAINMENT SERVICES, NAMELY, CONDUCTING LIVE POKER GAMES; ENTERTAINMENT, NAMELY, LIVE MUSIC CONCERTS; GAMBLING SERVICES; GAMING SERVICES IN THE NATURE OF CASINO GAMING; ORGANIZATION OF CULTURAL SHOWS; ORGANIZATION OF EVENTS FOR CULTURAL PURPOSES; ORGANIZATION OF EXHIBITIONS FOR CULTURAL OR EDUCATIONAL PURPOSES; ORGANIZATION OF SHOWS FOR CULTURAL PURPOSES; ORGANIZING AND HOSTING OF EVENTS FOR CULTURAL PURPOSES; ORGANIZING COMMUNITY SPORTING AND CULTURAL EVENTS; ORGANIZING CULTURAL AND ARTS EVENTS; PRODUCING ONGOING TELEVISION PROGRAMS ON BLACKJACK CARD TOURNAMENTS; PROVIDING CASINO FACILITIES; PROVIDING CASINO SERVICES FEATURING A CASINO PLAYERS REWARDS PROGRAM; PROVIDING CASINO SERVICES FEATURING STORED VALUE MEMBERSHIP CARDS FOR REDEEMING CASH, DISCOUNTS, AND OTHER BENEFITS; PROVIDING OFF-TRACK BETTING FACILITIES; PROVIDING ON-LINE CARD GAMES; PROVIDING ON-LINE POKER GAMES; PROVISION OF INFORMATION RELATING TO ORGANIZING COMMUNITY SPORTING AND CULTURAL ACTIVITIES, CONTESTS AND GAMES; WAGERING SERVICES, IN CLASS 41 (U.S. CLS. 100, 101 AND 107).



FIRST USE 4-0-2005; IN COMMERCE 4-0-2005.

NO CLAIM IS MADE TO THE EXCLUSIVE RIGHT TO USE "CASINO", APART FROM THE MARK AS SHOWN.

David J. Kybas

Director of the United States Patent and Trademark Office

THE MARK CONSISTS OF THE STYLIZED WORDS "GOLD MOUNTAIN CASINO" WITH A PICTURE OF A MOUNTAIN RANGE IN A RECTANGULAR FRAME LOCATED BETWEEN THE WORDS "MOUNTAIN" AND "CASINO".

Reg. No. 4,107,836 SER. NO. 85-279,757, FILED 3-29-2011.

KATHY DE JONGE, EXAMINING ATTORNEY

United States of America
United States Patent and Trademark Office

TENNIS
CONNECT

Reg. No. 4,107,837

Registered Mar. 6, 2012

Int. Cl.: 42

SERVICE MARK

PRINCIPAL REGISTER

TENNIS INDUSTRY ASSOCIATION (SOUTH CAROLINA CORPORATION)
1 CORPUS CHRISTI PLACE, #117
HILTON HEAD ISLAND, SC 29928

FOR: HOSTING WEBSITES ON THE INTERNET; PROVIDING TEMPORARY USE OF ON-LINE NONDOWNLOADABLE SOFTWARE AND APPLICATIONS FOR USE IN WEBSITE DEVELOPMENT, ONLINE MARKETING, AND CUSTOMER SERVICE, ALL IN THE FIELD OF TENNIS, IN CLASS 42 (U.S. CLS. 100 AND 101).

FIRST USE 8-19-2010; IN COMMERCE 8-19-2010.

NO CLAIM IS MADE TO THE EXCLUSIVE RIGHT TO USE "TENNIS", APART FROM THE MARK AS SHOWN.

THE MARK CONSISTS OF THE STYLIZED WORDS "TENNIS CONNECT". THE LETTER "O" IS IN THE FORM OF A TENNIS BALL.

SER. NO. 85-280,184, FILED 3-29-2011.

INGRID C. EULIN, EXAMINING ATTORNEY



David J. Kyffers

Director of the United States Patent and Trademark Office

United States of America

United States Patent and Trademark Office

SERENE COMFORT

Reg. No. 4,107,838

APG MANAGEMENT, INC. (MASSACHUSETTS CORPORATION), DBA SERENE COMFORT
2 GWEN DRIVE
AUBURN, MA 01501

Registered Mar. 6, 2012

Int. Cl.: 35

FOR: ONLINE RETAIL STORE SERVICES OF CLOTHING FOR OTHERS, NAMELY, BED JACKETS, CAFTANS, DRESSES, ENSEMBLES, FOOTWEAR, LINGERIE, LOUNGEWEAR, ROBES, PANTS, SLEEPWEAR, SLIPPERS, TOPS AND UNDERGARMENTS, IN CLASS 35 (U.S. CLS. 100, 101 AND 102).

SERVICE MARK

PRINCIPAL REGISTER

FIRST USE 11-23-2004; IN COMMERCE 11-24-2004.

THE MARK CONSISTS OF STANDARD CHARACTERS WITHOUT CLAIM TO ANY PARTICULAR FONT, STYLE, SIZE, OR COLOR.

SER. NO. 85-280,212, FILED 3-29-2011.

TRACY CROSS, EXAMINING ATTORNEY



David J. Kybas

Director of the United States Patent and Trademark Office

United States of America

United States Patent and Trademark Office

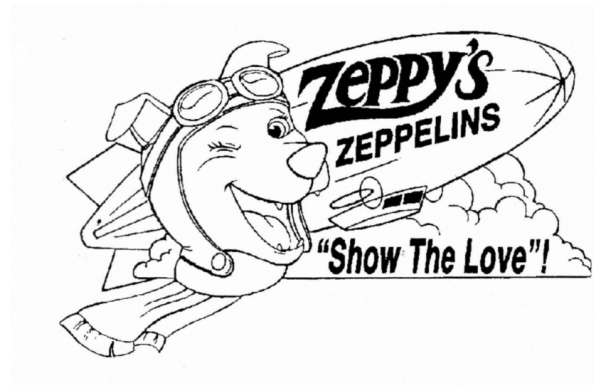

Reg. No. 4,107,839

Registered Mar. 6, 2012

Int. Cl.: 31

TRADEMARK

PRINCIPAL REGISTER

DISISTO, RENEE (UNITED STATES INDIVIDUAL)
#A
1722 . HOLLYWOOD WAY
BURBANK, CA 91505 AND

SOTO, MICHELE (UNITED STATES INDIVIDUAL)
#A
1722 . HOLLYWOOD WAY
BURBANK, CA 91505

FOR: DOG TREATS, IN CLASS 31 (U.S. CLS. 1 AND 46).

FIRST USE 3-1-2011; IN COMMERCE 3-1-2011.

THE MARK CONSISTS OF A STYLIZED IMAGE OF A DOG WEARING AN AVIATOR CAP, SCARF AND GOGGLES AND WINKING WITH HIS RIGHT EYE. THE BACKGROUND CONSISTS OF A STYLIZED ZEPPELIN FLYING ABOVE CLOUDS. ON THE RIGHT SIDE OF THE ZEPPELIN IS THE STACKED LETTERING "ZEPPY'S" AND "ZEPPELINS". BELOW THE ZEPPELIN AND AT THE BASE OF THE CLOUDS IS THE WORDING "SHOW THE LOVE!".

SER. NO. 85-280,592, FILED 3-29-2011.

PAULA MAHONEY, EXAMINING ATTORNEY



David J. Kybas

Director of the United States Patent and Trademark Office

United States of America

United States Patent and Trademark Office

The logo for "OneNeb" features the word "One" in a gold, sans-serif font, followed by a blue stylized graphic of two curved lines that resemble a nebula or a stylized "N", and the word "Neb" in a blue, sans-serif font.

Reg. No. 4,107,840

Registered Mar. 6, 2012

Int. Cls.: 9 and 35

TRADEMARK

SERVICE MARK

PRINCIPAL REGISTER

INGENIATRICS TECNOLOGIAS, S.L. (SPAIN LIMITED COMPANY (LTD.))
AV. AMÉRICO VESPUCCIO, 5-E, 1ª PL. MOD.12
PARQ CIENTÍFICO Y TECNOLÓGICO CARTUJA 93
SEVILLA, SPAIN

FOR: SCIENTIFIC APPARATUS AND INSTRUMENTS, NAMELY, NEBULIZERS FOR FLUID MANIPULATION IN THE NANO AND MICROMETRIC RANGE, NEBULIZERS FOR CONTROLLING THE PRODUCTION OF MICRO-JETS, SINGLE AND COMPLEX MICRO-PARTICLES, MICROFIBRES, AND MICROBUBBLES, AND NEBULIZERS FOR MASS AND OPTICAL SPECTROMETRY APPARATUS FOR CHEMICAL ELEMENTARY ANALYSIS, IN CLASS 9 (U.S. CLS. 21, 23, 26, 36 AND 38).

FOR: ADVERTISING; BUSINESS MANAGEMENT; BUSINESS ADMINISTRATION; RETAIL STORE AND ON-LINE RETAIL STORE SERVICES FEATURING NEBULIZERS FOR STEAM GENERATING, COOKING, REFRIGERATING, DRYING, VENTILATING, WATER SUPPLY AND SANITARY PURPOSES, MASS AND OPTICAL SPECTROMETRY EQUIPMENT USED FOR CHEMICAL ELEMENTARY ANALYSIS, IN CLASS 35 (U.S. CLS. 100, 101 AND 102).

OWNER OF ERPN CMNTY TM OFC REG. NO. 008464125, DATED 1-31-2010, EXPIRES 7-31-2019.

THE COLOR(S) GOLD AND BLUE IS/ARE CLAIMED AS A FEATURE OF THE MARK.

THE MARK CONSISTS OF THE STYLIZED TEXT "ONENEB", WITH THE TEXT "ONE" IN GOLD, THE TEXT "NEB" IN BLUE, AND TWO BLUE CURVES BETWEEN "ONE" AND "NEB".

SER. NO. 85-282,121, FILED 3-31-2011.

WANDA KAY PRICE, EXAMINING ATTORNEY



David J. Kyjars

Director of the United States Patent and Trademark Office

United States of America

United States Patent and Trademark Office



Reg. No. 4,107,841

Registered Mar. 6, 2012

Int. Cl.: 29

TRADEMARK

PRINCIPAL REGISTER

SIGMA ALIMENTOS, S.A. DE C.V. (MEXICO CORPORATION)
COLONIA CARRIZALEJO
AVENIDA GOMEZ MORIN NO. 1111
SAN PEDRO GARZA GARCIA, MEXICO 66254

FOR: COLD CUTS AND PROCESSED MEATS, NAMELY, BOLOGNA, MEAT BOLOGNA, BEEF BOLOGNA, CHICKEN BOLOGNA, GARLIC BOLOGNA, TURKEY BOLOGNA; HAMS, NAMELY, SMOKED HAM, HONEY CURED HAM, BLACK FOREST HAM, HAM STEAKS, AND BONELESS HAM; SAUSAGES, NAMELY, SKINLESS SMOKED SAUSAGE, SKINLESS POLISH SAUSAGE, SKINLESS SAUSAGE WITH CHEESE, SKINLESS SPICY SMOKED SAUSAGE, SMOKED BREAKFAST LINK, SMOKED MAPLE BREAKFAST LINK, SMOKED SAUSAGE LOOP, POLISH SMOKED SAUSAGE LOOP; SPICY SAUSAGE IN LINK FORM, PORK SAUSAGE; SALAMIS, COTTO SALAMI; FRANKFURTERS, NAMELY, MEAT FRANKS, BEEF FRANKS, CHICKEN FRANKS, TURKEY FRANKS, CHEESE FRANKS; CHORIZO, PASTRAMI, LOIN TURKEY BREAST, PICKLED PIG'S FEET, SLICED BEEF, ROAST BEEF, CHICKEN, PROCESSED PIMIENTO, PEPPERONI AND BACON, NAMELY, REGULAR SMOKED BACON, THICK SMOKED BACON, LOWER SODIUM SMOKED BACON AND SMOKED TURKEY BACON, CHEESE, NAMELY, STRING CHEESE AND AMERICAN PROCESSED CHEESE, YOGURTS AND PACKAGED SALADS EXCEPT THE FOLLOWING TYPES OF SALADS: MACARONI, RICE AND PASTA SALADS; PACKAGED MEATS AND PROCESSED FOODS, NAMELY, BREADED CHICKEN BREASTS, SEASONED CHICKEN BREAST, BREADED FISH FILLETS, BREADED FISH STRIPS, FRENCH FRIES POTATOES, FROZEN SHRIMP, BREADED FROZEN SHRIMP AND CORN DOGS, NAMELY, MEAT CORN DOGS, BEEF CORN DOGS, CHEESE CORN DOGS, TURKEY CORN DOGS, IN CLASS 29 (U.S. CL. 46).



OWNER OF MEXICO REG. NO. 1230414, DATED 5-15-2011, EXPIRES 5-15-2022.

THE COLOR(S) PINK, YELLOW, ORANGE, GRAY AND WHITE IS/ARE CLAIMED AS A FEATURE OF THE MARK.

OWNER OF U.S. REG. NOS. 1,283,523, 3,412,685 AND OTHERS.

NO CLAIM IS MADE TO THE EXCLUSIVE RIGHT TO USE "FOODS" AND "COMPANY", APART FROM THE MARK AS SHOWN.

David J. Kybas

Director of the United States Patent and Trademark Office

Reg. No. 4,107,841 THE MARK CONSISTS OF A WHITE BACKGROUND WITH THE WORDS "BAR S FOODS" IN THE COLOR PINK. A RAINBOW WITH THE COLORS YELLOW, ORANGE AND PINK APPEARS UNDER THE WORDS "BAR S FOODS". THE WORDS "A" IN THE COLOR GRAY; "SIGMA" IN THE COLOR PINK WITH A YELLOW CHECK MARK; AND THE WORD "COMPANY" IN THE COLOR GRAY APPEAR UNDER THE RAINBOW.

SER. NO. 85-282,459, FILED 3-31-2011.

NAPOLEON SHARMA, EXAMINING ATTORNEY

United States of America

United States Patent and Trademark Office

CADILLAC GAGE

Reg. No. 4,107,842

Registered Mar. 6, 2012

Int. Cl.: 12

TRADEMARK

PRINCIPAL REGISTER

TEXTRON INNOVATIONS INC. (DELAWARE CORPORATION)
40 WESTMINSTER STREET
PROVIDENCE, RI 02903

FOR: ARMORED VEHICLES, NAMELY, ARMORED CARS, TRUCKS, VANS, TANKS, PERSONNEL CARRIERS, AND AMPHIBIOUS TRUCKS, IN CLASS 12 (U.S. CLS. 19, 21, 23, 31, 35 AND 44).

FIRST USE 0-0-1980; IN COMMERCE 0-0-1980.

THE MARK CONSISTS OF STANDARD CHARACTERS WITHOUT CLAIM TO ANY PARTICULAR FONT, STYLE, SIZE, OR COLOR.

OWNER OF U.S. REG. NO. 3,124,182.

SER. NO. 85-283,782, FILED 4-1-2011.

REGINA DRUMMOND, EXAMINING ATTORNEY



David J. Kybas

Director of the United States Patent and Trademark Office

United States of America

United States Patent and Trademark Office

MenuMine

Reg. No. 4,107,843

Registered Mar. 6, 2012

Int. Cl.: 35

SERVICE MARK

PRINCIPAL REGISTER

FOOD SERVICE RESEARCH INSTITUTE, INC. (ILLINOIS CORPORATION)
6957 W. NORTH AVE.
OAK PARK, IL 60302

FOR: CONDUCTING BUSINESS AND MARKET RESEARCH SURVEYS; CONDUCTING MARKET SURVEYS; CONDUCTING MARKETING STUDIES; CONSUMER MARKETING RESEARCH AND CONSULTING RELATED THERETO; MARKET ANALYSIS; MARKET ANALYSIS AND RESEARCH SERVICES, IN CLASS 35 (U.S. CLS. 100, 101 AND 102).

FIRST USE 1-1-2010, THE MARK WAS FIRST USED ANYWHERE IN A DIFFERENT FORM OTHER THAN THAT SOUGHT TO BE REGISTERED AT LEAST AS EARLY AS 03/03/2003.; IN COMMERCE 1-1-2010, THE MARK WAS FIRST USED IN COMMERCE IN A DIFFERENT FORM OTHER THAN THAT SOUGHT TO BE REGISTERED AT LEAST AS EARLY AS 03/03/2003..

OWNER OF U.S. REG. NOS. 2,610,949, 3,018,991, AND 3,710,716.

THE COLOR(S) BLUE IS/ARE CLAIMED AS A FEATURE OF THE MARK.

THE MARK CONSISTS OF THE FOLLOWING: THE WORD "MENUMINE" APPEARING WITH A HAMMER ABOVE THE "INE" PART OF THE WORD ALL IN BLUE.

SER. NO. 85-284,543, FILED 4-2-2011.

LINDA ORNDORFF, EXAMINING ATTORNEY



David J. Kybas

Director of the United States Patent and Trademark Office

United States of America

United States Patent and Trademark Office



Reg. No. 4,107,844

Registered Mar. 6, 2012

Int. Cl.: 42

SERVICE MARK

PRINCIPAL REGISTER

COMPRESSION LABS, INC. (CALIFORNIA CORPORATION), DBA COMPRESSION LABS, INC.
1469 HAUCK DRIVE
SAN JOSE, CA 95118

FOR: DIGITAL COMPRESSION OF VIDEO AND AUDIO, IN CLASS 42 (U.S. CLS. 100 AND 101).

FIRST USE 8-10-2010; IN COMMERCE 8-10-2010.

NO CLAIM IS MADE TO THE EXCLUSIVE RIGHT TO USE "INC.", APART FROM THE MARK AS SHOWN.

THE MARK CONSISTS OF A DESIGN OF A FLASK TILTED TOWARDS THE LEFT AND A TRIANGLE INSIDE THE FLASK WHERE THE TRIANGLE IS POINTING TO THE RIGHT AND ON THE RIGHT OF THE FLASK IS THE STYLIZED WORDING "COMPRESSIONLABS INC."

SER. NO. 85-285,283, FILED 4-4-2011.

CIMMERIAN COLEMAN, EXAMINING ATTORNEY



David J. Kyfos

Director of the United States Patent and Trademark Office

United States of America

United States Patent and Trademark Office



Reg. No. 4,107,845

Registered Mar. 6, 2012

Int. Cls.: 20 and 24

TRADEMARK

PRINCIPAL REGISTER

FOGARTY HOLDINGS LIMITED (UNITED KINGDOM CORPORATION)
HAVENSIDE BOSTON
LINCOLNSHIRE PE21 0AH, UNITED KINGDOM

FOR: FURNITURE, FURNITURE MIRRORS, PICTURE FRAMES, FURNITURE OF WOOD, CORK, REED, CANE, WICKER, HORN, BONE, IVORY, WHALEBONE, SHELL, AMBER, MOTHER OF PEARL, MEERSCHAUM, AND SUBSTITUTES FOR THESE MATERIALS; FURNITURE OF PLASTIC; UPHOLSTERED FURNITURE, BEDS, SOFA AND CHAIR BEDS, MATTRESSES, BEDFRAMES, AND BOX SPRINGS FOR BEDS; SLEEPING BAGS, PILLOWS, CUSHIONS, BOLSTER CUSHIONS AND BOLSTER PILLOWS; SOFT SCULPTURE WALL DECORATIONS; FURNITURE PARTS, PARTS FOR MATTRESSES, PILLOWS AND CUSHIONS, IN CLASS 20 (U.S. CLS. 2, 13, 22, 25, 32 AND 50).

FOR: FABRIC CURTAINS, TEXTILE WALL HANGINGS, TEXTILE PLACEMATS, TEXTILE NAPKINS; BED LINENS, TABLE LINENS; FABRIC TABLE RUNNERS; UPHOLSTERY FABRIC; TEXTILE FABRICS FOR USE IN THE MANUFACTURE OF FURNITURE UPHOLSTERY; QUILTS, EIDERDOWN QUILTS, DUVETS, DUVET COVERS, BED COVERS, BED COVERLETS, BED SHEETS, BED SPREADS, BED BLANKETS, DRAPERIES, TABLE CRUMB CLOTHS OF TEXTILE, TEXTILE CURTAINS AND TEXTILE VALENCES, SEAT CUSHION COVERS, DISHCLOTHS, FACE TOWELS; MATTRESS FABRIC CASES AND COVERS; FABRIC PILLOW CASES; TOILET TANK COVERS MADE OF FABRIC; AND CLOTH TOWELS, IN CLASS 24 (U.S. CLS. 42 AND 50).



OWNER OF UNITED KINGDOM REG. NO. 2025444, DATED 10-25-1996, EXPIRES 6-29-2015.

THE MARK CONSISTS OF A BIRDS HEAD IN THE UPPER MIDDLE OF THE MARK. A SHIELD WITH A BOAT, MOON AND STARS SUPERIMPOSED THEREON BELOW THE BIRDS HEAD.

SER. NO. 85-285,356, FILED 4-4-2011.

ALEXANDER L. POWERS, EXAMINING ATTORNEY

David J. Kyros

Director of the United States Patent and Trademark Office

United States of America

United States Patent and Trademark Office



Reg. No. 4,107,846

Registered Mar. 6, 2012

Int. Cl.: 41

SERVICE MARK

PRINCIPAL REGISTER

WILSON, WENDY (UNITED STATES INDIVIDUAL)
519 E INDIANA AVE
COEUR D'ALENE, ID 83814

FOR: EDUCATION AND ENTERTAINMENT SERVICES, NAMELY, TRAINING CHRISTIAN WOMEN IN BIBLICAL KNOWLEDGE AND MINISTRY SKILLS, IN CLASS 41 (U.S. CLS. 100, 101 AND 107).

FIRST USE 6-22-2010; IN COMMERCE 7-6-2010.

NO CLAIM IS MADE TO THE EXCLUSIVE RIGHT TO USE "MINISTRY TRAINING", APART FROM THE MARK AS SHOWN.

THE COLOR(S) PINK, PURPLE AND MAROON IS/ARE CLAIMED AS A FEATURE OF THE MARK.

THE MARK CONSISTS OF THE PURPLE WORDING "WOMEN TO WOMEN MINISTRY TRAINING" AND AN IMAGE OF FOUR PURPLE STICK FIGURE WOMEN DRESSED IN A MAROON AND PURPLE SWIRL, WITH THEIR ARMS INTERTWINED WITH THE ONE ON THE LEFT REACHING HER RIGHT ARM UPWARD, AND THE ONE ON THE RIGHT WITH HER LEFT ARM REACHING OUT TO THE SIDE. THE WORD "TO" CONSISTS OF A STYLIZED PURPLE CROSS FOR THE "T" AND A PINK SUN WITH PURPLE RAYS FOR THE "O". THERE IS A PURPLE ARCH RESEMBLING A HILL UNDERLINING "WOMEN TO WOMEN" ABOVE THE REST OF THE DESIGN AND WORDING.

SER. NO. 85-286,060, FILED 4-5-2011.

TOBY BULLOFF, EXAMINING ATTORNEY



David J. Kybas

Director of the United States Patent and Trademark Office

United States of America

United States Patent and Trademark Office

ONSIP

Reg. No. 4,107,847

Registered Mar. 6, 2012

Int. Cls.: 38 and 42

SERVICE MARK

PRINCIPAL REGISTER

JUNCTION NETWORKS INC. (PENNSYLVANIA CORPORATION)
SUITE 307
2865 S. EAGLE ROAD
NEWTOWN, PA 189401546

FOR: TRANSMISSION OF VOICE, VIDEO, AND INSTANT MESSAGING OVER DIGITAL NETWORKS, IN CLASS 38 (U.S. CLS. 100, 101 AND 104).

FIRST USE 10-0-2007; IN COMMERCE 10-0-2007.

FOR: PROVIDING ON-LINE NON-DOWNLOADABLE SOFTWARE FOR MANAGING VOICE AND INSTANT MESSAGING SERVICES, IN CLASS 42 (U.S. CLS. 100 AND 101).

FIRST USE 10-0-2007; IN COMMERCE 10-0-2007.

THE MARK CONSISTS OF STANDARD CHARACTERS WITHOUT CLAIM TO ANY PARTICULAR FONT, STYLE, SIZE, OR COLOR.

SER. NO. 85-286,298, FILED 4-5-2011.

SHAILA SETTLES, EXAMINING ATTORNEY



David J. Kyjars

Director of the United States Patent and Trademark Office

United States of America

United States Patent and Trademark Office

CONCRETE EXPRESSIONS

Reg. No. 4,107,848

Registered Mar. 6, 2012

Int. Cls.: 37 and 42

SERVICE MARK

PRINCIPAL REGISTER

CONCRETE EXPRESSIONS, LLC (IOWA LIMITED LIABILITY COMPANY)
2109 P AVENUE
CLARINDA, IA 51632

FOR: INSTALLATION OF DECORATIVE CONCRETE; APPLICATION OF CONCRETE COATINGS FOR BEAUTIFICATION PURPOSES; INSTALLATION OF COMMERCIAL AND RESIDENTIAL FLOOR COATINGS, ACID STAINS, AND CONCRETE POLISHING, IN CLASS 37 (U.S. CLS. 100, 103 AND 106).

FIRST USE 5-30-2005; IN COMMERCE 5-30-2008.

FOR: CUSTOM DESIGN OF DECORATIVE CONCRETE BASED ON PERSONAL SELECTIONS MADE BY THE CUSTOMER, IN CLASS 42 (U.S. CLS. 100 AND 101).

FIRST USE 5-30-2005; IN COMMERCE 5-30-2008.

THE MARK CONSISTS OF STANDARD CHARACTERS WITHOUT CLAIM TO ANY PARTICULAR FONT, STYLE, SIZE, OR COLOR.

NO CLAIM IS MADE TO THE EXCLUSIVE RIGHT TO USE "CONCRETE" , APART FROM THE MARK AS SHOWN.

SER. NO. 85-286,824, FILED 4-5-2011.

SHAUNIA CARLYLE, EXAMINING ATTORNEY



David J. Kybas

Director of the United States Patent and Trademark Office

United States of America

United States Patent and Trademark Office



Reg. No. 4,107,849

Registered Mar. 6, 2012

Int. Cls.: 9, 14, 16 and 25

TRADEMARK

PRINCIPAL REGISTER

TIME OF CELEBRATION MINISTRIES CHURCH, INC. (TEXAS CORPORATION)
DR. JACQUELINE T. FLOWERS
10355 MILLS ROAD
HOUSTON, TX 77070

FOR: CD CASES, DVD CASES, PRE-RECORDED CDS, VIDEO TAPES, LASER DISKS AND DVDS FEATURING RELIGIOUS MATERIAL, IN CLASS 9 (U.S. CLS. 21, 23, 26, 36 AND 38).

FIRST USE 1-1-2008; IN COMMERCE 1-1-2008.

FOR: LAPEL PINS, IN CLASS 14 (U.S. CLS. 2, 27, 28 AND 50).

FIRST USE 1-1-2008; IN COMMERCE 1-1-2008.

FOR: PRINTED PAMPHLETS, BROCHURES, MANUALS, BOOKS, BOOKLETS, INFORMATIONAL LEAFLETS, FLYERS, INFORMATIONAL SHEETS AND NEWSLETTERS, DAILY PLANNERS, PRINTED CERTIFICATES, LETTERHEAD PAPER, ENVELOPES, BUSINESS CARDS, BOOKMARKS, ADHESIVE BACKED STICKERS, AND PRINTED INFORMATIONAL KITS COMPRISING ONE OR MORE OF THE FOREGOING MATERIALS, ALL IN THE FIELD OF RELIGION, IN CLASS 16 (U.S. CLS. 2, 5, 22, 23, 29, 37, 38 AND 50).

FIRST USE 1-1-2008; IN COMMERCE 1-1-2008.

FOR: SHIRTS, PANTS, AND HATS, IN CLASS 25 (U.S. CLS. 22 AND 39).

FIRST USE 1-1-2008; IN COMMERCE 1-1-2008.

NO CLAIM IS MADE TO THE EXCLUSIVE RIGHT TO USE "MINISTRIES CHURCH", APART FROM THE MARK AS SHOWN.

THE MARK CONSISTS OF THE WORDING, "TIME OF CELEBRATION MINISTRIES", ABOVE THE WORDING, "CHURCH" IN ALL CAPS, BETWEEN THE OUTSTRETCHED ARMS AND ABOVE THE HEAD OF A STYLIZED REPRESENTATION OF THE UPPER BODY OF A HUMAN, WITH AN UNSHADED CROSS INSIDE AN UNSHADED STYLIZED REPRESENTATION OF A SUN WITH RAYS ON THE CHEST OF THE HUMAN FIGURE, ABOVE A STYLIZED REPRESENTATION OF A GLOBE DEPICTING THE CONTINENTS OF THE WORLD WITH VERTICAL AND HORIZONTAL LINES FORMING SQUARES, WITH



David J. Kybas

Director of the United States Patent and Trademark Office

Reg. No. 4,107,849 THIN CURVED LINES OVERLAYING THE GLOBE AND PARTIAL HUMAN, WITH AN OVAL SHAPE DEPICTING A SHADOW BELOW THE GLOBE CONTAINING AN UNSHADED CURVED LINE.

SER. NO. 85-287,739, FILED 4-6-2011.

ODESSA BIBBINS, EXAMINING ATTORNEY

United States of America

United States Patent and Trademark Office

CASEACT

Reg. No. 4,107,850

CASEACT, LLC (NEW YORK LIMITED LIABILITY COMPANY)
P.O. BOX 040211
BROOKLYN, NY 11204

Registered Mar. 6, 2012

Int. Cl.: 9

FOR: COMPUTER SOFTWARE FOR HANDLING LANDLORD AND TENANT LEGAL MATTERS, IN CLASS 9 (U.S. CLS. 21, 23, 26, 36 AND 38).

TRADEMARK

FIRST USE 1-0-2011; IN COMMERCE 1-0-2011.

PRINCIPAL REGISTER

THE MARK CONSISTS OF STANDARD CHARACTERS WITHOUT CLAIM TO ANY PARTICULAR FONT, STYLE, SIZE, OR COLOR.

SER. NO. 85-287,950, FILED 4-6-2011.

KATHERINE E. HALMEN, EXAMINING ATTORNEY



David J. Kyffers

Director of the United States Patent and Trademark Office

United States of America

United States Patent and Trademark Office



Reg. No. 4,107,851

Registered Mar. 6, 2012

Int. Cl.: 9

TRADEMARK

PRINCIPAL REGISTER

SAVAGE IO, LLC (NEW YORK LIMITED LIABILITY COMPANY)
56 HARVESTER AVENUE
BATAVIA, NY 14020

FOR: COMPUTER HARDWARE; COMPUTER FILE SERVERS; STORAGE AREA NETWORK (SAN) COMPUTER HARDWARE AND OPERATING SOFTWARE; NETWORK ATTACHED STORAGE (NAS) COMPUTER HARDWARE AND OPERATING SOFTWARE; COMPUTER DATA STORAGE AND RETRIEVAL APPARATUS, CONSISTING OF COMPUTER PROCESSORS, COMPUTER NETWORKING HARDWARE, ELECTRONIC MEMORIES, OPERATING SOFTWARE AND COMPUTER HARDWARE DATA STORAGE UNITS, ALL SOLD AS A UNIT; COMPUTER HARDWARE AND COMPUTER SOFTWARE FOR DATA SECURITY AND DATA STORAGE SECURITY; SOFTWARE FOR DATA STORAGE AND INFORMATION MANAGEMENT; SOFTWARE FOR DATA ARCHIVING; SOFTWARE FOR DATA BACKUP AND RECOVERY; COMPUTER SOFTWARE FOR BUSINESS COLLABORATION AND WORK FLOW MANAGEMENT; COMPUTER SOFTWARE FOR CONTENT MANAGEMENT; COMPUTER SOFTWARE FOR DATA MOBILITY IN DATA STORAGE DEVICES; COMPUTER SOFTWARE FOR APPLICATION MANAGEMENT, NETWORK AND TELECOMMUNICATIONS MANAGEMENT, SERVER MANAGEMENT, AND STORAGE RESOURCE MANAGEMENT; COMPUTER SOFTWARE FOR VIRTUALIZATION OF COMPUTER DATA, IN CLASS 9 (U.S. CLS. 21, 23, 26, 36 AND 38).

FIRST USE 1-13-2011; IN COMMERCE 1-13-2011.

NO CLAIM IS MADE TO THE EXCLUSIVE RIGHT TO USE "IO", APART FROM THE MARK AS SHOWN.

THE MARK CONSISTS OF THE WORDS "SAVAGE IO" IN STYLIZED PRINT. THE LEFT PORTION OF THE MARK CONTAINS TWO CLAW-LIKE ELEMENTS POSITIONED AS IF TO FORM AN "S" SHAPE. THE "E" PORTION OF THE WORD "SAVAGE" IS CREATED BY AN IMAGE OF THREE CLAWED FINGERS TEARING THROUGH THE BACKGROUND. THE THREE CLAWED FINGERS REACH TO THE "I" IN "IO".

SER. NO. 85-288,524, FILED 4-7-2011.

MICHELE SWAIN, EXAMINING ATTORNEY



David J. Kyros

Director of the United States Patent and Trademark Office

United States of America

United States Patent and Trademark Office



Reg. No. 4,107,852

Registered Mar. 6, 2012

Int. Cl.: 35

SERVICE MARK

PRINCIPAL REGISTER

THE PURPLE SOCIETY (DELAWARE NON-PROFIT CORPORATION)
6104 E. CLINTON ST.
SCOTTSDALE, AZ 85254

FOR: ASSOCIATION SERVICES, NAMELY, PROMOTING THE PUBLIC INTEREST AND AWARENESS IN CANCER RESEARCH AND EDUCATION, IN CLASS 35 (U.S. CLS. 100, 101 AND 102).

FIRST USE 1-0-2008; IN COMMERCE 1-0-2008.

NO CLAIM IS MADE TO THE EXCLUSIVE RIGHT TO USE "SOCIETY", APART FROM THE MARK AS SHOWN.

THE COLOR(S) PURPLE AND RED IS/ARE CLAIMED AS A FEATURE OF THE MARK.

THE MARK CONSISTS OF THE STYLIZED LETTERS "IP" IN PURPLE WITH THE LETTER "I" HAVING A PURPLE CIRCLE ABOVE IT AND REPRESENTING THE STYLIZED IMAGE OF A STICK PERSON HOLDING A PURPLE BOX WITH RED HEARTS EMERGING FROM THE BOX. BELOW ARE THE PURPLE WORDS "THE IPURPLE SOCIETY", AGAIN WITH THE LETTER "I" HAVING A PURPLE CIRCLE ABOVE IT AND REPRESENTING A SMALLER STYLIZED IMAGE OF A STICK PERSON HOLDING A PURPLE BOX WITH RED HEARTS EMERGING FROM THE BOX. BELOW THAT ARE THE PURPLE WORDS "ONE IPERSON", AGAIN THE LETTER "I" HAVING A PURPLE CIRCLE ABOVE IT AND REPRESENTING A SMALLER STYLIZED IMAGE OF A STICK PERSON HOLDING A PURPLE BOX WITH RED HEARTS EMERGING FROM THE BOX, NEXT TO THE RED WORD "CAN" NEXT TO THE PURPLE PHRASE "MAKE A DIFFERENCE.", ABOVE THE PURPLE WEB ADDRESS "WWW.WERPURPLE.ORG".

SER. NO. 85-288,979, FILED 4-7-2011.

MARY CRAWFORD, EXAMINING ATTORNEY



David J. Kybas

Director of the United States Patent and Trademark Office

United States of America

United States Patent and Trademark Office

EC CAREGIVER AGREEMENT

Reg. No. 4,107,853

Registered Mar. 6, 2012

Int. Cls.: 42 and 45

SERVICE MARK

PRINCIPAL REGISTER

ELDER COUNSEL LLC (DELAWARE LIMITED LIABILITY COMPANY)
20 CORPORATE WOODS BOULEVARD, 3RD FLOOR
ALBANY, NY 12211

FOR: PROVIDING ONLINE NON-DOWNLOADABLE SOFTWARE THAT ENABLES USERS TO ACCESS A DATABASE OF LEGAL FORM DOCUMENTS FOR USE IN DRAFTING USER SPECIFIC LEGAL DOCUMENTS WITH A WORD PROCESSING PROGRAM, IN THE FIELDS OF ELDER LAW, ESTATE PLANNING AND SPECIAL NEEDS LAW; COMPUTER SERVICES, NAMELY, PROVIDING ONLINE NON-DOWNLOADABLE SOFTWARE THAT FACILITATES ACCESS TO AN INTERACTIVE DATABASE OF INSTRUCTIONS IN LEGAL DOCUMENT DRAFTING, AND INFORMATION IN THE FIELDS OF ELDER LAW, ESTATE PLANNING AND SPECIAL NEEDS LAW, IN CLASS 42 (U.S. CLS. 100 AND 101).

FIRST USE 7-1-2008; IN COMMERCE 7-1-2008.

FOR: PROVIDING A WEB-BASED SYSTEM AND ONLINE PORTAL FEATURING AN ON-LINE INTERACTIVE DATABASE OF LEGAL FORM DOCUMENTS, INSTRUCTIONS ON DRAFTING LEGAL DOCUMENTS, AND INFORMATION IN THE FIELDS OF ELDER LAW, ESTATE PLANNING AND SPECIAL NEEDS LAW, IN CLASS 45 (U.S. CLS. 100 AND 101).

FIRST USE 7-1-2008; IN COMMERCE 7-1-2008.

THE MARK CONSISTS OF STANDARD CHARACTERS WITHOUT CLAIM TO ANY PARTICULAR FONT, STYLE, SIZE, OR COLOR.

NO CLAIM IS MADE TO THE EXCLUSIVE RIGHT TO USE "CAREGIVER AGREEMENT", APART FROM THE MARK AS SHOWN.

SER. NO. 85-289,239, FILED 4-7-2011.

BARBARA A. GOLD, EXAMINING ATTORNEY



David J. Kybas

Director of the United States Patent and Trademark Office

United States of America

United States Patent and Trademark Office

The Financial Guys

Reg. No. 4,107,854

Registered Mar. 6, 2012

Int. Cl.: 36

SERVICE MARK

PRINCIPAL REGISTER

THE FINANCIAL GUYS LLC (NEW YORK LIMITED LIABILITY COMPANY)
6631 MAIN STREET
WILLIAMSVILLE, NY 14221

FOR: CAPITAL INVESTMENT SERVICES; FINANCIAL AND INVESTMENT SERVICES, NAMELY, ASSET AND INVESTMENT ACQUISITION, CONSULTATION, ADVISORY AND DEVELOPMENT; FINANCIAL AND INVESTMENT SERVICES, NAMELY, MANAGEMENT AND BROKERAGE IN THE FIELDS OF STOCKS, BONDS, OPTIONS, COMMODITIES, FUTURES AND OTHER SECURITIES, AND THE INVESTMENT OF FUNDS OF OTHERS; FINANCIAL PLANNING FOR RETIREMENT; INVESTMENT SERVICES, NAMELY, ASSET ACQUISITION, CONSULTATION, DEVELOPMENT AND MANAGEMENT SERVICES, IN CLASS 36 (U.S. CLS. 100, 101 AND 102).

FIRST USE 7-31-1999; IN COMMERCE 7-31-1999.

THE MARK CONSISTS OF STANDARD CHARACTERS WITHOUT CLAIM TO ANY PARTICULAR FONT, STYLE, SIZE, OR COLOR.

NO CLAIM IS MADE TO THE EXCLUSIVE RIGHT TO USE "FINANCIAL", APART FROM THE MARK AS SHOWN.

SER. NO. 85-289,860, FILED 4-8-2011.

JORDAN BAKER, EXAMINING ATTORNEY



David J. Kyffers

Director of the United States Patent and Trademark Office

United States of America

United States Patent and Trademark Office



Reg. No. 4,107,855

ASYNC RECRUITING, LLC (PENNSYLVANIA LIMITED LIABILITY COMPANY)
1328 ARTHUR AVE.
MAPLE GLEN, PA 19002

Registered Mar. 6, 2012

Int. Cl.: 41

FOR: PROVIDING AN INTERACTIVE WEB SITE WITH ONLINE INTERVIEWING APPLICATIONS TO SUPPORT RECRUITING, ADMISSIONS, AND GENERAL CANDIDATE SCREENING PROCESSES FOR COMMERCIAL PURPOSES, IN CLASS 41 (U.S. CLS. 100, 101 AND 107).

SERVICE MARK

PRINCIPAL REGISTER

FIRST USE 7-26-2011; IN COMMERCE 7-26-2011.

THE MARK CONSISTS OF THE WORDING, "VIEW WHENEVER DECIDE TOGETHER" IN WHITE STYLIZED FORM, WITHIN THE DESIGN OF TWO CONCENTRIC CIRCLES, A SOLID BLUE CIRCLE INSIDE AND BORDERED BY A THIN WHITE CIRCLE.

THE COLOR(S) BLUE AND WHITE IS/ARE CLAIMED AS A FEATURE OF THE MARK.

SER. NO. 85-290,271, FILED 4-8-2011.

BARBARA A. GOLD, EXAMINING ATTORNEY



David J. Kybas

Director of the United States Patent and Trademark Office

United States of America

United States Patent and Trademark Office

PINEBANK

ASSET MANAGEMENT

Reg. No. 4,107,856

PINEBANK ASSET MANAGEMENT, LP (DELAWARE LIMITED PARTNERSHIP)
100 PARK AVENUE, 32TH FLOOR
NEW YORK, NY 10017

Registered Mar. 6, 2012

Int. Cl.: 36

FOR: FINANCIAL SERVICES, NAMELY, FINANCIAL FUNDS MANAGEMENT, IN CLASS 36 (U.S. CLS. 100, 101 AND 102).

SERVICE MARK

FIRST USE 2-1-2011; IN COMMERCE 2-1-2011.

PRINCIPAL REGISTER

NO CLAIM IS MADE TO THE EXCLUSIVE RIGHT TO USE "ASSET MANAGEMENT", APART FROM THE MARK AS SHOWN.

THE MARK CONSISTS OF THE WORD "PINEBANK" IN STYLIZED TYPEFACE ABOVE A STYLIZED REPRESENTATION OF A BRIDGE WITH THE WORDS "ASSET MANAGEMENT" IN STYLIZED TYPEFACE BELOW.

SER. NO. 85-290,401, FILED 4-8-2011.

SUSAN LESLIE DUBOIS, EXAMINING ATTORNEY



David J. Kyros

Director of the United States Patent and Trademark Office

United States of America

United States Patent and Trademark Office

Wiink

Reg. No. 4,107,857

Registered Mar. 6, 2012

Int. Cl.: 43

SERVICE MARK

PRINCIPAL REGISTER

WIINKYS LLC (VIRGINIA LIMITED LIABILITY COMPANY), DBA WIINKYS
P.O. BOX 2631
SPRINGFIELD, VA 22152

FOR: CARRY-OUT RESTAURANTS; CONSULTATION SERVICES IN THE FIELD OF RESTAURANT MENU DEVELOPMENT; FAST FOOD AND NON-STOP RESTAURANT SERVICES; FAST-FOOD RESTAURANT SERVICES; FAST-FOOD RESTAURANTS; RESTAURANT; RESTAURANT SERVICES; RESTAURANT SERVICES FEATURING SANDWICHES; RESTAURANT SERVICES FEATURING CHAR BROIL, GRILL, STEAM AND FRY; RESTAURANT SERVICES, INCLUDING SIT-DOWN SERVICE OF FOOD AND TAKE-OUT RESTAURANT SERVICES; RESTAURANT SERVICES, NAMELY, PROVIDING OF FOOD AND BEVERAGES FOR CONSUMPTION ON AND OFF THE PREMISES; RESTAURANTS; RESTAURANTS FEATURING HOME DELIVERY; TAKE-OUT RESTAURANT SERVICES, IN CLASS 43 (U.S. CLS. 100 AND 101).

FIRST USE 7-27-2010; IN COMMERCE 7-27-2010.

THE MARK CONSISTS OF STANDARD CHARACTERS WITHOUT CLAIM TO ANY PARTICULAR FONT, STYLE, SIZE, OR COLOR.

SER. NO. 85-291,181, FILED 4-10-2011.

JOHN DWYER, EXAMINING ATTORNEY



David J. Kyros

Director of the United States Patent and Trademark Office

United States of America

United States Patent and Trademark Office



Reg. No. 4,107,858

Registered Mar. 6, 2012

Int. Cl.: 16

TRADEMARK

PRINCIPAL REGISTER

PATTERSON, MALCOLM (UNITED STATES INDIVIDUAL)
AGAINST THE GRAIN MAGAZINE - SUITE Q
14165 BISSONNET
HOUSTON, TX 77083

FOR: MAGAZINES IN THE FIELD OF THE TONSORIAL ARTS, IN CLASS 16 (U.S. CLS. 2, 5, 22, 23, 29, 37, 38 AND 50).

FIRST USE 8-1-2005; IN COMMERCE 8-1-2005.

NO CLAIM IS MADE TO THE EXCLUSIVE RIGHT TO USE "BARBERSHOP" AND "PUBLICATION", APART FROM THE MARK AS SHOWN.

THE COLOR(S) RED, BLACK, WHITE AND SILVER IS/ARE CLAIMED AS A FEATURE OF THE MARK.

THE MARK CONSISTS OF A BARBER POLE DESIGN WITH RED, BLACK AND WHITE STRIPES AND A SILVER AND RED BASE AND A BLACK, WHITE AND SILVER BULB AT THE TOP THAT POINTS TO THE RIGHT IN A BLACK BACKGROUND ENCASED IN A SILVER FRAME ALL OF WHICH IS HOUSED IN A RED BACKGROUND WITH THE WORDS "AGAINST THE GRAIN" OUTLINED IN WHITE LETTERS UNDER THE DESIGN, SURROUNDED BY A BLACK RECTANGULAR FRAME WITH THE WORDS "THE BARBERSHOP LIFESTYLE PUBLICATION" AT THE BOTTOM OUTLINED IN WHITE IN A BLACK RECTANGULAR FRAME.

SER. NO. 85-291,188, FILED 4-10-2011.

TRACY WHITTAKER-BROWN, EXAMINING ATTORNEY



David J. Kybas

Director of the United States Patent and Trademark Office

United States of America

United States Patent and Trademark Office

SKYDIVE KENTUCKY

Reg. No. 4,107,859

Registered Mar. 6, 2012

Int. Cl.: 35

SERVICE MARK

PRINCIPAL REGISTER

SKYDIVE KY, LLC (KENTUCKY LIMITED LIABILITY COMPANY), AKA SKYDIVE KENTUCKY
5878 COLUMBIA HIGHWAY
GREENSBURG, KY 42743

FOR: ON-LINE RETAIL STORE SERVICES FEATURING SKYDIVING GEAR, MANUALS, EDUCATIONAL MATERIALS AND ART AND LITERATURE RELATING TO SKYDIVING; RETAIL STORES FEATURING SKYDIVING GEAR, MANUALS, EDUCATIONAL MATERIALS AND ART AND LITERATURE RELATING TO SKYDIVING, IN CLASS 35 (U.S. CLS. 100, 101 AND 102).

FIRST USE 0-0-2003; IN COMMERCE 0-0-2003.

THE MARK CONSISTS OF STANDARD CHARACTERS WITHOUT CLAIM TO ANY PARTICULAR FONT, STYLE, SIZE, OR COLOR.

OWNER OF U.S. REG. NOS. 4,015,146 AND 4,033,875.

NO CLAIM IS MADE TO THE EXCLUSIVE RIGHT TO USE "SKYDIVE", APART FROM THE MARK AS SHOWN.

SEC. 2(F).

SER. NO. 85-292,495, FILED 4-12-2011.

JAY FLOWERS, EXAMINING ATTORNEY



David J. Kyffers

Director of the United States Patent and Trademark Office

United States of America

United States Patent and Trademark Office

SAVAGE IO

Reg. No. 4,107,860

Registered Mar. 6, 2012

Int. Cl.: 9

TRADEMARK

PRINCIPAL REGISTER

SAVAGE IO, LLC (NEW YORK LIMITED LIABILITY COMPANY)
56 HARVESTER AVENUE
BATAVIA, NY 14020

FOR: COMPUTER HARDWARE; COMPUTER FILE SERVERS; STORAGE AREA NETWORK (SAN) COMPUTER HARDWARE AND OPERATING SOFTWARE; NETWORK ATTACHED STORAGE (NAS) COMPUTER HARDWARE AND OPERATING SOFTWARE; COMPUTER DATA STORAGE AND RETRIEVAL APPARATUS, CONSISTING OF COMPUTER PROCESSORS, COMPUTER NETWORKING HARDWARE, ELECTRONIC MEMORIES, OPERATING SOFTWARE AND COMPUTER HARDWARE DATA STORAGE UNITS, ALL SOLD AS A UNIT; COMPUTER HARDWARE AND COMPUTER SOFTWARE FOR DATA SECURITY AND DATA STORAGE SECURITY; SOFTWARE FOR DATA STORAGE AND INFORMATION MANAGEMENT; SOFTWARE FOR DATA ARCHIVING; SOFTWARE FOR DATA BACKUP AND RECOVERY; COMPUTER SOFTWARE FOR BUSINESS COLLABORATION AND WORK FLOW MANAGEMENT; COMPUTER SOFTWARE FOR CONTENT MANAGEMENT; COMPUTER SOFTWARE FOR DATA MOBILITY IN DATA STORAGE DEVICES; COMPUTER SOFTWARE FOR APPLICATION MANAGEMENT, NETWORK AND TELECOMMUNICATIONS MANAGEMENT, SERVER MANAGEMENT, AND STORAGE RESOURCE MANAGEMENT; COMPUTER SOFTWARE FOR VIRTUALIZATION OF COMPUTER DATA, IN CLASS 9 (U.S. CLS. 21, 23, 26, 36 AND 38).

FIRST USE 12-10-2010; IN COMMERCE 12-10-2010.

THE MARK CONSISTS OF STANDARD CHARACTERS WITHOUT CLAIM TO ANY PARTICULAR FONT, STYLE, SIZE, OR COLOR.

NO CLAIM IS MADE TO THE EXCLUSIVE RIGHT TO USE "IO", APART FROM THE MARK AS SHOWN.

SER. NO. 85-292,498, FILED 4-12-2011.

MICHELE SWAIN, EXAMINING ATTORNEY



David J. Kyros

Director of the United States Patent and Trademark Office

United States of America

United States Patent and Trademark Office

HUGGABLE IMAGES

Reg. No. 4,107,861

JEANIE CRAIG (UNITED STATES INDIVIDUAL)

Registered Mar. 6, 2012

P.O. BOX 7861
SHAWNEE MISSION, KS 66207

Int. Cl.: 9

FOR: SAFETY TRAINING DOLLS FOR DEMONSTRATION AND TEACHING PURPOSES,
IN CLASS 9 (U.S. CLS. 21, 23, 26, 36 AND 38).

TRADEMARK

FIRST USE 6-30-2006; IN COMMERCE 12-23-2006.

PRINCIPAL REGISTER

THE MARK CONSISTS OF STANDARD CHARACTERS WITHOUT CLAIM TO ANY PARTICULAR FONT, STYLE, SIZE, OR COLOR.

OWNER OF U.S. REG. NO. 2,936,942.

SER. NO. 85-292,752, FILED 4-12-2011.

BERNICE MIDDLETON, EXAMINING ATTORNEY



David J. Kybas

Director of the United States Patent and Trademark Office

United States of America

United States Patent and Trademark Office

Wizard IV

Reg. No. 4,107,862

Registered Mar. 6, 2012

Int. Cl.: 16

TRADEMARK

PRINCIPAL REGISTER

HIZINC LLC (HAWAII LIMITED LIABILITY COMPANY)
333 KILAUEA AVE.
HILO, HI 96720

FOR: CHILDREN'S ACTIVITY BOOKS; EDUCATIONAL KITS SOLD AS A UNIT IN THE FIELD OF SCIENCE CONSISTING PRIMARILY OF PRINTED ACTIVITY BOOKS, WORKBOOKS, AND ALSO INCLUDING DVDS; PACKAGED KITS COMPRISING PRINTED INSTRUCTIONAL, EDUCATIONAL, AND TEACHING MATERIALS FOR EDUCATIONAL ACTIVITIES IN THE FIELD OF SCIENCE, IN CLASS 16 (U.S. CLS. 2, 5, 22, 23, 29, 37, 38 AND 50).

FIRST USE 10-28-2010; IN COMMERCE 3-20-2011.

THE MARK CONSISTS OF STANDARD CHARACTERS WITHOUT CLAIM TO ANY PARTICULAR FONT, STYLE, SIZE, OR COLOR.

SER. NO. 85-293,515, FILED 4-12-2011.

JAMES GRIFFIN, EXAMINING ATTORNEY



David J. Kyffers

Director of the United States Patent and Trademark Office

United States of America

United States Patent and Trademark Office

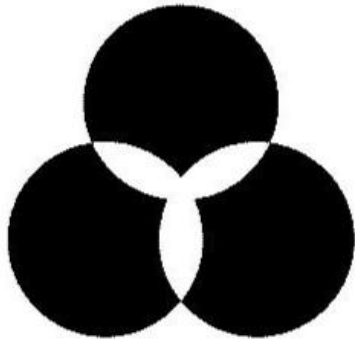

Advisor

Reg. No. 4,107,863

Registered Mar. 6, 2012

Int. Cl.: 42

SERVICE MARK

PRINCIPAL REGISTER

PROBLEM KNOWLEDGE COUPLER CORPORATION (DELAWARE CORPORATION)
BOX C13
1 MILL STREET
BURLINGTON, VT 05401

FOR: PROVIDING TEMPORARY USE OF NON-DOWNLOADABLE INTERNET-BASED SOFTWARE FOR MEDICAL PROVIDERS THAT PROCESSES CLINICALLY RELEVANT PATIENT INFORMATION TO PRODUCE EVIDENCE-BASED DIFFERENTIAL DIAGNOSES AND CARE STRATEGIES FOR USE WITH PATIENTS AND ELECTRONIC HEALTH RECORD SYSTEMS, IN CLASS 42 (U.S. CLS. 100 AND 101).

FIRST USE 2-21-2011; IN COMMERCE 2-21-2011.

NO CLAIM IS MADE TO THE EXCLUSIVE RIGHT TO USE "ADVISOR", APART FROM THE MARK AS SHOWN.

THE MARK CONSISTS OF THE WORD "ADVISOR"; THE TERM APPEARS TO THE RIGHT OF THREE OVERLAPPING CIRCLES IN A TRIANGULAR SHAPE.

SER. NO. 85-293,693, FILED 4-13-2011.

KATHRYN COWARD, EXAMINING ATTORNEY



David J. Kybas

Director of the United States Patent and Trademark Office

United States of America

United States Patent and Trademark Office

KDS

Reg. No. 4,107,864

Registered Mar. 6, 2012

Int. Cl.: 9

TRADEMARK

PRINCIPAL REGISTER

MURATEC-KDS CORP. (JAPAN CORPORATION)
39, MATSUDA-CHO, HIGASHI-KUJO, MINAMI-KU
KYOTO-SHI, KYOTO, JAPAN 601-8036

FOR: MEASURING APPARATUS, NAMELY, MEASURING TAPES, MEASURING RODS
AND FOLDING SCALES, IN CLASS 9 (U.S. CLS. 21, 23, 26, 36 AND 38).

FIRST USE 9-0-1965; IN COMMERCE 9-0-1965.

THE MARK CONSISTS OF STANDARD CHARACTERS WITHOUT CLAIM TO ANY PAR-
TICULAR FONT, STYLE, SIZE, OR COLOR.

OWNER OF U.S. REG. NO. 967,023.

SER. NO. 85-293,947, FILED 4-13-2011.

GINA HAYES, EXAMINING ATTORNEY



David J. Kyffers

Director of the United States Patent and Trademark Office

United States of America

United States Patent and Trademark Office

CROWN WEALTH MANAGEMENT
LIVE ABUNDANTLY, GIVE
GENEROUSLY.

Reg. No. 4,107,865

Registered Mar. 6, 2012

Int. Cl.: 36

SERVICE MARK

PRINCIPAL REGISTER

CROWN WEALTH MANAGEMNET, INC. (CALIFORNIA CORPORATION)
680
17011 BEACH BOULEVARD
HUNTINGTON BEACH, CA 92647

FOR: FINANCIAL SERVICES, NAMELY, WEALTH MANAGEMENT SERVICES, IN CLASS
36 (U.S. CLS. 100, 101 AND 102).

FIRST USE 7-1-2010; IN COMMERCE 7-14-2010.

THE MARK CONSISTS OF STANDARD CHARACTERS WITHOUT CLAIM TO ANY PAR-
TICULAR FONT, STYLE, SIZE, OR COLOR.

NO CLAIM IS MADE TO THE EXCLUSIVE RIGHT TO USE "WEALTH MANAGEMENT",
APART FROM THE MARK AS SHOWN.

SER. NO. 85-294,604, FILED 4-13-2011.

MICHELE SWAIN, EXAMINING ATTORNEY



David J. Kybas

Director of the United States Patent and Trademark Office

United States of America

United States Patent and Trademark Office

SILVER PERSPECTIVES

Reg. No. 4,107,866

Registered Mar. 6, 2012

Int. Cl.: 41

SERVICE MARK

PRINCIPAL REGISTER

SILVERSEA CRUISES LTD. (BAHAMAS CORPORATION)
110 EAST BROWARD BOULEVARD
FORT LAUDERDALE, FL 33301

FOR: EDUCATION, ACADEMIC AND ENRICHMENT PROGRAMS AND ENTERTAINMENT SERVICES, NAMELY, PROVIDING AND CONDUCTING CLASSES, SEMINARS, WORKSHOPS, LECTURES, PRESENTATIONS, SPEAKERS AND PROGRAMS ON CRUISE SHIPS IN THE FIELDS OF ANTHROPOLOGY, ART HISTORY, ASTRONOMY, AVIATION, BIOLOGY, BROADCASTING, BUSINESS, COMEDY, CULINARY ARTS, CULTURE, CURRENT AFFAIRS, DIPLOMACY, DRAMA, ENVIRONMENT, FILM, FOREIGN AFFAIRS, FORENSIC PATHOLOGY, GEOGRAPHY, GEOLOGY, HEALTH AND WELLBEING, HISTORY, INTERNATIONAL RELATIONS, JOURNALISM, LOCAL CULTURE, MARITIME HISTORY, MUSIC, MUSICAL THEATER, NATURAL HISTORY, OCEAN LINERS, PHOTOGRAPHY, POLITICS, RELIGION, SCIENCE, SPACE FLIGHT, SPORTS, TECHNOLOGY, THEATER, THEOLOGY, TRAVEL, WINE, WRITING AND ZOOLOGY AND DISTRIBUTION OF COURSE MATERIALS IN CONNECTION THEREWITH ON CRUISE SHIPS, IN CLASS 41 (U.S. CLS. 100, 101 AND 107).

FIRST USE 1-17-2011; IN COMMERCE 2-14-2011.

THE MARK CONSISTS OF STANDARD CHARACTERS WITHOUT CLAIM TO ANY PARTICULAR FONT, STYLE, SIZE, OR COLOR.

SER. NO. 85-295,151, FILED 4-14-2011.

SKYE YOUNG, EXAMINING ATTORNEY



David J. Kyros

Director of the United States Patent and Trademark Office

United States of America

United States Patent and Trademark Office

Eclectik Decor

Reg. No. 4,107,867

DESIL, SHERLY M. (UNITED STATES INDIVIDUAL)
248 E 28 STREET APT 1A
BROOKLYN, NY 11226

Registered Mar. 6, 2012

Int. Cl.: 41

FOR: PARTY AND WEDDING PLANNING, COORDINATION AND CONSULTATION SERVICES; PARTY PLANNING, IN CLASS 41 (U.S. CLS. 100, 101 AND 107).

SERVICE MARK

FIRST USE 8-8-2011; IN COMMERCE 8-22-2011.

PRINCIPAL REGISTER

THE MARK CONSISTS OF STANDARD CHARACTERS WITHOUT CLAIM TO ANY PARTICULAR FONT, STYLE, SIZE, OR COLOR.

NO CLAIM IS MADE TO THE EXCLUSIVE RIGHT TO USE "DECOR", APART FROM THE MARK AS SHOWN.

SER. NO. 85-296,131, FILED 4-15-2011.

STEVEN JACKSON, EXAMINING ATTORNEY



David J. Kyffers

Director of the United States Patent and Trademark Office

United States of America

United States Patent and Trademark Office



Reg. No. 4,107,868

Registered Mar. 6, 2012

Int. Cls.: 41 and 45

SERVICE MARK

PRINCIPAL REGISTER

NYP HOLDINGS, INC. (DELAWARE CORPORATION)
1211 AVENUE OF THE AMERICAS
NEW YORK, NY 10036

FOR: ENTERTAINMENT SERVICES, NAMELY, PROVIDING INFORMATION AND PHOTOGRAPHS ABOUT CELEBRITIES, CELEBRITY LIFE STYLES, GOSSIP, CULTURAL EVENTS, AND THE PERFORMING ARTS VIA THE INTERNET AND MOBILE ELECTRONIC DEVICES, IN CLASS 41 (U.S. CLS. 100, 101 AND 107).

FIRST USE 1-0-1998; IN COMMERCE 1-0-1998.

FOR: PROVIDING INFORMATION AND PHOTOGRAPHS ABOUT FASHION, IN CLASS 45 (U.S. CLS. 100 AND 101).

FIRST USE 1-0-1998; IN COMMERCE 1-0-1998.

OWNER OF U.S. REG. NOS. 2,851,018, 3,548,133 AND OTHERS.

THE MARK CONSISTS OF THE WORDS "PAGE SIX" IN A STYLIZED FONT, WHERE THE WORD "PAGE" APPEARS ON TOP OF THE WORD "SIX".

SER. NO. 85-296,381, FILED 4-15-2011.

LEIGH CAROLINE CASE, EXAMINING ATTORNEY



David J. Kyjars

Director of the United States Patent and Trademark Office

United States of America

United States Patent and Trademark Office

OSNOVA

Reg. No. 4,107,869

Registered Mar. 6, 2012

Int. Cl.: 9

TRADEMARK

PRINCIPAL REGISTER

ANTONENKO, ILYYA P. (UKRAINE INDIVIDUAL), DBA OSNOVA
11 SAN VINCENTE
RANCHO SANTA MARGARITA, CA 92688

FOR: DOWNLOADABLE ELECTRONIC PUBLICATIONS IN THE NATURE OF BOOKS, DICTIONARIES, MAGAZINES, NEWSLETTERS, AND JOURNALS IN THE FIELDS OF RELIGION, SCIENCE, LAW, EDUCATION, ENTERTAINMENT, SPORTS, HISTORY, CULTURE, CELEBRITIES, NEWS, CURRENT EVENTS, POLITICS, AND TECHNOLOGY, IN CLASS 9 (U.S. CLS. 21, 23, 26, 36 AND 38).

FIRST USE 10-18-2009; IN COMMERCE 10-18-2009.

THE MARK CONSISTS OF STANDARD CHARACTERS WITHOUT CLAIM TO ANY PARTICULAR FONT, STYLE, SIZE, OR COLOR.

THE ENGLISH TRANSLATION OF "OSNOVA" IN THE MARK IS "BASIS".

SER. NO. 85-296,551, FILED 4-15-2011.

GEOFFREY FOSDICK, EXAMINING ATTORNEY



David J. Kyffers

Director of the United States Patent and Trademark Office

United States of America

United States Patent and Trademark Office

ROAD SQUAD

Reg. No. 4,107,870

Registered Mar. 6, 2012

Int. Cl.: 37

SERVICE MARK

PRINCIPAL REGISTER

TA OPERATING LLC (DELAWARE LIMITED LIABILITY COMPANY)
SUITE 200
24601 CENTER RIDGE ROAD
WESTLAKE, OH 441455639

FOR: EMERGENCY ROAD SIDE REPAIR SERVICES; EMERGENCY ROADSIDE ASSISTANCE SERVICES, NAMELY, RESPONDING TO CALLS FOR ROADSIDE ASSISTANCE, FLAT TIRE CHANGING, EMERGENCY FUEL SUPPLYING, AND BATTERY JUMP STARTING, IN CLASS 37 (U.S. CLS. 100, 103 AND 106).

FIRST USE 1-1-2008; IN COMMERCE 1-1-2008.

THE MARK CONSISTS OF STANDARD CHARACTERS WITHOUT CLAIM TO ANY PARTICULAR FONT, STYLE, SIZE, OR COLOR.

OWNER OF U.S. REG. NO. 3,802,347.

SER. NO. 85-296,788, FILED 4-15-2011.

MIDGE BUTLER, EXAMINING ATTORNEY



David J. Kyffers

Director of the United States Patent and Trademark Office

United States of America

United States Patent and Trademark Office

LADYDUST

Reg. No. 4,107,871

Registered Mar. 6, 2012

Int. Cl.: 41

SERVICE MARK

PRINCIPAL REGISTER

MARINA TSIGONAKI (GREECE INDIVIDUAL), DBA LADYDUST
AGISILAOU 11, KASTELLA
PIRAEUS, GREECE 18533

FOR: DISC JOCKEY SERVICES; ENTERTAINMENT IN THE NATURE OF ACTING, NAMELY, PRESENTATION OF PLAYS, ACTING IN LEADING AND SUPPORTING ROLES IN FILMS AND TELEVISION PROGRAMS, DUBBING FOR FILMS; FASHION MODELING FOR ENTERTAINMENT PURPOSES; MODELING FOR ARTISTS; POEM AND LYRIC WRITING; PRODUCTION AND DISTRIBUTION OF RADIO PROGRAMS; WRITING OF ARTICLES FOR JOURNALS OTHER THAN FOR ADVERTISING OR PUBLICITY; WRITING OF TEXTS, IN CLASS 41 (U.S. CLS. 100, 101 AND 107).

FIRST USE 11-26-2003; IN COMMERCE 3-1-2011.

THE MARK CONSISTS OF STANDARD CHARACTERS WITHOUT CLAIM TO ANY PARTICULAR FONT, STYLE, SIZE, OR COLOR.

SER. NO. 85-297,091, FILED 4-16-2011.

ANDREA K. NADELMAN, EXAMINING ATTORNEY



David J. Kyros

Director of the United States Patent and Trademark Office

United States of America

United States Patent and Trademark Office

BigRyAT

Reg. No. 4,107,872

BIGRYAT ENTERTAINMENT, INC. (CALIFORNIA CORPORATION), DBA BIGRYAT
9 SOFTWIND
ALISO VIEJO, CA 92656

Registered Mar. 6, 2012

Int. Cl.: 41

FOR: ENTERTAINMENT SERVICES, NAMELY, LIVE MUSICAL PERFORMANCES BY A MUSICIAN, RAP ARTIST, BEAT MAKER, AND PERFORMANCE ARTIST; ENTERTAINMENT IN THE NATURE OF DANCE PERFORMANCES, IN CLASS 41 (U.S. CLS. 100, 101 AND 107).

SERVICE MARK

PRINCIPAL REGISTER

FIRST USE 6-1-1984; IN COMMERCE 6-1-1984.

THE MARK CONSISTS OF STANDARD CHARACTERS WITHOUT CLAIM TO ANY PARTICULAR FONT, STYLE, SIZE, OR COLOR.

THE NAME "BIGRYAT" IDENTIFIES A LIVING INDIVIDUAL WHOSE CONSENT IS OF RECORD.

SER. NO. 85-297,110, FILED 4-16-2011.

ELI HELLMAN, EXAMINING ATTORNEY



David J. Kybas

Director of the United States Patent and Trademark Office

United States of America

United States Patent and Trademark Office

ednovo

Reg. No. 4,107,873

Registered Mar. 6, 2012

Int. Cl.: 41

SERVICE MARK

PRINCIPAL REGISTER

EDNOVO (CALIFORNIA NON-PROFIT ORGANIZATION)
1000 ELWELL COURT, SUITE 110
PALO ALTO, CA 94303

FOR: EDUCATIONAL SERVICES, NAMELY, CONDUCTING ONLINE COURSES OF INSTRUCTION AT PRIMARY, SECONDARY AND COLLEGE LEVEL IN THE FIELD OF SCIENCE, MATH, SOCIAL STUDIES, LANGUAGES, AND ECONOMICS AND DISTRIBUTION OF COURSE MATERIAL IN CONNECTION THEREWITH, IN CLASS 41 (U.S. CLS. 100, 101 AND 107).

FIRST USE 1-4-2011; IN COMMERCE 1-4-2011.

THE MARK CONSISTS OF STANDARD CHARACTERS WITHOUT CLAIM TO ANY PARTICULAR FONT, STYLE, SIZE, OR COLOR.

SER. NO. 85-297,125, FILED 4-16-2011.

BARBARA RUTLAND, EXAMINING ATTORNEY



David J. Kybas

Director of the United States Patent and Trademark Office

United States of America

United States Patent and Trademark Office

ONE STEP

Reg. No. 4,107,874

Registered Mar. 6, 2012

Int. Cl.: 19

TRADEMARK

PRINCIPAL REGISTER

SUPER-TEK PRODUCTS, INC. (NEW YORK CORPORATION)
25-44 BOROUGH PLACE
WOODSIDE, NY 11377

FOR: THIN-SET MORTAR FOR CERAMIC, PORCELAIN, QUARRY MARBLE, PAVERS
AND OTHER NATURAL STONE TILE INSTALLATIONS, IN CLASS 19 (U.S. CLS. 1, 12, 33
AND 50).

FIRST USE 1-1-1986; IN COMMERCE 1-1-1986.

THE MARK CONSISTS OF STANDARD CHARACTERS WITHOUT CLAIM TO ANY PAR-
TICULAR FONT, STYLE, SIZE, OR COLOR.

SER. NO. 85-297,491, FILED 4-18-2011.

KYLE PEETE, EXAMINING ATTORNEY



David J. Kyffers

Director of the United States Patent and Trademark Office

United States of America

United States Patent and Trademark Office



Reg. No. 4,107,875

RYAN H MAGUIRE (UNITED STATES INDIVIDUAL)
4 FERRY ROAD
SAUNDERSTOWN, RI 02874

Registered Mar. 6, 2012

Int. Cl.: 41

FOR: ENTERTAINMENT SERVICES, NAMELY, THE PROVISION OF CONTINUING ART, MOVIES, FILMS, WEBISODES, GAMES, SHOWS FEATURING COMEDY, ACTION, SATIRE, DRAMA, SCI-FI DELIVERED BY PRINT, TELEVISION, RADIO, SATELLITE, THE INTERNET, OR LIVE, IN CLASS 41 (U.S. CLS. 100, 101 AND 107).

SERVICE MARK

PRINCIPAL REGISTER

FIRST USE 3-30-2011; IN COMMERCE 4-15-2011.

THE MARK CONSISTS OF A UNIQUE ICONIC SEVEN POINT SKULL DESIGN ON TOP OF THE WORD DESIGN "THUNDER HIGH CHIEF".

SER. NO. 85-297,503, FILED 4-18-2011.

MARGERY A. TIERNEY, EXAMINING ATTORNEY



David J. Kyffers

Director of the United States Patent and Trademark Office

United States of America

United States Patent and Trademark Office

CTC

Reg. No. 4,107,876

Registered Mar. 6, 2012

Int. Cl.: 9

TRADEMARK

PRINCIPAL REGISTER

CTC BATTERY, INC. (CALIFORNIA CORPORATION)
21363 CABOT BLVD
HAYWARD, CA 94545

FOR: BATTERIES, IN CLASS 9 (U.S. CLS. 21, 23, 26, 36 AND 38).

FIRST USE 3-3-2010; IN COMMERCE 3-3-2010.

THE MARK CONSISTS OF STANDARD CHARACTERS WITHOUT CLAIM TO ANY PARTICULAR FONT, STYLE, SIZE, OR COLOR.

SER. NO. 85-299,384, FILED 4-19-2011.

GINA HAYES, EXAMINING ATTORNEY



David J. Kybas

Director of the United States Patent and Trademark Office

United States of America

United States Patent and Trademark Office

Fresh Beauty Market

Reg. No. 4,107,877

Registered Mar. 6, 2012

Int. Cl.: 3

GSC PRODUCTS, LLC (NEW YORK LIMITED LIABILITY COMPANY), DBA YOUTHFUL TRENDS

YOURHFUL TRENDS
222 GUIDEBOARD ROAD
CLIFTON PARK, NY 12065

TRADEMARK

FOR: BODY AND BEAUTY CARE COSMETICS, IN CLASS 3 (U.S. CLS. 1, 4, 6, 50, 51 AND 52).

PRINCIPAL REGISTER

FIRST USE 12-1-2010; IN COMMERCE 1-1-2011.

THE MARK CONSISTS OF STANDARD CHARACTERS WITHOUT CLAIM TO ANY PARTICULAR FONT, STYLE, SIZE, OR COLOR.

NO CLAIM IS MADE TO THE EXCLUSIVE RIGHT TO USE "BEAUTY", APART FROM THE MARK AS SHOWN.

SER. NO. 85-300,382, FILED 4-20-2011.

KATHRYN COWARD, EXAMINING ATTORNEY



David J. Kyffers

Director of the United States Patent and Trademark Office

United States of America

United States Patent and Trademark Office

KONZERN

Reg. No. 4,107,878

Registered Mar. 6, 2012

Int. Cl.: 5

TRADEMARK

PRINCIPAL REGISTER

CHINA MEDICINE CORPORATION (NEVADA CORPORATION)
2/F, GUANGRI MANSION, NO. 9
1ST ALLEY, 1ST STREET, SIYOU NAN RD
GUANGZHOU, CHINA 510600

FOR: DIETARY AND NUTRITIONAL SUPPLEMENTS; DIETARY AND NUTRITIONAL SUPPLEMENTS USED FOR WEIGHT LOSS; DIETARY SUPPLEMENT FOR ELIMINATING TOXINS FROM THE INTESTINAL TRACT; FOOD SUPPLEMENTS; HERB TEAS FOR MEDICINAL PURPOSES; HERBAL SUPPLEMENTS; HERBAL TEAS FOR MEDICINAL PURPOSES; MEDICINAL DRINKS; MEDICINAL HERB EXTRACTS; MEDICINAL HERBAL EXTRACTS FOR MEDICAL PURPOSES; MEDICINAL TEA; NATURAL HERBAL SUPPLEMENTS, IN CLASS 5 (U.S. CLS. 6, 18, 44, 46, 51 AND 52).

FIRST USE 6-4-2010; IN COMMERCE 8-25-2010.

THE MARK CONSISTS OF STANDARD CHARACTERS WITHOUT CLAIM TO ANY PARTICULAR FONT, STYLE, SIZE, OR COLOR.

OWNER OF U.S. REG. NO. 3,550,633.

THE ENGLISH TRANSLATION OF "KONZERN" IN THE MARK IS GROUP OF COMPANIES.

SER. NO. 85-300,655, FILED 4-21-2011.

KAELIE KUNG, EXAMINING ATTORNEY



David J. Kypos

Director of the United States Patent and Trademark Office

United States of America

United States Patent and Trademark Office

WHORUSH

Reg. No. 4,107,879

SHCHEGOLEV, OLEG (RUSSIAN FED. INDIVIDUAL), DBA SEOQUAKE TEAM
PUSHKIN SOFIISKII BVL 7

Registered Mar. 6, 2012

ST. PETERSBURG 196600, RUSSIAN FED.

Int. Cls.: 35 and 42

FOR: MARKETING SERVICES, NAMELY, PROMOTING THE GOODS AND SERVICES OF OTHERS THROUGH SEARCH ENGINE REFERRAL TRAFFIC ANALYSIS AND REPORTING; MARKETING RESEARCH SERVICES FEATURING RESEARCH AND ANALYSIS OF THE WEBSITES OF OTHERS, IN CLASS 35 (U.S. CLS. 100, 101 AND 102).

SERVICE MARK

PRINCIPAL REGISTER

FIRST USE 3-6-2010; IN COMMERCE 3-6-2010.

FOR: DOMAIN NAME SEARCH SERVICES, NAMELY, CONDUCTING ONLINE COMPUTERIZED SEARCHES FOR FINDING REGISTERED AND UNREGISTERED INTERNET DOMAIN NAMES FOR THE AVAILABILITY OF DOMAIN NAMES; DOMAIN NAME SEARCH SERVICES, NAMELY, CONDUCTING ONLINE COMPUTERIZED SEARCHES FOR PROVIDING NOTIFICATION OF DOMAIN REGISTRATIONS AND CHANGES TO DOMAIN NAME REGISTRATION BASED ON USER-SPECIFIED CRITERIA FOR THE DETERMINING THE AVAILABILITY OF DOMAIN NAMES, IN CLASS 42 (U.S. CLS. 100 AND 101).

FIRST USE 3-6-2010; IN COMMERCE 3-6-2010.

THE MARK CONSISTS OF STANDARD CHARACTERS WITHOUT CLAIM TO ANY PARTICULAR FONT, STYLE, SIZE, OR COLOR.

SER. NO. 85-300,689, FILED 4-21-2011.

TRACY FLETCHER, EXAMINING ATTORNEY



David J. Kyjars

Director of the United States Patent and Trademark Office

United States of America
United States Patent and Trademark Office

BETHIN

Reg. No. 4,107,880

Registered Mar. 6, 2012

Int. Cl.: 5

TRADEMARK

PRINCIPAL REGISTER

CHINA MEDICINE CORPORATION (NEVADA CORPORATION)
2/F, GUANGRI MANSION, NO. 9
1ST ALLEY, 1ST STREET, SIYOU NAN RD
GUANGZHOU, CHINA 510600

FOR: DIETARY AND NUTRITIONAL SUPPLEMENTS; DIETARY AND NUTRITIONAL
SUPPLEMENTS USED FOR WEIGHT LOSS; FOOD SUPPLEMENTS, IN CLASS 5 (U.S. CLS.
6, 18, 44, 46, 51 AND 52).

FIRST USE 6-4-2010; IN COMMERCE 8-25-2010.

OWNER OF U.S. REG. NO. 3,550,969.

THE MARK CONSISTS OF THE STYLIZED WORD "BETHIN" AND THE DESIGN OF A
LEAF WHICH FORMS PART OF THE "I".

SER. NO. 85-300,693, FILED 4-21-2011.

KAELIE KUNG, EXAMINING ATTORNEY



David J. Kyros

Director of the United States Patent and Trademark Office

United States of America

United States Patent and Trademark Office



DENTAL
MANAGEMENT CLUB

Reg. No. 4,107,881

Registered Mar. 6, 2012

Int. Cl.: 35

WARSchAW, CATHY (UNITED STATES INDIVIDUAL), DBA WARSchAW LEARNING
INSTITUTE
#337
4785 BALBOA BLVD.
ENCINO, CA 91436

SERVICE MARK

PRINCIPAL REGISTER

FOR: ADMINISTRATION OF A DISCOUNT PROGRAM FOR ENABLING PARTICIPANTS TO OBTAIN DISCOUNTS ON GOODS AND SERVICES THROUGH USE OF A DISCOUNT MEMBERSHIP CARD; ADMINISTRATION OF A DISCOUNT PROGRAM FOR ENABLING PARTICIPANTS TO OBTAIN DISCOUNTS ON THE COST OF SERVICES OR RECEIVE IMPROVED SERVICES THROUGH USE OF A MEMBERSHIP CARD; ADVERTISING AND MARKETING CONSULTANCY; BUSINESS NETWORKING; MEMBERSHIP CLUB SERVICES PROVIDING DISCOUNTS AND PROCESSING REBATES FOR THE SERVICES OF OTHERS; PUBLIC OPINION POLLING, IN CLASS 35 (U.S. CLS. 100, 101 AND 102).

FIRST USE 3-0-2010; IN COMMERCE 3-0-2010.

NO CLAIM IS MADE TO THE EXCLUSIVE RIGHT TO USE "DENTAL MANAGEMENT CLUB", APART FROM THE MARK AS SHOWN.

THE COLOR(S) PURPLE, BLUE, BROWN, RED, GREEN AND ORANGE IS/ARE CLAIMED AS A FEATURE OF THE MARK.

THE MARK CONSISTS OF "DENTAL" IN PURPLE STYLIZED LETTERS WITH "MANAGEMENT CLUB" IN BLUE STYLIZED LETTERS BELOW IT. TO THE LEFT IS A BROWN STAGE WITH STYLIZED HUMAN FIGURES IN THE FOLLOWING COLORS: BLUE, RED, GREEN, PURPLE AND ORANGE.

SER. NO. 85-300,769, FILED 4-21-2011.

Kaelie Kung, EXAMINING ATTORNEY



David J. Kyjars

Director of the United States Patent and Trademark Office

United States of America

United States Patent and Trademark Office

FINDYOURFACEMATE

Reg. No. 4,107,882

Registered Mar. 6, 2012

Int. Cl.: 45

SERVICE MARK

PRINCIPAL REGISTER

FIND YOUR FACE MATE, LLC (NEW YORK LIMITED LIABILITY COMPANY)
15 CENTRAL PARK WEST
NEW YORK, NY 10023

FOR: DATING SERVICES, USING FACIAL RECOGNITION TECHNOLOGY, NAMELY, PROVIDING AN ON-LINE COMPUTER DATABASE FEATURING SINGLE PEOPLE INTERESTED IN MEETING OTHER SINGLE PEOPLE; INTERNET-BASED SOCIAL NETWORKING, INTRODUCTION, AND DATING SERVICES USING FACIAL RECOGNITION TECHNOLOGY, IN CLASS 45 (U.S. CLS. 100 AND 101).

FIRST USE 3-15-2011; IN COMMERCE 3-15-2011.

THE MARK CONSISTS OF STANDARD CHARACTERS WITHOUT CLAIM TO ANY PARTICULAR FONT, STYLE, SIZE, OR COLOR.

SER. NO. 85-301,367, FILED 4-21-2011.

FRED CARL, EXAMINING ATTORNEY



David J. Kybas

Director of the United States Patent and Trademark Office

United States of America

United States Patent and Trademark Office

VEGETARIAN SUPPORT

Reg. No. 4,107,883

COUNTRY LIFE, LLC (NEW YORK LIMITED LIABILITY COMPANY)
180 VANDERBILT MOTOR PARKWAY
HAUPPAUGE, NY 11788

Registered Mar. 6, 2012

Int. Cl.: 5

FOR: DIETARY AND NUTRITIONAL SUPPLEMENTS MADE IN WHOLE OR IN PART OF VEGETARIAN INGREDIENTS, IN CLASS 5 (U.S. CLS. 6, 18, 44, 46, 51 AND 52).

TRADEMARK

FIRST USE 1-17-2003; IN COMMERCE 1-17-2003.

PRINCIPAL REGISTER

THE MARK CONSISTS OF STANDARD CHARACTERS WITHOUT CLAIM TO ANY PARTICULAR FONT, STYLE, SIZE, OR COLOR.

NO CLAIM IS MADE TO THE EXCLUSIVE RIGHT TO USE "VEGETARIAN", APART FROM THE MARK AS SHOWN.

SEC. 2(F).

SER. NO. 85-301,468, FILED 4-21-2011.

WILLIAM ROSSMAN, EXAMINING ATTORNEY



David J. Kyros

Director of the United States Patent and Trademark Office

United States of America

United States Patent and Trademark Office

Conserve in Comfort

Reg. No. 4,107,884

Registered Mar. 6, 2012

Int. Cl.: 37

SERVICE MARK

PRINCIPAL REGISTER

WESSON ENERGY, INC. (CONNECTICUT CORPORATION)
165 RAILROAD HILL STREET
WATERBURY, CT 06708

FOR: HOME ENERGY ASSESSMENT SERVICES FOR THE PURPOSE OF DETERMINING HOME IMPROVEMENTS NEEDED TO IMPROVE ENERGY USE AND EFFICIENCY, IN CLASS 37 (U.S. CLS. 100, 103 AND 106).

FIRST USE 10-31-2009; IN COMMERCE 10-31-2009.

THE MARK CONSISTS OF STANDARD CHARACTERS WITHOUT CLAIM TO ANY PARTICULAR FONT, STYLE, SIZE, OR COLOR.

SER. NO. 85-301,475, FILED 4-21-2011.

SAIMA MAKHDOOM, EXAMINING ATTORNEY



David J. Kyffers

Director of the United States Patent and Trademark Office

United States of America

United States Patent and Trademark Office

KONZERN 

Reg. No. 4,107,885

Registered Mar. 6, 2012

Int. Cl.: 5

TRADEMARK

PRINCIPAL REGISTER

CHINA MEDICINE CORPORATION (NEVADA CORPORATION)
2/F, GUANGRI MANSION, NO. 9
1ST ALLEY, 1ST STREET, SIYOU NAN RD
GUANGZHOU, CHINA 510600

FOR: DIETARY AND NUTRITIONAL SUPPLEMENTS; DIETARY AND NUTRITIONAL SUPPLEMENTS USED FOR WEIGHT LOSS; DIETARY SUPPLEMENT FOR ELIMINATING TOXINS FROM THE INTESTINAL TRACT; FOOD SUPPLEMENTS; HERBAL SUPPLEMENTS; HERBAL TEAS FOR MEDICINAL PURPOSES; MEDICINAL DRINKS; MEDICINAL HERB EXTRACTS; MEDICINAL HERBAL EXTRACTS FOR MEDICAL PURPOSES; MEDICINAL HERBS; MEDICINAL TEA; NATURAL HERBAL SUPPLEMENTS, IN CLASS 5 (U.S. CLS. 6, 18, 44, 46, 51 AND 52).

FIRST USE 6-4-2010; IN COMMERCE 8-25-2010.

OWNER OF U.S. REG. NO. 3,550,633.

THE NON-LATIN CHARACTERS IN THE MARK TRANSLITERATE TO CAI AND THIS MEANS PICKING IN ENGLISH.

THE MARK CONSISTS OF THE STYLIZED WORDING "KONZERN" APPEARING TO THE LEFT OF A DESIGN COMPRISED OF STYLIZED CHINESE CHARACTERS RESEMBLING A HAND PICKING LEAVES FROM A TREE, WITH THE DESIGN CONTAINED WITHIN A SQUARE CARRIER.

THE ENGLISH TRANSLATION OF "KONZERN" IN THE MARK IS GROUP OF COMPANIES.

SER. NO. 85-301,856, FILED 4-22-2011.

KAELIE KUNG, EXAMINING ATTORNEY



David J. Kyffers

Director of the United States Patent and Trademark Office

United States of America

United States Patent and Trademark Office



Reg. No. 4,107,886

Registered Mar. 6, 2012

Int. Cl.: 5

TRADEMARK

PRINCIPAL REGISTER

CHINA MEDICINE CORPORATION (NEVADA CORPORATION)
2/F, GUANGRI MANSION, NO. 9
1ST ALLEY, 1ST STREET, SIYOU NAN RD
GUANGZHOU, CHINA 510600

FOR: DIETARY AND NUTRITIONAL SUPPLEMENTS; DIETARY AND NUTRITIONAL SUPPLEMENTS USED FOR WEIGHT LOSS; DIETARY SUPPLEMENT FOR ELIMINATING TOXINS FROM THE INTESTINAL TRACT; FOOD SUPPLEMENTS; HERB TEAS FOR MEDICINAL PURPOSES; HERBAL SUPPLEMENTS; HERBAL TEAS FOR MEDICINAL PURPOSES; MEDICINAL DRINKS; MEDICINAL HERB EXTRACTS; MEDICINAL HERBAL EXTRACTS FOR MEDICAL PURPOSES; MEDICINAL TEA; NATURAL HERBAL SUPPLEMENTS, IN CLASS 5 (U.S. CLS. 6, 18, 44, 46, 51 AND 52).

FIRST USE 6-4-2010; IN COMMERCE 8-25-2010.

THE MARK CONSISTS OF A DESIGN COMPRISED OF STYLIZED CHINESE CHARACTERS RESEMBLING A HAND PICKING LEAVES FROM A TREE, WITH THE DESIGN CONTAINED WITHIN A SQUARE CARRIER.

THE NON-LATIN CHARACTERS IN THE MARK TRANSLITERATE TO CAI AND THIS MEANS PICKING IN ENGLISH.

THE ENGLISH TRANSLATION OF THE STYLIZED CHINESE INSCRIPTION IN THE MARK IS PICKING.

SER. NO. 85-301,888, FILED 4-22-2011.

KALIE KUNG, EXAMINING ATTORNEY



David J. Kypos

Director of the United States Patent and Trademark Office

United States of America

United States Patent and Trademark Office

Firebar Bar the Blaze

Reg. No. 4,107,887

Registered Mar. 6, 2012

Int. Cl.: 9

TRADEMARK

PRINCIPAL REGISTER

HPS COMPANY, INC. (WEST VIRGINIA CORPORATION)
3207 PENNSYLVANIA AVENUE
CHARLESTON, WV 25302

FOR: FIRE-EXTINGUISHING SYSTEMS; SPRINKLER SYSTEMS FOR FIRE PROTECTION,
IN CLASS 9 (U.S. CLS. 21, 23, 26, 36 AND 38).

FIRST USE 2-28-2009; IN COMMERCE 2-28-2009.

THE MARK CONSISTS OF STANDARD CHARACTERS WITHOUT CLAIM TO ANY PAR-
TICULAR FONT, STYLE, SIZE, OR COLOR.

NO CLAIM IS MADE TO THE EXCLUSIVE RIGHT TO USE "FIREBAR", APART FROM THE
MARK AS SHOWN.

SER. NO. 85-302,449, FILED 4-22-2011.

STEVEN R. FINE, EXAMINING ATTORNEY



David J. Kybas

Director of the United States Patent and Trademark Office

United States of America

United States Patent and Trademark Office

Conclave

Reg. No. 4,107,888

10X10 ROOM LLC (MASSACHUSETTS LIMITED LIABILITY COMPANY)
38 ROBERTS RD, APT 2
CAMBRIDGE, MA 02138

Registered Mar. 6, 2012

Int. Cl.: 41

FOR: ENTERTAINMENT SERVICES, NAMELY, PROVIDING AN ON-LINE COMPUTER GAME, IN CLASS 41 (U.S. CLS. 100, 101 AND 107).

SERVICE MARK

FIRST USE 4-23-2011; IN COMMERCE 4-23-2011.

PRINCIPAL REGISTER

THE MARK CONSISTS OF STANDARD CHARACTERS WITHOUT CLAIM TO ANY PARTICULAR FONT, STYLE, SIZE, OR COLOR.

SER. NO. 85-302,991, FILED 4-23-2011.

LEIGH LOWRY, EXAMINING ATTORNEY



David J. Kybas

Director of the United States Patent and Trademark Office

United States of America

United States Patent and Trademark Office



Reg. No. 4,107,889

Registered Mar. 6, 2012

Int. Cl.: 42

SERVICE MARK

PRINCIPAL REGISTER

FIT OF PASSION LLC (PENNSYLVANIA LIMITED LIABILITY COMPANY), DBA FIT OF PASSION
412 N SAUNDERS AVE
PHILADELPHIA, PA 19104

FOR: PROVIDING AN INTERNET BASED SERVICE, NAMELY, A WEBSITE, AS WELL AS DOWNLOADABLE MOBILE APPLICATION SOFTWARE, AND A DATABASE ACCESSIBLE VIA A PRIVATE API, ALL OF WHICH FEATURE TECHNOLOGY THAT ENABLES USERS TO MATCH BODY AND CLOTHING MEASUREMENTS WITH OTHER CLOTHING ITEMS OF SIMILAR OR IDENTICAL FIT, IN CLASS 42 (U.S. CLS. 100 AND 101).

FIRST USE 4-1-2011; IN COMMERCE 4-1-2011.

THE MARK CONSISTS OF A STYLIZED COMBINED "FP" WITH A LIGHT SHADOW WITH A LIGHT GRAY UNDERScore WITH THE F MADE OF YELLOWISH GOLD MEASURING TAPE AND THE P COLORED IN SILVER FOLLOWED BY THE WORDS "FITOFPASSION" IN WHICH THE "FIT" AND "PASSION" ARE IN GRADATED GOLD AND THE "OF" IN GRADATED SILVER COLORING.

THE COLOR(S) THE COLORS LIGHT GRAY, YELLOWISH GOLD, SILVER, GRADATED GOLD, AND GRADATED SILVER IS/ARE CLAIMED AS A FEATURE OF THE MARK.

SER. NO. 85-303,115, FILED 4-24-2011.

ERIN FALK, EXAMINING ATTORNEY



David J. Kyjars

Director of the United States Patent and Trademark Office

United States of America

United States Patent and Trademark Office

CONCLUSIVE ANALYTICS

Reg. No. 4,107,890

Registered Mar. 6, 2012

Int. Cls.: 35 and 42

SERVICE MARK

PRINCIPAL REGISTER

CONCLUSIVE ANALYTICS, INC. (DELAWARE CORPORATION)
SUITE G
6900 NORTH PARK BLVD.
CHARLOTTE, NC 28216

FOR: BUSINESS MANAGEMENT AND CONSULTING SERVICES WITH RESPECT TO PROVIDING BUSINESS INTELLIGENCE INFORMATION RELATING TO THE MARKETING PRACTICES OF OTHERS; ADVERTISING SERVICES AND BUSINESS MANAGEMENT SERVICES, IN CLASS 35 (U.S. CLS. 100, 101 AND 102).

FIRST USE 4-15-2011; IN COMMERCE 4-15-2011.

FOR: PROVIDING TEMPORARY USE OF ONLINE NON-DOWNLOADABLE SOFTWARE FOR ANALYZING CONSUMER DATA TO PROVIDE INFORMATION RELATING TO CONSUMER PURCHASING BEHAVIORS AND TRENDS, CONSUMER PROFILES, AND BUSINESS INTELLIGENCE INFORMATION; PROVIDING TEMPORARY USE OF ONLINE NON-DOWNLOADABLE SOFTWARE FOR MANAGING AND CREATING ADVERTISING AND PROMOTIONAL MATERIALS, IN CLASS 42 (U.S. CLS. 100 AND 101).

FIRST USE 4-15-2011; IN COMMERCE 4-15-2011.

THE MARK CONSISTS OF STANDARD CHARACTERS WITHOUT CLAIM TO ANY PARTICULAR FONT, STYLE, SIZE, OR COLOR.

OWNER OF U.S. REG. NO. 3,496,588.

NO CLAIM IS MADE TO THE EXCLUSIVE RIGHT TO USE "ANALYTICS", APART FROM THE MARK AS SHOWN.

SER. NO. 85-303,331, FILED 4-25-2011.

KATHERINE CHANG, EXAMINING ATTORNEY



David J. Kyjars

Director of the United States Patent and Trademark Office

United States of America

United States Patent and Trademark Office

Petro-Diamond

Reg. No. 4,107,891

Registered Mar. 6, 2012

Int. Cls.: 4 and 39

TRADEMARK

SERVICE MARK

PRINCIPAL REGISTER

PETRO-DIAMOND INCORPORATED (DELAWARE CORPORATION)
1100 MAIN STREET, SECOND FLOOR
IRVINE, CA 926146714

FOR: AVIATION FUEL; BENZENE FUEL; BIODIESEL FUEL; DIESEL FUEL; DIESEL OIL; ETHANOL FUELS; FUEL FOR AIRCRAFT/SHIPS; FUEL FOR MOTOR VEHICLES, NAMELY, GAS, GASOLINE, DIESEL, OIL AND PETROLEUM; FUEL FROM CRUDE OIL; FUEL GAS; FUEL OIL; FUELS; GASEOUS FUELS; GASES FOR USE AS FUEL; GASOLINE; INDUSTRIAL GASOLINE; LIQUEFIED PETROLEUM GAS; LIQUEFIED PETROLEUM GASES; LIQUEFIED PETROLEUM GASES TO BE USED FOR DOMESTIC AND INDUSTRIAL PURPOSES AND IN MOTOR VEHICLES; LIQUID FUELS; METHANOL FUEL; MOTOR FUEL; PETROLEUM, IN CLASS 4 (U.S. CLS. 1, 6 AND 15).

FIRST USE 4-8-1983; IN COMMERCE 4-8-1983.

FOR: DISTRIBUTION SERVICES, NAMELY, DELIVERY OF FUELS, GAS, GASOLINE, DIESEL, OIL AND PETROLEUM PRODUCTS; FUEL DELIVERY SERVICES FEATURING GAS, GASOLINE, DIESEL, OIL AND PETROLEUM PRODUCTS; GAS SUPPLYING; STORAGE, DISTRIBUTION, AND TRANSPORTATION OF LIQUEFIED PETROLEUM GAS; TANKER TRANSPORT; TRANSMISSION OF OIL OR GAS THROUGH PIPELINES; TRANSPORT BROKERAGE; TRANSPORT BY PIPELINE; TRANSPORT BY TRUCK, RAIL, BARGE, VESSEL AND PIPELINE, AND TERMINALLING OF BULK PRODUCTS, NAMELY, GASOLINE, DIESEL, OIL AND PETROLEUM PRODUCTS; TRANSPORT OF FUELS, GAS, GASOLINE, DIESEL, OIL AND PETROLEUM PRODUCTS BY TRUCK, RAIL, BARGE, VESSEL AND PIPELINE, AND TERMINALLING; TRANSPORTATION AND STORAGE OF FUELS; TRUCKING SERVICES, NAMELY, HAULING OF FUELS, GAS, GASOLINE, DIESEL, OIL AND PETROLEUM PRODUCTS; WAREHOUSING SERVICES, NAMELY, STORAGE, DISTRIBUTION, PICK-UP, PACKING, AND SHIPPING OF FUELS, GAS, GASOLINE, DIESEL, OIL AND PETROLEUM PRODUCTS, IN CLASS 39 (U.S. CLS. 100 AND 105).

FIRST USE 4-8-1983; IN COMMERCE 4-8-1983.

THE MARK CONSISTS OF STANDARD CHARACTERS WITHOUT CLAIM TO ANY PARTICULAR FONT, STYLE, SIZE, OR COLOR.

SER. NO. 85-303,592, FILED 4-25-2011.



David J. Kyros

Director of the United States Patent and Trademark Office

Reg. No. 4,107,891 MICHELE SWAIN, EXAMINING ATTORNEY

United States of America

United States Patent and Trademark Office

Petro Diamond

Reg. No. 4,107,892

Registered Mar. 6, 2012

Int. Cls.: 4 and 39

TRADEMARK

SERVICE MARK

PRINCIPAL REGISTER

PETRO-DIAMOND INCORPORATED (DELAWARE CORPORATION)
1100 MAIN STREET, 2ND FLOOR
IRVINE, CA 926146714

FOR: AVIATION FUEL; BENZENE FUEL; BIODIESEL FUEL; DIESEL FUEL; DIESEL OIL; ETHANOL FUELS; FUEL FOR AIRCRAFT/SHIPS; FUEL FOR MOTOR VEHICLES, NAMELY, GAS, GASOLINE, DIESEL, OIL AND PETROLEUM; FUEL FROM CRUDE OIL; FUEL GAS; FUEL OIL; FUELS; GASEOUS FUELS; GASES FOR USE AS FUEL; GASOLINE; INDUSTRIAL GASOLINE; LIQUEFIED PETROLEUM GAS; LIQUEFIED PETROLEUM GASES; LIQUEFIED PETROLEUM GASES TO BE USED FOR DOMESTIC AND INDUSTRIAL PURPOSES AND IN MOTOR VEHICLES; LIQUID FUELS; METHANOL FUEL; MOTOR FUEL; PETROLEUM, IN CLASS 4 (U.S. CLS. 1, 6 AND 15).

FIRST USE 4-8-1983; IN COMMERCE 4-8-1983.

FOR: DISTRIBUTION SERVICES, NAMELY, DELIVERY OF FUELS, GAS, GASOLINE, DIESEL, OIL AND PETROLEUM PRODUCTS; FUEL DELIVERY SERVICES FEATURING GAS, GASOLINE, DIESEL, OIL AND PETROLEUM PRODUCTS; GAS SUPPLYING; STORAGE, DISTRIBUTION, AND TRANSPORTATION OF LIQUEFIED PETROLEUM GAS; TANKER TRANSPORT; TRANSMISSION OF OIL OR GAS THROUGH PIPELINES; TRANSPORT BROKERAGE; TRANSPORT BY PIPELINE; TRANSPORT BY TRUCK, RAIL, BARGE, VESSEL AND PIPELINE, AND TERMINALLING OF BULK PRODUCTS, NAMELY, GASOLINE, DIESEL, OIL AND PETROLEUM PRODUCTS; TRANSPORT OF FUELS, GAS, GASOLINE, DIESEL, OIL AND PETROLEUM PRODUCTS BY TRUCK, RAIL, BARGE, VESSEL AND PIPELINE, AND TERMINALLING; TRANSPORTATION AND STORAGE OF FUELS; TRUCKING SERVICES, NAMELY, HAULING OF FUELS, GAS, GASOLINE, DIESEL, OIL AND PETROLEUM PRODUCTS; WAREHOUSING SERVICES, NAMELY, STORAGE, DISTRIBUTION, PICK-UP, PACKING, AND SHIPPING OF FUELS, GAS, GASOLINE, DIESEL, OIL AND PETROLEUM PRODUCTS, IN CLASS 39 (U.S. CLS. 100 AND 105).

FIRST USE 4-8-1983; IN COMMERCE 4-8-1983.

THE MARK CONSISTS OF STANDARD CHARACTERS WITHOUT CLAIM TO ANY PARTICULAR FONT, STYLE, SIZE, OR COLOR.

NO CLAIM IS MADE TO THE EXCLUSIVE RIGHT TO USE "PETRO", APART FROM THE MARK AS SHOWN.



David J. Kyros

Director of the United States Patent and Trademark Office

Reg. No. 4,107,892 SER. NO. 85-303,776, FILED 4-25-2011.

MICHELE SWAIN, EXAMINING ATTORNEY

United States of America

United States Patent and Trademark Office

NOURISHING GENERATION ORGANIC

Reg. No. 4,107,893

THE NEST COLLECTIVE, INC. (DELAWARE CORPORATION)
1485 PARK AVENUE, SUITE 200
EMERYVILLE, CA 94608

Registered Mar. 6, 2012

Int. Cl.: 5

FOR: FOOD FOR INFANTS AND BABIES, NAMELY, ORGANIC PREPARED MEALS AND ORGANIC PREPARED SNACKS, IN CLASS 5 (U.S. CLS. 6, 18, 44, 46, 51 AND 52).

TRADEMARK

FIRST USE 9-30-2010; IN COMMERCE 9-30-2010.

PRINCIPAL REGISTER

THE MARK CONSISTS OF STANDARD CHARACTERS WITHOUT CLAIM TO ANY PARTICULAR FONT, STYLE, SIZE, OR COLOR.

OWNER OF U.S. REG. NO. 3,975,209.

NO CLAIM IS MADE TO THE EXCLUSIVE RIGHT TO USE "ORGANIC", APART FROM THE MARK AS SHOWN.

SER. NO. 85-303,855, FILED 4-25-2011.

MICHELE SWAIN, EXAMINING ATTORNEY



David J. Kyffers

Director of the United States Patent and Trademark Office

United States of America

United States Patent and Trademark Office



Reg. No. 4,107,894

Registered Mar. 6, 2012

Int. Cl.: 35

SERVICE MARK

PRINCIPAL REGISTER

SOL INVESTMENTS, S.A. (NICARAGUA CORPORATION)
DEL COLEGIO CENTROAMERICA 3KM SUR,
ALTOS VILLAFONTANA
MANAGUA, NICARAGUA

FOR: PROVIDING A WEB SITE WHERE USERS CAN POST ITEMS FOR SALE THROUGH ON-LINE CLASSIFIED ADVERTISEMENTS; PROVIDING AN INTERACTIVE REAL ESTATE WEBSITE WHICH PROMOTES HOUSING AND APARTMENT PROPERTIES THROUGH OFFERING PROSPECTIVE TENANTS VIDEO WALK THROUGHs, PROPERTY DESCRIPTIONS, TEXT, PRICE, LOCATION, MAPS AND OTHER INFORMATION THAT WOULD BE INFLUENTIAL TO A PROSPECTIVE TENANT IN MAKING A RENTAL DECISION; REAL ESTATE ADVERTISING SERVICES; REAL ESTATE MARKETING SERVICES, NAMELY, ON-LINE SERVICES FEATURING TOURS OF RESIDENTIAL AND COMMERCIAL REAL ESTATE, IN CLASS 35 (U.S. CLS. 100, 101 AND 102).

FIRST USE 3-31-2010; IN COMMERCE 3-31-2010.

NO CLAIM IS MADE TO THE EXCLUSIVE RIGHT TO USE "THE SOCIAL NETWORK APPLICATION FOR THE HOUSING MARKET", APART FROM THE MARK AS SHOWN.

THE COLOR(S) BLUE, GREEN, WHITE, GREY AND BLACK IS/ARE CLAIMED AS A FEATURE OF THE MARK.



THE MARK CONSISTS OF A SQUARE INSIDE OF WHICH APPEARS A SHOPPING CART CARRYING A SMALLER SQUARE OVER WHICH APPEARS THE DRAWING OF A HOUSE. THIS IS FOLLOWED BY THE WORDING "HOUSEMARKET" IN STYLIZED PROMINENT LETTERS, AND BELOW IT, APPEARS IN SMALLER SIZE AND COVERING THE EXACT SAME LENGTH "HOUSEMARKET" THE WORDING "THE SOCIAL NETWORK APPLICATION FOR THE HOUSING MARKET". THE COLOR BLUE APPEARS IN THE BIGGER SQUARE AND IN THE WORD "HOUSE". THE COLOR GREEN APPEARS IN THE SMALLER SQUARE THAT APPEARS INSIDE THE SHOPPING CART. THE COLOR WHITE APPEARS IN THE DRAWING OF THE HOUSE AND IN THE SHOPPING CART. THE COLOR GREY APPEARS IN THE OUTER BORDER OF THE BIGGER SQUARE AND IN THE WORDING "THE SOCIAL NETWORK APPLICATION FOR THE HOUSING MARKET". THE COLOR BLACK APPEARS IN THE WORD "MARKET".

David J. Kyros

Director of the United States Patent and Trademark Office

SER. NO. 85-304,104, FILED 4-25-2011.

Reg. No. 4,107,894 RONALD AIKENS, EXAMINING ATTORNEY

United States of America

United States Patent and Trademark Office



enginuity
energy LLC
project developers | energy engineers
designed for the environment

Reg. No. 4,107,895

Registered Mar. 6, 2012

Int. Cl.: 42

SERVICE MARK

PRINCIPAL REGISTER

ENGINUITY ENERGY, LLC (PENNSYLVANIA LIMITED LIABILITY COMPANY)
203 LYNNDALE COURT
MECHANICSBURG, PA 17050

FOR: ENGINEERING SERVICES IN THE FIELDS OF ENERGY CONSERVATION, CLEAN POWER GENERATION AND NUTRIENT RECOVERY FROM RENEWABLE RESOURCES , IN CLASS 42 (U.S. CLS. 100 AND 101).

FIRST USE 5-0-2008; IN COMMERCE 5-0-2008.

NO CLAIM IS MADE TO THE EXCLUSIVE RIGHT TO USE "ENERGY", "LLC", "PROJECT DEVELOPERS", AND "ENERGY ENGINEERS", APART FROM THE MARK AS SHOWN.

THE COLOR(S) WHITE, GREEN, GRAY AND BLACK IS/ARE CLAIMED AS A FEATURE OF THE MARK.

THE MARK CONSISTS OF A LOWER CASE GREEN LETTER "E" WITH WHITE STRIPES INSIDE A CIRCULAR DESIGN COMPOSED OF A GREEN AND WHITE LEAF SHAPE TO THE LEFT OF THE WORD "ENGINUITY" IN GREEN ABOVE A GREEN SWIRL LINE WITH THE WORDS "ENERGY" IN BLACK AND "LLC" IN GREEN ABOVE THE WORDS "PROJECT DEVELOPERS" AND "ENERGY ENGINEERS" IN GRAY SEPARATED BY A GREEN VERTICAL LINE ABOVE THE WORDS "DESIGN FOR THE ENVIRONMENT" IN GREEN.

SER. NO. 85-304,468, FILED 4-26-2011.

SHAILA SETTLES, EXAMINING ATTORNEY



David J. Kybas

Director of the United States Patent and Trademark Office

United States of America

United States Patent and Trademark Office

BOSTON KERATOPROSTHESIS

Reg. No. 4,107,896

Registered Mar. 6, 2012

Int. Cl.: 10

TRADEMARK

PRINCIPAL REGISTER

MASSACHUSETTS EYE AND EAR INFIRMARY (MASSACHUSETTS NON-PROFIT CORPORATION)
243 CHARLES STREET
BOSTON, MA 02114

FOR: KERATOPROSTHESES, IN CLASS 10 (U.S. CLS. 26, 39 AND 44).

FIRST USE 11-0-2005; IN COMMERCE 11-0-2005.

THE MARK CONSISTS OF STANDARD CHARACTERS WITHOUT CLAIM TO ANY PARTICULAR FONT, STYLE, SIZE, OR COLOR.

NO CLAIM IS MADE TO THE EXCLUSIVE RIGHT TO USE "KERATOPROSTHESIS", APART FROM THE MARK AS SHOWN.

SEC. 2(F).

SER. NO. 85-304,723, FILED 4-26-2011.

CHARLOTTE CORWIN, EXAMINING ATTORNEY



David J. Kyffers

Director of the United States Patent and Trademark Office

United States of America

United States Patent and Trademark Office

PROCEP

Reg. No. 4,107,897

RISE APPAREL LTD (CANADA LIMITED COMPANY (LTD.))
109-427 51ST AVE S.W.
CALGARY, CANADA

Registered Mar. 6, 2012

Int. Cl.: 25

FOR: COMPRESSION GARMENTS FOR ATHLETIC OR OTHER NON-MEDICAL USE, NAMELY, SOCKS, STOCKINGS, SHIRTS, SHORTS, ARM SLEEVES, LEG SLEEVES, UPPER AND LOWER BODY GARMENTS, NAMELY, LONG SLEEVE SHIRTS, SHORT SLEEVE SHIRTS, SLEEVELESS SHIRTS, SHORTS, PANTS, ARM SLEEVES, LEG SLEEVES, SOCKS, STOCKINGS, GLOVES, HATS, BODY SUITS, BRAS, UNDERWEAR, IN CLASS 25 (U.S. CLS. 22 AND 39).

TRADEMARK

PRINCIPAL REGISTER

FIRST USE 4-1-2011; IN COMMERCE 4-1-2011.

THE MARK CONSISTS OF STANDARD CHARACTERS WITHOUT CLAIM TO ANY PARTICULAR FONT, STYLE, SIZE, OR COLOR.

SER. NO. 85-305,069, FILED 4-26-2011.

TRACY CROSS, EXAMINING ATTORNEY



David J. Kybas

Director of the United States Patent and Trademark Office

United States of America

United States Patent and Trademark Office

GIVE AS YOU GET

Reg. No. 4,107,898

Registered Mar. 6, 2012

Int. Cl.: 36

SERVICE MARK

PRINCIPAL REGISTER

DAVID SANDAL (UNITED STATES INDIVIDUAL)
13504 COLETO CREEK TRAIL
AUSTIN, TX 78732

FOR: CHARITABLE FUNDRAISING SERVICES, NAMELY, PROVIDING A WEBSITE WHICH PROVIDES INDIVIDUALS WITH THE OPPORTUNITY TO MAKE MONETARY CONTRIBUTIONS TO THEIR FAVORITE CHARITY THROUGH PURCHASES FROM PARTICIPATING RETAILERS, IN CLASS 36 (U.S. CLS. 100, 101 AND 102).

FIRST USE 9-30-2010; IN COMMERCE 9-30-2010.

THE MARK CONSISTS OF STANDARD CHARACTERS WITHOUT CLAIM TO ANY PARTICULAR FONT, STYLE, SIZE, OR COLOR.

SER. NO. 85-305,710, FILED 4-27-2011.

HOWARD SMIGA, EXAMINING ATTORNEY



David J. Kybas

Director of the United States Patent and Trademark Office

United States of America

United States Patent and Trademark Office

InstaCompute

Reg. No. 4,107,899

Registered Mar. 6, 2012

Int. Cls.: 38 and 42

SERVICE MARK

PRINCIPAL REGISTER

TATA COMMUNICATIONS LIMITED (INDIA CORPORATION)
VSB, MAHATMA GANDHI ROAD, FORT
MUMBAI, INDIA

FOR: PROVIDING ACCESS TO METERED, CLOUD-BASED COMPUTING, STORAGE, AND DATA TRANSFER SERVICES OVER PACKET BASED NETWORKS, IN CLASS 38 (U.S. CLS. 100, 101 AND 104).

FIRST USE 10-7-2010; IN COMMERCE 10-7-2010.

FOR: CLOUD-BASED COMPUTING SERVICES, NAMELY, CLOUD HOSTING PROVIDER SERVICES FEATURING TECHNOLOGY WHICH PROVIDES ACCESS TO A POOL OF CONFIGURABLE COMPUTING RESOURCES, DATA STORAGE AND TRANSFER SERVICES, OPERATING SYSTEMS, AND SOFTWARE APPLICATIONS VIA GLOBAL NETWORK CONNECTED DATA CENTERS FOR THE PURPOSE OF DEVELOPING, TESTING, HOSTING, STORING, AND MANAGING SOFTWARE APPLICATIONS, IN CLASS 42 (U.S. CLS. 100 AND 101).

FIRST USE 10-7-2010; IN COMMERCE 10-7-2010.

THE MARK CONSISTS OF STANDARD CHARACTERS WITHOUT CLAIM TO ANY PARTICULAR FONT, STYLE, SIZE, OR COLOR.

PRIORITY CLAIMED UNDER SEC. 44(D) ON INDIA APPLICATION NO. 2051248, FILED 11-9-2010.

PRIORITY CLAIMED UNDER SEC. 44(D) ON INDIA APPLICATION NO. 2051249, FILED 11-9-2010.

PRIORITY CLAIMED UNDER SEC. 44(D) ON INDIA APPLICATION NO. 2051250, FILED 11-9-2010.

SER. NO. 85-306,186, FILED 4-27-2011.

RON FAIRBANKS, EXAMINING ATTORNEY



David J. Kyros

Director of the United States Patent and Trademark Office

United States of America

United States Patent and Trademark Office



Reg. No. 4,107,900

Registered Mar. 6, 2012

Int. Cl.: 35

SERVICE MARK

PRINCIPAL REGISTER

HOW'S THE LIVING, INC. (TENNESSEE CORPORATION)
2450 E.J. CHAPMAN DR., STE. 117, RM. 108
KNOXVILLE, TN 37996

FOR: PROVIDING A WEBSITE FEATURING RATINGS AND REVIEWS OF HOUSING, NAMELY, RESIDENCE HALLS, DORMITORIES, APARTMENTS, AND HOST FAMILIES, ALL FOR COMMERCIAL PURPOSES, IN CLASS 35 (U.S. CLS. 100, 101 AND 102).

FIRST USE 9-29-2010; IN COMMERCE 9-29-2010.

THE STIPLING IS FOR SHADING PURPOSES ONLY.

THE MARK CONSISTS OF THE WORDS "HOWSTHELIVING" WITH NO SPACES BETWEEN THE WORDS AND A QUESTION MARK FUNCTIONING AS AN APOSTROPHE BETWEEN THE LETTER "W" AND THE LETTER "S". THERE ARE QUESTION MARKS ABOVE EACH LETTER "I" IN THE WORD "LIVING," WHERE THE SECOND QUESTION MARK IS REVERSED. AT THE END OF THE WORD "LIVING" IS A DESIGN PORTION CONSISTING OF A BUILDING HAVING INWARDLY-CURVED SIDES WITH A QUESTION MARK ABOVE IT AND SIX (6) CONVEX-CURVED LINES BELOW IT RESEMBLING A WI-FI SYMBOL. THE BUILDING FUNCTIONS AS THE PERIOD IN THE QUESTION MARK. THE BUILDING HAS SIX (6) WINDOWS AND ONE (1) DOOR.

SER. NO. 85-306,223, FILED 4-27-2011.

ANDREA HACK, EXAMINING ATTORNEY



David J. Kyjars

Director of the United States Patent and Trademark Office

United States of America

United States Patent and Trademark Office



Reg. No. 4,107,901

Registered Mar. 6, 2012

Int. Cl.: 35

SERVICE MARK

PRINCIPAL REGISTER

ACEVES ANDRES (MEXICO INDIVIDUAL)
2027 GLADSTONE DR.
WHEATON, IL 60187

FOR: PREPARING ADVERTISEMENTS FOR OTHERS, NAMELY, PREPARING VIDEO ADVERTISING AND PROMOTIONAL VIDEOS FOR COMMERCIAL USE VIA THE INTERNET AND TELEVISION, DIGITAL CABLE AND VIDEO-ON-DEMAND OR DOWNLOAD, IN CLASS 35 (U.S. CLS. 100, 101 AND 102).

FIRST USE 4-14-2011; IN COMMERCE 4-14-2011.

NO CLAIM IS MADE TO THE EXCLUSIVE RIGHT TO USE "APP", APART FROM THE MARK AS SHOWN.

THE COLOR(S) BLUE AND WHITE IS/ARE CLAIMED AS A FEATURE OF THE MARK.

THE MARK CONSISTS OF A FILM PRODUCTION CLAPPERBOARD IN BLUE AND WHITE, WITH THE TOP BOARD HAVING ALTERNATING BLUE AND WHITE ARROWS, THE BOTTOM BOARD BEING BLUE WITH THE WORD "APP" IN WHITE WITH A WHITE LIGHT REFLECTION ON THE UPPER RIGHT CORNER OF THE WORD "APP". THE WORDING TO THE RIGHT SIDE OF THE PREVIOUSLY DESCRIBED ICON ARE THE WORDS "MY APP TRAILERS" WITH "MY" IN WHITE, "APP" IN LIGHT BLUE, AND "TRAILERS" IN WHITE WITH THE "I" IN "TRAILERS" DOTTED IN LIGHT BLUE. THE BLACK BACKGROUND IS NOT BEING CLAIMED BUT WAS NECESSARY TO MAKE WHITE LETTERS VISIBLE.

SER. NO. 85-306,275, FILED 4-27-2011.

LINDA POWELL, EXAMINING ATTORNEY



David J. Kybas

Director of the United States Patent and Trademark Office

United States of America

United States Patent and Trademark Office

GEMSTONE 77777

Reg. No. 4,107,902

IGT (NEVADA CORPORATION)
9295 PROTOTYPE DRIVE
RENO, NV 895218986

Registered Mar. 6, 2012

Int. Cl.: 9

FOR: GAMING MACHINES, NAMELY, DEVICES WHICH ACCEPT A WAGER, IN CLASS 9 (U.S. CLS. 21, 23, 26, 36 AND 38).

TRADEMARK

FIRST USE 12-14-2010; IN COMMERCE 12-14-2010.

PRINCIPAL REGISTER

THE MARK CONSISTS OF STANDARD CHARACTERS WITHOUT CLAIM TO ANY PARTICULAR FONT, STYLE, SIZE, OR COLOR.

NO CLAIM IS MADE TO THE EXCLUSIVE RIGHT TO USE "77777", APART FROM THE MARK AS SHOWN.

SER. NO. 85-306,365, FILED 4-27-2011.

CARYN GLASSER, EXAMINING ATTORNEY



David J. Kybas

Director of the United States Patent and Trademark Office

United States of America

United States Patent and Trademark Office

KARMAWELL

Reg. No. 4,107,903

Registered Mar. 6, 2012

Int. Cls.: 35, 36 and 41

SERVICE MARK

PRINCIPAL REGISTER

KARMAWELL INC. (DELAWARE CORPORATION)
SUITE 700
27 MAIDEN LANE
SAN FRANCISCO, CA 94108

FOR: PROVIDING A WEB-BASED SYSTEM AND ONLINE PORTAL THAT PROMOTES THE ONLINE RETAIL SALE OF A WIDE VARIETY OF GOODS AND SERVICES OF OTHERS FEATURING LINKS TO THE RETAIL WEBSITES OF OTHERS; PROVIDING A SEARCHABLE DATABASE IN THE FIELD OF CHARITABLE ORGANIZATIONS VIA THE INTERNET OR OTHER COMMUNICATIONS NETWORKS, IN CLASS 35 (U.S. CLS. 100, 101 AND 102).

FIRST USE 4-19-2011; IN COMMERCE 4-19-2011.

FOR: CHARITABLE FUNDRAISING SERVICES BY MEANS OF PROMOTING THE ONLINE RETAIL SALE OF A WIDE VARIETY OF GOODS AND SERVICES OF OTHERS AND WHERE A PORTION OF PROCEEDS ARE DIRECTED TO THE PURCHASER'S CHOICE OF CHARITIES, IN CLASS 36 (U.S. CLS. 100, 101 AND 102).

FIRST USE 4-19-2011; IN COMMERCE 4-19-2011.

FOR: PROVIDING ONLINE BLOGS, JOURNALS, AND INFORMATION IN THE FORM OF INSTANT MESSAGES, FEATURING CAUSE MARKETING AND CHARITABLE GIVING, IN CLASS 41 (U.S. CLS. 100, 101 AND 107).

FIRST USE 10-14-2010; IN COMMERCE 10-14-2010.

THE MARK CONSISTS OF STANDARD CHARACTERS WITHOUT CLAIM TO ANY PARTICULAR FONT, STYLE, SIZE, OR COLOR.

SER. NO. 85-307,015, FILED 4-28-2011.

JILL C. ALT, EXAMINING ATTORNEY



David J. Kyros

Director of the United States Patent and Trademark Office

United States of America

United States Patent and Trademark Office



Reg. No. 4,107,904

FORUM INFO-TECH, INC. (CALIFORNIA CORPORATION)
1247 POMONA ROAD, SUITE #105
CORONA, CA 92882

Registered Mar. 6, 2012

Int. Cl.: 42

FOR: CONSULTING SERVICES IN THE FIELD OF CLOUD COMPUTING, IN CLASS 42 (U.S. CLS. 100 AND 101).

SERVICE MARK

FIRST USE 4-1-2011; IN COMMERCE 4-1-2011.

PRINCIPAL REGISTER

NO CLAIM IS MADE TO THE EXCLUSIVE RIGHT TO USE "CLOUD" AND "I.T.", APART FROM THE MARK AS SHOWN.

THE MARK CONSISTS OF THE STYLIZED WORDING "LEVELCLOUD", WITHIN THE LETTER "O" IS A "START BUTTON" SIGN, THE WORDING "I.T. ANYTIME ANYWHERE" IS BELOW THAT WORDING AND A SERIES OF CLOUDS ARE ABOVE THE WORDING.

SER. NO. 85-307,017, FILED 4-28-2011.

SUE LAWRENCE, EXAMINING ATTORNEY



David J. Kybas

Director of the United States Patent and Trademark Office

United States of America

United States Patent and Trademark Office



Reg. No. 4,107,905

THE SWEET TOOTH SHOPPE INC. (TEXAS CORPORATION)
8503 FM 359/PO BOX 962
FULSHEAR, TX 77441

Registered Mar. 6, 2012

Int. Cls.: 35 and 43

FOR: RETAIL CANDY STORE SERVICES, IN CLASS 35 (U.S. CLS. 100, 101 AND 102).

SERVICE MARK

FIRST USE 3-17-2009; IN COMMERCE 3-17-2009.

PRINCIPAL REGISTER

FOR: RESTAURANT, CAFÉ, ICE CREAM PARLOR, COFFEE BAR AND COFFEE HOUSE SERVICES, IN CLASS 43 (U.S. CLS. 100 AND 101).

FIRST USE 3-17-2009; IN COMMERCE 3-17-2009.

NO CLAIM IS MADE TO THE EXCLUSIVE RIGHT TO USE "SHOPPE", APART FROM THE MARK AS SHOWN.

THE COLOR(S) BLACK, RED, GREEN, YELLOW, BLUE, ORANGE AND PURPLE IS/ARE CLAIMED AS A FEATURE OF THE MARK.

THE MARK CONSISTS OF THE WORDING "THE SWEET TOOTH SHOPPE" WITH THE WORDS "THE" AND "SHOPPE" IN BLACK; THE WORD "SWEET" WITH A RED "S", A GREEN "W", A YELLOW "E" FOLLOWED BY A BLUE "E", AND ORANGE "T" ALL WITH BLACK PIPING; AND THE WORD "TOOTH" WITH AN ORANGE "T", LETTERS "OO" FORMED BY TWO BLUE, PURPLE, RED, GREEN, YELLOW, AND BLACK SWIRL LOLLIPOPS, ONE WITH A RED HANDLE AND THE OTHER A YELLOW HANDLE, AND A GREEN "T" AND BLUE "H" ALL WITH BLACK PIPING.

SER. NO. 85-307,435, FILED 4-28-2011.

DAVID C. REIHNER, EXAMINING ATTORNEY



David J. Kybas

Director of the United States Patent and Trademark Office

United States of America

United States Patent and Trademark Office

AVOYA TRAVEL

Reg. No. 4,107,906

REVAGENCY, LLC (FLORIDA LIMITED LIABILITY COMPANY)
5201 BLUE LAGOON DRIVE SUITE 900
MIAMI, FL 33126

Registered Mar. 6, 2012

Int. Cls.: 39 and 43

FOR: TRAVEL AGENCY SERVICES, NAMELY, MAKING RESERVATIONS AND BOOKINGS FOR TRANSPORTATION AND ARRANGING OF CRUISES AND TOURS, IN CLASS 39 (U.S. CLS. 100 AND 105).

SERVICE MARK

FIRST USE 12-15-2003; IN COMMERCE 12-15-2003.

PRINCIPAL REGISTER

FOR: TRAVEL AGENCY SERVICES, NAMELY, MAKING RESERVATIONS AND BOOKINGS FOR TEMPORARY LODGING, IN CLASS 43 (U.S. CLS. 100 AND 101).

FIRST USE 12-15-2003; IN COMMERCE 12-15-2003.

THE MARK CONSISTS OF STANDARD CHARACTERS WITHOUT CLAIM TO ANY PARTICULAR FONT, STYLE, SIZE, OR COLOR.

OWNER OF U.S. REG. NO. 3,349,187.

NO CLAIM IS MADE TO THE EXCLUSIVE RIGHT TO USE "TRAVEL", APART FROM THE MARK AS SHOWN.

SER. NO. 85-307,880, FILED 4-28-2011.

KYLE PEETE, EXAMINING ATTORNEY



David J. Kyffers

Director of the United States Patent and Trademark Office

United States of America

United States Patent and Trademark Office

GR = C

Reg. No. 4,107,907

Registered Mar. 6, 2012

Int. Cls.: 42 and 45

SERVICE MARK

PRINCIPAL REGISTER

PMP RESOURCES, LLC (MASSACHUSETTS LIMITED LIABILITY COMPANY)
343 WASHINGTON STREET
MELROSE, MA 02176

FOR: COMPUTER SECURITY AND INFORMATION TECHNOLOGY CONSULTANCY IN THE FIELD OF INFORMATION SECURITY RISK MANAGEMENT FOR PRIVATE BUSINESSES, GOVERNMENTS, AND OTHER ORGANIZATIONS, IN CLASS 42 (U.S. CLS. 100 AND 101).

FIRST USE 4-22-2011; IN COMMERCE 4-22-2011.

FOR: REGULATORY COMPLIANCE CONSULTING SERVICES IN THE FIELD OF INFORMATION SECURITY FOR PRIVATE BUSINESSES, GOVERNMENTS, AND OTHER ORGANIZATIONS, IN CLASS 45 (U.S. CLS. 100 AND 101).

FIRST USE 4-22-2011; IN COMMERCE 4-22-2011.

THE MARK CONSISTS OF STANDARD CHARACTERS WITHOUT CLAIM TO ANY PARTICULAR FONT, STYLE, SIZE, OR COLOR.

SER. NO. 85-308,460, FILED 4-29-2011.

ERNEST SHOSHO, EXAMINING ATTORNEY



David J. Kybas

Director of the United States Patent and Trademark Office

United States of America

United States Patent and Trademark Office

AVOYA

Reg. No. 4,107,908

Registered Mar. 6, 2012

Int. Cls.: 39 and 43

SERVICE MARK

PRINCIPAL REGISTER

REVAGENCY, LLC (FLORIDA LIMITED LIABILITY COMPANY)
5201 BLUE LAGOON DRIVE SUITE 900
MIAMI, FL 33126

FOR: TRAVEL AGENCY SERVICES, NAMELY, MAKING RESERVATIONS AND BOOKINGS FOR TRANSPORTATION AND ARRANGING OF CRUISES, IN CLASS 39 (U.S. CLS. 100 AND 105).

FIRST USE 12-15-2003; IN COMMERCE 12-15-2003.

FOR: TRAVEL AGENCY SERVICES, NAMELY MAKING RESERVATIONS AND BOOKINGS FOR TEMPORARY LODGING, IN CLASS 43 (U.S. CLS. 100 AND 101).

FIRST USE 12-15-2003; IN COMMERCE 12-15-2003.

THE MARK CONSISTS OF STANDARD CHARACTERS WITHOUT CLAIM TO ANY PARTICULAR FONT, STYLE, SIZE, OR COLOR.

OWNER OF U.S. REG. NO. 3,349,187.

SER. NO. 85-308,813, FILED 4-29-2011.

KYLE PEETE, EXAMINING ATTORNEY



David J. Kybas

Director of the United States Patent and Trademark Office

United States of America

United States Patent and Trademark Office

Truly Blessed

Reg. No. 4,107,909

WING, RYAN (UNITED STATES INDIVIDUAL)
9460 E. CORRINE DR.
SCOTTSDALE, AZ 85260 AND

Registered Mar. 6, 2012

Int. Cl.: 25

BOCHANSKY, LUKE (UNITED STATES INDIVIDUAL)
9460 E. CORRINE DR.
SCOTTSDALE, AZ 85260

TRADEMARK

PRINCIPAL REGISTER

FOR: HATS; JACKETS; PANTS; SHIRTS; SHOES; SHORTS; SWEATSHIRTS, IN CLASS 25
(U.S. CLS. 22 AND 39).

FIRST USE 3-7-2008; IN COMMERCE 4-1-2008.

THE MARK CONSISTS OF STANDARD CHARACTERS WITHOUT CLAIM TO ANY PARTICULAR FONT, STYLE, SIZE, OR COLOR.

SER. NO. 85-308,898, FILED 4-29-2011.

JEAN IM, EXAMINING ATTORNEY



David J. Kyffers

Director of the United States Patent and Trademark Office

United States of America

United States Patent and Trademark Office



Reg. No. 4,107,910

Registered Mar. 6, 2012

Int. Cls.: 4 and 39

TRADEMARK

SERVICE MARK

PRINCIPAL REGISTER

PETRO-DIAMOND INCORPORATED (DELAWARE CORPORATION)
1100 MAIN STREET, SECOND FLOOR
IRVINE, CA 926146714

FOR: AVIATION FUEL; BENZENE FUEL; BIODIESEL FUEL; DIESEL FUEL; DIESEL OIL; ETHANOL FUELS; FUEL FOR AIRCRAFT/SHIPS; FUEL FOR MOTOR VEHICLES, NAMELY, GAS, GASOLINE, DIESEL, OIL AND PETROLEUM; FUEL FROM CRUDE OIL; FUEL GAS; FUEL OIL; FUELS; GASEOUS FUELS; GASES FOR USE AS FUEL; GASOLINE; INDUSTRIAL GASOLINE; LIQUEFIED PETROLEUM GAS; LIQUEFIED PETROLEUM GASES; LIQUEFIED PETROLEUM GASES TO BE USED FOR DOMESTIC AND INDUSTRIAL PURPOSES AND IN MOTOR VEHICLES; METHANOL FUEL; MOTOR FUEL; PETROLEUM, IN CLASS 4 (U.S. CLS. 1, 6 AND 15).

FIRST USE 1-3-2000; IN COMMERCE 1-3-2000.

FOR: DISTRIBUTION SERVICES, NAMELY, DELIVERY OF FUELS, GAS, GASOLINE, DIESEL, OIL AND PETROLEUM PRODUCTS; FUEL DELIVERY SERVICES FEATURING GAS, GASOLINE, DIESEL, OIL AND PETROLEUM PRODUCTS; GAS SUPPLYING; STORAGE, DISTRIBUTION, AND TRANSPORTATION OF LIQUEFIED PETROLEUM GAS; TANKER TRANSPORT; TRANSMISSION OF OIL OR GAS THROUGH PIPELINES; TRANSPORT BROKERAGE; TRANSPORT BY PIPELINE; TRANSPORT BY TRUCK, RAIL, BARGE, VESSEL AND PIPELINE, AND TERMINALLING OF BULK PRODUCTS, NAMELY, GASOLINE, DIESEL, OIL AND PETROLEUM PRODUCTS; TRANSPORT OF FUELS, GAS, GASOLINE, DIESEL, OIL AND PETROLEUM PRODUCTS BY TRUCK, RAIL, BARGE, VESSEL AND PIPELINE, AND TERMINALLING; TRANSPORTATION AND STORAGE OF FUELS; TRUCKING SERVICES, NAMELY, HAULING OF FUELS, GAS, GASOLINE, DIESEL, OIL AND PETROLEUM PRODUCTS; WAREHOUSING SERVICES, NAMELY, STORAGE, DISTRIBUTION, PICK-UP, PACKING, AND SHIPPING OF FUELS, GAS, GASOLINE, DIESEL, OIL AND PETROLEUM PRODUCTS, IN CLASS 39 (U.S. CLS. 100 AND 105).

FIRST USE 1-3-2000; IN COMMERCE 1-3-2000.

THE MARK CONSISTS OF A STYLIZED "DB" DESIGN IN A SQUARE-DIAMOND.

SER. NO. 85-309,070, FILED 4-30-2011.

MICHELE SWAIN, EXAMINING ATTORNEY



David J. Kyffers

Director of the United States Patent and Trademark Office

United States of America

United States Patent and Trademark Office

Meter Smart

Reg. No. 4,107,911

BLUE SKY SOFTWARE SOLUTIONS, INC. (ARIZONA CORPORATION)
1230 WEST WASHINGTON STREET, SUITE 207
TEMPE, AZ 85281

Registered Mar. 6, 2012

Int. Cl.: 35

FOR: UTILITY BILL MANAGEMENT SERVICES, NAMELY, TRACKING, REPORTING, ANALYZING AND DELIVERING ENERGY INFORMATION IN THE FORM OF UTILITY BILLS AND UTILITY METER DATA RATE SCHEDULES, IN CLASS 35 (U.S. CLS. 100, 101 AND 102).

SERVICE MARK

PRINCIPAL REGISTER

FIRST USE 2-15-2011; IN COMMERCE 4-15-2011.

THE MARK CONSISTS OF STANDARD CHARACTERS WITHOUT CLAIM TO ANY PARTICULAR FONT, STYLE, SIZE, OR COLOR.

NO CLAIM IS MADE TO THE EXCLUSIVE RIGHT TO USE "METER", APART FROM THE MARK AS SHOWN.

SER. NO. 85-309,164, FILED 4-30-2011.

SHAILA SETTLES, EXAMINING ATTORNEY



David J. Kyffers

Director of the United States Patent and Trademark Office

United States of America

United States Patent and Trademark Office

pd Petro
Diamond
TERMINAL COMPANY

Reg. No. 4,107,912

Registered Mar. 6, 2012

Int. Cls.: 4 and 39

TRADEMARK

SERVICE MARK

PRINCIPAL REGISTER

PETRO-DIAMOND INCORPORATED (DELAWARE CORPORATION)
1100 MAIN STREET, SECOND FLOOR
IRVINE, CA 926146714

FOR: AVIATION FUEL; BENZENE FUEL; BIODIESEL FUEL; DIESEL FUEL; DIESEL OIL; ETHANOL FUELS; FUEL FOR AIRCRAFT/SHIPS; FUEL FOR MOTOR VEHICLES, NAMELY, GAS, GASOLINE, DIESEL, OIL AND PETROLEUM; FUEL FROM CRUDE OIL; FUEL GAS; FUEL OIL; FUELS; GASEOUS FUELS; GASES FOR USE AS FUEL; GASOLINE; INDUSTRIAL GASOLINE; LIQUEFIED PETROLEUM GAS; LIQUEFIED PETROLEUM GASES; LIQUEFIED PETROLEUM GASES TO BE USED FOR DOMESTIC AND INDUSTRIAL PURPOSES AND IN MOTOR VEHICLES; LIQUID FUELS; METHANOL FUEL; MOTOR FUEL; PETROLEUM, IN CLASS 4 (U.S. CLS. 1, 6 AND 15).

FIRST USE 3-15-1985; IN COMMERCE 3-15-1985.

FOR: DISTRIBUTION SERVICES, NAMELY, DELIVERY OF FUELS, GAS, GASOLINE, DIESEL, OIL AND PETROLEUM PRODUCTS; FUEL DELIVERY SERVICES FEATURING GAS, GASOLINE, DIESEL, OIL AND PETROLEUM PRODUCTS; GAS SUPPLYING; STORAGE, DISTRIBUTION, AND TRANSPORTATION OF LIQUEFIED PETROLEUM GAS; TANKER TRANSPORT; TRANSMISSION OF OIL OR GAS THROUGH PIPELINES; TRANSPORT BROKERAGE; TRANSPORT BY PIPELINE; TRANSPORT BY TRUCK, RAIL, BARGE, VESSEL AND PIPELINE, AND TERMINALLING OF BULK PRODUCTS, NAMELY, GASOLINE, DIESEL, OIL AND PETROLEUM PRODUCTS; TRANSPORT OF FUELS, GAS, GASOLINE, DIESEL, OIL AND PETROLEUM PRODUCTS BY TRUCK, RAIL, BARGE, VESSEL AND PIPELINE, AND TERMINALLING; TRANSPORTATION AND STORAGE OF FUELS; TRUCKING SERVICES, NAMELY, HAULING OF FUELS, GAS, GASOLINE, DIESEL, OIL AND PETROLEUM PRODUCTS; WAREHOUSING SERVICES, NAMELY, STORAGE, DISTRIBUTION, PICK-UP, PACKING, AND SHIPPING OF FUELS, GAS, GASOLINE, DIESEL, OIL AND PETROLEUM PRODUCTS, IN CLASS 39 (U.S. CLS. 100 AND 105).

FIRST USE 3-15-1985; IN COMMERCE 3-15-1985.

NO CLAIM IS MADE TO THE EXCLUSIVE RIGHT TO USE "PETRO" AND "TERMINAL COMPANY", APART FROM THE MARK AS SHOWN.



David J. Kappas

Director of the United States Patent and Trademark Office

Reg. No. 4,107,912 THE MARK CONSISTS OF LOWER CASE LETTERS "D" AND "P" NEXT TO THE WORDING "PETRO DIAMOND" ABOVE THE WORDING "TERMINAL COMPANY" WHICH IS BETWEEN TWO LINES.

SER. NO. 85-309,570, FILED 5-2-2011.

MICHELE SWAIN, EXAMINING ATTORNEY

United States of America

United States Patent and Trademark Office



Reg. No. 4,107,913

Registered Mar. 6, 2012

Int. Cl.: 40

SERVICE MARK

PRINCIPAL REGISTER

TULSA RECYCLE & TRANSFER, INC. (OKLAHOMA CORPORATION)
1025 EAST LATIMER PLACE
TULSA, OK 741064962

FOR: RECYCLING; RECYCLING OF WASTE, TRASH AND RUBBISH; MATERIAL RECOVERY SERVICES IN CONNECTION WITH RECYCLING; RECYCLING SERVICES, NAMELY, MATERIALS RECYCLING FACILITIES, IN CLASS 40 (U.S. CLS. 100, 103 AND 106).

FIRST USE 4-11-2011; IN COMMERCE 4-11-2011.

NO CLAIM IS MADE TO THE EXCLUSIVE RIGHT TO USE "TULSA RECYCLE AND TRANSFER" AND THE INTERNATIONAL SYMBOL FOR RECYCLING, APART FROM THE MARK AS SHOWN.

THE MARK CONSISTS OF A CARTOON CHARACTER OF A RECYCLE BIN WITH A FACE, ARMS AND LEGS, BALLCAP AND BOOTS, WITH THE WORDING "MR. MURPH" ON THE HAT AND THE WORDING "TRT TULSA RECYCLE AND TRANSFER" UNDER THE INTERNATIONAL SYMBOL FOR RECYCLING.

SER. NO. 85-309,662, FILED 5-2-2011.

CURTIS FRENCH, EXAMINING ATTORNEY



David J. Kypos

Director of the United States Patent and Trademark Office

United States of America

United States Patent and Trademark Office



Reg. No. 4,107,914

SCHMITTER, YVETTE (UNITED STATES INDIVIDUAL)
200 WEST 72ND STREET, 8J
NEW YORK, NY 10023

Registered Mar. 6, 2012

Int. Cl.: 45

FOR: PROVIDING A WEBSITE FEATURING INFORMATION ABOUT INTERNET DATING TIPS AND INFORMATION, IN CLASS 45 (U.S. CLS. 100 AND 101).

SERVICE MARK

FIRST USE 5-3-2010; IN COMMERCE 1-3-2011.

PRINCIPAL REGISTER

NO CLAIM IS MADE TO THE EXCLUSIVE RIGHT TO USE "ONLINE DATING", APART FROM THE MARK AS SHOWN.

THE MARK CONSISTS OF THE LITERAL ELEMENTS "THE ONLINE DATING DIVA" WITH THE DESIGN OF A SHOE FORMING THE LETTER "I" IN "DIVA", ALL OF THE FOREGOING INSIDE OF A SOLID RECTANGULAR BACKGROUND.

SER. NO. 85-310,293, FILED 5-2-2011.

MARGARET POWER, EXAMINING ATTORNEY



David J. Kybas

Director of the United States Patent and Trademark Office

United States of America

United States Patent and Trademark Office

chapelboro

Reg. No. 4,107,915

Registered Mar. 6, 2012

Int. Cl.: 41

VILCOM INTERACTIVE MEDIA, LLC (NORTH CAROLINA LIMITED LIABILITY COMPANY), DBA 1360 WCHL
SUITE 130
88 VILCOM CIRCLE
CHAPEL HILL, NC 27514

SERVICE MARK

PRINCIPAL REGISTER

FOR: INFORMATION SERVICES, NAMELY, PROVIDING A WEB SITE FEATURING AUDIO, VIDEO, PHOTOGRAPHIC AND PROSE PRESENTATIONS FEATURING CURRENT EVENT NEWS REPORTING, SPORTS AND ENTERTAINMENT NEWS; ON-LINE JOURNALS, NAMELY, BLOGS FEATURING COMMUNITY INFORMATION AND COMMENTARY RELATING TO GENERAL CURRENT EVENTS, IN CLASS 41 (U.S. CLS. 100, 101 AND 107).

FIRST USE 8-11-2010; IN COMMERCE 4-29-2011.

THE MARK CONSISTS OF STANDARD CHARACTERS WITHOUT CLAIM TO ANY PARTICULAR FONT, STYLE, SIZE, OR COLOR.

SER. NO. 85-310,601, FILED 5-3-2011.

JOHN GARTNER, EXAMINING ATTORNEY



David J. Kyffers

Director of the United States Patent and Trademark Office

United States of America

United States Patent and Trademark Office

INSTANT OCEAN

Reg. No. 4,107,916

Registered Mar. 6, 2012

Int. Cls.: 1, 11 and 31

TRADEMARK

PRINCIPAL REGISTER

TETRA HOLDING (US), INC. (DELAWARE CORPORATION)
3001 COMMERCE STREET
BLACKSBURG, VA 24060

FOR: CHEMICALS AND BIOLOGICALLY ACTIVE ENZYMES AND MICROORGANISMS FOR USE AS WATER CONDITIONERS AND WATER PURIFIERS FOR USE IN IN-DOOR AQUARIA AND GARDEN PONDS; CHEMICALS FOR THE TREATMENT OF WATER IN INDOOR AQUARIA AND GARDEN PONDS; FERTILIZERS FOR AQUATIC PLANTS AND ORNAMENTAL PLANTS; CHEMICALS AND BIOLOGICALLY ACTIVE ENZYMES AND MICROORGANISMS FOR USE AS FILTERING MATERIAL FOR USE IN INDOOR AQUARIA AND GARDEN PONDS; CHEMICALS FOR THE CHEMICAL ANALYSIS OF WATER IN INDOOR AQUARIA AND GARDEN PONDS, IN CLASS 1 (U.S. CLS. 1, 5, 6, 10, 26 AND 46).

FIRST USE 12-31-2009; IN COMMERCE 12-31-2009.

FOR: PROTEIN SKIMMERS IN THE NATURE OF WATER PURIFICATION AND FILTRATION APPARATUS FOR USE IN INDOOR AQUARIA AND GARDEN PONDS; LIGHTS, HEATERS, AIR FILTERS AND WATER FILTERS, ALL FOR USE IN INDOOR AQUARIA AND GARDEN PONDS, IN CLASS 11 (U.S. CLS. 13, 21, 23, 31 AND 34).

FIRST USE 9-30-2006; IN COMMERCE 9-30-2006.

FOR: PET FOOD, IN CLASS 31 (U.S. CLS. 1 AND 46).

FIRST USE 12-31-2009; IN COMMERCE 12-31-2009.

THE MARK CONSISTS OF STANDARD CHARACTERS WITHOUT CLAIM TO ANY PARTICULAR FONT, STYLE, SIZE, OR COLOR.

OWNER OF U.S. REG. NO. 853,463.

SER. NO. 85-310,756, FILED 5-3-2011.

LINDA POWELL, EXAMINING ATTORNEY



David J. Kyros

Director of the United States Patent and Trademark Office

United States of America

United States Patent and Trademark Office

DOUBLE DOG

Reg. No. 4,107,917

Registered Mar. 6, 2012

Int. Cl.: 32

FLYING DOG BREWERY, LLLP (COLORADO LIMITED LIABILITY LIMITED PARTNERSHIP)

SUITE 104
2330 BROADWAY
DENVER, CO 80205

TRADEMARK

FOR: BREWED MALT-BASED ALCOHOLIC BEVERAGE IN THE NATURE OF A BEER, IN CLASS 32 (U.S. CLS. 45, 46 AND 48).

PRINCIPAL REGISTER

FIRST USE 1-0-2007; IN COMMERCE 2-0-2007.

THE MARK CONSISTS OF STANDARD CHARACTERS WITHOUT CLAIM TO ANY PARTICULAR FONT, STYLE, SIZE, OR COLOR.

OWNER OF U.S. REG. NOS. 3,495,109 AND 3,546,139.

SER. NO. 85-310,865, FILED 5-3-2011.

ODESSA BIBBINS, EXAMINING ATTORNEY



David J. Kyffers

Director of the United States Patent and Trademark Office

United States of America

United States Patent and Trademark Office

Number One Since Day One

Reg. No. 4,107,918

Registered Mar. 6, 2012

Int. Cl.: 41

SERVICE MARK

PRINCIPAL REGISTER

CAESARS LICENSE COMPANY, LLC (NEVADA LIMITED LIABILITY COMPANY)
ONE CAESARS PALACE DRIVE
LAS VEGAS, NV 89109

FOR: PROVIDING ENTERTAINMENT SERVICES IN THE NATURE OF CASINO GAMING;
CASINO SERVICES; CONDUCTING AND PROVIDING FACILITIES FOR SPECIAL EVENTS
FEATURING CASINO AND GAMING CONTESTS, IN CLASS 41 (U.S. CLS. 100, 101 AND
107).

FIRST USE 4-1-2011; IN COMMERCE 4-1-2011.

THE MARK CONSISTS OF STANDARD CHARACTERS WITHOUT CLAIM TO ANY PAR-
TICULAR FONT, STYLE, SIZE, OR COLOR.

SER. NO. 85-310,910, FILED 5-3-2011.

INGRID C. EULIN, EXAMINING ATTORNEY



David J. Kybas

Director of the United States Patent and Trademark Office

United States of America

United States Patent and Trademark Office

AKILAH

Reg. No. 4,107,919

Registered Mar. 6, 2012

Int. Cl.: 36

SERVICE MARK

PRINCIPAL REGISTER

PROJECT AKILAH, INC. (FLORIDA CORPORATION), AKA AKILAH INSTITUTE FOR WOMEN
109 N. BRUSH STREET, SUITE 300
TAMPA, FL 33602

FOR: CHARITABLE SERVICES, NAMELY, PROVIDING FINANCIAL SUPPORT TO PEOPLE FROM DISADVANTAGED COUNTRIES FOR THE PURPOSE OF FACILITATING EDUCATIONAL OPPORTUNITIES, IN CLASS 36 (U.S. CLS. 100, 101 AND 102).

FIRST USE 2-28-2009; IN COMMERCE 2-28-2009.

THE MARK CONSISTS OF STANDARD CHARACTERS WITHOUT CLAIM TO ANY PARTICULAR FONT, STYLE, SIZE, OR COLOR.

THE NAME(S), PORTRAIT(S), AND/OR SIGNATURE(S) SHOWN IN THE MARK DOES NOT IDENTIFY A PARTICULAR LIVING INDIVIDUAL.

THE ENGLISH TRANSLATION OF "AKILAH" IN THE MARK IS WISE, WISE ONE OR INTELLIGENT, ONE WHO REASONS.

SER. NO. 85-311,088, FILED 5-3-2011.

MARGERY A. TIERNEY, EXAMINING ATTORNEY



David J. Kyros

Director of the United States Patent and Trademark Office

United States of America

United States Patent and Trademark Office

FULLER

Reg. No. 4,107,920

Registered Mar. 6, 2012

Int. Cls.: 7 and 8

TRADEMARK

PRINCIPAL REGISTER

THE INNOVAK GROUP INC. (CANADA CORPORATION)
62 HYMUS BOULEVARD
POINTE-CLAIRE, QUEBEC, CANADA H9R1E1

FOR: POWER TOOL ACCESSORIES, NAMELY, DRILL BITS, INSERTS SCREWDRIVER BITS, ROTATING WIRE BRUSHES, JIGSAW BLADES, HACKSAW BLADES, SABERSAW BLADES, IN CLASS 7 (U.S. CLS. 13, 19, 21, 23, 31, 34 AND 35).

FIRST USE 12-31-1982; IN COMMERCE 12-31-1982.

FOR: FASTENING HAND TOOLS, NAMELY, SCREWDRIVERS, NUTDRIVERS, HEX KEYS; CUTTING HAND TOOLS, NAMELY, CHISELS, UTILITY KNIVES, TUBING CUTTERS, BOLT CUTTERS, SCISSORS, SNIPS, SAWS, HACKSAWS, SAW BLADES, FILES, MITTER BOXES; MECHANICS AND HOLDING HAND TOOLS, NAMELY, PLIERS, WRENCHES, COMBINATION WRENCHES, CLAMPS, SOCKET WRENCHES, RATCHETS; STRIKING HAND TOOLS, NAMELY, HAMMERS, MALLETS, AXES, PRY BAR, NAIL SETS, CENTER PUNCH; TOOL BELTS; HAND TOOL SETS, NONE OF THE AFOREMENTIONED GOODS INTENDED TO BE USED IN BLACKSMITHING, IN CLASS 8 (U.S. CLS. 23, 28 AND 44).

FIRST USE 12-31-1975; IN COMMERCE 12-31-1975.

THE MARK CONSISTS OF STANDARD CHARACTERS WITHOUT CLAIM TO ANY PARTICULAR FONT, STYLE, SIZE, OR COLOR.

PRIORITY CLAIMED UNDER SEC. 44(D) ON CANADA APPLICATION NO. 1525125, FILED 4-27-2011.

SER. NO. 85-311,293, FILED 5-3-2011.

EMILY CHUO, EXAMINING ATTORNEY



David J. Kyjars

Director of the United States Patent and Trademark Office

United States of America

United States Patent and Trademark Office

JAMESON

Reg. No. 4,107,921

Registered Mar. 6, 2012

Int. Cl.: 33

TRADEMARK

PRINCIPAL REGISTER

IRISH DISTILLERS LIMITED (IRELAND PRIVATE COMPANY LIMITED BY SHARES)
SIMMONSCOURT HOUSE, SIMMONSCOURT ROAD
BALLSBRIDGE, DUBLIN, IRELAND 4

FOR: ALCOHOLIC BEVERAGES EXCEPT BEERS, NAMELY, WHISKEY, IN CLASS 33 (U.S. CLS. 47 AND 49).

PRIORITY CLAIMED UNDER SEC. 44(D) ON ERPN CMNTY TM OFC APPLICATION NO. 009601221, FILED 12-15-2010, REG. NO. 009601221, DATED 4-26-2011, EXPIRES 12-15-2020.

OWNER OF U.S. REG. NOS. 899,349, 3,872,502 AND OTHERS.

THE MARK CONSISTS OF THE WORD "JAMESON" IN STYLIZED LETTERING, WITH PARTIAL OUTLINING ALONG THE RIGHT SIDES OF THE LETTERS GIVING THE LETTERS A THREE DIMENSIONAL LOOK, IN AN ARCH SHAPE.

SEC. 2(F).

SER. NO. 85-311,306, FILED 5-3-2011.

ANNE MADDEN, EXAMINING ATTORNEY



David J. Kyros

Director of the United States Patent and Trademark Office

United States of America

United States Patent and Trademark Office

BAD APPLES: BATTLE HARVEST

Reg. No. 4,107,922

ALLIANCE METAVERSAL STUDIO LLC (DELAWARE LIMITED LIABILITY COMPANY)
222 THIRD STREET
CAMBRIDGE, MA 02142

Registered Mar. 6, 2012

Int. Cl.: 9

FOR: PUZZLE-BASED VIDEO AND COMPUTER GAMES FEATURING ANTHROPOMORPHIC APPLES, IN CLASS 9 (U.S. CLS. 21, 23, 26, 36 AND 38).

TRADEMARK

FIRST USE 4-29-2011; IN COMMERCE 4-29-2011.

PRINCIPAL REGISTER

THE MARK CONSISTS OF STANDARD CHARACTERS WITHOUT CLAIM TO ANY PARTICULAR FONT, STYLE, SIZE, OR COLOR.

SER. NO. 85-311,815, FILED 5-4-2011.

MATTHEW PAPPAS, EXAMINING ATTORNEY



David J. Kappas

Director of the United States Patent and Trademark Office

United States of America

United States Patent and Trademark Office

AUDACIOUS IDEAS

Reg. No. 4,107,923

Registered Mar. 6, 2012

Int. Cl.: 41

SERVICE MARK

PRINCIPAL REGISTER

OPEN SOCIETY INSTITUTE (NEW YORK CHARITABLE TRUST)
400 WEST 59TH STREET, 4TH FLOOR
NEW YORK, NY 10019

FOR: PROVIDING A WEBSITE FEATURING A BLOG FEATURING PERSONAL OPINIONS
IN MATTERS OF GENERAL INTEREST AND A WIDE VARIETY OF TOPICS , IN CLASS
41 (U.S. CLS. 100, 101 AND 107).

FIRST USE 9-3-2007; IN COMMERCE 9-3-2007.

THE MARK CONSISTS OF STANDARD CHARACTERS WITHOUT CLAIM TO ANY PAR-
TICULAR FONT, STYLE, SIZE, OR COLOR.

NO CLAIM IS MADE TO THE EXCLUSIVE RIGHT TO USE "IDEAS", APART FROM THE
MARK AS SHOWN.

SER. NO. 85-312,045, FILED 5-4-2011.

JAY BESCH, EXAMINING ATTORNEY



David J. Kyros

Director of the United States Patent and Trademark Office

United States of America

United States Patent and Trademark Office



Reg. No. 4,107,924

Registered Mar. 6, 2012

Int. Cl.: 44

SERVICE MARK

PRINCIPAL REGISTER

OBAGI M.D., DR. ZEIN E. (UNITED STATES INDIVIDUAL)
270 NORTH CANON DRIVE
BEVERLY HILLS, CA 90210

FOR: BEAUTY SPA SERVICES, NAMELY, COSMETIC BODY AND FACIAL CARE; COSMETIC AND PLASTIC SURGERY; COSMETIC SKIN CARE SERVICES; FACIAL TREATMENT SERVICES, NAMELY, COSMETIC PEELS; LASER AND INTENSE PULSE LIGHT SKIN ENHANCEMENT PROCEDURES; MEDICAL CLINICS; MEDICAL SKIN CARE SERVICES; PERMANENT HAIR REMOVAL AND REDUCTION SERVICES; PHYSICIAN SERVICES, IN CLASS 44 (U.S. CLS. 100 AND 101).

FIRST USE 4-0-2010; IN COMMERCE 4-0-2010.

THE MARK CONSISTS OF A CIRCLE DIVIDED INTO THREE SHADED SEGMENTS.

SER. NO. 85-312,767, FILED 5-4-2011.

PAUL E. FAHRENKOPF, EXAMINING ATTORNEY



David J. Kybas

Director of the United States Patent and Trademark Office

United States of America

United States Patent and Trademark Office



Reg. No. 4,107,925

Registered Mar. 6, 2012

Int. Cl.: 44

SERVICE MARK

PRINCIPAL REGISTER

OBAGI M.D., DR. ZEIN E. (UNITED STATES INDIVIDUAL)
270 NORTH CANON DRIVE
BEVERLY HILLS, CA 90210

FOR: BEAUTY SPA SERVICES, NAMELY, COSMETIC BODY AND FACIAL CARE; COSMETIC AND PLASTIC SURGERY; COSMETIC SKIN CARE SERVICES; FACIAL TREATMENT SERVICES, NAMELY, COSMETIC PEELS; LASER AND INTENSE PULSE LIGHT SKIN ENHANCEMENT PROCEDURES; MEDICAL CLINICS; MEDICAL SKIN CARE SERVICES; PERMANENT HAIR REMOVAL AND REDUCTION SERVICES; PHYSICIAN SERVICES, IN CLASS 44 (U.S. CLS. 100 AND 101).

FIRST USE 4-0-2010; IN COMMERCE 4-0-2010.

THE MARK CONSISTS OF A CIRCLE DIVIDED INTO THREE SEGMENTS, WHICH ARE DEMARCATED BY THE COLORS GREY, BLUE, AND TURQUOISE.

THE COLOR(S) GREY, BLUE, AND TURQUOISE IS/ARE CLAIMED AS A FEATURE OF THE MARK.

SER. NO. 85-312,773, FILED 5-4-2011.

PAUL E. FAHRENKOPF, EXAMINING ATTORNEY



David J. Kypos

Director of the United States Patent and Trademark Office

United States of America

United States Patent and Trademark Office

HEAVY GREEN

Reg. No. 4,107,926

Registered Mar. 6, 2012

Int. Cl.: 9

TRADEMARK

PRINCIPAL REGISTER

HEAVY GREEN MANAGEMENT GROUP, LLC (NEW YORK LIMITED LIABILITY COMPANY)
124 ATLANTIC AVENUE
LYNNBROOK, NY 11563

FOR: SERIES OF MUSICAL SOUND RECORDINGS, IN CLASS 9 (U.S. CLS. 21, 23, 26, 36 AND 38).

FIRST USE 3-10-2010; IN COMMERCE 3-10-2010.

THE MARK CONSISTS OF STANDARD CHARACTERS WITHOUT CLAIM TO ANY PARTICULAR FONT, STYLE, SIZE, OR COLOR.

SER. NO. 85-313,093, FILED 5-5-2011.

MARTHA FROMM, EXAMINING ATTORNEY



David J. Kyffers

Director of the United States Patent and Trademark Office

United States of America

United States Patent and Trademark Office

HEAVY GREEN

Reg. No. 4,107,927

Registered Mar. 6, 2012

Int. Cl.: 41

SERVICE MARK

PRINCIPAL REGISTER

HEAVY GREEN MANAGEMENT GROUP, LLC (NEW YORK LIMITED LIABILITY COMPANY)
124 ATLANTIC AVENUE
LYNNBROOK, NY 11563

FOR: ENTERTAINMENT SERVICES IN THE NATURE OF RECORDING, PRODUCTION AND POST-PRODUCTION SERVICES IN THE FIELD OF MUSIC; CONCERT PRODUCTION SERVICES; PROVIDING ONLINE INFORMATION IN THE FIELD OF ENTERTAINMENT CONCERNING MUSIC, IN CLASS 41 (U.S. CLS. 100, 101 AND 107).

FIRST USE 3-10-2010; IN COMMERCE 3-10-2010.

THE MARK CONSISTS OF STANDARD CHARACTERS WITHOUT CLAIM TO ANY PARTICULAR FONT, STYLE, SIZE, OR COLOR.

SER. NO. 85-313,114, FILED 5-5-2011.

MARTHA FROMM, EXAMINING ATTORNEY



David J. Kyffers

Director of the United States Patent and Trademark Office

United States of America

United States Patent and Trademark Office



Reg. No. 4,107,928

Registered Mar. 6, 2012

Int. Cl.: 33

TRADEMARK

PRINCIPAL REGISTER

IRISH DISTILLERS LIMITED (IRELAND PRIVATE COMPANY LIMITED BY SHARES)
SIMMONSCOURT HOUSE, SIMMONSCOURT ROAD
BALLSBRIDGE, DUBLIN, IRELAND 4

FOR: ALCOHOLIC BEVERAGES EXCEPT BEERS, NAMELY, WHISKEY, IN CLASS 33 (U.S. CLS. 47 AND 49).

PRIORITY CLAIMED UNDER SEC. 44(D) ON ERPN CMNTY TM OFC APPLICATION NO. 009601352, FILED 12-15-2010, REG. NO. 009601352, DATED 4-26-2011, EXPIRES 12-15-2020.

NO CLAIM IS MADE TO THE EXCLUSIVE RIGHT TO USE "LIMITED", APART FROM THE MARK AS SHOWN.

THE NAME(S), PORTRAIT(S), AND/OR SIGNATURE(S) SHOWN IN THE MARK DOES NOT IDENTIFY A PARTICULAR LIVING INDIVIDUAL.

THE MARK CONSISTS OF THE LETTERS "JJ & S" IN THE CENTER OF A CIRCLE WITH A CIRCULAR OUTLINE AROUND THOSE LETTERS. THE CIRCULAR OUTLINE TAPERS AND BREAKS ON THE LEFT AT THE BOTTOM OF THE "J" AND ON THE RIGHT AT THE TOP OF THE "S." OUTSIDE OF THE CIRCULAR OUTLINE, BUT INSIDE THE TOP INNER EDGE OF THE CIRCLE, ARE THE WORDS "JOHN JAMESON" WITH A DOT BEFORE AND A DOT AFTER, AND OUTSIDE THE CIRCULAR OUTLINE, BUT INSIDE THE BOTTOM INNER EDGE OF THE CIRCLE, ARE THE WORDS "& SON LIMITED." OUTSIDE THE CIRCLE ON THE LEFT SIDE IS A SEMI-CIRCULAR OUTLINE THAT TAPERS AT THE ENDS.

SER. NO. 85-313,779, FILED 5-5-2011.

ANNE MADDEN, EXAMINING ATTORNEY



David J. Kyjars

Director of the United States Patent and Trademark Office

United States of America

United States Patent and Trademark Office



Reg. No. 4,107,929

Registered Mar. 6, 2012

Int. Cls.: 16 and 41

TRADEMARK

SERVICE MARK

PRINCIPAL REGISTER

GWI INTERNATIONAL PROGRAMAS DE ENSINO E FRANQUIAS LTDA. (BRAZIL CORPORATION)
AVENIDA GETÚLIO VARGAS, Nº 3812
ÁGUA VERDE - CURITIBA, BRAZIL 80240-041

FOR: (BASED ON USE IN COMMERCE) EDUCATIONAL BOOKS FEATURING LANGUAGE LEARNING; EDUCATIONAL KITS SOLD AS A UNIT IN THE FIELD OF LANGUAGE LEARNING CONSISTING PRIMARILY OF PRINTED INSTRUCTIONAL MATERIALS AND ALSO INCLUDING AUDIO CDS; EDUCATIONAL KITS SOLD AS A UNIT IN THE FIELD OF LANGUAGE LEARNING CONSISTING PRIMARILY OF EDUCATIONAL BOOKS, FLASH CARDS AND WORKSHEETS, AND ALSO INCLUDING AN EDUCATIONAL DVD; EDUCATIONAL KITS SOLD AS A UNIT IN THE FIELD OF LANGUAGE LEARNING CONSISTING PRIMARILY OF BOOKS, EDITORIAL MATERIAL, MAGAZINES, BROCHURES, NEWSLETTERS, CATALOGS, PUBLICATIONS, PHOTOGRAPHS AND TEACHING MATERIAL AND ALSO INCLUDING DVDS (BASED ON 44(D) PRIORITY APPLICATION) EDUCATIONAL BOOKS FEATURING LANGUAGE LEARNING; EDUCATIONAL KITS SOLD AS A UNIT IN THE FIELD OF LANGUAGE LEARNING CONSISTING PRIMARILY OF PRINTED INSTRUCTIONAL MATERIALS AND ALSO INCLUDING AUDIO CDS; EDUCATIONAL KITS SOLD AS A UNIT IN THE FIELD OF LANGUAGE LEARNING CONSISTING PRIMARILY OF EDUCATIONAL BOOKS, FLASH CARDS AND WORKSHEETS, AND ALSO INCLUDING AN EDUCATIONAL DVD; EDUCATIONAL KITS SOLD AS A UNIT IN THE FIELD OF LANGUAGE LEARNING CONSISTING PRIMARILY OF BOOKS, EDITORIAL MATERIAL, MAGAZINES, BROCHURES, NEWSLETTERS, CATALOGS, PUBLICATIONS, PHOTOGRAPHS AND TEACHING MATERIAL AND ALSO INCLUDING DVDS, IN CLASS 16 (U.S. CLS. 2, 5, 22, 23, 29, 37, 38 AND 50).



FIRST USE 12-0-2010, THE MARK WAS FIRST USED ANYWHERE IN A DIFFERENT FORM OTHER THAN THAT SOUGHT TO BE REGISTERED AT LEAST AS EARLY AS 03/00/1995; IN COMMERCE 12-0-2010, THE MARK WAS FIRST USED IN COMMERCE IN A DIFFERENT FORM OTHER THAN THAT SOUGHT TO BE REGISTERED AT LEAST AS EARLY AS 10/17/2003.

David J. Kypos

FOR: (BASED ON USE IN COMMERCE) LANGUAGE SCHOOLS FEATURING LANGUAGE COURSES IN ALL FORMS (BASED ON 44(D) PRIORITY APPLICATION) LANGUAGE SCHOOLS FEATURING LANGUAGE COURSES IN ALL FORMS, IN CLASS 41 (U.S. CLS. 100, 101 AND 107).

Reg. No. 4,107,929 FIRST USE 12-0-2010, THE MARK WAS FIRST USED ANYWHERE IN A DIFFERENT FORM OTHER THAN THAT SOUGHT TO BE REGISTERED AT LEAST AS EARLY AS 03/00/1995 ; IN COMMERCE 12-0-2010, THE MARK WAS FIRST USED IN COMMERCE IN A DIFFERENT FORM OTHER THAN THAT SOUGHT TO BE REGISTERED AT LEAST AS EARLY AS 10/17/2003.

PRIORITY CLAIMED UNDER SEC. 44(D) ON ARGENTINA APPLICATION NO. 3081426, FILED 4-20-2011.

THE COLOR(S) BLUE, WHITE AND RED IS/ARE CLAIMED AS A FEATURE OF THE MARK.

PRIORITY CLAIMED UNDER SEC. 44(D) ON ARGENTINA APPLICATION NO. 3081425, FILED 4-20-2011.

OWNER OF U.S. REG. NO. 2,973,037.

THE MARK CONSISTS OF A BLUE BALL DESIGN WITH THREE WHITE PARTIAL STRIPES ON THE BOTTOM RIGHT SIDE OF THE BALL WITH THE STYLIZED WORDS "WISE" IN BLUE AND "UP" IN RED.

SER. NO. 85-314,221, FILED 5-6-2011.

ANNE MADDEN, EXAMINING ATTORNEY

United States of America

United States Patent and Trademark Office

MY INCH OF THE OCEAN

Reg. No. 4,107,930

TERRAYEBO, INC. (MICHIGAN CORPORATION)
31401 MADISON AVE.
MADISON HEIGHTS, MI 48071

Registered Mar. 6, 2012

Int. Cl.: 42

FOR: COMPUTER PROGRAMMING SERVICES, NAMELY, CREATING PROGRAMS FOR INTERNET WEBSITES THAT ALLOW CUSTOMERS TO SELECT AND OBTAIN EXCLUSIVE VIRTUAL OWNERSHIP OF ANY GEOGRAPHIC LOCATION, AND TO FACILITATE THE SHARING OR OTHERWISE PROVIDING ELECTRONIC MEDIA OR INFORMATION OVER COMMUNICATION NETWORKS CONCERNING SUCH GEOGRAPHIC LOCATION, IN CLASS 42 (U.S. CLS. 100 AND 101).

SERVICE MARK

PRINCIPAL REGISTER

FIRST USE 6-26-2007; IN COMMERCE 11-12-2009.

THE MARK CONSISTS OF STANDARD CHARACTERS WITHOUT CLAIM TO ANY PARTICULAR FONT, STYLE, SIZE, OR COLOR.

SER. NO. 85-314,310, FILED 5-6-2011.

GIANCARLO CASTRO, EXAMINING ATTORNEY



David J. Kybas

Director of the United States Patent and Trademark Office

United States of America

United States Patent and Trademark Office

Toystar

Reg. No. 4,107,931

CONQUEST NATION INC. (NEW YORK CORPORATION)
11574 227 STREET
CAMBRIA HEIGHTS, NY 11411

Registered Mar. 6, 2012

Int. Cl.: 25

FOR: WEARABLE GARMENTS AND CLOTHING, NAMELY, SHIRTS, IN CLASS 25 (U.S. CLS. 22 AND 39).

TRADEMARK

FIRST USE 7-1-2008; IN COMMERCE 8-1-2008.

PRINCIPAL REGISTER

THE MARK CONSISTS OF STANDARD CHARACTERS WITHOUT CLAIM TO ANY PARTICULAR FONT, STYLE, SIZE, OR COLOR.

SER. NO. 85-315,116, FILED 5-7-2011.

LINDA ORNDORFF, EXAMINING ATTORNEY



David J. Kybas

Director of the United States Patent and Trademark Office

United States of America

United States Patent and Trademark Office



Reg. No. 4,107,932

Registered Mar. 6, 2012

Int. Cls.: 33, 40 and 41

TRADEMARK

SERVICE MARK

PRINCIPAL REGISTER

JUSTIN VINEYARDS & WINERY LLC (DELAWARE LIMITED LIABILITY COMPANY)
11444 W. OLYMPIC BLVD., 10TH FLOOR
LOS ANGELES, CA 90064

FOR: WINES, IN CLASS 33 (U.S. CLS. 47 AND 49).

FIRST USE 3-0-1990; IN COMMERCE 3-0-1990.

FOR: PROVIDING INFORMATION ABOUT WINE-MAKING; WINERY SERVICES, IN CLASS 40 (U.S. CLS. 100, 103 AND 106).

FIRST USE 3-0-1990; IN COMMERCE 3-0-1990.

FOR: ENTERTAINMENT SERVICES, NAMELY, WINE TASTINGS, IN CLASS 41 (U.S. CLS. 100, 101 AND 107).

FIRST USE 3-0-1990; IN COMMERCE 3-0-1990.

OWNER OF U.S. REG. NO. 2,201,175.

NO CLAIM IS MADE TO THE EXCLUSIVE RIGHT TO USE "VINEYARDS & WINERY", APART FROM THE MARK AS SHOWN.

THE NAME(S), PORTRAIT(S), AND/OR SIGNATURE(S) SHOWN IN THE MARK IDENTIFIES "JUSTIN", WHOSE CONSENT(S) TO REGISTER IS MADE OF RECORD.

THE MARK CONSISTS OF THE WORDS "JUSTIN VINEYARDS & WINERY" CENTERED WITHIN THE OUTER-CIRCLE AND A TRIANGLE CENTERED WITHIN THE INNER-CIRCLE.

SER. NO. 85-316,007, FILED 5-9-2011.

SUSAN STIGLITZ, EXAMINING ATTORNEY



David J. Kybas

Director of the United States Patent and Trademark Office

United States of America

United States Patent and Trademark Office



Reg. No. 4,107,933

Registered Mar. 6, 2012

Int. Cls.: 33, 40 and 41

TRADEMARK

SERVICE MARK

PRINCIPAL REGISTER

JUSTIN VINEYARDS & WINERY LLC (DELAWARE LIMITED LIABILITY COMPANY)
11444 W. OLYMPIC BLVD., 10TH FLOOR
LOS ANGELES, CA 90064

FOR: WINE, IN CLASS 33 (U.S. CLS. 47 AND 49).

FIRST USE 4-0-1987; IN COMMERCE 4-0-1987.

FOR: PROVIDING INFORMATION ABOUT WINE-MAKING; WINERY SERVICES, IN CLASS 40 (U.S. CLS. 100, 103 AND 106).

FIRST USE 4-0-1987; IN COMMERCE 4-0-1987.

FOR: ENTERTAINMENT SERVICES, NAMELY, WINE TASTINGS, IN CLASS 41 (U.S. CLS. 100, 101 AND 107).

FIRST USE 4-0-1987; IN COMMERCE 4-0-1987.

OWNER OF U.S. REG. NO. 2,201,175.

NO CLAIM IS MADE TO THE EXCLUSIVE RIGHT TO USE "VINEYARDS & WINERY", APART FROM THE MARK AS SHOWN.

THE NAME(S), PORTRAIT(S), AND/OR SIGNATURE(S) SHOWN IN THE MARK IDENTIFIES "JUSTIN", WHOSE CONSENT(S) TO REGISTER IS MADE OF RECORD.

THE MARK CONSISTS OF THE WORDS "JUSTIN VINEYARDS & WINERY" WITH UNDERLINE UNDERNEATH THE WORD "JUSTIN" AND A TRIANGLE CENTERED ABOVE THE WORDS.

SER. NO. 85-316,015, FILED 5-9-2011.

SUSAN STIGLITZ, EXAMINING ATTORNEY



David J. Kyffers

Director of the United States Patent and Trademark Office

United States of America

United States Patent and Trademark Office



Reg. No. 4,107,934

Registered Mar. 6, 2012

Int. Cl.: 43

SERVICE MARK

PRINCIPAL REGISTER

DISCHI, LLC (FLORIDA LIMITED LIABILITY COMPANY)
3900 N.W. 79 AVENUE, SUITE 124
DORAL, FL 33166

FOR: RESTAURANT SERVICES, IN CLASS 43 (U.S. CLS. 100 AND 101).

FIRST USE 5-5-2011; IN COMMERCE 5-5-2011.

NO CLAIM IS MADE TO THE EXCLUSIVE RIGHT TO USE "VENEZUELAN CUISINE",
APART FROM THE MARK AS SHOWN.

THE MARK CONSISTS OF THE WORDS "EL AREPAZO" FOLLOWED BY THE NUMBER
"2" CENTERED INSIDE AN OVAL DESIGN AND THE WORDING "VENEZUELAN CUISINE"
IN SMALLER LETTERING INSIDE A BANNER WITH THE DESIGN OF SEVEN STARS
BELOW.

THE WORDING "EL AREPAZO" HAS NO MEANING IN A FOREIGN LANGUAGE.

SER. NO. 85-316,024, FILED 5-9-2011.

STEVEN PEREZ, EXAMINING ATTORNEY



David J. Kybas

Director of the United States Patent and Trademark Office

United States of America

United States Patent and Trademark Office

Pony Express Relief

Reg. No. 4,107,935

Registered Mar. 6, 2012

Int. Cl.: 3

TRADEMARK

PRINCIPAL REGISTER

GENTLE TOUCH MASSAGE & HOLISTIC ALTERNATIVES, LLC (NEW JERSEY LIMITED LIABILITY COMPANY)
P.O. BOX 23
WEST MILFORD, NJ 07480

FOR: AROMATIC ESSENTIAL OILS; AROMATIC OILS; AROMATIC PREPARATIONS, NAMELY, BODY SPRAY; BATH OILS AND BATH SALTS; BODY OIL; MASSAGE OIL; MINERAL SALT IN THE NATURE OF BATH SALTS NOT FOR MEDICAL PURPOSES; NATURAL ESSENTIAL OILS; NON-MEDICATED HERBAL BODY CARE PRODUCTS, NAMELY, BODY OILS, SALVES, AND LIP BALMS, IN CLASS 3 (U.S. CLS. 1, 4, 6, 50, 51 AND 52).

FIRST USE 8-0-2008; IN COMMERCE 8-0-2008.

THE MARK CONSISTS OF STANDARD CHARACTERS WITHOUT CLAIM TO ANY PARTICULAR FONT, STYLE, SIZE, OR COLOR.

NO CLAIM IS MADE TO THE EXCLUSIVE RIGHT TO USE "RELIEF", APART FROM THE MARK AS SHOWN.

SER. NO. 85-316,730, FILED 5-10-2011.

JASON BLAIR, EXAMINING ATTORNEY



David J. Kyros

Director of the United States Patent and Trademark Office

United States of America

United States Patent and Trademark Office



Reg. No. 4,107,936

Registered Mar. 6, 2012

Int. Cl.: 33

TRADEMARK

PRINCIPAL REGISTER

IRISH DISTILLERS LIMITED (IRELAND PRIVATE COMPANY LIMITED BY SHARES)
SIMMONSCOURT HOUSE, SIMMONSCOURT ROAD
BALLSBRIDGE, DUBLIN, IRELAND 4

FOR: ALCOHOLIC BEVERAGES EXCEPT BEERS, NAMELY, WHISKEY, IN CLASS 33 (U.S. CLS. 47 AND 49).

OWNER OF ERPN CMNTY TM OFC REG. NO. 008480097, DATED 2-1-2010, EXPIRES 8-7-2019.

THE COLOR(S) RED, CREAM AND GOLD IS/ARE CLAIMED AS A FEATURE OF THE MARK.

NO CLAIM IS MADE TO THE EXCLUSIVE RIGHT TO USE "LIMITED", APART FROM THE MARK AS SHOWN.

THE NAME(S), PORTRAIT(S), AND/OR SIGNATURE(S) SHOWN IN THE MARK DOES NOT IDENTIFY A PARTICULAR LIVING INDIVIDUAL.

THE MARK CONSISTS OF THE LETTERS "JJ&S" IN CREAM LETTERING IN THE CENTER OF A CIRCLE THAT IS DARK RED IN THE LOWER LEFT HAND QUADRANT GRADATING TO A MEDIUM RED AT THE UPPER RIGHT QUADRANT. THERE IS A CREAM COLORED CIRCULAR OUTLINE AROUND THE LETTERS "JJ&S" THAT TAPERS AND BREAKS ON THE LEFT AT THE BOTTOM OF THE "J" AND ON THE RIGHT AT THE TOP OF THE "S." AROUND THE TOP INNER EDGE OF THE CIRCLE ARE THE WORDS "JOHN JAMESON" IN CREAM COLOR WITH A CREAM COLORED DOT BEFORE AND AFTER THOSE WORDS, ALL ON A DARK RED TO MEDIUM RED GROUND. AROUND THE BOTTOM INNER EDGE OF THE CIRCLE ARE THE WORDS "& SON LIMITED" IN CREAM LETTERING ON A DARK RED GROUND. OUTSIDE THE CIRCLE ON THE LEFT SIDE IS A SEMI-CIRCULAR OUTLINE IN GOLD WITH A THIN OUTER DARK RED BORDER. BOTH THE SEMI-CIRCULAR OUTLINE AND THE BORDER CURVE AROUND THE RED CIRCLE AND TAPER AT THE ENDS.



David J. Kyjars

SER. NO. 85-316,856, FILED 5-10-2011.

ANNE MADDEN, EXAMINING ATTORNEY

United States of America

United States Patent and Trademark Office

SPORTINGNEWS MAGAZINE

Reg. No. 4,107,937

AMERICAN CITY BUSINESS JOURNALS INC. (DELAWARE CORPORATION)
120 WEST MOREHEAD STREET
CHARLOTTE, NC 28202

Registered Mar. 6, 2012

Int. Cl.: 16

FOR: MAGAZINES FEATURING NEWS AND INFORMATION ABOUT SPORTS, IN CLASS 16 (U.S. CLS. 2, 5, 22, 23, 29, 37, 38 AND 50).

TRADEMARK

FIRST USE 8-1-2008; IN COMMERCE 8-1-2008.

PRINCIPAL REGISTER

THE MARK CONSISTS OF STANDARD CHARACTERS WITHOUT CLAIM TO ANY PARTICULAR FONT, STYLE, SIZE, OR COLOR.

OWNER OF U.S. REG. NOS. 1,175,109, 2,818,771 AND OTHERS.

NO CLAIM IS MADE TO THE EXCLUSIVE RIGHT TO USE "MAGAZINE", APART FROM THE MARK AS SHOWN.

SEC. 2(F).

SER. NO. 85-317,125, FILED 5-10-2011.

INGRID C. EULIN, EXAMINING ATTORNEY



David J. Kybas

Director of the United States Patent and Trademark Office

United States of America

United States Patent and Trademark Office



Reg. No. 4,107,938

Registered Mar. 6, 2012

Int. Cl.: 7

TRADEMARK

PRINCIPAL REGISTER

FNA IP HOLDINGS, INC. (ILLINOIS CORPORATION)
1825 GREENLEAF AVENUE
ELK GROVE VILLAGE, IL 60007

FOR: PRESSURE WASHERS, PARTS AND ACCESSORIES THERETO, IN CLASS 7 (U.S. CLS. 13, 19, 21, 23, 31, 34 AND 35).

FIRST USE 9-1-2009; IN COMMERCE 9-1-2009.

THE MARK CONSISTS OF AN OVAL-SHAPED DESIGN WITH SWIRLED EDGES.

SER. NO. 85-317,842, FILED 5-11-2011.

ELI HELLMAN, EXAMINING ATTORNEY



David J. Kybas

Director of the United States Patent and Trademark Office

United States of America

United States Patent and Trademark Office

QUICK-N-SLICK

Reg. No. 4,107,939

Registered Mar. 6, 2012

Int. Cl.: 3

TRADEMARK

PRINCIPAL REGISTER

CROFTGATE USA, LLC (FLORIDA LIMITED LIABILITY COMPANY)
2040 LEE STREET
HOLLYWOOD, FL 33020

FOR: POLISHING PREPARATIONS FOR AUTOMOBILES, RECREATIONAL VEHICLES, TRUCKS, VANS, BOATS AND AIRPLANES; AND POLYMER SEALANT FOR CLEANING, SHINING AND PROTECTING EXTERIOR SURFACES OF AUTOMOBILES, RECREATIONAL VEHICLES, TRUCKS, VANS, BOATS AND AIRPLANES, IN CLASS 3 (U.S. CLS. 1, 4, 6, 50, 51 AND 52).

FIRST USE 7-20-2009; IN COMMERCE 7-20-2009.

THE MARK CONSISTS OF STANDARD CHARACTERS WITHOUT CLAIM TO ANY PARTICULAR FONT, STYLE, SIZE, OR COLOR.

SER. NO. 85-318,158, FILED 5-11-2011.

ALEXANDER L. POWERS, EXAMINING ATTORNEY



David J. Kyros

Director of the United States Patent and Trademark Office

United States of America

United States Patent and Trademark Office



Reg. No. 4,107,940

Registered Mar. 6, 2012

Int. Cl.: 41

SERVICE MARK

PRINCIPAL REGISTER

SACRAMENTO COUNTY OFFICE OF EDUCATION (CALIFORNIA REGIONAL PUBLIC AGENCY)
10474 MATHER BLVD.
MATHER, CA 95655

FOR: EDUCATION SERVICES, NAMELY, PROVIDING ONLINE NON-DOWNLOADABLE VIDEOS, NON-DOWNLOADABLE MULTI-MEDIA PRESENTATIONS AND CLASSES IN THE FIELD OF ADULT LEARNING, NAMELY, READING, ENGLISH AS A SECOND LANGUAGE, LIFE SKILLS AND AMERICAN CITIZENSHIP, IN CLASS 41 (U.S. CLS. 100, 101 AND 107).

FIRST USE 11-7-2008; IN COMMERCE 11-7-2008.

NO CLAIM IS MADE TO THE EXCLUSIVE RIGHT TO USE "U.S.A. LEARNS", APART FROM THE MARK AS SHOWN.

THE COLOR(S) BLACK, WHITE, BLUE, RED, GRAY IS/ARE CLAIMED AS A FEATURE OF THE MARK.

THE MARK CONSISTS OF FOUR OF FIVE POINTS OF A FIVE-POINTED STAR HEAVILY OUTLINED IN WHITE WITH A BLACK SURROUND ON THE LEFT SIDE OF THE MARK, THE ABBREVIATION "U.S.A." IN UPPERCASE BLUE LETTERS WITH A WHITE OUTLINE LEFT-ALIGNED WITH THE CENTER OF THE STAR, THE WORD "LEARNS" IN RED LETTERS WITH A WHITE OUTLINE BELOW "U.S.A.," AND A GRAYSCALE DROPSHADOW FOR ALL THE ABOVE ELEMENTS.

SER. NO. 85-318,525, FILED 5-11-2011.

BARBARA BROWN, EXAMINING ATTORNEY



David J. Kyjars

Director of the United States Patent and Trademark Office

United States of America

United States Patent and Trademark Office

Lanmark360

Reg. No. 4,107,941

LANMARK 360, INC. (NEW JERSEY CORPORATION)
804 BROADWAY
LONG BRANCH, NJ 07764

Registered Mar. 6, 2012

Int. Cl.: 35

FOR: ADVERTISING AND MARKETING, IN CLASS 35 (U.S. CLS. 100, 101 AND 102).

SERVICE MARK

FIRST USE 3-1-2011; IN COMMERCE 3-1-2011.

PRINCIPAL REGISTER

THE MARK CONSISTS OF THE WORD "LANMARK" IN BLACK AND THE NUMBER "360" IN ORANGE. THE NUMBER "0" IN "360" CONTAINS A CIRCLE CUT OUT IN THE TOP RIGHT AREA TO SYMBOLIZE THE DEGREE SYMBOL.

THE COLOR(S) BLACK AND ORANGE IS/ARE CLAIMED AS A FEATURE OF THE MARK.

SER. NO. 85-319,403, FILED 5-12-2011.

TINA MAI, EXAMINING ATTORNEY



David J. Kybas

Director of the United States Patent and Trademark Office

United States of America

United States Patent and Trademark Office



Reg. No. 4,107,942

Registered Mar. 6, 2012

Int. Cls.: 25 and 39

TRADEMARK

SERVICE MARK

PRINCIPAL REGISTER

LBC LOGISTICS, LLC (CALIFORNIA LIMITED LIABILITY COMPANY)
1320 HAYES AVE
LONG BEACH, CA 90813

FOR: BEANIES; HATS; JACKETS; SHIRTS; SWEATERS, IN CLASS 25 (U.S. CLS. 22 AND 39).

FIRST USE 2-1-2010; IN COMMERCE 2-1-2010.

FOR: TRUCKING SERVICES, NAMELY, HAULING OF CARS, FOOD, CLOTHES, STEEL, TIRES, TOOLS, TOYS, HOME DECORATIONS, GROCERIES, SHOES, ELECTRONICS, OFFICE SUPPLIES, IN CLASS 39 (U.S. CLS. 100 AND 105).

FIRST USE 2-1-2010; IN COMMERCE 2-1-2010.

NO CLAIM IS MADE TO THE EXCLUSIVE RIGHT TO USE "LBC", "LOGISTICS" AND "LONG BEACH CA.", APART FROM THE MARK AS SHOWN.

THE MARK CONSISTS OF THE STYLIZED TEXT "LBC" IN BIG BLOCK LETTERS OVER A SILHOUETTE OF THE LONG BEACH SKYLINE. BELOW THE SILHOUETTE IS THE STYLIZED TEXT "LOGISTICS" INSIDE A OF A LONG OVAL SHAPED SPACE AND BELOW THERE ARE THE STYLIZED TEXT "LONG BEACH CA.".

SER. NO. 85-319,763, FILED 5-12-2011.

JOHN HWANG, EXAMINING ATTORNEY



David J. Kybas

Director of the United States Patent and Trademark Office

United States of America

United States Patent and Trademark Office

AUDIOSPARX

THE MUSIC THAT POWERS HOLLYWOOD

Reg. No. 4,107,943

NAVARR ENTERPRISES, INC. (FLORIDA CORPORATION)
2800 N 6TH ST UNIT 1 PMB 259
SAINT AUGUSTINE, FL 32084

Registered Mar. 6, 2012

Int. Cl.: 35

FOR: COMMERCIAL ADMINISTRATION OF THE LICENSING OF THE GOODS AND SERVICES OF OTHERS, IN CLASS 35 (U.S. CLS. 100, 101 AND 102).

SERVICE MARK

FIRST USE 4-1-2001; IN COMMERCE 4-1-2001.

PRINCIPAL REGISTER

NO CLAIM IS MADE TO THE EXCLUSIVE RIGHT TO USE "HOLLYWOOD" AND "MUSIC", APART FROM THE MARK AS SHOWN.

THE MARK CONSISTS OF THE LITERAL ELEMENTS "AUDIOSPARX THE MUSIC THAT POWERS HOLLYWOOD" WHEREIN THE LETTER "S" OF "SPARX" IS EXTENDED AS UNDERLINE TO THE WORD "AUDIO", THE WORD "AUDIOSPARX" IS WRITTEN ABOVE "THE MUSIC THAT POWERS HOLLYWOOD" AS SHOWN IN MARK.

SER. NO. 85-319,808, FILED 5-12-2011.

H. M. FISHER, EXAMINING ATTORNEY



David J. Kyffers

Director of the United States Patent and Trademark Office

United States of America

United States Patent and Trademark Office

TAMERLANE GLOBAL SERVICES

Reg. No. 4,107,944

Registered Mar. 6, 2012

Int. Cls.: 35 and 39

SERVICE MARK

PRINCIPAL REGISTER

TAMERLANE GLOBAL SERVICES, INC. (VIRGINIA CORPORATION)
1220 KING STREET
ALEXANDRIA, VA 22314

FOR: SUPPLY CHAIN MANAGEMENT, IN CLASS 35 (U.S. CLS. 100, 101 AND 102).

FIRST USE 10-11-2010; IN COMMERCE 10-11-2010.

FOR: SUPPLY CHAIN LOGISTICS AND REVERSE LOGISTICS SERVICES, NAMELY, STORAGE, TRANSPORTATION AND DELIVERY OF GOODS FOR OTHERS BY AIR, RAIL, SHIP OR TRUCK; TRANSPORT BROKERAGE SERVICES; FREIGHT FORWARDING AND FREIGHT BROKERAGE SERVICES; WAREHOUSING SERVICES; IMPORT AND EXPORT CARGO HANDLING SERVICES; CONSULTING AND PROJECT MANAGEMENT SERVICES IN EMERGING MARKETS AND CONFLICT ZONES, ALL RELATING TO THE FOREGOING, IN CLASS 39 (U.S. CLS. 100 AND 105).

FIRST USE 10-11-2010; IN COMMERCE 10-11-2010.

THE MARK CONSISTS OF STANDARD CHARACTERS WITHOUT CLAIM TO ANY PARTICULAR FONT, STYLE, SIZE, OR COLOR.

NO CLAIM IS MADE TO THE EXCLUSIVE RIGHT TO USE "GLOBAL SERVICES", APART FROM THE MARK AS SHOWN.

SER. NO. 85-319,951, FILED 5-13-2011.

ROSELLE HERRERA, EXAMINING ATTORNEY



David J. Kybas

Director of the United States Patent and Trademark Office

United States of America

United States Patent and Trademark Office

PARTNERS IN PROGRESS

Reg. No. 4,107,945

Registered Mar. 6, 2012

Int. Cl.: 41

SERVICE MARK

PRINCIPAL REGISTER

NATIONAL ORGANIZATION FOR RARE DISORDERS, INC. (NEW YORK CORPORATION)
P.O. BOX 1968
55 KENOSIA AVE.
DANBURY, CT 068131968

FOR: ARRANGING AND HOSTING SOCIAL ENTERTAINMENT EVENTS TO PROMOTE AWARENESS OF THE EXISTENCE, DIAGNOSIS AND TREATMENT OF RARE DISEASES AND DISORDERS, ORPHAN DRUGS, RELATED MEDICAL DEVICES AND RELATED SCIENTIFIC RESEARCH, AND THE ASSISTANCE OF INDIVIDUALS LIVING AND COPING WITH RARE DISEASES AND DISORDERS; PROVIDING RECOGNITION BY WAY OF AWARDS TO DEMONSTRATE EXCELLENCE IN THE FOREGOING FIELDS; EDUCATIONAL SERVICES, NAMELY CONDUCTING CONFERENCES IN THE FOREGOING FIELDS, IN CLASS 41 (U.S. CLS. 100, 101 AND 107).

FIRST USE 5-14-2009; IN COMMERCE 5-14-2009.

THE MARK CONSISTS OF STANDARD CHARACTERS WITHOUT CLAIM TO ANY PARTICULAR FONT, STYLE, SIZE, OR COLOR.

SER. NO. 85-320,229, FILED 5-13-2011.

LAURA HAMMEL, EXAMINING ATTORNEY



David J. Kyffers

Director of the United States Patent and Trademark Office

United States of America

United States Patent and Trademark Office

ALONE WE ARE RARE.
TOGETHER WE ARE STRONG.

Reg. No. 4,107,946

Registered Mar. 6, 2012

Int. Cl.: 41

SERVICE MARK

PRINCIPAL REGISTER

NATIONAL ORGANIZATION FOR RARE DISORDERS, INC. (NEW YORK CORPORATION)
P.O. BOX 1968
55 KENOSIA AVE.
DANBURY, CT 068131968

FOR: ARRANGING AND HOSTING EDUCATIONAL CONFERENCES AND SOCIAL ENTERTAINMENT EVENTS TO PROMOTE AWARENESS OF THE EXISTENCE, DIAGNOSIS AND TREATMENT OF RARE DISEASES AND DISORDERS, ORPHAN DRUGS, RELATED MEDICAL DEVICES AND RELATED SCIENTIFIC RESEARCH, AND THE ASSISTANCE OF INDIVIDUALS LIVING AND COPING WITH RARE DISEASES AND DISORDERS; PROVIDING A WEBSITE FEATURING INFORMATION ABOUT EDUCATIONAL CONFERENCES AND SOCIAL ENTERTAINMENT EVENTS IN THE FOREGOING FIELDS, IN CLASS 41 (U.S. CLS. 100, 101 AND 107).

FIRST USE 2-28-2009; IN COMMERCE 2-28-2009.

THE MARK CONSISTS OF STANDARD CHARACTERS WITHOUT CLAIM TO ANY PARTICULAR FONT, STYLE, SIZE, OR COLOR.

SER. NO. 85-320,245, FILED 5-13-2011.

LAURA HAMMEL, EXAMINING ATTORNEY



David J. Kyros

Director of the United States Patent and Trademark Office

United States of America

United States Patent and Trademark Office

ALONE WE ARE RARE.
TOGETHER WE ARE STRONG.

Reg. No. 4,107,947

Registered Mar. 6, 2012

Int. Cls.: 35 and 45

SERVICE MARK

PRINCIPAL REGISTER

NATIONAL ORGANIZATION FOR RARE DISORDERS, INC. (NEW YORK CORPORATION)
P.O. BOX 1968
55 KENOSIA AVE.
DANBURY, CT 068131968

FOR: PUBLIC ADVOCACY TO PROMOTE AWARENESS OF THE EXISTENCE, DIAGNOSIS AND TREATMENT OF RARE DISEASES AND DISORDERS, ORPHAN DRUGS, RELATED MEDICAL DEVICES AND RELATED SCIENTIFIC RESEARCH, AND THE ASSISTANCE OF INDIVIDUALS LIVING AND COPING WITH RARE DISEASES AND DISORDERS, IN CLASS 35 (U.S. CLS. 100, 101 AND 102).

FIRST USE 2-28-2009; IN COMMERCE 2-28-2009.

FOR: PROVIDING A WEBSITE FEATURING SUPPORTIVE PERSONAL NON-DOWNLOADABLE VIDEO PRESENTATIONS AND STORIES ABOUT INDIVIDUALS LIVING AND COPING WITH RARE DISEASES AND DISORDERS, IN CLASS 45 (U.S. CLS. 100 AND 101).

FIRST USE 2-28-2011; IN COMMERCE 2-28-2011.

THE MARK CONSISTS OF STANDARD CHARACTERS WITHOUT CLAIM TO ANY PARTICULAR FONT, STYLE, SIZE, OR COLOR.

SER. NO. 85-320,284, FILED 5-13-2011.

LAURA HAMMEL, EXAMINING ATTORNEY



David J. Kybas

Director of the United States Patent and Trademark Office

United States of America

United States Patent and Trademark Office

Mí ama

Reg. No. 4,107,948

Registered Mar. 6, 2012

Int. Cl.: 25

TRADEMARK

PRINCIPAL REGISTER

MILANOO.COM LIMITED (CHINA LIMITED COMPANY (LTD.))
FLAT/RM 2
19/F HENAN BLDG 90-92 JAFFE RD
WANCHAI HK, CHINA

FOR: BOTTOMS; DRESSES; GIRDLES; GLOVES; HATS; HOSIERY; JACKETS; MASQUERADE COSTUMES; SCARVES; SHIRTS; SHOES; TOPS; UNDERGARMENTS; WEDDING DRESSES, IN CLASS 25 (U.S. CLS. 22 AND 39).

FIRST USE 4-6-2011; IN COMMERCE 4-6-2011.

THE MARK CONSISTS OF THE WORDING "MI AMA" WITH AN ACCENT OVER THE LETTER "I".

THE ENGLISH TRANSLATION OF "MI AMA" IN THE MARK IS "IT LOVES ME".

SER. NO. 85-320,533, FILED 5-13-2011.

JAY BESCH, EXAMINING ATTORNEY



David J. Kyffers

Director of the United States Patent and Trademark Office

United States of America

United States Patent and Trademark Office



Reg. No. 4,107,949

Registered Mar. 6, 2012

Int. Cl.: 25

TRADEMARK

PRINCIPAL REGISTER

MILANOO.COM LIMITED (CHINA LIMITED COMPANY (LTD.))
FLAT/RM 2
19/F HENAN BLDG 90-92 JAFFE RD
WANCHAI HK, CHINA

FOR: BOTTOMS; DRESSES; GIRDLES; GLOVES; HATS; HOSIERY; JACKETS; MASQUERADE COSTUMES; SCARFS; SHIRTS; SHOES; TOPS; UNDERGARMENTS; WEDDING DRESSES, IN CLASS 25 (U.S. CLS. 22 AND 39).

FIRST USE 4-6-2011; IN COMMERCE 4-6-2011.

NO CLAIM IS MADE TO THE EXCLUSIVE RIGHT TO USE "COSPLAY", APART FROM THE MARK AS SHOWN.

THE MARK CONSISTS OF THE STYLIZED WORDING "COSPLAY SHOW" WITH THE LETTER "S" IN SHOW REVERSED, SHADING IN THE WORDING "SHOW" AND IN THE INNER BORDERS OF THE LETTERS "O," ALL ENCOMPASSED IN A DARK BACKGROUND.

SER. NO. 85-320,572, FILED 5-13-2011.

JAY BESCH, EXAMINING ATTORNEY



David J. Kybas

Director of the United States Patent and Trademark Office

United States of America

United States Patent and Trademark Office



Reg. No. 4,107,950

NET.SURVEILLANCE, INC. (CALIFORNIA CORPORATION)
6440 LUSK BOULEVARD, SUITE 102
SAN DIEGO, CA 92121

Registered Mar. 6, 2012

Int. Cls.: 42 and 45

FOR: SERVICES IN THE NATURE OF ASSESSMENT, EVALUATION, SURVEY, DESIGN, INTEGRATION, AND IMPLEMENTATION OF ON-SITE ELECTRONIC SECURITY AND MONITORING SYSTEMS AND PROGRAMS, IN CLASS 42 (U.S. CLS. 100 AND 101).

SERVICE MARK

FIRST USE 7-0-2010; IN COMMERCE 7-0-2010.

PRINCIPAL REGISTER

FOR: SECURITY PROTECTIVE SERVICES, NAMELY, VIDEO SURVEILLANCE, INTRUSION DETECTION, ACCESS CONTROL, PERIMETER PROTECTION, THEFT PREVENTION, REMOTE VIDEO MONITORING, AND ALARM MONITORING, IN CLASS 45 (U.S. CLS. 100 AND 101).

FIRST USE 7-0-2010; IN COMMERCE 7-0-2010.

NO CLAIM IS MADE TO THE EXCLUSIVE RIGHT TO USE "SECURITY SERVICES", APART FROM THE MARK AS SHOWN.

THE COLOR(S) RED AND GRAY IS/ARE CLAIMED AS A FEATURE OF THE MARK.

THE MARK CONSISTS OF THE WORDING "LAYER" IN RED, NUMBER "3" IN GRAY, THE WORDING "SECURITY SERVICES" IN RED.

SER. NO. 85-320,961, FILED 5-13-2011.

KEVON CHISOLM, EXAMINING ATTORNEY



David J. Kybas

Director of the United States Patent and Trademark Office

United States of America

United States Patent and Trademark Office

LAYER3 SECURITY SERVICES

Reg. No. 4,107,951

Registered Mar. 6, 2012

Int. Cls.: 42 and 45

SERVICE MARK

PRINCIPAL REGISTER

NET.SURVEILLANCE, INC. (CALIFORNIA CORPORATION)
6440 LUSK BOULEVARD, SUITE 102
SAN DIEGO, CA 92121

FOR: SERVICES IN THE NATURE OF ASSESSMENT, EVALUATION, SURVEY, DESIGN, INTEGRATION, AND IMPLEMENTATION OF ON-SITE ELECTRONIC SECURITY AND MONITORING SYSTEMS AND PROGRAMS, IN CLASS 42 (U.S. CLS. 100 AND 101).

FIRST USE 7-0-2010; IN COMMERCE 7-0-2010.

FOR: SECURITY PROTECTIVE SERVICES, NAMELY, VIDEO SURVEILLANCE, INTRUSION DETECTION, ACCESS CONTROL, PERIMETER PROTECTION, THEFT PREVENTION, REMOTE VIDEO MONITORING, AND ALARM MONITORING, IN CLASS 45 (U.S. CLS. 100 AND 101).

FIRST USE 7-0-2010; IN COMMERCE 7-0-2010.

THE MARK CONSISTS OF STANDARD CHARACTERS WITHOUT CLAIM TO ANY PARTICULAR FONT, STYLE, SIZE, OR COLOR.

NO CLAIM IS MADE TO THE EXCLUSIVE RIGHT TO USE "SECURITY SERVICES", APART FROM THE MARK AS SHOWN.

SER. NO. 85-320,977, FILED 5-13-2011.

KEVON CHISOLM, EXAMINING ATTORNEY



David J. Kyros

Director of the United States Patent and Trademark Office

United States of America

United States Patent and Trademark Office



Reg. No. 4,107,952

Registered Mar. 6, 2012

Int. Cl.: 12

TRADEMARK

PRINCIPAL REGISTER

BUGATTI INTERNATIONAL S.A. (LUXEMBOURG CORPORATION)
412F ROUTE D-ESCH
LUXEMBOURG, LUXEMBOURG 1030

FOR: AUTOMOBILES, IN CLASS 12 (U.S. CLS. 19, 21, 23, 31, 35 AND 44).

FIRST USE 1-31-2000; IN COMMERCE 1-31-2000.

OWNER OF U.S. REG. NOS. 2,956,068 AND 2,956,069.

THE MARK CONSISTS OF A THREE-DIMENSIONAL CONFIGURATION OF THE GRILL OF AN AUTOMOBILE, CONSISTING OF A FRAME THAT HAS A STRAIGHT BOTTOM WITH AN ELONGATED ARCH SHAPE ON THE TOP AND SIDES, THE GRILL WITHIN THE FRAME, AND AN OVAL FACE PLATE NEAR THE TOP-CENTER OF THE GRILL. THE MATTER SHOWN IN BROKEN LINES IS NOT PART OF THE MARK AND SERVES ONLY TO SHOW THE POSITION OF THE MARK.

SEC. 2(F).

SER. NO. 85-321,817, FILED 5-16-2011.

JAY BESCH, EXAMINING ATTORNEY



David J. Kyffers

Director of the United States Patent and Trademark Office

United States of America

United States Patent and Trademark Office

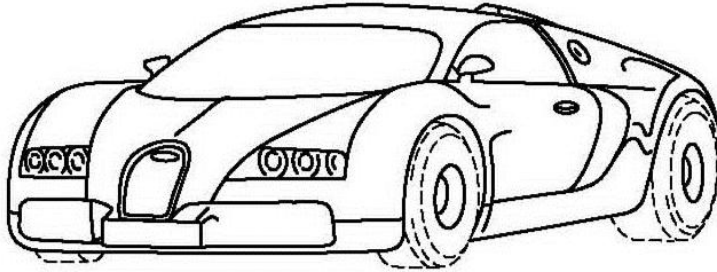

Reg. No. 4,107,953

Registered Mar. 6, 2012

Int. Cl.: 12

TRADEMARK

PRINCIPAL REGISTER

BUGATTI INTERNATIONAL S.A. (LUXEMBOURG CORPORATION)
412F ROUTE D-ESCH
LUXEMBOURG, LUXEMBOURG 1030

FOR: AUTOMOBILES, IN CLASS 12 (U.S. CLS. 19, 21, 23, 31, 35 AND 44).

FIRST USE 1-31-2000; IN COMMERCE 1-31-2000.

OWNER OF U.S. REG. NOS. 2,956,068 AND 2,956,069.

THE MARK CONSISTS OF A THREE-DIMENSIONAL CONFIGURATION OF AN AUTO-MOBILE. THE BROKEN LINES DEPICTING THE TIRES INDICATE PLACEMENT OF THE MARK ON THE GOODS AND ARE NOT PART OF THE MARK.

SEC. 2(F).

SER. NO. 85-321,828, FILED 5-16-2011.

JAY BESCH, EXAMINING ATTORNEY



David J. Kyros

Director of the United States Patent and Trademark Office

United States of America

United States Patent and Trademark Office

THE DIRECTOR

Reg. No. 4,107,954

Registered Mar. 6, 2012

Int. Cl.: 9

TRADEMARK

PRINCIPAL REGISTER

AUDIOCONTROL, INC. (WASHINGTON CORPORATION)
22410 70TH AVE. WEST
MOUNTLAKE TERRACE, WA 98043

FOR: AUDIO AMPLIFIERS; SIGNAL PROCESSORS; AUDIO EQUALIZERS; AUDIO CROSSOVERS FOR HOME AUDIO USE; MULTIPLE INPUT/MULTIPLE ZONE SPEAKER SWITCHES FOR HOME AUDIO SYSTEMS, IN CLASS 9 (U.S. CLS. 21, 23, 26, 36 AND 38).

FIRST USE 10-31-1990; IN COMMERCE 10-31-1990.

THE MARK CONSISTS OF STANDARD CHARACTERS WITHOUT CLAIM TO ANY PARTICULAR FONT, STYLE, SIZE, OR COLOR.

SER. NO. 85-322,258, FILED 5-16-2011.

INGA ERVIN, EXAMINING ATTORNEY



David J. Kybas

Director of the United States Patent and Trademark Office

United States of America

United States Patent and Trademark Office

LINCOLN CROWNE & COMPANY

Reg. No. 4,107,955

Registered Mar. 6, 2012

Int. Cl.: 36

SERVICE MARK

PRINCIPAL REGISTER

LINCOLN CROWNE & COMPANY PTY LIMITED (AUSTRALIA PROPRIETARY LIMITED COMPANY (P/L OR PTY. LTD.))
SUITE 3, LEVEL 18, AURORA PLACE, 88 PHIL
SYDNEY, AUSTRALIA 2000

FOR: INSURANCE AND FINANCIAL SERVICES, NAMELY, THE PROVISION OF SPECIAL-IST FINANCIAL AND STRATEGY ADVICE IN RELATION TO MERGERS DIVESTMENTS AND ACQUISITIONS; FINANCIAL CONSULTING SERVICES, IN CLASS 36 (U.S. CLS. 100, 101 AND 102).

FIRST USE 11-1-2003; IN COMMERCE 12-1-2003.

THE MARK CONSISTS OF STANDARD CHARACTERS WITHOUT CLAIM TO ANY PARTICULAR FONT, STYLE, SIZE, OR COLOR.

PRIORITY CLAIMED UNDER SEC. 44(D) ON AUSTRALIA APPLICATION NO. 1423961, FILED 5-9-2011.

NO CLAIM IS MADE TO THE EXCLUSIVE RIGHT TO USE "COMPANY", APART FROM THE MARK AS SHOWN.

SER. NO. 85-322,458, FILED 5-17-2011.

MARLENE BELL, EXAMINING ATTORNEY



David J. Kybas

Director of the United States Patent and Trademark Office

United States of America

United States Patent and Trademark Office



Reg. No. 4,107,956

Registered Mar. 6, 2012

Int. Cl.: 43

SERVICE MARK

PRINCIPAL REGISTER

CAFE PANINI LLC (FLORIDA LIMITED LIABILITY COMPANY)
7326 ROYAL PALM BLVD
MARGATE, FL 33065

FOR: CAFE AND RESTAURANT SERVICES, IN CLASS 43 (U.S. CLS. 100 AND 101).

FIRST USE 3-1-2011; IN COMMERCE 3-1-2011.

NO CLAIM IS MADE TO THE EXCLUSIVE RIGHT TO USE "CAFE PANINI", APART FROM THE MARK AS SHOWN.

THE MARK CONSISTS OF AN OVAL WITH TWO BEAKS. THE FIRST BREAK IS ON THE UPPER RIGHT HAND SIDE OF THE OVAL AND THE LOWER BREAK IS LOCATED ON THE LOWER RIGHT HAND SIDE OF THE OVAL. LOCATED IN THE UPPER LEFT HAND SIDE OF THE OVAL IS THE WORD "CAFE" WHICH COMPLETELY FILLS THE BREAK. ALL OF THE LETTER IN "CAFE" ARE SIMILAR EXCEPT FOR THE LETTER "F" WHICH EXTENDS ABOVE AND BELOW THE REST OF THE LETTERS IN THE WORD "CAFE". THE WORD "PANINI" IS LOCATED IN THE BREAK IN THE LOWER RIGHT HAND SIDE OF THE OVAL. EACH LETTER IN THE WORLD "PANINI" IS CAPITALIZED. THE WORD "PANINI" IS CONCAVE AS TO APPEAR AS TO FORM THE COMPLETED OVAL. LOCATED IN THE OVAL IS A DEPICTION OF AN ITALIAN CHEF WITH A THIN MUSTACHE. THE CHEF IS WEARING A LARGE CHEF HAT AND A HANKER CHIEF AROUND HIS NECK. THE CHEF IS HOLDING A PLATE WITH A PANINI/SANDWICH, OTHER FOOD AND A GLASS WITH A BEVERAGE IN IT.

SER. NO. 85-322,507, FILED 5-17-2011.

DOMINIC J. FERRAIUOLO, EXAMINING ATTORNEY



David J. Kybas

Director of the United States Patent and Trademark Office

United States of America

United States Patent and Trademark Office

Otoliv

Reg. No. 4,107,957

Registered Mar. 6, 2012

Int. Cl.: 5

TRADEMARK

PRINCIPAL REGISTER

ENTPRO AB (SWEDEN LIMITED LIABILITY COMPANY)
VÄSTERLÅNGGATAN 46
STOCKHOLM, SWEDEN 11129

FOR: EAR DROPS, IN CLASS 5 (U.S. CLS. 6, 18, 44, 46, 51 AND 52).

THE MARK CONSISTS OF STANDARD CHARACTERS WITHOUT CLAIM TO ANY PARTICULAR FONT, STYLE, SIZE, OR COLOR.

PRIORITY CLAIMED UNDER SEC. 44(D) ON SWEDEN APPLICATION NO. 2011/04152, FILED 5-15-2011, REG. NO. 500585, DATED 9-9-2011, EXPIRES 9-9-2021.

THE WORDING "OTOLIV" HAS NO MEANING IN A FOREIGN LANGUAGE.

SER. NO. 85-322,679, FILED 5-17-2011.

SARA BENJAMIN, EXAMINING ATTORNEY



David J. Kyffers

Director of the United States Patent and Trademark Office

United States of America

United States Patent and Trademark Office

LevelSteps

Reg. No. 4,107,958

Registered Mar. 6, 2012

Int. Cl.: 10

TRADEMARK

PRINCIPAL REGISTER

BENCHMARK BRANDS, INC. (TENNESSEE CORPORATION)
200
5250 TRIANGLE PARKWAY
NORCROSS, GA 30092

FOR: ORTHOPEDIC DEVICES, NAMELY, FOOT SUPPORTS, ANTI PRONATION INSERTS,
GAIT CORRECTING INSOLES AND INSERTS, IN CLASS 10 (U.S. CLS. 26, 39 AND 44).

FIRST USE 12-30-2010; IN COMMERCE 5-6-2011.

THE MARK CONSISTS OF STANDARD CHARACTERS WITHOUT CLAIM TO ANY PAR-
TICULAR FONT, STYLE, SIZE, OR COLOR.

SER. NO. 85-322,768, FILED 5-17-2011.

HOWARD B. LEVINE, EXAMINING ATTORNEY



David J. Kyros

Director of the United States Patent and Trademark Office

United States of America

United States Patent and Trademark Office

Scripture Tea

Reg. No. 4,107,959

Registered Mar. 6, 2012

Int. Cl.: 30

TRADEMARK

PRINCIPAL REGISTER

SCRIPTURE TEA PRODUCTS, INC. (FLORIDA CORPORATION)
650 CAYUGA DRIVE
WINTER SPRINGS, FL 32708

FOR: TEA BAGS, IN CLASS 30 (U.S. CL. 46).

FIRST USE 3-1-1981; IN COMMERCE 3-1-1981.

NO CLAIM IS MADE TO THE EXCLUSIVE RIGHT TO USE "TEA", APART FROM THE MARK AS SHOWN.

THE MARK CONSISTS OF THE WORDING "SCRIPTURE TEA" IN STYLIZED LETTERING.

SEC. 2(F).

SER. NO. 85-322,810, FILED 5-17-2011.

CHRIS WELLS, EXAMINING ATTORNEY



David J. Kybas

Director of the United States Patent and Trademark Office

United States of America

United States Patent and Trademark Office

BLUE RIVER DENIM

Reg. No. 4,107,960

Registered Mar. 6, 2012

Int. Cl.: 25

TRADEMARK

PRINCIPAL REGISTER

BLUE DRAGON INC (CALIFORNIA CORPORATION)
14600 S BROADWAY
GARDENA, CA 90248

FOR: CLOTHING AND SPORTSWEAR MADE IN WHOLE OR PART OF DENIM, NAMELY, JEANS, PANTS, T-SHIRTS, POLO SHIRTS, SHORTS, JACKETS, SWEATERS, SOCKS, UNDERWEAR, HATS AND FOOTWEAR, IN CLASS 25 (U.S. CLS. 22 AND 39).

FIRST USE 2-15-2011; IN COMMERCE 2-15-2011.

THE MARK CONSISTS OF STANDARD CHARACTERS WITHOUT CLAIM TO ANY PARTICULAR FONT, STYLE, SIZE, OR COLOR.

NO CLAIM IS MADE TO THE EXCLUSIVE RIGHT TO USE "DENIM", APART FROM THE MARK AS SHOWN.

SER. NO. 85-322,849, FILED 5-17-2011.

PRISCILLA MILTON, EXAMINING ATTORNEY



David J. Kybas

Director of the United States Patent and Trademark Office

United States of America

United States Patent and Trademark Office



RESOURCES

Managing Your Personal Life. Professionally.

Reg. No. 4,107,961

JDJ RESOURCES CORPORATION (MASSACHUSETTS CORPORATION)
31 MILK STREET, SUITE 401
BOSTON, MA 02109

Registered Mar. 6, 2012

Int. Cl.: 35

FOR: ACCOUNTING SERVICES, IN CLASS 35 (U.S. CLS. 100, 101 AND 102).

SERVICE MARK

FIRST USE 3-5-2009; IN COMMERCE 3-5-2009.

PRINCIPAL REGISTER

NO CLAIM IS MADE TO THE EXCLUSIVE RIGHT TO USE "RESOURCES" AND "PROFESSIONALLY", APART FROM THE MARK AS SHOWN.

THE MARK CONSISTS OF THE STYLIZED LETTERS "JDJ" WITH THE TERM "RESOURCES" LOCATED BELOW "JDJ"; THE WORDING "MANAGING YOUR PERSONAL LIFE. PROFESSIONALLY" IS LOCATED BELOW THE TERM "RESOURCES".

SER. NO. 85-323,567, FILED 5-18-2011.

LINDA E. BLOHM, EXAMINING ATTORNEY



David J. Kybas

Director of the United States Patent and Trademark Office

United States of America

United States Patent and Trademark Office

NOTIFYMD

Reg. No. 4,107,962

Registered Mar. 6, 2012

Int. Cl.: 38

SERVICE MARK

PRINCIPAL REGISTER

NOTIFYMD, INC. (DELAWARE CORPORATION)
318 SEABOARD LANE
FRANKLIN, TN 37067

FOR: ELECTRONIC VOICE MESSAGING SERVICES, NAMELY, THE RECORDING, STORAGE AND SUBSEQUENT TRANSMISSION OF, MEDICAL ONLY, VOICE MESSAGES BY TELEPHONE, FACSIMILE, PAGERS, E-MAIL, WIRELESS AND HAND HELD DEVICES, IN CLASS 38 (U.S. CLS. 100, 101 AND 104).

FIRST USE 8-31-1999; IN COMMERCE 8-31-1999.

THE MARK CONSISTS OF STANDARD CHARACTERS WITHOUT CLAIM TO ANY PARTICULAR FONT, STYLE, SIZE, OR COLOR.

OWNER OF U.S. REG. NO. 2,436,018.

SEC. 2(F).

SER. NO. 85-323,601, FILED 5-18-2011.

MICHELE SWAIN, EXAMINING ATTORNEY



David J. Kybas

Director of the United States Patent and Trademark Office

United States of America

United States Patent and Trademark Office



Reg. No. 4,107,963

Registered Mar. 6, 2012

Int. Cl.: 44

SERVICE MARK

PRINCIPAL REGISTER

COMMUNITY HEALTH SYSTEMS PROFESSIONAL SERVICES CORPORATION
(DELAWARE CORPORATION)
4000 MERIDIAN BOULEVARD
FRANKLIN, TN 37067

FOR: MATERNITY CLUB SERVICES, NAMELY, PROVIDING PRE- AND POST-NATAL FETUS, INFANT AND MATERNAL COUNSELING AND INFORMATION IN THE FIELD OF HEALTH, IN CLASS 44 (U.S. CLS. 100 AND 101).

FIRST USE 7-31-2006; IN COMMERCE 7-31-2006.

OWNER OF U.S. REG. NO. 2,442,377.

THE COLOR(S) BLUE AND PINK IS/ARE CLAIMED AS A FEATURE OF THE MARK.

NO CLAIM IS MADE TO THE EXCLUSIVE RIGHT TO USE "OB CLUB", APART FROM THE MARK AS SHOWN.

THE MARK CONSISTS OF THE WORD "TINY" IN BLUE AND THE LETTERS "T" "E" AND "S" OF THE WORD "TOES" IN BLUE WITH THE "O" SHOWN IN PINK WITH FIVE PINK DOTS OF VARYING SIZE GIVING THE IMPRESSION OF TOES BORDERING THE TOP OF THE "O" ABOVE A CURVED PINK LINE; THE WORDS "A TIP-TOP OB CLUB" IN BLUE ARE PLACED DIRECTLY BELOW THE CURVED PINK LINE.

SER. NO. 85-324,305, FILED 5-18-2011.

DEBRA LEE, EXAMINING ATTORNEY



David J. Kyjars

Director of the United States Patent and Trademark Office

United States of America

United States Patent and Trademark Office



Reg. No. 4,107,964

Registered Mar. 6, 2012

Int. Cl.: 35

SERVICE MARK

PRINCIPAL REGISTER

FARM RESCUE FOUNDATION (NORTH DAKOTA CORPORATION)
1313 BUSINESS LOOP EAST
P.O. BOX 1100
JAMESTOWN, ND 58401

FOR: CHARITABLE SERVICES, NAMELY, ORGANIZING AND CONDUCTING VOLUNTEER PROGRAMS AND COMMUNITY SERVICE PROJECTS TO PLANT AND HARVEST CROPS, FREE OF CHARGE, FOR FAMILY FARMERS WHO HAVE SUFFERED A MAJOR ILLNESS, INJURY OR NATURAL DISASTER, IN CLASS 35 (U.S. CLS. 100, 101 AND 102).

FIRST USE 1-21-2011; IN COMMERCE 1-21-2011.

NO CLAIM IS MADE TO THE EXCLUSIVE RIGHT TO USE "FARM RESCUE FOUNDATION", APART FROM THE MARK AS SHOWN.

THE MARK CONSISTS OF THE STYLIZED TEXT "FARM RESCUE FOUNDATION" WITH A WHEAT STOCK WRAPPED BELOW AND ALONG SIDE OF TEXT.

SER. NO. 85-324,395, FILED 5-18-2011.

SKYE YOUNG, EXAMINING ATTORNEY



David J. Kybas

Director of the United States Patent and Trademark Office

United States of America

United States Patent and Trademark Office

BishojoDerm

Reg. No. 4,107,965

Registered Mar. 6, 2012

Int. Cl.: 3

TRADEMARK

PRINCIPAL REGISTER

SULLIVAN, KARAH M. (CALIFORNIA SOLE PROPRIETORSHIP), DBA BISHOJODERM
3528 PIERCE STREET
RIVERSIDE, CA 92503

FOR: FACE CREAMS, IN CLASS 3 (U.S. CLS. 1, 4, 6, 50, 51 AND 52).

FIRST USE 5-4-2011; IN COMMERCE 5-16-2011.

THE MARK CONSISTS OF STANDARD CHARACTERS WITHOUT CLAIM TO ANY PARTICULAR FONT, STYLE, SIZE, OR COLOR.

THE ENGLISH TRANSLATION OF "BISHOJO" IN THE MARK IS BEAUTIFUL YOUNG GIRL.

SER. NO. 85-324,429, FILED 5-18-2011.

RON FAIRBANKS, EXAMINING ATTORNEY



David J. Kyros

Director of the United States Patent and Trademark Office

United States of America

United States Patent and Trademark Office

CLICK ON US FOR A SHOP YOU
CAN TRUST

Reg. No. 4,107,966

Registered Mar. 6, 2012

Int. Cl.: 35

SERVICE MARK

PRINCIPAL REGISTER

MYAUTONETWORK, INC. (DELAWARE CORPORATION)
1444 WEST 10TH PLACE
TEMPE, AZ 85281

FOR: REFERRALS IN THE FIELD OF AUTOMOTIVE COLLISION CENTERS, AUTOMOBILE REPAIR SHOPS, AUTOMOBILE PARTS SUPPLIERS, RENTAL CAR COMPANIES, NEW AND USED CAR DEALERS, AUTOMOBILE PAINTS AND SUPPLIES VIA THE INTERNET, TELEPHONE, AND ELECTRONIC, PRINTED, CELLULAR AND SATELLITE MEDIA; PROVIDING BUSINESS AND COMMERCIAL INFORMATION SERVICES REGARDING AUTOMOTIVE INSURANCE COMPANIES, COLLISION REPAIR PROCESS, MECHANICAL SERVICE AND REPAIR, INSURANCE CLAIMS PROCESS, AUTOMOBILE PAINTS AND SUPPLIES, AUTOMOBILE PARTS, VEHICLE SAFETY, MANUFACTURER REPAIR STANDARDS AND AUTOMOBILE REPAIR SHOPS VIA THE INTERNET, TELEPHONE, AND ELECTRONIC, PRINTED, CELLULAR AND SATELLITE MEDIA; PROVIDING BUSINESS BEST PRACTICES INFORMATION IN THE AREAS OF AUTOMOTIVE COLLISION CENTERS, AUTOMOBILE REPAIR SHOPS, AUTOMOBILE PARTS SUPPLIERS, AUTOMOBILE PAINTS AND SUPPLIES; CONDUCTING BUSINESS RESEARCH AND SURVEYS; ADVERTISING, MARKETING AND PROMOTION SERVICES, NAMELY, ADVERTISING AND PROMOTING THE PRODUCTS AND SERVICES OF THIRD PARTIES, IN CLASS 35 (U.S. CLS. 100, 101 AND 102).

FIRST USE 5-17-2011; IN COMMERCE 5-17-2011.

THE MARK CONSISTS OF STANDARD CHARACTERS WITHOUT CLAIM TO ANY PARTICULAR FONT, STYLE, SIZE, OR COLOR.

SER. NO. 85-324,624, FILED 5-19-2011.

JASON BLAIR, EXAMINING ATTORNEY



David J. Kyros

Director of the United States Patent and Trademark Office

United States of America

United States Patent and Trademark Office

DOME FOAM

Reg. No. 4,107,967

PULL'R HOLDING COMPANY, LLC (DELAWARE LIMITED LIABILITY COMPANY)
1000 GREENLEAF AVE.
ELK GROVE VILLAGE, IL 60007

Registered Mar. 6, 2012

Int. Cl.: 8

FOR: TOOL BELTS; TOOL HOLDERS; TOOL POUCHES FOR ATTACHMENT TO TOOL BELTS, IN CLASS 8 (U.S. CLS. 23, 28 AND 44).

TRADEMARK

FIRST USE 5-17-2011; IN COMMERCE 5-17-2011.

PRINCIPAL REGISTER

THE MARK CONSISTS OF STANDARD CHARACTERS WITHOUT CLAIM TO ANY PARTICULAR FONT, STYLE, SIZE, OR COLOR.

NO CLAIM IS MADE TO THE EXCLUSIVE RIGHT TO USE "FOAM", APART FROM THE MARK AS SHOWN.

SER. NO. 85-324,857, FILED 5-19-2011.

JANICE KIM, EXAMINING ATTORNEY



David J. Kybas

Director of the United States Patent and Trademark Office

United States of America

United States Patent and Trademark Office

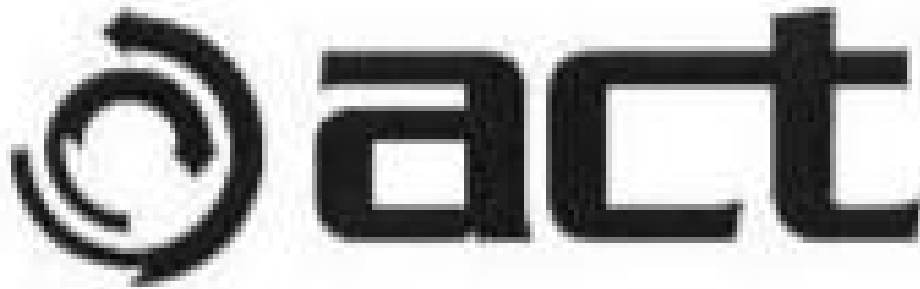

Reg. No. 4,107,968

Registered Mar. 6, 2012

Int. Cl.: 7

TRADEMARK

PRINCIPAL REGISTER

POWAGRIP INDUSTRIAL CO., LTD. (TAIWAN LIMITED LIABILITY COMPANY)
NO. 157, CHENGDU RD., SITUN DISTRICT
TAICHUNG CITY, TAIWAN 40751

FOR: AIR POWERED TOOLS, NAMELY, DRILLS, SCREWDRIVERS, RIVET HAMMERS, SAWS; POWER-OPERATED SCREWDRIVERS; POWER-DRIVEN WRENCHES; ELECTRIC GLUE GUNS; SANDING MACHINES; AIR BRUSHES FOR APPLYING PAINT; ELECTRIC KNIVES FOR MOWING MACHINES; ANGULAR BITS FOR METALWORKING MACHINES; POWER SAW BLADES FOR METALWORKING MACHINES; DRILL BITS FOR METALWORKING MACHINES; BAND SAWS; GRINDING AND POLISHING MACHINES. ELECTRIC INDUSTRIAL KNIVES; BLADE TOOLS FOR POWER LATHES; MILLS, NAMELY, ROLLING MILL, MILLS FOR HOUSEHOLD PURPOSES, OTHER THAN HAND-OPERATED, NAMELY, GRINDING MILL, END MILLS, THREAD MILLS; CORE DRILLING BITS, IN CLASS 7 (U.S. CLS. 13, 19, 21, 23, 31, 34 AND 35).

FIRST USE 4-13-2007; IN COMMERCE 6-30-2007.

THE MARK CONSISTS OF "ACT" IN STYLIZED LOWER CASE LETTERS FOLLOWING TWO CURVED, CONCENTRIC STYLIZED ARROWS.

SER. NO. 85-324,864, FILED 5-19-2011.

JANICE KIM, EXAMINING ATTORNEY



David J. Kyros

Director of the United States Patent and Trademark Office

United States of America

United States Patent and Trademark Office



Reg. No. 4,107,969

Registered Mar. 6, 2012

Int. Cl.: 28

TRADEMARK

PRINCIPAL REGISTER

NKOK, INC. (CALIFORNIA CORPORATION)
UNIT G-2
13668 E. VALLEY BLVD.
CITY OF INDUSTRY, CA 91746

FOR: REMOTE CONTROL TOYS, NAMELY, AIRPLANES, HELICOPTERS, FLYING VEHICLES, IN CLASS 28 (U.S. CLS. 22, 23, 38 AND 50).

FIRST USE 11-7-2010; IN COMMERCE 11-7-2010.

NO CLAIM IS MADE TO THE EXCLUSIVE RIGHT TO USE "AIR", APART FROM THE MARK AS SHOWN.

THE MARK CONSISTS OF THE STYLIZED WORD "AIR" ABOVE THE STYLIZED WORD "BANDITZ" TOGETHER WITH STREAKING LINES IMPLYING FAST MOVEMENT.

SER. NO. 85-324,991, FILED 5-19-2011.

ELLEN PERKINS, EXAMINING ATTORNEY



David J. Kybas

Director of the United States Patent and Trademark Office

United States of America

United States Patent and Trademark Office

PRIVATEER DARK

Reg. No. 4,107,970

REUNION ISLAND COFFEE LIMITED (CANADA CORPORATION)
2421 ROYAL WINDSOR DRIVE
OAKVILLE, ONTARIO, CANADA L6J7X6

Registered Mar. 6, 2012

Int. Cl.: 30

FOR: ROASTED GROUND COFFEE AND ROASTED WHOLE BEAN COFFEE, IN CLASS 30 (U.S. CL. 46).

TRADEMARK

FIRST USE 1-0-2002; IN COMMERCE 1-0-2002.

PRINCIPAL REGISTER

THE MARK CONSISTS OF STANDARD CHARACTERS WITHOUT CLAIM TO ANY PARTICULAR FONT, STYLE, SIZE, OR COLOR.

NO CLAIM IS MADE TO THE EXCLUSIVE RIGHT TO USE "DARK", APART FROM THE MARK AS SHOWN.

SER. NO. 85-326,104, FILED 5-20-2011.

APRIL ROACH, EXAMINING ATTORNEY



David J. Kyffers

Director of the United States Patent and Trademark Office

United States of America

United States Patent and Trademark Office

LAS HERMOSAS

Reg. No. 4,107,971

Registered Mar. 6, 2012

Int. Cl.: 30

TRADEMARK

PRINCIPAL REGISTER

REUNION ISLAND COFFEE LIMITED (CANADA CORPORATION)
2421 ROYAL WINDSOR DRIVE
OAKVILLE, ONTARIO, CANADA L6J7X6

FOR: ROASTED GROUND COFFEE AND ROASTED WHOLE BEAN COFFEE, IN CLASS 30 (U.S. CL. 46).

FIRST USE 1-0-2005; IN COMMERCE 1-0-2005.

THE MARK CONSISTS OF STANDARD CHARACTERS WITHOUT CLAIM TO ANY PARTICULAR FONT, STYLE, SIZE, OR COLOR.

THE ENGLISH TRANSLATION OF "LAS HERMOSAS" IN THE MARK IS THE MOST BEAUTIFUL.

SER. NO. 85-326,123, FILED 5-20-2011.

APRIL ROACH, EXAMINING ATTORNEY



David J. Kyffers

Director of the United States Patent and Trademark Office

United States of America

United States Patent and Trademark Office

lovendare

Reg. No. 4,107,972

ASSOCIATED DISTRIBUTORS INC (NEW YORK CORPORATION)
719 EASTERN PK ST3
BKLYN, NY 11213

Registered Mar. 6, 2012

Int. Cl.: 25

FOR: CLOTHING, NAMELY, SHIRTS, PANTS, TOPS, BOTTOMS, SKIRTS, JACKETS, COATS,
IN CLASS 25 (U.S. CLS. 22 AND 39).

TRADEMARK

FIRST USE 12-4-2010; IN COMMERCE 12-4-2010.

PRINCIPAL REGISTER

THE MARK CONSISTS OF STANDARD CHARACTERS WITHOUT CLAIM TO ANY PAR-
TICULAR FONT, STYLE, SIZE, OR COLOR.

SER. NO. 85-326,206, FILED 5-20-2011.

COLLEEN DOMBROW, EXAMINING ATTORNEY



David J. Kybas

Director of the United States Patent and Trademark Office

United States of America

United States Patent and Trademark Office

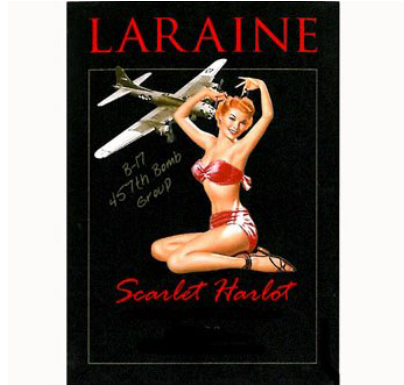

Reg. No. 4,107,973

Registered Mar. 6, 2012

Int. Cl.: 33

TRADEMARK

PRINCIPAL REGISTER

SIX MILE LAND COMPANY (CALIFORNIA CORPORATION)
P.O. BOX 400
ANGELS CAMP, CA 90067

FOR: WINE, IN CLASS 33 (U.S. CLS. 47 AND 49).

FIRST USE 9-26-2008; IN COMMERCE 9-26-2008.

OWNER OF U.S. REG. NOS. 1,852,554 AND 3,000,296.

THE COLOR(S) RED, WHITE, BLACK, GRAY, TAN AND BROWN IS/ARE CLAIMED AS A FEATURE OF THE MARK.

THE NAME(S), PORTRAIT(S), AND/OR SIGNATURE(S) SHOWN IN THE MARK DOES NOT IDENTIFY A PARTICULAR LIVING INDIVIDUAL.

THE MARK CONSISTS OF A BLACK SHADED-IN RECTANGLE WITH THE WORD LARAINÉ APPEARING IN RED ACROSS THE TOP OF THE RECTANGLE, A THIN GRAY RECTANGULAR BORDER WITHIN THE LARGER BLACK RECTANGLE, AND SITTING IN THE CENTER WITHIN THE GRAY RECTANGULAR BORDER IS A TAN WOMAN WITH BLACK EYES AND EYEBROWS, WHITE TEETH, RED LIPS, RED HAIR, WEARING A RED TWO-PIECE BATHING SUIT AND BROWN SANDALS. THERE IS A GRAY BOMBER AIRCRAFT WITH WHITE AND BLACK MARKINGS LOCATED IN THE UPPER LEFT CORNER OF THE INTERIOR RECTANGLE WITH THE WORDS "B-17 457TH BOMB GROUP" IN GRAY BELOW THE AIRCRAFT AND TO THE LEFT OF THE WOMAN, BELOW THE WOMAN ARE THE WORDS "SCARLET HARLOT" IN RED IN STYLIZED FORMAT.

SER. NO. 85-326,398, FILED 5-20-2011.

ASMAT KHAN, EXAMINING ATTORNEY



David J. Kypos

Director of the United States Patent and Trademark Office

United States of America

United States Patent and Trademark Office

SONFIDI

Reg. No. 4,107,974

Registered Mar. 6, 2012

Int. Cl.: 5

TRADEMARK

PRINCIPAL REGISTER

ACTELION PHARMACEUTICALS LTD (SWITZERLAND CORPORATION)
GEWERBESTRASSE 16
ALLSCHWIL, SWITZERLAND 4123

FOR: PHARMACEUTICAL PREPARATIONS FOR THE TREATMENT OF CARDIOVASCULAR AND PULMONARY DISEASES, INFLAMMATORY DISEASES, CANCER, AUTO-IMMUNE DISORDERS, DIGITAL ULCERS, GLYCOLIPID STORAGE DISEASES, CEREBROVASCULAR DISEASES, DISEASES AND DISORDERS OF THE CENTRAL NERVOUS SYSTEM AND OF THE PERIPHERAL NEUROLOGICAL SYSTEM, NEURODEGENERATIVE DISEASES AND DISORDERS, GASTROINTESTINAL DISORDERS, ANXIOLYTICS, ANTI-ALLERGICS, ANTI-INFECTIVES, IN CLASS 5 (U.S. CLS. 6, 18, 44, 46, 51 AND 52).

THE MARK CONSISTS OF STANDARD CHARACTERS WITHOUT CLAIM TO ANY PARTICULAR FONT, STYLE, SIZE, OR COLOR.

PRIORITY CLAIMED UNDER SEC. 44(D) ON SWITZERLAND APPLICATION NO. 500462011, FILED 1-3-2011, REG. NO. 610169, DATED 1-11-2011, EXPIRES 1-3-2021.

THE WORDING "SONFIDI" HAS NO MEANING IN A FOREIGN LANGUAGE.

SER. NO. 85-326,732, FILED 5-21-2011.

LAURA HAMMEL, EXAMINING ATTORNEY



David J. Kybas

Director of the United States Patent and Trademark Office

United States of America

United States Patent and Trademark Office

LEDAGA

Reg. No. 4,107,975

Registered Mar. 6, 2012

Int. Cl.: 5

TRADEMARK

PRINCIPAL REGISTER

ACTELION PHARMACEUTICALS LTD (SWITZERLAND CORPORATION)
GEWERBESTRASSE 16
ALLSCHWIL, SWITZERLAND 4123

FOR: PHARMACEUTICAL PREPARATIONS FOR THE TREATMENT OF CARDIOVASCULAR AND PULMONARY DISEASES, INFLAMMATORY DISEASES, CANCER, AUTO-IMMUNE DISORDERS, DIGITAL ULCERS, GLYCOLIPID STORAGE DISEASES, CEREBROVASCULAR DISEASES, DISEASES AND DISORDERS OF THE CENTRAL NERVOUS SYSTEM AND OF THE PERIPHERAL NEUROLOGICAL SYSTEM, NEURODEGENERATIVE DISEASES AND DISORDERS, GASTROINTESTINAL DISORDERS, ANXIOLYTICS, ANTI-ALLERGICS, ANTI-INFECTIVES, IN CLASS 5 (U.S. CLS. 6, 18, 44, 46, 51 AND 52).

THE MARK CONSISTS OF STANDARD CHARACTERS WITHOUT CLAIM TO ANY PARTICULAR FONT, STYLE, SIZE, OR COLOR.

PRIORITY CLAIMED UNDER SEC. 44(D) ON SWITZERLAND APPLICATION NO. 500452011, FILED 1-3-2011, REG. NO. 610168, DATED 1-11-2011, EXPIRES 1-3-2021.

THE WORDING "LEDAGA" HAS NO MEANING IN A FOREIGN LANGUAGE.

SER. NO. 85-326,738, FILED 5-21-2011.

LAURA HAMMEL, EXAMINING ATTORNEY



David J. Kybas

Director of the United States Patent and Trademark Office

United States of America

United States Patent and Trademark Office



Reg. No. 4,107,976

Registered Mar. 6, 2012

Int. Cl.: 41

SERVICE MARK

PRINCIPAL REGISTER

NORTHERN OHIO RAILWAY MUSEUM (OHIO CORPORATION)
P.O. BOX 458
CHIPPEWA LAKE, OH 442150458

FOR: MUSEUM SERVICES, IN CLASS 41 (U.S. CLS. 100, 101 AND 107).

FIRST USE 4-12-1970; IN COMMERCE 4-12-1970.

THE MARK CONSISTS OF THE WORDS "NORTHERN OHIO" INSIDE AN OVAL.

SEC. 2(F).

SER. NO. 85-327,700, FILED 5-23-2011.

KYLE PEETE, EXAMINING ATTORNEY



David J. Kybas

Director of the United States Patent and Trademark Office

United States of America

United States Patent and Trademark Office

Brain Trapped?

Reg. No. 4,107,977

Registered Mar. 6, 2012

Int. Cl.: 41

SERVICE MARK

PRINCIPAL REGISTER

MAXVICTOR, VIVACE (UNITED STATES INDIVIDUAL), FORMERLY MOTAMED, KATAYOON
420 EAST 82 STREET # 3 J
NEW YORK, NY 10028

FOR: EDUCATION SERVICES, NAMELY, PROVIDING MENTORING, TUTORING, CLASSES, SEMINARS AND WORKSHOPS IN THE FIELD OF ALL ASPECTS OF PERSONAL AND BUSINESS GROWTH AND DEVELOPMENT/ MOTIVATION; EDUCATION SERVICES, NAMELY, PROVIDING ON-LINE CLASSES, SEMINARS, WORKSHOPS, PRESENTATIONS IN THE FIELD OF ALL ASPECTS OF PERSONAL AND BUSINESS GROWTH AND DEVELOPMENT/ MOTIVATION; PERSONAL COACHING AND PROFESSIONAL COACHING IN THE FIELD OF ALL ASPECTS OF PERSONAL AND BUSINESS GROWTH AND DEVELOPMENT/ MOTIVATION; EDUCATION SERVICES, NAMELY, PROVIDING CLASSES, SEMINARS, WORKSHOPS, AND PRESENTATIONS IN THE FIELD OF ALL ASPECTS OF PERSONAL AND BUSINESS GROWTH AND DEVELOPMENT/ MOTIVATION; EDUCATIONAL AND ENTERTAINMENT SERVICES, NAMELY, PROVIDING MOTIVATIONAL AND EDUCATIONAL SPEAKERS; EDUCATIONAL AND ENTERTAINMENT SERVICES, NAMELY, PROVIDING MOTIVATIONAL AND EDUCATIONAL SPEAKERS IN THE FIELD OF SELF-AND PERSONAL IMPROVEMENT; EDUCATIONAL AND ENTERTAINMENT SERVICES, NAMELY, PROVIDING MOTIVATIONAL SPEAKING SERVICES IN THE FIELD OF ALL ASPECTS OF PERSONAL AND BUSINESS GROWTH AND DEVELOPMENT/ MOTIVATION; EDUCATIONAL SERVICES, NAMELY, CONDUCTING INFORMAL PROGRAMS IN THE FIELDS OF ALL ASPECTS OF PERSONAL AND BUSINESS GROWTH AND DEVELOPMENT/ MOTIVATION, USING ON-LINE ACTIVITIES AND INTERACTIVE EXHIBITS, AND PRINTABLE MATERIALS DISTRIBUTED THEREWITH; EDUCATIONAL SERVICES, NAMELY, CONDUCTING ON LINE AND TELEPHONIC INSTRUCTION AND COURSES IN THE FIELD ALL ASPECTS OF PERSONAL AND BUSINESS GROWTH AND DEVELOPMENT/ MOTIVATION; EDUCATIONAL SERVICES, NAMELY, CONDUCTING SEMINARS, LECTURES, TELESEMINARS, TELECLASSES, AND WORKSHOPS IN PERSONAL AWARENESS; EDUCATIONAL SERVICES, NAMELY, CONDUCTING CLASSES, SEMINARS, WORKSHOPS, AND PRESENTATIONS IN THE FIELD OF ALL ASPECTS OF PERSONAL AND BUSINESS GROWTH AND DEVELOPMENT/ MOTIVATION; EDUCATIONAL SERVICES, NAMELY, CONDUCTING CLASSES, SEMINARS, WORKSHOPS, AND PRESENTATIONS IN THE FIELD OF ALL ASPECTS OF PERSONAL AND BUSINESS GROWTH AND DEVELOPMENT/ MOTIVATION AND DISTRIBUTION OF PRINTED MATERIALS IN CONNECTION THEREWITH IN HARD COPY OR ELECTRONIC FORMAT ON THE SAME TOPICS; EDUCATIONAL SERVICES, NAMELY, CONDUCTING CLASSES, SEMINARS,



David J. Kyros

Director of the United States Patent and Trademark Office

Reg. No. 4,107,977 WORKSHOPS AND PRESENTATIONS IN THE FIELD OF ALL ASPECTS OF PERSONAL AND BUSINESS GROWTH AND DEVELOPMENT/ MOTIVATION AND DISTRIBUTION OF COURSE MATERIAL IN CONNECTION THEREWITH; EDUCATIONAL SERVICES, NAMELY, CONDUCTING CLASSES, SEMINARS, WORKSHOPS, AND PRESENTATIONS IN THE FIELD OF ALL ASPECTS OF PERSONAL AND BUSINESS GROWTH AND DEVELOPMENT/ MOTIVATION AND DISTRIBUTION OF TRAINING MATERIAL IN CONNECTION THEREWITH; EDUCATIONAL SERVICES, NAMELY, DEVELOPING AND CONDUCTING TRAINING COURSES AND DISTRIBUTION OF TRAINING MATERIALS IN CONNECTION THEREWITH FOR SUBJECT MATTERS AS REQUESTED BY CUSTOMERS; EDUCATIONAL SERVICES, NAMELY, PROVIDING CONTINUING PROFESSIONAL EDUCATION COURSES IN THE FIELD OF ALL ASPECTS OF PERSONAL AND BUSINESS GROWTH AND DEVELOPMENT/ MOTIVATION; EDUCATIONAL SERVICES, NAMELY, PROVIDING DISPLAYS AND EXHIBITS IN THE FIELD OF ALL ASPECTS OF PERSONAL AND BUSINESS GROWTH AND DEVELOPMENT/ MOTIVATION; EDUCATIONAL SERVICES, NAMELY, PROVIDING ON-LINE CLASSES, SEMINARS, WORKSHOPS, AND PRESENTATIONS IN THE FIELD OF ALL ASPECTS OF PERSONAL AND BUSINESS GROWTH AND DEVELOPMENT/ MOTIVATION; EDUCATIONAL SERVICES, NAMELY, PROVIDING CLASSES, SEMINARS, WORKSHOPS, AND PRESENTATIONS IN THE FIELDS OF ALL ASPECTS OF PERSONAL AND BUSINESS GROWTH AND DEVELOPMENT/ MOTIVATION; ENTERTAINMENT AND EDUCATIONAL SERVICES, NAMELY, THE PRESENTATION OF SEMINARS, LECTURES, WORKSHOPS AND PANEL DISCUSSIONS, AND ONGOING TELEVISION AND RADIO TALK SHOWS ALL IN THE FIELD OF PUBLIC INTEREST CONCERNING ALL ASPECTS OF PERSONAL AND BUSINESS GROWTH AND DEVELOPMENT/ MOTIVATION; ENTERTAINMENT SERVICES, NAMELY, PROVIDING A WEB SITE FEATURING PHOTOGRAPHIC AND PROSE PRESENTATIONS FEATURING MOTIVATIONAL SEMINARS, EDUCATIONAL PRESENTATIONS, PERSONAL COACHING AND EDUCATIONAL WORKSHOPS; ENTERTAINMENT SERVICES, NAMELY, PROVIDING A WEB SITE FEATURING PHOTOGRAPHIC, AUDIO, VIDEO AND PROSE PRESENTATIONS FEATURING MOTIVATIONAL SEMINARS, EDUCATIONAL PRESENTATIONS, AND PERSONAL COACHING AND EDUCATIONAL WORKSHOPS IN THE FIELD OF ALL ASPECTS OF PERSONAL AND BUSINESS GROWTH AND DEVELOPMENT/ MOTIVATION; ENTERTAINMENT SERVICES, NAMELY, PROVIDING A WEB SITE FEATURING PHOTOGRAPHIC, VIDEO AND PROSE PRESENTATIONS FEATURING MOTIVATIONAL SEMINARS, EDUCATIONAL PRESENTATIONS, PERSONAL COACHING AND EDUCATIONAL WORKSHOPS IN THE FIELD OF ALL ASPECTS OF PERSONAL AND BUSINESS GROWTH AND DEVELOPMENT/ MOTIVATION; PERSONAL COACHING SERVICES IN THE FIELD OF ALL ASPECTS OF PERSONAL AND BUSINESS GROWTH AND DEVELOPMENT/ MOTIVATION; PROFESSIONAL COACHING SERVICES IN THE FIELD OF ALL ASPECTS OF PERSONAL AND BUSINESS GROWTH AND DEVELOPMENT/ MOTIVATION, IN CLASS 41 (U.S. CLS. 100, 101 AND 107).

FIRST USE 6-4-2010; IN COMMERCE 6-4-2010.

THE MARK CONSISTS OF STANDARD CHARACTERS WITHOUT CLAIM TO ANY PARTICULAR FONT, STYLE, SIZE, OR COLOR.

SER. NO. 85-327,857, FILED 5-23-2011.

MICHAEL ENGEL, EXAMINING ATTORNEY

United States of America

United States Patent and Trademark Office



Reg. No. 4,107,978

Registered Mar. 6, 2012

Int. Cl.: 29

TRADEMARK

PRINCIPAL REGISTER

RYC FOODS, LLC (TEXAS LIMITED LIABILITY COMPANY)
1801 S. MOPAC, SUITE 300
AUSTIN, TX 78746

FOR: PROCESSED MEAT, NAMELY, BACON, HAM, MEAT, SALAMI, SAUSAGES, CHICKEN; CHEESE, IN CLASS 29 (U.S. CL. 46).

FIRST USE 9-8-2010; IN COMMERCE 9-8-2010.

NO CLAIM IS MADE TO THE EXCLUSIVE RIGHT TO USE "WHOLESOME MEATS", APART FROM THE MARK AS SHOWN.

THE COLOR(S) RED PANTONE 186C, YELLOW PANTONE 116C, GREEN PANTONE 355C, YELLOW PANTONE 3965C, BLACK PANTONE HEXACHROME BLACK C, AND WHITE IS/ARE CLAIMED AS A FEATURE OF THE MARK.

THE MARK CONSISTS OF AN OVAL WITH A RED RIBBON ON THE BOTTOM. "RYC" IS IN RED CAPITAL LETTERS INSIDE THE OVAL. THE OVAL IS FILLED IN WITH YELLOW AND GREEN AS THE BACKGROUND COLORS, WITH THE YELLOW AND GREEN SEPARATED BY A WHITE LINE. THE YELLOW IS LIGHTER IN THE MIDDLE OF THE OVAL GIVING THE APPEARANCE OF SUNSHINE. SHADES OF GREEN GIVE THE APPEARANCE OF GRASS IN THE BOTTOM SECTION OF THE OVAL. ALMOST ALL OF "RYC" IS ON TOP OF THE YELLOW BACKGROUND EXCEPT FOR THE BOTTOM PART OF "Y" WHICH GOES INTO THE WHITE LINE THAT SEPARATES THE YELLOW FROM THE GREEN, AND THE BOTTOM PART OF "C" WHICH CROSSES THE WHITE DIVIDING LINE AND INTO THE GREEN BOTTOM HALF OF THE OVAL BACKGROUND. "WHOLESOME MEATS" IS IN WHITE INSIDE OF A RED RIBBON THAT RUNS ALONG THE BOTTOM OF THE OVAL. THE COLOR BLACK APPEARS AS SHADING AROUND THE WORDING "RYC" AND THE RED RIBBON DESIGN.

SER. NO. 85-328,724, FILED 5-24-2011.

ALLISON SCHRODY, EXAMINING ATTORNEY



David J. Kyros

Director of the United States Patent and Trademark Office

United States of America

United States Patent and Trademark Office

FENDERSPLENDOR

Reg. No. 4,107,979

FENDER SPLENDOR, INC. (GEORGIA CORPORATION)

Registered Mar. 6, 2012

P. O. BOX 6277
GULF SHORES, AL 365476277

Int. Cl.: 9

FOR: AUTOMOTIVE ELECTRONIC ACCESSORY, NAMELY, A COATING THICKNESS GAUGE MEASURING DEVICE, IN CLASS 9 (U.S. CLS. 21, 23, 26, 36 AND 38).

TRADEMARK

FIRST USE 1-15-2005; IN COMMERCE 1-15-2005.

PRINCIPAL REGISTER

THE MARK CONSISTS OF STANDARD CHARACTERS WITHOUT CLAIM TO ANY PARTICULAR FONT, STYLE, SIZE, OR COLOR.

SER. NO. 85-328,727, FILED 5-24-2011.

ALICIA COLLINS, EXAMINING ATTORNEY



David J. Kybas

Director of the United States Patent and Trademark Office

United States of America

United States Patent and Trademark Office

STUDENTS UNITED FOR AMERICA'S TOOTHFAIRY

Reg. No. 4,107,980

Registered Mar. 6, 2012

Int. Cls.: 35 and 36

SERVICE MARK

PRINCIPAL REGISTER

NATIONAL CHILDREN'S ORAL HEALTH FOUNDATION (DELAWARE CORPORATION)
4108 PARK ROAD, SUITE 406
CHARLOTTE, NC 28209

FOR: PROMOTING PUBLIC AWARENESS OF ORAL HEALTH SERVICES, ORAL HEALTH CARE SERVICES, ORAL HYGIENE SERVICES, ORAL HYGIENE CARE SERVICES, DENTISTRY SERVICES, DENTAL CARE SERVICES, PREVENTIVE DENTAL CARE SERVICES, DENTAL SCREENING SERVICES, DENTAL EXAMINATION SERVICES, DENTAL TREATMENT SERVICES, DENTAL DISEASE TREATMENT SERVICES, PREVENTIVE DENTAL TREATMENT SERVICES; CHARITABLE SERVICES, NAMELY, ORGANIZING AND ADMINISTERING PROGRAMS AND PROJECTS FOR STUDENTS TO PROVIDE AND PROMOTE AWARENESS IN THE FIELD OF ORAL HEALTH SERVICES, ORAL HEALTH CARE SERVICES, ORAL HYGIENE SERVICES, ORAL HYGIENE CARE SERVICES, DENTISTRY SERVICES, DENTAL CARE SERVICES, PREVENTIVE DENTAL CARE SERVICES, DENTAL SCREENING SERVICES, DENTAL EXAMINATION SERVICES, DENTAL TREATMENT SERVICES, DENTAL DISEASE TREATMENT SERVICES, PREVENTIVE DENTAL TREATMENT SERVICES TO NEEDY PERSONS AND UNDESERVED GROUPS; CHARITABLE SERVICES, NAMELY, ORGANIZING AND CONDUCTING VOLUNTEER PROGRAMS AND COMMUNITY SERVICE PROJECTS IN THE FIELDS OF ORAL HEALTH SERVICES, ORAL HEALTH CARE SERVICES, ORAL HYGIENE SERVICES, ORAL HYGIENE CARE SERVICES, DENTISTRY SERVICES, DENTAL CARE SERVICES, PREVENTIVE DENTAL CARE SERVICES, DENTAL SCREENING SERVICES, DENTAL EXAMINATION SERVICES, DENTAL TREATMENT SERVICES, DENTAL DISEASE TREATMENT SERVICES, PREVENTIVE DENTAL TREATMENT SERVICES; AND ORGANIZING AND ADMINISTERING NETWORKS OF DENTIST AND ORAL HEALTH AND DENTAL CARE PROVIDERS AND SPECIALISTS, IN CLASS 35 (U.S. CLS. 100, 101 AND 102).

FIRST USE 7-1-2010; IN COMMERCE 7-1-2010.

FOR: CHARITABLE FUND RAISING; CHARITABLE FUNDRAISING SERVICES IN THE FIELD OF DENTAL HEALTH; PROVIDING FINANCIAL GRANTS TO LOCAL ORGANIZATIONS AND CLINICS TO ENABLE THEM TO PROVIDE DIRECT TREATMENT AND PREVENTIVE SERVICES IN SUPPORT OF ORAL HEALTH FOR UNDERSERVED GROUPS AND AREAS; PROVIDING FINANCIAL GRANTS TO PROGRAMS WHICH FURTHER ORAL HEALTH THROUGH ACCESS TO CARE, INTERVENTION, AND PREVENTIVE EDUCATION, IN CLASS 36 (U.S. CLS. 100, 101 AND 102).



David J. Kyjars

Director of the United States Patent and Trademark Office

Reg. No. 4,107,980 FIRST USE 7-1-2010; IN COMMERCE 7-1-2010.

THE MARK CONSISTS OF STANDARD CHARACTERS WITHOUT CLAIM TO ANY PARTICULAR FONT, STYLE, SIZE, OR COLOR.

OWNER OF U.S. REG. NOS. 3,753,071 AND 3,821,780.

SER. NO. 85-329,312, FILED 5-24-2011.

THEODORE MCBRIDE, EXAMINING ATTORNEY

United States of America

United States Patent and Trademark Office

PAYDAY PAWN

Reg. No. 4,107,981

Registered Mar. 6, 2012

Int. Cl.: 36

SERVICE MARK

PRINCIPAL REGISTER

ALI, ZARINA I (UNITED STATES INDIVIDUAL)
PO BOX 1014
MCDONOUGH, GA 30253

FOR: PAWN SHOPS, IN CLASS 36 (U.S. CLS. 100, 101 AND 102).

FIRST USE 12-1-2003; IN COMMERCE 12-15-2003.

THE MARK CONSISTS OF STANDARD CHARACTERS WITHOUT CLAIM TO ANY PARTICULAR FONT, STYLE, SIZE, OR COLOR.

NO CLAIM IS MADE TO THE EXCLUSIVE RIGHT TO USE "PAWN", APART FROM THE MARK AS SHOWN.

SER. NO. 85-329,452, FILED 5-25-2011.

ANN E. SAPPENFIELD, EXAMINING ATTORNEY



David J. Kyffers

Director of the United States Patent and Trademark Office

United States of America

United States Patent and Trademark Office

Djos

Reg. No. 4,107,982

HAGLOF, INC. (MISSISSIPPI CORPORATION)
100 SOLLEFTEA DRIVE
MADISON, MS 39110

Registered Mar. 6, 2012

Int. Cl.: 8

FOR: HAND TOOLS, NAMELY, AUGERS, IN CLASS 8 (U.S. CLS. 23, 28 AND 44).

TRADEMARK

FIRST USE 4-29-2011; IN COMMERCE 5-13-2011.

PRINCIPAL REGISTER

THE MARK CONSISTS OF STANDARD CHARACTERS WITHOUT CLAIM TO ANY PARTICULAR FONT, STYLE, SIZE, OR COLOR.

PRIORITY CLAIMED UNDER SEC. 44(D) ON ERPN CMNTY TM OFC APPLICATION NO. 00992986, FILED 4-29-2011, REG. NO. 009929886, DATED 9-22-2011, EXPIRES 4-29-2021.

SER. NO. 85-329,652, FILED 5-25-2011.

DOUGLAS LEE, EXAMINING ATTORNEY



David J. Kybas

Director of the United States Patent and Trademark Office

United States of America

United States Patent and Trademark Office

myntt

Reg. No. 4,107,983

Registered Mar. 6, 2012

Int. Cl.: 25

TRADEMARK

PRINCIPAL REGISTER

MYNTT, LLC (COLORADO LIMITED LIABILITY COMPANY)
919 TAYLOR LANE
ERIE, CO 80516

FOR: ATHLETIC APPAREL, NAMELY, SHIRTS, PANTS, JACKETS, FOOTWEAR, HATS AND CAPS, ATHLETIC UNIFORMS; BOTTOMS; GOLF PANTS, SHIRTS AND SKIRTS; GOLF SHIRTS; GOLF SHORTS; JACKETS; TOPS; WEARABLE GARMENTS AND CLOTHING, NAMELY, SHIRTS; WOMEN'S ATHLETIC TOPS WITH BUILT-IN BRAS; WOMEN'S CLOTHING, NAMELY, SHIRTS, DRESSES, SKIRTS, BLOUSES, IN CLASS 25 (U.S. CLS. 22 AND 39).

FIRST USE 9-10-2009; IN COMMERCE 5-5-2011.

THE MARK CONSISTS OF STANDARD CHARACTERS WITHOUT CLAIM TO ANY PARTICULAR FONT, STYLE, SIZE, OR COLOR.

SER. NO. 85-330,219, FILED 5-25-2011.

SUSAN RICHARDS, EXAMINING ATTORNEY



David J. Kybas

Director of the United States Patent and Trademark Office

United States of America

United States Patent and Trademark Office

BAR CODE DIRECT

Reg. No. 4,107,984

Registered Mar. 6, 2012

Int. Cls.: 35 and 42

SERVICE MARK

PRINCIPAL REGISTER

BAR CODE DIRECT, INC. (MASSACHUSETTS CORPORATION)
41 N. MAIN STREET P.O. BOX 459
GRAFTON, MA 01536

FOR: RETAIL SHOP AND DISTRIBUTORSHIP SERVICES IN THE FIELD OF COMMERCIAL, INSTITUTIONAL, GOVERNMENTAL AND INDUSTRIAL AUTOMATIC IDENTIFICATION SYSTEMS IN THE NATURE OF SCANNERS AND ELECTRONIC SCANNING EQUIPMENT, IN CLASS 35 (U.S. CLS. 100, 101 AND 102).

FIRST USE 7-1-1997; IN COMMERCE 7-0-1997.

FOR: DESIGN FOR OTHERS AND DESIGN CONSULTATION SERVICES BOTH IN THE FIELD OF COMMERCIAL, INSTITUTIONAL, GOVERNMENTAL AND INDUSTRIAL AUTOMATIC IDENTIFICATION SYSTEMS IN THE NATURE OF SCANNERS AND ELECTRONIC SCANNING EQUIPMENT, IN CLASS 42 (U.S. CLS. 100 AND 101).

FIRST USE 7-1-1997; IN COMMERCE 7-0-1997.

THE MARK CONSISTS OF STANDARD CHARACTERS WITHOUT CLAIM TO ANY PARTICULAR FONT, STYLE, SIZE, OR COLOR.

OWNER OF U.S. REG. NO. 2,514,913.

SEC. 2(F).

SER. NO. 85-330,688, FILED 5-26-2011.

KAPIL BHANOT, EXAMINING ATTORNEY



David J. Kybas

Director of the United States Patent and Trademark Office

United States of America

United States Patent and Trademark Office

CALEDON

Reg. No. 4,107,985

Registered Mar. 6, 2012

Int. Cl.: 31

TRADEMARK

PRINCIPAL REGISTER

CALEDON PRODUCE FARMS LTD. (CANADA CORPORATION)
P.O. BOX 67
107 9TH CONCESSION ROAD, R.R. #2
BURFORD, ONTARIO, CANADA N0E1A0

FOR: FRESH BROCCOLI, IN CLASS 31 (U.S. CLS. 1 AND 46).

FIRST USE 0-0-1997; IN COMMERCE 0-0-1997.

THE MARK CONSISTS OF STANDARD CHARACTERS WITHOUT CLAIM TO ANY PARTICULAR FONT, STYLE, SIZE, OR COLOR.

SEC. 2(F).

SER. NO. 85-330,834, FILED 5-26-2011.

ELIZABETH HUGHITT, EXAMINING ATTORNEY



David J. Kybas

Director of the United States Patent and Trademark Office

United States of America

United States Patent and Trademark Office



BAR CODE DIRECT

Reg. No. 4,107,986

Registered Mar. 6, 2012

Int. Cls.: 35 and 42

SERVICE MARK

PRINCIPAL REGISTER

BAR CODE DIRECT, INC. (MASSACHUSETTS CORPORATION)
41 N. MAIN STREET P.O. BOX 459
GRAFTON, MA 01536

FOR: RETAIL SHOP AND DISTRIBUTORSHIP SERVICES IN THE FIELD OF COMMERCIAL, INSTITUTIONAL, GOVERNMENTAL AND INDUSTRIAL AUTOMATIC IDENTIFICATION SYSTEMS IN THE NATURE OF SCANNERS AND ELECTRONIC SCANNING EQUIPMENT, IN CLASS 35 (U.S. CLS. 100, 101 AND 102).

FIRST USE 6-30-2009; IN COMMERCE 6-30-2009.

FOR: DESIGN FOR OTHERS AND DESIGN CONSULTATION SERVICES BOTH IN THE FIELD OF COMMERCIAL, INSTITUTIONAL, GOVERNMENTAL AND INDUSTRIAL AUTOMATIC IDENTIFICATION SYSTEMS IN THE NATURE OF SCANNERS AND ELECTRONIC SCANNING EQUIPMENT, IN CLASS 42 (U.S. CLS. 100 AND 101).

FIRST USE 12-31-2004; IN COMMERCE 12-31-2004.

OWNER OF U.S. REG. NO. 2,514,913.

THE COLOR(S) BLACK AND YELLOW IS/ARE CLAIMED AS A FEATURE OF THE MARK.

THE MARK CONSISTS OF A RHOMBUS DESIGN IN YELLOW WITH A BLACK BORDER; INSIDE THIS DESIGN ARE BLACK LINES; TO THE RIGHT OF THIS DESIGN ARE THE WORDS "BAR CODE DIRECT" IN BLACK LETTERS.

SEC. 2(F).

SER. NO. 85-330,836, FILED 5-26-2011.

KAPIL BHANOT, EXAMINING ATTORNEY

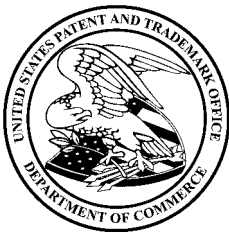

David J. Kybas

Director of the United States Patent and Trademark Office

United States of America

United States Patent and Trademark Office

riders' roost

Reg. No. 4,107,987

Registered Mar. 6, 2012

Int. Cl.: 43

SERVICE MARK

PRINCIPAL REGISTER

RIDER'S ROOST MOTORCYCLE RESORT, INC. (NORTH CAROLINA CORPORATION)
100 ELK CREEK DARBY RD
FERGUSON, NC 28624

FOR: RESORT LODGING SERVICES, IN CLASS 43 (U.S. CLS. 100 AND 101).

FIRST USE 5-26-1990; IN COMMERCE 5-26-1990.

THE MARK CONSISTS OF STANDARD CHARACTERS WITHOUT CLAIM TO ANY PARTICULAR FONT, STYLE, SIZE, OR COLOR.

NO CLAIM IS MADE TO THE EXCLUSIVE RIGHT TO USE "RIDERS'", APART FROM THE MARK AS SHOWN.

SER. NO. 85-330,895, FILED 5-26-2011.

SHANNON TWOHIG, EXAMINING ATTORNEY



David J. Kybas

Director of the United States Patent and Trademark Office

United States of America

United States Patent and Trademark Office

Reedycares

Reg. No. 4,107,988

Registered Mar. 6, 2012

Int. Cls.: 35 and 37

SERVICE MARK

PRINCIPAL REGISTER

REEDY INDUSTRIES, INC. (DELAWARE CORPORATION)
SUITE 200
2440 RAVINE WAY
GLENVIEW, IL 60025

FOR: CHARITABLE SERVICES, NAMELY, ORGANIZING AND CONDUCTING VOLUNTEER PROGRAMS FOR CONSTRUCTION OF SAFE PLAYGROUNDS FOR NEEDY CHILDREN AND THEIR FAMILIES, IN CLASS 35 (U.S. CLS. 100, 101 AND 102).

FIRST USE 6-1-2006; IN COMMERCE 6-1-2006.

FOR: CHARITABLE SERVICES, NAMELY, CONSTRUCTING SAFE PLAYGROUNDS FOR NEEDY CHILDREN AND THEIR FAMILIES, IN CLASS 37 (U.S. CLS. 100, 103 AND 106).

FIRST USE 6-1-2006; IN COMMERCE 6-1-2006.

THE MARK CONSISTS OF STANDARD CHARACTERS WITHOUT CLAIM TO ANY PARTICULAR FONT, STYLE, SIZE, OR COLOR.

SER. NO. 85-330,929, FILED 5-26-2011.

LEIGH CAROLINE CASE, EXAMINING ATTORNEY



David J. Kybas

Director of the United States Patent and Trademark Office

United States of America

United States Patent and Trademark Office



Reg. No. 4,107,989

Registered Mar. 6, 2012

Int. Cl.: 37

SERVICE MARK

PRINCIPAL REGISTER

LEL ENVIRONMENTAL, LTD. (TEXAS LIMITED PARTNERSHIP)
5034-A SPENCER HWY
PASADENA, TX 77505

FOR: HAZARDOUS WASTE DISPOSAL SERVICES, IN CLASS 37 (U.S. CLS. 100, 103 AND 106).

FIRST USE 5-1-2009; IN COMMERCE 5-1-2009.

THE MARK CONSISTS OF THE DESIGN OF A GLOBE WITH LIGHT BLUE OCEANS AND BLUE CONTINENTS AND THE DESIGN OF A GREEN AND YELLOW STEM WHICH ENCIRCLES THE GLOBE IN A THREE-DIMENSIONAL FASHION CASTING A GRAY SHADOW ON THE BACKGROUND AND ENDING IN A GREEN AND YELLOW LEAF ON THE RIGHT SIDE OF THE GLOBE SEPARATED THEREFROM AND EXTENDING OUTWARDLY IN A NORTHEASTERLY DIRECTION WITH THE STEM AND LEAF CASTING A GRAY SHADOW ON THE BACKGROUND.

THE COLOR(S) BLUE, LIGHT BLUE, GREEN, YELLOW AND GRAY IS/ARE CLAIMED AS A FEATURE OF THE MARK.

SER. NO. 85-331,478, FILED 5-26-2011.

JAY BESCH, EXAMINING ATTORNEY



David J. Kybas

Director of the United States Patent and Trademark Office

United States of America

United States Patent and Trademark Office

JOSLIN COMBO

Reg. No. 4,107,990

Registered Mar. 6, 2012

Int. Cl.: 10

TRADEMARK

PRINCIPAL REGISTER

FANCASTIC PRODUCTS, INC. (CALIFORNIA CORPORATION), DBA JOSLIN ORTHOPEDIC
GEAR
3900 FIFTH AVE., SUITE 240
SAN DIEGO, CA 92103

FOR: ARM SLINGS WITH AND WITHOUT SUPPORTING PILLOWS, IN CLASS 10 (U.S.
CLS. 26, 39 AND 44).

FIRST USE 2-21-2011; IN COMMERCE 2-21-2011.

THE MARK CONSISTS OF STANDARD CHARACTERS WITHOUT CLAIM TO ANY PAR-
TICULAR FONT, STYLE, SIZE, OR COLOR.

OWNER OF U.S. REG. NOS. 2,149,836 AND 3,091,912.

NO CLAIM IS MADE TO THE EXCLUSIVE RIGHT TO USE "COMBO", APART FROM THE
MARK AS SHOWN.

SER. NO. 85-331,895, FILED 5-26-2011.

KATHLEEN M. VANSTON, EXAMINING ATTORNEY



David J. Kybas

Director of the United States Patent and Trademark Office

United States of America

United States Patent and Trademark Office

MONTPELIER

Reg. No. 4,107,991

Registered Mar. 6, 2012

Int. Cl.: 36

SERVICE MARK

PRINCIPAL REGISTER

MONTPELIER RE HOLDINGS LTD. (BERMUDA LIMITED LIABILITY COMPANY)
MONTPELIER HOUSE
P.O. BOX HM2079 , 94 PITTS BAY ROAD
HAMILTON, BERMUDA HMHX

FOR: ADMINISTRATION OF EMPLOYEE PLANS CONCERNING INSURANCE AND FINANCE; FINANCIAL ADVISORY AND CONSULTANCY SERVICES, NAMELY, ADVICE AND CONSULTATION FOR CAPITAL STRUCTURING, INVESTMENTS, MERGERS AND ACQUISITIONS, NEW VENTURE DEVELOPMENT; FINANCIAL AND INVESTMENT SERVICES, NAMELY, ASSET AND INVESTMENT ACQUISITION, CONSULTATION, ADVISORY AND DEVELOPMENT; FINANCIAL MANAGEMENT; FINANCIAL RISK MANAGEMENT CONSULTATION; FINANCIAL SERVICES, NAMELY, INVESTMENT FUND TRANSFER AND TRANSACTION SERVICES; INSURANCE SERVICES, NAMELY, UNDERWRITING SERVICES IN THE FIELD OF COMMERCIAL, PROPERTY AND CASUALTY INSURANCE AND REINSURANCE; AND FINANCIAL RISK MANAGEMENT SERVICES IN THE FIELD OF COMMERCIAL PROPERTY AND CASUALTY INSURANCE AND REINSURANCE; INVESTMENT CONSULTANCY; INVESTMENT MANAGEMENT; INVESTMENT SERVICES, NAMELY, ASSET ACQUISITION, CONSULTATION, DEVELOPMENT AND MANAGEMENT SERVICES; PROVIDING FINANCIAL INFORMATION; PROVIDING WORKING CAPITAL, IN CLASS 36 (U.S. CLS. 100, 101 AND 102).

FIRST USE 11-15-2001; IN COMMERCE 11-15-2001.

THE MARK CONSISTS OF STANDARD CHARACTERS WITHOUT CLAIM TO ANY PARTICULAR FONT, STYLE, SIZE, OR COLOR.

OWNER OF U.S. REG. NOS. 3,569,599, 3,569,981, AND 3,617,585.

SER. NO. 85-332,041, FILED 5-27-2011.

COLLEEN DOMBROW, EXAMINING ATTORNEY



David J. Kyjars

Director of the United States Patent and Trademark Office

United States of America
United States Patent and Trademark Office

PARKSIDE

Reg. No. 4,107,992

PATEL, PJ (UNITED STATES INDIVIDUAL)
PO BOX 10028
ANAHEIM, CA 92812

Registered Mar. 6, 2012

Int. Cl.: 43

FOR: MOTEL AND HOTEL ACCOMMODATIONS, IN CLASS 43 (U.S. CLS. 100 AND 101).

SERVICE MARK

FIRST USE 9-15-1998; IN COMMERCE 9-15-1998.

PRINCIPAL REGISTER

THE MARK CONSISTS OF STANDARD CHARACTERS WITHOUT CLAIM TO ANY PARTICULAR FONT, STYLE, SIZE, OR COLOR.

SER. NO. 85-332,195, FILED 5-27-2011.

MARK SPARACINO, EXAMINING ATTORNEY



David J. Kybas

Director of the United States Patent and Trademark Office

United States of America

United States Patent and Trademark Office



Reg. No. 4,107,993

Registered Mar. 6, 2012

Int. Cls.: 16, 25 and 35

TRADEMARK

SERVICE MARK

PRINCIPAL REGISTER

MICHAEL WEIR (UNITED KINGDOM INDIVIDUAL)
69 OXFORD ROAD COWLEY
OXFORD, UNITED KINGDOM OX42ER

FOR: PRINTED MATTER, NAMELY, PRINTED PAPER LABELS; PAPER, CARDBOARD, GOODS MADE FROM PAPER AND CARDBOARD, NAMELY, PAPER AND CARDBOARD PACKAGING AND CONTAINERS; PLASTIC MATERIALS, NAMELY, BAGS AND BUBBLE PACKS FOR PACKAGING; GRAPHIC PRINTS AND POSTERS; GRAPHIC ART REPRODUCTIONS; SIGNBOARDS OF PAPER OR CARDBOARD, IN CLASS 16 (U.S. CLS. 2, 5, 22, 23, 29, 37, 38 AND 50).

FOR: SHIRTS, T-SHIRTS, SWEAT SHIRTS; HOODED TOPS; TANK TOPS; SWEATERS; JACKETS; COATS; RAIN COATS; PONCHOS; SHORTS; UNDERWEAR; UNDERGARMENTS; JEANS; TROUSERS; PANTS; SHORTS; LONG SLEEVE T-SHIRTS; CARGO SHORTS; TRACK SUITS; COLLEGIATE JACKETS; ZIP-UP TOPS; BANDANAS; ONE-PIECE BODYSUITS FOR BABIES; CHILDREN'S T-SHIRTS AND SWEAT SHIRTS; CLOTH BIBS; HATS; BASEBALL CAPS; SUN VISORS; BEANIES; RAIN HATS; TOQUES; CAPS; TOP HATS; SHOES; BOOTS; SANDALS; SNEAKERS; BASEBALL CLEATS; RAINBOOTS; FLIP FLOPS, IN CLASS 25 (U.S. CLS. 22 AND 39).

FOR: RETAIL STORE SERVICES FEATURING CLOTHING, HEADGEAR AND FOOTWEAR; ONLINE RETAIL STORE SERVICES FEATURING CLOTHING, HEADGEAR AND FOOTWEAR, IN CLASS 35 (U.S. CLS. 100, 101 AND 102).

OWNER OF ERPN CMNTY TM OFC REG. NO. 009472226, DATED 3-6-2011, EXPIRES 10-25-2020.

THE MARK CONSISTS OF THE DESIGN OF A SKULL BENEATH A ROBE AND AN OUT-STRETCHED RIGHT HAND AND POINTING WITH ITS INDEX FIGURE AND THE STYLIZED WORDING "I'M NOT LIKE YOU" BELOW AND TO THE RIGHT OF THE DESIGN. THE LETTER "T" IN THE WORDING IS DISPLAYED UPSIDE DOWN. THE WORD "YOU" IN THE MARK IS DISPLAYED BENEATH THE OTHER WORDING IN THE MARK, IN A MUCH LARGER SIZE, AND IN BUBBLE LETTERING.



David J. Kyros

Director of the United States Patent and Trademark Office

SER. NO. 85-332,380, FILED 5-27-2011.

KATHERINE CHANG, EXAMINING ATTORNEY

United States of America

United States Patent and Trademark Office

JUNIPER SLING

Reg. No. 4,107,994

PENHALIGON'S LIMITED (UNITED KINGDOM LIMITED COMPANY (LTD.))
DRAGON HOUSE, 37-39 ARTILLERY LANE
LONDON, UNITED KINGDOM

Registered Mar. 6, 2012

Int. Cl.: 3

FOR: PERFUMERY, IN CLASS 3 (U.S. CLS. 1, 4, 6, 50, 51 AND 52).

TRADEMARK

THE MARK CONSISTS OF STANDARD CHARACTERS WITHOUT CLAIM TO ANY PARTICULAR FONT, STYLE, SIZE, OR COLOR.

PRINCIPAL REGISTER

PRIORITY CLAIMED UNDER SEC. 44(D) ON ERPN CMNTY TM OFC APPLICATION NO. 009978131, FILED 5-18-2011, REG. NO. 009978131, DATED 9-29-2011, EXPIRES 5-18-2021.

SER. NO. 85-332,478, FILED 5-27-2011.

JACQUELINE A. LAVINE, EXAMINING ATTORNEY



David J. Kybas

Director of the United States Patent and Trademark Office

United States of America

United States Patent and Trademark Office

VALSTONE ASSET MANAGEMENT

Reg. No. 4,107,995

Registered Mar. 6, 2012

Int. Cl.: 36

SERVICE MARK

PRINCIPAL REGISTER

VALSTONE ASSET MANAGEMENT, L.L.C. (DELAWARE LIMITED LIABILITY COMPANY)
260 E. BROWN STREET, SUITE 250
BIRMINGHAM, MI 48009

FOR: FINANCIAL ASSET MANAGEMENT, IN CLASS 36 (U.S. CLS. 100, 101 AND 102).

FIRST USE 12-30-2008; IN COMMERCE 12-30-2008.

THE MARK CONSISTS OF STANDARD CHARACTERS WITHOUT CLAIM TO ANY PARTICULAR FONT, STYLE, SIZE, OR COLOR.

NO CLAIM IS MADE TO THE EXCLUSIVE RIGHT TO USE "ASSET MANAGEMENT", APART FROM THE MARK AS SHOWN.

SER. NO. 85-332,543, FILED 5-27-2011.

MIDGE BUTLER, EXAMINING ATTORNEY



David J. Kyffers

Director of the United States Patent and Trademark Office

United States of America

United States Patent and Trademark Office

Lilyance

Reg. No. 4,107,996

DOWN ETC. (CALIFORNIA CORPORATION)
228 TOWNSEND STREET
SAN FRANCISCO, CA 94107

Registered Mar. 6, 2012

Int. Cl.: 20

FOR: BEDS, MATTRESSES, PILLOWS AND BOLSTERS, IN CLASS 20 (U.S. CLS. 2, 13, 22, 25, 32 AND 50).

TRADEMARK

FIRST USE 4-23-2010; IN COMMERCE 4-23-2010.

PRINCIPAL REGISTER

THE MARK CONSISTS OF STANDARD CHARACTERS WITHOUT CLAIM TO ANY PARTICULAR FONT, STYLE, SIZE, OR COLOR.

SER. NO. 85-332,965, FILED 5-27-2011.

TOBY BULLOFF, EXAMINING ATTORNEY



David J. Kybas

Director of the United States Patent and Trademark Office

United States of America

United States Patent and Trademark Office

MONEYMOVES

Reg. No. 4,107,997

COLMAN, GAYLE (UNITED STATES INDIVIDUAL)
18 AUDUBON LANE
CARLISLE, MA 017411500

Registered Mar. 6, 2012

Int. Cls.: 36 and 41

FOR: PROVIDING FINANCIAL INFORMATION, ADVICE AND CONSULTING SERVICES,
IN CLASS 36 (U.S. CLS. 100, 101 AND 102).

SERVICE MARK

FIRST USE 5-5-2006; IN COMMERCE 12-8-2006.

PRINCIPAL REGISTER

FOR: PERSONAL COACHING SERVICES IN THE FIELD OF MONEY MANAGEMENT AND
MONEY AWARENESS; EDUCATIONAL SERVICES, NAMELY, PROVIDING LIVE LEC-
TURES AND SEMINARS IN THE FIELD OF MONEY MANAGEMENT AND MONEY ISSUES
AND DISTRIBUTION OF COURSE MATERIALS THEREWITH; AND NON-DOWNLOADABLE
ELECTRONIC NEWSLETTERS IN THE FIELD OF MONEY MANAGEMENT, IN CLASS 41
(U.S. CLS. 100, 101 AND 107).

FIRST USE 5-5-2006; IN COMMERCE 12-8-2006.

THE MARK CONSISTS OF STANDARD CHARACTERS WITHOUT CLAIM TO ANY PAR-
TICULAR FONT, STYLE, SIZE, OR COLOR.

SER. NO. 85-333,029, FILED 5-28-2011.

DAVID C. REIHNER, EXAMINING ATTORNEY



David J. Kybas

Director of the United States Patent and Trademark Office

United States of America

United States Patent and Trademark Office

HANAD

Reg. No. 4,107,998

Registered Mar. 6, 2012

Int. Cl.: 35

SERVICE MARK

PRINCIPAL REGISTER

HANAD-GLOBAL TRADE MANAGEMENT (OHIO LIMITED LIABILITY COMPANY)
HANAD INC.
PO BOX 10470
COLUMBUS, OH 43201

FOR: BUSINESS ADVISORY AND CONSULTANCY SERVICES RELATING TO EXPORT, EXPORT SERVICES, EXPORT PROMOTION INFORMATION AND SERVICES; EXPORT AGENCY SERVICES FOR THE GOODS OF OTHERS; EXPORT AND IMPORT AGENCIES; EXPORT AND IMPORT AGENCIES IN THE FIELD OF MEDICINES, MEDICAL DEVICES, PHARMACEUTICALS, CHEMICALS, BIOLOGICS, HEALTHCARE IT, COSMETICS, HEALTH SUPPLEMENTS, NEUTRICEUTICALS, CONSTRUCTION EQUIPMENTS, HEAVY MACHINERY, IN CLASS 35 (U.S. CLS. 100, 101 AND 102).

FIRST USE 5-18-2011; IN COMMERCE 5-18-2011.

THE MARK CONSISTS OF STANDARD CHARACTERS WITHOUT CLAIM TO ANY PARTICULAR FONT, STYLE, SIZE, OR COLOR.

SER. NO. 85-333,166, FILED 5-28-2011.

SKYE YOUNG, EXAMINING ATTORNEY



David J. Kypos

Director of the United States Patent and Trademark Office

United States of America

United States Patent and Trademark Office

GIRL FROM IPANEMA

Reg. No. 4,107,999

Registered Mar. 6, 2012

Int. Cls.: 3 and 44

TRADEMARK

SERVICE MARK

PRINCIPAL REGISTER

GIRL FROM IPANEMA LLC (NEW JERSEY LIMITED LIABILITY COMPANY)
95 SUMMIT AVENUE
SUMMIT, NJ 07901

FOR: COSMETIC PREPARATIONS FOR SKIN CARE; SKIN AND BODY TOPICAL LOTIONS, CREAMS AND OILS FOR COSMETIC USE; LIP GLOSS; DEPILATORY WAX; DEPILATORIES, IN CLASS 3 (U.S. CLS. 1, 4, 6, 50, 51 AND 52).

FIRST USE 1-1-2006; IN COMMERCE 1-1-2006.

FOR: BEAUTY SPA SERVICES, NAMELY, COSMETIC BODY CARE, IN CLASS 44 (U.S. CLS. 100 AND 101).

FIRST USE 1-1-2006; IN COMMERCE 1-1-2006.

THE MARK CONSISTS OF STANDARD CHARACTERS WITHOUT CLAIM TO ANY PARTICULAR FONT, STYLE, SIZE, OR COLOR.

SER. NO. 85-333,764, FILED 5-31-2011.

RONALD AIKENS, EXAMINING ATTORNEY



David J. Kyros

Director of the United States Patent and Trademark Office

United States of America

United States Patent and Trademark Office

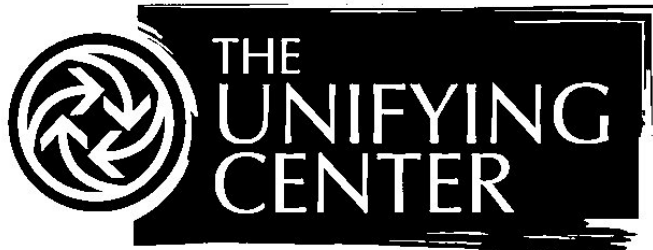

Reg. No. 4,108,000

Registered Mar. 6, 2012

Int. Cls.: 35 and 45

SERVICE MARK

PRINCIPAL REGISTER

THE UNIFYING CENTER, INC. (NEW YORK CORPORATION)
SUITE 318
373 NESCONSET HIGHWAY
HAUPPAUGE, NY 11788

FOR: PUBLIC ADVOCACY TO PROMOTE AWARENESS OF PROGRAMS FOCUSED ON GENDER-BASED MENTAL HEALTH CARE OF MEN AND BOYS, IN CLASS 35 (U.S. CLS. 100, 101 AND 102).

FIRST USE 1-18-2011; IN COMMERCE 1-18-2011.

FOR: PROVIDING COUNSELING FOR MEN AND BOYS THAT HAVE EXPERIENCED TRAUMA OR ABUSE COMPRISING INTERVIEWING THE VICTIM, IDENTIFYING WHAT THE PROBLEM IS AND SUGGESTING WHERE HELP CAN BE OBTAINED, IN CLASS 45 (U.S. CLS. 100 AND 101).

FIRST USE 1-18-2011; IN COMMERCE 1-18-2011.

NO CLAIM IS MADE TO THE EXCLUSIVE RIGHT TO USE "CENTER", APART FROM THE MARK AS SHOWN.

THE MARK CONSISTS OF A CIRCULAR SYMBOL CONTAINING FOUR ARROWS CURVING IN A CLOCKWISE POSITION. TO THE RIGHT THERE IS THE STYLIZED TEXT "THE UNIFYING CENTER".

SER. NO. 85-333,768, FILED 5-31-2011.

RONALD AIKENS, EXAMINING ATTORNEY



David J. Kybas

Director of the United States Patent and Trademark Office

United States of America

United States Patent and Trademark Office

NORFOLK MARKETS

Reg. No. 4,108,001

Registered Mar. 6, 2012

Int. Cl.: 36

SERVICE MARK

PRINCIPAL REGISTER

NORFOLK MANAGEMENT GROUP LLC (CONNECTICUT LIMITED LIABILITY COMPANY)
360 MADISON AVENUE, 24TH FLOOR
NEW YORK, NY 10017

FOR: FINANCIAL SERVICES, NAMELY, INVESTMENT BANKING SPECIALIZING IN ALTERNATIVE INVESTMENTS, PLACEMENT AGENT SERVICES IN CONNECTION WITH PRIVATE INVESTMENT FUNDS IN THE NATURE OF SERVING AS A PLACEMENT AGENT FOR SUCH FUNDS, FINANCIAL SERVICES IN THE NATURE OF STRUCTURING, FINANCIAL MANAGEMENT AND PLACEMENT AGENT SERVICES FOR COLLATERALIZED DEBT OBLIGATIONS, GUARANTEED NOTES AND OTHER STRUCTURED PRODUCTS, IN CLASS 36 (U.S. CLS. 100, 101 AND 102).

FIRST USE 1-1-1998; IN COMMERCE 1-1-1998.

THE MARK CONSISTS OF STANDARD CHARACTERS WITHOUT CLAIM TO ANY PARTICULAR FONT, STYLE, SIZE, OR COLOR.

OWNER OF U.S. REG. NOS. 2,958,782 AND 3,005,663.

NO CLAIM IS MADE TO THE EXCLUSIVE RIGHT TO USE "MARKETS", APART FROM THE MARK AS SHOWN.

SEC. 2(F).

SER. NO. 85-333,995, FILED 5-31-2011.

MIDGE BUTLER, EXAMINING ATTORNEY



David J. Kyffers

Director of the United States Patent and Trademark Office

United States of America

United States Patent and Trademark Office



Reg. No. 4,108,002

Registered Mar. 6, 2012

Int. Cl.: 43

SERVICE MARK

PRINCIPAL REGISTER

DAVIDSON HOTEL COMPANY LLC (DELAWARE LIMITED LIABILITY COMPANY)
SUITE 200
3340 PLAYERS CLUB PARKWAY
MEMPHIS, TN 38125

FOR: HOTELS; RESORT HOTELS, IN CLASS 43 (U.S. CLS. 100 AND 101).

FIRST USE 2-18-1991; IN COMMERCE 2-18-1991.

OWNER OF U.S. REG. NO. 1,720,981.

THE MARK CONSISTS OF A DESIGN CONSISTING OF STYLIZED LETTERS "D", "H", AND "C".

SER. NO. 85-334,169, FILED 5-31-2011.

HELENE LIWINSKI, EXAMINING ATTORNEY



David J. Kybas

Director of the United States Patent and Trademark Office

United States of America

United States Patent and Trademark Office



Reg. No. 4,108,003

KWARTER INC. (CALIFORNIA CORPORATION)
181 FREMONT ST
SAN FRANCISCO, CA 94105

Registered Mar. 6, 2012

Int. Cl.: 45

FOR: INTERNET-BASED SOCIAL NETWORKING SERVICES, IN CLASS 45 (U.S. CLS. 100 AND 101).

SERVICE MARK

FIRST USE 5-1-2011; IN COMMERCE 5-1-2011.

PRINCIPAL REGISTER

THE MARK CONSISTS OF A STYLIZED LETTER "K" INSIDE A DISTORTED SQUARE TO THE LEFT OF THE WORD "KWARTER"

THE ENGLISH TRANSLATION OF "KWARTER" IN THE MARK IS "QUARTER".

SER. NO. 85-334,534, FILED 5-31-2011.

NAAKWAMA ANKRAH, EXAMINING ATTORNEY



David J. Kybas

Director of the United States Patent and Trademark Office

United States of America

United States Patent and Trademark Office

CRAPPIE MAXX

Reg. No. 4,108,004

Registered Mar. 6, 2012

Int. Cl.: 28

TRADEMARK

PRINCIPAL REGISTER

BASS PRO INTELLECTUAL PROPERTY, L.L.C. (MISSOURI LIMITED LIABILITY COMPANY)
2500 E. KEARNEY STREET
SPRINGFIELD, MO 65898

FOR: FISHING EQUIPMENT, NAMELY, RODS, REELS, COMBINATION RODS AND REELS, TACKLE BAGS, FISHING LINES, AND FISHING ACCESSORIES, NAMELY, LURES, BASKETS, AND COUNTERS, IN CLASS 28 (U.S. CLS. 22, 23, 38 AND 50).

FIRST USE 12-0-2010; IN COMMERCE 12-0-2010.

THE MARK CONSISTS OF STANDARD CHARACTERS WITHOUT CLAIM TO ANY PARTICULAR FONT, STYLE, SIZE, OR COLOR.

OWNER OF U.S. REG. NO. 4,013,891.

NO CLAIM IS MADE TO THE EXCLUSIVE RIGHT TO USE "CRAPPIE", APART FROM THE MARK AS SHOWN.

SER. NO. 85-334,560, FILED 5-31-2011.

ELLEN BURNS, EXAMINING ATTORNEY



David J. Kyros

Director of the United States Patent and Trademark Office

United States of America

United States Patent and Trademark Office

RED LENTIL

Reg. No. 4,108,005

Registered Mar. 6, 2012

Int. Cl.: 43

SERVICE MARK

PRINCIPAL REGISTER

PANKAJ PRADHAN (INDIA INDIVIDUAL)
600 MOUNT AUBURN STREET
WATERTOWN, MA 02472

FOR: RESTAURANT SERVICES, IN CLASS 43 (U.S. CLS. 100 AND 101).

FIRST USE 9-30-2009; IN COMMERCE 9-30-2009.

THE MARK CONSISTS OF STANDARD CHARACTERS WITHOUT CLAIM TO ANY PARTICULAR FONT, STYLE, SIZE, OR COLOR.

SER. NO. 85-334,869, FILED 6-1-2011.

FLORENTINA BLANDU, EXAMINING ATTORNEY



David J. Kyros

Director of the United States Patent and Trademark Office

United States of America

United States Patent and Trademark Office

BLUE  LYNK

Reg. No. 4,108,006

BLUE LYNK, LLC (TEXAS LIMITED LIABILITY COMPANY)
1504 FALL CREEK DRIVE
CEDAR PARK, TX 78613

Registered Mar. 6, 2012

Int. Cl.: 42

FOR: ELECTRONICALLY LINKING DOCUMENTS, NAMELY, CONVERSION OF DOCUMENTS FROM PHYSICAL TO ELECTRONIC FORM, IN CLASS 42 (U.S. CLS. 100 AND 101).

SERVICE MARK

FIRST USE 6-1-2011; IN COMMERCE 6-1-2011.

PRINCIPAL REGISTER

NO CLAIM IS MADE TO THE EXCLUSIVE RIGHT TO USE "LINK", APART FROM THE MARK AS SHOWN.

THE MARK CONSISTS OF THE WORDS "BLUE" AND "LYNK" WITH THREE CONCENTRIC INTERLOCKING CIRCLES IN BETWEEN THE WORDS.

SER. NO. 85-335,168, FILED 6-1-2011.

KATHERINE E. HALMEN, EXAMINING ATTORNEY



David J. Kybas

Director of the United States Patent and Trademark Office

United States of America

United States Patent and Trademark Office

WebACE

Reg. No. 4,108,007

Registered Mar. 6, 2012

Int. Cl.: 45

SERVICE MARK

PRINCIPAL REGISTER

AURICO REPORTS, INC. (ILLINOIS CORPORATION)
116 WEST EASTMAN STREET
ARLINGTON HEIGHTS, IL 60004

FOR: BACKGROUND INVESTIGATION AND RESEARCH SERVICES; BACKGROUND INVESTIGATION SERVICES; DRUG, ALCOHOL AND DNA SCREENING FOR SECURITY AND EMPLOYMENT PURPOSES; EMPLOYMENT BACKGROUND SCREENING, NAMELY, BACKGROUND SCREENING OF CURRENT EMPLOYEES OF OTHERS; PERSONAL BACKGROUND INVESTIGATIONS; PRE-EMPLOYMENT BACKGROUND INVESTIGATION SERVICES; PRE-EMPLOYMENT BACKGROUND SCREENING; REVIEWING STANDARDS AND PRACTICES TO ASSURE COMPLIANCE WITH WHISTLEBLOWER, ETHICS LAWS AND REGULATIONS; SECURITY SERVICES, NAMELY, PROVIDING SECURITY ASSESSMENTS FOR BUSINESSES AND GOVERNMENTAL AGENCIES, IN CLASS 45 (U.S. CLS. 100 AND 101).

FIRST USE 6-1-2011; IN COMMERCE 6-1-2011.

THE MARK CONSISTS OF STANDARD CHARACTERS WITHOUT CLAIM TO ANY PARTICULAR FONT, STYLE, SIZE, OR COLOR.

SER. NO. 85-335,334, FILED 6-1-2011.

BRIAN NEVILLE, EXAMINING ATTORNEY



David J. Kyros

Director of the United States Patent and Trademark Office

United States of America

United States Patent and Trademark Office



Reg. No. 4,108,008

Registered Mar. 6, 2012

Int. Cl.: 35

SERVICE MARK

PRINCIPAL REGISTER

ZEBRAPLACE, INC. (ILLINOIS CORPORATION)
893 ELM ST.
WINNETKA, IL 60093

FOR: PROMOTING THE GOODS AND SERVICES OF OTHERS BY MEANS OF OPERATING AN ON-LINE SHOPPING MALL WITH LINKS TO THE RETAIL WEB SITES OF OTHERS AND IN WHICH BUYERS RECEIVE AN INCENTIVE BY USING THE WEB SITE TO PURCHASE GOODS AND SERVICES, IN CLASS 35 (U.S. CLS. 100, 101 AND 102).

FIRST USE 4-1-2011; IN COMMERCE 4-1-2011.

THE GRAY IN THE MARK IS FOR SHADING PURPOSES ONLY.

THE MARK CONSISTS OF A TOY ZEBRA SITTING IN A FLOATING CHAIR WHICH CASTS A SLIGHT SHADOW BENEATH IT.

SER. NO. 85-335,407, FILED 6-1-2011.

IRA J. GOODSaid, EXAMINING ATTORNEY



David J. Kybas

Director of the United States Patent and Trademark Office

United States of America

United States Patent and Trademark Office



BLUE ZONES

Reg. No. 4,108,009

Registered Mar. 6, 2012

Int. Cl.: 41

SERVICE MARK

PRINCIPAL REGISTER

BLUE ZONES, LLC (DELAWARE LIMITED LIABILITY COMPANY)
724 NORTH 1ST STREET
MINNEAPOLIS, MN 55401

FOR: EDUCATION SERVICES, NAMELY, PROVIDING LIVE AND ON-LINE INSTRUCTION, INFORMATION, CONSULTING AND MENTORING IN THE FIELD OF HEALTHY LIFESTYLES, HAPPINESS AND LONGEVITY; EDUCATIONAL SERVICES, NAMELY, CONDUCTING CLASSES, SEMINARS, CONFERENCES, WORKSHOPS IN THE FIELD OF HEALTHY LIFESTYLES, HAPPINESS AND LONGEVITY AND DISTRIBUTION OF COURSE MATERIAL IN CONNECTION THEREWITH; PROVIDING EDUCATIONAL MENTORING SERVICES AND PROGRAMS IN THE FIELD OF HEALTHY LIFESTYLES. ALL OF THE FOREGOING SERVICES ARE BASED ON RESEARCH INVOLVING CULTURES OF LONGEVITY AND WELLNESS. LONGEVITY-ORIENTED EXPEDITIONS TO CULTURES OF LONGEVITY AROUND THE WORLD, IN CLASS 41 (U.S. CLS. 100, 101 AND 107).

FIRST USE 5-1-2005; IN COMMERCE 5-1-2005.

THE MARK CONSISTS OF A DESIGN AND A LITERAL COMPONENT. THE DESIGN IS LOCATED TO THE LEFT OF THE LITERAL PORTION AND CONSISTS OF CURVED PIECES OF THE PERIPHERIES OF CONCENTRIC BLUE CIRCLES THAT APPEAR TO SPIN, AND INCLUDE A PORTION OF THE NEIGHBORING, ABSTRACT HUMAN FIGURE IN FADED ORANGE WITH UPRAISED ARMS AND LEGS AKIMBO. THE WORDING "BLUE ZONES" APPEARS TO THE RIGHT OF THE DESIGN IN STYLIZED UPPER-AND-LOWER, GRAY CAPITALS.

THE COLOR(S) BLUE, TAN-ORANGE, GRAY, AND WHITE IS/ARE CLAIMED AS A FEATURE OF THE MARK.

SER. NO. 85-335,451, FILED 6-1-2011.

JILL C. ALT, EXAMINING ATTORNEY



David J. Kyjars

Director of the United States Patent and Trademark Office

United States of America

United States Patent and Trademark Office

PINE KNOLL PUBLICATIONS

Reg. No. 4,108,010

PINE KNOLL PUBLICATIONS, INC. (CALIFORNIA CORPORATION)
1345 PINE KNOLL
REDLANDS, CA 92373

Registered Mar. 6, 2012

Int. Cls.: 9 and 16

FOR: AUDIO AND VIDEO RECORDINGS FEATURING RELIGIOUS INSTRUCTION, IN CLASS 9 (U.S. CLS. 21, 23, 26, 36 AND 38).

TRADEMARK

FIRST USE 6-1-1992; IN COMMERCE 6-1-1992.

PRINCIPAL REGISTER

FOR: PRINTED PUBLICATIONS, NAMELY, BOOKS, MAGAZINES AND PAMPHLETS, IN THE FIELD OF RELIGION, IN CLASS 16 (U.S. CLS. 2, 5, 22, 23, 29, 37, 38 AND 50).

FIRST USE 6-1-1992; IN COMMERCE 6-1-1992.

THE MARK CONSISTS OF STANDARD CHARACTERS WITHOUT CLAIM TO ANY PARTICULAR FONT, STYLE, SIZE, OR COLOR.

NO CLAIM IS MADE TO THE EXCLUSIVE RIGHT TO USE "PUBLICATIONS", APART FROM THE MARK AS SHOWN.

SER. NO. 85-335,490, FILED 6-1-2011.

LINDA MICKLEBURGH, EXAMINING ATTORNEY



David J. Kyros

Director of the United States Patent and Trademark Office

United States of America

United States Patent and Trademark Office

Text My Market

Reg. No. 4,108,011

HEMMING, JORDAN L (UTAH CORPORATION)
35 N 500 W
LEHI, UT 84043

Registered Mar. 6, 2012

Int. Cl.: 35

FOR: ADVERTISING AGENCY SPECIALIZING IN THE DESIGN AND EXECUTION OF WORD OF MOUTH, VIRAL, BUZZ AND EXPERIENTIAL MARKETING PROGRAMS; ADVERTISING AND MARKETING; ADVERTISING AND MARKETING CONSULTANCY , IN CLASS 35 (U.S. CLS. 100, 101 AND 102).

SERVICE MARK

PRINCIPAL REGISTER

FIRST USE 11-22-2010; IN COMMERCE 11-22-2010.

THE MARK CONSISTS OF STANDARD CHARACTERS WITHOUT CLAIM TO ANY PARTICULAR FONT, STYLE, SIZE, OR COLOR.

SER. NO. 85-335,551, FILED 6-1-2011.

MARK SPARACINO, EXAMINING ATTORNEY



David J. Kyffers

Director of the United States Patent and Trademark Office

United States of America

United States Patent and Trademark Office



Reg. No. 4,108,012

Registered Mar. 6, 2012

Int. Cls.: 39 and 41

SERVICE MARK

PRINCIPAL REGISTER

YACHTS 4 FUN, INC. (NEVADA CORPORATION)
195 MOUNT SAINT HELENS
HENDERSON, NV 89012

FOR: YACHT AND BOAT CHARTER SERVICES, IN CLASS 39 (U.S. CLS. 100 AND 105).

FIRST USE 4-1-2011; IN COMMERCE 4-1-2011.

FOR: INSTRUCTION IN THE FIELD OF BOATING , IN CLASS 41 (U.S. CLS. 100, 101 AND 107).

FIRST USE 4-1-2011; IN COMMERCE 4-1-2011.

NO CLAIM IS MADE TO THE EXCLUSIVE RIGHT TO USE "SELF MANAGED CHARTER SERVICES", APART FROM THE MARK AS SHOWN.

THE COLOR(S) BLUE, WHITE, BLACK, YELLOW, GOLD, AND BURNT ORANGE IS/ARE CLAIMED AS A FEATURE OF THE MARK.

THE MARK CONSISTS OF A BACKGROUND OF BLUE STARTING WITH A DARKER BLUE AT THE TOP OF THE DESIGN AND FADING TO A LIGHT BLUE AT THE BOTTOM OF THE DESIGN; THE WORDING "SELF MANAGED CHARTER SERVICES" IS IN WHITE LETTERING AND FORMS AN ARCH OVER THE ENTIRE DESIGN; BELOW THE LETTERING IS A THIN YELLOW LINE THAT FORMS ANOTHER ARCH OR HALF CIRCLE; BELOW THE YELLOW LINE IS A PARTIAL SUN IN BURNT ORANGE AT THE TOP FADING TO A LIGHT GOLD; IN FRONT OF THE PARTIAL SUN IS A YACHT IN BLACK WITH WHITE ACCENTS AND A DARK BLUE STRIPE ALONG THE LENGTH OF THE YACHT CROSSING FROM LEFT TO RIGHT IN FRONT OF THE PARTIAL SUN; A WHITE WAVE COMES UP ON THE BOW OF THE YACHT; BELOW THE YACHT IS A WHITE, LIGHT BLUE AND DARK BLUE WAVE DESIGN; TO THE RIGHT SIDE OF THE YACHT ARE THE WORDS "YACHTS4FUN" IN WHITE BLOCK LETTERS.

SER. NO. 85-335,576, FILED 6-1-2011.

AMY ALFIERI, EXAMINING ATTORNEY



David J. Kyros

Director of the United States Patent and Trademark Office

United States of America

United States Patent and Trademark Office

Hard Cards

Reg. No. 4,108,013

Registered Mar. 6, 2012

Int. Cl.: 16

TRADEMARK

PRINCIPAL REGISTER

RIFKIN, STACEY LEIGH (UNITED STATES INDIVIDUAL), DBA HARD CARDS
SUITE 222
5424 LAUREL CANYON BLVD
VALLEY VILLAGE, CA 91607 AND

PICARELLI, RONDA (UNITED STATES INDIVIDUAL), DBA HARD CARDS
SUITE 222
5424 LAUREL CANYON BLVD
VALLEY VILLAGE, CA 91607

FOR: GREETING CARDS, IN CLASS 16 (U.S. CLS. 2, 5, 22, 23, 29, 37, 38 AND 50).

FIRST USE 5-1-2008; IN COMMERCE 7-1-2008.

THE MARK CONSISTS OF STANDARD CHARACTERS WITHOUT CLAIM TO ANY PARTICULAR FONT, STYLE, SIZE, OR COLOR.

NO CLAIM IS MADE TO THE EXCLUSIVE RIGHT TO USE "CARDS", APART FROM THE MARK AS SHOWN.

SER. NO. 85-335,746, FILED 6-1-2011.

MARTHA FROMM, EXAMINING ATTORNEY



David J. Kyjars

Director of the United States Patent and Trademark Office

United States of America

United States Patent and Trademark Office

CAVA
CALIFORNIA VISUAL APPAREL

Reg. No. 4,108,014

FRANKLIN, MICHAEL (UNITED STATES INDIVIDUAL)
19661 FERNWOOD PLAZA
YORBA LINDA, CA 92886

Registered Mar. 6, 2012

Int. Cl.: 25

FOR: CLOTHING, NAMELY, T-SHIRTS, SHORTS, SWEAT PANTS, SWEAT SHIRTS, SWIMWEAR, JACKETS, WET SUITS, BELTS, JEANS, SLACKS, WOVEN SHIRTS, KNIT SHIRTS, TANK TOPS, SOCKS, SWEATERS, HATS, BEANIES, CAPS, FOOTWEAR, IN CLASS 25 (U.S. CLS. 22 AND 39).

TRADEMARK

PRINCIPAL REGISTER

FIRST USE 6-12-2010; IN COMMERCE 6-12-2010.

NO CLAIM IS MADE TO THE EXCLUSIVE RIGHT TO USE "CALIFORNIA" AND "APPAREL", APART FROM THE MARK AS SHOWN.

THE MARK CONSISTS OF THE STYLIZED WORDS "CAVA CALIFORNIA VISUAL APPAREL". THE LETTER "C" IS CONNECTED TO THE LETTER "A". THE LETTER "V" IS CONNECTED TO THE LETTER "A".

SER. NO. 85-336,041, FILED 6-2-2011.

CHRISTINA SOBRAL, EXAMINING ATTORNEY



David J. Kyros

Director of the United States Patent and Trademark Office

United States of America

United States Patent and Trademark Office

iGrad

Reg. No. 4,108,015

Registered Mar. 6, 2012

Int. Cl.: 36

SERVICE MARK

PRINCIPAL REGISTER

IGRAD INC. (DELAWARE CORPORATION), DBA IGRAD
SUITE 100
2163 NEWCASTLE AVE.
CARDIFF BY THE SEA, CA 92007

FOR: FINANCIAL INFORMATION RELATED TO FINANCIAL LITERACY; PROVIDING A WEBSITE FEATURING FINANCIAL INFORMATION RELATED TO FINANCIAL LITERACY, IN CLASS 36 (U.S. CLS. 100, 101 AND 102).

FIRST USE 9-1-2008; IN COMMERCE 12-1-2008.

THE MARK CONSISTS OF STANDARD CHARACTERS WITHOUT CLAIM TO ANY PARTICULAR FONT, STYLE, SIZE, OR COLOR.

SER. NO. 85-336,252, FILED 6-2-2011.

Laurie Kaufman, Examining Attorney



David J. Kybas

Director of the United States Patent and Trademark Office

United States of America

United States Patent and Trademark Office

PROJECT DIMENSIONS

Reg. No. 4,108,016

Registered Mar. 6, 2012

Int. Cls.: 37, 42 and 45

SERVICE MARK

PRINCIPAL REGISTER

PROJECT DIMENSIONS, INC. (CALIFORNIA CORPORATION)
3 PARK PLAZA
SUITE 1490
IRVINE, CA 92614

FOR: CONSTRUCTION MANAGEMENT SERVICES, CONSTRUCTION CONSULTATION SERVICES, CONSTRUCTION PROJECT MANAGEMENT SERVICES, IN CLASS 37 (U.S. CLS. 100, 103 AND 106).

FIRST USE 9-30-1986; IN COMMERCE 9-30-1986.

FOR: LAND USE EVALUATION SERVICES, IN CLASS 42 (U.S. CLS. 100 AND 101).

FIRST USE 9-30-1986; IN COMMERCE 9-30-1986.

FOR: ENTITLEMENT SERVICES, NAMELY, OBTAINING GOVERNMENT AND REGULATORY PERMITS, LICENSES AND APPROVALS TO BUILD SUBDIVISIONS, RESIDENTIAL, RETAIL, INFRASTRUCTURE, RESORT, AND/OR COMMERCIAL STRUCTURES FOR OTHERS, IN CLASS 45 (U.S. CLS. 100 AND 101).

FIRST USE 9-30-1986; IN COMMERCE 9-30-1986.

THE MARK CONSISTS OF STANDARD CHARACTERS WITHOUT CLAIM TO ANY PARTICULAR FONT, STYLE, SIZE, OR COLOR.

SER. NO. 85-336,271, FILED 6-2-2011.

KAREN K. BUSH, EXAMINING ATTORNEY



David J. Kyros

Director of the United States Patent and Trademark Office

United States of America

United States Patent and Trademark Office

MOSCOT ORIGINALS

Reg. No. 4,108,017

MOSCOT MANAGEMENT CORP. (NEW YORK CORPORATION)
118 ORCHARD STREET
NEW YORK, NY 10002

Registered Mar. 6, 2012

Int. Cl.: 9

FOR: EYEWEAR, IN CLASS 9 (U.S. CLS. 21, 23, 26, 36 AND 38).

TRADEMARK

FIRST USE 0-0-2002; IN COMMERCE 0-0-2002.

PRINCIPAL REGISTER

THE MARK CONSISTS OF STANDARD CHARACTERS WITHOUT CLAIM TO ANY PARTICULAR FONT, STYLE, SIZE, OR COLOR.

OWNER OF U.S. REG. NOS. 3,380,737, 3,876,255 AND OTHERS.

NO CLAIM IS MADE TO THE EXCLUSIVE RIGHT TO USE "ORIGINALS", APART FROM THE MARK AS SHOWN.

THE NAME "MOSCOT" IN THE MARK DOES NOT IDENTIFY A LIVING INDIVIDUAL.

SER. NO. 85-336,283, FILED 6-2-2011.

AMY KERTGATE, EXAMINING ATTORNEY



David J. Kyffers

Director of the United States Patent and Trademark Office

United States of America

United States Patent and Trademark Office



Reg. No. 4,108,018

Registered Mar. 6, 2012

Int. Cls.: 37, 39 and 40

SERVICE MARK

PRINCIPAL REGISTER

WASHINGTON BUSINESS SERVICES, INC. (MONTANA CORPORATION)
P.O. BOX 16630
101 INTERNATIONAL DRIVE
MISSOULA, MT 59808

FOR: CIVIL CONSTRUCTION OF SLURRY AND REACTIVE WALLS, DAMS AND WETLANDS, MINES, METAL MILLING AND SMELTING BUILDING FACILITIES, AND LANDFILLS; CAPPING AND CLOSURE OF SOLID WASTE LANDFILLS; DEMOLITION AND RESTORATION OF BUILDINGS; WASTE EXCAVATION AND DISPOSAL, REMOVAL AND DISPOSAL OF SOIL, SLUDGE, WASTE, AND WASTE WATER; LAND RECLAMATION, NAMELY, MINE RECLAMATION; DEMOLITION OF BUILDINGS AT NUCLEAR POWER PLANTS, IN CLASS 37 (U.S. CLS. 100, 103 AND 106).

FIRST USE 1-0-2010; IN COMMERCE 1-0-2010.

FOR: TRANSPORTATION OF ENVIRONMENTAL AND HAZARDOUS WASTE IN THE NATURE OF SOIL, SLUDGE, WASTE, WATER AND WASTE WATER; MARINE TRANSPORT, SHIP BROKERAGE SERVICES, RENTAL AND LEASING OF SHIPS AND MARINE VESSELS, BOAT CHARTERING, IN CLASS 39 (U.S. CLS. 100 AND 105).

FIRST USE 1-0-2010; IN COMMERCE 1-0-2010.

FOR: ENVIRONMENTAL REMEDIATION SERVICES, NAMELY, SOIL TREATMENT STABILIZATION AND FIXATION, STREAM RESTORATION, TREATMENT OF SOIL, SLUDGE, WASTE, WATER AND WASTE WATER; DECONTAMINATION AND DEMOLITION OF NUCLEAR POWER PLANT MACHINERY AND EQUIPMENT; HAZARDOUS AND NUCLEAR WASTE MANAGEMENT; METAL RECLAMATION SERVICES; RECYCLING IN THE NATURE OF RECOVERING OF ASSETS FROM BUILDINGS UNDERGOING DEMOLITION OR RESTORATION, INCLUDING EQUIPMENT, STRUCTURAL PARTS, METALS AND OTHER ASSETS, IN CLASS 40 (U.S. CLS. 100, 103 AND 106).

FIRST USE 1-0-2010; IN COMMERCE 1-0-2010.

OWNER OF U.S. REG. NOS. 2,212,939, 2,737,475, AND 3,586,080.



David J. Kybas

Director of the United States Patent and Trademark Office

Reg. No. 4,108,018 THE MARK CONSISTS OF THE LETTER "W" INSIDE OF A SHADED CIRCLE WITH THE RIGHT CORNER OF THE "W" GEOMETRICALLY CURVED INWARD.

SER. NO. 85-336,286, FILED 6-2-2011.

FRED CARL, EXAMINING ATTORNEY

United States of America

United States Patent and Trademark Office

MOSCOT SUN

Reg. No. 4,108,019

MOSCOT MANAGEMENT CORP. (NEW YORK CORPORATION)
118 ORCHARD STREET
NEW YORK, NY 10002

Registered Mar. 6, 2012

Int. Cl.: 9

FOR: EYEWEAR, IN CLASS 9 (U.S. CLS. 21, 23, 26, 36 AND 38).

TRADEMARK

FIRST USE 3-4-2011; IN COMMERCE 3-4-2011.

PRINCIPAL REGISTER

THE MARK CONSISTS OF STANDARD CHARACTERS WITHOUT CLAIM TO ANY PARTICULAR FONT, STYLE, SIZE, OR COLOR.

OWNER OF U.S. REG. NOS. 3,380,737, 3,876,255 AND OTHERS.

NO CLAIM IS MADE TO THE EXCLUSIVE RIGHT TO USE "SUN", APART FROM THE MARK AS SHOWN.

THE NAME "MOSCOT" IN THE MARK DOES NOT IDENTIFY A LIVING INDIVIDUAL.

SER. NO. 85-336,301, FILED 6-2-2011.

AMY KERTGATE, EXAMINING ATTORNEY



David J. Kyffers

Director of the United States Patent and Trademark Office

United States of America

United States Patent and Trademark Office

ARCFO

Reg. No. 4,108,020

NEW EDGE CAPITAL (NEW YORK LIMITED LIABILITY COMPANY), DBA ARCFO
300 HOPPER COURT
FRANKLIN LAKES, NJ 07417

Registered Mar. 6, 2012

Int. Cl.: 35

FOR: ACCOUNTS RECEIVABLE SERVICES, IN CLASS 35 (U.S. CLS. 100, 101 AND 102).

SERVICE MARK

FIRST USE 5-29-2011; IN COMMERCE 6-2-2011.

PRINCIPAL REGISTER

THE MARK CONSISTS OF STANDARD CHARACTERS WITHOUT CLAIM TO ANY PARTICULAR FONT, STYLE, SIZE, OR COLOR.

SER. NO. 85-336,677, FILED 6-2-2011.

ALLISON SCHRODY, EXAMINING ATTORNEY



David J. Kybas

Director of the United States Patent and Trademark Office

United States of America

United States Patent and Trademark Office

Durabag

Reg. No. 4,108,021

Registered Mar. 6, 2012

Int. Cl.: 16

TRADEMARK

PRINCIPAL REGISTER

RETZ, JOHN MICHAEL (UNITED STATES INDIVIDUAL)
2621 EISENHOWER AVENUE
AMES, IA 50010

FOR: PLASTIC BAGS FOR PACKAGING AND MIXING CHEMICAL COMPOUNDS, SPECIFICALLY COMPOUNDS USED IN THE REPAIR AND FINISHING OF DRYWALL, IN CLASS 16 (U.S. CLS. 2, 5, 22, 23, 29, 37, 38 AND 50).

FIRST USE 4-28-2011; IN COMMERCE 4-28-2011.

THE MARK CONSISTS OF STANDARD CHARACTERS WITHOUT CLAIM TO ANY PARTICULAR FONT, STYLE, SIZE, OR COLOR.

SER. NO. 85-336,997, FILED 6-2-2011.

PAUL E. FAHRENKOPF, EXAMINING ATTORNEY



David J. Kybas

Director of the United States Patent and Trademark Office

United States of America

United States Patent and Trademark Office

YELLOW SEARCH

Reg. No. 4,108,022

VANDERHORST, CHRISTOPHER R. (UNITED STATES INDIVIDUAL)
6085 SEBRING WARNER-RD N LOT 62
GREENVILLE, OH 45331

Registered Mar. 6, 2012

Int. Cl.: 35

FOR: PROVIDING ON-LINE DIRECTORY INFORMATION SERVICES ALSO FEATURING
HYPERLINKS TO OTHER WEB SITES, IN CLASS 35 (U.S. CLS. 100, 101 AND 102).

SERVICE MARK

FIRST USE 6-1-2011; IN COMMERCE 6-1-2011.

PRINCIPAL REGISTER

THE MARK CONSISTS OF STANDARD CHARACTERS WITHOUT CLAIM TO ANY PAR-
TICULAR FONT, STYLE, SIZE, OR COLOR.

NO CLAIM IS MADE TO THE EXCLUSIVE RIGHT TO USE "SEARCH", APART FROM THE
MARK AS SHOWN.

SER. NO. 85-337,053, FILED 6-3-2011.

JASON TURNER, EXAMINING ATTORNEY



David J. Kybas

Director of the United States Patent and Trademark Office

United States of America

United States Patent and Trademark Office

JUNIOR SCHOLASTIC

Reg. No. 4,108,023

SCHOLASTIC INC. (NEW YORK CORPORATION)
557 BROADWAY
NEW YORK, NY 10012

Registered Mar. 6, 2012

Int. Cl.: 16

FOR: EDUCATIONAL MAGAZINE FOR USE BY TEACHERS AND STUDENTS PUBLISHED DURING THE SCHOOL YEAR, IN CLASS 16 (U.S. CLS. 2, 5, 22, 23, 29, 37, 38 AND 50).

TRADEMARK

FIRST USE 9-0-1937; IN COMMERCE 9-0-1937.

PRINCIPAL REGISTER

THE MARK CONSISTS OF STANDARD CHARACTERS WITHOUT CLAIM TO ANY PARTICULAR FONT, STYLE, SIZE, OR COLOR.

OWNER OF U.S. REG. NOS. 273,405, 1,567,119 AND OTHERS.

SEC. 2(F).

SER. NO. 85-337,316, FILED 6-3-2011.

HOWARD SMIGA, EXAMINING ATTORNEY



David J. Kybas

Director of the United States Patent and Trademark Office

United States of America

United States Patent and Trademark Office

Magic Exterminating

Reg. No. 4,108,024

Registered Mar. 6, 2012

Int. Cl.: 37

SERVICE MARK

PRINCIPAL REGISTER

MAGIC PEST MANAGEMENT LLC (NEW YORK LIMITED LIABILITY COMPANY)
5901 KISSENA BLVD
FLUSHING, NY 11355

FOR: EXTERMINATING CONSULTATION; PEST CONTROL; PEST CONTROL AND EXTERMINATION OTHER THAN FOR AGRICULTURAL PURPOSES; TERMITE AND PEST CONTROL; VERMIN EXTERMINATING, IN CLASS 37 (U.S. CLS. 100, 103 AND 106).

FIRST USE 4-4-1968; IN COMMERCE 4-4-1968.

THE MARK CONSISTS OF STANDARD CHARACTERS WITHOUT CLAIM TO ANY PARTICULAR FONT, STYLE, SIZE, OR COLOR.

NO CLAIM IS MADE TO THE EXCLUSIVE RIGHT TO USE "EXTERMINATING", APART FROM THE MARK AS SHOWN.

SER. NO. 85-337,464, FILED 6-3-2011.

LEIGH CAROLINE CASE, EXAMINING ATTORNEY



David J. Kyffers

Director of the United States Patent and Trademark Office

United States of America

United States Patent and Trademark Office



Grand Expressions

Reg. No. 4,108,025

PERGO (EUROPE) AB (SWEDEN CORPORATION)
STRANDRIDAREGATAN 8
TRELLEBORG, SWEDEN SE-23125

Registered Mar. 6, 2012

Int. Cl.: 19

FOR: FLOORING, NAMELY, WOOD, THERMOSETTING LAMINATE, THERMOSETTING LAMINATE BONDED TO A BASE OF PARTICLE BOARD OR FIBERBOARD AND PARTICLE BOARD OR FIBERBOARD PROVIDED WITH A DECORATIVE SURFACE OR COATING, IN CLASS 19 (U.S. CLS. 1, 12, 33 AND 50).

TRADEMARK

PRINCIPAL REGISTER

FIRST USE 5-1-2011; IN COMMERCE 5-1-2011.

THE MARK CONSISTS OF A STYLIZED "G" IN A CIRCLE ABOVE THE WORDS "GRAND EXPRESSIONS".

SER. NO. 85-337,720, FILED 6-3-2011.

MICHELE SWAIN, EXAMINING ATTORNEY



David J. Kyros

Director of the United States Patent and Trademark Office

United States of America

United States Patent and Trademark Office

Sonoma Living

Reg. No. 4,108,026

NYT MANAGEMENT SERVICES, INC. (DELAWARE CORPORATION)
2202 WESTSHORE BLVD.
TAMPA, FL 33067

Registered Mar. 6, 2012

Int. Cl.: 16

FOR: NEWSPAPERS; NEWSPAPERS FOR GENERAL CIRCULATION, IN CLASS 16 (U.S. CLS. 2, 5, 22, 23, 29, 37, 38 AND 50).

TRADEMARK

FIRST USE 1-19-2009; IN COMMERCE 1-19-2009.

PRINCIPAL REGISTER

THE MARK CONSISTS OF STANDARD CHARACTERS WITHOUT CLAIM TO ANY PARTICULAR FONT, STYLE, SIZE, OR COLOR.

NO CLAIM IS MADE TO THE EXCLUSIVE RIGHT TO USE "SONOMA", APART FROM THE MARK AS SHOWN.

SER. NO. 85-337,825, FILED 6-3-2011.

MARY BOAGNI, EXAMINING ATTORNEY



David J. Kybas

Director of the United States Patent and Trademark Office

United States of America

United States Patent and Trademark Office

LEHMANN FARMS

Reg. No. 4,108,027

CLASSIC CULINARY PRODUCTS, INC. (MINNESOTA CORPORATION)
1310 RANDOLPH AVENUE
ST. PAUL, MN 55105

Registered Mar. 6, 2012

Int. Cls.: 29, 30 and 32

FOR: MARASCHINO CHERRIES; MARINATED VEGETABLES; PICKLED VEGETABLES;
PROCESSED OLIVES; PROCESSED STUFFED OLIVES, IN CLASS 29 (U.S. CL. 46).

TRADEMARK

FIRST USE 11-0-1986; IN COMMERCE 11-0-1986.

PRINCIPAL REGISTER

FOR: BARBEQUE SAUCE; KETCHUP; MUSTARD, IN CLASS 30 (U.S. CL. 46).

FIRST USE 1-0-1995; IN COMMERCE 1-0-1995.

FOR: NON-ALCOHOLIC COCKTAIL MIXES, IN CLASS 32 (U.S. CLS. 45, 46 AND 48).

FIRST USE 1-0-1993; IN COMMERCE 1-0-1993.

THE MARK CONSISTS OF STANDARD CHARACTERS WITHOUT CLAIM TO ANY PARTICULAR FONT, STYLE, SIZE, OR COLOR.

NO CLAIM IS MADE TO THE EXCLUSIVE RIGHT TO USE "FARMS", APART FROM THE MARK AS SHOWN.

SER. NO. 85-337,847, FILED 6-3-2011.

MARY BOAGNI, EXAMINING ATTORNEY



David J. Kyros

Director of the United States Patent and Trademark Office

United States of America

United States Patent and Trademark Office



Reg. No. 4,108,028

HURDLE JUMPERS (CALIFORNIA CORPORATION)

Registered Mar. 6, 2012

P.O. BOX 642600
LOS ANGELES, CA 90064

Int. Cl.: 44

FOR: CHARITABLE SERVICES, NAMELY, PROVIDING COMFORT KITS CONSISTING PRIMARILY OF PERSONAL CARE ITEMS TO CANCER PATIENTS, AND PROVIDING INFORMATION ON THE TREATMENT AND CARE OF CANCER PATIENTS, IN CLASS 44 (U.S. CLS. 100 AND 101).

SERVICE MARK

PRINCIPAL REGISTER

FIRST USE 2-21-2006; IN COMMERCE 3-0-2006.

NO CLAIM IS MADE TO THE EXCLUSIVE RIGHT TO USE "CANCER TREATMENT", APART FROM THE MARK AS SHOWN.

THE COLOR(S) PURPLE AND BLACK IS/ARE CLAIMED AS A FEATURE OF THE MARK.

THE MARK CONSISTS OF THE PURPLE WORDS "HURDLE JUMPERS" OVER THE BLACK WORDS "SOARING OVER THE OBSTACLES OF CANCER TREATMENT" WITH A PURPLE LINE EXTENDING UNDER THE WORD "JUMPERS" TO THE RIGHT AND A STYLIZED PURPLE JUMPING FIGURE ABOVE THE LINE.

SER. NO. 85-338,024, FILED 6-3-2011.

CHRISTINA SOBRAL, EXAMINING ATTORNEY



David J. Kyros

Director of the United States Patent and Trademark Office

United States of America

United States Patent and Trademark Office

Floral Wonders

Reg. No. 4,108,029

KAMIENIAK, EVA (UNITED STATES INDIVIDUAL), DBA FLORAL WONDERS
552 PHEASANT TR
SAINT CHARLES, IL 60174

Registered Mar. 6, 2012

Int. Cl.: 44

FOR: FLOWER ARRANGING, IN CLASS 44 (U.S. CLS. 100 AND 101).

SERVICE MARK

FIRST USE 9-1-2010; IN COMMERCE 9-1-2010.

PRINCIPAL REGISTER

THE MARK CONSISTS OF STANDARD CHARACTERS WITHOUT CLAIM TO ANY PARTICULAR FONT, STYLE, SIZE, OR COLOR.

NO CLAIM IS MADE TO THE EXCLUSIVE RIGHT TO USE "FLORAL", APART FROM THE MARK AS SHOWN.

SER. NO. 85-338,158, FILED 6-4-2011.

FRED CARL, EXAMINING ATTORNEY



David J. Kyffers

Director of the United States Patent and Trademark Office

United States of America

United States Patent and Trademark Office

ULTI - FILL

Reg. No. 4,108,030

HEARTLAND CEMENT SALES COMPANY (DELAWARE CORPORATION)
100 BROADHEAD ROAD, SUITE 230
BETHLEHEM, PA 18017

Registered Mar. 6, 2012

Int. Cl.: 19

FOR: HYDRAULIC CEMENT OR BLENDED HYDRAULIC CEMENT OR CEMENTITIOUS MATERIALS, NAMELY, RAPID HARDENING CEMENT, FAST SETTING CEMENT, AND HIGH STRENGTH CEMENT, IN CLASS 19 (U.S. CLS. 1, 12, 33 AND 50).

TRADEMARK

FIRST USE 4-8-2004; IN COMMERCE 8-31-2004.

PRINCIPAL REGISTER

THE MARK CONSISTS OF STANDARD CHARACTERS WITHOUT CLAIM TO ANY PARTICULAR FONT, STYLE, SIZE, OR COLOR.

OWNER OF U.S. REG. NOS. 2,957,996, 3,013,805 AND OTHERS.

SER. NO. 85-338,164, FILED 6-4-2011.

FRED CARL, EXAMINING ATTORNEY



David J. Kyfos

Director of the United States Patent and Trademark Office

United States of America

United States Patent and Trademark Office

ULTI - GROUT

Reg. No. 4,108,031

HEARTLAND CEMENT SALES COMPANY (DELAWARE CORPORATION)
100 BROADHEAD ROAD, SUITE 230
BETHLEHEM, PA 18017

Registered Mar. 6, 2012

Int. Cl.: 19

FOR: HYDRAULIC CEMENT OR BLENDED HYDRAULIC CEMENT OR CEMENTITIOUS MATERIALS, NAMELY, RAPID HARDENING CEMENT, FAST SETTING CEMENT, AND HIGH STRENGTH CEMENT, IN CLASS 19 (U.S. CLS. 1, 12, 33 AND 50).

TRADEMARK

FIRST USE 4-8-2004; IN COMMERCE 8-31-2004.

PRINCIPAL REGISTER

THE MARK CONSISTS OF STANDARD CHARACTERS WITHOUT CLAIM TO ANY PARTICULAR FONT, STYLE, SIZE, OR COLOR.

OWNER OF U.S. REG. NOS. 2,957,996, 3,013,805 AND OTHERS.

SER. NO. 85-338,165, FILED 6-4-2011.

FRED CARL, EXAMINING ATTORNEY



David J. Kyros

Director of the United States Patent and Trademark Office

United States of America

United States Patent and Trademark Office

BROKE GIRL'S GUIDE

Reg. No. 4,108,032

Registered Mar. 6, 2012

Int. Cl.: 35

SERVICE MARK

PRINCIPAL REGISTER

BROKE GIRL'S GUIDE, LLC (CALIFORNIA LIMITED LIABILITY COMPANY)
P.O. BOX 7244
SANTA MONICA, CA 904067244

FOR: PROMOTING THE GOODS AND SERVICES OF OTHERS BY TRANSMITTING EMAILS AND OTHER ELECTRONIC MESSAGES AND PROVIDING A WEBSITE FEATURING COUPONS, REBATES, DISCOUNTS, PRICE-COMPARISON INFORMATION, PRODUCT AND SERVICES DESCRIPTIONS AND REVIEWS, AND LINKS TO THE RETAIL WEBSITES OF OTHERS; ADVERTISING, MARKETING AND PROMOTION SERVICES; PROMOTING THE GOODS AND SERVICES OF OTHERS BY ARRANGING FOR ADVERTISERS TO AFFILIATE THEIR GOODS AND SERVICES WITH AN ENTERTAINMENT AND FASHION WEBSITE, IN CLASS 35 (U.S. CLS. 100, 101 AND 102).

FIRST USE 5-8-2008; IN COMMERCE 5-8-2008.

THE MARK CONSISTS OF STANDARD CHARACTERS WITHOUT CLAIM TO ANY PARTICULAR FONT, STYLE, SIZE, OR COLOR.

NO CLAIM IS MADE TO THE EXCLUSIVE RIGHT TO USE "GUIDE", APART FROM THE MARK AS SHOWN.

SER. NO. 85-338,183, FILED 6-4-2011.

KIMBERLY PERRY, EXAMINING ATTORNEY



David J. Kyros

Director of the United States Patent and Trademark Office

United States of America

United States Patent and Trademark Office

FLAVOR WORKS

Reg. No. 4,108,033

Registered Mar. 6, 2012

Int. Cl.: 32

TRADEMARK

PRINCIPAL REGISTER

THE CONCENTRATE MANUFACTURING COMPANY OF IRELAND (IRELAND CORPORATION)
CORNER HOUSE, 20 PARLIAMENT STREET
HAMILTON, BERMUDA HMHX

FOR: CONCENTRATES, SYRUPS OR POWDERS USED IN THE PREPARATION OF SOFT DRINKS, IN CLASS 32 (U.S. CLS. 45, 46 AND 48).

FIRST USE 4-0-2009; IN COMMERCE 4-0-2009.

THE MARK CONSISTS OF STANDARD CHARACTERS WITHOUT CLAIM TO ANY PARTICULAR FONT, STYLE, SIZE, OR COLOR.

NO CLAIM IS MADE TO THE EXCLUSIVE RIGHT TO USE "FLAVOR", APART FROM THE MARK AS SHOWN.

SER. NO. 85-338,420, FILED 6-6-2011.

DOUGLAS LEE, EXAMINING ATTORNEY



David J. Kyros

Director of the United States Patent and Trademark Office

United States of America

United States Patent and Trademark Office

Go Green Irrigation

Reg. No. 4,108,034

Registered Mar. 6, 2012

Int. Cl.: 37

SERVICE MARK

PRINCIPAL REGISTER

GO GREEN IRRIGATION (TEXAS LIMITED LIABILITY COMPANY)
14115 INWOOD ROAD
DALLAS, TX 75244

FOR: IRRIGATION DEVICES INSTALLATION AND REPAIR, IN CLASS 37 (U.S. CLS. 100, 103 AND 106).

FIRST USE 1-1-2009; IN COMMERCE 6-12-2009.

THE MARK CONSISTS OF STANDARD CHARACTERS WITHOUT CLAIM TO ANY PARTICULAR FONT, STYLE, SIZE, OR COLOR.

NO CLAIM IS MADE TO THE EXCLUSIVE RIGHT TO USE "IRRIGATION", APART FROM THE MARK AS SHOWN.

SER. NO. 85-338,496, FILED 6-6-2011.

LAURA HAMMEL, EXAMINING ATTORNEY



David J. Kybas

Director of the United States Patent and Trademark Office

United States of America

United States Patent and Trademark Office

SCORE

SYSTEMS • CULTURE • OBSERVATIONS • RECOGNITION • EMPOWERMENT

Reg. No. 4,108,035

Registered Mar. 6, 2012

Int. Cl.: 35

SERVICE MARK

PRINCIPAL REGISTER

WILLIAMA. GRAHAM COMPANY (PENNSYLVANIA CORPORATION), DBA THE GRAHAM COMPANY
THE GRAHAM BUILDING
ONE PENN SQUARE WEST
PHILADELPHIA, PA 19102

FOR: BUSINESS RISK MANAGEMENT CONSULTATION IN THE FIELD OF BUSINESS ASSESSMENT AND ANALYSIS OF SAFETY PROGRAMS , IN CLASS 35 (U.S. CLS. 100, 101 AND 102).

FIRST USE 11-30-2006; IN COMMERCE 11-30-2006.

THE MARK CONSISTS OF THE STYLIZED WORD "SCORE" UNDERLINED WITH THE STYLIZED WORDS "SYSTEMS", "CULTURE", "OBSERVATIONS", "RECOGNITION" AND "EMPOWERMENT" BELOW, EACH OF THESE WORDS SEPARATED BY A SQUARE-SHAPED BULLET.

SER. NO. 85-338,566, FILED 6-6-2011.

BRENDAN MCCAULEY, EXAMINING ATTORNEY



David J. Kyros

Director of the United States Patent and Trademark Office

United States of America

United States Patent and Trademark Office

ANGEL DAISY

Reg. No. 4,108,036

GREEN FUSE BOTANICALS, INC. (CALIFORNIA CORPORATION)
220 18TH ST.
SANTA MONICA, CA 90402

Registered Mar. 6, 2012

Int. Cl.: 31

FOR: LIVE PLANTS, NAMELY, LEUCANTHEMUM, IN CLASS 31 (U.S. CLS. 1 AND 46).

TRADEMARK

FIRST USE 10-1-2005; IN COMMERCE 10-1-2005.

PRINCIPAL REGISTER

THE MARK CONSISTS OF STANDARD CHARACTERS WITHOUT CLAIM TO ANY PARTICULAR FONT, STYLE, SIZE, OR COLOR.

NO CLAIM IS MADE TO THE EXCLUSIVE RIGHT TO USE "DAISY", APART FROM THE MARK AS SHOWN.

SER. NO. 85-338,653, FILED 6-6-2011.

JAMES STEIN, EXAMINING ATTORNEY



David J. Kyffers

Director of the United States Patent and Trademark Office

United States of America

United States Patent and Trademark Office

Urban Farm Store

Reg. No. 4,108,037

Registered Mar. 6, 2012

Int. Cl.: 35

SERVICE MARK

PRINCIPAL REGISTER

URBAN FARM STORE (OREGON CORPORATION)
2100 SE BELMONT ST
PORTLAND, OR 97214

FOR: RETAIL STORE SERVICES FEATURING ANIMAL FEEDS, LIVE CHICKENS, FARM-FRESH FOOD, GARDEN SUPPLIES AND RELATED ITEMS, IN CLASS 35 (U.S. CLS. 100, 101 AND 102).

FIRST USE 10-15-2008; IN COMMERCE 10-25-2008.

THE MARK CONSISTS OF STANDARD CHARACTERS WITHOUT CLAIM TO ANY PARTICULAR FONT, STYLE, SIZE, OR COLOR.

OWNER OF U.S. REG. NO. 3,721,571.

NO CLAIM IS MADE TO THE EXCLUSIVE RIGHT TO USE "FARM STORE", APART FROM THE MARK AS SHOWN.

SEC. 2(F).

SER. NO. 85-338,662, FILED 6-6-2011.

GIANCARLO CASTRO, EXAMINING ATTORNEY



David J. Kyffers

Director of the United States Patent and Trademark Office

United States of America

United States Patent and Trademark Office

ADS ON WHEELS

Reg. No. 4,108,038

DYSON, CHRISTOPHER (UNITED STATES INDIVIDUAL)
18 SENTRY ROAD
BEDFORD, NH 03110

Registered Mar. 6, 2012

Int. Cls.: 12 and 35

FOR: CUSTOM DESIGNED VINYL VEHICLE WRAPS SPECIFICALLY ADAPTED FOR VEHICLES, IN CLASS 12 (U.S. CLS. 19, 21, 23, 31, 35 AND 44).

TRADEMARK

FIRST USE 11-30-1999; IN COMMERCE 11-30-1999.

SERVICE MARK

FOR: MOBILE BILLBOARD ADVERTISING PROVIDED BY MEANS OF BILLBOARDS MOUNTED ON VEHICLES, AND PROMOTING THE GOODS AND SERVICES OF OTHERS BY PROVIDING MOBILE BILLBOARD SERVICES FOR OTHERS THROUGH A GLOBAL COMPUTER NETWORK, IN CLASS 35 (U.S. CLS. 100, 101 AND 102).

PRINCIPAL REGISTER

FIRST USE 11-30-1999; IN COMMERCE 11-30-1999.

THE MARK CONSISTS OF STANDARD CHARACTERS WITHOUT CLAIM TO ANY PARTICULAR FONT, STYLE, SIZE, OR COLOR.

OWNER OF U.S. REG. NO. 2,619,108.

SEC. 2(F).

SER. NO. 85-339,076, FILED 6-6-2011.

FLORENTINA BLANDU, EXAMINING ATTORNEY



David J. Kybas

Director of the United States Patent and Trademark Office

United States of America

United States Patent and Trademark Office



Reg. No. 4,108,039

Registered Mar. 6, 2012

Int. Cl.: 36

SERVICE MARK

PRINCIPAL REGISTER

CHILDREN'S CANCER RESEARCH FUND (MINNESOTA CHARITABLE CORPORATION)
SUITE 460
7301 OHMS LANE
MINNEAPOLIS, MN 55439

FOR: CHARITABLE FUNDRAISING SERVICES, IN CLASS 36 (U.S. CLS. 100, 101 AND 102).

FIRST USE 3-8-2004; IN COMMERCE 1-31-2011.

OWNER OF U.S. REG. NOS. 3,027,119 AND 3,027,121.

THE MARK CONSISTS OF A RECTANGULAR AREA WITH AN IMAGE OF A BUTTERFLY IN THE UPPER RIGHT HAND CORNER FOLLOWED BY A WAVY LINE TO INDICATE A FLIGHT PATH ABOVE THE WORDS "TIME TO FLY", ALL BORDERED BY A SOLID LINE.

SER. NO. 85-339,109, FILED 6-6-2011.

MEGHAN REINHART, EXAMINING ATTORNEY



David J. Kybas

Director of the United States Patent and Trademark Office

United States of America

United States Patent and Trademark Office



Reg. No. 4,108,040

URBAN STORE LLC (NEW MEXICO LIMITED LIABILITY COMPANY)
3209 SILVER AVE. SE
ALBUQUERQUE, NM 87106

Registered Mar. 6, 2012

Int. Cls.: 19, 20 and 35

FOR: PRE-FABRICATED GREENHOUSES NOT OF METAL, IN CLASS 19 (U.S. CLS. 1, 12, 33 AND 50).

TRADEMARK

FIRST USE 1-1-2011; IN COMMERCE 1-1-2011.

SERVICE MARK

FOR: PLASTIC RAINWATER COLLECTION CONTAINERS FOR DOMESTIC PURPOSES, IN CLASS 20 (U.S. CLS. 2, 13, 22, 25, 32 AND 50).

PRINCIPAL REGISTER

FIRST USE 1-1-2011; IN COMMERCE 1-1-2011.

FOR: RETAIL STORE SERVICES FEATURING GREEN AND ECO-FRIENDLY PRODUCTS IN THE NATURE OF MICRO-INTENSIVE 4-SEASON GARDENS, SEEDS, SOIL, COMPOST, ORGANIC PESTICIDES, SOLAR OVENS, FOOD DEHYDRATORS, SPROUTERS, COMPOSTERS, WORM BINS, RAIN BARRELS, MOVEABLE CHICKEN COOPS, SOLAR CHARGERS, SUSTAINABILITY BOOKS AND GIFTS, IN CLASS 35 (U.S. CLS. 100, 101 AND 102).

FIRST USE 1-1-2011; IN COMMERCE 1-1-2011.

NO CLAIM IS MADE TO THE EXCLUSIVE RIGHT TO USE "STORE" AS TO CLASSES 19 AND 20 AND "URBAN STORE" AS TO CLASS 35, APART FROM THE MARK AS SHOWN.



THE MARK CONSISTS OF THE WORDS "URBAN STORE" IN STYLIZED FONT WITH ONE LEAF COMING OFF OF THE UPPER LEFT PART OF THE "S", ANOTHER LEAF COMING OFF OF THE UPPER LEFT PART OF THE "B", AND TWO LEAVES COMING OFF OF THE RIGHT MIDDLE PART OF THE "N." THE WORD "URBAN" IS IMMEDIATELY ABOVE THE WORD "STORE." THERE IS A SILHOUETTE OF A CHICKEN FACING TO THE LEFT PLACED TO THE LEFT OF THE "S" IN "STORE." THE WORDS "URBAN STORE" AND THE CHICKEN ARE ON A SILHOUETTE OF A CITY SKYLINE, AND THERE IS A BORDER EXTENDING FROM THE SKYLINE SILHOUETTE AND RUNNING ALL THE WAY AROUND THE EDGE OF THE SKY. THE WORDS "URBAN STORE," CHICKEN SILHOUETTE, CITY SKYLINE, SKY, AND BORDER ARE CONTAINED WITHIN A SHAPE THAT HAS TWO SQUARE CORNERS ON THE UPPER RIGHT AND LOWER LEFT, AND TWO ROUNDED CORNERS ON THE UPPER LEFT AND LOWER RIGHT.

David J. Kybas

Director of the United States Patent and Trademark Office

Reg. No. 4,108,040 SER. NO. 85-339,203, FILED 6-6-2011.

JOHN WILKE, EXAMINING ATTORNEY

United States of America

United States Patent and Trademark Office

AZCHIA

Have you had your chia today?

Reg. No. 4,108,041

AZCHIA (ARIZONA CORPORATION)

Registered Mar. 6, 2012

P.O. BOX 506
SONOITA, AZ 85637

Int. Cls.: 29 and 31

FOR: PROCESSED EDIBLE CHIA SEEDS, IN CLASS 29 (U.S. CL. 46).

TRADEMARK

FIRST USE 6-3-2011; IN COMMERCE 6-27-2011.

PRINCIPAL REGISTER

FOR: UNPROCESSED EDIBLE CHIA SEEDS, IN CLASS 31 (U.S. CLS. 1 AND 46).

FIRST USE 4-15-2011; IN COMMERCE 6-27-2011.

THE MARK CONSISTS OF STANDARD CHARACTERS WITHOUT CLAIM TO ANY PARTICULAR FONT, STYLE, SIZE, OR COLOR.

SER. NO. 85-339,254, FILED 6-6-2011.

JOHN WILKE, EXAMINING ATTORNEY



David J. Kybas

Director of the United States Patent and Trademark Office

United States of America

United States Patent and Trademark Office



Reg. No. 4,108,042

Registered Mar. 6, 2012

Int. Cl.: 43

SERVICE MARK

PRINCIPAL REGISTER

AMERICAN BLUE RIBBON HOLDINGS, LLC (DELAWARE LIMITED LIABILITY COMPANY)
400 WEST 48TH AVENUE
DENVER, CO 80216

FOR: RESTAURANT SERVICES, IN CLASS 43 (U.S. CLS. 100 AND 101).

FIRST USE 2-9-2010; IN COMMERCE 2-9-2010.

OWNER OF U.S. REG. NOS. 1,394,423, 2,002,503 AND OTHERS.

NO CLAIM IS MADE TO THE EXCLUSIVE RIGHT TO USE "BAKERS" AND "RESTAURANT & PIES", APART FROM THE MARK AS SHOWN.

THE MARK CONSISTS OF TWO ROWS OF SIX SQUARES, THE TOP LEFT SQUARE CONTAINING THE WORD "THE" IN STYLIZED SCRIPT, THE SECOND TOP ROW SQUARE CONTAINING THE WORDS "BAKERS SQUARE" IN LOWER CASE LETTERS ON TOP OF THE WORD "RESTAURANT & PIES" IN SMALLER FONT AND CAPITAL LETTERS, AND THE REMAINING TOP ROW SQUARES THREE, FOUR, FIVE AND SIX EACH CONTAINING THE LETTERS "F", "O", "U" AND "R" RESPECTIVELY. IN THE BOTTOM ROW OF SIX SQUARES, FROM LEFT TO RIGHT, SQUARES ONE THROUGH SIX EACH CONTAIN THE LETTERS "S", "Q", "U", "A", "R" AND "E", RESPECTIVELY.

SER. NO. 85-339,695, FILED 6-7-2011.

ERNEST SHOSHO, EXAMINING ATTORNEY



David J. Kypos

Director of the United States Patent and Trademark Office

United States of America

United States Patent and Trademark Office

Whatever It Takes

Reg. No. 4,108,043

Registered Mar. 6, 2012

Int. Cl.: 44

SERVICE MARK

PRINCIPAL REGISTER

REFLECTIONS LANDSCAPE MAINTENANCE, INC (FLORIDA CORPORATION), DBA
PALM ATLANTIC LANDSCAPE MAINTENANCE
951 NW 51ST PLACE
FORT LAUDERDALE, FL 33309

FOR: THE PROVISION OF LANDSCAPE GARDENING MAINTENANCE SERVICES, IN
CLASS 44 (U.S. CLS. 100 AND 101).

FIRST USE 5-31-2011; IN COMMERCE 5-31-2011.

THE MARK CONSISTS OF STANDARD CHARACTERS WITHOUT CLAIM TO ANY PAR-
TICULAR FONT, STYLE, SIZE, OR COLOR.

SER. NO. 85-339,825, FILED 6-7-2011.

CHRISTINA SOBRAL, EXAMINING ATTORNEY



David J. Kyffers

Director of the United States Patent and Trademark Office

United States of America

United States Patent and Trademark Office

THE VAULT OF HORROR

Reg. No. 4,108,044

WILLIAM M. GAINES AGENT, INC. (NEW YORK CORPORATION)
68 SHELBOURNE LANE
MANHASSET HILLS, NY 11040

Registered Mar. 6, 2012

Int. Cl.: 16

FOR: SERIES OF FICTION WORKS, NAMELY, NOVELS, BOOKS, COMICS, AND
MAGAZINES, IN CLASS 16 (U.S. CLS. 2, 5, 22, 23, 29, 37, 38 AND 50).

TRADEMARK

FIRST USE 4-0-1950; IN COMMERCE 4-0-1950.

PRINCIPAL REGISTER

THE MARK CONSISTS OF STANDARD CHARACTERS WITHOUT CLAIM TO ANY PAR-
TICULAR FONT, STYLE, SIZE, OR COLOR.

SER. NO. 85-339,863, FILED 6-7-2011.

FLORENTINA BLANDU, EXAMINING ATTORNEY



David J. Kybas

Director of the United States Patent and Trademark Office

United States of America

United States Patent and Trademark Office

quesos de la costa

Reg. No. 4,108,045

Registered Mar. 6, 2012

Int. Cl.: 29

TRADEMARK

PRINCIPAL REGISTER

PACIFICOSTA FOODS CO. INC (CALIFORNIA CORPORATION)
1716 E. 58TH PL
UNIT 3
LOS ANGELES, CA 90001

FOR: CHEESE; CREAM, BEING DAIRY PRODUCTS; SOFT CHEESE, IN CLASS 29 (U.S. CL. 46).

FIRST USE 2-0-2011; IN COMMERCE 2-0-2011.

THE MARK CONSISTS OF STANDARD CHARACTERS WITHOUT CLAIM TO ANY PARTICULAR FONT, STYLE, SIZE, OR COLOR.

NO CLAIM IS MADE TO THE EXCLUSIVE RIGHT TO USE "QUESOS", APART FROM THE MARK AS SHOWN.

THE ENGLISH TRANSLATION OF "QUESOS DE LA COSTA" IN THE MARK IS CHEESE FROM THE COAST.

SER. NO. 85-339,894, FILED 6-7-2011.

HENRY S. ZAK, EXAMINING ATTORNEY



David J. Kyros

Director of the United States Patent and Trademark Office

United States of America

United States Patent and Trademark Office

VoiceFriend

Reg. No. 4,108,046

Registered Mar. 6, 2012

Int. Cl.: 38

SERVICE MARK

PRINCIPAL REGISTER

VOICEFRIEND, LLC (MASSACHUSETTS LIMITED LIABILITY COMPANY)
25 CRESCENT ST.
SUITE 135
WALTHAM, MA 02453

FOR: ONE WAY AND BI-DIRECTIONAL COMMUNICATIONS SERVICES USING VOICE, E-MAIL AND TEXT MESSAGING, NAMELY, TELEPHONE VOICE MESSAGING SERVICES, E-MAIL MESSAGING SERVICES AND TEXT WIRELESS DIGITAL MESSAGING SERVICES, IN CLASS 38 (U.S. CLS. 100, 101 AND 104).

FIRST USE 2-1-2006; IN COMMERCE 2-1-2006.

THE MARK CONSISTS OF STANDARD CHARACTERS WITHOUT CLAIM TO ANY PARTICULAR FONT, STYLE, SIZE, OR COLOR.

SER. NO. 85-339,960, FILED 6-7-2011.

AMY C. KEAN, EXAMINING ATTORNEY



David J. Kappas

Director of the United States Patent and Trademark Office

United States of America

United States Patent and Trademark Office

BOUNTY BOOTY

Reg. No. 4,108,047

WRIGHT, TIMOTHY A. (UNITED STATES INDIVIDUAL)
1023 WOODLAWN AVE.
NEWARK, OH 43055

Registered Mar. 6, 2012

Int. Cl.: 21

FOR: TOKENS, NAMELY, CERAMIC DISCS USED AS PURCHASE TOKENS, IN CLASS 21
(U.S. CLS. 2, 13, 23, 29, 30, 33, 40 AND 50).

TRADEMARK

FIRST USE 6-1-2011; IN COMMERCE 6-1-2011.

PRINCIPAL REGISTER

THE MARK CONSISTS OF STANDARD CHARACTERS WITHOUT CLAIM TO ANY PARTICULAR FONT, STYLE, SIZE, OR COLOR.

SER. NO. 85-340,053, FILED 6-7-2011.

SHAILA SETTLES, EXAMINING ATTORNEY



David J. Kyffers

Director of the United States Patent and Trademark Office

United States of America

United States Patent and Trademark Office

Rabid Deer

Reg. No. 4,108,048

EDDY, MICHAEL S (UNITED STATES INDIVIDUAL)
306 RIVER BLUFF DR
ORMOND BEACH, FL 32174

Registered Mar. 6, 2012

Int. Cl.: 16

FOR: APPLIQUES IN THE FORM OF DECALS; DECALS; DECORATIVE DECALS FOR VEHICLE WINDOWS, IN CLASS 16 (U.S. CLS. 2, 5, 22, 23, 29, 37, 38 AND 50).

TRADEMARK

FIRST USE 7-1-2008; IN COMMERCE 5-15-2011.

PRINCIPAL REGISTER

THE MARK CONSISTS OF STANDARD CHARACTERS WITHOUT CLAIM TO ANY PARTICULAR FONT, STYLE, SIZE, OR COLOR.

NO CLAIM IS MADE TO THE EXCLUSIVE RIGHT TO USE "DEER", APART FROM THE MARK AS SHOWN.

SER. NO. 85-340,059, FILED 6-7-2011.

JANICE KIM, EXAMINING ATTORNEY



David J. Kybas

Director of the United States Patent and Trademark Office

United States of America

United States Patent and Trademark Office

MAXSTICK

Reg. No. 4,108,049

MAX INTERNATIONAL CONVERTERS, INC. (PENNSYLVANIA CORPORATION)
2360 DAIRY ROAD
LANCASTER, PA 17601

Registered Mar. 6, 2012

Int. Cl.: 16

FOR: PAPER, NAMELY, ADHESIVE PAPER FOR USE WITH THERMAL AND INKJET PRINTERS, IN CLASS 16 (U.S. CLS. 2, 5, 22, 23, 29, 37, 38 AND 50).

TRADEMARK

FIRST USE 8-10-2007; IN COMMERCE 10-10-2007.

PRINCIPAL REGISTER

THE MARK CONSISTS OF STANDARD CHARACTERS WITHOUT CLAIM TO ANY PARTICULAR FONT, STYLE, SIZE, OR COLOR.

OWNER OF U.S. REG. NOS. 3,227,444, 3,227,446, AND 3,805,941.

SER. NO. 85-340,103, FILED 6-7-2011.

WILLIAM VERHOSEK, EXAMINING ATTORNEY



David J. Kybas

Director of the United States Patent and Trademark Office

United States of America

United States Patent and Trademark Office

CREATIVE IMPERATIVE

Reg. No. 4,108,050

BENJAMIN MICHAELIS, PH.D. LLC (NEW YORK LIMITED LIABILITY COMPANY)
920 BROADWAY; 8TH FLOOR
NEW YORK, NY 10010

Registered Mar. 6, 2012

Int. Cl.: 41

FOR: EDUCATIONAL SERVICES, NAMELY, PROVIDING ONLINE NON-DOWNLOADABLE BOOKS AND ARTICLES, BLOGS AND SEMINARS IN THE FIELD OF MENTAL HEALTH AND WELLNESS , IN CLASS 41 (U.S. CLS. 100, 101 AND 107).

SERVICE MARK

FIRST USE 6-1-2011; IN COMMERCE 6-1-2011.

PRINCIPAL REGISTER

THE MARK CONSISTS OF STANDARD CHARACTERS WITHOUT CLAIM TO ANY PARTICULAR FONT, STYLE, SIZE, OR COLOR.

SER. NO. 85-340,273, FILED 6-7-2011.

BARBARA BROWN, EXAMINING ATTORNEY



David J. Kyros

Director of the United States Patent and Trademark Office

United States of America

United States Patent and Trademark Office

NAV BAND

Reg. No. 4,108,051

BROOKS SPORTS, INC. (WASHINGTON CORPORATION)
19910 NORTH CREEK PARKWAY, SUITE 200
BOTHELL, WA 98011

Registered Mar. 6, 2012

Int. Cl.: 25

FOR: ATHLETIC FOOTWEAR, NAMELY, A FEATURE OF SHOE TECHNOLOGY IN THE NATURE OF SHOE STRAPS WHICH CREATE A BAND ON THE SHOE SURFACE TO ENSURES A COMFORTABLE AND SNUG FIT FOR ALL FOOT SHAPES, IN CLASS 25 (U.S. CLS. 22 AND 39).

TRADEMARK

PRINCIPAL REGISTER

FIRST USE 8-1-2011; IN COMMERCE 8-1-2011.

THE MARK CONSISTS OF STANDARD CHARACTERS WITHOUT CLAIM TO ANY PARTICULAR FONT, STYLE, SIZE, OR COLOR.

NO CLAIM IS MADE TO THE EXCLUSIVE RIGHT TO USE "BAND", APART FROM THE MARK AS SHOWN.

SER. NO. 85-340,314, FILED 6-7-2011.

INGRID C. EULIN, EXAMINING ATTORNEY



David J. Kybas

Director of the United States Patent and Trademark Office

United States of America

United States Patent and Trademark Office

PANDORA GENOMICS

Reg. No. 4,108,052

Registered Mar. 6, 2012

Int. Cl.: 44

SERVICE MARK

PRINCIPAL REGISTER

PANDORA GENOMICS, LLC (FLORIDA LIMITED LIABILITY COMPANY)
SUITE 100
518 SOUTH MAGNOLIA AVENUE
ORLANDO, FL 32801

FOR: GENETIC TESTING FOR MEDICAL PURPOSES, IN CLASS 44 (U.S. CLS. 100 AND 101).

FIRST USE 5-11-2011; IN COMMERCE 5-11-2011.

THE MARK CONSISTS OF STANDARD CHARACTERS WITHOUT CLAIM TO ANY PARTICULAR FONT, STYLE, SIZE, OR COLOR.

NO CLAIM IS MADE TO THE EXCLUSIVE RIGHT TO USE "GENOMICS", APART FROM THE MARK AS SHOWN.

SER. NO. 85-340,341, FILED 6-7-2011.

ANN E. SAPPENFIELD, EXAMINING ATTORNEY



David J. Kyros

Director of the United States Patent and Trademark Office

United States of America

United States Patent and Trademark Office

KID'S WEI

Reg. No. 4,108,053

PEI WEI ASIAN DINER, INC. (DELAWARE CORPORATION)
7676 E. PINNACLE PEAK ROAD
SCOTTSDALE, AZ 85255

Registered Mar. 6, 2012

Int. Cl.: 43

FOR: RESTAURANT SERVICES; CARRY-OUT RESTAURANT SERVICES, IN CLASS 43
(U.S. CLS. 100 AND 101).

SERVICE MARK

FIRST USE 0-0-2003; IN COMMERCE 0-0-2003.

PRINCIPAL REGISTER

THE MARK CONSISTS OF STANDARD CHARACTERS WITHOUT CLAIM TO ANY PARTICULAR FONT, STYLE, SIZE, OR COLOR.

OWNER OF U.S. REG. NOS. 2,598,916, 3,411,637 AND OTHERS.

NO CLAIM IS MADE TO THE EXCLUSIVE RIGHT TO USE "KID'S", APART FROM THE MARK AS SHOWN.

THE WORDING "WEI" HAS NO MEANING IN A FOREIGN LANGUAGE.

SER. NO. 85-340,415, FILED 6-7-2011.

HEATHER THOMPSON, EXAMINING ATTORNEY



David J. Kybas

Director of the United States Patent and Trademark Office

United States of America

United States Patent and Trademark Office

ALLERGY-BEE-GONE

Reg. No. 4,108,054

Registered Mar. 6, 2012

Int. Cl.: 30

TRADEMARK

PRINCIPAL REGISTER

WINTER PARK HONEY LLC (FLORIDA LIMITED LIABILITY COMPANY), DBA WINTER
PARK HONEY
7200 GRACE RD
ORLANDO, FL 32819

FOR: HONEY, IN CLASS 30 (U.S. CL. 46).

FIRST USE 11-1-2010; IN COMMERCE 3-11-2011.

THE MARK CONSISTS OF STANDARD CHARACTERS WITHOUT CLAIM TO ANY PAR-
TICULAR FONT, STYLE, SIZE, OR COLOR.

SER. NO. 85-340,443, FILED 6-7-2011.

SALLY SHIH, EXAMINING ATTORNEY



David J. Kybas

Director of the United States Patent and Trademark Office

United States of America

United States Patent and Trademark Office

LIVECITIZEN 
Where do you stand?

Reg. No. 4,108,055

ADVANCED VIDEO COMMUNICATIONS, INC. (CALIFORNIA CORPORATION)
633 W. 5TH STREET, SUITE 6800
LOS ANGELES, CA 90071

Registered Mar. 6, 2012

Int. Cls.: 38 and 45

FOR: TRANSMISSION AND DISTRIBUTION OF DATA OR AUDIO VISUAL IMAGES VIA A GLOBAL COMPUTER NETWORK OR THE INTERNET; PROVIDING ON-LINE CHAT ROOMS AND ELECTRONIC BULLETIN BOARDS FOR TRANSMISSION OF MESSAGES AMONG USERS IN THE FIELD OF GENERAL INTEREST, IN CLASS 38 (U.S. CLS. 100, 101 AND 104).

SERVICE MARK

PRINCIPAL REGISTER

FIRST USE 8-0-2008; IN COMMERCE 8-0-2008.

FOR: PROVIDING A SOCIAL NETWORK PLATFORM ENABLING CITIZENS TO ENGAGE IN AND PROVOKE DISCUSSIONS AND DEBATE TOPICS AND QUESTIONS, CREATE AND VOTE ON DAILY POLLS, AND ASK QUESTIONS TO COMMUNITY, IN CLASS 45 (U.S. CLS. 100 AND 101).

FIRST USE 8-0-2008; IN COMMERCE 8-0-2008.

OWNER OF U.S. REG. NO. 3,852,563.

THE MARK CONSISTS OF THE LITERAL ELEMENT "LIVE CITIZEN" ABOVE THE LITERAL ELEMENT "WHERE DO YOU STAND?" AND A DOTTED WAVE DESIGN APPEARING TO THE RIGHT OF THE LITERAL ELEMENTS.

SER. NO. 85-340,509, FILED 6-7-2011.

THOMAS MANOR, EXAMINING ATTORNEY



David J. Kybas

Director of the United States Patent and Trademark Office

United States of America

United States Patent and Trademark Office

STREAMAPI

Reg. No. 4,108,056

ADVANCED VIDEO COMMUNICATIONS, INC. (CALIFORNIA CORPORATION)
633 W. 5TH STREET, SUITE 6800
LOS ANGELES, CA 90071

Registered Mar. 6, 2012

Int. Cl.: 42

FOR: PROVIDING A WEBSITE FEATURING NON-DOWNLOADABLE COMPUTER SOFTWARE APPLICATIONS TECHNOLOGY THAT ENABLES INTERNET USERS TO INCORPORATE LIVE STREAMING VIDEO AND SOCIAL NETWORKING INTO A WEBSITE OR APPLICATION, IN CLASS 42 (U.S. CLS. 100 AND 101).

SERVICE MARK

PRINCIPAL REGISTER

FIRST USE 6-0-2009; IN COMMERCE 6-0-2009.

THE MARK CONSISTS OF STANDARD CHARACTERS WITHOUT CLAIM TO ANY PARTICULAR FONT, STYLE, SIZE, OR COLOR.

SER. NO. 85-340,572, FILED 6-8-2011.

THOMAS MANOR, EXAMINING ATTORNEY



David J. Kyros

Director of the United States Patent and Trademark Office

United States of America

United States Patent and Trademark Office

#streamAPI

Reg. No. 4,108,057

ADVANCED VIDEO COMMUNICATIONS, INC. (CALIFORNIA CORPORATION)
633 W. 5TH STREET, SUITE 6800
LOS ANGELES, CA 90071

Registered Mar. 6, 2012

Int. Cl.: 42

FOR: PROVIDING A WEBSITE FEATURING NON-DOWNLOADABLE COMPUTER SOFTWARE APPLICATIONS TECHNOLOGY THAT ENABLES INTERNET USERS TO INCORPORATE LIVE STREAMING VIDEO AND SOCIAL NETWORKING INTO A WEBSITE OR APPLICATION, IN CLASS 42 (U.S. CLS. 100 AND 101).

SERVICE MARK

PRINCIPAL REGISTER

FIRST USE 6-0-2009; IN COMMERCE 6-0-2009.

THE MARK CONSISTS OF THE LITERAL ELEMENT "STREAMAPI" IN A STYLIZED FORMAT WITH A CIRCLE WITH SQUARES DESIGN APPEARING TO THE LEFT OF THE LITERAL ELEMENT.

SER. NO. 85-340,577, FILED 6-8-2011.

THOMAS MANOR, EXAMINING ATTORNEY



David J. Kyros

Director of the United States Patent and Trademark Office

United States of America

United States Patent and Trademark Office

MONTANA LIFESTYLES

Reg. No. 4,108,058

Registered Mar. 6, 2012

Int. Cls.: 20 and 21

TRADEMARK

PRINCIPAL REGISTER

MONTANA SILVERSMITHS, INC. (DELAWARE CORPORATION)
1 STERLING LANE
COLUMBUS, MT 59019

FOR: PLASTIC SCULPTURES AND FIGURINES; PICTURE FRAMES, IN CLASS 20 (U.S. CLS. 2, 13, 22, 25, 32 AND 50).

FIRST USE 4-0-2000; IN COMMERCE 4-0-2000.

FOR: DINNERWARE; VASES, IN CLASS 21 (U.S. CLS. 2, 13, 23, 29, 30, 33, 40 AND 50).

FIRST USE 4-0-2000; IN COMMERCE 4-0-2000.

THE MARK CONSISTS OF STANDARD CHARACTERS WITHOUT CLAIM TO ANY PARTICULAR FONT, STYLE, SIZE, OR COLOR.

SER. NO. 85-340,779, FILED 6-8-2011.

LAURIE MAYES, EXAMINING ATTORNEY



David J. Kyros

Director of the United States Patent and Trademark Office

United States of America

United States Patent and Trademark Office

Atlas Shrugged

Reg. No. 4,108,059

Registered Mar. 6, 2012

Int. Cl.: 41

SERVICE MARK

PRINCIPAL REGISTER

ATLAS PRODUCTIONS, LLC (DELAWARE LIMITED LIABILITY COMPANY)
FLOOR 3
56 N. HADDON AVE
HADDONFIELD, NJ 08033

FOR: ENTERTAINMENT SERVICES, NAMELY, THE PROVISION OF NON-DOWNLOADABLE AUDIO-VISUAL WORKS, NAMELY, NON-DOWNLOADABLE FILMS, WHICH ARE ACCESSED AND DISTRIBUTED OVER A GLOBAL COMPUTER NETWORK; PRODUCTION OF LIVE-ACTION TELEVISION SERIES IN THE NATURE OF A TELEVISION DRAMA; DISTRIBUTION OF LIVE-ACTION MOTION PICTURE THEATRICAL FILMS AND PROVIDING MOTION PICTURE THEATERS; PRODUCTION OF LIVE-ACTION MOTION PICTURE THEATRICAL FILMS; ENTERTAINMENT IN THE NATURE OF THEATRICAL PRODUCTIONS, NAMELY, THEATRICAL PERFORMANCES BOTH ANIMATED AND LIVE ACTION; INTERNET SERVICES, NAMELY, PROVIDING INFORMATION VIA AN ELECTRONIC GLOBAL COMPUTER NETWORK IN THE FIELD OF ENTERTAINMENT RELATING SPECIFICALLY TO MOVIES, AND TELEVISION; PROVIDING NEWS ABOUT CURRENT EVENTS AND ENTERTAINMENT, AND INFORMATION RELATED TO EDUCATION AND CULTURAL EVENTS, VIA A GLOBAL COMPUTER NETWORK; AND PROVIDING ACTUAL ENTERTAINMENT VIA AN ELECTRONIC GLOBAL COMMUNICATIONS NETWORK NAMELY, PRODUCTION OF LIVE-ACTION AND ANIMATED PROGRAMS; AND PRODUCTION AND CREATION OF LIVE-ACTION MOTION PICTURE FILMS FOR DISTRIBUTION VIA A GLOBAL COMPUTER NETWORK, IN CLASS 41 (U.S. CLS. 100, 101 AND 107).



FIRST USE 2-8-2011; IN COMMERCE 2-8-2011.

THE MARK CONSISTS OF STANDARD CHARACTERS WITHOUT CLAIM TO ANY PARTICULAR FONT, STYLE, SIZE, OR COLOR.

SER. NO. 85-340,984, FILED 6-8-2011.

MARLENE BELL, EXAMINING ATTORNEY

David J. Kyjars

Director of the United States Patent and Trademark Office

United States of America

United States Patent and Trademark Office

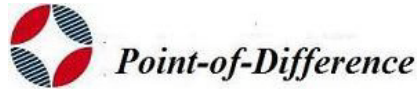

Reg. No. 4,108,060

Registered Mar. 6, 2012

Int. Cl.: 42

SERVICE MARK

PRINCIPAL REGISTER

O'LOUGHLIN, JAMES W. (UNITED STATES INDIVIDUAL), DBA ALLIED INFORMATION SOLUTIONS
3 BRAMBLETT HOLLOW
O'FALLON, MO 63366

FOR: CARTOGRAPHY AND MAPPING SERVICES FEATURING GEOPHYSICAL MAPS, IN CLASS 42 (U.S. CLS. 100 AND 101).

FIRST USE 7-1-2008; IN COMMERCE 7-1-2008.

THE MARK CONSISTS OF THE WORDING "POINT-OF-DIFFERENCE" AND DESIGN. THE DESIGN CONSISTS OF AN OUTLINE OF COMPASS POINTS IN ALTERNATING RED AND BLUE COLORS. TO THE RIGHT OF THE DESIGN IS THE WORDING "POINT-OF-DIFFERENCE" IN BLACK. THE COLOR WHITE IS THE BACKGROUND AND IS NOT CLAIMED AS A FEATURE OF THE MARK.

THE COLOR(S) RED, BLUE AND BLACK IS/ARE CLAIMED AS A FEATURE OF THE MARK.

SER. NO. 85-340,994, FILED 6-8-2011.

MARLENE BELL, EXAMINING ATTORNEY



David J. Kybas

Director of the United States Patent and Trademark Office

United States of America

United States Patent and Trademark Office

SOS STOP ONLY SUGAR DIET

Reg. No. 4,108,061

SURRELL, M.D., JAMES A. (UNITED STATES INDIVIDUAL)
416 WEST AVENUE B
NEWBERRY, MI 49868

Registered Mar. 6, 2012

Int. Cl.: 16

FOR: PRINTED MATERIALS, NAMELY, BOOKS, HANDOUTS, PAMPHLETS, BOOKMARKS, AND HARD COPY PRINTOUTS OF ELECTRONIC SLIDE PRESENTATIONS IN THE FIELDS OF DIET, FITNESS, HEALTH AND NUTRITION, IN CLASS 16 (U.S. CLS. 2, 5, 22, 23, 29, 37, 38 AND 50).

TRADEMARK

PRINCIPAL REGISTER

FIRST USE 9-9-2005; IN COMMERCE 9-9-2005.

THE MARK CONSISTS OF STANDARD CHARACTERS WITHOUT CLAIM TO ANY PARTICULAR FONT, STYLE, SIZE, OR COLOR.

NO CLAIM IS MADE TO THE EXCLUSIVE RIGHT TO USE "SUGAR DIET", APART FROM THE MARK AS SHOWN.

SER. NO. 85-341,006, FILED 6-8-2011.

MARLENE BELL, EXAMINING ATTORNEY



David J. Kybas

Director of the United States Patent and Trademark Office

United States of America

United States Patent and Trademark Office



Reg. No. 4,108,062

Registered Mar. 6, 2012

Int. Cl.: 35

SERVICE MARK

PRINCIPAL REGISTER

MAPLE FLOORING MANUFACTURERS ASSOCIATION, INC. (WISCONSIN NON-STOCK CORPORATION)
111 DEER LAKE ROAD, SUITE 100
DEERFIELD, IL 60015

FOR: ARRANGING AND CONDUCTING BUSINESS CONFERENCES; ARRANGING AND CONDUCTING TRADE SHOWS IN THE FIELD OF THE WOOD FLOORING INDUSTRY; ASSOCIATION SERVICES, NAMELY, PROMOTING THE INTERESTS OF MANUFACTURERS, DISTRIBUTORS AND INSTALLERS IN THE WOOD FLOORING INDUSTRY, IN CLASS 35 (U.S. CLS. 100, 101 AND 102).

FIRST USE 0-0-1991; IN COMMERCE 0-0-1991.

NO CLAIM IS MADE TO THE EXCLUSIVE RIGHT TO USE "MAPLE FLOORING MFRS. ASSN." AND "SINCE 1897", APART FROM THE MARK AS SHOWN.

THE MARK CONSISTS OF THE LETTERS "MFMA" ABOVE THE WORDS "MAPLE FLOORING MFRS. ASSN." ABOVE THE DESIGN OF A MAPLE LEAF WHICH CONTAINS THE WORDS "SINCE 1897" ABOVE THE WORDS "THE STANDARD OF PERFORMANCE", ALL ENCLOSED IN A SQUARE WITH ROUNDED CORNERS.

SER. NO. 85-341,190, FILED 6-8-2011.

BRIAN NEVILLE, EXAMINING ATTORNEY



David J. Kyffers

Director of the United States Patent and Trademark Office

United States of America

United States Patent and Trademark Office

DineTouch

Reg. No. 4,108,063

Registered Mar. 6, 2012

Int. Cl.: 42

SERVICE MARK

PRINCIPAL REGISTER

DINETOUCH, LLC (TENNESSEE LIMITED LIABILITY COMPANY)
3704 SPRUCE RIDGE WAY, APT. 1430
KNOXVILLE, TN 37920

FOR: COMPUTER SERVICES, NAMELY, PROVIDING A TECHNOLOGY CAPABLE OF ALLOWING RESTAURANTS TO INTERACTIVELY DISPLAY AND UPDATE THEIR MENUS AND ALSO ALLOWING RESTAURANT CUSTOMERS TO PLACE OR CONDUCT ORDER AND PAY FOR THEIR MEALS OR RELEVANT TRANSACTIONS ELECTRONICALLY, IN CLASS 42 (U.S. CLS. 100 AND 101).

FIRST USE 6-6-2011; IN COMMERCE 6-6-2011.

THE MARK CONSISTS OF THE WORD "DINETOUCH" PLUS A FINGERPRINT DESIGN PLACED IN THE MARK AS THE LETTER "O".

SER. NO. 85-341,320, FILED 6-8-2011.

ZACHARY BELLO, EXAMINING ATTORNEY



David J. Kyffers

Director of the United States Patent and Trademark Office

United States of America

United States Patent and Trademark Office

MFMA

Reg. No. 4,108,064

Registered Mar. 6, 2012

Int. Cl.: 19

TRADEMARK

PRINCIPAL REGISTER

MAPLE FLOORING MANUFACTURERS ASSOCIATION, INC. (WISCONSIN NON-STOCK CORPORATION)
111 DEER LAKE ROAD, SUITE 100
DEERFIELD, IL 60015

FOR: HARDWOOD FLOORING; WOOD SPORTS FLOORS; WOODEN FLOORING, IN CLASS 19 (U.S. CLS. 1, 12, 33 AND 50).

FIRST USE 0-0-1898; IN COMMERCE 0-0-1898.

THE MARK CONSISTS OF STANDARD CHARACTERS WITHOUT CLAIM TO ANY PARTICULAR FONT, STYLE, SIZE, OR COLOR.

SER. NO. 85-341,501, FILED 6-8-2011.

BRIAN NEVILLE, EXAMINING ATTORNEY



David J. Kybas

Director of the United States Patent and Trademark Office

United States of America

United States Patent and Trademark Office

boysdancetoo.

Reg. No. 4,108,065

Registered Mar. 6, 2012

Int. Cl.: 35

SERVICE MARK

PRINCIPAL REGISTER

BOYSDANCETOO LLC (NEW JERSEY LIMITED LIABILITY COMPANY), DBA
BOYSDANCETOO.
248 YORK ST.
JERSEY CITY, NJ 07302

FOR: RETAIL STORE SERVICES FEATURING MEN'S AND BOY'S CLOTHING, NAMELY, DANCEWEAR, PANTS, SWEATPANTS, JAZZ PANTS, SHIRTS, TEE SHIRTS, TANK TOPS, LEOTARDS, TIGHTS, DANCE BELTS, SWEATSHIRTS, HOODED SWEATSHIRTS, KNITWEAR, BIKE-TARDS, UNI-TARDS, DANCE SHOES, BALLET SHOES, JAZZ SHOES, SOCKS, WRIST BANDS, LEG WARMERS AND BAGS, IN CLASS 35 (U.S. CLS. 100, 101 AND 102).

FIRST USE 2-1-2010; IN COMMERCE 2-1-2010.

THE MARK CONSISTS OF STANDARD CHARACTERS WITHOUT CLAIM TO ANY PARTICULAR FONT, STYLE, SIZE, OR COLOR.

SER. NO. 85-341,570, FILED 6-8-2011.

KATHERINE CHANG, EXAMINING ATTORNEY



David J. Kyffers

Director of the United States Patent and Trademark Office

United States of America

United States Patent and Trademark Office

IOWA BOY

Reg. No. 4,108,066

Registered Mar. 6, 2012

Int. Cl.: 25

TRADEMARK

PRINCIPAL REGISTER

STOKES, GEORGE (UNITED STATES INDIVIDUAL)
SUITE 2-704
9811 W. CHARLESTON
LAS VEGAS, NV 89117

FOR: APRONS; ATHLETIC APPAREL, NAMELY, SHIRTS, PANTS, JACKETS, FOOTWEAR, HATS AND CAPS, ATHLETIC UNIFORMS; GLOVES; GLOVES FOR APPAREL; GOLF SHIRTS; GYM PANTS; HEADBANDS AGAINST SWEATING; HEADBANDS FOR CLOTHING; HOODED SWEAT SHIRTS; JACKETS; JERSEYS; JOGGING PANTS; KNITTED CAPS; KNITTED GLOVES; LONG-SLEEVED SHIRTS; OUTDOOR GLOVES; PANTS; POLO SHIRTS; RAINPROOF JACKETS; SHIRTS; SHIRTS AND SHORT-SLEEVED SHIRTS; SHORT-SLEEVED SHIRTS; SPORTS JACKETS; SPORTS SHIRTS; SWEAT BANDS; SWEAT JACKETS; SWEAT PANTS; SWEAT SHIRTS; SWEAT SHORTS; SWEAT SUITS; SWEATPANTS; SWIMWEAR; T-SHIRTS; WEARABLE GARMENTS AND CLOTHING, NAMELY, SHIRTS; WIND-JACKETS, IN CLASS 25 (U.S. CLS. 22 AND 39).

FIRST USE 11-7-2007; IN COMMERCE 11-7-2007.

THE MARK CONSISTS OF STANDARD CHARACTERS WITHOUT CLAIM TO ANY PARTICULAR FONT, STYLE, SIZE, OR COLOR.

SER. NO. 85-341,678, FILED 6-8-2011.

JEFFREY LOOK, EXAMINING ATTORNEY



David J. Kybas

Director of the United States Patent and Trademark Office

United States of America

United States Patent and Trademark Office

Mend Water

Reg. No. 4,108,067

Registered Mar. 6, 2012

Int. Cl.: 32

TRADEMARK

PRINCIPAL REGISTER

MEND WATER COMPANY, INC. (CALIFORNIA CORPORATION)
SUITE 1100
620 NEWPORT CENTER DRIVE
NEWPORT BEACH, CA 92660

FOR: BOTTLED WATER, IN CLASS 32 (U.S. CLS. 45, 46 AND 48).

FIRST USE 12-0-2007; IN COMMERCE 12-0-2007.

THE MARK CONSISTS OF STANDARD CHARACTERS WITHOUT CLAIM TO ANY PARTICULAR FONT, STYLE, SIZE, OR COLOR.

NO CLAIM IS MADE TO THE EXCLUSIVE RIGHT TO USE "WATER", APART FROM THE MARK AS SHOWN.

SER. NO. 85-342,016, FILED 6-9-2011.

JASON TURNER, EXAMINING ATTORNEY



David J. Kybas

Director of the United States Patent and Trademark Office

United States of America

United States Patent and Trademark Office

SOS DIET

Reg. No. 4,108,068

SURRELL, M.D., JAMES A. (UNITED STATES INDIVIDUAL)
416 WEST AVENUE B
NEWBERRY, MI 49868

Registered Mar. 6, 2012

Int. Cl.: 16

FOR: PRINTED MATERIALS, NAMELY, BOOKS, HANDOUTS, PAMPHLETS, BOOKMARKS, AND HARD COPY PRINTOUTS OF ELECTRONIC SLIDE PRESENTATIONS IN THE FIELDS OF DIET, FITNESS, HEALTH AND NUTRITION, IN CLASS 16 (U.S. CLS. 2, 5, 22, 23, 29, 37, 38 AND 50).

TRADEMARK

PRINCIPAL REGISTER

FIRST USE 9-9-2005; IN COMMERCE 9-9-2005.

THE MARK CONSISTS OF STANDARD CHARACTERS WITHOUT CLAIM TO ANY PARTICULAR FONT, STYLE, SIZE, OR COLOR.

NO CLAIM IS MADE TO THE EXCLUSIVE RIGHT TO USE "DIET", APART FROM THE MARK AS SHOWN.

SER. NO. 85-342,042, FILED 6-9-2011.

MARLENE BELL, EXAMINING ATTORNEY



David J. Kyros

Director of the United States Patent and Trademark Office

United States of America

United States Patent and Trademark Office

LANDPIE

Reg. No. 4,108,069

Registered Mar. 6, 2012

Int. Cl.: 35

SERVICE MARK

PRINCIPAL REGISTER

LANDPIE, LLC (ARIZONA LIMITED LIABILITY COMPANY)
18521
E. QUEEN CREEK RD SUITE 105-502
QUEEN CREEK, AZ 85142

FOR: ONLINE ADVERTISING AND MARKETING SERVICES IN THE AREA OF MATCHING CONSUMERS WITH INVESTMENT LAND, VACANT LAND, RECREATIONAL LAND, LAND LEASES, HOMESITES, DEVELOPMENT PROPERTIES, AND LAND AUCTIONS, IN CLASS 35 (U.S. CLS. 100, 101 AND 102).

FIRST USE 4-5-2011; IN COMMERCE 4-25-2011.

THE MARK CONSISTS OF STANDARD CHARACTERS WITHOUT CLAIM TO ANY PARTICULAR FONT, STYLE, SIZE, OR COLOR.

SER. NO. 85-342,239, FILED 6-9-2011.

ROBIN MITTLER, EXAMINING ATTORNEY



David J. Kybas

Director of the United States Patent and Trademark Office

United States of America

United States Patent and Trademark Office

TeachersCount

Reg. No. 4,108,070

TEACHERS COUNT, INC. (NORTH CAROLINA CORPORATION)
3 MINETTA LANE
NEW YORK, NY 10012

Registered Mar. 6, 2012

Int. Cls.: 35 and 41

FOR: PROMOTING PUBLIC AWARENESS OF THE IMPORTANT ROLE TEACHERS PLAY IN A CHILD'S EDUCATION, IN CLASS 35 (U.S. CLS. 100, 101 AND 102).

SERVICE MARK

FIRST USE 6-1-2003; IN COMMERCE 8-1-2003.

PRINCIPAL REGISTER

FOR: CHARITABLE SERVICES, NAMELY, DEVELOPING AND COORDINATING LOCAL, STATE AND NATIONAL EFFORTS TO RECOGNIZE AND REWARD THE EFFORTS OF TEACHERS, NAMELY, PROVISION OF AWARDS FOR EXCELLENCE IN THE FIELD OF TEACHING, IN CLASS 41 (U.S. CLS. 100, 101 AND 107).

FIRST USE 6-1-2003; IN COMMERCE 7-1-2003.

THE MARK CONSISTS OF THE STYLIZED WORDS "TEACHERS COUNT". A CHECK MARK IS LOCATED ABOVE THE LETTERS "N" AND "T" IN "COUNT".

SER. NO. 85-342,511, FILED 6-9-2011.

APRIL ROACH, EXAMINING ATTORNEY



David J. Kybas

Director of the United States Patent and Trademark Office

United States of America

United States Patent and Trademark Office



LANDPIE

GET A PIECE OF THE PIE...

Reg. No. 4,108,071

Registered Mar. 6, 2012

Int. Cl.: 35

SERVICE MARK

PRINCIPAL REGISTER

LANDPIE, LLC (ARIZONA LIMITED LIABILITY COMPANY)
18521
E. QUEEN CREEK RD SUITE 105-502
QUEEN CREEK, AZ 85142

FOR: ONLINE ADVERTISING AND MARKETING SERVICES IN THE AREA OF MATCHING CONSUMERS WITH INVESTMENT LAND, VACANT LAND, RECREATIONAL LAND, LAND LEASES, HOMESITES, DEVELOPMENT PROPERTIES, AND LAND AUCTIONS, IN CLASS 35 (U.S. CLS. 100, 101 AND 102).

FIRST USE 4-5-2011; IN COMMERCE 4-25-2011.

NO CLAIM IS MADE TO THE EXCLUSIVE RIGHT TO USE "LAND", APART FROM THE MARK AS SHOWN.

THE COLOR(S) BLUE, GREEN, BLACK, WHITE, IS/ARE CLAIMED AS A FEATURE OF THE MARK.

THE STIPPLING IS FOR SHADING PURPOSES ONLY.

THE MARK CONSISTS OF THE WORD "LANDPIE" IN WHICH ALL THE LETTERS IN THE MARK ARE BLUE. THE DESIGN HAS A GLOBE OF THE ENTIRE WORLD TO THE LEFT OF THE WORD "LANDPIE" THAT HAS THE BLUE COLOR IN ON THE GLOBE REPRESENTING THE WATER AND THE GREEN COLOR REPRESENTING THE LAND ON THE GLOBE, WITH THE LAND OUTLINED IN WHITE. THE GLOBE HAS A TRIANGLE SHAPE THAT REPRESENTS A PIECE OF PIE THAT IS COMING OUT OF THE GLOBE THAT IS BLUE AND GREEN AND WHITE IN COLOR AGAIN WITH THE GREEN AND WHITE REPRESENTING THE LAND AND THE BLUE REPRESENTING THE WATER. THE TRIANGLE COMING OUT OF THE GLOBE ALSO HAS TWO LETTERS ON IT WHICH ARE "LP" THAT ARE BLUE IN COLOR WITH A WHITE OUTLINE AROUND THE "LP". A BLUE BAR SPANS HORIZONTALLY BELOW "LANDPIE" WITH THE WORDS "GET A PIECE OF THE PIE..." WITH ALL THE LETTERS BEING BLACK IN COLOR.



David J. Kyffers

Director of the United States Patent and Trademark Office

SER. NO. 85-342,627, FILED 6-9-2011.

ROBIN MITTLER, EXAMINING ATTORNEY

United States of America

United States Patent and Trademark Office

SMART GIRLS' GUIDE

Reg. No. 4,108,072

Registered Mar. 6, 2012

Int. Cls.: 9 and 16

TRADEMARK

PRINCIPAL REGISTER

HUNT, ORTMANN, PALFFY, NIEVES, LUBKA, DARLING & MAH, INC. (CALIFORNIA CORPORATION)
301 N. LAKE AVE., STE. 700
PASADENA, CA 91101

FOR: DOWNLOADABLE ELECTRONIC PUBLICATIONS IN THE NATURE OF A HANDBOOK IN THE FIELD OF CONSTRUCTION LAW, IN CLASS 9 (U.S. CLS. 21, 23, 26, 36 AND 38).

FIRST USE 5-23-2011; IN COMMERCE 5-23-2011.

FOR: PRINTED GUIDES FOR CONSTRUCTION LAW, IN CLASS 16 (U.S. CLS. 2, 5, 22, 23, 29, 37, 38 AND 50).

FIRST USE 5-23-2011; IN COMMERCE 5-23-2011.

THE MARK CONSISTS OF STANDARD CHARACTERS WITHOUT CLAIM TO ANY PARTICULAR FONT, STYLE, SIZE, OR COLOR.

NO CLAIM IS MADE TO THE EXCLUSIVE RIGHT TO USE "GUIDE", APART FROM THE MARK AS SHOWN.

SER. NO. 85-342,682, FILED 6-9-2011.

PAUL MORENO, EXAMINING ATTORNEY



David J. Kybas

Director of the United States Patent and Trademark Office

United States of America

United States Patent and Trademark Office



Reg. No. 4,108,073

Registered Mar. 6, 2012

Int. Cl.: 6

TRADEMARK

PRINCIPAL REGISTER

ALLFASTENERS USA (OHIO LIMITED LIABILITY COMPANY)
69 ORCHARD STREET
RAMSEY, NJ 07446

FOR: FASTENERS, NAMELY, METAL BARS AND CHAINS; MECHANICAL FASTENING ELEMENTS OF METAL; METAL BONDING FASTENERS FOR MOUNTING AND DEMOUNTING OF CEILING AND WALL PANELS; METAL CLAMP-TYPE FASTENERS FOR HOLDING IN PLACE CURTAINS, TARPS, CANVAS, CLOTH AND FILM COVERING MATERIAL; METAL FASTENING ANCHORS; METAL FISH PLATES IN THE NATURE OF HARDWARE FOR FASTENING RAILS; METAL SASH FASTENERS FOR WINDOWS; METAL THREADED FASTENERS, IN CLASS 6 (U.S. CLS. 2, 12, 13, 14, 23, 25 AND 50).

FIRST USE 1-0-2009; IN COMMERCE 1-0-2009.

NO CLAIM IS MADE TO THE EXCLUSIVE RIGHT TO USE "USA", APART FROM THE MARK AS SHOWN.

THE COLOR(S) BLUE, WHITE, AND GREY IS/ARE CLAIMED AS A FEATURE OF THE MARK.

THE COLOR WHITE APPEARS IN THE LETTERS "AF". THE COLOR BLUE APPEARS IN THE WORDING "ALLFASTENERS", IN THE UPPER NINE VERTICAL BANDS AND IN THE INCOMPLETE RECTANGLE. THE COLOR GREY APPEARS IN THE WORD "USA", IN THE NINE LOWER VERTICAL BANDS AND IN THE HORIZONTAL BAND WHICH APPEARS UNDER THE INCOMPLETE RECTANGLE AND UNDER THE WORDING "ALLFASTENERS". THE COLOR WHITE ALSO APPEARS IN THE BACKGROUND OF THE MARK.

SER. NO. 85-342,776, FILED 6-9-2011.

EVELYN BRADLEY, EXAMINING ATTORNEY



David J. Kyjars

Director of the United States Patent and Trademark Office

United States of America

United States Patent and Trademark Office

CRITICAL THINKING TRIANGLE

Reg. No. 4,108,074

Registered Mar. 6, 2012

Int. Cl.: 41

SERVICE MARK

PRINCIPAL REGISTER

MINDWING CONCEPTS, INC. (MASSACHUSETTS CORPORATION)
BUILDING 101-R
ONE FEDERAL STREET
SPRINGFIELD, MA 011051222

FOR: EDUCATIONAL SERVICES, NAMELY, CONDUCTING TEACHING SEMINARS IN THE FIELD OF LANGUAGE ARTS AND DISTRIBUTING TRAINING MATERIALS IN CONNECTION THEREWITH, IN CLASS 41 (U.S. CLS. 100, 101 AND 107).

FIRST USE 1-15-2007; IN COMMERCE 1-15-2007.

THE MARK CONSISTS OF STANDARD CHARACTERS WITHOUT CLAIM TO ANY PARTICULAR FONT, STYLE, SIZE, OR COLOR.

NO CLAIM IS MADE TO THE EXCLUSIVE RIGHT TO USE "CRITICAL THINKING", APART FROM THE MARK AS SHOWN.

SER. NO. 85-342,860, FILED 6-10-2011.

PAUL E. FAHRENKOPF, EXAMINING ATTORNEY



David J. Kyffers

Director of the United States Patent and Trademark Office

United States of America

United States Patent and Trademark Office

HAVE YOU HAD YOUR CHIA TODAY?

Reg. No. 4,108,075

AZCHIA (ARIZONA CORPORATION)

Registered Mar. 6, 2012

P.O. BOX 506
SONOITA, AZ 85637

Int. Cls.: 29 and 31

FOR: PROCESSED EDIBLE CHIA SEEDS, IN CLASS 29 (U.S. CL. 46).

TRADEMARK

FIRST USE 4-15-2011; IN COMMERCE 5-1-2011.

PRINCIPAL REGISTER

FOR: UNPROCESSED EDIBLE CHIA SEEDS, IN CLASS 31 (U.S. CLS. 1 AND 46).

FIRST USE 4-15-2011; IN COMMERCE 5-1-2011.

THE MARK CONSISTS OF STANDARD CHARACTERS WITHOUT CLAIM TO ANY PARTICULAR FONT, STYLE, SIZE, OR COLOR.

SER. NO. 85-342,917, FILED 6-10-2011.

JOHN WILKE, EXAMINING ATTORNEY



David J. Kybas

Director of the United States Patent and Trademark Office

United States of America

United States Patent and Trademark Office

NANNY PLAN

Reg. No. 4,108,076

THE FOOD NANNY (UTAH LIMITED LIABILITY COMPANY)
4860 BENCH CREEK RD.
WOODLAND, UT 84036

Registered Mar. 6, 2012

Int. Cl.: 41

FOR: EDUCATION SERVICES, NAMELY, PROVIDING CLASSES IN THE FIELD OF COOKING; ENTERTAINMENT, NAMELY, A CONTINUING COOKING SHOW BROADCAST OVER TELEVISION AND RADIO, IN CLASS 41 (U.S. CLS. 100, 101 AND 107).

SERVICE MARK

FIRST USE 1-1-2003; IN COMMERCE 1-1-2005.

PRINCIPAL REGISTER

THE MARK CONSISTS OF STANDARD CHARACTERS WITHOUT CLAIM TO ANY PARTICULAR FONT, STYLE, SIZE, OR COLOR.

NO CLAIM IS MADE TO THE EXCLUSIVE RIGHT TO USE "PLAN", APART FROM THE MARK AS SHOWN.

SER. NO. 85-343,089, FILED 6-10-2011.

JUSTINE D. PARKER, EXAMINING ATTORNEY



David J. Kyffers

Director of the United States Patent and Trademark Office

United States of America

United States Patent and Trademark Office

GOLD TITLE

Reg. No. 4,108,077

GOLD TITLE, P.C. (NEW HAMPSHIRE PARTNERSHIP)
34 ESSEX STREET
ANDOVER, MA 01810

Registered Mar. 6, 2012

Int. Cl.: 45

FOR: REAL ESTATE SETTLEMENT SERVICES, NAMELY, REAL ESTATE CLOSINGS AND TITLE SEARCHES, IN CLASS 45 (U.S. CLS. 100 AND 101).

SERVICE MARK

FIRST USE 3-1-2004; IN COMMERCE 3-1-2004.

PRINCIPAL REGISTER

THE MARK CONSISTS OF STANDARD CHARACTERS WITHOUT CLAIM TO ANY PARTICULAR FONT, STYLE, SIZE, OR COLOR.

NO CLAIM IS MADE TO THE EXCLUSIVE RIGHT TO USE "TITLE", APART FROM THE MARK AS SHOWN.

SER. NO. 85-343,311, FILED 6-10-2011.

BARBARA A. GOLD, EXAMINING ATTORNEY



David J. Kybas

Director of the United States Patent and Trademark Office

United States of America
United States Patent and Trademark Office

NiteTables

Reg. No. 4,108,078

Registered Mar. 6, 2012

Int. Cls.: 42 and 43

SERVICE MARK

PRINCIPAL REGISTER

NITETABLES INC. (NEW YORK CORPORATION)
307 7TH AVENUE, SUITE 1106
NEW YORK, NY 10001

FOR: COMPUTER SERVICES, NAMELY, CUSTOMIZED WEBSITE PAGE DESIGN SERVICES, PROVIDING TEMPORARY USE OF WEB-BASED NON-DOWNLOADABLE SOFTWARE PROGRAMS FOR USE IN MAKING AND MANAGING ONLINE RESTAURANT AND NIGHTCLUB RESERVATIONS, AND WEB HOSTING SERVICES THEREFOR, IN CLASS 42 (U.S. CLS. 100 AND 101).

FIRST USE 1-1-2011; IN COMMERCE 2-8-2011.

FOR: PROVIDING ON-LINE RESTAURANT RESERVATIONS AND INFORMATION FOR OTHERS, IN CLASS 43 (U.S. CLS. 100 AND 101).

FIRST USE 1-1-2011; IN COMMERCE 2-8-2011.

THE MARK CONSISTS OF THE WORDING "NITETABLES", AS ONE WORD, WITH A CAPITAL LETTER "N" AND A CAPITAL LETTER "T" AND A STYLIZED LETTER "L" IN THE SHAPE OF A BOTTLE.

SER. NO. 85-343,446, FILED 6-10-2011.

ZACHARY BELLO, EXAMINING ATTORNEY



David J. Kyros

Director of the United States Patent and Trademark Office

United States of America

United States Patent and Trademark Office

Fiona's Prince

Reg. No. 4,108,079

Registered Mar. 6, 2012

**Int. Cls.: 14, 16, 18, 21,
25, 28 and 35**

TRADEMARK

SERVICE MARK

PRINCIPAL REGISTER

FIONA CHEN (TAIWAN INDIVIDUAL)
NO. 8, LANE 24, JINQ HSIU TUNG ROAD
YUANLIN TOWN
CHANGHWA HSIEN, TAIWAN R.O.C.

FOR: PRECIOUS METALS AND ALLOYS THEREOF; JEWELRY; ORNAMENTS OF PRECIOUS METAL; JEWELS; CUFF LINKS; TIE CLIPS; JEWELRY BOXES; WATCHES AND PARTS THEREFOR; CLOCKS AND PARTS THEREFOR; MEDALS MADE OF PRECIOUS METAL; NECKLACES; BRACELETS; PENDANTS; ANKLE RINGS AND ANKLETS BOTH IN THE NATURE OF ANKLE BRACELETS; SHOE ORNAMENTS MADE OF PRECIOUS METAL; WALL PLAQUES MADE OF PRECIOUS METAL; KEY RINGS, TRINKETS OR FOBS, ALL OF PRECIOUS METALS; RINGS, IN CLASS 14 (U.S. CLS. 2, 27, 28 AND 50).

FOR: PACKING PAPERS; NAPKIN PAPERS; PLACE MATS OF PAPER; STICKERS; BOOKS IN THE FIELD OF CHILDREN'S BOOKS, CHILDREN'S INTERACTIVE EDUCATIONAL BOOKS, BABY BOOKS, COLORING BOOKS, NOTE BOOKS, PICTURE BOOKS, STORY BOOKS; CARDS, NAMELY, BLANK CARDS, BLANK NOTE CARDS, CHRISTMAS CARDS, GIFT CARDS, GREETING CARDS, HOLIDAY CARDS, PICTURE CARDS, POST CARDS; ENVELOPES; WRITING PAPERS; BOOKMARKS; BOOKS CONTAINING CARTOON STRIPS; DESK CALENDARS; PAPER CONTAINERS; PENS; PAPER WEIGHTS; PENCIL BOXES; WRITING MATS IN THE NATURE OF PAPER PLACE MATS; COLOR BALLS OF PAPER IN THE NATURE OF PAPER PARTY DECORATIONS; PAPER DECORATIONS FOR DOOR KNOB IN THE NATURE OF PAPER PARTY DECORATIONS; PEN CASES, IN CLASS 16 (U.S. CLS. 2, 5, 22, 23, 29, 37, 38 AND 50).

FOR: BILLFOLDS; SCHOOL BAGS; TRUNKS; HANDBAGS; UMBRELLAS; KNAPSACKS FOR PETS; CLOTHING FOR PETS; BAGS FOR BABY ARTICLES IN THE NATURE OF DIAPER BAGS; BAGS FOR PET ARTICLES, NAMELY, SPECIALLY DESIGNED CANVAS, VINYL OR LEATHER BAGS ATTACHED TO ANIMAL LEASHES FOR HOLDING SMALL ITEMS SUCH AS KEYS, CREDIT CARDS, MONEY OR DISPOSABLE BAGS FOR DISPOSING OF PET WASTE; CARRYING BAGS FOR LUNCH BOXES IN THE NATURE OF BACKPACKS; SLING BAGS FOR CARRYING INFANTS; PURSES; COSMETIC CARRYING BOXES SOLD EMPTY; BAGS AND BACKPACKS FOR SPORTS; LEATHER ORNAMENTS FOR KEY RINGS IN THE NATURE OF LEATHER KEY CASES; NAME CARD CASES; SHOE BAGS FOR TRAVEL; BRIEFCASES; DOG SHOES, IN CLASS 18 (U.S. CLS. 1, 2, 3, 22 AND 41).



David J. Kybas

Director of the United States Patent and Trademark Office

Reg. No. 4,108,079 FOR: CLEANING BRUSHES FOR HOUSEHOLD USE; COMBS; VASES; DECORATIONS MADE OF CRYSTAL IN THE NATURE OF CRYSTAL PRISMS, CRYSTAL FIGURINES, CRYSTAL ORNAMENTS, CRYSTAL STATUES; DECORATIONS MADE OF GLASS IN THE NATURE OF CRYSTAL PRISMS, CRYSTAL FIGURINES, CRYSTAL ORNAMENTS, CRYSTAL STATUES; SHOEHORNS; CANDLESTICKS; RECEPTACLES IN THE NATURE OF BOWLS MADE OF GLASS; COSMETIC UTENSILS IN THE NATURE OF COSMETIC BRUSHES; TOILET PAPER HOLDERS; PIGGY BANKS, NOT OF METAL; ESSENCE STANDS IN THE NATURE OF SPICE RACKS; CUPS; CHOPSTICKS; SAUCERS; DISHES; CUTLERY IN THE NATURE OF COOKIE AND PASTRY CUTTERS , IN CLASS 21 (U.S. CLS. 2, 13, 23, 29, 30, 33, 40 AND 50).

FOR: CLOTHES, NAMELY, ANORAKS, PARKAS, BATHING COSTUMES, BLAZERS, BLOUSES, BLOUSONS; CHILDREN'S AND INFANT'S APPAREL, NAMELY, JUMPERS, OVERALL, SLEEPWEAR, PAJAMAS, ROMPERS AND ONE-PIECE GARMENTS; DRESSES; JEANS; LEISURE SUITS; MEN'S AND WOMEN'S JACKETS, TROUSERS, VESTS; MEN'S SUITS; WOMEN'S SUITS; OVERCOATS; PANTIES, SHORTS AND BRIEFS; PANTS; POLO SHIRTS; SHIRTS; SKIRTS; T-SHIRTS; WIND COATS; BOOTS; SHOES; SCARVES; HOODS; TIES; BOW TIES; HATS; CAPS; EAR FLAPS IN THE NATURE OF EAR MUFFS; SOCKS; GLOVES FOR CLOTHING; GIRDLES; SUSPENDERS; APRONS; METAL ACCESSORIES FOR BOOTS AND SHOES IN THE NATURE OF METAL FITTINGS FOR JAPANESE STYLE WOODEN CLOGS AND PROTECTIVE METAL MEMBERS FOR SHOES AND BOOTS; EYE SHADES FOR SLEEPING, IN CLASS 25 (U.S. CLS. 22 AND 39).

FOR: GAMES, NAMELY, BOARD GAMES, CARD GAMES, CHESS GAMES, DART GAMES; TOYS, NAMELY, BATH TOYS, CRIB TOYS, DRAWING TOYS, ELECTRONIC LEARNING TOYS; SPORTS EQUIPMENT, NAMELY, NORDIC WALKING POLES, LOWER BODY ALIGNMENT APPARATUS, INLINE ROLLER SKATING WHEELS AT THE END OF A CRUTCH-LIKE FRAME, VIBRATION DAMPENERS FOR RACKETS; FISHING TACKLES; BAGS FOR FISHING TACKLE; BOARD GAMES; CARDS, NAMELY, BINGO CARDS, KENO CARDS, LOTTERY CARDS, PLAYING CARDS; DECORATIONS FOR CHRISTMAS TREES; CHRISTMAS TREES OF PLASTIC IN THE NATURE OF TOY CHRISTMAS TREES; AUTOMATIC AND COIN-OPERATED AMUSEMENT GAME MACHINES, IN CLASS 28 (U.S. CLS. 22, 23, 38 AND 50).

FOR: IMPORT AND EXPORT AGENCIES; AGENTS FOR QUOTING, BIDDING AND SALES OF GOODS IN THE NATURE OF BIDDING QUOTATION AND ONLINE AUCTION BIDDING FOR OTHERS; AUCTIONING; DELIVERY OF ADVERTISING PRODUCTS, NAMELY, DISTRIBUTION OF ADVERTISING FLIERS, COUPONS, CATALOGS AND PROMOTIONAL ITEMS OF OTHERS; ON-LINE ADVERTISING SERVICES FOR OTHERS; BUSINESS MANAGEMENT ASSISTING SERVICES IN THE NATURE OF BUSINESS MANAGEMENT ASSISTANCE TO INDUSTRIAL OR COMMERCIAL COMPANIES; NETWORK AUCTION, NAMELY, AUCTION MANAGEMENT SERVICES PROVIDED TO OTHERS OVER AN ON-LINE WEB SITE ACCESSED THROUGH A GLOBAL COMPUTER NETWORK; ORGANIZATION OF TRADE FAIRS, EXHIBITIONS AND EXPOSITIONS FOR COMMERCIAL AND ADVERTISING PURPOSES; NETWORK ORDER SERVICES AND ELECTRONIC SHOPPING IN THE NATURE OF ON-LINE RETAIL STORE SERVICES FEATURING CLOTHES, STATIONERY, TEACHING MATERIALS, BOOKS AND MAGAZINES, WATCHES AND CLOCKS, EYEGLASSES, ORNAMENTS, PRECIOUS METAL GOODS, CLOTHING ACCESSORIES, BOOTS AND SHOES, LEATHER GOODS, PURSES, HANDBAGS, TRUNKS, INDOOR DECORATIONS, SLEEPING SETS, DECORATIONS, ARTWORK, TOYS, AMUSEMENT ARTICLES, KITCHENWARE AND CUTLERY, KITCHEN CONTAINERS, GOLF BAGS, SHOE PADS, UMBRELLAS, CLOTHING AND ARTICLES FOR PETS, KEY RINGS, PAPERS, PLATE MATS, STICKERS; MAIL ORDER SERVICES FEATURING CLOTHES, STATIONERY, TEACHING MATERIALS, BOOKS AND MAGAZINES, WATCHES AND CLOCKS, EYEGLASSES, ORNAMENTS, PRECIOUS METAL GOODS, CLOTHING ACCESSORIES, BOOTS AND SHOES, LEATHER GOODS, PURSES, HANDBAGS, TRUNKS, INDOOR DECORATIONS, SLEEPING SETS, DECORATIONS, ARTWORK, TOYS, AMUSEMENT ARTICLES, KITCHENWARE AND CUTLERY, KITCHEN CONTAINERS, GOLF BAGS, SHOE PADS, UMBRELLAS,

Reg. No. 4,108,079 CLOTHING AND ARTICLES FOR PETS, KEY RINGS, PAPERS, PLATE MATS, STICKERS. TV ORDER SERVICES IN THE NATURE OF PROVIDING HOME SHOPPING SERVICES IN THE FIELD OF CLOTHES, STATIONERY, TEACHING MATERIALS, BOOKS AND MAGAZINES, WATCHES AND CLOCKS, EYEGLASSES, ORNAMENTS, PRECIOUS METAL GOODS, CLOTHING ACCESSORIES, BOOTS AND SHOES, LEATHER GOODS, PURSES, HANDBAGS, TRUNKS, INDOOR DECORATIONS, SLEEPING SETS, DECORATIONS, ARTWORK, TOYS, AMUSEMENT ARTICLES, KITCHENWARE AND CUTLERY, KITCHEN CONTAINERS, GOLF BAGS, SHOE PADS, UMBRELLAS, CLOTHING AND ARTICLES FOR PETS, KEY RINGS, PAPERS, PLATE MATS, STICKERS BY MEANS OF TELEVISION; RETAIL CONVENIENCE STORES; RETAIL STORE SERVICES FEATURING A WIDE VARIETY OF CONSUMER GOODS OF OTHERS, NAMELY, CLOTHES, STATIONERY, TEACHING MATERIALS, BOOKS AND MAGAZINES, WATCHES AND CLOCKS, EYEGLASSES, ORNAMENTS, PRECIOUS METAL GOODS, CLOTHING ACCESSORIES, BOOTS AND SHOES, LEATHER GOODS, PURSES, HANDBAGS, TRUNKS, INDOOR DECORATIONS, SLEEPING SETS, DECORATIONS, ARTWORK, TOYS, AMUSEMENT ARTICLES, KITCHENWARE AND CUTLERY, KITCHEN CONTAINERS, GOLF BAGS, SHOE PADS, UMBRELLAS, CLOTHING AND ARTICLES FOR PETS, KEY RINGS, PAPERS, PLATE MATS, STICKERS; COMPUTER INFORMATION SYSTEM DATABASE ESTABLISHMENT SERVICES, NAMELY, COMPILING OF INFORMATION INTO COMPUTER DATABASES, IN CLASS 35 (U.S. CLS. 100, 101 AND 102).

OWNER OF TAIWAN REG. NO. 01384458, DATED 11-1-2009, EXPIRES 10-31-2019.

OWNER OF TAIWAN REG. NO. 01384124, DATED 11-1-2009, EXPIRES 10-31-2019.

OWNER OF TAIWAN REG. NO. 01384037, DATED 11-1-2009, EXPIRES 10-31-2019.

OWNER OF TAIWAN REG. NO. 01383953, DATED 11-1-2009, EXPIRES 10-31-2019.

OWNER OF TAIWAN REG. NO. 01383891, DATED 11-1-2009, EXPIRES 10-31-2019.

OWNER OF TAIWAN REG. NO. 01383832, DATED 11-1-2009, EXPIRES 10-31-2019.

OWNER OF TAIWAN REG. NO. 01383788, DATED 11-1-2009, EXPIRES 10-31-2019.

THE MARK CONSISTS OF THE WORDS "FIONA'S PRINCE" IN SCRIPT WITH TWO STARS BEFORE AND AFTER THE WORDS.

SER. NO. 85-343,607, FILED 6-10-2011.

SUE LAWRENCE, EXAMINING ATTORNEY

United States of America

United States Patent and Trademark Office

DUROLAC

Reg. No. 4,108,080

Registered Mar. 6, 2012

Int. Cl.: 6

TRADEMARK

PRINCIPAL REGISTER

ALUCOIL, S.A. (SPAIN SOCIEDAD ANONIMA (SA))
POLIG. INDUSTRIAL DE BAYAS
C/IRCIO, PARCELAS R-72 A R-77
MIRANDA DE EBRO, SPAIN 09200

FOR: COMMON METALS AND THEIR ALLOYS; METAL BUILDING MATERIALS; TRANSPORTABLE BUILDINGS OF METAL; MATERIALS OF METAL FOR RAILWAY TRACKS; NON-ELECTRIC CABLES AND WIRES OF COMMON METAL; IRON-MONGERY AND SMALL ITEMS OF METAL HARDWARE, NAMELY, COILS, PLATES OF ALUMINUM OR OTHER METALS; METALLIC PIPES AND TUBES; METAL SAFES; GOODS OF COMMON METAL, NAMELY, FACADES, ROOFING, SIDING, DOORS, SIGNS AND DISPLAYS; METAL ORES, IN CLASS 6 (U.S. CLS. 2, 12, 13, 14, 23, 25 AND 50).

THE MARK CONSISTS OF STANDARD CHARACTERS WITHOUT CLAIM TO ANY PARTICULAR FONT, STYLE, SIZE, OR COLOR.

OWNER OF ERPN CMNTY TM OFC REG. NO. 001460997, DATED 6-18-2001, EXPIRES 1-12-2020.

SER. NO. 85-343,619, FILED 6-10-2011.

MIDGE BUTLER, EXAMINING ATTORNEY



David J. Kyfos

Director of the United States Patent and Trademark Office

United States of America

United States Patent and Trademark Office

TERMOLAC

Reg. No. 4,108,081

Registered Mar. 6, 2012

Int. Cl.: 2

TRADEMARK

PRINCIPAL REGISTER

ALUCOIL, S.A. (SPAIN SOCIEDAD ANONIMA (SA))
POLIG. IND. DE BAYAS
C/IRCIO, PARCELAS R-72 A R-77
MIRANDA DE EBRO, SPAIN 09200

FOR: PAINTS, VARNISHES, LACQUERS; PRESERVATIVES AGAINST RUST AND AGAINST DETERIORATION OF WOOD; COLORANTS; MORDANT DYES; RAW NATURAL RESINS; METALS IN FOIL AND POWDER FORM FOR PAINTERS, DECORATORS, PRINTERS AND ARTISTS, IN CLASS 2 (U.S. CLS. 6, 11 AND 16).

THE MARK CONSISTS OF STANDARD CHARACTERS WITHOUT CLAIM TO ANY PARTICULAR FONT, STYLE, SIZE, OR COLOR.

OWNER OF ERPN CMNTY TM OFC REG. NO. 000690826, DATED 2-4-1999, EXPIRES 11-20-2017.

SER. NO. 85-343,634, FILED 6-10-2011.

MIDGE BUTLER, EXAMINING ATTORNEY



David J. Kyfos

Director of the United States Patent and Trademark Office

United States of America

United States Patent and Trademark Office

TAKE YOUR SHOT AT CANCER

Reg. No. 4,108,082

Registered Mar. 6, 2012

Int. Cl.: 36

SERVICE MARK

PRINCIPAL REGISTER

PENNIES IN ACTION FOUNDATION (PENNSYLVANIA FOUNDATION)
701 W. DUTTONS MILL ROAD
ASTON, PA 19014

FOR: CHARITABLE FUNDRAISING SERVICES, IN CLASS 36 (U.S. CLS. 100, 101 AND 102).

FIRST USE 6-10-2011; IN COMMERCE 6-10-2011.

THE MARK CONSISTS OF STANDARD CHARACTERS WITHOUT CLAIM TO ANY PARTICULAR FONT, STYLE, SIZE, OR COLOR.

SER. NO. 85-343,679, FILED 6-10-2011.

NELSON SNYDER, EXAMINING ATTORNEY



David J. Kybas

Director of the United States Patent and Trademark Office

United States of America

United States Patent and Trademark Office

Walker Solar MOGS

Reg. No. 4,108,083

WALKER SOLAR PRODUCTS, LLC (GEORGIA LIMITED LIABILITY COMPANY)
1789 COUNTY LINE ROAD
MANSFIELD, GA 30055

Registered Mar. 6, 2012

Int. Cl.: 7

FOR: ELECTRIC POWER GENERATORS FOR EMERGENCY USE, IN CLASS 7 (U.S. CLS. 13, 19, 21, 23, 31, 34 AND 35).

TRADEMARK

FIRST USE 5-10-2010; IN COMMERCE 6-1-2010.

PRINCIPAL REGISTER

THE MARK CONSISTS OF STANDARD CHARACTERS WITHOUT CLAIM TO ANY PARTICULAR FONT, STYLE, SIZE, OR COLOR.

NO CLAIM IS MADE TO THE EXCLUSIVE RIGHT TO USE "SOLAR", APART FROM THE MARK AS SHOWN.

SER. NO. 85-344,243, FILED 6-13-2011.

TINA MAI, EXAMINING ATTORNEY



David J. Kyffers

Director of the United States Patent and Trademark Office

United States of America

United States Patent and Trademark Office

Blind Shaman Therapy

Reg. No. 4,108,084

Registered Mar. 6, 2012

Int. Cls.: 41 and 44

SERVICE MARK

PRINCIPAL REGISTER

ALBEE, PAMELA (UNITED STATES INDIVIDUAL), DBA SHARED TRANSITIONS
1411 W GARLAND SUITE B
SPOKANE, WA 99205

FOR: CONTINUING EDUCATION SERVICES, NAMELY, PROVIDING LIVE AND ON-LINE CONTINUING PROFESSIONAL EDUCATION SEMINARS IN THE FIELD OF WELLNESS , IN CLASS 41 (U.S. CLS. 100, 101 AND 107).

FIRST USE 10-1-2010; IN COMMERCE 4-1-2011.

FOR: HEALTH CARE SERVICES, NAMELY, WELLNESS PROGRAMS, IN CLASS 44 (U.S. CLS. 100 AND 101).

FIRST USE 10-1-2010; IN COMMERCE 4-1-2011.

THE MARK CONSISTS OF STANDARD CHARACTERS WITHOUT CLAIM TO ANY PARTICULAR FONT, STYLE, SIZE, OR COLOR.

NO CLAIM IS MADE TO THE EXCLUSIVE RIGHT TO USE "SHAMAN THERAPY", APART FROM THE MARK AS SHOWN.

SER. NO. 85-344,519, FILED 6-13-2011.

HOWARD B. LEVINE, EXAMINING ATTORNEY



David J. Kyros

Director of the United States Patent and Trademark Office

United States of America

United States Patent and Trademark Office

FLIGHTLINE

Reg. No. 4,108,085

Registered Mar. 6, 2012

Int. Cl.: 14

TRADEMARK

PRINCIPAL REGISTER

ALLIED MARKETING GROUP, INC. (DELAWARE CORPORATION)
1555 REGAL ROW
DALLAS, TX 75247

FOR: WATCHES, IN CLASS 14 (U.S. CLS. 2, 27, 28 AND 50).

FIRST USE 6-28-2003; IN COMMERCE 6-28-2003.

THE MARK CONSISTS OF STANDARD CHARACTERS WITHOUT CLAIM TO ANY PARTICULAR FONT, STYLE, SIZE, OR COLOR.

SER. NO. 85-344,733, FILED 6-13-2011.

JAMES MACFARLANE, EXAMINING ATTORNEY



David J. Kybas

Director of the United States Patent and Trademark Office

United States of America

United States Patent and Trademark Office

Texas Southern University

Reg. No. 4,108,086

TEXAS SOUTHERN UNIVERSITY (TEXAS STATE UNIVERSITY)
3100 CLEBURNE ST., HH310
HOUSTON, TX 77004

Registered Mar. 6, 2012

Int. Cl.: 41

FOR: EDUCATION SERVICES IN THE NATURE OF COURSES AT THE UNIVERSITY LEVEL; ENTERTAINMENT IN THE NATURE OF COMPETITIONS IN THE FIELD OF ATHLETICS, IN CLASS 41 (U.S. CLS. 100, 101 AND 107).

SERVICE MARK

FIRST USE 6-1-1951; IN COMMERCE 6-1-1951.

PRINCIPAL REGISTER

THE MARK CONSISTS OF STANDARD CHARACTERS WITHOUT CLAIM TO ANY PARTICULAR FONT, STYLE, SIZE, OR COLOR.

NO CLAIM IS MADE TO THE EXCLUSIVE RIGHT TO USE "TEXAS" AND "UNIVERSITY", APART FROM THE MARK AS SHOWN.

SER. NO. 85-344,867, FILED 6-13-2011.

DAVID ELTON, EXAMINING ATTORNEY



David J. Kyros

Director of the United States Patent and Trademark Office

United States of America

United States Patent and Trademark Office

BLUEGREEN

Reg. No. 4,108,087

TRUJILLO, JUAN MANUEL (MEXICO INDIVIDUAL)
MATIAS NAVARRO 46

Registered Mar. 6, 2012

CAPILLA DE GUADALUPE, MEXICO 47700

Int. Cl.: 30

FOR: TABLE SYRUP, IN CLASS 30 (U.S. CL. 46).

TRADEMARK

FIRST USE 1-1-2010; IN COMMERCE 1-1-2010.

PRINCIPAL REGISTER

THE MARK CONSISTS OF STANDARD CHARACTERS WITHOUT CLAIM TO ANY PARTICULAR FONT, STYLE, SIZE, OR COLOR.

SER. NO. 85-344,983, FILED 6-13-2011.

ANN E. SAPPENFIELD, EXAMINING ATTORNEY



David J. Kybas

Director of the United States Patent and Trademark Office

United States of America

United States Patent and Trademark Office



Westrock

Reg. No. 4,108,088

Registered Mar. 6, 2012

Int. Cl.: 37

SERVICE MARK

PRINCIPAL REGISTER

WESTROCK AMERICA LLC (FLORIDA LIMITED LIABILITY COMPANY)
777 E ATLANTIC AVE
DELRAY BEACH, FL 334835360

FOR: REAL ESTATE DEVELOPMENT, IN CLASS 37 (U.S. CLS. 100, 103 AND 106).

FIRST USE 6-23-2008; IN COMMERCE 6-23-2008.

THE MARK CONSISTS OF TWO OBLONG HEXAGONAL FIGURES IN BLACK WITH WHITE INTERIORS, INTERLOCKED WITH A GRAY DIAMOND-SHAPED FIGURE PORTRAYED NEXT TO THE COMPANY NAME "WESTROCK".

THE COLOR(S) BLACK, WHITE AND GRAY IS/ARE CLAIMED AS A FEATURE OF THE MARK.

SER. NO. 85-345,210, FILED 6-14-2011.

BRIAN NEVILLE, EXAMINING ATTORNEY



David J. Kyffers

Director of the United States Patent and Trademark Office

United States of America

United States Patent and Trademark Office



Reg. No. 4,108,089

Registered Mar. 6, 2012

Int. Cl.: 35

SERVICE MARK

PRINCIPAL REGISTER

SOUTHWEST AIRLINES PILOTS' ASSOCIATION (TEXAS NON-PROFIT ASSOCIATION),
AKA SWAPA
1450 EMPIRE CENTRAL DR.
DALLAS, TX 75247

FOR: LABOR UNIONS, IN CLASS 35 (U.S. CLS. 100, 101 AND 102).

FIRST USE 10-1-2010; IN COMMERCE 10-1-2010.

NO CLAIM IS MADE TO THE EXCLUSIVE RIGHT TO USE "AIRLINE PILOTS' ASSOCIATION", APART FROM THE MARK AS SHOWN.

THE COLOR(S) NAVY BLUE, MEDIUM BLUE, LIGHT BLUE, AND GRAY IS/ARE CLAIMED AS A FEATURE OF THE MARK.

THE MARK CONSISTS OF THE STYLIZED WORD "SWAPA" IN THREE SHADES OF BLUE PROGRESSING FROM NAVY BLUE AT THE TOP TO LIGHT BLUE AT THE BOTTOM OF THE WORD; THREE WINGS ON EACH SIDE OF THE WORD, 3 TO THE LEFT OF THE "S" AND 3 TO THE RIGHT OF THE "A"; THE THREE WINGS ON EACH SIDE PROGRESS FROM DARK TO LIGHT BLUE FROM TOP TO BOTTOM; THE WORDS "SOUTHWEST AIRLINES PILOTS' ASSOCIATION" IN GRAY UNDERNEATH THE MARK.

SER. NO. 85-345,343, FILED 6-14-2011.

DAWN FELDMAN, EXAMINING ATTORNEY



David J. Kyros

Director of the United States Patent and Trademark Office

United States of America

United States Patent and Trademark Office

raduate Pest Control

Reg. No. 4,108,090

GRADUATE PEST CONTROL, INC. (NEW YORK CORPORATION)
641 6TH AVE WEST
EAST NORTHPORT, NY 11731

Registered Mar. 6, 2012

Int. Cl.: 37

FOR: PEST CONTROL, IN CLASS 37 (U.S. CLS. 100, 103 AND 106).

SERVICE MARK

FIRST USE 4-18-1983; IN COMMERCE 4-18-1983.

PRINCIPAL REGISTER

NO CLAIM IS MADE TO THE EXCLUSIVE RIGHT TO USE "PEST CONTROL", APART FROM THE MARK AS SHOWN.

THE MARK CONSISTS OF THE STYLIZED TEXT "GRADUATE PEST CONTROL" WITH A GRADUATION CAP AND A DIPLOMA SCROLL ON THE TOP OF THE ARM OF THE LETTER "G".

SER. NO. 85-345,495, FILED 6-14-2011.

JACQUELINE A. LAVINE, EXAMINING ATTORNEY



David J. Kyffers

Director of the United States Patent and Trademark Office

United States of America

United States Patent and Trademark Office

COOL NEON

Reg. No. 4,108,091

Registered Mar. 6, 2012

Int. Cls.: 9 and 11

TRADEMARK

PRINCIPAL REGISTER

JAMES, BENJAMIN (UNITED STATES INDIVIDUAL), DBA FUNHOUSE PRODUCTIONS
1433 MANDELA PARKWAY
OAKLAND, CA 94607

FOR: ELECTRO-LUMINESCENT LIGHT DEVICES, NAMELY, ELECTRO-LUMINESCENT ELECTRICAL WIRES AND PANELS, ELECTRO-LUMINESCENT IMAGE CONDUITS, ELECTRO-LUMINESCENT CONTROLLERS; LEDS, LED IMAGE CONDUITS, LED CONTROLLERS, LED PIXELS, LED BARS, LED PANELS; ELECTRICAL CABLES, IN CLASS 9 (U.S. CLS. 21, 23, 26, 36 AND 38).

FIRST USE 12-20-1999; IN COMMERCE 12-20-1999.

FOR: LED LIGHT DEVICES, NAMELY, LED ROPE LIGHTS, LED FIBER OPTIC LIGHTS, LED STRIP LIGHTS, IN CLASS 11 (U.S. CLS. 13, 21, 23, 31 AND 34).

FIRST USE 5-15-2002; IN COMMERCE 5-15-2002.

THE MARK CONSISTS OF STANDARD CHARACTERS WITHOUT CLAIM TO ANY PARTICULAR FONT, STYLE, SIZE, OR COLOR.

NO CLAIM IS MADE TO THE EXCLUSIVE RIGHT TO USE "NEON", APART FROM THE MARK AS SHOWN.

SER. NO. 85-345,873, FILED 6-14-2011.

ANNE E. GUSTASON, EXAMINING ATTORNEY



David J. Kyros

Director of the United States Patent and Trademark Office

United States of America

United States Patent and Trademark Office

GREEN & WHITE

Reg. No. 4,108,092

Registered Mar. 6, 2012

Int. Cl.: 6

TRADEMARK

PRINCIPAL REGISTER

HOUSTON WIRE & CABLE COMPANY (DELAWARE CORPORATION)
10201 NORTH LOOP EAST
HOUSTON, TX 77029

FOR: WIRE ROPES, IN CLASS 6 (U.S. CLS. 2, 12, 13, 14, 23, 25 AND 50).

FIRST USE 12-9-1983; IN COMMERCE 12-9-1983.

THE MARK CONSISTS OF STANDARD CHARACTERS WITHOUT CLAIM TO ANY PARTICULAR FONT, STYLE, SIZE, OR COLOR.

OWNER OF U.S. REG. NO. 1,661,429.

SEC. 2(F).

SER. NO. 85-346,042, FILED 6-14-2011.

FRANK LATTUCA, EXAMINING ATTORNEY



David J. Kybas

Director of the United States Patent and Trademark Office

United States of America

United States Patent and Trademark Office

Solutions in Spectroscopy

Reg. No. 4,108,093

AVANTES, INC. (COLORADO CORPORATION)

Registered Mar. 6, 2012

9769 W 119TH DR, STE 4
BROOMFIELD, CO 80021

Int. Cl.: 9

FOR: SCIENTIFIC APPARATUS, NAMELY, SPECTROMETERS AND PARTS AND FITTINGS THEREFOR, IN CLASS 9 (U.S. CLS. 21, 23, 26, 36 AND 38).

TRADEMARK

FIRST USE 3-26-2004; IN COMMERCE 3-26-2004.

PRINCIPAL REGISTER

THE MARK CONSISTS OF STANDARD CHARACTERS WITHOUT CLAIM TO ANY PARTICULAR FONT, STYLE, SIZE, OR COLOR.

NO CLAIM IS MADE TO THE EXCLUSIVE RIGHT TO USE "SPECTROSCOPY", APART FROM THE MARK AS SHOWN.

SEC. 2(F).

SER. NO. 85-346,170, FILED 6-14-2011.

SETH A. RAPPAPORT, EXAMINING ATTORNEY



David J. Kybas

Director of the United States Patent and Trademark Office

United States of America

United States Patent and Trademark Office

market earth

Reg. No. 4,108,094

Registered Mar. 6, 2012

Int. Cl.: 35

SERVICE MARK

PRINCIPAL REGISTER

MARKET EARTH INC (ILLINOIS CORPORATION)
214 BILTMORE DR
BARRINGTON, IL 60010

FOR: RETAIL GIFT SHOPS, IN CLASS 35 (U.S. CLS. 100, 101 AND 102).

FIRST USE 5-19-2011; IN COMMERCE 5-19-2011.

THE MARK CONSISTS OF STANDARD CHARACTERS WITHOUT CLAIM TO ANY PARTICULAR FONT, STYLE, SIZE, OR COLOR.

NO CLAIM IS MADE TO THE EXCLUSIVE RIGHT TO USE "MARKET", APART FROM THE MARK AS SHOWN.

SER. NO. 85-346,287, FILED 6-14-2011.

ALEXANDER L. POWERS, EXAMINING ATTORNEY



David J. Kybas

Director of the United States Patent and Trademark Office

United States of America

United States Patent and Trademark Office

TIME 4 KIDS

Reg. No. 4,108,095

KRIPA LLC (DELAWARE LIMITED LIABILITY COMPANY)
130 WEST 29TH STREET
NEW YORK, NY 10001

Registered Mar. 6, 2012

Int. Cl.: 14

FOR: WATCHES, IN CLASS 14 (U.S. CLS. 2, 27, 28 AND 50).

TRADEMARK

FIRST USE 7-20-2006; IN COMMERCE 9-6-2006.

PRINCIPAL REGISTER

THE MARK CONSISTS OF STANDARD CHARACTERS WITHOUT CLAIM TO ANY PARTICULAR FONT, STYLE, SIZE, OR COLOR.

NO CLAIM IS MADE TO THE EXCLUSIVE RIGHT TO USE "FOR KIDS", APART FROM THE MARK AS SHOWN.

SER. NO. 85-346,467, FILED 6-15-2011.

FRED CARL, EXAMINING ATTORNEY



David J. Kyffers

Director of the United States Patent and Trademark Office

United States of America

United States Patent and Trademark Office

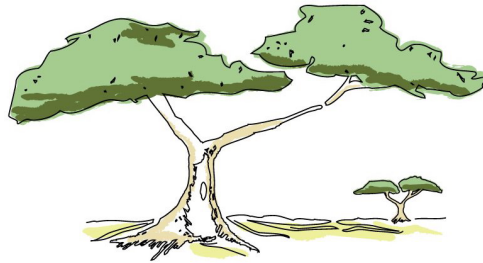

Reg. No. 4,108,096

Registered Mar. 6, 2012

Int. Cl.: 45

SERVICE MARK

PRINCIPAL REGISTER

VERNETTI LAW GROUP (TENNESSEE CORPORATION)
1468 WILLIAM HOLT BLVD.
KNOXVILLE, TN 37862

FOR: LEGAL SERVICES, IN CLASS 45 (U.S. CLS. 100 AND 101).

FIRST USE 8-9-2010; IN COMMERCE 8-9-2010.

THE MARK CONSISTS OF THE DESIGN OF TWO TREES SHOWN WITH BLACK OUTLINES AND DETAILING, DARK GREEN AND LIGHT GREEN LEAVES AND LIGHT BROWN TRUNKS. THE TREES ARE SHOWN ON A HORIZON WITH BLACK LINING AND DETAILING, AND LIGHT YELLOW EARTH. ALL OF THIS IS ON A WHITE BACKGROUND.

THE COLOR(S) BLACK, WHITE, LIGHT BROWN, DARK GREEN, LIGHT GREEN, AND LIGHT YELLOW IS/ARE CLAIMED AS A FEATURE OF THE MARK.

SER. NO. 85-346,476, FILED 6-15-2011.

FRED CARL, EXAMINING ATTORNEY



David J. Kybas

Director of the United States Patent and Trademark Office

United States of America

United States Patent and Trademark Office



Reg. No. 4,108,097

Registered Mar. 6, 2012

Int. Cl.: 28

TRADEMARK

PRINCIPAL REGISTER

SIMON, STEVEN M. (UNITED STATES INDIVIDUAL)
503 E. 6TH ST.; STE B
AUSTIN, TX 78701

FOR: FOOSBALL TABLES, IN CLASS 28 (U.S. CLS. 22, 23, 38 AND 50).

FIRST USE 3-17-2011; IN COMMERCE 3-17-2011.

NO CLAIM IS MADE TO THE EXCLUSIVE RIGHT TO USE "FOOS" , APART FROM THE MARK AS SHOWN.

THE COLOR(S) RED AND BLACK IS/ARE CLAIMED AS A FEATURE OF THE MARK.

THE MARK CONSISTS OF THE WORDING "X FOOS" APPEARING AS FOLLOWS: A LARGE BLACK LETTER "X" INSERTED WITHIN A BLACK CIRCLE, WITH RED LETTERS "FOOS" OUTLINED IN BLACK SUPERIMPOSED OVER THE LETTER "X".

SER. NO. 85-346,976, FILED 6-15-2011.

DAVID ELTON, EXAMINING ATTORNEY



David J. Kyfos

Director of the United States Patent and Trademark Office

United States of America

United States Patent and Trademark Office

**COUPON
SWAPPER**

Reg. No. 4,108,098

POA LLC (NEVADA LIMITED LIABILITY COMPANY)
42257 PROVIDENCE RIDGE DRIVE
CHANTILLY, VA 20152

Registered Mar. 6, 2012

Int. Cl.: 42

FOR: PROVIDING AN ONLINE WEBSITE FEATURING NON-DOWNLOADABLE SOFTWARE WHICH ALLOWS USERS TO FIND COUPONS FOR VARIOUS GOODS AND FOR SHARING INFORMATION REGARDING COUPONS WITH OTHERS OVER THE INTERNET, IN CLASS 42 (U.S. CLS. 100 AND 101).

SERVICE MARK

PRINCIPAL REGISTER

FIRST USE 9-0-2010; IN COMMERCE 9-0-2010.

NO CLAIM IS MADE TO THE EXCLUSIVE RIGHT TO USE "COUPON", APART FROM THE MARK AS SHOWN.

THE MARK CONSISTS OF A STYLIZED VERSION OF THE TERM "COUPON SWAPPER" WITH ARROWS MADE PART OF THE LETTERS "S" AND "N".

SER. NO. 85-347,130, FILED 6-15-2011.

COLLEEN KEARNEY, EXAMINING ATTORNEY



David J. Kyros

Director of the United States Patent and Trademark Office

United States of America

United States Patent and Trademark Office

PIX | System

Reg. No. 4,108,099

Registered Mar. 6, 2012

Int. Cls.: 9 and 42

TRADEMARK

SERVICE MARK

PRINCIPAL REGISTER

PIX SYSTEM LLC (CALIFORNIA LIMITED LIABILITY COMPANY)
455 MARKET STREET, SUITE 900
SAN FRANCISCO, CA 94105

FOR: COMPUTER SOFTWARE FOR PROJECT MANAGEMENT FOR THE PRODUCTION OF AUDIOVISUAL RECORDINGS, MUSICAL RECORDINGS, TELEVISION AND VIDEO GAMES; COMPUTER HARDWARE, NAMELY, LOCAL SERVERS AND SET TOP BOXES FOR TELEVISION AND SCREENING ROOMS, IN CLASS 9 (U.S. CLS. 21, 23, 26, 36 AND 38).

FIRST USE 1-1-2003; IN COMMERCE 1-1-2003.

FOR: COMPUTER SERVICES, NAMELY, ACTING AS AN APPLICATION SERVICE PROVIDER OF PROJECT MANAGEMENT SOFTWARE FOR THE PRODUCTION OF AUDIOVISUAL RECORDINGS, MUSICAL RECORDINGS, TELEVISION AND VIDEO GAMES; COMPUTER CONSULTING SERVICES RELATED TO THE PRODUCTION OF AUDIOVISUAL RECORDINGS, MUSICAL RECORDINGS, COMPUTER GAMES AND TELEVISION, IN CLASS 42 (U.S. CLS. 100 AND 101).

FIRST USE 1-1-2003; IN COMMERCE 1-1-2003.

NO CLAIM IS MADE TO THE EXCLUSIVE RIGHT TO USE "SYSTEM", APART FROM THE MARK AS SHOWN.

THE MARK CONSISTS OF PIX IN UPPERCASE LETTERS, FOLLOWED BY A VERTICAL LINE, FOLLOWED BY THE WORD "SYSTEM" IN TITLE CASE LETTERS.

SER. NO. 85-347,264, FILED 6-15-2011.

SUNG IN, EXAMINING ATTORNEY



David J. Kyros

Director of the United States Patent and Trademark Office

United States of America

United States Patent and Trademark Office

PristineMist

Reg. No. 4,108,100

Registered Mar. 6, 2012

Int. Cl.: 3

TRADEMARK

PRINCIPAL REGISTER

EARTH SCIENCE LABORATORIES, INC. (NEVADA CORPORATION)
113 SE 22ND STREET, SUITE 1
BENTONVILLE, AR 72712

FOR: CLEANING PREPARATIONS, NAMELY, HYDROGEN PEROXIDE COMPLEX USED TO CLEAN AND PREVENT DISCOLORATION IN SPA COVERS THAT ALSO ELIMINATES AND PREVENTS ODORS, IN CLASS 3 (U.S. CLS. 1, 4, 6, 50, 51 AND 52).

FIRST USE 12-15-2006; IN COMMERCE 12-15-2006.

THE MARK CONSISTS OF STANDARD CHARACTERS WITHOUT CLAIM TO ANY PARTICULAR FONT, STYLE, SIZE, OR COLOR.

OWNER OF U.S. REG. NOS. 1,740,753, 3,094,357 AND OTHERS.

SER. NO. 85-347,317, FILED 6-15-2011.

ELISSA GARBER KON, EXAMINING ATTORNEY



David J. Kyffers

Director of the United States Patent and Trademark Office

United States of America

United States Patent and Trademark Office



Reg. No. 4,108,101

HAVANA CLUB HOLDING, S.A. (LUXEMBOURG CORPORATION)
5 RUE EUGÈNE RUPPERT
LUXEMBOURG, LUXEMBOURG L-2453

Registered Mar. 6, 2012

Int. Cl.: 33

FOR: CUBAN RUM, IN CLASS 33 (U.S. CLS. 47 AND 49).

TRADEMARK

PRIORITY CLAIMED UNDER SEC. 44(D) ON BENELUX APPLICATION NO. 1217940, FILED 1-21-2011, REG. NO. 0894587, DATED 4-11-2011, EXPIRES 1-21-2021.

PRINCIPAL REGISTER

THE COLOR(S) BLUE, GOLD, RED, WHITE, GRAY AND BLACK IS/ARE CLAIMED AS A FEATURE OF THE MARK.

OWNER OF U.S. REG. NOS. 3,679,748, 3,679,786, AND 3,721,344.

NO CLAIM IS MADE TO THE EXCLUSIVE RIGHT TO USE "SELECCIÓN", APART FROM THE MARK AS SHOWN.

THE MARK CONSISTS OF TWO LABELS. THE LARGER LABEL IS A BLUE OBLONG AND BORDERED IN GOLD. IT CONTAINS A CIRCLE, COLORED RED AND BORDERED IN GOLD, WITH THE IMAGE OF A WOMAN, SHADED IN BLACK AND GOLD AND HOLDING A CROSS IN HER LEFT HAND, LOCATED IN THE CENTER AT THE TOP OF THE CIRCLE. TO THE RIGHT AND LEFT OF THE CIRCLE ARE TWO SETS OF GOLD FLOURISHES. BENEATH THE BLUE LABEL IS A WHITE LABEL, OUTLINED IN GRAY AND GOLD DOTS. IN THE CENTER OF THE LABEL, PRINTED IN BLUE LETTERS OUTLINED IN GOLD, IS THE WORD "SELECCIÓN" PRINTED OVER THE WORDS "DE MAESTROS"; TO THE LEFT AND RIGHT OF THE WORDS ARE GRAY FLOURISHES AND BENEATH THE WORDS ARE THREE GOLD MEDALS.

THE ENGLISH TRANSLATION OF THE WORDS "SELECCIÓN DE MAESTROS" IN THE MARK IS CHOICE OF THE MASTERS.

SER. NO. 85-347,623, FILED 6-16-2011.

MARLENE BELL, EXAMINING ATTORNEY



David J. Kyros

Director of the United States Patent and Trademark Office

United States of America

United States Patent and Trademark Office



Reg. No. 4,108,102

Registered Mar. 6, 2012

Int. Cl.: 30

TRADEMARK

PRINCIPAL REGISTER

TALENTI LLC (TEXAS LIMITED LIABILITY COMPANY)
9019 GOVERNORS ROW
DALLAS, TX 75247

FOR: GELATO; SORBET, IN CLASS 30 (U.S. CL. 46).

FIRST USE 8-1-2004; IN COMMERCE 8-1-2004.

OWNER OF U.S. REG. NOS. 2,804,298, 3,691,116, AND 3,694,671.

THE MARK CONSISTS OF THE STYLIZED TERM "TALENTI" AND ITS PLACEMENT ON TRANSPARENT PACKAGING FOR GOODS, NAMELY, SORBET AND GELATO. THE LID AND SHAPE OF THE CONTAINER ARE SHOWN IN BROKEN LINES AND ARE NOT PART OF THE MARK AND ARE NOT CLAIMED AS A FEATURE OF THE MARK. THE BROKEN LINES SERVE ONLY TO SHOW THE POSITION OF THE MARK ON THE CONTAINER FOR THE GOODS.

THE ENGLISH TRANSLATION OF "TALENTI" IN THE MARK IS "TALENTS".

SER. NO. 85-347,695, FILED 6-16-2011.

TASHIA BUNCH, EXAMINING ATTORNEY



David J. Kyffers

Director of the United States Patent and Trademark Office

United States of America

United States Patent and Trademark Office



Reg. No. 4,108,103

Registered Mar. 6, 2012

Int. Cl.: 29

TRADEMARK

PRINCIPAL REGISTER

GROW AND BEHOLD FOODS, LLC (NEW YORK LIMITED LIABILITY COMPANY)
15 CHADBOURNE ROAD
ROCHESTER, NY 14618

FOR: PASTURED-RAISED KOSHER MEATS, IN CLASS 29 (U.S. CL. 46).

FIRST USE 7-15-2010; IN COMMERCE 7-15-2010.

NO CLAIM IS MADE TO THE EXCLUSIVE RIGHT TO USE "KOSHER PASTURED MEATS",
APART FROM THE MARK AS SHOWN.

THE COLOR(S) GREEN, WHITE, AND BLACK IS/ARE CLAIMED AS A FEATURE OF THE
MARK.

THE MARK CONSISTS OF THE BLACK WORDING "GROW & BEHOLD KOSHER PAS-
TURED MEATS" APPEARING IN A WHITE BOX BENEATH A WHITE COW OUTLINED
IN BLACK. A DOTTED GREEN LINE APPEARS BELOW THE WORDS "GROW & BEHOLD"
AND ABOVE THE WORDS "KOSHER PASTURED MEATS." THE COW IS FEEDING ON A
GREEN PLANT AND IS STANDING ABOVE TWO WHITE PLANTS. THE BACKGROUND
IS GREEN IN THE SHAPE OF A SQUARE. A DOTTED GREEN LINE SURROUNDS THE
ENTIRE GREEN BACKGROUND.

SER. NO. 85-347,998, FILED 6-16-2011.

CHARLOTTE CORWIN, EXAMINING ATTORNEY



David J. Kybas

Director of the United States Patent and Trademark Office

United States of America

United States Patent and Trademark Office

SCRIPTURE GARDENS

Reg. No. 4,108,104

Registered Mar. 6, 2012

Int. Cls.: 3 and 4

TRADEMARK

PRINCIPAL REGISTER

KINGDOM GENERATION, LLC (NEW JERSEY LIMITED LIABILITY COMPANY)
1341 PROSPECT AVENUE
PLAINFIELD, NJ 07060

FOR: AROMATIC OILS; AROMATIC PREPARATIONS, NAMELY, ANOINTING OILS; BATH SOAPS IN LIQUID, SOLID OR GEL FORM; BODY LOTION, IN CLASS 3 (U.S. CLS. 1, 4, 6, 50, 51 AND 52).

FIRST USE 5-8-2011; IN COMMERCE 5-8-2011.

FOR: CANDLES, IN CLASS 4 (U.S. CLS. 1, 6 AND 15).

FIRST USE 5-8-2011; IN COMMERCE 5-8-2011.

THE MARK CONSISTS OF STANDARD CHARACTERS WITHOUT CLAIM TO ANY PARTICULAR FONT, STYLE, SIZE, OR COLOR.

SER. NO. 85-348,316, FILED 6-16-2011.

HELENE LIWINSKI, EXAMINING ATTORNEY



David J. Kyffers

Director of the United States Patent and Trademark Office

United States of America

United States Patent and Trademark Office



Reg. No. 4,108,105

THE ORIGINAL NY PIZZA CO (NORTH CAROLINA CORPORATION)
2763 NC HWY 55
CARY, NC 27519

Registered Mar. 6, 2012

Int. Cl.: 43

FOR: PIZZA PARLORS; RESTAURANT SERVICES FEATURING SANDWICHES, IN CLASS 43 (U.S. CLS. 100 AND 101).

SERVICE MARK

FIRST USE 2-14-1991; IN COMMERCE 2-14-1991.

PRINCIPAL REGISTER

NO CLAIM IS MADE TO THE EXCLUSIVE RIGHT TO USE " THE ORIGINAL NY PIZZA" , " NEW YORK CERTIFIED" AND "EST 1991", APART FROM THE MARK AS SHOWN.

THE MARK CONSISTS OF SHAPE OF A CREST, A SLICE OF PIZZA WITH 1 GRAIN STALK ON EACH SIDE. THERE IS A BRIDGE RIGHT BELOW IT IN WITH THE STYLIZED TEXT "NEW YORK" ON ONE SIDE AND "CERTIFIED" ON THE OTHER SIDE. BELOW THERE IS THE STYLIZED TEXT "NY PIZZA". BELOW THERE TEXT THERE IS A BANNER WITH THE STYLIZED TEXT "EST 1991". ABOVE THE CREST THERE IS A BANNER WITH THE STYLIZED TEXT "THE ORIGINAL".

SER. NO. 85-348,554, FILED 6-16-2011.

HENRY S. ZAK, EXAMINING ATTORNEY



David J. Kybas

Director of the United States Patent and Trademark Office

United States of America

United States Patent and Trademark Office

Trinéitte

Reg. No. 4,108,106

Registered Mar. 6, 2012

Int. Cls.: 9 and 14

TRADEMARK

PRINCIPAL REGISTER

NAZARENKO, VICTORIA (UNITED STATES INDIVIDUAL)
45 TALL OAKS COURT
OLD BRIDGE, NJ 08857

FOR: EYEWEAR ACCESSORIES, NAMELY, SPECTACLE HOLDERS, EYEGLASS HOLDERS, SUNGLASS HOLDERS, SPECTACLES, EYEGLASS FRAMES AND EYEGLASS CASES, IN CLASS 9 (U.S. CLS. 21, 23, 26, 36 AND 38).

FIRST USE 6-11-2011; IN COMMERCE 6-11-2011.

FOR: JEWELRY, PENDANTS, NECKLACES, BRACELETS, RING-HOLDERS AS PENDANTS, PENDANTS AS A RING-HOLDERS, RING-HOLDERS AS BRACELETS, BRACELETS AS RING-HOLDERS, RING-HOLDERS AS BANGLES, BANGLES AS WRIST- HOLDERS, JEWELRY CHAINS, WRISTBANDS BEING JEWELRY, RINGS, ENGAGEMENT RINGS, WEDDING BANDS, EARRINGS, CHARMS, BROOCHES, CUFFLINKS, NECKTIE PINS, ANKLETS BEING JEWELRY, WATCHES EXPENSIVE AND NON-EXPENSIVE, WATCH BANDS, WATCH CLASPS, JEWELRY CASES AND WATCH CASES, IN CLASS 14 (U.S. CLS. 2, 27, 28 AND 50).

FIRST USE 6-11-2011; IN COMMERCE 6-11-2011.

THE MARK CONSISTS OF STANDARD CHARACTERS WITHOUT CLAIM TO ANY PARTICULAR FONT, STYLE, SIZE, OR COLOR.

THE WORDING "TRINÉITTE" HAS NO MEANING IN A FOREIGN LANGUAGE.

SER. NO. 85-348,602, FILED 6-16-2011.

GENE MACIOL, EXAMINING ATTORNEY



David J. Kybas

Director of the United States Patent and Trademark Office

United States of America

United States Patent and Trademark Office

CRUNCH A COLOR

Reg. No. 4,108,107

Registered Mar. 6, 2012

Int. Cl.: 28

TRADEMARK

PRINCIPAL REGISTER

TINY GREEN BEE, LLC (CALIFORNIA LIMITED LIABILITY COMPANY)
1109 CORTEZ AVE
BURLINGAME, CA 94010

FOR: CARD GAMES, IN CLASS 28 (U.S. CLS. 22, 23, 38 AND 50).

FIRST USE 10-7-2011; IN COMMERCE 10-7-2007.

THE MARK CONSISTS OF STANDARD CHARACTERS WITHOUT CLAIM TO ANY PARTICULAR FONT, STYLE, SIZE, OR COLOR.

SER. NO. 85-348,642, FILED 6-16-2011.

GENE MACIOL, EXAMINING ATTORNEY



David J. Kybas

Director of the United States Patent and Trademark Office

United States of America

United States Patent and Trademark Office

HOLIDAY LIGHT SAVER

Reg. No. 4,108,108

HOLIDAY STORAGE SOLUTIONS, LLC (WASHINGTON LIMITED LIABILITY COMPANY)
30441 101ST AVE. SE
AUBURN, WA 98092

Registered Mar. 6, 2012

Int. Cl.: 20

FOR: NON-METAL HAND-OPERATED ELECTRICAL HOLIDAY LIGHT STORAGE REELS,
IN CLASS 20 (U.S. CLS. 2, 13, 22, 25, 32 AND 50).

TRADEMARK

FIRST USE 4-23-2009; IN COMMERCE 4-23-2009.

PRINCIPAL REGISTER

THE MARK CONSISTS OF STANDARD CHARACTERS WITHOUT CLAIM TO ANY PARTICULAR FONT, STYLE, SIZE, OR COLOR.

NO CLAIM IS MADE TO THE EXCLUSIVE RIGHT TO USE "HOLIDAY LIGHT", APART FROM THE MARK AS SHOWN.

SER. NO. 85-348,652, FILED 6-17-2011.

HEATHER BIDDULPH, EXAMINING ATTORNEY



David J. Kybas

Director of the United States Patent and Trademark Office

United States of America

United States Patent and Trademark Office

BRAND OF CHAMPIONS

Reg. No. 4,108,109

Registered Mar. 6, 2012

Int. Cl.: 26

TRADEMARK

PRINCIPAL REGISTER

MONTANA SILVERSMITHS, INC. (DELAWARE CORPORATION)
1 STERLING LANE
COLUMBUS, MT 59019

FOR: BELT BUCKLES; TROPHY BUCKLES; HAIR BARRETTES AND PONY TAIL HOLDERS,
IN CLASS 26 (U.S. CLS. 37, 39, 40, 42 AND 50).

FIRST USE 10-0-2010; IN COMMERCE 10-0-2010.

THE MARK CONSISTS OF STANDARD CHARACTERS WITHOUT CLAIM TO ANY PAR-
TICULAR FONT, STYLE, SIZE, OR COLOR.

NO CLAIM IS MADE TO THE EXCLUSIVE RIGHT TO USE "BRAND", APART FROM THE
MARK AS SHOWN.

SER. NO. 85-348,701, FILED 6-17-2011.

LAURIE MAYES, EXAMINING ATTORNEY



David J. Kybas

Director of the United States Patent and Trademark Office

United States of America

United States Patent and Trademark Office

WEITZ FUNDS

Reg. No. 4,108,110

Registered Mar. 6, 2012

Int. Cl.: 36

SERVICE MARK

PRINCIPAL REGISTER

WALLACE R. WEITZ & COMPANY (NEBRASKA CORPORATION)
SUITE 200
1125 S. 103RD STREET
OMAHA, NE 68124

FOR: INVESTMENT ADVISORY SERVICES; MUTUAL FUND INVESTMENT, IN CLASS 36 (U.S. CLS. 100, 101 AND 102).

FIRST USE 0-0-1983; IN COMMERCE 0-0-1983.

THE MARK CONSISTS OF STANDARD CHARACTERS WITHOUT CLAIM TO ANY PARTICULAR FONT, STYLE, SIZE, OR COLOR.

NO CLAIM IS MADE TO THE EXCLUSIVE RIGHT TO USE "FUNDS", APART FROM THE MARK AS SHOWN.

SEC. 2(F).

SER. NO. 85-348,830, FILED 6-17-2011.

AMY KELLY, EXAMINING ATTORNEY



David J. Kyros

Director of the United States Patent and Trademark Office

United States of America

United States Patent and Trademark Office



Reg. No. 4,108,111

Registered Mar. 6, 2012

Int. Cl.: 35

SERVICE MARK

PRINCIPAL REGISTER

CONVERGENCECOACHING, LLC (NEW YORK LIMITED LIABILITY COMPANY)
107 FOREST DRIVE
BELLEVUE, NE 68005

FOR: BUSINESS CONSULTATION SERVICES DIRECTED TOWARD INFORMATION TECHNOLOGY FIRMS IN THE NATURE OF COORDINATING INFORMATION TECHNOLOGY FIRMS TO BECOME MORE INTERACTIVE WITH CERTIFIED PUBLIC ACCOUNTANTS; BUSINESS CONSULTATION SERVICES DIRECTED TOWARD CERTIFIED PUBLIC ACCOUNTANT FIRMS IN THE NATURE OF COORDINATING CERTIFIED PUBLIC ACCOUNTANT FIRMS TO BECOME MORE INTERACTIVE WITH INFORMATION TECHNOLOGY, IN CLASS 35 (U.S. CLS. 100, 101 AND 102).

FIRST USE 1-25-2011; IN COMMERCE 1-25-2011.

OWNER OF U.S. REG. NOS. 2,817,764 AND 3,089,570.

NO CLAIM IS MADE TO THE EXCLUSIVE RIGHT TO USE "LLC", APART FROM THE MARK AS SHOWN.

THE MARK CONSISTS OF A GROUP OF THREE CIRCLES SET INSIDE EACH OTHER SURROUNDED BY A "C" WITH STYLIZED WORDING "CONVERGENCECOACHING, LLC" COMPLETING THE "C" INTO A FOURTH CIRCULAR SHAPE SURROUNDING THE OTHER THREE CIRCLES. STYLIZED WORDING "HELPING LEADERS ACHIEVE SUCCESS" APPEARING AT THE BOTTOM OF THE DESIGN.

SER. NO. 85-348,996, FILED 6-17-2011.

AMY ALFIERI, EXAMINING ATTORNEY



David J. Kybas

Director of the United States Patent and Trademark Office

United States of America

United States Patent and Trademark Office



Reg. No. 4,108,112

Registered Mar. 6, 2012

**Int. Cls.: 6, 8, 14, 20, 21,
25 and 26**

MONTANA SILVERSMITHS, INC. (DELAWARE CORPORATION)
1 STERLING LANE
COLUMBUS, MT 59019

FOR: FIGURINES MADE OF COMMON METAL; NON-LUMINOUS AND NON-MECHANICAL METAL SIGNS, IN CLASS 6 (U.S. CLS. 2, 12, 13, 14, 23, 25 AND 50).

FIRST USE 1-0-1993; IN COMMERCE 1-0-1993.

TRADEMARK

FOR: KNIVES AND FLATWARE, IN CLASS 8 (U.S. CLS. 23, 28 AND 44).

PRINCIPAL REGISTER

FIRST USE 1-0-1988; IN COMMERCE 1-0-1988.

FOR: JEWELRY; EARRINGS; NECKLACES; RINGS; BOLO TIES WITH PRECIOUS METAL TIPS; HAT ORNAMENTS OF PRECIOUS METAL; PERSONAL ORNAMENTS OF PRECIOUS METAL; ORNAMENTAL TRIM FOR FOOTWEAR MADE OF PRECIOUS METALS; TROPHIES AND DECORATIVE TROPHY BUCKLES MADE OF PRECIOUS METALS; WATCHES; FIGURINES MADE OF PRECIOUS METAL; TROPHIES OF PRECIOUS METAL IN THE NATURE OF ORNAMENTAL BUCKLES, IN CLASS 14 (U.S. CLS. 2, 27, 28 AND 50).

FIRST USE 1-0-1993; IN COMMERCE 1-0-1993.

FOR: PLASTIC SCULPTURES AND FIGURINES; PICTURE FRAMES, IN CLASS 20 (U.S. CLS. 2, 13, 22, 25, 32 AND 50).

FIRST USE 4-0-2000; IN COMMERCE 4-0-2000.

FOR: DINNERWARE; VASES, IN CLASS 21 (U.S. CLS. 2, 13, 23, 29, 30, 33, 40 AND 50).

FIRST USE 4-0-2000; IN COMMERCE 4-0-2000.

FOR: FOOTWEAR; SLIPPERS; BOLO TIES, IN CLASS 25 (U.S. CLS. 22 AND 39).

FIRST USE 1-0-2007; IN COMMERCE 1-0-2007.

FOR: BELT BUCKLES; HAIR BARRETTES AND PONY TAIL HOLDERS; BARRETTES; ORNAMENTAL TRIM IN THE NATURE OF TASSELS, FRINGE, RIBBONS AND BRAIDS



David J. Kybas

Director of the United States Patent and Trademark Office

Reg. No. 4,108,112 FOR TACK, SADDLERY AND APPAREL MADE OF PRECIOUS METALS AND NOT IN THE NATURE OF JEWELRY, IN CLASS 26 (U.S. CLS. 37, 39, 40, 42 AND 50).

FIRST USE 1-0-1993; IN COMMERCE 1-0-1993.

THE MARK CONSISTS OF THE SILHOUETTE OF A PERSON WEARING A COWBOY HAT RIDING A HORSE.

SER. NO. 85-349,153, FILED 6-17-2011.

LAURIE MAYES, EXAMINING ATTORNEY

United States of America

United States Patent and Trademark Office

STRAUB

Reg. No. 4,108,113

Registered Mar. 6, 2012

Int. Cls.: 32 and 40

TRADEMARK

SERVICE MARK

PRINCIPAL REGISTER

STRAUB BREWERY, INC. (PENNSYLVANIA CORPORATION)
303 SORG STREET
ST. MARYS, PA 15857

FOR: BEER, IN CLASS 32 (U.S. CLS. 45, 46 AND 48).

FIRST USE 0-0-1950; IN COMMERCE 0-0-1950.

FOR: BREWERY SERVICES, IN CLASS 40 (U.S. CLS. 100, 103 AND 106).

FIRST USE 0-0-1950; IN COMMERCE 0-0-1950.

THE MARK CONSISTS OF STANDARD CHARACTERS WITHOUT CLAIM TO ANY PARTICULAR FONT, STYLE, SIZE, OR COLOR.

OWNER OF U.S. REG. NOS. 3,695,835, 3,746,166, AND 3,748,712.

SEC. 2(F).

SER. NO. 85-349,332, FILED 6-17-2011.

GENE MACIOL, EXAMINING ATTORNEY



David J. Kybas

Director of the United States Patent and Trademark Office

United States of America

United States Patent and Trademark Office



Reg. No. 4,108,114

Registered Mar. 6, 2012

Int. Cl.: 45

SERVICE MARK

PRINCIPAL REGISTER

BAY AREA SPECIALIZED INVESTIGATIVE CONSULTING SERVICES, LLC (FLORIDA LIMITED LIABILITY COMPANY), DBA B.A.S.I.C.S., LLC.
25749 US 19 NORTH #202
CLEARWATER, FL 33763

FOR: PRIVATE INVESTIGATION AND INVESTIGATION CONSULTING SERVICES, IN CLASS 45 (U.S. CLS. 100 AND 101).

FIRST USE 3-15-2011; IN COMMERCE 3-15-2011.

THE MARK CONSISTS OF AN IMAGE OF A BRIDGE IN YELLOW COLOR WITH BLACK RUNWAY BELOW WHICH THE WORDS "B.A.S.I.C.S." IS WRITTEN IN RED COLOR AS SHOWN IN THE MARK SURROUNDED BY BLACK AND WHITE CLOUDS.

THE COLOR(S) YELLOW, WHITE, BLACK AND RED IS/ARE CLAIMED AS A FEATURE OF THE MARK.

SER. NO. 85-349,383, FILED 6-17-2011.

CHARLES L. JENKINS, EXAMINING ATTORNEY



David J. Kyffers

Director of the United States Patent and Trademark Office

United States of America

United States Patent and Trademark Office

DANCE-AWAY DIABETES THERAPY

Reg. No. 4,108,115

Registered Mar. 6, 2012

Int. Cls.: 9 and 41

TRADEMARK

SERVICE MARK

PRINCIPAL REGISTER

ZAHRA TABASSIAN, M.D., INC. (CALIFORNIA CORPORATION)
994 S. LA BREA AVENUE
INGLEWOOD, CA 90301

FOR: DIGITAL MEDIA, NAMELY, DVDS, CDS, HIGH DEFINITION DIGITAL DISCS FEATURING INSTRUCTION AND EDUCATION ON EXERCISE, HEALTH, NUTRITION, WELLNESS, EVALUATIONS, CONSULTATIONS AND RECOMMENDATIONS; MOTION PICTURE DOCUMENTARY FILMS FEATURING INSTRUCTION AND EDUCATION ON ILLNESSES AND EXERCISE; AUDIO RECORDINGS FEATURING INSTRUCTION AND EDUCATION ON ILLNESSES AND EXERCISE; AUDIO AND VIDEO RECORDINGS FEATURING INSTRUCTION AND EDUCATION ON ILLNESSES AND EXERCISE; VIDEOTAPE RECORDED WITH VIDEOS FEATURING A HEALTH, EXERCISE AND EDUCATIONAL SHOW, IN CLASS 9 (U.S. CLS. 21, 23, 26, 36 AND 38).

FIRST USE 3-1-2011; IN COMMERCE 4-21-2011.

FOR: EDUCATIONAL AND ENTERTAINMENT SERVICES, NAMELY, A CONTINUING PROGRAM ABOUT HEALTH AND EXERCISE AS THERAPY ACCESSIBLE BY RADIO, TELEVISION, SATELLITE, AUDIO, VIDEO AND COMPUTER NETWORKS; EDUCATIONAL AND ENTERTAINMENT SERVICES, NAMELY, PROVIDING MOTIVATIONAL SPEAKING SERVICES IN THE FIELD OF THERAPEUTIC DANCE, WELLNESS, HEALTH, NUTRITION, DAILY LIVING HABITS; EDUCATIONAL SERVICES, NAMELY, CONDUCTING ENTERTAINMENT EXHIBITIONS IN THE FIELD OF DANCE INSTRUCTION AND DANCE AS THERAPY; ENTERTAINMENT SERVICES, NAMELY, AN ON-GOING SERIES FEATURING INSTRUCTION AND EDUCATION ON ILLNESSES AND EXERCISE PROVIDED THROUGH TELEVISION, SATELLITE, INTERNET AND CABLE; ENTERTAINMENT, NAMELY, A CONTINUING HEALTH, EXERCISE AND EDUCATIONAL SHOW BROADCAST OVER TELEVISION AND INTERNET; ENTERTAINMENT IN THE NATURE OF THEATER PRODUCTIONS FEATURING A HEALTH, EXERCISE AND EDUCATIONAL SHOW, IN CLASS 41 (U.S. CLS. 100, 101 AND 107).

FIRST USE 3-1-2011; IN COMMERCE 4-21-2011.

THE MARK CONSISTS OF STANDARD CHARACTERS WITHOUT CLAIM TO ANY PARTICULAR FONT, STYLE, SIZE, OR COLOR.



David J. Kyros

Director of the United States Patent and Trademark Office

Reg. No. 4,108,115 NO CLAIM IS MADE TO THE EXCLUSIVE RIGHT TO USE "DIABETES THERAPY", APART FROM THE MARK AS SHOWN.

SER. NO. 85-349,674, FILED 6-17-2011.

CHARLOTTE CORWIN, EXAMINING ATTORNEY

United States of America

United States Patent and Trademark Office



W A T E R ' S E D G E D E S I G N

Reg. No. 4,108,116

ALICE P. GINES (UNITED STATES INDIVIDUAL)
711 145TH PL SW
LYNNWOOD, WA 98087

Registered Mar. 6, 2012

Int. Cl.: 41

FOR: PHOTOGRAPHY; PHOTOGRAPHY SERVICES, IN CLASS 41 (U.S. CLS. 100, 101 AND 107).

SERVICE MARK

FIRST USE 6-1-2011; IN COMMERCE 6-1-2011.

PRINCIPAL REGISTER

OWNER OF U.S. REG. NO. 3,112,361.

NO CLAIM IS MADE TO THE EXCLUSIVE RIGHT TO USE "DESIGN", APART FROM THE MARK AS SHOWN.

THE MARK CONSISTS OF A STYLIZED WHITE LOWER CASE LETTER "E" SUPERIMPOSED OVER A STYLIZED UPPER CASE LETTER "W", ALL APPEARING ABOVE THE WORDS "WATER'S EDGE DESIGN".

SER. NO. 85-349,733, FILED 6-17-2011.

CHARLES L. JENKINS, EXAMINING ATTORNEY



David J. Kybas

Director of the United States Patent and Trademark Office

United States of America

United States Patent and Trademark Office

JUMBALASSY

Reg. No. 4,108,117

Registered Mar. 6, 2012

Int. Cl.: 9

TRADEMARK

PRINCIPAL REGISTER

DUNCAN, ALEXANDER (ST.KITTS-NEVIS INDIVIDUAL)
1921 S. HOSMER
TACOMA, WA 98405

FOR: AUDIO AND VIDEO RECORDINGS FEATURING MUSIC AND ARTISTIC PERFORMANCES; DIGITAL MUSIC DOWNLOADABLE FROM THE INTERNET; DOWNLOADABLE MUSICAL SOUND RECORDINGS; DOWNLOADABLE RING TONES, GRAPHICS AND MUSIC VIA A GLOBAL COMPUTER NETWORK AND WIRELESS DEVICES; MUSICAL RECORDINGS; MUSICAL SOUND RECORDINGS; MUSICAL VIDEO RECORDINGS, IN CLASS 9 (U.S. CLS. 21, 23, 26, 36 AND 38).

FIRST USE 7-17-1990; IN COMMERCE 9-30-1991.

THE MARK CONSISTS OF STANDARD CHARACTERS WITHOUT CLAIM TO ANY PARTICULAR FONT, STYLE, SIZE, OR COLOR.

SER. NO. 85-349,823, FILED 6-18-2011.

LAURIE KAUFMAN, EXAMINING ATTORNEY



David J. Kyffers

Director of the United States Patent and Trademark Office

United States of America

United States Patent and Trademark Office

ALEX DUNCAN

Reg. No. 4,108,118

Registered Mar. 6, 2012

Int. Cl.: 9

TRADEMARK

PRINCIPAL REGISTER

DUNCAN, ALEX (ST.KITTS-NEVIS INDIVIDUAL)
1921 S. HOSMER
TACOMA, WA 98405

FOR: AUDIO AND VIDEO RECORDINGS FEATURING MUSIC AND ARTISTIC PERFORMANCES; COMPACT DISCS FEATURING MUSIC; DIGITAL MUSIC DOWNLOADABLE FROM THE INTERNET; DOWNLOADABLE MUSICAL SOUND RECORDINGS; DOWNLOADABLE RING TONES, GRAPHICS AND MUSIC VIA A GLOBAL COMPUTER NETWORK AND WIRELESS DEVICES; MUSICAL RECORDINGS; MUSICAL SOUND RECORDINGS; MUSICAL VIDEO RECORDINGS, IN CLASS 9 (U.S. CLS. 21, 23, 26, 36 AND 38).

FIRST USE 11-23-1983; IN COMMERCE 11-23-1983.

THE MARK CONSISTS OF STANDARD CHARACTERS WITHOUT CLAIM TO ANY PARTICULAR FONT, STYLE, SIZE, OR COLOR.

THE NAME "ALEX DUNCAN" IDENTIFIES A LIVING INDIVIDUAL WHOSE CONSENT IS OF RECORD.

SER. NO. 85-349,825, FILED 6-18-2011.

REBECCA POVARCHUK, EXAMINING ATTORNEY



David J. Kyros

Director of the United States Patent and Trademark Office

United States of America

United States Patent and Trademark Office

JOE BUILDER

Reg. No. 4,108,119

SQUARE AND LEVEL MEDIA PRODUCTIONS, INC. (ILLINOIS CORPORATION)
1951 JOHN'S DRIVE
GLENVIEW, IL 600251615

Registered Mar. 6, 2012

Int. Cl.: 41

FOR: ENTERTAINMENT IN THE NATURE OF LIVE RADIO PERSONALITY PERFORMANCES, IN CLASS 41 (U.S. CLS. 100, 101 AND 107).

SERVICE MARK

FIRST USE 2-17-2008; IN COMMERCE 2-17-2008.

PRINCIPAL REGISTER

THE MARK CONSISTS OF STANDARD CHARACTERS WITHOUT CLAIM TO ANY PARTICULAR FONT, STYLE, SIZE, OR COLOR.

NO CLAIM IS MADE TO THE EXCLUSIVE RIGHT TO USE "BUILDER", APART FROM THE MARK AS SHOWN.

THE NAME(S), PORTRAIT(S), AND/OR SIGNATURE(S) SHOWN IN THE MARK DOES NOT IDENTIFY A PARTICULAR LIVING INDIVIDUAL.

SER. NO. 85-349,855, FILED 6-18-2011.

ELLEN B. AWRICH, EXAMINING ATTORNEY



David J. Kybas

Director of the United States Patent and Trademark Office

United States of America

United States Patent and Trademark Office

Harry The Hipster

Reg. No. 4,108,120

EPSTEIN HARRY H (UNITED STATES INDIVIDUAL)
1706 CARROLL LN.
CHATTANOOGA, TN 37405

Registered Mar. 6, 2012

Int. Cl.: 41

FOR: ON-LINE JOURNALS, NAMELY, BLOGS FEATURING MUSIC, IN CLASS 41 (U.S. CLS. 100, 101 AND 107).

SERVICE MARK

FIRST USE 5-27-2011; IN COMMERCE 5-27-2011.

PRINCIPAL REGISTER

THE MARK CONSISTS OF STANDARD CHARACTERS WITHOUT CLAIM TO ANY PARTICULAR FONT, STYLE, SIZE, OR COLOR.

SER. NO. 85-349,932, FILED 6-19-2011.

SUNG IN, EXAMINING ATTORNEY



David J. Kyfos

Director of the United States Patent and Trademark Office

United States of America

United States Patent and Trademark Office

PASSPORTPARKING

Reg. No. 4,108,121

PASSPORT PARKING, LLC (NORTH CAROLINA LIMITED LIABILITY COMPANY)
P.O. BOX 30431
CHARLOTTE, NC 282300431

Registered Mar. 6, 2012

Int. Cls.: 35, 39 and 42

FOR: BUSINESS MANAGEMENT SERVICES FOR THE PARKING LOT AND GARAGE INDUSTRY, IN CLASS 35 (U.S. CLS. 100, 101 AND 102).

SERVICE MARK

FIRST USE 10-4-2010; IN COMMERCE 10-4-2010.

PRINCIPAL REGISTER

FOR: RENTAL OF PARKING LOT SPACES AND GARAGE SPACE, IN CLASS 39 (U.S. CLS. 100 AND 105).

FIRST USE 10-4-2010; IN COMMERCE 10-4-2010.

FOR: SOFTWARE AS A SERVICE (SAAS) SERVICES FEATURING PARKING MANAGEMENT SOFTWARE FOR THE PARKING LOT AND GARAGE INDUSTRY, IN CLASS 42 (U.S. CLS. 100 AND 101).

FIRST USE 10-4-2010; IN COMMERCE 10-4-2010.

THE MARK CONSISTS OF STANDARD CHARACTERS WITHOUT CLAIM TO ANY PARTICULAR FONT, STYLE, SIZE, OR COLOR.

SER. NO. 85-350,041, FILED 6-20-2011.

JAMES MACFARLANE, EXAMINING ATTORNEY



David J. Kyros

Director of the United States Patent and Trademark Office

United States of America

United States Patent and Trademark Office

BAYOU CLASSIC

Reg. No. 4,108,122

Registered Mar. 6, 2012

Int. Cls.: 4 and 32

TRADEMARK

PRINCIPAL REGISTER

BARBOUR INTERNATIONAL, INC. (MISSISSIPPI CORPORATION)
101 CYPRESS WAY
BRANDON, MS 39042

FOR: LUMP CHARCOAL; CHARCOAL BRIQUETTES, IN CLASS 4 (U.S. CLS. 1, 6 AND 15).

FIRST USE 3-0-2011; IN COMMERCE 3-0-2011.

FOR: BEER MAKING KITS , IN CLASS 32 (U.S. CLS. 45, 46 AND 48).

FIRST USE 2-0-2011; IN COMMERCE 2-0-2011.

THE MARK CONSISTS OF STANDARD CHARACTERS WITHOUT CLAIM TO ANY PARTICULAR FONT, STYLE, SIZE, OR COLOR.

OWNER OF U.S. REG. NOS. 1,898,816, 2,783,084 AND OTHERS.

SER. NO. 85-350,171, FILED 6-20-2011.

SUSAN LESLIE DUBOIS, EXAMINING ATTORNEY



David J. Kyros

Director of the United States Patent and Trademark Office

United States of America

United States Patent and Trademark Office

PAISAN

Reg. No. 4,108,123

Registered Mar. 6, 2012

Int. Cl.: 25

TRADEMARK

PRINCIPAL REGISTER

GUTU MIRCEA (UNITED STATES INDIVIDUAL), DBA CBGB LLC
186 STATE ROUTE 94
LAFAYETTE, NJ 07848

FOR: JERSEYS, IN CLASS 25 (U.S. CLS. 22 AND 39).

FIRST USE 1-7-2011; IN COMMERCE 5-1-2011.

THE MARK CONSISTS OF STANDARD CHARACTERS WITHOUT CLAIM TO ANY PARTICULAR FONT, STYLE, SIZE, OR COLOR.

THE ENGLISH TRANSLATION OF "PAISAN" IN THE MARK IS "FELLOW COUNTRYMEN".

SER. NO. 85-350,203, FILED 6-20-2011.

ALLISON SCHRODY, EXAMINING ATTORNEY



David J. Kybas

Director of the United States Patent and Trademark Office

United States of America

United States Patent and Trademark Office

INTREPID OUTDOORS

Reg. No. 4,108,124

Registered Mar. 6, 2012

Int. Cl.: 41

SERVICE MARK

PRINCIPAL REGISTER

INTREPID OUTDOORS, LLC (WYOMING LIMITED LIABILITY COMPANY)
373 NORTH WILDCAT ROAD
LABARGE, WY 83123

FOR: EDUCATIONAL AND ENTERTAINMENT SERVICES, NAMELY, A CONTINUING PROGRAM SERIES ABOUT HUNTING AND ASSOCIATED WILDERNESS RECREATIONAL ACTIVITIES ACCESSIBLE BY RADIO, TELEVISION, SATELLITE, AUDIO, VIDEO AND COMPUTER NETWORKS; ENTERTAINMENT AND EDUCATIONAL SERVICES, NAMELY, PROVIDING A WEBSITE FEATURING INFORMATION ABOUT HUNTING AND ASSOCIATED WILDERNESS RECREATIONAL ACTIVITIES, IN CLASS 41 (U.S. CLS. 100, 101 AND 107).

FIRST USE 10-1-2008; IN COMMERCE 10-1-2008.

THE MARK CONSISTS OF STANDARD CHARACTERS WITHOUT CLAIM TO ANY PARTICULAR FONT, STYLE, SIZE, OR COLOR.

NO CLAIM IS MADE TO THE EXCLUSIVE RIGHT TO USE "OUTDOORS" , APART FROM THE MARK AS SHOWN.

SER. NO. 85-350,390, FILED 6-20-2011.

BARBARA GAYNOR, EXAMINING ATTORNEY



David J. Kyffers

Director of the United States Patent and Trademark Office

United States of America

United States Patent and Trademark Office

INTREPID OUTDOORS

Reg. No. 4,108,125

Registered Mar. 6, 2012

Int. Cl.: 41

SERVICE MARK

PRINCIPAL REGISTER

INTREPID OUTDOORS, LLC (WYOMING LIMITED LIABILITY COMPANY)
373 NORTH WILDCAT ROAD
LABARGE, WY 83123

FOR: EDUCATIONAL AND ENTERTAINMENT SERVICES, NAMELY, A CONTINUING PROGRAM SERIES ABOUT HUNTING AND ASSOCIATED WILDERNESS RECREATIONAL ACTIVITIES ACCESSIBLE BY RADIO, TELEVISION, SATELLITE, AUDIO, VIDEO AND COMPUTER NETWORKS; ENTERTAINMENT AND EDUCATIONAL SERVICES, NAMELY, PROVIDING A WEBSITE FEATURING INFORMATION ABOUT HUNTING AND ASSOCIATED WILDERNESS RECREATIONAL ACTIVITIES, IN CLASS 41 (U.S. CLS. 100, 101 AND 107).

FIRST USE 6-14-2011; IN COMMERCE 6-14-2011.

NO CLAIM IS MADE TO THE EXCLUSIVE RIGHT TO USE "OUTDOORS", APART FROM THE MARK AS SHOWN.

THE MARK CONSISTS OF THE WORDS "INTREPID" AND "OUTDOORS" SEPARATED BY A LINE THEREBETWEEN.

SER. NO. 85-350,430, FILED 6-20-2011.

BARBARA GAYNOR, EXAMINING ATTORNEY



David J. Kyros

Director of the United States Patent and Trademark Office

United States of America

United States Patent and Trademark Office

Edifice Technologies

Reg. No. 4,108,126

Registered Mar. 6, 2012

Int. Cl.: 9

TRADEMARK

PRINCIPAL REGISTER

EDIFICE TECHNOLOGIES, LLC (WASHINGTON LIMITED LIABILITY COMPANY)
17311 135TH AVE NE, SUITE B500
WOODINVILLE, WA 98072

FOR: A COMPUTER SOFTWARE SYSTEM COMPRISED OF COMPUTER PROGRAMS FOR REMOTELY MONITORING AND MANAGING VIRTUAL COMPUTING RESOURCES THAT ARE DISTRIBUTED ACROSS MULTIPLE NETWORKS AND REGIONS, IN CLASS 9 (U.S. CLS. 21, 23, 26, 36 AND 38).

FIRST USE 5-1-2009; IN COMMERCE 6-1-2009.

THE MARK CONSISTS OF STANDARD CHARACTERS WITHOUT CLAIM TO ANY PARTICULAR FONT, STYLE, SIZE, OR COLOR.

NO CLAIM IS MADE TO THE EXCLUSIVE RIGHT TO USE "TECHNOLOGIES", APART FROM THE MARK AS SHOWN.

SER. NO. 85-350,498, FILED 6-20-2011.

JAY FLOWERS, EXAMINING ATTORNEY



David J. Kyros

Director of the United States Patent and Trademark Office

United States of America

United States Patent and Trademark Office

AMINOZORB

Reg. No. 4,108,127

Registered Mar. 6, 2012

Int. Cl.: 5

TRADEMARK

PRINCIPAL REGISTER

ALL AMERICAN PHARMACEUTICAL & NATURAL FOODS CORPORATION (MONTANA CORPORATION)
2376 MAIN STREET
BILLINGS, MT 59105

FOR: NUTRITIONAL SUPPLEMENTS CONTAINING AMINO ACIDS, IN CLASS 5 (U.S. CLS. 6, 18, 44, 46, 51 AND 52).

FIRST USE 6-1-2011; IN COMMERCE 6-12-2011.

THE MARK CONSISTS OF STANDARD CHARACTERS WITHOUT CLAIM TO ANY PARTICULAR FONT, STYLE, SIZE, OR COLOR.

SER. NO. 85-350,619, FILED 6-20-2011.

HEATHER BIDDULPH, EXAMINING ATTORNEY



David J. Kyffers

Director of the United States Patent and Trademark Office

United States of America

United States Patent and Trademark Office

TURF IGNITER

Reg. No. 4,108,128

INNOVATIVE CROP SOLUTIONS, INC. (IOWA CORPORATION)
24887 D AVE
RADCLIFFE, IA 50230

Registered Mar. 6, 2012

Int. Cl.: 1

FOR: FERTILIZERS FOR DOMESTIC USE, IN CLASS 1 (U.S. CLS. 1, 5, 6, 10, 26 AND 46).

TRADEMARK

FIRST USE 0-0-2010; IN COMMERCE 0-0-2010.

PRINCIPAL REGISTER

THE MARK CONSISTS OF STANDARD CHARACTERS WITHOUT CLAIM TO ANY PARTICULAR FONT, STYLE, SIZE, OR COLOR.

OWNER OF U.S. REG. NOS. 3,571,361 AND 3,582,298.

NO CLAIM IS MADE TO THE EXCLUSIVE RIGHT TO USE "TURF", APART FROM THE MARK AS SHOWN.

SER. NO. 85-350,684, FILED 6-20-2011.

NELSON SNYDER, EXAMINING ATTORNEY



David J. Kyffers

Director of the United States Patent and Trademark Office

United States of America

United States Patent and Trademark Office



Reg. No. 4,108,129

Registered Mar. 6, 2012

Int. Cl.: 16

TRADEMARK

PRINCIPAL REGISTER

CONNOLLY, TAMARA S. (UNITED STATES INDIVIDUAL)
60 ERIE STREET, SUITE 104
JERSEY CITY, NJ 07302

FOR: MEZUZAHS; PRINTED PAMPHLETS, BROCHURES, MANUALS, BOOKS, BOOKLETS, LEAFLETS, FLYERS, INFORMATIONAL SHEETS AND NEWSLETTERS, ADHESIVE BACKED STICKERS, AND KITS COMPRISING ONE OR MORE OF THE FOREGOING MATERIALS IN THE FIELD OF JUDAICA, IN CLASS 16 (U.S. CLS. 2, 5, 22, 23, 29, 37, 38 AND 50).

FIRST USE 6-16-2011; IN COMMERCE 6-16-2011.

NO CLAIM IS MADE TO THE EXCLUSIVE RIGHT TO USE THE REPRESENTATION OF THE STAR OF DAVID, APART FROM THE MARK AS SHOWN.

THE MARK CONSISTS OF A STYLIZED SHOWING OF A SIX POINTED STAR WITH SOLID COUNTER FILLED FAN SHAPES BETWEEN THE POINTS OF THE STAR AND WITH THE TERM "KLI" SHOWN IN THE MIDDLE OF THE STAR.

THE ENGLISH TRANSLATION OF "KLI" IN THE MARK IS "VESSEL".

SER. NO. 85-350,825, FILED 6-20-2011.

CHARLES L. JENKINS, EXAMINING ATTORNEY



David J. Kybas

Director of the United States Patent and Trademark Office

United States of America

United States Patent and Trademark Office

CLASSESUSA

Reg. No. 4,108,130

Registered Mar. 6, 2012

Int. Cl.: 41

SERVICE MARK

PRINCIPAL REGISTER

LIM HOLDINGS, INC. (DELAWARE CORPORATION)
475 ANTON BOULEVARD
COSTA MESA, CA 92626

FOR: PROVIDING AN INTERNET WEBSITE PORTAL IN THE FIELD OF HIGHER EDUCATION; PROVISION OF INFORMATION RELATING TO EDUCATIONAL SERVICES; PROVIDING ONLINE INFORMATION IN THE FIELD OF HIGHER EDUCATION; PROVIDING ONLINE INFORMATION ABOUT ONLINE AND CAMPUS-BASED COLLEGES AND UNIVERSITIES AND DEGREE AND CERTIFICATE PROGRAMS, IN CLASS 41 (U.S. CLS. 100, 101 AND 107).

FIRST USE 1-1-2001; IN COMMERCE 1-1-2001.

THE MARK CONSISTS OF STANDARD CHARACTERS WITHOUT CLAIM TO ANY PARTICULAR FONT, STYLE, SIZE, OR COLOR.

OWNER OF U.S. REG. NOS. 2,980,316 AND 2,982,463.

SEC. 2(F).

SER. NO. 85-351,030, FILED 6-20-2011.

DEZMONA MIZELLE, EXAMINING ATTORNEY



David J. Kybas

Director of the United States Patent and Trademark Office

United States of America

United States Patent and Trademark Office

CLASSESUSA.COM

Reg. No. 4,108,131

Registered Mar. 6, 2012

Int. Cl.: 41

SERVICE MARK

PRINCIPAL REGISTER

LIM HOLDINGS, INC. (DELAWARE CORPORATION)
475 ANTON BOULEVARD
COSTA MESA, CA 92626

FOR: PROVIDING AN INTERNET WEBSITE PORTAL IN THE FIELD OF HIGHER EDUCATION; PROVISION OF INFORMATION RELATING TO EDUCATIONAL SERVICES; PROVIDING ONLINE INFORMATION IN THE FIELD OF HIGHER EDUCATION; PROVIDING ONLINE INFORMATION ABOUT ONLINE AND CAMPUS-BASED COLLEGES AND UNIVERSITIES AND DEGREE AND CERTIFICATE PROGRAMS, IN CLASS 41 (U.S. CLS. 100, 101 AND 107).

FIRST USE 1-1-2001; IN COMMERCE 1-1-2001.

THE MARK CONSISTS OF STANDARD CHARACTERS WITHOUT CLAIM TO ANY PARTICULAR FONT, STYLE, SIZE, OR COLOR.

OWNER OF U.S. REG. NOS. 2,980,316 AND 2,982,463.

SEC. 2(F).

SER. NO. 85-351,039, FILED 6-20-2011.

DEZMONA MIZELLE, EXAMINING ATTORNEY



David J. Kybas

Director of the United States Patent and Trademark Office

United States of America

United States Patent and Trademark Office



TAKING THE STRESS OUT OF THE COLLEGE ACCEPTANCE PROCESS

Reg. No. 4,108,132

Registered Mar. 6, 2012

Int. Cl.: 41

SERVICE MARK

PRINCIPAL REGISTER

COLLEGE BOUND STRATEGIES, LLC (CALIFORNIA LIMITED LIABILITY COMPANY)
SUITE 160-D
26415 CARL BOYER DRIVE
SANTA CLARITA, CA 91350

FOR: EDUCATION SERVICES, NAMELY, ONE-ON-ONE MENTORING IN THE FIELD OF COLLEGE RESEARCH, APPLICATION PROCESS AND POSITIONING FINANCES TO MAXIMIZE STUDENT AID; EDUCATION SERVICES, NAMELY, PROVIDING CLASSES, SEMINARS, WORKSHOPS IN THE FIELD OF COLLEGE RESEARCH, APPLICATION PROCESS AND POSITIONING FINANCES TO MAXIMIZE STUDENT AID, IN CLASS 41 (U.S. CLS. 100, 101 AND 107).

FIRST USE 10-31-2010; IN COMMERCE 10-31-2010.

NO CLAIM IS MADE TO THE EXCLUSIVE RIGHT TO USE "COLLEGE BOUND STRATEGIES, LLC", APART FROM THE MARK AS SHOWN.

THE MARK CONSISTS OF A BUILDING WITH ROMAN COLUMNS AND THE STYLIZED TEXT "COLLEGE BOUND STRATEGIES LLC". TO THE RIGHT THERE IS THE STYLIZED TEXT "TAKING THE STRESS OUT OF THE COLLEGE ACCEPTANCE PROCESS".

SER. NO. 85-351,048, FILED 6-20-2011.

BRIAN NEVILLE, EXAMINING ATTORNEY



David J. Kyjars

Director of the United States Patent and Trademark Office

United States of America

United States Patent and Trademark Office



Reg. No. 4,108,133

Registered Mar. 6, 2012

Int. Cl.: 9

TRADEMARK

PRINCIPAL REGISTER

AFC TRIDENT, INC. (CALIFORNIA CORPORATION)
14270 ALBERS WAY
CHINO, CA 91710

FOR: PROTECTIVE COVERS FOR ELECTRONIC READING DEVICES; PROTECTIVE COVERS AND CASES FOR CELL PHONES, HAND-HELD COMPUTING DEVICES, AND HAND-HELD MOBILE DIGITAL ELECTRONIC DEVICES, IN CLASS 9 (U.S. CLS. 21, 23, 26, 36 AND 38).

FIRST USE 3-1-2011; IN COMMERCE 3-1-2011.

THE MARK CONSISTS OF A SHIELD BEHIND A TRIDENT.

SER. NO. 85-351,049, FILED 6-20-2011.

BRIAN NEVILLE, EXAMINING ATTORNEY



David J. Kybas

Director of the United States Patent and Trademark Office

United States of America

United States Patent and Trademark Office

HENNESSEY

Reg. No. 4,108,134

HPE DESIGN, LLC (TEXAS LIMITED LIABILITY COMPANY)
9281 SW 110 FRONTAGE RD
SEALY, TX 77474

Registered Mar. 6, 2012

Int. Cl.: 37

FOR: CUSTOMIZING AND MODIFYING AUTOMOTIVE VEHICLES TO CUSTOMERS' SPECIFICATIONS, IN CLASS 37 (U.S. CLS. 100, 103 AND 106).

SERVICE MARK

FIRST USE 6-1-2002; IN COMMERCE 6-1-2002.

PRINCIPAL REGISTER

THE MARK CONSISTS OF STANDARD CHARACTERS WITHOUT CLAIM TO ANY PARTICULAR FONT, STYLE, SIZE, OR COLOR.

SEC. 2(F).

SER. NO. 85-351,090, FILED 6-20-2011.

TINA BROWN, EXAMINING ATTORNEY



David J. Kybas

Director of the United States Patent and Trademark Office

United States of America

United States Patent and Trademark Office

SEIBON

Reg. No. 4,108,135

Registered Mar. 6, 2012

Int. Cl.: 12

TRADEMARK

PRINCIPAL REGISTER

SEIBON INTERNATIONAL, INC. (CALIFORNIA CORPORATION)
1215 BIXBY DRIVE
CITY OF INDUSTRY, CA 91745

FOR: CARBON FIBER AUTO BODY COMPONENTS AND PARTS, NAMELY, HOODS, DOORS, TRUNK LIDS, REAR SPOILERS, GRILLES, LIP SPOILERS, FENDERS, SIDE SKIRTS, ROOFS, HARD TOPS, AND SEATS, IN CLASS 12 (U.S. CLS. 19, 21, 23, 31, 35 AND 44).

FIRST USE 0-0-2002; IN COMMERCE 0-0-2002.

THE MARK CONSISTS OF STANDARD CHARACTERS WITHOUT CLAIM TO ANY PARTICULAR FONT, STYLE, SIZE, OR COLOR.

OWNER OF U.S. REG. NOS. 3,571,579, 3,571,580, AND 3,571,581.

SER. NO. 85-351,248, FILED 6-21-2011.

FONG HSU, EXAMINING ATTORNEY



David J. Kybas

Director of the United States Patent and Trademark Office

United States of America

United States Patent and Trademark Office



Reg. No. 4,108,136

Registered Mar. 6, 2012

Int. Cl.: 43

SERVICE MARK

PRINCIPAL REGISTER

ARMISTEAD, COLLIN (UNITED STATES INDIVIDUAL)
P.O. BOX 787
HOWE, TX 75459

FOR: RESTAURANT AND BAR SERVICES, IN CLASS 43 (U.S. CLS. 100 AND 101).

FIRST USE 3-1-2007; IN COMMERCE 3-1-2007.

NO CLAIM IS MADE TO THE EXCLUSIVE RIGHT TO USE "BAR & GRILL" AND THE PICTORIAL REPRESENTATION OF THE STATE OF TEXAS, APART FROM THE MARK AS SHOWN.

THE STIPPLING IS FOR SHADING PURPOSES ONLY.

THE MARK CONSISTS OF THE STYLIZED LETTERS AND WORDS "BIG SLICK'S BAR & GRILL A K". THE NAME "BIG SLICK'S" IN CAPITAL LETTERS WITH THE STATE OF TEXAS FLAG IN THE SHAPE OF THE STATE OF TEXAS AS THE PERIOD OVER THE 'I' IN THE WORD "SLICK'S". A MOTORCYCLE ENGINE IN THE CENTER WITH A ACE OF HEARTS PLAYING CARD COMING FROM BEHIND ENGINE ON THE LEFT AND A KING OF HEARTS PLAYING CARD COMING FROM BEHIND ENGINE ON THE RIGHT SIDE. ALL THIS ON A SHIELD WITH WINGS COMING FROM BEHIND THE SHIELD ON THE LEFT AND RIGHT OF SHIELD. "BAR & GRILL" BELOW THE SHIELD IN LETTERS WITH A TWO WAVY LINES GOING BEHIND THE WORDS "BAR & GRILL".

SER. NO. 85-351,317, FILED 6-21-2011.

ANTHONY RINKER, EXAMINING ATTORNEY



David J. Kybas

Director of the United States Patent and Trademark Office

United States of America

United States Patent and Trademark Office

TRIDENT

CASE

Reg. No. 4,108,137

AFC TRIDENT, INC. (CALIFORNIA CORPORATION)
14270 ALBERS WAY
CHINO, CA 91710

Registered Mar. 6, 2012

Int. Cl.: 9

FOR: PROTECTIVE COVERS FOR ELECTRONIC READING DEVICES; PROTECTIVE COVERS AND CASES FOR CELL PHONES, HAND-HELD COMPUTING DEVICES, AND HAND-HELD MOBILE DIGITAL ELECTRONIC DEVICES, IN CLASS 9 (U.S. CLS. 21, 23, 26, 36 AND 38).

TRADEMARK

PRINCIPAL REGISTER

FIRST USE 3-1-2011; IN COMMERCE 3-1-2011.

NO CLAIM IS MADE TO THE EXCLUSIVE RIGHT TO USE "CASE", APART FROM THE MARK AS SHOWN.

THE MARK CONSISTS OF THE WORD "TRIDENT" WITH THE WORD "CASE" AS PART OF THE SECOND "T" IN "TRIDENT", AND A DESIGN OF A TRIDENT FORMING THE FIRST "T" IN "TRIDENT".

SER. NO. 85-351,375, FILED 6-21-2011.

BRIAN NEVILLE, EXAMINING ATTORNEY



David J. Kybas

Director of the United States Patent and Trademark Office

United States of America

United States Patent and Trademark Office

RADIANCERAIL EXPRESS

Reg. No. 4,108,138

Registered Mar. 6, 2012

Int. Cl.: 19

TRADEMARK

PRINCIPAL REGISTER

TIMBERTECH LIMITED (OHIO LIMITED LIABILITY COMPANY)
894 PRAIRIE AVENUE
WILMINGTON, OH 45177

FOR: GOODS MADE FROM A COMPOSITE MATERIAL, NAMELY, AN ENGINEERED MATERIAL MADE OF RECYCLED WOOD AND POLYMERS USED AS A WOOD SUBSTITUTE FOR RAILINGS, IN CLASS 19 (U.S. CLS. 1, 12, 33 AND 50).

FIRST USE 4-25-2011; IN COMMERCE 4-25-2011.

THE MARK CONSISTS OF STANDARD CHARACTERS WITHOUT CLAIM TO ANY PARTICULAR FONT, STYLE, SIZE, OR COLOR.

OWNER OF U.S. REG. NO. 3,216,481.

NO CLAIM IS MADE TO THE EXCLUSIVE RIGHT TO USE "EXPRESS", APART FROM THE MARK AS SHOWN.

SER. NO. 85-351,440, FILED 6-21-2011.

ELIZABETH KAJUBI, EXAMINING ATTORNEY



David J. Kyros

Director of the United States Patent and Trademark Office

United States of America

United States Patent and Trademark Office

*Set
For you
By Cartier*

Reg. No. 4,108,139

Registered Mar. 6, 2012

Int. Cls.: 14 and 37

TRADEMARK

SERVICE MARK

PRINCIPAL REGISTER

CARTIER INTERNATIONAL A.G. (SWITZERLAND CORPORATION)
HINTERBERGSTRASSE 22, POSTFACH 61
6312 STEINHAUSEN, SWITZERLAND

FOR: JEWELRY, IN CLASS 14 (U.S. CLS. 2, 27, 28 AND 50).

FIRST USE 7-0-2009; IN COMMERCE 7-0-2009.

FOR: CUSTOMIZATION SERVICES FOR JEWELRY, IN CLASS 37 (U.S. CLS. 100, 103 AND 106).

FIRST USE 7-0-2009; IN COMMERCE 7-0-2009.

OWNER OF U.S. REG. NOS. 411,240, 897,537 AND OTHERS.

THE MARK CONSISTS OF THE STYLIZED WORDS "SET FOR YOU BY CARTIER".

SER. NO. 85-351,456, FILED 6-21-2011.

SEAN CROWLEY, EXAMINING ATTORNEY



David J. Kybas

Director of the United States Patent and Trademark Office

United States of America

United States Patent and Trademark Office

MakePace

Reg. No. 4,108,140

Registered Mar. 6, 2012

Int. Cl.: 42

SERVICE MARK

PRINCIPAL REGISTER

SECOND ROW LLC (ILLINOIS LIMITED LIABILITY COMPANY)
UNIT A
1438 N. MOHAWK ST.
CHICAGO, IL 60610

FOR: WEB-BASED APPLICATION PROVIDING TOOLS, NAMELY, PROVIDING A WEBSITE FEATURING NON-DOWNLOADABLE SOFTWARE FOR MANAGING WORKING TIME AND COMPARING WORKING TIME AND SALARY TO OTHERS, IN CLASS 42 (U.S. CLS. 100 AND 101).

FIRST USE 6-20-2011; IN COMMERCE 6-20-2011.

THE MARK CONSISTS OF STANDARD CHARACTERS WITHOUT CLAIM TO ANY PARTICULAR FONT, STYLE, SIZE, OR COLOR.

SER. NO. 85-351,611, FILED 6-21-2011.

JAMES STEIN, EXAMINING ATTORNEY



David J. Kyffers

Director of the United States Patent and Trademark Office

United States of America

United States Patent and Trademark Office

THRESHOLD COUNSEL

Reg. No. 4,108,141

Registered Mar. 6, 2012

Int. Cl.: 45

SERVICE MARK

PRINCIPAL REGISTER

THRESHOLD COUNSEL, PC (VIRGINIA CORPORATION)
4198 COX ROAD, SUITE 200
GLEN ALLEN, VA 23060

FOR: LEGAL SERVICES, IN CLASS 45 (U.S. CLS. 100 AND 101).

FIRST USE 5-15-2010; IN COMMERCE 5-15-2010.

THE MARK CONSISTS OF STANDARD CHARACTERS WITHOUT CLAIM TO ANY PARTICULAR FONT, STYLE, SIZE, OR COLOR.

NO CLAIM IS MADE TO THE EXCLUSIVE RIGHT TO USE "COUNSEL", APART FROM THE MARK AS SHOWN.

SER. NO. 85-351,647, FILED 6-21-2011.

LEIGH LOWRY, EXAMINING ATTORNEY



David J. Kybas

Director of the United States Patent and Trademark Office

United States of America

United States Patent and Trademark Office

THE MODERNIST PROJECT

Reg. No. 4,108,142

Registered Mar. 6, 2012

Int. Cl.: 41

SERVICE MARK

PRINCIPAL REGISTER

CHARLES SMITH WINES LLC (WASHINGTON LIMITED LIABILITY COMPANY)
820 MILL CREEK ROAD
WALLA WALLA, WA 99362

FOR: PROVIDING A WEB SITE FEATURING ON-LINE PUBLICATIONS IN THE NATURE OF TASTING NOTES AND ARTICLES IN THE FIELD OF WINE; ON-LINE PUBLICATION OF WINE VINTAGE AND VINEYARD SUMMARIES, HARVEST AND TASTING NOTES, AND HARVEST REPORTS; ENTERTAINMENT SERVICES, NAMELY, WINE TASTINGS, IN CLASS 41 (U.S. CLS. 100, 101 AND 107).

FIRST USE 5-19-2008; IN COMMERCE 5-19-2008.

THE MARK CONSISTS OF STANDARD CHARACTERS WITHOUT CLAIM TO ANY PARTICULAR FONT, STYLE, SIZE, OR COLOR.

SER. NO. 85-351,674, FILED 6-21-2011.

MARK PILARO, EXAMINING ATTORNEY



David J. Kybas

Director of the United States Patent and Trademark Office

United States of America

United States Patent and Trademark Office

RUN FOR OUR VETERANS

Reg. No. 4,108,143

Registered Mar. 6, 2012

Int. Cl.: 36

SERVICE MARK

PRINCIPAL REGISTER

VANDERBILT NROTC ALUMNI ASSOCIATION, INC. (TENNESSEE CORPORATION)
SUITE 3000
1350 AVENUE OF THE AMERICAS
NEW YORK, NY 10019

FOR: CHARITABLE FUND RAISING SERVICES; CHARITABLE FUND RAISING SERVICES BY MEANS OF COMPETITIVE ATHLETIC EVENTS; ACCEPTING AND ADMINISTERING MONETARY CHARITABLE CONTRIBUTIONS, IN CLASS 36 (U.S. CLS. 100, 101 AND 102).

FIRST USE 2-27-2010; IN COMMERCE 2-27-2010.

THE MARK CONSISTS OF STANDARD CHARACTERS WITHOUT CLAIM TO ANY PARTICULAR FONT, STYLE, SIZE, OR COLOR.

NO CLAIM IS MADE TO THE EXCLUSIVE RIGHT TO USE "RUN" AND "VETERANS", APART FROM THE MARK AS SHOWN.

SER. NO. 85-351,685, FILED 6-21-2011.

JEAN IM, EXAMINING ATTORNEY



David J. Kyffers

Director of the United States Patent and Trademark Office

United States of America

United States Patent and Trademark Office

Paperitis

Reg. No. 4,108,144

Registered Mar. 6, 2012

Int. Cls.: 9, 35 and 41

TRADEMARK

SERVICE MARK

PRINCIPAL REGISTER

LANFORD, INC. (DELAWARE CORPORATION)
201 PINE RIDGE
BOONE, NC 28607

FOR: AUDIO AND VIDEO RECORDINGS FEATURING COACHING AND CONSULTING INFORMATION IN THE AREA OF OFFICE EFFICIENCY, ORGANIZATION, AND PRODUCTIVITY; PROVIDING DOWNLOADABLE ELECTRONIC PUBLICATIONS IN THE NATURE OF ARTICLES, REPORTS, JOURNALS AND NEWSLETTERS IN THE FIELDS OF OFFICE EFFICIENCY, ORGANIZATION AND PRODUCTIVITY, IN CLASS 9 (U.S. CLS. 21, 23, 26, 36 AND 38).

FIRST USE 2-2-2011; IN COMMERCE 2-8-2011.

FOR: PROVIDING A WEBSITE FEATURING NON-DOWNLOADABLE AUDIO AND VIDEO RECORDINGS IN THE FIELD OF OFFICE EFFICIENCY, ORGANIZATION AND PRODUCTIVITY; PROVIDING A WEBSITE FEATURING INFORMATION IN THE FIELD OF OFFICE EFFICIENCY, ORGANIZATION AND PRODUCTIVITY; PROVIDING A WEBSITE FEATURING INFORMATION ABOUT BUSINESS CONSULTATIONS REGARDING OFFICE EFFICIENCY, ORGANIZATION AND PRODUCTIVITY, IN CLASS 35 (U.S. CLS. 100, 101 AND 102).

FIRST USE 2-2-2011; IN COMMERCE 2-8-2011.

FOR: PROVIDING A WEBSITE FEATURING ON-LINE, NON-DOWNLOADABLE PUBLICATIONS IN THE NATURE OF ARTICLES, REPORTS, JOURNALS AND NEWSLETTERS IN THE FIELDS OF OFFICE EFFICIENCY, ORGANIZATION AND PRODUCTIVITY; PROVIDING ON-LINE ELECTRONIC, NON-DOWNLOADABLE NEWSLETTERS, REPORTS, ARTICLES AND JOURNALS DELIVERED BY EMAIL IN THE FIELD OF OFFICE EFFICIENCY, ORGANIZATION AND PRODUCTIVITY, IN CLASS 41 (U.S. CLS. 100, 101 AND 107).

FIRST USE 2-2-2011; IN COMMERCE 2-8-2011.

THE MARK CONSISTS OF STANDARD CHARACTERS WITHOUT CLAIM TO ANY PARTICULAR FONT, STYLE, SIZE, OR COLOR.

SER. NO. 85-351,700, FILED 6-21-2011.



David J. Kyffers

Director of the United States Patent and Trademark Office

Reg. No. 4,108,144 KHANH LE, EXAMINING ATTORNEY

United States of America

United States Patent and Trademark Office

GRANDMA'S KITCHEN

Reg. No. 4,108,145

INTERNATIONAL MASTERS PUBLISHERS AB (SWEDEN CORPORATION)
ANGBATSBRON 1
MALMO, SWEDEN SE-21120

Registered Mar. 6, 2012

Int. Cl.: 38

FOR: PROVIDING ACCESS TO AN INTERACTIVE COMPUTER DATABASE FEATURING INFORMATION ABOUT FOOD, FOOD PREPARATION, COOKING, BAKING, RECIPES, DIET, KITCHENWARE, COOKING EQUIPMENT AND ACCESSORIES, FORUMS AND POLLS, IN CLASS 38 (U.S. CLS. 100, 101 AND 104).

SERVICE MARK

PRINCIPAL REGISTER

FIRST USE 12-2-1998; IN COMMERCE 12-2-1998.

THE MARK CONSISTS OF STANDARD CHARACTERS WITHOUT CLAIM TO ANY PARTICULAR FONT, STYLE, SIZE, OR COLOR.

OWNER OF U.S. REG. NOS. 2,666,500 AND 3,261,040.

NO CLAIM IS MADE TO THE EXCLUSIVE RIGHT TO USE "KITCHEN", APART FROM THE MARK AS SHOWN.

SER. NO. 85-351,753, FILED 6-21-2011.

SHAILA SETTLES, EXAMINING ATTORNEY



David J. Kyffers

Director of the United States Patent and Trademark Office

United States of America

United States Patent and Trademark Office

BEEDOCS

Reg. No. 4,108,146

Registered Mar. 6, 2012

Int. Cl.: 9

TRADEMARK

PRINCIPAL REGISTER

BEEDOCS, INC. (WASHINGTON CORPORATION), FORMERLY BEE DOCUMENTS, INC.
711 N 66TH ST.
SEATTLE, WA 98103

FOR: COMPUTER SOFTWARE FOR USE IN INPUT, PROCESSING, ANALYSIS, AND DISPLAY OF TEMPORAL INFORMATION, NAMELY, DATES, TIMES, GEOLOGICAL SPANS, AMOUNTS, DISTANCES, WEIGHTS, PRICES, OR QUANTITIES, IN CLASS 9 (U.S. CLS. 21, 23, 26, 36 AND 38).

FIRST USE 12-31-2003; IN COMMERCE 8-31-2008.

THE MARK CONSISTS OF STANDARD CHARACTERS WITHOUT CLAIM TO ANY PARTICULAR FONT, STYLE, SIZE, OR COLOR.

OWNER OF U.S. REG. NOS. 3,598,478 AND 3,876,031.

SER. NO. 85-351,844, FILED 6-21-2011.

MATTHEW MCDOWELL, EXAMINING ATTORNEY



David J. Kybas

Director of the United States Patent and Trademark Office

United States of America

United States Patent and Trademark Office



Reg. No. 4,108,147

Registered Mar. 6, 2012

Int. Cl.: 9

TRADEMARK

PRINCIPAL REGISTER

BEEDOCS, INC. (WASHINGTON CORPORATION), FORMERLY BEE DOCUMENTS, INC.
711 N 66TH ST.
SEATTLE, WA 98103

FOR: COMPUTER SOFTWARE FOR USE IN INPUT, PROCESSING, ANALYSIS, AND DISPLAY OF TEMPORAL INFORMATION, NAMELY, DATES, TIMES, GEOLOGICAL SPANS, AMOUNTS, DISTANCES, WEIGHTS, PRICES, OR QUANTITIES, IN CLASS 9 (U.S. CLS. 21, 23, 26, 36 AND 38).

FIRST USE 6-20-2010; IN COMMERCE 1-13-2011.

THE MARK CONSISTS OF DRAWING OF A DIARY-STYLE BOOK WITH A BLACK COVER AGAINST A WHITE BACKGROUND, OPENED TO DISPLAY TWO PAGES CONTAINING BROKEN HORIZONTAL COLOR BARS OF SALMON, GREEN, AND BLUE, GRAPHED ALONG A HORIZONTAL AXIS CONSISTING OF YEARS SPANNING 1980 TO 2030, AND CROSSED ON THE LOWER-RIGHT CORNER BY AN IMAGE OF A BLACK PEN POINTED DOWN AND LEFT WITH AN ORANGE CAP AND ORANGE TIP.

THE COLOR(S) SALMON, GREEN, BLUE, ORANGE, GRAY, BLACK, AND WHITE IS/ARE CLAIMED AS A FEATURE OF THE MARK.

SER. NO. 85-351,869, FILED 6-21-2011.

MATTHEW MCDOWELL, EXAMINING ATTORNEY



David J. Kybas

Director of the United States Patent and Trademark Office

United States of America

United States Patent and Trademark Office

inQueue

Reg. No. 4,108,148

Registered Mar. 6, 2012

Int. Cl.: 16

TRADEMARK

PRINCIPAL REGISTER

INQUEUE DESIGNS LLC (NEW YORK LIMITED LIABILITY COMPANY)
25 CENTRAL PARK WEST
NEW YORK, NY 10023

FOR: PAPER BASED DAY PLANNER FOR PERSONAL AND BUSINESS USE, FILING FOLDERS, PAPER LABELS AND PRINTED INSTRUCTIONAL MATERIALS FOR ORGANIZING PERSONAL FILES, PAPER CLIPS, PAPER FILE JACKETS, PAPER FOLDERS, PAPER FOR USE IN THE MANUFACTURE OF STATIONERY PRODUCTS, DAY PLANNERS AND ORGANIZERS, PAPER STATIONERY, PRINTING PAPERS, LEATHER APPOINTMENT BOOK COVERS, CARD FILES, FILE BOXES FOR STORAGE OF BUSINESS AND PERSONAL RECORDS, FILE POCKETS, FILING CARDS, STATIONERY, ENVELOPES, POST CARDS, NOTE CARDS, NOTE PAPER AND NOTELETS, WRITING INSTRUMENTS, GREETING CARDS, BOOK MARKS, BLANK JOURNALS AND BUSINESS RECORD BOOKS, MEMO PADS, NOTEBOOKS, DRAWING AND WRITING PADS, AND PERSONALIZED WRITING JOURNALS, CALENDARS AND DIARIES, APPOINTMENT BOOKS AND CARDS, ADDRESS AND TELEPHONE NUMBER BOOKS AND CARDS, DESKTOP ORGANIZERS, PERSONAL ORGANIZERS, ORGANIZERS FOR STATIONERY USE, PAPER BOXES, CHECKBOOK AND PASSBOOK WALLETS, DOCUMENT FOLDERS IN THE FORM OF WALLETS, CARRYING CASES MADE OF PAPER, STATIONERY CASES, AND HOLDERS FOR ALL THE AFORESAID GOODS, CARRYING CASES MADE OF PAPER, PASSPORT CASES, NOTEBOOKS, AGENDAS, DIARIES, POCKET DIARIES, STATIONERY TYPE PORTFOLIOS, BLANK AND LINED BLANK WRITING JOURNALS, ADHESIVES FOR STATIONERY PURPOSES, BLANK, LINED AND PRE PRINTED NOTE CARDS FOR WRITING, TAB NOTE CARDS WITH BLANK AND PRE PRINTED TEXT, PHOTO ALBUMS, GUEST BOOKS, STATIONERY CASES TO HOLD PAPER AND PLASTIC CARDS, SCRAP BOOKS, PERFORATED PAPER WITH DIE CUT SHAPES FOR PRINTING PURPOSES, IN CLASS 16 (U.S. CLS. 2, 5, 22, 23, 29, 37, 38 AND 50).

FIRST USE 5-12-2009; IN COMMERCE 5-12-2009.

OWNER OF U.S. REG. NOS. 3,745,407 AND 3,750,774.

THE MARK CONSISTS OF THE STYLIZED WORDING "INQUEUE", WITH THE LETTER "Q" BEING THE ONLY LETTER DISPLAYED IN UPPER CASE.

SER. NO. 85-351,960, FILED 6-21-2011.



David J. Kybas

Director of the United States Patent and Trademark Office

Reg. No. 4,108,148 DARRYL SPRUILL, EXAMINING ATTORNEY

United States of America

United States Patent and Trademark Office

Growing the Good Life

Reg. No. 4,108,149

METZGER-HAUGH, SUZANNE (UNITED STATES INDIVIDUAL)
501 IOLA ROAD
LOUISVILLE, KY 40207

Registered Mar. 6, 2012

Int. Cl.: 45

FOR: PROVIDING A FAITH-BASED RESOURCE WEBSITE PROVIDING INFORMATION REGARDING PERSONAL RELATIONSHIPS, LIFESTYLES AND FAITH VIA SOCIAL NETWORKS, IN CLASS 45 (U.S. CLS. 100 AND 101).

SERVICE MARK

FIRST USE 8-1-2009; IN COMMERCE 8-1-2009.

PRINCIPAL REGISTER

THE MARK CONSISTS OF STANDARD CHARACTERS WITHOUT CLAIM TO ANY PARTICULAR FONT, STYLE, SIZE, OR COLOR.

SER. NO. 85-352,171, FILED 6-21-2011.

PRISCILLA MILTON, EXAMINING ATTORNEY



David J. Kybas

Director of the United States Patent and Trademark Office

United States of America

United States Patent and Trademark Office



Reg. No. 4,108,150

Registered Mar. 6, 2012

Int. Cls.: 18 and 25

TRADEMARK

PRINCIPAL REGISTER

NAPPI HOLDINGS, LLC (TENNESSEE LIMITED LIABILITY COMPANY), DBA PETER NAPPI
1816 CEDAR LANE
NASHVILLE, TN 37212

FOR: LEATHER AND IMITATION LEATHER BAGS, IN CLASS 18 (U.S. CLS. 1, 2, 3, 22 AND 41).

FIRST USE 6-7-2011; IN COMMERCE 6-7-2011.

FOR: LEATHER BOOTS, IN CLASS 25 (U.S. CLS. 22 AND 39).

FIRST USE 6-7-2011; IN COMMERCE 6-7-2011.

NO CLAIM IS MADE TO THE EXCLUSIVE RIGHT TO USE "BORN 1887 EST. 2009 BOOTS BAGS & OTHER DRY GOODS VIETRI, ITALIA NASHVILLE, TENN", APART FROM THE MARK AS SHOWN.

THE NAME(S), PORTRAIT(S), AND/OR SIGNATURE(S) SHOWN IN THE MARK DOES NOT IDENTIFY A PARTICULAR LIVING INDIVIDUAL.

THE MARK CONSISTS OF THE WORDS "PETER NAPPI" IN CURSIVE AND APPEARING OVER THE MIDDLE OF TWO CIRCLES (ONE WITHIN THE OTHER), WITH THE WORDS "BOOTS BAGS & OTHER DRY GOODS" APPEARING BETWEEN THE TWO CIRCLES AND ABOVE "PETER NAPPI", AND "VIETRI, ITALIA · NASHVILLE, TENN" APPEARING BETWEEN THE TWO CIRCLES AND BELOW "PETER NAPPI", AND "BORN 1887" (UNDERLINED) APPEARING ABOVE "PETER NAPPI" INSIDE THE INNER CIRCLE, AND "EST. 2009" (WITH A LINE ABOVE THESE WORDS) APPEARING BELOW "PETER NAPPI" INSIDE THE INNER CIRCLE.

THE ENGLISH TRANSLATION OF "ITALIA" IN THE MARK IS "ITALY".

SER. NO. 85-352,314, FILED 6-21-2011.

ROSELLE HERRERA, EXAMINING ATTORNEY



David J. Kyros

Director of the United States Patent and Trademark Office

United States of America

United States Patent and Trademark Office

PRIMAL EDUCATION

Reg. No. 4,108,151

Registered Mar. 6, 2012

Int. Cl.: 41

SERVICE MARK

PRINCIPAL REGISTER

ISEGHOHI, AMEN (UNITED STATES INDIVIDUAL)
APT. 1307
19777 N. 76TH STREET
SCOTTSDALE, AZ 85255

FOR: EDUCATION SERVICES, NAMELY, PROVIDING CLASSES IN THE FIELD OF NUTRITION, FITNESS AND SELF ESTEEM, IN CLASS 41 (U.S. CLS. 100, 101 AND 107).

FIRST USE 3-1-2011; IN COMMERCE 3-1-2011.

THE MARK CONSISTS OF STANDARD CHARACTERS WITHOUT CLAIM TO ANY PARTICULAR FONT, STYLE, SIZE, OR COLOR.

NO CLAIM IS MADE TO THE EXCLUSIVE RIGHT TO USE "EDUCATION", APART FROM THE MARK AS SHOWN.

SER. NO. 85-352,427, FILED 6-22-2011.

CARYN GLASSER, EXAMINING ATTORNEY



David J. Kyffers

Director of the United States Patent and Trademark Office

United States of America

United States Patent and Trademark Office

ZIDENT

Reg. No. 4,108,152

MOORE, JARED (UNITED STATES INDIVIDUAL)
948 W 3070 N
LEHI, UT 84043

Registered Mar. 6, 2012

Int. Cl.: 10

FOR: DENTAL PROSTHESES; CERAMIC ALLOY USED IN DENTAL CROWNS; DENTAL PRODUCTS, NAMELY, CROWNS, BRIDGES, IMPLANTS, DENTURES, PARTIAL DENTURES, IN CLASS 10 (U.S. CLS. 26, 39 AND 44).

TRADEMARK

FIRST USE 6-1-2011; IN COMMERCE 6-1-2011.

PRINCIPAL REGISTER

THE MARK CONSISTS OF STANDARD CHARACTERS WITHOUT CLAIM TO ANY PARTICULAR FONT, STYLE, SIZE, OR COLOR.

SER. NO. 85-352,440, FILED 6-22-2011.

EMILY CHUO, EXAMINING ATTORNEY



David J. Kybas

Director of the United States Patent and Trademark Office

United States of America

United States Patent and Trademark Office



Reg. No. 4,108,153

Registered Mar. 6, 2012

Int. Cl.: 36

SERVICE MARK

PRINCIPAL REGISTER

ALYN HOSPITAL PEDIATRIC & ADOLESCENT REHABILITATION CENTER (ISRAEL
NON-PROFIT CORPORATION)
SHMARYAHU LEVIN STREET 84
KIRYAT HAYOVEL P.O.B 9117
JERUSALEM 91090, ISRAEL

FOR: CHARITABLE FUNDRAISING SERVICES, IN CLASS 36 (U.S. CLS. 100, 101 AND 102).

FIRST USE 12-0-2000; IN COMMERCE 12-0-2000.

THE MARK CONSISTS OF TWO HUMAN FIGURES, ONE WITH A CIRCULAR IMAGE ABOVE ITS RIGHT HAND AND ITS LEFT ARM AROUND THE OTHER FIGURE, BOTH ABOVE THE HEBREW SCRIPT OF "ALYN" WITH A CIRCULAR IMAGE CENTERED BELOW THE HEBREW SCRIPT.

THE NON-LATIN CHARACTERS IN THE MARK TRANSLITERATE TO "ALYN," AND THIS HAS NO MEANING IN A FOREIGN LANGUAGE.

SER. NO. 85-352,513, FILED 6-22-2011.

WILLIAM VERHOSEK, EXAMINING ATTORNEY



David J. Kyffers

Director of the United States Patent and Trademark Office

United States of America

United States Patent and Trademark Office

EPICOR

Reg. No. 4,108,154

Registered Mar. 6, 2012

Int. Cl.: 1

TRADEMARK

PRINCIPAL REGISTER

EMBRIA HEALTH SCIENCES, L.L.C. (IOWA LIMITED LIABILITY COMPANY)
P.O. BOX 2815
CEDAR RAPIDS, IA 52406

FOR: RAW MATERIALS FOR HUMAN AND ANIMAL HEALTH, NAMELY, CHEMICALS FOR USE IN THE MANUFACTURE OF DIETARY AND NUTRITIONAL SUPPLEMENTS, FOODS STUFFS AND BEVERAGES, IN CLASS 1 (U.S. CLS. 1, 5, 6, 10, 26 AND 46).

FIRST USE 3-23-2006; IN COMMERCE 3-23-2006.

THE MARK CONSISTS OF STANDARD CHARACTERS WITHOUT CLAIM TO ANY PARTICULAR FONT, STYLE, SIZE, OR COLOR.

OWNER OF U.S. REG. NOS. 3,137,307, 3,752,623 AND OTHERS.

SER. NO. 85-352,574, FILED 6-22-2011.

CURTIS FRENCH, EXAMINING ATTORNEY



David J. Kyros

Director of the United States Patent and Trademark Office

United States of America

United States Patent and Trademark Office

NUCUT

Reg. No. 4,108,155

PERFORMANCE BIOLUBES, L.L.C. (IOWA LIMITED LIABILITY COMPANY)
8011 PARKSIDE AVE
MORTON GROVE, IL 60053

Registered Mar. 6, 2012

Int. Cls.: 1 and 4

FOR: QUENCHING FLUIDS FOR USE IN METALWORKING, IN CLASS 1 (U.S. CLS. 1, 5, 6, 10, 26 AND 46).

TRADEMARK

FIRST USE 12-31-2004; IN COMMERCE 12-31-2004.

PRINCIPAL REGISTER

FOR: ALL PURPOSE LUBRICANTS AND INDUSTRIAL LUBRICANTS; CUTTING FLUIDS AND LUBRICANTS, NAMELY, GRINDING FLUIDS FOR USE IN METALWORKING, CUTTING OIL FOR USE IN INDUSTRIAL METAL WORKING, IN CLASS 4 (U.S. CLS. 1, 6 AND 15).

FIRST USE 12-31-2004; IN COMMERCE 12-31-2004.

THE MARK CONSISTS OF STANDARD CHARACTERS WITHOUT CLAIM TO ANY PARTICULAR FONT, STYLE, SIZE, OR COLOR.

SER. NO. 85-352,592, FILED 6-22-2011.

MICHAEL TANNER, EXAMINING ATTORNEY



David J. Kybas

Director of the United States Patent and Trademark Office

United States of America

United States Patent and Trademark Office



Reg. No. 4,108,156

Registered Mar. 6, 2012

Int. Cl.: 36

SERVICE MARK

PRINCIPAL REGISTER

DOGOODBUYUS LLC (DELAWARE LIMITED LIABILITY COMPANY)
77 EAST 12TH STREET, UNIT 8E
NEW YORK, NY 10003

FOR: CHARITABLE FUNDRAISING SERVICES BY MEANS OF SELLING GOODS TO RAISE FUNDS; CHARITABLE FUNDRAISING SERVICES, IN CLASS 36 (U.S. CLS. 100, 101 AND 102).

FIRST USE 5-25-2011; IN COMMERCE 5-25-2011.

THE MARK CONSISTS OF A RECTANGULAR LOZENGE WITH ROUNDED EDGES BORDERED IN CONCENTRIC RINGS OVER WHICH IS SUPERIMPOSED A BANNER PLACED ON THE DIAGONAL FROM THE UPPER LEFT HAND CORNER AND DESCENDING DOWNWARD. THE BANNER IS SURROUNDED BY FIVE STARS ABOVE AND FOUR STARS BENEATH. THE BANNER DISPLAYS THE WORDS "DOGOOD". THE RECTANGULAR LOZENGE CONTAINS THE WORDS "BUY US" IMMEDIATELY BELOW, AND ABOVE TWO HORIZONTAL LINES DIVIDED BY A STAR, AND BENEATH IS THE LETTERING "DOGOODBUY.US". THE LOZENGE IS CENTERED OVER A SERIES OF 40 TAPERED LINES RADIATING FROM THE CENTER.

SER. NO. 85-352,646, FILED 6-22-2011.

JORDAN BAKER, EXAMINING ATTORNEY



David J. Kybas

Director of the United States Patent and Trademark Office

United States of America

United States Patent and Trademark Office

ROCKER GIRL

Reg. No. 4,108,157

Registered Mar. 6, 2012

Int. Cl.: 25

TRADEMARK

PRINCIPAL REGISTER

ALL ACCESS APPAREL, INC. (CALIFORNIA CORPORATION)
1515 GAGE ROAD
MONTEBELLO, CA 90640

FOR: TOPS, IN CLASS 25 (U.S. CLS. 22 AND 39).

FIRST USE 4-10-2008; IN COMMERCE 4-10-2008.

THE MARK CONSISTS OF STANDARD CHARACTERS WITHOUT CLAIM TO ANY PARTICULAR FONT, STYLE, SIZE, OR COLOR.

NO CLAIM IS MADE TO THE EXCLUSIVE RIGHT TO USE "GIRL", APART FROM THE MARK AS SHOWN.

SER. NO. 85-352,829, FILED 6-22-2011.

DANIEL CAPSHAW, EXAMINING ATTORNEY



David J. Kyffers

Director of the United States Patent and Trademark Office

United States of America

United States Patent and Trademark Office



Stair Lift
RENTALS INC.

Reg. No. 4,108,158

Registered Mar. 6, 2012

Int. Cls.: 37 and 39

SERVICE MARK

PRINCIPAL REGISTER

STAIR LIFT RENTALS INC. (COLORADO CORPORATION)
1624 MARKET STREET, SUITE 202
DENVER, CO 80202

FOR: INSTALLATION, MAINTENANCE AND REPAIR OF MOTORIZED STAIR CHAIRS FOR RESIDENTIAL OR COMMERCIAL USE, IN CLASS 37 (U.S. CLS. 100, 103 AND 106).

FIRST USE 1-6-2009; IN COMMERCE 1-6-2009.

FOR: RENTAL OF MOTORIZED STAIR CHAIRS FOR RESIDENTIAL OR COMMERCIAL USE, IN CLASS 39 (U.S. CLS. 100 AND 105).

FIRST USE 1-6-2009; IN COMMERCE 1-6-2009.

NO CLAIM IS MADE TO THE EXCLUSIVE RIGHT TO USE "STAIR LIFT RENTALS INC.", APART FROM THE MARK AS SHOWN.

THE COLOR(S) BLUE, WHITE AND GREEN IS/ARE CLAIMED AS A FEATURE OF THE MARK.

THE MARK CONSISTS OF A GRAPHICAL DEPICTION OF A MOTORIZED CHAIR IN THE COLOR BLUE POISED OVER A SET OF STAIRS IN THE COLOR GREEN WITH WHITE STEPS ALL OF WHICH IS ABOVE THE WORDS "STAIR LIFT" IN THE COLOR BLUE WHICH IS ABOVE THE WORDS "RENTAL INC." IN THE COLOR GREEN.

SER. NO. 85-352,964, FILED 6-22-2011.

B. PARADEWELAI, EXAMINING ATTORNEY



David J. Kybas

Director of the United States Patent and Trademark Office

United States of America

United States Patent and Trademark Office

TERMINOX

Reg. No. 4,108,159

Registered Mar. 6, 2012

Int. Cl.: 11

TRADEMARK

PRINCIPAL REGISTER

BUDGET WATER INTERNATIONAL, INC. (PENNSYLVANIA CORPORATION)
700 BLAW AVENUE
PITTSBURG, PA 15238

FOR: WATER FILTRATION AND PURIFICATION UNIT FOR REMOVING IRON, SULFUR AND MANGANESE FROM PRIVATE WELL WATER, IN CLASS 11 (U.S. CLS. 13, 21, 23, 31 AND 34).

FIRST USE 0-0-2000; IN COMMERCE 0-0-2000.

THE MARK CONSISTS OF STANDARD CHARACTERS WITHOUT CLAIM TO ANY PARTICULAR FONT, STYLE, SIZE, OR COLOR.

SER. NO. 85-352,992, FILED 6-22-2011.

CAROLINE WOOD, EXAMINING ATTORNEY



David J. Kyffers

Director of the United States Patent and Trademark Office

United States of America

United States Patent and Trademark Office

I CAN STILL SHINE PROGRAM

Reg. No. 4,108,160

Registered Mar. 6, 2012

Int. Cl.: 45

SERVICE MARK

PRINCIPAL REGISTER

I CAN STILL SHINE PROGRAM INC. (TEXAS CORPORATION)
P.O. BOX 54884
HURST, TX 76054

FOR: CHARITABLE SERVICES, NAMELY, PROVIDING CLOTHING TO NEEDY PERSONS,
IN CLASS 45 (U.S. CLS. 100 AND 101).

FIRST USE 2-11-2011; IN COMMERCE 2-11-2011.

THE MARK CONSISTS OF STANDARD CHARACTERS WITHOUT CLAIM TO ANY PAR-
TICULAR FONT, STYLE, SIZE, OR COLOR.

NO CLAIM IS MADE TO THE EXCLUSIVE RIGHT TO USE "PROGRAM", APART FROM
THE MARK AS SHOWN.

SER. NO. 85-353,000, FILED 6-22-2011.

CAROLINE WOOD, EXAMINING ATTORNEY



David J. Kybas

Director of the United States Patent and Trademark Office

United States of America
United States Patent and Trademark Office

PUSHBAN

Reg. No. 4,108,161

NIPRO CORPORATION (JAPAN CORPORATION)
9-3, HONJO-NISHI 3-CHOME, KITA-KU
OSAKA-SHI, OSAKA, JAPAN

Registered Mar. 6, 2012

Int. Cl.: 5

FOR: ADHESIVE MEDICAL PLASTERS AND ADHESIVE BANDAGES, IN CLASS 5 (U.S. CLS. 6, 18, 44, 46, 51 AND 52).

TRADEMARK

FIRST USE 4-0-1994; IN COMMERCE 7-0-2010.

PRINCIPAL REGISTER

THE MARK CONSISTS OF STANDARD CHARACTERS WITHOUT CLAIM TO ANY PARTICULAR FONT, STYLE, SIZE, OR COLOR.

SER. NO. 85-353,127, FILED 6-22-2011.

FRED CARL, EXAMINING ATTORNEY



David J. Kyros

Director of the United States Patent and Trademark Office

United States of America

United States Patent and Trademark Office



Reg. No. 4,108,162

Registered Mar. 6, 2012

Int. Cl.: 25

TRADEMARK

PRINCIPAL REGISTER

MCCLORIA, PROVINE, III (UNITED STATES INDIVIDUAL)
5711 SATURN AVE.
LOS ANGELES, CA 90019

FOR: CLOTHING, NAMELY, DRESSES, IN CLASS 25 (U.S. CLS. 22 AND 39).

FIRST USE 12-4-2007; IN COMMERCE 6-1-2011.

THE MARK CONSISTS OF A DESIGN OF A WOMAN SHOWN IN BLACK BEIGE AND PINK, WITH A LOLLYPOP IN HER MOUTH SHOWN IN BLACK, WHITE AND RED, CONTAINED WITHIN A DOUBLE CIRCLE SHOWN IN BLACK, PINK AND WHITE AND THE WORDING "TASTY SIMONE" SHOWN IN BLACK WHITE AND PINK.

THE COLOR(S) BLACK, BEIGE, PINK, WHITE AND RED IS/ARE CLAIMED AS A FEATURE OF THE MARK.

SER. NO. 85-353,134, FILED 6-22-2011.

FRED CARL, EXAMINING ATTORNEY



David J. Kyfos

Director of the United States Patent and Trademark Office

United States of America

United States Patent and Trademark Office

ABA Business of Banking School

Reg. No. 4,108,163

Registered Mar. 6, 2012

Int. Cl.: 41

SERVICE MARK

PRINCIPAL REGISTER

AMERICAN BANKERS ASSOCIATION (D.C. CORPORATION)
1120 CONNECTICUT AVE, NW
WASHINGTON, DC 20036

FOR: EDUCATIONAL SERVICES, NAMELY, CONDUCTING COURSES IN FINANCIAL ANALYSIS AND MANAGEMENT, IN CLASS 41 (U.S. CLS. 100, 101 AND 107).

FIRST USE 9-1-2002, THE MARK WAS FIRST USED ANYWHERE IN A DIFFERENT FORM OTHER THAN THAT SOUGHT TO BE REGISTERED AT LEAST AS EARLY AS 10/18/2002.; IN COMMERCE 9-1-2002, THE MARK WAS FIRST USED IN COMMERCE IN A DIFFERENT FORM OTHER THAN THAT SOUGHT TO BE REGISTERED AT LEAST AS EARLY AS 09/01/2002..

THE MARK CONSISTS OF STANDARD CHARACTERS WITHOUT CLAIM TO ANY PARTICULAR FONT, STYLE, SIZE, OR COLOR.

OWNER OF U.S. REG. NOS. 2,993,649, 3,156,179 AND OTHERS.

NO CLAIM IS MADE TO THE EXCLUSIVE RIGHT TO USE "SCHOOL" , APART FROM THE MARK AS SHOWN.

SEC. 2(F).

SER. NO. 85-353,210, FILED 6-22-2011.

KRISTIN DAHLING, EXAMINING ATTORNEY



David J. Kyjars

Director of the United States Patent and Trademark Office

United States of America

United States Patent and Trademark Office

ZEE CIGS

Reg. No. 4,108,164

ZANZA BLUE, INC. (NEVADA CORPORATION)
5348 VEGAS DRIVE
LAS VEGAS, NV 89108

Registered Mar. 6, 2012

Int. Cls.: 34 and 35

FOR: ELECTRONIC CIGARETTES; ELECTRONIC CIGARETTES' COMPONENTS, PARTS AND STRUCTURAL PARTS, NAMELY, REFILL CARTRIDGES, CARTOMISERS AND ATOMIZERS , IN CLASS 34 (U.S. CLS. 2, 8, 9 AND 17).

TRADEMARK

FIRST USE 12-1-2010; IN COMMERCE 12-1-2010.

SERVICE MARK

FOR: ON-LINE RETAIL STORE SERVICES FEATURING ELECTRONIC CIGARETTES AND ELECTRONIC CIGARETTE COMPONENTS, IN CLASS 35 (U.S. CLS. 100, 101 AND 102).

PRINCIPAL REGISTER

FIRST USE 12-1-2010; IN COMMERCE 12-1-2010.

THE MARK CONSISTS OF STANDARD CHARACTERS WITHOUT CLAIM TO ANY PARTICULAR FONT, STYLE, SIZE, OR COLOR.

NO CLAIM IS MADE TO THE EXCLUSIVE RIGHT TO USE "CIGS", APART FROM THE MARK AS SHOWN.

SER. NO. 85-353,243, FILED 6-22-2011.

CURTIS FRENCH, EXAMINING ATTORNEY



David J. Kypos

Director of the United States Patent and Trademark Office

United States of America

United States Patent and Trademark Office



Reg. No. 4,108,165

Registered Mar. 6, 2012

Int. Cl.: 36

SERVICE MARK

PRINCIPAL REGISTER

BAHAMA BEACH CLUB, LTD. (BAHAMAS LIMITED COMPANY (LTD.))
C/O GRAHAM THOMPSON & CO.
SHIRLEY STREET & VICTORIA AVE.
NASSAU, BAHAMAS NP

FOR: ARRANGING OF LEASES AND RENTAL AGREEMENTS FOR REAL ESTATE; CLASSIFIED REAL ESTATE LISTINGS OF APARTMENT RENTALS, CONDOMINIUM RENTALS, AND HOUSING RENTALS; PROVIDING AN INTERNET WEBSITE PORTAL OFFERING INFORMATION IN THE FIELDS OF REAL ESTATE CONCERNING THE PURCHASE AND SALE OF NEW AND RESALE HOMES AND CONDOMINIUMS; REAL ESTATE LISTING SERVICES FOR HOUSING RENTALS, CONDOMINIUM RENTALS, APARTMENT RENTALS; REAL ESTATE MANAGEMENT OF VACATION HOMES AND CONDOMINIUMS; REAL ESTATE RENTAL SERVICES, NAMELY, RENTAL OF RESIDENTIAL HOUSING; REAL ESTATE SERVICES, NAMELY, RENTAL PROPERTY MANAGEMENT; REAL ESTATE SERVICES, NAMELY, LEASING AND MANAGEMENT FOR OTHERS OF RESIDENTIAL CONDOMINIUMS LOCATED WITHIN RESORT DEVELOPMENTS; REAL ESTATE SERVICES, NAMELY, RENTAL OF SHORT-TERM FURNISHED CONDOMINIUMS; REAL ESTATE SERVICES, NAMELY, RENTAL OF VACATION HOMES; REAL ESTATE SERVICES, NAMELY, RENTAL OF VACATION HOMES, CONDOMINIUMS, CABINS, AND VILLAS USING PAY PER CLICK ADVERTISING ON A GLOBAL COMPUTER NETWORK; REAL ESTATE SERVICES, NAMELY, VACATION HOME AND CONDOMINIUM RENTAL MANAGEMENT SERVICES; RENTAL OF HOMES AND CONDOMINIUMS, IN CLASS 36 (U.S. CLS. 100, 101 AND 102).

FIRST USE 11-0-2002; IN COMMERCE 11-0-2002.

NO CLAIM IS MADE TO THE EXCLUSIVE RIGHT TO USE "BAHAMA BEACH CLUB", APART FROM THE MARK AS SHOWN.

THE MARK CONSISTS OF THE WORDING "BAHAMA BEACH CLUB" IN STYLIZED FONT, BETWEEN THE WORDING "BAHAMA" AND "BEACH" APPEARS THREE OVERLAPPING SILHOUETTES OF DOLPHINS.

SER. NO. 85-353,290, FILED 6-22-2011.

MICHELE SWAIN, EXAMINING ATTORNEY



David J. Kyros

Director of the United States Patent and Trademark Office

United States of America

United States Patent and Trademark Office

Africa Reads

Reg. No. 4,108,166

AFRICA READS, INC. (RHODE ISLAND LIMITED LIABILITY COMPANY)
334 WICKENDEN STREET
PROVIDENCE, RI 02903

Registered Mar. 6, 2012

Int. Cl.: 41

FOR: CHARITABLE SERVICES, NAMELY, PROVIDING BOOKS AND SCHOOL SUPPLIES TO CHILDREN IN AFRICA, IN CLASS 41 (U.S. CLS. 100, 101 AND 107).

SERVICE MARK

FIRST USE 12-9-2005; IN COMMERCE 12-9-2005.

PRINCIPAL REGISTER

THE MARK CONSISTS OF STANDARD CHARACTERS WITHOUT CLAIM TO ANY PARTICULAR FONT, STYLE, SIZE, OR COLOR.

NO CLAIM IS MADE TO THE EXCLUSIVE RIGHT TO USE "AFRICA", APART FROM THE MARK AS SHOWN.

SER. NO. 85-353,425, FILED 6-22-2011.

JEFFREY LOOK, EXAMINING ATTORNEY



David J. Kybas

Director of the United States Patent and Trademark Office

United States of America

United States Patent and Trademark Office

HAWAII RANCHERS

Reg. No. 4,108,167

Registered Mar. 6, 2012

Int. Cl.: 29

HAWAII CATTLE PRODUCERS COOPERATIVE ASSOCIATION (HAWAII COOPERATIVE ASSOCIATION)
P.O. BOX 437199
KAMUELA, HI 96743

FOR: BEEF, IN CLASS 29 (U.S. CL. 46).

TRADEMARK

FIRST USE 4-30-2009; IN COMMERCE 5-20-2009.

PRINCIPAL REGISTER

THE MARK CONSISTS OF STANDARD CHARACTERS WITHOUT CLAIM TO ANY PARTICULAR FONT, STYLE, SIZE, OR COLOR.

NO CLAIM IS MADE TO THE EXCLUSIVE RIGHT TO USE "HAWAII", APART FROM THE MARK AS SHOWN.

SER. NO. 85-353,555, FILED 6-22-2011.

KIMBERLY PERRY, EXAMINING ATTORNEY



David J. Kyffers

Director of the United States Patent and Trademark Office

United States of America

United States Patent and Trademark Office



Reg. No. 4,108,168

Registered Mar. 6, 2012

Int. Cl.: 9

TRADEMARK

PRINCIPAL REGISTER

DIGITOPE LIMITED (UNITED KINGDOM CORPORATION)
16 PORTLAND HOUSE, STAG PLACE
LONDON, UNITED KINGDOM SW1E5RS

FOR: COMPUTER GRAPHICS SOFTWARE; COMPUTER SOFTWARE FOR PROCESSING DIGITAL IMAGES; COMPUTER SOFTWARE FOR PROCESSING DIGITAL MUSIC FILES , IN CLASS 9 (U.S. CLS. 21, 23, 26, 36 AND 38).

FIRST USE 2-6-2009; IN COMMERCE 2-6-2009.

THE MARK CONSISTS OF TRISKELION WITH RED, GREEN AND BLUE LEGS OVER A WHITE CIRCLE. THE COLOR GRAY REPRESENTS SHADING FOR CONTRAST PURPOSES AND IS NOT PART OF THE MARK.

THE COLOR(S) RED, GREEN, BLUE AND WHITE IS/ARE CLAIMED AS A FEATURE OF THE MARK.

SER. NO. 85-353,759, FILED 6-23-2011.

DAVID HOFFMAN, EXAMINING ATTORNEY



David J. Kyffers

Director of the United States Patent and Trademark Office

United States of America

United States Patent and Trademark Office



Reg. No. 4,108,169

Registered Mar. 6, 2012

Int. Cl.: 39

SERVICE MARK

PRINCIPAL REGISTER

VANGUARD TRADEMARK HOLDINGS USA, LLC (DELAWARE LIMITED LIABILITY COMPANY)
600 CORPORATE PARK DRIVE
ST. LOUIS, MO 63105

FOR: VEHICLE RENTING AND LEASING SERVICES AND RESERVATION SERVICES FOR THE RENTAL AND LEASING OF VEHICLES, IN CLASS 39 (U.S. CLS. 100 AND 105).

FIRST USE 5-1-2009; IN COMMERCE 5-1-2009.

OWNER OF U.S. REG. NOS. 2,405,024, 2,427,041 AND OTHERS.

NO CLAIM IS MADE TO THE EXCLUSIVE RIGHT TO USE "DRIVE", APART FROM THE MARK AS SHOWN.

THE MARK CONSISTS OF THE STYLIZED WORD "ALAMO" INSIDE OF A RECTANGLE WITH CURVED SIDES; BELOW ARE THE STYLIZED WORDS "DRIVE HAPPY".

SER. NO. 85-353,785, FILED 6-23-2011.

MARY CRAWFORD, EXAMINING ATTORNEY



David J. Kybas

Director of the United States Patent and Trademark Office

United States of America

United States Patent and Trademark Office

SKILLS@SEA

Reg. No. 4,108,170

Registered Mar. 6, 2012

Int. Cl.: 39

SERVICE MARK

PRINCIPAL REGISTER

LINDBLAD EXPEDITIONS, INC. (NEW YORK CORPORATION)
96 MORTON STREET
NEW YORK, NY 10014

FOR: TOUR GUIDE SERVICES; PLEASURE CRUISE SHIP SERVICES; ARRANGING AND CONDUCTING CRUISE SHIP EXPEDITIONS WORLDWIDE, IN CLASS 39 (U.S. CLS. 100 AND 105).

FIRST USE 10-0-2010; IN COMMERCE 10-0-2010.

THE MARK CONSISTS OF STANDARD CHARACTERS WITHOUT CLAIM TO ANY PARTICULAR FONT, STYLE, SIZE, OR COLOR.

SER. NO. 85-353,822, FILED 6-23-2011.

BRIAN PINO, EXAMINING ATTORNEY



David J. Kybas

Director of the United States Patent and Trademark Office

United States of America

United States Patent and Trademark Office

DIZZ

Reg. No. 4,108,171

Registered Mar. 6, 2012

Int. Cls.: 20 and 24

TRADEMARK

PRINCIPAL REGISTER

DIAZ SUNPROTECTION NV (BELGIUM CORPORATION)
RUISELEEDSESTEENWEG 3
TIELT, BELGIUM 8700 AND

DM CROSS ASSOCIATES, LLC (DELAWARE LIMITED LIABILITY COMPANY)
15 OAKWOOD AVENUE
NORWALK, CT 06850

FOR: WINDOW SHADES, IN CLASS 20 (U.S. CLS. 2, 13, 22, 25, 32 AND 50).

FIRST USE 5-14-2011; IN COMMERCE 5-14-2011.

FOR: CURTAIN FABRICS; TEXTILE FABRICS FOR HOME AND COMMERCIAL INTERIORS;
AND FABRIC WINDOW COVERINGS AND TREATMENTS, NAMELY, CURTAINS,
DRAPERIES, SHEERS, SWAGS, AND VALANCES, IN CLASS 24 (U.S. CLS. 42 AND 50).

FIRST USE 3-10-2010; IN COMMERCE 3-10-2010.

THE MARK CONSISTS OF STANDARD CHARACTERS WITHOUT CLAIM TO ANY PAR-
TICULAR FONT, STYLE, SIZE, OR COLOR.

SER. NO. 85-353,836, FILED 6-23-2011.

REBECCA SMITH, EXAMINING ATTORNEY



David J. Kybas

Director of the United States Patent and Trademark Office

United States of America

United States Patent and Trademark Office

CARNE ALOTA

Reg. No. 4,108,172

Registered Mar. 6, 2012

Int. Cl.: 30

TRADEMARK

PRINCIPAL REGISTER

MIGHTY TACO, INC. (NEW YORK CORPORATION)
9362 TRANSIT ROAD
EAST AMHERST, NY 14051

FOR: A BURRITO WITH MEAT, IN CLASS 30 (U.S. CL. 46).

FIRST USE 5-16-2011; IN COMMERCE 5-26-2011.

THE MARK CONSISTS OF STANDARD CHARACTERS WITHOUT CLAIM TO ANY PARTICULAR FONT, STYLE, SIZE, OR COLOR.

NO CLAIM IS MADE TO THE EXCLUSIVE RIGHT TO USE "CARNE", APART FROM THE MARK AS SHOWN.

THE ENGLISH TRANSLATION OF "CARNE" IS MEAT.

SER. NO. 85-353,837, FILED 6-23-2011.

BRIAN PINO, EXAMINING ATTORNEY



David J. Kyffers

Director of the United States Patent and Trademark Office

United States of America

United States Patent and Trademark Office

HEALTH ARCHITECT

Reg. No. 4,108,173

Registered Mar. 6, 2012

Int. Cl.: 5

TRADEMARK

PRINCIPAL REGISTER

O'BRIEN, PATRICK (UNITED STATES INDIVIDUAL)
5049 FRANCE AVENUE SOUTH
MINNEAPOLIS, MN 55410

FOR: NUTRITIONAL SUPPLEMENTS, IN CLASS 5 (U.S. CLS. 6, 18, 44, 46, 51 AND 52).

FIRST USE 12-1-2000; IN COMMERCE 12-1-2000.

THE MARK CONSISTS OF STANDARD CHARACTERS WITHOUT CLAIM TO ANY PARTICULAR FONT, STYLE, SIZE, OR COLOR.

NO CLAIM IS MADE TO THE EXCLUSIVE RIGHT TO USE "HEALTH", APART FROM THE MARK AS SHOWN.

SER. NO. 85-353,841, FILED 6-23-2011.

JEFFREY LOOK, EXAMINING ATTORNEY



David J. Kybas

Director of the United States Patent and Trademark Office

United States of America

United States Patent and Trademark Office

HEALTH ARCHITECT

Reg. No. 4,108,174

Registered Mar. 6, 2012

Int. Cl.: 44

SERVICE MARK

PRINCIPAL REGISTER

O'BRIEN, PATRICK (UNITED STATES INDIVIDUAL)
5049 FRANCE AVENUE SOUTH
MINNEAPOLIS, MN 55410

FOR: CHIROPRACTIC SERVICES, NAMELY, COUNSELING IN THE FIELD OF CHIROPRACTIC MEDICINE, NUTRITION, PHYSICAL THERAPY, AND ACUPUNCTURE THERAPY, IN CLASS 44 (U.S. CLS. 100 AND 101).

FIRST USE 12-1-2000; IN COMMERCE 12-1-2000.

THE MARK CONSISTS OF STANDARD CHARACTERS WITHOUT CLAIM TO ANY PARTICULAR FONT, STYLE, SIZE, OR COLOR.

NO CLAIM IS MADE TO THE EXCLUSIVE RIGHT TO USE "HEALTH", APART FROM THE MARK AS SHOWN.

SER. NO. 85-353,862, FILED 6-23-2011.

JEFFREY LOOK, EXAMINING ATTORNEY



David J. Kybas

Director of the United States Patent and Trademark Office

United States of America

United States Patent and Trademark Office



Reg. No. 4,108,175

LUFKIN, KENT (UNITED STATES INDIVIDUAL)
16736 NE 42ND COURT
REDMOND, WA 98052

Registered Mar. 6, 2012

Int. Cl.: 24

FOR: HAND-MADE LINEN PIECE GOODS, IN CLASS 24 (U.S. CLS. 42 AND 50).

TRADEMARK

FIRST USE 11-11-2008; IN COMMERCE 11-11-2008.

PRINCIPAL REGISTER

NO CLAIM IS MADE TO THE EXCLUSIVE RIGHT TO USE "HAND-MADE", "RAW MATERIALS" AND "DESIGNS", APART FROM THE MARK AS SHOWN.

THE MARK CONSISTS OF A STYLIZED ROUND SEAL WITH THE TEXT "RAW RM MATERIALS" STACKED IN THE CENTER, AND SURROUNDED BY THE WORDS "HAND-MADE DOWN TO EARTH DESIGNS", WITH TWO DOTS SEPARATING "HAND-MADE" AT THE TOP AND "DOWN TO EARTH DESIGNS" AT THE BOTTOM.

SER. NO. 85-353,884, FILED 6-23-2011.

KATHY DE JONGE, EXAMINING ATTORNEY



David J. Kybas

Director of the United States Patent and Trademark Office

United States of America

United States Patent and Trademark Office

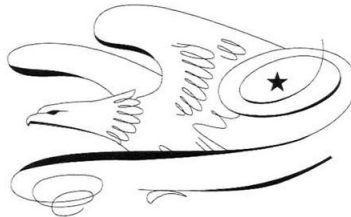

Reg. No. 4,108,176

Registered Mar. 6, 2012

Int. Cl.: 41

SERVICE MARK

PRINCIPAL REGISTER

EAGLE ENDURANCE, LLC (SOUTH CAROLINA LIMITED LIABILITY COMPANY)
250 ALSTON CIRCLE
GOOSE CREEK, SC 29445

FOR: ATHLETIC AND SPORTS EVENT SERVICES, NAMELY, ARRANGING, ORGANIZING, OPERATING AND CONDUCTING RUNNING RACES, IN CLASS 41 (U.S. CLS. 100, 101 AND 107).

FIRST USE 4-9-2011; IN COMMERCE 4-9-2011.

THE MARK CONSISTS OF A STYLIZED EAGLE IN FLIGHT WITH A FIVE POINT STAR AT THE REAR OF THE NEAREST WING AND TWO SPIRAL DESIGNS WITH ONE AT THE LOWER LEFT OF THE EAGLE CONNECTED TO ONE SURROUNDING THE STAR BY A CURVED LINE. THERE IS ONE PARALLEL CURVED LINE AT THE BOTTOM OF THE DESIGN.

SER. NO. 85-353,934, FILED 6-23-2011.

JEFFREY LOOK, EXAMINING ATTORNEY



David J. Kybas

Director of the United States Patent and Trademark Office

United States of America

United States Patent and Trademark Office



Reg. No. 4,108,177

Registered Mar. 6, 2012

Int. Cl.: 5

TRADEMARK

PRINCIPAL REGISTER

O'BRIEN, PATRICK (UNITED STATES INDIVIDUAL)
5049 FRANCE AVENUE SOUTH
MINNEAPOLIS, MN 55410

FOR: NUTRITIONAL SUPPLEMENTS, IN CLASS 5 (U.S. CLS. 6, 18, 44, 46, 51 AND 52).

FIRST USE 12-1-2000; IN COMMERCE 12-1-2000.

NO CLAIM IS MADE TO THE EXCLUSIVE RIGHT TO USE "HEALTH" OR "NUTRITION",
APART FROM THE MARK AS SHOWN.

THE MARK CONSISTS OF SIX CONCENTRIC CIRCLES WITH THE FOURTH INNER MOST CIRCLE SHADED. ARCHED AROUND THE TOP OF THE FOURTH INNER MOST CIRCLE ARE THE WORDS "HEALTH ARCHITECT". THE WORD "NUTRITION" APPEARS ARCHED ALONG THE BOTTOM OF THE FOURTH MOST INNER CIRCLE. INSIDE THE CONCENTRIC CIRCLE DESIGN IS A STYLIZED DEPICTION OF THE LEONARDO DA VINCI'S MEASURE OF MAN WITH A HEART IN THE CENTER OF THE MAN. THE WORDS "MIND" AND "BODY" APPEAR ON THE LEFT AND RIGHT SIDE OF THE MAN AT THE WAIST RESPECTIVELY. SURROUNDING THE MAN INSIDE IS THE FOURTH INNER MOST CIRCLE IS A CIRCULAR GRID PATTERN CONSISTING OF THREE CONCENTRIC SINGLE LINE CIRCLES AND HORIZONTAL, DIAGONAL AND VERTICAL LINES.

SER. NO. 85-353,937, FILED 6-23-2011.

JEFFREY LOOK, EXAMINING ATTORNEY



David J. Kybas

Director of the United States Patent and Trademark Office

United States of America

United States Patent and Trademark Office



Reg. No. 4,108,178

Registered Mar. 6, 2012

**Int. Cls.: 29, 30, 35, 41
and 43**

TRADEMARK

SERVICE MARK

PRINCIPAL REGISTER

THE CHEESE COURSE, INC. (FLORIDA CORPORATION)
#317
3250 N.E. 1ST AVENUE
MIAMI, FL 33137

FOR: SALADS EXCEPT MACARONI, RICE, AND PASTA SALAD; TAPENADES; CHEESE; CHEESE SPREADS; PREPARED WALNUTS; BRUSCHETTA TOPPINGS; SOUPS, IN CLASS 29 (U.S. CL. 46).

FIRST USE 6-18-2001; IN COMMERCE 6-18-2001.

FOR: RELISH; PESTO; BRUSCHETTA-TOPPED BREAD; SALAD DRESSING; QUICHE, IN CLASS 30 (U.S. CL. 46).

FIRST USE 6-18-2001; IN COMMERCE 6-18-2001.

FOR: RETAIL STORE SERVICES FEATURING KITCHEN AND HOUSEWARE ITEMS, KITCHEN GADGETS, KITCHEN UTENSILS, TABLEWARE, BOOKS, FOOD, GOURMET FOODS, PREPARED FOODS, CONDIMENTS, COFFEE, WATER, WINE, BEER, BEVERAGES, MEATS, DELI MEATS, SALAMI, CRACKERS, BREADS, BAKERY GOODS, CHEESE, AND IMPLEMENTS AND ACCESSORIES FOR STORING, PREPARING, AND SERVING CHEESES; PROVIDING A WEBSITE FEATURING INFORMATION FOR CONSUMERS IN THE FIELD OF CHEESES, FOOD, WINES, AND CULINARY ARTS, IN CLASS 35 (U.S. CLS. 100, 101 AND 102).

FIRST USE 8-20-1999; IN COMMERCE 6-18-2001.

FOR: ENTERTAINMENT SERVICES, NAMELY, WINE AND FOOD TASTINGS; ENTERTAINMENT SERVICES, NAMELY, CHEESE TASTINGS; EDUCATION SERVICES, NAMELY, PROVIDING CLASSES, DEMONSTRATIONS, AND PRESENTATIONS IN THE FIELD OF CHEESE, WINE, GOURMET FOOD, AND CULINARY ARTS, IN CLASS 41 (U.S. CLS. 100, 101 AND 107).

FIRST USE 8-20-1999; IN COMMERCE 6-18-2001.

FOR: PROVIDING AN ON-LINE SEARCHABLE DATABASE FEATURING INFORMATION ON CHEESES; PROVIDING INFORMATION ABOUT CHEESES, FOOD, AND WINE;



David J. Kyffers

Director of the United States Patent and Trademark Office

Reg. No. 4,108,178 PROVIDING OF FOOD AND DRINK; CATERING; BISTRO SERVICES; SOMMELIER SERVICES, NAMELY, PROVIDING ADVICE ON WINE AND PAIRING OF WINE WITH CHEESES AND OTHER FOODS, IN CLASS 43 (U.S. CLS. 100 AND 101).

FIRST USE 8-20-1999; IN COMMERCE 6-18-2001.

OWNER OF U.S. REG. NOS. 2,528,183 AND 2,602,215.

NO CLAIM IS MADE TO THE EXCLUSIVE RIGHT TO USE "ORIGINAL" AND "AUTHENTIC" AND "2000", APART FROM THE MARK AS SHOWN.

THE MARK CONSISTS OF AN OVAL ON WHICH THE WORD "ORIGINAL" APPEARS IN ALL CAPITAL LETTERS ON THE UPPER PORTION OF THE OVAL AND THE WORD "AUTHENTIC" APPEARS UPSIDE DOWN IN ALL CAPITAL LETTERS ON THE LOWER PORTION OF THE OVAL. THE NUMBER "2000" IS SHOWN ON THE OVAL AND IS DIVIDED SO THAT "20" APPEARS ON THE LEFT SIDE OF THE OVAL AND "00" APPEARS ON THE RIGHT SIDE OF THE OVAL. THE LETTERS "TCC" ARE INSIDE THE OVAL, SHOWN WITH THE "T" IN THE CENTER AND A "C" ON EACH SIDE, ARRANGED SYMMETRICALLY SO THAT THE LETTER "C" TO THE LEFT OF THE LETTER "T" FACES BACKWARDS. THE OVAL IS BORDERED WITH A SINGLE LINE OF SMALL DOTS ON BOTH ITS EXTERIOR AND INTERIOR.

SER. NO. 85-353,946, FILED 6-23-2011.

CHRISTINA SOBRAL, EXAMINING ATTORNEY

United States of America

United States Patent and Trademark Office

LIVING RICHLY

Reg. No. 4,108,179

Registered Mar. 6, 2012

Int. Cls.: 39 and 43

SERVICE MARK

PRINCIPAL REGISTER

PHILLIP ARCHER ENTERPRISES, INCORPORATED (TEXAS CORPORATION)
2633 MCKINNEY AVE
STE 130-505
DALLAS, TX 75204

FOR: TRAVEL BOOKING AGENCIES; COORDINATING TRAVEL ARRANGEMENTS FOR INDIVIDUALS AND FOR GROUPS; ARRANGING AND COORDINATING TRAVEL ARRANGEMENTS FOR INDIVIDUALS AND GROUPS, NAMELY, DESTINATIONS STAYS, HONEYMOONS, FAMILY VACATIONS, AND DESTINATION WEDDINGS; ARRANGING TRAVEL TOURS; ARRANGING TRAVEL TOURS AS A BONUS PROGRAM FOR CREDIT CARDS CUSTOMERS; MAKING TRAVEL AND EXCURSION ARRANGEMENTS FOR BANDS AND ORCHESTRAS; ORGANIZATION OF TRAVEL; ORGANIZATION OF EXCURSIONS, SIGHTSEEING TOURS, HOLIDAYS, TOURS AND TRAVEL; ORGANIZATION OF TRAVEL AND BOAT TRIPS; PROVIDING A WEB SITE FEATURING TRAVEL INFORMATION AND COMMENTARY; PROVIDING A WEBSITE FEATURING INFORMATION ON TRAVEL; PROVIDING INFORMATION, NEWS AND COMMENTARY IN THE FIELD OF TRAVEL; RESERVATION AND BOOKING OF SEATS FOR TRAVEL; TRAVEL AGENCY SERVICES, NAMELY, MAKING RESERVATIONS AND BOOKINGS FOR TRANSPORTATION; TRAVEL AND TOUR INFORMATION SERVICE; TRAVEL AND TOUR TICKET RESERVATION SERVICE; TRAVEL PLANNING FOR INDIVIDUALS, FAMILIES, AND GROUPS FOR SPECIAL OCCASIONS SUCH AS DESTINATION WEDDINGS AND HONEYMOONS; TRAVEL, EXCURSION AND CRUISE ARRANGEMENT, IN CLASS 39 (U.S. CLS. 100 AND 105).

FIRST USE 11-14-2010; IN COMMERCE 11-30-2010.

FOR: PROVIDING TRAVEL LODGING INFORMATION SERVICES AND TRAVEL LODGING BOOKING AGENCY SERVICES FOR TRAVELERS; TRAVEL AGENCY SERVICES, NAMELY, MAKING RESERVATIONS AND BOOKING FOR TEMPORARY LODGING; TRAVEL AGENCY SERVICES, NAMELY, MAKING RESERVATIONS AND BOOKINGS FOR RESTAURANTS AND MEALS, IN CLASS 43 (U.S. CLS. 100 AND 101).

FIRST USE 11-14-2010; IN COMMERCE 11-30-2010.

THE MARK CONSISTS OF STANDARD CHARACTERS WITHOUT CLAIM TO ANY PARTICULAR FONT, STYLE, SIZE, OR COLOR.



David J. Kybas

Director of the United States Patent and Trademark Office

Reg. No. 4,108,179 SER. NO. 85-354,019, FILED 6-23-2011.

KATHERINE CHANG, EXAMINING ATTORNEY

United States of America

United States Patent and Trademark Office



Reg. No. 4,108,180

ENDURAFIT, LLC (MARYLAND LIMITED LIABILITY COMPANY)
3706 CRONDALL LANE, SUITE 103
OWINGS MILLS, MD 21117

Registered Mar. 6, 2012

Int. Cl.: 12

FOR: BICYCLE FITTED COVERS; TRIATHLON EQUIPMENT, NAMELY, FITTED BICYCLE COVERS, IN CLASS 12 (U.S. CLS. 19, 21, 23, 31, 35 AND 44).

TRADEMARK

FIRST USE 4-10-2011; IN COMMERCE 4-10-2011.

PRINCIPAL REGISTER

NO CLAIM IS MADE TO THE EXCLUSIVE RIGHT TO USE "RACK JACKET", APART FROM THE MARK AS SHOWN.

THE MARK CONSISTS OF THE WORDS "RACK JACKET" WITH STYLIZED BICYCLE TIRES AND BICYCLE COVER.

SER. NO. 85-354,022, FILED 6-23-2011.

BRIAN CALLAGHAN, EXAMINING ATTORNEY



David J. Kybas

Director of the United States Patent and Trademark Office

United States of America

United States Patent and Trademark Office

NATIONAL INITIATIVE ON PAIN CONTROL

Reg. No. 4,108,181

Registered Mar. 6, 2012

Int. Cls.: 16 and 41

TRADEMARK

SERVICE MARK

PRINCIPAL REGISTER

KNOWLEDGEPOINT360 GROUP, LLC (DELAWARE LIMITED LIABILITY COMPANY)
125 CHUBB AVENUE
LYNDHURST, NJ 170713504

FOR: PRINT PRODUCTS, NAMELY, NEWSLETTERS DIRECTED TO THE MEDICAL PROFESSIONAL ON THE TOPIC OF CHRONIC PAIN, IN CLASS 16 (U.S. CLS. 2, 5, 22, 23, 29, 37, 38 AND 50).

FIRST USE 9-0-2001; IN COMMERCE 9-0-2001.

FOR: EDUCATIONAL SERVICES, NAMELY, SEMINARS DIRECTED TO THE MEDICAL PROFESSION ON THE TOPIC OF CHRONIC PAIN, IN CLASS 41 (U.S. CLS. 100, 101 AND 107).

FIRST USE 9-0-2001; IN COMMERCE 9-0-2001.

THE MARK CONSISTS OF STANDARD CHARACTERS WITHOUT CLAIM TO ANY PARTICULAR FONT, STYLE, SIZE, OR COLOR.

OWNER OF U.S. REG. NO. 2,950,682.

SEC. 2(F).

SER. NO. 85-354,123, FILED 6-23-2011.

MARC LEIPZIG, EXAMINING ATTORNEY



David J. Kybas

Director of the United States Patent and Trademark Office

United States of America

United States Patent and Trademark Office

Qualitest

Reg. No. 4,108,182

GENERICS BIDCO I, LLC (DELAWARE LIMITED LIABILITY COMPANY)
100 ENDO BLVD.
CHADDS FORD., PA 19317

Registered Mar. 6, 2012

Int. Cl.: 5

FOR: HOUSE MARK FOR A FULL LINE OF PHARMACEUTICAL PREPARATIONS, IN CLASS 5 (U.S. CLS. 6, 18, 44, 46, 51 AND 52).

TRADEMARK

FIRST USE 5-3-1984; IN COMMERCE 5-3-1984.

PRINCIPAL REGISTER

OWNER OF U.S. REG. NO. 2,499,673.

THE COLOR(S) BROWN AND WHITE IS/ARE CLAIMED AS A FEATURE OF THE MARK.

THE MARK CONSISTS OF THE LITERAL ELEMENT OF THE MARK IS "QUALITEST". THE LITERAL ELEMENT IS SHOWN IN WHITE AND UNDERLINED IN WHITE, REVERSED OUT OF A BROWN BACKGROUND.

SER. NO. 85-354,137, FILED 6-23-2011.

PAUL E. FAHRENKOPF, EXAMINING ATTORNEY



David J. Kyffers

Director of the United States Patent and Trademark Office

United States of America

United States Patent and Trademark Office

한방 생리대

G.T. Natural Herbal Pad

Reg. No. 4,108,183

SOOK JA CHUNG (UNITED STATES INDIVIDUAL)
3544 WEST 3RD STREET
LOS ANGELES, CA 90020

Registered Mar. 6, 2012

Int. Cl.: 5

FOR: FEMININE HYGIENE PADS; SANITARY PADS, IN CLASS 5 (U.S. CLS. 6, 18, 44, 46, 51 AND 52).

TRADEMARK

FIRST USE 5-1-2006; IN COMMERCE 5-1-2006.

PRINCIPAL REGISTER

OWNER OF U.S. REG. NOS. 3,368,305, 3,548,827, AND 4,005,481.

THE COLOR(S) RED AND DARK BLUE IS/ARE CLAIMED AS A FEATURE OF THE MARK.

THE NON-LATIN CHARACTERS IN THE MARK TRANSLITERATE TO "HANBANG SAENGRI-DAE" AND THIS MEANS "ORIENTAL HERBAL SANITARY PADS" IN ENGLISH.

NO CLAIM IS MADE TO THE EXCLUSIVE RIGHT TO USE "NATURAL HERBAL PAD" AND THE NON-LATIN CHARACTERS THAT TRANSLITERATES TO "HANBANG SAENGRI-DAE", APART FROM THE MARK AS SHOWN.

THE MARK CONSISTS OF KOREAN CHARACTERS WHICH TRANSLITERATES TO "HANBANG SAENGRI-DAE" WHICH MEANS "ORIENTAL HERBAL SANITARY PADS" IN COLOR RED APPEAR ON TOP. THE WORDS "G.T. NATURAL HERBAL PAD" IN COLOR DARK BLUE APPEAR UNDERNEATH.

THE ENGLISH TRANSLATION OF "HANBANG SAENGRI-DAE" IN THE MARK IS "ORIENTAL HERBAL SANITARY PADS."

SER. NO. 85-354,173, FILED 6-23-2011.

AMY HELLA, EXAMINING ATTORNEY



David J. Kypos

Director of the United States Patent and Trademark Office

United States of America

United States Patent and Trademark Office

The Analytical Plumb Line

Reg. No. 4,108,184

Registered Mar. 6, 2012

Int. Cl.: 42

SERVICE MARK

PRINCIPAL REGISTER

BION ANALYTICAL STANDARDS, LLC (SOUTH DAKOTA LIMITED LIABILITY COMPANY)
5709 WEST CHADWICK PLACE
SIOUX FALLS, SD 571060855

FOR: ANALYTICAL CHEMICAL LABORATORY SERVICES; TESTING AND EVALUATION OF SUBSTRATES FROM RENEWABLE FUEL PRODUCTION; DEVELOPING QUALITY CONTROL STANDARDS IN THE NATURE OF STANDARD OPERATING PROCEDURES AND LABORATORY QUALITY CONTROL PROTOCOLS FOR RENEWABLE FUEL PRODUCTION FACILITIES, IN CLASS 42 (U.S. CLS. 100 AND 101).

FIRST USE 0-0-2009; IN COMMERCE 0-0-2009.

THE MARK CONSISTS OF STANDARD CHARACTERS WITHOUT CLAIM TO ANY PARTICULAR FONT, STYLE, SIZE, OR COLOR.

SER. NO. 85-354,188, FILED 6-23-2011.

JACLYN KIDWELL WALKER, EXAMINING ATTORNEY



David J. Kybas

Director of the United States Patent and Trademark Office

United States of America

United States Patent and Trademark Office



Reg. No. 4,108,185

Registered Mar. 6, 2012

Int. Cl.: 41

SERVICE MARK

PRINCIPAL REGISTER

MIXED MARTIAL ARTS, LLC (OREGON LIMITED LIABILITY COMPANY)
250 NW FRANKLIN AVE. #402
BEND, OR 97701

FOR: ENTERTAINMENT SERVICES IN THE NATURE OF LIVE MIXED MARTIAL ARTS (MMA) EVENTS, IN CLASS 41 (U.S. CLS. 100, 101 AND 107).

FIRST USE 5-25-2010; IN COMMERCE 5-25-2010.

NO CLAIM IS MADE TO THE EXCLUSIVE RIGHT TO USE "BUDO FIGHTS", APART FROM THE MARK AS SHOWN.

THE NON-LATIN CHARACTERS IN THE MARK TRANSLITERATE TO "BU" AND "DO" AND THIS MEANS "WARRIOR" AND "THE WAY" IN ENGLISH.

THE MARK CONSISTS OF THE WORDING "BUDO FIGHTS" WITHIN A BANNER DESIGN OVERLAPPING AN 8 SIDED POLYGON. THE UPPER PORTION OF THE POLYGON CONTAINS THE JAPANESE CHARACTER THAT TRANSLITERATES TO "BU" AND THE LOWER HALF JAPANESE CHARACTER THAT TRANSLITERATES TO "DO". TAKEN TOGETHER "BU DO" TRANSLATES TO "THE MARTIAL WAY" OR "THE WARRIOR WAY".

THE ENGLISH TRANSLATION OF "BUDO" IN THE MARK IS "THE WARRIOR WAY" OR "THE MARTIAL WAY.

SER. NO. 85-354,275, FILED 6-23-2011.

JACLYN KIDWELL WALKER, EXAMINING ATTORNEY



David J. Kyros

Director of the United States Patent and Trademark Office

United States of America

United States Patent and Trademark Office

GINK

Reg. No. 4,108,186

Registered Mar. 6, 2012

Int. Cl.: 28

TRADEMARK

PRINCIPAL REGISTER

GEHRKE, GLADYS M. (UNITED STATES INDIVIDUAL), DBA GEHRKE'S GINK
P. O. BOX 730
ASOTIN, WA 99402

FOR: DRESSING FOR DRY FLIES FOR USE IN FLY FISHING, IN CLASS 28 (U.S. CLS. 22, 23, 38 AND 50).

FIRST USE 3-1-1973; IN COMMERCE 3-1-1973.

THE MARK CONSISTS OF STANDARD CHARACTERS WITHOUT CLAIM TO ANY PARTICULAR FONT, STYLE, SIZE, OR COLOR.

SER. NO. 85-354,480, FILED 6-23-2011.

TEJBIR SINGH, EXAMINING ATTORNEY



David J. Kybas

Director of the United States Patent and Trademark Office

United States of America

United States Patent and Trademark Office

XINK

Reg. No. 4,108,187

GLADYS M. GEHRKE (UNITED STATES INDIVIDUAL), DBA GEHRKE'S GINK
P. O. BOX 730
ASOTIN, WA 99402

Registered Mar. 6, 2012

Int. Cl.: 28

FOR: FLY FISHING LEADERS AND FISHING LINE SINKER DRESSING USED IN FLY FISHING, IN CLASS 28 (U.S. CLS. 22, 23, 38 AND 50).

TRADEMARK

FIRST USE 2-1-1978; IN COMMERCE 2-1-1978.

PRINCIPAL REGISTER

THE MARK CONSISTS OF STANDARD CHARACTERS WITHOUT CLAIM TO ANY PARTICULAR FONT, STYLE, SIZE, OR COLOR.

SER. NO. 85-354,493, FILED 6-23-2011.

TEJBIR SINGH, EXAMINING ATTORNEY



David J. Kybas

Director of the United States Patent and Trademark Office

United States of America

United States Patent and Trademark Office

MERIT

Reg. No. 4,108,188

Registered Mar. 6, 2012

Int. Cls.: 41 and 42

SERVICE MARK

PRINCIPAL REGISTER

MERIT AUDIO VISUAL, INC. (NEW YORK CORPORATION) DBA MERIT SOFTWARE
(NEW YORK CORPORATION), DBA MERIT SOFTWARE
121 WEST 27TH STREET
NEW YORK, NY 10001

FOR: EDUCATIONAL SERVICES, NAMELY, PROVIDING ON-LINE INSTRUCTION IN THE FIELD OF EDUCATIONAL SOFTWARE FOR TEACHING WRITING, READING, VOCABULARY, GRAMMAR, MATHEMATICS AND TEST TAKING; ADVISING IN THE GIVING OF EDUCATIONAL LESSONS USING SUCH SOFTWARE, IN CLASS 41 (U.S. CLS. 100, 101 AND 107).

FIRST USE 3-31-2009; IN COMMERCE 3-31-2009.

FOR: EDUCATIONAL SERVICES, NAMELY, PROVIDING NON-DOWNLOADABLE EDUCATIONAL SOFTWARE FOR TEACHING WRITING, VOCABULARY, GRAMMAR, MATHEMATICS AND TEST TAKING; LEASING OF THE SOFTWARE IN THE FIELD OF TEACHING WRITING, VOCABULARY, GRAMMAR, MATHEMATICS AND TEST TAKING, IN CLASS 42 (U.S. CLS. 100 AND 101).

FIRST USE 3-31-2009; IN COMMERCE 3-31-2009.

THE MARK CONSISTS OF STANDARD CHARACTERS WITHOUT CLAIM TO ANY PARTICULAR FONT, STYLE, SIZE, OR COLOR.

OWNER OF U.S. REG. NO. 3,039,547.

SER. NO. 85-354,533, FILED 6-23-2011.

NAKIA HENRY, EXAMINING ATTORNEY



David J. Kyffers

Director of the United States Patent and Trademark Office

United States of America

United States Patent and Trademark Office

PARTshare

Reg. No. 4,108,189

Registered Mar. 6, 2012

Int. Cl.: 9

TRADEMARK

PRINCIPAL REGISTER

COMPUTER DESIGN, INC. (TENNESSEE CORPORATION), DBA STRIKER SYSTEMS
104 S.C.T. DRIVE
WHITE HOUSE, TN 37188

FOR: COMPUTER PROGRAMS RECORDED ON DATA MEDIA (SOFTWARE) DESIGNED FOR USE IN CONSTRUCTION AND AUTOMATED MANUFACTURING (CAD/CAM) , IN CLASS 9 (U.S. CLS. 21, 23, 26, 36 AND 38).

FIRST USE 11-22-2004; IN COMMERCE 11-22-2004.

THE MARK CONSISTS OF STANDARD CHARACTERS WITHOUT CLAIM TO ANY PARTICULAR FONT, STYLE, SIZE, OR COLOR.

SER. NO. 85-354,561, FILED 6-23-2011.

BRIAN PINO, EXAMINING ATTORNEY



David J. Kyffers

Director of the United States Patent and Trademark Office

United States of America

United States Patent and Trademark Office

ROESCH

Reg. No. 4,108,190

Registered Mar. 6, 2012

Int. Cl.: 40

SERVICE MARK

PRINCIPAL REGISTER

ROESCH, INC. (DELAWARE CORPORATION)
P.O. BOX 328
BELLEVILLE, IL 62222

FOR: CUSTOMIZED STAMPING AND FABRICATING SHEET METAL; ASSEMBLING OF FURNISHED PARTS TO CUSTOMER SPECIFICATIONS; MATERIAL TREATMENT SERVICES, NAMELY, PORCELAIN ENAMELING OF SHEET METAL AND CAST IRON PARTS, IN CLASS 40 (U.S. CLS. 100, 103 AND 106).

FIRST USE 1-1-1974; IN COMMERCE 1-1-1974.

THE MARK CONSISTS OF STANDARD CHARACTERS WITHOUT CLAIM TO ANY PARTICULAR FONT, STYLE, SIZE, OR COLOR.

SEC. 2(F).

SER. NO. 85-354,600, FILED 6-23-2011.

DEIRDRE ROBERTSON, EXAMINING ATTORNEY



David J. Kybas

Director of the United States Patent and Trademark Office

United States of America

United States Patent and Trademark Office

ICE MAID

Reg. No. 4,108,191

ROESCH, INC. (DELAWARE CORPORATION)
P.O. BOX 328
BELLEVILLE, IL 62222

Registered Mar. 6, 2012

Int. Cl.: 16

FOR: PLASTIC BAGS FOR PACKAGING ICE, IN CLASS 16 (U.S. CLS. 2, 5, 22, 23, 29, 37, 38 AND 50).

TRADEMARK

FIRST USE 2-29-1976; IN COMMERCE 2-29-1976.

PRINCIPAL REGISTER

THE MARK CONSISTS OF STANDARD CHARACTERS WITHOUT CLAIM TO ANY PARTICULAR FONT, STYLE, SIZE, OR COLOR.

OWNER OF U.S. REG. NO. 1,485,183.

NO CLAIM IS MADE TO THE EXCLUSIVE RIGHT TO USE "ICE", APART FROM THE MARK AS SHOWN.

SER. NO. 85-354,608, FILED 6-23-2011.

DEIRDRE ROBERTSON, EXAMINING ATTORNEY



David J. Kyffers

Director of the United States Patent and Trademark Office

United States of America

United States Patent and Trademark Office

HAROLD C. RAMSER, SR. HANDICAP

Reg. No. 4,108,192

Registered Mar. 6, 2012

Int. Cl.: 41

SERVICE MARK

PRINCIPAL REGISTER

OAK TREE RACING ASSOCIATION (CALIFORNIA NON-PROFIT CORPORATION)
285 W. HUNTINGTON DRIVE
ARCADIA, CA 91007

FOR: ENTERTAINMENT, NAMELY, CONDUCTING HORSE RACES AND PROVIDING HORSE RACING ENTERTAINMENT INFORMATION THROUGH VARIOUS FORMS OF MEDIA, IN CLASS 41 (U.S. CLS. 100, 101 AND 107).

FIRST USE 0-0-1981; IN COMMERCE 0-0-1981.

THE MARK CONSISTS OF STANDARD CHARACTERS WITHOUT CLAIM TO ANY PARTICULAR FONT, STYLE, SIZE, OR COLOR.

NO CLAIM IS MADE TO THE EXCLUSIVE RIGHT TO USE "HANDICAP", APART FROM THE MARK AS SHOWN.

"HAROLD C. RAMSER, SR." DOES NOT IDENTIFY A LIVING INDIVIDUAL.

SER. NO. 85-354,906, FILED 6-23-2011.

DAVID YONTEF, EXAMINING ATTORNEY



David J. Kyfos

Director of the United States Patent and Trademark Office

United States of America

United States Patent and Trademark Office

FORMULA 77

Reg. No. 4,108,193

Registered Mar. 6, 2012

Int. Cl.: 3

TRADEMARK

PRINCIPAL REGISTER

RETAIL ROYALTY COMPANY (NEVADA CORPORATION)
101 CONVENTION CENTER
LAS VEGAS, NV 89109

FOR: BODY SPRAYS, IN CLASS 3 (U.S. CLS. 1, 4, 6, 50, 51 AND 52).

FIRST USE 7-0-2010; IN COMMERCE 7-0-2010.

THE MARK CONSISTS OF STANDARD CHARACTERS WITHOUT CLAIM TO ANY PARTICULAR FONT, STYLE, SIZE, OR COLOR.

OWNER OF U.S. REG. NOS. 3,628,711, 3,908,122, AND 3,958,012.

NO CLAIM IS MADE TO THE EXCLUSIVE RIGHT TO USE "FORMULA", APART FROM THE MARK AS SHOWN.

SER. NO. 85-354,987, FILED 6-24-2011.

MIDGE BUTLER, EXAMINING ATTORNEY



David J. Kyffers

Director of the United States Patent and Trademark Office

United States of America

United States Patent and Trademark Office



Reg. No. 4,108,194

Registered Mar. 6, 2012

Int. Cl.: 43

SERVICE MARK

PRINCIPAL REGISTER

BAHAMA BEACH CLUB, LTD. (BAHAMAS LIMITED COMPANY (LTD.))
C/O GRAHAM THOMPSON & CO.
SHIRLEY STREET & VICTORIA AVE.
NASSAU, BAHAMAS NP

FOR: HOTEL ACCOMMODATION SERVICES; HOTEL AND MOTEL SERVICES; HOTEL SERVICES; HOTELS; MAKING HOTEL RESERVATIONS FOR OTHERS; PROVIDING HOTEL ACCOMMODATION; PROVIDING ON-LINE REVIEWS OF RESTAURANTS AND HOTELS; PROVIDING PERSONALIZED INFORMATION ABOUT HOTELS AND TEMPORARY ACCOMMODATIONS FOR TRAVEL VIA THE INTERNET; PROVIDING TEMPORARY LODGING SERVICES IN THE NATURE OF A CONDOMINIUM HOTEL; RENTAL OF ROOMS AS TEMPORARY LIVING ACCOMMODATIONS; RESERVATION OF HOTEL ROOMS FOR TRAVELERS; RESERVATION OF HOTEL ROOMS FOR TRAVELLERS; RESORT HOTELS; HOTEL, RESTAURANT AND BAR SERVICES; RESTAURANT; RESTAURANT AND BAR SERVICES , IN CLASS 43 (U.S. CLS. 100 AND 101).

FIRST USE 11-0-2002; IN COMMERCE 11-0-2002.

NO CLAIM IS MADE TO THE EXCLUSIVE RIGHT TO USE "BAHAMA BEACH CLUB", APART FROM THE MARK AS SHOWN.

THE MARK CONSISTS OF THE WORDING "BAHAMA BEACH CLUB" IN STYLIZED FONT, BETWEEN THE WORDING "BAHAMA" AND "BEACH" APPEARS THREE OVERLAPPING SILHOUETTES OF DOLPHINS.

SER. NO. 85-355,079, FILED 6-24-2011.

MICHELE SWAIN, EXAMINING ATTORNEY



David J. Kyros

Director of the United States Patent and Trademark Office

United States of America

United States Patent and Trademark Office



Reg. No. 4,108,195

Registered Mar. 6, 2012

Int. Cl.: 45

SERVICE MARK

PRINCIPAL REGISTER

BAHAMA BEACH CLUB, LTD. (BAHAMAS LIMITED COMPANY (LTD.))
C/O GRAHAM THOMPSON & CO.
SHIRLEY STREET & VICTORIA AVE.
NASSAU, BAHAMAS NP

FOR: HOTEL CONCIERGE SERVICES; PERSONAL CONCIERGE SERVICES FOR OTHERS COMPRISING MAKING REQUESTED PERSONAL ARRANGEMENTS AND RESERVATIONS, RUNNING ERRANDS AND PROVIDING CUSTOMER SPECIFIC INFORMATION TO MEET INDIVIDUAL NEEDS, ALL RENDERED IN BUSINESS ESTABLISHMENTS, OFFICE BUILDINGS, HOTELS, RESIDENTIAL COMPLEXES, BEACH RESORTS AND HOMES, IN CLASS 45 (U.S. CLS. 100 AND 101).

FIRST USE 11-0-2002; IN COMMERCE 11-0-2002.

NO CLAIM IS MADE TO THE EXCLUSIVE RIGHT TO USE "BAHAMA BEACH CLUB", APART FROM THE MARK AS SHOWN.

THE MARK CONSISTS OF THE WORDING "BAHAMA BEACH CLUB" IN STYLIZED FONT, BETWEEN THE WORDING "BAHAMA" AND "BEACH" APPEARS THREE OVERLAPPING SILHOUETTES OF DOLPHINS.

SER. NO. 85-355,097, FILED 6-24-2011.

MICHELE SWAIN, EXAMINING ATTORNEY



David J. Kybas

Director of the United States Patent and Trademark Office

United States of America
United States Patent and Trademark Office

DOOBIZZ

Reg. No. 4,108,196

Registered Mar. 6, 2012

Int. Cl.: 41

SERVICE MARK

PRINCIPAL REGISTER

GROW AMERICA VENTURES, LLC (UTAH LIMITED LIABILITY COMPANY)
2036 LINCOLN AVENUE, # 104
OGDEN, UT 84043

FOR: EDUCATION SERVICES, NAMELY, PROVIDING NON-DOWNLOADABLE SELF-STUDY MATERIALS IN THE FIELD OF BUSINESS, IN CLASS 41 (U.S. CLS. 100, 101 AND 107).

FIRST USE 11-18-2010; IN COMMERCE 3-3-2011.

THE MARK CONSISTS OF STANDARD CHARACTERS WITHOUT CLAIM TO ANY PARTICULAR FONT, STYLE, SIZE, OR COLOR.

SER. NO. 85-355,120, FILED 6-24-2011.

KAREN BRACEY, EXAMINING ATTORNEY



David J. Kyffers

Director of the United States Patent and Trademark Office

United States of America

United States Patent and Trademark Office

ICE MAID EASY

Reg. No. 4,108,197

Registered Mar. 6, 2012

Int. Cls.: 11 and 16

TRADEMARK

PRINCIPAL REGISTER

ROESCH, INC. (DELAWARE CORPORATION)
P.O. BOX 328
BELLEVILLE, IL 62222

FOR: ICE BOXES, IN CLASS 11 (U.S. CLS. 13, 21, 23, 31 AND 34).

FIRST USE 3-14-2011; IN COMMERCE 3-14-2011.

FOR: PLASTIC BAGS FOR PACKAGING ICE , IN CLASS 16 (U.S. CLS. 2, 5, 22, 23, 29, 37, 38 AND 50).

FIRST USE 3-14-2011; IN COMMERCE 3-14-2011.

THE MARK CONSISTS OF STANDARD CHARACTERS WITHOUT CLAIM TO ANY PARTICULAR FONT, STYLE, SIZE, OR COLOR.

OWNER OF U.S. REG. NO. 1,485,183.

NO CLAIM IS MADE TO THE EXCLUSIVE RIGHT TO USE "ICE", APART FROM THE MARK AS SHOWN.

SER. NO. 85-355,124, FILED 6-24-2011.

DEIRDRE ROBERTSON, EXAMINING ATTORNEY



David J. Kybas

Director of the United States Patent and Trademark Office

United States of America

United States Patent and Trademark Office

Music Phenzes

Reg. No. 4,108,198

Registered Mar. 6, 2012

Int. Cl.: 41

SERVICE MARK

PRINCIPAL REGISTER

MUSIC PHENZES LLC (NEVADA LIMITED LIABILITY COMPANY)
2001 BOGART COURT
LAS VEGAS, NV 89117

FOR: MULTIMEDIA ENTERTAINMENT SERVICES IN THE NATURE OF RECORDING, PRODUCTION AND POST-PRODUCTION SERVICES IN THE FIELDS OF MUSIC, VIDEO, AND FILMS, IN CLASS 41 (U.S. CLS. 100, 101 AND 107).

FIRST USE 6-4-2008; IN COMMERCE 6-4-2008.

THE MARK CONSISTS OF STANDARD CHARACTERS WITHOUT CLAIM TO ANY PARTICULAR FONT, STYLE, SIZE, OR COLOR.

NO CLAIM IS MADE TO THE EXCLUSIVE RIGHT TO USE "MUSIC", APART FROM THE MARK AS SHOWN.

SER. NO. 85-355,166, FILED 6-24-2011.

INGA ERVIN, EXAMINING ATTORNEY



David J. Kyffers

Director of the United States Patent and Trademark Office

United States of America

United States Patent and Trademark Office

visibilit vitalIT manageabilit for business

Reg. No. 4,108,199

Registered Mar. 6, 2012

Int. Cl.: 42

SERVICE MARK

PRINCIPAL REGISTER

AGILIANIT INC. (WASHINGTON CORPORATION)
100
620 KIRKLAND WAY
KIRKLAND, WA 98033

FOR: COMPUTER TECHNOLOGY SUPPORT SERVICES, NAMELY, HELP DESK SERVICES,
IN CLASS 42 (U.S. CLS. 100 AND 101).

FIRST USE 3-4-2011; IN COMMERCE 5-20-2011.

THE MARK CONSISTS OF STANDARD CHARACTERS WITHOUT CLAIM TO ANY PAR-
TICULAR FONT, STYLE, SIZE, OR COLOR.

NO CLAIM IS MADE TO THE EXCLUSIVE RIGHT TO USE "FOR BUSINESS", APART
FROM THE MARK AS SHOWN.

SER. NO. 85-355,176, FILED 6-24-2011.

DAVID I, EXAMINING ATTORNEY



David J. Kyffers

Director of the United States Patent and Trademark Office

United States of America

United States Patent and Trademark Office

MR. WINTER

Reg. No. 4,108,200

MR. WINTER, INC. (FLORIDA CORPORATION)
8080 WEST 26TH CT.
HIALEAH, FL 33016

Registered Mar. 6, 2012

Int. Cl.: 11

FOR: WALK-IN REFRIGERATOR, IN CLASS 11 (U.S. CLS. 13, 21, 23, 31 AND 34).

TRADEMARK

FIRST USE 12-1-1986; IN COMMERCE 12-1-1986.

PRINCIPAL REGISTER

THE MARK CONSISTS OF STANDARD CHARACTERS WITHOUT CLAIM TO ANY PARTICULAR FONT, STYLE, SIZE, OR COLOR.

SER. NO. 85-355,256, FILED 6-24-2011.

ALYSSA STEEL, EXAMINING ATTORNEY



David J. Kybas

Director of the United States Patent and Trademark Office

United States of America

United States Patent and Trademark Office

STAPLEX

Reg. No. 4,108,201

THE STAPLEX COMPANY, INC. (NEW YORK CORPORATION)
777 FIFTH AVENUE
BROOKLYN, NY 11232

Registered Mar. 6, 2012

Int. Cl.: 7

FOR: POWER DRIVEN STAPLING MACHINES, IN CLASS 7 (U.S. CLS. 13, 19, 21, 23, 31, 34 AND 35).

TRADEMARK

FIRST USE 7-6-1949; IN COMMERCE 9-15-1949.

PRINCIPAL REGISTER

THE MARK CONSISTS OF STANDARD CHARACTERS WITHOUT CLAIM TO ANY PARTICULAR FONT, STYLE, SIZE, OR COLOR.

OWNER OF U.S. REG. NOS. 540,853, 771,731, AND 850,567.

SER. NO. 85-355,391, FILED 6-24-2011.

BRENDAN REGAN, EXAMINING ATTORNEY



David J. Kybas

Director of the United States Patent and Trademark Office

United States of America

United States Patent and Trademark Office

WE ARE EMERGING MARKETS

Reg. No. 4,108,202

GRAMERCY FUNDS MANAGEMENT LLC (DELAWARE LIMITED LIABILITY COMPANY)
20 DAYTON AVENUE
GREENWICH, CT 06830

Registered Mar. 6, 2012

Int. Cl.: 36

FOR: FINANCIAL SERVICES, NAMELY, INVESTMENT MANAGEMENT AND ADVISORY SERVICES, IN CLASS 36 (U.S. CLS. 100, 101 AND 102).

SERVICE MARK

FIRST USE 4-0-2010; IN COMMERCE 5-0-2010.

PRINCIPAL REGISTER

THE MARK CONSISTS OF STANDARD CHARACTERS WITHOUT CLAIM TO ANY PARTICULAR FONT, STYLE, SIZE, OR COLOR.

NO CLAIM IS MADE TO THE EXCLUSIVE RIGHT TO USE "EMERGING MARKETS", APART FROM THE MARK AS SHOWN.

SER. NO. 85-355,710, FILED 6-24-2011.

SHAUNIA CARLYLE, EXAMINING ATTORNEY



David J. Kybas

Director of the United States Patent and Trademark Office

United States of America

United States Patent and Trademark Office



Reg. No. 4,108,203

Registered Mar. 6, 2012

Int. Cl.: 28

NKOK, INC. (CALIFORNIA CORPORATION)
UNIT G-2
13668 E. VALLEY BLVD.
CITY OF INDUSTRY, CA 91746

FOR: TOY VEHICLES, IN CLASS 28 (U.S. CLS. 22, 23, 38 AND 50).

TRADEMARK

FIRST USE 6-9-2011; IN COMMERCE 6-9-2011.

PRINCIPAL REGISTER

NO CLAIM IS MADE TO THE EXCLUSIVE RIGHT TO USE "MACHINES", APART FROM THE MARK AS SHOWN.

THE MARK CONSISTS OF THE STYLIZED WORD "MEAN" ABOVE THE STYLIZED WORD "MACHINES" IMPLYING AGGRESSIVENESS.

SER. NO. 85-355,740, FILED 6-24-2011.

ELLEN PERKINS, EXAMINING ATTORNEY



David J. Kybas

Director of the United States Patent and Trademark Office

United States of America

United States Patent and Trademark Office



Reg. No. 4,108,204

Registered Mar. 6, 2012

Int. Cl.: 5

TRADEMARK

PRINCIPAL REGISTER

BAX INTERNATIONAL CORP. (FLORIDA CORPORATION), DBA VITAMIN NATION
10800 N.W. 21ST STREET SUITE 120
MIAMI, FL 33172

FOR: CALCIUM SUPPLEMENTS; DIETARY AND NUTRITIONAL SUPPLEMENTS; DIETARY AND NUTRITIONAL SUPPLEMENTS FOR ENDURANCE SPORTS; DIETARY AND NUTRITIONAL SUPPLEMENTS USED FOR WEIGHT LOSS; DIETARY FOOD SUPPLEMENTS; DIETARY SUPPLEMENTS; DIETARY SUPPLEMENTS FOR ANIMALS; DIETARY SUPPLEMENTS FOR HUMAN CONSUMPTION; DIETARY SUPPLEMENTS FOR PETS; HEALTH FOOD SUPPLEMENTS; HERBAL SUPPLEMENTS; LIQUID NUTRITIONAL SUPPLEMENT; LIQUID VITAMIN SUPPLEMENTS; MINERAL SUPPLEMENTS, IN CLASS 5 (U.S. CLS. 6, 18, 44, 46, 51 AND 52).

FIRST USE 10-1-2001; IN COMMERCE 10-1-2001.

NO CLAIM IS MADE TO THE EXCLUSIVE RIGHT TO USE "VITAMIN" , APART FROM THE MARK AS SHOWN.

THE COLOR(S) RED, WHITE & BLUE IS/ARE CLAIMED AS A FEATURE OF THE MARK.

THE MARK CONSISTS OF A STYLIZED DEPICTION OF THE AMERICAN FLAG IN RED, WHITE AND BLUE, WITH THE STYLIZED WORDING "VITAMIN NATION" APPEARING IN BLUE ACROSS THE FLAG.

SER. NO. 85-355,840, FILED 6-24-2011.

JAMES MACFARLANE, EXAMINING ATTORNEY



David J. Kyjars

Director of the United States Patent and Trademark Office

United States of America

United States Patent and Trademark Office

TN Rocks!

Reg. No. 4,108,205

LAURA BROCK (UNITED STATES INDIVIDUAL), DBA LAURA BROCK JEWELRY
1840 AUBURNDALE AVENUE
CHATTANOOGA, TN 37405

Registered Mar. 6, 2012

Int. Cl.: 14

FOR: JEWELRY MADE WITH ROCKS FROM THE STATE OF TENNESSEE, IN CLASS 14
(U.S. CLS. 2, 27, 28 AND 50).

TRADEMARK

FIRST USE 4-11-2011; IN COMMERCE 4-11-2011.

PRINCIPAL REGISTER

THE MARK CONSISTS OF STANDARD CHARACTERS WITHOUT CLAIM TO ANY PARTICULAR FONT, STYLE, SIZE, OR COLOR.

NO CLAIM IS MADE TO THE EXCLUSIVE RIGHT TO USE "TN", APART FROM THE MARK AS SHOWN.

SER. NO. 85-355,844, FILED 6-24-2011.

KATHY DE JONGE, EXAMINING ATTORNEY



David J. Kybas

Director of the United States Patent and Trademark Office

United States of America

United States Patent and Trademark Office

THE 10 MINUTE NO WORK WORKOUT

Reg. No. 4,108,206

Registered Mar. 6, 2012

Int. Cl.: 44

SERVICE MARK

PRINCIPAL REGISTER

GOGA STUDIOS, INC. (DELAWARE CORPORATION)
63 BARBOUR ROAD
HAMPTON, NH 03842

FOR: COUNSELING SERVICES IN THE FIELD OF HEALTH AND LIFESTYLE WELLNESS;
HEALTH SPA SERVICES FOR THE HEALTH AND WELLNESS OF THE MIND, BODY AND
SPIRIT, IN CLASS 44 (U.S. CLS. 100 AND 101).

FIRST USE 5-1-2011; IN COMMERCE 5-1-2011.

THE MARK CONSISTS OF STANDARD CHARACTERS WITHOUT CLAIM TO ANY PAR-
TICULAR FONT, STYLE, SIZE, OR COLOR.

NO CLAIM IS MADE TO THE EXCLUSIVE RIGHT TO USE "10 MINUTE" AND "WORKOUT",
APART FROM THE MARK AS SHOWN.

SER. NO. 85-355,857, FILED 6-24-2011.

DAVID MURRAY, EXAMINING ATTORNEY



David J. Kyros

Director of the United States Patent and Trademark Office

United States of America

United States Patent and Trademark Office

Our Whole-Body Approach to Dermatologic Services

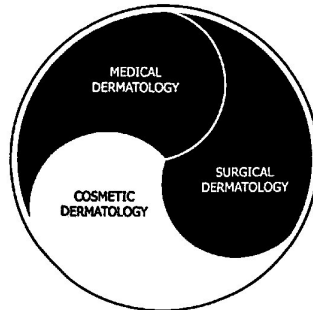

Reg. No. 4,108,207

Registered Mar. 6, 2012

Int. Cl.: 44

SERVICE MARK

PRINCIPAL REGISTER

RATIONAL DERMATOLOGY (COLORADO CORPORATION), DBA COLORADO DERMATOLOGY INSTITUTE
STE 225
8580 SCARBOROUGH DR
COLORADO SPRINGS, CO 80920

FOR: MEDICAL, SURGICAL, AND COSMETIC DERMATOLOGICAL SERVICES, IN CLASS 44 (U.S. CLS. 100 AND 101).

FIRST USE 10-0-2010; IN COMMERCE 10-0-2010.

NO CLAIM IS MADE TO THE EXCLUSIVE RIGHT TO USE "MEDICAL DERMATOLOGY", "SURGICAL DERMATOLOGY" AND "COSMETIC DERMATOLOGY", APART FROM THE MARK AS SHOWN.

THE MARK CONSISTS OF A CIRCLE WITH THREE DIFFERENT SECTIONS. THE FIRST SECTION CONTAINS THE STYLIZED TEXT "MEDICAL DERMATOLOGY"; THE SECOND SECTION CONTAINS THE STYLIZED TEXT "SURGICAL DERMATOLOGY"; THE THIRD SECTION CONTAINS THE STYLIZED TEXT "COSMETIC DERMATOLOGY". THE STYLIZED TEXT "OUR WHOLE-BODY APPROACH TO DERMATOLOGIC SERVICES" ARE WRITTEN ABOVE THE CIRCLE.

SER. NO. 85-356,047, FILED 6-24-2011.

EMILY CHUO, EXAMINING ATTORNEY



David J. Kyros

Director of the United States Patent and Trademark Office

United States of America

United States Patent and Trademark Office

Tahoe Project

Reg. No. 4,108,208

Registered Mar. 6, 2012

Int. Cl.: 35

SERVICE MARK

PRINCIPAL REGISTER

THE TAHOE PROJECT, INC. (CALIFORNIA CORPORATION)
1934 TOPPEWETAH STREET
SOUTH LAKE TAHOE, CA 96150

FOR: PROVIDING INFORMATION, NEWS AND COMMENTARY IN THE FIELD OF LAKE TAHOE GOVERNMENT, BUSINESS COMMUNITY AND ECONOMY; PROVIDING INFORMATION IN THE FIELD OF NATURAL RESOURCE MANAGEMENT RELATING TO THE ENVIRONMENT OF LAKE TAHOE, IN CLASS 35 (U.S. CLS. 100, 101 AND 102).

FIRST USE 4-23-2011; IN COMMERCE 6-10-2011.

THE MARK CONSISTS OF STANDARD CHARACTERS WITHOUT CLAIM TO ANY PARTICULAR FONT, STYLE, SIZE, OR COLOR.

NO CLAIM IS MADE TO THE EXCLUSIVE RIGHT TO USE "TAHOE", APART FROM THE MARK AS SHOWN.

SER. NO. 85-356,052, FILED 6-24-2011.

EMILY CHUO, EXAMINING ATTORNEY



David J. Kyros

Director of the United States Patent and Trademark Office

United States of America

United States Patent and Trademark Office

KYÄNI

Reg. No. 4,108,209

Registered Mar. 6, 2012

Int. Cl.: 35

SERVICE MARK

PRINCIPAL REGISTER

KYÄNI, INC. (IDAHO CORPORATION)
SUITE 350
1070 RIVERWALK DRIVE
IDAHO FALLS, ID 83402

FOR: MULTILEVEL MARKETING BUSINESS SERVICES, NAMELY, PROVIDING MARKETING AND BUSINESS CONSULTING SERVICES TO INDEPENDENT AGENTS ENGAGED IN DIRECT SALES OF NUTRITIONAL AND DIETARY SUPPLEMENTS AND FRUIT BEVERAGES; DISTRIBUTORSHIP SERVICES IN THE FIELDS OF NUTRITIONAL AND DIETARY SUPPLEMENTS AND FRUIT BEVERAGES; ONLINE RETAIL STORE SERVICES FEATURING NUTRITIONAL AND DIETARY SUPPLEMENTS AND FRUIT BEVERAGES, IN CLASS 35 (U.S. CLS. 100, 101 AND 102).

FIRST USE 11-20-2009; IN COMMERCE 11-20-2009.

THE MARK CONSISTS OF STANDARD CHARACTERS WITHOUT CLAIM TO ANY PARTICULAR FONT, STYLE, SIZE, OR COLOR.

OWNER OF U.S. REG. NOS. 3,111,790, 3,679,111 AND OTHERS.

THE ENGLISH TRANSLATION OF THE TERM "KYÄNI" IN THE MARK IS "STRONG MEDICINE".

SER. NO. 85-356,066, FILED 6-24-2011.

MICHAEL TANNER, EXAMINING ATTORNEY



David J. Kyffers

Director of the United States Patent and Trademark Office

United States of America

United States Patent and Trademark Office



Reg. No. 4,108,210

Registered Mar. 6, 2012

Int. Cl.: 31

TRADEMARK

PRINCIPAL REGISTER

GOLDEN C NATURAL FOODS (CALIFORNIA SOLE PROPRIETORSHIP)
PO BOX 685
NA
DOS PALOS, CA 93620

FOR: FRESH FRUITS, IN CLASS 31 (U.S. CLS. 1 AND 46).

FIRST USE 6-23-2011; IN COMMERCE 6-23-2011.

NO CLAIM IS MADE TO THE EXCLUSIVE RIGHT TO USE "PREMIUM MELONS", APART FROM THE MARK AS SHOWN.

SER. NO. 85-356,189, FILED 6-25-2011.

DAVID TOOLEY, EXAMINING ATTORNEY



David J. Kybas

Director of the United States Patent and Trademark Office

United States of America

United States Patent and Trademark Office



Reg. No. 4,108,211

Registered Mar. 6, 2012

Int. Cl.: 31

TRADEMARK

PRINCIPAL REGISTER

GOLDEN C NATURAL FOODS (CALIFORNIA SOLE PROPRIETORSHIP)
PO BOX 685
NA
DOS PALOS, CA 93620

FOR: FRESH FRUIT, IN CLASS 31 (U.S. CLS. 1 AND 46).

FIRST USE 6-23-2011; IN COMMERCE 6-23-2011.

NO CLAIM IS MADE TO THE EXCLUSIVE RIGHT TO USE "CALIFORNIA MELONS" ,
APART FROM THE MARK AS SHOWN.

SER. NO. 85-356,190, FILED 6-25-2011.

DAVID TOOLEY, EXAMINING ATTORNEY



David J. Kybas

Director of the United States Patent and Trademark Office

United States of America

United States Patent and Trademark Office



Reg. No. 4,108,212

Registered Mar. 6, 2012

Int. Cl.: 41

SERVICE MARK

PRINCIPAL REGISTER

CITY OF CRYSTAL LAKE (ILLINOIS CORPORATION)
100 W. WOODSTOCK STREET
CRYSTAL LAKE, IL 60014

FOR: PROVIDING RECREATION FACILITIES; PROVIDING RECREATIONAL AREAS IN THE NATURE OF CHILDREN'S PLAY AREAS; PROVIDING RECREATIONAL AREAS IN THE NATURE OF PLAY AREAS FOR CHILDREN; RECREATIONAL PARK SERVICES, IN CLASS 41 (U.S. CLS. 100, 101 AND 107).

FIRST USE 10-4-2010; IN COMMERCE 10-4-2010.

NO CLAIM IS MADE TO THE EXCLUSIVE RIGHT TO USE "RECREATION AREA" AND "CITY OF CRYSTAL LAKE ILLINOIS", APART FROM THE MARK AS SHOWN.

THE COLOR(S) MAROON, GREEN AND WHITE IS/ARE CLAIMED AS A FEATURE OF THE MARK.

THE MARK CONSISTS OF A MAROON SHADED CIRCLE OUTLINED IN GREEN CONTAINING THE WORDING "THREE OAKS" APPEARING IN GREEN, CONTAINING A DEPICTION OF THREE GREEN TREES, A MAROON BUILDING AND LANDSCAPE ON WHITE BACKGROUND IN THE CENTER OF THE CIRCLE WITH THE WORDS "RECREATION AREA" APPEARING IN GREEN ON THE LANDSCAPE, ALL APPEARING ABOVE A MAROON SHADED SEMICIRCLE OUTLINED IN GREEN CONTAINING THE WORDING "CITY OF CRYSTAL LAKE ILLINOIS" SUPERIMPOSED IN GREEN.

SER. NO. 85-356,260, FILED 6-25-2011.

KELLY TRUSILO, EXAMINING ATTORNEY



David J. Kyros

Director of the United States Patent and Trademark Office

United States of America

United States Patent and Trademark Office



Reg. No. 4,108,213

Registered Mar. 6, 2012

Int. Cl.: 45

SERVICE MARK

PRINCIPAL REGISTER

CITY OF CRYSTAL LAKE (ILLINOIS CORPORATION)
100 W. WOODSTOCK STREET
CRYSTAL LAKE, IL 60014

FOR: FIRE FIGHTING; FIRE FIGHTING SERVICES, IN CLASS 45 (U.S. CLS. 100 AND 101).

FIRST USE 10-1-2003; IN COMMERCE 10-1-2003.

NO CLAIM IS MADE TO THE EXCLUSIVE RIGHT TO USE "CRYSTAL LAKE", "FIRE" AND "RESCUE", APART FROM THE MARK AS SHOWN.

THE COLOR(S) RED AND WHITE IS/ARE CLAIMED AS A FEATURE OF THE MARK.

THE MARK CONSISTS OF A RED SHADED CIRCLE WITH THE WORDING "CRYSTAL LAKE" SUPERIMPOSED IN WHITE, WITH FOUR SCALLOPED BANNERS ON EACH FOUR SIDES OF THE CIRCLE, THE TOP CONTAINING THE WORD "FIRE, THE BOTTOM CONTAINING THE TERM "RESCUE", THE LEFT CONTAINING THE DEPICTION OF A FIRE HYDRANT AND THE RIGHT CONTAINING THE DEPICTION OF A LADDER AND AX.

SER. NO. 85-356,266, FILED 6-25-2011.

KELLY TRUSILO, EXAMINING ATTORNEY



David J. Kyffers

Director of the United States Patent and Trademark Office

United States of America

United States Patent and Trademark Office



Reg. No. 4,108,214

CITY OF CRYSTAL LAKE (ILLINOIS CORPORATION)
100 W. WOODSTOCK STREET
CRYSTAL LAKE, IL 60014

Registered Mar. 6, 2012

Int. Cl.: 35

FOR: PROMOTIONAL SERVICES FOR THE CITY OF CRYSTAL LAKE, ILLINOIS, IN CLASS 35 (U.S. CLS. 100, 101 AND 102).

SERVICE MARK

FIRST USE 10-1-2003; IN COMMERCE 10-1-2003.

PRINCIPAL REGISTER

NO CLAIM IS MADE TO THE EXCLUSIVE RIGHT TO USE "CITY OF CRYSTAL LAKE, ILLINOIS" AND "INCORPORATED SEPTEMBER, 1914", APART FROM THE MARK AS SHOWN.

THE MARK CONSISTS OF A CIRCLE WITH TREES AND WATER SURROUNDED BY ANOTHER CIRCLE CONTAINING THE WORDS "CITY OF CRYSTAL LAKE ILLINOIS INCORPORATED SEPTEMBER, 1914".

SER. NO. 85-356,270, FILED 6-25-2011.

KELLY TRUSILO, EXAMINING ATTORNEY



David J. Kybas

Director of the United States Patent and Trademark Office

United States of America

United States Patent and Trademark Office



DOOBIZZ

Reg. No. 4,108,215

GROW AMERICA VENTURES, LLC (UTAH LIMITED LIABILITY COMPANY)
2036 LINCOLN AVENUE, # 104
OGDEN, UT 84043

Registered Mar. 6, 2012

Int. Cl.: 41

FOR: EDUCATION SERVICES, NAMELY, PROVIDING NON-DOWNLOADABLE SELF-STUDY MATERIALS IN THE FIELD OF BUSINESS, IN CLASS 41 (U.S. CLS. 100, 101 AND 107).

SERVICE MARK

FIRST USE 11-18-2010; IN COMMERCE 3-3-2011.

PRINCIPAL REGISTER

THE MARK CONSISTS OF THE WORD "DOOBIZZ" WITH A 3 LEAVES IN A FAN ARRANGEMENT POSITIONED OVER THE "BIZZ" PORTION OF THE WORD.

SER. NO. 85-356,278, FILED 6-25-2011.

KAREN BRACEY, EXAMINING ATTORNEY



David J. Kybas

Director of the United States Patent and Trademark Office

United States of America
United States Patent and Trademark Office

jans

Reg. No. 4,108,216

JANS ENTERPRISES CORPORATION (CALIFORNIA CORPORATION), DBA WIRA CORP
1633 W. 2ND STREET
POMONA, CA 91766

Registered Mar. 6, 2012

Int. Cl.: 32

FOR: FRUIT DRINKS; FRUIT JUICE; VEGETABLE-FRUIT JUICES, IN CLASS 32 (U.S. CLS. 45, 46 AND 48).

TRADEMARK

FIRST USE 10-31-2008; IN COMMERCE 10-31-2008.

PRINCIPAL REGISTER

OWNER OF U.S. REG. NO. 3,707,176.

THE NAME(S), PORTRAIT(S), AND/OR SIGNATURE(S) SHOWN IN THE MARK DOES NOT IDENTIFY A PARTICULAR LIVING INDIVIDUAL.

THE MARK CONSISTS OF STYLIZED LETTERS OF "JANS".

SER. NO. 85-356,330, FILED 6-25-2011.

CHRIS WELLS, EXAMINING ATTORNEY



David J. Kybas

Director of the United States Patent and Trademark Office

United States of America

United States Patent and Trademark Office

BEER TALK

Reg. No. 4,108,217

ANDREW HAASL (UNITED STATES INDIVIDUAL)
300 LITTLE RD.
GREEN BAY, WI 54301

Registered Mar. 6, 2012

Int. Cl.: 16

FOR: PRINTED NEWSLETTER ABOUT BEER AND THE BEER BREWING PROCESS, IN CLASS 16 (U.S. CLS. 2, 5, 22, 23, 29, 37, 38 AND 50).

TRADEMARK

FIRST USE 6-1-2011; IN COMMERCE 10-1-2011.

PRINCIPAL REGISTER

THE MARK CONSISTS OF STANDARD CHARACTERS WITHOUT CLAIM TO ANY PARTICULAR FONT, STYLE, SIZE, OR COLOR.

NO CLAIM IS MADE TO THE EXCLUSIVE RIGHT TO USE "BEER", APART FROM THE MARK AS SHOWN.

SER. NO. 85-356,411, FILED 6-26-2011.

BARBARA GAYNOR, EXAMINING ATTORNEY



David J. Kybas

Director of the United States Patent and Trademark Office

United States of America

United States Patent and Trademark Office

Selene's Sensations Bakery

Reg. No. 4,108,218

SELENE'S SENSATIONS LLC (GEORGIA LIMITED LIABILITY COMPANY)

Registered Mar. 6, 2012

P. O. BOX 1119
PINE LAKE, GA 30072

Int. Cl.: 30

FOR: REDUCED FAT, REDUCED CARBOHYDRATE BAKERY DESSERTS AND FRUIT BREADS, IN CLASS 30 (U.S. CL. 46).

TRADEMARK

FIRST USE 2-22-2010; IN COMMERCE 2-28-2010.

PRINCIPAL REGISTER

THE MARK CONSISTS OF STANDARD CHARACTERS WITHOUT CLAIM TO ANY PARTICULAR FONT, STYLE, SIZE, OR COLOR.

NO CLAIM IS MADE TO THE EXCLUSIVE RIGHT TO USE "BAKERY", APART FROM THE MARK AS SHOWN.

THE NAME IDENTIFIES A PARTICULAR LIVING INDIVIDUAL WHOSE CONSENT IS OF RECORD.

SER. NO. 85-356,521, FILED 6-27-2011.

JOHN E. MICHOS, EXAMINING ATTORNEY



David J. Kyffers

Director of the United States Patent and Trademark Office

United States of America

United States Patent and Trademark Office

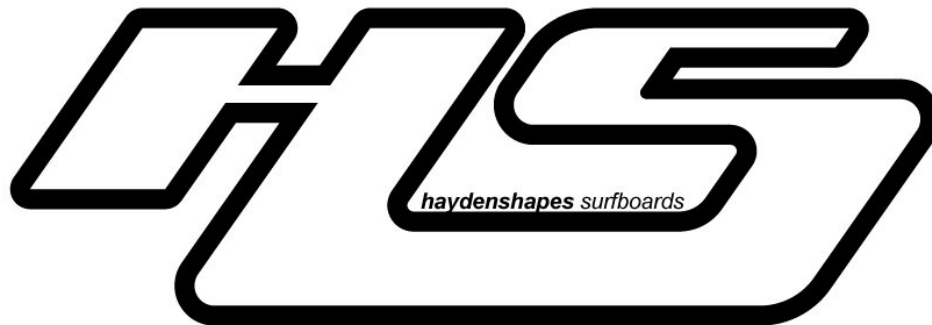

Reg. No. 4,108,219

Registered Mar. 6, 2012

Int. Cl.: 28

TRADEMARK

PRINCIPAL REGISTER

HAYDEN COX PTY LTD (AUSTRALIA LIMITED LIABILITY COMPANY)
32/14 POLO AVE
MONA VALE, AUSTRALIA 2103

FOR: SURFBOARDS, IN CLASS 28 (U.S. CLS. 22, 23, 38 AND 50).

FIRST USE 2-1-1999; IN COMMERCE 2-1-1999.

NO CLAIM IS MADE TO THE EXCLUSIVE RIGHT TO USE "SURFBOARDS", APART FROM THE MARK AS SHOWN.

THE MARK CONSISTS OF A STYLIZED REPRESENTATION OF THE LETTERS "HS" AND THE WORDING "HAYDENSHPES SURFBOARDS".

SER. NO. 85-356,528, FILED 6-27-2011.

JOHN E. MICHOS, EXAMINING ATTORNEY



David J. Kyffers

Director of the United States Patent and Trademark Office

United States of America

United States Patent and Trademark Office



Reg. No. 4,108,220

Registered Mar. 6, 2012

Int. Cl.: 41

SERVICE MARK

PRINCIPAL REGISTER

COLLYER, INC. (NORTH CAROLINA CORPORATION)
346 RED FOX CIRCLE
ASHEVILLE, NC 28803

FOR: PROVIDING FACILITIES FOR CHILDREN'S PARTIES AND FOR CHILDREN'S PLAY ACTIVITIES; CHILDREN'S ENTERTAINMENT AND AMUSEMENT CENTERS, NAMELY, INTERACTIVE PLAY AREAS; EDUCATIONAL AND ENTERTAINMENT SERVICES FOR CHILDREN, NAMELY, PROVIDING INTERACTIVE PLAY AREAS AND SOCIAL GATHERINGS FOR CHILDREN; ENTERTAINMENT IN THE NATURE OF PROVISION OF PLAY FACILITIES FOR CHILDREN FEATURING PLAY STRUCTURES FOR CHILDREN'S PARTIES AND SPECIAL EVENTS WITH FACILITATED ACTIVITIES AND GAMES; ENTERTAINMENT SERVICES, NAMELY, CONDUCTING PARTIES AND PROVIDING CHILDREN'S PARTY CENTERS FOR THE PURPOSE OF ENTERTAINING CHILDREN AND CELEBRATING BIRTHDAYS, IN CLASS 41 (U.S. CLS. 100, 101 AND 107).

FIRST USE 4-15-2011; IN COMMERCE 4-15-2011.

THE MARK CONSISTS OF THE HEAD OF A DOG WHICH IS OUTLINED IN BLACK AND HAS BLACK EARS AND NOSE AND A BLACK MASK AROUND ITS EYES, WHICH ARE WHITE THE DOG HAS BROWN EYEBROWS AND CHEEKS WHICH ARE DIVIDED BY A WHITE STRIPE AND WHITE MUZZLE.

THE COLOR(S) BLACK, BROWN AND WHITE IS/ARE CLAIMED AS A FEATURE OF THE MARK.

SER. NO. 85-356,555, FILED 6-27-2011.

ELIZABETH KAJUBI, EXAMINING ATTORNEY



David J. Kybas

Director of the United States Patent and Trademark Office

United States of America

United States Patent and Trademark Office

ENERGIZE YOUR FUTURE

Reg. No. 4,108,221

Registered Mar. 6, 2012

Int. Cl.: 41

SERVICE MARK

PRINCIPAL REGISTER

SHELL TRADEMARK MANAGEMENT BV (NETHERLANDS CORPORATION)
CAREL VAN BYLANDTLAAN 30, 2596HR
THE HAGUE, NETHERLANDS

FOR: EDUCATION SERVICES, NAMELY, PROVIDING ON-LINE COMPUTER GAMES AND ONLINE COMPUTER PUZZLES IN THE FIELD OF ENERGY RESOURCES AND CAREERS; PROVIDING A WEBSITE FEATURING ON-LINE PUBLICATIONS IN THE NATURE OF REPRODUCIBLE WORKSHEETS AND LESSON PLANS FOR TEACHERS IN THE FIELD OF ENERGY RESOURCES AND CAREERS; EDUCATIONAL SERVICES, NAMELY, PROVIDING TEACHER TRAINING IN THE FIELD OF INTERACTIVE CLASSROOM ACTIVITIES IN THE FIELD OF ENERGY RESOURCES AND CAREERS, IN CLASS 41 (U.S. CLS. 100, 101 AND 107).

FIRST USE 9-27-2006; IN COMMERCE 9-27-2006.

THE MARK CONSISTS OF STANDARD CHARACTERS WITHOUT CLAIM TO ANY PARTICULAR FONT, STYLE, SIZE, OR COLOR.

SER. NO. 85-356,587, FILED 6-27-2011.

KAPIL BHANOT, EXAMINING ATTORNEY



David J. Kyros

Director of the United States Patent and Trademark Office

United States of America

United States Patent and Trademark Office



Reg. No. 4,108,222

Registered Mar. 6, 2012

Int. Cl.: 41

SERVICE MARK

PRINCIPAL REGISTER

COLLYER, INC. (NORTH CAROLINA CORPORATION)
346 RED FOX CIRCLE
ASHEVILLE, NC 28803

FOR: PROVIDING FACILITIES FOR CHILDREN'S PARTIES AND FOR CHILDREN'S PLAY ACTIVITIES; CHILDREN'S ENTERTAINMENT AND AMUSEMENT CENTERS, NAMELY, INTERACTIVE PLAY AREAS; EDUCATIONAL AND ENTERTAINMENT SERVICES FOR CHILDREN, NAMELY, PROVIDING INTERACTIVE PLAY AREAS AND SOCIAL GATHERINGS FOR CHILDREN; ENTERTAINMENT IN THE NATURE OF PROVISION OF PLAY FACILITIES FOR CHILDREN FEATURING PLAY STRUCTURES FOR CHILDREN'S PARTIES AND SPECIAL EVENTS WITH FACILITATED ACTIVITIES AND GAMES; ENTERTAINMENT SERVICES, NAMELY, CONDUCTING PARTIES AND PROVIDING CHILDREN'S PARTY CENTERS FOR THE PURPOSE OF ENTERTAINING CHILDREN AND CELEBRATING BIRTHDAYS, IN CLASS 41 (U.S. CLS. 100, 101 AND 107).

FIRST USE 4-15-2011; IN COMMERCE 4-15-2011.

NO CLAIM IS MADE TO THE EXCLUSIVE RIGHT TO USE "PLAY" AND "INDOOR PLAY & PARTY CENTER", APART FROM THE MARK AS SHOWN.

THE COLOR(S) BLACK, WHITE, BLUE, RED, TAN, BROWN AND GREEN IS/ARE CLAIMED AS A FEATURE OF THE MARK.

THE MARK CONSISTS OF THE WORD "MOUNTAIN" IN BLACK LETTERING CENTERED AT TOP; TWO BLUE MOUNTAINS WITH WHITE PEAKS; A RED BANNER WITH THE WORDS "PLAY LODGE" IN TAN LETTERING; A TAN BANNER WITH THE WORDS "INDOOR PLAY & PARTY CENTER" IN BLACK LETTERING; A GREEN SEMI-CIRCLE WITH A BROWN PARTIAL RECTANGLE EXTENDING FROM EACH SIDE AT THE BOTTOM; EACH ELEMENT OUTLINED IN BLACK.

SER. NO. 85-356,635, FILED 6-27-2011.

ELIZABETH KAJUBI, EXAMINING ATTORNEY



David J. Kybas

Director of the United States Patent and Trademark Office

United States of America

United States Patent and Trademark Office

IRON DUKES

Reg. No. 4,108,223

Registered Mar. 6, 2012

**Int. Cls.: 16, 21, 24, 25
and 28**

TRADEMARK

PRINCIPAL REGISTER

DUKE UNIVERSITY (NORTH CAROLINA CORPORATION)
OFFICE OF COUNSEL
310 BLACKWELL STREET, 4TH FLOOR
DURHAM, NC 27701

FOR: DECALS, IN CLASS 16 (U.S. CLS. 2, 5, 22, 23, 29, 37, 38 AND 50).

FIRST USE 5-12-2011; IN COMMERCE 5-12-2011.

FOR: DRINKING VESSELS, IN CLASS 21 (U.S. CLS. 2, 13, 23, 29, 30, 33, 40 AND 50).

FIRST USE 5-12-2011; IN COMMERCE 5-12-2011.

FOR: BLANKETS FOR OUTDOOR USE, IN CLASS 24 (U.S. CLS. 42 AND 50).

FIRST USE 5-12-2011; IN COMMERCE 5-12-2011.

FOR: SHIRTS AND HATS FOR NON-INDUSTRIAL USES, IN CLASS 25 (U.S. CLS. 22 AND 39).

FIRST USE 5-12-2011; IN COMMERCE 5-12-2011.

FOR: GOLF BALLS, IN CLASS 28 (U.S. CLS. 22, 23, 38 AND 50).

FIRST USE 5-12-2011; IN COMMERCE 5-12-2011.

THE MARK CONSISTS OF STANDARD CHARACTERS WITHOUT CLAIM TO ANY PARTICULAR FONT, STYLE, SIZE, OR COLOR.

OWNER OF U.S. REG. NO. 1,003,662.

SER. NO. 85-356,737, FILED 6-27-2011.

ROBIN MITTLER, EXAMINING ATTORNEY



David J. Kyffers

Director of the United States Patent and Trademark Office

United States of America

United States Patent and Trademark Office

BELLE'S COUNTRY SAUSAGE

Reg. No. 4,108,224

Registered Mar. 6, 2012

Int. Cl.: 29

TRADEMARK

PRINCIPAL REGISTER

BELLE'S COUNTRY SAUSAGE, LLC (SOUTH CAROLINA LIMITED LIABILITY COMPANY)
1219 SAVANNAH HIGHWAY
CHARLESTON, SC 29407

FOR: SAUSAGES, IN CLASS 29 (U.S. CL. 46).

FIRST USE 5-22-2011; IN COMMERCE 6-11-2011.

THE MARK CONSISTS OF STANDARD CHARACTERS WITHOUT CLAIM TO ANY PARTICULAR FONT, STYLE, SIZE, OR COLOR.

NO CLAIM IS MADE TO THE EXCLUSIVE RIGHT TO USE "COUNTRY SAUSAGE", APART FROM THE MARK AS SHOWN.

SER. NO. 85-356,998, FILED 6-27-2011.

LAURA HAMMEL, EXAMINING ATTORNEY



David J. Kyffers

Director of the United States Patent and Trademark Office

United States of America

United States Patent and Trademark Office

BUCKET BUDDIES

Reg. No. 4,108,225

Registered Mar. 6, 2012

Int. Cl.: 36

SERVICE MARK

PRINCIPAL REGISTER

YOUNG, DEANNA (UNITED STATES INDIVIDUAL)
SUITE 2700
111 MONUMENT CIRCLE
INDIANAPOLIS, IN 46204

FOR: CHARITABLE FUND RAISING SERVICES, IN CLASS 36 (U.S. CLS. 100, 101 AND 102).

FIRST USE 11-30-2009; IN COMMERCE 11-30-2009.

THE MARK CONSISTS OF STANDARD CHARACTERS WITHOUT CLAIM TO ANY PARTICULAR FONT, STYLE, SIZE, OR COLOR.

SER. NO. 85-357,206, FILED 6-27-2011.

JEFFREY LOOK, EXAMINING ATTORNEY



David J. Kybas

Director of the United States Patent and Trademark Office

United States of America

United States Patent and Trademark Office

SAFE PAIN MANAGEMENT THROUGH ELECTRO THERAPY

Reg. No. 4,108,226

Registered Mar. 6, 2012

Int. Cl.: 35

SERVICE MARK

PRINCIPAL REGISTER

SAFE ENTERPRISES INC. (OHIO CORPORATION)
504 HARCOURT ROAD
MOUNT VERNON, OH 43050

FOR: ASSISTANCE IN BUSINESS MANAGEMENT AND PRODUCT COMMERCIALIZATION, WITHIN THE FRAMEWORK OF A FRANCHISE CONTRACT; BUSINESS MANAGEMENT ADVISORY SERVICES RELATING TO FRANCHISING; FRANCHISE SERVICES, NAMELY, OFFERING BUSINESS MANAGEMENT ASSISTANCE IN THE ESTABLISHMENT AND OPERATION OF PAIN MANAGEMENT AND STIMULATION PRODUCTS IN VENDING MACHINES, IN CLASS 35 (U.S. CLS. 100, 101 AND 102).

FIRST USE 2-9-2011; IN COMMERCE 2-9-2011.

THE MARK CONSISTS OF STANDARD CHARACTERS WITHOUT CLAIM TO ANY PARTICULAR FONT, STYLE, SIZE, OR COLOR.

NO CLAIM IS MADE TO THE EXCLUSIVE RIGHT TO USE "PAIN MANAGEMENT THROUGH ELECTRO THERAPY", APART FROM THE MARK AS SHOWN.

SER. NO. 85-357,445, FILED 6-27-2011.

YAT SYE, LEE, EXAMINING ATTORNEY



David J. Kyros

Director of the United States Patent and Trademark Office

United States of America

United States Patent and Trademark Office

Decorate your cupcakes from ordinary to extraordinary!

Reg. No. 4,108,227

Registered Mar. 6, 2012

Int. Cl.: 21

TRADEMARK

PRINCIPAL REGISTER

CUPCAKE CUTIES (CALIFORNIA LIMITED LIABILITY COMPANY)
209
466 FOOTHILL BLVD
LA CANADA, CA 91011

FOR: PACKAGED CUPCAKE DECORATING KITS COMPRISED OF PASTRY BAGS, PAPER OR PLASTIC DECORATIVE WRAPPERS FOR BAKED GOODS, CANDY SPRINKLES, CANDIES, AND CANDLES, ALL SOLD AS A UNIT, IN CLASS 21 (U.S. CLS. 2, 13, 23, 29, 30, 33, 40 AND 50).

FIRST USE 3-1-2011; IN COMMERCE 3-1-2011.

THE MARK CONSISTS OF STANDARD CHARACTERS WITHOUT CLAIM TO ANY PARTICULAR FONT, STYLE, SIZE, OR COLOR.

SER. NO. 85-357,501, FILED 6-27-2011.

JESSICA A. POWERS, EXAMINING ATTORNEY



David J. Kybas

Director of the United States Patent and Trademark Office

United States of America

United States Patent and Trademark Office

Rent Now

Reg. No. 4,108,228

Registered Mar. 6, 2012

Int. Cl.: 35

SERVICE MARK

PRINCIPAL REGISTER

PAPER TIGER, LLC (NEVADA LIMITED LIABILITY COMPANY)
1350 E. FLAMINGO RD. #753
LAS VEGAS, NV 89119

FOR: ADVERTISING AND COMMERCIAL INFORMATION SERVICES, VIA THE INTERNET; DISSEMINATION OF ADVERTISEMENTS; DISSEMINATION OF ADVERTISING FOR OTHERS VIA PUBLIC AND PRIVATE WIRELESS NETWORKS FOR DISPLAY ON MOBILE DEVICES; DISSEMINATION OF ADVERTISING FOR OTHERS VIA THE INTERNET; PROVIDING A SEARCHABLE ONLINE ADVERTISING GUIDE FEATURING THE GOODS AND SERVICES OF ONLINE VENDORS; PROVIDING AND RENTAL OF ADVERTISING SPACE ON THE INTERNET, IN CLASS 35 (U.S. CLS. 100, 101 AND 102).

FIRST USE 2-2-1998; IN COMMERCE 2-13-1998.

THE MARK CONSISTS OF STANDARD CHARACTERS WITHOUT CLAIM TO ANY PARTICULAR FONT, STYLE, SIZE, OR COLOR.

OWNER OF U.S. REG. NO. 3,231,428.

NO CLAIM IS MADE TO THE EXCLUSIVE RIGHT TO USE "RENT", APART FROM THE MARK AS SHOWN.

SER. NO. 85-357,537, FILED 6-27-2011.

KAELIE KUNG, EXAMINING ATTORNEY



David J. Kyffers

Director of the United States Patent and Trademark Office

United States of America

United States Patent and Trademark Office

THE ARIEL CENTER FOR COSMETIC SURGERY

Reg. No. 4,108,229

Registered Mar. 6, 2012

Int. Cl.: 44

SERVICE MARK

PRINCIPAL REGISTER

OBCT, INC. (CALIFORNIA CORPORATION)
2879 GATE ELEVEN PL.
CHULA VISTA, CA 91914

FOR: COSMETIC AND PLASTIC SURGERY, IN CLASS 44 (U.S. CLS. 100 AND 101).

FIRST USE 5-31-2011; IN COMMERCE 5-31-2011.

THE MARK CONSISTS OF STANDARD CHARACTERS WITHOUT CLAIM TO ANY PARTICULAR FONT, STYLE, SIZE, OR COLOR.

NO CLAIM IS MADE TO THE EXCLUSIVE RIGHT TO USE "CENTER FOR COSMETIC SURGERY", APART FROM THE MARK AS SHOWN.

SER. NO. 85-357,559, FILED 6-27-2011.

JOHN DALIER, EXAMINING ATTORNEY



David J. Kyffers

Director of the United States Patent and Trademark Office

United States of America

United States Patent and Trademark Office



Reg. No. 4,108,230

DESIGNARC, INC. (CALIFORNIA CORPORATION)
29 WEST CALLE LAURELES
SANTA BARBARA, CA 93105

Registered Mar. 6, 2012

Int. Cl.: 42

FOR: ARCHITECTURAL DESIGN; INTERIOR DESIGN SERVICES; LAND USE PLANNING SERVICES; LANDSCAPE ARCHITECTURAL DESIGN; URBAN DESIGN PLANNING SERVICES, IN CLASS 42 (U.S. CLS. 100 AND 101).

SERVICE MARK

FIRST USE 6-21-2006; IN COMMERCE 6-21-2006.

PRINCIPAL REGISTER

NO CLAIM IS MADE TO THE EXCLUSIVE RIGHT TO USE "ARCHITECTURE + INTERIORS", APART FROM THE MARK AS SHOWN.

THE MARK CONSISTS OF THE STYLIZED WORD "DESIGNARC" IN A DARK BOX, WITH A BOX EXTENDING FROM BEHIND AND SLIGHTLY BELOW, UNDER WHICH ARE THE WORDS "ARCHITECTURE + INTERIORS" AND WITHIN THE BOX TO THE FAR RIGHT IS WWW.DESIGNARC.NET.

SER. NO. 85-357,578, FILED 6-27-2011.

GIANCARLO CASTRO, EXAMINING ATTORNEY



David J. Kyffers

Director of the United States Patent and Trademark Office

United States of America

United States Patent and Trademark Office

QTANIUM

Reg. No. 4,108,231

Registered Mar. 6, 2012

Int. Cl.: 9

TRADEMARK

PRINCIPAL REGISTER

NAVMAN WIRELESS NORTH AMERICA, L.P. (DELAWARE LIMITED PARTNERSHIP)
SUITE 125
2701 PATROIT BLVD.
GLENVIEW, IL 60026

FOR: VEHICLE TRACKING DEVICES COMPRISED OF CELLULAR RADIO MODULES, COMPUTER SOFTWARE AND COMPUTER HARDWARE, SENSORS, TRANSMITTERS, RECEIVERS, AND GLOBAL POSITIONING SATELLITE RECEIVERS, ALL FOR USE IN CONNECTION WITH VEHICLE AND/OR EQUIPMENT TRACKING, MONITORING AND MANAGEMENT, IN CLASS 9 (U.S. CLS. 21, 23, 26, 36 AND 38).

FIRST USE 10-29-2010; IN COMMERCE 10-29-2010.

THE MARK CONSISTS OF STANDARD CHARACTERS WITHOUT CLAIM TO ANY PARTICULAR FONT, STYLE, SIZE, OR COLOR.

SER. NO. 85-357,692, FILED 6-28-2011.

ROBIN MITTLER, EXAMINING ATTORNEY



David J. Kyffers

Director of the United States Patent and Trademark Office

United States of America

United States Patent and Trademark Office

M-NAV

Reg. No. 4,108,232

Registered Mar. 6, 2012

Int. Cl.: 9

TRADEMARK

PRINCIPAL REGISTER

NAVMAN WIRELESS NORTH AMERICA, L.P. (DELAWARE LIMITED PARTNERSHIP)
SUITE 125
2701 PATRIOT BLVD.
GLENVIEW, IL 60026

FOR: GPS NAVIGATION AND PORTABLE TELECOMMUNICATION INSTANT MESSAGING
DEVICE, IN CLASS 9 (U.S. CLS. 21, 23, 26, 36 AND 38).

FIRST USE 4-28-2006; IN COMMERCE 4-28-2006.

THE MARK CONSISTS OF STANDARD CHARACTERS WITHOUT CLAIM TO ANY PAR-
TICULAR FONT, STYLE, SIZE, OR COLOR.

SER. NO. 85-357,693, FILED 6-28-2011.

ROBIN MITTLER, EXAMINING ATTORNEY



David J. Kybas

Director of the United States Patent and Trademark Office

United States of America

United States Patent and Trademark Office

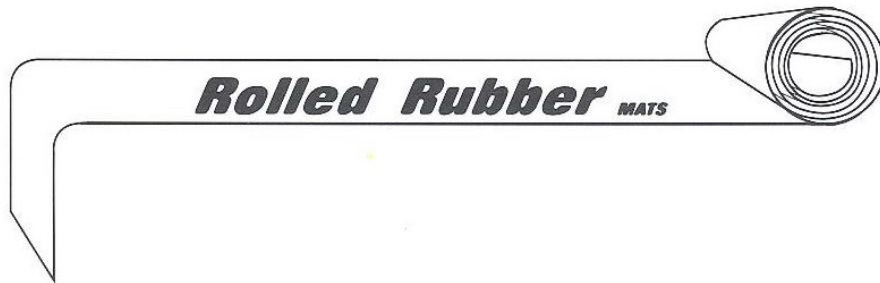

Reg. No. 4,108,233

Registered Mar. 6, 2012

Int. Cl.: 27

TRADEMARK

PRINCIPAL REGISTER

DOUBLE L GROUP, LTD. (IOWA CORPORATION)
2020 BELTLINE ROAD
DYERSVILLE, IA 52040

FOR: FLOOR MATS, IN CLASS 27 (U.S. CLS. 19, 20, 37, 42 AND 50).

FIRST USE 6-10-2011; IN COMMERCE 6-10-2011.

NO CLAIM IS MADE TO THE EXCLUSIVE RIGHT TO USE "ROLLED RUBBER MATS",
APART FROM THE MARK AS SHOWN.

THE MARK CONSISTS OF AN IMAGE OF A MAT ROLLED AT ONE END WITH THE
WORDS "ROLLED RUBBER MATS" DISPLAYED.

SER. NO. 85-357,801, FILED 6-28-2011.

ROSELLE HERRERA, EXAMINING ATTORNEY



David J. Kyffers

Director of the United States Patent and Trademark Office

United States of America

United States Patent and Trademark Office

TZ Courier

Reg. No. 4,108,234

Registered Mar. 6, 2012

Int. Cl.: 39

SERVICE MARK

PRINCIPAL REGISTER

TELEZYGOLOGY, INC. (DELAWARE CORPORATION), DBA TZ, INC.
SUITE 100
520 W. ERIE STREET
CHICAGO, IL 60654

FOR: SECURE PARCEL DISTRIBUTION AND EXCHANGE, NAMELY, PARCEL DELIVERY AND SHIPPING SERVICES BETWEEN PARCEL COLLECTION POINTS AND INTENDED RECIPIENTS IN CORPORATE MAIL ROOMS, IN CLASS 39 (U.S. CLS. 100 AND 105).

FIRST USE 1-15-2010; IN COMMERCE 2-1-2010.

THE MARK CONSISTS OF STANDARD CHARACTERS WITHOUT CLAIM TO ANY PARTICULAR FONT, STYLE, SIZE, OR COLOR.

NO CLAIM IS MADE TO THE EXCLUSIVE RIGHT TO USE "COURIER", APART FROM THE MARK AS SHOWN.

SER. NO. 85-357,815, FILED 6-28-2011.

ELLEN PERKINS, EXAMINING ATTORNEY



David J. Kyffers

Director of the United States Patent and Trademark Office

United States of America

United States Patent and Trademark Office

*Community
Bank
of the South*

Reg. No. 4,108,235

Registered Mar. 6, 2012

Int. Cl.: 36

SERVICE MARK

PRINCIPAL REGISTER

COMMUNITY BANK OF THE SOUTH (FLORIDA CORPORATION)
277 N. SYKES CREEK PARKWAY
MERRITT ISLAND, FL 32953

FOR: BANKING SERVICES, IN CLASS 36 (U.S. CLS. 100, 101 AND 102).

FIRST USE 2-1-1999; IN COMMERCE 11-1-1999.

NO CLAIM IS MADE TO THE EXCLUSIVE RIGHT TO USE "COMMUNITY BANK", APART FROM THE MARK AS SHOWN.

THE MARK CONSISTS OF THE STYLIZED TEXT "COMMUNITY" ABOVE THE STYLIZED TEXT "BANK". UNDER "BANK" IS THE STYLIZED TEXT "OF THE SOUTH".

SER. NO. 85-357,816, FILED 6-28-2011.

SARA BENJAMIN, EXAMINING ATTORNEY



David J. Kyffers

Director of the United States Patent and Trademark Office

United States of America

United States Patent and Trademark Office

TZ Concierge

Reg. No. 4,108,236

Registered Mar. 6, 2012

Int. Cl.: 35

SERVICE MARK

PRINCIPAL REGISTER

TELEZYGOLOGY, INC. (DELAWARE CORPORATION), DBA TZ, INC.
SUITE 100
520 W. ERIE STREET
CHICAGO, IL 60654

FOR: SECURE PARCEL MANAGEMENT, NAMELY, ARRANGING FOR PICKUP, DELIVERY AND TRANSPORTATION OF PARCELS IN THE RESIDENTIAL SECTOR, IN CLASS 35 (U.S. CLS. 100, 101 AND 102).

FIRST USE 1-15-2010; IN COMMERCE 2-1-2010.

THE MARK CONSISTS OF STANDARD CHARACTERS WITHOUT CLAIM TO ANY PARTICULAR FONT, STYLE, SIZE, OR COLOR.

NO CLAIM IS MADE TO THE EXCLUSIVE RIGHT TO USE "CONCIERGE", APART FROM THE MARK AS SHOWN.

SER. NO. 85-357,847, FILED 6-28-2011.

ELLEN PERKINS, EXAMINING ATTORNEY



David J. Kyffers

Director of the United States Patent and Trademark Office

United States of America

United States Patent and Trademark Office

UpscaleHype

Reg. No. 4,108,237

Registered Mar. 6, 2012

Int. Cl.: 45

SERVICE MARK

PRINCIPAL REGISTER

UPSCALEHYPE LLC (TEXAS LIMITED LIABILITY COMPANY)
13130 NEWBERRY ST.
SUGAR LAND, TX 77478

FOR: PROVIDING ON-LINE INFORMATION, NEWS AND COMMENTARY IN THE FIELD OF HIGH-END FASHION, CELEBRITY FASHION AND LUXURY LIFESTYLES, IN CLASS 45 (U.S. CLS. 100 AND 101).

FIRST USE 7-9-2008; IN COMMERCE 7-9-2008.

THE MARK CONSISTS OF STANDARD CHARACTERS WITHOUT CLAIM TO ANY PARTICULAR FONT, STYLE, SIZE, OR COLOR.

SER. NO. 85-358,002, FILED 6-28-2011.

JEFFREY LOOK, EXAMINING ATTORNEY



David J. Kybas

Director of the United States Patent and Trademark Office

United States of America

United States Patent and Trademark Office

JRESULTNET

Reg. No. 4,108,238

Registered Mar. 6, 2012

Int. Cl.: 9

TRADEMARK

PRINCIPAL REGISTER

DAWNING TECHNOLOGIES, INC. (NEW YORK CORPORATION)
SUITE 202
8140 COLLEGE PARKWAY
FT. MYERS, FL 33919

FOR: COMPUTER PROGRAMS FOR THE MANAGEMENT OF ELECTRONIC DATA IN A MEDICAL LABORATORY, INCLUDING PATIENT, ANALYTICAL DEVICE AND INFORMATION SYSTEM DATA AND RELATED DOCUMENTATION IN THE NATURE OF USER MANUALS SOLD TOGETHER AS A UNIT, IN CLASS 9 (U.S. CLS. 21, 23, 26, 36 AND 38).

FIRST USE 7-10-2001; IN COMMERCE 4-15-2002.

THE MARK CONSISTS OF STANDARD CHARACTERS WITHOUT CLAIM TO ANY PARTICULAR FONT, STYLE, SIZE, OR COLOR.

SER. NO. 85-358,010, FILED 6-28-2011.

SUSAN STIGLITZ, EXAMINING ATTORNEY



David J. Kybas

Director of the United States Patent and Trademark Office

United States of America

United States Patent and Trademark Office



Reg. No. 4,108,239

Registered Mar. 6, 2012

Int. Cl.: 38

SERVICE MARK

PRINCIPAL REGISTER

VALUEPULSE LLC (CALIFORNIA LIMITED LIABILITY COMPANY)
293 EL PORTAL DRIVE
PISMO BEACH, CA 93449

FOR: PROVIDING AN ONLINE FORUM FOR TRANSMISSION OF MESSAGES AMONG COMPUTER USERS FOR THE PURPOSE OF DISCUSSING SOCIAL, POLITICAL, CULTURAL AND BUSINESS ISSUES, IN CLASS 38 (U.S. CLS. 100, 101 AND 104).

FIRST USE 3-15-2011; IN COMMERCE 4-15-2011.

THE MARK CONSISTS OF THE UPPERCASE LETTERS "VP" ON THE LEFT PORTION OF THE MARK, WITH THE LEFTSIDE OF THE LETTER "V" IN THE COLOR GRAY AND THE RIGHT SIDE OF THE LETTER "V" FORMING INTO THE LEFT SIDE OF THE LETTER "P", THEN GRADUATING INTO THE COLOR ORANGE, FOLLOWED BY A GRAY VERTICAL LINE, WHICH IS FOLLOWED BY THE UPPERCASE WORD "VALUEPULSE" WITH THE "VALUE" PORTION OF THE WORD IN THE COLOR GRAY AND THE "PULSE" PORTION OF THE WORD IN THE COLOR ORANGE, ALL IN A STYLIZED FONT.

THE COLOR(S) GRAY AND ORANGE IS/ARE CLAIMED AS A FEATURE OF THE MARK.

SER. NO. 85-358,080, FILED 6-28-2011.

DORITT L. CARROLL, EXAMINING ATTORNEY



David J. Kyjars

Director of the United States Patent and Trademark Office

United States of America

United States Patent and Trademark Office

ADFLOW NETWORKS

Reg. No. 4,108,240

Registered Mar. 6, 2012

Int. Cl.: 35

SERVICE MARK

PRINCIPAL REGISTER

ADFLOW NETWORKS INC. (CANADA CORPORATION)
3170 HARVESTER ROAD, SUITE 102
BURLINGTON, ONTARIO, CANADA L7N3W8

FOR: MARKETING SERVICES, NAMELY, PROMOTING THE BRANDS OF OTHERS THROUGH THE USE OF DIGITAL SIGNAGE AND INTERACTIVE KIOSKS, IN CLASS 35 (U.S. CLS. 100, 101 AND 102).

FIRST USE 3-16-2003; IN COMMERCE 3-16-2003.

THE MARK CONSISTS OF STANDARD CHARACTERS WITHOUT CLAIM TO ANY PARTICULAR FONT, STYLE, SIZE, OR COLOR.

NO CLAIM IS MADE TO THE EXCLUSIVE RIGHT TO USE "NETWORKS", APART FROM THE MARK AS SHOWN.

SER. NO. 85-358,200, FILED 6-28-2011.

CHRISTOPHER BUONGIORNO, EXAMINING ATTORNEY



David J. Kybas

Director of the United States Patent and Trademark Office

United States of America

United States Patent and Trademark Office

ADFLOW HEALTH NETWORKS

Reg. No. 4,108,241

Registered Mar. 6, 2012

Int. Cls.: 9 and 35

TRADEMARK

SERVICE MARK

PRINCIPAL REGISTER

ADFLOW NETWORKS INC. (CANADA CORPORATION)
3170 HARVESTER ROAD, SUITE 102
BURLINGTON, ONTARIO, CANADA L7N3W8

FOR: INTERACTIVE COMPUTER KIOSKS FOR PROVIDING PERSONAL HEALTH DATA AND INFORMATION, IN CLASS 9 (U.S. CLS. 21, 23, 26, 36 AND 38).

FIRST USE 8-27-2010; IN COMMERCE 8-27-2010.

FOR: MARKETING SERVICES, NAMELY, PROMOTING THE BRANDS OF OTHERS THROUGH THE USE OF DIGITAL SIGNAGE AND INTERACTIVE KIOSKS, IN CLASS 35 (U.S. CLS. 100, 101 AND 102).

FIRST USE 8-27-2010; IN COMMERCE 8-27-2010.

THE MARK CONSISTS OF STANDARD CHARACTERS WITHOUT CLAIM TO ANY PARTICULAR FONT, STYLE, SIZE, OR COLOR.

NO CLAIM IS MADE TO THE EXCLUSIVE RIGHT TO USE "HEALTH NETWORKS", APART FROM THE MARK AS SHOWN.

SER. NO. 85-358,221, FILED 6-28-2011.

CHRISTOPHER BUONGIORNO, EXAMINING ATTORNEY



David J. Kybas

Director of the United States Patent and Trademark Office

United States of America

United States Patent and Trademark Office



Reg. No. 4,108,242

THRASH, WILLIAM (UNITED STATES INDIVIDUAL)
9289 DAVIES PLANTATION RD
BARTLETT, TN 38133

Registered Mar. 6, 2012

Int. Cl.: 35

FOR: RETAIL STORES FEATURING PORTABLE BUILDINGS AND PLAYGROUND EQUIPMENT, IN CLASS 35 (U.S. CLS. 100, 101 AND 102).

SERVICE MARK

FIRST USE 1-1-2010; IN COMMERCE 4-10-2010.

PRINCIPAL REGISTER

NO CLAIM IS MADE TO THE EXCLUSIVE RIGHT TO USE "AMISH", APART FROM THE MARK AS SHOWN.

THE MARK CONSISTS OF THE STYLIZED TEXT "THE AMISH CONNECTION" WITH AN AMISH HORSE AND BUGGY.

SER. NO. 85-358,305, FILED 6-28-2011.

TRICIA SONNEBORN, EXAMINING ATTORNEY



David J. Kybas

Director of the United States Patent and Trademark Office

United States of America

United States Patent and Trademark Office

Diverse Image

Reg. No. 4,108,243

BRIDGER WILLIAM R JR (UNITED STATES INDIVIDUAL)
68 PENNSYLVANIA AVE
WARETOWN, NJ 08758

Registered Mar. 6, 2012

Int. Cl.: 41

FOR: DIGITAL IMAGING SERVICES; PHOTOGRAPHY; PHOTOGRAPHY SERVICES; PORTRAIT PHOTOGRAPHY; PROVIDING FACILITIES FOR PRODUCING VIDEO, CINEMA AND PHOTOGRAPHY PRODUCTIONS; WEDDING PHOTOGRAPHY SERVICES, IN CLASS 41 (U.S. CLS. 100, 101 AND 107).

SERVICE MARK

PRINCIPAL REGISTER

FIRST USE 6-6-2009; IN COMMERCE 6-6-2009.

THE MARK CONSISTS OF STANDARD CHARACTERS WITHOUT CLAIM TO ANY PARTICULAR FONT, STYLE, SIZE, OR COLOR.

NO CLAIM IS MADE TO THE EXCLUSIVE RIGHT TO USE "IMAGE", APART FROM THE MARK AS SHOWN.

SER. NO. 85-358,404, FILED 6-28-2011.

RON FAIRBANKS, EXAMINING ATTORNEY



David J. Kyffers

Director of the United States Patent and Trademark Office

United States of America

United States Patent and Trademark Office

Mettler Method

Reg. No. 4,108,244

Registered Mar. 6, 2012

Int. Cl.: 44

SERVICE MARK

PRINCIPAL REGISTER

METTLER, PAUL RICHARD (UNITED STATES INDIVIDUAL)
2906 CROSSING COURT
CHAMPAIGN, IL 61822

FOR: PHYSICAL REHABILITATION; PHYSICAL THERAPY; PHYSICAL THERAPY EVALUATION AND TREATMENT OF MUSCULOSKELETAL CONDITIONS; PHYSICAL THERAPY EVALUATION, IDENTIFICATION, AND MANAGEMENT OF MOVEMENT DYSFUNCTION TO RESTORE, MAINTAIN, AND PROMOTE OPTIMAL PHYSICAL FUNCTION PREVENTING THE ONSET, SYMPTOMS AND PROGRESSION OF IMPAIRMENTS, FUNCTIONAL LIMITATIONS, AND DISABILITIES RESULTING FROM DISEASE, DISORDERS, CONDITIONS, OR INJURIES, IN CLASS 44 (U.S. CLS. 100 AND 101).

FIRST USE 11-10-2009; IN COMMERCE 11-10-2009.

THE MARK CONSISTS OF STANDARD CHARACTERS WITHOUT CLAIM TO ANY PARTICULAR FONT, STYLE, SIZE, OR COLOR.

NO CLAIM IS MADE TO THE EXCLUSIVE RIGHT TO USE "METHOD", APART FROM THE MARK AS SHOWN.

SER. NO. 85-358,410, FILED 6-28-2011.

KATINA MISTER, EXAMINING ATTORNEY



David J. Kybas

Director of the United States Patent and Trademark Office

United States of America

United States Patent and Trademark Office

Mary Ellen's

Made
BY
Hand

Reg. No. 4,108,245

Registered Mar. 6, 2012

Int. Cl.: 3

TRADEMARK

PRINCIPAL REGISTER

MARY ELLEN'S PRODUCTS, INC. (MINNESOTA CORPORATION)
SUITE 110
9437 GARFIELD AVENUE S.
BLOOMINGTON, MN 55420

FOR: HAND THERAPY GELS, IN CLASS 3 (U.S. CLS. 1, 4, 6, 50, 51 AND 52).

FIRST USE 3-1-2011; IN COMMERCE 3-12-2011.

NO CLAIM IS MADE TO THE EXCLUSIVE RIGHT TO USE "MADE BY HAND", APART FROM THE MARK AS SHOWN.

THE MARK CONSISTS OF THE WORDS "MARY ELLEN'S MADE BY HAND" IN STYLISTIC FORM.

SER. NO. 85-358,429, FILED 6-28-2011.

MICHAEL KEATING, EXAMINING ATTORNEY



David J. Kybas

Director of the United States Patent and Trademark Office

United States of America

United States Patent and Trademark Office



Reg. No. 4,108,246

Registered Mar. 6, 2012

Int. Cl.: 35

SERVICE MARK

PRINCIPAL REGISTER

GOODYSHIRT.COM, LLC (ILLINOIS LIMITED LIABILITY COMPANY), DBA
SLEEVECANDY
1630 ORRINGTON AVE
EVANSTON, IL 60201

FOR: RETAIL STORE SERVICES FEATURING T-SHIRTS, IN CLASS 35 (U.S. CLS. 100, 101 AND 102).

FIRST USE 6-1-2011; IN COMMERCE 6-13-2011.

NO CLAIM IS MADE TO THE EXCLUSIVE RIGHT TO USE "WEAR ORIGINAL", APART FROM THE MARK AS SHOWN.

THE COLOR(S) WHITE, LIGHT PINK, DARK PINK, AND BLACK IS/ARE CLAIMED AS A FEATURE OF THE MARK.

THE MARK CONSISTS OF THE WORDING "SLEEVECANDY" IN WHITE ABOVE THE WORDING "WEAR ORIGINAL" IN LIGHT PINK. THE WORDING APPEARS ON A DARK PINK STYLIZED RECTANGLE, WITH BLACK STITCHING ON THE OUTER EDGES OF THE RECTANGLE.

SER. NO. 85-358,501, FILED 6-28-2011.

KAREN SEVERSON, EXAMINING ATTORNEY



David J. Kyjars

Director of the United States Patent and Trademark Office

United States of America

United States Patent and Trademark Office

DORAL BIZ RUN

Reg. No. 4,108,247

Registered Mar. 6, 2012

Int. Cl.: 41

EXCEL EVENTS & PRODUCTIONS, LLC (FLORIDA LIMITED LIABILITY COMPANY),
DBA EXCEL SPORTS
STE 104
14345 SW 120 ST
MIAMI, FL 33186

SERVICE MARK

FOR: ENTERTAINMENT IN THE NATURE OF ATHLETIC AND SPORTS EVENT SERVICES, NAMELY, ARRANGING, ORGANIZING AND OPERATING RUNNING RACES , IN CLASS 41 (U.S. CLS. 100, 101 AND 107).

PRINCIPAL REGISTER

FIRST USE 5-1-2010; IN COMMERCE 9-16-2010.

THE MARK CONSISTS OF STANDARD CHARACTERS WITHOUT CLAIM TO ANY PARTICULAR FONT, STYLE, SIZE, OR COLOR.

NO CLAIM IS MADE TO THE EXCLUSIVE RIGHT TO USE "DORAL" OR "RUN", APART FROM THE MARK AS SHOWN.

SER. NO. 85-358,536, FILED 6-28-2011.

TINA L. SNAPP, EXAMINING ATTORNEY



David J. Kyfos

Director of the United States Patent and Trademark Office

United States of America

United States Patent and Trademark Office

TOUCH AND LEARN

Reg. No. 4,108,248

Registered Mar. 6, 2012

Int. Cls.: 9, 16 and 41

TRADEMARK

SERVICE MARK

PRINCIPAL REGISTER

UFI, INC. (DELAWARE CORPORATION)
7138 LITTLE RIVER TPK, SUITE 2005
ANNANDALE, VA 22003

FOR: ELECTRONIC PENS; ELECTRONIC BOOK READER; ELECTRONIC PUBLICATIONS, NAMELY, BOOKS CONTAINING TEXT FROM RELIGIOUS SOURCES SUCH AS THE KORAN AND AN ACCOMPANYING ELECTRONIC READER ON WHICH AUDIO RECORDINGS OF THE TEXT AND INFORMATION RELATED TO THE TEXT ARE STORED, AND WHICH RECORDINGS ARE TRIGGERED BY PASSING THE ELECTRONIC READER OVER THE TEXT, IN CLASS 9 (U.S. CLS. 21, 23, 26, 36 AND 38).

FIRST USE 9-1-2010; IN COMMERCE 9-1-2010.

FOR: EDUCATIONAL PUBLICATIONS, NAMELY, BOOKS IN THE FIELD OF RELIGION, IN CLASS 16 (U.S. CLS. 2, 5, 22, 23, 29, 37, 38 AND 50).

FIRST USE 9-1-2010; IN COMMERCE 9-1-2010.

FOR: PROVIDING RELIGIOUS EDUCATIONAL SERVICES, IN CLASS 41 (U.S. CLS. 100, 101 AND 107).

FIRST USE 9-1-2010; IN COMMERCE 9-1-2010.

THE MARK CONSISTS OF STANDARD CHARACTERS WITHOUT CLAIM TO ANY PARTICULAR FONT, STYLE, SIZE, OR COLOR.

SER. NO. 85-358,638, FILED 6-28-2011.

DOMINICK J. SALEMI, EXAMINING ATTORNEY



David J. Kybas

Director of the United States Patent and Trademark Office

United States of America

United States Patent and Trademark Office

TERRA FORCE

Reg. No. 4,108,249

Registered Mar. 6, 2012

Int. Cl.: 7

TRADEMARK

PRINCIPAL REGISTER

TERRA FORCE, INC (TEXAS CORPORATION)
SUITE 600
5200 EAST GRAND AVENUE
DALLAS, TX 75223

FOR: AGRICULTURAL MACHINERY, NAMELY, TILLERS, IN CLASS 7 (U.S. CLS. 13, 19, 21, 23, 31, 34 AND 35).

FIRST USE 12-1-2010; IN COMMERCE 12-1-2010.

THE MARK CONSISTS OF STANDARD CHARACTERS WITHOUT CLAIM TO ANY PARTICULAR FONT, STYLE, SIZE, OR COLOR.

NO CLAIM IS MADE TO THE EXCLUSIVE RIGHT TO USE "TERRA", APART FROM THE MARK AS SHOWN.

SER. NO. 85-358,690, FILED 6-28-2011.

JAMES MACFARLANE, EXAMINING ATTORNEY



David J. Kybas

Director of the United States Patent and Trademark Office

United States of America

United States Patent and Trademark Office



Reg. No. 4,108,250

Registered Mar. 6, 2012

Int. Cl.: 25

TRADEMARK

PRINCIPAL REGISTER

ELLIS, KENDRA (UNITED STATES INDIVIDUAL)
1112 OCEAN ST APT B
SANTA CRUZ, CA 95060

FOR: SOCKS THAT FACILITATE THE APPLICATION OF A WETSUIT, IN CLASS 25 (U.S. CLS. 22 AND 39).

FIRST USE 12-4-2010; IN COMMERCE 6-15-2011.

NO CLAIM IS MADE TO THE EXCLUSIVE RIGHT TO USE "SOCK", APART FROM THE MARK AS SHOWN.

THE MARK CONSISTS OF A CIRCLE. INSIDE THE CENTER OF THE CIRCLE IS A SOCK IN THE SHAPE OF A BREAKING WAVE. IN THE CENTER OF THE BREAKING WAVE ON THE SOCK THERE IS AN IMAGE OF A SURFER RIDING THE WAVE ON A SURFBOARD. AROUND THE BORDER ON THE INSIDE PERIMETER OF THE CIRCLE IS TRIANGULAR SHAPES OUTLINING THE IMAGE. ON THE OUTSIDE TOP CENTER PERIMETER OF THE CIRCLE ARE THE WORDS "THE SUIT SOCK".

SER. NO. 85-358,874, FILED 6-28-2011.

KATHRYN COWARD, EXAMINING ATTORNEY



David J. Kybas

Director of the United States Patent and Trademark Office

United States of America

United States Patent and Trademark Office



Reg. No. 4,108,251

Registered Mar. 6, 2012

Int. Cl.: 36

SERVICE MARK

PRINCIPAL REGISTER

FORE, HEIDI (UNITED STATES INDIVIDUAL), DBA RIVER VALLEY REALTY GROUP
9015 LINN STATION RD
LOUISVILLE, KY 40222

FOR: PROVIDING REAL ESTATE LISTINGS VIA THE INTERNET; REAL ESTATE AGEN-
CIES; REAL ESTATE BROKERAGE; REAL ESTATE LISTING; RESIDENTIAL REAL ESTATE
AGENCY SERVICES, IN CLASS 36 (U.S. CLS. 100, 101 AND 102).

FIRST USE 2-12-2011; IN COMMERCE 2-12-2011.

NO CLAIM IS MADE TO THE EXCLUSIVE RIGHT TO USE "RIVER VALLEY REALTY
GROUP", APART FROM THE MARK AS SHOWN.

THE COLOR(S) DARK ROYAL BLUE, LIGHT ROYAL BLUE, GREY AND WHITE IS/ARE
CLAIMED AS A FEATURE OF THE MARK.

THE MARK CONSISTS OF THREE HOUSES DARK ROYAL BLUE ON THE BOTTOM AND
LIGHT ROYAL BLUE TOWARDS THE TOP WITH WHITE WINDOWS, GETTING PROGRESS-
IVELY LARGER FROM LEFT TO RIGHT OVER A WAVE OF VARIOUS SHADES OF
ROYAL BLUE WATER, OVER THE WORDS "RIVER VALLEY REALTY GROUP" IN GREY.

SER. NO. 85-358,927, FILED 6-29-2011.

SHANNON TWOHIG, EXAMINING ATTORNEY



David J. Kybas

Director of the United States Patent and Trademark Office

United States of America

United States Patent and Trademark Office



Reg. No. 4,108,252

Registered Mar. 6, 2012

Int. Cls.: 36 and 45

SERVICE MARK

PRINCIPAL REGISTER

AVENUE 365 LENDER SERVICES, LLC (PENNSYLVANIA LIMITED LIABILITY COMPANY)
SUITE 440
4000 CHEMICAL ROAD
PLYMOUTH MEETING, PA 19462

FOR: INSURANCE AGENCY SERVICES FEATURING REAL ESTATE TITLE INSURANCE,
IN CLASS 36 (U.S. CLS. 100, 101 AND 102).

FIRST USE 1-1-2011; IN COMMERCE 5-13-2011.

FOR: CLOSING SERVICES FOR REAL ESTATE REFINANCES, PURCHASES AND MORT-
GAGE LOAN TRANSACTIONS, IN CLASS 45 (U.S. CLS. 100 AND 101).

FIRST USE 1-1-2011; IN COMMERCE 5-13-2011.

THE MARK CONSISTS OF AN OLIVE BRANCH CROWN DESIGN IN THE COLOR PUMPKIN
SURROUNDING A TYPICAL UNIVERSITY STYLE LETTER "U" IN THE COLOR PUMPKIN
OUTLINED IN THE COLOR WHITE AND AGAIN IN THE COLOR PUMPKIN; WITH A
BANNER LOCATED ON TOP OF THE "U" IN THE COLOR PUMPKIN CONTAINING THE
TEXT "AVE 365" SHOWN IN THE COLOR WHITE

THE COLOR(S) PUMPKIN AND WHITE IS/ARE CLAIMED AS A FEATURE OF THE MARK.

SER. NO. 85-358,993, FILED 6-29-2011.

LINDA E. BLOHM, EXAMINING ATTORNEY



David J. Kyjars

Director of the United States Patent and Trademark Office

United States of America

United States Patent and Trademark Office



Reg. No. 4,108,253

Registered Mar. 6, 2012

Int. Cl.: 42

SERVICE MARK

PRINCIPAL REGISTER

WAKE FOREST UNIVERSITY (NORTH CAROLINA CORPORATION)
1834 WAKE FOREST ROAD
WINSTON-SALEM, NC 27106

FOR: MEDICAL RESEARCH; SCIENTIFIC RESEARCH, IN CLASS 42 (U.S. CLS. 100 AND 101).

FIRST USE 3-17-2011; IN COMMERCE 3-17-2011.

THE MARK CONSISTS OF TWO STYLIZED STRANDS THAT FORM A STYLIZED LETTER "W" IN THE DESIGN OF A DNA HELIX.

SER. NO. 85-359,043, FILED 6-29-2011.

BARBARA A. GOLD, EXAMINING ATTORNEY



David J. Kybas

Director of the United States Patent and Trademark Office

United States of America

United States Patent and Trademark Office



Reg. No. 4,108,254

Registered Mar. 6, 2012

Int. Cl.: 44

SERVICE MARK

PRINCIPAL REGISTER

WAKE FOREST UNIVERSITY (NORTH CAROLINA CORPORATION)
1834 WAKE FOREST ROAD
WINSTON-SALEM, NC 27106

FOR: MEDICAL INFORMATION; MEDICAL SERVICES; CONSULTING SERVICES IN THE FIELD OF HEALTH; HEALTH CARE SERVICES, NAMELY, WELLNESS PROGRAMS; PROVIDING HEALTH INFORMATION, IN CLASS 44 (U.S. CLS. 100 AND 101).

FIRST USE 3-17-2011; IN COMMERCE 3-17-2011.

THE MARK CONSISTS OF TWO STYLIZED STRANDS THAT FORM A STYLIZED LETTER "W" IN THE DESIGN OF A DNA HELIX.

SER. NO. 85-359,117, FILED 6-29-2011.

BARBARA A. GOLD, EXAMINING ATTORNEY



David J. Kyjars

Director of the United States Patent and Trademark Office

United States of America

United States Patent and Trademark Office

PLANEX

Reg. No. 4,108,255

Registered Mar. 6, 2012

Int. Cl.: 7

TRADEMARK

PRINCIPAL REGISTER

TTS TOOLTECHNIC SYSTEMS AG & CO. KG (FED REP GERMANY LIMITED
PARTNERSHIP)
WERTSTRASSE 20
WENDLINGEN, FED REP GERMANY 73240

FOR: ELECTRICALLY DRIVEN POWER TOOLS, NAMELY, GRINDERS, SANDERS AND
POLISHERS, AND COMPRESSED AIR DRIVEN POWER TOOLS, NAMELY, GRINDERS,
SANDERS AND POLISHERS; MECHANICAL GRINDERS AND SANDERS; AND STRUC-
TURAL PARTS OF ALL AFOREMENTIONED GOODS, IN CLASS 7 (U.S. CLS. 13, 19, 21,
23, 31, 34 AND 35).

THE MARK CONSISTS OF STANDARD CHARACTERS WITHOUT CLAIM TO ANY PAR-
TICULAR FONT, STYLE, SIZE, OR COLOR.

OWNER OF FED REP GERMANY REG. NO. 30706511, DATED 6-25-2007, EXPIRES 2-28-
2017.

OWNER OF U.S. REG. NO. 3,436,452.

SER. NO. 85-359,122, FILED 6-29-2011.

APRIL ROACH, EXAMINING ATTORNEY



David J. Kyffers

Director of the United States Patent and Trademark Office

United States of America

United States Patent and Trademark Office



Reg. No. 4,108,256

Registered Mar. 6, 2012

Int. Cls.: 20, 22 and 24

TRADEMARK

PRINCIPAL REGISTER

DAQING CHEN (CHINA INDIVIDUAL), DBA DAKING CHEN
DAKING---CHEN@AHSUNFLOWER.COM
21580 ATLANTIC BLVD STE 170
STERLING, VA 20166

FOR: BED PILLOWS; BEDS, MATTRESSES, PILLOWS AND BOLSTERS; DECORATIVE 3D PILLOWS AND CUSHIONS; HEAD SUPPORTING PILLOWS, IN CLASS 20 (U.S. CLS. 2, 13, 22, 25, 32 AND 50).

FIRST USE 6-1-2000; IN COMMERCE 6-1-2000.

FOR: DOWN FEATHERS; DOWN FEATHERS FOR STUFFING MATERIAL; DOWN FEATHERS FOR USE AS STUFFING; FEATHERS AND DOWNS; FEATHERS FOR BEDDING, IN CLASS 22 (U.S. CLS. 1, 2, 7, 19, 22, 42 AND 50).

FIRST USE 6-1-2000; IN COMMERCE 6-1-2000.

FOR: BED COVERS; BED LINEN AND TABLE LINEN; BED THROWS; PILLOW CASES; PILLOW COVERS; PILLOW SHAMS; PILLOW-TOP, LOW-PROFILE BED SKIRTS; TEXTILE GOODS, NAMELY, A SYNTHETIC SHEET WITH FRAGRANCE FOR THE PURPOSE OF INSERTING INTO PILLOW SLIP AND UNDER FITTED SHEET TO EMIT FRAGRANCE, IN CLASS 24 (U.S. CLS. 42 AND 50).

FIRST USE 6-1-2000; IN COMMERCE 6-1-2000.

THE MARK CONSISTS OF A PARTIAL SUN IN ORANGE AND YELLOW COLOR ON THE TOP, WITH THE LETTERS "SUN" IN RED AND "FLOWER" IN BLUE.

THE COLOR(S) ORANGE, YELLOW, RED AND BLUE IS/ARE CLAIMED AS A FEATURE OF THE MARK.

SER. NO. 85-359,131, FILED 6-29-2011.

FONG HSU, EXAMINING ATTORNEY



David J. Kyffers

Director of the United States Patent and Trademark Office

United States of America

United States Patent and Trademark Office

CLAESON
the california in me

Reg. No. 4,108,257

Registered Mar. 6, 2012

Int. Cl.: 25

TRADEMARK

PRINCIPAL REGISTER

MT DESIGN GROUP LLC (NEW YORK LIMITED LIABILITY COMPANY)
143 AVENUE B, APT # 15E
NEW YORK, NY 10009

FOR: WOMEN'S CLOTHING, NAMELY, SHIRTS, SWEATSHIRTS, JEANS, PANTS, SHORTS, SKIRTS, DRESSES, ROMPERS, OVERALLS, SWIMSUITS, CARDIGANS, OUTERWEAR, NAMELY, COATS AND JACKETS, AND RAINWEAR; AND MEN'S CLOTHING, NAMELY, SHIRTS, SWEATSHIRTS, TEE SHIRTS, JEANS, PANTS, SHORTS, OVERALLS, SWIMSUITS, CARDIGANS, SWEATERS, OUTERWEAR, NAMELY, COATS AND JACKETS, AND RAINWEAR, IN CLASS 25 (U.S. CLS. 22 AND 39).

FIRST USE 2-21-2011; IN COMMERCE 2-21-2011.

THE MARK CONSISTS OF THE WORDS "CLAESON THE CALIFORNIA IN ME" WHEREIN THE WORD "CLAESON" IS IN STYLISTIC, BOLD FONT WITH AN UPPER CASE "L", THE REST OF THE LETTERS ALL IN LOWER CASE, AND THE LETTER "E" IS BACKWARDS. BENEATH "CLAESON THE CALIFORNIA IN ME" IS IN LOWERCASE LETTERS AND THE LETTERS "C" AND "A" IN THE WORD "CALIFORNIA" ARE IN BOLD FONT.

SER. NO. 85-359,140, FILED 6-29-2011.

KAREN BRACEY, EXAMINING ATTORNEY



David J. Kyjars

Director of the United States Patent and Trademark Office

United States of America

United States Patent and Trademark Office

WAKE FOREST BAPTIST MEDICAL CENTER

Reg. No. 4,108,258

Registered Mar. 6, 2012

Int. Cl.: 44

SERVICE MARK

PRINCIPAL REGISTER

WAKE FOREST UNIVERSITY (NORTH CAROLINA CORPORATION)
1834 WAKE FOREST ROAD
WINSTON-SALEM, NC 27106

FOR: MEDICAL SERVICES; MEDICAL INFORMATION; CONSULTING SERVICES IN THE FIELD OF HEALTH; HEALTH CARE SERVICES, NAMELY, WELLNESS PROGRAMS; PROVIDING HEALTH INFORMATION, IN CLASS 44 (U.S. CLS. 100 AND 101).

FIRST USE 3-17-2011; IN COMMERCE 3-17-2011.

THE MARK CONSISTS OF STANDARD CHARACTERS WITHOUT CLAIM TO ANY PARTICULAR FONT, STYLE, SIZE, OR COLOR.

OWNER OF U.S. REG. NOS. 2,319,344, 2,321,497 AND OTHERS.

NO CLAIM IS MADE TO THE EXCLUSIVE RIGHT TO USE "BAPTIST MEDICAL CENTER", APART FROM THE MARK AS SHOWN.

SER. NO. 85-359,150, FILED 6-29-2011.

BARBARA A. GOLD, EXAMINING ATTORNEY



David J. Kyffers

Director of the United States Patent and Trademark Office

United States of America

United States Patent and Trademark Office

Baby Translator

Reg. No. 4,108,259

Registered Mar. 6, 2012

Int. Cl.: 9

TRADEMARK

PRINCIPAL REGISTER

MARONDE, JUSTIN (UNITED STATES INDIVIDUAL)
43846 CHERRY GROVE CT. E.
CANTON, MI 48188

FOR: COMPUTER APPLICATION SOFTWARE FOR MOBILE PHONES, NAMELY, SOFTWARE FOR ENTERTAINMENT PURPOSES IN THE NATURE OF ANECDOTAL TRANSLATIONS OF BABY GIBBERISH, IN CLASS 9 (U.S. CLS. 21, 23, 26, 36 AND 38).

FIRST USE 3-23-2009; IN COMMERCE 3-23-2009.

THE MARK CONSISTS OF STANDARD CHARACTERS WITHOUT CLAIM TO ANY PARTICULAR FONT, STYLE, SIZE, OR COLOR.

NO CLAIM IS MADE TO THE EXCLUSIVE RIGHT TO USE "TRANSLATOR", APART FROM THE MARK AS SHOWN.

SER. NO. 85-359,180, FILED 6-29-2011.

RONALD DELGIZZI, EXAMINING ATTORNEY



David J. Kybas

Director of the United States Patent and Trademark Office

United States of America

United States Patent and Trademark Office

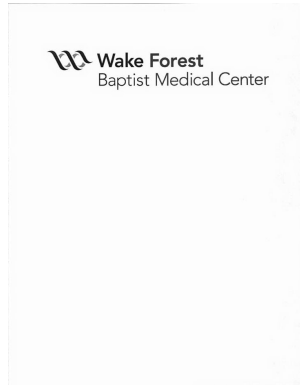

Reg. No. 4,108,260

Registered Mar. 6, 2012

Int. Cl.: 44

SERVICE MARK

PRINCIPAL REGISTER

WAKE FOREST UNIVERSITY (NORTH CAROLINA CORPORATION)
1834 WAKE FOREST ROAD
WINSTON-SALEM, NC 27106

FOR: MEDICAL INFORMATION; MEDICAL SERVICES; CONSULTING SERVICES IN THE FIELD OF HEALTH; HEALTH CARE SERVICES, NAMELY, WELLNESS PROGRAMS; PROVIDING HEALTH INFORMATION, IN CLASS 44 (U.S. CLS. 100 AND 101).

FIRST USE 3-17-2011; IN COMMERCE 3-17-2011.

OWNER OF U.S. REG. NOS. 2,319,344, 2,321,497 AND OTHERS.

NO CLAIM IS MADE TO THE EXCLUSIVE RIGHT TO USE "BAPTIST MEDICAL CENTER", APART FROM THE MARK AS SHOWN.

THE MARK CONSISTS OF THE WORDING, "WAKE FOREST BAPTIST MEDICAL CENTER", TO THE RIGHT OF TWO STYLIZED STRANDS THAT FORM A STYLIZED LETTER "W" IN THE DESIGN OF A DNA HELIX.

SER. NO. 85-359,192, FILED 6-29-2011.

BARBARA A. GOLD, EXAMINING ATTORNEY



David J. Kyjars

Director of the United States Patent and Trademark Office

United States of America

United States Patent and Trademark Office



Reg. No. 4,108,261

WAKE FOREST UNIVERSITY (NORTH CAROLINA CORPORATION)
1834 WAKE FOREST ROAD
WINSTON-SALEM, NC 27106

Registered Mar. 6, 2012

Int. Cl.: 41

FOR: EDUCATION SERVICES IN THE NATURE OF COURSES AT THE UNIVERSITY LEVEL
IN THE FIELD OF MEDICINE, IN CLASS 41 (U.S. CLS. 100, 101 AND 107).

SERVICE MARK

FIRST USE 3-17-2011; IN COMMERCE 3-17-2011.

PRINCIPAL REGISTER

OWNER OF U.S. REG. NOS. 2,319,344, 2,321,497 AND OTHERS.

NO CLAIM IS MADE TO THE EXCLUSIVE RIGHT TO USE "BAPTIST MEDICAL CENTER",
APART FROM THE MARK AS SHOWN.

THE MARK CONSISTS OF THE WORDING, "WAKE FOREST BAPTIST MEDICAL CENTER",
TO THE RIGHT OF TWO STYLIZED STRANDS THAT FORM A STYLIZED LETTER "W"
IN THE DESIGN OF A DNA HELIX.

SER. NO. 85-359,226, FILED 6-29-2011.

BARBARA A. GOLD, EXAMINING ATTORNEY



David J. Kyjars

Director of the United States Patent and Trademark Office

United States of America

United States Patent and Trademark Office

sculptees

Reg. No. 4,108,262

Registered Mar. 6, 2012

Int. Cl.: 25

TRADEMARK

PRINCIPAL REGISTER

THIBEAUX, STEPHANIE (UNITED STATES INDIVIDUAL)
1415 S. VOSS STE. 110-434
HOUSTON, TX 77057

FOR: CLOTHING, NAMELY, SHIRTS, PANTS, TOPS, BOTTOMS, SOCKS, UNDERGARMENTS, SWIMWEAR, DRESSES, BODY SHAPERS, SHOES, SKIRTS, SHORTS, LEGGINGS, HOSIERY, BODYSUITS, IN CLASS 25 (U.S. CLS. 22 AND 39).

FIRST USE 4-30-2008; IN COMMERCE 8-25-2008.

THE MARK CONSISTS OF STANDARD CHARACTERS WITHOUT CLAIM TO ANY PARTICULAR FONT, STYLE, SIZE, OR COLOR.

OWNER OF U.S. REG. NO. 3,548,061.

SER. NO. 85-359,321, FILED 6-29-2011.

GIANCARLO CASTRO, EXAMINING ATTORNEY



David J. Kybas

Director of the United States Patent and Trademark Office

United States of America

United States Patent and Trademark Office



the
CARIBE HOTELS
O R L A N D O

Reg. No. 4,108,263

SIERRA LODGINGS, INC. (CALIFORNIA CORPORATION)
8101 WORLD CENTER DRIVE
ORLANDO, FL 32821

Registered Mar. 6, 2012

Int. Cl.: 43

FOR: RESORT HOTELS; CONVENTION CENTERS, NAMELY PROVIDING CONVENTION FACILITIES, IN CLASS 43 (U.S. CLS. 100 AND 101).

SERVICE MARK

FIRST USE 1-0-2011; IN COMMERCE 1-0-2011.

PRINCIPAL REGISTER

OWNER OF U.S. REG. NO. 3,785,554.

THE COLOR(S) GRAY AND ORANGE IS/ARE CLAIMED AS A FEATURE OF THE MARK.

NO CLAIM IS MADE TO THE EXCLUSIVE RIGHT TO USE "HOTELS" OR "ORLANDO", APART FROM THE MARK AS SHOWN.

THE MARK CONSISTS OF THE WORDS "THE CARIBE HOTELS ORLANDO" IN STYLIZED FONT BELOW AN IMAGE OF A COMPASS ARROW. THE WORDS "THE CARIBE HOTELS" ARE IN GRAY AND "ORLANDO" AND THE IMAGE ARE IN ORANGE.

SER. NO. 85-359,332, FILED 6-29-2011.

KELLY BOULTON, EXAMINING ATTORNEY



David J. Kybas

Director of the United States Patent and Trademark Office

United States of America

United States Patent and Trademark Office

THE CARIBE HOTELS

Reg. No. 4,108,264

SIERRA LODGINGS, INC. (CALIFORNIA CORPORATION)
8101 WORLD CENTER DRIVE
ORLANDO, FL 32821

Registered Mar. 6, 2012

Int. Cl.: 43

FOR: RESORT HOTELS; CONVENTION CENTERS, NAMELY, PROVIDING CONVENTION FACILITIES, IN CLASS 43 (U.S. CLS. 100 AND 101).

SERVICE MARK

FIRST USE 1-0-2011; IN COMMERCE 1-0-2011.

PRINCIPAL REGISTER

THE MARK CONSISTS OF STANDARD CHARACTERS WITHOUT CLAIM TO ANY PARTICULAR FONT, STYLE, SIZE, OR COLOR.

OWNER OF U.S. REG. NO. 3,785,554.

NO CLAIM IS MADE TO THE EXCLUSIVE RIGHT TO USE "HOTELS", APART FROM THE MARK AS SHOWN.

SER. NO. 85-359,359, FILED 6-29-2011.

KELLY BOULTON, EXAMINING ATTORNEY



David J. Kybas

Director of the United States Patent and Trademark Office

United States of America

United States Patent and Trademark Office

Outside Van

Reg. No. 4,108,265

OUTSIDEVAN, LLC (OREGON LIMITED LIABILITY COMPANY)
2211 SHERMAN AVE.
HOOD RIVER, OR 97031

Registered Mar. 6, 2012

Int. Cl.: 12

FOR: VANS AND STRUCTURAL PARTS THEREFOR, IN CLASS 12 (U.S. CLS. 19, 21, 23, 31, 35 AND 44).

TRADEMARK

FIRST USE 5-17-2007; IN COMMERCE 3-5-2008.

PRINCIPAL REGISTER

THE MARK CONSISTS OF STANDARD CHARACTERS WITHOUT CLAIM TO ANY PARTICULAR FONT, STYLE, SIZE, OR COLOR.

NO CLAIM IS MADE TO THE EXCLUSIVE RIGHT TO USE "VAN", APART FROM THE MARK AS SHOWN.

SER. NO. 85-359,378, FILED 6-29-2011.

TRACY WHITTAKER-BROWN, EXAMINING ATTORNEY



David J. Kyffers

Director of the United States Patent and Trademark Office

United States of America

United States Patent and Trademark Office

WAKE FOREST BAPTIST MEDICAL CENTER

Reg. No. 4,108,266

WAKE FOREST UNIVERSITY (NORTH CAROLINA CORPORATION)
1834 WAKE FOREST ROAD
WINSTON-SALEM, NC 27106

Registered Mar. 6, 2012

Int. Cl.: 41

FOR: EDUCATION SERVICES IN THE NATURE OF COURSES AT THE UNIVERSITY LEVEL
IN THE FIELD OF MEDICINE, IN CLASS 41 (U.S. CLS. 100, 101 AND 107).

SERVICE MARK

FIRST USE 3-17-2011; IN COMMERCE 3-17-2011.

PRINCIPAL REGISTER

THE MARK CONSISTS OF STANDARD CHARACTERS WITHOUT CLAIM TO ANY PAR-
TICULAR FONT, STYLE, SIZE, OR COLOR.

OWNER OF U.S. REG. NOS. 2,319,344, 2,321,497 AND OTHERS.

NO CLAIM IS MADE TO THE EXCLUSIVE RIGHT TO USE "BAPTIST MEDICAL CENTER",
APART FROM THE MARK AS SHOWN.

SER. NO. 85-359,404, FILED 6-29-2011.

BARBARA A. GOLD, EXAMINING ATTORNEY



David J. Kyffers

Director of the United States Patent and Trademark Office

United States of America

United States Patent and Trademark Office

System Saver

Reg. No. 4,108,267

Registered Mar. 6, 2012

Int. Cl.: 7

TRADEMARK

PRINCIPAL REGISTER

WABCO IP HOLDINGS LLC[®] (DELAWARE LIMITED LIABILITY COMPANY)
ONE CENTENNIAL AVENUE
PISCATAWAY, NJ 08855

FOR: DRYERS USED FOR THE TRAPPING AND COLLECTING OF SOLID, LIQUID AND VAPOR CONTAMINANTS FROM COMPRESSED AIR AND GASSES IN THE OPERATION OF COMMERCIAL VEHICLE ENGINES, IN CLASS 7 (U.S. CLS. 13, 19, 21, 23, 31, 34 AND 35).

FIRST USE 5-1-1993; IN COMMERCE 5-1-1993.

THE MARK CONSISTS OF STANDARD CHARACTERS WITHOUT CLAIM TO ANY PARTICULAR FONT, STYLE, SIZE, OR COLOR.

NO CLAIM IS MADE TO THE EXCLUSIVE RIGHT TO USE "SYSTEM", APART FROM THE MARK AS SHOWN.

SER. NO. 85-359,427, FILED 6-29-2011.

MICHELLE DUBOIS, EXAMINING ATTORNEY



David J. Kyjars

Director of the United States Patent and Trademark Office

United States of America

United States Patent and Trademark Office

Hairbows Unlimited

Reg. No. 4,108,268

BABY LUGO, LLC (UTAH LIMITED LIABILITY COMPANY)
2541 STONEBURY LOOP ROAD
SPRINGVILLE, UT 84663

Registered Mar. 6, 2012

Int. Cl.: 35

FOR: WHOLESALE DISTRIBUTORSHIPS FEATURING TODDLER AND BABY CLOTHING AND ACCESSORIES, IN CLASS 35 (U.S. CLS. 100, 101 AND 102).

SERVICE MARK

FIRST USE 2-1-2009; IN COMMERCE 4-1-2009.

PRINCIPAL REGISTER

THE MARK CONSISTS OF STANDARD CHARACTERS WITHOUT CLAIM TO ANY PARTICULAR FONT, STYLE, SIZE, OR COLOR.

NO CLAIM IS MADE TO THE EXCLUSIVE RIGHT TO USE "HAIRBOWS", APART FROM THE MARK AS SHOWN.

SER. NO. 85-359,440, FILED 6-29-2011.

MICHELLE DUBOIS, EXAMINING ATTORNEY



David J. Kybas

Director of the United States Patent and Trademark Office

United States of America

United States Patent and Trademark Office



Reg. No. 4,108,269

WAKE FOREST UNIVERSITY (NORTH CAROLINA CORPORATION)
1834 WAKE FOREST ROAD
WINSTON-SALEM, NC 27106

Registered Mar. 6, 2012

Int. Cl.: 42

FOR: MEDICAL RESEARCH; SCIENTIFIC RESEARCH, IN CLASS 42 (U.S. CLS. 100 AND 101).

SERVICE MARK

FIRST USE 3-17-2011; IN COMMERCE 3-17-2011.

PRINCIPAL REGISTER

OWNER OF U.S. REG. NOS. 2,321,501 AND 2,324,117.

NO CLAIM IS MADE TO THE EXCLUSIVE RIGHT TO USE "SCHOOL OF MEDICINE", APART FROM THE MARK AS SHOWN.

THE MARK CONSISTS OF THE WORDING, "WAKE FOREST SCHOOL OF MEDICINE", TO THE RIGHT OF TWO STYLIZED STRANDS THAT FORM A STYLIZED LETTER "W" IN THE DESIGN OF A DNA HELIX.

SER. NO. 85-359,490, FILED 6-29-2011.

BARBARA A. GOLD, EXAMINING ATTORNEY



David J. Kyjars

Director of the United States Patent and Trademark Office

United States of America

United States Patent and Trademark Office

WALLCAST

Reg. No. 4,108,270

Registered Mar. 6, 2012

Int. Cl.: 41

SERVICE MARK

PRINCIPAL REGISTER

NEW WORLD SYMPHONY, INC. (FLORIDA NON-PROFIT CORPORATION)
500 17TH STREET
MIAMI BEACH, FL 33139

FOR: ENTERTAINMENT SERVICES IN THE NATURE OF LIVE MUSICAL PERFORMANCES WITH ACCOMPANYING DISPLAY OF AUDIO, VISUAL, AUDIOVISUAL, AND MULTIMEDIA WORKS; ENTERTAINMENT SERVICES IN THE NATURE OF DEVELOPMENT, PRODUCTION, AND POST-PRODUCTION SERVICES IN THE FIELDS OF MULTIMEDIA ENTERTAINMENT CONTENT, IN CLASS 41 (U.S. CLS. 100, 101 AND 107).

FIRST USE 8-0-2010; IN COMMERCE 8-0-2010.

THE MARK CONSISTS OF STANDARD CHARACTERS WITHOUT CLAIM TO ANY PARTICULAR FONT, STYLE, SIZE, OR COLOR.

SER. NO. 85-359,522, FILED 6-29-2011.

LINDA E. BLOHM, EXAMINING ATTORNEY



David J. Kybas

Director of the United States Patent and Trademark Office

United States of America

United States Patent and Trademark Office

PrevMED

Reg. No. 4,108,271

PREVMED, INC. (DELAWARE CORPORATION)
201 PIER ONE RD.
STEVENSVILLE, MD 21666

Registered Mar. 6, 2012

Int. Cl.: 44

FOR: DENTAL HYGIENIST SERVICES, IN CLASS 44 (U.S. CLS. 100 AND 101).

SERVICE MARK

FIRST USE 2-27-2011; IN COMMERCE 2-27-2011.

PRINCIPAL REGISTER

THE MARK CONSISTS OF A DARK BLUE HEART SURROUNDED BY A WHITE OUTLINE. A STYLIZED HAND IN THE COLOR WHITE APPEARS EXTENDING ON THE RIGHT SIDE OF THE HEART IN SUPPORT OF THE HEART. THE HEART DESIGN APPEARS WITHIN A DARK BLUE SQUARE WITH A LIGHT BLUE COLOR GRADATION RUNNING ACROSS IT AND THROUGH THE HEART. THE DARK BLUE SQUARE HAS ITS UPPER RIGHT HAND CORNER CLIPPED. THE WORDING "PREVMED" APPEARS TO THE LEFT SIDE OF THE HEART DESIGN WITH THE LETTERS "PREV" IN LIGHT BLUE AND THE LETTERS "MED" IN DARK BLUE.

THE COLOR(S) LIGHT BLUE, DARK BLUE AND WHITE IS/ARE CLAIMED AS A FEATURE OF THE MARK.

SER. NO. 85-359,556, FILED 6-29-2011.

ZHALEH DELANEY, EXAMINING ATTORNEY



David J. Kybas

Director of the United States Patent and Trademark Office

United States of America

United States Patent and Trademark Office

WAKE FOREST SCHOOL OF MEDICINE

Reg. No. 4,108,272

WAKE FOREST UNIVERSITY (NORTH CAROLINA CORPORATION)
1834 WAKE FOREST ROAD
WINSTON-SALEM, NC 27106

Registered Mar. 6, 2012

Int. Cl.: 42

FOR: MEDICAL RESEARCH; SCIENTIFIC RESEARCH, IN CLASS 42 (U.S. CLS. 100 AND 101).

SERVICE MARK

FIRST USE 3-17-2011; IN COMMERCE 3-17-2011.

PRINCIPAL REGISTER

THE MARK CONSISTS OF STANDARD CHARACTERS WITHOUT CLAIM TO ANY PARTICULAR FONT, STYLE, SIZE, OR COLOR.

OWNER OF U.S. REG. NOS. 2,321,501 AND 2,324,117.

NO CLAIM IS MADE TO THE EXCLUSIVE RIGHT TO USE "SCHOOL OF MEDICINE", APART FROM THE MARK AS SHOWN.

SER. NO. 85-359,564, FILED 6-29-2011.

BARBARA A. GOLD, EXAMINING ATTORNEY



David J. Kyffers

Director of the United States Patent and Trademark Office

United States of America

United States Patent and Trademark Office



Reg. No. 4,108,273

WAKE FOREST UNIVERSITY (NORTH CAROLINA CORPORATION)
1834 WAKE FOREST ROAD
WINSTON-SALEM, NC 27106

Registered Mar. 6, 2012

Int. Cl.: 41

FOR: EDUCATION SERVICES IN THE NATURE OF COURSES AT THE UNIVERSITY LEVEL
IN THE FIELD OF MEDICINE, IN CLASS 41 (U.S. CLS. 100, 101 AND 107).

SERVICE MARK

FIRST USE 3-17-2011; IN COMMERCE 3-17-2011.

PRINCIPAL REGISTER

OWNER OF U.S. REG. NOS. 2,321,501 AND 2,324,117.

NO CLAIM IS MADE TO THE EXCLUSIVE RIGHT TO USE "SCHOOL OF MEDICINE",
APART FROM THE MARK AS SHOWN.

THE MARK CONSISTS OF THE WORDING, "WAKE FOREST SCHOOL OF MEDICINE",
TO THE RIGHT OF TWO STYLIZED STRANDS THAT FORM A STYLIZED LETTER "W"
IN THE DESIGN OF A DNA HELIX.

SER. NO. 85-359,613, FILED 6-29-2011.

BARBARA A. GOLD, EXAMINING ATTORNEY



David J. Kyjars

Director of the United States Patent and Trademark Office

United States of America

United States Patent and Trademark Office



Reg. No. 4,108,274

Registered Mar. 6, 2012

Int. Cl.: 9

TRADEMARK

PRINCIPAL REGISTER

TOLTEQ GROUP LLC (TEXAS LIMITED LIABILITY COMPANY)
P.O. BOX 4207
CEDAR PARK, TX 78613

FOR: ELECTRONIC TEST AND MEASUREMENT DEVICES FOR THE COMPILATION AND DISSEMINATION OF DATA IN OIL AND GAS DRILLING IN THE NATURE OF MEASUREMENT-WHILE-DRILLING (MWD) TOOLS, ELECTRONIC PULSER MODULES, ELECTRONIC DIRECTIONAL MODULE, ELECTRONIC CONTROLLER UNIT, SOLENOID DRIVER UNIT, MWD SURFACE SYSTEM FOR TRANSMITTING DATA FROM MWD TOOLS TO THE SURFACE, POWER SUPPLIES, ANTI-STATIC TRANSORBS AND PIGTAILS, SOFTWARE PROGRAMS TO ANALYZE DRILLING DATA FROM MWD TOOLS, PULSER FILL STATION, IN CLASS 9 (U.S. CLS. 21, 23, 26, 36 AND 38).

FIRST USE 0-0-2006; IN COMMERCE 0-0-2006.

NO CLAIM IS MADE TO THE EXCLUSIVE RIGHT TO USE "ORIGINAL ENGINEERING", APART FROM THE MARK AS SHOWN.

THE MARK CONSISTS OF A FANCIFUL DESIGN OF AN AZTEC PYRAMID AND TO THE RIGHT OF THE DESIGN THE WORD "TOLTEQ" AND BELOW THE WORD "TOLTEQ", THE WORDS "ORIGINAL ENGINEERING".

SER. NO. 85-359,656, FILED 6-29-2011.

CAROLYN CATALDO, EXAMINING ATTORNEY



David J. Kyjars

Director of the United States Patent and Trademark Office

United States of America

United States Patent and Trademark Office

GIUSEPPE'S

Reg. No. 4,108,275

STANO, ANTHONY M. (UNITED STATES INDIVIDUAL)
537 E. 56TH AVENUE
DENVER, CO 80216

Registered Mar. 6, 2012

Int. Cl.: 29

FOR: FRESH MEAT; HAMBURGER; MEAT; MEAT, FISH, POULTRY AND GAME; MEAT, FROZEN; MEAT, POULTRY AND GAME; PACKAGED MEATS; PREPARED MEAT; PRESERVED MEATS AND SAUSAGES; SAUSAGES; SLICED MEAT; UNCOOKED SAUSAGES, IN CLASS 29 (U.S. CL. 46).

TRADEMARK

PRINCIPAL REGISTER

FIRST USE 11-4-1980; IN COMMERCE 11-4-1980.

THE MARK CONSISTS OF STANDARD CHARACTERS WITHOUT CLAIM TO ANY PARTICULAR FONT, STYLE, SIZE, OR COLOR.

SER. NO. 85-359,688, FILED 6-29-2011.

BRIAN PINO, EXAMINING ATTORNEY



David J. Kyffers

Director of the United States Patent and Trademark Office

United States of America

United States Patent and Trademark Office



Reg. No. 4,108,276

Registered Mar. 6, 2012

Int. Cl.: 42

SERVICE MARK

PRINCIPAL REGISTER

COLLECTIONS MARKETING CENTER, INC. (DELAWARE CORPORATION)
SUITE 100
300 WATER STREET
WILMINGTON, DE 19801

FOR: COMPUTER SERVICES, NAMELY, ONLINE COMPUTER NETWORK SERVICES, NAMELY, PROVIDING TEMPORARY USE OF ON-LINE NON-DOWNLOADABLE SOFTWARE FOR TRACKING AND SYNCHRONIZING FINANCIAL, DEBT AND COLLECTIONS DATA OVER COMPUTER NETWORKS FOR USE IN THE DEBT COLLECTION FIELD; INFORMATION TECHNOLOGY CONSULTING SERVICES AND PROVIDING INFORMATION REGARDING ELECTRONIC TECHNOLOGY IN THE NATURE OF SOFTWARE DEVELOPMENT VIA INTERNET DELIVERED APPLICATIONS VIA AN ONLINE WEBSITE FOR USE IN THE DEBT COLLECTION FIELD; MANAGED APPLICATION SERVICE PROVIDER FEATURING AN ADAPTIVE AND CONFIGURABLE COLLECTIONS SERVICES DELIVERED VIA AN APPLICATION SOFTWARE FOR USE IN CUSTOMIZING TELECOMMUNICATION SERVICE APPLICATIONS, NAMELY, SERVICES FOR THE QUEUING, HANDLING, LOGGING, RECORDING, MONITORING, TRACKING, SUPERVISION, MANAGEMENT, ROUTING, REPORTING, DISPOSITION AND DISTRIBUTION OF TELEPHONE CALLS, TEXT MESSAGE TRANSMISSIONS, E-MAILS, AND WEB BASED MESSAGE TRANSMISSIONS, FOR USE IN THE FIELD OF DEBT COLLECTION; COMPUTER SERVICES, NAMELY, PROVIDING TEMPORARY USE OF ONLINE NON-DOWNLOADABLE COMPUTER SOFTWARE FOR RECEIVING, PLAYING, SCHEDULING AND MANAGING AUTOMATED VOICE MESSAGING FOR USE IN DEBT COLLECTION; PROVIDING TEMPORARY USE OF ONLINE, NON-DOWNLOADABLE AUTOMATED VOICE MESSAGING SOFTWARE FOR RECEIVING, PLAYING, SCHEDULING AND MANAGING AUTOMATED VOICE MESSAGING FOR USE IN DEBT COLLECTION THAT WORKS WITH AUTOMATIC DIALERS AND INTERACTIVE VOICE RESPONSE TECHNOLOGY FOR USE IN THE DEBT COLLECTION FIELD, IN CLASS 42 (U.S. CLS. 100 AND 101).



FIRST USE 11-15-2008; IN COMMERCE 11-15-2008.

THE MARK CONSISTS OF THE LETTERS "CMC" IN BLUE WITH A CIRCULAR DESIGN IN THE UPPER LEFT CORNER MADE UP OF 3 CURVED LINES IN THE COLORS YELLOW, BLUE AND GREEN.

THE COLOR(S) YELLOW, BLUE AND GREEN IS/ARE CLAIMED AS A FEATURE OF THE MARK.

David J. Kappas

Director of the United States Patent and Trademark Office

Reg. No. 4,108,276 SER. NO. 85-359,707, FILED 6-29-2011.

CHRISTINA SOBRAL, EXAMINING ATTORNEY

United States of America

United States Patent and Trademark Office



Reg. No. 4,108,277

Registered Mar. 6, 2012

Int. Cl.: 36

SERVICE MARK

PRINCIPAL REGISTER

ING DIRECT BANCORP (DELAWARE CORPORATION)
1 SOUTH ORANGE STREET
WILMINGTON, DE 19801

FOR: FINANCIAL AND BANKING SERVICES FOR MINORS, NAMELY, SAVINGS ACCOUNT SERVICES FOR MINORS, IN CLASS 36 (U.S. CLS. 100, 101 AND 102).

FIRST USE 2-28-2010; IN COMMERCE 2-28-2010.

OWNER OF U.S. REG. NOS. 3,733,314, 3,745,893 AND OTHERS.

THE COLOR(S) ORANGE AND BLUE IS/ARE CLAIMED AS A FEATURE OF THE MARK.

NO CLAIM IS MADE TO THE EXCLUSIVE RIGHT TO USE "KIDS SAVINGS ACCOUNT", APART FROM THE MARK AS SHOWN.

THE MARK CONSISTS OF THE THREE-DIMENSIONAL IMAGE OF A SUSPENDED ORANGE BALL APPEARING TO THE RIGHT OF THE WORDS "KIDS SAVINGS ACCOUNT." THE WORD "KIDS" APPEARS IN BLUE WITH THE DOT OF THE LETTER I APPEARING IN ORANGE. THE WORD "SAVINGS" APPEARS IN ORANGE. THE WORD "ACCOUNT" AND ITS UNDERLINE APPEAR IN BLUE.

SER. NO. 85-359,708, FILED 6-29-2011.

SHANNON TWOHIG, EXAMINING ATTORNEY



David J. Kybas

Director of the United States Patent and Trademark Office

United States of America

United States Patent and Trademark Office



Reg. No. 4,108,278

CUBBAGE, CORY (UNITED STATES INDIVIDUAL)
200 RIGGS AVE.
SEVERNA PARK, MD 21146

Registered Mar. 6, 2012

Int. Cl.: 41

FOR: ORGANIZING SPORTING EVENTS, NAMELY, BOCCEBALL TOURNAMENTS, IN CLASS 41 (U.S. CLS. 100, 101 AND 107).

SERVICE MARK

FIRST USE 6-0-2010; IN COMMERCE 6-0-2010.

PRINCIPAL REGISTER

NO CLAIM IS MADE TO THE EXCLUSIVE RIGHT TO USE "BOCCEFEST", APART FROM THE MARK AS SHOWN.

THE COLOR(S) GREEN, RED, BLACK AND WHITE IS/ARE CLAIMED AS A FEATURE OF THE MARK.

THE MARK CONSISTS OF THE STYLIZED TERM "BOCCEFEST" IN BLACK FONT OUTLINED IN WHITE IN A RED BANNER THAT CURLS IN ON THE SIDES IN FRONT OF A GREEN SHIELD. THE GREEN SHIELD IS OUTLINED IN GREEN AND WHITE. INSIDE THE SHIELD IS A GREEN AND RED BOCCE BALL WITH WHITE HIGHLIGHTS. ABOVE THE SHIELD ARE FIVE BLACK STARS. ON THE LEFT SIDE OF THE SHIELD IS A RED STYLIZED FIGURE WITH WHITE HIGHLIGHTS POSED WITH A BALL IN THE FIGURE'S HAND. ON THE RIGHT SIDE OF THE FIGURE IS A GREEN STYLIZED FIGURE WITH WHITE HIGHLIGHTS POSED WITH A BALL IN THE FIGURE'S HAND.

SER. NO. 85-359,790, FILED 6-29-2011.

BRIAN PINO, EXAMINING ATTORNEY



David J. Kybas

Director of the United States Patent and Trademark Office

United States of America

United States Patent and Trademark Office

WAKE FOREST BAPTIST MEDICAL CENTER

Reg. No. 4,108,279

WAKE FOREST UNIVERSITY (NORTH CAROLINA CORPORATION)
1834 WAKE FOREST ROAD
WINSTON-SALEM, NC 27106

Registered Mar. 6, 2012

Int. Cl.: 42

FOR: MEDICAL RESEARCH; SCIENTIFIC RESEARCH, IN CLASS 42 (U.S. CLS. 100 AND 101).

SERVICE MARK

FIRST USE 3-17-2011; IN COMMERCE 3-17-2011.

PRINCIPAL REGISTER

THE MARK CONSISTS OF STANDARD CHARACTERS WITHOUT CLAIM TO ANY PARTICULAR FONT, STYLE, SIZE, OR COLOR.

OWNER OF U.S. REG. NOS. 2,319,344, 2,321,497 AND OTHERS.

NO CLAIM IS MADE TO THE EXCLUSIVE RIGHT TO USE "BAPTIST MEDICAL CENTER", APART FROM THE MARK AS SHOWN.

SER. NO. 85-359,794, FILED 6-29-2011.

BARBARA A. GOLD, EXAMINING ATTORNEY



David J. Kyffers

Director of the United States Patent and Trademark Office

United States of America

United States Patent and Trademark Office

Synergy4

Reg. No. 4,108,280

Registered Mar. 6, 2012

Int. Cl.: 5

TRADEMARK

PRINCIPAL REGISTER

SYNERGY O2, INC. (DELAWARE CORPORATION)
SUITE #450
9107 WILSHIRE BLVD.
BEVERLY HILLS, CA 90210

FOR: LIQUID NUTRITIONAL SUPPLEMENT, IN CLASS 5 (U.S. CLS. 6, 18, 44, 46, 51 AND 52).

FIRST USE 12-0-2009; IN COMMERCE 12-0-2009.

THE MARK CONSISTS OF STANDARD CHARACTERS WITHOUT CLAIM TO ANY PARTICULAR FONT, STYLE, SIZE, OR COLOR.

OWNER OF U.S. REG. NO. 3,771,354.

SER. NO. 85-359,850, FILED 6-29-2011.

YAT SYE, LEE, EXAMINING ATTORNEY



David J. Kybas

Director of the United States Patent and Trademark Office

United States of America

United States Patent and Trademark Office

GRO PRO

Reg. No. 4,108,281

IP HOLDINGS, LLC (WASHINGTON LIMITED LIABILITY COMPANY)
5408 NE 88TH ST. #A-101
VANCOUVER, WA 98665

Registered Mar. 6, 2012

Int. Cl.: 22

FOR: PLASTIC NETTING FOR USE AS A TRELIS IN GARDENING, IN CLASS 22 (U.S. CLS. 1, 2, 7, 19, 22, 42 AND 50).

TRADEMARK

FIRST USE 1-1-2005; IN COMMERCE 1-1-2005.

PRINCIPAL REGISTER

THE MARK CONSISTS OF STANDARD CHARACTERS WITHOUT CLAIM TO ANY PARTICULAR FONT, STYLE, SIZE, OR COLOR.

OWNER OF U.S. REG. NO. 3,388,278.

NO CLAIM IS MADE TO THE EXCLUSIVE RIGHT TO USE "GROW", APART FROM THE MARK AS SHOWN.

SER. NO. 85-359,902, FILED 6-29-2011.

MARK SPARACINO, EXAMINING ATTORNEY



David J. Kyfos

Director of the United States Patent and Trademark Office

United States of America

United States Patent and Trademark Office



Reg. No. 4,108,282

HILL COUNTRY PEST CONTROL, INC. (TEXAS CORPORATION)
877 HARPER RD
KERRVILLE, TX 78028

Registered Mar. 6, 2012

Int. Cl.: 37

FOR: PEST CONTROL; PEST CONTROL AND EXTERMINATION OTHER THAN FOR AGRICULTURAL PURPOSES, IN CLASS 37 (U.S. CLS. 100, 103 AND 106).

SERVICE MARK

FIRST USE 6-0-2010; IN COMMERCE 6-0-2010.

PRINCIPAL REGISTER

NO CLAIM IS MADE TO THE EXCLUSIVE RIGHT TO USE "PEST MANAGEMENT INC.", APART FROM THE MARK AS SHOWN.

THE MARK CONSISTS OF THE WORDING "PEST MANAGEMENT INC." WITH "INC." ON ITS END AND THE IMAGE OF TWO CURVED ARROWS CREATING AN OVERALL CIRCULAR DESIGN.

SER. NO. 85-360,054, FILED 6-29-2011.

WILLIAM VERHOSEK, EXAMINING ATTORNEY



David J. Kyffers

Director of the United States Patent and Trademark Office

United States of America

United States Patent and Trademark Office

HEAVY SWING PURCHASERS

Reg. No. 4,108,283

TRA GLOBAL, INC. (DELAWARE CORPORATION), DBA TRA, INC.
52 VANDERBILT AVENUE, 17TH FLOOR
NEW YORK, NY 10017

Registered Mar. 6, 2012

Int. Cl.: 35

FOR: MARKET ANALYSIS AND RESEARCH SERVICES; TARGETING SERVICES, NAMELY, SERVICES TO DETERMINE THE AUDIENCE REACHED AND/OR AFFECTED BY ADVERTISEMENTS OR BRANDED PROGRAMMING EFFORTS, IN CLASS 35 (U.S. CLS. 100, 101 AND 102).

SERVICE MARK

PRINCIPAL REGISTER

FIRST USE 3-0-2010; IN COMMERCE 3-0-2010.

THE MARK CONSISTS OF STANDARD CHARACTERS WITHOUT CLAIM TO ANY PARTICULAR FONT, STYLE, SIZE, OR COLOR.

NO CLAIM IS MADE TO THE EXCLUSIVE RIGHT TO USE "PURCHASERS", APART FROM THE MARK AS SHOWN.

SER. NO. 85-360,203, FILED 6-30-2011.

LINDA ORNDORFF, EXAMINING ATTORNEY



David J. Kyffers

Director of the United States Patent and Trademark Office

United States of America

United States Patent and Trademark Office



WHEN IN DOUBT,
MORE DARK CHOCOLATE

Reg. No. 4,108,284

Registered Mar. 6, 2012

Int. Cl.: 30

TRADEMARK

PRINCIPAL REGISTER

PECH, JULIE (UNITED STATES INDIVIDUAL)
6372 S. BENTON WAY
LITTLETON, CA 80123

FOR: CHOCOLATE BARS, IN CLASS 30 (U.S. CL. 46).

FIRST USE 3-25-2011; IN COMMERCE 3-25-2011.

OWNER OF U.S. REG. NO. 3,095,358.

NO CLAIM IS MADE TO THE EXCLUSIVE RIGHT TO USE "CHOCOLATE" AND "DARK CHOCOLATE", APART FROM THE MARK AS SHOWN.

THE MARK CONSISTS OF THE WORDS, "CHOCOLATE RX WHEN IN DOUBT, MORE DARK CHOCOLATE" WITH STYLIZED "RX" SYMBOL AND LETTERING. THE WORD "CHOCOLATE" IS ROUNDED OVER THE TOP OF THE "RX" SYMBOL DESIGN.

SER. NO. 85-360,218, FILED 6-30-2011.

DAVID HOFFMAN, EXAMINING ATTORNEY



David J. Kyfos

Director of the United States Patent and Trademark Office

United States of America

United States Patent and Trademark Office

BLUEFIN LABS

Reg. No. 4,108,285

Registered Mar. 6, 2012

Int. Cl.: 42

SERVICE MARK

PRINCIPAL REGISTER

BLUEFIN LABS, INC. (DELAWARE CORPORATION)
ONE KENDALL SQUARE, B17001
CAMBRIDGE, MA 02139

FOR: PROVIDING NON-DOWNLOADABLE SOFTWARE FOR MAPPING ELECTRONIC SOCIAL MEDIA COMMENTARY TO MASS MEDIA PROGRAMMING; COMPUTER SERVICES, NAMELY, PROVIDING ON-LINE NON-DOWNLOADABLE SOFTWARE FOR COLLECTING, AGGREGATING, AND PROVIDING TELEVISION AUDIENCE FEEDBACK FROM ELECTRONIC SOCIAL MEDIA SYSTEMS, IN CLASS 42 (U.S. CLS. 100 AND 101).

FIRST USE 1-31-2011; IN COMMERCE 1-31-2011.

THE MARK CONSISTS OF STANDARD CHARACTERS WITHOUT CLAIM TO ANY PARTICULAR FONT, STYLE, SIZE, OR COLOR.

NO CLAIM IS MADE TO THE EXCLUSIVE RIGHT TO USE "LABS", APART FROM THE MARK AS SHOWN.

SER. NO. 85-360,230, FILED 6-30-2011.

KRISTIN DAHLING, EXAMINING ATTORNEY



David J. Kyros

Director of the United States Patent and Trademark Office

United States of America

United States Patent and Trademark Office

CUTIE FRIENDS

Reg. No. 4,108,286

Registered Mar. 6, 2012

Int. Cl.: 24

TRADEMARK

PRINCIPAL REGISTER

IDEA NUOVA, INC. (NEW YORK CORPORATION)
302 FIFTH AVENUE
NEW YORK, NY 10001

FOR: BED BLANKETS; BED CANOPIES; BED COVERS; BED LINEN; BED SHEETS; BED SKIRTS; BED SPREADS; BLANKET THROWS; BED THROWS; COMFORTERS; COVERLETS; PILLOW CASES; PILLOW COVERS; PILLOW SHAMS; QUILTS, IN CLASS 24 (U.S. CLS. 42 AND 50).

FIRST USE 9-30-2010; IN COMMERCE 9-30-2010.

THE MARK CONSISTS OF STANDARD CHARACTERS WITHOUT CLAIM TO ANY PARTICULAR FONT, STYLE, SIZE, OR COLOR.

OWNER OF U.S. REG. NO. 4,023,469.

SER. NO. 85-360,303, FILED 6-30-2011.

LINDA E. BLOHM, EXAMINING ATTORNEY



David J. Kybas

Director of the United States Patent and Trademark Office

United States of America

United States Patent and Trademark Office

MIDDLE SISTER

Reg. No. 4,108,287

Registered Mar. 6, 2012

Int. Cl.: 33

TRADEMARK

PRINCIPAL REGISTER

CANOPY LICENSING, LLC (CALIFORNIA LIMITED LIABILITY COMPANY)
1403 JEFFERSON STREET
NAPA, CA 94559

FOR: ALCOHOLIC BEVERAGES EXCEPT BEERS, IN CLASS 33 (U.S. CLS. 47 AND 49).

FIRST USE 5-14-2008; IN COMMERCE 5-14-2008.

THE MARK CONSISTS OF STANDARD CHARACTERS WITHOUT CLAIM TO ANY PARTICULAR FONT, STYLE, SIZE, OR COLOR.

OWNER OF U.S. REG. NO. 3,464,496.

SER. NO. 85-360,385, FILED 6-30-2011.

DEIRDRE ROBERTSON, EXAMINING ATTORNEY



David J. Kybas

Director of the United States Patent and Trademark Office

United States of America

United States Patent and Trademark Office

REZNICK GROUP

Reg. No. 4,108,288

Registered Mar. 6, 2012

Int. Cls.: 35 and 36

SERVICE MARK

PRINCIPAL REGISTER

REZNICK GROUP, P.C. (MARYLAND CORPORATION), FORMERLY REZNICK, FEDDER AND SILVERMAN, CERTIFIED PUBLIC ACCOUNTANTS, A PROFESSIONAL CORPORATION

7501 WISCONSIN AVENUE, SUITE 400E
BETHESDA, MD 208146583

FOR: ACCOUNTING AND BUSINESS MANAGEMENT SERVICES, IN CLASS 35 (U.S. CLS. 100, 101 AND 102).

FIRST USE 10-5-2004; IN COMMERCE 10-5-2004.

FOR: FINANCIAL MANAGEMENT SERVICES, IN CLASS 36 (U.S. CLS. 100, 101 AND 102).

FIRST USE 10-5-2004; IN COMMERCE 10-5-2004.

THE MARK CONSISTS OF STANDARD CHARACTERS WITHOUT CLAIM TO ANY PARTICULAR FONT, STYLE, SIZE, OR COLOR.

OWNER OF U.S. REG. NO. 3,096,938.

NO CLAIM IS MADE TO THE EXCLUSIVE RIGHT TO USE "GROUP", APART FROM THE MARK AS SHOWN.

SEC. 2(F).

SER. NO. 85-360,398, FILED 6-30-2011.

DEIRDRE ROBERTSON, EXAMINING ATTORNEY



David J. Kybas

Director of the United States Patent and Trademark Office

United States of America

United States Patent and Trademark Office

FOOTBRIDGE FINANCIAL

Reg. No. 4,108,289

Registered Mar. 6, 2012

Int. Cl.: 36

SERVICE MARK

PRINCIPAL REGISTER

FOOTBRIDGE FINANCIAL LLC (NEW JERSEY LIMITED LIABILITY COMPANY)
C/O JAMES PEPE
242 FRANKLIN TURNPIKE
MAHWAH, NJ 07430

FOR: FINANCING AND LOAN SERVICES, IN CLASS 36 (U.S. CLS. 100, 101 AND 102).

FIRST USE 6-1-2011; IN COMMERCE 6-1-2011.

THE MARK CONSISTS OF STANDARD CHARACTERS WITHOUT CLAIM TO ANY PARTICULAR FONT, STYLE, SIZE, OR COLOR.

NO CLAIM IS MADE TO THE EXCLUSIVE RIGHT TO USE "FINANCIAL", APART FROM THE MARK AS SHOWN.

SER. NO. 85-360,473, FILED 6-30-2011.

KIM SAITO, EXAMINING ATTORNEY



David J. Kybas

Director of the United States Patent and Trademark Office

United States of America

United States Patent and Trademark Office



Reg. No. 4,108,290

Registered Mar. 6, 2012

Int. Cl.: 41

SERVICE MARK

PRINCIPAL REGISTER

AUDUBON NATURE INSTITUTE, INC. (LOUISIANA NON-PROFIT CORPORATION)
6500 MAGAZINE ST.
NEW ORLEANS, LA 70118

FOR: ENTERTAINMENT/EDUCATIONAL SERVICES IN THE NATURE OF A WATER PARK,
IN CLASS 41 (U.S. CLS. 100, 101 AND 107).

FIRST USE 3-15-2010; IN COMMERCE 7-15-2010.

NO CLAIM IS MADE TO THE EXCLUSIVE RIGHT TO USE "ZOO", APART FROM THE
MARK AS SHOWN.

THE MARK CONSISTS OF THE WORD "COOL" ON TOP OF THE WORD "ZOO" WHERE
BOTH WORDS ARE WRITTEN IN BOLD CAPITAL LETTERS. ON THE LEFT SIDE OF THE
WORDS IS AN IMAGE OF AN ALLIGATOR TAIL WHERE THE ALLIGATORS HEAD IS
LOCATED BELOW THE WORD "ZOO" SPLASHING IN A PILE OF WATER.

SER. NO. 85-360,481, FILED 6-30-2011.

REBECCA GILBERT, EXAMINING ATTORNEY



David J. Kybas

Director of the United States Patent and Trademark Office

United States of America

United States Patent and Trademark Office



Reg. No. 4,108,291

Registered Mar. 6, 2012

Int. Cl.: 43

SERVICE MARK

PRINCIPAL REGISTER

BAGEL BROTHERS OF NEW YORK INC. (FLORIDA CORPORATION)
10350 SW VILLAGE CENTER DRIVE
PORT SAINT LUCIE, FL 34987

FOR: DELICATESSENS, IN CLASS 43 (U.S. CLS. 100 AND 101).

FIRST USE 12-1-2005; IN COMMERCE 12-1-2006.

NO CLAIM IS MADE TO THE EXCLUSIVE RIGHT TO USE "ORIGINAL BAGEL BROTHERS OF NEW YORK", APART FROM THE MARK AS SHOWN.

THE STIPPLING IS FOR SHADING PURPOSES ONLY.

THE MARK CONSISTS OF THE WORDING "ORIGINAL BAGEL BROTHERS OF NEW YORK" WITH THE WORDING "ORIGINAL" AND "OF NEW YORK" APPEARING ON A DESIGN OF A BAGEL SANDWICH MADE OF CHEESE, LETTUCE AND TOMATO AND THE WORDING "BAGEL BROTHERS" APPEARING ON A BANNER ACROSS THE BAGEL SANDWICH SEPARATING THE WORDING "ORIGINAL" AND "OF NEW YORK", ALL APPEARING ON A PICTORIAL REPRESENTATION OF THE STATE OF NEW YORK.

SER. NO. 85-360,690, FILED 6-30-2011.

SAMUEL E. SHARPER JR., EXAMINING ATTORNEY



David J. Kyros

Director of the United States Patent and Trademark Office

United States of America

United States Patent and Trademark Office

NRDKNDY

Reg. No. 4,108,292

Registered Mar. 6, 2012

Int. Cl.: 25

TRADEMARK

PRINCIPAL REGISTER

SEEOH DESIGN CO. LLC (FLORIDA LIMITED LIABILITY COMPANY)
2942 SW 91 TERRACE
GAINESVILLE, FL 32608

FOR: CLOTHING, NAMELY, T-SHIRTS, SHORT AND LONG SLEEVE SHIRTS, TANK TOPS, POLO SHIRTS, DRESS SHIRTS, RUGBY SHIRTS, SWEATERS, VESTS, SCARVES, CARDIGANS, BLAZERS, SUITS, JACKETS, TRENCH COATS, COATS, JACKET, HOODED SWEATSHIRTS, SWEATSHIRTS, TRACK JACKETS, BATHING SUITS, BOARD SHORTS, BIKINIS, POCKET SQUARES, NECK TIES, BOW TIES, ROBES, WRISTBANDS, HEADBANDS, UNDERWEAR, PANTIES, BOXER SHORTS, GLOVES, PANTS, JEANS, SKIRTS, CARGO PANTS, CAPRIS, TUBE TOPS, DRESSES, VISORS, HATS, EAR MUFFS, BEANIES, SHOES, FLIP FLOPS, SANDALS, HEELS, BOOTS, BELTS, AND BANDANAS, IN CLASS 25 (U.S. CLS. 22 AND 39).

FIRST USE 10-10-2010; IN COMMERCE 2-10-2011.

THE MARK CONSISTS OF STANDARD CHARACTERS WITHOUT CLAIM TO ANY PARTICULAR FONT, STYLE, SIZE, OR COLOR.

SER. NO. 85-360,693, FILED 6-30-2011.

LAURA KOVALSKY, EXAMINING ATTORNEY



David J. Kyros

Director of the United States Patent and Trademark Office

United States of America

United States Patent and Trademark Office



snoreID

Reg. No. 4,108,293

Registered Mar. 6, 2012

Int. Cl.: 10

TRADEMARK

PRINCIPAL REGISTER

VO, THANH THUY DAO (UNITED STATES INDIVIDUAL)
9360 W. FLAMINGO RD.
SUITE 110-266
LAS VEGAS, NV 89147

FOR: THERAPEUTIC MOUTHPIECES FOR THE PREVENTION OF SNORING, IN CLASS 10 (U.S. CLS. 26, 39 AND 44).

FIRST USE 5-1-2011; IN COMMERCE 5-1-2011.

NO CLAIM IS MADE TO THE EXCLUSIVE RIGHT TO USE THE CADUCEUS SYMBOL, APART FROM THE MARK AS SHOWN.

THE COLOR(S) BLUE AND RED IS/ARE CLAIMED AS A FEATURE OF THE MARK.

THE MARK CONSISTS OF "SNOREID" IN BLUE STYLIZED LETTERS WITH THE "O" IN RED WITH A CADUCEUS IN BLUE WITHIN IT.

SER. NO. 85-360,695, FILED 6-30-2011.

HOWARD SMIGA, EXAMINING ATTORNEY



David J. Kyffers

Director of the United States Patent and Trademark Office

United States of America

United States Patent and Trademark Office

Fedwriters

Reg. No. 4,108,294

Registered Mar. 6, 2012

Int. Cl.: 42

SERVICE MARK

PRINCIPAL REGISTER

CHO, MITCHELL (UNITED STATES INDIVIDUAL)
UNIT G
2917 S WOODLEY ST.
ARLINGTON, VA 22206

FOR: TECHNICAL WRITING FOR OTHERS, IN CLASS 42 (U.S. CLS. 100 AND 101).

FIRST USE 6-15-2010; IN COMMERCE 9-3-2010.

THE MARK CONSISTS OF STANDARD CHARACTERS WITHOUT CLAIM TO ANY PARTICULAR FONT, STYLE, SIZE, OR COLOR.

OWNER OF U.S. REG. NO. 3,957,392.

SER. NO. 85-360,744, FILED 6-30-2011.

NATALIE POLZER, EXAMINING ATTORNEY



David J. Kybas

Director of the United States Patent and Trademark Office

United States of America

United States Patent and Trademark Office



Reg. No. 4,108,295

Registered Mar. 6, 2012

Int. Cl.: 45

SERVICE MARK

PRINCIPAL REGISTER

POINT 2 POINT GLOBAL SECURITY, INC. (CALIFORNIA CORPORATION)
3313 PAPER MILL RD., SUITE 204
PHOENIX, MD 21131

FOR: SECURITY CONSULTANCY; SECURITY GUARD SERVICES; SECURITY GUARDING FOR FACILITIES; SECURITY INSPECTION SERVICES FOR OTHERS; SECURITY SERVICES, NAMELY, PROVIDING EXECUTIVE PROTECTION; SECURITY SERVICES, NAMELY, PROVIDING SECURITY ASSESSMENTS FOR BUSINESSES AND GOVERNMENTAL AGENCIES, IN CLASS 45 (U.S. CLS. 100 AND 101).

FIRST USE 4-16-2004; IN COMMERCE 4-16-2004.

NO CLAIM IS MADE TO THE EXCLUSIVE RIGHT TO USE "GLOBAL SECURITY, INC", APART FROM THE MARK AS SHOWN.

THE COLOR(S) BLUE, GREEN AND BLACK IS/ARE CLAIMED AS A FEATURE OF THE MARK.

THE MARK CONSISTS OF THE BLACK WORDING "POINT 2 POINT" WITH EACH OF THE LETTER OS FORMED BY BLUE AND GREEN GLOBES OUTLINED IN BLACK. A BLACK ARROW ARCHES ABOVE THE TWO GLOBE DESIGNS AND POINTS TO EACH. BELOW THE SECOND WORD "POINT" APPEARS THE BLACK WORDING "GLOBAL SECURITY, INC".

SER. NO. 85-360,764, FILED 6-30-2011.

KRISTIN CARLSON, EXAMINING ATTORNEY



David J. Kyjars

Director of the United States Patent and Trademark Office

United States of America

United States Patent and Trademark Office

BREWS CRUISE

Reg. No. 4,108,296

BREWS CRUISE, INC. (NORTH CAROLINA CORPORATION)
112 CHARLAND FOREST
ASHEVILLE, NC 28803

Registered Mar. 6, 2012

Int. Cl.: 41

FOR: CONDUCTING ENTERTAINMENT EXHIBITIONS IN THE NATURE OF BEER FESTIVALS; GUIDED TOURS OF BREWERIES, IN CLASS 41 (U.S. CLS. 100, 101 AND 107).

SERVICE MARK

FIRST USE 6-1-2006; IN COMMERCE 12-1-2008.

PRINCIPAL REGISTER

THE MARK CONSISTS OF STANDARD CHARACTERS WITHOUT CLAIM TO ANY PARTICULAR FONT, STYLE, SIZE, OR COLOR.

NO CLAIM IS MADE TO THE EXCLUSIVE RIGHT TO USE "CRUISE", APART FROM THE MARK AS SHOWN.

SER. NO. 85-360,808, FILED 6-30-2011.

ALEXANDER L. POWERS, EXAMINING ATTORNEY



David J. Kyffers

Director of the United States Patent and Trademark Office

United States of America

United States Patent and Trademark Office

SIMMONS

Reg. No. 4,108,297

Registered Mar. 6, 2012

Int. Cl.: 35

SERVICE MARK

PRINCIPAL REGISTER

EXPERIAN MARKETING SOLUTIONS, INC. (DELAWARE CORPORATION)
475 ANTON BLVD.
COSTA MESA, CA 92626

FOR: BUSINESS SERVICES, NAMELY, CONSUMER RESEARCH AND CONSULTING RELATED THERETO; CONDUCTING BUSINESS AND MARKET RESEARCH SURVEYS; CONDUCTING MARKET SURVEYS; CONSUMER SURVEY SERVICES; MARKET RESEARCH AND BUSINESS ANALYSES; MARKET RESEARCH SERVICES; MARKET RESEARCH STUDIES; MARKETING SERVICES, NAMELY, CONSUMER MARKETING RESEARCH; PROVISION OF MARKET RESEARCH INFORMATION, IN CLASS 35 (U.S. CLS. 100, 101 AND 102).

FIRST USE 0-0-1950; IN COMMERCE 0-0-1950.

THE MARK CONSISTS OF STANDARD CHARACTERS WITHOUT CLAIM TO ANY PARTICULAR FONT, STYLE, SIZE, OR COLOR.

SEC. 2(F).

SER. NO. 85-360,813, FILED 6-30-2011.

LAURA HAMMEL, EXAMINING ATTORNEY



David J. Kyffers

Director of the United States Patent and Trademark Office

United States of America

United States Patent and Trademark Office

QUARTUS

Reg. No. 4,108,298

Registered Mar. 6, 2012

Int. Cl.: 42

SERVICE MARK

PRINCIPAL REGISTER

QUARTUS ENGINEERING INCORPORATED (CALIFORNIA CORPORATION)
10251 VISTA SORRENTO PARKWAY, SUITE #250
SAN DIEGO, CA 92121

FOR: CONSULTING IN THE FIELD OF ENGINEERING, IN CLASS 42 (U.S. CLS. 100 AND 101).

FIRST USE 11-21-1997; IN COMMERCE 11-21-1997.

THE MARK CONSISTS OF STANDARD CHARACTERS WITHOUT CLAIM TO ANY PARTICULAR FONT, STYLE, SIZE, OR COLOR.

OWNER OF U.S. REG. NO. 3,210,612.

SER. NO. 85-360,885, FILED 6-30-2011.

DOUGLAS LEE, EXAMINING ATTORNEY



David J. Kybas

Director of the United States Patent and Trademark Office

United States of America

United States Patent and Trademark Office

KIDNEY CARE HEALTH MONITOR

Reg. No. 4,108,299

Registered Mar. 6, 2012

Int. Cl.: 16

TRADEMARK

PRINCIPAL REGISTER

DATA CENTRUM COMMUNICATIONS, INC. (DELAWARE CORPORATION)
SUITE 275
650 FROM ROAD
PARAMUS, NJ 07652

FOR: PUBLICATIONS, NAMELY, NEWSLETTERS AND MAGAZINES IN THE FIELDS OF HEALTH ISSUES AND PATIENT AND DOCTOR EDUCATION, IN CLASS 16 (U.S. CLS. 2, 5, 22, 23, 29, 37, 38 AND 50).

FIRST USE 2-1-1998; IN COMMERCE 2-1-1998.

THE MARK CONSISTS OF STANDARD CHARACTERS WITHOUT CLAIM TO ANY PARTICULAR FONT, STYLE, SIZE, OR COLOR.

OWNER OF U.S. REG. NOS. 1,887,901, 2,545,836 AND OTHERS.

NO CLAIM IS MADE TO THE EXCLUSIVE RIGHT TO USE "KIDNEY CARE", APART FROM THE MARK AS SHOWN.

SEC. 2(F) AS TO "HEALTH".

SER. NO. 85-360,893, FILED 6-30-2011.

SANDRA BUJA, EXAMINING ATTORNEY



David J. Kybas

Director of the United States Patent and Trademark Office

United States of America

United States Patent and Trademark Office

MARATHON STRIDES AGAINST MS

Reg. No. 4,108,300

Registered Mar. 6, 2012

Int. Cl.: 36

SERVICE MARK

PRINCIPAL REGISTER

NATIONAL MULTIPLE SCLEROSIS SOCIETY (NEW YORK CORPORATION)
3RD FLOOR
733 THIRD AVENUE
NEW YORK, NY 10017

FOR: CHARITABLE FUNDRAISING SERVICES, IN CLASS 36 (U.S. CLS. 100, 101 AND 102).

FIRST USE 12-10-2003, THE MARK WAS FIRST USED ANYWHERE IN A DIFFERENT FORM OTHER THAN THAT SOUGHT TO BE REGISTERED AT LEAST AS EARLY AS 07/01/1998; IN COMMERCE 12-10-2003, THE MARK WAS FIRST USED IN COMMERCE IN A DIFFERENT FORM OTHER THAN THAT SOUGHT TO BE REGISTERED AT LEAST AS EARLY AS 07/01/1998.

THE MARK CONSISTS OF STANDARD CHARACTERS WITHOUT CLAIM TO ANY PARTICULAR FONT, STYLE, SIZE, OR COLOR.

OWNER OF U.S. REG. NO. 2,485,626.

NO CLAIM IS MADE TO THE EXCLUSIVE RIGHT TO USE MS, APART FROM THE MARK AS SHOWN.

SER. NO. 85-360,909, FILED 6-30-2011.

DORITT L. CARROLL, EXAMINING ATTORNEY



David J. Kybas

Director of the United States Patent and Trademark Office

United States of America

United States Patent and Trademark Office



Reg. No. 4,108,301

Registered Mar. 6, 2012

Int. Cl.: 12

TRADEMARK

PRINCIPAL REGISTER

MERCHSOURCE, LLC (CALIFORNIA LIMITED LIABILITY COMPANY)
19517 PAULING
FOOTHILL RANCH, CA 92610

FOR: BICYCLES, IN CLASS 12 (U.S. CLS. 19, 21, 23, 31, 35 AND 44).

FIRST USE 1-31-2011; IN COMMERCE 1-31-2011.

THE MARK CONSISTS OF AN ABSTRACT IMAGE OF A TREE CONTAINING ABSTRACT REPRESENTATIONS OF TWO BIRDS AND LARGE AND SMALL LEAF SHAPES INSIDE AND SURROUNDING THE TREE.

SER. NO. 85-360,914, FILED 6-30-2011.

MARK RADEMACHER, EXAMINING ATTORNEY



David J. Kybas

Director of the United States Patent and Trademark Office

United States of America

United States Patent and Trademark Office



Reg. No. 4,108,302

CALHOUN INTERNATIONAL LLC (FLORIDA LIMITED LIABILITY COMPANY)
100 NORTH TAMPA STREET, STE 2330
TAMPA, FL 33602

Registered Mar. 6, 2012

Int. Cl.: 35

FOR: BUSINESS MANAGEMENT CONSULTING AND ADVISORY SERVICES, IN CLASS 35 (U.S. CLS. 100, 101 AND 102).

SERVICE MARK

FIRST USE 12-22-2005; IN COMMERCE 12-22-2005.

PRINCIPAL REGISTER

NO CLAIM IS MADE TO THE EXCLUSIVE RIGHT TO USE "INTERNATIONAL", APART FROM THE MARK AS SHOWN.

THE MARK CONSISTS OF A WORLD GLOBE PARTIALLY SURROUNDED BY STYLIZED LETTERS "C" AND "I" TOGETHER WITH WORDS "CALHOUN INTERNATIONAL" AND THE WEB ADDRESS "CALHOUNINTERNATIONAL.COM".

SER. NO. 85-360,919, FILED 6-30-2011.

KATHLEEN LORENZO, EXAMINING ATTORNEY



David J. Kybas

Director of the United States Patent and Trademark Office

United States of America

United States Patent and Trademark Office

Mermaid Sand

Reg. No. 4,108,303

SCHOELLES, MARJORIE (UNITED STATES INDIVIDUAL)
5810 WAPITI DEER LANE
TALLAHASSEE, FL 32304

Registered Mar. 6, 2012

Int. Cl.: 16

FOR: COLORED CRAFT AND ART SAND, IN CLASS 16 (U.S. CLS. 2, 5, 22, 23, 29, 37, 38 AND 50).

TRADEMARK

FIRST USE 2-1-2011; IN COMMERCE 5-6-2011.

PRINCIPAL REGISTER

THE MARK CONSISTS OF STANDARD CHARACTERS WITHOUT CLAIM TO ANY PARTICULAR FONT, STYLE, SIZE, OR COLOR.

NO CLAIM IS MADE TO THE EXCLUSIVE RIGHT TO USE "SAND", APART FROM THE MARK AS SHOWN.

SER. NO. 85-360,965, FILED 6-30-2011.

MARK SHINER, EXAMINING ATTORNEY



David J. Kyffers

Director of the United States Patent and Trademark Office

United States of America

United States Patent and Trademark Office



Reg. No. 4,108,304

Registered Mar. 6, 2012

Int. Cl.: 45

SERVICE MARK

PRINCIPAL REGISTER

TEXAS CZECH GENEALOGICAL SOCIETY (TEXAS CORPORATION)
1231 CR 201 A
ANGLETON, TX 77515

FOR: GENEALOGICAL RESEARCH, IN CLASS 45 (U.S. CLS. 100 AND 101).

FIRST USE 2-1-2001; IN COMMERCE 2-1-2001.

NO CLAIM IS MADE TO THE EXCLUSIVE RIGHT TO USE "TEXAS CZECH GENEALOGICAL SOCIETY", APART FROM THE MARK AS SHOWN.

THE COLOR(S) RED, WHITE, BLUE AND BLACK, GRAY IS/ARE CLAIMED AS A FEATURE OF THE MARK.

THE MARK CONSISTS OF THREE SECTIONS. THE FIRST SECTION (ON THE LEFT) IS IN RED AND CONTAINS A WHITE UPRIGHT LION FROM THE HISTORIC "CZECH" COAT-OF-ARMS, WITH SUPERIMPOSED GRAY HIGHLIGHTS. THE TAIL OF THE LION IS SPLIT INTO TWO (2) INTERTWINING SECTIONS. IN THE CENTER OF THE LOGO IS THE IMAGE OF A WHITE QUILL PEN AND BLACK INK BOTTLE. THE WHITE QUILL PEN IS OUTLINED FIRST IN BLACK AND THEN IN WHITE. THE INK BOTTLE IS OUTLINED IN WHITE. A SECTION ON THE RIGHT OF THE PREVIOUS TWO (2) SECTIONS IS IN BLUE AND IS SUPERIMPOSED BY A WHITE FIVE (5) POINTED STAR

SER. NO. 85-360,978, FILED 6-30-2011.

REBECCA SMITH, EXAMINING ATTORNEY



David J. Kyjars

Director of the United States Patent and Trademark Office

United States of America
United States Patent and Trademark Office

mellow
MUSHROOM

Reg. No. 4,108,305

Registered Mar. 6, 2012

Int. Cl.: 43

SERVICE MARK

PRINCIPAL REGISTER

HOME-GROWN INDUSTRIES OF GEORGIA, INC. (GEORGIA CORPORATION)
150 GREAT SOUTHWEST PARKWAY
ATLANTA, GA 30336

FOR: RESTAURANT SERVICES, IN CLASS 43 (U.S. CLS. 100 AND 101).

FIRST USE 1-5-2010; IN COMMERCE 1-5-2010.

OWNER OF U.S. REG. NOS. 1,469,516 AND 3,569,705.

THE MARK CONSISTS OF THE WORDS "MELLOW MUSHROOM" IN STYLIZED FONT..

SER. NO. 85-360,991, FILED 6-30-2011.

KAREN K. BUSH, EXAMINING ATTORNEY



David J. Kybas

Director of the United States Patent and Trademark Office

United States of America

United States Patent and Trademark Office

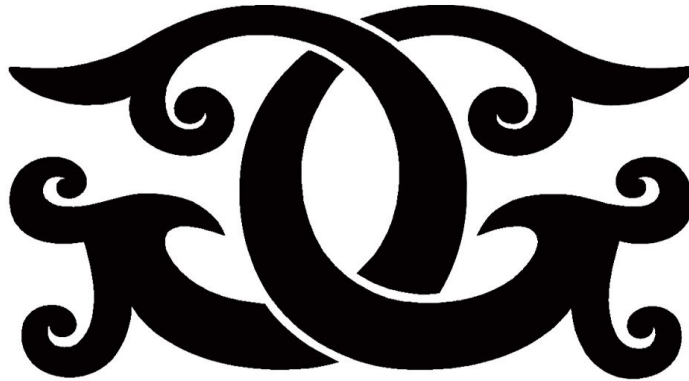

Reg. No. 4,108,306

Registered Mar. 6, 2012

Int. Cl.: 14

TRADEMARK

PRINCIPAL REGISTER

G & G CREATIONS, INC. (MASSACHUSETTS CORPORATION)
333 WASHINGTON STREET, SUITE 704
BOSTON, MA 02108

FOR: ARTICLES OF JEWELRY MADE, IN WHOLE OR IN PART, OF PRECIOUS METALS OR PLATED WITH THE SAME, WITH OR WITHOUT PRECIOUS AND/OR SEMI-PRECIOUS STONES AND/OR GEMS, NAMELY, RINGS, EARRINGS, NECKLACES, CHAINS, PENDANTS, BRACELETS, ARM CUFFS, BROOCHES, PINS, ANKLETS, CHARMS, AMULETS, CUFF LINKS, TIE CLIPS, TIE PINS, SHIRT STUDS, KEY RINGS, JEWELRY FOR USE IN THE HAIR, TIARAS AND MEDALLIONS; HOROLOGICAL INSTRUMENTS, NAMELY, WATCHES AND CLOCKS, IN CLASS 14 (U.S. CLS. 2, 27, 28 AND 50).

FIRST USE 1-1-2011; IN COMMERCE 1-1-2011.

THE MARK CONSISTS OF TWO CAPITAL LETTER "G"'S THAT ARE INTERLOCKED, THE "G" ON THE LEFT IS THE REVERSE IMAGE OF THE "G" ON THE RIGHT.

SER. NO. 85-360,997, FILED 6-30-2011.

BARNEY CHARLON, EXAMINING ATTORNEY



David J. Kyffers

Director of the United States Patent and Trademark Office

United States of America
United States Patent and Trademark Office

mellow
MUSHROOM

Reg. No. 4,108,307

HOME-GROWN INDUSTRIES OF GEORGIA, INC. (GEORGIA CORPORATION)
150 GREAT SOUTHWEST PARKWAY
ATLANTA, GA 30336

Registered Mar. 6, 2012

Int. Cl.: 25

FOR: CLOTHING, NAMELY, T-SHIRTS, HATS, SHORTS, APRONS, AND SWEAT SHIRTS,
IN CLASS 25 (U.S. CLS. 22 AND 39).

TRADEMARK

FIRST USE 1-5-2010; IN COMMERCE 1-5-2010.

PRINCIPAL REGISTER

OWNER OF U.S. REG. NOS. 1,469,516 AND 3,569,705.

THE MARK CONSISTS OF THE WORDS "MELLOW MUSHROOM" IN STYLIZED FONT.

SER. NO. 85-361,005, FILED 6-30-2011.

KAREN K. BUSH, EXAMINING ATTORNEY



David J. Kybas

Director of the United States Patent and Trademark Office

United States of America

United States Patent and Trademark Office

KEY ARTIST

Reg. No. 4,108,308

Registered Mar. 6, 2012

Int. Cl.: 35

SERVICE MARK

PRINCIPAL REGISTER

CORPORATE ENTERTAINMENT SPECIALISTS, INC. (FLORIDA CORPORATION)
11320 8TH STREET EAST
TREASURE ISLAND, FL 33706

FOR: TALENT AGENCY SERVICES, IN CLASS 35 (U.S. CLS. 100, 101 AND 102).

FIRST USE 7-9-2003; IN COMMERCE 11-17-2003.

THE MARK CONSISTS OF STANDARD CHARACTERS WITHOUT CLAIM TO ANY PARTICULAR FONT, STYLE, SIZE, OR COLOR.

NO CLAIM IS MADE TO THE EXCLUSIVE RIGHT TO USE "ARTIST", APART FROM THE MARK AS SHOWN.

SER. NO. 85-361,024, FILED 6-30-2011.

DAWN FELDMAN, EXAMINING ATTORNEY



David J. Kyffers

Director of the United States Patent and Trademark Office

United States of America

United States Patent and Trademark Office



CAREER GROUP INC.

Reg. No. 4,108,309

Registered Mar. 6, 2012

Int. Cl.: 35

SERVICE MARK

PRINCIPAL REGISTER

CAREER GROUP, INC. (CALIFORNIA CORPORATION)
SUITE 900
10100 SANTA MONICA BOULEVARD
LOS ANGELES, CA 90067

FOR: PERMANENT AND TEMPORARY PERSONNEL PLACEMENT SERVICES, IN CLASS 35 (U.S. CLS. 100, 101 AND 102).

FIRST USE 0-0-1987; IN COMMERCE 0-0-1987.

OWNER OF U.S. REG. NO. 3,027,547.

NO CLAIM IS MADE TO THE EXCLUSIVE RIGHT TO USE "GROUP INC.", APART FROM THE MARK AS SHOWN.

THE MARK CONSISTS OF STYLIZED LETTERS CG WITH THE WORDS "CAREER GROUP INC." UNDERNEATH THE LETTERS, TO THE LEFT OF THE WORDING AND LETTERS IS A VERTICAL BAR.

SEC. 2(F) AS TO CAREER GROUP.

SER. NO. 85-361,029, FILED 6-30-2011.

CHRISTINA SOBRAL, EXAMINING ATTORNEY



David J. Kyros

Director of the United States Patent and Trademark Office

United States of America

United States Patent and Trademark Office

7 LITTLE WORDS

Reg. No. 4,108,310

BLUE OX TECHNOLOGIES LTD. (MAINE CORPORATION)

Registered Mar. 6, 2012

PO BOX 135
CARIBOU, ME 04736

Int. Cl.: 9

FOR: COMPUTER GAME SOFTWARE, IN CLASS 9 (U.S. CLS. 21, 23, 26, 36 AND 38).

TRADEMARK

FIRST USE 5-0-2011; IN COMMERCE 5-0-2011.

PRINCIPAL REGISTER

THE MARK CONSISTS OF STANDARD CHARACTERS WITHOUT CLAIM TO ANY PARTICULAR FONT, STYLE, SIZE, OR COLOR.

NO CLAIM IS MADE TO THE EXCLUSIVE RIGHT TO USE "7" AND "WORDS", APART FROM THE MARK AS SHOWN.

SER. NO. 85-361,114, FILED 6-30-2011.

JIM RINGLE, EXAMINING ATTORNEY



David J. Kyffers

Director of the United States Patent and Trademark Office

United States of America

United States Patent and Trademark Office

MACKENZIE WRAPS

Reg. No. 4,108,311

Registered Mar. 6, 2012

Int. Cl.: 34

TRADEMARK

PRINCIPAL REGISTER

CLASSICO TOBACCO, LLC (FLORIDA LIMITED LIABILITY COMPANY)
13250 SW 131 STREET, UNIT 110
MIAMI, FL 33186

FOR: ROLL YOUR OWN TOBACCO, IN CLASS 34 (U.S. CLS. 2, 8, 9 AND 17).

FIRST USE 6-15-2011; IN COMMERCE 6-15-2011.

THE MARK CONSISTS OF STANDARD CHARACTERS WITHOUT CLAIM TO ANY PARTICULAR FONT, STYLE, SIZE, OR COLOR.

NO CLAIM IS MADE TO THE EXCLUSIVE RIGHT TO USE "WRAPS", APART FROM THE MARK AS SHOWN.

SER. NO. 85-361,119, FILED 6-30-2011.

JIM RINGLE, EXAMINING ATTORNEY



David J. Kyffers

Director of the United States Patent and Trademark Office

United States of America

United States Patent and Trademark Office

SPIRIT OF AUSTIN

Reg. No. 4,108,312

Registered Mar. 6, 2012

Int. Cl.: 33

TRADEMARK

PRINCIPAL REGISTER

DULCE VIDA SPIRITS, INC. (TEXAS CORPORATION), DBA DULCE VIDA SPIRITS
95 PASCAL LANE
AUSTIN, TX 78746

FOR: DISTILLED SPIRITS, IN CLASS 33 (U.S. CLS. 47 AND 49).

FIRST USE 4-1-2011; IN COMMERCE 4-1-2011.

THE MARK CONSISTS OF STANDARD CHARACTERS WITHOUT CLAIM TO ANY PARTICULAR FONT, STYLE, SIZE, OR COLOR.

NO CLAIM IS MADE TO THE EXCLUSIVE RIGHT TO USE "AUSTIN", APART FROM THE MARK AS SHOWN.

SER. NO. 85-361,138, FILED 6-30-2011.

IRA J. GOODSaid, EXAMINING ATTORNEY



David J. Kybas

Director of the United States Patent and Trademark Office

United States of America

United States Patent and Trademark Office



Reg. No. 4,108,313

Registered Mar. 6, 2012

Int. Cl.: 3

TRADEMARK

PRINCIPAL REGISTER

SUSAN J GONZALEZ (GEORGIA LIMITED LIABILITY COMPANY)
3363 CHATSWORTH WAY
POWDER SPRINGS, GA 30127

FOR: BODY AND BEAUTY CARE COSMETICS; COSMETIC CREAMS FOR SKIN CARE; COSMETIC PREPARATIONS FOR BODY CARE; COSMETIC PREPARATIONS FOR SKIN CARE; COSMETIC PREPARATIONS FOR SKIN RENEWAL; COSMETIC SKIN FRESHENERS; FRAGRANCED SKIN CARE PREPARATIONS, NAMELY, BODY LOTION; LOTIONS FOR FACE AND BODY CARE; LOTIONS FOR BODY SKIN; MOISTURIZING PREPARATIONS FOR THE SKIN; MOISTURIZING SOLUTIONS FOR THE SKIN; NATURAL COCOA BUTTER BASED PERSONAL CARE PRODUCTS, NAMELY, BODY LOTION, SHOWER GEL, SOAP, BODY POLISH, BODY AND FOOT SCRUB AND NON-MEDICATED SKIN CREAMS; NON-MEDICATED BALMS FOR USE ON LIPS; NON-MEDICATED COSMETIC SKIN CARE PREPARATIONS CONSISTING OF ORGANIC COCONUT VIRGIN OIL AND COCONUT VIRGIN OIL; NON-MEDICATED HERBAL BODY CARE PRODUCTS, NAMELY, BODY OILS, SALVES, AND LIP BALMS; NON-MEDICATED HERBAL BODY CARE PRODUCTS, NAMELY, BODY OIL; NON-MEDICATED LIP CARE PREPARATIONS; NON-MEDICATED PREPARATIONS ALL FOR THE CARE OF SKIN, HAIR AND SCALP; NON-MEDICATED SKIN CARE CREAMS AND LOTIONS; NON-MEDICATED SKIN CARE PREPARATIONS; NON-MEDICATED SKIN CARE PREPARATIONS, NAMELY, CREAMS, LOTIONS, GELS, TONERS, CLEANERS AND PEELS; NON-MEDICATED SKIN CARE PREPARATIONS, NAMELY, FACIAL, BODY; NON-MEDICATED SKIN CREAMS; SKIN AND BODY TOPICAL LOTIONS, CREAMS AND OILS FOR COSMETIC USE; SKIN CREAM; SKIN CREAMS; SKIN LOTION; SKIN MASKS; SKIN MOISTURIZER; SKIN MOISTURIZER MASKS; WRINKLE REMOVING SKIN CARE PREPARATIONS; ALL OF THE ABOVE MADE OR DERIVED FROM ORGANIC MATERIALS, IN CLASS 3 (U.S. CLS. 1, 4, 6, 50, 51 AND 52).

FIRST USE 6-1-2011; IN COMMERCE 6-15-2011.

NO CLAIM IS MADE TO THE EXCLUSIVE RIGHT TO USE "ORGANICS", APART FROM THE MARK AS SHOWN.

THE COLOR(S) PURPLE, BLACK AND GREEN IS/ARE CLAIMED AS A FEATURE OF THE MARK.

THE MARK CONSISTS OF A PURPLE CRESCENT MOON CURVING TO THE LEFT WITH TWO GREEN LEAVES AT THE TOP AND A BLACK STEM IN BETWEEN THE LEAVES.



David J. Kappas

Director of the United States Patent and Trademark Office

Reg. No. 4,108,313 THE WORD "M O O N" APPEARS BELOW THE IMAGE IN BLACK WITH TWELVE POINTED BLACK STARS BETWEEN EACH OF THE LETTERS. A HORIZONTAL BLACK LINE APPEARS BELOW THE WORD "M O O N" AND ABOVE THE WORD "ORGANICS" IN BLACK.

SER. NO. 85-361,269, FILED 6-30-2011.

JOHN WILKE, EXAMINING ATTORNEY

United States of America

United States Patent and Trademark Office



Reg. No. 4,108,314

Registered Mar. 6, 2012

Int. Cl.: 45

SERVICE MARK

PRINCIPAL REGISTER

MOSAIC, INC. (CALIFORNIA CORPORATION)
P.O. BOX 6249
EL MONTE, CA 91734

FOR: CHRISTIAN MINISTRY SERVICES, IN CLASS 45 (U.S. CLS. 100 AND 101).

FIRST USE 12-1-2010; IN COMMERCE 12-1-2010.

NO CLAIM IS MADE TO THE EXCLUSIVE RIGHT TO USE "INC." , APART FROM THE MARK AS SHOWN.

THE COLOR(S) BEIGE, GRAY, SILVER, TAN, BROWN, BLACK, MAROON, BLUE, DARK GREEN, LIGHT GREEN, PURPLE, RED, YELLOW AND LAVENDER IS/ARE CLAIMED AS A FEATURE OF THE MARK.

THE MARK CONSISTS OF A BEIGE AND TAN RIBBON AT THE BOTTOM WITH TWO BROWN ALMONDS WITH STYLIZED BLACK LINING INSIDE EACH ALMOND ON EACH END, WITH A BLACK AND SILVER STRIPED SWORD HANDLE TO THE RIGHT OF THE LEFT ALMOND WITH A GREY SNAKE TAIL WITH BLACK DOTS; ON THE LEFT SIDE OF THE RIGHT ALMOND IS AN BROWN ALMOND BRANCH WITH A GRAY SNAKE TAIL WITH BLACK DOTS AT THE BOTTOM OF THE BRANCH; IN THE MIDDLE OF THE BEIGE RIBBON ARE THE WORDS "MOSAIC, INC." APPEARING IN BOLD, MAROON COLORED FONT; ON THE LEFT SIDE, A SILVER HALF-ARCHED SWORD WITH A BEVELED BLACK CENTER LINE PROTRUDING IN THE MIDDLE UP THE LENGTH OF THE SWORD WITH THE GRAY SPOTTED SNAKE WRAPPED AROUND IT THREE-QUARTERS OF THE WAY UP IN THE COLORS GRAY WITH BLACK DOTS; THE TIP OF THE SILVER HALF-ARCHED SWORD TOUCHES THE TIP OF THE HALF-ARCHED BROWN AND BLACK ALMOND BRANCH AS IT MAKES ITS WAY HALF-ARCHED DOWN THE RIGHT SIDE OF THE ARCH TO THE BOTTOM OF THE BEIGE AND TAN RIBBON, ALSO WITH A GRAY SNAKE SPOTTED WITH BLACK DOTS WRAPPED AROUND IT THREE-QUARTERS OF THE WAY UP; THERE IS A FULL ARCHED BEIGE RIBBON ON THE INSIDE, FLANKING BOTH THE SWORD AND THE ALMOND BRANCH THAT READS "MYSTERIES OF SPIRITUAL AWARENESS IN COMMUNITIES" IN BLACK FONT; THE CENTER OF THE MARK IS A SOLID MAROON ARCH THAT CONTAINS A CROSS OUTLINED IN YELLOW TO LOOK LIKE STAINED GLASS WITH ASYMMETRICAL SHAPES OF RED, DARK GREEN, LIGHT GREEN, BLUE, LAVENDER AND PURPLE CONTAINED INSIDE THE CROSS



David J. Kybas

Director of the United States Patent and Trademark Office

Reg. No. 4,108,314 SER. NO. 85-361,301, FILED 6-30-2011.

JAY FLOWERS, EXAMINING ATTORNEY

United States of America

United States Patent and Trademark Office



Reg. No. 4,108,315

KNUDSEN, THOMAS (UNITED STATES INDIVIDUAL)
7936 MELITA AVE
NORTH HOLLYWOOD, CA 91605

Registered Mar. 6, 2012

Int. Cl.: 25

FOR: CLOTHING, NAMELY, T-SHIRTS, BUTTON DOWN SHIRTS, JACKETS, SWEAT SHIRTS, PANTS, SHORTS, SKIRTS AND DRESSES; FOOTWEAR; HEADGEAR, NAMELY, HATS, CAPS AND BEANIES, IN CLASS 25 (U.S. CLS. 22 AND 39).

TRADEMARK

FIRST USE 6-1-2011; IN COMMERCE 6-1-2011.

PRINCIPAL REGISTER

THE MARK CONSISTS OF RED GRAPHIC LOGO, WHICH IS A SPIRAL RESEMBLING THE LETTER "A". THE LOGO IS ACCOMPANIED BY THE WORD "ADHESIVE" IN THE COLOR BLACK AND IN ALL LOWER CASE FONT CREATED FOR THIS PURPOSE.

THE COLOR(S) RED, BLACK IS/ARE CLAIMED AS A FEATURE OF THE MARK.

SER. NO. 85-361,307, FILED 6-30-2011.

JAY FLOWERS, EXAMINING ATTORNEY



David J. Kybas

Director of the United States Patent and Trademark Office

United States of America

United States Patent and Trademark Office

Homegrown Blends

Reg. No. 4,108,316

LORENZO, JAYSON (UNITED STATES INDIVIDUAL)
2709 VIA JUANITA
CARLSBAD, CA 92010 AND

Registered Mar. 6, 2012

Int. Cl.: 25

JUDAL, JOEL (UNITED STATES INDIVIDUAL)
1613 WELFORD CIRCLE
HAYWARD, CA 94544 AND

TRADEMARK

HIMAKA, TODD (UNITED STATES INDIVIDUAL)
919 EAST 26TH STREET
NATIONAL CITY, CA 91950

PRINCIPAL REGISTER

FOR: WEARABLE GARMENTS AND CLOTHING, NAMELY, SHIRTS, IN CLASS 25 (U.S. CLS. 22 AND 39).

FIRST USE 4-1-2002; IN COMMERCE 4-1-2002.

THE MARK CONSISTS OF STANDARD CHARACTERS WITHOUT CLAIM TO ANY PARTICULAR FONT, STYLE, SIZE, OR COLOR.

NO CLAIM IS MADE TO THE EXCLUSIVE RIGHT TO USE "BLENDS", APART FROM THE MARK AS SHOWN.

SER. NO. 85-361,336, FILED 7-1-2011.

HANNO RITTNER, EXAMINING ATTORNEY



David J. Kyros

Director of the United States Patent and Trademark Office

United States of America

United States Patent and Trademark Office

A QUICK 'N EASY GUIDE

Reg. No. 4,108,317

Registered Mar. 6, 2012

Int. Cl.: 41

SERVICE MARK

PRINCIPAL REGISTER

THE LEWIS INSTITUTE, INC. (VIRGINIA CORPORATION)
5 GRAYLYN DRIVE
FAIRVIEW, NC 28730

FOR: EDUCATIONAL SERVICES PERTAINING TO METHODOLOGY FOR DEVELOPING AND IMPLEMENTING PROJECT MANAGEMENT, NAMELY, WORKSHOPS AND SEMINARS OFFERING TRAINING IN BUSINESS PROJECT MANAGEMENT, BUSINESS PROJECT PLANNING, BUSINESS PROJECT ANALYSIS, BUSINESS PROJECT IMPLEMENTATION AND BUSINESS PROJECT COMPLETION, IN CLASS 41 (U.S. CLS. 100, 101 AND 107).

FIRST USE 11-14-2010; IN COMMERCE 11-14-2010.

THE MARK CONSISTS OF STANDARD CHARACTERS WITHOUT CLAIM TO ANY PARTICULAR FONT, STYLE, SIZE, OR COLOR.

NO CLAIM IS MADE TO THE EXCLUSIVE RIGHT TO USE "GUIDE", APART FROM THE MARK AS SHOWN.

SER. NO. 85-361,396, FILED 7-1-2011.

DANIEL CAPSHAW, EXAMINING ATTORNEY



David J. Kyffers

Director of the United States Patent and Trademark Office

United States of America

United States Patent and Trademark Office

Northwest Navigator

Reg. No. 4,108,318

Registered Mar. 6, 2012

Int. Cls.: 16 and 41

NAVY REGION NORTHWEST, DEPARTMENT OF THE NAVY (UNITED STATES AGENCY
OF THE UNITED STATES GOVERNMENT)
CODE 00CC
875 NORTH RANDOLPH STREET
ARLINGTON, VA 222031995

TRADEMARK

FOR: NEWSPAPERS, IN CLASS 16 (U.S. CLS. 2, 5, 22, 23, 29, 37, 38 AND 50).

FIRST USE 12-31-2004; IN COMMERCE 12-31-2004.

SERVICE MARK

FOR: PROVIDING ON-LINE NON-DOWNLOADABLE NEWSPAPERS, IN CLASS 41 (U.S.
CLS. 100, 101 AND 107).

PRINCIPAL REGISTER

FIRST USE 12-31-2004; IN COMMERCE 12-31-2004.

THE MARK CONSISTS OF STANDARD CHARACTERS WITHOUT CLAIM TO ANY PAR-
TICULAR FONT, STYLE, SIZE, OR COLOR.

NO CLAIM IS MADE TO THE EXCLUSIVE RIGHT TO USE "NORTHWEST", APART FROM
THE MARK AS SHOWN.

SER. NO. 85-361,441, FILED 7-1-2011.

EMILY CARLSEN, EXAMINING ATTORNEY



David J. Kybas

Director of the United States Patent and Trademark Office

United States of America

United States Patent and Trademark Office



Reg. No. 4,108,319

Registered Mar. 6, 2012

Int. Cl.: 35

SERVICE MARK

PRINCIPAL REGISTER

RLM HEALTHCARE MARKETING & CONSULTING, INC. (FLORIDA CORPORATION)
1486 BELLEAIR ROAD
CLEARWATER, FL 33756

FOR: REFERRALS IN THE FIELD OF DENTAL SERVICE CONSULTANTS, IN CLASS 35
(U.S. CLS. 100, 101 AND 102).

FIRST USE 5-1-2011; IN COMMERCE 5-1-2011.

NO CLAIM IS MADE TO THE EXCLUSIVE RIGHT TO USE "DENTAL CONSULTANT",
APART FROM THE MARK AS SHOWN.

THE MARK CONSISTS OF A CIRCULAR DESIGN WITH A GRADIENT ARROW, THE
WORDS "DENTAL CONSULTANT CONNECTION" WRITTEN IN THE OUTER RIM, AND
THE LETTERS "DCC" WRITTEN IN THE INNER CIRCLE.

SER. NO. 85-361,513, FILED 7-1-2011.

ANDREA HACK, EXAMINING ATTORNEY



David J. Kybas

Director of the United States Patent and Trademark Office

United States of America

United States Patent and Trademark Office

BABYFIRST

Reg. No. 4,108,320

DRAEGER MEDICAL SYSTEMS, INC. (PENNSYLVANIA CORPORATION)
3135 QUARRY ROAD
TELFORD, PA 18969

Registered Mar. 6, 2012

Int. Cl.: 41

FOR: PROVIDING A WEBSITE FEATURING EDUCATIONAL INFORMATION AND EDUCATIONAL MATERIALS FOR CLINICIANS IN THE NEONATAL COMMUNITY AND TO THE PARENTS OF PREMATURE BABIES FOR EDUCATIONAL PURPOSES, IN CLASS 41 (U.S. CLS. 100, 101 AND 107).

SERVICE MARK

PRINCIPAL REGISTER

FIRST USE 4-7-2010; IN COMMERCE 4-7-2010.

THE MARK CONSISTS OF STANDARD CHARACTERS WITHOUT CLAIM TO ANY PARTICULAR FONT, STYLE, SIZE, OR COLOR.

SER. NO. 85-361,582, FILED 7-1-2011.

KATINA MISTER, EXAMINING ATTORNEY



David J. Kyffers

Director of the United States Patent and Trademark Office

United States of America

United States Patent and Trademark Office

OCULAR OCHO

Reg. No. 4,108,321

MOORE, EVA (UNITED STATES INDIVIDUAL)
15262 TRUMAN MANOR LANE
WALDORF, MD 20601

Registered Mar. 6, 2012

Int. Cl.: 44

FOR: HAIR REPLACEMENT, HAIR ADDITION, AND HAIR EXTENSION SERVICES, IN CLASS 44 (U.S. CLS. 100 AND 101).

SERVICE MARK

FIRST USE 4-1-2011; IN COMMERCE 6-1-2011.

PRINCIPAL REGISTER

THE MARK CONSISTS OF STANDARD CHARACTERS WITHOUT CLAIM TO ANY PARTICULAR FONT, STYLE, SIZE, OR COLOR.

THE ENGLISH TRANSLATION OF "OCHO" IN THE MARK IS "EIGHT".

SER. NO. 85-361,586, FILED 7-1-2011.

DAWN FELDMAN, EXAMINING ATTORNEY



David J. Kybas

Director of the United States Patent and Trademark Office

United States of America

United States Patent and Trademark Office



Reg. No. 4,108,322

C.F.P.I. TIMING & DATA, INC. (ALABAMA CORPORATION)
14080 PRESTON WOODS DRIVE
NORTHPORT, AL 35475

Registered Mar. 6, 2012

Int. Cl.: 41

FOR: TIMING OF SPORTS EVENTS, IN CLASS 41 (U.S. CLS. 100, 101 AND 107).

SERVICE MARK

FIRST USE 2-12-1999; IN COMMERCE 2-12-1999.

PRINCIPAL REGISTER

NO CLAIM IS MADE TO THE EXCLUSIVE RIGHT TO USE "TIMING", APART FROM THE MARK AS SHOWN.

THE MARK CONSISTS OF A DESIGN OF AN OVAL WITH THE WORDING "C.F.P.I." IN LARGE FONT AND THE WORDING "TIMING" BELOW IT IN SMALLER FONT, ALL APPEARING INSIDE OF THE OVAL. UNDERNEATH THE OVAL, CURVED ALONG THE BOTTOM, APPEARS THE WORDING "WWW.CFPITIMING.COM."

SER. NO. 85-361,606, FILED 7-1-2011.

COURTNEY ALVAREZ, EXAMINING ATTORNEY



David J. Kybas

Director of the United States Patent and Trademark Office

United States of America

United States Patent and Trademark Office

J.C.T. working today for a
better tomorrow

Reg. No. 4,108,323

SAWTELLE, VICKIE (UNITED STATES INDIVIDUAL)
1158 ARDMOOR DRIVE
BLOOMFIELD, MI 48301

Registered Mar. 6, 2012

Int. Cl.: 35

FOR: PUBLIC ADVOCACY TO PROMOTE AWARENESS OF JEFFERSON COUNTY, TENNESSEE, IN CLASS 35 (U.S. CLS. 100, 101 AND 102).

SERVICE MARK

FIRST USE 4-1-2009; IN COMMERCE 4-1-2009.

PRINCIPAL REGISTER

THE MARK CONSISTS OF STANDARD CHARACTERS WITHOUT CLAIM TO ANY PARTICULAR FONT, STYLE, SIZE, OR COLOR.

OWNER OF U.S. REG. NO. 3,947,317.

SER. NO. 85-361,610, FILED 7-1-2011.

GISELLE AGOSTO, EXAMINING ATTORNEY



David J. Kyffers

Director of the United States Patent and Trademark Office

United States of America

United States Patent and Trademark Office

TEAM ENTERPRISES

Reg. No. 4,108,324

Registered Mar. 6, 2012

Int. Cl.: 35

NEW TEAM, LLC (DELAWARE LIMITED LIABILITY COMPANY), DBA TEAM
ENTERPRISES, LLC
SUITE 2450
110 EAST BROWARD BLVD
FORT LAUDERDALE, FL 33301

SERVICE MARK

FOR: ADVERTISING, MARKETING AND PROMOTION SERVICES, IN CLASS 35 (U.S. CLS.
100, 101 AND 102).

PRINCIPAL REGISTER

FIRST USE 1-1-1991; IN COMMERCE 1-1-1991.

THE MARK CONSISTS OF STANDARD CHARACTERS WITHOUT CLAIM TO ANY PAR-
TICULAR FONT, STYLE, SIZE, OR COLOR.

NO CLAIM IS MADE TO THE EXCLUSIVE RIGHT TO USE "ENTERPRISES", APART FROM
THE MARK AS SHOWN.

SER. NO. 85-361,670, FILED 7-1-2011.

PATRICIA EVANKO, EXAMINING ATTORNEY



David J. Kyffers

Director of the United States Patent and Trademark Office

United States of America

United States Patent and Trademark Office



Reg. No. 4,108,325

Registered Mar. 6, 2012

Int. Cl.: 35

NEW TEAM, LLC (DELAWARE LIMITED LIABILITY COMPANY), DBA TEAM ENTERPRISES, LLC
SUITE 2450
110 EAST BROWARD BLVD
FORT LAUDERDALE, FL 33301

SERVICE MARK

FOR: ADVERTISING, MARKETING AND PROMOTION SERVICES, IN CLASS 35 (U.S. CLS. 100, 101 AND 102).

PRINCIPAL REGISTER

FIRST USE 1-1-1991; IN COMMERCE 1-1-1991.

NO CLAIM IS MADE TO THE EXCLUSIVE RIGHT TO USE "ENTERPRISES", APART FROM THE MARK AS SHOWN.

THE COLOR(S) BLUE AND WHITE IS/ARE CLAIMED AS A FEATURE OF THE MARK.

THE WORD "TEAM" APPEARS IN ALL CAPITAL LETTERS, WITH THE "T" IN WHITE AND THE LETTERS "E," "A" AND "M" IN BLUE LETTERS, WITH EACH INDIVIDUAL LETTER INSIDE A SEPARATE BOX IN SHADES OF BLUE, AND THE WORD "ENTERPRISES" BELOW THE BOXES IN LOWER CASE LETTERS IN BLUE .

SER. NO. 85-361,700, FILED 7-1-2011.

PATRICIA EVANKO, EXAMINING ATTORNEY



David J. Kybas

Director of the United States Patent and Trademark Office

United States of America

United States Patent and Trademark Office

Vintage Speed

Reg. No. 4,108,326

Registered Mar. 6, 2012

Int. Cl.: 25

TRADEMARK

PRINCIPAL REGISTER

WICKED QUICK INDUSTRIES, INC. (OREGON CORPORATION), DBA WICKED QUICK
14695 NW SPRINGVILLE ROAD
PORTLAND, OR 97229

FOR: HOODED SWEATSHIRTS; SHORT-SLEEVED OR LONG-SLEEVED T-SHIRTS, IN
CLASS 25 (U.S. CLS. 22 AND 39).

FIRST USE 1-28-2011; IN COMMERCE 1-28-2011.

THE MARK CONSISTS OF STANDARD CHARACTERS WITHOUT CLAIM TO ANY PAR-
TICULAR FONT, STYLE, SIZE, OR COLOR.

NO CLAIM IS MADE TO THE EXCLUSIVE RIGHT TO USE "VINTAGE", APART FROM
THE MARK AS SHOWN.

SER. NO. 85-361,816, FILED 7-1-2011.

ALYSSA STEEL, EXAMINING ATTORNEY



David J. Kybas

Director of the United States Patent and Trademark Office

United States of America

United States Patent and Trademark Office



Reg. No. 4,108,327

Registered Mar. 6, 2012

Int. Cl.: 35

SERVICE MARK

PRINCIPAL REGISTER

APTOLEAN (NEW JERSEY LIMITED LIABILITY COMPANY), DBA APTOLEAN, LLC
2495 SYLVAN AVENUE
TRENTON, NJ 08610

FOR: BUSINESS ADVISORY SERVICES, CONSULTANCY AND INFORMATION; BUSINESS AND MANAGEMENT CONSULTING FOR HEALTHCARE PROVIDERS AND RELATED BUSINESSES; BUSINESS ASSISTANCE, ADVISORY AND CONSULTING SERVICES IN THE FIELD OF LEAN SIX SIGMA PROCESS IMPROVEMENT; BUSINESS CONSULTATION; BUSINESS CONSULTATION IN THE FIELD OF BUSINESS LEADERSHIP DEVELOPMENT; BUSINESS CONSULTATION IN THE FIELD OF LEAN SIX SIGMA PROCESS IMPROVEMENT; BUSINESS CONSULTATION SERVICES IN THE FIELDS OF SUPPLY CHAIN ANALYSIS, REGULATION COMPLIANCE AND COUNTERFEIT DETECTION; BUSINESS CONSULTATION SERVICES, NAMELY, BUSINESS PROCESS IMPROVEMENT AND ENTERPRISE ARCHITECTURE DESIGN; BUSINESS CONSULTING SERVICES IN THE FIELD OF ORGANIZATIONAL CHANGE MANAGEMENT; BUSINESS CONSULTING SERVICES RELATING TO PRODUCT DISTRIBUTION, OPERATIONS MANAGEMENT SERVICES, LOGISTICS, REVERSE LOGISTICS, SUPPLY CHAIN, AND PRODUCTION SYSTEMS AND DISTRIBUTION SOLUTIONS; BUSINESS CONSULTING SERVICES RELATING TO THE INTEGRATION OF THE AREAS OF BUSINESS PROCESS TECHNOLOGY, ORGANIZATIONAL LEARNING, CHANGE MANAGEMENT, AND OPERATIONAL SUSTAINABILITY; BUSINESS MANAGEMENT CONSULTATION IN THE FIELD OF EXECUTIVE AND LEADERSHIP DEVELOPMENT; BUSINESS MANAGEMENT CONSULTING AND ADVISORY SERVICES; CONSULTING IN THE FIELDS OF HEALTHCARE OPERATIONS MANAGEMENT AND HOSPITAL OPERATIONS MANAGEMENT; CONSULTING SERVICES IN BUSINESS ORGANIZATION AND MANAGEMENT, IN CLASS 35 (U.S. CLS. 100, 101 AND 102).



FIRST USE 1-1-2011; IN COMMERCE 2-10-2011.

THE MARK CONSISTS OF THE WORD "APTOLEAN" IN BLACK SURROUNDED BY RED SWIRL MARKS ON A WHITE BACKGROUND.

THE COLOR(S) RED, WHITE, BLACK IS/ARE CLAIMED AS A FEATURE OF THE MARK.

SER. NO. 85-361,857, FILED 7-1-2011.

SAIMA MAKHDOOM, EXAMINING ATTORNEY

David J. Kyros

Director of the United States Patent and Trademark Office

United States of America

United States Patent and Trademark Office



Reg. No. 4,108,328

Registered Mar. 6, 2012

Int. Cl.: 41

SERVICE MARK

PRINCIPAL REGISTER

DRAEGER MEDICAL SYSTEMS, INC. (PENNSYLVANIA CORPORATION)
3135 QUARRY ROAD
TELFORD, PA 18969

FOR: PROVIDING A WEBSITE FEATURING EDUCATIONAL INFORMATION AND EDUCATIONAL MATERIALS FOR CLINICIANS IN THE NEONATAL COMMUNITY AND TO THE PARENTS OF PREMATURE BABIES FOR EDUCATIONAL PURPOSES, IN CLASS 41 (U.S. CLS. 100, 101 AND 107).

FIRST USE 4-7-2010; IN COMMERCE 4-7-2010.

THE MARK CONSISTS OF AN IMAGE OF A SLEEPING INFANT ADJACENT THE TERM "BABYFIRST".

SER. NO. 85-361,872, FILED 7-1-2011.

KATINA MISTER, EXAMINING ATTORNEY



David J. Kybas

Director of the United States Patent and Trademark Office

United States of America

United States Patent and Trademark Office

Let's Keep it Local!

Reg. No. 4,108,329

Registered Mar. 6, 2012

Int. Cl.: 36

SERVICE MARK

PRINCIPAL REGISTER

MECHANICS' CO-OPERATIVE BANK (MASSACHUSETTS CORPORATION)
308 BAY STREET
TAUNTON, MA 02780

FOR: BANKING, IN CLASS 36 (U.S. CLS. 100, 101 AND 102).

FIRST USE 1-1-2011; IN COMMERCE 1-1-2011.

THE MARK CONSISTS OF STANDARD CHARACTERS WITHOUT CLAIM TO ANY PARTICULAR FONT, STYLE, SIZE, OR COLOR.

SER. NO. 85-361,885, FILED 7-1-2011.

DAVID I, EXAMINING ATTORNEY



David J. Kyfos

Director of the United States Patent and Trademark Office

United States of America

United States Patent and Trademark Office

Advantage that Succeeds

Reg. No. 4,108,330

Registered Mar. 6, 2012

Int. Cl.: 35

SERVICE MARK

PRINCIPAL REGISTER

APTOLEAN (NEW JERSEY LIMITED LIABILITY COMPANY), DBA APTOLEAN, LLC
2495 SYLVAN AVENUE
TRENTON, NJ 08610

FOR: ASSISTANCE, ADVICE AND CONSULTANCY WITH REGARD TO BUSINESS PLANNING, BUSINESS ANALYSIS, BUSINESS MANAGEMENT AND BUSINESS ORGANIZATION RELATING TO PURCHASING FUNCTIONS; ASSISTANCE, ADVISORY SERVICES AND CONSULTANCY WITH REGARD TO BUSINESS PLANNING, BUSINESS ANALYSIS, BUSINESS MANAGEMENT, AND BUSINESS ORGANIZATION; BUSINESS AND MANAGEMENT CONSULTING FOR HEALTHCARE PROVIDERS AND RELATED BUSINESSES; BUSINESS ASSISTANCE, ADVISORY AND CONSULTING SERVICES IN THE FIELD OF LEAN SIX SIGMA PROCESS IMPROVEMENT; BUSINESS COLLABORATION SERVICES, NAMELY, PROVIDING A NATIONAL COMPUTER-BASED NETWORKING WEB SITE FOR HEALTH CARE EDUCATORS AND MEDICAL EDUCATORS TO COLLABORATE ACROSS DISCIPLINES TO HELP IMPROVE HEALTH CARE EDUCATION AND MEDICAL EDUCATION; BUSINESS CONSULTATION; BUSINESS CONSULTATION AND MANAGEMENT REGARDING MARKETING ACTIVITIES AND LAUNCHING OF NEW PRODUCTS; BUSINESS CONSULTATION IN THE FIELD OF BUSINESS LEADERSHIP DEVELOPMENT; BUSINESS CONSULTATION SERVICES; BUSINESS CONSULTATION SERVICES IN THE FIELDS OF SUPPLY CHAIN ANALYSIS, REGULATION COMPLIANCE AND COUNTERFEIT DETECTION; BUSINESS CONSULTATION SERVICES, NAMELY, BUSINESS PROCESS IMPROVEMENT AND ENTERPRISE ARCHITECTURE DESIGN; BUSINESS CONSULTING AND MANAGEMENT IN THE FIELD OF CLINICAL TRIALS, NAMELY, CLINICAL DATA AND REGULATORY SUBMISSION MANAGEMENT ON BEHALF OF MEDICAL, BIOPHARMACEUTICAL AND BIOTECHNOLOGY COMPANIES TO ASSIST THEM WITH CLINICAL RESEARCH, CLINICAL TRIALS AND APPLICATIONS FOR DRUG APPROVAL; BUSINESS CONSULTING SERVICE IN THE FIELD OF MEDICAL IMAGING CENTERS; BUSINESS CONSULTING SERVICES IN THE FIELD OF ORGANIZATIONAL CHANGE MANAGEMENT; BUSINESS MANAGEMENT CONSULTANCY IN THE FIELD OF PURCHASES, NAMELY, ASSISTING BUSINESSES IN IMPROVEMENT OF PURCHASING FUNCTIONS; BUSINESS MANAGEMENT CONSULTATION AND SERVICES, NAMELY, MANAGING AND ADMINISTERING NON-CORE FUNCTIONS, NAMELY, MAILING AND SHIPPING, RECORDS MANAGEMENT, INFORMATION SERVICES, ADMINISTRATION, PAYROLL AND ACCOUNTING, AND TELEMARKETING SERVICES; BUSINESS MANAGEMENT CONSULTATION IN THE FIELD OF EXECUTIVE AND LEADERSHIP DEVELOPMENT; BUSINESS MANAGEMENT CONSULTING IN THE FIELD OF TEAM DEVELOPMENT, IN CLASS 35 (U.S. CLS. 100, 101 AND 102).



David J. Kyros

Director of the United States Patent and Trademark Office

Reg. No. 4,108,330 FIRST USE 1-1-2011; IN COMMERCE 2-10-2011.

THE MARK CONSISTS OF STANDARD CHARACTERS WITHOUT CLAIM TO ANY PARTICULAR FONT, STYLE, SIZE, OR COLOR.

SER. NO. 85-361,892, FILED 7-1-2011.

SAIMA MAKHDOOM, EXAMINING ATTORNEY

United States of America

United States Patent and Trademark Office

TURNBERRY ISLE

Reg. No. 4,108,331

Registered Mar. 6, 2012

**Int. Cls.: 35, 37, 39, 41
and 43**

SERVICE MARK

PRINCIPAL REGISTER

TURNBERRY DEVELOPMENT, LLC (FLORIDA LIMITED LIABILITY COMPANY)
19501 BISCAYNE BLVD., SUITE 400
AVENTURA, FL 33180

FOR: RETAIL STORE SERVICES FEATURING CONVENIENCE ITEMS, CLOTHING, GOLF EQUIPMENT, AND GENERAL MERCHANDISE; PROVIDING FACILITIES FOR BUSINESS MEETINGS, IN CLASS 35 (U.S. CLS. 100, 101 AND 102).

FIRST USE 4-0-1977; IN COMMERCE 4-0-1977.

FOR: REAL ESTATE DEVELOPMENT AND CONSTRUCTION SERVICES, NAMELY, PLANNING, LAYING OUT, AND CONSTRUCTION OF RESIDENTIAL HOME AND CONDOMINIUM PROJECTS, COUNTRY CLUBS, AND RECREATIONAL FACILITIES, IN CLASS 37 (U.S. CLS. 100, 103 AND 106).

FIRST USE 4-0-1977; IN COMMERCE 4-0-1997.

FOR: MARINA SERVICES, IN CLASS 39 (U.S. CLS. 100 AND 105).

FIRST USE 4-0-1977; IN COMMERCE 4-0-1977.

FOR: COUNTRY CLUB SERVICES, PROVIDING FACILITIES FOR GOLF, TENNIS, SWIMMING AND RECREATION, HEALTH CLUB, EXERCISE AND SPA SERVICES; NIGHTCLUB SERVICES, IN CLASS 41 (U.S. CLS. 100, 101 AND 107).

FIRST USE 4-0-1977; IN COMMERCE 4-0-1977.

FOR: RESORT HOTEL AND LODGING SERVICES, RESTAURANT AND BAR SERVICES, CATERING SERVICES, PROVIDING MEETING AND CONFERENCE ROOM FACILITIES, IN CLASS 43 (U.S. CLS. 100 AND 101).

FIRST USE 4-0-1977; IN COMMERCE 4-0-1977.

THE MARK CONSISTS OF STANDARD CHARACTERS WITHOUT CLAIM TO ANY PARTICULAR FONT, STYLE, SIZE, OR COLOR.

OWNER OF U.S. REG. NOS. 1,597,428, 3,596,890 AND OTHERS.



David J. Kybas

Director of the United States Patent and Trademark Office

Reg. No. 4,108,331 SER. NO. 85-361,923, FILED 7-1-2011.

ALICIA COLLINS, EXAMINING ATTORNEY

United States of America

United States Patent and Trademark Office



Reg. No. 4,108,332

Registered Mar. 6, 2012

Int. Cl.: 35

SERVICE MARK

PRINCIPAL REGISTER

SNAP SERVICES, LLC (DELAWARE LIMITED LIABILITY COMPANY), DBA SNAP
SECOND FLOOR
ONE BLUE HILL PLAZA, P.O. BOX 1546
PEARL RIVER, NY 10965

FOR: ADMINISTRATION OF A CONSUMER LOYALTY PROGRAM TO PROMOTE RESTAURANT SERVICES AND RETAIL SERVICES OF OTHERS, IN CLASS 35 (U.S. CLS. 100, 101 AND 102).

FIRST USE 2-9-2011; IN COMMERCE 2-9-2011.

THE MARK CONSISTS OF THE WORD "SNAP" IN BLUE LOWER CASE WITH A DIALOGUE BALLOON (GREY BORDER, WHITE FIELD) SURROUNDING THE "S" AND AN ANGLED, BLUE AND WHITE SHADED STAR OFF THE TOP RIGHT OF THE "P".

THE COLOR(S) BLUE, GREY AND WHITE IS/ARE CLAIMED AS A FEATURE OF THE MARK.

SER. NO. 85-361,926, FILED 7-1-2011.

MARGERY A. TIERNEY, EXAMINING ATTORNEY



David J. Kyros

Director of the United States Patent and Trademark Office

United States of America

United States Patent and Trademark Office

SURGX

Reg. No. 4,108,333

DENNIS SZYMAITIS DMD (UNITED STATES INDIVIDUAL)
1172 HARVARD ROAD
PITTSBURGH, PA 15205

Registered Mar. 6, 2012

Int. Cl.: 10

FOR: DENTAL HAND INSTRUMENTS, NAMELY, PICKS AND MATERIAL PLACEMENT INSTRUMENTS; DENTAL BURS, IN CLASS 10 (U.S. CLS. 26, 39 AND 44).

TRADEMARK

FIRST USE 8-9-2011; IN COMMERCE 8-9-2011.

PRINCIPAL REGISTER

THE MARK CONSISTS OF STANDARD CHARACTERS WITHOUT CLAIM TO ANY PARTICULAR FONT, STYLE, SIZE, OR COLOR.

SER. NO. 85-361,949, FILED 7-1-2011.

MATTHEW PAPPAS, EXAMINING ATTORNEY



David J. Kappas

Director of the United States Patent and Trademark Office

United States of America

United States Patent and Trademark Office



Reg. No. 4,108,334

ANDERSON, KATHY L. (UNITED STATES INDIVIDUAL), DBA ANDERSON PRODUCTIONS
P.O. BOX 3461
EDMOND, OK 73083

Registered Mar. 6, 2012

Int. Cl.: 35

FOR: RETAIL STORE SERVICES FEATURING MEMORABILIA, SOUVENIRS, APPAREL, MAPS, GUIDES, JEWELRY, CANDY, IN CLASS 35 (U.S. CLS. 100, 101 AND 102).

SERVICE MARK

FIRST USE 6-1-2011; IN COMMERCE 6-1-2011.

PRINCIPAL REGISTER

NO CLAIM IS MADE TO THE EXCLUSIVE RIGHT TO USE "U.S. HIGHWAY 66" AND "LOS ANGELES" AND "CHICAGO", APART FROM THE MARK AS SHOWN.

THE MARK CONSISTS OF AN OVAL WITH A DARK BACKGROUND. A LIGHT CURVED STRIP EXTENDS ACROSS THE OVAL. "LOS ANGELES" IS IN THE STRIP AT THE LEFT SIDE OF THE STRIP AND "CHICAGO" IS IN THE STRIP AT THE RIGHT SIDE OF THE STRIP. "HIGHWAY" IS POSITIONED ABOVE THE LIGHT STRIP AT THE PROXIMATE CENTER OF THE STRIP AND "U.S." IS POSITIONED ABOVE "HIGHWAY". A GENERALLY HORIZONTAL ARC EXTENDS FROM THE TOP OF THE CURVED STRIP TO ENCLOSE "U.S. HIGHWAY". "66" IS POSITIONED BELOW THE STRIP AND BELOW THE "WAY" OF "HIGHWAY". A GENERALLY VERTICAL ARC IS POSITIONED ON EITHER SIDE OF THE "66" AND A GENERALLY HORIZONTAL ARC EXTENDS BELOW THE STRIP AND IS SLIGHTLY HORIZONTALLY OFFSET FROM THE UPPER GENERALLY HORIZONTAL ARC.

SER. NO. 85-361,954, FILED 7-1-2011.

BRENDAN MCCAULEY, EXAMINING ATTORNEY



David J. Kyros

Director of the United States Patent and Trademark Office

United States of America

United States Patent and Trademark Office

PROJECT BEAUTY SHARE

Reg. No. 4,108,335

FARLEY, JULIE (UNITED STATES INDIVIDUAL)
216 NORTH BERNARD
SPOKANE, WA 99201

Registered Mar. 6, 2012

Int. Cl.: 35

FOR: CHARITABLE SERVICES, NAMELY, COORDINATION OF THE PROCUREMENT AND DISTRIBUTION OF BEAUTY PRODUCT AND HYGIENE PRODUCT DONATIONS FROM INDIVIDUALS, MANUFACTURERS, WHOLESALERS AND RETAILERS TO ORGANIZATIONS PROVIDING SERVICES TO PEOPLE IN NEED, IN CLASS 35 (U.S. CLS. 100, 101 AND 102).

SERVICE MARK

PRINCIPAL REGISTER

FIRST USE 6-30-2009; IN COMMERCE 9-30-2009.

THE MARK CONSISTS OF STANDARD CHARACTERS WITHOUT CLAIM TO ANY PARTICULAR FONT, STYLE, SIZE, OR COLOR.

NO CLAIM IS MADE TO THE EXCLUSIVE RIGHT TO USE "BEAUTY", APART FROM THE MARK AS SHOWN.

SER. NO. 85-362,005, FILED 7-1-2011.

DORITT L. CARROLL, EXAMINING ATTORNEY



David J. Kyros

Director of the United States Patent and Trademark Office

United States of America

United States Patent and Trademark Office



Reg. No. 4,108,336

MORGAN-KELLER, INC. (MARYLAND CORPORATION)
70 THOMAS JOHNSON DRIVE, SUITE 200
FREDERICK, MD 21702

Registered Mar. 6, 2012

Int. Cls.: 37 and 42

FOR: BUILDING CONSTRUCTION; CONSTRUCTION CONSULTATION, IN CLASS 37 (U.S. CLS. 100, 103 AND 106).

SERVICE MARK

FIRST USE 5-9-2011; IN COMMERCE 5-9-2011.

PRINCIPAL REGISTER

FOR: COMMERCIAL BUILDING DESIGN, IN CLASS 42 (U.S. CLS. 100 AND 101).

FIRST USE 5-9-2011; IN COMMERCE 5-9-2011.

NO CLAIM IS MADE TO THE EXCLUSIVE RIGHT TO USE "TILT", APART FROM THE MARK AS SHOWN.

THE MARK CONSISTS OF A PARALLELOGRAM DESIGN ELEMENT ENCOMPASSING THE WORD "SECURETILT" IN WHICH THE MIXED CASE TEXT "SECURE" APPEARS IN THE UN-SHADED PORTION OF THE PARALLELOGRAM, AND THE UPPER CASE TEXT "TILT" APPEARS IN THE SHADED PORTION OF THE PARALLELOGRAM.

SER. NO. 85-362,006, FILED 7-1-2011.

KATHERINE CONNOLLY, EXAMINING ATTORNEY



David J. Kybas

Director of the United States Patent and Trademark Office

United States of America

United States Patent and Trademark Office

CARE FOR MISSION CRITICAL

Reg. No. 4,108,337

Registered Mar. 6, 2012

Int. Cls.: 35, 36, 44 and 45

SERVICE MARK

PRINCIPAL REGISTER

LOGISTICS HEALTH, INC. (WISCONSIN CORPORATION)
328 FRONT STREET SOUTH
LA CROSSE, WI 54601

FOR: HEALTH CARE COST MANAGEMENT SERVICES FOR OTHERS; MANAGED CARE SERVICES, NAMELY, ELECTRONIC PROCESSING OF HEALTH CARE INFORMATION; OPERATION OF MEDICAL CALL CENTERS THAT PROVIDE HEALTHCARE INFORMATION AND SERVICES VIA THE INTERNET, TELEPHONE AND OTHER MEANS, IN CLASS 35 (U.S. CLS. 100, 101 AND 102).

FIRST USE 6-1-2011; IN COMMERCE 6-1-2011.

FOR: ORGANIZATION AND ADMINISTRATION OF NETWORKS OF PREFERRED HEALTH CARE PROVIDERS, IN CLASS 36 (U.S. CLS. 100, 101 AND 102).

FIRST USE 6-1-2011; IN COMMERCE 6-1-2011.

FOR: HEALTH CARE; MEDICAL SERVICES; DENTIST SERVICES; MEDICAL SERVICES, NAMELY, PRE-EMPLOYMENT DRUG SCREENING; BEHAVIORAL HEALTH SERVICES; MOBILE MEDICAL SERVICES, IN CLASS 44 (U.S. CLS. 100 AND 101).

FIRST USE 6-1-2011; IN COMMERCE 6-1-2011.

FOR: HEALTH CARE ADVOCACY SERVICES TO MEMBERS OF HEALTH BENEFIT PLANS; INDIVIDUALIZED HEALTH CARE COORDINATION SERVICES, NAMELY, FACILITATING AN ARRAY OF SERVICES, NAMELY, MEDICAL CARE SERVICES, BEHAVIORAL HEALTH SERVICES, AND HEALTH CARE MANAGEMENT; CASE MANAGEMENT SERVICES, NAMELY, THE COORDINATION OF NECESSARY MEDICAL SERVICES, IN CLASS 45 (U.S. CLS. 100 AND 101).

FIRST USE 6-1-2011; IN COMMERCE 6-1-2011.

THE MARK CONSISTS OF STANDARD CHARACTERS WITHOUT CLAIM TO ANY PARTICULAR FONT, STYLE, SIZE, OR COLOR.

SER. NO. 85-362,017, FILED 7-1-2011.



David J. Kyjars

Director of the United States Patent and Trademark Office

Reg. No. 4,108,337 MATTHEW PAPPAS, EXAMINING ATTORNEY

United States of America

United States Patent and Trademark Office



Reg. No. 4,108,338

Registered Mar. 6, 2012

Int. Cl.: 25

TRADEMARK

PRINCIPAL REGISTER

FEAR THE EAR, LLC (NEBRASKA LIMITED LIABILITY COMPANY)
1002 G STREET
LINCOLN, NE 68508

FOR: HOODED SWEATSHIRTS; SHORTS; SWEAT SHIRTS; SWEATSHIRTS; T-SHIRTS;
TURTLE NECK SHIRTS, IN CLASS 25 (U.S. CLS. 22 AND 39).

FIRST USE 6-27-2011; IN COMMERCE 6-27-2011.

THE MARK CONSISTS OF A CORN COB WITH A FACE AND WELL-MUSCLED ARMS. KERNELS OF CORN APPEAR AS PECTORAL MUSCLES AND AS SIX-PACK ABDOMINAL MUSCLES. THE HUSK APPEARS AS A COLLAR COMING UP BEHIND THE FACE/NECK AND THE TASSEL APPEARS AS HAIR ON THE HEAD. BEHIND THIS IMAGE IS A SOLID OVAL WITH THREE PARTIAL OVALS APPEARING AROUND THE SOLID OVAL GOING FROM THE TOP OF THE EYES DOWN TO THE BOTTOM OF THE HANDS AND EXTENDING OUTSIDE OF THE HUSK ON THE LEFT AND THE ELBOW ON THE RIGHT. "FEAR THE EAR!" IN A STYLIZED FONT APPEARS AT THE LOWER RIGHT OF THE IMAGE WITH THE TOP OF THE "F" ALIGNED AT THE CENTER OF THE CORN COB JUST BENEATH THE HANDS. THE WORD "FEAR" IS LARGER THAN THE WORD "THE" ON ONE LINE. THE WORD "EAR!" APPEARS BELOW AND IS LARGER THAN EITHER "FEAR OR "THE" AND IS ALMOST FLUSH RIGHT. THE TEXT HAS AN INNER OUTLINE AS WELL AS OUTER OUTLINING FILLING THE SPACE BETWEEN ALL THE WORDS.

SER. NO. 85-362,060, FILED 7-1-2011.

BRENDAN REGAN, EXAMINING ATTORNEY



David J. Kybas

Director of the United States Patent and Trademark Office

United States of America

United States Patent and Trademark Office

The logo consists of the letters 'LHI' in a bold, black, sans-serif font. The letter 'I' is stylized with a white, curved line that starts at the top right of the letter and extends upwards and to the right, resembling a road or a path stretching into the horizon.

Reg. No. 4,108,339

LOGISTICS HEALTH, INC. (WISCONSIN CORPORATION)
328 FRONT STREET SOUTH
LA CROSSE, WI 54601

Registered Mar. 6, 2012

Int. Cls.: 35, 36, 44 and 45

FOR: HEALTH CARE COST MANAGEMENT SERVICES FOR OTHERS; MANAGED CARE SERVICES, NAMELY, ELECTRONIC PROCESSING OF HEALTH CARE INFORMATION; OPERATION OF MEDICAL CALL CENTERS THAT PROVIDE HEALTHCARE INFORMATION AND SERVICES VIA THE INTERNET, TELEPHONE AND OTHER MEANS, IN CLASS 35 (U.S. CLS. 100, 101 AND 102).

SERVICE MARK

PRINCIPAL REGISTER

FIRST USE 6-1-2011; IN COMMERCE 6-1-2011.

FOR: ORGANIZATION AND ADMINISTRATION OF NETWORKS OF PREFERRED HEALTH CARE PROVIDERS, IN CLASS 36 (U.S. CLS. 100, 101 AND 102).

FIRST USE 6-1-2011; IN COMMERCE 6-1-2011.

FOR: HEALTH CARE; MEDICAL SERVICES; DENTIST SERVICES; MEDICAL SERVICES, NAMELY, PRE-EMPLOYMENT DRUG SCREENING; BEHAVIORAL HEALTH SERVICES; MOBILE MEDICAL SERVICES, IN CLASS 44 (U.S. CLS. 100 AND 101).

FIRST USE 6-1-2011; IN COMMERCE 6-1-2011.

FOR: HEALTH CARE ADVOCACY SERVICES TO MEMBERS OF HEALTH BENEFIT PLANS; INDIVIDUALIZED HEALTH CARE COORDINATION SERVICES, NAMELY, FACILITATING AN ARRAY OF SERVICES, NAMELY, MEDICAL CARE SERVICES, BEHAVIORAL HEALTH SERVICES, AND HEALTH CARE MANAGEMENT; CASE MANAGEMENT SERVICES, NAMELY, THE COORDINATION OF NECESSARY MEDICAL SERVICES, IN CLASS 45 (U.S. CLS. 100 AND 101).

FIRST USE 6-1-2011; IN COMMERCE 6-1-2011.

OWNER OF U.S. REG. NO. 2,959,636.

THE MARK CONSISTS OF THE LETTERS "LHI", WITH A DESIGN APPEARING IN THE LETTER "I" REMINISCENT OF A ROAD STRETCHING OUTWARD INTO THE HORIZON.



David J. Kappas

Director of the United States Patent and Trademark Office

Reg. No. 4,108,339 SER. NO. 85-362,069, FILED 7-1-2011.

MATTHEW PAPPAS, EXAMINING ATTORNEY

United States of America

United States Patent and Trademark Office

CURLS ON THE GO

Reg. No. 4,108,340

Registered Mar. 6, 2012

Int. Cl.: 9

TRADEMARK

PRINCIPAL REGISTER

TEXTUREMEDIA, INC. (DELAWARE CORPORATION)
6604 NORTH LAMAR BLVD.
AUSTIN, TX 78752

FOR: COMPUTER APPLICATION SOFTWARE FOR MOBILE PHONES, NAMELY, SOFTWARE FOR PRESENTING NEWS AND INFORMATION IN THE FIELDS OF CURLY HAIR, HAIR CARE, HAIR STYLING, HAIR PRODUCTS AND HAIR CARE ACCESSORIES, IN CLASS 9 (U.S. CLS. 21, 23, 26, 36 AND 38).

FIRST USE 6-29-2011; IN COMMERCE 6-29-2011.

THE MARK CONSISTS OF STANDARD CHARACTERS WITHOUT CLAIM TO ANY PARTICULAR FONT, STYLE, SIZE, OR COLOR.

NO CLAIM IS MADE TO THE EXCLUSIVE RIGHT TO USE "CURLS", APART FROM THE MARK AS SHOWN.

SER. NO. 85-362,071, FILED 7-1-2011.

ANDREW RHIM, EXAMINING ATTORNEY



David J. Kyros

Director of the United States Patent and Trademark Office

United States of America

United States Patent and Trademark Office



Reg. No. 4,108,341

MONSIVAIS, PATRICK (UNITED STATES INDIVIDUAL)
PO BOX 16312
FORT WORTH, TX 76162

Registered Mar. 6, 2012

Int. Cl.: 5

FOR: MEDICATED AND PHARMACEUTICAL PREPARATIONS, NAMELY, DIETARY SUPPLEMENTS CONTAINING IRON AVAILABLE ONLY BY PRESCRIPTION FOR HUMANS, IN CLASS 5 (U.S. CLS. 6, 18, 44, 46, 51 AND 52).

TRADEMARK

FIRST USE 3-27-2010; IN COMMERCE 11-1-2010.

PRINCIPAL REGISTER

NO CLAIM IS MADE TO THE EXCLUSIVE RIGHT TO USE "PHARMACEUTICALS LLC", APART FROM THE MARK AS SHOWN.

THE COLOR(S) BLUE AND BLACK IS/ARE CLAIMED AS A FEATURE OF THE MARK.

THE MARK CONSISTS OF THREE OVERLAPPING BLUE RINGS, TO THE RIGHT OF WHICH APPEARS THE WORDING "GENSAVIS PHARMACEUTICALS LLC" IN THE COLOR BLACK.

THE WORDING "GENSAVIS" HAS NO MEANING IN A FOREIGN LANGUAGE.

SER. NO. 85-362,075, FILED 7-1-2011.

ANDREW RHIM, EXAMINING ATTORNEY



David J. Kyros

Director of the United States Patent and Trademark Office

United States of America

United States Patent and Trademark Office

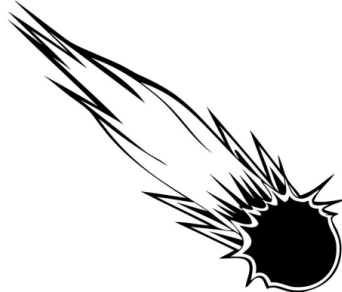

HYPERION
Electronics Accessories

Reg. No. 4,108,342

Registered Mar. 6, 2012

Int. Cl.: 9

TRADEMARK

PRINCIPAL REGISTER

HYPERION ELECTRONIC ACCESSORIES LLC (MICHIGAN LIMITED LIABILITY COMPANY)
#202
6575 BALSAM DR.
HUDSONVILLE, MI 49426

FOR: MOBILE TELEPHONE ACCESSORIES, NAMELY, MOBILE TELEPHONE BATTERIES, IN CLASS 9 (U.S. CLS. 21, 23, 26, 36 AND 38).

FIRST USE 5-25-2011; IN COMMERCE 5-25-2011.

NO CLAIM IS MADE TO THE EXCLUSIVE RIGHT TO USE "ELECTRONICS ACCESSORIES", APART FROM THE MARK AS SHOWN.

THE MARK CONSISTS OF A STYLIZED METEOR OR COMET DESCENDING FROM THE UPPER LEFT TO THE LOWER RIGHT OF THE MARK ABOVE THE WORD "HYPERION" IN A LARGER FONT WITH ALL UPPER CASE LETTERS WHICH IS ABOVE THE WORDS "ELECTRONICS ACCESSORIES" IN A SMALLER FONT AND TITLE CASE.

SER. NO. 85-362,078, FILED 7-1-2011.

ANDREW RHIM, EXAMINING ATTORNEY



David J. Kyros

Director of the United States Patent and Trademark Office

United States of America

United States Patent and Trademark Office

Fresh Millions

Reg. No. 4,108,343

EARLE, GEOFFREY SAMUEL (UNITED STATES INDIVIDUAL)
2901 OAKLANE DRIVE
AUSTIN, TX 78704

Registered Mar. 6, 2012

Int. Cl.: 41

FOR: ENTERTAINMENT, NAMELY, LIVE PERFORMANCES BY A MUSICAL BAND, IN CLASS 41 (U.S. CLS. 100, 101 AND 107).

SERVICE MARK

FIRST USE 12-1-2006; IN COMMERCE 10-31-2007.

PRINCIPAL REGISTER

THE MARK CONSISTS OF STANDARD CHARACTERS WITHOUT CLAIM TO ANY PARTICULAR FONT, STYLE, SIZE, OR COLOR.

SER. NO. 85-362,079, FILED 7-1-2011.

MATTHEW PAPPAS, EXAMINING ATTORNEY



David J. Kappas

Director of the United States Patent and Trademark Office

United States of America

United States Patent and Trademark Office

PERFORMANCE SOURCE

Reg. No. 4,108,344

Registered Mar. 6, 2012

Int. Cl.: 42

SERVICE MARK

PRINCIPAL REGISTER

ITA GROUP, INC. (IOWA CORPORATION)
SUITE 300
4800 WESTOWN PARKWAY
WEST DES MOINES, IA 50266

FOR: PROVIDING DATABASE MANAGEMENT TOOL FOR MEETING AND/OR EVENT PLANNING, NAMELY, PROVIDING TEMPORARY USE OF ON-LINE NON-DOWNLOADABLE SOFTWARE DEVELOPMENT TOOLS FOR USE IN DATABASE MANAGEMENT IN THE FIELD OF MEETING PLANNING AND EVENT PLANNING, IN CLASS 42 (U.S. CLS. 100 AND 101).

FIRST USE 11-2-2009; IN COMMERCE 11-2-2009.

THE MARK CONSISTS OF STANDARD CHARACTERS WITHOUT CLAIM TO ANY PARTICULAR FONT, STYLE, SIZE, OR COLOR.

SER. NO. 85-362,106, FILED 7-1-2011.

TARAH HARDY, EXAMINING ATTORNEY



David J. Kyros

Director of the United States Patent and Trademark Office

United States of America

United States Patent and Trademark Office



CAFE • PIES

Reg. No. 4,108,345

Registered Mar. 6, 2012

Int. Cls.: 30 and 43

TRADEMARK

SERVICE MARK

PRINCIPAL REGISTER

SHARI'S MANAGEMENT CORPORATION (DELAWARE CORPORATION)
9400 SW GEMINI DRIVE
BEAVERTON, OR 97008

FOR: COFFEES AND PIES, IN CLASS 30 (U.S. CL. 46).

FIRST USE 5-15-2011; IN COMMERCE 5-15-2011.

FOR: RESTAURANT SERVICES, IN CLASS 43 (U.S. CLS. 100 AND 101).

FIRST USE 5-15-2011; IN COMMERCE 5-15-2011.

NO CLAIM IS MADE TO THE EXCLUSIVE RIGHT TO USE "CAFE" AND "PIES", APART FROM THE MARK AS SHOWN.

THE MARK CONSISTS OF A GEOMETRICAL DESIGN CONSISTING OF A CENTRAL THIN-BORDERED OVAL CONTAINING THE WORD "SHARIS" IN A STYLIZED FONT WITH THE TWO LETTER S'S SLIGHTLY OVERLAPPING THE BORDER OF THE OVAL. BELOW THE OVAL ARE THE WORDS "CAFE" AND "PIES" IN A STYLIZED FONT; THE WORDS ARE SEPARATED BY A SMALL DIAMOND-SHAPED BULLET POINT.

SER. NO. 85-362,162, FILED 7-1-2011.

EMILY CARLSEN, EXAMINING ATTORNEY



David J. Kybas

Director of the United States Patent and Trademark Office

United States of America

United States Patent and Trademark Office



Reg. No. 4,108,346

Registered Mar. 6, 2012

Int. Cl.: 9

TRADEMARK

PRINCIPAL REGISTER

T-MOBILE USA, INC. (DELAWARE CORPORATION)
12920 S.E. 38TH STREET
BELLEVUE, WA 98006

FOR: MOBILE DEVICE SOFTWARE FOR UPLOADING AND SYNCHRONIZING CONTACT AND ADDRESS BOOK DATA TO A CLOUD-BASED DATA REPOSITORY, IN CLASS 9 (U.S. CLS. 21, 23, 26, 36 AND 38).

FIRST USE 3-11-2011; IN COMMERCE 3-11-2011.

THE MARK CONSISTS OF AN IMAGE OF A SPIRAL BOUND ADDRESS BOOK IN WHITE, WITH THREE TABS PRESENTED IN LIGHT BLUE AT THE RIGHT MARGIN, A VERTICAL BORDER PRESENTED IN LIGHT BLUE ALONG THE LEFT MARGIN, SPIRAL BINDING IN GRAY AT THE LEFT MARGIN WOVEN THROUGH BLACK HOLES, THE "@" SYMBOL PRESENTED IN MAGENTA IN THE CENTER OF THE BOOK, A RIGHT-POINTING ARROW SUPERIMPOSED OVER THE LOWER LEFT CORNER, AND A LEFT-POINTING ARROW SUPERIMPOSED OVER THE UPPER RIGHT CORNER, WITH BOTH ARROWS PRESENTED IN MAGENTA AND OUTLINED IN BLACK. THE ENTIRE DESIGN HAS A GRAY SHADOW BEHIND IT.

THE COLOR(S) MAGENTA, LIGHT BLUE, GRAY, BLACK, AND WHITE IS/ARE CLAIMED AS A FEATURE OF THE MARK.

SER. NO. 85-362,175, FILED 7-1-2011.

LINDSEY RUBIN, EXAMINING ATTORNEY



David J. Kybas

Director of the United States Patent and Trademark Office

United States of America

United States Patent and Trademark Office

**EVER
YONE**  **S**
AUSTIN

Reg. No. 4,108,347

Registered Mar. 6, 2012

Int. Cl.: 25

TRADEMARK

PRINCIPAL REGISTER

IDEAS BY SOPHIA (TEXAS LIMITED LIABILITY COMPANY)
338 BRANCH OAK WAY
SAN ANTONIO, TX 78230

FOR: CAPS; SHIRTS, IN CLASS 25 (U.S. CLS. 22 AND 39).

FIRST USE 3-19-2011; IN COMMERCE 3-19-2011.

NO CLAIM IS MADE TO THE EXCLUSIVE RIGHT TO USE "AUSTIN", APART FROM THE MARK AS SHOWN.

THE MARK CONSISTS OF THE WORDING "EVERYONE", WHICH IS SPLIT INTO "EVER" AND "YONE", ON SEPARATE LINES WITH A HEART DESIGN AND THE LETTER "S" TO THE RIGHT OF IT AND THE WORDING "AUSTIN" BELOW IT.

SER. NO. 85-362,181, FILED 7-1-2011.

COURTNEY ALVAREZ, EXAMINING ATTORNEY



David J. Kyffers

Director of the United States Patent and Trademark Office

United States of America

United States Patent and Trademark Office



Reg. No. 4,108,348

Registered Mar. 6, 2012

Int. Cl.: 43

SERVICE MARK

PRINCIPAL REGISTER

SHARIS MANAGEMENT CORPORATION (DELAWARE CORPORATION)
9400 SW GEMINI DRIVE
BEAVERTON, OR 97008

FOR: RESTAURANT SERVICES, IN CLASS 43 (U.S. CLS. 100 AND 101).

FIRST USE 5-15-2011; IN COMMERCE 5-15-2011.

NO CLAIM IS MADE TO THE EXCLUSIVE RIGHT TO USE "CAFE" AND "PIES", APART FROM THE MARK AS SHOWN.

THE MARK CONSISTS OF A GEOMETRICAL DESIGN CONSISTING OF A CENTRAL THIN-BORDERED OVAL BRACKETED ON BOTH SIDES BY TWO SETS OF HORIZONTAL PARALLEL LINES. THE PARALLEL LINES TO THE LEFT OF THE OVAL CONTAIN THE WORD "CAFE" IN A STYLIZED FONT AND THE PARALLEL LINES TO THE RIGHT OF THE OVAL CONTAIN THE WORD "PIES" IN A STYLIZED FONT. THE OVAL CONTAINS THE WORD "SHARIS" IN A STYLIZED FONT WITH THE TWO LETTER S'S SLIGHTLY OVERLAPPING THE BORDER OF THE OVAL.

SER. NO. 85-362,198, FILED 7-1-2011.

EMILY CARLSEN, EXAMINING ATTORNEY



David J. Kyffers

Director of the United States Patent and Trademark Office

United States of America

United States Patent and Trademark Office



Reg. No. 4,108,349

Registered Mar. 6, 2012

Int. Cl.: 9

TRADEMARK

PRINCIPAL REGISTER

TIME PLAZA (CALIFORNIA CORPORATION)
350 SOUTH LOS ANGELES STREET
LOS ANGELES, CA 90013

FOR: CASES FOR EYEGLASSES AND SUNGLASSES; CASES FOR SPECTACLES AND SUNGLASSES; CHAINS FOR SPECTACLES AND FOR SUNGLASSES; EYEWEAR, NAMELY, SUNGLASSES, EYEGLASSES AND OPHTHALMIC FRAMES AND CASES THEREFOR; EYEWEAR, NAMELY, SUNGLASSES; FRAMES FOR SPECTACLES AND SUNGLASSES; LENSES FOR SUNGLASSES; NOSE GUARDS WHICH CAN BE WORN BY ATTACHMENT TO EYEWEAR SUCH AS SUNGLASSES AND SKI GOGGLES; SPECTACLES AND SUNGLASSES; SUNGLASS CHAINS AND CORDS; SUNGLASS LENSES; SUNGLASSES; SUNGLASSES AND SPECTACLES, IN CLASS 9 (U.S. CLS. 21, 23, 26, 36 AND 38).

FIRST USE 1-5-2008; IN COMMERCE 6-1-2009.

OWNER OF U.S. REG. NOS. 3,844,440, 4,041,297 AND OTHERS.

THE MARK CONSISTS OF STYLISH CROSS SYMBOL CONNECTING WITH STYLISH FEATHERS IN THE LEFT AND RIGHT HAND SIDE ALONG WITH AN IDENTIFIER "SUN-V" UNDERNEATH.

SER. NO. 85-362,199, FILED 7-1-2011.

EMILY CARLSEN, EXAMINING ATTORNEY



David J. Kybas

Director of the United States Patent and Trademark Office

United States of America

United States Patent and Trademark Office

ZHUOYE

Reg. No. 4,108,350

Registered Mar. 6, 2012

Int. Cl.: 34

GUANGDONG ZHUOYE LIGHTER MANUFACTURING CO., LTD. (CHINA LIMITED LIABILITY COMPANY)
LIGHTER INDUSTRIAL ZONE
GUAN XU TOWN, DE QING DISTRICT
ZAO QING, GUANG DONG, CHINA

TRADEMARK

FOR: CIGARETTE LIGHTERS NOT FOR LAND VEHICLES, IN CLASS 34 (U.S. CLS. 2, 8, 9 AND 17).

PRINCIPAL REGISTER

FIRST USE 8-8-1989; IN COMMERCE 3-6-2010.

THE MARK CONSISTS OF A STYLIZED WORD "ZHUOYE".

THE WORDING "ZHUOYE" HAS NO MEANING IN ANY FOREIGN LANGUAGE.

SER. NO. 85-362,223, FILED 7-1-2011.

JUDITH HELFMAN, EXAMINING ATTORNEY



David J. Kybas

Director of the United States Patent and Trademark Office

United States of America

United States Patent and Trademark Office



Reg. No. 4,108,351

Registered Mar. 6, 2012

Int. Cl.: 36

SERVICE MARK

PRINCIPAL REGISTER

ENSVU PROPERTY MANAGEMENT, INC. (DELAWARE CORPORATION), DBA ENSUVI
PROPERTY MANAGEMENT, INC.
166 CRYSTAL SPRING DRIVE
SANFORD, NC 27332

FOR: REAL ESTATE SERVICE, NAMELY, RENTAL PROPERTY MANAGEMENT; REAL ESTATE SERVICES, NAMELY, RENTAL, BROKERAGE, LEASING AND MANAGEMENT OF COMMERCIAL PROPERTY, OFFICES AND OFFICE SPACE, IN CLASS 36 (U.S. CLS. 100, 101 AND 102).

FIRST USE 5-4-2011; IN COMMERCE 5-5-2011.

NO CLAIM IS MADE TO THE EXCLUSIVE RIGHT TO USE "PROPERTY MANAGEMENT", APART FROM THE MARK AS SHOWN.

THE COLOR(S) BLACK, WHITE, BROWN, AND GREEN IS/ARE CLAIMED AS A FEATURE OF THE MARK.

THE MARK CONSISTS OF A VERTICAL REPRESENTATION OF THE COMPANY NAME "ENSVU" IN THE COLOR OF GREEN ON THE LEFT SIDE ALONG WITH THE COMPANY DESCRIPTION "PROPERTY MANAGEMENT" ALSO IN GREEN LETTERS ALONG THE BOTTOM. THE SYMBOL ILLUSTRATION/DRAWING CONSISTS OF A GREEN AND BROWN COLORED EARTH WITH A WHITE ROOF AND CHIMNEY OVER THE EARTH. THE PEAK OF THE ROOF IS ATTACHED TO A WHITE CURVED LINE THAT RESEMBLES THE COMMON REAL ESTATE SIGN POST ON HOMES FOR RENT OR FOR SALE. THE BACKGROUND COLOR IS BLACK.

SER. NO. 85-362,245, FILED 7-1-2011.

KAPIL BHANOT, EXAMINING ATTORNEY



David J. Kybas

Director of the United States Patent and Trademark Office

United States of America

United States Patent and Trademark Office

■ ■ 90° Design

Reg. No. 4,108,352

Registered Mar. 6, 2012

Int. Cl.: 35

90 DEGREE DESIGN, LLC (NORTH CAROLINA LIMITED LIABILITY COMPANY), DBA
90 DEGREE DESIGN
PO BOX 12695
743 WEST JOHNSON STREET, SUITE A
RALEIGH, NC 27605

SERVICE MARK

PRINCIPAL REGISTER

FOR: ADVERTISING AGENCIES SPECIALIZING IN GOLF, REAL ESTATE AND START-UP MARKETING; ADVERTISING AGENCY SPECIALIZING IN THE DESIGN AND EXECUTION OF WORD OF MOUTH, VIRAL, BUZZ AND EXPERIENTIAL MARKETING PROGRAMS; BUSINESS CARD DESIGN SERVICES; BUSINESS MANAGEMENT CONSULTING WITH RELATION TO STRATEGY, MARKETING, SALES, OPERATION, PRODUCT DESIGN PARTICULARLY SPECIALIZING IN THE USE OF ANALYTIC AND STATISTIC MODELS FOR THE UNDERSTANDING AND PREDICTING OF CONSUMERS, BUSINESSES, AND MARKET TRENDS AND ACTIONS; BUSINESS MONITORING AND CONSULTING SERVICES, NAMELY, TRACKING WEB SITES AND APPLICATIONS OF OTHERS TO PROVIDE STRATEGY, INSIGHT, MARKETING, SALES, OPERATION, PRODUCT DESIGN, PARTICULARLY SPECIALIZING IN THE USE OF ANALYTIC AND STATISTIC MODELS FOR THE UNDERSTANDING AND PREDICTING OF CONSUMERS, BUSINESSES, AND MARKET TRENDS AND ACTIONS; CREATIVE MARKETING DESIGN SERVICES; DESIGN OF ADVERTISING BROCHURES FOR OTHERS; DESIGN OF ADVERTISING FLYERS FOR OTHERS; DESIGN OF ADVERTISING MATERIALS FOR OTHERS; DESIGN OF INTERNET ADVERTISING; MARKETING CONSULTING, NAMELY, GOLF AND RESORT MARKETING; ON-LINE RETAIL STORE SERVICES FEATURING PHYSICAL AND VIRTUAL MERCHANDISE FOR USE BY MEMBERS OF AN ONLINE COMMUNITY IN CONNECTION WITH A DESIGNATED WEBSITE FEATURING FICTIONAL CHARACTERS; PLANNING, DESIGN, DEVELOPMENT, MAINTENANCE, TRACKING AND REPORTING OF ONLINE MARKETING ACTIVITIES FOR THIRD PARTIES, IN CLASS 35 (U.S. CLS. 100, 101 AND 102).



FIRST USE 4-1-2006; IN COMMERCE 4-1-2006.

NO CLAIM IS MADE TO THE EXCLUSIVE RIGHT TO USE "DESIGN", APART FROM THE MARK AS SHOWN.

David J. Kyros

THE MARK CONSISTS OF FOUR SQUARES STACKED TWO ON TWO TO THE LEFT OF A "90" WITH A SMALL DEGREE SYMBOL AT THE TOP RIGHT, THEN THE WORD "DESIGN" TO THE RIGHT.

Reg. No. 4,108,352 SER. NO. 85-362,295, FILED 7-1-2011.

ANDREW LEASER, EXAMINING ATTORNEY

United States of America

United States Patent and Trademark Office

Indian Creek Winery

Reg. No. 4,108,353

INDIAN CREEK WINERY, LLC (MISSOURI LIMITED LIABILITY COMPANY)
39799 HIGHWAY 24
MONROE CITY, MO 63456

Registered Mar. 6, 2012

Int. Cl.: 33

FOR: WINE, IN CLASS 33 (U.S. CLS. 47 AND 49).

TRADEMARK

FIRST USE 5-29-2005; IN COMMERCE 5-1-2006.

PRINCIPAL REGISTER

THE MARK CONSISTS OF STANDARD CHARACTERS WITHOUT CLAIM TO ANY PARTICULAR FONT, STYLE, SIZE, OR COLOR.

NO CLAIM IS MADE TO THE EXCLUSIVE RIGHT TO USE "WINERY", APART FROM THE MARK AS SHOWN.

SER. NO. 85-362,448, FILED 7-2-2011.

KATHLEEN M. VANSTON, EXAMINING ATTORNEY



David J. Kybas

Director of the United States Patent and Trademark Office

United States of America

United States Patent and Trademark Office

BSN

Reg. No. 4,108,354

NICK K GATES (UNITED STATES INDIVIDUAL), DBA BUSINESS DIRECTORY
2601 LAZY HOLLOW DR #116
HOUSTON, TX 77063

Registered Mar. 6, 2012

Int. Cl.: 35

FOR: PROVIDING ON-LINE DIRECTORY INFORMATION SERVICES ALSO FEATURING
HYPERLINKS TO OTHER WEB SITES, IN CLASS 35 (U.S. CLS. 100, 101 AND 102).

SERVICE MARK

FIRST USE 1-1-2009; IN COMMERCE 1-1-2009.

PRINCIPAL REGISTER

THE MARK CONSISTS OF STANDARD CHARACTERS WITHOUT CLAIM TO ANY PAR-
TICULAR FONT, STYLE, SIZE, OR COLOR.

SER. NO. 85-362,507, FILED S.R. 7-3-2011 AM. P.R. 10-25-2011.

RAMONA ORTIGA, EXAMINING ATTORNEY



David J. Kybas

Director of the United States Patent and Trademark Office

United States of America

United States Patent and Trademark Office

THE BRA FAIRY

Reg. No. 4,108,355

HEILMAN, KIMBERLY (UNITED STATES INDIVIDUAL)
6742 BLACKBURN RUN
KING GEORGE, VA 22485

Registered Mar. 6, 2012

Int. Cl.: 35

FOR: RETAIL STORE SERVICES FEATURING CUSTOM FITTED SUPPORT BRAS, IN CLASS 35 (U.S. CLS. 100, 101 AND 102).

SERVICE MARK

FIRST USE 4-1-2009; IN COMMERCE 4-1-2009.

PRINCIPAL REGISTER

THE MARK CONSISTS OF STANDARD CHARACTERS WITHOUT CLAIM TO ANY PARTICULAR FONT, STYLE, SIZE, OR COLOR.

NO CLAIM IS MADE TO THE EXCLUSIVE RIGHT TO USE "BRA", APART FROM THE MARK AS SHOWN.

SER. NO. 85-362,605, FILED 7-4-2011.

COLLEEN DOMBROW, EXAMINING ATTORNEY



David J. Kybas

Director of the United States Patent and Trademark Office

United States of America

United States Patent and Trademark Office



Reg. No. 4,108,356

Registered Mar. 6, 2012

CERTIFICATION MARK

PRINCIPAL REGISTER

USAA LLC (CALIFORNIA LIMITED LIABILITY COMPANY), DBA INTERNATIONAL
INSTITUTE OF EVENT MANAGEMENT
PO BOX 1234
LOS GATOS, CA 95032

FOR: PLANNING, ORGANIZING AND MANAGING BUSINESS AND SOCIAL EVENTS, IN
CLASS B (U.S. CL. B).

FIRST USE 7-1-2011; IN COMMERCE 7-1-2011.

NO CLAIM IS MADE TO THE EXCLUSIVE RIGHT TO USE "CERTIFIED EVENT MANAGE-
MENT PROFESSIONAL", APART FROM THE MARK AS SHOWN.

THE MARK CONSISTS OF TWO CONCENTRIC CIRCLES. THE TEXT "CERTIFIED EVENT
MANAGEMENT PROFESSIONAL" BORDERING THE PERIMETER BETWEEN THE TWO
CONCENTRIC CIRCLES. THE TEXT "CEMP" PLACED PROMINENTLY AT THE CENTER
OF THE INNER CIRCLE.

THE CERTIFICATION MARK, AS USED BY AUTHORIZED PERSONS, CERTIFIES INDI-
VIDUALS AUTHORIZED BY THE INTERNATIONAL INSTITUTE OF EVENT MANAGEMENT
TO INDICATE THAT THESE INDIVIDUALS DEMONSTRATED A PARTICULAR LEVEL
OF COMPETENCY AND MET CERTAIN EDUCATIONAL STANDARDS IN CONNECTION
WITH PLANNING, ORGANIZING AND MANAGING BUSINESS AND SOCIAL EVENTS..

SER. NO. 85-362,717, FILED 7-4-2011.

ALEXANDER L. POWERS, EXAMINING ATTORNEY



David J. Kybas

Director of the United States Patent and Trademark Office

United States of America

United States Patent and Trademark Office



Reg. No. 4,108,357

Registered Mar. 6, 2012

Int. Cls.: 14 and 35

TRADEMARK

SERVICE MARK

PRINCIPAL REGISTER

OBJECT BREAST CANCER, LLC (NEW YORK LIMITED LIABILITY COMPANY)
6 ALLAPARTUS CIRCLE
OSSINING, NY 10562

FOR: JEWELRY, IN CLASS 14 (U.S. CLS. 2, 27, 28 AND 50).

FIRST USE 7-4-2011; IN COMMERCE 7-4-2011.

FOR: ON-LINE WHOLESALE AND RETAIL STORE SERVICES FEATURING JEWELRY, IN CLASS 35 (U.S. CLS. 100, 101 AND 102).

FIRST USE 7-4-2011; IN COMMERCE 7-4-2011.

THE MARK CONSISTS OF THE WORDS "OBJECT BREAST CANCER" WITHIN A STYLIZED CANCER TUMOR IMAGE.

SER. NO. 85-362,807, FILED 7-5-2011.

DOUGLAS LEE, EXAMINING ATTORNEY



David J. Kybas

Director of the United States Patent and Trademark Office

United States of America

United States Patent and Trademark Office

Real Hospitality Group

Reg. No. 4,108,358

Registered Mar. 6, 2012

Int. Cl.: 35

SERVICE MARK

PRINCIPAL REGISTER

REAL HOSPITALITY GROUP (MARYLAND LIMITED LIABILITY COMPANY)
9748 STEPHEN DECATUR HWY SUITE 111
OCEAN CITY, MD 21842

FOR: ADMINISTRATIVE HOTEL MANAGEMENT; HOTEL MANAGEMENT FOR OTHERS;
MANAGING AND OPERATING RESORT HOTELS AND BUSINESS CONFERENCE CENTERS
OF OTHERS , IN CLASS 35 (U.S. CLS. 100, 101 AND 102).

FIRST USE 6-1-2010; IN COMMERCE 6-1-2010.

THE MARK CONSISTS OF STANDARD CHARACTERS WITHOUT CLAIM TO ANY PAR-
TICULAR FONT, STYLE, SIZE, OR COLOR.

NO CLAIM IS MADE TO THE EXCLUSIVE RIGHT TO USE "HOSPITALITY GROUP", APART
FROM THE MARK AS SHOWN.

SER. NO. 85-362,821, FILED 7-5-2011.

TARAH HARDY, EXAMINING ATTORNEY



David J. Kybas

Director of the United States Patent and Trademark Office

United States of America

United States Patent and Trademark Office

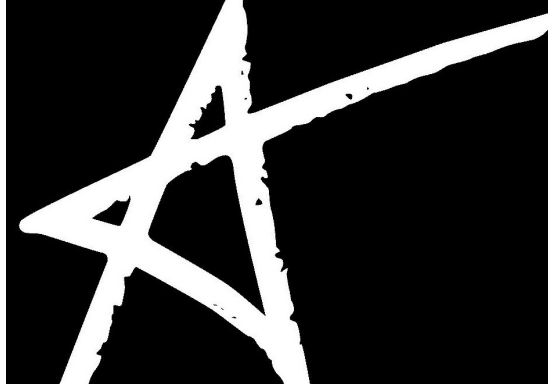

Reg. No. 4,108,359

Registered Mar. 6, 2012

Int. Cl.: 29

TRADEMARK

PRINCIPAL REGISTER

AMERICAN FOODS GROUP (DELAWARE LIMITED LIABILITY COMPANY)
1120 LAKE AVE
FAIRMONT, MN 56031

FOR: MEAT, IN CLASS 29 (U.S. CL. 46).

FIRST USE 5-18-1989; IN COMMERCE 5-18-1989.

OWNER OF U.S. REG. NOS. 2,088,714 AND 3,487,669.

THE MARK CONSISTS OF STYLIZED LETTER "A".

SER. NO. 85-362,837, FILED 7-5-2011.

KAPIL BHANOT, EXAMINING ATTORNEY



David J. Kyjars

Director of the United States Patent and Trademark Office

United States of America

United States Patent and Trademark Office

DOMINION VALLEY COUNTRY CLUB

Reg. No. 4,108,360

Registered Mar. 6, 2012

Int. Cls.: 35, 36, 37 and 41

SERVICE MARK

PRINCIPAL REGISTER

TB PROPRIETARY CORPORATION (DELAWARE CORPORATION)
SUITE 1414
1105 NORTH MARKET STREET
WILMINGTON, DE 19801

FOR: REAL ESTATE SALES MANAGEMENT, IN CLASS 35 (U.S. CLS. 100, 101 AND 102).

FIRST USE 9-30-2000; IN COMMERCE 9-30-2000.

FOR: REAL ESTATE SERVICES, NAMELY, REAL ESTATE MANAGEMENT, LEASING, AND BROKERAGE OF CONDOMINIUMS AND RESIDENTIAL HOUSES, IN CLASS 36 (U.S. CLS. 100, 101 AND 102).

FIRST USE 9-30-2000; IN COMMERCE 9-30-2000.

FOR: LAND DEVELOPMENT AND CONSTRUCTION SERVICES, NAMELY, PLANNING, LAYING OUT AND CUSTOM CONSTRUCTION OF RESIDENTIAL COMMUNITIES, IN CLASS 37 (U.S. CLS. 100, 103 AND 106).

FIRST USE 9-30-2000; IN COMMERCE 9-30-2000.

FOR: RESIDENTIAL COMMUNITY COUNTRY CLUB AND GOLF COURSE SERVICES, IN CLASS 41 (U.S. CLS. 100, 101 AND 107).

FIRST USE 9-30-2000; IN COMMERCE 9-30-2000.

THE MARK CONSISTS OF STANDARD CHARACTERS WITHOUT CLAIM TO ANY PARTICULAR FONT, STYLE, SIZE, OR COLOR.

OWNER OF U.S. REG. NO. 2,792,387.

NO CLAIM IS MADE TO THE EXCLUSIVE RIGHT TO USE "COUNTRY CLUB", APART FROM THE MARK AS SHOWN.

SER. NO. 85-362,842, FILED 7-5-2011.

CARYN GLASSER, EXAMINING ATTORNEY



David J. Kyros

Director of the United States Patent and Trademark Office

United States of America

United States Patent and Trademark Office

camp **FR.E.S.H.**

Family • Recreation • Education • Sharing • Health

Reg. No. 4,108,361

FONTBONNE UNIVERSITY (MISSOURI NON-PROFIT CORPORATION)
6800 WYDOWN BLVD.
ST. LOUIS, MO 63105

Registered Mar. 6, 2012

Int. Cl.: 41

FOR: EDUCATIONAL SERVICES, NAMELY, CONDUCTING CAMPS FEATURING CLASSES, WORKSHOPS AND FIELD TRIPS FOR PARTICIPANTS TO EXPLORE THE CUISINE, LIFESTYLE AND CULTURE OF COUNTRIES AROUND THE GLOBE, IN CLASS 41 (U.S. CLS. 100, 101 AND 107).

SERVICE MARK

PRINCIPAL REGISTER

FIRST USE 4-5-2011; IN COMMERCE 4-5-2011.

NO CLAIM IS MADE TO THE EXCLUSIVE RIGHT TO USE "CAMP", APART FROM THE MARK AS SHOWN.

THE MARK CONSISTS OF THE WORD "CAMPFR.E.S.H.", ABOVE A DESIGN CONSISTING OF A SMEARED LINE AND UNDERNEATH, THE WORDS "FAMILY", "RECREATION", "EDUCATION", "SHARING", AND "HEALTH".

SER. NO. 85-362,906, FILED 7-5-2011.

KATHY DE JONGE, EXAMINING ATTORNEY



David J. Kyros

Director of the United States Patent and Trademark Office

United States of America

United States Patent and Trademark Office

UTILITECH

Reg. No. 4,108,362

LF, LLC (DELAWARE LIMITED LIABILITY COMPANY)
P.O. BOX 39

Registered Mar. 6, 2012

MOUNT MOURNE, NC 28123

Int. Cls.: 6 and 11

FOR: WATER TANKS OF METAL FOR HOUSEHOLD PURPOSES; METAL WATER STORAGE TANKS, IN CLASS 6 (U.S. CLS. 2, 12, 13, 14, 23, 25 AND 50).

TRADEMARK

FIRST USE 1-19-2010; IN COMMERCE 1-19-2010.

PRINCIPAL REGISTER

FOR: FLASHLIGHTS, IN CLASS 11 (U.S. CLS. 13, 21, 23, 31 AND 34).

FIRST USE 6-5-2011; IN COMMERCE 6-5-2011.

THE MARK CONSISTS OF STANDARD CHARACTERS WITHOUT CLAIM TO ANY PARTICULAR FONT, STYLE, SIZE, OR COLOR.

OWNER OF U.S. REG. NOS. 3,779,536, 3,858,393 AND OTHERS.

SER. NO. 85-362,920, FILED 7-5-2011.

LOURDES AYALA, EXAMINING ATTORNEY



David J. Kybas

Director of the United States Patent and Trademark Office

United States of America

United States Patent and Trademark Office

FlexFinancing

Reg. No. 4,108,363

BABCOCK AUTOMOTIVE ADVERTISING LLC (VIRGINIA LIMITED LIABILITY COMPANY)
10807 MAIN STREET SUITE 400
FAIRFAX, VA 22030

Registered Mar. 6, 2012

Int. Cl.: 39

FOR: LEASING OF CARS, IN CLASS 39 (U.S. CLS. 100 AND 105).

SERVICE MARK

FIRST USE 6-3-2011; IN COMMERCE 6-3-2011.

PRINCIPAL REGISTER

THE MARK CONSISTS OF THE STYLIZED WORDING "FLEXFINANCING".

SER. NO. 85-362,924, FILED 7-5-2011.

DOUGLAS LEE, EXAMINING ATTORNEY



David J. Kyffers

Director of the United States Patent and Trademark Office

United States of America

United States Patent and Trademark Office

MOTOWHEELS

Reg. No. 4,108,364

Registered Mar. 6, 2012

Int. Cl.: 35

SERVICE MARK

PRINCIPAL REGISTER

MOTOWHEELS (CALIFORNIA CORPORATION)
SUITE 1
11306 SUNCO DR.
RANCHO CORDOVA, CA 95742

FOR: RETAIL STORE AND ON-LINE RETAIL STORE SERVICES FEATURING MOTOR-CYCLE PARTS AND CLOTHING, IN CLASS 35 (U.S. CLS. 100, 101 AND 102).

FIRST USE 1-1-1999; IN COMMERCE 1-1-1999.

THE MARK CONSISTS OF STANDARD CHARACTERS WITHOUT CLAIM TO ANY PARTICULAR FONT, STYLE, SIZE, OR COLOR.

SER. NO. 85-362,936, FILED 7-5-2011.

DOUGLAS LEE, EXAMINING ATTORNEY



David J. Kyffers

Director of the United States Patent and Trademark Office

United States of America

United States Patent and Trademark Office

FRENCH PRESS G-M

Reg. No. 4,108,365

Registered Mar. 6, 2012

Int. Cl.: 9

TRADEMARK

PRINCIPAL REGISTER

GLEN MILLS INC. (NEW JERSEY CORPORATION)
220 DELAWANNA AVENUE
CLIFTON, NJ 07014

FOR: LABORATORY APPARATUS AND INSTRUMENTS, NAMELY, HOMOGENIZERS, AND STRUCTURAL AND REPLACEMENT PARTS, IN CLASS 9 (U.S. CLS. 21, 23, 26, 36 AND 38).

FIRST USE 3-14-2011; IN COMMERCE 3-14-2011.

THE MARK CONSISTS OF STANDARD CHARACTERS WITHOUT CLAIM TO ANY PARTICULAR FONT, STYLE, SIZE, OR COLOR.

NO CLAIM IS MADE TO THE EXCLUSIVE RIGHT TO USE "FRENCH PRESS", APART FROM THE MARK AS SHOWN.

SER. NO. 85-362,968, FILED 7-5-2011.

JOHN WILKE, EXAMINING ATTORNEY



David J. Kybas

Director of the United States Patent and Trademark Office

United States of America

United States Patent and Trademark Office

HARVEST HOSTS

Reg. No. 4,108,366

HARVEST HOSTS, LLC (ARIZONA LIMITED LIABILITY COMPANY)
PO BOX 2414
PRESCOTT, AZ 86302

Registered Mar. 6, 2012

Int. Cl.: 35

FOR: PROVIDING AN ON-LINE DIRECTORY INFORMATION SERVICE FEATURING INFORMATION REGARDING OVERNIGHT PARKING AND/OR CAMPING AT WINERIES, FARMS AND OTHER AGRICULTURAL OR AG-TOURISM LOCATIONS, IN CLASS 35 (U.S. CLS. 100, 101 AND 102).

SERVICE MARK

PRINCIPAL REGISTER

FIRST USE 10-1-2009; IN COMMERCE 10-1-2009.

THE MARK CONSISTS OF STANDARD CHARACTERS WITHOUT CLAIM TO ANY PARTICULAR FONT, STYLE, SIZE, OR COLOR.

NO CLAIM IS MADE TO THE EXCLUSIVE RIGHT TO USE "HOSTS", APART FROM THE MARK AS SHOWN.

SER. NO. 85-362,979, FILED 7-5-2011.

PRISCILLA MILTON, EXAMINING ATTORNEY



David J. Kybas

Director of the United States Patent and Trademark Office

United States of America

United States Patent and Trademark Office

THE LIMITED

Reg. No. 4,108,367

Registered Mar. 6, 2012

Int. Cl.: 35

SERVICE MARK

PRINCIPAL REGISTER

LIMITED STORES, LLC (DELAWARE LIMITED LIABILITY COMPANY)
7775 WALTON PARKWAY
NEW ALBANY, OH 43054

FOR: MAIL ORDER CATALOG SERVICES AND ON-LINE RETAIL STORE SERVICES
FEATURING CLOTHING, JEWELRY, HANDBAGS AND HAIR ACCESSORIES, IN CLASS
35 (U.S. CLS. 100, 101 AND 102).

FIRST USE 7-1-2001; IN COMMERCE 7-1-2001.

THE MARK CONSISTS OF STANDARD CHARACTERS WITHOUT CLAIM TO ANY PAR-
TICULAR FONT, STYLE, SIZE, OR COLOR.

OWNER OF U.S. REG. NOS. 1,062,519, 3,357,866 AND OTHERS.

SER. NO. 85-363,087, FILED 7-5-2011.

AMY HELLA, EXAMINING ATTORNEY



David J. Kybas

Director of the United States Patent and Trademark Office

United States of America

United States Patent and Trademark Office



Reg. No. 4,108,368

BABY BLOOM PHOTOGRAPHY INC. (KANSAS CORPORATION)
183 N BELLE TERRE
WICHITA, KS 67230

Registered Mar. 6, 2012

Int. Cl.: 41

FOR: PHOTOGRAPHY SERVICES; PORTRAIT PHOTOGRAPHY, IN CLASS 41 (U.S. CLS. 100, 101 AND 107).

SERVICE MARK

FIRST USE 8-0-2009; IN COMMERCE 8-0-2009.

PRINCIPAL REGISTER

NO CLAIM IS MADE TO THE EXCLUSIVE RIGHT TO USE "PHOTOGRAPHY", APART FROM THE MARK AS SHOWN.

THE COLOR(S) RED, BLACK, BLUE AND GREEN IS/ARE CLAIMED AS A FEATURE OF THE MARK.

THE MARK CONSISTS OF RED FLOWER HAVING GREEN STEM WITH BLACK CENTER AND OUTLINE IN BETWEEN WORDS "BABY" AND "BLOOM" BOTH IN BLACK STYLIZED TEXT; WORD "PHOTOGRAPHY" IN BLUE STYLIZED TEXT APPEARS AT LOWER RIGHT.

SER. NO. 85-363,128, FILED 7-5-2011.

LEIGH LOWRY, EXAMINING ATTORNEY



David J. Kybas

Director of the United States Patent and Trademark Office

United States of America

United States Patent and Trademark Office

TAM-SHIELD

Reg. No. 4,108,369

Registered Mar. 6, 2012

Int. Cl.: 19

TRADEMARK

PRINCIPAL REGISTER

TAMKO BUILDING PRODUCTS, INC. (MISSOURI CORPORATION)
220 W. FOURTH STREET
JOPLIN, MO 64802

FOR: BUILDING MATERIALS, NAMELY, SYNTHETIC ROOFING UNDERLAYMENT, IN CLASS 19 (U.S. CLS. 1, 12, 33 AND 50).

FIRST USE 5-10-2011; IN COMMERCE 5-17-2011.

THE MARK CONSISTS OF STANDARD CHARACTERS WITHOUT CLAIM TO ANY PARTICULAR FONT, STYLE, SIZE, OR COLOR.

OWNER OF U.S. REG. NOS. 3,247,643, 3,358,069 AND OTHERS.

SER. NO. 85-363,285, FILED 7-5-2011.

DAVID I, EXAMINING ATTORNEY



David J. Kyfos

Director of the United States Patent and Trademark Office

United States of America

United States Patent and Trademark Office



Reg. No. 4,108,370

Registered Mar. 6, 2012

Int. Cl.: 35

SERVICE MARK

PRINCIPAL REGISTER

LOVELY DAY LLC (NEW YORK LIMITED LIABILITY COMPANY)
SUITE 606
10 JAY STREET
BROOKLYN, NY 11201

FOR: ARRANGING AND CONDUCTING SPECIAL EVENTS FOR BUSINESS PURPOSES,
IN CLASS 35 (U.S. CLS. 100, 101 AND 102).

FIRST USE 10-1-2009; IN COMMERCE 10-1-2009.

THE MARK CONSISTS OF THE WORDING "THE FEAST" IN WHITE INSIDE OVERLAPPING
CIRCLES OF RED, ORANGE, YELLOW, GREEN, BLUE, PINK, VIOLET.

THE COLOR(S) WHITE, RED, ORANGE, YELLOW, GREEN, BLUE, PINK, VIOLET IS/ARE
CLAIMED AS A FEATURE OF THE MARK.

SER. NO. 85-363,451, FILED 7-5-2011.

KAPIL BHANOT, EXAMINING ATTORNEY



David J. Kybas

Director of the United States Patent and Trademark Office

United States of America
United States Patent and Trademark Office

Bass Church

Reg. No. 4,108,371

Registered Mar. 6, 2012

Int. Cl.: 41

SERVICE MARK

PRINCIPAL REGISTER

MINDELIXIR MEDIA CORPORATION (DELAWARE CORPORATION)
#6A
718 N POPLAR ST.
CHARLOTTE, NC 28202

FOR: ENTERTAINMENT IN THE NATURE OF HEAVY ELECTRONIC MUSIC EVENT, IN CLASS 41 (U.S. CLS. 100, 101 AND 107).

FIRST USE 2-1-2010; IN COMMERCE 5-1-2010.

THE MARK CONSISTS OF STANDARD CHARACTERS WITHOUT CLAIM TO ANY PARTICULAR FONT, STYLE, SIZE, OR COLOR.

NO CLAIM IS MADE TO THE EXCLUSIVE RIGHT TO USE "BASS", APART FROM THE MARK AS SHOWN.

SER. NO. 85-363,509, FILED 7-5-2011.

JOHN GARTNER, EXAMINING ATTORNEY



David J. Kybas

Director of the United States Patent and Trademark Office

United States of America

United States Patent and Trademark Office

QUICK WITZ

Reg. No. 4,108,372

MCLAUGHLIN, REBECCA (UNITED STATES INDIVIDUAL)
110 COLEY WAY
GREENVILLE, SC 29615

Registered Mar. 6, 2012

Int. Cl.: 16

FOR: EDUCATIONAL KITS IN THE FIELD OF MENTAL ACUMEN TRAINING, CONSISTING PRIMARILY OF PRINTED INSTRUCTIONAL MATERIALS AND INCLUDING PRERECORDED AUDIO AND VISUAL CDS AND/OR DVDS, SOLD AS A UNIT, IN CLASS 16 (U.S. CLS. 2, 5, 22, 23, 29, 37, 38 AND 50).

TRADEMARK

PRINCIPAL REGISTER

FIRST USE 10-7-2009; IN COMMERCE 10-7-2009.

SER. NO. 85-363,513, FILED 7-5-2011.

JUDITH HELFMAN, EXAMINING ATTORNEY



David J. Kybas

Director of the United States Patent and Trademark Office

United States of America

United States Patent and Trademark Office

VICTORIA JACKSON SURVIVAL KIT

Reg. No. 4,108,373

Registered Mar. 6, 2012

Int. Cl.: 3

TRADEMARK

PRINCIPAL REGISTER

MAKE UP YOUR LIFE, LLC (DELAWARE LIMITED LIABILITY COMPANY)
9663 SANTA MONICA BOULEVARD, #700
BEVERLY HILLS, CA 90210

FOR: COSMETIC KITS CONTAINING LIP COLOR, EYE SHADOW, BLUSH, MASCARA,
LIP PENCIL, EYE PENCIL, LIP BRUSH, MIRROR, BLUSH BRUSH AND EYE SHADOW
APPLICATOR, IN CLASS 3 (U.S. CLS. 1, 4, 6, 50, 51 AND 52).

FIRST USE 12-31-1995; IN COMMERCE 12-31-1995.

THE MARK CONSISTS OF STANDARD CHARACTERS WITHOUT CLAIM TO ANY PAR-
TICULAR FONT, STYLE, SIZE, OR COLOR.

OWNER OF U.S. REG. NOS. 1,700,094 AND 3,376,324.

NO CLAIM IS MADE TO THE EXCLUSIVE RIGHT TO USE "KIT", APART FROM THE
MARK AS SHOWN.

THE NAME "VICTORIA JACKSON" IDENTIFIES A LIVING INDIVIDUAL WHOSE CONSENT
IS OF RECORD.

SER. NO. 85-363,526, FILED 7-5-2011.

JOHN GARTNER, EXAMINING ATTORNEY



David J. Kyffers

Director of the United States Patent and Trademark Office

United States of America

United States Patent and Trademark Office

THE RIEGER HOTEL GRILL & EXCHANGE

Reg. No. 4,108,374

ROUNDTABLE HOSPITALITY, LLC (MISSOURI LIMITED LIABILITY COMPANY)
1924 MAIN STREET
KANSAS CITY, MO 64108

Registered Mar. 6, 2012

Int. Cl.: 43

FOR: CATERING SERVICES; RESTAURANT AND BAR SERVICES, IN CLASS 43 (U.S. CLS. 100 AND 101).

SERVICE MARK

FIRST USE 12-18-2010; IN COMMERCE 12-18-2010.

PRINCIPAL REGISTER

THE MARK CONSISTS OF STANDARD CHARACTERS WITHOUT CLAIM TO ANY PARTICULAR FONT, STYLE, SIZE, OR COLOR.

NO CLAIM IS MADE TO THE EXCLUSIVE RIGHT TO USE "HOTEL GRILL", APART FROM THE MARK AS SHOWN.

SER. NO. 85-363,533, FILED 7-5-2011.

LINDA M. KING, EXAMINING ATTORNEY



David J. Kybas

Director of the United States Patent and Trademark Office

United States of America

United States Patent and Trademark Office

METROCAL PROPERTIES

Reg. No. 4,108,375

ALLENSWORTH, DEANNA (UNITED STATES INDIVIDUAL)
14742 BEACH BLVD. #435
LA MIRADA, CA 90638

Registered Mar. 6, 2012

Int. Cl.: 36

FOR: FINANCIAL EVALUATION, LEASING OF REAL ESTATE, REAL ESTATE AGENCIES, REAL ESTATE BROKERS, REAL ESTATE MANAGEMENT, IN CLASS 36 (U.S. CLS. 100, 101 AND 102).

SERVICE MARK

FIRST USE 11-1-2009; IN COMMERCE 1-1-2010.

PRINCIPAL REGISTER

THE MARK CONSISTS OF STANDARD CHARACTERS WITHOUT CLAIM TO ANY PARTICULAR FONT, STYLE, SIZE, OR COLOR.

NO CLAIM IS MADE TO THE EXCLUSIVE RIGHT TO USE "PROPERTIES", APART FROM THE MARK AS SHOWN.

SER. NO. 85-363,568, FILED 7-5-2011.

ANNE E. GUSTASON, EXAMINING ATTORNEY



David J. Kyros

Director of the United States Patent and Trademark Office

United States of America

United States Patent and Trademark Office

ASSETWISE INVESTMENTS

Reg. No. 4,108,376

ASSETWISE INVESTMENTS, INC. (CALIFORNIA CORPORATION)
7777 ALVARADO ROAD, SUITE 319
LA MESA, CA 91941

Registered Mar. 6, 2012

Int. Cl.: 36

FOR: FINANCIAL AND INVESTMENT SERVICES, NAMELY, PROVISION OF FINANCIAL ANALYSIS, CONSULTATION, PLANNING, ASSET AND PORTFOLIO MANAGEMENT, RETIREMENT PLANNING, RISK MANAGEMENT AND INVESTMENT SERVICES, IN CLASS 36 (U.S. CLS. 100, 101 AND 102).

SERVICE MARK

PRINCIPAL REGISTER

FIRST USE 5-25-2011; IN COMMERCE 5-25-2011.

THE MARK CONSISTS OF STANDARD CHARACTERS WITHOUT CLAIM TO ANY PARTICULAR FONT, STYLE, SIZE, OR COLOR.

NO CLAIM IS MADE TO THE EXCLUSIVE RIGHT TO USE "INVESTMENTS", APART FROM THE MARK AS SHOWN.

SER. NO. 85-363,629, FILED 7-5-2011.

CHERYL CLAYTON, EXAMINING ATTORNEY



David J. Kybas

Director of the United States Patent and Trademark Office

United States of America

United States Patent and Trademark Office

CIO Advantage

Reg. No. 4,108,377

Registered Mar. 6, 2012

Int. Cl.: 42

SERVICE MARK

PRINCIPAL REGISTER

CIO ADVANTAGE LLC (NORTH CAROLINA LIMITED LIABILITY COMPANY)
4407 HOPSON ROAD, #1213
MORRISVILLE, NC 27560

FOR: CONSULTING IN THE FIELD OF INFORMATION TECHNOLOGY, IN CLASS 42 (U.S. CLS. 100 AND 101).

FIRST USE 6-10-2011; IN COMMERCE 6-10-2011.

THE MARK CONSISTS OF STANDARD CHARACTERS WITHOUT CLAIM TO ANY PARTICULAR FONT, STYLE, SIZE, OR COLOR.

NO CLAIM IS MADE TO THE EXCLUSIVE RIGHT TO USE "CIO", APART FROM THE MARK AS SHOWN.

SER. NO. 85-363,630, FILED 7-5-2011.

TINA MAI, EXAMINING ATTORNEY



David J. Kyffers

Director of the United States Patent and Trademark Office

United States of America

United States Patent and Trademark Office

HORIZON GROWERS

Reg. No. 4,108,378

HORIZON MAC COOPERATIVE (CALIFORNIA CORPORATION)
1625 SHAW AVENUE
CLOVIS, CA 93611

Registered Mar. 6, 2012

Int. Cl.: 29

FOR: PREPARED NUTS; PROCESSED NUTS; ROASTED NUTS; SEASONED NUTS; SHELLLED NUTS, IN CLASS 29 (U.S. CL. 46).

TRADEMARK

FIRST USE 7-1-2009; IN COMMERCE 7-1-2009.

PRINCIPAL REGISTER

THE MARK CONSISTS OF STANDARD CHARACTERS WITHOUT CLAIM TO ANY PARTICULAR FONT, STYLE, SIZE, OR COLOR.

NO CLAIM IS MADE TO THE EXCLUSIVE RIGHT TO USE "GROWERS", APART FROM THE MARK AS SHOWN.

SER. NO. 85-363,635, FILED 7-5-2011.

CHERYL CLAYTON, EXAMINING ATTORNEY



David J. Kybas

Director of the United States Patent and Trademark Office

United States of America

United States Patent and Trademark Office

MRET

Reg. No. 4,108,379

Registered Mar. 6, 2012

Int. Cl.: 11

TRADEMARK

PRINCIPAL REGISTER

SMIRNOV IGOR (UNITED STATES INDIVIDUAL)
741 LYNWOOD DRIVE
ENCINITAS, CA 92024

FOR: WATER TREATMENT DEVICE, NAMELY, AN ELECTROMAGNETIC WATER ACTIVATOR FOR INFLUENCING THE ENERGETIC QUALITY OF WATER BY AMENDING THE INFORMATION CONTAINED IN THE CLUSTERS OF WATER MOLECULES, IN CLASS 11 (U.S. CLS. 13, 21, 23, 31 AND 34).

FIRST USE 4-1-2000; IN COMMERCE 4-1-2000.

THE MARK CONSISTS OF STANDARD CHARACTERS WITHOUT CLAIM TO ANY PARTICULAR FONT, STYLE, SIZE, OR COLOR.

SER. NO. 85-363,637, FILED 7-5-2011.

ROBIN CHOSID, EXAMINING ATTORNEY



David J. Kybas

Director of the United States Patent and Trademark Office

United States of America

United States Patent and Trademark Office



Reg. No. 4,108,380

HORIZON MAC COOPERATIVE (CALIFORNIA CORPORATION)
1625 SHAW AVENUE
CLOVIS, CA 93611

Registered Mar. 6, 2012

Int. Cl.: 29

FOR: PREPARED NUTS; PROCESSED NUTS; ROASTED NUTS; SEASONED NUTS; SHELLED NUTS, IN CLASS 29 (U.S. CL. 46).

TRADEMARK

FIRST USE 7-1-2009; IN COMMERCE 7-1-2009.

PRINCIPAL REGISTER

NO CLAIM IS MADE TO THE EXCLUSIVE RIGHT TO USE "GROWERS", APART FROM THE MARK AS SHOWN.

THE MARK CONSISTS OF A STYLIZED PISTACHIO NUT IN A THIN BANNER OVER THE WORD "HORIZON", WHICH IS OVER A BANNER CONTAINING THE WORD "GROWERS".

SER. NO. 85-363,640, FILED 7-5-2011.

CHERYL CLAYTON, EXAMINING ATTORNEY



David J. Kybas

Director of the United States Patent and Trademark Office

United States of America

United States Patent and Trademark Office

SMART PASSIVE

Reg. No. 4,108,381

ASSETWISE INVESTMENTS, INC. (CALIFORNIA CORPORATION)
7777 ALVARADO ROAD, SUITE 319
LA MESA, CA 91941

Registered Mar. 6, 2012

Int. Cl.: 36

FOR: FINANCIAL PORTFOLIO ANALYSIS AND MANAGEMENT SERVICES, IN CLASS 36 (U.S. CLS. 100, 101 AND 102).

SERVICE MARK

FIRST USE 5-25-2011; IN COMMERCE 5-25-2011.

PRINCIPAL REGISTER

THE MARK CONSISTS OF STANDARD CHARACTERS WITHOUT CLAIM TO ANY PARTICULAR FONT, STYLE, SIZE, OR COLOR.

NO CLAIM IS MADE TO THE EXCLUSIVE RIGHT TO USE "PASSIVE", APART FROM THE MARK AS SHOWN.

SER. NO. 85-363,642, FILED 7-5-2011.

CHERYL CLAYTON, EXAMINING ATTORNEY



David J. Kybas

Director of the United States Patent and Trademark Office

United States of America

United States Patent and Trademark Office

IDIG ARCHAEOLOGY

Reg. No. 4,108,382

Registered Mar. 6, 2012

Int. Cls.: 8 and 9

TRADEMARK

PRINCIPAL REGISTER

BON TOOL COMPANY (PENNSYLVANIA CORPORATION)
4430 GIBSONIA ROAD
GIBSONIA, PA 15044

FOR: HAND TOOLS, NAMELY, SHOVELS, TROWELS, PICKS, AUGERS, HOES, HAMMERS, CHISELS, SQUARES, MACHETES, AND POST DRIVERS, IN CLASS 8 (U.S. CLS. 23, 28 AND 44).

FIRST USE 4-3-2011; IN COMMERCE 4-3-2011.

FOR: DISTANCE MEASURING APPARATUS; DUST MASKS; HARD HATS; KNEE PADS FOR WORKERS; LEVEL INDICATORS; MEASURING TAPES; PLUMB BOBS; PROTECTIVE WORK GLOVES; SAFETY EYEWEAR; TRANSITS; TRIPODS, IN CLASS 9 (U.S. CLS. 21, 23, 26, 36 AND 38).

FIRST USE 4-3-2011; IN COMMERCE 4-3-2011.

THE MARK CONSISTS OF STANDARD CHARACTERS WITHOUT CLAIM TO ANY PARTICULAR FONT, STYLE, SIZE, OR COLOR.

NO CLAIM IS MADE TO THE EXCLUSIVE RIGHT TO USE "ARCHAEOLOGY" , APART FROM THE MARK AS SHOWN.

SER. NO. 85-363,711, FILED 7-5-2011.

HAI-LY LAM, EXAMINING ATTORNEY



David J. Kybas

Director of the United States Patent and Trademark Office

United States of America

United States Patent and Trademark Office

BCSN HD

Reg. No. 4,108,383

BUCKEYE CABLEVISION, INC. (OHIO CORPORATION)
5555 AIRPORT HIGHWAY, SUITE 110
TOLEDO, OH 43615

Registered Mar. 6, 2012

Int. Cl.: 41

FOR: ENTERTAINMENT IN THE NATURE OF ON-GOING CABLE TELEVISION PROGRAMS
IN THE FIELD OF SPORTS, IN CLASS 41 (U.S. CLS. 100, 101 AND 107).

SERVICE MARK

FIRST USE 4-3-2011; IN COMMERCE 4-3-2011.

PRINCIPAL REGISTER

OWNER OF U.S. REG. NO. 2,955,761.

NO CLAIM IS MADE TO THE EXCLUSIVE RIGHT TO USE "HD", APART FROM THE MARK
AS SHOWN.

THE MARK CONSISTS OF "BCSN HD". THE "C" AND THE "S" RUN ARE CONNECTED
AND THERE IS A SPACE BETWEEN "BCSN" AND "HD".

SER. NO. 85-364,488, FILED 7-6-2011.

MICHAEL SOUDERS, EXAMINING ATTORNEY



David J. Kyffers

Director of the United States Patent and Trademark Office

United States of America

United States Patent and Trademark Office

Inventive Media

Reg. No. 4,108,384

INVENTIVE MEDIA INC. (CONNECTICUT CORPORATION)
68 WATER STREET
NORWALK, CT 06854

Registered Mar. 6, 2012

Int. Cl.: 40

FOR: CUSTOM MANUFACTURE OF SIGNS TO THE ORDER AND SPECIFICATION OF OTHERS, IN CLASS 40 (U.S. CLS. 100, 103 AND 106).

SERVICE MARK

FIRST USE 3-16-2007; IN COMMERCE 4-13-2007.

PRINCIPAL REGISTER

THE MARK CONSISTS OF STANDARD CHARACTERS WITHOUT CLAIM TO ANY PARTICULAR FONT, STYLE, SIZE, OR COLOR.

NO CLAIM IS MADE TO THE EXCLUSIVE RIGHT TO USE "MEDIA", APART FROM THE MARK AS SHOWN.

SER. NO. 85-364,522, FILED 7-6-2011.

MIDGE BUTLER, EXAMINING ATTORNEY



David J. Kybas

Director of the United States Patent and Trademark Office

United States of America

United States Patent and Trademark Office



Reg. No. 4,108,385

Registered Mar. 6, 2012

Int. Cl.: 38

SERVICE MARK

PRINCIPAL REGISTER

APEX ELECTRONIC DATA INTERCHANGE, INC. (UTAH CORPORATION)
174 S. 1100 EAST
AMERICAN FORK, UT 84003

FOR: ELECTRONIC DATA INTERCHANGE SERVICES IN THE FIELD OF HEALTHCARE TRANSACTIONS SUCH AS CLAIMS, ELIGIBILITY, CLAIM STATUS, ELECTRONIC REMITTANCE ADVICE, PRIOR AUTHORIZATIONS, ATTACHMENTS AND REFERRALS THAT ALLOW DIRECT TRANSACTION AND PAYMENT COMMUNICATIONS BETWEEN HEALTHCARE PROVIDERS AND PAYERS, IN CLASS 38 (U.S. CLS. 100, 101 AND 104).

FIRST USE 4-1-2001; IN COMMERCE 4-1-2001.

OWNER OF U.S. REG. NO. 3,383,916.

NO CLAIM IS MADE TO THE EXCLUSIVE RIGHT TO USE "EDI", APART FROM THE MARK AS SHOWN.

THE MARK CONSISTS OF THE WORDS "APEX EDI" NEXT TO A CIRCLE WITH AN UPSIDE DOWN LETTER "V" IN THE CENTER WITH A LINE DOWN EACH SLOPED SIDE.

SER. NO. 85-364,539, FILED 7-6-2011.

ALEXANDER L. POWERS, EXAMINING ATTORNEY



David J. Kyffers

Director of the United States Patent and Trademark Office

United States of America

United States Patent and Trademark Office

MAIOLI BREWS

Reg. No. 4,108,386

MAIOLI, ANDREW T (UNITED STATES INDIVIDUAL)
33 GLEN EDEN CT
HENDERSON, NV 89074

Registered Mar. 6, 2012

Int. Cl.: 16

FOR: ART PRINTS; GRAPHIC ART REPRODUCTIONS; PRINTED ART REPRODUCTIONS,
IN CLASS 16 (U.S. CLS. 2, 5, 22, 23, 29, 37, 38 AND 50).

TRADEMARK

FIRST USE 11-0-2010; IN COMMERCE 11-0-2010.

PRINCIPAL REGISTER

THE MARK CONSISTS OF STANDARD CHARACTERS WITHOUT CLAIM TO ANY PAR-
TICULAR FONT, STYLE, SIZE, OR COLOR.

NO CLAIM IS MADE TO THE EXCLUSIVE RIGHT TO USE "BREWS", APART FROM THE
MARK AS SHOWN.

SER. NO. 85-364,547, FILED 7-6-2011.

SARA BENJAMIN, EXAMINING ATTORNEY



David J. Kybas

Director of the United States Patent and Trademark Office

United States of America

United States Patent and Trademark Office



La Mezcaleria

Reg. No. 4,108,387

VIDA Y ESTILO, CORP. (FLORIDA CORPORATION)
410 ESPAÑOLA WAY
MIAMI BEACH, FL 33139

Registered Mar. 6, 2012

Int. Cl.: 43

FOR: RESTAURANT SERVICES, IN CLASS 43 (U.S. CLS. 100 AND 101).

SERVICE MARK

FIRST USE 1-31-2011; IN COMMERCE 1-31-2011.

PRINCIPAL REGISTER

THE MARK CONSISTS OF THE WORDS "LA MEZCALERIA" IN A STYLIZED FONT. THERE IS AN IMAGE OF A PLANT ABOVE THE WORD "MEZCALERIA".

THE WORDING "MEZCALERIA" HAS NO MEANING IN A FOREIGN LANGUAGE.

SER. NO. 85-364,602, FILED 7-6-2011.

KIM MONINGHOFF, EXAMINING ATTORNEY



David J. Kybas

Director of the United States Patent and Trademark Office

United States of America

United States Patent and Trademark Office

Rick Goacher Planning

Reg. No. 4,108,388

Registered Mar. 6, 2012

Int. Cl.: 45

SERVICE MARK

PRINCIPAL REGISTER

RICK GOACHER PLANNING, INC. (CALIFORNIA CORPORATION)
8921 RESEARCH DRIVE
IRVINE, CA 92618

FOR: PERMITTING, NAMELY, OBTAINING ENVIRONMENTAL, DESIGN, ZONING AND OTHER GOVERNMENTAL PERMITS FOR DEVELOPMENT PROJECTS; PREPARING ENVIRONMENTAL COMPLIANCE REPORTS, IN CLASS 45 (U.S. CLS. 100 AND 101).

FIRST USE 6-1-1993; IN COMMERCE 6-1-1993.

THE MARK CONSISTS OF STANDARD CHARACTERS WITHOUT CLAIM TO ANY PARTICULAR FONT, STYLE, SIZE, OR COLOR.

NO CLAIM IS MADE TO THE EXCLUSIVE RIGHT TO USE "PLANNING", APART FROM THE MARK AS SHOWN.

THE NAME "RICK GOACHER" IDENTIFIES A LIVING INDIVIDUAL WHOSE CONSENT IS OF RECORD.

SER. NO. 85-364,650, FILED 7-6-2011.

KIM MONINGHOFF, EXAMINING ATTORNEY



David J. Kybas

Director of the United States Patent and Trademark Office

United States of America

United States Patent and Trademark Office



Reg. No. 4,108,389

Registered Mar. 6, 2012

Int. Cl.: 36

SERVICE MARK

PRINCIPAL REGISTER

A TEAM REALTY, INC. (CALIFORNIA CORPORATION)
22020 CLARENDON STREET, SUITE 200
WOODLAND HILLS, CA 91367

FOR: REAL ESTATE AGENCY SERVICES, IN CLASS 36 (U.S. CLS. 100, 101 AND 102).

FIRST USE 12-31-2000; IN COMMERCE 12-31-2000.

THE MARK CONSISTS OF AN IMAGE OF A HOUSE INSIDE A BUBBLE WITH A SMALLER BUBBLE IN THE LOWER RIGHT HAND CORNER.

SER. NO. 85-364,660, FILED 7-6-2011.

ANDREA HACK, EXAMINING ATTORNEY



David J. Kyffers

Director of the United States Patent and Trademark Office

United States of America

United States Patent and Trademark Office



Reg. No. 4,108,390

Registered Mar. 6, 2012

Int. Cl.: 41

SERVICE MARK

PRINCIPAL REGISTER

CALIFORNIA SCIENCE CENTER FOUNDATION (CALIFORNIA CORPORATION)
700 EXPOSITION PARK DR.
LOS ANGELES, CA 90037

FOR: MUSEUMS; EDUCATIONAL SERVICES, NAMELY, INTERACTIVE EXHIBITS IN THE FIELD OF SCIENCE, TEACHER TRAINING IN THE FIELD OF SCIENCE, EDUCATIONAL SEMINARS IN THE FIELD OF SCIENCE, SUMMER CAMPS, EDUCATIONAL DEMONSTRATIONS, AND SHOWING EDUCATIONAL FILMS, IN CLASS 41 (U.S. CLS. 100, 101 AND 107).

FIRST USE 2-7-1998; IN COMMERCE 2-7-1998.

THE MARK CONSISTS OF FOUR SOLID CIRCLES OF DIFFERENT DIAMETERS ARRANGED IN A LINE WITH A PORTION OF EACH CIRCLE'S CIRCUMFERENCE TOUCHING A PART OF EACH ADJACENT CIRCLE WITH THE FIRST AND THIRD CIRCLE AT DIFFERENT HEIGHTS THAN THE SECOND AND FOURTH CIRCLE THAT ARE AT THE SAME HEIGHT. THE WORDING OF THE MARK, "CALIFORNIASCIENCENTER", EXTENDING ACROSS ALL FOUR CIRCLES AND AN ABSTRACTION OF A MOLECULE CONTAINED IN THE UPPER PORTION OF THE THIRD CIRCLE REPRESENTED BY THREE EMPTY CIRCLES CONNECTED BY STRAIGHT RODS.

SER. NO. 85-364,737, FILED 7-6-2011.

ANDREA HACK, EXAMINING ATTORNEY



David J. Kyros

Director of the United States Patent and Trademark Office

United States of America

United States Patent and Trademark Office

Prolific Living

Reg. No. 4,108,391

Registered Mar. 6, 2012

Int. Cl.: 41

SERVICE MARK

PRINCIPAL REGISTER

FARNOOSH BROCK (NORTH CAROLINA SOLE PROPRIETORSHIP), DBA PROLIFIC LIVING
316 BRIDGEGATE DRIVE
CARY, NC 27519

FOR: EDUCATION SERVICES, NAMELY, PROVIDING ON-LINE SEMINARS AND WORKSHOPS AND CLASSES IN THE FIELD OF SELF-IMPROVEMENT, PERSONAL GROWTH, PERSONAL DEVELOPMENT, AND BUSINESS LEADERSHIP DEVELOPMENT PROVIDED THROUGH WEBCASTS AND PODCASTS; EDUCATIONAL AND ENTERTAINMENT SERVICES, NAMELY, CONDUCTING CLASSES, SEMINARS, AND WORKSHOPS IN THE FIELD OF SELF-IMPROVEMENT, PERSONAL GROWTH, PERSONAL DEVELOPMENT, AND BUSINESS LEADERSHIP DEVELOPMENT AND DISTRIBUTION OF COURSE MATERIALS IN CONNECTION THEREWITH, AND EDUCATION CONSULTING RELATED THERETO; ON-LINE JOURNALS, NAMELY, BLOGS FEATURING NEWS AND INFORMATION IN THE FIELD OF SELF-IMPROVEMENT, PERSONAL GROWTH, PERSONAL DEVELOPMENT, AND BUSINESS LEADERSHIP DEVELOPMENT; ON-LINE PUBLICATION OF ELECTRONIC NEWSLETTERS, ELECTRONIC WHITE PAPERS, AND ELECTRONIC GUIDES IN THE FIELD OF SELF-IMPROVEMENT, PERSONAL GROWTH, PERSONAL DEVELOPMENT, AND BUSINESS LEADERSHIP DEVELOPMENT, IN CLASS 41 (U.S. CLS. 100, 101 AND 107).

FIRST USE 3-24-2008; IN COMMERCE 3-24-2008.

THE MARK CONSISTS OF STANDARD CHARACTERS WITHOUT CLAIM TO ANY PARTICULAR FONT, STYLE, SIZE, OR COLOR.

SER. NO. 85-364,781, FILED 7-6-2011.

KIM MONINGHOFF, EXAMINING ATTORNEY



David J. Kybas

Director of the United States Patent and Trademark Office

United States of America

United States Patent and Trademark Office

ROYAL OIL

Reg. No. 4,108,392

TOO FACED COSMETICS, INC. (CALIFORNIA CORPORATION)
17361 ARMSTRONG AVENUE
IRVINE, CA 92614

Registered Mar. 6, 2012

Int. Cl.: 3

FOR: BODY OIL; SKIN BRONZER, IN CLASS 3 (U.S. CLS. 1, 4, 6, 50, 51 AND 52).

TRADEMARK

FIRST USE 6-1-2011; IN COMMERCE 6-1-2011.

PRINCIPAL REGISTER

THE MARK CONSISTS OF STANDARD CHARACTERS WITHOUT CLAIM TO ANY PARTICULAR FONT, STYLE, SIZE, OR COLOR.

NO CLAIM IS MADE TO THE EXCLUSIVE RIGHT TO USE "OIL", APART FROM THE MARK AS SHOWN.

SER. NO. 85-364,802, FILED 7-6-2011.

KATHERINE CHANG, EXAMINING ATTORNEY



David J. Kyffers

Director of the United States Patent and Trademark Office

United States of America

United States Patent and Trademark Office

EXOTIC COLOR

Reg. No. 4,108,393

Registered Mar. 6, 2012

Int. Cl.: 3

TRADEMARK

PRINCIPAL REGISTER

TOO FACED COSMETICS, INC. (CALIFORNIA CORPORATION)
17361 ARMSTRONG AVENUE
IRVINE, CA 92614

FOR: COSMETICS, IN CLASS 3 (U.S. CLS. 1, 4, 6, 50, 51 AND 52).

FIRST USE 6-1-2011; IN COMMERCE 6-1-2011.

THE MARK CONSISTS OF STANDARD CHARACTERS WITHOUT CLAIM TO ANY PARTICULAR FONT, STYLE, SIZE, OR COLOR.

NO CLAIM IS MADE TO THE EXCLUSIVE RIGHT TO USE "COLOR", APART FROM THE MARK AS SHOWN.

SER. NO. 85-365,381, FILED 7-7-2011.

KATHERINE CHANG, EXAMINING ATTORNEY



David J. Kyffers

Director of the United States Patent and Trademark Office

United States of America

United States Patent and Trademark Office

PERFECT EYES

Reg. No. 4,108,394

Registered Mar. 6, 2012

Int. Cl.: 3

TRADEMARK

PRINCIPAL REGISTER

TOO FACED COSMETICS, INC. (CALIFORNIA CORPORATION)
17361 ARMSTRONG AVENUE
IRVINE, CA 92614

FOR: COSMETICS, IN CLASS 3 (U.S. CLS. 1, 4, 6, 50, 51 AND 52).

FIRST USE 6-1-2011; IN COMMERCE 6-1-2011.

THE MARK CONSISTS OF STANDARD CHARACTERS WITHOUT CLAIM TO ANY PARTICULAR FONT, STYLE, SIZE, OR COLOR.

NO CLAIM IS MADE TO THE EXCLUSIVE RIGHT TO USE "EYES", APART FROM THE MARK AS SHOWN.

SER. NO. 85-365,412, FILED 7-7-2011.

KATHERINE CHANG, EXAMINING ATTORNEY



David J. Kyffers

Director of the United States Patent and Trademark Office

United States of America

United States Patent and Trademark Office

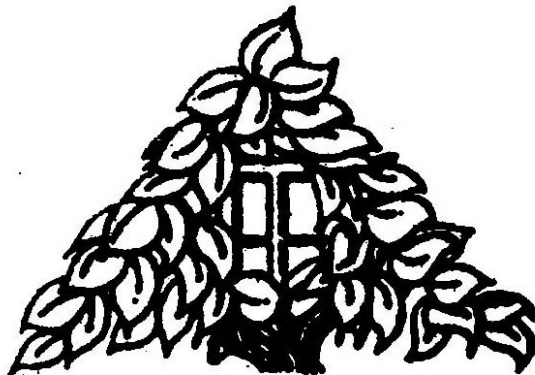

Reg. No. 4,108,395

Registered Mar. 6, 2012

Int. Cl.: 36

SERVICE MARK

PRINCIPAL REGISTER

GARDEN HOMES MANAGEMENT CORPORATION (CONNECTICUT CORPORATION)
29 KNAPP STREET
STAMFORD, CT 06907

FOR: MANAGEMENT OF APARTMENTS, GARDEN APARTMENTS AND MANUFACTURED HOUSING COMMUNITIES, IN CLASS 36 (U.S. CLS. 100, 101 AND 102).

FIRST USE 6-1-2001; IN COMMERCE 6-1-2001.

OWNER OF U.S. REG. NO. 929,331.

THE MARK CONSISTS OF A FANCIFUL ARRANGEMENT OF LEAVES SHAPED AS A TRIANGLE SURROUNDING A FOUR-PANED WINDOW.

SER. NO. 85-365,794, FILED 7-7-2011.

KELLY CHOE, EXAMINING ATTORNEY



David J. Kybas

Director of the United States Patent and Trademark Office

United States of America

United States Patent and Trademark Office



Reg. No. 4,108,396

Registered Mar. 6, 2012

Int. Cl.: 42

SERVICE MARK

PRINCIPAL REGISTER

5TH SEASON OUTFITTERS LLC (OHIO LIMITED LIABILITY COMPANY)
520 BIRCH HILL DR B-13
MEDINA, OH 44256

FOR: CREATING AN ON-LINE COMMUNITY FOR HUNTERS, FISHERMAN, AND OUTDOORSMAN FOR THE PURPOSE OF SHARING INFORMATION, IN CLASS 42 (U.S. CLS. 100 AND 101).

FIRST USE 6-1-2010; IN COMMERCE 12-1-2010.

THE MARK CONSISTS OF THE NUMBER FIVE WITH ANTLERS COMING OUT OF THE TOP LIKE A WHITETAILED DEER.

SER. NO. 85-365,813, FILED 7-7-2011.

DOUGLAS LEE, EXAMINING ATTORNEY



David J. Kyffers

Director of the United States Patent and Trademark Office

United States of America

United States Patent and Trademark Office

WineNabber

Reg. No. 4,108,397

Registered Mar. 6, 2012

Int. Cl.: 35

SERVICE MARK

PRINCIPAL REGISTER

NABBER LLC (WYOMING LIMITED LIABILITY COMPANY)
69 BAYBERRY ROAD
PRINCETON, NJ 08540

FOR: ADVERTISING SERVICES, NAMELY, PROMOTING THE FOOD AND WINE OF OTHERS; PROVIDING A WEBSITE FOR USERS WITH SPECIFIC INFORMED RECOMMENDATIONS OF SPECIFIC CONSUMER PRODUCTS AND SERVICES VALIDATED BY THE USERS' INPUTTED PREFERENCES AND SOCIAL NETWORK, IN CLASS 35 (U.S. CLS. 100, 101 AND 102).

FIRST USE 7-7-2011; IN COMMERCE 7-7-2011.

THE MARK CONSISTS OF THE STYLIZED WORDING "WINENABBER", WITH THE LETTER "R" TILTED UPWARD, AS IT IS BEING NABBED BY A STYLIZED HAND.

SER. NO. 85-365,989, FILED 7-7-2011.

ELLEN B. AWRICH, EXAMINING ATTORNEY



David J. Kyffers

Director of the United States Patent and Trademark Office

United States of America

United States Patent and Trademark Office



Reg. No. 4,108,398

Registered Mar. 6, 2012

Int. Cl.: 36

SERVICE MARK

PRINCIPAL REGISTER

KEYSTONE WOUNDED WARRIORS (PENNSYLVANIA CORPORATION)
KOZLOFF STOUTT
2640 WESTVIEW DRIVE
WYOMISSING, PA 19610

FOR: CHARITABLE FUNDRAISING TO SUPPORT THE NEEDS OF SEVERELY INJURED
U.S. MILITARY PERSONNEL, IN CLASS 36 (U.S. CLS. 100, 101 AND 102).

FIRST USE 6-18-2011; IN COMMERCE 6-18-2011.

THE MARK CONSISTS OF A WARRIOR PULLING ANOTHER WARRIOR.

SER. NO. 85-366,774, FILED 7-8-2011.

ROBIN CHOSID, EXAMINING ATTORNEY



David J. Kappas

Director of the United States Patent and Trademark Office

United States of America

United States Patent and Trademark Office

AMPLIFIER DUAL

Reg. No. 4,108,399

Registered Mar. 6, 2012

Int. Cl.: 31

TRADEMARK

PRINCIPAL REGISTER

LAND O'LAKES, INC. (MINNESOTA CORPORATION)
4001 LEXINGTON AVENUE NORTH
ARDEN HILLS, MN 55126

FOR: ANIMAL FEED, IN CLASS 31 (U.S. CLS. 1 AND 46).

FIRST USE 3-5-2010; IN COMMERCE 3-5-2010.

THE MARK CONSISTS OF STANDARD CHARACTERS WITHOUT CLAIM TO ANY PARTICULAR FONT, STYLE, SIZE, OR COLOR.

OWNER OF U.S. REG. NOS. 2,043,557, 2,268,765, AND 2,479,773.

SER. NO. 85-366,804, FILED 7-8-2011.

EDWARD NELSON, EXAMINING ATTORNEY



David J. Kyffers

Director of the United States Patent and Trademark Office

United States of America

United States Patent and Trademark Office

MON BIJOU

Reg. No. 4,108,400

HORIZON GROUP USA, INC. (NEW JERSEY CORPORATION)
76 STIRLING ROAD
WARREN, NJ 07059

Registered Mar. 6, 2012

Int. Cl.: 28

FOR: HOBBY AND CRAFT KITS COMPRISED PRIMARILY OF BEADS, GLITTER, GEM-STONES, BRACELETS, PENDANTS, RINGS, BOTTLE CAPS, AND NECKLACES FOR MAKING JEWELRY AND JEWELRY BOXES , IN CLASS 28 (U.S. CLS. 22, 23, 38 AND 50).

TRADEMARK

FIRST USE 6-30-2010; IN COMMERCE 6-30-2010.

PRINCIPAL REGISTER

THE MARK CONSISTS OF STANDARD CHARACTERS WITHOUT CLAIM TO ANY PARTICULAR FONT, STYLE, SIZE, OR COLOR.

THE ENGLISH TRANSLATION OF "MON BIJOU" IN THE MARK IS "MY JEWEL".

SER. NO. 85-366,968, FILED 7-8-2011.

REGINA DRUMMOND, EXAMINING ATTORNEY



David J. Kyros

Director of the United States Patent and Trademark Office

United States of America

United States Patent and Trademark Office

MECCA TO MANHATTAN : MUSLIM WOMEN MOVING MOUNTAINS

Reg. No. 4,108,401

Registered Mar. 6, 2012

Int. Cl.: 41

SERVICE MARK

PRINCIPAL REGISTER

TURNING POINT FOR WOMEN AND FAMILIES (NEW YORK NON-PROFIT ORGANIZATION)
PO BOX 670086
FLUSHING, NY 11367

FOR: PROVIDING AN IN-PERSON EDUCATIONAL FORUM FOR ADOLESCENT MUSLIM GIRLS AND YOUNG WOMEN, OFFERING OPPORTUNITIES THROUGH MOTIVATIONAL WORKSHOPS TO DEVELOP SELF-ESTEEM, LEADERSHIP AND COMMUNICATION SKILLS AND OFFERING SELF-EMPOWERMENT TOOLS THAT MUSLIM GIRLS AND YOUNG WOMEN CAN USE TO ADVOCATE FOR THEMSELVES AND OTHER MUSLIM WOMEN, IN CLASS 41 (U.S. CLS. 100, 101 AND 107).

FIRST USE 2-28-2009; IN COMMERCE 2-28-2009.

THE MARK CONSISTS OF STANDARD CHARACTERS WITHOUT CLAIM TO ANY PARTICULAR FONT, STYLE, SIZE, OR COLOR.

SER. NO. 85-367,396, FILED 7-10-2011.

LUCY ARANT, EXAMINING ATTORNEY



David J. Kybas

Director of the United States Patent and Trademark Office

United States of America

United States Patent and Trademark Office

JETSET HOMES

Reg. No. 4,108,402

GILT TRAVEL, INC. (DELAWARE CORPORATION)
40 WEST 20TH STREET, 7TH FLOOR
NEW YORK, NY 10011

Registered Mar. 6, 2012

Int. Cl.: 43

FOR: RESERVATION OF VACATION HOMES FOR TRAVELERS, IN CLASS 43 (U.S. CLS. 100 AND 101).

SERVICE MARK

FIRST USE 5-31-2011; IN COMMERCE 5-31-2011.

PRINCIPAL REGISTER

THE MARK CONSISTS OF STANDARD CHARACTERS WITHOUT CLAIM TO ANY PARTICULAR FONT, STYLE, SIZE, OR COLOR.

NO CLAIM IS MADE TO THE EXCLUSIVE RIGHT TO USE "HOMES", APART FROM THE MARK AS SHOWN.

SER. NO. 85-367,555, FILED 7-11-2011.

BRIAN NEVILLE, EXAMINING ATTORNEY



David J. Kyffers

Director of the United States Patent and Trademark Office

United States of America

United States Patent and Trademark Office

SR Education Group

Reg. No. 4,108,403

Registered Mar. 6, 2012

Int. Cls.: 35, 36 and 41

SERVICE MARK

PRINCIPAL REGISTER

REACH NETWORK, INC (WASHINGTON CORPORATION), DBA SR EDUCATION GROUP
SUITE B-1
123 LAKE STREET SOUTH
KIRKLAND, WA 98033

FOR: INFORMATION SERVICES, NAMELY, PROVIDING A WEBSITE FEATURING INFORMATION IN THE FIELD OF CAREER PATHS; PROVIDING SERVICES TO EDUCATIONAL INSTITUTIONS, NAMELY, DISTRIBUTION OF INFORMATION ABOUT EDUCATIONAL INSTITUTIONS TO PROSPECTIVE STUDENTS, IN CLASS 35 (U.S. CLS. 100, 101 AND 102).

FIRST USE 7-13-2010; IN COMMERCE 7-13-2010.

FOR: INFORMATION SERVICES, NAMELY, PROVIDING A WEBSITE FEATURING INFORMATION IN THE FIELD OF FINANCIAL AID AND SCHOLARSHIPS FOR EDUCATION AND TRAINING, IN CLASS 36 (U.S. CLS. 100, 101 AND 102).

FIRST USE 7-13-2010; IN COMMERCE 7-13-2010.

FOR: INFORMATION SERVICES, NAMELY, PROVIDING A WEBSITE FEATURING INFORMATION IN THE FIELD OF EDUCATIONAL INSTITUTIONS, EDUCATIONAL SERVICES, EDUCATIONAL PROGRAMS, EDUCATIONAL CERTIFICATE PROGRAMS, VOCATIONAL TRAINING, AND EDUCATIONAL INSTITUTION ADMISSIONS REQUIREMENTS, IN CLASS 41 (U.S. CLS. 100, 101 AND 107).

FIRST USE 7-13-2010; IN COMMERCE 7-13-2010.

THE MARK CONSISTS OF STANDARD CHARACTERS WITHOUT CLAIM TO ANY PARTICULAR FONT, STYLE, SIZE, OR COLOR.

NO CLAIM IS MADE TO THE EXCLUSIVE RIGHT TO USE "EDUCATION GROUP", APART FROM THE MARK AS SHOWN.

SER. NO. 85-367,893, FILED 7-11-2011.

DEIRDRE ROBERTSON, EXAMINING ATTORNEY



David J. Kyffers

Director of the United States Patent and Trademark Office

United States of America

United States Patent and Trademark Office

Digi-Extend n' Squeeze

Reg. No. 4,108,404

GOLDBERG, ELLIOTT (UNITED STATES INDIVIDUAL)
45 FRANKLIN ROAD
SCARSDALE, NY 10583

Registered Mar. 6, 2012

Int. Cl.: 10

FOR: MANUALLY-OPERATED EXERCISE EQUIPMENT FOR PHYSICAL THERAPY PURPOSES, IN CLASS 10 (U.S. CLS. 26, 39 AND 44).

TRADEMARK

FIRST USE 5-1-2011; IN COMMERCE 5-1-2011.

PRINCIPAL REGISTER

THE MARK CONSISTS OF STANDARD CHARACTERS WITHOUT CLAIM TO ANY PARTICULAR FONT, STYLE, SIZE, OR COLOR.

OWNER OF U.S. REG. NO. 3,220,445.

SER. NO. 85-368,512, FILED 7-11-2011.

ROBERT C. CLARK JR., EXAMINING ATTORNEY



David J. Kybas

Director of the United States Patent and Trademark Office

United States of America

United States Patent and Trademark Office

CLK PIANO

Reg. No. 4,108,405

Registered Mar. 6, 2012

Int. Cl.: 41

SERVICE MARK

PRINCIPAL REGISTER

KELLEY II, CHRISTOPHER LEE (UNITED STATES INDIVIDUAL)
29 CORNELIA ST, APT 2
BROOKLYN, NY 11221

FOR: ENTERTAINMENT SERVICES IN THE NATURE OF LIVE MUSICAL PERFORMANCES; ENTERTAINMENT SERVICES, NAMELY, PROVIDING A WEB SITE FEATURING NON-DOWNLOADABLE MUSICAL PERFORMANCES, MUSICAL VIDEOS, RELATED FILM CLIPS, PHOTOGRAPHS, AND OTHER MULTIMEDIA MATERIALS FEATURING MUSIC, IN CLASS 41 (U.S. CLS. 100, 101 AND 107).

FIRST USE 0-0-2009; IN COMMERCE 0-0-2009.

THE MARK CONSISTS OF STANDARD CHARACTERS WITHOUT CLAIM TO ANY PARTICULAR FONT, STYLE, SIZE, OR COLOR.

NO CLAIM IS MADE TO THE EXCLUSIVE RIGHT TO USE "PIANO", APART FROM THE MARK AS SHOWN.

SER. NO. 85-368,581, FILED 7-12-2011.

TIMOTHY FINNEGAN, EXAMINING ATTORNEY



David J. Kyros

Director of the United States Patent and Trademark Office

United States of America

United States Patent and Trademark Office

EXPANDING BRAND CONNECTIONS

Reg. No. 4,108,406

JANINE GORDON ASSOCIATES LLC (NEW YORK LIMITED LIABILITY COMPANY)
14 EAST 75TH STREET, #5C
NEW YORK, NY 10021

Registered Mar. 6, 2012

Int. Cl.: 35

FOR: PUBLIC RELATIONS AND BRAND MANAGEMENT SERVICES, IN CLASS 35 (U.S. CLS. 100, 101 AND 102).

SERVICE MARK

FIRST USE 7-6-2011; IN COMMERCE 7-6-2011.

PRINCIPAL REGISTER

THE MARK CONSISTS OF STANDARD CHARACTERS WITHOUT CLAIM TO ANY PARTICULAR FONT, STYLE, SIZE, OR COLOR.

NO CLAIM IS MADE TO THE EXCLUSIVE RIGHT TO USE "BRAND", APART FROM THE MARK AS SHOWN.

SER. NO. 85-368,844, FILED 7-12-2011.

FRANK LATTUCA, EXAMINING ATTORNEY



David J. Kyffers

Director of the United States Patent and Trademark Office

United States of America

United States Patent and Trademark Office



MOVERNATION

Reg. No. 4,108,407

Registered Mar. 6, 2012

Int. Cl.: 39

SERVICE MARK

PRINCIPAL REGISTER

MOVING & STORAGE INC. (FLORIDA CORPORATION)
3155 N. ANDREWS AVE. EXTENSION
POMPANO BEACH, FL 33064

FOR: MOVING COMPANY SERVICES, IN CLASS 39 (U.S. CLS. 100 AND 105).

FIRST USE 7-1-2011; IN COMMERCE 7-1-2011.

NO CLAIM IS MADE TO THE EXCLUSIVE RIGHT TO USE "MOVER", APART FROM THE MARK AS SHOWN.

THE COLOR(S) RED AND GRAY IS/ARE CLAIMED AS A FEATURE OF THE MARK.

THE MARK CONSISTS OF THE WORD MOVER IN RED AND THE NATION IN GRAY, WITH RED AND GRAY CURVED ARROWS FORMING A STYLIZED SPHERE.

SER. NO. 85-369,006, FILED 7-12-2011.

ANNE MADDEN, EXAMINING ATTORNEY



David J. Kyffers

Director of the United States Patent and Trademark Office

United States of America

United States Patent and Trademark Office

REPLENISH

Reg. No. 4,108,408

Registered Mar. 6, 2012

Int. Cl.: 31

TRADEMARK

PRINCIPAL REGISTER

DRICKS ENTERPRISES, INC. (CALIFORNIA CORPORATION)
P.O. BOX 75496
SAN CLEMENTE, CA 92673

FOR: CAT FOOD; DOG FOOD, IN CLASS 31 (U.S. CLS. 1 AND 46).

FIRST USE 3-1-2011; IN COMMERCE 4-1-2011.

THE MARK CONSISTS OF STANDARD CHARACTERS WITHOUT CLAIM TO ANY PARTICULAR FONT, STYLE, SIZE, OR COLOR.

OWNER OF U.S. REG. NO. 3,971,863.

SER. NO. 85-369,202, FILED 7-12-2011.

LINDA MICKLEBURGH, EXAMINING ATTORNEY



David J. Kyffers

Director of the United States Patent and Trademark Office

United States of America

United States Patent and Trademark Office



Reg. No. 4,108,409

Registered Mar. 6, 2012

Int. Cls.: 35 and 41

SERVICE MARK

PRINCIPAL REGISTER

THE UNIFYING CENTER, INC. (NEW YORK CORPORATION)
SUITE 318
373 NESCONSET HIGHWAY
HAUPPAUGE, NY 11788

FOR: PUBLIC ADVOCACY TO PROMOTE AWARENESS OF PROGRAMS FOCUSED ON GENDER-BASED MENTAL HEALTH CARE OF MEN AND BOYS, IN CLASS 35 (U.S. CLS. 100, 101 AND 102).

FIRST USE 1-18-2011; IN COMMERCE 1-29-2011.

FOR: TRAINING SERVICES IN THE FIELD OF GENDER-BASED MENTAL HEALTH CARE OF MEN AND BOYS; EDUCATION SERVICES, NAMELY, PROVIDING EDUCATIONAL AND TRAINING WORKSHOPS, CLASSES AND SEMINARS SPECIFIC TO GENDER-BASED MENTAL-HEALTH CARE OF MEN AND BOYS, IN CLASS 41 (U.S. CLS. 100, 101 AND 107).

FIRST USE 1-18-2011; IN COMMERCE 1-29-2011.

THE MARK CONSISTS OF THE 3 WORDS "SHIFT YOUR MIND" STACKED: "SHIFT" HAS AN ARROW POINTING RIGHT ON THE HORIZONTAL STROKE OF THE "T", AND THE WORD IS ALL CAPS IN OPTIMA TYPE; "YOUR" IS ALL CAPS, K/O TYPE IN OPTIMA TYPE FONT, AND IN A RECTANGULAR BOX; "MIND" HAS AN ARROW POINTING DOWN ON THE FIRST STROKE OF THE "M", AND THE WORD IS ALL CAPS IN OPTIMA TYPE FONT.

SER. NO. 85-369,342, FILED 7-12-2011.

RONALD AIKENS, EXAMINING ATTORNEY



David J. Kybas

Director of the United States Patent and Trademark Office

United States of America

United States Patent and Trademark Office

fueling a low carbon future

Reg. No. 4,108,410

Registered Mar. 6, 2012

Int. Cl.: 40

SERVICE MARK

PRINCIPAL REGISTER

RECYCOIL (COLORADO LIMITED LIABILITY COMPANY), FORMERLY ROCKY MOUNTAIN SUSTAINABLE ENTERPRISES
1708 WALNUT STREET
BOULDER, CO 80302

FOR: COOKING OIL AND VEGETABLE OIL RECYCLING SERVICES; MATERIAL TREATMENT SERVICES IN CONNECTION WITH RECYCLING, IN CLASS 40 (U.S. CLS. 100, 103 AND 106).

FIRST USE 6-15-2011; IN COMMERCE 6-20-2011.

THE MARK CONSISTS OF STANDARD CHARACTERS WITHOUT CLAIM TO ANY PARTICULAR FONT, STYLE, SIZE, OR COLOR.

SER. NO. 85-370,406, FILED 7-13-2011.

ANGELA M. MICHELI, EXAMINING ATTORNEY



David J. Kybas

Director of the United States Patent and Trademark Office

United States of America

United States Patent and Trademark Office

WHDESIGNS

Reg. No. 4,108,411

WENDY HENCH (UNITED STATES INDIVIDUAL)
15 PENNS LANDING
SELINGROVE, PA 17870

Registered Mar. 6, 2012

Int. Cl.: 42

FOR: CUSTOM DESIGN AND DEVELOPMENT OF ORIGINAL ARTWORK NAMELY CUSTOMIZED FASHION DOLLS, IN CLASS 42 (U.S. CLS. 100 AND 101).

SERVICE MARK

FIRST USE 3-1-2004; IN COMMERCE 3-1-2004.

PRINCIPAL REGISTER

THE MARK CONSISTS OF STANDARD CHARACTERS WITHOUT CLAIM TO ANY PARTICULAR FONT, STYLE, SIZE, OR COLOR.

SER. NO. 85-370,411, FILED 7-13-2011.

ANGELA M. MICHELI, EXAMINING ATTORNEY



David J. Kybas

Director of the United States Patent and Trademark Office

United States of America

United States Patent and Trademark Office



Reg. No. 4,108,412

Registered Mar. 6, 2012

Int. Cl.: 35

SERVICE MARK

PRINCIPAL REGISTER

THE CHEESE COURSE, INC. (FLORIDA CORPORATION)
#317
3250 N.E. 1ST AVENUE
MIAMI, FL 33137

FOR: RETAIL STORE SERVICES FEATURING KITCHEN AND HOUSEWARE ITEMS, KITCHEN GADGETS, KITCHEN UTENSILS, TABLEWARE, BOOKS, FOOD, GOURMET FOODS, PREPARED FOODS, CONDIMENTS, COFFEE, WATER, WINE, BEER, BEVERAGES, MEATS, DELI MEATS, SALAMI, CRACKERS, BREADS, BAKERY GOODS, CHEESE, AND IMPLEMENTS AND ACCESSORIES FOR STORING, PREPARING, AND SERVING CHEESES; PROVIDING A WEBSITE FEATURING INFORMATION FOR CONSUMERS IN THE FIELD OF CHEESES, FOOD, WINES, AND CULINARY ARTS, IN CLASS 35 (U.S. CLS. 100, 101 AND 102).

FIRST USE 8-20-1999; IN COMMERCE 6-18-2001.

OWNER OF U.S. REG. NOS. 2,528,183 AND 2,602,215.

THE COLOR(S) RUST AND TAN IS/ARE CLAIMED AS A FEATURE OF THE MARK.

NO CLAIM IS MADE TO THE EXCLUSIVE RIGHT TO USE "ORIGINAL" AND "AUTHENTIC" AND "2000", APART FROM THE MARK AS SHOWN.



THE MARK CONSISTS OF A RUST-COLORED OVAL ON WHICH THE WORD "ORIGINAL" APPEARS IN ALL CAPITAL LETTERS IN TAN ON THE UPPER PORTION OF THE OVAL AND THE WORD "AUTHENTIC" APPEARS UPSIDE DOWN IN ALL CAPITAL LETTERS IN TAN ON THE LOWER PORTION OF THE OVAL. THE NUMBER "2000" IS SHOWN IN TAN ON THE OVAL AND IS DIVIDED SO THAT "20" APPEARS ON THE LEFT SIDE OF THE OVAL AND "00" APPEARS ON THE RIGHT SIDE OF THE OVAL. THE LETTERS "TCC" ARE INSIDE THE OVAL IN RUST ON A TAN FIELD, SHOWN WITH THE "T" IN THE CENTER AND A "C" ON EACH SIDE, ARRANGED SYMMETRICALLY SO THAT THE LETTER "C" TO THE LEFT OF THE LETTER "T" FACES BACKWARDS. THE OVAL IS BORDERED WITH A SINGLE LINE OF SMALL DOTS IN RUST ON BOTH ITS EXTERIOR AND INTERIOR.

David J. Kybas

SER. NO. 85-370,560, FILED 7-13-2011.

Reg. No. 4,108,412 CHRISTINA SOBRAL, EXAMINING ATTORNEY

United States of America

United States Patent and Trademark Office

The VELVET *nights.com*

Reg. No. 4,108,413

Registered Mar. 6, 2012

Int. Cl.: 35

SERVICE MARK

PRINCIPAL REGISTER

THE VELVET NIGHTS, LLC (NORTH CAROLINA LIMITED LIABILITY COMPANY)
424 BEATEN PATH ROAD
MOORESVILLE, NC 28117

FOR: PROMOTING THE GOODS AND SERVICES OF OTHERS BY PROVIDING A COMMUNITY DRIVEN WEBSITE; PROMOTING, ADVERTISING AND MARKETING OF THE BRANDS, PRODUCTS, SERVICES AND ONLINE WEBSITES OF INDIVIDUALS, BUSINESSES AND NONPROFIT ORGANIZATIONS; PROVIDING A SEARCHABLE ON-LINE ADVERTISING WEBSITE AND GUIDE FEATURING THE GOODS AND SERVICES OF OTHER VENDORS VIA THE INTERNET; PROVIDING A SEARCHABLE WEBSITE FEATURING THE GOODS AND SERVICES OF OTHER VENDORS, IN CLASS 35 (U.S. CLS. 100, 101 AND 102).

FIRST USE 6-1-2010; IN COMMERCE 6-10-2010.

THE MARK CONSISTS OF THE WORDS THEVELVETNIGHTS.COM IN STYLIZED WRITING.

SER. NO. 85-371,041, FILED 7-14-2011.

ELLEN BURNS, EXAMINING ATTORNEY



David J. Kyffers

Director of the United States Patent and Trademark Office

United States of America

United States Patent and Trademark Office

BigOven

Reg. No. 4,108,414

Registered Mar. 6, 2012

Int. Cl.: 42

SERVICE MARK

PRINCIPAL REGISTER

LAKEFRONT SOFTWARE, INC. (WASHINGTON CORPORATION)
3018 E LAURELHURST DRIVE
SEATTLE, WA 98105

FOR: PROVIDING A WEBSITE FEATURING A SEARCH ENGINE FOR RECIPES; PROVIDING A WEBSITE FEATURING RESOURCES, NAMELY, A WEBSITE FEATURING PRIMARILY NON-DOWNLOADABLE SOFTWARE FOR RECIPE SHARING AND MANAGEMENT, NUTRITION AND MEAL PLANNING AND ALSO FEATURING NON-DOWNLOADABLE PUBLICATIONS IN THE NATURE OF RECIPES IN THE FIELD OF COOKING; PROVIDING A WEBSITE FEATURING TECHNOLOGY THAT ENABLES USERS TO MANAGE AND SHARE THEIR COOKING, IN CLASS 42 (U.S. CLS. 100 AND 101).

FIRST USE 2-14-2004; IN COMMERCE 2-14-2004.

THE MARK CONSISTS OF STANDARD CHARACTERS WITHOUT CLAIM TO ANY PARTICULAR FONT, STYLE, SIZE, OR COLOR.

SER. NO. 85-371,066, FILED 7-14-2011.

ELIZABETH KAJUBI, EXAMINING ATTORNEY



David J. Kyffers

Director of the United States Patent and Trademark Office

United States of America

United States Patent and Trademark Office

Tone at the Bottom

Reg. No. 4,108,415

TAYLOR, LARRY (UNITED STATES INDIVIDUAL)
4041 SOUTH HARVARD BLVD
LOS ANGELES, CA 90062

Registered Mar. 6, 2012

Int. Cl.: 35

FOR: BUSINESS ORGANIZATION AND MANAGEMENT CONSULTING, IN CLASS 35 (U.S. CLS. 100, 101 AND 102).

SERVICE MARK

FIRST USE 6-1-2010; IN COMMERCE 11-1-2010.

PRINCIPAL REGISTER

THE MARK CONSISTS OF STANDARD CHARACTERS WITHOUT CLAIM TO ANY PARTICULAR FONT, STYLE, SIZE, OR COLOR.

SER. NO. 85-371,103, FILED 7-14-2011.

SUNG IN, EXAMINING ATTORNEY



David J. Kyfos

Director of the United States Patent and Trademark Office

United States of America

United States Patent and Trademark Office



Reg. No. 4,108,416

Registered Mar. 6, 2012

Int. Cl.: 29

TRADEMARK

PRINCIPAL REGISTER

SMART & FINAL STORES LLC (CALIFORNIA LIMITED LIABILITY COMPANY)
600 CITADEL DRIVE
COMMERCE, CA 90040

FOR: BEEF, IN CLASS 29 (U.S. CL. 46).

FIRST USE 1-4-2010; IN COMMERCE 1-4-2010.

NO CLAIM IS MADE TO THE EXCLUSIVE RIGHT TO USE "FINEST", APART FROM THE MARK AS SHOWN.

THE MARK CONSISTS OF A DEPICTION OF A COW OUTLINED WITH ROPE ABOVE THE WORDS "CATTLEMAN'S FINEST" ALSO OUTLINED WITH ROPE.

SER. NO. 85-371,458, FILED 7-14-2011.

ESTHER A. BORSUK, EXAMINING ATTORNEY



David J. Kybas

Director of the United States Patent and Trademark Office

United States of America

United States Patent and Trademark Office

HairBows
Unlimited

Reg. No. 4,108,417

BABY LUGO, LLC (UTAH LIMITED LIABILITY COMPANY)
2541 STONEBURY LOOP ROAD
SPRINGVILLE, UT 84663

Registered Mar. 6, 2012

Int. Cl.: 35

FOR: WHOLESALE DISTRIBUTORSHIPS FEATURING TODDLER AND BABY CLOTHING AND ACCESSORIES, IN CLASS 35 (U.S. CLS. 100, 101 AND 102).

SERVICE MARK

FIRST USE 2-1-2009; IN COMMERCE 4-1-2009.

PRINCIPAL REGISTER

NO CLAIM IS MADE TO THE EXCLUSIVE RIGHT TO USE "HAIRBOWS", APART FROM THE MARK AS SHOWN.

THE COLOR(S) PINK, WHITE, PURPLE, BLACK, AND REDDISH-PINK IS/ARE CLAIMED AS A FEATURE OF THE MARK.

THE MARK CONSISTS OF THE WORDING "HAIRBOWS UNLIMITED" IN STYLIZED LETTERING. ALL LETTERS ARE PURPLE AND OUTLINED IN WHITE WITH A BLACK SHADOW, WITH THE EXCEPTION OF THE FOLLOWING: THE LETTER "O" IN "BOWS" CONSISTS OF A PINK HEART ENCIRCLED BY 19 SMALLER PINK HEARTS WITH THE POINT OF THE SMALLER HEARTS POINTING TOWARD THE LARGER MIDDLE HEART. THE HEARTS ARE OUTLINED IN WHITE AND CONTAIN A BLACK SHADOW. THIS HEART DESIGN IS REPLICATED WITH IDENTICAL COLORING AND IN A SMALLER SIZE AS THE DOT OF THE FIRST LETTER "I" IN "UNLIMITED." THE SAME HEART DESIGN USING REDDISH-PINK HEARTS, OUTLINED IN WHITE WITH A BLACK SHADOW, APPEARS AS THE DOT OF THE SECOND LETTER "I" IN "UNLIMITED" AND THE DOT OF THE LETTER "I" IN "HAIR."



SER. NO. 85-371,468, FILED 7-14-2011.

MICHELLE DUBOIS, EXAMINING ATTORNEY

David J. Kyros

Director of the United States Patent and Trademark Office

United States of America

United States Patent and Trademark Office

ADDGENE

Reg. No. 4,108,418

Registered Mar. 6, 2012

Int. Cls.: 1 and 42

TRADEMARK

SERVICE MARK

PRINCIPAL REGISTER

ADDGENE, INC. (MASSACHUSETTS CORPORATION)
ONE KENDALL SQUARE
CAMBRIDGE, MA 02139

FOR: MOLECULAR BIOLOGY RESEARCH TOOLS, IN THE NATURE OF BIOLOGICAL AND BIOCHEMICAL REAGENTS, SPECIFICALLY CLONES, VECTORS, PLASMIDS, GENOMIC DNA, RECOMBINANT DNA, BIOLOGICAL LIBRARIES, AND BIOLOGICAL ENTITIES, NAMELY, BACTERIA; BIOLOGICAL AND CHEMICAL KITS COMPRISED OF BIOLOGICAL AND CHEMICAL MATERIALS, NAMELY, CLONES, VECTORS, PLASMIDS, GENOMIC DNA, RECOMBINANT DNA, BIOLOGICAL LIBRARIES, AND BIOLOGICAL ENTITIES, NAMELY, BACTERIA, AND TEST TUBES, VIALS, AND RELATED CONTAINERS, FOR SCIENTIFIC AND MEDICAL RESEARCH PURPOSES, IN CLASS 1 (U.S. CLS. 1, 5, 6, 10, 26 AND 46).

FIRST USE 9-8-2004; IN COMMERCE 9-8-2004.

FOR: PROVIDING INFORMATION RELATING TO MOLECULAR BIOLOGY RESEARCH TOOLS, NAMELY, CLONES, VECTORS, PLASMIDS, GENOMIC DNA, RECOMBINANT DNA, BIOLOGICAL LIBRARIES, AND BIOLOGICAL ENTITIES, NAMELY, BACTERIA; PROVIDING SCIENTIFIC AND MEDICAL RESEARCH INFORMATION ON MOLECULAR BIOLOGY RESEARCH TOOLS AND PROTOCOLS RELATING TO MOLECULAR BIOLOGY RESEARCH TOOL USE; PROVIDING SCIENTIFIC INFORMATION ON THE USE, SELECTION, PRODUCTION, APPLICATION, STRUCTURE AND ACTIVITIES OF MOLECULAR BIOLOGY RESEARCH TOOLS; PROVIDING TECHNICAL SUPPORT RELATING TO MOLECULAR BIOLOGY RESEARCH TOOLS SELECTION AND USE, NAMELY, PROVIDING TECHNICAL CONSULTATION SERVICES; ONLINE COMPUTER SERVICES IN THE NATURE OF PROVIDING A SEARCH ENGINE FOR OBTAINING DATA, NAMELY, SEARCHING, RETRIEVING, AND PROVIDING INFORMATION MOLECULAR BIOLOGY RESEARCH TOOLS ON A GLOBAL NETWORK, IN CLASS 42 (U.S. CLS. 100 AND 101).

FIRST USE 9-8-2004; IN COMMERCE 9-8-2004.

THE MARK CONSISTS OF STANDARD CHARACTERS WITHOUT CLAIM TO ANY PARTICULAR FONT, STYLE, SIZE, OR COLOR.

OWNER OF U.S. REG. NO. 2,995,635.



David J. Kappas

Director of the United States Patent and Trademark Office

Reg. No. 4,108,418 SER. NO. 85-371,610, FILED 7-14-2011.

SEAN CROWLEY, EXAMINING ATTORNEY

United States of America

United States Patent and Trademark Office

INTRODUCE ME

Reg. No. 4,108,419

Registered Mar. 6, 2012

Int. Cl.: 42

SERVICE MARK

PRINCIPAL REGISTER

SKYECANDY PTY LTD (AUSTRALIA CORPORATION)
UNIT 11
69 GLADSTONE ST
KOGARAH., AUSTRALIA NSW2217

FOR: ONLINE-ACCESSIBLE SOFTWARE AS A SERVICE FEATURING SOFTWARE FOR THE PURPOSE OF ACCESSING, CREATING, EDITING, MODIFYING, TRANSMITTING, SHARING AND STORING DATING-RELATED INTRODUCTIONS, SOCIAL-NETWORKING INTRODUCTIONS, BUSINESS INTRODUCTIONS, CAREERS AND EMPLOYMENT INTRODUCTIONS, INTRODUCTIONS CONTACT MANAGEMENT, AND INTRODUCTION IDENTITY MANAGEMENT, IN CLASS 42 (U.S. CLS. 100 AND 101).

FIRST USE 7-8-2011; IN COMMERCE 7-8-2011.

THE MARK CONSISTS OF STANDARD CHARACTERS WITHOUT CLAIM TO ANY PARTICULAR FONT, STYLE, SIZE, OR COLOR.

NO CLAIM IS MADE TO THE EXCLUSIVE RIGHT TO USE "INTRODUCE", APART FROM THE MARK AS SHOWN.

SER. NO. 85-371,919, FILED 7-14-2011.

TINA MAI, EXAMINING ATTORNEY



David J. Kybas

Director of the United States Patent and Trademark Office

United States of America

United States Patent and Trademark Office

MARIE DEAN

Reg. No. 4,108,420

PICKETT, ADRIENE (UNITED STATES INDIVIDUAL)

Registered Mar. 6, 2012

P.O. BOX 641655
LOS ANGELES, CA 90064

Int. Cl.: 3

FOR: BODY AND BEAUTY CARE COSMETICS; COSMETIC CREAMS; COSMETIC CREAMS FOR SKIN CARE; COSMETIC HAIR DRESSING PREPARATIONS; COSMETIC OILS; COSMETIC PREPARATIONS FOR THE HAIR AND SCALP; COSMETIC SOAPS; FACE CREAMS FOR COSMETIC USE; LOTIONS FOR COSMETIC PURPOSES; SKIN AND BODY TOPICAL LOTIONS, CREAMS AND OILS FOR COSMETIC USE, IN CLASS 3 (U.S. CLS. 1, 4, 6, 50, 51 AND 52).

TRADEMARK

PRINCIPAL REGISTER

FIRST USE 1-8-2010; IN COMMERCE 1-8-2010.

THE MARK CONSISTS OF STANDARD CHARACTERS WITHOUT CLAIM TO ANY PARTICULAR FONT, STYLE, SIZE, OR COLOR.

OWNER OF U.S. REG. NO. 3,947,229.

THE NAME(S), PORTRAIT(S), AND/OR SIGNATURE(S) SHOWN IN THE MARK DOES NOT IDENTIFY A PARTICULAR LIVING INDIVIDUAL.

SER. NO. 85-372,034, FILED 7-15-2011.

BRIDGETT SMITH, EXAMINING ATTORNEY



David J. Kyros

Director of the United States Patent and Trademark Office

United States of America

United States Patent and Trademark Office

ENP

Reg. No. 4,108,421

Registered Mar. 6, 2012

Int. Cl.: 35

SERVICE MARK

PRINCIPAL REGISTER

EVERY NEIGHBORHOOD PARTNERSHIP (CALIFORNIA CHARITABLE, NON-PROFIT CORPORATION)
7676 N. PALM AVE., STE. 101
FRESNO, CA 93711

FOR: CHARITABLE SERVICES, NAMELY, ORGANIZING AND CONDUCTING VOLUNTEER PROGRAMS AND COMMUNITY SERVICE PROJECTS, IN CLASS 35 (U.S. CLS. 100, 101 AND 102).

FIRST USE 11-1-2007; IN COMMERCE 11-1-2007.

THE MARK CONSISTS OF STANDARD CHARACTERS WITHOUT CLAIM TO ANY PARTICULAR FONT, STYLE, SIZE, OR COLOR.

SER. NO. 85-372,036, FILED 7-15-2011.

BRIDGETT SMITH, EXAMINING ATTORNEY



David J. Kyffers

Director of the United States Patent and Trademark Office

United States of America

United States Patent and Trademark Office



Reg. No. 4,108,422

FEARLESS MEDIA, LLC (NEW YORK LIMITED LIABILITY COMPANY)
575 MADISON AVE SUITE 1006
NEW YORK, NY 10022

Registered Mar. 6, 2012

Int. Cl.: 35

FOR: ADVERTISING SERVICES, NAMELY, PROMOTING THE BRANDS, GOODS AND SERVICES OF OTHERS, IN CLASS 35 (U.S. CLS. 100, 101 AND 102).

SERVICE MARK

FIRST USE 4-1-2011; IN COMMERCE 4-1-2011.

PRINCIPAL REGISTER

THE MARK CONSISTS OF THE CAPITAL LETTER "F" CENTERED INSIDE A BUZZ SAW BLADE.

SER. NO. 85-372,185, FILED 7-15-2011.

ESTHER BELENKER, EXAMINING ATTORNEY



David J. Kybas

Director of the United States Patent and Trademark Office

United States of America

United States Patent and Trademark Office

RIGHT ANGLE

Reg. No. 4,108,423

RANIR, LLC (DELAWARE LIMITED LIABILITY COMPANY)
4701 EAST PARIS AVENUE S.E.
GRAND RAPIDS, MI 49512

Registered Mar. 6, 2012

Int. Cl.: 21

FOR: DENTAL FLOSSING DEVICES, NAMELY, DENTAL FLOSS HOLDERS AND DENTAL FLOSS, IN CLASS 21 (U.S. CLS. 2, 13, 23, 29, 30, 33, 40 AND 50).

TRADEMARK

FIRST USE 1-0-2009; IN COMMERCE 1-0-2009.

PRINCIPAL REGISTER

THE MARK CONSISTS OF STANDARD CHARACTERS WITHOUT CLAIM TO ANY PARTICULAR FONT, STYLE, SIZE, OR COLOR.

SER. NO. 85-372,223, FILED 7-15-2011.

INGA ERVIN, EXAMINING ATTORNEY



David J. Kybas

Director of the United States Patent and Trademark Office

United States of America

United States Patent and Trademark Office

GOV-PASS

Reg. No. 4,108,424

SECURITY IDENTIFICATION SYSTEMS CORPORATION, INC. (FLORIDA CORPORATION)
3595 FISCAL COURT
WEST PALM BEACH, FL 33404

Registered Mar. 6, 2012

Int. Cl.: 9

FOR: COMPUTER SOFTWARE AND HARDWARE FOR USE IN DIGITALLY VERIFYING THE IDENTITY OF AN INDIVIDUAL, IN CLASS 9 (U.S. CLS. 21, 23, 26, 36 AND 38).

TRADEMARK

FIRST USE 4-17-2011; IN COMMERCE 4-17-2011.

PRINCIPAL REGISTER

THE MARK CONSISTS OF STANDARD CHARACTERS WITHOUT CLAIM TO ANY PARTICULAR FONT, STYLE, SIZE, OR COLOR.

SER. NO. 85-372,237, FILED 7-15-2011.

FONG HSU, EXAMINING ATTORNEY



David J. Kybas

Director of the United States Patent and Trademark Office

United States of America

United States Patent and Trademark Office

Text My Information

Reg. No. 4,108,425

Registered Mar. 6, 2012

Int. Cl.: 35

SERVICE MARK

PRINCIPAL REGISTER

MASTER MY MARKETING, LLC (MISSISSIPPI LIMITED LIABILITY COMPANY)
E-25
499 SPRINGRIDGE RD
CLINTON, MS 39056

FOR: PROMOTING AND MARKETING THE GOODS AND SERVICES OF OTHERS BY
DISTRIBUTING ADVERTISING MATERIAL VIA TEXT MESSAGES, IN CLASS 35 (U.S.
CLS. 100, 101 AND 102).

FIRST USE 6-1-2007; IN COMMERCE 1-1-2010.

THE MARK CONSISTS OF STANDARD CHARACTERS WITHOUT CLAIM TO ANY PAR-
TICULAR FONT, STYLE, SIZE, OR COLOR.

NO CLAIM IS MADE TO THE EXCLUSIVE RIGHT TO USE "TEXT" AND "INFORMATION",
APART FROM THE MARK AS SHOWN.

SER. NO. 85-372,285, FILED 7-15-2011.

JOHN WILKE, EXAMINING ATTORNEY



David J. Kyffers

Director of the United States Patent and Trademark Office

United States of America

United States Patent and Trademark Office

GLOBAL STRATEGY DESIGN LLC

Reg. No. 4,108,426

Registered Mar. 6, 2012

Int. Cl.: 35

SERVICE MARK

PRINCIPAL REGISTER

GLOBAL STRATEGY DESIGN, LLC (NEW JERSEY LIMITED LIABILITY COMPANY)
SUITE 378
16 MOUNT BETHEL ROAD
WARREN, NJ 07059

FOR: BUSINESS MANAGEMENT, PROJECT MANAGEMENT, STRATEGIC MANAGEMENT,
AND BUSINESS CONSULTATION SERVICES FOR OTHERS, IN CLASS 35 (U.S. CLS. 100,
101 AND 102).

FIRST USE 1-11-2005; IN COMMERCE 1-11-2005.

THE MARK CONSISTS OF STANDARD CHARACTERS WITHOUT CLAIM TO ANY PAR-
TICULAR FONT, STYLE, SIZE, OR COLOR.

OWNER OF U.S. REG. NO. 3,091,723.

NO CLAIM IS MADE TO THE EXCLUSIVE RIGHT TO USE "LLC", APART FROM THE
MARK AS SHOWN.

SEC. 2(F).

SER. NO. 85-372,289, FILED 7-15-2011.

RON FAIRBANKS, EXAMINING ATTORNEY



David J. Kyros

Director of the United States Patent and Trademark Office

United States of America

United States Patent and Trademark Office

TEAL TELLS

Reg. No. 4,108,427

Registered Mar. 6, 2012

Int. Cl.: 41

SERVICE MARK

PRINCIPAL REGISTER

NATIONAL OVARIAN CANCER COALITION, INC. (TEXAS NON-PROFIT CORPORATION)
SUITE 100
4900 HOPYARD
PLEASANTON, CA 945881701

FOR: ON-LINE ELECTRONIC NEWSLETTERS DELIVERED BY E-MAIL IN THE FIELD OF PROVIDING OVARIAN CANCER INFORMATION, IN CLASS 41 (U.S. CLS. 100, 101 AND 107).

FIRST USE 11-0-2010; IN COMMERCE 11-0-2010.

THE MARK CONSISTS OF STANDARD CHARACTERS WITHOUT CLAIM TO ANY PARTICULAR FONT, STYLE, SIZE, OR COLOR.

SER. NO. 85-372,292, FILED 7-15-2011.

RON FAIRBANKS, EXAMINING ATTORNEY



David J. Kyffers

Director of the United States Patent and Trademark Office

United States of America

United States Patent and Trademark Office

MARLBORO SOUTHERN CUT

Reg. No. 4,108,428

PHILIP MORRIS USA INC. (VIRGINIA CORPORATION)
6601 WEST BROAD STREET
RICHMOND, VA 23230

Registered Mar. 6, 2012

Int. Cl.: 34

FOR: TOBACCO PRODUCTS, NAMELY, CIGARETTES, IN CLASS 34 (U.S. CLS. 2, 8, 9 AND 17).

TRADEMARK

FIRST USE 3-9-2011; IN COMMERCE 3-9-2011.

PRINCIPAL REGISTER

THE MARK CONSISTS OF STANDARD CHARACTERS WITHOUT CLAIM TO ANY PARTICULAR FONT, STYLE, SIZE, OR COLOR.

OWNER OF U.S. REG. NOS. 68,502, 632,881, AND 938,510.

SER. NO. 85-372,397, FILED 7-15-2011.

PATRICIA EVANKO, EXAMINING ATTORNEY



David J. Kybas

Director of the United States Patent and Trademark Office

United States of America

United States Patent and Trademark Office

YESTech

Reg. No. 4,108,429

NORDSON CORPORATION (OHIO CORPORATION)
28601 CLEMENS ROAD
WESTLAKE, OH 44145

Registered Mar. 6, 2012

Int. Cl.: 9

FOR: MACHINES FOR OPTICAL OR X-RAY INSPECTION OF ELECTRONIC PRODUCTS,
IN CLASS 9 (U.S. CLS. 21, 23, 26, 36 AND 38).

TRADEMARK

FIRST USE 7-25-2003; IN COMMERCE 7-25-2003.

PRINCIPAL REGISTER

THE MARK CONSISTS OF STANDARD CHARACTERS WITHOUT CLAIM TO ANY PAR-
TICULAR FONT, STYLE, SIZE, OR COLOR.

SER. NO. 85-372,450, FILED 7-15-2011.

JESSICA FATHY, EXAMINING ATTORNEY



David J. Kybas

Director of the United States Patent and Trademark Office

United States of America

United States Patent and Trademark Office

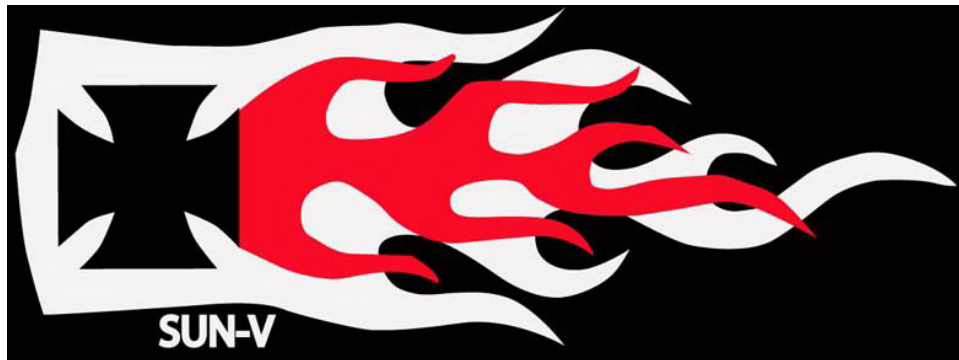

Reg. No. 4,108,430

Registered Mar. 6, 2012

Int. Cl.: 9

TRADEMARK

PRINCIPAL REGISTER

TIME PLAZA (CALIFORNIA CORPORATION)
350 SOUTH LOS ANGELES STREET
LOS ANGELES, CA 90013

FOR: CASES FOR EYEGLASSES AND SUNGLASSES; CASES FOR SPECTACLES AND SUNGLASSES; CHAINS FOR SPECTACLES AND FOR SUNGLASSES; EYEWEAR, NAMELY, SUNGLASSES, EYEGLASSES AND OPHTHALMIC FRAMES AND CASES THEREFOR; EYEWEAR, NAMELY, SUNGLASSES; FRAMES FOR SPECTACLES AND SUNGLASSES; LENSES FOR SUNGLASSES; NOSE GUARDS WHICH CAN BE WORN BY ATTACHMENT TO EYEWEAR SUCH AS SUNGLASSES AND SKI GOGGLES; SPECTACLES AND SUNGLASSES; SUNGLASS CHAINS AND CORDS; SUNGLASS LENSES; SUNGLASSES; SUNGLASSES AND SPECTACLES, IN CLASS 9 (U.S. CLS. 21, 23, 26, 36 AND 38).

FIRST USE 7-1-2008; IN COMMERCE 3-15-2009.

OWNER OF U.S. REG. NOS. 3,844,406, 4,041,297 AND OTHERS.

THE COLOR(S) RED, BLACK AND WHITE IS/ARE CLAIMED AS A FEATURE OF THE MARK.

THE MARK CONSISTS OF A BLACK BACKGROUND WITH A WHITE FLAME DESIGN INSIDE, BELOW WHICH APPEARS THE WHITE WORDING "SUN-V". A BLACK CROSS IS SUPERIMPOSED OVER THE LEFT SIDE OF THE FLAMES, WITH RED FLAMES EXTENDING OUT THE RIGHT PORTION OF THE CROSS.

SER. NO. 85-372,503, FILED 7-15-2011.

EMILY CARLSEN, EXAMINING ATTORNEY



David J. Kyffers

Director of the United States Patent and Trademark Office

United States of America

United States Patent and Trademark Office

WHOGREW

Reg. No. 4,108,431

Registered Mar. 6, 2012

Int. Cls.: 9 and 35

TRADEMARK

SERVICE MARK

PRINCIPAL REGISTER

ERIC D. WEINERT (UNITED STATES INDIVIDUAL)
P.O. BOX 59
PAPAIKOU, HI 96781

FOR: DOWNLOADABLE SOFTWARE IN THE NATURE OF A MOBILE APPLICATION FOR USE IN PROVIDING INFORMATION ABOUT GOODS AVAILABLE FOR PURCHASE TO CONSUMERS AT THE POINT OF PURCHASE; DOWNLOADABLE SOFTWARE IN THE NATURE OF A MOBILE APPLICATION FOR USE IN PROVIDING INFORMATION ABOUT FARMS THAT PROVIDE PRODUCE AVAILABLE FOR PURCHASE AT RETAIL LOCATIONS, IN CLASS 9 (U.S. CLS. 21, 23, 26, 36 AND 38).

FIRST USE 6-14-2011; IN COMMERCE 6-14-2011.

FOR: PROMOTING THE SALE OF GOODS OF OTHERS BY PROVIDING INFORMATION ABOUT GOODS AVAILABLE FOR PURCHASE TO CONSUMERS AT THE POINT OF PURCHASE VIA A GLOBAL COMMUNICATION NETWORK; PROMOTING THE SALE OF GOODS OF OTHERS BY PROVIDING A WEBSITE FEATURING INFORMATION ABOUT GOODS AVAILABLE FOR PURCHASE AT RETAIL LOCATIONS; PROMOTING THE SALE OF GOODS OF OTHERS BY PROVIDING INFORMATION ABOUT FARMS THAT PROVIDE PRODUCE TO CONSUMERS AT THE POINT OF PURCHASE VIA A GLOBAL COMMUNICATION NETWORK; PROMOTING THE SALE OF GOODS OF OTHERS BY PROVIDING A WEBSITE FEATURING INFORMATION ABOUT FARMS THAT PROVIDE PRODUCE AVAILABLE FOR PURCHASE AT RETAIL LOCATIONS, IN CLASS 35 (U.S. CLS. 100, 101 AND 102).

FIRST USE 6-14-2011; IN COMMERCE 6-14-2011.

THE MARK CONSISTS OF STANDARD CHARACTERS WITHOUT CLAIM TO ANY PARTICULAR FONT, STYLE, SIZE, OR COLOR.

SER. NO. 85-372,504, FILED 7-15-2011.

HAI-LY LAM, EXAMINING ATTORNEY



David J. Kyros

Director of the United States Patent and Trademark Office

United States of America

United States Patent and Trademark Office

Gourmoo

Reg. No. 4,108,432

Registered Mar. 6, 2012

Int. Cls.: 35 and 41

SERVICE MARK

PRINCIPAL REGISTER

DAIRY MANAGEMENT INC. (D.C. CORPORATION)
SUITE 900
10255 WEST HIGGINS ROAD
ROSEMONT, IL 60018

FOR: PROMOTING PUBLIC AWARENESS OF THE BENEFITS OF DAIRY AND DAIRY PRODUCTS; PROVIDING A WEBSITE FEATURING INFORMATION FOR CONSUMERS ABOUT THE BENEFITS OF DAIRY AND DAIRY PRODUCTS IN THE NATURE OF PHOTOGRAPHIC, AUDIO, VIDEO, AND PROSE PRESENTATIONS, IN CLASS 35 (U.S. CLS. 100, 101 AND 102).

FIRST USE 9-20-2011; IN COMMERCE 9-20-2011.

FOR: PROVIDING A WEBSITE FEATURING ENTERTAINMENT AND EDUCATIONAL PROGRAMS IN THE NATURE OF PHOTOGRAPHIC, AUDIO, VIDEO, AND PROSE PRESENTATIONS IN THE FIELD OF DAIRY, DAIRY FARMS, AND HOW DAIRY PRODUCTS ARE PRODUCED, IN CLASS 41 (U.S. CLS. 100, 101 AND 107).

FIRST USE 9-20-2011; IN COMMERCE 9-20-2011.

THE MARK CONSISTS OF STANDARD CHARACTERS WITHOUT CLAIM TO ANY PARTICULAR FONT, STYLE, SIZE, OR COLOR.

OWNER OF U.S. REG. NO. 3,975,908.

SER. NO. 85-372,711, FILED 7-15-2011.

DOMINIC J. FERRAIUOLO, EXAMINING ATTORNEY



David J. Kypos

Director of the United States Patent and Trademark Office

United States of America

United States Patent and Trademark Office

ScaleXtreme

Reg. No. 4,108,433

Registered Mar. 6, 2012

Int. Cls.: 9 and 42

TRADEMARK

SERVICE MARK

PRINCIPAL REGISTER

SCALEXTREME INC. (DELAWARE CORPORATION)
540 UNIVERSITY AVENUE, SUITE 50
PALO ALTO, CA 94301

FOR: COMPUTER SOFTWARE FOR COMPUTER SYSTEMS MANAGEMENT, IN CLASS 9
(U.S. CLS. 21, 23, 26, 36 AND 38).

FIRST USE 5-0-2011; IN COMMERCE 5-0-2011.

FOR: SOFTWARE AS A SERVICE (SAAS) TO PROVIDE COMPUTER SYSTEMS MANAGEMENT, IN CLASS 42 (U.S. CLS. 100 AND 101).

FIRST USE 5-0-2011; IN COMMERCE 5-0-2011.

THE MARK CONSISTS OF STANDARD CHARACTERS WITHOUT CLAIM TO ANY PARTICULAR FONT, STYLE, SIZE, OR COLOR.

SER. NO. 85-372,937, FILED 7-15-2011.

KIM SAITO, EXAMINING ATTORNEY



David J. Kybas

Director of the United States Patent and Trademark Office

United States of America

United States Patent and Trademark Office

WAX N WAXING

Reg. No. 4,108,434

Registered Mar. 6, 2012

Int. Cl.: 3

TRADEMARK

PRINCIPAL REGISTER

DANIEL CEPEDA (UNITED STATES INDIVIDUAL)
1424 E. CALIFORNIA AVE.
GLENDALE, CA 91206 AND

PATRICIA CEPEDA (UNITED STATES INDIVIDUAL)
1424 E. CALIFORNIA AVE.
GLENDALE, CA 91206

FOR: DEPILATORIES; DEPILATORY CREAMS; DEPILATORY WAX; HAIR REMOVING CREAM; LOTIONS FOR FACE AND BODY CARE; WAX FOR REMOVING BODY HAIR; WAX STRIPPING PREPARATIONS, IN CLASS 3 (U.S. CLS. 1, 4, 6, 50, 51 AND 52).

FIRST USE 7-1-2009; IN COMMERCE 7-1-2009.

THE MARK CONSISTS OF STANDARD CHARACTERS WITHOUT CLAIM TO ANY PARTICULAR FONT, STYLE, SIZE, OR COLOR.

SER. NO. 85-372,943, FILED 7-15-2011.

KIM SAITO, EXAMINING ATTORNEY



David J. Kybas

Director of the United States Patent and Trademark Office

United States of America

United States Patent and Trademark Office



Reg. No. 4,108,435

Registered Mar. 6, 2012

Int. Cl.: 30

TRADEMARK

PRINCIPAL REGISTER

SEMPIO FOOD SERVICES, INC. (CALIFORNIA CORPORATION)
16831 KNOTT AVENUE
LA MIRADA, CA 90638

FOR: RICE, IN CLASS 30 (U.S. CL. 46).

FIRST USE 9-23-2009; IN COMMERCE 9-23-2009.

THE MARK CONSISTS OF RECTANGLE WITH ROUNDED CORNERS, HORIZONTAL RED BAND AT TOP AND BOTTOM, FLYING BIRD FACING LEFT BEFORE WHITE BACKGROUND, WITH BLACK BEAK, WHITE WINGS WITH BLACK WINGTIPS, RED CROWN, AND BLACK NECK.

THE COLOR(S) RED, BLACK, AND WHITE IS/ARE CLAIMED AS A FEATURE OF THE MARK.

SER. NO. 85-373,142, FILED 7-16-2011.

BARBARA A. GOLD, EXAMINING ATTORNEY



David J. Kybas

Director of the United States Patent and Trademark Office

United States of America

United States Patent and Trademark Office

Hurricane Bay

Reg. No. 4,108,436

CO-PACKERS OF AMERICA, INC. (FLORIDA CORPORATION)
1735 PATTERSON AVENUE
DELAND, FL 32724

Registered Mar. 6, 2012

Int. Cl.: 30

FOR: DIPPING SAUCES; HOT SAUCES; MARINADES; SALSA; SAUCES, IN CLASS 30 (U.S. CL. 46).

TRADEMARK

FIRST USE 4-1-1995; IN COMMERCE 4-1-1995.

PRINCIPAL REGISTER

THE MARK CONSISTS OF STANDARD CHARACTERS WITHOUT CLAIM TO ANY PARTICULAR FONT, STYLE, SIZE, OR COLOR.

SER. NO. 85-373,150, FILED 7-16-2011.

BARBARA A. GOLD, EXAMINING ATTORNEY



David J. Kybas

Director of the United States Patent and Trademark Office

United States of America

United States Patent and Trademark Office

DECOR THE FLOOR

Reg. No. 4,108,437

MILLENNIUM WEAVERS LLC (GEORGIA LIMITED LIABILITY COMPANY)
3331 BOX DRIVE
DALTON, GA 30720

Registered Mar. 6, 2012

Int. Cl.: 35

FOR: ON-LINE RETAIL STORE SERVICES FEATURING SOFT FLOORING, NAMELY, CARPETS AND RUGS, IN CLASS 35 (U.S. CLS. 100, 101 AND 102).

SERVICE MARK

FIRST USE 8-2-2011; IN COMMERCE 8-2-2011.

PRINCIPAL REGISTER

THE MARK CONSISTS OF STANDARD CHARACTERS WITHOUT CLAIM TO ANY PARTICULAR FONT, STYLE, SIZE, OR COLOR.

SER. NO. 85-373,375, FILED 7-17-2011.

KAPIL BHANOT, EXAMINING ATTORNEY



David J. Kybas

Director of the United States Patent and Trademark Office

United States of America

United States Patent and Trademark Office

TASTE THE GOOD LIFE

Reg. No. 4,108,438

Registered Mar. 6, 2012

Int. Cl.: 45

SERVICE MARK

PRINCIPAL REGISTER

SOCIAL APPETIZER, LLC (NEVADA LIMITED LIABILITY COMPANY)
P.O. BOX 260553
ENCINO, CA 91426

FOR: PROVISION OF A WEB SITE FEATURING INFORMATION ON FASHION; PROVISION OF A WEB SITE FEATURING INFORMATION ON LIFESTYLES, IN CLASS 45 (U.S. CLS. 100 AND 101).

FIRST USE 7-15-2011; IN COMMERCE 7-15-2011.

THE MARK CONSISTS OF STANDARD CHARACTERS WITHOUT CLAIM TO ANY PARTICULAR FONT, STYLE, SIZE, OR COLOR.

SER. NO. 85-373,437, FILED 7-18-2011.

THEODORE MCBRIDE, EXAMINING ATTORNEY



David J. Kybas

Director of the United States Patent and Trademark Office

United States of America

United States Patent and Trademark Office

RELIEF

Reg. No. 4,108,439

Registered Mar. 6, 2012

Int. Cl.: 10

TRADEMARK

PRINCIPAL REGISTER

DELTA MEDICAL SYSTEMS, INC. (GEORGIA CORPORATION), DBA THE DELTA GROUP
SUITE 400
6865 SHILOH ROAD EAST
ALPHARETTA, GA 30202 AND

DELTA MEDICAL SUPPLY GROUP, INC. (PENNSYLVANIA CORPORATION), DBA THE
DELTA GROUP
PO BOX 128
18 CHESTNUT STREET
POMEROY, PA 193670128

FOR: GLOVES FOR MEDICAL USE, IN CLASS 10 (U.S. CLS. 26, 39 AND 44).

FIRST USE 3-17-2005; IN COMMERCE 3-17-2005.

THE MARK CONSISTS OF STANDARD CHARACTERS WITHOUT CLAIM TO ANY PARTICULAR FONT, STYLE, SIZE, OR COLOR.

OWNER OF U.S. REG. NO. 2,971,841.

SER. NO. 85-373,462, FILED 7-18-2011.

THEODORE MCBRIDE, EXAMINING ATTORNEY



David J. Kyros

Director of the United States Patent and Trademark Office

United States of America

United States Patent and Trademark Office

BOSTON FENCING CLUB

Reg. No. 4,108,440

Registered Mar. 6, 2012

Int. Cl.: 41

SERVICE MARK

PRINCIPAL REGISTER

BOSTON FENCING CLUB, INC. (MASSACHUSETTS CORPORATION)
#2
110 CLEMATIS AVENUE
WALTHAM, MA 02453

FOR: PROVIDING FENCING INSTRUCTION AND PROVIDING FITNESS AND EXERCISE FACILITIES, NAMELY FOR FENCING; EDUCATION SERVICES, NAMELY, PROVIDING CLASSES AND GROUP AND INDIVIDUAL INSTRUCTION IN THE FIELD OF FENCING; ARRANGING AND CONDUCTING ATHLETIC COMPETITIONS, TRAINING AND INSTRUCTION IN THE FIELD OF FENCING, IN CLASS 41 (U.S. CLS. 100, 101 AND 107).

FIRST USE 5-23-1974; IN COMMERCE 5-23-1974.

THE MARK CONSISTS OF STANDARD CHARACTERS WITHOUT CLAIM TO ANY PARTICULAR FONT, STYLE, SIZE, OR COLOR.

NO CLAIM IS MADE TO THE EXCLUSIVE RIGHT TO USE "FENCING CLUB", APART FROM THE MARK AS SHOWN.

SEC. 2(F).

SER. NO. 85-373,486, FILED 7-18-2011.

MICHELE SWAIN, EXAMINING ATTORNEY



David J. Kybas

Director of the United States Patent and Trademark Office

United States of America

United States Patent and Trademark Office

The District at Eastover

Reg. No. 4,108,441

Registered Mar. 6, 2012

Int. Cl.: 35

SERVICE MARK

PRINCIPAL REGISTER

1254 EASTOVER, LLC (MISSISSIPPI LIMITED LIABILITY COMPANY)
SUITE 200
308 E PEARL ST
JACKSON, MS 39201

FOR: REAL ESTATE MARKETING SERVICES IN THE FIELD OF MIXED-USE DEVELOPMENT, IN CLASS 35 (U.S. CLS. 100, 101 AND 102).

FIRST USE 9-13-2006; IN COMMERCE 10-9-2006.

THE MARK CONSISTS OF STANDARD CHARACTERS WITHOUT CLAIM TO ANY PARTICULAR FONT, STYLE, SIZE, OR COLOR.

SER. NO. 85-373,536, FILED 7-18-2011.

AMY HELLA, EXAMINING ATTORNEY



David J. Kyffers

Director of the United States Patent and Trademark Office

United States of America

United States Patent and Trademark Office

Flextorch

Reg. No. 4,108,442

Registered Mar. 6, 2012

Int. Cl.: 11

TRADEMARK

PRINCIPAL REGISTER

BITTOOLS (CANADA CORPORATION), AKA BII TOOLS
133 NEWPORT SQUARE
THORNHILL, ONTARIO, CANADA L4J7N6

FOR: FLASHLIGHT HOLDERS; FLASHLIGHT POINTERS; FLASHLIGHTS, IN CLASS 11
(U.S. CLS. 13, 21, 23, 31 AND 34).

FIRST USE 6-1-2011; IN COMMERCE 6-1-2011.

THE MARK CONSISTS OF STANDARD CHARACTERS WITHOUT CLAIM TO ANY PARTICULAR FONT, STYLE, SIZE, OR COLOR.

SER. NO. 85-373,597, FILED 7-18-2011.

ESTHER A. BORSUK, EXAMINING ATTORNEY



David J. Kybas

Director of the United States Patent and Trademark Office

United States of America

United States Patent and Trademark Office

NPCC

Reg. No. 4,108,443

NANSEMOND PRECAST CONCRETE CO., INC. (VIRGINIA CORPORATION)
3737 NANSEMOND PARKWAY
SUFFOLK, VA 23435

Registered Mar. 6, 2012

Int. Cl.: 40

FOR: CONTRACT MANUFACTURING IN THE FIELD OF CONCRETE BUILDING MATERIALS; MANUFACTURING SERVICES FOR OTHERS IN THE FIELD OF CONCRETE BUILDING MATERIALS, IN CLASS 40 (U.S. CLS. 100, 103 AND 106).

SERVICE MARK

FIRST USE 6-1-1985; IN COMMERCE 6-1-1985.

PRINCIPAL REGISTER

THE MARK CONSISTS OF THE STYLIZED TEXT "NPCC".

SER. NO. 85-373,620, FILED 7-18-2011.

ELLEN BURNS, EXAMINING ATTORNEY



David J. Kyffers

Director of the United States Patent and Trademark Office

United States of America

United States Patent and Trademark Office

Be Offshore!

Reg. No. 4,108,444

Registered Mar. 6, 2012

Int. Cl.: 39

SERVICE MARK

PRINCIPAL REGISTER

HENDRICKSON, JON (UNITED STATES INDIVIDUAL)
2801 FREEMAN STREET
COCONUT GROVE, FL 33133 AND

HENDRICKSON, REBECCA (UNITED STATES INDIVIDUAL)
2801 FREEMAN STREET
COCONUT GROVE, FL 33133

FOR: YACHT AND BOAT CHARTER SERVICES, IN CLASS 39 (U.S. CLS. 100 AND 105).

FIRST USE 7-8-2011; IN COMMERCE 7-8-2011.

THE MARK CONSISTS OF THE WORDS BE OFFSHORE IN BLACK LETTERS WITH A LIGHT GREEN OUTLINE FOLLOWED BY AN EXCLAMATION POINT.

THE COLOR(S) BLACK AND LIGHT GREEN IS/ARE CLAIMED AS A FEATURE OF THE MARK.

SER. NO. 85-373,645, FILED 7-18-2011.

VIVIAN MICZNIK FIRST, EXAMINING ATTORNEY



David J. Kybas

Director of the United States Patent and Trademark Office

United States of America

United States Patent and Trademark Office

Cambridge Brewing Company

Reg. No. 4,108,445

Registered Mar. 6, 2012

Int. Cl.: 32

TRADEMARK

PRINCIPAL REGISTER

CAMBRIDGE BREWING COMPANY, INC. (MASSACHUSETTS CORPORATION)
1 KENDALL SQUARE, BLDG 100
CAMBRIDGE, MA 02139

FOR: BEER, IN CLASS 32 (U.S. CLS. 45, 46 AND 48).

FIRST USE 5-0-1989; IN COMMERCE 9-0-1990.

THE MARK CONSISTS OF STANDARD CHARACTERS WITHOUT CLAIM TO ANY PARTICULAR FONT, STYLE, SIZE, OR COLOR.

NO CLAIM IS MADE TO THE EXCLUSIVE RIGHT TO USE "BREWING OR COMPANY", APART FROM THE MARK AS SHOWN.

SEC. 2(F).

SER. NO. 85-373,704, FILED 7-18-2011.

THEODORE MCBRIDE, EXAMINING ATTORNEY



David J. Kybas

Director of the United States Patent and Trademark Office

United States of America

United States Patent and Trademark Office

Furrybones

Reg. No. 4,108,446

Registered Mar. 6, 2012

Int. Cl.: 20

TRADEMARK

PRINCIPAL REGISTER

YTC SUMMIT INTERNATIONAL, INC. (CALIFORNIA CORPORATION)
12037 CLARK STREET
ARCADIA, CA 91006

FOR: COLD CAST RESIN FIGURINES, IN CLASS 20 (U.S. CLS. 2, 13, 22, 25, 32 AND 50).

FIRST USE 9-5-2008; IN COMMERCE 1-5-2009.

THE MARK CONSISTS OF STANDARD CHARACTERS WITHOUT CLAIM TO ANY PARTICULAR FONT, STYLE, SIZE, OR COLOR.

SER. NO. 85-373,761, FILED 7-18-2011.

WILLIAM JACKSON, EXAMINING ATTORNEY



David J. Kybas

Director of the United States Patent and Trademark Office

United States of America

United States Patent and Trademark Office



Reg. No. 4,108,447

Registered Mar. 6, 2012

Int. Cl.: 35

SERVICE MARK

PRINCIPAL REGISTER

CLEAR BLUE, INC. (NORTH CAROLINA CORPORATION)
SUITE 21
16740 BIRKDALE COMMONS PARKWAY
HUNTERSVILLE, NC 28078

FOR: ADVERTISING AGENCY SERVICES, IN CLASS 35 (U.S. CLS. 100, 101 AND 102).

FIRST USE 7-3-2011; IN COMMERCE 7-3-2011.

OWNER OF U.S. REG. NOS. 2,629,966, 2,629,967, AND 3,920,267.

THE MARK CONSISTS OF AN OUTER CIRCLE AND AN INNER CIRCLE WITH THE
STYLIZED WORDS "CLEAR BLUE" ACROSS THE MIDDLE OF THE INNER CIRCLE.

SER. NO. 85-373,765, FILED 7-18-2011.

RAUL CORDOVA, EXAMINING ATTORNEY



David J. Kyffers

Director of the United States Patent and Trademark Office

United States of America

United States Patent and Trademark Office

ZOPHEEZ

Reg. No. 4,108,448

Registered Mar. 6, 2012

Int. Cl.: 25

TRADEMARK

PRINCIPAL REGISTER

ZOPHEEZ, LLC (CALIFORNIA LIMITED LIABILITY COMPANY)
359 ARNO WAY
PACIFIC PALISADES, CA 90272

FOR: BABY BODYSUITS; BABY BOTTOMS; BABY LAYETTES FOR CLOTHING; BABY TOPS; CHILDREN'S AND INFANT'S APPAREL, NAMELY, JUMPERS, OVERALL SLEEPWEAR, PAJAMAS, ROMPERS AND ONE-PIECE GARMENTS; CLOTHING FOR BABIES, TODDLERS AND CHILDREN, TREATED WITH FIRE AND HEAT RETARDANTS, NAMELY, PAJAMAS, JACKETS, SHIRTS, PANTS, JUMPERS; INFANT AND TODDLER ONE PIECE CLOTHING; ONE PIECE GARMENT FOR INFANTS AND TODDLERS; ONE-PIECE GARMENTS FOR CHILDREN; ONE-PIECE PLAY SUITS; PAJAMAS; SHIRTS FOR INFANTS, BABIES, TODDLERS AND CHILDREN, IN CLASS 25 (U.S. CLS. 22 AND 39).

FIRST USE 7-1-2010; IN COMMERCE 7-13-2011.

THE MARK CONSISTS OF STANDARD CHARACTERS WITHOUT CLAIM TO ANY PARTICULAR FONT, STYLE, SIZE, OR COLOR.

SER. NO. 85-373,907, FILED 7-18-2011.

MEGHAN REINHART, EXAMINING ATTORNEY



David J. Kyros

Director of the United States Patent and Trademark Office

United States of America

United States Patent and Trademark Office

winner's circle

Reg. No. 4,108,449

CURRY'S AUTO SERVICE, INC. (VIRGINIA CORPORATION)
4003A WESTFAX DRIVE
CHANTILLY, VA 20151

Registered Mar. 6, 2012

Int. Cl.: 16

FOR: COUPON BOOKS, IN CLASS 16 (U.S. CLS. 2, 5, 22, 23, 29, 37, 38 AND 50).

TRADEMARK

FIRST USE 2-1-2011; IN COMMERCE 2-1-2011.

PRINCIPAL REGISTER

THE MARK CONSISTS OF STANDARD CHARACTERS WITHOUT CLAIM TO ANY PARTICULAR FONT, STYLE, SIZE, OR COLOR.

SER. NO. 85-373,929, FILED 7-18-2011.

JOHN DALIER, EXAMINING ATTORNEY



David J. Kyffers

Director of the United States Patent and Trademark Office

United States of America

United States Patent and Trademark Office

COLOR ME

Reg. No. 4,108,450

Registered Mar. 6, 2012

Int. Cl.: 9

TRADEMARK

PRINCIPAL REGISTER

BK FRAMES, CORP. (FLORIDA CORPORATION)
SUITE 14F
5700 COLLINS AVENUE
MIAMI BEACH, FL 33140

FOR: CASES FOR EYEGLASSES AND SUNGLASSES; EYEGLOSS FRAMES; SUNGLASSES,
IN CLASS 9 (U.S. CLS. 21, 23, 26, 36 AND 38).

FIRST USE 6-1-2010; IN COMMERCE 6-1-2010.

THE MARK CONSISTS OF STANDARD CHARACTERS WITHOUT CLAIM TO ANY PAR-
TICULAR FONT, STYLE, SIZE, OR COLOR.

SER. NO. 85-373,942, FILED 7-18-2011.

MARILYN IZZI, EXAMINING ATTORNEY



David J. Kyffers

Director of the United States Patent and Trademark Office

United States of America

United States Patent and Trademark Office

Our Energy Saves You Energy.

Reg. No. 4,108,451

Registered Mar. 6, 2012

Int. Cl.: 17

TRADEMARK

PRINCIPAL REGISTER

ANDERSON PRODUCTS, INC. (MINNESOTA CORPORATION), DBA ANCO PRODUCTS,
INC.
2500 17TH STREET
ELKHART, IN 46517

FOR: ACOUSTIC AND THERMAL INSULATION FOR USE IN THE AUTOMOTIVE, HVAC,
APPLIANCE AND COMMERCIAL INTERIOR INDUSTRIES, IN CLASS 17 (U.S. CLS. 1, 5,
12, 13, 35 AND 50).

FIRST USE 11-21-2007; IN COMMERCE 1-7-2008.

THE MARK CONSISTS OF STANDARD CHARACTERS WITHOUT CLAIM TO ANY PAR-
TICULAR FONT, STYLE, SIZE, OR COLOR.

SER. NO. 85-374,105, FILED 7-18-2011.

JEFF DEFORD, EXAMINING ATTORNEY



David J. Kyffers

Director of the United States Patent and Trademark Office

United States of America

United States Patent and Trademark Office

*Best in
Backyards*

Reg. No. 4,108,452

EASTERN JUNGLE GYM, INC. (NEW YORK CORPORATION)
30 COMMERCE DRIVE
CARMEL, NY 10512

Registered Mar. 6, 2012

Int. Cl.: 35

FOR: RETAIL STORE SERVICES IN THE FIELD OF PLAYGROUND EQUIPMENT, SWING SETS, TRAMPOLINES, BASKETBALL HOOPS, RUBBER MULCH AND OUTDOOR SHEDS, IN CLASS 35 (U.S. CLS. 100, 101 AND 102).

SERVICE MARK

FIRST USE 1-27-2011; IN COMMERCE 1-27-2011.

PRINCIPAL REGISTER

THE MARK CONSISTS OF THE WORDS BEST IN BACKYARDS IN STYLIZED LETTERING TO THE RIGHT OF A DESIGN OF STYLIZED LEAVES OF GRASS.

SER. NO. 85-374,122, FILED 7-18-2011.

APRIL ROACH, EXAMINING ATTORNEY



David J. Kyros

Director of the United States Patent and Trademark Office

United States of America

United States Patent and Trademark Office



Find New Passion

Married Dating with Social Sophistication

Reg. No. 4,108,453

Registered Mar. 6, 2012

Int. Cl.: 45

SERVICE MARK

PRINCIPAL REGISTER

VILNITS, ANNA (UNITED STATES INDIVIDUAL)
14 LIBERTY HILL CR.
ASHLAND, MA 01721

FOR: DATING SERVICES, IN CLASS 45 (U.S. CLS. 100 AND 101).

FIRST USE 12-20-2007; IN COMMERCE 12-20-2007.

NO CLAIM IS MADE TO THE EXCLUSIVE RIGHT TO USE "MARRIED DATING" , APART FROM THE MARK AS SHOWN.

THE MARK CONSISTS OF SILHOUETTES OF A MAN AND A WOMAN ON THE LEFT, STANDING FACE TO FACE CLOSE TO EACH OTHER UNDER AN UMBRELLA, THE WORDS "FIND NEW PASSION" WITH A BORDER ON THE RIGHT OF THE IMAGE, AND THE WORDS "MARRIED DATING WITH SOCIAL SOPHISTICATION" ALSO ON THE RIGHT OF THE IMAGE AND BELOW "FIND NEW PASSION".

SER. NO. 85-374,226, FILED 7-18-2011.

LINDA MICKLEBURGH, EXAMINING ATTORNEY



David J. Kyffers

Director of the United States Patent and Trademark Office

United States of America

United States Patent and Trademark Office

ADMURA

Reg. No. 4,108,454

Registered Mar. 6, 2012

Int. Cl.: 35

SERVICE MARK

PRINCIPAL REGISTER

RATESPECIAL LLC (CALIFORNIA LIMITED LIABILITY COMPANY)
234 E COLORADO BLVD., SUITE 600
PASADENA, CA 91101

FOR: ADVERTISING AND DIRECTORY SERVICES, NAMELY, PROMOTING THE SERVICES OF OTHERS BY PROVIDING A WEB PAGE FEATURING LINKS TO THE WEBSITES OF OTHERS; MARKETING SERVICES, NAMELY, PROVIDING INFORMATIONAL WEB PAGES DESIGNED TO GENERATE SALES TRAFFIC VIA HYPERLINKS TO OTHER WEB SITES; ONLINE ADVERTISING AND PROMOTIONAL SERVICES, IN CLASS 35 (U.S. CLS. 100, 101 AND 102).

FIRST USE 1-26-2009; IN COMMERCE 1-26-2009.

THE MARK CONSISTS OF STANDARD CHARACTERS WITHOUT CLAIM TO ANY PARTICULAR FONT, STYLE, SIZE, OR COLOR.

SER. NO. 85-374,268, FILED 7-18-2011.

KELLY TRUSILO, EXAMINING ATTORNEY



David J. Kybas

Director of the United States Patent and Trademark Office

United States of America

United States Patent and Trademark Office

willages

Reg. No. 4,108,455

Registered Mar. 6, 2012

Int. Cl.: 35

SERVICE MARK

PRINCIPAL REGISTER

JARANDON ADAMS (UNITED STATES INDIVIDUAL)
7902 TWINING OAKS LN
SPRING, TX 77379

FOR: ADVERTISING AND DIRECTORY SERVICES, NAMELY, PROMOTING THE SERVICES OF OTHERS BY PROVIDING A WEB PAGE FEATURING LINKS TO THE WEBSITES OF OTHERS; PROMOTING THE GOODS AND SERVICES OF OTHERS BY PROVIDING HYPERLINKS TO OTHER WEBSITES; PROVIDING A SEARCHABLE ON-LINE ADVERTISING WEBSITE AND GUIDE FEATURING THE GOODS AND SERVICES OF OTHER VENDORS VIA THE INTERNET; PROVIDING A SEARCHABLE ONLINE ADVERTISING WEBSITE AND INFORMATIONAL GUIDE FEATURING THE GOODS AND SERVICES OF OTHER VENDORS VIA THE INTERNET IN THE FIELD OF SOCIAL NETWORKING; PROVIDING A SEARCHABLE WEBSITE FEATURING THE GOODS AND SERVICES OF OTHER VENDORS; PROVIDING A WEBSITE AT WHICH CUSTOMERS CAN MANAGE ACCOUNT INFORMATION RELATED TO TELECOMMUNICATIONS PRODUCTS AND SERVICES, IN CLASS 35 (U.S. CLS. 100, 101 AND 102).

FIRST USE 1-15-2011; IN COMMERCE 5-31-2011.

THE MARK CONSISTS OF STANDARD CHARACTERS WITHOUT CLAIM TO ANY PARTICULAR FONT, STYLE, SIZE, OR COLOR.

SER. NO. 85-374,319, FILED 7-18-2011.

PAUL MORENO, EXAMINING ATTORNEY



David J. Kyffers

Director of the United States Patent and Trademark Office

United States of America

United States Patent and Trademark Office

PRODISCOVER

Reg. No. 4,108,456

TECHNOLOGY PATHWAYS, LLC (CALIFORNIA LIMITED LIABILITY COMPANY)
1132 FIRST ST.
CORONADO, CA 92118

Registered Mar. 6, 2012

Int. Cl.: 9

FOR: SOFTWARE FOR USE AS COMPUTER DISK FORENSICS TOOL, NAMELY, SOFTWARE FOR USE BY COMPUTER SECURITY CONSULTANTS AND LAW ENFORCEMENT OFFICIALS TO COLLECT AND ANALYZE COMPUTER DISK IMAGE EVIDENCE, IN CLASS 9 (U.S. CLS. 21, 23, 26, 36 AND 38).

TRADEMARK

PRINCIPAL REGISTER

FIRST USE 4-3-2002; IN COMMERCE 4-3-2002.

THE MARK CONSISTS OF STANDARD CHARACTERS WITHOUT CLAIM TO ANY PARTICULAR FONT, STYLE, SIZE, OR COLOR.

SER. NO. 85-374,332, FILED 7-18-2011.

JACQUELINE A. LAVINE, EXAMINING ATTORNEY



David J. Kybas

Director of the United States Patent and Trademark Office

United States of America

United States Patent and Trademark Office

CENTRAL EDGE

Reg. No. 4,108,457

Registered Mar. 6, 2012

Int. Cl.: 35

SERVICE MARK

PRINCIPAL REGISTER

CENTRAL PRODUCTS, LLC (INDIANA LIMITED LIABILITY COMPANY)
7750 GEORGETOWN ROAD
INDIANAPOLIS, IN 46268

FOR: WHOLESALE AND RETAIL STORE SERVICES AND ON-LINE RETAIL AND WHOLESALE STORE SERVICES FEATURING EQUIPMENT AND SUPPLIES USED IN THE FOODSERVICE INDUSTRY , IN CLASS 35 (U.S. CLS. 100, 101 AND 102).

FIRST USE 1-18-2011; IN COMMERCE 1-18-2011.

THE MARK CONSISTS OF STANDARD CHARACTERS WITHOUT CLAIM TO ANY PARTICULAR FONT, STYLE, SIZE, OR COLOR.

OWNER OF U.S. REG. NO. 3,945,103.

SER. NO. 85-374,603, FILED 7-19-2011.

MICHELE SWAIN, EXAMINING ATTORNEY



David J. Kybas

Director of the United States Patent and Trademark Office

United States of America

United States Patent and Trademark Office

SITFC

Reg. No. 4,108,458

Registered Mar. 6, 2012

Int. Cls.: 44 and 45

SERVICE MARK

PRINCIPAL REGISTER

THE BAIR FOUNDATION, A NON-PROFIT CORPORATION (PENNSYLVANIA CORPORATION)
241 HIGH STREET
NEW WILMINGTON, PA 16142

FOR: SOCIAL SERVICES IN THE NATURE OF PSYCHOLOGICAL COUNSELING AND TREATMENT IN THE NATURE OF BEHAVIORAL MODIFICATION FOR FOSTER CHILDREN WITH EMOTIONAL PROBLEMS RESULTING PRIMARILY AS A RESULT OF PAST ABUSE, IN CLASS 44 (U.S. CLS. 100 AND 101).

FIRST USE 9-20-2010; IN COMMERCE 9-20-2010.

FOR: SOCIAL SERVICES IN THE NATURE OF EMOTIONAL COUNSELING FOR FOSTER CHILDREN WITH EMOTIONAL PROBLEMS RESULTING PRIMARILY AS A RESULT OF PAST ABUSE, IN CLASS 45 (U.S. CLS. 100 AND 101).

FIRST USE 9-20-2010; IN COMMERCE 9-20-2010.

THE MARK CONSISTS OF STANDARD CHARACTERS WITHOUT CLAIM TO ANY PARTICULAR FONT, STYLE, SIZE, OR COLOR.

SER. NO. 85-374,614, FILED 7-19-2011.

SETH A. RAPPAPORT, EXAMINING ATTORNEY



David J. Kybas

Director of the United States Patent and Trademark Office

United States of America

United States Patent and Trademark Office



Reg. No. 4,108,459

Registered Mar. 6, 2012

Int. Cl.: 28

TRADEMARK

PRINCIPAL REGISTER

VINCI CO., LLC (VIRGINIA LIMITED LIABILITY COMPANY)
8422 WEST BROAD STREET
HENRICO, VA 23294

FOR: BASEBALL GLOVES; SOFTBALL GLOVES, IN CLASS 28 (U.S. CLS. 22, 23, 38 AND 50).

FIRST USE 1-31-2002; IN COMMERCE 1-31-2002.

THE MARK CONSISTS OF THE LETTER "V" IN GOLD LETTERING INSIDE A BLACK OVAL.

THE COLOR(S) BLACK AND GOLD IS/ARE CLAIMED AS A FEATURE OF THE MARK.

SER. NO. 85-374,679, FILED 7-19-2011.

YAT SYE, LEE, EXAMINING ATTORNEY



David J. Kybas

Director of the United States Patent and Trademark Office

United States of America

United States Patent and Trademark Office

People Training People

Reg. No. 4,108,460

Registered Mar. 6, 2012

Int. Cl.: 41

SERVICE MARK

PRINCIPAL REGISTER

GREGORY MILLER AND COMPANY LLC (NEW YORK LIMITED LIABILITY COMPANY)
SUITE 2B
33 W 82ND ST
NEW YORK, NY 10024

FOR: TRAINING SERVICES IN THE FIELD OF COMPUTER SOFTWARE, IN CLASS 41 (U.S. CLS. 100, 101 AND 107).

FIRST USE 1-0-2002; IN COMMERCE 1-0-2002.

THE MARK CONSISTS OF STANDARD CHARACTERS WITHOUT CLAIM TO ANY PARTICULAR FONT, STYLE, SIZE, OR COLOR.

SER. NO. 85-374,715, FILED 7-19-2011.

ANNE FARRELL, EXAMINING ATTORNEY



David J. Kyffers

Director of the United States Patent and Trademark Office

United States of America

United States Patent and Trademark Office

LAY ME DOWN 2 SLEEP

Reg. No. 4,108,461

Registered Mar. 6, 2012

Int. Cl.: 28

TRADEMARK

PRINCIPAL REGISTER

VITAMINS PLAYWEAR LTD. (NEW YORK CORPORATION)
SUITE 910
10 WEST 33RD STREET
NEW YORK, NY 10001

FOR: STUFFED AND PLUSH TOYS, IN CLASS 28 (U.S. CLS. 22, 23, 38 AND 50).

FIRST USE 4-0-2011; IN COMMERCE 4-0-2011.

THE MARK CONSISTS OF STANDARD CHARACTERS WITHOUT CLAIM TO ANY PARTICULAR FONT, STYLE, SIZE, OR COLOR.

SER. NO. 85-374,740, FILED 7-19-2011.

BENJAMIN OKEKE, EXAMINING ATTORNEY



David J. Kybas

Director of the United States Patent and Trademark Office

United States of America

United States Patent and Trademark Office

Monster Soup

Reg. No. 4,108,462

Registered Mar. 6, 2012

Int. Cl.: 9

TRADEMARK

PRINCIPAL REGISTER

KIEFFER BROS., LLC (WISCONSIN LIMITED LIABILITY COMPANY)
STE 407
103 W. COLLEGE AVE.
APPLETON, WI 54911

FOR: COMPUTER GAME SOFTWARE FOR USE ON MOBILE AND CELLULAR PHONES,
IN CLASS 9 (U.S. CLS. 21, 23, 26, 36 AND 38).

FIRST USE 6-15-2011; IN COMMERCE 6-15-2011.

THE MARK CONSISTS OF STANDARD CHARACTERS WITHOUT CLAIM TO ANY PAR-
TICULAR FONT, STYLE, SIZE, OR COLOR.

SER. NO. 85-374,860, FILED 7-19-2011.

ANTHONY RINKER, EXAMINING ATTORNEY



David J. Kyffers

Director of the United States Patent and Trademark Office

United States of America

United States Patent and Trademark Office

Women Together Fighting Cancer

Reg. No. 4,108,463

THE WTFC ORGANIZATION, INC. (NEW YORK CORPORATION)
109 SAGAMORE DRIVE
PLAINVIEW, NY 11803

Registered Mar. 6, 2012

Int. Cl.: 36

FOR: CHARITABLE FUNDRAISING TO SUPPORT BREAST CANCER RESEARCH, IN
CLASS 36 (U.S. CLS. 100, 101 AND 102).

SERVICE MARK

FIRST USE 10-0-2010; IN COMMERCE 10-0-2010.

PRINCIPAL REGISTER

THE MARK CONSISTS OF STANDARD CHARACTERS WITHOUT CLAIM TO ANY PAR-
TICULAR FONT, STYLE, SIZE, OR COLOR.

OWNER OF U.S. REG. NO. 3,640,783.

SER. NO. 85-374,883, FILED 7-19-2011.

JUDITH HELFMAN, EXAMINING ATTORNEY



David J. Kybas

Director of the United States Patent and Trademark Office

United States of America

United States Patent and Trademark Office

JAARS

Reg. No. 4,108,464

JAARS, INC. (NORTH CAROLINA NON-PROFIT CORPORATION)
7405 JAARS ROAD
WAXHAW, NC 28173

Registered Mar. 6, 2012

Int. Cl.: 39

FOR: TRANSPORTATION SERVICES, NAMELY THE TRANSPORTATION OF PASSENGERS AND CARGO BY AIR, LAND AND SEA, IN CLASS 39 (U.S. CLS. 100 AND 105).

SERVICE MARK

FIRST USE 11-0-1998; IN COMMERCE 11-0-1998.

PRINCIPAL REGISTER

THE MARK CONSISTS OF THE LETTERS "JAARS" WITH A SWISH OF WHITE CUTTING THROUGH THE LETTERS.

SER. NO. 85-374,943, FILED 7-19-2011.

FONG HSU, EXAMINING ATTORNEY



David J. Kybas

Director of the United States Patent and Trademark Office

United States of America

United States Patent and Trademark Office

JAARS

Reg. No. 4,108,465

Registered Mar. 6, 2012

Int. Cl.: 39

SERVICE MARK

PRINCIPAL REGISTER

JAARS, INC. (NORTH CAROLINA NON-PROFIT CORPORATION)
7405 JAARS ROAD
WAXHAW, NC 28173

FOR: TRANSPORTATION SERVICES, NAMELY THE TRANSPORTATION OF PASSENGERS AND CARGO BY AIR, LAND AND SEA, IN CLASS 39 (U.S. CLS. 100 AND 105).

FIRST USE 0-0-1966; IN COMMERCE 0-0-1966.

THE MARK CONSISTS OF STANDARD CHARACTERS WITHOUT CLAIM TO ANY PARTICULAR FONT, STYLE, SIZE, OR COLOR.

SER. NO. 85-374,949, FILED 7-19-2011.

FONG HSU, EXAMINING ATTORNEY



David J. Kybas

Director of the United States Patent and Trademark Office

United States of America

United States Patent and Trademark Office

P290

Reg. No. 4,108,466

Registered Mar. 6, 2012

Int. Cl.: 13

TRADEMARK

PRINCIPAL REGISTER

SIG SAUER INC. (DELAWARE CORPORATION)
18 INDUSTRIAL DRIVE
EXETER, NH 03833

FOR: PISTOLS, IN CLASS 13 (U.S. CLS. 2 AND 9).

FIRST USE 2-28-2011; IN COMMERCE 2-28-2011.

THE MARK CONSISTS OF STANDARD CHARACTERS WITHOUT CLAIM TO ANY PARTICULAR FONT, STYLE, SIZE, OR COLOR.

OWNER OF U.S. REG. NOS. 3,131,875, 3,328,965 AND OTHERS.

SER. NO. 85-374,979, FILED 7-19-2011.

KRISTINA MORRIS, EXAMINING ATTORNEY



David J. Kyffers

Director of the United States Patent and Trademark Office

United States of America

United States Patent and Trademark Office

BACK-U-PRESSURE

Reg. No. 4,108,467

CITRIN COMPANIES, LLC (CALIFORNIA LIMITED LIABILITY COMPANY)
P.O. BOX 429
SAN MATEO, CA 94401

Registered Mar. 6, 2012

Int. Cl.: 10

FOR: MASSAGE THERAPY BALL, IN CLASS 10 (U.S. CLS. 26, 39 AND 44).

TRADEMARK

FIRST USE 7-4-2010; IN COMMERCE 10-19-2010.

PRINCIPAL REGISTER

THE MARK CONSISTS OF STANDARD CHARACTERS WITHOUT CLAIM TO ANY PARTICULAR FONT, STYLE, SIZE, OR COLOR.

SER. NO. 85-375,180, FILED 7-19-2011.

ROBERT STRUCK, EXAMINING ATTORNEY



David J. Kybas

Director of the United States Patent and Trademark Office

United States of America

United States Patent and Trademark Office

AN IDEAL BALANCE OF SOFTNESS & STRENGTH

Reg. No. 4,108,468

GEORGIA-PACIFIC CONSUMER PRODUCTS LP (DELAWARE LIMITED PARTNERSHIP)
133 PEACHTREE ST, NE
ATLANTA, GA 30303

Registered Mar. 6, 2012

Int. Cl.: 16

FOR: BATHROOM TISSUE, IN CLASS 16 (U.S. CLS. 2, 5, 22, 23, 29, 37, 38 AND 50).

TRADEMARK

FIRST USE 10-14-2008; IN COMMERCE 12-0-2008.

PRINCIPAL REGISTER

THE MARK CONSISTS OF STANDARD CHARACTERS WITHOUT CLAIM TO ANY PARTICULAR FONT, STYLE, SIZE, OR COLOR.

SER. NO. 85-375,186, FILED 7-19-2011.

KELLY BOULTON, EXAMINING ATTORNEY



David J. Kyffers

Director of the United States Patent and Trademark Office

United States of America

United States Patent and Trademark Office

EDWARDS

Reg. No. 4,108,469

Registered Mar. 6, 2012

Int. Cl.: 15

TRADEMARK

PRINCIPAL REGISTER

THE GETZEN COMPANY, INC. (WISCONSIN CORPORATION)
PO BOX 440
530 SOUTH HIGHWAY H
ELKHORN, WI 53121

FOR: MUSICAL INSTRUMENTS, NAMELY, TROMBONES, CORNETS, FLUEGELHORNS, TRUMPETS, AND PARTS AND ACCESSORIES THEREFOR---NAMELY, MOUTHPIECES, LEADPIPES, SLIDES, BULLET BRACE AND INSTRUMENT CASES, IN CLASS 15 (U.S. CLS. 2, 21 AND 36).

FIRST USE 4-1-1991; IN COMMERCE 4-1-1991.

THE MARK CONSISTS OF STANDARD CHARACTERS WITHOUT CLAIM TO ANY PARTICULAR FONT, STYLE, SIZE, OR COLOR.

SEC. 2(F).

SER. NO. 85-375,187, FILED 7-19-2011.

KELLY BOULTON, EXAMINING ATTORNEY



David J. Kyffers

Director of the United States Patent and Trademark Office

United States of America

United States Patent and Trademark Office

Professionally Significant Degrees

Reg. No. 4,108,470

INTERNATIONAL EXPORT INSTITUTE, INC. (ARIZONA CORPORATION)
11225 N 28TH DRIVE, SUITE B 201
PHOENIX, AZ 85029

Registered Mar. 6, 2012

Int. Cl.: 35

FOR: RECRUITMENT OF STUDENTS FOR HIGHER EDUCATION INSTITUTIONS, IN CLASS 35 (U.S. CLS. 100, 101 AND 102).

SERVICE MARK

FIRST USE 11-1-2010; IN COMMERCE 11-1-2010.

PRINCIPAL REGISTER

THE MARK CONSISTS OF STANDARD CHARACTERS WITHOUT CLAIM TO ANY PARTICULAR FONT, STYLE, SIZE, OR COLOR.

SER. NO. 85-375,253, FILED 7-19-2011.

JENNY PARK, EXAMINING ATTORNEY



David J. Kyffers

Director of the United States Patent and Trademark Office

United States of America

United States Patent and Trademark Office

RESORB

Reg. No. 4,108,471

Registered Mar. 6, 2012

Int. Cls.: 17 and 27

TRADEMARK

PRINCIPAL REGISTER

OIL-DRI CORPORATION OF AMERICA (ILLINOIS CORPORATION)
SUITE 400
410 NORTH MICHIGAN AVENUE
CHICAGO, IL 60611

FOR: ABSORBENT PRODUCTS, NAMELY, PERFORATED AND NON-PERFORATED PADS AND ROLLS FOR THE CONTAINMENT AND CLEAN-UP OF OIL BASED CHEMICALS, OILS AND LIQUIDS; ABSORBENT PRODUCTS, NAMELY, BARRIER CURTAINS IN THE NATURE OF FLOATING BUFFERS OR BOOMS FOR THE CONTAINMENT OF POLLUTANTS; SPILL KITS COMPRISING OIL ABSORBENT PADS, ROLLS AND BOOMS FOR CONTAINING SPILLS OF OIL BASED CHEMICALS, OILS AND LIQUIDS, IN CLASS 17 (U.S. CLS. 1, 5, 12, 13, 35 AND 50).

FIRST USE 12-31-1992; IN COMMERCE 12-31-1992.

FOR: DISPOSABLE ABSORBENT FLOOR PADS, IN CLASS 27 (U.S. CLS. 19, 20, 37, 42 AND 50).

FIRST USE 12-31-1992; IN COMMERCE 12-31-1992.

THE MARK CONSISTS OF STANDARD CHARACTERS WITHOUT CLAIM TO ANY PARTICULAR FONT, STYLE, SIZE, OR COLOR.

SER. NO. 85-375,306, FILED 7-19-2011.

KELLEY WELLS, EXAMINING ATTORNEY



David J. Kypos

Director of the United States Patent and Trademark Office

United States of America

United States Patent and Trademark Office



Reg. No. 4,108,472

MASATO PEARLS, LLC (LOUISIANA LIMITED LIABILITY COMPANY)
3721 COBBLESTONE DR.
LAKE CHARLES, LA 70605

Registered Mar. 6, 2012

Int. Cl.: 14

FOR: BRACELETS; EARRINGS; NECKLACES; PENDANTS; RINGS, IN CLASS 14 (U.S. CLS. 2, 27, 28 AND 50).

TRADEMARK

FIRST USE 11-26-2007; IN COMMERCE 11-26-2007.

PRINCIPAL REGISTER

THE MARK CONSISTS OF THE STYLIZED TEXT "M" AGAINST A RECTANGULAR BACKGROUND, AND A CIRCULAR OBJECT BELOW AND CENTER OF THE "M".

SER. NO. 85-375,433, FILED 7-19-2011.

ANDREW LEASER, EXAMINING ATTORNEY



David J. Kybas

Director of the United States Patent and Trademark Office

United States of America

United States Patent and Trademark Office

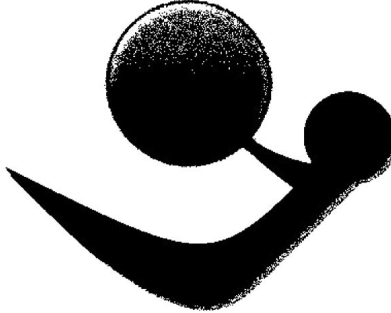

THE LIVING TEMPLE WORKOUT

Reg. No. 4,108,473

KAREN M. LAWYER (UNITED STATES INDIVIDUAL)
12 ARCTIC SPRINGS
JEFFERSONVILLE, IN 47130

Registered Mar. 6, 2012

Int. Cl.: 9

FOR: DIGITAL MEDIA, NAMELY, DVDS FEATURING CHRISTIAN EXERCISE, IN CLASS 9 (U.S. CLS. 21, 23, 26, 36 AND 38).

TRADEMARK

FIRST USE 2-28-2010; IN COMMERCE 2-28-2010.

PRINCIPAL REGISTER

NO CLAIM IS MADE TO THE EXCLUSIVE RIGHT TO USE "WORKOUT", APART FROM THE MARK AS SHOWN.

THE STIPPLING IS FOR SHADING PURPOSES ONLY.

THE MARK CONSISTS OF THE STYLIZED WORDS "THE LIVING TEMPLE WORKOUT" BELOW THE ABSTRACT DESIGN OF A SITTING PERSON WITH LEGS RAISED AND ARMS HOLDING A BALANCE BALL.

SER. NO. 85-375,437, FILED 7-19-2011.

ANDREW LEASER, EXAMINING ATTORNEY



David J. Kybas

Director of the United States Patent and Trademark Office

United States of America

United States Patent and Trademark Office

TRINIDAD

Reg. No. 4,108,474

Registered Mar. 6, 2012

Int. Cl.: 30

TRADEMARK

PRINCIPAL REGISTER

TRINIDAD COFFEE COMPANY, INC. (CALIFORNIA CORPORATION)
9828 FIRESTONE BLVD.
DOWNEY, CA 90241

FOR: CAFFEINE-FREE COFFEE; COFFEE; COFFEE; COFFEE AND TEA; COFFEE BEANS;
COFFEE PODS; GROUND COFFEE BEANS; ROASTED COFFEE BEANS, IN CLASS 30 (U.S.
CL. 46).

FIRST USE 8-1-1999; IN COMMERCE 4-21-2000.

THE MARK CONSISTS OF STANDARD CHARACTERS WITHOUT CLAIM TO ANY PAR-
TICULAR FONT, STYLE, SIZE, OR COLOR.

SER. NO. 85-375,528, FILED 7-19-2011.

MARIA-VICTORIA SUAREZ, EXAMINING ATTORNEY



David J. Kybas

Director of the United States Patent and Trademark Office

United States of America

United States Patent and Trademark Office

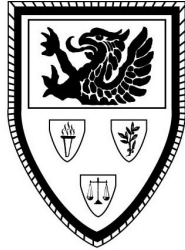

TRINIDAD

Reg. No. 4,108,475

Registered Mar. 6, 2012

Int. Cl.: 30

TRADEMARK

PRINCIPAL REGISTER

TRINIDAD COFFEE COMPANY, INC. (CALIFORNIA CORPORATION)
9828 FIRESTONE BLVD.
DOWNEY, CA 90241

FOR: CAFFEINE-FREE COFFEE; COFFEE; COFFEE; COFFEE AND TEA; COFFEE BEANS;
COFFEE PODS; GROUND COFFEE BEANS; ROASTED COFFEE BEANS, IN CLASS 30 (U.S.
CL. 46).

FIRST USE 4-1-2000; IN COMMERCE 4-21-2000.

THE MARK CONSISTS OF THE STYLIZED WORD "TRINIDAD" APPEARING WITH A LOGO. THE LOGO IS IN THE SHAPE OF A SHIELD, WITH AN IMAGE OF A GRIFFIN IN THE UPPER HALF OF THE SHIELD. THE LOWER HALF OF THE SHIELD CONTAINS THREE SMALLER SHIELDS, EACH CONTAINING AN IMAGE. STARTING FROM THE UPPER LEFT, THE IMAGE INSIDE THE SMALL SHIELD IS OF A TORCH. THE UPPER RIGHT SMALL SHIELD CONTAINS AN IMAGE OF A PLANT. THE LOWER SMALL SHIELD CONTAINS AN IMAGE OF A SCALE. THE STYLIZED WORD "TRINIDAD" IS IN ALL CAPITAL LETTERS, WITH THE LETTERS "T" AND "D" BEING LARGER THAN THE OTHER LETTERS IN THE WORD "TRINIDAD".

SER. NO. 85-375,540, FILED 7-19-2011.

MARIA-VICTORIA SUAREZ, EXAMINING ATTORNEY



David J. Kyros

Director of the United States Patent and Trademark Office

United States of America

United States Patent and Trademark Office

GRO PRO

Reg. No. 4,108,476

IP HOLDINGS LLC (WASHINGTON LIMITED LIABILITY COMPANY)
5408 NE 88TH ST. #A-101
VANCOUVER, WA 98665

Registered Mar. 6, 2012

Int. Cls.: 8, 9, 17, 20 and 22

FOR: HAND TOOLS, NAMELY, PRUNERS; HAND-PUMPED SPRAYERS FOR INDOOR GARDENING; SCALPELS FOR HOBBY USE, IN CLASS 8 (U.S. CLS. 23, 28 AND 44).

FIRST USE 1-1-2005; IN COMMERCE 7-8-2011.

TRADEMARK

FOR: HYDROMETERS; MAGNIFYING LENSES; MEASURING CUPS; THERMOMETERS NOT FOR MEDICAL USE, IN CLASS 9 (U.S. CLS. 21, 23, 26, 36 AND 38).

PRINCIPAL REGISTER

FIRST USE 1-1-2005; IN COMMERCE 7-8-2011.

FOR: PLASTIC FILM THAT IS REFLECTIVE FOR USE IN HOME OR AUTO WINDOWS, IN CLASS 17 (U.S. CLS. 1, 5, 12, 13, 35 AND 50).

FIRST USE 1-1-2005; IN COMMERCE 7-8-2011.

FOR: NON-METAL GARDEN STAKES; NON-METAL PLANT HANGERS, IN CLASS 20 (U.S. CLS. 2, 13, 22, 25, 32 AND 50).

FIRST USE 1-1-2005; IN COMMERCE 7-8-2011.

FOR: CARGO AND CARRIER EQUIPMENT FOR VEHICLES, NAMELY, TOW ROPES, TOW STRAPS, RATCHET TIE-DOWN STRAPS, QUICK RELEASE TIE DOWN STRAPS, LASHING STRAPS, AND TARP STRAPS; HORTICULTURAL BAGS AND SACKS, NAMELY, BAGS AND SACKS MADE OF WOVEN SYNTHETIC OR NATURAL FIBERS OR PLASTICS MATERIALS, ALL FOR USE IN GROWING ANY TYPE OF PLANT, SHRUB OR TREE, IN CLASS 22 (U.S. CLS. 1, 2, 7, 19, 22, 42 AND 50).

FIRST USE 1-1-2005; IN COMMERCE 7-8-2011.

THE MARK CONSISTS OF STANDARD CHARACTERS WITHOUT CLAIM TO ANY PARTICULAR FONT, STYLE, SIZE, OR COLOR.

OWNER OF U.S. REG. NO. 3,388,278.

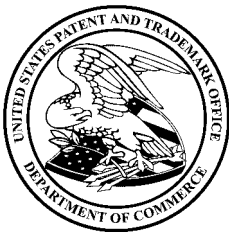

David J. Kyros

Director of the United States Patent and Trademark Office

Reg. No. 4,108,476 NO CLAIM IS MADE TO THE EXCLUSIVE RIGHT TO USE "GROW", APART FROM THE MARK AS SHOWN.

SER. NO. 85-375,551, FILED 7-19-2011.

BRIDGETT SMITH, EXAMINING ATTORNEY

United States of America

United States Patent and Trademark Office



Reg. No. 4,108,477

RHEMA CHRISTIAN CENTER (OHIO CORPORATION)
2100 AGLER ROAD
COLUMBUS, OH 43224

Registered Mar. 6, 2012

Int. Cl.: 41

FOR: EDUCATIONAL AND ENTERTAINMENT SERVICES, NAMELY, A CONTINUING PROGRAM ABOUT CHRISTIANITY AND RELIGIOUS ACTIVITIES ACCESSIBLE BY RADIO, TELEVISION, SATELLITE, AUDIO, VIDEO AND COMPUTER NETWORKS, IN CLASS 41 (U.S. CLS. 100, 101 AND 107).

SERVICE MARK

PRINCIPAL REGISTER

FIRST USE 9-8-1996; IN COMMERCE 9-8-1996.

NO CLAIM IS MADE TO THE EXCLUSIVE RIGHT TO USE "TELEVISION", APART FROM THE MARK AS SHOWN.

THE MARK CONSISTS OF THE STYLIZED WORD OVERCOMERS INSIDE A RECTANGULAR CARRIER ABOVE THE WORD TELEVISION IN STYLIZED SCRIPT FONT. BEHIND THE RECTANGULAR CARRIER IS A LARGE STYLIZED LETTER "O".

SER. NO. 85-375,557, FILED 7-19-2011.

WILLIAM ROSSMAN, EXAMINING ATTORNEY



David J. Kyros

Director of the United States Patent and Trademark Office

United States of America

United States Patent and Trademark Office

CashCall

Reg. No. 4,108,478

Registered Mar. 6, 2012

Int. Cl.: 36

SERVICE MARK

PRINCIPAL REGISTER

CASHCALL, INC. (CALIFORNIA CORPORATION)
1600 SOUTH DOUGLASS ROAD
ANAHEIM, CA 92660

FOR: INSTALLMENT LOANS; MORTGAGE BANKING SERVICES, NAMELY, ORIGINATION, ACQUISITION, SERVICING, SECURITIZATION AND BROKERAGE OF MORTGAGE LOANS, IN CLASS 36 (U.S. CLS. 100, 101 AND 102).

FIRST USE 7-1-2003; IN COMMERCE 7-1-2003.

THE MARK CONSISTS OF STANDARD CHARACTERS WITHOUT CLAIM TO ANY PARTICULAR FONT, STYLE, SIZE, OR COLOR.

SER. NO. 85-375,566, FILED 7-19-2011.

WILLIAM JACKSON, EXAMINING ATTORNEY



David J. Kyros

Director of the United States Patent and Trademark Office

United States of America

United States Patent and Trademark Office

PIC

Reg. No. 4,108,479

THE ANGELUS CORPORATION (WISCONSIN CORPORATION)
N53 W24747 SOUTH CORPORATE DRIVE
SUSSIX, WI 530890330

Registered Mar. 6, 2012

Int. Cl.: 9

FOR: ELECTRONIC CABLES, CABLE CONNECTORS, CABLE ASSEMBLIES, CABLE HARNESSSES AND GASKETS, IN CLASS 9 (U.S. CLS. 21, 23, 26, 36 AND 38).

TRADEMARK

FIRST USE 7-26-1971; IN COMMERCE 7-26-1971.

PRINCIPAL REGISTER

THE MARK CONSISTS OF STANDARD CHARACTERS WITHOUT CLAIM TO ANY PARTICULAR FONT, STYLE, SIZE, OR COLOR.

SER. NO. 85-375,669, FILED 7-20-2011.

PAUL MORENO, EXAMINING ATTORNEY



David J. Kybas

Director of the United States Patent and Trademark Office

United States of America

United States Patent and Trademark Office

SPARCO

Reg. No. 4,108,480

Registered Mar. 6, 2012

Int. Cl.: 8

TRADEMARK

PRINCIPAL REGISTER

S. P. RICHARDS COMPANY (GEORGIA CORPORATION)
P.O. BOX 1266
SMYRNA, GA 30081

FOR: SCISSORS; UTILITY KNIVES, IN CLASS 8 (U.S. CLS. 23, 28 AND 44).

FIRST USE 0-0-1996; IN COMMERCE 0-0-1996.

THE MARK CONSISTS OF STANDARD CHARACTERS WITHOUT CLAIM TO ANY PARTICULAR FONT, STYLE, SIZE, OR COLOR.

OWNER OF U.S. REG. NO. 1,671,540.

SER. NO. 85-375,713, FILED 7-20-2011.

MATTHEW EINSTEIN, EXAMINING ATTORNEY



David J. Kybas

Director of the United States Patent and Trademark Office

United States of America

United States Patent and Trademark Office

ADITUS

Reg. No. 4,108,481

Registered Mar. 6, 2012

Int. Cl.: 35

SERVICE MARK

PRINCIPAL REGISTER

ADITUS, INC. (ILLINOIS CORPORATION)
4701 MIDLOTHIAN TURNPIKE, SUITE 4
CRESTWOOD, IL 60445

FOR: ONLINE MEDIA MONITORING SERVICES USING COMPUTER SOFTWARE TO AUTOMATICALLY MONITOR INTERNET WEBSITES AND ONLINE PUBLICATIONS FOR CUSTOMER-SPECIFIED TOPICS AND TO CAPTURE RELEVANT CONTENT ON THOSE TOPICS, AND PROVIDING DOCUMENTATION AND ANALYSIS OF THAT ONLINE CONTENT TO OTHERS FOR BUSINESS PURPOSES, IN CLASS 35 (U.S. CLS. 100, 101 AND 102).

FIRST USE 6-28-2011; IN COMMERCE 7-19-2011.

THE MARK CONSISTS OF STANDARD CHARACTERS WITHOUT CLAIM TO ANY PARTICULAR FONT, STYLE, SIZE, OR COLOR.

THE WORDING ADITUS HAS NO MEANING IN A FOREIGN LANGUAGE.

SER. NO. 85-375,716, FILED 7-20-2011.

SHANNON TWOHIG, EXAMINING ATTORNEY



David J. Kybas

Director of the United States Patent and Trademark Office

United States of America

United States Patent and Trademark Office

MYLOLLIFLOPS

Reg. No. 4,108,482

MYLOLLIFLOPS, LLC (NEW JERSEY LIMITED LIABILITY COMPANY)
120 WHITLOCK CT.
MANALAPAN, NJ 07726

Registered Mar. 6, 2012

Int. Cl.: 25

FOR: FOOTWEAR, IN CLASS 25 (U.S. CLS. 22 AND 39).

TRADEMARK

FIRST USE 4-30-2007; IN COMMERCE 6-7-2007.

PRINCIPAL REGISTER

THE MARK CONSISTS OF STANDARD CHARACTERS WITHOUT CLAIM TO ANY PARTICULAR FONT, STYLE, SIZE, OR COLOR.

SER. NO. 85-375,737, FILED 7-20-2011.

JIM RINGLE, EXAMINING ATTORNEY



David J. Kybas

Director of the United States Patent and Trademark Office

United States of America

United States Patent and Trademark Office

ACE

Reg. No. 4,108,483

ACE RADON CORPORATION (COLORADO CORPORATION)
77 E. POWERS AVENUE
LITTLETON, CO 80121

Registered Mar. 6, 2012

Int. Cl.: 37

FOR: INSTALLING, REPAIRING, AND MAINTAINING SYSTEMS TO MITIGATE RADON LEVELS IN BUILDINGS, IN CLASS 37 (U.S. CLS. 100, 103 AND 106).

SERVICE MARK

FIRST USE 12-31-1994; IN COMMERCE 12-31-1994.

PRINCIPAL REGISTER

THE MARK CONSISTS OF STANDARD CHARACTERS WITHOUT CLAIM TO ANY PARTICULAR FONT, STYLE, SIZE, OR COLOR.

SER. NO. 85-375,743, FILED 7-20-2011.

EMILY CHUO, EXAMINING ATTORNEY



David J. Kybas

Director of the United States Patent and Trademark Office

United States of America

United States Patent and Trademark Office

SPARCO

Reg. No. 4,108,484

S. P. RICHARDS COMPANY (GEORGIA CORPORATION)
P.O. BOX 1266
SMYRNA, GA 30081

Registered Mar. 6, 2012

Int. Cl.: 20

FOR: BULLETIN BOARDS; KEY CABINETS; PICTURE FRAMES; WALL PLAQUES MADE OF PLASTIC OR WOOD, IN CLASS 20 (U.S. CLS. 2, 13, 22, 25, 32 AND 50).

TRADEMARK

FIRST USE 0-0-1999; IN COMMERCE 0-0-1999.

PRINCIPAL REGISTER

THE MARK CONSISTS OF STANDARD CHARACTERS WITHOUT CLAIM TO ANY PARTICULAR FONT, STYLE, SIZE, OR COLOR.

OWNER OF U.S. REG. NO. 1,671,540.

SER. NO. 85-375,761, FILED 7-20-2011.

MATTHEW EINSTEIN, EXAMINING ATTORNEY



David J. Kyros

Director of the United States Patent and Trademark Office

United States of America

United States Patent and Trademark Office



Reg. No. 4,108,485

ACE RADON CORPORATION (COLORADO CORPORATION)
77 E. POWERS AVENUE
LITTLETON, CO 80121

Registered Mar. 6, 2012

Int. Cl.: 37

FOR: INSTALLING, REPAIRING, AND MAINTAINING SYSTEMS TO MITIGATE RADON LEVELS IN BUILDINGS, IN CLASS 37 (U.S. CLS. 100, 103 AND 106).

SERVICE MARK

FIRST USE 12-31-1994; IN COMMERCE 12-31-1994.

PRINCIPAL REGISTER

NO CLAIM IS MADE TO THE EXCLUSIVE RIGHT TO USE "RADON", APART FROM THE MARK AS SHOWN.

THE MARK CONSISTS OF THE TERM "ACE RADON" TOGETHER WITH THE DESIGN OF A HOUSE AND AN EVERGREEN TREE.

SER. NO. 85-375,775, FILED 7-20-2011.

EMILY CHUO, EXAMINING ATTORNEY



David J. Kybas

Director of the United States Patent and Trademark Office

United States of America

United States Patent and Trademark Office

CORDYS

Reg. No. 4,108,486

Registered Mar. 6, 2012

Int. Cl.: 38

SERVICE MARK

PRINCIPAL REGISTER

CORDYS SOFTWARE B.V. (NETHERLANDS CORPORATION)
VANENBURGERALLEE 3
3882 RH PUTTEN, NETHERLANDS

FOR: TELECOMMUNICATIONS CONSULTATION; TELECOMMUNICATION SERVICES, NAMELY, PROVIDING MULTI-USER ACCESS TO THE INTERNET, IN CLASS 38 (U.S. CLS. 100, 101 AND 104).

THE MARK CONSISTS OF STANDARD CHARACTERS WITHOUT CLAIM TO ANY PARTICULAR FONT, STYLE, SIZE, OR COLOR.

OWNER OF ERPN CMNTY TM OFC REG. NO. 003255858, DATED 6-7-2005, EXPIRES 7-7-2013.

OWNER OF U.S. REG. NO. 2,916,131.

SER. NO. 85-375,777, FILED 7-20-2011.

EMILY CHUO, EXAMINING ATTORNEY



David J. Kyros

Director of the United States Patent and Trademark Office

United States of America

United States Patent and Trademark Office

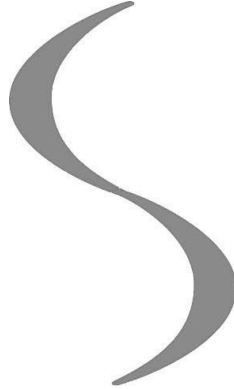

Reg. No. 4,108,487

Registered Mar. 6, 2012

Int. Cls.: 27 and 35

TRADEMARK

SERVICE MARK

PRINCIPAL REGISTER

SILK ROAD SOURCING, LLC (OHIO LIMITED LIABILITY COMPANY)
161 CHARLES AVENUE
AMHERST, OH 44001

FOR: FLOOR COVERINGS, IN CLASS 27 (U.S. CLS. 19, 20, 37, 42 AND 50).

FIRST USE 8-31-2010; IN COMMERCE 8-31-2010.

FOR: BUSINESS SERVICES, NAMELY, COMBINED STRATEGIC GOODS OR SERVICES SOURCING AND COOPERATIVE PURCHASING FOR OTHERS, IN CLASS 35 (U.S. CLS. 100, 101 AND 102).

FIRST USE 8-31-2010; IN COMMERCE 8-31-2010.

THE MARK CONSISTS OF CURVED LINE OF VARIABLE THICKNESS.

SER. NO. 85-375,779, FILED 7-20-2011.

EMILY CHUO, EXAMINING ATTORNEY



David J. Kybas

Director of the United States Patent and Trademark Office

United States of America

United States Patent and Trademark Office

SPARCO

Reg. No. 4,108,488

Registered Mar. 6, 2012

Int. Cl.: 12

TRADEMARK

PRINCIPAL REGISTER

S. P. RICHARDS COMPANY (GEORGIA CORPORATION)
P.O. BOX 1266
SMYRNA, GA 30081

FOR: DOLLIES; HAND TRUCKS, IN CLASS 12 (U.S. CLS. 19, 21, 23, 31, 35 AND 44).

FIRST USE 0-0-1996; IN COMMERCE 0-0-1996.

THE MARK CONSISTS OF STANDARD CHARACTERS WITHOUT CLAIM TO ANY PARTICULAR FONT, STYLE, SIZE, OR COLOR.

OWNER OF U.S. REG. NO. 1,671,540.

SER. NO. 85-375,805, FILED 7-20-2011.

MATTHEW EINSTEIN, EXAMINING ATTORNEY



David J. Kybas

Director of the United States Patent and Trademark Office

United States of America

United States Patent and Trademark Office

OI

Reg. No. 4,108,489

Registered Mar. 6, 2012

Int. Cl.: 9

TRADEMARK

PRINCIPAL REGISTER

DETECTOR ELECTRONICS CORPORATION (MINNESOTA CORPORATION)
6901 WEST 110TH STREET
BLOOMINGTON, MN 55438

FOR: FIRE DETECTION SYSTEMS COMPRISING DETECTORS AND CONTROL UNITS,
IN CLASS 9 (U.S. CLS. 21, 23, 26, 36 AND 38).

FIRST USE 7-30-1975; IN COMMERCE 7-30-1975.

THE MARK CONSISTS OF STANDARD CHARACTERS WITHOUT CLAIM TO ANY PAR-
TICULAR FONT, STYLE, SIZE, OR COLOR.

OWNER OF U.S. REG. NO. 1,166,190.

SER. NO. 85-375,808, FILED 7-20-2011.

EMILY CHUO, EXAMINING ATTORNEY



David J. Kybas

Director of the United States Patent and Trademark Office

United States of America

United States Patent and Trademark Office

SPARCO

Reg. No. 4,108,490

Registered Mar. 6, 2012

Int. Cl.: 21

TRADEMARK

PRINCIPAL REGISTER

S. P. RICHARDS COMPANY (GEORGIA CORPORATION)
P.O. BOX 1266
SMYRNA, GA 30081

FOR: WASTEPAPER BASKETS, IN CLASS 21 (U.S. CLS. 2, 13, 23, 29, 30, 33, 40 AND 50).

FIRST USE 0-0-1998; IN COMMERCE 0-0-1998.

THE MARK CONSISTS OF STANDARD CHARACTERS WITHOUT CLAIM TO ANY PARTICULAR FONT, STYLE, SIZE, OR COLOR.

OWNER OF U.S. REG. NO. 1,671,540.

SER. NO. 85-375,812, FILED 7-20-2011.

MATTHEW EINSTEIN, EXAMINING ATTORNEY



David J. Kybas

Director of the United States Patent and Trademark Office

United States of America

United States Patent and Trademark Office

SPARCO

Reg. No. 4,108,491

S. P. RICHARDS COMPANY (GEORGIA CORPORATION)
P.O. BOX 1266
SMYRNA, GA 30081

Registered Mar. 6, 2012

Int. Cl.: 17

FOR: ADHESIVE PACKING TAPE FOR INDUSTRIAL OR COMMERCIAL USE; PLASTIC FILM FOR USE IN LAMINATING PAPER, IN CLASS 17 (U.S. CLS. 1, 5, 12, 13, 35 AND 50).

TRADEMARK

FIRST USE 0-0-1996; IN COMMERCE 0-0-1996.

PRINCIPAL REGISTER

THE MARK CONSISTS OF STANDARD CHARACTERS WITHOUT CLAIM TO ANY PARTICULAR FONT, STYLE, SIZE, OR COLOR.

OWNER OF U.S. REG. NO. 1,671,540.

SER. NO. 85-375,817, FILED 7-20-2011.

MATTHEW EINSTEIN, EXAMINING ATTORNEY



David J. Kybas

Director of the United States Patent and Trademark Office

United States of America

United States Patent and Trademark Office

SPARCO

Reg. No. 4,108,492

Registered Mar. 6, 2012

Int. Cl.: 9

TRADEMARK

PRINCIPAL REGISTER

S. P. RICHARDS COMPANY (GEORGIA CORPORATION)
P.O. BOX 1266
SMYRNA, GA 30081

FOR: CALL BELLS; COMPUTER STANDS SPECIALLY DESIGNED FOR HOLDING A COMPUTER, PRINTER AND ACCESSORIES; LAPTOP CARRYING CASES; MAGNIFYING GLASSES; PHOTOCOPY MACHINES, IN CLASS 9 (U.S. CLS. 21, 23, 26, 36 AND 38).

FIRST USE 0-0-1996; IN COMMERCE 0-0-1996.

THE MARK CONSISTS OF STANDARD CHARACTERS WITHOUT CLAIM TO ANY PARTICULAR FONT, STYLE, SIZE, OR COLOR.

OWNER OF U.S. REG. NO. 1,671,540.

SER. NO. 85-375,822, FILED 7-20-2011.

MATTHEW EINSTEIN, EXAMINING ATTORNEY



David J. Kybas

Director of the United States Patent and Trademark Office

United States of America

United States Patent and Trademark Office



Reg. No. 4,108,493

Registered Mar. 6, 2012

Int. Cl.: 19

TRADEMARK

PRINCIPAL REGISTER

JAIN (AMERICAS) INC. (OHIO CORPORATION)
1819 WALCUTT ROAD, SUITE I
COLUMBUS, OH 43228

FOR: NON-METAL DOOR AND WINDOW CASINGS, FRAMES AND TRIMS; NON-METAL BUILDING PRODUCTS, NAMELY, SHUTTERS, SHINGLES, AND SIDING, IN CLASS 19 (U.S. CLS. 1, 12, 33 AND 50).

FIRST USE 6-22-2010; IN COMMERCE 6-22-2010.

OWNER OF U.S. REG. NO. 4,022,598.

THE MARK CONSISTS OF A STYLIZED VERSION OF THE LETTERS "EF" WITH THE UPPER RIGHT PORTION OF THE LETTER "E" DEPICTING A LEAF.

SER. NO. 85-375,825, FILED 7-20-2011.

LINDA MICKLEBURGH, EXAMINING ATTORNEY



David J. Kybas

Director of the United States Patent and Trademark Office

United States of America

United States Patent and Trademark Office

Fruit & Vegetable Nutrition Made Easy!

Reg. No. 4,108,494

INNOCENZI, MARK (UNITED STATES INDIVIDUAL)
740 APPLE RIDGE RD
FRANKLIN LAKES, NJ 07417

Registered Mar. 6, 2012

Int. Cl.: 5

FOR: NUTRITIONAL SUPPLEMENTS, IN CLASS 5 (U.S. CLS. 6, 18, 44, 46, 51 AND 52).

TRADEMARK

FIRST USE 5-1-2011; IN COMMERCE 5-1-2011.

PRINCIPAL REGISTER

THE MARK CONSISTS OF STANDARD CHARACTERS WITHOUT CLAIM TO ANY PARTICULAR FONT, STYLE, SIZE, OR COLOR.

SER. NO. 85-375,841, FILED 7-20-2011.

AMY KERTGATE, EXAMINING ATTORNEY



David J. Kybas

Director of the United States Patent and Trademark Office

United States of America

United States Patent and Trademark Office

VISIO PLEX

Reg. No. 4,108,495

PROGRESSIVE LABORATORIES, INC. (TEXAS CORPORATION)
1701 WEST WALNUT HILL LANE
IRVING, TX 75038

Registered Mar. 6, 2012

Int. Cl.: 5

FOR: DIETARY NUTRITIONAL SUPPLEMENT USED FOR VISION SUPPORT, IN CLASS 5 (U.S. CLS. 6, 18, 44, 46, 51 AND 52).

TRADEMARK

FIRST USE 4-16-1992; IN COMMERCE 5-16-1992.

PRINCIPAL REGISTER

THE MARK CONSISTS OF STANDARD CHARACTERS WITHOUT CLAIM TO ANY PARTICULAR FONT, STYLE, SIZE, OR COLOR.

SER. NO. 85-375,922, FILED 7-20-2011.

KRISTIN DAHLING, EXAMINING ATTORNEY



David J. Kybas

Director of the United States Patent and Trademark Office

United States of America

United States Patent and Trademark Office

JUST2TRADE

Reg. No. 4,108,496

Registered Mar. 6, 2012

Int. Cl.: 36

SERVICE MARK

PRINCIPAL REGISTER

SUCCESS TRADE SECURITIES, INC. (D.C. CORPORATION)
1900 L STREET, N.W.
WASHINGTON, DC 20036

FOR: SECURITIES BROKERAGE SERVICES, ON-LINE SECURITIES TRADING SERVICES,
DISCOUNT SECURITIES BROKERAGE SERVICES, IN CLASS 36 (U.S. CLS. 100, 101 AND
102).

FIRST USE 12-0-2006; IN COMMERCE 12-0-2006.

THE MARK CONSISTS OF STANDARD CHARACTERS WITHOUT CLAIM TO ANY PAR-
TICULAR FONT, STYLE, SIZE, OR COLOR.

SER. NO. 85-375,938, FILED 7-20-2011.

DAVID H. STINE, EXAMINING ATTORNEY



David J. Kyffers

Director of the United States Patent and Trademark Office

United States of America

United States Patent and Trademark Office

The Hierarchy of Movement

Reg. No. 4,108,497

ALLARD KINETICS INC. (COLORADO CORPORATION)
3484 16TH CIRCLE
BOULDER, CO 80304

Registered Mar. 6, 2012

Int. Cl.: 44

FOR: BODYWORK THERAPY SERVICES, NAMELY MANUAL THERAPY, BREATH THERAPY AND MOVEMENT THERAPY, IN CLASS 44 (U.S. CLS. 100 AND 101).

SERVICE MARK

FIRST USE 3-26-2011; IN COMMERCE 3-26-2011.

PRINCIPAL REGISTER

THE MARK CONSISTS OF STANDARD CHARACTERS WITHOUT CLAIM TO ANY PARTICULAR FONT, STYLE, SIZE, OR COLOR.

SER. NO. 85-376,048, FILED 7-20-2011.

JOHN GARTNER, EXAMINING ATTORNEY



David J. Kybas

Director of the United States Patent and Trademark Office

United States of America

United States Patent and Trademark Office

MOXI Z

Reg. No. 4,108,498

Registered Mar. 6, 2012

Int. Cl.: 9

TRADEMARK

PRINCIPAL REGISTER

E I SPECTRA, LLC (DELAWARE LIMITED LIABILITY COMPANY)
19622 NORTHEAST 125TH COURT
WOODINVILLE, WA 98007

FOR: SCIENTIFIC MEASURING INSTRUMENTS, NAMELY, AUTOMATED PARTICLE COUNTING EQUIPMENT, SINGLE USE CELL COUNTING CASSETTES, IMMUNOFLUORESCENCE ANALYZERS, PIPETTES, PIPETTE TIPS, AND REPLACEMENT PARTS FOR THE SAME, ALL FOR CARRYING OUT CHEMICAL ANALYSES, TECHNICAL MEASUREMENTS AND TESTS, AND/OR COUNTING BIOLOGICAL CELLS AND PARTICLES, FOR BOTH DIAGNOSTIC AND NON-DIAGNOSTIC APPLICATIONS, IN CLASS 9 (U.S. CLS. 21, 23, 26, 36 AND 38).

FIRST USE 6-7-2011; IN COMMERCE 6-7-2011.

THE MARK CONSISTS OF STANDARD CHARACTERS WITHOUT CLAIM TO ANY PARTICULAR FONT, STYLE, SIZE, OR COLOR.

SER. NO. 85-376,056, FILED 7-20-2011.

AMY HELLA, EXAMINING ATTORNEY



David J. Kyffers

Director of the United States Patent and Trademark Office

United States of America

United States Patent and Trademark Office

BUILDING BRANDS IN THE ARTISAN ECONOMY

Reg. No. 4,108,499

Registered Mar. 6, 2012

Int. Cl.: 35

LAD COMMUNICATIONS, INC. (OREGON CORPORATION), DBA WATERSHED
COMMUNICATIONS, INC.

STE 100
431 NW FLANDERS
PORTLAND, OR 97209

SERVICE MARK

PRINCIPAL REGISTER

FOR: ADVERTISING AND MARKETING CONSULTANCY; ADVERTISING AND MARKET-
ING SERVICES PROVIDED BY MEANS OF INDIRECT METHODS OF MARKETING COM-
MUNICATIONS, NAMELY, SOCIAL MEDIA, SEARCH ENGINE MARKETING, INQUIRY
MARKETING, INTERNET MARKETING, MOBILE MARKETING, BLOGGING AND OTHER
FORMS OF PASSIVE, SHARABLE OR VIRAL COMMUNICATIONS CHANNELS; ADVERT-
ISING AND MARKETING SERVICES, NAMELY, PROMOTING THE GOODS AND SERVICES
OF OTHERS; ADVERTISING SERVICES, NAMELY, PROMOTING AND MARKETING THE
GOODS AND SERVICES OF OTHERS THROUGH ALL PUBLIC COMMUNICATION MEANS;
ADVERTISING SERVICES, PUBLIC RELATIONS AND MARKETING SERVICES, NAMELY,
PROMOTING AND MARKETING THE GOODS AND SERVICES OF OTHERS THROUGH
ALL PUBLIC COMMUNICATION MEANS; ARRANGING AND CONDUCTING MARKETING
PROMOTIONAL EVENTS FOR OTHERS; BUSINESS MANAGEMENT CONSULTING WITH
RELATION TO STRATEGY, MARKETING, SALES, OPERATION, PRODUCT DESIGN
PARTICULARLY SPECIALIZING IN THE USE OF ANALYTIC AND STATISTIC MODELS
FOR THE UNDERSTANDING AND PREDICTING OF CONSUMERS, BUSINESSES, AND
MARKET TRENDS AND ACTIONS; CREATIVE MARKETING DESIGN SERVICES; PUBLIC
RELATIONS, IN CLASS 35 (U.S. CLS. 100, 101 AND 102).

FIRST USE 11-1-2010; IN COMMERCE 11-1-2010.

THE MARK CONSISTS OF STANDARD CHARACTERS WITHOUT CLAIM TO ANY PAR-
TICULAR FONT, STYLE, SIZE, OR COLOR.

SER. NO. 85-376,067, FILED 7-20-2011.

JOHN SCHUYLER YARD, EXAMINING ATTORNEY



David J. Kyffers

Director of the United States Patent and Trademark Office

United States of America

United States Patent and Trademark Office

STADEA

Reg. No. 4,108,500

Registered Mar. 6, 2012

Int. Cl.: 7

TRADEMARK

PRINCIPAL REGISTER

EPORTAL LLC (CALIFORNIA LIMITED LIABILITY COMPANY)
2463 BRANNAN PL
SANTA CLARA, CA 95050

FOR: CORE DRILLING BITS; POWER-OPERATED GRINDING WHEELS; ABRASIVE WHEELS FOR POWER-OPERATED GRINDERS; ROUTER BITS; TOOL BITS FOR MACHINES; PADS FOR FLOOR POLISHING MACHINES; GRINDERS; BLADES FOR POWER SAWS; BLADES FOR POWER TOOLS; POWER SAW BLADES; DIAMOND-POINTED METAL-CUTTING TOOLS; FLAP DISCS FOR POWER-OPERATED GRINDERS; GRINDING AND POLISHING MACHINES; GRINDING TOOLS FOR GRINDING MACHINES; POLISHING DISCS FOR AUTOMATED WET-POLISHING MULTI-HEAD MACHINES; POLISHING SYSTEM FOR USE IN SINGLE-HEAD MACHINES COMPRISING GRINDING AND POLISHING DISCS FOR STONE PROFILING AND EDGES; POWER-OPERATED TOOLS, NAMELY, GRINDERS; MACHINE PARTS, NAMELY, POLISHING DISCS FOR FLOOR POLISHING MACHINES AND HAND-HELD POLISHING MACHINES, IN CLASS 7 (U.S. CLS. 13, 19, 21, 23, 31, 34 AND 35).

FIRST USE 3-1-2011; IN COMMERCE 5-1-2011.

THE MARK CONSISTS OF STANDARD CHARACTERS WITHOUT CLAIM TO ANY PARTICULAR FONT, STYLE, SIZE, OR COLOR.

SER. NO. 85-376,123, FILED 7-20-2011.

MARGERY A. TIERNEY, EXAMINING ATTORNEY



David J. Kyffers

Director of the United States Patent and Trademark Office

United States of America

United States Patent and Trademark Office

PIM

Reg. No. 4,108,501

Registered Mar. 6, 2012

Int. Cl.: 41

SERVICE MARK

PRINCIPAL REGISTER

PHILOSOPHY IN MOTION (WYOMING LIMITED LIABILITY COMPANY)
2710 THOMES AVE STE 577
CHEYENNE, WY 82001

FOR: EDUCATIONAL AND ENTERTAINMENT SERVICES, NAMELY, CONDUCTING SEMINARS, CLASSES, AND WORKSHOPS IN THE FIELD OF STORY AND SCRIPT WRITING AND DISTRIBUTION OF COURSE MATERIALS IN CONNECTION THEREWITH, AND EDUCATION CONSULTING RELATED THERETO, IN CLASS 41 (U.S. CLS. 100, 101 AND 107).

FIRST USE 5-15-2011; IN COMMERCE 7-16-2011.

THE MARK CONSISTS OF STANDARD CHARACTERS WITHOUT CLAIM TO ANY PARTICULAR FONT, STYLE, SIZE, OR COLOR.

SER. NO. 85-376,124, FILED 7-20-2011.

MARGERY A. TIERNEY, EXAMINING ATTORNEY



David J. Kybas

Director of the United States Patent and Trademark Office

United States of America

United States Patent and Trademark Office

INJOY

Reg. No. 4,108,502

Registered Mar. 6, 2012

Int. Cl.: 41

SERVICE MARK

PRINCIPAL REGISTER

INJOY PRESENTS LLC (CALIFORNIA LIMITED LIABILITY COMPANY)
6278 CHILDS AVENUE
SAN DIEGO, CA 92139

FOR: ARRANGING AND CONDUCTING NIGHTCLUB ENTERTAINMENT EVENTS; ARRANGING AND CONDUCTING NIGHTCLUB PARTIES; DISC JOCKEY SERVICES; DISC JOCKEYS FOR PARTIES AND SPECIAL EVENTS; MASTER OF CEREMONY SERVICES FOR PARTIES AND SPECIAL EVENTS; PARTY AND WEDDING PLANNING, COORDINATION AND CONSULTATION SERVICES; PROVIDING INFORMATION IN THE FIELD OF WEDDING PARTY PLANNING, IN CLASS 41 (U.S. CLS. 100, 101 AND 107).

FIRST USE 1-30-2000; IN COMMERCE 1-30-2000.

THE MARK CONSISTS OF STANDARD CHARACTERS WITHOUT CLAIM TO ANY PARTICULAR FONT, STYLE, SIZE, OR COLOR.

SER. NO. 85-376,161, FILED 7-20-2011.

JOHN DWYER, EXAMINING ATTORNEY



David J. Kyffers

Director of the United States Patent and Trademark Office

United States of America

United States Patent and Trademark Office

GOODSTOCK

Reg. No. 4,108,503

KNUPP & WATSON & WALLMAN, INC. (WISCONSIN CORPORATION)
5201 OLD MIDDLETON ROAD
MADISON, WI 53705

Registered Mar. 6, 2012

Int. Cl.: 35

FOR: ADVERTISING, MARKETING AND PROMOTION SERVICES, IN CLASS 35 (U.S. CLS. 100, 101 AND 102).

SERVICE MARK

FIRST USE 12-0-2004; IN COMMERCE 12-0-2004.

PRINCIPAL REGISTER

THE MARK CONSISTS OF STANDARD CHARACTERS WITHOUT CLAIM TO ANY PARTICULAR FONT, STYLE, SIZE, OR COLOR.

SER. NO. 85-376,180, FILED 7-20-2011.

CURTIS FRENCH, EXAMINING ATTORNEY



David J. Kyjars

Director of the United States Patent and Trademark Office

United States of America

United States Patent and Trademark Office

May the best price win

Reg. No. 4,108,504

YU, BENJAMIN (UNITED STATES INDIVIDUAL)
12952 STOCKTON AVE.
PLAINFIELD, IL 60585

Registered Mar. 6, 2012

Int. Cl.: 35

FOR: ELECTRONIC COMMERCE SERVICES, NAMELY, PROVIDING INFORMATION ABOUT PRODUCTS VIA TELECOMMUNICATION NETWORKS FOR ADVERTISING AND SALES PURPOSES, IN CLASS 35 (U.S. CLS. 100, 101 AND 102).

SERVICE MARK

FIRST USE 4-22-2011; IN COMMERCE 4-22-2011.

PRINCIPAL REGISTER

THE MARK CONSISTS OF STANDARD CHARACTERS WITHOUT CLAIM TO ANY PARTICULAR FONT, STYLE, SIZE, OR COLOR.

SER. NO. 85-376,240, FILED 7-20-2011.

TIMOTHY FINNEGAN, EXAMINING ATTORNEY



David J. Kybas

Director of the United States Patent and Trademark Office

United States of America

United States Patent and Trademark Office



Reg. No. 4,108,505

Registered Mar. 6, 2012

Int. Cls.: 25 and 26

TRADEMARK

PRINCIPAL REGISTER

CHELSEA BABY, LLC (MINNESOTA LIMITED LIABILITY COMPANY)
UNIT 5
1901 DUPONT AVE. SOUTH
MINNEAPOLIS, MN 55403

FOR: SHOES, IN CLASS 25 (U.S. CLS. 22 AND 39).

FIRST USE 2-26-2010; IN COMMERCE 2-26-2010.

FOR: SHOE ORNAMENTS NOT OF PRECIOUS METAL, IN CLASS 26 (U.S. CLS. 37, 39, 40, 42 AND 50).

FIRST USE 2-26-2010; IN COMMERCE 2-26-2010.

THE MARK CONSISTS OF THE LETTER C SURROUNDED BY AN ORNAMENTAL BORDER.

SER. NO. 85-376,320, FILED 7-20-2011.

WILLIAM BRECKENFELD, EXAMINING ATTORNEY



David J. Kybas

Director of the United States Patent and Trademark Office

United States of America

United States Patent and Trademark Office

ALPHA BOILERS

Reg. No. 4,108,506

Registered Mar. 6, 2012

Int. Cl.: 11

TRADEMARK

PRINCIPAL REGISTER

ALPHA BOILERS, INC. (DELAWARE CORPORATION)
3890 WEST FLAGLER STREET
MIAMI, FL 33134

FOR: INDUSTRIAL BOILERS, IN CLASS 11 (U.S. CLS. 13, 21, 23, 31 AND 34).

FIRST USE 12-31-1988; IN COMMERCE 12-31-1988.

THE MARK CONSISTS OF STANDARD CHARACTERS WITHOUT CLAIM TO ANY PARTICULAR FONT, STYLE, SIZE, OR COLOR.

NO CLAIM IS MADE TO THE EXCLUSIVE RIGHT TO USE "BOILERS", APART FROM THE MARK AS SHOWN.

SER. NO. 85-376,324, FILED 7-20-2011.

GEORGE LORENZO, EXAMINING ATTORNEY



David J. Kybas

Director of the United States Patent and Trademark Office

United States of America

United States Patent and Trademark Office

Pedal Power

Reg. No. 4,108,507

Registered Mar. 6, 2012

Int. Cl.: 35

SERVICE MARK

PRINCIPAL REGISTER

PORTLAND PEDAL POWER, LLC (OREGON LIMITED LIABILITY COMPANY)
PO BOX 8163
PORTLAND, OR 97207

FOR: ADVERTISING AND PROMOTIONAL SERVICES; ADVERTISING AND MARKETING SERVICES, NAMELY, PROMOTING THE GOODS AND SERVICES OF OTHERS; ADVERTISING, MARKETING AND PROMOTING THE GOODS AND SERVICES OF OTHERS USING BICYCLES; PROVIDING ADVERTISING SPACE ON BICYCLES; RENTAL OF ADVERTISING SPACE, IN CLASS 35 (U.S. CLS. 100, 101 AND 102).

FIRST USE 5-15-2009; IN COMMERCE 5-15-2009.

THE MARK CONSISTS OF STANDARD CHARACTERS WITHOUT CLAIM TO ANY PARTICULAR FONT, STYLE, SIZE, OR COLOR.

SER. NO. 85-376,357, FILED 7-20-2011.

JACLYN KIDWELL WALKER, EXAMINING ATTORNEY



David J. Kyffers

Director of the United States Patent and Trademark Office

United States of America

United States Patent and Trademark Office



Reg. No. 4,108,508

ALPHA BOILERS, INC. (DELAWARE CORPORATION)
3890 WEST FLAGLER STREET
MIAMI, FL 33134

Registered Mar. 6, 2012

Int. Cl.: 11

FOR: INDUSTRIAL BOILERS, IN CLASS 11 (U.S. CLS. 13, 21, 23, 31 AND 34).

TRADEMARK

FIRST USE 12-31-1988; IN COMMERCE 12-31-1988.

PRINCIPAL REGISTER

THE MARK CONSISTS OF THE STYLIZED LETTERING OF THE WORD ALPHA WITH A DESIGN OF A CIRCLE TO THE LEFT OF THE WORD ALPHA AND INSIDE OF THE CIRCLE ARE LINES THAT OVERLAP EACH OTHER. BEHIND THE CIRCLE THAT APPEARS TO THE LEFT OF THE WORD ALPHA IS A DESIGN OF A TRIANGLE.

SER. NO. 85-376,360, FILED 7-20-2011.

GEORGE LORENZO, EXAMINING ATTORNEY



David J. Kyfos

Director of the United States Patent and Trademark Office

United States of America

United States Patent and Trademark Office

Shepherd Ross

Reg. No. 4,108,509

SHEPHERD ROSS, P.C. (COLORADO CORPORATION)
1401 17TH STREET, SUITE 1050
DENVER, CO 80202

Registered Mar. 6, 2012

Int. Cl.: 45

FOR: LEGAL SERVICES, IN CLASS 45 (U.S. CLS. 100 AND 101).

SERVICE MARK

FIRST USE 7-1-2011; IN COMMERCE 7-1-2011.

PRINCIPAL REGISTER

THE MARK CONSISTS OF STANDARD CHARACTERS WITHOUT CLAIM TO ANY PARTICULAR FONT, STYLE, SIZE, OR COLOR.

SER. NO. 85-376,363, FILED 7-20-2011.

EDWARD NELSON, EXAMINING ATTORNEY



David J. Kyros

Director of the United States Patent and Trademark Office

United States of America

United States Patent and Trademark Office

BRAIN HOST

Reg. No. 4,108,510

Registered Mar. 6, 2012

Int. Cls.: 42 and 45

SERVICE MARK

PRINCIPAL REGISTER

BRAIN HOST, LLC (OHIO LIMITED LIABILITY COMPANY)
SUITE 363
3660 CENTER ROAD
BRECKSVILLE, OH 44218

FOR: DESIGN, CREATION, HOSTING, MAINTENANCE OF WEBSITES FOR OTHERS; DOMAIN NAME SEARCH SERVICES, NAMELY, CONDUCTING ONLINE COMPUTERIZED SEARCHES FOR THE AVAILABILITY OF DOMAIN NAMES ; E-MAIL SYSTEM DESIGN AND IMPLEMENTATION FOR OTHERS; UPDATING WEBSITES FOR OTHERS; WEB PUBLISHING, NAMELY, CREATING A WEBSITE AND UPLOADING IT ONTO AN INTERNET SERVER, IN CLASS 42 (U.S. CLS. 100 AND 101).

FIRST USE 8-24-2010; IN COMMERCE 8-24-2010.

FOR: DOMAIN NAME REGISTRATION SERVICES, IN CLASS 45 (U.S. CLS. 100 AND 101).

FIRST USE 8-24-2010; IN COMMERCE 8-24-2010.

THE MARK CONSISTS OF STANDARD CHARACTERS WITHOUT CLAIM TO ANY PARTICULAR FONT, STYLE, SIZE, OR COLOR.

NO CLAIM IS MADE TO THE EXCLUSIVE RIGHT TO USE "HOST", APART FROM THE MARK AS SHOWN.

SER. NO. 85-376,377, FILED 7-20-2011.

WENDY JUN, EXAMINING ATTORNEY



David J. Kyros

Director of the United States Patent and Trademark Office

United States of America

United States Patent and Trademark Office

ENCORE

Reg. No. 4,108,511

Registered Mar. 6, 2012

Int. Cl.: 37

SERVICE MARK

PRINCIPAL REGISTER

HARNISCHFEGER TECHNOLOGIES, INC. (DELAWARE CORPORATION)
2751 CENTERVILLE ROAD, SUITE 342
WILMINGTON, DE 19808

FOR: EXCHANGING AND REPAIRING MINING MACHINE COMPONENTS, IN CLASS 37
(U.S. CLS. 100, 103 AND 106).

FIRST USE 6-0-2007; IN COMMERCE 6-0-2007.

THE MARK CONSISTS OF STANDARD CHARACTERS WITHOUT CLAIM TO ANY PARTICULAR FONT, STYLE, SIZE, OR COLOR.

OWNER OF U.S. REG. NO. 3,301,217.

SER. NO. 85-376,393, FILED 7-20-2011.

EDWARD NELSON, EXAMINING ATTORNEY



David J. Kybas

Director of the United States Patent and Trademark Office

United States of America

United States Patent and Trademark Office

moveAtlas

Reg. No. 4,108,512

Registered Mar. 6, 2012

Int. Cl.: 42

SERVICE MARK

PRINCIPAL REGISTER

AWGI, LLC (DELAWARE LIMITED LIABILITY COMPANY)
1212 ST. GEORGE ROAD
EVANSVILLE, IN 47711

FOR: APPLICATION SERVICE PROVIDER (ASP) FEATURING SOFTWARE FOR USE IN THE SELECTION OF TRANSPORTATION AND STORAGE OF GOODS OF OTHERS AND TRANSPORTATION LOGISTICS SERVICES , IN CLASS 42 (U.S. CLS. 100 AND 101).

FIRST USE 7-15-2011; IN COMMERCE 7-15-2011.

THE MARK CONSISTS OF STANDARD CHARACTERS WITHOUT CLAIM TO ANY PARTICULAR FONT, STYLE, SIZE, OR COLOR.

OWNER OF U.S. REG. NOS. 3,119,627, 3,718,117 AND OTHERS.

SER. NO. 85-376,404, FILED 7-20-2011.

HENRY S. ZAK, EXAMINING ATTORNEY



David J. Kyffers

Director of the United States Patent and Trademark Office

United States of America

United States Patent and Trademark Office



Reg. No. 4,108,513

Registered Mar. 6, 2012

Int. Cl.: 25

COMERCIALIZADORA COLOSO, S.A. DE C.V. (MEXICO CORPORATION)
MALECON DEL RIO #103
COL. LA MARTINICA
LEÓN, GTO., MEXICO 37500

FOR: FOOTWEAR, IN CLASS 25 (U.S. CLS. 22 AND 39).

TRADEMARK

FIRST USE 3-6-2007; IN COMMERCE 4-20-2010.

PRINCIPAL REGISTER

THE MARK CONSISTS OF THE WORD COLOSO IN STYLIZED LETTERS INSIDE A FOUR SIDED BANNER.

THE ENGLISH TRANSLATION OF COLOSO IN THE MARK IS COLOSSUS.

SER. NO. 85-376,413, FILED 7-20-2011.

GEOFFREY FOSDICK, EXAMINING ATTORNEY



David J. Kybas

Director of the United States Patent and Trademark Office

United States of America

United States Patent and Trademark Office

ATEMA

Reg. No. 4,108,514

Registered Mar. 6, 2012

Int. Cls.: 35 and 41

SERVICE MARK

PRINCIPAL REGISTER

ATEMA, INC. (ILLINOIS CORPORATION)
742 N. LASALLE DRIVE SUITE 400
CHICAGO, IL 60654

FOR: BUSINESS MANAGEMENT AND CONSULTATION IN THE FIELD OF STEEL ERECTION AND FABRICATION, IN CLASS 35 (U.S. CLS. 100, 101 AND 102).

FIRST USE 0-0-2003; IN COMMERCE 0-0-2003.

FOR: EDUCATIONAL SERVICES, NAMELY, PROVIDING SEMINARS, WORKSHOPS AND ON-SITE TRAINING IN THE FIELDS OF STEEL ERECTION AND FABRICATION, IN CLASS 41 (U.S. CLS. 100, 101 AND 107).

FIRST USE 0-0-2003; IN COMMERCE 0-0-2003.

THE MARK CONSISTS OF STANDARD CHARACTERS WITHOUT CLAIM TO ANY PARTICULAR FONT, STYLE, SIZE, OR COLOR.

SER. NO. 85-376,425, FILED 7-20-2011.

ANNE FARRELL, EXAMINING ATTORNEY



David J. Kyros

Director of the United States Patent and Trademark Office

United States of America

United States Patent and Trademark Office

GBC

Reg. No. 4,108,515

GREENBALL CORPORATION (CALIFORNIA CORPORATION)
222 S. HARBOR BOULEVARD - SUITE 700
ANAHEIM, CA 92805

Registered Mar. 6, 2012

Int. Cl.: 12

FOR: INNER TUBES FOR VEHICLE TIRES; TIRES FOR VEHICLES, IN CLASS 12 (U.S. CLS. 19, 21, 23, 31, 35 AND 44).

TRADEMARK

FIRST USE 9-1-2000; IN COMMERCE 9-1-2000.

PRINCIPAL REGISTER

THE MARK CONSISTS OF STANDARD CHARACTERS WITHOUT CLAIM TO ANY PARTICULAR FONT, STYLE, SIZE, OR COLOR.

OWNER OF U.S. REG. NOS. 2,985,054 AND 3,562,016.

SER. NO. 85-376,436, FILED 7-20-2011.

BENJAMIN OKEKE, EXAMINING ATTORNEY



David J. Kybas

Director of the United States Patent and Trademark Office

United States of America

United States Patent and Trademark Office

KEYS WORLD

Reg. No. 4,108,516

Registered Mar. 6, 2012

Int. Cl.: 43

SERVICE MARK

PRINCIPAL REGISTER

KEYS WORLD, INC. (FLORIDA CORPORATION)
C/O JERRY D. LUPTAK
18720 MACK AVE, STE 220
GROSSE POINTE FARMS, MI 48236

FOR: MAKING HOTEL RESERVATIONS FOR OTHERS, IN CLASS 43 (U.S. CLS. 100 AND 101).

FIRST USE 6-1-2003; IN COMMERCE 6-1-2003.

THE MARK CONSISTS OF STANDARD CHARACTERS WITHOUT CLAIM TO ANY PARTICULAR FONT, STYLE, SIZE, OR COLOR.

SER. NO. 85-376,451, FILED 7-20-2011.

ROBIN CHOSID, EXAMINING ATTORNEY



David J. Kyffers

Director of the United States Patent and Trademark Office

United States of America

United States Patent and Trademark Office

PROSTA GLAN

Reg. No. 4,108,517

PROGRESSIVE LABORATORIES, INC. (TEXAS CORPORATION)
1701 WEST WALNUT HILL LANE
IRVING, TX 75038

Registered Mar. 6, 2012

Int. Cl.: 5

FOR: DIETARY NUTRITIONAL SUPPLEMENT USED FOR PROSTATE SUPPORT, IN CLASS 5 (U.S. CLS. 6, 18, 44, 46, 51 AND 52).

TRADEMARK

FIRST USE 1-28-1991; IN COMMERCE 2-28-1991.

PRINCIPAL REGISTER

THE MARK CONSISTS OF STANDARD CHARACTERS WITHOUT CLAIM TO ANY PARTICULAR FONT, STYLE, SIZE, OR COLOR.

SER. NO. 85-376,474, FILED 7-20-2011.

KRISTIN DAHLING, EXAMINING ATTORNEY



David J. Kybas

Director of the United States Patent and Trademark Office

United States of America

United States Patent and Trademark Office

THE FINANCIAL GOURMET

Reg. No. 4,108,518

Registered Mar. 6, 2012

Int. Cl.: 36

SERVICE MARK

PRINCIPAL REGISTER

FINANCIAL GOURMET LICENSING, LLC (MISSOURI LIMITED LIABILITY COMPANY)
805 WEST US HIGHWAY 50
O'FALLON, IL 62269

FOR: FINANCIAL ADVISORY AND CONSULTANCY SERVICES; INVESTMENT AND INSURANCE CONSULTANCY AND BROKERAGE SERVICES, IN CLASS 36 (U.S. CLS. 100, 101 AND 102).

FIRST USE 1-0-2007; IN COMMERCE 1-0-2007.

THE MARK CONSISTS OF STANDARD CHARACTERS WITHOUT CLAIM TO ANY PARTICULAR FONT, STYLE, SIZE, OR COLOR.

NO CLAIM IS MADE TO THE EXCLUSIVE RIGHT TO USE "FINANCIAL", APART FROM THE MARK AS SHOWN.

SER. NO. 85-376,500, FILED 7-20-2011.

VERNA BETH RIRIE, EXAMINING ATTORNEY



David J. Kybas

Director of the United States Patent and Trademark Office

United States of America

United States Patent and Trademark Office

MICROSPUN

Reg. No. 4,108,519

Registered Mar. 6, 2012

Int. Cl.: 23

TRADEMARK

PRINCIPAL REGISTER

ORCHARD YARN AND THREAD COMPANY, INC. (NEW YORK CORPORATION), DBA
LION BRAND YARN COMPANY
34 WEST 15TH STREET
NEW YORK, NY 10011

FOR: KNITTING AND CROCHET YARNS, IN CLASS 23 (U.S. CL. 43).

FIRST USE 6-19-2001; IN COMMERCE 6-19-2001.

THE MARK CONSISTS OF STANDARD CHARACTERS WITHOUT CLAIM TO ANY PARTICULAR FONT, STYLE, SIZE, OR COLOR.

SER. NO. 85-376,508, FILED 7-20-2011.

COURTNEY ALVAREZ, EXAMINING ATTORNEY



David J. Kybas

Director of the United States Patent and Trademark Office

United States of America

United States Patent and Trademark Office

NAKED CLEAN

Reg. No. 4,108,520

ONE STEP (CALIFORNIA CORPORATION)
1409 TURQUOISE DRIVE
CARLSBAD, CA 92011

Registered Mar. 6, 2012

Int. Cl.: 3

FOR: ALL-PURPOSE CLEANERS, SPECIFICALLY EXCLUDING PERSONAL CARE PRODUCTS, IN CLASS 3 (U.S. CLS. 1, 4, 6, 50, 51 AND 52).

TRADEMARK

FIRST USE 6-30-2008; IN COMMERCE 10-17-2009.

PRINCIPAL REGISTER

THE MARK CONSISTS OF STANDARD CHARACTERS WITHOUT CLAIM TO ANY PARTICULAR FONT, STYLE, SIZE, OR COLOR.

OWNER OF U.S. REG. NOS. 3,615,338 AND 3,721,156.

NO CLAIM IS MADE TO THE EXCLUSIVE RIGHT TO USE "CLEAN", APART FROM THE MARK AS SHOWN.

SER. NO. 85-376,567, FILED 7-20-2011.

LINDA MICKLEBURGH, EXAMINING ATTORNEY



David J. Kyffers

Director of the United States Patent and Trademark Office

United States of America

United States Patent and Trademark Office

adorn & flourish

Reg. No. 4,108,521

PETERSON, KATE (UNITED STATES INDIVIDUAL)
1347 NAVELLIER ST
EL CERRITO, CA 94530

Registered Mar. 6, 2012

Int. Cl.: 14

FOR: JEWELRY, IN CLASS 14 (U.S. CLS. 2, 27, 28 AND 50).

TRADEMARK

FIRST USE 8-1-2006; IN COMMERCE 8-1-2006.

PRINCIPAL REGISTER

THE MARK CONSISTS OF STANDARD CHARACTERS WITHOUT CLAIM TO ANY PARTICULAR FONT, STYLE, SIZE, OR COLOR.

SER. NO. 85-376,636, FILED 7-20-2011.

DEZMONA MIZELLE, EXAMINING ATTORNEY



David J. Kyros

Director of the United States Patent and Trademark Office

United States of America

United States Patent and Trademark Office

OUTKICK THE COVERAGE

Reg. No. 4,108,522

Registered Mar. 6, 2012

Int. Cl.: 41

SERVICE MARK

PRINCIPAL REGISTER

OUTKICK THE COVERAGE, LLC (TENNESSEE LIMITED LIABILITY COMPANY)
921 WARREN STREET
NASHVILLE, TN 37208

FOR: ENTERTAINMENT IN THE NATURE OF PROVIDING AN INFORMATIONAL AND ENTERTAINMENT WEBSITE IN THE FIELDS OF CELEBRITY GOSSIP, ENTERTAINMENT, SPORTS AND FITNESS , IN CLASS 41 (U.S. CLS. 100, 101 AND 107).

FIRST USE 7-20-2011; IN COMMERCE 7-20-2011.

THE MARK CONSISTS OF STANDARD CHARACTERS WITHOUT CLAIM TO ANY PARTICULAR FONT, STYLE, SIZE, OR COLOR.

SER. NO. 85-376,723, FILED 7-20-2011.

B. PARADEWELAI, EXAMINING ATTORNEY



David J. Kyffers

Director of the United States Patent and Trademark Office

United States of America

United States Patent and Trademark Office

wise

Reg. No. 4,108,523

Registered Mar. 6, 2012

Int. Cl.: 41

SERVICE MARK

PRINCIPAL REGISTER

WORKING IN SUPPORT OF EDUCATION, INC. (NEW YORK NON-PROFIT CORPORATION)
227 EAST 56TH STREET, SUITE 201
NEW YORK, NY 10022

FOR: PROVIDING PHILANTHROPIC AND VOLUNTEER SERVICES IN THE NATURE OF DEVELOPING PROJECT BASED EDUCATIONAL COURSES TO STUDENTS WHICH DEVELOP A FEASIBLE PROPOSAL FOR COMMUNITY IMPROVEMENT; CREATING EDUCATIONAL COURSES WHICH PROMOTE FINANCIAL KNOWLEDGE AND SKILLS AMONG YOUNG ADULTS; OFFERING COURSES AND CONSULTING IN CREATING COURSES ON THE HIGH SCHOOL LEVEL FOR URBAN ENVIRONMENTS; CREATING SEMINARS FOR YOUNG ADULTS WHICH EXAMINE VARIOUS CAREER OPPORTUNITIES AND THE TRANSITION FROM SCHOOL TO THE WORK PLACE, THROUGH WORKPLACE SKILLS DEVELOPMENT AND CAREER WORK EXPERIENCE, IN CLASS 41 (U.S. CLS. 100, 101 AND 107).

FIRST USE 12-1-1998; IN COMMERCE 12-1-1998.

OWNER OF U.S. REG. NOS. 2,966,502 AND 2,966,503.

THE MARK CONSISTS OF THE WORD WISE IN STYLIZED TYPEFACE, WITH AN EXCLAMATION POINT REPRESENTING THE LETTER I.

SER. NO. 85-376,739, FILED 7-20-2011.

B. PARADEWELAI, EXAMINING ATTORNEY



David J. Kyffers

Director of the United States Patent and Trademark Office

United States of America

United States Patent and Trademark Office

TrailerMedix

Reg. No. 4,108,524

Registered Mar. 6, 2012

Int. Cl.: 37

SERVICE MARK

PRINCIPAL REGISTER

TRAILERMEDIX INC. (GEORGIA CORPORATION)
SUITE 5244
4115 COLUMBIA ROAD
MARTINEZ, GA 30907

FOR: INSTALLATION, MAINTENANCE AND REPAIR OF TRAILERS AND TRAILER TOWING EQUIPMENT, IN CLASS 37 (U.S. CLS. 100, 103 AND 106).

FIRST USE 7-1-2011; IN COMMERCE 7-14-2011.

THE MARK CONSISTS OF STANDARD CHARACTERS WITHOUT CLAIM TO ANY PARTICULAR FONT, STYLE, SIZE, OR COLOR.

SER. NO. 85-376,785, FILED 7-20-2011.

BRIAN PINO, EXAMINING ATTORNEY



David J. Kyffers

Director of the United States Patent and Trademark Office

United States of America

United States Patent and Trademark Office

IT EXTEND

Reg. No. 4,108,525

Registered Mar. 6, 2012

Int. Cl.: 42

SERVICE MARK

PRINCIPAL REGISTER

INTEGRATECHS, INC. (UTAH CORPORATION)
SUITE 103
315 SOUTH 500 EAST
AMERICAN FORK, UT 84003

FOR: PROVIDING VIRTUAL COMPUTER SYSTEMS AND VIRTUAL COMPUTER ENVIRONMENTS THROUGH CLOUD COMPUTING, IN CLASS 42 (U.S. CLS. 100 AND 101).

FIRST USE 3-11-2011; IN COMMERCE 7-19-2011.

THE MARK CONSISTS OF STANDARD CHARACTERS WITHOUT CLAIM TO ANY PARTICULAR FONT, STYLE, SIZE, OR COLOR.

NO CLAIM IS MADE TO THE EXCLUSIVE RIGHT TO USE "IT", APART FROM THE MARK AS SHOWN.

SER. NO. 85-376,829, FILED 7-21-2011.

JAMES GRIFFIN, EXAMINING ATTORNEY



David J. Kyffers

Director of the United States Patent and Trademark Office

United States of America

United States Patent and Trademark Office

IT DATASAFE

Reg. No. 4,108,526

Registered Mar. 6, 2012

Int. Cl.: 42

SERVICE MARK

PRINCIPAL REGISTER

INTEGRATECHS, INC. (UTAH CORPORATION)
SUITE 103
315 SOUTH 500 EAST
AMERICAN FORK, UT 84003

FOR: REMOTE COMPUTER BACKUP SERVICES, IN CLASS 42 (U.S. CLS. 100 AND 101).

FIRST USE 3-11-2011; IN COMMERCE 7-19-2011.

THE MARK CONSISTS OF STANDARD CHARACTERS WITHOUT CLAIM TO ANY PARTICULAR FONT, STYLE, SIZE, OR COLOR.

NO CLAIM IS MADE TO THE EXCLUSIVE RIGHT TO USE "IT", APART FROM THE MARK AS SHOWN.

SER. NO. 85-376,832, FILED 7-21-2011.

JAMES GRIFFIN, EXAMINING ATTORNEY



David J. Kyffers

Director of the United States Patent and Trademark Office

United States of America

United States Patent and Trademark Office

IT REMOTEPRO

Reg. No. 4,108,527

Registered Mar. 6, 2012

Int. Cl.: 42

SERVICE MARK

PRINCIPAL REGISTER

INTEGRATECHS, INC. (UTAH CORPORATION)
SUITE 103
315 SOUTH 500 EAST
AMERICAN FORK, UT 84003

FOR: COMPUTER AND NETWORK MONITORING SERVICE WHICH TRACKS THE PERFORMANCE AND AVAILABILITY OF COMPUTER AND NETWORK SYSTEMS OF OTHERS, PROVIDES REPORTING AND ALERTING REGARDING SUCH PERFORMANCE AND AVAILABILITY, AND PROVIDES ALERTS CONCERNING SUCH PERFORMANCE AND AVAILABILITY, IN CLASS 42 (U.S. CLS. 100 AND 101).

FIRST USE 3-11-2011; IN COMMERCE 7-19-2011.

THE MARK CONSISTS OF STANDARD CHARACTERS WITHOUT CLAIM TO ANY PARTICULAR FONT, STYLE, SIZE, OR COLOR.

NO CLAIM IS MADE TO THE EXCLUSIVE RIGHT TO USE "IT", APART FROM THE MARK AS SHOWN.

SER. NO. 85-376,834, FILED 7-21-2011.

JAMES GRIFFIN, EXAMINING ATTORNEY



David J. Kyffers

Director of the United States Patent and Trademark Office

United States of America

United States Patent and Trademark Office

KINNEXA

Reg. No. 4,108,528

Registered Mar. 6, 2012

Int. Cl.: 9

TRADEMARK

PRINCIPAL REGISTER

HUANG, YA-HUI (TAIWAN INDIVIDUAL)
NO. 28, LIXING ST., WEST DIST.,
CHIAYI CITY, TAIWAN 600

FOR: ELECTRICAL CONNECTORS, IN CLASS 9 (U.S. CLS. 21, 23, 26, 36 AND 38).

FIRST USE 5-31-2011; IN COMMERCE 5-31-2011.

THE MARK CONSISTS OF THE STYLIZED WORD "KINNEXA".

SER. NO. 85-376,851, FILED 7-21-2011.

JULIE GUTTADAURO, EXAMINING ATTORNEY



David J. Kybas

Director of the United States Patent and Trademark Office

United States of America

United States Patent and Trademark Office

THE SOFISTAFUNK RX

Reg. No. 4,108,529

Registered Mar. 6, 2012

Int. Cl.: 25

TRADEMARK

PRINCIPAL REGISTER

MCINTOSH, ARLINDA A (UNITED STATES INDIVIDUAL)
474 BLOOMFIELD AVENUE
VERONA, NJ 07044

FOR: BOTTOMS; KNIT BOTTOMS; KNIT SKIRTS; SKIRTS; SKIRTS AND DRESSES; TRAVEL CLOTHING CONTAINED IN A PACKAGE COMPRISING REVERSIBLE JACKETS, PANTS, SKIRTS, TOPS AND A BELT OR SCARF; WOMEN'S CLOTHING, NAMELY, SHIRTS, DRESSES, SKIRTS, BLOUSES; WOVEN BOTTOMS; WOVEN SKIRTS, IN CLASS 25 (U.S. CLS. 22 AND 39).

FIRST USE 9-5-2009; IN COMMERCE 9-5-2009.

THE MARK CONSISTS OF STANDARD CHARACTERS WITHOUT CLAIM TO ANY PARTICULAR FONT, STYLE, SIZE, OR COLOR.

OWNER OF U.S. REG. NO. 2,825,143.

NO CLAIM IS MADE TO THE EXCLUSIVE RIGHT TO USE "THE", APART FROM THE MARK AS SHOWN.

SER. NO. 85-376,857, FILED 7-21-2011.

SANDRA BUJA, EXAMINING ATTORNEY



David J. Kybas

Director of the United States Patent and Trademark Office

United States of America

United States Patent and Trademark Office

BUY ONE GIVE SIGHT

Reg. No. 4,108,530

Registered Mar. 6, 2012

Int. Cl.: 9

TRADEMARK

PRINCIPAL REGISTER

ROCKRIDGE CAPITAL, LLC (CALIFORNIA LIMITED PARTNERSHIP), DBA SHAUNS
SHADES
6015 MANCHESTER DRIVE
OAKLAND, CA 94618

FOR: CASES FOR EYEGLASSES AND SUNGLASSES; EYEWEAR, NAMELY, SUNGLASSES,
EYEGLASSES AND OPHTHALMIC FRAMES AND CASES THEREFOR; GOGGLES FOR
SPORTS, IN CLASS 9 (U.S. CLS. 21, 23, 26, 36 AND 38).

FIRST USE 5-31-2011; IN COMMERCE 5-31-2011.

THE MARK CONSISTS OF STANDARD CHARACTERS WITHOUT CLAIM TO ANY PAR-
TICULAR FONT, STYLE, SIZE, OR COLOR.

SER. NO. 85-376,862, FILED 7-21-2011.

ROSELLE HERRERA, EXAMINING ATTORNEY



David J. Kybas

Director of the United States Patent and Trademark Office

United States of America

United States Patent and Trademark Office

WE DO IT DIFFERENTLY!

Reg. No. 4,108,531

Registered Mar. 6, 2012

Int. Cl.: 42

SERVICE MARK

PRINCIPAL REGISTER

RAMA KRISHNA, PASUMARTHY (INDIA INDIVIDUAL)
KANURU, NEAR AUTO NAGAR BUS TERMINAL
FF8, VIJAYA LAKSHMI TOWERS-2, SANATH NAGAR
VIJAYAWADA, AP, INDIA 520007

FOR: COMPUTER AND TECHNOLOGICAL PROFESSIONAL SERVICES; NAMELY PROVIDING INFORMATION IN THE FIELDS OF TECHNOLOGY AND SOFTWARE DEVELOPMENT VIA AN ON-LINE WEBSITE, IN CLASS 42 (U.S. CLS. 100 AND 101).

FIRST USE 7-19-2011; IN COMMERCE 7-19-2011.

THE MARK CONSISTS OF STANDARD CHARACTERS WITHOUT CLAIM TO ANY PARTICULAR FONT, STYLE, SIZE, OR COLOR.

SER. NO. 85-376,892, FILED 7-21-2011.

BENJAMIN OKEKE, EXAMINING ATTORNEY



David J. Kybas

Director of the United States Patent and Trademark Office

United States of America

United States Patent and Trademark Office

SOMEDAYS

Reg. No. 4,108,532

Registered Mar. 6, 2012

Int. Cl.: 25

TRADEMARK

PRINCIPAL REGISTER

LIANG JIAN WEI (AUSTRALIA INDIVIDUAL)
19 / 20 BELMORE ST BURWOOD
NSW, AUSTRALIA 2134 AND

RACHEL ANN EVANS (AUSTRALIA INDIVIDUAL)
18 LEWISHAM STREET DULWICH HILL
NSW, AUSTRALIA 2203

FOR: BEACH COVER-UPS; COATS; COLLARS; GIRDLES; JACKETS; JERSEYS; JUMPERS;
LEATHER COATS; PULLOVERS; SHIRTS; SINGLETS; SKIRTS; SWEATERS; TEE SHIRTS;
TROUSERS, IN CLASS 25 (U.S. CLS. 22 AND 39).

FIRST USE 3-17-2010; IN COMMERCE 3-17-2010.

SER. NO. 85-376,896, FILED 7-21-2011.

KATHERINE CHANG, EXAMINING ATTORNEY



David J. Kybas

Director of the United States Patent and Trademark Office

United States of America

United States Patent and Trademark Office

I-vision

Reg. No. 4,108,533

Registered Mar. 6, 2012

Int. Cl.: 9

TRADEMARK

PRINCIPAL REGISTER

SHENZHEN I VISION ELECTRONICS CO., LTD. (CHINA LIMITED COMPANY (LTD.))
NORTH, 1ST FLOOR, BLDG 124, 1ST IND PARK
GUO WEI RD, LIANTANG, LUOHU DISTRICT
SHENZHEN 518004, CHINA

FOR: ANSWERING MACHINES; CAMCORDERS; COMPUTER CAMERAS; COMPUTER PERIPHERAL DEVICES; PICKUPS; REMOTE CONTROLS FOR RADIOS, TELEVISIONS, STEREOS; SOUND ALARMS; THEFT ALARMS; VIDEO MONITORS; VIDEO RECORDERS, IN CLASS 9 (U.S. CLS. 21, 23, 26, 36 AND 38).

FIRST USE 9-1-2006; IN COMMERCE 12-27-2006.

THE MARK CONSISTS OF THE STYLIZED WORD "I-VISION" INSIDE AN INCOMPLETE OVAL.

SER. NO. 85-376,898, FILED 7-21-2011.

BENJAMIN OKEKE, EXAMINING ATTORNEY



David J. Kybas

Director of the United States Patent and Trademark Office

United States of America

United States Patent and Trademark Office

STRATASYS

Reg. No. 4,108,534

Registered Mar. 6, 2012

Int. Cl.: 40

SERVICE MARK

PRINCIPAL REGISTER

STRATASYS, INC. (DELAWARE CORPORATION)
7665 COMMERCE WAY
EDEN PRAIRIE, MN 55344

FOR: FABRICATION AND FINISHING SERVICES, NAMELY, FABRICATION AND POST-PRODUCTION FINISHING OF PARTS, MODELS, PROTOTYPES, JIGS AND FIXTURES TO THE ORDER AND SPECIFICATION OF OTHERS , IN CLASS 40 (U.S. CLS. 100, 103 AND 106).

FIRST USE 1-31-1990; IN COMMERCE 1-31-1990.

THE MARK CONSISTS OF STANDARD CHARACTERS WITHOUT CLAIM TO ANY PARTICULAR FONT, STYLE, SIZE, OR COLOR.

OWNER OF U.S. REG. NOS. 1,762,444, 2,611,577, AND 3,122,441.

SER. NO. 85-376,918, FILED 7-21-2011.

SANI KHOURI, EXAMINING ATTORNEY



David J. Kybas

Director of the United States Patent and Trademark Office

United States of America

United States Patent and Trademark Office

CAFÉ PILON

Reg. No. 4,108,535

Registered Mar. 6, 2012

Int. Cl.: 30

TRADEMARK

PRINCIPAL REGISTER

ROWLAND COFFEE ROASTERS, INC. (OHIO CORPORATION)
ONE STRAWBERRY LANE
ORRVILLE, OH 44667

FOR: COFFEE, IN CLASS 30 (U.S. CL. 46).

FIRST USE 1-23-1951; IN COMMERCE 1-23-1951.

THE MARK CONSISTS OF STANDARD CHARACTERS WITHOUT CLAIM TO ANY PARTICULAR FONT, STYLE, SIZE, OR COLOR.

OWNER OF U.S. REG. NOS. 536,894, 3,190,107, AND 3,271,169.

NO CLAIM IS MADE TO THE EXCLUSIVE RIGHT TO USE "CAFE", APART FROM THE MARK AS SHOWN.

THE WORDING "PILON" HAS NO MEANING IN A FOREIGN LANGUAGE.

SER. NO. 85-376,927, FILED 7-21-2011.

LAKEISHA LEWIS, EXAMINING ATTORNEY



David J. Kybas

Director of the United States Patent and Trademark Office

United States of America

United States Patent and Trademark Office

Wear Your Self Out

Reg. No. 4,108,536

Registered Mar. 6, 2012

Int. Cl.: 25

TRADEMARK

PRINCIPAL REGISTER

MUSEWEAR LLC (WYOMING LIMITED LIABILITY COMPANY)
SUITE 47674
PO BOX 37635
PHILADELPHIA, PA 19101

FOR: FLIP FLOPS, IN CLASS 25 (U.S. CLS. 22 AND 39).

FIRST USE 7-20-2011; IN COMMERCE 7-20-2011.

THE MARK CONSISTS OF STANDARD CHARACTERS WITHOUT CLAIM TO ANY PARTICULAR FONT, STYLE, SIZE, OR COLOR.

SER. NO. 85-376,943, FILED 7-21-2011.

RENEE MCCRAY, EXAMINING ATTORNEY



David J. Kybas

Director of the United States Patent and Trademark Office

United States of America

United States Patent and Trademark Office

HAPPY PARK

Reg. No. 4,108,537

INFINIDY CORP. (CANADA CORPORATION)
THE HUB - 151 CHARLES STREET, SUITE 100
KITCHENER, ONTARIO, CANADA N2G1H6

Registered Mar. 6, 2012

Int. Cl.: 9

FOR: DOWNLOADABLE ELECTRONIC GAME PROGRAM, IN CLASS 9 (U.S. CLS. 21, 23, 26, 36 AND 38).

TRADEMARK

FIRST USE 7-20-2011; IN COMMERCE 7-20-2011.

PRINCIPAL REGISTER

THE MARK CONSISTS OF STANDARD CHARACTERS WITHOUT CLAIM TO ANY PARTICULAR FONT, STYLE, SIZE, OR COLOR.

SER. NO. 85-376,961, FILED 7-21-2011.

BARBARA A. GOLD, EXAMINING ATTORNEY



David J. Kybas

Director of the United States Patent and Trademark Office

United States of America

United States Patent and Trademark Office

CARMARSH

Reg. No. 4,108,538

1-800-FLOWERS.COM, INC. (DELAWARE CORPORATION)
ONE OLD COUNTRY ROAD, SUITE 500
CARLE PLACE, NY 11514

Registered Mar. 6, 2012

Int. Cl.: 30

FOR: CHOCOLATE CANDIES, NAMELY LAYERS OF CARAMEL AND MARSHMALLOW COVERED IN CHOCOLATE, IN CLASS 30 (U.S. CL. 46).

TRADEMARK

FIRST USE 0-0-1965; IN COMMERCE 0-0-1965.

PRINCIPAL REGISTER

THE MARK CONSISTS OF STANDARD CHARACTERS WITHOUT CLAIM TO ANY PARTICULAR FONT, STYLE, SIZE, OR COLOR.

SER. NO. 85-376,965, FILED 7-21-2011.

MATTHEW KLINE, EXAMINING ATTORNEY



David J. Kybas

Director of the United States Patent and Trademark Office

United States of America

United States Patent and Trademark Office

SWITCHVOX

Reg. No. 4,108,539

Registered Mar. 6, 2012

Int. Cls.: 9 and 42

TRADEMARK

SERVICE MARK

PRINCIPAL REGISTER

DIGIUM, INC. (DELAWARE CORPORATION)
445 JAN DAVIS DRIVE
HUNTSVILLE, AL 35806

FOR: COMPUTER TELEPHONY SOFTWARE; COMPUTER TELEPHONY HARDWARE; UNIFIED COMMUNICATIONS HARDWARE; UNIFIED COMMUNICATIONS SOFTWARE; TELEPHONES; SOFTWARE FOR USE WITH TELEPHONE COMMUNICATIONS; DATA COMMUNICATIONS HARDWARE FOR TRANSMITTING HUMAN COMMUNICATIONS; DATA COMMUNICATIONS HARDWARE FOR TRANSMITTING HUMAN COMMUNICATIONS, IN CLASS 9 (U.S. CLS. 21, 23, 26, 36 AND 38).

FIRST USE 3-0-2005; IN COMMERCE 3-0-2005.

FOR: TECHNICAL SUPPORT SERVICES, NAMELY, TROUBLESHOOTING IN THE NATURE OF DIAGNOSING COMPUTER HARDWARE AND SOFTWARE PROBLEMS, IN CLASS 42 (U.S. CLS. 100 AND 101).

FIRST USE 3-0-2005; IN COMMERCE 3-0-2005.

THE MARK CONSISTS OF STANDARD CHARACTERS WITHOUT CLAIM TO ANY PARTICULAR FONT, STYLE, SIZE, OR COLOR.

OWNER OF U.S. REG. NOS. 3,091,712, 3,465,465, AND 3,470,373.

SER. NO. 85-376,968, FILED 7-21-2011.

TRACY FLETCHER, EXAMINING ATTORNEY



David J. Kyros

Director of the United States Patent and Trademark Office

United States of America

United States Patent and Trademark Office

ACULYN

Reg. No. 4,108,540

ROHM AND HAAS COMPANY (DELAWARE CORPORATION)
100 INDEPENDENCE MALL WEST
PHILADELPHIA, PA 191062399

Registered Mar. 6, 2012

Int. Cl.: 1

FOR: CHEMICALS FOR USE IN THE MANUFACTURE OF PERSONAL CARE PREPARATIONS, IN CLASS 1 (U.S. CLS. 1, 5, 6, 10, 26 AND 46).

TRADEMARK

FIRST USE 4-19-1990; IN COMMERCE 4-19-1990.

PRINCIPAL REGISTER

THE MARK CONSISTS OF STANDARD CHARACTERS WITHOUT CLAIM TO ANY PARTICULAR FONT, STYLE, SIZE, OR COLOR.

OWNER OF U.S. REG. NO. 1,653,377.

SER. NO. 85-376,979, FILED 7-21-2011.

TARAH HARDY, EXAMINING ATTORNEY



David J. Kybas

Director of the United States Patent and Trademark Office

United States of America
United States Patent and Trademark Office

LIQUIGARD

Reg. No. 4,108,541

Registered Mar. 6, 2012

Int. Cl.: 1

TRADEMARK

PRINCIPAL REGISTER

FIRESTONE BUILDING PRODUCTS COMPANY, LLC (INDIANA LIMITED LIABILITY COMPANY)
250 W. 96TH STREET
INDIANAPOLIS, IN 46260

FOR: ROOFING ADHESIVE, IN CLASS 1 (U.S. CLS. 1, 5, 6, 10, 26 AND 46).

FIRST USE 6-15-2011; IN COMMERCE 6-15-2011.

THE MARK CONSISTS OF STANDARD CHARACTERS WITHOUT CLAIM TO ANY PARTICULAR FONT, STYLE, SIZE, OR COLOR.

SER. NO. 85-376,989, FILED 7-21-2011.

JAMES A. RAUEN, EXAMINING ATTORNEY



David J. Kybas

Director of the United States Patent and Trademark Office

United States of America

United States Patent and Trademark Office

WHERE HEAT MEETS SWEET

Reg. No. 4,108,542

Registered Mar. 6, 2012

Int. Cl.: 30

TRADEMARK

PRINCIPAL REGISTER

TRINI MIKE'S, INC. (FLORIDA CORPORATION)
6538 COLLINS AVE, #373
MIAMI BEACH, FL 33141

FOR: CONDIMENT, NAMELY, PEPPER SAUCE, IN CLASS 30 (U.S. CL. 46).

FIRST USE 4-20-2009; IN COMMERCE 4-20-2009.

THE MARK CONSISTS OF STANDARD CHARACTERS WITHOUT CLAIM TO ANY PARTICULAR FONT, STYLE, SIZE, OR COLOR.

SER. NO. 85-376,999, FILED 7-21-2011.

ZACHARY BELLO, EXAMINING ATTORNEY



David J. Kyffers

Director of the United States Patent and Trademark Office

United States of America

United States Patent and Trademark Office

Mentor or Die

Reg. No. 4,108,543

Registered Mar. 6, 2012

Int. Cl.: 25

TRADEMARK

PRINCIPAL REGISTER

HALL, KEVIN (UNITED STATES INDIVIDUAL)
#6
12426 CANAL DR.
RANCHO CUCAMONGA, CA 91739

FOR: T-SHIRTS, IN CLASS 25 (U.S. CLS. 22 AND 39).

FIRST USE 4-1-2011; IN COMMERCE 5-7-2011.

THE MARK CONSISTS OF STANDARD CHARACTERS WITHOUT CLAIM TO ANY PARTICULAR FONT, STYLE, SIZE, OR COLOR.

SER. NO. 85-377,013, FILED 7-21-2011.

WENDY JUN, EXAMINING ATTORNEY



David J. Kybas

Director of the United States Patent and Trademark Office

United States of America
United States Patent and Trademark Office

REDIDOG

Reg. No. 4,108,544

COGENT SOLUTIONS GROUP LLC (KENTUCKY LIMITED LIABILITY COMPANY)
P.O. BOX 11686
LEXINGTON, KY 40577

Registered Mar. 6, 2012

Int. Cl.: 5

FOR: JOINT SUPPLEMENT FOR ANIMALS, IN CLASS 5 (U.S. CLS. 6, 18, 44, 46, 51 AND 52).

TRADEMARK

FIRST USE 10-30-2008; IN COMMERCE 10-30-2008.

PRINCIPAL REGISTER

THE MARK CONSISTS OF STANDARD CHARACTERS WITHOUT CLAIM TO ANY PARTICULAR FONT, STYLE, SIZE, OR COLOR.

SER. NO. 85-377,017, FILED 7-21-2011.

ANDREA HACK, EXAMINING ATTORNEY



David J. Kyffers

Director of the United States Patent and Trademark Office

United States of America
United States Patent and Trademark Office

ECOFLEX

Reg. No. 4,108,545

Registered Mar. 6, 2012

Int. Cl.: 27

TRADEMARK

PRINCIPAL REGISTER

MOHAWK CARPET DISTRIBUTION, INC. (DELAWARE CORPORATION)
P.O. BOX 12069
CALHOUN, GA 30703

FOR: CARPET BACKING, IN CLASS 27 (U.S. CLS. 19, 20, 37, 42 AND 50).

FIRST USE 12-15-1999; IN COMMERCE 12-15-1999.

THE MARK CONSISTS OF STANDARD CHARACTERS WITHOUT CLAIM TO ANY PARTICULAR FONT, STYLE, SIZE, OR COLOR.

SER. NO. 85-377,026, FILED 7-21-2011.

TRACY FLETCHER, EXAMINING ATTORNEY



David J. Kybas

Director of the United States Patent and Trademark Office

United States of America

United States Patent and Trademark Office

MOJAVE

Reg. No. 4,108,546

FOUR GREEN FIELDS LLC (NEW YORK LIMITED LIABILITY COMPANY)
140 SEVENTH AVENUE SOUTH
NEW YORK, NY 11030

Registered Mar. 6, 2012

Int. Cl.: 43

FOR: RESTAURANT SERVICES, IN CLASS 43 (U.S. CLS. 100 AND 101).

SERVICE MARK

FIRST USE 1-31-2007; IN COMMERCE 1-31-2007.

PRINCIPAL REGISTER

THE MARK CONSISTS OF STANDARD CHARACTERS WITHOUT CLAIM TO ANY PARTICULAR FONT, STYLE, SIZE, OR COLOR.

SER. NO. 85-377,027, FILED 7-21-2011.

JEAN IM, EXAMINING ATTORNEY



David J. Kybas

Director of the United States Patent and Trademark Office

United States of America

United States Patent and Trademark Office

INSOUCIANT

Reg. No. 4,108,547

Registered Mar. 6, 2012

Int. Cl.: 9

TRADEMARK

PRINCIPAL REGISTER

TERMINAL DESIGN INC. (NEW YORK CORPORATION)
125 CONGRESS STREET
BROOKLYN, NY 11201

FOR: PRINTING FONTS THAT CAN BE DOWNLOADED PROVIDED BY MEANS OF ELECTRONIC TRANSMISSION; TYPEFACE FONTS RECORDED ON MAGNETIC MEDIA, IN CLASS 9 (U.S. CLS. 21, 23, 26, 36 AND 38).

FIRST USE 7-20-2011; IN COMMERCE 7-20-2011.

THE MARK CONSISTS OF STANDARD CHARACTERS WITHOUT CLAIM TO ANY PARTICULAR FONT, STYLE, SIZE, OR COLOR.

SER. NO. 85-377,033, FILED 7-21-2011.

KHANH LE, EXAMINING ATTORNEY



David J. Kybas

Director of the United States Patent and Trademark Office

United States of America

United States Patent and Trademark Office

Robot Heart

Reg. No. 4,108,548

MUELLER, GEORGE G. (UNITED STATES INDIVIDUAL)
C/O 8 WEST 40TH STREET 12TH FLOOR
NEW YORK, NY 10018

Registered Mar. 6, 2012

Int. Cls.: 9, 25 and 41

FOR: PROTECTIVE AND/OR ANTI-GLARE EYEWEAR, NAMELY SUNGLASSES, GOGGLES AND SPECTACLES, IN CLASS 9 (U.S. CLS. 21, 23, 26, 36 AND 38).

TRADEMARK

FIRST USE 8-1-2008; IN COMMERCE 8-1-2008.

SERVICE MARK

FOR: CLOTHING, NAMELY, JACKETS, SHIRTS, TEE SHIRTS, PANTS, SKIRTS, VESTS, SCARVES AND SWEATERS; FOOTWEAR, NAMELY, SLIPPERS AND SANDALS; HEADGEAR, NAMELY, HATS AND CAPS, IN CLASS 25 (U.S. CLS. 22 AND 39).

PRINCIPAL REGISTER

FIRST USE 8-1-2008; IN COMMERCE 8-1-2008.

FOR: ENTERTAINMENT SERVICES IN THE NATURE OF DANCE CLUB SERVICES FEATURING LIVE AND PRE-RECORDED MUSIC, VIDEOS AND DANCING; ORGANIZATION OF MUSIC FESTIVALS, IN CLASS 41 (U.S. CLS. 100, 101 AND 107).

FIRST USE 8-1-2008; IN COMMERCE 8-1-2008.

THE MARK CONSISTS OF STANDARD CHARACTERS WITHOUT CLAIM TO ANY PARTICULAR FONT, STYLE, SIZE, OR COLOR.

SER. NO. 85-377,046, FILED 7-21-2011.

RUSS HERMAN, EXAMINING ATTORNEY



David J. Kypos

Director of the United States Patent and Trademark Office

United States of America

United States Patent and Trademark Office

SKOAL X-TRA

Reg. No. 4,108,549

Registered Mar. 6, 2012

Int. Cl.: 34

TRADEMARK

PRINCIPAL REGISTER

U.S. SMOKELESS TOBACCO MANUFACTURING COMPANY LLC (VIRGINIA LIMITED LIABILITY COMPANY)
6603 WEST BROAD STREET
RICHMOND, VA 23230

FOR: TOBACCO PRODUCTS, NAMELY, SMOKELESS TOBACCO, IN CLASS 34 (U.S. CLS. 2, 8, 9 AND 17).

FIRST USE 3-14-2011; IN COMMERCE 3-14-2011.

THE MARK CONSISTS OF STANDARD CHARACTERS WITHOUT CLAIM TO ANY PARTICULAR FONT, STYLE, SIZE, OR COLOR.

OWNER OF U.S. REG. NOS. 504,609, 1,344,928 AND OTHERS.

SER. NO. 85-377,058, FILED 7-21-2011.

CURTIS FRENCH, EXAMINING ATTORNEY



David J. Kyffers

Director of the United States Patent and Trademark Office

United States of America

United States Patent and Trademark Office



Reg. No. 4,108,550

Registered Mar. 6, 2012

Int. Cl.: 25

TRADEMARK

PRINCIPAL REGISTER

SIMPLICITY4ME (NEW YORK LIMITED LIABILITY COMPANY)
2A
2674 MARION AVENUE
BRONX, NY 10458

FOR: BUTTON DOWN SHIRTS; CAPS; HOODED SWEATSHIRTS; JEANS; SHOES; T-SHIRTS;
UNDER GARMENTS, IN CLASS 25 (U.S. CLS. 22 AND 39).

FIRST USE 3-1-2010; IN COMMERCE 3-1-2010.

THE MARK CONSISTS OF A TREE WITH A STRONG TRUNK WITH THICK AND THIN
BRANCHES.

SER. NO. 85-377,059, FILED 7-21-2011.

TARAH HARDY, EXAMINING ATTORNEY



David J. Kyffers

Director of the United States Patent and Trademark Office

United States of America

United States Patent and Trademark Office

Hog-n-The Road

Reg. No. 4,108,551

DEKOSTER, CHRISTOPHER (UNITED STATES INDIVIDUAL)
6589 EAGLE RIDGE RD
WALKER, MN 56484

Registered Mar. 6, 2012

Int. Cl.: 43

FOR: CATERING SERVICES; RESTAURANT SERVICES, IN CLASS 43 (U.S. CLS. 100 AND 101).

SERVICE MARK

FIRST USE 3-1-2009; IN COMMERCE 6-20-2009.

PRINCIPAL REGISTER

THE MARK CONSISTS OF STANDARD CHARACTERS WITHOUT CLAIM TO ANY PARTICULAR FONT, STYLE, SIZE, OR COLOR.

SER. NO. 85-377,062, FILED 7-21-2011.

JOHN WILKE, EXAMINING ATTORNEY



David J. Kybas

Director of the United States Patent and Trademark Office

United States of America

United States Patent and Trademark Office

SKOAL READYCUT

Reg. No. 4,108,552

Registered Mar. 6, 2012

Int. Cl.: 34

TRADEMARK

PRINCIPAL REGISTER

U.S. SMOKELESS TOBACCO MANUFACTURING COMPANY LLC (VIRGINIA LIMITED LIABILITY COMPANY)
6603 WEST BROAD STREET
RICHMOND, VA 23230

FOR: TOBACCO PRODUCTS, NAMELY, SMOKELESS TOBACCO, IN CLASS 34 (U.S. CLS. 2, 8, 9 AND 17).

FIRST USE 3-14-2011; IN COMMERCE 3-14-2011.

THE MARK CONSISTS OF STANDARD CHARACTERS WITHOUT CLAIM TO ANY PARTICULAR FONT, STYLE, SIZE, OR COLOR.

OWNER OF U.S. REG. NOS. 504,609, 1,344,928 AND OTHERS.

SER. NO. 85-377,082, FILED 7-21-2011.

CURTIS FRENCH, EXAMINING ATTORNEY



David J. Kyffers

Director of the United States Patent and Trademark Office

United States of America

United States Patent and Trademark Office

COPENHAGEN SNUS

Reg. No. 4,108,553

Registered Mar. 6, 2012

Int. Cl.: 34

TRADEMARK

PRINCIPAL REGISTER

U.S. SMOKELESS TOBACCO MANUFACTURING COMPANY LLC (VIRGINIA LIMITED LIABILITY COMPANY)
6603 WEST BROAD STREET
RICHMOND, VA 23230

FOR: TOBACCO PRODUCTS, NAMELY, SMOKELESS TOBACCO, IN CLASS 34 (U.S. CLS. 2, 8, 9 AND 17).

FIRST USE 2-28-2011; IN COMMERCE 2-28-2011.

THE MARK CONSISTS OF STANDARD CHARACTERS WITHOUT CLAIM TO ANY PARTICULAR FONT, STYLE, SIZE, OR COLOR.

OWNER OF U.S. REG. NOS. 504,609, 1,344,928 AND OTHERS.

NO CLAIM IS MADE TO THE EXCLUSIVE RIGHT TO USE "SNUS", APART FROM THE MARK AS SHOWN.

SER. NO. 85-377,097, FILED 7-21-2011.

CURTIS FRENCH, EXAMINING ATTORNEY



David J. Kyffers

Director of the United States Patent and Trademark Office

United States of America

United States Patent and Trademark Office

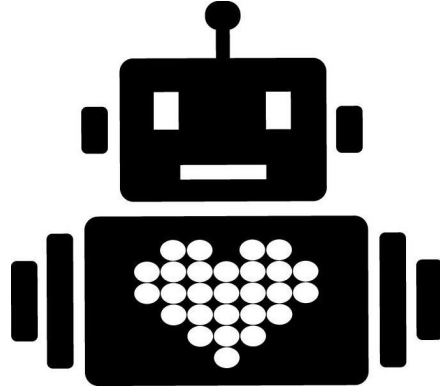

Reg. No. 4,108,554

Registered Mar. 6, 2012

Int. Cls.: 9, 25 and 41

TRADEMARK

SERVICE MARK

PRINCIPAL REGISTER

MUELLER, GEORGE, G. (UNITED STATES INDIVIDUAL)
C/O 8 WEST 40TH ST 12TH FLOOR
NEW YORK, NY 10018

FOR: PROTECTIVE AND/OR ANTI-GLARE EYEWEAR, NAMELY SUNGLASSES, GOGGLES AND SPECTACLES, IN CLASS 9 (U.S. CLS. 21, 23, 26, 36 AND 38).

FIRST USE 8-1-2008; IN COMMERCE 8-1-2008.

FOR: CLOTHING, NAMELY, JACKETS, SHIRTS, TEE SHIRTS, PANTS, SKIRTS, VESTS, SCARVES AND SWEATERS; FOOTWEAR, NAMELY, SLIPPERS AND SANDALS; HEADGEAR, NAMELY, HATS AND CAPS, IN CLASS 25 (U.S. CLS. 22 AND 39).

FIRST USE 8-1-2008; IN COMMERCE 8-1-2008.

FOR: ENTERTAINMENT SERVICES IN THE NATURE OF DANCE CLUB SERVICES FEATURING LIVE AND PRE-RECORDED MUSIC, VIDEOS AND DANCING; ORGANIZATION OF MUSIC FESTIVALS, IN CLASS 41 (U.S. CLS. 100, 101 AND 107).

FIRST USE 8-1-2008; IN COMMERCE 8-1-2008.

THE MARK CONSISTS OF A STYLIZED SILHOUETTE OF THE HEAD AND TORSO OF A TOY ROBOT WITH THE IMAGE OF A HEART IN THE CENTER OF THE TORSO COMPRISED OF 27 DOTS.

SER. NO. 85-377,099, FILED 7-21-2011.

RON FAIRBANKS, EXAMINING ATTORNEY



David J. Kybas

Director of the United States Patent and Trademark Office

United States of America

United States Patent and Trademark Office

THYROMETRIX

Reg. No. 4,108,555

Registered Mar. 6, 2012

Int. Cl.: 10

TRADEMARK

PRINCIPAL REGISTER

SCREENING DEVICES CANADA INC. (CANADA CORPORATION)
2127 ROUTE 124
HATFIELD POINT, NB, CANADA E5T2P8

FOR: APPARATUS FOR CLINICAL DIAGNOSIS, IN CLASS 10 (U.S. CLS. 26, 39 AND 44).

FIRST USE 5-24-2011; IN COMMERCE 6-17-2011.

THE MARK CONSISTS OF STANDARD CHARACTERS WITHOUT CLAIM TO ANY PARTICULAR FONT, STYLE, SIZE, OR COLOR.

SER. NO. 85-377,119, FILED 7-21-2011.

SANJEEV VOHRA, EXAMINING ATTORNEY



David J. Kybas

Director of the United States Patent and Trademark Office

United States of America

United States Patent and Trademark Office

VIVOLO DI SASSO

Reg. No. 4,108,556

CASA VINICOLA BOTTER CARLO & C. (C.V.B.C.) S.P.A. (ITALY JOINT STOCK COMPANY)
VIA CADORNA N. 17

Registered Mar. 6, 2012

FOSSALTA DI PIAVE (VE), ITALY 30020

Int. Cl.: 33

FOR: WINES AND SPARKLING WINES, IN CLASS 33 (U.S. CLS. 47 AND 49).

TRADEMARK

FIRST USE 0-0-2009; IN COMMERCE 0-0-2009.

PRINCIPAL REGISTER

THE MARK CONSISTS OF STANDARD CHARACTERS WITHOUT CLAIM TO ANY PARTICULAR FONT, STYLE, SIZE, OR COLOR.

THE ENGLISH TRANSLATION OF DI SASSO IN THE MARK IS OF STONE. THE WORDING VIVOLO HAS NO MEANING IN A FOREIGN LANGUAGE.

SER. NO. 85-377,129, FILED 7-21-2011.

ALICIA COLLINS, EXAMINING ATTORNEY



David J. Kybas

Director of the United States Patent and Trademark Office

United States of America

United States Patent and Trademark Office

You Are "Nuts" If You Drink & Drive

Reg. No. 4,108,557

Registered Mar. 6, 2012

Int. Cl.: 29

TRADEMARK

PRINCIPAL REGISTER

LUCKY LOTTO SNACKS, INC. (PENNSYLVANIA CORPORATION)
750 WASHINGTON ROAD, APT. 1403
PITTSBURGH, PA 15228

FOR: ROASTED NUTS, IN CLASS 29 (U.S. CL. 46).

FIRST USE 6-6-2011; IN COMMERCE 6-6-2011.

THE MARK CONSISTS OF STANDARD CHARACTERS WITHOUT CLAIM TO ANY PARTICULAR FONT, STYLE, SIZE, OR COLOR.

SER. NO. 85-377,148, FILED 7-21-2011.

ELI HELLMAN, EXAMINING ATTORNEY



David J. Kybas

Director of the United States Patent and Trademark Office

United States of America

United States Patent and Trademark Office

HITECHTRADER.COM

Reg. No. 4,108,558

THETA ENTERPRISES INC. (NEW JERSEY CORPORATION), DBA HITECHTRADER.COM
136 HULME STREET
MOUNT HOLLY, NJ 08060

Registered Mar. 6, 2012

Int. Cl.: 35

FOR: ONLINE RETAIL STORE FEATURING NEW AND USED LABORATORY AND PROCESS EQUIPMENT AND SUPPLIES, IN CLASS 35 (U.S. CLS. 100, 101 AND 102).

SERVICE MARK

FIRST USE 6-28-1999; IN COMMERCE 6-28-1999.

PRINCIPAL REGISTER

THE MARK CONSISTS OF STANDARD CHARACTERS WITHOUT CLAIM TO ANY PARTICULAR FONT, STYLE, SIZE, OR COLOR.

SER. NO. 85-377,153, FILED 7-21-2011.

KATHY DE JONGE, EXAMINING ATTORNEY



David J. Kybas

Director of the United States Patent and Trademark Office

United States of America

United States Patent and Trademark Office

HITCHSWITCH

Reg. No. 4,108,559

Registered Mar. 6, 2012

Int. Cl.: 42

SERVICE MARK

PRINCIPAL REGISTER

HITCHSWITCH INC. (NEW YORK CORPORATION)
P.O BOX 425
BRONX, NY 10471

FOR: PROVIDING A WEBSITE FEATURING ON-LINE NON-DOWNLOADABLE SOFTWARE THAT ENABLES USERS TO CHANGE THEIR NAME, IN CLASS 42 (U.S. CLS. 100 AND 101).

FIRST USE 2-24-2011; IN COMMERCE 2-24-2011.

THE MARK CONSISTS OF STANDARD CHARACTERS WITHOUT CLAIM TO ANY PARTICULAR FONT, STYLE, SIZE, OR COLOR.

SER. NO. 85-377,174, FILED 7-21-2011.

JILL C. ALT, EXAMINING ATTORNEY



David J. Kybas

Director of the United States Patent and Trademark Office

United States of America

United States Patent and Trademark Office

YOU HITCH, WE SWITCH

Reg. No. 4,108,560

Registered Mar. 6, 2012

Int. Cl.: 42

SERVICE MARK

PRINCIPAL REGISTER

HITCHSWITCH INC. (NEW YORK CORPORATION)
P.O BOX 425
BRONX, NY 10471

FOR: PROVIDING A WEBSITE FEATURING ON-LINE NON-DOWNLOADABLE SOFTWARE THAT ENABLES USERS TO CHANGE THEIR NAME, IN CLASS 42 (U.S. CLS. 100 AND 101).

FIRST USE 2-24-2011; IN COMMERCE 2-24-2011.

THE MARK CONSISTS OF STANDARD CHARACTERS WITHOUT CLAIM TO ANY PARTICULAR FONT, STYLE, SIZE, OR COLOR.

SER. NO. 85-377,179, FILED 7-21-2011.

JILL C. ALT, EXAMINING ATTORNEY



David J. Kybas

Director of the United States Patent and Trademark Office

United States of America

United States Patent and Trademark Office

CHAINLINKS

Reg. No. 4,108,561

Registered Mar. 6, 2012

Int. Cl.: 39

SERVICE MARK

PRINCIPAL REGISTER

LOYOLA UNIVERSITY CHICAGO (ILLINOIS CORPORATION)
ATTN. LOYOLA LIMITED ADVISOR
820 N. MICHIGAN AVE. SUITE 1406
CHICAGO, IL 60611

FOR: BICYCLE RENTAL, IN CLASS 39 (U.S. CLS. 100 AND 105).

FIRST USE 4-1-2011; IN COMMERCE 6-1-2011.

THE MARK CONSISTS OF STANDARD CHARACTERS WITHOUT CLAIM TO ANY PARTICULAR FONT, STYLE, SIZE, OR COLOR.

SER. NO. 85-377,180, FILED 7-21-2011.

JOHN HWANG, EXAMINING ATTORNEY



David J. Kyffers

Director of the United States Patent and Trademark Office

United States of America

United States Patent and Trademark Office

KICKS IS CRACK

Reg. No. 4,108,562

DRY GDS (NEW YORK CORPORATION)
1152 W 19TH ST.
NEW YORK, NY 10026

Registered Mar. 6, 2012

Int. Cl.: 25

FOR: HATS; JACKETS; SWEATSHIRTS; T-SHIRTS, IN CLASS 25 (U.S. CLS. 22 AND 39).

TRADEMARK

FIRST USE 1-1-2004; IN COMMERCE 1-1-2004.

PRINCIPAL REGISTER

THE MARK CONSISTS OF STANDARD CHARACTERS WITHOUT CLAIM TO ANY PARTICULAR FONT, STYLE, SIZE, OR COLOR.

SER. NO. 85-377,202, FILED 7-21-2011.

EMILY CARLSEN, EXAMINING ATTORNEY



David J. Kybas

Director of the United States Patent and Trademark Office

United States of America

United States Patent and Trademark Office

All My Payments

Reg. No. 4,108,563

Registered Mar. 6, 2012

Int. Cl.: 36

SERVICE MARK

PRINCIPAL REGISTER

TECT SECT HOLDINGS, LLC (CALIFORNIA LIMITED LIABILITY COMPANY), DBA
ECREDABLE, LLC
PO BOX 634
ALPHARETTA, GA 30009

FOR: CREDIT REPORTING AGENCY; CREDIT REPORTING SERVICES; CREDIT SCORING
SERVICES; EVALUATION OF THE CREDIT WORTHINESS OF COMPANIES AND PRIVATE
INDIVIDUALS, IN CLASS 36 (U.S. CLS. 100, 101 AND 102).

FIRST USE 6-14-2011; IN COMMERCE 6-14-2011.

THE MARK CONSISTS OF STANDARD CHARACTERS WITHOUT CLAIM TO ANY PAR-
TICULAR FONT, STYLE, SIZE, OR COLOR.

SER. NO. 85-377,206, FILED 7-21-2011.

JOHN HWANG, EXAMINING ATTORNEY



David J. Kyffers

Director of the United States Patent and Trademark Office

United States of America

United States Patent and Trademark Office

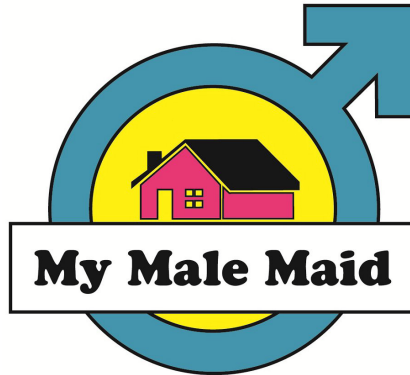

Reg. No. 4,108,564

Registered Mar. 6, 2012

Int. Cl.: 37

SERVICE MARK

PRINCIPAL REGISTER

MY MALE MAID, LLC (FLORIDA LIMITED LIABILITY COMPANY)
165 HERITAGE WAY
WEST PALM BEACH, FL 33407

FOR: CLEANING OF BUILDINGS; CLEANING OF COMMERCIAL PREMISES; CLEANING OF RESIDENTIAL HOUSES, IN CLASS 37 (U.S. CLS. 100, 103 AND 106).

FIRST USE 1-0-2011; IN COMMERCE 1-0-2011.

NO CLAIM IS MADE TO THE EXCLUSIVE RIGHT TO USE "MALE MAID", APART FROM THE MARK AS SHOWN.

THE COLOR(S) WHITE, BLUE, YELLOW, BLACK, PINK IS/ARE CLAIMED AS A FEATURE OF THE MARK.

THE MARK CONSISTS OF MALE SYMBOL IN BLUE AND OUTLINED IN BLACK WITH THE INTERIOR YELLOW. WITHIN THE YELLOW IS A BLACK AND PINK HOUSE. OVER BOTH THE SYMBOL IS A BLACK OUTLINED WHITE RECTANGLE WITH MY MALE MAID IN BLACK STYLIZED LETTERS.

SER. NO. 85-377,221, FILED 7-21-2011.

SUE LAWRENCE, EXAMINING ATTORNEY



David J. Kybas

Director of the United States Patent and Trademark Office

United States of America

United States Patent and Trademark Office

ALTUS

Reg. No. 4,108,565

Registered Mar. 6, 2012

Int. Cls.: 36 and 37

SERVICE MARK

PRINCIPAL REGISTER

ALTUS PROPERTIES, LLC (MISSOURI LIMITED LIABILITY COMPANY)
10561 OLD OLIVE STREET ROAD, SUITE 200
ST. LOUIS, MO 63141

FOR: REAL ESTATE SERVICES, NAMELY, THE ACQUISITION, LEASING, AND MANAGEMENT OF COMMERCIAL REAL ESTATE, IN CLASS 36 (U.S. CLS. 100, 101 AND 102).

FIRST USE 7-0-2007; IN COMMERCE 7-0-2007.

FOR: REAL ESTATE DEVELOPMENT OF COMMERCIAL PROPERTY, IN CLASS 37 (U.S. CLS. 100, 103 AND 106).

FIRST USE 7-0-2007; IN COMMERCE 7-0-2007.

THE MARK CONSISTS OF STANDARD CHARACTERS WITHOUT CLAIM TO ANY PARTICULAR FONT, STYLE, SIZE, OR COLOR.

OWNER OF U.S. REG. NO. 3,858,842.

SER. NO. 85-377,256, FILED 7-21-2011.

LAURIE KAUFMAN, EXAMINING ATTORNEY



David J. Kybas

Director of the United States Patent and Trademark Office

United States of America

United States Patent and Trademark Office

CIPADECK

Reg. No. 4,108,566

Registered Mar. 6, 2012

Int. Cls.: 1 and 2

TRADEMARK

PRINCIPAL REGISTER

87317 CANADA LIMITED (CANADA LIMITED COMPANY (LTD.)), DBA CPD
CONSTRUCTION PRODUCTS
219 CONNIE CRESCENT, UNIT 13
CONCORD, ONTARIO, CANADA L4K1L4

FOR: SOLVENT BASED VOC COMPLIANT CONCRETE CURING AND SEALING COM-
POUND USED ON NEW AND OLD CONCRETE TO FACILITATE PROPER CURING AND
SEALING; SOLVENT BASED VOC COMPLIANT CONCRETE AND PAVER SEALER USED
TO SEAL AND PROTECT CURED CONCRETE AND PAVER STONES, IN CLASS 1 (U.S.
CLS. 1, 5, 6, 10, 26 AND 46).

FIRST USE 9-0-2010; IN COMMERCE 9-0-2010.

FOR: EPOXY COATING USED ON STEEL BRIDGE DECKS TO PROTECT AGAINST HEAVY
DUTY TRAFFIC AND ADVERSE WEATHER CONDITIONS, IN CLASS 2 (U.S. CLS. 6, 11
AND 16).

FIRST USE 12-0-2008; IN COMMERCE 12-0-2008.

THE MARK CONSISTS OF STANDARD CHARACTERS WITHOUT CLAIM TO ANY PAR-
TICULAR FONT, STYLE, SIZE, OR COLOR.

SER. NO. 85-377,263, FILED 7-21-2011.

CHRIS WELLS, EXAMINING ATTORNEY



David J. Kyffers

Director of the United States Patent and Trademark Office

United States of America

United States Patent and Trademark Office

GOLDRUN

Reg. No. 4,108,567

Registered Mar. 6, 2012

Int. Cls.: 9 and 35

TRADEMARK

SERVICE MARK

PRINCIPAL REGISTER

GOLDRUN CORPORATION (DELAWARE CORPORATION)
4TH FLOOR
132 EAST 28TH STREET
NEW YORK, NY 10016

FOR: COMPUTER APPLICATION SOFTWARE FOR MOBILE PHONES, NAMELY, SOFTWARE FOR ENABLING USERS TO SEE, INTERACT WITH AND TAKE PICTURES OF GPS-LINKED VIRTUAL OBJECTS POSITIONED IN THE REAL WORLD, USING INTERACTIVE AUGMENTED REALITY TO ENGAGE CONSUMERS, INCREASE PRODUCT SALES, INCREASE BRAND LOYALTY, DRIVE TRAFFIC TO BOTH PHYSICAL AND ONLINE DESTINATIONS AND TO FACILITATE ONLINE ADVERTISING, MARKETING, REWARDS PROGRAMS, INCENTIVE PROGRAMS AND LOYALTY PROGRAMS OF OTHERS, IN CLASS 9 (U.S. CLS. 21, 23, 26, 36 AND 38).

FIRST USE 11-1-2010; IN COMMERCE 11-1-2010.

FOR: ADVERTISING, MARKETING AND PROMOTION SERVICES; PROMOTING THE GOODS AND SERVICES OF OTHERS BY PROVIDING ADVERTISEMENTS, PROMOTIONAL DISPLAYS, PURCHASING INCENTIVES AND REWARDS, VIRTUAL TOURS, CONTESTS, SCAVENGER HUNTS AND INTERACTIVE AUGMENTED REALITY VIA MOBILE PHONES AND OTHER WIRELESS COMMUNICATIONS DEVICES; PROMOTING THE GOODS AND SERVICES OF OTHERS VIA A GLOBAL COMPUTER NETWORK, IN CLASS 35 (U.S. CLS. 100, 101 AND 102).

FIRST USE 11-1-2010; IN COMMERCE 11-1-2010.

THE MARK CONSISTS OF STANDARD CHARACTERS WITHOUT CLAIM TO ANY PARTICULAR FONT, STYLE, SIZE, OR COLOR.

SER. NO. 85-377,303, FILED 7-21-2011.

DAVID I, EXAMINING ATTORNEY



David J. Kyffers

Director of the United States Patent and Trademark Office

United States of America
United States Patent and Trademark Office

QUALIROOF

Reg. No. 4,108,568

APT ACQUISITION CORP. (GEORGIA CORPORATION)
109 CONICA LANE
HARMONY, PA 16037

Registered Mar. 6, 2012

Int. Cl.: 2

FOR: COATINGS IN THE NATURE OF SEALERS FOR USE IN WATERPROOFING ROOFS,
IN CLASS 2 (U.S. CLS. 6, 11 AND 16).

TRADEMARK

FIRST USE 3-4-1998; IN COMMERCE 3-4-1998.

PRINCIPAL REGISTER

THE MARK CONSISTS OF STANDARD CHARACTERS WITHOUT CLAIM TO ANY PAR-
TICULAR FONT, STYLE, SIZE, OR COLOR.

SER. NO. 85-377,320, FILED 7-21-2011.

ANNE E. GUSTASON, EXAMINING ATTORNEY



David J. Kybas

Director of the United States Patent and Trademark Office

United States of America

United States Patent and Trademark Office

BITPRO

Reg. No. 4,108,569

ERIEZ MANUFACTURING CO. (PENNSYLVANIA CORPORATION)
2200 ASBURY ROAD
ERIE, PA 16506

Registered Mar. 6, 2012

Int. Cl.: 7

FOR: FLOTATION SEPARATION EQUIPMENT FOR SEPARATING AND RECOVERING BITUMEN FROM MIXTURES OF MATERIALS, IN CLASS 7 (U.S. CLS. 13, 19, 21, 23, 31, 34 AND 35).

TRADEMARK

FIRST USE 9-30-2006; IN COMMERCE 9-30-2006.

PRINCIPAL REGISTER

THE MARK CONSISTS OF STANDARD CHARACTERS WITHOUT CLAIM TO ANY PARTICULAR FONT, STYLE, SIZE, OR COLOR.

SER. NO. 85-377,329, FILED 7-21-2011.

JAY FLOWERS, EXAMINING ATTORNEY



David J. Kyffers

Director of the United States Patent and Trademark Office

United States of America

United States Patent and Trademark Office

WE ARE TELECOM.

Reg. No. 4,108,570

Registered Mar. 6, 2012

Int. Cl.: 45

SERVICE MARK

PRINCIPAL REGISTER

KELLER AND HECKMAN LLP (D.C. LIMITED PARTNERSHIP)
SUITE 500 WEST
1001 G STREET, NW
WASHINGTON, DC 20001

FOR: LEGAL SERVICES, IN CLASS 45 (U.S. CLS. 100 AND 101).

FIRST USE 3-1-2011; IN COMMERCE 3-1-2011.

THE MARK CONSISTS OF STANDARD CHARACTERS WITHOUT CLAIM TO ANY PARTICULAR FONT, STYLE, SIZE, OR COLOR.

SER. NO. 85-377,340, FILED 7-21-2011.

SHANNON TWOHIG, EXAMINING ATTORNEY



David J. Kybas

Director of the United States Patent and Trademark Office

United States of America

United States Patent and Trademark Office



Reg. No. 4,108,571

Registered Mar. 6, 2012

Int. Cl.: 28

TRADEMARK

PRINCIPAL REGISTER

HISTORICAL FOLK TOYS, LLC (INDIANA LIMITED LIABILITY COMPANY)
381 OLD STATE RD. 46, PO BOX 271
NASHVILLE, IN 47448

FOR: PLAYING CARDS; FOLK TOYS, NAMELY YO-YOS, TOY WHISTLES, PADDLE BALL, SPINNING TOPS, CUP AND BALL TOYS, JUGGLING SETS, AND JUMP ROPES; FOLK GAMES, NAMELY JACKS, DICE, BOWLING PINS, HOPSCOTCH SETS, AND MARBLES; HOBBY CRAFT KITS COMPRISING KNITTING NEEDLES, YARN, AND INSTRUCTIONS; HOBBY CRAFT KITS FOR CREATING QUILTS COMPRISING FABRIC, BATTING, STUFFING, NEEDLES, THREAD AND INSTRUCTIONS; HOBBY CRAFT KITS FOR CROSS-STITCH COMPRISING CLOTH, FLOSS, NEEDLES, GRAPHS AND INSTRUCTIONS; HOBBY CRAFT KITS FOR WEAVING COMPRISING LOOM, YARN, LOOM UTENSILS AND INSTRUCTIONS; HOBBY CRAFT KITS FOR SEWING COMPRISING BUTTONS AND/OR NEEDLES, THREAD OR YARN, GENERAL SEWING UTENSILS AND INSTRUCTIONS; HOBBY CRAFT KITS FOR SPINNING YARN COMPRISING WOOL OR COTTON OR OTHER MATERIAL FOR SPINNING, SPINDLES AND INSTRUCTIONS; HOBBY CRAFT KITS FOR CROCHET COMPRISING CROCHET HOOKS, YARN AND INSTRUCTIONS; AND HOBBY CRAFT KITS FOR CREATING DOLLS AND STUFFED ANIMALS COMPRISING MATERIAL, CLOTH, PATTERNS, NEEDLES, FLOSS, LACE, RIBBONS STUFFING AND INSTRUCTIONS, IN CLASS 28 (U.S. CLS. 22, 23, 38 AND 50).

FIRST USE 0-0-2010; IN COMMERCE 0-0-2010.

NO CLAIM IS MADE TO THE EXCLUSIVE RIGHT TO USE "HISTORICAL FOLK TOYS", APART FROM THE MARK AS SHOWN.

THE MARK CONSISTS OF THE WORDS "HISTORICAL FOLK TOYS" ON ONE LINE IN A STYLIZED AND ITALICIZED SERIF FONT AND CENTERED WITHIN A HORIZONTAL BANNER WITH SLIGHTLY ROLLED ENDS.

SER. NO. 85-377,362, FILED 7-21-2011.

RONALD DELGIZZI, EXAMINING ATTORNEY



David J. Kyffers

Director of the United States Patent and Trademark Office

United States of America

United States Patent and Trademark Office

Your one stop shop for cow drop

Reg. No. 4,108,572

CHINO VALLEY COMPOST LLC (CALIFORNIA LIMITED LIABILITY COMPANY)
7360 PINE AVE
CHINO, CA 91708

Registered Mar. 6, 2012

Int. Cl.: 1

FOR: COMPOST, IN CLASS 1 (U.S. CLS. 1, 5, 6, 10, 26 AND 46).

TRADEMARK

FIRST USE 10-15-2009; IN COMMERCE 1-5-2010.

PRINCIPAL REGISTER

THE MARK CONSISTS OF STANDARD CHARACTERS WITHOUT CLAIM TO ANY PARTICULAR FONT, STYLE, SIZE, OR COLOR.

SER. NO. 85-377,363, FILED 7-21-2011.

MARC LEIPZIG, EXAMINING ATTORNEY



David J. Kyffers

Director of the United States Patent and Trademark Office

United States of America

United States Patent and Trademark Office

EQP

Reg. No. 4,108,573

Registered Mar. 6, 2012

Int. Cl.: 35

SERVICE MARK

PRINCIPAL REGISTER

EMERSON ECOLOGICS, LLC (DELAWARE LIMITED LIABILITY COMPANY)
7 COMMERCE DRIVE
BEDFORD, NH 03110

FOR: PROVIDING CONSUMER PRODUCT INFORMATION IN THE FIELD OF NUTRITIONAL SUPPLEMENTS; PROVIDING A WEBSITE FEATURING CONSUMER PRODUCT INFORMATION IN THE FIELD OF NUTRITIONAL SUPPLEMENTS; PROMOTING THE GOODS OF OTHERS IN THE FIELD OF NUTRITIONAL SUPPLEMENTS VIA THE INTERNET; COMPUTER SERVICES, NAMELY, PROVIDING A WEBSITE IN THE FIELDS OF CONSUMER PRODUCT AND BUSINESS INFORMATION, WHEREIN CONSUMERS AND PROFESSIONALS CAN ACCESS INFORMATION REGARDING NUTRITIONAL SUPPLEMENTS, IN CLASS 35 (U.S. CLS. 100, 101 AND 102).

FIRST USE 7-0-2010; IN COMMERCE 7-0-2010.

THE MARK CONSISTS OF STANDARD CHARACTERS WITHOUT CLAIM TO ANY PARTICULAR FONT, STYLE, SIZE, OR COLOR.

SER. NO. 85-377,370, FILED 7-21-2011.

JAMES A. RAUEN, EXAMINING ATTORNEY



David J. Kybas

Director of the United States Patent and Trademark Office

United States of America

United States Patent and Trademark Office

Kap Slap

Reg. No. 4,108,574

Registered Mar. 6, 2012

Int. Cl.: 41

SERVICE MARK

PRINCIPAL REGISTER

LUCAS, JARED (UNITED STATES INDIVIDUAL)
39 UNIVERSITY DRIVE BOX F214
BETHLEHEM, PA 18015

FOR: DISC JOCKEY SERVICES, IN CLASS 41 (U.S. CLS. 100, 101 AND 107).

FIRST USE 3-20-2010; IN COMMERCE 2-8-2011.

THE MARK CONSISTS OF STANDARD CHARACTERS WITHOUT CLAIM TO ANY PARTICULAR FONT, STYLE, SIZE, OR COLOR.

SER. NO. 85-377,376, FILED 7-21-2011.

DORITT L. CARROLL, EXAMINING ATTORNEY



David J. Kyros

Director of the United States Patent and Trademark Office

United States of America

United States Patent and Trademark Office

Sippin'Smart

Reg. No. 4,108,575

Registered Mar. 6, 2012

Int. Cl.: 41

SERVICE MARK

PRINCIPAL REGISTER

SCHILLING NUTRITION THERAPY, LLC. (TENNESSEE LIMITED LIABILITY COMPANY)
5118 N. CHARLOTTE CIRCLE
MEMPHIS, TN 38117

FOR: PROVIDING A WEBSITE FEATURING BLOGS AND NON-DOWNLOADABLE PUBLICATIONS IN THE NATURE OF NEWS, INFORMATION, AND COMMENTARY FROM A REGISTERED DIETITIAN IN THE FIELD(S) OF HEALTHY ALCOHOL CONSUMPTION AND THE HEALTH BENEFITS OF MODERATE ALCOHOL CONSUMPTION, IN CLASS 41 (U.S. CLS. 100, 101 AND 107).

FIRST USE 1-0-2010; IN COMMERCE 1-0-2010.

THE MARK CONSISTS OF STANDARD CHARACTERS WITHOUT CLAIM TO ANY PARTICULAR FONT, STYLE, SIZE, OR COLOR.

SER. NO. 85-377,395, FILED 7-21-2011.

VIVIAN MICZNIK FIRST, EXAMINING ATTORNEY



David J. Kybas

Director of the United States Patent and Trademark Office

United States of America

United States Patent and Trademark Office



Reg. No. 4,108,576

Registered Mar. 6, 2012

Int. Cl.: 41

SERVICE MARK

PRINCIPAL REGISTER

BLACK TIE PHOTOBOOTH (NORTH DAKOTA LIMITED LIABILITY COMPANY)
1722 35TH SW STREET SUITE E
FARGO, ND 58103

FOR: RENTAL OF PORTABLE PHOTOGRAPHY AND/OR VIDEOGRAPHY BOOTHS FOR
TAKING OF PICTURES AND VIDEOS, IN CLASS 41 (U.S. CLS. 100, 101 AND 107).

FIRST USE 6-0-2009; IN COMMERCE 6-2-2009.

THE MARK CONSISTS OF A TUXEDO SLANTED TO ONE SIDE.

THE COLOR(S) BLACK AND WHITE IS/ARE CLAIMED AS A FEATURE OF THE MARK.

SER. NO. 85-377,407, FILED 7-21-2011.

VIVIAN MICZNIK FIRST, EXAMINING ATTORNEY



David J. Kybas

Director of the United States Patent and Trademark Office

United States of America

United States Patent and Trademark Office

Eat Real Food. Feel Real
Good.

Reg. No. 4,108,577

SCHILLING NUTRITION THERAPY, LLC. (TENNESSEE LIMITED LIABILITY COMPANY)
5118 N. CHARLOTTE CIRCLE
MEMPHIS, TN 38117

Registered Mar. 6, 2012

Int. Cl.: 44

FOR: DIETITIAN SERVICE; NUTRITIONAL THERAPY SERVICES, IN CLASS 44 (U.S. CLS. 100 AND 101).

SERVICE MARK

FIRST USE 1-0-2010; IN COMMERCE 1-0-2010.

PRINCIPAL REGISTER

THE MARK CONSISTS OF STANDARD CHARACTERS WITHOUT CLAIM TO ANY PARTICULAR FONT, STYLE, SIZE, OR COLOR.

SER. NO. 85-377,412, FILED 7-21-2011.

VIVIAN MICZNIK FIRST, EXAMINING ATTORNEY



David J. Kyffers

Director of the United States Patent and Trademark Office

United States of America

United States Patent and Trademark Office

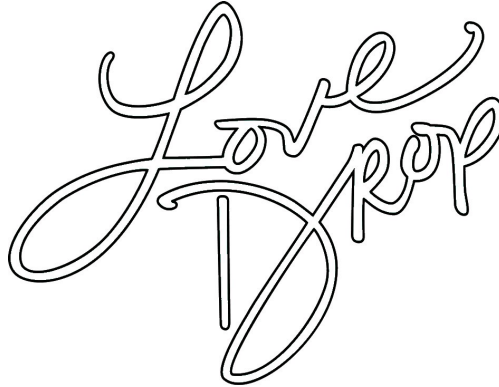

Reg. No. 4,108,578

Registered Mar. 6, 2012

Int. Cl.: 25

TRADEMARK

PRINCIPAL REGISTER

HANNAH MARTINDALE (UNITED STATES INDIVIDUAL), DBA LOVE DROP
308 N CHESTER AVE
PASADENA, CA 91106

FOR: CAPRI PANTS; DENIMS; DRESSES; HALTER TOPS; HEADWEAR; JACKETS; PANTS;
SHIRTS; SHORTS; SKIRTS; SKORTS; SWEATERS; SWEATSHIRTS; T-SHIRTS; TANK-
TOPS; TOPS, IN CLASS 25 (U.S. CLS. 22 AND 39).

FIRST USE 2-0-2009; IN COMMERCE 2-0-2009.

THE MARK CONSISTS OF THE WORDS LOVE DROP IN STYLIZED SCRIPT FONT.

SER. NO. 85-377,456, FILED 7-21-2011.

WON TEAK OH, EXAMINING ATTORNEY



David J. Kybas

Director of the United States Patent and Trademark Office

United States of America

United States Patent and Trademark Office

INTELEX

Reg. No. 4,108,579

Registered Mar. 6, 2012

Int. Cl.: 9

TRADEMARK

PRINCIPAL REGISTER

INTELEX TECHNOLOGIES INC. (CANADA CORPORATION)
905 KING STREET WEST, SUITE 600
TORONTO, ONTARIO, CANADA M6K3G9

FOR: COMPUTER SOFTWARE, NAMELY COMPUTER SOFTWARE FOR USE IN BUSINESS MANAGEMENT AND PROCESS SYSTEMS FOR CLIENT SERVER ARCHITECTURE, FOR DATABASE INTEGRATION, FOR DATABASE MANAGEMENT AND FOR DATA ACCESS AND DATA CONTROL, IN THE FIELDS OF CORPORATE DATA, COMPLIANCE ENVIRONMENTAL SYSTEMS, HEALTH AND SAFETY, TRAINING, PRODUCT QUALITY, AND BUSINESS MANAGEMENT FUNCTIONS, IN CLASS 9 (U.S. CLS. 21, 23, 26, 36 AND 38).

FIRST USE 0-0-1992; IN COMMERCE 0-0-1992.

THE MARK CONSISTS OF STANDARD CHARACTERS WITHOUT CLAIM TO ANY PARTICULAR FONT, STYLE, SIZE, OR COLOR.

SER. NO. 85-377,457, FILED 7-21-2011.

GEOFFREY FOSDICK, EXAMINING ATTORNEY



David J. Kyfos

Director of the United States Patent and Trademark Office

United States of America

United States Patent and Trademark Office

InstaVantage

Reg. No. 4,108,580

Registered Mar. 6, 2012

Int. Cl.: 42

SERVICE MARK

PRINCIPAL REGISTER

ANAMETRIX, INC. (DELAWARE CORPORATION)
#A200
10225 BARNES CANYON ROAD
SAN DIEGO, CA 92121

FOR: APPLICATION SERVICE PROVIDER (ASP) FEATURING SOFTWARE FOR USE IN BUSINESS ANALYTICS; PROVIDING A NON-DOWNLOADABLE SOFTWARE SUITE FOR USE IN BUSINESS ANALYTICS, IN CLASS 42 (U.S. CLS. 100 AND 101).

FIRST USE 7-15-2011; IN COMMERCE 7-15-2011.

THE MARK CONSISTS OF STANDARD CHARACTERS WITHOUT CLAIM TO ANY PARTICULAR FONT, STYLE, SIZE, OR COLOR.

OWNER OF U.S. REG. NO. 3,885,784.

SER. NO. 85-377,490, FILED 7-21-2011.

JAMES MACFARLANE, EXAMINING ATTORNEY



David J. Kyros

Director of the United States Patent and Trademark Office

United States of America

United States Patent and Trademark Office

FLECIA

Reg. No. 4,108,581

FLECIA, LLC (FLORIDA LIMITED LIABILITY COMPANY)
1305 RACHEL LANE
TALLAHASSEE, FL 32308

Registered Mar. 6, 2012

Int. Cl.: 35

FOR: BRANDING SERVICES, NAMELY, CONSULTING, DEVELOPMENT, MANAGEMENT AND MARKETING OF BRANDS FOR BUSINESSES, IN CLASS 35 (U.S. CLS. 100, 101 AND 102).

SERVICE MARK

FIRST USE 4-26-2011; IN COMMERCE 7-21-2011.

PRINCIPAL REGISTER

THE MARK CONSISTS OF STANDARD CHARACTERS WITHOUT CLAIM TO ANY PARTICULAR FONT, STYLE, SIZE, OR COLOR.

SER. NO. 85-377,500, FILED 7-21-2011.

JOHN DALIER, EXAMINING ATTORNEY



David J. Kybas

Director of the United States Patent and Trademark Office

United States of America

United States Patent and Trademark Office

jospel

Reg. No. 4,108,582

Registered Mar. 6, 2012

Int. Cl.: 41

SERVICE MARK

PRINCIPAL REGISTER

RHONDA WILLIAMS (UNITED STATES INDIVIDUAL)
PARK WEST STATION, P.O. BOX 20214
NEW YORK, NY 10025

FOR: ENTERTAINMENT AND EDUCATIONAL SERVICES, NAMELY, THE PRESENTATION OF SEMINARS, WORKSHOPS AND PANEL DISCUSSIONS, AND ONGOING TELEVISION AND RADIO SHOWS ALL IN THE FIELD OF JAZZ AND GOSPEL MUSIC; ENTERTAINMENT IN THE NATURE OF LIVE PERFORMANCES BY JAZZ AND GOSPEL MUSIC GROUPS; ENTERTAINMENT SERVICES IN THE NATURE OF LIVE MUSICAL PERFORMANCES; ENTERTAINMENT, NAMELY, LIVE MUSIC CONCERTS, IN CLASS 41 (U.S. CLS. 100, 101 AND 107).

FIRST USE 6-29-2011; IN COMMERCE 6-29-2011.

THE MARK CONSISTS OF STANDARD CHARACTERS WITHOUT CLAIM TO ANY PARTICULAR FONT, STYLE, SIZE, OR COLOR.

SER. NO. 85-377,514, FILED 7-21-2011.

WILLIAM BRECKENFELD, EXAMINING ATTORNEY



David J. Kyffers

Director of the United States Patent and Trademark Office

United States of America

United States Patent and Trademark Office

DOAT

Reg. No. 4,108,583

DOAT MEDIA LTD. (ISRAEL LIMITED CORPORATION)
2 HALAMED HEY ST.
GIVATAIM, ISRAEL 53631

Registered Mar. 6, 2012

Int. Cl.: 9

FOR: COMPUTER SEARCH ENGINE SOFTWARE, IN CLASS 9 (U.S. CLS. 21, 23, 26, 36 AND 38).

TRADEMARK

FIRST USE 5-23-2011; IN COMMERCE 5-23-2011.

PRINCIPAL REGISTER

THE MARK CONSISTS OF STANDARD CHARACTERS WITHOUT CLAIM TO ANY PARTICULAR FONT, STYLE, SIZE, OR COLOR.

SER. NO. 85-377,517, FILED 7-21-2011.

WILLIAM BRECKENFELD, EXAMINING ATTORNEY



David J. Kybas

Director of the United States Patent and Trademark Office

United States of America

United States Patent and Trademark Office

SiteVantage

Reg. No. 4,108,584

Registered Mar. 6, 2012

Int. Cl.: 42

SERVICE MARK

PRINCIPAL REGISTER

ANAMETRIX, INC. (DELAWARE CORPORATION)
#A200
10225 BARNES CANYON ROAD
SAN DIEGO, CA 92121

FOR: CLOUD COMPUTING FEATURING SOFTWARE FOR USE BY OTHERS TO TRACK, MEASURE, AND FURTHER ANALYZE THEIR WEB SITE AND ONLINE ADVERTISING CAMPAIGNS IN A SINGLE INTERFACE , IN CLASS 42 (U.S. CLS. 100 AND 101).

FIRST USE 7-15-2011; IN COMMERCE 7-15-2011.

THE MARK CONSISTS OF STANDARD CHARACTERS WITHOUT CLAIM TO ANY PARTICULAR FONT, STYLE, SIZE, OR COLOR.

SER. NO. 85-377,518, FILED 7-21-2011.

JAMES MACFARLANE, EXAMINING ATTORNEY



David J. Kyros

Director of the United States Patent and Trademark Office

United States of America

United States Patent and Trademark Office

Baker Benji

Reg. No. 4,108,585

Registered Mar. 6, 2012

Int. Cl.: 25

TRADEMARK

PRINCIPAL REGISTER

JACKSON PAYNE ASSOCIATES, LLC (TEXAS LIMITED LIABILITY COMPANY)
5919 MAPLE AVE
DALLAS, TX 75235

FOR: FOOTWEAR FOR MEN, IN CLASS 25 (U.S. CLS. 22 AND 39).

FIRST USE 1-1-2011; IN COMMERCE 1-1-2011.

THE MARK CONSISTS OF STANDARD CHARACTERS WITHOUT CLAIM TO ANY PARTICULAR FONT, STYLE, SIZE, OR COLOR.

SER. NO. 85-377,529, FILED 7-21-2011.

NAKIA HENRY, EXAMINING ATTORNEY



David J. Kybas

Director of the United States Patent and Trademark Office

United States of America

United States Patent and Trademark Office

VantageBuilder

Reg. No. 4,108,586

Registered Mar. 6, 2012

Int. Cl.: 42

SERVICE MARK

PRINCIPAL REGISTER

ANAMETRIX, INC. (DELAWARE CORPORATION)
#A200
10225 BARNES CANYON ROAD
SAN DIEGO, CA 92121

FOR: CLOUD COMPUTING FEATURING SOFTWARE FOR USE BY OTHERS TO TRACK, MEASURE, AND ANALYZE DATA FROM MULTIPLE CHANNELS, NAMELY, EMAIL, WEBSITE TRAFFIC, AD SERVING, PROMOTIONAL VIDEOS; CLOUD COMPUTING FEATURING SOFTWARE FOR USE BY OTHERS TO CREATE VISUAL ANALYSIS OF DATA FROM MULTIPLE CHANNELS, NAMELY, EMAIL, WEBSITE TRAFFIC, AD SERVING, PROMOTIONAL VIDEOS IN A SINGLE INTERFACE FOR A HOLISTIC VIEW OF THEIR MARKETING STRATEGY, IN CLASS 42 (U.S. CLS. 100 AND 101).

FIRST USE 7-15-2011; IN COMMERCE 7-15-2011.

THE MARK CONSISTS OF STANDARD CHARACTERS WITHOUT CLAIM TO ANY PARTICULAR FONT, STYLE, SIZE, OR COLOR.

SER. NO. 85-377,539, FILED 7-21-2011.

JAMES MACFARLANE, EXAMINING ATTORNEY



David J. Kyros

Director of the United States Patent and Trademark Office

United States of America

United States Patent and Trademark Office

FunnelVantage

Reg. No. 4,108,587

Registered Mar. 6, 2012

Int. Cl.: 42

SERVICE MARK

PRINCIPAL REGISTER

ANAMETRIX, INC. (DELAWARE CORPORATION)
#A200
10225 BARNES CANYON ROAD
SAN DIEGO, CA 92121

FOR: CLOUD COMPUTING FEATURING SOFTWARE FOR USE BY OTHERS TO TRACK, MEASURE, AND ANALYZE DATA FROM MULTIPLE CHANNELS, NAMELY, EMAIL, WEBSITE TRAFFIC, AD SERVING, PROMOTIONAL VIDEOS IN A SINGLE INTEGRATED VIEW ENABLING USERS TO SWITCH BETWEEN MULTIPLE ADVERTISING CAMPAIGNS AND MEASURE THEIR PERFORMANCE AGAINST SET KEY PERFORMANCE INDICATORS, IN CLASS 42 (U.S. CLS. 100 AND 101).

FIRST USE 7-15-2011; IN COMMERCE 7-15-2011.

THE MARK CONSISTS OF STANDARD CHARACTERS WITHOUT CLAIM TO ANY PARTICULAR FONT, STYLE, SIZE, OR COLOR.

SER. NO. 85-377,551, FILED 7-21-2011.

JAMES MACFARLANE, EXAMINING ATTORNEY



David J. Kyffers

Director of the United States Patent and Trademark Office

United States of America

United States Patent and Trademark Office

Basepump

Reg. No. 4,108,588

BASE PRODUCTS CORPORATION (NEW YORK CORPORATION)
265 MAYVILLE AVENUE
KENMORE, NY 14217

Registered Mar. 6, 2012

Int. Cl.: 7

FOR: SUMP PUMPS, IN CLASS 7 (U.S. CLS. 13, 19, 21, 23, 31, 34 AND 35).

TRADEMARK

FIRST USE 12-27-1999; IN COMMERCE 12-27-1999.

PRINCIPAL REGISTER

THE MARK CONSISTS OF STANDARD CHARACTERS WITHOUT CLAIM TO ANY PARTICULAR FONT, STYLE, SIZE, OR COLOR.

SER. NO. 85-377,562, FILED 7-21-2011.

JOHN SCHUYLER YARD, EXAMINING ATTORNEY



David J. Kyffers

Director of the United States Patent and Trademark Office

United States of America

United States Patent and Trademark Office

ZIRLUMINA

Reg. No. 4,108,589

VALLEY DENTAL ARTS, INC. (MINNESOTA CORPORATION)
1745 NORTHWESTERN AVENUE
STILLWATER, MN 55082

Registered Mar. 6, 2012

Int. Cl.: 10

FOR: DENTAL CROWNS; DENTAL BRIDGES; DENTAL PROSTHESES, IN CLASS 10 (U.S. CLS. 26, 39 AND 44).

TRADEMARK

FIRST USE 7-11-2011; IN COMMERCE 7-11-2011.

PRINCIPAL REGISTER

THE MARK CONSISTS OF STANDARD CHARACTERS WITHOUT CLAIM TO ANY PARTICULAR FONT, STYLE, SIZE, OR COLOR.

SER. NO. 85-377,580, FILED 7-21-2011.

CORY BOONE, EXAMINING ATTORNEY



David J. Kybas

Director of the United States Patent and Trademark Office

United States of America

United States Patent and Trademark Office



Reg. No. 4,108,590

Registered Mar. 6, 2012

Int. Cl.: 24

TRADEMARK

PRINCIPAL REGISTER

TOWELMATE, INC. (CALIFORNIA CORPORATION)
4025 CAMINO DEL RIO SOUTH
SUITE 300
SAN DIEGO, CA 92108

FOR: BEACH TOWELS; FACE TOWELS OF TEXTILES; GOLF TOWELS; TOWELS, IN CLASS 24 (U.S. CLS. 42 AND 50).

FIRST USE 8-4-2010; IN COMMERCE 8-4-2010.

OWNER OF U.S. REG. NO. 3,955,805.

THE MARK CONSISTS OF A STYLIZED HUMAN FIGURE RUNNING LOCATED ON THE LEFT OF THE LITERAL ELEMENT TOWELMATE PRINTED WITH THE TOWEL PORTION IN A BOLDER FONT THAN THE MATE PORTION.

SER. NO. 85-377,596, FILED 7-21-2011.

ANTHONY RINKER, EXAMINING ATTORNEY



David J. Kyffers

Director of the United States Patent and Trademark Office

United States of America

United States Patent and Trademark Office

LEVEL 10

Reg. No. 4,108,591

Registered Mar. 6, 2012

Int. Cl.: 42

SERVICE MARK

PRINCIPAL REGISTER

BLUESKY CREATIVE, INC. (OHIO CORPORATION)
14 SUNNYBROOK DRIVE
CINCINNATI, OH 45237

FOR: COMPUTER SERVICES, NAMELY, PROVIDING ONLINE SOFTWARE APPLICATION FOR DATABASES ENTRY, INFORMATION TRACKING, FORMS GENERATION, PRINTER OPERATION, PRINTING SOLUTIONS AND MANAGEMENT, FORMS DESIGN AND FORMS MANAGEMENT, AND PRINT-ON-DEMAND SOLUTIONS, IN CLASS 42 (U.S. CLS. 100 AND 101).

FIRST USE 12-1-2005; IN COMMERCE 12-1-2005.

THE MARK CONSISTS OF STANDARD CHARACTERS WITHOUT CLAIM TO ANY PARTICULAR FONT, STYLE, SIZE, OR COLOR.

SER. NO. 85-377,599, FILED 7-21-2011.

PATRICIA EVANKO, EXAMINING ATTORNEY



David J. Kybas

Director of the United States Patent and Trademark Office

United States of America

United States Patent and Trademark Office

No Surprises Billing & Inventory Plan

Reg. No. 4,108,592

U.S. LINEN AND UNIFORM, INC. (WASHINGTON CORPORATION)
1106 HARDING STREET
RICHLAND, WA 99352

Registered Mar. 6, 2012

Int. Cls.: 43 and 45

FOR: RENTAL OF LINENS, RENTAL OF INDUSTRIAL TOWELS; RENTAL OF FLOOR MATS IN THE NATURE OF RUGS, IN CLASS 43 (U.S. CLS. 100 AND 101).

SERVICE MARK

FIRST USE 10-7-2010; IN COMMERCE 10-7-2010.

PRINCIPAL REGISTER

FOR: RENTAL OF WORK UNIFORMS, IN CLASS 45 (U.S. CLS. 100 AND 101).

FIRST USE 10-7-2010; IN COMMERCE 10-7-2010.

THE MARK CONSISTS OF STANDARD CHARACTERS WITHOUT CLAIM TO ANY PARTICULAR FONT, STYLE, SIZE, OR COLOR.

NO CLAIM IS MADE TO THE EXCLUSIVE RIGHT TO USE "BILLING & INVENTORY PLAN", APART FROM THE MARK AS SHOWN.

SER. NO. 85-377,616, FILED 7-21-2011.

ROBIN MITTLER, EXAMINING ATTORNEY



David J. Kybas

Director of the United States Patent and Trademark Office

United States of America

United States Patent and Trademark Office

WARMQUEST

Reg. No. 4,108,593

Registered Mar. 6, 2012

Int. Cl.: 35

SERVICE MARK

PRINCIPAL REGISTER

HEATIZON RMC, LLC (UTAH LIMITED LIABILITY COMPANY), DBA WARMQUEST
4137 SOUTH 500 WEST
MURRAY, UT 84123

FOR: ON-LINE WHOLESALE AND RETAIL STORE SERVICES FEATURING RADIANT HEATING PRODUCTS, NAMELY PRODUCTS FOR FLOOR WARMING, SNOW MELTING, ROOF DEICING AND SPACE HEATING; RETAIL STORES FEATURING RADIANT HEATING PRODUCTS, NAMELY PRODUCTS FOR FLOOR WARMING, SNOW MELTING, ROOF DEICING AND SPACE HEATING; WHOLESALE DISTRIBUTORSHIPS FEATURING RADIANT HEATING PRODUCTS, NAMELY PRODUCTS FOR FLOOR WARMING, SNOW MELTING, ROOF DEICING AND SPACE HEATING, IN CLASS 35 (U.S. CLS. 100, 101 AND 102).

FIRST USE 0-0-2004; IN COMMERCE 0-0-2004.

THE MARK CONSISTS OF STANDARD CHARACTERS WITHOUT CLAIM TO ANY PARTICULAR FONT, STYLE, SIZE, OR COLOR.

SER. NO. 85-377,644, FILED 7-21-2011.

GRETТА YAO, EXAMINING ATTORNEY



David J. Kyros

Director of the United States Patent and Trademark Office

United States of America

United States Patent and Trademark Office

Soapbox Bags

Reg. No. 4,108,594

NEWMAN-MARTINS, SARA (UNITED STATES INDIVIDUAL)
3635 MOORE ST.
LOS ANGELES, CA 90066

Registered Mar. 6, 2012

Int. Cl.: 18

FOR: HANDBAGS, PURSES AND WALLETS, IN CLASS 18 (U.S. CLS. 1, 2, 3, 22 AND 41).

TRADEMARK

FIRST USE 5-3-2002; IN COMMERCE 5-3-2002.

PRINCIPAL REGISTER

THE MARK CONSISTS OF STANDARD CHARACTERS WITHOUT CLAIM TO ANY PARTICULAR FONT, STYLE, SIZE, OR COLOR.

NO CLAIM IS MADE TO THE EXCLUSIVE RIGHT TO USE "BAGS", APART FROM THE MARK AS SHOWN.

SER. NO. 85-377,651, FILED 7-21-2011.

MIDGE BUTLER, EXAMINING ATTORNEY



David J. Kyffers

Director of the United States Patent and Trademark Office

United States of America

United States Patent and Trademark Office

CareerGoggles

Reg. No. 4,108,595

Registered Mar. 6, 2012

Int. Cl.: 41

SERVICE MARK

PRINCIPAL REGISTER

HAMMOND, KATHLEEN (UNITED STATES INDIVIDUAL)
UNIT 200
1025 MAXWELL LANE
HOBOKEN, NJ 07030

FOR: PROFESSIONAL COACHING SERVICES IN THE FIELD OF CAREER DEVELOPMENT AND SUCCESS IN BUSINESS; TRAINING SERVICES IN THE FIELD OF CAREER DEVELOPMENT AND SUCCESS IN BUSINESS, IN CLASS 41 (U.S. CLS. 100, 101 AND 107).

FIRST USE 5-18-2011; IN COMMERCE 6-12-2011.

THE MARK CONSISTS OF STANDARD CHARACTERS WITHOUT CLAIM TO ANY PARTICULAR FONT, STYLE, SIZE, OR COLOR.

SER. NO. 85-377,673, FILED 7-21-2011.

MIDGE BUTLER, EXAMINING ATTORNEY



David J. Kybas

Director of the United States Patent and Trademark Office

United States of America

United States Patent and Trademark Office

Spheres

Reg. No. 4,108,596

Registered Mar. 6, 2012

Int. Cl.: 41

SERVICE MARK

PRINCIPAL REGISTER

FULL-LIFE CENTERS, LLC (ILLINOIS LIMITED LIABILITY COMPANY)
2750 RACINE
CHICAGO, IL 60614

FOR: BUSINESS EDUCATION AND TRAINING SERVICES, NAMELY, DEVELOPING, AND FACILITATING CUSTOMIZED IN-COMPANY LEADERSHIP AND EXECUTIVE DEVELOPMENT PROGRAMS, PROVIDING EXECUTIVE COACHING SERVICES, AND PROVIDING PUBLIC AND IN-COMPANY KEYNOTE PRESENTATIONS TO BUSINESS LEADERS, IN CLASS 41 (U.S. CLS. 100, 101 AND 107).

FIRST USE 5-31-2011; IN COMMERCE 5-31-2011.

THE MARK CONSISTS OF STANDARD CHARACTERS WITHOUT CLAIM TO ANY PARTICULAR FONT, STYLE, SIZE, OR COLOR.

OWNER OF U.S. REG. NOS. 2,493,505 AND 3,468,547.

SER. NO. 85-377,674, FILED 7-21-2011.

PATRICIA EVANKO, EXAMINING ATTORNEY



David J. Kyjars

Director of the United States Patent and Trademark Office

United States of America

United States Patent and Trademark Office

Bringing Life Home

Reg. No. 4,108,597

Registered Mar. 6, 2012

Int. Cl.: 37

SERVICE MARK

PRINCIPAL REGISTER

ANDERSON, GARY (UNITED STATES INDIVIDUAL)
1060 SOUTH RICHFIELD ROAD
PLACENTIA, CA 92870

FOR: CUSTOM POOL BUILDING SERVICES, IN CLASS 37 (U.S. CLS. 100, 103 AND 106).

FIRST USE 6-1-2011; IN COMMERCE 6-1-2011.

THE MARK CONSISTS OF STANDARD CHARACTERS WITHOUT CLAIM TO ANY PARTICULAR FONT, STYLE, SIZE, OR COLOR.

SER. NO. 85-377,677, FILED 7-21-2011.

KAREN SEVERSON, EXAMINING ATTORNEY



David J. Kyffers

Director of the United States Patent and Trademark Office

United States of America

United States Patent and Trademark Office

AIR-O-FAN

Reg. No. 4,108,598

Registered Mar. 6, 2012

Int. Cl.: 7

TRADEMARK

PRINCIPAL REGISTER

AIR-O FAN PRODUCTS CORPORATION (CALIFORNIA CORPORATION)
507 E. DINUBA AVE.
REEDLEY, CA 93654

FOR: AGRICULTURAL MACHINES, NAMELY, SPRAYERS; TRACTOR TOWED AGRICULTURAL IMPLEMENTS, NAMELY, SPRAYERS, IN CLASS 7 (U.S. CLS. 13, 19, 21, 23, 31, 34 AND 35).

FIRST USE 12-31-1943; IN COMMERCE 12-31-1943.

THE MARK CONSISTS OF STANDARD CHARACTERS WITHOUT CLAIM TO ANY PARTICULAR FONT, STYLE, SIZE, OR COLOR.

SER. NO. 85-377,685, FILED 7-21-2011.

ALYSSA STEEL, EXAMINING ATTORNEY



David J. Kyros

Director of the United States Patent and Trademark Office

United States of America

United States Patent and Trademark Office

fantas-eyes

Reg. No. 4,108,599

Registered Mar. 6, 2012

Int. Cl.: 9

TRADEMARK

PRINCIPAL REGISTER

FANTAS EYES, INC. (NEW YORK CORPORATION)
9TH FLOOR
385 FIFTH AVENUE
NEW YORK, NY 10016

FOR: SUNGLASSES, IN CLASS 9 (U.S. CLS. 21, 23, 26, 36 AND 38).

FIRST USE 2-12-1990; IN COMMERCE 2-12-1990.

THE MARK CONSISTS OF STANDARD CHARACTERS WITHOUT CLAIM TO ANY PARTICULAR FONT, STYLE, SIZE, OR COLOR.

SER. NO. 85-377,693, FILED 7-21-2011.

WON TEAK OH, EXAMINING ATTORNEY



David J. Kyffers

Director of the United States Patent and Trademark Office

United States of America

United States Patent and Trademark Office

KITTY & STELLA

Reg. No. 4,108,600

Registered Mar. 6, 2012

Int. Cl.: 35

SERVICE MARK

PRINCIPAL REGISTER

CLUE HOLDINGS PTY LTD (AUSTRALIA PROPRIETARY LIMITED COMPANY (P/L OR PTY. LTD.))
9 PARSLEY ROAD, VAUCLUSE
SYDNEY, AUSTRALIA

FOR: AUTOMATED AND COMPUTERIZED TRADING OF GOODS AND SERVICES FOR OTHERS PROVIDED OVER A GLOBAL COMMUNICATION INFORMATION NETWORK; ON-LINE RETAIL STORE SERVICES FEATURING APPAREL, FOOTWEAR, WATCHES, WALLETS, HATS, MESSENGER BAGS, HANDBAGS, TOTE BAGS, BACKPACKS, BANDANAS, UNDERWEAR, BELTS, PRINTED MATTER, TOYS, JEWELRY, SUNGLASSES, SOAPS, PERFUMERY, COSMETICS, KITCHEN AND HOUSEHOLD UTENSILS AND FURNISHINGS AND ACCESSORIES; RETAIL STORE SERVICES FEATURING APPAREL, FOOTWEAR, WATCHES, WALLETS, HATS, MESSENGER BAGS, HANDBAGS, TOTE BAGS, BACKPACKS, BANDANAS, UNDERWEAR, BELTS, PRINTED MATTER, TOYS, JEWELRY, SUNGLASSES, SOAPS, PERFUMERY, COSMETICS, KITCHEN AND HOUSEHOLD UTENSILS AND FURNISHINGS AND ACCESSORIES; ADVERTISING AND ADVERTISEMENT SERVICES, IN CLASS 35 (U.S. CLS. 100, 101 AND 102).

FIRST USE 4-7-2009; IN COMMERCE 4-7-2009.

THE MARK CONSISTS OF STANDARD CHARACTERS WITHOUT CLAIM TO ANY PARTICULAR FONT, STYLE, SIZE, OR COLOR.

SER. NO. 85-377,700, FILED 7-21-2011.

PATRICIA EVANKO, EXAMINING ATTORNEY



David J. Kyjars

Director of the United States Patent and Trademark Office

United States of America

United States Patent and Trademark Office

SCANSMART

Reg. No. 4,108,601

Registered Mar. 6, 2012

Int. Cl.: 42

SERVICE MARK

PRINCIPAL REGISTER

J2 GLOBAL COMMUNICATIONS, INC. (DELAWARE CORPORATION)
6922 HOLLYWOOD BLVD., 5TH FLOOR
HOLLYWOOD, CA 90028

FOR: COMPUTER VIRUS PROTECTION SERVICES; ONLINE COMPUTER SERVICES, NAMELY, PROVIDING SPAM FILTERING SERVICES TO PROTECT WEBSITES AND ON-LINE APPLICATIONS FROM RECEIVING UNSOLICITED MESSAGES; PROVIDING ONLINE NON-DOWNLOADABLE COMPUTER ANTI-VIRUS SOFTWARE; PROVIDING ONLINE NON-DOWNLOADABLE COMPUTER SOFTWARE USED FOR SPAM AND VIRUS FILTERING; AND PROVIDING ONLINE NON-DOWNLOADABLE COMPUTER SOFTWARE USED FOR TRANSMITTING, RECEIVING, SCANNING AND HOSTING EMAIL, IN CLASS 42 (U.S. CLS. 100 AND 101).

FIRST USE 5-20-2011; IN COMMERCE 5-20-2011.

THE MARK CONSISTS OF STANDARD CHARACTERS WITHOUT CLAIM TO ANY PARTICULAR FONT, STYLE, SIZE, OR COLOR.

SER. NO. 85-377,721, FILED 7-21-2011.

CHARLES L. JENKINS, EXAMINING ATTORNEY



David J. Kybas

Director of the United States Patent and Trademark Office

United States of America

United States Patent and Trademark Office

Jeffco

Reg. No. 4,108,602

JEFFCO CONCRETE CONTRACTORS, LLC (ALABAMA LIMITED LIABILITY COMPANY)
10945 COMMERCIAL DRIVE
TUSCALOOSA, AL 35405

Registered Mar. 6, 2012

Int. Cl.: 37

FOR: GENERAL CONSTRUCTION SERVICES, NAMELY ARCHITECTURAL AND DECORATIVE CONCRETE PAVING AND FLOORING, IN CLASS 37 (U.S. CLS. 100, 103 AND 106).

SERVICE MARK

FIRST USE 8-23-1983; IN COMMERCE 8-23-1983.

PRINCIPAL REGISTER

THE MARK CONSISTS OF STANDARD CHARACTERS WITHOUT CLAIM TO ANY PARTICULAR FONT, STYLE, SIZE, OR COLOR.

SER. NO. 85-377,725, FILED 7-21-2011.

RICHARD WHITE, EXAMINING ATTORNEY



David J. Kyffers

Director of the United States Patent and Trademark Office

United States of America

United States Patent and Trademark Office

HH

haute hippie

Reg. No. 4,108,603

POUND, PATRICIA WESCOAT (UNITED STATES INDIVIDUAL)
301 E. 62ND STREET #15C
NEW YORK, NY 10065

Registered Mar. 6, 2012

Int. Cl.: 35

FOR: RETAIL STORE AND ON-LINE RETAIL STORE SERVICES FEATURING CLOTHING AND ACCESSORIES, IN CLASS 35 (U.S. CLS. 100, 101 AND 102).

SERVICE MARK

FIRST USE 6-17-2011; IN COMMERCE 6-17-2011.

PRINCIPAL REGISTER

OWNER OF U.S. REG. NOS. 3,651,794, 3,751,566, AND 3,766,849.

THE MARK CONSISTS OF A STYLIZED "HH" LOGO ABOVE THE WORDS "HAUTE HIPPIE" IN LOWERCASE LETTERS.

SER. NO. 85-377,753, FILED 7-21-2011.

SUE LAWRENCE, EXAMINING ATTORNEY



David J. Kybas

Director of the United States Patent and Trademark Office

United States of America

United States Patent and Trademark Office

HAUTE HIPPIE

Reg. No. 4,108,604

POUND, PATRICIA WESCOAT (UNITED STATES INDIVIDUAL)
301 E. 62ND STREET #15C
NEW YORK, NY 10065

Registered Mar. 6, 2012

Int. Cl.: 35

FOR: RETAIL STORE AND ON-LINE RETAIL STORE SERVICES FEATURING CLOTHING AND ACCESSORIES, IN CLASS 35 (U.S. CLS. 100, 101 AND 102).

SERVICE MARK

FIRST USE 6-17-2011; IN COMMERCE 6-17-2011.

PRINCIPAL REGISTER

THE MARK CONSISTS OF STANDARD CHARACTERS WITHOUT CLAIM TO ANY PARTICULAR FONT, STYLE, SIZE, OR COLOR.

OWNER OF U.S. REG. NOS. 3,651,794, 3,751,566, AND 3,766,849.

SER. NO. 85-377,759, FILED 7-21-2011.

SUE LAWRENCE, EXAMINING ATTORNEY



David J. Kyros

Director of the United States Patent and Trademark Office

United States of America

United States Patent and Trademark Office

Give your mouth a Vacation!

Reg. No. 4,108,605

Registered Mar. 6, 2012

Int. Cl.: 30

TRADEMARK

PRINCIPAL REGISTER

EXOTIC BLENDS INC. (FLORIDA CORPORATION), DBA TASTE MIAMI
1900 DIANA DR. C-3
HALLANDALE, FL 33009

FOR: FOOD SEASONINGS, IN CLASS 30 (U.S. CL. 46).

FIRST USE 7-12-2011; IN COMMERCE 7-12-2011.

THE MARK CONSISTS OF STANDARD CHARACTERS WITHOUT CLAIM TO ANY PARTICULAR FONT, STYLE, SIZE, OR COLOR.

SER. NO. 85-377,771, FILED 7-21-2011.

MARY BOAGNI, EXAMINING ATTORNEY



David J. Kyffers

Director of the United States Patent and Trademark Office

United States of America

United States Patent and Trademark Office

Texttoken

Reg. No. 4,108,606

TEXTTOKEN LLC (ARIZONA LIMITED LIABILITY COMPANY)
2437 S SARATOGA
MESA, AZ 85202

Registered Mar. 6, 2012

Int. Cl.: 35

FOR: PROMOTING AND MARKETING THE GOODS AND SERVICES OF OTHERS BY DISTRIBUTING ADVERTISING MATERIAL, COUPONS AND DISCOUNT OFFERS VIA TEXT MESSAGES, IN CLASS 35 (U.S. CLS. 100, 101 AND 102).

SERVICE MARK

FIRST USE 7-20-2011; IN COMMERCE 7-20-2011.

PRINCIPAL REGISTER

THE MARK CONSISTS OF STANDARD CHARACTERS WITHOUT CLAIM TO ANY PARTICULAR FONT, STYLE, SIZE, OR COLOR.

SER. NO. 85-377,815, FILED 7-21-2011.

GISELLE AGOSTO, EXAMINING ATTORNEY



David J. Kyros

Director of the United States Patent and Trademark Office

United States of America

United States Patent and Trademark Office

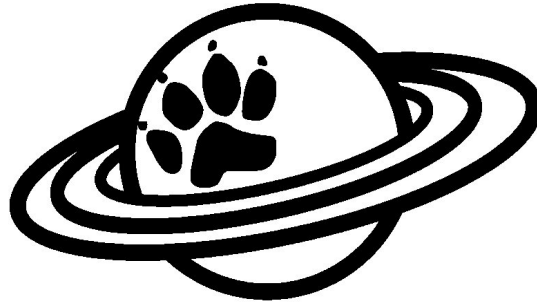

Reg. No. 4,108,607

Registered Mar. 6, 2012

Int. Cl.: 18

TRADEMARK

PRINCIPAL REGISTER

CASAS, ALBERT (UNITED STATES INDIVIDUAL)
#3
2018 BROADWAY
OCEANSIDE, CA 92054

FOR: DOG COLLARS, IN CLASS 18 (U.S. CLS. 1, 2, 3, 22 AND 41).

FIRST USE 5-22-2011; IN COMMERCE 5-22-2011.

THE MARK CONSISTS OF AN IMAGE OF A PLANET WITH THREE RINGS AROUND IT HORIZONTALLY. ON THE LEFT SIDE OF THE PLANET IS A PAWPRINT WITH FOUR TOES.

SER. NO. 85-377,819, FILED 7-21-2011.

COURTNEY ALVAREZ, EXAMINING ATTORNEY



David J. Kybas

Director of the United States Patent and Trademark Office

United States of America

United States Patent and Trademark Office

LiftingLarge.com

Reg. No. 4,108,608

LIFTINGLARGE.COM LLC (NEW MEXICO LIMITED LIABILITY COMPANY)
1102 38TH STREET SE
RIO RANCHO, NM 87124

Registered Mar. 6, 2012

Int. Cl.: 35

FOR: ON-LINE RETAIL STORE SERVICES FEATURING POWERLIFTING EQUIPMENT
AND ACCESSORIES, IN CLASS 35 (U.S. CLS. 100, 101 AND 102).

SERVICE MARK

FIRST USE 1-12-2004; IN COMMERCE 1-12-2004.

PRINCIPAL REGISTER

THE MARK CONSISTS OF STANDARD CHARACTERS WITHOUT CLAIM TO ANY PAR-
TICULAR FONT, STYLE, SIZE, OR COLOR.

SER. NO. 85-377,823, FILED 7-21-2011.

DARRYL SPRUILL, EXAMINING ATTORNEY



David J. Kybas

Director of the United States Patent and Trademark Office

United States of America

United States Patent and Trademark Office

PLUNGE

Reg. No. 4,108,609

TSG SKI & GOLF, LLC (DELAWARE LIMITED LIABILITY COMPANY)
565 MOUNTAIN VILLAGE BLVD.
TELLURIDE, CO 81435

Registered Mar. 6, 2012

Int. Cl.: 41

FOR: PROVIDING SKI SLOPES; SKI RESORTS, IN CLASS 41 (U.S. CLS. 100, 101 AND 107).

SERVICE MARK

FIRST USE 11-0-1972; IN COMMERCE 11-0-1972.

PRINCIPAL REGISTER

THE MARK CONSISTS OF STANDARD CHARACTERS WITHOUT CLAIM TO ANY PARTICULAR FONT, STYLE, SIZE, OR COLOR.

SER. NO. 85-377,858, FILED 7-21-2011.

AHSEN KHAN, EXAMINING ATTORNEY



David J. Kybas

Director of the United States Patent and Trademark Office

United States of America

United States Patent and Trademark Office

DocMate

Reg. No. 4,108,610

SOFTWARE ANALYSIS AND FORENSIC ENGINEERING (CALIFORNIA CORPORATION)
20863 STEVENS CREEK BLVD. #456
CUPERTINO, CA 95014

Registered Mar. 6, 2012

Int. Cl.: 9

FOR: COMPUTER SOFTWARE FOR COMPARING AND ANALYZING DOCUMENT FILES,
IN CLASS 9 (U.S. CLS. 21, 23, 26, 36 AND 38).

TRADEMARK

FIRST USE 7-21-2011; IN COMMERCE 7-21-2011.

PRINCIPAL REGISTER

THE MARK CONSISTS OF STANDARD CHARACTERS WITHOUT CLAIM TO ANY PAR-
TICULAR FONT, STYLE, SIZE, OR COLOR.

SER. NO. 85-377,863, FILED 7-21-2011.

MICHAEL SOUDERS, EXAMINING ATTORNEY



David J. Kybas

Director of the United States Patent and Trademark Office

United States of America

United States Patent and Trademark Office



Reg. No. 4,108,611

Registered Mar. 6, 2012

Int. Cl.: 36

SERVICE MARK

PRINCIPAL REGISTER

FREESTONE CAPITAL MANAGEMENT, LLC (DELAWARE LIMITED LIABILITY COMPANY)
1918 8TH AVENUE, SUITE 3400
SEATTLE, WA 98101

FOR: INVESTMENT ADVISORY SERVICES; PROVIDING INVESTMENT AND FINANCIAL INFORMATION, ADVICE, CONSULTATION AND MANAGEMENT SERVICES; FINANCIAL PORTFOLIO MANAGEMENT AND ANALYSIS SERVICES; FINANCIAL PLANNING SERVICES; TRUST AND ESTATE PLANNING SERVICES; RETIREMENT PLANNING SERVICES; CHARITABLE AND PHILANTHROPIC MONETARY GIVING ADVISORY SERVICES; PROVIDING INFORMATION IN THE FIELD OF CHARITABLE AND PHILANTHROPIC MONETARY GIVING THROUGH FINANCIAL AND ESTATE PLANNING; INSURANCE AGENCY AND BROKERAGE SERVICES; REAL ESTATE INVESTMENT SERVICES; PRIVATE EQUITY INVESTMENT SERVICES; SECURITY BROKERAGE SERVICES; INVESTMENT BANKING SERVICES; PROVIDING INFORMATION RELATED TO ALL OF THE FOREGOING SERVICES AND ASSOCIATED ACCOUNTS VIA THE INTERNET, IN CLASS 36 (U.S. CLS. 100, 101 AND 102).

FIRST USE 3-5-2010; IN COMMERCE 3-5-2010.

THE MARK CONSISTS OF A CIRCLE DESIGN.

SER. NO. 85-377,866, FILED 7-21-2011.

JOHN HWANG, EXAMINING ATTORNEY



David J. Kybas

Director of the United States Patent and Trademark Office

United States of America

United States Patent and Trademark Office



Reg. No. 4,108,612

Registered Mar. 6, 2012

Int. Cl.: 2

TRADEMARK

PRINCIPAL REGISTER

BURTIN POLYMER LABORATORIES, INC. (GEORGIA CORPORATION)
100 ENTERPRISE DR.
CARTERSVILLE, GA 30120

FOR: SPRAY-ON POLYURETHANE AND POLYUREA COATING TO PROTECT SURFACES AGAINST CORROSION AND IMPACT FOR USE IN THE AUTOMOBILE AND TRUCK INDUSTRY, IN CLASS 2 (U.S. CLS. 6, 11 AND 16).

FIRST USE 1-15-2010; IN COMMERCE 8-1-2010.

OWNER OF U.S. REG. NO. 3,961,668.

THE COLOR(S) BLACK, WHITE AND GRAY IS/ARE CLAIMED AS A FEATURE OF THE MARK.

NO CLAIM IS MADE TO THE EXCLUSIVE RIGHT TO USE "LINER", APART FROM THE MARK AS SHOWN.

THE MARK CONSISTS OF THE OUTLINE OF A LARGE CALIBRE BULLET IN BLACK, WITH A GRAY DISC REPRESENTING THE PERCUSSIVE CAP AND A GREY NOSE, WITH THE WORDS "BULLET" IN BLACK IN THE LOWER SECTION AND THE WORD "LINER" IN THE UPPER SECTION. THE BACKGROUND IS IN WHITE.

SER. NO. 85-377,873, FILED 7-21-2011.

JOHN HWANG, EXAMINING ATTORNEY



David J. Kyros

Director of the United States Patent and Trademark Office

United States of America

United States Patent and Trademark Office

FOR JOINT HEALTH NOT JUST PAIN

Reg. No. 4,108,613

Registered Mar. 6, 2012

Int. Cl.: 5

TRADEMARK

PRINCIPAL REGISTER

SUPPLEMENT TESTING INSTITUTE, INC. (ARIZONA CORPORATION)
5257 E. VIA SEMPREVERDE
TUCSON, AZ 85750

FOR: DIETARY SUPPLEMENTS, IN CLASS 5 (U.S. CLS. 6, 18, 44, 46, 51 AND 52).

FIRST USE 5-31-2004; IN COMMERCE 5-31-2004.

THE MARK CONSISTS OF STANDARD CHARACTERS WITHOUT CLAIM TO ANY PARTICULAR FONT, STYLE, SIZE, OR COLOR.

OWNER OF U.S. REG. NO. 2,943,238.

SEC. 2(F).

SER. NO. 85-377,875, FILED 7-21-2011.

WENDY JUN, EXAMINING ATTORNEY



David J. Kybas

Director of the United States Patent and Trademark Office

United States of America

United States Patent and Trademark Office

ADELLE

Reg. No. 4,108,614

Registered Mar. 6, 2012

Int. Cl.: 9

TRADEMARK

PRINCIPAL REGISTER

TYPETOGETHER S.R.O. (CZECH REPUBLIC LIMITED LIABILITY COMPANY)
U SPARTY 551/14
PRAGUE, CZECH REPUBLIC 17000PRAH

FOR: PRINTING FONTS THAT CAN BE DOWNLOADED PROVIDED BY MEANS OF ELECTRONIC TRANSMISSION; TYPEFACE FONTS RECORDED ON MAGNETIC MEDIA , IN CLASS 9 (U.S. CLS. 21, 23, 26, 36 AND 38).

FIRST USE 7-5-2009; IN COMMERCE 7-5-2009.

THE MARK CONSISTS OF STANDARD CHARACTERS WITHOUT CLAIM TO ANY PARTICULAR FONT, STYLE, SIZE, OR COLOR.

SER. NO. 85-377,886, FILED 7-21-2011.

JOHN WILKE, EXAMINING ATTORNEY



David J. Kybas

Director of the United States Patent and Trademark Office

United States of America

United States Patent and Trademark Office

BOUNCY MOUSE

Reg. No. 4,108,615

Registered Mar. 6, 2012

Int. Cl.: 9

TRADEMARK

PRINCIPAL REGISTER

MUNKADOO GAMES, LLC (CALIFORNIA LIMITED LIABILITY COMPANY)
C/O 1888 CENTURY PARK EAST, SUITE 1700
LOS ANGELES, CA 900671721

FOR: VIDEO GAME SOFTWARE; ELECTRONIC GAME SOFTWARE; ELECTRONIC GAME SOFTWARE FOR WIRELESS DEVICES; ELECTRONIC GAME SOFTWARE FOR HANDHELD ELECTRONIC DEVICES AND TABLETS; ELECTRONIC GAME SOFTWARE FOR CELLULAR TELEPHONES; INTERACTIVE GAME PROGRAMS; INTERACTIVE GAME SOFTWARE, IN CLASS 9 (U.S. CLS. 21, 23, 26, 36 AND 38).

FIRST USE 7-21-2011; IN COMMERCE 7-21-2011.

THE MARK CONSISTS OF STANDARD CHARACTERS WITHOUT CLAIM TO ANY PARTICULAR FONT, STYLE, SIZE, OR COLOR.

SER. NO. 85-377,891, FILED 7-21-2011.

STEVEN PEREZ, EXAMINING ATTORNEY



David J. Kyffers

Director of the United States Patent and Trademark Office

United States of America

United States Patent and Trademark Office

ABRIL

Reg. No. 4,108,616

Registered Mar. 6, 2012

Int. Cl.: 9

TRADEMARK

PRINCIPAL REGISTER

TYPETOGETHER S.R.O. (CZECH REPUBLIC LIMITED LIABILITY COMPANY)
U SPARTY 551/14
PRAGUE, CZECH REPUBLIC 17000PRAH

FOR: PRINTING FONTS THAT CAN BE DOWNLOADED PROVIDED BY MEANS OF ELECTRONIC TRANSMISSION; TYPEFACE FONTS RECORDED ON MAGNETIC MEDIA , IN CLASS 9 (U.S. CLS. 21, 23, 26, 36 AND 38).

FIRST USE 7-1-2011; IN COMMERCE 7-1-2011.

THE MARK CONSISTS OF STANDARD CHARACTERS WITHOUT CLAIM TO ANY PARTICULAR FONT, STYLE, SIZE, OR COLOR.

THE ENGLISH TRANSLATION OF "ABRIL" IN THE MARK IS "APRIL".

SER. NO. 85-377,910, FILED 7-21-2011.

JOHN WILKE, EXAMINING ATTORNEY



David J. Kybas

Director of the United States Patent and Trademark Office

United States of America

United States Patent and Trademark Office

BREE

Reg. No. 4,108,617

Registered Mar. 6, 2012

Int. Cl.: 9

TRADEMARK

PRINCIPAL REGISTER

TYPETOGETHER, S.R.O. (CZECH REPUBLIC LIMITED LIABILITY COMPANY)
U SPARTY 551/14
PRAGUE, CZECH REPUBLIC 17000PRAH

FOR: PRINTING FONTS THAT CAN BE DOWNLOADED PROVIDED BY MEANS OF ELECTRONIC TRANSMISSION; TYPEFACE FONTS RECORDED ON MAGNETIC MEDIA, IN CLASS 9 (U.S. CLS. 21, 23, 26, 36 AND 38).

FIRST USE 2-1-2008; IN COMMERCE 2-1-2008.

THE MARK CONSISTS OF STANDARD CHARACTERS WITHOUT CLAIM TO ANY PARTICULAR FONT, STYLE, SIZE, OR COLOR.

SER. NO. 85-377,922, FILED 7-21-2011.

MEGHAN REINHART, EXAMINING ATTORNEY



David J. Kybas

Director of the United States Patent and Trademark Office

United States of America

United States Patent and Trademark Office

PARAGON VINEYARD

Reg. No. 4,108,618

Registered Mar. 6, 2012

Int. Cl.: 33

TRADEMARK

PRINCIPAL REGISTER

PARAGON VINEYARD CO., INC. (NEVADA CORPORATION)
4915 ORCUTT ROAD
SAN LUIS OBISPO, CA 93401

FOR: WINE, IN CLASS 33 (U.S. CLS. 47 AND 49).

FIRST USE 9-2-2002; IN COMMERCE 9-2-2002.

THE MARK CONSISTS OF STANDARD CHARACTERS WITHOUT CLAIM TO ANY PARTICULAR FONT, STYLE, SIZE, OR COLOR.

OWNER OF U.S. REG. NO. 1,811,648.

NO CLAIM IS MADE TO THE EXCLUSIVE RIGHT TO USE "VINEYARD", APART FROM THE MARK AS SHOWN.

SER. NO. 85-377,951, FILED 7-21-2011.

KAREN BRACEY, EXAMINING ATTORNEY



David J. Kyffers

Director of the United States Patent and Trademark Office

United States of America

United States Patent and Trademark Office

THOUGHTFULNESS DOESN'T TAKE A HOLIDAY

Reg. No. 4,108,619

TIPPYGRAM, LLC (GEORGIA LIMITED LIABILITY COMPANY)
541 10TH STREET, NW #445
ATLANTA, GA 30318

Registered Mar. 6, 2012

Int. Cl.: 16

FOR: GREETING POSTCARDS WITH ENVELOPES, IN CLASS 16 (U.S. CLS. 2, 5, 22, 23, 29, 37, 38 AND 50).

TRADEMARK

FIRST USE 7-11-2011; IN COMMERCE 7-11-2011.

PRINCIPAL REGISTER

THE MARK CONSISTS OF STANDARD CHARACTERS WITHOUT CLAIM TO ANY PARTICULAR FONT, STYLE, SIZE, OR COLOR.

SER. NO. 85-377,961, FILED 7-21-2011.

JAMES MACFARLANE, EXAMINING ATTORNEY



David J. Kybas

Director of the United States Patent and Trademark Office

United States of America

United States Patent and Trademark Office



Reg. No. 4,108,620

LIANG JIAN WEI (AUSTRALIA INDIVIDUAL)
19 / 20 BELMORE ST BURWOOD
NSW, AUSTRALIA 2134 AND

Registered Mar. 6, 2012

Int. Cl.: 25

RACHEL ANN EVANS (AUSTRALIA INDIVIDUAL)
18 LEWISHAM STREET DULWICH HILL
NSW, AUSTRALIA 2203

TRADEMARK

PRINCIPAL REGISTER

FOR: BEACH COVER-UPS; COATS; COLLARS; GIRDLES; JACKETS; JERSEYS; JUMPERS;
LEATHER COATS; PULLOVERS; SHIRTS; SINGLETS; SKIRTS; SWEATERS; TEE SHIRTS;
TROUSERS, IN CLASS 25 (U.S. CLS. 22 AND 39).

FIRST USE 3-17-2010; IN COMMERCE 3-17-2010.

SER. NO. 85-377,978, FILED 7-21-2011.

KATHERINE CHANG, EXAMINING ATTORNEY



David J. Kybas

Director of the United States Patent and Trademark Office

United States of America

United States Patent and Trademark Office



Reg. No. 4,108,621

Registered Mar. 6, 2012

Int. Cl.: 1

TRADEMARK

PRINCIPAL REGISTER

YIYANG HONGYUAN RARE EARTH CO., LTD. (CHINA LIMITED LIABILITY COMPANY)
JIAOYU STREET, WUYI EAST ROAD
YIYANG CITY, HUNAN, CHINA

FOR: ALKALINE-EARTH METALS; CERIUM; DYSPROSIUM; ERBIUM; EUROPIUM; HYDROGEN; LANTHANUM; NEODYMIUM; RARE EARTHS; SAMARIUM; SCANDIUM; TERBIUM; THULIUM; YTTERBIUM; YTTRIUM, IN CLASS 1 (U.S. CLS. 1, 5, 6, 10, 26 AND 46).

FIRST USE 7-11-2008; IN COMMERCE 7-11-2008.

THE MARK CONSISTS OF STYLIZED CHINESE CHARACTERS, A RUNNING DEER AND WORD "JU LU".

THE NON-LATIN CHARACTERS IN THE MARK TRANSLITERATE TO "JU LU" AND THIS MEANS "GIGANTIC DEER" IN ENGLISH.

THE ENGLISH TRANSLATION OF "JU LU" IN THE MARK IS GIGANTIC DEER".

SER. NO. 85-377,990, FILED 7-22-2011.

FONG HSU, EXAMINING ATTORNEY



David J. Kybas

Director of the United States Patent and Trademark Office

United States of America

United States Patent and Trademark Office



Reg. No. 4,108,622

Registered Mar. 6, 2012

Int. Cl.: 36

SERVICE MARK

PRINCIPAL REGISTER

THE BRIAN GRANT FOUNDATION (OREGON CHARITABLE, NON-PROFIT CORPORATION)
SUITE 30
720 NW DAVIS
PORTLAND, OR 97209

FOR: CHARITABLE FUND RAISING SERVICES, IN CLASS 36 (U.S. CLS. 100, 101 AND 102).

FIRST USE 6-22-2010; IN COMMERCE 6-22-2010.

THE MARK CONSISTS OF A STYLIZED LOWER CASE B SUPERIMPOSED OVER A STYLIZED LOWER CASE G.

SER. NO. 85-377,991, FILED 7-22-2011.

SUNG IN, EXAMINING ATTORNEY



David J. Kyfos

Director of the United States Patent and Trademark Office

United States of America

United States Patent and Trademark Office

Own it 2 Keep it

Reg. No. 4,108,623

PADS 2 HOME REALTY CORPORATION (NEW YORK CORPORATION)
3 OAKLAND HEIGHTS
BETHEL, CT 06801

Registered Mar. 6, 2012

Int. Cl.: 36

FOR: REAL ESTATE CONSULTATION, IN CLASS 36 (U.S. CLS. 100, 101 AND 102).

SERVICE MARK

FIRST USE 7-0-2011; IN COMMERCE 7-0-2011.

PRINCIPAL REGISTER

THE MARK CONSISTS OF STANDARD CHARACTERS WITHOUT CLAIM TO ANY PARTICULAR FONT, STYLE, SIZE, OR COLOR.

SER. NO. 85-378,008, FILED 7-22-2011.

LINDA POWELL, EXAMINING ATTORNEY



David J. Kybas

Director of the United States Patent and Trademark Office

United States of America

United States Patent and Trademark Office

FEEL GOOD - PERFORM BETTER

Reg. No. 4,108,624

Registered Mar. 6, 2012

Int. Cl.: 10

TRADEMARK

PRINCIPAL REGISTER

RICE, DAVID A. (UNITED STATES INDIVIDUAL), DBA BALANCE POINT MASSAGE
3910 NORMAL STREET, SUITE A
SAN DIEGO, CA 92103

FOR: MASSAGE APPARATUS, IN CLASS 10 (U.S. CLS. 26, 39 AND 44).

FIRST USE 3-22-2011; IN COMMERCE 3-22-2011.

THE MARK CONSISTS OF STANDARD CHARACTERS WITHOUT CLAIM TO ANY PARTICULAR FONT, STYLE, SIZE, OR COLOR.

SER. NO. 85-378,009, FILED 7-22-2011.

LINDA POWELL, EXAMINING ATTORNEY



David J. Kybas

Director of the United States Patent and Trademark Office

United States of America

United States Patent and Trademark Office



Reg. No. 4,108,625

Registered Mar. 6, 2012

Int. Cl.: 9

TRADEMARK

PRINCIPAL REGISTER

ROCKRIDGE CAPITAL, LLC (CALIFORNIA LIMITED LIABILITY COMPANY), DBA
SHAUNS SHADES
6015 MANCHESTER DRIVE
OAKLAND, CA 94618

FOR: CASES FOR EYEGLASSES AND SUNGLASSES; EYEWEAR, NAMELY, SUNGLASSES,
EYEGLASSES AND OPHTHALMIC FRAMES AND CASES THEREFOR; GOGGLES FOR
SPORTS, IN CLASS 9 (U.S. CLS. 21, 23, 26, 36 AND 38).

FIRST USE 5-31-2011; IN COMMERCE 5-31-2011.

THE MARK CONSISTS OF THREE CIRCLES FORMING THE BRAILLE LETTER "S".

SER. NO. 85-378,013, FILED 7-22-2011.

ROSELLE HERRERA, EXAMINING ATTORNEY



David J. Kyffers

Director of the United States Patent and Trademark Office

United States of America

United States Patent and Trademark Office



Reg. No. 4,108,626

Registered Mar. 6, 2012

Int. Cls.: 35 and 36

SERVICE MARK

PRINCIPAL REGISTER

MOSES, INC. (MICHIGAN CORPORATION)
1380 SPAULDING AVENUE SE
GRAND RAPIDS, MI 49546

FOR: CHARITABLE SERVICES, NAMELY, ORGANIZING AND CONDUCTING VOLUNTEER PROGRAMS AND COMMUNITY SERVICE PROJECTS IN THE UNITED STATES AND ABROAD; ORGANIZING AND DEVELOPING PROJECTS THAT AIM TO IMPROVE THE LIVES OF UNDERPRIVILEGED AND IMPOVERISHED PEOPLE; ORGANIZING AND CONDUCTING CHARITY AUCTIONS FOR CHARITABLE FUNDRAISING SERVICES, IN CLASS 35 (U.S. CLS. 100, 101 AND 102).

FIRST USE 5-24-1992; IN COMMERCE 5-24-1992.

FOR: CHARITABLE FUNDRAISING SERVICES, IN CLASS 36 (U.S. CLS. 100, 101 AND 102).

FIRST USE 5-24-1992; IN COMMERCE 5-24-1992.

THE MARK CONSISTS OF A SHEPHERD-LIKE CHARACTER WITH A SHEPHERD'S CROOK.

SER. NO. 85-378,073, FILED 7-22-2011.

GEOFFREY FOSDICK, EXAMINING ATTORNEY



David J. Kypos

Director of the United States Patent and Trademark Office

United States of America

United States Patent and Trademark Office

SURROUND

Reg. No. 4,108,627

Registered Mar. 6, 2012

Int. Cl.: 21

TRADEMARK

PRINCIPAL REGISTER

SPECIALIZED CARE CO. (NEW HAMPSHIRE CORPORATION)
206 WOODLAND RD.
HAMPTON, NH 03842

FOR: TOOTHBRUSHES, IN CLASS 21 (U.S. CLS. 2, 13, 23, 29, 30, 33, 40 AND 50).

FIRST USE 6-12-2002; IN COMMERCE 6-12-2002.

THE MARK CONSISTS OF STANDARD CHARACTERS WITHOUT CLAIM TO ANY PARTICULAR FONT, STYLE, SIZE, OR COLOR.

OWNER OF U.S. REG. NO. 2,842,019.

SEC. 2(F).

SER. NO. 85-378,097, FILED 7-22-2011.

MICHAEL WEBSTER, EXAMINING ATTORNEY



David J. Kyffers

Director of the United States Patent and Trademark Office

United States of America

United States Patent and Trademark Office



Reg. No. 4,108,628

Registered Mar. 6, 2012

Int. Cl.: 6

TRADEMARK

PRINCIPAL REGISTER

SYSTEM 22, INC. (PENNSYLVANIA CORPORATION)
7A ROWELL ROAD
BOYERTOWN, PA 19512

FOR: METAL FASTENERS, NAMELY, BOLTS, NUTS, SCREWS, STUDS, IN CLASS 6 (U.S. CLS. 2, 12, 13, 14, 23, 25 AND 50).

FIRST USE 1-1-2011; IN COMMERCE 1-1-2011.

THE MARK CONSISTS OF THE LITERAL ELEMENT "22"; THE OUTLINE DEFINING A STYLIZED SHAPE OF THE NUMERAL '2'; AN INNER DIVISION DIVIDING THE NUMERAL '2' INTO TWO DISTINCT NUMERALS '2'.

SER. NO. 85-378,193, FILED 7-22-2011.

KEVON CHISOLM, EXAMINING ATTORNEY



David J. Kybas

Director of the United States Patent and Trademark Office

United States of America

United States Patent and Trademark Office

DOORYARD

Reg. No. 4,108,629

Registered Mar. 6, 2012

Int. Cl.: 33

TRADEMARK

PRINCIPAL REGISTER

WOOD, STEPHEN M. (UNITED STATES INDIVIDUAL), DBA POVERTY LANE ORCHARDS
98 POVERTY LANE
LEBANON, NH 03766

FOR: HARD CIDER; WINE, IN CLASS 33 (U.S. CLS. 47 AND 49).

FIRST USE 6-20-2011; IN COMMERCE 6-20-2011.

THE MARK CONSISTS OF STANDARD CHARACTERS WITHOUT CLAIM TO ANY PARTICULAR FONT, STYLE, SIZE, OR COLOR.

OWNER OF U.S. REG. NOS. 2,319,885, 3,076,448, AND 3,198,638.

SER. NO. 85-378,212, FILED 7-22-2011.

EUGENIA MARTIN, EXAMINING ATTORNEY



David J. Kybas

Director of the United States Patent and Trademark Office

United States of America

United States Patent and Trademark Office

22

Reg. No. 4,108,630

SYSTEM 22, INC. (PENNSYLVANIA CORPORATION)
7A ROWELL ROAD
BOYERTOWN, PA 19512

Registered Mar. 6, 2012

Int. Cl.: 6

FOR: METAL FASTENERS, NAMELY, BOLTS, NUTS, SCREWS, STUDS, IN CLASS 6 (U.S. CLS. 2, 12, 13, 14, 23, 25 AND 50).

TRADEMARK

FIRST USE 1-1-2000; IN COMMERCE 1-1-2000.

PRINCIPAL REGISTER

THE MARK CONSISTS OF STANDARD CHARACTERS WITHOUT CLAIM TO ANY PARTICULAR FONT, STYLE, SIZE, OR COLOR.

SER. NO. 85-378,214, FILED 7-22-2011.

KEVON CHISOLM, EXAMINING ATTORNEY



David J. Kybas

Director of the United States Patent and Trademark Office

United States of America

United States Patent and Trademark Office

EQUAL EXCHANGE

Reg. No. 4,108,631

Registered Mar. 6, 2012

Int. Cl.: 29

TRADEMARK

PRINCIPAL REGISTER

EQUAL EXCHANGE, INC. (MASSACHUSETTS CORPORATION)
50 UNITED DRIVE
WEST BRIDGEWATER, MA 02379

FOR: OLIVE OIL, IN CLASS 29 (U.S. CL. 46).

FIRST USE 7-11-2011; IN COMMERCE 7-11-2011.

THE MARK CONSISTS OF STANDARD CHARACTERS WITHOUT CLAIM TO ANY PARTICULAR FONT, STYLE, SIZE, OR COLOR.

OWNER OF U.S. REG. NOS. 3,281,705, 3,729,761 AND OTHERS.

SER. NO. 85-378,231, FILED 7-22-2011.

CHRISTOPHER SIDOTI, EXAMINING ATTORNEY



David J. Kyffers

Director of the United States Patent and Trademark Office

United States of America

United States Patent and Trademark Office

SANTEE



Reg. No. 4,108,632

Registered Mar. 6, 2012

Int. Cls.: 7 and 12

TRADEMARK

PRINCIPAL REGISTER

DAE-IL, USA, INC. (DELAWARE CORPORATION)
18225 SERENE DRIVE STE. 150
MORGAN HILL, CA 95037

FOR: EXHAUST PIPES, MUFFLERS, AND EXHAUST SYSTEMS FOR MOTORCYCLES COMPRISED OF HEAT SHIELDS, BAFFLES, CLAMPS AND SNAP RINGS, IN CLASS 7 (U.S. CLS. 13, 19, 21, 23, 31, 34 AND 35).

FIRST USE 2-1-2007; IN COMMERCE 2-1-2007.

FOR: STRUCTURAL PARTS FOR MOTORCYCLES, NAMELY, FRAMES, SEATS, OIL TANKS, SWINGARM SUSPENSION SYSTEMS, HANDLEBARS, HIGHWAY BARS, TRANSMISSION MOUNTING PLATES, AXLES, IN CLASS 12 (U.S. CLS. 19, 21, 23, 31, 35 AND 44).

FIRST USE 2-1-2007; IN COMMERCE 2-1-2007.

OWNER OF U.S. REG. NOS. 2,306,983 AND 2,967,564.

THE MARK CONSISTS OF THE WORD SANTEE IN STYLIZED LETTERS, TWO CURVED LINES AFTER THE LAST LETTER OF THE WORD ENDING IN POINTS, A LARGE LINE UNDERLINING THE WORD SANTEE WHICH STARTS OUT STRAIGHT THEN ANGLES TO A POINT WHICH MEETS WITH THE POINT OF THE SECOND CURVED LINE.

SER. NO. 85-378,239, FILED 7-22-2011.

PAUL MORENO, EXAMINING ATTORNEY



David J. Kyros

Director of the United States Patent and Trademark Office

United States of America

United States Patent and Trademark Office

I'M FABULOUS

Reg. No. 4,108,633

Registered Mar. 6, 2012

Int. Cl.: 3

TRADEMARK

PRINCIPAL REGISTER

ANAIS, CORPORATION (FLORIDA CORPORATION)
600 ANCHOR POINT
DELRAY BEACH, FL 33444

FOR: ANTI-AGING CREAMS; ANTI-WRINKLE CREAMS; BATH BEADS; BATH CREAM; BATH GEL; BATH MILKS; BATH OILS; BATHING LOTIONS; BEAUTY MASKS; BODY BUTTER; BODY SCRUB; COSMETICS; COSMETICS, NAMELY, LIP PRIMER; COSMETICS, NAMELY, LIP REPAIRERS; ESSENTIAL OILS; ESSENTIAL OILS FOR PERSONAL USE; EXFOLIANTS FOR THE FACE, AND INGREDIENTS SOLD AS A COMPONENT THEREOF; FACIAL SCRUBS; HAIR CARE PREPARATIONS; LIP BALM; LIPSTICK; NATURAL MINERAL MAKE-UP; NON-MEDICATED ANTI-AGING SERUM; NON-MEDICATED LIP CARE PREPARATIONS; NON-MEDICATED SKIN CARE CREAMS AND LOTIONS; NON-MEDICATED SKIN CARE PREPARATIONS; NON-MEDICATED SKIN CARE PREPARATIONS, NAMELY, BODY AND BATH GELS, CREAMS, LOTIONS, AND SERUMS, AND INGREDIENTS SOLD AS A COMPONENT THEREOF; NON-MEDICATED INGREDIENTS SOLD AS A COMPONENT OF BATH, SHOWER, SKIN CARE AND HAIR CARE PREPARATIONS; PERFUMES; SHOWER GELS; SKIN CARE PREPARATIONS, NAMELY, SKIN PEELS; SKIN CARE PRODUCTS, NAMELY, NON-MEDICATED SKIN SERUM; SKIN CLEANSERS; SKIN TONERS, IN CLASS 3 (U.S. CLS. 1, 4, 6, 50, 51 AND 52).

FIRST USE 1-12-2011; IN COMMERCE 1-12-2011.

THE MARK CONSISTS OF STANDARD CHARACTERS WITHOUT CLAIM TO ANY PARTICULAR FONT, STYLE, SIZE, OR COLOR.

SER. NO. 85-378,248, FILED 7-22-2011.

EUGENIA MARTIN, EXAMINING ATTORNEY



David J. Kyffers

Director of the United States Patent and Trademark Office

United States of America

United States Patent and Trademark Office

HOMESTEAD

Reg. No. 4,108,634

Registered Mar. 6, 2012

Int. Cls.: 43 and 44

SERVICE MARK

PRINCIPAL REGISTER

GENESIS IP, LLC (DELAWARE LIMITED LIABILITY COMPANY)
101 EAST STATE STREET
KENNETT SQUARE, PA 19348

FOR: PROVIDING ASSISTED LIVING FACILITIES, IN CLASS 43 (U.S. CLS. 100 AND 101).

FIRST USE 0-0-2004; IN COMMERCE 0-0-2004.

FOR: HEALTH CARE SERVICES RENDERED IN A GERIATRIC CARE FACILITY, NAMELY, PROVIDING IN-FACILITY GERIATRIC HEALTH CARE MANAGEMENT SERVICES FOR PATIENTS WITH ALZHEIMER'S, DEMENTIA OR MEMORY IMPAIRED NEEDS AND PROVIDING REHABILITATION SERVICES, IN CLASS 44 (U.S. CLS. 100 AND 101).

FIRST USE 9-0-1995; IN COMMERCE 9-0-1995.

THE MARK CONSISTS OF STANDARD CHARACTERS WITHOUT CLAIM TO ANY PARTICULAR FONT, STYLE, SIZE, OR COLOR.

OWNER OF U.S. REG. NO. 3,003,182.

SER. NO. 85-378,256, FILED 7-22-2011.

MICHAEL TANNER, EXAMINING ATTORNEY



David J. Kybas

Director of the United States Patent and Trademark Office

United States of America

United States Patent and Trademark Office

sessionette

Reg. No. 4,108,635

Registered Mar. 6, 2012

Int. Cl.: 41

SERVICE MARK

PRINCIPAL REGISTER

LITTLE NEST PORTRAITS (DELAWARE LIMITED LIABILITY COMPANY)
1825 DELAWARE AVENUE
WILMINGTON, DE 19806

FOR: PHOTOGRAPHY SERVICES, IN CLASS 41 (U.S. CLS. 100, 101 AND 107).

FIRST USE 1-1-2011; IN COMMERCE 1-1-2011.

THE MARK CONSISTS OF STANDARD CHARACTERS WITHOUT CLAIM TO ANY PARTICULAR FONT, STYLE, SIZE, OR COLOR.

SER. NO. 85-378,294, FILED 7-22-2011.

ANNE MADDEN, EXAMINING ATTORNEY



David J. Kyffers

Director of the United States Patent and Trademark Office

United States of America
United States Patent and Trademark Office

ArborSystems

Reg. No. 4,108,636

ARBORSYSTEMS, INC. (NEBRASKA CORPORATION)

Registered Mar. 6, 2012

P.O. BOX 34645
OMAHA, NE 68134

Int. Cl.: 8

FOR: HAND OPERATED TREE INJECTION TOOL FOR INJECTING CHEMICALS BETWEEN THE BARK AND SAPWOOD OF A TREE, IN CLASS 8 (U.S. CLS. 23, 28 AND 44).

TRADEMARK

FIRST USE 12-31-1996; IN COMMERCE 12-31-1996.

PRINCIPAL REGISTER

THE MARK CONSISTS OF STANDARD CHARACTERS WITHOUT CLAIM TO ANY PARTICULAR FONT, STYLE, SIZE, OR COLOR.

SER. NO. 85-378,314, FILED 7-22-2011.

BRIDGETT SMITH, EXAMINING ATTORNEY



David J. Kybas

Director of the United States Patent and Trademark Office

United States of America

United States Patent and Trademark Office

THE ONE-EYED CATS

Reg. No. 4,108,637

JOHN L. BISHOP (UNITED STATES INDIVIDUAL)
300 SUMMIT HOUSE
WEST CHESTER, PA 19382

Registered Mar. 6, 2012

Int. Cl.: 41

FOR: ENTERTAINMENT SERVICES IN THE NATURE OF LIVE MUSICAL PERFORMANCES,
IN CLASS 41 (U.S. CLS. 100, 101 AND 107).

SERVICE MARK

FIRST USE 8-10-2011; IN COMMERCE 8-10-2011.

PRINCIPAL REGISTER

THE MARK CONSISTS OF STANDARD CHARACTERS WITHOUT CLAIM TO ANY PARTICULAR FONT, STYLE, SIZE, OR COLOR.

SER. NO. 85-378,320, FILED 7-22-2011.

MIDGE BUTLER, EXAMINING ATTORNEY



David J. Kybas

Director of the United States Patent and Trademark Office

United States of America

United States Patent and Trademark Office

ArborSystems

Reg. No. 4,108,638

ARBORSYSTEMS, INC. (NEBRASKA CORPORATION)

Registered Mar. 6, 2012

P.O. BOX 34645
OMAHA, NE 68134

Int. Cl.: 5

FOR: HERBICIDES, INSECTICIDES AND FUNGICIDES FOR PROFESSIONAL USE, IN CLASS 5 (U.S. CLS. 6, 18, 44, 46, 51 AND 52).

TRADEMARK

FIRST USE 12-31-1996; IN COMMERCE 12-31-1996.

PRINCIPAL REGISTER

THE MARK CONSISTS OF STANDARD CHARACTERS WITHOUT CLAIM TO ANY PARTICULAR FONT, STYLE, SIZE, OR COLOR.

SER. NO. 85-378,330, FILED 7-22-2011.

BRIDGETT SMITH, EXAMINING ATTORNEY



David J. Kybas

Director of the United States Patent and Trademark Office

United States of America

United States Patent and Trademark Office

ArborSystems

Reg. No. 4,108,639

ARBORSYSTEMS, INC. (NEBRASKA CORPORATION)

Registered Mar. 6, 2012

P.O. BOX 34645
OMAHA, NE 68134

Int. Cl.: 1

FOR: NUTRIENT SUPPLEMENTS FOR TREES; PLANT GROWTH REGULATING PREPARATIONS, IN CLASS 1 (U.S. CLS. 1, 5, 6, 10, 26 AND 46).

TRADEMARK

FIRST USE 12-31-1996; IN COMMERCE 12-31-1996.

PRINCIPAL REGISTER

THE MARK CONSISTS OF STANDARD CHARACTERS WITHOUT CLAIM TO ANY PARTICULAR FONT, STYLE, SIZE, OR COLOR.

SER. NO. 85-378,339, FILED 7-22-2011.

BRIDGETT SMITH, EXAMINING ATTORNEY



David J. Kybas

Director of the United States Patent and Trademark Office

United States of America

United States Patent and Trademark Office

TRADITIONS

Reg. No. 4,108,640

PERFECT PLUS, INC. (CALIFORNIA CORPORATION)
9595 WILSHIRE BLVD., SUITE 601
BEVERLY HILLS, CA 90212

Registered Mar. 6, 2012

Int. Cl.: 3

FOR: HAIR CARE PRODUCTS, NAMELY, SHAMPOO, CONDITIONERS, HAIR SPRAY, STYLING GELS, AND MOUSSE, IN CLASS 3 (U.S. CLS. 1, 4, 6, 50, 51 AND 52).

TRADEMARK

FIRST USE 3-25-2011; IN COMMERCE 3-25-2011.

PRINCIPAL REGISTER

THE MARK CONSISTS OF STANDARD CHARACTERS WITHOUT CLAIM TO ANY PARTICULAR FONT, STYLE, SIZE, OR COLOR.

SER. NO. 85-378,386, FILED 7-22-2011.

AMY ALFIERI, EXAMINING ATTORNEY



David J. Kybas

Director of the United States Patent and Trademark Office

United States of America
United States Patent and Trademark Office

CashCall

Reg. No. 4,108,641

CASHCALL, INC. (CALIFORNIA CORPORATION)
1600 SOUTH DOUGLASS ROAD
ANAHEIM, CA 92660

Registered Mar. 6, 2012

Int. Cl.: 36

FOR: INSTALLMENT LOANS; MORTGAGE BANKING SERVICES, NAMELY, ORIGINATION, ACQUISITION, SERVICING, SECURITIZATION AND BROKERAGE OF MORTGAGE LOANS, IN CLASS 36 (U.S. CLS. 100, 101 AND 102).

SERVICE MARK

FIRST USE 7-1-2003; IN COMMERCE 7-1-2003.

PRINCIPAL REGISTER

THE MARK CONSISTS OF THE WORD CASHCALL IN A SPECIFIC SPECIAL FONT WITH THE FIRST "C" IN THE SHAPE OF A PHONE.

SER. NO. 85-378,406, FILED 7-22-2011.

WILLIAM JACKSON, EXAMINING ATTORNEY



David J. Kyros

Director of the United States Patent and Trademark Office

United States of America

United States Patent and Trademark Office

LYALVALE

Reg. No. 4,108,642

Registered Mar. 6, 2012

Int. Cl.: 13

TRADEMARK

PRINCIPAL REGISTER

LYALVALE EXPRESS LIMITED (ENGLAND LIMITED COMPANY (LTD.))
EXPRESS ESTATE
FISHERWICK
LICHFIELD, STAFFS, ENGLAND WS138XA

FOR: FIREARMS; AMMUNITION AND GUIDED CARTRIDGES FOR GUNS, RIFLES AND BLANKS; GUN PARTS; CARTRIDGE AND CARTRIDGE SHOT POUCHES, COVERS AND STORAGE APPARATUS AND EQUIPMENT, NAMELY, FITTED COVERS FOR USE WITH FIREARMS, GUN SCABBARDS, GUN CASES, GUN CLEANING BRUSHES, GUN MOUNTS, GUN LOCKS, PORTABLE AND STATIONARY GUN STORAGE STRONGBOXES, ALL ADAPTED FOR USE WITH THE AFORESAID GOODS; REPLACEMENT AND STRUCTURAL PARTS AND FITTINGS FOR ALL THE AFORESAID GOODS, IN CLASS 13 (U.S. CLS. 2 AND 9).

FIRST USE 3-0-1999; IN COMMERCE 3-0-1999.

THE MARK CONSISTS OF STANDARD CHARACTERS WITHOUT CLAIM TO ANY PARTICULAR FONT, STYLE, SIZE, OR COLOR.

OWNER OF U.S. REG. NO. 2,475,329.

SER. NO. 85-378,430, FILED 7-22-2011.

JEAN IM, EXAMINING ATTORNEY



David J. Kypos

Director of the United States Patent and Trademark Office

United States of America

United States Patent and Trademark Office



Reg. No. 4,108,643

Registered Mar. 6, 2012

Int. Cl.: 36

SERVICE MARK

PRINCIPAL REGISTER

FIRST CONNECTICUT BANCORP, INC. (MARYLAND CORPORATION)
ONE FARM GLEN BLVD.
FARMINGTON, CT 06032

FOR: BANKING SERVICES, IN CLASS 36 (U.S. CLS. 100, 101 AND 102).

FIRST USE 11-16-2009; IN COMMERCE 11-16-2009.

THE MARK CONSISTS OF A SQUARE DESIGN WITH A FLAME SHAPE IN THE MIDDLE IN WHITE, THE LEFT SIDE OF THE LOGO IN BLUE AND THE RIGHT SIDE IN GREEN.

THE COLOR(S) BLUE, GREEN AND WHITE IS/ARE CLAIMED AS A FEATURE OF THE MARK.

SER. NO. 85-378,465, FILED 7-22-2011.

JANICE L. MCMORROW, EXAMINING ATTORNEY



David J. Kybas

Director of the United States Patent and Trademark Office

United States of America

United States Patent and Trademark Office



Reg. No. 4,108,644

Registered Mar. 6, 2012

Int. Cl.: 25

TRADEMARK

PRINCIPAL REGISTER

PIRASTEH, ARRASH (UNITED STATES INDIVIDUAL)
5981 ARATHAO RD. UNIT 1306
DALLAS, TX 75248

FOR: BEANIES; BELTS FOR CLOTHING; BIKINIS; HEAD SCARVES; HEADBANDS; HEADBANDS FOR CLOTHING; HOODED SWEATSHIRTS; LADIES' UNDERWEAR; MEN'S UNDERWEAR; PANTS; SCARVES; SHORT-SLEEVED OR LONG-SLEEVED T-SHIRTS; SHORTS; SOCKS; SWIMSUITS; T-SHIRTS; UNDERWEAR, IN CLASS 25 (U.S. CLS. 22 AND 39).

FIRST USE 3-0-2010; IN COMMERCE 3-0-2010.

THE MARK CONSISTS OF STYLIZED GRIFFON IN A FLYING LIKE POSITION ABOVE THE STYLIZED TERMS "AZAD".

THE ENGLISH TRANSLATION OF AZAD IN THE MARK IS FREEDOM.

SER. NO. 85-378,476, FILED 7-22-2011.

SEAN CROWLEY, EXAMINING ATTORNEY



David J. Kybas

Director of the United States Patent and Trademark Office

United States of America

United States Patent and Trademark Office



Reg. No. 4,108,645

Registered Mar. 6, 2012

Int. Cl.: 36

SERVICE MARK

PRINCIPAL REGISTER

FIRST CONNECTICUT BANCORP, INC. (MARYLAND CORPORATION)
ONE FARM GLEN BLVD.
FARMINGTON, MA 06032

FOR: BANKING SERVICES, IN CLASS 36 (U.S. CLS. 100, 101 AND 102).

FIRST USE 11-16-2009; IN COMMERCE 11-16-2009.

THE MARK CONSISTS OF A SQUARE DESIGN WITH A FLAME SHAPE IN THE MIDDLE IN WHITE, THE LEFT SIDE OF THE LOGO IN BLUE AND THE RIGHT SIDE IN SILVER.

THE COLOR(S) BLUE, SILVER AND WHITE IS/ARE CLAIMED AS A FEATURE OF THE MARK.

SER. NO. 85-378,491, FILED 7-22-2011.

JANICE L. MCMORROW, EXAMINING ATTORNEY



David J. Kybas

Director of the United States Patent and Trademark Office

United States of America

United States Patent and Trademark Office



Reg. No. 4,108,646

Registered Mar. 6, 2012

Int. Cl.: 36

SERVICE MARK

PRINCIPAL REGISTER

FIRST CONNECTICUT BANCORP, INC. (MARYLAND CORPORATION)
ONE FARM GLEN BLVD.
FARMINGTON, CT 06032

FOR: BANKING SERVICES, IN CLASS 36 (U.S. CLS. 100, 101 AND 102).

FIRST USE 11-16-2009; IN COMMERCE 11-16-2009.

THE MARK CONSISTS OF A SQUARE DESIGN WITH A FLAME SHAPE IN THE MIDDLE.

SER. NO. 85-378,529, FILED 7-22-2011.

JANICE L. MCMORROW, EXAMINING ATTORNEY



David J. Kybas

Director of the United States Patent and Trademark Office

United States of America

United States Patent and Trademark Office



Reg. No. 4,108,647

Registered Mar. 6, 2012

Int. Cl.: 41

SERVICE MARK

PRINCIPAL REGISTER

H.E.R. DAY CORPORATION (NEW JERSEY NON-PROFIT CORPORATION)
1622 NORTHUMBERLAND WAY
MONMOUTH JUNCTION, NJ 08852

FOR: CONDUCTING EDUCATIONAL EXHIBITIONS IN THE NATURE OF COUNSELING FOR GRIEF AND MOURNING; EDUCATION SERVICES, NAMELY, PROVIDING SEMINARS IN THE FIELDS OF GRIEF AND COUNSELING, IN CLASS 41 (U.S. CLS. 100, 101 AND 107).

FIRST USE 5-1-2009; IN COMMERCE 5-1-2009.

THE MARK CONSISTS OF A CURVED BANNER DISPLAYING THE STYLIZED TEXT "H.E.R. DAY". BELOW THE BANNER IS THE STYLIZED TEXT ""HERE EVERYONE RELATES"".

SER. NO. 85-378,550, FILED 7-22-2011.

TINA MAI, EXAMINING ATTORNEY



David J. Kybas

Director of the United States Patent and Trademark Office

United States of America

United States Patent and Trademark Office

VILLAGES IN PARTNERSHIP

Reg. No. 4,108,648

Registered Mar. 6, 2012

Int. Cl.: 35

SERVICE MARK

PRINCIPAL REGISTER

VILLAGES IN PARTNERSHIP, INC. (NEW JERSEY NON-PROFIT CORPORATION)
20 HIGH STREET
ALLENTOWN, NJ 08501

FOR: CHARITABLE SERVICES, NAMELY, ORGANIZING, COORDINATING AND IMPLEMENTING PROJECTS DESIGNED TO IMPROVE LIVING CONDITIONS IN IMPOVERISHED AFRICAN VILLAGES, IN CLASS 35 (U.S. CLS. 100, 101 AND 102).

FIRST USE 5-0-2009; IN COMMERCE 5-0-2009.

THE MARK CONSISTS OF STANDARD CHARACTERS WITHOUT CLAIM TO ANY PARTICULAR FONT, STYLE, SIZE, OR COLOR.

SER. NO. 85-378,554, FILED 7-22-2011.

REBECCA SMITH, EXAMINING ATTORNEY



David J. Kybas

Director of the United States Patent and Trademark Office

United States of America

United States Patent and Trademark Office

DESIGN THE FUTURE

Reg. No. 4,108,649

SECURITY BENEFIT LIFE INSURANCE COMPANY (KANSAS CORPORATION)
ONE SECURITY BENEFIT PLACE
TOPEKA, KS 66636

Registered Mar. 6, 2012

Int. Cl.: 36

FOR: ANNUITY UNDERWRITING SERVICES FOR FLEXIBLE PREMIUM INDIVIDUAL ANNUITIES, IN CLASS 36 (U.S. CLS. 100, 101 AND 102).

SERVICE MARK

FIRST USE 4-18-2011; IN COMMERCE 4-18-2011.

PRINCIPAL REGISTER

THE MARK CONSISTS OF STANDARD CHARACTERS WITHOUT CLAIM TO ANY PARTICULAR FONT, STYLE, SIZE, OR COLOR.

SER. NO. 85-378,556, FILED 7-22-2011.

JANICE L. MCMORROW, EXAMINING ATTORNEY



David J. Kybas

Director of the United States Patent and Trademark Office

United States of America

United States Patent and Trademark Office

YOU'VE COME TO THE RIGHT PLACE

Reg. No. 4,108,650

Registered Mar. 6, 2012

Int. Cl.: 36

SERVICE MARK

PRINCIPAL REGISTER

FIRST CONNECTICUT BANCORP, INC. (MARYLAND CORPORATION)
ONE FARM GLEN BLVD.
FARMINGTON, CT 06032

FOR: BANKING SERVICES, IN CLASS 36 (U.S. CLS. 100, 101 AND 102).

FIRST USE 11-16-2009; IN COMMERCE 11-16-2009.

THE MARK CONSISTS OF STANDARD CHARACTERS WITHOUT CLAIM TO ANY PARTICULAR FONT, STYLE, SIZE, OR COLOR.

SER. NO. 85-378,559, FILED 7-22-2011.

JANICE L. MCMORROW, EXAMINING ATTORNEY



David J. Kybas

Director of the United States Patent and Trademark Office

United States of America

United States Patent and Trademark Office



Reg. No. 4,108,651

Registered Mar. 6, 2012

Int. Cl.: 35

SERVICE MARK

PRINCIPAL REGISTER

VILLAGES IN PARTNERSHIP, INC. (NEW JERSEY NON-PROFIT CORPORATION)
20 HIGH STREET
ALLENTOWN, NJ 08501

FOR: CHARITABLE SERVICES, NAMELY, ORGANIZING, COORDINATING AND IMPLEMENTING PROJECTS DESIGNED TO IMPROVE LIVING CONDITIONS IN IMPOVERISHED AFRICAN VILLAGES , IN CLASS 35 (U.S. CLS. 100, 101 AND 102).

FIRST USE 5-0-2009; IN COMMERCE 5-0-2009.

THE MARK CONSISTS OF THE LETTER "VIP" APPEARING WITHIN A GREEN REPRESENTATION OF THE AFRICAN CONTINENT.

THE COLOR(S) GREEN IS/ARE CLAIMED AS A FEATURE OF THE MARK.

SER. NO. 85-378,577, FILED 7-22-2011.

REBECCA SMITH, EXAMINING ATTORNEY



David J. Kybas

Director of the United States Patent and Trademark Office

United States of America

United States Patent and Trademark Office

STRATEGYONE

Reg. No. 4,108,652

Registered Mar. 6, 2012

Int. Cl.: 35

SERVICE MARK

PRINCIPAL REGISTER

EDELMAN, INC. (DELAWARE CORPORATION)
63RD FLOOR
200 EAST RANDOLPH STREET
CHICAGO, IL 60601

FOR: BUSINESS SERVICES, NAMELY, CONSUMER RESEARCH AND CONSULTING RELATED THERETO, IN CLASS 35 (U.S. CLS. 100, 101 AND 102).

FIRST USE 3-0-1999; IN COMMERCE 3-0-1999.

THE MARK CONSISTS OF STANDARD CHARACTERS WITHOUT CLAIM TO ANY PARTICULAR FONT, STYLE, SIZE, OR COLOR.

SER. NO. 85-378,608, FILED 7-22-2011.

ASMAT KHAN, EXAMINING ATTORNEY



David J. Kybas

Director of the United States Patent and Trademark Office

United States of America

United States Patent and Trademark Office

CANTUNES

Reg. No. 4,108,653

COOLER CONVERSATIONS LLC (INDIANA LIMITED LIABILITY COMPANY)
6284 RUCKER ROAD, SUITE M
INDIANAPOLIS, IN 46220

Registered Mar. 6, 2012

Int. Cl.: 21

FOR: INSULATING SLEEVE HOLDERS FOR BEVERAGE CANS, IN CLASS 21 (U.S. CLS. 2, 13, 23, 29, 30, 33, 40 AND 50).

TRADEMARK

FIRST USE 4-12-2010; IN COMMERCE 4-12-2010.

PRINCIPAL REGISTER

THE MARK CONSISTS OF STANDARD CHARACTERS WITHOUT CLAIM TO ANY PARTICULAR FONT, STYLE, SIZE, OR COLOR.

SER. NO. 85-378,620, FILED 7-22-2011.

APRIL HESIK, EXAMINING ATTORNEY



David J. Kyffers

Director of the United States Patent and Trademark Office

United States of America

United States Patent and Trademark Office

Marketsmith

Reg. No. 4,108,654

Registered Mar. 6, 2012

Int. Cl.: 35

SERVICE MARK

PRINCIPAL REGISTER

MARKETSMITH, INC. (NEW JERSEY CORPORATION)
18 CATTANO AVENUE
MORRISTOWN, NJ 07960

FOR: PROVIDING MARKETING CONSULTING SERVICES, NAMELY, ACQUIRING AND ANALYZING CONSUMER INFORMATION AND DEVELOPING MARKETING PROGRAMS AND SOLUTIONS AND COMMUNICATION STRATEGIES TO ASSIST BUSINESS CLIENTS AND NON-PROFIT CLIENTS IN THE PROMOTION AND SALE OF THEIR GOODS AND SERVICES, IN CLASS 35 (U.S. CLS. 100, 101 AND 102).

FIRST USE 5-13-1999; IN COMMERCE 5-13-1999.

THE MARK CONSISTS OF STANDARD CHARACTERS WITHOUT CLAIM TO ANY PARTICULAR FONT, STYLE, SIZE, OR COLOR.

SER. NO. 85-378,691, FILED 7-22-2011.

DOMINIC FATHY, EXAMINING ATTORNEY



David J. Kybas

Director of the United States Patent and Trademark Office

United States of America

United States Patent and Trademark Office

METAL EDGE

Reg. No. 4,108,655

Registered Mar. 6, 2012

Int. Cl.: 16

TRADEMARK

PRINCIPAL REGISTER

ZENBU MAGAZINES LLC (NEW YORK LIMITED LIABILITY COMPANY)
11TH FLOOR
104 WEST 29TH STREET
NEW YORK, NY 10001

FOR: MAGAZINES IN THE FIELD OF MUSIC AND PERSONALITIES IN THE ENTERTAINMENT INDUSTRY, IN CLASS 16 (U.S. CLS. 2, 5, 22, 23, 29, 37, 38 AND 50).

FIRST USE 10-16-1984; IN COMMERCE 10-16-1984.

THE MARK CONSISTS OF STANDARD CHARACTERS WITHOUT CLAIM TO ANY PARTICULAR FONT, STYLE, SIZE, OR COLOR.

NO CLAIM IS MADE TO THE EXCLUSIVE RIGHT TO USE "METAL", APART FROM THE MARK AS SHOWN.

SER. NO. 85-378,722, FILED 7-22-2011.

DAVID MURRAY, EXAMINING ATTORNEY



David J. Kyros

Director of the United States Patent and Trademark Office

United States of America

United States Patent and Trademark Office



Reg. No. 4,108,656

Registered Mar. 6, 2012

Int. Cl.: 20

TRADEMARK

PRINCIPAL REGISTER

BLUE FROG CREATIVE PRINTWORKS, LLC (MASSACHUSETTS LIMITED LIABILITY COMPANY)
345 CENTRAL STREET
LEOMINSTER, MA 01453

FOR: WINDOW SHADES, IN CLASS 20 (U.S. CLS. 2, 13, 22, 25, 32 AND 50).

FIRST USE 1-10-2011; IN COMMERCE 7-19-2011.

THE MARK CONSISTS OF A STYLIZED BLUE FROG WITH LIGHT GREEN SPOTS POSED ABOVE THE BLACK, STYLIZED AND CAPITALIZED PRINT PHRASE "BLUE FROG." THE BLUE COLOR SHADING OF THE FROG IS LIGHTEST AT TOP OF THE HEAD AND LEFT FRONT FOOT AND DARKENS DOWN THE LENGTH OF THE BODY TO THE BOTTOM OF THE RIGHT BACK FOOT. THE BACK RIGHT FOOT OF THE FROG IS POSITIONED BETWEEN THE TWO WORDS OF THE LITERAL ELEMENT.

THE COLOR(S) BLUE, LIGHT GREEN, BLACK IS/ARE CLAIMED AS A FEATURE OF THE MARK.

SER. NO. 85-378,733, FILED 7-22-2011.

MATTHEW EINSTEIN, EXAMINING ATTORNEY



David J. Kyros

Director of the United States Patent and Trademark Office

United States of America

United States Patent and Trademark Office



Reg. No. 4,108,657

Registered Mar. 6, 2012

Int. Cl.: 44

SERVICE MARK

PRINCIPAL REGISTER

MIAMI CHILDREN'S SMILES, P.A. (FLORIDA CORPORATION)
SUITE 301
3850 BIRD ROAD
MIAMI, FL 33146

FOR: DENTISTRY; PEDIATRIC DENTISTRY; DENTAL RESTORATION; DENTAL FILLING INSTALLATION, DENTAL CROWN INSTALLATION; ENDODONTIC THERAPY; AND SEDATION DENTISTRY, IN CLASS 44 (U.S. CLS. 100 AND 101).

FIRST USE 6-30-2008; IN COMMERCE 6-30-2008.

THE MARK CONSISTS OF MCS, WHERE THE M IS A CUTOUT WITHIN A CIRCLE, THE CIRCLE CONTAINING PALM TREE SILHOUETTES, THE C IS PARTIALLY UNDERLYING THE CIRCLE, THE S IS HANGING FROM THE C, AND A SMILE IS LOCATED UNDER THE CIRCLE.

SER. NO. 85-378,762, FILED 7-22-2011.

REBECCA EISINGER, EXAMINING ATTORNEY



David J. Kyffers

Director of the United States Patent and Trademark Office

United States of America

United States Patent and Trademark Office

PT

Reg. No. 4,108,658

Registered Mar. 6, 2012

Int. Cl.: 12

TRADEMARK

PRINCIPAL REGISTER

CHARLES STEVEN POWERS (UNITED STATES INDIVIDUAL)
SUITE 120
8101 KINGSTON RD
SHREVEPORT, LA 71108

FOR: SCREW PROPELLERS, IN CLASS 12 (U.S. CLS. 19, 21, 23, 31, 35 AND 44).

FIRST USE 1-1-1988; IN COMMERCE 7-1-2011.

THE MARK CONSISTS OF STANDARD CHARACTERS WITHOUT CLAIM TO ANY PARTICULAR FONT, STYLE, SIZE, OR COLOR.

SER. NO. 85-378,795, FILED 7-22-2011.

JAY FLOWERS, EXAMINING ATTORNEY



David J. Kyffers

Director of the United States Patent and Trademark Office

United States of America

United States Patent and Trademark Office

Index Equity Plus

Reg. No. 4,108,659

Registered Mar. 6, 2012

Int. Cl.: 36

SERVICE MARK

PRINCIPAL REGISTER

RUNNYMEDE CAPITAL MANAGEMENT, INC. (DELAWARE CORPORATION)
PO BOX 359
MENDHAM, NJ 079450359

FOR: ADVICE RELATING TO INVESTMENTS; FINANCIAL ANALYSIS AND CONSULTATION; FINANCIAL FORECASTING; FINANCIAL INVESTMENT ANALYSIS AND STOCK RESEARCH; FINANCIAL INVESTMENT IN THE FIELD OF SECURITIES; FINANCIAL PLANNING AND INVESTMENT ADVISORY SERVICES; FINANCIAL PORTFOLIO MANAGEMENT; INVESTMENT ADVICE; INVESTMENT ADVISORY SERVICES; INVESTMENT MANAGEMENT; PROVIDING FINANCIAL SERVICES WITH RESPECT TO SECURITIES AND OTHER FINANCIAL INSTRUMENTS AND PRODUCTS, NAMELY, MONEY MANAGEMENT SERVICES, IN CLASS 36 (U.S. CLS. 100, 101 AND 102).

FIRST USE 6-1-1994; IN COMMERCE 6-1-1994.

THE MARK CONSISTS OF STANDARD CHARACTERS WITHOUT CLAIM TO ANY PARTICULAR FONT, STYLE, SIZE, OR COLOR.

OWNER OF U.S. REG. NO. 2,073,562.

NO CLAIM IS MADE TO THE EXCLUSIVE RIGHT TO USE "INDEX EQUITY", APART FROM THE MARK AS SHOWN.

SER. NO. 85-378,797, FILED 7-22-2011.

JAY FLOWERS, EXAMINING ATTORNEY



David J. Kypos

Director of the United States Patent and Trademark Office

United States of America

United States Patent and Trademark Office

REseat

Reg. No. 4,108,660

Registered Mar. 6, 2012

Int. Cl.: 36

SERVICE MARK

PRINCIPAL REGISTER

RECYCLING ASSOCIATION OF MINNESOTA (MINNESOTA NON-PROFIT ASSOCIATION)
2250 WABASH AVE.
SAINT PAUL, MN 55114

FOR: CHARITABLE FUNDRAISING SERVICES BY MEANS OF COLLECTING AND REDEEMING RECYCLABLES FOR DONATION OF REDEMPTION PROCEEDS TO CHARITABLE ORGANIZATIONS, IN CLASS 36 (U.S. CLS. 100, 101 AND 102).

FIRST USE 7-19-2011; IN COMMERCE 7-19-2011.

THE MARK CONSISTS OF STANDARD CHARACTERS WITHOUT CLAIM TO ANY PARTICULAR FONT, STYLE, SIZE, OR COLOR.

SER. NO. 85-378,803, FILED 7-22-2011.

REBECCA EISINGER, EXAMINING ATTORNEY



David J. Kybas

Director of the United States Patent and Trademark Office

United States of America

United States Patent and Trademark Office

MIAMICHILDRENSSMILES.COM

Reg. No. 4,108,661

Registered Mar. 6, 2012

Int. Cl.: 44

SERVICE MARK

PRINCIPAL REGISTER

MIAMI CHILDREN'S SMILES, P.A. (FLORIDA CORPORATION)
SUITE 301
3850 BIRD ROAD
MIAMI, FL 33146

FOR: DENTISTRY; PEDIATRIC DENTISTRY; DENTAL RESTORATION; DENTAL FILLING
INSTALLATION, DENTAL CROWN INSTALLATION; ENDODONTIC THERAPY; AND
SEDATION DENTISTRY, IN CLASS 44 (U.S. CLS. 100 AND 101).

FIRST USE 2-14-2008; IN COMMERCE 2-14-2008.

THE MARK CONSISTS OF STANDARD CHARACTERS WITHOUT CLAIM TO ANY PAR-
TICULAR FONT, STYLE, SIZE, OR COLOR.

SER. NO. 85-378,804, FILED 7-22-2011.

REBECCA EISINGER, EXAMINING ATTORNEY



David J. Kyffers

Director of the United States Patent and Trademark Office

United States of America

United States Patent and Trademark Office



Reg. No. 4,108,662

Registered Mar. 6, 2012

Int. Cl.: 13

TRADEMARK

PRINCIPAL REGISTER

J&T MUNITIONS, INC. (KENTUCKY CORPORATION)
P.O. BOX 430
WINCHESTER, KY 40391

FOR: FIREARMS; GUN PARTS, IN CLASS 13 (U.S. CLS. 2 AND 9).

FIRST USE 5-0-2007; IN COMMERCE 5-0-2007.

THE MARK CONSISTS OF A LINE DRAWING OF A WINGED DRAGON.

SER. NO. 85-378,892, FILED 7-22-2011.

GEORGE LORENZO, EXAMINING ATTORNEY



David J. Kyffers

Director of the United States Patent and Trademark Office

United States of America

United States Patent and Trademark Office

Stakz

Reg. No. 4,108,663

Registered Mar. 6, 2012

Int. Cls.: 30 and 43

STAK Z YOGURT, INC. (KENTUCKY CORPORATION), DBA STAKZ SELF SERVE FROZEN YOGURT

C/O: FRED HIGGINS, REGISTERED AGENT
2017 NASHVILLE ROAD
BOWLING GREEN, KY 42101

TRADEMARK

FOR: FROZEN YOGURT; FROZEN YOGURT CONFECTIONS; FROZEN YOGURT MIXES , IN CLASS 30 (U.S. CL. 46).

SERVICE MARK

FIRST USE 9-4-2010; IN COMMERCE 9-4-2010.

PRINCIPAL REGISTER

FOR: FAST-FOOD RESTAURANTS; FROZEN YOGURT SHOP SERVICES IN THE NATURE OF A RESTAURANT; RESTAURANT; RESTAURANT SERVICES; RESTAURANTS; SELF-SERVICE RESTAURANTS; TAKE-OUT RESTAURANT SERVICES, IN CLASS 43 (U.S. CLS. 100 AND 101).

FIRST USE 9-4-2010; IN COMMERCE 9-4-2010.

THE MARK CONSISTS OF STANDARD CHARACTERS WITHOUT CLAIM TO ANY PARTICULAR FONT, STYLE, SIZE, OR COLOR.

SER. NO. 85-378,903, FILED 7-22-2011.

KALIE KUNG, EXAMINING ATTORNEY



David J. Kyffers

Director of the United States Patent and Trademark Office

United States of America

United States Patent and Trademark Office

Vegas Towers

Reg. No. 4,108,664

Registered Mar. 6, 2012

Int. Cl.: 9

TRADEMARK

PRINCIPAL REGISTER

FUNG, KATHY (HONG KONG INDIVIDUAL)
100
798 POST ST
SAN FRANCISCO, CA 94109

FOR: COMPUTER APPLICATION SOFTWARE FOR MOBILE PHONES, NAMELY, SOFTWARE FOR PLAYING COMPUTER GAMES, IN CLASS 9 (U.S. CLS. 21, 23, 26, 36 AND 38).

FIRST USE 8-1-2010; IN COMMERCE 4-12-2011.

THE MARK CONSISTS OF STANDARD CHARACTERS WITHOUT CLAIM TO ANY PARTICULAR FONT, STYLE, SIZE, OR COLOR.

SER. NO. 85-378,921, FILED 7-22-2011.

DAWN FELDMAN, EXAMINING ATTORNEY



David J. Kybas

Director of the United States Patent and Trademark Office

United States of America

United States Patent and Trademark Office

LUXURAS

Reg. No. 4,108,665

Registered Mar. 6, 2012

Int. Cl.: 44

SERVICE MARK

PRINCIPAL REGISTER

SHANE A. NELSON, D.D.S., PC (MISSOURI PROFESSIONAL CORPORATION), DBA
LUXURAS DENTISTRY
14886 METCALF AVE
OVERLAND PARK, KS 66223

FOR: COSMETIC DENTISTRY; DENTAL SERVICES, NAMELY, PERFORMING RESTORATIVE AND COSMETIC PROCEDURES; DENTAL SERVICES, NAMELY, TREATMENT OF PATIENTS WITH SNORING, SLEEP APNEA AND TMJ (TEMPOROMANDIBULAR JOINT) DISORDERS; DENTIST SERVICES; DENTISTRY; NEUROMUSCULAR DENTISTRY; ORAL SURGERY AND DENTAL IMPLANT SERVICES; SPORTS DENTISTRY; LASER DENTISTRY, IN CLASS 44 (U.S. CLS. 100 AND 101).

FIRST USE 4-15-2011; IN COMMERCE 7-7-2011.

THE MARK CONSISTS OF STANDARD CHARACTERS WITHOUT CLAIM TO ANY PARTICULAR FONT, STYLE, SIZE, OR COLOR.

SER. NO. 85-378,922, FILED 7-22-2011.

DAWN FELDMAN, EXAMINING ATTORNEY



David J. Kyffers

Director of the United States Patent and Trademark Office

United States of America

United States Patent and Trademark Office

CRAFT BEER NOT CRAP BEER

Reg. No. 4,108,666

Registered Mar. 6, 2012

Int. Cl.: 25

TRADEMARK

PRINCIPAL REGISTER

WORDEN, ERIKA (UNITED STATES INDIVIDUAL)
911 CEDAR POINT BLVD.
SWANSBORO, NC 28570

FOR: HATS; T-SHIRTS, IN CLASS 25 (U.S. CLS. 22 AND 39).

FIRST USE 10-11-2008; IN COMMERCE 11-23-2008.

THE MARK CONSISTS OF STANDARD CHARACTERS WITHOUT CLAIM TO ANY PARTICULAR FONT, STYLE, SIZE, OR COLOR.

SER. NO. 85-378,949, FILED 7-22-2011.

DEIRDRE ROBERTSON, EXAMINING ATTORNEY



David J. Kybas

Director of the United States Patent and Trademark Office

United States of America

United States Patent and Trademark Office

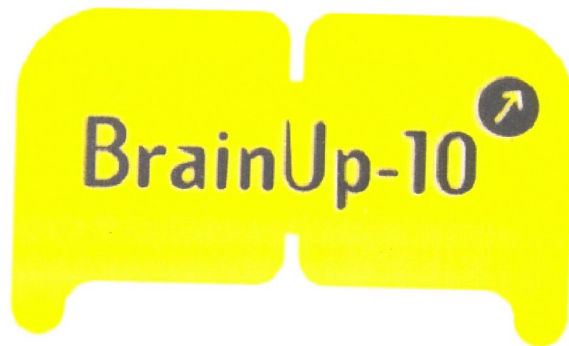

Reg. No. 4,108,667

Registered Mar. 6, 2012

Int. Cl.: 5

TRADEMARK

PRINCIPAL REGISTER

CENTRO INTERNACIONAL DE BIOMEDICINA (CHILE NON-PROFIT ORGANIZATION)
VITACURA AV. 3568, OF. 513, VITACURA
SANTIAGO, CHILE

FOR: PHARMACEUTICAL PRODUCTS OF NUTRACEUTICAL TYPE TO PREVENT AND /OR TO TREAT NEURODEGENERATIVE DISORDERS RELATED TO BRAIN AGING , IN CLASS 5 (U.S. CLS. 6, 18, 44, 46, 51 AND 52).

OWNER OF CHILE REG. NO. 885419, DATED 5-31-2010, EXPIRES 5-31-2020.

THE COLOR(S) YELLOW AND BLACK IS/ARE CLAIMED AS A FEATURE OF THE MARK.

THE MARK CONSISTS OF A BIFACED SYMMETRICAL YELLOW SHAPE THAT RESEMBLES A DRAWING OF A FRONTAL BRAIN CUT IN HALF. IN THE CENTER OF THE IMAGE ARE THE WORDS "BRAINUP-10" IN BLACK LETTERS, AND IN THE UPPER RIGHT HAND SECTION OF THE SHAPE IS A BLACK CIRCLE WITH AN ARROW IN THE COLOR YELLOW WHICH IS AT A 45 DEGREE ANGLE POINTING TO THE RIGHT.

SER. NO. 85-378,956, FILED 7-22-2011.

ALLISON HOLTZ, EXAMINING ATTORNEY



David J. Kybas

Director of the United States Patent and Trademark Office

United States of America

United States Patent and Trademark Office

Taking the guesswork out of giving

Reg. No. 4,108,668

Registered Mar. 6, 2012

Int. Cl.: 42

SERVICE MARK

PRINCIPAL REGISTER

C.A. CIOFFI (NEW JERSEY LIMITED LIABILITY COMPANY)
505 MAPLE AVE.
SOUTH PLAINFIELD, NJ 07080

FOR: PROVIDING A WEBSITE FEATURING TECHNOLOGY THAT ENABLES USERS TO CALCULATE THE APPROPRIATE MONETARY VALUE OF PROSPECTIVE GIFTS, IN CLASS 42 (U.S. CLS. 100 AND 101).

FIRST USE 8-27-2007; IN COMMERCE 8-27-2007.

THE MARK CONSISTS OF STANDARD CHARACTERS WITHOUT CLAIM TO ANY PARTICULAR FONT, STYLE, SIZE, OR COLOR.

SER. NO. 85-378,958, FILED 7-22-2011.

EDWARD NELSON, EXAMINING ATTORNEY



David J. Kyffers

Director of the United States Patent and Trademark Office

United States of America

United States Patent and Trademark Office

Infineco

Reg. No. 4,108,669

Registered Mar. 6, 2012

Int. Cl.: 35

SERVICE MARK

PRINCIPAL REGISTER

INFINECO (CALIFORNIA LIMITED LIABILITY COMPANY)
SUITE 550
999 N. SEPULVEDA BLVD.
EL SEGUNDO, CA 90245

FOR: CONSULTING SERVICES IN THE FIELD OF ENERGY USAGE MANAGEMENT AND ENERGY EFFICIENCY; CONSULTING SERVICES IN THE FIELDS OF ENERGY CONSUMPTION AND USAGE CONSERVATION TO IMPROVE ENERGY EFFICIENCY, IN CLASS 35 (U.S. CLS. 100, 101 AND 102).

FIRST USE 8-1-2009; IN COMMERCE 9-1-2009.

THE MARK CONSISTS OF STANDARD CHARACTERS WITHOUT CLAIM TO ANY PARTICULAR FONT, STYLE, SIZE, OR COLOR.

SER. NO. 85-378,960, FILED 7-22-2011.

EDWARD NELSON, EXAMINING ATTORNEY



David J. Kyfos

Director of the United States Patent and Trademark Office

United States of America

United States Patent and Trademark Office

Gnosis

Reg. No. 4,108,670

Registered Mar. 6, 2012

Int. Cl.: 30

TRADEMARK

PRINCIPAL REGISTER

SCHILLING, FREDERICK (UNITED STATES INDIVIDUAL)
2305 ASHLAND STREET, SUITE #C-506
ASHLAND, OR 97520

FOR: CHOCOLATE AND CHOCOLATES, IN CLASS 30 (U.S. CL. 46).

FIRST USE 3-1-2008; IN COMMERCE 3-1-2008.

THE MARK CONSISTS OF STANDARD CHARACTERS WITHOUT CLAIM TO ANY PARTICULAR FONT, STYLE, SIZE, OR COLOR.

SER. NO. 85-378,970, FILED 7-22-2011.

WON TEAK OH, EXAMINING ATTORNEY



David J. Kyffers

Director of the United States Patent and Trademark Office

United States of America

United States Patent and Trademark Office

ClickySticky

Reg. No. 4,108,671

MERGE MOBILE, INC. (DELAWARE CORPORATION)
224 AVENIDA DEL MAR, SUITE D
SAN CLEMENTE, CA 92672

Registered Mar. 6, 2012

Int. Cl.: 9

FOR: COMPUTER APPLICATION SOFTWARE FOR MOBILE PHONES AND HANDHELD COMPUTERS, NAMELY, SOFTWARE FOR CHILDREN'S ELECTRONIC STICKER BOOK, IN CLASS 9 (U.S. CLS. 21, 23, 26, 36 AND 38).

TRADEMARK

FIRST USE 4-9-2010; IN COMMERCE 4-9-2010.

PRINCIPAL REGISTER

THE MARK CONSISTS OF STANDARD CHARACTERS WITHOUT CLAIM TO ANY PARTICULAR FONT, STYLE, SIZE, OR COLOR.

SER. NO. 85-378,971, FILED 7-22-2011.

JEAN IM, EXAMINING ATTORNEY



David J. Kyffers

Director of the United States Patent and Trademark Office

United States of America

United States Patent and Trademark Office

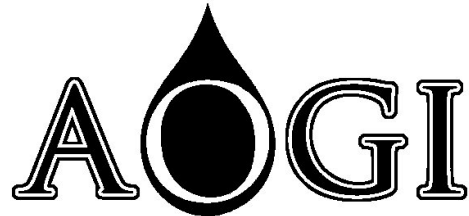

Reg. No. 4,108,672

Registered Mar. 6, 2012

Int. Cl.: 11

TRADEMARK

PRINCIPAL REGISTER

ALTERNATIVE MARKET SOLUTIONS LLC (NORTH CAROLINA LIMITED LIABILITY COMPANY)
301 MCCULLOUGH DRIVE, 4TH FLOOR
CHARLOTTE, NC 28262

FOR: WATER FILTRATION PITCHERS SOLD EMPTY, IN CLASS 11 (U.S. CLS. 13, 21, 23, 31 AND 34).

FIRST USE 4-11-2011; IN COMMERCE 4-11-2011.

THE MARK CONSISTS OF THE STYLIZED WORD "AOGI". AN IMAGE OF A DROP OF WATER IN THE BACKGROUND OF THE LETTER "O".

SER. NO. 85-378,978, FILED 7-22-2011.

KAELIE KUNG, EXAMINING ATTORNEY



David J. Kybas

Director of the United States Patent and Trademark Office

United States of America

United States Patent and Trademark Office

SWIM-A-THON

Reg. No. 4,108,673

Registered Mar. 6, 2012

Int. Cl.: 36

SERVICE MARK

PRINCIPAL REGISTER

UNITED STATES SWIMMING, INC. (COLORADO NON-PROFIT CORPORATION), DBA
USA SWIMMING
ONE OLYMPIC PLAZA
COLORADO SPRINGS, CO 80909

FOR: CHARITABLE FUNDRAISING SERVICES; CHARITABLE FUNDRAISING SERVICES
BY MEANS OF ORGANIZING AND CONDUCTING SPECIAL EVENTS; FUNDRAISING
SERVICES, NAMELY, ORGANIZING FUNDRAISING PROGRAMS INVOLVING SWIMMING
EVENTS FOR SWIM CLUBS, SWIM TEAMS, SCHOOLS AND OTHER GROUPS; CHARIT-
ABLE FUNDRAISING SERVICES FOR OTHERS, IN CLASS 36 (U.S. CLS. 100, 101 AND 102).

FIRST USE 4-30-1969; IN COMMERCE 4-30-1969.

THE MARK CONSISTS OF STANDARD CHARACTERS WITHOUT CLAIM TO ANY PAR-
TICULAR FONT, STYLE, SIZE, OR COLOR.

OWNER OF U.S. REG. NOS. 975,215 AND 2,989,444.

SER. NO. 85-378,993, FILED 7-22-2011.

KAELIE KUNG, EXAMINING ATTORNEY



David J. Kyffers

Director of the United States Patent and Trademark Office

United States of America

United States Patent and Trademark Office



Reg. No. 4,108,674

Registered Mar. 6, 2012

Int. Cl.: 25

TRADEMARK

PRINCIPAL REGISTER

MILLBERN, JEFFREY (UNITED STATES INDIVIDUAL)
APT 1
2139 W CONCORD PL
CHICAGO, IL 60647

FOR: BLOUSES; DRESSES; JACKETS; PANTS; PONCHOS; SCARVES; SHAWLS; SHORTS;
SKIRTS; T-SHIRTS; WOVEN TOPS, IN CLASS 25 (U.S. CLS. 22 AND 39).

FIRST USE 6-4-2011; IN COMMERCE 6-4-2011.

THE MARK CONSISTS OF A TRAPEZOIDAL GEOMETRIC SHAPE THAT RESEMBLES TWO INVERTED TRIANGLES. INSIDE THE TOP OF THE SHAPE IS THE STYLIZED TEXT "BANNER" AND INSIDE THE BOTTOM OF THE SHAPE IS THE STYLIZED TEXT "YEAR". BETWEEN THESE TWO WORDS ARE THREE OVERLAPPING, DOWNWARD POINTING TRIANGLES.

SER. NO. 85-378,996, FILED 7-22-2011.

KAELIE KUNG, EXAMINING ATTORNEY



David J. Kappas

Director of the United States Patent and Trademark Office

United States of America

United States Patent and Trademark Office

Travilla

Reg. No. 4,108,675

Registered Mar. 6, 2012

Int. Cl.: 25

TRADEMARK

PRINCIPAL REGISTER

TRAVILLA BRAND INTERNATIONAL, INC. (ARIZONA CORPORATION)
5828 E. CALLE DEL NORTE
PHOENIX, AZ 85018

FOR: APPAREL FOR DANCERS, NAMELY, TEE SHIRTS, SWEATSHIRTS, PANTS, LEGGINGS, SHORTS AND JACKETS; BLOUSES; DRESSING GOWNS; EVENING DRESSES; JACKETS; SLACKS; WEDDING DRESSES; WOMEN'S CEREMONIAL DRESSES; WOMEN'S CLOTHING, NAMELY, SHIRTS, DRESSES, SKIRTS, BLOUSES, IN CLASS 25 (U.S. CLS. 22 AND 39).

FIRST USE 1-1-1950; IN COMMERCE 1-1-1950.

THE MARK CONSISTS OF A STYLIZED SIGNATURE OF THE WORD TRAVILLA IN BLACK SEMI CURSIVE WITH A CAPITAL T.

SER. NO. 85-379,093, FILED 7-22-2011.

TARAH HARDY, EXAMINING ATTORNEY



David J. Kybas

Director of the United States Patent and Trademark Office

United States of America

United States Patent and Trademark Office

WORK FIRST

Reg. No. 4,108,676

Registered Mar. 6, 2012

Int. Cl.: 36

SERVICE MARK

PRINCIPAL REGISTER

WORK FIRST CASUALTY COMPANY (DELAWARE CORPORATION)
SUITE 101
3411 SLIVERSIDE ROAD, BAYNARD BUILDING
WILMINGTON, DE 19810

FOR: INSURANCE CARRIER SERVICES; INSURANCE UNDERWRITING SERVICES FOR WORKERS COMPENSATION INSURANCE, IN CLASS 36 (U.S. CLS. 100, 101 AND 102).

FIRST USE 4-1-2006; IN COMMERCE 4-1-2006.

THE MARK CONSISTS OF STANDARD CHARACTERS WITHOUT CLAIM TO ANY PARTICULAR FONT, STYLE, SIZE, OR COLOR.

SER. NO. 85-379,099, FILED 7-22-2011.

NAAKWAMA ANKRAH, EXAMINING ATTORNEY



David J. Kyros

Director of the United States Patent and Trademark Office

United States of America

United States Patent and Trademark Office

itx

Reg. No. 4,108,677

Registered Mar. 6, 2012

Int. Cl.: 9

TRADEMARK

PRINCIPAL REGISTER

ITX CORP. (NEW YORK CORPORATION)
1169 PITTSFORD-VICTOR ROAD, SUITE 100
PITTSFORD, NY 14534

FOR: COMPUTER SOFTWARE FOR MANAGING, STORING, RETRIEVING, ACCESSING, TRACKING, PROFILING, CATEGORIZING, SEARCHING, ARCHIVING AND DELIVERING COMPUTER FILES, DOCUMENTS, IMAGES, AUDIO FILES, VIDEO AND FILM; COMPUTER SOFTWARE, NAMELY, COMPUTER E-COMMERCE SOFTWARE TO ALLOW USERS TO PERFORM ELECTRONIC BUSINESS TRANSACTIONS VIA A GLOBAL COMPUTER NETWORK; COMPUTER SEARCH ENGINE SOFTWARE; COMPUTER SOFTWARE DEVELOPMENT TOOLS; COMPUTER SOFTWARE FOR ACCESSING INFORMATION DIRECTORIES THAT MAY BE DOWNLOADED FROM THE GLOBAL COMPUTER NETWORK; COMPUTER SOFTWARE FOR CREATING SEARCHABLE DATABASES OF INFORMATION AND DATA; COMPUTER SOFTWARE FOR ORGANIZING AND VIEWING DIGITAL IMAGES AND PHOTOGRAPHS; WEB SITE DEVELOPMENT SOFTWARE, IN CLASS 9 (U.S. CLS. 21, 23, 26, 36 AND 38).

FIRST USE 3-0-2010; IN COMMERCE 3-0-2010.

OWNER OF U.S. REG. NOS. 2,897,094 AND 2,897,095.

THE MARK CONSISTS OF THE LETTERS "ITX" IN LOWERCASE STYLIZED LETTERS.

SER. NO. 85-379,127, FILED 7-22-2011.

KIMBERLY PERRY, EXAMINING ATTORNEY



David J. Kybas

Director of the United States Patent and Trademark Office

United States of America

United States Patent and Trademark Office

ITX

Reg. No. 4,108,678

Registered Mar. 6, 2012

Int. Cl.: 9

TRADEMARK

PRINCIPAL REGISTER

ITX CORP. (NEW YORK CORPORATION)
1169 PITTSFORD-VICTOR ROAD, SUITE 100
PITTSFORD, NY 14534

FOR: COMPUTER SOFTWARE FOR MANAGING, STORING, RETRIEVING, ACCESSING, TRACKING, PROFILING, CATEGORIZING, SEARCHING, ARCHIVING AND DELIVERING COMPUTER FILES, DOCUMENTS, IMAGES, AUDIO FILES, VIDEO AND FILM; COMPUTER SOFTWARE, NAMELY, COMPUTER E-COMMERCE SOFTWARE TO ALLOW USERS TO PERFORM ELECTRONIC BUSINESS TRANSACTIONS VIA A GLOBAL COMPUTER NETWORK; COMPUTER SEARCH ENGINE SOFTWARE; COMPUTER SOFTWARE DEVELOPMENT TOOLS; COMPUTER SOFTWARE FOR ACCESSING INFORMATION DIRECTORIES THAT MAY BE DOWNLOADED FROM THE GLOBAL COMPUTER NETWORK; COMPUTER SOFTWARE FOR CREATING SEARCHABLE DATABASES OF INFORMATION AND DATA; COMPUTER SOFTWARE FOR ORGANIZING AND VIEWING DIGITAL IMAGES AND PHOTOGRAPHS; WEB SITE DEVELOPMENT SOFTWARE, IN CLASS 9 (U.S. CLS. 21, 23, 26, 36 AND 38).

FIRST USE 10-1-1997; IN COMMERCE 10-1-1997.

THE MARK CONSISTS OF STANDARD CHARACTERS WITHOUT CLAIM TO ANY PARTICULAR FONT, STYLE, SIZE, OR COLOR.

OWNER OF U.S. REG. NOS. 2,897,094 AND 2,897,095.

SER. NO. 85-379,129, FILED 7-22-2011.

KIMBERLY PERRY, EXAMINING ATTORNEY



David J. Kyros

Director of the United States Patent and Trademark Office

United States of America

United States Patent and Trademark Office

PIKES PEAK ASCENT

Reg. No. 4,108,679

PIKES PEAK MARATHON, INC. (COLORADO CORPORATION)
441 MANITOU AVENUE
MANITOU SPRINGS, CO 80829

Registered Mar. 6, 2012

Int. Cl.: 41

FOR: ARRANGING AND CONDUCTING ATHLETIC COMPETITIONS, IN CLASS 41 (U.S. CLS. 100, 101 AND 107).

SERVICE MARK

FIRST USE 8-31-1980; IN COMMERCE 8-31-1980.

PRINCIPAL REGISTER

THE MARK CONSISTS OF STANDARD CHARACTERS WITHOUT CLAIM TO ANY PARTICULAR FONT, STYLE, SIZE, OR COLOR.

OWNER OF U.S. REG. NO. 2,401,881.

NO CLAIM IS MADE TO THE EXCLUSIVE RIGHT TO USE "ASCENT", APART FROM THE MARK AS SHOWN.

SEC. 2(F).

SER. NO. 85-379,131, FILED 7-22-2011.

KIMBERLY PERRY, EXAMINING ATTORNEY



David J. Kybas

Director of the United States Patent and Trademark Office

United States of America

United States Patent and Trademark Office

PIKES PEAK MARATHON

Reg. No. 4,108,680

PIKES PEAK MARATHON, INC. (COLORADO CORPORATION)
441 MANITOU AVENUE
MANITOU SPRINGS, CO 80829

Registered Mar. 6, 2012

Int. Cl.: 41

FOR: ARRANGING AND CONDUCTING ATHLETIC COMPETITIONS, IN CLASS 41 (U.S. CLS. 100, 101 AND 107).

SERVICE MARK

FIRST USE 8-31-1956; IN COMMERCE 8-31-1956.

PRINCIPAL REGISTER

THE MARK CONSISTS OF STANDARD CHARACTERS WITHOUT CLAIM TO ANY PARTICULAR FONT, STYLE, SIZE, OR COLOR.

OWNER OF U.S. REG. NO. 2,399,856.

NO CLAIM IS MADE TO THE EXCLUSIVE RIGHT TO USE "MARATHON", APART FROM THE MARK AS SHOWN.

SEC. 2(F).

SER. NO. 85-379,132, FILED 7-22-2011.

KIMBERLY PERRY, EXAMINING ATTORNEY



David J. Kyros

Director of the United States Patent and Trademark Office

United States of America

United States Patent and Trademark Office

ALT.

Reg. No. 4,108,681

Registered Mar. 6, 2012

Int. Cl.: 28

TRADEMARK

PRINCIPAL REGISTER

BERGERON, SIMON (CANADA INDIVIDUAL)
361 GOUNOD
MONTREAL, QUEBEC, CANADA H2R1B5

FOR: SKIS, IN CLASS 28 (U.S. CLS. 22, 23, 38 AND 50).

FIRST USE 1-3-2011; IN COMMERCE 1-4-2011.

THE MARK CONSISTS OF STANDARD CHARACTERS WITHOUT CLAIM TO ANY PARTICULAR FONT, STYLE, SIZE, OR COLOR.

SER. NO. 85-379,135, FILED 7-22-2011.

KIMBERLY PERRY, EXAMINING ATTORNEY



David J. Kybas

Director of the United States Patent and Trademark Office

United States of America

United States Patent and Trademark Office

Stranded Treasures

Reg. No. 4,108,682

Registered Mar. 6, 2012

Int. Cl.: 14

TRADEMARK

PRINCIPAL REGISTER

MAHER, SHARLENE (UNITED STATES INDIVIDUAL), DBA STRANDED TREASURES
UNIT C28
950 S. KANNER HIGHWAY
STUART, FL 34994

FOR: HAIR JEWELRY IN THE NATURE OF JEWELRY FOR USE IN THE HAIR; JEWELRY,
IN CLASS 14 (U.S. CLS. 2, 27, 28 AND 50).

FIRST USE 8-27-2006; IN COMMERCE 8-27-2006.

THE MARK CONSISTS OF STANDARD CHARACTERS WITHOUT CLAIM TO ANY PAR-
TICULAR FONT, STYLE, SIZE, OR COLOR.

SER. NO. 85-379,304, FILED 7-24-2011.

EDWARD NELSON, EXAMINING ATTORNEY



David J. Kyffers

Director of the United States Patent and Trademark Office

United States of America

United States Patent and Trademark Office

CALCICURE

Reg. No. 4,108,683

VEDCO, INC. (DELAWARE CORPORATION)
5503 CORPORATE DRIVE
ST. JOSEPH, MO 64507

Registered Mar. 6, 2012

Int. Cl.: 5

FOR: VETERINARY PHARMACEUTICAL PREPARATIONS, NAMELY, CALCIUM SUPPLEMENTS, IN CLASS 5 (U.S. CLS. 6, 18, 44, 46, 51 AND 52).

TRADEMARK

FIRST USE 8-31-2006; IN COMMERCE 8-31-2006.

PRINCIPAL REGISTER

THE MARK CONSISTS OF STANDARD CHARACTERS WITHOUT CLAIM TO ANY PARTICULAR FONT, STYLE, SIZE, OR COLOR.

SER. NO. 85-379,308, FILED 7-24-2011.

EDWARD NELSON, EXAMINING ATTORNEY



David J. Kybas

Director of the United States Patent and Trademark Office

United States of America

United States Patent and Trademark Office

ZINGER DIGITAL SIGNS

Reg. No. 4,108,684

Registered Mar. 6, 2012

Int. Cl.: 35

SERVICE MARK

PRINCIPAL REGISTER

ZINGER TECHNOLOGIES, LLC (FLORIDA LIMITED LIABILITY COMPANY), DBA ZINGER
DIGITAL SIGNS
1001 W. CYPRESS CREEK RD. STE 104
FORT LAUDERDALE, FL 33309

FOR: DEVELOPMENT, OPERATION AND ADMINISTRATION OF DIGITAL SIGNAGE
SYSTEMS AND DIGITAL ADVERTISING SYSTEMS FOR OTHERS, NAMELY, PROVIDING
ADVERTISING SPACE BY ELECTRONIC MEANS AND GLOBAL COMPUTER INFORMA-
TION NETWORKS, IN CLASS 35 (U.S. CLS. 100, 101 AND 102).

FIRST USE 1-20-2011; IN COMMERCE 1-20-2011.

THE MARK CONSISTS OF STANDARD CHARACTERS WITHOUT CLAIM TO ANY PAR-
TICULAR FONT, STYLE, SIZE, OR COLOR.

NO CLAIM IS MADE TO THE EXCLUSIVE RIGHT TO USE "DIGITAL SIGNS", APART
FROM THE MARK AS SHOWN.

SER. NO. 85-379,323, FILED 7-24-2011.

FRANK LATTUCA, EXAMINING ATTORNEY



David J. Kyros

Director of the United States Patent and Trademark Office

United States of America

United States Patent and Trademark Office



Reg. No. 4,108,685

Registered Mar. 6, 2012

Int. Cl.: 39

SERVICE MARK

PRINCIPAL REGISTER

FLYING TIGERS AIR CARGO, LLC (OHIO LIMITED LIABILITY COMPANY)
6909 ENGLE ROAD, SUITE 6
CLEVELAND, OH 44130

FOR: SUPPLY CHAIN LOGISTICS AND REVERSE LOGISTICS SERVICES, NAMELY, STORAGE, TRANSPORTATION AND DELIVERY OF DOCUMENTS, PACKAGES, RAW MATERIALS, AND OTHER FREIGHT FOR OTHERS BY AIR, RAIL, SHIP OR TRUCK, IN CLASS 39 (U.S. CLS. 100 AND 105).

FIRST USE 3-20-2010; IN COMMERCE 3-20-2010.

OWNER OF U.S. REG. NOS. 969,394 AND 1,549,521.

THE MARK CONSISTS OF TIGER FACE WITH A SOLID BLOCK UNDER IT CONTAINING THE WORDS "FLYING TIGERS".

SER. NO. 85-379,350, FILED 7-24-2011.

DOMINIC J. FERRAIUOLO, EXAMINING ATTORNEY



David J. Kybas

Director of the United States Patent and Trademark Office

United States of America

United States Patent and Trademark Office

STOCKATO

Reg. No. 4,108,686

Registered Mar. 6, 2012

Int. Cl.: 36

SERVICE MARK

PRINCIPAL REGISTER

STOCKATO LLC (D.C. LIMITED LIABILITY COMPANY)
2501 PORTER ST. #806
WASHINGTON, DC 20008

FOR: FINANCIAL ANALYSES; FINANCIAL ANALYSIS AND RESEARCH SERVICES; FINANCIAL COUNSELING SERVICES, NAMELY, HELPING OTHERS BUILD A BETTER WORKING RELATIONSHIP WITH THEIR MONEY; FINANCIAL EVALUATION, TRACKING, ANALYSIS, FORECASTING, CONSULTANCY, ADVISORY AND RESEARCH SERVICES RELATING TO SECURITIES AND OTHER FINANCIAL INSTRUMENTS; FINANCIAL FORECASTING; FINANCIAL RESEARCH AND INFORMATION SERVICES; FINANCIAL SERVICES, NAMELY, THE TRADING OF FINANCIAL INSTRUMENTS, SECURITIES, SHARES, OPTIONS AND OTHER DERIVATIVE PRODUCTS; PROVIDING FINANCIAL INFORMATION; PROVIDING FINANCIAL SERVICES WITH RESPECT TO SECURITIES AND OTHER FINANCIAL INSTRUMENTS AND PRODUCTS, NAMELY, TRADING OF AND INVESTMENTS IN SECURITIES AND FINANCIAL INSTRUMENTS AND PRODUCTS FOR OTHERS, IN CLASS 36 (U.S. CLS. 100, 101 AND 102).

FIRST USE 10-13-2010; IN COMMERCE 10-13-2010.

THE MARK CONSISTS OF STANDARD CHARACTERS WITHOUT CLAIM TO ANY PARTICULAR FONT, STYLE, SIZE, OR COLOR.

SER. NO. 85-379,358, FILED 7-24-2011.

DOMINIC J. FERRAIUOLO, EXAMINING ATTORNEY



David J. Kybas

Director of the United States Patent and Trademark Office

United States of America

United States Patent and Trademark Office

You Are Home

Reg. No. 4,108,687

SMITH, NYSSA (UNITED STATES INDIVIDUAL)
2300 S. ATHERTON STREET
STATE COLLEGE, PA 16801

Registered Mar. 6, 2012

Int. Cl.: 36

FOR: RESIDENTIAL REAL ESTATE AGENCY SERVICES, IN CLASS 36 (U.S. CLS. 100, 101 AND 102).

SERVICE MARK

FIRST USE 5-8-2011; IN COMMERCE 5-8-2011.

PRINCIPAL REGISTER

THE MARK CONSISTS OF STANDARD CHARACTERS WITHOUT CLAIM TO ANY PARTICULAR FONT, STYLE, SIZE, OR COLOR.

SER. NO. 85-379,375, FILED 7-24-2011.

DOMINIC J. FERRAIUOLO, EXAMINING ATTORNEY



David J. Kybas

Director of the United States Patent and Trademark Office

United States of America

United States Patent and Trademark Office

Einar

Reg. No. 4,108,688

Registered Mar. 6, 2012

Int. Cl.: 28

TRADEMARK

PRINCIPAL REGISTER

DANDY INNOVATIONS, LLC (NEW JERSEY LIMITED LIABILITY COMPANY)
249 STONEHURST BOULEVARD
FREEHOLD, NJ 07728

FOR: STUFFED AND PLUSH TOYS, IN CLASS 28 (U.S. CLS. 22, 23, 38 AND 50).

FIRST USE 12-10-2010; IN COMMERCE 5-20-2011.

THE MARK CONSISTS OF STANDARD CHARACTERS WITHOUT CLAIM TO ANY PARTICULAR FONT, STYLE, SIZE, OR COLOR.

SER. NO. 85-379,431, FILED 7-24-2011.

KAPIL BHANOT, EXAMINING ATTORNEY



David J. Kybas

Director of the United States Patent and Trademark Office

United States of America

United States Patent and Trademark Office

PROTECT AMERICA'S HEARTBEAT

Reg. No. 4,108,689

Registered Mar. 6, 2012

Int. Cl.: 35

SERVICE MARK

PRINCIPAL REGISTER

NATIONAL ACTIVE AND RETIRED FEDERAL EMPLOYEES ASSOCIATION (D.C. NON-PROFIT ASSOCIATION), AKA NARFE
606 NORTH WASHINGTON STREET
ALEXANDRIA, VA 22314

FOR: PUBLIC ADVOCACY TO PROMOTE AWARENESS OF THE NEED TO PROTECT THE PAY AND BENEFITS OF ACTIVE AND RETIRED FEDERAL EMPLOYEES, IN CLASS 35 (U.S. CLS. 100, 101 AND 102).

FIRST USE 2-1-2011; IN COMMERCE 2-1-2011.

THE MARK CONSISTS OF STANDARD CHARACTERS WITHOUT CLAIM TO ANY PARTICULAR FONT, STYLE, SIZE, OR COLOR.

SER. NO. 85-379,434, FILED 7-24-2011.

KIMBERLY PERRY, EXAMINING ATTORNEY



David J. Kyffers

Director of the United States Patent and Trademark Office

United States of America

United States Patent and Trademark Office

BOTANICAL KINETICS

Reg. No. 4,108,690

AVEDA CORPORATION (DELAWARE CORPORATION)
4000 PHEASANT RIDGE DRIVE
MINNEAPOLIS, MN 55449

Registered Mar. 6, 2012

Int. Cl.: 3

FOR: COSMETICS; NON-MEDICATED SKIN CARE PREPARATIONS, IN CLASS 3 (U.S. CLS. 1, 4, 6, 50, 51 AND 52).

TRADEMARK

FIRST USE 12-17-1990; IN COMMERCE 12-17-1990.

PRINCIPAL REGISTER

THE MARK CONSISTS OF STANDARD CHARACTERS WITHOUT CLAIM TO ANY PARTICULAR FONT, STYLE, SIZE, OR COLOR.

OWNER OF U.S. REG. NO. 1,693,912.

NO CLAIM IS MADE TO THE EXCLUSIVE RIGHT TO USE "BOTANICAL", APART FROM THE MARK AS SHOWN.

SER. NO. 85-379,435, FILED 7-24-2011.

BRIAN CALLAGHAN, EXAMINING ATTORNEY



David J. Kyffers

Director of the United States Patent and Trademark Office

United States of America

United States Patent and Trademark Office

Aquacube

Reg. No. 4,108,691

Registered Mar. 6, 2012

Int. Cl.: 11

TRADEMARK

PRINCIPAL REGISTER

PRIMUS AUSTRALIA PTY LTD (AUSTRALIA CORPORATION)
LEVEL 3, 20 ENTERPRISE DRIVE
BUNDOORA, AUSTRALIA 3083

FOR: GAS WATER HEATERS; GAS WATER HEATERS; HAND HELD SHOWER HEADS;
HAND SHOWERS; HAND-HELD SHOWERS; HOT WATER HEATERS; HYBRID WATER
HEATER; PORTABLE SHOWERS; SHOWERS; SOLAR WATER HEATERS; TANKLESS
WATER HEATERS; WATER HEATERS, IN CLASS 11 (U.S. CLS. 13, 21, 23, 31 AND 34).

THE MARK CONSISTS OF STANDARD CHARACTERS WITHOUT CLAIM TO ANY PAR-
TICULAR FONT, STYLE, SIZE, OR COLOR.

OWNER OF AUSTRALIA REG. NO. 1291629, DATED 8-4-2009, EXPIRES 8-4-2019.

SER. NO. 85-379,489, FILED 7-25-2011.

TRACY CROSS, EXAMINING ATTORNEY



David J. Kyffers

Director of the United States Patent and Trademark Office

United States of America

United States Patent and Trademark Office



Reg. No. 4,108,692

Registered Mar. 6, 2012

Int. Cl.: 20

TRADEMARK

PRINCIPAL REGISTER

EASI (ZHUHAI) CO., LTD. (CHINA LIMITED COMPANY (LTD.))
#8863, ZHUHAI GRAND ROAD
PINGSHA TOWN, ZHUHAI, CHINA

FOR: COAT RACKS; CONTAINERS, NOT OF METAL FOR COMMERCIAL USE; FURNITURE;
FURNITURE FITTINGS, NOT OF METAL; FURNITURE, NAMELY, SHOWCASES; NON-
METAL FABRIC HANGING ORGANIZER; PLASTIC BOXES; SHELVES FOR STORAGE;
SHOE RACKS; WARDROBES, IN CLASS 20 (U.S. CLS. 2, 13, 22, 25, 32 AND 50).

FIRST USE 8-6-2007; IN COMMERCE 8-6-2007.

THE MARK CONSISTS OF A DESIGN COMPRISING A CIRCULAR DESIGN ON THE TOP
RIGHT CORNER AND THREE SQUARE DESIGN ON THE OTHER THREE CORNERS. TWO
CHINESE CHARACTERS WHICH TRANSLITERATE INTO YI XIN ARE LOCATED BELOW
THE DESIGN.

THE NON-LATIN CHARACTERS IN THE MARK TRANSLITERATE TO YI; XIN AND THIS
MEANS SUITABLE; HAPPINESS IN ENGLISH.

SER. NO. 85-379,503, FILED 7-25-2011.

TRACY CROSS, EXAMINING ATTORNEY



David J. Kyros

Director of the United States Patent and Trademark Office

United States of America

United States Patent and Trademark Office

EARTHCHOICE

Reg. No. 4,108,693

Registered Mar. 6, 2012

Int. Cl.: 16

TRADEMARK

PRINCIPAL REGISTER

DOMTAR INC. (CANADA CORPORATION)
395 DE MAISONNEUVE BLVD. WEST
MONTREAL, CANADA H3A1L6

FOR: COMPUTER PAPER; COPY PAPER; ENVELOPES; PAPER; PRINTING PAPER;
WRITING PAPER, IN CLASS 16 (U.S. CLS. 2, 5, 22, 23, 29, 37, 38 AND 50).

FIRST USE 9-0-2005; IN COMMERCE 9-0-2005.

THE MARK CONSISTS OF STANDARD CHARACTERS WITHOUT CLAIM TO ANY PARTICULAR FONT, STYLE, SIZE, OR COLOR.

OWNER OF U.S. REG. NOS. 2,961,513 AND 3,181,831.

SER. NO. 85-379,566, FILED 7-25-2011.

JAMES GRIFFIN, EXAMINING ATTORNEY



David J. Kyffers

Director of the United States Patent and Trademark Office

United States of America

United States Patent and Trademark Office

WHERE INFLAMMATION MEETS LIPIDS

Reg. No. 4,108,694

CLEVELAND HEARTLAB LLC (DELAWARE LIMITED LIABILITY COMPANY)
10265 CARNEGIE AVENUE
CLEVELAND, OH 44106

Registered Mar. 6, 2012

Int. Cl.: 41

FOR: ORGANISATION OF CONFERENCES AND SYMPOSIA IN THE FIELD OF MEDICAL SCIENCE, IN CLASS 41 (U.S. CLS. 100, 101 AND 107).

SERVICE MARK

FIRST USE 7-31-2010; IN COMMERCE 7-31-2010.

PRINCIPAL REGISTER

THE MARK CONSISTS OF STANDARD CHARACTERS WITHOUT CLAIM TO ANY PARTICULAR FONT, STYLE, SIZE, OR COLOR.

SER. NO. 85-379,583, FILED 7-25-2011.

KATHERINE E. HALMEN, EXAMINING ATTORNEY



David J. Kybas

Director of the United States Patent and Trademark Office

United States of America

United States Patent and Trademark Office



Reg. No. 4,108,695

STEPHANIE BARNARD DESIGNS INC. (CALIFORNIA CORPORATION)
28461 EL PEPPINO
LAGUNA NIGUEL, CA 92677

Registered Mar. 6, 2012

Int. Cl.: 16

FOR: INK PADS; RUBBER STAMPS; STAMPING INKS; WRITING INK, IN CLASS 16 (U.S. CLS. 2, 5, 22, 23, 29, 37, 38 AND 50).

TRADEMARK

FIRST USE 6-0-2001; IN COMMERCE 8-1-2009.

PRINCIPAL REGISTER

THE NAME STEPHANIE BARNARD IDENTIFIES A LIVING INDIVIDUAL WHOSE CONSENT IS OF RECORD.

THE MARK CONSISTS OF THE STYLIZED TEXT "STEPHANIE" ABOVE THE STYLIZED TEXT "BARNARD". ABOVE AND BELOW THE TEXT ARE THREE DOTS IN A ROW. THE WORDS AND IMAGES ARE SURROUNDED BY A BACKGROUND WITH CURVED AND POINTED EDGES.

SER. NO. 85-379,614, FILED 7-25-2011.

CAROLYN CATALDO, EXAMINING ATTORNEY



David J. Kybas

Director of the United States Patent and Trademark Office

United States of America

United States Patent and Trademark Office

JELASTIC

Reg. No. 4,108,696

Registered Mar. 6, 2012

Int. Cl.: 9

TRADEMARK

PRINCIPAL REGISTER

HIVEXT TECHNOLOGIES, INC. (BR.VIRGIN ISLANDS CORPORATION)
JAYLA PLACE, WICKHAMS CAY I, ROAD TOWN
TORTOLA, BR.VIRGIN ISLANDS

FOR: COMPUTER SOFTWARE USED TO MANAGE SERVER APPLICATION DEPLOYMENT;
COMPUTER SOFTWARE USED TO DEPLOY CLOUD-BASED SERVERS AND APPLICATIONS;
COMPUTER SOFTWARE USED TO IMPLEMENT SERVER-BASED VIRTUAL ENVIRONMENTS
AND APPLICATION SERVERS; COMPUTER SOFTWARE USED TO INSTANTIATE AND CONTROL
VIRTUAL SERVERS AND VIRTUAL ENVIRONMENTS, IN CLASS 9 (U.S. CLS. 21, 23, 26, 36
AND 38).

FIRST USE 7-15-2011; IN COMMERCE 7-15-2011.

THE MARK CONSISTS OF STANDARD CHARACTERS WITHOUT CLAIM TO ANY PARTICULAR
FONT, STYLE, SIZE, OR COLOR.

SER. NO. 85-379,619, FILED 7-25-2011.

H. M. FISHER, EXAMINING ATTORNEY



David J. Kybas

Director of the United States Patent and Trademark Office

United States of America

United States Patent and Trademark Office



Reg. No. 4,108,697

Registered Mar. 6, 2012

Int. Cl.: 36

SERVICE MARK

PRINCIPAL REGISTER

WALNUT HILL CAPITAL LLC (CALIFORNIA LIMITED LIABILITY COMPANY)
SUITE 838
50 CALIFORNIA STREET
SAN FRANCISCO, CA 94111

FOR: REAL ESTATE INVESTMENT SERVICES; REAL ESTATE MANAGEMENT SERVICES;
REAL ESTATE FUNDS INVESTMENT SERVICES; PURCHASE AND SALE OF DEBT SE-
CURED BY REAL ESTATE, IN CLASS 36 (U.S. CLS. 100, 101 AND 102).

FIRST USE 4-20-2011; IN COMMERCE 4-20-2011.

THE MARK CONSISTS OF THREE STYLIZED BARS, PARTIALLY WHITE AND DARK
BLUE, SUPERIMPOSED ON A DARK BLUE CIRCLE.

THE COLOR(S) DARK BLUE AND WHITE IS/ARE CLAIMED AS A FEATURE OF THE
MARK.

SER. NO. 85-379,622, FILED 7-25-2011.

LAKEISHA LEWIS, EXAMINING ATTORNEY



David J. Kyjars

Director of the United States Patent and Trademark Office

United States of America

United States Patent and Trademark Office



Reg. No. 4,108,698

Registered Mar. 6, 2012

Int. Cl.: 44

SERVICE MARK

PRINCIPAL REGISTER

THE MOSES H. CONE MEMORIAL HOSPITAL OPERATING CORPORATION (NORTH CAROLINA NON-PROFIT CORPORATION)
1200 NORTH ELM STREET
GREENSBORO, NC 27401

FOR: HEALTHCARE, IN CLASS 44 (U.S. CLS. 100 AND 101).

FIRST USE 5-20-2011; IN COMMERCE 5-20-2011.

OWNER OF U.S. REG. NO. 2,087,296.

NO CLAIM IS MADE TO THE EXCLUSIVE RIGHT TO USE "HEALTH", APART FROM THE MARK AS SHOWN.

THE MARK CONSISTS OF IN PART, OF A DEPICTION OF A PERSON TOGETHER WITH A TREE OR PLANT ABOVE THE WORDS CONE HEALTH UNDERLINED.

SER. NO. 85-379,626, FILED 7-25-2011.

BRIAN CALLAGHAN, EXAMINING ATTORNEY



David J. Kyffers

Director of the United States Patent and Trademark Office

United States of America

United States Patent and Trademark Office

Refinery

Reg. No. 4,108,699

BOWMAN, JASON (UNITED STATES INDIVIDUAL)
3418 W. LYNDALE
CHICAGO, IL 60647

Registered Mar. 6, 2012

Int. Cl.: 35

FOR: ON-LINE RETAIL CONSIGNMENT STORES FEATURING CLOTHING AND ACCESSORIES FOR MEN, WOMEN AND CHILDREN, IN CLASS 35 (U.S. CLS. 100, 101 AND 102).

SERVICE MARK

FIRST USE 4-10-2011; IN COMMERCE 7-1-2011.

PRINCIPAL REGISTER

THE MARK CONSISTS OF STANDARD CHARACTERS WITHOUT CLAIM TO ANY PARTICULAR FONT, STYLE, SIZE, OR COLOR.

SER. NO. 85-379,632, FILED 7-25-2011.

CARYN GLASSER, EXAMINING ATTORNEY



David J. Kybas

Director of the United States Patent and Trademark Office

United States of America

United States Patent and Trademark Office

A Higher State of Grind

Reg. No. 4,108,700

Registered Mar. 6, 2012

Int. Cl.: 30

TRADEMARK

PRINCIPAL REGISTER

SECOND CHANCE COFFEE COMPANY LLC (ILLINOIS LIMITED LIABILITY COMPANY)
657 CHILDS STREET
WHEATON, IL 60187

FOR: COFFEE, IN CLASS 30 (U.S. CL. 46).

FIRST USE 6-21-2011; IN COMMERCE 6-21-2011.

THE MARK CONSISTS OF STANDARD CHARACTERS WITHOUT CLAIM TO ANY PARTICULAR FONT, STYLE, SIZE, OR COLOR.

SER. NO. 85-379,667, FILED 7-25-2011.

HOWARD SMIGA, EXAMINING ATTORNEY



David J. Kyffers

Director of the United States Patent and Trademark Office

United States of America

United States Patent and Trademark Office

PORTACAL

Reg. No. 4,108,701

INSTRUMENT DEPOT INC. (NEW YORK CORPORATION)
115 METRO PARK
ROCHESTER, NY 14623

Registered Mar. 6, 2012

Int. Cl.: 9

FOR: GAS CALIBRATION KITS FOR PORTABLE ENVIRONMENTAL INSTRUMENTATION CONSISTING PRIMARILY OF GAS CYLINDERS, CALIBRATION GASSES, TUBING AND AIR FLOW REGULATORS FOR THE CALIBRATION/FUNCTION CHECK OF ELECTRO-CHEMICAL SOURCES , 23, 26, 36 AND 38), IN CLASS 9 (U.S. CLS. 21, 23, 26, 36 AND 38).

TRADEMARK

PRINCIPAL REGISTER

FIRST USE 1-31-1993; IN COMMERCE 1-31-1993.

THE MARK CONSISTS OF STANDARD CHARACTERS WITHOUT CLAIM TO ANY PARTICULAR FONT, STYLE, SIZE, OR COLOR.

SER. NO. 85-379,686, FILED 7-25-2011.

JEFF DEFORD, EXAMINING ATTORNEY



David J. Kyffers

Director of the United States Patent and Trademark Office

United States of America

United States Patent and Trademark Office

POINT 65° N

Reg. No. 4,108,702

POINT 65 SWEDEN AB (SWEDEN CORPORATION), DBA POINT 65
BOX 1431
SOLNA, AR 17127

Registered Mar. 6, 2012

Int. Cl.: 12

FOR: KAYAKS, IN CLASS 12 (U.S. CLS. 19, 21, 23, 31, 35 AND 44).

TRADEMARK

FIRST USE 2-16-1996; IN COMMERCE 8-1-2010.

PRINCIPAL REGISTER

THE MARK CONSISTS OF STANDARD CHARACTERS WITHOUT CLAIM TO ANY PARTICULAR FONT, STYLE, SIZE, OR COLOR.

SER. NO. 85-379,687, FILED 7-25-2011.

CHERYL CLAYTON, EXAMINING ATTORNEY



David J. Kyffers

Director of the United States Patent and Trademark Office

United States of America

United States Patent and Trademark Office

Phase 9

Reg. No. 4,108,703

Registered Mar. 6, 2012

Int. Cl.: 42

SERVICE MARK

PRINCIPAL REGISTER

PHASE NINE INC. (FLORIDA CORPORATION)
11486 ROCKINGHAM DRIVE
PORT ST. LUCIE, FL 33401

FOR: DESIGN AND CREATING WEB SITES FOR OTHERS; GRAPHIC DESIGN, IN CLASS 42 (U.S. CLS. 100 AND 101).

FIRST USE 2-16-2004; IN COMMERCE 1-1-2005.

THE MARK CONSISTS OF STANDARD CHARACTERS WITHOUT CLAIM TO ANY PARTICULAR FONT, STYLE, SIZE, OR COLOR.

SER. NO. 85-379,718, FILED 7-25-2011.

ELIZABETH KAJUBI, EXAMINING ATTORNEY



David J. Kybas

Director of the United States Patent and Trademark Office

United States of America

United States Patent and Trademark Office

SEPTALIGN

Reg. No. 4,108,704

ARION DEVICES LLC (CONNECTICUT LIMITED LIABILITY COMPANY)
50 WESSKUM WOOD ROAD
RIVERSIDE, CT 06878

Registered Mar. 6, 2012

Int. Cl.: 10

FOR: SPLINTS; SPLINTS; SPLINTS FOR USE IN THE NOSE AFTER NASAL SURGERY, IN CLASS 10 (U.S. CLS. 26, 39 AND 44).

TRADEMARK

FIRST USE 4-1-2010; IN COMMERCE 2-10-2011.

PRINCIPAL REGISTER

THE MARK CONSISTS OF STANDARD CHARACTERS WITHOUT CLAIM TO ANY PARTICULAR FONT, STYLE, SIZE, OR COLOR.

SER. NO. 85-379,748, FILED 7-25-2011.

DOMINIC FATHY, EXAMINING ATTORNEY



David J. Kybas

Director of the United States Patent and Trademark Office

United States of America

United States Patent and Trademark Office

DOCUNITY

Reg. No. 4,108,705

Registered Mar. 6, 2012

Int. Cl.: 9

TRADEMARK

PRINCIPAL REGISTER

DOCUNITY, LLC (GEORGIA LIMITED LIABILITY COMPANY)
44 POWERS COURT AVENUE
MILTON, GA 30004

FOR: COMPUTER SOFTWARE APPLICATIONS NAMELY, DATABASE AND DOCUMENT MANAGEMENT, ENTERPRISE PRINT CAPTURE, SCANNING OF PAPER BASED DOCUMENTS, APPLICATION INTEGRATION, DOCUMENT RETRIEVAL, DATA MINING AND CAPTURE, AND DISTRIBUTION, PROVISION OF STORAGE, RECALL AND MANAGEMENT OF DATA, DOCUMENTS AND ELECTRONIC MAIL STORED WITHIN A DOCUMENT MANAGEMENT REPOSITORY OVER A LOCAL OR WIDE AREA NETWORK, IN CLASS 9 (U.S. CLS. 21, 23, 26, 36 AND 38).

FIRST USE 7-19-2011; IN COMMERCE 7-19-2011.

THE MARK CONSISTS OF STANDARD CHARACTERS WITHOUT CLAIM TO ANY PARTICULAR FONT, STYLE, SIZE, OR COLOR.

SER. NO. 85-379,750, FILED 7-25-2011.

MARGERY A. TIERNEY, EXAMINING ATTORNEY



David J. Kybas

Director of the United States Patent and Trademark Office

United States of America

United States Patent and Trademark Office

ActionPod

Reg. No. 4,108,706

Registered Mar. 6, 2012

Int. Cl.: 9

TRADEMARK

PRINCIPAL REGISTER

JOHN MANS, INC. (COLORADO CORPORATION)
2640 MAPLETON AVE.
BOULDER, CO 80304

FOR: CAMERA MOUNTS, IN CLASS 9 (U.S. CLS. 21, 23, 26, 36 AND 38).

FIRST USE 0-0-2009; IN COMMERCE 0-0-2009.

THE MARK CONSISTS OF STANDARD CHARACTERS WITHOUT CLAIM TO ANY PARTICULAR FONT, STYLE, SIZE, OR COLOR.

SER. NO. 85-379,756, FILED 7-25-2011.

ELLEN B. AWRICH, EXAMINING ATTORNEY



David J. Kybas

Director of the United States Patent and Trademark Office

United States of America

United States Patent and Trademark Office

FlareDinkum

Reg. No. 4,108,707

Registered Mar. 6, 2012

Int. Cl.: 9

TRADEMARK

PRINCIPAL REGISTER

JOHN MANS, INC. (COLORADO CORPORATION)
2640 MAPLETON AVE.
BOULDER, CO 80304

FOR: CAMERA LENS SHADES, IN CLASS 9 (U.S. CLS. 21, 23, 26, 36 AND 38).

FIRST USE 0-0-2009; IN COMMERCE 0-0-2009.

THE MARK CONSISTS OF STANDARD CHARACTERS WITHOUT CLAIM TO ANY PARTICULAR FONT, STYLE, SIZE, OR COLOR.

SER. NO. 85-379,761, FILED 7-25-2011.

ELLEN B. AWRICH, EXAMINING ATTORNEY



David J. Kyffers

Director of the United States Patent and Trademark Office

United States of America

United States Patent and Trademark Office

MMI

Reg. No. 4,108,708

Registered Mar. 6, 2012

Int. Cl.: 45

SERVICE MARK

PRINCIPAL REGISTER

DOMAINE SELECT WINE ESTATES, LLC (DELAWARE LIMITED LIABILITY COMPANY)
SUITE 2302
555 EIGHTH AVENUE
NEW YORK, NY 10018

FOR: REVIEWING WINE PRODUCTION METHODS TO CONFIRM THAT THIRD PARTY WINE PRODUCERS MAKE THEIR WINE IN ACCORDANCE WITH THE LUNAR CALENDAR, USE LIMITED NATURAL VINEYARD TREATMENTS, EMPLOY STRICTLY INDIGENOUS YEAST, DO NOT MANIPULATE THEIR WINES AND LIMIT FILTRATION OR FINING, IN CLASS 45 (U.S. CLS. 100 AND 101).

FIRST USE 10-0-2005; IN COMMERCE 10-0-2005.

THE MARK CONSISTS OF STANDARD CHARACTERS WITHOUT CLAIM TO ANY PARTICULAR FONT, STYLE, SIZE, OR COLOR.

SER. NO. 85-379,782, FILED 7-25-2011.

KATINA MISTER, EXAMINING ATTORNEY



David J. Kyffers

Director of the United States Patent and Trademark Office

United States of America

United States Patent and Trademark Office

FOR THE HEALTH OF ALL.

Reg. No. 4,108,709

BCBSM, INC. (MINNESOTA CORPORATION)

Registered Mar. 6, 2012

P.O. BOX 64560
ST. PAUL, MN 55164

Int. Cl.: 36

FOR: CLAIMS ADMINISTRATION SERVICES IN THE FIELD OF HEALTH INSURANCE;
HEALTH INSURANCE UNDERWRITING, IN CLASS 36 (U.S. CLS. 100, 101 AND 102).

SERVICE MARK

FIRST USE 7-18-2011; IN COMMERCE 7-18-2011.

PRINCIPAL REGISTER

THE MARK CONSISTS OF STANDARD CHARACTERS WITHOUT CLAIM TO ANY PARTICULAR FONT, STYLE, SIZE, OR COLOR.

SER. NO. 85-379,808, FILED 7-25-2011.

JEFFERY COWARD, EXAMINING ATTORNEY



David J. Kybas

Director of the United States Patent and Trademark Office

United States of America

United States Patent and Trademark Office

HÔTEL COSTES

Reg. No. 4,108,710

Registered Mar. 6, 2012

Int. Cl.: 43

SERVICE MARK

PRINCIPAL REGISTER

HÔTEL COSTES (FRANCE JOINT STOCK COMPANY)
239-241 RUE SAINT HONORE
PARIS, FRANCE 75001

FOR: HOTELS; CAFÉ, RESTAURANT, AND BAR SERVICES, IN CLASS 43 (U.S. CLS. 100 AND 101).

THE MARK CONSISTS OF STANDARD CHARACTERS WITHOUT CLAIM TO ANY PARTICULAR FONT, STYLE, SIZE, OR COLOR.

OWNER OF ERPN CMNTY TM OFC REG. NO. 006284582, DATED 8-18-2008, EXPIRES 9-6-2017.

OWNER OF U.S. REG. NO. 3,847,170.

NO CLAIM IS MADE TO THE EXCLUSIVE RIGHT TO USE "HOTEL", APART FROM THE MARK AS SHOWN.

SER. NO. 85-379,845, FILED 7-25-2011.

GEOFFREY FOSDICK, EXAMINING ATTORNEY



David J. Kyfos

Director of the United States Patent and Trademark Office

United States of America

United States Patent and Trademark Office

SPARQ.ME

Reg. No. 4,108,711

Registered Mar. 6, 2012

Int. Cl.: 42

SERVICE MARK

PRINCIPAL REGISTER

MSKYNET, INC. (DELAWARE CORPORATION)
3305 115TH AVE NE #303
BELLEVUE, WA 98004

FOR: SOFTWARE AS A SERVICE (SAAS) SERVICES, NAMELY, HOSTING SOFTWARE FOR USE BY OTHERS FOR USE IN DYNAMIC UNIFORM RESOURCE IDENTIFIER INVOCATION, NAMELY, FOR USE IN INVOKING A MOBILE CAMERA PHONE TO INSTANTLY CONNECT TO CONTENT SUCH AS WEBSITES, PHONE NUMBERS, ADDRESSES, AND MOBILE APPLICATIONS WHEN THE PHONE'S USER SCANS A BAR CODE CONTAINING A COMMAND FOR THE CONNECTION TO OCCUR, IN CLASS 42 (U.S. CLS. 100 AND 101).

FIRST USE 11-2-2010; IN COMMERCE 12-1-2010.

THE MARK CONSISTS OF STANDARD CHARACTERS WITHOUT CLAIM TO ANY PARTICULAR FONT, STYLE, SIZE, OR COLOR.

SER. NO. 85-379,850, FILED 7-25-2011.

CARYN GLASSER, EXAMINING ATTORNEY



David J. Kyffers

Director of the United States Patent and Trademark Office

United States of America

United States Patent and Trademark Office

VCs on Skis

Reg. No. 4,108,712

REITLER KAILAS & ROSENBLATT, LLC (NEW YORK LIMITED LIABILITY COMPANY)
885 THIRD AVENUE, 20TH FLOOR
NEW YORK, NY 10022

Registered Mar. 6, 2012

Int. Cls.: 35 and 41

FOR: BUSINESS NETWORKING SERVICES, IN CLASS 35 (U.S. CLS. 100, 101 AND 102).

SERVICE MARK

FIRST USE 3-24-2006; IN COMMERCE 3-24-2006.

PRINCIPAL REGISTER

FOR: EDUCATIONAL SEMINARS ON VENTURE CAPITAL FINANCING AND ON EMERGING AND START-UP COMPANIES, AND DISTRIBUTING MATERIALS IN CONNECTION THEREWITH, IN CLASS 41 (U.S. CLS. 100, 101 AND 107).

FIRST USE 3-24-2006; IN COMMERCE 3-24-2006.

THE MARK CONSISTS OF STANDARD CHARACTERS WITHOUT CLAIM TO ANY PARTICULAR FONT, STYLE, SIZE, OR COLOR.

SER. NO. 85-379,859, FILED 7-25-2011.

GEOFFREY FOSDICK, EXAMINING ATTORNEY



David J. Kybas

Director of the United States Patent and Trademark Office

United States of America

United States Patent and Trademark Office

Litróf

Reg. No. 4,108,713

Registered Mar. 6, 2012

Int. Cl.: 16

TRADEMARK

PRINCIPAL REGISTER

LITROF MEDIA, LLC (ARIZONA LIMITED LIABILITY COMPANY)
SUITE 5
3815 E GROVE STREET
PHOENIX, AZ 85040

FOR: GENERAL FEATURE MAGAZINE IN THE FIELD OF ART AND PHOTOGRAPHY;
GENERAL FEATURE MAGAZINES; MAGAZINES FEATURING ART AND PHOTOGRAPHY;
MAGAZINES IN THE FIELD OF ART AND PHOTOGRAPHY, IN CLASS 16 (U.S. CLS. 2, 5,
22, 23, 29, 37, 38 AND 50).

FIRST USE 6-3-2011; IN COMMERCE 6-8-2011.

THE MARK CONSISTS OF STANDARD CHARACTERS WITHOUT CLAIM TO ANY PARTICULAR FONT, STYLE, SIZE, OR COLOR.

THE ENGLISH TRANSLATION OF LITRÓF IN THE MARK IS SPECTRUM.

SER. NO. 85-379,869, FILED 7-25-2011.

JOHN WILKE, EXAMINING ATTORNEY



David J. Kybas

Director of the United States Patent and Trademark Office

United States of America

United States Patent and Trademark Office

LEETDREAMS

Reg. No. 4,108,714

GREG CANTRELL (UNITED STATES INDIVIDUAL)
5101 LAURELVIEW AVE.
CARMICHAEL, CA 95608 AND

Registered Mar. 6, 2012

Int. Cl.: 9

ALYSON CANTRELL (UNITED STATES INDIVIDUAL)
5101 LAURELVIEW AVE.
CARMICHAEL, CA 95608 AND

TRADEMARK

PRINCIPAL REGISTER

MEGHAN STONE (UNITED STATES INDIVIDUAL)
5101 LAURELVIEW AVE.
CARMICHAEL, CA 95608 AND

KEVIN STONE (UNITED STATES INDIVIDUAL)
5101 LAURELVIEW AVE.
CARMICHAEL, CA 95608

FOR: ELECTRIC LIGHT SWITCHES; LIGHT SWITCHES, IN CLASS 9 (U.S. CLS. 21, 23, 26, 36 AND 38).

FIRST USE 6-22-2011; IN COMMERCE 6-22-2011.

THE MARK CONSISTS OF STANDARD CHARACTERS WITHOUT CLAIM TO ANY PARTICULAR FONT, STYLE, SIZE, OR COLOR.

SER. NO. 85-379,906, FILED 7-25-2011.

CARYN GLASSER, EXAMINING ATTORNEY



David J. Kyros

Director of the United States Patent and Trademark Office

United States of America

United States Patent and Trademark Office

EveryArt

Reg. No. 4,108,715

Registered Mar. 6, 2012

Int. Cl.: 35

SERVICE MARK

PRINCIPAL REGISTER

EVERYART, INC. (DELAWARE CORPORATION)
168 BERNARD STREET
SAN FRANCISCO, CA 94109

FOR: COMMISSIONING OF WORKS OF ART, IN CLASS 35 (U.S. CLS. 100, 101 AND 102).

FIRST USE 10-12-2010; IN COMMERCE 7-5-2011.

THE MARK CONSISTS OF STANDARD CHARACTERS WITHOUT CLAIM TO ANY PARTICULAR FONT, STYLE, SIZE, OR COLOR.

SER. NO. 85-379,915, FILED 7-25-2011.

DAVID MURRAY, EXAMINING ATTORNEY



David J. Kyffers

Director of the United States Patent and Trademark Office

United States of America

United States Patent and Trademark Office

STAR LANE

Reg. No. 4,108,716

INVESTORS OF AMERICA, LP (NEVADA LIMITED PARTNERSHIP), DBA STAR LANE
135 N. MERAMEC
CLAYTON, MO 63105

Registered Mar. 6, 2012

Int. Cl.: 33

FOR: WINE, IN CLASS 33 (U.S. CLS. 47 AND 49).

TRADEMARK

FIRST USE 11-30-2004; IN COMMERCE 11-30-2004.

PRINCIPAL REGISTER

THE MARK CONSISTS OF STANDARD CHARACTERS WITHOUT CLAIM TO ANY PARTICULAR FONT, STYLE, SIZE, OR COLOR.

SER. NO. 85-379,917, FILED 7-25-2011.

TINA L. SNAPP, EXAMINING ATTORNEY



David J. Kybas

Director of the United States Patent and Trademark Office

United States of America

United States Patent and Trademark Office

BIOMEDIX

Reg. No. 4,108,717

Registered Mar. 6, 2012

Int. Cls.: 9, 10 and 42

TRADEMARK

SERVICE MARK

PRINCIPAL REGISTER

BIOMEDIX VASCULAR SOLUTIONS, INC. (DELAWARE CORPORATION)
178 E 9TH STREET
ST. PAUL, MN 55101

FOR: COMPUTER SOFTWARE FOR MEDICAL PRACTICE MANAGEMENT AND MANAGEMENT OF ELECTRONIC HEALTH RECORDS; COMPUTER SOFTWARE FOR THE MANAGEMENT OF PRODUCTIVITY AND ACCREDITATION OF HEALTHCARE LABORATORIES; COMPUTER SOFTWARE FOR THE MANAGEMENT OF FINANCIAL AND THERAPEUTIC OUTCOMES FOR VASCULAR PRACTICES, IN CLASS 9 (U.S. CLS. 21, 23, 26, 36 AND 38).

FIRST USE 9-0-1997; IN COMMERCE 9-0-1997.

FOR: MEDICAL APPARATUS FOR THE DIAGNOSIS AND DETECTION OF VASCULAR DISEASES AND CONDITIONS, IN CLASS 10 (U.S. CLS. 26, 39 AND 44).

FIRST USE 9-0-1997; IN COMMERCE 9-0-1997.

FOR: PROVIDING TEMPORARY USE OF A WEB-BASED SOFTWARE APPLICATION FOR TRANSMITTING, STORING, MONITORING, AND ANALYZING PATIENT DATA FOR THE DIAGNOSIS AND TREATMENT OF VASCULAR HEALTH OR MEDICAL CONDITIONS; PROVIDING TEMPORARY USE OF A WEB-BASED SOFTWARE APPLICATION FOR THE PURPOSE OF ALLOWING VASCULAR SPECIALISTS TO REMOTELY MANAGE, TREAT AND DIAGNOSE VASCULAR PATIENTS, IN CLASS 42 (U.S. CLS. 100 AND 101).

FIRST USE 9-0-1997; IN COMMERCE 9-0-1997.

THE MARK CONSISTS OF STANDARD CHARACTERS WITHOUT CLAIM TO ANY PARTICULAR FONT, STYLE, SIZE, OR COLOR.

SER. NO. 85-379,919, FILED 7-25-2011.

HENRY S. ZAK, EXAMINING ATTORNEY



David J. Kyros

Director of the United States Patent and Trademark Office

United States of America

United States Patent and Trademark Office

LaAmistad

Reg. No. 4,108,718

Registered Mar. 6, 2012

Int. Cl.: 41

SERVICE MARK

PRINCIPAL REGISTER

THE BILL MANESS OUTREACH CENTER, INC. (GEORGIA CORPORATION)
3434 ROSWELL ROAD, N.W.
ATLANTA, GA 30305

FOR: CHARITABLE SERVICES, NAMELY, ACADEMIC MENTORING OF SCHOOL AGE CHILDREN; CONDUCTING AFTER SCHOOL TUTORING PROGRAMS, IN CLASS 41 (U.S. CLS. 100, 101 AND 107).

FIRST USE 9-1-2001; IN COMMERCE 9-1-2001.

THE MARK CONSISTS OF STANDARD CHARACTERS WITHOUT CLAIM TO ANY PARTICULAR FONT, STYLE, SIZE, OR COLOR.

THE ENGLISH TRANSLATION OF "LAAMISTAD" IN THE MARK IS "THE FRIENDSHIP".

SER. NO. 85-379,935, FILED 7-25-2011.

MICHAEL TANNER, EXAMINING ATTORNEY



David J. Kybas

Director of the United States Patent and Trademark Office

United States of America

United States Patent and Trademark Office

THERAREST

Reg. No. 4,108,719

KCI LICENSING, INC. (DELAWARE CORPORATION)
8023 VANTAGE DRIVE
SAN ANTONIO, TX 78230

Registered Mar. 6, 2012

Int. Cl.: 10

FOR: PRESSURE REDUCING THERAPEUTIC HEALTH-CARE MATTRESSES FOR SKIN CARE MANAGEMENT, IN CLASS 10 (U.S. CLS. 26, 39 AND 44).

TRADEMARK

FIRST USE 12-31-1989; IN COMMERCE 12-31-1989.

PRINCIPAL REGISTER

THE MARK CONSISTS OF STANDARD CHARACTERS WITHOUT CLAIM TO ANY PARTICULAR FONT, STYLE, SIZE, OR COLOR.

OWNER OF U.S. REG. NOS. 1,653,319 AND 2,952,720.

SER. NO. 85-379,936, FILED 7-25-2011.

B. PARADEWELAI, EXAMINING ATTORNEY



David J. Kybas

Director of the United States Patent and Trademark Office

United States of America
United States Patent and Trademark Office

TRAKNET

Reg. No. 4,108,720

Registered Mar. 6, 2012

Int. Cl.: 9

TRADEMARK

PRINCIPAL REGISTER

BIOMEDIX VASCULAR SOLUTIONS, INC. (DELAWARE CORPORATION)
178 E 9TH STREET
ST. PAUL, MN 55101

FOR: COMPUTER SOFTWARE FOR MEDICAL PRACTICE MANAGEMENT AND MANAGEMENT OF ELECTRONIC HEALTH RECORDS; COMPUTER SOFTWARE FOR THE MANAGEMENT OF PRODUCTIVITY AND ACCREDITATION OF HEALTHCARE LABORATORIES; COMPUTER SOFTWARE FOR THE MANAGEMENT OF FINANCIAL AND THERAPEUTIC OUTCOMES FOR VASCULAR PRACTICES, IN CLASS 9 (U.S. CLS. 21, 23, 26, 36 AND 38).

FIRST USE 12-0-2007; IN COMMERCE 12-0-2007.

THE MARK CONSISTS OF STANDARD CHARACTERS WITHOUT CLAIM TO ANY PARTICULAR FONT, STYLE, SIZE, OR COLOR.

SER. NO. 85-379,939, FILED 7-25-2011.

HENRY S. ZAK, EXAMINING ATTORNEY



David J. Kyffers

Director of the United States Patent and Trademark Office

United States of America

United States Patent and Trademark Office

Trip Sports

Reg. No. 4,108,721

TRIP SPORTS, INC. (IOWA CORPORATION)
P.O. BOX 336
WAPAKONETA, OH 45895

Registered Mar. 6, 2012

Int. Cl.: 41

FOR: ORGANIZING, ARRANGING, AND CONDUCTING BASKETBALL EVENTS, IN CLASS 41 (U.S. CLS. 100, 101 AND 107).

SERVICE MARK

FIRST USE 0-0-1998; IN COMMERCE 0-0-1999.

PRINCIPAL REGISTER

THE MARK CONSISTS OF STANDARD CHARACTERS WITHOUT CLAIM TO ANY PARTICULAR FONT, STYLE, SIZE, OR COLOR.

NO CLAIM IS MADE TO THE EXCLUSIVE RIGHT TO USE "SPORTS", APART FROM THE MARK AS SHOWN.

SEC. 2(F).

SER. NO. 85-379,950, FILED 7-25-2011.

EDWARD FENNESSY, EXAMINING ATTORNEY



David J. Kyffers

Director of the United States Patent and Trademark Office

United States of America

United States Patent and Trademark Office

ΩΨΦ

Reg. No. 4,108,722

Registered Mar. 6, 2012

**COLLECTIVE
MEMBERSHIP**

PRINCIPAL REGISTER

OMEGA PSI PHI FRATERNITY, INC. (GEORGIA CORPORATION)
3951 SNAPPINGER PARKWAY
DECATUR, GA 30035

FOR: INDICATING MEMBERSHIP IN A FRATERNAL ORGANIZATION, IN CLASS 200
(U.S. CL. 200).

FIRST USE 11-17-1911; IN COMMERCE 11-17-1911.

THE MARK CONSISTS OF THE GREEK LETTERS OMEGA PSI PHI.

SER. NO. 85-379,955, FILED 7-25-2011.

KEVON CHISOLM, EXAMINING ATTORNEY



David J. Kybas

Director of the United States Patent and Trademark Office

United States of America

United States Patent and Trademark Office

OMEGA PSI PHI

Reg. No. 4,108,723

Registered Mar. 6, 2012

**COLLECTIVE
MEMBERSHIP**

PRINCIPAL REGISTER

OMEGA PSI PHI FRATERNITY, INC. (GEORGIA CORPORATION)
3951 SNAPPINGER PARKWAY
DECATUR, GA 30035

FOR: INDICATING MEMBERSHIP IN A FRATERNAL ORGANIZATION, IN CLASS 200
(U.S. CL. 200).

FIRST USE 11-17-1911; IN COMMERCE 11-17-1911.

THE MARK CONSISTS OF STANDARD CHARACTERS WITHOUT CLAIM TO ANY PARTICULAR FONT, STYLE, SIZE, OR COLOR.

SER. NO. 85-379,960, FILED 7-25-2011.

KEVON CHISOLM, EXAMINING ATTORNEY



David J. Kybas

Director of the United States Patent and Trademark Office

United States of America
United States Patent and Trademark Office

LUXURAS

Reg. No. 4,108,724

Registered Mar. 6, 2012

Int. Cl.: 40

SERVICE MARK

PRINCIPAL REGISTER

SHANE A. NELSON, D.D.S., PC (MISSOURI PROFESSIONAL CORPORATION), DBA
LUXURAS DENTISTRY
14886 METCALF AVE
OVERLAND PARK, KS 66223

FOR: CUSTOM MANUFACTURE OF DENTAL PROSTHETICS, IN CLASS 40 (U.S. CLS. 100,
103 AND 106).

FIRST USE 4-15-2011; IN COMMERCE 7-7-2011.

THE MARK CONSISTS OF STANDARD CHARACTERS WITHOUT CLAIM TO ANY PAR-
TICULAR FONT, STYLE, SIZE, OR COLOR.

SER. NO. 85-379,961, FILED 7-25-2011.

DAWN FELDMAN, EXAMINING ATTORNEY



David J. Kybas

Director of the United States Patent and Trademark Office

United States of America

United States Patent and Trademark Office

Happiness Made To Order.

Reg. No. 4,108,725

Registered Mar. 6, 2012

Int. Cl.: 43

SERVICE MARK

PRINCIPAL REGISTER

GOOD TIMES DRIVE THRU INC. (COLORADO CORPORATION), DBA GOOD TIMES
BURGERS & FROZEN CUSTARD
601 CORPORATE CIRCLE
GOLDEN, CO 80401

FOR: RESTAURANT SERVICES FEATURING HAMBURGERS, CHICKEN SANDWICHES
AND, FROZEN CUSTARD, IN CLASS 43 (U.S. CLS. 100 AND 101).

FIRST USE 1-3-2011; IN COMMERCE 6-1-2011.

THE MARK CONSISTS OF STANDARD CHARACTERS WITHOUT CLAIM TO ANY PAR-
TICULAR FONT, STYLE, SIZE, OR COLOR.

SER. NO. 85-379,962, FILED 7-25-2011.

KEVON CHISOLM, EXAMINING ATTORNEY



David J. Kyffers

Director of the United States Patent and Trademark Office

United States of America

United States Patent and Trademark Office

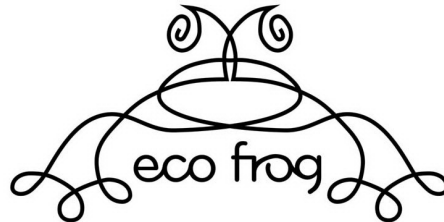

Reg. No. 4,108,726

Registered Mar. 6, 2012

Int. Cl.: 3

TRADEMARK

PRINCIPAL REGISTER

DEBORAH E. CROWLEY (UNITED STATES INDIVIDUAL), DBA FLEXEFFECT
INTERNATIONAL
1604 H ST
EUREKA, CA 95501

FOR: SKIN CARE PRODUCTS, NAMELY, NON-MEDICATED SKIN SERUM, IN CLASS 3
(U.S. CLS. 1, 4, 6, 50, 51 AND 52).

FIRST USE 2-1-2011; IN COMMERCE 3-1-2011.

THE MARK CONSISTS OF SINGLE LINE DRAWING OF A FROG WITH THE WORD "ECO
FROG" BETWEEN LEGS.

SER. NO. 85-379,976, FILED 7-25-2011.

HENRY S. ZAK, EXAMINING ATTORNEY



David J. Kybas

Director of the United States Patent and Trademark Office

United States of America

United States Patent and Trademark Office

MAGICWAND

Reg. No. 4,108,727

FAIRY LICEMOTHERS, LLC (NEW YORK LIMITED LIABILITY COMPANY)
2463 LONG BEACH ROAD
OCEANSIDE, NY 11572

Registered Mar. 6, 2012

Int. Cl.: 10

FOR: LICE COMBS, IN CLASS 10 (U.S. CLS. 26, 39 AND 44).

TRADEMARK

FIRST USE 7-8-2008; IN COMMERCE 7-8-2008.

PRINCIPAL REGISTER

THE MARK CONSISTS OF STANDARD CHARACTERS WITHOUT CLAIM TO ANY PARTICULAR FONT, STYLE, SIZE, OR COLOR.

SER. NO. 85-379,977, FILED 7-25-2011.

HENRY S. ZAK, EXAMINING ATTORNEY



David J. Kyffers

Director of the United States Patent and Trademark Office

United States of America

United States Patent and Trademark Office

RUBY AND JENNA

Reg. No. 4,108,728

Registered Mar. 6, 2012

Int. Cls.: 18, 25 and 35

TRADEMARK

SERVICE MARK

PRINCIPAL REGISTER

RUBY AND JENNA LLC (NEW YORK LIMITED LIABILITY COMPANY)
17TH FLOOR
1384 BROADWAY
NEW YORK, NY 10018

FOR: ALL PURPOSE SPORT BAGS; ALL-PURPOSE ATHLETIC BAGS; ATTACHE CASES; BACKPACKS; BACKPACKS, BOOK BAGS, SPORTS BAGS, BUM BAGS, WALLETS AND HANDBAGS; BEACH BAGS; BOOK BAGS; BRIEFBAGS; CARRYALLS; CLUTCH BAGS; DUFFEL BAGS; GARMENT BAGS FOR TRAVEL; GYM BAGS; HANDBAGS; HIPSACKS; KNAPSACKS; LEATHER CASES; LEATHER PURSES; LUGGAGE; MESSENGER BAGS; OVERNIGHT CASES; POCKETBOOKS; PURSES; ROLL BAGS; SCHOOL BAGS; SHOULDER BAGS; SLING BAGS; SPORTS BAGS; SUIT BAGS; TOTE BAGS; UMBRELLAS; VANITY CASES SOLD EMPTY; WAIST PACKS; WALLETS, IN CLASS 18 (U.S. CLS. 1, 2, 3, 22 AND 41).

FIRST USE 4-1-2011; IN COMMERCE 4-1-2011.

FOR: ANKLE SOCKS; ANKLETS; ANTI-PERSPIRANT SOCKS; ATHLETIC APPAREL, NAMELY, SHIRTS, PANTS, JACKETS, FOOTWEAR, HATS AND CAPS, ATHLETIC UNIFORMS; ATHLETIC FOOTWEAR; BASKETBALL SNEAKERS; BICYCLE GLOVES; BOXER SHORTS; CAPRI PANTS; CAPS; CARGO PANTS; CHILDREN'S HEADWEAR; CLOTHING, NAMELY, HAND-WARMERS; CROSS-COUNTRY MITTENS; DENIMS; DRESS PANTS; DRESS SHIRTS; DRESS SUITS; DRESSES; EVENING DRESSES; FOOTWEAR; GLOVES; GLOVES AS CLOTHING; GLOVES FOR APPAREL; GOLF SHIRTS; GYM PANTS; GYM SHORTS; HATS; HEAD SCARVES; HEADWEAR; HOODED SWEAT SHIRTS; HOSIERY; JACKETS; JEGGINGS, NAMELY, PANTS THAT ARE PARTIALLY JEANS AND PARTIALLY LEGGINGS; JOGGING PANTS; KNITTED GLOVES; LINGERIE; LOUNGE PANTS; MEN'S AND WOMEN'S JACKETS, COATS, TROUSERS, VESTS; MEN'S SOCKS; MITTENS; MITTENS MODIFIED TO COVER THE HAND AND AN ANIMAL LEASH HANDLE OR OTHER LOOP; MOTORCYCLE GLOVES; NON-SLIP SOCKS; OUTDOOR GLOVES; OUTDOOR MITTENS; OUTER JACKETS; PAJAMA BOTTOMS; PAJAMAS; PANTIES, SHORTS AND BRIEFS; PANTS; POLO SHIRTS; RAIN JACKETS; RAINPROOF JACKETS; RIDING GLOVES; SANDALS; SANDALS AND BEACH SHOES; SCARVES; SHIRTS; SHOES; SHORTS; SHOULDER SCARVES; SKI GLOVES; SKIRTS AND DRESSES; SKULLIES; SLEEP PANTS; SLEEPWEAR; SLIPPER SOCKS; SLIPPERS; SNEAKERS; SNOWBOARD MITTENS; SOCKS AND STOCKINGS; SPORT SHIRTS; SWEAT BANDS; SWEAT PANTS; SWEAT SHIRTS; SWEATERS; SWIMWEAR; T-SHIRTS; THERMAL SOCKS; TRACK PANTS; TRIATHLON CLOTHING,



David J. Kybas

Director of the United States Patent and Trademark Office

Reg. No. 4,108,728 NAMELY, TRIATHLON TIGHTS, TRIATHLON SHORTS, TRIATHLON SINGLETs, TRIATHLON SHIRTS, TRIATHLON SUITS; UNDERWEAR; WOOLLEN SOCKS, IN CLASS 25 (U.S. CLS. 22 AND 39).

FIRST USE 4-1-2011; IN COMMERCE 4-1-2011.

FOR: RETAIL APPAREL STORES; RETAIL CLOTHING STORES; RETAIL DEPARTMENT STORES; RETAIL GIFT SHOPS, IN CLASS 35 (U.S. CLS. 100, 101 AND 102).

FIRST USE 4-1-2011; IN COMMERCE 4-1-2011.

THE MARK CONSISTS OF STANDARD CHARACTERS WITHOUT CLAIM TO ANY PARTICULAR FONT, STYLE, SIZE, OR COLOR.

SER. NO. 85-379,982, FILED 7-25-2011.

GEORGE LORENZO, EXAMINING ATTORNEY

United States of America

United States Patent and Trademark Office

FIT TO FIGHT COLORECTAL CANCER

Reg. No. 4,108,729

POLYMEDCO, INC. (NEW YORK CORPORATION)
510 FURNACE DOCK ROAD
CORTLANDT MANOR, NY 10567

Registered Mar. 6, 2012

Int. Cl.: 44

FOR: PROVIDING INFORMATION IN THE FIELD OF HEALTH CARE AND CANCER TREATMENT, IN CLASS 44 (U.S. CLS. 100 AND 101).

SERVICE MARK

FIRST USE 10-14-2010; IN COMMERCE 10-14-2010.

PRINCIPAL REGISTER

THE MARK CONSISTS OF STANDARD CHARACTERS WITHOUT CLAIM TO ANY PARTICULAR FONT, STYLE, SIZE, OR COLOR.

SER. NO. 85-379,986, FILED 7-25-2011.

ROBERT STRUCK, EXAMINING ATTORNEY



David J. Kybas

Director of the United States Patent and Trademark Office

United States of America
United States Patent and Trademark Office

CorLeptin

Reg. No. 4,108,730

TRUDERMA LLC (NEVADA LIMITED LIABILITY COMPANY)
8820 W. RUSSELL RD. SUITE 110
LAS VEGAS, NV 89148

Registered Mar. 6, 2012

Int. Cl.: 5

FOR: DIETARY AND NUTRITIONAL SUPPLEMENTS USED FOR WEIGHT LOSS, IN CLASS 5 (U.S. CLS. 6, 18, 44, 46, 51 AND 52).

TRADEMARK

FIRST USE 7-10-2011; IN COMMERCE 7-22-2011.

PRINCIPAL REGISTER

THE MARK CONSISTS OF STANDARD CHARACTERS WITHOUT CLAIM TO ANY PARTICULAR FONT, STYLE, SIZE, OR COLOR.

SER. NO. 85-380,001, FILED 7-25-2011.

TARAH HARDY, EXAMINING ATTORNEY



David J. Kybas

Director of the United States Patent and Trademark Office

United States of America

United States Patent and Trademark Office

BOYS LIKE US

Reg. No. 4,108,731

BATMANGLIJ, ROSTAM (UNITED STATES INDIVIDUAL)
16000 VENTURA BLVD., STE. 600
ENCINO, CA 91436

Registered Mar. 6, 2012

Int. Cl.: 9

FOR: SERIES OF MUSICAL SOUND RECORDINGS, NAMELY, PRERECORDED ANALOG AND DIGITAL AUDIO AND VIDEO CASSETTES, TAPES AND DISCS FEATURING DRAMATIC AND NON-DRAMATIC PERFORMANCES OF MUSICAL WORKS, IN CLASS 9 (U.S. CLS. 21, 23, 26, 36 AND 38).

TRADEMARK

PRINCIPAL REGISTER

FIRST USE 5-0-2010; IN COMMERCE 5-0-2010.

THE MARK CONSISTS OF STANDARD CHARACTERS WITHOUT CLAIM TO ANY PARTICULAR FONT, STYLE, SIZE, OR COLOR.

SER. NO. 85-380,004, FILED 7-25-2011.

TARAH HARDY, EXAMINING ATTORNEY



David J. Kyffers

Director of the United States Patent and Trademark Office

United States of America

United States Patent and Trademark Office

ALEXANDER & HORNING

Reg. No. 4,108,732

ALEXANDER & HORNING, INC. (MICHIGAN CORPORATION)
20643 STEPHENS ROAD
ST. CLAIR SHORES, MI 48080

Registered Mar. 6, 2012

Int. Cl.: 29

FOR: PROCESSED MEATS, NAMELY SAUSAGE, BACON, CANADIAN BACON, HAMS, HOT DOGS, DELI MEATS AND MEAT SNACKS, IN CLASS 29 (U.S. CL. 46).

TRADEMARK

FIRST USE 9-0-1987; IN COMMERCE 9-0-1987.

PRINCIPAL REGISTER

THE MARK CONSISTS OF THE WORDS ALEXANDER & HORNING PLACED BETWEEN TWO SETS OF LINES RUNNING THE LENGTH OF THE WORDS.

SER. NO. 85-380,014, FILED 7-25-2011.

ANDREA BUTLER, EXAMINING ATTORNEY



David J. Kybas

Director of the United States Patent and Trademark Office

United States of America

United States Patent and Trademark Office



Reg. No. 4,108,733

ALPHA DELTA PI SORORITY (GEORGIA NON-PROFIT CORPORATION)
1386 PONCE DE LEON AVENUE, NE
ATLANTA, GA 30306

Registered Mar. 6, 2012

Int. Cls.: 6, 16, 21 and 25

FOR: METAL KEY CHAINS, IN CLASS 6 (U.S. CLS. 2, 12, 13, 14, 23, 25 AND 50).

TRADEMARK

FIRST USE 6-0-2001; IN COMMERCE 6-0-2001.

PRINCIPAL REGISTER

FOR: NOTE CARDS, IN CLASS 16 (U.S. CLS. 2, 5, 22, 23, 29, 37, 38 AND 50).

FIRST USE 6-0-2001; IN COMMERCE 6-0-2001.

FOR: COFFEE MUGS, IN CLASS 21 (U.S. CLS. 2, 13, 23, 29, 30, 33, 40 AND 50).

FIRST USE 6-0-2001; IN COMMERCE 6-0-2001.

FOR: JACKETS; NIGHT SHIRTS; PAJAMAS; SHORTS; SOCKS; SWEAT PANTS; SWEAT-SHIRTS; T-SHIRTS; WARM UP SUITS, IN CLASS 25 (U.S. CLS. 22 AND 39).

FIRST USE 6-0-2001; IN COMMERCE 6-0-2001.

OWNER OF U.S. REG. NO. 2,782,678.

THE MARK CONSISTS OF STYLIZED LION DESIGN.

SER. NO. 85-380,019, FILED 7-25-2011.

INGA ERVIN, EXAMINING ATTORNEY



David J. Kybas

Director of the United States Patent and Trademark Office

United States of America

United States Patent and Trademark Office

B-100

Reg. No. 4,108,734

RICH, BOBBY (UNITED STATES INDIVIDUAL)
4933 E COMMISSARY CT
TUCSON, AZ 85712

Registered Mar. 6, 2012

Int. Cl.: 41

FOR: ENTERTAINMENT SERVICES, NAMELY, PROVIDING AN ON-GOING RADIO PROGRAM IN THE FIELD OF ENTERTAINMENT INFORMATION AND MUSIC, IN CLASS 41 (U.S. CLS. 100, 101 AND 107).

SERVICE MARK

FIRST USE 3-1-1975; IN COMMERCE 3-1-1975.

PRINCIPAL REGISTER

THE MARK CONSISTS OF STANDARD CHARACTERS WITHOUT CLAIM TO ANY PARTICULAR FONT, STYLE, SIZE, OR COLOR.

SER. NO. 85-380,076, FILED 7-25-2011.

MATTHEW EINSTEIN, EXAMINING ATTORNEY



David J. Kybas

Director of the United States Patent and Trademark Office

United States of America
United States Patent and Trademark Office

GRIPTONITE

Reg. No. 4,108,735

DILLON BRUNO (UNITED STATES INDIVIDUAL)
P.O. BOX 573

Registered Mar. 6, 2012

LOS ANGELES, CA 90078

Int. Cl.: 12

FOR: AUTOMOBILES AND STRUCTURAL PARTS THEREFOR, IN CLASS 12 (U.S. CLS. 19, 21, 23, 31, 35 AND 44).

TRADEMARK

FIRST USE 6-1-2011; IN COMMERCE 6-1-2011.

PRINCIPAL REGISTER

THE MARK CONSISTS OF STANDARD CHARACTERS WITHOUT CLAIM TO ANY PARTICULAR FONT, STYLE, SIZE, OR COLOR.

SER. NO. 85-380,090, FILED 7-25-2011.

ELLEN B. AWRICH, EXAMINING ATTORNEY



David J. Kybas

Director of the United States Patent and Trademark Office

United States of America

United States Patent and Trademark Office



Reg. No. 4,108,736

Registered Mar. 6, 2012

Int. Cl.: 43

SERVICE MARK

PRINCIPAL REGISTER

ATALLAH, IHAB (EGYPT INDIVIDUAL)
300 SW 1ST STREET, SUITE 103
FORT LAUDERDALE, FL 33301

FOR: BAR, CAFE, AND COCKTAIL LOUNGE SERVICES, IN CLASS 43 (U.S. CLS. 100 AND 101).

FIRST USE 2-0-2007; IN COMMERCE 2-0-2007.

OWNER OF U.S. REG. NO. 3,821,303.

THE MARK CONSISTS OF A CARTOON DEPICTION OF A CAMEL SITTING ON A BENCH SMOKING ON A HOOKAH UNDERNEATH THE WORDS OFF THE HOOKAH ARRANGED IN AN ARC.

SER. NO. 85-380,121, FILED 7-25-2011.

JOHN WILKE, EXAMINING ATTORNEY



David J. Kyfos

Director of the United States Patent and Trademark Office

United States of America

United States Patent and Trademark Office

OLARK

Reg. No. 4,108,737

Registered Mar. 6, 2012

Int. Cl.: 42

SERVICE MARK

PRINCIPAL REGISTER

HABLA, INC. (DELAWARE CORPORATION)
245 RAMONA ST.
PALO ALTO, CA 94301

FOR: APPLICATION SERVICE PROVIDER (ASP) FEATURING SOFTWARE FOR USE IN LIVE CHATS; COMPUTER SERVICES, NAMELY, ACTING AS AN APPLICATION SERVICE PROVIDER IN THE FIELD OF INFORMATION MANAGEMENT TO HOST COMPUTER APPLICATION SOFTWARE FOR THE PURPOSE OF LIVE CHATS, IN CLASS 42 (U.S. CLS. 100 AND 101).

FIRST USE 6-0-2009; IN COMMERCE 6-0-2009.

THE MARK CONSISTS OF STANDARD CHARACTERS WITHOUT CLAIM TO ANY PARTICULAR FONT, STYLE, SIZE, OR COLOR.

THE NAME(S), PORTRAIT(S), AND/OR SIGNATURE(S) SHOWN IN THE MARK DOES NOT IDENTIFY A PARTICULAR LIVING INDIVIDUAL.

THE WORDING OLARK HAS NO MEANING IN A FOREIGN LANGUAGE.

SER. NO. 85-380,139, FILED 7-25-2011.

ERIN FALK, EXAMINING ATTORNEY



David J. Kyros

Director of the United States Patent and Trademark Office

United States of America

United States Patent and Trademark Office

whatever you need,
whatever it takes

Reg. No. 4,108,738

Registered Mar. 6, 2012

Int. Cl.: 35

SERVICE MARK

PRINCIPAL REGISTER

GMD CONSULTING, INC. (ARIZONA CORPORATION), DBA GMD GRAPHICS
3401 W FLOWER ST
PHOENIX, AZ 85017

FOR: ADVERTISING AND MARKETING; ADVERTISING AND MARKETING CONSULTANCY; ADVERTISING AND MARKETING SERVICES, NAMELY, PROMOTING THE GOODS AND SERVICES OF OTHERS; ADVERTISING SERVICES, NAMELY, CREATING CORPORATE LOGOS FOR OTHERS; ADVERTISING SERVICES, NAMELY, PROMOTING AND MARKETING THE GOODS AND SERVICES OF OTHERS THROUGH ALL PUBLIC COMMUNICATION MEANS; ADVERTISING SERVICES, NAMELY, PROMOTING THE BRANDS, GOODS AND SERVICES OF OTHERS, IN CLASS 35 (U.S. CLS. 100, 101 AND 102).

FIRST USE 5-1-2011; IN COMMERCE 5-1-2011.

THE MARK CONSISTS OF STANDARD CHARACTERS WITHOUT CLAIM TO ANY PARTICULAR FONT, STYLE, SIZE, OR COLOR.

SER. NO. 85-380,145, FILED 7-25-2011.

JOHN WILKE, EXAMINING ATTORNEY



David J. Kybas

Director of the United States Patent and Trademark Office

United States of America

United States Patent and Trademark Office

THE BIG SOCIAL

Reg. No. 4,108,739

TELLIGENT SYSTEMS, INC. (TEXAS CORPORATION)
17950 PRESTON ROAD, SUITE 310
DALLAS, TX 75252

Registered Mar. 6, 2012

Int. Cl.: 41

FOR: EDUCATIONAL SERVICES, NAMELY, CONDUCTING SEMINARS, CONFERENCES AND WORKSHOPS FEATURING COMMUNITY SOFTWARE AND DISTRIBUTION OF COURSE MATERIALS IN CONNECTION THEREWITH, IN CLASS 41 (U.S. CLS. 100, 101 AND 107).

SERVICE MARK

PRINCIPAL REGISTER

FIRST USE 4-0-2011; IN COMMERCE 4-0-2011.

THE MARK CONSISTS OF STANDARD CHARACTERS WITHOUT CLAIM TO ANY PARTICULAR FONT, STYLE, SIZE, OR COLOR.

SER. NO. 85-380,150, FILED 7-25-2011.

ODESSA BIBBINS, EXAMINING ATTORNEY



David J. Kyffers

Director of the United States Patent and Trademark Office

United States of America

United States Patent and Trademark Office

SUN DELLA

Reg. No. 4,108,740

Registered Mar. 6, 2012

Int. Cl.: 32

TRADEMARK

PRINCIPAL REGISTER

SUN DELLA (ILLINOIS CORPORATION)
7001 W 62ND ST.
CHICAGO, IL 60638

FOR: FRUIT JUICE, IN CLASS 32 (U.S. CLS. 45, 46 AND 48).

FIRST USE 2-1-2011; IN COMMERCE 2-1-2011.

THE MARK CONSISTS OF STANDARD CHARACTERS WITHOUT CLAIM TO ANY PARTICULAR FONT, STYLE, SIZE, OR COLOR.

SER. NO. 85-380,173, FILED 7-25-2011.

ANGELA DUONG, EXAMINING ATTORNEY



David J. Kybas

Director of the United States Patent and Trademark Office

United States of America

United States Patent and Trademark Office

Re-Stim

Reg. No. 4,108,741

Registered Mar. 6, 2012

Int. Cl.: 3

TRADEMARK

PRINCIPAL REGISTER

BLATTER, WILLIAM C (UNITED STATES INDIVIDUAL), DBA HLCC
SUITE 101
4 AVIS DR
LATHAM, NY 12110

FOR: COSMETIC HAIR DRESSING PREPARATIONS; HAIR CARE LOTIONS; HAIR LOTION,
IN CLASS 3 (U.S. CLS. 1, 4, 6, 50, 51 AND 52).

FIRST USE 4-5-2011; IN COMMERCE 7-21-2011.

THE MARK CONSISTS OF STANDARD CHARACTERS WITHOUT CLAIM TO ANY PAR-
TICULAR FONT, STYLE, SIZE, OR COLOR.

SER. NO. 85-380,179, FILED 7-25-2011.

LINDA MICKLEBURGH, EXAMINING ATTORNEY



David J. Kybas

Director of the United States Patent and Trademark Office

United States of America

United States Patent and Trademark Office

PIMEL

Reg. No. 4,108,742

Registered Mar. 6, 2012

Int. Cl.: 1

TRADEMARK

PRINCIPAL REGISTER

ASAHI KASEI E-MATERIALS CORPORATION (JAPAN CORPORATION)
1-105 KANDA JINBOCHO CHIYODA-KU
TOKYO 101-8101, JAPAN

FOR: PHOTSENSITIVE RESINS; PHOTSENSITIVE RESIN COMPOSITION FOR USE IN INDUSTRY; PHOTSENSITIVE RESIN VARNISH FOR USE IN INDUSTRY; PHOTSENSITIVE CHEMICALS; PHOTSENSITIVE FILMS; PHOTSENSITIVE DRY FILM RESIST; CHEMICALS USED IN PHOTOGRAPHY, IN CLASS 1 (U.S. CLS. 1, 5, 6, 10, 26 AND 46).

FIRST USE 1-1-1987; IN COMMERCE 1-1-1987.

THE MARK CONSISTS OF STANDARD CHARACTERS WITHOUT CLAIM TO ANY PARTICULAR FONT, STYLE, SIZE, OR COLOR.

OWNER OF U.S. REG. NO. 1,638,051.

SER. NO. 85-380,188, FILED 7-25-2011.

MICHAEL ENGEL, EXAMINING ATTORNEY



David J. Kybas

Director of the United States Patent and Trademark Office

United States of America

United States Patent and Trademark Office



Reg. No. 4,108,743

Registered Mar. 6, 2012

Int. Cl.: 44

SERVICE MARK

PRINCIPAL REGISTER

BHONSLE, VERONICA A. (UNITED STATES INDIVIDUAL)
6052 COLLEGE AVENUE
OAKLAND, CA 94618

FOR: HAIR SALON SERVICES, IN CLASS 44 (U.S. CLS. 100 AND 101).

FIRST USE 11-25-2002; IN COMMERCE 12-1-2002.

THE MARK CONSISTS OF A WAVY VERTICAL LINE WITH AN ACCENT MARK ABOVE IT AND THE WORD VERO BELOW IT.

THE ENGLISH TRANSLATION OF VERO IN THE MARK IS TRUTH.

SER. NO. 85-380,242, FILED 7-25-2011.

JASON TURNER, EXAMINING ATTORNEY



David J. Kyffers

Director of the United States Patent and Trademark Office

United States of America

United States Patent and Trademark Office

everyappliancepart.com

Reg. No. 4,108,744

SERVALL COMPANY (MICHIGAN CORPORATION), DBA 1ST SOURCE SERVALL
6761 E 10 MILE RD
CENTER LINE, MI 48015

Registered Mar. 6, 2012

Int. Cl.: 35

FOR: DISTRIBUTORSHIPS IN THE FIELD OF REPLACEMENT PARTS FOR APPLIANCES AND HEATING AND COOLING SUPPLIES, IN CLASS 35 (U.S. CLS. 100, 101 AND 102).

SERVICE MARK

FIRST USE 12-8-2010; IN COMMERCE 12-8-2010.

PRINCIPAL REGISTER

THE MARK CONSISTS OF STANDARD CHARACTERS WITHOUT CLAIM TO ANY PARTICULAR FONT, STYLE, SIZE, OR COLOR.

SER. NO. 85-380,246, FILED 7-25-2011.

ROBERT C. CLARK JR., EXAMINING ATTORNEY



David J. Kybas

Director of the United States Patent and Trademark Office

United States of America

United States Patent and Trademark Office

ICAKE CLOTHING

Reg. No. 4,108,745

Registered Mar. 6, 2012

Int. Cl.: 25

TRADEMARK

PRINCIPAL REGISTER

DUNHAM, TINA (UNITED STATES INDIVIDUAL)
11TH FLOOR
1515 BROADWAY
NEW YORK, NY 10036

FOR: COATS; DRESSES; FOOTWEAR; HATS; JACKETS; JEANS; PANTS; SHIRTS; SKIRTS;
SOCKS; SWEAT PANTS; SWEAT SHIRTS; T-SHIRTS; UNDERWEAR, IN CLASS 25 (U.S.
CLS. 22 AND 39).

FIRST USE 12-1-2009; IN COMMERCE 12-1-2009.

THE MARK CONSISTS OF STANDARD CHARACTERS WITHOUT CLAIM TO ANY PAR-
TICULAR FONT, STYLE, SIZE, OR COLOR.

NO CLAIM IS MADE TO THE EXCLUSIVE RIGHT TO USE "CLOTHING", APART FROM
THE MARK AS SHOWN.

SER. NO. 85-380,250, FILED 7-25-2011.

INGRID C. EULIN, EXAMINING ATTORNEY



David J. Kyffers

Director of the United States Patent and Trademark Office

United States of America

United States Patent and Trademark Office

REHAB ARISCES

Reg. No. 4,108,746

REHAB ARISCES, LLC (WISCONSIN LIMITED LIABILITY COMPANY)
845 SOUTH MAIN STREET, SUITE 120
FOND DU LAC, WI 54935

Registered Mar. 6, 2012

Int. Cl.: 44

FOR: PHYSICAL THERAPY; SPEECH THERAPY; OCCUPATIONAL THERAPY, IN CLASS
44 (U.S. CLS. 100 AND 101).

SERVICE MARK

FIRST USE 4-1-2011; IN COMMERCE 4-1-2011.

PRINCIPAL REGISTER

THE MARK CONSISTS OF STANDARD CHARACTERS WITHOUT CLAIM TO ANY PAR-
TICULAR FONT, STYLE, SIZE, OR COLOR.

NO CLAIM IS MADE TO THE EXCLUSIVE RIGHT TO USE "REHAB", APART FROM THE
MARK AS SHOWN.

SER. NO. 85-380,265, FILED 7-25-2011.

JANET LEE, EXAMINING ATTORNEY



David J. Kybas

Director of the United States Patent and Trademark Office

United States of America

United States Patent and Trademark Office

Specific Object

Reg. No. 4,108,747

Registered Mar. 6, 2012

Int. Cl.: 35

SERVICE MARK

PRINCIPAL REGISTER

SPECIFIC OBJECTIVE, INC. (NEW YORK CORPORATION)
SUITE M285
601 WEST 26TH STREET
NEW YORK, NY 10001

FOR: RETAIL STORE AND ON-LINE RETAIL STORE SERVICES FEATURING ART BOOKS,
ARTWORK AND RELATED MATERIALS, IN CLASS 35 (U.S. CLS. 100, 101 AND 102).

FIRST USE 4-22-2004; IN COMMERCE 4-22-2004.

THE MARK CONSISTS OF STANDARD CHARACTERS WITHOUT CLAIM TO ANY PAR-
TICULAR FONT, STYLE, SIZE, OR COLOR.

SER. NO. 85-380,270, FILED 7-25-2011.

ROBERT STRUCK, EXAMINING ATTORNEY



David J. Kybas

Director of the United States Patent and Trademark Office

United States of America

United States Patent and Trademark Office

Janify

Reg. No. 4,108,748

Registered Mar. 6, 2012

Int. Cl.: 37

SERVICE MARK

PRINCIPAL REGISTER

JANIFY LLC (TENNESSEE LIMITED LIABILITY COMPANY)
1309 WILLOW GROVE DR
KNOXVILLE, TN 37932

FOR: CARPET AND RUG CLEANING; CLEANING OF COMMERCIAL PREMISES;
CLEANING OF INDUSTRIAL PREMISES; JANITORIAL SERVICES; WINDOW CLEANING,
IN CLASS 37 (U.S. CLS. 100, 103 AND 106).

FIRST USE 7-20-2011; IN COMMERCE 7-20-2011.

THE MARK CONSISTS OF STANDARD CHARACTERS WITHOUT CLAIM TO ANY PAR-
TICULAR FONT, STYLE, SIZE, OR COLOR.

SER. NO. 85-380,280, FILED 7-25-2011.

TIMOTHY FINNEGAN, EXAMINING ATTORNEY



David J. Kybas

Director of the United States Patent and Trademark Office

United States of America

United States Patent and Trademark Office

Snozzie

Reg. No. 4,108,749

Registered Mar. 6, 2012

Int. Cl.: 24

TRADEMARK

PRINCIPAL REGISTER

JANE BAHK (UNITED STATES INDIVIDUAL)
1312 SAN ANTONIO AVENUE
ALAMEDA, CA 94501

FOR: REUSABLE TEXTILE CLOTH ADAPTED TO BE WORN ABOUT AN APPENDAGE OF A USER, NAMELY, A CUSTOMIZED HANDKERCHIEF, IN CLASS 24 (U.S. CLS. 42 AND 50).

FIRST USE 3-22-2010; IN COMMERCE 3-22-2010.

THE MARK CONSISTS OF STANDARD CHARACTERS WITHOUT CLAIM TO ANY PARTICULAR FONT, STYLE, SIZE, OR COLOR.

SER. NO. 85-380,306, FILED 7-25-2011.

CHRISTINA SOBRAL, EXAMINING ATTORNEY



David J. Kyffers

Director of the United States Patent and Trademark Office

United States of America

United States Patent and Trademark Office



Reg. No. 4,108,750

TYRI INTERNATIONAL (WISCONSIN CORPORATION)
621 GLORIA DRIVE
PLOVER, WI 54467

Registered Mar. 6, 2012

Int. Cl.: 11

FOR: LIGHTING APPARATUS FOR VEHICLES, IN CLASS 11 (U.S. CLS. 13, 21, 23, 31 AND 34).

TRADEMARK

FIRST USE 1-1-2006; IN COMMERCE 1-1-2006.

PRINCIPAL REGISTER

THE MARK CONSISTS OF A CIRCULAR MOTION IMAGE CONSISTING OF TWO ARCS THAT SURROUND THE STYLIZED TEXT "TYRI" ON THE TOP AND BOTTOM.

SER. NO. 85-380,310, FILED 7-25-2011.

GEORGE LORENZO, EXAMINING ATTORNEY



David J. Kybas

Director of the United States Patent and Trademark Office

United States of America

United States Patent and Trademark Office

STEPHANIE ANNE

Reg. No. 4,108,751

STEPHANIE ANN KANTIS (UNITED STATES INDIVIDUAL)
3419 WESTMINSTER, SUITE 32
DALLAS, TX 75205

Registered Mar. 6, 2012

Int. Cl.: 14

FOR: JEWELRY, IN CLASS 14 (U.S. CLS. 2, 27, 28 AND 50).

TRADEMARK

FIRST USE 5-31-2010; IN COMMERCE 7-31-2010.

PRINCIPAL REGISTER

THE MARK CONSISTS OF STANDARD CHARACTERS WITHOUT CLAIM TO ANY PARTICULAR FONT, STYLE, SIZE, OR COLOR.

THE NAME(S), PORTRAIT(S), AND/OR SIGNATURE(S) SHOWN IN THE MARK IDENTIFIES THE APPLICANT, STEPHANIE ANN KANTIS, WHOSE CONSENT(S) TO REGISTER IS MADE OF RECORD.

SER. NO. 85-380,313, FILED 7-25-2011.

JAY FLOWERS, EXAMINING ATTORNEY



David J. Kyffers

Director of the United States Patent and Trademark Office

United States of America

United States Patent and Trademark Office

REWINED

Reg. No. 4,108,752

REWINED, LLC (SOUTH CAROLINA LIMITED LIABILITY COMPANY)
2825 CANE SLASH ROAD
JOHNS ISLAND, SC 29455

Registered Mar. 6, 2012

Int. Cl.: 4

FOR: SCENTED CANDLES, IN CLASS 4 (U.S. CLS. 1, 6 AND 15).

TRADEMARK

FIRST USE 8-23-2009; IN COMMERCE 4-13-2011.

PRINCIPAL REGISTER

THE MARK CONSISTS OF STANDARD CHARACTERS WITHOUT CLAIM TO ANY PARTICULAR FONT, STYLE, SIZE, OR COLOR.

SER. NO. 85-380,318, FILED 7-25-2011.

GEORGE LORENZO, EXAMINING ATTORNEY



David J. Kybas

Director of the United States Patent and Trademark Office

United States of America

United States Patent and Trademark Office

The logo for "SHIELDTHIS" features the word in a bold, blue, sans-serif font with a white outline and an orange shadow. Below the text is a stylized orange and blue triangular shape pointing to the right.

Reg. No. 4,108,753

Registered Mar. 6, 2012

Int. Cl.: 3

TRADEMARK

PRINCIPAL REGISTER

SHIELDTHIS (CALIFORNIA SOLE PROPRIETORSHIP)
18 RED BARN COURT
OAKLEY, CA 94561

FOR: AUTOMOBILE AND CAR WAX PREPARATIONS; PREPARATIONS FOR CLEANING, PROTECTING AND PRESERVING VEHICLE SURFACES, IN CLASS 3 (U.S. CLS. 1, 4, 6, 50, 51 AND 52).

FIRST USE 5-15-2011; IN COMMERCE 5-15-2011.

THE MARK CONSISTS OF THE WORDING "SHIELDTHIS" IN STYLIZED FONT AND IN THE COLOR OF BLUE. THE WORDING HAS A WHITE AND ORANGE BORDER. DIRECTLY BELOW THE WORDING IS A SIDEWARDS TRIANGULAR SHAPE IN THE COLOR OF ORANGE AND HAS A WHITE AND BLUE BORDER.

THE COLOR(S) ORANGE, BLUE, AND WHITE IS/ARE CLAIMED AS A FEATURE OF THE MARK.

SER. NO. 85-380,321, FILED 7-25-2011.

ALLISON SCHRODY, EXAMINING ATTORNEY



David J. Kyros

Director of the United States Patent and Trademark Office

United States of America

United States Patent and Trademark Office

AUNT NEE'S

Reg. No. 4,108,754

Registered Mar. 6, 2012

Int. Cl.: 30

TRADEMARK

PRINCIPAL REGISTER

AUNT NEE'S TASTE OF MEXICO SALSA, LLC (MICHIGAN LIMITED LIABILITY COMPANY), AKA AUNT NEE'S FRESH FOODS, LLC
31711 PIERCE
GARDEN CITY, MI 48135

FOR: FLOUR-BASED CHIPS; SPICE BLENDS; SPICE RUBS; SPICES; TORTILLA CHIPS,
IN CLASS 30 (U.S. CL. 46).

FIRST USE 8-1-2006; IN COMMERCE 8-1-2006.

THE MARK CONSISTS OF STANDARD CHARACTERS WITHOUT CLAIM TO ANY PARTICULAR FONT, STYLE, SIZE, OR COLOR.

SER. NO. 85-380,324, FILED 7-25-2011.

REBECCA POVARCHUK, EXAMINING ATTORNEY



David J. Kyffers

Director of the United States Patent and Trademark Office

United States of America

United States Patent and Trademark Office

eden's bouquet

Reg. No. 4,108,755

Registered Mar. 6, 2012

Int. Cl.: 25

TRADEMARK

PRINCIPAL REGISTER

STENERSEN, JENNIFER J (UNITED STATES INDIVIDUAL)
PO BOX 429
32300 NE C C LONDON RD
YACOLT, WA 98675

FOR: DRESSES; HATS; JACKETS; PANTS; SKIRTS; TOPS, IN CLASS 25 (U.S. CLS. 22 AND 39).

FIRST USE 6-0-2006; IN COMMERCE 6-0-2006.

THE MARK CONSISTS OF STANDARD CHARACTERS WITHOUT CLAIM TO ANY PARTICULAR FONT, STYLE, SIZE, OR COLOR.

SER. NO. 85-380,330, FILED 7-25-2011.

MELISSA VALLILLO, EXAMINING ATTORNEY



David J. Kyffers

Director of the United States Patent and Trademark Office

United States of America

United States Patent and Trademark Office

DangerDate

Reg. No. 4,108,756

EMERGENCYLAND (CALIFORNIA LIMITED LIABILITY COMPANY)
#928

Registered Mar. 6, 2012

22631 PACIFIC COAST HWY.
MALIBU, CA 90265

Int. Cl.: 45

FOR: COMPUTER DATING SERVICES, IN CLASS 45 (U.S. CLS. 100 AND 101).

SERVICE MARK

FIRST USE 11-22-2009; IN COMMERCE 11-25-2009.

PRINCIPAL REGISTER

THE MARK CONSISTS OF STANDARD CHARACTERS WITHOUT CLAIM TO ANY PARTICULAR FONT, STYLE, SIZE, OR COLOR.

SER. NO. 85-380,366, FILED 7-25-2011.

JANICE KIM, EXAMINING ATTORNEY



David J. Kyffers

Director of the United States Patent and Trademark Office

United States of America

United States Patent and Trademark Office

OLAVE

Reg. No. 4,108,757

Registered Mar. 6, 2012

Int. Cl.: 30

TRADEMARK

PRINCIPAL REGISTER

VALLE GRANDE S.A. (CHILE CORPORATION)
AVDA. DEL PARQUE N° 4161, OF. 302
CIUDAD EMPRESARIAL HUECHURABA
SANTIAGO, CHILE

FOR: VINEGARS AND BALSAMIC VINEGAR, IN CLASS 30 (U.S. CL. 46).

THE MARK CONSISTS OF STANDARD CHARACTERS WITHOUT CLAIM TO ANY PARTICULAR FONT, STYLE, SIZE, OR COLOR.

OWNER OF CHILE REG. NO. 693.672, DATED 7-21-2011, EXPIRES 5-24-2014.

THE WORDING OLAVE HAS NO MEANING IN A FOREIGN LANGUAGE.

SER. NO. 85-380,367, FILED 7-25-2011.

JANICE KIM, EXAMINING ATTORNEY



David J. Kybas

Director of the United States Patent and Trademark Office

United States of America

United States Patent and Trademark Office

Play On Words

Reg. No. 4,108,758

Registered Mar. 6, 2012

Int. Cl.: 28

TRADEMARK

PRINCIPAL REGISTER

BEUNING, DAVID J. (UNITED STATES INDIVIDUAL)
9613 PALMER ROAD
BLOOMINGTON, MN 55437

FOR: CARD GAMES, IN CLASS 28 (U.S. CLS. 22, 23, 38 AND 50).

FIRST USE 7-1-2011; IN COMMERCE 7-15-2011.

THE MARK CONSISTS OF STANDARD CHARACTERS WITHOUT CLAIM TO ANY PARTICULAR FONT, STYLE, SIZE, OR COLOR.

SER. NO. 85-380,396, FILED 7-25-2011.

NATALIE POLZER, EXAMINING ATTORNEY



David J. Kyffers

Director of the United States Patent and Trademark Office

United States of America

United States Patent and Trademark Office

LOPROX

Reg. No. 4,108,759

MEDICIS PHARMACEUTICAL CORPORATION (DELAWARE CORPORATION)
7720 NORTH DOBSON ROAD
SCOTTSDALE, AZ 85256

Registered Mar. 6, 2012

Int. Cl.: 5

FOR: SEBORRHEIC DERMATITIS TREATMENT PREPARATIONS, IN CLASS 5 (U.S. CLS. 6, 18, 44, 46, 51 AND 52).

TRADEMARK

FIRST USE 3-26-2003; IN COMMERCE 3-26-2003.

PRINCIPAL REGISTER

THE MARK CONSISTS OF STANDARD CHARACTERS WITHOUT CLAIM TO ANY PARTICULAR FONT, STYLE, SIZE, OR COLOR.

OWNER OF U.S. REG. NO. 1,221,402.

SER. NO. 85-380,415, FILED 7-25-2011.

KATHRYN COWARD, EXAMINING ATTORNEY



David J. Kyros

Director of the United States Patent and Trademark Office

United States of America

United States Patent and Trademark Office

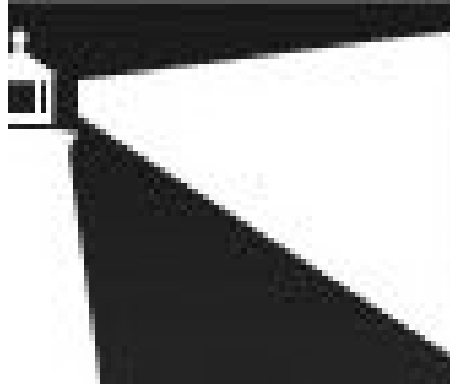

Reg. No. 4,108,760

Registered Mar. 6, 2012

Int. Cl.: 36

SERVICE MARK

PRINCIPAL REGISTER

POINT JUDITH MANAGEMENT COMPANY III, LLC (DELAWARE LIMITED LIABILITY COMPANY)
50 PARK ROW WEST, SUITE 107
PROVIDENCE, RI 02903

FOR: FINANCIAL AND INVESTMENT SERVICES, NAMELY, INVESTMENT AND MANAGEMENT SERVICES RELATED TO THE OPERATION OF VENTURE CAPITAL FUNDS; MANAGING VENTURE CAPITAL FUNDS FOR OTHERS; VENTURE CAPITAL SERVICES, NAMELY, PROVIDING VENTURE CAPITAL FOR THE ESTABLISHMENT, OPERATION AND EXPANSION OF EMERGING TECHNOLOGY COMPANIES; AND VENTURE CAPITAL FINANCING SERVICES, IN CLASS 36 (U.S. CLS. 100, 101 AND 102).

FIRST USE 1-1-2011; IN COMMERCE 1-1-2011.

THE MARK CONSISTS OF AN IMAGE OF A LIGHTHOUSE WITH A SHINING LIGHT.

SER. NO. 85-380,460, FILED 7-25-2011.

SOPHIA S. KIM, EXAMINING ATTORNEY



David J. Kybas

Director of the United States Patent and Trademark Office

United States of America

United States Patent and Trademark Office

JALDA

Reg. No. 4,108,761

Registered Mar. 6, 2012

Int. Cl.: 18

TRADEMARK

PRINCIPAL REGISTER

HOFF, JALDA W. (NETHERLANDS INDIVIDUAL)
8570 WILSHIRE BLVD SUITE 210
BEVERLY HILLS, CA 90211

FOR: BACKPACKS, BOOK BAGS, SPORTS BAGS, BUM BAGS, WALLETS AND HANDBAGS; CHAIN MESH PURSES; CHANGE PURSES; CLUTCH BAGS; CLUTCH PURSES; CLUTCHES; COIN PURSES; COIN PURSES NOT MADE OF PRECIOUS METAL; COIN PURSES, NOT OF PRECIOUS METALS; DOLLY BAGS; EVENING HANDBAGS; FASHION HANDBAGS; FITTED PROTECTIVE COVERS FOR HANDBAGS, BRIEFCASES, VALISES, SUITCASES, AND BRIEFCASE-LIKE PORTFOLIOS; GENTLEMEN'S HANDBAGS; HANDBAGS; HANDBAGS FOR LADIES; HANDBAGS FOR MEN; HANDBAGS, PURSES AND WALLETS; INTERCHANGEABLE DECORATIVE COVERS FOR ACCESSORIZATION PURPOSES THAT ARE SPECIALLY ADAPTED TO HANDBAGS; LEATHER HANDBAGS; LEATHER PURSES; MEN'S CLUTCH BAGS; MULTI-PURPOSE PURSES; MULTISTRANDED, BEADED CLIP THAT ATTACHES TO THE OUTSIDE OF A WOMEN'S PURSE AS A DECORATIVE ACCESSORY; POCHETTES; PURSE CHARMS; PURSES; PURSES; PURSES AND WALLETS; PURSES AND WALLETS OF PRECIOUS METAL; PURSES MADE OF PRECIOUS METAL; PURSES NOT MADE OF PRECIOUS METAL; PURSES OF PRECIOUS METAL; PURSES, NOT OF PRECIOUS METAL; SMALL CLUTCH PURSES; SMALL PURSES; STRAPS FOR HANDBAGS; WRIST MOUNTED PURSES, IN CLASS 18 (U.S. CLS. 1, 2, 3, 22 AND 41).

FIRST USE 4-1-2002; IN COMMERCE 3-15-2003.

THE MARK CONSISTS OF STANDARD CHARACTERS WITHOUT CLAIM TO ANY PARTICULAR FONT, STYLE, SIZE, OR COLOR.

SER. NO. 85-380,462, FILED 7-25-2011.

SOPHIA S. KIM, EXAMINING ATTORNEY



David J. Kybas

Director of the United States Patent and Trademark Office

United States of America

United States Patent and Trademark Office

SCRASSAGE

Reg. No. 4,108,762

Registered Mar. 6, 2012

Int. Cl.: 44

SERVICE MARK

PRINCIPAL REGISTER

JULIE ADAM (UNITED STATES INDIVIDUAL), DBA JULZ THERAPEUTIC MASSAGE
4307 NORTHGATE DRIVE
CARPENTERSVILLE, IL 60110

FOR: HEALTH SPA SERVICES FOR HEALTH AND WELLNESS OF THE BODY AND SPIRIT, NAMELY, PROVIDING MASSAGE, FACIAL AND BODY TREATMENT SERVICES, COSMETIC BODY CARE SERVICES; MASSAGE; MASSAGE THERAPY SERVICES; MASSAGES; SALON SERVICES, NAMELY, FACIALS, MANICURES AND MESSAGES THAT ARE PROVIDED IN A TRAILER OUTFITTED WITH CHAIR, TABLE AND SINK ACCESSORIES, IN CLASS 44 (U.S. CLS. 100 AND 101).

FIRST USE 5-1-2011; IN COMMERCE 5-1-2011.

THE MARK CONSISTS OF STANDARD CHARACTERS WITHOUT CLAIM TO ANY PARTICULAR FONT, STYLE, SIZE, OR COLOR.

SER. NO. 85-380,472, FILED 7-25-2011.

KATHLEEN KOLACZ, EXAMINING ATTORNEY



David J. Kyffers

Director of the United States Patent and Trademark Office

United States of America

United States Patent and Trademark Office

VPSNOW

Reg. No. 4,108,763

EONIX CORPORATION (NEVADA CORPORATION)
2360 CORPORATE CIRCLE SUITE 400
HENDERSON, NV 89074

Registered Mar. 6, 2012

Int. Cl.: 42

FOR: APPLICATION SERVICE PROVIDER (ASP), NAMELY, HOSTING COMPUTER SOFTWARE APPLICATIONS OF OTHERS; COMPUTER SERVICES, NAMELY, CLOUD HOSTING PROVIDER SERVICES; COMPUTER SERVICES, NAMELY, MANAGING WEB SITES FOR OTHERS; COMPUTER SERVICES, NAMELY, MONITORING THE WEB SITES OF OTHERS TO IMPROVE THEIR SCALABILITY AND PERFORMANCE; COMPUTER SERVICES, NAMELY, MONITORING, TESTING, ANALYZING, AND REPORTING ON THE INTERNET TRAFFIC CONTROL AND CONTENT CONTROL OF THE WEB SITES OF OTHERS; COMPUTER SERVICES, NAMELY, PROVIDING VIRTUAL AND NON VIRTUAL APPLICATION SERVERS, WEB SERVERS, FILE SERVERS, CO-LOCATION SERVERS, LOAD BALANCING SERVERS, REDUNDANCY SERVERS, MEDIA SERVERS AND DATABASE SERVERS OF VARIABLE CAPACITY TO THIRD PARTY COMPUTING AND DATA STORAGE FACILITIES, IN CLASS 42 (U.S. CLS. 100 AND 101).

SERVICE MARK

PRINCIPAL REGISTER

FIRST USE 6-10-2006; IN COMMERCE 6-10-2006.

THE MARK CONSISTS OF STANDARD CHARACTERS WITHOUT CLAIM TO ANY PARTICULAR FONT, STYLE, SIZE, OR COLOR.

SER. NO. 85-380,479, FILED 7-25-2011.

JULIE GUTTADAURO, EXAMINING ATTORNEY



David J. Kyros

Director of the United States Patent and Trademark Office

United States of America

United States Patent and Trademark Office

Roadshow

Reg. No. 4,108,764

FETCH SOFTWARES LLC (NEW HAMPSHIRE LIMITED LIABILITY COMPANY)
4 CEDARWOOD LN #407
LEBANON, NH 03766

Registered Mar. 6, 2012

Int. Cl.: 9

FOR: COMPUTER PROGRAM FOR STORAGE AND PLAYBACK OF DIGITAL VIDEO ON MOBILE COMPUTING DEVICES, IN CLASS 9 (U.S. CLS. 21, 23, 26, 36 AND 38).

TRADEMARK

FIRST USE 6-21-2011; IN COMMERCE 6-21-2011.

PRINCIPAL REGISTER

THE MARK CONSISTS OF STANDARD CHARACTERS WITHOUT CLAIM TO ANY PARTICULAR FONT, STYLE, SIZE, OR COLOR.

SER. NO. 85-380,547, FILED 7-25-2011.

ELIZABETH HUGHITT, EXAMINING ATTORNEY



David J. Kybas

Director of the United States Patent and Trademark Office

United States of America

United States Patent and Trademark Office

THE SUMMER OF MASSACRE

Reg. No. 4,108,765

Registered Mar. 6, 2012

Int. Cl.: 41

SERVICE MARK

PRINCIPAL REGISTER

ESCOBAR, STEVEN J (UNITED STATES INDIVIDUAL)
7007 STANSBURY AVE
VAN NUYS, CA 91405 AND

CASTRO, JOSE M (UNITED STATES INDIVIDUAL)
7007 STANSBURY AVE
VAN NUYS, CA 91405

FOR: PRODUCTION AND DISTRIBUTION OF INDEPENDENT MOTION PICTURES , IN CLASS 41 (U.S. CLS. 100, 101 AND 107).

FIRST USE 9-1-2009; IN COMMERCE 5-1-2011.

THE MARK CONSISTS OF STANDARD CHARACTERS WITHOUT CLAIM TO ANY PARTICULAR FONT, STYLE, SIZE, OR COLOR.

SER. NO. 85-380,571, FILED 7-26-2011.

JOHN HWANG, EXAMINING ATTORNEY



David J. Kyros

Director of the United States Patent and Trademark Office

United States of America

United States Patent and Trademark Office

BETTER THAN RISK FREE MONEY BACK GUARANTEE!

Reg. No. 4,108,766

A.J. RASSAMNI (UNITED STATES INDIVIDUAL)
3854 N. BLACKSTONE AVE.
FRESNO, CA 93726

Registered Mar. 6, 2012

Int. Cl.: 37

FOR: AUTOMOBILE DETAILING, IN CLASS 37 (U.S. CLS. 100, 103 AND 106).

SERVICE MARK

FIRST USE 10-31-1997; IN COMMERCE 10-31-1997.

PRINCIPAL REGISTER

THE MARK CONSISTS OF STANDARD CHARACTERS WITHOUT CLAIM TO ANY PARTICULAR FONT, STYLE, SIZE, OR COLOR.

SER. NO. 85-380,578, FILED 7-26-2011.

IRA J. GOODSaid, EXAMINING ATTORNEY



David J. Kyffers

Director of the United States Patent and Trademark Office

United States of America

United States Patent and Trademark Office

FESTIVAL OF FIRE

Reg. No. 4,108,767

NATIONAL JET RACING ASSOCIATION (FLORIDA CORPORATION)
219 BAYBERRY DR
BYRON, GA 31008

Registered Mar. 6, 2012

Int. Cl.: 41

FOR: ORGANIZATION OF JET POWERED DRAG RACING EVENTS AND COMPETITIONS,
IN CLASS 41 (U.S. CLS. 100, 101 AND 107).

SERVICE MARK

FIRST USE 9-8-2010; IN COMMERCE 12-17-2010.

PRINCIPAL REGISTER

THE MARK CONSISTS OF STANDARD CHARACTERS WITHOUT CLAIM TO ANY PARTICULAR FONT, STYLE, SIZE, OR COLOR.

SER. NO. 85-380,596, FILED 7-26-2011.

NAKIA HENRY, EXAMINING ATTORNEY



David J. Kyros

Director of the United States Patent and Trademark Office

United States of America

United States Patent and Trademark Office

KooGame

Reg. No. 4,108,768

Registered Mar. 6, 2012

Int. Cl.: 41

SHENZHEN KOOGAME TECHNOLOGIES CO.,LTD. (CHINA LIMITED LIABILITY COMPANY)

A501-III RM WUHAN UNIVERSITY PRODUCTION AND RESEARCH BUILDING NO.6YUEXING 2 ROAD NANSHAN, SHENZHEN, CHINA

SERVICE MARK

PRINCIPAL REGISTER

FOR: ARRANGING AND CONDUCTING EDUCATIONAL CONFERENCES; BOOKMOBILE SERVICES; ELECTRONIC GAMES SERVICES PROVIDED BY MEANS OF THE INTERNET; LAYOUT SERVICES OTHER THAN FOR ADVERTISING PURPOSES; PROVIDING INFORMATION ON-LINE RELATING TO COMPUTER GAMES AND COMPUTER ENHANCEMENTS FOR GAMES; PROVIDING ON-LINE CARD GAMES; PROVIDING ON-LINE NON-DOWNLOADABLE ELECTRONIC DICTIONARIES; PUBLICATION OF BOOKS, IN CLASS 41 (U.S. CLS. 100, 101 AND 107).

FIRST USE 12-18-2009; IN COMMERCE 5-27-2010.

THE MARK CONSISTS OF THE LETTERS OF KOOGAME.

THE WORDING KOOGAME HAS NO MEANING IN A FOREIGN LANGUAGE.

SER. NO. 85-380,639, FILED 7-26-2011.

INGA ERVIN, EXAMINING ATTORNEY



David J. Kybas

Director of the United States Patent and Trademark Office

United States of America

United States Patent and Trademark Office

NPD-2000

Reg. No. 4,108,769

FRAC TECH SERVICES, LLC (TEXAS LIMITED LIABILITY COMPANY)
16858 INTERSTATE HIGHWAY 20
CISCO, TX 76437

Registered Mar. 6, 2012

Int. Cl.: 1

FOR: CHEMICAL ADDITIVES FOR USE IN THE RECOVERY OF FLUIDS FROM UNDERGROUND FORMATIONS, IN CLASS 1 (U.S. CLS. 1, 5, 6, 10, 26 AND 46).

TRADEMARK

FIRST USE 1-0-2010; IN COMMERCE 1-0-2010.

PRINCIPAL REGISTER

THE MARK CONSISTS OF STANDARD CHARACTERS WITHOUT CLAIM TO ANY PARTICULAR FONT, STYLE, SIZE, OR COLOR.

SER. NO. 85-380,649, FILED 7-26-2011.

MATTHEW EINSTEIN, EXAMINING ATTORNEY



David J. Kybas

Director of the United States Patent and Trademark Office

United States of America

United States Patent and Trademark Office

BOTTOMDOLLARSHOES

Reg. No. 4,108,770

BOTTOM DOLLAR SHOES, LLC (VIRGINIA LIMITED LIABILITY COMPANY)
6489 KNOTTS ISLAND ROAD
VIRGINIA BEACH, VA 23457

Registered Mar. 6, 2012

Int. Cl.: 35

FOR: ON-LINE RETAIL STORE SERVICES FEATURING WOMEN'S FOOTWEAR AND CLUBWEAR, IN CLASS 35 (U.S. CLS. 100, 101 AND 102).

SERVICE MARK

FIRST USE 1-1-2000; IN COMMERCE 1-1-2000.

PRINCIPAL REGISTER

THE MARK CONSISTS OF STANDARD CHARACTERS WITHOUT CLAIM TO ANY PARTICULAR FONT, STYLE, SIZE, OR COLOR.

SER. NO. 85-380,677, FILED 7-26-2011.

ROBIN MITTLER, EXAMINING ATTORNEY



David J. Kybas

Director of the United States Patent and Trademark Office

United States of America

United States Patent and Trademark Office

AMZINI

Reg. No. 4,108,771

Registered Mar. 6, 2012

Int. Cl.: 42

SERVICE MARK

PRINCIPAL REGISTER

AMZINI ENTERPRISES, LLC (NORTH CAROLINA LIMITED LIABILITY COMPANY)
SUITE 426
222 EAST BLAND STREET
CHARLOTTE, NC 28203

FOR: COMPUTER SERVICES, NAMELY, HOSTING AN INTERACTIVE WEB SITE THAT
ALLOWS USERS TO SEARCH FOR AND MANAGE SOCIAL NETWORKS, IN CLASS 42
(U.S. CLS. 100 AND 101).

FIRST USE 10-1-2010; IN COMMERCE 3-6-2011.

THE MARK CONSISTS OF STANDARD CHARACTERS WITHOUT CLAIM TO ANY PAR-
TICULAR FONT, STYLE, SIZE, OR COLOR.

SER. NO. 85-380,770, FILED 7-26-2011.

JOHN HWANG, EXAMINING ATTORNEY



David J. Kyros

Director of the United States Patent and Trademark Office

United States of America

United States Patent and Trademark Office



CHART HOUSE

Reg. No. 4,108,772

Registered Mar. 6, 2012

Int. Cl.: 43

SERVICE MARK

PRINCIPAL REGISTER

CHLN, INC. (DELAWARE CORPORATION)
1510 WEST LOOP SOUTH
HOUSTON, TX 77027

FOR: RESTAURANT AND BAR SERVICES, IN CLASS 43 (U.S. CLS. 100 AND 101).

FIRST USE 12-7-2009; IN COMMERCE 12-7-2009.

OWNER OF U.S. REG. NOS. 1,061,033 AND 3,397,586.

SER. NO. 85-380,793, FILED 7-26-2011.

BARBARA GAYNOR, EXAMINING ATTORNEY



David J. Kyffers

Director of the United States Patent and Trademark Office

United States of America

United States Patent and Trademark Office

Hoops On Fire

Reg. No. 4,108,773

FELTER, ANDY (NETHERLANDS INDIVIDUAL)
#514

Registered Mar. 6, 2012

2286 E. CARSON ST.
LONG BEACH, CA 90807

Int. Cl.: 41

FOR: SPORTS TRAINING SERVICES, IN CLASS 41 (U.S. CLS. 100, 101 AND 107).

SERVICE MARK

FIRST USE 6-15-2011; IN COMMERCE 6-15-2011.

PRINCIPAL REGISTER

THE MARK CONSISTS OF STANDARD CHARACTERS WITHOUT CLAIM TO ANY PARTICULAR FONT, STYLE, SIZE, OR COLOR.

SER. NO. 85-380,796, FILED 7-26-2011.

KIM MONINGHOFF, EXAMINING ATTORNEY



David J. Kybas

Director of the United States Patent and Trademark Office

United States of America

United States Patent and Trademark Office

DPA

Reg. No. 4,108,774

Registered Mar. 6, 2012

Int. Cls.: 9 and 42

TRADEMARK

SERVICE MARK

PRINCIPAL REGISTER

DEARBORN GROUP, INC. (MICHIGAN CORPORATION)
33604 EIGHT MILE ROAD
FARMINGTON HILLS, MI 48335

FOR: ELECTRONIC COMPONENTRY GOODS, NAMELY, COMPUTER SOFTWARE AND HARDWARE FOR USE IN OPERATING AUTOMOBILE COMMUNICATION NETWORKS, SOFTWARE FOR DIAGNOSTICS IN THE AUTOMOTIVE AND AUTOMATION INDUSTRIES, SOFTWARE FOR DATABASE MANAGEMENT IN THE AUTOMOTIVE AND AUTOMOTION INDUSTRIES, DIAGNOSTIC ADAPTERS, ADAPTERS, IN CLASS 9 (U.S. CLS. 21, 23, 26, 36 AND 38).

FIRST USE 1-0-1998; IN COMMERCE 1-0-1998.

FOR: TECHNICAL CONSULTATION IN THE FIELDS OF AUTOMOTIVE ELECTRONICS; COMPUTER PROGRAMMING FOR OTHERS; DESIGN FOR OTHERS IN THE FIELD OF AUTOMOTIVE ELECTRONICS, IN CLASS 42 (U.S. CLS. 100 AND 101).

FIRST USE 1-0-1998; IN COMMERCE 1-0-1998.

THE MARK CONSISTS OF STANDARD CHARACTERS WITHOUT CLAIM TO ANY PARTICULAR FONT, STYLE, SIZE, OR COLOR.

SER. NO. 85-380,798, FILED 7-26-2011.

ANDREA HACK, EXAMINING ATTORNEY



David J. Kyffers

Director of the United States Patent and Trademark Office

United States of America

United States Patent and Trademark Office

FARMfresh FROM RIGHT AROUND THE BLOCK, NOT AROUND THE COUNTRY.

Reg. No. 4,108,775

Registered Mar. 6, 2012

Int. Cl.: 16

TRADEMARK

PRINCIPAL REGISTER

SOUTH FLORIDA FRESH (FLORIDA LIMITED LIABILITY COMPANY)
#311
1131 ALTA LOMA RD.
WEST HOLLYWOOD, CA 90069

FOR: MAGAZINES IN THE FIELD OF U.S. AGRICULTURE, FARMING, AND THE COUNTRY'S LOCAL, FRESH FOOD, AND HEALTHY LIFESTYLE MOVEMENT, IN CLASS 16 (U.S. CLS. 2, 5, 22, 23, 29, 37, 38 AND 50).

FIRST USE 7-1-2010; IN COMMERCE 7-1-2010.

THE MARK CONSISTS OF STANDARD CHARACTERS WITHOUT CLAIM TO ANY PARTICULAR FONT, STYLE, SIZE, OR COLOR.

SER. NO. 85-380,802, FILED 7-26-2011.

LINDA ESTRADA, EXAMINING ATTORNEY



David J. Kybas

Director of the United States Patent and Trademark Office

United States of America

United States Patent and Trademark Office

COPPER IS THE NEW SILVER

Reg. No. 4,108,776

CARRS COINS AND ROCKS (FLORIDA CORPORATION)
4644 W. GANDY BLVD. STE. 427
TAMPA, FL 33611

Registered Mar. 6, 2012

Int. Cl.: 35

FOR: ON-LINE RETAIL STORE SERVICES FEATURING COPPER BULLION COINS, COPPER BULLION BARS AND COPPER BULLION ROUNDS, IN CLASS 35 (U.S. CLS. 100, 101 AND 102).

SERVICE MARK

FIRST USE 4-0-2010; IN COMMERCE 4-0-2010.

PRINCIPAL REGISTER

THE MARK CONSISTS OF STANDARD CHARACTERS WITHOUT CLAIM TO ANY PARTICULAR FONT, STYLE, SIZE, OR COLOR.

SER. NO. 85-380,825, FILED 7-26-2011.

SETH A. RAPPAPORT, EXAMINING ATTORNEY



David J. Kybas

Director of the United States Patent and Trademark Office

United States of America

United States Patent and Trademark Office

CORN FED DIESEL

Reg. No. 4,108,777

SELL, JUSTIN (UNITED STATES INDIVIDUAL), DBA CORN FED DIESEL
6491 E. CR 650 SOUTH
WALTON, IN 46994

Registered Mar. 6, 2012

Int. Cls.: 35 and 37

FOR: WHOLESALE AND RETAIL STORE SERVICES FEATURING VEHICLE PARTS, IN CLASS 35 (U.S. CLS. 100, 101 AND 102).

SERVICE MARK

FIRST USE 6-10-2010; IN COMMERCE 6-10-2010.

PRINCIPAL REGISTER

FOR: MOTOR VEHICLE MAINTENANCE AND REPAIR, IN CLASS 37 (U.S. CLS. 100, 103 AND 106).

FIRST USE 6-10-2010; IN COMMERCE 6-10-2010.

THE MARK CONSISTS OF STANDARD CHARACTERS WITHOUT CLAIM TO ANY PARTICULAR FONT, STYLE, SIZE, OR COLOR.

SER. NO. 85-380,827, FILED 7-26-2011.

MICHAEL KEATING, EXAMINING ATTORNEY



David J. Kybas

Director of the United States Patent and Trademark Office

United States of America
United States Patent and Trademark Office

MAXAND

Reg. No. 4,108,778

ECO VERDE TECHNOLOGIES, INC. (FLORIDA CORPORATION)
110 SE 6TH ST, SUITE 1900
FT. LAUDERDALE, FL 33301

Registered Mar. 6, 2012

Int. Cl.: 1

FOR: HORTICULTURAL PRODUCTS, NAMELY, SOIL AMENDMENTS THAT ARE INCORPORATED INTO OR ONTO A TURF, LAWN OR SOIL PROFILE FOR CREATING A HEALTH MEDIUM FOR INCREASED ROOT GROWTH AND/OR A SMOOTHER TURF OR LAWN SURFACE CUT OR APPEARANCE, IN CLASS 1 (U.S. CLS. 1, 5, 6, 10, 26 AND 46).

TRADEMARK

PRINCIPAL REGISTER

FIRST USE 5-21-2011; IN COMMERCE 7-14-2011.

THE MARK CONSISTS OF STANDARD CHARACTERS WITHOUT CLAIM TO ANY PARTICULAR FONT, STYLE, SIZE, OR COLOR.

SER. NO. 85-380,833, FILED 7-26-2011.

JORDAN BAKER, EXAMINING ATTORNEY



David J. Kyffers

Director of the United States Patent and Trademark Office

United States of America

United States Patent and Trademark Office



Reg. No. 4,108,779

AMG HOLDINGS CORP (HAWAII CORPORATION)
P.O. BOX 22359
HONOLULU, HI 96823

Registered Mar. 6, 2012

Int. Cl.: 43

FOR: RESTAURANT SERVICES, IN CLASS 43 (U.S. CLS. 100 AND 101).

SERVICE MARK

FIRST USE 5-1-2011; IN COMMERCE 6-15-2011.

PRINCIPAL REGISTER

THE MARK CONSISTS OF A ROUND CIRCLE THAT LOOKS LIKE GRILL MARKS. WITHIN THE CIRCLE THERE IS THE STYLIZED TEXT "GRYLT" IN AT 30 DEGREE ANGLE. DIRECTLY ABOVE THE TEXT WITHIN THE GRILL CIRCLE IS A SMALL FLAME.

SER. NO. 85-380,852, FILED 7-26-2011.

DAVID H. STINE, EXAMINING ATTORNEY



David J. Kyros

Director of the United States Patent and Trademark Office

United States of America

United States Patent and Trademark Office

Serving the Children of Yesterday

Reg. No. 4,108,780

Registered Mar. 6, 2012

Int. Cl.: 43

SERVICE MARK

PRINCIPAL REGISTER

JOHNSON COUNTY COMMITTEE ON AGING (TEXAS NON-PROFIT CORPORATION),
DBA MEALS-ON-WHEELS OF JOHNSON AND ELLIS COUNTIES
106 E. KILPATRICK STREET
CLEBURNE, TX 76031

FOR: CHARITABLE SERVICES, NAMELY, PROVIDING FOOD TO NEEDY PERSONS, IN
CLASS 43 (U.S. CLS. 100 AND 101).

FIRST USE 1-1-2004; IN COMMERCE 1-1-2004.

THE MARK CONSISTS OF STANDARD CHARACTERS WITHOUT CLAIM TO ANY PAR-
TICULAR FONT, STYLE, SIZE, OR COLOR.

SER. NO. 85-380,856, FILED 7-26-2011.

CHRISTOPHER LAW, EXAMINING ATTORNEY



David J. Kybas

Director of the United States Patent and Trademark Office

United States of America
United States Patent and Trademark Office

Pawbender

Reg. No. 4,108,781

Registered Mar. 6, 2012

Int. Cl.: 31

TRADEMARK

PRINCIPAL REGISTER

GOOD TIMES DRIVE THRU INC. (COLORADO CORPORATION), DBA GOOD TIMES
BURGERS & FROZEN CUSTARD
601 CORPORATE CIRCLE
GOLDEN, CO 80401

FOR: DOG TREAT, IN CLASS 31 (U.S. CLS. 1 AND 46).

FIRST USE 3-1-2010; IN COMMERCE 5-1-2010.

THE MARK CONSISTS OF STANDARD CHARACTERS WITHOUT CLAIM TO ANY PARTICULAR FONT, STYLE, SIZE, OR COLOR.

SER. NO. 85-380,899, FILED 7-26-2011.

KEVON CHISOLM, EXAMINING ATTORNEY



David J. Kybas

Director of the United States Patent and Trademark Office

United States of America

United States Patent and Trademark Office

AVINDY

Reg. No. 4,108,782

AVINDY DESIGNS LLC (GEORGIA LIMITED LIABILITY COMPANY)
887 W. MARIETTA ST. NW, STE. # M-101
ATLANTA, GA 30318

Registered Mar. 6, 2012

Int. Cl.: 14

FOR: HANDCRAFTED JEWELRY, IN CLASS 14 (U.S. CLS. 2, 27, 28 AND 50).

TRADEMARK

FIRST USE 7-10-2002; IN COMMERCE 7-14-2002.

PRINCIPAL REGISTER

THE MARK CONSISTS OF STANDARD CHARACTERS WITHOUT CLAIM TO ANY PARTICULAR FONT, STYLE, SIZE, OR COLOR.

SER. NO. 85-380,903, FILED 7-26-2011.

MIDGE BUTLER, EXAMINING ATTORNEY



David J. Kybas

Director of the United States Patent and Trademark Office

United States of America

United States Patent and Trademark Office



Reg. No. 4,108,783

Registered Mar. 6, 2012

Int. Cl.: 35

SERVICE MARK

PRINCIPAL REGISTER

BEASLEY TIRE SERVICE - KINGWOOD, INC. (TEXAS CORPORATION)
22422 LOOP 494
KINGWOOD, TX 77339

FOR: RETAIL TIRE STORES, IN CLASS 35 (U.S. CLS. 100, 101 AND 102).

FIRST USE 8-30-2009; IN COMMERCE 8-30-2009.

THE MARK CONSISTS OF BLACK TIRE TREAD, GREY TIRE WALL, GREY GROOVES, PINK ARM, PINK NOSE, PINK LEGS, RED TONGUE, WHITE SHOES, GREY SHADOW IN SHOES, GREY SHADOW IN MOUTH, WHITE EYES, WHITE CHEEKS, WHITE TEETH.

THE COLOR(S) BLACK, GREY, PINK, RED, WHITE IS/ARE CLAIMED AS A FEATURE OF THE MARK.

SER. NO. 85-380,941, FILED 7-26-2011.

WILLIAM VERHOSEK, EXAMINING ATTORNEY



David J. Kybas

Director of the United States Patent and Trademark Office

United States of America

United States Patent and Trademark Office

SHARPERLENDING

Reg. No. 4,108,784

SHARPERLENDING, LLC (WASHINGTON LIMITED LIABILITY COMPANY)
4315 S. SCOTT STREET
SPOKANE, WA 99203

Registered Mar. 6, 2012

Int. Cl.: 36

FOR: PROVIDING A WEBSITE FEATURING FINANCIAL INFORMATION FOR USE BY MORTGAGE LENDERS AND BROKERS IN WRITING AND MANAGING ALL REPORTS AND DOCUMENTS , IN CLASS 36 (U.S. CLS. 100, 101 AND 102).

SERVICE MARK

FIRST USE 1-1-2004; IN COMMERCE 1-1-2004.

PRINCIPAL REGISTER

THE MARK CONSISTS OF STANDARD CHARACTERS WITHOUT CLAIM TO ANY PARTICULAR FONT, STYLE, SIZE, OR COLOR.

SER. NO. 85-380,943, FILED 7-26-2011.

WILLIAM VERHOSEK, EXAMINING ATTORNEY



David J. Kybas

Director of the United States Patent and Trademark Office

United States of America

United States Patent and Trademark Office

RGS

Reg. No. 4,108,785

Registered Mar. 6, 2012

Int. Cl.: 13

TRADEMARK

PRINCIPAL REGISTER

MARK E. HISLE (UNITED STATES INDIVIDUAL)
9951 HEDDEN ROAD
EVANSVILLE, IN 47725

FOR: FIREWORKS, IN CLASS 13 (U.S. CLS. 2 AND 9).

FIRST USE 3-31-2007; IN COMMERCE 3-31-2007.

THE MARK CONSISTS OF STANDARD CHARACTERS WITHOUT CLAIM TO ANY PARTICULAR FONT, STYLE, SIZE, OR COLOR.

SER. NO. 85-380,944, FILED 7-26-2011.

DAVID I, EXAMINING ATTORNEY



David J. Kyros

Director of the United States Patent and Trademark Office

United States of America

United States Patent and Trademark Office

THE REALLY GOOD STUFF

Reg. No. 4,108,786

Registered Mar. 6, 2012

Int. Cl.: 13

TRADEMARK

PRINCIPAL REGISTER

MARK E. HISLE (UNITED STATES INDIVIDUAL)
9951 HEDDEN ROAD
EVANSVILLE, IN 47725

FOR: FIREWORKS, IN CLASS 13 (U.S. CLS. 2 AND 9).

FIRST USE 3-31-2007; IN COMMERCE 3-31-2007.

THE MARK CONSISTS OF STANDARD CHARACTERS WITHOUT CLAIM TO ANY PARTICULAR FONT, STYLE, SIZE, OR COLOR.

SER. NO. 85-380,951, FILED 7-26-2011.

DAVID I, EXAMINING ATTORNEY



David J. Kybas

Director of the United States Patent and Trademark Office

United States of America

United States Patent and Trademark Office

SmartFreightWare

Reg. No. 4,108,787

SMART FREIGHT SOLUTIONS, INC. (KANSAS CORPORATION)
19310 MIDLAND DR.
SHAWNEE, KS 66218

Registered Mar. 6, 2012

Int. Cl.: 42

FOR: CLOUD COMPUTING FEATURING SOFTWARE FOR USE OF MANAGING AND DOCUMENTING AN ENTIRE SHIPPING PROCESS VIA THE INTERNET FOR ALL MODES OF TRANSPORTATION; PROVIDING TEMPORARY USE OF NON-DOWNLOADABLE COMPUTER SOFTWARE FOR PREPARING SHIPPING DOCUMENTS OVER COMPUTER NETWORKS, INTRANETS AND THE INTERNET, IN CLASS 42 (U.S. CLS. 100 AND 101).

SERVICE MARK

PRINCIPAL REGISTER

FIRST USE 3-6-2006; IN COMMERCE 3-6-2006.

THE MARK CONSISTS OF STANDARD CHARACTERS WITHOUT CLAIM TO ANY PARTICULAR FONT, STYLE, SIZE, OR COLOR.

SER. NO. 85-380,966, FILED 7-26-2011.

DOUGLAS LEE, EXAMINING ATTORNEY



David J. Kyfos

Director of the United States Patent and Trademark Office

United States of America

United States Patent and Trademark Office



Reg. No. 4,108,788

LUDLUM MEASUREMENTS, INC. (TEXAS CORPORATION)
501 OAK STREET
SWEETWATER, TX 79556

Registered Mar. 6, 2012

Int. Cl.: 9

FOR: PHOTOMULTIPLIER TUBES FOR USE IN RADIATION DETECTION, IN CLASS 9
(U.S. CLS. 21, 23, 26, 36 AND 38).

TRADEMARK

FIRST USE 1-1-1994; IN COMMERCE 1-1-1994.

PRINCIPAL REGISTER

THE MARK CONSISTS OF A TRIANGLE CONTAINING FOUR WAVY LINES.

SER. NO. 85-381,020, FILED 7-26-2011.

LINDA MICKLEBURGH, EXAMINING ATTORNEY



David J. Kybas

Director of the United States Patent and Trademark Office

United States of America

United States Patent and Trademark Office

Making the Complex Comprehensible

Reg. No. 4,108,789

MURPHY, DENISE (UNITED STATES INDIVIDUAL)
111 MARBURTH AVENUE
TOWSON, MD 21286

Registered Mar. 6, 2012

Int. Cl.: 35

FOR: PROFESSIONAL BUSINESS CONSULTING, IN CLASS 35 (U.S. CLS. 100, 101 AND 102).

SERVICE MARK

FIRST USE 7-1-2009; IN COMMERCE 7-1-2009.

PRINCIPAL REGISTER

THE MARK CONSISTS OF STANDARD CHARACTERS WITHOUT CLAIM TO ANY PARTICULAR FONT, STYLE, SIZE, OR COLOR.

SER. NO. 85-381,031, FILED 7-26-2011.

BARNEY CHARLON, EXAMINING ATTORNEY



David J. Kybas

Director of the United States Patent and Trademark Office

United States of America

United States Patent and Trademark Office

SHOW OFF

Reg. No. 4,108,790

SPRING MEADOW NURSERY, INC. (MICHIGAN CORPORATION)
12601 120TH AVE.
GRAND HAVEN, MI 49417

Registered Mar. 6, 2012

Int. Cl.: 31

FOR: LIVE PLANTS, NAMELY, FORSYTHIA, IN CLASS 31 (U.S. CLS. 1 AND 46).

TRADEMARK

FIRST USE 8-1-2009; IN COMMERCE 3-1-2010.

PRINCIPAL REGISTER

THE MARK CONSISTS OF STANDARD CHARACTERS WITHOUT CLAIM TO ANY PARTICULAR FONT, STYLE, SIZE, OR COLOR.

SER. NO. 85-381,039, FILED 7-26-2011.

IRA J. GOODSaid, EXAMINING ATTORNEY



David J. Kyffers

Director of the United States Patent and Trademark Office

United States of America

United States Patent and Trademark Office

ROCKET

Reg. No. 4,108,791

MONTEREY CHEMICAL COMPANY (CALIFORNIA CORPORATION)
3654 S. WILLOW AVENUE
FRESNO, CA 93725

Registered Mar. 6, 2012

Int. Cl.: 1

FOR: SURFACTANTS FOR USE IN CONNECTION WITH AGRICULTURAL PESTICIDES,
IN CLASS 1 (U.S. CLS. 1, 5, 6, 10, 26 AND 46).

TRADEMARK

FIRST USE 4-2-1998; IN COMMERCE 5-14-1998.

PRINCIPAL REGISTER

THE MARK CONSISTS OF STANDARD CHARACTERS WITHOUT CLAIM TO ANY PARTICULAR FONT, STYLE, SIZE, OR COLOR.

SER. NO. 85-381,071, FILED 7-26-2011.

GEOFFREY FOSDICK, EXAMINING ATTORNEY



David J. Kybas

Director of the United States Patent and Trademark Office

United States of America

United States Patent and Trademark Office

LADYLIKE

Reg. No. 4,108,792

Registered Mar. 6, 2012

Int. Cl.: 3

TRADEMARK

PRINCIPAL REGISTER

JAMES HERNANDEZ NEW YORK, INC. (NEW YORK CORPORATION)
#2
3808 MAPLE AVENUE
BROOKLYN, NY 11224

FOR: HAIR CONDITIONERS; HAIR STYLING PREPARATIONS; SHAMPOOS, IN CLASS 3
(U.S. CLS. 1, 4, 6, 50, 51 AND 52).

FIRST USE 3-30-2009; IN COMMERCE 3-30-2009.

THE MARK CONSISTS OF STANDARD CHARACTERS WITHOUT CLAIM TO ANY PARTICULAR FONT, STYLE, SIZE, OR COLOR.

SER. NO. 85-381,107, FILED 7-26-2011.

WILLIAM ROSSMAN, EXAMINING ATTORNEY



David J. Kyros

Director of the United States Patent and Trademark Office

United States of America

United States Patent and Trademark Office

FRONTIER-6

Reg. No. 4,108,793

Registered Mar. 6, 2012

Int. Cl.: 28

TRADEMARK

PRINCIPAL REGISTER

DESILVIS, MICHAEL A. (UNITED STATES INDIVIDUAL)
218 NORTH MACOMB STREET
MONROE, MI 48162

FOR: BOARD GAMES, IN CLASS 28 (U.S. CLS. 22, 23, 38 AND 50).

FIRST USE 8-15-1980; IN COMMERCE 3-9-1982.

THE MARK CONSISTS OF STANDARD CHARACTERS WITHOUT CLAIM TO ANY PARTICULAR FONT, STYLE, SIZE, OR COLOR.

SER. NO. 85-381,113, FILED 7-26-2011.

ANDREW LEASER, EXAMINING ATTORNEY



David J. Kybas

Director of the United States Patent and Trademark Office

United States of America
United States Patent and Trademark Office

ELMCROFT

Reg. No. 4,108,794

Registered Mar. 6, 2012

Int. Cl.: 43

SERVICE MARK

PRINCIPAL REGISTER

SENIOR CARE, INC. (DELAWARE CORPORATION)
SUITE 101
9510 ORMSBY STATION ROAD
LOUISVILLE, KY 40223

FOR: PROVIDING ASSISTED LIVING FACILITIES, IN CLASS 43 (U.S. CLS. 100 AND 101).

FIRST USE 3-0-2001; IN COMMERCE 3-0-2001.

THE MARK CONSISTS OF STANDARD CHARACTERS WITHOUT CLAIM TO ANY PARTICULAR FONT, STYLE, SIZE, OR COLOR.

SER. NO. 85-381,123, FILED 7-26-2011.

ANDREW LEASER, EXAMINING ATTORNEY



David J. Kyffers

Director of the United States Patent and Trademark Office

United States of America

United States Patent and Trademark Office

HUBPAGES

Reg. No. 4,108,795

Registered Mar. 6, 2012

Int. Cl.: 42

SERVICE MARK

PRINCIPAL REGISTER

HUBPAGES, INC. (DELAWARE CORPORATION)
95 MINNA STREET, THIRD FLOOR
SAN FRANCISCO, CA 94105

FOR: COMPUTER SERVICES, NAMELY, HOSTING AN INTERACTIVE WEBSITE THAT
ALLOWS USERS TO PUBLISH ORIGINAL CONTENT, INCLUDING ARTICLES, PHOTOS,
AND VIDEOS AND TO EARN REVENUE FROM THEIR PUBLICATIONS, IN CLASS 42 (U.S.
CLS. 100 AND 101).

FIRST USE 8-5-2006; IN COMMERCE 8-5-2006.

THE MARK CONSISTS OF STANDARD CHARACTERS WITHOUT CLAIM TO ANY PAR-
TICULAR FONT, STYLE, SIZE, OR COLOR.

SER. NO. 85-381,151, FILED 7-26-2011.

LINDA MICKLEBURGH, EXAMINING ATTORNEY



David J. Kybas

Director of the United States Patent and Trademark Office

United States of America

United States Patent and Trademark Office

Wealth Advisor

Reg. No. 4,108,796

Registered Mar. 6, 2012

Int. Cl.: 16

TRADEMARK

PRINCIPAL REGISTER

CPAMERICA INTERNATIONAL, INC. (GEORGIA CORPORATION)
11801 RESEARCH DRIVE
ALACHUA, FL 32615

FOR: PUBLICATION, NAMELY NEWSLETTERS DIRECTED TO CPAS CONTAINING INFORMATION ABOUT ACCUMULATING, PROTECTING AND TRANSFERRING WEALTH, IN CLASS 16 (U.S. CLS. 2, 5, 22, 23, 29, 37, 38 AND 50).

FIRST USE 12-2-1999; IN COMMERCE 12-2-1999.

THE MARK CONSISTS OF STANDARD CHARACTERS WITHOUT CLAIM TO ANY PARTICULAR FONT, STYLE, SIZE, OR COLOR.

OWNER OF U.S. REG. NO. 2,500,708.

NO CLAIM IS MADE TO THE EXCLUSIVE RIGHT TO USE "WEALTH", APART FROM THE MARK AS SHOWN.

SER. NO. 85-381,172, FILED 7-26-2011.

CHRISTINA SOBRAL, EXAMINING ATTORNEY



David J. Kyjars

Director of the United States Patent and Trademark Office

United States of America

United States Patent and Trademark Office



Reg. No. 4,108,797

Registered Mar. 6, 2012

Int. Cl.: 19

TRADEMARK

PRINCIPAL REGISTER

SARANA KREASI LESTARI (INDONESIA CORPORATION)
5463 WATER TOWER PROMINADE
ARVADA, CO 80002

FOR: NON-METAL DOORS; NON-METAL WINDOWS; WOODEN DOORS, IN CLASS 19
(U.S. CLS. 1, 12, 33 AND 50).

FIRST USE 11-0-1998; IN COMMERCE 11-0-1998.

THE MARK CONSISTS OF A SQUARE CONTAINING AN IMAGE OF A STYLIZED INDONE-
SIAN DOOR. ACROSS THE ENTIRE FRONT OF THE IMAGE IS THE WORD SARANA.

THE ENGLISH TRANSLATION OF SARANA IN THE MARK IS MEANS.

SER. NO. 85-381,176, FILED 7-26-2011.

BARNEY CHARLON, EXAMINING ATTORNEY



David J. Kybas

Director of the United States Patent and Trademark Office

United States of America

United States Patent and Trademark Office

Your Healthy Practice

Reg. No. 4,108,798

CPAMERICA INTERNATIONAL, INC. (GEORGIA CORPORATION)
11801 RESEARCH DRIVE
ALACHUA, FL 32615

Registered Mar. 6, 2012

Int. Cl.: 16

FOR: PUBLICATIONS, NAMELY, NEWSLETTERS DIRECTED TO THE MEDICAL PROFESSION, IN CLASS 16 (U.S. CLS. 2, 5, 22, 23, 29, 37, 38 AND 50).

TRADEMARK

FIRST USE 8-10-1987; IN COMMERCE 8-25-1987.

PRINCIPAL REGISTER

THE MARK CONSISTS OF STANDARD CHARACTERS WITHOUT CLAIM TO ANY PARTICULAR FONT, STYLE, SIZE, OR COLOR.

OWNER OF U.S. REG. NO. 1,706,643.

NO CLAIM IS MADE TO THE EXCLUSIVE RIGHT TO USE "PRACTICE", APART FROM THE MARK AS SHOWN.

SER. NO. 85-381,182, FILED 7-26-2011.

CHRISTINA SOBRAL, EXAMINING ATTORNEY



David J. Kybas

Director of the United States Patent and Trademark Office

United States of America

United States Patent and Trademark Office

WHERE A GOOD NIGHT'S REST
COST LESS

Reg. No. 4,108,799

Registered Mar. 6, 2012

Int. Cl.: 43

SERVICE MARK

PRINCIPAL REGISTER

DOSCH, MARK, A (UNITED STATES INDIVIDUAL)
200 E BISMARCK EXPRESSWAY
BISMARCK, ND 58504 AND

DOSCH, DEBRA, L (UNITED STATES INDIVIDUAL)
200 E BISMARCK EXPRESSWAY
BISMARCK, ND 58504

FOR: HOTEL ACCOMMODATION SERVICES; HOTEL AND MOTEL SERVICES; HOTELS;
PROVIDING HOTEL ACCOMMODATION, IN CLASS 43 (U.S. CLS. 100 AND 101).

FIRST USE 11-18-2010; IN COMMERCE 11-18-2010.

THE MARK CONSISTS OF STANDARD CHARACTERS WITHOUT CLAIM TO ANY PARTICULAR FONT, STYLE, SIZE, OR COLOR.

SER. NO. 85-381,263, FILED 7-26-2011.

LAKEISHA LEWIS, EXAMINING ATTORNEY



David J. Kybas

Director of the United States Patent and Trademark Office

United States of America

United States Patent and Trademark Office

LIQUIDXSTREAM

Reg. No. 4,108,800

Registered Mar. 6, 2012

Int. Cl.: 9

TRADEMARK

PRINCIPAL REGISTER

LIQUIDXSTREAM SYSTEMS, INC. (CANADA CORPORATION)
8480 GOLF BLVD
MONTREAL, QUEBEC, CANADA H1J3A1

FOR: COMMUNICATIONS EQUIPMENT FOR MANAGING VIDEO AND DIGITAL DATA, NAMELY, TRANSMITTERS, RECEIVERS, TRANSCEIVERS, MODULATORS, SIGNAL PROCESSORS AND UNITS MADE UP TO TWO OR MORE OF THE FOREGOING, IN CLASS 9 (U.S. CLS. 21, 23, 26, 36 AND 38).

FIRST USE 5-31-2005; IN COMMERCE 5-31-2005.

THE MARK CONSISTS OF STANDARD CHARACTERS WITHOUT CLAIM TO ANY PARTICULAR FONT, STYLE, SIZE, OR COLOR.

SER. NO. 85-381,265, FILED 7-26-2011.

ROBERT STRUCK, EXAMINING ATTORNEY



David J. Kyffers

Director of the United States Patent and Trademark Office

United States of America

United States Patent and Trademark Office

LXS

Reg. No. 4,108,801

LIQUIDXSTREAM SYSTEMS, INC. (CANADA CORPORATION)
8480 GOLF BLVD
MONTREAL, QUEBEC, CANADA H1J3A1

Registered Mar. 6, 2012

Int. Cl.: 9

FOR: COMMUNICATIONS EQUIPMENT FOR MANAGING VIDEO AND DIGITAL DATA, NAMELY, TRANSMITTERS, RECEIVERS, TRANSCEIVERS, MODULATORS, SIGNAL PROCESSORS AND UNITS MADE UP OF TWO OR MORE OF THE FOREGOING, IN CLASS 9 (U.S. CLS. 21, 23, 26, 36 AND 38).

TRADEMARK

PRINCIPAL REGISTER

FIRST USE 5-31-2005; IN COMMERCE 5-31-2005.

THE MARK CONSISTS OF STANDARD CHARACTERS WITHOUT CLAIM TO ANY PARTICULAR FONT, STYLE, SIZE, OR COLOR.

SER. NO. 85-381,316, FILED 7-26-2011.

ROBERT STRUCK, EXAMINING ATTORNEY



David J. Kyffers

Director of the United States Patent and Trademark Office

United States of America

United States Patent and Trademark Office

LIQUIDQAM

Reg. No. 4,108,802

LIQUIDXSTREAM SYSTEMS, INC. (CANADA CORPORATION)
8480 GOLF BLVD

Registered Mar. 6, 2012

MONTREAL, QUEBEC, CANADA H1J3A1

Int. Cl.: 9

FOR: SIGNAL PROCESSOR AND MODULATOR FOR USE IN MANAGING VIDEO AND DIGITAL DATA, IN CLASS 9 (U.S. CLS. 21, 23, 26, 36 AND 38).

TRADEMARK

FIRST USE 4-16-2008; IN COMMERCE 4-16-2008.

PRINCIPAL REGISTER

THE MARK CONSISTS OF STANDARD CHARACTERS WITHOUT CLAIM TO ANY PARTICULAR FONT, STYLE, SIZE, OR COLOR.

SER. NO. 85-381,342, FILED 7-26-2011.

ROBERT STRUCK, EXAMINING ATTORNEY



David J. Kybas

Director of the United States Patent and Trademark Office

United States of America

United States Patent and Trademark Office

CONTEGO

Reg. No. 4,108,803

CONTEGO INTERNATIONAL, INC. (INDIANA CORPORATION)
334 WEST GREYHOUND PASS
CARMEL, IN 46032

Registered Mar. 6, 2012

Int. Cl.: 2

FOR: INTUMESCENT FIRE BARRIER LATEX PAINT, IN CLASS 2 (U.S. CLS. 6, 11 AND 16).

TRADEMARK

FIRST USE 5-31-2003; IN COMMERCE 5-31-2003.

PRINCIPAL REGISTER

THE MARK CONSISTS OF STANDARD CHARACTERS WITHOUT CLAIM TO ANY PARTICULAR FONT, STYLE, SIZE, OR COLOR.

SER. NO. 85-381,361, FILED 7-26-2011.

JEFFREY LOOK, EXAMINING ATTORNEY



David J. Kybas

Director of the United States Patent and Trademark Office

United States of America

United States Patent and Trademark Office

THE FIRE STOPS HERE

Reg. No. 4,108,804

Registered Mar. 6, 2012

Int. Cl.: 2

TRADEMARK

PRINCIPAL REGISTER

CONTEGO INTERNATIONAL, INC. (INDIANA CORPORATION)
334 WEST GREYHOUND PASS
CARMEL, IN 46032

FOR: INTUMESCENT FIRE BARRIER LATEX PAINT, IN CLASS 2 (U.S. CLS. 6, 11 AND 16).

FIRST USE 5-31-2003; IN COMMERCE 5-31-2003.

THE MARK CONSISTS OF STANDARD CHARACTERS WITHOUT CLAIM TO ANY PARTICULAR FONT, STYLE, SIZE, OR COLOR.

SER. NO. 85-381,366, FILED 7-26-2011.

JEFFREY LOOK, EXAMINING ATTORNEY



David J. Kybas

Director of the United States Patent and Trademark Office

United States of America

United States Patent and Trademark Office



Reg. No. 4,108,805

Registered Mar. 6, 2012

Int. Cl.: 44

SERVICE MARK

PRINCIPAL REGISTER

DR. CHARLIE PRINS (UNITED STATES INDIVIDUAL), DBA PRINS CHIROPRACTIC
1308 SOLANO AVENUE
ALBANY, CA 94706

FOR: CHIROPRACTIC SERVICES, IN CLASS 44 (U.S. CLS. 100 AND 101).

FIRST USE 12-31-1989; IN COMMERCE 12-31-1989.

THE MARK CONSISTS OF A STYLIZED LETTER P.

SER. NO. 85-381,370, FILED 7-26-2011.

KELLY BOULTON, EXAMINING ATTORNEY



David J. Kybas

Director of the United States Patent and Trademark Office

United States of America

United States Patent and Trademark Office

ACCELERATED RETURNS

Reg. No. 4,108,806

PHYTEX, LLC (MAINE LIMITED LIABILITY COMPANY)
10 MOULTON STREET, 5TH FLOOR
PORTLAND, ME 04101

Registered Mar. 6, 2012

Int. Cl.: 5

FOR: LIVESTOCK FEED SUPPLEMENTS, IN CLASS 5 (U.S. CLS. 6, 18, 44, 46, 51 AND 52).

TRADEMARK

FIRST USE 4-4-2011; IN COMMERCE 4-4-2011.

PRINCIPAL REGISTER

THE MARK CONSISTS OF STANDARD CHARACTERS WITHOUT CLAIM TO ANY PARTICULAR FONT, STYLE, SIZE, OR COLOR.

SER. NO. 85-381,380, FILED 7-26-2011.

LOURDES AYALA, EXAMINING ATTORNEY



David J. Kybas

Director of the United States Patent and Trademark Office

United States of America

United States Patent and Trademark Office

TOODALU

Reg. No. 4,108,807

Registered Mar. 6, 2012

Int. Cl.: 35

SERVICE MARK

PRINCIPAL REGISTER

TOODALU LLC (ILLINOIS LIMITED LIABILITY COMPANY), DBA TOODALU
SUITE 1501
200 S WACKER DRIVE
CHICAGO, IL 60606

FOR: PROMOTING THE GOODS OF OTHERS, NAMELY, PROVIDING COUPONS, REBATES
AND VOUCHERS FOR THE GOODS OF OTHERS, IN CLASS 35 (U.S. CLS. 100, 101 AND
102).

FIRST USE 1-26-2010; IN COMMERCE 3-1-2011.

THE MARK CONSISTS OF STANDARD CHARACTERS WITHOUT CLAIM TO ANY PAR-
TICULAR FONT, STYLE, SIZE, OR COLOR.

SER. NO. 85-381,413, FILED 7-26-2011.

ROBERT STRUCK, EXAMINING ATTORNEY



David J. Kyros

Director of the United States Patent and Trademark Office

United States of America

United States Patent and Trademark Office

CRUZIN' CHROME

Reg. No. 4,108,808

CRUZIN CHROME, LLC (TENNESSEE LIMITED LIABILITY COMPANY)
309 NORTH MARKET STREET
PARIS, TN 38242

Registered Mar. 6, 2012

Int. Cl.: 39

FOR: RENTAL SERVICES FEATURING AUTOMOTIVE WHEELS AND TIRES, IN CLASS 39 (U.S. CLS. 100 AND 105).

SERVICE MARK

FIRST USE 11-10-2008; IN COMMERCE 1-28-2010.

PRINCIPAL REGISTER

THE MARK CONSISTS OF STANDARD CHARACTERS WITHOUT CLAIM TO ANY PARTICULAR FONT, STYLE, SIZE, OR COLOR.

SER. NO. 85-381,474, FILED 7-26-2011.

DOMINICK J. SALEMI, EXAMINING ATTORNEY



David J. Kybas

Director of the United States Patent and Trademark Office

United States of America

United States Patent and Trademark Office

ICELANTIK

Reg. No. 4,108,809

VENDURA INDUSTRIES, INC. (WISCONSIN CORPORATION)
1202 FEMRITE DRIVE
MADISON, WI 53716

Registered Mar. 6, 2012

Int. Cl.: 19

FOR: BUILDING MATERIALS, NAMELY, COMPOSITE PANELS COMPOSED PRIMARILY OF NONMETAL MATERIALS, IN CLASS 19 (U.S. CLS. 1, 12, 33 AND 50).

TRADEMARK

FIRST USE 5-0-2010; IN COMMERCE 5-0-2010.

PRINCIPAL REGISTER

THE MARK CONSISTS OF STANDARD CHARACTERS WITHOUT CLAIM TO ANY PARTICULAR FONT, STYLE, SIZE, OR COLOR.

SER. NO. 85-381,476, FILED 7-26-2011.

DOMINICK J. SALEMI, EXAMINING ATTORNEY



David J. Kybas

Director of the United States Patent and Trademark Office

United States of America

United States Patent and Trademark Office

DYNAMIC BPM

Reg. No. 4,108,810

Registered Mar. 6, 2012

Int. Cl.: 9

TRADEMARK

PRINCIPAL REGISTER

DYNAMICBPM (IDAHO CORPORATION)
SUITE 110
3943 IRVINE BLVD
IRVINE, CA 92602

FOR: COMPUTER SOFTWARE THAT PROVIDES REAL-TIME, INTEGRATED BUSINESS MANAGEMENT INTELLIGENCE BY COMBINING INFORMATION FROM VARIOUS DATABASES AND PRESENTING IT IN AN EASY-TO-UNDERSTAND USER INTERFACE, IN CLASS 9 (U.S. CLS. 21, 23, 26, 36 AND 38).

FIRST USE 2-1-2009; IN COMMERCE 2-1-2009.

THE MARK CONSISTS OF STANDARD CHARACTERS WITHOUT CLAIM TO ANY PARTICULAR FONT, STYLE, SIZE, OR COLOR.

NO CLAIM IS MADE TO THE EXCLUSIVE RIGHT TO USE "BPM", APART FROM THE MARK AS SHOWN.

SER. NO. 85-381,501, FILED 7-26-2011.

DOMINICK J. SALEMI, EXAMINING ATTORNEY



David J. Kyffers

Director of the United States Patent and Trademark Office

United States of America

United States Patent and Trademark Office

TEEN SUCCESS

Reg. No. 4,108,811

PLANNED PARENTHOOD MAR MONTE, INC. (CALIFORNIA CORPORATION)
1691 THE ALAMEDA
SAN JOSE, CA 95126

Registered Mar. 6, 2012

Int. Cl.: 41

FOR: EDUCATIONAL SERVICES, NAMELY, PROVIDING CLASSES, WORKSHOPS, MENTORING, AND GROUP COACHING IN THE FIELDS OF PREGNANCY AND PARENTING, IN CLASS 41 (U.S. CLS. 100, 101 AND 107).

SERVICE MARK

FIRST USE 12-0-1990; IN COMMERCE 11-0-2004.

PRINCIPAL REGISTER

THE MARK CONSISTS OF STANDARD CHARACTERS WITHOUT CLAIM TO ANY PARTICULAR FONT, STYLE, SIZE, OR COLOR.

OWNER OF U.S. REG. NO. 3,965,572.

NO CLAIM IS MADE TO THE EXCLUSIVE RIGHT TO USE "TEEN", APART FROM THE MARK AS SHOWN.

SER. NO. 85-381,524, FILED 7-26-2011.

EMILY CARLSEN, EXAMINING ATTORNEY



David J. Kybas

Director of the United States Patent and Trademark Office

United States of America

United States Patent and Trademark Office

The Perils

Reg. No. 4,108,812

NORDMAN, ERIC CHARLES (UNITED STATES INDIVIDUAL)
7549 WESTGATE STREET
LENXA, KS 662163157

Registered Mar. 6, 2012

Int. Cl.: 41

FOR: ENTERTAINMENT IN THE NATURE OF VISUAL AND AUDIO PERFORMANCES, NAMELY, MUSICAL BAND, ROCK GROUP, GYMNASTIC, DANCE, AND BALLET PERFORMANCES, IN CLASS 41 (U.S. CLS. 100, 101 AND 107).

SERVICE MARK

FIRST USE 12-3-2010; IN COMMERCE 12-3-2010.

PRINCIPAL REGISTER

THE MARK CONSISTS OF STANDARD CHARACTERS WITHOUT CLAIM TO ANY PARTICULAR FONT, STYLE, SIZE, OR COLOR.

SER. NO. 85-381,526, FILED 7-26-2011.

EMILY CARLSEN, EXAMINING ATTORNEY



David J. Kybas

Director of the United States Patent and Trademark Office

United States of America

United States Patent and Trademark Office

NO APOLOGIES

Reg. No. 4,108,813

Registered Mar. 6, 2012

Int. Cl.: 32

TRADEMARK

PRINCIPAL REGISTER

BLUE POINT BREWING COMPANY (NEW YORK CORPORATION)
161 RIVER AVENUE
PATCHOGUE, NY 11772

FOR: BEER, ALE AND LAGER, IN CLASS 32 (U.S. CLS. 45, 46 AND 48).

FIRST USE 1-12-2007; IN COMMERCE 1-30-2007.

THE MARK CONSISTS OF STANDARD CHARACTERS WITHOUT CLAIM TO ANY PARTICULAR FONT, STYLE, SIZE, OR COLOR.

SER. NO. 85-381,544, FILED 7-26-2011.

JOHN GARTNER, EXAMINING ATTORNEY



David J. Kyffers

Director of the United States Patent and Trademark Office

United States of America
United States Patent and Trademark Office

RastafaRye

Reg. No. 4,108,814

Registered Mar. 6, 2012

Int. Cl.: 32

TRADEMARK

PRINCIPAL REGISTER

BLUE POINT BREWING COMPANY (NEW YORK CORPORATION)
161 RIVER AVENUE
PATCHOGUE, NY 11772

FOR: BEER, ALE AND LAGER, IN CLASS 32 (U.S. CLS. 45, 46 AND 48).

FIRST USE 1-31-2009; IN COMMERCE 1-31-2009.

THE MARK CONSISTS OF STANDARD CHARACTERS WITHOUT CLAIM TO ANY PARTICULAR FONT, STYLE, SIZE, OR COLOR.

SER. NO. 85-381,576, FILED 7-26-2011.

JOHN GARTNER, EXAMINING ATTORNEY



David J. Kybas

Director of the United States Patent and Trademark Office

United States of America

United States Patent and Trademark Office

TERRALEVER

Reg. No. 4,108,815

TERRALEVER, LLC (ARIZONA LIMITED LIABILITY COMPANY)
425 SOUTH MILL AVE., SUITE 201
TEMPE, AZ 85281

Registered Mar. 6, 2012

Int. Cl.: 42

FOR: PLANNING, DESIGN, DEVELOPMENT, MAINTENANCE AND OPTIMIZATION OF ONLINE WEBSITES FOR THIRD PARTIES; CONSULTING SERVICES IN THE FIELD OF SEARCH ENGINE OPTIMIZATION, IN CLASS 42 (U.S. CLS. 100 AND 101).

SERVICE MARK

FIRST USE 9-30-2002; IN COMMERCE 9-30-2002.

PRINCIPAL REGISTER

THE MARK CONSISTS OF STANDARD CHARACTERS WITHOUT CLAIM TO ANY PARTICULAR FONT, STYLE, SIZE, OR COLOR.

SER. NO. 85-381,593, FILED 7-26-2011.

JANICE L. MCMORROW, EXAMINING ATTORNEY



David J. Kyros

Director of the United States Patent and Trademark Office

United States of America

United States Patent and Trademark Office



Reg. No. 4,108,816

Registered Mar. 6, 2012

Int. Cl.: 16

TRADEMARK

PRINCIPAL REGISTER

CHICKABUG, LLC (MARYLAND LIMITED LIABILITY COMPANY)
8148 CASEY COURT
ELKRIDGE, MD 21075

FOR: GREETING CARDS; STICKERS; ADDRESS LABELS; PRINTED INVITATIONS; PAPER BANNERS; FOOD WRAPPERS; PLACE CARDS; PAPER LABELS FOR WATER BOTTLES, IN CLASS 16 (U.S. CLS. 2, 5, 22, 23, 29, 37, 38 AND 50).

FIRST USE 10-21-2009; IN COMMERCE 10-21-2009.

THE MARK CONSISTS OF THE STYLIZED TEXT "CHICKABUG" IN ALL LOWERCASE LETTERS. A SMALL BIRD AND A LARGE BIRD ARE PERCHED ON TOP OF THE LETTERS "B" AND "U" RESPECTIVELY, TOUCHING NOSE-TO-NOSE. THEIR WINGS ARE IN THE SHAPE OF HEARTS.

SER. NO. 85-381,634, FILED 7-26-2011.

STEVEN JACKSON, EXAMINING ATTORNEY



David J. Kybas

Director of the United States Patent and Trademark Office

United States of America

United States Patent and Trademark Office

LITTLE BORROWED DRESS

Reg. No. 4,108,817

Registered Mar. 6, 2012

Int. Cls.: 35 and 45

SERVICE MARK

PRINCIPAL REGISTER

LITTLE BORROWED DRESS, INC. (WASHINGTON CORPORATION)
9845 GLORY DRIVE
OLYMPIA, WA 98513

FOR: ONLINE RETAIL CLOTHING STORE; ONLINE RETAIL CLOTHING BOUTIQUE;
ONLINE RETAIL WEDDING STORE FEATURING WEDDING CLOTHING AND ACCESSOR-
IES, IN CLASS 35 (U.S. CLS. 100, 101 AND 102).

FIRST USE 2-10-2011; IN COMMERCE 2-10-2011.

FOR: RENTAL OF CLOTHING; RENTAL OF WEDDING CLOTHING AND ACCESSORIES;
RENTAL OF BRIDESMAID DRESSES, IN CLASS 45 (U.S. CLS. 100 AND 101).

FIRST USE 2-10-2011; IN COMMERCE 2-10-2011.

THE MARK CONSISTS OF STANDARD CHARACTERS WITHOUT CLAIM TO ANY PAR-
TICULAR FONT, STYLE, SIZE, OR COLOR.

NO CLAIM IS MADE TO THE EXCLUSIVE RIGHT TO USE "DRESS", APART FROM THE
MARK AS SHOWN.

SER. NO. 85-381,682, FILED 7-26-2011.

LAKEISHA LEWIS, EXAMINING ATTORNEY



David J. Kyjars

Director of the United States Patent and Trademark Office

United States of America

United States Patent and Trademark Office

MOVEMENT PLAY

Reg. No. 4,108,818

TURNER, ROSIE (UNITED STATES INDIVIDUAL)
1427 LARKIN STREET #6
SAN FRANCISCO, CA 94109

Registered Mar. 6, 2012

Int. Cl.: 41

FOR: ORGANIZING COMMUNITY FESTIVALS FEATURING A VARIETY OF ACTIVITIES, NAMELY, MUSICAL PERFORMANCES, DANCES, ART-MAKING, ART EXHIBITIONS, EDUCATIONAL WORKSHOPS AND CLASSES IN THE FIELDS OF DANCE AND EXERCISE, IN CLASS 41 (U.S. CLS. 100, 101 AND 107).

SERVICE MARK

PRINCIPAL REGISTER

FIRST USE 7-9-2008; IN COMMERCE 7-9-2008.

THE MARK CONSISTS OF STANDARD CHARACTERS WITHOUT CLAIM TO ANY PARTICULAR FONT, STYLE, SIZE, OR COLOR.

SER. NO. 85-381,709, FILED 7-26-2011.

SKYE YOUNG, EXAMINING ATTORNEY



David J. Kybas

Director of the United States Patent and Trademark Office

United States of America

United States Patent and Trademark Office

CHOPPED SALAD A-GO-GO

Reg. No. 4,108,819

Registered Mar. 6, 2012

Int. Cl.: 29

TRADEMARK

PRINCIPAL REGISTER

RUBIO'S RESTAURANTS, INC. (DELAWARE CORPORATION)
1920 WRIGHT PLACE, SUITE 300
CARLSBAD, CA 92008

FOR: SALADS EXCEPT MACARONI, RICE, AND PASTA SALAD, IN CLASS 29 (U.S. CL. 46).

FIRST USE 7-17-2007; IN COMMERCE 7-17-2007.

THE MARK CONSISTS OF STANDARD CHARACTERS WITHOUT CLAIM TO ANY PARTICULAR FONT, STYLE, SIZE, OR COLOR.

OWNER OF U.S. REG. NOS. 3,496,729, 3,613,080, AND 3,613,081.

NO CLAIM IS MADE TO THE EXCLUSIVE RIGHT TO USE "CHOPPED SALAD", APART FROM THE MARK AS SHOWN.

SER. NO. 85-381,710, FILED 7-26-2011.

JENNIFER VASQUEZ, EXAMINING ATTORNEY



David J. Kybas

Director of the United States Patent and Trademark Office

United States of America

United States Patent and Trademark Office

QUESADILLAS A-GO-GO

Reg. No. 4,108,820

Registered Mar. 6, 2012

Int. Cl.: 30

TRADEMARK

PRINCIPAL REGISTER

RUBIO'S RESTAURANTS, INC. (DELAWARE CORPORATION)
1920 WRIGHT PLACE, SUITE 300
CARLSBAD, CA 92008

FOR: QUESADILLAS, IN CLASS 30 (U.S. CL. 46).

FIRST USE 7-17-2007; IN COMMERCE 7-17-2007.

THE MARK CONSISTS OF STANDARD CHARACTERS WITHOUT CLAIM TO ANY PARTICULAR FONT, STYLE, SIZE, OR COLOR.

OWNER OF U.S. REG. NOS. 3,496,729, 3,613,080, AND 3,613,081.

NO CLAIM IS MADE TO THE EXCLUSIVE RIGHT TO USE "QUESADILLAS", APART FROM THE MARK AS SHOWN.

SER. NO. 85-381,732, FILED 7-26-2011.

JENNIFER VASQUEZ, EXAMINING ATTORNEY



David J. Kybas

Director of the United States Patent and Trademark Office

United States of America

United States Patent and Trademark Office

INVESTMENTQ

Reg. No. 4,108,821

Registered Mar. 6, 2012

Int. Cl.: 35

SERVICE MARK

PRINCIPAL REGISTER

FS ALTERNATIVE INVESTMENT RESEARCH, INC. (NEW JERSEY CORPORATION)
76 WOODLAND AVENUE
WEST ORANGE, NJ 07052

FOR: BUSINESS CONSULTING SERVICES IN THE FIELD OF COMPANY EVALUATION;
BUSINESS MANAGEMENT CONSULTING AND ADVISORY SERVICES; BUSINESS OR-
GANIZATION AND MANAGEMENT CONSULTING; PROVIDING BUSINESS MANAGEMENT
INFORMATION IN CONNECTION WITH CONSULTING AND ADVISORY SERVICES IN
THE FIELD OF STRATEGIC PLANNING, IN CLASS 35 (U.S. CLS. 100, 101 AND 102).

FIRST USE 0-0-2006; IN COMMERCE 0-0-2006.

THE MARK CONSISTS OF STANDARD CHARACTERS WITHOUT CLAIM TO ANY PAR-
TICULAR FONT, STYLE, SIZE, OR COLOR.

SER. NO. 85-381,733, FILED 7-26-2011.

LAKEISHA LEWIS, EXAMINING ATTORNEY



David J. Kyffers

Director of the United States Patent and Trademark Office

United States of America

United States Patent and Trademark Office

G-P-S

Reg. No. 4,108,822

Registered Mar. 6, 2012

Int. Cl.: 3

TRADEMARK

PRINCIPAL REGISTER

GHODOUSSI, VAHID (UNITED STATES INDIVIDUAL)
5910 HAYMARKET ROAD
MEMPHIS, TN 38120

FOR: AUTOMOBILE POLISH, IN CLASS 3 (U.S. CLS. 1, 4, 6, 50, 51 AND 52).

FIRST USE 7-11-2011; IN COMMERCE 7-18-2011.

THE MARK CONSISTS OF STANDARD CHARACTERS WITHOUT CLAIM TO ANY PARTICULAR FONT, STYLE, SIZE, OR COLOR.

SER. NO. 85-381,741, FILED 7-26-2011.

DOUGLAS LEE, EXAMINING ATTORNEY



David J. Kyffers

Director of the United States Patent and Trademark Office

United States of America

United States Patent and Trademark Office

Arize

Reg. No. 4,108,823

Registered Mar. 6, 2012

Int. Cl.: 5

TRADEMARK

PRINCIPAL REGISTER

NATURAL HERBAL REMEDIES (WYOMING LIMITED LIABILITY COMPANY)
SUITE 4060
2510 WARREN AVENUE
CHEYENNE, WY 82001

FOR: HERBAL SUPPLEMENTS, IN CLASS 5 (U.S. CLS. 6, 18, 44, 46, 51 AND 52).

FIRST USE 7-20-2006; IN COMMERCE 9-30-2006.

THE MARK CONSISTS OF STANDARD CHARACTERS WITHOUT CLAIM TO ANY PARTICULAR FONT, STYLE, SIZE, OR COLOR.

SER. NO. 85-381,761, FILED 7-26-2011.

DOUGLAS LEE, EXAMINING ATTORNEY



David J. Kybas

Director of the United States Patent and Trademark Office

United States of America

United States Patent and Trademark Office

VENREZ

Reg. No. 4,108,824

Registered Mar. 6, 2012

Int. Cl.: 41

SERVICE MARK

PRINCIPAL REGISTER

BEREZ, STEVEN (UNITED STATES INDIVIDUAL)
119 5TH AVENUE, 3RD FLOOR
SERLING ROOKS FERRARA MCKOY & WOROB LLP
NEW YORK, NY 10003

FOR: ENTERTAINMENT IN THE NATURE OF LIVE PERFORMANCES BY ROCK BAND,
IN CLASS 41 (U.S. CLS. 100, 101 AND 107).

FIRST USE 8-1-2009; IN COMMERCE 8-1-2009.

THE MARK CONSISTS OF STANDARD CHARACTERS WITHOUT CLAIM TO ANY PAR-
TICULAR FONT, STYLE, SIZE, OR COLOR.

SER. NO. 85-381,791, FILED 7-26-2011.

JANICE KIM, EXAMINING ATTORNEY



David J. Kybas

Director of the United States Patent and Trademark Office

United States of America

United States Patent and Trademark Office

PACIFICA

Reg. No. 4,108,825

Registered Mar. 6, 2012

Int. Cl.: 24

TRADEMARK

PRINCIPAL REGISTER

CALIFORNIA UMBRELLA, INC. (CALIFORNIA CORPORATION)
1480 E. GRAND AVE.,
POMONA, CA 91766

FOR: FABRICS FOR UMBRELLAS, AWNINGS, PAVILIONS AND OTHER SHADE STRUCTURES; FABRICS FOR OUTDOOR UMBRELLA COVERS, IN CLASS 24 (U.S. CLS. 42 AND 50).

FIRST USE 6-1-2011; IN COMMERCE 6-1-2011.

THE MARK CONSISTS OF STANDARD CHARACTERS WITHOUT CLAIM TO ANY PARTICULAR FONT, STYLE, SIZE, OR COLOR.

SER. NO. 85-381,797, FILED 7-26-2011.

JANICE KIM, EXAMINING ATTORNEY



David J. Kyffers

Director of the United States Patent and Trademark Office

United States of America

United States Patent and Trademark Office

SUNLINE

Reg. No. 4,108,826

Registered Mar. 6, 2012

Int. Cl.: 18

TRADEMARK

PRINCIPAL REGISTER

MARCH PRODUCTS, INC. (CALIFORNIA CORPORATION)
1480 E. GRAND AVE.,
POMONA, CA 91766

FOR: PATIO UMBRELLAS; UMBRELLAS, IN CLASS 18 (U.S. CLS. 1, 2, 3, 22 AND 41).

FIRST USE 12-17-1959; IN COMMERCE 12-17-1959.

THE MARK CONSISTS OF STANDARD CHARACTERS WITHOUT CLAIM TO ANY PARTICULAR FONT, STYLE, SIZE, OR COLOR.

SER. NO. 85-381,803, FILED 7-26-2011.

LAKEISHA LEWIS, EXAMINING ATTORNEY



David J. Kybas

Director of the United States Patent and Trademark Office

United States of America

United States Patent and Trademark Office

B73lean

Reg. No. 4,108,827

Registered Mar. 6, 2012

Int. Cl.: 7

TRADEMARK

PRINCIPAL REGISTER

MULTI-DUTI MANUFACTURING, INC. (COLORADO CORPORATION)
325 KAREN LANE
COLORADO SPRINGS, CO 80907

FOR: CENTRIFUGAL PUMPS, IN CLASS 7 (U.S. CLS. 13, 19, 21, 23, 31, 34 AND 35).

FIRST USE 10-31-2010; IN COMMERCE 10-31-2010.

THE MARK CONSISTS OF STANDARD CHARACTERS WITHOUT CLAIM TO ANY PARTICULAR FONT, STYLE, SIZE, OR COLOR.

SER. NO. 85-381,816, FILED 7-26-2011.

JACLYN KIDWELL WALKER, EXAMINING ATTORNEY



David J. Kybas

Director of the United States Patent and Trademark Office

United States of America

United States Patent and Trademark Office

TOXIC SLUDGE

Reg. No. 4,108,828

Registered Mar. 6, 2012

Int. Cl.: 32

TRADEMARK

PRINCIPAL REGISTER

BLUE POINT BREWING COMPANY (NEW YORK CORPORATION)
161 RIVER AVENUE
PATCHOGUE, NY 11772

FOR: BEER, ALE AND LAGER, IN CLASS 32 (U.S. CLS. 45, 46 AND 48).

FIRST USE 9-15-2010; IN COMMERCE 9-15-2010.

THE MARK CONSISTS OF STANDARD CHARACTERS WITHOUT CLAIM TO ANY PARTICULAR FONT, STYLE, SIZE, OR COLOR.

SER. NO. 85-381,960, FILED 7-27-2011.

JOHN GARTNER, EXAMINING ATTORNEY



David J. Kybas

Director of the United States Patent and Trademark Office

United States of America

United States Patent and Trademark Office

TruGrit

Reg. No. 4,108,829

Registered Mar. 6, 2012

Int. Cl.: 37

SERVICE MARK

PRINCIPAL REGISTER

JEFFCO CONCRETE CONTRACTORS, LLC (ALABAMA LIMITED LIABILITY COMPANY)
10945 COMMERCIAL DRIVE
TUSCALOOSA, AL 35405

FOR: GENERAL CONSTRUCTION SERVICES, NAMELY ARCHITECTURAL AND DECORATIVE CONCRETE PAVING AND FLOORING, IN CLASS 37 (U.S. CLS. 100, 103 AND 106).

FIRST USE 5-23-2011; IN COMMERCE 5-23-2011.

THE MARK CONSISTS OF STANDARD CHARACTERS WITHOUT CLAIM TO ANY PARTICULAR FONT, STYLE, SIZE, OR COLOR.

SER. NO. 85-382,010, FILED 7-27-2011.

RICHARD WHITE, EXAMINING ATTORNEY



David J. Kybas

Director of the United States Patent and Trademark Office

United States of America

United States Patent and Trademark Office

BEYOND ABOVE-AND-BEYOND

Reg. No. 4,108,830

Registered Mar. 6, 2012

Int. Cl.: 5

TRADEMARK

PRINCIPAL REGISTER

BEN VENUE LABORATORIES, INC. (DELAWARE CORPORATION)
300 NORTHFIELD ROAD
BEDFORD, OH 44146

FOR: HOUSE MARK FOR A FULL LINE OF PHARMACEUTICAL PREPARATIONS AND CHEMICAL PREPARATIONS FOR MEDICAL PURPOSES, IN CLASS 5 (U.S. CLS. 6, 18, 44, 46, 51 AND 52).

FIRST USE 2-1-2011; IN COMMERCE 2-1-2011.

THE MARK CONSISTS OF STANDARD CHARACTERS WITHOUT CLAIM TO ANY PARTICULAR FONT, STYLE, SIZE, OR COLOR.

SER. NO. 85-382,161, FILED 7-27-2011.

ROBERT STRUCK, EXAMINING ATTORNEY



David J. Kybas

Director of the United States Patent and Trademark Office

United States of America

United States Patent and Trademark Office

Tangleweed

Reg. No. 4,108,831

JUDD, SCOTT (UNITED STATES INDIVIDUAL), DBA TANGLEWEED
2709 N. ALBANY AVE.
CHICAGO, IL 60647 AND

Registered Mar. 6, 2012

Int. Cl.: 41

RAINEY, KENNETH P. W. (UNITED STATES INDIVIDUAL), DBA TANGLEWEED
2649 N. ALBANY AVE.
CHICAGO, IL 60647 AND

SERVICE MARK

WARGASKI, PAUL (UNITED STATES INDIVIDUAL), DBA TANGLEWEED
3663 W. BELLE PLAINE AVE.
CHICAGO, IL 60618 AND

PRINCIPAL REGISTER

OH, SE-IL (UNITED STATES INDIVIDUAL), DBA TANGLEWEED
UNIT #3
4139 N. MOZART ST.
CHICAGO, IL 60618

FOR: ENTERTAINMENT, NAMELY, LIVE PERFORMANCES BY A MUSICAL BAND, IN CLASS 41 (U.S. CLS. 100, 101 AND 107).

FIRST USE 6-1-2004; IN COMMERCE 6-1-2004.

THE MARK CONSISTS OF STANDARD CHARACTERS WITHOUT CLAIM TO ANY PARTICULAR FONT, STYLE, SIZE, OR COLOR.

SER. NO. 85-382,226, FILED 7-27-2011.

KELLEY WELLS, EXAMINING ATTORNEY



David J. Kypos

Director of the United States Patent and Trademark Office

United States of America

United States Patent and Trademark Office

Right Brain Success

Reg. No. 4,108,832

Registered Mar. 6, 2012

Int. Cl.: 41

SERVICE MARK

PRINCIPAL REGISTER

ROSE A. LONGHILL (UNITED STATES INDIVIDUAL), DBA SWAN CENTER SEMINARS
PO BOX 25689
348 JADE ROAD
SILVERTHORNE, CO 80497

FOR: EDUCATIONAL SERVICES, NAMELY, CONDUCTING SEMINARS, LECTURES, TELESEMINARS, TELECLASSES, AND WORKSHOPS IN PERSONAL AWARENESS , IN CLASS 41 (U.S. CLS. 100, 101 AND 107).

FIRST USE 7-30-1989; IN COMMERCE 2-15-1990.

THE MARK CONSISTS OF STANDARD CHARACTERS WITHOUT CLAIM TO ANY PARTICULAR FONT, STYLE, SIZE, OR COLOR.

SER. NO. 85-382,269, FILED 7-27-2011.

INGA ERVIN, EXAMINING ATTORNEY



David J. Kyffers

Director of the United States Patent and Trademark Office

United States of America

United States Patent and Trademark Office

PowerDepo

Reg. No. 4,108,833

Registered Mar. 6, 2012

Int. Cl.: 41

SERVICE MARK

PRINCIPAL REGISTER

TIFFANY ALLEY & ASSOCIATES, INC. (GEORGIA CORPORATION)
11539 PARK WOODS CIRCLE, SUITE 301
ALPHARETTA, GA 30005

FOR: VIDEOTAPING LEGAL DEPOSITIONS, IN CLASS 41 (U.S. CLS. 100, 101 AND 107).

FIRST USE 6-2-2011; IN COMMERCE 6-2-2011.

THE MARK CONSISTS OF STANDARD CHARACTERS WITHOUT CLAIM TO ANY PARTICULAR FONT, STYLE, SIZE, OR COLOR.

SER. NO. 85-382,303, FILED 7-27-2011.

JOHN GARTNER, EXAMINING ATTORNEY



David J. Kybas

Director of the United States Patent and Trademark Office

United States of America

United States Patent and Trademark Office

HeadacheFree

Reg. No. 4,108,834

Registered Mar. 6, 2012

Int. Cl.: 5

TRADEMARK

PRINCIPAL REGISTER

GARY ANTHONY L'EUROPA (UNITED STATES INDIVIDUAL)
227 CENTERVILLE RD
227 CENTERVILLE RD
WARWICK, RI 02886

FOR: DIETARY AND NUTRITIONAL SUPPLEMENTS, IN CLASS 5 (U.S. CLS. 6, 18, 44, 46, 51 AND 52).

FIRST USE 12-3-2003; IN COMMERCE 9-14-2004.

THE MARK CONSISTS OF STANDARD CHARACTERS WITHOUT CLAIM TO ANY PARTICULAR FONT, STYLE, SIZE, OR COLOR.

SER. NO. 85-382,352, FILED 7-27-2011.

KELLEY WELLS, EXAMINING ATTORNEY



David J. Kyffers

Director of the United States Patent and Trademark Office

United States of America

United States Patent and Trademark Office

DANCE HALL PIMPS

Reg. No. 4,108,835

ENTERED APPRENTICE MUSIC, LLC (CALIFORNIA LIMITED LIABILITY COMPANY)
7119 W. SUNSET BLVD., #348
LOS ANGELES, CA 90046

Registered Mar. 6, 2012

Int. Cl.: 41

FOR: LIVE PERFORMANCES BY A MUSICAL GROUP; ON-LINE JOURNALS, NAMELY, BLOGS FEATURING MUSIC, IN CLASS 41 (U.S. CLS. 100, 101 AND 107).

SERVICE MARK

FIRST USE 6-6-2009; IN COMMERCE 6-6-2009.

PRINCIPAL REGISTER

THE MARK CONSISTS OF STANDARD CHARACTERS WITHOUT CLAIM TO ANY PARTICULAR FONT, STYLE, SIZE, OR COLOR.

SER. NO. 85-382,365, FILED 7-27-2011.

GEOFFREY FOSDICK, EXAMINING ATTORNEY



David J. Kyros

Director of the United States Patent and Trademark Office

United States of America

United States Patent and Trademark Office

YO-MAZING!

Reg. No. 4,108,836

PACIFIC VALLEY DAIRY, INC. (MISSOURI CORPORATION)
20 MIDWEST DRIVE
PACIFIC, MO 63069

Registered Mar. 6, 2012

Int. Cl.: 30

FOR: FROZEN YOGURT MIXES AND FROZEN YOGURT FLAVORING, IN CLASS 30 (U.S. CL. 46).

TRADEMARK

FIRST USE 11-17-2009; IN COMMERCE 11-17-2009.

PRINCIPAL REGISTER

THE MARK CONSISTS OF STANDARD CHARACTERS WITHOUT CLAIM TO ANY PARTICULAR FONT, STYLE, SIZE, OR COLOR.

SER. NO. 85-382,405, FILED 7-27-2011.

JENNIFER DIXON, EXAMINING ATTORNEY



David J. Kybas

Director of the United States Patent and Trademark Office

United States of America

United States Patent and Trademark Office

QuickMurals

Reg. No. 4,108,837

STARFIELD HOLDINGS, LLC (DELAWARE LIMITED LIABILITY COMPANY)
PO BOX 45062
WESTLAKE, OH 44145

Registered Mar. 6, 2012

Int. Cl.: 27

FOR: WALL PAPER, IN CLASS 27 (U.S. CLS. 19, 20, 37, 42 AND 50).

TRADEMARK

FIRST USE 3-0-2010; IN COMMERCE 3-0-2010.

PRINCIPAL REGISTER

THE MARK CONSISTS OF STANDARD CHARACTERS WITHOUT CLAIM TO ANY PARTICULAR FONT, STYLE, SIZE, OR COLOR.

SER. NO. 85-382,414, FILED 7-27-2011.

ERNEST SHOSHO, EXAMINING ATTORNEY



David J. Kybas

Director of the United States Patent and Trademark Office

United States of America

United States Patent and Trademark Office

ECOSTAPLE

Reg. No. 4,108,838

Registered Mar. 6, 2012

Int. Cl.: 22

TRADEMARK

PRINCIPAL REGISTER

FORMED FIBER TECHNOLOGIES, LLC (DELAWARE LIMITED LIABILITY COMPANY)
125 ALLIED ROAD
AUBURN, ME 04210

FOR: POLYESTER FIBERS, IN CLASS 22 (U.S. CLS. 1, 2, 7, 19, 22, 42 AND 50).

FIRST USE 9-14-2011; IN COMMERCE 9-14-2011.

THE MARK CONSISTS OF STANDARD CHARACTERS WITHOUT CLAIM TO ANY PARTICULAR FONT, STYLE, SIZE, OR COLOR.

SER. NO. 85-382,415, FILED 7-27-2011.

REBECCA SMITH, EXAMINING ATTORNEY



David J. Kyros

Director of the United States Patent and Trademark Office

United States of America

United States Patent and Trademark Office

Buck Denver asks...

Reg. No. 4,108,839

Registered Mar. 6, 2012

Int. Cl.: 9

TRADEMARK

PRINCIPAL REGISTER

PHIL VISCHER IP, LLC (ILLINOIS LIMITED LIABILITY COMPANY)
401 S. CARLTON AVE., SUITE 200
WHEATON, IL 60187

FOR: DIGITAL MEDIA, NAMELY, DVDS AND DOWNLOADABLE AUDIO AND VIDEO FILES FEATURING FAMILY AND RELIGIOUS CONTENT; DOWNLOADABLE ELECTRONIC NEWSLETTERS DELIVERED BY E-MAIL IN THE FIELD OF FAMILY LIFE AND RELIGION; DOWNLOADABLE ELECTRONIC PUBLICATIONS IN THE NATURE OF CURRICULA FOR CHILDREN AND FAMILIES IN THE FIELD OF RELIGION, IN CLASS 9 (U.S. CLS. 21, 23, 26, 36 AND 38).

FIRST USE 4-20-2011; IN COMMERCE 4-20-2011.

THE MARK CONSISTS OF STANDARD CHARACTERS WITHOUT CLAIM TO ANY PARTICULAR FONT, STYLE, SIZE, OR COLOR.

THE NAME(S), PORTRAIT(S), AND/OR SIGNATURE(S) SHOWN IN THE MARK DOES NOT IDENTIFY A PARTICULAR LIVING INDIVIDUAL.

SER. NO. 85-382,436, FILED 7-27-2011.

ALYSSA STEEL, EXAMINING ATTORNEY



David J. Kybas

Director of the United States Patent and Trademark Office

United States of America

United States Patent and Trademark Office

Galley Beach

Reg. No. 4,108,840

SILVA RESTAURANT MANAGEMENT INC. (MASSACHUSETTS CORPORATION)
16 HELEN'S DRIVE
NANTUCKET, MA 02554

Registered Mar. 6, 2012

Int. Cl.: 43

FOR: RESTAURANT SERVICES, IN CLASS 43 (U.S. CLS. 100 AND 101).

SERVICE MARK

FIRST USE 4-8-2010; IN COMMERCE 4-8-2010.

PRINCIPAL REGISTER

THE MARK CONSISTS OF STANDARD CHARACTERS WITHOUT CLAIM TO ANY PARTICULAR FONT, STYLE, SIZE, OR COLOR.

SER. NO. 85-382,464, FILED 7-27-2011.

MARK T. MULLEN, EXAMINING ATTORNEY



David J. Kybas

Director of the United States Patent and Trademark Office

United States of America

United States Patent and Trademark Office

OJON

Reg. No. 4,108,841

Registered Mar. 6, 2012

Int. Cls.: 35 and 44

SERVICE MARK

PRINCIPAL REGISTER

OJON CORPORATION (DELAWARE CORPORATION)
767 FIFTH AVENUE
NEW YORK, NY 10153

FOR: ONLINE RETAIL STORE SERVICES FEATURING PERSONAL CARE PRODUCTS, COSMETICS, TOILETRIES, BATH AND BODY PRODUCTS, SKIN CARE PRODUCTS, HAIR CARE PREPARATIONS, AND BEAUTY TREATMENTS, IN CLASS 35 (U.S. CLS. 100, 101 AND 102).

FIRST USE 2-28-2004; IN COMMERCE 2-28-2004.

FOR: BEAUTY CONSULTATION SERVICES IN THE FIELD OF SELECTION AND USE OF COSMETICS, TOILETRIES, BODY PRODUCTS, SKIN CARE PRODUCTS, BEAUTY TREATMENTS, HAIR CARE PREPARATIONS AND PERSONAL APPEARANCE; PROVIDING INFORMATION REGARDING THE SELECTION AND USE OF COSMETICS, TOILETRIES, SKIN CARE PRODUCTS, BODY PRODUCTS, BEAUTY TREATMENTS, HAIR CARE PREPARATIONS AND PERSONAL APPEARANCE, IN CLASS 44 (U.S. CLS. 100 AND 101).

FIRST USE 12-31-2003; IN COMMERCE 12-31-2003.

THE MARK CONSISTS OF STANDARD CHARACTERS WITHOUT CLAIM TO ANY PARTICULAR FONT, STYLE, SIZE, OR COLOR.

OWNER OF U.S. REG. NOS. 3,164,351, 3,713,869 AND OTHERS.

SER. NO. 85-382,476, FILED 7-27-2011.

LAURA KOVALSKY, EXAMINING ATTORNEY



David J. Kyjars

Director of the United States Patent and Trademark Office

United States of America

United States Patent and Trademark Office

SurfExplorer

Reg. No. 4,108,842

SURF EXPLORER, INC. (CALIFORNIA CORPORATION)
330 BONAIR STREET
LA JOLLA, CA 92037

Registered Mar. 6, 2012

Int. Cl.: 9

FOR: DOWNLOADABLE SOFTWARE FOR DISPLAYING AND SHARING INFORMATION ABOUT SURFING CONDITIONS, IN CLASS 9 (U.S. CLS. 21, 23, 26, 36 AND 38).

TRADEMARK

FIRST USE 7-26-2010; IN COMMERCE 7-26-2010.

PRINCIPAL REGISTER

THE MARK CONSISTS OF STANDARD CHARACTERS WITHOUT CLAIM TO ANY PARTICULAR FONT, STYLE, SIZE, OR COLOR.

SER. NO. 85-382,483, FILED 7-27-2011.

LAURA KOVALSKY, EXAMINING ATTORNEY



David J. Kybas

Director of the United States Patent and Trademark Office

United States of America

United States Patent and Trademark Office



Reg. No. 4,108,843

Registered Mar. 6, 2012

Int. Cl.: 45

SERVICE MARK

PRINCIPAL REGISTER

SIRIUS INTERNATIONAL SECURITY AND INVESTIGATIONS, INC. (MARYLAND CORPORATION)
120 RECORD STREET
FREDERICK, MD 217015412

FOR: PRIVATE INVESTIGATION; SECURITY GUARD SERVICES, IN CLASS 45 (U.S. CLS. 100 AND 101).

FIRST USE 7-23-2007; IN COMMERCE 7-24-2007.

THE MARK CONSISTS OF A STYLIZED LETTER "S" IN THE CENTER OF A STYLIZED STAR WITH SIX POINTS. TO THE RIGHT IS THE STYLIZED TEXT "SIRIUS".

SER. NO. 85-382,498, FILED 7-27-2011.

KELLEY WELLS, EXAMINING ATTORNEY



David J. Kyffers

Director of the United States Patent and Trademark Office

United States of America

United States Patent and Trademark Office

INEVO

Reg. No. 4,108,844

Registered Mar. 6, 2012

Int. Cl.: 44

SERVICE MARK

PRINCIPAL REGISTER

DUBYAK MANAGEMENT LLC (PENNSYLVANIA LIMITED LIABILITY COMPANY), DBA
INEVO CONTOURING
9365 MCKNIGHT ROAD
PITTSBURGH, PA 15237

FOR: PROVIDING NON-SURGICAL LASER THERAPY FOR LIPOLYSIS, WEIGHT LOSS, FAT LOSS, CELLULITE REMOVAL, SPOT REDUCTION, AND BODY CONTOURING; PROVIDING WEIGHT LOSS PROGRAM SERVICES; PROVIDING ONLINE WEIGHT LOSS PROGRAM SERVICES; PROVIDING WEIGHT LOSS PROGRAMS AND COSMETIC BODY CARE SERVICES IN THE NATURE OF NON-SURGICAL BODY CONTOURING, IN CLASS 44 (U.S. CLS. 100 AND 101).

FIRST USE 7-25-2011; IN COMMERCE 7-25-2011.

THE MARK CONSISTS OF STANDARD CHARACTERS WITHOUT CLAIM TO ANY PARTICULAR FONT, STYLE, SIZE, OR COLOR.

SER. NO. 85-382,540, FILED 7-27-2011.

LINDA MICKLEBURGH, EXAMINING ATTORNEY



David J. Kyffers

Director of the United States Patent and Trademark Office

United States of America

United States Patent and Trademark Office

COPTRAX

Reg. No. 4,108,845

Registered Mar. 6, 2012

Int. Cl.: 9

TRADEMARK

PRINCIPAL REGISTER

VIDEO LABS, LLC (TEXAS LIMITED LIABILITY COMPANY)
500 SORA LANE
COPPELL, TX 75019

FOR: AUTOMATED SELF CONTAINED ELECTRONIC SURVEILLANCE DEVICES CAPABLE OF RECORDING AND DOWNLOADING DIGITAL VIDEO AND AUDIO FILES AND GPS TRACKING AND NAVIGATION, IN CLASS 9 (U.S. CLS. 21, 23, 26, 36 AND 38).

FIRST USE 12-1-2010; IN COMMERCE 2-26-2011.

THE MARK CONSISTS OF STANDARD CHARACTERS WITHOUT CLAIM TO ANY PARTICULAR FONT, STYLE, SIZE, OR COLOR.

SER. NO. 85-382,541, FILED 7-27-2011.

KELLEY WELLS, EXAMINING ATTORNEY



David J. Kyffers

Director of the United States Patent and Trademark Office

United States of America

United States Patent and Trademark Office

INADb

Reg. No. 4,108,846

Registered Mar. 6, 2012

Int. Cl.: 25

TRADEMARK

PRINCIPAL REGISTER

WILKS, TIMOTHY (UNITED STATES INDIVIDUAL), DBA REAL DAD! INC.
SUITE 2B
621 EAST 105TH STREET
BROOKLYN, NY 11236

FOR: CLOTHING, NAMELY, SHIRTS, T-SHIRTS, JACKETS AND HATS, IN CLASS 25 (U.S. CLS. 22 AND 39).

FIRST USE 1-1-2010; IN COMMERCE 1-1-2010.

THE MARK CONSISTS OF STANDARD CHARACTERS WITHOUT CLAIM TO ANY PARTICULAR FONT, STYLE, SIZE, OR COLOR.

SER. NO. 85-382,551, FILED 7-27-2011.

GRETТА YAO, EXAMINING ATTORNEY



David J. Kybas

Director of the United States Patent and Trademark Office

United States of America

United States Patent and Trademark Office

HATCHideas

Reg. No. 4,108,847

HATCH, JAMES A (UNITED STATES INDIVIDUAL)
115 CAVENROCK COURT
FREDERICK, MD 21702

Registered Mar. 6, 2012

Int. Cl.: 35

FOR: ADVERTISING AND BUSINESS MANAGEMENT CONSULTANCY, IN CLASS 35 (U.S. CLS. 100, 101 AND 102).

SERVICE MARK

FIRST USE 5-7-2000; IN COMMERCE 1-1-2011.

PRINCIPAL REGISTER

THE MARK CONSISTS OF STANDARD CHARACTERS WITHOUT CLAIM TO ANY PARTICULAR FONT, STYLE, SIZE, OR COLOR.

SER. NO. 85-382,557, FILED 7-27-2011.

GRETTA YAO, EXAMINING ATTORNEY



David J. Kybas

Director of the United States Patent and Trademark Office

United States of America

United States Patent and Trademark Office

IJAIAAM

Reg. No. 4,108,848

Registered Mar. 6, 2012

Int. Cl.: 25

TRADEMARK

PRINCIPAL REGISTER

WILKS, TIMOTHY (UNITED STATES INDIVIDUAL), DBA REAL DAD! INC.
SUITE 2B
621 EAST 105TH STREET
BROOKLYN, NY 11236

FOR: CLOTHING, NAMELY, SHIRTS, T-SHIRTS, JACKETS AND HATS, IN CLASS 25 (U.S. CLS. 22 AND 39).

FIRST USE 1-1-2010; IN COMMERCE 1-1-2010.

THE MARK CONSISTS OF STANDARD CHARACTERS WITHOUT CLAIM TO ANY PARTICULAR FONT, STYLE, SIZE, OR COLOR.

SER. NO. 85-382,558, FILED 7-27-2011.

GRETТА YAO, EXAMINING ATTORNEY



David J. Kybas

Director of the United States Patent and Trademark Office

United States of America

United States Patent and Trademark Office

GASTRO-ZIN

Reg. No. 4,108,849

Registered Mar. 6, 2012

Int. Cl.: 5

TRADEMARK

PRINCIPAL REGISTER

MOTHER MILK DHA, LLC (GEORGIA CORPORATION)
P.O. BOX 502
HOLLY SPRINGS, GA 30142

FOR: DIETARY AND NUTRITIONAL SUPPLEMENTS; DIETARY BEVERAGE SUPPLEMENTS FOR HUMAN CONSUMPTION IN LIQUID AND DRY MIX FORM FOR THERAPEUTIC PURPOSES; DIETARY SUPPLEMENTAL DRINKS; DIETARY SUPPLEMENTS FOR PETS; DIETARY SUPPLEMENTS FOR PETS IN THE NATURE OF A POWDERED DRINK MIX, IN CLASS 5 (U.S. CLS. 6, 18, 44, 46, 51 AND 52).

FIRST USE 11-1-2010; IN COMMERCE 1-4-2011.

THE MARK CONSISTS OF STANDARD CHARACTERS WITHOUT CLAIM TO ANY PARTICULAR FONT, STYLE, SIZE, OR COLOR.

SER. NO. 85-382,569, FILED 7-27-2011.

ALYSSA STEEL, EXAMINING ATTORNEY



David J. Kyffers

Director of the United States Patent and Trademark Office

United States of America

United States Patent and Trademark Office

WHERE COPPER IS BETTER THAN GOLD

Reg. No. 4,108,850

Registered Mar. 6, 2012

Int. Cl.: 29

TRADEMARK

PRINCIPAL REGISTER

COPPER RIVER SEAFOODS (ALASKA CORPORATION)
CORPORATE CAMPUS
1118 E 5TH AVE
ANCHORAGE, AK 99501

FOR: SEAFOOD, NAMELY, SALMON, COD, HALIBUT, ROCKFISH, ROCKSOLE, KING
CRAB AND PRAWNS, IN CLASS 29 (U.S. CL. 46).

FIRST USE 7-1-2011; IN COMMERCE 7-1-2011.

THE MARK CONSISTS OF STANDARD CHARACTERS WITHOUT CLAIM TO ANY PAR-
TICULAR FONT, STYLE, SIZE, OR COLOR.

SER. NO. 85-382,690, FILED 7-27-2011.

JENNIFER DIXON, EXAMINING ATTORNEY



David J. Kybas

Director of the United States Patent and Trademark Office

United States of America

United States Patent and Trademark Office

SANISERV

Reg. No. 4,108,851

MD HOLDINGS, LLC (INDIANA LIMITED LIABILITY COMPANY)
451 EAST COUNTY LINE ROAD
MOORESVILLE, IN 46158

Registered Mar. 6, 2012

Int. Cl.: 11

FOR: ELECTRIC YOGURT MAKERS; ELECTRICAL ICE-CREAM MAKERS; ICE CREAM FREEZERS; ICE CREAM MAKERS, IN CLASS 11 (U.S. CLS. 13, 21, 23, 31 AND 34).

TRADEMARK

FIRST USE 12-31-1965; IN COMMERCE 12-31-1965.

PRINCIPAL REGISTER

THE MARK CONSISTS OF STANDARD CHARACTERS WITHOUT CLAIM TO ANY PARTICULAR FONT, STYLE, SIZE, OR COLOR.

SER. NO. 85-382,692, FILED 7-27-2011.

JAY FLOWERS, EXAMINING ATTORNEY



David J. Kybas

Director of the United States Patent and Trademark Office

United States of America

United States Patent and Trademark Office

Destination Knowledge

Reg. No. 4,108,852

DKMARSH, INC. (FLORIDA CORPORATION)
354 WILLOW LANE
ELLENTON, FL 34222

Registered Mar. 6, 2012

Int. Cl.: 35

FOR: RETAIL SERVICES BY DIRECT SOLICITATION BY SALES AGENTS IN THE FIELD OF EDUCATIONAL COMPUTER SOFTWARE, IN CLASS 35 (U.S. CLS. 100, 101 AND 102).

SERVICE MARK

FIRST USE 3-1-2004; IN COMMERCE 3-1-2004.

PRINCIPAL REGISTER

THE MARK CONSISTS OF STANDARD CHARACTERS WITHOUT CLAIM TO ANY PARTICULAR FONT, STYLE, SIZE, OR COLOR.

SER. NO. 85-382,713, FILED 7-27-2011.

KATHERINE CHANG, EXAMINING ATTORNEY



David J. Kybas

Director of the United States Patent and Trademark Office

United States of America
United States Patent and Trademark Office

Golf Infuzion

Reg. No. 4,108,853

INFUZION MEDIA, LLC (TEXAS LIMITED LIABILITY COMPANY)
2650 CEDAR SPRINGS ROAD, #5544
DALLAS, TX 75201

Registered Mar. 6, 2012

Int. Cl.: 41

FOR: PROVIDING A WEBSITE FEATURING INFORMATION ON GOLF AND GOLF INSTRUCTION, IN CLASS 41 (U.S. CLS. 100, 101 AND 107).

SERVICE MARK

FIRST USE 3-0-2011; IN COMMERCE 3-0-2011.

PRINCIPAL REGISTER

THE MARK CONSISTS OF STANDARD CHARACTERS WITHOUT CLAIM TO ANY PARTICULAR FONT, STYLE, SIZE, OR COLOR.

NO CLAIM IS MADE TO THE EXCLUSIVE RIGHT TO USE "GOLF", APART FROM THE MARK AS SHOWN.

SER. NO. 85-382,725, FILED 7-27-2011.

DAVID TOOLEY, EXAMINING ATTORNEY



David J. Kyffers

Director of the United States Patent and Trademark Office

United States of America

United States Patent and Trademark Office

PANCRACIO

Reg. No. 4,108,854

Registered Mar. 6, 2012

Int. Cl.: 33

TRADEMARK

PRINCIPAL REGISTER

PANCRACIO SUCESORES, S.L. (SPAIN CORPORATION)
GENERAL ESCÁMEZ 3
CADIZ, SPAIN 11008

FOR: FLAVORED VODKA AND OTHER SPIRITS, IN CLASS 33 (U.S. CLS. 47 AND 49).

FIRST USE 3-31-2011; IN COMMERCE 3-31-2011.

OWNER OF U.S. REG. NO. 3,981,110.

THE MARK CONSISTS OF THE STYLIZED WORDING "PANCRACIO".

THE WORDING "PANCRACIO" HAS NO MEANING IN A FOREIGN LANGUAGE.

SER. NO. 85-382,745, FILED 7-27-2011.

TINA BROWN, EXAMINING ATTORNEY



David J. Kyffers

Director of the United States Patent and Trademark Office

United States of America
United States Patent and Trademark Office

SIP

Reg. No. 4,108,855

LODI VINTNERS INC. (CALIFORNIA CORPORATION)
3750 E. WOODBRIDGE ROAD
ACAMPO, CA 95220

Registered Mar. 6, 2012

Int. Cl.: 33

FOR: CHAMPAGNE; SPARKLING WINES; WINE, IN CLASS 33 (U.S. CLS. 47 AND 49).

TRADEMARK

FIRST USE 10-27-2011; IN COMMERCE 10-27-2011.

PRINCIPAL REGISTER

THE MARK CONSISTS OF A DESIGN CONSISTING OF THE LETTERS SIP WRITTEN IN STYLIZED FORM.

SER. NO. 85-382,840, FILED 7-27-2011.

MIDGE BUTLER, EXAMINING ATTORNEY



David J. Kyffers

Director of the United States Patent and Trademark Office

United States of America
United States Patent and Trademark Office

PrimoDish

Reg. No. 4,108,856

Registered Mar. 6, 2012

Int. Cl.: 35

SERVICE MARK

PRINCIPAL REGISTER

PRIMO ANALYTICS, INC. (TEXAS CORPORATION)
10709 BERTHOUND DRIVE
AUSTIN, TX 78758

FOR: PROVIDING A WEBSITE WHERE USERS CAN POST RATINGS, REVIEWS AND RECOMMENDATIONS ON RESTAURANTS, FOOD AND WINE FOR COMMERCIAL PURPOSES, IN CLASS 35 (U.S. CLS. 100, 101 AND 102).

FIRST USE 9-3-2010; IN COMMERCE 3-20-2011.

THE MARK CONSISTS OF STANDARD CHARACTERS WITHOUT CLAIM TO ANY PARTICULAR FONT, STYLE, SIZE, OR COLOR.

SER. NO. 85-382,880, FILED 7-27-2011.

GIANCARLO CASTRO, EXAMINING ATTORNEY



David J. Kybas

Director of the United States Patent and Trademark Office

United States of America

United States Patent and Trademark Office

SKYHOOK

Reg. No. 4,108,857

Registered Mar. 6, 2012

Int. Cls.: 35 and 42

SERVICE MARK

PRINCIPAL REGISTER

HARRIS MARKETING, LLC (ARIZONA LIMITED LIABILITY COMPANY), DBA SKYHOOK
INTERNET MARKETING
7447 E NATAL AVE
MESA, AZ 85209

FOR: ADVERTISING AND MARKETING SERVICES PROVIDED BY MEANS OF INDIRECT METHODS OF MARKETING COMMUNICATIONS, NAMELY, SOCIAL MEDIA, SEARCH ENGINE MARKETING, INQUIRY MARKETING, INTERNET MARKETING, MOBILE MARKETING, BLOGGING AND OTHER FORMS OF PASSIVE, SHARABLE OR VIRAL COMMUNICATIONS CHANNELS; ADVERTISING CONSULTATION; ADVERTISING COPYWRITING; ADVERTISING ON THE INTERNET FOR OTHERS; ADVERTISING SERVICES, NAMELY, CREATING CORPORATE AND BRAND IDENTITY FOR OTHERS; ADVERTISING SERVICES, NAMELY, CREATING CORPORATE LOGOS FOR OTHERS; ADVERTISING SERVICES, NAMELY, PROMOTING THE BRANDS, GOODS AND SERVICES OF OTHERS; ADVERTISING, MARKETING AND PROMOTION SERVICES; ADVERTISING, PROMOTION AND MARKETING SERVICES IN THE NATURE OF E-MAIL BLAST CAMPAIGNS FOR OTHERS; ANALYSIS OF ADVERTISING RESPONSE; BUSINESS MONITORING AND CONSULTING SERVICES, NAMELY, TRACKING WEB SITES AND APPLICATIONS OF OTHERS TO PROVIDE STRATEGY, INSIGHT, MARKETING, SALES, OPERATION, PRODUCT DESIGN, PARTICULARLY SPECIALIZING IN THE USE OF ANALYTIC AND STATISTIC MODELS FOR THE UNDERSTANDING AND PREDICTING OF CONSUMERS, BUSINESSES, AND MARKET TRENDS AND ACTIONS; DESIGN OF INTERNET ADVERTISING; PAY PER CLICK (PPC) ADVERTISING MANAGEMENT SERVICES; PLANNING, DESIGN, DEVELOPMENT, MAINTENANCE, TRACKING AND REPORTING OF ONLINE MARKETING ACTIVITIES FOR THIRD PARTIES; PREPARATION AND REALIZATION OF MEDIA AND ADVERTISING PLANS AND CONCEPTS; PROVIDING ADVERTISING, MARKETING AND PROMOTIONAL SERVICES, NAMELY, DEVELOPMENT OF ADVERTISING CAMPAIGNS FOR INTERNET WEB SITES, SOCIAL MEDIA SITES, ONLINE DIRECTORY SITES, ONLINE COMMUNITY SITES, IN CLASS 35 (U.S. CLS. 100, 101 AND 102).



FIRST USE 7-29-2009; IN COMMERCE 7-29-2009.

David J. Kyffers

Director of the United States Patent and Trademark Office

FOR: CREATION, DESIGN, DEVELOPMENT AND MAINTENANCE OF WEB SITES FOR THIRD PARTIES; DESIGN OF HOME PAGES, COMPUTER SOFTWARE AND WEB SITES; DESIGNING WEBSITES FOR ADVERTISING PURPOSES; PLANNING, DESIGN, DEVELOPMENT, MAINTENANCE AND OPTIMIZATION OF ONLINE WEBSITES FOR THIRD PARTIES; TECHNOLOGICAL PLANNING AND CONSULTING SERVICES IN THE FIELD OF INTERNET

Reg. No. 4,108,857 MARKETING AND ADVERTISING, WEB SITE DESIGN, WEB SITE DEVELOPMENT, WEB SITE CONTENT STRATEGY, USER INTERFACE DESIGN, INFORMATION ARCHITECTURE, SEARCH ENGINE OPTIMIZATION, ONLINE PAID ADVERTISING, SOCIAL MEDIA STRATEGIES, CUSTOMER RELATIONSHIP MANAGEMENT STRATEGIES, WEB SITE VISITOR CONVERSION RATE OPTIMIZATION, IN CLASS 42 (U.S. CLS. 100 AND 101).

FIRST USE 7-29-2009; IN COMMERCE 7-29-2009.

THE MARK CONSISTS OF STANDARD CHARACTERS WITHOUT CLAIM TO ANY PARTICULAR FONT, STYLE, SIZE, OR COLOR.

SER. NO. 85-382,897, FILED 7-27-2011.

GIANCARLO CASTRO, EXAMINING ATTORNEY

United States of America

United States Patent and Trademark Office



Reg. No. 4,108,858

ROSS, REBECCA (UNITED STATES INDIVIDUAL)
423 DON FERNANDO WAY
SAN JOSE, CA 95123

Registered Mar. 6, 2012

Int. Cl.: 30

FOR: BAKERY DESSERTS; BAKERY GOODS, IN CLASS 30 (U.S. CL. 46).

TRADEMARK

FIRST USE 10-14-2010; IN COMMERCE 12-15-2010.

PRINCIPAL REGISTER

NO CLAIM IS MADE TO THE EXCLUSIVE RIGHT TO USE "COOKIES" , APART FROM THE MARK AS SHOWN.

THE MARK CONSISTS OF A STYLIZED WOMAN HOLDING A COOKIE JAR WITH HER LEFT HAND, WITH HER RIGHT HAND IN THE TOP OF THE COOKIE JAR; THE WORD "COOKIES" APPEARS ON THE COOKIE JAR.

SER. NO. 85-382,959, FILED 7-27-2011.

WON TEAK OH, EXAMINING ATTORNEY



David J. Kyros

Director of the United States Patent and Trademark Office

United States of America

United States Patent and Trademark Office

SUTAMI

Reg. No. 4,108,859

Registered Mar. 6, 2012

Int. Cl.: 7

CHINA HANGZHOU SUTAMI INDUSTRY TECHNOLOGY CO., LTD. (CHINA LIMITED COMPANY (LTD.))
ROOM D, 10TH ECOMMERCE BUILDING
NO. 118 WEST WENSAN ROAD, HANGZHOU CITY
ZHEJIANG PROVINCE, CHINA

TRADEMARK

PRINCIPAL REGISTER

FOR: AXLES FOR MACHINES; BEARINGS, AS PARTS OF MACHINES; BELTS FOR CONVEYORS; CONNECTING RODS FOR MACHINES, MOTORS AND ENGINES; ENGINE BEARINGS; MACHINE PARTS, NAMELY, BEARING HOUSINGS; MACHINE PARTS, NAMELY, BEARING INSERTS; MACHINE PARTS, NAMELY, BEARINGS AND BUSHINGS; MACHINE PARTS, NAMELY, ROLL MILL BEARINGS; MACHINE PARTS, NAMELY, ROLLER BEARINGS, IN CLASS 7 (U.S. CLS. 13, 19, 21, 23, 31, 34 AND 35).

FIRST USE 6-1-2008; IN COMMERCE 10-12-2009.

THE MARK CONSISTS OF STANDARD CHARACTERS WITHOUT CLAIM TO ANY PARTICULAR FONT, STYLE, SIZE, OR COLOR.

THE WORDING "SUTAMI" HAS NO MEANING IN A FOREIGN LANGUAGE.

SER. NO. 85-382,976, FILED 7-27-2011.

APRIL HESIK, EXAMINING ATTORNEY



David J. Kypos

Director of the United States Patent and Trademark Office

United States of America

United States Patent and Trademark Office



Reg. No. 4,108,860

Registered Mar. 6, 2012

Int. Cl.: 35

SERVICE MARK

PRINCIPAL REGISTER

TRADEMARKS INFORMATION INTERNATIONAL LLC (CALIFORNIA LIMITED LIABILITY COMPANY)
3905 STATE ST. #7-134
SANTA BARBARA, CA 93105

FOR: TRADEMARK MONITORING, IN CLASS 35 (U.S. CLS. 100, 101 AND 102).

FIRST USE 7-25-2011; IN COMMERCE 7-25-2011.

THE MARK CONSISTS OF A DESIGN OF A CHECK MARK.

SER. NO. 85-383,043, FILED 7-28-2011.

STEPHANIE ALI, EXAMINING ATTORNEY



David J. Kybas

Director of the United States Patent and Trademark Office

United States of America

United States Patent and Trademark Office

TEST OUR METAL

Reg. No. 4,108,861

Registered Mar. 6, 2012

Int. Cls.: 11 and 20

TRADEMARK

PRINCIPAL REGISTER

MD HOLDINGS, LLC (INDIANA LIMITED LIABILITY COMPANY)
451 EAST COUNTY LINE ROAD
MOORESVILLE, IN 46158

FOR: BAKING OVENS; COMMERCIAL COOKING OVENS; CONVECTION OVENS; COOK-
AND HOLD- OVENS; COOKING OVENS; INDUSTRIAL COOKING OVENS, IN CLASS 11
(U.S. CLS. 13, 21, 23, 31 AND 34).

FIRST USE 5-16-2008; IN COMMERCE 5-16-2008.

FOR: BUFFETS; DISPLAY STANDS; DISPLAY TABLES; INDUSTRIAL WORK TABLES;
METAL CABINETS; METAL DISPLAY STANDS; STORAGE RACKS, IN CLASS 20 (U.S.
CLS. 2, 13, 22, 25, 32 AND 50).

FIRST USE 5-16-2008; IN COMMERCE 5-16-2008.

THE MARK CONSISTS OF STANDARD CHARACTERS WITHOUT CLAIM TO ANY PAR-
TICULAR FONT, STYLE, SIZE, OR COLOR.

SER. NO. 85-383,357, FILED 7-28-2011.

JAY FLOWERS, EXAMINING ATTORNEY



David J. Kybas

Director of the United States Patent and Trademark Office

United States of America

United States Patent and Trademark Office

COOKSAVOR

Reg. No. 4,108,862

Registered Mar. 6, 2012

Int. Cl.: 11

TRADEMARK

PRINCIPAL REGISTER

MD HOLDINGS, LLC (INDIANA LIMITED LIABILITY COMPANY)
451 EAST COUNTY LINE ROAD
MOORESVILLE, IN 46158

FOR: COOK- AND HOLD- OVENS, IN CLASS 11 (U.S. CLS. 13, 21, 23, 31 AND 34).

FIRST USE 11-1-2010; IN COMMERCE 11-1-2010.

THE MARK CONSISTS OF STANDARD CHARACTERS WITHOUT CLAIM TO ANY PARTICULAR FONT, STYLE, SIZE, OR COLOR.

SER. NO. 85-383,362, FILED 7-28-2011.

JAY FLOWERS, EXAMINING ATTORNEY



David J. Kyffers

Director of the United States Patent and Trademark Office

United States of America

United States Patent and Trademark Office

ROASTRIGHT

Reg. No. 4,108,863

Registered Mar. 6, 2012

Int. Cl.: 11

TRADEMARK

PRINCIPAL REGISTER

MD HOLDINGS, LLC (INDIANA LIMITED LIABILITY COMPANY)
451 EAST COUNTY LINE ROAD
MOORESVILLE, IN 46158

FOR: COOK- AND HOLD- OVENS, IN CLASS 11 (U.S. CLS. 13, 21, 23, 31 AND 34).

FIRST USE 11-1-2010; IN COMMERCE 11-1-2010.

THE MARK CONSISTS OF STANDARD CHARACTERS WITHOUT CLAIM TO ANY PARTICULAR FONT, STYLE, SIZE, OR COLOR.

SER. NO. 85-383,366, FILED 7-28-2011.

JAY FLOWERS, EXAMINING ATTORNEY



David J. Kybas

Director of the United States Patent and Trademark Office

United States of America

United States Patent and Trademark Office

COMBOCHEF

Reg. No. 4,108,864

MD HOLDINGS, LLC (INDIANA LIMITED LIABILITY COMPANY)
451 EAST COUNTY LINE ROAD
MOORESVILLE, IN 46158

Registered Mar. 6, 2012

Int. Cl.: 11

FOR: BAKING OVENS; COMBINATION STEAMERS AND OVENS; COMMERCIAL COOKING OVENS; CONVECTION OVENS; COOK- AND HOLD- OVENS; COOKING OVENS; INDUSTRIAL COOKING OVENS , IN CLASS 11 (U.S. CLS. 13, 21, 23, 31 AND 34).

TRADEMARK

FIRST USE 11-1-2010; IN COMMERCE 11-1-2010.

PRINCIPAL REGISTER

THE MARK CONSISTS OF STANDARD CHARACTERS WITHOUT CLAIM TO ANY PARTICULAR FONT, STYLE, SIZE, OR COLOR.

SER. NO. 85-383,367, FILED 7-28-2011.

JAY FLOWERS, EXAMINING ATTORNEY



David J. Kyffers

Director of the United States Patent and Trademark Office

United States of America

United States Patent and Trademark Office

SMARTCHOICE

Reg. No. 4,108,865

MD HOLDINGS, LLC (INDIANA LIMITED LIABILITY COMPANY)
451 EAST COUNTY LINE ROAD
MOORESVILLE, IN 46158

Registered Mar. 6, 2012

Int. Cl.: 11

FOR: BAKING OVENS; COMBINATION STEAMERS AND OVENS; COMMERCIAL COOKING OVENS; CONVECTION OVENS; COOK- AND HOLD- OVENS; COOKING OVENS; INDUSTRIAL COOKING OVENS , IN CLASS 11 (U.S. CLS. 13, 21, 23, 31 AND 34).

TRADEMARK

FIRST USE 11-1-2010; IN COMMERCE 11-1-2010.

PRINCIPAL REGISTER

THE MARK CONSISTS OF STANDARD CHARACTERS WITHOUT CLAIM TO ANY PARTICULAR FONT, STYLE, SIZE, OR COLOR.

SER. NO. 85-383,372, FILED 7-28-2011.

JAY FLOWERS, EXAMINING ATTORNEY



David J. Kybas

Director of the United States Patent and Trademark Office

United States of America

United States Patent and Trademark Office

MARCHING AHEAD

Reg. No. 4,108,866

Registered Mar. 6, 2012

Int. Cls.: 20 and 21

TRADEMARK

PRINCIPAL REGISTER

MD HOLDINGS, LLC (INDIANA LIMITED LIABILITY COMPANY)
451 EAST COUNTY LINE ROAD
MOORESVILLE, IN 46158

FOR: DECORATIONS OF PLASTIC FOR FOODSTUFFS; PLASTIC BINS; PLASTIC BOXES; PLASTIC CONTAINERS AND COVERS FOR THE FOOD INDUSTRY; PLASTIC CONTAINERS FOR COMMERCIAL USE, NAMELY, FOR STORING AND DISPENSING BULK FOODS; PLASTIC STORAGE CONTAINERS FOR COMMERCIAL OR INDUSTRIAL USE; PLASTIC TUBS, IN CLASS 20 (U.S. CLS. 2, 13, 22, 25, 32 AND 50).

FIRST USE 5-16-2008; IN COMMERCE 5-16-2008.

FOR: BOWLS; COLANDERS; CROCKERY, NAMELY, POTS, DISHES, DRINKING CUPS AND SAUCERS, BOWLS, SERVING BOWLS AND TRAYS; DISHES AND PLATES; DRINKING GLASSES, NAMELY, TUMBLERS; LADLES, FOR KITCHEN USE; MUGS; PAILS; PITCHERS; PLASTIC BUCKETS; SCOOPS; SERVING DISHES; SERVING LADLES; SERVING TONGS; SERVING TRAYS; TRASH CANS, IN CLASS 21 (U.S. CLS. 2, 13, 23, 29, 30, 33, 40 AND 50).

FIRST USE 5-16-2008; IN COMMERCE 5-16-2008.

THE MARK CONSISTS OF STANDARD CHARACTERS WITHOUT CLAIM TO ANY PARTICULAR FONT, STYLE, SIZE, OR COLOR.

SER. NO. 85-383,381, FILED 7-28-2011.

JAY FLOWERS, EXAMINING ATTORNEY



David J. Kybas

Director of the United States Patent and Trademark Office

United States of America

United States Patent and Trademark Office

GRITS & BISCUITS

Reg. No. 4,108,867

Registered Mar. 6, 2012

Int. Cl.: 41

SERVICE MARK

PRINCIPAL REGISTER

LEWIS, ERIKA (UNITED STATES INDIVIDUAL)
950 FULTON STREET
PO BOX 381077
BROOKLYN, NY 11238 AND

SLADE, ALZO (UNITED STATES INDIVIDUAL)
950 FULTON STREET
PO BOX 381077
BROOKLYN, NY 11238 AND

SLADE, MAURICE (UNITED STATES INDIVIDUAL)
950 FULTON STREET
PO BOX 381077
BROOKLYN, NY 11238

FOR: ENTERTAINMENT IN THE NATURE OF SOUTHERN THEMED EVENTS, IN CLASS 41 (U.S. CLS. 100, 101 AND 107).

FIRST USE 7-30-2010; IN COMMERCE 7-30-2010.

THE MARK CONSISTS OF STANDARD CHARACTERS WITHOUT CLAIM TO ANY PARTICULAR FONT, STYLE, SIZE, OR COLOR.

SER. NO. 85-383,792, FILED 7-28-2011.

PATRICIA EVANKO, EXAMINING ATTORNEY



David J. Kybas

Director of the United States Patent and Trademark Office

United States of America

United States Patent and Trademark Office

MOJO FutureTech

Reg. No. 4,108,868

PACIFIC VIBRATIONS LLC (CALIFORNIA LIMITED LIABILITY COMPANY)
3946 LONG PLACE
CARLSBAD, CA 92008

Registered Mar. 6, 2012

Int. Cl.: 25

FOR: CLOTHING, NAMELY, T-SHIRTS, HATS, SHOES, SHORTS, WRISTBANDS, IN CLASS 25 (U.S. CLS. 22 AND 39).

TRADEMARK

FIRST USE 1-25-2011; IN COMMERCE 1-25-2011.

PRINCIPAL REGISTER

THE MARK CONSISTS OF STANDARD CHARACTERS WITHOUT CLAIM TO ANY PARTICULAR FONT, STYLE, SIZE, OR COLOR.

SER. NO. 85-384,226, FILED 7-29-2011.

REBECCA GILBERT, EXAMINING ATTORNEY



David J. Kyros

Director of the United States Patent and Trademark Office

United States of America

United States Patent and Trademark Office

WE LOOK BETTER NAKED

Reg. No. 4,108,869

Registered Mar. 6, 2012

Int. Cl.: 29

TRADEMARK

PRINCIPAL REGISTER

KIND, LLC (DELAWARE LIMITED LIABILITY COMPANY)
P.O. BOX 705 MIDTOWN STATION
NEW YORK, NY 10018

FOR: HEALTHY SNACKS, NAMELY, FOOD BARS COMPRISED PRIMARILY OF NUTS, FRUITS AND NUTS, AND ALSO CONTAINING OTHER INGREDIENTS, IN CLASS 29 (U.S. CL. 46).

FIRST USE 8-0-2004; IN COMMERCE 4-30-2005.

THE MARK CONSISTS OF STANDARD CHARACTERS WITHOUT CLAIM TO ANY PARTICULAR FONT, STYLE, SIZE, OR COLOR.

SER. NO. 85-384,915, FILED 7-29-2011.

JUSTINE D. PARKER, EXAMINING ATTORNEY



David J. Kyros

Director of the United States Patent and Trademark Office

United States of America

United States Patent and Trademark Office

DO THE KIND THING – FOR
YOUR BODY, YOUR TASTE
BUDS, & THE WORLD!

Reg. No. 4,108,870

KIND, LLC (DELAWARE LIMITED LIABILITY COMPANY)
P.O. BOX 705 MIDTOWN STATION
NEW YORK, NY 10018

Registered Mar. 6, 2012

Int. Cl.: 29

FOR: HEALTHY SNACKS, NAMELY, FOOD BARS COMPRISED PRIMARILY OF NUTS, FRUITS AND NUTS, AND ALSO CONTAINING OTHER INGREDIENTS, IN CLASS 29 (U.S. CL. 46).

TRADEMARK

FIRST USE 5-10-2010; IN COMMERCE 5-10-2010.

PRINCIPAL REGISTER

THE MARK CONSISTS OF STANDARD CHARACTERS WITHOUT CLAIM TO ANY PARTICULAR FONT, STYLE, SIZE, OR COLOR.

SER. NO. 85-384,933, FILED 7-29-2011.

JUSTINE D. PARKER, EXAMINING ATTORNEY



David J. Kyros

Director of the United States Patent and Trademark Office

United States of America

United States Patent and Trademark Office

NOT FOR SALE

Reg. No. 4,108,871

NOT FOR SALE FUND (CALIFORNIA NON-PROFIT CORPORATION)
270 CAPISTRANO RD., SUITE 2
SAN FRANCISCO, CA 94019

Registered Mar. 6, 2012

Int. Cl.: 25

FOR: CLOTHING GOODS, NAMELY, SHIRTS, SWEATSHIRTS; ATHLETIC APPAREL, NAMELY, SHIRTS AND JACKETS; HEADWEAR; HATS, IN CLASS 25 (U.S. CLS. 22 AND 39).

TRADEMARK

FIRST USE 1-1-2009; IN COMMERCE 1-1-2009.

PRINCIPAL REGISTER

THE MARK CONSISTS OF STANDARD CHARACTERS WITHOUT CLAIM TO ANY PARTICULAR FONT, STYLE, SIZE, OR COLOR.

OWNER OF U.S. REG. NOS. 3,434,085 AND 3,456,341.

SER. NO. 85-385,071, FILED 7-29-2011.

JOHN GARTNER, EXAMINING ATTORNEY



David J. Kybas

Director of the United States Patent and Trademark Office

United States of America

United States Patent and Trademark Office

CHOZEN

Reg. No. 4,108,872

Registered Mar. 6, 2012

Int. Cl.: 35

SERVICE MARK

PRINCIPAL REGISTER

CHOZEN INC. (NEVADA CORPORATION)
#170-74
11700 W. CHARLESTON BLVD.
LAS VEGAS, NV 89135

FOR: ON-LINE RETAIL STORE SERVICES FEATURING GENERAL MERCHANDISE, NAMELY, CLOTHING, HATS, ACCESSORIES, NECKLACES, WATCHES, BRACELETS, SKATEBOARDS, SURFBOARDS, SNOWBOARDS, WAKEBOARDS AND STICKERS, IN CLASS 35 (U.S. CLS. 100, 101 AND 102).

FIRST USE 1-0-2008; IN COMMERCE 1-0-2008.

THE MARK CONSISTS OF STANDARD CHARACTERS WITHOUT CLAIM TO ANY PARTICULAR FONT, STYLE, SIZE, OR COLOR.

OWNER OF U.S. REG. NOS. 3,525,560, 3,951,808 AND OTHERS.

SER. NO. 85-385,440, FILED 7-30-2011.

JENNIFER DIXON, EXAMINING ATTORNEY



David J. Kyros

Director of the United States Patent and Trademark Office

United States of America
United States Patent and Trademark Office

BARIWISE

Reg. No. 4,108,873

Registered Mar. 6, 2012

Int. Cl.: 5

TRADEMARK

PRINCIPAL REGISTER

DIET DIRECT, INC. (NORTH CAROLINA CORPORATION)
SUITE B
3200 CORPORATE DRIVE
WILMINGTON, NC 28405

FOR: DIETARY FOOD SUPPLEMENTS, IN CLASS 5 (U.S. CLS. 6, 18, 44, 46, 51 AND 52).

FIRST USE 1-1-2008; IN COMMERCE 1-1-2008.

THE MARK CONSISTS OF STANDARD CHARACTERS WITHOUT CLAIM TO ANY PARTICULAR FONT, STYLE, SIZE, OR COLOR.

SER. NO. 85-385,991, FILED 8-1-2011.

REBECCA SMITH, EXAMINING ATTORNEY



David J. Kybas

Director of the United States Patent and Trademark Office

United States of America

United States Patent and Trademark Office

THE POWER OF NATURE, WHEN YOU NEED IT MOST

Reg. No. 4,108,874

Registered Mar. 6, 2012

Int. Cl.: 5

TRADEMARK

PRINCIPAL REGISTER

LAKWOOD RANCH NUTRITIONAL SCIENCES, LLC (FLORIDA LIMITED LIABILITY COMPANY)
20510 E. 79TH AVENUE
LAKWOOD RANCH, FL 34202

FOR: DIETARY SUPPLEMENTS; HERBAL SUPPLEMENTS; NUTRITIONAL SUPPLEMENTS; POWDERED NUTRITIONAL SUPPLEMENT DRINK MIX; VITAMINS, IN CLASS 5 (U.S. CLS. 6, 18, 44, 46, 51 AND 52).

FIRST USE 8-29-2011; IN COMMERCE 8-29-2011.

THE MARK CONSISTS OF STANDARD CHARACTERS WITHOUT CLAIM TO ANY PARTICULAR FONT, STYLE, SIZE, OR COLOR.

SER. NO. 85-386,230, FILED 8-1-2011.

KATHERINE E. HALMEN, EXAMINING ATTORNEY



David J. Kybas

Director of the United States Patent and Trademark Office

United States of America

United States Patent and Trademark Office

SOCENTUM

Reg. No. 4,108,875

Registered Mar. 6, 2012

Int. Cl.: 5

TRADEMARK

PRINCIPAL REGISTER

BAYER AKTIENGESELLSCHAFT (FED REP GERMANY AKTIENGESELLSCHAFT)
KAISER-WILHELM-ALLEE
LEVERKUSEN, FED REP GERMANY 51373

FOR: PHARMACEUTICAL PREPARATIONS AND SUBSTANCES FOR THE TREATMENT OF CANCER, PULMONARY HYPERTENSION, HEMOPHILIA, CARDIOVASCULAR DISEASES, ANTICOAGULANTS AND PLATELET AGGREGATION INHIBITORS, ANTI INFECTION PHARMACEUTICAL PREPARATIONS, ANTIVIRAL PHARMACEUTICAL PREPARATIONS, IN CLASS 5 (U.S. CLS. 6, 18, 44, 46, 51 AND 52).

THE MARK CONSISTS OF STANDARD CHARACTERS WITHOUT CLAIM TO ANY PARTICULAR FONT, STYLE, SIZE, OR COLOR.

PRIORITY CLAIMED UNDER SEC. 44(D) ON FED REP GERMANY APPLICATION NO. 302011023782, FILED 4-27-2011, REG. NO. 302011023782, DATED 5-12-2011, EXPIRES 4-30-2021.

SER. NO. 85-386,307, FILED 8-1-2011.

WILLIAM VERHOSEK, EXAMINING ATTORNEY



David J. Kyffers

Director of the United States Patent and Trademark Office

United States of America

United States Patent and Trademark Office

SOCERTAS

Reg. No. 4,108,876

Registered Mar. 6, 2012

Int. Cl.: 5

TRADEMARK

PRINCIPAL REGISTER

BAYER AKTIENGESELLSCHAFT (FED REP GERMANY AKTIENGESELLSCHAFT)
KAISER-WILHELM-ALLEE
LEVERKUSEN, FED REP GERMANY 51373

FOR: PHARMACEUTICAL PREPARATIONS AND SUBSTANCES FOR THE TREATMENT OF CANCER, PULMONARY HYPERTENSION, HEMOPHILIA, CARDIOVASCULAR DISEASES, ANTICOAGULANTS AND PLATELET AGGREGATION INHIBITORS, ANTI INFECTION PHARMACEUTICAL PREPARATIONS, ANTIVIRAL PHARMACEUTICAL PREPARATIONS, IN CLASS 5 (U.S. CLS. 6, 18, 44, 46, 51 AND 52).

THE MARK CONSISTS OF STANDARD CHARACTERS WITHOUT CLAIM TO ANY PARTICULAR FONT, STYLE, SIZE, OR COLOR.

PRIORITY CLAIMED UNDER SEC. 44(D) ON FED REP GERMANY APPLICATION NO. 302011023783, FILED 4-27-2011, REG. NO. 302011023783, DATED 5-12-2011, EXPIRES 4-30-2021.

SER. NO. 85-386,360, FILED 8-1-2011.

WILLIAM VERHOSEK, EXAMINING ATTORNEY



David J. Kyffers

Director of the United States Patent and Trademark Office

United States of America

United States Patent and Trademark Office

NEXGEN

Reg. No. 4,108,877

S. ABRAHAM & SONS, INC. (MICHIGAN CORPORATION)
4001--3 MILE ROAD NW
WALKER, MI 49504

Registered Mar. 6, 2012

Int. Cl.: 9

FOR: ORDER ENTRY COMPUTER SOFTWARE FOR THE FOOD DISTRIBUTION INDUSTRY,
IN CLASS 9 (U.S. CLS. 21, 23, 26, 36 AND 38).

TRADEMARK

FIRST USE 1-31-2011; IN COMMERCE 1-31-2011.

PRINCIPAL REGISTER

THE MARK CONSISTS OF STANDARD CHARACTERS WITHOUT CLAIM TO ANY PARTICULAR FONT, STYLE, SIZE, OR COLOR.

SER. NO. 85-386,546, FILED 8-2-2011.

KATINA MISTER, EXAMINING ATTORNEY



David J. Kybas

Director of the United States Patent and Trademark Office

United States of America

United States Patent and Trademark Office



Reg. No. 4,108,878

ALEXANDER & HORNUNG, INC. (MICHIGAN CORPORATION)
20643 STEPHENS ROAD
ST. CLAIR SHORES, MI 48080

Registered Mar. 6, 2012

Int. Cl.: 29

FOR: PROCESSED MEATS, NAMELY SAUSAGE, BACON, CANADIAN BACON, HAMS, HOT DOGS, DELI MEATS AND MEAT SNACKS, IN CLASS 29 (U.S. CL. 46).

TRADEMARK

FIRST USE 9-0-1987; IN COMMERCE 9-0-1987.

PRINCIPAL REGISTER

THE MARK CONSISTS OF AN ALPINE MAN BLOWING A HORN WITH CLOUDS AND SUN IN THE BACKGROUND.

SER. NO. 85-386,788, FILED 8-2-2011.

ANDREA BUTLER, EXAMINING ATTORNEY



David J. Kyffers

Director of the United States Patent and Trademark Office

United States of America

United States Patent and Trademark Office

YOU WRAP & WAVE

Reg. No. 4,108,879

Registered Mar. 6, 2012

Int. Cl.: 9

TRADEMARK

PRINCIPAL REGISTER

CONAIR CORPORATION (DELAWARE CORPORATION)
ONE CUMMINGS POINT ROAD
STAMFORD, CT 06902

FOR: ELECTRIC HAND-HELD HAIR STYLING IRONS, IN CLASS 9 (U.S. CLS. 21, 23, 26, 36 AND 38).

FIRST USE 12-0-2010; IN COMMERCE 12-0-2010.

THE MARK CONSISTS OF STANDARD CHARACTERS WITHOUT CLAIM TO ANY PARTICULAR FONT, STYLE, SIZE, OR COLOR.

OWNER OF U.S. REG. NO. 3,976,844.

SER. NO. 85-387,155, FILED 8-2-2011.

BARBARA GAYNOR, EXAMINING ATTORNEY



David J. Kybas

Director of the United States Patent and Trademark Office

United States of America
United States Patent and Trademark Office

GreatSeal

Reg. No. 4,108,880

SAF-T-SCREENS, INC. (TEXAS CORPORATION)
347 HWY 289
COMFORT, TX 78013

Registered Mar. 6, 2012

Int. Cl.: 17

FOR: ADHESIVE SEALANT AND CAULKING COMPOUND, IN CLASS 17 (U.S. CLS. 1, 5, 12, 13, 35 AND 50).

TRADEMARK

FIRST USE 4-1-2006; IN COMMERCE 4-1-2006.

PRINCIPAL REGISTER

THE MARK CONSISTS OF THE WORD GREATSEAL IN VERANDA FONT AND BLACK IN COLOR.

THE COLOR(S) BLACK IS/ARE CLAIMED AS A FEATURE OF THE MARK.

SEC. 2(F).

SER. NO. 85-387,886, FILED 8-3-2011.

REBECCA EISINGER, EXAMINING ATTORNEY



David J. Kyffers

Director of the United States Patent and Trademark Office

United States of America

United States Patent and Trademark Office

MAKING HEALTH HAPPEN

Reg. No. 4,108,881

Registered Mar. 6, 2012

Int. Cl.: 44

SERVICE MARK

PRINCIPAL REGISTER

JACQUELINE I. FULOP-GOODLING (UNITED STATES INDIVIDUAL)
SUITE 806
30 EAST 40TH STREET
NEW YORK, NY 10016

FOR: HEALTH SPA SERVICES, NAMELY COSMETIC BODY CARE SERVICES, IN CLASS
44 (U.S. CLS. 100 AND 101).

FIRST USE 7-1-2011; IN COMMERCE 7-1-2011.

THE MARK CONSISTS OF STANDARD CHARACTERS WITHOUT CLAIM TO ANY PAR-
TICULAR FONT, STYLE, SIZE, OR COLOR.

SER. NO. 85-387,890, FILED 8-3-2011.

JAY BESCH, EXAMINING ATTORNEY



David J. Kybas

Director of the United States Patent and Trademark Office

United States of America

United States Patent and Trademark Office

WORLDQUEST

Reg. No. 4,108,882

REMINGTON HOTELS, LP (DELAWARE LIMITED PARTNERSHIP)
14185 DALLAS PARKWAY, SUITE 1150
DALLAS, TX 75254

Registered Mar. 6, 2012

Int. Cl.: 43

FOR: HEALTH RESORT SERVICES, NAMELY, PROVIDING FOOD AND LODGING THAT SPECIALIZE IN PROMOTING PATRONS' GENERAL HEALTH AND WELL-BEING; HOTEL SERVICES; HOTEL, BAR AND RESTAURANT SERVICES; RESORT HOTELS; RESORT LODGING SERVICES, IN CLASS 43 (U.S. CLS. 100 AND 101).

SERVICE MARK

PRINCIPAL REGISTER

FIRST USE 7-31-2006; IN COMMERCE 7-31-2006.

THE MARK CONSISTS OF STANDARD CHARACTERS WITHOUT CLAIM TO ANY PARTICULAR FONT, STYLE, SIZE, OR COLOR.

SER. NO. 85-389,227, FILED 8-4-2011.

LAURA KOVALSKY, EXAMINING ATTORNEY



David J. Kyffers

Director of the United States Patent and Trademark Office

United States of America

United States Patent and Trademark Office

ECONOLINE

Reg. No. 4,108,883

FORD MOTOR COMPANY (DELAWARE CORPORATION)
ONE AMERICAN ROAD
DEARBORN, MI 48126

Registered Mar. 6, 2012

Int. Cl.: 12

FOR: VANS; EXTERIOR INSIGNIA BADGES FOR MOTOR VEHICLES, IN CLASS 12 (U.S. CLS. 19, 21, 23, 31, 35 AND 44).

TRADEMARK

FIRST USE 9-1-1960; IN COMMERCE 9-1-1960.

PRINCIPAL REGISTER

THE MARK CONSISTS OF STANDARD CHARACTERS WITHOUT CLAIM TO ANY PARTICULAR FONT, STYLE, SIZE, OR COLOR.

OWNER OF U.S. REG. NO. 1,494,156.

SER. NO. 85-389,241, FILED 8-4-2011.

SHAILA SETTLES, EXAMINING ATTORNEY



David J. Kybas

Director of the United States Patent and Trademark Office

United States of America

United States Patent and Trademark Office



Reg. No. 4,108,884

Registered Mar. 6, 2012

Int. Cl.: 43

SERVICE MARK

PRINCIPAL REGISTER

GEOFFREY, LLC (DELAWARE LIMITED LIABILITY COMPANY)
ONE GEOFFREY WAY
WAYNE, NJ 07470

FOR: RESTAURANTS, CAFE AND ICE CREAM SHOP SERVICES IN THE NATURE OF A RESTAURANT, IN CLASS 43 (U.S. CLS. 100 AND 101).

FIRST USE 11-3-2010; IN COMMERCE 11-3-2010.

OWNER OF U.S. REG. NO. 3,926,927.

THE MARK CONSISTS OF THE IMAGE OF A JESTER.

SER. NO. 85-389,613, FILED 8-4-2011.

ARETHA SOMERVILLE, EXAMINING ATTORNEY



David J. Kybas

Director of the United States Patent and Trademark Office

United States of America
United States Patent and Trademark Office

MARQUIS

Reg. No. 4,108,885

PREMIX-MARBLETITE MANUFACTURING CO. (FLORIDA CORPORATION)
1259 NW 21ST STREET
POMPANO BEACH, FL 33069

Registered Mar. 6, 2012

Int. Cl.: 19

FOR: AGGREGATE MATERIAL COMPOSED OF QUARTZ, CEMENT, AND DYE FOR USE AS A SWIMMING POOL FINISH, IN CLASS 19 (U.S. CLS. 1, 12, 33 AND 50).

TRADEMARK

FIRST USE 3-16-1995; IN COMMERCE 3-16-1995.

PRINCIPAL REGISTER

THE MARK CONSISTS OF STANDARD CHARACTERS WITHOUT CLAIM TO ANY PARTICULAR FONT, STYLE, SIZE, OR COLOR.

SER. NO. 85-389,868, FILED 8-4-2011.

KATHERINE E. HALMEN, EXAMINING ATTORNEY



David J. Kybas

Director of the United States Patent and Trademark Office

United States of America

United States Patent and Trademark Office



Reg. No. 4,108,886

Registered Mar. 6, 2012

Int. Cls.: 3, 5 and 21

TRADEMARK

PRINCIPAL REGISTER

S. C. JOHNSON & SON, INC. (WISCONSIN CORPORATION)
1525 HOWE STREET
RACINE, WI 53403

FOR: ALL PURPOSE HOUSEHOLD CLEANERS, TOILET BOWL CLEANERS, SHOWER CLEANER, DISPOSABLE WIPES IMPREGNATED WITH CLEANING CHEMICALS OR COMPOUNDS FOR HOUSEHOLD USE, DISPOSABLE PADS IMPREGNATED WITH CLEANING CHEMICALS OR COMPOUNDS FOR HOUSEHOLD USE, IN CLASS 3 (U.S. CLS. 1, 4, 6, 50, 51 AND 52).

FIRST USE 5-18-2011; IN COMMERCE 5-18-2011.

FOR: DISINFECTANT BATHROOM CLEANERS, IN CLASS 5 (U.S. CLS. 6, 18, 44, 46, 51 AND 52).

FIRST USE 5-30-2011; IN COMMERCE 5-30-2011.

FOR: BRUSH FOR HOUSEHOLD CLEANING; BATTERY OPERATED UNIT SOLD EMPTY FOR DISPENSING ALL PURPOSE CLEANER, IN CLASS 21 (U.S. CLS. 2, 13, 23, 29, 30, 33, 40 AND 50).

FIRST USE 6-6-2011; IN COMMERCE 6-6-2011.

OWNER OF U.S. REG. NOS. 1,599,107, 2,680,700 AND OTHERS.

THE MARK CONSISTS OF THE WORDS "SCRUBBING BUBBLES" AND THREE BUBBLE CHARACTERS WITH BUBBLES ALL AROUND.

SER. NO. 85-390,034, FILED 8-4-2011.

ELI HELLMAN, EXAMINING ATTORNEY



David J. Kypos

Director of the United States Patent and Trademark Office

United States of America

United States Patent and Trademark Office



Reg. No. 4,108,887

Registered Mar. 6, 2012

Int. Cl.: 36

SERVICE MARK

PRINCIPAL REGISTER

JFLENDINGAHAND.COM, LLC (INDIANA LIMITED LIABILITY COMPANY)
14033 ILLINOIS ROAD
FORT WAYNE, IN 46814

FOR: ACCEPTING AND ADMINISTERING MONETARY CHARITABLE CONTRIBUTIONS; CHARITABLE FUNDRAISING SERVICES; CHARITABLE FUNDRAISING SERVICES, NAMELY, BY PROVIDING INDIVIDUALS WITH THE INFORMATION AND OPPORTUNITY TO MAKE MONETARY DONATIONS TO THEIR FAVORITE CHARITY, IN CLASS 36 (U.S. CLS. 100, 101 AND 102).

FIRST USE 4-1-2011; IN COMMERCE 4-1-2011.

THE MARK CONSISTS OF INTERLOCKING HANDS FORMING THE SHAPE OF A HEART IN WHICH THE HAND ON THE LEFT IS RED, THE HAND ON THE RIGHT IS A DARKER SHADE OF RED AND WHITE IS USED TO SEPARATE THE FINGERS ON THE HANDS.

THE COLOR(S) RED AND WHITE IS/ARE CLAIMED AS A FEATURE OF THE MARK.

SER. NO. 85-390,490, FILED 8-5-2011.

ADA HAN, EXAMINING ATTORNEY



David J. Kybas

Director of the United States Patent and Trademark Office

United States of America

United States Patent and Trademark Office

THIS IS YOUR PLANET

Reg. No. 4,108,888

Registered Mar. 6, 2012

Int. Cl.: 41

SERVICE MARK

PRINCIPAL REGISTER

PFIP, LLC (NEW HAMPSHIRE LIMITED LIABILITY COMPANY)
26 FOX RUN ROAD
NEWINGTON, NH 03801

FOR: PHYSICAL FITNESS INSTRUCTION AND TRAINING; HEALTH CLUB SERVICES, NAMELY, PROVIDING INSTRUCTION AND EQUIPMENT IN THE FIELD OF PHYSICAL EXERCISE, IN CLASS 41 (U.S. CLS. 100, 101 AND 107).

FIRST USE 6-6-2011; IN COMMERCE 6-6-2011.

THE MARK CONSISTS OF STANDARD CHARACTERS WITHOUT CLAIM TO ANY PARTICULAR FONT, STYLE, SIZE, OR COLOR.

OWNER OF U.S. REG. NOS. 2,327,099, 4,025,158 AND OTHERS.

SER. NO. 85-390,519, FILED 8-5-2011.

CURTIS FRENCH, EXAMINING ATTORNEY



David J. Kyffers

Director of the United States Patent and Trademark Office

United States of America

United States Patent and Trademark Office

ZIPLOC

Reg. No. 4,108,889

Registered Mar. 6, 2012

Int. Cl.: 21

TRADEMARK

PRINCIPAL REGISTER

S. C. JOHNSON & SON, INC. (WISCONSIN CORPORATION)
1525 HOWE STREET
RACINE, WI 53403

FOR: GLASS STORAGE CONTAINERS FOR DOMESTIC AND HOUSEHOLD USE, IN CLASS 21 (U.S. CLS. 2, 13, 23, 29, 30, 33, 40 AND 50).

FIRST USE 5-28-2011; IN COMMERCE 5-28-2011.

THE MARK CONSISTS OF STANDARD CHARACTERS WITHOUT CLAIM TO ANY PARTICULAR FONT, STYLE, SIZE, OR COLOR.

OWNER OF U.S. REG. NOS. 886,112, 2,853,908 AND OTHERS.

SER. NO. 85-390,538, FILED 8-5-2011.

ELI HELLMAN, EXAMINING ATTORNEY



David J. Kybas

Director of the United States Patent and Trademark Office

United States of America

United States Patent and Trademark Office

"I will care for your
needs, and together we
will care for the needs of
others."

Reg. No. 4,108,890

JFLENDINGAHAND.COM, LLC (INDIANA LIMITED LIABILITY COMPANY)
14033 ILLINOIS RD
FORT WAYNE, IN 46814

Registered Mar. 6, 2012

Int. Cl.: 36

FOR: ACCEPTING AND ADMINISTERING MONETARY CHARITABLE CONTRIBUTIONS;
CHARITABLE FUNDRAISING SERVICES; CHARITABLE FUNDRAISING SERVICES,
NAMELY, BY PROVIDING INDIVIDUALS WITH THE INFORMATION AND OPPORTUNITY
TO MAKE MONETARY DONATIONS TO THEIR FAVORITE CHARITY, IN CLASS 36 (U.S.
CLS. 100, 101 AND 102).

SERVICE MARK

PRINCIPAL REGISTER

FIRST USE 3-1-2011; IN COMMERCE 3-1-2011.

THE MARK CONSISTS OF STANDARD CHARACTERS WITHOUT CLAIM TO ANY PAR-
TICULAR FONT, STYLE, SIZE, OR COLOR.

SER. NO. 85-390,658, FILED 8-5-2011.

ADA HAN, EXAMINING ATTORNEY



David J. Kybas

Director of the United States Patent and Trademark Office

United States of America

United States Patent and Trademark Office



REDEYE

Reg. No. 4,108,891

STRATASYS, INC. (DELAWARE CORPORATION)
7665 COMMERCE WAY
EDEN PRAIRIE, MN 55344

Registered Mar. 6, 2012

Int. Cl.: 40

FOR: FABRICATION AND FINISHING SERVICES, NAMELY, FABRICATION AND POST-PRODUCTION FINISHING OF PARTS, MODELS, PROTOTYPES, JIGS AND FIXTURES TO THE ORDER AND SPECIFICATION OF OTHERS , IN CLASS 40 (U.S. CLS. 100, 103 AND 106).

SERVICE MARK

PRINCIPAL REGISTER

FIRST USE 10-17-2005; IN COMMERCE 10-17-2005.

OWNER OF U.S. REG. NOS. 3,184,263, 3,184,264, AND 3,827,584.

THE MARK CONSISTS OF THE WORD REDEYE WITH A CIRCLE HAVING TWO BROKEN ORBITAL LINES THEREIN.

SER. NO. 85-391,774, FILED 8-8-2011.

SANI KHOURI, EXAMINING ATTORNEY



David J. Kybas

Director of the United States Patent and Trademark Office

United States of America

United States Patent and Trademark Office



Reg. No. 4,108,892

Registered Mar. 6, 2012

Int. Cl.: 36

SERVICE MARK

PRINCIPAL REGISTER

FINANCIAL GOURMET LICENSING, LLC (MISSOURI LIMITED LIABILITY COMPANY)
805 WEST US HIGHWAY 50
O'FALLON, IL 62269

FOR: FINANCIAL ADVISORY AND CONSULTANCY SERVICES; INVESTMENT AND INSURANCE CONSULTANCY AND BROKERAGE SERVICES, IN CLASS 36 (U.S. CLS. 100, 101 AND 102).

FIRST USE 1-0-2007; IN COMMERCE 1-0-2007.

THE MARK CONSISTS OF AN IMAGE OF A CHEF HOLDING A TRAY OF MONEY.

SER. NO. 85-391,866, FILED 8-8-2011.

VERNA BETH RIRIE, EXAMINING ATTORNEY



David J. Kyffers

Director of the United States Patent and Trademark Office

United States of America

United States Patent and Trademark Office



Reg. No. 4,108,893

Registered Mar. 6, 2012

Int. Cl.: 36

SERVICE MARK

PRINCIPAL REGISTER

FINANCIAL GOURMET LICENSING, LLC (MISSOURI LIMITED LIABILITY COMPANY)
805 WEST US HIGHWAY 50
O'FALLON, IL 62269

FOR: FINANCIAL ADVISORY AND CONSULTANCY SERVICES; INVESTMENT AND INSURANCE CONSULTANCY AND BROKERAGE SERVICES, IN CLASS 36 (U.S. CLS. 100, 101 AND 102).

FIRST USE 1-0-2007; IN COMMERCE 1-0-2007.

THE MARK CONSISTS OF AN IMAGE OF A CHEF HOLDING A BASKET OF MONEY.

SER. NO. 85-391,938, FILED 8-8-2011.

VERNA BETH RIRIE, EXAMINING ATTORNEY



David J. Kyffers

Director of the United States Patent and Trademark Office

United States of America

United States Patent and Trademark Office



Reg. No. 4,108,894

Registered Mar. 6, 2012

Int. Cl.: 36

SERVICE MARK

PRINCIPAL REGISTER

FINANCIAL GOURMET LICENSING, LLC (MISSOURI LIMITED LIABILITY COMPANY)
805 WEST US HIGHWAY 50
O'FALLON, IL 62269

FOR: FINANCIAL ADVISORY AND CONSULTANCY SERVICES; INVESTMENT AND INSURANCE CONSULTANCY AND BROKERAGE SERVICES, IN CLASS 36 (U.S. CLS. 100, 101 AND 102).

FIRST USE 1-0-2007; IN COMMERCE 1-0-2007.

THE MARK CONSISTS OF AN IMAGE OF A CHEF HOLDING A TRAY OF MONEY.

SER. NO. 85-391,947, FILED 8-8-2011.

VERNA BETH RIRIE, EXAMINING ATTORNEY



David J. Kyffers

Director of the United States Patent and Trademark Office

United States of America

United States Patent and Trademark Office

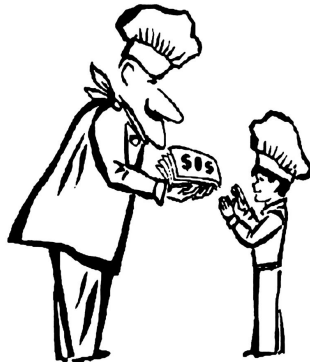

Reg. No. 4,108,895

Registered Mar. 6, 2012

Int. Cl.: 36

SERVICE MARK

PRINCIPAL REGISTER

FINANCIAL GOURMET LICENSING, LLC (MISSOURI LIMITED LIABILITY COMPANY)
805 WEST US HIGHWAY 50
O'FALLON, IL 62269

FOR: FINANCIAL ADVISORY AND CONSULTANCY SERVICES; INVESTMENT AND INSURANCE CONSULTANCY AND BROKERAGE SERVICES, IN CLASS 36 (U.S. CLS. 100, 101 AND 102).

FIRST USE 1-0-2007; IN COMMERCE 1-0-2007.

THE MARK CONSISTS OF AN IMAGE OF A CHEF HOLDING A TRAY OF MONEY IN FRONT OF AN IMAGE OF A CHILD WEARING A CHEF'S HAT.

SER. NO. 85-391,961, FILED 8-8-2011.

VERNA BETH RIRIE, EXAMINING ATTORNEY



David J. Kyffers

Director of the United States Patent and Trademark Office

United States of America

United States Patent and Trademark Office



Reg. No. 4,108,896

Registered Mar. 6, 2012

Int. Cl.: 36

SERVICE MARK

PRINCIPAL REGISTER

FINANCIAL GOURMET LICENSING, LLC (MISSOURI LIMITED LIABILITY COMPANY)
805 WEST US HIGHWAY 50
O'FALLON, IL 62269

FOR: FINANCIAL ADVISORY AND CONSULTANCY SERVICES; INVESTMENT AND INSURANCE CONSULTANCY AND BROKERAGE SERVICES, IN CLASS 36 (U.S. CLS. 100, 101 AND 102).

FIRST USE 1-0-2007; IN COMMERCE 1-0-2007.

THE MARK CONSISTS OF AN IMAGE OF A CHEF HOLDING A TRAY OF MONEY AND HANDS ATTEMPTING TO GRAB THE MONEY.

SER. NO. 85-391,972, FILED 8-8-2011.

VERNA BETH RIRIE, EXAMINING ATTORNEY



David J. Kybas

Director of the United States Patent and Trademark Office

United States of America

United States Patent and Trademark Office

SURORA 700

Reg. No. 4,108,897

Registered Mar. 6, 2012

Int. Cl.: 10

TRADEMARK

PRINCIPAL REGISTER

STRYKER CORPORATION (MICHIGAN CORPORATION)
OFFICE OF THE GENERAL COUNSEL
2825 AIRVIEW BOULEVARD
KALAMAZOO, MI 49002

FOR: PORTABLE HEAD-WORN LIGHT FOR ILLUMINATION FOR USE BY MEDICAL/SURGICAL PERSONNEL DURING A MEDICAL OR SURGICAL PROCEDURE, IN CLASS 10 (U.S. CLS. 26, 39 AND 44).

FIRST USE 7-21-2011; IN COMMERCE 7-21-2011.

THE MARK CONSISTS OF STANDARD CHARACTERS WITHOUT CLAIM TO ANY PARTICULAR FONT, STYLE, SIZE, OR COLOR.

SER. NO. 85-394,038, FILED 8-10-2011.

EDWARD NELSON, EXAMINING ATTORNEY



David J. Kybas

Director of the United States Patent and Trademark Office

United States of America

United States Patent and Trademark Office

K-PRO

Reg. No. 4,108,898

Registered Mar. 6, 2012

Int. Cl.: 7

TRADEMARK

PRINCIPAL REGISTER

ERIEZ MANUFACTURING CO. (PENNSYLVANIA CORPORATION)
2200 ASBURY ROAD
ERIE, PA 16506

FOR: FLOTATION SEPARATION EQUIPMENT FOR SEPARATING AND RECOVERING TARGET PARTICLES FROM MIXTURES OF MATERIALS, IN CLASS 7 (U.S. CLS. 13, 19, 21, 23, 31, 34 AND 35).

FIRST USE 2-28-2006; IN COMMERCE 2-28-2006.

THE MARK CONSISTS OF STANDARD CHARACTERS WITHOUT CLAIM TO ANY PARTICULAR FONT, STYLE, SIZE, OR COLOR.

SER. NO. 85-396,339, FILED 8-12-2011.

JAY FLOWERS, EXAMINING ATTORNEY



David J. Kyffers

Director of the United States Patent and Trademark Office

United States of America
United States Patent and Trademark Office

PHOSPRO

Reg. No. 4,108,899

ERIEZ MANUFACTURING CO. (PENNSYLVANIA CORPORATION)
2200 ASBURY ROAD
ERIE, PA 16506

Registered Mar. 6, 2012

Int. Cl.: 7

FOR: FLOTATION SEPARATION EQUIPMENT FOR SEPARATING AND RECOVERING TARGET PARTICLES FROM MIXTURES OF MATERIALS, IN CLASS 7 (U.S. CLS. 13, 19, 21, 23, 31, 34 AND 35).

TRADEMARK

FIRST USE 2-1-2007; IN COMMERCE 2-1-2007.

PRINCIPAL REGISTER

THE MARK CONSISTS OF STANDARD CHARACTERS WITHOUT CLAIM TO ANY PARTICULAR FONT, STYLE, SIZE, OR COLOR.

SER. NO. 85-396,379, FILED 8-12-2011.

JAY FLOWERS, EXAMINING ATTORNEY



David J. Kyffers

Director of the United States Patent and Trademark Office

United States of America

United States Patent and Trademark Office

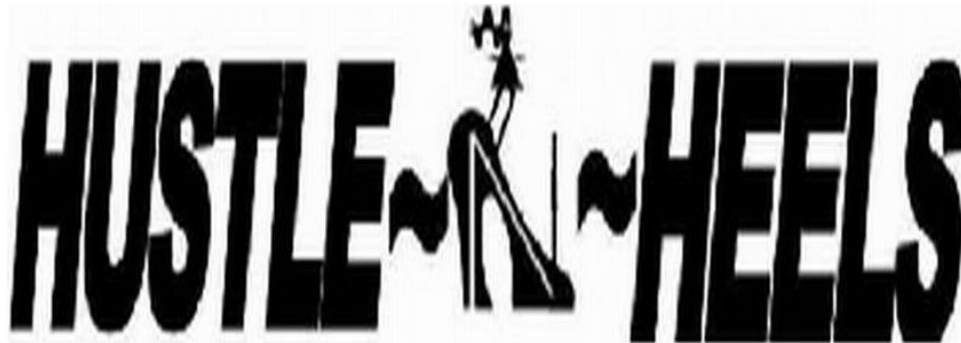

Reg. No. 4,108,900

B2 SQUARED (NEVADA PARTNERSHIP)
5575 SIMMONS STREET, SUITE 1-333
NORTH LAS VEGAS, NV 89031

Registered Mar. 6, 2012

Int. Cl.: 25

FOR: HATS; SHORT-SLEEVED OR LONG-SLEEVED T-SHIRTS; T-SHIRTS; T-SHIRTS FOR WOMEN, IN CLASS 25 (U.S. CLS. 22 AND 39).

TRADEMARK

FIRST USE 9-2-2010; IN COMMERCE 2-11-2011.

PRINCIPAL REGISTER

THE MARK CONSISTS OF THE WORDING "HUSTLE N HEELS". THERE IS A DASH (E.G. "-") BEFORE AND AFTER THE LETTER "N". THE LETTER "N" IS LAYERED OVER A PICTURE OF A FEMALE STANDING IN AN OVER-SIZED HIGH HEEL SHOE.

SER. NO. 85-397,099, FILED 8-12-2011.

LAURIE KAUFMAN, EXAMINING ATTORNEY



David J. Kybas

Director of the United States Patent and Trademark Office

United States of America

United States Patent and Trademark Office



Reg. No. 4,108,901

SNAP-ON INCORPORATED (DELAWARE CORPORATION)
2801 80TH STREET
KENOSHA, WI 53143

Registered Mar. 6, 2012

Int. Cl.: 8

FOR: HAND TOOLS, NAMELY, SCREWDRIVERS, IN CLASS 8 (U.S. CLS. 23, 28 AND 44).

TRADEMARK

FIRST USE 3-31-2006; IN COMMERCE 3-31-2006.

PRINCIPAL REGISTER

OWNER OF U.S. REG. NO. 3,360,711.

THE MARK CONSISTS OF A SCREW INSIDE OF A NUT WITH THE WORD "INSTINCT".

SER. NO. 85-398,913, FILED 8-16-2011.

NAKIA HENRY, EXAMINING ATTORNEY



David J. Kybas

Director of the United States Patent and Trademark Office

United States of America

United States Patent and Trademark Office

CHAPS

Reg. No. 4,108,902

Registered Mar. 6, 2012

Int. Cl.: 25

TRADEMARK

PRINCIPAL REGISTER

PRL USA HOLDINGS, INC. (DELAWARE CORPORATION)
103 FOULK ROAD
WILMINGTON, DE 19803

FOR: A FULL LINE OF CLOTHING, EXCLUDING CHAPS, IN CLASS 25 (U.S. CLS. 22 AND 39).

FIRST USE 1-23-1974; IN COMMERCE 1-23-1974.

THE MARK CONSISTS OF STANDARD CHARACTERS WITHOUT CLAIM TO ANY PARTICULAR FONT, STYLE, SIZE, OR COLOR.

OWNER OF U.S. REG. NOS. 3,195,249, 3,566,039 AND OTHERS.

SER. NO. 85-399,043, FILED 8-16-2011.

BRENDAN REGAN, EXAMINING ATTORNEY



David J. Kybas

Director of the United States Patent and Trademark Office

United States of America

United States Patent and Trademark Office

SIELOX

Reg. No. 4,108,903

Registered Mar. 6, 2012

Int. Cl.: 41

SERVICE MARK

PRINCIPAL REGISTER

SIELOX, LLC (MINNESOTA LIMITED LIABILITY COMPANY)
170 EAST 9TH AVENUE
RUNNEMEDE, NJ 08078

FOR: TRAINING OTHERS IN THE INSTALLATION AND USE OF ACCESS AND MONITORING SYSTEMS, IN CLASS 41 (U.S. CLS. 100, 101 AND 107).

FIRST USE 1-6-2006; IN COMMERCE 1-6-2006.

THE MARK CONSISTS OF STANDARD CHARACTERS WITHOUT CLAIM TO ANY PARTICULAR FONT, STYLE, SIZE, OR COLOR.

OWNER OF U.S. REG. NO. 3,295,334.

SER. NO. 85-399,819, FILED 8-17-2011.

KIMBERLY FRYE, EXAMINING ATTORNEY



David J. Kybas

Director of the United States Patent and Trademark Office

United States of America

United States Patent and Trademark Office

SAN ANTONIO WINERY CARDINALE

Reg. No. 4,108,904

Registered Mar. 6, 2012

Int. Cl.: 33

TRADEMARK

PRINCIPAL REGISTER

SAN ANTONIO WINERY, INC. (CALIFORNIA CORPORATION)
737 LAMAR STREET
LOS ANGELES, CA 90031

FOR: WINE, IN CLASS 33 (U.S. CLS. 47 AND 49).

FIRST USE 12-31-1999; IN COMMERCE 12-31-1999.

THE MARK CONSISTS OF STANDARD CHARACTERS WITHOUT CLAIM TO ANY PARTICULAR FONT, STYLE, SIZE, OR COLOR.

OWNER OF U.S. REG. NOS. 3,258,274 AND 3,569,248.

NO CLAIM IS MADE TO THE EXCLUSIVE RIGHT TO USE "WINERY", APART FROM THE MARK AS SHOWN.

SER. NO. 85-399,915, FILED 8-17-2011.

JILL C. ALT, EXAMINING ATTORNEY



David J. Kybas

Director of the United States Patent and Trademark Office

United States of America

United States Patent and Trademark Office

DOMTAR

Reg. No. 4,108,905

Registered Mar. 6, 2012

Int. Cls.: 1, 16 and 40

TRADEMARK

SERVICE MARK

PRINCIPAL REGISTER

DOMTAR INC. (CANADA CORPORATION)
395 DE MAISONNEUVE BLVD. WEST
MONTREAL, QUEBEC, CANADA H3A1L6

FOR: GROUNDWOOD PULP; PAPER PULP; PAPER PULP FOR MANUFACTURING PURPOSES; WOOD PULP FOR MANUFACTURING PURPOSES, IN CLASS 1 (U.S. CLS. 1, 5, 6, 10, 26 AND 46).

FIRST USE 7-19-1963; IN COMMERCE 7-19-1963.

FOR: ABSORBENT PADS OF PAPER AND CELLULOSE FOR USE IN FOOD PACKAGING; BANNERS OF PAPER; CARBONLESS PAPER; COPY PAPER; GRAPH PAPER; GROCERY PAPER; GUMMED PAPER; LABEL PAPER; LAMINATED PAPER; MASKING PAPER; OFFSET PAPER; OILPROOF PAPER; PAPER; PAPER FOOD WRAP; PAPER FOR USE AS MATERIAL OF STOCK CERTIFICATES (SHOKENSHI); PAPER FOR USE IN THE GRAPHIC ARTS INDUSTRY; PAPER FOR WRAPPING AND PACKAGING; PAPER PACKAGING AND CONTAINERS FOR FOOD AND BEVERAGES COMPRISED OF MATERIALS DESIGNED TO LESSEN ADVERSE EFFECTS ON THE ENVIRONMENT; PAPER TAPE; PAPERS FOR USE IN THE GRAPHIC ARTS INDUSTRY; PUBLICATION PAPER; RECYCLED PAPER; SAFETY PAPER; SPECIALTY PAPERS, NAMELY, VEGETABLE PARCHMENT, FOR USE IN FOOD WRAPPING, PREPARATION, PROCESSING AND PACKAGING APPLICATIONS; THERMOSENSITIVE PAPER, IN CLASS 16 (U.S. CLS. 2, 5, 22, 23, 29, 37, 38 AND 50).

FIRST USE 7-19-1963; IN COMMERCE 7-19-1963.

FOR: CONVERTING PAPER INTO MAILING ENVELOPES AND OTHER MAILERS; CUSTOM MANUFACTURE OF PAPER, PULP AND PAPER PRODUCTS; CUSTOM MANUFACTURING OF PAPER AND PAPER PRODUCTS; MANUFACTURING SERVICES FOR OTHERS IN THE FIELD OF PAPER, NAMELY, MANUFACTURING PAPER FORMS, MANUFACTURING CONTINUOUS PAPER FORMS, PUNCHING HOLES IN PAPER, DIE CUTTING TABS IN PAPER, AND CONVERTING PAPER INTO FORMS; PAPER FINISHING; PAPER TREATMENT, IN CLASS 40 (U.S. CLS. 100, 103 AND 106).

FIRST USE 7-0-2002; IN COMMERCE 7-0-2002.

THE MARK CONSISTS OF STANDARD CHARACTERS WITHOUT CLAIM TO ANY PARTICULAR FONT, STYLE, SIZE, OR COLOR.



David J. Kyffers

Director of the United States Patent and Trademark Office

Reg. No. 4,108,905 OWNER OF U.S. REG. NOS. 797,669, 893,509 AND OTHERS.

SER. NO. 85-400,313, FILED 8-17-2011.

JAMES GRIFFIN, EXAMINING ATTORNEY

United States of America

United States Patent and Trademark Office

OLAVE

Reg. No. 4,108,906

Registered Mar. 6, 2012

Int. Cl.: 29

TRADEMARK

PRINCIPAL REGISTER

VALLE GRANDE S.A. (CHILE CORPORATION)
AVDA. DEL PARQUE N° 4161
OF. 302 CIUDAD EMPRESARIAL HUECHURABA
SANTIAGO, CHILE

FOR: OLIVE OIL, IN CLASS 29 (U.S. CL. 46).

FIRST USE 1-31-2003; IN COMMERCE 3-31-2004.

THE MARK CONSISTS OF STANDARD CHARACTERS WITHOUT CLAIM TO ANY PARTICULAR FONT, STYLE, SIZE, OR COLOR.

THE WORDING OLAVE HAS NO MEANING IN A FOREIGN LANGUAGE.

SER. NO. 85-401,591, FILED 8-18-2011.

JANICE KIM, EXAMINING ATTORNEY



David J. Kybas

Director of the United States Patent and Trademark Office

United States of America

United States Patent and Trademark Office

877-655-UWIN

Reg. No. 4,108,907

CLOCKWORK IP, LLC (DELAWARE CORPORATION)
50 CENTRAL AVE SUITE 920
SARASOTA, FL 34236

Registered Mar. 6, 2012

Int. Cl.: 36

FOR: WARRANTY SERVICES PROGRAMS, NAMELY, UNDER WRITING WARRANTY PROGRAMS IN THE FIELD OF PLUMBING, ELECTRICAL, HEATING, VENTILATION, AND AIR CONDITIONING, IN CLASS 36 (U.S. CLS. 100, 101 AND 102).

SERVICE MARK

FIRST USE 5-30-2005; IN COMMERCE 5-30-2005.

PRINCIPAL REGISTER

THE MARK CONSISTS OF STANDARD CHARACTERS WITHOUT CLAIM TO ANY PARTICULAR FONT, STYLE, SIZE, OR COLOR.

SER. NO. 85-402,209, FILED 8-19-2011.

KATINA MISTER, EXAMINING ATTORNEY



David J. Kybas

Director of the United States Patent and Trademark Office

United States of America

United States Patent and Trademark Office

BRILLIANT VISION

Reg. No. 4,108,908

Registered Mar. 6, 2012

Int. Cl.: 5

TRADEMARK

PRINCIPAL REGISTER

PROGRESSIVE LABORATORIES, INC. (TEXAS CORPORATION)
1701 W WALNUT HILL LANE
IRVING, TX 75038

FOR: DIETARY AND NUTRITIONAL SUPPLEMENTS; DIETARY SUPPLEMENTS; DIETARY SUPPLEMENTS FOR HUMAN CONSUMPTION; MINERAL NUTRITIONAL SUPPLEMENTS; MINERAL SUPPLEMENTS; NUTRITIONAL SUPPLEMENTS; VITAMIN AND MINERAL SUPPLEMENTS; VITAMIN SUPPLEMENTS, IN CLASS 5 (U.S. CLS. 6, 18, 44, 46, 51 AND 52).

FIRST USE 2-1-2008; IN COMMERCE 5-2-2008.

THE MARK CONSISTS OF STANDARD CHARACTERS WITHOUT CLAIM TO ANY PARTICULAR FONT, STYLE, SIZE, OR COLOR.

NO CLAIM IS MADE TO THE EXCLUSIVE RIGHT TO USE "VISION", APART FROM THE MARK AS SHOWN.

SER. NO. 85-402,214, FILED 8-19-2011.

KRISTIN DAHLING, EXAMINING ATTORNEY



David J. Kyros

Director of the United States Patent and Trademark Office

United States of America

United States Patent and Trademark Office

CORYZA FORTE

Reg. No. 4,108,909

PROGRESSIVE LABORATORIES, INC. (TEXAS CORPORATION)
1701 W WALNUT HILL LANE
IRVING, TX 75038

Registered Mar. 6, 2012

Int. Cl.: 5

FOR: DIETARY NUTRITIONAL SUPPLEMENT FOR IMMUNE SYSTEM SUPPORT, IN CLASS 5 (U.S. CLS. 6, 18, 44, 46, 51 AND 52).

TRADEMARK

FIRST USE 7-31-1990; IN COMMERCE 8-31-1990.

PRINCIPAL REGISTER

THE MARK CONSISTS OF STANDARD CHARACTERS WITHOUT CLAIM TO ANY PARTICULAR FONT, STYLE, SIZE, OR COLOR.

NO CLAIM IS MADE TO THE EXCLUSIVE RIGHT TO USE "CORYZA", APART FROM THE MARK AS SHOWN.

SER. NO. 85-402,261, FILED 8-19-2011.

KRISTIN DAHLING, EXAMINING ATTORNEY



David J. Kybas

Director of the United States Patent and Trademark Office

United States of America

United States Patent and Trademark Office

BillMeLater

Reg. No. 4,108,910

Registered Mar. 6, 2012

Int. Cl.: 36

SERVICE MARK

PRINCIPAL REGISTER

BILL ME LATER, INC. (DELAWARE CORPORATION)
9690 DEERECO ROAD, SUITE 705
TIMONIUM, MD 21093

FOR: CREDIT SERVICES, NAMELY, PROVIDING REVOLVING CREDIT ACCOUNT SERVICES AND BILL PAYMENT SERVICES TO OTHERS, IN CLASS 36 (U.S. CLS. 100, 101 AND 102).

FIRST USE 6-0-2007; IN COMMERCE 6-0-2007.

OWNER OF U.S. REG. NOS. 2,583,715 AND 3,333,091.

THE MARK CONSISTS OF A CHECK MARK IN A BOX APPEARING IMMEDIATELY TO THE LEFT OF THE WORDING BILLMELATER IN MIXED UPPER AND LOWER CASE LETTERS.

SER. NO. 85-402,333, FILED 8-19-2011.

KAPIL BHANOT, EXAMINING ATTORNEY



David J. Kybas

Director of the United States Patent and Trademark Office

United States of America

United States Patent and Trademark Office

Los Rakas

Reg. No. 4,108,911

SOY RAKA LLC (CALIFORNIA LIMITED LIABILITY COMPANY)
22402 RALSTON LANE
HAYWARD, CA 94541

Registered Mar. 6, 2012

Int. Cl.: 35

FOR: ENTERTAINMENT MARKETING SERVICES, NAMELY, MARKETING, PROMOTION AND ADVERTISING FOR RECORDING AND PERFORMING ARTISTS, IN CLASS 35 (U.S. CLS. 100, 101 AND 102).

SERVICE MARK

FIRST USE 6-1-2005; IN COMMERCE 7-18-2006.

PRINCIPAL REGISTER

THE MARK CONSISTS OF STANDARD CHARACTERS WITHOUT CLAIM TO ANY PARTICULAR FONT, STYLE, SIZE, OR COLOR.

THE NON-LATIN CHARACTERS IN THE MARK TRANSLITERATE TO LOS RAKAS AND THIS MEANS THE GHETTO BOYS IN ENGLISH.

SER. NO. 85-404,320, FILED 8-23-2011.

JANICE KIM, EXAMINING ATTORNEY



David J. Kyffers

Director of the United States Patent and Trademark Office

United States of America

United States Patent and Trademark Office



TEXAS SOUTHERN UNIVERSITY

Reg. No. 4,108,912

TEXAS SOUTHERN UNIVERSITY (TEXAS STATE UNIVERSITY)
3100 CLEBURNE ST., HH310
HOUSTON, TX 77004

Registered Mar. 6, 2012

Int. Cl.: 41

FOR: EDUCATION SERVICES IN THE NATURE OF COURSES AT THE UNIVERSITY LEVEL, IN CLASS 41 (U.S. CLS. 100, 101 AND 107).

SERVICE MARK

FIRST USE 1-1-1991; IN COMMERCE 1-1-1991.

PRINCIPAL REGISTER

NO CLAIM IS MADE TO THE EXCLUSIVE RIGHT TO USE "TEXAS" AND "UNIVERSITY", APART FROM THE MARK AS SHOWN.

THE MARK CONSISTS OF THE LETTERS "TSU" ENCLOSED WITHIN TWO LINED RECTANGULAR BORDERS ABOVE THE WORDS "TEXAS SOUTHERN UNIVERSITY".

SER. NO. 85-405,121, FILED 8-23-2011.

DAVID ELTON, EXAMINING ATTORNEY



David J. Kybas

Director of the United States Patent and Trademark Office

United States of America

United States Patent and Trademark Office

AMORETTI

Reg. No. 4,108,913

Registered Mar. 6, 2012

Int. Cls.: 29 and 32

TRADEMARK

PRINCIPAL REGISTER

JAMARA LICENSING, LLC (NEVADA LIMITED LIABILITY COMPANY)
SUITE 259
4936 VERDUGO WAY
CAMARILLO, CA 93012

FOR: OLIVE OIL, IN CLASS 29 (U.S. CL. 46).

FIRST USE 3-15-2009; IN COMMERCE 4-17-2009.

FOR: FLAVORED NON-ALCOHOLIC MIXES USED IN THE PREPARATION OF NON-ALCOHOLIC AND ALCOHOLIC BEVERAGES, IN CLASS 32 (U.S. CLS. 45, 46 AND 48).

FIRST USE 8-2-2010; IN COMMERCE 8-2-2010.

THE MARK CONSISTS OF STANDARD CHARACTERS WITHOUT CLAIM TO ANY PARTICULAR FONT, STYLE, SIZE, OR COLOR.

OWNER OF U.S. REG. NOS. 1,659,954, 2,586,461 AND OTHERS.

THE ENGLISH TRANSLATION OF "AMORETTI" IN THE MARK IS "LITTLE LOVE".

SER. NO. 85-407,885, FILED 8-25-2011.

DAWN FELDMAN, EXAMINING ATTORNEY



David J. Kyffers

Director of the United States Patent and Trademark Office

United States of America

United States Patent and Trademark Office

VELOCITY

Reg. No. 4,108,914

Registered Mar. 6, 2012

Int. Cl.: 42

SERVICE MARK

PRINCIPAL REGISTER

VELOCITY PHARMACEUTICAL DEVELOPMENT, LLC (DELAWARE LIMITED LIABILITY COMPANY)
SUITE 202
400 OYSTER POINT BOULEVARD
SOUTH SAN FRANCISCO, CA 94080

FOR: PRODUCT RESEARCH AND DEVELOPMENT IN THE FIELD OF DRUG AND PHARMACEUTICAL DEVELOPMENT, IN CLASS 42 (U.S. CLS. 100 AND 101).

FIRST USE 8-15-2011; IN COMMERCE 8-15-2011.

THE MARK CONSISTS OF STANDARD CHARACTERS WITHOUT CLAIM TO ANY PARTICULAR FONT, STYLE, SIZE, OR COLOR.

SER. NO. 85-408,510, FILED 8-26-2011.

RONALD DELGIZZI, EXAMINING ATTORNEY



David J. Kyros

Director of the United States Patent and Trademark Office

United States of America

United States Patent and Trademark Office

VELOCITY PHARMACEUTICAL DEVELOPMENT

Reg. No. 4,108,915

Registered Mar. 6, 2012

Int. Cl.: 42

SERVICE MARK

PRINCIPAL REGISTER

VELOCITY PHARMACEUTICAL DEVELOPMENT, LLC (DELAWARE LIMITED LIABILITY COMPANY)
SUITE 202
400 OYSTER POINT BOULEVARD
SOUTH SAN FRANCISCO, CA 94080

FOR: PRODUCT RESEARCH AND DEVELOPMENT IN THE FIELD OF DRUG AND PHARMACEUTICAL DEVELOPMENT, IN CLASS 42 (U.S. CLS. 100 AND 101).

FIRST USE 8-15-2011; IN COMMERCE 8-15-2011.

THE MARK CONSISTS OF STANDARD CHARACTERS WITHOUT CLAIM TO ANY PARTICULAR FONT, STYLE, SIZE, OR COLOR.

NO CLAIM IS MADE TO THE EXCLUSIVE RIGHT TO USE "PHARMACEUTICAL DEVELOPMENT", APART FROM THE MARK AS SHOWN.

SER. NO. 85-408,518, FILED 8-26-2011.

RONALD DELGIZZI, EXAMINING ATTORNEY



David J. Kyffers

Director of the United States Patent and Trademark Office

United States of America

United States Patent and Trademark Office

Amoretti

Reg. No. 4,108,916

Registered Mar. 6, 2012

Int. Cls.: 29 and 32

TRADEMARK

PRINCIPAL REGISTER

JAMARA LICENSING, LLC (NEVADA LIMITED LIABILITY COMPANY)
SUITE 259
4936 VERDUGO WAY
CAMARILLO, CA 93012

FOR: OLIVE OIL, IN CLASS 29 (U.S. CL. 46).

FIRST USE 3-15-2009; IN COMMERCE 4-17-2009.

FOR: FLAVORED NON-ALCOHOLIC MIXES USED IN THE PREPARATION OF NON-ALCOHOLIC AND ALCOHOLIC BEVERAGES, IN CLASS 32 (U.S. CLS. 45, 46 AND 48).

FIRST USE 8-2-2010; IN COMMERCE 8-2-2010.

OWNER OF U.S. REG. NOS. 1,659,954, 2,586,461 AND OTHERS.

THE MARK CONSISTS OF "AMORETTI" IN STYLIZED FORM.

THE ENGLISH TRANSLATION OF "AMORETTI" IN THE MARK IS "LITTLE LOVE".

SER. NO. 85-409,040, FILED 8-27-2011.

DAWN FELDMAN, EXAMINING ATTORNEY



David J. Kybas

Director of the United States Patent and Trademark Office

United States of America

United States Patent and Trademark Office

THE FAMILY CREWS

Reg. No. 4,108,917

Registered Mar. 6, 2012

Int. Cl.: 41

SERVICE MARK

PRINCIPAL REGISTER

BLACK ENTERTAINMENT TELEVISION LLC (D.C. LIMITED LIABILITY COMPANY),
DBA BET
BUSINESS & LEGAL AFFAIRS
ONE BET PLAZA, 1235 W STREET, N.E.
WASHINGTON, DC 20018

FOR: ENTERTAINMENT IN THE NATURE OF ON-GOING TELEVISION PROGRAMS IN
THE FIELD OF REALITY VIA TELEVISION, CABLE, WIRELESS, SATELLITE AND THE
INTERNET, IN CLASS 41 (U.S. CLS. 100, 101 AND 107).

FIRST USE 2-15-2010; IN COMMERCE 2-15-2010.

THE MARK CONSISTS OF STANDARD CHARACTERS WITHOUT CLAIM TO ANY PAR-
TICULAR FONT, STYLE, SIZE, OR COLOR.

SER. NO. 85-409,212, FILED 8-29-2011.

HANNO RITTNER, EXAMINING ATTORNEY



David J. Kyffers

Director of the United States Patent and Trademark Office

United States of America

United States Patent and Trademark Office

WHEN IT COUNTS

Reg. No. 4,108,918

SIG SAUER INC. (DELAWARE CORPORATION)
18 INDUSTRIAL AVENUE
EXETER, NH 03833

Registered Mar. 6, 2012

Int. Cl.: 13

FOR: FIREARMS, IN CLASS 13 (U.S. CLS. 2 AND 9).

TRADEMARK

FIRST USE 12-31-2010; IN COMMERCE 12-31-2010.

PRINCIPAL REGISTER

THE MARK CONSISTS OF STANDARD CHARACTERS WITHOUT CLAIM TO ANY PARTICULAR FONT, STYLE, SIZE, OR COLOR.

SER. NO. 85-409,260, FILED 8-29-2011.

KRISTINA MORRIS, EXAMINING ATTORNEY



David J. Kyffers

Director of the United States Patent and Trademark Office

United States of America

United States Patent and Trademark Office

Little Lilly

Reg. No. 4,108,919

Registered Mar. 6, 2012

Int. Cl.: 25

TRADEMARK

PRINCIPAL REGISTER

SUGARTOWN WORLDWIDE LLC (DELAWARE LIMITED LIABILITY COMPANY)
222 PIEDMONT AVE., NE
ATLANTA, GA 30308

FOR: DRESSES, IN CLASS 25 (U.S. CLS. 22 AND 39).

FIRST USE 10-1-1995; IN COMMERCE 10-1-1995.

THE MARK CONSISTS OF STANDARD CHARACTERS WITHOUT CLAIM TO ANY PARTICULAR FONT, STYLE, SIZE, OR COLOR.

OWNER OF U.S. REG. NO. 3,931,627.

SER. NO. 85-409,755, FILED 8-29-2011.

GEORGE LORENZO, EXAMINING ATTORNEY



David J. Kybas

Director of the United States Patent and Trademark Office

United States of America

United States Patent and Trademark Office

BAYOU

Reg. No. 4,108,920

Registered Mar. 6, 2012

Int. Cls.: 11 and 21

TRADEMARK

PRINCIPAL REGISTER

BARBOUR INTERNATIONAL, INC. (MICHIGAN CORPORATION)
101 CYPRESS WAY
BRANDON, MS 39042

FOR: DEEP FAT FRYERS, IN CLASS 11 (U.S. CLS. 13, 21, 23, 31 AND 34).

FIRST USE 4-0-1994; IN COMMERCE 4-0-1994.

FOR: NON-ELECTRIC DEEP FRYERS; DOUBLE BOILERS; NON-ELECTRIC PRESSURE COOKERS; CAST IRON COOKWARE, NAMELY, POTS AND PANS; STIRRING AND SERVING SPOONS AND FRYING AND SERVING FORKS, IN CLASS 21 (U.S. CLS. 2, 13, 23, 29, 30, 33, 40 AND 50).

FIRST USE 5-0-2000; IN COMMERCE 5-0-2011.

THE MARK CONSISTS OF STANDARD CHARACTERS WITHOUT CLAIM TO ANY PARTICULAR FONT, STYLE, SIZE, OR COLOR.

OWNER OF U.S. REG. NOS. 1,898,816, 2,783,084 AND OTHERS.

SER. NO. 85-415,867, FILED 9-6-2011.

SUSAN LESLIE DUBOIS, EXAMINING ATTORNEY



David J. Kybas

Director of the United States Patent and Trademark Office

United States of America

United States Patent and Trademark Office

QX

Reg. No. 4,108,921

Registered Mar. 6, 2012

Int. Cl.: 12

TRADEMARK

PRINCIPAL REGISTER

NISSAN JIDOSHA KABUSHIKI KAISHA (JAPAN CORPORATION), TA NISSAN MOTOR CO., LTD.
NO. 2 TAKARACHO, KANAGAWA-KU
YOKOHAMA-SHI, KANAGAWA, JAPAN 2208623

FOR: MOTOR VEHICLES, NAMELY, AUTOMOBILES AND STRUCTURAL PARTS THEREFOR, IN CLASS 12 (U.S. CLS. 19, 21, 23, 31, 35 AND 44).

FIRST USE 11-30-1996; IN COMMERCE 11-30-1996.

THE MARK CONSISTS OF STANDARD CHARACTERS WITHOUT CLAIM TO ANY PARTICULAR FONT, STYLE, SIZE, OR COLOR.

SER. NO. 85-416,389, FILED 9-7-2011.

CAROLYN CATALDO, EXAMINING ATTORNEY



David J. Kyffers

Director of the United States Patent and Trademark Office

United States of America

United States Patent and Trademark Office

GA GA GRAPE

Reg. No. 4,108,922

SAVORY FOODS, INC. (MICHIGAN CORPORATION)
900 HYNES AVENUE SW
GRAND RAPIDS, MI 49501

Registered Mar. 6, 2012

Int. Cl.: 30

FOR: COOKIE DOUGH, IN CLASS 30 (U.S. CL. 46).

TRADEMARK

FIRST USE 8-15-2011; IN COMMERCE 8-15-2011.

PRINCIPAL REGISTER

THE MARK CONSISTS OF STANDARD CHARACTERS WITHOUT CLAIM TO ANY PARTICULAR FONT, STYLE, SIZE, OR COLOR.

NO CLAIM IS MADE TO THE EXCLUSIVE RIGHT TO USE "GRAPE", APART FROM THE MARK AS SHOWN.

SER. NO. 85-420,125, FILED 9-12-2011.

MICHAEL ENGEL, EXAMINING ATTORNEY



David J. Kybas

Director of the United States Patent and Trademark Office

United States of America

United States Patent and Trademark Office

BUBBLE LUEY

Reg. No. 4,108,923

SAVORY FOODS, INC. (MICHIGAN CORPORATION)
900 HYNES AVENUE SW
GRAND RAPIDS, MI 49501

Registered Mar. 6, 2012

Int. Cl.: 30

FOR: COOKIE DOUGH, IN CLASS 30 (U.S. CL. 46).

TRADEMARK

FIRST USE 8-15-2011; IN COMMERCE 8-15-2011.

PRINCIPAL REGISTER

THE MARK CONSISTS OF STANDARD CHARACTERS WITHOUT CLAIM TO ANY PARTICULAR FONT, STYLE, SIZE, OR COLOR.

NO CLAIM IS MADE TO THE EXCLUSIVE RIGHT TO USE "BUBBLE", APART FROM THE MARK AS SHOWN.

SER. NO. 85-420,177, FILED 9-12-2011.

MICHAEL ENGEL, EXAMINING ATTORNEY



David J. Kyjars

Director of the United States Patent and Trademark Office

United States of America

United States Patent and Trademark Office

GATOR

Reg. No. 4,108,924

Registered Mar. 6, 2012

Int. Cl.: 12

TRADEMARK

PRINCIPAL REGISTER

GREENBALL CORPORATION (CALIFORNIA CORPORATION)
222 S. HARBOR BOULEVARD, SUITE 700
ANAHEIM, CA 92805

FOR: TIRES, IN CLASS 12 (U.S. CLS. 19, 21, 23, 31, 35 AND 44).

FIRST USE 5-16-2001; IN COMMERCE 5-16-2001.

THE MARK CONSISTS OF STANDARD CHARACTERS WITHOUT CLAIM TO ANY PARTICULAR FONT, STYLE, SIZE, OR COLOR.

OWNER OF U.S. REG. NO. 2,985,054.

SER. NO. 85-420,231, FILED 9-12-2011.

BENJAMIN OKEKE, EXAMINING ATTORNEY



David J. Kyffers

Director of the United States Patent and Trademark Office

United States of America

United States Patent and Trademark Office



Reg. No. 4,108,925

Registered Mar. 6, 2012

**COLLECTIVE
MEMBERSHIP**

PRINCIPAL REGISTER

THE INTERNATIONAL BROTHERHOOD OF MAGICIANS (MISSOURI NON-PROFIT CORPORATION)
13 POINT WEST BLVD.
ST. CHARLES, MO 633014431

FOR: INDICATING MEMBERSHIP IN AN ORGANIZATION OF MAGICIANS, IN CLASS 200 (U.S. CL. 200).

FIRST USE 5-0-1922; IN COMMERCE 6-4-1935.

THE MARK CONSISTS OF A CIRCULAR SEAL DESIGN WITH THE WORDS "THE INTERNATIONAL BROTHERHOOD OF MAGICIANS" ARRANGED IN A CIRCLE WITHIN THE SEAL DESIGN AND ENCIRCLING A DEPICTION OF TWO HANDS SHAKING, A REPRESENTATION OF HERMES HOLDING THE CADUCEUS, AND AN OAK LEAF WITH TWO ACORNS AND THE LETTERS "IBM" SUPERIMPOSED OVER A GLOBE SHOWING LONGITUDE AND LATITUDE LINES.

SEC. 2(F) AS TO "THE INTERNATIONAL BROTHERHOOD OF MAGICIANS".

SER. NO. 85-421,753, FILED 9-13-2011.

LUCY ARANT, EXAMINING ATTORNEY



David J. Kybas

Director of the United States Patent and Trademark Office

United States of America

United States Patent and Trademark Office

TOUCHY

Reg. No. 4,108,926

DOAT MEDIA LTD. (ISRAEL LIMITED COMPANY (LTD.))
2 HALAMED HEY ST.
GIVATAIM, ISRAEL 53631

Registered Mar. 6, 2012

Int. Cl.: 9

FOR: COMPUTER SOFTWARE, NAMELY, SOFTWARE DEVELOPMENT TOOLS FOR THE CREATION OF MOBILE INTERNET APPLICATIONS, IN CLASS 9 (U.S. CLS. 21, 23, 26, 36 AND 38).

TRADEMARK

FIRST USE 9-10-2011; IN COMMERCE 9-10-2011.

PRINCIPAL REGISTER

THE MARK CONSISTS OF STANDARD CHARACTERS WITHOUT CLAIM TO ANY PARTICULAR FONT, STYLE, SIZE, OR COLOR.

SER. NO. 85-423,722, FILED 9-15-2011.

WILLIAM BRECKENFELD, EXAMINING ATTORNEY



David J. Kybas

Director of the United States Patent and Trademark Office

United States of America

United States Patent and Trademark Office



Reg. No. 4,108,927

Registered Mar. 6, 2012

Int. Cls.: 29 and 30

TRADEMARK

PRINCIPAL REGISTER

H. J. HEINZ COMPANY (PENNSYLVANIA CORPORATION)
ONE PPG PLACE SUITE 3100
PITTSBURGH, PA 15222

FOR: BAKED BEANS, IN CLASS 29 (U.S. CL. 46).

FIRST USE 8-15-2011; IN COMMERCE 8-15-2011.

FOR: GRAVY, IN CLASS 30 (U.S. CL. 46).

FIRST USE 9-1-2006; IN COMMERCE 9-1-2006.

OWNER OF U.S. REG. NOS. 221,041, 3,959,631 AND OTHERS.

THE MARK CONSISTS OF A KEYSTONE DEVICE.

SER. NO. 85-426,630, FILED 9-20-2011.

HEATHER THOMPSON, EXAMINING ATTORNEY



David J. Kybas

Director of the United States Patent and Trademark Office

United States of America

United States Patent and Trademark Office

SOUTHBAYBUILT.COM

Reg. No. 4,108,928

PETRASEK, KEVIN (UNITED STATES INDIVIDUAL)

Registered Mar. 6, 2012

P.O. BOX 2121
EL SEGUNDO, CA 90245

Int. Cl.: 35

FOR: ON-LINE RETAIL STORE SERVICES FEATURING SHIRTS, SHORTS, HATS, JACKETS, SANDALS, SUNGLASSES, AND SWEATSHIRTS, IN CLASS 35 (U.S. CLS. 100, 101 AND 102).

SERVICE MARK

FIRST USE 2-18-2011; IN COMMERCE 2-18-2011.

PRINCIPAL REGISTER

THE MARK CONSISTS OF STANDARD CHARACTERS WITHOUT CLAIM TO ANY PARTICULAR FONT, STYLE, SIZE, OR COLOR.

SER. NO. 85-426,876, FILED 9-20-2011.

KATHERINE CONNOLLY, EXAMINING ATTORNEY



David J. Kybas

Director of the United States Patent and Trademark Office

United States of America

United States Patent and Trademark Office

O-THORITY

Reg. No. 4,108,929

Registered Mar. 6, 2012

Int. Cl.: 44

SERVICE MARK

PRINCIPAL REGISTER

OJON CORPORATION (DELAWARE CORPORATION)
767 FIFTH AVENUE
NEW YORK, NY 10153

FOR: BEAUTY CONSULTATION SERVICES, IN CLASS 44 (U.S. CLS. 100 AND 101).

FIRST USE 3-31-2011; IN COMMERCE 3-31-2011.

THE MARK CONSISTS OF STANDARD CHARACTERS WITHOUT CLAIM TO ANY PARTICULAR FONT, STYLE, SIZE, OR COLOR.

SER. NO. 85-427,042, FILED 9-20-2011.

LAURA KOVALSKY, EXAMINING ATTORNEY



David J. Kybas

Director of the United States Patent and Trademark Office

United States of America

United States Patent and Trademark Office

ORDERMYCHECKS.COM

Reg. No. 4,108,930

HARLAND CLARKE CORP. (DELAWARE CORPORATION)
10931 LAUREATE DRIVE
SAN ANTONIO, TX 78249

Registered Mar. 6, 2012

Int. Cl.: 16

FOR: ADDRESS LABELS; ADDRESS STAMPS; BANK CHECKS; CHECK BOOK COVERS,
IN CLASS 16 (U.S. CLS. 2, 5, 22, 23, 29, 37, 38 AND 50).

TRADEMARK

FIRST USE 4-30-2010; IN COMMERCE 4-30-2010.

PRINCIPAL REGISTER

THE MARK CONSISTS OF STANDARD CHARACTERS WITHOUT CLAIM TO ANY PAR-
TICULAR FONT, STYLE, SIZE, OR COLOR.

SER. NO. 85-427,589, FILED 9-20-2011.

EMILY CARLSEN, EXAMINING ATTORNEY



David J. Kybas

Director of the United States Patent and Trademark Office

United States of America

United States Patent and Trademark Office

ISUTAMI

Reg. No. 4,108,931

Registered Mar. 6, 2012

Int. Cl.: 7

CHINA HANGZHOU SUTAMI INDUSTRY TECHNOLOGY CO., LTD. (CHINA LIMITED COMPANY (LTD.))
ROOM D, 10TH ECOMMERCE BUILDING
NO. 118 WEST WENSAN ROAD, HANGZHOU CITY
ZHEJIANG PROVINCE, CHINA

TRADEMARK

PRINCIPAL REGISTER

FOR: AXLES FOR MACHINES; BEARINGS, AS PARTS OF MACHINES; BELTS FOR CONVEYORS; CONNECTING RODS FOR MACHINES, MOTORS AND ENGINES; ENGINE BEARINGS; MACHINE PARTS, NAMELY, BEARING HOUSINGS; MACHINE PARTS, NAMELY, BEARING INSERTS; MACHINE PARTS, NAMELY, BEARINGS AND BUSHINGS; MACHINE PARTS, NAMELY, ROLL MILL BEARINGS; MACHINE PARTS, NAMELY, ROLLER BEARINGS, IN CLASS 7 (U.S. CLS. 13, 19, 21, 23, 31, 34 AND 35).

FIRST USE 5-1-2010; IN COMMERCE 8-1-2010.

THE MARK CONSISTS OF THE STYLIZED WORD "ISUTAMI".

THE WORDING "ISUTAMI" HAS NO MEANING IN A FOREIGN LANGUAGE.

SER. NO. 85-427,766, FILED 9-21-2011.

APRIL HESIK, EXAMINING ATTORNEY



David J. Kyfos

Director of the United States Patent and Trademark Office

United States of America

United States Patent and Trademark Office

RIGHT THE FIRST TIME, ON
TIME.

Reg. No. 4,108,932

Registered Mar. 6, 2012

Int. Cl.: 37

SERVICE MARK

PRINCIPAL REGISTER

ABRA AUTOMOTIVE SYSTEMS, INC. (MINNESOTA CORPORATION), AKA ABRA AUTO
BODY & GLASS
6601 SHINGLE CREEK PARKWAY
BROOKLYN CENTER, MN 55430

FOR: VEHICLE BODY REPAIR, MAINTENANCE, REFINISHING AND PAINTING SERVICES;
AUTO GLASS REPAIR AND INSTALLATION, IN CLASS 37 (U.S. CLS. 100, 103 AND 106).

FIRST USE 9-1-2000; IN COMMERCE 9-1-2000.

THE MARK CONSISTS OF STANDARD CHARACTERS WITHOUT CLAIM TO ANY PAR-
TICULAR FONT, STYLE, SIZE, OR COLOR.

SER. NO. 85-428,358, FILED 9-21-2011.

LINDA M. KING, EXAMINING ATTORNEY



David J. Kyffers

Director of the United States Patent and Trademark Office

United States of America

United States Patent and Trademark Office

Forest Fines

Reg. No. 4,108,933

Registered Mar. 6, 2012

Int. Cl.: 1

TRADEMARK

PRINCIPAL REGISTER

AGRI SERVICE, INC. (CALIFORNIA CORPORATION)
203
380 S MELROSE DR.
VISTA, CA 92081

FOR: GROUND BRUSH MULCH MADE FROM RECYCLED LANDSCAPE TRIMMINGS, IN CLASS 1 (U.S. CLS. 1, 5, 6, 10, 26 AND 46).

FIRST USE 1-1-1996; IN COMMERCE 1-1-1996.

THE MARK CONSISTS OF STANDARD CHARACTERS WITHOUT CLAIM TO ANY PARTICULAR FONT, STYLE, SIZE, OR COLOR.

SER. NO. 85-428,506, FILED 9-21-2011.

JACQUELINE A. LAVINE, EXAMINING ATTORNEY



David J. Kybas

Director of the United States Patent and Trademark Office

United States of America

United States Patent and Trademark Office

LIFE FITNESS

Reg. No. 4,108,934

Registered Mar. 6, 2012

Int. Cl.: 14

TRADEMARK

PRINCIPAL REGISTER

BRUNSWICK CORPORATION (DELAWARE CORPORATION)
1 N. FIELD COURT
LAKE FOREST, IL 60045

FOR: WATCHES, IN CLASS 14 (U.S. CLS. 2, 27, 28 AND 50).

FIRST USE 6-30-2007; IN COMMERCE 6-30-2007.

THE MARK CONSISTS OF STANDARD CHARACTERS WITHOUT CLAIM TO ANY PARTICULAR FONT, STYLE, SIZE, OR COLOR.

OWNER OF U.S. REG. NOS. 1,525,954, 1,966,143 AND OTHERS.

SER. NO. 85-428,970, FILED 9-22-2011.

JESSICA FATHY, EXAMINING ATTORNEY



David J. Kyffers

Director of the United States Patent and Trademark Office

United States of America

United States Patent and Trademark Office

CHRONIC TONIC

Reg. No. 4,108,935

Registered Mar. 6, 2012

Int. Cl.: 5

TRADEMARK

PRINCIPAL REGISTER

SAM BROWN SALES COMPANY (MICHIGAN CORPORATION)
19270 WEST EIGHT MILE ROAD
SOUTHFIELD, MI 48075

FOR: AIR FRESHENER SPRAYS, IN CLASS 5 (U.S. CLS. 6, 18, 44, 46, 51 AND 52).

FIRST USE 9-8-2011; IN COMMERCE 9-8-2011.

THE MARK CONSISTS OF STANDARD CHARACTERS WITHOUT CLAIM TO ANY PARTICULAR FONT, STYLE, SIZE, OR COLOR.

SER. NO. 85-429,258, FILED 9-22-2011.

DAVID C. REIHNER, EXAMINING ATTORNEY



David J. Kybas

Director of the United States Patent and Trademark Office

United States of America

United States Patent and Trademark Office

I-BUILDINGSOLUTIONS.COM

Reg. No. 4,108,936

Registered Mar. 6, 2012

Int. Cl.: 42

INTELLIGENT BUILDING SOLUTIONS, LLC (NEW JERSEY LIMITED LIABILITY COMPANY)
SUITE 200
409 MINNISINK ROAD
TOTOWA, NJ 07512

SERVICE MARK

FOR: CONSULTING IN THE FIELDS OF ENGINEERING AND ARCHITECTURE; CONSULTING SERVICES IN THE FIELD OF DESIGN AND DEVELOPMENT OF ENGINEERING PROCESSES, IN CLASS 42 (U.S. CLS. 100 AND 101).

PRINCIPAL REGISTER

FIRST USE 12-0-2009; IN COMMERCE 2-0-2010.

THE MARK CONSISTS OF STANDARD CHARACTERS WITHOUT CLAIM TO ANY PARTICULAR FONT, STYLE, SIZE, OR COLOR.

SER. NO. 85-432,604, FILED 9-27-2011.

JENNY PARK, EXAMINING ATTORNEY



David J. Kybas

Director of the United States Patent and Trademark Office

United States of America
United States Patent and Trademark Office



Reg. No. 4,108,937

Registered Mar. 6, 2012

Int. Cl.: 41

SERVICE MARK

PRINCIPAL REGISTER

SEMINOLE TRIBE OF FLORIDA (UNITED STATES FEDERALLY-RECOGNIZED INDIAN TRIBE)
6300 STIRLING ROAD
HOLLYWOOD, FL 33024

FOR: ENTERTAINMENT SERVICES IN THE NATURE OF LIVE MUSICAL PERFORMANCES AND COMEDY SHOWS, AT CASINO-COMPLEX PROPERTIES, IN CLASS 41 (U.S. CLS. 100, 101 AND 107).

FIRST USE 6-19-2008; IN COMMERCE 6-19-2008.

NO CLAIM IS MADE TO THE EXCLUSIVE RIGHT TO USE "LIVE", APART FROM THE MARK AS SHOWN.

THE MARK CONSISTS OF THE WORDS "PARADISE LIVE" OVER THE SILHOUETTE OF HALF OF A GUITAR.

SER. NO. 85-432,894, FILED 9-27-2011.

KATHLEEN M. VANSTON, EXAMINING ATTORNEY



David J. Kyffers

Director of the United States Patent and Trademark Office

United States of America

United States Patent and Trademark Office

MARATHON

Reg. No. 4,108,938

DEPUY, INC. (DELAWARE CORPORATION)
700 ORTHOPAEDIC DRIVE
WARSAW, IN 46581

Registered Mar. 6, 2012

Int. Cl.: 10

FOR: ORTHOPAEDIC IMPLANTS MADE OF ARTIFICIAL MATERIALS; LINERS FOR ARTIFICIAL JOINTS, IN CLASS 10 (U.S. CLS. 26, 39 AND 44).

TRADEMARK

FIRST USE 0-0-2000; IN COMMERCE 0-0-2000.

PRINCIPAL REGISTER

THE MARK CONSISTS OF STANDARD CHARACTERS WITHOUT CLAIM TO ANY PARTICULAR FONT, STYLE, SIZE, OR COLOR.

SER. NO. 85-432,999, FILED 9-27-2011.

DAVID TAYLOR, EXAMINING ATTORNEY



David J. Kybas

Director of the United States Patent and Trademark Office

United States of America

United States Patent and Trademark Office

NOT-ONLY-FOR-PROFIT

Reg. No. 4,108,939

Registered Mar. 6, 2012

Int. Cl.: 29

TRADEMARK

PRINCIPAL REGISTER

KIND, LLC (DELAWARE LIMITED LIABILITY COMPANY)
P.O. BOX 705
MIDTOWN STATION
NEW YORK, NY 10018

FOR: HEALTHY SNACKS, NAMELY, FOOD BARS COMPRISED PRIMARILY OF NUTS, FRUITS AND NUTS, AND ALSO CONTAINING OTHER INGREDIENTS, IN CLASS 29 (U.S. CL. 46).

FIRST USE 1-1-2005; IN COMMERCE 7-4-2011.

THE MARK CONSISTS OF STANDARD CHARACTERS WITHOUT CLAIM TO ANY PARTICULAR FONT, STYLE, SIZE, OR COLOR.

SER. NO. 85-433,677, FILED S.R. 9-28-2011 AM. P.R. 10-21-2011.

JUSTINE D. PARKER, EXAMINING ATTORNEY



David J. Kybas

Director of the United States Patent and Trademark Office

United States of America

United States Patent and Trademark Office



Reg. No. 4,108,940

Registered Mar. 6, 2012

Int. Cls.: 25 and 41

TRADEMARK

SERVICE MARK

PRINCIPAL REGISTER

GREATER CLEVELAND SPORTS COMMISSION (OHIO CORPORATION)
SUITE 100
334 EUCLID AVENUE
CLEVELAND, OH 44114

FOR: T-SHIRTS, POLO SHIRTS, IN CLASS 25 (U.S. CLS. 22 AND 39).

FIRST USE 6-15-2011; IN COMMERCE 6-15-2011.

FOR: ENTERTAINMENT SERVICES, NAMELY, ORGANIZING AND CONDUCTING SPORTS COMPETITIONS FOR SENIOR CITIZENS, IN CLASS 41 (U.S. CLS. 100, 101 AND 107).

FIRST USE 6-15-2011; IN COMMERCE 6-15-2011.

NO CLAIM IS MADE TO THE EXCLUSIVE RIGHT TO USE "SUMMER NATIONAL SENIOR GAMES CLEVELAND, OHIO * 2013", APART FROM THE MARK AS SHOWN.

THE MARK CONSISTS OF THE STYLIZED WORDING "SUMMER NATIONAL SENIOR GAMES CLEVELAND, OHIO * 2013" SUPERIMPOSED OVER A DESIGN ELEMENT COMPRISED OF A STYLIZED DEPICTION OF A TORCH WITH A STYLIZED DEPICTION OF A GUITAR NECK FORMING THE HANDLE OF THE TORCH, WITH A FIVE-POINTED STAR CONTAINED WITHIN THE FLAME OF THE TORCH.

SER. NO. 85-434,934, FILED 9-29-2011.

MICHAEL GAAFAR, EXAMINING ATTORNEY



David J. Kybas

Director of the United States Patent and Trademark Office

United States of America

United States Patent and Trademark Office

Party Prints

Reg. No. 4,108,941

LINDSEY, ELEANOR (UNITED STATES INDIVIDUAL)
7020 E. RIDGE DRIVE
SHERWOOD, AR 72120

Registered Mar. 6, 2012

Int. Cl.: 25

FOR: CLOTHING DECORATION KITS COMPRISING SHIRTS, PAINT, AND INSTRUCTIONS SOLD AS A UNIT THEREWITH, IN CLASS 25 (U.S. CLS. 22 AND 39).

TRADEMARK

FIRST USE 7-28-2000; IN COMMERCE 8-15-2000.

PRINCIPAL REGISTER

THE MARK CONSISTS OF STANDARD CHARACTERS WITHOUT CLAIM TO ANY PARTICULAR FONT, STYLE, SIZE, OR COLOR.

NO CLAIM IS MADE TO THE EXCLUSIVE RIGHT TO USE "PRINTS", APART FROM THE MARK AS SHOWN.

SER. NO. 85-435,956, FILED 9-30-2011.

KAPIL BHANOT, EXAMINING ATTORNEY



David J. Kybas

Director of the United States Patent and Trademark Office

United States of America
United States Patent and Trademark Office

Helix

Reg. No. 4,108,942

PERCEPTRON, INC. (MICHIGAN CORPORATION)
47827 HALYARD DRIVE
PLYMOUTH, MI 48170

Registered Mar. 6, 2012

Int. Cl.: 9

FOR: OPTICAL INSPECTION APPARATUS; COMPUTER SOFTWARE AND HARDWARE
FOR USE WITH OPTICAL INSPECTION APPARATUS, IN CLASS 9 (U.S. CLS. 21, 23, 26, 36
AND 38).

TRADEMARK

FIRST USE 3-0-2011; IN COMMERCE 3-0-2011.

PRINCIPAL REGISTER

THE MARK CONSISTS OF THE WORD "HELIX" WITH A CURVED LINE BELOW AND A
SERIES OF SMALL LINES OVER THE LETTER "X".

SER. NO. 85-436,668, FILED 9-30-2011.

DEIRDRE ROBERTSON, EXAMINING ATTORNEY



David J. Kyffers

Director of the United States Patent and Trademark Office

United States of America

United States Patent and Trademark Office

RIBOLI FAMILY

Reg. No. 4,108,943

Registered Mar. 6, 2012

Int. Cl.: 33

TRADEMARK

PRINCIPAL REGISTER

SAN ANTONIO WINERY, INC. (CALIFORNIA CORPORATION)
737 LAMAR STREET
LOS ANGELES, CA 90031

FOR: WINE, IN CLASS 33 (U.S. CLS. 47 AND 49).

FIRST USE 1-8-1998; IN COMMERCE 1-8-1998.

THE MARK CONSISTS OF STANDARD CHARACTERS WITHOUT CLAIM TO ANY PARTICULAR FONT, STYLE, SIZE, OR COLOR.

SER. NO. 85-436,884, FILED 9-30-2011.

JILL C. ALT, EXAMINING ATTORNEY



David J. Kybas

Director of the United States Patent and Trademark Office

United States of America

United States Patent and Trademark Office

SANTO STEFANO

Reg. No. 4,108,944

SAN ANTONIO WINERY, INC. (CALIFORNIA CORPORATION)
737 LAMAR STREET
LOS ANGELES, CA 90031

Registered Mar. 6, 2012

Int. Cl.: 33

FOR: WINE, IN CLASS 33 (U.S. CLS. 47 AND 49).

TRADEMARK

FIRST USE 10-0-1999; IN COMMERCE 10-0-1999.

PRINCIPAL REGISTER

THE MARK CONSISTS OF STANDARD CHARACTERS WITHOUT CLAIM TO ANY PARTICULAR FONT, STYLE, SIZE, OR COLOR.

OWNER OF U.S. REG. NO. 2,613,104.

THE ENGLISH TRANSLATION OF SANTO STEFANO IN THE MARK IS SAINT STEVEN.

SER. NO. 85-436,893, FILED 9-30-2011.

JILL C. ALT, EXAMINING ATTORNEY



David J. Kyros

Director of the United States Patent and Trademark Office

United States of America

United States Patent and Trademark Office

GLYCOPLEX

Reg. No. 4,108,945

PROGRESSIVE LABORATORIES, INC. (TEXAS CORPORATION)
1701 W. WALNUT HILL LANE
IRVING, TX 75038

Registered Mar. 6, 2012

Int. Cl.: 5

FOR: VITAMIN B COMPLEX DIETARY NUTRITIONAL SUPPLEMENT, IN CLASS 5 (U.S. CLS. 6, 18, 44, 46, 51 AND 52).

TRADEMARK

FIRST USE 7-31-1990; IN COMMERCE 8-31-1990.

PRINCIPAL REGISTER

THE MARK CONSISTS OF STANDARD CHARACTERS WITHOUT CLAIM TO ANY PARTICULAR FONT, STYLE, SIZE, OR COLOR.

SER. NO. 85-438,821, FILED 10-4-2011.

KRISTIN DAHLING, EXAMINING ATTORNEY



David J. Kybas

Director of the United States Patent and Trademark Office

United States of America

United States Patent and Trademark Office

GYNECRINE

Reg. No. 4,108,946

PROGRESSIVE LABORATORIES, INC. (TEXAS CORPORATION)
1701 W. WALNUT HILL LANE
IRVING, TX 75038

Registered Mar. 6, 2012

Int. Cl.: 5

FOR: DIETARY AND NUTRITIONAL SUPPLEMENTS; DIETARY SUPPLEMENTS; DIETARY SUPPLEMENTS FOR HUMAN CONSUMPTION; MINERAL SUPPLEMENTS; VITAMIN AND MINERAL SUPPLEMENTS; VITAMIN SUPPLEMENTS, IN CLASS 5 (U.S. CLS. 6, 18, 44, 46, 51 AND 52).

TRADEMARK

PRINCIPAL REGISTER

FIRST USE 12-13-1997; IN COMMERCE 1-13-1998.

THE MARK CONSISTS OF STANDARD CHARACTERS WITHOUT CLAIM TO ANY PARTICULAR FONT, STYLE, SIZE, OR COLOR.

SER. NO. 85-438,943, FILED 10-4-2011.

KRISTIN DAHLING, EXAMINING ATTORNEY



David J. Kyros

Director of the United States Patent and Trademark Office

United States of America

United States Patent and Trademark Office



Reg. No. 4,108,947

Registered Mar. 6, 2012

Int. Cl.: 16

TRADEMARK

PRINCIPAL REGISTER

GEORGIA-PACIFIC CONSUMER PRODUCTS LP (DELAWARE LIMITED PARTNERSHIP)
133 PEACHTREE ST, NE
ATLANTA, GA 30303

FOR: PAPER TOWELS, IN CLASS 16 (U.S. CLS. 2, 5, 22, 23, 29, 37, 38 AND 50).

FIRST USE 1-4-2011; IN COMMERCE 5-0-2011.

OWNER OF U.S. REG. NOS. 2,973,549, 3,873,565 AND OTHERS.

THE COLOR(S) BLACK, WHITE, GRAY, TAN AND RED IS/ARE CLAIMED AS A FEATURE OF THE MARK.

THE NAME(S), PORTRAIT(S), AND/OR SIGNATURE(S) SHOWN IN THE MARK DOES NOT IDENTIFY A PARTICULAR LIVING INDIVIDUAL.

THE MARK CONSISTS OF THE WORD BRAWNY IN BLACK LETTERS, SHADOWED IN WHITE AND SURROUNDED BY A GRAY SHIELD DESIGN. THERE IS A RED SHIELD BEHIND THE GRAY SHIELD. IN THE TOP PORTION OF THE RED SHIELD IS A SMILING TAN MAN WITH BLACK HAIR WEARING A RED AND BLACK PLAID SHIRT AND A GRAY UNDERSHIRT.

SER. NO. 85-440,846, FILED 10-6-2011.

KELLY BOULTON, EXAMINING ATTORNEY



David J. Kyffers

Director of the United States Patent and Trademark Office

United States of America

United States Patent and Trademark Office

THE MOST IMPORTANT LANGUAGE YOU WILL EVER LEARN

Reg. No. 4,108,948

Registered Mar. 6, 2012

Int. Cl.: 16

TRADEMARK

PRINCIPAL REGISTER

MOODY BIBLE INSTITUTE OF CHICAGO (ILLINOIS CORPORATION)
820 NORTH LASALLE BOULEVARD
CHICAGO, IL 60610

FOR: SERIES OF PUBLICATIONS, NAMELY, BOOKS, PAMPHLETS, BROCHURES AND PRINTED MATERIALS RELATED TO PERSONAL SKILLS AND RELATIONSHIPS , IN CLASS 16 (U.S. CLS. 2, 5, 22, 23, 29, 37, 38 AND 50).

FIRST USE 7-0-2011; IN COMMERCE 7-0-2011.

THE MARK CONSISTS OF STANDARD CHARACTERS WITHOUT CLAIM TO ANY PARTICULAR FONT, STYLE, SIZE, OR COLOR.

SER. NO. 85-441,284, FILED 10-6-2011.

FRANK LATTUCA, EXAMINING ATTORNEY



David J. Kybas

Director of the United States Patent and Trademark Office

United States of America

United States Patent and Trademark Office

Born to Eat

Reg. No. 4,108,949

Registered Mar. 6, 2012

Int. Cl.: 41

SERVICE MARK

PRINCIPAL REGISTER

SCHILLING NUTRITION THERAPY, LLC. (TENNESSEE LIMITED LIABILITY COMPANY)
5118 N. CHARLOTTE CIRCLE
MEMPHIS, TN 38117

FOR: EDUCATION SERVICES, NAMELY, PROVIDING LIVE AND ON-LINE CLASSES, SEMINARS, WORKSHOPS IN THE FIELD OF DISORDERED EATING AND NUTRITIONAL STRATEGIES.; PROVIDING A WEBSITE FEATURING BLOGS AND NON-DOWNLOADABLE PUBLICATIONS IN THE NATURE OF ARTICLES, NEWS, INTERVIEWS AND EDUCATIONAL MATERIALS IN THE FIELD(S) OF DISORDERED EATING AND NUTRITIONAL STRATEGIES, IN CLASS 41 (U.S. CLS. 100, 101 AND 107).

FIRST USE 10-1-2009; IN COMMERCE 10-1-2009.

THE MARK CONSISTS OF STANDARD CHARACTERS WITHOUT CLAIM TO ANY PARTICULAR FONT, STYLE, SIZE, OR COLOR.

SER. NO. 85-441,369, FILED 10-6-2011.

VIVIAN MICZNIK FIRST, EXAMINING ATTORNEY



David J. Kyros

Director of the United States Patent and Trademark Office

United States of America

United States Patent and Trademark Office

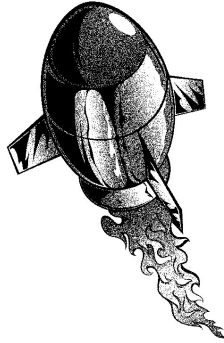

Reg. No. 4,108,950

Registered Mar. 6, 2012

Int. Cl.: 28

TRADEMARK

PRINCIPAL REGISTER

LIGHTUPTOYS.COM LLC (INDIANA LIMITED LIABILITY COMPANY)
8512 COMMERCE PARK DRIVE
SELLERSBURG, IN 47172

FOR: BUBBLE MAKING GUN AND SOLUTION SETS, IN CLASS 28 (U.S. CLS. 22, 23, 38 AND 50).

FIRST USE 4-15-2010; IN COMMERCE 4-15-2010.

THE STIPLING IS FOR SHADING PURPOSES ONLY.

THE MARK CONSISTS OF A ROCKET SHIP WITH FLAMES.

SER. NO. 85-442,692, FILED 10-7-2011.

MATTHEW PAPPAS, EXAMINING ATTORNEY



David J. Kappas

Director of the United States Patent and Trademark Office

United States of America
United States Patent and Trademark Office

Furrybones

Reg. No. 4,108,951

Registered Mar. 6, 2012

**Int. Cls.: 14, 18, 21, 25
and 28**

TRADEMARK

PRINCIPAL REGISTER

YTC SUMMIT INTERNATIONAL, INC. (CALIFORNIA CORPORATION)
12037 CLARK STREET
ARCADIA, CA 91006

FOR: JEWELRY, IN CLASS 14 (U.S. CLS. 2, 27, 28 AND 50).

FIRST USE 9-5-2008; IN COMMERCE 9-7-2010.

FOR: HANDBAGS, IN CLASS 18 (U.S. CLS. 1, 2, 3, 22 AND 41).

FIRST USE 9-5-2008; IN COMMERCE 7-1-2011.

FOR: COOKIE JARS; MUGS, IN CLASS 21 (U.S. CLS. 2, 13, 23, 29, 30, 33, 40 AND 50).

FIRST USE 9-5-2008; IN COMMERCE 8-6-2010.

FOR: HATS; SHORTS; SWEATSHIRTS; T-SHIRTS; TANK TOPS, IN CLASS 25 (U.S. CLS. 22 AND 39).

FIRST USE 9-5-2008; IN COMMERCE 7-1-2010.

FOR: PLUSH DOLLS; VINYL DOLLS, IN CLASS 28 (U.S. CLS. 22, 23, 38 AND 50).

FIRST USE 9-5-2008; IN COMMERCE 2-26-2010.

THE MARK CONSISTS OF STANDARD CHARACTERS WITHOUT CLAIM TO ANY PARTICULAR FONT, STYLE, SIZE, OR COLOR.

SER. NO. 85-445,771, FILED 10-12-2011.

WILLIAM JACKSON, EXAMINING ATTORNEY



David J. Kybas

Director of the United States Patent and Trademark Office

United States of America

United States Patent and Trademark Office

SNUG RUG

Reg. No. 4,108,952

Registered Mar. 6, 2012

Int. Cl.: 24

TRADEMARK

PRINCIPAL REGISTER

CLOUD B, INC. (CALIFORNIA CORPORATION)
2255 JEFFERSON STREET
TORRANCE, CA 90501

FOR: BABY BLANKETS, IN CLASS 24 (U.S. CLS. 42 AND 50).

FIRST USE 6-1-2011; IN COMMERCE 6-1-2011.

THE MARK CONSISTS OF STANDARD CHARACTERS WITHOUT CLAIM TO ANY PARTICULAR FONT, STYLE, SIZE, OR COLOR.

SER. NO. 85-447,255, FILED 10-13-2011.

JANICE L. MCMORROW, EXAMINING ATTORNEY



David J. Kybas

Director of the United States Patent and Trademark Office

United States of America

United States Patent and Trademark Office

FLOORCOMFORT

Reg. No. 4,108,953

Registered Mar. 6, 2012

Int. Cl.: 6

TRADEMARK

PRINCIPAL REGISTER

PAK-LITE, INC. (GEORGIA CORPORATION)
550 OLD PEACHTREE RD.
SUWANEE, GA 30024

FOR: ALUMINUM TAPE USED TO JOIN PANELS FOR USE IN WALL, ATTIC, CEILING AND FLOORING APPLICATIONS IN THE BUILDING INDUSTRY, IN CLASS 6 (U.S. CLS. 2, 12, 13, 14, 23, 25 AND 50).

FIRST USE 7-21-2011; IN COMMERCE 7-21-2011.

THE MARK CONSISTS OF STANDARD CHARACTERS WITHOUT CLAIM TO ANY PARTICULAR FONT, STYLE, SIZE, OR COLOR.

SER. NO. 85-464,705, FILED 11-4-2011.

TARA PATE, EXAMINING ATTORNEY



David J. Kyffers

Director of the United States Patent and Trademark Office

United States of America

United States Patent and Trademark Office

S.O.C.

Reg. No. 4,108,954

Registered Mar. 6, 2012

Int. Cl.: 18

TRADEMARK

PRINCIPAL REGISTER

SANDPIPER OF CALIFORNIA, INC. (CALIFORNIA CORPORATION)
687 ANITA ST.
CHULA VISTA, CA 91910

FOR: BACKPACKS; NECK AND WALLET ID HOLDERS, NAMELY, WALLETS AND CARD HOLDERS IN THE NATURE OF WALLETS CARRIED AROUND THE USER'S NECK, FOR HOLDING IDENTIFICATION CARDS; TOILETRY BAGS SOLD EMPTY; NYLON BRIEF CASES; GARMENT BAGS FOR TRAVEL; PACKS, NAMELY, ALL-PURPOSE CARRYING BAGS; ROLLING ALL PURPOSE CARRYING BAGS; ROLLING CARRYING CASES; RUCK SACKS; AND LUGGAGE STRAPS, IN CLASS 18 (U.S. CLS. 1, 2, 3, 22 AND 41).

FIRST USE 7-1-2008; IN COMMERCE 9-1-2008.

THE MARK CONSISTS OF STANDARD CHARACTERS WITHOUT CLAIM TO ANY PARTICULAR FONT, STYLE, SIZE, OR COLOR.

SER. NO. 85-975,646, FILED 10-26-2010.

MICHAEL GAAFAR, EXAMINING ATTORNEY



David J. Kyffers

Director of the United States Patent and Trademark Office

United States of America

United States Patent and Trademark Office

REINVENTING GEOSPATIAL

Reg. No. 4,108,955

REINVENTING GEOSPATIAL, INC. (VIRGINIA CORPORATION)
12020 SUNRISE VALLEY DRIVE, SUITE 100
RESTON, VA 20191

Registered Mar. 6, 2012

Int. Cl.: 42

FOR: MAINTENANCE OF SOFTWARE, SOFTWARE SYSTEMS, AND INTERNET WEB SITES, IN CLASS 42 (U.S. CLS. 100 AND 101).

SERVICE MARK

FIRST USE 7-16-2009; IN COMMERCE 7-16-2009.

PRINCIPAL REGISTER

THE MARK CONSISTS OF STANDARD CHARACTERS WITHOUT CLAIM TO ANY PARTICULAR FONT, STYLE, SIZE, OR COLOR.

NO CLAIM IS MADE TO THE EXCLUSIVE RIGHT TO USE "GEOSPATIAL", APART FROM THE MARK AS SHOWN.

SER. NO. 85-975,900, FILED 6-11-2010.

MAYUR VAGHANI, EXAMINING ATTORNEY



David J. Kybas

Director of the United States Patent and Trademark Office

United States of America

United States Patent and Trademark Office

NY STYLE

Reg. No. 4,108,956

Registered Mar. 6, 2012

Int. Cls.: 14 and 35

TRADEMARK

SERVICE MARK

PRINCIPAL REGISTER

LERNCO, INC. (DELAWARE CORPORATION)
1105 NORTH MARKET STREET
WILMINGTON, DE 19801

FOR: JEWELRY AND WATCHES, IN CLASS 14 (U.S. CLS. 2, 27, 28 AND 50).

FIRST USE 8-1-2008; IN COMMERCE 8-1-2008.

FOR: RETAIL STORE SERVICES, MAIL ORDER CATALOG SERVICES AND ON-LINE STORE SERVICES FEATURING JEWELRY, WATCHES, BAGS, CASES, PACKS, WALLETS, CLOTHING, IN CLASS 35 (U.S. CLS. 100, 101 AND 102).

FIRST USE 8-1-2008; IN COMMERCE 8-1-2008.

THE MARK CONSISTS OF STANDARD CHARACTERS WITHOUT CLAIM TO ANY PARTICULAR FONT, STYLE, SIZE, OR COLOR.

NO CLAIM IS MADE TO THE EXCLUSIVE RIGHT TO USE "NY", APART FROM THE MARK AS SHOWN.

SER. NO. 85-975,924, FILED 10-14-2010.

VIVIAN MICZNIK FIRST, EXAMINING ATTORNEY



David J. Kyffers

Director of the United States Patent and Trademark Office

United States of America

United States Patent and Trademark Office

LIFESTYLE LEMONAID

Reg. No. 4,108,957

Registered Mar. 6, 2012

Int. Cls.: 41, 44 and 45

SERVICE MARK

PRINCIPAL REGISTER

JOEL, NICOLE ELIZABETH (UNITED STATES INDIVIDUAL)
SUITE 200
15250 VENTURA BLVD.
SHERMAN OAKS, CA 91403

FOR: ENTERTAINMENT AND EDUCATIONAL SERVICES, NAMELY, A CONTINUING TELEVISION PROGRAM FEATURING BEAUTY, DIET, FASHION, FRIENDSHIPS, CHILDREN AND MARRIAGE, ACCESSIBLE BY THE INTERNET; ENTERTAINMENT AND EDUCATIONAL SERVICES, NAMELY, PROVIDING A WEBSITE FEATURING INFORMATION, ADVICE AND COMMENTARY RELATING TO CHILDREN'S ENTERTAINMENT, CHILDREN'S EDUCATION, AND PARENTING CONCERNING THE EDUCATION AND ENTERTAINMENT OF CHILDREN, IN CLASS 41 (U.S. CLS. 100, 101 AND 107).

FIRST USE 5-31-2009; IN COMMERCE 5-31-2009.

FOR: PROVIDING A WEBSITE FEATURING INFORMATION, ADVICE AND COMMENTARY RELATING TO BEAUTY, DIET, AND PARENTING CONCERNING THE HEALTH AND NUTRITION OF CHILDREN, IN CLASS 44 (U.S. CLS. 100 AND 101).

FIRST USE 5-31-2009; IN COMMERCE 5-31-2009.

FOR: PROVIDING A WEBSITE FEATURING INFORMATION, ADVICE AND COMMENTARY RELATING TO FASHION, LIFESTYLES, AND MARRIAGE LIFESTYLE, IN CLASS 45 (U.S. CLS. 100 AND 101).

FIRST USE 5-31-2009; IN COMMERCE 5-31-2009.

THE MARK CONSISTS OF STANDARD CHARACTERS WITHOUT CLAIM TO ANY PARTICULAR FONT, STYLE, SIZE, OR COLOR.

NO CLAIM IS MADE TO THE EXCLUSIVE RIGHT TO USE "LIFESTYLE", APART FROM THE MARK AS SHOWN.

SER. NO. 85-976,239, FILED 5-10-2010.

SOPHIA S. KIM, EXAMINING ATTORNEY



David J. Kyros

Director of the United States Patent and Trademark Office

United States of America

United States Patent and Trademark Office

CARLOS FALCHI

Reg. No. 4,108,958

FALCHI IP, LLC (DELAWARE LIMITED LIABILITY COMPANY)
260 WEST 39TH STREET
NEW YORK, NY 10018

Registered Mar. 6, 2012

Int. Cl.: 18

FOR: HANDBAGS; AND PURSES, IN CLASS 18 (U.S. CLS. 1, 2, 3, 22 AND 41).

FIRST USE 0-0-1972; IN COMMERCE 0-0-1972.

TRADEMARK

OWNER OF U.S. REG. NOS. 1,116,624 AND 1,477,810.

PRINCIPAL REGISTER

THE NAME "CARLOS FALCHI" IDENTIFIES A LIVING INDIVIDUAL WHOSE CONSENT IS OF RECORD.

SN 76-147,756, FILED 10-16-2000.

MARK SPARACINO, EXAMINING ATTORNEY



David J. Kybas

Director of the United States Patent and Trademark Office

United States of America

United States Patent and Trademark Office

SLI LIGHTING

Reg. No. 4,108,959

Registered Mar. 6, 2012

Int. Cls.: 9, 10, and 11

TRADEMARK

PRINCIPAL REGISTER

FLOWIL INTERNATIONAL LIGHTING (HOLDING) BV (NETHERLANDS CORPORATION)
ROKIN 55
AMSTERDAM, NETHERLANDS 1012 KK

FOR: STARTERS FOR ELECTRIC LAMPS; ELECTRONIC STARTERS FOR FLUORESCENT LAMPS; BALLASTS FOR LAMPS AND LIGHTING FITTINGS; ELECTRIC TRANSFORMERS FOR USE WITH LIGHTING DEVICES; LIGHTING TRANSFORMERS; UV PHOTOCELLS; AND COMPONENT PARTS OF THE AFORESAID GOODS SOLD TOGETHER AS A UNIT; DOWNLOADABLE PLANNING AND SIMULATION SOFTWARE PROGRAMS FOR LIGHTING APPLICATIONS FOR DOMESTIC AND INDUSTRIAL PURPOSES, IN CLASS 9 (U.S. CLS. 21, 23, 26, 36 AND 38).

FIRST USE 6-0-2006; IN COMMERCE 6-0-2006.

FOR: ELECTRIC LIGHT BULBS AND ULTRAVIOLET LAMPS FOR COSMETIC PURPOSES, IN CLASS 10 (U.S. CLS. 26, 39 AND 44).

FIRST USE 6-0-2006; IN COMMERCE 6-0-2006.

FOR: APPARATUS AND INSTALLATION FOR LIGHTING, NAMELY, INCANDESCENT LAMPS, FLUORESCENT LAMPS, DISCHARGE LAMPS; TUNGSTEN-HALOGEN LAMPS; ELECTRIC LIGHTING FIXTURES; CONTACT TRACKS FOR LIGHTING; LUMINARIES; FLUORESCENT LIGHT TUBES; LIGHT BULBS; LAMPS; FILAMENTS FOR LAMPS; ARC LAMPS; ELECTRIC DISCHARGE TUBES FOR LIGHTING; LAMP CASINGS; LAMP GLASSES; LAMP HANGING SUPPORTS, LAMP REFLECTORS, LAMP SHADES; LUMINOUS TUBES FOR LIGHTING; SOCKETS FOR ELECTRIC LIGHTS; TORCH LIGHTS IN THE NATURE OF FLASHLIGHTS; POCKET SEARCH LIGHTS; AND COMPONENT PARTS FOR THE AFORESAID GOODS SOLD TOGETHER AS A UNIT, IN CLASS 11 (U.S. CLS. 13, 21, 23, 31 AND 34).

FIRST USE 6-0-2006; IN COMMERCE 6-0-2006.

OWNER OF U.S. REG. NOS. 1,641,722, 3,171,665, AND OTHERS.

NO CLAIM IS MADE TO THE EXCLUSIVE RIGHT TO USE "LIGHTING", APART FROM THE MARK AS SHOWN.



David J. Kyffers

Director of the United States Patent and Trademark Office

Reg. No. 4,108,959 THE MARK CONSISTS OF "SLI LIGHTING" OVER A RECTANGULAR SHAPED BAR THAT IS BLACK ON BOTH ENDS AND WHITE IN THE MIDDLE.

SN 76-666,983, FILED 10-4-2006.

CHARLOTTE CORWIN, EXAMINING ATTORNEY

United States of America

United States Patent and Trademark Office

REBEL WITH A CAUSE

Reg. No. 4,108,960

STEVENS, ANDREW E. (UNITED STATES INDIVIDUAL)
9080 SANTA MONICA BOULEVARD
LOS ANGELES, CA 90069

Registered Mar. 6, 2012

Int. Cl.: 41

FOR: CONDUCTING SEMINARS, LECTURES AND EDUCATIONAL FORUMS ON THE SUBJECT OF HUNGARIAN RESISTANCE TO THE NAZI OCCUPATION OF HUNGARY DURING WORLD WAR II, IN CLASS 41 (U.S. CLS. 100, 101 AND 107).

SERVICE MARK

FIRST USE 5-20-2011; IN COMMERCE 5-20-2011.

PRINCIPAL REGISTER

THE MARK CONSISTS OF STANDARD CHARACTERS WITHOUT CLAIM TO ANY PARTICULAR FONT, STYLE, SIZE, OR COLOR.

SN 76-681,417, FILED 9-4-2007.

SAMUEL E. SHARPER JR., EXAMINING ATTORNEY



David J. Kyffers

Director of the United States Patent and Trademark Office

United States of America

United States Patent and Trademark Office

SQUARE DEAL

Reg. No. 4,108,961

Registered Mar. 6, 2012

Int. Cl.: 9

TRADEMARK

PRINCIPAL REGISTER

WINVIEW, INC. (DELAWARE CORPORATION)
225 CROSSROADS SUITE 389
CARMEL, CA 93923

FOR: ELECTRONIC GAME SYSTEM COMPRISED OF COMPUTER HARDWARE AND GAME SOFTWARE FOR PLAYING INTERACTIVE ELECTRONIC GAMES, NAMELY, VIDEO POKER TYPE CARD GAMES; INTERACTIVE GAME SOFTWARE FOR PLAYING VIDEO POKER TYPE CARD GAMES, IN CLASS 9 (U.S. CLS. 21, 23, 26, 36 AND 38).

FIRST USE 11-15-2011; IN COMMERCE 11-15-2011.

THE MARK CONSISTS OF STANDARD CHARACTERS WITHOUT CLAIM TO ANY PARTICULAR FONT, STYLE, SIZE, OR COLOR.

SN 76-682,347, FILED 9-27-2007.

MICHAEL GAAFAR, EXAMINING ATTORNEY



David J. Kybas

Director of the United States Patent and Trademark Office

United States of America
United States Patent and Trademark Office

EASIWALL

Reg. No. 4,108,962

PIERCE ENTERPRISES, INC. (COLORADO CORPORATION)
13041 NORTH TRAVOIS TRAIL
PARKER, CO 80138

Registered Mar. 6, 2012

Int. Cl.: 19

FOR: PREFABRICATED BOARD AND WALL PANELS MADE OF COMPRESSED WHEAT OR RICE STRAW, IN CLASS 19 (U.S. CLS. 1, 12, 33 AND 50).

TRADEMARK

FIRST USE 11-23-2011; IN COMMERCE 11-23-2011.

PRINCIPAL REGISTER

THE MARK CONSISTS OF STANDARD CHARACTERS WITHOUT CLAIM TO ANY PARTICULAR FONT, STYLE, SIZE, OR COLOR.

SN 76-684,157, FILED 11-19-2007.

JOHN WILKE, EXAMINING ATTORNEY



David J. Kybas

Director of the United States Patent and Trademark Office

United States of America

United States Patent and Trademark Office

QUAKELIVE

Reg. No. 4,108,963

Registered Mar. 6, 2012

Int. Cl.: 25

TRADEMARK

PRINCIPAL REGISTER

ID SOFTWARE LLC (DELAWARE LIMITED LIABILITY COMPANY)
1500 N GREENVILLE AVE, SUITE 700
RICHARDSON, TX 75081

FOR: CLOTHING, NAMELY, T-SHIRTS, IN CLASS 25 (U.S. CLS. 22 AND 39).

FIRST USE 8-15-2010; IN COMMERCE 8-15-2010.

THE MARK CONSISTS OF STANDARD CHARACTERS WITHOUT CLAIM TO ANY PARTICULAR FONT, STYLE, SIZE, OR COLOR.

OWNER OF U.S. REG. NOS. 2,265,714, 3,941,007, AND OTHERS.

SN 76-684,496, FILED 11-30-2007.

REBECCA POVARCHUK, EXAMINING ATTORNEY



David J. Kybas

Director of the United States Patent and Trademark Office

United States of America

United States Patent and Trademark Office

FUTURE COUNTRY FUTURE NATION FUTURE CITIES

Reg. No. 4,108,964

Registered Mar. 6, 2012

Int. Cls.: 35 and 36

SERVICE MARK

PRINCIPAL REGISTER

ANDERSON, KENT G (UNITED STATES INDIVIDUAL)
925 N GRIFFIN
FUTURE SM TM
BISMARCK, ND 58501

FOR: RETAIL TOY STORES; RETAIL COSMETIC STORES; RETAIL MUSIC STORES; RETAIL COMPUTER STORES; RETAIL CLOTHING STORES; RETAIL FURNITURE STORES; AUTOMOBILE DEALERSHIPS; RETAIL AUTOMOBILE PARTS AND ACCESSORIES STORES; RETAIL SPORTING GOODS STORES; RETAIL GIFT SHOPS; RETAIL STORES; RETAIL FOOD AND BEVERAGES STORES; RETAIL GROCERY AND PHARMACY STORES; MOTORCYCLES STORES AND DEALERSHIPS; AIR CRAFT DEALERSHIPS; BOAT DEALERSHIPS; AUTOMOBILE DEALERSHIPS; OFFICE SUPPLY STORES; DEPARTMENT STORES; ADVERTISING SERVICES; MARKETING SERVICES; RETAIL FOOD AND BEVERAGE STORES; RETAIL HOBBY AND CRAFT STORES; RETAIL FURNITURE STORES; RETAIL STORES FEATURING, TOYS, COSMETICS, CLOTHING, FURNITURE, FOOD, BEVERAGES, CLOTHING, JEWELRY, ELECTRONICS, AUTOMOBILES; INDEPENDENT SALES REPRESENTATIVES IN THE FIELD OF AUTOMOBILES, AIRCRAFT, ELECTRONICS, TECHNOLOGY, TOYS, FOOD AND COSMETICS, FURNITURE, CLOTHING, JEWELRY, AIRCRAFT; RESTAURANT FRANCHISING; ONLINE RETAIL STORES FEATURING AUTOMOBILES, TOYS, COSMETICS, MUSIC, FURNITURE, JEWELRY; ONLINE AUCTION SERVICES, IN CLASS 35 (U.S. CLS. 100, 101 AND 102).

FIRST USE 6-14-2008; IN COMMERCE 6-14-2008.

FOR: FINANCIAL SERVICES, NAMELY, BANKING AND INVESTMENT BANKING SERVICES; FINANCING AND LOAN SERVICES; INVESTMENT ADVISORY SERVICES; VENTURE CAPITAL SERVICES, NAMELY, PROVIDING FINANCING TO EMERGING AND START -UP COMPANIES; INSURANCE AGENCIES IN THE FIELD OF HOME BUSINESS, LIFE, ACCIDENT, INSURANCE SERVICES, WRITING PROPERTY AND CASUALTY INSURANCE; STOCK EXCHANGE INFORMATION SERVICES, IN CLASS 36 (U.S. CLS. 100, 101 AND 102).

FIRST USE 6-14-2008; IN COMMERCE 6-14-2008.

OWNER OF U.S. REG. NOS. 2,780,176, 3,184,164, AND 3,360,112.



David J. Kyjars

Director of the United States Patent and Trademark Office

Reg. No. 4,108,964 THE MARK CONSISTS OF THE WORDING "FUTURE COUNTRY FUTURE NATION FUTURE CITIES" IN A STYLIZED FONT.

SN 76-690,507, FILED 6-12-2008.

KEVON CHISOLM, EXAMINING ATTORNEY

United States of America

United States Patent and Trademark Office

SUCCEDEDUCATION

Reg. No. 4,108,965

Registered Mar. 6, 2012

Int. Cl.: 41

SERVICE MARK

PRINCIPAL REGISTER

BLEVINS, SANDRA (UNITED STATES INDIVIDUAL)
ONE ST. THOMAS STREET, #12C
TORONTO, CANADA M5S3M5

FOR: PERSONAL COACHING SERVICES IN THE FIELDS OF LEADERSHIP, CAREER, RELATIONSHIPS, MENTAL AND PHYSICAL PERFORMANCE AND LIFE FULFILLMENT SKILL DEVELOPMENT; EDUCATIONAL SERVICES, NAMELY, CONDUCTING CLASSES, SEMINARS AND WORKSHOPS IN THE FIELDS OF LEADERSHIP, CAREER, RELATIONSHIPS, MENTAL AND PHYSICAL PERFORMANCE AND LIFE FULFILLMENT SKILL DEVELOPMENT, IN CLASS 41 (U.S. CLS. 100, 101 AND 107).

FIRST USE 12-21-2011; IN COMMERCE 12-21-2011.

THE MARK CONSISTS OF STANDARD CHARACTERS WITHOUT CLAIM TO ANY PARTICULAR FONT, STYLE, SIZE, OR COLOR.

SN 76-691,684, FILED 7-30-2008.

KHANH LE, EXAMINING ATTORNEY



David J. Kybas

Director of the United States Patent and Trademark Office

United States of America

United States Patent and Trademark Office

SUCCESSION

Reg. No. 4,108,966

Registered Mar. 6, 2012

Int. Cl.: 41

SERVICE MARK

PRINCIPAL REGISTER

BLEVINS, SANDRA LEIGH (UNITED STATES INDIVIDUAL)
ONE ST THOMAS STREET, #12C
TORONTO, CANADA M5S3M5

FOR: PERSONAL COACHING SERVICES IN THE FIELDS OF LEADERSHIP, CAREER, RELATIONSHIPS, MENTAL AND PHYSICAL PERFORMANCE AND LIFE FULFILLMENT SKILL DEVELOPMENT; EDUCATIONAL SERVICES, NAMELY, CONDUCTING CLASSES, SEMINARS AND WORKSHOPS IN THE FIELDS OF LEADERSHIP, CAREER, RELATIONSHIPS, MENTAL AND PHYSICAL PERFORMANCE AND LIFE FULFILLMENT SKILL DEVELOPMENT, IN CLASS 41 (U.S. CLS. 100, 101 AND 107).

FIRST USE 1-10-2012; IN COMMERCE 1-10-2012.

THE MARK CONSISTS OF STANDARD CHARACTERS WITHOUT CLAIM TO ANY PARTICULAR FONT, STYLE, SIZE, OR COLOR.

SN 76-691,867, FILED 8-6-2008.

SAIMA MAKHDOOM, EXAMINING ATTORNEY



David J. Kyros

Director of the United States Patent and Trademark Office

United States of America

United States Patent and Trademark Office

ZIP CHAIN

Reg. No. 4,108,967

Registered Mar. 6, 2012

Int. Cl.: 7

TRADEMARK

PRINCIPAL REGISTER

TSUBAKIMOTO CHAIN CO. (JAPAN CORPORATION)
NAKANOSHIMA MITSUI BUILDING
3-3-3, NAKANOSHIMA, KITA-KU.; OSAKA-SHI
OSAKA 5300005, JAPAN

FOR: LOADING-UNLOADING MACHINES AND APPARATUS, NAMELY, CHAIN CONVEYORS, BUCKET ELEVATORS, LIFTERS, NAMELY, INDUSTRIAL LIFT TABLES, MACHINE ELEMENTS NOT FOR LAND VEHICLES, NAMELY, CHAINS, CABLE DRAG CHAINS, BELTS, SPROCKETS, GEARS, GEARBOXES, PULLEYS, COUPLINGS, CLUTCHES, TORQUE LIMITERS, REDUCTION GEARS FOR ELECTROMOTIVE MOTORS, SPEED CHANGE GEARS, POWER TRANSMISSION DEVICES FOR INDUSTRIES, SHOCK ABSORBERS, CYLINDERS, AND BEARINGS, IN CLASS 7 (U.S. CLS. 13, 19, 21, 23, 31, 34 AND 35).

FIRST USE 3-1-2009; IN COMMERCE 3-1-2009.

THE MARK CONSISTS OF STANDARD CHARACTERS WITHOUT CLAIM TO ANY PARTICULAR FONT, STYLE, SIZE, OR COLOR.

PRIORITY CLAIMED UNDER SEC. 44(D) ON JAPAN APPLICATION NO. 2008-025411, FILED 4-2-2008.

OWNER OF U.S. REG. NO. 3,658,311.

NO CLAIM IS MADE TO THE EXCLUSIVE RIGHT TO USE "CHAIN", APART FROM THE MARK AS SHOWN.

SN 76-702,425, FILED 5-19-2008.

ANDREW RHIM, EXAMINING ATTORNEY



David J. Kyffers

Director of the United States Patent and Trademark Office

United States of America

United States Patent and Trademark Office

KIMIYA INTERNATIONAL

Reg. No. 4,108,968

Registered Mar. 6, 2012

Int. Cl.: 36

SERVICE MARK

PRINCIPAL REGISTER

KIMIYA INTERNATIONAL (TEXAS CORPORATION)
85325 CLEARBROOK DR.
FORT WORTH, TX 76123

FOR: CHARITABLE FOUNDATION SERVICES, NAMELY, PROVIDING FUNDRAISING ACTIVITIES, FUNDING, SCHOLARSHIPS AND/OR FINANCIAL ASSISTANCE FOR UNDERPRIVILEGED WOMEN IN THEIR BUSINESS ENDEAVORS; CHARITABLE SERVICES, NAMELY, PROVIDING FINANCIAL SUPPORT TO DISADVANTAGED WOMEN IN THE UNITED STATES AND OTHER COUNTRIES FOR THE PURPOSE OF FACILITATING ECONOMIC DEVELOPMENT, IN CLASS 36 (U.S. CLS. 100, 101 AND 102).

FIRST USE 5-4-2010; IN COMMERCE 2-1-2011.

THE MARK CONSISTS OF STANDARD CHARACTERS WITHOUT CLAIM TO ANY PARTICULAR FONT, STYLE, SIZE, OR COLOR.

NO CLAIM IS MADE TO THE EXCLUSIVE RIGHT TO USE "INTERNATIONAL", APART FROM THE MARK AS SHOWN.

THE ENGLISH TRANSLATION OF "KIMIYA" IN THE MARK IS "ALCHEMY."

SN 76-702,862, FILED 5-7-2010.

LINDA MICKLEBURGH, EXAMINING ATTORNEY



David J. Kyros

Director of the United States Patent and Trademark Office

United States of America
United States Patent and Trademark Office

SAFETTI

Reg. No. 4,108,969

Registered Mar. 6, 2012

Int. Cls.: 9, 16, and 42

TRADEMARK

SERVICE MARK

PRINCIPAL REGISTER

DET NORSKE VERITAS AS (NORWAY CORPORATION)
DET NORSKE VERITAS AS
VERITASVELEN 1 N-1363 HOVIK, NORWAY

FOR: COMPUTER SOFTWARE FOR QUANTITATIVE RISK ASSESSMENT FOR USE IN THE PROCESS INDUSTRY, CHEMICAL INDUSTRY, PETROCHEMICAL INDUSTRY, OFFSHORE INDUSTRY, IN CLASS 9 (U.S. CLS. 21, 23, 26, 36 AND 38).

FIRST USE 6-1-1981; IN COMMERCE 6-1-1981.

FOR: BROCHURES IN THE FIELD OF THE PROCESS INDUSTRY, CHEMICAL INDUSTRY, PETROCHEMICAL INDUSTRY, OFFSHORE INDUSTRY, IN CLASS 16 (U.S. CLS. 2, 5, 22, 23, 29, 37, 38 AND 50).

FIRST USE 6-1-1981; IN COMMERCE 6-1-1981.

FOR: SCIENTIFIC RESEARCH AND SCIENTIFIC TECHNOLOGICAL CONSULTATION SERVICES IN THE TECHNOLOGY FIELD OF QUANTITATIVE RISK ASSESSMENT BY USE OF COMPUTERS AND SOFTWARE; DESIGN AND DEVELOPMENT OF COMPUTER SOFTWARE AND SERVICES FOR OTHERS; COMPUTER SERVICES, NAMELY, INSTALLATION AND MAINTENANCE OF COMPUTER SOFTWARE FOR OTHERS, UPDATING OF COMPUTER SOFTWARE FOR OTHERS, COMPUTER SYSTEMS ANALYSIS FOR OTHERS; TECHNICAL SUPPORT SERVICES, NAMELY, TROUBLESHOOTING OF COMPUTER SOFTWARE PROBLEMS FOR OTHERS, IN CLASS 42 (U.S. CLS. 100 AND 101).

FIRST USE 6-1-1981; IN COMMERCE 6-1-1981.

THE MARK CONSISTS OF STANDARD CHARACTERS WITHOUT CLAIM TO ANY PARTICULAR FONT, STYLE, SIZE, OR COLOR.

THE WORDING "SAFETTI" HAS NO MEANING IN A FOREIGN LANGUAGE.

SN 76-703,022, FILED 10-5-2006.

WILLIAM ROSSMAN, EXAMINING ATTORNEY



David J. Kyffers

Director of the United States Patent and Trademark Office

United States of America

United States Patent and Trademark Office

PRECISION SAFETY

Reg. No. 4,108,970

Registered Mar. 6, 2012

Int. Cl.: 5

TRADEMARK

PRINCIPAL REGISTER

MAGID GLOVE & SAFETY MANUFACTURING CO., L.L.C. (ILLINOIS LIMITED LIABILITY COMPANY)
2060 NORTH KOLMAR AVENUE
CHICAGO, IL 60639

FOR: INDUSTRIAL SAFETY EQUIPMENT, NAMELY, FIRST AID KITS CONTAINING ADHESIVE AND NON-ADHESIVE BANDAGES FOR PROTECTING AND CONCEALING CUTS, SCRAPES, BURNS, ABRASIONS, AND WOUNDS, WOUND DRESSINGS, GAUZE, GAUZE PADS, ADHESIVE MEDICAL TAPE, STERILE COTTON AND COTTON BALLS FOR MEDICAL USE, ANTIBIOTICS AND ANTISEPTIC PRODUCTS AND PREPARATIONS FOR WOUNDS AND RASHES, ANTIFUNGAL AND ANTIBIOTIC OINTMENTS AND WASHES FOR WOUNDS AND RASHES, MEDICATIONS FOR RELIEF FROM PAIN, ALLERGIES, INFLUENZA AND COLDS, MEDICATED PRE-MOISTENED WIPES, SPRAY, DROP, PUMP AND POUR SANITIZERS FOR PERSONAL USE, SAFETY PINS, TWEEZERS, SCISSORS, COLD PACKS, SPLINTS, AND DISPOSABLE GLOVES FOR MEDICAL USE, IN CLASS 5 (U.S. CLS. 6, 18, 44, 46, 51 AND 52).

FIRST USE 0-0-1998; IN COMMERCE 0-0-1998.

THE MARK CONSISTS OF STANDARD CHARACTERS WITHOUT CLAIM TO ANY PARTICULAR FONT, STYLE, SIZE, OR COLOR.

OWNER OF U.S. REG. NOS. 1,448,313 AND 2,488,134.

NO CLAIM IS MADE TO THE EXCLUSIVE RIGHT TO USE "SAFETY", APART FROM THE MARK AS SHOWN.

SN 76-703,328, FILED 6-10-2010.

ANDREW RHIM, EXAMINING ATTORNEY



David J. Kypos

Director of the United States Patent and Trademark Office

United States of America

United States Patent and Trademark Office

EXPERIENCE THE REVOLUTION

Reg. No. 4,108,971

REVOLVE, LLC (DELAWARE LIMITED LIABILITY COMPANY)
2802 EAST JAMES STREET
GILBERT, AZ 85296

Registered Mar. 6, 2012

Int. Cl.: 20

FOR: CHAIRS, CAMPING FURNITURE, STADIUM CHAIRS, REVOLVING CHAIRS, IN CLASS 20 (U.S. CLS. 2, 13, 22, 25, 32 AND 50).

TRADEMARK

FIRST USE 6-25-2011; IN COMMERCE 6-25-2011.

PRINCIPAL REGISTER

THE MARK CONSISTS OF STANDARD CHARACTERS WITHOUT CLAIM TO ANY PARTICULAR FONT, STYLE, SIZE, OR COLOR.

SN 76-703,420, FILED 6-18-2010.

GRETCHEN ULRICH, EXAMINING ATTORNEY



David J. Kybas

Director of the United States Patent and Trademark Office

United States of America
United States Patent and Trademark Office

MARU
LAWTON PERCUSSION

Reg. No. 4,108,972

LAWTON, MARLA (UNITED STATES INDIVIDUAL)
1479 BRIGHTON AVE.
ARROYO GRANDE, CA 93420

Registered Mar. 6, 2012

Int. Cl.: 15

FOR: MUSICAL PERCUSSION INSTRUMENTS, NAMELY, SHEKERE INSTRUMENTS CONSISTING OF A DRIED GOURD, DRIED GOURD PERCUSSION INSTRUMENTS, AND GUIRO PERCUSSION INSTRUMENT CONSISTING OF A HOLLOW GOURD, IN CLASS 15 (U.S. CLS. 2, 21 AND 36).

TRADEMARK

PRINCIPAL REGISTER

FIRST USE 3-1-1993; IN COMMERCE 8-8-2002.

NO CLAIM IS MADE TO THE EXCLUSIVE RIGHT TO USE "PERCUSSION", APART FROM THE MARK AS SHOWN.

THE NAME(S), PORTRAIT(S), AND/OR SIGNATURE(S) SHOWN IN THE MARK DOES NOT IDENTIFY A PARTICULAR LIVING INDIVIDUAL.

THE MARK CONSISTS OF THE STYLIZED WORD "MARU." THE UPPER PORTION OF THE LETTER "A" IN "MARU" CONSISTS OF MANY HORIZONTAL LINES. BELOW THIS ARE THE WORDS "LAWTON PERCUSSION".

THE ENGLISH TRANSLATION OF "MARU" IN THE MARK IS CIRCLE.

SN 76-703,822, FILED 7-19-2010.

SIMON TENG, EXAMINING ATTORNEY



David J. Kybas

Director of the United States Patent and Trademark Office

United States of America

United States Patent and Trademark Office

Twist-Erase 

Reg. No. 4,108,973

PENTEL OF AMERICA, LTD. (ILLINOIS CORPORATION)
2715 COLUMBIA STREET
TORRANCE, CA 90509

Registered Mar. 6, 2012

Int. Cl.: 16

FOR: WRITING INSTRUMENTS, IN CLASS 16 (U.S. CLS. 2, 5, 22, 23, 29, 37, 38 AND 50).

TRADEMARK

FIRST USE 8-0-2010; IN COMMERCE 8-0-2010.

PRINCIPAL REGISTER

OWNER OF U.S. REG. NO. 1,552,825.

SN 76-704,008, FILED 8-4-2010.

JAMES GRIFFIN, EXAMINING ATTORNEY



David J. Kyffers

Director of the United States Patent and Trademark Office

United States of America

United States Patent and Trademark Office

JULIA JORDAN

Reg. No. 4,108,974

SHAZDEH FASHIONS, INC. (NEW YORK CORPORATION)
1375 BROADWAY
NEW YORK, NY 10018

Registered Mar. 6, 2012

Int. Cl.: 25

FOR: LADIES APPAREL, NAMELY, TOPS, SHIRTS, SHORTS, JEANS, PANTS, SWEATERS, DRESSES, SPORTSWEAR, NAMELY, JOGGING SUITS, SWEAT PANTS, BODY SUITS AND TIGHTS, INTIMATE APPAREL, NAMELY, ROBES AND NIGHTGOWNS, HOSIERY, AND FOOTWEAR, IN CLASS 25 (U.S. CLS. 22 AND 39).

TRADEMARK

PRINCIPAL REGISTER

FIRST USE 3-0-2011; IN COMMERCE 3-0-2011.

THE MARK CONSISTS OF STANDARD CHARACTERS WITHOUT CLAIM TO ANY PARTICULAR FONT, STYLE, SIZE, OR COLOR.

"JULIA JORDAN" IS NOT A LIVING INDIVIDUAL AND IS AN ARBITRARY MADE UP NAME.

SN 76-704,747, FILED 10-1-2010.

CARYN GLASSER, EXAMINING ATTORNEY



David J. Kyros

Director of the United States Patent and Trademark Office

United States of America

United States Patent and Trademark Office

PERFORM

Reg. No. 4,108,975

SUPERMAX INCORPORATED. (NEW YORK CORPORATION)
2225 WHITE OAK CIRCLE
AURORA, IL 60504

Registered Mar. 6, 2012

Int. Cl.: 10

FOR: MEDICAL GLOVES, IN CLASS 10 (U.S. CLS. 26, 39 AND 44).

TRADEMARK

FIRST USE 1-1-2011; IN COMMERCE 1-1-2011.

PRINCIPAL REGISTER

THE MARK CONSISTS OF STANDARD CHARACTERS WITHOUT CLAIM TO ANY PARTICULAR FONT, STYLE, SIZE, OR COLOR.

SN 76-705,252, FILED 11-8-2010.

JAMES GRIFFIN, EXAMINING ATTORNEY



David J. Kybas

Director of the United States Patent and Trademark Office

United States of America

United States Patent and Trademark Office

MY SOCIAL MANIA

Reg. No. 4,108,976

Registered Mar. 6, 2012

Int. Cl.: 38

SERVICE MARK

PRINCIPAL REGISTER

WILSON, STEVEN (UNITED STATES INDIVIDUAL)
646 WINDELLWOOD CIRCLE
SMYRNA, TN 37167

FOR: PEER-TO-PEER MESSAGING SERVICES, NAMELY, ELECTRONIC TRANSMISSION OF DATA, TEXT MESSAGES, INSTANT MESSAGES, INFORMATION AND IMAGES VIA THE INTERNET AND OTHER COMMUNICATIONS NETWORKS; TELECOMMUNICATIONS SERVICES, NAMELY, PROVIDING ONLINE AND TELECOMMUNICATION FACILITIES IN THE NATURE OF CHAT ROOMS FOR ELECTRONIC TRANSMISSION OF DATA, TEXT MESSAGES, INSTANT MESSAGES, INFORMATION AND IMAGES VIA THE INTERNET AND OTHER COMMUNICATIONS NETWORKS, IN CLASS 38 (U.S. CLS. 100, 101 AND 104).

FIRST USE 1-11-2011; IN COMMERCE 1-11-2011.

THE MARK CONSISTS OF STANDARD CHARACTERS WITHOUT CLAIM TO ANY PARTICULAR FONT, STYLE, SIZE, OR COLOR.

NO CLAIM IS MADE TO THE EXCLUSIVE RIGHT TO USE "SOCIAL", APART FROM THE MARK AS SHOWN.

SN 76-705,465, FILED 11-24-2010.

LEIGH CAROLINE CASE, EXAMINING ATTORNEY



David J. Kyros

Director of the United States Patent and Trademark Office

United States of America

United States Patent and Trademark Office

BUSHMAN

Reg. No. 4,108,977

Registered Mar. 6, 2012

Int. Cl.: 20

TRADEMARK

PRINCIPAL REGISTER

CHANNELL COMMERCIAL CORPORATION (DELAWARE CORPORATION)
76040 YNEZ ROAD
P.O. BOX 9022
TEMECULA, CA 925899022

FOR: POLYETHYLENE TANKS, NAMELY, RAINWATER STORAGE TANKS, MOLASSES TANKS, TRANSPORTER TANKS, BELLY TANKS; OTHER POLYETHYLENE PRODUCTS, NAMELY, GRADE LEVEL BOXES, VAULTS, AND HAND HOLES ALL IN THE NATURE OF PLASTIC STORAGE CONTAINERS FOR INDUSTRIAL OR COMMERCIAL USE, IN CLASS 20 (U.S. CLS. 2, 13, 22, 25, 32 AND 50).

FIRST USE 12-1-2011; IN COMMERCE 12-1-2011.

THE MARK CONSISTS OF STANDARD CHARACTERS WITHOUT CLAIM TO ANY PARTICULAR FONT, STYLE, SIZE, OR COLOR.

OWNER OF U.S. REG. NOS. 3,268,901 AND 3,481,152.

SN 76-706,234, FILED 2-1-2011.

TASNEEM HUSSAIN, EXAMINING ATTORNEY



David J. Kypos

Director of the United States Patent and Trademark Office

United States of America

United States Patent and Trademark Office



Reg. No. 4,108,978

ELECTRA INVESTMENTS, INC. (GEORGIA CORPORATION)
4079 STEPHANIE CT.
KENNESAW, GA 30152

Registered Mar. 6, 2012

Int. Cl.: 43

FOR: FOOD SERVICE, NAMELY, FULL SERVICE CASUAL RESTAURANT, IN CLASS 43
(U.S. CLS. 100 AND 101).

SERVICE MARK

FIRST USE 9-26-2011; IN COMMERCE 9-26-2011.

PRINCIPAL REGISTER

NO CLAIM IS MADE TO THE EXCLUSIVE RIGHT TO USE "THE ORIGINAL FIREWATER GRILL", APART FROM THE MARK AS SHOWN.

THE COLORS WHITE, RED, BLACK AND GRAY ARE CLAIMED AS A FEATURE OF THE MARK.

THE MARK CONSISTS OF THE WORDING "THE ORIGINAL LULU'S FIREWATER GRILL" IN STYLIZED LETTERING INSIDE A BLACK OVAL. THE WORDING "THE ORIGINAL" AND "FIREWATER GRILL" APPEARS IN UPPERCASE WHITE LETTERING. THE WORD "LULU'S" APPEARS IN RED WITH A WHITE OUTLINE. A RED THICK BORDER APPEARS AROUND THE OVAL. A WHITE STAR APPEARS ON EACH SIDE OF THE WORD "LULU'S". A GRAY HIGHLIGHT APPEARS IN THE MIDDLE AREA OF THE OVAL. WHITE SHINES APPEAR THROUGHOUT THE UPPER AREA INSIDE THE WORD "LULU'S".

SN 76-707,211, FILED 4-11-2011.

MARK RADEMACHER, EXAMINING ATTORNEY



David J. Kyros

Director of the United States Patent and Trademark Office

United States of America

United States Patent and Trademark Office

JACO PASTORIUS

Reg. No. 4,108,979

JACO PASTORIUS, INC. (FLORIDA CORPORATION)
111 W. 57TH ST., SUITE 1120
NEW YORK, NY 10019

Registered Mar. 6, 2012

Int. Cl.: 25

FOR: SHIRTS, IN CLASS 25 (U.S. CLS. 22 AND 39).

TRADEMARK

FIRST USE 12-21-2011; IN COMMERCE 12-21-2011.

PRINCIPAL REGISTER

THE MARK CONSISTS OF STANDARD CHARACTERS WITHOUT CLAIM TO ANY PARTICULAR FONT, STYLE, SIZE, OR COLOR.

"JACO PASTORIUS" IS THE NAME OF AN INDIVIDUAL WHO IS NOW DECEASED.

SN 77-001,736, FILED 9-18-2006.

KAREN K. BUSH, EXAMINING ATTORNEY



David J. Kyffers

Director of the United States Patent and Trademark Office

United States of America

United States Patent and Trademark Office

LIQUID

Reg. No. 4,108,980

W.L. ACTIVEWEAR INC. (CANADA CORPORATION)
8484 ESPLANADE
MONTREAL, CANADA H2P-2R7

Registered Mar. 6, 2012

Int. Cl.: 25

FOR: BASEBALL CAPS; HATS, SHIRTS, AND SHORTS FOR SURFERS AND SUMMER WEAR, IN CLASS 25 (U.S. CLS. 22 AND 39).

TRADEMARK

FIRST USE 1-0-1998; IN COMMERCE 1-0-1998.

PRINCIPAL REGISTER

THE MARK CONSISTS OF STANDARD CHARACTERS WITHOUT CLAIM TO ANY PARTICULAR FONT, STYLE, SIZE, OR COLOR.

SN 77-018,404, FILED 10-11-2006.

KEVON CHISOLM, EXAMINING ATTORNEY



David J. Kybas

Director of the United States Patent and Trademark Office

United States of America

United States Patent and Trademark Office

DDB Remedy

Reg. No. 4,108,981

Registered Mar. 6, 2012

Int. Cl.: 35

SERVICE MARK

PRINCIPAL REGISTER

DDB WORLDWIDE COMMUNICATIONS GROUP INC. (NEW YORK CORPORATION)
437 MADISON AVENUE
NEW YORK, NY 10022

FOR: ADVERTISING AGENCY SERVICES, NAMELY, PROMOTING THE SERVICES OF OTHERS IN THE HEALTH CARE AND PHARMACEUTICAL FIELDS; DIRECT MARKETING ADVERTISING SERVICES; ADVERTISING AND MARKETING CONSULTING SERVICES; CONCEPT AND BRAND DEVELOPMENT IN THE HEALTH CARE AND PHARMACEUTICAL FIELDS; PUBLIC RELATIONS, ADVERTISING AND BUSINESS SERVICES, NAMELY, THE PLANNING, PURCHASE AND PROCUREMENT OF MEDIA TIME AND SPACE FOR ADVERTISING, MARKET RESEARCH AND ANALYSIS SERVICE; ADVERTISING AGENCIES, NAMELY, PROMOTING THE GOODS AND SERVICES OF THE HEALTH CARE AND PHARMACEUTICAL INDUSTRIES THROUGH THE DISTRIBUTION OF PRINTED, AUDIO AND VISUAL MATERIALS AND BY RENDERING SALES PROMOTION ADVICE; SPEAKER BUREAU MANAGEMENT SERVICES, NAMELY, MANAGEMENT OF SPEAKERS' APPEARANCES FOR OTHERS IN THE HEALTHCARE AND PHARMACEUTICAL FIELDS, IN CLASS 35 (U.S. CLS. 100, 101 AND 102).

FIRST USE 9-17-2010; IN COMMERCE 9-17-2010.

THE MARK CONSISTS OF STANDARD CHARACTERS WITHOUT CLAIM TO ANY PARTICULAR FONT, STYLE, SIZE, OR COLOR.

SN 77-059,471, FILED 12-7-2006.

KATHLEEN LORENZO, EXAMINING ATTORNEY



David J. Kyjars

Director of the United States Patent and Trademark Office

United States of America

United States Patent and Trademark Office

TACKLE BOXERS

Reg. No. 4,108,982

AFTCO MFG. CO., INC. (CALIFORNIA CORPORATION)
17351 MURPHY AVE
IRVINE, CA 92614

Registered Mar. 6, 2012

Int. Cl.: 25

FOR: UNDERWEAR, IN CLASS 25 (U.S. CLS. 22 AND 39).

TRADEMARK

FIRST USE 11-16-2011; IN COMMERCE 11-16-2011.

PRINCIPAL REGISTER

THE MARK CONSISTS OF STANDARD CHARACTERS WITHOUT CLAIM TO ANY PARTICULAR FONT, STYLE, SIZE, OR COLOR.

NO CLAIM IS MADE TO THE EXCLUSIVE RIGHT TO USE "BOXERS", APART FROM THE MARK AS SHOWN.

SN 77-074,273, FILED 1-2-2007.

TEJBIR SINGH, EXAMINING ATTORNEY



David J. Kybas

Director of the United States Patent and Trademark Office

United States of America

United States Patent and Trademark Office

LIFE, SIMPLY ORGANIZED.

Reg. No. 4,108,983

Registered Mar. 6, 2012

Int. Cls.: 6, 21, and 22

TRADEMARK

PRINCIPAL REGISTER

HOME PRODUCTS INTERNATIONAL, INC. (DELAWARE CORPORATION)
4501 WEST 47TH STREET
CHICAGO, IL 60632

FOR: METAL HOOKS, IN CLASS 6 (U.S. CLS. 2, 12, 13, 14, 23, 25 AND 50).

FIRST USE 1-0-2009; IN COMMERCE 1-0-2009.

FOR: CLEANING BRUSHES FOR CLEANING BATHROOM TOILETS AND SHOWERS; KITCHEN AND BATHROOM ACCESSORIES, NAMELY, TOWEL BARS, SOAP DISHES, TOOTHBRUSH HOLDERS, SHOWER ORGANIZERS IN THE NATURE OF SHOWER CADDIES THAT CONTAIN SHELVES, RACKS AND STANDS TO HOLD SHOWER ITEMS AND SUPPLIES; HOLDERS FOR USE IN SHOWER, IN THE NATURE OF SHOWER CADDIES; PORTABLE HOUSEHOLD CONTAINERS, PLASTIC STORAGE CONTAINERS FOR HOUSEHOLD OR KITCHEN USE; IRONING BOARDS, SHAPED IRONING BOARD PADS AND SHAPED IRONING BOARD COVERS; INDOOR LAUNDRY DRYERS, NAMELY, INDOOR LAUNDRY CLOTHES DRYING RACKS, IN CLASS 21 (U.S. CLS. 2, 13, 23, 29, 30, 33, 40 AND 50).

FIRST USE 1-0-2009; IN COMMERCE 1-0-2009.

FOR: LAUNDRY BAGS, NAMELY, NYLON, MESH AND CLOTH LAUNDRY BAGS; LINGERIE LAUNDRY BAGS, IN CLASS 22 (U.S. CLS. 1, 2, 7, 19, 22, 42 AND 50).

FIRST USE 1-0-2009; IN COMMERCE 1-0-2009.

THE MARK CONSISTS OF STANDARD CHARACTERS WITHOUT CLAIM TO ANY PARTICULAR FONT, STYLE, SIZE, OR COLOR.

SN 77-075,224, FILED 1-3-2007.

STEVEN JACKSON, EXAMINING ATTORNEY



David J. Kyros

Director of the United States Patent and Trademark Office

United States of America

United States Patent and Trademark Office

MALA MUJER

Reg. No. 4,108,984

Registered Mar. 6, 2012

Int. Cl.: 25

TRADEMARK

PRINCIPAL REGISTER

DA MARIA MALO FEIJO (SPAIN INDIVIDUAL)
C/ URBANIZACION EL RECREO 3A FASE, LOCAL
TARIFA CADIZ, SPAIN 11380

FOR: CLOTHING, NAMELY, ATHLETIC UNIFORMS, ATHLETIC FOOTWEAR, PLASTIC BABY BIBS, BABY BUNTING, BATH ROBES, BATHING SUITS, BATHING TRUNKS, NECK BANDS, WRIST BANDS, BEACH WEAR, BED JACKET, BELTS, BERETS, BERMUDA SHORTS, BIB OVERALLS, BIKINIS, BLAZER, BLOUSES, BLOUSONS, CARDIGANS, COVER-UPS, CAMISOLES, CAPES, CHEMISETTES, CROP TOPS, CULOTTES, CUMMERBUND, CUFFS, COVERALLS, COATS, DRESSES, DRESSING GOWNS, DICKIES, DUNGAREES, DUSTERS, EVENING GOWNS, FOUNDATION GARMENTS, FLIGHT SUITS, FROCKS, GARTER BELTS, GAUCHOS, GLOVES, GOWNS, COATS, NAMELY, GREAT COATS, GYM SHORTS, GYM SUITS, HALTER TOPS, HOUSECOATS, INFANT WEAR, CLOTH BABY BIBS, JACKETS, JERSEYS, JEANS, JOGGING SUITS, JUMPERS, KERCHIEFS, KNEE HIGHS, KNICKERS, LAYETTES, LEATHER JACKETS, LEATHER COATS, LEG WARMERS, LINGERIE, MANTILLAS, MANTLES, MINISKIRTS, MITTENS, MOCCASINS, MOCK-TURTLENECK SWEATERS, NECK WEAR, NECK TIES, NIGHT SHIRTS, OVER COATS, OVERALLS, PANTS, PANTS SUITS, PANTIES, PAJAMAS, PELISSES, PELERINES, POLO SHIRTS, PONCHOS, QUILTED VESTS, RAIN COATS, RAIN JACKETS, RAIN WEAR, ROBES, SCARVES, SHIFTS, SKI COATS, SUN SUITS, STOLE, SWEATERS, KNIT SHIRT, SPORT SHIRTS, SWEATSHIRTS, SWEATPANTS, SNOW SUITS, SUSPENDERS, SWIMSUITS, TAILLEURS, TEDDIES, TENNIS WEAR, THERMAL UNDERWEAR, T-SHIRTS, TIES, TIGHTS, TOPS, TROUSERS, TUNICS, TURBANS, TURTLENECK SWEATERS, TUXEDOS, UNDERCLOTHES, UNDERPANTS, UNDERSHIRTS, VESTS, WARM UP SUITS, WET SUITS; HEAD WEAR NAMELY, HATS, HEAD BANDS, SUN-VISORS, CAPS; FOOTWEAR, NAMELY, ATHLETIC SHOES, BEACH SHOES, BOOTS, CANVAS SHOES, DRESS SHOES, SANDALS, SNEAKERS, SHOES, SLIPPERS, IN CLASS 25 (U.S. CLS. 22 AND 39).



FIRST USE 4-0-2003; IN COMMERCE 8-0-2010.

THE MARK CONSISTS OF STANDARD CHARACTERS WITHOUT CLAIM TO ANY PARTICULAR FONT, STYLE, SIZE, OR COLOR.

NO CLAIM IS MADE TO THE EXCLUSIVE RIGHT TO USE "MUJER", APART FROM THE MARK AS SHOWN.

THE ENGLISH TRANSLATION OF "MALA MUJER" IS BAD WOMAN.

David J. Kyffers

Director of the United States Patent and Trademark Office

Reg. No. 4,108,984 SN 77-095,708, FILED 1-31-2007.

MICHAEL ENGEL, EXAMINING ATTORNEY

United States of America

United States Patent and Trademark Office

SLEEPING BEAUTY

Reg. No. 4,108,985

DISNEY ENTERPRISES, INC. (DELAWARE CORPORATION)
500 SOUTH BUENA VISTA STREET
BURBANK, CA 91521

Registered Mar. 6, 2012

Int. Cls.: 3 and 30

FOR: NON-MEDICATED TOILETRIES, COSMETICS, IN CLASS 3 (U.S. CLS. 1, 4, 6, 50, 51 AND 52).

TRADEMARK

FIRST USE 2-16-2010; IN COMMERCE 2-16-2010.

PRINCIPAL REGISTER

FOR: COFFEE; TEA, IN CLASS 30 (U.S. CL. 46).

FIRST USE 8-24-2009; IN COMMERCE 8-24-2009.

THE MARK CONSISTS OF STANDARD CHARACTERS WITHOUT CLAIM TO ANY PARTICULAR FONT, STYLE, SIZE, OR COLOR.

OWNER OF U.S. REG. NO. 2,895,966.

SN 77-098,498, FILED 2-2-2007.

JASON BLAIR, EXAMINING ATTORNEY



David J. Kybas

Director of the United States Patent and Trademark Office

United States of America

United States Patent and Trademark Office

THE LAST GREAT RACE

Reg. No. 4,108,986

Registered Mar. 6, 2012

Int. Cls.: 38 and 41

SERVICE MARK

PRINCIPAL REGISTER

IDITAROD TRAIL COMMITTEE (ALASKA NON-PROFIT CORPORATION)
MILE 2.2 KNIK GOOSE BAY ROAD
WASILLA, AK 99654

FOR: PROVIDING LIVE STREAMING OF AUDIO-VIDEO RECORDINGS FEATURING SLED DOG RACES, RACE UPDATES, HUMAN AND CANINE RACERS, RACE LOGISTICS, AND WEATHER AND TRAIL CONDITIONS, IN CLASS 38 (U.S. CLS. 100, 101 AND 104).

FIRST USE 12-14-2011; IN COMMERCE 12-14-2011.

FOR: ORGANIZING AND CONDUCTING SLED DOG RACES; PROVIDING A WEBSITE THAT FEATURES INFORMATION, IMAGES, AUDIO AND VIDEO CLIPS AND LESSON PLANS FEATURING SLED DOG RACING, ITS HISTORY, RACE UPDATES, RACE RESULTS, HUMAN AND CANINE RACERS AND RACE LOGISTICS; PROVIDING EMAIL NEWSLETTERS FEATURING SLED DOG RACING AND RACE UPDATES, IN CLASS 41 (U.S. CLS. 100, 101 AND 107).

FIRST USE 3-0-1980; IN COMMERCE 3-0-1980.

THE MARK CONSISTS OF STANDARD CHARACTERS WITHOUT CLAIM TO ANY PARTICULAR FONT, STYLE, SIZE, OR COLOR.

SEC. 2(F).

OWNER OF U.S. REG. NO. 1,483,830.

NO CLAIM IS MADE TO THE EXCLUSIVE RIGHT TO USE "RACE", APART FROM THE MARK AS SHOWN.

SN 77-116,654, FILED 2-26-2007.

MARY CRAWFORD, EXAMINING ATTORNEY



David J. Kyros

Director of the United States Patent and Trademark Office

United States of America

United States Patent and Trademark Office



Reg. No. 4,108,987

Registered Mar. 6, 2012

Int. Cl.: 9

TRADEMARK

PRINCIPAL REGISTER

ORACLE AMERICA, INC. (DELAWARE CORPORATION)
500 ORACLE PARKWAY
REDWOOD SHORES, CA 94065

FOR: DATA STORAGE DEVICES, NAMELY, BLANK TAPE LIBRARIES FOR STORAGE OF COMPUTER DATA, MAGNETIC TAPE DRIVES, COMPUTER STORAGE DEVICES, NAMELY, HIGH-SPEED STORAGE DISK SUBSYSTEMS FOR STORAGE AND BACKUP OF ELECTRONIC DATA EITHER LOCALLY OR VIA A TELECOMMUNICATIONS NETWORK, COMPUTER SOFTWARE FOR THE STORAGE OF DATA AND INFORMATION, COMPUTER HARDWARE, COMPUTER NETWORKING HARDWARE DEVICES WITH DATA STORAGE CAPABILITY, COMPUTER PERIPHERAL EQUIPMENT, AND BLANK ELECTRONIC DATA STORAGE MEDIA; COMPUTER HARDWARE, IN CLASS 9 (U.S. CLS. 21, 23, 26, 36 AND 38).

FIRST USE 3-17-1998; IN COMMERCE 3-17-1998.

OWNER OF U.S. REG. NO. 2,709,631.

SN 77-144,269, FILED 3-29-2007.

MICHAEL GAFFAR, EXAMINING ATTORNEY



David J. Kyffers

Director of the United States Patent and Trademark Office

United States of America

United States Patent and Trademark Office

EPIQ

Reg. No. 4,108,988

Registered Mar. 6, 2012

Int. Cls.: 9, 35, and 42

TRADEMARK

SERVICE MARK

PRINCIPAL REGISTER

EPIQ SYSTEMS, INC. (MISSOURI CORPORATION)
501 KANSAS AVENUE
KANSAS CITY, MO 66105

FOR: COMPUTER HARDWARE AND SOFTWARE USED TO COLLECT, HOST, ANALYZE, FILTER, CREATE, STORE, TRACK, MANAGE, CONVERT, DE-DUPLICATE, PROCESS, REVIEW, CLUSTER AND PRODUCE, DATABASES, IMAGES, E-MAIL, FILES AND OTHER DOCUMENTS AND DATA REQUIRED FOR LEGAL AND GOVERNMENTAL INVESTIGATIONS, EDISCOVERY AND LITIGATION, AND TO LOCATE, TRACK, CREATE, PRODUCE, AND MANAGE, LEGAL CLAIMS, LEGAL CLAIMANTS, LEGAL REPORTS, LEGAL MAILINGS AND NOTIFICATIONS, ALL DIRECTED TO THE LEGAL AND FIDUCIARY SERVICES INDUSTRIES, IN CLASS 9 (U.S. CLS. 21, 23, 26, 36 AND 38).

FIRST USE 0-0-2000; IN COMMERCE 0-0-2000.

FOR: COMPUTERIZED LEGAL DATABASES AND MANAGEMENT OF SAME; CASE AND DOCUMENT MANAGEMENT SERVICES FOR OTHERS IN THE LEGAL AND FIDUCIARY SERVICES INDUSTRIES, NAMELY, ACTING AS CLAIMS, CLASS ACTION, DATABASE, DOCUMENT, AND SETTLEMENT ADMINISTRATORS IN LAWSUITS, BANKRUPTCY AND CORPORATE RESTRUCTURING CASES, MASS TORT LITIGATION, INTERNAL CORPORATE AND GOVERNMENTAL INVESTIGATIONS; PREPARING DEVELOPING AND DISSEMINATING CLASS ACTION NOTICES AND NOTICE PLANS AND CREATING DEBTOR AND CREDITOR SCHEDULES AND STATEMENTS OF AFFAIRS FOR OTHERS IN THE BANKRUPTCY AND CORPORATE RESTRUCTURING FIELDS, IN CLASS 35 (U.S. CLS. 100, 101 AND 102).

FIRST USE 0-0-2000; IN COMMERCE 0-0-2000.

FOR: CONSULTING FOR OTHERS IN THE FIELDS OF SELECTING, IMPLEMENTING AND USING COMPUTER HARDWARE AND SOFTWARE SYSTEMS, AND IN THE FIELD OF TECHNICAL SUPPORT THEREFORE, DIRECTED TO THE LEGAL AND FIDUCIARY SERVICES INDUSTRIES; COMPUTER SOFTWARE DESIGN AND DEVELOPMENT; DESIGN, CREATION, IMPLEMENTATION AND MAINTENANCE OF WEB SITES FOR OTHERS DIRECTED TO THE LEGAL AND FIDUCIARY SERVICES INDUSTRIES, IN CLASS 42 (U.S. CLS. 100 AND 101).

FIRST USE 0-0-2000; IN COMMERCE 0-0-2000.



David J. Kybas

Director of the United States Patent and Trademark Office

Reg. No. 4,108,988 THE MARK CONSISTS OF STANDARD CHARACTERS WITHOUT CLAIM TO ANY PARTICULAR FONT, STYLE, SIZE, OR COLOR.

SN 77-150,968, FILED 4-6-2007.

ELISSA GARBER KON, EXAMINING ATTORNEY

United States of America

United States Patent and Trademark Office

XD GEAR

Reg. No. 4,108,989

SPRINGFIELD, INC. (ILLINOIS CORPORATION)
420 WEST MAIN STREET
GENESEO, IL 61254

Registered Mar. 6, 2012

Int. Cl.: 25

FOR: CLOTHING, NAMELY, SWEATSHIRTS AND HATS, IN CLASS 25 (U.S. CLS. 22 AND 39).

TRADEMARK

FIRST USE 0-0-2007; IN COMMERCE 0-0-2007.

PRINCIPAL REGISTER

THE MARK CONSISTS OF STANDARD CHARACTERS WITHOUT CLAIM TO ANY PARTICULAR FONT, STYLE, SIZE, OR COLOR.

OWNER OF U.S. REG. NO. 2,782,651.

NO CLAIM IS MADE TO THE EXCLUSIVE RIGHT TO USE "GEAR", APART FROM THE MARK AS SHOWN.

SN 77-156,282, FILED 4-13-2007.

HENRY S. ZAK, EXAMINING ATTORNEY



David J. Kybas

Director of the United States Patent and Trademark Office

United States of America

United States Patent and Trademark Office

WISH THEM WELL

Reg. No. 4,108,990

LATHIAN SYSTEMS, INC. (CALIFORNIA CORPORATION)

Registered Mar. 6, 2012

23785 EL TORO RD #430
LAKE FOREST, CA 92630

Int. Cls.: 38 and 42

FOR: PROVIDING ON-LINE CHAT ROOMS FOR TRANSMISSION OF MESSAGES AMONG COMPUTER USERS CONCERNING HEALTH AND WELLNESS; PROVIDING ON-LINE CHAT ROOMS IN THE FIELD OF HEALTH AND WELLNESS, IN CLASS 38 (U.S. CLS. 100, 101 AND 104).

SERVICE MARK

PRINCIPAL REGISTER

FIRST USE 12-21-2011; IN COMMERCE 12-21-2011.

FOR: COMPUTER SERVICES, NAMELY, HOSTING ON-LINE WEB FACILITIES FOR OTHERS FOR ORGANIZING AND CONDUCTING ON-LINE INTERACTIVE DISCUSSIONS; COMPUTER SERVICES, NAMELY, CREATING AN ONLINE VIRTUAL COMMUNITY FOR REGISTERED USERS TO PROMOTE HEALTH-ORIENTED AND WELLNESS-ORIENTED COMMUNICATIONS, VIA A GLOBAL COMPUTER NETWORK, IN CLASS 42 (U.S. CLS. 100 AND 101).

FIRST USE 12-21-2011; IN COMMERCE 12-21-2011.

THE MARK CONSISTS OF STANDARD CHARACTERS WITHOUT CLAIM TO ANY PARTICULAR FONT, STYLE, SIZE, OR COLOR.

SN 77-159,060, FILED 4-17-2007.

JORDAN BAKER, EXAMINING ATTORNEY



David J. Kybas

Director of the United States Patent and Trademark Office

United States of America

United States Patent and Trademark Office

101 RUN

Reg. No. 4,108,991

THE ROB NELSON COMPANY (WASHINGTON CORPORATION)
1701 BROADWAY
VANCOUVER, WA 98663

Registered Mar. 6, 2012

Int. Cl.: 41

FOR: ENTERTAINMENT IN THE NATURE OF STAGING RUNNING RACES, IN CLASS 41
(U.S. CLS. 100, 101 AND 107).

SERVICE MARK

FIRST USE 1-8-2012; IN COMMERCE 1-8-2012.

PRINCIPAL REGISTER

THE MARK CONSISTS OF STANDARD CHARACTERS WITHOUT CLAIM TO ANY PARTICULAR FONT, STYLE, SIZE, OR COLOR.

NO CLAIM IS MADE TO THE EXCLUSIVE RIGHT TO USE "RUN", APART FROM THE MARK AS SHOWN.

SN 77-178,000, FILED 5-10-2007.

CURTIS FRENCH, EXAMINING ATTORNEY



David J. Kyffers

Director of the United States Patent and Trademark Office

United States of America

United States Patent and Trademark Office



Reg. No. 4,108,992

Registered Mar. 6, 2012

Int. Cls.: 35 and 41

SERVICE MARK

PRINCIPAL REGISTER

HSM ARGENTINA S.A. (ARGENTINA SOCIEDAD ANONIMA)
AV. CORRIENTES 222, PISO 6
BUENOS AIRES, ARGENTINA

FOR: PROVIDING INFORMATION IN THE FIELD OF BUSINESS MANAGEMENT VIA ELECTRONIC COMMUNICATIONS NETWORKS; PROVIDING ON-LINE INFORMATION IN THE FIELD OF BUSINESS PROMOTION AND MARKETING; BUSINESS MARKETING CONSULTING SERVICES, IN CLASS 35 (U.S. CLS. 100, 101 AND 102).

FIRST USE 7-11-2007; IN COMMERCE 7-11-2007.

FOR: ORGANIZATION OF CONFERENCES, SYMPOSIA, FORA, EXHIBITIONS AND EXPOSITIONS FOR EDUCATIONAL PURPOSES IN THE FIELD OF BUSINESS MANAGEMENT; EDUCATIONAL SERVICES, NAMELY, CONDUCTING CLASSES, SEMINARS AND WORKSHOPS IN THE FIELD OF EXECUTIVE MANAGEMENT; EDUCATIONAL SERVICES, NAMELY, EXECUTIVE TRAINING IN THE FIELD OF FINANCE, MARKETING, STRATEGY, COSTS, LEADERSHIP AND BENCH MARKING; EDUCATIONAL SERVICES IN THE NATURE OF CORRESPONDENCE COURSES ON THE SUBJECTS OF EXECUTIVE TRAINING IN THE FIELD OF FINANCE, MARKETING, STRATEGY, COSTS, LEADERSHIP AND BENCH MARKING, IN CLASS 41 (U.S. CLS. 100, 101 AND 107).

FIRST USE 11-8-2005; IN COMMERCE 11-8-2005.

OWNER OF U.S. REG. NO. 2,878,162.

THE COLOR(S) BLUE AND WHITE IS/ARE CLAIMED AS A FEATURE OF THE MARK.

THE MARK CONSISTS OF THE WORDS "HSM" AND "INSPIRING IDEAS" IN WHITE LETTERING, WITH A WHITE SLASH UNDER "HSM," IN A BLUE SQUARE.

SN 77-193,148, FILED 5-30-2007.

LINDA E. BLOHM, EXAMINING ATTORNEY



David J. Kyffers

Director of the United States Patent and Trademark Office

United States of America

United States Patent and Trademark Office

iPING

Reg. No. 4,108,993

Registered Mar. 6, 2012

Int. Cl.: 9

TRADEMARK

PRINCIPAL REGISTER

KARSTEN MANUFACTURING CORPORATION (ARIZONA CORPORATION)
LEGAL DEPARTMENT
2201 WEST DESERT COVE
PHOENIX, AZ 85029

FOR: CONSUMER MOBILE TELEPHONE EQUIPMENT, NAMELY, MOBILE TELEPHONES AND PDA'S, IN CLASS 9 (U.S. CLS. 21, 23, 26, 36 AND 38).

FIRST USE 6-17-2011; IN COMMERCE 6-17-2011.

THE MARK CONSISTS OF STANDARD CHARACTERS WITHOUT CLAIM TO ANY PARTICULAR FONT, STYLE, SIZE, OR COLOR.

OWNER OF U.S. REG. NOS. 704,552, 1,647,448, AND OTHERS.

SN 77-195,817, FILED 6-1-2007.

KATHERINE STOIDES, EXAMINING ATTORNEY



David J. Kyffers

Director of the United States Patent and Trademark Office

United States of America

United States Patent and Trademark Office

DISKENVY

Reg. No. 4,108,994

DISK ENVY, INC. (NEW YORK CORPORATION)
423 GEYSER ROAD
BALLSTON SPA, NY 12020

Registered Mar. 6, 2012

Int. Cls.: 39 and 42

FOR: ELECTRONIC STORAGE OF DIGITAL CONTENT, IN CLASS 39 (U.S. CLS. 100 AND 105).

SERVICE MARK

FIRST USE 3-1-2011; IN COMMERCE 3-1-2011.

PRINCIPAL REGISTER

FOR: HOSTING OF DIGITAL CONTENT ON THE INTERNET, IN CLASS 42 (U.S. CLS. 100 AND 101).

FIRST USE 3-1-2011; IN COMMERCE 3-1-2011.

THE MARK CONSISTS OF STANDARD CHARACTERS WITHOUT CLAIM TO ANY PARTICULAR FONT, STYLE, SIZE, OR COLOR.

SN 77-207,145, FILED 6-15-2007.

TOBY BULLOFF, EXAMINING ATTORNEY



David J. Kybas

Director of the United States Patent and Trademark Office

United States of America

United States Patent and Trademark Office

XEOHEALTH

Reg. No. 4,108,995

Registered Mar. 6, 2012

Int. Cl.: 16

TRADEMARK

PRINCIPAL REGISTER

MEDIKREDIT INTEGRATED HEALTHCARE SOLUTIONS (PTY) LTD (SOUTH AFRICA COMPANY)
132 JAN SMUTS AVENUE
PARKWOOD, JOHANNESBURG, 2193, SOUTH AFRICA

FOR: PRINTED MATTER, NAMELY, INSTRUCTIONAL MATERIAL, MANUALS AND LEAFLETS IN THE FIELDS OF HEALTH CARE SERVICES AND THE ADMINISTRATION AND MANAGEMENT OF HEALTH CARE SERVICES, BENEFITS AND RISKS, IN CLASS 16 (U.S. CLS. 2, 5, 22, 23, 29, 37, 38 AND 50).

FIRST USE 6-10-2010; IN COMMERCE 6-10-2010.

THE MARK CONSISTS OF STANDARD CHARACTERS WITHOUT CLAIM TO ANY PARTICULAR FONT, STYLE, SIZE, OR COLOR.

SN 77-217,595, FILED 6-28-2007.

DEZMONA MIZELLE, EXAMINING ATTORNEY



David J. Kyffers

Director of the United States Patent and Trademark Office

United States of America

United States Patent and Trademark Office

ROBERT JORDAN'S

Reg. No. 4,108,996

RJC FRANCHISING, LLC (INDIANA LIMITED LIABILITY COMPANY)
320 CORTEZ ROAD W.
BRADENTON, FL 34207

Registered Mar. 6, 2012

Int. Cl.: 43

FOR: RESTAURANT SERVICES; CREAMERY SERVICES, NAMELY, RESTAURANTS FEATURING CHEESE, ICE CREAM, AND OTHER DAIRY PRODUCTS, IN CLASS 43 (U.S. CLS. 100 AND 101).

SERVICE MARK

FIRST USE 12-28-2011; IN COMMERCE 12-28-2011.

PRINCIPAL REGISTER

THE MARK CONSISTS OF STANDARD CHARACTERS WITHOUT CLAIM TO ANY PARTICULAR FONT, STYLE, SIZE, OR COLOR.

THE NAME(S), PORTRAIT(S), AND/OR SIGNATURE(S) SHOWN IN THE MARK IDENTIFIES A LIVING INDIVIDUAL, ROBERT JORDAN, WHOSE CONSENT(S) TO REGISTER IS SUBMITTED.

SN 77-217,968, FILED 6-28-2007.

LINDSEY RUBIN, EXAMINING ATTORNEY



David J. Kyros

Director of the United States Patent and Trademark Office

United States of America

United States Patent and Trademark Office

MALTESSE

Reg. No. 4,108,997

CASTELAIN EXPANSION (FRANCE SOCIETE ANONYME)
13, RUE PASTEUR
BENIFONTAINE, FRANCE 62410

Registered Mar. 6, 2012

Int. Cl.: 32

FOR: BEERS; MINERAL AND AERATED WATERS; FRUIT DRINKS AND FRUIT JUICES;
SYRUPS FOR MAKING FRUIT DRINKS, IN CLASS 32 (U.S. CLS. 45, 46 AND 48).

TRADEMARK

FIRST USE 11-21-2011; IN COMMERCE 11-21-2011.

PRINCIPAL REGISTER

THE MARK CONSISTS OF STANDARD CHARACTERS WITHOUT CLAIM TO ANY PARTICULAR FONT, STYLE, SIZE, OR COLOR.

SN 77-226,918, FILED 7-11-2007.

THEODORE MCBRIDE, EXAMINING ATTORNEY



David J. Kybas

Director of the United States Patent and Trademark Office

United States of America

United States Patent and Trademark Office

TOSHIMI TEA ON TAP

Reg. No. 4,108,998

Registered Mar. 6, 2012

Int. Cl.: 30

TRADEMARK

PRINCIPAL REGISTER

SEA BREEZE FRUIT FLAVORS, INC. (NEW JERSEY CORPORATION)
441 ROUTE 202
TOWACO, NJ 07082

FOR: HOT AND COLD PREPARED TEA BASED BEVERAGES, IN CLASS 30 (U.S. CL. 46).

FIRST USE 11-1-2011; IN COMMERCE 11-1-2011.

THE MARK CONSISTS OF STANDARD CHARACTERS WITHOUT CLAIM TO ANY PARTICULAR FONT, STYLE, SIZE, OR COLOR.

OWNER OF U.S. REG. NO. 3,277,575.

NO CLAIM IS MADE TO THE EXCLUSIVE RIGHT TO USE "TEA ON TAP", APART FROM THE MARK AS SHOWN.

THE FOREIGN WORDING IN THE MARK TRANSLATES INTO ENGLISH AS "SMART AND BEAUTIFUL".

SN 77-227,093, FILED 7-11-2007.

JORDAN BAKER, EXAMINING ATTORNEY



David J. Kyros

Director of the United States Patent and Trademark Office

United States of America

United States Patent and Trademark Office

IMARK

Reg. No. 4,108,999

Registered Mar. 6, 2012

Int. Cl.: 36

SERVICE MARK

PRINCIPAL REGISTER

IMARK BUILDERS, INC. (MARYLAND CORPORATION)
P.O. BOX 498
JOPPA, MD 21085

FOR: INVESTMENTS, NAMELY, FINANCIAL INVESTMENT IN THE FIELD OF REAL ESTATE; REAL ESTATE BROKERAGE, IN CLASS 36 (U.S. CLS. 100, 101 AND 102).

FIRST USE 0-0-2009; IN COMMERCE 0-0-2009.

THE MARK CONSISTS OF STANDARD CHARACTERS WITHOUT CLAIM TO ANY PARTICULAR FONT, STYLE, SIZE, OR COLOR.

SN 77-246,988, FILED 8-3-2007.

JENNIFER VASQUEZ, EXAMINING ATTORNEY



David J. Kybas

Director of the United States Patent and Trademark Office

United States of America

United States Patent and Trademark Office

VERSAFUND

Reg. No. 4,109,000

Registered Mar. 6, 2012

Int. Cls.: 35, 36, and 45

SERVICE MARK

PRINCIPAL REGISTER

VERSA IP, LLC (DELAWARE LIMITED LIABILITY COMPANY)
2929 ARCH STREET
CIRA CENTER
PHILADELPHIA, PA 191042868

FOR: BUSINESS MANAGEMENT, AND THE BUSINESS MANAGEMENT OF BUSINESS ACQUISITIONS FOR OTHERS; BUSINESS ACQUISITIONS CONSULTATION SERVICES; BUSINESS MANAGEMENT AND CONSULTING SERVICES; BUSINESS INVESTIGATIONS, EVALUATIONS, EXPERT APPRAISALS, INFORMATION AND RESEARCH IN THE FIELDS OF REVIEWING ASSETS, LIABILITIES, PRODUCTS, SERVICES, MARKET POSITION, COSTS, PRICING, BUSINESS PRACTICES AND BUSINESS PROCESSES; NEGOTIATION OF COMMERCIAL TRANSACTIONS FOR THIRD PARTIES IN THE FIELD OF LOANS, IN CLASS 35 (U.S. CLS. 100, 101 AND 102).

FIRST USE 12-2-2011; IN COMMERCE 12-2-2011.

FOR: FINANCIAL AND FINANCING SERVICES, NAMELY, PRIVATE EQUITY INVESTMENT SERVICES AND THE PURCHASE FOR OTHERS OF SECURITIES AND OTHER FINANCIAL INSTRUMENTS FROM BOTH PUBLIC AND PRIVATE ISSUERS; FINANCIAL CONSULTATION SERVICES RELATED TO CORPORATE ACQUISITIONS, EXPANSIONS, RESTRUCTURINGS AND BUYOUTS; INVESTMENT MANAGEMENT SERVICES; INVESTMENT BANKING SERVICES; INVESTMENT CONSULTATION AND ADVISORY SERVICES; INVESTMENT PORTFOLIO MANAGEMENT SERVICES; FINANCIAL INVESTMENT MANAGEMENT SERVICES, NAMELY, ASSET MANAGEMENT; INVESTMENT OF FUNDS FOR OTHERS; ARRANGING AND CONDUCTING CAPITAL MARKETS TRANSACTIONS FOR OTHERS; FINANCIAL SERVICES, NAMELY, ASSISTING OTHERS WITH THE COMPLETION OF FINANCIAL TRANSACTIONS FOR STOCKS, BONDS AND OTHER SECURITIES; ARRANGING FOR OTHERS TRANSACTIONS INVOLVING PRIVATE AND PUBLIC EQUITY AND DEBT, NAMELY, SALES, PURCHASES, AND PARTICIPATIONS, AND CONSULTING AND ADVISORY SERVICES RELATING THERETO; FINANCIAL DUE DILIGENCE SERVICES FOR BUSINESSES IN CONNECTION WITH BUSINESS ACQUISITION TRANSACTIONS; RAISING FUNDS FOR INVESTMENT IN CONNECTION WITH ALL FORMS OF INVESTMENT IN PUBLIC AND PRIVATE EQUITY AND DEBT; AND LOAN ORIGATION SERVICES; CREDIT AND LOAN SERVICES; FISCAL ASSESSMENT AND EVALUATION; EVALUATION OF CREDIT REPORT DATA, IN CLASS 36 (U.S. CLS. 100, 101 AND 102).

FIRST USE 12-2-2011; IN COMMERCE 12-2-2011.



David J. Kyros

Director of the United States Patent and Trademark Office

Reg. No. 4,109,000 FOR: PREPARING BUSINESS MERGER AND ACQUISITION DOCUMENTS; LOAN ADMINISTRATION SERVICES, NAMELY, MORTGAGE LOAN CLOSING SERVICES; BACKGROUND INVESTIGATION AND RESEARCH SERVICES IN THE FIELDS OF CIVIL AND CRIMINAL PROCEEDINGS AND OTHER ASPECTS OF OTHER PERSONS OR ENTITIES; AND PREPARING LOAN DOCUMENTS, IN CLASS 45 (U.S. CLS. 100 AND 101).

FIRST USE 12-2-2011; IN COMMERCE 12-2-2011.

THE MARK CONSISTS OF STANDARD CHARACTERS WITHOUT CLAIM TO ANY PARTICULAR FONT, STYLE, SIZE, OR COLOR.

SN 77-248,371, FILED 8-7-2007.

ELLEN B. AWRICH, EXAMINING ATTORNEY

United States of America

United States Patent and Trademark Office

VERSA SPECIAL SITUATIONS FUND

Reg. No. 4,109,001

Registered Mar. 6, 2012

Int. Cls.: 35, 36, and 45

SERVICE MARK

PRINCIPAL REGISTER

VERSA IP, LLC (DELAWARE LIMITED LIABILITY COMPANY)
2929 ARCH STREET
CIRA CENTER
PHILADELPHIA, PA 191042868

FOR: BUSINESS MANAGEMENT, AND THE BUSINESS MANAGEMENT OF BUSINESS ACQUISITIONS FOR OTHERS; BUSINESS ACQUISITIONS CONSULTATION SERVICES; BUSINESS MANAGEMENT AND CONSULTING SERVICES; BUSINESS INVESTIGATIONS, EVALUATIONS, EXPERT APPRAISALS, INFORMATION AND RESEARCH IN THE FIELDS OF REVIEWING ASSETS, LIABILITIES, PRODUCTS, SERVICES, MARKET POSITION, COSTS, PRICING, BUSINESS PRACTICES AND BUSINESS PROCESSES; AND NEGOTIATION OF COMMERCIAL TRANSACTIONS FOR THIRD PARTIES IN THE FIELD OF LOANS, IN CLASS 35 (U.S. CLS. 100, 101 AND 102).

FIRST USE 11-30-2011; IN COMMERCE 11-30-2011.

FOR: FINANCIAL AND FINANCING SERVICES, NAMELY, PRIVATE EQUITY INVESTMENT SERVICES AND THE PURCHASE FOR OTHERS OF SECURITIES AND OTHER FINANCIAL INSTRUMENTS FROM BOTH PUBLIC AND PRIVATE ISSUERS; FINANCIAL CONSULTATION SERVICES RELATED TO CORPORATE ACQUISITIONS, EXPANSIONS, RESTRUCTURINGS AND BUYOUTS; INVESTMENT MANAGEMENT SERVICES; INVESTMENT BANKING SERVICES; INVESTMENT CONSULTATION AND ADVISORY SERVICES; INVESTMENT PORTFOLIO MANAGEMENT SERVICES; FINANCIAL INVESTMENT MANAGEMENT SERVICES, NAMELY, ASSET MANAGEMENT; INVESTMENT OF FUNDS FOR OTHERS; ARRANGING AND CONDUCTING CAPITAL MARKETS TRANSACTIONS FOR OTHERS; FINANCIAL SERVICES, NAMELY, ASSISTING OTHERS WITH THE COMPLETION OF FINANCIAL TRANSACTIONS FOR STOCKS, BONDS AND OTHER SECURITIES; ARRANGING FOR OTHERS TRANSACTIONS INVOLVING PRIVATE AND PUBLIC EQUITY AND DEBT, NAMELY, SALES, PURCHASES, AND PARTICIPATIONS, AND CONSULTING AND ADVISORY SERVICES RELATING THERETO; FINANCIAL DUE DILIGENCE SERVICES FOR BUSINESSES IN CONNECTION WITH BUSINESS ACQUISITION TRANSACTIONS; RAISING FUNDS FOR INVESTMENT IN CONNECTION WITH ALL FORMS OF INVESTMENT IN PUBLIC AND PRIVATE EQUITY AND DEBT; AND LOAN ORIGATION SERVICES; CREDIT AND LOAN SERVICES; FISCAL ASSESSMENT AND EVALUATION; EVALUATION OF CREDIT REPORT DATA, IN CLASS 36 (U.S. CLS. 100, 101 AND 102).



David J. Kyjars

Director of the United States Patent and Trademark Office

FIRST USE 11-30-2011; IN COMMERCE 11-30-2011.

Reg. No. 4,109,001 FOR: PREPARING BUSINESS MERGER AND ACQUISITION DOCUMENTS; LOAN ADMINISTRATION SERVICES, NAMELY, MORTGAGE LOAN CLOSING SERVICES; BACKGROUND INVESTIGATION AND RESEARCH SERVICES IN THE FIELDS OF CIVIL AND CRIMINAL PROCEEDINGS AND OTHER ASPECTS OF OTHER PERSONS OR ENTITIES; AND PREPARING LOAN DOCUMENTS, IN CLASS 45 (U.S. CLS. 100 AND 101).

FIRST USE 11-30-2011; IN COMMERCE 11-30-2011.

THE MARK CONSISTS OF STANDARD CHARACTERS WITHOUT CLAIM TO ANY PARTICULAR FONT, STYLE, SIZE, OR COLOR.

NO CLAIM IS MADE TO THE EXCLUSIVE RIGHT TO USE "SPECIAL SITUATIONS FUND", APART FROM THE MARK AS SHOWN.

SN 77-248,376, FILED 8-7-2007.

ELLEN B. AWRICH, EXAMINING ATTORNEY

United States of America

United States Patent and Trademark Office

BIO-PRUF TREATED

Reg. No. 4,109,002

Registered Mar. 6, 2012

**CERTIFICATION MARK
GOODS**

PRINCIPAL REGISTER

ROHM AND HAAS CHEMICALS LLC (DELAWARE LIMITED LIABILITY COMPANY)
100 INDEPENDENCE MALL WEST
PHILADELPHIA, PA 191062399

FOR: FINISHED PRODUCTS IN THE BUILDING AND CONSTRUCTION, PAINT AND COATINGS INDUSTRIES, WHICH HAVE BEEN TREATED WITH PROPRIETOR'S ANTIMICROBIAL AGENT, IN CLASS A (U.S. CL. A).

FIRST USE 12-31-2009; IN COMMERCE 12-31-2009.

THE MARK CONSISTS OF STANDARD CHARACTERS WITHOUT CLAIM TO ANY PARTICULAR FONT, STYLE, SIZE, OR COLOR.

OWNER OF U.S. REG. NOS. 1,654,009, 1,670,696, AND 1,678,038.

NO CLAIM IS MADE TO THE EXCLUSIVE RIGHT TO USE "TREATED", APART FROM THE MARK AS SHOWN.

THE CERTIFICATION MARK, AS USED BY PERSONS AUTHORIZED BY CERTIFIER, CERTIFIES THAT THE GOODS ARE MANUFACTURED IN ACCORDANCE WITH PROCESSES SUBJECT TO CERTIFIER'S INSPECTION AND APPROVAL. CERTIFIER SUPPLIES SAID PERSONS WITH ANTIMICROBIAL AGENT, STANDARDS, SPECIFICATIONS, AND INSTRUCTIONS REQUIRING MINIMUM LEVELS OF SAID AGENT IN THE GOODS SO THAT THEY HAVE ANTIBACTERIAL AND ANTIFUNGAL ACTIVITY AT THE TIME OF MANUFACTURE.

SN 77-257,035, FILED 8-16-2007.

CIMMERIAN COLEMAN, EXAMINING ATTORNEY



David J. Kybas

Director of the United States Patent and Trademark Office

United States of America
United States Patent and Trademark Office

FLAMEBOY

Reg. No. 4,109,003

Registered Mar. 6, 2012

Int. Cl.: 9

TRADEMARK

PRINCIPAL REGISTER

SEVEN WELLS, LLC (CALIFORNIA LIMITED LIABILITY COMPANY), DBA I. E.
DISTRIBUTION,
1008 BRIOSO DRIVE
COSTA MESA, CA 92627

FOR: ACCESSORIES FOR ALL-PURPOSE BAGS, NAMELY, CELLULAR TELEPHONE
CASES, CASES FOR PORTABLE AND HANDHELD DIGITAL ELECTRONIC DEVICES , IN
CLASS 9 (U.S. CLS. 21, 23, 26, 36 AND 38).

FIRST USE 10-8-2009; IN COMMERCE 10-8-2009.

THE MARK CONSISTS OF STANDARD CHARACTERS WITHOUT CLAIM TO ANY PAR-
TICULAR FONT, STYLE, SIZE, OR COLOR.

SN 77-257,145, FILED 8-16-2007.

REBECCA EISINGER, EXAMINING ATTORNEY



David J. Kybas

Director of the United States Patent and Trademark Office

United States of America

United States Patent and Trademark Office

HEALTHY IDEAS

Reg. No. 4,109,004

Registered Mar. 6, 2012

Int. Cls.: 29 and 30

TRADEMARK

PRINCIPAL REGISTER

AHOLD LICENSING SARL (SWITZERLAND LIMITED LIABILITY COMPANY)
2 RUE JEAN-PETITOT
GENEVA, SWITZERLAND 1204

FOR: CHEESE, MILK, SOY MILK, RICE MILK FOR USE AS A MILK SUBSTITUTE, RICOTTA CHEESE, COTTAGE CHEESE, YOGURT, EGG SUBSTITUTE, CANNED FRUITS, DRIED FRUITS, FROZEN FRUITS, DEHYDRATED FRUIT SNACKS, CANNED VEGETABLES, FROZEN VEGETABLES, FROZEN BERRIES, PROCESSED POTATOES, FROZEN FISH, CANNED FISH, NUT BUTTERS, DRIED BEANS, CANNED SOUPS, DRIED SOUP MIXES, LUNCHEON MEATS, FRESH AND PROCESSED SHRIMP AND SEAFOOD, VEGETABLE SALADS, GARDEN SALADS, FRESH, CANNED, PROCESSED AND FROZEN MEATS AND POULTRY, TOFU, MEAT SUBSTITUTES, IN CLASS 29 (U.S. CL. 46).

FIRST USE 1-0-2009; IN COMMERCE 1-0-2009.

FOR: BREAD, BAGELS, ROLLS, FROZEN PIZZA, FROZEN ENTREES CONSISTING PRIMARILY OF PASTA OR RICE, PASTA, CRACKERS, PUDDING, PANCAKE MIXES, PROCESSED UNPOPPED POPCORN, SPAGHETTI SAUCE, TOMATO SAUCE, PASTA SAUCE, BREAKFAST CEREAL, CEREAL-BASED SNACK BARS, GRANOLA SNACKS, WHEAT-BASED SNACK BARS, PROCESSED OATS AND OATMEAL, GRITS, RICE, PIEROGIES, DUMPLINGS, IN CLASS 30 (U.S. CL. 46).

FIRST USE 1-0-2009; IN COMMERCE 1-0-2009.

THE MARK CONSISTS OF STANDARD CHARACTERS WITHOUT CLAIM TO ANY PARTICULAR FONT, STYLE, SIZE, OR COLOR.

SN 77-279,294, FILED 9-13-2007.

COLLEEN DOMBROW, EXAMINING ATTORNEY



David J. Kybas

Director of the United States Patent and Trademark Office

United States of America

United States Patent and Trademark Office

DEFIANCE

Reg. No. 4,109,005

Registered Mar. 6, 2012

Int. Cl.: 24

TRADEMARK

PRINCIPAL REGISTER

GLEN RAVEN, INC. (NORTH CAROLINA CORPORATION)
1831 NORTH PARK AVENUE
GLEN RAVEN, NC 27217

FOR: FABRIC FINISH SOLD AS A COMPONENT OF FINISHED FABRICS TO RESIST FADING AND ACT AS AN ANTIMICROBIAL AND ANTIFUNGAL AGENT, IN CLASS 24 (U.S. CLS. 42 AND 50).

FIRST USE 5-18-2001; IN COMMERCE 9-24-2007.

THE MARK CONSISTS OF STANDARD CHARACTERS WITHOUT CLAIM TO ANY PARTICULAR FONT, STYLE, SIZE, OR COLOR.

SN 77-292,815, FILED 10-1-2007.

JAY FLOWERS, EXAMINING ATTORNEY



David J. Kyffers

Director of the United States Patent and Trademark Office

United States of America

United States Patent and Trademark Office

THE STONES

Reg. No. 4,109,006

MUSIDOR B.V. (NETHERLANDS LIMITED LIABILITY COMPANY)
HERENGRACHT 566

Registered Mar. 6, 2012

AMSTERDAM, NETHERLANDS NL-1017CH

Int. Cl.: 25

FOR: CLOTHING, NAMELY, T-SHIRTS, IN CLASS 25 (U.S. CLS. 22 AND 39).

FIRST USE 2-25-2011; IN COMMERCE 2-25-2011.

TRADEMARK

THE MARK CONSISTS OF STANDARD CHARACTERS WITHOUT CLAIM TO ANY PARTICULAR FONT, STYLE, SIZE, OR COLOR.

PRINCIPAL REGISTER

OWNER OF U.S. REG. NOS. 1,358,893, 2,201,605, AND 3,035,916.

SN 77-296,613, FILED 10-4-2007.

MARGARET POWER, EXAMINING ATTORNEY



David J. Kyros

Director of the United States Patent and Trademark Office

United States of America

United States Patent and Trademark Office

OPTUMHEALTH EACCESS

Reg. No. 4,109,007

Registered Mar. 6, 2012

Int. Cl.: 36

SERVICE MARK

PRINCIPAL REGISTER

UNITEDHEALTH GROUP INCORPORATED (MINNESOTA CORPORATION)
9900 BREN ROAD EAST, MN008-T202
MINNETONKA, MN 55343

FOR: HEALTH SAVINGS ACCOUNT SERVICES, NAMELY, PROVIDING BANKING SERVICES AND SAVINGS ACCOUNT ADMINISTRATION FOR CONSUMER-DRIVEN HEALTH CARE PLANS AND DEFINED CONTRIBUTION HEALTH CARE PLANS; FINANCIAL MANAGEMENT, ADMINISTRATION, AND UNDERWRITING OF HEALTH SAVINGS ACCOUNTS; MEDICAL INSURANCE SERVICES, NAMELY, PROVIDING A QUALIFIED MEDICAL INSURANCE PLAN WITH A TAX ADVANTAGED MEDICAL SAVINGS ACCOUNT; BANKING SERVICES; DEBIT CARD SERVICES; ELECTRONIC FUNDS TRANSFER; DEBIT CARD TRANSACTION PROCESSING SERVICES; CASH MANAGEMENT SERVICES; ON-LINE BANKING SERVICES, IN CLASS 36 (U.S. CLS. 100, 101 AND 102).

FIRST USE 12-0-2007; IN COMMERCE 12-0-2007.

THE MARK CONSISTS OF STANDARD CHARACTERS WITHOUT CLAIM TO ANY PARTICULAR FONT, STYLE, SIZE, OR COLOR.

OWNER OF U.S. REG. NOS. 1,801,041, 2,679,582, AND OTHERS.

NO CLAIM IS MADE TO THE EXCLUSIVE RIGHT TO USE "EACCESS", APART FROM THE MARK AS SHOWN.

SN 77-297,772, FILED 10-5-2007.

SANJEEV VOHRA, EXAMINING ATTORNEY



David J. Kyros

Director of the United States Patent and Trademark Office

United States of America

United States Patent and Trademark Office

OPTUMHEALTH EINVESTOR

Reg. No. 4,109,008

Registered Mar. 6, 2012

Int. Cl.: 36

SERVICE MARK

PRINCIPAL REGISTER

UNITEDHEALTH GROUP INCORPORATED (MINNESOTA CORPORATION)
9900 BREN ROAD EAST
MN008-T202
MINNETONKA, MN 55343

FOR: HEALTH SAVINGS ACCOUNT SERVICES, NAMELY, PROVIDING BANKING SERVICES AND SAVINGS ACCOUNT ADMINISTRATION FOR CONSUMER-DRIVEN HEALTH CARE PLANS AND DEFINED CONTRIBUTION HEALTH CARE PLANS; FINANCIAL MANAGEMENT, ADMINISTRATION, AND UNDERWRITING OF HEALTH SAVINGS ACCOUNTS; MEDICAL INSURANCE SERVICES, NAMELY, PROVIDING A QUALIFIED MEDICAL INSURANCE PLAN WITH A TAX ADVANTAGED MEDICAL SAVINGS ACCOUNT; BANKING SERVICES; DEBIT CARD SERVICES; ELECTRONIC FUNDS TRANSFER; DEBIT CARD TRANSACTION PROCESSING SERVICES; CASH MANAGEMENT SERVICES; ON-LINE BANKING SERVICES, IN CLASS 36 (U.S. CLS. 100, 101 AND 102).

FIRST USE 12-0-2007; IN COMMERCE 12-0-2007.

THE MARK CONSISTS OF STANDARD CHARACTERS WITHOUT CLAIM TO ANY PARTICULAR FONT, STYLE, SIZE, OR COLOR.

OWNER OF U.S. REG. NOS. 1,801,041, 2,679,582, AND OTHERS.

NO CLAIM IS MADE TO THE EXCLUSIVE RIGHT TO USE "EINVESTOR", APART FROM THE MARK AS SHOWN.

SN 77-297,787, FILED 10-5-2007.

SANJEEV VOHRA, EXAMINING ATTORNEY



David J. Kyros

Director of the United States Patent and Trademark Office

United States of America

United States Patent and Trademark Office

OPTUMHEALTH ESAVER

Reg. No. 4,109,009

Registered Mar. 6, 2012

Int. Cl.: 36

SERVICE MARK

PRINCIPAL REGISTER

UNITEDHEALTH GROUP INCORPORATED (MINNESOTA CORPORATION)
9900 BREN ROAD EAST, MN008-T202
MINNETONKA, MN 55343

FOR: HEALTH SAVINGS ACCOUNT SERVICES, NAMELY, PROVIDING BANKING SERVICES AND SAVINGS ACCOUNT ADMINISTRATION FOR CONSUMER-DRIVEN HEALTH CARE PLANS AND DEFINED CONTRIBUTION HEALTH CARE PLANS; FINANCIAL MANAGEMENT, ADMINISTRATION, AND UNDERWRITING OF HEALTH SAVINGS ACCOUNTS; MEDICAL INSURANCE SERVICES, NAMELY, PROVIDING A QUALIFIED MEDICAL INSURANCE PLAN WITH A TAX ADVANTAGED MEDICAL SAVINGS ACCOUNT; BANKING SERVICES; DEBIT CARD SERVICES; ELECTRONIC FUNDS TRANSFER; DEBIT CARD TRANSACTION PROCESSING SERVICES; CASH MANAGEMENT SERVICES; ON-LINE BANKING SERVICES, IN CLASS 36 (U.S. CLS. 100, 101 AND 102).

FIRST USE 12-0-2007; IN COMMERCE 12-0-2007.

THE MARK CONSISTS OF STANDARD CHARACTERS WITHOUT CLAIM TO ANY PARTICULAR FONT, STYLE, SIZE, OR COLOR.

OWNER OF U.S. REG. NOS. 1,801,041, 2,679,582, AND OTHERS.

NO CLAIM IS MADE TO THE EXCLUSIVE RIGHT TO USE "ESAVER", APART FROM THE MARK AS SHOWN.

SN 77-298,340, FILED 10-8-2007.

SANJEEV VOHRA, EXAMINING ATTORNEY



David J. Kyros

Director of the United States Patent and Trademark Office

United States of America

United States Patent and Trademark Office



LEVITON

Reg. No. 4,109,010

Registered Mar. 6, 2012

Int. Cl.: 9

TRADEMARK

PRINCIPAL REGISTER

LEVITON MANUFACTURING CO., INC. (DELAWARE CORPORATION)
201 NORTH SERVICE ROAD
MELVILLE, NY 11747

FOR: PIN AND SLEEVE DEVICES FOR ELECTRICAL PLUGS AND CONNECTORS; POWER SUPPLIES, NAMELY, ETHERNET SWITCHES, GATEWAY ROUTERS IN THE NATURE OF COMPUTER CONTROL HARDWARE, IN CLASS 9 (U.S. CLS. 21, 23, 26, 36 AND 38).

FIRST USE 1-1-2011; IN COMMERCE 1-1-2011.

SN 77-305,803, FILED 10-17-2007.

ROBERT C. CLARK JR., EXAMINING ATTORNEY



David J. Kyffers

Director of the United States Patent and Trademark Office

United States of America

United States Patent and Trademark Office



Reg. No. 4,109,011

Registered Mar. 6, 2012

Int. Cls.: 17 and 21

TRADEMARK

PRINCIPAL REGISTER

HOMAX PRODUCTS, INC. (DELAWARE CORPORATION)
200 WESTERLY ROAD
BELLINGHAM, WA 98226

FOR: CAULKING; CAULKING COMPOUNDS; RUBBER SEALANT FOR CAULKING AND WEATHERSTRIPPING; ADHESIVE SEALANT AND CAULKING COMPOUND; ADHESIVE SEALANTS FOR GENERAL USE; SEALANTS FOR BUILDINGS; WATERPROOF SEALANTS; WEATHERSTRIPPING SEALANTS IN THE NATURE OF CAULK, IN CLASS 17 (U.S. CLS. 1, 5, 12, 13, 35 AND 50).

FIRST USE 6-30-2009; IN COMMERCE 6-30-2009.

FOR: DISPENSERS FOR CLEANING SOLUTIONS; CLEANING IMPLEMENTS, NAMELY, CLEANING SPONGES, SCOURING SPONGES, SCRUB SPONGES, SPONGES FOR HOUSEHOLD USE, TOILET SPONGES; CLEANING BRUSHES, NAMELY, BATH BRUSHES, DISHWASHING BRUSHES, SCRUBBING BRUSHES, TOILET BRUSHES, WASHING BRUSHES; SOAP DISHES; WALL SOAP DISHES; TOWEL BARS; SHOWER CADDIES; SQUEEGEES; SQUEEGEES FOR DISHES; CLEANING KITS COMPRISING BATH BRUSHES, DISHWASHING BRUSHES, SCRUBBING BRUSHES, TOILET BRUSHES, WASHING BRUSHES, SQUEEGEES, AND DETACHABLE EXTENSION HANDLES FOR USE THEREWITH, IN CLASS 21 (U.S. CLS. 2, 13, 23, 29, 30, 33, 40 AND 50).

FIRST USE 6-30-2009; IN COMMERCE 6-30-2009.

OWNER OF U.S. REG. NOS. 1,131,133, 2,044,129, AND OTHERS.

THE MARK CONSISTS OF THE WORD "MAGIC" BELOW A CURVED LINE IN A BOX.

SN 77-308,930, FILED 10-19-2007.

KEVIN CORWIN, EXAMINING ATTORNEY



David J. Kybas

Director of the United States Patent and Trademark Office

United States of America

United States Patent and Trademark Office

ICKIE LICKIES

Reg. No. 4,109,012

Registered Mar. 6, 2012

Int. Cl.: 28

TRADEMARK

PRINCIPAL REGISTER

PAYNE, MALCOLM (UNITED STATES INDIVIDUAL)
APT. #5E
120 DEBS PLACE
BRONX, NY 10475

FOR: BOARD GAMES; PLUSH TOYS, IN CLASS 28 (U.S. CLS. 22, 23, 38 AND 50).

FIRST USE 11-15-2011; IN COMMERCE 11-15-2011.

THE MARK CONSISTS OF STANDARD CHARACTERS WITHOUT CLAIM TO ANY PARTICULAR FONT, STYLE, SIZE, OR COLOR.

SN 77-315,772, FILED 10-29-2007.

DAYNA BROWNE, EXAMINING ATTORNEY



David J. Kybas

Director of the United States Patent and Trademark Office

United States of America

United States Patent and Trademark Office

StarStar

Reg. No. 4,109,013

ZOOVE CORP. (DELAWARE CORPORATION)
2300 GENG ROAD, SUITE 150
PALO ALTO, CA 94303

Registered Mar. 6, 2012

Int. Cl.: 9

FOR: COMPUTER SOFTWARE FOR ACCESSING DATA FROM A WIRELESS DEVICE, IN CLASS 9 (U.S. CLS. 21, 23, 26, 36 AND 38).

TRADEMARK

FIRST USE 7-1-2010; IN COMMERCE 7-1-2010.

PRINCIPAL REGISTER

THE MARK CONSISTS OF STANDARD CHARACTERS WITHOUT CLAIM TO ANY PARTICULAR FONT, STYLE, SIZE, OR COLOR.

SN 77-319,346, FILED 11-1-2007.

KAREN K. BUSH, EXAMINING ATTORNEY



David J. Kyjars

Director of the United States Patent and Trademark Office

United States of America

United States Patent and Trademark Office

MAPP

Reg. No. 4,109,014

Registered Mar. 6, 2012

Int. Cl.: 37

SERVICE MARK

PRINCIPAL REGISTER

PEPCO HOLDINGS, INC. (DELAWARE CORPORATION)
701 9TH STREET, N.W.
WASHINGTON, DC 20068

FOR: CONSTRUCTION AND MAINTENANCE OF ELECTRICAL TRANSMISSION LINES, SYSTEMS AND EQUIPMENT; CONSTRUCTION AND INSTALLATION OF POWER PROJECTS AND FACILITIES, IN CLASS 37 (U.S. CLS. 100, 103 AND 106).

FIRST USE 12-8-2011; IN COMMERCE 12-8-2011.

THE MARK CONSISTS OF STANDARD CHARACTERS WITHOUT CLAIM TO ANY PARTICULAR FONT, STYLE, SIZE, OR COLOR.

SN 77-321,856, FILED 11-5-2007.

PAULA MAHONEY, EXAMINING ATTORNEY



David J. Kybas

Director of the United States Patent and Trademark Office

United States of America

United States Patent and Trademark Office

EVERYONE A CHANGEMAKER

Reg. No. 4,109,015

Registered Mar. 6, 2012

Int. Cl.: 36

SERVICE MARK

PRINCIPAL REGISTER

ASHOKA: INNOVATORS FOR THE PUBLIC (D.C. NON-PROFIT CORPORATION)
1700 NORTH MOORE STREET, SUITE 2000
ARLINGTON, VA 22209

FOR: CHARITABLE FUNDRAISING AND PHILANTHROPIC SERVICES, NAMELY, PROVIDING FINANCIAL INFORMATION ON IDENTIFYING AND ASSESSING PHILANTHROPIC AND FINANCIAL INVESTMENTS IN ORGANIZATIONS PROVIDING SOCIAL SERVICES; PROVIDING FINANCIAL INFORMATION VIA A GLOBAL COMPUTER NETWORK, IN CLASS 36 (U.S. CLS. 100, 101 AND 102).

FIRST USE 8-22-2007; IN COMMERCE 8-22-2007.

THE MARK CONSISTS OF STANDARD CHARACTERS WITHOUT CLAIM TO ANY PARTICULAR FONT, STYLE, SIZE, OR COLOR.

OWNER OF U.S. REG. NO. 3,344,165.

SN 77-330,934, FILED 11-15-2007.

YAT SYE, LEE, EXAMINING ATTORNEY



David J. Kybas

Director of the United States Patent and Trademark Office

United States of America

United States Patent and Trademark Office

LIFE STAGES

Reg. No. 4,109,016

Registered Mar. 6, 2012

Int. Cl.: 44

SERVICE MARK

PRINCIPAL REGISTER

GILLETTE CHILDREN'S SPECIALTY HEALTHCARE (MINNESOTA NON-PROFIT CORPORATION)
200 EAST UNIVERSITY AVE.
ST. PAUL, MN 55101

FOR: CLINICAL CONSULTATION SERVICES, NAMELY, MEDICAL AND PSYCHOLOGICAL CONSULTATION SERVICES PROVIDED IN ONE-ON-ONE SETTINGS FOR INDIVIDUALS WITH DISABILITIES AND THEIR FAMILIES IN THE AREAS OF HEALTHCARE MANAGEMENT AND TRANSITION TO NEW ENVIRONMENTS AND LIFE SITUATIONS, AND DISTRIBUTION OF INSTRUCTIONAL MATERIALS THEREWITH, IN CLASS 44 (U.S. CLS. 100 AND 101).

FIRST USE 12-21-2011; IN COMMERCE 12-21-2011.

THE MARK CONSISTS OF STANDARD CHARACTERS WITHOUT CLAIM TO ANY PARTICULAR FONT, STYLE, SIZE, OR COLOR.

SN 77-335,742, FILED 11-21-2007.

JASON LOTT, EXAMINING ATTORNEY



David J. Kyros

Director of the United States Patent and Trademark Office

United States of America

United States Patent and Trademark Office

HORIZON UPTOWN

Reg. No. 4,109,017

Registered Mar. 6, 2012

Int. Cls.: 37 and 42

SERVICE MARK

PRINCIPAL REGISTER

LEND LEASE HORIZON LLC (COLORADO LIMITED LIABILITY COMPANY)
1401 17TH STREET
DENVER, CO 80202

FOR: BUILDING MAINTENANCE AND REPAIR SERVICES, NAMELY, BUILDING AND REPAIR OF RESEARCH AND RECREATIONAL FACILITIES, CIVIL WORKS AND INFRASTRUCTURE PROJECTS, INDUSTRIAL, COMMERCIAL, HEALTH CARE, TOURISM, RETAIL AND RESIDENTIAL REAL ESTATE, PARKS, GARDENS, CIVIL WORKS AND INFRASTRUCTURE PROJECTS; CLEANING SERVICES FOR RESEARCH AND RECREATIONAL FACILITIES, CIVIL WORKS AND INFRASTRUCTURE PROJECTS, INDUSTRIAL, COMMERCIAL, HEALTH CARE, TOURISM, RETAIL AND RESIDENTIAL REAL ESTATE, PARKS, GARDENS, CIVIL WORKS AND INFRASTRUCTURE PROJECTS; CONSTRUCTION PROJECT MANAGEMENT SERVICES FOR OTHERS; PROVIDING INFORMATION IN THE FIELDS OF BUILDING MAINTENANCE AND REPAIR SERVICES, IN CLASS 37 (U.S. CLS. 100, 103 AND 106).

FIRST USE 0-0-2007; IN COMMERCE 0-0-2007.

FOR: ENGINEERING SERVICES, CIVIL ENGINEERING SERVICES; ARCHITECTURAL SERVICES, NAMELY, ARCHITECTURAL DESIGN SERVICES; ENVIRONMENTAL CONSULTATION, NAMELY, CONSULTATION IN THE FIELD OF ENVIRONMENTAL ASSESSMENT, COMPLIANCE AND PLANNING; COMPUTER SOFTWARE DESIGN FOR OTHERS, DESIGN FOR NEW PRODUCT DEVELOPMENT; INTERIOR AND EXTERIOR BUILDING DESIGN SERVICES; PLANNING AND LAYOUT DESIGN FOR ALL KINDS OF INDUSTRIAL REAL ESTATE, IN CLASS 42 (U.S. CLS. 100 AND 101).

FIRST USE 0-0-2007; IN COMMERCE 0-0-2007.

THE MARK CONSISTS OF STANDARD CHARACTERS WITHOUT CLAIM TO ANY PARTICULAR FONT, STYLE, SIZE, OR COLOR.

SN 77-335,907, FILED 11-23-2007.

PATRICIA EVANKO, EXAMINING ATTORNEY



David J. Kyffers

Director of the United States Patent and Trademark Office

United States of America

United States Patent and Trademark Office

ipop

Reg. No. 4,109,018

Registered Mar. 6, 2012

Int. Cl.: 32

TRADEMARK

PRINCIPAL REGISTER

MORGAN, GEORGE (UNITED STATES INDIVIDUAL)
5 MAGGIO LANE
OLD BETHPAGE, NY 11804

FOR: SOFT DRINKS, IN CLASS 32 (U.S. CLS. 45, 46 AND 48).

FIRST USE 11-1-2011; IN COMMERCE 11-1-2011.

THE MARK CONSISTS OF STANDARD CHARACTERS WITHOUT CLAIM TO ANY PARTICULAR FONT, STYLE, SIZE, OR COLOR.

SN 77-339,081, FILED 11-28-2007.

JASON TURNER, EXAMINING ATTORNEY



David J. Kybas

Director of the United States Patent and Trademark Office

United States of America

United States Patent and Trademark Office

PACNET

Reg. No. 4,109,019

Registered Mar. 6, 2012

Int. Cl.: 35

SERVICE MARK

PRINCIPAL REGISTER

PACNET LIMITED (BERMUDA CORPORATION)
CLARENDON HOUSE, 2 CHURCH STREET
HAMILTON HM 11, BERMUDA

FOR: SALES PROMOTION SERVICES FOR OTHERS; PROMOTING THE GOODS AND SERVICES OF OTHERS BY DISTRIBUTING ADVERTISING MATERIALS THROUGH A VARIETY OF METHODS; BUSINESS ADVICE AND COMMERCIAL INFORMATION AND INQUIRIES IN THE FIELD OF TELECOMMUNICATION SERVICES; CONTESTS AND INCENTIVE AWARD PROGRAMS TO PROMOTE THE SALE OF PRODUCTS AND SERVICES OF OTHERS; DATA PROCESSING SERVICES; DATA CENTRE SERVICE AND DATA CENTRE MANAGEMENT SERVICES; PROMOTING THE GOODS AND SERVICES OF OTHERS THROUGH ON-LINE ORDERING AND CATALOGING OF THOSE GOODS AND SERVICES; PROCUREMENT SERVICES FOR OTHERS PURCHASING TELECOMMUNICATIONS PRODUCTS AND SERVICES FOR OTHER BUSINESSES; PROVISION OF INFORMATION, ADVISORY AND CONSULTANCY SERVICES FOR THE AFORESAID SERVICES, IN CLASS 35 (U.S. CLS. 100, 101 AND 102).

FIRST USE 0-0-2000; IN COMMERCE 0-0-2000.

THE MARK CONSISTS OF STANDARD CHARACTERS WITHOUT CLAIM TO ANY PARTICULAR FONT, STYLE, SIZE, OR COLOR.

OWNER OF U.S. REG. NOS. 2,164,941 AND 2,778,162.

SN 77-347,633, FILED 12-10-2007.

FRANK LATTUCA, EXAMINING ATTORNEY



David J. Kyffers

Director of the United States Patent and Trademark Office

United States of America

United States Patent and Trademark Office

PACNET

Reg. No. 4,109,020

Registered Mar. 6, 2012

Int. Cl.: 38

SERVICE MARK

PRINCIPAL REGISTER

PACNET LIMITED (BERMUDA CORPORATION)
CLARENDON HOUSE
2 CHURCH STREET
HAMILTON HM 11, BERMUDA

FOR: TELECOMMUNICATIONS SERVICES, NAMELY, PROVIDING ACCESS TO TELECOMMUNICATIONS NETWORKS BY MEANS OF A GLOBAL COMMUNICATIONS NETWORK; TELECOMMUNICATIONS SERVICES, NAMELY, ELECTRONIC TRANSMISSION OF MESSAGES, IMAGES, VOICE, AND DATA BETWEEN COMPUTER NETWORKS; DATA COMMUNICATION SERVICES, NAMELY, ELECTRONIC TRANSMISSION OF DATA AND DOCUMENTS BETWEEN SERVER AND CLIENT; ELECTRONIC DATA TRANSMISSION SERVICES OVER TELECOMMUNICATIONS NETWORKS; REMOTE ELECTRONIC TRANSMISSION OF DATA BY MEANS OF TELECOMMUNICATIONS; ELECTRONIC TRANSMISSION OF MESSAGES; COMPUTER SUPPORTED ELECTRONIC TRANSFER OF MESSAGES AND IMAGES; TRANSMISSION OF DIGITAL INFORMATION, NAMELY, RECEIVING AND EXCHANGE OF INFORMATION, MESSAGES, IMAGES AND DATA; INTERNET SERVICE PROVIDER SERVICES, NAMELY, PROVIDING ACCESS, AND LEASING ACCESS TIME, TO A GLOBAL COMMUNICATIONS NETWORK; INTERNET SERVICE PROVIDER SERVICES, NAMELY, PROVIDING ACCESS, AND LEASING ACCESS TIME, TO A COMPUTER DATABASE; INTERNET SERVICE PROVIDER AND INTERNET SERVICE PROVIDER MANAGEMENT SERVICES, NAMELY, MANAGEMENT, CONSULTANCY AND ADVISORY SERVICES IN THE FIELD OF TELECOMMUNICATIONS FOR BUSINESS OR DOMESTIC PURPOSES; RENTAL OF TELECOMMUNICATIONS EQUIPMENT, COMPONENTS, SUPPLIES AND SYSTEMS; COMMUNICATIONS BY FIBER OPTIC NETWORKS, NAMELY, PROVIDING FIBER OPTIC NETWORK SERVICES; TELECOMMUNICATIONS ROUTING AND JUNCTION SERVICES; TELECOMMUNICATIONS, NAMELY, PROVIDING ACCESS TO A COMPUTER NETWORK VIA MULTIPLEXES, FIBER CABLES, CROSS CONNECT SWITCHES, NAMELY, DATA, VIDEO AND GRAPHICS TRANSMISSION; PROVIDING TELECOMMUNICATIONS GATEWAY SERVICES AND FRAME RELAY CONNECTIVITY SERVICES FOR DATA TRANSFER; INTERNET BACKBONE SERVICES, NAMELY, A HIGH-SPEED LINE OR SERIES OF CONNECTIONS THAT FORMS A MAJOR PATHWAY WITHIN A NETWORK. VIDEO, DATA AND AUDIO TELECONFERENCING VIA THE INTERNET; ASYNCHRONOUS TRANSFER MODE SERVICES; INTERNET PROTOCOL (IP) COMMUNICATIONS SERVICES; VIRTUAL PRIVATE NETWORK (VPN) SERVICES AND PRIVATE LINE SERVICES; ELECTRONIC DATA TRANSMISSION PACKET SERVICES; SWITCHED DATA, VIDEO AND MULTIMEDIA SERVICES; MESSAGING CENTER SERVICES IN THE NATURE OF TELEPHONE VOICE MESSAGING SERVICES;



David J. Kyros

Director of the United States Patent and Trademark Office

Reg. No. 4,109,020 PROVIDING NETWORK ACCESS POINT SERVICES FOR THE EXCHANGE OF INTERNET TRAFFIC AMONG INTERNET TRAFFIC CARRIERS; PROVISION OF INFORMATION, ADVISORY AND CONSULTANCY SERVICES FOR THE AFORESAID SERVICES, IN CLASS 38 (U.S. CLS. 100, 101 AND 104).

FIRST USE 0-0-2002; IN COMMERCE 0-0-2002.

THE MARK CONSISTS OF STANDARD CHARACTERS WITHOUT CLAIM TO ANY PARTICULAR FONT, STYLE, SIZE, OR COLOR.

SN 77-347,640, FILED 12-10-2007.

FRANK LATTUCA, EXAMINING ATTORNEY

United States of America

United States Patent and Trademark Office

PACNET

Reg. No. 4,109,021

Registered Mar. 6, 2012

Int. Cl.: 39

SERVICE MARK

PRINCIPAL REGISTER

PACNET LIMITED (BERMUDA CORPORATION)
CLARENDON HOUSE, 2 CHURCH STREET
HAMILTON HM 11, BERMUDA

FOR: COMPUTER-BASED ELECTRONIC DATA STORAGE SERVICES; COMPUTERIZED ELECTRONIC DATA STORAGE SERVICES, COMPUTERIZED ELECTRONIC BUSINESS INFORMATION STORAGE OF ELECTRONIC FILES; ELECTRONIC STORAGE OF TECHNICAL INFORMATION IN THE FORM OF ELECTRONIC FILES, IN CLASS 39 (U.S. CLS. 100 AND 105).

FIRST USE 2-0-2011; IN COMMERCE 2-0-2011.

THE MARK CONSISTS OF STANDARD CHARACTERS WITHOUT CLAIM TO ANY PARTICULAR FONT, STYLE, SIZE, OR COLOR.

OWNER OF U.S. REG. NOS. 2,164,941 AND 2,778,162.

SN 77-347,642, FILED 12-10-2007.

FRANK LATTUCA, EXAMINING ATTORNEY



David J. Kyffers

Director of the United States Patent and Trademark Office

United States of America

United States Patent and Trademark Office

PACNET



Reg. No. 4,109,022

Registered Mar. 6, 2012

Int. Cl.: 9

TRADEMARK

PRINCIPAL REGISTER

PACNET LIMITED (BERMUDA CORPORATION)
CLARENDON HOUSE, 2 CHURCH STREET
HAMILTON HM11, BERMUDA

FOR: TELECOMMUNICATIONS AND INFORMATION TECHNOLOGY EQUIPMENT, COMPONENTS, SUPPLIES AND SYSTEMS, NAMELY, TELEPHONE SWITCHES, ROUTERS AND GATEWAYS FOR TELECOMMUNICATION AND COMPUTER USE; PERIPHERAL EQUIPMENT FOR USE IN LOCAL AREA NETWORKS AND WIDE AREA NETWORKS; SECURITY SYSTEMS COMPOSED OF COMPUTER HARDWARE AND SOFTWARE FOR USE AS AN INTERNET FIREWALL; COMPUTER SOFTWARE FOR USE IN PROVIDING COMPUTER AND NETWORK SECURITY, ELECTRONIC MAILS AND MESSAGING, FAX TRANSMISSIONS, DESKTOP VIDEO CONFERENCING, HIGH-SPEED VIDEO TRANSFER, AND COLLABORATIVE DOCUMENT SHARING SERVICES; COMPUTER SOFTWARE PROGRAMS FOR ACCESSING A GLOBAL COMPUTER NETWORK OR INTERACTIVE COMPUTER COMMUNICATIONS NETWORK, IN CLASS 9 (U.S. CLS. 21, 23, 26, 36 AND 38).

FIRST USE 9-21-2009; IN COMMERCE 9-21-2009.

OWNER OF U.S. REG. NOS. 2,164,941 AND 2,778,162.

THE MARK CONSISTS OF THE WORD "PACNET" IN SPECIAL FORM WITH THREE CURVED LINES BELOW THE FINAL THREE LETTERS OF THE WORD.

SN 77-347,760, FILED 12-10-2007.

FRANK LATTUCA, EXAMINING ATTORNEY



David J. Kybas

Director of the United States Patent and Trademark Office

United States of America

United States Patent and Trademark Office

PACNET



Reg. No. 4,109,023

Registered Mar. 6, 2012

Int. Cl.: 37

SERVICE MARK

PRINCIPAL REGISTER

PACNET LIMITED (BERMUDA CORPORATION)
CLARENDON HOUSE, 2 CHURCH STREET
HAMILTON HM 11, BERMUDA

FOR: INSTALLATION, MAINTENANCE AND REPAIR FOR TELECOMMUNICATIONS NETWORKS AND APPARATUS, COMPUTERIZED NETWORKS, COMPUTER HARDWARE, AUDIO, VIDEO AND INTERACTIVE EQUIPMENT, COMPONENTS, SUPPLIES AND SYSTEMS, AND RELATED EQUIPMENT, COMPONENTS, SUPPLIES AND SYSTEMS; UNDERWATER CONSTRUCTION, MAINTENANCE AND UNDERWATER REPAIR OF TELECOMMUNICATIONS CABLES, NETWORKS AND SYSTEMS; PROVISION OF INFORMATION, ADVISORY AND CONSULTANCY SERVICES FOR THE AFORESAID SERVICES, IN CLASS 37 (U.S. CLS. 100, 103 AND 106).

FIRST USE 0-0-2002; IN COMMERCE 0-0-2002.

OWNER OF U.S. REG. NOS. 2,164,941 AND 2,778,162.

THE MARK CONSISTS OF THE WORD "PACNET" IN SPECIAL FORM WITH THREE CURVED LINES BELOW THE FINAL THREE LETTERS OF THE WORD.

SN 77-347,912, FILED 12-10-2007.

FRANK LATTUCA, EXAMINING ATTORNEY



David J. Kyros

Director of the United States Patent and Trademark Office

United States of America

United States Patent and Trademark Office



Reg. No. 4,109,024

Registered Mar. 6, 2012

Int. Cl.: 31

TRADEMARK

PRINCIPAL REGISTER

MARS, INCORPORATED (DELAWARE CORPORATION)
6885 ELM STREET
MCLEAN, VA 22101

FOR: PET FOOD, IN CLASS 31 (U.S. CLS. 1 AND 46).

FIRST USE 12-0-2011; IN COMMERCE 12-0-2011.

OWNER OF U.S. REG. NO. 1,343,090.

THE COLOR(S) BLACK, WHITE, AND GOLD IS/ARE CLAIMED AS A FEATURE OF THE MARK.

THE MARK CONSISTS OF THE WORDING "CESAR" IN WHITE LETTERING WHICH APPEARS INSIDE A BLACK OVAL. THE OVAL IS BORDERED BY TWO GOLD ARCHING BANDS. A THIN BLACK BAND CONSISTING OF THE EDGE OF THE BLACK OVAL, ENCIRCLES THE GOLD BANDS. THE COLORS GRAY AND WHITE REPRESENT SHADING ON THE BLACK OVAL DESIGN AND GOLD PERIMETER, RESPECTIVELY, AND ARE NOT PART OF THE MARK.

SN 77-356,696, FILED 12-20-2007.

WENDY GOODMAN, EXAMINING ATTORNEY



David J. Kybas

Director of the United States Patent and Trademark Office

United States of America

United States Patent and Trademark Office

PADS

Reg. No. 4,109,025

Registered Mar. 6, 2012

Int. Cls.: 35, 41, and 45

SERVICE MARK

PRINCIPAL REGISTER

AMERICAN COLLEGE OF SPORTS MEDICINE, INC. (WISCONSIN CORPORATION)
401 WEST MICHIGAN STREET
INDIANAPOLIS, IN 46202

FOR: PROMOTING THE INTERESTS OF INDIVIDUALS AND ENTITIES OPPOSED TO DOPING AND THE USE OF ILLEGAL, UNAPPROVED AND UNSAFE SUBSTANCES AND TECHNIQUES IN THE FIELD OF SPORTS, IN CLASS 35 (U.S. CLS. 100, 101 AND 102).

FIRST USE 7-16-2007; IN COMMERCE 7-16-2007.

FOR: EDUCATION SERVICES, NAMELY, DEVELOPING, ARRANGING AND CONDUCTING PROGRAMS ABOUT DOPING AND THE USE OF ILLEGAL, UNAPPROVED AND UNSAFE SUBSTANCES AND TECHNIQUES IN THE FIELD OF SPORTS, AND WRITTEN MATERIALS DISTRIBUTED IN CONNECTION THEREWITH, IN CLASS 41 (U.S. CLS. 100, 101 AND 107).

FIRST USE 7-16-2007; IN COMMERCE 7-16-2007.

FOR: PROVIDING INFORMATION RELATED TO THE USE OF ILLEGAL, UNAPPROVED AND UNSAFE SUBSTANCES AND TECHNIQUES IN THE FIELD OF SPORTS, IN CLASS 45 (U.S. CLS. 100 AND 101).

FIRST USE 7-16-2007; IN COMMERCE 7-16-2007.

THE MARK CONSISTS OF STANDARD CHARACTERS WITHOUT CLAIM TO ANY PARTICULAR FONT, STYLE, SIZE, OR COLOR.

SN 77-363,267, FILED 1-3-2008.

DANNEAN HETZEL, EXAMINING ATTORNEY



David J. Kyffers

Director of the United States Patent and Trademark Office

United States of America

United States Patent and Trademark Office

GOSPEL MUSIC HERITAGE MONTH

Reg. No. 4,109,026

Registered Mar. 6, 2012

Int. Cl.: 41

SERVICE MARK

PRINCIPAL REGISTER

GOSPEL MUSIC CHANNEL, LLC (DELAWARE LIMITED LIABILITY COMPANY)
SUITE 240
1514 CLEVELAND AVENUE
ATLANTA, GA 30344

FOR: PRODUCTION OF RADIO AND TELEVISION PROGRAMS; ENTERTAINMENT IN THE NATURE OF ONGOING RADIO AND TELEVISION PROGRAMS IN THE FIELD OF MUSIC; DISTRIBUTION OF TELEVISION PROGRAMMING TO CABLE TELEVISION SYSTEMS; ENTERTAINMENT SERVICES, NAMELY, PROVIDING A RADIO PROGRAM IN THE FIELD OF MUSIC VIA A GLOBAL COMPUTER NETWORK; ENTERTAINMENT SERVICES, NAMELY, PROVIDING A TELEVISION PROGRAM IN THE FIELD OF MUSIC VIA A GLOBAL COMPUTER NETWORK; ENTERTAINMENT, NAMELY, LIVE MUSIC CONCERTS, IN CLASS 41 (U.S. CLS. 100, 101 AND 107).

FIRST USE 9-0-2009; IN COMMERCE 9-0-2009.

THE MARK CONSISTS OF STANDARD CHARACTERS WITHOUT CLAIM TO ANY PARTICULAR FONT, STYLE, SIZE, OR COLOR.

NO CLAIM IS MADE TO THE EXCLUSIVE RIGHT TO USE "GOSPEL MUSIC", APART FROM THE MARK AS SHOWN.

SN 77-363,361, FILED 1-3-2008.

LINDSEY RUBIN, EXAMINING ATTORNEY



David J. Kybas

Director of the United States Patent and Trademark Office

United States of America

United States Patent and Trademark Office

OPTIMIZE TO GOALS

Reg. No. 4,109,027

CLICKSOFTWARE TECHNOLOGIES LTD (ISRAEL CORPORATION)
94 EM-HAMOSHAVOT ROAD AZORIM PARK
PETACH-TIKVA, ISRAEL 49527

Registered Mar. 6, 2012

Int. Cl.: 42

FOR: ADVISORY SERVICES IN THE FIELDS OF INFORMATION TECHNOLOGY MANAGEMENT USING A METHODOLOGY THAT MATCHES THE BUSINESS OPTIMIZATION POLICY AND PROCESS TO THE CUSTOMER'S GOALS, IN CLASS 42 (U.S. CLS. 100 AND 101).

SERVICE MARK

PRINCIPAL REGISTER

FIRST USE 5-19-2011; IN COMMERCE 5-19-2011.

THE MARK CONSISTS OF STANDARD CHARACTERS WITHOUT CLAIM TO ANY PARTICULAR FONT, STYLE, SIZE, OR COLOR.

SN 77-367,156, FILED 1-9-2008.

ANTHONY RINKER, EXAMINING ATTORNEY



David J. Kybas

Director of the United States Patent and Trademark Office

United States of America

United States Patent and Trademark Office

NO DRAWING-SENSORY MARK

Reg. No. 4,109,028

Registered Mar. 6, 2012

Int. Cls.: 35 and 36

SERVICE MARK

PRINCIPAL REGISTER

CREDIT SUISSE GROUP AG (SWITZERLAND CORPORATION)
PARADEPLATZ 8
ZURICH 8001, SWITZERLAND

FOR: ECONOMIC FORECASTING AND ANALYSIS; COLLECTION, PREPARATION, COMPOSITION, PROCESSING, ACQUISITION AND PROVISION OF BUSINESS INFORMATION, DATA, STATISTICS, AND INDICES; PROVIDING STATISTICAL INFORMATION FOR BUSINESS OR COMMERCIAL PURPOSES; COMPILATION AND PROVISION OF TRADE AND BUSINESS PRICE AND STATISTICAL INFORMATION, IN CLASS 35 (U.S. CLS. 100, 101 AND 102).

FIRST USE 2-5-2008; IN COMMERCE 2-5-2008.

FOR: BANKING, MONETARY EXCHANGE AND INVESTMENT SERVICES, NAMELY, ASSET ACQUISITION, CONSULTATION, DEVELOPMENT AND MANAGEMENT; TRUST SERVICES, NAMELY, INVESTMENT AND TRUST COMPANY SERVICES; RENTAL OF AUTOMATED TELLER MACHINES AND CASH DISPENSERS OPERATED BY MAGNETIC CARDS; ACQUISITION AND TRANSFER OF MONETARY CLAIMS; BANKING AND FINANCIAL SERVICES, NAMELY, CORPORATE AND COMMERCIAL LENDING, INVESTMENT BANKING, FINANCIAL ASSET MANAGEMENT, FINANCIAL SERVICES, NAMELY, PROVIDING FOR THE EXCHANGE OF FOREIGN CURRENCIES, THE EXCHANGE OF COMMODITIES IN THE FORM OF PRECIOUS METALS, THE EXCHANGE OF CORPORATE AND GOVERNMENT SECURITIES, THE EXCHANGE OF STRUCTURED PRODUCTS IN THE NATURE OF EQUITY LINKED SECURITIES, AND THE EXCHANGE OF DERIVATIVES, NAMELY, INTEREST RATE EQUITY AND CURRENCY SWAPS AND OPTIONS, COMMODITY SWAPS AND OPTIONS, AND ASSET TRADING AND CREDIT DERIVATIVES IN EMERGING AND DEVELOPED MARKETS, ALL FOR THE BENEFIT OF THIRD PARTIES; PROVIDING TRUST MANAGEMENT ACCOUNTS AND ESTATE TRUST MANAGEMENT SERVICES; INSURANCE SERVICES, NAMELY, INSURANCE CONSULTING AND INSURANCE BROKERAGE SERVICES; PROVIDING COMPUTER DATABASES FEATURING INFORMATION IN THE FIELDS OF FINANCE, INSURANCE, AND REAL ESTATE; FINANCIAL MANAGEMENT, IN CLASS 36 (U.S. CLS. 100, 101 AND 102).

FIRST USE 2-5-2008; IN COMMERCE 2-5-2008.

THE MARK IS A SOUND COMPRISED OF A FEMALE SINGING IN "C" MAJOR FOR THE DURATION OF TWO SECONDS. THE MELODY SHE SINGS IS IN "4/4" TIME AND CAN BE DESCRIBED AS AN EIGHTH NOTE ON "F4", FOLLOWED BY AN EIGHTH NOTE ON "E4", AN EIGHTH REST, AN EIGHTH ON "G4", AND EIGHTH REST, AN EIGHTH NOTE ON "D4", AND A TIED HALF NOTE ON "C4".

SN 77-367,233, FILED 1-9-2008.

RUSS HERMAN, EXAMINING ATTORNEY



David J. Kypas

Director of the United States Patent and Trademark Office

United States of America

United States Patent and Trademark Office

MONTECEDRO

Reg. No. 4,109,029

Registered Mar. 6, 2012

Int. Cl.: 43

SERVICE MARK

PRINCIPAL REGISTER

EPISCOPAL HOME COMMUNITIES, THE (CALIFORNIA CORPORATION)
1111 S. ARROYO PARKWAY #230
PASADENA, CA 91105

FOR: RETIREMENT HOMES, IN CLASS 43 (U.S. CLS. 100 AND 101).

FIRST USE 8-0-2010; IN COMMERCE 9-14-2010.

THE MARK CONSISTS OF STANDARD CHARACTERS WITHOUT CLAIM TO ANY PARTICULAR FONT, STYLE, SIZE, OR COLOR.

THE FOREIGN WORDING IN THE MARK TRANSLATES INTO ENGLISH AS MOUNTAIN CEDAR.

SN 77-370,077, FILED 1-11-2008.

JERI J. FICKES, EXAMINING ATTORNEY



David J. Kybas

Director of the United States Patent and Trademark Office

United States of America

United States Patent and Trademark Office

ONE DROP

Reg. No. 4,109,030

FONDATION ONE DROP (CANADA CORPORATION)
8400 SECOND AVENUE
MONTREAL, QUEBEC, CANADA H1Z4M6

Registered Mar. 6, 2012

Int. Cls.: 14, 25, 35, and 36

FOR: FINE AND COSTUME JEWELLERY, NAMELY, NECKLACES AND CHARMS, IN CLASS 14 (U.S. CLS. 2, 27, 28 AND 50).

FIRST USE 3-0-2009; IN COMMERCE 3-0-2009.

TRADEMARK

FOR: CLOTHING, WEARING APPAREL AND ACCESSORIES, NAMELY, T-SHIRTS, HEADGEAR, NAMELY, CAPS, IN CLASS 25 (U.S. CLS. 22 AND 39).

SERVICE MARK

PRINCIPAL REGISTER

FIRST USE 3-0-2009; IN COMMERCE 3-0-2009.

FOR: PROMOTING PUBLIC AWARENESS CONCERNING WATER PROBLEMS IN THE WORLD RELATING TO EXCESSIVE WATER CONSUMPTION AND THE LACK OF ACCESS TO CLEAN WATER THROUGH PUBLICATIONS, WEBSITES, FUNDRAISING ACTIVITIES, LIVE THEATRICAL PERFORMANCES, BUSINESS DEVELOPMENT, PLANNING AND MANAGEMENT OF HUMANITARIAN PROJECTS FOR THE IMPROVEMENT OF QUALITY OF LIFE AND LIVING CONDITIONS OF UNDERPRIVILEGED POPULATIONS, IN CLASS 35 (U.S. CLS. 100, 101 AND 102).

FIRST USE 10-0-2007; IN COMMERCE 10-0-2007.

FOR: CHARITABLE FUND RAISING; FINANCING OF HUMANITARIAN PROJECTS FOR THE IMPROVEMENT OF QUALITY OF LIFE AND LIVING CONDITIONS OF UNDERPRIVILEGED POPULATIONS, IN CLASS 36 (U.S. CLS. 100, 101 AND 102).

FIRST USE 10-0-2007; IN COMMERCE 10-0-2007.

THE MARK CONSISTS OF STANDARD CHARACTERS WITHOUT CLAIM TO ANY PARTICULAR FONT, STYLE, SIZE, OR COLOR.

SN 77-380,600, FILED 1-25-2008.

MIDGE BUTLER, EXAMINING ATTORNEY



David J. Kyros

Director of the United States Patent and Trademark Office

United States of America

United States Patent and Trademark Office



Reg. No. 4,109,031

FONDATION ONE DROP (CANADA CORPORATION)
8400 SECOND AVENUE
MONTREAL, QUEBEC, CANADA H1Z4M6

Registered Mar. 6, 2012

Int. Cls.: 14, 25, 35, and 36

FOR: FINE AND COSTUME JEWELLERY, NAMELY, NECKLACES AND CHARMS, IN CLASS 14 (U.S. CLS. 2, 27, 28 AND 50).

FIRST USE 3-0-2009; IN COMMERCE 3-0-2009.

TRADEMARK

FOR: CLOTHING, WEARING APPAREL AND ACCESSORIES, NAMELY, T-SHIRTS, HEADGEAR, NAMELY, CAPS, IN CLASS 25 (U.S. CLS. 22 AND 39).

SERVICE MARK

PRINCIPAL REGISTER

FIRST USE 3-0-2009; IN COMMERCE 3-0-2009.

FOR: PROMOTING PUBLIC AWARENESS CONCERNING WATER PROBLEMS IN THE WORLD RELATING TO EXCESSIVE WATER CONSUMPTION AND THE LACK OF ACCESS TO CLEAN WATER THROUGH PUBLICATIONS, WEBSITES, FUNDRAISING ACTIVITIES, LIVE THEATRICAL PERFORMANCES; BUSINESS DEVELOPMENT, PLANNING AND MANAGEMENT OF HUMANITARIAN PROJECTS FOR THE IMPROVEMENT OF QUALITY OF LIFE AND LIVING CONDITIONS OF UNDERPRIVILEGED POPULATIONS, IN CLASS 35 (U.S. CLS. 100, 101 AND 102).

FIRST USE 10-0-2007; IN COMMERCE 10-0-2007.

FOR: CHARITABLE FUND RAISING; FINANCING OF HUMANITARIAN PROJECTS FOR THE IMPROVEMENT OF QUALITY OF LIFE AND LIVING CONDITIONS OF UNDERPRIVILEGED POPULATIONS, IN CLASS 36 (U.S. CLS. 100, 101 AND 102).

FIRST USE 10-0-2007; IN COMMERCE 10-0-2007.

THE MARK CONSISTS OF A STYLIZED NUMERAL "1" WITH A WATER DROP AT THE LOWER RIGHT SIDE AND THE WORDS "ONE DROP" AT THE UPPER RIGHT SIDE.

SN 77-380,611, FILED 1-25-2008.

MIDGE BUTLER, EXAMINING ATTORNEY



David J. Kyros

Director of the United States Patent and Trademark Office

United States of America

United States Patent and Trademark Office

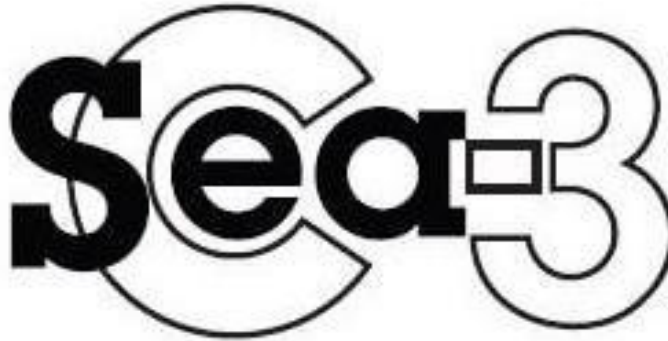

Reg. No. 4,109,032

OCEAN ORGANICS, INC. (MICHIGAN CORPORATION)
2153 NEWPORT ROAD
ANN ARBOR, MI 48103

Registered Mar. 6, 2012

Int. Cl.: 1

FOR: FERTILIZERS AND SOIL CONDITIONERS FOR AGRICULTURAL AND DOMESTIC USE, NAMELY, FOR GOLF COURSE, ATHLETIC FIELDS, SOD FARMS, PROFESSIONAL AND GENERAL LANDSCAPE AND TURF USE, IN CLASS 1 (U.S. CLS. 1, 5, 6, 10, 26 AND 46).

TRADEMARK

PRINCIPAL REGISTER

FIRST USE 4-0-2008; IN COMMERCE 12-12-2011.

THE MARK CONSISTS OF "C-3" WITH THE WORD "SEA" IMPOSED ON TOP OF THE LETTER "C".

SN 77-383,137, FILED 1-29-2008.

SUSAN RICHARDS, EXAMINING ATTORNEY



David J. Kyffers

Director of the United States Patent and Trademark Office

United States of America

United States Patent and Trademark Office



Reg. No. 4,109,033

OCEAN ORGANICS, INC. (MICHIGAN CORPORATION)
2153 NEWPORT ROAD
ANN ARBOR, MI 48103

Registered Mar. 6, 2012

Int. Cl.: 1

FOR: FERTILIZERS AND SOIL CONDITIONERS FOR AGRICULTURAL AND DOMESTIC USE, NAMELY, FOR GOLF COURSE, ATHLETIC FIELDS, SOD FARMS, PROFESSIONAL AND GENERAL LANDSCAPE AND TURF USE, IN CLASS 1 (U.S. CLS. 1, 5, 6, 10, 26 AND 46).

TRADEMARK

PRINCIPAL REGISTER

FIRST USE 4-0-2008; IN COMMERCE 12-12-2011.

THE MARK CONSISTS OF "C-4" WITH THE WORD "SEA" IMPOSED ON TOP OF THE LETTER "C".

SN 77-383,145, FILED 1-29-2008.

SUSAN RICHARDS, EXAMINING ATTORNEY



David J. Kyros

Director of the United States Patent and Trademark Office

United States of America

United States Patent and Trademark Office

CURRENT AFFAIR

Reg. No. 4,109,034

CONNECTICUT CURRANT, LLC (CONNECTICUT LIMITED LIABILITY COMPANY)
50 NORTHWEST CORNER ROAD
PRESTON, CT 06365

Registered Mar. 6, 2012

Int. Cl.: 32

FOR: FRUIT JUICE; FRUIT DRINKS; FRUIT JUICE AND FRUIT DRINK CONCENTRATES,
IN CLASS 32 (U.S. CLS. 45, 46 AND 48).

TRADEMARK

FIRST USE 6-15-2008; IN COMMERCE 6-15-2008.

PRINCIPAL REGISTER

THE MARK CONSISTS OF STANDARD CHARACTERS WITHOUT CLAIM TO ANY PAR-
TICULAR FONT, STYLE, SIZE, OR COLOR.

NO CLAIM IS MADE TO THE EXCLUSIVE RIGHT TO USE "CURRANT", APART FROM
THE MARK AS SHOWN.

SN 77-394,870, FILED 2-12-2008.

KEVIN CORWIN, EXAMINING ATTORNEY



David J. Kyffers

Director of the United States Patent and Trademark Office

United States of America

United States Patent and Trademark Office

BLESS YOUR HEART

Reg. No. 4,109,035

Registered Mar. 6, 2012

Int. Cl.: 16

TRADEMARK

PRINCIPAL REGISTER

BENEFICENCE, INC. (COLORADO CORPORATION)
P. O. BOX 99
LIVERMORE, CO 80536

FOR: BLANK OR PARTIALLY PRINTED PAPER LABELS; BLANK OR PARTIALLY PRINTED POSTCARDS; BOOKS AND BOOKLETS IN THE FIELD OF BLESSINGS; BROCHURES ABOUT BLESSINGS; GIFT BOOKS FEATURING BLESSINGS; JOURNALS CONCERNING BLESSINGS; LEAFLETS ABOUT BLESSINGS; PAMPHLETS IN THE FIELD OF BLESSINGS; PARTIALLY PRINTED FORMS; PRINTED EMBLEMS; PRINTED MATERIALS, NAMELY, PRESS RELEASES FEATURING BLESSINGS; PRINTED PAPER LABELS; WORKBOOKS DIRECTED TO BLESSINGS; PRINTED FORMS; PRINTED INFORMATIONAL CARDS IN THE FIELD OF BLESSINGS; PRINTED INFORMATIONAL FOLDERS IN THE FIELD OF BLESSINGS; CARDS, NAMELY, NOTE CARDS CONTAINING BLESSINGS; GREETING CARDS AND POSTCARDS; BOOKMARKERS; BOOKMARKS; POSTERS, IN CLASS 16 (U.S. CLS. 2, 5, 22, 23, 29, 37, 38 AND 50).

FIRST USE 10-21-2011; IN COMMERCE 10-21-2011.

THE MARK CONSISTS OF STANDARD CHARACTERS WITHOUT CLAIM TO ANY PARTICULAR FONT, STYLE, SIZE, OR COLOR.

SN 77-396,366, FILED 2-13-2008.

ANDREA BUTLER, EXAMINING ATTORNEY



David J. Kyjars

Director of the United States Patent and Trademark Office

United States of America

United States Patent and Trademark Office

TOUGHBUOY

Reg. No. 4,109,036

Registered Mar. 6, 2012

Int. Cl.: 20

TRADEMARK

PRINCIPAL REGISTER

THE TOUGHBUOY COMPANY (MICHIGAN CORPORATION)
3051 CURTIS ROAD
COLEMAN, MI 48618

FOR: PLASTIC MOLDED TRAYS, IN CLASS 20 (U.S. CLS. 2, 13, 22, 25, 32 AND 50).

FIRST USE 7-15-2008; IN COMMERCE 7-15-2008.

THE MARK CONSISTS OF STANDARD CHARACTERS WITHOUT CLAIM TO ANY PARTICULAR FONT, STYLE, SIZE, OR COLOR.

SN 77-396,934, FILED 2-14-2008.

CHARLOTTE CORWIN, EXAMINING ATTORNEY



David J. Kybas

Director of the United States Patent and Trademark Office

United States of America

United States Patent and Trademark Office

C2C CALL TO CHANGE

Reg. No. 4,109,037

Registered Mar. 6, 2012

Int. Cl.: 44

SERVICE MARK

PRINCIPAL REGISTER

BENSINGER, DUPONT & ASSOCIATES (ILLINOIS CORPORATION)
SUITE 2200
134 N LASALLE STREET
CHICAGO, IL 60602

FOR: GAMBLING ADDICTION COUNSELING SERVICES, IN CLASS 44 (U.S. CLS. 100 AND 101).

FIRST USE 1-28-2008; IN COMMERCE 1-28-2008.

THE MARK CONSISTS OF THE LETTERS AND NUMBER "C2C" IN A LARGE FONT ABOVE THE WORDING "CALL TO CHANGE" IN A SMALLER FONT.

SN 77-401,915, FILED 2-20-2008.

KATHERINE CHANG, EXAMINING ATTORNEY



David J. Kyffers

Director of the United States Patent and Trademark Office

United States of America
United States Patent and Trademark Office

u[✦]tique

Reg. No. 4,109,038

Registered Mar. 6, 2012

Int. Cl.: 3

TRADEMARK

PRINCIPAL REGISTER

UTIQUE, INC. (DELAWARE CORPORATION)
456 GEARY STREET
SAN FRANCISCO, CA 94102

FOR: AROMATHERAPY SPRAYS; COSMETICS AND MAKE-UP; MAKE-UP KITS COMPRISED OF COSMETICS; SHAVING KITS CONSISTING OF SHAVING CREAMS AND SHAVING PREPARATIONS; EYE MASKS; BEAUTY MASKS; SKIN MASKS; SKIN MOISTURIZER; STAIN REMOVERS; HAIR STYLING SPRAY; STYLING MOUSSE; HAIR CARE KITS, CONSISTING OF SHAMPOO, CONDITIONER, GEL; SUN CREAMS, IN CLASS 3 (U.S. CLS. 1, 4, 6, 50, 51 AND 52).

FIRST USE 3-13-2009; IN COMMERCE 3-13-2009.

SN 77-414,959, FILED 3-6-2008.

DEZMONA MIZELLE, EXAMINING ATTORNEY



David J. Kyffers

Director of the United States Patent and Trademark Office

United States of America

United States Patent and Trademark Office

TITRIX

Reg. No. 4,109,039

Registered Mar. 6, 2012

Int. Cl.: 6

TRADEMARK

PRINCIPAL REGISTER

IAP RESEARCH, INC. (OHIO CORPORATION)
2763 CULVER AVENUE
DAYTON, OH 454293723

FOR: TITANIUM MATRIX COMPOSITES USING NANO-SIZED REINFORCING PARTICLES TO ACHIEVE SPECIFIC PERFORMANCE ATTRIBUTES SUCH AS HARDNESS, MODULUS, OR WEAR RESISTANCE, IN CLASS 6 (U.S. CLS. 2, 12, 13, 14, 23, 25 AND 50).

FIRST USE 12-15-2011; IN COMMERCE 12-15-2011.

THE MARK CONSISTS OF STANDARD CHARACTERS WITHOUT CLAIM TO ANY PARTICULAR FONT, STYLE, SIZE, OR COLOR.

SN 77-415,777, FILED 3-7-2008.

MICHAEL GAFFAR, EXAMINING ATTORNEY



David J. Kybas

Director of the United States Patent and Trademark Office

United States of America

United States Patent and Trademark Office

SOUNDALA

Reg. No. 4,109,040

Registered Mar. 6, 2012

Int. Cls.: 9 and 11

TRADEMARK

PRINCIPAL REGISTER

BRUCE ROBERTSON (UNITED STATES INDIVIDUAL)
SUITE 200
12030 W. WASHINGTON BLVD.
WEST LOS ANGELES, CA 90066

FOR: LIGHT AND SOUND ENTERTAINMENT DEVICES, NAMELY, ELECTRONIC DEVICES WHICH PRODUCE SYNCHRONIZED LIGHT AND SOUND AND A CONTROL UNIT WHICH GENERATES AND SYNCHRONIZES THE LIGHTS AND SOUNDS; LIGHT AND SOUND ENTERTAINMENT DEVICES COMPRISED OF A FLASH MEMORY OR HARD DISK DRIVES WHICH STORE AUDIO MEDIA AND OTHER DIGITIZED SOUND RECORDINGS AND PLAY SYNCHRONIZED LIGHT SHOWS; INTERACTIVE DISPLAYS CONSISTING OF LIGHTS AND SPEAKERS WHICH PRODUCE SYNCHRONIZED LIGHT AND SOUND; ENTERTAINMENT APPARATUS AND PARTS THEREOF, NAMELY, AUDIO MIXERS, AUDIO SPEAKERS, ELECTRICITY CONDUITS, ELECTRICAL CIRCUITS FOR USE IN REPRODUCING MUSIC, SOUNDS AND LIGHTS; APPARATUS FOR THE TRANSMITTING, AMPLIFYING AND REPRODUCTION OF SOUND, LIGHTS AND IMAGES, NAMELY, MP-3 PLAYERS, DIGITAL MUSIC PLAYERS, STEREO TUNERS, LIQUID CRYSTAL DISPLAYS, SOUND AND STEREO AMPLIFIERS, AND SPEAKERS; SOFTWARE PROGRAMS FOR PLAYING MUSIC AND FOR COMPUTER CONTROLLED LIGHTS; COMPUTER CONTROLLED SOUND APPARATUS, NAMELY, SYNCHRONIZABLE PLAYERS AND RECORDERS THAT PLAY MUSIC AND CONTROL LIGHTS; IMAGE GENERATING AND/OR DISPLAY UNITS FOR THE DISPLAY OF SYNCHRONIZED LIGHTS AND MUSIC; LIGHT AND SOUND ENTERTAINMENT DEVICES, NAMELY, ELECTRONIC DEVICES FOR DOWNLOADING AUDIO PROGRAMS FROM AN EXTERNAL SOURCE, SUCH AS THE INTERNET, VIA A NETWORK INTERFACE, OR FROM ANOTHER COMPUTER NETWORK, A COMPUTER, OR ANOTHER ELECTRONIC MEMORY DEVICE TO THE STORAGE MEMORY AND WHICH CAN PLAY MUSIC AND SYNCHRONIZED LIGHT SHOWS; IMAGE GENERATION AND REPRESENTATION UNITS FOR REPRESENTATION AND VISUALIZATION OF MOVING PICTURES AND LIGHTS; APPARATUS WITH LCD, VIDEO, FLAT PANEL DISPLAY SCREENS FOR PLAYING MUSIC AND GENERATING SYNCHRONIZED LIGHT; STRUCTURAL PARTS FOR THE AFORESAID GOODS; ELECTRONIC DEVICES, NAMELY, ELECTRO-LUMINESCENT LIGHTING SYSTEMS THAT ARE COMPRISED OF ILLUMINATED CIRCUITS AND MICROPROCESSOR-BASED ELECTRONIC CONTROLLERS WHICH PRODUCE LIGHT DISPLAYS FOR ORNAMENTAL AND AMBIENT LIGHTING PURPOSES; CONTROLLER FOR ELECTRIC LIGHT DISPLAYS; CONTROLLER FOR ELECTRIC SOUND AND LIGHT DISPLAY; ELECTRONIC LIGHT DISPLAYS PRIMARILY CONSISTING OF INCANDESCENT LIGHTS, ELECTRIC SWITCHES, AND A POWER SUPPLY UNIT; ELEC-



David J. Kyros

Director of the United States Patent and Trademark Office

Reg. No. 4,109,040 TRIC LUMINESCENT DISPLAY PANELS; INCANDESCENT LIGHT DISPLAYS, IN CLASS 9 (U.S. CLS. 21, 23, 26, 36 AND 38).

FIRST USE 12-8-2011; IN COMMERCE 12-8-2011.

FOR: ELECTRIC LUMINESCENT ART AND LIGHTING DISPLAYS THAT INCORPORATE BAFFLES AND COLOR FILTERS WHICH ISOLATE INDIVIDUAL PORTIONS OF THE ART OR PATTERNS FOR USE IN DISPLAY, COMMERCIAL, INDUSTRIAL, RESIDENTIAL, AND ARCHITECTURAL ACCENT LIGHTING APPLICATIONS, FOR PUBLIC AND PRIVATE EVENTS, PARTIES, AND PERFORMANCES OR STAGE, CONCERT, NIGHTCLUB, BAR, RESTAURANT, TRADE SHOW OR THEATRE USE; ELECTRIC LUMINESCENT ART AND LIGHTING DISPLAYS THAT INCORPORATE INTERACTION OR FEEDBACK WITH THE USER FOR USE IN DISPLAY, COMMERCIAL, INDUSTRIAL, RESIDENTIAL, AND ARCHITECTURAL ACCENT LIGHTING APPLICATIONS, FOR PUBLIC AND PRIVATE EVENTS, PARTIES, AND PERFORMANCES OR STAGE, CONCERT, NIGHTCLUB, BAR, RESTAURANT, TRADE SHOW OR THEATRE USE, IN CLASS 11 (U.S. CLS. 13, 21, 23, 31 AND 34).

FIRST USE 12-8-2011; IN COMMERCE 12-8-2011.

THE MARK CONSISTS OF STANDARD CHARACTERS WITHOUT CLAIM TO ANY PARTICULAR FONT, STYLE, SIZE, OR COLOR.

SN 77-419,199, FILED 3-11-2008.

DARRYL SPRUILL, EXAMINING ATTORNEY

United States of America

United States Patent and Trademark Office

CLEAR MESSAGES FOR A COMPLEX WORLD

Reg. No. 4,109,041

Registered Mar. 6, 2012

Int. Cls.: 16 and 41

TRADEMARK

SERVICE MARK

PRINCIPAL REGISTER

BETTERCOM, INC. (DELAWARE CORPORATION)
4TH FLOOR
200 FIFTH AVENUE
WALTHAM, MA 02451

FOR: PRINTED INSTRUCTIONAL EDUCATIONAL AND TEACHING MATERIALS IN THE FIELD OF BUSINESS WRITING, BUSINESS AND ORAL PRESENTATIONS, PRESENTATION SKILLS DEVELOPMENT, PUBLIC SPEAKING, AND SPEECH WRITING AND DELIVERY, AND COMMUNICATIONS AND INTERPERSONAL SKILLS, IN CLASS 16 (U.S. CLS. 2, 5, 22, 23, 29, 37, 38 AND 50).

FIRST USE 12-1-2011; IN COMMERCE 12-1-2011.

FOR: EDUCATIONAL SERVICES, NAMELY, CONDUCTING SEMINARS AND WORKSHOPS, AND PROVIDING INSTRUCTION IN THE FORM OF EDUCATIONAL COURSES AND SEMINARS, ALL IN THE FIELD OF BUSINESS WRITING, BUSINESS AND ORAL PRESENTATIONS, PRESENTATION SKILLS DEVELOPMENT, PUBLIC SPEAKING, SPEECH WRITING AND DELIVERY, AND COMMUNICATIONS AND INTERPERSONAL SKILLS, IN CLASS 41 (U.S. CLS. 100, 101 AND 107).

FIRST USE 12-1-2011; IN COMMERCE 12-1-2011.

THE MARK CONSISTS OF STANDARD CHARACTERS WITHOUT CLAIM TO ANY PARTICULAR FONT, STYLE, SIZE, OR COLOR.

SN 77-419,945, FILED 3-12-2008.

LIEF MARTIN, EXAMINING ATTORNEY



David J. Kyros

Director of the United States Patent and Trademark Office

United States of America

United States Patent and Trademark Office

MICHAEL O'ROURKE

Reg. No. 4,109,042

Registered Mar. 6, 2012

Int. Cls.: 3, 9, and 21

TRADEMARK

PRINCIPAL REGISTER

O'ROURKE, MICHAEL (UNITED STATES INDIVIDUAL)
1135 TOPANGA CANYON BLVD.
TOPANGA, CA 90290

FOR: HAIR CARE PRODUCTS, NAMELY, HAIR SHAMPOOS, HAIR LOTIONS, HAIR CONDITIONERS, HAIR CREAMS, HAIR SPRAYS, HAIR GELS, HAIR POMADES, HAIR MOUSSES, IN CLASS 3 (U.S. CLS. 1, 4, 6, 50, 51 AND 52).

FIRST USE 12-0-2009; IN COMMERCE 12-0-2009.

FOR: ELECTRIC FLAT IRONS; ELECTRIC CURLING IRONS FOR HAIR, IN CLASS 9 (U.S. CLS. 21, 23, 26, 36 AND 38).

FIRST USE 12-0-2009; IN COMMERCE 12-0-2009.

FOR: HAIR BRUSHES, IN CLASS 21 (U.S. CLS. 2, 13, 23, 29, 30, 33, 40 AND 50).

FIRST USE 12-0-2009; IN COMMERCE 12-0-2009.

THE MARK CONSISTS OF STANDARD CHARACTERS WITHOUT CLAIM TO ANY PARTICULAR FONT, STYLE, SIZE, OR COLOR.

SN 77-421,690, FILED 3-13-2008.

CARRIE GENOVESE, EXAMINING ATTORNEY



David J. Kybas

Director of the United States Patent and Trademark Office

United States of America

United States Patent and Trademark Office

RAPTOR

Reg. No. 4,109,043

FORD MOTOR COMPANY (DELAWARE CORPORATION)
ONE AMERICAN ROAD
DEARBORN, MI 48126

Registered Mar. 6, 2012

Int. Cl.: 12

FOR: PICK-UP TRUCKS FOR HIGHWAY USE, IN CLASS 12 (U.S. CLS. 19, 21, 23, 31, 35 AND 44).

TRADEMARK

FIRST USE 1-16-2010; IN COMMERCE 1-16-2010.

PRINCIPAL REGISTER

THE MARK CONSISTS OF STANDARD CHARACTERS WITHOUT CLAIM TO ANY PARTICULAR FONT, STYLE, SIZE, OR COLOR.

PRIORITY CLAIMED UNDER SEC. 44(D) ON CANADA APPLICATION NO. 1367098, FILED 10-2-2007.

SN 77-424,675, FILED 3-18-2008.

KELLY CHOE, EXAMINING ATTORNEY



David J. Kybas

Director of the United States Patent and Trademark Office

United States of America

United States Patent and Trademark Office

VAN GOGH

Reg. No. 4,109,044

WEISZ, JORDAN (UNITED STATES INDIVIDUAL)
32-51 42ND STREET
ASTORIA, NY 11103

Registered Mar. 6, 2012

Int. Cl.: 35

FOR: DRIVE-THROUGH RETAIL STORE SERVICES FEATURING COFFEE AND RELATED GOODS; RETAIL BAKERY SHOPS; RETAIL CANDY STORES; RETAIL ICE CREAM STORE SERVICES, IN CLASS 35 (U.S. CLS. 100, 101 AND 102).

SERVICE MARK

FIRST USE 1-9-2011; IN COMMERCE 1-9-2011.

PRINCIPAL REGISTER

THE MARK CONSISTS OF STANDARD CHARACTERS WITHOUT CLAIM TO ANY PARTICULAR FONT, STYLE, SIZE, OR COLOR.

SN 77-426,651, FILED 3-19-2008.

SHAUNIA CARLYLE, EXAMINING ATTORNEY



David J. Kyros

Director of the United States Patent and Trademark Office

United States of America

United States Patent and Trademark Office

Vedä

Reg. No. 4,109,045

Registered Mar. 6, 2012

Int. Cl.: 28

TRADEMARK

PRINCIPAL REGISTER

D'EREDITA D'SIGN & D'VELOPMENT, LTD. (NEW YORK CORPORATION)
709 HICKORY STREET
LIVERPOOL, NY 13088

FOR: EXERCISING EQUIPMENT, NAMELY, ROWING MACHINES, IN CLASS 28 (U.S. CLS. 22, 23, 38 AND 50).

FIRST USE 1-5-2012; IN COMMERCE 1-5-2012.

THE MARK CONSISTS OF STANDARD CHARACTERS WITHOUT CLAIM TO ANY PARTICULAR FONT, STYLE, SIZE, OR COLOR.

"VEDA" HAS NO MEANING IN A FOREIGN LANGUAGE.

SN 77-432,535, FILED 3-26-2008.

ESTHER BELENKER, EXAMINING ATTORNEY



David J. Kybas

Director of the United States Patent and Trademark Office

United States of America

United States Patent and Trademark Office

ARGYLECULTURE

Reg. No. 4,109,046

Registered Mar. 6, 2012

Int. Cl.: 25

TRADEMARK

PRINCIPAL REGISTER

SIMMONS, RUSSELL (UNITED STATES INDIVIDUAL)
512 SEVENTH AVENUE, 43RD FLOOR
C/O RUSH COMMUNICATIONS
NEW YORK, NY 10018

FOR: CLOTHING, NAMELY, SHIRTS, T-SHIRTS, POLO SHIRTS, CARDIGANS, PANTS, TROUSERS, SLACKS, JEANS, CARGO PANTS, DENIM JEANS, HOODED SWEAT SHIRTS, SWEAT PANTS, SWEATERS, VESTS, JACKETS, SHELL JACKETS, SPORTS JACKETS, COATS, HEAVY COATS, BLAZERS, SUITS, HATS, HEADWEAR, BELTS, IN CLASS 25 (U.S. CLS. 22 AND 39).

FIRST USE 1-15-2009; IN COMMERCE 1-15-2009.

THE MARK CONSISTS OF STANDARD CHARACTERS WITHOUT CLAIM TO ANY PARTICULAR FONT, STYLE, SIZE, OR COLOR.

SN 77-433,731, FILED 3-27-2008.

JAMES STEIN, EXAMINING ATTORNEY



David J. Kybas

Director of the United States Patent and Trademark Office

United States of America

United States Patent and Trademark Office

SPRINGBOARD

Reg. No. 4,109,047

Registered Mar. 6, 2012

Int. Cl.: 42

SERVICE MARK

PRINCIPAL REGISTER

GORILLA NATION MEDIA, LLC (CALIFORNIA LIMITED LIABILITY COMPANY)
FLOOR 3
5140 W GOLDLEAF CIRCLE
LOS ANGELES, CA 90056

FOR: ONLINE NON-DOWNLOADABLE COMPUTER SOFTWARE, NAMELY, AD SERVING SOFTWARE THAT ALLOWS MIDTHAIL WEB PUBLISHERS TO CREATE, MANAGE, DISTRIBUTE AND MONETIZE TEXTUAL, GRAPHICAL AND AUDIO ADVERTISING CONTENT OVER A GLOBAL COMMUNICATIONS NETWORK; ONLINE NON-DOWNLOADABLE SOFTWARE THAT ALLOWS MIDTHAIL WEB PUBLISHERS TO CREATE VIDEO WIDGETS, NAMELY, PORTABLE COMPUTER CODE CAPABLE OF BEING EMBEDDED WITHIN A WEB PAGE, IN CLASS 42 (U.S. CLS. 100 AND 101).

FIRST USE 7-0-2009; IN COMMERCE 7-0-2009.

THE MARK CONSISTS OF STANDARD CHARACTERS WITHOUT CLAIM TO ANY PARTICULAR FONT, STYLE, SIZE, OR COLOR.

SN 77-439,470, FILED 4-3-2008.

THOMAS MANOR, EXAMINING ATTORNEY



David J. Kyffers

Director of the United States Patent and Trademark Office

United States of America

United States Patent and Trademark Office

POWERSHOP

Reg. No. 4,109,048

Registered Mar. 6, 2012

Int. Cl.: 42

SERVICE MARK

PRINCIPAL REGISTER

BRIDGELINE DIGITAL, INC. (DELAWARE CORPORATION)
10 SIXTH RD.
WOBURN, MA 01801

FOR: PROVIDING ON-LINE NON-DOWNLOADABLE SOFTWARE, NAMELY, SHOPPING-CART SOFTWARE FOR USERS TO PERFORM ELECTRONIC BUSINESS TRANSACTIONS WORLDWIDE, NAMELY, ORDER PROCESSING OF MERCHANT GOODS AND SERVICES VIA A GLOBAL COMPUTER NETWORK; PROVIDING ON-LINE NON-DOWNLOADABLE SOFTWARE FOR CREATING AND ENHANCING AN ON-LINE PRODUCT ORDERING SYSTEM; PROVIDING ON-LINE NON-DOWNLOADABLE SOFTWARE FOR AUTOMATED ELECTRONIC STORE DESIGN, CONSTRUCTION, MAINTENANCE AND OPERATION; AND PROVIDING ON-LINE NON-DOWNLOADABLE SOFTWARE FOR PROVIDING REAL-TIME OVERVIEW OF ONLINE STORE PERFORMANCE, NAMELY, SALES TRENDS, DEMOGRAPHICS, PROFIT MARGINS, ALERTS ON LOW INVENTORY, FULFILLMENT DEFICIENCIES, AND PRODUCTION ISSUES; DESIGN AND DEVELOPMENT OF ON-LINE COMPUTER SOFTWARE SYSTEMS; COMPUTER SOFTWARE DEVELOPMENT, IN CLASS 42 (U.S. CLS. 100 AND 101).

FIRST USE 7-5-2007; IN COMMERCE 7-5-2007.

THE MARK CONSISTS OF STANDARD CHARACTERS WITHOUT CLAIM TO ANY PARTICULAR FONT, STYLE, SIZE, OR COLOR.

SN 77-441,721, FILED 4-7-2008.

BRIAN NEVILLE, EXAMINING ATTORNEY



David J. Kyros

Director of the United States Patent and Trademark Office

United States of America

United States Patent and Trademark Office

MONKEY POWER MAKING SOLAR POWER MAINSTREAM

Reg. No. 4,109,049

KOMODO ENTERPRISES, INC. (NEVADA CORPORATION)
8915 RESEARCH DRIVE, SUITE 100
IRVINE, CA 926184258

Registered Mar. 6, 2012

Int. Cls.: 37 and 42

FOR: INSTALLATION, MAINTENANCE, AND REPAIR SERVICES, NAMELY, INSTALLATION, MAINTENANCE, AND REPAIR OF ELECTRICITY GENERATORS, SOLAR POWERED ELECTRICITY GENERATORS, SOLAR CELLS, AND SOLAR COLLECTORS, IN CLASS 37 (U.S. CLS. 100, 103 AND 106).

SERVICE MARK

PRINCIPAL REGISTER

FIRST USE 2-8-2008; IN COMMERCE 2-8-2008.

FOR: INDUSTRIAL ANALYSIS AND RESEARCH SERVICES IN THE FIELD OF ELECTRICITY GENERATION; CONSULTING SERVICES IN THE FIELD OF DESIGN OF ELECTRICITY GENERATING EQUIPMENT, NAMELY, ELECTRICITY GENERATORS, SOLAR POWERED ELECTRICITY GENERATORS, SOLAR CELLS, AND SOLAR COLLECTORS; DESIGN FOR OTHERS IN THE FIELD OF ELECTRICITY GENERATORS; DESIGN OF SOLAR POWERED ELECTRICITY GENERATORS; ENVIRONMENTAL SERVICES, NAMELY, TECHNICAL CONSULTATION IN THE FIELD OF ENVIRONMENTAL SCIENCE, ENGINEERING SERVICES, AND DESIGN FOR OTHERS IN THE FIELD OF ELECTRICITY GENERATION, IN CLASS 42 (U.S. CLS. 100 AND 101).

FIRST USE 1-6-2012; IN COMMERCE 1-6-2012.

THE MARK CONSISTS OF STANDARD CHARACTERS WITHOUT CLAIM TO ANY PARTICULAR FONT, STYLE, SIZE, OR COLOR.

SN 77-443,312, FILED 4-8-2008.

SETH A. RAPPAPORT, EXAMINING ATTORNEY



David J. Kypos

Director of the United States Patent and Trademark Office

United States of America
United States Patent and Trademark Office

ISOLATOR

Reg. No. 4,109,050

BLUNT WRAP U.S.A., INC. (LOUISIANA CORPORATION)
594 ASBURY DRIVE, SUITE C
MANDEVILLE, LA 70471

Registered Mar. 6, 2012

Int. Cl.: 34

FOR: TOBACCO PRODUCTS, ACCESSORIES, AND SMOKING ARTICLES, NAMELY, CIGARS, IN CLASS 34 (U.S. CLS. 2, 8, 9 AND 17).

TRADEMARK

FIRST USE 12-14-2011; IN COMMERCE 12-15-2011.

PRINCIPAL REGISTER

THE MARK CONSISTS OF STANDARD CHARACTERS WITHOUT CLAIM TO ANY PARTICULAR FONT, STYLE, SIZE, OR COLOR.

SN 77-452,976, FILED 4-20-2008.

CARRIE GENOVESE, EXAMINING ATTORNEY



David J. Kybas

Director of the United States Patent and Trademark Office

United States of America

United States Patent and Trademark Office

WORLDCAT NAVIGATOR

Reg. No. 4,109,051

OCLC ONLINE COMPUTER LIBRARY CENTER, INC. (OHIO CORPORATION)
6565 KILGOUR PLACE
DUBLIN, OH 430173395

Registered Mar. 6, 2012

Int. Cl.: 9

FOR: INTERLIBRARY LOAN COMPUTER SOFTWARE, IN CLASS 9 (U.S. CLS. 21, 23, 26, 36 AND 38).

TRADEMARK

FIRST USE 3-26-2009; IN COMMERCE 3-26-2009.

PRINCIPAL REGISTER

THE MARK CONSISTS OF STANDARD CHARACTERS WITHOUT CLAIM TO ANY PARTICULAR FONT, STYLE, SIZE, OR COLOR.

OWNER OF U.S. REG. NO. 2,194,670.

SN 77-454,260, FILED 4-22-2008.

DAYNA BROWNE, EXAMINING ATTORNEY



David J. Kyffers

Director of the United States Patent and Trademark Office

United States of America

United States Patent and Trademark Office

CARNIVALE LUNE BLEUE

Reg. No. 4,109,052

CARNIVALE LUNE BLEUE LIMITED (CANADA CORPORATION)
5915 HAZELDEAN ROAD

Registered Mar. 6, 2012

STITTSVILLE, ONTARIO, CANADA K2S1B9

Int. Cl.: 41

FOR: ENTERTAINMENT SERVICES, NAMELY, CONDUCTING CARNIVALS, IN CLASS 41 (U.S. CLS. 100, 101 AND 107).

SERVICE MARK

FIRST USE 12-31-2010; IN COMMERCE 12-31-2010.

PRINCIPAL REGISTER

THE MARK CONSISTS OF STANDARD CHARACTERS WITHOUT CLAIM TO ANY PARTICULAR FONT, STYLE, SIZE, OR COLOR.

NO CLAIM IS MADE TO THE EXCLUSIVE RIGHT TO USE "CARNIVALE", APART FROM THE MARK AS SHOWN.

THE FOREIGN WORDING IN THE MARK TRANSLATES INTO ENGLISH AS "BLUE MOON CARNIVAL".

SN 77-456,921, FILED 4-24-2008.

MICHAEL GAFFAR, EXAMINING ATTORNEY



David J. Kyffers

Director of the United States Patent and Trademark Office

United States of America
United States Patent and Trademark Office

ROWDOCK

Reg. No. 4,109,053

WILSON, ALFRED WENDELL (UNITED STATES INDIVIDUAL)
6041 GENIE TERRACE
MANASSAS, VA 201128849

Registered Mar. 6, 2012

Int. Cl.: 28

FOR: BODY PROTECTORS FOR LIMBS, IN CLASS 28 (U.S. CLS. 22, 23, 38 AND 50).

TRADEMARK

FIRST USE 10-1-2011; IN COMMERCE 10-1-2011.

PRINCIPAL REGISTER

THE MARK CONSISTS OF STANDARD CHARACTERS WITHOUT CLAIM TO ANY PARTICULAR FONT, STYLE, SIZE, OR COLOR.

SN 77-458,408, FILED 4-25-2008.

STEVEN JACKSON, EXAMINING ATTORNEY



David J. Kyffers

Director of the United States Patent and Trademark Office

United States of America

United States Patent and Trademark Office

HAUTE TOMATO

Reg. No. 4,109,054

Registered Mar. 6, 2012

Int. Cl.: 5

ARLEN, MICHAEL W. (UNITED STATES INDIVIDUAL), DBA/AKA ARLEN
NUTRACEUTICALS,
SUITE 200
11400 W. OLYMPIC BLVD.
LOS ANGELES, CA 900641557

TRADEMARK

FOR: A NUTRITIONALLY FORTIFIED TOMATO JUICE BEVERAGE, IN CLASS 5 (U.S.
CLS. 6, 18, 44, 46, 51 AND 52).

PRINCIPAL REGISTER

FIRST USE 11-30-2011; IN COMMERCE 11-30-2011.

THE MARK CONSISTS OF STANDARD CHARACTERS WITHOUT CLAIM TO ANY PAR-
TICULAR FONT, STYLE, SIZE, OR COLOR.

NO CLAIM IS MADE TO THE EXCLUSIVE RIGHT TO USE "TOMATO", APART FROM
THE MARK AS SHOWN.

SN 77-460,058, FILED 4-28-2008.

WENDY GOODMAN, EXAMINING ATTORNEY



David J. Kyros

Director of the United States Patent and Trademark Office

United States of America

United States Patent and Trademark Office

WPIC

Reg. No. 4,109,055

PHYSICAL OPTICS CORPORATION (CALIFORNIA CORPORATION)
1845 W. 205TH STREET
TORRANCE, CA 90501

Registered Mar. 6, 2012

Int. Cl.: 9

FOR: COMPUTER SOFTWARE AND HARDWARE FOR CONTROLLING AND MANAGING PATIENT MEDICAL INFORMATION, IN CLASS 9 (U.S. CLS. 21, 23, 26, 36 AND 38).

TRADEMARK

FIRST USE 8-4-2006; IN COMMERCE 8-4-2006.

PRINCIPAL REGISTER

THE MARK CONSISTS OF STANDARD CHARACTERS WITHOUT CLAIM TO ANY PARTICULAR FONT, STYLE, SIZE, OR COLOR.

SN 77-460,153, FILED 4-28-2008.

DARRYL SPRUILL, EXAMINING ATTORNEY



David J. Kybas

Director of the United States Patent and Trademark Office

United States of America

United States Patent and Trademark Office

NIRVANA NATURALS

Reg. No. 4,109,056

Registered Mar. 6, 2012

Int. Cl.: 31

TRADEMARK

PRINCIPAL REGISTER

MIDNIGHT CREATIONS, LLC (CALIFORNIA LIMITED LIABILITY COMPANY)
6160 ENTERPRISE DR UNIT G
DIAMOND SPRINGS, CA 95619

FOR: PET TREATS, IN CLASS 31 (U.S. CLS. 1 AND 46).

FIRST USE 11-18-2011; IN COMMERCE 11-18-2011.

THE MARK CONSISTS OF STANDARD CHARACTERS WITHOUT CLAIM TO ANY PARTICULAR FONT, STYLE, SIZE, OR COLOR.

NO CLAIM IS MADE TO THE EXCLUSIVE RIGHT TO USE "NATURALS", APART FROM THE MARK AS SHOWN.

SN 77-463,380, FILED 5-1-2008.

JOHN DWYER, EXAMINING ATTORNEY



David J. Kyffers

Director of the United States Patent and Trademark Office

United States of America

United States Patent and Trademark Office



Reg. No. 4,109,057

Registered Mar. 6, 2012

Int. Cl.: 25

TRADEMARK

PRINCIPAL REGISTER

ROYAL PAPER CONVERTING, INC. (ARIZONA CORPORATION)
711 N. 17TH STREET, SUITE 6
PHOENIX, AZ 85007

FOR: MEN, WOMEN AND CHILDREN'S HATS, FOOTWEAR, SOCKS, UNDERWEAR, TOPS, JACKETS, BOTTOMS; WOMEN AND CHILDREN'S DRESSES AND BLOUSES, IN CLASS 25 (U.S. CLS. 22 AND 39).

FIRST USE 1-5-2011; IN COMMERCE 1-5-2011.

THE MARK CONSISTS OF STYLIZED LETTERS "AS" WITHIN A SHIELD HAVING THE NUMBER "13" IN A CIRCLE BELOW, THE SHIELD HAVING A STYLIZED CROWN AT TOP AND SCROLLS ON EACH SIDE THEREOF.

SN 77-465,644, FILED 5-5-2008.

ELI HELLMAN, EXAMINING ATTORNEY



David J. Kyffers

Director of the United States Patent and Trademark Office

United States of America

United States Patent and Trademark Office

WE'RE ALL BABES

Reg. No. 4,109,058

Registered Mar. 6, 2012

Int. Cl.: 14

TRADEMARK

PRINCIPAL REGISTER

JOAN C. LEE (UNITED STATES INDIVIDUAL), DBA J.C. LEE,
9155 WARBLER PLACE
LOS ANGELES, CA 90069

FOR: JEWELRY, IN CLASS 14 (U.S. CLS. 2, 27, 28 AND 50).

FIRST USE 12-28-2011; IN COMMERCE 12-28-2011.

THE MARK CONSISTS OF STANDARD CHARACTERS WITHOUT CLAIM TO ANY PARTICULAR FONT, STYLE, SIZE, OR COLOR.

SN 77-466,833, FILED 5-6-2008.

JOHN E. MICHOS, EXAMINING ATTORNEY



David J. Kyffers

Director of the United States Patent and Trademark Office

United States of America

United States Patent and Trademark Office



Reg. No. 4,109,059

Registered Mar. 6, 2012

Int. Cl.: 6

TRADEMARK

PRINCIPAL REGISTER

LUMINA SPHERE LLC (ARIZONA LIMITED LIABILITY COMPANY)
3655 W. ANTHEM WAY, SUITE A109-419
ANTHEM, AZ 85086

FOR: SCULPTURES OF METAL, IN CLASS 6 (U.S. CLS. 2, 12, 13, 14, 23, 25 AND 50).

FIRST USE 1-7-2009; IN COMMERCE 9-28-2011.

THE MARK CONSISTS OF AN EXCLAMATION MARK WITH: 1. THE TOP PORTION FORMED BY THE OUTLINE OF AN UPSIDE DOWN TEARDROP OR RAINDROP SHAPE. 2. THE BOTTOM PORTION COMPRISED OF A PARTIALLY SHADED CIRCLE - WITH THIS SHADING FORMING THE SHAPE OF A CRESCENT WITHIN THE CIRCLE.

SN 77-468,434, FILED 5-7-2008.

KIM MONINGHOFF, EXAMINING ATTORNEY



David J. Kybas

Director of the United States Patent and Trademark Office

United States of America

United States Patent and Trademark Office

PLAYFUL DATING

Reg. No. 4,109,060

Registered Mar. 6, 2012

Int. Cl.: 45

SERVICE MARK

PRINCIPAL REGISTER

WEBSITE COMMERCE INC. (CANADA CORPORATION)
78 LAMBERT CRESCENT
BRANTFORD, ONTARIO, CANADA N3T0E9

FOR: COMPUTER SERVICES, NAMELY, PROVIDING INFORMATION REGARDING ON-LINE DATING AND INTRODUCTION SERVICES AND PROVIDING AN ON-LINE DATING AND INTRODUCTION SERVICES, IN CLASS 45 (U.S. CLS. 100 AND 101).

FIRST USE 1-11-2012; IN COMMERCE 1-11-2012.

THE MARK CONSISTS OF STANDARD CHARACTERS WITHOUT CLAIM TO ANY PARTICULAR FONT, STYLE, SIZE, OR COLOR.

NO CLAIM IS MADE TO THE EXCLUSIVE RIGHT TO USE "DATING", APART FROM THE MARK AS SHOWN.

SN 77-470,145, FILED 5-9-2008.

CIMMERIAN COLEMAN, EXAMINING ATTORNEY



David J. Kyfos

Director of the United States Patent and Trademark Office

United States of America

United States Patent and Trademark Office

NETLETS

Reg. No. 4,109,061

Registered Mar. 6, 2012

Int. Cl.: 41

SERVICE MARK

PRINCIPAL REGISTER

NETLETS, LLC (NEW JERSEY LIMITED LIABILITY COMPANY)
27 GRANBY DRIVE
MADISON, CT 06443

FOR: ENTERTAINMENT SERVICES, NAMELY, PROVIDING ONLINE COMPUTER GAMES FEATURING ANIMATED CHARACTERS AND CHILDREN'S ENTERTAINMENT, IN CLASS 41 (U.S. CLS. 100, 101 AND 107).

FIRST USE 1-1-2009; IN COMMERCE 1-1-2009.

THE MARK CONSISTS OF STANDARD CHARACTERS WITHOUT CLAIM TO ANY PARTICULAR FONT, STYLE, SIZE, OR COLOR.

SN 77-470,241, FILED 5-9-2008.

LINDA LAVACHE, EXAMINING ATTORNEY



David J. Kybas

Director of the United States Patent and Trademark Office

United States of America

United States Patent and Trademark Office

the dragons of blizzard island

Reg. No. 4,109,062

BIG BANG INC. (NEW JERSEY CORPORATION)
219 SHERMAN STREET
BOONTON, NJ 07005

Registered Mar. 6, 2012

Int. Cl.: 16

FOR: SERIES OF FICTION BOOKS; COMIC BOOKS; CHILDREN'S BOOKS, IN CLASS 16
(U.S. CLS. 2, 5, 22, 23, 29, 37, 38 AND 50).

TRADEMARK

FIRST USE 11-0-2011; IN COMMERCE 11-0-2011.

PRINCIPAL REGISTER

THE MARK CONSISTS OF STANDARD CHARACTERS WITHOUT CLAIM TO ANY PARTICULAR FONT, STYLE, SIZE, OR COLOR.

SN 77-470,326, FILED 5-9-2008.

SOPHIA S. KIM, EXAMINING ATTORNEY



David J. Kybas

Director of the United States Patent and Trademark Office

United States of America

United States Patent and Trademark Office

THE KITCHEN IS OUR TEMPLE

Reg. No. 4,109,063

Registered Mar. 6, 2012

Int. Cl.: 30

TRADEMARK

PRINCIPAL REGISTER

TEMPLE SPICE, LLC (CALIFORNIA LIMITED LIABILITY COMPANY)
4403 THACHER ROAD
OJAI, CA 93023

FOR: SPICE BLENDS; SPICE RUBS; SPICES, IN CLASS 30 (U.S. CL. 46).

FIRST USE 12-9-2011; IN COMMERCE 12-9-2011.

THE MARK CONSISTS OF STANDARD CHARACTERS WITHOUT CLAIM TO ANY PARTICULAR FONT, STYLE, SIZE, OR COLOR.

SN 77-470,336, FILED 5-9-2008.

EDWARD FENNESSY, EXAMINING ATTORNEY



David J. Kyros

Director of the United States Patent and Trademark Office

United States of America

United States Patent and Trademark Office

SLICES OF INDULGENCE

Reg. No. 4,109,064

HAB ENTERPRISES, INC. (CALIFORNIA CORPORATION)
4427 LONGRIDGE AVENUE
SHERMAN OAKS, CA 91423

Registered Mar. 6, 2012

Int. Cl.: 43

FOR: RESTAURANT SERVICES; TAKE-OUT RESTAURANT SERVICES, IN CLASS 43 (U.S. CLS. 100 AND 101).

SERVICE MARK

FIRST USE 1-5-2012; IN COMMERCE 1-5-2012.

PRINCIPAL REGISTER

THE MARK CONSISTS OF STANDARD CHARACTERS WITHOUT CLAIM TO ANY PARTICULAR FONT, STYLE, SIZE, OR COLOR.

SN 77-471,799, FILED 5-12-2008.

FRANK LATTUCA, EXAMINING ATTORNEY



David J. Kyffers

Director of the United States Patent and Trademark Office

United States of America
United States Patent and Trademark Office

TRIPEASE

Reg. No. 4,109,065

MARINO, ANTHONY (UNITED STATES INDIVIDUAL)
297 BAYSHORE DRIVE
PALM HARBOR, FL 34683

Registered Mar. 6, 2012

Int. Cl.: 25

FOR: APPAREL, NAMELY, SHIRTS, T-SHIRTS, IN CLASS 25 (U.S. CLS. 22 AND 39).

TRADEMARK

FIRST USE 12-1-2011; IN COMMERCE 12-1-2011.

PRINCIPAL REGISTER

THE MARK CONSISTS OF STANDARD CHARACTERS WITHOUT CLAIM TO ANY PARTICULAR FONT, STYLE, SIZE, OR COLOR.

SN 77-473,069, FILED 5-13-2008.

DOMINIC FATHY, EXAMINING ATTORNEY



David J. Kybas

Director of the United States Patent and Trademark Office

United States of America

United States Patent and Trademark Office

BRING GOURMET TO EVERYDAY

Reg. No. 4,109,066

PARTYLITE WORLDWIDE, INC. (DELAWARE CORPORATION)
59 ARMSTRONG ROAD
PLYMOUTH, MA 02360

Registered Mar. 6, 2012

Int. Cls.: 29, 30, and 35

FOR: JAMS, JELLIES, FRUIT-BASED SPREADS, SOUP MIXES, FLAVORED EDIBLE OILS, SNACK-DIP MIXES, IN CLASS 29 (U.S. CL. 46).

TRADEMARK

FIRST USE 9-1-2008; IN COMMERCE 9-1-2008.

SERVICE MARK

FOR: SALSA-DIP MIXES, DRIED HERB AND SPICE MIXES, MIXES FOR MAKING BAKERY GOODS, SALSA, MARINADE, MUSTARD, SALAD DRESSING, BREAD MIXES, SALT, PEPPER, SAUCES, COCOA MIX, IN CLASS 30 (U.S. CL. 46).

PRINCIPAL REGISTER

FIRST USE 9-1-2008; IN COMMERCE 9-1-2008.

FOR: CONDUCTING MAIL ORDER CATALOG SERVICES AND HOME PRODUCT DEMONSTRATIONS FEATURING GOURMET FOOD PRODUCTS, IN CLASS 35 (U.S. CLS. 100, 101 AND 102).

FIRST USE 9-1-2008; IN COMMERCE 9-1-2008.

THE MARK CONSISTS OF STANDARD CHARACTERS WITHOUT CLAIM TO ANY PARTICULAR FONT, STYLE, SIZE, OR COLOR.

SN 77-473,986, FILED 5-14-2008.

SHAILA SETTLES, EXAMINING ATTORNEY



David J. Kyros

Director of the United States Patent and Trademark Office

United States of America

United States Patent and Trademark Office

PIELICIOUS!

Reg. No. 4,109,067

HAB ENTERPRISES, INC. (CALIFORNIA CORPORATION)
4427 LONGRIDGE AVENUE
SHERMAN OAKS, CA 91423

Registered Mar. 6, 2012

Int. Cl.: 43

FOR: RESTAURANT SERVICES; TAKE-OUT RESTAURANT SERVICES, IN CLASS 43 (U.S. CLS. 100 AND 101).

SERVICE MARK

FIRST USE 1-5-2012; IN COMMERCE 1-5-2012.

PRINCIPAL REGISTER

THE MARK CONSISTS OF STANDARD CHARACTERS WITHOUT CLAIM TO ANY PARTICULAR FONT, STYLE, SIZE, OR COLOR.

SN 77-479,573, FILED 5-20-2008.

FRANK LATTUCA, EXAMINING ATTORNEY



David J. Kyffers

Director of the United States Patent and Trademark Office

United States of America

United States Patent and Trademark Office

Focus on Perfect Skin

Reg. No. 4,109,068

MANA PRODUCTS, INC. (NEW YORK CORPORATION)
32-02 QUEENS BOULEVARD
LONG ISLAND CITY, NY 11101

Registered Mar. 6, 2012

Int. Cl.: 3

FOR: COSMETICS AND NON-MEDICATED SKINCARE PRODUCTS, IN CLASS 3 (U.S. CLS. 1, 4, 6, 50, 51 AND 52).

TRADEMARK

FIRST USE 11-30-2011; IN COMMERCE 11-30-2011.

PRINCIPAL REGISTER

THE MARK CONSISTS OF STANDARD CHARACTERS WITHOUT CLAIM TO ANY PARTICULAR FONT, STYLE, SIZE, OR COLOR.

SN 77-480,820, FILED 5-21-2008.

INGRID C. EULIN, EXAMINING ATTORNEY



David J. Kybas

Director of the United States Patent and Trademark Office

United States of America

United States Patent and Trademark Office

PRIMALUX

Reg. No. 4,109,069

Registered Mar. 6, 2012

Int. Cl.: 25

TRADEMARK

PRINCIPAL REGISTER

INTERNATIONAL MERCHANDISING INC. SDN BHD (CO#645198-T) (MALAYSIA CORPORATION)

312, 3RD FLOOR, BLOCK C, KELANA SQUARE

17 JALAN SS 7/26, 47301 PETALING JAYA

SELANGOR DARUL EHSAN, MALAYSIA

FOR: ATHLETIC CLOTHING AND CASUAL CLOTHING, NAMELY, OUTDOOR JACKETS, SWEATERS, PULLOVERS, T-SHIRTS, PANTS, SKIRTS, DRESSES, BLOUSES, SHORTS, CULOTTES, SWEAT TOPS, SWEAT BOTTOMS, JOGGING SUITS, TWIN SETS, JERSEYS, TANK TOPS, BLAZERS; HEADWEAR, NAMELY, HATS AND CAPS; GOLFWEAR, NAMELY, OUTDOOR JACKETS, PANTS, GOLF SHIRTS, SOCKS, SHORTS, SWEATERS, AND HATS, IN CLASS 25 (U.S. CLS. 22 AND 39).

FIRST USE 2-28-2008; IN COMMERCE 2-28-2008.

THE MARK CONSISTS OF STANDARD CHARACTERS WITHOUT CLAIM TO ANY PARTICULAR FONT, STYLE, SIZE, OR COLOR.

SN 77-481,033, FILED 5-22-2008.

MICHAEL TANNER, EXAMINING ATTORNEY



David J. Kyffers

Director of the United States Patent and Trademark Office

United States of America

United States Patent and Trademark Office

Beauty Rules

Reg. No. 4,109,070

MANA PRODUCTS, INC. (NEW YORK CORPORATION)
32-02 QUEENS BOULEVARD
LONG ISLAND CITY, NY 11101

Registered Mar. 6, 2012

Int. Cl.: 3

FOR: COSMETICS, IN CLASS 3 (U.S. CLS. 1, 4, 6, 50, 51 AND 52).

TRADEMARK

FIRST USE 11-30-2011; IN COMMERCE 11-30-2011.

PRINCIPAL REGISTER

THE MARK CONSISTS OF STANDARD CHARACTERS WITHOUT CLAIM TO ANY PARTICULAR FONT, STYLE, SIZE, OR COLOR.

SN 77-481,870, FILED 5-22-2008.

INGRID C. EULIN, EXAMINING ATTORNEY



David J. Kyffers

Director of the United States Patent and Trademark Office

United States of America
United States Patent and Trademark Office

MAC
MID-AMERICAN
CONFERENCE

Reg. No. 4,109,071

Registered Mar. 6, 2012

Int. Cls.: 16 and 41

TRADEMARK

SERVICE MARK

PRINCIPAL REGISTER

MID-AMERICAN CONFERENCE (OHIO NON-PROFIT ORGANIZATION)
15TH FLOOR
24 PUBLIC SQUARE
CLEVELAND, OH 44113

FOR: PUBLICATIONS, NAMELY, BOOKS, PAMPHLETS, BROCHURES, NEWSLETTERS, JOURNALS, MAGAZINES, HANDBOOKS, MANUALS AND PROGRAMS IN THE FIELDS OF ATHLETIC ACTIVITIES, IN CLASS 16 (U.S. CLS. 2, 5, 22, 23, 29, 37, 38 AND 50).

FIRST USE 7-1-2008; IN COMMERCE 7-1-2008.

FOR: ENTERTAINMENT IN THE NATURE OF COMPETITIONS IN THE FIELD OF SPORTING ACTIVITIES, NAMELY, COLLEGIATE SPORTING EVENTS AND SPORT EXHIBITION EVENTS, IN CLASS 41 (U.S. CLS. 100, 101 AND 107).

FIRST USE 7-1-2008; IN COMMERCE 7-1-2008.

NO CLAIM IS MADE TO THE EXCLUSIVE RIGHT TO USE "CONFERENCE", APART FROM THE MARK AS SHOWN.

THE MARK CONSISTS OF THREE STYLIZED CAPITAL LETTERS SPELLING "MAC". CENTERED AND BELOW THE WORD "MAC" ARE THE WORDS "MID-AMERICAN", CONSISTING OF THE SAME STYLIZED CAPITAL LETTERS AS "MAC", BUT IN A SMALLER SIZED FONT. CENTERED AND BELOW THE WORDS "MID-AMERICAN" IS THE WORD "CONFERENCE", CONSISTING OF SAME STYLIZED CAPITAL LETTERS AND FONT SIZE AS "MID-AMERICAN".

SN 77-482,016, FILED 5-23-2008.

RAMONA ORTIGA, EXAMINING ATTORNEY



David J. Kyros

Director of the United States Patent and Trademark Office

United States of America

United States Patent and Trademark Office



Reg. No. 4,109,072

Registered Mar. 6, 2012

Int. Cl.: 36

SERVICE MARK

PRINCIPAL REGISTER

THE WARRANTY GROUP, INC. (DELAWARE CORPORATION)
175 WEST JACKSON BLVD.
CHICAGO, IL 60604

FOR: PROVIDING EXTENDED WARRANTIES, EITHER INDIVIDUALLY OR IN COMBINATION, RELATING TO HOME HEATING SYSTEMS, AIR CONDITIONING UNITS, DUCT WORK, ELECTRICAL AND PLUMBING, WATER HEATERS, DISHWASHERS, OVENS, COOKTOPS, APPLIANCES, WASHERS AND DRYERS, ICE MAKERS, FREEZERS, REFRIGERATORS, TRASH COMPACTORS, WELL PUMPS, SEPTIC SYSTEMS, SWIMMING POOLS AND POOL SPAS, IN CLASS 36 (U.S. CLS. 100, 101 AND 102).

FIRST USE 4-30-2008; IN COMMERCE 4-30-2008.

NO CLAIM IS MADE TO THE EXCLUSIVE RIGHT TO USE "WARRANTY", APART FROM THE MARK AS SHOWN.

THE MARK CONSISTS OF THE WORDING "MAIN ST." THE "T" IN "ST." IS A DESIGN ELEMENT OF AN OUTDOOR LAMP POST. BELOW THE WORDING "MAIN ST." PLUS DESIGN IS THE WORDING "WARRANTY". A STRAIGHT LINE SEPARATES THE TOP AND BOTTOM WORDINGS.

SN 77-483,847, FILED 5-27-2008.

WENDY JUN, EXAMINING ATTORNEY



David J. Kyffers

Director of the United States Patent and Trademark Office

United States of America

United States Patent and Trademark Office

True-SOA

Reg. No. 4,109,073

Registered Mar. 6, 2012

Int. Cl.: 9

TRADEMARK

PRINCIPAL REGISTER

PICOR CORPORATION (DELAWARE CORPORATION)
51 INDUSTRIAL DRIVE
NORTH SMITHFIELD, RI 02896

FOR: SEMICONDUCTORS, ELECTRONIC CIRCUIT BOARDS, ELECTRONIC INTEGRATED CIRCUITS, INTEGRATED CIRCUIT CHIPS, INTEGRATED CIRCUIT MODULES AND PRINTED CIRCUITS RELATING TO POWER MANAGEMENT AND POWER CONVERSION; SYSTEMS IN A PACKAGE, NAMELY, INTEGRATED CIRCUITS AND PRINTED CIRCUIT BOARDS FOR POWER MANAGEMENT AND POWER MANAGEMENT APPLICATIONS, IN CLASS 9 (U.S. CLS. 21, 23, 26, 36 AND 38).

FIRST USE 12-30-2011; IN COMMERCE 12-30-2011.

THE MARK CONSISTS OF STANDARD CHARACTERS WITHOUT CLAIM TO ANY PARTICULAR FONT, STYLE, SIZE, OR COLOR.

SN 77-486,637, FILED 5-29-2008.

MARK SPARACINO, EXAMINING ATTORNEY



David J. Kyffers

Director of the United States Patent and Trademark Office

United States of America

United States Patent and Trademark Office

AUTO PARTS TODAY

Reg. No. 4,109,074

Registered Mar. 6, 2012

Int. Cl.: 35

SERVICE MARK

PRINCIPAL REGISTER

RADIATOR EXPRESS WAREHOUSE, INC. (CALIFORNIA CORPORATION)
4401 PARK ROAD
BENICIA, CA 94510

FOR: RETAIL AND WHOLESALE AUTOMOBILE PARTS AND ACCESSORIES STORES;
RETAIL AND WHOLESALE TELEPHONE ORDERING SERVICES FEATURING VEHICLE
PARTS AND ACCESSORIES; RETAIL AND WHOLESALE COMPUTERIZED ON-LINE OR-
DERING SERVICES FEATURING VEHICLE PARTS AND ACCESSORIES, IN CLASS 35
(U.S. CLS. 100, 101 AND 102).

FIRST USE 1-1-2010; IN COMMERCE 1-1-2010.

THE MARK CONSISTS OF STANDARD CHARACTERS WITHOUT CLAIM TO ANY PAR-
TICULAR FONT, STYLE, SIZE, OR COLOR.

NO CLAIM IS MADE TO THE EXCLUSIVE RIGHT TO USE "AUTO PARTS", APART FROM
THE MARK AS SHOWN.

SN 77-489,122, FILED 6-2-2008.

MATTHEW KLINE, EXAMINING ATTORNEY



David J. Kypas

Director of the United States Patent and Trademark Office

United States of America

United States Patent and Trademark Office

"WHAT WILL YOU DO WITH
YOUR 6%?"

Reg. No. 4,109,075

PEARCE ENTERPRISES LLC (MARYLAND LIMITED LIABILITY COMPANY)
2334 SHEPPARD ROAD
MONKTON, MD 21111

Registered Mar. 6, 2012

Int. Cl.: 36

FOR: PROVIDING REAL ESTATE LISTINGS AND REAL ESTATE INFORMATION VIA THE
INTERNET, IN CLASS 36 (U.S. CLS. 100, 101 AND 102).

SERVICE MARK

FIRST USE 1-20-2012; IN COMMERCE 1-20-2012.

PRINCIPAL REGISTER

THE MARK CONSISTS OF STANDARD CHARACTERS WITHOUT CLAIM TO ANY PAR-
TICULAR FONT, STYLE, SIZE, OR COLOR.

SN 77-491,448, FILED 6-5-2008.

MARK RADEMACHER, EXAMINING ATTORNEY



David J. Kybas

Director of the United States Patent and Trademark Office

United States of America

United States Patent and Trademark Office

FLEX READY

Reg. No. 4,109,076

FLEXPATHS, LLC (NEW JERSEY LIMITED LIABILITY COMPANY)
55 ALPINE TERRACE
HILLSDALE, NJ 07642

Registered Mar. 6, 2012

Int. Cl.: 35

FOR: PROVIDING PERSONNEL PLACEMENT SERVICES VIA AN ONLINE WEBSITE, NAMELY, JOB PLACEMENT COUNSELING AND LINKS TO OTHER RECRUITING WEBSITES AND PROVIDING INFORMATION FOR FLEXIBLE WORK ARRANGEMENTS, IN CLASS 35 (U.S. CLS. 100, 101 AND 102).

SERVICE MARK

PRINCIPAL REGISTER

FIRST USE 6-15-2007; IN COMMERCE 6-15-2007.

THE MARK CONSISTS OF STANDARD CHARACTERS WITHOUT CLAIM TO ANY PARTICULAR FONT, STYLE, SIZE, OR COLOR.

SN 77-491,470, FILED 6-5-2008.

MICHAEL SOUDERS, EXAMINING ATTORNEY



David J. Kybas

Director of the United States Patent and Trademark Office

United States of America
United States Patent and Trademark Office

M STREET

Reg. No. 4,109,077

C&C JEWELRY MFG., INC. (CALIFORNIA CORPORATION)
323 WEST 8TH STREET, 4TH FLOOR
LOS ANGELES, CA 90014

Registered Mar. 6, 2012

Int. Cl.: 14

FOR: JEWELRY, IN CLASS 14 (U.S. CLS. 2, 27, 28 AND 50).

TRADEMARK

FIRST USE 8-22-2011; IN COMMERCE 8-22-2011.

PRINCIPAL REGISTER

THE MARK CONSISTS OF STANDARD CHARACTERS WITHOUT CLAIM TO ANY PARTICULAR FONT, STYLE, SIZE, OR COLOR.

SN 77-492,156, FILED 6-5-2008.

ASMAT KHAN, EXAMINING ATTORNEY



David J. Kybas

Director of the United States Patent and Trademark Office

United States of America

United States Patent and Trademark Office

TWILIGHT COLLECTION

Reg. No. 4,109,078

C&C JEWELRY MFG., INC. (CALIFORNIA CORPORATION)
323 WEST 8TH STREET, 4TH FLOOR
LOS ANGELES, CA 90014

Registered Mar. 6, 2012

Int. Cl.: 14

FOR: JEWELRY, IN CLASS 14 (U.S. CLS. 2, 27, 28 AND 50).

TRADEMARK

FIRST USE 8-22-2011; IN COMMERCE 8-22-2011.

PRINCIPAL REGISTER

THE MARK CONSISTS OF STANDARD CHARACTERS WITHOUT CLAIM TO ANY PARTICULAR FONT, STYLE, SIZE, OR COLOR.

NO CLAIM IS MADE TO THE EXCLUSIVE RIGHT TO USE "COLLECTION", APART FROM THE MARK AS SHOWN.

SN 77-492,178, FILED 6-5-2008.

ASMAT KHAN, EXAMINING ATTORNEY



David J. Kyffers

Director of the United States Patent and Trademark Office

United States of America

United States Patent and Trademark Office



Reg. No. 4,109,079

Registered Mar. 6, 2012

Int. Cl.: 20

TRADEMARK

PRINCIPAL REGISTER

SCHILLER, STEPHEN (UNITED STATES INDIVIDUAL)
12660 BONITA BEACH RD.
BONITA SPRINGS, FL 34135

FOR: INDOOR PREMIUM BEDDING, NAMELY, MATTRESSES, BOX SPRINGS AND MATTRESS FOUNDATIONS FOR USE IN INDOOR SLEEPING AREAS, IN CLASS 20 (U.S. CLS. 2, 13, 22, 25, 32 AND 50).

FIRST USE 12-27-2011; IN COMMERCE 12-27-2011.

THE MARK CONSISTS OF THE SANSKRIT SYMBOL FOR OM.

SN 77-493,943, FILED 6-9-2008.

LINDA POWELL, EXAMINING ATTORNEY



David J. Kybas

Director of the United States Patent and Trademark Office

United States of America

United States Patent and Trademark Office



Reg. No. 4,109,080

Registered Mar. 6, 2012

Int. Cl.: 25

TRADEMARK

PRINCIPAL REGISTER

JONAS BROTHERS PROPERTIES LLC (DELAWARE LIMITED LIABILITY COMPANY)
250 W. 57TH STREET
STE. 2003
NEW YORK, NY 10107

FOR: TOPS, HEADWEAR, PULLOVERS, WRISTBANDS, IN CLASS 25 (U.S. CLS. 22 AND 39).

FIRST USE 7-31-2009; IN COMMERCE 7-31-2009.

OWNER OF U.S. REG. NO. 3,640,972.

THE MARK CONSISTS OF SHIELD DESIGN WITH THE LETTERS "JB" IN THE MIDDLE OF THE SHIELD.

SN 77-494,369, FILED 6-9-2008.

KIM SAITO, EXAMINING ATTORNEY



David J. Kyffers

Director of the United States Patent and Trademark Office

United States of America

United States Patent and Trademark Office

ICOMMAND

Reg. No. 4,109,081

Registered Mar. 6, 2012

Int. Cl.: 9

TRADEMARK

PRINCIPAL REGISTER

CERNER INNOVATION, INC. (DELAWARE CORPORATION)
13725 W. 109TH ST., SUITE 101
LENEXA, KS 66215

FOR: COMPUTER SOFTWARE FOR USE IN THE HEALTHCARE FIELD, NAMELY, SOFTWARE FOR MANAGING, STORING, ANALYZING, MAINTAINING, PROCESSING, STRUCTURING, REVIEWING, BUILDING, EDITING, DISTRIBUTING, COMMUNICATING, ORGANIZING, SHARING, REFERENCING, MONITORING AND INTEGRATING HEALTHCARE INFORMATION; COMPUTER SOFTWARE FOR AUTOMATING CLINICAL AND ADMINISTRATIVE HEALTHCARE PROCESSES, IN CLASS 9 (U.S. CLS. 21, 23, 26, 36 AND 38).

FIRST USE 8-8-2011; IN COMMERCE 8-8-2011.

THE MARK CONSISTS OF STANDARD CHARACTERS WITHOUT CLAIM TO ANY PARTICULAR FONT, STYLE, SIZE, OR COLOR.

SN 77-495,082, FILED 6-10-2008.

REBECCA POVARCHUK, EXAMINING ATTORNEY



David J. Kyffers

Director of the United States Patent and Trademark Office

United States of America

United States Patent and Trademark Office

SUNDEFENSE

Reg. No. 4,109,082

PELLA CORPORATION (IOWA CORPORATION)
102 MAIN STREET
PELLA, IA 50219

Registered Mar. 6, 2012

Int. Cl.: 2

FOR: GLASS COATINGS FOR WINDOWS AND DOORS, IN CLASS 2 (U.S. CLS. 6, 11 AND 16).

TRADEMARK

FIRST USE 5-21-2009; IN COMMERCE 5-21-2009.

PRINCIPAL REGISTER

THE MARK CONSISTS OF STANDARD CHARACTERS WITHOUT CLAIM TO ANY PARTICULAR FONT, STYLE, SIZE, OR COLOR.

SN 77-495,773, FILED 6-10-2008.

DORITT L. CARROLL, EXAMINING ATTORNEY



David J. Kybas

Director of the United States Patent and Trademark Office

United States of America

United States Patent and Trademark Office



Reg. No. 4,109,083

Registered Mar. 6, 2012

Int. Cl.: 14

TRADEMARK

PRINCIPAL REGISTER

MICHAEL C. FINA COMPANY (NEW YORK CORPORATION)
545 FIFTH AVENUE
NEW YORK, NY 10017

FOR: CUFFLINKS, IN CLASS 14 (U.S. CLS. 2, 27, 28 AND 50).

FIRST USE 12-1-2011; IN COMMERCE 12-1-2011.

THE MARK CONSISTS OF A STYLIZED LEAF.

SN 77-497,630, FILED 6-12-2008.

WENDY JUN, EXAMINING ATTORNEY



David J. Kyffers

Director of the United States Patent and Trademark Office

United States of America

United States Patent and Trademark Office

DOWN UNDERS

Reg. No. 4,109,084

SANDERS & ASSOCIATES, INC. (WASHINGTON CORPORATION)
11616 NE 30TH PLACE
BELLEVUE, WA 98005

Registered Mar. 6, 2012

Int. Cl.: 16

FOR: BABIES' DIAPERS OF PAPER; DISPOSABLE DIAPERS, IN CLASS 16 (U.S. CLS. 2, 5, 22, 23, 29, 37, 38 AND 50).

TRADEMARK

FIRST USE 1-17-2012; IN COMMERCE 1-17-2012.

PRINCIPAL REGISTER

THE MARK CONSISTS OF STANDARD CHARACTERS WITHOUT CLAIM TO ANY PARTICULAR FONT, STYLE, SIZE, OR COLOR.

SN 77-498,040, FILED 6-13-2008.

KATHRYN COWARD, EXAMINING ATTORNEY



David J. Kybas

Director of the United States Patent and Trademark Office

United States of America

United States Patent and Trademark Office

BOURBON COUNTRY

Reg. No. 4,109,085

Registered Mar. 6, 2012

**Int. Cls.: 16, 18, 21, and
25**

GREATER LOUISVILLE CONVENTION & VISITORS BUREAU (KENTUCKY INDEPENDENT
COMMISSION ESTABLISHED BY KENTUCKY STATUTE.)

401 W. MAIN ST.
SUITE 2300
LOUISVILLE, KY 40202

FOR: COASTER SETS OF PAPER; PENS; POSTERS, IN CLASS 16 (U.S. CLS. 2, 5, 22, 23, 29,
37, 38 AND 50).

FIRST USE 6-30-2008; IN COMMERCE 6-30-2008.

FOR: TOTE BAGS; LUGGAGE TAGS; UMBRELLAS, IN CLASS 18 (U.S. CLS. 1, 2, 3, 22 AND
41).

FIRST USE 6-30-2008; IN COMMERCE 6-30-2008.

FOR: FLASKS; SHOT GLASSES; PORTABLE COOLERS; INSULATED CONTAINERS FOR
BEVERAGE CANS; COASTER SETS NOT OF PAPER AND NOT BEING OF TEXTILE;
TASTING GLASSES; PAPER CUPS, IN CLASS 21 (U.S. CLS. 2, 13, 23, 29, 30, 33, 40 AND
50).

FIRST USE 6-30-2008; IN COMMERCE 6-30-2008.

FOR: T-SHIRTS; SWEATSHIRTS; BALL CAPS, IN CLASS 25 (U.S. CLS. 22 AND 39).

FIRST USE 6-30-2008; IN COMMERCE 6-30-2008.

THE MARK CONSISTS OF STANDARD CHARACTERS WITHOUT CLAIM TO ANY PAR-
TICULAR FONT, STYLE, SIZE, OR COLOR.

OWNER OF U.S. REG. NOS. 3,474,128 AND 3,477,274.

SN 77-498,087, FILED 6-13-2008.

MARIA-VICTORIA SUAREZ, EXAMINING ATTORNEY

TRADEMARK

PRINCIPAL REGISTER



David J. Kyffers

Director of the United States Patent and Trademark Office

United States of America

United States Patent and Trademark Office

RESTORESENSOR

Reg. No. 4,109,086

MEDTRONIC, INC. (MINNESOTA CORPORATION)
710 MEDTRONIC PARKWAY
MINNEAPOLIS, MN 554325604

Registered Mar. 6, 2012

Int. Cl.: 10

FOR: IMPLANTABLE NEUROLOGICAL STIMULATOR AND COMPONENT PARTS THEREFOR, IN CLASS 10 (U.S. CLS. 26, 39 AND 44).

TRADEMARK

FIRST USE 11-22-2011; IN COMMERCE 11-22-2011.

PRINCIPAL REGISTER

THE MARK CONSISTS OF STANDARD CHARACTERS WITHOUT CLAIM TO ANY PARTICULAR FONT, STYLE, SIZE, OR COLOR.

OWNER OF U.S. REG. NOS. 2,978,117, 3,166,759, AND 3,204,643.

SN 77-503,050, FILED 6-19-2008.

B. PARADEWELAI, EXAMINING ATTORNEY



David J. Kybas

Director of the United States Patent and Trademark Office

United States of America

United States Patent and Trademark Office



Reg. No. 4,109,087

BETHUNE, ANDREW J. (UNITED STATES INDIVIDUAL)
2893 PIMLICO LANE
SAGINAW, MI 48603

Registered Mar. 6, 2012

Int. Cl.: 36

FOR: FUND RAISING SERVICES, NAMELY, ORGANIZING, ARRANGING AND CONDUCTING FUND RAISING PROGRAMS FOR THE BENEFIT OF SCHOOLS AND NON-PROFIT ORGANIZATIONS, IN CLASS 36 (U.S. CLS. 100, 101 AND 102).

SERVICE MARK

FIRST USE 2-28-2009; IN COMMERCE 3-31-2009.

PRINCIPAL REGISTER

THE MARK CONSISTS OF THE WORD "MOTHERGREEN" WITH THE LETTER "O" REPRESENTED BY A STYLIZED GLOBE WITH A FANCIFUL MERMAID DESIGN BEHIND THE GLOBE.

SN 77-503,153, FILED 6-19-2008.

JAMES LOVELACE, EXAMINING ATTORNEY



David J. Kybas

Director of the United States Patent and Trademark Office

United States of America

United States Patent and Trademark Office

ADAPTIVESTIM

Reg. No. 4,109,088

MEDTRONIC, INC. (MINNESOTA CORPORATION)
710 MEDTRONIC PARKWAY
MINNEAPOLIS, MN 554325604

Registered Mar. 6, 2012

Int. Cl.: 10

FOR: IMPLANTABLE NEUROLOGICAL STIMULATOR ALGORITHM FEATURE SOLD AS AN INTEGRAL COMPONENT OF AN IMPLANTABLE NEUROLOGICAL STIMULATOR, IN CLASS 10 (U.S. CLS. 26, 39 AND 44).

TRADEMARK

FIRST USE 11-22-2011; IN COMMERCE 11-22-2011.

PRINCIPAL REGISTER

THE MARK CONSISTS OF STANDARD CHARACTERS WITHOUT CLAIM TO ANY PARTICULAR FONT, STYLE, SIZE, OR COLOR.

SN 77-503,171, FILED 6-19-2008.

B. PARADEWELAI, EXAMINING ATTORNEY



David J. Kyffers

Director of the United States Patent and Trademark Office

United States of America

United States Patent and Trademark Office

KARUM

Reg. No. 4,109,089

KARUM GROUP LLC (DELAWARE LIMITED LIABILITY COMPANY)
101 SECOND STREET, SUITE 350
SAN FRANCISCO, CA 94105

Registered Mar. 6, 2012

Int. Cl.: 36

FOR: CREDIT CARD SERVICES; CREDIT CARD TRANSACTION PROCESSING SERVICES,
IN CLASS 36 (U.S. CLS. 100, 101 AND 102).

SERVICE MARK

FIRST USE 7-12-2008; IN COMMERCE 7-12-2008.

PRINCIPAL REGISTER

THE MARK CONSISTS OF STANDARD CHARACTERS WITHOUT CLAIM TO ANY PAR-
TICULAR FONT, STYLE, SIZE, OR COLOR.

SN 77-503,305, FILED 6-19-2008.

JULIE WATSON, EXAMINING ATTORNEY



David J. Kybas

Director of the United States Patent and Trademark Office

United States of America

United States Patent and Trademark Office



Reg. No. 4,109,090

Registered Mar. 6, 2012

Int. Cl.: 36

SERVICE MARK

PRINCIPAL REGISTER

KARUM GROUP LLC (DELAWARE LIMITED LIABILITY COMPANY)
101 SECOND STREET, SUITE 350
SAN FRANCISCO, CA 94105

FOR: CREDIT CARD SERVICES; CREDIT CARD TRANSACTION PROCESSING SERVICES,
IN CLASS 36 (U.S. CLS. 100, 101 AND 102).

FIRST USE 7-12-2008; IN COMMERCE 7-12-2008.

THE MARK CONSISTS OF A MISCELLANEOUS DESIGN MADE UP OF THREE GROUPS OF CIRCLES AND SIX BICONCAVE LINES, NAMELY, ONE GROUP OF THREE LARGE CIRCLES AND TWO LONG BICONCAVE LINES, ONE GROUP OF THREE MEDIUM CIRCLES AND TWO MEDIUM BICONCAVE LINES, AND ONE GROUP OF SMALL CIRCLES AND TWO SHORT BICONCAVE LINES ARRANGED AS FOLLOWS: THE GROUP OF LARGE CIRCLES APPEARS ON THE LEFT-HAND SIDE OF THE MARK AND IN THAT GROUP ONE CIRCLE IS SHOWN IN THE NORTH POSITION, ONE CIRCLE IS SHOWN IN THE WEST POSITION, AND ONE CIRCLE IS SHOWN IN THE SOUTH POSITION, THE CIRCLE IN THE NORTH POSITION IS CONNECTED TO THE CIRCLE IN THE WEST POSITION BY A LONG BICONCAVE LINE, AND THE CIRCLE IN THE WEST POSITION IS CONNECTED TO THE CIRCLE IN THE SOUTH POSITION BY A LONG BICONCAVE LINE; THE GROUP OF MEDIUM CIRCLES APPEARS ON THE RIGHT-HAND SIDE OF THE MARK AND IN THAT GROUP ONE CIRCLE IS SHOWN IN THE NORTH POSITION, ONE CIRCLE IS SHOWN IN THE EAST POSITION, AND ONE CIRCLE IS SHOWN IN THE SOUTH POSITION, THE CIRCLE IN THE NORTH POSITION IS CONNECTED TO THE CIRCLE IN THE EAST POSITION BY A MEDIUM BICONCAVE LINE, AND THE CIRCLE IN THE EAST POSITION IS CONNECTED TO THE CIRCLE IN THE SOUTH POSITION BY A MEDIUM BICONCAVE LINE; AND THE GROUP OF SMALL CIRCLES APPEARS IN THE MIDDLE OF THE MARK IN THE SAME ARRANGEMENT AS THE GROUP OF LARGE CIRCLES BUT WITH SMALL CIRCLES AND SHORT BICONCAVE LINES.



SN 77-503,351, FILED 6-19-2008.

JULIE WATSON, EXAMINING ATTORNEY

David J. Kyffers

Director of the United States Patent and Trademark Office

United States of America

United States Patent and Trademark Office

NEOBRYXOL

Reg. No. 4,109,091

Registered Mar. 6, 2012

Int. Cl.: 5

TRADEMARK

PRINCIPAL REGISTER

BRYOMED, INC. (NEVADA CORPORATION)
2533 N. CARSON STREET, SUITE 4081
CARSON CITY, NV 89706

FOR: HOMEOPATHIC PREPARATIONS, NAMELY, HOMEOPATHIC REMEDIES IN THE NATURE OF ALL NATURAL DIETARY SUPPLEMENTS, AND NUTRITIONAL SUPPLEMENTS; HOMEOPATHIC MEDICATIONS FOR PHYSICAL AND SEXUAL PERFORMANCE, RESPIRATORY PROBLEMS AND ALLERGIES, NERVOUS SYSTEM AND MOOD SUPPORT, IMMUNE SYSTEM SUPPORT, NAMELY, AS AN IMMUNOSTIMULATOR AND AN IMMUNOMODULATOR, SKIN PROBLEMS AND TO BE USED FOR TREATING CANCER SYMPTOMS; AND HOMEOPATHIC SUPPLEMENTS, IN CLASS 5 (U.S. CLS. 6, 18, 44, 46, 51 AND 52).

FIRST USE 11-29-2011; IN COMMERCE 11-29-2011.

THE MARK CONSISTS OF STANDARD CHARACTERS WITHOUT CLAIM TO ANY PARTICULAR FONT, STYLE, SIZE, OR COLOR.

SN 77-503,538, FILED 6-19-2008.

ANDREA BUTLER, EXAMINING ATTORNEY



David J. Kyros

Director of the United States Patent and Trademark Office

United States of America

United States Patent and Trademark Office

DECOMASH

Reg. No. 4,109,092

OLIVE ROOT, LLC (KANSAS LIMITED LIABILITY COMPANY)
26950 OLD KANSAS CITY ROAD
PAOLA, KS 66071

Registered Mar. 6, 2012

Int. Cl.: 42

FOR: COMPUTER SERVICES, NAMELY, SEARCH ENGINE SERVICES; PROVIDING ON-LINE, NON-DOWNLOADABLE COMPUTER SOFTWARE FOR USE IN FINDING AND RE-VIEWING IMAGES, IN CLASS 42 (U.S. CLS. 100 AND 101).

SERVICE MARK

FIRST USE 5-13-2010; IN COMMERCE 5-13-2010.

PRINCIPAL REGISTER

THE MARK CONSISTS OF STANDARD CHARACTERS WITHOUT CLAIM TO ANY PARTICULAR FONT, STYLE, SIZE, OR COLOR.

SN 77-504,765, FILED 6-21-2008.

JORDAN BAKER, EXAMINING ATTORNEY



David J. Kyffers

Director of the United States Patent and Trademark Office

United States of America

United States Patent and Trademark Office

RENATUS

Reg. No. 4,109,093

Registered Mar. 6, 2012

Int. Cls.: 11 and 40

TRADEMARK

SERVICE MARK

PRINCIPAL REGISTER

MARK R. MUTH (UNITED STATES INDIVIDUAL)
PO BOX 220
WELLINGTON, CO 80549

FOR: APPARATUS FOR HYDROLYZING BIOLOGICAL MATERIALS FOR INDUSTRIAL USE, IN CLASS 11 (U.S. CLS. 13, 21, 23, 31 AND 34).

FIRST USE 1-24-2011; IN COMMERCE 1-24-2011.

FOR: BIOLOGICAL MATERIAL HYDROLYZING SERVICES, IN CLASS 40 (U.S. CLS. 100, 103 AND 106).

FIRST USE 1-24-2012; IN COMMERCE 1-24-2012.

THE MARK CONSISTS OF STANDARD CHARACTERS WITHOUT CLAIM TO ANY PARTICULAR FONT, STYLE, SIZE, OR COLOR.

THE ENGLISH TRANSLATION OF THE WORD "RENATUS" IN THE MARK IS "REBIRTH".

SN 77-506,401, FILED 6-24-2008.

JANICE KIM, EXAMINING ATTORNEY



David J. Kybas

Director of the United States Patent and Trademark Office

United States of America

United States Patent and Trademark Office

QUALCRIMP

Reg. No. 4,109,094

Registered Mar. 6, 2012

Int. Cl.: 10

TRADEMARK

PRINCIPAL REGISTER

EDWARDS LIFESCIENCES CORPORATION (DELAWARE CORPORATION)
C/O TRADEMARK ADMINISTRATOR, LEGAL DEPT.
ONE EDWARDS WAY
IRVINE, CA 92614

FOR: PROTECTIVE SLEEVE FOR HEART VALVES, IN CLASS 10 (U.S. CLS. 26, 39 AND 44).

FIRST USE 1-16-2009; IN COMMERCE 1-16-2009.

THE MARK CONSISTS OF STANDARD CHARACTERS WITHOUT CLAIM TO ANY PARTICULAR FONT, STYLE, SIZE, OR COLOR.

SN 77-507,104, FILED 6-24-2008.

KAELIE KUNG, EXAMINING ATTORNEY



David J. Kyffers

Director of the United States Patent and Trademark Office

United States of America

United States Patent and Trademark Office

THIS IS HER STORY

Reg. No. 4,109,095

Registered Mar. 6, 2012

Int. Cl.: 9

TRADEMARK

PRINCIPAL REGISTER

BRAVE NEW GIRLS LIMITED, LLC (TENNESSEE LIMITED LIABILITY COMPANY)
1711 EIGHTEENTH AVENUE SOUTH, SUITE B2
NASHVILLE, TN 37212

FOR: PRERECORDED AUDIO AND AUDIO/VISUAL MEDIA, NAMELY, PRERECORDED COMPACT DISCS, AUDIO CASSETTES, VIDEOCASSETTES, DVDS AND PHONOGRAPH RECORDS FEATURING MUSIC; PRERECORDED AUDIO AND AUDIO/VISUAL MEDIA IN DIGITAL FORMATS, NAMELY, MUSICAL DATA IN DIGITAL FORM DOWNLOADED FROM A GLOBAL COMPUTER NETWORK AND RECORDED ON MAGNETIC MEDIA; MOTION PICTURE FILMS FEATURING MUSIC; MULTIMEDIA SOFTWARE RECORDED ON CD-ROM FEATURING MUSIC; COMPUTER SOFTWARE FOR USE AS A SCREEN SAVER; DOWNLOADABLE ELECTRONIC PUBLICATIONS IN THE NATURE OF BOOKS AND MAGAZINES IN THE FIELD OF ENTERTAINMENT AND MUSIC, IN CLASS 9 (U.S. CLS. 21, 23, 26, 36 AND 38).

FIRST USE 8-31-2008; IN COMMERCE 8-31-2008.

THE MARK CONSISTS OF STANDARD CHARACTERS WITHOUT CLAIM TO ANY PARTICULAR FONT, STYLE, SIZE, OR COLOR.

SN 77-508,020, FILED 6-25-2008.

WILLIAM BRECKENFELD, EXAMINING ATTORNEY



David J. Kypos

Director of the United States Patent and Trademark Office

United States of America

United States Patent and Trademark Office

PIPELINEDASHBOARD

Reg. No. 4,109,096

Registered Mar. 6, 2012

Int. Cl.: 9

TRADEMARK

PRINCIPAL REGISTER

ENERGY SOLUTIONS INTERNATIONAL, INC. (TEXAS CORPORATION)
7904 N. SAM HOUSTON PARKWAY W.
SUITE 235
HOUSTON, TX 77064

FOR: COMPUTER PROGRAMS FOR USE IN PIPELINE OPERATION AND CONTROL IN THE ENERGY INDUSTRY, IN CLASS 9 (U.S. CLS. 21, 23, 26, 36 AND 38).

FIRST USE 5-31-2011; IN COMMERCE 5-31-2011.

THE MARK CONSISTS OF STANDARD CHARACTERS WITHOUT CLAIM TO ANY PARTICULAR FONT, STYLE, SIZE, OR COLOR.

SN 77-509,783, FILED 6-27-2008.

RONALD AIKENS, EXAMINING ATTORNEY



David J. Kyros

Director of the United States Patent and Trademark Office

United States of America

United States Patent and Trademark Office

BOBBI'S PARTY

Reg. No. 4,109,097

Registered Mar. 6, 2012

Int. Cl.: 3

TRADEMARK

PRINCIPAL REGISTER

BOBBI BROWN PROFESSIONAL COSMETICS INC. (DELAWARE CORPORATION)
TRADEMARK DEPARTMENT
767 FIFTH AVENUE
NEW YORK, NY 10153

FOR: FRAGRANCES FOR PERSONAL USE, IN CLASS 3 (U.S. CLS. 1, 4, 6, 50, 51 AND 52).

FIRST USE 10-3-2011; IN COMMERCE 10-3-2011.

THE MARK CONSISTS OF STANDARD CHARACTERS WITHOUT CLAIM TO ANY PARTICULAR FONT, STYLE, SIZE, OR COLOR.

OWNER OF U.S. REG. NOS. 1,700,112, 2,458,679, AND OTHERS.

THE NAME "BOBBI" IDENTIFIES A LIVING INDIVIDUAL WHOSE CONSENT IS OF RECORD.

SN 77-511,028, FILED 6-30-2008.

ROBERT STRUCK, EXAMINING ATTORNEY



David J. Kyros

Director of the United States Patent and Trademark Office

United States of America

United States Patent and Trademark Office

TWILIGHT

Reg. No. 4,109,098

Registered Mar. 6, 2012

Int. Cls.: 20 and 24

TRADEMARK

PRINCIPAL REGISTER

SUMMIT ENTERTAINMENT, LLC (DELAWARE LIMITED LIABILITY COMPANY)
1630 STEWART STREET, SUITE 120
SANTA MONICA, CA 90404

FOR: KEY CHAINS MADE OF PLASTIC, DECORATIVE WALL PLAQUES OF WOOD,
DECORATIVE WALL PLAQUES OF PLASTIC, PICTURE FRAMES, PLASTIC NOVELTY
LICENSE PLATES, AND WOOD BOXES, IN CLASS 20 (U.S. CLS. 2, 13, 22, 25, 32 AND 50).

FIRST USE 9-0-2008; IN COMMERCE 9-0-2008.

FOR: BED LINENS, IN CLASS 24 (U.S. CLS. 42 AND 50).

FIRST USE 9-0-2008; IN COMMERCE 9-0-2008.

THE MARK CONSISTS OF STANDARD CHARACTERS WITHOUT CLAIM TO ANY PAR-
TICULAR FONT, STYLE, SIZE, OR COLOR.

SN 77-511,072, FILED 6-30-2008.

SKYE YOUNG, EXAMINING ATTORNEY



David J. Kybas

Director of the United States Patent and Trademark Office

United States of America

United States Patent and Trademark Office

FRIENDLY FEET

Reg. No. 4,109,099

SPARANO, JOSEPH D. (UNITED STATES INDIVIDUAL)
1201 BLACK HORSE PIKE
GLENDDORA, NJ 08029

Registered Mar. 6, 2012

Int. Cl.: 25

FOR: PAPER SHOES USED WHEN GOING THROUGH METAL DETECTORS TO KEEP FEET AND SOCKS CLEAN, IN CLASS 25 (U.S. CLS. 22 AND 39).

TRADEMARK

FIRST USE 1-21-2012; IN COMMERCE 1-21-2012.

PRINCIPAL REGISTER

THE MARK CONSISTS OF STANDARD CHARACTERS WITHOUT CLAIM TO ANY PARTICULAR FONT, STYLE, SIZE, OR COLOR.

SN 77-512,552, FILED 7-1-2008.

MICHAEL SOUDERS, EXAMINING ATTORNEY



David J. Kybas

Director of the United States Patent and Trademark Office

United States of America

United States Patent and Trademark Office

Bio-Control

Reg. No. 4,109,100

MANA PRODUCTS, INC. (NEW YORK CORPORATION)
32-02 QUEENS BOULEVARD
LONG ISLAND CITY, NY 11101

Registered Mar. 6, 2012

Int. Cl.: 5

FOR: MEDICATED SKINCARE PREPARATIONS, IN CLASS 5 (U.S. CLS. 6, 18, 44, 46, 51 AND 52).

TRADEMARK

FIRST USE 11-30-2011; IN COMMERCE 11-30-2011.

PRINCIPAL REGISTER

THE MARK CONSISTS OF STANDARD CHARACTERS WITHOUT CLAIM TO ANY PARTICULAR FONT, STYLE, SIZE, OR COLOR.

SN 77-514,124, FILED 7-2-2008.

JIM RINGLE, EXAMINING ATTORNEY



David J. Kyffers

Director of the United States Patent and Trademark Office

United States of America

United States Patent and Trademark Office

PIPELINE CRISIS WINNING STRATEGIES

Reg. No. 4,109,101

SNIPES, WILLIAM J. (UNITED STATES INDIVIDUAL)
125 BROAD STREET
NEW YORK, NY 10004 AND

Registered Mar. 6, 2012

Int. Cls.: 16, 35, 41, and 45

SCHROEDER, WILLIAM E. (UNITED STATES INDIVIDUAL)
125 BROAD STREET
NEW YORK, NY 10004

TRADEMARK

SERVICE MARK

PRINCIPAL REGISTER

FOR: PUBLICATIONS, NAMELY, PAMPHLETS, BROCHURES, AND NEWSLETTERS, IN THE FIELDS OF EDUCATION, EMPLOYMENT, ECONOMIC DEVELOPMENT, CRIMINAL JUSTICE, PRISON REFORM, THE ACHIEVEMENT GAP, AND EDUCATIONAL AND PROFESSIONAL OPPORTUNITIES, AS THESE FIELDS RELATE TO YOUNG BLACK MEN, IN CLASS 16 (U.S. CLS. 2, 5, 22, 23, 29, 37, 38 AND 50).

FIRST USE 7-11-2008; IN COMMERCE 7-11-2008.

FOR: PROMOTING PUBLIC AWARENESS OF THE NEED FOR REFORMS IN THE FIELDS OF EARLY-CHILDHOOD EDUCATION, PUBLIC-SCHOOL EDUCATION, EMPLOYMENT POLICIES, EMPLOYMENT PROGRAMS, EMPLOYMENT TRAINING, WORKFORCE DEVELOPMENT, CRIMINAL JUSTICE, PRISON REFORM, AND REENTRY OF INMATES INTO SOCIETY; PROVIDING A WEBSITE FEATURING INFORMATION ON PROMOTING PUBLIC AWARENESS OF THE NEED FOR REFORMS IN EMPLOYMENT POLICIES, EMPLOYMENT PROGRAMS, EMPLOYMENT TRAINING, WORKFORCE DEVELOPMENT, AND STRATEGIES FOR INCREASING PROFESSIONAL OPPORTUNITIES FOR YOUNG BLACK MEN, IN CLASS 35 (U.S. CLS. 100, 101 AND 102).

FIRST USE 3-1-2007; IN COMMERCE 3-1-2007.

FOR: PROVIDING A WEBSITE FEATURING EDUCATION INFORMATION IN THE FIELDS OF EARLY-CHILDHOOD EDUCATION, PUBLIC-SCHOOL EDUCATION, AND STRATEGIES FOR CLOSING THE ACHIEVEMENT GAP AND INCREASING EDUCATIONAL OPPORTUNITIES FOR YOUNG BLACK MEN; EDUCATIONAL SERVICES, NAMELY, CONDUCTING CONFERENCES AND WORKSHOPS ON EARLY-CHILDHOOD EDUCATION, PUBLIC-SCHOOL EDUCATION, EMPLOYMENT POLICIES, CRIMINAL JUSTICE, PRISON REFORM, REENTRY OF INMATES INTO SOCIETY, THE ACHIEVEMENT GAP, AND STRATEGIES FOR INCREASING EDUCATIONAL AND PROFESSIONAL OPPORTUNITIES FOR YOUNG BLACK MEN, IN CLASS 41 (U.S. CLS. 100, 101 AND 107).



David J. Kyjars

Director of the United States Patent and Trademark Office

Reg. No. 4,109,101 FIRST USE 3-1-2007; IN COMMERCE 3-1-2007.

FOR: PROVIDING A WEBSITE FEATURING INFORMATION ON SOCIAL SERVICES AND LEGAL AFFAIRS, NAMELY, THE TREATMENT OF YOUNG BLACK MEN IN THE CRIMINAL JUSTICE SYSTEM AND INFORMATION IN THE FIELDS OF PRISON REFORM AND FACILITATING THE REENTRY OF INMATES INTO SOCIETY, AS THESE FIELDS RELATE TO YOUNG BLACK MEN, IN CLASS 45 (U.S. CLS. 100 AND 101).

FIRST USE 7-28-2008; IN COMMERCE 7-28-2008.

THE MARK CONSISTS OF STANDARD CHARACTERS WITHOUT CLAIM TO ANY PARTICULAR FONT, STYLE, SIZE, OR COLOR.

SN 77-514,506, FILED 7-3-2008.

MICHAEL GAAFAR, EXAMINING ATTORNEY

United States of America

United States Patent and Trademark Office

WINNING STRATEGIES FOR YOUNG BLACK MEN

Reg. No. 4,109,102

SNIPES, WILLIAM J. (UNITED STATES INDIVIDUAL)
125 BROAD STREET
NEW YORK, NY 10004 AND

Registered Mar. 6, 2012

**Int. Cls.: 16, 35, 41, and
45**

SCHROEDER, WILLIAM E. (UNITED STATES INDIVIDUAL)
125 BROAD STREET
NEW YORK, NY 10004

TRADEMARK

SERVICE MARK

PRINCIPAL REGISTER

FOR: PUBLICATIONS, NAMELY, PAMPHLETS, BROCHURES, AND NEWSLETTERS, IN THE FIELDS OF EDUCATION, EMPLOYMENT, ECONOMIC DEVELOPMENT, CRIMINAL JUSTICE, PRISON REFORM, THE ACHIEVEMENT GAP, AND EDUCATIONAL AND PROFESSIONAL OPPORTUNITIES, AS THESE FIELDS RELATE TO YOUNG BLACK MEN, IN CLASS 16 (U.S. CLS. 2, 5, 22, 23, 29, 37, 38 AND 50).

FIRST USE 7-13-2007; IN COMMERCE 7-13-2007.

FOR: PROMOTING PUBLIC AWARENESS OF THE NEED FOR REFORMS IN THE FIELDS OF EARLY-CHILDHOOD EDUCATION, PUBLIC-SCHOOL EDUCATION, EMPLOYMENT POLICIES, EMPLOYMENT PROGRAMS, EMPLOYMENT TRAINING, WORKFORCE DEVELOPMENT, CRIMINAL JUSTICE, PRISON REFORM, AND REENTRY OF INMATES INTO SOCIETY; PROVIDING A WEBSITE FEATURING INFORMATION ON PROMOTING PUBLIC AWARENESS OF THE NEED FOR REFORMS IN EMPLOYMENT POLICIES, EMPLOYMENT PROGRAMS, EMPLOYMENT TRAINING, WORKFORCE DEVELOPMENT, AND STRATEGIES FOR INCREASING PROFESSIONAL OPPORTUNITIES FOR YOUNG BLACK MEN, IN CLASS 35 (U.S. CLS. 100, 101 AND 102).

FIRST USE 7-14-2006; IN COMMERCE 7-14-2006.

FOR: PROVIDING A WEBSITE FEATURING EDUCATION INFORMATION IN THE FIELDS OF EARLY-CHILDHOOD EDUCATION, PUBLIC-SCHOOL EDUCATION, AND STRATEGIES FOR CLOSING THE ACHIEVEMENT GAP AND INCREASING EDUCATIONAL OPPORTUNITIES FOR YOUNG BLACK MEN; EDUCATIONAL SERVICES, NAMELY, CONDUCTING CONFERENCES AND WORKSHOPS ON EARLY-CHILDHOOD EDUCATION, PUBLIC-SCHOOL EDUCATION, EMPLOYMENT POLICIES, CRIMINAL JUSTICE, PRISON REFORM, REENTRY OF INMATES INTO SOCIETY, THE ACHIEVEMENT GAP, AND STRATEGIES FOR INCREASING EDUCATIONAL AND PROFESSIONAL OPPORTUNITIES FOR YOUNG BLACK MEN, IN CLASS 41 (U.S. CLS. 100, 101 AND 107).



David J. Kybas

Director of the United States Patent and Trademark Office

Reg. No. 4,109,102 FIRST USE 7-14-2006; IN COMMERCE 7-14-2006.

FOR: PROVIDING A WEBSITE FEATURING INFORMATION ON SOCIAL SERVICES AND LEGAL AFFAIRS, NAMELY, THE TREATMENT OF YOUNG BLACK MEN IN THE CRIMINAL JUSTICE SYSTEM AND INFORMATION IN THE FIELDS OF PRISON REFORM AND FACILITATING THE REENTRY OF INMATES INTO SOCIETY, AS THESE FIELDS RELATE TO YOUNG BLACK MEN, IN CLASS 45 (U.S. CLS. 100 AND 101).

FIRST USE 7-28-2008; IN COMMERCE 7-28-2008.

THE MARK CONSISTS OF STANDARD CHARACTERS WITHOUT CLAIM TO ANY PARTICULAR FONT, STYLE, SIZE, OR COLOR.

SN 77-514,521, FILED 7-3-2008.

MICHAEL GAAFAR, EXAMINING ATTORNEY

United States of America

United States Patent and Trademark Office

TROJAN PLEASURES

Reg. No. 4,109,103

Registered Mar. 6, 2012

Int. Cl.: 5

TRADEMARK

PRINCIPAL REGISTER

CHURCH & DWIGHT CO., INC. (DELAWARE CORPORATION)
469 NORTH HARRISON STREET
LAW DEPARTMENT
PRINCETON, NJ 08543

FOR: PERSONAL LUBRICANTS, IN CLASS 5 (U.S. CLS. 6, 18, 44, 46, 51 AND 52).

FIRST USE 7-19-2010; IN COMMERCE 7-19-2010.

THE MARK CONSISTS OF STANDARD CHARACTERS WITHOUT CLAIM TO ANY PARTICULAR FONT, STYLE, SIZE, OR COLOR.

OWNER OF U.S. REG. NOS. 544,931, 1,653,581, AND 1,674,927.

SN 77-515,961, FILED 7-7-2008.

FRED CARL, EXAMINING ATTORNEY



David J. Kybas

Director of the United States Patent and Trademark Office

United States of America

United States Patent and Trademark Office

body after baby

Reg. No. 4,109,104

FRANCISCO, DON (UNITED STATES INDIVIDUAL)
25936 AVENIDA CABRILLO
SAN JUAN CAPISTRANO, CA 92675

Registered Mar. 6, 2012

Int. Cl.: 35

FOR: ON-LINE RETAIL STORE SERVICES FEATURING POSTPARTUM RECOVERY ITEMS, NAMELY, POSTPARTUM GARMENTS AND CLOTHING, SCAR MANAGEMENT ITEMS IN THE NATURE OF LOTIONS AND OINTMENTS AND BEAUTY AIDS, IN CLASS 35 (U.S. CLS. 100, 101 AND 102).

SERVICE MARK

PRINCIPAL REGISTER

FIRST USE 11-14-2010; IN COMMERCE 10-10-2011.

THE MARK CONSISTS OF THE WORDING "BODY AFTER BABY" WITH THE DESIGN OF A MOTHER'S STOMACH TO THE LEFT OF THIS WORDING.

SN 77-524,112, FILED 7-16-2008.

DAVID COLLIER, EXAMINING ATTORNEY



David J. Kypos

Director of the United States Patent and Trademark Office

United States of America

United States Patent and Trademark Office

HD Visual Reality

Reg. No. 4,109,105

Registered Mar. 6, 2012

Int. Cl.: 9

TRADEMARK

PRINCIPAL REGISTER

VIVANTE CORPORATION (CALIFORNIA CORPORATION)
268 SANTA ANA COURT
SUNNYVALE, CA 94085

FOR: COMPUTER HARDWARE AND COMPUTER SOFTWARE USED IN HANDHELD DEVICES FOR STORING, MANAGING AND OPERATING MULTIMEDIA APPLICATIONS THAT MANAGE DISPLAYS OF DIGITAL MEDIA, THAT PRODUCE MULTIMEDIA CONTENT, THAT MANAGE POWER CONSUMPTION OF DEVICES USING SUCH MULTIMEDIA APPLICATIONS, AND THAT ENHANCE THE AUDIO CLARITY AND VIDEO AND GRAPHIC DISPLAYS IN HANDHELD COMPUTING DEVICES AND WIRELESS COMMUNICATIONS DEVICES; INTEGRATED CIRCUITS (ICS) AND OPERATING SYSTEM SOFTWARE AND ELECTRONIC INTEGRATED CIRCUIT COMPONENT PARTS USED IN AND IN CONJUNCTION WITH SUCH ICS, ALL FOR USE IN HAND HELD DEVICES, NAMELY, CELLULAR HANDSETS, MOBILE TELEPHONES, TABLET COMPUTERS, PERSONAL DIGITAL ASSISTANTS, LCD DISPLAYS, DIGITAL VIDEO RECORDERS AND PLAYERS, ELECTRONIC ORGANIZERS, ELECTRONIC NOTEPADS, AND INSTRUCTIONAL MANUALS AND INSTRUCTIONAL MATERIALS SOLD AS A UNIT THEREWITH, IN CLASS 9 (U.S. CLS. 21, 23, 26, 36 AND 38).

FIRST USE 4-5-2007; IN COMMERCE 4-5-2007.

THE MARK CONSISTS OF STANDARD CHARACTERS WITHOUT CLAIM TO ANY PARTICULAR FONT, STYLE, SIZE, OR COLOR.

NO CLAIM IS MADE TO THE EXCLUSIVE RIGHT TO USE "HD", APART FROM THE MARK AS SHOWN.

SN 77-535,127, FILED 7-30-2008.

RENEE SERVANCE, EXAMINING ATTORNEY



David J. Kyros

Director of the United States Patent and Trademark Office

United States of America

United States Patent and Trademark Office

SAMMY'S BEACH BAR RUM

Reg. No. 4,109,106

RED HEAD, INC. (CALIFORNIA CORPORATION)
P.O. BOX 5395
NOVATO, CA 94948

Registered Mar. 6, 2012

Int. Cl.: 33

FOR: ALCOHOLIC COCKTAIL MIXES; RUM, IN CLASS 33 (U.S. CLS. 47 AND 49).

TRADEMARK

FIRST USE 11-10-2011; IN COMMERCE 11-10-2011.

PRINCIPAL REGISTER

THE MARK CONSISTS OF STANDARD CHARACTERS WITHOUT CLAIM TO ANY PARTICULAR FONT, STYLE, SIZE, OR COLOR.

NO CLAIM IS MADE TO THE EXCLUSIVE RIGHT TO USE "BEACH BAR RUM", APART FROM THE MARK AS SHOWN.

SN 77-536,411, FILED 7-31-2008.

ELLEN PERKINS, EXAMINING ATTORNEY



David J. Kyffers

Director of the United States Patent and Trademark Office

United States of America

United States Patent and Trademark Office

JEANNIE IN A BOTTLE

Reg. No. 4,109,107

COLUMBIA PICTURES INDUSTRIES, INC. (DELAWARE CORPORATION)
10202 W. WASHINGTON BLVD.
CULVER CITY, CA 90232

Registered Mar. 6, 2012

Int. Cl.: 9

FOR: SLOT MACHINES, ELECTRONIC GAMING MACHINES; COMPUTER GAME CARTRIDGES, IN CLASS 9 (U.S. CLS. 21, 23, 26, 36 AND 38).

TRADEMARK

FIRST USE 6-30-2009; IN COMMERCE 6-30-2009.

PRINCIPAL REGISTER

THE MARK CONSISTS OF STANDARD CHARACTERS WITHOUT CLAIM TO ANY PARTICULAR FONT, STYLE, SIZE, OR COLOR.

SN 77-546,786, FILED 8-14-2008.

MARTHA SANTOMARTINO, EXAMINING ATTORNEY



David J. Kybas

Director of the United States Patent and Trademark Office

United States of America

United States Patent and Trademark Office



Reg. No. 4,109,108

Registered Mar. 6, 2012

Int. Cl.: 25

TRADEMARK

PRINCIPAL REGISTER

WENGER S.A. (SWITZERLAND CORPORATION)
ROUTE DE BALE 63
DELEMONT, SWITZERLAND CH-2800

FOR: FOOTWEAR, IN CLASS 25 (U.S. CLS. 22 AND 39).

FIRST USE 9-0-2008; IN COMMERCE 9-0-2008.

THE MARK CONSISTS OF A CHROME COLORED CROSS ON A RED SQUARE WITH ROUNDED EDGES, OUTLINED BY A CHROME COLORED SQUARE WITH ROUNDED EDGES.

THE COLOR(S) RED AND CHROME IS/ARE CLAIMED AS A FEATURE OF THE MARK.

SN 77-547,618, FILED 8-14-2008.

ELLEN B. AWRICH, EXAMINING ATTORNEY



David J. Kybas

Director of the United States Patent and Trademark Office

United States of America

United States Patent and Trademark Office

DREAM TOWNHOUSE

Reg. No. 4,109,109

Registered Mar. 6, 2012

Int. Cl.: 28

TRADEMARK

PRINCIPAL REGISTER

MATTEL, INC. (DELAWARE CORPORATION)
M1-1518
333 CONTINENTAL BLVD.
EL SEGUNDO, CA 90245

FOR: TOYS, GAMES AND PLAYTHINGS, NAMELY, DOLL PLAYSETS AND ACCESSORIES THEREFOR, IN CLASS 28 (U.S. CLS. 22, 23, 38 AND 50).

FIRST USE 12-7-2011; IN COMMERCE 12-7-2011.

THE MARK CONSISTS OF STANDARD CHARACTERS WITHOUT CLAIM TO ANY PARTICULAR FONT, STYLE, SIZE, OR COLOR.

OWNER OF U.S. REG. NOS. 1,671,877 AND 3,094,954.

NO CLAIM IS MADE TO THE EXCLUSIVE RIGHT TO USE "TOWNHOUSE", APART FROM THE MARK AS SHOWN.

SN 77-549,696, FILED 8-18-2008.

DAVID H. STINE, EXAMINING ATTORNEY



David J. Kyffers

Director of the United States Patent and Trademark Office

United States of America

United States Patent and Trademark Office

SO GOOD FOR SO LITTLE

Reg. No. 4,109,110

Registered Mar. 6, 2012

Int. Cls.: 29 and 30

TRADEMARK

PRINCIPAL REGISTER

CONAGRA FOODS RDM, INC. (DELAWARE CORPORATION)
ONE CONAGRA DRIVE
OMAHA, NE 68102

FOR: SAUSAGES; FROZEN PREPARED MEALS AND ENTREES CONSISTING PRIMARILY OF BEEF, PORK, POULTRY, SEAFOOD, OR VEGETABLES; FROZEN APPETIZERS CONSISTING PRIMARILY OF BEEF, PORK, POULTRY, SEAFOOD, VEGETABLES, OR CHEESE; FROZEN PREPARED MEAL KITS CONSISTING PRIMARILY OF BEEF, PORK, POULTRY, SEAFOOD OR VEGETABLES; FROZEN PREPARED CHICKEN, NAMELY, CHICKEN PAT-TIES, CHICKEN NUGGETS, CHICKEN STRIPS, FRIED CHICKEN, SKINLESS CHICKEN PIECES, CHICKEN WINGS, CHICKEN DRUMSTICKS, POPCORN CHICKEN, AND ROTIS-SERIE CHICKEN; BEEF STEW; PACKAGED MEAL AND SIDE DISH KITS CONSISTING PRIMARILY OF BEEF, PORK, POULTRY, SEAFOOD, VEGETABLES, CHILI, OR BEEF STEW, IN CLASS 29 (U.S. CL. 46).

FIRST USE 2-1-2011; IN COMMERCE 2-1-2011.

FOR: POT PIES; FROZEN PREPARED MEALS AND ENTREES CONSISTING PRIMARILY OF ENCHILADAS, TAMALES, TACOS, PASTA, RICE OR PIZZA; FROZEN PREPARED MEAL KITS CONSISTING PRIMARILY OF PASTA OR RICE; PACKAGED MEAL AND SIDE DISH KITS CONSISTING PRIMARILY OF PASTA OR RICE, IN CLASS 30 (U.S. CL. 46).

FIRST USE 2-1-2011; IN COMMERCE 2-1-2011.

THE MARK CONSISTS OF STANDARD CHARACTERS WITHOUT CLAIM TO ANY PAR-TICULAR FONT, STYLE, SIZE, OR COLOR.

SN 77-558,992, FILED 8-29-2008.

NORA BUCHANAN WILL, EXAMINING ATTORNEY



David J. Kyros

Director of the United States Patent and Trademark Office

United States of America

United States Patent and Trademark Office

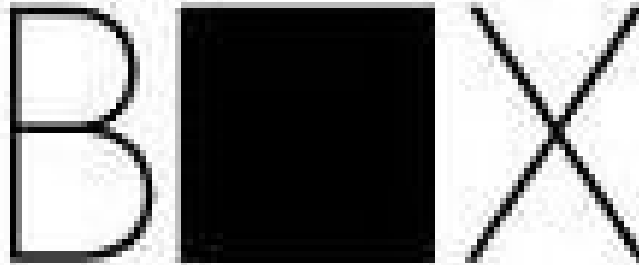

Reg. No. 4,109,111

Registered Mar. 6, 2012

Int. Cl.: 33

TRADEMARK

PRINCIPAL REGISTER

URBAN WINE VENTURES, LLC (ILLINOIS LIMITED LIABILITY COMPANY)
118 N. PEORIA, 3RD FLOOR
CHICAGO, IL 60607

FOR: WINE, IN CLASS 33 (U.S. CLS. 47 AND 49).

FIRST USE 12-13-2011; IN COMMERCE 12-13-2011.

NO CLAIM IS MADE TO THE EXCLUSIVE RIGHT TO USE "BOX" , APART FROM THE MARK AS SHOWN.

THE MARK CONSISTS OF THE LETTER "B", A SHADED SQUARE AND THE LETTER "X".

SN 77-559,573, FILED 8-30-2008.

WILLIAM P. SHANAHAN, EXAMINING ATTORNEY



David J. Kybas

Director of the United States Patent and Trademark Office

United States of America

United States Patent and Trademark Office

B  **X** **WINE**

Reg. No. 4,109,112

Registered Mar. 6, 2012

Int. Cl.: 33

TRADEMARK

PRINCIPAL REGISTER

URBAN WINE VENTURES, LLC (ILLINOIS LIMITED LIABILITY COMPANY)
118 N. PEORIA, 3RD FLOOR
CHICAGO, IL 60607

FOR: WINE, IN CLASS 33 (U.S. CLS. 47 AND 49).

FIRST USE 12-13-2011; IN COMMERCE 12-13-2011.

NO CLAIM IS MADE TO THE EXCLUSIVE RIGHT TO USE "BOX WINE" , APART FROM THE MARK AS SHOWN.

THE MARK CONSISTS OF THE LETTER "B", A SHADED SQUARE AND THE LETTERS "X", "W", "I", "N" AND "E".

SN 77-559,707, FILED 9-1-2008.

WILLIAM P. SHANAHAN, EXAMINING ATTORNEY



David J. Kyffers

Director of the United States Patent and Trademark Office

United States of America

United States Patent and Trademark Office

Blessyourheart

Reg. No. 4,109,113

Registered Mar. 6, 2012

Int. Cl.: 16

TRADEMARK

PRINCIPAL REGISTER

BENEFICENCE, INC. (COLORADO CORPORATION)
P.O. BOX 99
LIVERMORE, CO 80536

FOR: A SERIES OF BOOKS, WRITTEN ARTICLES, HANDOUTS AND WORKSHEETS IN THE FIELD OF BLESSINGS; BLANK OR PARTIALLY PRINTED PAPER LABELS; BLANK OR PARTIALLY PRINTED POSTCARDS; BOOKS AND BOOKLETS IN THE FIELD OF BLESSINGS; BROCHURES ABOUT BLESSINGS; GIFT BOOKS FEATURING BLESSINGS; INFORMATIONAL LETTERS CONCERNING BLESSINGS; JOURNALS CONCERNING BLESSINGS; LEAFLETS ABOUT BLESSINGS; PAMPHLETS IN THE FIELD OF BLESSINGS; PARTIALLY PRINTED FORMS; PRINTED CALENDARS; PRINTED EMBLEMS; PRINTED GREETING CARDS WITH ELECTRONIC INFORMATION STORED THEREIN; PRINTED MATERIALS, NAMELY, PRESS RELEASES FEATURING BLESSINGS; PRINTED PAPER LABELS; WORKBOOKS DIRECTED TO BLESSINGS; PERSONALIZED WRITTEN OR PRINTED MESSAGES IN DECORATIVE MINIATURE ENVELOPES CONTAINED IN A JAR; PRINTED FORMS; PRINTED INFORMATIONAL CARDS IN THE FIELD OF BLESSINGS; PRINTED INFORMATIONAL FOLDERS IN THE FIELD OF BLESSINGS; CARDS, NAMELY, NOTE CARDS CONTAINING BLESSINGS; GREETING CARDS AND POSTCARDS; HOLDERS SPECIALLY ADAPTED FOR HOLDING GREETING CARDS; MUSICAL GREETING CARDS; PAPER BOXES FOR STORING GREETING CARDS; BOOKMARKERS; BOOKMARKS; POSTERS, IN CLASS 16 (U.S. CLS. 2, 5, 22, 23, 29, 37, 38 AND 50).

FIRST USE 10-21-2011; IN COMMERCE 10-21-2011.

THE MARK CONSISTS OF A STYLIZED LETTER "B" IN THE SHAPE OF A HEART FORMING THE LETTER "B" IN THE WORDS "BLESSYOURHEART".

SN 77-562,101, FILED 9-4-2008.

STEVEN JACKSON, EXAMINING ATTORNEY



David J. Kyros

Director of the United States Patent and Trademark Office

United States of America

United States Patent and Trademark Office

RENEWAL RITUALS

Reg. No. 4,109,114

Registered Mar. 6, 2012

Int. Cl.: 41

SERVICE MARK

PRINCIPAL REGISTER

HALL, KATHLEEN A. (UNITED STATES INDIVIDUAL)
495 OWLS NEST LANE
CLARKESVILLE, GA 30523

FOR: EDUCATIONAL SERVICES AND TRAINING, NAMELY, CONDUCTING SEMINARS, WEB SEMINARS, WORKSHOPS AND CONFERENCES IN THE FIELD OF PERSONAL SPIRITUAL GROWTH, HEALING AND WELLNESS, AND IDENTIFYING, OVERCOMING AND AVOIDING STRESS AND DESTRUCTIVE BEHAVIOR, IN CLASS 41 (U.S. CLS. 100, 101 AND 107).

FIRST USE 6-1-2008; IN COMMERCE 6-1-2008.

THE MARK CONSISTS OF STANDARD CHARACTERS WITHOUT CLAIM TO ANY PARTICULAR FONT, STYLE, SIZE, OR COLOR.

SN 77-565,407, FILED 9-9-2008.

EDWARD NELSON, EXAMINING ATTORNEY



David J. Kyffers

Director of the United States Patent and Trademark Office

United States of America
United States Patent and Trademark Office

COMPEED

Reg. No. 4,109,115

Registered Mar. 6, 2012

Int. Cl.: 3

TRADEMARK

PRINCIPAL REGISTER

JOHNSON & JOHNSON (NEW JERSEY CORPORATION)
ONE JOHNSON & JOHNSON PLAZA
NEW BRUNSWICK, NJ 089337001

FOR: NON-MEDICATED FOOT PREPARATIONS FOR THE PROTECTION OF SKIN FROM IRRITATION AND RUBBING, FOR THE PREVENTION OF WOUNDS, AND FOR THE PREVENTION OF BLISTERS , IN CLASS 3 (U.S. CLS. 1, 4, 6, 50, 51 AND 52).

FIRST USE 10-30-2008; IN COMMERCE 10-30-2008.

THE MARK CONSISTS OF STANDARD CHARACTERS WITHOUT CLAIM TO ANY PARTICULAR FONT, STYLE, SIZE, OR COLOR.

OWNER OF U.S. REG. NOS. 1,547,009 AND 2,406,575.

SN 77-566,261, FILED 9-10-2008.

FLORENTINA BLANDU, EXAMINING ATTORNEY



David J. Kybas

Director of the United States Patent and Trademark Office

United States of America

United States Patent and Trademark Office

AquaChill

Reg. No. 4,109,116

Registered Mar. 6, 2012

Int. Cls.: 11 and 37

TRADEMARK

SERVICE MARK

PRINCIPAL REGISTER

BEUTLER CORPORATION (CALIFORNIA CORPORATION)
4700 LANGE AVENUE
MCCLELLAN, CA 95652

FOR: AIR CLEANING UNITS; AIR CONDITIONERS; AIR CONDITIONING APPARATUS AND INSTALLATIONS; AIR CONDITIONING INSTALLATIONS; AIR CONDITIONING UNITS; AIR FILTERS FOR AIR CONDITIONING UNITS; AIR-CONDITIONING, AIR COOLING AND VENTILATION APPARATUS AND INSTRUMENTS, IN CLASS 11 (U.S. CLS. 13, 21, 23, 31 AND 34).

FIRST USE 6-1-2008; IN COMMERCE 7-15-2011.

FOR: INSTALLATION AND REPAIR OF AIR CONDITIONING APPARATUS; INSTALLATION OF AIR CONDITIONING SYSTEMS, HVACS, AIR CLEANING SYSTEMS, AIR FILTERS, HUMIDIFIERS, AND ACCESSORIES THEREFOR, IN CLASS 37 (U.S. CLS. 100, 103 AND 106).

FIRST USE 6-1-2008; IN COMMERCE 7-15-2011.

THE MARK CONSISTS OF STANDARD CHARACTERS WITHOUT CLAIM TO ANY PARTICULAR FONT, STYLE, SIZE, OR COLOR.

SN 77-571,323, FILED 9-16-2008.

APRIL HESIK, EXAMINING ATTORNEY



David J. Kybas

Director of the United States Patent and Trademark Office

United States of America

United States Patent and Trademark Office



Reg. No. 4,109,117

Registered Mar. 6, 2012

Int. Cl.: 33

TRADEMARK

PRINCIPAL REGISTER

DISTILLERIA F. LLI CAFFO S.R.L. (ITALY CORPORATION)
VIA MATTEOTTI, 11
LIMBADI (VV), ITALY 89844

FOR: ALCOHOLIC BEVERAGES, NAMELY, VODKA, LIQUEURS, BITTERS, RUM, GRAPPA, WHISKEY, GIN, WINES, SPARKLING WINES, BRANDY, EAU-DE-VIE AND FRUIT BASED ALCOHOLIC DRINKS, IN CLASS 33 (U.S. CLS. 47 AND 49).

FIRST USE 3-27-2009; IN COMMERCE 3-27-2009.

NO CLAIM IS MADE TO THE EXCLUSIVE RIGHT TO USE "VODKA", APART FROM THE MARK AS SHOWN.

THE COLOR(S) BLACK AND GRAY IS/ARE CLAIMED AS A FEATURE OF THE MARK.

THE STIPLING IS FOR SHADING PURPOSES ONLY.

THE MARK CONSISTS OF "ALPINA LUX VODKA" IN BLACK OVER AN EIGHT POINTED GRAY STAR AND WITH A GRAY BORDER AROUND EACH LETTER.

SN 77-571,610, FILED 9-16-2008.

NAAKWAMA ANKRAH, EXAMINING ATTORNEY



David J. Kyros

Director of the United States Patent and Trademark Office

United States of America

United States Patent and Trademark Office

ABSORBINE EXTREME

Reg. No. 4,109,118

Registered Mar. 6, 2012

Int. Cl.: 5

TRADEMARK

PRINCIPAL REGISTER

W.F. YOUNG, INCORPORATED (MASSACHUSETTS CORPORATION)
302 BENTON DRIVE
EAST LONGMEADOW, MA 01028

FOR: EXTERNAL ANALGESIC, IN CLASS 5 (U.S. CLS. 6, 18, 44, 46, 51 AND 52).

FIRST USE 12-9-2011; IN COMMERCE 12-9-2011.

THE MARK CONSISTS OF STANDARD CHARACTERS WITHOUT CLAIM TO ANY PARTICULAR FONT, STYLE, SIZE, OR COLOR.

OWNER OF U.S. REG. NOS. 49,322, 1,489,833, AND OTHERS.

SN 77-577,899, FILED 9-24-2008.

SANJEEV VOHRA, EXAMINING ATTORNEY



David J. Kyffers

Director of the United States Patent and Trademark Office

United States of America

United States Patent and Trademark Office

ADULT BOWL

Reg. No. 4,109,119

Registered Mar. 6, 2012

Int. Cl.: 35

SERVICE MARK

PRINCIPAL REGISTER

ADULT BOWL, LLC (FLORIDA LIMITED LIABILITY COMPANY)
SUITE SIX
5201 SEMINOLE BLVD
ST PETERSBURG, FL 33708

FOR: ARRANGING AND CONDUCTING TRADE SHOWS IN THE FIELDS OF ADULT ENTERTAINMENT AND ENTERTAINMENT EXCLUDING THE FIELD OF BOWLING , IN CLASS 35 (U.S. CLS. 100, 101 AND 102).

FIRST USE 6-25-2010; IN COMMERCE 6-25-2010.

THE MARK CONSISTS OF STANDARD CHARACTERS WITHOUT CLAIM TO ANY PARTICULAR FONT, STYLE, SIZE, OR COLOR.

NO CLAIM IS MADE TO THE EXCLUSIVE RIGHT TO USE "ADULT", APART FROM THE MARK AS SHOWN.

SN 77-586,365, FILED 10-6-2008.

MICHAEL GAFFAR, EXAMINING ATTORNEY



David J. Kyffers

Director of the United States Patent and Trademark Office

United States of America
United States Patent and Trademark Office

PUNGO

Reg. No. 4,109,120

PUNGO, INC. (TEXAS CORPORATION)
2 GETTYSBURG LANE
RICHARDSON, TX 75080

Registered Mar. 6, 2012

Int. Cl.: 9

FOR: PORTABLE TRANSMITTER AND RECEIVER FOR SENDING SIGNALS TO THE HEARING IMPAIRED, IN CLASS 9 (U.S. CLS. 21, 23, 26, 36 AND 38).

TRADEMARK

FIRST USE 6-26-2011; IN COMMERCE 10-31-2011.

PRINCIPAL REGISTER

THE MARK CONSISTS OF STANDARD CHARACTERS WITHOUT CLAIM TO ANY PARTICULAR FONT, STYLE, SIZE, OR COLOR.

SN 77-589,467, FILED 10-9-2008.

TOBY BULLOFF, EXAMINING ATTORNEY



David J. Kybas

Director of the United States Patent and Trademark Office

United States of America

United States Patent and Trademark Office



Reg. No. 4,109,121

Registered Mar. 6, 2012

Int. Cl.: 9

TRADEMARK

PRINCIPAL REGISTER

PUNGO, INC. (TEXAS CORPORATION)
2 GETTYSBURG LANE
RICHARDSON, TX 75080

FOR: PORTABLE TRANSMITTER AND RECEIVER FOR SENDING SIGNALS TO THE HEARING IMPAIRED, IN CLASS 9 (U.S. CLS. 21, 23, 26, 36 AND 38).

FIRST USE 6-26-2011; IN COMMERCE 10-31-2011.

THE MARK CONSISTS OF TWO SETS OF PARENTHESES SURROUNDING THE LETTER "P" WITHIN A CIRCLE.

SN 77-589,478, FILED 10-9-2008.

TOBY BULLOFF, EXAMINING ATTORNEY



David J. Kybas

Director of the United States Patent and Trademark Office

United States of America

United States Patent and Trademark Office

REF FOR THE DEAF

Reg. No. 4,109,122

PUNGO, INC. (TEXAS CORPORATION)
2 GETTYSBURG LANE
RICHARDSON, TX 75080

Registered Mar. 6, 2012

Int. Cl.: 9

FOR: PORTABLE TRANSMITTER AND RECEIVER FOR SENDING SIGNALS TO THE HEARING IMPAIRED, IN CLASS 9 (U.S. CLS. 21, 23, 26, 36 AND 38).

TRADEMARK

FIRST USE 6-26-2011; IN COMMERCE 10-31-2011.

PRINCIPAL REGISTER

THE MARK CONSISTS OF STANDARD CHARACTERS WITHOUT CLAIM TO ANY PARTICULAR FONT, STYLE, SIZE, OR COLOR.

SN 77-589,492, FILED 10-9-2008.

TOBY BULLOFF, EXAMINING ATTORNEY



David J. Kybas

Director of the United States Patent and Trademark Office

United States of America
United States Patent and Trademark Office

DIAMANTI

Reg. No. 4,109,123

CAPITOL WHOLESALE MEATS, INC. (ILLINOIS CORPORATION)
8751 W. 50TH STREET
MCCOOK, IL 60525

Registered Mar. 6, 2012

Int. Cl.: 29

FOR: MEAT PRODUCTS, NAMELY, GYROS, BEEF AND PORK PRODUCTS, NAMELY, GYROS MEAT, BEEF AND PORK, IN CLASS 29 (U.S. CL. 46).

TRADEMARK

FIRST USE 6-21-2005; IN COMMERCE 6-21-2005.

PRINCIPAL REGISTER

THE MARK CONSISTS OF STANDARD CHARACTERS WITHOUT CLAIM TO ANY PARTICULAR FONT, STYLE, SIZE, OR COLOR.

THE ENGLISH TRANSLATION OF THE WORD "DIAMANTI" IN THE MARK IS DIAMOND.

SN 77-595,858, FILED 10-20-2008.

JAMES STEIN, EXAMINING ATTORNEY



David J. Kybas

Director of the United States Patent and Trademark Office

United States of America

United States Patent and Trademark Office

SureSource

Reg. No. 4,109,124

Registered Mar. 6, 2012

Int. Cl.: 9

TRADEMARK

PRINCIPAL REGISTER

CLINICAL INK, INC. (NORTH CAROLINA CORPORATION)
100 N. CHERRY STREET, SUITE 520
WINSTON-SALEM, NC 27101

FOR: COMPUTER SOFTWARE USED TO REPRODUCE PAPER CLINICAL TRIAL SOURCE DOCUMENTS AS SECURE DIGITAL DATA FORMS INCORPORATING DATA ENTRY, DATA VALIDATION RULES, ELECTRONIC SIGNATURE CAPTURE AND DATA TRANSMISSION FEATURES FOR USE IN CLINICAL RESEARCH STUDIES, IN CLASS 9 (U.S. CLS. 21, 23, 26, 36 AND 38).

FIRST USE 8-9-2011; IN COMMERCE 8-9-2011.

THE MARK CONSISTS OF STANDARD CHARACTERS WITHOUT CLAIM TO ANY PARTICULAR FONT, STYLE, SIZE, OR COLOR.

SN 77-598,650, FILED 10-23-2008.

DAVID COLLIER, EXAMINING ATTORNEY



David J. Kyffers

Director of the United States Patent and Trademark Office

United States of America

United States Patent and Trademark Office

Clinical Ink

Reg. No. 4,109,125

Registered Mar. 6, 2012

Int. Cl.: 42

SERVICE MARK

PRINCIPAL REGISTER

CLINICAL INK, INC. (NORTH CAROLINA CORPORATION)
100 N. CHERRY STREET, SUITE 520
WINSTON-SALEM, NC 27101

FOR: DESIGNING AND DEVELOPING COMPUTER SOFTWARE IN THE FIELD OF CLINICAL RESEARCH STUDIES; APPLICATION SERVICE PROVIDER FEATURING SOFTWARE USED TO REPRODUCE PAPER CLINICAL TRIAL SOURCE DOCUMENTS AS SECURE DIGITAL DATA FORMS INCORPORATING DATA ENTRY, DATA VALIDATION RULES, ELECTRONIC SIGNATURE CAPTURE AND DATA TRANSMISSION FEATURES FOR USE IN CLINICAL RESEARCH STUDIES; APPLICATION SERVICE PROVIDER, NAMELY, HOSTING, MANAGING, DEVELOPING AND MAINTAINING APPLICATIONS, SOFTWARE, WEB SITES AND DATABASES OF OTHERS IN THE FIELD OF CLINICAL RESEARCH STUDIES, IN CLASS 42 (U.S. CLS. 100 AND 101).

FIRST USE 8-9-2011; IN COMMERCE 8-9-2011.

THE MARK CONSISTS OF STANDARD CHARACTERS WITHOUT CLAIM TO ANY PARTICULAR FONT, STYLE, SIZE, OR COLOR.

NO CLAIM IS MADE TO THE EXCLUSIVE RIGHT TO USE "CLINICAL", APART FROM THE MARK AS SHOWN.

SN 77-598,695, FILED 10-23-2008.

DAVID COLLIER, EXAMINING ATTORNEY



David J. Kyros

Director of the United States Patent and Trademark Office

United States of America

United States Patent and Trademark Office



Reg. No. 4,109,126

Registered Mar. 6, 2012

Int. Cl.: 3

TRADEMARK

PRINCIPAL REGISTER

BEAUTY BY DANNA, INC. (WASHINGTON CORPORATION)
13833 SE 78TH PL
NEWCASTLE, WA 98059

FOR: SKIN CLEANSER, SKIN TONER, SKIN MOISTURIZING MASK, MOISTURIZING CREAM, OATMEAL BEAUTY MASK, DARK CIRCLE EYE ESSENCE LOTION, LIP BALM, AND LIP GLOSS, IN CLASS 3 (U.S. CLS. 1, 4, 6, 50, 51 AND 52).

FIRST USE 10-10-2009; IN COMMERCE 10-10-2009.

THE MARK CONSISTS OF A PLANT GROWING OUT OF THE GROUND.

SN 77-599,433, FILED 10-23-2008.

DAVID MILLER, EXAMINING ATTORNEY



David J. Kybas

Director of the United States Patent and Trademark Office

United States of America

United States Patent and Trademark Office

HOW TO MAKE IT IN AMERICA

Reg. No. 4,109,127

HOME BOX OFFICE, INC. (DELAWARE CORPORATION)
1100 AVENUE OF THE AMERICAS
NEW YORK, NY 10036

Registered Mar. 6, 2012

Int. Cl.: 16

FOR: PRINTED MATTER, NAMELY, POSTERS, FEATURING CONTENT FROM OR RELATED TO AN ONGOING COMEDY TELEVISION SERIES, IN CLASS 16 (U.S. CLS. 2, 5, 22, 23, 29, 37, 38 AND 50).

TRADEMARK

FIRST USE 3-1-2010; IN COMMERCE 3-1-2010.

PRINCIPAL REGISTER

THE MARK CONSISTS OF STANDARD CHARACTERS WITHOUT CLAIM TO ANY PARTICULAR FONT, STYLE, SIZE, OR COLOR.

SN 77-603,724, FILED 10-30-2008.

ELLEN PERKINS, EXAMINING ATTORNEY



David J. Kyffers

Director of the United States Patent and Trademark Office

United States of America

United States Patent and Trademark Office

MATCH AT THE BREAKERS

Reg. No. 4,109,128

THE BREAKERS PALM BEACH, INC. (FLORIDA CORPORATION)
ONE SOUTH COUNTY ROAD
PALM BEACH, FL 33480

Registered Mar. 6, 2012

Int. Cl.: 35

FOR: RETAIL STORE SERVICES FEATURING SHOES, IN CLASS 35 (U.S. CLS. 100, 101 AND 102).

SERVICE MARK

FIRST USE 12-8-2011; IN COMMERCE 12-8-2011.

PRINCIPAL REGISTER

THE MARK CONSISTS OF STANDARD CHARACTERS WITHOUT CLAIM TO ANY PARTICULAR FONT, STYLE, SIZE, OR COLOR.

OWNER OF U.S. REG. NO. 3,075,874.

SN 77-605,279, FILED 10-31-2008.

JEFF DEFORD, EXAMINING ATTORNEY



David J. Kybas

Director of the United States Patent and Trademark Office

United States of America

United States Patent and Trademark Office

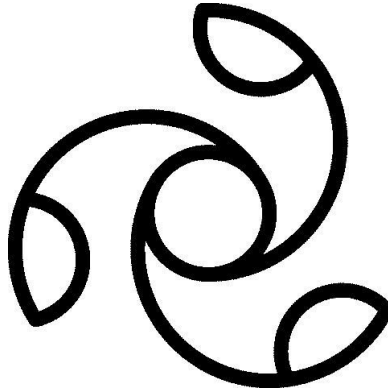

Reg. No. 4,109,129

Registered Mar. 6, 2012

Int. Cl.: 25

TRADEMARK

PRINCIPAL REGISTER

JOCKEY INTERNATIONAL, INC. (WISCONSIN CORPORATION)
2300 60TH STREET
KENOSHA, WI 531411417

FOR: CLOTHING NOT FOR MEDICAL PURPOSES, NAMELY, SCRUBS TOPS AND BOTTOMS, SHIRTS, PANTS AND LAB COATS, IN CLASS 25 (U.S. CLS. 22 AND 39).

FIRST USE 8-31-2009; IN COMMERCE 8-31-2009.

THE MARK CONSISTS OF A SWIRL DESIGN COMPRISED OF A CENTRAL CIRCLE WITH 3 CURVED LINES EMANATING FROM THE CIRCLE; EACH CURVED LINE ENDS IN A CLOSED SEMI-CIRCLE.

SN 77-607,960, FILED 11-5-2008.

PAUL MORENO, EXAMINING ATTORNEY



David J. Kybas

Director of the United States Patent and Trademark Office

United States of America

United States Patent and Trademark Office



Reg. No. 4,109,130

Registered Mar. 6, 2012

Int. Cl.: 25

TRADEMARK

PRINCIPAL REGISTER

ILLINOIS LIBRARY ASSOCIATION (ILLINOIS CORPORATION)
SUITE 301
33 WEST GRAND AVENUE
CHICAGO, IL 60654

FOR: T-SHIRTS, IN CLASS 25 (U.S. CLS. 22 AND 39).

FIRST USE 11-1-2011; IN COMMERCE 11-1-2011.

THE MARK CONSISTS OF AN IMAGE OF A FORK AND KNIFE SIGNIFYING EAT, AN IMAGE OF A BED SIGNIFYING SLEEP AND AN IMAGE OF A PERSON WITH AN OPEN BOOK SIGNIFYING READ.

SN 77-608,630, FILED 11-6-2008.

JANICE KIM, EXAMINING ATTORNEY



David J. Kybas

Director of the United States Patent and Trademark Office

United States of America

United States Patent and Trademark Office

LAPIDARY LEGENDS

Reg. No. 4,109,131

AMERICA'S COLLECTIBLES NETWORK, INC. (TENNESSEE CORPORATION)
9600 PARKSIDE DRIVE
KNOXVILLE, TN 37922

Registered Mar. 6, 2012

Int. Cl.: 14

FOR: GEMSTONES, IN CLASS 14 (U.S. CLS. 2, 27, 28 AND 50).

TRADEMARK

FIRST USE 12-13-2011; IN COMMERCE 12-13-2011.

PRINCIPAL REGISTER

THE MARK CONSISTS OF STANDARD CHARACTERS WITHOUT CLAIM TO ANY PARTICULAR FONT, STYLE, SIZE, OR COLOR.

NO CLAIM IS MADE TO THE EXCLUSIVE RIGHT TO USE "LAPIDARY", APART FROM THE MARK AS SHOWN.

SN 77-608,971, FILED 11-6-2008.

SUSAN RICHARDS, EXAMINING ATTORNEY



David J. Kyffers

Director of the United States Patent and Trademark Office

United States of America

United States Patent and Trademark Office

CHICAGO BOOTH

Reg. No. 4,109,132

UNIVERSITY OF CHICAGO, THE (ILLINOIS NOT-FOR-PROFIT CORPORATION)
5801 ELLIS AVENUE
CHICAGO, IL 60637

Registered Mar. 6, 2012

Int. Cl.: 16

FOR: STATIONERY, BUSINESS CARDS, BINDERS; PAPER GOODS AND PRINTED MATTER, NAMELY, CALENDARS AND DECALS; PUBLICATIONS, NAMELY, JOURNALS, CATALOGUES, AND BOOKS RELATING TO BUSINESS AND MANAGEMENT, IN CLASS 16 (U.S. CLS. 2, 5, 22, 23, 29, 37, 38 AND 50).

TRADEMARK

PRINCIPAL REGISTER

FIRST USE 11-0-2008; IN COMMERCE 11-0-2008.

THE MARK CONSISTS OF STANDARD CHARACTERS WITHOUT CLAIM TO ANY PARTICULAR FONT, STYLE, SIZE, OR COLOR.

OWNER OF U.S. REG. NOS. 1,876,527 AND 2,668,437.

NO CLAIM IS MADE TO THE EXCLUSIVE RIGHT TO USE "CHICAGO", APART FROM THE MARK AS SHOWN.

SN 77-609,356, FILED 11-6-2008.

MICHELE SWAIN, EXAMINING ATTORNEY



David J. Kybas

Director of the United States Patent and Trademark Office

United States of America

United States Patent and Trademark Office

SONEPAR

Reg. No. 4,109,133

Registered Mar. 6, 2012

**Int. Cls.: 9, 11, 35, 37, 38,
and 39**

TRADEMARK

SERVICE MARK

PRINCIPAL REGISTER

SOCIETE DE NEGOCE ET DE PARTICIPATION (FRANCE CORPORATION)
43-47 AVENUE DE LA GRANDE ARMEE
PARIS, FRANCE 75116

FOR: (BASED ON 44(E)) ELECTRIC INSTALLATIONS, NAMELY, WIRELESS ELECTRONIC AND TESTING EQUIPMENT FOR THE REMOTE CONTROL OF INDUSTRIAL OPERATIONS; ELECTRIC DEVICES AND INSTALLATIONS, NAMELY, REMOTE CONTROLLERS FOR THE REMOTE CONTROL OF ELECTRICAL APPLIANCES, AIR CONDITIONING AND HEATING APPLIANCES, AND LIGHTING EQUIPMENT; ELECTRIC SWITCHES; ELECTRICAL APPLIANCE FOR COMMUTATION, NAMELY, ELECTRICAL COMMUTATORS, ELECTRICAL SUPPLY SOCKETS; ELECTRIC TERMINALS; DISTRIBUTION BOXES FOR ELECTRICITY; CABLE JOINT BOXES FOR ELECTRICITY; PLUGBOARD BOXES AND ELECTRIC PLUGBOARDS; ELECTRICAL CABLES FOR USE IN CONNECTIONS AND ELECTRICAL CONTACTS; ELECTRICAL CONTACTS OF PRECIOUS METAL; ELECTRICAL CONNECTORS; ELECTRIC CONNECTION BOXES; ELECTRIC SOCKET COVER; ELECTRIC CONTROL PANELS; POWERLINES TRANSMISSION MACHINES AND APPARATUS; ELECTRIC METERING DEVICE, NAMELY, ELECTRIC METERS AND ELECTRIC METERING EQUIPMENT, FIRE AND SMOKE DETECTORS, ELECTRIC ADAPTORS, POWER ADAPTORS FOR APPARATUS AND GOODS FOR LIGHTING, HEATING, AIR CONDITIONING AND AIR COOLING AND HOUSEHOLD ELECTRICAL APPLIANCES AND FOR APPARATUS AND INSTRUMENTS FOR CONDUCTING, SWITCHING, CONNECTING, TRANSFORMING, ACCUMULATING, REGULATING, MEASURING OR CONTROLLING ELECTRICITY, NAMELY, ELECTRIC CABLES AND ELECTRIC DUCTS; ELECTRIC TRANSFORMERS; ELECTRIC CIRCUIT BREAKERS, ELECTRIC CONTACTORS AND SWITCHES; ELECTRICAL INDUCTORS; ELECTRICAL ARMATURES; ELECTRICAL RELAYS; RHEOSTATS; OVER-VOLTAGE PROTECTION CONTROLLERS; ELECTRIC CHOKE COILS; SEMI CONDUCTORS; TEMPERATURE REGULATORS; CURRENT RECTIFIERS, ELECTRONIC PENCILS, DEVICES, NAMELY, DISTRIBUTION CONSOLES FOR SWITCHING ELECTRICITY FOR THE DISTRIBUTION OF ELECTRICITY TO BE STORED IN DESKS; DEVICES, NAMELY, ELECTRICITY DISTRIBUTION BOXES FOR THE DISTRIBUTION OF ELECTRICITY TO BE STORED IN CUPBOARDS; DISTRIBUTION BOXES FOR ELECTRICITY; FUSES; LIGHTNING PROTECTORS, NAMELY, LIGHTNING RODS, ELECTRICAL LIGHTNING CONDUCTORS; ANTENNAS AND ELECTRIC OR ELECTRONIC INSTRUMENTS FOR SAFETY, NAMELY, CAMERAS, SECURITY PANELS, BURGLAR ALARMS AND SECURITY PASSIVE INFRARED AND GLASS BREAK SENSORS FOR MOVEMENT OR NOISE; SIRENS; ELECTRONIC CHIMES FOR DOORS; ELECTRIC BUZZERS; METAL DETECTORS; SMOKE DETECTORS; WATER LEVEL INDICATORS; MAGNETIC EN-



David J. Kyros

Director of the United States Patent and Trademark Office

Reg. No. 4,109,133 CODERS; MICROPHONES; SOUND AMPLIFIERS; LOUDSPEAKERS; CASES FOR LOUDSPEAKERS; AUDIBLE WARNING DEVICES, NAMELY, ACOUSTIC BURGLAR ALARMS; WARNING SIGNALS, NAMELY, SIRENS AND AUDIBLE WARNING DEVICES CONNECTED TO SECURITY SYSTEMS; FIRE ALARMS; LUMINOUS BEACONS THAT ACT AS LIGHTS; BALLASTS FOR LIGHTING PURPOSES; ELECTRIC LUMINESCENT DISPLAY PANELS; FLASH BULBS, FLASH LAMPS; THERMIONIC LAMPS; FLUORESCENT SCREENS; ELECTRIC LANTERNS WITH SIGNALS PRIMARILY USED AS A SIGNALING DEVICE; ELECTRICAL SOLDERING IRON; BATTERIES; POWER SUPPLIES; VIDEO AND AUDIO COMPACT DISC PLAYERS; ELECTRIC CARD READERS AND ELECTRONIC LOCKS WITH CODES; ELECTRIC DOOR OPENERS, ELECTRIC AND ELECTRONIC ENTRANCE INTERCOMS; COIN OPERATED GATES FOR CAR PARKS OR PARKING LOTS; ELECTRICAL OR ELECTRONIC APPLIANCES FOR MONITORING CONSUMPTION OF ELECTRICITY; DOMESTIC AND INDUSTRIAL POWER INSTRUMENTS, NAMELY, ELECTRIC ENERGY METERS, ELECTRICAL ENERGY UTILIZATION METERING DEVICES, BOTH REMOTE AND INSTALLED; ELECTRICAL OR ELECTRONIC APPLIANCE FOR ANALYSIS OF SIGNALS CURRENT AND VOLTAGE, NAMELY, TEST AND MEASUREMENT EQUIPMENT, AUTOMATION DEVICES AND REMOTE MONITORING EQUIPMENT, NAMELY, DATA RECORDERS AND DATA RELAYS FOR ELECTRICAL TEST AND MEASUREMENT DEVICES; APPARATUS FOR CAPTURING, TESTING AND MEASURING EQUIPMENT, NAMELY, METERING EQUIPMENT FOR TESTING, MEASURING AND CAPTURING INFORMATION ON ENERGY USAGE AND QUALITY; AUTOMATION DEVICES AND REMOTE MONITORING EQUIPMENT, FOR COUNTING, COLLECTING, STORING, CONVERTING, PROCESSING, ENTERING, BROADCASTING, TRANSMITTING DATA, INFORMATION AND SIGNALS, NAMELY, ELECTRONIC APPARATUS FOR THE REMOTE CONTROL OF INDUSTRIAL OPERATIONS; TELEBREAKERS; MEASURING DEVICES AND INSTRUMENTS, NAMELY, HANDHELD VOLTAGE CURRENT METERS AND WAVE FORM METERS; VOLT METERS; AMMETERS; FREQUENCY METERS; TEMPERATURE INDICATORS; SPEED INDICATORS; ELECTRICITY CONDUITS; ELECTRIC CABLES; RIGID ELECTRONIC WIRE; CONDUCTING WIRE FOR LUMINOUS RAYS; INSULATED COPPER WIRE; COAXIAL CABLES; MAGNETIC TELEPHONE WIRE, MAGNETIC TELEPHONE SAFETY WIRE AND ELECTRIC TELEVISION CABLES; PROTECTIVE SHEATHS FOR ELECTRIC CABLES; COMPUTER, DATA TRANSMISSION AND TELEPHONE CABLES; COMPUTER CABLES AND ELECTRICAL SOCKETS FOR COMPUTER EQUIPMENT; ELECTRICAL AND ELECTRONIC APPLIANCES, NAMELY, ELECTRICAL OUTLET TESTERS AND CONTINUITY TEST APPARATUS FOR ELECTRICAL CIRCUITS FOR TESTING IT AND ELECTRIC WIRING; ELECTRIC AND ELECTRONIC CABLE TESTERS; ELECTRIC CONVERTERS; JUNCTION SLEEVES FOR ELECTRIC CABLES; CONNECTIONS FOR ELECTRIC LINES; ELECTRICAL IDENTIFICATION WIRE FOR ELECTRIC WIRES; MAGNETIC WIRES; MAGNETIC TELEPHONE WIRES; ELECTRIC AND OPTICAL CONNECTION WIRES; ELECTRONIC INDICATOR PANELS OF ELECTRIC LOSS; ELECTRONIC INDICATOR BOARDS; ANTENNAS; ANTI-INTERFERENCE DEVICES, NAMELY, INTERFERENCE METERS AND FILTERS FOR RADIO INTERFERENCE SUPPRESSION; CONTROL DEVICES FOR ELEVATORS, NAMELY, ELECTRIC CONTROLLERS TO MANAGE POWER, MOVEMENT AND FUNCTION OF ELEVATORS; OPTICAL CHARACTER READERS, KNEE PADS FOR WORK MEN, PROTECTIVE WORK GLOVES, PROTECTIVE GLOVES FOR INDUSTRIAL USE, NAMELY, PROTECTIVE GLOVES FOR PROTECTION AGAINST ACCIDENTS; SAFETY GOGGLES, GAS MASKS; PROTECTIVE EYE PIECES; PROTECTIVE HELMETS; SHOES FOR PROTECTION AGAINST ACCIDENTS, IRRADIATION AND FIRE; ELECTRIC APPARATUSES AND INSTRUMENTS, NAMELY, APPARATUSES AND INSTRUMENTS FOR CONVEYING, DISTRIBUTING, TRANSFORMING, STORING, REGULATING OR CONTROLLING ELECTRICAL CURRENT; ELECTRICAL COUPLINGS, ACCUMULATOR JARS; CASES FOR ACCUMULATORS; ACIDIMETER FOR ACCUMULATORS; CHARGERS FOR ELECTRIC BATTERIES; REELS OF ELECTROMAGNETS; ELECTRICAL COILS; HOLDERS FOR ELECTRICAL COILS; CATHODE RAY TUBES; PHOTOVOLTAIC CELLS; ELECTRONIC COMPONENTS, NAMELY, INTEGRATED CIRCUITS, SEMICONDUCTORS, DIODES, FOR ELECTRONIC INSTALLATIONS, ELECTRIC CIRCUIT BREAKERS; FLASHING SAFETY LIGHTS; BAR CODE SCANNERS; LABORATORY EQUIPMENT, NAMELY, ELECTRIC BATH HEATERS, IN CLASS 9 (U.S. CLS. 21, 23, 26, 36 AND 38).

Reg. No. 4,109,133 FOR: (BASED ON 44(E)) LUMINOUS TUBES FOR LIGHTING FOR PUBLICITY; LAMPS FOR PROJECTORS; HEAT REGULATORS, NAMELY, HEAT EXCHANGERS; HEATING APPLIANCES, NAMELY, HEATING FURNACES, ELECTRIC RADIATORS, NOT FOR MOTORS AND ENGINES; HUMIDIFIERS FOR CENTRAL HEATING RADIATORS, HEATING RADIATORS; HOT WATER HEATERS; HEAT RECOVERY MACHINES, NAMELY, VENTILATORS; HEAT EXCHANGERS NOT BEING PARTS OF MACHINES; HOT PLATES; HEATING PLATES; SOLAR COLLECTOR; HEAT ACCUMULATORS AND HEAT REGENERATORS; ELECTRIC LIGHTING FIXTURES, NAMELY, POWER FAILURE BACK-UPS SAFETY LIGHTING; LANTERNS; CHANDELIERS; FLASHLIGHTS; LIGHTING LAMPS; ELECTRIC STRING LIGHTS; ELECTRIC LIGHTS FOR AQUARIUMS; FLOOR LAMPS; LABORATORY LAMPS; SAFETY LAMPS FOR UNDERGROUND USE; FILAMENTS FOR ELECTRIC LAMPS; ELECTRIC HEATING FILAMENTS; ARC LAMPS; LAMP HANGING SUPPORTS; LAMP REFLECTORS, LAMP SHADES; CEILING LIGHTS; LUMINOUS TUBES FOR LIGHTING; SOCKETS FOR ELECTRIC LIGHTS; ELECTRIC FLASHLIGHTS FOR LIGHTING; POCKET SEARCH LIGHTS; LIGHTING DIFFUSERS; TUBES WITH ELECTRIC DISCHARGES FOR LIGHTING; SUN LAMPS FOR COSMETIC USE; LIGHTING BULBS; FLUORESCENT LIGHTING TUBES, ELECTRIC BULBS, DEVICES AND INSTALLATIONS FOR DRYING, NAMELY, ELECTRIC HAND DRYING APPARATUS FOR WASHROOMS; DRYERS, NAMELY, ELECTRIC HOT AIR HAND DRYERS; IONIZATION DEVICES FOR AIR TREATMENT, NAMELY, WATER IONIZERS FOR HOUSEHOLD PURPOSES; AIR CLEANING DEVICES AND MACHINES, NAMELY, AIR CLEANING UNITS CONTAINING AN AIR FILTER; AIR DEODORIZATION DEVICES, NAMELY, ELECTRIC AIR DEODORIZERS; AIR COOLING DEVICES, NAMELY, EVAPORATIVE AIR COOLERS, ELECTRIC AIR CONDITIONING FANS, AND AIR CONDITIONERS; VENTILATING FANS FOR COMMERCIAL AND INDUSTRIAL USE, VENTILATION HOODS; EXTRACTOR HOODS FOR KITCHENS; ELECTRIC COOKING STOVES; FREEZERS; ICE MAKING MACHINES, REFRIGERATORS, COLD COMBUSTION CHAMBERS; ELECTRIC LANTERNS WITH SIGNALS PRIMARILY USED AS A LIGHTING DEVICE; OPTICAL LAMPS FOR LIGHTING PURPOSES, IN CLASS 11 (U.S. CLS. 13, 21, 23, 31 AND 34).

FOR: (BASED ON USE IN COMMERCE) WHOLESALE STORE, RETAIL STORE AND DISTRIBUTORSHIP SERVICES AND ONLINE WHOLESALE, RETAIL STORE AND DISTRIBUTORSHIP SERVICES FEATURING TOOLS AND INSTRUMENTS TO CUT AND PROCESS WIRES, SHEATHS AND CABLES, SCREWS, BOLTS AND PRODUCTS FOR MECHANICAL OR CHEMICAL FIXING, FLEXIBLE PIPES, INSULATING PRODUCTS AND MATERIALS, DEVICES FOR HOME AUTOMATION, BUILDING AUTOMATION AND INDUSTRIAL AUTOMATISMS, IT EQUIPMENT INCLUDING DATA PROCESSING PERIPHERALS, CONNECTION CABLES AND SOCKETS FOR IT MATERIALS AND INSTALLATIONS, DEVICES AND INSTRUMENTS FOR OPERATION, DISTRIBUTION, CONNECTION, TRANSFORMATION, ACCUMULATION, ADJUSTMENT, MEASUREMENT, MONITORING CONTROL OF ELECTRICAL CURRENTS, INCLUDING CABLES AND CONDUITS, DEVICES AND PRODUCTS FOR LIGHTING, HEATING, AIR CONDITIONING, AIR COOLING AND HOUSEHOLD APPLIANCES, AND DEVICES AND INSTRUMENTS FOR MONITORING THE SAFETY OF PEOPLE, GOODS AND SITE ACCESS; ARRANGING AND CONDUCTING TRADE SHOW EXHIBITIONS FOR APPARATUS AND INSTRUMENTS FOR CONVEYING, DISTRIBUTING, TRANSFORMING, STORING, REGULATING OR CONTROLLING ELECTRIC CURRENT IN THE FIELDS OF ELECTRIC AND INDUSTRIAL EQUIPMENT FOR COMMERCIAL OR PUBLICITY PURPOSES; PURCHASING AGENT SERVICES, NAMELY, PURCHASING OF PRODUCTS FOR OTHERS; (BASED ON 44(E)) BUSINESS ADVICE AND ANALYSIS, NAMELY, PURCHASING OF INDUSTRIAL EQUIPMENT LIKELY TO MEET THE TECHNICAL REQUIREMENTS DEFINED IN A TECHNICAL SPECIFICATION; ADVERTISING SERVICES; CONDUCTING MARKETING STUDIES, IN CLASS 35 (U.S. CLS. 100, 101 AND 102).

FIRST USE 0-0-1960; IN COMMERCE 0-0-1998.

FOR: (BASED ON 44(E)) INSTALLATION, MAINTENANCE AND REPAIR OF ALARM, ACCESS CONTROL, ALARM MONITORING AND INDUSTRIAL AUTOMATION CONTROL

Reg. No. 4,109,133 DEVICES FOR HOME AND INDUSTRY; RENTAL OF HAND AND POWER TOOLS; INSTALLATION, MAINTENANCE AND REPAIR OF APPARATUS AND INSTRUMENTS FOR CONVEYING, DISTRIBUTING, TRANSFORMING, STORING, REGULATING OR CONTROLLING ELECTRIC CURRENT, ELECTRONIC MOTORS, CIRCUIT BREAKER PANEL BOARDS, PROGRAMMABLE LOGIC CONTROLLERS (PLCS); INSTALLATION, MAINTENANCE AND REPAIR OF DEVICES AND PRODUCTS, NAMELY, ELECTRIC MOTORS, CIRCUIT BREAKER PANEL BOARDS, AND PHASE-LOCKED LOOP (PLL) CONTROL SYSTEMS FOR LIGHTNING, HEATING, AIR CONDITIONING COOLING OF AIR AND HOUSEHOLD APPLIANCES, IN CLASS 37 (U.S. CLS. 100, 103 AND 106).

FOR: (BASED ON 44(E)) PROVIDING TELECOMMUNICATION CONNECTIONS TO A GLOBAL COMPUTER NETWORK; ELECTRONIC MAIL SERVICES; PROVIDING TELECOMMUNICATION CONNECTIONS TO THE INTERNET OR DATABASES; TRANSMISSION AND DISTRIBUTION OF DATA OR AUDIOVISUAL IMAGES VIA A GLOBAL COMPUTER NETWORK OR THE INTERNET; COMMUNICATION BY COMPUTER TERMINALS; DATA COMMUNICATION BY ELECTRONIC MAIL; INFORMATION TRANSMISSION VIA ELECTRONIC COMMUNICATION NETWORKS; ELECTRONIC MESSAGE SENDING; ELECTRONIC MESSAGE TRANSMISSION, IN CLASS 38 (U.S. CLS. 100, 101 AND 104).

FOR: (BASED ON 44(E)) DELIVERY OF GOODS BY AUTO, TRUCK, AIRPLANE, TRAIN, SHIP, AND COURIER, IN CLASS 39 (U.S. CLS. 100 AND 105).

THE MARK CONSISTS OF STANDARD CHARACTERS WITHOUT CLAIM TO ANY PARTICULAR FONT, STYLE, SIZE, OR COLOR.

OWNER OF FRANCE REG. NO. 099806224, DATED 8-3-1999, RENEWED AS REG. NO. 2400117, DATED 8-3-2009, EXPIRES 8-3-2019.

OWNER OF U.S. REG. NO. 2,668,329.

SN 77-611,358, FILED 11-10-2008.

MARK SPARACINO, EXAMINING ATTORNEY

United States of America

United States Patent and Trademark Office

BrilliantBody

Reg. No. 4,109,134

Registered Mar. 6, 2012

Int. Cl.: 41

SERVICE MARK

PRINCIPAL REGISTER

INSIGHT DYNAMICS, LLC (DELAWARE LIMITED LIABILITY COMPANY), DBA INSIGHT DYNAMICS,
11 KIRBY LANE
RYE, NY 105804307

FOR: EDUCATIONAL SERVICES, NAMELY, PROVIDING LIVE AND ON-LINE CLASSES, SEMINARS, WORKSHOPS, ONE-ON-ONE SESSIONS AND TRAINING IN THE FIELD OF HEALTH CARE AND PRACTICES IN THE FIELD OF SOMATIC MOVEMENT THERAPY; PRODUCTION OF A MULTIMEDIA TOOLKIT COMPRISING SOUND RECORDINGS, DVD AND ONLINE NON-DOWNLOADABLE INFORMATIONAL BROCHURES, NEWSLETTERS, AND ADVERTISEMENTS FEATURING INFORMATION IN THE FIELD OF SOMATIC MOVEMENT THERAPY; PUBLICATION OF BOOKS, WORKBOOKS, PRINTED INFORMATIONAL BROCHURES AND NEWSLETTERS IN THE FIELD OF SOMATIC MOVEMENT THERAPY, IN CLASS 41 (U.S. CLS. 100, 101 AND 107).

FIRST USE 5-31-2007; IN COMMERCE 9-30-2007.

THE MARK CONSISTS OF STANDARD CHARACTERS WITHOUT CLAIM TO ANY PARTICULAR FONT, STYLE, SIZE, OR COLOR.

SN 77-617,404, FILED 11-19-2008.

REGINA DRUMMOND, EXAMINING ATTORNEY



David J. Kyros

Director of the United States Patent and Trademark Office

United States of America

United States Patent and Trademark Office

BUILD YOUR OWN BUSINESS

Reg. No. 4,109,135

WILLIAMS, ALAN (UNITED STATES INDIVIDUAL)
2450 DEERFIELD DRIVE
KENNESAW, GA 30144

Registered Mar. 6, 2012

Int. Cl.: 28

FOR: EQUIPMENT SOLD AS A UNIT FOR PLAYING BOARD GAMES, IN CLASS 28 (U.S. CLS. 22, 23, 38 AND 50).

TRADEMARK

FIRST USE 12-2-2011; IN COMMERCE 12-2-2011.

PRINCIPAL REGISTER

THE MARK CONSISTS OF STANDARD CHARACTERS WITHOUT CLAIM TO ANY PARTICULAR FONT, STYLE, SIZE, OR COLOR.

SN 77-622,625, FILED 11-26-2008.

AMY HELLA, EXAMINING ATTORNEY



David J. Kybas

Director of the United States Patent and Trademark Office

United States of America

United States Patent and Trademark Office



Reg. No. 4,109,136

Registered Mar. 6, 2012

Int. Cl.: 25

TRADEMARK

PRINCIPAL REGISTER

THE ARMOR ALL/STP PRODUCTS COMPANY (DELAWARE CORPORATION)
1221 BROADWAY
OAKLAND, CA 94612

FOR: CAPS, IN CLASS 25 (U.S. CLS. 22 AND 39).

FIRST USE 8-5-2011; IN COMMERCE 8-5-2011.

OWNER OF U.S. REG. NOS. 929,938, 1,061,958, AND OTHERS.

THE COLOR(S) WHITE, RED, BLUE, BLACK AND GRAY IS/ARE CLAIMED AS A FEATURE OF THE MARK.

THE MARK CONSISTS OF THE COLOR WHITE APPEARS IN THE WORDING "STP" AND THE OUTLINE OF THE OVAL; THE COLOR RED APPEARS IN THE BACKGROUND OF THE OVAL; THE COLOR BLUE APPEARS IN THE OUTLINE OF THE WORDING "STP" AND THE BORDER OF THE OVAL; THE COLOR BLACK APPEARS IN THE OUTLINE OF THE WORDING "STP"; THE COLOR GRAY APPEARS IN THE OUTLINE OF THE WORDING "STP", THE BORDER OF THE OVAL AND THE OVAL'S SHADOW.

SN 77-622,712, FILED 11-26-2008.

LEIGH LOWRY, EXAMINING ATTORNEY



David J. Kyffers

Director of the United States Patent and Trademark Office

United States of America

United States Patent and Trademark Office

EMAGINEIF

Reg. No. 4,109,137

DONNELLY, CHAD (UNITED STATES INDIVIDUAL)
612 JASMINE AVE.

Registered Mar. 6, 2012

CORONA DEL MAR, CA 92625

Int. Cls.: 38 and 45

FOR: PROVIDING ON-LINE CHAT ROOMS AND ELECTRONIC BULLETIN BOARDS FOR TRANSMISSION OF MESSAGES AMONG USERS IN THE FIELD OF GENERAL INTEREST; PROVIDING EMAIL AND INSTANT MESSAGING SERVICES, IN CLASS 38 (U.S. CLS. 100, 101 AND 104).

SERVICE MARK

PRINCIPAL REGISTER

FIRST USE 6-30-2011; IN COMMERCE 6-30-2011.

FOR: ONLINE SOCIAL NETWORKING SERVICES, NAMELY, NETWORKING SERVICES FOR FAMILIES, IN CLASS 45 (U.S. CLS. 100 AND 101).

FIRST USE 6-30-2011; IN COMMERCE 6-30-2011.

THE MARK CONSISTS OF STANDARD CHARACTERS WITHOUT CLAIM TO ANY PARTICULAR FONT, STYLE, SIZE, OR COLOR.

SN 77-624,153, FILED 12-1-2008.

STEVEN JACKSON, EXAMINING ATTORNEY



David J. Kypos

Director of the United States Patent and Trademark Office

United States of America

United States Patent and Trademark Office

The Wisdom of Menopause

Reg. No. 4,109,138

Registered Mar. 6, 2012

Int. Cl.: 41

SERVICE MARK

PRINCIPAL REGISTER

CHRISTIANE NORTHRUP, INC. (MAINE CORPORATION)
12 PORTLAND STREET
YARMOUTH, ME 04096

FOR: PROVIDING ON-LINE PUBLICATIONS IN THE NATURE OF AN E-BOOK IN THE FIELD OF WOMEN'S HEALTH ISSUES, IN CLASS 41 (U.S. CLS. 100, 101 AND 107).

FIRST USE 12-27-2011; IN COMMERCE 12-27-2011.

THE MARK CONSISTS OF STANDARD CHARACTERS WITHOUT CLAIM TO ANY PARTICULAR FONT, STYLE, SIZE, OR COLOR.

OWNER OF U.S. REG. NO. 3,485,596.

NO CLAIM IS MADE TO THE EXCLUSIVE RIGHT TO USE "MENOPAUSE", APART FROM THE MARK AS SHOWN.

SN 77-624,838, FILED 12-2-2008.

ODESSA BIBBINS, EXAMINING ATTORNEY



David J. Kybas

Director of the United States Patent and Trademark Office

United States of America

United States Patent and Trademark Office

MR. SOUVLAKI

Reg. No. 4,109,139

MR. SOUVLAKI LTD. (CANADA LIMITED COMPANY (LTD.))
26 DAMIAN DRIVE
RICHMOND HILL, CANADA L4B3Z9

Registered Mar. 6, 2012

Int. Cl.: 43

FOR: FAST-FOOD RESTAURANTS; TAKE-OUT RESTAURANT SERVICES, IN CLASS 43
(U.S. CLS. 100 AND 101).

SERVICE MARK

FIRST USE 10-0-2011; IN COMMERCE 10-0-2011.

PRINCIPAL REGISTER

THE MARK CONSISTS OF STANDARD CHARACTERS WITHOUT CLAIM TO ANY PARTICULAR FONT, STYLE, SIZE, OR COLOR.

NO CLAIM IS MADE TO THE EXCLUSIVE RIGHT TO USE "SOUVLAKI", APART FROM THE MARK AS SHOWN.

THE NAME(S), PORTRAIT(S), AND/OR SIGNATURE(S) SHOWN IN THE MARK DOES NOT IDENTIFY A PARTICULAR LIVING INDIVIDUAL.

SN 77-631,158, FILED 12-11-2008.

SUSAN RICHARDS, EXAMINING ATTORNEY



David J. Kyros

Director of the United States Patent and Trademark Office

United States of America

United States Patent and Trademark Office

TIBION

Reg. No. 4,109,140

Registered Mar. 6, 2012

Int. Cl.: 10

TRADEMARK

PRINCIPAL REGISTER

TIBION CORPORATION (CALIFORNIA CORPORATION)
247 SANTA ANA COURT
SUNNYVALE, CA 94085

FOR: MEDICAL BRACES FOR KNEE; ORTHOPEDIC BRACES; ORTHOTICS EXERCISE MACHINES FOR THERAPEUTIC PURPOSES, IN CLASS 10 (U.S. CLS. 26, 39 AND 44).

FIRST USE 11-19-2009; IN COMMERCE 11-19-2009.

THE MARK CONSISTS OF STANDARD CHARACTERS WITHOUT CLAIM TO ANY PARTICULAR FONT, STYLE, SIZE, OR COLOR.

SN 77-632,458, FILED 12-12-2008.

MATTHEW PAPPAS, EXAMINING ATTORNEY



David J. Kyffers

Director of the United States Patent and Trademark Office

United States of America

United States Patent and Trademark Office

AT-EASE

Reg. No. 4,109,141

Registered Mar. 6, 2012

Int. Cl.: 5

TRADEMARK

PRINCIPAL REGISTER

HUMANETICS CORPORATION (MINNESOTA CORPORATION)
SUITE 770
1550 UTICA AVE. S.
MINNEAPOLIS, MN 55416

FOR: DIETARY SUPPLEMENTS, IN CLASS 5 (U.S. CLS. 6, 18, 44, 46, 51 AND 52).

FIRST USE 10-11-2011; IN COMMERCE 10-11-2011.

THE MARK CONSISTS OF STANDARD CHARACTERS WITHOUT CLAIM TO ANY PARTICULAR FONT, STYLE, SIZE, OR COLOR.

SN 77-632,866, FILED 12-15-2008.

SEAN CROWLEY, EXAMINING ATTORNEY



David J. Kybas

Director of the United States Patent and Trademark Office

United States of America

United States Patent and Trademark Office

THE TIDE



Reg. No. 4,109,142

Registered Mar. 6, 2012

Int. Cl.: 39

SERVICE MARK

PRINCIPAL REGISTER

TRANSPORTATION DISTRICT COMMISSION OF HAMPTON ROADS (VIRGINIA CORPORATION)
3400 VICTORIA BOULEVARD
HAMPTON, VA 23661

FOR: TRANSPORTATION OF PASSENGERS BY MEANS OF RAIL, IN CLASS 39 (U.S. CLS. 100 AND 105).

FIRST USE 1-1-2010; IN COMMERCE 8-29-2011.

THE MARK CONSISTS OF THE WORDING "THE TIDE" PLACED ABOVE A STYLIZED DEPICTION OF AN OCEAN WAVE FORMED BY TWO CURVED LINES.

SN 77-632,929, FILED 12-15-2008.

MICHAEL GAFFAR, EXAMINING ATTORNEY



David J. Kyffers

Director of the United States Patent and Trademark Office

United States of America

United States Patent and Trademark Office

THE TIDE

Reg. No. 4,109,143

Registered Mar. 6, 2012

Int. Cl.: 39

SERVICE MARK

PRINCIPAL REGISTER

TRANSPORTATION DISTRICT COMMISSION OF HAMPTON ROADS (VIRGINIA CORPORATION)
3400 VICTORIA BOULEVARD
HAMPTON, VA 23661

FOR: TRANSPORTATION OF PASSENGERS BY MEANS OF RAIL, IN CLASS 39 (U.S. CLS. 100 AND 105).

FIRST USE 1-1-2010; IN COMMERCE 8-29-2011.

THE MARK CONSISTS OF STANDARD CHARACTERS WITHOUT CLAIM TO ANY PARTICULAR FONT, STYLE, SIZE, OR COLOR.

SN 77-632,946, FILED 12-15-2008.

MICHAEL GAAFAR, EXAMINING ATTORNEY



David J. Kyros

Director of the United States Patent and Trademark Office

United States of America

United States Patent and Trademark Office

POROPLATE PROGRESSIEVE

Reg. No. 4,109,144

PUROLATOR FACET, INC. (DELAWARE CORPORATION)
8439 TRIAD DRIVE
GREENSBORO, NC 27409

Registered Mar. 6, 2012

Int. Cl.: 11

FOR: FILTERS AND DEMULSIFIERS, AND PARTS THEREFOR FOR PURIFYING FLUIDS,
IN CLASS 11 (U.S. CLS. 13, 21, 23, 31 AND 34).

TRADEMARK

FIRST USE 12-31-2009; IN COMMERCE 12-31-2009.

PRINCIPAL REGISTER

THE MARK CONSISTS OF STANDARD CHARACTERS WITHOUT CLAIM TO ANY PARTICULAR FONT, STYLE, SIZE, OR COLOR.

OWNER OF U.S. REG. NO. 793,342.

THE ENGLISH TRANSLATION OF "PROGRESSIEVE" IN THE MARK IS "PROGRESSIVE".

SN 77-633,456, FILED 12-15-2008.

JACQUELINE A. LAVINE, EXAMINING ATTORNEY



David J. Kybas

Director of the United States Patent and Trademark Office

United States of America

United States Patent and Trademark Office

THE ELDER SCROLLS

Reg. No. 4,109,145

ZENIMAX MEDIA INC. (DELAWARE CORPORATION)
1370 PICCARD DRIVE
ROCKVILLE, MD 20850

Registered Mar. 6, 2012

Int. Cl.: 9

FOR: PRE-RECORDED CDS AND DVDS FEATURING MUSIC; MOTION PICTURE FILMS
FEATURING FANTASY GAMES, IN CLASS 9 (U.S. CLS. 21, 23, 26, 36 AND 38).

TRADEMARK

FIRST USE 5-1-2002; IN COMMERCE 5-1-2002.

PRINCIPAL REGISTER

THE MARK CONSISTS OF STANDARD CHARACTERS WITHOUT CLAIM TO ANY PAR-
TICULAR FONT, STYLE, SIZE, OR COLOR.

OWNER OF U.S. REG. NOS. 1,943,732, 3,375,520, AND OTHERS.

SN 77-635,645, FILED 12-18-2008.

DARRYL SPRUILL, EXAMINING ATTORNEY



David J. Kybas

Director of the United States Patent and Trademark Office

United States of America

United States Patent and Trademark Office



Reg. No. 4,109,146

Registered Mar. 6, 2012

Int. Cls.: 5 and 32

TRADEMARK

PRINCIPAL REGISTER

COURAGE SPORTS, INC. (NEVADA CORPORATION)
P.O. BOX 1493
FAIRACRES, NM 88033

FOR: NUTRITIONAL DRINKS FOR MEAL REPLACEMENT AND NUTRITIONAL SUPPLEMENTS, IN CLASS 5 (U.S. CLS. 6, 18, 44, 46, 51 AND 52).

FIRST USE 1-4-2012; IN COMMERCE 1-4-2012.

FOR: SPORTS DRINKS, IN CLASS 32 (U.S. CLS. 45, 46 AND 48).

FIRST USE 1-4-2012; IN COMMERCE 1-4-2012.

THE MARK CONSISTS OF THE CHINESE SYMBOL FOR COURAGE.

THE NON-LATIN CHARACTERS IN THE MARK TRANSLITERATE TO YONG AND THIS MEANS COURAGE IN ENGLISH.

SN 77-637,290, FILED 12-19-2008.

JENNIFER VASQUEZ, EXAMINING ATTORNEY



David J. Kyros

Director of the United States Patent and Trademark Office

United States of America

United States Patent and Trademark Office

ARGUS SUBSEA

Reg. No. 4,109,147

Registered Mar. 6, 2012

Int. Cls.: 7, 9, and 37

TRADEMARK

SERVICE MARK

PRINCIPAL REGISTER

GALATHEA GROUP, INC. (DELAWARE CORPORATION)
2800 POST OAK BLVD.
SUITE 2000
HOUSTON, TX 77056

FOR: OIL WELL PUMPING MACHINES FOR BOTH SURFACE AND SUBSEA APPLICATIONS, AND MANIFOLDS AND CONNECTORS FOR OIL WELL PUMPING MACHINES; REPLACEMENT PARTS FOR OIL-WELL PUMPING MACHINES FOR BOTH SURFACE AND SUBSEA APPLICATIONS, NAMELY, VALVES, CASING HANGERS, CASING HEADS, TUBING HEADS, TUBING HANGERS, COILED TUBING CONNECTORS, CHOKES, AND FLANGE PROTECTORS; REMOTE UNDERWATER OIL WELL PUMPING MACHINE COMPLETION SYSTEMS COMPRISED OF WELLHEADS, REMOTE FLOWLINE COILED TUBING CONNECTORS, REMOTE COILED TUBING CONNECTORS AND OILFIELD EQUIPMENT IN THE NATURE OF CHRISTMAS TREES COMPRISED OF PRESSURE GAUGES AND SAFETY VALVES FOR FLOW SHUTOFF IN OIL WELL CONSTRUCTION; HYDRAULIC CONTROL SYSTEMS FOR OIL PRODUCTION AND DRILLING MACHINES, COMPRISED OF HYDRAULIC CONTROLS, VALVES, TUBING HANGERS, CONNECTORS AND CHOKES, IN CLASS 7 (U.S. CLS. 13, 19, 21, 23, 31, 34 AND 35).

FIRST USE 5-31-2009; IN COMMERCE 2-20-2010.



FOR: OILFIELD EQUIPMENT FOR BOTH SURFACE AND SUBSEA APPLICATIONS, NAMELY, CONTROL VALVES AND FLOW REGULATORS FOR REGULATING THE FLOW OF LIQUID PETROLEUM; OILFIELD EQUIPMENT IN THE NATURE OF CHRISTMAS TREES COMPRISED OF PRESSURE GAUGES AND SAFETY VALVES FOR FLOW SHUTOFF IN OIL WELL CONSTRUCTION; ELECTRO-HYDRAULIC CONTROL SYSTEMS FOR OIL PRODUCTION AND DRILLING MACHINES, COMPRISED OF ELECTRO-HYDRAULIC CONTROLS, VALVES, TUBING HANGERS, CONNECTORS AND CHOKES, IN CLASS 9 (U.S. CLS. 21, 23, 26, 36 AND 38).

FIRST USE 5-31-2009; IN COMMERCE 2-20-2010.

FOR: INSTALLATION OF SUBSEA OILFIELD EQUIPMENT DURING DRILLING, PRODUCTION AND WORKOVER INTERVENTION ACTIVITIES, AND CONSULTATION RELATED THERETO, IN CLASS 37 (U.S. CLS. 100, 103 AND 106).

FIRST USE 5-31-2009; IN COMMERCE 2-20-2010.

David J. Kyros

Director of the United States Patent and Trademark Office

Reg. No. 4,109,147 THE MARK CONSISTS OF STANDARD CHARACTERS WITHOUT CLAIM TO ANY PARTICULAR FONT, STYLE, SIZE, OR COLOR.

NO CLAIM IS MADE TO THE EXCLUSIVE RIGHT TO USE "SUBSEA", APART FROM THE MARK AS SHOWN.

SN 77-639,239, FILED 12-23-2008.

STEVEN R. FINE, EXAMINING ATTORNEY

United States of America

United States Patent and Trademark Office

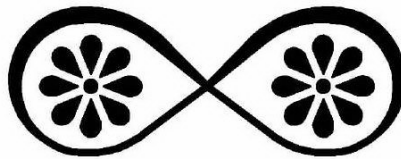

INFINITY FLOWER

Reg. No. 4,109,148

Registered Mar. 6, 2012

Int. Cl.: 25

TRADEMARK

PRINCIPAL REGISTER

EVA KLEIN BOUHASSIRA (NEW YORK SOLE PROPRIETORSHIP), DBA INFINITY FLOWER,
50 HAMILTON AVENUE
HASTINGS ON HUDSON, NY 10706

FOR: BATHROBES; BELTS; BLOUSES; BOTTOMS; COATS; FOOTWEAR; HEAD WEAR; HOODED SWEAT SHIRTS; INFANT WEAR; JACKETS; JEANS; LADIES' SUITS; NECKWEAR; PANTS; PULLOVERS; SCARVES; SHIRTS; SHORT-SLEEVED OR LONG-SLEEVED T-SHIRTS; SHORTS; SKIRT SUITS; SKIRTS AND DRESSES; SLEEPWEAR; SOCKS AND STOCKINGS; SWEAT PANTS; SWEAT SHIRTS; SWEAT SUITS; SWEATERS; SWIMWEAR; TANK TOPS; TEE SHIRTS; TENNIS WEAR; TOPS; UNDERWEAR, IN CLASS 25 (U.S. CLS. 22 AND 39).

FIRST USE 1-11-2012; IN COMMERCE 1-11-2012.

THE MARK CONSISTS OF "INFINITY FLOWER" AND TWO STYLIZED FLOWERS INSIDE AN INFINITY SYMBOL.

SN 77-640,278, FILED 12-28-2008.

PAUL E. FAHRENKOPF, EXAMINING ATTORNEY



David J. Kyffers

Director of the United States Patent and Trademark Office

United States of America

United States Patent and Trademark Office

ICONOCLAST

Reg. No. 4,109,149

Registered Mar. 6, 2012

Int. Cl.: 33

TRADEMARK

PRINCIPAL REGISTER

RUTHERFORD HILL WINERY (CALIFORNIA CORPORATION)
200 RUTHERFORD HILL ROAD
RUTHERFORD, CA 94573

FOR: WINE, IN CLASS 33 (U.S. CLS. 47 AND 49).

FIRST USE 12-0-2011; IN COMMERCE 12-0-2011.

THE MARK CONSISTS OF STANDARD CHARACTERS WITHOUT CLAIM TO ANY PARTICULAR FONT, STYLE, SIZE, OR COLOR.

SN 77-643,904, FILED 1-6-2009.

RENEE MCCRAY, EXAMINING ATTORNEY



David J. Kybas

Director of the United States Patent and Trademark Office

United States of America

United States Patent and Trademark Office

MrsMuzik

Reg. No. 4,109,150

Registered Mar. 6, 2012

Int. Cl.: 25

TRADEMARK

PRINCIPAL REGISTER

BACO, ARBELLA (CANADA INDIVIDUAL)
P.O. BOX 101
ELMA, NY 14059 AND

YAKO, SHAMIRAN (CANADA INDIVIDUAL)
P. O. BOX 101
ELMA, NY 14059

FOR: CLOTHING, NAMELY, T-SHIRTS, POLO SHIRTS, FLEECE T-SHIRTS, FLEECE SHIRTS,
APRONS, HATS AND SWEATSHIRTS, IN CLASS 25 (U.S. CLS. 22 AND 39).

FIRST USE 6-15-2011; IN COMMERCE 10-5-2011.

THE MARK CONSISTS OF STANDARD CHARACTERS WITHOUT CLAIM TO ANY PARTICULAR FONT, STYLE, SIZE, OR COLOR.

SN 77-644,727, FILED 1-7-2009.

SAIMA MAKHDOOM, EXAMINING ATTORNEY



David J. Kybas

Director of the United States Patent and Trademark Office

United States of America

United States Patent and Trademark Office

Ground Rules

Reg. No. 4,109,151

Registered Mar. 6, 2012

Int. Cls.: 1 and 31

TRADEMARK

PRINCIPAL REGISTER

CONRAD FAFARD, INC. (MASSACHUSETTS CORPORATION)
711 SILVER STREET
AGAWAM, MA 01001

FOR: PEAT; POTTING SOIL; POTTING COMPOST; MANURE; SOIL AMENDMENTS; AND SOIL CONDITIONERS FOR HORTICULTURAL USE, IN CLASS 1 (U.S. CLS. 1, 5, 6, 10, 26 AND 46).

FIRST USE 12-1-2010; IN COMMERCE 12-1-2010.

FOR: TOP SOIL; MULCH; AND RAW BARK, IN CLASS 31 (U.S. CLS. 1 AND 46).

FIRST USE 12-1-2010; IN COMMERCE 12-1-2010.

THE MARK CONSISTS OF STANDARD CHARACTERS WITHOUT CLAIM TO ANY PARTICULAR FONT, STYLE, SIZE, OR COLOR.

SN 77-645,642, FILED 1-8-2009.

LANA PHAM, EXAMINING ATTORNEY



David J. Kybas

Director of the United States Patent and Trademark Office

United States of America

United States Patent and Trademark Office

GREENBELT

Reg. No. 4,109,152

Registered Mar. 6, 2012

Int. Cl.: 19

TRADEMARK

PRINCIPAL REGISTER

HARDWOODS SPECIALTY PRODUCTS LP (CANADA LIMITED PARTNERSHIP,
ORGANIZED UNDER THE LAWS OF THE PROVINCE OF MANITOBA, CANADA)
9440 202ND STREET, SUITE 306
LANGLEY, BC, CANADA V1M4A6

FOR: WOOD PRODUCTS, NAMELY, PLYWOOD, FIBER BOARD, PARTICLE BOARD,
HARDWOOD LUMBER, AND MOLDINGS, IN CLASS 19 (U.S. CLS. 1, 12, 33 AND 50).

FIRST USE 10-0-2010; IN COMMERCE 10-0-2010.

THE MARK CONSISTS OF STANDARD CHARACTERS WITHOUT CLAIM TO ANY PAR-
TICULAR FONT, STYLE, SIZE, OR COLOR.

SN 77-646,714, FILED 1-9-2009.

SARA BENJAMIN, EXAMINING ATTORNEY



David J. Kyffers

Director of the United States Patent and Trademark Office

United States of America

United States Patent and Trademark Office



mr. recipe

Reg. No. 4,109,153

Registered Mar. 6, 2012

Int. Cl.: 30

TRADEMARK

PRINCIPAL REGISTER

MR. RECIPE, LLC (NEW YORK LIMITED LIABILITY COMPANY)
454 HOPI CT.
NEW YORK, NY 109014126

FOR: SPICE BLENDS, CAYENNE PEPPER; VANILLA, VANILLA BEANS, GROUND VANILLA BEANS, VANILLA EXTRACT, VANILLA PASTE, SPICES, GROUND PEPPER, PEPPER SPICES, IN CLASS 30 (U.S. CL. 46).

FIRST USE 0-0-2007; IN COMMERCE 0-0-2007.

OWNER OF U.S. REG. NO. 2,903,847.

THE MARK CONSISTS OF A STYLIZED REPRESENTATION OF A CHEF WITH A LONG, CURLING MUSTACHE, WEARING A CHEF'S HAT AND EXTENDING HIS RIGHT ARM TO HOLD OUT A COVERED PLATE, WITH THE LOWER CASE WORDING "MR. RECIPE" APPEARING TO THE RIGHT.

SN 77-651,755, FILED 1-17-2009.

KRISTIN CARLSON, EXAMINING ATTORNEY



David J. Kybas

Director of the United States Patent and Trademark Office

United States of America

United States Patent and Trademark Office

RAY

Reg. No. 4,109,154

Registered Mar. 6, 2012

Int. Cl.: 20

TRADEMARK

PRINCIPAL REGISTER

ALLSEATING CORPORATION (CANADA CORPORATION)
UNIT 3
5800 AVEBURY ROAD
MISSISSAUGA, CANADA L5R3M3

FOR: FURNITURE, NAMELY, CHAIRS NOT RELATING TO SPORTS OR A SPORTS TEAM,
IN CLASS 20 (U.S. CLS. 2, 13, 22, 25, 32 AND 50).

FIRST USE 6-1-2009; IN COMMERCE 6-1-2009.

THE MARK CONSISTS OF STANDARD CHARACTERS WITHOUT CLAIM TO ANY PAR-
TICULAR FONT, STYLE, SIZE, OR COLOR.

SN 77-653,132, FILED 1-21-2009.

DAVID TAYLOR, EXAMINING ATTORNEY



David J. Kyfos

Director of the United States Patent and Trademark Office

United States of America

United States Patent and Trademark Office

RUSSIAN STANDARD GOLD

Reg. No. 4,109,155

Registered Mar. 6, 2012

Int. Cl.: 33

TRADEMARK

PRINCIPAL REGISTER

RUSSIAN STANDARD INTELLECTUAL PROPERTY HOLDING AG (SWITZERLAND CORPORATION)
ZUGERSTRASSE 49
CHAM, SWITZERLAND 6330

FOR: ALCOHOLIC BEVERAGES, NAMELY, VODKA, IN CLASS 33 (U.S. CLS. 47 AND 49).

FIRST USE 8-0-2011; IN COMMERCE 8-0-2011.

THE MARK CONSISTS OF STANDARD CHARACTERS WITHOUT CLAIM TO ANY PARTICULAR FONT, STYLE, SIZE, OR COLOR.

OWNER OF U.S. REG. NOS. 2,561,253, 3,565,846, AND OTHERS.

NO CLAIM IS MADE TO THE EXCLUSIVE RIGHT TO USE "RUSSIAN", APART FROM THE MARK AS SHOWN.

SN 77-658,671, FILED 1-28-2009.

JANICE KIM, EXAMINING ATTORNEY



David J. Kybas

Director of the United States Patent and Trademark Office

United States of America

United States Patent and Trademark Office

WELLFIT

Reg. No. 4,109,156

INFINITI CLASSICS INTERNATIONAL, INC. (NEW YORK CORPORATION)
1365 - 38TH STREET
BROOKLYN, NY 11218

Registered Mar. 6, 2012

Int. Cl.: 25

FOR: SOCKS, HOSIERY, BODY WEAR, NAMELY, PANTIES, UNDERSHIRTS, CAMISOLES, BRAS, BODY SUITS, GLOVES AND SCARVES, IN CLASS 25 (U.S. CLS. 22 AND 39).

TRADEMARK

FIRST USE 11-1-2011; IN COMMERCE 11-1-2011.

PRINCIPAL REGISTER

THE MARK CONSISTS OF STANDARD CHARACTERS WITHOUT CLAIM TO ANY PARTICULAR FONT, STYLE, SIZE, OR COLOR.

SN 77-661,050, FILED 2-2-2009.

LOURDES AYALA, EXAMINING ATTORNEY



David J. Kybas

Director of the United States Patent and Trademark Office

United States of America

United States Patent and Trademark Office

CONTAGIOUS WILDS

Reg. No. 4,109,157

Registered Mar. 6, 2012

Int. Cl.: 9

TRADEMARK

PRINCIPAL REGISTER

ARISTOCRAT TECHNOLOGIES AUSTRALIA PTY LTD (AUSTRALIA CORPORATION)
BUILDING A, PINNACLE OFFICE PARK
85 EPPING ROAD
NORTH RYDE, NSW, AUSTRALIA 2113

FOR: SOFTWARE FEATURE OF GAMING MACHINES THAT WHEN SYMBOLS CONNECT, NEXT TO ONE ANOTHER, OR AT BORDERS OR DIAGONAL BORDERS, CERTAIN OTHER SYMBOLS TURN WILD, IN CLASS 9 (U.S. CLS. 21, 23, 26, 36 AND 38).

FIRST USE 9-1-2009; IN COMMERCE 9-1-2009.

THE MARK CONSISTS OF STANDARD CHARACTERS WITHOUT CLAIM TO ANY PARTICULAR FONT, STYLE, SIZE, OR COLOR.

PRIORITY CLAIMED UNDER SEC. 44(D) ON AUSTRALIA APPLICATION NO. 1257075, FILED 8-14-2008, REG. NO. 1257075, DATED 8-14-2008, EXPIRES 8-14-2018.

SN 77-662,235, FILED 2-3-2009.

SUSAN RICHARDS, EXAMINING ATTORNEY



David J. Kyros

Director of the United States Patent and Trademark Office

United States of America

United States Patent and Trademark Office

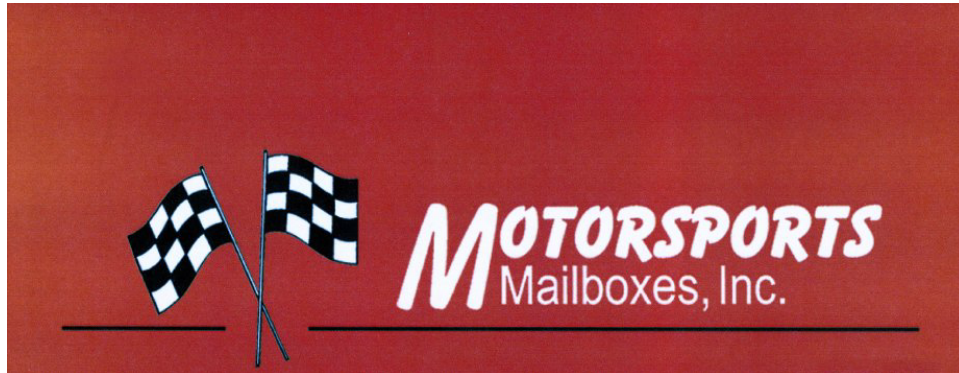

Reg. No. 4,109,158

Registered Mar. 6, 2012

Int. Cl.: 20

MOTORSPORTS MAILBOXES, INC. (ILLINOIS CORPORATION)
112 LANDMARK DRIVE
SUITE B
NORMAL, IL 61761

FOR: NON-METAL MAILBOXES, IN CLASS 20 (U.S. CLS. 2, 13, 22, 25, 32 AND 50).

TRADEMARK

FIRST USE 11-17-2011; IN COMMERCE 11-17-2011.

PRINCIPAL REGISTER

NO CLAIM IS MADE TO THE EXCLUSIVE RIGHT TO USE "MAILBOXES INC.", APART FROM THE MARK AS SHOWN.

THE COLOR(S) BLACK, GRAY, WHITE AND RED IS/ARE CLAIMED AS A FEATURE OF THE MARK.

THE MARK CONSISTS OF THE WORDING "MOTORSPORTS MAILBOXES, INC.", A DESIGN OF CROSSED CHECKERED FLAGS, AND UNDERSCORING. THE COLOR WHITE APPEARS IN THE WORDING "MOTORSPORTS MAILBOXES, INC." AND HALF OF THE CHECKS ON THE FLAGS. THE COLOR BLACK APPEARS IN THE REMAINING CHECKS AND THE UNDERSCORING. THE COLOR GRAY APPEARS ON THE FLAGS' STAFFS. THE COLOR RED APPEARS IN THE BACKGROUND.

SN 77-666,086, FILED 2-9-2009.

ALLISON HOLTZ, EXAMINING ATTORNEY



David J. Kybas

Director of the United States Patent and Trademark Office

United States of America

United States Patent and Trademark Office

PRUDENTIAL INCOMEFLEX SELECT

Reg. No. 4,109,159

Registered Mar. 6, 2012

Int. Cl.: 36

SERVICE MARK

PRINCIPAL REGISTER

THE PRUDENTIAL INSURANCE COMPANY OF AMERICA (NEW JERSEY CORPORATION)
751 BROAD STREET
NEWARK, NJ 07102

FOR: FINANCIAL SERVICES, NAMELY, UNDERWRITING AND ADMINISTERING ANNUITIES AND DEFINED CONTRIBUTION PLANS; INVESTMENT SERVICES, NAMELY, INVESTMENT MANAGEMENT SERVICES FOR FUNDING RETIREMENT; AND RETIREMENT SERVICES, NAMELY, INVESTMENT, PLANNING AND ADMINISTERING RETIREMENT PLANS, IN CLASS 36 (U.S. CLS. 100, 101 AND 102).

FIRST USE 1-15-2009; IN COMMERCE 1-15-2009.

THE MARK CONSISTS OF STANDARD CHARACTERS WITHOUT CLAIM TO ANY PARTICULAR FONT, STYLE, SIZE, OR COLOR.

OWNER OF U.S. REG. NOS. 1,580,456, 3,522,211, AND OTHERS.

SN 77-669,862, FILED 2-13-2009.

ANN E. SAPPENFIELD, EXAMINING ATTORNEY



David J. Kyjars

Director of the United States Patent and Trademark Office

United States of America

United States Patent and Trademark Office

SANI 3

Reg. No. 4,109,160

SOCIETE FRANCAISE D'ASSAINISSEMENT-SFA (FRANCE SOCIÉTÉ ANONYME (SA))
8 RUE D'ABOUKIR
75002 PARIS, FRANCE

Registered Mar. 6, 2012

Int. Cls.: 7 and 11

FOR: SHREDDERS FOR WATER CLOSETS; MINI-PUMPING STATIONS, NAMELY, SHREDDER WATER-PUMPS, IN CLASS 7 (U.S. CLS. 13, 19, 21, 23, 31, 34 AND 35).

TRADEMARK

FIRST USE 7-1-2011; IN COMMERCE 7-1-2011.

PRINCIPAL REGISTER

FOR: SANITARY INSTALLATIONS, NAMELY, TOILETS AND PARTS THEREFOR, NAMELY, FLUSHING APPARATUS, NAMELY, LEVERS, TOILET BOWLS, FLUSHING HANDLES, WATER TANKS AND TOILET SEATS, AND WASHBASINS, MACERATOR AND UPFLUSH TOILETS, IN CLASS 11 (U.S. CLS. 13, 21, 23, 31 AND 34).

FIRST USE 7-1-2011; IN COMMERCE 7-1-2011.

THE MARK CONSISTS OF STANDARD CHARACTERS WITHOUT CLAIM TO ANY PARTICULAR FONT, STYLE, SIZE, OR COLOR.

SN 77-670,387, FILED 2-13-2009.

NORA BUCHANAN WILL, EXAMINING ATTORNEY



David J. Kybas

Director of the United States Patent and Trademark Office

United States of America

United States Patent and Trademark Office

IMPOSSIBLE ODDS FOUNDATION

Reg. No. 4,109,161

Registered Mar. 6, 2012

Int. Cl.: 36

SERVICE MARK

PRINCIPAL REGISTER

IMPOSSIBLE ODDS FOUNDATION, INC. (KENTUCKY CORPORATION)
33 WRIGHT COURT
ALEXANDRIA, KY 41001

FOR: CHARITABLE FUNDRAISING SERVICES, IN CLASS 36 (U.S. CLS. 100, 101 AND 102).

FIRST USE 1-1-2012; IN COMMERCE 1-1-2012.

THE MARK CONSISTS OF STANDARD CHARACTERS WITHOUT CLAIM TO ANY PARTICULAR FONT, STYLE, SIZE, OR COLOR.

NO CLAIM IS MADE TO THE EXCLUSIVE RIGHT TO USE "FOUNDATION", APART FROM THE MARK AS SHOWN.

SN 77-675,023, FILED 2-20-2009.

IRA J. GOODSaid, EXAMINING ATTORNEY



David J. Kybas

Director of the United States Patent and Trademark Office

United States of America

United States Patent and Trademark Office

NEVERMIND

Reg. No. 4,109,162

SUZHOU HUA JIN KNITTING CO., LTD. (CALIFORNIA CORPORATION)
463 PUBEI ROAD LUXU TOWN
WUJIANG CITY, CHINA

Registered Mar. 6, 2012

Int. Cl.: 25

FOR: JEANS, IN CLASS 25 (U.S. CLS. 22 AND 39).

TRADEMARK

FIRST USE 3-4-2011; IN COMMERCE 3-4-2011.

PRINCIPAL REGISTER

THE MARK CONSISTS OF STANDARD CHARACTERS WITHOUT CLAIM TO ANY PARTICULAR FONT, STYLE, SIZE, OR COLOR.

SN 77-684,332, FILED 3-5-2009.

SUE LAWRENCE, EXAMINING ATTORNEY



David J. Kyffers

Director of the United States Patent and Trademark Office

United States of America

United States Patent and Trademark Office

COLD WATER NOW

Reg. No. 4,109,163

EMERSON ELECTRIC CO. (MISSOURI CORPORATION)
8000 WEST FLORISSANT AVE.
ST. LOUIS, MO 63136

Registered Mar. 6, 2012

Int. Cl.: 11

FOR: WATER DISPENSING UNITS FOR DOMESTIC USE COMPRISED PRIMARILY OF FAUCET, WATER TANK, COLD WATER CHILLER UNITS, WATER FILTERING UNITS, AND COMPONENT PARTS THEREFOR, SOLD AS A UNIT; WATER DISPENSING UNITS FOR DOMESTIC USE COMPRISED PRIMARILY OF FAUCET, WATER TANK, COLD WATER CHILLER UNITS, AND COMPONENT PARTS THEREFOR, SOLD AS A UNIT, IN CLASS 11 (U.S. CLS. 13, 21, 23, 31 AND 34).

TRADEMARK

PRINCIPAL REGISTER

FIRST USE 10-30-2009; IN COMMERCE 10-30-2011.

THE MARK CONSISTS OF STANDARD CHARACTERS WITHOUT CLAIM TO ANY PARTICULAR FONT, STYLE, SIZE, OR COLOR.

NO CLAIM IS MADE TO THE EXCLUSIVE RIGHT TO USE "COLD WATER", APART FROM THE MARK AS SHOWN.

SN 77-688,101, FILED 3-11-2009.

KAREN BRACEY, EXAMINING ATTORNEY



David J. Kyffers

Director of the United States Patent and Trademark Office

United States of America

United States Patent and Trademark Office

VIVE TU MUSICA WITH 5

Reg. No. 4,109,164

WM. WRIGLEY JR. COMPANY (DELAWARE CORPORATION)
410 NORTH MICHIGAN AVENUE
CHICAGO, IL 60611

Registered Mar. 6, 2012

Int. Cl.: 35

FOR: ADVERTISING AND PROMOTIONAL SERVICES, IN CLASS 35 (U.S. CLS. 100, 101 AND 102).

SERVICE MARK

FIRST USE 7-0-2010; IN COMMERCE 7-0-2010.

PRINCIPAL REGISTER

THE MARK CONSISTS OF STANDARD CHARACTERS WITHOUT CLAIM TO ANY PARTICULAR FONT, STYLE, SIZE, OR COLOR.

THE ENGLISH TRANSLATION OF "VIVE TU MUSICA" IN THE MARK IS LIVE YOUR MUSIC.

SN 77-690,904, FILED 3-13-2009.

CIMMERIAN COLEMAN, EXAMINING ATTORNEY



David J. Kybas

Director of the United States Patent and Trademark Office

United States of America

United States Patent and Trademark Office

SWITCH & SERVE

Reg. No. 4,109,165

Registered Mar. 6, 2012

Int. Cls.: 8 and 21

TRADEMARK

PRINCIPAL REGISTER

WILD EYE DESIGNS INC. (FLORIDA CORPORATION)
5380 N OCEAN DR. EASTPOINT II 3J
SINGER ISLAND, FL 33404

FOR: KITCHEN UTENSILS, NAMELY, SALAD SPOONS, SALAD FORKS, APPETIZER FORKS, DESSERT FORKS, RICE SPOONS, TEA SPOONS, SUGAR SCOOPS AND SPOONS, RICE SCOOPS, CAKE AND PIE CUTTERS, CHEESE SLICERS AND CHEESE PLANES, IN CLASS 8 (U.S. CLS. 23, 28 AND 44).

FIRST USE 11-10-2011; IN COMMERCE 11-10-2011.

FOR: KITCHEN UTENSILS, NAMELY, TONGS, LADLES, NAMELY, SOUP LADLES, SAUCE LADLES, ICE CREAM SCOOPS, ICE SCOOPS; JAPANESE STYLE COOKED RICE SCOOPS (SHAMOJI); MIXING SPOONS, BASTING SPOONS, SLOTTED SPOONS AND SKIMMERS, WHISKS, PASTA SERVING FORKS, CAKE AND PIE LIFTERS, VEGETABLE MASHERS, IN CLASS 21 (U.S. CLS. 2, 13, 23, 29, 30, 33, 40 AND 50).

FIRST USE 11-10-2011; IN COMMERCE 11-10-2011.

THE MARK CONSISTS OF STANDARD CHARACTERS WITHOUT CLAIM TO ANY PARTICULAR FONT, STYLE, SIZE, OR COLOR.

NO CLAIM IS MADE TO THE EXCLUSIVE RIGHT TO USE "SERVE", APART FROM THE MARK AS SHOWN.

SN 77-691,284, FILED 3-15-2009.

ROBERT C. CLARK JR., EXAMINING ATTORNEY



David J. Kybas

Director of the United States Patent and Trademark Office

United States of America

United States Patent and Trademark Office

INVITE

Reg. No. 4,109,166

Registered Mar. 6, 2012

Int. Cl.: 7

TRADEMARK

PRINCIPAL REGISTER

EMERSON ELECTRIC CO. (MISSOURI CORPORATION)
8000 WEST FLORISSANT AVE.
ST. LOUIS, MO 63136

FOR: WATER DISPENSING UNITS FOR DOMESTIC USE COMPRISED PRIMARILY OF FAUCET, WATER TANK, HOT WATER HEATER UNITS, WATER FILTERING UNITS, AND COMPONENT PARTS THEREFOR, SOLD AS A UNIT; WATER DISPENSING UNITS FOR DOMESTIC USE COMPRISED PRIMARILY OF FAUCET, WATER TANK, HOT WATER HEATER UNITS, AND COMPONENT PARTS THEREFOR, SOLD AS A UNIT, IN CLASS 7 (U.S. CLS. 13, 19, 21, 23, 31, 34 AND 35).

FIRST USE 1-15-2010; IN COMMERCE 10-30-2011.

THE MARK CONSISTS OF STANDARD CHARACTERS WITHOUT CLAIM TO ANY PARTICULAR FONT, STYLE, SIZE, OR COLOR.

SN 77-693,930, FILED 3-18-2009.

KAREN BRACEY, EXAMINING ATTORNEY



David J. Kybas

Director of the United States Patent and Trademark Office

United States of America

United States Patent and Trademark Office

INVOLVE

Reg. No. 4,109,167

EMERSON ELECTRIC CO. (MISSOURI CORPORATION)
8000 WEST FLORISSANT AVE.
ST. LOUIS, MO 63136

Registered Mar. 6, 2012

Int. Cl.: 7

FOR: WATER DISPENSING UNITS FOR DOMESTIC USE COMPRISED PRIMARILY OF FAUCET, WATER TANK, HOT WATER HEATER UNITS, WATER FILTERING UNITS, AND COMPONENT PARTS THEREFOR, SOLD AS A UNIT; WATER DISPENSING UNITS FOR DOMESTIC USE COMPRISED PRIMARILY OF FAUCET, WATER TANK, HOT WATER HEATER UNITS, AND COMPONENT PARTS THEREFOR, SOLD AS A UNIT, IN CLASS 7 (U.S. CLS. 13, 19, 21, 23, 31, 34 AND 35).

TRADEMARK

PRINCIPAL REGISTER

FIRST USE 1-15-2010; IN COMMERCE 10-30-2011.

THE MARK CONSISTS OF STANDARD CHARACTERS WITHOUT CLAIM TO ANY PARTICULAR FONT, STYLE, SIZE, OR COLOR.

SN 77-693,932, FILED 3-18-2009.

KAREN BRACEY, EXAMINING ATTORNEY



David J. Kyffers

Director of the United States Patent and Trademark Office

United States of America

United States Patent and Trademark Office

COMMONKINDNESS

Reg. No. 4,109,168

Registered Mar. 6, 2012

Int. Cls.: 35 and 36

SERVICE MARK

PRINCIPAL REGISTER

COMMONKINDNESS, INC. (DELAWARE CORPORATION)
15 CENTRAL AVE
SAUSALITO, CA 94965

FOR: PROVIDING ADVERTISING AND PROMOTIONAL SERVICES, NAMELY, PROVIDING A WEBSITE FEATURING COUPONS FOR USE WITH THIRD-PARTY RETAILERS, IN CLASS 35 (U.S. CLS. 100, 101 AND 102).

FIRST USE 11-1-2008; IN COMMERCE 9-1-2009.

FOR: PROVIDING A WEBSITE THAT ACCEPTS AND ADMINISTERS MONETARY CHARITABLE CONTRIBUTIONS TO NON-PROFIT ORGANIZATIONS ON BEHALF OF MEMBERS WHO PATRONIZE PARTICIPATING RETAILERS, IN CLASS 36 (U.S. CLS. 100, 101 AND 102).

FIRST USE 11-1-2008; IN COMMERCE 9-1-2009.

THE MARK CONSISTS OF STANDARD CHARACTERS WITHOUT CLAIM TO ANY PARTICULAR FONT, STYLE, SIZE, OR COLOR.

SN 77-694,421, FILED 3-19-2009.

MARK RADEMACHER, EXAMINING ATTORNEY



David J. Kybas

Director of the United States Patent and Trademark Office

United States of America

United States Patent and Trademark Office

SEAL MULTI

Reg. No. 4,109,169

Registered Mar. 6, 2012

Int. Cl.: 5

TRADEMARK

PRINCIPAL REGISTER

DE BIE, JEREMY (UNITED STATES INDIVIDUAL)
PO BOX 231
SEAL BEACH, CA 90740

FOR: NUTRITIONAL SUPPLEMENTS, IN CLASS 5 (U.S. CLS. 6, 18, 44, 46, 51 AND 52).

FIRST USE 1-1-2010; IN COMMERCE 1-1-2010.

THE MARK CONSISTS OF STANDARD CHARACTERS WITHOUT CLAIM TO ANY PARTICULAR FONT, STYLE, SIZE, OR COLOR.

NO CLAIM IS MADE TO THE EXCLUSIVE RIGHT TO USE "MULTI", APART FROM THE MARK AS SHOWN.

SN 77-696,164, FILED 3-20-2009.

SUNG IN, EXAMINING ATTORNEY



David J. Kyffers

Director of the United States Patent and Trademark Office

United States of America

United States Patent and Trademark Office

ROYAL TRASH

Reg. No. 4,109,170

Registered Mar. 6, 2012

Int. Cl.: 25

TRADEMARK

PRINCIPAL REGISTER

OWCZAREK, JAKUB (POLAND INDIVIDUAL)
PO BOX 17771
ENCINO, CA 91416

FOR: T-SHIRTS, IN CLASS 25 (U.S. CLS. 22 AND 39).

FIRST USE 12-12-2011; IN COMMERCE 12-12-2011.

THE MARK CONSISTS OF STANDARD CHARACTERS WITHOUT CLAIM TO ANY PARTICULAR FONT, STYLE, SIZE, OR COLOR.

SN 77-696,643, FILED 3-23-2009.

HELENE LIWINSKI, EXAMINING ATTORNEY



David J. Kybas

Director of the United States Patent and Trademark Office

United States of America

United States Patent and Trademark Office

The Michaux Conservancy

Reg. No. 4,109,171

THE NOISETTE FOUNDATION (SOUTH CAROLINA LIMITED LIABILITY COMPANY)
1360 TRUXTON AVENUE, STE. 200
NORTH CHARLESTON, SC 29405

Registered Mar. 6, 2012

Int. Cl.: 35

FOR: BUSINESS SERVICES FOR FUND RAISING PROGRAMS, NAMELY, DEVELOPING FUND RAISING PROGRAM CATALOGS, BROCHURES, PRICE SHEETS, ORDER FORMS, AND OTHER DOCUMENTS FOR NOT-FOR-PROFIT ORGANIZATIONS, IN CLASS 35 (U.S. CLS. 100, 101 AND 102).

SERVICE MARK

PRINCIPAL REGISTER

FIRST USE 1-9-2009; IN COMMERCE 1-10-2010.

THE MARK CONSISTS OF STANDARD CHARACTERS WITHOUT CLAIM TO ANY PARTICULAR FONT, STYLE, SIZE, OR COLOR.

NO CLAIM IS MADE TO THE EXCLUSIVE RIGHT TO USE "CONSERVANCY", APART FROM THE MARK AS SHOWN.

SN 77-700,193, FILED 3-26-2009.

BRENDAN REGAN, EXAMINING ATTORNEY



David J. Kyjars

Director of the United States Patent and Trademark Office

United States of America

United States Patent and Trademark Office

TLC

Reg. No. 4,109,172

LAYALINA TOBACCO MANUFACTURING F.Z.C. (UNITED ARAB EMIR. CORPORATION)
P.O. BOX 21215
AJMAN, UNITED ARAB EMIR.

Registered Mar. 6, 2012

Int. Cl.: 34

FOR: TOBACCO, IN CLASS 34 (U.S. CLS. 2, 8, 9 AND 17).

TRADEMARK

FIRST USE 8-15-2011; IN COMMERCE 8-15-2011.

PRINCIPAL REGISTER

THE MARK CONSISTS OF STANDARD CHARACTERS WITHOUT CLAIM TO ANY PARTICULAR FONT, STYLE, SIZE, OR COLOR.

SN 77-701,215, FILED 3-27-2009.

MARK PILARO, EXAMINING ATTORNEY



David J. Kybas

Director of the United States Patent and Trademark Office

United States of America

United States Patent and Trademark Office

SunSource

Reg. No. 4,109,173

AIR PRODUCTS AND CHEMICALS, INC. (DELAWARE CORPORATION)
7201 HAMILTON BLVD.
ALLENTOWN, PA 18195

Registered Mar. 6, 2012

Int. Cl.: 42

FOR: RESEARCH AND DEVELOPMENT RELATED TO THE PHOTOVOLTAIC INDUSTRY, NAMELY, THE USE OF INDUSTRIAL GASES AND DEPOSITION AND CLEANING CHEMICALS FOR THE PRODUCTION OF SOLAR CELLS, IN CLASS 42 (U.S. CLS. 100 AND 101).

SERVICE MARK

PRINCIPAL REGISTER

FIRST USE 3-24-2009; IN COMMERCE 9-9-2009.

THE MARK CONSISTS OF STANDARD CHARACTERS WITHOUT CLAIM TO ANY PARTICULAR FONT, STYLE, SIZE, OR COLOR.

SN 77-701,914, FILED 3-30-2009.

PAM WILLIS, EXAMINING ATTORNEY



David J. Kybas

Director of the United States Patent and Trademark Office

United States of America

United States Patent and Trademark Office

AMECA EDGE CODE

Reg. No. 4,109,174

Registered Mar. 6, 2012

Int. Cl.: 37

SERVICE MARK

PRINCIPAL REGISTER

AUTOMOTIVE MANUFACTURERS EQUIPMENT AGENCY, INC. (MARYLAND CORPORATION)
1550 SMALL FARMS DRIVE
WESTMINISTER, MD 21157

FOR: BRAKE MARKING SERVICES, NAMELY, MARKING OF BRAKE FRICTION MATERIALS FOR AUTOMOBILES WITH MANUFACTURER IDENTIFICATION MARKINGS FOR COMPLIANCE STATE AND LOCAL REQUIREMENTS, IN CLASS 37 (U.S. CLS. 100, 103 AND 106).

FIRST USE 7-1-2010; IN COMMERCE 7-1-2010.

THE MARK CONSISTS OF STANDARD CHARACTERS WITHOUT CLAIM TO ANY PARTICULAR FONT, STYLE, SIZE, OR COLOR.

OWNER OF U.S. REG. NO. 3,004,004.

SN 77-702,367, FILED 3-30-2009.

BENJAMIN OKEKE, EXAMINING ATTORNEY



David J. Kyros

Director of the United States Patent and Trademark Office

United States of America

United States Patent and Trademark Office

NIELSEN FOCUS

Reg. No. 4,109,175

Registered Mar. 6, 2012

Int. Cls.: 9 and 35

TRADEMARK

SERVICE MARK

PRINCIPAL REGISTER

THE NIELSEN COMPANY (US), LLC (DELAWARE LIMITED LIABILITY COMPANY)
150 N. MARTINGALE ROAD
SCHAUMBURG, IL 60173

FOR: DATABASES ON CD-ROM CONTAINING INFORMATION REGARDING AND RELATING TO THE TRANSMISSION AND RECEIPT OF PROGRAMMING AND CONTENT VIA, SUBSCRIBERS TO, STATIONS CARRIED BY, COMPETITIVE SYSTEMS WITH, AND GEOGRAPHIC SCOPE OF CABLE SYSTEMS AND ALTERNATIVE MEDIA DELIVERY SYSTEMS, AND REGARDING AND RELATING TO THE TELEVISION, DIGITAL AUDIO, DIGITAL MEDIA, AND BROADBAND BROADCASTS CARRIED VIA SUCH SYSTEMS, IN CLASS 9 (U.S. CLS. 21, 23, 26, 36 AND 38).

FIRST USE 10-29-2011; IN COMMERCE 10-29-2011.

FOR: PROVIDING DATABASES CONTAINING MARKETING AND MARKET RESEARCH INFORMATION REGARDING AND RELATING TO THE TRANSMISSION AND RECEIPT OF PROGRAMMING AND CONTENT VIA, SUBSCRIBERS TO, STATIONS CARRIED BY, COMPETITIVE SYSTEMS WITH, AND GEOGRAPHIC SCOPE OF CABLE SYSTEMS AND ALTERNATIVE MEDIA DELIVERY SYSTEMS, AND REGARDING AND RELATING TO THE TELEVISION, DIGITAL AUDIO, DIGITAL MEDIA, AND BROADBAND BROADCASTS CARRIED VIA SUCH SYSTEMS, IN CLASS 35 (U.S. CLS. 100, 101 AND 102).

FIRST USE 10-29-2011; IN COMMERCE 10-29-2011.

THE MARK CONSISTS OF STANDARD CHARACTERS WITHOUT CLAIM TO ANY PARTICULAR FONT, STYLE, SIZE, OR COLOR.

OWNER OF U.S. REG. NOS. 2,448,024, 3,544,156, AND OTHERS.

SN 77-703,065, FILED 3-31-2009.

WARREN L. OLANDRIA, EXAMINING ATTORNEY



David J. Kyffers

Director of the United States Patent and Trademark Office

United States of America

United States Patent and Trademark Office

SPEEDBOARD

Reg. No. 4,109,176

SPETALNICK, JEFF (UNITED STATES INDIVIDUAL)
260 W. 52ND STREET, 20TH FLOOR
NEW YORK, NY 10019

Registered Mar. 6, 2012

Int. Cl.: 9

FOR: COMPUTER SOFTWARE FOR USE IN TYPING, DATA AND TEXT ENTRY, IN CLASS 9 (U.S. CLS. 21, 23, 26, 36 AND 38).

TRADEMARK

FIRST USE 3-8-2011; IN COMMERCE 3-8-2011.

PRINCIPAL REGISTER

THE MARK CONSISTS OF STANDARD CHARACTERS WITHOUT CLAIM TO ANY PARTICULAR FONT, STYLE, SIZE, OR COLOR.

SN 77-706,023, FILED 4-3-2009.

ANN E. SAPPENFIELD, EXAMINING ATTORNEY



David J. Kybas

Director of the United States Patent and Trademark Office

United States of America

United States Patent and Trademark Office

SONIC SURFACES

Reg. No. 4,109,177

3919161 CANADA INC. (CANADA CORPORATION)
300 MONTEE DE LIESSE
ST. LAURENT, QUEBEC, CANADA H4T1N9

Registered Mar. 6, 2012

Int. Cl.: 19

FOR: NON-METAL FLOORING, NAMELY, WOODEN FLOORING; NON-METAL FLOORING, NAMELY, NATURAL FLOORING, SOLID WOOD FLOORING, HARDWOOD FLOORING, BLANK VINYL FLOORING; NON-METAL FLOORING, NAMELY, BLOCK STRIP VINYL FLOORING AND PVC FLOORING; FLOORING, NAMELY, LAMINATE FLOORING, IN CLASS 19 (U.S. CLS. 1, 12, 33 AND 50).

TRADEMARK

PRINCIPAL REGISTER

FIRST USE 2-0-2009; IN COMMERCE 2-0-2009.

OWNER OF CANADA REG. NO. TMA676066, DATED 11-1-2006, EXPIRES 11-1-2021.

NO CLAIM IS MADE TO THE EXCLUSIVE RIGHT TO USE "SURFACES", APART FROM THE MARK AS SHOWN.

THE MARK CONSISTS OF A STYLIZED VERSION OF THE WORDS "SONIC SURFACES".

SN 77-708,635, FILED 4-7-2009.

KELLEY WELLS, EXAMINING ATTORNEY



David J. Kyffers

Director of the United States Patent and Trademark Office

United States of America

United States Patent and Trademark Office



Reg. No. 4,109,178

Registered Mar. 6, 2012

Int. Cl.: 3

TRADEMARK

PRINCIPAL REGISTER

ÉMINENCE ORGANIC SKIN CARE INC. (CANADA CORPORATION)
#1503-289 DRAKE STREET
VANCOUVER, B.C., CANADA V6B5Z5

FOR: BEAUTY MASKS; CLEANSING CREAMS; CLEANSING MILK FOR TOILET PURPOSES; COSMETIC CREAMS; COSMETIC CREAMS FOR SKIN CARE; COSMETIC OILS; COSMETIC OILS FOR THE EPIDERMIS; COSMETIC PREPARATIONS; COSMETIC SOAPS; COSMETIC SUNTAN LOTIONS; COSMETICS; ESSENTIAL OILS; ESSENTIAL OILS FOR PERSONAL USE; EYE CREAM; EYE GELS; EYE MAKE-UP; FACE CREAMS; FACIAL CLEANSERS; FACIAL CREAMS; FACIAL EMULSIONS; FACIAL MAKE-UP; FACIAL MASKS; FACIAL SCRUBS; FOAMS CONTAINING COSMETICS AND SUNSCREENS; LOTIONS FOR COSMETIC PURPOSES; LOTIONS FOR SKIN, FACE AND BODY; MAKE-UP; NON-MEDICATED BATH PREPARATIONS; NON-MEDICATED SKIN CARE PREPARATIONS, NAMELY, CREAMS, LOTIONS, GELS, TONERS, CLEANERS AND PEELS; NON-MEDICATED SKIN CREAMS; OILS FOR COSMETIC PURPOSES; SKIN CLARIFIERS; SKIN CLEANSERS; SKIN CLEANSING CREAM; SKIN CLEANSING LOTION; SKIN CONDITIONERS; SKIN CREAMS; SKIN MASKS; SKIN MOISTURIZER; SKIN MOISTURIZER MASKS; SKIN SOAP; SKIN TONERS; SUN-TANNING PREPARATIONS; SUNSCREEN CREAMS, IN CLASS 3 (U.S. CLS. 1, 4, 6, 50, 51 AND 52).

FIRST USE 9-1-2008; IN COMMERCE 1-10-2009.

OWNER OF U.S. REG. NO. 3,532,447.

THE COLOR(S) ANTIQUE GOLD-GREEN IS/ARE CLAIMED AS A FEATURE OF THE MARK.

THE MARK CONSISTS OF AN ANTIQUE GOLD-GREEN COLORED CIRCULAR DESIGN WITH A WHITE CROSS OR A WHITE PLUS SYMBOL INSIDE THE CIRCLE, HAVING A WHITE CHARACTER "É" IN AN ANTIQUE GOLD-GREEN SQUARE BOX WITH ITS OUTER FRAME CONSISTING OF AN ANTIQUE GOLD-GREEN AND A WHITE FRAME AROUND SAID SQUARE BOX THAT IS LOCATED AT THE LOWER BOTTOM END OF THE CIRCLE.

SN 77-708,737, FILED 4-7-2009.

DAVID TAYLOR, EXAMINING ATTORNEY



David J. Kypas

Director of the United States Patent and Trademark Office

United States of America

United States Patent and Trademark Office

KADE KLIMA

Reg. No. 4,109,179

Registered Mar. 6, 2012

Int. Cl.: 39

SERVICE MARK

PRINCIPAL REGISTER

ACP KLIMA, LLC (NEVADA LIMITED LIABILITY COMPANY)
SUITE 204
1000 EAST WILLIAM STREET
CARSON CITY, NV 89701

FOR: DISTRIBUTORSHIP SERVICES IN THE FIELD OF HEATING, VENTILATING AND AIR CONDITIONING PRODUCTS, AND EQUIPMENT AND PARTS FOR HEATERS, VENTILATING AND AIR CONDITIONING UNITS FOR AUTOS AND TRUCKS, IN CLASS 39 (U.S. CLS. 100 AND 105).

FIRST USE 11-1-2010; IN COMMERCE 11-1-2010.

THE MARK CONSISTS OF STANDARD CHARACTERS WITHOUT CLAIM TO ANY PARTICULAR FONT, STYLE, SIZE, OR COLOR.

NO CLAIM IS MADE TO THE EXCLUSIVE RIGHT TO USE "KLIMA", APART FROM THE MARK AS SHOWN.

THE ENGLISH TRANSLATION OF "KLIMA" IN THE MARK IS CLIMATE.

SN 77-710,937, FILED 4-9-2009.

LAURIE MAYES, EXAMINING ATTORNEY



David J. Kyffers

Director of the United States Patent and Trademark Office

United States of America

United States Patent and Trademark Office

TECHNODNA

Reg. No. 4,109,180

RASQUIDES RICARDO J (UNITED STATES INDIVIDUAL)
5303 SW 153 RD AVENUE
MIRAMAR, FL 33027

Registered Mar. 6, 2012

Int. Cl.: 25

FOR: T-SHIRTS, SHORTS, TANK-TOPS, SKIRTS AND DRESSES, CAPS, SHORT AND LONG SLEEVES SHIRTS, IN CLASS 25 (U.S. CLS. 22 AND 39).

TRADEMARK

FIRST USE 9-14-2010; IN COMMERCE 10-7-2011.

PRINCIPAL REGISTER

THE MARK CONSISTS OF STANDARD CHARACTERS WITHOUT CLAIM TO ANY PARTICULAR FONT, STYLE, SIZE, OR COLOR.

SN 77-713,712, FILED 4-14-2009.

PAM WILLIS, EXAMINING ATTORNEY



David J. Kybas

Director of the United States Patent and Trademark Office

United States of America

United States Patent and Trademark Office

SIPPYTIP

Reg. No. 4,109,181

JOHNSON SERVICES INC. (MARYLAND CORPORATION)
8919 DOUBLE HILLS ROAD
DENTON, MD 21629

Registered Mar. 6, 2012

Int. Cl.: 10

FOR: CUPS ADAPTED FOR FEEDING BABIES AND CHILDREN, IN CLASS 10 (U.S. CLS. 26, 39 AND 44).

TRADEMARK

FIRST USE 11-16-2011; IN COMMERCE 11-17-2011.

PRINCIPAL REGISTER

THE MARK CONSISTS OF STANDARD CHARACTERS WITHOUT CLAIM TO ANY PARTICULAR FONT, STYLE, SIZE, OR COLOR.

SN 77-718,859, FILED 4-21-2009.

LAURA KOVALSKY, EXAMINING ATTORNEY



David J. Kybas

Director of the United States Patent and Trademark Office

United States of America

United States Patent and Trademark Office

BIOLISTIX

Reg. No. 4,109,182

BIOLISTIX S.E.N.C. (CANADA SOCIÉTÉ EN NOM COLLECTIF (SENC))
390, JEAN-LOUIS BOUDREAU STREET
GRANBY (QUÉBEC), CANADA J2H0A4

Registered Mar. 6, 2012

Int. Cls.: 41, 44, and 45

FOR: LECTURES IN THE FOLLOWING FIELDS: PHYTOTHERAPY, ORTHOTHERAPY, NATUROTHERAPY, AND IMPROVEMENT TECHNIQUES OF PHYSICAL FITNESS AND HUMAN BEHAVIOR; CONSULTATIONS IN THE FIELD OF IMPROVEMENT TECHNIQUES OF PHYSICAL FITNESS, IN CLASS 41 (U.S. CLS. 100, 101 AND 107).

SERVICE MARK

PRINCIPAL REGISTER

FIRST USE 7-17-2009; IN COMMERCE 12-14-2011.

FOR: CONSULTATIONS IN THE FOLLOWING FIELDS: PHYTOTHERAPY, ORTHOTHERAPY, AND NATUROTHERAPY, IN CLASS 44 (U.S. CLS. 100 AND 101).

FIRST USE 7-17-2009; IN COMMERCE 12-14-2011.

FOR: CONSULTATIONS IN THE FIELD OF SELF-IMPROVEMENT TECHNIQUES OF HUMAN BEHAVIOR, IN CLASS 45 (U.S. CLS. 100 AND 101).

FIRST USE 7-17-2009; IN COMMERCE 12-14-2011.

THE MARK CONSISTS OF THE WORD "BIOLISTIX" IN WHICH THE LETTER "O" IS FORMED BY A CRESCENT SURROUNDING A CIRCLE.

SN 77-720,833, FILED 4-23-2009.

H. M. FISHER, EXAMINING ATTORNEY



David J. Kybas

Director of the United States Patent and Trademark Office

United States of America

United States Patent and Trademark Office

POWER CURVE

Reg. No. 4,109,183

Registered Mar. 6, 2012

Int. Cl.: 8

TRADEMARK

PRINCIPAL REGISTER

FISKARS BRANDS, INC. (WISCONSIN CORPORATION)
2537 DANIELS STREET
MADISON, WI 537186772

FOR: HAND-OPERATED LAWN AND GARDEN TOOLS, NAMELY, PRUNERS AND LOPPERS; A LEVER MECHANISM INCORPORATED INTO HAND OPERATED LAWN AND GARDEN TOOLS, NAMELY, PRUNERS AND LOPPERS, IN CLASS 8 (U.S. CLS. 23, 28 AND 44).

FIRST USE 12-21-2011; IN COMMERCE 12-21-2011.

THE MARK CONSISTS OF STANDARD CHARACTERS WITHOUT CLAIM TO ANY PARTICULAR FONT, STYLE, SIZE, OR COLOR.

SN 77-721,015, FILED 4-23-2009.

CHRISTINE COOPER, EXAMINING ATTORNEY



David J. Kyffers

Director of the United States Patent and Trademark Office

United States of America

United States Patent and Trademark Office

PALS  **Practical Assisted
Living Structures**

Reg. No. 4,109,184

ROCKFALL LLC (CONNECTICUT LIMITED LIABILITY COMPANY)
25 COLUMBUS AVE
MERIDEN, CT 064515334

Registered Mar. 6, 2012

Int. Cl.: 19

FOR: PRE-FABRICATED MODULAR HOME ADDITIONS, EQUIPPED TO SERVICE THE ELDERLY AND/OR PHYSICALLY DISABLED, IN CLASS 19 (U.S. CLS. 1, 12, 33 AND 50).

TRADEMARK

FIRST USE 11-30-2010; IN COMMERCE 11-30-2010.

PRINCIPAL REGISTER

NO CLAIM IS MADE TO THE EXCLUSIVE RIGHT TO USE "PRACTICAL ASSISTED LIVING STRUCTURES", APART FROM THE MARK AS SHOWN.

THE STIPPLING IS FOR SHADING PURPOSES ONLY.

THE MARK CONSISTS OF THE STYLIZED TEXT "PALS PRACTICAL ASSISTED LIVING STRUCTURES" WITH A GRAPHIC REPRESENTATION OF A HOUSE IN A SQUARE FRAME.

SN 77-724,318, FILED 4-28-2009.

KRISTIN CARLSON, EXAMINING ATTORNEY



David J. Kybas

Director of the United States Patent and Trademark Office

United States of America

United States Patent and Trademark Office

HIGH Q LASER

Reg. No. 4,109,185

Registered Mar. 6, 2012

Int. Cl.: 10

TRADEMARK

PRINCIPAL REGISTER

HIGH Q LASER TECHNOLOGIES GMBH (AUSTRIA CORPORATION)
SCHULGASSE 11
ROETHIS, AUSTRIA 6832

FOR: LASERS FOR MEDICAL USE, IN CLASS 10 (U.S. CLS. 26, 39 AND 44).

FIRST USE 6-15-2009; IN COMMERCE 6-15-2009.

OWNER OF U.S. REG. NO. 2,687,955.

NO CLAIM IS MADE TO THE EXCLUSIVE RIGHT TO USE "LASER", APART FROM THE MARK AS SHOWN.

THE MARK CONSISTS OF THE STYLIZED WORD "HIGH" FOLLOWED BY THE LETTER "Q" AND THE WORD "LASER".

SN 77-725,025, FILED 4-29-2009.

LINDA E. BLOHM, EXAMINING ATTORNEY



David J. Kyfos

Director of the United States Patent and Trademark Office

United States of America

United States Patent and Trademark Office

BT SERIES

Reg. No. 4,109,186

Registered Mar. 6, 2012

Int. Cl.: 11

TRADEMARK

PRINCIPAL REGISTER

TRIPLEX MANUFACTURING L.P. (ILLINOIS LIMITED PARTNERSHIP)
2700 WEST 50TH STREET
CHICAGO, IL 60632

FOR: LIGHTS AND LIGHTING APPARATUS FOR VEHICLES, IN CLASS 11 (U.S. CLS. 13, 21, 23, 31 AND 34).

FIRST USE 12-31-2009; IN COMMERCE 12-31-2009.

THE MARK CONSISTS OF STANDARD CHARACTERS WITHOUT CLAIM TO ANY PARTICULAR FONT, STYLE, SIZE, OR COLOR.

NO CLAIM IS MADE TO THE EXCLUSIVE RIGHT TO USE "SERIES", APART FROM THE MARK AS SHOWN.

SN 77-728,241, FILED 5-4-2009.

JACLYN KIDWELL WALKER, EXAMINING ATTORNEY



David J. Kyffers

Director of the United States Patent and Trademark Office

United States of America

United States Patent and Trademark Office

FEARLESS WOMEN

Reg. No. 4,109,187

Registered Mar. 6, 2012

Int. Cl.: 41

SERVICE MARK

PRINCIPAL REGISTER

HALPIN, MARY ANN (UNITED STATES INDIVIDUAL), DBA MARY ANN HALPIN
PHOTOGRAPHY,
3202 DOS PALOS DRIVE
LOS ANGELES, CA 90068

FOR: PHOTOGRAPHY SERVICES; EDUCATION SERVICES, NAMELY, PROVIDING
WORKSHOPS AND SEMINARS IN THE FIELD OF PHOTOGRAPHY, IN CLASS 41 (U.S.
CLS. 100, 101 AND 107).

FIRST USE 4-20-2005; IN COMMERCE 4-20-2005.

THE MARK CONSISTS OF STANDARD CHARACTERS WITHOUT CLAIM TO ANY PAR-
TICULAR FONT, STYLE, SIZE, OR COLOR.

SN 77-730,383, FILED 5-6-2009.

DEIRDRE ROBERTSON, EXAMINING ATTORNEY



David J. Kybas

Director of the United States Patent and Trademark Office

United States of America

United States Patent and Trademark Office

SLINGGUIDE

Reg. No. 4,109,188

Registered Mar. 6, 2012

Int. Cls.: 38 and 42

SERVICE MARK

PRINCIPAL REGISTER

SLING MEDIA INC. (DELAWARE CORPORATION)
1051 E. HILLSDALE BLVD., SUITE 500
FOSTER CITY, CA 94404

FOR: STREAMING OF AUDIO AND VIDEO MATERIAL ON THE INTERNET; INFORMATION TRANSMISSION VIA ELECTRONIC COMMUNICATIONS NETWORKS; ELECTRONICALLY TRANSMITTING VIDEO, IMAGE, AUDIO AND DATA INFORMATION; PROVIDING ACCESS TO ELECTRONIC SITES FEATURING VIDEO, IMAGE, AUDIO, AND DATA INFORMATION, IN CLASS 38 (U.S. CLS. 100, 101 AND 104).

FIRST USE 11-30-2008; IN COMMERCE 11-30-2008.

FOR: PROVIDING WEBSITES FEATURING ON-LINE NON-DOWNLOADABLE SOFTWARE ALLOWING WEBSITE USERS TO REMOTELY ACCESS, RECORD AND VIEW TELEVISION PROGRAMMING VIA PERSONAL COMPUTERS, MOBILE PHONES, PERSONAL DIGITAL ASSISTANTS, AND LAPTOP COMPUTERS; PROVIDING WEBSITES FEATURING ON-LINE NON-DOWNLOADABLE SOFTWARE ALLOWING WEBSITE USERS TO SEARCH, CATEGORIZE, AND DISPLAY VIDEO, IMAGE, AUDIO, AND DATA INFORMATION IN THE FIELD OF ENTERTAINMENT AND GENERAL INTEREST, IN CLASS 42 (U.S. CLS. 100 AND 101).

FIRST USE 11-30-2008; IN COMMERCE 11-30-2008.

THE MARK CONSISTS OF STANDARD CHARACTERS WITHOUT CLAIM TO ANY PARTICULAR FONT, STYLE, SIZE, OR COLOR.

SN 77-730,779, FILED 5-6-2009.

STEVEN R. FINE, EXAMINING ATTORNEY



David J. Kyros

Director of the United States Patent and Trademark Office

United States of America

United States Patent and Trademark Office

RICHES OF ROYALTY

Reg. No. 4,109,189

Registered Mar. 6, 2012

Int. Cl.: 9

TRADEMARK

PRINCIPAL REGISTER

BALLY GAMING, INC. (NEVADA CORPORATION), DBA BALLY TECHNOLOGIES,
ATTN: PAMELA BOWSHER, LAW DEPT.
6601 SOUTH BERMUDA ROAD
LAS VEGAS, NV 89119

FOR: GAMING DEVICES, NAMELY, SLOT MACHINES, WITH OR WITHOUT VIDEO
OUTPUT, IN CLASS 9 (U.S. CLS. 21, 23, 26, 36 AND 38).

FIRST USE 9-27-2010; IN COMMERCE 9-27-2010.

THE MARK CONSISTS OF STANDARD CHARACTERS WITHOUT CLAIM TO ANY PAR-
TICULAR FONT, STYLE, SIZE, OR COLOR.

SN 77-731,965, FILED 5-7-2009.

RONALD AIKENS, EXAMINING ATTORNEY



David J. Kybas

Director of the United States Patent and Trademark Office

United States of America

United States Patent and Trademark Office



Reg. No. 4,109,190

Registered Mar. 6, 2012

Int. Cl.: 26

TRADEMARK

PRINCIPAL REGISTER

SUMMIT ENTERTAINMENT, LLC (DELAWARE LIMITED LIABILITY COMPANY)
1630 STEWART STREET, SUITE 120
SANTA MONICA, CA 90404

FOR: BARRETTES, AND ORNAMENTAL NOVELTY BUTTONS, IN CLASS 26 (U.S. CLS. 37, 39, 40, 42 AND 50).

FIRST USE 10-0-2009; IN COMMERCE 10-0-2009.

THE MARK CONSISTS OF A SHADED OVAL ENCIRCLING A HERALDIC LION, WITH A HAND, PALM FACING FORWARD AND FINGERS SLIGHTLY APART, POSITIONED ABOVE THE LION, AND THREE ADJACENT CLOVERS WITHIN A V-SHAPED STRIPE POSITIONED BELOW THE LION, THE CLOVER ON THE RIGHT BEING PARTIALLY OBSTRUCTED BY THE BACK FOOT OF THE LION.

SN 77-733,352, FILED 5-10-2009.

MEGHAN REINHART, EXAMINING ATTORNEY



David J. Kybas

Director of the United States Patent and Trademark Office

United States of America

United States Patent and Trademark Office



Reg. No. 4,109,191

Registered Mar. 6, 2012

Int. Cl.: 3

TRADEMARK

PRINCIPAL REGISTER

YOO, KYUNG DONG (REPUBLIC OF KOREA INDIVIDUAL)
SUJEONG-GU, SEONGNAM SI
116-108, JUGONG APT., 10.SINHEUNG-DONG
GYEONGGI-DO, REPUBLIC OF KOREA 461-708

FOR: FOUNDATIONS; CLEANSING CREAMS; MASSAGE CREAMS; SKIN LOTIONS; NOURISHING CREAMS, NAMELY, NOURISHING HAND CREAMS, NOURISHING BODY CREAMS, NOURISHING FACE CREAMS; SUNSCREEN LOTIONS, NAMELY, SUN TAN LOTION AND SUN-BLOCK LOTION; EYE CREAMS; BADIAN ESSENCE FOR COSMETIC USE, IN CLASS 3 (U.S. CLS. 1, 4, 6, 50, 51 AND 52).

FIRST USE 12-9-2011; IN COMMERCE 12-9-2011.

THE MARK CONSISTS OF THE WORDING "EVERTRIED" WITH THE LETTER "T" CONSISTING OF A TRIANGLE WITH A CURVED ARROW ON THE TIP OF THE TRIANGLE. BENEATH THE TERM "EVERTRIED" IS A LINE. UNDERNEATH THE LINE IS THE TERM "EVERTRIED" WITHOUT ANY DESIGN ELEMENTS.

SN 77-733,824, FILED 5-11-2009.

MICHAEL WIENER, EXAMINING ATTORNEY



David J. Kyjars

Director of the United States Patent and Trademark Office

United States of America

United States Patent and Trademark Office

COMFORTEK

Reg. No. 4,109,192

COMMERCIAL VEHICLE GROUP, INC. (DELAWARE CORPORATION)
7800 WALTON PARKWAY
NEW ALBANY, OH 43054

Registered Mar. 6, 2012

Int. Cls.: 12 and 27

FOR: VEHICLE INTERIOR TRIM COMPONENTS, IN CLASS 12 (U.S. CLS. 19, 21, 23, 31, 35 AND 44).

TRADEMARK

FIRST USE 11-0-2010; IN COMMERCE 11-0-2010.

PRINCIPAL REGISTER

FOR: VEHICLE INTERIOR FLOORING, NAMELY, CARPETING AND FLOOR MATS, IN CLASS 27 (U.S. CLS. 19, 20, 37, 42 AND 50).

FIRST USE 11-0-2010; IN COMMERCE 11-0-2010.

THE MARK CONSISTS OF STANDARD CHARACTERS WITHOUT CLAIM TO ANY PARTICULAR FONT, STYLE, SIZE, OR COLOR.

SN 77-733,983, FILED 5-11-2009.

BRIAN NEVILLE, EXAMINING ATTORNEY



David J. Kybas

Director of the United States Patent and Trademark Office

United States of America

United States Patent and Trademark Office

MARINADE ON DEMAND

Reg. No. 4,109,193

Registered Mar. 6, 2012

Int. Cl.: 17

TRADEMARK

PRINCIPAL REGISTER

CRYOVAC, INC. (NEW JERSEY CORPORATION)
200 RIVEFRONT BOULEVARD
ELMWOOD PARK, NJ 07407

FOR: PLASTIC FILMS FOR PACKAGING FOOD AND FOODSTUFFS; PLASTIC FILMS USED IN THERMOPLASTIC OR SEMI-RIGID CONTAINERS WHICH INCLUDE A SEPARATE COMPARTMENT FOR EACH OF FRESH AND PROCESSED MEAT, CHICKEN AND FISH AS WELL AS FLAVORINGS, SAUCES, CONDIMENTS AND MARINADES, IN CLASS 17 (U.S. CLS. 1, 5, 12, 13, 35 AND 50).

FIRST USE 5-2-2011; IN COMMERCE 5-2-2011.

THE MARK CONSISTS OF STANDARD CHARACTERS WITHOUT CLAIM TO ANY PARTICULAR FONT, STYLE, SIZE, OR COLOR.

NO CLAIM IS MADE TO THE EXCLUSIVE RIGHT TO USE "MARINADE", APART FROM THE MARK AS SHOWN.

SN 77-734,568, FILED 5-12-2009.

HELENE LIWINSKI, EXAMINING ATTORNEY



David J. Kyffers

Director of the United States Patent and Trademark Office

United States of America

United States Patent and Trademark Office

GOLD LIVE

Reg. No. 4,109,194

Registered Mar. 6, 2012

Int. Cl.: 9

TRADEMARK

PRINCIPAL REGISTER

KITCO METALS INC. (CANADA CORPORATION)
620 CATHCART, SUITE 900
MONTREAL, QUEBEC, CANADA H3B1M1

FOR: DOWNLOADABLE SOFTWARE IN THE FIELD OF PRECIOUS METALS TRADING, FOR USE IN STREAMING INFORMATION ON THE CHANGING VALUE OF PRECIOUS METALS ON THE COMMODITIES MARKET, IN CLASS 9 (U.S. CLS. 21, 23, 26, 36 AND 38).

FIRST USE 0-0-2002; IN COMMERCE 0-0-2010.

THE MARK CONSISTS OF STANDARD CHARACTERS WITHOUT CLAIM TO ANY PARTICULAR FONT, STYLE, SIZE, OR COLOR.

PRIORITY CLAIMED UNDER SEC. 44(D) ON CANADA APPLICATION NO. 1424579, FILED 1-15-2009, REG. NO. TMA770,703, DATED 6-25-2010, EXPIRES 6-25-2025.

NO CLAIM IS MADE TO THE EXCLUSIVE RIGHT TO USE "GOLD", APART FROM THE MARK AS SHOWN.

SN 77-735,720, FILED 5-13-2009.

WILLIAM ROSSMAN, EXAMINING ATTORNEY



David J. Kyros

Director of the United States Patent and Trademark Office

United States of America

United States Patent and Trademark Office

CLOSE QUARTERS

Reg. No. 4,109,195

Registered Mar. 6, 2012

Int. Cl.: 31

TRADEMARK

PRINCIPAL REGISTER

SPITFIRE GLOBAL, INC. (FLORIDA CORPORATION)
8000 SAILBOAT KEY BLVD.
#406
ST. PETE BEACH, FL 33707

FOR: ANIMAL LITTER, IN CLASS 31 (U.S. CLS. 1 AND 46).

FIRST USE 7-3-2008; IN COMMERCE 12-12-2011.

THE MARK CONSISTS OF STANDARD CHARACTERS WITHOUT CLAIM TO ANY PARTICULAR FONT, STYLE, SIZE, OR COLOR.

SN 77-740,895, FILED 5-20-2009.

ANNE FARRELL, EXAMINING ATTORNEY



David J. Kybas

Director of the United States Patent and Trademark Office

United States of America

United States Patent and Trademark Office

ORONEM

Reg. No. 4,109,196

Registered Mar. 6, 2012

Int. Cl.: 5

TRADEMARK

PRINCIPAL REGISTER

ORO AGRI INC. (MISSOURI CORPORATION)
990 TROPHY CLUB DRIVE
IP SERVICE DEPARTMENT
TROPHY CLUB, TX 76262

FOR: AGRICULTURAL PESTICIDES, IN CLASS 5 (U.S. CLS. 6, 18, 44, 46, 51 AND 52).

FIRST USE 1-1-2012; IN COMMERCE 1-1-2012.

THE MARK CONSISTS OF STANDARD CHARACTERS WITHOUT CLAIM TO ANY PARTICULAR FONT, STYLE, SIZE, OR COLOR.

SN 77-741,946, FILED 5-21-2009.

BENJAMIN OKEKE, EXAMINING ATTORNEY



David J. Kybas

Director of the United States Patent and Trademark Office

United States of America

United States Patent and Trademark Office



Reg. No. 4,109,197

Registered Mar. 6, 2012

Int. Cl.: 21

TRADEMARK

PRINCIPAL REGISTER

JAMES C. DORSEY (UNITED STATES INDIVIDUAL)
8306 WILSHIRE BLVD., SUITE 415
BEVERLY HILLS, CA 902112382

FOR: DECORATIVE DRINKING CUP, IN CLASS 21 (U.S. CLS. 2, 13, 23, 29, 30, 33, 40 AND 50).

FIRST USE 10-1-2011; IN COMMERCE 10-1-2011.

THE MARK CONSISTS OF FOUR CURVES RANGING FROM SMALL TO LARGE IN A BULLHORN FORMATION REPRESENTING SOUND WAVES.

SN 77-742,172, FILED 5-21-2009.

CYNTHIA TRIPI, EXAMINING ATTORNEY



David J. Kybas

Director of the United States Patent and Trademark Office

United States of America

United States Patent and Trademark Office

H-E-B

Reg. No. 4,109,198

Registered Mar. 6, 2012

Int. Cl.: 21

TRADEMARK

PRINCIPAL REGISTER

HEB GROCERY COMPANY, LP (TEXAS LIMITED PARTNERSHIP)
CORPORATE LAW DEPARTMENT
646 SOUTH MAIN
SAN ANTONIO, TX 78204

FOR: CLEANING PADS, SCRUB SPONGES, IN CLASS 21 (U.S. CLS. 2, 13, 23, 29, 30, 33, 40 AND 50).

FIRST USE 10-31-2007; IN COMMERCE 10-31-2008.

THE MARK CONSISTS OF STANDARD CHARACTERS WITHOUT CLAIM TO ANY PARTICULAR FONT, STYLE, SIZE, OR COLOR.

OWNER OF U.S. REG. NOS. 1,530,250, 1,867,930, AND OTHERS.

SN 77-742,217, FILED 5-21-2009.

LAKEISHA LEWIS, EXAMINING ATTORNEY



David J. Kybas

Director of the United States Patent and Trademark Office

United States of America

United States Patent and Trademark Office

OPEN DEALER EXCHANGE

Reg. No. 4,109,199

Registered Mar. 6, 2012

Int. Cls.: 9, 35, and 36

TRADEMARK

SERVICE MARK

PRINCIPAL REGISTER

OPEN DEALER EXCHANGE, LLC (DELAWARE LIMITED LIABILITY COMPANY)
SUITE 300
5607 NEW KING DRIVE
TROY, MI 48098

FOR: COMPUTER SOFTWARE FOR PROVIDING AN ON-LINE DATABASE FOR DATA COLLECTION AND INTEGRATION FOR PROCESSING AND GENERATION OF LOAN APPLICATIONS FOR INDIRECT FINANCING RELATING TO AUTOMOBILES, IN CLASS 9 (U.S. CLS. 21, 23, 26, 36 AND 38).

FIRST USE 2-2-2011; IN COMMERCE 2-2-2011.

FOR: MATCHING BORROWERS WITH POTENTIAL LENDERS IN THE FIELD OF FINANCING OF AUTOMOBILE PURCHASES WITHIN THE DEALERSHIP AND VIA A GLOBAL TELECOMMUNICATIONS NETWORK, IN CLASS 35 (U.S. CLS. 100, 101 AND 102).

FIRST USE 2-2-2011; IN COMMERCE 2-2-2011.

FOR: ELECTRONIC LOAN ORIGATION SERVICES; FINANCING RELATING TO AUTOMOBILES, IN CLASS 36 (U.S. CLS. 100, 101 AND 102).

FIRST USE 2-2-2011; IN COMMERCE 2-2-2011.

THE MARK CONSISTS OF STANDARD CHARACTERS WITHOUT CLAIM TO ANY PARTICULAR FONT, STYLE, SIZE, OR COLOR.

NO CLAIM IS MADE TO THE EXCLUSIVE RIGHT TO USE "DEALER EXCHANGE", APART FROM THE MARK AS SHOWN.

SN 77-742,946, FILED 5-22-2009.

JANICE L. MCMORROW, EXAMINING ATTORNEY



David J. Kybas

Director of the United States Patent and Trademark Office

United States of America

United States Patent and Trademark Office

TYPING WITH THE STARS

Reg. No. 4,109,200

TYPING WITH THE STARS, INC. (FLORIDA CORPORATION)
840 E OAKLAND PARK BLVD. STE. 124
FT. LAUDERDALE, FL 33334

Registered Mar. 6, 2012

Int. Cl.: 9

FOR: EDUCATIONAL COMPUTER PROGRAM FOR TEACHING TYPING AND KEYBOARDING WHICH IS DOWNLOADABLE, IN CLASS 9 (U.S. CLS. 21, 23, 26, 36 AND 38).

TRADEMARK

FIRST USE 12-19-2011; IN COMMERCE 12-19-2011.

PRINCIPAL REGISTER

THE MARK CONSISTS OF STANDARD CHARACTERS WITHOUT CLAIM TO ANY PARTICULAR FONT, STYLE, SIZE, OR COLOR.

OWNER OF U.S. REG. NO. 3,636,367.

NO CLAIM IS MADE TO THE EXCLUSIVE RIGHT TO USE "TYPING", APART FROM THE MARK AS SHOWN.

SN 77-742,980, FILED 5-22-2009.

PATRICIA EVANKO, EXAMINING ATTORNEY



David J. Kyros

Director of the United States Patent and Trademark Office

United States of America

United States Patent and Trademark Office

BWHAM!

Reg. No. 4,109,201

SHADY GLEN ENTERPRISES LIMITED (CANADA CORPORATION)
4212 ROCKRIDGE CRESCENT
WEST VANCOUVER, BC, CANADA V7W1B1

Registered Mar. 6, 2012

Int. Cl.: 30

FOR: FOOD PRODUCTS, NAMELY, VINEGAR, SALAD DRESSINGS, MARINADES, DIPPING SAUCES, IN CLASS 30 (U.S. CL. 46).

TRADEMARK

FIRST USE 1-4-2012; IN COMMERCE 1-4-2012.

PRINCIPAL REGISTER

THE MARK CONSISTS OF STANDARD CHARACTERS WITHOUT CLAIM TO ANY PARTICULAR FONT, STYLE, SIZE, OR COLOR.

SN 77-747,740, FILED 5-29-2009.

RONALD MCMORROW, EXAMINING ATTORNEY



David J. Kyfos

Director of the United States Patent and Trademark Office

United States of America

United States Patent and Trademark Office

MSGV

Reg. No. 4,109,202

Registered Mar. 6, 2012

Int. Cls.: 38 and 41

SERVICE MARK

PRINCIPAL REGISTER

MSG HOLDINGS, L.P. (DELAWARE LIMITED PARTNERSHIP)
TWO PENN PLAZA
NEW YORK, NY 10121

FOR: BROADCASTING OF VIDEO AND AUDIO PROGRAMMING OVER THE INTERNET; TELEVISION BROADCASTING SERVICES; BROADCASTING SERVICES, NAMELY, BROADCASTING OF TELEVISION PROGRAMMING VIA CABLE, GLOBAL COMPUTER NETWORK, AUDIO AND VIDEO MEDIA, WIRELESS COMMUNICATIONS AND WIRED COMMUNICATIONS, IN CLASS 38 (U.S. CLS. 100, 101 AND 104).

FIRST USE 10-22-2011; IN COMMERCE 10-22-2011.

FOR: TELEVISION PROGRAMMING SERVICES; PROVIDING AN INTERNET WEBSITE PORTAL IN THE FIELD OF SPORTING EVENTS; PROVIDING SPORTS NEWS AND INFORMATION VIA A GLOBAL COMPUTER NETWORK; PRODUCTION AND SCHEDULING OF TELEVISION PROGRAMS RELATING PRIMARILY TO SPORTS DISTRIBUTED VIA TELEVISION, AUDIO AND VIDEO MEDIA AND WIRELESS COMMUNICATIONS, WIRED COMMUNICATIONS AND GLOBAL COMPUTER NETWORKS, IN CLASS 41 (U.S. CLS. 100, 101 AND 107).

FIRST USE 6-6-2011; IN COMMERCE 6-6-2011.

THE MARK CONSISTS OF STANDARD CHARACTERS WITHOUT CLAIM TO ANY PARTICULAR FONT, STYLE, SIZE, OR COLOR.

OWNER OF U.S. REG. NOS. 3,097,675, 3,321,382, AND OTHERS.

SN 77-747,922, FILED 5-29-2009.

CIMMERIAN COLEMAN, EXAMINING ATTORNEY



David J. Kyffers

Director of the United States Patent and Trademark Office

United States of America

United States Patent and Trademark Office



Reg. No. 4,109,203

TELMEX USA, L.L.C. (DELAWARE LIMITED LIABILITY COMPANY)
3350 S.W. 148TH AVENUE
MIRAMAR, FL 33027

Registered Mar. 6, 2012

Int. Cl.: 38

FOR: TELECOMMUNICATION ACCESS SERVICES, IN CLASS 38 (U.S. CLS. 100, 101 AND 104).

SERVICE MARK

FIRST USE 8-10-2009; IN COMMERCE 8-10-2009.

PRINCIPAL REGISTER

NO CLAIM IS MADE TO THE EXCLUSIVE RIGHT TO USE "USA" AND "PIN FREE", APART FROM THE MARK AS SHOWN.

THE COLOR(S) BLACK AND BLUE IS/ARE CLAIMED AS A FEATURE OF THE MARK.

THE MARK CONSISTS OF THE WORDS "TELMEX USA" IN BLACK AND THE WORD "PINFREE" WITH "PIN" IN BLACK AND "FREE" IN BLUE IN SPECIAL FORM WITH A HALF CIRCLE IN BLUE.

SN 77-750,069, FILED 6-2-2009.

ELISSA GARBER KON, EXAMINING ATTORNEY



David J. Kybas

Director of the United States Patent and Trademark Office

United States of America

United States Patent and Trademark Office

BLACK RAIN GENETICS

Reg. No. 4,109,204

Registered Mar. 6, 2012

Int. Cls.: 5 and 35

TRADEMARK

SERVICE MARK

PRINCIPAL REGISTER

BLACK RAIN GENETICS, INC. (NEBRASKA CORPORATION)
SUITE A
310 EASTGATE DRIVE
BLAIR, NE 68008

FOR: ANIMAL SEMEN, NAMELY, ANIMAL SEMEN FOR THE WAGYU BREED OF BLACK ANGUS CATTLE, IN CLASS 5 (U.S. CLS. 6, 18, 44, 46, 51 AND 52).

FIRST USE 7-16-2009; IN COMMERCE 7-16-2009.

FOR: MAIL ORDER SERVICES OF WAGYU CATTLE SEMEN FOR ARTIFICIAL INSEMINATION FOR BREEDING PURPOSES, IN CLASS 35 (U.S. CLS. 100, 101 AND 102).

FIRST USE 7-16-2009; IN COMMERCE 7-16-2009.

THE MARK CONSISTS OF STANDARD CHARACTERS WITHOUT CLAIM TO ANY PARTICULAR FONT, STYLE, SIZE, OR COLOR.

NO CLAIM IS MADE TO THE EXCLUSIVE RIGHT TO USE "GENETICS", APART FROM THE MARK AS SHOWN.

SN 77-750,959, FILED 6-3-2009.

B. PARADEWELAI, EXAMINING ATTORNEY



David J. Kyros

Director of the United States Patent and Trademark Office

United States of America

United States Patent and Trademark Office

ACA JOE

Reg. No. 4,109,205

PARADISE PROPERTY INVESTMENTS, L.L.C. (NEVADA LIMITED LIABILITY COMPANY)
5190 NEIL ROAD, SUITE 430
RENO, NV 89502

Registered Mar. 6, 2012

Int. Cl.: 25

FOR: POLO SHIRTS, SHORTS, SHIRTS, CARGO PANTS AND SWEATSHIRTS, IN CLASS
25 (U.S. CLS. 22 AND 39).

TRADEMARK

FIRST USE 12-1-2011; IN COMMERCE 12-1-2011.

PRINCIPAL REGISTER

THE MARK CONSISTS OF STANDARD CHARACTERS WITHOUT CLAIM TO ANY PAR-
TICULAR FONT, STYLE, SIZE, OR COLOR.

OWNER OF U.S. REG. NO. 2,947,576.

SN 77-750,967, FILED 6-3-2009.

KATHLEEN M. VANSTON, EXAMINING ATTORNEY



David J. Kybas

Director of the United States Patent and Trademark Office

United States of America

United States Patent and Trademark Office

AMAZON FRUSTRATION-FREE

Reg. No. 4,109,206

Registered Mar. 6, 2012

Int. Cls.: 42 and 45

SERVICE MARK

PRINCIPAL REGISTER

AMAZON TECHNOLOGIES, INC. (NEVADA CORPORATION)
ATTN: TRADEMARKS
PO BOX 8102
RENO, NV 89507

FOR: PACKAGING DESIGN FOR OTHERS, NAMELY, DESIGN SERVICES TO MANUFACTURERS OF CONSUMER PRODUCT PACKAGING; DESIGN OF CONSUMER PRODUCT PACKAGING AND WRAPPING MATERIALS FOR MANUFACTURERS; EVALUATION OF CONSUMER PRODUCT PACKAGING FOR OTHERS FOR THE PURPOSE OF ACCREDITATION, CERTIFICATION, AND QUALITY CONTROL; QUALITY CONTROL AND RELATED CONSULTANCY SERVICES FOR MANUFACTURERS CONCERNING PACKAGING STANDARDS AND QUALITY ASSURANCE; ACCREDITATION SERVICES FOR MANUFACTURERS, NAMELY, DEVELOPING STANDARDS FOR PACKAGING FOR THE PURPOSE OF ACCREDITATION; DEVELOPING VOLUNTARY STANDARDS, CERTIFICATION CRITERIA AND GUIDELINES IN THE FIELD OF CONSUMER PRODUCT PACKAGING FOR ACCREDITATION, CERTIFICATION AND QUALITY CONTROL PURPOSES; CONSULTING SERVICES TO MANUFACTURERS, NAMELY, PROVIDING INFORMATION CONCERNING THE DEVELOPMENT OF VOLUNTARY STANDARDS, GUIDELINES, AND CERTIFICATION CRITERIA IN THE FIELD OF CONSUMER PRODUCT PACKAGING, IN CLASS 42 (U.S. CLS. 100 AND 101).

FIRST USE 11-3-2008; IN COMMERCE 11-3-2008.



FOR: CONSULTING SERVICES TO MANUFACTURERS, NAMELY, PROVIDING INFORMATION CONCERNING COMPLIANCE WITH VOLUNTARY STANDARDS, GUIDELINES, AND CERTIFICATION CRITERIA IN THE FIELD OF CONSUMER PRODUCT PACKAGING; LICENSING OF CONSUMER PRODUCT PACKAGING STANDARDS, NAMELY, PRODUCT PACKAGING AND MATERIAL STANDARDS THAT WERE DEVELOPED ACCORDING TO ACCREDITATION CRITERIA AND BASED ON SET STANDARDS AND GUIDELINES, IN CLASS 45 (U.S. CLS. 100 AND 101).

FIRST USE 11-3-2008; IN COMMERCE 11-3-2008.

David J. Kyros

THE MARK CONSISTS OF STANDARD CHARACTERS WITHOUT CLAIM TO ANY PARTICULAR FONT, STYLE, SIZE, OR COLOR.

SN 77-752,678, FILED 6-4-2009.

Reg. No. 4,109,206 AMY ALFIERI, EXAMINING ATTORNEY

United States of America

United States Patent and Trademark Office

valeritas

Reg. No. 4,109,207

Registered Mar. 6, 2012

Int. Cl.: 10

TRADEMARK

PRINCIPAL REGISTER

VALERITAS, INC. (DELAWARE CORPORATION)
SUITE 100
750 ROUTE 202 SOUTH
BRIDGEWATER, NJ 08807

FOR: MEDICAL APPARATUS, NAMELY, INFUSION AND INJECTION DEVICES FOR ADMINISTERING DRUGS, IN CLASS 10 (U.S. CLS. 26, 39 AND 44).

FIRST USE 1-3-2012; IN COMMERCE 1-3-2012.

THE MARK CONSISTS OF THE MARK "VALERITAS" IN LOWER CASE LETTERING, ALL LETTERS IN GRAY EXCEPT THE LETTER "I" WHICH IS IN GREEN, WITH GREEN DOTS ARCING ABOVE AND BELOW THE LETTER "I".

THE COLOR(S) GRAY AND GREEN IS/ARE CLAIMED AS A FEATURE OF THE MARK.

SN 77-752,695, FILED 6-4-2009.

ELLEN B. AWRICH, EXAMINING ATTORNEY



David J. Kyros

Director of the United States Patent and Trademark Office

United States of America

United States Patent and Trademark Office

THINK-FRIENDLY

Reg. No. 4,109,208

Registered Mar. 6, 2012

Int. Cl.: 41

SERVICE MARK

PRINCIPAL REGISTER

THE MACKSTONE CORPORATION (MISSOURI CORPORATION), DBA THE DUNCAN COMPANY,
613 NEWTON COURT
LIBERTY, MO 64068

FOR: ARRANGING PROFESSIONAL WORKSHOP AND TRAINING COURSES; CONDUCTING WORKSHOPS AND SEMINARS IN PERSONAL AWARENESS; CONDUCTING WORKSHOPS AND SEMINARS IN MANAGING PERSONAL AND ORGANIZATIONAL CHANGE, PRINCIPLE-CENTERED LEADERSHIP AND PROBLEM SOLVING; CONTINUING EDUCATION SERVICES, NAMELY, PROVIDING LIVE AND ON-LINE CONTINUING PROFESSIONAL EDUCATION SEMINARS IN THE FIELD OF CHANGE MANAGEMENT; EDUCATIONAL AND ENTERTAINMENT SERVICES, NAMELY, PROVIDING MOTIVATIONAL AND EDUCATIONAL SPEAKERS; EDUCATIONAL AND ENTERTAINMENT SERVICES, NAMELY, PROVIDING MOTIVATIONAL AND EDUCATIONAL SPEAKERS IN THE FIELD OF SELF- AND PERSONAL IMPROVEMENT; EDUCATIONAL SERVICES, NAMELY, CONDUCTING SEMINARS AND WORKSHOPS IN THE FIELD OF MANAGING PERSONAL AND ORGANIZATIONAL CHANGE AND DISTRIBUTION OF COURSE MATERIAL IN CONNECTION THEREWITH; LIFE COACHING SERVICES IN THE FIELD OF CHANGE MANAGEMENT; PROVIDING GROUP COACHING AND LEARNING FORUMS IN THE FIELD OF LEADERSHIP DEVELOPMENT; PROVIDING ON-LINE TRAINING IN THE FIELD OF CHANGE MANAGEMENT AND DISTRIBUTION OF COURSE MATERIALS IN CONNECTION THEREWITH; WORKSHOPS AND SEMINARS IN THE FIELD OF PERSONAL AND ORGANIZATIONAL CHANGE MANAGEMENT, IN CLASS 41 (U.S. CLS. 100, 101 AND 107).



FIRST USE 12-1-2005; IN COMMERCE 12-1-2005.

THE MARK CONSISTS OF STANDARD CHARACTERS WITHOUT CLAIM TO ANY PARTICULAR FONT, STYLE, SIZE, OR COLOR.

SN 77-752,797, FILED 6-5-2009.

KIM SAITO, EXAMINING ATTORNEY

David J. Kyffers

Director of the United States Patent and Trademark Office

United States of America

United States Patent and Trademark Office

TALK-FRIENDLY

Reg. No. 4,109,209

Registered Mar. 6, 2012

Int. Cl.: 41

SERVICE MARK

PRINCIPAL REGISTER

THE MACKSTONE CORPORATION (MISSOURI CORPORATION), DBA THE DUNCAN COMPANY,
613 NEWTON COURT
LIBERTY, MO 64068

FOR: ARRANGING PROFESSIONAL WORKSHOP AND TRAINING COURSES; CONDUCTING WORKSHOPS AND SEMINARS IN PERSONAL AWARENESS; CONDUCTING WORKSHOPS AND SEMINARS IN MANAGING PERSONAL AND ORGANIZATIONAL CHANGE, PRINCIPLE-CENTERED LEADERSHIP AND PROBLEM SOLVING; CONTINUING EDUCATION SERVICES, NAMELY, PROVIDING LIVE AND ON-LINE CONTINUING PROFESSIONAL EDUCATION SEMINARS IN THE FIELD OF CHANGE MANAGEMENT; EDUCATIONAL AND ENTERTAINMENT SERVICES, NAMELY, PROVIDING MOTIVATIONAL AND EDUCATIONAL SPEAKERS; EDUCATIONAL AND ENTERTAINMENT SERVICES, NAMELY, PROVIDING MOTIVATIONAL AND EDUCATIONAL SPEAKERS IN THE FIELD OF SELF- AND PERSONAL IMPROVEMENT; EDUCATIONAL SERVICES, NAMELY, CONDUCTING SEMINARS AND WORKSHOPS IN THE FIELD OF MANAGING PERSONAL AND ORGANIZATIONAL CHANGE AND DISTRIBUTION OF COURSE MATERIAL IN CONNECTION THEREWITH; LIFE COACHING SERVICES IN THE FIELD OF CHANGE MANAGEMENT; PROVIDING GROUP COACHING AND LEARNING FORUMS IN THE FIELD OF LEADERSHIP DEVELOPMENT; PROVIDING ON-LINE TRAINING IN THE FIELD OF CHANGE MANAGEMENT AND DISTRIBUTION OF COURSE MATERIALS IN CONNECTION THEREWITH; WORKSHOPS AND SEMINARS IN THE FIELD OF PERSONAL AND ORGANIZATIONAL CHANGE MANAGEMENT, IN CLASS 41 (U.S. CLS. 100, 101 AND 107).



FIRST USE 12-1-2005; IN COMMERCE 12-1-2005.

THE MARK CONSISTS OF STANDARD CHARACTERS WITHOUT CLAIM TO ANY PARTICULAR FONT, STYLE, SIZE, OR COLOR.

SN 77-752,804, FILED 6-5-2009.

KIM SAITO, EXAMINING ATTORNEY

David J. Kyffers

Director of the United States Patent and Trademark Office

United States of America

United States Patent and Trademark Office

TRUST-FRIENDLY

Reg. No. 4,109,210

Registered Mar. 6, 2012

Int. Cl.: 41

SERVICE MARK

PRINCIPAL REGISTER

THE MACKSTONE CORPORATION (MISSOURI CORPORATION), DBA THE DUNCAN COMPANY,
613 NEWTON COURT
LIBERTY, MO 64068

FOR: ARRANGING PROFESSIONAL WORKSHOP AND TRAINING COURSES; CONDUCTING WORKSHOPS AND SEMINARS IN PERSONAL AWARENESS; CONDUCTING WORKSHOPS AND SEMINARS IN MANAGING PERSONAL AND ORGANIZATIONAL CHANGE, PRINCIPLE-CENTERED LEADERSHIP AND PROBLEM SOLVING; CONTINUING EDUCATION SERVICES, NAMELY, PROVIDING LIVE AND ON-LINE CONTINUING PROFESSIONAL EDUCATION SEMINARS IN THE FIELD OF CHANGE MANAGEMENT; EDUCATIONAL AND ENTERTAINMENT SERVICES, NAMELY, PROVIDING MOTIVATIONAL AND EDUCATIONAL SPEAKERS; EDUCATIONAL AND ENTERTAINMENT SERVICES, NAMELY, PROVIDING MOTIVATIONAL AND EDUCATIONAL SPEAKERS IN THE FIELD OF SELF- AND PERSONAL IMPROVEMENT; EDUCATIONAL SERVICES, NAMELY, CONDUCTING SEMINARS AND WORKSHOPS IN THE FIELD OF MANAGING PERSONAL AND ORGANIZATIONAL CHANGE AND DISTRIBUTION OF COURSE MATERIAL IN CONNECTION THEREWITH; LIFE COACHING SERVICES IN THE FIELD OF CHANGE MANAGEMENT; PROVIDING GROUP COACHING AND LEARNING FORUMS IN THE FIELD OF LEADERSHIP DEVELOPMENT; PROVIDING ON-LINE TRAINING IN THE FIELD OF CHANGE MANAGEMENT AND DISTRIBUTION OF COURSE MATERIALS IN CONNECTION THEREWITH; WORKSHOPS AND SEMINARS IN THE FIELD OF PERSONAL AND ORGANIZATIONAL CHANGE MANAGEMENT, IN CLASS 41 (U.S. CLS. 100, 101 AND 107).



FIRST USE 12-1-2005; IN COMMERCE 12-1-2005.

THE MARK CONSISTS OF STANDARD CHARACTERS WITHOUT CLAIM TO ANY PARTICULAR FONT, STYLE, SIZE, OR COLOR.

SN 77-752,808, FILED 6-5-2009.

KIM SAITO, EXAMINING ATTORNEY

David J. Kyffers

Director of the United States Patent and Trademark Office

United States of America

United States Patent and Trademark Office



flowrest
Breathe well. Sleep well.

Reg. No. 4,109,211

VAPOTHERM, INC. (MARYLAND CORPORATION)
198 LOG CANOE CIRCLE
STEVENSVILLE, MD 21666

Registered Mar. 6, 2012

Int. Cl.: 10

FOR: MEDICAL APPARATUS FOR TREATING RESPIRATORY CONDITIONS, IN CLASS 10 (U.S. CLS. 26, 39 AND 44).

TRADEMARK

FIRST USE 7-29-2011; IN COMMERCE 7-29-2011.

PRINCIPAL REGISTER

OWNER OF U.S. REG. NO. 3,583,979.

THE MARK CONSISTS OF A PERSON SLEEPING ON A PILLOW WITH THE WORDING "FLOWREST" AND "BREATHE WELL. SLEEP WELL." UNDERNEATH.

SN 77-754,930, FILED 6-9-2009.

BRENDAN MCCAULEY, EXAMINING ATTORNEY



David J. Kybas

Director of the United States Patent and Trademark Office

United States of America

United States Patent and Trademark Office

TAGG CLEAN-HANDS

Reg. No. 4,109,212

TAGG DESIGN INC. (CANADA CORPORATION)
9-222 PELLATT AVE.
TORONTO, CANADA M9N2P6

Registered Mar. 6, 2012

Int. Cls.: 16, 19, 20, and 42

FOR: DECALS RELATING TO INFECTION CONTROL; PRINTED INSTRUCTION MANUALS, INSTRUCTION NOTICES AND GUIDES RELATING TO INFECTION CONTROL, IN CLASS 16 (U.S. CLS. 2, 5, 22, 23, 29, 37, 38 AND 50).

TRADEMARK

FIRST USE 3-0-2008; IN COMMERCE 11-9-2011.

SERVICE MARK

FOR: NON-LUMINOUS, NON-MECHANICAL SIGNS NOT OF METAL RELATING TO INFECTION CONTROL, IN CLASS 19 (U.S. CLS. 1, 12, 33 AND 50).

PRINCIPAL REGISTER

FIRST USE 3-0-2008; IN COMMERCE 11-9-2011.

FOR: WALL-MOUNTED HAND SANITIZING STATIONS COMPRISED OF A WOOD STAND WITH LAMINATE FINISH, ONE OR MORE SHELVES, A WALL-MOUNTING BRACKET, AND A SIGN SOLD TOGETHER AS A UNIT; WALL-MOUNTED HAND SANITIZING STATIONS COMPRISED OF A WOOD STAND WITH LAMINATE FINISH, WALL-MOUNTING BRACKET, AND A SIGN SOLD TOGETHER AS A UNIT; FREE-STANDING MOBILE HAND SANITIZING STATIONS COMPRISED OF A WOOD STAND WITH LAMINATE FINISH AND BASE BUMPER, A COUNTERTOP, A SIGN, DECALS AND WHEELS SOLD TOGETHER AS A UNIT; FREE-STANDING NON-MOBILE HAND SANITIZING STATIONS COMPRISED OF A WOOD STAND WITH LAMINATE FINISH AND BASE BUMPER, A COUNTERTOP, A SIGN AND DECALS SOLD TOGETHER AS A UNIT; FREE-STANDING MOBILE HAND SANITIZING STATIONS COMPRISED OF A WOOD STAND WITH LAMINATE FINISH AND BASE BUMPER, A COUNTERTOP, ONE OR MORE DRAWERS, A SIGN, DECALS AND WHEELS SOLD TOGETHER AS A UNIT; FREE-STANDING NON-MOBILE HAND SANITIZING STATIONS COMPRISED OF A WOOD STAND WITH LAMINATE FINISH AND BASE BUMPER, A COUNTERTOP, ONE OR MORE DRAWERS, A SIGN AND DECALS SOLD TOGETHER AS A UNIT, IN CLASS 20 (U.S. CLS. 2, 13, 22, 25, 32 AND 50).

FIRST USE 3-0-2008; IN COMMERCE 11-9-2011.

FOR: PROVIDING A WEB SITE THAT GIVES USERS THE ABILITY TO CREATE AND CUSTOMIZE SIGNS, DOWNLOAD ICONS AND EDIT DOWNLOADABLE NOTICES, ALL IN THE FIELD OF INFECTION CONTROL, IN CLASS 42 (U.S. CLS. 100 AND 101).



David J. Kyros

Director of the United States Patent and Trademark Office

Reg. No. 4,109,212 FIRST USE 12-11-2009; IN COMMERCE 12-11-2009.

THE MARK CONSISTS OF STANDARD CHARACTERS WITHOUT CLAIM TO ANY PARTICULAR FONT, STYLE, SIZE, OR COLOR.

SN 77-755,318, FILED 6-9-2009.

BRIAN CALLAGHAN, EXAMINING ATTORNEY

United States of America

United States Patent and Trademark Office



Ezy-clean

Reg. No. 4,109,213

Registered Mar. 6, 2012

Int. Cl.: 7

TRADEMARK

PRINCIPAL REGISTER

SANTOS (FRANCE SOCIÉTÉ PAR ACTIONS SIMPLIFIÉE (SAS))
140-150 ROGER SALENGRO
VAULX-EN-VELIN, FRANCE 69120

FOR: ELECTRIC ALIMENTARY CENTRIFUGAL JUICER MACHINES AND ELECTRIC CITRUS PRESSES, ALL FOR PROFESSIONAL OR INDUSTRIAL PURPOSES, NOTABLY FOR USE IN COMMERCIAL KITCHENS, BARS, HOTELS AND GROCER'S SHOPS, IN CLASS 7 (U.S. CLS. 13, 19, 21, 23, 31, 34 AND 35).

FIRST USE 9-30-2008; IN COMMERCE 5-3-2000.

PRIORITY CLAIMED UNDER SEC. 44(D) ON FRANCE APPLICATION NO. 083617917, FILED 12-16-2008, REG. NO. 083617917, DATED 12-16-2008, EXPIRES 12-16-2018.

THE MARK CONSISTS OF A CONICAL CENTRIFUGE BASKET ATOP A BASE, THIS FIGURE INCLUDES A SMILEY FACE AND AN ARROW SYMBOLISING AN EASY MOVEMENT OF DISASSEMBLING FOR CLEANING, ALL LOCATED ON THE LEFT SIDE OF THE WORDS "EZY-CLEAN".

SN 77-755,726, FILED 6-9-2009.

LOURDES AYALA, EXAMINING ATTORNEY



David J. Kybas

Director of the United States Patent and Trademark Office

United States of America

United States Patent and Trademark Office

Laughing My Tail Off

Reg. No. 4,109,214

Registered Mar. 6, 2012

Int. Cl.: 18

TRADEMARK

PRINCIPAL REGISTER

WEINBERG, KAREN M (UNITED STATES INDIVIDUAL)
108 JADESTONE
IRVINE, CA 92603 AND

JOUNG, SARAH S (UNITED STATES INDIVIDUAL)
2012 WEST FATHOM LANE
ANAHEIM, CA 92801

FOR: COLLARS FOR PETS; DOG COLLARS; DOG COLLARS AND LEADS; DOG LEASHES;
PET PRODUCTS, NAMELY, PET RESTRAINING DEVICES CONSISTING OF LEASHES
AND COLLARS, IN CLASS 18 (U.S. CLS. 1, 2, 3, 22 AND 41).

FIRST USE 8-26-2008; IN COMMERCE 5-18-2009.

THE MARK CONSISTS OF STANDARD CHARACTERS WITHOUT CLAIM TO ANY PAR-
TICULAR FONT, STYLE, SIZE, OR COLOR.

SN 77-755,859, FILED 6-10-2009.

LINDA ESTRADA, EXAMINING ATTORNEY



David J. Kyros

Director of the United States Patent and Trademark Office

United States of America

United States Patent and Trademark Office

EMPLOYMENT TO EMPOWERMENT

Reg. No. 4,109,215

Registered Mar. 6, 2012

Int. Cls.: 35 and 41

SERVICE MARK

PRINCIPAL REGISTER

THE ENTREPRENEUR'S SOURCE, INC. (DELAWARE CORPORATION)
BUILDING 2, 900 MAIN STREET SOUTH
SOUTHBURY, CT 06488

FOR: CONSULTING SERVICES FOR INDIVIDUALS SEEKING TO BECOME SELF-EMPLOYED THROUGH FRANCHISE OWNERSHIP OR TO IMPROVE THE PERFORMANCE OF THEIR FRANCHISE BUSINESS, IN CLASS 35 (U.S. CLS. 100, 101 AND 102).

FIRST USE 11-14-2011; IN COMMERCE 11-14-2011.

FOR: PROVIDING ON-LINE COURSES, WORKSHOPS AND SEMINARS FOR INDIVIDUALS SEEKING TO BECOME SELF-EMPLOYED THROUGH FRANCHISE OWNERSHIP OR TO IMPROVE THE PERFORMANCE OF THEIR FRANCHISE BUSINESS; PROVIDING VIA A GLOBAL COMPUTER NETWORK COURSES, SEMINARS, WEB-CASTS AND WORKSHOPS FOR INDIVIDUALS SEEKING TO BECOME SELF-EMPLOYED THROUGH FRANCHISE OWNERSHIP OR TO IMPROVE THE PERFORMANCE OF THEIR FRANCHISE BUSINESS; PERSONAL COACHING SERVICES, NAMELY, COACHING INDIVIDUALS SEEKING TO BECOME SELF-EMPLOYED THROUGH FRANCHISE OWNERSHIP OR TO IMPROVE THE PERFORMANCE OF THEIR FRANCHISE BUSINESS, IN CLASS 41 (U.S. CLS. 100, 101 AND 107).

FIRST USE 11-14-2011; IN COMMERCE 11-14-2011.

THE MARK CONSISTS OF STANDARD CHARACTERS WITHOUT CLAIM TO ANY PARTICULAR FONT, STYLE, SIZE, OR COLOR.

NO CLAIM IS MADE TO THE EXCLUSIVE RIGHT TO USE "EMPLOYMENT", APART FROM THE MARK AS SHOWN.

SN 77-757,987, FILED 6-12-2009.

CHRIS WELLS, EXAMINING ATTORNEY



David J. Kyjars

Director of the United States Patent and Trademark Office

United States of America

United States Patent and Trademark Office

By your side.

Reg. No. 4,109,216

Registered Mar. 6, 2012

Int. Cls.: 9 and 16

TRADEMARK

PRINCIPAL REGISTER

BRAIN INJURY ASSOCIATION OF FLORIDA, INC. (FLORIDA CORPORATION)
1621 METROPOLITAN BLVD. SUITE B
TALLAHASSEE, FL 32308

FOR: EDUCATIONAL PUBLICATIONS, NAMELY, ELECTRONIC PRESENTATIONS IN THE NATURE OF INSTRUCTIONAL CDS, DVDS AND VIDEO IN THE FIELDS OF PREVENTION, ASSISTANCE AND SUPPORT IN THE FIELD OF BRAIN INJURIES, IN CLASS 9 (U.S. CLS. 21, 23, 26, 36 AND 38).

FIRST USE 6-10-2006; IN COMMERCE 7-1-2008.

FOR: A SERIES OF BOOKS, WRITTEN ARTICLES, HANDOUTS AND WORKSHEETS IN THE FIELD OF BRAIN INJURIES; ART PRINTS; EDUCATIONAL PUBLICATIONS, NAMELY, BOOKS, WRITTEN ARTICLES, HANDOUTS, WORKSHEETS, POSTERS AND PLACCARDS, IN THE FIELDS OF PREVENTION, ASSISTANCE AND SUPPORT IN THE FIELD OF BRAIN INJURIES, IN CLASS 16 (U.S. CLS. 2, 5, 22, 23, 29, 37, 38 AND 50).

FIRST USE 6-10-2006; IN COMMERCE 6-10-2008.

THE MARK CONSISTS OF STANDARD CHARACTERS WITHOUT CLAIM TO ANY PARTICULAR FONT, STYLE, SIZE, OR COLOR.

SN 77-761,057, FILED 6-16-2009.

THOMAS MANOR, EXAMINING ATTORNEY



David J. Kyros

Director of the United States Patent and Trademark Office

United States of America

United States Patent and Trademark Office

BIOLITE DISPLAY

Reg. No. 4,109,217

ALPINE ELECTRONICS, INC. (JAPAN CORPORATION)
1-1-8, NISHI GOTANDA SHINAGAWA-KU
TOKYO, JAPAN 141-8501

Registered Mar. 6, 2012

Int. Cl.: 9

FOR: CD PLAYERS; SOUND EQUALIZERS; AUDIO ELECTRONIC COMPONENTS, NAMELY, SURROUND SOUND SYSTEMS; CHANNEL DIVIDERS; DIGITAL/ANALOG CONVERTERS AND FREQUENCY PROCESSORS FOR AUDIO AND VISUAL APPARATUS, IN CLASS 9 (U.S. CLS. 21, 23, 26, 36 AND 38).

TRADEMARK

PRINCIPAL REGISTER

FIRST USE 9-30-2009; IN COMMERCE 9-30-2009.

THE MARK CONSISTS OF STANDARD CHARACTERS WITHOUT CLAIM TO ANY PARTICULAR FONT, STYLE, SIZE, OR COLOR.

NO CLAIM IS MADE TO THE EXCLUSIVE RIGHT TO USE "DISPLAY", APART FROM THE MARK AS SHOWN.

SN 77-763,481, FILED 6-18-2009.

PAUL E. FAHRENKOPF, EXAMINING ATTORNEY



David J. Kyffers

Director of the United States Patent and Trademark Office

United States of America

United States Patent and Trademark Office

BATTLE RAM CHARIOT

Reg. No. 4,109,218

Registered Mar. 6, 2012

Int. Cl.: 28

TRADEMARK

PRINCIPAL REGISTER

MATTEL, INC. (DELAWARE CORPORATION)
M1-1518
333 CONTINENTAL BOULEVARD
EL SEGUNDO, CA 90245

FOR: TOYS, GAMES AND PLAYTHINGS, NAMELY, TOY VEHICLES AND ACCESSORIES THEREFOR, IN CLASS 28 (U.S. CLS. 22, 23, 38 AND 50).

FIRST USE 12-15-2011; IN COMMERCE 12-15-2011.

THE MARK CONSISTS OF STANDARD CHARACTERS WITHOUT CLAIM TO ANY PARTICULAR FONT, STYLE, SIZE, OR COLOR.

NO CLAIM IS MADE TO THE EXCLUSIVE RIGHT TO USE "CHARIOT", APART FROM THE MARK AS SHOWN.

SN 77-768,130, FILED 6-25-2009.

COLLEEN DOMBROW, EXAMINING ATTORNEY



David J. Kyjars

Director of the United States Patent and Trademark Office

United States of America

United States Patent and Trademark Office

KNOWLEDGE THE NEW MONEY

Reg. No. 4,109,219

CASHFLOW TECHNOLOGIES, INC. (NEVADA CORPORATION)
4330 N. CIVIC CENTER PLAZA, SUITE 101
SCOTTSDALE, AZ 85251

Registered Mar. 6, 2012

Int. Cl.: 28

FOR: BOARD GAMES AND EQUIPMENT SOLD AS A UNIT FOR PLAYING BOARD GAMES
USED FOR FINANCIAL EDUCATION, IN CLASS 28 (U.S. CLS. 22, 23, 38 AND 50).

TRADEMARK

FIRST USE 7-0-2010; IN COMMERCE 7-0-2010.

PRINCIPAL REGISTER

THE MARK CONSISTS OF STANDARD CHARACTERS WITHOUT CLAIM TO ANY PAR-
TICULAR FONT, STYLE, SIZE, OR COLOR.

SN 77-768,451, FILED 6-25-2009.

KEVON CHISOLM, EXAMINING ATTORNEY



David J. Kybas

Director of the United States Patent and Trademark Office

United States of America
United States Patent and Trademark Office

VOLTURI

Reg. No. 4,109,220

SUMMIT ENTERTAINMENT, LLC (DELAWARE LIMITED LIABILITY COMPANY)
1630 STEWART STREET, SUITE 120
SANTA MONICA, CA 90404

Registered Mar. 6, 2012

Int. Cl.: 20

FOR: PILLOWS, PLASTIC KEY CHAINS, PLASTIC NOVELTY LICENSE PLATES, AND
WOOD BOXES, IN CLASS 20 (U.S. CLS. 2, 13, 22, 25, 32 AND 50).

TRADEMARK

FIRST USE 9-22-2008; IN COMMERCE 9-22-2008.

PRINCIPAL REGISTER

THE MARK CONSISTS OF STANDARD CHARACTERS WITHOUT CLAIM TO ANY PAR-
TICULAR FONT, STYLE, SIZE, OR COLOR.

SN 77-770,782, FILED 6-30-2009.

JAY FLOWERS, EXAMINING ATTORNEY



David J. Kybas

Director of the United States Patent and Trademark Office

United States of America

United States Patent and Trademark Office

LUXIANCE

Reg. No. 4,109,221

SOLAIS LIGHTING, INC. (DELAWARE CORPORATION)
67 POLAND STREET
BRIDGEPORT, CT 066053266

Registered Mar. 6, 2012

Int. Cl.: 11

FOR: LIGHTING, NAMELY, LAMPS AND LIGHTING FIXTURES, IN CLASS 11 (U.S. CLS. 13, 21, 23, 31 AND 34).

TRADEMARK

FIRST USE 8-1-2010; IN COMMERCE 8-1-2010.

PRINCIPAL REGISTER

THE MARK CONSISTS OF STANDARD CHARACTERS WITHOUT CLAIM TO ANY PARTICULAR FONT, STYLE, SIZE, OR COLOR.

THE WORDING "LUXIANCE" HAS NO MEANING IN A FOREIGN LANGUAGE.

SN 77-770,958, FILED 6-30-2009.

ODESSA BIBBINS, EXAMINING ATTORNEY



David J. Kybas

Director of the United States Patent and Trademark Office

United States of America

United States Patent and Trademark Office

SEED

Reg. No. 4,109,222

Registered Mar. 6, 2012

Int. Cl.: 7

TRADEMARK

PRINCIPAL REGISTER

SEED CO., LTD (JAPAN CORPORATION)
3-5-25, UCHINDAI-CHO, MIYAKOJIMA-KU
OSAKA-SHI
OSAKA, JAPAN

FOR: MACHINERY FOR THE MECHANICAL RECYCLING OF USED PAPER, NAMELY, MACHINES FOR PULP MAKING, PAPER SHREDDING MACHINES, CRUSHING UNITS AND BEATING UNITS FOR PULP MAKING MACHINES, AND BEATING MACHINES AND MASHING MACHINES FOR USE IN BEATING UNITS; MACHINES FOR PAPER MAKING; PAPER-MAKING MACHINERY, NAMELY, PAPER PULP FEEDING UNITS, PAPER MAKING NET CONVEYOR UNITS, DEWATERING ROLL UNITS, DRYING BELT CONVEYOR UNITS, SMOOTH SURFACE FINISHING ROLL UNITS AND HEATER PLATE UNITS FOR PAPER MAKING APPARATUS, MESH BELTS FOR PAPER MAKING NET CONVEYOR UNITS, DEWATERING ROLLS AND PRESS ROLLS FOR DEWATERING ROLL UNITS, SMOOTH SURFACE BELTS FOR DRYING BELT CONVEYOR UNITS, IN CLASS 7 (U.S. CLS. 13, 19, 21, 23, 31, 34 AND 35).

FIRST USE 4-11-2011; IN COMMERCE 4-11-2011.

THE MARK CONSISTS OF THE STYLIZED WORD "SEED".

SN 77-771,014, FILED 6-30-2009.

HEATHER THOMPSON, EXAMINING ATTORNEY



David J. Kybas

Director of the United States Patent and Trademark Office

United States of America

United States Patent and Trademark Office

CLEANMIX

Reg. No. 4,109,223

Registered Mar. 6, 2012

Int. Cl.: 19

TRADEMARK

PRINCIPAL REGISTER

GST INTERNATIONAL, LLC (CALIFORNIA LIMITED LIABILITY COMPANY)
SUITE 300D
555 5TH ST.
SANTA ROSA, CA 95401

FOR: CONCRETE, IN CLASS 19 (U.S. CLS. 1, 12, 33 AND 50).

FIRST USE 6-1-2010; IN COMMERCE 6-1-2010.

THE MARK CONSISTS OF STANDARD CHARACTERS WITHOUT CLAIM TO ANY PARTICULAR FONT, STYLE, SIZE, OR COLOR.

SN 77-771,067, FILED 6-30-2009.

ZACHARY BELLO, EXAMINING ATTORNEY



David J. Kybas

Director of the United States Patent and Trademark Office

United States of America

United States Patent and Trademark Office

STUDIO HARCOURT PARIS

Reg. No. 4,109,224

FINANCIERE HARCOURT (FRANCE SOCIÉTÉ ANONYME (SA))
10 RUE JEAN GOUJON
75008 PARIS, FRANCE

Registered Mar. 6, 2012

Int. Cl.: 16

FOR: PHOTOGRAPHS, IN CLASS 16 (U.S. CLS. 2, 5, 22, 23, 29, 37, 38 AND 50).

TRADEMARK

FIRST USE 7-5-2010; IN COMMERCE 7-5-2010.

PRINCIPAL REGISTER

THE MARK CONSISTS OF STANDARD CHARACTERS WITHOUT CLAIM TO ANY PARTICULAR FONT, STYLE, SIZE, OR COLOR.

NO CLAIM IS MADE TO THE EXCLUSIVE RIGHT TO USE "STUDIO" AND "PARIS", APART FROM THE MARK AS SHOWN.

SN 77-772,474, FILED 7-1-2009.

MICHELE SWAIN, EXAMINING ATTORNEY



David J. Kybas

Director of the United States Patent and Trademark Office

United States of America

United States Patent and Trademark Office

NEPTUNEWINE

Reg. No. 4,109,225

NEPTUNE, PETER (UNITED STATES INDIVIDUAL)
17561 JACARANDA LANE
IRVINE, CA 92612

Registered Mar. 6, 2012

Int. Cl.: 35

FOR: MANAGEMENT AND BUSINESS CONSULTING SERVICES IN THE FIELD OF WINE,
IN CLASS 35 (U.S. CLS. 100, 101 AND 102).

SERVICE MARK

FIRST USE 1-1-2008; IN COMMERCE 1-1-2008.

PRINCIPAL REGISTER

THE MARK CONSISTS OF STANDARD CHARACTERS WITHOUT CLAIM TO ANY PAR-
TICULAR FONT, STYLE, SIZE, OR COLOR.

SN 77-773,707, FILED 7-2-2009.

FRED CARL, EXAMINING ATTORNEY



David J. Kyfos

Director of the United States Patent and Trademark Office

United States of America
United States Patent and Trademark Office

THE
ARGENT
ARCHIVES

Reg. No. 4,109,226

Registered Mar. 6, 2012

Int. Cl.: 16

TRADEMARK

PRINCIPAL REGISTER

ALTEMUS, ROBERT L. (UNITED STATES INDIVIDUAL)
613 EAST 6TH STREET
4B
NEW YORK, NY 10009

FOR: CALENDARS; COFFEE TABLE BOOKS FEATURING FANTASY AND SCIENCE FICTION; COMIC BOOKS; GRAPHIC NOVELS; POSTERS, IN CLASS 16 (U.S. CLS. 2, 5, 22, 23, 29, 37, 38 AND 50).

FIRST USE 8-27-2011; IN COMMERCE 12-1-2011.

NO CLAIM IS MADE TO THE EXCLUSIVE RIGHT TO USE "ARCHIVES", APART FROM THE MARK AS SHOWN.

THE MARK CONSISTS OF THE WORDING "THE ARGENT ARCHIVES" IN STYLIZED FONT

SN 77-775,653, FILED 7-7-2009.

DOMINIC FATHY, EXAMINING ATTORNEY



David J. Kybas

Director of the United States Patent and Trademark Office

United States of America

United States Patent and Trademark Office

MIRA HEALTHCARE

Reg. No. 4,109,227

C/HCA, INC. (DELAWARE CORPORATION)
ONE PARK PLAZA
NASHVILLE, TN 37203

Registered Mar. 6, 2012

Int. Cl.: 44

FOR: HEALTHCARE SERVICES, EXCLUDING DENTAL SERVICES; MEDICAL SERVICES, EXCLUDING DENTAL SERVICES, IN CLASS 44 (U.S. CLS. 100 AND 101).

SERVICE MARK

FIRST USE 5-0-2010; IN COMMERCE 5-0-2010.

PRINCIPAL REGISTER

THE MARK CONSISTS OF STANDARD CHARACTERS WITHOUT CLAIM TO ANY PARTICULAR FONT, STYLE, SIZE, OR COLOR.

NO CLAIM IS MADE TO THE EXCLUSIVE RIGHT TO USE "HEALTHCARE", APART FROM THE MARK AS SHOWN.

THE ENGLISH TRANSLATION OF "MIRA" IN THE MARK IS "SIGHT" OR "LOOK" IN SPANISH.

SN 77-777,842, FILED 7-9-2009.

JERI J. FICKES, EXAMINING ATTORNEY



David J. Kybas

Director of the United States Patent and Trademark Office

United States of America

United States Patent and Trademark Office

REVERE SECURITY

Reg. No. 4,109,228

Registered Mar. 6, 2012

Int. Cls.: 9, 42, and 45

TRADEMARK

SERVICE MARK

PRINCIPAL REGISTER

REVERE SECURITY CORPORATION (DELAWARE CORPORATION)
4500 WESTGROVE DRIVE
SUITE 335
ADDISON, TX 75001

FOR: CRYPTOGRAPHIC PROTECTION SOFTWARE FEATURING CRYPTOGRAPHIC ALGORITHMS; COMPUTER HARDWARE INCORPORATING CRYPTOGRAPHIC ALGORITHMS; COMPUTER SOFTWARE IN THE FIELD OF CRYPTOGRAPHY AND DATA ENCRYPTION, IN CLASS 9 (U.S. CLS. 21, 23, 26, 36 AND 38).

FIRST USE 11-30-2011; IN COMMERCE 11-30-2011.

FOR: RESEARCH IN THE FIELD OF CRYPTOGRAPHY AND DATA ENCRYPTION; RESEARCH AND DEVELOPMENT OF COMPUTER SOFTWARE IN THE FIELD OF CRYPTOGRAPHY AND DATA ENCRYPTION, IN CLASS 42 (U.S. CLS. 100 AND 101).

FIRST USE 11-1-2010; IN COMMERCE 11-1-2010.

FOR: LICENSING OF CRYPTOGRAPHIC ALGORITHMS, IN CLASS 45 (U.S. CLS. 100 AND 101).

FIRST USE 10-5-2011; IN COMMERCE 10-5-2011.

THE MARK CONSISTS OF STANDARD CHARACTERS WITHOUT CLAIM TO ANY PARTICULAR FONT, STYLE, SIZE, OR COLOR.

NO CLAIM IS MADE TO THE EXCLUSIVE RIGHT TO USE "SECURITY", APART FROM THE MARK AS SHOWN.

SN 77-780,448, FILED 7-14-2009.

HOWARD SMIGA, EXAMINING ATTORNEY



David J. Kybas

Director of the United States Patent and Trademark Office

United States of America

United States Patent and Trademark Office

LINKEDIN

Reg. No. 4,109,229

Registered Mar. 6, 2012

Int. Cl.: 45

SERVICE MARK

PRINCIPAL REGISTER

LINKEDIN CORPORATION (DELAWARE CORPORATION)
2029 STIERLIN COURT
MOUNTAIN VIEW, CA 94043

FOR: PROVIDING INFORMATION IN THE FIELD OF PERSONAL DEVELOPMENT, NAMELY, SELF-IMPROVEMENT, SELF-FULFILLMENT AND INTERPERSONAL COMMUNICATIONS RELATING TO COMMUNITY, HUMANITARIAN AND PHILANTHROPIC ACTIVITIES, IN CLASS 45 (U.S. CLS. 100 AND 101).

FIRST USE 9-7-2011; IN COMMERCE 9-7-2011.

THE MARK CONSISTS OF STANDARD CHARACTERS WITHOUT CLAIM TO ANY PARTICULAR FONT, STYLE, SIZE, OR COLOR.

OWNER OF U.S. REG. NOS. 3,074,241, 3,074,242, AND 3,303,349.

SN 77-782,849, FILED 7-16-2009.

BERYL GARDNER, EXAMINING ATTORNEY



David J. Kyros

Director of the United States Patent and Trademark Office

United States of America

United States Patent and Trademark Office

HEALTHCARE FOR YOUR CAR

Reg. No. 4,109,230

Registered Mar. 6, 2012

Int. Cl.: 35

SERVICE MARK

PRINCIPAL REGISTER

SOUTHWESTRE (TEXAS CORPORATION)
15920 ADDISON ROAD
ADDISON, TX 75001

FOR: ADMINISTRATION OF A VEHICLE REPAIR AND MAINTENANCE SERVICE PLAN OVER A GLOBAL COMPUTER NETWORK, NAMELY, COORDINATING OTHER SERVICE PROVIDERS TO PERFORM VEHICLE REPAIR AND MAINTENANCE , IN CLASS 35 (U.S. CLS. 100, 101 AND 102).

FIRST USE 9-1-2011; IN COMMERCE 9-1-2011.

THE MARK CONSISTS OF STANDARD CHARACTERS WITHOUT CLAIM TO ANY PARTICULAR FONT, STYLE, SIZE, OR COLOR.

SN 77-783,059, FILED 7-16-2009.

JANICE L. MCMORROW, EXAMINING ATTORNEY



David J. Kybas

Director of the United States Patent and Trademark Office

United States of America

United States Patent and Trademark Office

AIE

Reg. No. 4,109,231

Registered Mar. 6, 2012

Int. Cl.: 9

TRADEMARK

PRINCIPAL REGISTER

ATTIVIO, INC. (DELAWARE CORPORATION)
275 GROVE STREET
NEWTON, MA 02466

FOR: COMPUTER SEARCH ENGINE SOFTWARE, COMPUTER SOFTWARE FOR APPLICATION AND DATABASE INTEGRATION, AND COMPUTER SOFTWARE DEVELOPMENT TOOLS ALL FOR THE SEARCH, COLLECTION, RETRIEVAL, AND REPORTING ON ENTERPRISE DATA, MEDIA, COMMUNICATIONS AND DOCUMENTS, IN CLASS 9 (U.S. CLS. 21, 23, 26, 36 AND 38).

FIRST USE 3-31-2008; IN COMMERCE 3-31-2008.

THE MARK CONSISTS OF STANDARD CHARACTERS WITHOUT CLAIM TO ANY PARTICULAR FONT, STYLE, SIZE, OR COLOR.

SN 77-786,112, FILED 7-21-2009.

MAYUR VAGHANI, EXAMINING ATTORNEY



David J. Kybas

Director of the United States Patent and Trademark Office

United States of America

United States Patent and Trademark Office

CHOOSE.COMMIT.PREVAIL.

Reg. No. 4,109,232

Registered Mar. 6, 2012

Int. Cl.: 16

TRADEMARK

PRINCIPAL REGISTER

VIBRYNT, INC. (DELAWARE CORPORATION)
701 GALVESTON DRIVE
REDWOOD CITY, CA 94063

FOR: PRINTED PUBLICATIONS, NAMELY, EDUCATIONAL AND TRAINING MANUALS, HANDBOOKS, BROCHURES, BOOKLETS, MAGAZINES, PICTURES, AND PAMPHLETS REGARDING ABDOMINAL IMPLANTS AND WELLNESS, IN CLASS 16 (U.S. CLS. 2, 5, 22, 23, 29, 37, 38 AND 50).

FIRST USE 9-8-2011; IN COMMERCE 9-8-2011.

THE MARK CONSISTS OF STANDARD CHARACTERS WITHOUT CLAIM TO ANY PARTICULAR FONT, STYLE, SIZE, OR COLOR.

SN 77-786,460, FILED 7-21-2009.

ALLISON HOLTZ, EXAMINING ATTORNEY



David J. Kybas

Director of the United States Patent and Trademark Office

United States of America
United States Patent and Trademark Office

QUIDDITCH

Reg. No. 4,109,233

Registered Mar. 6, 2012

Int. Cl.: 24

TRADEMARK

PRINCIPAL REGISTER

WARNER BROS. ENTERTAINMENT INC. (DELAWARE CORPORATION)
4000 WARNER BOULEVARD
BURBANK, CA 91522

FOR: BED LINENS, NAMELY, BED BLANKETS, IN CLASS 24 (U.S. CLS. 42 AND 50).

FIRST USE 6-18-2010; IN COMMERCE 6-18-2010.

THE MARK CONSISTS OF STANDARD CHARACTERS WITHOUT CLAIM TO ANY PARTICULAR FONT, STYLE, SIZE, OR COLOR.

OWNER OF U.S. REG. NOS. 2,456,415, 4,019,970, AND OTHERS.

SN 77-794,439, FILED 7-31-2009.

DANNEAN HETZEL, EXAMINING ATTORNEY



David J. Kyros

Director of the United States Patent and Trademark Office

United States of America

United States Patent and Trademark Office

PINK DOLLAZ

Reg. No. 4,109,234

Registered Mar. 6, 2012

Int. Cl.: 25

TRADEMARK

PRINCIPAL REGISTER

PINK DOLLAZ ENTERTAINMENT. (CALIFORNIA PARTNERSHIP)
2908 W. 94TH STREET
INGLEWOOD, CA 90305

FOR: SHIRTS, IN CLASS 25 (U.S. CLS. 22 AND 39).

FIRST USE 1-8-2010; IN COMMERCE 1-8-2010.

THE MARK CONSISTS OF STANDARD CHARACTERS WITHOUT CLAIM TO ANY PARTICULAR FONT, STYLE, SIZE, OR COLOR.

SN 77-796,121, FILED 8-4-2009.

RUSS HERMAN, EXAMINING ATTORNEY



David J. Kybas

Director of the United States Patent and Trademark Office

United States of America

United States Patent and Trademark Office

MY TOTAL HEALTHCARE

Reg. No. 4,109,235

Registered Mar. 6, 2012

Int. Cls.: 16, 41, 42, and 44

TRADEMARK

SERVICE MARK

PRINCIPAL REGISTER

H. LEE MOFFITT CANCER CENTER AND RESEARCH INSTITUTE, INC. (FLORIDA CORPORATION), AKA MOFFITT CANCER CENTER, 12902 MAGNOLIA DRIVE MRC-TTO TAMPA, FL 33612

FOR: PUBLICATIONS, NAMELY, BROCHURES, GUIDES, PAMPHLETS IN THE FIELDS OF PATIENT CARE, AND MEDICAL STUDIES AND RESEARCH RELATED TO ONCOLOGY AND OTHER DISEASES AND MEDICAL CONDITIONS, IN CLASS 16 (U.S. CLS. 2, 5, 22, 23, 29, 37, 38 AND 50).

FIRST USE 3-30-2011; IN COMMERCE 3-30-2011.

FOR: EDUCATION SERVICES, NAMELY, PROVIDING PROGRAMS AND SEMINARS IN THE FIELD OF MEDICINE AND PATIENT CARE, IN CLASS 41 (U.S. CLS. 100, 101 AND 107).

FIRST USE 3-30-2011; IN COMMERCE 3-30-2011.

FOR: MEDICAL AND SCIENTIFIC RESEARCH IN THE FIELD OF MEDICAL CONDITIONS AND DISEASE PREVENTION, EARLY DETECTION, AND CARE; MEDICAL AND SCIENTIFIC RESEARCH SERVICES IN THE FIELD OF CANCER TREATMENT AND DIAGNOSIS, IN CLASS 42 (U.S. CLS. 100 AND 101).

FIRST USE 3-30-2011; IN COMMERCE 3-30-2011.

FOR: MEDICAL SERVICES, NAMELY, THE PREVENTION, EARLY DETECTION, DIAGNOSIS, STAGING AND TREATMENT OF DISEASE; PROVIDING MEDICAL INFORMATION SERVICES TO PATIENTS WITH CANCER AND OTHER DISEASES VIA A COMPUTER NETWORK, IN CLASS 44 (U.S. CLS. 100 AND 101).

FIRST USE 3-30-2011; IN COMMERCE 11-18-2011.

THE MARK CONSISTS OF STANDARD CHARACTERS WITHOUT CLAIM TO ANY PARTICULAR FONT, STYLE, SIZE, OR COLOR.



David J. Kyros

Director of the United States Patent and Trademark Office

Reg. No. 4,109,235 NO CLAIM IS MADE TO THE EXCLUSIVE RIGHT TO USE "HEALTHCARE", APART FROM THE MARK AS SHOWN.

SN 77-797,177, FILED 8-5-2009.

MICHAEL KEATING, EXAMINING ATTORNEY

United States of America

United States Patent and Trademark Office

PR FOR PEOPLE

Reg. No. 4,109,236

Registered Mar. 6, 2012

Int. Cl.: 16

TRADEMARK

PRINCIPAL REGISTER

XANTHUS COMMUNICATIONS LLC (WASHINGTON LIMITED LIABILITY COMPANY)
357 GARFIELD STREET
SEATTLE, WA 981093134

FOR: A SERIES OF BOOKS AND WRITTEN ARTICLES IN THE FIELD OF ADVERTISING SERVICES, PUBLIC RELATIONS AND MARKETING SERVICES, IN CLASS 16 (U.S. CLS. 2, 5, 22, 23, 29, 37, 38 AND 50).

FIRST USE 12-1-2009; IN COMMERCE 12-1-2009.

THE MARK CONSISTS OF STANDARD CHARACTERS WITHOUT CLAIM TO ANY PARTICULAR FONT, STYLE, SIZE, OR COLOR.

NO CLAIM IS MADE TO THE EXCLUSIVE RIGHT TO USE "PR", APART FROM THE MARK AS SHOWN.

SN 77-798,395, FILED 8-6-2009.

RUSS HERMAN, EXAMINING ATTORNEY



David J. Kybas

Director of the United States Patent and Trademark Office

United States of America

United States Patent and Trademark Office

DUAL

Reg. No. 4,109,237

Registered Mar. 6, 2012

Int. Cl.: 36

SERVICE MARK

PRINCIPAL REGISTER

POPULAR, INC. (PUERTO RICO CORPORATION)
POPULAR CENTER BUILDING, 9TH FLOOR
209 MUNOZ RIVERA AVENUE
SAN JUAN, PUERTO RICO 00918

FOR: CREDIT CARD SERVICES, IN CLASS 36 (U.S. CLS. 100, 101 AND 102).

FIRST USE 11-1-2010; IN COMMERCE 11-1-2010.

THE MARK CONSISTS OF STANDARD CHARACTERS WITHOUT CLAIM TO ANY PARTICULAR FONT, STYLE, SIZE, OR COLOR.

SN 77-799,374, FILED 8-7-2009.

DARRYL SPRUILL, EXAMINING ATTORNEY



David J. Kybas

Director of the United States Patent and Trademark Office

United States of America

United States Patent and Trademark Office

REAL FEMINISTS ARE STILL PRO-LIFE

Reg. No. 4,109,238

ENRIGHT, WENDI L. (UNITED STATES INDIVIDUAL)
3030 EVELYN DRIVE
SCHENECTADY, NY 12303

Registered Mar. 6, 2012

Int. Cls.: 9 and 16

FOR: DOWNLOADABLE ELECTRONIC PUBLICATIONS IN THE NATURE OF BOOKS AND A SERIES OF ARTICLES, ALL OF THE FOREGOING IN THE FIELD OF PROMOTING WOMEN'S RIGHTS AND THE RIGHTS OF UNBORN CHILDREN, IN CLASS 9 (U.S. CLS. 21, 23, 26, 36 AND 38).

TRADEMARK

PRINCIPAL REGISTER

FIRST USE 1-17-2010; IN COMMERCE 1-17-2010.

FOR: PUBLICATIONS, NAMELY, WRITTEN BOOKS AND A SERIES OF ARTICLES, ALL OF THE FOREGOING IN THE FIELD OF PROMOTING WOMEN'S RIGHTS AND THE RIGHTS OF UNBORN CHILDREN; BUMPER STICKERS, IN CLASS 16 (U.S. CLS. 2, 5, 22, 23, 29, 37, 38 AND 50).

FIRST USE 1-17-2010; IN COMMERCE 1-17-2010.

THE MARK CONSISTS OF STANDARD CHARACTERS WITHOUT CLAIM TO ANY PARTICULAR FONT, STYLE, SIZE, OR COLOR.

SN 77-800,573, FILED 8-10-2009.

MAYUR VAGHANI, EXAMINING ATTORNEY



David J. Kyjars

Director of the United States Patent and Trademark Office

United States of America

United States Patent and Trademark Office



Reg. No. 4,109,239

Registered Mar. 6, 2012

Int. Cl.: 10

TRADEMARK

PRINCIPAL REGISTER

KAMABRY, INC. (NEW YORK CORPORATION)
42 COLONIAL LANE
BELLPORT, NY 11713

FOR: MEDICAL DEVICES FOR KEGEL EXERCISES, NAMELY, PELVIC FLOOR EXERCISERS FOR USE TO TREAT SYMPTOMS OF URINARY INCONTINENCE AND FOR THERAPEUTIC PURPOSES, IN CLASS 10 (U.S. CLS. 26, 39 AND 44).

FIRST USE 12-9-2011; IN COMMERCE 12-9-2011.

NO CLAIM IS MADE TO THE EXCLUSIVE RIGHT TO USE "INC.", APART FROM THE MARK AS SHOWN.

THE MARK CONSISTS OF A SILHOUETTE OF A WOMAN WITH THE WORD "INNER" ON THE LEFT SIDE THEREOF AND THE WORD "PEACE" ON THE RIGHT SIDE THEREOF WITH THE WORDS "BY KAMABRY INC." BELOW THE WORD "PEACE".

SN 77-804,355, FILED 8-13-2009.

MARLENE BELL, EXAMINING ATTORNEY



David J. Kybas

Director of the United States Patent and Trademark Office

United States of America

United States Patent and Trademark Office

DARK BAZAAR

Reg. No. 4,109,240

Registered Mar. 6, 2012

Int. Cl.: 25

TRADEMARK

PRINCIPAL REGISTER

JAKKS PACIFIC, INC. (DELAWARE CORPORATION)
22619 PACIFIC COAST HIGHWAY
MALIBU, CA 90265

FOR: HALLOWEEN AND MASQUERADE COSTUMES, AND ACCESSORIES SOLD AS A UNIT IN CONNECTION THEREWITH, NAMELY, MASKS, GLOVES, HEADWEAR AND WIGS; COSTUMES AND COSTUME ACCESSORIES SOLD AS A UNIT IN CONNECTION THEREWITH, NAMELY, PROPS, JEWELRY, HEADWEAR, MASKS; COSTUMES FOR USE IN ROLE-PLAYING GAMES, IN CLASS 25 (U.S. CLS. 22 AND 39).

FIRST USE 7-9-2009; IN COMMERCE 8-31-2009.

THE MARK CONSISTS OF STANDARD CHARACTERS WITHOUT CLAIM TO ANY PARTICULAR FONT, STYLE, SIZE, OR COLOR.

SN 77-808,771, FILED 8-20-2009.

ELLEN PERKINS, EXAMINING ATTORNEY



David J. Kyffers

Director of the United States Patent and Trademark Office

United States of America

United States Patent and Trademark Office

GREAT DAY FOODS

Reg. No. 4,109,241

Registered Mar. 6, 2012

Int. Cl.: 29

TRADEMARK

PRINCIPAL REGISTER

COUNTRY CREEK FARMS, LLC (TENNESSEE LIMITED LIABILITY COMPANY)
5211 VILLAGE PARKWAY DRIVE, SUITE #101
ROGERS, AR 72758

FOR: FROZEN BREAKFAST ENTREES CONSISTING OF MEAT, EGGS, AND CHEESE;
FROZEN BREAKFAST FOODS IN THE NATURE OF SAUSAGES WRAPPED IN A PANCAKE
BATTER, IN CLASS 29 (U.S. CL. 46).

FIRST USE 8-1-2011; IN COMMERCE 8-1-2011.

THE MARK CONSISTS OF STANDARD CHARACTERS WITHOUT CLAIM TO ANY PAR-
TICULAR FONT, STYLE, SIZE, OR COLOR.

OWNER OF U.S. REG. NOS. 3,173,454, 3,184,903, AND 3,577,533.

NO CLAIM IS MADE TO THE EXCLUSIVE RIGHT TO USE "FOODS", APART FROM THE
MARK AS SHOWN.

SN 77-809,078, FILED 8-20-2009.

AMEEN IMAM, EXAMINING ATTORNEY



David J. Kybas

Director of the United States Patent and Trademark Office

United States of America

United States Patent and Trademark Office



Reg. No. 4,109,242

Registered Mar. 6, 2012

Int. Cl.: 29

TRADEMARK

PRINCIPAL REGISTER

COUNTRY CREEK FARMS, LLC (TENNESSEE LIMITED LIABILITY COMPANY)
5211 VILLAGE PARKWAY DRIVE, SUITE #101
ROGERS, AR 72758

FOR: FROZEN BREAKFAST ENTREES CONSISTING OF MEAT, EGGS, AND CHEESE;
FROZEN BREAKFAST FOODS IN THE NATURE OF SAUSAGES WRAPPED IN A PANCAKE
BATTER, IN CLASS 29 (U.S. CL. 46).

FIRST USE 8-1-2011; IN COMMERCE 8-1-2011.

OWNER OF U.S. REG. NOS. 3,173,454, 3,184,903, AND 3,577,533.

NO CLAIM IS MADE TO THE EXCLUSIVE RIGHT TO USE "FOODS", APART FROM THE
MARK AS SHOWN.

THE MARK CONSISTS OF A WEATHERVANE OVER THE WORDS "GREAT DAY" WITH
AN ARM OF THE WEATHERVANE FORMING THE CROSS OF THE "T" IN THE WORD
"GREAT", WITH THE WORD "FOODS" BENEATH, ALL APPEARING SUPERIMPOSED
UPON AN OBLONG SCALLOPED SEAL.

SN 77-809,096, FILED 8-20-2009.

AMEEN IMAM, EXAMINING ATTORNEY



David J. Kyros

Director of the United States Patent and Trademark Office

United States of America

United States Patent and Trademark Office

SO-CAL Tacos

Reg. No. 4,109,243

WOOLEY, SUZANNE PATRICK (UNITED STATES INDIVIDUAL), DBA SO-CAL TACOS,
9071 SARANAC TRAIL
FORT WORTH, TX 76118

Registered Mar. 6, 2012

Int. Cl.: 43

FOR: RESTAURANT SERVICES, NAMELY, PROVIDING OF FOOD AND DRINK VIA A
MOBILE TRUCK, IN CLASS 43 (U.S. CLS. 100 AND 101).

SERVICE MARK

FIRST USE 6-1-2009; IN COMMERCE 9-13-2011.

PRINCIPAL REGISTER

THE MARK CONSISTS OF STANDARD CHARACTERS WITHOUT CLAIM TO ANY PAR-
TICULAR FONT, STYLE, SIZE, OR COLOR.

NO CLAIM IS MADE TO THE EXCLUSIVE RIGHT TO USE "TACOS", APART FROM THE
MARK AS SHOWN.

SN 77-810,823, FILED 8-23-2009.

PRISCILLA MILTON, EXAMINING ATTORNEY



David J. Kyros

Director of the United States Patent and Trademark Office

United States of America

United States Patent and Trademark Office

BEN 10 ULTIMATE ALIEN

Reg. No. 4,109,244

Registered Mar. 6, 2012

Int. Cl.: 21

TRADEMARK

PRINCIPAL REGISTER

THE CARTOON NETWORK, INC. (DELAWARE CORPORATION)
ONE CNN CENTER, 10N
C/O TURNER BROADCASTING SYSTEM, INC.
ATLANTA, GA 30303

FOR: LUNCH BOXES, IN CLASS 21 (U.S. CLS. 2, 13, 23, 29, 30, 33, 40 AND 50).

FIRST USE 7-1-2011; IN COMMERCE 7-1-2011.

THE MARK CONSISTS OF STANDARD CHARACTERS WITHOUT CLAIM TO ANY PARTICULAR FONT, STYLE, SIZE, OR COLOR.

OWNER OF U.S. REG. NOS. 3,080,336, 3,206,776, AND OTHERS.

SN 77-811,059, FILED 8-24-2009.

DAVID ELTON, EXAMINING ATTORNEY



David J. Kybas

Director of the United States Patent and Trademark Office

United States of America

United States Patent and Trademark Office

THE EARTH'S BEST WAY TO GROW

Reg. No. 4,109,245

Registered Mar. 6, 2012

Int. Cls.: 3 and 5

TRADEMARK

PRINCIPAL REGISTER

THE HAIN CELESTIAL GROUP, INC. (DELAWARE CORPORATION)
SUITE 250
58 SOUTH SERVICE ROAD
MELVILLE, NY 11747

FOR: LAUNDRY DETERGENT, IN CLASS 3 (U.S. CLS. 1, 4, 6, 50, 51 AND 52).

FIRST USE 12-31-2009; IN COMMERCE 12-31-2009.

FOR: BABY FOOD; CEREAL WHICH IS SPECIALLY FORMULATED FOR INFANTS AND TODDLERS; AND SANITIZING WIPES, IN CLASS 5 (U.S. CLS. 6, 18, 44, 46, 51 AND 52).

FIRST USE 12-31-2006; IN COMMERCE 12-31-2006.

THE MARK CONSISTS OF STANDARD CHARACTERS WITHOUT CLAIM TO ANY PARTICULAR FONT, STYLE, SIZE, OR COLOR.

OWNER OF U.S. REG. NOS. 1,560,438, 3,568,538, AND OTHERS.

SN 77-811,267, FILED 8-24-2009.

ANDREW RHIM, EXAMINING ATTORNEY



David J. Kyros

Director of the United States Patent and Trademark Office

United States of America

United States Patent and Trademark Office

DEFENDER POWER AND LIGHT

Reg. No. 4,109,246

Registered Mar. 6, 2012

Int. Cls.: 9, 11, and 20

TRADEMARK

PRINCIPAL REGISTER

BIRCHWOOD PROPERTIES LIMITED (UNITED KINGDOM PRIVATE LIMITED COMPANY)
LODGE WAY HOUSE, LODGE WAY
HARLESTONE ROAD
NORTHAMPTON, UNITED KINGDOM NN5 7UG

FOR: ELECTRICAL PLUGS AND SOCKETS FOR USE BY CONTRACTORS; ELECTRICAL CABLES FOR USE BY CONTRACTORS; ELECTRICAL PLUG AND SOCKET ASSEMBLIES FOR USE BY CONTRACTORS; ELECTRICAL CONNECTION ASSEMBLIES FOR USE BY CONTRACTORS; AND PARTS AND FITTINGS FOR ALL THE AFORESAID GOODS, NONE OF THE AFOREMENTIONED GOODS FOR USE IN OR ON VEHICLES, IN CLASS 9 (U.S. CLS. 21, 23, 26, 36 AND 38).

FIRST USE 7-0-2003; IN COMMERCE 7-0-2003.

FOR: LIGHTING APPARATUS FOR CONSTRUCTION SITE LIGHTING; LIGHTING APPARATUSES FOR USE AT CONSTRUCTION SITES AND FOR USE BY TRADESMEN AND CONTRACTORS, NAMELY, FLUORESCENT LIGHTING APPARATUS, LIGHT-EMITTING DIODE LIGHTING, ELECTRIC LIGHT BULBS, ELECTRICAL TORCHES AND FESTOON LIGHTING ASSEMBLIES AND PARTS AND FITTINGS FOR ALL OF THE AFORESAID GOODS, NONE OF THE AFOREMENTIONED GOODS FOR USE IN OR ON VEHICLES; LIGHTING APPARATUSES FOR USE AT CONSTRUCTION SITES AND FOR USE BY TRADESMEN AND CONTRACTORS, NAMELY, LIGHTING APPARATUS INCORPORATING HALOGEN BULBS AND TUBES, IN CLASS 11 (U.S. CLS. 13, 21, 23, 31 AND 34).

FIRST USE 7-0-2003; IN COMMERCE 0-0-2010.

FOR: PLASTIC STORAGE DRUMS FOR USE IN STORING ELECTRICAL CABLES, IN CLASS 20 (U.S. CLS. 2, 13, 22, 25, 32 AND 50).

FIRST USE 0-0-1996; IN COMMERCE 0-0-2010.

THE MARK CONSISTS OF STANDARD CHARACTERS WITHOUT CLAIM TO ANY PARTICULAR FONT, STYLE, SIZE, OR COLOR.

NO CLAIM IS MADE TO THE EXCLUSIVE RIGHT TO USE "POWER AND LIGHT", APART FROM THE MARK AS SHOWN.



David J. Kyros

Director of the United States Patent and Trademark Office

Reg. No. 4,109,246 SN 77-819,646, FILED 9-3-2009.

ERIN FALK, EXAMINING ATTORNEY

United States of America

United States Patent and Trademark Office



Reg. No. 4,109,247

Registered Mar. 6, 2012

Int. Cl.: 3

TRADEMARK

PRINCIPAL REGISTER

KARAYAN, DANIEL (UNITED STATES INDIVIDUAL)
1604 RANDOLPH RIDGE TRAIL
AUSTIN, TX 78746

FOR: COSMETICS, NON-MEDICATED SKIN CARE PRODUCTS, NAMELY, LOTION, CREAM, MIST, SERUM, GEL, POLISH AND CLEANSER, IN CLASS 3 (U.S. CLS. 1, 4, 6, 50, 51 AND 52).

FIRST USE 10-12-2010; IN COMMERCE 10-12-2010.

THE MARK CONSISTS OF THE LETTERS "DM" IN A STYLIZED FORMAT LOCATED ABOVE THE STYLIZED LETTERS "DAMI".

SN 77-820,898, FILED 9-4-2009.

LINDA ORNDORFF, EXAMINING ATTORNEY



David J. Kybas

Director of the United States Patent and Trademark Office

United States of America

United States Patent and Trademark Office



Reg. No. 4,109,248

Registered Mar. 6, 2012

Int. Cl.: 3

TRADEMARK

PRINCIPAL REGISTER

KARAYAN, DANIEL (UNITED STATES INDIVIDUAL)
1604 RANDOLPH RIDGE TRAIL
AUSTIN, TX 78746

FOR: COSMETICS, NON-MEDICATED SKIN CARE PRODUCTS, NAMELY, LOTION, CREAM, MIST, SERUM, GEL, POLISH AND CLEANSER, IN CLASS 3 (U.S. CLS. 1, 4, 6, 50, 51 AND 52).

FIRST USE 10-12-2010; IN COMMERCE 10-12-2010.

THE MARK CONSISTS OF THE LETTERS "DM" IN STYLIZED FORMAT.

SN 77-820,901, FILED 9-4-2009.

LINDA ORNDORFF, EXAMINING ATTORNEY



David J. Kybas

Director of the United States Patent and Trademark Office

United States of America

United States Patent and Trademark Office

HONEY CHILD

Reg. No. 4,109,249

Registered Mar. 6, 2012

Int. Cl.: 25

TRADEMARK

PRINCIPAL REGISTER

HONEY CHILD ENTERPRISES, LLC (FLORIDA LIMITED LIABILITY COMPANY)
6619 SOUTH DIXIE HIGHWAY
PMB 382
MIAMI, FL 33413

FOR: FULL LINE OF CHILDREN'S CLOTHING, NAMELY, SHIRTS, TOPS, PANTS, BOTTOMS, BLOUSES, SKIRTS, JUMPERS, SHORTS, JACKETS, DRESSES; HEADWEAR; AND FOOTWEAR, IN CLASS 25 (U.S. CLS. 22 AND 39).

FIRST USE 10-1-2011; IN COMMERCE 10-1-2011.

THE MARK CONSISTS OF STANDARD CHARACTERS WITHOUT CLAIM TO ANY PARTICULAR FONT, STYLE, SIZE, OR COLOR.

OWNER OF U.S. REG. NOS. 2,669,693 AND 2,804,780.

NO CLAIM IS MADE TO THE EXCLUSIVE RIGHT TO USE "CHILD", APART FROM THE MARK AS SHOWN.

SN 77-821,983, FILED 9-8-2009.

MYRIAH HABEEB, EXAMINING ATTORNEY



David J. Kyffers

Director of the United States Patent and Trademark Office

United States of America

United States Patent and Trademark Office

REEL DOG

Reg. No. 4,109,250

COOL RIDE PRODUCTS, INC (FLORIDA CORPORATION)
19565 MONTANA LANE
BOCA RATON, FL 33434

Registered Mar. 6, 2012

Int. Cl.: 18

FOR: FISHING AND BOATING THEMED DOG CLOTHING, APPAREL AND ACCESSORIES, NAMELY, COATS; COLLARS; LEADS, LEASHES, SHOES, SHIRTS, SHORTS, SWEAT-SHIRTS, BATHING SUITS; CARRIERS, BANDANNAS, DRY BAGS, HARNESSSES, MUZZLES AND RAINCOATS, IN CLASS 18 (U.S. CLS. 1, 2, 3, 22 AND 41).

TRADEMARK

PRINCIPAL REGISTER

FIRST USE 1-0-2008; IN COMMERCE 6-0-2010.

THE MARK CONSISTS OF STANDARD CHARACTERS WITHOUT CLAIM TO ANY PARTICULAR FONT, STYLE, SIZE, OR COLOR.

NO CLAIM IS MADE TO THE EXCLUSIVE RIGHT TO USE "DOG", APART FROM THE MARK AS SHOWN.

SN 77-822,092, FILED 9-8-2009.

JANET LEE, EXAMINING ATTORNEY



David J. Kybas

Director of the United States Patent and Trademark Office

United States of America

United States Patent and Trademark Office

TEMPS-40

Reg. No. 4,109,251

THE ZIEGLER COMPANIES, INC. (WISCONSIN CORPORATION)
200 SOUTH WACKER DRIVE, SUITE 2000
CHICAGO, IL 60606

Registered Mar. 6, 2012

Int. Cl.: 36

FOR: FINANCIAL SERVICES IN THE NATURE OF AN INVESTMENT SECURITY, IN CLASS 36 (U.S. CLS. 100, 101 AND 102).

SERVICE MARK

FIRST USE 11-8-2011; IN COMMERCE 11-8-2011.

PRINCIPAL REGISTER

THE MARK CONSISTS OF STANDARD CHARACTERS WITHOUT CLAIM TO ANY PARTICULAR FONT, STYLE, SIZE, OR COLOR.

SN 77-823,834, FILED 9-10-2009.

THOMAS MANOR, EXAMINING ATTORNEY



David J. Kyros

Director of the United States Patent and Trademark Office

United States of America

United States Patent and Trademark Office

IJCO

Reg. No. 4,109,252

Registered Mar. 6, 2012

Int. Cls.: 9, 16, and 41

TRADEMARK

SERVICE MARK

PRINCIPAL REGISTER

PROFESSIONAL COACHING PUBLICATIONS, INC. (ILLINOIS CORPORATION)
7309 RANDOLPH ST.
FOREST PARK, IL 60130

FOR: DOWNLOADABLE JOURNALS, MONOGRAPHS, AND SERIES OF WRITTEN ARTICLES IN THE FIELD OF COACHING IN ORGANIZATIONS; ELECTRONIC PUBLICATIONS, NAMELY, JOURNALS AND SERIES OF WRITTEN ARTICLES IN THE FIELD OF COACHING IN ORGANIZATIONS RECORDED ON COMPUTER MEDIA, IN CLASS 9 (U.S. CLS. 21, 23, 26, 36 AND 38).

FIRST USE 9-30-2008; IN COMMERCE 9-30-2008.

FOR: PRINTED JOURNALS, MONOGRAPHS, AND SERIES OF WRITTEN ARTICLES IN THE FIELD OF COACHING IN ORGANIZATIONS, IN CLASS 16 (U.S. CLS. 2, 5, 22, 23, 29, 37, 38 AND 50).

FIRST USE 9-30-2008; IN COMMERCE 9-30-2008.

FOR: PROVIDING ON-LINE PUBLICATIONS IN THE NATURE OF JOURNALS, MONOGRAPHS, AND SERIES OF WRITTEN ARTICLES IN THE FIELD OF COACHING IN ORGANIZATIONS; PROVIDING A WEBSITE FEATURING INFORMATION ON COACHING IN ORGANIZATIONS, IN CLASS 41 (U.S. CLS. 100, 101 AND 107).

FIRST USE 9-30-2008; IN COMMERCE 9-30-2008.

THE MARK CONSISTS OF STANDARD CHARACTERS WITHOUT CLAIM TO ANY PARTICULAR FONT, STYLE, SIZE, OR COLOR.

SN 77-824,144, FILED 9-10-2009.

ROBIN CHOSID, EXAMINING ATTORNEY



David J. Kyffers

Director of the United States Patent and Trademark Office

United States of America

United States Patent and Trademark Office

Sharing the Wealth of Information

Reg. No. 4,109,253

Registered Mar. 6, 2012

Int. Cl.: 42

SERVICE MARK

PRINCIPAL REGISTER

ARRAY ANALYTICS, LLC (VIRGINIA LIMITED LIABILITY COMPANY)
PO BOX 27
PENLAND, NC 28765

FOR: PROVIDING ONLINE, NON-DOWNLOADABLE SOFTWARE FEATURING INFORMATION AND ANALYSIS TOOLS FOR USE IN THE FIELDS OF FINANCE, INVESTMENT, AND FANTASY SPORTS LEAGUES, IN CLASS 42 (U.S. CLS. 100 AND 101).

FIRST USE 9-29-2009; IN COMMERCE 12-1-2011.

THE MARK CONSISTS OF STANDARD CHARACTERS WITHOUT CLAIM TO ANY PARTICULAR FONT, STYLE, SIZE, OR COLOR.

SN 77-825,718, FILED 9-14-2009.

CORY BOONE, EXAMINING ATTORNEY



David J. Kybas

Director of the United States Patent and Trademark Office

United States of America

United States Patent and Trademark Office

GOD'S GIFT

Reg. No. 4,109,254

Registered Mar. 6, 2012

Int. Cl.: 3

COMPASSIONATE CONSULTANT FOR WELLNESS, LLC (CALIFORNIA LIMITED LIABILITY COMPANY)

#116

5301 LAUREL CANYON BLVD.
VALLEY VILLAGE, CA 91607

TRADEMARK

PRINCIPAL REGISTER

FOR: BODY CARE PRODUCTS, NAMELY, BODY LOTION, BODY SPRAY, SHAMPOOS, CONDITIONERS, NON-MEDICATED LIP BALMS, BODY POLISHES, SOAPS, SHOWER GELS, FACE MASKS, MASSAGE OILS, IN CLASS 3 (U.S. CLS. 1, 4, 6, 50, 51 AND 52).

FIRST USE 12-21-2011; IN COMMERCE 12-21-2011.

THE MARK CONSISTS OF STANDARD CHARACTERS WITHOUT CLAIM TO ANY PARTICULAR FONT, STYLE, SIZE, OR COLOR.

SN 77-826,536, FILED 9-15-2009.

JOHN HWANG, EXAMINING ATTORNEY



David J. Kyffers

Director of the United States Patent and Trademark Office

United States of America

United States Patent and Trademark Office

NAT GEO WILD

Reg. No. 4,109,255

Registered Mar. 6, 2012

Int. Cl.: 9

TRADEMARK

PRINCIPAL REGISTER

NATIONAL GEOGRAPHIC SOCIETY (D.C. CORPORATION)
1145 17TH STREET, N.W.
WASHINGTON, DC 20036

FOR: PRE-RECORDED DATA CARRIERS, NAMELY, DVDS FEATURING ENTERTAINMENT, EDUCATION, ADVENTURE, CULTURAL, EXPLORATION, GENERAL INTEREST, GEOGRAPHY, NATURAL HISTORY, WILDLIFE, NATURE, AND ENVIRONMENTAL TOPICS; DOWNLOADABLE GRAPHICS, GAMES, IMAGES AND VIDEOS FEATURING A WIDE RANGE OF ENTERTAINMENT, EDUCATION, ADVENTURE, CULTURAL, EXPLORATION, GENERAL INTEREST, GEOGRAPHY, NATURAL HISTORY, WILDLIFE, NATURE, AND ENVIRONMENTAL TOPICS VIA WIRELESS COMMUNICATION DEVICES; CONTENT FOR MOBILE APPLICATIONS, NAMELY, STILL AND ANIMATED WALLPAPERS, RING TONES, SCREEN SAVERS, GAMES AND AUDIO-VISUAL PROGRAMS FEATURING A WIDE RANGE OF ENTERTAINMENT, EDUCATION, ADVENTURE, CULTURAL, EXPLORATION, GENERAL INTEREST, GEOGRAPHY, NATURAL HISTORY, WILDLIFE, NATURE, AND ENVIRONMENTAL TOPICS, ALL FOR MOBILE DEVICES; HAND-HELD UNITS FOR PLAYING ELECTRONIC GAMES FOR USE WITH EXTERNAL DISPLAY SCREEN OR MONITOR, IN CLASS 9 (U.S. CLS. 21, 23, 26, 36 AND 38).

FIRST USE 4-0-2010; IN COMMERCE 4-0-2010.

THE MARK CONSISTS OF STANDARD CHARACTERS WITHOUT CLAIM TO ANY PARTICULAR FONT, STYLE, SIZE, OR COLOR.

OWNER OF U.S. REG. NOS. 2,411,079, 3,370,945, AND OTHERS.

SN 77-827,419, FILED 9-16-2009.

HEATHER BIDDULPH, EXAMINING ATTORNEY



David J. Kybas

Director of the United States Patent and Trademark Office

United States of America

United States Patent and Trademark Office



Reg. No. 4,109,256

Registered Mar. 6, 2012

Int. Cl.: 25

TRADEMARK

PRINCIPAL REGISTER

LIVE BETTER LIVE GREEN, INC. (DELAWARE CORPORATION)
PMB 7090, 2711 CENTERVILLE RD., STE. 120
WILIMINGTON, DE 19808

FOR: CLOTHING, NAMELY, SHIRTS, HEADWEAR, IN CLASS 25 (U.S. CLS. 22 AND 39).

FIRST USE 9-17-2010; IN COMMERCE 9-17-2010.

NO CLAIM IS MADE TO THE EXCLUSIVE RIGHT TO USE "GREEN", APART FROM THE MARK AS SHOWN.

THE COLOR(S) GREEN IS/ARE CLAIMED AS A FEATURE OF THE MARK.

THE MARK CONSISTS OF A CIRCLE IN GREEN CONTAINING THE WORDS "LIVE BETTER" WHICH CONNECTS IN ITS LOWER CENTER PORTION TO FORM A STYLIZED TREE DESIGN IN WHICH THE WORDS "LIVE GREEN" APPEAR.

SN 77-828,870, FILED 9-17-2009.

THOMAS MANOR, EXAMINING ATTORNEY



David J. Kyfos

Director of the United States Patent and Trademark Office

United States of America

United States Patent and Trademark Office



Reg. No. 4,109,257

Registered Mar. 6, 2012

Int. Cl.: 9

TRADEMARK

PRINCIPAL REGISTER

JAY-Y ENTERPRISE CO. INC. (CALIFORNIA CORPORATION)
632 NEW YORK DRIVE
POMONA, CA 91768

FOR: SUNGLASSES, IN CLASS 9 (U.S. CLS. 21, 23, 26, 36 AND 38).

FIRST USE 12-28-2009; IN COMMERCE 8-5-2011.

THE MARK CONSISTS OF THE STYLIZED LETTERS "DQ" FEATURED INSIDE A SQUARE.

SN 77-829,065, FILED 9-17-2009.

CHARISMA HAMPTON, EXAMINING ATTORNEY



David J. Kyffers

Director of the United States Patent and Trademark Office

United States of America

United States Patent and Trademark Office

KRAKEN

Reg. No. 4,109,258

Registered Mar. 6, 2012

Int. Cl.: 1

TRADEMARK

PRINCIPAL REGISTER

REKLAIM, INC. (WASHINGTON CORPORATION)
3401 FREMONT AVENUE N, SUITE 242
SEATTLE, WA 98103

FOR: CARBON BLACK FOR INDUSTRIAL PURPOSES; CARBON BLACK FOR USE AS A FILLER OR REINFORCEMENT COMPOUND IN THE MANUFACTURE OF A VARIETY OF GOODS; CARBON BLACK FOR USE IN RUBBER AND PLASTICS PROCESSING APPLICATIONS; ADSORBING ACTIVATED CARBON FOR WATER AND AIR TREATMENT AND FILTERING; CARBON BLACK RESINS; CARBON BLACK FOR DISTILLING CONTAMINATED SOLVENTS; CARBON BLACK DISPERSIONS FOR USE IN THE MANUFACTURING OF COLORINGS AND COATINGS FOR A VARIETY OF GOODS; CARBON BLACK, IN CLASS 1 (U.S. CLS. 1, 5, 6, 10, 26 AND 46).

FIRST USE 9-27-2011; IN COMMERCE 9-27-2011.

THE MARK CONSISTS OF STANDARD CHARACTERS WITHOUT CLAIM TO ANY PARTICULAR FONT, STYLE, SIZE, OR COLOR.

SN 77-829,253, FILED 9-17-2009.

LESLIE RICHARDS, EXAMINING ATTORNEY



David J. Kypos

Director of the United States Patent and Trademark Office

United States of America

United States Patent and Trademark Office

GLADIATOR ASS

Reg. No. 4,109,259

GEMINI ROGUE LLC (MARYLAND LIMITED LIABILITY COMPANY)
2572 RIVA RD. UNIT 14B
ANNAPOLIS, MD 21401

Registered Mar. 6, 2012

Int. Cl.: 25

FOR: BOXER SHORTS; HATS; SHIRTS; T-SHIRTS; TIES, IN CLASS 25 (U.S. CLS. 22 AND 39).

TRADEMARK

FIRST USE 8-8-2009; IN COMMERCE 7-30-2011.

PRINCIPAL REGISTER

THE MARK CONSISTS OF STANDARD CHARACTERS WITHOUT CLAIM TO ANY PARTICULAR FONT, STYLE, SIZE, OR COLOR.

OWNER OF U.S. REG. NO. 3,640,456.

SN 77-830,574, FILED 9-20-2009.

SUNG IN, EXAMINING ATTORNEY



David J. Kyffers

Director of the United States Patent and Trademark Office

United States of America

United States Patent and Trademark Office

VETLOGIC

Reg. No. 4,109,260

MCALLISTER SOFTWARE SYSTEMS, LLC (DELAWARE LIMITED LIABILITY COMPANY)
#5 SUGAR CREEK ROAD
PIEDMONT, MO 63957

Registered Mar. 6, 2012

Int. Cl.: 42

FOR: WEBSITE CONSULTING AND DEVELOPMENT IN THE FIELD OF VETERINARY PRACTICE MANAGEMENT, IN CLASS 42 (U.S. CLS. 100 AND 101).

SERVICE MARK

FIRST USE 1-0-2010; IN COMMERCE 1-0-2010.

PRINCIPAL REGISTER

THE MARK CONSISTS OF STANDARD CHARACTERS WITHOUT CLAIM TO ANY PARTICULAR FONT, STYLE, SIZE, OR COLOR.

SN 77-833,455, FILED 9-23-2009.

JACQUELINE A. LAVINE, EXAMINING ATTORNEY



David J. Kybas

Director of the United States Patent and Trademark Office

United States of America

United States Patent and Trademark Office

ACOS

Reg. No. 4,109,261

Registered Mar. 6, 2012

Int. Cl.: 2

TRADEMARK

PRINCIPAL REGISTER

CRIOUS TECH LLC (DELAWARE LIMITED LIABILITY COMPANY)
P.O. BOX 14257
ST. PAUL, MN 55114

FOR: HIGH SOLID ASPHALT RESURFACER, NAMELY, BITUMEN-BASED COATINGS FOR USE ON PAVEMENT; HIGH SOLID POLYMERIZED LIQUID ASPHALT ASPHALT-BASED COATINGS; ASPHALT-BASED COATINGS AND SEALANTS FOR USE ON PAVEMENTS; ROADWAY BITUMEN-BASED ASPHALT SEALANT; COLD OVERLAY BITUMEN-BASED ASPHALT SEALANT, IN CLASS 2 (U.S. CLS. 6, 11 AND 16).

FIRST USE 6-1-2011; IN COMMERCE 6-1-2011.

THE MARK CONSISTS OF STANDARD CHARACTERS WITHOUT CLAIM TO ANY PARTICULAR FONT, STYLE, SIZE, OR COLOR.

SN 77-833,763, FILED 9-24-2009.

STEVEN JACKSON, EXAMINING ATTORNEY



David J. Kyffers

Director of the United States Patent and Trademark Office

United States of America

United States Patent and Trademark Office

HAVE YOU KEGELED TODAY?

Reg. No. 4,109,262

Registered Mar. 6, 2012

Int. Cl.: 10

TRADEMARK

PRINCIPAL REGISTER

KAMABRY, INC. (NEW YORK CORPORATION)
42 COLONIAL LANE
BELLPORT, NY 11713

FOR: MEDICAL DEVICES FOR KEGEL EXERCISES, NAMELY, PELVIC FLOOR EXERCISERS FOR USE TO TREAT SYMPTOMS OF URINARY INCONTINENCE AND FOR THERAPEUTIC PURPOSES, IN CLASS 10 (U.S. CLS. 26, 39 AND 44).

FIRST USE 12-9-2011; IN COMMERCE 12-9-2011.

THE MARK CONSISTS OF STANDARD CHARACTERS WITHOUT CLAIM TO ANY PARTICULAR FONT, STYLE, SIZE, OR COLOR.

SN 77-834,924, FILED 9-25-2009.

MARLENE BELL, EXAMINING ATTORNEY



David J. Kybas

Director of the United States Patent and Trademark Office

United States of America

United States Patent and Trademark Office

PETER NERO AND THE PHILADELPHIA POPS

Reg. No. 4,109,263

FINGER PRINCE, INC. (PENNSYLVANIA CORPORATION)
202 HIDDEN ACRES LANE
MEDIA, PA 190631666

Registered Mar. 6, 2012

Int. Cl.: 41

FOR: ENTERTAINMENT IN THE NATURE OF LIVE PERFORMANCES AND SHOWS BY
A MUSICAL BAND, IN CLASS 41 (U.S. CLS. 100, 101 AND 107).

SERVICE MARK

FIRST USE 7-3-2011; IN COMMERCE 7-3-2011.

PRINCIPAL REGISTER

THE MARK CONSISTS OF STANDARD CHARACTERS WITHOUT CLAIM TO ANY PAR-
TICULAR FONT, STYLE, SIZE, OR COLOR.

SEC. 2(F) AS TO "PHILADELPHIA POPS".

OWNER OF U.S. REG. NOS. 2,197,233, 2,650,910, AND 3,026,067.

THE NAME(S), PORTRAIT(S), AND/OR SIGNATURE(S) SHOWN IN THE MARK IDENTIFIES
"PETER NERO", WHOSE CONSENT(S) TO REGISTER IS MADE OF RECORD.

SN 77-835,059, FILED 9-25-2009.

NAPOLEON SHARMA, EXAMINING ATTORNEY



David J. Kyffers

Director of the United States Patent and Trademark Office

United States of America

United States Patent and Trademark Office

NEUROSHAPE

Reg. No. 4,109,264

NEUROBRANDS LLC (CALIFORNIA LIMITED LIABILITY COMPANY)
501 SANTA MONICA BLVD 2ND FLOOR
SANTA MONICA, CA 90401

Registered Mar. 6, 2012

Int. Cl.: 5

FOR: DIETARY BEVERAGE SUPPLEMENTS FOR HUMAN CONSUMPTION IN LIQUID AND DRY MIX FORM FOR THERAPEUTIC PURPOSES; DIETARY SUPPLEMENTAL DRINKS; DIETARY SUPPLEMENTS; NUTRITIONALLY FORTIFIED BEVERAGES; VITAMIN FORTIFIED BEVERAGES, IN CLASS 5 (U.S. CLS. 6, 18, 44, 46, 51 AND 52).

TRADEMARK

PRINCIPAL REGISTER

FIRST USE 7-31-2009; IN COMMERCE 10-3-2011.

THE MARK CONSISTS OF STANDARD CHARACTERS WITHOUT CLAIM TO ANY PARTICULAR FONT, STYLE, SIZE, OR COLOR.

OWNER OF U.S. REG. NOS. 3,609,755, 3,677,431, AND OTHERS.

SN 77-836,769, FILED 9-28-2009.

ANDREA K. NADELMAN, EXAMINING ATTORNEY



David J. Kyros

Director of the United States Patent and Trademark Office

United States of America

United States Patent and Trademark Office

CLEARTHREAD

Reg. No. 4,109,265

Registered Mar. 6, 2012

Int. Cls.: 35 and 37

SERVICE MARK

PRINCIPAL REGISTER

DAVACO, INC. (TEXAS CORPORATION)
SUITE 100
6688 N. CENTRAL EXPRESSWAY
DALLAS, TX 75206

FOR: BUSINESS MANAGEMENT, APPOINTMENT SCHEDULING, AND BUSINESS CONSULTING SERVICES FOR OTHERS ABOUT LOGISTICS AND CONSOLIDATION OF PROJECTS INVOLVING THE DESIGN, REMODELING, CONSTRUCTION, FIXTURE INSTALLATION, OR RETROFITTING OF RETAIL STORES; ONLINE AUCTION SERVICES IN THE FIELD OF PRODUCTS AND SERVICES USED BY RETAIL STORES; BUSINESS SERVICES, NAMELY, COMBINED STRATEGIC GOODS OR SERVICES AUTOMATED SOURCING AND COOPERATIVE PURCHASING FOR OTHERS OF PRODUCTS AND SERVICES USED BY RETAIL STORES; MARKETING AND PROMOTIONAL SERVICES FOR OTHERS; PRODUCT MERCHANDISING, IN CLASS 35 (U.S. CLS. 100, 101 AND 102).

FIRST USE 9-1-2009; IN COMMERCE 9-1-2009.

FOR: CONSTRUCTION MANAGEMENT; CONSTRUCTION IN THE FIELD OF RETAIL STORES; INSTALLATION OF RETAIL STORE SIGNAGE AND FIXTURES IN THE NATURE OF SHELVING AND DISPLAY CASES; PROVIDING A WEB SITE FOR USERS TO OBTAIN UPDATES ON RETAIL STORE CONSTRUCTION PROJECTS, RETROFITS AND REMODELS, IN CLASS 37 (U.S. CLS. 100, 103 AND 106).

FIRST USE 9-1-2009; IN COMMERCE 9-1-2009.

THE MARK CONSISTS OF STANDARD CHARACTERS WITHOUT CLAIM TO ANY PARTICULAR FONT, STYLE, SIZE, OR COLOR.

SN 77-836,993, FILED 9-29-2009.

NELSON SNYDER, EXAMINING ATTORNEY



David J. Kypos

Director of the United States Patent and Trademark Office

United States of America

United States Patent and Trademark Office

no sinz

Reg. No. 4,109,266

Registered Mar. 6, 2012

Int. Cl.: 25

TRADEMARK

PRINCIPAL REGISTER

RIVERA, CAFERINO (UNITED STATES INDIVIDUAL)
31 HIGHLAND AVE.
BEACON FALLS, CT 06403

FOR: CAPS; SWEAT SHIRTS; T-SHIRTS, IN CLASS 25 (U.S. CLS. 22 AND 39).

FIRST USE 7-17-2010; IN COMMERCE 7-17-2010.

THE MARK CONSISTS OF STANDARD CHARACTERS WITHOUT CLAIM TO ANY PARTICULAR FONT, STYLE, SIZE, OR COLOR.

SN 77-840,158, FILED 10-2-2009.

SHARON MEIER, EXAMINING ATTORNEY



David J. Kybas

Director of the United States Patent and Trademark Office

United States of America

United States Patent and Trademark Office

rent2buy

Reg. No. 4,109,267

RENT2BUY, INC. (DELAWARE CORPORATION)
831-38 ROUTE 10, #226
WHIPPANY, NJ 07981

Registered Mar. 6, 2012

Int. Cl.: 35

FOR: PROVIDING A WEBSITE FOR CONNECTING POTENTIAL SELLERS AND PURCHASERS OF PRODUCTS AND SERVICES, EXCLUDING SERVICES IN THE FIELD OF AUTOMOBILE RENTAL, IN CLASS 35 (U.S. CLS. 100, 101 AND 102).

SERVICE MARK

FIRST USE 8-0-2009; IN COMMERCE 5-23-2011.

PRINCIPAL REGISTER

NO CLAIM IS MADE TO THE EXCLUSIVE RIGHT TO USE "RENT TO BUY", APART FROM THE MARK AS SHOWN.

THE MARK CONSISTS OF "RENT2BUY" WITH THE NUMBER "2" EXTENDED TO FORM A HALF CIRCLE WITH 2 DOTS OVER THE LETTER "T".

SN 77-843,089, FILED 10-7-2009.

AMY KERTGATE, EXAMINING ATTORNEY



David J. Kybas

Director of the United States Patent and Trademark Office

United States of America

United States Patent and Trademark Office



Helping Unlock Your Child's Creative Potential & Imagination.

Reg. No. 4,109,268

Registered Mar. 6, 2012

Int. Cl.: 41

SERVICE MARK

PRINCIPAL REGISTER

RAINBOW MONTESSORI SCHOOL (OKLAHOMA LIMITED LIABILITY COMPANY)
9130 EAST 77TH STREET
ANIL REDDY
TULSA, OK 74133

FOR: EDUCATIONAL SERVICES IN THE NATURE OF PRE-SCHOOL AND ELEMENTARY EDUCATION PROGRAMS PROVIDED THROUGH MONTESSORI SCHOOLS, IN CLASS 41 (U.S. CLS. 100, 101 AND 107).

FIRST USE 3-15-2010; IN COMMERCE 3-15-2010.

NO CLAIM IS MADE TO THE EXCLUSIVE RIGHT TO USE "MONTESSORI SCHOOL", APART FROM THE MARK AS SHOWN.

THE MARK CONSISTS OF A RAINBOW WITH THE STYLIZED TEXT "RAINBOW MONTESSORI SCHOOL" WHEREIN "MONTESSORI SCHOOL" IS WITHIN A RECTANGLE, AND THE WORDING "HELPING UNLOCK YOUR CHILD'S CREATIVE POTENTIAL & IMAGINATION" IS PRESENTED IN STYLIZED FONT BELOW THE RECTANGLE.

SN 77-847,629, FILED 10-13-2009.

GRETCHEN ULRICH, EXAMINING ATTORNEY



David J. Kybas

Director of the United States Patent and Trademark Office

United States of America

United States Patent and Trademark Office

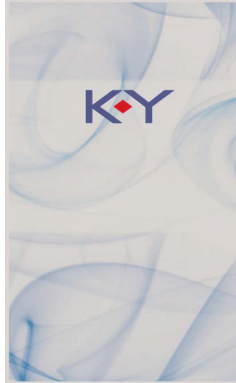

Reg. No. 4,109,269

Registered Mar. 6, 2012

Int. Cl.: 5

TRADEMARK

PRINCIPAL REGISTER

JOHNSON & JOHNSON (NEW JERSEY CORPORATION)
ONE JOHNSON & JOHNSON PLAZA
NEW BRUNSWICK, NJ 089337001

FOR: VAGINAL MOISTURIZERS, IN CLASS 5 (U.S. CLS. 6, 18, 44, 46, 51 AND 52).

FIRST USE 4-27-2011; IN COMMERCE 4-27-2011.

OWNER OF U.S. REG. NOS. 54,124, 1,904,052, AND OTHERS.

THE COLOR(S) RED, BLUE AND WHITE IS/ARE CLAIMED AS A FEATURE OF THE MARK.

THE MARK CONSISTS OF LETTERS "K" AND "Y" IN BLUE WITH A RED DIAMOND IN THE MIDDLE APPEARING AMONG WHITE AND BLUE SWIRLS.

SN 77-848,468, FILED 10-14-2009.

MARGARET POWER, EXAMINING ATTORNEY



David J. Kyffers

Director of the United States Patent and Trademark Office

United States of America

United States Patent and Trademark Office

Heroes of the Health League

Reg. No. 4,109,270

ALLIANCE FOR CONSUMER EDUCATION (D.C. CORPORATION), AKA ACE,
900 17TH STREET, NW, SUITE 300
WASHINGTON, DC 20006

Registered Mar. 6, 2012

Int. Cl.: 41

FOR: EDUCATION SERVICES, NAMELY, PROVIDING PROGRAMS IN THE FIELDS OF
HYGIENE, IN CLASS 41 (U.S. CLS. 100, 101 AND 107).

SERVICE MARK

FIRST USE 10-15-2009; IN COMMERCE 6-26-2011.

PRINCIPAL REGISTER

THE MARK CONSISTS OF STANDARD CHARACTERS WITHOUT CLAIM TO ANY PAR-
TICULAR FONT, STYLE, SIZE, OR COLOR.

NO CLAIM IS MADE TO THE EXCLUSIVE RIGHT TO USE "HEALTH", APART FROM THE
MARK AS SHOWN.

SN 77-849,226, FILED 10-15-2009.

JORDAN BAKER, EXAMINING ATTORNEY



David J. Kybas

Director of the United States Patent and Trademark Office

United States of America

United States Patent and Trademark Office

OPTIKK

Reg. No. 4,109,271

Registered Mar. 6, 2012

Int. Cl.: 28

TRADEMARK

PRINCIPAL REGISTER

MATTEL, INC. (DELAWARE CORPORATION)
M1-1518
333 CONTINENTAL BOULEVARD
EL SEGUNDO, CA 90245

FOR: TOYS, GAMES AND PLAYTHINGS, NAMELY, TOY ACTION FIGURES AND ACCESSORIES THEREFOR, IN CLASS 28 (U.S. CLS. 22, 23, 38 AND 50).

FIRST USE 11-25-2011; IN COMMERCE 11-25-2011.

THE MARK CONSISTS OF STANDARD CHARACTERS WITHOUT CLAIM TO ANY PARTICULAR FONT, STYLE, SIZE, OR COLOR.

SN 77-849,390, FILED 10-15-2009.

JOHN HWANG, EXAMINING ATTORNEY



David J. Kyffers

Director of the United States Patent and Trademark Office

United States of America

United States Patent and Trademark Office

LORYNA

Reg. No. 4,109,272

NOVARTIS AG (SWITZERLAND CORPORATION)
CH - 4002

Registered Mar. 6, 2012

BASEL, SWITZERLAND

Int. Cl.: 5

FOR: ORAL CONTRACEPTIVES, IN CLASS 5 (U.S. CLS. 6, 18, 44, 46, 51 AND 52).

TRADEMARK

FIRST USE 5-4-2011; IN COMMERCE 5-4-2011.

PRINCIPAL REGISTER

THE MARK CONSISTS OF STANDARD CHARACTERS WITHOUT CLAIM TO ANY PARTICULAR FONT, STYLE, SIZE, OR COLOR.

THE WORDING "LORYNA" HAS NO MEANING IN A FOREIGN LANGUAGE.

SN 77-850,568, FILED 10-16-2009.

CHRISTINE MARTIN, EXAMINING ATTORNEY



David J. Kybas

Director of the United States Patent and Trademark Office

United States of America

United States Patent and Trademark Office

Dentanimals

Reg. No. 4,109,273

HELENA A. DELUCA (UNITED STATES INDIVIDUAL)
7800 W OAKLAND PARK BLVD. C-106
SUNRISE, FL 33351

Registered Mar. 6, 2012

Int. Cl.: 16

FOR: ART PICTURES; ART PRINTS; ART PRINTS ON CANVAS; FRAMED ART PICTURES;
FRAMED ART PRINTS, IN CLASS 16 (U.S. CLS. 2, 5, 22, 23, 29, 37, 38 AND 50).

TRADEMARK

FIRST USE 1-1-2012; IN COMMERCE 1-1-2012.

PRINCIPAL REGISTER

THE MARK CONSISTS OF STANDARD CHARACTERS WITHOUT CLAIM TO ANY PARTICULAR FONT, STYLE, SIZE, OR COLOR.

SN 77-851,268, FILED 10-18-2009.

LEIGH CAROLINE CASE, EXAMINING ATTORNEY



David J. Kyffers

Director of the United States Patent and Trademark Office

United States of America

United States Patent and Trademark Office

PLUM STREET

Reg. No. 4,109,274

Registered Mar. 6, 2012

Int. Cl.: 41

SERVICE MARK

PRINCIPAL REGISTER

SPORTS DREAMMAKERS, INC. (MICHIGAN CORPORATION)
3221 CARTER AVENUE #187
MARINA DEL REY, CA 90292

FOR: PROVIDING AN INTERACTIVE WEBSITE FEATURING HOLISTIC COLLEGE COUNSELING SERVICES, NAMELY, INTERACTIVE EDUCATIONAL MULTIMEDIA PROGRAMS AND DECISION MAKING TECHNIQUES TO ASSIST STUDENTS IN PLANNING AND PREPARING FOR FURTHER EDUCATION TO HELP STUDENTS ACHIEVE PERSONAL EDUCATIONAL AND ATHLETIC GOALS, IN CLASS 41 (U.S. CLS. 100, 101 AND 107).

FIRST USE 12-13-2011; IN COMMERCE 12-13-2011.

THE MARK CONSISTS OF STANDARD CHARACTERS WITHOUT CLAIM TO ANY PARTICULAR FONT, STYLE, SIZE, OR COLOR.

SN 77-853,283, FILED 10-20-2009.

ANTHONY RINKER, EXAMINING ATTORNEY



David J. Kybas

Director of the United States Patent and Trademark Office

United States of America

United States Patent and Trademark Office

THE VENETIAN GOLD

Reg. No. 4,109,275

Registered Mar. 6, 2012

Int. Cl.: 33

TRADEMARK

PRINCIPAL REGISTER

BOTTEGA, SANDRO (ITALY INDIVIDUAL)
VIA TARLAZZI, 43
COLLE UMBERTO (TV), ITALY 31014

FOR: LIQUEURS, SPIRITS, VODKA AND WINE, IN CLASS 33 (U.S. CLS. 47 AND 49).

FIRST USE 11-22-2011; IN COMMERCE 11-22-2011.

THE MARK CONSISTS OF STANDARD CHARACTERS WITHOUT CLAIM TO ANY PARTICULAR FONT, STYLE, SIZE, OR COLOR.

SN 77-854,620, FILED 10-22-2009.

IRA J. GOODSaid, EXAMINING ATTORNEY



David J. Kyffers

Director of the United States Patent and Trademark Office

United States of America
United States Patent and Trademark Office

**teammates
matter.**

Reg. No. 4,109,276

J. ALAN WILLIAMS (UNITED STATES INDIVIDUAL)
214 LEONARD AVE.
NASHVILLE, TN 37205

Registered Mar. 6, 2012

Int. Cl.: 25

FOR: CLOTHING ARTICLES, NAMELY, SHIRTS, NAMELY, SHORT-SLEEVED, LONG-SLEEVED AND COLLARED SHIRTS, SHORTS, SWEAT SHIRTS AND SWEAT PANTS, HATS AND OTHER FORMS OF HEADWEAR, NAMELY, TOBOGGANS, JACKETS AND COATS, IN CLASS 25 (U.S. CLS. 22 AND 39).

TRADEMARK

PRINCIPAL REGISTER

FIRST USE 12-1-2010; IN COMMERCE 12-1-2010.

THE MARK CONSISTS OF THE WORDING "TEAMMATES MATTER" WITH A PERIOD AT THE END. THERE ARE THREE DOTS ABOVE BOTH OF THE LETTERS "M" IN THE WORD TEAMMATES.

SN 77-855,063, FILED 10-22-2009.

JAY FLOWERS, EXAMINING ATTORNEY



David J. Kyjars

Director of the United States Patent and Trademark Office

United States of America

United States Patent and Trademark Office

ALUMASIL

Reg. No. 4,109,277

INTEPLAST GROUP, LTD. (TEXAS LIMITED PARTNERSHIP)
9 PEACH TREE HILL ROAD
LIVINGSTON, NJ 07039

Registered Mar. 6, 2012

Int. Cl.: 19

FOR: NON-METALLIC CONSTRUCTION MATERIALS, NAMELY, MINERAL-BASED CEMENTITIOUS MATERIALS FOR USE AS CEMENT; BUILDING MATERIALS MADE FROM MINERAL-BASED CEMENTITIOUS MATERIALS, NAMELY, BLOCKS, BRICKS, STONES, PAVERS, IN CLASS 19 (U.S. CLS. 1, 12, 33 AND 50).

TRADEMARK

PRINCIPAL REGISTER

FIRST USE 8-1-2011; IN COMMERCE 8-1-2011.

THE MARK CONSISTS OF STANDARD CHARACTERS WITHOUT CLAIM TO ANY PARTICULAR FONT, STYLE, SIZE, OR COLOR.

SN 77-858,344, FILED 10-27-2009.

DEIRDRE ROBERTSON, EXAMINING ATTORNEY



David J. Kyffers

Director of the United States Patent and Trademark Office

United States of America

United States Patent and Trademark Office

NEW MOON

Reg. No. 4,109,278

Registered Mar. 6, 2012

Int. Cl.: 14

TRADEMARK

PRINCIPAL REGISTER

SUMMIT ENTERTAINMENT, LLC (DELAWARE LIMITED LIABILITY COMPANY)
1630 STEWART STREET, SUITE 120
SANTA MONICA, CA 90404

FOR: JEWELRY, JEWELRY BOXES, JEWELRY BOXES OF METAL, RING SETS, RUBBER BRACELETS, AND SILVER WRIST CUFF BRACELETS; BRASS WRIST CUFF BRACELETS, JEWELRY SETS, AND WATCHES, IN CLASS 14 (U.S. CLS. 2, 27, 28 AND 50).

FIRST USE 9-0-2009; IN COMMERCE 9-0-2009.

THE MARK CONSISTS OF STANDARD CHARACTERS WITHOUT CLAIM TO ANY PARTICULAR FONT, STYLE, SIZE, OR COLOR.

SN 77-859,327, FILED 10-28-2009.

ALLISON HOLTZ, EXAMINING ATTORNEY



David J. Kyffers

Director of the United States Patent and Trademark Office

United States of America

United States Patent and Trademark Office

SKEWETT

Reg. No. 4,109,279

AZEEZ, TOYOSI A (UNITED STATES INDIVIDUAL), AKA FOUNDER,
4840 BROOKGROVE CT.
LIMA, OH 45807

Registered Mar. 6, 2012

Int. Cls.: 14 and 25

FOR: RUBBER OR SILICON WRISTBANDS IN THE NATURE OF A BRACELET, IN CLASS
14 (U.S. CLS. 2, 27, 28 AND 50).

TRADEMARK

FIRST USE 7-10-2010; IN COMMERCE 7-30-2010.

PRINCIPAL REGISTER

FOR: SHORT-SLEEVED OR LONG-SLEEVED T-SHIRTS, IN CLASS 25 (U.S. CLS. 22 AND
39).

FIRST USE 7-10-2010; IN COMMERCE 7-30-2010.

THE MARK CONSISTS OF STANDARD CHARACTERS WITHOUT CLAIM TO ANY PAR-
TICULAR FONT, STYLE, SIZE, OR COLOR.

SN 77-864,154, FILED 11-3-2009.

DORITT L. CARROLL, EXAMINING ATTORNEY



David J. Kyros

Director of the United States Patent and Trademark Office

United States of America

United States Patent and Trademark Office

SUPPLIES ONTHEFLY.COM

Reg. No. 4,109,280

SYSCO CORPORATION (DELAWARE CORPORATION)
1390 ENCLAVE PARKWAY
HOUSTON, TX 770771390

Registered Mar. 6, 2012

Int. Cl.: 35

FOR: ON-LINE RETAIL STORE SERVICES FEATURING RESTAURANT SUPPLIES AND EQUIPMENT; ON-LINE RETAIL STORE SERVICES FEATURING OFFICE SUPPLIES, IN CLASS 35 (U.S. CLS. 100, 101 AND 102).

SERVICE MARK

FIRST USE 10-6-2008; IN COMMERCE 10-6-2008.

PRINCIPAL REGISTER

THE MARK CONSISTS OF STANDARD CHARACTERS WITHOUT CLAIM TO ANY PARTICULAR FONT, STYLE, SIZE, OR COLOR.

NO CLAIM IS MADE TO THE EXCLUSIVE RIGHT TO USE "SUPPLIES", APART FROM THE MARK AS SHOWN.

SN 77-864,539, FILED 11-4-2009.

RAMONA ORTIGA, EXAMINING ATTORNEY



David J. Kybas

Director of the United States Patent and Trademark Office

United States of America

United States Patent and Trademark Office

EDC

Reg. No. 4,109,281

WEAVEXX, LLC (DELAWARE LIMITED LIABILITY COMPANY)
51 FLEX WAY
YOUNGSVILLE, NC 27596

Registered Mar. 6, 2012

Int. Cl.: 7

FOR: BELTS FOR CONVEYORS MADE OF FABRIC FOR PAPER MAKING MACHINES, IN CLASS 7 (U.S. CLS. 13, 19, 21, 23, 31, 34 AND 35).

TRADEMARK

FIRST USE 8-27-2010; IN COMMERCE 8-27-2010.

PRINCIPAL REGISTER

THE MARK CONSISTS OF STANDARD CHARACTERS WITHOUT CLAIM TO ANY PARTICULAR FONT, STYLE, SIZE, OR COLOR.

SN 77-865,893, FILED 11-5-2009.

ALICIA COLLINS, EXAMINING ATTORNEY



David J. Kybas

Director of the United States Patent and Trademark Office

United States of America

United States Patent and Trademark Office

GIRL FRIEND BEER

Reg. No. 4,109,282

Registered Mar. 6, 2012

Int. Cls.: 16, 21, and 25

TRADEMARK

PRINCIPAL REGISTER

ROB FAUCETTE (UNITED STATES INDIVIDUAL)
527 NORTH BRONSON AVENUE
LOS ANGELES, CA 90004

FOR: PAPER GOODS AND PRINTED MATTER, NAMELY, NAPKINS, CALENDARS, PENS, PENCILS, POSTERS AND PRINTS, CUSTOM AND PRINTED PAINTINGS ON CANVAS AND PAPER, BUMPER STICKERS AND DECALS, COASTERS MADE OF PAPER, COASTERS MADE OF PAPER PRESS BOARD, STATIONERY, TRADING CARDS, BLANK JOURNALS AND DIARIES, CONTAINERS FOR STORAGE OR TRANSPORT MADE OF PAPER OR CARDBOARD, CARDBOARD SIGNBOARDS, CARDS, NAMELY, GREETING CARDS, NOTECARDS AND POSTCARDS, COOK BOOKS, FLAGS AND PENNANTS OF PAPER, LUNCH BAGS MADE OF TEXTILE, PRINTED NOVELTY BEER LABELS AND TEMPORARY TATTOOS, IN CLASS 16 (U.S. CLS. 2, 5, 22, 23, 29, 37, 38 AND 50).

FIRST USE 10-1-2011; IN COMMERCE 10-1-2011.

FOR: HOUSEWARES AND GLASS, NAMELY, MUGS, DRINKING STEINS, SHOT GLASSES, PINT GLASSES, LO-BALL GLASSES, COCKTAIL SHAKERS, PLATES, INSULATED WRAP FOR CANS AND BOTTLES TO KEEP THE CONTENTS COLD, PITCHERS, PLASTIC CUPS, PORTABLE COOLERS, BOTTLE OPENERS AND COASTERS NOT OF PAPER AND NOT BEING TABLE LINEN, IN CLASS 21 (U.S. CLS. 2, 13, 23, 29, 30, 33, 40 AND 50).

FIRST USE 10-1-2011; IN COMMERCE 10-1-2011.

FOR: CLOTHING, NAMELY, HATS, WRAPS, CAPS, BEANIES, SHIRTS, LONG-SLEEVE SHIRTS, SHORT-SLEEVE SHIRTS, BUTTON-DOWN SHIRTS, TANK TOPS, SWEATERS, SWEATSHIRTS, SWEAT PANTS, APRONS, JACKETS, COATS, UNDERWEAR, AND PANTIES, IN CLASS 25 (U.S. CLS. 22 AND 39).

FIRST USE 10-1-2011; IN COMMERCE 10-1-2011.

THE MARK CONSISTS OF STANDARD CHARACTERS WITHOUT CLAIM TO ANY PARTICULAR FONT, STYLE, SIZE, OR COLOR.

NO CLAIM IS MADE TO THE EXCLUSIVE RIGHT TO USE "BEER", APART FROM THE MARK AS SHOWN.



David J. Kyjars

Director of the United States Patent and Trademark Office

Reg. No. 4,109,282 SN 77-869,276, FILED 11-10-2009.

WILLIAM VERHOSEK, EXAMINING ATTORNEY

United States of America

United States Patent and Trademark Office

CERTAIN D

Reg. No. 4,109,283

Registered Mar. 6, 2012

Int. Cl.: 5

TRADEMARK

PRINCIPAL REGISTER

HORMEL FOODS, LLC (MINNESOTA LIMITED LIABILITY COMPANY)
LAW DEPARTMENT
1 HORMEL PLACE
AUSTIN, MN 55912

FOR: VITAMIN AND NUTRITIONAL SUPPLEMENTS, ALL CONTAINING VITAMIN D, IN CLASS 5 (U.S. CLS. 6, 18, 44, 46, 51 AND 52).

FIRST USE 5-4-2011; IN COMMERCE 5-4-2011.

THE MARK CONSISTS OF STANDARD CHARACTERS WITHOUT CLAIM TO ANY PARTICULAR FONT, STYLE, SIZE, OR COLOR.

NO CLAIM IS MADE TO THE EXCLUSIVE RIGHT TO USE "D", APART FROM THE MARK AS SHOWN.

SN 77-870,454, FILED 11-11-2009.

SANJEEV VOHRA, EXAMINING ATTORNEY



David J. Kyros

Director of the United States Patent and Trademark Office

United States of America

United States Patent and Trademark Office

JAANI

Reg. No. 4,109,284

Registered Mar. 6, 2012

Int. Cl.: 25

TRADEMARK

PRINCIPAL REGISTER

LYN, JASON (UNITED STATES INDIVIDUAL)
4528 159TH STREET
FLUSHING, NY 11358 AND

SAEED, NUREED (UNITED STATES INDIVIDUAL)
189 SCHERMERHORN STREET
APT. 9E
NEW YORK, NY 11201 AND

WILSON, KOREY VANCE (UNITED STATES INDIVIDUAL)
78 SOUTH MAPLE AVENUE
SPRINGFIELD, NJ 07081

FOR: INFANT, TODDLER AND CHILDREN'S CLOTHING, NAMELY, PANTS, TROUSERS, SLACKS, JEANS, DENIM JEANS, OVERALLS, COVERALLS, JUMPERS, JUMP SUITS, SHORTS, BOXER SHORTS, SHIRTS, T-SHIRTS, UNDER SHIRTS, NIGHT SHIRTS, RUGBY SHIRTS, POLO SHIRTS, TOPS, CROP TOPS, TANK TOPS, HALTER TOPS, SWEAT SHIRTS, SWEAT SHORTS, SWEAT PANTS, BLOUSES, SKIRTS, DRESSES, SWEATERS, CARDIGANS, VESTS, PULLOVERS, PARKAS, ANORAKS, PONCHOS, JACKETS, SPORTS JACKETS, REVERSIBLE JACKETS, COATS, BLAZERS, SUITS, TURTLENECKS, SWIMWEAR, BEACHWEAR, NAMELY, SWIMWEAR, SANDALS AND SWIM COVER-UPS, CAPS, BERETS, HATS, HEADBANDS, WRIST BANDS, HEADWEAR, EAR MUFFS, SCARVES, BANDANAS, BELTS, SUSPENDERS, NECKWEAR, NECKTIES, TIES, BOW TIES, CLOTH BIBS, CLOTH DIAPERS, BOOTIES, INFANTWEAR, BABY BUNTINGS, UNDERWEAR, BRIEFS, SWIM AND BATHING TRUNKS, SINGLETs, SOCKS, LOUNGEWEAR, ROBES, BATHROBES, PAJAMAS, SLEEPWEAR, NIGHT GOWNS, HOSIERY, KNIT HOSIERY, LEG WARMERS, BODYSUITS, LEGGINGS, TIGHTS, LEOTARDS, UNITARDS, GLOVES, MITTENS, FOOTWEAR, SHOES, SNEAKERS, BOOTS, GALOSHES, SANDALS, SLIPPERS AND RAINWEAR, IN CLASS 25 (U.S. CLS. 22 AND 39).

FIRST USE 9-1-2011; IN COMMERCE 9-1-2011.

THE MARK CONSISTS OF STANDARD CHARACTERS WITHOUT CLAIM TO ANY PARTICULAR FONT, STYLE, SIZE, OR COLOR.

SN 77-874,912, FILED 11-17-2009.



David J. Kyros

Director of the United States Patent and Trademark Office

Reg. No. 4,109,284 TINA L. SNAPP, EXAMINING ATTORNEY

United States of America

United States Patent and Trademark Office

ANN TAYLOR

Reg. No. 4,109,285

ANSCO, INC. (DELAWARE CORPORATION)
7 TIMES SQUARE
NEW YORK, NY 10036

Registered Mar. 6, 2012

Int. Cl.: 20

FOR: PILLOWS, IN CLASS 20 (U.S. CLS. 2, 13, 22, 25, 32 AND 50).

TRADEMARK

FIRST USE 11-7-2011; IN COMMERCE 11-7-2011.

PRINCIPAL REGISTER

THE MARK CONSISTS OF STANDARD CHARACTERS WITHOUT CLAIM TO ANY PARTICULAR FONT, STYLE, SIZE, OR COLOR.

OWNER OF U.S. REG. NOS. 1,782,601, 1,881,093, AND OTHERS.

THE NAME(S), PORTRAIT(S), AND/OR SIGNATURE(S) SHOWN IN THE MARK DOES NOT IDENTIFY A PARTICULAR LIVING INDIVIDUAL.

SN 77-877,386, FILED 11-20-2009.

LINDA M. KING, EXAMINING ATTORNEY



David J. Kyffers

Director of the United States Patent and Trademark Office

United States of America

United States Patent and Trademark Office

INSIDEVIEW

Reg. No. 4,109,286

Registered Mar. 6, 2012

Int. Cl.: 9

TRADEMARK

PRINCIPAL REGISTER

INSIDEVIEW TECHNOLOGIES, INC. (CALIFORNIA CORPORATION)
444 DE HARO STREET, SUITE 210
SAN FRANCISCO, CA 94107

FOR: COMPUTER SOFTWARE FOR PROVIDING ACCESS TO SEARCHABLE COMPUTER DATABASES VIA A GLOBAL COMPUTER NETWORK THAT END USERS CAN USE TO RUN USER-DEFINED SEARCHES AND OBTAIN DATA AND INFORMATION REGARDING BUSINESS OPPORTUNITIES, SELLING OPPORTUNITIES, PROSPECTS, AND THE PROSPECTS' PRODUCTS, SERVICES, PRIORITIES, DECISION-MAKING STRUCTURE, PREFERENCES AND PROCESSES, CURRENT AND FORMER OFFICERS, DIRECTORS AND MANAGERS, STRATEGIC INITIATIVES, RISKS, CHALLENGES AND COMPETITORS, AND INSTRUCTIONAL MANUALS PROVIDED THEREWITH, IN CLASS 9 (U.S. CLS. 21, 23, 26, 36 AND 38).

FIRST USE 8-0-2006; IN COMMERCE 8-0-2006.

THE MARK CONSISTS OF STANDARD CHARACTERS WITHOUT CLAIM TO ANY PARTICULAR FONT, STYLE, SIZE, OR COLOR.

OWNER OF U.S. REG. NO. 3,528,036.

SN 77-879,202, FILED 11-23-2009.

JOHN WILKE, EXAMINING ATTORNEY



David J. Kybas

Director of the United States Patent and Trademark Office

United States of America

United States Patent and Trademark Office

A SMART WAY TO BANK

Reg. No. 4,109,287

Registered Mar. 6, 2012

Int. Cls.: 35 and 36

SERVICE MARK

PRINCIPAL REGISTER

BMO FINANCIAL CORP. (DELAWARE CORPORATION)
111 WEST MONROE STREET
CHICAGO, IL 60603

FOR: ONLINE FINANCIAL SERVICES, NAMELY, PROVIDING AN ON-LINE COMPUTER WEB SITE THAT PROVIDES COMMERCIAL FINANCIAL TRANSACTION DATA, ACCOUNT MANAGEMENT, FINANCIAL REPORTING, ACCOUNTING FEATURES AND RELATED REFERENCE INFORMATION, IN CLASS 35 (U.S. CLS. 100, 101 AND 102).

FIRST USE 7-31-2009; IN COMMERCE 7-31-2009.

FOR: BANKING AND FINANCIAL SERVICES, NAMELY, CREDIT CARD SERVICES; MORTGAGE LENDING AND HOME EQUITY LOANS; BUSINESS LOANS; LOAN FINANCING, SECURED AND UNSECURED INSTALLMENT LOANS; BANKING SERVICES, NAMELY, CERTIFICATE OF DEPOSIT, INDIVIDUAL RETIREMENT ACCOUNT, MONEY MARKET, AND CHECKING ACCOUNT SERVICES; INVESTMENT BROKERAGE INCLUDING STOCKS, BONDS AND MUTUAL FUNDS; RETIREMENT PLANNING, NAMELY, FINANCIAL PLANNING FOR RETIREMENT; TRUST SERVICES, NAMELY, TRUST MANAGEMENT SERVICES, INVESTMENT AND TRUST COMPANY SERVICES, ESTATE TRUST MANAGEMENT, FINANCIAL TRUST OPERATIONS; AND MANAGEMENT OF MUTUAL FUNDS; ONLINE BANKING AND FINANCIAL SERVICES, NAMELY, ON-LINE TRADING OF FINANCIAL INSTRUMENTS, SHARES, OPTIONS AND OTHER DERIVATIVE PRODUCTS, ON-LINE FINANCIAL PLANNING SERVICES; FINANCIAL PLANNING, FINANCIAL PORTFOLIO MANAGEMENT, FINANCIAL FORECASTING, FINANCIAL ANALYSIS AND CONSULTATION, IN CLASS 36 (U.S. CLS. 100, 101 AND 102).

FIRST USE 7-31-2009; IN COMMERCE 7-31-2009.

THE MARK CONSISTS OF STANDARD CHARACTERS WITHOUT CLAIM TO ANY PARTICULAR FONT, STYLE, SIZE, OR COLOR.

NO CLAIM IS MADE TO THE EXCLUSIVE RIGHT TO USE "BANK", APART FROM THE MARK AS SHOWN.

SN 77-879,655, FILED 11-24-2009.

JENNIFER MARTIN, EXAMINING ATTORNEY



David J. Kyros

Director of the United States Patent and Trademark Office

United States of America

United States Patent and Trademark Office

INSPECT MY RIDE

Reg. No. 4,109,288

WORLD OMNI FINANCIAL CORP. (FLORIDA CORPORATION)
190 JIM MORAN BLVD.
DEERFIELD BEACH, FL 33442

Registered Mar. 6, 2012

Int. Cl.: 42

FOR: INSPECTION SERVICES FOR NEW AND USED VEHICLES FOR PERSONS BUYING OR SELLING THEIR VEHICLES, IN CLASS 42 (U.S. CLS. 100 AND 101).

SERVICE MARK

FIRST USE 9-9-2010; IN COMMERCE 9-9-2010.

PRINCIPAL REGISTER

THE MARK CONSISTS OF STANDARD CHARACTERS WITHOUT CLAIM TO ANY PARTICULAR FONT, STYLE, SIZE, OR COLOR.

NO CLAIM IS MADE TO THE EXCLUSIVE RIGHT TO USE "INSPECT", APART FROM THE MARK AS SHOWN.

SN 77-879,767, FILED 11-24-2009.

DEZMONA MIZELLE, EXAMINING ATTORNEY



David J. Kyffers

Director of the United States Patent and Trademark Office

United States of America

United States Patent and Trademark Office

TRUCK CHAPS

Reg. No. 4,109,289

Registered Mar. 6, 2012

Int. Cl.: 12

TRADEMARK

PRINCIPAL REGISTER

ZAHASKY, LARRY (UNITED STATES INDIVIDUAL)
11221 SW 38TH STREET
MUSTANG, OK 73064 AND

ZAHASKY, JANE (UNITED STATES INDIVIDUAL)
11221 SW 38TH STREET
MUSTANG, OK 73064

FOR: MAGNETIC MATERIALS IN THE FORM OF PANELS THAT ARE APPLIED TO EXTERIOR METAL TRUCK BED SURFACES TO PROTECT THEM FROM DAMAGE, IN CLASS 12 (U.S. CLS. 19, 21, 23, 31, 35 AND 44).

FIRST USE 5-1-2009; IN COMMERCE 10-14-2011.

THE MARK CONSISTS OF STANDARD CHARACTERS WITHOUT CLAIM TO ANY PARTICULAR FONT, STYLE, SIZE, OR COLOR.

NO CLAIM IS MADE TO THE EXCLUSIVE RIGHT TO USE "TRUCK", APART FROM THE MARK AS SHOWN.

SN 77-880,599, FILED 11-25-2009.

CORY BOONE, EXAMINING ATTORNEY



David J. Kyros

Director of the United States Patent and Trademark Office

United States of America

United States Patent and Trademark Office

SHAM-ROCKIN'

Reg. No. 4,109,290

FSC FRANCHISE CO., LLC (DELAWARE LIMITED LIABILITY COMPANY)
5510 WEST LASALLE STREET, SUITE 200
TAMPA, FL 33607

Registered Mar. 6, 2012

Int. Cl.: 43

FOR: RESTAURANT AND BAR SERVICES; TAKE-OUT RESTAURANT SERVICES, IN CLASS 43 (U.S. CLS. 100 AND 101).

SERVICE MARK

FIRST USE 6-0-2009; IN COMMERCE 6-0-2009.

PRINCIPAL REGISTER

THE MARK CONSISTS OF STANDARD CHARACTERS WITHOUT CLAIM TO ANY PARTICULAR FONT, STYLE, SIZE, OR COLOR.

SN 77-880,600, FILED 11-25-2009.

CORY BOONE, EXAMINING ATTORNEY



David J. Kybas

Director of the United States Patent and Trademark Office

United States of America

United States Patent and Trademark Office



Reg. No. 4,109,291

Registered Mar. 6, 2012

Int. Cl.: 3

TRADEMARK

PRINCIPAL REGISTER

DASPIN, JOAN B. (UNITED STATES INDIVIDUAL)
4 PINEVIEW LANE
BOONTON, NJ 07005

FOR: AROMATHERAPY BODY CARE PRODUCTS, NAMELY, BODY LOTION, SHOWER GEL, CUTICLE CREAM, SHAMPOO, CONDITIONER, NON-MEDICATED LIP BALM, SOAP, BODY POLISH, BODY AND FOOT SCRUB AND NON-MEDICATED FOOT CREAM; BATH OILS AND BATH SALTS; BEAUTY CREAMS; BEAUTY CREAMS FOR BODY CARE; BEAUTY GELS; BEAUTY LOTIONS; BEAUTY MASKS; BEAUTY MILKS; BEAUTY SERUMS; BODY AND BEAUTY CARE COSMETICS; BODY SPRAY USED AS A PERSONAL DEODORANT AND AS FRAGRANCE; COSMETIC OLIVE OIL FOR THE FACE AND BODY; COSMETIC PREPARATIONS FOR THE CARE OF MOUTH AND TEETH; COSMETIC PREPARATIONS FOR THE HAIR AND SCALP; COSMETICS AND COSMETIC PREPARATIONS; COSMETICS AND MAKE-UP; COSMETICS IN THE FORM OF MILKS, LOTIONS AND EMULSIONS; DISPOSABLE WIPES IMPREGNATED WITH CLEANING CHEMICALS OR COMPOUNDS FOR INDUSTRIAL AND COMMERCIAL USE; EAU DE TOILETTE AND EAU DE COLOGNE; FACE AND BODY BEAUTY CREAMS; FACE AND BODY CREAMS; FACE AND BODY GLITTER; FACE AND BODY LOTIONS; FACE AND BODY MILK; FACE CREAMS AND CLEANSERS CONTAINING BENZOYL PEROXIDE FOR COSMETIC PURPOSES; FACE MILK AND LOTIONS; FACIAL BEAUTY MASKS; FOAMS CONTAINING COSMETICS AND SUNSCREENS; FRAGRANCES AND PERFUMERY; HAIR CARE PREPARATIONS CONSISTING OF ORGANIC COCONUT VIRGIN OIL AND COCONUT VIRGIN OIL; HAIR GEL AND HAIR MOUSSE; HAIR SHAMPOOS AND CONDITIONERS; HAIR SPRAYS AND HAIR GELS; LIQUID SOAPS FOR HANDS AND FACE; LIQUID SOAPS FOR HANDS, FACE AND BODY; LOTIONS FOR FACE AND BODY CARE; MAKE-UP FOR THE FACE AND BODY; MAKE-UP PREPARATIONS FOR THE FACE AND BODY; MAKE-UP REMOVING MILK, GEL, LOTIONS AND CREAMS; NAIL GROOMING PRODUCTS, NAMELY, TIPS, GLUE, LACQUER AND GLITTER; NATURAL COCOA BUTTER BASED PERSONAL CARE PRODUCTS, NAMELY, BODY LOTION, SHOWER GEL, SOAP, BODY POLISH, BODY AND FOOT SCRUB AND NON-MEDICATED SKIN CREAMS; NON-MEDICATED COSMETIC SKIN CARE PREPARATIONS CONSISTING OF ORGANIC COCONUT VIRGIN OIL AND COCONUT VIRGIN OIL; NON-MEDICATED PREPARATIONS ALL FOR THE CARE OF SKIN, HAIR AND SCALP; NON-MEDICATED SKIN CARE PREPARATIONS, NAMELY, CREAMS, LOTIONS, GELS, TONERS, CLEANERS AND PEELS; NON-MEDICATED SKIN CREAM FOR GENERAL SKIN RASH AND IRRITATION RESULTING FROM SKIN SHINGLES; OILS FOR PERFUMES AND SCENTS; PERFUMES AND COLOGNES; PERFUMES AND TOILET WATERS; PERFUMES, AFTERSHAVES AND COLOGNES; PET



David J. Kybas

Director of the United States Patent and Trademark Office

Reg. No. 4,109,291 SHAMPOO AND CONDITIONER; SKIN AND BODY TOPICAL LOTIONS, CREAMS AND OILS FOR COSMETIC USE; SKIN CREAMS IN LIQUID AND IN SOLID FORM; SKIN CREAMS IN LIQUID AND SOLID; SKIN CREAMS IN LIQUID AND SOLID FORM; SOAPS AND DETERGENTS; TONING LOTION, FOR THE FACE, BODY AND HANDS; TOPICAL HERBAL CREAM FOR FIRING AND ENHANCING BREASTS, IN CLASS 3 (U.S. CLS. 1, 4, 6, 50, 51 AND 52).

FIRST USE 6-1-2008; IN COMMERCE 6-15-2011.

THE MARK CONSISTS OF THE WORD "MEDSOURCE" SUPERIMPOSED ON A BEAKER AND PIPETTE.

SN 77-881,466, FILED 11-27-2009.

LIEF MARTIN, EXAMINING ATTORNEY

United States of America

United States Patent and Trademark Office

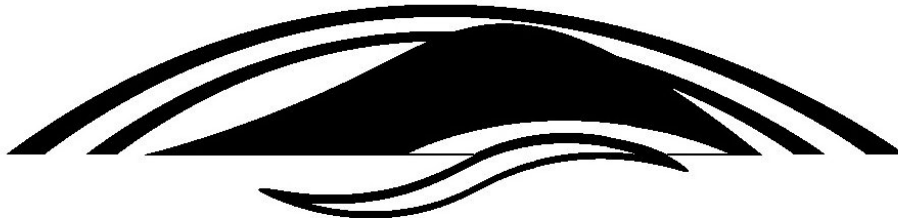

NORTHWEST ANTHROPOLOGY

Reg. No. 4,109,292

Registered Mar. 6, 2012

Int. Cl.: 42

SERVICE MARK

PRINCIPAL REGISTER

NORTHWEST ANTHROPOLOGY LLC (WASHINGTON LIMITED LIABILITY COMPANY)
2754 STONECREEK DRIVE
RICHLAND, WA 99354

FOR: PROVIDING INTERNATIONAL CULTURAL RESOURCE MANAGEMENT SERVICES, NAMELY, PROVIDING SCIENTIFIC RESEARCH INFORMATION IN THE FIELDS OF ANTHROPOLOGY AND ARCHAEOLOGY, IN CLASS 42 (U.S. CLS. 100 AND 101).

FIRST USE 1-1-2010; IN COMMERCE 1-1-2010.

NO CLAIM IS MADE TO THE EXCLUSIVE RIGHT TO USE "NORTHWEST ANTHROPOLOGY", APART FROM THE MARK AS SHOWN.

THE MARK CONSISTS OF THE WORDING "NORTHWEST ANTHROPOLOGY" IN A STYLIZED FONT AND A DESIGN OF A ROUNDED STYLIZED MOUNTAIN WITH TWO ARCS OVER THE MOUNTAIN AND A SQUIGGLY WAVE AT THE BASE OF THE MOUNTAIN REPRESENTING A RIVER ABOVE THE WORDS.

SN 77-882,035, FILED 11-30-2009.

RENEE MCCRAY, EXAMINING ATTORNEY



David J. Kyjars

Director of the United States Patent and Trademark Office

United States of America

United States Patent and Trademark Office

Atlantika



Reg. No. 4,109,293

ATLANTIKA, INC. (CONNECTICUT CORPORATION)
253 PUTNAM ROAD
NEW CANAAN, CT 06840

Registered Mar. 6, 2012

Int. Cl.: 29

FOR: FRESH SEAFOOD, IN CLASS 29 (U.S. CL. 46).

TRADEMARK

FIRST USE 11-11-2011; IN COMMERCE 11-11-2011.

PRINCIPAL REGISTER

THE MARK CONSISTS OF THE WORD "ATLANTIKA" AND THE IMAGE OF A FISH IN A CIRCLE.

SN 77-882,314, FILED 11-30-2009.

TARA PATE, EXAMINING ATTORNEY



David J. Kyffers

Director of the United States Patent and Trademark Office

United States of America

United States Patent and Trademark Office

inkpoop

Reg. No. 4,109,294

Registered Mar. 6, 2012

Int. Cl.: 35

SERVICE MARK

PRINCIPAL REGISTER

ZIDEK, JAMES (UNITED STATES INDIVIDUAL)
76 STERLING HEIGHTS ROAD
VERNON HILLS, IL 60061

FOR: RETAIL STORE AND ON-LINE RETAIL STORE SERVICES FEATURING NEW AND RE-CONDITIONED INK AND TONER CARTRIDGES FOR PRINTERS, FACSIMILE MACHINES AND COPIERS, IN CLASS 35 (U.S. CLS. 100, 101 AND 102).

FIRST USE 9-30-2010; IN COMMERCE 9-30-2010.

THE MARK CONSISTS OF STANDARD CHARACTERS WITHOUT CLAIM TO ANY PARTICULAR FONT, STYLE, SIZE, OR COLOR.

SN 77-882,716, FILED 11-30-2009.

NICHOLAS ALTREE, EXAMINING ATTORNEY



David J. Kybas

Director of the United States Patent and Trademark Office

United States of America

United States Patent and Trademark Office

MOTOLOGIC

Reg. No. 4,109,295

Registered Mar. 6, 2012

Int. Cl.: 37

SERVICE MARK

PRINCIPAL REGISTER

MOTOLOGIC, INC. (DELAWARE CORPORATION)
5008 AIRPORT ROAD
ROANOKE, VA 24012

FOR: PROVIDING ONLINE SEARCHABLE COMPUTER DATABASES IN THE FIELD OF MOTOR VEHICLE SERVICE AND REPAIR PROCEDURES, MOTOR VEHICLE DIAGNOSTIC PROCEDURES, MOTOR VEHICLE TECHNICAL SERVICE BULLETINS, VEHICLE-SPECIFIC COMPONENT LOCATOR, PARTS REMOVAL AND INSTALLATION PROCEDURES, ESTIMATED LABOR TIMES TO MAKE REPAIRS TO MOTOR VEHICLES, VEHICLE MAINTENANCE INTERVALS AND RECOMMENDATIONS ON PREVENTIVE MAINTENANCE; DATABASE ACCESSIBLE VIA A GLOBAL COMPUTER NETWORK PROVIDING VEHICLE-SPECIFIC TECHNICAL REPAIR AND MAINTENANCE INFORMATION, STEP-BY-STEP REPAIR PROCEDURES, VEHICLE MANUFACTURERS' RECALL INFORMATION AND SERVICE BULLETINS ISSUED BY VEHICLE MANUFACTURERS, IN CLASS 37 (U.S. CLS. 100, 103 AND 106).

FIRST USE 11-11-2011; IN COMMERCE 11-11-2011.

THE MARK CONSISTS OF STANDARD CHARACTERS WITHOUT CLAIM TO ANY PARTICULAR FONT, STYLE, SIZE, OR COLOR.

SN 77-883,612, FILED 12-1-2009.

BENJAMIN OKEKE, EXAMINING ATTORNEY



David J. Kyffers

Director of the United States Patent and Trademark Office

United States of America

United States Patent and Trademark Office

INFLATABELT

Reg. No. 4,109,296

KEY SAFETY SYSTEMS, INC. (DELAWARE CORPORATION)
7000 NINETEEN MILE ROAD
STERLING HEIGHTS, MI 48314

Registered Mar. 6, 2012

Int. Cl.: 12

FOR: SAFETY BELTS FOR VEHICLES FOR MOTOR CARS; SEAT BELTS FOR USE IN VEHICLES, IN CLASS 12 (U.S. CLS. 19, 21, 23, 31, 35 AND 44).

TRADEMARK

FIRST USE 11-15-2011; IN COMMERCE 11-15-2011.

PRINCIPAL REGISTER

THE MARK CONSISTS OF STANDARD CHARACTERS WITHOUT CLAIM TO ANY PARTICULAR FONT, STYLE, SIZE, OR COLOR.

SN 77-883,664, FILED 12-1-2009.

KRISTINA MORRIS, EXAMINING ATTORNEY



David J. Kyros

Director of the United States Patent and Trademark Office

United States of America

United States Patent and Trademark Office

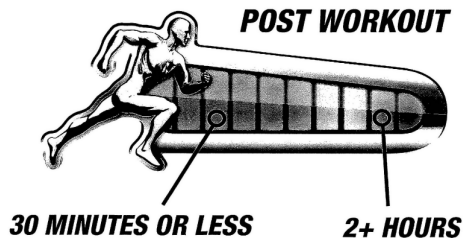

Reg. No. 4,109,297

Registered Mar. 6, 2012

Int. Cl.: 5

TRADEMARK

PRINCIPAL REGISTER

ABBOTT LABORATORIES (ILLINOIS CORPORATION)
100 ABBOTT PARK ROAD
ABBOTT PARK, IL 60064

FOR: NUTRITIONAL SUPPLEMENTS, IN CLASS 5 (U.S. CLS. 6, 18, 44, 46, 51 AND 52).

FIRST USE 3-31-2009; IN COMMERCE 3-31-2009.

OWNER OF U.S. REG. NO. 3,599,456.

THE MARK CONSISTS OF A MAN IN RUNNING MOTION NEXT TO A GRAPH THAT STARTS WIDE AND GRADUALLY GETS SMALLER. THE WORDING "POST WORKOUT" APPEARS ABOVE THE GRAPH DESIGN AND THE WORDING "30 MINUTES OR LESS" AND "2+ HOURS" APPEARS BELOW THE GRAPH DESIGN.

SN 77-884,087, FILED 12-2-2009.

KATHERINE CONNOLLY, EXAMINING ATTORNEY



David J. Kyffers

Director of the United States Patent and Trademark Office

United States of America

United States Patent and Trademark Office

EAGLE ROCK ENERGY PARTNERS

Reg. No. 4,109,298

Registered Mar. 6, 2012

Int. Cls.: 35, 39, and 40

SERVICE MARK

PRINCIPAL REGISTER

EAGLE ROCK ENERGY PARTNERS, L.P. (DELAWARE LIMITED PARTNERSHIP)
SUITE 2700
1415 LOUISIANA STREET
HOUSTON, TX 77002

FOR: MANAGING THE EXPLORATION, PRODUCTION AND OPERATION OF OIL AND NATURAL GAS PROPERTIES FOR OTHERS, IN CLASS 35 (U.S. CLS. 100, 101 AND 102).

FIRST USE 6-6-2006; IN COMMERCE 10-26-2006.

FOR: THE TRANSMISSION OF NATURAL GAS THROUGH PIPELINES, IN CLASS 39 (U.S. CLS. 100 AND 105).

FIRST USE 6-6-2006; IN COMMERCE 10-26-2006.

FOR: NATURAL GAS INDUSTRY SERVICES, NAMELY, THE GATHERING, FRACTIONATING, COMPRESSING, AND TREATING OF NATURAL GAS, IN CLASS 40 (U.S. CLS. 100, 103 AND 106).

FIRST USE 6-6-2006; IN COMMERCE 10-26-2006.

THE MARK CONSISTS OF STANDARD CHARACTERS WITHOUT CLAIM TO ANY PARTICULAR FONT, STYLE, SIZE, OR COLOR.

OWNER OF U.S. REG. NO. 2,944,838.

NO CLAIM IS MADE TO THE EXCLUSIVE RIGHT TO USE "ENERGY PARTNERS", APART FROM THE MARK AS SHOWN.

SN 77-884,280, FILED 12-2-2009.

LINDA POWELL, EXAMINING ATTORNEY



David J. Kybas

Director of the United States Patent and Trademark Office

United States of America

United States Patent and Trademark Office



EAGLE ROCK
ENERGY PARTNERS

Reg. No. 4,109,299

Registered Mar. 6, 2012

Int. Cls.: 35, 39, and 40

SERVICE MARK

PRINCIPAL REGISTER

EAGLE ROCK ENERGY PARTNERS, L.P. (DELAWARE LIMITED PARTNERSHIP)
SUITE 2700
1415 LOUISIANA STREET
HOUSTON, TX 77002

FOR: MANAGING THE EXPLORATION, PRODUCTION AND OPERATION OF OIL AND NATURAL GAS PROPERTIES FOR OTHERS, IN CLASS 35 (U.S. CLS. 100, 101 AND 102).

FIRST USE 3-17-2008; IN COMMERCE 3-17-2008.

FOR: THE TRANSMISSION OF NATURAL GAS THROUGH PIPELINES, IN CLASS 39 (U.S. CLS. 100 AND 105).

FIRST USE 3-17-2008; IN COMMERCE 3-17-2008.

FOR: NATURAL GAS INDUSTRY SERVICES, NAMELY, THE GATHERING, FRACTIONATING, COMPRESSING, AND TREATING OF NATURAL GAS, IN CLASS 40 (U.S. CLS. 100, 103 AND 106).

FIRST USE 3-17-2008; IN COMMERCE 3-17-2008.

OWNER OF U.S. REG. NO. 2,944,838.

NO CLAIM IS MADE TO THE EXCLUSIVE RIGHT TO USE "ENERGY PARTNERS", APART FROM THE MARK AS SHOWN.

THE MARK CONSISTS OF THE TERM "EAGLE ROCK ENERGY PARTNERS" IN STYLIZED FONT TO THE RIGHT OF A STYLIZED PROFILE OF AN EAGLE.

SN 77-884,313, FILED 12-2-2009.

LINDA POWELL, EXAMINING ATTORNEY



David J. Kyjars

Director of the United States Patent and Trademark Office

United States of America

United States Patent and Trademark Office

LOVE AT FIRST LAUGH

Reg. No. 4,109,300

JOSHUA LIEBLING (UNITED STATES INDIVIDUAL)
2971 BELLMORE AVENUE
BELLMORE, NY 11710

Registered Mar. 6, 2012

Int. Cls.: 16, 25, and 41

FOR: POSTERS, NOTEPADS, IN CLASS 16 (U.S. CLS. 2, 5, 22, 23, 29, 37, 38 AND 50).

TRADEMARK

FIRST USE 11-22-2011; IN COMMERCE 11-22-2011.

SERVICE MARK

FOR: HATS, SHIRTS, SWEATSHIRTS, IN CLASS 25 (U.S. CLS. 22 AND 39).

PRINCIPAL REGISTER

FIRST USE 10-17-2011; IN COMMERCE 10-17-2011.

FOR: ONLINE JOURNALS, NAMELY, BLOGS IN THE FIELD OF THE SCIENCE OF LAUGHTER, LOVE OF HUMOR, AND INTERPERSONAL RELATIONSHIPS, IN CLASS 41 (U.S. CLS. 100, 101 AND 107).

FIRST USE 2-14-2010; IN COMMERCE 2-14-2010.

THE MARK CONSISTS OF STANDARD CHARACTERS WITHOUT CLAIM TO ANY PARTICULAR FONT, STYLE, SIZE, OR COLOR.

SN 77-884,556, FILED 12-2-2009.

NICHOLAS COLEMAN, EXAMINING ATTORNEY



David J. Kyros

Director of the United States Patent and Trademark Office

United States of America

United States Patent and Trademark Office



Reg. No. 4,109,301

Registered Mar. 6, 2012

Int. Cl.: 41

SERVICE MARK

PRINCIPAL REGISTER

COMPETITOR GROUP, INC. (DELAWARE CORPORATION)
9477 WAPLES STREET, SUITE 150
SAN DIEGO, CA 92121

FOR: ENTERTAINMENT IN THE NATURE OF ORGANIZING A SPORTING EVENT IN THE NATURE OF A RUNNING RACE AND RELATED SPORTING AND ENTERTAINMENT EVENTS, NAMELY, ORGANIZING COMMUNITY FAIRS FEATURING VENDOR BOOTHS OF FOOD AND RACE RELATED SPORTING GOODS, AND PLANNING PARTIES AND DINNERS, IN CLASS 41 (U.S. CLS. 100, 101 AND 107).

FIRST USE 8-2-2011; IN COMMERCE 8-2-2011.

OWNER OF U.S. REG. NOS. 2,131,333, 3,422,420, AND OTHERS.

NO CLAIM IS MADE TO THE EXCLUSIVE RIGHT TO USE "SAN DIEGO MARATHON & 1/2", APART FROM THE MARK AS SHOWN.

THE MARK CONSISTS OF THE WORDS "ROCK 'N' ROLL SAN DIEGO MARATHON & 1/2" AND OTHER DESIGNS SURROUNDED BY A RECTANGULAR BORDER. A STYLIZED OCEAN WAVE AND PALM TREE ARE LOCATED IN FRONT OF A SETTING SUN WITHIN A SQUARE BORDER.

SN 77-884,784, FILED 12-2-2009.

BRENDAN REGAN, EXAMINING ATTORNEY



David J. Kybas

Director of the United States Patent and Trademark Office

United States of America

United States Patent and Trademark Office

The Organized Cook

Reg. No. 4,109,302

SPILSBURY, TONI (UNITED STATES INDIVIDUAL), DBA THE ORGANIZED COOK,
224 BETHWICK CIRCLE
LAS VEGAS, NV 89183

Registered Mar. 6, 2012

Int. Cl.: 16

FOR: COOK BOOKS, IN CLASS 16 (U.S. CLS. 2, 5, 22, 23, 29, 37, 38 AND 50).

TRADEMARK

FIRST USE 11-0-2010; IN COMMERCE 11-0-2010.

PRINCIPAL REGISTER

THE MARK CONSISTS OF STANDARD CHARACTERS WITHOUT CLAIM TO ANY PARTICULAR FONT, STYLE, SIZE, OR COLOR.

NO CLAIM IS MADE TO THE EXCLUSIVE RIGHT TO USE "COOK", APART FROM THE MARK AS SHOWN.

SN 77-885,417, FILED 12-3-2009.

NATALIE POLZER, EXAMINING ATTORNEY



David J. Kyffers

Director of the United States Patent and Trademark Office

United States of America

United States Patent and Trademark Office

GREEN PRECAST

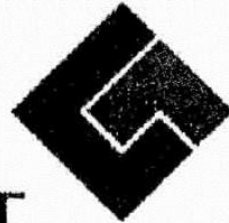

Reg. No. 4,109,303

Registered Mar. 6, 2012

Int. Cl.: 37

SERVICE MARK

PRINCIPAL REGISTER

SAKER, SALVATORE ALFREDO (AUSTRALIA INDIVIDUAL)
P.O. BOX 2655
ABU DHABI, UNITED ARAB EMIR.

FOR: BUILDING CONSTRUCTION SERVICES; CONSTRUCTION OF MODULAR STRUCTURES FOR RESIDENTIAL AND COMMERCIAL USE; BUILDING RENOVATION AND RESTORATION SERVICES; CONSULTING SERVICES FOR REPAIR, RENOVATION AND RESTORATION OF BUILDINGS AND STRUCTURES, IN CLASS 37 (U.S. CLS. 100, 103 AND 106).

FIRST USE 12-12-2011; IN COMMERCE 12-12-2011.

NO CLAIM IS MADE TO THE EXCLUSIVE RIGHT TO USE "GREEN PRECAST", APART FROM THE MARK AS SHOWN.

THE MARK CONSISTS OF THE WORDS "GREEN PRECAST" WITH A BROKEN DIAMOND DESIGN.

SN 77-885,432, FILED 12-3-2009.

ANDREA HACK, EXAMINING ATTORNEY



David J. Kybas

Director of the United States Patent and Trademark Office

United States of America

United States Patent and Trademark Office

SPENNARE

Reg. No. 4,109,304

Registered Mar. 6, 2012

Int. Cl.: 20

TRADEMARK

PRINCIPAL REGISTER

KG SPENNARE AB (SWEDEN CORPORATION)
HASTHOLMSVAGEN 32
131 30 NACKA, SWEDEN

FOR: DISPLAY STANDS, NAMELY, BANNER STANDS, POP-UP DISPLAY STANDS, AND PORTABLE EXHIBIT DISPLAY STANDS, AND PORTABLE EXHIBIT STANDS, IN CLASS 20 (U.S. CLS. 2, 13, 22, 25, 32 AND 50).

FIRST USE 2-17-2005; IN COMMERCE 2-17-2005.

THE MARK CONSISTS OF STANDARD CHARACTERS WITHOUT CLAIM TO ANY PARTICULAR FONT, STYLE, SIZE, OR COLOR.

PRIORITY CLAIMED UNDER SEC. 44(D) ON CANADA APPLICATION NO. 1460768, FILED 11-27-2009.

THE ENGLISH TRANSLATION OF "SPENNARE" IN THE MARK IS TO "PLUCK" OR "TO FLEECE".

SN 77-886,031, FILED 12-4-2009.

BARNEY CHARLON, EXAMINING ATTORNEY



David J. Kyros

Director of the United States Patent and Trademark Office

United States of America

United States Patent and Trademark Office

JACKSON ASSURE

Reg. No. 4,109,305

JACKSON NATIONAL LIFE INSURANCE COMPANY (MICHIGAN CORPORATION)
1 CORPORATE WAY
LANSING, MI 48951

Registered Mar. 6, 2012

Int. Cl.: 36

FOR: FINANCIAL SERVICES, NAMELY, UNDERWRITING SIMPLIFIED ISSUE WHOLE LIFE INSURANCE, IN CLASS 36 (U.S. CLS. 100, 101 AND 102).

SERVICE MARK

FIRST USE 6-4-2007; IN COMMERCE 6-4-2007.

PRINCIPAL REGISTER

THE MARK CONSISTS OF STANDARD CHARACTERS WITHOUT CLAIM TO ANY PARTICULAR FONT, STYLE, SIZE, OR COLOR.

OWNER OF U.S. REG. NOS. 1,489,625, 3,680,231, AND OTHERS.

NO CLAIM IS MADE TO THE EXCLUSIVE RIGHT TO USE "ASSURE", APART FROM THE MARK AS SHOWN.

SN 77-886,350, FILED 12-4-2009.

SETH A. RAPPAPORT, EXAMINING ATTORNEY



David J. Kybas

Director of the United States Patent and Trademark Office

United States of America

United States Patent and Trademark Office

JACKSON ACCUMULATOR

Reg. No. 4,109,306

JACKSON NATIONAL LIFE INSURANCE COMPANY (MICHIGAN CORPORATION)
1 CORPORATE WAY
LANSING, MI 48951

Registered Mar. 6, 2012

Int. Cl.: 36

FOR: FINANCIAL SERVICES, NAMELY, UNDERWRITING UNIVERSAL LIFE INSURANCE,
IN CLASS 36 (U.S. CLS. 100, 101 AND 102).

SERVICE MARK

FIRST USE 7-30-2007; IN COMMERCE 7-30-2007.

PRINCIPAL REGISTER

THE MARK CONSISTS OF STANDARD CHARACTERS WITHOUT CLAIM TO ANY PAR-
TICULAR FONT, STYLE, SIZE, OR COLOR.

OWNER OF U.S. REG. NOS. 1,489,625, 3,680,232, AND OTHERS.

NO CLAIM IS MADE TO THE EXCLUSIVE RIGHT TO USE "ACCUMULATOR", APART
FROM THE MARK AS SHOWN.

SN 77-886,352, FILED 12-4-2009.

SETH A. RAPPAPORT, EXAMINING ATTORNEY



David J. Kybas

Director of the United States Patent and Trademark Office

United States of America

United States Patent and Trademark Office



Reg. No. 4,109,307

Registered Mar. 6, 2012

Int. Cl.: 41

SERVICE MARK

PRINCIPAL REGISTER

BERRY, XAVIER J. (UNITED STATES INDIVIDUAL), DBA YOUNG X,
936 CIMARRON DR.
DAVENPORT, IA 52804

FOR: ENTERTAINMENT SERVICES IN THE NATURE OF LIVE MUSICAL PERFORMANCES;
MUSIC COMPOSITION FOR OTHERS; MUSIC PRODUCTION SERVICES; SONG WRITING
SERVICES; MUSIC PUBLISHING SERVICES, IN CLASS 41 (U.S. CLS. 100, 101 AND 107).

FIRST USE 12-1-2006; IN COMMERCE 12-1-2008.

THE MARK CONSISTS OF THE STYLIZED WORD "YOUNG" ABOVE A SHIELD WITH
WINGS. ON THE SHIELD APPEARS A STYLIZED LETTER "X".

SN 77-886,686, FILED 12-4-2009.

GEOFFREY FOSDICK, EXAMINING ATTORNEY



David J. Kybas

Director of the United States Patent and Trademark Office

United States of America

United States Patent and Trademark Office

TRIARCHY

Reg. No. 4,109,308

Registered Mar. 6, 2012

Int. Cls.: 9 and 41

TRADEMARK

SERVICE MARK

PRINCIPAL REGISTER

BEECK, ALBERTO, M. (UNITED STATES INDIVIDUAL)
APT. 502
575 CRANDON BLVD.
KEY BISCAYNE, FL 33149

FOR: DIGITAL MEDIA, NAMELY, PRE-RECORDED VIDEO CASSETTES, DIGITAL VIDEO DISCS, DIGITAL VERSATILE DISCS, DOWNLOADABLE AUDIO AND VIDEO RECORDINGS, DVDS, AND HIGH DEFINITION DIGITAL DISCS FEATURING MUSICAL AND ARTISTIC PERFORMANCES; DIGITAL TRADING CARDS IN THE NATURE OF MULTIMEDIA SOFTWARE RECORDED ON MAGNETIC MEDIA FEATURING MUSICAL AND ARTISTIC PERFORMANCES; PRE-RECORDED CDS FEATURING MUSICAL AND ARTISTIC PERFORMANCES; PRE-RECORDED CDS, VIDEO TAPES, LASER DISKS AND DVDS FEATURING MUSICAL AND ARTISTIC PERFORMANCES; PRE-RECORDED DIGITAL MEDIA FEATURING MUSICAL AND ARTISTIC PERFORMANCES; PRE-RECORDED DIGITAL VIDEO DISCS FEATURING MUSICAL AND ARTISTIC PERFORMANCES; PRE-RECORDED DVDS FEATURING MUSICAL AND ARTISTIC PERFORMANCES; PRE-RECORDED ELECTRONIC AND DIGITAL MEDIA FEATURING MUSICAL AND ARTISTIC PERFORMANCES; PRE-RECORDED ELECTRONIC MEDIA FEATURING MUSICAL AND ARTISTIC PERFORMANCES; PRERECORDED MAGNETIC DATA CARRIERS FEATURING MUSICAL AND ARTISTIC PERFORMANCES; RECORDING AND PLAYING DEVICES FOR SOUND AND IMAGE CARRIERS, IN CLASS 9 (U.S. CLS. 21, 23, 26, 36 AND 38).

FIRST USE 1-24-2008; IN COMMERCE 1-24-2008.



FOR: ENTERTAINMENT SERVICES, NAMELY, NON-DOWNLOADABLE RINGTONES, PRE-RECORDED MUSIC, VIDEO AND GRAPHICS PRESENTED TO MOBILE COMMUNICATIONS DEVICES VIA A GLOBAL COMPUTER NETWORK AND WIRELESS NETWORKS; PRODUCTION OF SOUND AND IMAGE RECORDINGS ON SOUND AND IMAGE CARRIERS; RENTAL OF IMAGE-RECORDED MAGNETIC TAPES; RENTAL OF PRE-RECORDED VIDEOS THAT MAY BE DOWNLOADED FROM AN INTERNET WEB SITE; RENTAL OF RECORDS OR SOUND-RECORDED MAGNETIC TAPES, IN CLASS 41 (U.S. CLS. 100, 101 AND 107).

FIRST USE 1-24-2008; IN COMMERCE 1-24-2008.

THE MARK CONSISTS OF STANDARD CHARACTERS WITHOUT CLAIM TO ANY PARTICULAR FONT, STYLE, SIZE, OR COLOR.

David J. Kyros

Director of the United States Patent and Trademark Office

Reg. No. 4,109,308 SN 77-887,186, FILED 12-6-2009.

RICHARD WHITE, EXAMINING ATTORNEY

United States of America

United States Patent and Trademark Office



Reg. No. 4,109,309

Registered Mar. 6, 2012

Int. Cl.: 25

TRADEMARK

PRINCIPAL REGISTER

BADOGGY (NEW YORK LIMITED LIABILITY COMPANY)
1284 HANCOCK STREET
BROOKLYN, NY 11221

FOR: HATS; PANTS; SHORTS; SWEAT SHIRTS; T-SHIRTS, IN CLASS 25 (U.S. CLS. 22 AND 39).

FIRST USE 3-2-2010; IN COMMERCE 1-1-2011.

THE MARK CONSISTS OF A DOG PULLING AND BITING A TSHIRT. BELOW, THERE IS THE STYLIZED TEXT "BADOGGY".

SN 77-888,085, FILED 12-7-2009.

SHANNON TWOHIG, EXAMINING ATTORNEY



David J. Kyffers

Director of the United States Patent and Trademark Office

United States of America

United States Patent and Trademark Office

BAD BOYS MAKE NOISE

Reg. No. 4,109,310

Registered Mar. 6, 2012

Int. Cl.: 25

TRADEMARK

PRINCIPAL REGISTER

MADDOX, CHARLES (UNITED STATES INDIVIDUAL)
2837 SHADOW CANYON CIRCLE
NORCO, CA 92860

FOR: DRESS SHIRTS; GLOVES; HATS; JACKETS; PANTS; POLO SHIRTS; SHORTS; SKULL CAPS; SWEAT SHIRTS; SWEATERS; T-SHIRTS; VESTS, IN CLASS 25 (U.S. CLS. 22 AND 39).

FIRST USE 8-2-2011; IN COMMERCE 9-28-2011.

THE MARK CONSISTS OF STANDARD CHARACTERS WITHOUT CLAIM TO ANY PARTICULAR FONT, STYLE, SIZE, OR COLOR.

SN 77-888,589, FILED 12-8-2009.

CHERYL CLAYTON, EXAMINING ATTORNEY



David J. Kybas

Director of the United States Patent and Trademark Office

United States of America

United States Patent and Trademark Office

SOLITAIRE

Reg. No. 4,109,311

Registered Mar. 6, 2012

Int. Cl.: 9

TRADEMARK

PRINCIPAL REGISTER

OPTRONIC TECHNOLOGIES, INC. (CALIFORNIA CORPORATION)
89 HANGAR WAY
WATSONVILLE, CA 95076

FOR: TELESCOPIC EQUIPMENT, NAMELY, AUTOGUIDERS IN THE NATURE OF AN ELECTRONIC DEVICE USED IN ASTROPHOTOGRAPHY TO KEEP THE CELESTIAL OBJECT BEING PHOTOGRAPHED FROM DRIFTING ACROSS THE FIELD OF VIEW, IN CLASS 9 (U.S. CLS. 21, 23, 26, 36 AND 38).

FIRST USE 3-2-2009; IN COMMERCE 6-12-2009.

THE MARK CONSISTS OF STANDARD CHARACTERS WITHOUT CLAIM TO ANY PARTICULAR FONT, STYLE, SIZE, OR COLOR.

SN 77-889,574, FILED 12-9-2009.

SANJEEV VOHRA, EXAMINING ATTORNEY



David J. Kyffers

Director of the United States Patent and Trademark Office

United States of America

United States Patent and Trademark Office

MUSIC MOVER

Reg. No. 4,109,312

BELKIN INTERNATIONAL, INC. (DELAWARE CORPORATION)
12045 EAST WATERFRONT DRIVE
PLAYA VISTA, CA 90094

Registered Mar. 6, 2012

Int. Cl.: 9

FOR: COMPUTER SOFTWARE APPLICATIONS AND COMPUTER SOFTWARE UPDATES FOR PLAYING DIGITAL MUSIC FILES, SOLD IN DOWNLOADABLE FORM AND AS A COMPONENT PART OF NETWORKING AND DIGITAL COMMUNICATIONS DEVICES, IN CLASS 9 (U.S. CLS. 21, 23, 26, 36 AND 38).

TRADEMARK

PRINCIPAL REGISTER

FIRST USE 4-0-2010; IN COMMERCE 4-0-2010.

THE MARK CONSISTS OF STANDARD CHARACTERS WITHOUT CLAIM TO ANY PARTICULAR FONT, STYLE, SIZE, OR COLOR.

NO CLAIM IS MADE TO THE EXCLUSIVE RIGHT TO USE "MUSIC", APART FROM THE MARK AS SHOWN.

SN 77-889,751, FILED 12-9-2009.

ADA HAN, EXAMINING ATTORNEY



David J. Kybas

Director of the United States Patent and Trademark Office

United States of America

United States Patent and Trademark Office

THE YOUNG ICONS

Reg. No. 4,109,313

Registered Mar. 6, 2012

Int. Cl.: 41

SERVICE MARK

PRINCIPAL REGISTER

ENTERTAINMENT CONTENT, INC. (CALIFORNIA CORPORATION)
1925 CENTURY PARK EAST, SUITE 1025
LOS ANGELES, CA 90067

FOR: ENTERTAINMENT SERVICES, NAMELY, ONGOING TELEVISION PROGRAMS IN THE FIELD OF SUCCESSFUL YOUNG PEOPLE, VARIETY, LIFESTYLE, AND NEWS; ONGOING TELEVISION PROGRAMS PRESENTED OVER THE INTERNET IN THE FIELD OF SUCCESSFUL YOUNG PEOPLE, VARIETY, LIFESTYLE, AND NEWS; PROVIDING ENTERTAINMENT, EDUCATIONAL, AND INFORMATIONAL AUDIOVISUAL PERFORMANCE PROGRAMMING IN THE FIELD OF SUCCESSFUL YOUNG PEOPLE, VARIETY, LIFESTYLE, AND NEWS ACCESSIBLE BY SATELLITE, TELEVISION, CABLE TELEVISION, INTERNET, WIRELESS NETWORKS, AND THROUGH TRANSMISSION OF AUDIO AND/OR VIDEO SIGNALS TO ANY TYPE OF VISUAL DISPLAY DEVICE; PRODUCTION OF TELEVISION PROGRAMS, IN CLASS 41 (U.S. CLS. 100, 101 AND 107).

FIRST USE 10-0-2010; IN COMMERCE 10-0-2010.

THE MARK CONSISTS OF STANDARD CHARACTERS WITHOUT CLAIM TO ANY PARTICULAR FONT, STYLE, SIZE, OR COLOR.

SN 77-890,926, FILED 12-10-2009.

JORDAN BAKER, EXAMINING ATTORNEY



David J. Kyffers

Director of the United States Patent and Trademark Office

United States of America

United States Patent and Trademark Office

BRAIN

Reg. No. 4,109,314

Registered Mar. 6, 2012

Int. Cl.: 9

TRADEMARK

PRINCIPAL REGISTER

RED.COM, INC. (WASHINGTON CORPORATION)
34 PARKER
IRVINE, CA 92618

FOR: CONTROLLING MECHANISM FOR DIGITAL CAMERAS THAT CONTROLS THE CAPTURING, MANIPULATION AND PRESERVATION OF IMAGES, IN CLASS 9 (U.S. CLS. 21, 23, 26, 36 AND 38).

FIRST USE 11-5-2010; IN COMMERCE 11-5-2010.

THE MARK CONSISTS OF STANDARD CHARACTERS WITHOUT CLAIM TO ANY PARTICULAR FONT, STYLE, SIZE, OR COLOR.

SN 77-893,149, FILED 12-14-2009.

DAWN FELDMAN, EXAMINING ATTORNEY



David J. Kybas

Director of the United States Patent and Trademark Office

United States of America

United States Patent and Trademark Office

Motion Trend

Reg. No. 4,109,315

Registered Mar. 6, 2012

Int. Cl.: 20

TRADEMARK

PRINCIPAL REGISTER

SOUTH BAY INTERNATIONAL (CALIFORNIA CORPORATION)
2665 POMONA BLVD.
POMONA, CA 91768

FOR: BEDROOM FURNITURE, BEDS, IN CLASS 20 (U.S. CLS. 2, 13, 22, 25, 32 AND 50).

FIRST USE 8-30-2011; IN COMMERCE 9-19-2011.

THE MARK CONSISTS OF STANDARD CHARACTERS WITHOUT CLAIM TO ANY PARTICULAR FONT, STYLE, SIZE, OR COLOR.

NO CLAIM IS MADE TO THE EXCLUSIVE RIGHT TO USE "MOTION", APART FROM THE MARK AS SHOWN.

SN 77-893,350, FILED 12-15-2009.

RENEE MCCRAY, EXAMINING ATTORNEY



David J. Kyffers

Director of the United States Patent and Trademark Office

United States of America

United States Patent and Trademark Office

JUST BASICS

Reg. No. 4,109,316

Registered Mar. 6, 2012

Int. Cl.: 16

TRADEMARK

PRINCIPAL REGISTER

OMX, INC. (NEVADA CORPORATION)
263 SHUMAN BLVD.
NAPERVILLE, IL 60563

FOR: OFFICE AND ORGANIZATIONAL SUPPLIES, NAMELY, FILE BOXES FOR STORAGE OF BUSINESS AND PERSONAL RECORDS, EXCLUDING PAPER FOR USE BY ARTISTS OR FOR USE IN HANDICRAFT, EASELS FOR USE BY ARTISTS, PLASTIC AND CARD-BOARD PAINT STORAGE BOXES FOR ARTISTS' USE, ARTISTS' PAINT BRUSHES, ARTISTS' CANVASES, ARTISTS' PALETTES, ARTISTS' SAUCERS FOR HOLDING PAINT, ARTISTS' PAPER DRAWING BOOKS, MODELING COMPOUND, AND PASTE FOR STATIONERY OR HOUSEHOLD PURPOSE, IN CLASS 16 (U.S. CLS. 2, 5, 22, 23, 29, 37, 38 AND 50).

FIRST USE 12-19-2011; IN COMMERCE 12-19-2011.

THE MARK CONSISTS OF STANDARD CHARACTERS WITHOUT CLAIM TO ANY PARTICULAR FONT, STYLE, SIZE, OR COLOR.

SN 77-894,087, FILED 12-15-2009.

BRENDAN MCCAULEY, EXAMINING ATTORNEY



David J. Kyros

Director of the United States Patent and Trademark Office

United States of America

United States Patent and Trademark Office

57 ESV

Reg. No. 4,109,317

Registered Mar. 6, 2012

Int. Cl.: 9

TRADEMARK

PRINCIPAL REGISTER

AEGIS FLOW TECHNOLOGIES, L.L.C. (LOUISIANA LIMITED LIABILITY COMPANY)
6041 INDUSTRIAL DRIVE
GEISMAR, LA 70734

FOR: AUTOMATIC VALVES, IN CLASS 9 (U.S. CLS. 21, 23, 26, 36 AND 38).

FIRST USE 10-1-2011; IN COMMERCE 10-1-2011.

THE MARK CONSISTS OF STANDARD CHARACTERS WITHOUT CLAIM TO ANY PARTICULAR FONT, STYLE, SIZE, OR COLOR.

NO CLAIM IS MADE TO THE EXCLUSIVE RIGHT TO USE "ESV", APART FROM THE MARK AS SHOWN.

SN 77-894,392, FILED 12-16-2009.

DAVID ELTON, EXAMINING ATTORNEY



David J. Kyffers

Director of the United States Patent and Trademark Office

United States of America
United States Patent and Trademark Office

VERVANO

Reg. No. 4,109,318

VERVANO, LLC (TEXAS LIMITED LIABILITY COMPANY)
911 W. 29TH STREET
AUSTIN, TX 78705

Registered Mar. 6, 2012

Int. Cl.: 20

FOR: FURNITURE, IN CLASS 20 (U.S. CLS. 2, 13, 22, 25, 32 AND 50).

TRADEMARK

FIRST USE 8-31-2011; IN COMMERCE 8-31-2011.

PRINCIPAL REGISTER

THE MARK CONSISTS OF STANDARD CHARACTERS WITHOUT CLAIM TO ANY PARTICULAR FONT, STYLE, SIZE, OR COLOR.

SN 77-894,463, FILED 12-16-2009.

SUSAN RICHARDS, EXAMINING ATTORNEY



David J. Kybas

Director of the United States Patent and Trademark Office

United States of America

United States Patent and Trademark Office

AMERICAN NINJA WARRIOR

Reg. No. 4,109,319

Registered Mar. 6, 2012

Int. Cl.: 9

TRADEMARK

PRINCIPAL REGISTER

TOKYO BROADCASTING SYSTEM TELEVISION, INC. (JAPAN CORPORATION)
5-3-6 AKASAKA, MINATO-KU
TOKYO, JAPAN 107-8006

FOR: PRE-RECORDED COMPACT DISCS, LASER DISCS, CD-ROMS, DVDS, DVD-ROMS, VIDEOTAPES, VIDEOCASSETTES, AND OTHER PRE-RECORDED OPTICAL, ELECTRONIC, DIGITAL, AND MAGNETIC MEDIA FEATURING COMPETITION-BASED ENTERTAINMENT AND COMPANION PROGRAMMING WITH ACTUAL AND/OR FICTIONAL CHARACTERS INVOLVED IN COMEDIC, DRAMATIC, DOCUMENTAL, LIVE-ACTION AND ANIMATED STORIES; COMPUTER GAME SOFTWARE; COMPUTER GAME PROGRAMS AND CARTRIDGES; ELECTRONIC GAME PROGRAMS; VIDEO GAME SOFTWARE; COMPUTER SCREEN SAVER SOFTWARE; DOWNLOADABLE GRAPHICS AND SOUND RECORDINGS VIA A GLOBAL COMPUTER NETWORK AND WIRELESS DEVICES; ANALOG AND DIGITAL MATERIALS, NAMELY, DOWNLOADABLE VIDEO RECORDINGS, AUDIO RECORDINGS, DIGITAL PHOTOGRAPHS, DIGITAL STILL IMAGES, DIGITAL MOVING IMAGES, COMPUTER SOFTWARE SCREEN SAVERS, AND DIGITAL COMPUTER DESKTOP BACKGROUND IMAGES FOR COMPUTERS AND WIRELESS DEVICES; MOTION PICTURE FILMS FEATURING COMPETITION-BASED ENTERTAINMENT AND COMPANION PROGRAMMING WITH ACTUAL AND/OR FICTIONAL CHARACTERS INVOLVED IN COMEDIC, DRAMATIC, DOCUMENTAL AND ANIMATED STORIES, IN CLASS 9 (U.S. CLS. 21, 23, 26, 36 AND 38).

FIRST USE 7-1-2010; IN COMMERCE 7-1-2011.

THE MARK CONSISTS OF STANDARD CHARACTERS WITHOUT CLAIM TO ANY PARTICULAR FONT, STYLE, SIZE, OR COLOR.

OWNER OF U.S. REG. NOS. 3,387,835 AND 3,680,200.

NO CLAIM IS MADE TO THE EXCLUSIVE RIGHT TO USE "AMERICAN", APART FROM THE MARK AS SHOWN.

SN 77-894,610, FILED 12-16-2009.

PATRICIA EVANKO, EXAMINING ATTORNEY



David J. Kyros

Director of the United States Patent and Trademark Office

United States of America

United States Patent and Trademark Office

FOX SOCCER PLUS

Reg. No. 4,109,320

Registered Mar. 6, 2012

Int. Cl.: 41

SERVICE MARK

PRINCIPAL REGISTER

TWENTIETH CENTURY FOX FILM CORPORATION (DELAWARE CORPORATION)
10201 WEST PICO BOULEVARD
LOS ANGELES, CA 90035

FOR: PRODUCTION AND DISTRIBUTION OF TELEVISION PROGRAMS FEATURING SPORTS, NEWS AND ENTERTAINMENT; ENTERTAINMENT SERVICES IN THE NATURE OF ONGOING TELEVISION PROGRAMS FEATURING SPORTS, NEWS AND ENTERTAINMENT; PROVIDING ON-LINE INFORMATION IN THE FIELD OF TELEVISION AND VIDEO ENTERTAINMENT FEATURING SPORTS, CURRENT EVENT NEWS AND ENTERTAINMENT VIA THE INTERNET; ENTERTAINMENT SERVICES IN THE NATURE OF NON-DOWNLOADABLE VIDEOS AND IMAGES FEATURING TELEVISION SHOWS, SPORTS, NEWS AND ENTERTAINMENT TRANSMITTED VIA THE INTERNET AND WIRELESS COMMUNICATION NETWORKS, IN CLASS 41 (U.S. CLS. 100, 101 AND 107).

FIRST USE 3-1-2010; IN COMMERCE 3-1-2010.

THE MARK CONSISTS OF STANDARD CHARACTERS WITHOUT CLAIM TO ANY PARTICULAR FONT, STYLE, SIZE, OR COLOR.

OWNER OF U.S. REG. NOS. 3,094,354, 3,195,046, AND OTHERS.

NO CLAIM IS MADE TO THE EXCLUSIVE RIGHT TO USE "SOCCER", APART FROM THE MARK AS SHOWN.

SN 77-894,813, FILED 12-16-2009.

JAY FLOWERS, EXAMINING ATTORNEY



David J. Kybas

Director of the United States Patent and Trademark Office

United States of America

United States Patent and Trademark Office

GET BETTER - GET NOTICED

Reg. No. 4,109,321

Registered Mar. 6, 2012

Int. Cl.: 41

SERVICE MARK

PRINCIPAL REGISTER

ACCELERATION PRODUCTS, INC. (NORTH DAKOTA CORPORATION)
SUITE E
2301 - 25TH STREET SOUTH
FARGO, ND 58103

FOR: EDUCATIONAL SERVICES, NAMELY, CONDUCTING SEMINARS IN THE FIELD OF EXERCISE AND SPORT TRAINING; SPORT SKILLS TRAINING INSTRUCTION; PHYSICAL FITNESS INSTRUCTION; PROVIDING ON-LINE INFORMATION FOR ATHLETES, TRAINERS, COACHES AND FACILITY DIRECTORS TO ASSIST IN PHYSICAL FITNESS TRAINING, IN CLASS 41 (U.S. CLS. 100, 101 AND 107).

FIRST USE 12-22-2011; IN COMMERCE 12-22-2011.

THE MARK CONSISTS OF STANDARD CHARACTERS WITHOUT CLAIM TO ANY PARTICULAR FONT, STYLE, SIZE, OR COLOR.

SN 77-894,985, FILED 12-16-2009.

KELLY CHOE, EXAMINING ATTORNEY



David J. Kybas

Director of the United States Patent and Trademark Office

United States of America

United States Patent and Trademark Office

PETRO SHIELD

Reg. No. 4,109,322

FEDERATED MUTUAL INSURANCE COMPANY (MINNESOTA CORPORATION)
121 EAST PARK SQUARE
OWATONNA, MN 55060

Registered Mar. 6, 2012

Int. Cls.: 35 and 36

FOR: BUSINESS RISK MANAGEMENT, IN CLASS 35 (U.S. CLS. 100, 101 AND 102).

SERVICE MARK

FIRST USE 6-3-2010; IN COMMERCE 6-3-2010.

PRINCIPAL REGISTER

FOR: FINANCIAL RISK MANAGEMENT; INSURANCE UNDERWRITING IN THE FIELD OF PETROLEUM OR FUELS DERIVED FROM PETROLEUM, IN CLASS 36 (U.S. CLS. 100, 101 AND 102).

FIRST USE 6-3-2010; IN COMMERCE 6-3-2010.

THE MARK CONSISTS OF STANDARD CHARACTERS WITHOUT CLAIM TO ANY PARTICULAR FONT, STYLE, SIZE, OR COLOR.

OWNER OF U.S. REG. NOS. 1,326,307, 1,669,015, AND OTHERS.

NO CLAIM IS MADE TO THE EXCLUSIVE RIGHT TO USE "PETRO", APART FROM THE MARK AS SHOWN.

SN 77-895,858, FILED 12-17-2009.

WENDY JUN, EXAMINING ATTORNEY



David J. Kyros

Director of the United States Patent and Trademark Office

United States of America

United States Patent and Trademark Office

MIL LEL

Reg. No. 4,109,323

Registered Mar. 6, 2012

Int. Cl.: 29

TRADEMARK

PRINCIPAL REGISTER

DAIRY FARMERS LIMITED (AUSTRALIA CORPORATION)
737 BOURKE STREET, DOCKLANDS
VICTORIA, AUSTRALIA 3008

FOR: DAIRY PRODUCTS, EXCLUDING ICE CREAM, ICE MILK AND FROZEN YOGURT;
MILK PRODUCTS, EXCLUDING ICE CREAM, ICE MILK AND FROZEN YOGURT; CHEESES,
IN CLASS 29 (U.S. CL. 46).

FIRST USE 6-15-2005; IN COMMERCE 6-15-2005.

THE MARK CONSISTS OF STANDARD CHARACTERS WITHOUT CLAIM TO ANY PAR-
TICULAR FONT, STYLE, SIZE, OR COLOR.

THE WORDING "MIL LEL" HAS NO MEANING IN A FOREIGN LANGUAGE.

SN 77-896,135, FILED 12-17-2009.

DEZMONA MIZELLE, EXAMINING ATTORNEY



David J. Kyffers

Director of the United States Patent and Trademark Office

United States of America

United States Patent and Trademark Office

INGENDA COMMUNICATIONS

Reg. No. 4,109,324

CHANDLER CHICCO COMPANIES LLC (DELAWARE LIMITED LIABILITY COMPANY)
450 WEST 15TH STREET
NEW YORK, NY 10011

Registered Mar. 6, 2012

Int. Cl.: 35

FOR: ADVERTISING AND MARKETING SERVICES; PUBLIC RELATIONS AND PUBLICITY SERVICES; PROMOTION SERVICES; BUSINESS CONSULTATION; CORPORATE AND BRAND IDENTITY CONSULTATION; CREATING CORPORATE AND BRAND IDENTITIES FOR OTHERS, IN CLASS 35 (U.S. CLS. 100, 101 AND 102).

SERVICE MARK

PRINCIPAL REGISTER

FIRST USE 1-15-2010; IN COMMERCE 3-16-2010.

THE MARK CONSISTS OF STANDARD CHARACTERS WITHOUT CLAIM TO ANY PARTICULAR FONT, STYLE, SIZE, OR COLOR.

NO CLAIM IS MADE TO THE EXCLUSIVE RIGHT TO USE "COMMUNICATIONS", APART FROM THE MARK AS SHOWN.

SN 77-896,866, FILED 12-18-2009.

MARILYN IZZI, EXAMINING ATTORNEY



David J. Kybas

Director of the United States Patent and Trademark Office

United States of America

United States Patent and Trademark Office

COMPETITIVE VET

Reg. No. 4,109,325

Registered Mar. 6, 2012

Int. Cl.: 44

SERVICE MARK

PRINCIPAL REGISTER

INITIUTY, INC. (WYOMING CORPORATION)
70 MAIN STREET
LYNNFIELD, MA 01940

FOR: VETERINARY SERVICES, IN CLASS 44 (U.S. CLS. 100 AND 101).

FIRST USE 9-24-2011; IN COMMERCE 9-24-2011.

THE MARK CONSISTS OF STANDARD CHARACTERS WITHOUT CLAIM TO ANY PARTICULAR FONT, STYLE, SIZE, OR COLOR.

NO CLAIM IS MADE TO THE EXCLUSIVE RIGHT TO USE "VET", APART FROM THE MARK AS SHOWN.

SN 77-896,884, FILED 12-18-2009.

DAVID COLLIER, EXAMINING ATTORNEY



David J. Kyffers

Director of the United States Patent and Trademark Office

United States of America

United States Patent and Trademark Office

COMPETITIVE PET

Reg. No. 4,109,326

Registered Mar. 6, 2012

Int. Cl.: 44

SERVICE MARK

PRINCIPAL REGISTER

INITUITY, INC. (WYOMING CORPORATION)
70 MAIN STREET
LYNNFIELD, MA 01940

FOR: VETERINARY SERVICES, IN CLASS 44 (U.S. CLS. 100 AND 101).

FIRST USE 9-24-2011; IN COMMERCE 9-24-2011.

THE MARK CONSISTS OF STANDARD CHARACTERS WITHOUT CLAIM TO ANY PARTICULAR FONT, STYLE, SIZE, OR COLOR.

NO CLAIM IS MADE TO THE EXCLUSIVE RIGHT TO USE "PET", APART FROM THE MARK AS SHOWN.

SN 77-896,905, FILED 12-18-2009.

DAVID COLLIER, EXAMINING ATTORNEY



David J. Kybas

Director of the United States Patent and Trademark Office

United States of America

United States Patent and Trademark Office



Reg. No. 4,109,327

Registered Mar. 6, 2012

Int. Cl.: 18

TRADEMARK

PRINCIPAL REGISTER

JUJU ROO LLC (CALIFORNIA LIMITED LIABILITY COMPANY)
P.O. BOX 1488
SEASIDE, CA 93955

FOR: BABY CARRIERS WORN ON THE BODY, IN CLASS 18 (U.S. CLS. 1, 2, 3, 22 AND 41).

FIRST USE 12-30-2011; IN COMMERCE 12-30-2011.

SN 77-897,526, FILED 12-19-2009.

SUSAN STIGLITZ, EXAMINING ATTORNEY



David J. Kyffers

Director of the United States Patent and Trademark Office

United States of America

United States Patent and Trademark Office

CUISINART PROFILE

Reg. No. 4,109,328

Registered Mar. 6, 2012

Int. Cl.: 21

TRADEMARK

PRINCIPAL REGISTER

CONAIR CORPORATION (DELAWARE CORPORATION)
ONE CUMMINGS POINT ROAD
STAMFORD, CT 06902

FOR: COOKWARE, NAMELY, POTS AND PANS; COOKWARE, NAMELY, SAUCEPOTS, STOCKPOTS, SAUTÉ PANS, SKILLETS, POT COVERS, SKILLET COVERS, IN CLASS 21 (U.S. CLS. 2, 13, 23, 29, 30, 33, 40 AND 50).

FIRST USE 2-0-2010; IN COMMERCE 2-0-2010.

THE MARK CONSISTS OF STANDARD CHARACTERS WITHOUT CLAIM TO ANY PARTICULAR FONT, STYLE, SIZE, OR COLOR.

OWNER OF U.S. REG. NOS. 1,183,520, 2,729,355, AND 3,136,857.

SN 77-900,351, FILED 12-23-2009.

ERIN FALK, EXAMINING ATTORNEY



David J. Kybas

Director of the United States Patent and Trademark Office

United States of America

United States Patent and Trademark Office

BERRIES PARADISE A PIECE OF HEAVEN

Reg. No. 4,109,329

Registered Mar. 6, 2012

Int. Cl.: 31

TRADEMARK

PRINCIPAL REGISTER

BERRIES PARADISE, S.A.P.I DE C.V. (MEXICO CORPORATION)
TORRES QUINTERO NO. 53, COL. CENTRO
LOS REYES MICHOCAN, MEXICO C.P.60300

FOR: FRESH FRUITS AND FRESH VEGETABLES; UNPROCESSED AGRICULTURAL AND HORTICULTURAL PRODUCTS, NAMELY, BLUEBERRIES, BLACKBERRIES, RASPBERRIES, MULBERRIES, AND GRAPES, IN CLASS 31 (U.S. CLS. 1 AND 46).

FIRST USE 10-17-2009; IN COMMERCE 10-17-2009.

THE MARK CONSISTS OF STANDARD CHARACTERS WITHOUT CLAIM TO ANY PARTICULAR FONT, STYLE, SIZE, OR COLOR.

NO CLAIM IS MADE TO THE EXCLUSIVE RIGHT TO USE "BERRIES", APART FROM THE MARK AS SHOWN.

SN 77-900,381, FILED 12-23-2009.

KRISTIN DAHLING, EXAMINING ATTORNEY



David J. Kybas

Director of the United States Patent and Trademark Office

United States of America

United States Patent and Trademark Office

DWEEZILLA

Reg. No. 4,109,330

Registered Mar. 6, 2012

Int. Cl.: 25

TRADEMARK

PRINCIPAL REGISTER

ZAPPA, DWEEZIL (UNITED STATES INDIVIDUAL)
C/O STUART A. DITSKY CPA, SUITE 1040
9255 SUNSET BLVD.
WEST HOLLYWOOD, CA 90069

FOR: TOPS AND T-SHIRTS, IN CLASS 25 (U.S. CLS. 22 AND 39).

FIRST USE 5-0-2011; IN COMMERCE 5-0-2011.

THE MARK CONSISTS OF STANDARD CHARACTERS WITHOUT CLAIM TO ANY PARTICULAR FONT, STYLE, SIZE, OR COLOR.

OWNER OF U.S. REG. NOS. 2,214,879, 2,272,497, AND OTHERS.

SN 77-900,610, FILED 12-23-2009.

JUDITH HELFMAN, EXAMINING ATTORNEY



David J. Kyros

Director of the United States Patent and Trademark Office

United States of America

United States Patent and Trademark Office

IONATOR HOM

Reg. No. 4,109,331

Registered Mar. 6, 2012

Int. Cls.: 3 and 5

TRADEMARK

PRINCIPAL REGISTER

ACTIVEION CLEANING SOLUTIONS LLC (DELAWARE LIMITED LIABILITY COMPANY)
800 WASHINGTON AVENUE NORTH
SUITE 512
MINNEAPOLIS, MN 55401

FOR: CLEANSERS FOR PERSONAL HYGIENIC USE; CLEANERS FOR MEDICAL USE ON SUPPLIES, EQUIPMENT, AND MEDICAL FACILITY SURFACES, IN CLASS 3 (U.S. CLS. 1, 4, 6, 50, 51 AND 52).

FIRST USE 12-17-2009; IN COMMERCE 12-17-2009.

FOR: SANITIZING PREPARATIONS AND DISINFECTANTS FOR PERSONAL HYGIENIC USE; SANITIZING PREPARATIONS AND DISINFECTANTS FOR MEDICAL USE ON SUPPLIES, EQUIPMENT, AND MEDICAL FACILITY SURFACES, IN CLASS 5 (U.S. CLS. 6, 18, 44, 46, 51 AND 52).

FIRST USE 12-17-2009; IN COMMERCE 12-17-2009.

THE MARK CONSISTS OF STANDARD CHARACTERS WITHOUT CLAIM TO ANY PARTICULAR FONT, STYLE, SIZE, OR COLOR.

NO CLAIM IS MADE TO THE EXCLUSIVE RIGHT TO USE "HOME", APART FROM THE MARK AS SHOWN.

SN 77-902,845, FILED 12-30-2009.

HOWARD B. LEVINE, EXAMINING ATTORNEY



David J. Kyros

Director of the United States Patent and Trademark Office

United States of America

United States Patent and Trademark Office

SOUTHERN TO THE CORE

Reg. No. 4,109,332

Registered Mar. 6, 2012

Int. Cls.: 16 and 21

TRADEMARK

PRINCIPAL REGISTER

K. ROSE PUBLISHING, INC. (TENNESSEE CORPORATION)
102 HARTMAN DRIVE
SUITE G-164
LEBANON, TN 37087

FOR: A SERIES OF BOOKS AND WRITTEN ARTICLES IN THE FIELD OF COOKING AND RECIPES; PRINTED RECIPE CARDS, IN CLASS 16 (U.S. CLS. 2, 5, 22, 23, 29, 37, 38 AND 50).

FIRST USE 11-30-2011; IN COMMERCE 11-30-2011.

FOR: RECIPE BOXES, IN CLASS 21 (U.S. CLS. 2, 13, 23, 29, 30, 33, 40 AND 50).

FIRST USE 8-31-2011; IN COMMERCE 8-31-2011.

THE MARK CONSISTS OF STANDARD CHARACTERS WITHOUT CLAIM TO ANY PARTICULAR FONT, STYLE, SIZE, OR COLOR.

NO CLAIM IS MADE TO THE EXCLUSIVE RIGHT TO USE "SOUTHERN", APART FROM THE MARK AS SHOWN.

SN 77-903,521, FILED 12-31-2009.

DAWN HAN, EXAMINING ATTORNEY



David J. Kyjars

Director of the United States Patent and Trademark Office

United States of America

United States Patent and Trademark Office

Seed to Scent

Reg. No. 4,109,333

Registered Mar. 6, 2012

Int. Cl.: 3

TRADEMARK

PRINCIPAL REGISTER

AUSTIN ADVISORY GROUP (NEW YORK LIMITED LIABILITY COMPANY)
50 WEST 9TH STREET, #5B
NEW YORK, NY 10011

FOR: FRAGRANCES, IN CLASS 3 (U.S. CLS. 1, 4, 6, 50, 51 AND 52).

FIRST USE 11-10-2010; IN COMMERCE 11-10-2010.

THE MARK CONSISTS OF STANDARD CHARACTERS WITHOUT CLAIM TO ANY PARTICULAR FONT, STYLE, SIZE, OR COLOR.

SN 77-903,666, FILED 12-31-2009.

MATTHEW KLINE, EXAMINING ATTORNEY



David J. Kyffers

Director of the United States Patent and Trademark Office

United States of America

United States Patent and Trademark Office

NexSheen

Reg. No. 4,109,334

Registered Mar. 6, 2012

Int. Cl.: 3

TRADEMARK

PRINCIPAL REGISTER

M3 COSMETIC LABS LLC (FLORIDA LIMITED LIABILITY COMPANY)
330 CARSWELL AVENUE
HOLLY HILL, FL 32117

FOR: CONDITIONERS; GEL FOR STYLING HAIR; HAIR EMOLLIENTS; HAIR LOTION;
HAIR OILS; HAIR RELAXERS; HAIR SHAMPOO; HAIR SPRAY, IN CLASS 3 (U.S. CLS. 1,
4, 6, 50, 51 AND 52).

FIRST USE 9-6-2011; IN COMMERCE 9-6-2011.

THE MARK CONSISTS OF STANDARD CHARACTERS WITHOUT CLAIM TO ANY PAR-
TICULAR FONT, STYLE, SIZE, OR COLOR.

SN 77-904,524, FILED 1-4-2010.

SCOTT BIBB, EXAMINING ATTORNEY



David J. Kybas

Director of the United States Patent and Trademark Office

United States of America

United States Patent and Trademark Office

SUPER RAY

Reg. No. 4,109,335

HOME BOX OFFICE, INC. (DELAWARE CORPORATION)
1100 AVENUE OF THE AMERICAS
NEW YORK, NY 10036

Registered Mar. 6, 2012

Int. Cl.: 25

FOR: CLOTHING, NAMELY, T-SHIRTS, IN CLASS 25 (U.S. CLS. 22 AND 39).

TRADEMARK

FIRST USE 10-30-2010; IN COMMERCE 10-30-2010.

PRINCIPAL REGISTER

THE MARK CONSISTS OF STANDARD CHARACTERS WITHOUT CLAIM TO ANY PARTICULAR FONT, STYLE, SIZE, OR COLOR.

THE NAME(S), PORTRAIT(S), AND/OR SIGNATURE(S) SHOWN IN THE MARK DOES NOT IDENTIFY A PARTICULAR LIVING INDIVIDUAL.

SN 77-905,306, FILED 1-5-2010.

CHRISTINE COOPER, EXAMINING ATTORNEY



David J. Kyffers

Director of the United States Patent and Trademark Office

United States of America

United States Patent and Trademark Office

SHUN THE SUN

Reg. No. 4,109,336

Registered Mar. 6, 2012

Int. Cl.: 41

SERVICE MARK

PRINCIPAL REGISTER

GREGORY ALLEN (UNITED STATES INDIVIDUAL)
1425 S. GREENFIELD ROAD, STE. 102
MESA, AZ 85206

FOR: DISSEMINATION OF EDUCATIONAL MATERIALS IN THE FIELD OF SKIN CANCER AWARENESS AND PREVENTION; ATHLETIC AND SPORTS EVENT SERVICES, NAMELY, ARRANGING, ORGANIZING, OPERATING AND CONDUCTING SKIN CANCER AWARENESS FAMILY FUN RUNS AND ROAD RACES OF 5K AND HALF MARATHON DISTANCES, IN CLASS 41 (U.S. CLS. 100, 101 AND 107).

FIRST USE 11-12-2011; IN COMMERCE 11-12-2011.

THE MARK CONSISTS OF STANDARD CHARACTERS WITHOUT CLAIM TO ANY PARTICULAR FONT, STYLE, SIZE, OR COLOR.

SN 77-905,812, FILED 1-6-2010.

KRISTIN DAHLING, EXAMINING ATTORNEY



David J. Kyffers

Director of the United States Patent and Trademark Office

United States of America

United States Patent and Trademark Office

Method Genius

Reg. No. 4,109,337

Registered Mar. 6, 2012

Int. Cl.: 9

TRADEMARK

PRINCIPAL REGISTER

CAMBRIDGESOFT CORPORATION (DELAWARE CORPORATION)
100 CAMBRIDGEPARK DRIVE
CAMBRIDGE, MA 02140

FOR: BIOS (BASIC INPUT OUT PUT SYSTEM) COMPUTER PROGRAMS; BIOS (BASIC INPUT/OUTPUT SYSTEM) COMPUTER PROGRAM; COMPUTER SEARCH ENGINE SOFTWARE; COMPUTERS FOR USE IN DATA MANAGEMENT, IN CLASS 9 (U.S. CLS. 21, 23, 26, 36 AND 38).

FIRST USE 12-11-2009; IN COMMERCE 12-11-2009.

THE MARK CONSISTS OF STANDARD CHARACTERS WITHOUT CLAIM TO ANY PARTICULAR FONT, STYLE, SIZE, OR COLOR.

NO CLAIM IS MADE TO THE EXCLUSIVE RIGHT TO USE "METHOD", APART FROM THE MARK AS SHOWN.

SN 77-905,893, FILED 1-6-2010.

MARC LEIPZIG, EXAMINING ATTORNEY



David J. Kyffers

Director of the United States Patent and Trademark Office

United States of America

United States Patent and Trademark Office

SERIOUS ABOUT SINUS

Reg. No. 4,109,338

Registered Mar. 6, 2012

Int. Cl.: 44

SERVICE MARK

PRINCIPAL REGISTER

JOHNSON & JOHNSON (NEW JERSEY CORPORATION)
ONE JOHNSON & JOHNSON PLAZA
NEW BRUNSWICK, NJ 089337001

FOR: INTERACTIVE WEBSITE FEATURING SINUS AND HEALTH CARE TOPICS;
PROVIDING INFORMATION ON SINUS AND HEALTH CARE TOPICS, IN CLASS 44 (U.S.
CLS. 100 AND 101).

FIRST USE 3-17-2010; IN COMMERCE 3-17-2010.

THE MARK CONSISTS OF STANDARD CHARACTERS WITHOUT CLAIM TO ANY PAR-
TICULAR FONT, STYLE, SIZE, OR COLOR.

SN 77-906,021, FILED 1-6-2010.

ESTHER A. BORSUK, EXAMINING ATTORNEY



David J. Kybas

Director of the United States Patent and Trademark Office

United States of America

United States Patent and Trademark Office

Reaction Genius

Reg. No. 4,109,339

CAMBRIGESOFT CORPORATION (DELAWARE CORPORATION)
100 CAMBRIDGEPARK DRIVE
CAMBRIDGE, MA 02140

Registered Mar. 6, 2012

Int. Cl.: 9

FOR: COMPUTER SOFTWARE FOR CREATING AND SEARCHING FOR CHEMICAL REACTION DATA, IN CLASS 9 (U.S. CLS. 21, 23, 26, 36 AND 38).

TRADEMARK

FIRST USE 2-0-2011; IN COMMERCE 2-0-2011.

PRINCIPAL REGISTER

THE MARK CONSISTS OF STANDARD CHARACTERS WITHOUT CLAIM TO ANY PARTICULAR FONT, STYLE, SIZE, OR COLOR.

NO CLAIM IS MADE TO THE EXCLUSIVE RIGHT TO USE "REACTION", APART FROM THE MARK AS SHOWN.

SN 77-906,430, FILED 1-6-2010.

MARC LEIPZIG, EXAMINING ATTORNEY



David J. Kybas

Director of the United States Patent and Trademark Office

United States of America

United States Patent and Trademark Office

gymmatrix

Reg. No. 4,109,340

PLANET BEACH BRANDS, LLC (LOUISIANA LIMITED LIABILITY COMPANY)
920 POEYFARRE, PH3
NEW ORLEANS, LA 70130

Registered Mar. 6, 2012

Int. Cls.: 25 and 35

FOR: ATHLETIC APPAREL, NAMELY, SHIRTS, PANTS, JACKETS, FOOTWEAR, HATS AND CAPS, ATHLETIC UNIFORMS; GLOVES AS CLOTHING; GYM PANTS; GYM SHORTS; JACKETS; JERSEYS; PANTS; SHORT-SLEEVED OR LONG-SLEEVED T-SHIRTS; SHORTS; SPORT SHIRTS; SPORTS SHIRTS; SPORTS SHIRTS WITH SHORT SLEEVES; SWEAT SHIRTS; T-SHIRTS; YOGA PANTS, IN CLASS 25 (U.S. CLS. 22 AND 39).

TRADEMARK

SERVICE MARK

FIRST USE 1-1-2010; IN COMMERCE 10-1-2010.

PRINCIPAL REGISTER

FOR: FRANCHISING, NAMELY, OFFERING BUSINESS MANAGEMENT ASSISTANCE IN THE ESTABLISHMENT AND/OR OPERATION OF A FITNESS AND EXERCISE FACILITY, IN CLASS 35 (U.S. CLS. 100, 101 AND 102).

FIRST USE 1-1-2010; IN COMMERCE 1-4-2010.

THE MARK CONSISTS OF STANDARD CHARACTERS WITHOUT CLAIM TO ANY PARTICULAR FONT, STYLE, SIZE, OR COLOR.

SN 77-910,176, FILED 1-12-2010.

THEODORE MCBRIDE, EXAMINING ATTORNEY



David J. Kyros

Director of the United States Patent and Trademark Office

United States of America

United States Patent and Trademark Office

LUXIA

Reg. No. 4,109,341

PACIFIC COAST FEATHER COMPANY (WASHINGTON CORPORATION)
P.O. BOX 80385
SEATTLE, WA 98108

Registered Mar. 6, 2012

Int. Cl.: 20

FOR: FIBERS SOLD AS AN INTEGRAL COMPONENT OF PILLOWS, IN CLASS 20 (U.S. CLS. 2, 13, 22, 25, 32 AND 50).

TRADEMARK

FIRST USE 2-1-2009; IN COMMERCE 2-1-2009.

PRINCIPAL REGISTER

THE MARK CONSISTS OF STANDARD CHARACTERS WITHOUT CLAIM TO ANY PARTICULAR FONT, STYLE, SIZE, OR COLOR.

SN 77-912,101, FILED 1-14-2010.

MARC LEIPZIG, EXAMINING ATTORNEY



David J. Kybas

Director of the United States Patent and Trademark Office

United States of America

United States Patent and Trademark Office

SMALLTALK

Reg. No. 4,109,342

Registered Mar. 6, 2012

Int. Cls.: 38 and 41

SERVICE MARK

PRINCIPAL REGISTER

RED ROCK VALLEY LIMITED (NEVADA LIMITED LIABILITY COMPANY)
6000 SOUTH EASTERN AVENUE
SUITE 14B
LAS VEGAS, NV 89119

FOR: MULTIMEDIA BROADCASTING SERVICES, NAMELY, AUDIO BROADCASTING, TELEVISION BROADCASTING, CABLE TELEVISION BROADCASTING, SATELLITE TELEVISION BROADCASTING, RADIO BROADCASTING, CABLE RADIO BROADCASTING, INTERNET WEB CAST BROADCASTING, AND STREAMING OF AUDIO AND AUDIOVISUAL CHILDREN'S EDUCATION, TRAINING, AND ENTERTAINMENT PROGRAMS AND CONTENT; MULTIMEDIA BROADCASTING SERVICES, NAMELY, MULTIMEDIA BROADCASTING OF CHILDREN'S EDUCATION, TRAINING, AND ENTERTAINMENT PROGRAMS IN THE NATURE OF TALK AND VARIETY SHOWS WITH AN AUDIENCE COMPRISED OF YOUNG PEOPLE FEATURING ISSUES OF CONCERN TO CHILDREN AND INTERVIEWING OF CHILDREN, IN CLASS 38 (U.S. CLS. 100, 101 AND 104).

FIRST USE 5-1-2011; IN COMMERCE 5-1-2011.

FOR: EDUCATION, TRAINING, AND ENTERTAINMENT SERVICES, NAMELY, TELEVISION AND RADIO PROGRAMS AND PROGRAMS PROVIDED BY MEANS OF THE INTERNET AND OTHER BROADCASTING AND MULTIMEDIA IN THE NATURE OF TALK AND VARIETY SHOWS WITH AN AUDIENCE COMPRISED OF YOUNG PEOPLE FEATURING ISSUES OF CONCERN TO CHILDREN AND INTERVIEWING OF CHILDREN, IN CLASS 41 (U.S. CLS. 100, 101 AND 107).

FIRST USE 5-1-2011; IN COMMERCE 5-1-2011.

THE MARK CONSISTS OF STANDARD CHARACTERS WITHOUT CLAIM TO ANY PARTICULAR FONT, STYLE, SIZE, OR COLOR.

SN 77-912,872, FILED 1-15-2010.

JAMES A. RAUEN, EXAMINING ATTORNEY



David J. Kyffers

Director of the United States Patent and Trademark Office

United States of America

United States Patent and Trademark Office

EL PUBERTITO

Reg. No. 4,109,343

ALAYN RODOLFO PALAREA (UNITED STATES INDIVIDUAL)
719 ADAMS STREET
JACKSONVILLE, TX 75766

Registered Mar. 6, 2012

Int. Cl.: 41

FOR: ENTERTAINMENT SERVICES, NAMELY, LIVE PERFORMANCES AND PERSONAL APPEARANCES BY A COSTUMED CHARACTER AND RECORDED FOR THE PURPOSE OF DISTRIBUTION THROUGH BROADCAST MEDIA, IN CLASS 41 (U.S. CLS. 100, 101 AND 107).

SERVICE MARK

PRINCIPAL REGISTER

FIRST USE 7-1-2006; IN COMMERCE 7-1-2006.

THE MARK CONSISTS OF STANDARD CHARACTERS WITHOUT CLAIM TO ANY PARTICULAR FONT, STYLE, SIZE, OR COLOR.

THE ENGLISH TRANSLATION OF "EL PUBERTITO" IN THE MARK IS "THE YOUNG TEENAGE BOY".

SN 77-913,276, FILED 1-15-2010.

BRENDAN MCCAULEY, EXAMINING ATTORNEY



David J. Kyros

Director of the United States Patent and Trademark Office

United States of America

United States Patent and Trademark Office

NEVO

Reg. No. 4,109,344

Registered Mar. 6, 2012

Int. Cl.: 3

TRADEMARK

PRINCIPAL REGISTER

PRAVANA INTERNATIONAL CORPORATION (CALIFORNIA CORPORATION)
195 DAPPLEGRAY RD
BELL CANYON, CA 91307

FOR: HAIR COLORING PREPARATIONS; HAIR CARE PREPARATIONS, IN CLASS 3 (U.S. CLS. 1, 4, 6, 50, 51 AND 52).

FIRST USE 1-1-2012; IN COMMERCE 1-1-2012.

THE MARK CONSISTS OF STANDARD CHARACTERS WITHOUT CLAIM TO ANY PARTICULAR FONT, STYLE, SIZE, OR COLOR.

SN 77-913,580, FILED 1-16-2010.

MICHAEL SOUDERS, EXAMINING ATTORNEY



David J. Kyffers

Director of the United States Patent and Trademark Office

United States of America

United States Patent and Trademark Office

VIDEO CORNER

Reg. No. 4,109,345

Registered Mar. 6, 2012

Int. Cl.: 41

SERVICE MARK

PRINCIPAL REGISTER

AEROBICS AND FITNESS ASSOCIATION OF AMERICA (CALIFORNIA CORPORATION)
SUITE 200
15250 VENTURA BLVD.
SHERMAN OAKS, CA 91403

FOR: EDUCATIONAL SERVICES, NAMELY, PROVIDING INSTRUCTION AND ADMINISTERING EXAMS VIA WEBSITES ON A GLOBAL COMPUTER NETWORK IN THE FIELD OF CONTINUING EDUCATION FOR FITNESS PROFESSIONALS ON THE SUBJECTS OF AEROBICS, FITNESS, EXERCISE AND HEALTH, IN CLASS 41 (U.S. CLS. 100, 101 AND 107).

FIRST USE 6-6-2010; IN COMMERCE 6-6-2010.

THE MARK CONSISTS OF STANDARD CHARACTERS WITHOUT CLAIM TO ANY PARTICULAR FONT, STYLE, SIZE, OR COLOR.

NO CLAIM IS MADE TO THE EXCLUSIVE RIGHT TO USE "VIDEO", APART FROM THE MARK AS SHOWN.

SN 77-914,114, FILED 1-18-2010.

DANIEL CAPSHAW, EXAMINING ATTORNEY



David J. Kyffers

Director of the United States Patent and Trademark Office

United States of America

United States Patent and Trademark Office



Reg. No. 4,109,346

Registered Mar. 6, 2012

Int. Cl.: 10

TRADEMARK

PRINCIPAL REGISTER

FEMASYS INC. (DELAWARE CORPORATION)
SUITE 100
5000 RESEARCH COURT
SUWANEE, GA 30024

FOR: MEDICAL DEVICES FOR USE IN THE FIELD OF WOMEN'S HEALTH, NAMELY, MEDICAL APPARATUS FOR GYNECOLOGICAL PROCEDURES, IN CLASS 10 (U.S. CLS. 26, 39 AND 44).

FIRST USE 7-7-2010; IN COMMERCE 7-7-2010.

NO CLAIM IS MADE TO THE EXCLUSIVE RIGHT TO USE THE DESIGN OF FEMALE SYMBOL, APART FROM THE MARK AS SHOWN.

THE MARK CONSISTS OF THE TERM "FEMASYS" AND A STYLIZED DRAWING OF THE FEMALE SYMBOL INSIDE OF A PARTIAL RECTANGLE.

SN 77-914,709, FILED 1-19-2010.

SALLY SHIH, EXAMINING ATTORNEY



David J. Kyros

Director of the United States Patent and Trademark Office

United States of America

United States Patent and Trademark Office

FEMASYS

Reg. No. 4,109,347

Registered Mar. 6, 2012

Int. Cl.: 10

TRADEMARK

PRINCIPAL REGISTER

FEMASYS INC. (DELAWARE CORPORATION)
SUITE 100
5000 RESEARCH COURT
SUWANEE, GA 30024

FOR: MEDICAL DEVICES FOR USE IN THE FIELD OF WOMEN'S HEALTH, NAMELY, MEDICAL APPARATUS AND CATHETERS FOR GYNECOLOGICAL PROCEDURES, IN CLASS 10 (U.S. CLS. 26, 39 AND 44).

FIRST USE 7-7-2010; IN COMMERCE 7-7-2010.

THE MARK CONSISTS OF STANDARD CHARACTERS WITHOUT CLAIM TO ANY PARTICULAR FONT, STYLE, SIZE, OR COLOR.

SN 77-914,734, FILED 1-19-2010.

SALLY SHIH, EXAMINING ATTORNEY



David J. Kybas

Director of the United States Patent and Trademark Office

United States of America

United States Patent and Trademark Office

FEMVUE

Reg. No. 4,109,348

Registered Mar. 6, 2012

Int. Cl.: 10

TRADEMARK

PRINCIPAL REGISTER

FEMASYS INC. (DELAWARE CORPORATION)
5000 RESEARCH COURT
SUITE 100
SUWANEE, GA 30024

FOR: MEDICAL DEVICES FOR USE IN THE FIELD OF WOMEN'S HEALTH, NAMELY, MEDICAL APPARATUS FOR GYNECOLOGICAL PROCEDURES; KITS COMPRISING MEDICAL DEVICES FOR USE IN THE FIELD OF WOMEN'S HEALTH, NAMELY, MEDICAL APPARATUS AND CATHETERS FOR GYNECOLOGICAL PROCEDURES, IN CLASS 10 (U.S. CLS. 26, 39 AND 44).

FIRST USE 7-7-2010; IN COMMERCE 7-7-2010.

THE MARK CONSISTS OF STANDARD CHARACTERS WITHOUT CLAIM TO ANY PARTICULAR FONT, STYLE, SIZE, OR COLOR.

SN 77-914,748, FILED 1-19-2010.

SALLY SHIH, EXAMINING ATTORNEY



David J. Kyros

Director of the United States Patent and Trademark Office

United States of America

United States Patent and Trademark Office

PRO LINE FUSION

Reg. No. 4,109,349

Registered Mar. 6, 2012

Int. Cl.: 9

TRADEMARK

PRINCIPAL REGISTER

ROCKWELL COLLINS, INC. (DELAWARE CORPORATION)
400 COLLINS ROAD NE
CEDAR RAPIDS, IA 52498

FOR: AIRBORNE AVIONICS SYSTEM COMPRISED OF COMPUTER HARDWARE, COMPUTER SOFTWARE AND INTERFACE DEVICES, FOR OPERATING AIRPLANE CONTROLS, FOR OPERATING AIRPLANE COMMUNICATION RADIOS AND FOR OPERATING NAVIGATION SYSTEMS, IN CLASS 9 (U.S. CLS. 21, 23, 26, 36 AND 38).

FIRST USE 5-13-2011; IN COMMERCE 5-13-2011.

THE MARK CONSISTS OF STANDARD CHARACTERS WITHOUT CLAIM TO ANY PARTICULAR FONT, STYLE, SIZE, OR COLOR.

SN 77-915,533, FILED 1-20-2010.

BILL DAWE, EXAMINING ATTORNEY



David J. Kybas

Director of the United States Patent and Trademark Office

United States of America

United States Patent and Trademark Office



INTERNATIONAL ASSOCIATION OF CLAIM PROFESSIONALS

Reg. No. 4,109,350

Registered Mar. 6, 2012

Int. Cls.: 16, 35, and 41

INTERNATIONAL ASSOCIATION OF CLAIM PROFESSIONALS (ILLINOIS NOT FOR PROFIT CORPORATION)

C.O.-NICOLETTI, GONSEN, SPINNER & OWEN
555 5TH AVENUE - 8TH FLOOR
NEW YORK, NY 10017

TRADEMARK

FOR: MAGAZINES AND BULLETINS ON INSURANCE AND RELATED MATTERS, IN CLASS 16 (U.S. CLS. 2, 5, 22, 23, 29, 37, 38 AND 50).

SERVICE MARK

FIRST USE 10-0-2009; IN COMMERCE 10-0-2009.

PRINCIPAL REGISTER

FOR: ASSOCIATION SERVICES, NAMELY, PROMOTING THE INTERESTS OF INSURANCE PROFESSIONALS, IN CLASS 35 (U.S. CLS. 100, 101 AND 102).

FIRST USE 10-0-2009; IN COMMERCE 10-0-2009.

FOR: EDUCATIONAL SERVICES, NAMELY, SEMINARS, LECTURES, AND MEETINGS ON INSURANCE AND RELATED MATTERS, IN CLASS 41 (U.S. CLS. 100, 101 AND 107).

FIRST USE 10-0-2009; IN COMMERCE 10-0-2009.

NO CLAIM IS MADE TO THE EXCLUSIVE RIGHT TO USE "INTERNATIONAL ASSOCIATION OF CLAIM PROFESSIONALS", APART FROM THE MARK AS SHOWN.

THE COLOR(S) GREEN, BLACK AND WHITE IS/ARE CLAIMED AS A FEATURE OF THE MARK.

THE MARK CONSISTS OF A SQUARE LIKE FIGURE WITH A BLACK QUARTER CIRCLE. THE WHITE LETTERS "IACP" APPEAR IN THE BLACK PORTION OF THE SQUARE. THE REMAINDER OF THE SQUARE, UPPER RIGHT CORNER, APPEARS IN GREEN. THE BLACK WORDS "INTERNATIONAL ASSOCIATION OF CLAIM PROFESSIONALS" APPEAR BELOW AND TO THE RIGHT OF THE DESIGN ELEMENT.



David J. Kyppas

SN 77-915,577, FILED 1-20-2010.

MATTHEW PAPPAS, EXAMINING ATTORNEY

United States of America

United States Patent and Trademark Office

Dramatic Adventures

Reg. No. 4,109,351

Registered Mar. 6, 2012

Int. Cl.: 16

TRADEMARK

PRINCIPAL REGISTER

DRAMATIC ADVENTURES, INC. (COLORADO CORPORATION)
2348 CHERRY STREET
DENVER, CO 80207

FOR: PRINTED EDUCATIONAL MATERIALS IN THE FIELD OF DEVELOPMENT OF SOCIAL, EMOTIONAL AND PROBLEM SOLVING SKILLS, IN CLASS 16 (U.S. CLS. 2, 5, 22, 23, 29, 37, 38 AND 50).

FIRST USE 7-5-2011; IN COMMERCE 7-5-2011.

THE MARK CONSISTS OF STANDARD CHARACTERS WITHOUT CLAIM TO ANY PARTICULAR FONT, STYLE, SIZE, OR COLOR.

SN 77-915,912, FILED 1-20-2010.

BARBARA BROWN, EXAMINING ATTORNEY



David J. Kyjars

Director of the United States Patent and Trademark Office

United States of America

United States Patent and Trademark Office

FB CONNECT

Reg. No. 4,109,352

Registered Mar. 6, 2012

Int. Cl.: 38

SERVICE MARK

PRINCIPAL REGISTER

AMERICAN FARM BUREAU FEDERATION (ILLINOIS CORPORATION)
SUITE 1000W
600 MARYLAND AVENUE, S.W.
WASHINGTON, DC 20024

FOR: PROVIDING APPLICANT'S MEMBERS AND OTHERS ACCESS TO INFORMATION REGARDING THEIR ELECTED OFFICIALS, INCLUDING CONTACT INFORMATION, STAFF CONTACTS, BIOGRAPHICAL INFORMATION, INFORMATION ON VOTES, BILLS AND PACS CONTRIBUTIONS, AND OTHER SIMILAR INFORMATION VIA THE INTERNET, IN CLASS 38 (U.S. CLS. 100, 101 AND 104).

FIRST USE 2-0-2010; IN COMMERCE 2-0-2010.

THE MARK CONSISTS OF STANDARD CHARACTERS WITHOUT CLAIM TO ANY PARTICULAR FONT, STYLE, SIZE, OR COLOR.

NO CLAIM IS MADE TO THE EXCLUSIVE RIGHT TO USE "CONNECT", APART FROM THE MARK AS SHOWN.

SN 77-917,134, FILED 1-21-2010.

KATINA MISTER, EXAMINING ATTORNEY



David J. Kyffers

Director of the United States Patent and Trademark Office

United States of America

United States Patent and Trademark Office

FB CONNECTION

Reg. No. 4,109,353

Registered Mar. 6, 2012

Int. Cl.: 38

SERVICE MARK

PRINCIPAL REGISTER

AMERICAN FARM BUREAU FEDERATION (ILLINOIS CORPORATION)
SUITE 1000W
600 MARYLAND AVENUE, S.W.
WASHINGTON, DC 20024

FOR: PROVIDING APPLICANT'S MEMBERS AND OTHERS ACCESS TO INFORMATION REGARDING THEIR ELECTED OFFICIALS, INCLUDING CONTACT INFORMATION, STAFF CONTACTS, BIOGRAPHICAL INFORMATION, INFORMATION ON VOTES, BILLS AND PACS CONTRIBUTIONS, AND OTHER SIMILAR INFORMATION VIA THE INTERNET --, IN CLASS 38 (U.S. CLS. 100, 101 AND 104).

FIRST USE 1-1-2011; IN COMMERCE 1-1-2011.

THE MARK CONSISTS OF STANDARD CHARACTERS WITHOUT CLAIM TO ANY PARTICULAR FONT, STYLE, SIZE, OR COLOR.

NO CLAIM IS MADE TO THE EXCLUSIVE RIGHT TO USE "CONNECTION", APART FROM THE MARK AS SHOWN.

SN 77-917,160, FILED 1-21-2010.

KATINA MISTER, EXAMINING ATTORNEY



David J. Kyffers

Director of the United States Patent and Trademark Office

United States of America

United States Patent and Trademark Office



Reg. No. 4,109,354

Registered Mar. 6, 2012

Int. Cl.: 38

SERVICE MARK

PRINCIPAL REGISTER

AMERICAN FARM BUREAU FEDERATION (ILLINOIS CORPORATION)
SUITE 1000W
600 MARYLAND AVENUE, S.W.
WASHINGTON, DC 20024

FOR: PROVIDING APPLICANT'S MEMBERS AND OTHERS ACCESS TO INFORMATION REGARDING THEIR ELECTED OFFICIALS, INCLUDING CONTACT INFORMATION, STAFF CONTACTS, BIOGRAPHICAL INFORMATION, INFORMATION ON VOTES, BILLS AND PACS CONTRIBUTIONS, AND OTHER SIMILAR INFORMATION VIA THE INTERNET, IN CLASS 38 (U.S. CLS. 100, 101 AND 104).

FIRST USE 2-0-2010; IN COMMERCE 2-0-2010.

NO CLAIM IS MADE TO THE EXCLUSIVE RIGHT TO USE "CONNECT", APART FROM THE MARK AS SHOWN.

THE COLOR(S) BLUE, WHITE, BLACK AND YELLOW IS/ARE CLAIMED AS A FEATURE OF THE MARK.

THE MARK CONSISTS OF THE STYLIZED LETTERS "FB" TO THE LEFT OF THE WORDING "FB CONNECT", ALL IN WHITE, TO THE RIGHT OF A PICTURE OF A COMPUTER IN BLACK AND WHITE ATOP A YELLOW BALE OF HAY, ALL AGAINST A BLUE BACKGROUND.

SN 77-917,193, FILED 1-21-2010.

KATINA MISTER, EXAMINING ATTORNEY



David J. Kybas

Director of the United States Patent and Trademark Office

United States of America

United States Patent and Trademark Office



Reg. No. 4,109,355

Registered Mar. 6, 2012

Int. Cl.: 38

SERVICE MARK

PRINCIPAL REGISTER

AMERICAN FARM BUREAU FEDERATION (ILLINOIS CORPORATION)
SUITE 1000W
600 MARYLAND AVENUE, S.W.
WASHINGTON, DC 20024

FOR: PROVIDING APPLICANT'S MEMBERS AND OTHERS ACCESS TO INFORMATION REGARDING THEIR ELECTED OFFICIALS, INCLUDING CONTACT INFORMATION, STAFF CONTACTS, BIOGRAPHICAL INFORMATION, INFORMATION ON VOTES, BILLS AND PACS CONTRIBUTIONS, AND OTHER SIMILAR INFORMATION VIA THE INTERNET --, IN CLASS 38 (U.S. CLS. 100, 101 AND 104).

FIRST USE 2-0-2010; IN COMMERCE 2-0-2010.

NO CLAIM IS MADE TO THE EXCLUSIVE RIGHT TO USE "CONNECT", APART FROM THE MARK AS SHOWN.

THE MARK CONSISTS OF THE STYLIZED LETTERS "FB" AND THE TERM "FB CONNECT" TO THE RIGHT OF A PICTURE OF A COMPUTER ATOP A BALE OF HAY.

SN 77-917,201, FILED 1-21-2010.

KATINA MISTER, EXAMINING ATTORNEY



David J. Kyffers

Director of the United States Patent and Trademark Office

United States of America

United States Patent and Trademark Office



Reg. No. 4,109,356

Registered Mar. 6, 2012

Int. Cl.: 38

SERVICE MARK

PRINCIPAL REGISTER

AMERICAN FARM BUREAU FEDERATION (ILLINOIS CORPORATION)
SUITE 1000W
600 MARYLAND AVENUE, S.W.
WASHINGTON, DC 20024

FOR: PROVIDING APPLICANT'S MEMBERS AND OTHERS ACCESS TO INFORMATION REGARDING THEIR ELECTED OFFICIALS, INCLUDING CONTACT INFORMATION, STAFF CONTACTS, BIOGRAPHICAL INFORMATION, INFORMATION ON VOTES, BILLS AND PACS CONTRIBUTIONS, AND OTHER SIMILAR INFORMATION VIA THE INTERNET --, IN CLASS 38 (U.S. CLS. 100, 101 AND 104).

FIRST USE 1-1-2011; IN COMMERCE 1-1-2011.

NO CLAIM IS MADE TO THE EXCLUSIVE RIGHT TO USE "CONNECTION", APART FROM THE MARK AS SHOWN.

THE COLOR(S) BLUE, WHITE, BLACK AND YELLOW IS/ARE CLAIMED AS A FEATURE OF THE MARK.

THE MARK CONSISTS OF THE STYLIZED LETTERS "FB" AND THE TERM "FB CONNECTION" IN WHITE TO THE RIGHT OF A PICTURE OF A COMPUTER IN BLACK AND WHITE ATOP A YELLOW BALE OF HAY, ALL AGAINST A BLUE BACKGROUND.

SN 77-917,220, FILED 1-21-2010.

KATINA MISTER, EXAMINING ATTORNEY



David J. Kybas

Director of the United States Patent and Trademark Office

United States of America

United States Patent and Trademark Office

PURSUIT SERIES

Reg. No. 4,109,357

Registered Mar. 6, 2012

Int. Cl.: 12

TRADEMARK

PRINCIPAL REGISTER

DISC BRAKES AUSTRALIA PTY LIMITED (AUSTRALIA CORPORATION)
UNIT 3
SLOUGH BUSINESS PARK, HOLKER STREET
SILVERWATER NSW, AUSTRALIA 2128

FOR: BRAKE DISCS FOR VEHICLES; DISC BRAKE PADS FOR VEHICLE BRAKING SYSTEMS; DISC BRAKE ROTORS FOR VEHICLE BRAKING SYSTEMS; VEHICLE DISC BRAKES, IN CLASS 12 (U.S. CLS. 19, 21, 23, 31, 35 AND 44).

FIRST USE 10-22-2009; IN COMMERCE 10-22-2009.

THE MARK CONSISTS OF STANDARD CHARACTERS WITHOUT CLAIM TO ANY PARTICULAR FONT, STYLE, SIZE, OR COLOR.

NO CLAIM IS MADE TO THE EXCLUSIVE RIGHT TO USE "SERIES", APART FROM THE MARK AS SHOWN.

SN 77-917,799, FILED 1-22-2010.

JOHN SCHUYLER YARD, EXAMINING ATTORNEY



David J. Kyffers

Director of the United States Patent and Trademark Office

United States of America

United States Patent and Trademark Office

FORENSIC PERSPECTIVES

Reg. No. 4,109,358

GOTTLIEB, MARK S. (UNITED STATES INDIVIDUAL), DBA MSGCPA'S,
98 CUTTER MILL RD. SUITE 490 NORTH
GREAT NECK, NY 11021

Registered Mar. 6, 2012

Int. Cl.: 45

FOR: LITIGATION SUPPORT IN ECONOMICS, ACCOUNTING AND FINANCE, IN CLASS
45 (U.S. CLS. 100 AND 101).

SERVICE MARK

FIRST USE 4-23-2010; IN COMMERCE 4-23-2010.

PRINCIPAL REGISTER

THE MARK CONSISTS OF STANDARD CHARACTERS WITHOUT CLAIM TO ANY PAR-
TICULAR FONT, STYLE, SIZE, OR COLOR.

NO CLAIM IS MADE TO THE EXCLUSIVE RIGHT TO USE "FORENSIC", APART FROM
THE MARK AS SHOWN.

SN 77-919,270, FILED 1-25-2010.

CHERYL CLAYTON, EXAMINING ATTORNEY



David J. Kybas

Director of the United States Patent and Trademark Office

United States of America
United States Patent and Trademark Office

TACBIO

Reg. No. 4,109,359

Registered Mar. 6, 2012

Int. Cl.: 9

TRADEMARK

PRINCIPAL REGISTER

DEPARTMENT OF THE ARMY (UNITED STATES AGENCY OF THE UNITED STATES
GOVERNMENT)
THE PENTAGON
WASHINGTON, DC 20310

FOR: DEVICES FOR THE DETECTION OF BIOLOGICAL THREAT AGENTS, IN CLASS 9
(U.S. CLS. 21, 23, 26, 36 AND 38).

FIRST USE 9-0-2010; IN COMMERCE 9-0-2010.

THE MARK CONSISTS OF STANDARD CHARACTERS WITHOUT CLAIM TO ANY PAR-
TICULAR FONT, STYLE, SIZE, OR COLOR.

SN 77-922,777, FILED 1-28-2010.

DANIEL CAPSHAW, EXAMINING ATTORNEY



David J. Kyros

Director of the United States Patent and Trademark Office

United States of America
United States Patent and Trademark Office

iCloseCRM

Reg. No. 4,109,360

GROUPLINK CORPORATION (UTAH CORPORATION)
563 WEST 500 SOUTH, SUITE 400
BOUNTIFUL, UT 84010

Registered Mar. 6, 2012

Int. Cl.: 9

FOR: COMPUTER SOFTWARE FOR USE IN CUSTOMER RELATIONSHIP MANAGEMENT (CRM), IN CLASS 9 (U.S. CLS. 21, 23, 26, 36 AND 38).

TRADEMARK

FIRST USE 12-28-2009; IN COMMERCE 12-28-2009.

PRINCIPAL REGISTER

THE MARK CONSISTS OF STANDARD CHARACTERS WITHOUT CLAIM TO ANY PARTICULAR FONT, STYLE, SIZE, OR COLOR.

SN 77-923,984, FILED 1-29-2010.

LINDA E. BLOHM, EXAMINING ATTORNEY



David J. Kybas

Director of the United States Patent and Trademark Office

United States of America

United States Patent and Trademark Office

Toastie Toes

Reg. No. 4,109,361

JUDITH A. KASAMEYER (UNITED STATES INDIVIDUAL)
103 NORTH MAIN STREET
COHASSET, MA 02025

Registered Mar. 6, 2012

Int. Cl.: 12

FOR: COVERS FOR CHILDREN'S CAR SEATS; VEHICLE SEAT COVERS, IN CLASS 12
(U.S. CLS. 19, 21, 23, 31, 35 AND 44).

TRADEMARK

FIRST USE 2-2-2011; IN COMMERCE 2-2-2011.

PRINCIPAL REGISTER

THE MARK CONSISTS OF STANDARD CHARACTERS WITHOUT CLAIM TO ANY PARTICULAR FONT, STYLE, SIZE, OR COLOR.

NO CLAIM IS MADE TO THE EXCLUSIVE RIGHT TO USE "TOASTIE TOES", APART FROM THE MARK AS SHOWN.

SN 77-925,410, FILED 2-1-2010.

STEVEN R. FINE, EXAMINING ATTORNEY



David J. Kybas

Director of the United States Patent and Trademark Office

United States of America

United States Patent and Trademark Office

ZenSoles

Reg. No. 4,109,362

Registered Mar. 6, 2012

Int. Cl.: 5

TRADEMARK

PRINCIPAL REGISTER

VIANA ENTERPRISES INC (FLORIDA CORPORATION), DBA VIANA ENTERPRISES INC,
6875 SW 81 ST
MIAMI, FL 33143

FOR: TRANSDERMAL PATCHES FOR USE IN THE TREATMENT OF FOOT PAIN, IN CLASS
5 (U.S. CLS. 6, 18, 44, 46, 51 AND 52).

FIRST USE 11-15-2011; IN COMMERCE 11-15-2011.

THE MARK CONSISTS OF STANDARD CHARACTERS WITHOUT CLAIM TO ANY PAR-
TICULAR FONT, STYLE, SIZE, OR COLOR.

SN 77-926,844, FILED 2-3-2010.

SOPHIA S. KIM, EXAMINING ATTORNEY



David J. Kybas

Director of the United States Patent and Trademark Office

United States of America

United States Patent and Trademark Office

MERCURY

Reg. No. 4,109,363

Registered Mar. 6, 2012

Int. Cl.: 9

TRADEMARK

PRINCIPAL REGISTER

BALLY GAMING, INC. (NEVADA CORPORATION), DBA BALLY TECHNOLOGIES,
ATTN: PAMELA BOWSHER, LAW DEPT.
6601 SOUTH BERMUDA ROAD
LAS VEGAS, NV 89119

FOR: GAMING DEVICES, NAMELY, SLOT MACHINES WITH OR WITHOUT VIDEO
OUTPUT, IN CLASS 9 (U.S. CLS. 21, 23, 26, 36 AND 38).

FIRST USE 6-24-2011; IN COMMERCE 6-24-2011.

THE MARK CONSISTS OF STANDARD CHARACTERS WITHOUT CLAIM TO ANY PAR-
TICULAR FONT, STYLE, SIZE, OR COLOR.

SN 77-927,253, FILED 2-3-2010.

THEODORE MCBRIDE, EXAMINING ATTORNEY



David J. Kybas

Director of the United States Patent and Trademark Office

United States of America

United States Patent and Trademark Office

THE HILT

Reg. No. 4,109,364

Registered Mar. 6, 2012

Int. Cl.: 33

TRADEMARK

PRINCIPAL REGISTER

COOL HAND VINEYARDS, LLC (CALIFORNIA LIMITED LIABILITY COMPANY)
P.O. BOX 191
BUELLTON, CA 93427

FOR: WINE, IN CLASS 33 (U.S. CLS. 47 AND 49).

FIRST USE 7-31-2011; IN COMMERCE 7-31-2011.

THE MARK CONSISTS OF STANDARD CHARACTERS WITHOUT CLAIM TO ANY PARTICULAR FONT, STYLE, SIZE, OR COLOR.

SN 77-928,066, FILED 2-4-2010.

MARC LEIPZIG, EXAMINING ATTORNEY



David J. Kybas

Director of the United States Patent and Trademark Office

United States of America

United States Patent and Trademark Office

MAGIC OF HEALTHY LIVING

Reg. No. 4,109,365

DISNEY ENTERPRISES, INC. (DELAWARE CORPORATION)
500 SOUTH BUENA VISTA STREET
BURBANK, CA 91521

Registered Mar. 6, 2012

Int. Cl.: 35

FOR: PROVIDING ADVERTISING AND MARKETING SERVICES TO PROMOTE PUBLIC INTEREST IN BETTER LIFESTYLE CHOICES, IN CLASS 35 (U.S. CLS. 100, 101 AND 102).

SERVICE MARK

FIRST USE 9-30-2010; IN COMMERCE 9-30-2010.

PRINCIPAL REGISTER

THE MARK CONSISTS OF STANDARD CHARACTERS WITHOUT CLAIM TO ANY PARTICULAR FONT, STYLE, SIZE, OR COLOR.

SN 77-929,393, FILED 2-5-2010.

KATHERINE CONNOLLY, EXAMINING ATTORNEY



David J. Kyros

Director of the United States Patent and Trademark Office

United States of America

United States Patent and Trademark Office



Reg. No. 4,109,366

Registered Mar. 6, 2012

Int. Cl.: 14

TRADEMARK

PRINCIPAL REGISTER

GIVENS, JAIME L (TEXAS SOLE PROPRIETORSHIP), DBA FOXI GAL,
4607 TIMBERGLEN ROAD
DALLAS, TX 75217

FOR: BODY JEWELRY; BRACELETS; BROACHES; BRONZE JEWELRY; BROOCHES; CHARMS; CHARMS FOR COLLAR JEWELRY AND BRACELET; COSTUME JEWELRY; DIAMOND JEWELRY; GEMSTONE JEWELRY; JEWELRY; JEWELRY AND IMITATION JEWELRY; JEWELRY BOXES; JEWELRY BOXES NOT OF METAL; JEWELRY BOXES OF METAL; JEWELRY BOXES OF PRECIOUS METAL; JEWELRY BROOCHES; JEWELRY CASES; JEWELRY CASES NOT OF PRECIOUS METAL; JEWELRY CASES OF PRECIOUS METAL; JEWELRY CHAINS; JEWELRY FOR ATTACHMENT TO CLOTHING; JEWELRY FOR THE HEAD; JEWELRY IN THE NATURE OF ARMBANDS; JEWELRY PINS FOR USE ON HATS; JEWELRY TO BE AFFIXED TO BIKINIS; JEWELRY WATCHES; JEWELRY, NAMELY, AMULETS; JEWELRY, NAMELY, ANKLETS; JEWELRY, NAMELY, ARM CUFFS; JEWELRY, NAMELY, DOG TAGS FOR WEAR BY HUMANS FOR DECORATIVE PURPOSES; JEWELRY, NAMELY, MAGNETIC NECKLACES; JEWELRY, NAMELY, MAGNETIC PENDANTS; JEWELRY, NAMELY, STONE PENDANTS; LEATHER JEWELRY AND ACCESSORY BOXES; PET JEWELRY; PINS BEING JEWELRY; PLASTIC BRACELETS IN THE NATURE OF JEWELRY; PRECIOUS AND SEMI-PRECIOUS CRYSTAL STONES AND BEADS FOR USE IN JEWELRY; RINGS; RINGS BEING JEWELRY; STAINLESS STEEL JEWELRY BRACELETS; WATCHES AND JEWELRY; WATCHES, CLOCKS, JEWELRY AND IMITATION JEWELRY, IN CLASS 14 (U.S. CLS. 2, 27, 28 AND 50).

FIRST USE 1-1-2011; IN COMMERCE 1-1-2011.

THE MARK CONSISTS OF THE WORDING "FOXI GAL" WITH AN IMAGE OF A FIGURE THAT IS PART WOMAN AND PART FOX.

SN 77-929,714, FILED 2-6-2010.

MARGARET POWER, EXAMINING ATTORNEY



David J. Kyppas

Director of the United States Patent and Trademark Office

United States of America

United States Patent and Trademark Office

ICE-AX

Reg. No. 4,109,367

SNI SOLUTIONS, INC. (ILLINOIS CORPORATION)
205 N. STEWART ST.
GENESEO, IL 61254

Registered Mar. 6, 2012

Int. Cl.: 1

FOR: CHEMICAL PREPARATIONS FOR MELTING SNOW AND ICE, IN CLASS 1 (U.S. CLS. 1, 5, 6, 10, 26 AND 46).

TRADEMARK

FIRST USE 1-1-2010; IN COMMERCE 2-10-2010.

PRINCIPAL REGISTER

THE MARK CONSISTS OF STANDARD CHARACTERS WITHOUT CLAIM TO ANY PARTICULAR FONT, STYLE, SIZE, OR COLOR.

SN 77-930,800, FILED 2-8-2010.

DAVID C. REIHNER, EXAMINING ATTORNEY



David J. Kybas

Director of the United States Patent and Trademark Office

United States of America

United States Patent and Trademark Office



Reg. No. 4,109,368

W2007 STRATOSPHERE PROPCO, L.P. (DELAWARE LIMITED PARTNERSHIP)
2000 LAS VEGAS BOULEVARD SOUTH
LAS VEGAS, NV 89104

Registered Mar. 6, 2012

Int. Cl.: 25

FOR: BOTTOMS; FOOTWEAR; HEADWEAR; LOUNGEWEAR; SCARVES; SLEEPWEAR;
SWIMWEAR; TOPS; UNDERGARMENTS, IN CLASS 25 (U.S. CLS. 22 AND 39).

TRADEMARK

FIRST USE 4-1-2010; IN COMMERCE 4-1-2010.

PRINCIPAL REGISTER

OWNER OF U.S. REG. NOS. 2,086,400, 2,086,401, AND 3,212,812.

NO CLAIM IS MADE TO THE EXCLUSIVE RIGHT TO USE "LAS VEGAS", APART FROM
THE MARK AS SHOWN.

THE MARK CONSISTS OF THE WORDS "SKY JUMP STRATOSPHERE LAS VEGAS"
STAGGERED AND VERTICALLY POSITIONED OVER A TARGET.

SN 77-931,375, FILED 2-9-2010.

PAUL E. FAHRENKOPF, EXAMINING ATTORNEY



David J. Kybas

Director of the United States Patent and Trademark Office

United States of America

United States Patent and Trademark Office



Reg. No. 4,109,369

W2007 STRATOSPHERE PROPCO, L.P. (DELAWARE LIMITED PARTNERSHIP)
2000 LAS VEGAS BOULEVARD SOUTH
LAS VEGAS, NV 89104

Registered Mar. 6, 2012

Int. Cl.: 21

FOR: BEVERAGeware; SHOT GLASSES, IN CLASS 21 (U.S. CLS. 2, 13, 23, 29, 30, 33, 40 AND 50).

TRADEMARK

FIRST USE 4-1-2010; IN COMMERCE 4-1-2010.

PRINCIPAL REGISTER

OWNER OF U.S. REG. NOS. 2,086,400, 2,086,401, AND 3,212,812.

NO CLAIM IS MADE TO THE EXCLUSIVE RIGHT TO USE "LAS VEGAS", APART FROM THE MARK AS SHOWN.

THE MARK CONSISTS OF THE WORDS "SKY JUMP STRATOSPHERE LAS VEGAS" STAGGERED AND VERTICALLY POSITIONED OVER A TARGET.

SN 77-931,465, FILED 2-9-2010.

PAUL E. FAHRENKOPF, EXAMINING ATTORNEY



David J. Kybas

Director of the United States Patent and Trademark Office

United States of America

United States Patent and Trademark Office

Garro Habanesis

Reg. No. 4,109,370

Registered Mar. 6, 2012

Int. Cl.: 16

TRADEMARK

PRINCIPAL REGISTER

GARO BOULDOUKIAN (UNITED STATES INDIVIDUAL), DBA GARO HABANO FINE CIGARS,
3200 LA CRESCENTA AVE SUITE A
GLENDALE, CA 91208

FOR: CIGAR BANDS, IN CLASS 16 (U.S. CLS. 2, 5, 22, 23, 29, 37, 38 AND 50).

FIRST USE 4-14-2011; IN COMMERCE 4-14-2011.

THE MARK CONSISTS OF STANDARD CHARACTERS WITHOUT CLAIM TO ANY PARTICULAR FONT, STYLE, SIZE, OR COLOR.

NO CLAIM IS MADE TO THE EXCLUSIVE RIGHT TO USE "HABANESIS", APART FROM THE MARK AS SHOWN.

THE TERM "HABANESIS" HAS NO MEANING IN A FOREIGN LANGUAGE. THE TERM IDENTIFIES A STYLE OF TOBACCO GROWN FROM CUBAN SEED.

SN 77-932,438, FILED 2-10-2010.

RUSS HERMAN, EXAMINING ATTORNEY



David J. Kyros

Director of the United States Patent and Trademark Office

United States of America

United States Patent and Trademark Office

TRUWALK

Reg. No. 4,109,371

Registered Mar. 6, 2012

Int. Cl.: 25

TRADEMARK

PRINCIPAL REGISTER

THE ROCKPORT COMPANY, LLC (DELAWARE LIMITED LIABILITY COMPANY)
1895 J.W. FOSTER BOULEVARD
CANTON, MA 02021

FOR: FOOTWEAR, IN CLASS 25 (U.S. CLS. 22 AND 39).

FIRST USE 8-27-2010; IN COMMERCE 8-27-2010.

THE MARK CONSISTS OF STANDARD CHARACTERS WITHOUT CLAIM TO ANY PARTICULAR FONT, STYLE, SIZE, OR COLOR.

SN 77-933,319, FILED 2-11-2010.

DAVID ELTON, EXAMINING ATTORNEY



David J. Kyfos

Director of the United States Patent and Trademark Office

United States of America

United States Patent and Trademark Office

THE VALUE OF KNOWING

Reg. No. 4,109,372

Registered Mar. 6, 2012

Int. Cls.: 42 and 44

SERVICE MARK

PRINCIPAL REGISTER

PATHWAY GENOMICS CORPORATION (DELAWARE CORPORATION)
4045 SORRENTO VALLEY BLVD
SAN DIEGO, CA 92121

FOR: PROVIDING SCIENTIFIC ANALYSIS AND INFORMATIONAL REPORTS BASED UPON RESULTS OF LABORATORY TESTING IN THE FIELD OF GENETICS; PROVIDING ONLINE COMPUTER DATABASES FEATURING MEDICAL AND SCIENTIFIC RESEARCH INFORMATION BASED ON AGGREGATED RESULTS OF GENOTYPING; PROVIDING ONLINE COMPUTER DATABASES FEATURING INFORMATION BASED ON AGGREGATED RESULTS OF GENOTYPING FOR RESEARCH OR ANALYSIS PURPOSES; APPLICATION SERVICE PROVIDER (ASP) FEATURING SOFTWARE FOR PROVIDING ACCESS TO MULTIPLE DATABASES THAT CONTAIN AGGREGATED RESULTS OF GENOTYPING; APPLICATION SERVICE PROVIDER (ASP) FEATURING SOFTWARE FOR USE IN DATA MANAGEMENT, DATA STORAGE, DATA ANALYSIS, REPORT GENERATION, USER IDENTIFICATION, AND MEMBERSHIP IDENTIFICATION, ALL IN THE FIELDS OF GENETICS, GENETIC TESTING, AND PERSONALIZED MEDICINE; SCIENTIFIC RESEARCH IN THE FIELDS OF GENETICS, GENETIC TESTING, GENETIC SCREENING, GENOTYPING, PHENOTYPING, MOLECULAR ANALYTICS, AND ANCESTRY, IN CLASS 42 (U.S. CLS. 100 AND 101).

FIRST USE 5-24-2010; IN COMMERCE 5-24-2010.

FOR: PROVIDING ONLINE COMPUTER DATABASES FEATURING INFORMATION BASED ON AGGREGATED RESULTS OF GENOTYPING FOR PERSONALIZED HEALTH AND WELLNESS INFORMATION PURPOSES AND FOR HEALTH CARE PURPOSES, IN CLASS 44 (U.S. CLS. 100 AND 101).

FIRST USE 5-24-2010; IN COMMERCE 5-24-2010.

THE MARK CONSISTS OF STANDARD CHARACTERS WITHOUT CLAIM TO ANY PARTICULAR FONT, STYLE, SIZE, OR COLOR.

SN 77-933,463, FILED 2-11-2010.

DOUGLAS LEE, EXAMINING ATTORNEY



David J. Kyros

Director of the United States Patent and Trademark Office

United States of America

United States Patent and Trademark Office

XEROX ECONCIERGE

Reg. No. 4,109,373

XEROX CORPORATION (NEW YORK CORPORATION)
45 GLOVER AVE., P.O. BOX 4505
NORWALK, CT 068564505

Registered Mar. 6, 2012

Int. Cls.: 35 and 37

FOR: DATABASE MANAGEMENT SERVICES; COMPILATION OF BUSINESS INFORMATION IN THE NATURE OF REPORTS AND STATISTICS FOR FINANCIAL PURPOSES, SUPPORT PURPOSES, AND MAINTENANCE PURPOSES, IN CLASS 35 (U.S. CLS. 100, 101 AND 102).

SERVICE MARK

PRINCIPAL REGISTER

FIRST USE 4-22-2011; IN COMMERCE 4-22-2011.

FOR: INSTALLATION, MAINTENANCE AND REPAIR OF OFFICE MACHINE AND APPARATUS; INSTALLATION, MAINTENANCE AND REPAIR OF COPYING APPARATUS, PRINTERS, SCANNERS, FACSIMILE TRANSMITTING AND RECEIVING APPARATUS, DOCUMENT HANDLING APPARATUS, AND MULTIFUNCTIONAL DEVICES COMPOSED OF TWO OR MORE OF A COPIER, A PRINTER, A FACSIMILE MACHINE AND A SCANNER, IN CLASS 37 (U.S. CLS. 100, 103 AND 106).

FIRST USE 4-22-2011; IN COMMERCE 4-22-2011.

THE MARK CONSISTS OF STANDARD CHARACTERS WITHOUT CLAIM TO ANY PARTICULAR FONT, STYLE, SIZE, OR COLOR.

OWNER OF U.S. REG. NOS. 2,768,136, 3,299,372, AND OTHERS.

SN 77-933,773, FILED 2-11-2010.

SETH A. RAPPAPORT, EXAMINING ATTORNEY



David J. Kypos

Director of the United States Patent and Trademark Office

United States of America
United States Patent and Trademark Office

TANGLED

Reg. No. 4,109,374

Registered Mar. 6, 2012

Int. Cl.: 14

TRADEMARK

PRINCIPAL REGISTER

DISNEY ENTERPRISES, INC. (DELAWARE CORPORATION)
500 SOUTH BUENA VISTA STREET
BURBANK, CA 91521

FOR: CLOCKS; JEWELRY; WATCHES, IN CLASS 14 (U.S. CLS. 2, 27, 28 AND 50).

FIRST USE 10-31-2010; IN COMMERCE 10-31-2010.

THE MARK CONSISTS OF STANDARD CHARACTERS WITHOUT CLAIM TO ANY PARTICULAR FONT, STYLE, SIZE, OR COLOR.

SN 77-933,861, FILED 2-11-2010.

WILLIAM BRECKENFELD, EXAMINING ATTORNEY



David J. Kyffers

Director of the United States Patent and Trademark Office

United States of America
United States Patent and Trademark Office

TANGLED

Reg. No. 4,109,375

DISNEY ENTERPRISES, INC. (DELAWARE CORPORATION)
500 SOUTH BUENA VISTA STREET
BURBANK, CA 91521

Registered Mar. 6, 2012

Int. Cl.: 30

FOR: CANDIES, IN CLASS 30 (U.S. CL. 46).

TRADEMARK

FIRST USE 11-30-2011; IN COMMERCE 11-30-2011.

PRINCIPAL REGISTER

THE MARK CONSISTS OF STANDARD CHARACTERS WITHOUT CLAIM TO ANY PARTICULAR FONT, STYLE, SIZE, OR COLOR.

SN 77-934,537, FILED 2-12-2010.

WILLIAM BRECKENFELD, EXAMINING ATTORNEY



David J. Kyffers

Director of the United States Patent and Trademark Office

United States of America
United States Patent and Trademark Office

TANGLED

Reg. No. 4,109,376

Registered Mar. 6, 2012

Int. Cl.: 29

TRADEMARK

PRINCIPAL REGISTER

DISNEY ENTERPRISES, INC. (DELAWARE CORPORATION)
500 SOUTH BUENA VISTA STREET
BURBANK, CA 91521

FOR: FRUIT-BASED SNACK FOODS, IN CLASS 29 (U.S. CL. 46).

FIRST USE 10-31-2011; IN COMMERCE 10-31-2011.

THE MARK CONSISTS OF STANDARD CHARACTERS WITHOUT CLAIM TO ANY PARTICULAR FONT, STYLE, SIZE, OR COLOR.

SN 77-934,544, FILED 2-12-2010.

WILLIAM BRECKENFELD, EXAMINING ATTORNEY



David J. Kyffers

Director of the United States Patent and Trademark Office

United States of America

United States Patent and Trademark Office

ECO-BUILT

Reg. No. 4,109,377

Registered Mar. 6, 2012

Int. Cl.: 19

TRADEMARK

PRINCIPAL REGISTER

TROUT, EDWARD J. (UNITED STATES INDIVIDUAL), DBA MONTANA BUILDERS,
5415 FOREST HILLS DRIVE
BILLINGS, MT 59101

FOR: MANUFACTURED HOMES; MANUFACTURED HOUSING, NAMELY, MOBILE HOMES; MANUFACTURED HOUSING, NAMELY, TRANSPORTABLE HOMES; PRE-FABRICATED HOMES , IN CLASS 19 (U.S. CLS. 1, 12, 33 AND 50).

FIRST USE 7-15-2010; IN COMMERCE 7-15-2010.

THE MARK CONSISTS OF STANDARD CHARACTERS WITHOUT CLAIM TO ANY PARTICULAR FONT, STYLE, SIZE, OR COLOR.

SN 77-935,313, FILED 2-13-2010.

MARK SPARACINO, EXAMINING ATTORNEY



David J. Kyffers

Director of the United States Patent and Trademark Office

United States of America

United States Patent and Trademark Office

COLASOL

Reg. No. 4,109,378

Registered Mar. 6, 2012

Int. Cl.: 1

TRADEMARK

PRINCIPAL REGISTER

COLAS (FRANCE SOCIÉTÉ ANONYME (SA))
7 PLACE RENÉ CLAIR
BOULOGNE-BILLANCOURT, FRANCE 92100

FOR: CHEMICAL PREPARATIONS FOR STABILIZING SOIL AND AGGREGATES FOR USE IN CONSTRUCTION, REPAIR AND MAINTENANCE OF ROADS, HIGHWAYS AND OTHER TRAFFIC WAYS AND SURFACES; HYDROCARBON-BASED CHEMICAL PREPARATIONS AND EMULSIFIERS FOR STABILIZING SOIL AND AGGREGATES FOR USE IN CONSTRUCTION, REPAIR AND MAINTENANCE OF ROADS, HIGHWAYS AND OTHER TRAFFIC WAYS AND SURFACES, IN CLASS 1 (U.S. CLS. 1, 5, 6, 10, 26 AND 46).

FIRST USE 9-1-2009; IN COMMERCE 9-1-2009.

THE MARK CONSISTS OF STANDARD CHARACTERS WITHOUT CLAIM TO ANY PARTICULAR FONT, STYLE, SIZE, OR COLOR.

SN 77-939,174, FILED 2-18-2010.

LINDA ORNDORFF, EXAMINING ATTORNEY



David J. Kypos

Director of the United States Patent and Trademark Office

United States of America
United States Patent and Trademark Office

BlueLoop

Reg. No. 4,109,379

DREW ZODROW (UNITED STATES INDIVIDUAL)
1314 W. MCDERMOTT, SUITE 106-530
ALLEN, TX 75013

Registered Mar. 6, 2012

Int. Cl.: 9

FOR: COMPUTER SOFTWARE FOR CONTROLLING AND MANAGING PATIENT MEDICAL INFORMATION, IN CLASS 9 (U.S. CLS. 21, 23, 26, 36 AND 38).

TRADEMARK

FIRST USE 2-11-2011; IN COMMERCE 8-20-2011.

PRINCIPAL REGISTER

THE MARK CONSISTS OF STANDARD CHARACTERS WITHOUT CLAIM TO ANY PARTICULAR FONT, STYLE, SIZE, OR COLOR.

SN 77-939,468, FILED 2-18-2010.

FONG HSU, EXAMINING ATTORNEY



David J. Kybas

Director of the United States Patent and Trademark Office

United States of America

United States Patent and Trademark Office

GUNVISION

Reg. No. 4,109,380

Registered Mar. 6, 2012

Int. Cl.: 9

TRADEMARK

PRINCIPAL REGISTER

GUNVISION SYSTEMS, LLC (TEXAS LIMITED LIABILITY COMPANY)
14121 HWY 290 WEST
BLDG. 3A
AUSTIN, TX 78737

FOR: HEAD-MOUNTED VIDEO DISPLAY AND A FIREARM MOUNT FOR ATTACHING A VIDEO CAMERA TO A FIREARM, SOLD TOGETHER AS A UNIT, IN CLASS 9 (U.S. CLS. 21, 23, 26, 36 AND 38).

FIRST USE 3-1-2010; IN COMMERCE 3-1-2010.

THE MARK CONSISTS OF STANDARD CHARACTERS WITHOUT CLAIM TO ANY PARTICULAR FONT, STYLE, SIZE, OR COLOR.

SN 77-939,484, FILED 2-18-2010.

KIMBERLY FRYE, EXAMINING ATTORNEY



David J. Kybas

Director of the United States Patent and Trademark Office

United States of America
United States Patent and Trademark Office

Majestics

Reg. No. 4,109,381

CARLOS RAMIREZ (UNITED STATES INDIVIDUAL)
P.O. BOX 3163
COVINA, CA 91722

Registered Mar. 6, 2012

Int. Cl.: 20

FOR: CAR ACCESSORIES, NAMELY, CAR PLAQUES, IN CLASS 20 (U.S. CLS. 2, 13, 22, 25, 32 AND 50).

TRADEMARK

FIRST USE 10-4-2011; IN COMMERCE 10-26-2011.

PRINCIPAL REGISTER

THE MARK CONSISTS OF THE STYLIZED WORD "MAJESTICS" WITH A STYLIZED UNDERLINE.

SN 77-939,505, FILED 2-19-2010.

GINA HAYES, EXAMINING ATTORNEY



David J. Kybas

Director of the United States Patent and Trademark Office

United States of America

United States Patent and Trademark Office



TM SERIES
water meters

Reg. No. 4,109,382

Registered Mar. 6, 2012

Int. Cl.: 9

TRADEMARK

PRINCIPAL REGISTER

GREAT PLAINS INDUSTRIES, INC. (KANSAS CORPORATION)
5252 EAST 36TH STREET
WICHITA, KS 672203205

FOR: WATER METERS AND FLOW METERS, IN CLASS 9 (U.S. CLS. 21, 23, 26, 36 AND 38).

FIRST USE 9-26-2011; IN COMMERCE 9-26-2011.

NO CLAIM IS MADE TO THE EXCLUSIVE RIGHT TO USE "SERIES WATER METERS", APART FROM THE MARK AS SHOWN.

THE COLOR(S) WHITE, BLUE AND BLACK IS/ARE CLAIMED AS A FEATURE OF THE MARK.

THE MARK CONSISTS OF A BLUE AND WHITE WATER DROP FALLING INTO BROKEN BLUE RINGS OF WATER, WITH THE BOLDED WORDS "TM SERIES" IN BLACK UNDER THE DESIGN AND WITH THE WORDS "WATER METERS" IN BLACK UN-BOLDED SCRIPT UNDER "TM SERIES".

SN 77-940,111, FILED 2-19-2010.

SIMON TENG, EXAMINING ATTORNEY



David J. Kybas

Director of the United States Patent and Trademark Office

United States of America

United States Patent and Trademark Office



Reg. No. 4,109,383

Registered Mar. 6, 2012

Int. Cl.: 16

TRADEMARK

PRINCIPAL REGISTER

EARTHWORKS SYSTEM, LLC (OHIO LIMITED LIABILITY COMPANY)
33200 BAINBRIDGE ROAD
SUITE D
SOLON, OH 44139

FOR: NON-MAGNETICALLY ENCODED PLASTIC TRANSACTION, INFORMATION AND IDENTIFICATION CARDS, IN CLASS 16 (U.S. CLS. 2, 5, 22, 23, 29, 37, 38 AND 50).

FIRST USE 1-0-2008; IN COMMERCE 1-0-2008.

OWNER OF U.S. REG. NO. 3,462,902.

NO CLAIM IS MADE TO THE EXCLUSIVE RIGHT TO USE "RECYCLED" AND THE RECYCLING SYMBOL, APART FROM THE MARK AS SHOWN.

THE MARK CONSISTS OF THE DESIGN OF TWO CONCENTRIC CIRCLES CONTAINING THE WORDING "EARTHWORKS RECYCLED" AND A RECYCLING SYMBOL IN THE CENTER.

SN 77-942,288, FILED 2-23-2010.

DAWN HAN, EXAMINING ATTORNEY



David J. Kybas

Director of the United States Patent and Trademark Office

United States of America

United States Patent and Trademark Office



Reg. No. 4,109,384

Registered Mar. 6, 2012

Int. Cl.: 16

TRADEMARK

PRINCIPAL REGISTER

EARTHWORKS SYSTEM, LLC (OHIO LIMITED LIABILITY COMPANY)
33200 BAINBRIDGE ROAD
SUITE D
SOLON, OH 44139

FOR: NON-MAGNETICALLY ENCODED PLASTIC TRANSACTION, INFORMATION AND IDENTIFICATION CARDS, IN CLASS 16 (U.S. CLS. 2, 5, 22, 23, 29, 37, 38 AND 50).

FIRST USE 12-0-2010; IN COMMERCE 12-0-2010.

THE MARK CONSISTS OF THE WORDING "EW" SURROUNDED BY THREE CHASING ARROWS THAT FORM AN OVERALL ROUND SHAPE.

SN 77-942,345, FILED 2-23-2010.

DAWN HAN, EXAMINING ATTORNEY



David J. Kyffers

Director of the United States Patent and Trademark Office

United States of America

United States Patent and Trademark Office

JOINT VENTURE

Reg. No. 4,109,385

APPLE INC. (CALIFORNIA CORPORATION)
1 INFINITE LOOP
CUPERTINO, CA 95014

Registered Mar. 6, 2012

Int. Cls.: 35, 37, 41, and 42

FOR: RETAIL STORE SERVICES FEATURING COMPUTERS, COMPUTER SOFTWARE, COMPUTER PERIPHERALS, AND CONSUMER ELECTRONIC DEVICES, AND DEMONSTRATION OF PRODUCTS RELATING THERETO, IN CLASS 35 (U.S. CLS. 100, 101 AND 102).

SERVICE MARK

FIRST USE 3-3-2011; IN COMMERCE 3-3-2011.

PRINCIPAL REGISTER

FOR: MAINTENANCE, INSTALLATION AND REPAIR OF COMPUTER HARDWARE, COMPUTER PERIPHERALS, COMPUTER NETWORKS, AND CONSUMER ELECTRONIC DEVICES; INFORMATION, ADVISORY AND CONSULTANCY SERVICES RELATING TO ALL THE AFORESAID, IN CLASS 37 (U.S. CLS. 100, 103 AND 106).

FIRST USE 3-3-2011; IN COMMERCE 3-3-2011.

FOR: EDUCATION AND TRAINING SERVICES, NAMELY, PERSONAL INSTRUCTION AND CONDUCTING CLASSES, WORKSHOPS, CONFERENCES AND SEMINARS IN THE FIELD OF COMPUTERS, COMPUTER SOFTWARE, COMPUTER PERIPHERALS, AND CONSUMER ELECTRONICS, IN CLASS 41 (U.S. CLS. 100, 101 AND 107).

FIRST USE 3-3-2011; IN COMMERCE 3-3-2011.

FOR: TECHNICAL SUPPORT AND CONSULTING SERVICES PERTAINING TO COMPUTER HARDWARE, COMPUTER PERIPHERALS, COMPUTER SOFTWARE AND CONSUMER ELECTRONICS, NAMELY, TROUBLESHOOTING IN THE NATURE OF COMPUTER DIAGNOSTIC SERVICES FOR COMPUTER HARDWARE, COMPUTER PERIPHERALS, COMPUTER SOFTWARE AND CONSUMER ELECTRONIC DEVICES AND CONSULTING SERVICES IN THE FIELD OF SELECTION, IMPLEMENTATION AND USE OF COMPUTER HARDWARE AND SOFTWARE SYSTEMS FOR OTHERS, IN CLASS 42 (U.S. CLS. 100 AND 101).

FIRST USE 3-3-2011; IN COMMERCE 3-3-2011.



David J. Kyjars

Director of the United States Patent and Trademark Office

Reg. No. 4,109,385 THE MARK CONSISTS OF STANDARD CHARACTERS WITHOUT CLAIM TO ANY PARTICULAR FONT, STYLE, SIZE, OR COLOR.

PRIORITY CLAIMED UNDER SEC. 44(D) ON JAMAICA APPLICATION NO. 54,380, FILED 8-26-2009.

SN 77-942,739, FILED 2-23-2010.

MARY CRAWFORD, EXAMINING ATTORNEY

United States of America

United States Patent and Trademark Office



FREEHOTWATER

Reg. No. 4,109,386

Registered Mar. 6, 2012

**Int. Cls.: 6, 11, 37, 40,
and 42**

TRADEMARK

SERVICE MARK

PRINCIPAL REGISTER

GEMTECH SALES CORPORATION (CALIFORNIA CORPORATION), DBA FREE HOT WATER,
2146 BERING DRIVE
SAN JOSE, CA 95131

FOR: METAL STRUCTURES FOR MOUNTING SOLAR PANELS; SOLAR PANEL MOUNTS MADE OF METAL, IN CLASS 6 (U.S. CLS. 2, 12, 13, 14, 23, 25 AND 50).

FIRST USE 10-10-2009; IN COMMERCE 10-10-2009.

FOR: SOLAR COLLECTORS; SOLAR ENERGY RECEIVERS; SOLAR HEAT COLLECTION PANELS; SOLAR THERMAL INSTALLATIONS, NAMELY, SOLAR THERMAL MODULES; SOLAR THERMAL-BASED POWER PLANTS; SOLAR WATER HEATERS, IN CLASS 11 (U.S. CLS. 13, 21, 23, 31 AND 34).

FIRST USE 10-10-2009; IN COMMERCE 10-10-2009.

FOR: INSTALLATION AND MAINTENANCE OF SOLAR THERMAL INSTALLATIONS, IN CLASS 37 (U.S. CLS. 100, 103 AND 106).

FIRST USE 10-10-2009; IN COMMERCE 10-10-2009.

FOR: TECHNICAL CONSULTATION IN THE FIELD OF PRODUCTION OF SOLAR ENERGY, IN CLASS 40 (U.S. CLS. 100, 103 AND 106).

FIRST USE 10-10-2009; IN COMMERCE 10-10-2009.

FOR: TECHNICAL PLANNING OF PHOTOVOLTAIC/SOLAR THERMAL HYBRID INSTALLATIONS; TECHNICAL PLANNING OF SOLAR ENERGY BASED POWER PLANTS; TECHNICAL PLANNING OF SOLAR THERMAL INSTALLATIONS, IN CLASS 42 (U.S. CLS. 100 AND 101).

FIRST USE 10-10-2009; IN COMMERCE 10-10-2009.

THE MARK CONSISTS OF A CIRCULAR DESIGN WITH TOP BEING A STYLIZED HALF SUN SURROUNDING A STYLIZED ELECTRICAL OUTLET PLUG AND THE BOTTOM HALF BEING A BROKEN SEMI-CIRCULAR DESIGN, TO THE LEFT OF THE WORDS



David J. Kyffers

Director of the United States Patent and Trademark Office

Reg. No. 4,109,386 "FREEHOTWATER". THE BACKGROUND OF THE CIRCULAR DESIGN IS RED, AS IS THE ELECTRICAL OUTLET PLUG, WITH THE DESIGN PORTION THEREON BEING IN WHITE, AND "FREE" AND "WATER" ARE BLUE, WHILE "HOT" IS RED.

THE COLOR(S) RED, WHITE AND BLUE IS/ARE CLAIMED AS A FEATURE OF THE MARK.

SN 77-943,567, FILED 2-25-2010.

KARANENDRA S. CHHINA, EXAMINING ATTORNEY

United States of America

United States Patent and Trademark Office

LOCAL SOLUTIONS FOR LOCAL PROBLEMS

Reg. No. 4,109,387

Registered Mar. 6, 2012

Int. Cl.: 35

SERVICE MARK

PRINCIPAL REGISTER

VOLUNTARY PURCHASING GROUPS, INC. (TEXAS CORPORATION)
230 FM 87
P.O. BOX 460
BONHAM, TX 75418

FOR: WHOLESALE DISTRIBUTORSHIP SERVICES FEATURING FERTILIZERS, HERBICIDES, AND PESTICIDES, IN CLASS 35 (U.S. CLS. 100, 101 AND 102).

FIRST USE 7-0-2007; IN COMMERCE 7-0-2007.

THE MARK CONSISTS OF STANDARD CHARACTERS WITHOUT CLAIM TO ANY PARTICULAR FONT, STYLE, SIZE, OR COLOR.

SN 77-943,747, FILED 2-24-2010.

KATHLEEN LORENZO, EXAMINING ATTORNEY



David J. Kybas

Director of the United States Patent and Trademark Office

United States of America

United States Patent and Trademark Office

KID SWIGS

Reg. No. 4,109,388

HOOD RIVER JUICE COMPANY, INC. (OREGON CORPORATION)
1590 COUNTRY CLUB ROAD
HOOD RIVER, OR 97031

Registered Mar. 6, 2012

Int. Cl.: 32

FOR: FRUIT JUICES, IN CLASS 32 (U.S. CLS. 45, 46 AND 48).

TRADEMARK

FIRST USE 5-21-2010; IN COMMERCE 5-21-2010.

PRINCIPAL REGISTER

THE MARK CONSISTS OF STANDARD CHARACTERS WITHOUT CLAIM TO ANY PARTICULAR FONT, STYLE, SIZE, OR COLOR.

SN 77-944,204, FILED 2-24-2010.

KATHY DE JONGE, EXAMINING ATTORNEY



David J. Kybas

Director of the United States Patent and Trademark Office

United States of America

United States Patent and Trademark Office

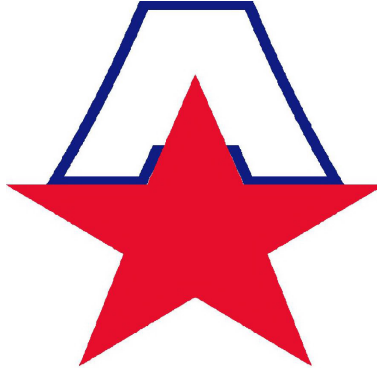

Reg. No. 4,109,389

Registered Mar. 6, 2012

Int. Cl.: 9

TRADEMARK

PRINCIPAL REGISTER

MARX, JON (UNITED STATES INDIVIDUAL)
100 E. FRONTAGE ROAD
PINE ISLAND, MN 55963

FOR: DECORATIVE MAGNETS; DECORATIVE REFRIGERATOR MAGNETS; FRIDGE MAGNETS; MAGNETS; REFRIGERATOR MAGNETS, IN CLASS 9 (U.S. CLS. 21, 23, 26, 36 AND 38).

FIRST USE 5-3-2010; IN COMMERCE 5-3-2010.

THE MARK CONSISTS OF A RED FIVE POINT STAR SUPERIMPOSED OVER AND BENEATH AN "A" IN WHITE OUTLINED IN BLUE.

THE COLOR(S) RED, WHITE AND BLUE IS/ARE CLAIMED AS A FEATURE OF THE MARK.

SN 77-946,164, FILED 2-26-2010.

JASON TURNER, EXAMINING ATTORNEY



David J. Kybas

Director of the United States Patent and Trademark Office

United States of America

United States Patent and Trademark Office



Reg. No. 4,109,390

Registered Mar. 6, 2012

Int. Cl.: 9

TRADEMARK

PRINCIPAL REGISTER

RUBIN, CARMEN (UNITED STATES INDIVIDUAL)
225 PADDINGTON COURT
MANALAPAN, NJ 07726

FOR: DOWNLOADABLE ELECTRONIC PUBLICATIONS IN THE NATURE OF CHILDREN'S BOOKS AND CHILDREN'S STORYBOOKS, IN CLASS 9 (U.S. CLS. 21, 23, 26, 36 AND 38).

FIRST USE 10-13-2011; IN COMMERCE 10-13-2011.

THE MARK CONSISTS OF THE WORD "ASHTI" IN STYLIZED YELLOW FONT, CAPITAL "A" AND REST OF WORD IN LOWER CASE, DOT OF "I" IS A ROUND, RED AND WHITE PEPPERMINT CANDY; TO THE RIGHT OF THE WORD "ASHTI" IS A LITTLE GIRL WITH BROWN SKIN, EYEBROWS, LIPS AND EYES, FRECKLES, BLACK EYELASHES AND WHITE EYEBALLS AND TEETH; AND DARK BROWN WAVY HAIR IN PIGTAILS WITH YELLOW RIBBONS, WEARING ROUND WHITE EARRINGS IN BOTH EARS, A PURPLE SWEATER AND BLUE JEANS; THE WORD "LOVE" IS WRITTEN IN BLUE VERTICAL BLOCK LETTERS DOWN THE LEFT PANTS LEG; THE "O" IN "LOVE" IS A RED HEART WITH A WHITE SCALLOPED EDGING; WHITE SNEAKERS; POSED LEANING AGAINST THE LETTER "I" IN THE WORD "ASHTI" WITH ARMS CROSSED AND LEFT LEG CROSSED OVER RIGHT LEG. THE PEPPERMINT CANDY DESIGN AND THE LITTLE GIRL ARE ALL OUTLINED IN THE COLOR BLACK.

THE COLOR(S) YELLOW, RED, WHITE, BROWN, PURPLE, BLUE, BLACK IS/ARE CLAIMED AS A FEATURE OF THE MARK.

SN 77-946,621, FILED 2-27-2010.

KAREN BRACEY, EXAMINING ATTORNEY



David J. Kyros

Director of the United States Patent and Trademark Office

United States of America

United States Patent and Trademark Office

SPRING FEVER

Reg. No. 4,109,391

Registered Mar. 6, 2012

Int. Cl.: 9

TRADEMARK

PRINCIPAL REGISTER

VIDEO GAMING TECHNOLOGIES, INC. (TENNESSEE CORPORATION)
155 FRANKLIN ROAD, SUITE 255
BRENTWOOD, TN 37027

FOR: COMPUTER SOFTWARE AND FIRMWARE FOR GAMES OF CHANCE ON ANY COMPUTERIZED PLATFORM, INCLUDING DEDICATED GAMING CONSOLES, VIDEO BASED SLOT MACHINES, REEL BASED SLOT MACHINES, AND VIDEO LOTTERY TERMINALS; GAMING DEVICES, NAMELY, GAMING MACHINES, SLOT MACHINES, BINGO MACHINES, WITH OR WITHOUT VIDEO OUTPUT, IN CLASS 9 (U.S. CLS. 21, 23, 26, 36 AND 38).

FIRST USE 11-7-2011; IN COMMERCE 11-7-2011.

THE MARK CONSISTS OF STANDARD CHARACTERS WITHOUT CLAIM TO ANY PARTICULAR FONT, STYLE, SIZE, OR COLOR.

OWNER OF U.S. REG. NOS. 3,140,235 AND 3,410,436.

SN 77-946,869, FILED 2-28-2010.

KARANENDRA S. CHHINA, EXAMINING ATTORNEY



David J. Kyros

Director of the United States Patent and Trademark Office

United States of America

United States Patent and Trademark Office

MR. MONEY BAGS LOADED!

Reg. No. 4,109,392

Registered Mar. 6, 2012

Int. Cl.: 9

TRADEMARK

PRINCIPAL REGISTER

VIDEO GAMING TECHNOLOGIES, INC. (TENNESSEE CORPORATION)
155 FRANKLIN ROAD, SUITE 255
BRENTWOOD, TN 37027

FOR: COMPUTER SOFTWARE AND FIRMWARE FOR GAMES OF CHANCE ON ANY COMPUTERIZED PLATFORM, INCLUDING DEDICATED GAMING CONSOLES, VIDEO BASED SLOT MACHINES, REEL BASED SLOT MACHINES, AND VIDEO LOTTERY TERMINALS; GAMING DEVICES, NAMELY, GAMING MACHINES, SLOT MACHINES, BINGO MACHINES, WITH OR WITHOUT VIDEO OUTPUT, IN CLASS 9 (U.S. CLS. 21, 23, 26, 36 AND 38).

FIRST USE 11-7-2011; IN COMMERCE 11-7-2011.

THE MARK CONSISTS OF STANDARD CHARACTERS WITHOUT CLAIM TO ANY PARTICULAR FONT, STYLE, SIZE, OR COLOR.

OWNER OF U.S. REG. NO. 3,152,743.

SN 77-946,871, FILED 2-28-2010.

KARANENDRA S. CHHINA, EXAMINING ATTORNEY



David J. Kyros

Director of the United States Patent and Trademark Office

United States of America

United States Patent and Trademark Office



Reg. No. 4,109,393

MYAPP LLC (OHIO LIMITED LIABILITY COMPANY)
1372 E. LONG ST.
COLUMBUS, OH 43203

Registered Mar. 6, 2012

Int. Cl.: 45

FOR: ONLINE SOCIAL NETWORKING SERVICES PROVIDED THROUGH A COMMUNITY WEBSITE, IN CLASS 45 (U.S. CLS. 100 AND 101).

SERVICE MARK

FIRST USE 2-15-2010; IN COMMERCE 4-29-2011.

PRINCIPAL REGISTER

NO CLAIM IS MADE TO THE EXCLUSIVE RIGHT TO USE ".US", APART FROM THE MARK AS SHOWN.

THE MARK CONSISTS OF THE STYLIZED TERM "MYAPP .US", INCLUDING A DESIGN OF A HUMAN CREATED WITH THE LETTER "Y".

SN 77-947,366, FILED 3-1-2010.

BENJAMIN OKEKE, EXAMINING ATTORNEY



David J. Kybas

Director of the United States Patent and Trademark Office

United States of America

United States Patent and Trademark Office



Reg. No. 4,109,394

Registered Mar. 6, 2012

Int. Cls.: 25 and 41

TRADEMARK

SERVICE MARK

PRINCIPAL REGISTER

TRIYOUTH, INC. (PENNSYLVANIA CORPORATION)
P.O. BOX 22545
PHILADELPHIA, PA 19110

FOR: SPORTS APPAREL, NAMELY, BIKE PANTS, BIKE SHORTS, BIKE JERSEYS, BIKE GLOVES, SWIM CAPS, WETSUITS, TRIATHLON SUITS, RACING BELTS, RUNNING PANTS, RUNNING SHORTS, RUNNING SHIRTS, SWEATPANTS, SWEATSHIRTS; CLOTHING, NAMELY, JACKETS, BASEBALL CAPS, HEADBANDS, SOCKS; FOOTWEAR, NAMELY, FLIP-FLOPS, SANDALS, SHOES, BOOTS; BATHING SUITS, IN CLASS 25 (U.S. CLS. 22 AND 39).

FIRST USE 2-1-2010; IN COMMERCE 3-1-2010.

FOR: ATHLETIC AND SPORTS EVENT SERVICES, NAMELY, ARRANGING, ORGANIZING, OPERATING AND CONDUCTING TRIATHLON RACES; PROVIDING NEWS AND INFORMATION IN THE FIELD OF SPORTS, IN CLASS 41 (U.S. CLS. 100, 101 AND 107).

FIRST USE 2-1-2010; IN COMMERCE 3-1-2010.

THE MARK CONSISTS OF THE WORDING "TRIYOUTHALON" ABOVE THE FIGURE OF A PERSON WITH ARMS EXTENDED UPWARD, SUCH THAT THE "YOUTH" PORTION OF THE WORDING APPEARS IN A CIRCLE.

SN 77-949,143, FILED 3-3-2010.

MATTHEW PAPPAS, EXAMINING ATTORNEY



David J. Kappas

Director of the United States Patent and Trademark Office

United States of America

United States Patent and Trademark Office

CLEANER WATER FOR A BRIGHTER FUTURE

Reg. No. 4,109,395

Registered Mar. 6, 2012

Int. Cl.: 35

SERVICE MARK

PRINCIPAL REGISTER

LAKESIDE EQUIPMENT CORPORATION (DELAWARE CORPORATION)
11022 E. DEVON AVENUE
BARTLETT, IL 60103

FOR: RETAIL STORE AND ON-LINE RETAIL STORE SERVICES FEATURING WATER TREATMENT EQUIPMENT; WHOLESALE DISTRIBUTORSHIPS FEATURING WATER TREATMENT EQUIPMENT, IN CLASS 35 (U.S. CLS. 100, 101 AND 102).

FIRST USE 0-0-2010; IN COMMERCE 0-0-2010.

THE MARK CONSISTS OF STANDARD CHARACTERS WITHOUT CLAIM TO ANY PARTICULAR FONT, STYLE, SIZE, OR COLOR.

SN 77-950,024, FILED 3-3-2010.

GRETCHEN ULRICH, EXAMINING ATTORNEY



David J. Kybas

Director of the United States Patent and Trademark Office

United States of America

United States Patent and Trademark Office

MyBusiness Checking

Reg. No. 4,109,396

Registered Mar. 6, 2012

Int. Cl.: 36

SERVICE MARK

PRINCIPAL REGISTER

FLORIDACENTRAL CREDIT UNION (FLORIDA CREDIT UNION)
3333 HENDERSON BLVD
TAMPA, FL 33609

FOR: CHECKING ACCOUNT SERVICES, IN CLASS 36 (U.S. CLS. 100, 101 AND 102).

FIRST USE 8-1-2010; IN COMMERCE 8-1-2010.

THE MARK CONSISTS OF STANDARD CHARACTERS WITHOUT CLAIM TO ANY PARTICULAR FONT, STYLE, SIZE, OR COLOR.

NO CLAIM IS MADE TO THE EXCLUSIVE RIGHT TO USE "CHECKING", APART FROM THE MARK AS SHOWN.

SN 77-950,799, FILED 3-4-2010.

HEATHER BIDDULPH, EXAMINING ATTORNEY



David J. Kybas

Director of the United States Patent and Trademark Office

United States of America

United States Patent and Trademark Office



Paulistânia

Reg. No. 4,109,397

Registered Mar. 6, 2012

Int. Cl.: 32

TRADEMARK

PRINCIPAL REGISTER

MARCELO STEIN (BRAZIL INDIVIDUAL)
DANIELJCABO@AOL.COM
LA JOLLA, CA 92038

FOR: BEER; BEER WORT; BEER, ALE AND LAGER; BEER, ALE AND PORTER; BEER, ALE, LAGER, STOUT AND PORTER; BEER, ALE, LAGER, STOUT, PORTER, SHANDY; BEER-BASED COOLERS; BLACK BEER; BREWED MALT-BASED ALCOHOLIC BEVERAGE IN THE NATURE OF A BEER; COFFEE-FLAVORED BEER; DE-ALCOHOLISED BEER; EXTRACTS OF HOPS FOR MAKING BEER; FLAVORED BEERS; GINGER BEER; HOP EXTRACTS FOR MANUFACTURING BEER, IN CLASS 32 (U.S. CLS. 45, 46 AND 48).

FIRST USE 10-12-2009; IN COMMERCE 4-10-2010.

THE MARK CONSISTS OF STANDARD CHARACTERS WITHOUT CLAIM TO ANY PARTICULAR FONT, STYLE, SIZE, OR COLOR.

NO CLAIM IS MADE TO THE EXCLUSIVE RIGHT TO USE "PAULISTANIA", APART FROM THE MARK AS SHOWN.

SN 77-951,587, FILED 3-5-2010.

SUSAN RICHARDS, EXAMINING ATTORNEY



David J. Kyros

Director of the United States Patent and Trademark Office

United States of America

United States Patent and Trademark Office

BIBIGO

Reg. No. 4,109,398

Registered Mar. 6, 2012

Int. Cl.: 43

SERVICE MARK

PRINCIPAL REGISTER

CJ FOODVILLE CORP. (REPUBLIC OF KOREA CORPORATION)
8F, KOO SAN TOWER
3250, BANGBAE-DONG, SEOCHO-KU
SEOUL, REPUBLIC OF KOREA

FOR: BAR SERVICES; CAFETERIAS; FAST-FOOD RESTAURANTS; RESTAURANT; RESTAURANT SERVICES FEATURING KOREAN FOOD OR CUISINE; SELF-SERVICE RESTAURANTS; SNACK BARS, IN CLASS 43 (U.S. CLS. 100 AND 101).

FIRST USE 5-9-2010; IN COMMERCE 9-6-2010.

THE MARK CONSISTS OF STANDARD CHARACTERS WITHOUT CLAIM TO ANY PARTICULAR FONT, STYLE, SIZE, OR COLOR.

SN 77-951,961, FILED 3-5-2010.

JENNIFER DIXON, EXAMINING ATTORNEY



David J. Kyros

Director of the United States Patent and Trademark Office

United States of America

United States Patent and Trademark Office

BED BUGS

Reg. No. 4,109,399

Registered Mar. 6, 2012

Int. Cl.: 28

TRADEMARK

PRINCIPAL REGISTER

HASBRO, INC. (RHODE ISLAND CORPORATION)
1027 NEWPORT AVENUE
PAWTUCKET, RI 02862

FOR: PARLOR GAMES, IN CLASS 28 (U.S. CLS. 22, 23, 38 AND 50).

FIRST USE 12-31-1985; IN COMMERCE 12-31-1985.

THE MARK CONSISTS OF STANDARD CHARACTERS WITHOUT CLAIM TO ANY PARTICULAR FONT, STYLE, SIZE, OR COLOR.

OWNER OF U.S. REG. NO. 2,534,545.

SN 77-957,377, FILED 3-12-2010.

JENNY PARK, EXAMINING ATTORNEY



David J. Kyffers

Director of the United States Patent and Trademark Office

United States of America

United States Patent and Trademark Office

ethicalpro.com
Value you can Trust. Solutions you Desire.

Reg. No. 4,109,400

PRODROMOS, INC (IDAHO CORPORATION)
5465 E. TERRA LINDA WAY
NAMPA, ID 83687

Registered Mar. 6, 2012

Int. Cl.: 35

FOR: ONLINE BUSINESS DIRECTORY FEATURING ETHICAL COMPANIES OF ALL AREAS OF COMMERCE, THAT HAVE SIGNED A CODE OF ETHICS AGREEMENT AND ARE REVIEWED BY PEERS AND CONSUMERS , IN CLASS 35 (U.S. CLS. 100, 101 AND 102).

SERVICE MARK

FIRST USE 1-1-2010; IN COMMERCE 10-1-2010.

PRINCIPAL REGISTER

THE MARK CONSISTS OF FOUR CIRCLES MAKING THE SHAPE OF A SWOOSH AND THE STYLIZED TEXT "ETHICALPRO.COM VALUE YOU CAN TRUST. SOLUTIONS YOU DESIRE.".

SN 77-958,041, FILED 3-12-2010.

DEZMONA MIZELLE, EXAMINING ATTORNEY



David J. Kybas

Director of the United States Patent and Trademark Office

United States of America

United States Patent and Trademark Office

TruSyn

Reg. No. 4,109,401

Registered Mar. 6, 2012

Int. Cl.: 4

TRADEMARK

PRINCIPAL REGISTER

TRUSOUTH OIL, LLC (LOUISIANA LIMITED LIABILITY COMPANY)
10411 HIGHWAY 1
SHREVEPORT, LA 71115

FOR: MOTOR OILS, IN CLASS 4 (U.S. CLS. 1, 6 AND 15).

FIRST USE 8-15-2011; IN COMMERCE 8-15-2011.

THE MARK CONSISTS OF STANDARD CHARACTERS WITHOUT CLAIM TO ANY PARTICULAR FONT, STYLE, SIZE, OR COLOR.

SN 77-959,000, FILED 3-15-2010.

SUSAN RICHARDS, EXAMINING ATTORNEY



David J. Kybas

Director of the United States Patent and Trademark Office

United States of America
United States Patent and Trademark Office

SORLOX

Reg. No. 4,109,402

SORLOX CORPORATION (CALIFORNIA CORPORATION)
8 CORPORATE PARK, SUITE 300
IRVINE, CA 926065196

Registered Mar. 6, 2012

Int. Cl.: 9

FOR: SCIENTIFIC APPARATUS, NAMELY, APPARATUS FOR COMPRESSING PLASMA TO A HIGH ENERGY STATE, IN CLASS 9 (U.S. CLS. 21, 23, 26, 36 AND 38).

TRADEMARK

FIRST USE 12-14-2010; IN COMMERCE 12-29-2011.

PRINCIPAL REGISTER

THE MARK CONSISTS OF STANDARD CHARACTERS WITHOUT CLAIM TO ANY PARTICULAR FONT, STYLE, SIZE, OR COLOR.

SN 77-959,426, FILED 3-15-2010.

DOUGLAS LEE, EXAMINING ATTORNEY



David J. Kyfos

Director of the United States Patent and Trademark Office

United States of America

United States Patent and Trademark Office



Reg. No. 4,109,403

Registered Mar. 6, 2012

Int. Cl.: 39

SERVICE MARK

PRINCIPAL REGISTER

THE JUNK TRUCK L.L.C. (WISCONSIN LIMITED LIABILITY COMPANY)
34835 ELM STREET
OCONOMOWOC, WI 53066

FOR: JUNK REMOVAL; JUNK, TRASH AND DEBRIS REMOVAL, IN CLASS 39 (U.S. CLS. 100 AND 105).

FIRST USE 8-1-2008; IN COMMERCE 8-1-2008.

NO CLAIM IS MADE TO THE EXCLUSIVE RIGHT TO USE "JUNK TRUCK", APART FROM THE MARK AS SHOWN.

THE COLOR(S) GREEN, BLACK, WHITE AND GREY IS/ARE CLAIMED AS A FEATURE OF THE MARK.

THE MARK CONSISTS OF A GREEN, BLACK AND GREY STYLIZED TRUCK. GREEN, BLACK AND WHITE ON SIGN WITH THE NAME "THE JUNK TRUCK" APPEARING IN BLACK AND WHITE.

SN 77-959,550, FILED 3-15-2010.

JAY FLOWERS, EXAMINING ATTORNEY



David J. Kyfos

Director of the United States Patent and Trademark Office

United States of America

United States Patent and Trademark Office



Reg. No. 4,109,404

Registered Mar. 6, 2012

**Int. Cls.: 9, 18, 21, 25,
and 35**

TRADEMARK

SERVICE MARK

PRINCIPAL REGISTER

TRB ACQUISITIONS LLC (NEW YORK LIMITED LIABILITY COMPANY)
34 WEST 33RD STREET
9TH FLOOR SOUTH
NEW YORK, NY 10001

FOR: CHILDREN'S ACCESSORIES, NAMELY, CHILDREN'S SWIM GOGGLES AND SUNGLASSES, IN CLASS 9 (U.S. CLS. 21, 23, 26, 36 AND 38).

FIRST USE 4-12-2010; IN COMMERCE 4-12-2010.

FOR: CHILDREN'S ACCESSORIES, NAMELY, CHILDREN'S HANDBAGS, DRAWSTRING BAGS AND BACKPACKS, IN CLASS 18 (U.S. CLS. 1, 2, 3, 22 AND 41).

FIRST USE 4-12-2010; IN COMMERCE 4-12-2010.

FOR: CHILDREN'S ACCESSORIES, NAMELY, CHILDREN'S LUNCH BOXES, IN CLASS 21 (U.S. CLS. 2, 13, 23, 29, 30, 33, 40 AND 50).

FIRST USE 4-12-2010; IN COMMERCE 4-12-2010.

FOR: CHILDREN'S CLOTHING, NAMELY, RAINWEAR, FLEECE TOPS, FLEECE PANTS, WINTER JACKETS, SNOW PANTS, FLEECE JACKETS, PANTS, TENNIS TOPS, DRESSES, SLEEPWEAR, HATS, MITTENS, GLOVES, TOPS, LEGGINGS, SHORTS, CAPRIS, CORDUROY TIER SKIRTS, POLO DRESSES, RUGBY SHIRTS, STRIPED POLO SHIRTS, YOKE SWEATERS, T-SHIRTS, COLLARED SHIRTS, LONG-SLEEVE SHIRTS, IN CLASS 25 (U.S. CLS. 22 AND 39).

FIRST USE 4-12-2010; IN COMMERCE 4-12-2010.

FOR: RETAIL STORE SERVICES AND ONLINE RETAIL STORE SERVICES FEATURING CHILDREN'S CLOTHING, APPAREL AND ACCESSORIES, IN CLASS 35 (U.S. CLS. 100, 101 AND 102).

FIRST USE 4-12-2010; IN COMMERCE 4-12-2010.

THE MARK CONSISTS OF A STYLIZED RENDITION OF A SITTING BEAR WITH A CURVED LINE ABOVE AND A STRAIGHT LINE UNDERNEATH.



David J. Kybas

Director of the United States Patent and Trademark Office

Reg. No. 4,109,404 SN 77-959,682, FILED 3-16-2010.

COLLEEN KEARNEY, EXAMINING ATTORNEY

United States of America

United States Patent and Trademark Office

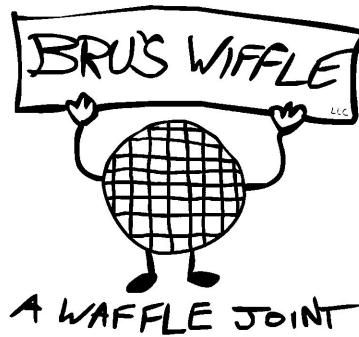

Reg. No. 4,109,405

Registered Mar. 6, 2012

Int. Cl.: 43

SERVICE MARK

PRINCIPAL REGISTER

BRU'S WIFFLE LLC (CALIFORNIA LIMITED LIABILITY COMPANY)
2408 WILSHIRE BLVD
SANTA MONICA, CA 90403

FOR: RESTAURANT SERVICES, IN CLASS 43 (U.S. CLS. 100 AND 101).

FIRST USE 7-15-2010; IN COMMERCE 7-15-2010.

NO CLAIM IS MADE TO THE EXCLUSIVE RIGHT TO USE "LLC" AND "A WAFFLE JOINT",
APART FROM THE MARK AS SHOWN.

THE MARK CONSISTS OF A PERSON MADE OUT OF HANDS AND LEGS AND A WAFFLE
SHAPE BODY. HE IS HOLDING A BANNER WITH THE STYLIZED TEXT "BRU'S WIFFLE
LLC" INSIDE. BELOW THERE IS THE STYLIZED TEXT "A WAFFLE JOINT".

SN 77-960,971, FILED 3-17-2010.

MARILYN IZZI, EXAMINING ATTORNEY



David J. Kybas

Director of the United States Patent and Trademark Office

United States of America

United States Patent and Trademark Office

ALOE PHYLA

Reg. No. 4,109,406

GONZALEZ, MARICELA (UNITED STATES INDIVIDUAL)
1418 BROADWAY AVE
CHULA VISTA, CA 91911

Registered Mar. 6, 2012

Int. Cl.: 5

FOR: PHARMACEUTICAL PREPARATIONS, NAMELY, NATURAL SUPPLEMENTS CONTAINING ALOE FOR USE IN STRENGTHENING THE BODY'S IMMUNE SYSTEM, PROMOTING THE NATURAL BLOOD-CLEANSING FUNCTIONS OF THE BODY, AND STRENGTHENING CELLS, IN CLASS 5 (U.S. CLS. 6, 18, 44, 46, 51 AND 52).

TRADEMARK

PRINCIPAL REGISTER

FIRST USE 12-1-2008; IN COMMERCE 12-1-2008.

THE MARK CONSISTS OF STANDARD CHARACTERS WITHOUT CLAIM TO ANY PARTICULAR FONT, STYLE, SIZE, OR COLOR.

NO CLAIM IS MADE TO THE EXCLUSIVE RIGHT TO USE "ALOE", APART FROM THE MARK AS SHOWN.

SN 77-961,792, FILED 3-18-2010.

JOHN DWYER, EXAMINING ATTORNEY



David J. Kybas

Director of the United States Patent and Trademark Office

United States of America

United States Patent and Trademark Office

AQUA GENIE

Reg. No. 4,109,407

Registered Mar. 6, 2012

Int. Cl.: 1

TRADEMARK

PRINCIPAL REGISTER

P.I. INC. (TENNESSEE CORPORATION)
1712 CONGRESS PARKWAY
ATHENS, TN 373710669

FOR: WATER PURIFYING CHEMICALS FOR SWIMMING POOLS; WATER TREATMENT CHEMICALS FOR USE IN SWIMMING POOLS, IN CLASS 1 (U.S. CLS. 1, 5, 6, 10, 26 AND 46).

FIRST USE 11-0-2011; IN COMMERCE 11-0-2011.

THE MARK CONSISTS OF STANDARD CHARACTERS WITHOUT CLAIM TO ANY PARTICULAR FONT, STYLE, SIZE, OR COLOR.

SN 77-961,885, FILED 3-18-2010.

SUSAN RICHARDS, EXAMINING ATTORNEY



David J. Kyffers

Director of the United States Patent and Trademark Office

United States of America

United States Patent and Trademark Office

OPEN ACADEMIC MODEL

Reg. No. 4,109,408

Registered Mar. 6, 2012

Int. Cl.: 41

SERVICE MARK

PRINCIPAL REGISTER

THE TRUSTEES OF THE STEVENS INSTITUTE OF TECHNOLOGY (NEW JERSEY
NON-PROFIT CORPORATION)
CASTLE POINT ON HUDSON
HOBOKEN, NJ 07030

FOR: EDUCATIONAL SERVICES, NAMELY, PROVIDING CLASSES, AND CLASSES
UTILIZING CASE STUDIES, IN THE FIELD OF SYSTEMS ENGINEERING AND SYSTEMS
ENGINEERING CHALLENGES AND PROBLEMS WITHIN INDUSTRY AND GOVERNMENT;
EDUCATIONAL RESEARCH, IN CLASS 41 (U.S. CLS. 100, 101 AND 107).

FIRST USE 10-0-2010; IN COMMERCE 10-0-2010.

THE MARK CONSISTS OF STANDARD CHARACTERS WITHOUT CLAIM TO ANY PAR-
TICULAR FONT, STYLE, SIZE, OR COLOR.

NO CLAIM IS MADE TO THE EXCLUSIVE RIGHT TO USE "ACADEMIC MODEL", APART
FROM THE MARK AS SHOWN.

SN 77-961,979, FILED 3-18-2010.

ELI HELLMAN, EXAMINING ATTORNEY



David J. Kyfos

Director of the United States Patent and Trademark Office

United States of America

United States Patent and Trademark Office

? INTENTION

Reg. No. 4,109,409

Registered Mar. 6, 2012

Int. Cls.: 14, 18, and 25

TRADEMARK

PRINCIPAL REGISTER

GONZALEZ, ROBERT RANDALL (UNITED STATES INDIVIDUAL)
26500 W. AGOURA ROAD, #102-249
CALABASAS, CA 91302 AND

RANDALL, KATHRYN H. (UNITED STATES INDIVIDUAL)
26500 W. AGOURA ROAD, #102-249
CALABASAS, CA 91302

FOR: JEWELRY, NAMELY, NECKLACES, BRACELETS, PENDANTS, CHARMS, IN CLASS 14 (U.S. CLS. 2, 27, 28 AND 50).

FIRST USE 9-22-2011; IN COMMERCE 9-22-2011.

FOR: BACKPACKS, BOOK BAGS, SPORTS BAGS, BAGS AND HOLDALLS FOR SPORTS CLOTHING, BEACH BAGS, TOTE BAGS, TRAVELLING BAGS, IN CLASS 18 (U.S. CLS. 1, 2, 3, 22 AND 41).

FIRST USE 9-22-2011; IN COMMERCE 9-22-2011.

FOR: CLOTHING, NAMELY, T-SHIRTS, HEADWEAR, HATS, TANK TOPS, IN CLASS 25 (U.S. CLS. 22 AND 39).

FIRST USE 9-28-2011; IN COMMERCE 9-28-2011.

THE MARK CONSISTS OF STANDARD CHARACTERS WITHOUT CLAIM TO ANY PARTICULAR FONT, STYLE, SIZE, OR COLOR.

SN 77-963,303, FILED 3-19-2010.

KIMBERLY FRYE, EXAMINING ATTORNEY



David J. Kybas

Director of the United States Patent and Trademark Office

United States of America

United States Patent and Trademark Office



Reg. No. 4,109,410

Registered Mar. 6, 2012

Int. Cl.: 30

TRADEMARK

PRINCIPAL REGISTER

FLOWERS BAKERIES BRANDS, LLC (DELAWARE LIMITED LIABILITY COMPANY)
1919 FLOWERS CIRCLE
THOMASVILLE, GA 31757

FOR: CORN AND WHEAT TORTILLAS; CORN AND NACHO CHIPS; SALSA, IN CLASS 30
(U.S. CL. 46).

FIRST USE 3-0-2010; IN COMMERCE 3-0-2010.

THE MARK CONSISTS OF THE WORD "JUAREZ" IN BLACK LETTERS WITH A GREEN LINE CENTERED ABOVE THE WORD "JUAREZ" WITH A GREEN, WHITE, RED AND BLACK SOMBRERO CENTERED ABOVE THE GREEN LINE, ALL AGAINST A WHITE OUTLINED CREAM BACKGROUND WITH WHITE SPECKLES AND ENCIRCLED IN A BLACK OUTLINED HALF RECTANGULAR AND HALF CURVED SHAPE.

THE COLOR(S) BLACK, GREEN, WHITE, RED AND CREAM IS/ARE CLAIMED AS A FEATURE OF THE MARK.

SN 77-963,700, FILED 3-19-2010.

MARIAM MAHMOUDI, EXAMINING ATTORNEY



David J. Kybas

Director of the United States Patent and Trademark Office

United States of America

United States Patent and Trademark Office

BED & EDGE WEED CONTROL

Reg. No. 4,109,411

KNOX FERTILIZER COMPANY, INC. (INDIANA CORPORATION)
2660 EAST 100 S, PO BOX 248
KNOX, IN 46534

Registered Mar. 6, 2012

Int. Cls.: 1 and 5

FOR: FERTILIZERS THAT ALSO CONTAIN HERBICIDES, IN CLASS 1 (U.S. CLS. 1, 5, 6, 10, 26 AND 46).

TRADEMARK

FIRST USE 12-2-2010; IN COMMERCE 12-2-2010.

PRINCIPAL REGISTER

FOR: HERBICIDES, IN CLASS 5 (U.S. CLS. 6, 18, 44, 46, 51 AND 52).

FIRST USE 12-2-2010; IN COMMERCE 12-2-2010.

THE MARK CONSISTS OF STANDARD CHARACTERS WITHOUT CLAIM TO ANY PARTICULAR FONT, STYLE, SIZE, OR COLOR.

NO CLAIM IS MADE TO THE EXCLUSIVE RIGHT TO USE "BED" AND "WEED CONTROL", APART FROM THE MARK AS SHOWN.

SN 77-965,935, FILED 3-23-2010.

TARA PATE, EXAMINING ATTORNEY



David J. Kybas

Director of the United States Patent and Trademark Office

United States of America

United States Patent and Trademark Office

Z - ICE CREAM

Reg. No. 4,109,412

TABIBIAN, PAYAM (UNITED STATES INDIVIDUAL)
11575 SENECA HILL CT.
GREAT FALLS, VA 22066

Registered Mar. 6, 2012

Int. Cl.: 43

FOR: FAST FOOD RESTAURANT, IN CLASS 43 (U.S. CLS. 100 AND 101).

SERVICE MARK

FIRST USE 10-15-2011; IN COMMERCE 10-15-2011.

PRINCIPAL REGISTER

THE MARK CONSISTS OF STANDARD CHARACTERS WITHOUT CLAIM TO ANY PARTICULAR FONT, STYLE, SIZE, OR COLOR.

SN 77-967,466, FILED 3-24-2010.

RENEE MCCRAY, EXAMINING ATTORNEY



David J. Kyffers

Director of the United States Patent and Trademark Office

United States of America

United States Patent and Trademark Office

WHAT DO YOU WANT TO DO BEFORE YOU DIE?

Reg. No. 4,109,413

Registered Mar. 6, 2012

Int. Cl.: 25

TRADEMARK

PRINCIPAL REGISTER

THE BURIED LIFE, INC. (CALIFORNIA CORPORATION)
6060 CENTER DRIVE
TENTH FLOOR, C/O FULWIDER PATTON LLP
LOS ANGELES, CA 90045

FOR: CLOTHING, NAMELY, T-SHIRTS, SHIRTS, SWEATSHIRTS AND SWEATPANTS, IN
CLASS 25 (U.S. CLS. 22 AND 39).

FIRST USE 11-10-2007; IN COMMERCE 11-10-2007.

THE MARK CONSISTS OF STANDARD CHARACTERS WITHOUT CLAIM TO ANY PAR-
TICULAR FONT, STYLE, SIZE, OR COLOR.

SN 77-967,869, FILED 3-24-2010.

ELIZABETH KAJUBI, EXAMINING ATTORNEY



David J. Kybas

Director of the United States Patent and Trademark Office

United States of America

United States Patent and Trademark Office

IT'S LIKE A TRIP TO THE GYM FOR YOUR PELVIC MUSCLES

Reg. No. 4,109,414

KAMABRY, INC. (NEW YORK CORPORATION)
42 COLONIAL LANE
BELLPORT, NY 11713

Registered Mar. 6, 2012

Int. Cl.: 10

FOR: MEDICAL DEVICES FOR KEGEL EXERCISES, NAMELY, PELVIC FLOOR EXERCISERS FOR USE TO TREAT SYMPTOMS OF URINARY INCONTINENCE AND FOR THERAPEUTIC PURPOSES, IN CLASS 10 (U.S. CLS. 26, 39 AND 44).

TRADEMARK

FIRST USE 12-9-2011; IN COMMERCE 12-9-2011.

PRINCIPAL REGISTER

THE MARK CONSISTS OF STANDARD CHARACTERS WITHOUT CLAIM TO ANY PARTICULAR FONT, STYLE, SIZE, OR COLOR.

SN 77-968,260, FILED 3-25-2010.

BARNEY CHARLON, EXAMINING ATTORNEY



David J. Kyros

Director of the United States Patent and Trademark Office

United States of America

United States Patent and Trademark Office

SWINGSPY

Reg. No. 4,109,415

Registered Mar. 6, 2012

Int. Cl.: 42

SERVICE MARK

PRINCIPAL REGISTER

SPY MOTION LLC (ILLINOIS LIMITED LIABILITY COMPANY)
1350 TRI-STATE PARKWAY
GURNEE, IL 60031

FOR: PROVIDING A WEB SITE THAT OFFERS TEMPORARY USE OF NON-DOWNLOADABLE SOFTWARE THAT ALLOWS USERS TO CAPTURE AND PROCESS VIDEOS RELATED TO GOLF INSTRUCTION, IN CLASS 42 (U.S. CLS. 100 AND 101).

FIRST USE 1-28-2011; IN COMMERCE 1-28-2011.

THE MARK CONSISTS OF STANDARD CHARACTERS WITHOUT CLAIM TO ANY PARTICULAR FONT, STYLE, SIZE, OR COLOR.

SN 77-968,735, FILED 3-25-2010.

MAYUR VAGHANI, EXAMINING ATTORNEY



David J. Kybas

Director of the United States Patent and Trademark Office

United States of America

United States Patent and Trademark Office

AGAVEN

Reg. No. 4,109,416

Registered Mar. 6, 2012

Int. Cl.: 30

TRADEMARK

PRINCIPAL REGISTER

INDUSTRIALIZADORA INTEGRAL DEL AGAVE (MEXICO SOCIEDAD ANONIMA (SA DE CV)))
PERIFERICO SUR NO. 7750
TLAQUEPAQUE, MEXICO 45601

FOR: CARAO FRUIT SYRUP FOR USE AS FOOD; FLAVORED AND SWEETENED GELATINS; FLAVORED, SWEETENED GELATIN DESSERTS; FLAVORING SYRUP; MOLASSES SYRUP; NATURAL SWEETENER; STARCH SYRUP; TABLE SYRUP, IN CLASS 30 (U.S. CL. 46).

FIRST USE 6-6-2011; IN COMMERCE 6-6-2011.

THE MARK CONSISTS OF STANDARD CHARACTERS WITHOUT CLAIM TO ANY PARTICULAR FONT, STYLE, SIZE, OR COLOR.

THE WORDING "AGAVEN" HAS NO MEANING IN A FOREIGN LANGUAGE.

SN 77-970,046, FILED 3-26-2010.

GINA FINK, EXAMINING ATTORNEY



David J. Kybas

Director of the United States Patent and Trademark Office

United States of America

United States Patent and Trademark Office

FAR STAR

Reg. No. 4,109,417

FAR STAR VENTURES LLC (WASHINGTON LIMITED LIABILITY COMPANY)
814 W GARFIELD ST.
SEATTLE, WA 98119

Registered Mar. 6, 2012

Int. Cls.: 36 and 42

FOR: HOLDING COMPANY SERVICES, NAMELY, ACQUISITION, MANAGEMENT, AND TRANSFER OF REAL ESTATE HOLDINGS, IN CLASS 36 (U.S. CLS. 100, 101 AND 102).

SERVICE MARK

FIRST USE 4-8-2007; IN COMMERCE 4-8-2007.

PRINCIPAL REGISTER

FOR: ENGINEERING SERVICES, NAMELY, TECHNICAL PROJECT PLANNING AND DESIGN ENGINEERING IN THE FIELDS OF ERGONOMICS, COMPUTER PROGRAMMING AND ELECTRONIC HARDWARE, IN CLASS 42 (U.S. CLS. 100 AND 101).

FIRST USE 4-8-2007; IN COMMERCE 4-8-2007.

THE MARK CONSISTS OF STANDARD CHARACTERS WITHOUT CLAIM TO ANY PARTICULAR FONT, STYLE, SIZE, OR COLOR.

SN 77-978,070, FILED 4-15-2009.

ROBIN CHOSID, EXAMINING ATTORNEY



David J. Kybas

Director of the United States Patent and Trademark Office

United States of America

United States Patent and Trademark Office

BUILDING SAFETY JOURNAL ONLINE

Reg. No. 4,109,418

Registered Mar. 6, 2012

Int. Cl.: 41

SERVICE MARK

PRINCIPAL REGISTER

INTERNATIONAL CODE COUNCIL, INC. (CALIFORNIA CORPORATION)
5360 WORKMAN MILL ROAD
WHITTIER, CA 90601

FOR: ONLINE PUBLICATION OF MAGAZINES, NEWSLETTERS, ARTICLES, ANNOUNCEMENTS AND INFORMATIONAL MATERIALS, ALL DEALING WITH BUILDING, CONSTRUCTION AND SAFETY CODES, STANDARDS, REGULATIONS AND RULES, DIRECTED TO GOVERNMENT OFFICIALS, ARCHITECTS, ENGINEERS AND OTHERS CONCERNED WITH BUILDING, CONSTRUCTION AND SAFETY CODES, STANDARDS, REGULATIONS AND RULES, IN CLASS 41 (U.S. CLS. 100, 101 AND 107).

FIRST USE 10-31-2009; IN COMMERCE 10-31-2009.

THE MARK CONSISTS OF STANDARD CHARACTERS WITHOUT CLAIM TO ANY PARTICULAR FONT, STYLE, SIZE, OR COLOR.

SEC. 2(F) AS TO "BUILDING SAFETY JOURNAL".

OWNER OF U.S. REG. NOS. 2,861,796, 2,893,985, AND 3,746,158.

NO CLAIM IS MADE TO THE EXCLUSIVE RIGHT TO USE "JOURNAL ONLINE", APART FROM THE MARK AS SHOWN.

SN 77-981,788, FILED 9-10-2009.

KAREN SEVERSON, EXAMINING ATTORNEY



David J. Kyros

Director of the United States Patent and Trademark Office

United States of America

United States Patent and Trademark Office



Reg. No. 4,109,419

Registered Mar. 6, 2012

Int. Cls.: 14, 16, and 18

TRADEMARK

PRINCIPAL REGISTER

MCCREARY, PAMELA (UNITED STATES INDIVIDUAL)
2261 NORTH 68TH STREET
WAUWATOSA, WI 53213

FOR: JEWELRY, IN CLASS 14 (U.S. CLS. 2, 27, 28 AND 50).

FIRST USE 1-1-2011; IN COMMERCE 1-1-2011.

FOR: NOTE CARDS AND PAPERWEIGHTS, IN CLASS 16 (U.S. CLS. 2, 5, 22, 23, 29, 37, 38 AND 50).

FIRST USE 1-1-2011; IN COMMERCE 1-1-2011.

FOR: CLOTH TOTE BAGS, IN CLASS 18 (U.S. CLS. 1, 2, 3, 22 AND 41).

FIRST USE 1-1-2011; IN COMMERCE 1-1-2011.

THE MARK CONSISTS OF THE SYMBOL FOR THE WORD AT AND THE SYMBOL FOR THE WORD PEACE.

SN 77-982,005, FILED 2-20-2009.

RENEE SERVANCE, EXAMINING ATTORNEY



David J. Kybas

Director of the United States Patent and Trademark Office

United States of America

United States Patent and Trademark Office

NAT GEO

Reg. No. 4,109,420

Registered Mar. 6, 2012

Int. Cl.: 38

SERVICE MARK

PRINCIPAL REGISTER

NATIONAL GEOGRAPHIC SOCIETY (D.C. CORPORATION)
1145 17TH STREET, N.W.
WASHINGTON, DC 20036

FOR: ELECTRONIC AND DIGITAL TRANSMISSION OF DATA, IMAGES, SIGNALS, AND MESSAGES; TEXT AND NUMERIC WIRELESS DIGITAL MESSAGING SERVICES; WIRELESS COMMUNICATIONS SERVICES, NAMELY, TRANSMISSION OF GRAPHICS TO MOBILE TELEPHONES AND MOBILE WIRELESS ELECTRONIC DEVICES; MOBILE MEDIA SERVICES IN THE NATURE OF ELECTRONIC TRANSMISSION OF ENTERTAINMENT MEDIA CONTENT; VIDEO BROADCASTING; ELECTRONIC TRANSMISSION OF INFORMATION, TEXT, SOUND AND IMAGES; BROADCASTING AND TRANSMISSION OF TELEVISION PROGRAMS VIA COMPUTER OR COMMUNICATIONS NETWORKS; VIDEO-ON-DEMAND TRANSMISSION SERVICES; ELECTRONIC TRANSMISSION OF SOUND, IMAGES AND DATA, INCLUDING STREAMING AUDIO AND VIDEO MATERIAL ACROSS BROAD BAND NETWORKS AND A GLOBAL COMPUTER NETWORK; ELECTRONIC TRANSMISSION VIA COMPUTER OF SOUND, IMAGES, DATA AND RADIO AND TELEVISION PROGRAMS; WIRELESS COMMUNICATION SERVICES, NAMELY, TRANSMISSION OF RING TONES, LOGO GRAPHICS, GAMES, SOUND, INFORMATION AND DATA TO MOBILE TELEPHONES, WIRELESS DEVICES AND PERSONAL COMMUNICATIONS DEVICES, IN CLASS 38 (U.S. CLS. 100, 101 AND 104).

FIRST USE 10-0-2007; IN COMMERCE 10-0-2007.

THE MARK CONSISTS OF STANDARD CHARACTERS WITHOUT CLAIM TO ANY PARTICULAR FONT, STYLE, SIZE, OR COLOR.

OWNER OF U.S. REG. NOS. 242,080, 997,183, AND 2,411,079.

SN 77-982,741, FILED 11-20-2009.

HEATHER BIDDULPH, EXAMINING ATTORNEY



David J. Kyros

Director of the United States Patent and Trademark Office

United States of America

United States Patent and Trademark Office

NAT GEO

Reg. No. 4,109,421

Registered Mar. 6, 2012

Int. Cl.: 41

SERVICE MARK

PRINCIPAL REGISTER

NATIONAL GEOGRAPHIC SOCIETY (D.C. CORPORATION)
1145 17TH STREET, N.W.
WASHINGTON, DC 20036

FOR: ENTERTAINMENT SERVICES, NAMELY, PROVIDING ON-LINE COMPUTER GAMES AND VIDEO GAMES; PROVIDING TEMPORARY USE OF NON-DOWNLOADABLE COMPUTER GAMES AND VIDEO GAMES; PRODUCTION AND DISTRIBUTION OF MOTION PICTURE FILMS AND TELEVISION PROGRAMS; ONGOING TELEVISION SERIES FEATURING ANIMATION, LIVE ACTION, NON-FICTION CONTENT, NEWS AND STORIES, MUSIC, COMEDY OR DRAMA; THEATRICAL EXHIBITION OF MOTION PICTURE FILMS; PROVIDING VIDEOS AND WEBCASTS VIA THE INTERNET FEATURING MOTION PICTURES, FILMS AND TELEVISION PROGRAMS FEATURING ANIMATION, LIVE ACTION, NON-FICTION CONTENT, NEWS AND STORIES, MUSIC, COMEDY OR DRAMA; PROVIDING INFORMATION IN THE FIELD OF ENTERTAINMENT FEATURING ADVENTURE, CULTURAL, EXPLORATION, GENERAL INTEREST, GEOGRAPHY, SCIENCE, NATURAL HISTORY, WILDLIFE, NATURE, AND ENVIRONMENTAL TOPICS, IN CLASS 41 (U.S. CLS. 100, 101 AND 107).

FIRST USE 10-0-2007; IN COMMERCE 10-0-2007.

THE MARK CONSISTS OF STANDARD CHARACTERS WITHOUT CLAIM TO ANY PARTICULAR FONT, STYLE, SIZE, OR COLOR.

OWNER OF U.S. REG. NOS. 242,080, 997,183, AND 2,411,079.

SN 77-982,742, FILED 11-20-2009.

HEATHER BIDDULPH, EXAMINING ATTORNEY



David J. Kyjars

Director of the United States Patent and Trademark Office

United States of America

United States Patent and Trademark Office

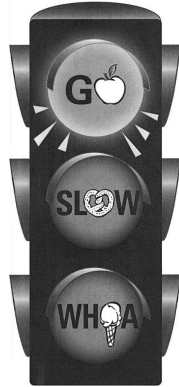

Reg. No. 4,109,422

Registered Mar. 6, 2012

Int. Cl.: 28

TRADEMARK

PRINCIPAL REGISTER

FLAGHOUSE, INC. (NEW YORK CORPORATION)
601 ROUTE 46 WEST
HASBROUCK HEIGHTS, NJ 07604

FOR: SPORT BALLS; BALLS FOR GAMES; BEAN BAGS; SPORTS FIELD EQUIPMENT SETS AND INDOOR SPORTS EQUIPMENT SETS COMPRISING PLASTIC CONES, FLEXIBLE ROUND BOUNDARY MARKERS IN VARIOUS SIZES; TOY BUCKETS; PARACHUTES FOR PLAY, IN CLASS 28 (U.S. CLS. 22, 23, 38 AND 50).

FIRST USE 1-31-2011; IN COMMERCE 8-31-2011.

THE MARK CONSISTS OF A PICTURE OF A STOP LIGHT WITH THE TOP LIGHT SHOWING THE WORD "GO" WITH THE "O" IN THE SHAPE OF AN APPLE; THE MIDDLE LIGHT SHOWING THE WORD "SLOW" WITH THE "O" SHAPED AS A PRETZEL; AND THE BOTTOM LIGHT SHOWING THE WORD "WHOA" WITH THE "O" IN THE SHAPE OF AN ICE CREAM CONE. OWNER IS NOT CLAIMING COLOR OR SHADING AS A FEATURE OF THE MARK.

SN 77-982,775, FILED 5-26-2009.

ALLISON HOLTZ, EXAMINING ATTORNEY



David J. Kybas

Director of the United States Patent and Trademark Office

United States of America

United States Patent and Trademark Office

MONSTER HIGH

Reg. No. 4,109,423

Registered Mar. 6, 2012

Int. Cl.: 21

TRADEMARK

PRINCIPAL REGISTER

MATTEL, INC. (DELAWARE CORPORATION)
333 CONTINENTAL BLVD.
M1-1518
EL SEGUNDO, CA 90245

FOR: LUNCH BOXES, IN CLASS 21 (U.S. CLS. 2, 13, 23, 29, 30, 33, 40 AND 50).

FIRST USE 11-15-2011; IN COMMERCE 11-15-2011.

THE MARK CONSISTS OF STANDARD CHARACTERS WITHOUT CLAIM TO ANY PARTICULAR FONT, STYLE, SIZE, OR COLOR.

SN 77-982,794, FILED 5-22-2009.

JILL C. ALT, EXAMINING ATTORNEY



David J. Kyffers

Director of the United States Patent and Trademark Office

United States of America

United States Patent and Trademark Office

MARC NEW YORK ANDREW MARC

Reg. No. 4,109,424

Registered Mar. 6, 2012

Int. Cl.: 25

TRADEMARK

PRINCIPAL REGISTER

G-III LEATHER FASHIONS, INC. (NEW YORK CORPORATION)
35TH FLOOR
512 SEVENTH AVENUE
NEW YORK, NY 100184202

FOR: FOOTWEAR, SHOES AND BOOTS, IN CLASS 25 (U.S. CLS. 22 AND 39).

FIRST USE 11-0-2011; IN COMMERCE 11-0-2011.

THE MARK CONSISTS OF STANDARD CHARACTERS WITHOUT CLAIM TO ANY PARTICULAR FONT, STYLE, SIZE, OR COLOR.

OWNER OF U.S. REG. NOS. 1,221,846, 3,464,631, AND OTHERS.

NO CLAIM IS MADE TO THE EXCLUSIVE RIGHT TO USE "NEW YORK", APART FROM THE MARK AS SHOWN.

THE NAME(S), PORTRAIT(S), AND/OR SIGNATURE(S) SHOWN IN THE MARK IDENTIFIES "ANDREW MARC", WHOSE CONSENT(S) TO REGISTER IS MADE OF RECORD.

SN 77-982,833, FILED 12-5-2008.

WARREN L. OLANDRIA, EXAMINING ATTORNEY



David J. Kybas

Director of the United States Patent and Trademark Office

United States of America

United States Patent and Trademark Office



Reg. No. 4,109,425

Registered Mar. 6, 2012

Int. Cl.: 42

SERVICE MARK

PRINCIPAL REGISTER

ALPHA & OMEGA, INC. (COLORADO CORPORATION)
4735 MONTVIEW BLVD.
DENVER, CO 80207

FOR: PROVIDING A WEBSITE FEATURING ONLINE, NON-DOWNLOADABLE SOFTWARE TOOLS FOR THE PURPOSES OF MONITORING ENERGY USE, PROVIDING ENERGY MODELING AND PROVIDING ENERGY ASSESSMENTS, IN CLASS 42 (U.S. CLS. 100 AND 101).

FIRST USE 12-30-2010; IN COMMERCE 12-30-2010.

THE MARK CONSISTS OF A GREEN STYLIZED HOUSE WITH A GREEN LIGHT BULB INSIDE THE HOUSE.

THE COLOR(S) GREEN IS/ARE CLAIMED AS A FEATURE OF THE MARK.

SN 77-982,844, FILED 3-25-2010.

WILLIAM BRECKENFELD, EXAMINING ATTORNEY



David J. Kybas

Director of the United States Patent and Trademark Office

United States of America

United States Patent and Trademark Office

TT RS

Reg. No. 4,109,426

AUDI AG (FED REP GERMANY CORPORATION)
85045

Registered Mar. 6, 2012

INGOLSTADT, FED REP GERMANY

Int. Cls.: 12, 20, 28, and 37

FOR: VEHICLES, NAMELY, AUTOMOBILES, SPORT CARS; ENGINES FOR LAND VEHICLES, IN CLASS 12 (U.S. CLS. 19, 21, 23, 31, 35 AND 44).

FIRST USE 9-14-2010; IN COMMERCE 4-19-2011.

TRADEMARK

FOR: NON-METAL KEYHOLDERS, NAMELY, LEATHER AND IMITATION LEATHER KEYHOLDERS, IN CLASS 20 (U.S. CLS. 2, 13, 22, 25, 32 AND 50).

SERVICE MARK

PRINCIPAL REGISTER

FIRST USE 12-15-2011; IN COMMERCE 12-15-2011.

FOR: MODEL CARS, IN CLASS 28 (U.S. CLS. 22, 23, 38 AND 50).

FIRST USE 7-31-2011; IN COMMERCE 7-31-2011.

FOR: REPAIR AND MAINTENANCE OF VEHICLES AND PARTS THEREOF; REPAIR AND MAINTENANCE OF VEHICLE ENGINES AND PARTS THEREOF, IN CLASS 37 (U.S. CLS. 100, 103 AND 106).

FIRST USE 4-19-2011; IN COMMERCE 4-19-2011.

THE MARK CONSISTS OF STANDARD CHARACTERS WITHOUT CLAIM TO ANY PARTICULAR FONT, STYLE, SIZE, OR COLOR.

PRIORITY CLAIMED UNDER SEC. 44(D) ON FED REP GERMANY APPLICATION NO. 302008072687, FILED 11-17-2008, REG. NO. 302008072687, DATED 11-17-2008, EXPIRES 11-30-2018.

OWNER OF U.S. REG. NOS. 2,519,018, 3,274,155, AND OTHERS.

SN 77-982,845, FILED 4-3-2009.

SHARON MEIER, EXAMINING ATTORNEY

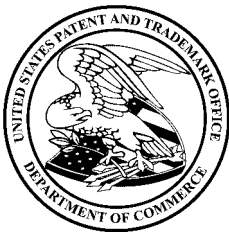

David J. Kybas

Director of the United States Patent and Trademark Office

United States of America

United States Patent and Trademark Office

SMART SENSE

Reg. No. 4,109,427

Registered Mar. 6, 2012

**Int. Cls.: 3, 5, 6, 8, 10, 16,
21, 29, 30, and 32**

TRADEMARK

PRINCIPAL REGISTER

SEARS BRANDS, LLC (ILLINOIS LIMITED LIABILITY COMPANY)
3333 BEVERLY ROAD
HOFFMAN ESTATES, IL 60179

FOR: SHAVING PREPARATIONS; SHAVING CREAM; SHAVING FOAM; SHAVING GEL; SHAVING LOTIONS; AFTERSHAVE PREPARATIONS; DENTAL CARE PRODUCTS, NAMELY, TOOTH PASTE, MOUTHWASH, NON-MEDICATED ANTI-PLAQUE PREPARATIONS, TOOTH WHITENING PREPARATIONS, DENTIFRICES; DENTURE CLEANING PREPARATIONS; FOOT POWDER; CLEANING, SCOURING AND POLISHING PREPARATIONS; GENERAL PURPOSE CLEANING, POLISHING, AND ABRASIVE LIQUIDS AND POWDERS; AMMONIA FOR CLEANING PURPOSES; GLASS CLEANING PREPARATION; IMPREGNATED CLEANING, DUSTING OR POLISHING CLOTHS; LAUNDRY BLEACH; LAUNDRY DETERGENT; FABRIC SOFTENERS FOR LAUNDRY USE; DISH SOAPS; AIR FRESHENERS, IN CLASS 3 (U.S. CLS. 1, 4, 6, 50, 51 AND 52).

FIRST USE 7-16-2011; IN COMMERCE 7-16-2011.

FOR: MEDICATED SHAMPOOS; ANTISEPTIC MOUTH RINSE; DENTAL RINSES; SANITARY NAPKINS; FEMININE HYGIENE PADS; TAMPONS; INCONTINENCE DIAPERS, PADS AND GARMENTS; BANDAGES FOR SKIN WOUNDS; ADHESIVE BANDAGES; MEDICAL ADHESIVE TAPE; FIRST AID DRESSINGS; GAUZE; GAUZE PADS; DIETARY SUPPLEMENTAL DRINKS; MEAL REPLACEMENT DRINKS; DIETARY DRINK MIX FOR USE AS A MEAL REPLACEMENT; OVER THE COUNTER DRUGS, NAMELY, ANALGESICS; ANTIBIOTIC, ANTIFUNGAL AND ANTISEPTIC CREAMS AND OINTMENTS; PAIN RELIEF MEDICATION; ALLERGY MEDICATIONS; ANTI-DIARRHEA MEDICATIONS; ANTIHISTAMINES; ANTACIDS; COLD AND FLU MEDICATIONS; COUGH SYRUPS, COUGH SUPPRESSANTS; APPETITE SUPPRESSANT PREPARATIONS; DECONGESTANTS; ENEMA PREPARATIONS; EXPECTORANTS; EYE DROPS; HEMORRHOIDAL PREPARATIONS; HYDROCORTISONE CREAMS AND OINTMENTS; LAXATIVES; MOTION SICKNESS MEDICATION; NASAL SPRAYS; NOSE DROPS; PAIN RELIEVERS; SALINE SOLUTIONS AND SPRAYS; SHAMPOOS AND SPRAYS TO REPEL LICE; SLEEP INDUCING PREPARATIONS; STRESS MEDICATIONS; SUPPOSITORIES; VAGINAL FUNGICIDE; SMOKING CESSATION PREPARATIONS; TRANSDERMAL PATCHES FOR ASSISTING IN CESSATION OF SMOKING; LOZENGES FOR MEDICINAL PURPOSES FOR ASSISTING IN THE CESSATION OF SMOKING; MEDICATED ANTI-PLAQUE PREPARATIONS; MEDICATED PETROLEUM JELLY; ANTIBACTERIAL ALCOHOL SKIN SANITIZER GELS, IN CLASS 5 (U.S. CLS. 6, 18, 44, 46, 51 AND 52).



David J. Kappas

Director of the United States Patent and Trademark Office

Reg. No. 4,109,427 FIRST USE 7-2-2011; IN COMMERCE 7-2-2011.

FOR: ALUMINUM FOIL, IN CLASS 6 (U.S. CLS. 2, 12, 13, 14, 23, 25 AND 50).

FIRST USE 9-2-2010; IN COMMERCE 9-2-2010.

FOR: DISPOSABLE TABLEWARE, NAMELY, KNIVES, FORKS AND SPOONS; RAZORS AND RAZOR BLADES, IN CLASS 8 (U.S. CLS. 23, 28 AND 44).

FIRST USE 6-19-2010; IN COMMERCE 6-19-2010.

FOR: CHEMICALLY ACTIVATED HOT AND COLD GEL PACKS FOR MEDICAL PURPOSES; ELASTIC BANDAGES, IN CLASS 10 (U.S. CLS. 26, 39 AND 44).

FIRST USE 7-31-2010; IN COMMERCE 7-31-2010.

FOR: PAPER NAPKINS AND TOWELS, BATHROOM TISSUE, TRASH BAGS, FACIAL TISSUE, PLASTIC SANDWICH BAGS, PLASTIC BAGS FOR PACKAGING, PAPER BAGS OR SACKS, PLASTIC WRAP, IN CLASS 16 (U.S. CLS. 2, 5, 22, 23, 29, 37, 38 AND 50).

FIRST USE 8-16-2010; IN COMMERCE 8-16-2010.

FOR: TOOTHBRUSHES; DENTAL FLOSS; PLASTIC STORAGE CONTAINERS FOR HOUSEHOLD OR DOMESTIC USE; MOPS; BROOMS; PAPER PLATES, IN CLASS 21 (U.S. CLS. 2, 13, 23, 29, 30, 33, 40 AND 50).

FIRST USE 5-22-2010; IN COMMERCE 5-22-2010.

FOR: NON-DAIRY CREAMER, PROCESSED NUTS, TRAIL MIX CONSISTING PRIMARILY OF PROCESSED NUTS, SEEDS, DRIED FRUIT; BEEF JERKY, IN CLASS 29 (U.S. CL. 46).

FIRST USE 7-30-2011; IN COMMERCE 7-30-2011.

FOR: COFFEE, TEA, ICED TEA, COOKIES, CRACKERS, RICE CAKES, SUGAR, BROWN SUGAR, POWDERED SUGAR, SUGAR SUBSTITUTES, VINEGAR, IN CLASS 30 (U.S. CL. 46).

FIRST USE 9-11-2010; IN COMMERCE 9-11-2010.

FOR: ENERGY DRINKS, FRUIT JUICE, VEGETABLE JUICE, FRUIT DRINK, POP, SOFT DRINKS, POWDERS USED IN THE PREPARATION OF SOFT DRINKS, SPARKLING WATER, BOTTLED WATER, IN CLASS 32 (U.S. CLS. 45, 46 AND 48).

FIRST USE 7-0-2010; IN COMMERCE 7-0-2010.

THE MARK CONSISTS OF STANDARD CHARACTERS WITHOUT CLAIM TO ANY PARTICULAR FONT, STYLE, SIZE, OR COLOR.

SN 77-982,852, FILED 5-13-2009.

RAUL CORDOVA, EXAMINING ATTORNEY

United States of America

United States Patent and Trademark Office



Reg. No. 4,109,428

Registered Mar. 6, 2012

Int. Cl.: 25

TRADEMARK

PRINCIPAL REGISTER

SUMMIT ENTERTAINMENT, LLC (DELAWARE LIMITED LIABILITY COMPANY)
1630 STEWART STREET, SUITE 120
SANTA MONICA, CA 90404

FOR: CLOTHING, NAMELY, T-SHIRTS, SWEATSHIRTS, JERSEYS, SWEATERS, HOODED SHIRTS AND WRIST BANDS; HEADWEAR; FOOTWEAR, IN CLASS 25 (U.S. CLS. 22 AND 39).

FIRST USE 5-1-2008; IN COMMERCE 5-1-2008.

THE MARK CONSISTS OF A SHADED OVAL ENCIRCLING A HERALDIC LION, WITH A HAND, PALM FACING FORWARD AND FINGERS SLIGHTLY APART, POSITIONED ABOVE THE LION, AND THREE ADJACENT CLOWERS WITHIN A V-SHAPED STRIPE POSITIONED BELOW THE LION, THE CLOVER ON THE RIGHT BEING PARTIALLY OBSTRUCTED BY THE BACK FOOT OF THE LION.

SN 77-982,858, FILED 5-10-2009.

MEGHAN REINHART, EXAMINING ATTORNEY



David J. Kyjars

Director of the United States Patent and Trademark Office

United States of America

United States Patent and Trademark Office

SET IT AND FORGET IT

Reg. No. 4,109,429

Registered Mar. 6, 2012

Int. Cl.: 11

TRADEMARK

PRINCIPAL REGISTER

RONCO HOLDINGS, INC. (TEXAS CORPORATION)
15505 LONG VISTA DRIVE
SUITE 250
AUSTIN, TX 78728

FOR: HOUSEHOLD GOODS, NAMELY, ROTISSERIES, ELECTRIC FOOD DEHYDRATORS AND STRUCTURAL PARTS THEREFOR, NAMELY, DEHYDRATOR TRAYS AND SCREENS, IN CLASS 11 (U.S. CLS. 13, 21, 23, 31 AND 34).

FIRST USE 12-31-1999; IN COMMERCE 12-31-1999.

THE MARK CONSISTS OF STANDARD CHARACTERS WITHOUT CLAIM TO ANY PARTICULAR FONT, STYLE, SIZE, OR COLOR.

SN 77-982,861, FILED 5-16-2008.

REGINA DRUMMOND, EXAMINING ATTORNEY



David J. Kybas

Director of the United States Patent and Trademark Office

United States of America

United States Patent and Trademark Office

EXTREMELY ME

Reg. No. 4,109,430

Registered Mar. 6, 2012

Int. Cls.: 25 and 26

TRADEMARK

PRINCIPAL REGISTER

FAMILY DOLLAR STORES OF MICHIGAN, INC. (MICHIGAN CORPORATION)
10401 OLD MONROE ROAD
MATTHEWS, NC 28105

FOR: CLOTHING FOR GIRLS, NAMELY, UNDERWEAR, PANTIES, FOOTWEAR, SHOES, SANDALS, SLIPPERS, HEADGEAR IN THE NATURE OF HATS, HEADBANDS, IN CLASS 25 (U.S. CLS. 22 AND 39).

FIRST USE 7-31-2011; IN COMMERCE 7-31-2011.

FOR: HAIR ACCESSORIES, NAMELY, HAIR CLIPS, HAIR PINS, HAIR ELASTIC BANDS, HAIR CLOTHES IN THE NATURE OF HAIR WRAPS, AND HAIR SCRUNCHIES, IN CLASS 26 (U.S. CLS. 37, 39, 40, 42 AND 50).

FIRST USE 5-31-2011; IN COMMERCE 5-31-2011.

THE MARK CONSISTS OF STANDARD CHARACTERS WITHOUT CLAIM TO ANY PARTICULAR FONT, STYLE, SIZE, OR COLOR.

SN 77-982,873, FILED 11-19-2009.

HEATHER BIDDULPH, EXAMINING ATTORNEY



David J. Kybas

Director of the United States Patent and Trademark Office

United States of America

United States Patent and Trademark Office

GO SLOW WHOA

Reg. No. 4,109,431

FLAGHOUSE, INC. (NEW YORK CORPORATION)
601 ROUTE 46 WEST
HASBROUCK HEIGHTS, NJ 07604

Registered Mar. 6, 2012

Int. Cl.: 28

FOR: SPORT BALLS; BALLS FOR GAMES; BEAN BAGS; SPORTS FIELD EQUIPMENT SETS AND INDOOR SPORTS EQUIPMENT SETS COMPRISING PLASTIC CONES, FLEXIBLE ROUND BOUNDARY MARKERS IN VARIOUS SIZES; TOY BUCKETS; PARACHUTES FOR PLAY, IN CLASS 28 (U.S. CLS. 22, 23, 38 AND 50).

TRADEMARK

PRINCIPAL REGISTER

FIRST USE 8-24-2011; IN COMMERCE 11-8-2010.

THE MARK CONSISTS OF STANDARD CHARACTERS WITHOUT CLAIM TO ANY PARTICULAR FONT, STYLE, SIZE, OR COLOR.

SN 77-982,874, FILED 5-26-2009.

ALLISON HOLTZ, EXAMINING ATTORNEY



David J. Kybas

Director of the United States Patent and Trademark Office

United States of America

United States Patent and Trademark Office

little 77
by american eagle

Reg. No. 4,109,432

RETAIL ROYALTY COMPANY (NEVADA CORPORATION)
101 CONVENTION CENTER DRIVE
LAS VEGAS, NV 89109

Registered Mar. 6, 2012

Int. Cl.: 25

FOR: CLOTHING, NAMELY, SHORTALLS, LAYETTES, AND JUMPSUITS, IN CLASS 25 (U.S. CLS. 22 AND 39).

TRADEMARK

FIRST USE 7-0-2010; IN COMMERCE 7-0-2010.

PRINCIPAL REGISTER

OWNER OF U.S. REG. NOS. 3,033,841, 3,674,435, AND OTHERS.

THE MARK CONSISTS OF THE WORD "LITTLE" WITH THE NUMBER "77" FOLLOWED BY THE WORDS "BY AMERICAN EAGLE".

SN 77-982,887, FILED 12-18-2009.

TARA PATE, EXAMINING ATTORNEY



David J. Kyffers

Director of the United States Patent and Trademark Office

United States of America

United States Patent and Trademark Office

MONSTER HIGH

Reg. No. 4,109,433

Registered Mar. 6, 2012

Int. Cl.: 18

TRADEMARK

PRINCIPAL REGISTER

MATTEL, INC. (DELAWARE CORPORATION)
333 CONTINENTAL BLVD.
M1-1518
EL SEGUNDO, CA 90245

FOR: LUGGAGE, SCHOOL BOOK BAGS, TOTE BAGS, HANDBAGS, TRUNKS, IN CLASS 18 (U.S. CLS. 1, 2, 3, 22 AND 41).

FIRST USE 11-15-2011; IN COMMERCE 11-15-2011.

THE MARK CONSISTS OF STANDARD CHARACTERS WITHOUT CLAIM TO ANY PARTICULAR FONT, STYLE, SIZE, OR COLOR.

SN 77-982,898, FILED 5-22-2009.

JILL C. ALT, EXAMINING ATTORNEY



David J. Kybas

Director of the United States Patent and Trademark Office

United States of America

United States Patent and Trademark Office

Real Work Tools

Reg. No. 4,109,434

MATTOON RURAL KING SUPPLY, INC (ILLINOIS CORPORATION)
4216 DEWITT AVENUE
MATTOON, IL 61938

Registered Mar. 6, 2012

Int. Cls.: 6 and 20

FOR: METAL TOOL BOXES, IN CLASS 6 (U.S. CLS. 2, 12, 13, 14, 23, 25 AND 50).

FIRST USE 10-1-2011; IN COMMERCE 10-1-2011.

TRADEMARK

FOR: METAL TOOL CABINETS; NON-METAL TOOL BOXES; TOOL BOXES NOT OF METAL; TOOL CHESTS NOT OF METAL, IN CLASS 20 (U.S. CLS. 2, 13, 22, 25, 32 AND 50).

PRINCIPAL REGISTER

FIRST USE 10-1-2011; IN COMMERCE 10-1-2011.

THE MARK CONSISTS OF STANDARD CHARACTERS WITHOUT CLAIM TO ANY PARTICULAR FONT, STYLE, SIZE, OR COLOR.

NO CLAIM IS MADE TO THE EXCLUSIVE RIGHT TO USE "WORK TOOLS", APART FROM THE MARK AS SHOWN.

SN 77-982,899, FILED 5-23-2009.

LINDA POWELL, EXAMINING ATTORNEY



David J. Kybas

Director of the United States Patent and Trademark Office

United States of America

United States Patent and Trademark Office



WEYERHAEUSER

LUMIN

Reg. No. 4,109,435

WEYERHAEUSER NR COMPANY (WASHINGTON CORPORATION)
33663 WEYERHAEUSER WAY SOUTH
FEDERAL WAY, WA 98003

Registered Mar. 6, 2012

Int. Cl.: 19

FOR: NON-METALLIC BUILDING MATERIALS, NAMELY, PLYWOOD, IN CLASS 19 (U.S. CLS. 1, 12, 33 AND 50).

TRADEMARK

FIRST USE 10-31-2009; IN COMMERCE 10-31-2009.

PRINCIPAL REGISTER

OWNER OF U.S. REG. NOS. 817,189, 818,501, AND OTHERS.

THE MARK CONSISTS OF THE TERMS "WEYERHAEUSER LUMIN" WITH A DESIGN TO THE UPPER LEFT OF THE TERM "LUMIN".

THE WORDING "LUMIN" HAS NO MEANING IN A FOREIGN LANGUAGE.

SN 77-982,905, FILED 12-4-2008.

ESTHER A. BORSUK, EXAMINING ATTORNEY



David J. Kyffers

Director of the United States Patent and Trademark Office

United States of America

United States Patent and Trademark Office

CNO

Reg. No. 4,109,436

Registered Mar. 6, 2012

Int. Cl.: 36

SERVICE MARK

PRINCIPAL REGISTER

CDOC, INC. (DELAWARE CORPORATION)
11825 N. PENNSYLVANIA STREET
CARMEL, IN 46082

FOR: LIFE, HEALTH AND ANNUITY INSURANCE UNDERWRITING SERVICES; LIFE, HEALTH AND ANNUITY ADMINISTRATION SERVICES, INCLUDING CLAIMS AND POLICYHOLDER SERVICES; ACTUARIAL SERVICES; INVESTMENT ADVISORY SERVICES; INVESTMENT MANAGEMENT SERVICES, IN CLASS 36 (U.S. CLS. 100, 101 AND 102).

FIRST USE 1-1-2006; IN COMMERCE 1-1-2006.

THE MARK CONSISTS OF STANDARD CHARACTERS WITHOUT CLAIM TO ANY PARTICULAR FONT, STYLE, SIZE, OR COLOR.

SN 77-982,920, FILED 3-24-2010.

DEBRA LEE, EXAMINING ATTORNEY



David J. Kybas

Director of the United States Patent and Trademark Office

United States of America

United States Patent and Trademark Office

FULL SAIL LIVE

Reg. No. 4,109,437

Registered Mar. 6, 2012

Int. Cl.: 41

SERVICE MARK

PRINCIPAL REGISTER

FULL SAIL, LLC (FLORIDA LIMITED LIABILITY COMPANY)
3300 UNIVERSITY BOULEVARD
WINTER PARK, FL 32792

FOR: ENTERTAINMENT SERVICES, NAMELY, LIVE MUSIC CONCERTS, THEATRICAL PERFORMANCES, DANCE PERFORMANCES, COMEDY SHOWS, PERFORMANCES BY AMATEUR AND PROFESSIONAL ENTERTAINERS; ENTERTAINMENT SERVICES, NAMELY, LIVE APPEARANCES BY A PROFESSIONAL ENTERTAINER, ARTIST, TEACHER OR LECTURER; PRODUCTION OF LIVE PERFORMANCES AND PRERECORDED PERFORMANCES AND LECTURE PROGRAMS FEATURING MUSIC CONCERTS, THEATRICAL PERFORMANCES, DANCE PERFORMANCES, FICTION AND NON-FICTION DRAMATIC PERFORMANCES, COMEDY SHOWS AND PERFORMANCES BY AMATEUR AND PROFESSIONAL ENTERTAINERS; PLANNING AND CONDUCTING A SERIES OF FILM FESTIVALS, IN CLASS 41 (U.S. CLS. 100, 101 AND 107).

FIRST USE 9-0-2011; IN COMMERCE 9-0-2011.

THE MARK CONSISTS OF STANDARD CHARACTERS WITHOUT CLAIM TO ANY PARTICULAR FONT, STYLE, SIZE, OR COLOR.

OWNER OF U.S. REG. NOS. 2,025,339, 2,996,883, AND OTHERS.

NO CLAIM IS MADE TO THE EXCLUSIVE RIGHT TO USE "LIVE", APART FROM THE MARK AS SHOWN.

SN 77-982,930, FILED 2-8-2010.

KELLY BOULTON, EXAMINING ATTORNEY



David J. Kyros

Director of the United States Patent and Trademark Office

United States of America

United States Patent and Trademark Office

FULL SAIL

Reg. No. 4,109,438

Registered Mar. 6, 2012

Int. Cl.: 41

SERVICE MARK

PRINCIPAL REGISTER

FULL SAIL, LLC (FLORIDA LIMITED LIABILITY COMPANY)
3300 UNIVERSITY BOULEVARD
WINTER PARK, FL 32792

FOR: ENTERTAINMENT SERVICES, NAMELY, LIVE MUSIC CONCERTS, THEATRICAL PERFORMANCES, DANCE PERFORMANCES, COMEDY SHOWS, PERFORMANCES BY AMATEUR AND PROFESSIONAL ENTERTAINERS; ENTERTAINMENT SERVICES, NAMELY, LIVE APPEARANCES BY A PROFESSIONAL ENTERTAINER, ARTIST, TEACHER OR LECTURER; PRODUCTION OF LIVE PERFORMANCES AND PRERECORDED PERFORMANCES AND LECTURE PROGRAMS FEATURING MUSIC CONCERTS, THEATRICAL PERFORMANCES, DANCE PERFORMANCES, FICTION AND NON-FICTION DRAMATIC PERFORMANCES, COMEDY SHOWS AND PERFORMANCES BY AMATEUR AND PROFESSIONAL ENTERTAINERS; PLANNING AND CONDUCTING A SERIES OF FILM FESTIVALS, IN CLASS 41 (U.S. CLS. 100, 101 AND 107).

FIRST USE 9-0-2011; IN COMMERCE 9-0-2011.

THE MARK CONSISTS OF STANDARD CHARACTERS WITHOUT CLAIM TO ANY PARTICULAR FONT, STYLE, SIZE, OR COLOR.

OWNER OF U.S. REG. NOS. 2,025,339, 2,996,883, AND OTHERS.

SN 77-982,931, FILED 2-8-2010.

KELLY BOULTON, EXAMINING ATTORNEY



David J. Kyros

Director of the United States Patent and Trademark Office

United States of America

United States Patent and Trademark Office

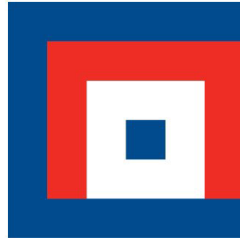

Reg. No. 4,109,439

Registered Mar. 6, 2012

Int. Cl.: 36

SERVICE MARK

PRINCIPAL REGISTER

CDOC, INC. (DELAWARE CORPORATION)
11825 N. PENNSYLVANIA STREET
CARMEL, IN 46032

FOR: LIFE, HEALTH AND ANNUITY INSURANCE UNDERWRITING SERVICES; LIFE, HEALTH AND ANNUITY ADMINISTRATION SERVICES, INCLUDING CLAIMS AND POLICYHOLDER SERVICES; ACTUARIAL SERVICES; INVESTMENT ADVISORY SERVICES; INVESTMENT MANAGEMENT SERVICES, IN CLASS 36 (U.S. CLS. 100, 101 AND 102).

FIRST USE 5-11-2010; IN COMMERCE 5-11-2010.

THE MARK CONSISTS OF A SQUARE-SHAPED GRAPHIC DESIGN COMPRISED OF FOUR NESTED COMPONENTS, I.E., A THREE-SIDED BLUE U-SHAPED FIGURE NESTING A RED U-SHAPED FIGURE THAT IS NESTING A SMALLER WHITE SQUARE WITH A SMALL BLUE SQUARE NESTED IN ITS MIDDLE.

THE COLOR(S) BLUE, RED AND WHITE IS/ARE CLAIMED AS A FEATURE OF THE MARK.

SN 77-982,934, FILED 3-24-2010.

DEBRA LEE, EXAMINING ATTORNEY



David J. Kyffers

Director of the United States Patent and Trademark Office

United States of America

United States Patent and Trademark Office

RIOT GAMES

Reg. No. 4,109,440

Registered Mar. 6, 2012

Int. Cls.: 9, 38, and 41

TRADEMARK

SERVICE MARK

PRINCIPAL REGISTER

RIOT GAMES, INC. (CALIFORNIA CORPORATION)
2450 BROADWAY
SANTA MONICA, CA 90404

FOR: OPTICAL DISK-BASED GAME SOFTWARE FOR USE ON COMPUTERS; DOWNLOADABLE VIDEO GAME SOFTWARE; OPTICAL DISCS FEATURING COMPUTER GAMES, AND COMPUTER GAME-RELATED CONTENT; COMPUTER PROGRAMS FOR USE IN TRACKING THE STATUS OF VARIOUS USERS OF ONLINE INTERACTIVE GAMING SERVICES AND FOR MATCHING ONLINE GAME PLAYERS WITH OTHER PLAYERS OF ALL SKILL LEVELS; MULTI-PLAYER INTERACTIVE ONLINE COMPUTER GAME PROGRAMS, IN CLASS 9 (U.S. CLS. 21, 23, 26, 36 AND 38).

FIRST USE 10-27-2009; IN COMMERCE 10-27-2009.

FOR: PROVIDING ON-LINE CHAT ROOMS OR INTERACTIVE DISCUSSION FORUMS FOR TRANSMISSION OF MESSAGES AMONG THE PARTICIPANTS OF MULTI PLAYER GAMES, COMPUTER GAMES AND ACTIVITIES, IN CLASS 38 (U.S. CLS. 100, 101 AND 104).

FIRST USE 10-27-2009; IN COMMERCE 10-27-2009.

FOR: ENTERTAINMENT SERVICES, NAMELY, PROVIDING ON-LINE COMPUTER GAMES FOR OTHERS OVER GLOBAL AND LOCAL AREA COMPUTER NETWORKS; PROVIDING A CONTENT MANAGEMENT SYSTEM ENABLING PLAYERS TO VIEW STATISTICAL INFORMATION ON THE PERFORMANCE OF OTHER PLAYERS IN THE FIELD OF MEDIA AND ENTERTAINMENT FOR COMMUNITIES OF PEOPLE THAT PLAY MASSIVELY MULTI PLAYER ONLINE GAMES; PROVIDING INTERACTIVE ONLINE COMPUTER GAMES VIA THE WORLD WIDE WEB; PROVIDING INFORMATION ABOUT ONLINE COMPUTER GAMES AND VIDEO GAMES VIA THE WORLD WIDE WEB; PROVIDING MULTI PLAYER INTERACTIVE GAMES OVER THE WORLD WIDE WEB; PROVIDING TRACKING OF USERS OF ONLINE INTERACTIVE GAMING SERVICES AND MATCHING ONLINE GAME PLAYERS WITH OTHER PLAYERS OF ALL SKILL LEVELS; PROVIDING A WEBSITE FEATURING ON-LINE PRODUCT TRIVIA, TIPS AND STRATEGIES FOR COMPUTER GAMES; FAN CLUB SERVICES, IN CLASS 41 (U.S. CLS. 100, 101 AND 107).

FIRST USE 10-27-2009; IN COMMERCE 10-27-2009.



David J. Kyffers

Director of the United States Patent and Trademark Office

Reg. No. 4,109,440 THE MARK CONSISTS OF STANDARD CHARACTERS WITHOUT CLAIM TO ANY PARTICULAR FONT, STYLE, SIZE, OR COLOR.

NO CLAIM IS MADE TO THE EXCLUSIVE RIGHT TO USE "GAMES", APART FROM THE MARK AS SHOWN.

SN 77-982,952, FILED 12-7-2006.

JENNIFER DIXON, EXAMINING ATTORNEY

United States of America

United States Patent and Trademark Office

LOOKNY

Reg. No. 4,109,441

DUANE READE INTERNATIONAL, LLC (DELAWARE LIMITED LIABILITY COMPANY)
440 9TH AVENUE, 6TH FLOOR
NEW YORK, NY 10001

Registered Mar. 6, 2012

Int. Cl.: 18

FOR: COSMETIC BAGS SOLD EMPTY, IN CLASS 18 (U.S. CLS. 1, 2, 3, 22 AND 41).

TRADEMARK

FIRST USE 10-31-2009; IN COMMERCE 10-31-2009.

PRINCIPAL REGISTER

THE MARK CONSISTS OF STANDARD CHARACTERS WITHOUT CLAIM TO ANY PARTICULAR FONT, STYLE, SIZE, OR COLOR.

SN 77-982,957, FILED 7-29-2009.

KIM MONINGHOFF, EXAMINING ATTORNEY



David J. Kybas

Director of the United States Patent and Trademark Office

United States of America

United States Patent and Trademark Office

SOUNDHOUND

Reg. No. 4,109,442

Registered Mar. 6, 2012

Int. Cls.: 9, 35, and 38

TRADEMARK

SERVICE MARK

PRINCIPAL REGISTER

SOUNDHOUND, INC. (DELAWARE CORPORATION)
1731 TECHNOLOGY DRIVE, SUITE 700
SAN JOSE, CA 95110

FOR: COMPUTER SEARCH ENGINE SOFTWARE; COMPUTER SOFTWARE FOR USE IN SEARCHING VIA TEXT, SOUND, SPEECH, AND MUSICAL QUERIES; COMPUTER SOFTWARE FOR USE IN RECOGNIZING AND IDENTIFYING SOUND, SPEECH, AND MUSIC BY COMPARING INPUT SAMPLES WITH KNOWN SAMPLES; COMPUTER SOFTWARE FOR DISPLAY OF TEXT, GRAPHICS, AND LYRICS, IN CLASS 9 (U.S. CLS. 21, 23, 26, 36 AND 38).

FIRST USE 12-0-2009; IN COMMERCE 12-0-2009.

FOR: ONLINE RETAIL STORE SERVICES IN THE FIELD OF ENTERTAINMENT FEATURING LINKS FOR PURCHASING MUSICAL WORKS, DOWNLOADABLE RINGTONES, PRE-RECORDED AUDIO AND AUDIOVISUAL WORKS; ADVERTISING SERVICES, NAMELY, PROVIDING ADVERTISING SPACE ON WEB SITES AND MOBILE APPLICATIONS ACCESSIBLE VIA THE GLOBAL COMPUTER NETWORK AND VIA TELECOMMUNICATION NETWORKS; PROMOTING THE GOODS AND SERVICES OF OTHERS BY DISSEMINATING ADVERTISEMENTS VIA A GLOBAL COMPUTER NETWORK AND VIA TELECOMMUNICATION NETWORKS TO WEB BROWSERS AND MOBILE APPLICATIONS, IN CLASS 35 (U.S. CLS. 100, 101 AND 102).

FIRST USE 12-0-2009; IN COMMERCE 12-0-2009.

FOR: ELECTRONIC TRANSMISSION OF STREAMED AND DOWNLOADABLE AUDIO AND VIDEO FILES, AND TEXT FILES, VIA COMPUTERS AND OTHER COMMUNICATIONS NETWORKS; DELIVERY OF MESSAGES BY ELECTRONIC TRANSMISSION, IN CLASS 38 (U.S. CLS. 100, 101 AND 104).

FIRST USE 12-0-2009; IN COMMERCE 12-0-2009.

THE MARK CONSISTS OF STANDARD CHARACTERS WITHOUT CLAIM TO ANY PARTICULAR FONT, STYLE, SIZE, OR COLOR.

SN 77-982,962, FILED 11-24-2009.



David J. Kyjars

Director of the United States Patent and Trademark Office

Reg. No. 4,109,442 JULIE WATSON, EXAMINING ATTORNEY

United States of America

United States Patent and Trademark Office

BASEBALL BEER

Reg. No. 4,109,443

STALEY, THOMAS C. (UNITED STATES INDIVIDUAL)

Registered Mar. 6, 2012

P.O. BOX 1209
FRISCO, TX 75034

Int. Cl.: 32

FOR: BEER, IN CLASS 32 (U.S. CLS. 45, 46 AND 48).

TRADEMARK

FIRST USE 12-12-2011; IN COMMERCE 12-12-2011.

PRINCIPAL REGISTER

NO CLAIM IS MADE TO THE EXCLUSIVE RIGHT TO USE "BEER" , APART FROM THE MARK AS SHOWN.

SN 78-176,564, FILED 10-21-2002.

MARIA-VICTORIA SUAREZ, EXAMINING ATTORNEY



David J. Kybas

Director of the United States Patent and Trademark Office

United States of America

United States Patent and Trademark Office

LOWER YOUR CARBS.
NOT YOUR
STANDARDS.

Reg. No. 4,109,444

FRANK BRUNCKHORST CO., L.L.C. (NEW YORK LIMITED LIABILITY COMPANY)
24 ROCK STREET
BROOKLYN, NY 11206

Registered Mar. 6, 2012

Int. Cl.: 29

FOR: PROCESSED MEATS, NAMELY, TURKEY, CHICKEN, BEEF, HAM AND PORK;
CHEESES, IN CLASS 29 (U.S. CL. 46).

TRADEMARK

FIRST USE 5-13-2004; IN COMMERCE 5-13-2004.

PRINCIPAL REGISTER

THE MARK CONSISTS OF STANDARD CHARACTERS WITHOUT CLAIM TO ANY PARTICULAR FONT, STYLE, SIZE, OR COLOR.

NO CLAIM IS MADE TO THE EXCLUSIVE RIGHT TO USE "CARBS", APART FROM THE MARK AS SHOWN.

SN 78-408,066, FILED 4-26-2004.

CHARLOTTE CORWIN, EXAMINING ATTORNEY



David J. Kybas

Director of the United States Patent and Trademark Office

United States of America

United States Patent and Trademark Office

TIME TO SPA

Reg. No. 4,109,445

Registered Mar. 6, 2012

Int. Cl.: 3

TRADEMARK

PRINCIPAL REGISTER

COSMETICS LIMITED (BAHAMAS CORPORATION)
SUITE 104A, SAFFREY SQUARE
NASSAU, BAHAMAS 78073

FOR: NON-MEDICATED TOILET PREPARATIONS, NAMELY, POWDERS, CREAMS, SERUMS, GELS, OILS AND LOTIONS; SKIN CLEANSERS, CONDITIONERS, CLARIFIERS AND TONERS ALL FOR THE FACE, HANDS AND BODY; NON-MEDICATED LIP CARE PREPARATIONS; BODY SCRUB; NAIL POLISH; NAIL POLISH REMOVER; EMERY BOARDS; COSMETICS; SOAPS; SHOWER AND BATH PREPARATIONS; HAIR CARE PREPARATIONS; SHAVING AND AFTERSHAVE PREPARATIONS; AROMATHERAPY PRODUCTS, NAMELY, CREAMS, SERUMS, GELS, OILS AND LOTIONS; DENTIFRICES, IN CLASS 3 (U.S. CLS. 1, 4, 6, 50, 51 AND 52).

FIRST USE 12-31-2002; IN COMMERCE 12-31-2003.

THE MARK CONSISTS OF STANDARD CHARACTERS WITHOUT CLAIM TO ANY PARTICULAR FONT, STYLE, SIZE, OR COLOR.

OWNER OF U.S. REG. NO. 2,694,980.

SN 78-432,727, FILED 6-9-2004.

RUDY R. SINGLETON, EXAMINING ATTORNEY



David J. Kypos

Director of the United States Patent and Trademark Office

United States of America

United States Patent and Trademark Office

CHICCO D'UVA

Reg. No. 4,109,446

VINTWOOD INTERNATIONAL, LTD. (NEW YORK CORPORATION)
40 PROSPECT STREET
HUNTINGTON, NY 11743

Registered Mar. 6, 2012

Int. Cl.: 33

FOR: WINES, IN CLASS 33 (U.S. CLS. 47 AND 49).

TRADEMARK

FIRST USE 7-11-2011; IN COMMERCE 7-11-2011.

PRINCIPAL REGISTER

THE MARK CONSISTS OF STANDARD CHARACTERS WITHOUT CLAIM TO ANY PARTICULAR FONT, STYLE, SIZE, OR COLOR.

NO CLAIM IS MADE TO THE EXCLUSIVE RIGHT TO USE "D'UVA", APART FROM THE MARK AS SHOWN.

THE FOREIGN WORDING IN THE MARK TRANSLATES INTO ENGLISH AS A SINGLE GRAPE.

SN 78-434,850, FILED 6-14-2004.

CHERYL CLAYTON, EXAMINING ATTORNEY



David J. Kybas

Director of the United States Patent and Trademark Office

United States of America

United States Patent and Trademark Office

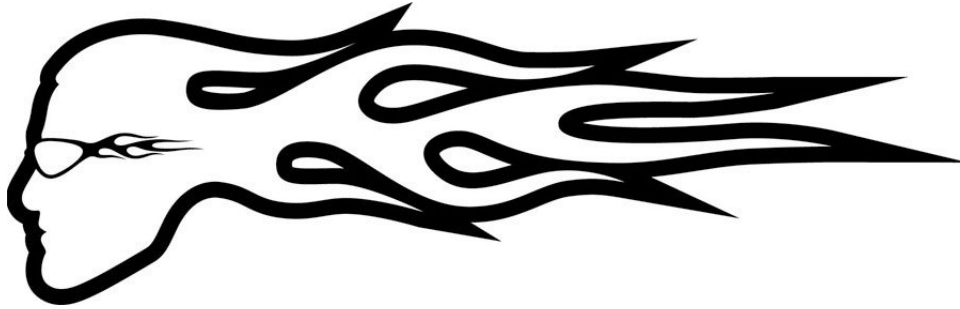

Reg. No. 4,109,447

SOLARAY CORPORATION (OKLAHOMA CORPORATION)
710 SOUTH ADAMS
SAPULPA, OK 74066

Registered Mar. 6, 2012

Int. Cl.: 25

FOR: CLOTHING, NAMELY, BANDANAS AND DO-RAGS, IN CLASS 25 (U.S. CLS. 22 AND 39).

TRADEMARK

FIRST USE 5-25-2011; IN COMMERCE 5-25-2011.

PRINCIPAL REGISTER

SN 78-726,450, FILED 10-4-2005.

KAREN BRACEY, EXAMINING ATTORNEY



David J. Kyffers

Director of the United States Patent and Trademark Office

United States of America

United States Patent and Trademark Office

ZEN TV

Reg. No. 4,109,448

FOX, SANDY (UNITED STATES INDIVIDUAL)
4225 ALCOVE AVENUE
STUDIO CITY, CA 91604 AND

Registered Mar. 6, 2012

Int. Cl.: 41

LANG, LEX (UNITED STATES INDIVIDUAL)
4225 ALCOVE AVENUE
STUDIO CITY, CA 91604

SERVICE MARK

PRINCIPAL REGISTER

FOR: ENTERTAINMENT SERVICES IN THE NATURE OF TELEVISION NETWORK SERVICES, NAMELY, PRODUCTION OF TELEVISION SHOWS, TELEVISION PROGRAM SYNDICATION, PRODUCTION AND DISTRIBUTION IN DIGITAL FORMAT OF TELEVISION PROGRAMS TO TELEVISION STATIONS; ENTERTAINMENT SERVICES, NAMELY, PRODUCTION OF INTERACTIVE TELEVISION PROGRAMS IN THE FIELD OF NEWS AND VARIETY PROGRAMS, IN CLASS 41 (U.S. CLS. 100, 101 AND 107).

FIRST USE 11-7-2005; IN COMMERCE 12-1-2005.

THE MARK CONSISTS OF STANDARD CHARACTERS WITHOUT CLAIM TO ANY PARTICULAR FONT, STYLE, SIZE, OR COLOR.

NO CLAIM IS MADE TO THE EXCLUSIVE RIGHT TO USE "TV", APART FROM THE MARK AS SHOWN.

SN 78-748,373, FILED 11-7-2005.

ALYSSA STEEL, EXAMINING ATTORNEY



David J. Kybas

Director of the United States Patent and Trademark Office

United States of America
United States Patent and Trademark Office

FRICKIN'

Reg. No. 4,109,449

FRICKER'S PROGRESSIVE CONCEPTS, INC. (OHIO CORPORATION)
228 BYERS ROAD
MIAMISBURG, OH 45342

Registered Mar. 6, 2012

Int. Cl.: 25

FOR: CLOTHING, NAMELY, T-SHIRTS AND SWEATSHIRTS, IN CLASS 25 (U.S. CLS. 22 AND 39).

TRADEMARK

FIRST USE 0-0-1992; IN COMMERCE 0-0-1992.

PRINCIPAL REGISTER

THE MARK CONSISTS OF STANDARD CHARACTERS WITHOUT CLAIM TO ANY PARTICULAR FONT, STYLE, SIZE, OR COLOR.

OWNER OF U.S. REG. NOS. 1,749,070, 2,156,001, AND 2,991,119.

SN 78-750,978, FILED 11-10-2005.

PATRICIA EVANKO, EXAMINING ATTORNEY



David J. Kybas

Director of the United States Patent and Trademark Office

United States of America

United States Patent and Trademark Office

B. WEAR

Reg. No. 4,109,450

BYER CALIFORNIA (CALIFORNIA CORPORATION)
66 POTRERO AVENUE
SAN FRANCISCO, CA 94103

Registered Mar. 6, 2012

Int. Cl.: 25

FOR: CLOTHING, NAMELY, DRESSES, SKIRTS, BLOUSES, SKORTS, SHORTS, SHIRTS, PANTS, JACKETS, SWEATERS, VESTS AND JUMPSUITS, IN CLASS 25 (U.S. CLS. 22 AND 39).

TRADEMARK

FIRST USE 8-11-2009; IN COMMERCE 8-11-2009.

PRINCIPAL REGISTER

THE MARK CONSISTS OF STANDARD CHARACTERS WITHOUT CLAIM TO ANY PARTICULAR FONT, STYLE, SIZE, OR COLOR.

SN 78-767,884, FILED 12-6-2005.

JIM RINGLE, EXAMINING ATTORNEY



David J. Kyffers

Director of the United States Patent and Trademark Office

United States of America

United States Patent and Trademark Office

INTERNATIONAL REPORT

Reg. No. 4,109,451

4273371 CANADA INC. (CANADA CORPORATION)
5525 PARE STREET

Registered Mar. 6, 2012

MONTREAL, QUEBEC, CANADA H4P1P7

Int. Cl.: 25

FOR: MEN'S CLOTHING AND APPAREL, NAMELY, POLO SHIRTS, SHIRTS, SWEATERS,
IN CLASS 25 (U.S. CLS. 22 AND 39).

TRADEMARK

FIRST USE 12-1-2011; IN COMMERCE 12-1-2011.

PRINCIPAL REGISTER

THE MARK CONSISTS OF STANDARD CHARACTERS WITHOUT CLAIM TO ANY PAR-
TICULAR FONT, STYLE, SIZE, OR COLOR.

SN 78-812,174, FILED 2-10-2006.

CARRIE GENOVESE, EXAMINING ATTORNEY



David J. Kybas

Director of the United States Patent and Trademark Office

United States of America
United States Patent and Trademark Office

PROMGIRL

Reg. No. 4,109,452

PROMGIRL, LLC (DELAWARE LIMITED LIABILITY COMPANY)
311 FAWN HILL LANE
NARBERTH, PA 10036

Registered Mar. 6, 2012

Int. Cl.: 25

FOR: DRESS SHIRTS; DRESS SUITS; DRESSES; DRESSING GOWNS; EVENING DRESSES;
EVENING GOWNS; FOOTWEAR, NAMELY, PUMPS; GOWNS; PUMPS; SHOES; TOPS;
WOMEN'S SHOES, IN CLASS 25 (U.S. CLS. 22 AND 39).

TRADEMARK

FIRST USE 1-21-1999; IN COMMERCE 1-21-1999.

PRINCIPAL REGISTER

OWNER OF U.S. REG. NO. 3,013,558.

THE MARK CONSISTS OF THE WORDS "PROMGIRL" IN CAPITAL LETTERS WITH A
"TIARA" OVER THE "O".

SN 78-875,952, FILED 5-3-2006.

DEIRDRE ROBERTSON, EXAMINING ATTORNEY



David J. Kyros

Director of the United States Patent and Trademark Office

United States of America

United States Patent and Trademark Office



Reg. No. 4,109,453

Registered Mar. 6, 2012

Int. Cls.: 9 and 16

TRADEMARK

PRINCIPAL REGISTER

ROGERS, LYNNE JOY (UNITED STATES INDIVIDUAL)
15825 VAN AKEN BLVD. #302W
SHAKER HEIGHTS, OH 44120

FOR: VIDEO DISKS AND VIDEO TAPES WITH RECORDED ANIMATED CARTOONS, IN CLASS 9 (U.S. CLS. 21, 23, 26, 36 AND 38).

FIRST USE 1-10-2008; IN COMMERCE 1-7-2011.

FOR: CARTOON PRINTS; CARTOON STRIPS; NEWSPAPER CARTOONS, IN CLASS 16 (U.S. CLS. 2, 5, 22, 23, 29, 37, 38 AND 50).

FIRST USE 1-10-2008; IN COMMERCE 1-7-2011.

THE WORD "THE" APPEARS IN THE COLOR GOLD, WITH THE DESIGN OF A BROWN BOX ON TOP OF THE LETTER "T". THE LETTER "R" IN "RECYCLABLES" APPEARS IN BROWN AND IS COMPRISED OF A BROWN BARREL A BROWN WOOD STUMP AND A BROWN BOTTLE. THE DESIGNS OF THE BOX AND THE BARREL HAVE BLACK INTERIORS AND SHADING. THE EACH OF THE REMAINING LETTERS TERM "RECYCLABLES" APPEARS IN DIFFERENT COLORS, THE TWO LETTER "E"S APPEAR IN PINK, THE TWO LETTER "C"S APPEAR IN GREEN, THE "Y" WHICH MADE UP OF CANS APPEARS IN YELLOW, THE TWO LETTER "L"S, WHICH ARE ALSO SHOWN AS CANS, APPEAR IN BLUE, THE "A" APPEARS IN RED, THE LETTER "S" WHICH APPEARS AS CRUMPLED PAPER APPEARS IN GOLD AND THE "B" APPEARS IN THE COLOR PURPLE.

THE COLOR(S) RED, BLUE, YELLOW, GREEN, GOLD, BROWN, BLACK, PINK AND PURPLE IS/ARE CLAIMED AS A FEATURE OF THE MARK.

SN 78-947,448, FILED 8-8-2006.

ELLEN PERKINS, EXAMINING ATTORNEY



David J. Kyros

Director of the United States Patent and Trademark Office

United States of America

United States Patent and Trademark Office

PRETTY UGLY

Reg. No. 4,109,454

PRETTY UGLY LLC (DELAWARE LIMITED LIABILITY COMPANY)
45 FERNWOOD AVENUE
EDISON, NJ 08837

Registered Mar. 6, 2012

Int. Cl.: 28

FOR: STUFFED TOYS, IN CLASS 28 (U.S. CLS. 22, 23, 38 AND 50).

TRADEMARK

FIRST USE 6-0-2002; IN COMMERCE 6-0-2002.

PRINCIPAL REGISTER

THE MARK CONSISTS OF STANDARD CHARACTERS WITHOUT CLAIM TO ANY PARTICULAR FONT, STYLE, SIZE, OR COLOR.

SN 78-962,521, FILED 8-29-2006.

ZHALEH DELANEY, EXAMINING ATTORNEY



David J. Kybas

Director of the United States Patent and Trademark Office

United States of America

United States Patent and Trademark Office



BIO-SIMPLEX[∞]

Reg. No. 4,109,455

Registered Mar. 6, 2012

Int. Cls.: 9 and 17

TRADEMARK

PRINCIPAL REGISTER

SAINT-GOBAIN PERFORMANCE PLASTICS CORPORATION (CALIFORNIA CORPORATION)
1199 CHILlicoTHE ROAD
AURORA, OH 44202

FOR: FLUID PROCESSING EQUIPMENT AND PRODUCTS, NAMELY, SPINNER FLASKS FOR LABORATORY PURPOSES, IN CLASS 9 (U.S. CLS. 21, 23, 26, 36 AND 38).

FIRST USE 9-20-2004; IN COMMERCE 11-15-2004.

FOR: FLUID PROCESSING EQUIPMENT AND PRODUCTS, NAMELY, PLASTIC MANIFOLD-PIPES AND PLASTIC TUBING, IN CLASS 17 (U.S. CLS. 1, 5, 12, 13, 35 AND 50).

FIRST USE 1-25-2005; IN COMMERCE 4-4-2005.

THE MARK CONSISTS OF THE STYLIZED WORDING "BIO-SIMPLEX" WITH A PERIOD AND INFINITY SYMBOL SITUATED TO THE RIGHT OF THE LETTER "X".

SN 78-968,106, FILED 9-6-2006.

MICHAEL WEBSTER, EXAMINING ATTORNEY



David J. Kybas

Director of the United States Patent and Trademark Office

United States of America

United States Patent and Trademark Office

ALPINE DIAMONDS

Reg. No. 4,109,456

Registered Mar. 6, 2012

Int. Cl.: 14

TRADEMARK

PRINCIPAL REGISTER

SELECT JEWELRY INC. (NEW YORK CORPORATION)
47-28 37TH STREET
3RD FLOOR
LONG ISLAND CITY, NY 11101

FOR: JEWELRY MADE WITH AND/OR INCLUDING REAL DIAMONDS, NAMELY, WEDDING BANDS, RINGS, BRACELETS, PENDANTS, EARRINGS, NECKLACES, BROOCHES AND PINS , IN CLASS 14 (U.S. CLS. 2, 27, 28 AND 50).

FIRST USE 11-1-2011; IN COMMERCE 11-1-2011.

THE MARK CONSISTS OF STANDARD CHARACTERS WITHOUT CLAIM TO ANY PARTICULAR FONT, STYLE, SIZE, OR COLOR.

NO CLAIM IS MADE TO THE EXCLUSIVE RIGHT TO USE "DIAMONDS", APART FROM THE MARK AS SHOWN.

SN 85-000,529, FILED 3-29-2010.

CHRIS WELLS, EXAMINING ATTORNEY



David J. Kybas

Director of the United States Patent and Trademark Office

United States of America

United States Patent and Trademark Office



your
garden
show

Reg. No. 4,109,457

Registered Mar. 6, 2012

Int. Cls.: 42, 44, and 45

SERVICE MARK

PRINCIPAL REGISTER

YGS, INC. (DELAWARE CORPORATION)
9501 W 144TH PL., SUITE 202
ORLAND PARK, IL 60462

FOR: PROVIDING A WEBSITE FEATURING INFORMATION ABOUT CLIMATE, WEATHER, SOIL SAMPLING AND CROP OBSERVATION; COMPUTER SERVICES, NAMELY, CREATING AN ON-LINE COMMUNITY FOR REGISTERED USERS TO PARTICIPATE IN DISCUSSIONS, GET FEEDBACK FROM THEIR PEERS, FORM VIRTUAL COMMUNITIES, AND ENGAGE IN SOCIAL NETWORKING; PROVIDING A WEBSITE FEATURING CLIMATE-RELATED DATA FOR USE BY OTHERS IN SCIENTIFIC STUDIES; PROVIDING A WEBSITE THAT ENABLES USERS TO AUTHOR AND PUBLISH INSTRUCTIONAL CONTENT FOR OTHERS; CREATING AND MAINTAINING BLOGS FOR OTHERS, IN CLASS 42 (U.S. CLS. 100 AND 101).

FIRST USE 5-29-2010; IN COMMERCE 5-29-2010.

FOR: PROVIDING A WEBSITE FEATURING INFORMATION ABOUT GARDENING AND GARDENING-RELATED ACTIVITIES; PROVIDING A WEBSITE THAT ALLOWS USERS TO LOG AND TRACK THE USER'S GARDENING ACTIVITIES, REMINDERS, DEADLINES, AND KEY DATES; PROVIDING A WEBSITE THAT DISPLAYS INFORMATION AND IMAGES PROVIDED BY THE USER ABOUT THE USER AND THE USER'S GARDEN AND GARDENING ACTIVITIES; PROVIDING A WEBSITE FEATURING GARDENING-RELATED DATA FOR USE BY OTHERS IN SCIENTIFIC STUDIES, IN CLASS 44 (U.S. CLS. 100 AND 101).

FIRST USE 5-29-2010; IN COMMERCE 5-29-2010.

FOR: ONLINE SOCIAL NETWORKING IN THE FIELD OF GARDENING, IN CLASS 45 (U.S. CLS. 100 AND 101).

FIRST USE 5-29-2010; IN COMMERCE 5-29-2010.

NO CLAIM IS MADE TO THE EXCLUSIVE RIGHT TO USE "GARDEN", APART FROM THE MARK AS SHOWN.

THE MARK CONSISTS OF DESIGN OF A BEE AGAINST A SQUARE WITH THE WORDS "YOUR GARDEN SHOW" NEXT TO THE DESIGN.



David J. Kyffers

Director of the United States Patent and Trademark Office

Reg. No. 4,109,457 SN 85-000,595, FILED 3-29-2010.

FRANK LATTUCA, EXAMINING ATTORNEY

United States of America

United States Patent and Trademark Office

GIIRS

Reg. No. 4,109,458

Registered Mar. 6, 2012

Int. Cls.: 9, 16, 35, and 36

TRADEMARK

SERVICE MARK

PRINCIPAL REGISTER

GIIRS, LLC (PENNSYLVANIA LIMITED LIABILITY COMPANY)
8 WALNUT AVENUE
BERWYN, PA 19312

FOR: DOWNLOADABLE REPORTS AND ELECTRONIC PUBLICATIONS IN THE NATURE OF NEWSLETTERS, MAGAZINES, GUIDES, BROCHURES, MANUALS AND PROSPECTUSES FEATURING INFORMATION CONCERNING THE ENVIRONMENTAL, ECONOMIC AND SOCIAL IMPACT OF BUSINESSES AND PRIVATE EQUITY FUNDS, IN CLASS 9 (U.S. CLS. 21, 23, 26, 36 AND 38).

FIRST USE 10-25-2011; IN COMMERCE 10-25-2011.

FOR: PRINTED REPORTS AND PUBLICATIONS IN THE NATURE OF NEWSLETTERS, MAGAZINES, GUIDES, BROCHURES, MANUALS AND PROSPECTUSES FEATURING INFORMATION CONCERNING THE ENVIRONMENTAL, ECONOMIC AND SOCIAL IMPACT OF BUSINESSES AND PRIVATE EQUITY FUNDS; PRINTED SURVEYS AND ASSESSMENTS IN THE FIELD OF ENVIRONMENTAL, ECONOMIC AND SOCIAL IMPACT OF BUSINESSES AND PRIVATE EQUITY FUNDS, IN CLASS 16 (U.S. CLS. 2, 5, 22, 23, 29, 37, 38 AND 50).

FIRST USE 10-25-2011; IN COMMERCE 10-25-2011.

FOR: RATING SERVICES, NAMELY, RATING PRIVATE EQUITY FUNDS BASED UPON THEIR ECONOMIC IMPACT AND PROVIDING A WEBSITE FEATURING INFORMATION CONCERNING THE ECONOMIC IMPACT OF EQUITY FUNDS, IN CLASS 35 (U.S. CLS. 100, 101 AND 102).

FIRST USE 1-25-2011; IN COMMERCE 1-25-2011.

FOR: FINANCIAL CONSULTING SERVICES IN THE FIELD OF MEASURING THE ECONOMIC IMPACT OF PRIVATE EQUITY FUNDS, IN CLASS 36 (U.S. CLS. 100, 101 AND 102).

FIRST USE 1-25-2011; IN COMMERCE 1-25-2011.

THE MARK CONSISTS OF STANDARD CHARACTERS WITHOUT CLAIM TO ANY PARTICULAR FONT, STYLE, SIZE, OR COLOR.

SN 85-000,748, FILED 3-29-2010.



David J. Kyffers

Director of the United States Patent and Trademark Office

Reg. No. 4,109,458 KATHLEEN M. VANSTON, EXAMINING ATTORNEY

United States of America

United States Patent and Trademark Office

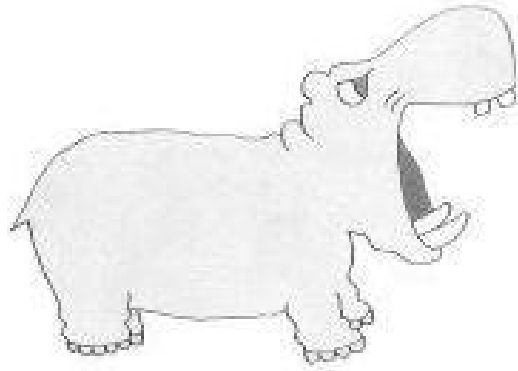

Reg. No. 4,109,459

Registered Mar. 6, 2012

Int. Cl.: 30

TRADEMARK

PRINCIPAL REGISTER

KINSHIP ENTERPRISE, LLC (MASSACHUSETTS LIMITED LIABILITY COMPANY)
14 POLLYWOG LANE
WESTON, MA 02493

FOR: CRACKERS, FROZEN CONFECTIONS, CHOCOLATE, CANDIES, POPCORN, GRANOLA, GRANOLA BARS, AND BAKED GOODS INCLUDING COOKIES AND CUPCAKES, IN CLASS 30 (U.S. CL. 46).

FIRST USE 5-1-2011; IN COMMERCE 5-1-2011.

THE MARK CONSISTS OF A HIPPO WITH A WIDE EYE AND MOUTH OPEN. TWO TEETH HANG FROM THE UPPER LIP AND FANGS PROTRUDE FROM THE LOWER LIP.

SN 85-003,071, FILED 3-31-2010.

NICHOLAS COLEMAN, EXAMINING ATTORNEY



David J. Kybas

Director of the United States Patent and Trademark Office

United States of America

United States Patent and Trademark Office

PARCEL IQ

Reg. No. 4,109,460

FIRST AMERICAN FINANCIAL CORPORATION (DELAWARE CORPORATION)
1 FIRST AMERICAN WAY
SANTA ANA, CA 92707

Registered Mar. 6, 2012

Int. Cl.: 36

FOR: PROVIDING AN ON-LINE SEARCHABLE DATABASE FEATURING INFORMATION ON REAL PROPERTY, INCLUDING THE DELIVERY OF PROPERTY OWNERSHIP REPORTS, LEGAL AND VESTING REPORTS, REAL ESTATE DOCUMENT IMAGES, AUTOMATED VALUATION MODELS AND FLOOD REPORTS, IN CLASS 36 (U.S. CLS. 100, 101 AND 102).

SERVICE MARK

PRINCIPAL REGISTER

FIRST USE 2-28-2011; IN COMMERCE 2-28-2011.

THE MARK CONSISTS OF STANDARD CHARACTERS WITHOUT CLAIM TO ANY PARTICULAR FONT, STYLE, SIZE, OR COLOR.

NO CLAIM IS MADE TO THE EXCLUSIVE RIGHT TO USE "PARCEL", APART FROM THE MARK AS SHOWN.

SN 85-004,651, FILED 4-1-2010.

HENRY S. ZAK, EXAMINING ATTORNEY



David J. Kyffers

Director of the United States Patent and Trademark Office

United States of America

United States Patent and Trademark Office

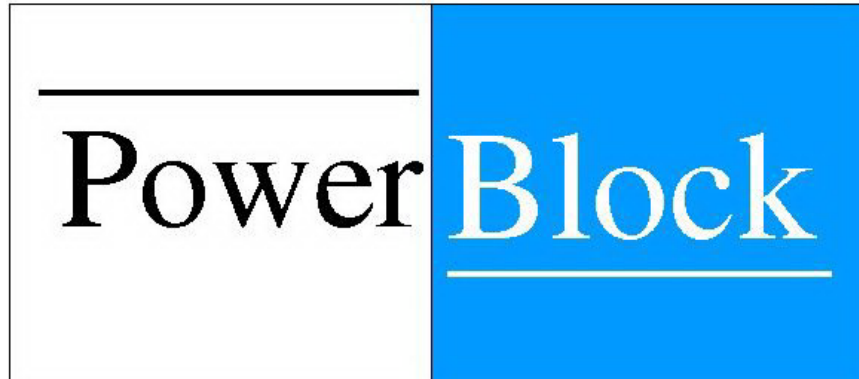

Reg. No. 4,109,461

Registered Mar. 6, 2012

Int. Cl.: 7

TRADEMARK

PRINCIPAL REGISTER

POWERSECURE, INC. (DELAWARE CORPORATION)
1609 HERITAGE COMMERCE COURT
WAKE FOREST, NC 27587

FOR: ELECTRIC POWER GENERATION EQUIPMENT, NAMELY, ELECTRIC GENERATORS, INTERNAL COMBUSTION ENGINES FOR POWER GENERATION OTHER THAN FOR LAND VEHICLES, AND INTEGRAL FUEL TANKS SOLD AS A COMPONENT OF ELECTRIC GENERATORS, IN CLASS 7 (U.S. CLS. 13, 19, 21, 23, 31, 34 AND 35).

FIRST USE 1-26-2009; IN COMMERCE 2-26-2009.

OWNER OF U.S. REG. NO. 3,251,709.

THE COLOR(S) WHITE, BLUE AND BLACK IS/ARE CLAIMED AS A FEATURE OF THE MARK.

NO CLAIM IS MADE TO THE EXCLUSIVE RIGHT TO USE "POWER", APART FROM THE MARK AS SHOWN.

THE MARK CONSISTS OF THE WORD "POWER" RENDERED IN BLACK WITH A BLACK OVERLINE ON A WHITE BACKGROUND AND THE WORD "BLOCK" RENDERED IN WHITE WITH A WHITE UNDERLINE ON A BLUE BACKGROUND.

SN 85-004,834, FILED 4-2-2010.

ELISSA GARBER KON, EXAMINING ATTORNEY



David J. Kybas

Director of the United States Patent and Trademark Office

United States of America

United States Patent and Trademark Office

NEKO FLIES

Reg. No. 4,109,462

NEKOCHAN ENTERPRISES INC. (CANADA CORPORATION)
#202 - 15388 24TH AVENUE
SURREY, BC, CANADA V4A2J2

Registered Mar. 6, 2012

Int. Cl.: 28

FOR: PET TOYS, IN CLASS 28 (U.S. CLS. 22, 23, 38 AND 50).

TRADEMARK

FIRST USE 10-31-2009; IN COMMERCE 10-31-2009.

PRINCIPAL REGISTER

THE MARK CONSISTS OF STANDARD CHARACTERS WITHOUT CLAIM TO ANY PARTICULAR FONT, STYLE, SIZE, OR COLOR.

NO CLAIM IS MADE TO THE EXCLUSIVE RIGHT TO USE "NEKO", APART FROM THE MARK AS SHOWN.

THE ENGLISH TRANSLATION OF "NEKO" IN THE MARK IS CAT.

SN 85-005,332, FILED 4-2-2010.

TRACY WHITTAKER-BROWN, EXAMINING ATTORNEY



David J. Kyffers

Director of the United States Patent and Trademark Office

United States of America

United States Patent and Trademark Office

Tour de Sewer

Reg. No. 4,109,463

WET INK, INC (COLORADO CORPORATION), DBA ALPHAGRAPHICS,
8290 WET 80TH AVENUE
ARVADA, CO 80005

Registered Mar. 6, 2012

Int. Cl.: 39

FOR: ARRANGING, ORGANIZING, AND CONDUCTING CYCLING TOURS AND TRIPS,
IN CLASS 39 (U.S. CLS. 100 AND 105).

SERVICE MARK

FIRST USE 2-18-2011; IN COMMERCE 2-18-2011.

PRINCIPAL REGISTER

THE MARK CONSISTS OF STANDARD CHARACTERS WITHOUT CLAIM TO ANY PARTICULAR FONT, STYLE, SIZE, OR COLOR.

THE ENGLISH TRANSLATION OF "TOUR DE SEWER" IN THE MARK IS "TOUR OF SEWER".

SN 85-005,844, FILED 4-4-2010.

GRETТА YAO, EXAMINING ATTORNEY



David J. Kyffers

Director of the United States Patent and Trademark Office

United States of America

United States Patent and Trademark Office

TEAM BISCUITS & BURGERS

Reg. No. 4,109,464

ARMOUR, GARY H. (UNITED STATES INDIVIDUAL)
6314 NEESE-COMMERCE RD
HULL, GA 30646

Registered Mar. 6, 2012

Int. Cl.: 43

FOR: CAFE AND RESTAURANT SERVICES; CARRY-OUT RESTAURANTS; FAST FOOD AND NON-STOP RESTAURANT SERVICES; FOOD PREPARATION SERVICES; PROVIDING OF FOOD AND DRINK; RESTAURANT; RESTAURANT SERVICES; RESTAURANT SERVICES FEATURING SANDWICHES, IN CLASS 43 (U.S. CLS. 100 AND 101).

SERVICE MARK

PRINCIPAL REGISTER

FIRST USE 10-17-2011; IN COMMERCE 10-17-2011.

THE MARK CONSISTS OF STANDARD CHARACTERS WITHOUT CLAIM TO ANY PARTICULAR FONT, STYLE, SIZE, OR COLOR.

NO CLAIM IS MADE TO THE EXCLUSIVE RIGHT TO USE "BISCUITS & BURGERS", APART FROM THE MARK AS SHOWN.

SN 85-005,847, FILED 4-4-2010.

GRETTA YAO, EXAMINING ATTORNEY



David J. Kyros

Director of the United States Patent and Trademark Office

United States of America

United States Patent and Trademark Office

two figs

Reg. No. 4,109,465

Registered Mar. 6, 2012

Int. Cl.: 25

TRADEMARK

PRINCIPAL REGISTER

TWO FIGS, LLC (CALIFORNIA LIMITED LIABILITY COMPANY)
855 FOLSOM STREET, NO 718
SAN FRANCISCO, CA 94117

FOR: BRALETTES; BRAS; BRIEFS; CAMISOLES; CHEMISES; DRESSING GOWNS; DRESSING GOWNS AND BATH ROBES; FITTED SWIMMING COSTUMES WITH BRA CUPS; LADIES' UNDERWEAR; LINGERIE; LINGERIE ACCESSORIES, NAMELY, REMOVABLE SILICONE BREAST ENHANCER PADS USED IN A BRA; LONG UNDERWEAR; MATERNITY BRAS; MATERNITY LINGERIE; MATERNITY SLEEPWEAR; MEN'S UNDERWEAR; MOISTURE-WICKING SPORTS BRAS; NIGHT GOWNS; PAJAMA BOTTOMS; PAJAMAS; PANTIES; PANTIES, SHORTS AND BRIEFS; PERSPIRATION ABSORBENT UNDERWEAR CLOTHING; ROBES; SLEEPWEAR; SPORTS BRA; SPORTS BRAS; SWIMWEAR; THONGS; UNDERWEAR; WOMEN'S UNDERWEAR; WOVEN OR KNITTED UNDERWEAR, IN CLASS 25 (U.S. CLS. 22 AND 39).

FIRST USE 1-6-2009; IN COMMERCE 1-1-2010.

THE MARK CONSISTS OF STANDARD CHARACTERS WITHOUT CLAIM TO ANY PARTICULAR FONT, STYLE, SIZE, OR COLOR.

SN 85-008,996, FILED 4-8-2010.

KAREN K. BUSH, EXAMINING ATTORNEY



David J. Kyros

Director of the United States Patent and Trademark Office

United States of America

United States Patent and Trademark Office

TORK

Reg. No. 4,109,466

SCA HYGIENE PRODUCTS AB (SWEDEN CORPORATION)
SE-405 03
GÖTEBORG, SWEDEN

Registered Mar. 6, 2012

Int. Cl.: 3

FOR: SOAPS FOR HOUSEHOLD USE AND FOR PERSONAL USE, IN CLASS 3 (U.S. CLS. 1, 4, 6, 50, 51 AND 52).

TRADEMARK

FIRST USE 12-3-1996; IN COMMERCE 12-31-1996.

PRINCIPAL REGISTER

THE MARK CONSISTS OF STANDARD CHARACTERS WITHOUT CLAIM TO ANY PARTICULAR FONT, STYLE, SIZE, OR COLOR.

OWNER OF U.S. REG. NOS. 1,168,341, 3,505,332, AND OTHERS.

THE ENGLISH TRANSLATION OF THE WORD "TORK" IN THE MARK IS DRIER.

SN 85-009,694, FILED 4-8-2010.

REBECCA GILBERT, EXAMINING ATTORNEY



David J. Kybas

Director of the United States Patent and Trademark Office

United States of America

United States Patent and Trademark Office

IDEOS

Reg. No. 4,109,467

Registered Mar. 6, 2012

Int. Cl.: 9

TRADEMARK

PRINCIPAL REGISTER

HUAWEI TECHNOLOGIES CO., LTD. (CHINA CORPORATION)
ADMIN. BLDG. HUAWEI TECHNOLOGIES CO LTD
BANTIAN, LONGGANG DISTRICT
SHENZHEN, CHINA

FOR: MOBILE TELEPHONE HANDSETS; COMPUTERS, IN CLASS 9 (U.S. CLS. 21, 23, 26, 36 AND 38).

FIRST USE 10-1-2010; IN COMMERCE 10-1-2010.

THE MARK CONSISTS OF STANDARD CHARACTERS WITHOUT CLAIM TO ANY PARTICULAR FONT, STYLE, SIZE, OR COLOR.

SN 85-010,089, FILED 4-9-2010.

MARK SPARACINO, EXAMINING ATTORNEY



David J. Kyfos

Director of the United States Patent and Trademark Office

United States of America

United States Patent and Trademark Office

Kabable

Reg. No. 4,109,468

TOMLINSON RICHARD D (TENNESSEE SOLE PROPRIETORSHIP)
114 HAYFIELD LN
UNIONVILLE, TN 37180

Registered Mar. 6, 2012

Int. Cl.: 10

FOR: MEDICAL REHABILITATION APPARATUS FOR MEDICAL PURPOSES, NAMELY, A MECHANICAL DEVICE FOR STRENGTHENING THE HAND, FINGERS, WRIST, AND FOREARM OF PATIENTS WITH HAND OR FOREARM HANDICAPS AND OTHER MOBILITY PROBLEMS AFFECTING THESE AREAS, IN CLASS 10 (U.S. CLS. 26, 39 AND 44).

TRADEMARK

PRINCIPAL REGISTER

FIRST USE 10-22-2011; IN COMMERCE 10-22-2011.

THE MARK CONSISTS OF STANDARD CHARACTERS WITHOUT CLAIM TO ANY PARTICULAR FONT, STYLE, SIZE, OR COLOR.

SN 85-010,374, FILED 1-21-2011.

DAVID HOFFMAN, EXAMINING ATTORNEY



David J. Kyfos

Director of the United States Patent and Trademark Office

United States of America

United States Patent and Trademark Office

VIDEX

Reg. No. 4,109,469

Registered Mar. 6, 2012

Int. Cls.: 38 and 42

SERVICE MARK

PRINCIPAL REGISTER

VIDEX, INC. (CALIFORNIA CORPORATION)
1800 WYATT DRIVE, SUITE 7
SANTA CLARA, CA 95054

FOR: TRANSMISSION, ELECTRONIC DELIVERY AND STREAMING OF DIGITAL MEDIA CONTENT, NAMELY, VIDEO, AUDIO, IMAGES AND TEXT, FOR OTHERS VIA THE INTERNET, TELEPHONE NETWORKS, CELLULAR NETWORKS, WIRELESS NETWORKS, CABLE TELEVISION NETWORKS AND OTHER TELECOMMUNICATIONS NETWORKS, IN CLASS 38 (U.S. CLS. 100, 101 AND 104).

FIRST USE 1-1-2010; IN COMMERCE 12-12-2011.

FOR: DESIGN AND DEVELOPMENT OF COMPUTER SYSTEMS IN THE FIELD OF TRANSMISSION, ELECTRONIC DELIVERY AND STREAMING OF DIGITAL MEDIA CONTENT, NAMELY, VIDEO, AUDIO, IMAGES AND TEXT, FOR OTHERS VIA THE INTERNET, TELEPHONE NETWORKS, CELLULAR NETWORKS, WIRELESS NETWORKS, CABLE TELEVISION NETWORKS AND OTHER TELECOMMUNICATIONS NETWORKS; CONSULTING SERVICES AND PRODUCT RESEARCH IN THE FIELD OF THE TRANSMISSION, ELECTRONIC DELIVERY AND STREAMING OF DIGITAL MEDIA CONTENT, NAMELY, VIDEO, AUDIO, IMAGES AND TEXT, FOR OTHERS VIA THE INTERNET, TELEPHONE NETWORKS, CELLULAR NETWORKS, WIRELESS NETWORKS, CABLE TELEVISION NETWORKS AND OTHER TELECOMMUNICATIONS NETWORKS; PRODUCT DEVELOPMENT CONSULTATION REGARDING EQUIPMENT, ELECTRONIC DEVICES AND COMPUTER SYSTEMS USED IN CONNECTION WITH THE TRANSMISSION, ELECTRONIC DELIVERY AND STREAMING OF DIGITAL MEDIA CONTENT, IN CLASS 42 (U.S. CLS. 100 AND 101).

FIRST USE 1-1-2010; IN COMMERCE 12-12-2011.

THE MARK CONSISTS OF STANDARD CHARACTERS WITHOUT CLAIM TO ANY PARTICULAR FONT, STYLE, SIZE, OR COLOR.

SN 85-010,469, FILED 4-9-2010.

FLORENTINA BLANDU, EXAMINING ATTORNEY



David J. Kyros

Director of the United States Patent and Trademark Office

United States of America

United States Patent and Trademark Office

SWEET KAHAI

Reg. No. 4,109,470

Registered Mar. 6, 2012

Int. Cl.: 30

TRADEMARK

PRINCIPAL REGISTER

LEWIS BROTHERS BAKERIES, INCORPORATED (MISSOURI CORPORATION), DBA
LEWIS BAKERIES, INC.,
500 N. FULTON AVENUE
EVANSVILLE, IN 47710

FOR: BREAD; ROLLS, IN CLASS 30 (U.S. CL. 46).

FIRST USE 3-7-2011; IN COMMERCE 3-7-2011.

THE MARK CONSISTS OF STANDARD CHARACTERS WITHOUT CLAIM TO ANY PARTICULAR FONT, STYLE, SIZE, OR COLOR.

NO CLAIM IS MADE TO THE EXCLUSIVE RIGHT TO USE "SWEET", APART FROM THE MARK AS SHOWN.

SN 85-011,368, FILED 4-12-2010.

ALLISON SCHRODY, EXAMINING ATTORNEY



David J. Kybas

Director of the United States Patent and Trademark Office

United States of America

United States Patent and Trademark Office

THE ORIGINAL HEALTH HERO COIN

Reg. No. 4,109,471

KAUFMAN, PATRICIA (UNITED STATES INDIVIDUAL)
1205 SWAN HARBOUR CIRCLE
FORT WASHINGTON, MD 20744 AND

Registered Mar. 6, 2012

Int. Cl.: 14

CALZINI, KATHRYN (UNITED STATES INDIVIDUAL)
2108 DOVE RIDGE DRIVE
VIRGINIA BEACH, VA 23464 AND

TRADEMARK

ROYLE, ELIZABETH (UNITED STATES INDIVIDUAL)
799 ADRIAN COURT
VIRGINIA BEACH, VA 23452

PRINCIPAL REGISTER

FOR: MEDALS AND MEDALLIONS; COLLECTIBLE COINS; AND COMMEMORATIVE COINS, IN CLASS 14 (U.S. CLS. 2, 27, 28 AND 50).

FIRST USE 2-11-2011; IN COMMERCE 10-20-2011.

THE MARK CONSISTS OF STANDARD CHARACTERS WITHOUT CLAIM TO ANY PARTICULAR FONT, STYLE, SIZE, OR COLOR.

NO CLAIM IS MADE TO THE EXCLUSIVE RIGHT TO USE "ORIGINAL" AND "COIN", APART FROM THE MARK AS SHOWN.

SN 85-012,618, FILED 4-13-2010.

DANIEL CAPSHAW, EXAMINING ATTORNEY



David J. Kyros

Director of the United States Patent and Trademark Office

United States of America

United States Patent and Trademark Office

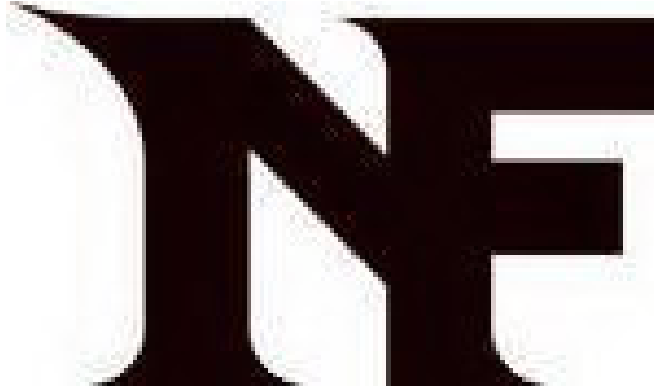

Reg. No. 4,109,472

Registered Mar. 6, 2012

Int. Cl.: 25

TRADEMARK

PRINCIPAL REGISTER

MARK G. DODGEN (UNITED STATES INDIVIDUAL)
4212 ERIK AVE
AMARILLO, TX 79106

FOR: ATHLETIC APPAREL, NAMELY, SHIRTS, PANTS, JACKETS, FOOTWEAR, HATS AND CAPS, ATHLETIC UNIFORMS; BOARD SHORTS; BODY SHIRTS; BOXER SHORTS; CLOTHING FOR ATHLETIC USE, NAMELY, PADDED SHIRTS; CLOTHING FOR WEAR IN WRESTLING GAMES; DRESS SHIRTS; HOODED SWEAT SHIRTS; KNIT SHIRTS; LIGHT-REFLECTING JACKETS; LONG-SLEEVED SHIRTS; MOISTURE-WICKING SPORTS SHIRTS; OPEN-NECKED SHIRTS; POLO SHIRTS; SHIRTS; SHIRTS AND SHORT-SLEEVED SHIRTS; SHIRTS FOR INFANTS, BABIES, TODDLERS AND CHILDREN; SHORT-SLEEVED OR LONG-SLEEVED T-SHIRTS; SHORT-SLEEVED SHIRTS; SPORT SHIRTS; SPORTS JACKETS; SPORTS SHIRTS; SPORTS SHIRTS WITH SHORT SLEEVES; SWEAT JACKETS; SWEAT SHIRTS; SWEAT SHORTS; T-SHIRTS; TEE SHIRTS; WIND RESISTANT JACKETS, IN CLASS 25 (U.S. CLS. 22 AND 39).

FIRST USE 12-3-2010; IN COMMERCE 12-3-2010.

THE MARK CONSISTS OF THE STYLIZED LETTERS "NF" WHERE THE RIGHT VERTICAL STROKE OF THE "N" IS COMBINED WITH THE LETTER "F" SO THEY OVERLA.

SN 85-013,442, FILED 4-14-2010.

ANTHONY RINKER, EXAMINING ATTORNEY



David J. Kybas

Director of the United States Patent and Trademark Office

United States of America

United States Patent and Trademark Office

Meridian-IQ

Reg. No. 4,109,473

AIQ, INC. (DELAWARE CORPORATION)
270 RUTHERFORD BOULEVARD, 2ND FLOOR
CLIFTON, NJ 07014

Registered Mar. 6, 2012

Int. Cls.: 35 and 36

FOR: PROVIDING REFERRALS IN THE FIELD OF FINANCIAL ADVISORS AND INVESTMENT ADVISORS, IN CLASS 35 (U.S. CLS. 100, 101 AND 102).

SERVICE MARK

FIRST USE 12-7-2011; IN COMMERCE 12-7-2011.

PRINCIPAL REGISTER

FOR: PROVIDING REVIEWS OF FINANCIAL ADVISORS AND INVESTMENT ADVISORS, IN CLASS 36 (U.S. CLS. 100, 101 AND 102).

FIRST USE 12-7-2011; IN COMMERCE 12-7-2011.

THE MARK CONSISTS OF STANDARD CHARACTERS WITHOUT CLAIM TO ANY PARTICULAR FONT, STYLE, SIZE, OR COLOR.

SN 85-014,004, FILED 4-14-2010.

JOHN DWYER, EXAMINING ATTORNEY



David J. Kyros

Director of the United States Patent and Trademark Office

United States of America

United States Patent and Trademark Office

WASTE WIZARD

Reg. No. 4,109,474

WM HEALTHCARE SOLUTIONS, INC. (DELAWARE CORPORATION)
1001 FANNIN, SUITE 4000
HOUSTON, TX 77002

Registered Mar. 6, 2012

Int. Cl.: 40

FOR: PROVIDING INFORMATION IN THE FIELD OF WASTE MANAGEMENT FOR PHARMACEUTICAL WASTE VIA THE INTERNET; CONSULTING SERVICES IN THE FIELD OF WASTE MANAGEMENT FOR PHARMACEUTICAL WASTE; AND PROVIDING A SEARCHABLE INTERNET DATABASE OF INFORMATION IN THE FIELD OF WASTE MANAGEMENT FOR PHARMACEUTICAL WASTE, IN CLASS 40 (U.S. CLS. 100, 103 AND 106).

SERVICE MARK

PRINCIPAL REGISTER

FIRST USE 12-20-2011; IN COMMERCE 12-20-2011.

THE MARK CONSISTS OF STANDARD CHARACTERS WITHOUT CLAIM TO ANY PARTICULAR FONT, STYLE, SIZE, OR COLOR.

NO CLAIM IS MADE TO THE EXCLUSIVE RIGHT TO USE "WASTE", APART FROM THE MARK AS SHOWN.

SN 85-014,564, FILED 4-15-2010.

TRACY CROSS, EXAMINING ATTORNEY



David J. Kypos

Director of the United States Patent and Trademark Office

United States of America

United States Patent and Trademark Office

XPRESSNAP CAFÉ

Reg. No. 4,109,475

Registered Mar. 6, 2012

Int. Cl.: 16

TRADEMARK

PRINCIPAL REGISTER

SCA TISSUE NORTH AMERICA LLC (DELAWARE LIMITED LIABILITY COMPANY)
2929 ARCH STREET
CIRA CENTRE, SUITE 2600
PHILADELPHIA, PA 19104

FOR: PAPER GOODS, NAMELY, PAPER NAPKINS, IN CLASS 16 (U.S. CLS. 2, 5, 22, 23, 29, 37, 38 AND 50).

FIRST USE 10-0-2010; IN COMMERCE 10-0-2010.

THE MARK CONSISTS OF STANDARD CHARACTERS WITHOUT CLAIM TO ANY PARTICULAR FONT, STYLE, SIZE, OR COLOR.

OWNER OF U.S. REG. NOS. 2,830,790 AND 3,386,749.

NO CLAIM IS MADE TO THE EXCLUSIVE RIGHT TO USE "CAFÉ", APART FROM THE MARK AS SHOWN.

SN 85-014,844, FILED 4-15-2010.

ELI HELLMAN, EXAMINING ATTORNEY



David J. Kyros

Director of the United States Patent and Trademark Office

United States of America

United States Patent and Trademark Office

BROADWAY & BROOME

Reg. No. 4,109,476

Registered Mar. 6, 2012

Int. Cl.: 25

TRADEMARK

PRINCIPAL REGISTER

MADEWELL INC. (DELAWARE CORPORATION)
770 BROADWAY
C/O J. CREW GROUP, INC.
NEW YORK, NY 10003

FOR: CLOTHING, NAMELY, DRESSES, SKIRTS, SHIRTS, IN CLASS 25 (U.S. CLS. 22 AND 39).

FIRST USE 11-1-2010; IN COMMERCE 11-1-2010.

THE MARK CONSISTS OF STANDARD CHARACTERS WITHOUT CLAIM TO ANY PARTICULAR FONT, STYLE, SIZE, OR COLOR.

SN 85-015,820, FILED 4-16-2010.

HANNO RITTNER, EXAMINING ATTORNEY



David J. Kybas

Director of the United States Patent and Trademark Office

United States of America

United States Patent and Trademark Office

BEAVER

Reg. No. 4,109,477

WILLIAM A. O'BRIEN (UNITED STATES INDIVIDUAL)
307 GREENS FARMS ROAD
WESTPORT, CT 06880

Registered Mar. 6, 2012

Int. Cl.: 32

FOR: BEER, ALE, LAGER, STOUT, PORTER, SHANDY; MALT LIQUOR, IN CLASS 32 (U.S. CLS. 45, 46 AND 48).

TRADEMARK

FIRST USE 11-1-2011; IN COMMERCE 11-1-2011.

PRINCIPAL REGISTER

THE MARK CONSISTS OF STANDARD CHARACTERS WITHOUT CLAIM TO ANY PARTICULAR FONT, STYLE, SIZE, OR COLOR.

SN 85-016,445, FILED 4-17-2010.

PATRICIA EVANKO, EXAMINING ATTORNEY



David J. Kybas

Director of the United States Patent and Trademark Office

United States of America

United States Patent and Trademark Office



Reg. No. 4,109,478

Registered Mar. 6, 2012

Int. Cl.: 32

TRADEMARK

PRINCIPAL REGISTER

AGUAS DE SOLAN DE CABRAS, S.A. (SPAIN CORPORATION)
PARAJE DE SOLAN DE CABRAS
BETETA (CUENCA), SPAIN E-16870

FOR: MINERAL AND AERATED WATER, NAMELY, MINERAL WATER, SPARKLING WATER; FRUIT JUICES AND BEVERAGES, IN CLASS 32 (U.S. CLS. 45, 46 AND 48).

FIRST USE 2-15-2010; IN COMMERCE 2-15-2010.

OWNER OF U.S. REG. NOS. 3,048,852, 3,057,173, AND 3,078,578.

THE COLOR(S) SILVER, YELLOW, BLUE, AND WHITE IS/ARE CLAIMED AS A FEATURE OF THE MARK.

NO CLAIM IS MADE TO THE EXCLUSIVE RIGHT TO USE THE SHAPE OF THE BOTTLE, THE COLOR BLUE AND "AGUAS", APART FROM THE MARK AS SHOWN.

THE MARK CONSISTS OF A THREE-DIMENSIONAL CONFIGURATION OF THE BOTTLE FOR THE GOODS WITH WORDING AND TWO-DIMENSIONAL DESIGNS THEREON. THE BOTTLE IS BLUE WITH VERTICAL SIDES THAT ARE SLIGHTLY INDENTED AND A NARROWER NECK. THE FLAT CAP AND TOP PART OF THE BOTTLE ARE WHITE. THE WORDING "SOLAN DE CABRAS" IS BLUE WITHIN A YELLOW SQUARE WITH BLUE AND SILVER OUTLINING. THE COLORS BLUE AND SILVER ALSO APPEAR IN A CIRCLE THAT OVERLAPS THE SQUARE AND IN V-SHAPED LINES BELOW THE SQUARE. IMPRESSED INTO THE BOTTLE IS THE WORDING "BALNEARIO Y AGUAS SOLAN DE CABRAS" AND A DESIGN OF TWO GOATS, A TREE, AND A CROWN. THE SAME DESIGN APPEARS ON THE TOP OF THE BOTTLE CAP IN BLUE. THE DOTTED LINES OUTLINING THE CAP INDICATE PLACEMENT OF THE MARK ON THE GOODS AND ARE NOT PART OF THE MARK.

THE ENGLISH TRANSLATION OF "CABRAS" AND "BALNEARIO Y AGUAS" IN THE MARK IS GOATS AND HEALTH AND WATER. THE WORDING "SOLAN" HAS NO MEANING IN A FOREIGN LANGUAGE.

SN 85-016,832, FILED 4-19-2010.

KIM MONINGHOFF, EXAMINING ATTORNEY



David J. Kyros

Director of the United States Patent and Trademark Office

United States of America

United States Patent and Trademark Office



Reg. No. 4,109,479

Registered Mar. 6, 2012

Int. Cl.: 25

TRADEMARK

PRINCIPAL REGISTER

DOWNHILLIE GOLF, LLC (NORTH CAROLINA LIMITED LIABILITY COMPANY)
9902 SILVERLING DRIVE
WAXHAW, NC 28173

FOR: HATS, IN CLASS 25 (U.S. CLS. 22 AND 39).

FIRST USE 12-2-2011; IN COMMERCE 12-2-2011.

THE MARK CONSISTS OF A TRIANGLE WITH A GOLF BALL WITH MOTION MARKS INDICATING A DOWNHILL LIE. INSIDE TRIANGLE THE ABBREVIATION "DHL" EXISTS. BELOW THE TRIANGLE THERE IS THE STYLIZED TEXT "DOWNHILL LIE".

SN 85-018,063, FILED 4-20-2010.

FRANK LATTUCA, EXAMINING ATTORNEY



David J. Kyffers

Director of the United States Patent and Trademark Office

United States of America

United States Patent and Trademark Office

Esprit Rouge

Reg. No. 4,109,480

Registered Mar. 6, 2012

Int. Cl.: 33

TRADEMARK

PRINCIPAL REGISTER

TABLAS CREEK VINEYARD (CALIFORNIA LIMITED PARTNERSHIP)
9339 ADELAIDA ROAD
PASO ROBLES, CA 93446

FOR: WINE, IN CLASS 33 (U.S. CLS. 47 AND 49).

FIRST USE 12-1-2010; IN COMMERCE 12-22-2011.

THE MARK CONSISTS OF STANDARD CHARACTERS WITHOUT CLAIM TO ANY PARTICULAR FONT, STYLE, SIZE, OR COLOR.

OWNER OF U.S. REG. NO. 3,496,415.

NO CLAIM IS MADE TO THE EXCLUSIVE RIGHT TO USE "ROUGE", APART FROM THE MARK AS SHOWN.

THE ENGLISH TRANSLATION OF "ESPRIT ROUGE" IN THE MARK IS "RED SPIRIT".

SN 85-018,714, FILED 4-20-2010.

KELLEY WELLS, EXAMINING ATTORNEY



David J. Kyffers

Director of the United States Patent and Trademark Office

United States of America

United States Patent and Trademark Office

Esprit Blanc

Reg. No. 4,109,481

Registered Mar. 6, 2012

Int. Cl.: 33

TRADEMARK

PRINCIPAL REGISTER

TABLAS CREEK VINEYARD (CALIFORNIA LIMITED PARTNERSHIP)
9339 ADELAI DA ROAD
PASO ROBLES, CA 93446

FOR: WINE, IN CLASS 33 (U.S. CLS. 47 AND 49).

FIRST USE 12-1-2010; IN COMMERCE 12-22-2011.

THE MARK CONSISTS OF STANDARD CHARACTERS WITHOUT CLAIM TO ANY PARTICULAR FONT, STYLE, SIZE, OR COLOR.

OWNER OF U.S. REG. NO. 3,496,415.

NO CLAIM IS MADE TO THE EXCLUSIVE RIGHT TO USE "BLANC", APART FROM THE MARK AS SHOWN.

THE ENGLISH TRANSLATION OF "ESPRIT BLANC" IN THE MARK IS "WHITE SPIRIT".

SN 85-018,790, FILED 4-20-2010.

KELLEY WELLS, EXAMINING ATTORNEY



David J. Kyffers

Director of the United States Patent and Trademark Office

United States of America

United States Patent and Trademark Office



Reg. No. 4,109,482

Registered Mar. 6, 2012

Int. Cl.: 30

TRADEMARK

PRINCIPAL REGISTER

TRIBECA OVENS, INC. (NEW YORK CORPORATION)
447 GOTHAM PARKWAY
CARLSTADT, NJ 07072

FOR: BREAD AND ROLLS FOR CONSUMPTION ON OR OFF THE PREMISES, IN CLASS 30 (U.S. CL. 46).

FIRST USE 6-15-2010; IN COMMERCE 7-15-2010.

OWNER OF U.S. REG. NO. 2,076,751.

NO CLAIM IS MADE TO THE EXCLUSIVE RIGHT TO USE "ARTISAN BAKERS", "SMALL BATCH", "ALL-NATURAL", AND "HAND CRAFTED", APART FROM THE MARK AS SHOWN.

SN 85-019,798, FILED 4-21-2010.

SARA BENJAMIN, EXAMINING ATTORNEY



David J. Kybas

Director of the United States Patent and Trademark Office

United States of America

United States Patent and Trademark Office

DIAMOND JUBILEE

Reg. No. 4,109,483

IGT (NEVADA CORPORATION)
9295 PROTOTYPE DRIVE
RENO, NV 895218986

Registered Mar. 6, 2012

Int. Cl.: 9

FOR: GAMING MACHINES, NAMELY, DEVICES WHICH ACCEPT A WAGER, IN CLASS 9 (U.S. CLS. 21, 23, 26, 36 AND 38).

TRADEMARK

FIRST USE 11-21-2011; IN COMMERCE 11-21-2011.

PRINCIPAL REGISTER

THE MARK CONSISTS OF STANDARD CHARACTERS WITHOUT CLAIM TO ANY PARTICULAR FONT, STYLE, SIZE, OR COLOR.

SN 85-021,191, FILED 4-22-2010.

PRISCILLA MILTON, EXAMINING ATTORNEY



David J. Kybas

Director of the United States Patent and Trademark Office

United States of America

United States Patent and Trademark Office



Reg. No. 4,109,484

MEMORBANDS, LLC (ALABAMA LIMITED LIABILITY COMPANY)
843 MOUNTAIN BRANCH LANE
BIRMINGHAM, AL 35226

Registered Mar. 6, 2012

Int. Cl.: 14

FOR: GEL BRACELETS WITH WORDS OR PHRASES ON THEM, IN CLASS 14 (U.S. CLS. 2, 27, 28 AND 50).

TRADEMARK

FIRST USE 11-4-2011; IN COMMERCE 11-4-2011.

PRINCIPAL REGISTER

THE MARK CONSISTS OF THE WORD "MEMORBANDS" IN RED SURROUNDED BY A RED BRACELET WITH WHITE LINES RUNNING THROUGH IT IN FRONT OF A WHITE BACKGROUND.

THE COLOR(S) RED AND WHITE IS/ARE CLAIMED AS A FEATURE OF THE MARK.

SN 85-021,417, FILED 4-23-2010.

ODESSA BIBBINS, EXAMINING ATTORNEY



David J. Kyffers

Director of the United States Patent and Trademark Office

United States of America

United States Patent and Trademark Office

EAR MILES

Reg. No. 4,109,485

MAHNKEN ENTERPRISES, INC (WASHINGTON CORPORATION)
35115 SE RIDGE ST
SNOQUALMIE, WA 98065

Registered Mar. 6, 2012

Int. Cl.: 35

FOR: ADMINISTRATION OF A CONSUMER LOYALTY PROGRAM TO PROMOTE RESTAURANT SERVICES AND RETAIL SERVICES OF OTHERS; CUSTOMER LOYALTY SERVICES AND CUSTOMER CLUB SERVICES, FOR COMMERCIAL, PROMOTIONAL AND/OR ADVERTISING PURPOSES, IN CLASS 35 (U.S. CLS. 100, 101 AND 102).

SERVICE MARK

PRINCIPAL REGISTER

FIRST USE 12-1-2007; IN COMMERCE 12-1-2007.

THE MARK CONSISTS OF STANDARD CHARACTERS WITHOUT CLAIM TO ANY PARTICULAR FONT, STYLE, SIZE, OR COLOR.

NO CLAIM IS MADE TO THE EXCLUSIVE RIGHT TO USE "MILES", APART FROM THE MARK AS SHOWN.

SN 85-021,638, FILED 4-23-2010.

JAMES STEIN, EXAMINING ATTORNEY



David J. Kypos

Director of the United States Patent and Trademark Office

United States of America

United States Patent and Trademark Office



Reg. No. 4,109,486

Registered Mar. 6, 2012

Int. Cl.: 44

SERVICE MARK

PRINCIPAL REGISTER

JOHNSON & JOHNSON (NEW JERSEY CORPORATION)
ONE JOHNSON & JOHNSON PLAZA
NEW BRUNSWICK, NJ 089337001

FOR: PROVIDING WEBSITE FEATURING EDUCATIONAL INFORMATION FOR PATIENTS AND CAREGIVERS REGARDING PROSTATE CANCER, IN CLASS 44 (U.S. CLS. 100 AND 101).

FIRST USE 9-1-2010; IN COMMERCE 9-1-2010.

NO CLAIM IS MADE TO THE EXCLUSIVE RIGHT TO USE "PROSTATE CANCER", APART FROM THE MARK AS SHOWN.

THE MARK CONSISTS OF A SIGN OF A ROADMAP WITH AN ARROW, ALL IN A SQUARE WITH THE STYLIZED WORDS "MY PROSTATE CANCER ROADMAP" UNDERNEATH THE SIGN.

SN 85-022,766, FILED 4-26-2010.

TRACY CROSS, EXAMINING ATTORNEY



David J. Kybas

Director of the United States Patent and Trademark Office

United States of America

United States Patent and Trademark Office

ANDEX

Reg. No. 4,109,487

Registered Mar. 6, 2012

Int. Cls.: 36 and 41

SERVICE MARK

PRINCIPAL REGISTER

MORNINGSTAR, INC. (ILLINOIS CORPORATION)
22 W. WASHINGTON ST.
CHICAGO, IL 60602

FOR: PROVIDING FINANCIAL INFORMATION DERIVED FROM OR BASED UPON HISTORICAL INDICES AND/OR INVESTMENT STATISTICS, IN CLASS 36 (U.S. CLS. 100, 101 AND 102).

FIRST USE 12-9-2010; IN COMMERCE 12-9-2010.

FOR: PROVIDING ON-LINE CHARTS, REPORTS, PERIODICALS AND NEWSLETTERS FEATURING FINANCIAL DATA ON THE ECONOMY AND VARIOUS FINANCIAL MARKETS, IN CLASS 41 (U.S. CLS. 100, 101 AND 107).

FIRST USE 12-9-2010; IN COMMERCE 12-9-2010.

THE MARK CONSISTS OF STANDARD CHARACTERS WITHOUT CLAIM TO ANY PARTICULAR FONT, STYLE, SIZE, OR COLOR.

SN 85-023,469, FILED 4-26-2010.

CHRISTOPHER BUONGIORNO, EXAMINING ATTORNEY



David J. Kybas

Director of the United States Patent and Trademark Office

United States of America

United States Patent and Trademark Office

MASS.FLO.ENGINEERING

Reg. No. 4,109,488

DIESEL INJECTION SERVICE CO., INC. (KENTUCKY CORPORATION)
4710 ALLMOND AVENUE
LOUISVILLE, KY 402090389

Registered Mar. 6, 2012

Int. Cl.: 7

FOR: HYDRAULIC DIESEL FUEL INJECTORS; ELECTRONIC DIESEL FUEL INJECTORS; TURBOCHARGER COMPRESSOR WHEELS; TURBOCHARGER TURBINES; TURBOCHARGERS; DIESEL FUEL INJECTION PUMPS; DIESEL FUEL PUMPS, IN CLASS 7 (U.S. CLS. 13, 19, 21, 23, 31, 34 AND 35).

TRADEMARK

PRINCIPAL REGISTER

FIRST USE 4-1-2011; IN COMMERCE 4-1-2011.

THE MARK CONSISTS OF STANDARD CHARACTERS WITHOUT CLAIM TO ANY PARTICULAR FONT, STYLE, SIZE, OR COLOR.

SN 85-024,080, FILED 4-27-2010.

JANET LEE, EXAMINING ATTORNEY



David J. Kybas

Director of the United States Patent and Trademark Office

United States of America

United States Patent and Trademark Office

STAYNTELL!



Reg. No. 4,109,489

Registered Mar. 6, 2012

Int. Cls.: 35 and 36

SERVICE MARK

PRINCIPAL REGISTER

STAYNTELL INC. (SOUTH CAROLINA CORPORATION)
4290 ARABELLA WAY
LITTLE RIVER, SC 29566

FOR: PROVIDING AN INTERNET WEBSITE ALLOWING OWNERS, MANAGERS AND AGENTS TO ADVERTISE VACATION PROPERTIES FOR RENT, EXCHANGE AND SALE AND ALLOWING CONSUMERS TO FIND VACATION PROPERTIES FOR RENTAL, EXCHANGE AND PURCHASE, IN CLASS 35 (U.S. CLS. 100, 101 AND 102).

FIRST USE 4-1-2011; IN COMMERCE 4-1-2011.

FOR: PROVIDING AN INTERNET WEBSITE ALLOWING OWNERS, MANAGERS AND AGENTS TO LIST VACATION PROPERTIES FOR RENT, EXCHANGE AND SALE AND ALLOWING CONSUMERS TO FIND VACATION PROPERTIES FOR RENTAL, EXCHANGE AND PURCHASE, IN CLASS 36 (U.S. CLS. 100, 101 AND 102).

FIRST USE 4-1-2011; IN COMMERCE 4-1-2011.

THE MARK CONSISTS OF THE WORD "STAYNTELL" WITH A LARGE "N", THE LETTERS "STAY" IN BLACK, THE LETTER "N" IS IN BLUE WHILE THE LETTERS "TELL" ARE IN BLACK; THE BUBBLE IS IN BLUE, AND WITHIN THE BUBBLE IS A SUITCASE DESIGN IN QUOTATION MARKS IN COLOR WHITE.

THE COLOR(S) BLUE, WHITE AND BLACK IS/ARE CLAIMED AS A FEATURE OF THE MARK.

SN 85-024,464, FILED 4-27-2010.

ZACHARY BELLO, EXAMINING ATTORNEY



David J. Kybas

Director of the United States Patent and Trademark Office

United States of America

United States Patent and Trademark Office

YOGURFIT

Reg. No. 4,109,490

Registered Mar. 6, 2012

Int. Cl.: 30

TRADEMARK

PRINCIPAL REGISTER

PICO PLATA AVV, LIMITED (ST.KITTS-NEVIS LIMITED LIABILITY COMPANY)
355 ALHAMBRA CIRCLE, SUITE 801
CORAL GABLES, FL 33134

FOR: FROZEN DAIRY DESSERTS, NAMELY, SHAKES COMBINED WITH FRUITS, NUTS, CEREALS, SHAVED ICE, RICE CAKES AND CONFECTIONARIES, NAMELY, CANDIES , IN CLASS 30 (U.S. CL. 46).

FIRST USE 6-30-2011; IN COMMERCE 6-30-2011.

THE MARK CONSISTS OF STANDARD CHARACTERS WITHOUT CLAIM TO ANY PARTICULAR FONT, STYLE, SIZE, OR COLOR.

OWNER OF U.S. REG. NO. 3,956,096.

SN 85-024,477, FILED 4-27-2010.

ELISSA GARBER KON, EXAMINING ATTORNEY



David J. Kybas

Director of the United States Patent and Trademark Office

United States of America

United States Patent and Trademark Office



Reg. No. 4,109,491

Registered Mar. 6, 2012

Int. Cl.: 12

TRADEMARK

PRINCIPAL REGISTER

ROUSSEAU, JOHN (UNITED STATES INDIVIDUAL)
PO BOX 1141
LEXINGTON, TN 38351

FOR: ENVIRONMENTALLY-FRIENDLY OXYHYDROGEN GAS GENERATOR SYSTEM FOR LAND VEHICLES WHICH PRODUCES OXYHYDROGEN GAS FROM WATER USING ELECTRICAL CURRENT, NAMELY, A SYSTEM COMPRISING OF A WATER AND ELECTROLYTE RESERVOIR, METAL ELECTROLYZING PLATES WITH GASKETS OF VARIOUS SIZES AND SHAPES SEPARATING THE PLATES, AND A NON-CONDUCTIVE HOUSING FOR THE ELECTROLYZING PLATES, IN CLASS 12 (U.S. CLS. 19, 21, 23, 31, 35 AND 44).

FIRST USE 1-1-2010; IN COMMERCE 1-1-2010.

THE MARK CONSISTS OF THE STYLIZED WORDING "HHOGREENMACHINE" AND A DESIGN COMPRISED OF THREE ADJACENT HEXAGONS ARRANGED WITH TWO HEXAGONS ON THE BOTTOM AND ONE HEXAGON ADJACENT TO THOSE HEXAGONS ON THE TOP.

SN 85-024,685, FILED 4-27-2010.

CYNTHIA TRIPI, EXAMINING ATTORNEY



David J. Kyffers

Director of the United States Patent and Trademark Office

United States of America

United States Patent and Trademark Office

GO ENERGIES

Reg. No. 4,109,492

Registered Mar. 6, 2012

Int. Cl.: 42

SERVICE MARK

PRINCIPAL REGISTER

ARKIPELAGO INTERNATIONAL, INC. (NORTH CAROLINA CORPORATION)
3301 BRUNT MILL DRIVE
WILMINGTON, NC 28403

FOR: COMPUTER SERVICES, NAMELY, PROVIDING USERS REMOTE MONITORING OF USE OF AND AN INVENTORY OF CONSUMABLE PRODUCTS, NAMELY, GAS AND FUEL SUPPLIES, THROUGH COMPUTER NETWORKS, IN CLASS 42 (U.S. CLS. 100 AND 101).

FIRST USE 9-1-2011; IN COMMERCE 9-1-2011.

THE MARK CONSISTS OF STANDARD CHARACTERS WITHOUT CLAIM TO ANY PARTICULAR FONT, STYLE, SIZE, OR COLOR.

SN 85-025,946, FILED 4-29-2010.

ODESSA BIBBINS, EXAMINING ATTORNEY



David J. Kyffers

Director of the United States Patent and Trademark Office

United States of America

United States Patent and Trademark Office



Reg. No. 4,109,493

CALLIDUS BIOPHARMA, INC. (DELAWARE CORPORATION)
3220 PILLMAN DRIVE, SUITE 301
BENSALEM, PA 19020

Registered Mar. 6, 2012

Int. Cl.: 5

FOR: PHARMACEUTICALS USED IN ENZYME REPLACEMENT THERAPIES, IN CLASS 5 (U.S. CLS. 6, 18, 44, 46, 51 AND 52).

TRADEMARK

FIRST USE 10-1-2011; IN COMMERCE 10-1-2011.

PRINCIPAL REGISTER

NO CLAIM IS MADE TO THE EXCLUSIVE RIGHT TO USE "BIOPHARMA", APART FROM THE MARK AS SHOWN.

THE MARK CONSISTS OF A DESIGN OF THREE STACKED DIAGONAL BARS WITH A FAINT MIRROR IMAGE IN THE BACKGROUND. TO THE RIGHT OF THE DESIGN IS THE WORDING "CALLIDUS" WITH A LINE UNDERNEATH THE "CALL" LETTERING AND THE WORD "BIOPHARMA" TO THE RIGHT OF THE UNDERLINE.

SN 85-025,948, FILED 4-29-2010.

JENNIFER VASQUEZ, EXAMINING ATTORNEY



David J. Kyros

Director of the United States Patent and Trademark Office

United States of America

United States Patent and Trademark Office

Claim Your Domain

Reg. No. 4,109,494

GO DADDY OPERATING COMPANY, LLC (DELAWARE LIMITED LIABILITY COMPANY)
14455 N. HAYDEN ROAD, SUITE 219
SCOTTSDALE, AZ 85260

Registered Mar. 6, 2012

Int. Cl.: 45

FOR: REGISTRATION OF DOMAIN NAMES FOR IDENTIFICATION OF USERS ON A
GLOBAL COMPUTER NETWORK, IN CLASS 45 (U.S. CLS. 100 AND 101).

SERVICE MARK

FIRST USE 4-15-2010; IN COMMERCE 4-15-2010.

PRINCIPAL REGISTER

THE MARK CONSISTS OF STANDARD CHARACTERS WITHOUT CLAIM TO ANY PAR-
TICULAR FONT, STYLE, SIZE, OR COLOR.

NO CLAIM IS MADE TO THE EXCLUSIVE RIGHT TO USE "DOMAIN", APART FROM THE
MARK AS SHOWN.

SN 85-026,279, FILED 4-29-2010.

KAREN K. BUSH, EXAMINING ATTORNEY



David J. Kybas

Director of the United States Patent and Trademark Office

United States of America

United States Patent and Trademark Office

STAAR CONNECTION

Reg. No. 4,109,495

Registered Mar. 6, 2012

Int. Cl.: 9

TRADEMARK

PRINCIPAL REGISTER

KAMICO INSTRUCTIONAL MEDIA, INC. (TEXAS CORPORATION)
P.O. BOX 1143
SALADO, TX 76571

FOR: COMPUTER SOFTWARE FOR USE IN EDUCATIONAL DATABASE MANAGEMENT;
AND INTERACTIVE COMPUTER SOFTWARE FOR USE IN EDUCATING CHILDREN AND
ADULTS IN THE FIELD OF SCIENCE, MATH, READING, SPELLING, GRAMMAR, COM-
POSITION, SOCIAL STUDIES, AND FINE ARTS, IN CLASS 9 (U.S. CLS. 21, 23, 26, 36 AND
38).

FIRST USE 2-8-2010; IN COMMERCE 2-8-2010.

THE MARK CONSISTS OF STANDARD CHARACTERS WITHOUT CLAIM TO ANY PAR-
TICULAR FONT, STYLE, SIZE, OR COLOR.

OWNER OF U.S. REG. NOS. 2,698,790, 3,109,882, AND OTHERS.

NO CLAIM IS MADE TO THE EXCLUSIVE RIGHT TO USE "STAAR", APART FROM THE
MARK AS SHOWN.

SN 85-028,431, FILED 5-3-2010.

TASNEEM HUSSAIN, EXAMINING ATTORNEY



David J. Kybas

Director of the United States Patent and Trademark Office

United States of America

United States Patent and Trademark Office

STAAR CONNECTION

Reg. No. 4,109,496

Registered Mar. 6, 2012

Int. Cl.: 41

SERVICE MARK

PRINCIPAL REGISTER

KAMICO INSTRUCTIONAL MEDIA, INC. (TEXAS CORPORATION)
P.O. BOX 1143
SALADO, TX 76571

FOR: EDUCATIONAL TRAINING, NAMELY, CONDUCTING WORKSHOPS AND TEACHER TRAINING SEMINARS ON A VARIETY OF ACADEMIC TOPICS RELATED TO NATION-WIDE CURRICULUM AND STATE SPECIFIC CURRICULUM FOR STUDENTS IN GRADES K-12; PUBLICATION OF EDUCATIONAL TEXTS AND GRAPHICS IN THE FORM OF TEXTBOOKS, WORKBOOKS, AND MAGAZINES; PROVIDING ON-LINE COMPUTER DATABASES IN THE FIELD OF K-12 EDUCATIONAL CURRICULUM, IN CLASS 41 (U.S. CLS. 100, 101 AND 107).

FIRST USE 4-19-2010; IN COMMERCE 4-19-2010.

THE MARK CONSISTS OF STANDARD CHARACTERS WITHOUT CLAIM TO ANY PARTICULAR FONT, STYLE, SIZE, OR COLOR.

OWNER OF U.S. REG. NOS. 2,698,790, 3,109,882, AND OTHERS.

NO CLAIM IS MADE TO THE EXCLUSIVE RIGHT TO USE "STAAR", APART FROM THE MARK AS SHOWN.

SN 85-028,443, FILED 5-3-2010.

TASNEEM HUSSAIN, EXAMINING ATTORNEY



David J. Kyros

Director of the United States Patent and Trademark Office

United States of America

United States Patent and Trademark Office

STAAR CONNECTION

Reg. No. 4,109,497

KAMICO INSTRUCTIONAL MEDIA, INC. (TEXAS CORPORATION)

Registered Mar. 6, 2012

P.O. BOX 1143
SALADO, TX 76571

Int. Cl.: 16

FOR: PRINTED MATERIALS, NAMELY, TEXTBOOKS, MANUALS, AND WORKBOOKS FEATURING PRIMARY AND SECONDARY EDUCATIONAL CURRICULUM SUBJECTS FOR USE IN TEACHING AND TRAINING CHILDREN AND ADULTS, IN CLASS 16 (U.S. CLS. 2, 5, 22, 23, 29, 37, 38 AND 50).

TRADEMARK

PRINCIPAL REGISTER

FIRST USE 2-8-2011; IN COMMERCE 2-8-2011.

THE MARK CONSISTS OF STANDARD CHARACTERS WITHOUT CLAIM TO ANY PARTICULAR FONT, STYLE, SIZE, OR COLOR.

OWNER OF U.S. REG. NOS. 2,698,790, 3,109,882, AND OTHERS.

NO CLAIM IS MADE TO THE EXCLUSIVE RIGHT TO USE "STAAR", APART FROM THE MARK AS SHOWN.

SN 85-028,470, FILED 5-3-2010.

TASNEEM HUSSAIN, EXAMINING ATTORNEY



David J. Kyros

Director of the United States Patent and Trademark Office

United States of America

United States Patent and Trademark Office

GODDESS SOULMATE MOTHER FRIEND

Reg. No. 4,109,498

Registered Mar. 6, 2012

Int. Cls.: 3 and 4

TRADEMARK

PRINCIPAL REGISTER

HONEY CHILD ENTERPRISES, LLC (FLORIDA LIMITED LIABILITY COMPANY)
6619 SOUTH DIXIE HIGHWAY
PMB 382
MIAMI, FL 33413

FOR: PERSONAL CARE PRODUCTS, NAMELY, AFTERSHAVE, BATH BEADS, BATH OIL, NON-MEDICATED BATH SALTS, BUBBLE BATH, COLOGNE, CREAM FOR THE EYES, CREAM FOR THE FACE, CREAM FOR THE HANDS, ESSENTIAL OILS, EXFOLIATORS FOR THE SKIN IN THE NATURE OF SKIN CLEANSERS, EYE GELS, EYE MAKEUP PENCILS, EYE SHADOW, FACE HIGHLIGHTER, NAMELY, BLUSH, FACIAL MASKS, FACE SCRUB, NON-MEDICATED FOOT SOAK, FOUNDATION, FRAGRANT BODY SPLASH, FRAGRANT BODY MIST, HAIR CONDITIONER, HAIR POMADE, HAIR SHAMPOO, HAIR STYLING GEL, HAIR STYLING MOUSSE, LIP BALM, NON-MEDICATED CLEANSER FOR THE FACE, NON-MEDICATED FOOT DEODORANT SPRAY, POWDER FOR THE BODY, SALT SCRUBS FOR THE SKIN, SHOWER GEL, SKIN BRONZING CREAM, SUN BLOCK, COSMETIC SUNTAN LOTION AND HOME FRAGRANCE PRODUCTS, NAMELY, POTPOURRI, ROOM FRAGRANCING GELS, SCENTED ROOM FRAGRANCES AND TOILETRY KITS, NAMELY, NON-MEDICATED TOILETRIES, IN CLASS 3 (U.S. CLS. 1, 4, 6, 50, 51 AND 52).

FIRST USE 10-1-2011; IN COMMERCE 10-1-2011.

FOR: CANDLES, IN CLASS 4 (U.S. CLS. 1, 6 AND 15).

FIRST USE 10-1-2011; IN COMMERCE 10-1-2011.

THE MARK CONSISTS OF STANDARD CHARACTERS WITHOUT CLAIM TO ANY PARTICULAR FONT, STYLE, SIZE, OR COLOR.

OWNER OF U.S. REG. NO. 3,188,291.

SN 85-028,713, FILED 5-3-2010.

JESSICA A. POWERS, EXAMINING ATTORNEY



David J. Kyros

Director of the United States Patent and Trademark Office

United States of America

United States Patent and Trademark Office

MONKEY SEA MONKEY DOO

Reg. No. 4,109,499

Registered Mar. 6, 2012

Int. Cl.: 3

TRADEMARK

PRINCIPAL REGISTER

MONKEY SEA MONKEY DOO (CALIFORNIA CORPORATION)
25 GINGERWOOD
IRVINE, CA 92603

FOR: BABY SHAMPOO; BODY LOTION; BODY WASH GEL; BUBBLE BATH; DETANGLING HAIR SPRAY; HAIR CONDITIONER; HAIR SPRAYS; BATH SOAPS IN LIQUID, SOLID OR GEL FORM; BODY WASH FOR PERSONAL CARE; SHAMPOO; SHAMPOO-CONDITIONERS; SHOWER GEL; SKIN AND BODY TOPICAL LOTIONS; 2 IN 1 SHAMPOO AND CONDITIONER FOR CHILDREN; GEL SHAMPOO FOR CHILDREN; LOTIONS FOR FACE AND BODY CARE; FACE AND BODY CREAM FOR CHILDREN; BABY BUBBLE BATH; BABY HAIR CONDITIONER; BABY LOTION; AND SHOWER AND BATH GEL, IN CLASS 3 (U.S. CLS. 1, 4, 6, 50, 51 AND 52).

FIRST USE 12-1-2011; IN COMMERCE 12-1-2011.

THE MARK CONSISTS OF STANDARD CHARACTERS WITHOUT CLAIM TO ANY PARTICULAR FONT, STYLE, SIZE, OR COLOR.

SN 85-029,804, FILED 5-4-2010.

BARBARA A. GOLD, EXAMINING ATTORNEY



David J. Kyros

Director of the United States Patent and Trademark Office

United States of America

United States Patent and Trademark Office

VALET CONNECTOR

Reg. No. 4,109,500

CISCO TECHNOLOGY, INC. (CALIFORNIA CORPORATION)
170 WEST TASMAN DRIVE
SAN JOSE, CA 95134

Registered Mar. 6, 2012

Int. Cl.: 9

FOR: COMPUTER HARDWARE, NAMELY, NETWORK ADAPTERS, IN CLASS 9 (U.S. CLS. 21, 23, 26, 36 AND 38).

TRADEMARK

FIRST USE 4-0-2010; IN COMMERCE 4-0-2010.

PRINCIPAL REGISTER

THE MARK CONSISTS OF STANDARD CHARACTERS WITHOUT CLAIM TO ANY PARTICULAR FONT, STYLE, SIZE, OR COLOR.

PRIORITY CLAIMED UNDER SEC. 44(D) ON CANADA APPLICATION NO. 1473487, FILED 3-17-2010.

NO CLAIM IS MADE TO THE EXCLUSIVE RIGHT TO USE "CONNECTOR", APART FROM THE MARK AS SHOWN.

SN 85-030,133, FILED 5-4-2010.

TASNEEM HUSSAIN, EXAMINING ATTORNEY



David J. Kybas

Director of the United States Patent and Trademark Office

United States of America

United States Patent and Trademark Office



LITTLE MARVELS
Montessori

Reg. No. 4,109,501

AA CONSULTING (TEXAS CORPORATION)
4025 HIGHLAND SHORES DR
PLANO, TX 75024

Registered Mar. 6, 2012

Int. Cl.: 41

FOR: EDUCATION SERVICES, NAMELY, CONDUCTING CLASSES FOR PRESCHOOL AGE CHILDREN IN BASIC EDUCATIONAL SKILLS, IN CLASS 41 (U.S. CLS. 100, 101 AND 107).

SERVICE MARK

FIRST USE 11-5-2010; IN COMMERCE 11-5-2010.

PRINCIPAL REGISTER

NO CLAIM IS MADE TO THE EXCLUSIVE RIGHT TO USE "MONTESSORI", APART FROM THE MARK AS SHOWN.

THE COLOR(S) RED, BLACK AND GRAY IS/ARE CLAIMED AS A FEATURE OF THE MARK.

THE MARK CONSISTS OF THE RED AND BLACK LETTERS "L" AND "M" EMBEDDED IN A RED AND BLACK CASTLE DESIGN WITH A BLACK DOOR AND RED STEPS WITH GRAY SHADING IN THE CASTLE FOREGROUND. THERE IS A RED ADULT FIGURE STANDING ON THE LETTER "L" HOLDING A BLACK CHILD FIGURE. THE STYLIZED WORDING "LITTLE MARVELS" IS IN RED AND BLACK. THE WORD "MONTESSORI" IS IN BLACK AND GRAY.

SN 85-030,310, FILED 5-4-2010.

BRENDAN MCCAULEY, EXAMINING ATTORNEY



David J. Kybas

Director of the United States Patent and Trademark Office

United States of America

United States Patent and Trademark Office

SEXY LITTLE BRIDE

Reg. No. 4,109,502

VICTORIA'S SECRET STORES BRAND MANAGEMENT, INC. (DELAWARE CORPORATION)
FOUR LIMITED PARKWAY
REYNOLDSBURG, OH 43068

Registered Mar. 6, 2012

Int. Cl.: 25

FOR: BRAS; LINGERIE; NIGHTIES; PAJAMAS; ROBES; SLEEPWEAR, IN CLASS 25 (U.S. CLS. 22 AND 39).

TRADEMARK

FIRST USE 2-28-2011; IN COMMERCE 2-28-2011.

PRINCIPAL REGISTER

THE MARK CONSISTS OF STANDARD CHARACTERS WITHOUT CLAIM TO ANY PARTICULAR FONT, STYLE, SIZE, OR COLOR.

OWNER OF U.S. REG. NOS. 3,161,607, 3,480,520, AND OTHERS.

SN 85-030,966, FILED 5-5-2010.

TEJBIR SINGH, EXAMINING ATTORNEY



David J. Kybas

Director of the United States Patent and Trademark Office

United States of America

United States Patent and Trademark Office



Reg. No. 4,109,503

Registered Mar. 6, 2012

Int. Cls.: 35 and 42

SERVICE MARK

PRINCIPAL REGISTER

ADBRITE, INC. (DELAWARE CORPORATION)
731 MARKET STREET, SUITE 500
SAN FRANCISCO, CA 94103

FOR: RENTAL OF ONLINE ADVERTISING SPACE; ADVERTISING CONSULTATION; ADVERTISING AND MARKETING; ADVERTISING AGENCIES; ADVERTISING NETWORKS, NAMELY, SERVICES WHICH CONNECT ONLINE SITES THAT WANT TO HOST ADVERTISEMENTS WITH ADVERTISERS WHO WANT TO RUN ADVERTISEMENTS; DISSEMINATION OF ADVERTISING FOR OTHERS VIA THE INTERNET OR OTHER COMMUNICATIONS NETWORK; ONLINE ADVERTISING SERVICES FOR OTHERS, NAMELY, PROVIDING ADVERTISING SPACE ON INTERNET WEBSITES; COLLECTION OF USER DATA FOR ADVERTISING PURPOSES, NAMELY, CONDUCTING CONSUMER TRACKING BEHAVIOR RESEARCH AND CONSUMER BEHAVIOR ANALYSIS, IN CLASS 35 (U.S. CLS. 100, 101 AND 102).

FIRST USE 10-4-2010; IN COMMERCE 10-4-2010.

FOR: APPLICATION SERVICE PROVIDER FEATURING SOFTWARE FOR USE IN DISPLAYING AND DISTRIBUTING ELECTRONIC MEDIA OVER THE INTERNET FOR ADVERTISING AND MARKETING PURPOSES, IN CLASS 42 (U.S. CLS. 100 AND 101).

FIRST USE 10-4-2010; IN COMMERCE 10-4-2010.

THE MARK CONSISTS OF THE LETTER "A" COMPRISED OF SMALL INDIVIDUAL SQUARES.

SN 85-030,982, FILED 5-5-2010.

JENNIFER MARTIN, EXAMINING ATTORNEY



David J. Kybas

Director of the United States Patent and Trademark Office

United States of America

United States Patent and Trademark Office

SENSICODE

Reg. No. 4,109,504

Registered Mar. 6, 2012

Int. Cl.: 2

TRADEMARK

PRINCIPAL REGISTER

SENSIENT IMAGING TECHNOLOGIES INC. (CALIFORNIA CORPORATION)
777 EAST WISCONSIN AVENUE
MILWAUKEE, WI 53202

FOR: PRINTING INK; INK FOR INKJET PRINTERS; INKS FOR PRINTING ON WIRE AND CABLE; INDUSTRIAL PRINTING INKS; COATING COMPOSITION IN THE NATURE OF PAINT FOR INDUSTRIAL APPLICATIONS; HIGH RESOLUTION PRINTING INKS; LARGE CHARACTER PRINTING INKS; INKS FOR USE IN CONNECTION WITH STENCILS, IN CLASS 2 (U.S. CLS. 6, 11 AND 16).

FIRST USE 1-3-2011; IN COMMERCE 1-3-2011.

THE MARK CONSISTS OF STANDARD CHARACTERS WITHOUT CLAIM TO ANY PARTICULAR FONT, STYLE, SIZE, OR COLOR.

SN 85-031,168, FILED 5-5-2010.

HOWARD B. LEVINE, EXAMINING ATTORNEY



David J. Kybas

Director of the United States Patent and Trademark Office

United States of America

United States Patent and Trademark Office

SENSIMAIL

Reg. No. 4,109,505

Registered Mar. 6, 2012

Int. Cl.: 2

TRADEMARK

PRINCIPAL REGISTER

SENSIENT IMAGING TECHNOLOGIES INC. (CALIFORNIA CORPORATION)
777 EAST WISCONSIN AVENUE
MILWAUKEE, WI 53202

FOR: PRINTING INK; INK FOR INKJET PRINTERS; INKS FOR PRINTING ON WIRE AND CABLE; INDUSTRIAL PRINTING INKS; COATING COMPOSITION IN THE NATURE OF PAINT FOR INDUSTRIAL APPLICATIONS; HIGH RESOLUTION PRINTING INKS; LARGE CHARACTER PRINTING INKS; INKS FOR USE IN CONNECTION WITH STENCILS, IN CLASS 2 (U.S. CLS. 6, 11 AND 16).

FIRST USE 5-15-2010; IN COMMERCE 5-15-2010.

THE MARK CONSISTS OF STANDARD CHARACTERS WITHOUT CLAIM TO ANY PARTICULAR FONT, STYLE, SIZE, OR COLOR.

SN 85-031,170, FILED 5-5-2010.

HOWARD B. LEVINE, EXAMINING ATTORNEY



David J. Kyffers

Director of the United States Patent and Trademark Office

United States of America

United States Patent and Trademark Office

HANDLED WITH CARE

Reg. No. 4,109,506

Registered Mar. 6, 2012

Int. Cls.: 31 and 35

TRADEMARK

SERVICE MARK

PRINCIPAL REGISTER

STAR PRODUCE LTD. (CANADA CORPORATION)
366 EDSON STREET, SASKATOON
SASKATCHEWAN, CANADA S7J0P9

FOR: FRESH FRUITS AND VEGETABLES, IN CLASS 31 (U.S. CLS. 1 AND 46).

FIRST USE 8-0-2009; IN COMMERCE 10-0-2009.

FOR: DISTRIBUTORSHIP SERVICES TO WHOLESALERS, FOOD SERVICE COMPANIES AND GROCERS IN THE FIELD OF FRUITS AND VEGETABLES, IN CLASS 35 (U.S. CLS. 100, 101 AND 102).

FIRST USE 8-0-2009; IN COMMERCE 10-0-2009.

THE MARK CONSISTS OF STANDARD CHARACTERS WITHOUT CLAIM TO ANY PARTICULAR FONT, STYLE, SIZE, OR COLOR.

OWNER OF CANADA REG. NO. TMA789399, DATED 2-1-2011, EXPIRES 2-1-2026.

SN 85-031,218, FILED 5-5-2010.

CIMMERIAN COLEMAN, EXAMINING ATTORNEY



David J. Kybas

Director of the United States Patent and Trademark Office

United States of America

United States Patent and Trademark Office

IxCacao Brownies

Reg. No. 4,109,507

WHITNEY, HEIDI L (UNITED STATES INDIVIDUAL)
555 PASO ROBLES DR.
SANTA BARBARA, CA 93108

Registered Mar. 6, 2012

Int. Cl.: 30

FOR: BROWNIES, IN CLASS 30 (U.S. CL. 46).

TRADEMARK

FIRST USE 5-1-2011; IN COMMERCE 8-1-2011.

PRINCIPAL REGISTER

THE MARK CONSISTS OF STANDARD CHARACTERS WITHOUT CLAIM TO ANY PARTICULAR FONT, STYLE, SIZE, OR COLOR.

NO CLAIM IS MADE TO THE EXCLUSIVE RIGHT TO USE "BROWNIES", APART FROM THE MARK AS SHOWN.

THE WORDING "IXCACAO" HAS NO MEANING IN A FOREIGN LANGUAGE.

SN 85-031,360, FILED 5-6-2010.

CHARISMA HAMPTON, EXAMINING ATTORNEY



David J. Kyffers

Director of the United States Patent and Trademark Office

United States of America

United States Patent and Trademark Office

OpenPublic

Reg. No. 4,109,508

Registered Mar. 6, 2012

Int. Cl.: 9

TRADEMARK

PRINCIPAL REGISTER

PHASE2 TECHNOLOGY, LLC (VIRGINIA LIMITED LIABILITY COMPANY)
1033 NORTH FAIRFAX STREET, SUITE 400
ALEXANDRIA, VA 22314

FOR: DOWNLOADABLE COMPUTER SOFTWARE FOR THE PURPOSE OF PUBLISHING AND SHARING INFORMATION ONLINE FROM GOVERNMENT AGENCIES, IN CLASS 9 (U.S. CLS. 21, 23, 26, 36 AND 38).

FIRST USE 3-7-2011; IN COMMERCE 3-7-2011.

THE MARK CONSISTS OF STANDARD CHARACTERS WITHOUT CLAIM TO ANY PARTICULAR FONT, STYLE, SIZE, OR COLOR.

SN 85-032,111, FILED 5-6-2010.

BILL DAWE, EXAMINING ATTORNEY



David J. Kybas

Director of the United States Patent and Trademark Office

United States of America

United States Patent and Trademark Office

HEALTHY CHICK

Reg. No. 4,109,509

HEALTHY CHICK, INC (NEVADA CORPORATION)
1835 A SOUTH CENTRE CITY PKWY, STE. 181
ESCONDIDO, CA 92025

Registered Mar. 6, 2012

**Int. Cls.: 3, 5, 7, 9, 25, 28,
29, 35, and 41**

FOR: NON-MEDICATED SKIN CARE PREPARATIONS, HAIR CARE PREPARATIONS, BODY AND BEAUTY CARE COSMETICS, COSMETICS, AND COTTON SWABS FOR CLEANING THE EAR, IN CLASS 3 (U.S. CLS. 1, 4, 6, 50, 51 AND 52).

TRADEMARK

FIRST USE 10-1-2011; IN COMMERCE 10-1-2011.

SERVICE MARK

FOR: NUTRITIONAL SUPPLEMENTS, ENERGY BOOSTING BARS FOR USE AS A MEAL SUBSTITUTE, DIETARY SUPPLEMENT DRINK MIXES, AND FEMININE HYGIENE PADS, IN CLASS 5 (U.S. CLS. 6, 18, 44, 46, 51 AND 52).

PRINCIPAL REGISTER

FIRST USE 10-1-2011; IN COMMERCE 10-1-2011.

FOR: ELECTRIC FOOD PROCESSORS , IN CLASS 7 (U.S. CLS. 13, 19, 21, 23, 31, 34 AND 35).

FIRST USE 10-1-2011; IN COMMERCE 10-1-2011.

FOR: AUDIO AND VIDEO RECORDINGS FEATURING CONTENT IN THE FIELD OF BODY IMAGE, WEIGHTLOSS, FITNESS, EXERCISE AND POSITIVE AFFIRMATION, IN CLASS 9 (U.S. CLS. 21, 23, 26, 36 AND 38).

FIRST USE 10-1-2011; IN COMMERCE 10-1-2011.

FOR: CLOTHING, NAMELY, SHIRTS, T-SHIRTS, HEADWEAR, TOPS AND BOTTOMS, IN CLASS 25 (U.S. CLS. 22 AND 39).

FIRST USE 10-1-2011; IN COMMERCE 10-1-2011.

FOR: MANUALLY-OPERATED EXERCISE EQUIPMENT; YOGA MATS, IN CLASS 28 (U.S. CLS. 22, 23, 38 AND 50).

FIRST USE 10-1-2011; IN COMMERCE 10-1-2011.



David J. Kyffers

Director of the United States Patent and Trademark Office

Reg. No. 4,109,509 FOR: TRAIL MIX CONSISTING OF PROCESSED NUTS, SEEDS AND DRIED FRUIT; PROCESSED NUTS; PROCESSED EDIBLE SEEDS, IN CLASS 29 (U.S. CL. 46).

FIRST USE 10-1-2011; IN COMMERCE 10-1-2011.

FOR: ONLINE RETAIL STORE SERVICES FEATURING NON-MEDICATED SKIN CARE PREPARATIONS, HAIR CARE PREPARATIONS, COSMETICS, COTTON SWABS FOR CLEANING THE EAR, NUTRITIONAL SUPPLEMENTS, ENERGY BOOSTING BARS FOR USE AS A MEAL SUBSTITUTE, DIETARY SUPPLEMENT DRINK MIXES, FEMININE HYGIENE PADS, FOOD PROCESSORS, AUDIO AND VIDEO RECORDINGS, CLOTHING, EXERCISE EQUIPMENT, YOGA MATS, AND FOOD, IN CLASS 35 (U.S. CLS. 100, 101 AND 102).

FIRST USE 10-1-2011; IN COMMERCE 10-1-2011.

FOR: CONDUCTING WORKSHOPS AND SEMINARS IN THE FIELD OF HEALTH, NAMELY, FOR ACHIEVING HEALTHY LIFESTYLE WELLNESS, IN CLASS 41 (U.S. CLS. 100, 101 AND 107).

FIRST USE 10-1-2011; IN COMMERCE 10-1-2011.

THE MARK CONSISTS OF STANDARD CHARACTERS WITHOUT CLAIM TO ANY PARTICULAR FONT, STYLE, SIZE, OR COLOR.

NO CLAIM IS MADE TO THE EXCLUSIVE RIGHT TO USE "HEALTHY", APART FROM THE MARK AS SHOWN.

SN 85-032,233, FILED 5-6-2010.

LOURDES AYALA, EXAMINING ATTORNEY

United States of America

United States Patent and Trademark Office



Reg. No. 4,109,510

RICHARD F. RUDINGER (UNITED STATES INDIVIDUAL)
7312 PARKVIEW DRIVE
FREDERICK, MD 21702

Registered Mar. 6, 2012

Int. Cls.: 5, 23, and 24

FOR: WOUND DRESSINGS CONTAINING COPPER FIBERS, IN CLASS 5 (U.S. CLS. 6, 18, 44, 46, 51 AND 52).

TRADEMARK

FIRST USE 2-1-2009; IN COMMERCE 11-1-2011.

PRINCIPAL REGISTER

FOR: YARN AND THREAD, CONTAINING COPPER FIBERS, FOR TEXTILE PURPOSES; YARNS AND THREADS, CONTAINING COPPER FIBERS, FOR TEXTILE USE, IN CLASS 23 (U.S. CL. 43).

FIRST USE 2-1-2009; IN COMMERCE 11-1-2009.

FOR: FABRICS, CONTAINING COPPER FIBERS, FOR TEXTILE USE; TEXTILE FABRICS, CONTAINING COPPER FIBERS, FOR THE MANUFACTURE OF CLOTHING, IN CLASS 24 (U.S. CLS. 42 AND 50).

FIRST USE 2-1-2009; IN COMMERCE 11-1-2009.

NO CLAIM IS MADE TO THE EXCLUSIVE RIGHT TO USE "29 CU" , APART FROM THE MARK AS SHOWN.

THE COLOR(S) COPPER, BLACK AND WHITE IS/ARE CLAIMED AS A FEATURE OF THE MARK.

THE MARK CONSISTS OF "29 CU" IN WHITE SURROUNDED BY A COPPER SHADED SQUARE, SITUATED TO THE LEFT OF THE LETTERS "TEC" IN BLACK. THE NUMBER "29" APPEARS IN SMALLER TEXT ABOVE THE LETTER "U" IN "CU."

SN 85-032,717, FILED 5-7-2010.

MATTHEW PAPPAS, EXAMINING ATTORNEY

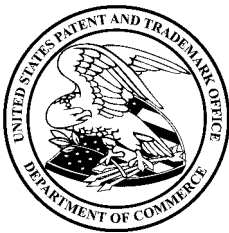

David J. Kyppas

Director of the United States Patent and Trademark Office

United States of America

United States Patent and Trademark Office

HPI-Process

Reg. No. 4,109,511

EM HOLDING GMBH & CO KG (FED REP GERMANY LIMITED LIABILITY COMPANY)
RUDOLFSTRASSE 112

Registered Mar. 6, 2012

PLANEGG, FED REP GERMANY D-82152

Int. Cl.: 37

FOR: CLEANING OF WELLS; WATER WELL DRILLING, IN CLASS 37 (U.S. CLS. 100, 103 AND 106).

SERVICE MARK

FIRST USE 9-30-2011; IN COMMERCE 9-30-2011.

PRINCIPAL REGISTER

THE MARK CONSISTS OF STANDARD CHARACTERS WITHOUT CLAIM TO ANY PARTICULAR FONT, STYLE, SIZE, OR COLOR.

SN 85-034,532, FILED 5-10-2010.

ROSELLE HERRERA, EXAMINING ATTORNEY



David J. Kybas

Director of the United States Patent and Trademark Office

United States of America

United States Patent and Trademark Office

WQHYDRA

Reg. No. 4,109,512

Registered Mar. 6, 2012

Int. Cl.: 9

TRADEMARK

PRINCIPAL REGISTER

WORLDQUANT, LLC (DELAWARE LIMITED LIABILITY COMPANY)
THIRD FLOOR
1700 EAST PUTNAM AVENUE
OLD GREENWICH, CT 06870

FOR: COMPUTER PROGRAMS FOR USE IN CONNECTION WITH ELECTRONIC TRADING OF VARIOUS FINANCIAL INSTRUMENTS, NAMELY, SOFTWARE FOR ELECTRONICALLY TRADING SECURITIES, IN CLASS 9 (U.S. CLS. 21, 23, 26, 36 AND 38).

FIRST USE 7-12-2011; IN COMMERCE 7-12-2011.

THE MARK CONSISTS OF STANDARD CHARACTERS WITHOUT CLAIM TO ANY PARTICULAR FONT, STYLE, SIZE, OR COLOR.

SN 85-034,540, FILED 5-10-2010.

CHRISTINE COOPER, EXAMINING ATTORNEY



David J. Kybas

Director of the United States Patent and Trademark Office

United States of America

United States Patent and Trademark Office

PRIMER CONTACTO USA

Reg. No. 4,109,513

MELALEUCA, INC. (IDAHO CORPORATION)
3910 S. YELLOWSTONE HWY.
IDAHO FALLS, ID 83402

Registered Mar. 6, 2012

Int. Cl.: 35

FOR: LEGAL EXPENSE PLAN SERVICES, NAMELY, PROVIDING ATTORNEY REFERRALS,
IN CLASS 35 (U.S. CLS. 100, 101 AND 102).

SERVICE MARK

FIRST USE 6-0-2010; IN COMMERCE 6-0-2010.

PRINCIPAL REGISTER

THE MARK CONSISTS OF STANDARD CHARACTERS WITHOUT CLAIM TO ANY PARTICULAR FONT, STYLE, SIZE, OR COLOR.

NO CLAIM IS MADE TO THE EXCLUSIVE RIGHT TO USE "USA", APART FROM THE MARK AS SHOWN.

THE ENGLISH TRANSLATION OF "PRIMER CONTACTO" IN THE MARK IS "FIRST CONTACT".

SN 85-035,129, FILED 5-11-2010.

STEVEN JACKSON, EXAMINING ATTORNEY



David J. Kybas

Director of the United States Patent and Trademark Office

United States of America

United States Patent and Trademark Office



Reg. No. 4,109,514

Registered Mar. 6, 2012

Int. Cls.: 37, 44, and 45

SERVICE MARK

PRINCIPAL REGISTER

GAFFEY HOME NURSING AND HOSPICE INC. (ILLINOIS CORPORATION)
3408 EAST 23RD STREET
STERLING, IL 61081

FOR: HOUSEKEEPING SERVICES, NAMELY, CLEANING OF RESIDENTIAL HOUSES; MEDICAL WASTE, BLOOD AND BODILY FLUID CLEANING AND DISPOSAL SERVICES, IN CLASS 37 (U.S. CLS. 100, 103 AND 106).

FIRST USE 6-0-2011; IN COMMERCE 6-0-2011.

FOR: HEALTH CARE; NURSING SERVICES; HOME HEALTH CARE SERVICES; HOME NURSING AID SERVICES; REHABILITATION PATIENT CARE SERVICES; HOSPICE CARE; MEDICAL SERVICES IN THE NATURE OF MEDICAL CARE FOR OLDER INDIVIDUALS AND DISABLED INDIVIDUALS; MEDICAL CARE FOR CHILDREN, NAMELY, PEDIATRIC HEALTH CARE SERVICES, IN CLASS 44 (U.S. CLS. 100 AND 101).

FIRST USE 6-0-2011; IN COMMERCE 6-0-2011.

FOR: IN-HOME SUPPORT SERVICES TO SENIOR PERSONS, NAMELY, GERIATRIC CARE MANAGEMENT SERVICES IN THE NATURE OF THE COORDINATION OF NECESSARY SERVICES AND PERSONAL CARE FOR OLDER INDIVIDUALS, AND MANAGING THE PERSONAL AFFAIRS OF A PERSON WHO IS DEEMED INCAPABLE DUE TO REASONS SUCH AS AGE, PHYSICAL DISABILITY OR MENTAL LIMITATIONS; IN-HOME SUPPORT SERVICES TO DISABLED PERSONS, NAMELY, DISABILITY CARE MANAGEMENT SERVICES IN THE NATURE OF THE COORDINATION OF NECESSARY SERVICES AND PERSONAL CARE FOR DISABLED INDIVIDUALS, AND MANAGING THE PERSONAL AFFAIRS OF A PERSON WHO IS DEEMED INCAPABLE DUE TO REASONS SUCH AS PHYSICAL DISABILITY OR MENTAL LIMITATIONS; IN-HOME SUPPORT SERVICES TO CHILDREN, NAMELY, PEDIATRIC CARE MANAGEMENT SERVICES IN THE NATURE OF THE COORDINATION OF NECESSARY SERVICES AND PERSONAL CARE FOR CHILDREN, AND MANAGING THE PERSONAL AFFAIRS OF A PERSON WHO IS DEEMED INCAPABLE DUE TO REASONS SUCH AS AGE OR MENTAL LIMITATIONS; COMPANIONSHIP SERVICES FOR SENIOR PERSONS, DISABLED PERSONS, AND CHILDREN; HOMEMAKER SERVICES, NAMELY, PERSONAL CHEF SERVICES, IN CLASS 45 (U.S. CLS. 100 AND 101).



David J. Kyffers

Director of the United States Patent and Trademark Office

FIRST USE 6-0-2011; IN COMMERCE 6-0-2011.

Reg. No. 4,109,514 THE MARK CONSISTS OF A DEPICTION OF A HOUSE INSIDE A HEART WITH THE WORD "GAFFEY" UNDERNEATH THE HOUSE INSIDE A HEART.

SN 85-035,626, FILED 5-11-2010.

COLLEEN DOMBROW, EXAMINING ATTORNEY

United States of America

United States Patent and Trademark Office



BRYAN ROWE

Reg. No. 4,109,515

Registered Mar. 6, 2012

Int. Cl.: 16

TRADEMARK

PRINCIPAL REGISTER

THE ROWE GROUP, LLC (COLORADO LIMITED LIABILITY COMPANY), DBA BRYAN ROWE PHOTOGRAPHY,
357 HOLLYBERRY LANE
BOULDER, CO 80305

FOR: PHOTOGRAPHS, IN CLASS 16 (U.S. CLS. 2, 5, 22, 23, 29, 37, 38 AND 50).

FIRST USE 4-1-2010; IN COMMERCE 12-1-2011.

THE NAME(S), PORTRAIT(S), AND/OR SIGNATURE(S) SHOWN IN THE MARK IDENTIFIES "BRYAN ROWE", WHOSE CONSENT(S) TO REGISTER IS MADE OF RECORD.

THE MARK CONSISTS OF A CIRCULAR DESIGN FORMED BY THREE BLACK TEAR-DROP SHAPES SURROUNDING A WHITE 3-POINTED PINWHEEL SHAPED INTERIOR, APPEARING TO THE LEFT OF THE LETTERS "BRYAN ROWE", WHERE THE A IS MISSING THE CROSS-BAR LINE AND THE LETTERS "BRYAN" APPEAR IN BOLD FONT, COMPARED TO THE LETTERS "ROWE".

SN 85-035,627, FILED 5-11-2010.

COLLEEN DOMBROW, EXAMINING ATTORNEY



David J. Kyros

Director of the United States Patent and Trademark Office

United States of America

United States Patent and Trademark Office



Reg. No. 4,109,516

Registered Mar. 6, 2012

Int. Cl.: 41

SERVICE MARK

PRINCIPAL REGISTER

AMERICAN LIBRARY ASSOCIATION (MASSACHUSETTS CORPORATION)
50 EAST HURON
CHICAGO, IL 606112795

FOR: EDUCATIONAL SERVICES, NAMELY, PROVIDING INCENTIVES TO AUTHORS TO DEMONSTRATE EXCELLENCE IN THE FIELD OF LITERATURE FOR YOUNG ADULTS THROUGH THE ISSUANCE OF AWARDS, IN CLASS 41 (U.S. CLS. 100, 101 AND 107).

FIRST USE 12-1-2009; IN COMMERCE 12-1-2009.

OWNER OF U.S. REG. NO. 2,746,968.

NO CLAIM IS MADE TO THE EXCLUSIVE RIGHT TO USE "EXCELLENCE IN YOUNG ADULT NONFICTION" AND "WINNER", APART FROM THE MARK AS SHOWN.

THE MARK CONSISTS OF A SEAL WITH TWO CONCENTRIC CIRCLES. CENTERED WITHIN THE CENTER CIRCLE IS A STYLIZED DEPICTION OF A BOOK FROM WHICH GROWS A TREE AND ITS ROOTS. BELOW THE BOOK IS THE WORD "WINNER" PRESENTED IN STYLIZED FONT. IN THE OUTER, SECOND, CONCENTRIC CIRCLE ARE THE WORDS "EXCELLENCE IN YOUNG ADULT NONFICTION" PRESENTED IN STYLIZED FONT ARCED AROUND THE TOP OF THE INNER CIRCLE. THE LETTERS "YALSA-ALA" ARE PRESENTED IN STYLIZED FONT AND ARE ARCED AROUND THE BOTTOM OF THE CIRCLE AND FLANKED WITH TWO DOTS.

SN 85-035,706, FILED 5-11-2010.

GRETCHEN ULRICH, EXAMINING ATTORNEY



David J. Kyjars

Director of the United States Patent and Trademark Office

United States of America

United States Patent and Trademark Office

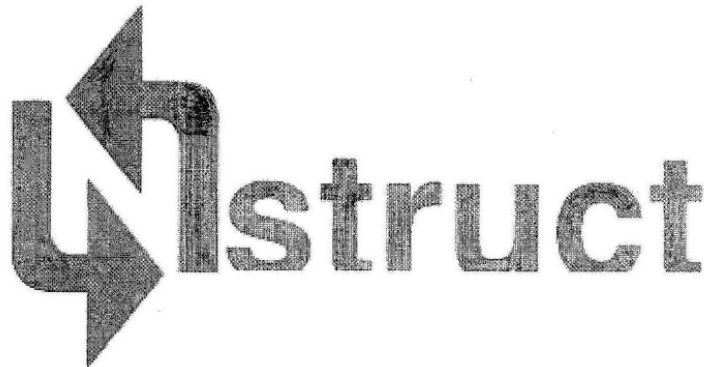

Reg. No. 4,109,517

AMERICAN BLUES COMPANY INC. (NEW YORK CORPORATION)
1407 BROADWAY, SUITE 907
NEW YORK, NY 10018

Registered Mar. 6, 2012

Int. Cl.: 25

FOR: COATS; COATS OF DENIM; DENIM JACKETS; DENIMS; JEANS; MEN'S AND WOMEN'S JACKETS, COATS, TROUSERS, VESTS; PANTS; SHORT TROUSERS; SHORT-SLEEVED OR LONG-SLEEVED T-SHIRTS; SHORT-SLEEVED SHIRTS; SHORTS; TROUSERS, IN CLASS 25 (U.S. CLS. 22 AND 39).

TRADEMARK

PRINCIPAL REGISTER

FIRST USE 6-1-2011; IN COMMERCE 6-1-2011.

THE MARK CONSISTS OF FIRST LETTER "N" OF THE MARK "NSTRUCT" IS IN A PARTICULAR STYLE IN THAT 2 ARROWS (LEFT AND RIGHT) MAKES THE LETTER "N", WITH LEFT ARROW POINTING TO RIGHT ARROW'S LOWER PART AND RIGHT ARROW POINTING TO LEFT ARROW'S TOP PART; THE REST LETTERS ("STRUCT") OF THE MARK "NSTRUCT" ALSO IN PARTICULAR STYLE IN THAT LOWER EDGE OF THESE LETTERS ARE CUT A LITTLE MAKING A STRAIGHT LINE AT THE BOTTOM.

SN 85-035,828, FILED 5-11-2010.

JASON BLAIR, EXAMINING ATTORNEY



David J. Kyjars

Director of the United States Patent and Trademark Office

United States of America

United States Patent and Trademark Office

HOWLING COW

Reg. No. 4,109,518

Registered Mar. 6, 2012

Int. Cls.: 29 and 30

TRADEMARK

PRINCIPAL REGISTER

NORTH CAROLINA STATE UNIVERSITY (NORTH CAROLINA STATE UNIVERSITY)
2721 SULLIVAN DR., 1107 ADMIN I BLDG.
CAMPUS ENTERPRISES, CAMPUS BOX 7291
RALEIGH, NC 276957291

FOR: MILK AND DAIRY PRODUCTS EXCLUDING ICE CREAM, ICE MILK AND FROZEN YOGURT, IN CLASS 29 (U.S. CL. 46).

FIRST USE 11-1-2011; IN COMMERCE 11-15-2011.

FOR: ICE CREAM AND ICE CREAM DESSERTS, IN CLASS 30 (U.S. CL. 46).

FIRST USE 2-10-2011; IN COMMERCE 2-10-2011.

THE MARK CONSISTS OF STANDARD CHARACTERS WITHOUT CLAIM TO ANY PARTICULAR FONT, STYLE, SIZE, OR COLOR.

SN 85-036,475, FILED 5-12-2010.

TARA PATE, EXAMINING ATTORNEY



David J. Kyjars

Director of the United States Patent and Trademark Office

United States of America

United States Patent and Trademark Office

DELL

Reg. No. 4,109,519

Registered Mar. 6, 2012

Int. Cl.: 28

TRADEMARK

PRINCIPAL REGISTER

PLAYMATES TOYS INC. (CALIFORNIA CORPORATION)
SUITE 800
909 NORTH SEPULVEDA BLVD.
EL SEGUNDO, CA 90245

FOR: DOLLS AND RELATED DOLL ACCESSORIES, IN CLASS 28 (U.S. CLS. 22, 23, 38 AND 50).

FIRST USE 10-28-2010; IN COMMERCE 10-28-2010.

THE MARK CONSISTS OF STANDARD CHARACTERS WITHOUT CLAIM TO ANY PARTICULAR FONT, STYLE, SIZE, OR COLOR.

SN 85-037,379, FILED 5-13-2010.

GENE MACIOL, EXAMINING ATTORNEY



David J. Kybas

Director of the United States Patent and Trademark Office

United States of America
United States Patent and Trademark Office

BARCHÁN

Reg. No. 4,109,520

BARCHAN ENTERTAINMENT CORPORATION (DELAWARE CORPORATION)
3400 WEST OLIVE AVENUE, SUITE 370
BURBANK, CA 91505

Registered Mar. 6, 2012

Int. Cl.: 38

FOR: INTERNET SERVICES, NAMELY, STREAMING OF AUDIO AND VIDEO, MOVIES, MOTION PICTURES, DOCUMENTARIES, FILMS, TELEVISION PROGRAMS, GRAPHICS, ANIMATION AND MULTIMEDIA PRESENTATIONS, VIA THE INTERNET, IN CLASS 38 (U.S. CLS. 100, 101 AND 104).

SERVICE MARK

PRINCIPAL REGISTER

FIRST USE 6-24-2010; IN COMMERCE 6-24-2010.

THE MARK CONSISTS OF STANDARD CHARACTERS WITHOUT CLAIM TO ANY PARTICULAR FONT, STYLE, SIZE, OR COLOR.

SN 85-037,634, FILED 5-13-2010.

CORY BOONE, EXAMINING ATTORNEY



David J. Kyros

Director of the United States Patent and Trademark Office

United States of America

United States Patent and Trademark Office

PEN AND POST

Reg. No. 4,109,521

Registered Mar. 6, 2012

Int. Cl.: 35

SERVICE MARK

PRINCIPAL REGISTER

HAEDRICH, MICHAEL (UNITED STATES INDIVIDUAL)
14137 NW MEADOWRIDGE DRIVE
PORTLAND, OR 972292369

FOR: ASSOCIATION SERVICES, NAMELY, PROMOTING THE INTERESTS OF AUTHORS, EDITORS, AND OTHERS IN THE PUBLISHING INDUSTRY; AUCTION MANAGEMENT SERVICES PROVIDED TO OTHERS OVER AN ON-LINE WEB SITE ACCESSED THROUGH A GLOBAL COMPUTER NETWORK; BUSINESS NETWORKING; CLUB SERVICES, NAMELY, PROMOTING THE INTERESTS OF AUTHORS, EDITORS, AND OTHERS IN THE PUBLISHING INDUSTRY; LITERARY AGENCIES; ON-LINE BUSINESS NETWORKING SERVICES; ON-LINE PROFESSIONAL NETWORKING SERVICES; PROMOTION OF BUSINESS OPPORTUNITIES; PROMOTIONAL SERVICES, NAMELY, LAUNCH PARTIES TO INTRODUCE A NEW BOOK, AUTHOR, BOOK PUBLISHER OR RETAILER, IN CLASS 35 (U.S. CLS. 100, 101 AND 102).

FIRST USE 6-13-2010; IN COMMERCE 10-4-2010.

THE MARK CONSISTS OF STANDARD CHARACTERS WITHOUT CLAIM TO ANY PARTICULAR FONT, STYLE, SIZE, OR COLOR.

SN 85-038,374, FILED 5-13-2010.

DANNEAN HETZEL, EXAMINING ATTORNEY



David J. Kyros

Director of the United States Patent and Trademark Office

United States of America

United States Patent and Trademark Office

NASHBAR

Reg. No. 4,109,522

Registered Mar. 6, 2012

Int. Cl.: 35

SERVICE MARK

PRINCIPAL REGISTER

PERFORMANCE, INC. (NORTH CAROLINA CORPORATION)
ONE PERFORMANCE WAY
CHAPEL HILL, NC 27514

FOR: CATALOG ORDERING SERVICE FEATURING PRODUCTS AND SERVICES IN THE FIELD OF BICYCLES AND BICYCLE PARTS, BICYCLE REPAIR AND APPAREL; ELECTRONIC CATALOG SERVICES FEATURING PRODUCTS AND SERVICES IN THE FIELD OF BICYCLES AND BICYCLE PARTS, BICYCLE REPAIR AND APPAREL; ON-LINE RETAIL STORE SERVICES FEATURING PRODUCTS AND SERVICES IN THE FIELD OF BICYCLES AND BICYCLE PARTS, BICYCLE REPAIR AND APPAREL, IN CLASS 35 (U.S. CLS. 100, 101 AND 102).

FIRST USE 11-17-2011; IN COMMERCE 11-17-2011.

THE MARK CONSISTS OF STANDARD CHARACTERS WITHOUT CLAIM TO ANY PARTICULAR FONT, STYLE, SIZE, OR COLOR.

SN 85-038,890, FILED 5-14-2010.

TRACY WHITTAKER-BROWN, EXAMINING ATTORNEY



David J. Kyffers

Director of the United States Patent and Trademark Office

United States of America

United States Patent and Trademark Office



Reg. No. 4,109,523

Registered Mar. 6, 2012

Int. Cl.: 33

TRADEMARK

PRINCIPAL REGISTER

DIAGEO NORTH AMERICA, INC. (CONNECTICUT CORPORATION)
801 MAIN AVENUE
NORWALK, CT 06851

FOR: ALCOHOLIC BEVERAGES EXCEPT BEERS, IN CLASS 33 (U.S. CLS. 47 AND 49).

FIRST USE 11-30-2011; IN COMMERCE 11-30-2011.

OWNER OF U.S. REG. NOS. 1,285,506, 3,435,814, AND OTHERS.

THE COLOR(S) RED, YELLOW, BLUE, BROWN, WHITE, TAN AND BLACK IS/ARE CLAIMED AS A FEATURE OF THE MARK.

THE NAME(S), PORTRAIT(S), AND/OR SIGNATURE(S) SHOWN IN THE MARK DOES NOT IDENTIFY A PARTICULAR LIVING INDIVIDUAL.

THE MARK CONSISTS OF A PIRATE WITH ONE FOOT ON A BARREL. THE COLOR RED APPEARS ON THE PIRATE'S COAT AND HAT; THE COLOR YELLOW APPEARS ON THE TRIM OF THE PIRATE'S COAT, HAT AND CAPE; THE COLOR BLUE APPEARS ON THE PIRATE'S CAPE AND PANTS; THE COLOR BROWN APPEARS ON THE PIRATE'S BOOTS; THE COLOR WHITE APPEARS ON THE PIRATE'S SHIRT; THE COLORS TAN AND BLACK APPEAR ON THE BARREL.

SN 85-039,004, FILED 5-14-2010.

HEATHER THOMPSON, EXAMINING ATTORNEY



David J. Kybas

Director of the United States Patent and Trademark Office

United States of America

United States Patent and Trademark Office

BOOGIE BUDDY

Reg. No. 4,109,524

Registered Mar. 6, 2012

Int. Cl.: 28

TRADEMARK

PRINCIPAL REGISTER

LITTLE BUSY BODIES, INC. (DELAWARE CORPORATION)
7874 SW NIMBUS
BEAVERTON, OR 97008

FOR: PLUSH TOYS; FLUFF TOYS; STUFFED TOYS; STUFFED TOY ANIMALS; DOLLS;
PROMOTIONAL TOYS, NAMELY, STUFFED ANIMALS, IN CLASS 28 (U.S. CLS. 22, 23, 38
AND 50).

FIRST USE 8-0-2010; IN COMMERCE 8-0-2010.

THE MARK CONSISTS OF STANDARD CHARACTERS WITHOUT CLAIM TO ANY PAR-
TICULAR FONT, STYLE, SIZE, OR COLOR.

OWNER OF U.S. REG. NOS. 3,541,165, 3,560,905, AND 3,750,406.

SN 85-039,330, FILED 5-14-2010.

CURTIS FRENCH, EXAMINING ATTORNEY



David J. Kybas

Director of the United States Patent and Trademark Office

United States of America

United States Patent and Trademark Office

US CLUB SOCCER PLAYER DEVELOPMENT PROGRAM

Reg. No. 4,109,525

Registered Mar. 6, 2012

Int. Cl.: 41

NATIONAL ASSOCIATION OF COMPETITIVE SOCCER CLUBS (CALIFORNIA CORPORATION)

#301
192 EAST BAY STREET
CHARLESTON, SC 29401

SERVICE MARK

PRINCIPAL REGISTER

FOR: PROVIDING A TRAINING PROGRAM FOR THE DEVELOPMENT OF ELITE SOCCER PLAYERS; PUBLICATION OF TEXTS IN THE NATURE OF TEXT BOOKS, PERIODICALS, LEAFLETS, AND BROCHURES; ARRANGING AND CONDUCTING EDUCATIONAL DEMONSTRATIONS; LIVE DEMONSTRATIONS, NAMELY, PERSONAL APPEARANCES OF OR BY SPORTS PERSONALITIES FOR TEACHING, ENTERTAINMENT, EDUCATIONAL AND PERSONAL COACHING PURPOSES, IN CLASS 41 (U.S. CLS. 100, 101 AND 107).

FIRST USE 6-0-2011; IN COMMERCE 6-0-2011.

THE MARK CONSISTS OF STANDARD CHARACTERS WITHOUT CLAIM TO ANY PARTICULAR FONT, STYLE, SIZE, OR COLOR.

SEC. 2(F) AS TO "US CLUB SOCCER".

OWNER OF U.S. REG. NOS. 2,958,764 AND 3,751,594.

NO CLAIM IS MADE TO THE EXCLUSIVE RIGHT TO USE "SOCCER PLAYER DEVELOPMENT PROGRAM", APART FROM THE MARK AS SHOWN.

SN 85-039,882, FILED 5-17-2010.

KEVIN CORWIN, EXAMINING ATTORNEY



David J. Kyros

Director of the United States Patent and Trademark Office

United States of America

United States Patent and Trademark Office

US CLUB SOCCER PDP

Reg. No. 4,109,526

Registered Mar. 6, 2012

Int. Cl.: 41

NATIONAL ASSOCIATION OF COMPETITIVE SOCCER CLUBS (CALIFORNIA CORPORATION)

#301

192 EAST BAY STREET

CHARLESTON, SC 29401

SERVICE MARK

PRINCIPAL REGISTER

FOR: PROVIDING A TRAINING PROGRAM FOR THE DEVELOPMENT OF ELITE SOCCER PLAYERS; PUBLICATION OF TEXTS IN THE NATURE OF TEXT BOOKS, PERIODICALS, LEAFLETS, AND BROCHURES; ARRANGING AND CONDUCTING EDUCATIONAL DEMONSTRATIONS; LIVE DEMONSTRATIONS, NAMELY, PERSONAL APPEARANCES OF OR BY SPORTS PERSONALITIES FOR TEACHING, ENTERTAINMENT, EDUCATIONAL AND PERSONAL COACHING PURPOSES, IN CLASS 41 (U.S. CLS. 100, 101 AND 107).

FIRST USE 6-30-2011; IN COMMERCE 6-30-2011.

THE MARK CONSISTS OF STANDARD CHARACTERS WITHOUT CLAIM TO ANY PARTICULAR FONT, STYLE, SIZE, OR COLOR.

SEC. 2(F) AS TO "US CLUB SOCCER".

OWNER OF U.S. REG. NOS. 2,958,764 AND 3,751,594.

NO CLAIM IS MADE TO THE EXCLUSIVE RIGHT TO USE "SOCCER", APART FROM THE MARK AS SHOWN.

SN 85-039,885, FILED 5-17-2010.

KEVIN CORWIN, EXAMINING ATTORNEY



David J. Kyros

Director of the United States Patent and Trademark Office

United States of America

United States Patent and Trademark Office

SUNFRESH GARDEN

Reg. No. 4,109,527

SUNFRESH NATURAL LLC (NEW JERSEY LIMITED LIABILITY COMPANY)
61 WILLET ST.
PASSAIC, NJ 07055

Registered Mar. 6, 2012

Int. Cl.: 32

FOR: FRUIT JUICES SOLD EXCLUSIVELY TO RETAIL STORES, IN CLASS 32 (U.S. CLS. 45, 46 AND 48).

TRADEMARK

FIRST USE 12-23-2011; IN COMMERCE 12-23-2011.

PRINCIPAL REGISTER

THE MARK CONSISTS OF STANDARD CHARACTERS WITHOUT CLAIM TO ANY PARTICULAR FONT, STYLE, SIZE, OR COLOR.

SN 85-040,546, FILED 5-17-2010.

JEFFREY LOOK, EXAMINING ATTORNEY



David J. Kybas

Director of the United States Patent and Trademark Office

United States of America

United States Patent and Trademark Office

GROWUMS

Reg. No. 4,109,528

Registered Mar. 6, 2012

Int. Cl.: 41

SERVICE MARK

PRINCIPAL REGISTER

PREFERRED COMMERCE, INC. (FLORIDA CORPORATION)
1655 PALM BEACH LAKES BLVD., SUITE 800
WEST PALM BEACH, FL 33401

FOR: ENTERTAINMENT SERVICES, NAMELY, PROVIDING VIRTUAL ENVIRONMENTS IN WHICH USERS CAN INTERACT FOR EDUCATIONAL AND ENTERTAINMENT PURPOSES; ENTERTAINMENT SERVICES, NAMELY, PROVIDING ONLINE, NON-DOWNLOADABLE VIRTUAL FRUITS, VEGETABLES, AND PLANTS FOR USE IN VIRTUAL ENVIRONMENTS CREATED FOR ENTERTAINMENT PURPOSES, IN CLASS 41 (U.S. CLS. 100, 101 AND 107).

FIRST USE 10-0-2011; IN COMMERCE 10-0-2011.

THE MARK CONSISTS OF STANDARD CHARACTERS WITHOUT CLAIM TO ANY PARTICULAR FONT, STYLE, SIZE, OR COLOR.

SN 85-040,661, FILED 5-17-2010.

LESLEY LAMOTHE, EXAMINING ATTORNEY



David J. Kyros

Director of the United States Patent and Trademark Office

United States of America

United States Patent and Trademark Office

BLUSH

Reg. No. 4,109,529

FINE AGROCHEMICALS LIMITED (UNITED KINGDOM LIMITED COMPANY (LTD.))
HILL END HOUSE

Registered Mar. 6, 2012

WHITTINGTON WORCESTER, UNITED KINGDOM WR52RQ

Int. Cl.: 1

FOR: PLANT GROWTH REGULATORS FOR AGRICULTURAL, HORTICULTURAL, AND
FLORICULTURAL USE, IN CLASS 1 (U.S. CLS. 1, 5, 6, 10, 26 AND 46).

TRADEMARK

FIRST USE 8-24-2010; IN COMMERCE 8-24-2010.

PRINCIPAL REGISTER

THE MARK CONSISTS OF STANDARD CHARACTERS WITHOUT CLAIM TO ANY PAR-
TICULAR FONT, STYLE, SIZE, OR COLOR.

SN 85-041,169, FILED 5-18-2010.

ELLEN BURNS, EXAMINING ATTORNEY



David J. Kybas

Director of the United States Patent and Trademark Office

United States of America

United States Patent and Trademark Office

SMART ESSENTIALS

Reg. No. 4,109,530

JOHNSON & JOHNSON (NEW JERSEY CORPORATION)
ONE JOHNSON & JOHNSON PLAZA
NEW BRUNSWICK, NJ 089337001

Registered Mar. 6, 2012

Int. Cl.: 3

FOR: MEDICATED SUN CARE PREPARATIONS, NAMELY, SUN CARE LOTIONS, IN CLASS 3 (U.S. CLS. 1, 4, 6, 50, 51 AND 52).

TRADEMARK

FIRST USE 12-9-2010; IN COMMERCE 12-9-2010.

PRINCIPAL REGISTER

THE MARK CONSISTS OF STANDARD CHARACTERS WITHOUT CLAIM TO ANY PARTICULAR FONT, STYLE, SIZE, OR COLOR.

SN 85-041,444, FILED 5-18-2010.

COLLEEN KEARNEY, EXAMINING ATTORNEY



David J. Kybas

Director of the United States Patent and Trademark Office

United States of America

United States Patent and Trademark Office

Safelink

Reg. No. 4,109,531

Registered Mar. 6, 2012

Int. Cl.: 1

TRADEMARK

PRINCIPAL REGISTER

THE NIPPON SYNTHETIC CHEMICAL INDUSTRY CO., LTD. (JAPAN CORPORATION)
1-88 OYODONAKA 1-CHOME, KITA-KU,
OSAKA-SHI, OSAKA-FU, JAPAN

FOR: CHEMICALS FOR INDUSTRIAL PURPOSES, NAMELY, CROSSLINKING AGENTS FOR REACTIVE POLYMER; ANTIBACTERIAL AGENTS FOR INDUSTRIAL PURPOSE ONLY; MILDEW PROOFING AGENTS FOR INDUSTRIAL PURPOSE ONLY, IN CLASS 1 (U.S. CLS. 1, 5, 6, 10, 26 AND 46).

FIRST USE 2-25-2010; IN COMMERCE 11-28-2011.

THE MARK CONSISTS OF STANDARD CHARACTERS WITHOUT CLAIM TO ANY PARTICULAR FONT, STYLE, SIZE, OR COLOR.

SN 85-041,668, FILED 5-18-2010.

Laurie Kaufman, Examining Attorney



David J. Kyros

Director of the United States Patent and Trademark Office

United States of America

United States Patent and Trademark Office

BeautyHeat

Reg. No. 4,109,532

MENTIS, DIMITRIOS (UNITED STATES INDIVIDUAL)
1000 NW 105TH AVENUE
PLANTATION, FL 33322

Registered Mar. 6, 2012

Int. Cl.: 5

FOR: DIETARY SUPPLEMENTS, IN CLASS 5 (U.S. CLS. 6, 18, 44, 46, 51 AND 52).

TRADEMARK

FIRST USE 10-1-2011; IN COMMERCE 10-1-2011.

PRINCIPAL REGISTER

THE MARK CONSISTS OF STANDARD CHARACTERS WITHOUT CLAIM TO ANY PARTICULAR FONT, STYLE, SIZE, OR COLOR.

SN 85-041,669, FILED 5-18-2010.

INGA ERVIN, EXAMINING ATTORNEY



David J. Kyfos

Director of the United States Patent and Trademark Office

United States of America

United States Patent and Trademark Office

LITTLE EMILY

Reg. No. 4,109,533

Registered Mar. 6, 2012

Int. Cl.: 25

TRADEMARK

PRINCIPAL REGISTER

KAHN LUCAS LANCASTER, INC. (PENNSYLVANIA CORPORATION)
SUITE 600
112 WEST 34TH STREET
NEW YORK, NY 10120

FOR: GIRLS' APPAREL, NAMELY, DRESSES, SKIRTS, PANTS, AND TOPS, IN CLASS 25
(U.S. CLS. 22 AND 39).

FIRST USE 12-1-2011; IN COMMERCE 12-1-2011.

THE MARK CONSISTS OF STANDARD CHARACTERS WITHOUT CLAIM TO ANY PARTICULAR FONT, STYLE, SIZE, OR COLOR.

OWNER OF U.S. REG. NO. 3,780,941.

THE NAME(S), PORTRAIT(S), AND/OR SIGNATURE(S) SHOWN IN THE MARK DOES NOT IDENTIFY A PARTICULAR LIVING INDIVIDUAL.

SN 85-041,993, FILED 5-18-2010.

JANICE KIM, EXAMINING ATTORNEY



David J. Kybas

Director of the United States Patent and Trademark Office

United States of America

United States Patent and Trademark Office

OVER THE MOUNTAIN SCHOOL OF ETIQUETTE

Reg. No. 4,109,534

Registered Mar. 6, 2012

Int. Cl.: 45

SERVICE MARK

PRINCIPAL REGISTER

OVER THE MOUNTAIN SCHOOL OF ETIQUETTE, LLC (ALABAMA LIMITED LIABILITY COMPANY)
4194 PAXTON PLACE
BIRMINGHAM, AL 35242

FOR: ETIQUETTE CONSULTING FOR CHILDREN, TEENAGERS, ADULTS AND BUSINESS EMPLOYEES, IN CLASS 45 (U.S. CLS. 100 AND 101).

FIRST USE 7-31-2010; IN COMMERCE 7-31-2010.

THE MARK CONSISTS OF STANDARD CHARACTERS WITHOUT CLAIM TO ANY PARTICULAR FONT, STYLE, SIZE, OR COLOR.

NO CLAIM IS MADE TO THE EXCLUSIVE RIGHT TO USE "SCHOOL OF ETIQUETTE", APART FROM THE MARK AS SHOWN.

SN 85-042,139, FILED 5-19-2010.

LINDA E. BLOHM, EXAMINING ATTORNEY



David J. Kyros

Director of the United States Patent and Trademark Office

United States of America

United States Patent and Trademark Office

CQA

Reg. No. 4,109,535

THE VIRGINIA WINERIES ASSOCIATION (VIRGINIA CORPORATION)
701 EAST FRANKLIN STREET, SUITE 809
RICHMOND, VA 23219

Registered Mar. 6, 2012

Int. Cl.: 35

FOR: ASSOCIATION SERVICES, NAMELY, PROMOTING THE INTERESTS OF WINERIES AND VINEYARDS, IN CLASS 35 (U.S. CLS. 100, 101 AND 102).

SERVICE MARK

FIRST USE 11-23-2011; IN COMMERCE 11-23-2011.

PRINCIPAL REGISTER

THE MARK CONSISTS OF STANDARD CHARACTERS WITHOUT CLAIM TO ANY PARTICULAR FONT, STYLE, SIZE, OR COLOR.

SN 85-043,088, FILED 5-19-2010.

MARK T. MULLEN, EXAMINING ATTORNEY



David J. Kybas

Director of the United States Patent and Trademark Office

United States of America

United States Patent and Trademark Office

Beautify Your Game

Reg. No. 4,109,536

SERENE ART LLC (NEVADA LIMITED LIABILITY COMPANY)
PO BOX 530850
HENDERSON, NV 89053

Registered Mar. 6, 2012

Int. Cls.: 14, 25, 26, and 28

FOR: JEWELRY, IN CLASS 14 (U.S. CLS. 2, 27, 28 AND 50).

FIRST USE 5-17-2011; IN COMMERCE 5-17-2011.

TRADEMARK

FOR: CLOTHING, NAMELY, GOLF PANTS, GOLF SHORTS, GOLF SKORTS, GOLF SHIRTS, GOLF VESTS, GOLF SWEATERS, GOLF SOCKS, GOLF SHOES, TENNIS SHIRTS, TENNIS SKIRTS, TENNIS SHORTS, TENNIS DRESSES, TENNIS SHOES, HATS, VISORS, HEAD-BANDS, WRISTBANDS, SCARVES, AND BELTS, IN CLASS 25 (U.S. CLS. 22 AND 39).

PRINCIPAL REGISTER

FIRST USE 7-16-2011; IN COMMERCE 7-16-2011.

FOR: BELT BUCKLES, IN CLASS 26 (U.S. CLS. 37, 39, 40, 42 AND 50).

FIRST USE 5-18-2010; IN COMMERCE 5-18-2010.

FOR: GOLF AND TENNIS ACCESSORIES, NAMELY, GOLF BALLS, GOLF BALL MARKERS, GOLF TEES, GOLF GLOVES, GOLF BAGS, GOLF CLUB COVERS, GOLF BAG COVERS, GOLF BAG TAGS, GOLF CLUB LABELS, GOLF CLUB GRIPS, DIVOT REPAIR TOOLS, HOLDERS SPECIALLY ADAPTED FOR HOLDING GOLF BALL MARKERS, CLIPS FOR ATTACHING GOLF BALL MARKERS TO ARTICLES OF CLOTHING, BAGS FOR GOLF TEES, TENNIS RACKET COVERS, BAGS SPECIALLY ADAPTED FOR CARRYING TENNIS RACKETS, AND TENNIS RACKET STRING DAMPERS, IN CLASS 28 (U.S. CLS. 22, 23, 38 AND 50).

FIRST USE 5-12-2010; IN COMMERCE 5-12-2010.

THE MARK CONSISTS OF STANDARD CHARACTERS WITHOUT CLAIM TO ANY PARTICULAR FONT, STYLE, SIZE, OR COLOR.

SN 85-043,366, FILED 5-20-2010.

MARK RADEMACHER, EXAMINING ATTORNEY



David J. Kyffers

Director of the United States Patent and Trademark Office

United States of America

United States Patent and Trademark Office



Reg. No. 4,109,537

Registered Mar. 6, 2012

Int. Cl.: 9

AW SHEEPSHOT HOLDING COMPANY, INC. (DELAWARE CORPORATION), DBA
AW-LAKE COMPANY,
8809 INDUSTRIAL DRIVE
FRANKSVILLE, WI 53126

FOR: CORIOLIS MASS FLOW METERS, IN CLASS 9 (U.S. CLS. 21, 23, 26, 36 AND 38).

TRADEMARK

FIRST USE 9-30-2011; IN COMMERCE 9-30-2011.

PRINCIPAL REGISTER

NO CLAIM IS MADE TO THE EXCLUSIVE RIGHT TO USE "CORIOLIS TECHNOLOGY",
APART FROM THE MARK AS SHOWN.

THE MARK CONSISTS OF THE WORDS "TRICOR CORIOLIS TECHNOLOGY" AND A
LOGO COMPRISING THREE EYEBROW-SHAPED SYMBOLS ARRANGED IN A TRIANGU-
LAR PATTERN, EACH EYEBROW-SHAPED SYMBOL HAVING A RELATIVELY THICK
EYEBROW-SHAPED ELEMENT AND AN ADJACENT RELATIVELY THIN EYEBROW-
SHAPED ELEMENT, SO THAT THE EFFECT OF EACH EYEBROW-SHAPED SYMBOL IS
TO SYMBOLIZE A SURGING WAVE OF LIQUID.

SN 85-043,413, FILED 5-20-2010.

COLLEEN KEARNEY, EXAMINING ATTORNEY



David J. Kyros

Director of the United States Patent and Trademark Office

United States of America

United States Patent and Trademark Office

PROJECT-A-SKETCH

Reg. No. 4,109,538

Registered Mar. 6, 2012

Int. Cl.: 28

TRADEMARK

PRINCIPAL REGISTER

TECH 4 KIDS INC. (CANADA CORPORATION)
1200 AEROWOOD DRIVE
UNIT 28
MISSISSAUGA, ONTARIO, CANADA L4W2S7

FOR: SKETCHING TOYS, IN CLASS 28 (U.S. CLS. 22, 23, 38 AND 50).

FIRST USE 8-31-2010; IN COMMERCE 8-31-2010.

THE MARK CONSISTS OF STANDARD CHARACTERS WITHOUT CLAIM TO ANY PARTICULAR FONT, STYLE, SIZE, OR COLOR.

SN 85-044,204, FILED 5-20-2010.

JEFFREY LOOK, EXAMINING ATTORNEY



David J. Kybas

Director of the United States Patent and Trademark Office

United States of America

United States Patent and Trademark Office

FOAM FLINGER

Reg. No. 4,109,539

Registered Mar. 6, 2012

Int. Cl.: 28

TRADEMARK

PRINCIPAL REGISTER

TECH 4 KIDS INC. (CANADA CORPORATION)
1200 AEROWOOD DRIVE
UNIT 28
MISSISSAUGA, ONTARIO, CANADA L4W2S7

FOR: PROJECTILE TOYS AND LAUNCHERS, IN CLASS 28 (U.S. CLS. 22, 23, 38 AND 50).

FIRST USE 1-31-2010; IN COMMERCE 1-31-2011.

THE MARK CONSISTS OF STANDARD CHARACTERS WITHOUT CLAIM TO ANY PARTICULAR FONT, STYLE, SIZE, OR COLOR.

NO CLAIM IS MADE TO THE EXCLUSIVE RIGHT TO USE "FOAM", APART FROM THE MARK AS SHOWN.

SN 85-044,220, FILED 5-20-2010.

JEFFREY LOOK, EXAMINING ATTORNEY



David J. Kyffers

Director of the United States Patent and Trademark Office

United States of America

United States Patent and Trademark Office

SPLAT SHOT

Reg. No. 4,109,540

Registered Mar. 6, 2012

Int. Cl.: 28

TRADEMARK

PRINCIPAL REGISTER

TECH 4 KIDS INC. (CANADA CORPORATION)
1200 AEROWOOD DRIVE
UNIT 28
MISSISSAUGA, ONTARIO, CANADA L4W2S7

FOR: EQUIPMENT FOR PLAYING A SKILL AND ACTION-TYPE GAME CONSISTING OF PADDLES, TARGETS, LAUNCHERS AND DEFORMABLE PLASTIC BALLS , IN CLASS 28 (U.S. CLS. 22, 23, 38 AND 50).

FIRST USE 1-31-2010; IN COMMERCE 1-31-2011.

THE MARK CONSISTS OF STANDARD CHARACTERS WITHOUT CLAIM TO ANY PARTICULAR FONT, STYLE, SIZE, OR COLOR.

SN 85-044,226, FILED 5-20-2010.

JEFFREY LOOK, EXAMINING ATTORNEY



David J. Kyros

Director of the United States Patent and Trademark Office

United States of America

United States Patent and Trademark Office

SWITCH LITE

Reg. No. 4,109,541

Registered Mar. 6, 2012

Int. Cl.: 11

TRADEMARK

PRINCIPAL REGISTER

TECH 4 KIDS INC. (CANADA CORPORATION)
1200 AEROWOOD DRIVE
UNIT 28
MISSISSAUGA, ONTARIO, CANADA L4W2S7

FOR: FLASHLIGHTS AND CLIP-ON LIGHTS, NAMELY, LIGHTS TO BE TEMPORARILY ATTACHED TO A CHILD'S CLOTHING, IN CLASS 11 (U.S. CLS. 13, 21, 23, 31 AND 34).

FIRST USE 8-31-2010; IN COMMERCE 8-31-2010.

THE MARK CONSISTS OF STANDARD CHARACTERS WITHOUT CLAIM TO ANY PARTICULAR FONT, STYLE, SIZE, OR COLOR.

NO CLAIM IS MADE TO THE EXCLUSIVE RIGHT TO USE "LITE", APART FROM THE MARK AS SHOWN.

SN 85-044,232, FILED 5-20-2010.

JEFFREY LOOK, EXAMINING ATTORNEY



David J. Kyffers

Director of the United States Patent and Trademark Office

United States of America

United States Patent and Trademark Office

BLAST'N SPLASH

Reg. No. 4,109,542

Registered Mar. 6, 2012

Int. Cl.: 28

TRADEMARK

PRINCIPAL REGISTER

TECH 4 KIDS INC. (CANADA CORPORATION)
1200 AEROWOOD DRIVE
UNIT 28
MISSISSAUGA, ONTARIO, CANADA L4W2S7

FOR: OUTDOOR TOYS, NAMELY, WATER GUNS AND WATER CANNONS, IN CLASS 28
(U.S. CLS. 22, 23, 38 AND 50).

FIRST USE 1-31-2010; IN COMMERCE 1-31-2011.

THE MARK CONSISTS OF STANDARD CHARACTERS WITHOUT CLAIM TO ANY PARTICULAR FONT, STYLE, SIZE, OR COLOR.

SN 85-044,241, FILED 5-20-2010.

JEFFREY LOOK, EXAMINING ATTORNEY



David J. Kybas

Director of the United States Patent and Trademark Office

United States of America

United States Patent and Trademark Office

YOUTHMINISTRY360

Reg. No. 4,109,543

Registered Mar. 6, 2012

Int. Cls.: 9 and 16

TRADEMARK

PRINCIPAL REGISTER

YOUTH MINISTRY 360, INC. (ALABAMA CORPORATION)
P.O. BOX 36545
BIRMINGHAM, AL 35236

FOR: PRE-RECORDED VIDEO TAPES, AUDIO TAPES, DVD'S, COMPACT DISCS AND CD-ROMS IN THE NATURE OF INSTRUCTIONAL, EDUCATIONAL, TEACHING, AND ENTERTAINMENT MATERIALS IN THE FIELDS OF CHRISTIANITY, RELIGION, SPIRITUALITY, FAITH, AND THEOLOGY; ONLINE PRODUCTS, NAMELY, DOWNLOADABLE TEXT, ONLINE BOOKS, AUDIO, GRAPHICS, PHOTOGRAPHS AND VIDEOS ON THE INTERNET IN THE NATURE OF INSTRUCTIONAL, EDUCATIONAL, TEACHING AND ENTERTAINMENT MATERIALS IN THE FIELDS OF CHRISTIANITY, RELIGION, SPIRITUALITY, FAITH, AND THEOLOGY, IN CLASS 9 (U.S. CLS. 21, 23, 26, 36 AND 38).

FIRST USE 5-1-2010; IN COMMERCE 8-1-2010.

FOR: PRINTED MATERIALS AND PUBLICATIONS, NAMELY, BOOKS, BOOKLETS, BROCHURES, PAMPHLETS, PRINTED PERIODICALS, POSTERS, POST CARDS, CALENDARS, DIARIES, AND NEWSLETTERS IN THE NATURE OF INSTRUCTIONAL, EDUCATIONAL, TEACHING AND ENTERTAINMENT MATERIALS IN THE FIELDS OF CHRISTIANITY, RELIGION, SPIRITUALITY, FAITH AND THEOLOGY, IN CLASS 16 (U.S. CLS. 2, 5, 22, 23, 29, 37, 38 AND 50).

FIRST USE 8-1-2010; IN COMMERCE 8-1-2010.

THE MARK CONSISTS OF STANDARD CHARACTERS WITHOUT CLAIM TO ANY PARTICULAR FONT, STYLE, SIZE, OR COLOR.

SN 85-044,323, FILED 5-20-2010.

KYLE PEETE, EXAMINING ATTORNEY



David J. Kyros

Director of the United States Patent and Trademark Office

United States of America

United States Patent and Trademark Office



Reg. No. 4,109,544

Registered Mar. 6, 2012

Int. Cl.: 25

TRADEMARK

PRINCIPAL REGISTER

CHEN MING-TE (TAIWAN INDIVIDUAL)
FON-CHOU CITY
NO.2, LANE334, SAN-FON ROAD
TAICHUNG HSIEN, TAIWAN 412

FOR: ANGLERS' SHOES, BASEBALL SHOES, BEACH SHOES, BOWLING SHOES, BOXING SHOES, CANVAS SHOES, ESPARTO SHOES, FOOTBALL SHOES, GOLF SHOES, GYM-NASTIC SHOES, HANDBALL SHOES, HOCKEY SHOES, HOSIERY, SHOES, SHOES AND BOOTS, SOCCER SHOES, SPORT SHOES, TENNIS SHOES, TRAINING SHOES, VOLLEY-BALL SHOES, WOMEN'S SHOES, WOODEN SHOES, MAN'S SHOES, WORK SHOES AND BOOTS, BABY'S SHOES, IN CLASS 25 (U.S. CLS. 22 AND 39).

FIRST USE 8-21-2010; IN COMMERCE 8-21-2010.

THE MARK CONSISTS OF AN OUTLINE OF A FLOWER, WHEREIN THE CENTER OF THE FLOWER IS DIVIDED INTO TWO PETALS POINTING IN THE LEFT AND RIGHT DIRECTION. TO THE LEFT OF THE LEFT PETAL ARE THREE SEPALS FACING IN THE LEFTWARD DIRECTION, WHEREIN THE TOP AND BOTTOM SEPALS ARE OUTLINED, AND THE MIDDLE SEPAL PROTRUDES IN A DOWNWARD DIRECTION. TO THE RIGHT OF THE RIGHT PETAL ARE OUTLINES OF THREE SEPALS FACING IN THE RIGHTWARD DIRECTION, WHEREIN THE TOP AND BOTTOM SEPALS ARE OUTLINED, AND THE MIDDLE SEPAL PROTRUDES IN A DOWNWARD DIRECTION.

SN 85-044,528, FILED 5-21-2010.

AMY C. KEAN, EXAMINING ATTORNEY



David J. Kappas

Director of the United States Patent and Trademark Office

United States of America
United States Patent and Trademark Office

LITTLE BU

Reg. No. 4,109,545

DENTE, PATRICIA (UNITED STATES INDIVIDUAL)
11F ENNISMORE GARDENS
LONDON SW7 1AA, UNITED KINGDOM

Registered Mar. 6, 2012

Int. Cl.: 3

FOR: COSMETICS; NAIL POLISH, IN CLASS 3 (U.S. CLS. 1, 4, 6, 50, 51 AND 52).

TRADEMARK

FIRST USE 10-5-2011; IN COMMERCE 10-5-2011.

PRINCIPAL REGISTER

THE MARK CONSISTS OF STANDARD CHARACTERS WITHOUT CLAIM TO ANY PARTICULAR FONT, STYLE, SIZE, OR COLOR.

SN 85-044,707, FILED 5-21-2010.

JULIE GUTTADAURO, EXAMINING ATTORNEY



David J. Kybas

Director of the United States Patent and Trademark Office

United States of America

United States Patent and Trademark Office

PRO

Reg. No. 4,109,546

Registered Mar. 6, 2012

Int. Cl.: 9

TRADEMARK

PRINCIPAL REGISTER

REMOTE TECHNOLOGIES INCORPORATED (MINNESOTA CORPORATION)
5775 12TH AVE. EAST
SUITE 180
SHAKOPEE, MN 55379

FOR: HOME AUTOMATION SYSTEMS COMPRISING WIRELESS AND WIRED CONTROLLERS, CONTROL PROCESSORS, CONTROLLED DEVICES, AND SOFTWARE FOR LIGHTING, HVAC, SECURITY, SAFETY, AUDIO, VISUAL, AND OTHER HOME CONTROL APPLICATIONS, IN CLASS 9 (U.S. CLS. 21, 23, 26, 36 AND 38).

FIRST USE 12-23-2011; IN COMMERCE 12-23-2011.

THE MARK CONSISTS OF THE TERM "PRO" IN STYLIZED LETTERS.

SN 85-044,719, FILED 5-21-2010.

NAPOLEON SHARMA, EXAMINING ATTORNEY



David J. Kyffers

Director of the United States Patent and Trademark Office

United States of America

United States Patent and Trademark Office

KRAFT FIGHT HUNGER BOWL

Reg. No. 4,109,547

KRAFT FOODS GLOBAL BRANDS LLC (DELAWARE LIMITED LIABILITY COMPANY)
THREE LAKES DRIVE
NORTHFIELD, IL 60093

Registered Mar. 6, 2012

Int. Cl.: 41

FOR: ENTERTAINMENT SERVICES IN THE NATURE OF FOOTBALL EXHIBITIONS, IN CLASS 41 (U.S. CLS. 100, 101 AND 107).

SERVICE MARK

FIRST USE 12-16-2011; IN COMMERCE 12-16-2011.

PRINCIPAL REGISTER

THE MARK CONSISTS OF STANDARD CHARACTERS WITHOUT CLAIM TO ANY PARTICULAR FONT, STYLE, SIZE, OR COLOR.

NO CLAIM IS MADE TO THE EXCLUSIVE RIGHT TO USE "BOWL", APART FROM THE MARK AS SHOWN.

SN 85-044,914, FILED 5-21-2010.

PAUL E. FAHRENKOPF, EXAMINING ATTORNEY



David J. Kybas

Director of the United States Patent and Trademark Office

United States of America

United States Patent and Trademark Office

MARKOMETER

Reg. No. 4,109,548

Registered Mar. 6, 2012

Int. Cl.: 42

SERVICE MARK

PRINCIPAL REGISTER

221A, INC. (NORTH CAROLINA CORPORATION)
ATTN: JOHN EKLUND
8800 DARCY HOPKINS DR.
CHARLOTTE, NC 28227

FOR: APPLICATION SERVICE PROVIDER (ASP) FEATURING SOFTWARE FOR USE IN ANALYZING DATA RELATING TO THE VIEWING AND USE OF WEBSITE LANDING PAGES, WEBSITE FORMS, DOMAIN NAMES, ASSOCIATED TELEPHONE NUMBERS, AND FOR USE IN THE ANALYZING OF DATA RELATING TO THE SALE OF PRODUCTS AND SERVICES, PROMOTIONAL EXPENDITURES, AND DATA ABOUT CUSTOMERS AND POTENTIAL CUSTOMERS; APPLICATION SERVICE PROVIDER (ASP), NAMELY, HOSTING COMPUTER SOFTWARE APPLICATIONS OF OTHERS; CLOUD COMPUTING FEATURING SOFTWARE FOR USE IN ANALYZING DATA RELATING TO THE VIEWING AND USE OF WEBSITE LANDING PAGES, WEBSITE FORMS, DOMAIN NAMES, ASSOCIATED TELEPHONE NUMBERS, AND FOR USE IN THE ANALYZING OF DATA RELATING TO THE SALE OF PRODUCTS AND SERVICES, PROMOTIONAL EXPENDITURES, AND DATA ABOUT CUSTOMERS AND POTENTIAL CUSTOMERS; DESIGN OF HOMEPAGES AND WEBSITES; DESIGN, CREATION, HOSTING, MAINTENANCE OF WEBSITES FOR OTHERS; DESIGNING AND DEVELOPING WEBPAGES ON THE INTERNET; GRAPHIC DESIGN SERVICES; HOMEPAGE AND WEBPAGE DESIGN; PROVIDING A WEBSITE FEATURING NON-DOWNLOADABLE SOFTWARE FOR USE IN ANALYZING DATA RELATING TO THE VIEWING AND USE OF WEBSITE LANDING PAGES, WEBSITE FORMS, DOMAIN NAMES, ASSOCIATED TELEPHONE NUMBERS, AND FOR USE IN THE ANALYZING OF DATA RELATING TO THE SALE OF PRODUCTS AND SERVICES, PROMOTIONAL EXPENDITURES, AND DATA ABOUT CUSTOMERS AND POTENTIAL CUSTOMERS; PROVIDING A WEBSITE FEATURING RESOURCES, NAMELY, NON-DOWNLOADABLE SOFTWARE FOR USE IN ANALYZING DATA RELATING TO THE VIEWING AND USE OF WEBSITE LANDING PAGES, WEBSITE FORMS, DOMAIN NAMES, ASSOCIATED TELEPHONE NUMBERS, AND FOR USE IN THE ANALYZING OF DATA RELATING TO THE SALE OF PRODUCTS AND SERVICES, PROMOTIONAL EXPENDITURES, AND DATA ABOUT CUSTOMERS AND POTENTIAL CUSTOMERS; PROVIDING TEMPORARY USE OF A WEB-BASED SOFTWARE APPLICATION FOR USE IN ANALYZING DATA RELATING TO THE VIEWING AND USE OF WEBSITE LANDING PAGES, WEBSITE FORMS, DOMAIN NAMES, ASSOCIATED TELEPHONE NUMBERS, AND FOR USE IN THE ANALYZING OF DATA RELATING TO THE SALE OF PRODUCTS AND SERVICES, PROMOTIONAL EXPENDITURES, AND DATA ABOUT CUSTOMERS AND POTENTIAL CUSTOMERS; PROVIDING TEMPORARY USE OF ON-LINE NONDOWNLOADABLE SOFTWARE AND



David J. Kappas

Director of the United States Patent and Trademark Office

Reg. No. 4,109,548 APPLICATIONS FOR USE IN ANALYZING DATA RELATING TO THE VIEWING AND USE OF WEBSITE LANDING PAGES, WEBSITE FORMS, DOMAIN NAMES, ASSOCIATED TELEPHONE NUMBERS, AND FOR USE IN THE ANALYZING OF DATA RELATING TO THE SALE OF PRODUCTS AND SERVICES, PROMOTIONAL EXPENDITURES, AND DATA ABOUT CUSTOMERS AND POTENTIAL CUSTOMERS; WEB SITE DESIGN, IN CLASS 42 (U.S. CLS. 100 AND 101).

FIRST USE 10-1-2011; IN COMMERCE 10-1-2011.

THE MARK CONSISTS OF STANDARD CHARACTERS WITHOUT CLAIM TO ANY PARTICULAR FONT, STYLE, SIZE, OR COLOR.

SN 85-046,091, FILED 5-24-2010.

MICHAEL ENGEL, EXAMINING ATTORNEY

United States of America

United States Patent and Trademark Office

EXCELERATION

Reg. No. 4,109,549

Registered Mar. 6, 2012

Int. Cl.: 9

TRADEMARK

PRINCIPAL REGISTER

SPORTSFIT, LLC (VIRGINIA LIMITED LIABILITY COMPANY)
7619 WHIRLAWAY DRIVE
MIDLOTHIAN, VA 23112

FOR: AUDIO AND VIDEO RECORDINGS FEATURING TRAINING AND TECHNIQUES TO DEVELOP SPEED AND AGILITY; DVDS FEATURING TRAINING AND TECHNIQUES TO DEVELOP SPEED AND AGILITY, IN CLASS 9 (U.S. CLS. 21, 23, 26, 36 AND 38).

FIRST USE 11-1-2011; IN COMMERCE 11-1-2011.

THE MARK CONSISTS OF STANDARD CHARACTERS WITHOUT CLAIM TO ANY PARTICULAR FONT, STYLE, SIZE, OR COLOR.

SN 85-046,097, FILED 5-24-2010.

SUSAN STIGLITZ, EXAMINING ATTORNEY



David J. Kybas

Director of the United States Patent and Trademark Office

United States of America

United States Patent and Trademark Office

NOVACELL

Reg. No. 4,109,550

Registered Mar. 6, 2012

Int. Cl.: 9

TRADEMARK

PRINCIPAL REGISTER

SUNCORE, INC. (NEVADA CORPORATION)
25 EDELMAN
IRVINE, CA 92618

FOR: BATTERIES; PHOTOVOLTAIC MODULES THAT GENERATE ELECTRICAL POWER;
PHOTOVOLTAIC MODULES THAT GENERATE ELECTRICAL POWER FOR ELECTRONIC
DEVICES AND CELLULAR PHONES, BATTERY WITH SOLAR POWERED CHARGER,
SOLAR POWERED CHARGER FOR ELECTRONIC POWER STORAGE DEVICES, IN CLASS
9 (U.S. CLS. 21, 23, 26, 36 AND 38).

FIRST USE 9-0-2011; IN COMMERCE 9-0-2011.

THE MARK CONSISTS OF STANDARD CHARACTERS WITHOUT CLAIM TO ANY PAR-
TICULAR FONT, STYLE, SIZE, OR COLOR.

SN 85-046,206, FILED 5-24-2010.

JEFFREY LOOK, EXAMINING ATTORNEY



David J. Kyffers

Director of the United States Patent and Trademark Office

United States of America

United States Patent and Trademark Office



NICHOLSON

Reg. No. 4,109,551

Registered Mar. 6, 2012

Int. Cls.: 37 and 42

SERVICE MARK

PRINCIPAL REGISTER

SOLETANCHE FREYSSINET (FRANCE SOCIÉTÉ ANONYME (SA))
133 BOULEVARD NATIONAL
92500 RUEIL MALMAISON, FRANCE

FOR: BUILDING CONSTRUCTION; CONSTRUCTION OF PUBLIC WORKS, NAMELY, ROADS, EXPRESSWAYS, TUNNELS, PORTS, DOCKS, DIKES, CANALS, PIERS AND BRIDGES; CONSTRUCTION OF CIVIL ENGINEERING STRUCTURES, NAMELY, AIRPORTS, OFFICE OR RESIDENCE TOWERS, FINANCE OR COMMERCIAL CENTERS, CAR PARKS, HOTELS, HISTORIC MONUMENTS, MUSEUMS, OIL DRILLING PLATFORMS, SUBWAY AND RAILWAY LINES, SUBWAY OR RAILWAY STATIONS, LAND RECLAIMED FROM THE SEA, HYDROELECTRIC POWER STATIONS, THERMAL POWER STATIONS, NUCLEAR POWER STATIONS; EXCAVATION OF TRENCHES OR WALLS IN THE GROUND; CONSTRUCTION SERVICES, NAMELY, INJECTION OF PREPARATIONS INTO THE GROUND FOR CONSOLIDATION AND WATERPROOFING OF STRUCTURAL FOUNDATIONS; FOUNDATION CONTRACTOR SERVICES; GROUND TREATMENT AND GROUND IMPROVEMENT SERVICES, NAMELY, CEMENT OR CHEMICAL GROUTING, JET GROUTING SERVICES; INSTALLATION OF DEEP FOUNDATIONS; INSTALLATION OF EARTH RETENTION AND SLOPE STABILIZATION SYSTEMS USING ROCK AND SOIL ANCHORS, IN CLASS 37 (U.S. CLS. 100, 103 AND 106).

FIRST USE 1-1-2006; IN COMMERCE 1-1-2006.



FOR: CONSULTATION IN THE FIELD OF CIVIL ENGINEERING; TECHNICAL ENGINEERING CONSULTATION IN THE GEOTECHNICAL CONSTRUCTION INDUSTRY; TECHNOLOGY CONSULTATION IN THE FIELD OF CIVIL ENGINEERING AS IT RELATES TO EXCAVATION OF TRENCHES OR WALLS IN THE GROUND, INJECTION OF PREPARATIONS INTO THE GROUND, DRILLING, STUDIES AND SOIL INSPECTION; DESIGN OF DEEP FOUNDATIONS; DESIGN OF EARTH RETENTION AND SLOPE STABILIZATION SYSTEMS USING ROCK AND SOIL ANCHORS, IN CLASS 42 (U.S. CLS. 100 AND 101).

FIRST USE 1-1-2006; IN COMMERCE 1-1-2006.

THE MARK CONSISTS OF AN IMAGE OF A GLOBE, WITH THE COLOR BLUE AT THE TOP AND THE COLOR RED AT THE BOTTOM, WITH TWO SPIRAL PATHS AROUND THE GLOBE IN THE COLOR WHITE WITH THE STYLIZED WORD "NICHOLSON" AT THE BOTTOM IN THE COLOR BLUE.

David J. Kybas

Director of the United States Patent and Trademark Office

Reg. No. 4,109,551 THE COLOR(S) BLUE, RED AND WHITE IS/ARE CLAIMED AS A FEATURE OF THE MARK.

SN 85-046,253, FILED 5-24-2010.

KELLEY WELLS, EXAMINING ATTORNEY

United States of America

United States Patent and Trademark Office

TASTE THE VALUE

Reg. No. 4,109,552

Registered Mar. 6, 2012

Int. Cl.: 35

SERVICE MARK

PRINCIPAL REGISTER

VALERO MARKETING AND SUPPLY COMPANY (DELAWARE CORPORATION)
COMMERCIAL LAW DEPT.
ONE VALERO WAY
SAN ANTONIO, TX 78249

FOR: RETAIL CONVENIENCE STORE SERVICES FEATURING FOOD AND DRINK ITEMS,
IN CLASS 35 (U.S. CLS. 100, 101 AND 102).

FIRST USE 12-1-2010; IN COMMERCE 12-1-2010.

THE MARK CONSISTS OF STANDARD CHARACTERS WITHOUT CLAIM TO ANY PAR-
TICULAR FONT, STYLE, SIZE, OR COLOR.

SN 85-046,637, FILED 5-24-2010.

LOURDES AYALA, EXAMINING ATTORNEY



David J. Kybas

Director of the United States Patent and Trademark Office

United States of America

United States Patent and Trademark Office

HIGH OCTANE SOCIAL SHOPPING

Reg. No. 4,109,553

Registered Mar. 6, 2012

Int. Cls.: 9 and 35

TRADEMARK

SERVICE MARK

PRINCIPAL REGISTER

NEXTMEDIA OPERATING, INC. (DELAWARE CORPORATION)
SUITE 205E
6312 S. FIDDLER'S GREEN CIRCLE
GREENWOOD VILLAGE, CO 80111

FOR: CONSUMER COUPONS DOWNLOADED FROM A GLOBAL COMPUTER NETWORK,
IN CLASS 9 (U.S. CLS. 21, 23, 26, 36 AND 38).

FIRST USE 12-20-2011; IN COMMERCE 12-20-2011.

FOR: PROMOTING THE GOODS AND SERVICES OF OTHERS THROUGH A WEB SITE,
SOCIAL MEDIA PLATFORM AND E-BLASTS THAT ADVERTISE, PROMOTE AND DIS-
TRIBUTE DISCOUNT OFFERS, SPECIAL PRICING PROMOTIONS, COUPONS AND RE-
BATES; PROMOTING THE GOODS AND SERVICES OF OTHERS BY PROVIDING A WEB
SITE FEATURING LINKS TO THE RETAIL WEB SITES OF OTHERS, AND DISCOUNT IN-
FORMATION; ADVERTISING AND COMMERCIAL INFORMATION SERVICES VIA THE
INTERNET; ADVERTISING VIA ELECTRONIC MEDIA AND SPECIFICALLY THE INTER-
NET, RADIO BROADCASTS ON TERRESTRIAL SIGNALS, ONLINE AND MOBILE
STREAMING; PROVIDING ADVERTISING SPACE ON THE INTERNET, IN CLASS 35 (U.S.
CLS. 100, 101 AND 102).

FIRST USE 12-20-2011; IN COMMERCE 12-20-2011.

THE MARK CONSISTS OF STANDARD CHARACTERS WITHOUT CLAIM TO ANY PAR-
TICULAR FONT, STYLE, SIZE, OR COLOR.

NO CLAIM IS MADE TO THE EXCLUSIVE RIGHT TO USE "SOCIAL SHOPPING", APART
FROM THE MARK AS SHOWN.

SN 85-047,125, FILED 5-25-2010.

DEZMONA MIZELLE, EXAMINING ATTORNEY



David J. Kyffers

Director of the United States Patent and Trademark Office

United States of America

United States Patent and Trademark Office



Reg. No. 4,109,554

Registered Mar. 6, 2012

Int. Cl.: 25

CRYSTAL ADELL (TEXAS SOLE PROPRIETORSHIP), DBA BLACK WOMEN DO
WORKOUT!,
BWDW@BWDWO.COM
2249 CRYSTAL FALLS DRIVE
FRISCO, TX 75034

TRADEMARK

FOR: ATHLETIC APPAREL, NAMELY, SHIRTS, PANTS, JACKETS, FOOTWEAR, HATS
AND CAPS, ATHLETIC UNIFORMS, IN CLASS 25 (U.S. CLS. 22 AND 39).

PRINCIPAL REGISTER

FIRST USE 3-15-2010; IN COMMERCE 3-15-2010.

THE MARK CONSISTS OF AN OVAL CONTAINING A SMALLER OVAL, AN IMAGE OF
A MUSCULAR AFRICAN AMERICAN WOMAN WITH NATURAL HAIR HOLDING UP A
BARBELL CLOSE TO THE TOP OF HER HEAD, AND THE WORDING "BLACK WOMEN
"DO" WORKOUT!".

SN 85-047,923, FILED 5-26-2010.

KATHY DE JONGE, EXAMINING ATTORNEY



David J. Kybas

Director of the United States Patent and Trademark Office

United States of America

United States Patent and Trademark Office



Reg. No. 4,109,555

Registered Mar. 6, 2012

Int. Cl.: 29

TRADEMARK

PRINCIPAL REGISTER

CHUNHO FOOD CO., LTD. (REPUBLIC OF KOREA LIMITED LIABILITY COMPANY)
#389-2, DUCKPO2-DONG, SASANG-GU
BUSAN, REPUBLIC OF KOREA 617-042

FOR: PROCESSED SWEET POTATOES; PROCESSED RED GINSENG FOR USE AS A VEGETABLE; PROCESSED GINSENG FOR USE AS A VEGETABLE; TOMATO EXTRACTS; MEAT EXTRACTS; PRESERVED EDIBLE SNAIL EXTRACTS; PRESERVED GINGKO NUT EXTRACTS; PRESERVED GARLIC EXTRACTS NOT FOR USE AS A SEASONING; PRESERVED KELP EXTRACTS; PRESERVED CORNUS FRUIT EXTRACTS FOR USE AS A NON-MEDICATED INGREDIENT IN FOOD; PRESERVED EDIBLE MUGWORT EXTRACTS NOT FOR MEDICAL USE; PRESERVED JUJUBES EXTRACTS NOT FOR MEDICAL USE; PROCESSED POMEGRANATE EXTRACTS FOR USE AS A NON-MEDICATED INGREDIENT IN FOOD; PROCESSED PUMPKIN EXTRACTS; PROCESSED ONION EXTRACTS; PROCESSED BLACK GARLIC EXTRACTS FOR USE AS A VEGETABLE AND NOT A SEASONING; PROCESSED APPLE EXTRACTS FOR USE AS A NON-MEDICATED INGREDIENT IN FOOD; PROCESSED GRAPE EXTRACTS FOR USE AS A NON-MEDICATED INGREDIENT IN FOOD; PROCESSED, EDIBLE BELLFLOWER ROOT EXTRACTS FOR USE AS A NON-MEDICATED INGREDIENT IN FOOD; CANNED OYSTERS NOT LIVE, FOR HUMAN CONSUMPTION; CANNED EDIBLE SNAILS NOT LIVE, FOR HUMAN CONSUMPTION; PRESERVED RED GINSENG OR GINSENG FOR USE AS A VEGETABLE; PROCESSED NUTS; PRESERVED FRUITS; PROCESSED MUSHROOM; PRESERVED JUJUBES, NON-MEDICATED; PROCESSED AND PRESERVED PEARS; PRESERVED VEGETABLES; PROCESSED GARLIC USED AS A VEGETABLE, NOT AS SEASONING; PROCESSED FRUIT EXTRACTS OF ACANTHOPANAX AND ORIENTAL RAISIN TREE, NAMELY, HOVENIA DULCIS, NOT FOR MEDICINAL PURPOSES AND FOR HUMAN CONSUMPTION AS A FOOD; PROCESSED FRUIT OF ORIENTAL RAISIN TREE, NAMELY, HOVENIA DULCIS, NOT FOR MEDICINAL PURPOSES AND FOR HUMAN CONSUMPTION AS A FOOD; PROCESSED EDIBLE BELLFLOWER ROOTS; FOOD ADDITIVES, NAMELY, NATURAL FOOD EXTRACTS DERIVED FROM FISH, ALGAE, SEAWEED, FISH OR SHARK CARTILAGE NOT FOR MEDICINAL PURPOSES AND FOR HUMAN CONSUMPTION; PROCESSED, EDIBLE SEAWEED; PROCESSED ALGAE FOR HUMAN CONSUMPTION; PROCESSED CHLORELLA NOT FOR MEDICINAL PURPOSES AND FOR HUMAN CONSUMPTION, IN CLASS 29 (U.S. CL. 46).



David J. Kyjars

FIRST USE 3-24-2009; IN COMMERCE 3-26-2010.

Reg. No. 4,109,555 NO CLAIM IS MADE TO THE EXCLUSIVE RIGHT TO USE "FOOD", APART FROM THE MARK AS SHOWN.

THE COLOR(S) GREEN, ORANGE, PURPLE, AND BLACK IS/ARE CLAIMED AS A FEATURE OF THE MARK.

THE MARK CONSISTS OF THE WORDS "CHUNHO FOOD" IN BLACK, NEXT TO A GREEN HEART, AN ORANGE HEART, AND A PURPLE HEART, THE HEARTS ARRANGED IN A CIRCLE.

THE ENGLISH TRANSLATION OF "CHUNHO" IN THE MARK IS "GROUNDWATER SPRINGS WHICH GATHER TO BE A LAKE". THIS EXPRESSES THE WILLINGNESS OF THE CORPORATION TO PROSPER.

SN 85-048,032, FILED 5-26-2010.

MARILYN IZZI, EXAMINING ATTORNEY

United States of America

United States Patent and Trademark Office



Reg. No. 4,109,556

KRAFT FOODS GLOBAL BRANDS LLC (DELAWARE LIMITED LIABILITY COMPANY)
THREE LAKES DRIVE
NORTHFIELD, IL 60093

Registered Mar. 6, 2012

Int. Cl.: 41

FOR: ENTERTAINMENT SERVICES IN THE NATURE OF FOOTBALL EXHIBITIONS, IN CLASS 41 (U.S. CLS. 100, 101 AND 107).

SERVICE MARK

FIRST USE 12-16-2011; IN COMMERCE 12-16-2011.

PRINCIPAL REGISTER

NO CLAIM IS MADE TO THE EXCLUSIVE RIGHT TO USE "BOWL", APART FROM THE MARK AS SHOWN.

THE MARK CONSISTS OF "KRAFT" IN A HEXAGON AND THE WORDS "FIGHT HUNGER BOWL" IN A SHIELD WITH LINES DEPICTING A PARTIAL FOOTBALL AND PARTIAL FOOTBALL FIELD.

SN 85-048,545, FILED 5-26-2010.

PAUL E. FAHRENKOPF, EXAMINING ATTORNEY



David J. Kybas

Director of the United States Patent and Trademark Office

United States of America

United States Patent and Trademark Office



Reg. No. 4,109,557

Registered Mar. 6, 2012

Int. Cls.: 42 and 44

SERVICE MARK

PRINCIPAL REGISTER

THE REGENTS OF THE UNIVERSITY OF COLORADO (COLORADO CORPORATION)
1800 GRANT STREET, 8TH FLOOR
DENVER, CO 80203

FOR: MEDICAL AND SCIENTIFIC RESEARCH IN THE FIELDS OF BIOTECHNOLOGY, PHARMACEUTICAL DEVELOPMENT AND CLINICAL MEDICINE; RESEARCH AND DEVELOPMENT OF TECHNOLOGY IN THE FIELDS OF BIOTECHNOLOGY, PHARMACEUTICAL DEVELOPMENT AND CLINICAL MEDICINE; DIAGNOSTIC SERVICES IN THE FIELDS OF LIQUID CHROMATOGRAPHY MASS SPECTROMETRY, HIGH-PERFORMANCE LIQUID CHROMATOGRAPHY, GAS CHROMATOGRAPHY- MASS SPECTROMETRY, NUCLEAR MAGNETIC RESONANCE SPECTROSCOPY, IMMUNO-ASSAYS AND PROTEIN ARRAY AND CHIP TECHNOLOGIES, IN CLASS 42 (U.S. CLS. 100 AND 101).

FIRST USE 1-1-2011; IN COMMERCE 1-1-2011.

FOR: MEDICAL TESTING FOR DIAGNOSTIC OR TREATMENT PURPOSES; CONSULTING SERVICES IN THE FIELDS OF DIAGNOSTIC MEDICAL TESTING AND NUTRITION, IN CLASS 44 (U.S. CLS. 100 AND 101).

FIRST USE 1-1-2011; IN COMMERCE 1-1-2011.

THE MARK CONSISTS OF THE LITERAL ELEMENT "C42" IN BLACK AND THE DESIGN OF THE LETTER "I" IN A HALF CIRCLE THAT ARE DISPLAYED IN GREY AND YELLOW. THE COLOR WHITE REPRESENTS THE BACKGROUND AND IS NOT PART OF THE MARK.

THE COLOR(S) BLACK, GREY, AND YELLOW IS/ARE CLAIMED AS A FEATURE OF THE MARK.

SN 85-049,091, FILED 5-27-2010.

ROSELLE HERRERA, EXAMINING ATTORNEY



David J. Kybas

Director of the United States Patent and Trademark Office

United States of America

United States Patent and Trademark Office

DOZER DAY WHERE KIDS DRIVE!

Reg. No. 4,109,558

THE NUTTER FAMILY FOUNDATION (WASHINGTON NON-PROFIT CORPORATION)
9400 NE 134TH ST.
VANCOUVER, WA 98662

Registered Mar. 6, 2012

Int. Cls.: 16 and 25

FOR: BOOKS, NAMELY, CHILDREN'S BOOKS, COLORING BOOKS AND CHILDREN'S
ACTIVITY BOOKS; STICKERS, IN CLASS 16 (U.S. CLS. 2, 5, 22, 23, 29, 37, 38 AND 50).

TRADEMARK

FIRST USE 0-0-2005; IN COMMERCE 0-0-2005.

PRINCIPAL REGISTER

FOR: CLOTHING, NAMELY, SWEATSHIRTS, HOODED SWEATSHIRTS AND T-SHIRTS,
IN CLASS 25 (U.S. CLS. 22 AND 39).

FIRST USE 0-0-2005; IN COMMERCE 0-0-2005.

THE MARK CONSISTS OF STANDARD CHARACTERS WITHOUT CLAIM TO ANY PAR-
TICULAR FONT, STYLE, SIZE, OR COLOR.

SN 85-049,104, FILED 5-27-2010.

NICHOLAS ALTREE, EXAMINING ATTORNEY



David J. Kybas

Director of the United States Patent and Trademark Office

United States of America

United States Patent and Trademark Office



Reg. No. 4,109,559

Registered Mar. 6, 2012

Int. Cls.: 16 and 25

TRADEMARK

PRINCIPAL REGISTER

THE NUTTER FAMILY FOUNDATION (WASHINGTON NON-PROFIT CORPORATION)
9400 NE 134TH STREET
VANCOUVER, WA 98662

FOR: BOOKS, NAMELY, CHILDREN'S BOOKS, COLORING BOOKS AND CHILDREN'S
ACTIVITY BOOKS; STICKERS, IN CLASS 16 (U.S. CLS. 2, 5, 22, 23, 29, 37, 38 AND 50).

FIRST USE 0-0-2005; IN COMMERCE 0-0-2011.

FOR: CLOTHING, NAMELY, SWEATSHIRTS, HOODED SWEATSHIRTS AND T-SHIRTS,
IN CLASS 25 (U.S. CLS. 22 AND 39).

FIRST USE 0-0-2005; IN COMMERCE 0-0-2011.

THE MARK CONSISTS OF A STYLIZED BULLDOZER IN A BOX, WITH THE EDGES OF
THE BULLDOZER EXTENDING BEYOND THE BOX, ABOVE THE WORDS "DOZER DAY"
IN BLOCK LETTERS, WHICH ARE ABOVE THE WORDS "WHERE KIDS DRIVE!" IN
STYLIZED LETTERS.

SN 85-049,109, FILED 5-27-2010.

NICHOLAS ALTREE, EXAMINING ATTORNEY



David J. Kyffers

Director of the United States Patent and Trademark Office

United States of America

United States Patent and Trademark Office



Reg. No. 4,109,560

Registered Mar. 6, 2012

Int. Cls.: 14, 18, 24, and 26

LORD WILLY'S LLC (NEW YORK LIMITED LIABILITY COMPANY)
223 MOTT STREET
NEW YORK, NY 10012

FOR: JEWELRY, WATCHES, CUFF-LINKS, TIE CLIPS AND TIE BARS, IN CLASS 14 (U.S. CLS. 2, 27, 28 AND 50).

FIRST USE 11-15-2005; IN COMMERCE 11-15-2005.

TRADEMARK

PRINCIPAL REGISTER

FOR: LUGGAGE, TRUNKS, TRAVEL BAGS, UMBRELLAS, SUIT CARRIERS, WALLETS, LEATHER SHOULDER BELTS, BRIEFCASES, ATTACHE CASES, ATHLETIC BAGS, TOILETRY BAGS SOLD EMPTY, GARMENT BAGS FOR TRAVEL, MESSENGER BAGS, SUITCASES; LEATHER AND IMITATION LEATHER BAGS, IN CLASS 18 (U.S. CLS. 1, 2, 3, 22 AND 41).

FIRST USE 11-15-2005; IN COMMERCE 11-15-2005.

FOR: HAND TOWELS, BATH TOWELS, KITCHEN TOWELS, DRAPERY, CURTAINS, BED LINENS, BED SHEETS, COMFORTERS, DUVETS, DINING LINENS, TEXTILE TABLE-CLOTHS, TEXTILE NAPKINS; CUSTOM TEXTILE FABRICS FOR USE IN MAKING CLOTHING AND HOUSEHOLD FURNISHINGS, IN CLASS 24 (U.S. CLS. 42 AND 50).

FIRST USE 11-15-2005; IN COMMERCE 11-15-2005.

FOR: BELT BUCKLES, COLLAR STAYS, BUTTONS, ORNAMENTAL NOVELTY BADGES, IN CLASS 26 (U.S. CLS. 37, 39, 40, 42 AND 50).

FIRST USE 11-15-2005; IN COMMERCE 11-15-2005.

OWNER OF U.S. REG. NO. 3,522,680.

THE MARK CONSISTS OF A SILHOUETTE OF A MAN HOLDING AN UMBRELLA WEARING A FORMAL JACKET, BOXER SHORTS, AND SHOES.

SN 85-050,147, FILED 5-28-2010.

ALEXANDER L. POWERS, EXAMINING ATTORNEY



David J. Kyros

Director of the United States Patent and Trademark Office

United States of America

United States Patent and Trademark Office

LORD WILLY'S

Reg. No. 4,109,561

LORD WILLY'S LLC (NEW YORK LIMITED LIABILITY COMPANY)
223 MOTT STREET
NEW YORK, NY 10012

Registered Mar. 6, 2012

Int. Cls.: 18, 24, 25, and 26

FOR: LUGGAGE, TRUNKS, TRAVEL BAGS, UMBRELLAS, SUIT CARRIERS, WALLETS, LEATHER SHOULDER BELTS, BRIEFCASES, ATTACHE CASES, ATHLETIC BAGS, TOILETRY BAGS SOLD EMPTY, GARMENT BAGS FOR TRAVEL, MESSENGER BAGS, SUITCASES; LEATHER AND IMITATION LEATHER BAGS, IN CLASS 18 (U.S. CLS. 1, 2, 3, 22 AND 41).

TRADEMARK

PRINCIPAL REGISTER

FIRST USE 11-15-2005; IN COMMERCE 11-15-2005.

FOR: HAND TOWELS, BATH TOWELS, KITCHEN TOWELS, DRAPERY, CURTAINS, BED LINENS, BED SHEETS, COMFORTERS, DUVETS, DINING LINENS, TEXTILE TABLE-CLOTHS, TEXTILE NAPKINS; CUSTOM TEXTILE FABRICS FOR USE IN MAKING CLOTHING AND HOUSEHOLD FURNISHINGS, IN CLASS 24 (U.S. CLS. 42 AND 50).

FIRST USE 11-15-2005; IN COMMERCE 11-15-2005.

FOR: CLOTHING, NAMELY, SHIRTS, TIES, JACKETS, PANTS, SUITS, TUXEDOS, POCKET SQUARES, VESTS, COATS, HATS, GLOVES, SCARVES, POLO SHIRTS, SHORTS, UNDERWEAR, PAJAMAS, SOCKS, SWEATERS, T-SHIRTS, ROBES, UNDERSHIRTS, BELTS, SUSPENDERS, SWIMWEAR, FOOTWEAR, SLIPPERS, CLOTHING HANGERS, SHOE TREES, IN CLASS 25 (U.S. CLS. 22 AND 39).

FIRST USE 1-4-2012; IN COMMERCE 1-4-2012.

FOR: BELT BUCKLES, COLLAR STAYS, BUTTONS, ORNAMENTAL NOVELTY BADGES, IN CLASS 26 (U.S. CLS. 37, 39, 40, 42 AND 50).

FIRST USE 11-25-2005; IN COMMERCE 11-25-2005.

THE MARK CONSISTS OF STANDARD CHARACTERS WITHOUT CLAIM TO ANY PARTICULAR FONT, STYLE, SIZE, OR COLOR.

OWNER OF U.S. REG. NO. 3,514,206.



David J. Kyffers

Director of the United States Patent and Trademark Office

Reg. No. 4,109,561 SN 85-050,156, FILED 5-28-2010.

ALEXANDER L. POWERS, EXAMINING ATTORNEY

United States of America

United States Patent and Trademark Office

DOLCE DOLLS

Reg. No. 4,109,562

Registered Mar. 6, 2012

Int. Cl.: 16

TRADEMARK

PRINCIPAL REGISTER

DOLCE DOLLS LLC (MINNESOTA LIMITED LIABILITY COMPANY)
BOX 384
1169 PORTER STREET
CLEARWATER, MN 55320

FOR: BOOKS IN THE FIELD OF DOLLS, DOLL STORIES AND DOLL CHARACTERS;
PRINTED MUSIC BOOKS; SHEET MUSIC; SONG BOOKS, IN CLASS 16 (U.S. CLS. 2, 5, 22,
23, 29, 37, 38 AND 50).

FIRST USE 5-6-2011; IN COMMERCE 12-30-2011.

THE MARK CONSISTS OF STANDARD CHARACTERS WITHOUT CLAIM TO ANY PAR-
TICULAR FONT, STYLE, SIZE, OR COLOR.

NO CLAIM IS MADE TO THE EXCLUSIVE RIGHT TO USE "DOLLS", APART FROM THE
MARK AS SHOWN.

THE ENGLISH TRANSLATION OF "DOLCE" IN THE MARK IS "SWEET".

SN 85-050,202, FILED 5-28-2010.

DAVID ELTON, EXAMINING ATTORNEY



David J. Kyffers

Director of the United States Patent and Trademark Office

United States of America

United States Patent and Trademark Office

IDINING

Reg. No. 4,109,563

ABROMOVITZ, JORDAN (UNITED STATES INDIVIDUAL)
35 HIGHLAND ROAD APT 5411
BETHEL PARK, PA 15102

Registered Mar. 6, 2012

Int. Cl.: 35

FOR: PROVIDING SELF-SERVICE FOOD KIOSK SERVICES, IN CLASS 35 (U.S. CLS. 100, 101 AND 102).

SERVICE MARK

FIRST USE 1-1-2011; IN COMMERCE 1-1-2011.

PRINCIPAL REGISTER

THE MARK CONSISTS OF STANDARD CHARACTERS WITHOUT CLAIM TO ANY PARTICULAR FONT, STYLE, SIZE, OR COLOR.

SN 85-050,841, FILED 5-29-2010.

ANGELA M. MICHELI, EXAMINING ATTORNEY



David J. Kybas

Director of the United States Patent and Trademark Office

United States of America

United States Patent and Trademark Office

GRADVOCATES

Reg. No. 4,109,564

Registered Mar. 6, 2012

Int. Cl.: 41

SERVICE MARK

PRINCIPAL REGISTER

W&R HOLDINGS LIMITED LIABILITY COMPANY (NEW JERSEY LIMITED LIABILITY COMPANY)
PO BOX 733
RED BANK, NJ 07701

FOR: EDUCATIONAL SERVICES, NAMELY, PROVIDING EDITING, REVIEWING, WRITING, PREPARATION, COUNSELING, AND CONSULTING IN THE FIELDS OF HIGHER-EDUCATION ADMISSIONS, SPECIFICALLY RELATING TO PERSONAL STATEMENTS, ESSAYS, RESUMES, APPLICATIONS, AND SCHOOL CORRESPONDENCE, IN CLASS 41 (U.S. CLS. 100, 101 AND 107).

FIRST USE 6-30-2010; IN COMMERCE 6-30-2010.

THE MARK CONSISTS OF STANDARD CHARACTERS WITHOUT CLAIM TO ANY PARTICULAR FONT, STYLE, SIZE, OR COLOR.

SN 85-050,842, FILED 5-29-2010.

STEPHANIE ALI, EXAMINING ATTORNEY



David J. Kybas

Director of the United States Patent and Trademark Office

United States of America
United States Patent and Trademark Office

PAULTWO

Reg. No. 4,109,565

Registered Mar. 6, 2012

Int. Cl.: 35

SERVICE MARK

PRINCIPAL REGISTER

PAULTWO LLC (LOUISIANA LIMITED LIABILITY COMPANY)
10156 PERKINS ROWE #311 F
BATON ROUGE, LA 70810

FOR: CREATIVE SERVICES, NAMELY, BRAND DEVELOPMENT SERVICES FOR CORPORATE AND INDIVIDUAL CLIENTS, BUSINESS MARKETING STRATEGY SERVICES, BUSINESS CONSULTATION IN THE NATURE OF BUSINESS PLAN DEVELOPMENT, AND PRODUCTION OF ADVERTISING MATERIALS, IN CLASS 35 (U.S. CLS. 100, 101 AND 102).

FIRST USE 12-14-2006; IN COMMERCE 12-14-2006.

THE MARK CONSISTS OF STANDARD CHARACTERS WITHOUT CLAIM TO ANY PARTICULAR FONT, STYLE, SIZE, OR COLOR.

SN 85-052,124, FILED 6-1-2010.

REBECCA EISINGER, EXAMINING ATTORNEY



David J. Kybas

Director of the United States Patent and Trademark Office

United States of America

United States Patent and Trademark Office

ANEDOT

Reg. No. 4,109,566

Registered Mar. 6, 2012

Int. Cl.: 42

SERVICE MARK

PRINCIPAL REGISTER

PAULTWO LLC (LOUISIANA LIMITED LIABILITY COMPANY)
10156 PERKINS ROWE
#311 F
BATON ROUGE, LA 70810

FOR: PROVIDING ONLINE, NON DOWNLOADABLE SOFTWARE IN THE FORM OF A WEBSITE PORTAL FOR ACCEPTING MONETARY CONTRIBUTIONS AND DONOR INFORMATION RELATING TO CAMPAIGNS OF VARIOUS TYPES, SUCH AS POLITICAL, ACADEMIC AND NON PROFIT, MANAGING THE DONOR INFORMATION TO CREATE A CONTACT SYSTEM AND AUTOMATICALLY GENERATING AND FILING REQUIRED MONETARY CONTRIBUTION REPORTS, IN CLASS 42 (U.S. CLS. 100 AND 101).

FIRST USE 11-21-2011; IN COMMERCE 11-21-2011.

THE MARK CONSISTS OF STANDARD CHARACTERS WITHOUT CLAIM TO ANY PARTICULAR FONT, STYLE, SIZE, OR COLOR.

SN 85-052,136, FILED 6-1-2010.

REBECCA EISINGER, EXAMINING ATTORNEY



David J. Kyros

Director of the United States Patent and Trademark Office

United States of America
United States Patent and Trademark Office

COMBAZEE

Reg. No. 4,109,567

COMBAZEE, INC. (CALIFORNIA CORPORATION)
47532 AVALON HEIGHTS TERRACE
FREMONT, CA 94539

Registered Mar. 6, 2012

Int. Cl.: 28

FOR: BUILDING BLOCKS AND BLOCK CONNECTORS FOR PLAY, IN CLASS 28 (U.S. CLS. 22, 23, 38 AND 50).

TRADEMARK

FIRST USE 12-27-2011; IN COMMERCE 12-27-2011.

PRINCIPAL REGISTER

THE MARK CONSISTS OF STANDARD CHARACTERS WITHOUT CLAIM TO ANY PARTICULAR FONT, STYLE, SIZE, OR COLOR.

SN 85-052,152, FILED 6-1-2010.

REBECCA EISINGER, EXAMINING ATTORNEY



David J. Kybas

Director of the United States Patent and Trademark Office

United States of America

United States Patent and Trademark Office

BACKNBLOOM

Reg. No. 4,109,568

Registered Mar. 6, 2012

Int. Cls.: 9 and 41

TRADEMARK

SERVICE MARK

PRINCIPAL REGISTER

STEELE, LORI JEAN (UNITED STATES INDIVIDUAL)
LOWER
308 18TH AVE.
MANHATTAN BEACH, CA 90266 AND

KABABIE, ALBERTO (MEXICO INDIVIDUAL)
LOWER
308 18TH AVE.
MANHATTAN BEACH, CA 90266

FOR: AUDIO RECORDINGS FEATURING A SERIES OF PRE-RECORDED PHONOGRAPH RECORDS CONSISTING OF MUSICAL PERFORMANCES, IN CLASS 9 (U.S. CLS. 21, 23, 26, 36 AND 38).

FIRST USE 4-23-2009; IN COMMERCE 4-23-2009.

FOR: ENTERTAINMENT SERVICES IN THE NATURE OF LIVE MUSICAL PERFORMANCES, IN CLASS 41 (U.S. CLS. 100, 101 AND 107).

FIRST USE 4-23-2009; IN COMMERCE 4-23-2009.

THE MARK CONSISTS OF STANDARD CHARACTERS WITHOUT CLAIM TO ANY PARTICULAR FONT, STYLE, SIZE, OR COLOR.

SN 85-052,565, FILED 6-2-2010.

WILLIAM BRECKENFELD, EXAMINING ATTORNEY



David J. Kyfos

Director of the United States Patent and Trademark Office

United States of America

United States Patent and Trademark Office

DUCK'S ALPHABET

Reg. No. 4,109,569

Registered Mar. 6, 2012

Int. Cl.: 41

SERVICE MARK

PRINCIPAL REGISTER

GENERAL WORD L.P. (CAYMAN ISLANDS LIMITED PARTNERSHIP)
405 LEXINGTON AVENUE
C/O MOSES & SINGER, THE CHRYSLERBUILDINGBUILDING
NEW YORK, NY 10174

FOR: PROVISION OF EDUCATION AND ENTERTAINMENT FOR CHILDREN BY MEANS OF THE INTERNET, NAMELY, PROVIDING A WEBSITE FEATURING EDUCATIONAL GAMES IN THE FIELDS OF LANGUAGE AND THE ALPHABET, IN CLASS 41 (U.S. CLS. 100, 101 AND 107).

FIRST USE 9-30-2010; IN COMMERCE 9-30-2010.

THE MARK CONSISTS OF STANDARD CHARACTERS WITHOUT CLAIM TO ANY PARTICULAR FONT, STYLE, SIZE, OR COLOR.

NO CLAIM IS MADE TO THE EXCLUSIVE RIGHT TO USE "ALPHABET", APART FROM THE MARK AS SHOWN.

SN 85-052,916, FILED 6-2-2010.

ROBERT STRUCK, EXAMINING ATTORNEY



David J. Kyffers

Director of the United States Patent and Trademark Office

United States of America

United States Patent and Trademark Office

TELOMERES FOR LIFE

Reg. No. 4,109,570

DREAM MASTER, LLC (NEVADA LIMITED LIABILITY COMPANY)
6935 SOUTH SAPPHIRE WAY
CHANDLER, AZ 85249

Registered Mar. 6, 2012

Int. Cl.: 5

FOR: NUTRITIONAL SUPPLEMENTS, IN CLASS 5 (U.S. CLS. 6, 18, 44, 46, 51 AND 52).

TRADEMARK

FIRST USE 10-5-2010; IN COMMERCE 10-5-2010.

PRINCIPAL REGISTER

THE MARK CONSISTS OF STANDARD CHARACTERS WITHOUT CLAIM TO ANY PARTICULAR FONT, STYLE, SIZE, OR COLOR.

NO CLAIM IS MADE TO THE EXCLUSIVE RIGHT TO USE "TELOMERES", APART FROM THE MARK AS SHOWN.

SN 85-053,119, FILED 6-2-2010.

JILL C. ALT, EXAMINING ATTORNEY



David J. Kyffers

Director of the United States Patent and Trademark Office

United States of America

United States Patent and Trademark Office



Reg. No. 4,109,571

Registered Mar. 6, 2012

Int. Cl.: 36

SERVICE MARK

PRINCIPAL REGISTER

WOMEN AGAINST ABUSE, INC. (PENNSYLVANIA NON-PROFIT CORPORATION)
SUITE 1341
100 SOUTH BROAD STREET
PHILADELPHIA, PA 19110

FOR: CHARITABLE FUNDRAISING SERVICES BY MEANS OF FOOD COMPETITION
EVENT TO SUPPORT DOMESTIC VIOLENCE AWARENESS, IN CLASS 36 (U.S. CLS. 100,
101 AND 102).

FIRST USE 6-0-2008; IN COMMERCE 6-0-2008.

THE MARK CONSISTS OF IS A DEPICTION OF THE WORD "DISH" ON TOP OF THE
WORDS "IT UP". BELOW THE WORDS "IT UP" IS A COOKING PAN. ABOVE THE WORD
"DISH" IS A CURVED LINE ILLUSTRATING HEAT.

SN 85-053,504, FILED 6-3-2010.

CHRISTINA SOBRAL, EXAMINING ATTORNEY



David J. Kyros

Director of the United States Patent and Trademark Office

United States of America

United States Patent and Trademark Office

KATE'S GOURMET SALSA

Reg. No. 4,109,572

KATE'S GOURMET SALSA, LLC (MISSOURI LIMITED LIABILITY COMPANY)
3500 EAST ROUTE M
ASHLAND, MO 65010

Registered Mar. 6, 2012

Int. Cls.: 29 and 30

FOR: CONDIMENTS, NAMELY, JAMS AND JELLIES, IN CLASS 29 (U.S. CL. 46).

TRADEMARK

FIRST USE 2-28-2010; IN COMMERCE 2-28-2010.

PRINCIPAL REGISTER

FOR: CONDIMENTS, NAMELY, SALSAS, IN CLASS 30 (U.S. CL. 46).

FIRST USE 2-28-2010; IN COMMERCE 2-28-2010.

THE MARK CONSISTS OF STANDARD CHARACTERS WITHOUT CLAIM TO ANY PARTICULAR FONT, STYLE, SIZE, OR COLOR.

NO CLAIM IS MADE TO THE EXCLUSIVE RIGHT TO USE "GOURMET SALSA", APART FROM THE MARK AS SHOWN.

SN 85-054,058, FILED 6-3-2010.

TINA MAI, EXAMINING ATTORNEY



David J. Kybas

Director of the United States Patent and Trademark Office

United States of America

United States Patent and Trademark Office

Okie

Reg. No. 4,109,573

Registered Mar. 6, 2012

Int. Cl.: 5

TRADEMARK

PRINCIPAL REGISTER

KENT NUTRITION GROUP, INC. (IOWA CORPORATION)
1600 OREGON STREET
MUSCATINE, IA 52761

FOR: MEDICATED LIVESTOCK FEEDS, IN CLASS 5 (U.S. CLS. 6, 18, 44, 46, 51 AND 52).

FIRST USE 10-1-2010; IN COMMERCE 10-1-2010.

THE MARK CONSISTS OF STANDARD CHARACTERS WITHOUT CLAIM TO ANY PARTICULAR FONT, STYLE, SIZE, OR COLOR.

SN 85-054,177, FILED 6-3-2010.

CHARLES L. JENKINS, EXAMINING ATTORNEY



David J. Kybas

Director of the United States Patent and Trademark Office

United States of America

United States Patent and Trademark Office

OWN THE SUN

Reg. No. 4,109,574

Registered Mar. 6, 2012

Int. Cl.: 11

TRADEMARK

PRINCIPAL REGISTER

SHIZUOKA SEIKI KABUSHIKI KAISHA (JAPAN CORPORATION), TA SHIZUOKA SEIKI
CO., LTD.,
4-1 YAMANA-CHO, FUKUROI-SHI
SHIZUOKA-KEN, JAPAN 437-0042

FOR: INFRARED OIL HEATER, FAR INFRARED OIL HEATER AND HOT AIR SPOT
HEATER, IN CLASS 11 (U.S. CLS. 13, 21, 23, 31 AND 34).

FIRST USE 11-11-2011; IN COMMERCE 11-11-2011.

THE MARK CONSISTS OF STANDARD CHARACTERS WITHOUT CLAIM TO ANY PAR-
TICULAR FONT, STYLE, SIZE, OR COLOR.

SN 85-054,271, FILED 6-3-2010.

GRETCHEN ULRICH, EXAMINING ATTORNEY



David J. Kybas

Director of the United States Patent and Trademark Office

United States of America

United States Patent and Trademark Office

INVATION

Reg. No. 4,109,575

Registered Mar. 6, 2012

Int. Cl.: 7

TRADEMARK

PRINCIPAL REGISTER

B & H MANUFACTURING COMPANY, INC. (CALIFORNIA CORPORATION)
3461 ROEDING ROAD
CERES, CA 95307

FOR: COMMERCIAL AND INDUSTRIAL MACHINES FOR APPLYING LABELS AND COMPONENTS THEREFOR, IN CLASS 7 (U.S. CLS. 13, 19, 21, 23, 31, 34 AND 35).

FIRST USE 11-0-2011; IN COMMERCE 11-0-2011.

THE MARK CONSISTS OF STANDARD CHARACTERS WITHOUT CLAIM TO ANY PARTICULAR FONT, STYLE, SIZE, OR COLOR.

SN 85-055,932, FILED 6-7-2010.

KEVIN CORWIN, EXAMINING ATTORNEY



David J. Kybas

Director of the United States Patent and Trademark Office

United States of America

United States Patent and Trademark Office



Reg. No. 4,109,576

PARK CITY SKI PLACES, LLC (MARYLAND LIMITED LIABILITY COMPANY)
10846 BREWER HOUSE RD
NORTH BETHESDA, MD 20852

Registered Mar. 6, 2012

Int. Cl.: 37

FOR: REAL ESTATE PROPERTY CLEANING, REPAIR AND MAINTENANCE SERVICES,
IN CLASS 37 (U.S. CLS. 100, 103 AND 106).

SERVICE MARK

FIRST USE 12-8-2009; IN COMMERCE 12-27-2009.

PRINCIPAL REGISTER

NO CLAIM IS MADE TO THE EXCLUSIVE RIGHT TO USE "PARK CITY SKI PLACES",
APART FROM THE MARK AS SHOWN.

THE COLOR(S) GRAY, DARK RED AND LIGHT RED IS/ARE CLAIMED AS A FEATURE
OF THE MARK.

THE MARK CONSISTS OF THE STYLIZED WORDING "PARK CITY SKI PLACES" IN DARK
RED WITH THE DESIGN OF TWO MOUNTAINS OUTLINED IN GRAY WITH LIGHT RED
PEAKS AND A SKIER OUTLINED IN DARK RED APPEARING ON THE LEFT SIDE OF THE
MOUNTAIN DESIGN.

SN 85-056,535, FILED 6-7-2010.

KATHERINE CONNOLLY, EXAMINING ATTORNEY



David J. Kybas

Director of the United States Patent and Trademark Office

United States of America

United States Patent and Trademark Office



Reg. No. 4,109,577

Registered Mar. 6, 2012

Int. Cls.: 39, 40, and 42

SERVICE MARK

PRINCIPAL REGISTER

GRUPO PAVISA, S.A. DE C.V. (MEXICO COMPANY)
GENERAL AGUSTÍN MILLAN #10
COL. SAN ANDRES ATOTO
NAUCALPAN, MEXICO

FOR: DISTRIBUTION SERVICES, NAMELY, DELIVERY OF GLASS PRODUCTS, IN CLASS 39 (U.S. CLS. 100 AND 105).

FIRST USE 3-26-1980; IN COMMERCE 3-8-2006.

FOR: MANUFACTURING SERVICES FOR OTHERS IN THE FIELD OF GLASS PRODUCTS; PROCESSING AND FINISHING OF GLASS, IN CLASS 40 (U.S. CLS. 100, 103 AND 106).

FIRST USE 3-26-1980; IN COMMERCE 3-8-2006.

FOR: DESIGN SERVICES FOR PACKAGING; NEW PRODUCT DESIGN SERVICES, IN CLASS 42 (U.S. CLS. 100 AND 101).

FIRST USE 3-26-1980; IN COMMERCE 3-8-2006.

THE MARK CONSISTS OF A STYLIZED BOTTLE DESIGN WITHIN A BROKEN CIRCLE AND THE WORD "PAVISA".

SN 85-057,041, FILED 6-8-2010.

JOHN DWYER, EXAMINING ATTORNEY



David J. Kybas

Director of the United States Patent and Trademark Office

United States of America

United States Patent and Trademark Office

MORE VRP

Reg. No. 4,109,578

Registered Mar. 6, 2012

Int. Cl.: 9

TRADEMARK

PRINCIPAL REGISTER

MORE IT RESOURCES LTD (ISRAEL PRIVATE LIMITED COMPANY)
1 BEN GURION ST.
BNEY-BRAK, ISRAEL 51201

FOR: SOFTWARE THAT DEPLOYS VIRTUAL RESOURCE PARTITIONING FOR OPTIMIZING A DATA CENTER BY MANAGING RESOURCE TRAFFIC, PHYSICAL RESOURCES, AND VIRTUAL RESOURCES MANAGEMENT, IN CLASS 9 (U.S. CLS. 21, 23, 26, 36 AND 38).

FIRST USE 1-31-2008; IN COMMERCE 1-31-2008.

THE MARK CONSISTS OF STANDARD CHARACTERS WITHOUT CLAIM TO ANY PARTICULAR FONT, STYLE, SIZE, OR COLOR.

SN 85-057,756, FILED 6-8-2010.

JILL PRATER, EXAMINING ATTORNEY



David J. Kyffers

Director of the United States Patent and Trademark Office

United States of America

United States Patent and Trademark Office

FIRST STREET

Reg. No. 4,109,579

Registered Mar. 6, 2012

Int. Cl.: 9

TRADEMARK

PRINCIPAL REGISTER

SAGE PUBLICATIONS, INC. (DELAWARE CORPORATION)
2455 TELLER ROAD
THOUSAND OAKS, CA 91320

FOR: DOWNLOADABLE MULTI-MEDIA FILES CONTAINING TEXT, AUDIO, VIDEO, AND INTERNET WEB LINKS RELATING TO GOVERNMENTAL INFORMATION, LEGISLATIVE INFORMATION, POLITICAL INFORMATION AND PROFESSIONAL INFORMATION IN THE FIELDS OF GOVERNMENT, LEGISLATURE, POLITICS AND BUSINESS, IN CLASS 9 (U.S. CLS. 21, 23, 26, 36 AND 38).

FIRST USE 4-0-2011; IN COMMERCE 4-0-2011.

THE MARK CONSISTS OF STANDARD CHARACTERS WITHOUT CLAIM TO ANY PARTICULAR FONT, STYLE, SIZE, OR COLOR.

SN 85-058,959, FILED 6-9-2010.

LAURIE MAYES, EXAMINING ATTORNEY



David J. Kyffers

Director of the United States Patent and Trademark Office

United States of America

United States Patent and Trademark Office

INFUSEAMERICA

Reg. No. 4,109,580

Registered Mar. 6, 2012

Int. Cl.: 44

SERVICE MARK

PRINCIPAL REGISTER

NUFACTOR, INC. (CALIFORNIA CORPORATION)
41093 COUNTY CENTER DRIVE
TEMECULA, CA 92591

FOR: HEALTH CARE SERVICES IN THE NATURE OF INFUSION SERVICES, NAMELY, PROVIDING INTRAVENOUS AND SUBCUTANEOUS BIOPHARMACEUTICALS, BIOLOGICS AND PHARMACEUTICALS AND THE INFUSION OF INTRAVENOUS AND SUBCUTANEOUS BIOPHARMACEUTICALS, BIOLOGICS AND PHARMACEUTICALS TO PATIENTS, IN CLASS 44 (U.S. CLS. 100 AND 101).

FIRST USE 11-24-2010; IN COMMERCE 11-24-2010.

THE MARK CONSISTS OF STANDARD CHARACTERS WITHOUT CLAIM TO ANY PARTICULAR FONT, STYLE, SIZE, OR COLOR.

SN 85-059,502, FILED 6-10-2010.

NAAKWAMA ANKRAH, EXAMINING ATTORNEY



David J. Kyffers

Director of the United States Patent and Trademark Office

United States of America

United States Patent and Trademark Office

EVEREST

Reg. No. 4,109,581

CONOPCO, INC. (NEW YORK CORPORATION)
700 SYLVAN AVENUE
ENGLEWOOD CLIFFS, NJ 07632

Registered Mar. 6, 2012

Int. Cl.: 3

FOR: DEODORANTS AND ANTI-PERSPIRANTS, IN CLASS 3 (U.S. CLS. 1, 4, 6, 50, 51 AND 52).

TRADEMARK

FIRST USE 1-0-2011; IN COMMERCE 1-0-2011.

PRINCIPAL REGISTER

THE MARK CONSISTS OF STANDARD CHARACTERS WITHOUT CLAIM TO ANY PARTICULAR FONT, STYLE, SIZE, OR COLOR.

SN 85-060,380, FILED 6-11-2010.

JANICE L. MCMORROW, EXAMINING ATTORNEY



David J. Kybas

Director of the United States Patent and Trademark Office

United States of America

United States Patent and Trademark Office

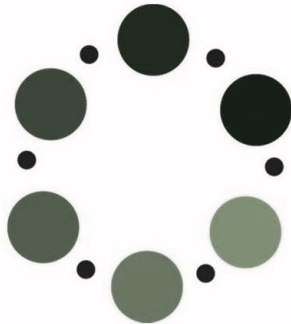

Reg. No. 4,109,582

Registered Mar. 6, 2012

Int. Cl.: 42

SERVICE MARK

PRINCIPAL REGISTER

ARGUS I. CUNNINGHAM, (UNITED STATES INDIVIDUAL)
BOX 817
PSC 817
FPO AE, ITALY 09622

FOR: PROVIDING A WEBSITE FEATURING TECHNOLOGY THAT FACILITATES SHAREHOLDERS' ELECTRONIC COMMUNICATION AND SOCIAL MEDIA INTERACTION FOR THE PURPOSE OF IMPROVING CORPORATE GOVERNANCE OVERSIGHT; PROVIDING ON-LINE NON-DOWNLOADABLE SOFTWARE THAT FACILITATES SHAREHOLDERS' ELECTRONIC COMMUNICATION AND SOCIAL MEDIA INTERACTION FOR THE PURPOSE OF IMPROVING CORPORATE GOVERNANCE OVERSIGHT, IN CLASS 42 (U.S. CLS. 100 AND 101).

FIRST USE 11-30-2010; IN COMMERCE 11-30-2011.

THE MARK CONSISTS OF A CIRCULAR ARRANGEMENT OF ALTERNATING LARGE AND SMALL DOTS.

SN 85-060,508, FILED 6-11-2010.

LAURIE KAUFMAN, EXAMINING ATTORNEY



David J. Kybas

Director of the United States Patent and Trademark Office

United States of America

United States Patent and Trademark Office

MYBUY

Reg. No. 4,109,583

Registered Mar. 6, 2012

Int. Cls.: 10, 18, and 35

TRADEMARK

SERVICE MARK

PRINCIPAL REGISTER

CORSKO UNLIMITED, INC. (ILLINOIS CORPORATION)
1620 BARCLAY BLVD.
BUFFALO GROVE, IL 600894523

FOR: DIAGNOSTIC SETS COMPRISING OTOSCOPES, AND OPHTHALMOSCOPES FOR DIAGNOSING EAR, NOSE AND THROAT DISEASES; CLINICAL THERMOMETERS; MEDICAL SCISSORS; SURGICAL FORCEPS; NEEDLES FOR MEDICAL PURPOSES; SYRINGES FOR MEDICAL PURPOSES; DOCTOR AND HEALTH PROFESSIONAL MEDICAL BAGS AND MEDICAL CASES FOR TRANSPORTATION OF EQUIPMENT AND DESIGNED TO HOLD MEDICAL INSTRUMENTS, NAMELY, STETHOSCOPES, OTOSCOPES, OPHTHALMOSCOPES, DERMATOSCOPES, THERMOMETERS, MEDICAL SCISSORS, SURGICAL FORCEPS, NEEDLES FOR MEDICAL PURPOSES, AND SYRINGES FOR MEDICAL PURPOSES, SOLD EMPTY, IN CLASS 10 (U.S. CLS. 26, 39 AND 44).

FIRST USE 1-2-2011; IN COMMERCE 1-2-2011.

FOR: GENERAL PURPOSE MEDICAL BAGS SOLD EMPTY, IN CLASS 18 (U.S. CLS. 1, 2, 3, 22 AND 41).

FIRST USE 1-2-2011; IN COMMERCE 1-2-2011.

FOR: ONLINE AND CATALOG RETAIL AND WHOLESALE STORE SERVICES FEATURING MEDICAL, NURSING, HEALTHCARE, DENTAL, AND VETERINARY UNIFORMS, CLOTHING, LAB COATS, SCRUBS, SURGICAL SCRUB SUITS, SHOES, FOOTWEAR, DISPOSABLE PROTECTIVE GLOVES FOR MEDICAL PURPOSES, AND APPAREL AND MEDICAL APPARATUS, SUPPLIES AND INSTRUMENTS, NAMELY, MEDICAL APPARATUS AND INSTRUMENTS, NAMELY, STETHOSCOPES, BLOOD TESTING APPARATUS, BLOOD PRESSURE MONITORS AND SPHYGMOMANOMETERS, ECG MONITORING APPARATUS, PULSE OXIMETERS, OTOSCOPES, OPHTHALMOSCOPES, DERMATOSCOPES, IN CLASS 35 (U.S. CLS. 100, 101 AND 102).

FIRST USE 1-2-2011; IN COMMERCE 1-2-2011.

THE MARK CONSISTS OF STANDARD CHARACTERS WITHOUT CLAIM TO ANY PARTICULAR FONT, STYLE, SIZE, OR COLOR.

SN 85-060,526, FILED 6-11-2010.



David J. Kyros

Director of the United States Patent and Trademark Office

Reg. No. 4,109,583 MARK RADEMACHER, EXAMINING ATTORNEY

United States of America

United States Patent and Trademark Office

YOUR CATHOLIC COMPANION

Reg. No. 4,109,584

Registered Mar. 6, 2012

Int. Cl.: 9

TRADEMARK

PRINCIPAL REGISTER

ROYAL CONSUMER INFORMATION PRODUCTS, INC. (DELAWARE CORPORATION)
2 RIVERVIEW DRIVE, 3RD FLOOR
SOMERSET, NJ 08873

FOR: HAND HELD ELECTRONIC INSTRUMENTS HAVING AN ELECTRONIC CATHOLIC BIBLE AND ELECTRONIC RELIGIOUS TEXT, IN CLASS 9 (U.S. CLS. 21, 23, 26, 36 AND 38).

FIRST USE 11-15-2011; IN COMMERCE 11-15-2011.

THE MARK CONSISTS OF STANDARD CHARACTERS WITHOUT CLAIM TO ANY PARTICULAR FONT, STYLE, SIZE, OR COLOR.

NO CLAIM IS MADE TO THE EXCLUSIVE RIGHT TO USE "CATHOLIC", APART FROM THE MARK AS SHOWN.

SN 85-060,593, FILED 6-11-2010.

DAVID C. REIHNER, EXAMINING ATTORNEY



David J. Kyffers

Director of the United States Patent and Trademark Office

United States of America

United States Patent and Trademark Office

IT'S L.A. CLOSE

Reg. No. 4,109,585

Registered Mar. 6, 2012

Int. Cl.: 41

SERVICE MARK

PRINCIPAL REGISTER

SAN PASQUAL CASINO DEVELOPMENT GROUP INC. (CALIFORNIA CORPORATION)
16300 NYEMII PASS ROAD
VALLEY CENTER, CA 92082

FOR: ENTERTAINMENT SERVICES, NAMELY, CASINO GAMING; GAMING SERVICES IN THE NATURE OF CASINO GAMING; CASINO SERVICES; AND ENTERTAINMENT SERVICES, NAMELY, LIVE APPEARANCES BY A PROFESSIONAL ENTERTAINER, IN CLASS 41 (U.S. CLS. 100, 101 AND 107).

FIRST USE 6-0-2010; IN COMMERCE 6-0-2010.

THE MARK CONSISTS OF STANDARD CHARACTERS WITHOUT CLAIM TO ANY PARTICULAR FONT, STYLE, SIZE, OR COLOR.

NO CLAIM IS MADE TO THE EXCLUSIVE RIGHT TO USE "L.A.", APART FROM THE MARK AS SHOWN.

SN 85-061,174, FILED 6-11-2010.

ANNE FARRELL, EXAMINING ATTORNEY



David J. Kyros

Director of the United States Patent and Trademark Office

United States of America

United States Patent and Trademark Office

IT'S L.A. CLOSE

Reg. No. 4,109,586

Registered Mar. 6, 2012

Int. Cl.: 43

SERVICE MARK

PRINCIPAL REGISTER

SAN PASQUAL CASINO DEVELOPMENT GROUP INC. (CALIFORNIA CORPORATION)
16300 NYEMII PASS ROAD
VALLEY CENTER, CA 92082

FOR: HOTEL ACCOMMODATION SERVICES; HOTEL SERVICES FOR PREFERRED CUSTOMERS; HOTEL, BAR AND RESTAURANT SERVICES; HOTEL, RESTAURANT AND CATERING SERVICES; BAR AND RESTAURANT SERVICES; CAFE AND RESTAURANT SERVICES; AND RESTAURANT SERVICES, IN CLASS 43 (U.S. CLS. 100 AND 101).

FIRST USE 6-0-2010; IN COMMERCE 6-0-2010.

THE MARK CONSISTS OF STANDARD CHARACTERS WITHOUT CLAIM TO ANY PARTICULAR FONT, STYLE, SIZE, OR COLOR.

NO CLAIM IS MADE TO THE EXCLUSIVE RIGHT TO USE "L.A.", APART FROM THE MARK AS SHOWN.

SN 85-061,187, FILED 6-11-2010.

ANNE FARRELL, EXAMINING ATTORNEY



David J. Kyros

Director of the United States Patent and Trademark Office

United States of America

United States Patent and Trademark Office



Reg. No. 4,109,587

Registered Mar. 6, 2012

Int. Cl.: 32

TRADEMARK

PRINCIPAL REGISTER

FRITO-LAY TRADING COMPANY GMBH (SWITZERLAND LIMITED LIABILITY COMPANY)
SPITALGASSE 2
BERN CH, SWITZERLAND 3011

FOR: FRUIT JUICES AND FRUIT NECTARS, IN CLASS 32 (U.S. CLS. 45, 46 AND 48).

FIRST USE 4-30-2010; IN COMMERCE 4-30-2010.

OWNER OF U.S. REG. NO. 2,027,315.

THE MARK CONSISTS OF THE WORD "LOOZA" IN AN OVAL SHAPE WITH A LEAF DESIGN ABOVE THE "O"'S.

SN 85-061,758, FILED 6-14-2010.

SUSAN RICHARDS, EXAMINING ATTORNEY



David J. Kybas

Director of the United States Patent and Trademark Office

United States of America

United States Patent and Trademark Office



Reg. No. 4,109,588

Registered Mar. 6, 2012

Int. Cl.: 5

TRADEMARK

PRINCIPAL REGISTER

PURACAP PHARMACEUTICAL LLC (NEW JERSEY LIMITED LIABILITY COMPANY)
1001 DURHAM AVE.
SOUTH PLAINFIELD, NJ 07080

FOR: PHARMACEUTICALS FOR USE IN TREATMENT OF SEIZURES, HYPERTENSION, CARDIOVASCULAR DISEASE, DISEASE OF THE ENDOCRINE SYSTEM, GASTROENTEROLOGICAL DISEASE, HEMATOLOGICAL DISEASE, INFECTIOUS DISEASE, DISEASE OF THE IMMUNE SYSTEM, MUSCULOSKELETAL DISEASE, KIDNEY DISEASE, DISEASE OF THE NERVOUS SYSTEM, GYNECOLOGICAL DISEASE, CANCER, DISEASES OF THE EYE, EAR, NOSE AND THROAT, MENTAL ILLNESS, RHEUMATOLOGICAL DISEASE, BONE DISEASE, SKIN WOUNDS, CONTACT DERMATITIS, HEADACHES, MIGRAINE HEADACHES, MUSCLE PAIN, INFLAMMATION, AND FOR USE IN DENTAL, COSMETIC, MAXILLOFACIAL, AND PLASTIC SURGERY, ALL AVAILABLE AS TABLETS, CAPSULES, SOFTGELS, LIQUIDS, CREAMS, AND POWDERS, IN CLASS 5 (U.S. CLS. 6, 18, 44, 46, 51 AND 52).

FIRST USE 1-9-2012; IN COMMERCE 1-9-2012.

NO CLAIM IS MADE TO THE EXCLUSIVE RIGHT TO USE "PHARMACEUTICAL", APART FROM THE MARK AS SHOWN.

THE MARK CONSISTS OF THE WORD "PURACAP" OVER THE WORD "PHARMACEUTICAL" AND SURROUNDED BY AN ELLIPTICAL SHAPE WITH ITS LOWER RIGHT-QUADRANT OMITTED.

SN 85-061,827, FILED 6-14-2010.

KRISTIN DAHLING, EXAMINING ATTORNEY



David J. Kybas

Director of the United States Patent and Trademark Office

United States of America

United States Patent and Trademark Office

THE BEST REVENGE

Reg. No. 4,109,589

Registered Mar. 6, 2012

Int. Cl.: 25

TRADEMARK

PRINCIPAL REGISTER

NAGUIAT, RAMON (UNITED STATES INDIVIDUAL)
505 NORTH FIGUEROA ST.
APT #423
LOS ANGELES, CA 90012

FOR: HATS; PANTS; SHIRTS; SHOES; SHORTS; SWEAT SHIRTS, IN CLASS 25 (U.S. CLS. 22 AND 39).

FIRST USE 12-4-2011; IN COMMERCE 12-4-2011.

THE MARK CONSISTS OF STANDARD CHARACTERS WITHOUT CLAIM TO ANY PARTICULAR FONT, STYLE, SIZE, OR COLOR.

SN 85-062,228, FILED 6-14-2010.

PAM WILLIS, EXAMINING ATTORNEY



David J. Kyffers

Director of the United States Patent and Trademark Office

United States of America
United States Patent and Trademark Office

WI  E
WRAP

Reg. No. 4,109,590

CERTAINTEED CORPORATION (DELAWARE CORPORATION)
750 E. SWEDESFORD ROAD
VALLEY FORGE, PA 194820101

Registered Mar. 6, 2012

Int. Cl.: 17

FOR: INSULATION BLANKETS FOR USE IN BUILDING AND CONSTRUCTION, IN CLASS 17 (U.S. CLS. 1, 5, 12, 13, 35 AND 50).

TRADEMARK

FIRST USE 6-0-2010; IN COMMERCE 6-0-2010.

PRINCIPAL REGISTER

NO CLAIM IS MADE TO THE EXCLUSIVE RIGHT TO USE "WRAP", APART FROM THE MARK AS SHOWN.

THE MARK CONSISTS OF THE LETTERS "WI", THE LETTER "D" AS A BOX DESIGN, AND THE LETTER "E", ABOVE THE WORD "WRAP".

SN 85-062,373, FILED 6-14-2010.

GINA HAYES, EXAMINING ATTORNEY



David J. Kyffers

Director of the United States Patent and Trademark Office

United States of America

United States Patent and Trademark Office

CHANGERX

Reg. No. 4,109,591

INSIGHT EQUITY A.P.X., LP (TEXAS LIMITED PARTNERSHIP)
1400 CIVIC PLACE, SUITE 250
SOUTHLAKE, TX 760927641

Registered Mar. 6, 2012

Int. Cl.: 9

FOR: OPHTHALMIC LENSES FOR EYEGLASSES, IN CLASS 9 (U.S. CLS. 21, 23, 26, 36 AND 38).

TRADEMARK

FIRST USE 9-30-2011; IN COMMERCE 9-30-2011.

PRINCIPAL REGISTER

THE MARK CONSISTS OF STANDARD CHARACTERS WITHOUT CLAIM TO ANY PARTICULAR FONT, STYLE, SIZE, OR COLOR.

SN 85-063,072, FILED 6-15-2010.

JAY BESCH, EXAMINING ATTORNEY



David J. Kybas

Director of the United States Patent and Trademark Office

United States of America

United States Patent and Trademark Office

QILROY

Reg. No. 4,109,592

Registered Mar. 6, 2012

Int. Cl.: 9

TRADEMARK

PRINCIPAL REGISTER

QUALCOMM INCORPORATED (DELAWARE CORPORATION)
PATENT AND TRADEMARK DEPARTMENT
5775 MOREHOUSE DRIVE
SAN DIEGO, CA 92121

FOR: SOFTWARE FOR DISPLAYING AND SHARING A USER'S LOCATION AND FINDING, LOCATING, AND INTERACTING WITH OTHER USERS AND PLACES FOR USE IN WIRELESS COMMUNICATION DEVICES AND COMPUTERS, NAMELY, COMPUTERS, CELLULAR TELEPHONES, MP3 PLAYERS, AND PERSONAL DIGITAL ASSISTANTS (PDAS), IN CLASS 9 (U.S. CLS. 21, 23, 26, 36 AND 38).

FIRST USE 8-23-2010; IN COMMERCE 8-23-2010.

THE MARK CONSISTS OF STANDARD CHARACTERS WITHOUT CLAIM TO ANY PARTICULAR FONT, STYLE, SIZE, OR COLOR.

THE WORD(S) "QILROY" HAS NO MEANING IN A FOREIGN LANGUAGE.

SN 85-063,797, FILED 6-15-2010.

ROBERT STRUCK, EXAMINING ATTORNEY



David J. Kyffers

Director of the United States Patent and Trademark Office

United States of America

United States Patent and Trademark Office



LaVault.com

Reg. No. 4,109,593

Registered Mar. 6, 2012

Int. Cls.: 9 and 39

TRADEMARK

SERVICE MARK

PRINCIPAL REGISTER

LAVOULT.COM, LLC (CALIFORNIA LIMITED LIABILITY COMPANY)
350 NUTMEG STREET NO. 303
SAN DIEGO, CA 92103

FOR: COMPUTER SOFTWARE FOR STORING TEXT MESSAGES ON A SERVER COMPUTER AND ALLOWING USER ACCESS TO THE STORED E-MAIL , IN CLASS 9 (U.S. CLS. 21, 23, 26, 36 AND 38).

FIRST USE 7-6-2011; IN COMMERCE 7-6-2011.

FOR: ELECTRONIC STORAGE OF TEXT MESSAGES ON A SERVER COMPUTER, IN CLASS 39 (U.S. CLS. 100 AND 105).

FIRST USE 7-6-2011; IN COMMERCE 7-6-2011.

THE MARK CONSISTS OF THE WORDING "LAVOULT.COM" TO THE RIGHT OF THE DESIGN OF A COMBINATION LOCK WITH A LIGHTNING BOLT IN THE CENTER.

THE WORDING "LAVOULT" HAS NO MEANING IN A FOREIGN LANGUAGE.

SN 85-065,433, FILED 6-17-2010.

CHRISTINE COOPER, EXAMINING ATTORNEY



David J. Kybas

Director of the United States Patent and Trademark Office

United States of America

United States Patent and Trademark Office



Reg. No. 4,109,594

Registered Mar. 6, 2012

Int. Cls.: 16 and 41

TRADEMARK

SERVICE MARK

PRINCIPAL REGISTER

NU BOWWOW, LLC (PENNSYLVANIA LIMITED LIABILITY COMPANY)
421 N PENNSYLVANIA AVE
MORRISVILLE, PA 19067

FOR: A SERIES OF BOOKS, WRITTEN ARTICLES, HANDOUTS, WORKSHEETS AND INSTRUCTIONS IN THE FIELD OF PET CARE, NAMELY, THE CARE AND TRAINING OF PUPPIES AND DOGS, IN CLASS 16 (U.S. CLS. 2, 5, 22, 23, 29, 37, 38 AND 50).

FIRST USE 10-25-2010; IN COMMERCE 10-25-2010.

FOR: EDUCATION AND ENTERTAINMENT SERVICES, NAMELY, CONDUCTING CLASSES IN THE FIELD OF PET CARE, NAMELY, THE CARE AND TRAINING OF PUPPIES AND DOGS, IN CLASS 41 (U.S. CLS. 100, 101 AND 107).

FIRST USE 10-25-2010; IN COMMERCE 10-25-2010.

NO CLAIM IS MADE TO THE EXCLUSIVE RIGHT TO USE "PUPPY STARTER KIT", APART FROM THE MARK AS SHOWN.

THE COLOR(S) BLUE, BROWN, BLACK AND RED IS/ARE CLAIMED AS A FEATURE OF THE MARK.

THE MARK CONSISTS OF THE STYLIZED WORDS "NU BOW WOW THE PUPPY STARTER KIT" AND DESIGN. THE LETTERS "NU", "BO" AND "WO" ARE BLUE, THE LETTER "W" IN THE TERM "BOW" IS BROWN AND IS STYLIZED AS A DOG'S FACE WITH BLACK EYES AND NOSE AND A RED TONGUE. THE LAST LETTER "W" IN THE TERM "WOW" IS BROWN. THE LETTERS "NU" APPEARS ABOVE THE TERM "BOW" WHICH IS ABOVE THE TERM "WOW" AND BELOW IS THE WORDING "THE PUPPY STARTER KIT" IN BROWN, ALL ON A TRANSPARENT BACKGROUND.

SN 85-065,670, FILED 6-17-2010.

MARLENE BELL, EXAMINING ATTORNEY



David J. Kyjars

Director of the United States Patent and Trademark Office

United States of America

United States Patent and Trademark Office

TIDDLIWINKS

Reg. No. 4,109,595

Registered Mar. 6, 2012

**Int. Cls.: 11, 16, 20, 21,
24, 27, and 28**

KIDS LINE, LLC (CALIFORNIA LIMITED LIABILITY COMPANY)
400 SOUTH HOPE STREET
6TH FLOOR
LOS ANGELES, CA 90071

FOR: LIGHTING DEVICES AND ACCESSORIES, NAMELY, ELECTRIC NIGHT LIGHTS,
IN CLASS 11 (U.S. CLS. 13, 21, 23, 31 AND 34).

TRADEMARK

FIRST USE 4-20-2006; IN COMMERCE 4-20-2006.

PRINCIPAL REGISTER

FOR: WALL DECORATIONS, NAMELY, METALLIC DECALS, IN CLASS 16 (U.S. CLS. 2,
5, 22, 23, 29, 37, 38 AND 50).

FIRST USE 12-23-2010; IN COMMERCE 12-23-2010.

FOR: NON METAL AND NON-PAPER CONTAINERS FOR STORAGE, NAMELY, HAMPERS;
SHOWER CURTAIN RINGS, IN CLASS 20 (U.S. CLS. 2, 13, 22, 25, 32 AND 50).

FIRST USE 2-10-2003; IN COMMERCE 2-10-2003.

FOR: BASKETS OF CLOTH, SOAP DISHES; SOAP AND LOTION DISPENSERS; WASTE
BASKETS, IN CLASS 21 (U.S. CLS. 2, 13, 23, 29, 30, 33, 40 AND 50).

FIRST USE 2-15-2008; IN COMMERCE 2-15-2008.

FOR: WALL HANGINGS, NAMELY, WALL HANGINGS OF TEXTILE; INFANT AND
CHILDREN'S BEDDING AND ACCESSORIES, NAMELY, BLANKETS, COMFORTERS,
QUILTS, FABRIC VALANCES, DRAPERIES, DUST RUFFLES, SHEETS; BASSINET BED-
DING, NAMELY, CANOPIES; CRIB BEDDING SETS, NAMELY, COMFORTERS, QUILTS,
VALANCES, DRAPERIES, DUST RUFFLES, SHEETS, BUMPERS; FULL BEDDING SETS,
NAMELY, COMFORTERS, QUILTS, VALANCES, DRAPERIES, DUST RUFFLES, SHEETS,
PILLOW SHAMS; CRADLE BEDDING SETS, NAMELY, COMFORTERS, QUILTS, BUMPERS,
SHEETS, BATH TOWELS, HOODED TOWELS, AND FACE CLOTHS FOR WASHING;
SHOWER CURTAIN ACCESSORIES, NAMELY, SHOWER CURTAIN LINERS AND SHOWER
CURTAINS, IN CLASS 24 (U.S. CLS. 42 AND 50).

FIRST USE 12-31-2003; IN COMMERCE 12-31-2003.



David J. Kyffers

Director of the United States Patent and Trademark Office

Reg. No. 4,109,595 FOR: WALL HANGINGS, NAMELY, NON-TEXTILE WALL HANGINGS; RUGS, IN CLASS 27 (U.S. CLS. 19, 20, 37, 42 AND 50).

FIRST USE 2-10-2003; IN COMMERCE 2-10-2003.

FOR: STUFFED AND PLUSH TOYS; CRIB MOBILES; MOBILES FOR CHILDREN, IN CLASS 28 (U.S. CLS. 22, 23, 38 AND 50).

FIRST USE 12-31-2003; IN COMMERCE 12-31-2003.

THE MARK CONSISTS OF STANDARD CHARACTERS WITHOUT CLAIM TO ANY PARTICULAR FONT, STYLE, SIZE, OR COLOR.

SN 85-066,095, FILED 6-18-2010.

DEZMONA MIZELLE, EXAMINING ATTORNEY

United States of America

United States Patent and Trademark Office

Joe Palooka

Reg. No. 4,109,596

VJIB, LLC (NEW JERSEY LIMITED LIABILITY COMPANY)
P.O. BOX 1400
RIDGEWOOD, NJ 07451

Registered Mar. 6, 2012

Int. Cls.: 16, 25, and 41

FOR: COMIC BOOKS, IN CLASS 16 (U.S. CLS. 2, 5, 22, 23, 29, 37, 38 AND 50).

FIRST USE 9-30-2011; IN COMMERCE 9-30-2011.

TRADEMARK

SERVICE MARK

FOR: T-SHIRTS; SWEAT SHIRTS; HOODED SWEAT SHIRTS; HEADGEAR, NAMELY, BASEBALL CAPS, KNITTED CAPS; BEANIES, IN CLASS 25 (U.S. CLS. 22 AND 39).

PRINCIPAL REGISTER

FIRST USE 1-13-2012; IN COMMERCE 1-13-2012.

FOR: PROVIDING ONLINE NON-DOWNLOADABLE COMIC BOOKS AND GRAPHIC NOVELS, IN CLASS 41 (U.S. CLS. 100, 101 AND 107).

FIRST USE 10-5-2011; IN COMMERCE 10-5-2011.

THE MARK CONSISTS OF STANDARD CHARACTERS WITHOUT CLAIM TO ANY PARTICULAR FONT, STYLE, SIZE, OR COLOR.

THE NAME "JOE PALOOKA" DOES NOT IDENTIFY A LIVING INDIVIDUAL.

SN 85-066,540, FILED 6-18-2010.

SHANNON TWOHIG, EXAMINING ATTORNEY



David J. Kyros

Director of the United States Patent and Trademark Office

United States of America

United States Patent and Trademark Office

EMSYS

Reg. No. 4,109,597

Registered Mar. 6, 2012

Int. Cl.: 9

TRADEMARK

PRINCIPAL REGISTER

W R SYSTEMS, LTD. (NEW YORK CORPORATION)
11351 RANDOM HILLS ROAD
SUITE 400
FAIRFAX, VA 22030

FOR: CONTINUOUS EMISSIONS MONITORING SYSTEMS CONSISTING OF COMPUTER SOFTWARE, OPTICAL SENSORS, AND LASER DETECTORS FOR MEASURING MARINE VESSEL EMISSIONS, IN CLASS 9 (U.S. CLS. 21, 23, 26, 36 AND 38).

FIRST USE 2-2-2010; IN COMMERCE 6-24-2011.

THE MARK CONSISTS OF STANDARD CHARACTERS WITHOUT CLAIM TO ANY PARTICULAR FONT, STYLE, SIZE, OR COLOR.

SN 85-067,632, FILED 6-21-2010.

APRIL HESIK, EXAMINING ATTORNEY



David J. Kybas

Director of the United States Patent and Trademark Office

United States of America

United States Patent and Trademark Office

CLINIKOL

Reg. No. 4,109,598

Registered Mar. 6, 2012

Int. Cl.: 35

SERVICE MARK

PRINCIPAL REGISTER

CONISUS, LLC (DELAWARE LIMITED LIABILITY COMPANY)
1300 PARKWOOD CIRCLE, SUITE 425
ATLANTA, GA 30339

FOR: ORGANIZING AND SCHEDULING BUSINESS MEETINGS BETWEEN PHYSICIANS AND BIOPHARMACEUTICAL COMPANIES IN THE MEDICAL FIELD, IN CLASS 35 (U.S. CLS. 100, 101 AND 102).

FIRST USE 9-24-2009; IN COMMERCE 9-24-2009.

THE MARK CONSISTS OF STANDARD CHARACTERS WITHOUT CLAIM TO ANY PARTICULAR FONT, STYLE, SIZE, OR COLOR.

SN 85-068,444, FILED 6-22-2010.

HEATHER BIDDULPH, EXAMINING ATTORNEY



David J. Kyffers

Director of the United States Patent and Trademark Office

United States of America

United States Patent and Trademark Office



Reg. No. 4,109,599

4 LIFE TM HOLDINGS, LLC (ARIZONA LIMITED LIABILITY COMPANY)
P.O. BOX 28278
SCOTTSDALE, AZ 85255

Registered Mar. 6, 2012

Int. Cl.: 5

FOR: DIETARY SUPPLEMENTAL DRINKS IN THE NATURE OF VITAMIN AND MINERAL BEVERAGES, IN CLASS 5 (U.S. CLS. 6, 18, 44, 46, 51 AND 52).

TRADEMARK

FIRST USE 1-1-2011; IN COMMERCE 1-1-2011.

PRINCIPAL REGISTER

THE MARK CONSISTS OF THE LETTER "Q" WITH THE WORD "BOOST" INSIDE. THE TOP, LEFT SIDE PORTION OF THE "Q" IS RED AND THE BOTTOM, RIGHT SIDE PORTION OF THE "Q" INCLUDING THE HOOKED PORTION IS BLACK. THE WORD "BOOST" IS IN BLACK ON A WHITE BACKGROUND WITH A RED OUTLINE. THE REST OF THE AREA INSIDE THE "Q" BUT OUTSIDE THE RED OUTLINE IS WHITE.

THE COLOR(S) RED, BLACK, AND WHITE IS/ARE CLAIMED AS A FEATURE OF THE MARK.

SN 85-068,824, FILED 6-22-2010.

MARGARET POWER, EXAMINING ATTORNEY



David J. Kyros

Director of the United States Patent and Trademark Office

United States of America

United States Patent and Trademark Office



Reg. No. 4,109,600

4 LIFE TM HOLDINGS, LLC (ARIZONA LIMITED LIABILITY COMPANY)
P.O. BOX 28278
SCOTTSDALE, AZ 85255

Registered Mar. 6, 2012

Int. Cl.: 5

FOR: DIETARY AIDS, NAMELY, DIURETICS, IN CLASS 5 (U.S. CLS. 6, 18, 44, 46, 51 AND 52).

TRADEMARK

FIRST USE 1-1-2011; IN COMMERCE 1-1-2011.

PRINCIPAL REGISTER

NO CLAIM IS MADE TO THE EXCLUSIVE RIGHT TO USE "RELEASE", APART FROM THE MARK AS SHOWN.

THE COLOR(S) RED, BLACK, AND WHITE IS/ARE CLAIMED AS A FEATURE OF THE MARK.

THE MARK CONSISTS OF THE LETTER "Q" WITH THE WORD "RELEASE" INSIDE. THE TOP, LEFT SIDE PORTION OF THE "Q" IS RED AND THE BOTTOM, RIGHT SIDE PORTION OF THE "Q" INCLUDING THE HOOKED PORTION IS BLACK. THE WORD "RELEASE" IS IN BLACK ON A WHITE BACKGROUND WITH A RED OUTLINE. THE REST OF THE AREA INSIDE THE "Q" BUT OUTSIDE THE RED OUTLINE IS WHITE.

SN 85-068,828, FILED 6-22-2010.

MARGARET POWER, EXAMINING ATTORNEY



David J. Kyros

Director of the United States Patent and Trademark Office

United States of America

United States Patent and Trademark Office



Reg. No. 4,109,601

4 LIFE TM HOLDINGS, LLC (ARIZONA LIMITED LIABILITY COMPANY)
P.O. BOX 28278
SCOTTSDALE, AZ 85255

Registered Mar. 6, 2012

Int. Cl.: 5

FOR: DIETARY SUPPLEMENTS CONTAINING FATTY ACIDS, IN CLASS 5 (U.S. CLS. 6, 18, 44, 46, 51 AND 52).

TRADEMARK

FIRST USE 1-1-2011; IN COMMERCE 1-1-2011.

PRINCIPAL REGISTER

NO CLAIM IS MADE TO THE EXCLUSIVE RIGHT TO USE "FATS", APART FROM THE MARK AS SHOWN.

THE COLOR(S) RED, BLACK, AND WHITE IS/ARE CLAIMED AS A FEATURE OF THE MARK.

THE MARK CONSISTS OF THE LETTER "Q" WITH THE WORD "FATS" INSIDE. THE TOP, LEFT SIDE PORTION OF THE "Q" IS RED AND THE BOTTOM, RIGHT SIDE PORTION OF THE "Q" INCLUDING THE HOOKED PORTION IS BLACK. THE WORD "FATS" IS IN BLACK ON A WHITE BACKGROUND WITH A RED OUTLINE. THE REST OF THE AREA INSIDE THE "Q" BUT OUTSIDE THE RED OUTLINE IS WHITE.

SN 85-068,831, FILED 6-22-2010.

MARGARET POWER, EXAMINING ATTORNEY



David J. Kyros

Director of the United States Patent and Trademark Office

United States of America

United States Patent and Trademark Office



Reg. No. 4,109,602

4 LIFE TM HOLDINGS, LLC (ARIZONA LIMITED LIABILITY COMPANY)
P.O. BOX 28278
SCOTTSDALE, AZ 85255

Registered Mar. 6, 2012

Int. Cl.: 5

FOR: DIETARY AIDS, NAMELY, VITAMINS, IN CLASS 5 (U.S. CLS. 6, 18, 44, 46, 51 AND 52).

TRADEMARK

FIRST USE 1-1-2011; IN COMMERCE 1-1-2011.

PRINCIPAL REGISTER

NO CLAIM IS MADE TO THE EXCLUSIVE RIGHT TO USE "Q", APART FROM THE MARK AS SHOWN.

THE COLOR(S) RED, BLACK, AND WHITE IS/ARE CLAIMED AS A FEATURE OF THE MARK.

THE MARK CONSISTS OF THE LETTER "Q" WITH THE WORD "VIT" INSIDE. THE TOP, LEFT SIDE PORTION OF THE "Q" IS RED AND THE BOTTOM, RIGHT SIDE PORTION OF THE "Q" INCLUDING THE HOOKED PORTION IS BLACK. THE WORD "VIT" IS IN BLACK ON A WHITE BACKGROUND WITH A RED OUTLINE. THE REST OF THE AREA INSIDE THE "Q" BUT OUTSIDE THE RED OUTLINE IS WHITE.

SN 85-068,840, FILED 6-22-2010.

MARGARET POWER, EXAMINING ATTORNEY



David J. Kyros

Director of the United States Patent and Trademark Office

United States of America

United States Patent and Trademark Office

Conquer What You Chase

Reg. No. 4,109,603

NW & A LLC (MICHIGAN LIMITED LIABILITY COMPANY)
8236 BRIDGEWAY DR
DEXTER, MI 48130

Registered Mar. 6, 2012

Int. Cls.: 16 and 35

FOR: BUMPER STICKERS, IN CLASS 16 (U.S. CLS. 2, 5, 22, 23, 29, 37, 38 AND 50).

TRADEMARK

FIRST USE 10-0-2010; IN COMMERCE 4-7-2011.

SERVICE MARK

FOR: BUSINESS CONSULTING SERVICES IN THE FIELD OF SALES AND MARKETING,
IN CLASS 35 (U.S. CLS. 100, 101 AND 102).

PRINCIPAL REGISTER

FIRST USE 3-16-2011; IN COMMERCE 4-16-2011.

THE MARK CONSISTS OF STANDARD CHARACTERS WITHOUT CLAIM TO ANY PARTICULAR FONT, STYLE, SIZE, OR COLOR.

SN 85-069,110, FILED 6-22-2010.

MARLENE BELL, EXAMINING ATTORNEY



David J. Kybas

Director of the United States Patent and Trademark Office

United States of America
United States Patent and Trademark Office

TRU-BOLT

Reg. No. 4,109,604

MENARD, INC. (WISCONSIN CORPORATION)
5101 MENARD DRIVE
EAU CLAIRE, WI 54703

Registered Mar. 6, 2012

Int. Cl.: 6

FOR: FIRE-RESISTANT AND THEFT-RESISTIVE METALLIC LOCKABLE SAFES FOR
STORING VALUABLES INCLUDING FILES, IN CLASS 6 (U.S. CLS. 2, 12, 13, 14, 23, 25 AND
50).

TRADEMARK

FIRST USE 9-1-2010; IN COMMERCE 9-1-2010.

PRINCIPAL REGISTER

THE MARK CONSISTS OF STANDARD CHARACTERS WITHOUT CLAIM TO ANY PAR-
TICULAR FONT, STYLE, SIZE, OR COLOR.

SN 85-069,929, FILED 6-23-2010.

JENNIFER VASQUEZ, EXAMINING ATTORNEY



David J. Kybas

Director of the United States Patent and Trademark Office

United States of America

United States Patent and Trademark Office

THE GOOD FLOCK

Reg. No. 4,109,605

Registered Mar. 6, 2012

Int. Cls.: 9, 11, and 18

TRADEMARK

PRINCIPAL REGISTER

THE GOOD FLOCK, LLC (OREGON LIMITED LIABILITY COMPANY)
2232 N.W. EVERETT STREET
#41
PORTLAND, OR 97210

FOR: CARRYING CASES, BAGS, AND POUCHES, ALL SPECIFICALLY ADAPTED FOR CARRYING ELECTRONIC EQUIPMENT, NAMELY, PORTABLE PHONES, LAPTOPS AND PORTABLE COMPUTERS, PORTABLE MEDIA PLAYERS, PERSONAL DIGITAL ASSISTANTS, AND ELECTRONIC BOOK READERS; EYEWEAR CASES, IN CLASS 9 (U.S. CLS. 21, 23, 26, 36 AND 38).

FIRST USE 12-1-2011; IN COMMERCE 12-1-2011.

FOR: LAMPS AND LIGHTING FIXTURES, IN CLASS 11 (U.S. CLS. 13, 21, 23, 31 AND 34).

FIRST USE 12-1-2011; IN COMMERCE 12-1-2011.

FOR: BACKPACKS; ALL-PURPOSE CARRYING BAGS; ATHLETIC BAGS; WALLETS; HANDBAGS; BOOK BAGS; DUFFEL BAGS; SHOULDER BAGS; TOTE BAGS; BUSINESS CARD CASES; CREDIT CARD CASES; DOCUMENT CASES, IN CLASS 18 (U.S. CLS. 1, 2, 3, 22 AND 41).

FIRST USE 12-1-2011; IN COMMERCE 12-1-2011.

THE MARK CONSISTS OF STANDARD CHARACTERS WITHOUT CLAIM TO ANY PARTICULAR FONT, STYLE, SIZE, OR COLOR.

SN 85-069,951, FILED 6-23-2010.

SAIMA MAKHDOOM, EXAMINING ATTORNEY



David J. Kyros

Director of the United States Patent and Trademark Office

United States of America

United States Patent and Trademark Office



Reg. No. 4,109,606

Registered Mar. 6, 2012

Int. Cls.: 9, 11, and 18

TRADEMARK

PRINCIPAL REGISTER

THE GOOD FLOCK, LLC (OREGON LIMITED LIABILITY COMPANY)
2232 N.W. EVERETT STREET
#41
PORTLAND, OR 97210

FOR: CARRYING CASES, BAGS, AND POUCHES, ALL SPECIFICALLY ADAPTED FOR CARRYING ELECTRONIC EQUIPMENT, NAMELY, PORTABLE PHONES, LAPTOPS AND PORTABLE COMPUTERS, PORTABLE MEDIA PLAYERS, PERSONAL DIGITAL ASSISTANTS, AND ELECTRONIC BOOK READERS; EYEWEAR CASES, IN CLASS 9 (U.S. CLS. 21, 23, 26, 36 AND 38).

FIRST USE 12-1-2011; IN COMMERCE 12-1-2011.

FOR: LAMPS AND LIGHTING FIXTURES, IN CLASS 11 (U.S. CLS. 13, 21, 23, 31 AND 34).

FIRST USE 12-1-2011; IN COMMERCE 12-1-2011.

FOR: BACKPACKS; ALL-PURPOSE CARRYING BAGS; ATHLETIC BAGS; WALLETS; HANDBAGS; BOOK BAGS; DUFFEL BAGS; SHOULDER BAGS; TOTE BAGS; BUSINESS CARD CASES; CREDIT CARD CASES; DOCUMENT CASES, IN CLASS 18 (U.S. CLS. 1, 2, 3, 22 AND 41).

FIRST USE 12-1-2011; IN COMMERCE 12-1-2011.

THE MARK CONSISTS OF A PAIR OF BIRDS.

SN 85-069,955, FILED 6-23-2010.

SAIMA MAKHDOOM, EXAMINING ATTORNEY



David J. Kyjars

Director of the United States Patent and Trademark Office

United States of America

United States Patent and Trademark Office



Reg. No. 4,109,607

Registered Mar. 6, 2012

Int. Cl.: 3

TRADEMARK

PRINCIPAL REGISTER

LIMANATURAL INC. (JAPAN CORPORATION)
3-1-15, NISHI-IKEBUKURO
TOSHIMA-KU, TOKYO, JAPAN

FOR: EYE MOISTURIZING CREAM, BODY LIQUID LOTION, RINSE-OFF FACIAL MASK, CLEANSING GEL, FACIAL WASH, FACIAL TONERS, MILKY LOTION, MOISTURIZING CREAM, LIQUID LOTION, MIST FACIAL TONERS, SUNSCREEN CREAM, COSMETIC OIL, FACE SOAP BAR, HAND CREAMS, LIP CREAMS, TOOTH POWDER, UV LIQUID FOUNDATION, UV FOUNDATION, UV COMPACT FOUNDATION, FACIAL CONCEALERS, EYE SHADOW, EYEBROW PENCILS, MASCARAS, BLUSH, LIPSTICKS, LIP GLOSS, HAIR TREATMENT SPRAY, HAIR CREAM, HAIR STYLING FOAM, SHAMPOO, HAIR RINSES, BODY SOAPS, VOLUMIZING SHAMPOO, VOLUMIZING RINSES, AND HENNA HAIR COLOR, IN CLASS 3 (U.S. CLS. 1, 4, 6, 50, 51 AND 52).

FIRST USE 5-10-1990; IN COMMERCE 1-1-2011.

THE MARK CONSISTS OF "LIMANATURAL" AND A HEART DESIGN WITH A LETTER "L" INSIDE.

SN 85-070,249, FILED 6-23-2010.

GINA HAYES, EXAMINING ATTORNEY



David J. Kyjars

Director of the United States Patent and Trademark Office

United States of America

United States Patent and Trademark Office

MINDSCAPE COMMUNICATION

Reg. No. 4,109,608

REAMER, BARBARA (UNITED STATES INDIVIDUAL)
5940 VIENNA WAY
LANSING, MI 48917

Registered Mar. 6, 2012

Int. Cl.: 35

FOR: ADVERTISING AND BUSINESS SERVICES, NAMELY, BUSINESS CONSULTING AND INFORMATION SERVICES, AUDITS IN THE FIELD OF COMMUNICATIONS, BUSINESS EVALUATION OF COMMUNICATION STRATEGIES, IN CLASS 35 (U.S. CLS. 100, 101 AND 102).

SERVICE MARK

PRINCIPAL REGISTER

FIRST USE 2-17-2009; IN COMMERCE 2-17-2009.

THE MARK CONSISTS OF STANDARD CHARACTERS WITHOUT CLAIM TO ANY PARTICULAR FONT, STYLE, SIZE, OR COLOR.

NO CLAIM IS MADE TO THE EXCLUSIVE RIGHT TO USE "COMMUNICATION", APART FROM THE MARK AS SHOWN.

SN 85-070,292, FILED 6-24-2010.

FRANK LATTUCA, EXAMINING ATTORNEY



David J. Kyffers

Director of the United States Patent and Trademark Office

United States of America

United States Patent and Trademark Office

HERSHEY'S SIMPLE PLEASURES

Reg. No. 4,109,609

Registered Mar. 6, 2012

Int. Cl.: 30

TRADEMARK

PRINCIPAL REGISTER

HERSHEY CHOCOLATE & CONFECTIONERY CORPORATION (DELAWARE CORPORATION)
4860 ROBB STREET, SUITE 204
WHEAT RIDGE, CO 80033

FOR: CANDY; CHOCOLATE, IN CLASS 30 (U.S. CL. 46).

FIRST USE 7-31-2011; IN COMMERCE 7-31-2011.

THE MARK CONSISTS OF STANDARD CHARACTERS WITHOUT CLAIM TO ANY PARTICULAR FONT, STYLE, SIZE, OR COLOR.

OWNER OF U.S. REG. NOS. 54,041, 1,367,943, AND OTHERS.

SN 85-070,353, FILED 6-24-2010.

SHARON MEIER, EXAMINING ATTORNEY



David J. Kyffers

Director of the United States Patent and Trademark Office

United States of America

United States Patent and Trademark Office

NICHOLAS

Reg. No. 4,109,610

Registered Mar. 6, 2012

Int. Cl.: 28

TRADEMARK

PRINCIPAL REGISTER

MATTEL, INC. (DELAWARE CORPORATION)
M1-1518
333 CONTINENTAL BOULEVARD
EL SEGUNDO, CA 90245

FOR: TOYS, GAMES AND PLAYTHINGS, NAMELY, DOLLS, DOLL CLOTHING AND DOLL ACCESSORIES, IN CLASS 28 (U.S. CLS. 22, 23, 38 AND 50).

FIRST USE 2-10-2011; IN COMMERCE 2-10-2011.

THE MARK CONSISTS OF STANDARD CHARACTERS WITHOUT CLAIM TO ANY PARTICULAR FONT, STYLE, SIZE, OR COLOR.

SN 85-070,447, FILED 6-24-2010.

JESSICA FATHY, EXAMINING ATTORNEY



David J. Kyros

Director of the United States Patent and Trademark Office

United States of America

United States Patent and Trademark Office

TRIO

Reg. No. 4,109,611

YAROS, ANDREW (UNITED STATES INDIVIDUAL)
930 VIA MIL CUMBRES #47
SOLANA BEACH, CA 92075

Registered Mar. 6, 2012

Int. Cl.: 21

FOR: HOLDERS FOR TOILET PAPER; PRE-MOISTENED TOWELETTES FOR CLEANING;
TOILET PAPER DISPENSERS, IN CLASS 21 (U.S. CLS. 2, 13, 23, 29, 30, 33, 40 AND 50).

TRADEMARK

FIRST USE 12-2-2011; IN COMMERCE 12-2-2011.

PRINCIPAL REGISTER

THE MARK CONSISTS OF STANDARD CHARACTERS WITHOUT CLAIM TO ANY PARTICULAR FONT, STYLE, SIZE, OR COLOR.

SN 85-070,694, FILED 6-24-2010.

ROBIN CHOSID, EXAMINING ATTORNEY



David J. Kyros

Director of the United States Patent and Trademark Office

United States of America

United States Patent and Trademark Office

HERO PROJECT

Reg. No. 4,109,612

Registered Mar. 6, 2012

Int. Cls.: 9 and 41

TRADEMARK

SERVICE MARK

PRINCIPAL REGISTER

GLU MOBILE INC. (DELAWARE CORPORATION)
45 FREMONT STREET, SUITE 2800
SAN FRANCISCO, CA 94105

FOR: COMPUTER GAME SOFTWARE; ELECTRONIC GAME SOFTWARE; ELECTRONIC GAME SOFTWARE FOR CELLULAR TELEPHONES; ELECTRONIC GAME SOFTWARE FOR HANDHELD ELECTRONIC DEVICES; ELECTRONIC GAME SOFTWARE FOR WIRELESS DEVICES; DOWNLOADABLE ELECTRONIC GAME SOFTWARE FOR USE WITH SOCIAL NETWORKING APPLICATIONS AND ON SOCIAL NETWORKING WEBSITES; NONE OF THE AFOREMENTIONED GAME SOFTWARE BEING OF THE MUSIC GAME GENRE, IN CLASS 9 (U.S. CLS. 21, 23, 26, 36 AND 38).

FIRST USE 12-9-2010; IN COMMERCE 12-9-2010.

FOR: MULTIMEDIA PUBLISHING OF GAMES; PROVIDING A COMPUTER GAME THAT MAY BE ACCESSED NETWORK-WIDE BY NETWORK USERS; PROVIDING INFORMATION ON-LINE RELATING TO COMPUTER GAMES AND COMPUTER ENHANCEMENTS FOR GAMES; NONE OF THE AFOREMENTIONED COMPUTER GAMES BEING OF THE MUSIC GAME GENRE, IN CLASS 41 (U.S. CLS. 100, 101 AND 107).

FIRST USE 12-9-2010; IN COMMERCE 12-9-2010.

THE MARK CONSISTS OF STANDARD CHARACTERS WITHOUT CLAIM TO ANY PARTICULAR FONT, STYLE, SIZE, OR COLOR.

SN 85-070,862, FILED 6-24-2010.

KEVIN CORWIN, EXAMINING ATTORNEY



David J. Kyros

Director of the United States Patent and Trademark Office

United States of America

United States Patent and Trademark Office

The logo for "LongStrip" features the word "Long" in a bold, black, sans-serif font, followed by "Strip" in a thinner, black, sans-serif font. Below the text are three horizontal lines: a thick red line, a thin black line, and another thick black line.

Reg. No. 4,109,613

Registered Mar. 6, 2012

Int. Cl.: 19

TRADEMARK

PRINCIPAL REGISTER

INDUSTRIAS AUXILIARES FAUS S.L.U. (SPAIN CORPORATION)
AVDA. DE ALAMANSA S/N 46700 GRANDIA
VALENCIA, SPAIN

FOR: LAMINATE FLOORING, IN CLASS 19 (U.S. CLS. 1, 12, 33 AND 50).

FIRST USE 12-1-2005; IN COMMERCE 12-1-2005.

NO CLAIM IS MADE TO THE EXCLUSIVE RIGHT TO USE "LONGSTRIP", APART FROM THE MARK AS SHOWN.

THE COLOR(S) BLACK AND RED IS/ARE CLAIMED AS A FEATURE OF THE MARK.

THE MARK CONSISTS OF THE WORDS "LONG" AND "STRIP" IN STYLIZED LETTERS IN BLACK. THE LETTERS FOR THE WORD "LONG" ARE IN BOLD FONT AND THE LETTERS FOR THE WORD "STRIP" ARE IN A THINNER FONT. DIRECTLY BELOW THESE TWO WORDS ARE THREE HORIZONTAL LINES. THE FIRST LINE IS IN BLACK, THE SECOND LINE IS IN RED, AND THE THIRD LINE IS IN BLACK.

SN 85-070,979, FILED 6-24-2010.

DEIRDRE ROBERTSON, EXAMINING ATTORNEY



David J. Kyffers

Director of the United States Patent and Trademark Office

United States of America

United States Patent and Trademark Office

THE REDBURY

Reg. No. 4,109,614

Registered Mar. 6, 2012

Int. Cls.: 43 and 45

SERVICE MARK

PRINCIPAL REGISTER

SBE HOTEL GROUP, LLC (DELAWARE LIMITED LIABILITY COMPANY)
8000 BEVERLY BOULEVARD
LOS ANGELES, CA 90048

FOR: HOTEL SERVICES; RESORT LODGING SERVICES; RESERVATION SERVICES, NAMELY, HOTEL, RESORT AND RESTAURANT RESERVATION SERVICES; RESTAURANT AND BAR SERVICES; PROVIDING EXHIBITION, CONFERENCE AND MEETING FACILITIES; CATERING, IN CLASS 43 (U.S. CLS. 100 AND 101).

FIRST USE 9-1-2010; IN COMMERCE 9-1-2010.

FOR: SPECIAL HOTEL SERVICES AS PART OF A PROGRAM FOR FREQUENT OR PREFERRED HOTEL GUESTS, NAMELY, PERSONAL CONCIERGE SERVICES FOR OTHERS COMPRISING MAKING REQUESTED PERSONAL ARRANGEMENTS AND RESERVATIONS, RUNNING ERRANDS AND PROVIDING CUSTOMER SPECIFIC INFORMATION TO MEET INDIVIDUAL NEEDS, ALL RENDERED IN HOTELS, IN CLASS 45 (U.S. CLS. 100 AND 101).

FIRST USE 9-1-2010; IN COMMERCE 9-1-2010.

THE MARK CONSISTS OF STANDARD CHARACTERS WITHOUT CLAIM TO ANY PARTICULAR FONT, STYLE, SIZE, OR COLOR.

SN 85-071,384, FILED 6-25-2010.

MICHAEL WIENER, EXAMINING ATTORNEY



David J. Kyros

Director of the United States Patent and Trademark Office

United States of America

United States Patent and Trademark Office

ACCOUNTING CS

Reg. No. 4,109,615

Registered Mar. 6, 2012

Int. Cl.: 9

TRADEMARK

PRINCIPAL REGISTER

THOMSON REUTERS (TAX & ACCOUNTING) INC. (TEXAS CORPORATION)
MAIL STOP 270
2395 MIDWAY ROAD
CARROLLTON, TX 750062521

FOR: COMPUTER SOFTWARE THAT IS INSTALLED LOCALLY ON COMPUTERS OR COMPUTER SERVERS FOR USE EXCLUSIVELY BY ACCOUNTING FIRMS FOR CREATING CUSTOMIZED FINANCIAL REPORTS FOR CLIENTS, PAYROLL PROCESSING FOR CLIENTS, GENERATING FORMS IN ELECTRONIC OR PRINT FORMAT, DOCUMENT MANAGEMENT, AND COMPILATION OF FINANCIAL INFORMATION FOR TAX RETURNS AND AUDIT REVIEW, IN CLASS 9 (U.S. CLS. 21, 23, 26, 36 AND 38).

FIRST USE 5-24-2010; IN COMMERCE 5-24-2010.

THE MARK CONSISTS OF STANDARD CHARACTERS WITHOUT CLAIM TO ANY PARTICULAR FONT, STYLE, SIZE, OR COLOR.

NO CLAIM IS MADE TO THE EXCLUSIVE RIGHT TO USE "ACCOUNTING", APART FROM THE MARK AS SHOWN.

SN 85-071,687, FILED 6-25-2010.

ROBIN CHOSID, EXAMINING ATTORNEY



David J. Kyffers

Director of the United States Patent and Trademark Office

United States of America

United States Patent and Trademark Office

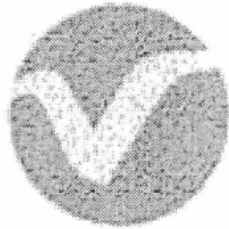

VELCRO

Reg. No. 4,109,616

Registered Mar. 6, 2012

Int. Cl.: 17

TRADEMARK

PRINCIPAL REGISTER

VELCRO INDUSTRIES B.V. (NETHERLANDS ANTILLES LIMITED LIABILITY COMPANY)
CASTORWEG 22-24
CURACAO, NETHERLANDS ANTILLES

FOR: MOLDED AND EXTRUDED PLASTIC MATERIAL HAVING A SURFACE OF HOOKS
AND SYNTHETIC FIBER MATERIAL HAVING A SURFACE OF LOOPS, ALL FOR USE IN
MANUFACTURE, IN CLASS 17 (U.S. CLS. 1, 5, 12, 13, 35 AND 50).

FIRST USE 1-4-2011; IN COMMERCE 1-4-2011.

OWNER OF U.S. REG. NOS. 1,846,829, 2,225,651, AND OTHERS.

THE MARK CONSISTS OF THE STYLIZED WORDING "VELCRO", TO THE LEFT OF WHICH
IS A CIRCULAR DESIGN WITH A STYLIZED "V" STRETCHING FROM ONE SIDE OF THE
CIRCULAR DESIGN TO THE OTHER. THE STIPLING IN THE CIRCULAR DESIGN AND
THE STYLIZED "V" IS INTENDED TO INDICATE CONTRAST.

SN 85-071,750, FILED 6-25-2010.

JAMES STEIN, EXAMINING ATTORNEY



David J. Kybas

Director of the United States Patent and Trademark Office

United States of America

United States Patent and Trademark Office

SPIRIT OF THE FRENCH QUARTER

Reg. No. 4,109,617

SAZERAC COMPANY, INC. (LOUISIANA CORPORATION)
3850 N. CAUSEWAY BLVD., SUITE 1695
METAIRIE, LA 70002

Registered Mar. 6, 2012

Int. Cl.: 33

FOR: ALCOHOLIC BEVERAGES, NAMELY, LIQUEUR, WHISKEY AND VODKA, IN CLASS
33 (U.S. CLS. 47 AND 49).

TRADEMARK

FIRST USE 12-0-2011; IN COMMERCE 12-0-2011.

PRINCIPAL REGISTER

THE MARK CONSISTS OF STANDARD CHARACTERS WITHOUT CLAIM TO ANY PAR-
TICULAR FONT, STYLE, SIZE, OR COLOR.

OWNER OF U.S. REG. NO. 3,362,465.

NO CLAIM IS MADE TO THE EXCLUSIVE RIGHT TO USE "FRENCH QUARTER", APART
FROM THE MARK AS SHOWN.

SN 85-072,710, FILED 6-28-2010.

SANI KHOURI, EXAMINING ATTORNEY



David J. Kybas

Director of the United States Patent and Trademark Office

United States of America

United States Patent and Trademark Office

HANES INK

Reg. No. 4,109,618

Registered Mar. 6, 2012

Int. Cl.: 25

TRADEMARK

PRINCIPAL REGISTER

HBI BRANDED APPAREL LIMITED, INC. (DELAWARE CORPORATION)
1000 EAST HANES MILL ROAD
WINSTON-SALEM, NC 27105

FOR: SHIRTS; T-SHIRTS, IN CLASS 25 (U.S. CLS. 22 AND 39).

FIRST USE 11-17-2011; IN COMMERCE 11-17-2011.

THE MARK CONSISTS OF STANDARD CHARACTERS WITHOUT CLAIM TO ANY PARTICULAR FONT, STYLE, SIZE, OR COLOR.

OWNER OF U.S. REG. NOS. 847,649, 3,084,956, AND OTHERS.

SN 85-072,723, FILED 6-28-2010.

KATHY DE JONGE, EXAMINING ATTORNEY



David J. Kyffers

Director of the United States Patent and Trademark Office

United States of America

United States Patent and Trademark Office



Reg. No. 4,109,619

Registered Mar. 6, 2012

Int. Cl.: 35

SERVICE MARK

PRINCIPAL REGISTER

LHP OPERATIONS CO., LLC (DELAWARE LIMITED LIABILITY COMPANY)
SUITE 200
2800 NORTH DALLAS PARKWAY
PLANO, TX 75093

FOR: MANAGEMENT OF HOSPITALS AND OTHER HEALTHCARE PROVIDER INSTITUTIONS, IN CLASS 35 (U.S. CLS. 100, 101 AND 102).

FIRST USE 6-29-2010; IN COMMERCE 6-29-2010.

THE MARK CONSISTS OF A GREEK CROSS, MADE UP OF INCOMPLETE, NON-CONNECTING LINES, AND THE LETTERS "LHP".

SN 85-074,087, FILED 6-29-2010.

TOBY BULLOFF, EXAMINING ATTORNEY



David J. Kyros

Director of the United States Patent and Trademark Office

United States of America

United States Patent and Trademark Office

IWOOLY

Reg. No. 4,109,620

Registered Mar. 6, 2012

Int. Cls.: 9 and 18

TRADEMARK

PRINCIPAL REGISTER

THE GOOD FLOCK, LLC (OREGON LIMITED LIABILITY COMPANY)
2232 N.W. EVERETT STREET, #41
PORTLAND, OR 97210

FOR: POUCHES SPECIFICALLY ADAPTED FOR CARRYING ELECTRONIC EQUIPMENT, NAMELY, PORTABLE PHONES, LAPTOPS AND PORTABLE COMPUTERS, PORTABLE MEDIA PLAYERS, PERSONAL DIGITAL ASSISTANTS, AND ELECTRONIC BOOK READERS; EYEWEAR CASES, IN CLASS 9 (U.S. CLS. 21, 23, 26, 36 AND 38).

FIRST USE 12-1-2011; IN COMMERCE 12-1-2011.

FOR: WALLETS; BUSINESS CARD CASES; CREDIT CARD CASES; DOCUMENT CASES, IN CLASS 18 (U.S. CLS. 1, 2, 3, 22 AND 41).

FIRST USE 12-1-2011; IN COMMERCE 12-1-2011.

THE MARK CONSISTS OF STANDARD CHARACTERS WITHOUT CLAIM TO ANY PARTICULAR FONT, STYLE, SIZE, OR COLOR.

SN 85-074,327, FILED 6-29-2010.

SAIMA MAKHDOOM, EXAMINING ATTORNEY



David J. Kybas

Director of the United States Patent and Trademark Office

United States of America

United States Patent and Trademark Office

THE WORLD OF SKATEBOARDING IN THE PALM OF YOUR HANDS

Reg. No. 4,109,621

Registered Mar. 6, 2012

Int. Cls.: 9 and 35

TRADEMARK

SERVICE MARK

PRINCIPAL REGISTER

FANACTION HOLDINGS LLC (DELAWARE LIMITED LIABILITY COMPANY)
CAMBRIDGE INNOVATION CENTER, 14TH FLOOR
1 BROADWAY
CAMBRIDGE, MA 02142

FOR: COMPUTER APPLICATION SOFTWARE FOR MOBILE PHONES AND PERSONAL DIGITAL ASSISTANTS, NAMELY, SOFTWARE FOR INTERNET-BASED SOCIAL NETWORKING, FOR PROVISION OF ENTERTAINMENT SERVICES FOR AUDIENCE PARTICIPATION AT SPORTS AND OTHER ENTERTAINMENT EVENTS, AND FOR MERCHANDIZING IN CONNECTION WITH SPORTS AND OTHER ENTERTAINMENT EVENTS; MOBILE PHONES AND PERSONAL DIGITAL ASSISTANTS, IN CLASS 9 (U.S. CLS. 21, 23, 26, 36 AND 38).

FIRST USE 8-31-2010; IN COMMERCE 8-31-2010.

FOR: PROMOTION OF SPORTING EVENTS AND OTHER ENTERTAINMENT EVENTS OF OTHERS, IN CLASS 35 (U.S. CLS. 100, 101 AND 102).

FIRST USE 8-31-2010; IN COMMERCE 8-31-2010.

THE MARK CONSISTS OF STANDARD CHARACTERS WITHOUT CLAIM TO ANY PARTICULAR FONT, STYLE, SIZE, OR COLOR.

NO CLAIM IS MADE TO THE EXCLUSIVE RIGHT TO USE "SKATEBOARDING", APART FROM THE MARK AS SHOWN.

SN 85-075,690, FILED 7-1-2010.

LEIGH CAROLINE CASE, EXAMINING ATTORNEY



David J. Kyros

Director of the United States Patent and Trademark Office

United States of America
United States Patent and Trademark Office

VITASURGE

Reg. No. 4,109,622

COTY US LLC (DELAWARE LIMITED LIABILITY COMPANY)
2 PARK AVENUE
NEW YORK, NY 10016

Registered Mar. 6, 2012

Int. Cl.: 3

FOR: NAIL CARE PREPARATIONS, IN CLASS 3 (U.S. CLS. 1, 4, 6, 50, 51 AND 52).

TRADEMARK

FIRST USE 11-30-2010; IN COMMERCE 11-30-2010.

PRINCIPAL REGISTER

THE MARK CONSISTS OF STANDARD CHARACTERS WITHOUT CLAIM TO ANY PARTICULAR FONT, STYLE, SIZE, OR COLOR.

SN 85-076,324, FILED 7-1-2010.

PAUL E. FAHRENKOPF, EXAMINING ATTORNEY



David J. Kyffers

Director of the United States Patent and Trademark Office

United States of America

United States Patent and Trademark Office

SPLIT REMEDY

Reg. No. 4,109,623

Registered Mar. 6, 2012

Int. Cl.: 3

TRADEMARK

PRINCIPAL REGISTER

ALBERTO-CULVER INTERNATIONAL, INC. (DELAWARE CORPORATION)
2525 ARMITAGE AVENUE
MELROSE PARK, IL 60160

FOR: HAIR CARE PREPARATIONS, IN CLASS 3 (U.S. CLS. 1, 4, 6, 50, 51 AND 52).

FIRST USE 1-1-2012; IN COMMERCE 1-1-2012.

THE MARK CONSISTS OF STANDARD CHARACTERS WITHOUT CLAIM TO ANY PARTICULAR FONT, STYLE, SIZE, OR COLOR.

SN 85-076,400, FILED 7-1-2010.

JOHN E. MICHOS, EXAMINING ATTORNEY



David J. Kyffers

Director of the United States Patent and Trademark Office

United States of America

United States Patent and Trademark Office

iii | IndependentEducation

Reg. No. 4,109,624

Registered Mar. 6, 2012

Int. Cls.: 35 and 41

SERVICE MARK

PRINCIPAL REGISTER

INDEPENDENT EDUCATION, INC. (D.C. CORPORATION)
1524 35TH STREET, NW
WASHINGTON, DC 20007

FOR: ASSOCIATION SERVICES, NAMELY, PROMOTING THE INTERESTS OF INDEPENDENT SCHOOLS AND THE EDUCATIONAL MISSIONS OF INDEPENDENT SCHOOLS, IN CLASS 35 (U.S. CLS. 100, 101 AND 102).

FIRST USE 9-2-2010; IN COMMERCE 9-2-2010.

FOR: EDUCATIONAL SERVICES, NAMELY, CONDUCTING PROGRAMS, CONFERENCES, WEBINARS, AND WORKSHOPS IN THE FIELDS OF EDUCATION, EDUCATOR TRAINING, AND THE OPERATION AND MANAGEMENT OF INDEPENDENT SCHOOLS, AND PRINTED MATERIALS DISTRIBUTED THEREWITH, IN CLASS 41 (U.S. CLS. 100, 101 AND 107).

FIRST USE 9-2-2010; IN COMMERCE 9-2-2010.

NO CLAIM IS MADE TO THE EXCLUSIVE RIGHT TO USE "EDUCATION", APART FROM THE MARK AS SHOWN.

THE MARK CONSISTS OF THE STYLIZED LETTERS "III" FOLLOWED BY A VERTICAL LINE AND THE WORDING "INDEPENDENTEDUCATION".

SN 85-077,072, FILED 7-2-2010.

PATRICIA EVANKO, EXAMINING ATTORNEY



David J. Kyjars

Director of the United States Patent and Trademark Office

United States of America

United States Patent and Trademark Office

ONTARGET

Reg. No. 4,109,625

Registered Mar. 6, 2012

Int. Cl.: 35

SERVICE MARK

PRINCIPAL REGISTER

SALESLABS, INC. (NEVADA CORPORATION)
12TH FLOOR
44 WALL STREET
NEW YORK, NY 10005

FOR: PROVISION OF BUSINESS INFORMATION, AND PUBLIC OPINION POLLING VIA THE INTERNET, ON SUBJECT MATTER RELATED TO REVENUE GROWTH, IN CLASS 35 (U.S. CLS. 100, 101 AND 102).

FIRST USE 3-0-2010; IN COMMERCE 3-0-2010.

THE MARK CONSISTS OF STANDARD CHARACTERS WITHOUT CLAIM TO ANY PARTICULAR FONT, STYLE, SIZE, OR COLOR.

SN 85-078,537, FILED 7-6-2010.

PRISCILLA MILTON, EXAMINING ATTORNEY



David J. Kyjars

Director of the United States Patent and Trademark Office

United States of America
United States Patent and Trademark Office

AIR4ORCE

Reg. No. 4,109,626

MOTO TASSINARI, INC. (NEW HAMPSHIRE CORPORATION)
4 TECHNOLOGY DRIVE
WEST LEBANON, NH 03784

Registered Mar. 6, 2012

Int. Cl.: 7

FOR: MOTORCYCLE ENGINE PARTS, NAMELY, TUNABLE AIR INTAKE BOOTS, IN CLASS 7 (U.S. CLS. 13, 19, 21, 23, 31, 34 AND 35).

TRADEMARK

FIRST USE 6-1-2010; IN COMMERCE 6-1-2010.

PRINCIPAL REGISTER

THE MARK CONSISTS OF STANDARD CHARACTERS WITHOUT CLAIM TO ANY PARTICULAR FONT, STYLE, SIZE, OR COLOR.

SN 85-078,747, FILED 7-6-2010.

PRISCILLA MILTON, EXAMINING ATTORNEY



David J. Kybas

Director of the United States Patent and Trademark Office

United States of America

United States Patent and Trademark Office

homesolv

Reg. No. 4,109,627

Registered Mar. 6, 2012

Int. Cl.: 3

TRADEMARK

PRINCIPAL REGISTER

CITRA SOLV, LLC (CONNECTICUT LIMITED LIABILITY COMPANY)
188 SHADOW LAKE ROAD
RIDGEFIELD, CT 06877

FOR: ADHESIVE REMOVERS, ALL PURPOSE CLEANING PREPARATIONS, ALL-PURPOSE CLEANERS, ANTIBACTERIAL SKIN SOAPS, ANTIBACTERIAL SOAP, AROMATIC BODY CARE PRODUCTS, NAMELY, SOAP, AROMATIC ESSENTIAL OILS, AROMATIC OILS, AUTOMATIC DISHWASHING DETERGENTS, AUTOMOBILE CARPET AND UPHOLSTERY CLEANING PREPARATIONS, AUTOMOBILE CLEANERS, AUTOMOBILE TIRE CLEANING AND POLISHING PREPARATIONS, AUTOMOBILE, TIRE, GLASS AND WHEEL CLEANING PREPARATIONS, AUTOMOTIVE CLEANING PREPARATIONS, BAR SOAP, BATH AND SHOWER GELS AND SALTS NOT FOR MEDICAL PURPOSES, BATH SOAPS, BATH SOAPS IN LIQUID, SOLID OR GEL FORM, BIOTECHNOLOGICAL CHEMICAL AND SPRAY CLEANERS FOR INDUSTRIAL AND HOUSEHOLD APPLICATIONS SUCH AS STAIN REMOVAL, ODOR ELIMINATION, AND BIOREMEDIATION OF MANY TYPES OF ORGANIC AND HYDROCARBON-BASED MATERIALS, BIOTECHNOLOGICAL CLEANING SOLUTION FOR ELIMINATING ODORS, BREAKING DOWN ORGANICS, AND REMOVING STAINS, BLEACHING PREPARATIONS FOR HOUSEHOLD USE, BODY WASH, CAKES OF TOILET SOAP, CARPET CLEANERS, CARPET CLEANERS WITH DEODORIZER, CARPET CLEANING PREPARATIONS, CARPET SHAMPOO, CLEANING AGENTS AND PREPARATIONS, CLEANING AGENTS FOR CLEANING SURFACES, CLEANING AND POLISHING PREPARATIONS, CLEANING AND WASHING PREPARATIONS, CLEANING PREPARATIONS FOR HOUSEHOLD PURPOSES, CLEANING PREPARATIONS, CLEANING PREPARATIONS FOR CLEANSING DRAINS, CLEANING PREPARATIONS FOR CLEANING SURFACES, CLEANING PREPARATIONS THAT ELIMINATE BACTERIA THAT CAUSE PRODUCTS TO AGE OR PRODUCE FOUL ODORS, CLEANING PREPARATIONS CONTAINING MICROBIAL ENZYMES, USED TO PRESERVE DRAIN SYSTEMS AND WATERWAYS, CLEANSING AND POLISHING PREPARATIONS, DEGREASING PREPARATIONS FOR VARIOUS TYPES OF SURFACES, DETERGENT SOAP, DETERGENTS FOR AUTOMOBILES, DETERGENTS FOR HOUSEHOLD USE, DETERGENTS FOR MACHINE DISHWASHING, DE-GREASING PREPARATIONS FOR HOUSEHOLD PURPOSES, DISH DETERGENTS, DISHWASHER DETERGENTS, DISHWASHING DETERGENTS, DISINFECTANT SOAPS, DISPOSABLE WIPES IMPREGNATED WITH CLEANSING CHEMICALS OR COMPOUNDS FOR HOUSEHOLD USE, DRAIN OPENERS, DRYER SHEETS IMPREGNATED WITH CLEANING GEL AND BAGS FOR USE IN CONNECTION THEREWITH, ESSENTIAL OILS FOR HOUSEHOLD USE, ESSENTIAL OILS FOR USE IN AROMATHERAPY, FABRIC SOFTENERS, FABRIC SOFTENERS FOR LAUNDRY USE, FOAM CLEANING PREPARA-



David J. Kyros

Director of the United States Patent and Trademark Office

Reg. No. 4,109,627 TIONS, FOAM CLEANSERS FOR PERSONAL USE, FRAGRANCE EMITTING WICKS FOR ROOM FRAGRANCE, FURNITURE POLISH, GLASS CLEANERS, GLASS CLEANING PREPARATIONS, GLUE REMOVERS, GUM REMOVING PREPARATIONS, HAND SOAPS, HOUSEHOLD CLEANING PREPARATIONS, LAUNDRY BLEACH, LAUNDRY DETERGENTS, LAUNDRY PRE-SOAK, LIQUID SOAP, OVEN CLEANERS LIQUID SOAPS FOR HANDS, FACE AND BODY, PAINT REMOVER, PET ODOR REMOVERS, PET STAIN REMOVERS, REEDS AND SCENTED OILS SOLD AS A UNIT FOR USE IN ROOM SCENT DIFFUSERS, ROOM FRAGRANCES, SOAPS AND DETERGENTS, SOAPS FOR HOUSEHOLD USE, SOAPS FOR PERSONAL USE, SPOT REMOVER, STAIN REMOVERS, STAIN REMOVING PREPARATIONS, TOILET BOWL DETERGENTS, UPHOLSTERY CLEANERS, WOOD CONDITIONER, BRIGHTENER AND RENEWER, IN CLASS 3 (U.S. CLS. 1, 4, 6, 50, 51 AND 52).

FIRST USE 6-16-2011; IN COMMERCE 6-16-2011.

OWNER OF U.S. REG. NOS. 1,919,148 AND 2,531,417.

THE MARK CONSISTS OF A CURSIVE STYLIZED VERSION OF THE WORD PORTION "HOME" COMBINED WITH A PRINTED VERSION OF THE WORD PORTION "SOLV".

SN 85-078,774, FILED 7-6-2010.

JENNIFER MARTIN, EXAMINING ATTORNEY

United States of America

United States Patent and Trademark Office

INQUIRY INVESTIGATIONS

Reg. No. 4,109,628

Registered Mar. 6, 2012

Int. Cls.: 9 and 16

TRADEMARK

PRINCIPAL REGISTER

DELTA EDUCATION, LLC (DELAWARE LIMITED LIABILITY COMPANY)
80 NORTHWEST BLVD
NASHUA, NH 03063

FOR: TEACHER RESOURCE SOFTWARE FOR USE IN FACILITATING STUDENT LEARNING INVOLVING OBJECT-BASED VIRTUAL LABS, SUBJECT-SPECIFIC TUTORIALS, ASSESSMENT QUESTIONS, HANDOUT GRAPHICS, ANIMATIONS, UTILITY ALLOWING FOR MODIFICATION OF EDITORIAL CONTENT AND WEB DELIVERY, GLOSSARY OF SUBJECT-RELATED TERMS, CORRELATION OF RELATED KIT MATERIALS AND SOFTWARE CONTENT TO NATIONAL SCIENCE EDUCATION STANDARDS, WEB-LINKS FOR STATE STANDARDS ALL FOR USE WITH A SERIES OF MIDDLE SCHOOL AND HIGH-SCHOOL INVESTIGATION KITS, IN CLASS 9 (U.S. CLS. 21, 23, 26, 36 AND 38).

FIRST USE 1-0-2008; IN COMMERCE 1-0-2008.

FOR: SERIES OF MIDDLE SCHOOL AND HIGH SCHOOL INVESTIGATION KITS COMPRISED OF PRINTED PAPER MATERIALS, NAMELY, CURRICULUM GUIDES, STUDENT COPYMASTER WORKSHEETS, TEACHER'S GUIDE BOOKLETS, STUDENT GUIDE SHEETS, MATERIAL SAFETY DATA SHEETS, LAMINATED PAPER POSTERS, PRINTED ARTICLES FOR STUDENTS, CHEMICALS AND CHEMICAL REAGENTS, NAMELY, ACIDS, BASES, SALTS, INORGANICS, ORGANICS, INDICATORS AND BUFFERS, STRAWS, STRING, MAGNIFIERS AND MAGNETS, SOLD TOGETHER AS A UNIT, IN CLASS 16 (U.S. CLS. 2, 5, 22, 23, 29, 37, 38 AND 50).

FIRST USE 1-0-2008; IN COMMERCE 1-0-2008.

NO CLAIM IS MADE TO THE EXCLUSIVE RIGHT TO USE "INQUIRY INVESTIGATIONS", APART FROM THE MARK AS SHOWN.

THE MARK CONSISTS OF THE WORD "INQUIRY" ON TOP OF THE WORD "INVESTIGATIONS" WITH A SWIRL PATTERN AROUND THE "I" IN "INQUIRY".

SN 85-078,862, FILED 7-6-2010.

KATHY DE JONGE, EXAMINING ATTORNEY



David J. Kyros

Director of the United States Patent and Trademark Office

United States of America

United States Patent and Trademark Office

Perform Mints

Reg. No. 4,109,629

Registered Mar. 6, 2012

Int. Cl.: 30

TRADEMARK

PRINCIPAL REGISTER

PROTICA INC. (DELAWARE CORPORATION)
1002 MACARTHUR RD
WHITEHALL, PA 180527002

FOR: CANDY MINTS, IN CLASS 30 (U.S. CL. 46).

FIRST USE 4-18-2011; IN COMMERCE 4-18-2011.

THE MARK CONSISTS OF STANDARD CHARACTERS WITHOUT CLAIM TO ANY PARTICULAR FONT, STYLE, SIZE, OR COLOR.

NO CLAIM IS MADE TO THE EXCLUSIVE RIGHT TO USE "MINTS", APART FROM THE MARK AS SHOWN.

SN 85-079,037, FILED 7-7-2010.

CHRISTOPHER BUONGIORNO, EXAMINING ATTORNEY



David J. Kybas

Director of the United States Patent and Trademark Office

United States of America

United States Patent and Trademark Office



Reg. No. 4,109,630

Registered Mar. 6, 2012

Int. Cl.: 7

TRADEMARK

PRINCIPAL REGISTER

MOTO TASSINARI, INC. (NEW HAMPSHIRE CORPORATION)
4 TECHNOLOGY DRIVE
WEST LEBANON, NH 03784

FOR: MOTORCYCLE PARTS, NAMELY, PARTS THAT MAKE THE MOTOR RUN MORE EFFICIENTLY IN THE NATURE OF REED VALVES AND INTAKE BOOTS WITH INTERCHANGEABLE VELOCITY STACKS FOR MOTORS, IN CLASS 7 (U.S. CLS. 13, 19, 21, 23, 31, 34 AND 35).

FIRST USE 6-1-2010; IN COMMERCE 6-1-2010.

THE MARK CONSISTS OF TWO STRAIGHT BARS THAT ARE NEARLY VERTICAL WITH THE BOTTOM ENDS OF THE BARS CLOSER TO EACH OTHER THAN THE TOP ENDS AND A THIRD BAR NEARLY HORIZONTAL, WITH A BEND IN THE MIDDLE SO THAT THE MIDDLE IS HIGHER THAN THE ENDS, PLACED ABOVE THE TWO NEARLY VERTICAL BARS.

SN 85-079,398, FILED 7-7-2010.

PRISCILLA MILTON, EXAMINING ATTORNEY



David J. Kybas

Director of the United States Patent and Trademark Office

United States of America

United States Patent and Trademark Office

QUESTCARE DOCASSIST

Reg. No. 4,109,631

Registered Mar. 6, 2012

Int. Cl.: 35

SERVICE MARK

PRINCIPAL REGISTER

QUESTCARE MEDICAL SERVICES, P.A. (TEXAS PROFESSIONAL ASSOCIATION)
12221 MERIT DRIVE, SUITE 1610
DALLAS, TX 75251

FOR: PROVIDING MEDICAL DICTATION AND MEDICAL TRANSCRIPTION SERVICES, NAMELY, MAKING NOTES IN MEDICAL RECORDS AS DICTATED BY PHYSICIANS, CONCERNING PHYSICIANS' EXAMINATIONS OF PATIENTS, IN CLASS 35 (U.S. CLS. 100, 101 AND 102).

FIRST USE 5-0-2010; IN COMMERCE 5-0-2010.

THE MARK CONSISTS OF STANDARD CHARACTERS WITHOUT CLAIM TO ANY PARTICULAR FONT, STYLE, SIZE, OR COLOR.

OWNER OF U.S. REG. NOS. 2,364,219 AND 3,708,432.

SN 85-079,473, FILED 7-7-2010.

ALYSSA STEEL, EXAMINING ATTORNEY



David J. Kybas

Director of the United States Patent and Trademark Office

United States of America

United States Patent and Trademark Office

LIFE OPENS UP WHEN YOU DO

Reg. No. 4,109,632

THE PROCTER & GAMBLE COMPANY (OHIO CORPORATION)
ONE PROCTER & GAMBLE PLAZA
CINCINNATI, OH 45202

Registered Mar. 6, 2012

Int. Cls.: 3 and 21

FOR: TOOTHPASTE, MOUTHWASH, COSMETIC TOOTH WHITENERS, BREATH FRESHENING SPRAYS, IN CLASS 3 (U.S. CLS. 1, 4, 6, 50, 51 AND 52).

TRADEMARK

FIRST USE 6-20-2011; IN COMMERCE 6-20-2011.

PRINCIPAL REGISTER

FOR: TOOTHBRUSHES, DENTAL FLOSS, IN CLASS 21 (U.S. CLS. 2, 13, 23, 29, 30, 33, 40 AND 50).

FIRST USE 6-20-2011; IN COMMERCE 6-20-2011.

THE MARK CONSISTS OF STANDARD CHARACTERS WITHOUT CLAIM TO ANY PARTICULAR FONT, STYLE, SIZE, OR COLOR.

SN 85-080,257, FILED 7-8-2010.

ANGELA M. MICHELI, EXAMINING ATTORNEY



David J. Kybas

Director of the United States Patent and Trademark Office

United States of America

United States Patent and Trademark Office

OXBOW

Reg. No. 4,109,633

Registered Mar. 6, 2012

Int. Cl.: 32

TRADEMARK

PRINCIPAL REGISTER

OXBOW BREWING COMPANY, LLC (MAINE LIMITED LIABILITY COMPANY)
274 JONES WOODS ROAD
NEWCASTLE, ME 04553

FOR: BEER, IN CLASS 32 (U.S. CLS. 45, 46 AND 48).

FIRST USE 8-14-2011; IN COMMERCE 12-27-2011.

THE MARK CONSISTS OF STANDARD CHARACTERS WITHOUT CLAIM TO ANY PARTICULAR FONT, STYLE, SIZE, OR COLOR.

SN 85-080,664, FILED 7-8-2010.

ANDREA K. NADELMAN, EXAMINING ATTORNEY



David J. Kyros

Director of the United States Patent and Trademark Office

United States of America

United States Patent and Trademark Office

PRECIOUS
ELEMENTS

Reg. No. 4,109,634

RICHLINE GROUP, INC. (DELAWARE CORPORATION)
1385 BROADWAY
NEW YORK, NY 10018

Registered Mar. 6, 2012

Int. Cl.: 14

FOR: JEWELRY CONTAINING PRECIOUS METALS, IN CLASS 14 (U.S. CLS. 2, 27, 28 AND 50).

TRADEMARK

FIRST USE 5-31-2011; IN COMMERCE 5-31-2011.

PRINCIPAL REGISTER

OWNER OF U.S. REG. NOS. 2,028,007, 2,698,075, AND 3,728,344.

THE COLOR(S) GREEN AND WHITE IS/ARE CLAIMED AS A FEATURE OF THE MARK.

NO CLAIM IS MADE TO THE EXCLUSIVE RIGHT TO USE "PRECIOUS", APART FROM THE MARK AS SHOWN.

THE MARK CONSISTS OF THE WORDS "PRECIOUS ELEMENTS" IN THE COLOR GREEN WITH THE LETTER "I" IN THE WORD "PRECIOUS" BEING REPRESENTED BY A LEAF IN GREEN AGAINST A WHITE BACKGROUND.

SN 85-081,312, FILED 7-9-2010.

SUSAN LESLIE DUBOIS, EXAMINING ATTORNEY



David J. Kyros

Director of the United States Patent and Trademark Office

United States of America

United States Patent and Trademark Office

e9

Reg. No. 4,109,635

Registered Mar. 6, 2012

Int. Cl.: 32

TRADEMARK

PRINCIPAL REGISTER

NATURE'S SUNSHINE PRODUCTS, INC. (UTAH CORPORATION)
75 EAST 1700 SOUTH
P.O. BOX 19005
PROVO, UT 84605

FOR: POWDERS USED IN THE PREPARATION OF ENERGY DRINKS, IN CLASS 32 (U.S. CLS. 45, 46 AND 48).

FIRST USE 10-22-2010; IN COMMERCE 10-22-2010.

THE MARK CONSISTS OF STANDARD CHARACTERS WITHOUT CLAIM TO ANY PARTICULAR FONT, STYLE, SIZE, OR COLOR.

SN 85-081,515, FILED 7-9-2010.

WENDY JUN, EXAMINING ATTORNEY



David J. Kybas

Director of the United States Patent and Trademark Office

United States of America

United States Patent and Trademark Office

Heritage. Research. Results.

Reg. No. 4,109,636

Registered Mar. 6, 2012

Int. Cl.: 3

TRADEMARK

PRINCIPAL REGISTER

SWEDISH SKIN CARE, INC. (CALIFORNIA CORPORATION)
468 N. CAMDEN DRIVE, 3RD FLOOR
BEVERLY HILLS, CA 90210

FOR: NON-MEDICATED SKIN CARE PREPARATIONS; NON-MEDICATED BODY CARE PREPARATIONS, NAMELY, TOPICAL SKIN SPRAYS FOR COSMETIC PURPOSES, EXFOLIATING CREAM, SKIN CLEANSER, FACIAL SCRUB, BODY SCRUB, SKIN LOTION, SKIN GELS, SKIN MOISTURIZER, SOAP, TONER, SKIN CLEANSER, SKIN CONDITIONER AND NON-MEDICATED SKIN ASTRINGENT, IN CLASS 3 (U.S. CLS. 1, 4, 6, 50, 51 AND 52).

FIRST USE 8-3-2011; IN COMMERCE 8-3-2011.

THE MARK CONSISTS OF STANDARD CHARACTERS WITHOUT CLAIM TO ANY PARTICULAR FONT, STYLE, SIZE, OR COLOR.

SN 85-082,070, FILED 7-11-2010.

BARBARA GAYNOR, EXAMINING ATTORNEY



David J. Kybas

Director of the United States Patent and Trademark Office

United States of America

United States Patent and Trademark Office



Reg. No. 4,109,637

Registered Mar. 6, 2012

Int. Cl.: 45

SERVICE MARK

PRINCIPAL REGISTER

MANAGEMENT AND TRAINING CONSULTANTS, INC. (DELAWARE CORPORATION),
AKA MTCI,
SUITE 201
3800 FETTLER PARK DR.
DUMFRIES, VA 22025

FOR: PERSONAL GROWTH AND MOTIVATION CONSULTING SERVICES, IN CLASS 45
(U.S. CLS. 100 AND 101).

FIRST USE 8-13-2010; IN COMMERCE 3-22-2011.

THE MARK CONSISTS OF THE WORDING "MTCI RESILIENCY ""MAXIMIZING HUMAN POTENTIAL"". THE MARK FEATURES A RECTANGLE OUTLINED IN BLUE ON THE OUTSIDE, THE MIDDLE OUTLINE IS IN GREY AND THE INSIDE IS IN BLUE. THE WORDING "MTCI" IS IN BLUE AND OUTLINED IN WHITE. BEHIND THE "MTCI" ARE TWO CURVED LINES, ONE IN GREY AND ONE IN BLUE. TO THE RIGHT OF THE "MTCI" IS THE WORD "RESILIENCY" WHICH IS FEATURED IN PURPLE ON THE TOP AND FADING TO BLACK ON THE BOTTOM. UNDERNEATH THE TERM "RESILIENCY" IS THE WORDING "MAXIMIZING HUMAN POTENTIAL" IN BLACK.

THE COLOR(S) BLUE, GREY, PURPLE, WHITE, AND BLACK IS/ARE CLAIMED AS A FEATURE OF THE MARK.

SN 85-082,587, FILED 7-12-2010.

LOURDES AYALA, EXAMINING ATTORNEY



David J. Kyffers

Director of the United States Patent and Trademark Office

United States of America

United States Patent and Trademark Office

Park Place

Reg. No. 4,109,638

Registered Mar. 6, 2012

Int. Cl.: 19

TRADEMARK

PRINCIPAL REGISTER

JEFFREY COURT, INC. (CALIFORNIA CORPORATION)
SUITE 130
8141 E. KAISER BLVD
ANAHEIM HILLS, CA 92808

FOR: BUILDING MATERIALS, NAMELY, STONE TILES, IN CLASS 19 (U.S. CLS. 1, 12, 33 AND 50).

FIRST USE 12-26-2011; IN COMMERCE 12-26-2011.

THE MARK CONSISTS OF STANDARD CHARACTERS WITHOUT CLAIM TO ANY PARTICULAR FONT, STYLE, SIZE, OR COLOR.

SN 85-083,183, FILED 7-13-2010.

NAPOLEON SHARMA, EXAMINING ATTORNEY



David J. Kybas

Director of the United States Patent and Trademark Office

United States of America

United States Patent and Trademark Office

DEAL DRAW POKER

Reg. No. 4,109,639

IGT (NEVADA CORPORATION)
9295 PROTOTYPE DRIVE
RENO, NV 895218986

Registered Mar. 6, 2012

Int. Cl.: 9

FOR: GAMING MACHINES, NAMELY, DEVICES WHICH ACCEPT A WAGER, IN CLASS 9 (U.S. CLS. 21, 23, 26, 36 AND 38).

TRADEMARK

FIRST USE 11-17-2011; IN COMMERCE 11-17-2011.

PRINCIPAL REGISTER

THE MARK CONSISTS OF STANDARD CHARACTERS WITHOUT CLAIM TO ANY PARTICULAR FONT, STYLE, SIZE, OR COLOR.

NO CLAIM IS MADE TO THE EXCLUSIVE RIGHT TO USE "DRAW POKER", APART FROM THE MARK AS SHOWN.

SN 85-083,609, FILED 7-13-2010.

LINDA LAVACHE, EXAMINING ATTORNEY



David J. Kybas

Director of the United States Patent and Trademark Office

United States of America

United States Patent and Trademark Office

ASPEN LEAF

Reg. No. 4,109,640

Registered Mar. 6, 2012

Int. Cls.: 30 and 43

TRADEMARK

SERVICE MARK

PRINCIPAL REGISTER

ROCKY MOUNTAIN CHOCOLATE FACTORY, INC. (COLORADO CORPORATION)
265 TURNER DRIVE
DURANGO, CO 81303

FOR: FROZEN YOGURT, FROZEN YOGURT CONFECTIONS, FROZEN YOGURT COMBINED WITH FRUIT, NUTS AND OTHER TOPPINGS, IN CLASS 30 (U.S. CL. 46).

FIRST USE 12-16-2010; IN COMMERCE 12-16-2010.

FOR: RESTAURANTS FEATURING FROZEN YOGURT AND OTHER CONFECTIONS, IN CLASS 43 (U.S. CLS. 100 AND 101).

FIRST USE 12-16-2010; IN COMMERCE 12-16-2010.

THE MARK CONSISTS OF STANDARD CHARACTERS WITHOUT CLAIM TO ANY PARTICULAR FONT, STYLE, SIZE, OR COLOR.

SN 85-084,636, FILED 7-14-2010.

WON TEAK OH, EXAMINING ATTORNEY



David J. Kybas

Director of the United States Patent and Trademark Office

United States of America

United States Patent and Trademark Office



Reg. No. 4,109,641

Registered Mar. 6, 2012

Int. Cl.: 21

TRADEMARK

PRINCIPAL REGISTER

PETER PATTERSON GLASSWORKS (ILLINOIS CORPORATION)
888 TOWER ROAD # E
MUNDELEIN, IL 60060

FOR: MEMORIAL KEEPSAKES, NAMELY, HAND SCULPTED GLASS ARTWORK CONTAINING CREMAINS OF HUMAN OR PET ORIGIN, COMBINED WITH OTHER GLASS COLORS AND ADORNMENTS , IN CLASS 21 (U.S. CLS. 2, 13, 23, 29, 30, 33, 40 AND 50).

FIRST USE 1-1-2011; IN COMMERCE 1-1-2011.

NO CLAIM IS MADE TO THE EXCLUSIVE RIGHT TO USE "GLOW KEEPSAKES", APART FROM THE MARK AS SHOWN.

THE MARK CONSISTS OF A RECTANGLE CONTAINING THE STYLIZED WORDING "ETERNAL GLO KEEPSAKES" WITH A SCROLL BEFORE AND AFTER THE WORDING.

SN 85-084,840, FILED 7-14-2010.

MARLENE BELL, EXAMINING ATTORNEY



David J. Kyros

Director of the United States Patent and Trademark Office

United States of America

United States Patent and Trademark Office



Reg. No. 4,109,642

Registered Mar. 6, 2012

Int. Cls.: 25 and 41

TRADEMARK

SERVICE MARK

PRINCIPAL REGISTER

MICHAEL LUZBET (UNITED STATES INDIVIDUAL)
14204 SW 24 STREET
MIAMI, FL 33175

FOR: CLOTHING, NAMELY, SHIRTS, T-SHIRTS, SHORTS, WARM-UP SUITS, RASH GUARDS, TANK TOPS, SLEEVELESS HOODED SWEATSHIRTS, SAUNA SUITS, PANTS, ROBES, UNDERWEAR, BOXING JERSEYS, BRIEFS, JACKETS, JOGGING SUITS, MUSCLE SHIRTS, SWEATPANTS, SWEATSHIRTS, BOXING TRUNKS, TRACK SUITS AND HEADWEAR, IN CLASS 25 (U.S. CLS. 22 AND 39).

FIRST USE 8-20-2010; IN COMMERCE 8-20-2010.

FOR: HEALTH CLUB SERVICES, NAMELY, PROVIDING INSTRUCTION AND EQUIPMENT IN THE FIELD OF PHYSICAL EXERCISE; TRAINING IN FIGHTING AND MARTIAL ARTS, NAMELY, PROVIDING INSTRUCTION AND EQUIPMENT IN THE FIELD OF MIXED MARTIAL ARTS, IN CLASS 41 (U.S. CLS. 100, 101 AND 107).

FIRST USE 12-14-2011; IN COMMERCE 12-14-2011.

THE MARK CONSISTS OF AN ARTISTIC RENDERING OF A HUMAN ARM CLUTCHING A SECOND ARM AT THE WRIST, CENTERED ABOVE THE WORDING "THE WINNER" IN A STYLIZED FORMAT. BOTH THE IMAGE AND THE WORDING ARE ENCOMPASSED BY A TRIANGLE-LIKE DESIGN.

SN 85-086,852, FILED 7-16-2010.

MARK RADEMACHER, EXAMINING ATTORNEY



David J. Kybas

Director of the United States Patent and Trademark Office

United States of America

United States Patent and Trademark Office

ACL Calculator

Reg. No. 4,109,643

Registered Mar. 6, 2012

Int. Cl.: 42

SERVICE MARK

PRINCIPAL REGISTER

HARBINGER TECHNOLOGY SOLUTIONS, LLC (VIRGINIA LIMITED LIABILITY COMPANY)
SUITE 1501
555 E. MAIN ST.
NORFOLK, VA 23510

FOR: COMPUTER SERVICE, NAMELY, ACTING AS AN APPLICATION SERVICE PROVIDER IN THE FIELD OF KNOWLEDGE MANAGEMENT TO HOST COMPUTER APPLICATION SOFTWARE FOR CREATING SEARCHABLE DATABASES OF INFORMATION AND DATA, IN CLASS 42 (U.S. CLS. 100 AND 101).

FIRST USE 11-20-2010; IN COMMERCE 12-20-2010.

NO CLAIM IS MADE TO THE EXCLUSIVE RIGHT TO USE "ACL CALCULATOR", APART FROM THE MARK AS SHOWN.

THE COLOR(S) GOLD AND GRAY IS/ARE CLAIMED AS A FEATURE OF THE MARK.

THE MARK CONSISTS OF AN UPPERCASE "A", "C" AND "L" IN GOLD, THE WORD "CALCULATOR" IN GRAY WITH A GRAY BAR UNDERNEATH THE WORD, THE "O" IN "CALCULATOR" IS DEPICTED AS NINE DOTS IN ROWS AND COLUMNS OF THREE, THE MIDDLE DOT IN THE FIRST ROW IS GOLD AND THE OTHER TWO DOTS ON EITHER SIDE ARE GRAY, THE FIRST TWO DOTS ON THE SECOND ROW ARE GRAY AND THE LAST DOT IN THE ROW IS GOLD, THE FIRST DOT ON THE THIRD ROW IS GOLD AND THE LAST TWO DOTS ARE GRAY.

SN 85-087,691, FILED 7-19-2010.

KAREN SEVERSON, EXAMINING ATTORNEY



David J. Kyjars

Director of the United States Patent and Trademark Office

United States of America

United States Patent and Trademark Office

STEP OUT OF PAIN, FEEL THE GAIN

Reg. No. 4,109,644

Registered Mar. 6, 2012

Int. Cl.: 9

TRADEMARK

PRINCIPAL REGISTER

THE FLOWWALKING COMPANY LLC (INDIANA LIMITED LIABILITY COMPANY)
1907 REDWOOD LANE
MUNSTER, IN 46321

FOR: PRE-RECORDED CDS AND DVDS FEATURING EXERCISE CLASSES AND INFORMATION ABOUT FITNESS AND HEALTH PROGRAMS, IN CLASS 9 (U.S. CLS. 21, 23, 26, 36 AND 38).

FIRST USE 12-21-2011; IN COMMERCE 12-21-2011.

THE MARK CONSISTS OF STANDARD CHARACTERS WITHOUT CLAIM TO ANY PARTICULAR FONT, STYLE, SIZE, OR COLOR.

SN 85-088,054, FILED 7-19-2010.

BARBARA A. GOLD, EXAMINING ATTORNEY



David J. Kyffers

Director of the United States Patent and Trademark Office

United States of America

United States Patent and Trademark Office

Truth Or Lies

Reg. No. 4,109,645

Registered Mar. 6, 2012

Int. Cl.: 28

TRADEMARK

PRINCIPAL REGISTER

IMAGINATION HOLDINGS PTY LTD (AUSTRALIA LIMITED LIABILITY COMPANY)
LEVEL 1, 300 RUNDLE ST
ADELAIDE, AUSTRALIA 5000

FOR: BOARD GAMES, IN CLASS 28 (U.S. CLS. 22, 23, 38 AND 50).

FIRST USE 10-1-2010; IN COMMERCE 7-1-2011.

THE MARK CONSISTS OF STANDARD CHARACTERS WITHOUT CLAIM TO ANY PARTICULAR FONT, STYLE, SIZE, OR COLOR.

OWNER OF U.S. REG. NO. 3,379,114.

SN 85-088,169, FILED 7-20-2010.

GISELLE AGOSTO, EXAMINING ATTORNEY



David J. Kyffers

Director of the United States Patent and Trademark Office

United States of America

United States Patent and Trademark Office

iii | Independent Education
Schools for Every Child

Reg. No. 4,109,646

Registered Mar. 6, 2012

**COLLECTIVE
MEMBERSHIP**

PRINCIPAL REGISTER

INDEPENDENT EDUCATION, INC. (D.C. CORPORATION)
1524 35TH STREET, NW
WASHINGTON, DC 20007

FOR: INDICATING MEMBERSHIP IN AN ASSOCIATION OF INDEPENDENT SCHOOLS,
IN CLASS 200 (U.S. CL. 200).

FIRST USE 9-22-2010; IN COMMERCE 9-22-2010.

NO CLAIM IS MADE TO THE EXCLUSIVE RIGHT TO USE "EDUCATION", APART FROM
THE MARK AS SHOWN.

THE MARK CONSISTS OF THE STYLIZED LETTERS "III" FOLLOWED BY A VERTICAL
LINE AND THE WORDING "INDEPENDENT EDUCATION" WITH THE WORDING "SCHOOLS
FOR EVERY CHILD" BELOW.

SN 85-088,300, FILED 7-20-2010.

PATRICIA EVANKO, EXAMINING ATTORNEY



David J. Kyjars

Director of the United States Patent and Trademark Office

United States of America

United States Patent and Trademark Office



FUGAKU

Reg. No. 4,109,647

GYOKUCHO TRADING CO., LTD. (JAPAN CORPORATION)

Registered Mar. 6, 2012

58-14, OMURA
MIKI-SHI, HYOGO-KEN, JAPAN

Int. Cl.: 8

FOR: LAWN AND SHRUB EDGING HAND TOOLS AND HAND OPERATED SAWS, IN CLASS 8 (U.S. CLS. 23, 28 AND 44).

TRADEMARK

FIRST USE 10-12-2011; IN COMMERCE 10-12-2011.

PRINCIPAL REGISTER

THE MARK CONSISTS OF STYLIZED WORD "FUGAKU" AND A DESIGN OF A MOUNTAIN WITHIN A SEMICIRCLE WITH A REFLECTION OF THE MOUNTAIN UNDERNEATH. THE STYLIZED LETTER "A" IN "FUGAKU" INCLUDES A WAVY LATERAL LINE INSIDE.

THE ENGLISH TRANSLATION OF "FUGAKU" IN THE MARK IS "MOUNT FUJI".

SN 85-088,974, FILED 7-20-2010.

LINDA E. BLOHM, EXAMINING ATTORNEY



David J. Kyros

Director of the United States Patent and Trademark Office

United States of America

United States Patent and Trademark Office

WAYMEDIA

Reg. No. 4,109,648

WAY-FM MEDIA GROUP, INC. (FLORIDA NON-PROFIT CORPORATION)
5475 TECH CENTER DRIVE, #210
COLORADO SPRINGS, CO 80919

Registered Mar. 6, 2012

Int. Cls.: 35, 38, and 41

FOR: ADVERTISING SERVICES, NAMELY, PROMOTING THE SOUND AND VISUAL RECORDINGS OF OTHERS; AND PROMOTION IN THE FIELD OF ENTERTAINMENT, NAMELY, PROMOTING THE MUSIC CONCERTS OF OTHERS, IN CLASS 35 (U.S. CLS. 100, 101 AND 102).

SERVICE MARK

PRINCIPAL REGISTER

FIRST USE 11-1-2011; IN COMMERCE 11-1-2011.

FOR: RADIO BROADCASTING SERVICES; RADIO BROADCASTING; RADIO PROGRAM BROADCASTING; STREAMING OF AUDIO MATERIAL ON THE INTERNET; AND PROVIDING A WEBSITE OVER A GLOBAL COMPUTER NETWORK FEATURING INFORMATION ON RADIO BROADCASTING, IN CLASS 38 (U.S. CLS. 100, 101 AND 104).

FIRST USE 11-1-2011; IN COMMERCE 11-1-2011.

FOR: ENTERTAINMENT IN THE NATURE OF ON-GOING RADIO PROGRAMS IN THE FIELD OF CHRISTIAN AND INSPIRATIONAL MUSIC, MUSICAL AND PERFORMING ARTISTS, LIVE INTERVIEWS AND CONCERTS; PROVIDING A WEBSITE OVER A GLOBAL COMPUTER INFORMATION NETWORK FEATURING INFORMATION ON PERFORMING ARTISTS, MUSIC, AND RELIGIOUS INSTRUCTION; PROVIDING NEWSLETTERS IN THE FIELD OF CHRISTIAN AND INSPIRATIONAL MUSIC, MUSICAL AND PERFORMING ARTISTS, LIVE INTERVIEWS, AND CONCERTS VIA E-MAIL, IN CLASS 41 (U.S. CLS. 100, 101 AND 107).

FIRST USE 11-1-2011; IN COMMERCE 11-1-2011.

THE MARK CONSISTS OF STANDARD CHARACTERS WITHOUT CLAIM TO ANY PARTICULAR FONT, STYLE, SIZE, OR COLOR.

OWNER OF U.S. REG. NOS. 3,212,790 AND 3,251,010.

SN 85-089,183, FILED 7-21-2010.

LINDSEY RUBIN, EXAMINING ATTORNEY



David J. Kyros

Director of the United States Patent and Trademark Office

United States of America

United States Patent and Trademark Office

GLAMOUR

Reg. No. 4,109,649

ADVANCE MAGAZINE PUBLISHERS INC. (NEW YORK CORPORATION)
FOUR TIMES SQUARE
NEWYORK, NY 10036

Registered Mar. 6, 2012

Int. Cl.: 9

FOR: COMPUTER APPLICATION SOFTWARE FOR SMARTPHONES, CELL PHONES, PDA DEVICES, AND TABLET COMPUTERS, NAMELY, SOFTWARE FOR ACCESSING, VIEWING, INTERACTING WITH AND DOWNLOADING CONTENT FROM ELECTRONIC MAGAZINES AND WEBSITES, IN CLASS 9 (U.S. CLS. 21, 23, 26, 36 AND 38).

TRADEMARK

PRINCIPAL REGISTER

FIRST USE 8-15-2010; IN COMMERCE 8-15-2010.

THE MARK CONSISTS OF STANDARD CHARACTERS WITHOUT CLAIM TO ANY PARTICULAR FONT, STYLE, SIZE, OR COLOR.

OWNER OF U.S. REG. NOS. 407,439, 3,019,078, AND OTHERS.

SN 85-089,218, FILED 7-21-2010.

BARBARA GAYNOR, EXAMINING ATTORNEY



David J. Kyros

Director of the United States Patent and Trademark Office

United States of America

United States Patent and Trademark Office



Reg. No. 4,109,650

Registered Mar. 6, 2012

Int. Cls.: 18, 24, 25, and 28

SRI SPORTS LIMITED (JAPAN CORPORATION)
6-9, WAKINOHAMA-CHO 3-CHOME, CHUO-KU,
HYOGO
KOBE-SHI, JAPAN

FOR: CARRY ALL BAGS; DUFFEL BAGS; BACKPACKS; SHOE BAGS FOR TRAVEL; AND UMBRELLAS, IN CLASS 18 (U.S. CLS. 1, 2, 3, 22 AND 41).

TRADEMARK

FIRST USE 6-0-2010; IN COMMERCE 6-0-2010.

PRINCIPAL REGISTER

FOR: TOWELS, IN CLASS 24 (U.S. CLS. 42 AND 50).

FIRST USE 6-0-2010; IN COMMERCE 6-0-2010.

FOR: GOLF APPAREL, NAMELY, CAPS, HATS, VISORS, SHIRTS, WIND SHIRTS, RAIN SHIRTS, RAIN JACKETS, AND RAIN PANTS, IN CLASS 25 (U.S. CLS. 22 AND 39).

FIRST USE 6-0-2010; IN COMMERCE 6-0-2010.

FOR: GOLF CLUBS; GOLF CLUB HEADS, NAMELY, WOODS, HYBRIDS, IRONS, WEDGES, PUTTERS, NIBLICKS; GOLF CLUB SHAFTS; GOLF CLUB GRIPS; GOLF GLOVES; GOLF BALLS; GOLF BAGS; GOLF BAG COVERS; GOLF BALL SHAG BAGS USED TO STORE GOLF BALLS; GOLF CLUB HEAD COVERS; AND GOLF BALL BAGS, IN CLASS 28 (U.S. CLS. 22, 23, 38 AND 50).

FIRST USE 6-0-2010; IN COMMERCE 6-0-2010.

OWNER OF U.S. REG. NO. 2,286,233.

THE MARK CONSISTS OF A REPRESENTATION OF A GOLF BALL DROPPING INTO A HOLE.

SN 85-089,796, FILED 7-21-2010.

JOHN E. MICHOS, EXAMINING ATTORNEY



David J. Kyros

Director of the United States Patent and Trademark Office

United States of America

United States Patent and Trademark Office

PAMPERED HANDS

Reg. No. 4,109,651

COLGATE-PALMOLIVE COMPANY (DELAWARE CORPORATION)
300 PARK AVENUE
NEW YORK, NY 10022

Registered Mar. 6, 2012

Int. Cl.: 3

FOR: PERSONAL CARE PRODUCTS, NAMELY, NON-MEDICATED SKIN CLEANSING PREPARATIONS, IN CLASS 3 (U.S. CLS. 1, 4, 6, 50, 51 AND 52).

TRADEMARK

FIRST USE 2-4-2011; IN COMMERCE 2-4-2011.

PRINCIPAL REGISTER

THE MARK CONSISTS OF STANDARD CHARACTERS WITHOUT CLAIM TO ANY PARTICULAR FONT, STYLE, SIZE, OR COLOR.

NO CLAIM IS MADE TO THE EXCLUSIVE RIGHT TO USE "HANDS", APART FROM THE MARK AS SHOWN.

SN 85-089,973, FILED 7-21-2010.

DAVID COLLIER, EXAMINING ATTORNEY



David J. Kyros

Director of the United States Patent and Trademark Office

United States of America

United States Patent and Trademark Office

MONSTER SEAL A FLAT

Reg. No. 4,109,652

WILLIAM J. MARTIN (UNITED STATES INDIVIDUAL)
66 EAST SANTA CLARA STREET
SAN JOSE, CA 95113

Registered Mar. 6, 2012

Int. Cl.: 1

FOR: TIRE SEALING COMPOUNDS, IN CLASS 1 (U.S. CLS. 1, 5, 6, 10, 26 AND 46).

TRADEMARK

FIRST USE 11-30-2011; IN COMMERCE 11-30-2011.

PRINCIPAL REGISTER

THE MARK CONSISTS OF STANDARD CHARACTERS WITHOUT CLAIM TO ANY PARTICULAR FONT, STYLE, SIZE, OR COLOR.

OWNER OF U.S. REG. NO. 3,645,394.

NO CLAIM IS MADE TO THE EXCLUSIVE RIGHT TO USE "SEAL A FLAT", APART FROM THE MARK AS SHOWN.

SN 85-090,569, FILED 7-22-2010.

SUNG IN, EXAMINING ATTORNEY



David J. Kyffers

Director of the United States Patent and Trademark Office

United States of America

United States Patent and Trademark Office

MESS IN THE NEST

Reg. No. 4,109,653

GRASS COLLECTION, LLC (ARIZONA LIMITED LIABILITY COMPANY)
4815 E. CAREFREE HWY #108-167
CAVE CREEK, AZ 85331

Registered Mar. 6, 2012

Int. Cl.: 24

FOR: BEDDING, NAMELY, SHEETS AND BLANKETS, IN CLASS 24 (U.S. CLS. 42 AND 50).

TRADEMARK

FIRST USE 10-24-2011; IN COMMERCE 10-24-2011.

PRINCIPAL REGISTER

THE MARK CONSISTS OF STANDARD CHARACTERS WITHOUT CLAIM TO ANY PARTICULAR FONT, STYLE, SIZE, OR COLOR.

SN 85-092,046, FILED 7-23-2010.

JANICE L. MCMORROW, EXAMINING ATTORNEY



David J. Kybas

Director of the United States Patent and Trademark Office

United States of America

United States Patent and Trademark Office

REFLECT 2 PROTECT

Reg. No. 4,109,654

Registered Mar. 6, 2012

Int. Cl.: 9

TRADEMARK

PRINCIPAL REGISTER

FLASHBRITE INC. (NEW JERSEY CORPORATION)
301 WAGARAW RD
HAWTHORNE, NJ 07506

FOR: SAFETY PRODUCTS TO BE WORN ON CLOTHING OR ON THE BODY FOR REFLECTING PURPOSES, NAMELY, PROTECTIVE, AND REFLECTIVE, TRIM, MARKER AND STRIPING TAPES FEATURING DIE-CUT MATERIALS, WITH PRESSURE SENSITIVE SELF-ADHESIVE BACKING, IN DECAL, ROLL, STRIP AND SHEET FORM; SAFETY PRODUCTS, NAMELY, REFLECTIVE LEG BANDS FOR DOGS AND OTHER ANIMALS, IN CLASS 9 (U.S. CLS. 21, 23, 26, 36 AND 38).

FIRST USE 7-22-2009; IN COMMERCE 7-22-2009.

THE MARK CONSISTS OF STANDARD CHARACTERS WITHOUT CLAIM TO ANY PARTICULAR FONT, STYLE, SIZE, OR COLOR.

NO CLAIM IS MADE TO THE EXCLUSIVE RIGHT TO USE "REFLECT", APART FROM THE MARK AS SHOWN.

SN 85-092,199, FILED 7-24-2010.

KATHLEEN LORENZO, EXAMINING ATTORNEY



David J. Kybas

Director of the United States Patent and Trademark Office

United States of America

United States Patent and Trademark Office

Bible 360

Reg. No. 4,109,655

Registered Mar. 6, 2012

Int. Cl.: 9

TRADEMARK

PRINCIPAL REGISTER

HEARST PRODUCTIONS, INC. (DELAWARE CORPORATION)
300 WEST 57TH STREET
NEW YORK, NY 10019

FOR: COMPUTER APPLICATION SOFTWARE FOR MOBILE PHONES AND HAND-HELD COMPUTING DEVICES THAT DISPLAY STORIES FROM THE BIBLE, IN CLASS 9 (U.S. CLS. 21, 23, 26, 36 AND 38).

FIRST USE 12-16-2011; IN COMMERCE 12-16-2011.

THE MARK CONSISTS OF STANDARD CHARACTERS WITHOUT CLAIM TO ANY PARTICULAR FONT, STYLE, SIZE, OR COLOR.

NO CLAIM IS MADE TO THE EXCLUSIVE RIGHT TO USE "BIBLE", APART FROM THE MARK AS SHOWN.

SN 85-093,319, FILED 7-26-2010.

TEJBIR SINGH, EXAMINING ATTORNEY



David J. Kybas

Director of the United States Patent and Trademark Office

United States of America

United States Patent and Trademark Office

embRACE it

Reg. No. 4,109,656

ORRCO (PENNSYLVANIA CORPORATION)

Registered Mar. 6, 2012

190 ORR DR
GREENSBURG, PA 15601

Int. Cl.: 25

FOR: ATHLETIC APPAREL, NAMELY, SHIRTS, PANTS, JACKETS, FOOTWEAR, HATS AND CAPS, ATHLETIC UNIFORMS, IN CLASS 25 (U.S. CLS. 22 AND 39).

TRADEMARK

FIRST USE 3-27-2011; IN COMMERCE 3-27-2011.

PRINCIPAL REGISTER

THE MARK CONSISTS OF STANDARD CHARACTERS WITHOUT CLAIM TO ANY PARTICULAR FONT, STYLE, SIZE, OR COLOR.

SN 85-093,634, FILED 7-27-2010.

ALLISON SCHRODY, EXAMINING ATTORNEY



David J. Kybas

Director of the United States Patent and Trademark Office

United States of America

United States Patent and Trademark Office

GenZ

Reg. No. 4,109,657

Registered Mar. 6, 2012

Int. Cl.: 41

SERVICE MARK

PRINCIPAL REGISTER

JAFFEE, RICHARD I (UNITED STATES INDIVIDUAL)
RIJ1127@GMAIL.COM
5 OVERBROOK LANE
WESTON, CT 06883

FOR: EDUCATIONAL AND ENTERTAINMENT SERVICES, NAMELY, PROVIDING ON-LINE INTERACTIVE CHILDREN'S STORIES, IN CLASS 41 (U.S. CLS. 100, 101 AND 107).

FIRST USE 12-1-2011; IN COMMERCE 12-1-2011.

THE MARK CONSISTS OF STANDARD CHARACTERS WITHOUT CLAIM TO ANY PARTICULAR FONT, STYLE, SIZE, OR COLOR.

SN 85-094,352, FILED 7-27-2010.

SHANNON TWOHIG, EXAMINING ATTORNEY



David J. Kyfos

Director of the United States Patent and Trademark Office

United States of America

United States Patent and Trademark Office

COLOR EXPLOSION

Reg. No. 4,109,658

L'OREAL USA CREATIVE, INC. (DELAWARE CORPORATION)
575 FIFTH AVENUE
NEW YORK, NY 10017

Registered Mar. 6, 2012

Int. Cl.: 3

FOR: EYE SHADOW, IN CLASS 3 (U.S. CLS. 1, 4, 6, 50, 51 AND 52).

TRADEMARK

FIRST USE 7-0-2011; IN COMMERCE 7-0-2011.

PRINCIPAL REGISTER

THE MARK CONSISTS OF STANDARD CHARACTERS WITHOUT CLAIM TO ANY PARTICULAR FONT, STYLE, SIZE, OR COLOR.

NO CLAIM IS MADE TO THE EXCLUSIVE RIGHT TO USE "COLOR", APART FROM THE MARK AS SHOWN.

SN 85-094,437, FILED 7-28-2010.

JOHN HWANG, EXAMINING ATTORNEY



David J. Kybas

Director of the United States Patent and Trademark Office

United States of America

United States Patent and Trademark Office

AGORA

Reg. No. 4,109,659

SANOFI (FRANCE SOCIETE ANONYME)
174, AVENUE DE FRANCE
PARIS, FRANCE 75013

Registered Mar. 6, 2012

Int. Cls.: 42 and 44

FOR: PROVIDING MEDICAL AND SCIENTIFIC RESEARCH INFORMATION IN THE FIELD OF CLINICAL TRIALS FOR DRONEDARONE, IN CLASS 42 (U.S. CLS. 100 AND 101).

SERVICE MARK

FIRST USE 11-3-2010; IN COMMERCE 11-3-2010.

PRINCIPAL REGISTER

FOR: PROVIDING AN INTERNET WEB SITE FOR MEDICAL PROFESSIONALS THAT ALLOWS FOR THE EXCHANGE OF INFORMATION IN THE FIELD OF ATRIAL FIBRILLATION FOR PURPOSES OF MONITORING AND DIAGNOSING MEDICAL CONDITIONS, IN CLASS 44 (U.S. CLS. 100 AND 101).

FIRST USE 11-3-2010; IN COMMERCE 11-3-2010.

THE MARK CONSISTS OF STANDARD CHARACTERS WITHOUT CLAIM TO ANY PARTICULAR FONT, STYLE, SIZE, OR COLOR.

SN 85-094,566, FILED 7-28-2010.

MICHAEL LITZAU, EXAMINING ATTORNEY



David J. Kybas

Director of the United States Patent and Trademark Office

United States of America

United States Patent and Trademark Office



Reg. No. 4,109,660

Registered Mar. 6, 2012

Int. Cl.: 4

TRADEMARK

PRINCIPAL REGISTER

SCENTSY, INC. (IDAHO CORPORATION)
P. O. BOX 1335
MERIDIAN, ID 83680

FOR: FRAGRANT, PERFUMED, AND SCENTED WICKLESS CANDLES; FRAGRANT, PERFUMED, AND SCENTED WAX BARS AND CHIPS FOR USE IN FRAGRANCE WARMERS, IN CLASS 4 (U.S. CLS. 1, 6 AND 15).

FIRST USE 8-15-2010; IN COMMERCE 8-15-2010.

OWNER OF U.S. REG. NOS. 3,417,399 AND 3,542,934.

THE COLOR(S) PURPLE, LIGHT PURPLE AND WHITE IS/ARE CLAIMED AS A FEATURE OF THE MARK.

NO CLAIM IS MADE TO THE EXCLUSIVE RIGHT TO USE "AUTHENTIC" AND "PRODUCT", APART FROM THE MARK AS SHOWN.

THE MARK CONSISTS OF A STYLIZED CIRCLE DESIGN FOR A LOGO CONTAINING THE WORD "SCENTSY" SHOWN IN WHITE CURSIVE LETTERING IN THE CENTER OF THE LIGHT PURPLE CIRCLE AND SUPERIMPOSED ON TOP OF PURPLE SIX-POINT STAR, ALL FORMING THE INNER CIRCLE OF THE DESIGN. IN A PURPLE CIRCULAR BAND (THE OUTER CIRCLE) AROUND THE INNER CIRCLE THE WORD "AUTHENTIC" APPEARS AT THE TOP OF THE OUTER CIRCLE AND THE WORD "PRODUCT" APPEARS AT THE BOTTOM OF THE OUTER CIRCLE, BOTH IN BLOCK CAPITAL WHITE LETTERING. A WHITE FIVE-POINT STAR IS SHOWN IN THE OUTER CIRCLE ON THE LEFT SIDE NEXT TO THE "S" IN THE WORD "SCENTSY" AND ANOTHER WHITE FIVE-POINT STAR IS SHOWN IN THE OUTER CIRCLE ON THE RIGHT SIDE NEXT TO THE "Y" IN THE WORD "SCENTSY".

SN 85-094,736, FILED 7-28-2010.

JOHN GARTNER, EXAMINING ATTORNEY



David J. Kappas

Director of the United States Patent and Trademark Office

United States of America

United States Patent and Trademark Office

Pro-Fire

Reg. No. 4,109,661

Registered Mar. 6, 2012

Int. Cl.: 7

TRADEMARK

PRINCIPAL REGISTER

U. S. PERFORMANCE INC. (TEXAS CORPORATION)
8314 WHITE SETTLEMENT RD
FORT WORTH, TX 76108

FOR: AUTOMOTIVE PARTS, NAMELY, AUTOMOTIVE DISTRIBUTORS, AUTOMOTIVE DISTRIBUTOR CAPS, AUTOMOTIVE DISTRIBUTOR ROTORS, AUTOMOTIVE DISTRIBUTOR GEARS, AUTOMOTIVE DISTRIBUTOR VACUUM ADVANCE, AUTOMOTIVE DISTRIBUTOR MAGNETIC PICK UP, AUTOMOTIVE COILS, AUTOMOTIVE COIL COVERS, AUTOMOTIVE SPARK PLUG WIRE, AUTOMOTIVE SPARK PLUG WIRE RETAINERS, AUTOMOTIVE IGNITION MODULES, AUTOMOTIVE IGNITION SYSTEMS, IN CLASS 7 (U.S. CLS. 13, 19, 21, 23, 31, 34 AND 35).

FIRST USE 3-10-2011; IN COMMERCE 5-3-2011.

THE MARK CONSISTS OF STANDARD CHARACTERS WITHOUT CLAIM TO ANY PARTICULAR FONT, STYLE, SIZE, OR COLOR.

SN 85-095,255, FILED 7-28-2010.

DAVID H. STINE, EXAMINING ATTORNEY



David J. Kyffers

Director of the United States Patent and Trademark Office

United States of America

United States Patent and Trademark Office

WEATHERTECH

Reg. No. 4,109,662

Registered Mar. 6, 2012

Int. Cl.: 19

TRADEMARK

PRINCIPAL REGISTER

MACNEIL IP LLC (ILLINOIS LIMITED LIABILITY COMPANY)
1 MACNEIL COURT
BOLINGBROOK, IL 60440

FOR: PLASTIC FLOOR TILES, IN CLASS 19 (U.S. CLS. 1, 12, 33 AND 50).

FIRST USE 11-7-2011; IN COMMERCE 11-7-2011.

THE MARK CONSISTS OF STANDARD CHARACTERS WITHOUT CLAIM TO ANY PARTICULAR FONT, STYLE, SIZE, OR COLOR.

OWNER OF U.S. REG. NOS. 2,576,007, 3,534,011, AND OTHERS.

SN 85-096,524, FILED 7-30-2010.

GRETТА YAO, EXAMINING ATTORNEY



David J. Kybas

Director of the United States Patent and Trademark Office

United States of America

United States Patent and Trademark Office

STEP SHOX

Reg. No. 4,109,663

Registered Mar. 6, 2012

Int. Cl.: 28

TRADEMARK

PRINCIPAL REGISTER

OK-1 MANUFACTURING COMPANY (OKLAHOMA CORPORATION)
709 S. VETERANS DRIVE
ALTUS, OK 73522

FOR: VIBRATION DAMPING PADS FOR USE WITH EXERCISE PLATFORMS, IN CLASS 28 (U.S. CLS. 22, 23, 38 AND 50).

FIRST USE 6-29-2011; IN COMMERCE 6-29-2011.

THE MARK CONSISTS OF STANDARD CHARACTERS WITHOUT CLAIM TO ANY PARTICULAR FONT, STYLE, SIZE, OR COLOR.

NO CLAIM IS MADE TO THE EXCLUSIVE RIGHT TO USE "STEP", APART FROM THE MARK AS SHOWN.

SN 85-097,235, FILED 7-30-2010.

MARK T. MULLEN, EXAMINING ATTORNEY



David J. Kybas

Director of the United States Patent and Trademark Office

United States of America

United States Patent and Trademark Office

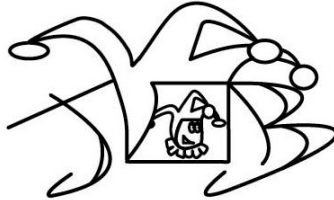

Reg. No. 4,109,664

LANE, JOHN D (UNITED STATES INDIVIDUAL)
1473 S VIVIAN WAY
LAKEWOOD, CO 80228

Registered Mar. 6, 2012

Int. Cl.: 25

FOR: CLOTHING, NAMELY, SHIRTS, PANTS, SHORTS, JACKETS, HEADWEAR, FOOTWEAR, SOCKS, SHOES, IN CLASS 25 (U.S. CLS. 22 AND 39).

TRADEMARK

FIRST USE 12-7-2011; IN COMMERCE 12-7-2011.

PRINCIPAL REGISTER

THE MARK CONSISTS OF THE STYLIZED LETTERS "JYOB". THE LETTER "Y" IS FORMED BY A STYLIZED JESTER HAT AND THE LETTER "O" IS SQUARE WITH THE SQUARE CONTAINING A JESTER WEARING A JESTER HAT.

SN 85-097,389, FILED 7-30-2010.

JULIE WATSON, EXAMINING ATTORNEY



David J. Kybas

Director of the United States Patent and Trademark Office

United States of America

United States Patent and Trademark Office

STRUTTA

Reg. No. 4,109,665

Registered Mar. 6, 2012

**Int. Cls.: 35, 38, 41, and
42**

SERVICE MARK

PRINCIPAL REGISTER

STRUTTA.COM MEDIA, INC. (CANADA CORPORATION)
375 WATER STREET
SUITE 350
VANCOUVER, B.C., CANADA V6B5C6

FOR: VOTING SERVICES, NAMELY, SERVICES ALLOWING USERS TO CAST VOTES IN CONTESTS VIA THE INTERNET, MOBILE PHONES AND MOBILE DEVICES; PUBLIC OPINION POLLING; ADVERTISING AGENCIES, NAMELY, PROMOTING THE GOODS AND SERVICES OF OTHERS; DEVELOPING PROMOTIONAL CAMPAIGNS FOR BUSINESS; ON-LINE ADVERTISING SERVICES FOR OTHERS; ADVERTISING AND PROMOTIONAL SERVICES, IN CLASS 35 (U.S. CLS. 100, 101 AND 102).

FIRST USE 6-1-2009; IN COMMERCE 6-1-2009.

FOR: AUDIO AND VIDEO BROADCASTING SERVICES OVER THE INTERNET; VIDEO BROADCASTING SERVICES OVER THE INTERNET OR OTHER COMMUNICATIONS NETWORK FEATURING THE UPLOADED, POSTED AND TAGGED VIDEOS OF OTHERS; ELECTRONIC TRANSMISSION OF DATA, PHOTOS, AUDIO AND VIDEO CLIPS VIA THE INTERNET; BROADCASTING OF VIDEO AND AUDIO PROGRAMMING OVER THE INTERNET, IN CLASS 38 (U.S. CLS. 100, 101 AND 104).

FIRST USE 6-1-2009; IN COMMERCE 6-1-2009.

FOR: ARRANGING OF CONTESTS, IN CLASS 41 (U.S. CLS. 100, 101 AND 107).

FIRST USE 6-1-2009; IN COMMERCE 6-1-2009.

FOR: PROVIDING A WEBSITE FEATURING TECHNOLOGY THAT ENABLES USERS TO CREATE A VOTING EVENT, VOTE ON THE ISSUE, CHANGE THEIR VOTE AT WILL AND TRACK THE INPUT AND DISPLAY IT IN A UNIQUE GRAPHICAL WAY; PROVIDING A WEBSITE FEATURING TEMPORARY USE OF NON-DOWNLOADABLE SOFTWARE ALLOWING USERS TO UPLOAD, POST AND DISPLAY ONLINE VIDEOS, PHOTOS, TEXT AND AUDIO FOR SHARING WITH OTHERS FOR ENTERTAINMENT PURPOSES; PROVIDING A WEBSITE ALLOWING USERS TO DOWNLOAD VIDEOS, PHOTOS, TEXT AND AUDIO FOR SHARING WITH OTHERS FOR ENTERTAINMENT PURPOSES, IN CLASS 42 (U.S. CLS. 100 AND 101).



David J. Kyjars

Director of the United States Patent and Trademark Office

Reg. No. 4,109,665 FIRST USE 6-1-2009; IN COMMERCE 6-1-2009.

THE MARK CONSISTS OF STANDARD CHARACTERS WITHOUT CLAIM TO ANY PARTICULAR FONT, STYLE, SIZE, OR COLOR.

SN 85-099,402, FILED 8-3-2010.

KAREN BRACEY, EXAMINING ATTORNEY

United States of America

United States Patent and Trademark Office

Ultr▲aspire

Reg. No. 4,109,666

Registered Mar. 6, 2012

Int. Cls.: 18 and 21

TRADEMARK

PRINCIPAL REGISTER

ELITE CREATORS, LLC (IDAHO LIMITED LIABILITY COMPANY), DBA ULTRASPIRE,
IN HOUSE COUNSEL
3884 SOUTH RIVER ROAD, BUILDING B
ST GEORGE, UT 84770

FOR: BACKPACKS, BOOK BAGS, SPORTS BAGS, BUM BAGS, WALLETS AND HANDBAGS;
POUCHES AND BAGS SOLD EMPTY FOR ATTACHMENT TO BACKPACKS; SMALL
BACKPACKS, IN CLASS 18 (U.S. CLS. 1, 2, 3, 22 AND 41).

FIRST USE 1-1-2010; IN COMMERCE 8-1-2011.

FOR: BOTTLES, SOLD EMPTY; INSULATING SLEEVE HOLDER FOR BOTTLES; PLASTIC
WATER BOTTLE HOLDERS AND ATTACHED CARABINER CLIP SOLD AS A UNIT;
PLASTIC WATER BOTTLES SOLD EMPTY; SPORTS BOTTLES SOLD EMPTY; SQUEEZE
BOTTLE SOLD EMPTY; VACUUM BOTTLES, IN CLASS 21 (U.S. CLS. 2, 13, 23, 29, 30, 33,
40 AND 50).

FIRST USE 1-1-2010; IN COMMERCE 8-1-2011.

THE MARK CONSISTS OF THE LETTERS "ULTR" AND "A" APPEARING AS A STYLIZED
UPPER CASE "A" IN RED WITH THE LETTERS "SPIR" AND "E" APPEARING IN BLACK.

THE COLOR(S) RED AND BLACK IS/ARE CLAIMED AS A FEATURE OF THE MARK.

SN 85-099,452, FILED 8-3-2010.

BRIAN NEVILLE, EXAMINING ATTORNEY



David J. Kybas

Director of the United States Patent and Trademark Office

United States of America

United States Patent and Trademark Office



DUE TORRI

Reg. No. 4,109,667

GERARDO CESARI S.P.A. (ITALY CORPORATION)
VIA LUIGI CIOCCA, 35
QUINZANO (BRESCIA), ITALY 25027

Registered Mar. 6, 2012

Int. Cl.: 33

FOR: ALCOHOLIC BEVERAGES EXCEPT BEERS; WINES; SPARKLING WINES; DISTILLED SPIRITS, IN CLASS 33 (U.S. CLS. 47 AND 49).

TRADEMARK

FIRST USE 4-3-1978; IN COMMERCE 4-9-1979.

PRINCIPAL REGISTER

OWNER OF U.S. REG. NOS. 2,389,417 AND 2,407,900.

THE MARK CONSISTS OF THE WORDING "DUE TORRI" UNDER A DESIGN OF TWO SHIELDS, EACH WITH AN IMAGE AND UNDER THE TWO SHIELDS, ABOVE THE WORDING "DUE TORRI" IS A STYLIZED BANNER WITH THE WORDING "DUE TORRI".

THE ENGLISH TRANSLATION OF "DUE TORRI" AND "TORRI" IN THE MARK IS TWO TOWERS AND TOWERS RESPECTIVELY.

SN 85-099,544, FILED 8-3-2010.

PAM WILLIS, EXAMINING ATTORNEY



David J. Kybas

Director of the United States Patent and Trademark Office

United States of America

United States Patent and Trademark Office

Koobrick & Rousseau

Reg. No. 4,109,668

KOBRICK & ROUSSEAU (GEORGIA LIMITED LIABILITY COMPANY)
923 PEACHTREE ST. NE. SUITE#1136
ATLANTA, GA 30309

Registered Mar. 6, 2012

Int. Cl.: 25

FOR: JACKETS; SHOES; SWEATERS; T-SHIRTS; TOPS, IN CLASS 25 (U.S. CLS. 22 AND 39).

TRADEMARK

FIRST USE 8-10-2010; IN COMMERCE 8-20-2010.

PRINCIPAL REGISTER

THE MARK CONSISTS OF STANDARD CHARACTERS WITHOUT CLAIM TO ANY PARTICULAR FONT, STYLE, SIZE, OR COLOR.

SN 85-101,383, FILED 8-5-2010.

CURTIS FRENCH, EXAMINING ATTORNEY



David J. Kybas

Director of the United States Patent and Trademark Office

United States of America

United States Patent and Trademark Office

I AM Renewed 4Life

Reg. No. 4,109,669

Registered Mar. 6, 2012

Int. Cls.: 16, 21, and 25

TRADEMARK

PRINCIPAL REGISTER

COMPASS LIFE SOLUTIONS, LLC (TEXAS LIMITED LIABILITY COMPANY)
141 W. MAIN ST.
AZLE, TX 76020

FOR: A SERIES OF BOOKS, WRITTEN ARTICLES, HANDOUTS AND WORKSHEETS IN THE FIELD OF RELIGION; BOOKS IN THE FIELD OF RELIGION; STICKERS, IN CLASS 16 (U.S. CLS. 2, 5, 22, 23, 29, 37, 38 AND 50).

FIRST USE 8-4-2011; IN COMMERCE 8-4-2011.

FOR: COFFEE MUGS, IN CLASS 21 (U.S. CLS. 2, 13, 23, 29, 30, 33, 40 AND 50).

FIRST USE 8-4-2011; IN COMMERCE 8-4-2011.

FOR: BASEBALL CAPS AND HATS; CAP VISORS; SHIRTS; WRIST BANDS, IN CLASS 25 (U.S. CLS. 22 AND 39).

FIRST USE 8-4-2011; IN COMMERCE 8-4-2011.

THE MARK CONSISTS OF THE PHRASE "IAMRENEWED4LIFE" IN STYLIZED LETTERS WITH A SLIGHTLY LARGER STYLIZED "4".

SN 85-103,012, FILED 8-9-2010.

LAURIE KAUFMAN, EXAMINING ATTORNEY



David J. Kybas

Director of the United States Patent and Trademark Office

United States of America

United States Patent and Trademark Office

EPURPOSING

Reg. No. 4,109,670

Registered Mar. 6, 2012

Int. Cl.: 9

TRADEMARK

PRINCIPAL REGISTER

VIRIDISTOR, LLC (CALIFORNIA LIMITED LIABILITY COMPANY)
2913 EL CAMINO REAL
#742
TUSTIN, CA 92782

FOR: COMPUTER SOFTWARE FOR TRANSFORMING OR CREATING OTHER FORMATS OF ANY FILE OR COMPUTER DATASTREAM MAKING IT AVAILABLE FOR DELIVERY THROUGH EITHER PHYSICAL OR ELECTRONIC MEANS, IN CLASS 9 (U.S. CLS. 21, 23, 26, 36 AND 38).

FIRST USE 5-16-2011; IN COMMERCE 5-16-2011.

THE MARK CONSISTS OF STANDARD CHARACTERS WITHOUT CLAIM TO ANY PARTICULAR FONT, STYLE, SIZE, OR COLOR.

SN 85-103,503, FILED 8-9-2010.

DAVID TOOLEY, EXAMINING ATTORNEY



David J. Kyffers

Director of the United States Patent and Trademark Office

United States of America

United States Patent and Trademark Office

encircle

Reg. No. 4,109,671

AFP ADVANCED FOOD PRODUCTS LLC (DELAWARE LIMITED LIABILITY COMPANY)
402 SOUTH CUSTER AVENUE
NEW HOLLAND, PA 17557

Registered Mar. 6, 2012

Int. Cl.: 5

FOR: VITAMIN AND MINERAL FORTIFIED BEVERAGES, IN CLASS 5 (U.S. CLS. 6, 18, 44, 46, 51 AND 52).

TRADEMARK

FIRST USE 8-13-2010; IN COMMERCE 8-13-2010.

PRINCIPAL REGISTER

SN 85-103,990, FILED 8-10-2010.

SIMON TENG, EXAMINING ATTORNEY



David J. Kybas

Director of the United States Patent and Trademark Office

United States of America

United States Patent and Trademark Office

SHELF UNBOUND

Reg. No. 4,109,672

Registered Mar. 6, 2012

Int. Cl.: 9

TRADEMARK

PRINCIPAL REGISTER

SHELF MEDIA GROUP, LLC (TEXAS LIMITED LIABILITY COMPANY)
3322 GREENVIEW DRIVE
GARLAND, TX 75044

FOR: ELECTRONIC PUBLICATIONS, NAMELY, DOWNLOADABLE DIGITAL MAGAZINES
FEATURING INDEPENDENTLY PUBLISHED BOOKS, IN CLASS 9 (U.S. CLS. 21, 23, 26, 36
AND 38).

FIRST USE 9-1-2010; IN COMMERCE 9-1-2010.

THE MARK CONSISTS OF STANDARD CHARACTERS WITHOUT CLAIM TO ANY PAR-
TICULAR FONT, STYLE, SIZE, OR COLOR.

SN 85-104,848, FILED 8-11-2010.

KATHLEEN LORENZO, EXAMINING ATTORNEY



David J. Kyffers

Director of the United States Patent and Trademark Office

United States of America

United States Patent and Trademark Office

LEAN SL

Reg. No. 4,109,673

Registered Mar. 6, 2012

Int. Cl.: 7

TRADEMARK

PRINCIPAL REGISTER

LEANTECHNIK AG (FED REP GERMANY CORPORATION)
IM LIPPERFELD 7C
D - 46047 OBERHAUSEN, FED REP GERMANY

FOR: LIFTING DEVICE, NAMELY, LOADING AND UNLOADING MACHINES WITH SYNCHRONIZED THRUSTING ROTATION USED IN THE PRODUCTION LINES AND ASSEMBLY AREAS OF MANUFACTURERS FOR LIFTING, LOADING AND UNLOADING OF MATERIALS PRIMARILY IN THE AUTOMOBILE, APPLIANCE AND FURNITURE MANUFACTURING INDUSTRIES, IN CLASS 7 (U.S. CLS. 13, 19, 21, 23, 31, 34 AND 35).

FIRST USE 11-30-2010; IN COMMERCE 11-30-2010.

THE MARK CONSISTS OF STANDARD CHARACTERS WITHOUT CLAIM TO ANY PARTICULAR FONT, STYLE, SIZE, OR COLOR.

OWNER OF U.S. REG. NO. 2,680,060.

SN 85-105,137, FILED 8-11-2010.

ADA HAN, EXAMINING ATTORNEY



David J. Kyros

Director of the United States Patent and Trademark Office

United States of America

United States Patent and Trademark Office

C. WONDER

Reg. No. 4,109,674

Registered Mar. 6, 2012

Int. Cl.: 4

TRADEMARK

PRINCIPAL REGISTER

C. WONDER LLC (DELAWARE LIMITED LIABILITY COMPANY)
11TH FLOOR
598 MADISON AVENUE
NEW YORK, NY 10022

FOR: CANDLES, IN CLASS 4 (U.S. CLS. 1, 6 AND 15).

FIRST USE 10-22-2011; IN COMMERCE 10-22-2011.

THE MARK CONSISTS OF STANDARD CHARACTERS WITHOUT CLAIM TO ANY PARTICULAR FONT, STYLE, SIZE, OR COLOR.

SN 85-105,529, FILED 8-11-2010.

FLORENTINA BLANDU, EXAMINING ATTORNEY



David J. Kybas

Director of the United States Patent and Trademark Office

United States of America

United States Patent and Trademark Office

C. WONDER

Reg. No. 4,109,675

Registered Mar. 6, 2012

Int. Cl.: 14

TRADEMARK

PRINCIPAL REGISTER

C. WONDER LLC (DELAWARE LIMITED LIABILITY COMPANY)
11TH FLOOR
598 MADISON AVENUE
NEW YORK, NY 10022

FOR: JEWELRY, NAMELY, EARRINGS, NECKLACES, BRACELETS, AND WATCHES, IN CLASS 14 (U.S. CLS. 2, 27, 28 AND 50).

FIRST USE 10-22-2011; IN COMMERCE 10-22-2011.

THE MARK CONSISTS OF STANDARD CHARACTERS WITHOUT CLAIM TO ANY PARTICULAR FONT, STYLE, SIZE, OR COLOR.

SN 85-105,531, FILED 8-11-2010.

FLORENTINA BLANDU, EXAMINING ATTORNEY



David J. Kyffers

Director of the United States Patent and Trademark Office

United States of America

United States Patent and Trademark Office

Wild Bartenders

Reg. No. 4,109,676

KISS ME WILD PRODUCTIONS INC. (FLORIDA CORPORATION)
1802 NORTH ALAFAYA TRAIL SUITE 185
ORLANDO, FL 32826

Registered Mar. 6, 2012

Int. Cl.: 35

FOR: ARRANGING AND CONDUCTING MARKETING PROMOTIONAL EVENTS FOR OTHERS, IN CLASS 35 (U.S. CLS. 100, 101 AND 102).

SERVICE MARK

FIRST USE 10-26-2011; IN COMMERCE 10-26-2011.

PRINCIPAL REGISTER

THE MARK CONSISTS OF STANDARD CHARACTERS WITHOUT CLAIM TO ANY PARTICULAR FONT, STYLE, SIZE, OR COLOR.

NO CLAIM IS MADE TO THE EXCLUSIVE RIGHT TO USE "BARTENDERS", APART FROM THE MARK AS SHOWN.

SN 85-106,791, FILED 8-13-2010.

ESTHER A. BORSUK, EXAMINING ATTORNEY



David J. Kybas

Director of the United States Patent and Trademark Office

United States of America

United States Patent and Trademark Office

AMAZON OJ

Reg. No. 4,109,677

SAMBAZON, INC. (DELAWARE CORPORATION)
1160 CALLE CORDILLERA
SAN CLEMENTE, CA 92673

Registered Mar. 6, 2012

Int. Cl.: 32

FOR: NON ALCOHOLIC FRUIT BASED DRINKS, IN CLASS 32 (U.S. CLS. 45, 46 AND 48).

TRADEMARK

FIRST USE 10-1-2011; IN COMMERCE 10-1-2011.

PRINCIPAL REGISTER

THE MARK CONSISTS OF STANDARD CHARACTERS WITHOUT CLAIM TO ANY PARTICULAR FONT, STYLE, SIZE, OR COLOR.

NO CLAIM IS MADE TO THE EXCLUSIVE RIGHT TO USE "OJ", APART FROM THE MARK AS SHOWN.

SN 85-107,300, FILED 8-13-2010.

TRACY CROSS, EXAMINING ATTORNEY



David J. Kyffers

Director of the United States Patent and Trademark Office

United States of America

United States Patent and Trademark Office

Ophelia

Reg. No. 4,109,678

Registered Mar. 6, 2012

Int. Cl.: 41

SERVICE MARK

PRINCIPAL REGISTER

DEBRA GAIL WHITE (UNITED STATES INDIVIDUAL), AKA OPHELIA,
131 ORCHARD ST APT 45
SOMERVILLE, MA 02144

FOR: ENTERTAINMENT IN THE NATURE OF VISUAL AND AUDIO PERFORMANCES, NAMELY, MUSICAL BAND, ROCK GROUP, GYMNASTIC, DANCE, AND BALLET PERFORMANCES; ENTERTAINMENT, NAMELY, LIVE PERFORMANCES BY A MUSICAL BAND; ENTERTAINMENT, NAMELY, LIVE PERFORMANCES BY MUSICAL BANDS; PROVIDING A WEBSITE FOR ENTERTAINMENT PURPOSES WHERE USERS CAN VIEW AND POST PHOTOS, VIDEO, AND RECORDED MUSIC, IN CLASS 41 (U.S. CLS. 100, 101 AND 107).

FIRST USE 5-17-2011; IN COMMERCE 5-17-2011.

THE MARK CONSISTS OF STANDARD CHARACTERS WITHOUT CLAIM TO ANY PARTICULAR FONT, STYLE, SIZE, OR COLOR.

SN 85-107,736, FILED 8-14-2010.

SUSAN LESLIE DUBOIS, EXAMINING ATTORNEY



David J. Kyros

Director of the United States Patent and Trademark Office

United States of America

United States Patent and Trademark Office

CIRCOR SELECT

Reg. No. 4,109,679

Registered Mar. 6, 2012

Int. Cl.: 9

TRADEMARK

PRINCIPAL REGISTER

LESLIE CONTROLS, INC. (NEW JERSEY CORPORATION)
12501 TELECOM DRIVE
TAMPA, FL 33637

FOR: COMPUTER SOFTWARE FOR THE SIZING OF VALVES AND OTHER RELATED FLOW, PRESSURE, TEMPERATURE AND LEVEL CONTROL DEVICES, IN CLASS 9 (U.S. CLS. 21, 23, 26, 36 AND 38).

FIRST USE 7-31-2010; IN COMMERCE 7-31-2010.

THE MARK CONSISTS OF STANDARD CHARACTERS WITHOUT CLAIM TO ANY PARTICULAR FONT, STYLE, SIZE, OR COLOR.

SN 85-108,259, FILED 8-16-2010.

GISELLE AGOSTO, EXAMINING ATTORNEY



David J. Kybas

Director of the United States Patent and Trademark Office

United States of America

United States Patent and Trademark Office

BMOB

Reg. No. 4,109,680

Registered Mar. 6, 2012

Int. Cl.: 25

TRADEMARK

PRINCIPAL REGISTER

ROBERT JAMES JENSEN (UNITED STATES INDIVIDUAL), DBA BIG MAN ON BOARD,
120 WILSON DRIVE
LANDER, WY 82520

FOR: HATS; PANTS; SHIRTS, IN CLASS 25 (U.S. CLS. 22 AND 39).

FIRST USE 6-1-2011; IN COMMERCE 6-1-2011.

THE MARK CONSISTS OF STANDARD CHARACTERS WITHOUT CLAIM TO ANY PARTICULAR FONT, STYLE, SIZE, OR COLOR.

SN 85-110,676, FILED 8-18-2010.

PRISCILLA MILTON, EXAMINING ATTORNEY



David J. Kybas

Director of the United States Patent and Trademark Office

United States of America

United States Patent and Trademark Office

On My Way

Reg. No. 4,109,681

Registered Mar. 6, 2012

Int. Cl.: 25

TRADEMARK

PRINCIPAL REGISTER

ROBERT JAMES JENSEN (UNITED STATES INDIVIDUAL), DBA BIG MAN ON BOARD,
120 WILSON DRIVE
LANDER, WY 82520

FOR: HATS; PANTS; SHIRTS, IN CLASS 25 (U.S. CLS. 22 AND 39).

FIRST USE 6-1-2011; IN COMMERCE 6-1-2011.

THE MARK CONSISTS OF STANDARD CHARACTERS WITHOUT CLAIM TO ANY PARTICULAR FONT, STYLE, SIZE, OR COLOR.

SN 85-110,725, FILED 8-18-2010.

PRISCILLA MILTON, EXAMINING ATTORNEY



David J. Kybas

Director of the United States Patent and Trademark Office

United States of America

United States Patent and Trademark Office

FAMILY LIFE

Reg. No. 4,109,682

Registered Mar. 6, 2012

Int. Cl.: 30

TRADEMARK

PRINCIPAL REGISTER

LEWIS BROTHERS BAKERIES, INCORPORATED (MISSOURI CORPORATION), DBA
LEWIS BAKERIES, INC.,
500 N. FULTON AVENUE
EVANSVILLE, IN 47710

FOR: BREAD AND BUNS, IN CLASS 30 (U.S. CL. 46).

FIRST USE 10-10-2011; IN COMMERCE 10-10-2011.

THE MARK CONSISTS OF STANDARD CHARACTERS WITHOUT CLAIM TO ANY PARTICULAR FONT, STYLE, SIZE, OR COLOR.

SN 85-111,516, FILED 8-19-2010.

JACQUELINE A. LAVINE, EXAMINING ATTORNEY



David J. Kybas

Director of the United States Patent and Trademark Office

United States of America

United States Patent and Trademark Office



**The Three Dimensions of Service:
Quality, Capability, Professionalism**

Reg. No. 4,109,683

Registered Mar. 6, 2012

Int. Cl.: 42

SERVICE MARK

PRINCIPAL REGISTER

STRUCTURAL SERVICES & SOLUTIONS, LLC (ALABAMA LIMITED LIABILITY COMPANY)
4570 ARROWHEAD DRIVE SE
DECATUR, AL 35603

FOR: STRUCTURAL ENGINEERING DESIGN SERVICES; ENGINEERING SERVICES IN THE FIELD OF REDUCTION OF OPERATING COSTS; ENGINEERING SERVICES, PARTICULARLY TECHNICAL PROJECT PLANNING AND DESIGN ENGINEERING IN THE FIELDS OF STRUCTURAL PROJECTS, MECHANICAL PRODUCTS, AND SYSTEM DESIGN; DESIGN OF ENGINEERING PRODUCTS, IN CLASS 42 (U.S. CLS. 100 AND 101).

FIRST USE 11-30-2010; IN COMMERCE 11-30-2010.

NO CLAIM IS MADE TO THE EXCLUSIVE RIGHT TO USE "QUALITY, CAPABILITY, PROFESSIONALISM", APART FROM THE MARK AS SHOWN.

THE COLOR(S) DARK BLUE, BLUE-GRAY AND BLACK IS/ARE CLAIMED AS A FEATURE OF THE MARK.

THE MARK CONSISTS OF A CUBE VIEWED FROM THE ANGLE OF ONE CORNER OF THE CUBE, AND WITH THE APPEARANCE OF BEING MADE UP OF MANY SMALLER CUBES. THE EDGES OF THE LARGE CUBE ARE IN DARK BLUE COLORING, THE SMALLER CUBES ARE IN A BLUE-GRAY, LIGHTER COLORING, THE OUTLINE OF THE SMALLER CUBES ARE IN A BLUE-GRAY, LIGHTER COLORING. THE THREE SIDES OF THE CUBE WHICH ARE VISIBLE EACH CONTAIN A CAPITAL LETTER, "S" IN THICK, DARK BLUE COLORING. BELOW THE CUBE AND CENTERED ON TWO LINES ARE THE WORDS: "THE THREE DIMENSIONS OF SERVICE: QUALITY, CAPABILITY, PROFESSIONALISM," AND THOSE WORDS ARE IN BLACK COLORING.

SN 85-111,990, FILED 8-20-2010.

KATHRYN COWARD, EXAMINING ATTORNEY



David J. Kyffers

Director of the United States Patent and Trademark Office

United States of America

United States Patent and Trademark Office

PROTEIN TO THE NTH DEGREE

Reg. No. 4,109,684

Registered Mar. 6, 2012

Int. Cl.: 5

TRADEMARK

PRINCIPAL REGISTER

NTH DEGREE INNOVATIONS, INC. (NEW JERSEY CORPORATION)
3 FISHER DRIVE
MILLTOWN, NJ 08550

FOR: DIETARY SUPPLEMENTS CONTAINING PROTEIN; NUTRITIONAL DRINK MIX FOR USE AS A MEAL REPLACEMENT CONTAINING PROTEIN; NUTRITIONAL SHAKES FOR USE AS A MEAL SUBSTITUTE CONTAINING PROTEIN; NUTRITIONAL SUPPLEMENT IN THE NATURE OF A NUTRIENT-DENSE, PROTEIN-BASED DRINK MIX; NUTRITIONAL SUPPLEMENTS CONTAINING PROTEIN; POWDERED NUTRITIONAL SUPPLEMENT DRINK MIX CONTAINING PROTEIN; PROTEIN SUPPLEMENTS, IN CLASS 5 (U.S. CLS. 6, 18, 44, 46, 51 AND 52).

FIRST USE 8-1-2011; IN COMMERCE 8-1-2011.

THE MARK CONSISTS OF STANDARD CHARACTERS WITHOUT CLAIM TO ANY PARTICULAR FONT, STYLE, SIZE, OR COLOR.

NO CLAIM IS MADE TO THE EXCLUSIVE RIGHT TO USE "PROTEIN" , APART FROM THE MARK AS SHOWN.

SN 85-112,602, FILED 8-20-2010.

LAURIE MAYES, EXAMINING ATTORNEY



David J. Kybas

Director of the United States Patent and Trademark Office

United States of America

United States Patent and Trademark Office



Reg. No. 4,109,685

Registered Mar. 6, 2012

Int. Cl.: 37

SERVICE MARK

PRINCIPAL REGISTER

PARAMOUNT DRYWALL, INC. (FLORIDA CORPORATION)
5995 SW 71 ST SUITE 1A
SOUTH MIAMI, FL 33143

FOR: APPLICATION OF CONVENTIONAL STUCCO; DRYWALL CONTRACTOR SERVICES,
IN CLASS 37 (U.S. CLS. 100, 103 AND 106).

FIRST USE 9-1-2009; IN COMMERCE 9-1-2009.

THE MARK CONSISTS OF MAN HOLDING A SHEET OF DRYWALL IN HIS RIGHT HAND
AND TOOL IN HIS LEFT. THE MAN IS WEARING A HARDHAT, T-SHIRT, PANTS AND
BOOTS, AND HAS BUSHY EYEBROWS, A BEARD AND GOATEE.

SN 85-112,751, FILED 8-20-2010.

CAROLYN CATALDO, EXAMINING ATTORNEY



David J. Kyfos

Director of the United States Patent and Trademark Office

United States of America

United States Patent and Trademark Office

STRONG FOUNDATIONS

Reg. No. 4,109,686

Registered Mar. 6, 2012

Int. Cl.: 44

SERVICE MARK

PRINCIPAL REGISTER

VISITING NURSE SERVICE OF NEW YORK (NEW YORK CORPORATION)
107 E 70TH STREET
NEW YORK, NY 10021

FOR: HEALTH CARE SERVICES, NAMELY, WELLNESS PROGRAMS; HEALTHCARE; HOME HEALTH CARE SERVICES; MEDICAL SERVICES; MEDICAL, PHYSICAL REHABILITATION AND PHYSICAL THERAPY SERVICES; NURSING SERVICES; PHYSICAL THERAPY; PHYSICAL THERAPY EVALUATION AND TREATMENT OF ELDERLY, DISABLED, FRAIL OR OTHER INDIVIDUALS AT RISK OF BECOMING FALL VICTIMS; PROVIDING MEDICAL INFORMATION, IN CLASS 44 (U.S. CLS. 100 AND 101).

FIRST USE 3-23-2011; IN COMMERCE 3-23-2011.

THE MARK CONSISTS OF STANDARD CHARACTERS WITHOUT CLAIM TO ANY PARTICULAR FONT, STYLE, SIZE, OR COLOR.

SN 85-113,613, FILED 8-23-2010.

MARTHA FROMM, EXAMINING ATTORNEY



David J. Kybas

Director of the United States Patent and Trademark Office

United States of America

United States Patent and Trademark Office

GROOVY REFLECTIONS

Reg. No. 4,109,687

WENDEL, GERALDINE (UNITED STATES INDIVIDUAL)
13612 CARLSBAD DR
SANTA ANA, CA 92705

Registered Mar. 6, 2012

Int. Cl.: 25

FOR: HATS; SWEAT SHIRTS; T-SHIRTS, IN CLASS 25 (U.S. CLS. 22 AND 39).

TRADEMARK

FIRST USE 6-30-2009; IN COMMERCE 7-30-2010.

PRINCIPAL REGISTER

THE MARK CONSISTS OF STANDARD CHARACTERS WITHOUT CLAIM TO ANY PARTICULAR FONT, STYLE, SIZE, OR COLOR.

SN 85-114,885, FILED 8-24-2010.

ELISSA GARBER KON, EXAMINING ATTORNEY



David J. Kybas

Director of the United States Patent and Trademark Office

United States of America

United States Patent and Trademark Office

EL CAIMAN

Reg. No. 4,109,688

Registered Mar. 6, 2012

Int. Cl.: 16

TRADEMARK

PRINCIPAL REGISTER

KARE DISTRIBUTION, INC. (DELAWARE CORPORATION)
26TH FLOOR
1250 BROADWAY
NEW YORK, NY 10001

FOR: PRE-PAID TELEPHONE CALLING CARDS, NOT MAGNETICALLY ENCODED, IN CLASS 16 (U.S. CLS. 2, 5, 22, 23, 29, 37, 38 AND 50).

FIRST USE 2-14-2011; IN COMMERCE 2-14-2011.

THE MARK CONSISTS OF STANDARD CHARACTERS WITHOUT CLAIM TO ANY PARTICULAR FONT, STYLE, SIZE, OR COLOR.

SN 85-114,955, FILED 8-24-2010.

HEATHER BIDDULPH, EXAMINING ATTORNEY



David J. Kybas

Director of the United States Patent and Trademark Office

United States of America

United States Patent and Trademark Office



Reg. No. 4,109,689

Registered Mar. 6, 2012

Int. Cl.: 16

TRADEMARK

PRINCIPAL REGISTER

KARE DISTRIBUTION, INC. (DELAWARE CORPORATION)
26TH FLOOR
1250 BROADWAY
NEW YORK, NY 10001

FOR: PRE-PAID TELEPHONE CALLING CARDS, NOT MAGNETICALLY ENCODED, IN CLASS 16 (U.S. CLS. 2, 5, 22, 23, 29, 37, 38 AND 50).

FIRST USE 2-14-2011; IN COMMERCE 2-14-2011.

THE MARK CONSISTS OF A CAPED, COSTUMED IMAGE OF A MALE WRESTLER WEARING A MASK, BELT AND BOOTS. THE WORDS "EL CAIMAN" APPEAR DIRECTLY BELOW THIS IMAGE.

SN 85-114,968, FILED 8-24-2010.

HEATHER BIDDULPH, EXAMINING ATTORNEY



David J. Kybas

Director of the United States Patent and Trademark Office

United States of America

United States Patent and Trademark Office

PRISCILLA'S

Reg. No. 4,109,690

CARANDO GOURMET FOODS CORPORATION (MASSACHUSETTS CORPORATION)
181 TAYLOR STREET
SPRINGFIELD, MA 01105

Registered Mar. 6, 2012

Int. Cl.: 30

FOR: QUICHE, IN CLASS 30 (U.S. CL. 46).

TRADEMARK

FIRST USE 1-1-2004; IN COMMERCE 1-1-2004.

PRINCIPAL REGISTER

THE MARK CONSISTS OF STANDARD CHARACTERS WITHOUT CLAIM TO ANY PARTICULAR FONT, STYLE, SIZE, OR COLOR.

SN 85-116,333, FILED 8-26-2010.

AMY ALFIERI, EXAMINING ATTORNEY



David J. Kybas

Director of the United States Patent and Trademark Office

United States of America

United States Patent and Trademark Office

COTTON CANDY

Reg. No. 4,109,691

INTERNATIONAL FRUIT GENETICS, LLC (CALIFORNIA LIMITED LIABILITY COMPANY)
441 VINELAND ROAD
BAKERSFIELD, CA 933079556

Registered Mar. 6, 2012

Int. Cl.: 31

FOR: FRUITS, NAMELY, FRESH GRAPES, IN CLASS 31 (U.S. CLS. 1 AND 46).

TRADEMARK

FIRST USE 8-26-2011; IN COMMERCE 8-26-2011.

PRINCIPAL REGISTER

THE MARK CONSISTS OF STANDARD CHARACTERS WITHOUT CLAIM TO ANY PARTICULAR FONT, STYLE, SIZE, OR COLOR.

SN 85-118,179, FILED 8-29-2010.

JOHN HWANG, EXAMINING ATTORNEY



David J. Kybas

Director of the United States Patent and Trademark Office

United States of America

United States Patent and Trademark Office

LUXCODE

Reg. No. 4,109,692

Registered Mar. 6, 2012

Int. Cl.: 35

SERVICE MARK

PRINCIPAL REGISTER

PAYMENT TRANSACTION SERVICES, INC. (DELAWARE CORPORATION)
SUITE 4000
1000 WINTER STREET
WALTHAM, MA 02451

FOR: PROMOTING THE GOODS AND SERVICES OF OTHERS THROUGH THE ISSUANCE AND DISTRIBUTION OF DISCOUNT, GIFT AND LOYALTY REWARDS CARDS; PROMOTING THE GOODS AND SERVICES OF OTHERS THROUGH THE DISTRIBUTION VIA MAIL, E-MAIL AND WIRELESS MEDIA OF CODES THAT MAY BE USED TO OBTAIN DISCOUNTS, GIFTS AND LOYALTY REWARDS; ADMINISTRATION OF A PROGRAM ENABLING PARTICIPANTS TO OBTAIN GIFTS, LOYALTY REWARDS AND DISCOUNTS ON GOODS AND SERVICES, IN CLASS 35 (U.S. CLS. 100, 101 AND 102).

FIRST USE 6-1-2011; IN COMMERCE 6-1-2011.

THE MARK CONSISTS OF STANDARD CHARACTERS WITHOUT CLAIM TO ANY PARTICULAR FONT, STYLE, SIZE, OR COLOR.

SN 85-118,319, FILED 8-30-2010.

WILLIAM JACKSON, EXAMINING ATTORNEY



David J. Kyros

Director of the United States Patent and Trademark Office

United States of America

United States Patent and Trademark Office

SPARIANS

Reg. No. 4,109,693

Registered Mar. 6, 2012

Int. Cls.: 41 and 43

SERVICE MARK

PRINCIPAL REGISTER

SPARIANS, LLC (NORTH CAROLINA LIMITED LIABILITY COMPANY)
SUITE 120
141 PARK STREET
RALEIGH, NC 27609

FOR: PROVIDING BOWLING ALLEYS; PARTY PLANNING AND PARTY PLANNING CONSULTATION; WEDDING RECEPTION PLANNING AND WEDDING RECEPTION PLANNING CONSULTATION; NIGHT CLUBS, IN CLASS 41 (U.S. CLS. 100, 101 AND 107).

FIRST USE 12-13-2010; IN COMMERCE 12-13-2010.

FOR: RESTAURANT AND BAR SERVICES, IN CLASS 43 (U.S. CLS. 100 AND 101).

FIRST USE 12-13-2010; IN COMMERCE 12-13-2010.

THE MARK CONSISTS OF STANDARD CHARACTERS WITHOUT CLAIM TO ANY PARTICULAR FONT, STYLE, SIZE, OR COLOR.

SN 85-118,359, FILED 8-30-2010.

ESTHER A. BORSUK, EXAMINING ATTORNEY



David J. Kyffers

Director of the United States Patent and Trademark Office

United States of America

United States Patent and Trademark Office

CRUSHER



Reg. No. 4,109,694

Registered Mar. 6, 2012

Int. Cl.: 38

SERVICE MARK

PRINCIPAL REGISTER

CRUSHER SOLUTIONS, LLC (DELAWARE LIMITED LIABILITY COMPANY)
446 KENT AVENUE, SUITE 11E
BROOKLYN, NY 11211

FOR: STREAMING OF AUDIO, VIDEO AND AUDIOVISUAL MATERIAL IN THE FIELD OF PSYCHOLOGICAL DISORDERS ON THE INTERNET, IN CLASS 38 (U.S. CLS. 100, 101 AND 104).

FIRST USE 12-11-2011; IN COMMERCE 12-11-2011.

THE MARK CONSISTS OF THE WORD "CRUSHER" AND THE DESIGN OF A FIST.

SN 85-118,778, FILED 8-30-2010.

LEIGH CAROLINE CASE, EXAMINING ATTORNEY



David J. Kyffers

Director of the United States Patent and Trademark Office

United States of America

United States Patent and Trademark Office

DETECHTIVE

Reg. No. 4,109,695

Registered Mar. 6, 2012

Int. Cl.: 35

SERVICE MARK

PRINCIPAL REGISTER

SYX SERVICES INC. (NEW YORK CORPORATION)
SUITE 35
7795 WEST FLAGLER STREET
MIAMI, FL 33144

FOR: PROMOTING THE SALE OF TOYS, COMPUTER HARDWARE AND SOFTWARE, COMPUTER SUPPLIES AND ACCESSORIES AND OTHER ELECTRONIC PRODUCTS VIA THE INTERNET, IN CLASS 35 (U.S. CLS. 100, 101 AND 102).

FIRST USE 9-1-2010; IN COMMERCE 9-1-2010.

THE MARK CONSISTS OF STANDARD CHARACTERS WITHOUT CLAIM TO ANY PARTICULAR FONT, STYLE, SIZE, OR COLOR.

SN 85-119,636, FILED 8-31-2010.

JANICE L. MCMORROW, EXAMINING ATTORNEY



David J. Kyffers

Director of the United States Patent and Trademark Office

United States of America

United States Patent and Trademark Office

OHTAKE·ROOTKOGYO

Reg. No. 4,109,696

OHTAKE ROOT KOGYO CO., LTD. (JAPAN CORPORATION)
27 KANEGASAKI HAGISHO ICHINOSEKI
IWATE, 021-0902, JAPAN

Registered Mar. 6, 2012

Int. Cl.: 7

FOR: POWER OPERATED TOOLS, NAMELY, AUTOMATIC SCREW FEEDING MACHINES, SCREW FEEDING MACHINES, POWER OPERATED SCREWDRIVERS, AUTOMATIC SCREW TIGHTENING MACHINES, IN CLASS 7 (U.S. CLS. 13, 19, 21, 23, 31, 34 AND 35).

TRADEMARK

FIRST USE 12-0-1997; IN COMMERCE 12-0-1997.

PRINCIPAL REGISTER

THE MARK CONSISTS OF STANDARD CHARACTERS WITHOUT CLAIM TO ANY PARTICULAR FONT, STYLE, SIZE, OR COLOR.

SN 85-119,944, FILED 8-31-2010.

MARK T. MULLEN, EXAMINING ATTORNEY



David J. Kybas

Director of the United States Patent and Trademark Office

United States of America

United States Patent and Trademark Office

The Metaphysical

Reg. No. 4,109,697

Registered Mar. 6, 2012

Int. Cl.: 41

SERVICE MARK

PRINCIPAL REGISTER

THE ANOINTED EMPIRE, INC. (NEW YORK CORPORATION)
SUITE 540
45-02 DITMARS BOULEVARD
ASTORIA, NY 11105

FOR: EDUCATIONAL SERVICES, NAMELY, CONDUCTING CLASSES, SEMINARS, CONFERENCES AND WORKSHOPS OF INSTRUCTION IN THE FIELDS OF DANCE AND FILM PRODUCTION; ARTIST DEVELOPMENT, NAMELY, COACHING AND MENTORING THE CAREERS OF OTHERS IN THE FIELDS OF DANCE, MOTION PICTURE, TELEVISION, COMMERCIAL, AND VISUAL ARTS INDUSTRIES; CHOREOGRAPHY AND DANCE CONSULTING FOR OTHERS IN THE MOTION PICTURE, TELEVISION, COMMERCIAL, AND VISUAL ARTS INDUSTRIES; ENTERTAINMENT IN THE NATURE OF LIVE THEATRICAL AND LIVE STAGE PRODUCTION, TELEVISION AND FILM PRODUCTION; AND ENTERTAINMENT IN THE NATURE OF LIVE DANCE PERFORMANCES, IN CLASS 41 (U.S. CLS. 100, 101 AND 107).

FIRST USE 10-15-2011; IN COMMERCE 10-15-2011.

THE MARK CONSISTS OF STANDARD CHARACTERS WITHOUT CLAIM TO ANY PARTICULAR FONT, STYLE, SIZE, OR COLOR.

THE WORD(S) "METAPHYSICAL" HAS NO MEANING IN A FOREIGN LANGUAGE.

SN 85-120,400, FILED 8-31-2010.

ALICE BENMAMAN, EXAMINING ATTORNEY



David J. Kyros

Director of the United States Patent and Trademark Office

United States of America

United States Patent and Trademark Office

MAKO

Reg. No. 4,109,698

Registered Mar. 6, 2012

Int. Cl.: 8

TRADEMARK

PRINCIPAL REGISTER

MAKO ENTERPRISES, L.L.C. (IOWA LIMITED LIABILITY COMPANY)
6110 OAKWOOD HILLS DRIVE
JOHNSTON, IA 50131

FOR: HAND TOOLS FOR LEVELING CONCRETE, NAMELY, A HAND TOOL MOUNTED ON A SURFACE TO SUPPORT SCREEDS TO ASSIST IN LEVELING CONCRETE, IN CLASS 8 (U.S. CLS. 23, 28 AND 44).

FIRST USE 12-10-2011; IN COMMERCE 12-10-2011.

THE MARK CONSISTS OF STANDARD CHARACTERS WITHOUT CLAIM TO ANY PARTICULAR FONT, STYLE, SIZE, OR COLOR.

SN 85-122,046, FILED 9-2-2010.

CARYN GLASSER, EXAMINING ATTORNEY



David J. Kybas

Director of the United States Patent and Trademark Office

United States of America

United States Patent and Trademark Office



Reg. No. 4,109,699

EL-OMAR, BILAL (LEBANON INDIVIDUAL)
5911 EDSSELL ROAD, #711
ALEXANDRIA, VA 22304

Registered Mar. 6, 2012

Int. Cl.: 35

FOR: RETAIL STORE AND ON-LINE RETAIL STORE SERVICES FEATURING CHILDREN'S CLOTHING, BOOKS AND TOYS, IN CLASS 35 (U.S. CLS. 100, 101 AND 102).

SERVICE MARK

FIRST USE 12-19-2011; IN COMMERCE 12-19-2011.

PRINCIPAL REGISTER

THE MARK CONSISTS OF AN IMAGE OF A BLUE INDIVIDUAL PRAYING WITH ANOTHER SMALLER PINK INDIVIDUAL KNEELING IN FRONT. BELOW THAT IS THE PINK WORD "SMALL" NEXT TO THE WORD "MUSLIM", WITH AN ORANGE LETTER "M", GREEN LETTER "U", PINK LETTER "S", BLUE LETTER "L", GREEN LETTER "I", AND PINK LETTER "M". BELOW THAT IS THE WORD "WWW.SMALLMUSLIM.COM", WHICH FADES LEFT TO RIGHT FROM YELLOW TO GREEN TO YELLOW. ALL OF THE WORDING IS OUTLINED IN WHITE AND THE ENTIRE MARK APPEARS ON A LIGHT GREEN BACKGROUND.

THE COLOR(S) BLUE, PINK, ORANGE, GREEN, YELLOW AND WHITE IS/ARE CLAIMED AS A FEATURE OF THE MARK.

SN 85-122,155, FILED 9-2-2010.

NELSON SNYDER, EXAMINING ATTORNEY



David J. Kybas

Director of the United States Patent and Trademark Office

United States of America

United States Patent and Trademark Office

gotta trainer?

Reg. No. 4,109,700

DREAM1122, LLC (GEORGIA LIMITED LIABILITY COMPANY)
285 CEN OLY PRK DR STE2204
ATLANTA, GA 30313

Registered Mar. 6, 2012

Int. Cl.: 41

FOR: TRAINING COURSES IN STRATEGIC PLANNING RELATING TO ADVERTISING, PROMOTION, MARKETING AND BUSINESS, IN CLASS 41 (U.S. CLS. 100, 101 AND 107).

SERVICE MARK

FIRST USE 10-5-2009; IN COMMERCE 10-5-2009.

PRINCIPAL REGISTER

THE MARK CONSISTS OF STANDARD CHARACTERS WITHOUT CLAIM TO ANY PARTICULAR FONT, STYLE, SIZE, OR COLOR.

SN 85-123,661, FILED 9-6-2010.

ERIN FALK, EXAMINING ATTORNEY



David J. Kybas

Director of the United States Patent and Trademark Office

United States of America

United States Patent and Trademark Office

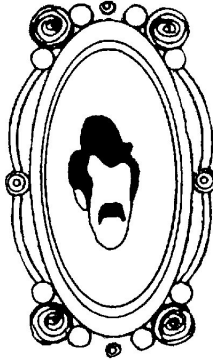

Reg. No. 4,109,701

Registered Mar. 6, 2012

Int. Cl.: 44

SERVICE MARK

PRINCIPAL REGISTER

KOCH, ALEX (UNITED STATES INDIVIDUAL)
33315 W. 7 MILE RD
LIVONIA, MI 48152

FOR: BARBER SHOP SERVICES, IN CLASS 44 (U.S. CLS. 100 AND 101).

FIRST USE 10-2-2000; IN COMMERCE 10-2-2000.

THE MARK CONSISTS OF AN ABSTRACT IMAGE OF A MAN'S FACE IN AN OVAL EMBELLISHED PICTURE FRAME.

SN 85-123,821, FILED 9-7-2010.

TRACY CROSS, EXAMINING ATTORNEY



David J. Kyfos

Director of the United States Patent and Trademark Office

United States of America

United States Patent and Trademark Office



TWICE THE VICE
SPIRITED CHOCOLATES

Reg. No. 4,109,702

Registered Mar. 6, 2012

Int. Cl.: 30

TRADEMARK

PRINCIPAL REGISTER

SANTA MONICA CHOCOLATE COMPANY, LLC (CALIFORNIA LIMITED LIABILITY COMPANY)
PO BOX 3066
SANTA MONICA, CA 904083066

FOR: CHOCOLATE AND CHOCOLATES; CHOCOLATE CANDIES; FILLED CHOCOLATE, IN CLASS 30 (U.S. CL. 46).

FIRST USE 12-1-2010; IN COMMERCE 12-15-2010.

NO CLAIM IS MADE TO THE EXCLUSIVE RIGHT TO USE "SPIRITED CHOCOLATES", APART FROM THE MARK AS SHOWN.

THE MARK CONSISTS OF A LARGE, STYLIZED LETTER "V" IN OUTLINE FORM, WITHOUT SERIFS, PLACED ABOVE THE PHRASE "TWICE THE VICE" IN STYLIZED FONT, BELOW WHICH IS THE PHRASE "SPIRITED CHOCOLATES" IN SMALLER STYLIZED FONT.

SN 85-125,289, FILED 9-8-2010.

APRIL HESIK, EXAMINING ATTORNEY



David J. Kyffers

Director of the United States Patent and Trademark Office

United States of America

United States Patent and Trademark Office

LANDSHARK LANDING

Reg. No. 4,109,703

MARGARITAVILLE ENTERPRISES, LLC (DELAWARE LIMITED LIABILITY COMPANY)
256 WORTH AVENUE, SUITE Q-R
PALM BEACH, FL 33480

Registered Mar. 6, 2012

Int. Cl.: 43

FOR: PROVIDING PAVILION FACILITIES FOR CONCERTS, EXHIBITIONS AND OTHER FUNCTIONS; SERVING FOOD AND DRINKS, IN CLASS 43 (U.S. CLS. 100 AND 101).

SERVICE MARK

FIRST USE 6-28-2010; IN COMMERCE 6-28-2010.

PRINCIPAL REGISTER

THE MARK CONSISTS OF STANDARD CHARACTERS WITHOUT CLAIM TO ANY PARTICULAR FONT, STYLE, SIZE, OR COLOR.

OWNER OF U.S. REG. NOS. 3,424,713, 3,773,467, AND OTHERS.

NO CLAIM IS MADE TO THE EXCLUSIVE RIGHT TO USE "LANDING", APART FROM THE MARK AS SHOWN.

SN 85-126,312, FILED 9-9-2010.

WILLIAM VERHOSEK, EXAMINING ATTORNEY



David J. Kyros

Director of the United States Patent and Trademark Office

United States of America

United States Patent and Trademark Office



Reg. No. 4,109,704

Registered Mar. 6, 2012

Int. Cl.: 5

TRADEMARK

PRINCIPAL REGISTER

RECKITT BENCKISER LLC (DELAWARE LIMITED LIABILITY COMPANY)
399 INTERPACE PARKWAY
PARSIPPANY, NJ 07054

FOR: COUGH AND COLD PREPARATIONS; PREPARATIONS FOR THE TREATMENT OF RESPIRATORY AND PULMONARY CONDITIONS; EXPECTORANTS; DECONGESTANTS, IN CLASS 5 (U.S. CLS. 6, 18, 44, 46, 51 AND 52).

FIRST USE 12-5-2011; IN COMMERCE 12-5-2011.

THE MARK CONSISTS OF A GREEN CHARACTER HAVING PINK LIPS WEARING GREEN AND BROWN STRIPED PANTS WITH BROWN SUSPENDERS AND BROWN SHOES, A WHITE TANK-TOP T-SHIRT AND A BROWN FEDORA ABOVE THE CHARACTERS HEAD.

THE COLOR(S) GREEN, WHITE, BROWN AND PINK IS/ARE CLAIMED AS A FEATURE OF THE MARK.

SN 85-126,596, FILED 9-10-2010.

WENDY JUN, EXAMINING ATTORNEY



David J. Kybas

Director of the United States Patent and Trademark Office

United States of America
United States Patent and Trademark Office

rexflex

Reg. No. 4,109,705

GOLDEN PHOENIX FIBERWEBS, INC. (TAIWAN CORPORATION)
NO.18, BADE ROAD
SINYING CITY, TAINAN COUNTY, TAIWAN 730

Registered Mar. 6, 2012

Int. Cl.: 24

FOR: LATEX-FREE ELASTIC NONWOVEN FABRICS AND LATEX-FREE ELASTIC NON-
WOVEN LAMINATES IN THE NATURE OF FABRICS, NAMELY, SMMMS (SOUNBOND-
MELTBLOWN-MELTBLOWN-MELTBLOWN-SOUNBOND), SMMS (SOUNBOND-MELT-
BLOWN-MELTBLOWN-SOUNBOND), MELTBLOWN, SPUNBOND, THERMAL BOND,
SPUNLACE, AND SPUNMELT FABRICS, ALL FOR MEDICAL, HEALTH CARE, HYGIENE,
INDUSTRIAL, PERSONAL PROTECTION, TEXTILE, AND DOMESTIC USE, IN CLASS 24
(U.S. CLS. 42 AND 50).

TRADEMARK

PRINCIPAL REGISTER

FIRST USE 9-10-2010; IN COMMERCE 9-10-2010.

THE MARK CONSISTS OF THE STYLIZED TERM "TEXFLEX".

SN 85-127,965, FILED 9-13-2010.

REBECCA EISINGER, EXAMINING ATTORNEY



David J. Kybas

Director of the United States Patent and Trademark Office

United States of America

United States Patent and Trademark Office

REVEAL-A-WHEEL

Reg. No. 4,109,706

IGT (NEVADA CORPORATION)
9295 PROTOTYPE DRIVE
RENO, NV 895218986

Registered Mar. 6, 2012

Int. Cl.: 9

FOR: A FEATURE OF GAMING MACHINES, NAMELY, DEVICES THAT ACCEPT A WAGER,
IN CLASS 9 (U.S. CLS. 21, 23, 26, 36 AND 38).

TRADEMARK

FIRST USE 11-15-2011; IN COMMERCE 11-15-2011.

PRINCIPAL REGISTER

THE MARK CONSISTS OF STANDARD CHARACTERS WITHOUT CLAIM TO ANY PAR-
TICULAR FONT, STYLE, SIZE, OR COLOR.

SN 85-128,565, FILED 9-13-2010.

JIM RINGLE, EXAMINING ATTORNEY



David J. Kybas

Director of the United States Patent and Trademark Office

United States of America

United States Patent and Trademark Office

XTRACARE

Reg. No. 4,109,707

Registered Mar. 6, 2012

Int. Cl.: 5

TRADEMARK

PRINCIPAL REGISTER

LANG, XIAO (CHINA INDIVIDUAL)
JIANGBEI
RM402, UNIT 4, NORTH BANK FORTUNE CENTRE
NINGBO, CHINA 315020

FOR: MEDICATED TOPICAL GEL FOR THE PREVENTION AND TREATMENT OF COLD AND FLU; TOPICAL ANALGESICS; HAND-SANITIZING PREPARATIONS; SANITIZING WIPES; MEDICATED COSMETICS; PAIN RELIEF OINTMENT; DANDRUFF SHAMPOO; ACNE TREATMENT PREPARATIONS; ANTIBACTERIAL HAND WASH; ATHLETE'S FOOT PREPARATIONS; MEDICATED LIP BALM, IN CLASS 5 (U.S. CLS. 6, 18, 44, 46, 51 AND 52).

FIRST USE 12-1-2009; IN COMMERCE 12-1-2009.

THE MARK CONSISTS OF STANDARD CHARACTERS WITHOUT CLAIM TO ANY PARTICULAR FONT, STYLE, SIZE, OR COLOR.

SN 85-130,746, FILED 9-16-2010.

MARILYN IZZI, EXAMINING ATTORNEY



David J. Kyros

Director of the United States Patent and Trademark Office

United States of America

United States Patent and Trademark Office

CRIMSON HEXAGON FORSIGHT

Reg. No. 4,109,708

Registered Mar. 6, 2012

Int. Cl.: 42

SERVICE MARK

PRINCIPAL REGISTER

CRIMSON HEXAGON, INC. (DELAWARE CORPORATION)
155 SEAPORT BOULEVARD
BOSTON, MA 02210

FOR: PROVIDING TEMPORARY USE OF ON-LINE NON-DOWNLOADABLE SOFTWARE FOR MONITORING AND ANALYZING ON-LINE SOCIAL MEDIA POSTS FOR THE PURPOSE OF GAINING MARKET INTELLIGENCE AND INTELLIGENCE PERTAINING TO MARKET COMPETITORS, IN CLASS 42 (U.S. CLS. 100 AND 101).

FIRST USE 10-5-2010; IN COMMERCE 10-5-2010.

THE MARK CONSISTS OF STANDARD CHARACTERS WITHOUT CLAIM TO ANY PARTICULAR FONT, STYLE, SIZE, OR COLOR.

SN 85-132,145, FILED 9-17-2010.

MARC LEIPZIG, EXAMINING ATTORNEY



David J. Kybas

Director of the United States Patent and Trademark Office

United States of America

United States Patent and Trademark Office

VIVERE

Reg. No. 4,109,709

Registered Mar. 6, 2012

Int. Cls.: 42 and 44

SERVICE MARK

PRINCIPAL REGISTER

VIVERE HEALTH, LLC (DELAWARE LIMITED LIABILITY COMPANY)
SUITE 520
720 COOL SPRINGS BOULEVARD
FRANKLIN, TN 37067

FOR: IN VITRO FERTILIZATION MEDICAL LABORATORIES; AND IN VITRO FERTILIZATION MEDICAL LABORATORY SERVICES, IN CLASS 42 (U.S. CLS. 100 AND 101).

FIRST USE 7-0-2010; IN COMMERCE 7-0-2010.

FOR: FERTILITY MEDICAL CLINICS; MEDICAL SERVICES IN THE FIELD OF WOMEN'S HEALTH AND FERTILITY; AND MEDICAL SERVICES IN THE FIELD OF WOMEN'S HEALTH AND FERTILITY, NAMELY, IN VITRO FERTILIZATION AND HUMAN FERTILITY TREATMENT SERVICES, IN CLASS 44 (U.S. CLS. 100 AND 101).

FIRST USE 7-0-2010; IN COMMERCE 7-0-2010.

THE MARK CONSISTS OF STANDARD CHARACTERS WITHOUT CLAIM TO ANY PARTICULAR FONT, STYLE, SIZE, OR COLOR.

THE ENGLISH TRANSLATION OF "VIVERE" IN THE MARK IS "TO LIVE".

SN 85-132,318, FILED 9-17-2010.

NELSON SNYDER, EXAMINING ATTORNEY



David J. Kyros

Director of the United States Patent and Trademark Office

United States of America

United States Patent and Trademark Office

POKER 1-2-3

Reg. No. 4,109,710

Registered Mar. 6, 2012

Int. Cl.: 9

TRADEMARK

PRINCIPAL REGISTER

POKER 123, LLC (NEVADA LIMITED LIABILITY COMPANY)
C/O REG. AGENT, STEVE GIORGIONE, CPA
3910 PECOS-MCLEOD, C-100
LAS VEGAS, NV 89121

FOR: COMPUTERIZED VIDEO TABLE GAMES FOR GAMING PURPOSES; COMPUTER GAME SOFTWARE FOR GAMING MACHINES, NAMELY, DEVICES WHICH ACCEPT A WAGER, IN CLASS 9 (U.S. CLS. 21, 23, 26, 36 AND 38).

FIRST USE 12-19-2011; IN COMMERCE 12-19-2011.

THE MARK CONSISTS OF STANDARD CHARACTERS WITHOUT CLAIM TO ANY PARTICULAR FONT, STYLE, SIZE, OR COLOR.

NO CLAIM IS MADE TO THE EXCLUSIVE RIGHT TO USE "POKER", APART FROM THE MARK AS SHOWN.

SN 85-132,325, FILED 9-17-2010.

SETH A. RAPPAPORT, EXAMINING ATTORNEY



David J. Kyros

Director of the United States Patent and Trademark Office

United States of America

United States Patent and Trademark Office



Reg. No. 4,109,711

Registered Mar. 6, 2012

Int. Cls.: 42 and 44

SERVICE MARK

PRINCIPAL REGISTER

VIVERE HEALTH, LLC (DELAWARE LIMITED LIABILITY COMPANY)
SUITE 520
720 COOL SPRINGS BOULEVARD
FRANKLIN, TN 37067

FOR: IN VITRO FERTILIZATION MEDICAL LABORATORIES; AND IN VITRO FERTILIZATION MEDICAL LABORATORY SERVICES, IN CLASS 42 (U.S. CLS. 100 AND 101).

FIRST USE 7-0-2010; IN COMMERCE 7-0-2010.

FOR: FERTILITY MEDICAL CLINICS; MEDICAL SERVICES IN THE FIELD OF WOMEN'S HEALTH AND FERTILITY; AND MEDICAL SERVICES IN THE FIELD OF WOMEN'S HEALTH AND FERTILITY, NAMELY, IN VITRO FERTILIZATION AND HUMAN FERTILITY TREATMENT SERVICES, IN CLASS 44 (U.S. CLS. 100 AND 101).

FIRST USE 7-0-2010; IN COMMERCE 7-0-2010.

NO CLAIM IS MADE TO THE EXCLUSIVE RIGHT TO USE "HEALTH", APART FROM THE MARK AS SHOWN.

THE MARK CONSISTS OF THE WORDING "VIVERE" IN LOWER CASE LETTERING WITH TWO CURVED DESIGNS SURROUNDING THE DOT OVER THE "I" IN A SHAPE OF STYLIZED HEART AND/OR UTERUS WITH THE WORDING "HEALTH" CENTERED BELOW IN BLOCK LETTERS.

THE ENGLISH TRANSLATION OF "VIVERE" IN THE MARK IS "TO LIVE".

SN 85-132,342, FILED 9-17-2010.

NELSON SNYDER, EXAMINING ATTORNEY



David J. Kybas

Director of the United States Patent and Trademark Office

United States of America

United States Patent and Trademark Office

ROCK PREMIER

Reg. No. 4,109,712

NORTH TOP USA INC. (CALIFORNIA CORPORATION)
225 S. OLIVE ST., #507
LOS ANGELES, CA 90012

Registered Mar. 6, 2012

Int. Cl.: 25

FOR: BOMBER JACKETS; DENIM JACKETS; DENIMS; JEANS; PANTS; SHIRTS; SKIRTS;
SKIRTS AND DRESSES; SWEATERS, IN CLASS 25 (U.S. CLS. 22 AND 39).

TRADEMARK

FIRST USE 8-15-2011; IN COMMERCE 8-15-2011.

PRINCIPAL REGISTER

THE MARK CONSISTS OF STANDARD CHARACTERS WITHOUT CLAIM TO ANY PARTICULAR FONT, STYLE, SIZE, OR COLOR.

SN 85-132,581, FILED 9-17-2010.

BRIAN CALLAGHAN, EXAMINING ATTORNEY



David J. Kybas

Director of the United States Patent and Trademark Office

United States of America

United States Patent and Trademark Office

Volagi

Reg. No. 4,109,713

Registered Mar. 6, 2012

Int. Cl.: 12

TRADEMARK

PRINCIPAL REGISTER

VOJAGI, LLC/DBA VOLAGI CYCLES (CALIFORNIA CORPORATION)
374 BLODGETT STREET
SUITE 4
COTATI, CA 949318707

FOR: BICYCLE BRAKES; BICYCLE FRAMES; BICYCLE PARTS, NAMELY, DERAILEURS;
BICYCLE PARTS, NAMELY, FORKS; BICYCLE PARTS, NAMELY, CHAIN STAY; BI-
CYCLES; FRAMES FOR BICYCLES; RACING BICYCLES; ROAD RACING BICYCLES;
STRUCTURAL PARTS OF BICYCLES, IN CLASS 12 (U.S. CLS. 19, 21, 23, 31, 35 AND 44).

FIRST USE 6-24-2010; IN COMMERCE 9-1-2010.

THE MARK CONSISTS OF STANDARD CHARACTERS WITHOUT CLAIM TO ANY PAR-
TICULAR FONT, STYLE, SIZE, OR COLOR.

SN 85-132,920, FILED 9-19-2010.

JILL C. ALT, EXAMINING ATTORNEY



David J. Kybas

Director of the United States Patent and Trademark Office

United States of America

United States Patent and Trademark Office

simple

Reg. No. 4,109,714

Registered Mar. 6, 2012

Int. Cls.: 9 and 42

TRADEMARK

SERVICE MARK

PRINCIPAL REGISTER

BEST RESPONSE STRATEGIES, LLC (VIRGINIA LIMITED LIABILITY COMPANY)
6603 THREE CHOPT ROAD
RICHMOND, VA 23226

FOR: SOFTWARE, NAMELY, COMPUTER SOFTWARE FOR MANAGING AND TRACKING INTERACTIONS WITH CUSTOMERS AND POTENTIAL CUSTOMERS, CUSTOMER RELATIONSHIP MANAGEMENT SOFTWARE, INTERNET PORTAL SOFTWARE IN THE NATURE OF COMPUTER SOFTWARE THAT PROVIDES WEB-BASED ACCESS TO APPLICATIONS AND SERVICES THROUGH A WEB OPERATING SYSTEM OR PORTAL INTERFACE, SALES-TRACKING SOFTWARE, MARKETING-TRACKING SOFTWARE, MARKETING ANALYSIS SOFTWARE, REPORTING SOFTWARE FOR REPORTING CUSTOMER CONTACT EFFICIENCY, CUSTOMER CONTACT-TRACKING SOFTWARE, CALL-TRACKING SOFTWARE, AND DATABASE MANAGEMENT SOFTWARE; INTERACTIVE MARKETING SOFTWARE ENABLING USERS, MERCHANTS, MANUFACTURERS AND RETAILERS TO SHARE THE LOCATION AND DETAILED INFORMATION OF PRODUCTS AND SERVICES THROUGH THE USE OF WIRELESS COMMUNICATIONS, IN CLASS 9 (U.S. CLS. 21, 23, 26, 36 AND 38).

FIRST USE 2-14-2011; IN COMMERCE 2-14-2011.

FOR: DESIGN, DEVELOPMENT, INSTALLATION, INTEGRATION AND MAINTENANCE OF SOFTWARE FOR MANAGING AND TRACKING INTERACTIONS WITH CUSTOMERS AND POTENTIAL CUSTOMERS, CUSTOMER RELATIONSHIP MANAGEMENT SOFTWARE, INTERNET PORTAL SOFTWARE, SALES-TRACKING SOFTWARE, MARKETING-TRACKING SOFTWARE, MARKETING ANALYSIS SOFTWARE, REPORTING SOFTWARE FOR REPORTING CUSTOMER CONTACT EFFICIENCY, CUSTOMER CONTACT-TRACKING SOFTWARE, CALL-TRACKING SOFTWARE, AND DATABASE MANAGEMENT SOFTWARE, INTERACTIVE MARKETING SOFTWARE ENABLING USERS, MERCHANTS, MANUFACTURERS AND RETAILERS TO SHARE THE LOCATION AND DETAILED INFORMATION OF PRODUCTS AND SERVICES THROUGH THE USE OF WIRELESS COMMUNICATIONS; COMPUTER SOFTWARE DEVELOPMENT AND COMPUTER PROGRAMMING DEVELOPMENT FOR OTHERS, INSTALLATION, MAINTENANCE AND REPAIR OF COMPUTER SOFTWARE, AND TECHNICAL SUPPORT SERVICES, NAMELY, TROUBLESHOOTING OF COMPUTER SOFTWARE PROBLEMS, IN CLASS 42 (U.S. CLS. 100 AND 101).



David J. Kappas

Director of the United States Patent and Trademark Office

FIRST USE 2-14-2011; IN COMMERCE 2-14-2011.

Reg. No. 4,109,714 THE MARK CONSISTS OF THE WORD "SIMPLE" IN LOWER CASE BLOCK LETTERS,
WITH "SIMP" SHADED.

SN 85-133,439, FILED 9-20-2010.

TOBY BULLOFF, EXAMINING ATTORNEY

United States of America

United States Patent and Trademark Office

SIMPLE

Reg. No. 4,109,715

Registered Mar. 6, 2012

Int. Cls.: 9 and 42

TRADEMARK

SERVICE MARK

PRINCIPAL REGISTER

BEST RESPONSE STRATEGIES, LLC (VIRGINIA LIMITED LIABILITY COMPANY)
6603 THREE CHOPT ROAD
RICHMOND, VA 23226

FOR: SOFTWARE, NAMELY, COMPUTER SOFTWARE FOR MANAGING AND TRACKING INTERACTIONS WITH CUSTOMERS AND POTENTIAL CUSTOMERS, CUSTOMER RELATIONSHIP MANAGEMENT SOFTWARE, INTERNET PORTAL SOFTWARE IN THE NATURE OF COMPUTER SOFTWARE THAT PROVIDES WEB-BASED ACCESS TO APPLICATIONS AND SERVICES THROUGH A WEB OPERATING SYSTEM OR PORTAL INTERFACE, SALES-TRACKING SOFTWARE, MARKETING-TRACKING SOFTWARE, MARKETING ANALYSIS SOFTWARE, REPORTING SOFTWARE FOR REPORTING CUSTOMER CONTACT EFFICIENCY, CUSTOMER CONTACT-TRACKING SOFTWARE, CALL-TRACKING SOFTWARE, AND DATABASE MANAGEMENT SOFTWARE; INTERACTIVE MARKETING SOFTWARE ENABLING USERS, MERCHANTS, MANUFACTURERS AND RETAILERS TO SHARE THE LOCATION AND DETAILED INFORMATION OF PRODUCTS AND SERVICES THROUGH THE USE OF WIRELESS COMMUNICATIONS, IN CLASS 9 (U.S. CLS. 21, 23, 26, 36 AND 38).

FIRST USE 2-14-2011; IN COMMERCE 2-14-2011.

FOR: DESIGN, DEVELOPMENT, INSTALLATION, INTEGRATION AND MAINTENANCE OF SOFTWARE FOR MANAGING AND TRACKING INTERACTIONS WITH CUSTOMERS AND POTENTIAL CUSTOMERS, CUSTOMER RELATIONSHIP MANAGEMENT SOFTWARE, INTERNET PORTAL SOFTWARE, SALES-TRACKING SOFTWARE, MARKETING-TRACKING SOFTWARE, MARKETING ANALYSIS SOFTWARE, REPORTING SOFTWARE FOR REPORTING CUSTOMER CONTACT EFFICIENCY, CUSTOMER CONTACT-TRACKING SOFTWARE, CALL-TRACKING SOFTWARE, AND DATABASE MANAGEMENT SOFTWARE, INTERACTIVE MARKETING SOFTWARE ENABLING USERS, MERCHANTS, MANUFACTURERS AND RETAILERS TO SHARE THE LOCATION AND DETAILED INFORMATION OF PRODUCTS AND SERVICES THROUGH THE USE OF WIRELESS COMMUNICATIONS; COMPUTER SOFTWARE DEVELOPMENT AND COMPUTER PROGRAMMING DEVELOPMENT FOR OTHERS, INSTALLATION, MAINTENANCE AND REPAIR OF COMPUTER SOFTWARE, AND TECHNICAL SUPPORT SERVICES, NAMELY, TROUBLESHOOTING OF COMPUTER SOFTWARE PROBLEMS, IN CLASS 42 (U.S. CLS. 100 AND 101).

FIRST USE 2-14-2011; IN COMMERCE 2-14-2011.



David J. Kyjars

Director of the United States Patent and Trademark Office

Reg. No. 4,109,715 THE MARK CONSISTS OF STANDARD CHARACTERS WITHOUT CLAIM TO ANY PARTICULAR FONT, STYLE, SIZE, OR COLOR.

SN 85-133,442, FILED 9-20-2010.

TOBY BULLOFF, EXAMINING ATTORNEY

United States of America

United States Patent and Trademark Office

Signum

Bio-inducer

Reg. No. 4,109,716

Registered Mar. 6, 2012

Int. Cl.: 1

TRADEMARK

PRINCIPAL REGISTER

RIZOBACTER ARGENTINA S.A. (ARGENTINA CORPORATION)
AVENIDA DR. ARTURO FRONDIZI 1150
PERGAMINO, ARGENTINA B2702HDA

FOR: INOCULANTS, NAMELY, BIOLOGICAL MICROORGANISMS USED IN FERMENTATION OF SILAGE; NATURAL FERTILIZERS; NON-CHEMICAL BIO-FERTILIZERS , IN CLASS 1 (U.S. CLS. 1, 5, 6, 10, 26 AND 46).

FIRST USE 12-1-2009; IN COMMERCE 10-1-2011.

NO CLAIM IS MADE TO THE EXCLUSIVE RIGHT TO USE "BIO-INDUCER", APART FROM THE MARK AS SHOWN.

THE COLOR(S) BLUE, PALE BLUE AND GRAY IS/ARE CLAIMED AS A FEATURE OF THE MARK.

THE MARK CONSISTS OF THE WORD "SIGNUM" WITH THE ROOT "SIG" IN BLUE COLOR, AND THE PORTION "NUM" IN PALE BLUE COLOR; OVER THE EXPRESSION "BIO-INDUCER" IN GREY COLOR AND SMALLER LETTERS.

SN 85-135,098, FILED 9-21-2010.

JOHN SCHUYLER YARD, EXAMINING ATTORNEY



David J. Kyros

Director of the United States Patent and Trademark Office

United States of America

United States Patent and Trademark Office

SEXY FOREVER

Reg. No. 4,109,717

Registered Mar. 6, 2012

Int. Cl.: 5

TRADEMARK

PRINCIPAL REGISTER

PCC LICENSING, INC. (NEVADA CORPORATION)
23679 CALABASAS ROAD, PMB 664
CALABASAS, CA 91302

FOR: DIETARY SUPPLEMENTS IN THE NATURE OF WEIGHT LOSS POWDERS; DIETARY SUPPLEMENTS; DIETARY SUPPLEMENTAL DRINKS; HERBAL SUPPLEMENTS; MULTI-VITAMIN PREPARATIONS; NUTRITIONAL SUPPLEMENTS; VITAMIN AND MINERAL SUPPLEMENTS; VITAMIN SUPPLEMENTS; VITAMIN PREPARATIONS, IN CLASS 5 (U.S. CLS. 6, 18, 44, 46, 51 AND 52).

FIRST USE 1-0-2011; IN COMMERCE 1-0-2011.

THE MARK CONSISTS OF STANDARD CHARACTERS WITHOUT CLAIM TO ANY PARTICULAR FONT, STYLE, SIZE, OR COLOR.

SN 85-135,587, FILED 9-22-2010.

CHRISTINE COOPER, EXAMINING ATTORNEY



David J. Kyjars

Director of the United States Patent and Trademark Office

United States of America

United States Patent and Trademark Office

[duodecim]

Reg. No. 4,109,718

Registered Mar. 6, 2012

Int. Cl.: 9

TRADEMARK

PRINCIPAL REGISTER

KABUSHIKI KAISHA SQUARE ENIX (JAPAN CORPORATION), TA SQUARE ENIX CO.,
LTD.,
3-22-7 YOYOGI, SHIBUYA-KU
TOKYO, JAPAN

FOR: COMPUTER GAME SOFTWARE; VIDEO GAME SOFTWARE, IN CLASS 9 (U.S. CLS.
21, 23, 26, 36 AND 38).

FIRST USE 3-3-2011; IN COMMERCE 3-22-2011.

THE MARK CONSISTS OF STANDARD CHARACTERS WITHOUT CLAIM TO ANY PAR-
TICULAR FONT, STYLE, SIZE, OR COLOR.

OWNER OF JAPAN REG. NO. 5395256, DATED 3-4-2011, EXPIRES 3-4-2021.

SN 85-135,645, FILED 9-22-2010.

GINA FINK, EXAMINING ATTORNEY



David J. Kyros

Director of the United States Patent and Trademark Office

United States of America

United States Patent and Trademark Office

Kimberly Anne

Reg. No. 4,109,719

DIPAULO, KIMBERLY (UNITED STATES INDIVIDUAL)
1102 126TH STREET
COLLEGE POINT, NY 11356

Registered Mar. 6, 2012

Int. Cl.: 42

FOR: DESIGN FOR OTHERS IN THE FIELD OF INFORMATIONAL GRAPHICS AND DATA
VISUALIZATION MATERIALS, IN CLASS 42 (U.S. CLS. 100 AND 101).

SERVICE MARK

FIRST USE 3-10-2011; IN COMMERCE 7-1-2011.

PRINCIPAL REGISTER

THE MARK CONSISTS OF THE STYLIZED TEXT "KIMBERLY ANNE".

SN 85-135,754, FILED 9-22-2010.

JENNIFER VASQUEZ, EXAMINING ATTORNEY



David J. Kybas

Director of the United States Patent and Trademark Office

United States of America

United States Patent and Trademark Office

SPECIALTY PHARMACY SERVICES YOU CAN RELY ON

Reg. No. 4,109,720

Registered Mar. 6, 2012

Int. Cl.: 35

SERVICE MARK

PRINCIPAL REGISTER

INDEPENDENT HEALTH ASSOCIATION, INC. (NEW YORK CORPORATION)
511 FARBER LAKES DRIVE
WILLIAMSVILLE, NY 14221

FOR: SPECIALTY PHARMACY SERVICES, NAMELY, DISTRIBUTORSHIP SERVICES IN THE FIELD OF SPECIAL PURPOSE HIGH-COST, INFUSION-BASED, INJECTABLE AND ORAL PHARMACEUTICALS FEATURING THE PROVISION OF PHARMACEUTICALS ORDERED BY HEALTH CARE PROVIDERS FOR USE BY HEALTH BENEFIT PLAN SUBSCRIBERS; ADMINISTERING PHARMACY REIMBURSEMENT PROGRAMS AND SERVICES IN THE FIELD OF SPECIALTY PHARMACEUTICALS FOR HEALTH BENEFIT PLAN SUBSCRIBERS, IN CLASS 35 (U.S. CLS. 100, 101 AND 102).

FIRST USE 10-0-2010; IN COMMERCE 10-0-2010.

THE MARK CONSISTS OF STANDARD CHARACTERS WITHOUT CLAIM TO ANY PARTICULAR FONT, STYLE, SIZE, OR COLOR.

NO CLAIM IS MADE TO THE EXCLUSIVE RIGHT TO USE "SPECIALTY PHARMACY SERVICES", APART FROM THE MARK AS SHOWN.

SN 85-135,828, FILED 9-22-2010.

MAUREEN DALL, EXAMINING ATTORNEY



David J. Kyros

Director of the United States Patent and Trademark Office

United States of America

United States Patent and Trademark Office

SIMPLE

Reg. No. 4,109,721

Registered Mar. 6, 2012

Int. Cl.: 35

SERVICE MARK

PRINCIPAL REGISTER

BEST RESPONSE STRATEGIES, LLC (VIRGINIA LIMITED LIABILITY COMPANY)
6603 THREE CHOPT ROAD
RICHMOND, VA 23226

FOR: DIRECT MARKETING SERVICES, ON-LINE MARKETING, NAMELY, DISSEMINATION OF ADVERTISING FOR OTHERS OVER A GLOBAL COMPUTER NETWORK AND OTHER TELECOMMUNICATION DEVICES, BUSINESS CONSULTATION IN THE NATURE OF DEVELOPING MARKETING STRATEGIES FOR CROSS MEDIA DISTRIBUTION, BUSINESS CONSULTING SERVICES IN THE NATURE OF DEVELOPING MARKETING STRATEGIES FOR IMPLEMENTING INTERACTIVE SOFTWARE FOR MANAGING AND TRACKING INTERACTIONS WITH CUSTOMERS AND POTENTIAL CUSTOMERS, CUSTOMER RELATIONSHIP MANAGEMENT SOFTWARE, INTERNET PORTAL SOFTWARE, SALES-TRACKING SOFTWARE, MARKETING-TRACKING SOFTWARE, MARKETING ANALYSIS SOFTWARE, REPORTING SOFTWARE FOR REPORTING CUSTOMER CONTACT EFFICIENCY, CUSTOMER CONTACT-TRACKING SOFTWARE, CALL-TRACKING SOFTWARE, AND DATABASE MANAGEMENT SOFTWARE; DEVELOPMENT, OPERATION AND ADMINISTRATION OF DIGITAL ADVERTISING SYSTEMS FOR OTHERS, NAMELY, PROVIDING ADVERTISING SPACE BY ELECTRONIC MEANS AND GLOBAL COMPUTER INFORMATION NETWORKS; ELECTRONIC COMMERCE SERVICES, NAMELY, PROVIDING INFORMATION ABOUT PRODUCTS VIA TELECOMMUNICATION NETWORKS FOR ADVERTISING AND SALES PURPOSES; ELECTRONIC PROCESSING OF ORDERS FOR OTHERS; ELECTRONIC SIGNATURE VERIFICATION SERVICES PROVIDED IN CONNECTION WITH COMMERCIAL TRANSACTIONS OF OTHERS; INCENTIVE AWARD PROGRAMS TO PROMOTE THE SALE OF PRODUCTS AND SERVICES OF OTHERS; INFOMEDIARY SERVICES, NAMELY, FACILITATING TRANSACTIONS BETWEEN BUYERS AND SELLERS THROUGH PROVIDING BUYERS WITH INFORMATION ABOUT SELLERS, GOODS, AND/OR SERVICES; INFORMATION OR ENQUIRIES ON BUSINESS AND MARKETING, IN CLASS 35 (U.S. CLS. 100, 101 AND 102).



FIRST USE 3-1-2011; IN COMMERCE 3-1-2011.

THE MARK CONSISTS OF STANDARD CHARACTERS WITHOUT CLAIM TO ANY PARTICULAR FONT, STYLE, SIZE, OR COLOR.

David J. Kyros

SN 85-136,206, FILED 9-23-2010.

TOBY BULLOFF, EXAMINING ATTORNEY

United States of America
United States Patent and Trademark Office

FitWise

Reg. No. 4,109,722

ROSAN HUDSON ENTERPRISES, LLC (DELAWARE LIMITED LIABILITY COMPANY)
47 SUNNY BRANCH ROAD - PO BOX 827
FAR HILLS, NJ 07931

Registered Mar. 6, 2012

Int. Cl.: 25

FOR: CLOTHING WAISTBAND THAT EXPANDS AND CONTRACTS, IN CLASS 25 (U.S. CLS. 22 AND 39).

TRADEMARK

FIRST USE 8-31-2010; IN COMMERCE 8-31-2010.

PRINCIPAL REGISTER

SN 85-136,710, FILED 9-23-2010.

MARIA-VICTORIA SUAREZ, EXAMINING ATTORNEY



David J. Kybas

Director of the United States Patent and Trademark Office

United States of America

United States Patent and Trademark Office

TAPE BACKUP IS DEAD

Reg. No. 4,109,723

DHK STORAGE, LLC (VIRGINIA LIMITED LIABILITY COMPANY)
21010 SOUTHBANK ST #100
STERLING, VA 20165

Registered Mar. 6, 2012

Int. Cl.: 9

FOR: BACKUP DRIVES FOR COMPUTERS; COMPUTER STORAGE DEVICES, NAMELY, HIGH-SPEED STORAGE SUBSYSTEMS FOR STORAGE AND BACKUP OF ELECTRONIC DATA EITHER LOCALLY OR VIA A TELECOMMUNICATIONS NETWORK, IN CLASS 9 (U.S. CLS. 21, 23, 26, 36 AND 38).

TRADEMARK

PRINCIPAL REGISTER

FIRST USE 1-6-2011; IN COMMERCE 1-6-2011.

THE MARK CONSISTS OF STANDARD CHARACTERS WITHOUT CLAIM TO ANY PARTICULAR FONT, STYLE, SIZE, OR COLOR.

SN 85-136,730, FILED 9-23-2010.

MARCIE MILONE, EXAMINING ATTORNEY



David J. Kyjars

Director of the United States Patent and Trademark Office

United States of America

United States Patent and Trademark Office

SPREEDIA

Reg. No. 4,109,724

Registered Mar. 6, 2012

Int. Cls.: 35 and 45

SERVICE MARK

PRINCIPAL REGISTER

SPREEDIA, LLC (DELAWARE LIMITED LIABILITY COMPANY)
APT. 22
402 HIGHLAND AVENUE
SOMERVILLE, MA 02144

FOR: ON-LINE INFORMATION SERVICES, NAMELY, PROVIDING COMMERCIAL INFORMATION ON SHOPPING AND MERCHANDISE FOR CONSUMERS, AND PROVIDING INFORMATION ON PRODUCT DISCOUNTS FOR CONSUMERS VIA A WEBSITE AND THROUGH VARIOUS FORMS OF SOCIAL MEDIA, IN CLASS 35 (U.S. CLS. 100, 101 AND 102).

FIRST USE 2-22-2011; IN COMMERCE 2-22-2011.

FOR: PROVIDING ONLINE INFORMATION SERVICES IN THE FIELD OF FASHION, IN CLASS 45 (U.S. CLS. 100 AND 101).

FIRST USE 2-22-2011; IN COMMERCE 2-22-2011.

THE MARK CONSISTS OF STANDARD CHARACTERS WITHOUT CLAIM TO ANY PARTICULAR FONT, STYLE, SIZE, OR COLOR.

SN 85-136,754, FILED 9-23-2010.

MICHAEL WEBSTER, EXAMINING ATTORNEY



David J. Kyros

Director of the United States Patent and Trademark Office

United States of America

United States Patent and Trademark Office



Reg. No. 4,109,725

Registered Mar. 6, 2012

Int. Cl.: 30

TRADEMARK

PRINCIPAL REGISTER

PRODUCTOS ALIMENTICIOS Y DIETETICOS RELAMPAGO, S.A. DE C.V. (MEXICO CORPORATION)
VIADUCTO TLALPAN NO. 5161
COLONIA LA JOYA, MEXICO C.P.14090

FOR: RICE PUDDING, IN CLASS 30 (U.S. CL. 46).

FIRST USE 8-31-2011; IN COMMERCE 8-31-2011.

OWNER OF U.S. REG. NOS. 1,940,178 AND 3,296,738.

THE COLOR(S) WHITE, BEIGE, RED, BROWN, BLACK, YELLOW, AND BLUE IS/ARE CLAIMED AS A FEATURE OF THE MARK.

THE MARK CONSISTS OF THE WORDS "D'GARI" IN SPECIAL SCRIPT IN WHITE ON A RED BACKGROUND ENCLOSED A DRAWING OF THE HEAD OF A SMILING BOY WITH BROWN HAIR BLACK EYES, RED TONGUE, BEIGE SKIN, ON A BLUE AND WHITE CONE LIKE BACKGROUND. ANOTHER BOY, IN BEIGE, BROWN, BLACK, RED, YELLOW, AND BLUE, HOLDING A YELLOW AND WHITE CUP, WITH HIS THUMB UP, WITH BLUE CURVED LINES BEHIND HIM, ABOVE THE BLUE PORTION OF THE CONE DESIGN.

SN 85-138,001, FILED 9-24-2010.

GRETTA YAO, EXAMINING ATTORNEY



David J. Kyffers

Director of the United States Patent and Trademark Office

United States of America

United States Patent and Trademark Office



Reg. No. 4,109,726

Registered Mar. 6, 2012

Int. Cls.: 16, 35, and 36

TRADEMARK

SERVICE MARK

PRINCIPAL REGISTER

THE CHEST FOUNDATION (ILLINOIS NON-PROFIT CORPORATION)
3300 DUNDEE ROAD
NORTHBROOK, IL 60062

FOR: PRINTED PUBLICATIONS, NAMELY, PROFESSIONAL JOURNALS AND NEWSLETTERS IN THE FIELD OF TREATMENT OF HEART AND LUNG DISEASES, IN CLASS 16 (U.S. CLS. 2, 5, 22, 23, 29, 37, 38 AND 50).

FIRST USE 10-0-2010; IN COMMERCE 11-0-2010.

FOR: ASSOCIATION SERVICES, NAMELY, PROMOTING THE INTERESTS OF SPECIALISTS IN CARDIOLOGY, PULMONOLOGY, CARDIOTHORACIC SURGERY, HYPERTENSION, CRITICAL CARE MEDICINE AND RELATED DISCIPLINES, IN CLASS 35 (U.S. CLS. 100, 101 AND 102).

FIRST USE 10-0-2010; IN COMMERCE 11-20-2010.

FOR: PHILANTHROPIC SERVICES, NAMELY, PROVIDING MONETARY RESOURCES TO ADVANCE THE PREVENTION AND TREATMENT OF DISEASES OF THE CHEST, IN CLASS 36 (U.S. CLS. 100, 101 AND 102).

FIRST USE 10-0-2010; IN COMMERCE 11-0-2010.

THE MARK CONSISTS OF THE STYLIZED WORDING "ONE BREATH MAKE THE MOST OF IT" TO THE LEFT OF A BUBBLE WAND WITH SIX BUBBLES FLOATING ABOVE THE WAND.

SN 85-138,048, FILED 9-24-2010.

DAVID I, EXAMINING ATTORNEY



David J. Kypos

Director of the United States Patent and Trademark Office

United States of America

United States Patent and Trademark Office



Reg. No. 4,109,727

Registered Mar. 6, 2012

Int. Cl.: 30

TRADEMARK

PRINCIPAL REGISTER

PRODUCTOS ALIMENTICIOS Y DIETETICOS RELAMPAGO, S.A. DE C.V. (MEXICO CORPORATION)
VIADUCTO TLALPAN NO. 5161
COLONIA LA JOYA, MEXICO C.P.14090

FOR: CUSTARD, IN CLASS 30 (U.S. CL. 46).

FIRST USE 8-31-2011; IN COMMERCE 8-31-2011.

OWNER OF U.S. REG. NOS. 1,940,178 AND 3,296,738.

THE COLOR(S) SILVER, WHITE, BEIGE, RED, BROWN, BLACK, AND YELLOW IS/ARE CLAIMED AS A FEATURE OF THE MARK.

THE MARK CONSISTS OF THE WORDS "D'GARI" IN SPECIAL SCRIPT IN WHITE ON A RED BACKGROUND ENCLOSING A DRAWING OF THE HEAD OF A SMILING BOY WITH BROWN HAIR BLACK EYES, RED TONGUE, BEIGE SKIN, ON A BEIGE AND BROWN CONE LIKE BACKGROUND ANOTHER BOY, IN BEIGE, BROWN, BLACK, RED, YELLOW, AND BLUE, HOLDING A SILVER SPOON AND A YELLOW, RED, AND WHITE CUP, ABOVE THE BROWN PORTION OF THE CONE DESIGN.

SN 85-138,103, FILED 9-24-2010.

GRETTA YAO, EXAMINING ATTORNEY



David J. Kybas

Director of the United States Patent and Trademark Office

United States of America

United States Patent and Trademark Office



Reg. No. 4,109,728

Registered Mar. 6, 2012

Int. Cl.: 35

SERVICE MARK

PRINCIPAL REGISTER

ZOOM REMOTE PROFESSIONALS (KANSAS LIMITED LIABILITY COMPANY)
17522 W. 111TH CT
OLATHE, KS 66061

FOR: JOB PLACEMENT, IN CLASS 35 (U.S. CLS. 100, 101 AND 102).

FIRST USE 3-1-2011; IN COMMERCE 12-12-2011.

NO CLAIM IS MADE TO THE EXCLUSIVE RIGHT TO USE "REMOTE PROFESSIONALS",
APART FROM THE MARK AS SHOWN.

THE COLOR(S) LIGHT BLUE AND DARK BLUE IS/ARE CLAIMED AS A FEATURE OF
THE MARK.

THE MARK CONSISTS OF A STYLIZED PENTAGON SPLIT VERTICALLY IN HALF ABOVE
THE STYLIZED TEXT "ZOOM REMOTE PROFESSIONALS" WHERE THE LEFT HALF OF
THE PENTAGON DEPICTS A SKYSCRAPER IN A LIGHT BLUE COLOR AND THE RIGHT
HALF OF THE PENTAGON DEPICTS A HOUSE DARK BLUE IN COLOR; THE WORD
"ZOOM" IS CENTERED BELOW THE PENTAGON IN DARK BLUE BOLD FONT; THE
WORDS "REMOTE PROFESSIONALS" ARE CENTERED BELOW THE WORD "ZOOM" IN
LIGHT BLUE FONT.

SN 85-138,260, FILED 9-25-2010.

ADA HAN, EXAMINING ATTORNEY



David J. Kyjars

Director of the United States Patent and Trademark Office

United States of America

United States Patent and Trademark Office

LOZZ DOZZ

Reg. No. 4,109,729

Registered Mar. 6, 2012

Int. Cl.: 25

TRADEMARK

PRINCIPAL REGISTER

ALONSO, ELFA RAQUEL (UNITED STATES INDIVIDUAL)
15585 OCEAN WALK CIRCLE #314
FT. MYERS, FL 33908

FOR: CHILDREN'S, BABIES AND TODDLER'S CLOTHING, NAMELY, SHIRTS, T-SHIRTS, SNAP CROTCH SHIRTS, BODYSUITS, ROMPERS, PANTIES, DRESSES, SKIRTS, BLOUSES, JACKETS, COATS, FABRIC BELTS, LEATHER BELTS, CAPS, HATS, VISORS, BEANIES, FLEECE PULLOVERS, SWEATERS, JEANS, PANTS, TROUSERS, OVERALLS, SWEAT PANTS, POLO SHIRTS, SWEATSHIRTS, TANK TOPS, SHORTS, SWIM SUITS, TRUNKS, BANDANAS, SHOES, SANDALS, FOOTWEAR, THERMAL UNDERWEAR, SOCKS, NIGHT GOWNS, PAJAMAS, WIND SHIRTS, PONCHOS, VESTS, PARKAS, BOXER SHORTS, BRIEFS, UNDERWEAR, YOGA PANTS, BATHROBES, JERSEYS, CLOTH BIBS, CAPRI PANTS, IN CLASS 25 (U.S. CLS. 22 AND 39).

FIRST USE 12-15-2011; IN COMMERCE 12-15-2011.

THE MARK CONSISTS OF STANDARD CHARACTERS WITHOUT CLAIM TO ANY PARTICULAR FONT, STYLE, SIZE, OR COLOR.

THE WORDING "LOZZ DOZZ" HAS NO MEANING IN A FOREIGN LANGUAGE.

SN 85-139,177, FILED 9-27-2010.

JULIE WATSON, EXAMINING ATTORNEY



David J. Kyros

Director of the United States Patent and Trademark Office

United States of America

United States Patent and Trademark Office

BELONG

Reg. No. 4,109,730

HNI TECHNOLOGIES INC. (IOWA CORPORATION)
408 EAST 2ND STREET
MUSCATINE, IA 52761

Registered Mar. 6, 2012

Int. Cl.: 20

FOR: FURNITURE, IN CLASS 20 (U.S. CLS. 2, 13, 22, 25, 32 AND 50).

TRADEMARK

FIRST USE 11-26-2011; IN COMMERCE 11-26-2011.

PRINCIPAL REGISTER

THE MARK CONSISTS OF STANDARD CHARACTERS WITHOUT CLAIM TO ANY PARTICULAR FONT, STYLE, SIZE, OR COLOR.

SN 85-139,720, FILED 9-28-2010.

BENJAMIN OKEKE, EXAMINING ATTORNEY



David J. Kybas

Director of the United States Patent and Trademark Office

United States of America

United States Patent and Trademark Office

Raisin expectations

Reg. No. 4,109,731

Registered Mar. 6, 2012

Int. Cl.: 29

TRADEMARK

PRINCIPAL REGISTER

PEELED INC. (DELAWARE CORPORATION), DBA PEELED SNACKS,
530 3RD AVENUE SUITE 2R
BROOKLYN, NY 11215

FOR: DRIED FRUITS, IN CLASS 29 (U.S. CL. 46).

FIRST USE 12-30-2010; IN COMMERCE 12-30-2010.

THE MARK CONSISTS OF THE WORDS "RAISIN EXPECTATIONS" IN STYLIZED FORM.

SN 85-140,945, FILED 9-29-2010.

SHAUNIA CARLYLE, EXAMINING ATTORNEY



David J. Kyffers

Director of the United States Patent and Trademark Office

United States of America

United States Patent and Trademark Office

BAM!

Reg. No. 4,109,732

Registered Mar. 6, 2012

Int. Cl.: 35

SERVICE MARK

PRINCIPAL REGISTER

BOOKS-A-MILLION, INC. (DELAWARE CORPORATION)
402 INDUSTRIAL LANE
BIRMINGHAM, AL 35211

FOR: RETAIL STORE SERVICES, WHOLESALE DISTRIBUTORSHIPS AND ONLINE RETAIL STORE SERVICES FEATURING BOOKS, PUBLICATIONS, MAGAZINES, GREETING CARDS, CALENDARS AND RELATED PRINTED MATTER AND STATIONERY; COMPUTERIZED ON-LINE RETAIL STORE SERVICES PROVIDED BY MEANS OF A GLOBAL COMPUTER NETWORK AND COMPUTERIZED ON-LINE RETAIL ORDERING SERVICES BOTH FEATURING BOOKS, BOOKS ON TAPE, DVDS, GAMES, TOYS, COFFEE, COMPUTER SOFTWARE, PRE-RECORDED AUDIO CASSETTES, VIDEOCASSETTES, COMPACT DISKS, FLOPPY DISKS, CD-ROMS, ALL FEATURING MUSIC, MOVIES, PUBLICATIONS AND ITEMS OF A BROAD RANGE OF INTERESTS; RETAIL NEWSSTAND SERVICES; ON-LINE RETAIL ORDERING SERVICES FEATURING COFFEE AND MUGS; BOOK, CARD AND GIFT RETAIL STORE, IN CLASS 35 (U.S. CLS. 100, 101 AND 102).

FIRST USE 4-2-1993; IN COMMERCE 4-2-1993.

THE MARK CONSISTS OF STANDARD CHARACTERS WITHOUT CLAIM TO ANY PARTICULAR FONT, STYLE, SIZE, OR COLOR.

OWNER OF U.S. REG. NOS. 2,436,877, 2,506,340, AND OTHERS.

SN 85-142,843, FILED 10-1-2010.

HANNO RITTNER, EXAMINING ATTORNEY



David J. Kyffers

Director of the United States Patent and Trademark Office

United States of America

United States Patent and Trademark Office

BUSINESSMAN

Reg. No. 4,109,733

DELTA CO., LTD. (JAPAN CORPORATION)
1-11-29 TERAUCHI, TOYONAKA-SHI
OSAKA, 561-0872, JAPAN

Registered Mar. 6, 2012

Int. Cl.: 12

FOR: AUTOMOBILES; FITTINGS FOR AUTOMOBILE BODIES; FITTINGS FOR AUTOMOBILE STRUCTURAL PARTS, IN CLASS 12 (U.S. CLS. 19, 21, 23, 31, 35 AND 44).

TRADEMARK

FIRST USE 9-24-2010; IN COMMERCE 10-1-2010.

PRINCIPAL REGISTER

THE MARK CONSISTS OF STANDARD CHARACTERS WITHOUT CLAIM TO ANY PARTICULAR FONT, STYLE, SIZE, OR COLOR.

SN 85-144,127, FILED 10-4-2010.

CHARLOTTE CORWIN, EXAMINING ATTORNEY



David J. Kybas

Director of the United States Patent and Trademark Office

United States of America

United States Patent and Trademark Office



Reg. No. 4,109,734

Registered Mar. 6, 2012

Int. Cl.: 43

SERVICE MARK

PRINCIPAL REGISTER

NY'S BEST PIZZA, INC. (CALIFORNIA CORPORATION)
853 CASTLETON AVE.
STATEN ISLAND, NY 10310

FOR: PIZZA PARLORS, IN CLASS 43 (U.S. CLS. 100 AND 101).

FIRST USE 10-1-2010; IN COMMERCE 10-1-2010.

NO CLAIM IS MADE TO THE EXCLUSIVE RIGHT TO USE "NY'S BEST PIZZA" , APART FROM THE MARK AS SHOWN.

THE COLOR(S) GREEN, RED, BLACK, AND YELLOW IS/ARE CLAIMED AS A FEATURE OF THE MARK.

THE MARK CONSISTS OF A GREEN RECTANGLE OVER A PIZZA. THE LITERAL ELEMENT OF THE MARK IS IN RED WITHIN THE GREEN RECTANGLE. THE GREEN RECTANGLE APPEARS ON TOP OF A PIZZA WHICH IS PRIMARILY YELLOW WITH RED AND GREEN FLECKS. THE ENTIRE DESIGN SITS OVER A BLACK RECTANGULAR BACKGROUND.

SN 85-144,131, FILED 10-4-2010.

DORITT L. CARROLL, EXAMINING ATTORNEY



David J. Kyros

Director of the United States Patent and Trademark Office

United States of America

United States Patent and Trademark Office

SHOP FOR A CAUSE

Reg. No. 4,109,735

Registered Mar. 6, 2012

Int. Cls.: 36 and 42

SERVICE MARK

PRINCIPAL REGISTER

BIDDINGFORGOOD, INC. (DELAWARE CORPORATION)
125 CAMBRIDGE PARK DRIVE
CAMBRIDGE, MA 02140

FOR: FUND RAISING SERVICES FOR CHARITABLE OR NONPROFIT ENTITIES; ON-LINE FUND RAISING SERVICES FOR CHARITABLE OR NONPROFIT ENTITIES; PROVIDING INFORMATION OVER GLOBAL COMPUTER NETWORKS ABOUT CHARITABLE FUND RAISING CONDUCTED BY CHARITABLE OR NONPROFIT ENTITIES, IN CLASS 36 (U.S. CLS. 100, 101 AND 102).

FIRST USE 5-13-2010; IN COMMERCE 5-13-2010.

FOR: HOSTING OF ON-LINE CHARITABLE FUND RAISING AUCTION WEBSITES OF OTHERS OVER GLOBAL COMPUTER NETWORKS, IN CLASS 42 (U.S. CLS. 100 AND 101).

FIRST USE 5-13-2010; IN COMMERCE 5-13-2010.

THE MARK CONSISTS OF STANDARD CHARACTERS WITHOUT CLAIM TO ANY PARTICULAR FONT, STYLE, SIZE, OR COLOR.

SN 85-145,544, FILED 10-5-2010.

FRANK LATTUCA, EXAMINING ATTORNEY



David J. Kyjars

Director of the United States Patent and Trademark Office

United States of America

United States Patent and Trademark Office



Reg. No. 4,109,736

Registered Mar. 6, 2012

Int. Cls.: 35 and 43

SERVICE MARK

PRINCIPAL REGISTER

BUBBAQUE'S, LLC (FLORIDA LIMITED LIABILITY COMPANY)
1326 EAST LUMSDEN RD
BRANDON, FL 33511

FOR: RESTAURANT FRANCHISING, NAMELY, OFFERING BUSINESS MANAGEMENT ASSISTANCE IN THE ESTABLISHMENT AND/OR OPERATION OF RESTAURANTS , IN CLASS 35 (U.S. CLS. 100, 101 AND 102).

FIRST USE 8-26-2010; IN COMMERCE 9-22-2010.

FOR: RESTAURANT AND BAR SERVICES, INCLUDING RESTAURANT CARRYOUT SERVICES; RESTAURANT, BAR AND CATERING SERVICES, IN CLASS 43 (U.S. CLS. 100 AND 101).

FIRST USE 9-17-2010; IN COMMERCE 9-17-2010.

OWNER OF U.S. REG. NO. 3,854,342.

THE MARK CONSISTS OF THE WORD "BUBBAQUE'S" IN CAPITAL LETTERS APPEARING ON THE FACE OF A WOODEN PLANK.

SN 85-146,090, FILED 10-6-2010.

GRETCHEN ULRICH, EXAMINING ATTORNEY



David J. Kyros

Director of the United States Patent and Trademark Office

United States of America

United States Patent and Trademark Office

THE OUTCOME IS INCOME

Reg. No. 4,109,737

Registered Mar. 6, 2012

Int. Cl.: 36

SERVICE MARK

PRINCIPAL REGISTER

HERBERT J. SIMS & CO. INC. (NEW YORK CORPORATION)
2150 POST ROAD
FAIRFIELD, CT 06824

FOR: BROKERAGE OF BONDS; BROKERAGE SERVICES FOR STOCKS AND BONDS; BROKERAGE SERVICES FOR CAPITAL INVESTMENTS; BROKERAGE SERVICES IN THE FIELD OF SECURITIES AND COMMODITIES INVESTING; COMMODITY BROKERAGE; FINANCIAL AND INVESTMENT SERVICES, NAMELY, MANAGEMENT AND BROKERAGE IN THE FIELDS OF STOCKS, BONDS, OPTIONS, COMMODITIES, FUTURES AND OTHER SECURITIES, AND THE INVESTMENT OF FUNDS OF OTHERS; FINANCIAL INVESTMENT BROKERAGE SERVICES; INVESTMENT BROKERAGE; SECURITIES BROKERAGE SERVICES; DERIVATIVES BROKERAGE, IN CLASS 36 (U.S. CLS. 100, 101 AND 102).

FIRST USE 11-14-2011; IN COMMERCE 11-14-2011.

THE MARK CONSISTS OF STANDARD CHARACTERS WITHOUT CLAIM TO ANY PARTICULAR FONT, STYLE, SIZE, OR COLOR.

NO CLAIM IS MADE TO THE EXCLUSIVE RIGHT TO USE "INCOME", APART FROM THE MARK AS SHOWN.

SN 85-146,675, FILED 10-6-2010.

TINA MAI, EXAMINING ATTORNEY



David J. Kypos

Director of the United States Patent and Trademark Office

United States of America

United States Patent and Trademark Office

OUTWORK. OUTSMART. OUTPERFORM.

Reg. No. 4,109,738

Registered Mar. 6, 2012

Int. Cl.: 36

SERVICE MARK

PRINCIPAL REGISTER

HERBERT J. SIMS & CO. INC. (NEW YORK CORPORATION)
2150 POST ROAD
FAIRFIELD, CT 06824

FOR: INVESTMENT BANKING SERVICES; BANKING AND FINANCING SERVICES; LOAN FINANCING; PROJECT FINANCING; FINANCING OF REAL ESTATE DEVELOPMENT PROJECTS; REAL ESTATE FINANCING SERVICES; FINANCIAL ADVISORY SERVICES; FINANCIAL SERVICES, NAMELY, DEBT SETTLEMENT IN THE NATURE OF DEBT RESTRUCTURING; FINANCIAL ADVISORY SERVICES IN THE FIELDS OF MERGERS AND ACQUISITION; FINANCIAL ASSET MANAGEMENT; LOAN SERVICING; REAL ESTATE INVESTMENT; REAL ESTATE OWNERSHIP SHARING SERVICES, NAMELY, MANAGING AND ARRANGING FOR CO-OWNERSHIP OF REAL ESTATE, IN CLASS 36 (U.S. CLS. 100, 101 AND 102).

FIRST USE 10-13-2011; IN COMMERCE 10-13-2011.

THE MARK CONSISTS OF STANDARD CHARACTERS WITHOUT CLAIM TO ANY PARTICULAR FONT, STYLE, SIZE, OR COLOR.

SN 85-146,685, FILED 10-6-2010.

TINA MAI, EXAMINING ATTORNEY



David J. Kybas

Director of the United States Patent and Trademark Office

United States of America

United States Patent and Trademark Office

GREENFIELD PUBLISHING INC.

Reg. No. 4,109,739

Registered Mar. 6, 2012

Int. Cl.: 41

SERVICE MARK

PRINCIPAL REGISTER

GREENFIELD PUBLISHING (MINNESOTA CORPORATION), TA GRENFIELD PUBLISHING INC.,
3525 HAUG AVENUE SOUTH EAST
ROCKFORD, MN 55373

FOR: BOOK PUBLISHING, IN CLASS 41 (U.S. CLS. 100, 101 AND 107).

FIRST USE 10-15-2010; IN COMMERCE 10-15-2010.

THE MARK CONSISTS OF STANDARD CHARACTERS WITHOUT CLAIM TO ANY PARTICULAR FONT, STYLE, SIZE, OR COLOR.

NO CLAIM IS MADE TO THE EXCLUSIVE RIGHT TO USE "PUBLISHING INC.", APART FROM THE MARK AS SHOWN.

SN 85-147,017, FILED 10-7-2010.

LINDSEY RUBIN, EXAMINING ATTORNEY



David J. Kybas

Director of the United States Patent and Trademark Office

United States of America

United States Patent and Trademark Office

DELTA WING

Reg. No. 4,109,740

Registered Mar. 6, 2012

Int. Cl.: 8

TRADEMARK

PRINCIPAL REGISTER

SHEAR MAGIC CORPORATION (NEW JERSEY CORPORATION)
P.O. BOX 246
MOUNT LAUREL, NJ 08054

FOR: SNOW SHOVELS, IN CLASS 8 (U.S. CLS. 23, 28 AND 44).

FIRST USE 11-7-2011; IN COMMERCE 11-7-2011.

THE MARK CONSISTS OF STANDARD CHARACTERS WITHOUT CLAIM TO ANY PARTICULAR FONT, STYLE, SIZE, OR COLOR.

SN 85-147,496, FILED 10-7-2010.

ALYSSA STEEL, EXAMINING ATTORNEY



David J. Kybas

Director of the United States Patent and Trademark Office

United States of America

United States Patent and Trademark Office

MEETSMART

Reg. No. 4,109,741

Registered Mar. 6, 2012

Int. Cl.: 35

SERVICE MARK

PRINCIPAL REGISTER

CONFERENCE AND LOGISTICS CONSULTANTS, INC. (MARYLAND CORPORATION)
31 OLD SOLOMONS ISLAND ROAD
ANNAPOLIS, MD 21401

FOR: BUSINESS MEETING PLANNING, IN CLASS 35 (U.S. CLS. 100, 101 AND 102).

FIRST USE 2-1-2011; IN COMMERCE 2-1-2011.

THE MARK CONSISTS OF STANDARD CHARACTERS WITHOUT CLAIM TO ANY PARTICULAR FONT, STYLE, SIZE, OR COLOR.

SN 85-147,896, FILED 10-7-2010.

DEZMONA MIZELLE, EXAMINING ATTORNEY



David J. Kybas

Director of the United States Patent and Trademark Office

United States of America

United States Patent and Trademark Office

THINK REO

Reg. No. 4,109,742

RESEARCH ELECTRO-OPTICS, INC. (COLORADO CORPORATION)
5505 AIRPORT BLVD.
BOULDER, CO 80301

Registered Mar. 6, 2012

Int. Cls.: 2, 9, and 42

FOR: OPTICAL COATINGS, THIN FILM COATINGS, ANTI-REFLECTIVE COATINGS, AND REFLECTIVE COATINGS , IN CLASS 2 (U.S. CLS. 6, 11 AND 16).

TRADEMARK

FIRST USE 1-1-2004; IN COMMERCE 1-1-2004.

SERVICE MARK

FOR: OPTICAL DEVICES, COMPONENTS AND MATERIALS, NAMELY, SEMICONDUCTOR DEVICES; THIN FILM OPTICAL FILTERS; OPTICAL FILTERS; REFLECTORS; BEAM SPLITTERS; PRISMS FOR SCIENTIFIC PURPOSES, OPTICAL REFLECTORS, THIN FILM REFLECTORS, ANTI-REFLECTIVE LENSES, INTERFEROMETERS, ETALONS, POLARIZERS, OPTICAL WINDOWS, ANTI-REFLECTIVE WINDOWS, OPTICAL LENSES, OPTICAL SOURCES, OUTPUT COUPLERS, AND LASERS NOT FOR MEDICAL USE , IN CLASS 9 (U.S. CLS. 21, 23, 26, 36 AND 38).

PRINCIPAL REGISTER

FIRST USE 1-1-2004; IN COMMERCE 1-1-2004.

FOR: DESIGN AND TECHNOLOGICAL CONSULTING SERVICES IN THE FIELDS OF OPTICAL FILMS AND COATINGS, ELECTRO-OPTICS, AND OPTICAL, PHOTONICS AND SEMICONDUCTOR DEVICES, IN CLASS 42 (U.S. CLS. 100 AND 101).

FIRST USE 1-1-2004; IN COMMERCE 1-1-2004.

THE MARK CONSISTS OF STANDARD CHARACTERS WITHOUT CLAIM TO ANY PARTICULAR FONT, STYLE, SIZE, OR COLOR.

OWNER OF U.S. REG. NOS. 3,902,168 AND 3,902,169.

SN 85-148,294, FILED 10-8-2010.

H. M. FISHER, EXAMINING ATTORNEY



David J. Kyffers

Director of the United States Patent and Trademark Office

United States of America

United States Patent and Trademark Office

SHOW COMPANION

Reg. No. 4,109,743

EAT.TV, INC (DELAWARE CORPORATION)
42 OAK MOUNTAIN COURT
SAN RAFAEL, CA 94903

Registered Mar. 6, 2012

Int. Cl.: 9

FOR: COMPUTER SOFTWARE FOR SYNCING A TELEVISION TO A MOBILE DEVICE, IN CLASS 9 (U.S. CLS. 21, 23, 26, 36 AND 38).

TRADEMARK

FIRST USE 10-8-2010; IN COMMERCE 10-8-2010.

PRINCIPAL REGISTER

THE MARK CONSISTS OF STANDARD CHARACTERS WITHOUT CLAIM TO ANY PARTICULAR FONT, STYLE, SIZE, OR COLOR.

SN 85-148,910, FILED 10-8-2010.

SALLY SHIH, EXAMINING ATTORNEY



David J. Kybas

Director of the United States Patent and Trademark Office

United States of America

United States Patent and Trademark Office

Silver-Armed

Reg. No. 4,109,744

Registered Mar. 6, 2012

Int. Cl.: 8

TRADEMARK

PRINCIPAL REGISTER

LUXWARE ENTERPRISE CORP. (TAIWAN CORPORATION)
7F.-3, NO.77
SEC. 1, SINTAI 5TH RD., SIJHIH CITY
TAIPEI COUNTY 221, TAIWAN

FOR: CUTLERY MADE IN WHOLE OR SUBSTANTIAL PART OF SILVER, NAMELY, HOUSEHOLD AND KITCHEN KNIVES, FORKS AND SPOONS, IN CLASS 8 (U.S. CLS. 23, 28 AND 44).

FIRST USE 12-2-2011; IN COMMERCE 12-2-2011.

THE MARK CONSISTS OF STANDARD CHARACTERS WITHOUT CLAIM TO ANY PARTICULAR FONT, STYLE, SIZE, OR COLOR.

SN 85-149,050, FILED 10-9-2010.

LIEF MARTIN, EXAMINING ATTORNEY



David J. Kypos

Director of the United States Patent and Trademark Office

United States of America

United States Patent and Trademark Office



Reg. No. 4,109,745

Registered Mar. 6, 2012

Int. Cl.: 25

TRADEMARK

PRINCIPAL REGISTER

TONI & ASH ENTERTAINMENT, LLC (TENNESSEE LIMITED LIABILITY COMPANY)
PO BOX 24191
KNOXVILLE, TN 37933

FOR: HOODED SWEAT SHIRTS; SHORT-SLEEVED OR LONG-SLEEVED T-SHIRTS; SWEAT SHIRTS; TANK TOPS; TOPS, IN CLASS 25 (U.S. CLS. 22 AND 39).

FIRST USE 10-15-2010; IN COMMERCE 12-1-2010.

THE MARK CONSISTS OF AN IMAGE CONTAINING AN ILLUSTRATED RABBIT WHICH HAS TWO EARS, FACIAL FEATURES CONTAINING A NOSE, POINTED TEETH, AND CLOSED, LASHED EYES, AND LACED TENNIS SHOES, A SET OF MUSICAL NOTES IN THE UPPER RIGHT HAND CORNER, AND THE PHRASE "BUNNY GOT BITE" IN STYLIZED TYPE BELOW THE ILLUSTRATED RABBIT.

SN 85-149,658, FILED 10-11-2010.

MICHAEL SOUDERS, EXAMINING ATTORNEY



David J. Kybas

Director of the United States Patent and Trademark Office

United States of America

United States Patent and Trademark Office

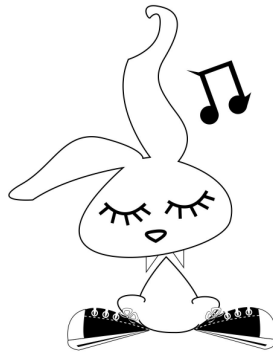

Reg. No. 4,109,746

Registered Mar. 6, 2012

Int. Cl.: 25

TRADEMARK

PRINCIPAL REGISTER

TONI & ASH ENTERTAINMENT, LLC (TENNESSEE LIMITED LIABILITY COMPANY)
PO BOX 24191
KNOXVILLE, TN 37933

FOR: HOODED SWEAT SHIRTS; SHORT-SLEEVED OR LONG-SLEEVED T-SHIRTS; SWEAT SHIRTS; TANK TOPS; TOPS, IN CLASS 25 (U.S. CLS. 22 AND 39).

FIRST USE 10-15-2010; IN COMMERCE 12-1-2010.

THE MARK CONSISTS OF AN IMAGE OF AN ILLUSTRATED RABBIT WHICH HAS TWO EARS, FACIAL FEATURES CONTAINING A NOSE, POINTED TEETH, AND CLOSED, LASHED EYES, AND LACED TENNIS SHOES, CONTAINING A SET OF MUSICAL NOTES IN THE UPPER RIGHT HAND CORNER.

SN 85-149,660, FILED 10-11-2010.

MICHAEL SOUDERS, EXAMINING ATTORNEY



David J. Kybas

Director of the United States Patent and Trademark Office

United States of America

United States Patent and Trademark Office

MY DIAMOND STORY

Reg. No. 4,109,747

Registered Mar. 6, 2012

Int. Cl.: 14

TRADEMARK

PRINCIPAL REGISTER

DHOLAKIYA, HASMUKH (UNITED STATES INDIVIDUAL)
SUITE 303
15 WEST 47TH STREET
NEW YORK, NY 10036

FOR: CUT DIAMONDS; DIAMOND JEWELRY; DIAMONDS; GEMSTONE JEWELRY;
GEMSTONES; JEWELRY; PRECIOUS GEMSTONES; SEMI-PRECIOUS GEMSTONES, IN
CLASS 14 (U.S. CLS. 2, 27, 28 AND 50).

FIRST USE 9-12-2011; IN COMMERCE 9-12-2011.

THE MARK CONSISTS OF STANDARD CHARACTERS WITHOUT CLAIM TO ANY PAR-
TICULAR FONT, STYLE, SIZE, OR COLOR.

NO CLAIM IS MADE TO THE EXCLUSIVE RIGHT TO USE "DIAMOND", APART FROM
THE MARK AS SHOWN.

SN 85-150,869, FILED 10-12-2010.

KATHY DE JONGE, EXAMINING ATTORNEY



David J. Kybas

Director of the United States Patent and Trademark Office

United States of America

United States Patent and Trademark Office



Reg. No. 4,109,748

Registered Mar. 6, 2012

Int. Cl.: 21

TRADEMARK

PRINCIPAL REGISTER

OROZCO PACHECO, GRACIELA (MEXICO INDIVIDUAL)
ESTACIÓN FTE. EST. F.F.C.C. LOS LOPEZ
CAMINO STA. ANA D CONDE S/N TRINIDAD
LEON, GUANAJUATO, MEXICO

FOR: CERAMIC FIGURINES; CERAMIC SCULPTURES, VASES, VESSELS, BOWLS, PLATES AND POTS; DISHES; FLOWERPOTS; PLATES; SERVING DISHES; STATUES OF CERAMIC, CRYSTAL AND TERRACOTTA; STATUETTES OF CERAMIC, CRYSTAL AND TERRACOTTA, IN CLASS 21 (U.S. CLS. 2, 13, 23, 29, 30, 33, 40 AND 50).

FIRST USE 11-30-2007; IN COMMERCE 12-15-2007.

THE MARK CONSISTS OF A COUNTRY MAN HOLDING A BOX WITH A STAND INSIDE OF WHICH APPEARS AN IMAGE OF A SAINT. ON TOP OF THE BOX APPEARS A CROSS. BELOW THE STANDING MAN APPEARS THE WORD "TRINITATE" IN STYLIZED LETTERS INSIDE A HORIZONTALLY POSITIONED RECTANGLE THAT CONTAINS AN INNER AND OUTER BORDER. THE INNER BORDER BEING THINNER AND THE OUTER BORDER BEING THICKER.

THE WORDING "TRINITATE" HAS NO MEANING IN A FOREIGN LANGUAGE.

SN 85-151,477, FILED 10-13-2010.

ELIZABETH HUGHITT, EXAMINING ATTORNEY



David J. Kybas

Director of the United States Patent and Trademark Office

United States of America

United States Patent and Trademark Office

RADIUMONE

Reg. No. 4,109,749

Registered Mar. 6, 2012

Int. Cl.: 35

SERVICE MARK

PRINCIPAL REGISTER

RADIUMONE, INC. (DELAWARE CORPORATION)
525 MARKET STREET, 18TH FLOOR
SAN FRANCISCO, CA 94105

FOR: DISSEMINATION AND PLACEMENT OF ADVERTISING FOR OTHERS VIA THE INTERNET; ADVERTISING SERVICES, NAMELY, TRACKING, ADMINISTERING, BILLING, AND REPORTING OF ONLINE ADVERTISING; PROVIDING ADVERTISING DATA REPORTS, ADVERTISEMENT TARGETING, AND MANAGEMENT OF ELECTRONICALLY STORED ADVERTISING; EVALUATING SOCIAL MEDIA DATA AND INFORMATION FOR OTHERS FOR ADVERTISING AND MARKETING PURPOSES, IN CLASS 35 (U.S. CLS. 100, 101 AND 102).

FIRST USE 10-18-2010; IN COMMERCE 10-18-2010.

THE MARK CONSISTS OF STANDARD CHARACTERS WITHOUT CLAIM TO ANY PARTICULAR FONT, STYLE, SIZE, OR COLOR.

SN 85-151,665, FILED 10-13-2010.

JOHN WILKE, EXAMINING ATTORNEY



David J. Kyros

Director of the United States Patent and Trademark Office

United States of America

United States Patent and Trademark Office

VERO ANDINO BY CUNA DE OLIVARES

Reg. No. 4,109,750

Registered Mar. 6, 2012

Int. Cl.: 29

TRADEMARK

PRINCIPAL REGISTER

ALMA CUYANA S.A. (ARGENTINA CORPORATION)
GRAL. M. ACHA SUR 28, PISO 1
SAN JUAN, SAN JUAN, ARGENTINA

FOR: CRYSTALLIZED FRUITS; DRIED VEGETABLES; EDIBLE OILS; FRUIT PRESERVES; GHERKINS; GROUND ALMONDS; OLIVE OIL; PALM OIL FOR FOOD; PREPARED NUTS; PRESERVED SOYA BEANS FOR FOOD; PRESERVED VEGETABLES; PRESERVED, DRIED AND COOKED OLIVES; PROCESSED BEANS; PROCESSED MUSHROOMS; PROCESSED ONIONS; STEWED FRUIT; TAHINI; TINNED VEGETABLES, IN CLASS 29 (U.S. CL. 46).

FIRST USE 9-27-2010; IN COMMERCE 10-19-2011.

THE MARK CONSISTS OF STANDARD CHARACTERS WITHOUT CLAIM TO ANY PARTICULAR FONT, STYLE, SIZE, OR COLOR.

NO CLAIM IS MADE TO THE EXCLUSIVE RIGHT TO USE "ANDINO", APART FROM THE MARK AS SHOWN.

THE NAME(S), PORTRAIT(S), AND/OR SIGNATURE(S) SHOWN IN THE MARK DOES NOT IDENTIFY A PARTICULAR LIVING INDIVIDUAL.

THE ENGLISH TRANSLATION OF "VERO ANDINO BY CUNA DE OLIVARES" IN THE MARK IS TRUE ANDEAN BY CRADLE OF OLIVE GARDEN.

SN 85-152,875, FILED 10-14-2010.

WANDA KAY PRICE, EXAMINING ATTORNEY



David J. Kyros

Director of the United States Patent and Trademark Office

United States of America

United States Patent and Trademark Office

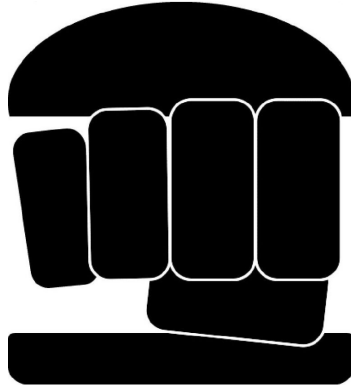

Reg. No. 4,109,751

Registered Mar. 6, 2012

Int. Cl.: 41

SERVICE MARK

PRINCIPAL REGISTER

FIST BURGER LLC (NEW YORK LIMITED LIABILITY COMPANY)
18 EAST SUNRISE HIGHWAY, SUITE 205
FREEPORT, NY 11520

FOR: ON-LINE JOURNALS, NAMELY, BLOGS FEATURING USER COMMENTS, CRITICISMS AND OPINIONS IN THE FIELDS OF CURRENT EVENTS OR PUBLIC OPINION, IN CLASS 41 (U.S. CLS. 100, 101 AND 107).

FIRST USE 9-9-2010; IN COMMERCE 9-9-2010.

THE MARK CONSISTS OF AN IMAGE OF A FIST IN BETWEEN THE TOP AND BOTTOM HALVES OF A HAMBURGER BUN.

SN 85-153,260, FILED 10-14-2010.

CHARLES L. JENKINS, EXAMINING ATTORNEY



David J. Kybas

Director of the United States Patent and Trademark Office

United States of America

United States Patent and Trademark Office

AS SURE AS THE SUN RISES

Reg. No. 4,109,752

Registered Mar. 6, 2012

Int. Cl.: 37

SERVICE MARK

PRINCIPAL REGISTER

HARMON SOLAR (ARIZONA CORPORATION)
STE 112
21410 N. 15TH LANE
PHOENIX, AZ 85027

FOR: BUILDING CONSTRUCTION SERVICES, NAMELY, INSTALLING BOTH RESIDENTIAL AND COMMERCIAL SOLAR PANELS, IN CLASS 37 (U.S. CLS. 100, 103 AND 106).

FIRST USE 6-1-2011; IN COMMERCE 6-1-2011.

THE MARK CONSISTS OF STANDARD CHARACTERS WITHOUT CLAIM TO ANY PARTICULAR FONT, STYLE, SIZE, OR COLOR.

SN 85-153,305, FILED 10-15-2010.

JOHN DALIER, EXAMINING ATTORNEY



David J. Kybas

Director of the United States Patent and Trademark Office

United States of America

United States Patent and Trademark Office

PlayGolfPlanet

Reg. No. 4,109,753

Registered Mar. 6, 2012

Int. Cl.: 41

SERVICE MARK

PRINCIPAL REGISTER

PLAYGOLFPLANET.COM, LLC (FLORIDA LIMITED LIABILITY COMPANY)
310 HEATHERWOOD COURT
WINTER SPRINGS, FL 32708

FOR: PROVIDING AN ONLINE GOLF HANDICAP SERVICE TO PERMIT TRACKING OF MEMBERS HANDICAP; PROVIDING A WEBSITE THROUGH WHICH GOLFERS RESERVE TEE TIMES AT GOLF COURSES; ON-LINE JOURNALS, NAMELY, BLOGS IN THE FIELD OF GOLF; PROVIDING ON-LINE INFORMATION, NAMELY, NEWS ON THE SPORT OF GOLF, IN CLASS 41 (U.S. CLS. 100, 101 AND 107).

FIRST USE 1-5-2011; IN COMMERCE 1-5-2011.

THE MARK CONSISTS OF STANDARD CHARACTERS WITHOUT CLAIM TO ANY PARTICULAR FONT, STYLE, SIZE, OR COLOR.

SN 85-153,634, FILED 10-15-2010.

ANTHONY RINKER, EXAMINING ATTORNEY



David J. Kyffers

Director of the United States Patent and Trademark Office

United States of America

United States Patent and Trademark Office

RESTAURANT STORY

Reg. No. 4,109,754

Registered Mar. 6, 2012

Int. Cl.: 9

TRADEMARK

PRINCIPAL REGISTER

TEAMLAVA, LLC (CALIFORNIA LIMITED LIABILITY COMPANY)
570 AVOCET DRIVE, SUITE 8204
REDWOOD CITY, CA 94065

FOR: COMPUTER SOFTWARE FOR GAMES FOR USE ON WIRELESS DEVICES, COMPUTERS AND PORTABLE AND HANDHELD DIGITAL-ELECTRONIC DEVICES; COMPUTER-GAME PROGRAMS; INTERACTIVE-GAME PROGRAMS, IN CLASS 9 (U.S. CLS. 21, 23, 26, 36 AND 38).

FIRST USE 12-15-2010; IN COMMERCE 12-15-2010.

THE MARK CONSISTS OF STANDARD CHARACTERS WITHOUT CLAIM TO ANY PARTICULAR FONT, STYLE, SIZE, OR COLOR.

SN 85-153,785, FILED 10-15-2010.

MARK SPARACINO, EXAMINING ATTORNEY



David J. Kyffers

Director of the United States Patent and Trademark Office

United States of America

United States Patent and Trademark Office

SAFE AND SECURE

Reg. No. 4,109,755

BRADLEY J. ROUSSEAU (UNITED STATES INDIVIDUAL)
5344 ANDERLIE LANE
WHTIE BEAR LAKE, MN 55110

Registered Mar. 6, 2012

Int. Cl.: 12

FOR: DURABLE MEDICAL EQUIPMENT, NAMELY, WHEELCHAIRS AND WHEELCHAIR LIFTS SOLD AS AN INTEGRAL COMPONENT OF WHEELCHAIRS, IN CLASS 12 (U.S. CLS. 19, 21, 23, 31, 35 AND 44).

TRADEMARK

FIRST USE 12-14-2011; IN COMMERCE 12-14-2011.

PRINCIPAL REGISTER

THE MARK CONSISTS OF STANDARD CHARACTERS WITHOUT CLAIM TO ANY PARTICULAR FONT, STYLE, SIZE, OR COLOR.

SN 85-153,844, FILED 10-15-2010.

MAYUR VAGHANI, EXAMINING ATTORNEY



David J. Kyros

Director of the United States Patent and Trademark Office

United States of America

United States Patent and Trademark Office

JUST4ME

Reg. No. 4,109,756

CLINTON SAVINGS BANK (MASSACHUSETTS CORPORATION)
200 CHURCH STREET
CLINTON, MA 01510

Registered Mar. 6, 2012

Int. Cl.: 36

FOR: DEBIT CARD SERVICES FOR BANKING, IN CLASS 36 (U.S. CLS. 100, 101 AND 102).

SERVICE MARK

FIRST USE 11-30-2010; IN COMMERCE 11-30-2010.

PRINCIPAL REGISTER

THE MARK CONSISTS OF STANDARD CHARACTERS WITHOUT CLAIM TO ANY PARTICULAR FONT, STYLE, SIZE, OR COLOR.

SN 85-154,604, FILED 10-18-2010.

COLLEEN DOMBROW, EXAMINING ATTORNEY



David J. Kybas

Director of the United States Patent and Trademark Office

United States of America

United States Patent and Trademark Office



Reg. No. 4,109,757

Registered Mar. 6, 2012

Int. Cl.: 11

TRADEMARK

PRINCIPAL REGISTER

SAFEWAY WATER SYSTEMS, INC. (FLORIDA CORPORATION)
1735 S. E. 73 PLACE
OCALA, FL 34480

FOR: WATER FILTERS; FILTERS FOR DRINKING WATER; WATER TREATMENT EQUIPMENT, NAMELY, REVERSE OSMOSIS UNITS; STERILIZERS, NOT FOR MEDICAL PURPOSES, NAMELY, UV LIGHT STERILIZERS; WATER CONDITIONING UNITS, IN CLASS 11 (U.S. CLS. 13, 21, 23, 31 AND 34).

FIRST USE 10-18-2010; IN COMMERCE 1-2-2011.

NO CLAIM IS MADE TO THE EXCLUSIVE RIGHT TO USE "WATER", APART FROM THE MARK AS SHOWN.

THE STIPLING SHOWN IN THE DRAWING IS A FEATURE OF THE MARK.

THE MARK CONSISTS OF A LIFE PRESERVER DESIGN THAT SHOWS WATER WAVES IN THE INTERIOR. THE DESIGN IS PRESENTED OVER THE STYLIZED TERM "SAFEWAY", WHICH IS OVER THE STYLIZED TERM "WATER".

SN 85-154,756, FILED 10-18-2010.

TRACY WHITTAKER-BROWN, EXAMINING ATTORNEY



David J. Kyjars

Director of the United States Patent and Trademark Office

United States of America

United States Patent and Trademark Office

FIND YOUR NEXT

Reg. No. 4,109,758

Registered Mar. 6, 2012

Int. Cl.: 41

SERVICE MARK

PRINCIPAL REGISTER

SUMA PARTNERS LLC (TEXAS LIMITED LIABILITY COMPANY)
#842
1302 WAUGH DR.
HOUSTON, TX 77019

FOR: CONDUCTING EDUCATIONAL EXHIBITIONS IN THE NATURE OF CONFERENCES, ELECTRONIC CONFERENCES, WEBINARS, SPECIAL EVENTS, SUMMITS, ROAD SHOWS, BUSINESS SEMINARS IN THE FIELD OF BUSINESS GROWTH THROUGH STRATEGIC ANALYSIS OF MARKET DYNAMICS AND MARKET RESEARCH; PROVIDING ONLINE NON-DOWNLOADABLE VIDEOS AND PODCASTS IN THE FIELD OF BUSINESS GROWTH THROUGH STRATEGIC ANALYSIS OF MARKET DYNAMICS AND MARKET RESEARCH; ARRANGING AND CONDUCTING WORKSHOPS AND SEMINARS IN THE FIELD OF BUSINESS GROWTH THROUGH STRATEGIC ANALYSIS OF MARKET DYNAMICS AND MARKET RESEARCH; EDUCATIONAL SERVICES, NAMELY, CONDUCTING PROGRAMS IN THE FIELD OF BUSINESS GROWTH THROUGH STRATEGIC ANALYSIS OF MARKET DYNAMICS AND MARKET RESEARCH USING ON-LINE ACTIVITIES AND INTERACTIVE EXHIBITS, AND PRINTABLE MATERIALS DISTRIBUTED THEREWITH; TRAINING SERVICES IN THE FIELD OF BUSINESS GROWTH THROUGH STRATEGIC ANALYSIS OF MARKET DYNAMICS AND MARKET RESEARCH, IN CLASS 41 (U.S. CLS. 100, 101 AND 107).

FIRST USE 12-13-2011; IN COMMERCE 12-13-2011.

THE MARK CONSISTS OF STANDARD CHARACTERS WITHOUT CLAIM TO ANY PARTICULAR FONT, STYLE, SIZE, OR COLOR.

SN 85-155,163, FILED 10-18-2010.

APRIL HESIK, EXAMINING ATTORNEY



David J. Kyros

Director of the United States Patent and Trademark Office

United States of America

United States Patent and Trademark Office



**BLACK RIVER
ROASTERS**

Reg. No. 4,109,759

Registered Mar. 6, 2012

Int. Cl.: 30

TRADEMARK

PRINCIPAL REGISTER

AMERICAN ROASTING COMPANY, LLC (VERMONT LIMITED LIABILITY COMPANY)
P.O. BOX 296
64 OLD TURNPIKE ROAD
OLDWICK, NJ 08858

FOR: COFFEE; COFFEE BEANS; COFFEE PODS; COFFEE-BASED BEVERAGES; GROUND COFFEE BEANS; ROASTED COFFEE BEANS, IN CLASS 30 (U.S. CL. 46).

FIRST USE 4-1-2011; IN COMMERCE 4-1-2011.

NO CLAIM IS MADE TO THE EXCLUSIVE RIGHT TO USE "BLACK RIVER ROASTERS", APART FROM THE MARK AS SHOWN.

THE MARK CONSISTS OF A CLUSTER OF GRASS AND CATTAILS IN A RIVER. BENEATH THE GRASS AND CATTAILS IS THE WORDS "BLACK RIVER" IN ALL CAPITAL LETTERS. BENEATH THESE WORDS IS THE WORD "ROASTERS" CAPITALIZED IN A SMALLER FONT THAN THE WORDS "BLACK RIVER".

SN 85-155,315, FILED 10-18-2010.

LINDA LAVACHE, EXAMINING ATTORNEY



David J. Kyffers

Director of the United States Patent and Trademark Office

United States of America

United States Patent and Trademark Office

Totally Unique Cabins

Reg. No. 4,109,760

MILLER, SCOTT (UNITED STATES INDIVIDUAL)
N7486 MEADOW LANE
CRIVITZ, WI 54114

Registered Mar. 6, 2012

Int. Cl.: 40

FOR: CUSTOM FABRICATION OF TIMBER, FOR BUILDING CONSTRUCTION, IN CLASS 40 (U.S. CLS. 100, 103 AND 106).

SERVICE MARK

FIRST USE 11-2-2010; IN COMMERCE 10-29-2011.

PRINCIPAL REGISTER

THE MARK CONSISTS OF STANDARD CHARACTERS WITHOUT CLAIM TO ANY PARTICULAR FONT, STYLE, SIZE, OR COLOR.

NO CLAIM IS MADE TO THE EXCLUSIVE RIGHT TO USE "CABINS", APART FROM THE MARK AS SHOWN.

SN 85-155,488, FILED 10-18-2010.

GRETTA YAO, EXAMINING ATTORNEY



David J. Kybas

Director of the United States Patent and Trademark Office

United States of America

United States Patent and Trademark Office



Reg. No. 4,109,761

Registered Mar. 6, 2012

Int. Cl.: 30

TRADEMARK

PRINCIPAL REGISTER

ZARDAIN, EDUARDO ALVAREZ (MEXICO INDIVIDUAL)
AV. 7 # 1112, COL. CENTRO
VERACRUZ, MEXICO 94500

FOR: COFFEE, NAMELY, ROASTED COFFEE BEANS, ROASTED AND GROUND COFFEE,
SOLUBLE COFFEE, IN CLASS 30 (U.S. CL. 46).

FIRST USE 5-11-2011; IN COMMERCE 5-11-2011.

THE MARK CONSISTS OF AN ANTIQUE MAP OF THE WORLD WITH THE WORDS "IL
MONDO" IN WHITE ON A BROWN, REDDISH AND ORANGE BACKGROUND.

THE COLOR(S) WHITE, BROWN, RED AND ORANGE IS/ARE CLAIMED AS A FEATURE
OF THE MARK.

THE ENGLISH TRANSLATION OF THE WORD "IL MONDO" IN THE MARK IS THE WORLD.

SN 85-156,703, FILED 10-20-2010.

NAAKWAMA ANKRAH, EXAMINING ATTORNEY



David J. Kyros

Director of the United States Patent and Trademark Office

United States of America

United States Patent and Trademark Office

SuperD

Reg. No. 4,109,762

Registered Mar. 6, 2012

Int. Cl.: 42

SERVICE MARK

PRINCIPAL REGISTER

SHENZHEN SUPER PERFECT OPTICS LIMITED (CHINA CORPORATION)
HUA QIAO CHENG, NANSHAN DIST.
101. BLOCK EAST H1, E. INDUSTRIAL ESTATE
SHENZHEN, GUANGDONG, CHINA

FOR: UPDATING OF COMPUTER SOFTWARE FOR OTHERS, IN CLASS 42 (U.S. CLS. 100 AND 101).

FIRST USE 10-20-2010; IN COMMERCE 10-12-2011.

THE MARK CONSISTS OF THE STYLIZED WORDING "SUPER" IN THE COLOR BLACK AND A STYLIZED LETTER "D", WHERE THE LEFT UPRIGHT PORTION OF THE MARK IS IN THE COLOR BLUE, THE TOP RIGHT ARC OF THE LETTER IS IN THE COLOR PURPLE, AND THE BOTTOM RIGHT PORTION IS IN THE COLOR GRAY.

THE COLOR(S) BLACK, BLUE, PURPLE AND GRAY IS/ARE CLAIMED AS A FEATURE OF THE MARK.

SN 85-157,362, FILED 10-20-2010.

JAY BESCH, EXAMINING ATTORNEY



David J. Kyros

Director of the United States Patent and Trademark Office

United States of America

United States Patent and Trademark Office



Reg. No. 4,109,763

INNOVAIR CORPORATION (FLORIDA CORPORATION)
11490 N.W. 39 STREET, SUITE 102
MIAMI, FL 33178

Registered Mar. 6, 2012

Int. Cl.: 11

FOR: AIR CONDITIONERS AND STRUCTURAL PARTS THEREFOR, IN CLASS 11 (U.S. CLS. 13, 21, 23, 31 AND 34).

TRADEMARK

FIRST USE 5-20-2009; IN COMMERCE 5-26-2009.

PRINCIPAL REGISTER

NO CLAIM IS MADE TO THE EXCLUSIVE RIGHT TO USE "ECO FRIENDLY", APART FROM THE MARK AS SHOWN.

THE MARK CONSISTS OF THE DESIGN OF A LEAF ENCIRCLED BY TWO ARROWS WITH THE STYLIZED WORD "ECO" IN LARGE FONT TO THE RIGHT FOLLOWED BY THE WORD "FRIENDLY" AND THE WORDING "BE FRIENDLY." "BE GREEN." UNDERNEATH IN SMALLER LETTERING.

SN 85-157,917, FILED 10-22-2010.

JEFFREY LOOK, EXAMINING ATTORNEY



David J. Kyffers

Director of the United States Patent and Trademark Office

United States of America

United States Patent and Trademark Office

ASHLEY-ROSE

Reg. No. 4,109,764

Registered Mar. 6, 2012

Int. Cl.: 28

TRADEMARK

PRINCIPAL REGISTER

BATTAT INCORPORATED (DELAWARE CORPORATION)
1560 MILITARY TURNPIKE
PLATTSBURGH, NY 12901

FOR: DOLLS AND ACCESSORIES THEREFOR, IN CLASS 28 (U.S. CLS. 22, 23, 38 AND 50).

FIRST USE 7-31-2011; IN COMMERCE 7-31-2011.

THE MARK CONSISTS OF STANDARD CHARACTERS WITHOUT CLAIM TO ANY PARTICULAR FONT, STYLE, SIZE, OR COLOR.

SN 85-158,149, FILED 10-21-2010.

ANTHONY RINKER, EXAMINING ATTORNEY



David J. Kybas

Director of the United States Patent and Trademark Office

United States of America

United States Patent and Trademark Office

EVELYN

Reg. No. 4,109,765

Registered Mar. 6, 2012

Int. Cl.: 28

TRADEMARK

PRINCIPAL REGISTER

BATTAT INCORPORATED (DELAWARE CORPORATION)
1560 MILITARY TURNPIKE
PLATTSBURGH, NY 12901

FOR: DOLLS AND ACCESSORIES THEREFOR, IN CLASS 28 (U.S. CLS. 22, 23, 38 AND 50).

FIRST USE 7-31-2011; IN COMMERCE 7-31-2011.

THE MARK CONSISTS OF STANDARD CHARACTERS WITHOUT CLAIM TO ANY PARTICULAR FONT, STYLE, SIZE, OR COLOR.

SN 85-158,207, FILED 10-21-2010.

ANTHONY RINKER, EXAMINING ATTORNEY



David J. Kyffers

Director of the United States Patent and Trademark Office

United States of America

United States Patent and Trademark Office

HOME TUNE-UP

Reg. No. 4,109,766

Registered Mar. 6, 2012

Int. Cls.: 9, 35, and 37

TRADEMARK

SERVICE MARK

PRINCIPAL REGISTER

CMC ENERGY SERVICES, INC. (MARYLAND CORPORATION)
7010 GLENBROOK ROAD
BETHESDA, MD 20814

FOR: COMPUTER SOFTWARE USED TO COLLECT DATA FOR EXISTING HOMES IN ORDER TO IDENTIFY THE GROUP OF IMPROVEMENTS THAT COST LESS ON A YEARLY BASIS WHEN FINANCED THAN THE RESULTING SAVINGS ON ENERGY BILLS; COMPUTER SOFTWARE USED TO ANALYZE DATA TO DETERMINE SAVINGS AND COSTS FOR THE GROUP OF IMPROVEMENTS BASED ON A WHOLE HOUSE CALCULATION WHICH TAKES INTO ACCOUNT THE INTERRELATIONSHIP OF ALL FEATURES TO BE IMPROVED; COMPUTER SOFTWARE USED TO REPORT THE ESTIMATED SAVINGS, COSTS AND PAYBACK FOR THE IMPROVEMENTS THAT ARE NOT ELIGIBLE TO BE INCLUDED IN THE AFOREMENTIONED GROUP; COMPUTER SOFTWARE USED TO PRINT A DETAILED REPORT EXPLAINING EACH RECOMMENDATION AND OTHER INFORMATION FOR OBTAINING QUALIFIED CONTRACTORS AND LONG-TERM LOW INTEREST FINANCING, IN CLASS 9 (U.S. CLS. 21, 23, 26, 36 AND 38).

FIRST USE 5-15-2007; IN COMMERCE 5-15-2007.

FOR: ENERGY AUDITING, IN CLASS 35 (U.S. CLS. 100, 101 AND 102).

FIRST USE 1-16-2010; IN COMMERCE 1-16-2010.

FOR: INSTALLATION OF WEATHERIZATION, LIGHTING, SEALANT, THERMOSTATS, METERING, AND CONTROLS TO ENHANCE ENERGY EFFICIENCY, IN CLASS 37 (U.S. CLS. 100, 103 AND 106).

FIRST USE 1-1-2011; IN COMMERCE 1-1-2011.

THE MARK CONSISTS OF STANDARD CHARACTERS WITHOUT CLAIM TO ANY PARTICULAR FONT, STYLE, SIZE, OR COLOR.

OWNER OF U.S. REG. NO. 2,858,629.

NO CLAIM IS MADE TO THE EXCLUSIVE RIGHT TO USE "HOME", APART FROM THE MARK AS SHOWN.



David J. Kybas

Director of the United States Patent and Trademark Office

Reg. No. 4,109,766 SN 85-158,721, FILED 10-22-2010.

CHRISTINE MARTIN, EXAMINING ATTORNEY

United States of America

United States Patent and Trademark Office

INFINITY BLADE

Reg. No. 4,109,767

EPIC GAMES, INC. (MARYLAND CORPORATION)
620 CROSSROADS BOULEVARD
CARY, NC 27518

Registered Mar. 6, 2012

Int. Cl.: 9

FOR: DOWNLOADABLE COMPUTER GAME APPLICATION SOFTWARE FOR MULTIMEDIA SMART PHONES, WIRELESS MOBILE DEVICES, AND PORTABLE MEDIA PLAYERS, IN CLASS 9 (U.S. CLS. 21, 23, 26, 36 AND 38).

TRADEMARK

FIRST USE 12-8-2010; IN COMMERCE 12-8-2010.

PRINCIPAL REGISTER

THE MARK CONSISTS OF STANDARD CHARACTERS WITHOUT CLAIM TO ANY PARTICULAR FONT, STYLE, SIZE, OR COLOR.

SN 85-159,083, FILED 10-22-2010.

ROBIN MITTLER, EXAMINING ATTORNEY



David J. Kybas

Director of the United States Patent and Trademark Office

United States of America

United States Patent and Trademark Office

INFINITY BLADE

Reg. No. 4,109,768

EPIC GAMES, INC. (MARYLAND CORPORATION)
620 CROSSROADS BOULEVARD
CARY, NC 27518

Registered Mar. 6, 2012

Int. Cl.: 25

FOR: CLOTHING, NAMELY, T-SHIRTS, IN CLASS 25 (U.S. CLS. 22 AND 39).

TRADEMARK

FIRST USE 8-1-2011; IN COMMERCE 8-1-2011.

PRINCIPAL REGISTER

THE MARK CONSISTS OF STANDARD CHARACTERS WITHOUT CLAIM TO ANY PARTICULAR FONT, STYLE, SIZE, OR COLOR.

SN 85-159,112, FILED 10-22-2010.

ROBIN MITTLER, EXAMINING ATTORNEY



David J. Kyffers

Director of the United States Patent and Trademark Office

United States of America

United States Patent and Trademark Office

SERVICED APARTMENTS MADE EASY

Reg. No. 4,109,769

BRIDGESTREET TM, LLC (DELAWARE LIMITED LIABILITY COMPANY)
485 SPRING PARK PLACE, SUITE 200
HERNDON, VA 20170

Registered Mar. 6, 2012

Int. Cl.: 43

FOR: PROVIDING FURNISHED TEMPORARY HOUSING AND ACCOMMODATIONS TO THE GENERAL PUBLIC AS AN ALTERNATIVE TO HOTEL AND/OR MOTEL ACCOMMODATIONS, IN CLASS 43 (U.S. CLS. 100 AND 101).

SERVICE MARK

FIRST USE 7-0-2011; IN COMMERCE 7-0-2011.

PRINCIPAL REGISTER

THE MARK CONSISTS OF STANDARD CHARACTERS WITHOUT CLAIM TO ANY PARTICULAR FONT, STYLE, SIZE, OR COLOR.

NO CLAIM IS MADE TO THE EXCLUSIVE RIGHT TO USE "SERVICED APARTMENTS", APART FROM THE MARK AS SHOWN.

SN 85-159,333, FILED 10-22-2010.

RAUL CORDOVA, EXAMINING ATTORNEY



David J. Kyros

Director of the United States Patent and Trademark Office

United States of America

United States Patent and Trademark Office

PSYCHEPOLITICS

Reg. No. 4,109,770

ASSOCIATES CONSULTING CORP. (MASSACHUSETTS CORPORATION)
18 HOBBS BROOK ROAD
WESTON, MA 02493

Registered Mar. 6, 2012

Int. Cls.: 35 and 41

FOR: PROVIDING A WEBSITE FEATURING INFORMATION IN THE FIELD OF POLITICS,
IN CLASS 35 (U.S. CLS. 100, 101 AND 102).

SERVICE MARK

FIRST USE 4-15-2010; IN COMMERCE 4-15-2010.

PRINCIPAL REGISTER

FOR: ENTERTAINMENT AND EDUCATIONAL SERVICES, NAMELY, PROVIDING A
WEBSITE FEATURING INFORMATION ABOUT CURRENT EVENT NEWS, IN CLASS 41
(U.S. CLS. 100, 101 AND 107).

FIRST USE 4-15-2010; IN COMMERCE 4-15-2010.

THE MARK CONSISTS OF STANDARD CHARACTERS WITHOUT CLAIM TO ANY PAR-
TICULAR FONT, STYLE, SIZE, OR COLOR.

SN 85-159,408, FILED 10-22-2010.

COURTNEY ALVAREZ, EXAMINING ATTORNEY



David J. Kybas

Director of the United States Patent and Trademark Office

United States of America
United States Patent and Trademark Office

sportsmedx

Reg. No. 4,109,771

NOBLE, JAMIE (UNITED STATES INDIVIDUAL)
303 POTRERO STREET #62
SANTA CRUZ, CA 95060

Registered Mar. 6, 2012

Int. Cl.: 41

FOR: PERSONAL FITNESS TRAINING SERVICES AND CONSULTANCY, IN CLASS 41
(U.S. CLS. 100, 101 AND 107).

SERVICE MARK

FIRST USE 6-22-2010; IN COMMERCE 6-22-2010.

PRINCIPAL REGISTER

THE MARK CONSISTS OF STANDARD CHARACTERS WITHOUT CLAIM TO ANY PARTICULAR FONT, STYLE, SIZE, OR COLOR.

SN 85-159,905, FILED 10-25-2010.

PAM WILLIS, EXAMINING ATTORNEY



David J. Kybas

Director of the United States Patent and Trademark Office

United States of America

United States Patent and Trademark Office



Reg. No. 4,109,772

EQUINOX HOLDINGS, INC. (DELAWARE CORPORATION)
895 BROADWAY, 3RD FLOOR
NEW YORK, NY 10003

Registered Mar. 6, 2012

Int. Cl.: 25

FOR: CLOTHING, NAMELY, PANTS, SHORTS, TOPS, T-SHIRTS, TANK TOPS, SWEAT-SHIRTS, SWEATERS, JACKETS AND HATS, IN CLASS 25 (U.S. CLS. 22 AND 39).

TRADEMARK

FIRST USE 2-28-2011; IN COMMERCE 2-28-2011.

PRINCIPAL REGISTER

OWNER OF U.S. REG. NOS. 3,377,795 AND 3,542,542.

THE COLOR(S) ORANGE IS/ARE CLAIMED AS A FEATURE OF THE MARK.

THE MARK CONSISTS OF TWO NON-CONNECTING HALF CIRCLES OF THE COLOR ORANGE FORMING THE LETTER "O".

SN 85-160,231, FILED 10-25-2010.

KIM SAITO, EXAMINING ATTORNEY



David J. Kybas

Director of the United States Patent and Trademark Office

United States of America

United States Patent and Trademark Office

SHINTO

Reg. No. 4,109,773

Registered Mar. 6, 2012

Int. Cl.: 20

TRADEMARK

PRINCIPAL REGISTER

JANUS ET CIE (CALIFORNIA CORPORATION)
8687 MELROSE AVENUE
WEST HOLLYWOOD, CA 90069

FOR: INDOOR AND OUTDOOR FURNITURE, NAMELY, ARMCHAIRS, ARMOIRES, BENCHES, BOOK STANDS, BOOKCASES, CABINETS, PLANT STANDS, HAND OPERATED NON-METAL GARDEN HOSE REELS, HOSE HANGERS NOT OF METAL, CHAIRS, ROCKING CHAIRS, CHAISE LOUNGES, SETTEES, BEDROOM FURNITURE, CHESTS OF DRAWERS, LOVE SEATS, COUCHES, CREDENZAS, PLASTIC TUBS, CUSHIONS, DESKS, DINING ROOM TABLES, COFFEE TABLES, CONSOLES, END TABLES, CAFE TABLES, SOFA TABLES, PEDESTAL TABLES, EXTENSION TABLES, OFFICE FURNITURE, CHILDREN'S FURNITURE, OTTOMANS, DRESSERS, WALL UNITS, SEATS, SOFAS AND STOOLS, IN CLASS 20 (U.S. CLS. 2, 13, 22, 25, 32 AND 50).

FIRST USE 1-0-2007; IN COMMERCE 1-0-2007.

THE MARK CONSISTS OF STANDARD CHARACTERS WITHOUT CLAIM TO ANY PARTICULAR FONT, STYLE, SIZE, OR COLOR.

SN 85-160,258, FILED 10-25-2010.

ANTHONY RINKER, EXAMINING ATTORNEY



David J. Kybas

Director of the United States Patent and Trademark Office

United States of America

United States Patent and Trademark Office

Spitter Spatter

Reg. No. 4,109,774

SPITTER SPATTER, INC (NORTH CAROLINA CORPORATION)
2643 ASHER VIEW COURT
RALEIGH, NC 27606

Registered Mar. 6, 2012

Int. Cl.: 25

FOR: CHILDREN'S AND INFANT'S APPAREL, NAMELY, JUMPERS, OVERALL SLEEPWEAR, PAJAMAS, ROMPERS AND ONE-PIECE GARMENTS, IN CLASS 25 (U.S. CLS. 22 AND 39).

TRADEMARK

FIRST USE 7-28-2008; IN COMMERCE 9-14-2010.

PRINCIPAL REGISTER

THE MARK CONSISTS OF STANDARD CHARACTERS WITHOUT CLAIM TO ANY PARTICULAR FONT, STYLE, SIZE, OR COLOR.

SN 85-160,861, FILED 10-25-2010.

BRIDGETT SMITH, EXAMINING ATTORNEY



David J. Kyros

Director of the United States Patent and Trademark Office

United States of America

United States Patent and Trademark Office

THE UNTOUCHABLES SERIES

Reg. No. 4,109,775

Registered Mar. 6, 2012

Int. Cl.: 28

WILDGAME INNOVATIONS, LLC (LOUISIANA LIMITED LIABILITY COMPANY)
1ST FLOOR
101 CASON ROAD
BROUSSARD, LA 70518

FOR: HUNTING GAME CALLS, IN CLASS 28 (U.S. CLS. 22, 23, 38 AND 50).

TRADEMARK

FIRST USE 12-9-2010; IN COMMERCE 12-9-2010.

PRINCIPAL REGISTER

THE MARK CONSISTS OF STANDARD CHARACTERS WITHOUT CLAIM TO ANY PARTICULAR FONT, STYLE, SIZE, OR COLOR.

NO CLAIM IS MADE TO THE EXCLUSIVE RIGHT TO USE "SERIES", APART FROM THE MARK AS SHOWN.

SN 85-161,444, FILED 10-26-2010.

COURTNEY ALVAREZ, EXAMINING ATTORNEY



David J. Kyffers

Director of the United States Patent and Trademark Office

United States of America

United States Patent and Trademark Office

The logo for Telecomtrak features the word "telecomtrak" in a lowercase, sans-serif font. A horizontal line passes through the center of the letters. At the left end of this line is a semi-circle, and at the right end is a full circle. Below the word, a faint, mirrored reflection of the word and its graphical elements is visible.

Reg. No. 4,109,776

JAGUAR TECHNOLOGIES, INC. (FLORIDA CORPORATION)
P.O. BOX 887
ORANGE PARK, FL 32067

Registered Mar. 6, 2012

Int. Cl.: 42

FOR: PROVIDING ON-LINE NON-DOWNLOADABLE SOFTWARE FOR MANAGEMENT AND ADMINISTRATION OF, AND TRAINING FOR, PERFORMANCE OF CABLE INSTALLATION SERVICES, AND MANAGEMENT OF ASSOCIATED PERSONNEL, IN CLASS 42 (U.S. CLS. 100 AND 101).

SERVICE MARK

PRINCIPAL REGISTER

FIRST USE 12-1-2011; IN COMMERCE 12-1-2011.

THE MARK CONSISTS OF THE WORD "TELECOMTRAK" WITH A MODIFIED ARROW THROUGH THE CENTER. THE LEFT END OF THE ARROW IS A HALF CIRCLE, AND THE RIGHT END OF THE ARROW IS A CIRCLE. A MIRRORED IMAGE OF THE BOTTOM HALF OF "TELECOMTRAK" APPEARS BELOW THE WORD.

SN 85-162,612, FILED 10-27-2010.

SUSAN RICHARDS, EXAMINING ATTORNEY



David J. Kybas

Director of the United States Patent and Trademark Office

United States of America

United States Patent and Trademark Office

TRUSTFILE

Reg. No. 4,109,777

AVALARA, INC. (WASHINGTON CORPORATION)
100 RAVINE LANE NE, SUITE 220
BAINBRIDGE ISLAND, WA 98110

Registered Mar. 6, 2012

Int. Cls.: 9 and 35

FOR: COMPUTER SOFTWARE, NAMELY, DATABASE SOFTWARE, SPREADSHEET SOFTWARE, SOFTWARE FOR USE IN ASSISTING IN TAX COLLECTION AND REPORTING TAX INFORMATION AND TAXABLE EVENTS, IN CLASS 9 (U.S. CLS. 21, 23, 26, 36 AND 38).

TRADEMARK

SERVICE MARK

FIRST USE 11-11-2003; IN COMMERCE 11-11-2003.

PRINCIPAL REGISTER

FOR: ONLINE SERVICES, NAMELY, TAX CONSULTATION IN THE NATURE OF PROVIDING INFORMATION RELATING TO TAX COLLECTION AND REPORTING REQUIREMENTS, IN CLASS 35 (U.S. CLS. 100, 101 AND 102).

FIRST USE 11-11-2003; IN COMMERCE 11-11-2003.

THE MARK CONSISTS OF STANDARD CHARACTERS WITHOUT CLAIM TO ANY PARTICULAR FONT, STYLE, SIZE, OR COLOR.

OWNER OF U.S. REG. NO. 2,903,954.

SN 85-163,051, FILED 10-27-2010.

DEIRDRE ROBERTSON, EXAMINING ATTORNEY



David J. Kyjars

Director of the United States Patent and Trademark Office

United States of America

United States Patent and Trademark Office

PINK BLUSH

Reg. No. 4,109,778

OREGON CHERRY GROWERS, INC. (OREGON COOPERATIVE CORPORATION)
POST OFFICE BOX 7357
SALEM, OR 97301

Registered Mar. 6, 2012

Int. Cl.: 29

FOR: PROCESSED CHERRIES, IN CLASS 29 (U.S. CL. 46).

TRADEMARK

FIRST USE 5-17-2011; IN COMMERCE 7-22-2011.

PRINCIPAL REGISTER

THE MARK CONSISTS OF STANDARD CHARACTERS WITHOUT CLAIM TO ANY PARTICULAR FONT, STYLE, SIZE, OR COLOR.

NO CLAIM IS MADE TO THE EXCLUSIVE RIGHT TO USE "PINK", APART FROM THE MARK AS SHOWN.

SN 85-163,710, FILED 10-28-2010.

ROSELLE HERRERA, EXAMINING ATTORNEY



David J. Kyffers

Director of the United States Patent and Trademark Office

United States of America

United States Patent and Trademark Office

CHOOSE BETTER

Reg. No. 4,109,779

Registered Mar. 6, 2012

Int. Cls.: 29 and 30

TRADEMARK

PRINCIPAL REGISTER

MICHAEL FOODS OF DELAWARE, INC. (DELAWARE CORPORATION)
SUITE 400
301 CARLSON PARKWAY
MINNETONKA, MN 55305

FOR: BUTTER, CHEESE; PROCESSED POTATOES, EGGS, LIQUID EGGS, EGG SUBSTITUTES, IN CLASS 29 (U.S. CL. 46).

FIRST USE 5-30-2011; IN COMMERCE 5-30-2011.

FOR: BAGELS; ENGLISH MUFFINS, IN CLASS 30 (U.S. CL. 46).

FIRST USE 11-14-2011; IN COMMERCE 11-14-2011.

THE MARK CONSISTS OF STANDARD CHARACTERS WITHOUT CLAIM TO ANY PARTICULAR FONT, STYLE, SIZE, OR COLOR.

SN 85-166,036, FILED 11-1-2010.

JANICE KIM, EXAMINING ATTORNEY



David J. Kyros

Director of the United States Patent and Trademark Office

United States of America

United States Patent and Trademark Office

Expect Amazing

Reg. No. 4,109,780

Registered Mar. 6, 2012

Int. Cl.: 14

TRADEMARK

PRINCIPAL REGISTER

A. JAFFE, INC. (NEW YORK CORPORATION)
154 WEST 14TH STREET
NEW YORK, NY 10011

FOR: JEWELRY, IN CLASS 14 (U.S. CLS. 2, 27, 28 AND 50).

FIRST USE 11-21-2011; IN COMMERCE 11-21-2011.

THE MARK CONSISTS OF STANDARD CHARACTERS WITHOUT CLAIM TO ANY PARTICULAR FONT, STYLE, SIZE, OR COLOR.

SN 85-166,039, FILED 11-1-2010.

RICHARD WHITE, EXAMINING ATTORNEY



David J. Kyffers

Director of the United States Patent and Trademark Office

United States of America

United States Patent and Trademark Office

SHELF KICKER

Reg. No. 4,109,781

Registered Mar. 6, 2012

Int. Cls.: 35 and 41

SERVICE MARK

PRINCIPAL REGISTER

HARTUNGKEMP, INC. (MINNESOTA CORPORATION)
1128 HARMON PLACE
SUITE 200
MINNEAPOLIS, MN 55403

FOR: PROVIDING CONSULTING SERVICES TO BUSINESSES IN CONNECTION WITH THEIR PRODUCT BRANDING, MARKETING AND ADVERTISING, IN CLASS 35 (U.S. CLS. 100, 101 AND 102).

FIRST USE 10-0-2011; IN COMMERCE 10-0-2011.

FOR: PROVIDING SEMINARS, SPEAKING ENGAGEMENTS AND WORK SHOPS TO BUSINESSES IN THE FIELD OF PRODUCT BRANDING, MARKETING AND ADVERTISING, IN CLASS 41 (U.S. CLS. 100, 101 AND 107).

FIRST USE 11-0-2011; IN COMMERCE 11-0-2011.

THE MARK CONSISTS OF STANDARD CHARACTERS WITHOUT CLAIM TO ANY PARTICULAR FONT, STYLE, SIZE, OR COLOR.

SN 85-166,240, FILED 11-1-2010.

TASNEEM HUSSAIN, EXAMINING ATTORNEY



David J. Kyros

Director of the United States Patent and Trademark Office

United States of America

United States Patent and Trademark Office

Think Soft

Reg. No. 4,109,782

MATRIGEN LLC (CALIFORNIA LIMITED LIABILITY COMPANY)
#201-343
BREA, CA 92821

Registered Mar. 6, 2012

Int. Cl.: 9

FOR: PLATES, GLASS SLIDES OR CHIPS HAVING MULTI-WELL ARRAYS THAT CAN BE USED IN CHEMICAL ANALYSIS, BIOLOGICAL ANALYSIS OR PATTERNING FOR SCIENTIFIC, LABORATORY OR MEDICAL RESEARCH USE, IN CLASS 9 (U.S. CLS. 21, 23, 26, 36 AND 38).

TRADEMARK

PRINCIPAL REGISTER

FIRST USE 4-9-2010; IN COMMERCE 10-4-2011.

THE MARK CONSISTS OF STANDARD CHARACTERS WITHOUT CLAIM TO ANY PARTICULAR FONT, STYLE, SIZE, OR COLOR.

SN 85-166,256, FILED 11-1-2010.

ALLISON HOLTZ, EXAMINING ATTORNEY



David J. Kybas

Director of the United States Patent and Trademark Office

United States of America

United States Patent and Trademark Office

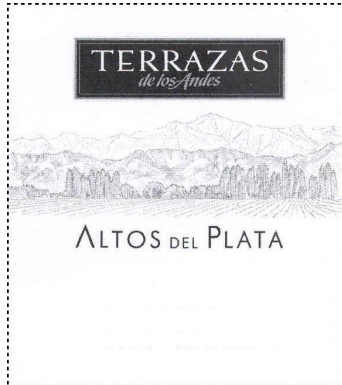

Reg. No. 4,109,783

Registered Mar. 6, 2012

Int. Cl.: 33

TRADEMARK

PRINCIPAL REGISTER

BODEGAS CHANDON S.A. (ARGENTINA CORPORATION)
AVENIDA PASEO COLON 746
2ND FLOOR
BUENOS AIRES, ARGENTINA C1063 ACU

FOR: ALCOHOLIC BEVERAGES EXCEPT BEERS, IN CLASS 33 (U.S. CLS. 47 AND 49).

FIRST USE 10-18-2010; IN COMMERCE 8-0-2011.

OWNER OF U.S. REG. NOS. 2,646,157 AND 2,646,158.

NO CLAIM IS MADE TO THE EXCLUSIVE RIGHT TO USE "LOS ANDES", APART FROM THE MARK AS SHOWN.

THE GRAY TONES ARE FOR SHADING PURPOSES ONLY.

THE MARK CONSISTS OF A LABEL DESIGN. AT THE TOP OF THE LABEL IS A SHADED RECTANGLE CONTAINING AN INTERIOR BORDER AND FEATURING THE STYLIZED WORDS "TERRAZAS DE LOS ANDES". UNDERNEATH THE SHADED RECTANGLE IS A MOUNTAIN RANGE WITH TREES AND A FIELD AT THE FOOT OF THE MOUNTAINS. THE STYLIZED WORDS "ALTOS DEL PLATA" APPEAR UNDERNEATH THE MOUNTAIN RANGE. ALL OF THESE ELEMENTS APPEAR ON A RECTANGULAR BACKGROUND. THE DOTTED LINES INDICATE THE BOUNDARIES OF THE RECTANGULAR BACKGROUND OF THE MARK.

THE ENGLISH TRANSLATION OF "ALTOS DEL PLATA" AND "TERRAZAS DE LOS ANDES" IN THE MARK IS "SILVER HEIGHTS" AND "TERRACES OF THE ANDES" RESPECTIVELY.

SN 85-166,491, FILED 11-1-2010.

JULIE WATSON, EXAMINING ATTORNEY



David J. Kyros

Director of the United States Patent and Trademark Office

United States of America

United States Patent and Trademark Office

OLE SMOKY

Reg. No. 4,109,784

OLE SMOKY DISTILLERY, LLC (TENNESSEE LIMITED LIABILITY COMPANY)
236 E. MAIN ST. #136
SEVIERVILLE, TN 37862

Registered Mar. 6, 2012

Int. Cl.: 34

FOR: CIGARETTE LIGHTERS; CIGAR LIGHTERS, IN CLASS 34 (U.S. CLS. 2, 8, 9 AND 17).

TRADEMARK

FIRST USE 6-30-2010; IN COMMERCE 6-30-2010.

PRINCIPAL REGISTER

THE MARK CONSISTS OF STANDARD CHARACTERS WITHOUT CLAIM TO ANY PARTICULAR FONT, STYLE, SIZE, OR COLOR.

OWNER OF U.S. REG. NO. 3,895,189.

SN 85-166,544, FILED 11-1-2010.

THOMAS MANOR, EXAMINING ATTORNEY



David J. Kyffers

Director of the United States Patent and Trademark Office

United States of America

United States Patent and Trademark Office



Reg. No. 4,109,785

Registered Mar. 6, 2012

Int. Cls.: 18 and 25

TRADEMARK

PRINCIPAL REGISTER

B POSITIVEWARE LLC (NEW YORK LIMITED LIABILITY COMPANY)
103 SISSON RD.
SOUTH GLENS FALLS, NY 12803

FOR: ATHLETIC BAGS; GYM BAGS; HIKING BAGS, IN CLASS 18 (U.S. CLS. 1, 2, 3, 22 AND 41).

FIRST USE 1-1-2011; IN COMMERCE 1-1-2011.

FOR: ATHLETIC APPAREL, NAMELY, SHIRTS, PANTS, JACKETS, FOOTWEAR, HATS AND CAPS, ATHLETIC UNIFORMS; ATHLETIC SHOES, IN CLASS 25 (U.S. CLS. 22 AND 39).

FIRST USE 7-1-2011; IN COMMERCE 7-1-2011.

OWNER OF U.S. REG. NO. 3,773,244.

THE COLOR(S) BLACK, LIGHT RED AND DARK RED IS/ARE CLAIMED AS A FEATURE OF THE MARK.

THE MARK CONSISTS OF A BLACK OVAL SURROUNDING A LOWER CASE LETTER "B" WHICH IS LIGHT RED AT THE TOP AND DARK RED AT THE BOTTOM. INSIDE OF THE LETTER "B" IS A BLACK PLUS SIGN. THE COLOR WHITE REPRESENTS BACKGROUND, SHADING AND TRANSPARENT AREAS AND IS NOT PART OF THE MARK.

SN 85-166,947, FILED 11-2-2010.

WENDY GOODMAN, EXAMINING ATTORNEY



David J. Kybas

Director of the United States Patent and Trademark Office

United States of America

United States Patent and Trademark Office

HOME PLACE

Reg. No. 4,109,786

Registered Mar. 6, 2012

Int. Cl.: 43

SERVICE MARK

PRINCIPAL REGISTER

GOVINDA CORPORATION (GEORGIA CORPORATION)
246 HWY 49 NORTH
BYRON, GA 31008

FOR: AGENCY SERVICES FOR THE RESERVATION OF TEMPORARY ACCOMMODATION;
HOTEL AND MOTEL SERVICES; PROVIDING CONFERENCE ROOMS; RENTAL OF ROOMS
AS TEMPORARY LIVING ACCOMMODATIONS; RENTAL OF ROOMS FOR SOCIAL
FUNCTIONS, IN CLASS 43 (U.S. CLS. 100 AND 101).

FIRST USE 8-1-2011; IN COMMERCE 8-1-2011.

THE MARK CONSISTS OF STANDARD CHARACTERS WITHOUT CLAIM TO ANY PAR-
TICULAR FONT, STYLE, SIZE, OR COLOR.

NO CLAIM IS MADE TO THE EXCLUSIVE RIGHT TO USE "HOME", APART FROM THE
MARK AS SHOWN.

SN 85-167,186, FILED 11-2-2010.

MARK RADEMACHER, EXAMINING ATTORNEY



David J. Kyfos

Director of the United States Patent and Trademark Office

United States of America

United States Patent and Trademark Office

AC3

Reg. No. 4,109,787

Registered Mar. 6, 2012

Int. Cls.: 41 and 42

SERVICE MARK

PRINCIPAL REGISTER

CORE EDUCATION AND CONSULTING SOLUTIONS, INC. (TENNESSEE CORPORATION)
3 RAVINIA DRIVE
STE. 1900
ATLANTA, GA 30346

FOR: EDUCATIONAL ASSESSMENT; CONSULTING SERVICES IN THE FIELD OF EDUCATION ASSESSMENT AND PLANNING; EDUCATIONAL TESTING EVALUATION, IN CLASS 41 (U.S. CLS. 100, 101 AND 107).

FIRST USE 9-1-2010; IN COMMERCE 9-1-2010.

FOR: PROVIDING A WEBSITE FEATURING RESOURCES, NAMELY, A WEBSITE FEATURING PRIMARILY NON-DOWNLOADABLE SOFTWARE FOR ADMINISTERING, COLLECTING AND REVIEWING EDUCATIONAL TESTS AND EDUCATIONAL TEST DATA; PROVIDING A WEBSITE FEATURING RESOURCES, NAMELY, A WEBSITE FEATURING PRIMARILY NON-DOWNLOADABLE SOFTWARE FOR USE IN ANALYZING AND INTERPRETING STUDENT FORMATIVE ASSESSMENT TESTING DATA CONSULTING SERVICES, NAMELY, DESIGN, DEVELOPMENT AND ANALYSIS OF TESTS FOR TESTING STUDENTS; PROVIDING A WEBSITE FEATURING RESOURCES, NAMELY, A WEBSITE FEATURING PRIMARILY NON-DOWNLOADABLE SOFTWARE FOR DESIGNING FORMATIVE EDUCATIONAL ASSESSMENT PROCEDURES, IN CLASS 42 (U.S. CLS. 100 AND 101).

FIRST USE 9-1-2010; IN COMMERCE 9-1-2010.

THE MARK CONSISTS OF STANDARD CHARACTERS WITHOUT CLAIM TO ANY PARTICULAR FONT, STYLE, SIZE, OR COLOR.

SN 85-167,298, FILED 11-2-2010.

RONALD AIKENS, EXAMINING ATTORNEY



David J. Kyros

Director of the United States Patent and Trademark Office

United States of America

United States Patent and Trademark Office



Reg. No. 4,109,788

Registered Mar. 6, 2012

Int. Cl.: 7

TRADEMARK

PRINCIPAL REGISTER

SHS AUTO PARTS, INC. (NEW YORK CORPORATION)
41-27 37TH ST
LONG ISLAND CITY, NY 11101

FOR: AIR FILTERS FOR VEHICLE MOTORS AND ENGINES; FUEL FILTERS; OIL FILTERS;
WATER PUMPS FOR LAND VEHICLES, IN CLASS 7 (U.S. CLS. 13, 19, 21, 23, 31, 34 AND
35).

FIRST USE 3-0-2011; IN COMMERCE 3-0-2011.

THE MARK CONSISTS OF THE WORDING "SHS" IN WHITE ON A BLUE RECTANGULAR
BACKGROUND.

THE COLOR(S) BLUE AND WHITE IS/ARE CLAIMED AS A FEATURE OF THE MARK.

SN 85-167,678, FILED 11-3-2010.

BRIAN NEVILLE, EXAMINING ATTORNEY



David J. Kyffers

Director of the United States Patent and Trademark Office

United States of America
United States Patent and Trademark Office

local\$teals

Reg. No. 4,109,789

NEW COW KINGDOM, LLC (TEXAS LIMITED LIABILITY COMPANY)
1150 N LOOP 1604 W STE 108-632
SAN ANTONIO, TX 78248

Registered Mar. 6, 2012

Int. Cls.: 35 and 36

FOR: PROMOTING THE GOODS AND SERVICES OF OTHERS BY PROVIDING A WEBSITE FEATURING COUPONS, REBATES, PRICE-COMPARISON INFORMATION, PRODUCT REVIEWS, LINKS TO THE RETAIL WEBSITES OF OTHERS, AND DISCOUNT INFORMATION, IN CLASS 35 (U.S. CLS. 100, 101 AND 102).

SERVICE MARK

PRINCIPAL REGISTER

FIRST USE 4-1-2011; IN COMMERCE 4-1-2011.

FOR: CHARITABLE FUNDRAISING SERVICES BY MEANS OF SELLING MERCHANT VOUCHERS AND CERTIFICATES TO RAISE FUNDS FOR ORGANIZATIONS, IN CLASS 36 (U.S. CLS. 100, 101 AND 102).

FIRST USE 4-1-2011; IN COMMERCE 4-1-2011.

THE MARK CONSISTS OF THE TERM "LOCALSTEALS" WITH A DOLLAR SIGN ON A HANG TAG TAKING THE PLACE OF THE FIRST LETTER "S" IN "STEALS". THE HANG TAG IS ORANGE WITH A WHITE DOLLAR SIGN ON IT; THE REST OF THE LETTERS ARE BLUE.

THE COLOR(S) BLUE, ORANGE AND WHITE IS/ARE CLAIMED AS A FEATURE OF THE MARK.

SN 85-168,302, FILED 11-3-2010.

JAMES GRIFFIN, EXAMINING ATTORNEY



David J. Kybas

Director of the United States Patent and Trademark Office

United States of America

United States Patent and Trademark Office

Unlock Potential

Reg. No. 4,109,790

Registered Mar. 6, 2012

Int. Cl.: 9

TRADEMARK

PRINCIPAL REGISTER

PARAMETRIC TECHNOLOGY CORPORATION (MASSACHUSETTS CORPORATION)
140 KENDRICK STREET
NEEDHAM, MA 024942714

FOR: COMPUTER SOFTWARE FOR COMPUTER AIDED DESIGN (CAD), COMPUTER AIDED MANUFACTURING (CAM), AND COMPUTER AIDED ENGINEERING (CAE); SOFTWARE FOR VISUALIZATION AND DIGITAL MOCKUP, NAMELY, SOFTWARE FOR PROVIDING TWO-DIMENSIONAL AND THREE-DIMENSIONAL VISUALIZATION AND GRAPHICAL CAPABILITIES FOR COMPUTER CREATED DRAWINGS, DESIGNS, MODELS AND RENDERINGS; SOFTWARE FOR THE MANAGEMENT OF THE PRODUCT DEVELOPMENT PROCESS, NAMELY, SOFTWARE FOR COMPUTER AIDED DESIGN (CAD) DATA MANAGEMENT, PRODUCT DATA MANAGEMENT (PDM), PRODUCT PROCESS AND PRODUCTION AUTOMATION; SOFTWARE FOR WORKFLOWS, AND SHARED WORKSPACES FOR THE PURPOSES OF PRODUCT LIFECYCLE MANAGEMENT (PLM), COLLABORATION, CONFIGURATION AND CHANGE MANAGEMENT, REQUIREMENTS MANAGEMENT, AND MANUFACTURING PLANNING; COMPUTER AND SOFTWARE DEVELOPMENT TOOLKITS, HAVING APPLICATION PROGRAMMING INTERFACES, DEVELOPMENT UTILITIES, AND SAMPLE CODE, ALLOWING FOR THE CREATION OF COMPATIBLE APPLICATIONS; AND ACCOMPANYING USER GUIDES SOLD WITH ALL THE FOREGOING COMPUTER SOFTWARE AS A UNIT, IN CLASS 9 (U.S. CLS. 21, 23, 26, 36 AND 38).

FIRST USE 6-22-2011; IN COMMERCE 6-22-2011.

THE MARK CONSISTS OF STANDARD CHARACTERS WITHOUT CLAIM TO ANY PARTICULAR FONT, STYLE, SIZE, OR COLOR.

SN 85-168,800, FILED 11-4-2010.

STEVEN JACKSON, EXAMINING ATTORNEY



David J. Kyros

Director of the United States Patent and Trademark Office

United States of America

United States Patent and Trademark Office

POCKET T.O.M.

Reg. No. 4,109,791

PASSY-MUIR, INC. (CALIFORNIA CORPORATION)
4521 CAMPUS DRIVE, #273
IRVINE, CA 92612

Registered Mar. 6, 2012

Int. Cl.: 16

FOR: MEDICAL DEVICES, NAMELY, AN ANATOMICAL MODEL FOR USE IN DEMONSTRATION AND TRAINING, IN CLASS 16 (U.S. CLS. 2, 5, 22, 23, 29, 37, 38 AND 50).

TRADEMARK

FIRST USE 3-15-2011; IN COMMERCE 3-15-2011.

PRINCIPAL REGISTER

THE MARK CONSISTS OF STANDARD CHARACTERS WITHOUT CLAIM TO ANY PARTICULAR FONT, STYLE, SIZE, OR COLOR.

OWNER OF U.S. REG. NO. 3,217,286.

SN 85-169,506, FILED 11-4-2010.

JULIE VEPPUMTHARA, EXAMINING ATTORNEY



David J. Kyffers

Director of the United States Patent and Trademark Office

United States of America

United States Patent and Trademark Office



Reg. No. 4,109,792

Registered Mar. 6, 2012

Int. Cl.: 25

TRADEMARK

PRINCIPAL REGISTER

EPIC GAMES, INC. (MARYLAND CORPORATION)
620 CROSSROADS BOULEVARD
CARY, NC 27518

FOR: CLOTHING, NAMELY, T-SHIRTS, IN CLASS 25 (U.S. CLS. 22 AND 39).

FIRST USE 8-1-2011; IN COMMERCE 8-1-2011.

THE MARK CONSISTS OF A SWORD IN A SCABBARD.

SN 85-169,908, FILED 11-5-2010.

ROBIN MITTLER, EXAMINING ATTORNEY



David J. Kybas

Director of the United States Patent and Trademark Office

United States of America

United States Patent and Trademark Office

XCELOPROTECT

Reg. No. 4,109,793

CAPSUGEL BELGIUM NV (BELGIUM OPEN LIMITED LIABILITY COMPANY)
RIJKSWEG 11
BORNEM, BELGIUM 2880

Registered Mar. 6, 2012

Int. Cl.: 7

FOR: CAPSULE FILLING MACHINE PARTS, NAMELY, ISOLATION CONTAINMENT HOODS, IN CLASS 7 (U.S. CLS. 13, 19, 21, 23, 31, 34 AND 35).

TRADEMARK

FIRST USE 11-0-2010; IN COMMERCE 11-0-2010.

PRINCIPAL REGISTER

THE MARK CONSISTS OF STANDARD CHARACTERS WITHOUT CLAIM TO ANY PARTICULAR FONT, STYLE, SIZE, OR COLOR.

OWNER OF U.S. REG. NO. 3,811,444.

SN 85-170,357, FILED 11-5-2010.

MICHAEL GAAFAR, EXAMINING ATTORNEY



David J. Kyffers

Director of the United States Patent and Trademark Office

United States of America

United States Patent and Trademark Office

au[!]ction com

Reg. No. 4,109,794

Registered Mar. 6, 2012

Int. Cl.: 35

SERVICE MARK

PRINCIPAL REGISTER

AUCTION.COM, LLC (DELAWARE LIMITED LIABILITY COMPANY)
ONE MAUCHLY
IRVINE, CA 92618

FOR: ARRANGING AND CONDUCTION OF AUCTION SALES; AUCTION MANAGEMENT SERVICES PROVIDED TO OTHERS OVER AN ON-LINE WEB SITE ACCESSED THROUGH A GLOBAL COMPUTER NETWORK; ON-LINE AUCTION SERVICES; ON-LINE TRADING SERVICES IN WHICH SELLER POSTS PRODUCTS TO BE AUCTIONED AND BIDDING IS DONE VIA THE INTERNET; OPERATING ON-LINE MARKETPLACES FOR SELLERS OF GOODS AND/OR SERVICES; PROVIDING ON-LINE AUCTION SERVICES, IN CLASS 35 (U.S. CLS. 100, 101 AND 102).

FIRST USE 9-6-2010; IN COMMERCE 9-6-2010.

NO CLAIM IS MADE TO THE EXCLUSIVE RIGHT TO USE "AUCTION.COM", APART FROM THE MARK AS SHOWN.

THE MARK CONSISTS OF THE WORD "AUCTION.COM" WITH AN EXCLAMATION POINT WHERE THE EXCLAMATION POINT SERVES AS BOTH THE "I" IN "AUCTION" AND THE DOT BEFORE "COM".

SN 85-172,009, FILED 11-8-2010.

ROBERT C. CLARK JR., EXAMINING ATTORNEY



David J. Kyffers

Director of the United States Patent and Trademark Office

United States of America

United States Patent and Trademark Office

CINETIQUE

Reg. No. 4,109,795

Registered Mar. 6, 2012

Int. Cl.: 41

SERVICE MARK

PRINCIPAL REGISTER

SIRXIA, INC. (WYOMING CORPORATION)
2710 THOMES AVE
SUITE 627
CHEYENNE, WY 82001

FOR: VIDEO STUDIO SERVICES; PHOTOGRAPHY STUDIO SERVICES; PROVIDING FACILITIES FOR PRODUCING VIDEO AND PHOTOGRAPHY PRODUCTIONS; MULTIMEDIA ENTERTAINMENT SERVICES IN THE NATURE OF RECORDING, PRODUCTION AND POST-PRODUCTION SERVICES IN THE FIELDS OF VIDEO AND FILMS; VIDEO EDITING SERVICES; POST-PRODUCTION EDITING SERVICES IN THE FIELDS OF VIDEO AND FILMS, IN CLASS 41 (U.S. CLS. 100, 101 AND 107).

FIRST USE 10-0-2005; IN COMMERCE 10-0-2005.

THE MARK CONSISTS OF STANDARD CHARACTERS WITHOUT CLAIM TO ANY PARTICULAR FONT, STYLE, SIZE, OR COLOR.

THE ENGLISH TRANSLATION OF "CINETIQUE" IS "KINETICS".

SN 85-172,141, FILED 11-9-2010.

TARAH HARDY, EXAMINING ATTORNEY



David J. Kyros

Director of the United States Patent and Trademark Office

United States of America

United States Patent and Trademark Office

KALA MANA

Reg. No. 4,109,796

Registered Mar. 6, 2012

Int. Cl.: 41

SERVICE MARK

PRINCIPAL REGISTER

SIRXIA, INC. (WYOMING CORPORATION)
2710 THOMES AVE
SUITE 627
CHEYENNE, WY 82001

FOR: BOOK PUBLISHING; PUBLISHING SERVICES, NAMELY, PUBLICATION OF BOOKS, E-BOOKS, AND MOTION PICTURE AND TELEVISION SCRIPTS; ELECTRONIC PUBLISHING SERVICES, NAMELY, ONLINE PUBLICATION OF TEXTUAL, AUDIO, AND AUDIOVISUAL WORKS IN THE NATURE OF BOOKS, E-BOOKS, AUDIO BOOKS, MUSIC AND ILLUSTRATIONS IN THE FIELD OF BUSINESS, CULTURE, AND ENTERTAINMENT; VIDEO PRODUCTION SERVICES, IN CLASS 41 (U.S. CLS. 100, 101 AND 107).

FIRST USE 7-0-2009; IN COMMERCE 7-0-2009.

THE MARK CONSISTS OF STANDARD CHARACTERS WITHOUT CLAIM TO ANY PARTICULAR FONT, STYLE, SIZE, OR COLOR.

THE ENGLISH TRANSLATION OF "KALA MANA" IS "ALL POWER COMES FROM WITHIN".

SN 85-172,148, FILED 11-9-2010.

TARAH HARDY, EXAMINING ATTORNEY



David J. Kyros

Director of the United States Patent and Trademark Office

United States of America

United States Patent and Trademark Office

CORE CAREERS

Reg. No. 4,109,797

Registered Mar. 6, 2012

Int. Cl.: 41

SERVICE MARK

PRINCIPAL REGISTER

CORE EDUCATION AND CONSULTING SOLUTIONS, INC. (TENNESSEE CORPORATION)
THREE RAVINIA DRIVE
SUITE 1900
ATLANTA, GA 30346

FOR: EDUCATION SERVICES, NAMELY, PROVIDING ON-LINE VOCATIONAL EDUCATION COURSES FOR THE PURPOSE OF VOCATIONAL GUIDANCE AND CAREER COUNSELING TO STUDENTS OF ALL LEVELS; EDUCATIONAL SERVICES, NAMELY, DEVELOPING ON-LINE TRAINING COURSES IN CONNECTION WITH PREPARATION TO ENTER A WIDE VARIETY OF CAREERS, IN CLASS 41 (U.S. CLS. 100, 101 AND 107).

FIRST USE 6-1-2011; IN COMMERCE 6-1-2011.

THE MARK CONSISTS OF STANDARD CHARACTERS WITHOUT CLAIM TO ANY PARTICULAR FONT, STYLE, SIZE, OR COLOR.

NO CLAIM IS MADE TO THE EXCLUSIVE RIGHT TO USE "CAREERS", APART FROM THE MARK AS SHOWN.

SN 85-172,502, FILED 11-9-2010.

RONALD AIKENS, EXAMINING ATTORNEY



David J. Kyffers

Director of the United States Patent and Trademark Office

United States of America

United States Patent and Trademark Office

Cara Mae

Reg. No. 4,109,798

Registered Mar. 6, 2012

Int. Cl.: 3

TRADEMARK

PRINCIPAL REGISTER

CARA MAE NATURALS, LLC (NORTH CAROLINA LIMITED LIABILITY COMPANY)
31 PARK AVE. NORTH
ASHEVILLE, NC 288013118

FOR: AROMATIC BODY CARE PRODUCTS, NAMELY, BODY LOTION, SHOWER GEL, CUTICLE CREAM, SHAMPOO, CONDITIONER, NON-MEDICATED LIP BALM, SOAP, BODY POLISH, BODY AND FOOT SCRUB AND NON-MEDICATED FOOT CREAM; AROMATIC PREPARATIONS, NAMELY, CREAM, LOTION, BODY SPRAY; BABY BUBBLE BATH; BABY HAND SOAP; BABY LOTION; BAR SOAP; BATH AND SHOWER GELS AND SALTS NOT FOR MEDICAL PURPOSES; BATH FIZZIES; BATH GEL; BATH GELS; BATH LOTION; BATH SALTS; BATH SALTS; BATH SOAPS; BATH SOAPS IN LIQUID, SOLID OR GEL FORM; BATHING LOTIONS; BEAUTY GELS; BEAUTY LOTIONS; BODY LOTION; BODY LOTIONS; BODY SPRAY USED AS A PERSONAL DEODORANT AND AS FRAGRANCE; BODY SPRAYS; BREATH FRESHENING SPRAYS; COSMETIC SOAPS; COSMETIC SUNTAN LOTIONS; EYE LOTIONS; FACE AND BODY LOTIONS; FACIAL LOTION; FOOT DEODORANT SPRAY; HAND LOTIONS; HAND SOAPS; HANDMADE SOAP BARS; LIP BALM; LIP GLOSS; LIQUID BATH SOAPS; LIQUID SOAP; LIQUID SOAPS; LIQUID SOAPS FOR HANDS AND FACE; LIQUID SOAPS FOR HANDS, FACE AND BODY; LOTIONS FOR COSMETIC PURPOSES; LOTIONS FOR FACE AND BODY CARE; MASSAGE LOTIONS; MINERAL SALT IN THE NATURE OF BATH SALTS NOT FOR MEDICAL PURPOSES; NATURAL COCOA BUTTER BASED PERSONAL CARE PRODUCTS, NAMELY, BODY LOTION, SHOWER GEL, SOAP, BODY POLISH, BODY AND FOOT SCRUB AND NON-MEDICATED SKIN CREAMS; NATURAL SOAP BARS; NATURALLY HANDMADE SOAP BARS; NON-MEDICATED BATH SALTS; NON-MEDICATED DIAPER RASH OINTMENTS AND LOTIONS; NON-MEDICATED FOOT LOTIONS; NON-MEDICATED HERBAL BODY CARE PRODUCTS, NAMELY, BODY OILS, SALVES, AND LIP BALMS; NON-MEDICATED LIP BALM THAT DOES NOT CONTAIN BEESWAX; NON-MEDICATED LIP CARE PREPARATIONS; NON-MEDICATED LIP PROTECTORS; NON-MEDICATED SKIN CARE CREAMS AND LOTIONS; NON-MEDICATED SKIN CARE PREPARATIONS, NAMELY, CREAMS, LOTIONS, GELS, TONERS, CLEANERS AND PEELS; ORGANIC SOAP BARS; SCENTED BODY LOTIONS AND CREAMS; SCENTED BODY SPRAY; SHAVING BALM; SHAVING LOTION; SHAVING LOTIONS; SHAVING SOAP; SHAVING SOAPS; SKIN AND BODY TOPICAL LOTIONS, CREAMS AND OILS FOR COSMETIC USE; SKIN CARE PREPARATIONS, NAMELY, BODY BALM; SKIN CLEANSING LOTION; SKIN LOTION; SKIN LOTIONS; SKIN SOAP; SKIN TONERS; SOAPS FOR BODY CARE; SOAPS FOR HOUSEHOLD USE; SOAPS FOR PERSONAL USE; SOAPS FOR TOILET PURPOSES; SUN CARE LOTIONS; SUN TAN LOTION; SUN-BLOCK LOTIONS; SUN-TANNING OILS AND LOTIONS; TOILET



David J. Kyros

Director of the United States Patent and Trademark Office

Reg. No. 4,109,798 SOAP; TOILET SOAPS; TONING LOTION, FOR THE FACE, BODY AND HANDS, IN CLASS 3 (U.S. CLS. 1, 4, 6, 50, 51 AND 52).

FIRST USE 12-1-2011; IN COMMERCE 12-20-2011.

THE MARK CONSISTS OF STANDARD CHARACTERS WITHOUT CLAIM TO ANY PARTICULAR FONT, STYLE, SIZE, OR COLOR.

THE NAME(S), PORTRAIT(S), AND/OR SIGNATURE(S) SHOWN IN THE MARK DOES NOT IDENTIFY A PARTICULAR LIVING INDIVIDUAL.

SN 85-172,532, FILED 11-9-2010.

RUSS HERMAN, EXAMINING ATTORNEY

United States of America

United States Patent and Trademark Office

SEAWAX

Reg. No. 4,109,799

SEAWAX MARINE COATINGS (FRANCE CORPORATION)
BOULEVARD DU CERCERON
SAINT-RAPHAEL, FRANCE 83700

Registered Mar. 6, 2012

Int. Cls.: 1 and 2

FOR: ADHESIVES AND GLUES FOR INDUSTRIAL AND COMMERCIAL USE; ARTIFICIAL AND SYNTHETIC RESINS; UNPROCESSED PLASTICS, IN CLASS 1 (U.S. CLS. 1, 5, 6, 10, 26 AND 46).

TRADEMARK

FIRST USE 1-1-2011; IN COMMERCE 1-1-2011.

PRINCIPAL REGISTER

FOR: ANTI-CORROSIVE AND FIRE RETARDANT COATINGS; ANTI-FOULING PAINTS; BACTERICIDAL PAINTS; COATING PREPARATIONS HAVING WATER REPELLENT PROPERTIES; COLOR PIGMENTS; LACQUERS IN THE NATURE OF A COATING; MORDANTS FOR USE IN THE MARINE INDUSTRY; PAINT THINNERS; PRIMERS; RUST INHIBITING PREPARATIONS IN THE NATURE OF A COATING FOR USE ON VEHICLES; RUST PREVENTATIVES IN THE NATURE OF A COATING; THICKENERS FOR COLOURS; THINNERS FOR COLOURS , IN CLASS 2 (U.S. CLS. 6, 11 AND 16).

FIRST USE 1-1-2011; IN COMMERCE 1-1-2011.

THE MARK CONSISTS OF STANDARD CHARACTERS WITHOUT CLAIM TO ANY PARTICULAR FONT, STYLE, SIZE, OR COLOR.

THE WORDING "SEAWAX" HAS NO MEANING IN A FOREIGN LANGUAGE.

SN 85-172,548, FILED 11-9-2010.

PRISCILLA MILTON, EXAMINING ATTORNEY



David J. Kyros

Director of the United States Patent and Trademark Office

United States of America

United States Patent and Trademark Office

AIM STAR 
NETWORK
where happiness comes true

Reg. No. 4,109,800

Registered Mar. 6, 2012

Int. Cl.: 35

SERVICE MARK

PRINCIPAL REGISTER

AIM STAR NETWORK CO., LTD. (THAILAND CORPORATION)
1191 SUKHUMVIT RD., NORTH KLONGTON
WATTANA BANGKOK 10110, THAILAND

FOR: WHOLESALE STORE SERVICES FEATURING NUTRITIONAL SUPPLEMENTS, PERSONAL CARE PRODUCTS, COSMETICS, HOME CARE PRODUCTS, AND PERSONAL CARE PRODUCTS; WHOLESALE DISTRIBUTORSHIPS IN THE FIELD OF NUTRITIONAL SUPPLEMENTS, PERSONAL CARE PRODUCTS, COSMETICS, HOME CARE PRODUCTS, AND PERSONAL CARE PRODUCTS; COMPUTERIZED ONLINE WHOLESALE STORE SERVICES FEATURING NUTRITIONAL SUPPLEMENTS, PERSONAL CARE PRODUCTS, COSMETICS, HOME CARE PRODUCTS, AND PERSONAL CARE PRODUCTS; COMPUTERIZED ONLINE WHOLESALE DISTRIBUTORSHIPS IN THE FIELD OF NUTRITIONAL SUPPLEMENTS, PERSONAL CARE PRODUCTS, COSMETICS, HOME CARE PRODUCTS, AND PERSONAL CARE PRODUCTS; BUSINESS CONSULTATION IN THE NATURE OF RENDERING ASSISTANCE TO OTHERS IN CONNECTION WITH THE ESTABLISHMENT AND OPERATION OF DISTRIBUTORSHIPS; ASSOCIATION SERVICES, NAMELY, PROMOTING THE INTERESTS OF INDEPENDENT BUSINESS OWNERS, IN CLASS 35 (U.S. CLS. 100, 101 AND 102).

FIRST USE 6-2-2011; IN COMMERCE 6-2-2011.

NO CLAIM IS MADE TO THE EXCLUSIVE RIGHT TO USE "NETWORK", APART FROM THE MARK AS SHOWN.

THE MARK CONSISTS OF THE WORDS "AIM STAR" ABOVE THE WORD "NETWORK" TO THE LEFT A V ARRANGEMENT OF FIVE SMALL STARS POINTING TO A LARGER STAR TO THE RIGHT WITH AN ANGULAR V WEDGE CUTOUT, ALL ABOVE THE WORDS "WHERE HAPPINESS COMES TRUE".

SN 85-172,996, FILED 11-9-2010.

AISHA SALEM, EXAMINING ATTORNEY



David J. Kyros

Director of the United States Patent and Trademark Office

United States of America

United States Patent and Trademark Office



Reg. No. 4,109,801

WEEKS, JAVED J. (UNITED STATES INDIVIDUAL)
2995 NW 36TH LANE
FORT LAUDERDALE, FL 33311 AND

Registered Mar. 6, 2012

Int. Cl.: 25

WEEKS, MARVA N (ST.KITTS-NEVIS INDIVIDUAL)
PO BOX # 460067
FORT LAUDERDALE, FL 33346

TRADEMARK

PRINCIPAL REGISTER

FOR: BELTS; DRESSES; HATS; JACKETS; JEANS; ONE PIECE GARMENT FOR INFANTS AND TODDLERS; PANTS; SCARVES; SHORTS; SKIRTS; SOCKS; SWEATERS; SWEAT-SHIRTS; SWIMWEAR; T-SHIRTS; TIES; UNDERGARMENTS, IN CLASS 25 (U.S. CLS. 22 AND 39).

FIRST USE 11-26-2009; IN COMMERCE 1-14-2010.

THE MARK CONSISTS OF THE STYLIZED TEXT "IREPSKN ST.KITTS & NEVIS".

SN 85-173,361, FILED 11-10-2010.

RONALD AIKENS, EXAMINING ATTORNEY



David J. Kyros

Director of the United States Patent and Trademark Office

United States of America

United States Patent and Trademark Office

WEATHER WARRIOR

Reg. No. 4,109,802

VARIFORM, INC. (MISSOURI CORPORATION)
2600 GRAND BLVD., SUITE 900
KANSAS CITY, MO 64108

Registered Mar. 6, 2012

Int. Cl.: 19

FOR: COLOR HOLD ENHANCER SOLD AS A CONSTITUENT OF VINYL SIDING AND VINYL SIDING ACCESSORIES, NAMELY, INSIDE CORNER POSTS, J CHANNEL, UNDER-SILL TRIM, AND OUTSIDE CORNER POSTS, IN CLASS 19 (U.S. CLS. 1, 12, 33 AND 50).

TRADEMARK

FIRST USE 1-1-2011; IN COMMERCE 1-1-2011.

PRINCIPAL REGISTER

THE MARK CONSISTS OF STANDARD CHARACTERS WITHOUT CLAIM TO ANY PARTICULAR FONT, STYLE, SIZE, OR COLOR.

SN 85-173,362, FILED 11-10-2010.

RONALD AIKENS, EXAMINING ATTORNEY



David J. Kyros

Director of the United States Patent and Trademark Office

United States of America

United States Patent and Trademark Office



Reg. No. 4,109,803

Registered Mar. 6, 2012

Int. Cl.: 30

TRADEMARK

PRINCIPAL REGISTER

JMI LLC (NEBRASKA LIMITED LIABILITY COMPANY)
1000 SUZANNE AVE
PAPILLION, NE 68046

FOR: HABANERO PASTE, IN CLASS 30 (U.S. CL. 46).

FIRST USE 1-4-2011; IN COMMERCE 3-6-2011.

NO CLAIM IS MADE TO THE EXCLUSIVE RIGHT TO USE "HABANERO", APART FROM THE MARK AS SHOWN.

THE MARK CONSISTS OF THE STYLIZED TEXT "JPASTE HABANERO INSPIRED".

SN 85-173,920, FILED 11-10-2010.

PRISCILLA MILTON, EXAMINING ATTORNEY



David J. Kybas

Director of the United States Patent and Trademark Office

United States of America

United States Patent and Trademark Office

FIREGRIP

Reg. No. 4,109,804

MANSFIELD, ZACHARY (UNITED STATES INDIVIDUAL)
1838 COTTONWOOD CIRCLE
PASO ROBLES, CA 93446

Registered Mar. 6, 2012

Int. Cl.: 34

FOR: SMOKERS' ARTICLES, NAMELY, LIGHTER HOLDERS FOR WATER PIPES AND BONGS, IN CLASS 34 (U.S. CLS. 2, 8, 9 AND 17).

TRADEMARK

FIRST USE 8-10-2011; IN COMMERCE 8-10-2011.

PRINCIPAL REGISTER

THE MARK CONSISTS OF STANDARD CHARACTERS WITHOUT CLAIM TO ANY PARTICULAR FONT, STYLE, SIZE, OR COLOR.

SN 85-174,117, FILED 11-10-2010.

AMY C. KEAN, EXAMINING ATTORNEY



David J. Kappas

Director of the United States Patent and Trademark Office

United States of America

United States Patent and Trademark Office

AIR BAND

Reg. No. 4,109,805

Registered Mar. 6, 2012

Int. Cl.: 9

TRADEMARK

PRINCIPAL REGISTER

MAAG AUDIO, LLC (UTAH LIMITED LIABILITY COMPANY)
1271 N LAKEVIEW DR
PROVO, UT 84604

FOR: APPARATUS FOR RECORDING, TRANSMISSION OR REPRODUCTION OF SOUND, NAMELY, MICROPHONE PREAMPLIFIERS AND SOUND EQUALIZERS, IN CLASS 9 (U.S. CLS. 21, 23, 26, 36 AND 38).

FIRST USE 3-10-2011; IN COMMERCE 3-10-2011.

THE MARK CONSISTS OF STANDARD CHARACTERS WITHOUT CLAIM TO ANY PARTICULAR FONT, STYLE, SIZE, OR COLOR.

SN 85-174,129, FILED 11-11-2010.

CAROLYN CATALDO, EXAMINING ATTORNEY



David J. Kybas

Director of the United States Patent and Trademark Office

United States of America

United States Patent and Trademark Office

RARE AND WELL DONE

Reg. No. 4,109,806

Registered Mar. 6, 2012

Int. Cl.: 43

SERVICE MARK

PRINCIPAL REGISTER

CHRISTOPHER V. PERRY FAMILY LIMITED PARTNERSHIP (TEXAS LIMITED PARTNERSHIP)
1051 PINELOCH, SUITE 800
HOUSTON, TX 77062

FOR: CATERING SERVICES; PROVIDING PROGRESSIVE DINNER EVENTS WHERE PARTICIPANTS SAMPLE MEALS AND DRINKS AT A SERIES OF RESTAURANTS , IN CLASS 43 (U.S. CLS. 100 AND 101).

FIRST USE 6-1-2010; IN COMMERCE 6-1-2010.

THE MARK CONSISTS OF STANDARD CHARACTERS WITHOUT CLAIM TO ANY PARTICULAR FONT, STYLE, SIZE, OR COLOR.

SN 85-174,143, FILED 11-11-2010.

SHAUNIA CARLYLE, EXAMINING ATTORNEY



David J. Kyffers

Director of the United States Patent and Trademark Office

United States of America

United States Patent and Trademark Office

AWNEX

Reg. No. 4,109,807

Registered Mar. 6, 2012

Int. Cl.: 40

SERVICE MARK

PRINCIPAL REGISTER

AWNEX, INC. (GEORGIA CORPORATION)
260 VALLEY STREET
SUITE 100
BALL GROUND, GA 30107

FOR: CUSTOM MANUFACTURE OF FABRIC AND METAL AWNINGS AND CANOPIES,
IN CLASS 40 (U.S. CLS. 100, 103 AND 106).

FIRST USE 1-1-2011; IN COMMERCE 1-1-2011.

THE MARK CONSISTS OF STANDARD CHARACTERS WITHOUT CLAIM TO ANY PAR-
TICULAR FONT, STYLE, SIZE, OR COLOR.

SN 85-174,428, FILED 11-11-2010.

MARGERY A. TIERNEY, EXAMINING ATTORNEY



David J. Kybas

Director of the United States Patent and Trademark Office

United States of America

United States Patent and Trademark Office

SNACK-A-PILLAR

Reg. No. 4,109,808

HANDI-CRAFT COMPANY (MISSOURI CORPORATION)
4433 FYLER AVENUE
ST. LOUIS, MO 63116

Registered Mar. 6, 2012

Int. Cl.: 21

FOR: STACKABLE HOUSEHOLD FOOD CONTAINERS, IN CLASS 21 (U.S. CLS. 2, 13, 23, 29, 30, 33, 40 AND 50).

TRADEMARK

FIRST USE 3-9-2011; IN COMMERCE 3-9-2011.

PRINCIPAL REGISTER

THE MARK CONSISTS OF STANDARD CHARACTERS WITHOUT CLAIM TO ANY PARTICULAR FONT, STYLE, SIZE, OR COLOR.

SN 85-174,532, FILED 11-11-2010.

KRISTIN DAHLING, EXAMINING ATTORNEY



David J. Kybas

Director of the United States Patent and Trademark Office

United States of America

United States Patent and Trademark Office

CHAIR PEDIA

Reg. No. 4,109,809

Registered Mar. 6, 2012

Int. Cl.: 38

SERVICE MARK

PRINCIPAL REGISTER

STEINFELD, MANFRED (UNITED STATES INDIVIDUAL)
1300 N. LAKE SHORE DRIVE
CHICAGO, IL 606105166

FOR: TELECOMMUNICATION SERVICES, NAMELY, PROVIDING MULTIPLE-USER ACCESS TO A GLOBAL COMPUTER INFORMATION NETWORK RELATING TO FURNITURE AND RESOURCES FOR FURNITURE DESIGN AND EXHIBITION OF SUCH SERVICES, IN CLASS 38 (U.S. CLS. 100, 101 AND 104).

FIRST USE 12-12-2011; IN COMMERCE 12-12-2011.

THE MARK CONSISTS OF STANDARD CHARACTERS WITHOUT CLAIM TO ANY PARTICULAR FONT, STYLE, SIZE, OR COLOR.

NO CLAIM IS MADE TO THE EXCLUSIVE RIGHT TO USE "CHAIR", APART FROM THE MARK AS SHOWN.

SN 85-174,707, FILED 11-11-2010.

MARILYN IZZI, EXAMINING ATTORNEY



David J. Kyros

Director of the United States Patent and Trademark Office

United States of America

United States Patent and Trademark Office

RapidNap

Reg. No. 4,109,810

ROSES SOUTHWEST PAPERS, INC. (NEW MEXICO CORPORATION)
1701 SECOND ST. SW
ALBUQUERQUE, NM 87102

Registered Mar. 6, 2012

Int. Cl.: 16

FOR: PAPER NAPKINS, IN CLASS 16 (U.S. CLS. 2, 5, 22, 23, 29, 37, 38 AND 50).

TRADEMARK

FIRST USE 2-14-2011; IN COMMERCE 2-14-2011.

PRINCIPAL REGISTER

THE MARK CONSISTS OF STANDARD CHARACTERS WITHOUT CLAIM TO ANY PARTICULAR FONT, STYLE, SIZE, OR COLOR.

SN 85-174,753, FILED 11-11-2010.

PAM WILLIS, EXAMINING ATTORNEY



David J. Kybas

Director of the United States Patent and Trademark Office

United States of America

United States Patent and Trademark Office

NATURE'S TURN

Reg. No. 4,109,811

Registered Mar. 6, 2012

Int. Cl.: 29

TRADEMARK

PRINCIPAL REGISTER

CAKE DEVELOPMENT GROUP (CALIFORNIA CORPORATION)
SUITE 463
137 NORTH LARCHMONT BLVD.
LOS ANGELES, CA 90004

FOR: CANNED FRUITS AND VEGETABLES; CUT FRUITS AND VEGETABLES; SLICED FRUITS AND VEGETABLES; FRUIT JELLIES; JAMS; MARINATED VEGETABLES; PICKLED FRUITS AND VEGETABLES; PICKLES; PEELED WHOLE TOMATOES; PRESERVED FRUITS AND VEGETABLES; COOKED FRUITS AND VEGETABLES; STEWED FRUITS AND VEGETABLES; VEGETABLE PASTE; VEGETABLE PUREE; VEGETABLE SALADS; APPLE-SAUCE; CANNED FRUIT COCKTAILS, IN CLASS 29 (U.S. CL. 46).

FIRST USE 4-1-2010; IN COMMERCE 4-1-2010.

THE MARK CONSISTS OF STANDARD CHARACTERS WITHOUT CLAIM TO ANY PARTICULAR FONT, STYLE, SIZE, OR COLOR.

SN 85-174,771, FILED 11-11-2010.

FLORENTINA BLANDU, EXAMINING ATTORNEY



David J. Kybas

Director of the United States Patent and Trademark Office

United States of America

United States Patent and Trademark Office

Smart Utility Network Alliance

Reg. No. 4,109,812

SMART UTILITY NETWORK ALLIANCE (TEXAS LIMITED LIABILITY COMPANY)
108 BRENTWOOD COURT
ALLEN, TX 75013

Registered Mar. 6, 2012

Int. Cl.: 42

FOR: DEVELOPMENT OF NEW TECHNOLOGY FOR OTHERS IN THE FIELD OF SMART UTILITY NETWORKS, IN CLASS 42 (U.S. CLS. 100 AND 101).

SERVICE MARK

FIRST USE 10-12-2010; IN COMMERCE 1-3-2011.

PRINCIPAL REGISTER

THE MARK CONSISTS OF STANDARD CHARACTERS WITHOUT CLAIM TO ANY PARTICULAR FONT, STYLE, SIZE, OR COLOR.

NO CLAIM IS MADE TO THE EXCLUSIVE RIGHT TO USE "UTILITY NETWORK ALLIANCE", APART FROM THE MARK AS SHOWN.

SN 85-174,902, FILED 11-11-2010.

LINDA E. BLOHM, EXAMINING ATTORNEY



David J. Kybas

Director of the United States Patent and Trademark Office

United States of America

United States Patent and Trademark Office

Suna Certified

Reg. No. 4,109,813

SMART UTILITY NETWORK ALLIANCE (TEXAS LIMITED LIABILITY COMPANY)
108 BRENTWOOD COURT
ALLEN, TN 75013

Registered Mar. 6, 2012

Int. Cl.: 42

FOR: DEVELOPMENT OF NEW TECHNOLOGY FOR OTHERS IN THE FIELD OF SMART UTILITY NETWORKS, IN CLASS 42 (U.S. CLS. 100 AND 101).

SERVICE MARK

FIRST USE 12-10-2010; IN COMMERCE 3-1-2011.

PRINCIPAL REGISTER

THE MARK CONSISTS OF STANDARD CHARACTERS WITHOUT CLAIM TO ANY PARTICULAR FONT, STYLE, SIZE, OR COLOR.

NO CLAIM IS MADE TO THE EXCLUSIVE RIGHT TO USE "CERTIFIED", APART FROM THE MARK AS SHOWN.

SN 85-175,049, FILED 11-11-2010.

LINDA E. BLOHM, EXAMINING ATTORNEY



David J. Kyjars

Director of the United States Patent and Trademark Office

United States of America

United States Patent and Trademark Office

NEW WAY NEW YOU

Reg. No. 4,109,814

Registered Mar. 6, 2012

Int. Cl.: 44

SERVICE MARK

PRINCIPAL REGISTER

ALTICOR INC. (MICHIGAN CORPORATION)
78-2M
7575 FULTON STREET, EAST
ADA, MI 49355

FOR: WEIGHT MANAGEMENT SERVICES, NAMELY, PROVIDING WEIGHT LOSS AND/OR WEIGHT MAINTENANCE PROGRAMS INCLUDING SUPPORT MATERIALS, COUNSELING, PROVIDING ADVICE AND INFORMATION IN THE FIELD OF WEIGHT CONTROL AND NUTRITION, IN CLASS 44 (U.S. CLS. 100 AND 101).

FIRST USE 4-11-2011; IN COMMERCE 4-11-2011.

THE MARK CONSISTS OF STANDARD CHARACTERS WITHOUT CLAIM TO ANY PARTICULAR FONT, STYLE, SIZE, OR COLOR.

SN 85-175,272, FILED 11-12-2010.

RAUL CORDOVA, EXAMINING ATTORNEY



David J. Kyros

Director of the United States Patent and Trademark Office

United States of America

United States Patent and Trademark Office

NWNY

Reg. No. 4,109,815

Registered Mar. 6, 2012

Int. Cl.: 44

SERVICE MARK

PRINCIPAL REGISTER

ALTICOR INC. (MICHIGAN CORPORATION)
78-2M
7575 FULTON STREET, EAST
ADA, MI 49355

FOR: WEIGHT MANAGEMENT SERVICES, NAMELY, PROVIDING WEIGHT LOSS AND/OR WEIGHT MAINTENANCE PROGRAMS INCLUDING SUPPORT MATERIALS, COUNSELING, PROVIDING ADVICE AND INFORMATION IN THE FIELD OF WEIGHT CONTROL AND NUTRITION, IN CLASS 44 (U.S. CLS. 100 AND 101).

FIRST USE 4-11-2011; IN COMMERCE 4-11-2011.

THE MARK CONSISTS OF STANDARD CHARACTERS WITHOUT CLAIM TO ANY PARTICULAR FONT, STYLE, SIZE, OR COLOR.

SN 85-175,276, FILED 11-12-2010.

RAUL CORDOVA, EXAMINING ATTORNEY



David J. Kybas

Director of the United States Patent and Trademark Office

United States of America

United States Patent and Trademark Office

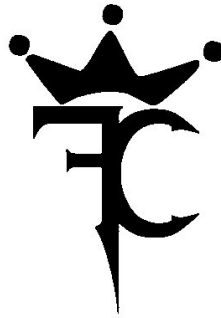

Reg. No. 4,109,816

Registered Mar. 6, 2012

Int. Cl.: 25

TRADEMARK

PRINCIPAL REGISTER

FOSTER, CLAYTON (UNITED STATES INDIVIDUAL)
2F
804 HENDRIX ST
BROOKLYN, NY 11207

FOR: JACKETS; SHIRTS; SWEATERS, IN CLASS 25 (U.S. CLS. 22 AND 39).

FIRST USE 1-1-2011; IN COMMERCE 4-1-2011.

THE MARK CONSISTS OF A CROWN APPEARING ABOVE THE STYLIZED TEXT "FC".

SN 85-175,358, FILED 11-12-2010.

MICHAEL SOUDERS, EXAMINING ATTORNEY



David J. Kybas

Director of the United States Patent and Trademark Office

United States of America

United States Patent and Trademark Office



Reg. No. 4,109,817

Registered Mar. 6, 2012

Int. Cl.: 44

SERVICE MARK

PRINCIPAL REGISTER

VHS OF MICHIGAN, INC. (DELAWARE CORPORATION)
C/O VANGUARD HEALTH SYSTEMS, 20 BURTON
HILLS, BLVD., SUITE 100
NASHVILLE, TN 37215

FOR: HOSPITAL SERVICES; MEDICAL SERVICES; EMERGENCY MEDICAL ASSISTANCE,
IN CLASS 44 (U.S. CLS. 100 AND 101).

FIRST USE 3-23-2010; IN COMMERCE 3-23-2010.

NO CLAIM IS MADE TO THE EXCLUSIVE RIGHT TO USE "ER", APART FROM THE MARK
AS SHOWN.

THE MARK CONSISTS OF A STOPWATCH DESIGN, INCLUDING "ER" AND "DMC"
WITHIN THE WATCH FACE.

SN 85-175,679, FILED 11-12-2010.

JULIE VEPPUMTHARA, EXAMINING ATTORNEY



David J. Kybas

Director of the United States Patent and Trademark Office

United States of America

United States Patent and Trademark Office

It Pays To Have Friends

Reg. No. 4,109,818

Registered Mar. 6, 2012

Int. Cl.: 45

SERVICE MARK

PRINCIPAL REGISTER

FRIEND LINKED LLC (UTAH LIMITED LIABILITY COMPANY)
2607 W. NORTH FORTY WAY
SOUTH JORDAN, UT 84095

FOR: INTERNET-BASED SOCIAL NETWORKING SERVICES; ON-LINE SOCIAL NETWORKING SERVICES; ONLINE SOCIAL NETWORKING SERVICES PROVIDED THROUGH A COMMUNITY WEBSITE, IN CLASS 45 (U.S. CLS. 100 AND 101).

FIRST USE 1-1-2011; IN COMMERCE 1-1-2011.

THE MARK CONSISTS OF STANDARD CHARACTERS WITHOUT CLAIM TO ANY PARTICULAR FONT, STYLE, SIZE, OR COLOR.

SN 85-175,723, FILED 11-12-2010.

STEVEN PEREZ, EXAMINING ATTORNEY



David J. Kybas

Director of the United States Patent and Trademark Office

United States of America

United States Patent and Trademark Office

WHAT THE FUDGE? BROWNIE

Reg. No. 4,109,819

CONOPCO, INC. (NEW YORK CORPORATION)
700 SYLVAN AVENUE
ENGLEWOOD CLIFFS, NJ 07632

Registered Mar. 6, 2012

Int. Cl.: 30

FOR: ICE CREAMS, FROZEN CONFECTIONS, ICE CREAM SANDWICHES, IN CLASS 30
(U.S. CL. 46).

TRADEMARK

FIRST USE 3-0-2011; IN COMMERCE 3-0-2011.

PRINCIPAL REGISTER

THE MARK CONSISTS OF STANDARD CHARACTERS WITHOUT CLAIM TO ANY PARTICULAR FONT, STYLE, SIZE, OR COLOR.

NO CLAIM IS MADE TO THE EXCLUSIVE RIGHT TO USE "BROWNIE", APART FROM THE MARK AS SHOWN.

SN 85-175,724, FILED 11-12-2010.

TRACY FLETCHER, EXAMINING ATTORNEY



David J. Kybas

Director of the United States Patent and Trademark Office

United States of America

United States Patent and Trademark Office



Reg. No. 4,109,820

Registered Mar. 6, 2012

Int. Cl.: 6

TRADEMARK

PRINCIPAL REGISTER

ATLAS ROOFING CORPORATION (MISSISSIPPI CORPORATION)
SUITE 190
802 HIGHWAY 19 NORTH
MERIDIAN, MS 39307

FOR: STEEP SLOPE ROOF VENTILATION SYSTEM COMPRISED OF METAL EAVE VENTS
AND METAL RIDGE VENTS, IN CLASS 6 (U.S. CLS. 2, 12, 13, 14, 23, 25 AND 50).

FIRST USE 11-1-2011; IN COMMERCE 11-1-2011.

THE MARK CONSISTS OF THE WORD "TECHNIFLO" IN STYLIZED PRINT, WITH "TECHNI"
IN LOWER CASE, SLIGHTLY STYLIZED LETTERS FOLLOWED BY THE LARGER
SHADOW-EFFECT LETTERS "FLO".

SN 85-175,854, FILED 11-12-2010.

PAM WILLIS, EXAMINING ATTORNEY



David J. Kyffers

Director of the United States Patent and Trademark Office

United States of America

United States Patent and Trademark Office

STEM

Reg. No. 4,109,821

Registered Mar. 6, 2012

Int. Cls.: 9 and 14

TRADEMARK

PRINCIPAL REGISTER

STEM INNOVATION, LLC (DELAWARE LIMITED LIABILITY COMPANY)
9000 SHERIDAN STREET, SUITE 140
PEMBROKE PINES, FL 33024

FOR: WIRELESS AND INTERNET PROTOCOL VIDEO CAMERAS WITH AUDIO, FOR USE VIA TELECOMMUNICATIONS NETWORKS AND GLOBAL COMMUNICATIONS NETWORKS; NETWORK-ENABLED VIDEO CAMERAS WITH AUDIO; VIDEO CAMERAS; DIGITAL VIDEO CAMERAS; VIDEO CAMERAS WITH AUDIO; DOCKING STATIONS FOR USE WITH HANDHELD ELECTRONIC DEVICES; ELECTRONIC DOCKING STATIONS; AUDIO SPEAKERS; SPEAKER SYSTEMS INCORPORATING DOCKING STATIONS FOR USE WITH PORTABLE AUDIO DEVICES; DEVICES FOR TRANSMISSION OF WIRELESS VIDEO SIGNALS TO PLAYBACK DEVICES; WIRELESS COMMUNICATION DEVICES FOR VOICE, DATA OR IMAGE TRANSMISSION AND/OR RECEPTION; COMPUTER HARDWARE FOR UPLOAD, STORAGE, RETRIEVAL, DOWNLOAD, TRANSMISSION AND DELIVERY OF DIGITAL CONTENT; DOWNLOADABLE SOFTWARE IN THE NATURE OF MOBILE APPLICATIONS, IN CLASS 9 (U.S. CLS. 21, 23, 26, 36 AND 38).

FIRST USE 7-12-2010; IN COMMERCE 12-8-2010.

FOR: CLOCKS, IN CLASS 14 (U.S. CLS. 2, 27, 28 AND 50).

FIRST USE 7-12-2010; IN COMMERCE 12-8-2010.

THE MARK CONSISTS OF STANDARD CHARACTERS WITHOUT CLAIM TO ANY PARTICULAR FONT, STYLE, SIZE, OR COLOR.

SN 85-175,963, FILED 11-12-2010.

PATRICIA EVANKO, EXAMINING ATTORNEY



David J. Kyros

Director of the United States Patent and Trademark Office

United States of America

United States Patent and Trademark Office



Reg. No. 4,109,822

JOHN MATOUK & CO. (NEW YORK CORPORATION)
11 EAST 26TH STREET
NEW YORK, NY 10010

Registered Mar. 6, 2012

Int. Cls.: 24, 25, and 35

FOR: HOUSEHOLD LINEN, NAMELY, BED LINEN, PILLOW CASES, BLANKETS, DUVET COVERS, SHAMS, TROWS, IN CLASS 24 (U.S. CLS. 42 AND 50).

TRADEMARK

FIRST USE 5-15-2010; IN COMMERCE 8-1-2010.

SERVICE MARK

FOR: BATHROBES; PAJAMAS, IN CLASS 25 (U.S. CLS. 22 AND 39).

PRINCIPAL REGISTER

FIRST USE 5-15-2010; IN COMMERCE 8-1-2010.

FOR: RETAIL STORE SERVICES AND ONLINE RETAIL STORE SERVICES FEATURING SOAPS, CANDLES, LINENS, AND CLOTHING, IN CLASS 35 (U.S. CLS. 100, 101 AND 102).

FIRST USE 6-30-2010; IN COMMERCE 6-30-2010.

OWNER OF U.S. REG. NO. 3,044,861.

THE COLOR(S) BLUE AND WHITE IS/ARE CLAIMED AS A FEATURE OF THE MARK.

NO CLAIM IS MADE TO THE EXCLUSIVE RIGHT TO USE "& COMPANY" AND "1929", APART FROM THE MARK AS SHOWN.

THE NAME "JOHN MATOUK" DOES NOT IDENTIFY A LIVING INDIVIDUAL.

THE MARK CONSISTS OF A BLUE CIRCLE WITH THE FOLLOWING WORDING IN WHITE "JOHN MATOUK & COMPANY" AROUND THE UPPER HALF OF THE CIRCLE AND THE WORDING "1929" AND "M" AT THE BOTTOM OF THE CIRCLE. THE CENTER OF THE CIRCLE CONTAINS A WHITE TREE AND TWO BIRDS. THE OUTSIDE AND INNER SIDE OF THE CIRCLE IS OUTLINED IN WHITE DOTTED LINES.



David J. Kyffers

SN 85-176,752, FILED 11-15-2010.

TARAH HARDY, EXAMINING ATTORNEY

United States of America

United States Patent and Trademark Office

Penumbra



Reg. No. 4,109,823

Registered Mar. 6, 2012

Int. Cl.: 10

TRADEMARK

PRINCIPAL REGISTER

PENUMBRA, INC. (DELAWARE CORPORATION)
1351 HARBOR BAY PKWY
ALAMEDA, CA 94502

FOR: MEDICAL DEVICES FOR TREATMENT OF STROKES, NAMELY, DEVICES FOR ENDOVASCULAR OCCLUSION OF ANEURYSMS; MEDICAL DEVICES FOR TREATMENT OF ENDOVASCULAR DISEASE, NAMELY, MICROCATHERETERS AND GUIDING CATHETERS, IN CLASS 10 (U.S. CLS. 26, 39 AND 44).

FIRST USE 8-23-2007; IN COMMERCE 8-23-2007.

OWNER OF U.S. REG. NOS. 3,421,021, 3,633,499, AND 3,678,273.

NO CLAIM IS MADE TO THE EXCLUSIVE RIGHT TO USE "PENUMBRA", APART FROM THE MARK AS SHOWN.

THE MARK CONSISTS OF A STYLIZED LETTER "P" WITHIN A CIRCLE WITH THE WORD "PENUMBRA" TO THE LEFT OF THE STYLIZED LETTER "P".

SN 85-177,020, FILED 11-15-2010.

JEFFREY LOOK, EXAMINING ATTORNEY



David J. Kyffers

Director of the United States Patent and Trademark Office

United States of America

United States Patent and Trademark Office



Reg. No. 4,109,824

Registered Mar. 6, 2012

Int. Cl.: 16

TRADEMARK

PRINCIPAL REGISTER

INSCAPE PUBLISHING, INC. (DELAWARE CORPORATION)
SUITE 800
6465 WAYZATA BLVD.
MINNEAPOLIS, MN 554261725

FOR: PRINTED MATERIALS, NAMELY, PAMPHLETS, BROCHURES, MANUALS, AND TESTS IN THE FIELD OF BEHAVIOR EVALUATION, BEHAVIORAL COUNSELING, AND PERSONAL DEVELOPMENT, THAT ARE USED IN PARENTAL TRAINING, BUSINESS MANAGEMENT AND EMPLOYEE TRAINING, IN CLASS 16 (U.S. CLS. 2, 5, 22, 23, 29, 37, 38 AND 50).

FIRST USE 4-28-2011; IN COMMERCE 4-28-2011.

OWNER OF U.S. REG. NOS. 2,028,076, 2,740,991, AND OTHERS.

NO CLAIM IS MADE TO THE EXCLUSIVE RIGHT TO USE "DISC", APART FROM THE MARK AS SHOWN.

THE MARK CONSISTS OF A SOLID CIRCLE WITH THE WORD "DISC" APPEARING HORIZONTALLY OVER THE CENTER OF THE CIRCLE.

SN 85-177,028, FILED 11-15-2010.

ALYSSA STEEL, EXAMINING ATTORNEY



David J. Kyffers

Director of the United States Patent and Trademark Office

United States of America

United States Patent and Trademark Office



Reg. No. 4,109,825

Registered Mar. 6, 2012

Int. Cl.: 9

TRADEMARK

PRINCIPAL REGISTER

SHUFFLE MASTER, INC. (MINNESOTA CORPORATION)
1106 PALMS AIRPORT DRIVE
LAS VEGAS, NV 89119

FOR: SOFTWARE FOR PROVIDING A GAME OF CHANCE ON A GAMING PLATFORM THAT ENABLES ELECTRONIC CREDIT WAGERING, IN CLASS 9 (U.S. CLS. 21, 23, 26, 36 AND 38).

FIRST USE 11-15-2010; IN COMMERCE 11-15-2010.

OWNER OF U.S. REG. NOS. 2,233,569, 2,397,403, AND 2,650,060.

NO CLAIM IS MADE TO THE EXCLUSIVE RIGHT TO USE "THREE CARD POKER", APART FROM THE MARK AS SHOWN.

THE MARK CONSISTS OF THE OUTLINE OF THREE PLAYING CARDS WITH A DIAMOND DESIGN ON THE FACE OF EACH CARD WITH "THREE CARD POKER" UNDER THE PLAYING CARDS.

SN 85-177,369, FILED 11-15-2010.

JOHN DWYER, EXAMINING ATTORNEY



David J. Kybas

Director of the United States Patent and Trademark Office

United States of America

United States Patent and Trademark Office

BELLA Beauty As Defined By You

Reg. No. 4,109,826

Registered Mar. 6, 2012

Int. Cl.: 16

TRADEMARK

PRINCIPAL REGISTER

BELLA MEDIA GROUP, LLC (NEW YORK LIMITED LIABILITY COMPANY)
7247 AMBOY ROAD
STATEN ISLAND, NY 10307

FOR: MAGAZINES IN THE FIELD OF BEAUTY AND HEALTH FEATURING TIPS ON COSMETICS, COSMETIC SURGERY, NATURAL REMEDIES, GENERAL HEALTH AND PROFESSIONAL ADVICE, IN CLASS 16 (U.S. CLS. 2, 5, 22, 23, 29, 37, 38 AND 50).

FIRST USE 1-5-2011; IN COMMERCE 1-5-2011.

THE MARK CONSISTS OF STANDARD CHARACTERS WITHOUT CLAIM TO ANY PARTICULAR FONT, STYLE, SIZE, OR COLOR.

THE ENGLISH TRANSLATION OF "BELLA" IN THE MARK IS "BEAUTIFUL".

SN 85-177,840, FILED 11-16-2010.

WILLIAM P. SHANAHAN, EXAMINING ATTORNEY



David J. Kyros

Director of the United States Patent and Trademark Office

United States of America

United States Patent and Trademark Office



Reg. No. 4,109,827

Registered Mar. 6, 2012

Int. Cl.: 33

TRADEMARK

PRINCIPAL REGISTER

LOPEZ BELTRAN, JUAN FRANCISCO (SPAIN INDIVIDUAL)
18210 - PELIGROS
POL. ASEGURA, C/ ALMERÍA, S/N
PELIGROS, GRANADA, SPAIN 18210 AND

LOPEZ BELTRAN, FRANCISCO JAVIER (SPAIN INDIVIDUAL)
POL. ASEGURA, C/ ALMERÍA, S/N
PELIGROS, GRANADA, SPAIN 18210

FOR: ALCOHOLIC BEVERAGES EXCEPT BEERS CONTAINING RED WINE, IN CLASS 33
(U.S. CLS. 47 AND 49).

FIRST USE 6-0-2011; IN COMMERCE 6-0-2011.

NO CLAIM IS MADE TO THE EXCLUSIVE RIGHT TO USE "RED WINE SODA", APART
FROM THE MARK AS SHOWN.

THE MARK CONSISTS OF THE WORDS "TINTANO RED WINE SODA" IN STYLIZED
LETTERS, THE WORD "TINTANO" APPEARING OVER A BANNER, AND THE WORD
"RED WINE SODA" APPEARING OVER A BIGGER BANNER POSITIONED JUST BELOW
THE WORD TINTANO'S BANNER. THE BACK CONSISTS OF MANY CIRCLES AND RINGS
OF DIFFERENT SIZES.

THE WORDING TINTANO HAS NO MEANING IN A FOREIGN LANGUAGE.

SN 85-178,006, FILED 11-16-2010.

JAY BESCH, EXAMINING ATTORNEY



David J. Kyros

Director of the United States Patent and Trademark Office

United States of America

United States Patent and Trademark Office

RIVER ROSE

Reg. No. 4,109,828

Registered Mar. 6, 2012

Int. Cl.: 33

TRADEMARK

PRINCIPAL REGISTER

MISSISSIPPI RIVER DISTILLING COMPANY (IOWA LIMITED LIABILITY COMPANY)
PO BOX 801
LECLAIRE, IA 52753

FOR: DISTILLED SPIRITS; GIN, IN CLASS 33 (U.S. CLS. 47 AND 49).

FIRST USE 4-15-2011; IN COMMERCE 4-15-2011.

THE MARK CONSISTS OF STANDARD CHARACTERS WITHOUT CLAIM TO ANY PARTICULAR FONT, STYLE, SIZE, OR COLOR.

SN 85-178,266, FILED 11-16-2010.

ARETHA SOMERVILLE, EXAMINING ATTORNEY



David J. Kybas

Director of the United States Patent and Trademark Office

United States of America

United States Patent and Trademark Office

INFRATECH



Reg. No. 4,109,829

Registered Mar. 6, 2012

Int. Cls.: 9, 12, and 45

TRADEMARK

SERVICE MARK

PRINCIPAL REGISTER

ARGOPOWER, LLC (FLORIDA LIMITED LIABILITY COMPANY)
SUITE 8
1 OLEANDER COURT
COCOA, FL 32922

FOR: ANODE BATTERIES; FUEL CELLS; MAGNESIUM-AIR FUEL CELLS; RENEWABLE BATTERY SYSTEM TO PROVIDE BACKUP POWER, IN CLASS 9 (U.S. CLS. 21, 23, 26, 36 AND 38).

FIRST USE 8-27-2010; IN COMMERCE 11-4-2010.

FOR: BOATS AND STRUCTURAL PARTS THEREFOR; JON BOATS; KAYAK-LIKE BOATS; SELF-PROPELLED, AUTONOMOUS ELECTRIC WATERCRAFT IN THE NATURE OF BOATS AND VESSELS; AMPHIBIOUS VEHICLES; UNMANNED SURFACE VEHICLES, NAMELY, UNMANNED WATER VEHICLES, IN CLASS 12 (U.S. CLS. 19, 21, 23, 31, 35 AND 44).

FIRST USE 8-27-2010; IN COMMERCE 11-4-2010.

FOR: PROVIDING RECONNAISSANCE AND SURVEILLANCE SERVICES IN MARITIME AND HARBOR LOCATIONS; MARITIME AND HARBOR SURVEILLANCE SERVICES, IN CLASS 45 (U.S. CLS. 100 AND 101).

FIRST USE 8-27-2010; IN COMMERCE 11-4-2010.

THE MARK CONSISTS OF THE WORD "INFRATECH" WITH THE LETTERS "I" AND "T" IN A LARGER POINT SIZE AND IN MEDIUM BLUE AND THE LETTERS "N", "F", "R", "A", "E", "C" AND "H" IN DARK BLUE; A STYLIZED SHIP HULL WITH HALF IN DARK BLUE AND HALF IN MEDIUM BLUE; SIX STARS IN MEDIUM BLUE; AND FOUR CURVED LINES IN RED UNDER THE STYLIZED SHIP HULL.

THE COLOR(S) RED, MEDIUM BLUE, AND DARK BLUE IS/ARE CLAIMED AS A FEATURE OF THE MARK.

SN 85-178,668, FILED 11-17-2010.

DOUGLAS LEE, EXAMINING ATTORNEY

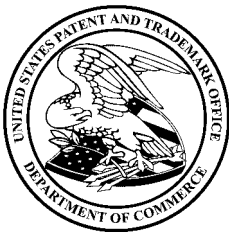

David J. Kyros

Director of the United States Patent and Trademark Office

United States of America

United States Patent and Trademark Office



Reg. No. 4,109,830

Registered Mar. 6, 2012

Int. Cl.: 11

TRADEMARK

PRINCIPAL REGISTER

SUPA TECHNOLOGY CO. LTD. (TAIWAN CORPORATION)
7F., NO.19-5, SANCHONG RD.
NANGANG DISTRICT
TAIPEI CITY, TAIWAN 115

FOR: LIGHT BULBS; CHANDELIERS; DESK LAMPS; SEARCHLIGHTS; FLOOR LAMPS; SPOT LIGHTS; LIGHT REFLECTORS; SOLAR-POWERED ALL-WEATHER LIGHTS; TABLE LAMPS; ELECTRIC LAMPS; ELECTRIC LIGHTING FIXTURES, NAMELY, DOWN LIGHTS; FLUORESCENT LAMPS; EMERGENCY LIGHTS IN THE NATURE OF ELECTRIC LIGHTING FIXTURES, NAMELY, POWER FAILURE BACKUP SAFETY LIGHTING; AQUARIUM LIGHTS; LED (LIGHT EMITTING DIODE) LIGHT BULBS; LED (LIGHT EMITTING DIODE) LIGHTING FIXTURES; LED LIGHT ASSEMBLIES FOR STREET LIGHTS, SIGNS, COMMERCIAL LIGHTING, AUTOMOBILES, BUILDINGS, AND OTHER ARCHITECTURAL USES; ELECTRIC NIGHT LIGHTS; WALL LIGHTS; STREET LAMPS; MINER'S LIGHTS IN THE NATURE OF HEADLAMPS, IN CLASS 11 (U.S. CLS. 13, 21, 23, 31 AND 34).

FIRST USE 6-14-2011; IN COMMERCE 10-26-2011.

OWNER OF U.S. REG. NO. 3,245,295.

NO CLAIM IS MADE TO THE EXCLUSIVE RIGHT TO USE "LIGHTING", APART FROM THE MARK AS SHOWN.

THE MARK CONSISTS OF THE WORDS "GONAV LIGHTING" IN STYLIZED FONT TO THE RIGHT OF A DESIGN COMPRISED OF CIRCLES WITH ATTACHED CURVED LINES WITH FOUR STAR SHAPED ELEMENTS AND TWO DIAMOND SHAPED ELEMENTS.

SN 85-179,145, FILED 11-17-2010.

ERNEST SHOSHO, EXAMINING ATTORNEY



David J. Kypos

Director of the United States Patent and Trademark Office

United States of America

United States Patent and Trademark Office

HEALTHPAD

Reg. No. 4,109,831

Registered Mar. 6, 2012

Int. Cl.: 44

SERVICE MARK

PRINCIPAL REGISTER

HEALTHPER, INC. (DELAWARE CORPORATION)
124 BROOKSTONE DRIVE
PRINCETON, NJ 08540

FOR: ONLINE SERVICES, NAMELY, PROVIDING A WEBSITE DESIGNED TO ENCOURAGE PARTICIPATION IN HEALTH AND WELLNESS PROGRAMS, IN CLASS 44 (U.S. CLS. 100 AND 101).

FIRST USE 9-1-2010; IN COMMERCE 9-1-2010.

THE MARK CONSISTS OF STANDARD CHARACTERS WITHOUT CLAIM TO ANY PARTICULAR FONT, STYLE, SIZE, OR COLOR.

SN 85-179,268, FILED 11-17-2010.

TRACY CROSS, EXAMINING ATTORNEY



David J. Kyffers

Director of the United States Patent and Trademark Office

United States of America

United States Patent and Trademark Office

AIRTAR

Reg. No. 4,109,832

Registered Mar. 6, 2012

Int. Cl.: 28

TRADEMARK

PRINCIPAL REGISTER

MORTON, LARRY (UNITED STATES INDIVIDUAL)
P.O. BOX 995
CASCADE, ID 83611

FOR: TOY GUITARS, IN CLASS 28 (U.S. CLS. 22, 23, 38 AND 50).

FIRST USE 12-2-2011; IN COMMERCE 12-2-2011.

THE MARK CONSISTS OF STANDARD CHARACTERS WITHOUT CLAIM TO ANY PARTICULAR FONT, STYLE, SIZE, OR COLOR.

SN 85-179,826, FILED 11-18-2010.

NAAKWAMA ANKRAH, EXAMINING ATTORNEY



David J. Kybas

Director of the United States Patent and Trademark Office

United States of America

United States Patent and Trademark Office

BRINGING MOBILE APPS TO OUTDOORSMEN!

Reg. No. 4,109,833

Registered Mar. 6, 2012

Int. Cl.: 9

TRADEMARK

PRINCIPAL REGISTER

CONNECTED, LLC (ALABAMA LIMITED LIABILITY COMPANY)
3215 GLASGOW CIRCLE
BIRMINGHAM, AL 35242

FOR: COMPUTER APPLICATION SOFTWARE FOR MOBILE PHONES, NAMELY, SOFTWARE FOR PROVIDING HUNTING, FISHING AND BOATING INFORMATION, IN CLASS 9 (U.S. CLS. 21, 23, 26, 36 AND 38).

FIRST USE 1-13-2010; IN COMMERCE 1-13-2010.

THE MARK CONSISTS OF STANDARD CHARACTERS WITHOUT CLAIM TO ANY PARTICULAR FONT, STYLE, SIZE, OR COLOR.

SN 85-179,952, FILED 11-18-2010.

PAM WILLIS, EXAMINING ATTORNEY



David J. Kybas

Director of the United States Patent and Trademark Office

United States of America

United States Patent and Trademark Office

WORKSIGHT

Reg. No. 4,109,834

Registered Mar. 6, 2012

Int. Cl.: 9

TRADEMARK

PRINCIPAL REGISTER

PRECO ELECTRONICS, INC. (IDAHO CORPORATION)
10335 W. EMERALD STREET
BOISE, ID 83704

FOR: RADAR OBJECT DETECTION SYSTEMS, NAMELY, VEHICLE-MOUNTED RADAR DETECTOR AND ALARM FOR OBJECTS SURROUNDING THE VEHICLE INCLUDING ANY ZONES OBSCURED FROM THE OPERATOR'S VIEW , IN CLASS 9 (U.S. CLS. 21, 23, 26, 36 AND 38).

FIRST USE 5-20-2011; IN COMMERCE 5-20-2011.

THE MARK CONSISTS OF STANDARD CHARACTERS WITHOUT CLAIM TO ANY PARTICULAR FONT, STYLE, SIZE, OR COLOR.

SN 85-180,108, FILED 11-18-2010.

JOHN E. MICHOS, EXAMINING ATTORNEY



David J. Kyffers

Director of the United States Patent and Trademark Office

United States of America

United States Patent and Trademark Office

8THBRIDGE

Reg. No. 4,109,835

Registered Mar. 6, 2012

Int. Cl.: 35

SERVICE MARK

PRINCIPAL REGISTER

8THBRIDGE, INC. (DELAWARE CORPORATION)
110 NORTH 5TH STREET, SUITE 420
MINNEAPOLIS, MN 55403

FOR: PROVIDING MARKETING SOLUTIONS FOR ORGANIZATIONS TO CREATE AND EXTEND THEIR PRODUCT AND BRAND STRATEGIES BY PROVIDING SOCIAL MEDIA MARKETING SOLUTIONS AND INTERNET-BASED FUNCTIONALITY TO ENABLE SALES OF GOODS AND OTHER CONSUMER TRANSACTIONS ON SOCIAL MEDIA WEB SITES, MOBILE DEVICES, AND SOFTWARE APPLICATIONS, IN CLASS 35 (U.S. CLS. 100, 101 AND 102).

FIRST USE 1-21-2011; IN COMMERCE 1-21-2011.

THE MARK CONSISTS OF STANDARD CHARACTERS WITHOUT CLAIM TO ANY PARTICULAR FONT, STYLE, SIZE, OR COLOR.

SN 85-180,125, FILED 11-18-2010.

CURTIS FRENCH, EXAMINING ATTORNEY



David J. Kyffers

Director of the United States Patent and Trademark Office

United States of America

United States Patent and Trademark Office

SWEET TWEETS

Reg. No. 4,109,836

THE TOPPS COMPANY, INC. (DELAWARE CORPORATION)
ONE WHITEHALL STREET
NEW YORK, NY 10004

Registered Mar. 6, 2012

Int. Cl.: 30

FOR: CANDY SOLD AFFIXED TO NOTE CARDS USED TO WRITE PERSONAL MESSAGES,
IN CLASS 30 (U.S. CL. 46).

TRADEMARK

FIRST USE 3-0-2011; IN COMMERCE 3-0-2011.

PRINCIPAL REGISTER

THE MARK CONSISTS OF STANDARD CHARACTERS WITHOUT CLAIM TO ANY PARTICULAR FONT, STYLE, SIZE, OR COLOR.

SN 85-180,175, FILED 11-18-2010.

ANGELA M. MICHELI, EXAMINING ATTORNEY



David J. Kybas

Director of the United States Patent and Trademark Office

United States of America

United States Patent and Trademark Office

EMP³OWER

Reg. No. 4,109,837

ADVANCED NEUROMODULATION SYSTEMS, INC. (TEXAS CORPORATION)
6901 PRESTON ROAD
PLANO, TX 75024

Registered Mar. 6, 2012

Int. Cl.: 42

FOR: MEDICAL AND SCIENTIFIC RESEARCH, NAMELY, CONDUCTING CLINICAL TRIALS, IN CLASS 42 (U.S. CLS. 100 AND 101).

SERVICE MARK

FIRST USE 2-15-2011; IN COMMERCE 2-15-2011.

PRINCIPAL REGISTER

THE MARK CONSISTS OF THE WORD "EMP3OWER" WITH THE "3" BEING A SUPERSCRIPT.

SN 85-180,195, FILED 11-18-2010.

ANGELA M. MICHELI, EXAMINING ATTORNEY



David J. Kybas

Director of the United States Patent and Trademark Office

United States of America

United States Patent and Trademark Office

Get Some

Reg. No. 4,109,838

Registered Mar. 6, 2012

Int. Cl.: 33

TRADEMARK

PRINCIPAL REGISTER

INFOMAR INC. (NEW YORK CORPORATION)
120 EAST 89TH ST., SUITE 6C
NEW YORK, NY 10128

FOR: VODKA, IN CLASS 33 (U.S. CLS. 47 AND 49).

FIRST USE 3-29-2010; IN COMMERCE 3-29-2010.

THE MARK CONSISTS OF STANDARD CHARACTERS WITHOUT CLAIM TO ANY PARTICULAR FONT, STYLE, SIZE, OR COLOR.

SN 85-180,200, FILED 11-18-2010.

ANGELA M. MICHELI, EXAMINING ATTORNEY



David J. Kybas

Director of the United States Patent and Trademark Office

United States of America

United States Patent and Trademark Office

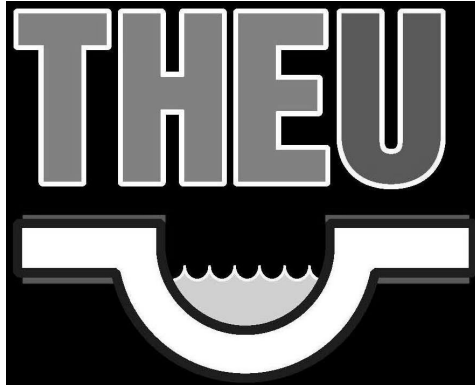

Reg. No. 4,109,839

Registered Mar. 6, 2012

Int. Cl.: 11

TRADEMARK

PRINCIPAL REGISTER

VANGURA KITCHEN TOPS, INC. (PENNSYLVANIA CORPORATION)
14431 ROUTE 30
NORTH HUNTINGDON, PA 15642

FOR: UNDERMOUNT LAMINATE SINKS, IN CLASS 11 (U.S. CLS. 13, 21, 23, 31 AND 34).

FIRST USE 12-5-2011; IN COMMERCE 12-5-2011.

THE MARK CONSISTS OF THE WORD "THEU" OVER THE SCHEMATIC OF A SINK WITH WATER THEREIN.

SN 85-180,272, FILED 11-18-2010.

PAUL E. FAHRENKOPF, EXAMINING ATTORNEY



David J. Kybas

Director of the United States Patent and Trademark Office

United States of America

United States Patent and Trademark Office

ENDLESS EDGE

Reg. No. 4,109,840

VANGURA KITCHEN TOPS, INC. (PENNSYLVANIA CORPORATION)
14431 ROUTE 30
NORTH HUNTINGDON, PA 15642

Registered Mar. 6, 2012

Int. Cl.: 19

FOR: WRAPAROUND LAMINATE COUNTERTOP BORDERS, IN CLASS 19 (U.S. CLS. 1, 12, 33 AND 50).

TRADEMARK

FIRST USE 12-5-2011; IN COMMERCE 12-5-2011.

PRINCIPAL REGISTER

THE MARK CONSISTS OF STANDARD CHARACTERS WITHOUT CLAIM TO ANY PARTICULAR FONT, STYLE, SIZE, OR COLOR.

SN 85-180,291, FILED 11-18-2010.

PAUL E. FAHRENKOPF, EXAMINING ATTORNEY



David J. Kybas

Director of the United States Patent and Trademark Office

United States of America

United States Patent and Trademark Office

MEMBLLY

Reg. No. 4,109,841

FORALLTIME LLC (DELAWARE LIMITED LIABILITY COMPANY)
51 PARKS DRIVE
SHERBORN, MA 01770

Registered Mar. 6, 2012

Int. Cls.: 9 and 42

FOR: DOWNLOADABLE SOFTWARE FOR THE PURPOSE OF CAPTURING PHOTOGRAPHIC IMAGES AND VIDEOS DIGITALLY, IN CLASS 9 (U.S. CLS. 21, 23, 26, 36 AND 38).

TRADEMARK

FIRST USE 1-1-2011; IN COMMERCE 12-15-2011.

SERVICE MARK

FOR: PROVIDING ONLINE NON-DOWNLOADABLE SOFTWARE FOR THE PURPOSE OF CAPTURING PHOTOGRAPHIC IMAGES AND VIDEOS DIGITALLY, IN CLASS 42 (U.S. CLS. 100 AND 101).

PRINCIPAL REGISTER

FIRST USE 1-1-2011; IN COMMERCE 12-15-2011.

THE MARK CONSISTS OF STANDARD CHARACTERS WITHOUT CLAIM TO ANY PARTICULAR FONT, STYLE, SIZE, OR COLOR.

SN 85-180,643, FILED 11-19-2010.

ELLEN B. AWRICH, EXAMINING ATTORNEY



David J. Kybas

Director of the United States Patent and Trademark Office

United States of America

United States Patent and Trademark Office

Paolo Bentini

Reg. No. 4,109,842

BELLE COSE, LLC (FLORIDA LIMITED LIABILITY COMPANY)
2800 ISLAND BOULEVARD
AVENTURA, FL 33160

Registered Mar. 6, 2012

Int. Cls.: 18 and 25

FOR: HANDBAGS AND WALLETS, IN CLASS 18 (U.S. CLS. 1, 2, 3, 22 AND 41).

TRADEMARK

FIRST USE 10-28-2010; IN COMMERCE 10-28-2010.

PRINCIPAL REGISTER

FOR: BELTS AND SHOES , IN CLASS 25 (U.S. CLS. 22 AND 39).

FIRST USE 5-2-2011; IN COMMERCE 5-2-2011.

THE NAME(S), PORTRAIT(S), AND/OR SIGNATURE(S) SHOWN IN THE MARK DOES NOT IDENTIFY A PARTICULAR LIVING INDIVIDUAL.

THE MARK CONSISTS OF THE STYLIZED WORDS "PAOLO BENTINI".

SN 85-180,739, FILED 11-19-2010.

KEVON CHISOLM, EXAMINING ATTORNEY



David J. Kybas

Director of the United States Patent and Trademark Office

United States of America

United States Patent and Trademark Office

ARMADILLO

Reg. No. 4,109,843

Registered Mar. 6, 2012

Int. Cl.: 12

TRADEMARK

PRINCIPAL REGISTER

DONGGUAN HONGYI WIPER CO., LTD. (CHINA CORPORATION)
AREA NO.9 & 11, MIN YING INDUSTRIAL
ZONE. CH'A SHAN TOWN, DONG GUAN CITY
GUANG DONG, CHINA

FOR: CAR WINDOW SHADES; VEHICLE HOODS; VEHICLE PARTS, NAMELY, SUN VISORS; VEHICLE PARTS, NAMELY, WINDSHIELD VISORS; VEHICLE PARTS, NAMELY, WINDSHIELD WIPERS; VEHICLE WINDOWS; VEHICLE WINDSCREENS; VELOMOBILE BODIES, NAMELY, SPECIALLY ADAPTED FOR WEATHER PROTECTION SHELLS FOR USE ON BICYCLES AND ADULT TRICYCLES; WIND BLOCKERS TO BE AFFIXED IN THE PASSENGER AREA OF LAND VEHICLES; WINDSCREEN WIPERS; WINDSCREEN WIPERS FOR AUTOMOBILES; WINDSCREEN WIPERS FOR MOTOR CARS; WINDSCREENS FOR MOTOR CARS; WINDSHIELD WIPER BLADES; WINDSHIELD WIPER BLADES FOR VEHICLES, IN CLASS 12 (U.S. CLS. 19, 21, 23, 31, 35 AND 44).

FIRST USE 9-1-2010; IN COMMERCE 9-1-2010.

THE MARK CONSISTS OF STANDARD CHARACTERS WITHOUT CLAIM TO ANY PARTICULAR FONT, STYLE, SIZE, OR COLOR.

SN 85-180,762, FILED 11-19-2010.

JESSICA A. POWERS, EXAMINING ATTORNEY



David J. Kyros

Director of the United States Patent and Trademark Office

United States of America

United States Patent and Trademark Office

POWERLOCK

Reg. No. 4,109,844

DIRECT ENERGY BUSINESS, LLC (DELAWARE LIMITED LIABILITY COMPANY)
1001 LIBERTY AVENUE, SUITE 1200
PITTSBURGH, PA 15222

Registered Mar. 6, 2012

Int. Cl.: 35

FOR: ENERGY MANAGEMENT SERVICES, NAMELY, ENERGY SUPPLY COORDINATION FOR OTHERS FOR ELECTRIC ENERGY; AND PROCUREMENT SERVICES, NAMELY, PURCHASING ELECTRIC ENERGY FOR THE BENEFIT OF OTHERS AT A STATED FIXED PRICE FOR A STATED DURATION OF TIME, IN CLASS 35 (U.S. CLS. 100, 101 AND 102).

SERVICE MARK

PRINCIPAL REGISTER

FIRST USE 12-0-2010; IN COMMERCE 12-0-2010.

THE MARK CONSISTS OF STANDARD CHARACTERS WITHOUT CLAIM TO ANY PARTICULAR FONT, STYLE, SIZE, OR COLOR.

SN 85-180,834, FILED 11-19-2010.

WENDY JUN, EXAMINING ATTORNEY



David J. Kyffers

Director of the United States Patent and Trademark Office

United States of America

United States Patent and Trademark Office

TOUCHSTONE

Reg. No. 4,109,845

COREFILING LIMITED (UNITED KINGDOM CORPORATION)
OSNEY MEAD HOUSE
OSNEY MEDE, OXFORD, UNITED KINGDOM OX20FA

Registered Mar. 6, 2012

Int. Cl.: 9

FOR: SOFTWARE TO PREPARE, READ OR REVIEW COMPUTERIZED BUSINESS AND FINANCIAL REPORTS AND DATA, IN CLASS 9 (U.S. CLS. 21, 23, 26, 36 AND 38).

TRADEMARK

FIRST USE 2-1-2009; IN COMMERCE 5-5-2009.

PRINCIPAL REGISTER

THE MARK CONSISTS OF STANDARD CHARACTERS WITHOUT CLAIM TO ANY PARTICULAR FONT, STYLE, SIZE, OR COLOR.

SN 85-180,999, FILED 11-19-2010.

BRIAN NEVILLE, EXAMINING ATTORNEY



David J. Kybas

Director of the United States Patent and Trademark Office

United States of America

United States Patent and Trademark Office

THINGWORX

Reg. No. 4,109,846

THINGWORX, INC. (DELAWARE CORPORATION)
350 EAGLEVIEW BLVD, SUITE 150
EXTON, PA 19341

Registered Mar. 6, 2012

Int. Cl.: 9

FOR: SOFTWARE APPLICATION PLATFORM FOR CONNECTING PEOPLE, SERVICES AND DEVICES TO THE INTERNET, IN CLASS 9 (U.S. CLS. 21, 23, 26, 36 AND 38).

TRADEMARK

FIRST USE 2-0-2011; IN COMMERCE 2-0-2011.

PRINCIPAL REGISTER

THE MARK CONSISTS OF STANDARD CHARACTERS WITHOUT CLAIM TO ANY PARTICULAR FONT, STYLE, SIZE, OR COLOR.

SN 85-181,040, FILED 11-19-2010.

MIDGE BUTLER, EXAMINING ATTORNEY



David J. Kybas

Director of the United States Patent and Trademark Office

United States of America

United States Patent and Trademark Office



Reg. No. 4,109,847

Registered Mar. 6, 2012

Int. Cl.: 41

SERVICE MARK

PRINCIPAL REGISTER

CAPABEL PRODUCTIONS, LLC (COLORADO LIMITED LIABILITY COMPANY)
8066 EAGLE RD.
LARKSPUR, CO 80118

FOR: DISTRIBUTION OF TELEVISION PROGRAMMING TO CABLE TELEVISION SYSTEMS;
ORGANIZING, ARRANGING, AND CONDUCTING LAWN MOWER RACING EVENTS , IN
CLASS 41 (U.S. CLS. 100, 101 AND 107).

FIRST USE 9-15-2010; IN COMMERCE 10-17-2010.

THE MARK CONSISTS OF THE WORDS "MOW OFF" APPEARING BELOW A SILHOUETTE
FIGURE OF A RACER PUSHING A LAWN MOWER ACROSS A WAVE FROM LEFT TO
RIGHT.

SN 85-181,112, FILED 11-19-2010.

ARETHA SOMERVILLE, EXAMINING ATTORNEY



David J. Kybas

Director of the United States Patent and Trademark Office

United States of America

United States Patent and Trademark Office

I don't have the patience
to become a patient

Reg. No. 4,109,848

CANCER PREVENTION INSTITUTE OF CALIFORNIA (CALIFORNIA CORPORATION)
2201 WALNUT AVE., SUITE 300
FREMONT, CA 94538

Registered Mar. 6, 2012

Int. Cls.: 35 and 36

FOR: ADVERTISING, PUBLIC RELATIONS, AND MARKETING SERVICES, NAMELY, ADVERTISING AND PROMOTING PUBLIC AWARENESS IN THE FIELD OF CANCER RESEARCH AND PREVENTION, IN CLASS 35 (U.S. CLS. 100, 101 AND 102).

SERVICE MARK

FIRST USE 10-4-2010; IN COMMERCE 10-4-2010.

PRINCIPAL REGISTER

FOR: CHARITABLE FUNDRAISING SERVICES, NAMELY, RAISE FUNDS FOR CANCER RESEARCH, EDUCATION AND PREVENTION; CHARITABLE FUNDRAISING SERVICES, IN CLASS 36 (U.S. CLS. 100, 101 AND 102).

FIRST USE 10-4-2010; IN COMMERCE 10-4-2010.

THE MARK CONSISTS OF STANDARD CHARACTERS WITHOUT CLAIM TO ANY PARTICULAR FONT, STYLE, SIZE, OR COLOR.

SN 85-181,171, FILED 11-19-2010.

LANA PHAM, EXAMINING ATTORNEY



David J. Kybas

Director of the United States Patent and Trademark Office

United States of America

United States Patent and Trademark Office



Reg. No. 4,109,849

FIRST SLING TECHNOLOGY LLC (OKLAHOMA LIMITED LIABILITY COMPANY)
5701 STONEGATE LANE
MUSTANG, OK 73064

Registered Mar. 6, 2012

Int. Cl.: 22

FOR: CARGO SLINGS OF ROPE OR FABRIC; NON-METAL SLINGS FOR LOADING, IN CLASS 22 (U.S. CLS. 1, 2, 7, 19, 22, 42 AND 50).

TRADEMARK

FIRST USE 2-13-2011; IN COMMERCE 2-13-2011.

PRINCIPAL REGISTER

OWNER OF U.S. REG. NO. 3,357,427.

NO CLAIM IS MADE TO THE EXCLUSIVE RIGHT TO USE "FULL INSPECTION ROUND-SLING TECHNOLOGY", APART FROM THE MARK AS SHOWN.

THE MARK CONSISTS OF THE WORD "FIRST" IN UPPER CASE WITH THE WORDS "FULL INSPECTION ROUND-SLING TECHNOLOGY" IN SMALLER LETTERS UNDERNEATH, ALL IN A STYLIZED FORMAT.

SN 85-181,177, FILED 11-19-2010.

PAM WILLIS, EXAMINING ATTORNEY



David J. Kyffers

Director of the United States Patent and Trademark Office

United States of America

United States Patent and Trademark Office

MPLS POINT

Reg. No. 4,109,850

PRINCETON TECTONICS, INC. (NEW JERSEY CORPORATION), AKA PRINCETON TEC,
261 ROUTE 130
BORDENTOWN, NJ 08505

Registered Mar. 6, 2012

Int. Cl.: 11

FOR: PERSONAL BATTERY-POWERED LIGHT WITH MOUNTING BRACKET FOR AT-
TACHMENT TO CLOTHING AND TO HEADGEAR, IN CLASS 11 (U.S. CLS. 13, 21, 23, 31
AND 34).

TRADEMARK

FIRST USE 3-19-2011; IN COMMERCE 3-19-2011.

PRINCIPAL REGISTER

THE MARK CONSISTS OF STANDARD CHARACTERS WITHOUT CLAIM TO ANY PAR-
TICULAR FONT, STYLE, SIZE, OR COLOR.

SN 85-181,343, FILED 11-19-2010.

KHANH LE, EXAMINING ATTORNEY



David J. Kyffers

Director of the United States Patent and Trademark Office

United States of America

United States Patent and Trademark Office

MPLS SWITCH

Reg. No. 4,109,851

PRINCETON TECTONICS, INC. (NEW JERSEY CORPORATION), AKA PRINCETON TEC,
261 ROUTE 130
BORDENTOWN, NJ 08505

Registered Mar. 6, 2012

Int. Cl.: 11

FOR: PERSONAL BATTERY-POWERED LIGHT WITH MOUNTING BRACKET FOR AT-
TACHMENT TO CLOTHING AND TO HEADGEAR, IN CLASS 11 (U.S. CLS. 13, 21, 23, 31
AND 34).

TRADEMARK

FIRST USE 9-24-2010; IN COMMERCE 9-24-2010.

PRINCIPAL REGISTER

THE MARK CONSISTS OF STANDARD CHARACTERS WITHOUT CLAIM TO ANY PAR-
TICULAR FONT, STYLE, SIZE, OR COLOR.

SN 85-181,353, FILED 11-19-2010.

KHANH LE, EXAMINING ATTORNEY



David J. Kyffers

Director of the United States Patent and Trademark Office

United States of America

United States Patent and Trademark Office



Reg. No. 4,109,852

Registered Mar. 6, 2012

Int. Cl.: 37

SERVICE MARK

PRINCIPAL REGISTER

BUILDING MATERIALS HOLDING CORPORATION (CALIFORNIA CORPORATION)
SUITE 200
720 PARK BOULEVARD
BOISE, ID 83712

FOR: SERVICES IN THE BUILDING CONSTRUCTION FIELD, NAMELY, PROVIDING RETAIL STORE SERVICES FEATURING BUILDING MATERIALS INCLUDING ENGINEERED LUMBER PRODUCTS, DIMENSIONAL FRAMING LUMBER, CONSTRUCTION HARDWARE, WINDOWS, DOORS, MILLWORK, ROOF AND FLOOR TRUSSES, AND MANUFACTURED WALL PANELS TO HIGH-VOLUME AND CUSTOM HOMEBUILDERS, IN CLASS 37 (U.S. CLS. 100, 103 AND 106).

FIRST USE 11-15-2010; IN COMMERCE 11-15-2010.

OWNER OF U.S. REG. NOS. 2,015,252, 2,772,209, AND 2,931,314.

THE COLOR(S) WHITE, BURGUNDY, DARK BLUE, LIGHT BLUE AND BLACK IS/ARE CLAIMED AS A FEATURE OF THE MARK.

NO CLAIM IS MADE TO THE EXCLUSIVE RIGHT TO USE "BUILDING MATERIALS AND CONSTRUCTION SERVICES", APART FROM THE MARK AS SHOWN.

THE MARK CONSISTS OF A STYLIZED DESIGN OF THE OUTWARD FORM OF A HOUSE CONSISTING OF AN IRREGULAR TRIANGLE ON THE LEFT TOP OF THE DESIGN IN BURGUNDY AND AN IRREGULAR SMALLER TRIANGLE ON THE RIGHT TOP OF THE DESIGN IN LIGHT BLUE. BELOW THESE IRREGULAR TRIANGLES IS A WHITE LINE THAT SIMULATES THE ROOF OUTLINE OF A HOUSE. THE FORM OF THE HOUSE IS DARK BLUE WITH THE WORDS "BMC" SHOWN IN WHITE INSIDE THE HOUSE. BELOW THE STYLIZED DESIGN ARE THE WORDS, "BUILDING MATERIALS AND CONSTRUCTION SERVICES" SHOWN IN BLACK.

SN 85-181,688, FILED 11-19-2010.

ESTHER A. BORSUK, EXAMINING ATTORNEY



David J. Kyffers

Director of the United States Patent and Trademark Office

United States of America

United States Patent and Trademark Office

Politext

Reg. No. 4,109,853

Registered Mar. 6, 2012

Int. Cl.: 35

SERVICE MARK

PRINCIPAL REGISTER

MARSHALL, KOURI C. (UNITED STATES INDIVIDUAL), DBA POLITEXT,
UNIT 104
1901 LINCOLN ROAD, NE
WASHINGTON, DC 20002

FOR: INFORMATION ABOUT POLITICAL ELECTIONS, IN CLASS 35 (U.S. CLS. 100, 101
AND 102).

FIRST USE 5-31-2011; IN COMMERCE 5-31-2011.

THE MARK CONSISTS OF STANDARD CHARACTERS WITHOUT CLAIM TO ANY PAR-
TICULAR FONT, STYLE, SIZE, OR COLOR.

SN 85-181,926, FILED 11-21-2010.

NAAKWAMA ANKRAH, EXAMINING ATTORNEY



David J. Kybas

Director of the United States Patent and Trademark Office

United States of America

United States Patent and Trademark Office

DECORWOOD

Reg. No. 4,109,854

Registered Mar. 6, 2012

Int. Cl.: 19

TRADEMARK

PRINCIPAL REGISTER

UNILIN FLOORING NC, LLC (NORTH CAROLINA LIMITED LIABILITY COMPANY)
P.O. BOX 800
MISTY YOUNG - LEGAL DEPT
CHATSWORTH, GA 30705

FOR: LAMINATE FLOORING, IN CLASS 19 (U.S. CLS. 1, 12, 33 AND 50).

FIRST USE 12-15-2010; IN COMMERCE 12-15-2010.

THE MARK CONSISTS OF STANDARD CHARACTERS WITHOUT CLAIM TO ANY PARTICULAR FONT, STYLE, SIZE, OR COLOR.

SN 85-182,063, FILED 11-22-2010.

STEVEN PEREZ, EXAMINING ATTORNEY



David J. Kyffers

Director of the United States Patent and Trademark Office

United States of America

United States Patent and Trademark Office

DISCOVER THE GENIUS IN YOUR CHILD

Reg. No. 4,109,855

SIRUVAL, INC. (NEW JERSEY CORPORATION)
40 BRUNSWICK AVE., SUITE 202
EDISON, NJ 08817

Registered Mar. 6, 2012

Int. Cl.: 41

FOR: EDUCATIONAL SERVICES, NAMELY, PROVIDING TUTORING IN THE FIELDS OF MATH AND ENGLISH, IN CLASS 41 (U.S. CLS. 100, 101 AND 107).

SERVICE MARK

FIRST USE 11-11-2011; IN COMMERCE 11-11-2011.

PRINCIPAL REGISTER

THE MARK CONSISTS OF STANDARD CHARACTERS WITHOUT CLAIM TO ANY PARTICULAR FONT, STYLE, SIZE, OR COLOR.

SN 85-182,095, FILED 11-22-2010.

KEVIN DINALLO, EXAMINING ATTORNEY



David J. Kybas

Director of the United States Patent and Trademark Office

United States of America

United States Patent and Trademark Office

MicroStar Setting

Reg. No. 4,109,856

Registered Mar. 6, 2012

Int. Cl.: 14

TRADEMARK

PRINCIPAL REGISTER

DHOLAKIYA, HASMUKH (UNITED STATES INDIVIDUAL)
15 WEST 47TH STREET
SUITE 303
NEW YORK, NY 10036

FOR: CUT DIAMONDS; DIAMOND JEWELRY; DIAMONDS; GEMSTONE JEWELRY;
GEMSTONES; JEWELRY; PRECIOUS GEMSTONES; SEMI-PRECIOUS GEMSTONES, IN
CLASS 14 (U.S. CLS. 2, 27, 28 AND 50).

FIRST USE 4-0-2011; IN COMMERCE 4-0-2011.

THE MARK CONSISTS OF STANDARD CHARACTERS WITHOUT CLAIM TO ANY PAR-
TICULAR FONT, STYLE, SIZE, OR COLOR.

NO CLAIM IS MADE TO THE EXCLUSIVE RIGHT TO USE "SETTING", APART FROM THE
MARK AS SHOWN.

SN 85-182,155, FILED 11-22-2010.

KATHY DE JONGE, EXAMINING ATTORNEY



David J. Kyros

Director of the United States Patent and Trademark Office

United States of America

United States Patent and Trademark Office

ADAPTitude : Why it's not Fair (or Smart) to Treat People Equally

Reg. No. 4,109,857

DALTON ALLIANCES, INC. (MARYLAND CORPORATION)
6004 JERRY'S DR
COLUMBIA, MD 21044

Registered Mar. 6, 2012

Int. Cl.: 41

FOR: EDUCATION SERVICES, NAMELY, PROVIDING WORKSHOPS, ONLINE COURSES, AND SPEECHES IN THE FIELD OF BUSINESS CONSULTS; ENTERTAINMENT SERVICES, NAMELY, PROVIDING WEBCASTS IN THE FIELD OF BUSINESS CONSULTS, IN CLASS 41 (U.S. CLS. 100, 101 AND 107).

SERVICE MARK

PRINCIPAL REGISTER

FIRST USE 12-30-2010; IN COMMERCE 12-30-2010.

THE MARK CONSISTS OF STANDARD CHARACTERS WITHOUT CLAIM TO ANY PARTICULAR FONT, STYLE, SIZE, OR COLOR.

SN 85-182,348, FILED 11-22-2010.

ARETHA SOMERVILLE, EXAMINING ATTORNEY



David J. Kybas

Director of the United States Patent and Trademark Office

United States of America

United States Patent and Trademark Office

YouCake

Reg. No. 4,109,858

Registered Mar. 6, 2012

Int. Cl.: 30

TRADEMARK

PRINCIPAL REGISTER

YOUCAKE, INC. (NEW YORK CORPORATION)
ONE IRVING PLACE, #V11H
NEW YORK, NY 10003

FOR: EDIBLE CAKE DECORATIONS, IN CLASS 30 (U.S. CL. 46).

FIRST USE 10-1-2007; IN COMMERCE 10-1-2007.

THE MARK CONSISTS OF STANDARD CHARACTERS WITHOUT CLAIM TO ANY PARTICULAR FONT, STYLE, SIZE, OR COLOR.

SN 85-182,392, FILED 11-22-2010.

JESSICA A. POWERS, EXAMINING ATTORNEY



David J. Kybas

Director of the United States Patent and Trademark Office

United States of America

United States Patent and Trademark Office



Reg. No. 4,109,859

Registered Mar. 6, 2012

Int. Cl.: 5

TRADEMARK

PRINCIPAL REGISTER

TEVA ANIMAL HEALTH, INC. (DELAWARE CORPORATION)
3915 SOUTH 48TH STREET TERRACE
ST. JOSEPH, MO 64503

FOR: VETERINARY PHARMACEUTICAL PREPARATIONS FOR THE TREATMENT OF
INTESTINAL DISEASES, DERMATOLOGICAL CONDITIONS, PAIN, BACTERIAL INFEC-
TIONS, AND ALLERGIES, IN CLASS 5 (U.S. CLS. 6, 18, 44, 46, 51 AND 52).

FIRST USE 12-1-2000; IN COMMERCE 12-1-2000.

OWNER OF U.S. REG. NOS. 2,149,925, 2,847,926, AND OTHERS.

THE MARK CONSISTS OF THE OVERLAPPING IMAGES OF HORSE, DOG AND A CAT.
THE IMAGES APPEAR IN A SQUARE FRAME. THE ACRONYM "DVM" IS WRITTEN BELOW
THE SQUARE FRAME DESCRIBED BEFORE.

SN 85-182,585, FILED 11-22-2010.

ANDREA BUTLER, EXAMINING ATTORNEY



David J. Kybas

Director of the United States Patent and Trademark Office

United States of America

United States Patent and Trademark Office

DARFLEX H2O

Reg. No. 4,109,860

DARTEX COATINGS INC. (RHODE ISLAND CORPORATION)
22 STEEL STREET
SLATERSVILLE, RI 02876

Registered Mar. 6, 2012

Int. Cl.: 17

FOR: NON-METAL LINER MATERIAL FOR CURED-IN-PLACE REPAIR OF CONDUITS, PIPES AND TUNNELS, IN CLASS 17 (U.S. CLS. 1, 5, 12, 13, 35 AND 50).

TRADEMARK

FIRST USE 12-2-2011; IN COMMERCE 12-2-2011.

PRINCIPAL REGISTER

THE MARK CONSISTS OF STANDARD CHARACTERS WITHOUT CLAIM TO ANY PARTICULAR FONT, STYLE, SIZE, OR COLOR.

OWNER OF U.S. REG. NOS. 3,569,095 AND 3,569,096.

NO CLAIM IS MADE TO THE EXCLUSIVE RIGHT TO USE "H2O", APART FROM THE MARK AS SHOWN.

SN 85-182,702, FILED 11-22-2010.

KATHRYN COWARD, EXAMINING ATTORNEY



David J. Kybas

Director of the United States Patent and Trademark Office

United States of America

United States Patent and Trademark Office

NewsSynergy:.

Reg. No. 4,109,861

NEWPORT TELEVISION LLC (DELAWARE LIMITED LIABILITY COMPANY)
460 NICHOLS RD. SUITE 250
KANSAS CITY, MO 64112

Registered Mar. 6, 2012

Int. Cls.: 9 and 38

FOR: COMPUTER APPLICATION SOFTWARE FOR MOBILE PHONES, PORTABLE MEDIA PLAYERS, AND HANDHELD COMPUTERS, NAMELY, SOFTWARE FOR BROADCASTING NEWS, IN CLASS 9 (U.S. CLS. 21, 23, 26, 36 AND 38).

TRADEMARK

FIRST USE 8-30-2010; IN COMMERCE 8-30-2010.

SERVICE MARK

PRINCIPAL REGISTER

FOR: TRANSMISSION OF NEWS; BROADCASTING NEWS PROGRAMS VIA A GLOBAL COMPUTER NETWORK; BROADCASTING SERVICES, NAMELY, TRANSMISSION OF NEWS PROGRAMS VIA DIGITAL COMMUNICATIONS NETWORKS; VIDEO BROADCASTING SERVICES, NAMELY, BROADCASTING NEWS OVER THE INTERNET OR OTHER COMMUNICATIONS NETWORK, IN CLASS 38 (U.S. CLS. 100, 101 AND 104).

FIRST USE 8-30-2010; IN COMMERCE 8-30-2010.

THE MARK CONSISTS OF "NEWSSYNERGY" IN A STYLIZED FORMAT, FOLLOWED BY EIGHT DOTS FORMING A CIRCLE.

SN 85-182,733, FILED 11-22-2010.

PATRICIA EVANKO, EXAMINING ATTORNEY



David J. Kyjars

Director of the United States Patent and Trademark Office

United States of America
United States Patent and Trademark Office

VAP

Reg. No. 4,109,862

ALDILA GOLF CORP. (DELAWARE CORPORATION)
14145 DANIELSON STREET, SUITE B
POWAY, CA 92064

Registered Mar. 6, 2012

Int. Cl.: 28

FOR: ARCHERY ARROWS; ARCHERY EQUIPMENT, NAMELY, ARROW NOCKS, NOCK INSERTS, ARROW POINTS, ARROW TIPS, ARROW SHAFTS AND FLETCHING, IN CLASS 28 (U.S. CLS. 22, 23, 38 AND 50).

TRADEMARK

FIRST USE 1-1-2011; IN COMMERCE 1-1-2011.

PRINCIPAL REGISTER

THE MARK CONSISTS OF STANDARD CHARACTERS WITHOUT CLAIM TO ANY PARTICULAR FONT, STYLE, SIZE, OR COLOR.

SN 85-182,755, FILED 11-22-2010.

PATRICIA EVANKO, EXAMINING ATTORNEY



David J. Kybas

Director of the United States Patent and Trademark Office

United States of America

United States Patent and Trademark Office



Reg. No. 4,109,863

Registered Mar. 6, 2012

Int. Cl.: 25

TRADEMARK

PRINCIPAL REGISTER

TUCKER, ASHLEY (UNITED STATES INDIVIDUAL)
4600 SARADON CT
CHARLOTTE, NC 28215

FOR: CLOTHING, NAMELY, SHIRTS, DRESSES, JEANS, SHORTS, LEGGINGS, JACKETS, BLAZERS, COATS, SWEATERS, PANTS, BLOUSES, BUTTON-DOWN SHIRTS, SKIRTS, TANK TOPS, AND SWIMWEAR, IN CLASS 25 (U.S. CLS. 22 AND 39).

FIRST USE 10-20-2011; IN COMMERCE 10-20-2011.

THE MARK CONSISTS OF A GRAPHIC OF A MAN AND A WOMAN DRESSED FORMALLY STANDING TOGETHER HOLDING HANDS WITH A GRAPHIC OF AN "X" WHERE THEIR MOUTHS ARE LOCATED. UNDERNEATH THE COUPLE THERE IS THE STYLIZED TEXT "THECOMMON". ABOVE THE COUPLE IS A GRAPHIC OF A PROHIBITION SYMBOL.

SN 85-182,921, FILED 11-22-2010.

ALYSSA STEEL, EXAMINING ATTORNEY



David J. Kybas

Director of the United States Patent and Trademark Office

United States of America

United States Patent and Trademark Office

EPIOMED

Reg. No. 4,109,864

Registered Mar. 6, 2012

Int. Cl.: 42

SERVICE MARK

PRINCIPAL REGISTER

EPIOMED THERAPEUTICS, INC. (DELAWARE CORPORATION)
1111 OAK KNOLL ROAD
25 MAUCHLY SUITE 316
IRVINE, CA 92618

FOR: CONDUCTING EARLY EVALUATIONS IN THE FIELD OF NEW PHARMACEUTICALS;
DEVELOPMENT OF PHARMACEUTICAL PREPARATIONS AND MEDICINES; PHARMA-
CEUTICAL DRUG DEVELOPMENT SERVICES; PHARMACEUTICAL RESEARCH AND
DEVELOPMENT; RESEARCH AND DEVELOPMENT IN THE PHARMACEUTICAL FIELD,
IN CLASS 42 (U.S. CLS. 100 AND 101).

FIRST USE 1-1-2011; IN COMMERCE 6-1-2011.

THE MARK CONSISTS OF STANDARD CHARACTERS WITHOUT CLAIM TO ANY PAR-
TICULAR FONT, STYLE, SIZE, OR COLOR.

SN 85-183,120, FILED 11-23-2010.

AMY ALFIERI, EXAMINING ATTORNEY



David J. Kybas

Director of the United States Patent and Trademark Office

United States of America

United States Patent and Trademark Office



Reg. No. 4,109,865

AMERICAN COLLEGE OF RADIOLOGY (CALIFORNIA NON-PROFIT CORPORATION)
1891 PRESTON WHITE DRIVE
RESTON, VA 201914397 AND

Registered Mar. 6, 2012

Int. Cl.: 35

RADIOLOGICAL SOCIETY OF NORTH AMERICA, INC. (ILLINOIS NON-PROFIT CORPORATION)

SERVICE MARK

820 JORIE BLVD.
OAK BROOK, IL 605232251

PRINCIPAL REGISTER

FOR: PROMOTING AWARENESS OF THE NEED FOR PATIENT SAFETY BY MINIMIZING RADIATION EXPOSURE IN THE FIELD OF MEDICAL IMAGING STUDIES, SUCH AWARENESS BEING PROMOTED TO PROFESSIONALS IN THE SAME FIELD, OTHER PHYSICIANS AND HEALTH PROFESSIONALS, AND THE PUBLIC, IN CLASS 35 (U.S. CLS. 100, 101 AND 102).

FIRST USE 11-29-2010; IN COMMERCE 11-29-2010.

THE MARK CONSISTS OF A STYLIZED OWL.

SN 85-183,146, FILED 11-23-2010.

DAVID HOFFMAN, EXAMINING ATTORNEY



David J. Kybas

Director of the United States Patent and Trademark Office

United States of America

United States Patent and Trademark Office

MYTALENT

Reg. No. 4,109,866

MYTALENT NETWORKS, INC. (FLORIDA CORPORATION)
1221 BRICKELL AVE., SUITE 900
MIAMI, FL 33131

Registered Mar. 6, 2012

Int. Cl.: 41

FOR: ELECTRONIC PUBLISHING SERVICES, NAMELY, PUBLISHING ONLINE WORKS OF OTHERS FEATURING USER-CREATED TEXT, AUDIO, VIDEO, AND GRAPHICS; PROVIDING ONLINE JOURNALS AND WEB LOGS FEATURING USER-CREATED CONTENT, IN CLASS 41 (U.S. CLS. 100, 101 AND 107).

SERVICE MARK

PRINCIPAL REGISTER

FIRST USE 1-1-2002; IN COMMERCE 1-1-2002.

THE MARK CONSISTS OF STANDARD CHARACTERS WITHOUT CLAIM TO ANY PARTICULAR FONT, STYLE, SIZE, OR COLOR.

SN 85-183,182, FILED 11-23-2010.

VERNA BETH RIRIE, EXAMINING ATTORNEY



David J. Kybas

Director of the United States Patent and Trademark Office

United States of America

United States Patent and Trademark Office



Reg. No. 4,109,867

Registered Mar. 6, 2012

Int. Cl.: 41

SERVICE MARK

PRINCIPAL REGISTER

WILLIAMSON, DR. DECAROL (UNITED STATES INDIVIDUAL)
2618 NEW VILLAGE WAY
WILMINGTON, NC 28480

FOR: ENTERTAINMENT SERVICES, NAMELY, A CONTINUING NEWS SHOW IN THE FIELD OF AGRICULTURE BROADCAST OVER TELEVISION AND RADIO, IN CLASS 41 (U.S. CLS. 100, 101 AND 107).

FIRST USE 11-8-2011; IN COMMERCE 11-8-2011.

NO CLAIM IS MADE TO THE EXCLUSIVE RIGHT TO USE "AG NETWORK", APART FROM THE MARK AS SHOWN.

THE COLOR(S) GOLD, BROWN, BLACK IS/ARE CLAIMED AS A FEATURE OF THE MARK.

THE MARK CONSISTS OF THE LETTERS "AG" IN THE COLOR GOLD, THE WORD "NETWORK" IN THE COLOR BROWN WITH THE "O" IN THE SHAPE OF A COG, THE WORDS "YOUR DAILY LIFE" IN THE COLOR BLACK, AND A WHEAT POD IN THE COLOR BROWN POSITIONED BESIDE THE "AG" AND ABOVE THE "E" IN "NETWORK".

SN 85-183,685, FILED 11-23-2010.

NICHOLAS ALTREE, EXAMINING ATTORNEY



David J. Kybas

Director of the United States Patent and Trademark Office

United States of America

United States Patent and Trademark Office

SCOREFEEDER

Reg. No. 4,109,868

Registered Mar. 6, 2012

Int. Cl.: 42

SERVICE MARK

PRINCIPAL REGISTER

PETNO, DAVE (UNITED STATES INDIVIDUAL)
80 WEST CASE
HUDSON, OH 44236

FOR: PROVIDING AN INTERACTIVE SECURED-ACCESS WEBSITE FEATURING TECHNOLOGY THAT ENABLES USERS WITH REGISTERED PASSWORDS AND IDENTIFICATIONS TO UPLOAD AND SHARE HIGH SCHOOL SPORTING EVENT SCORES WITH NEWS REPORTING STATIONS FOR INCLUSION ON WEBSITES AND BROADCASTS, IN CLASS 42 (U.S. CLS. 100 AND 101).

FIRST USE 12-1-2010; IN COMMERCE 12-1-2010.

THE MARK CONSISTS OF STANDARD CHARACTERS WITHOUT CLAIM TO ANY PARTICULAR FONT, STYLE, SIZE, OR COLOR.

SN 85-183,820, FILED 11-23-2010.

DAVID YONTEF, EXAMINING ATTORNEY



David J. Kyffers

Director of the United States Patent and Trademark Office

United States of America

United States Patent and Trademark Office

Health Cafe

Reg. No. 4,109,869

DREAMBRANDS, INC. (ARIZONA CORPORATION)
11645 NORTH CVAE CREEK ROAD
PHOENIX, AZ 85020

Registered Mar. 6, 2012

Int. Cl.: 29

FOR: COFFEE CREAMER; NON-DAIRY CREAMER, IN CLASS 29 (U.S. CL. 46).

TRADEMARK

FIRST USE 12-5-2011; IN COMMERCE 12-5-2011.

PRINCIPAL REGISTER

THE MARK CONSISTS OF STANDARD CHARACTERS WITHOUT CLAIM TO ANY PARTICULAR FONT, STYLE, SIZE, OR COLOR.

SN 85-183,870, FILED 11-23-2010.

DOMINIC J. FERRAIUOLO, EXAMINING ATTORNEY



David J. Kyffers

Director of the United States Patent and Trademark Office

United States of America

United States Patent and Trademark Office

RIBBON OF PROTECTION

Reg. No. 4,109,870

Registered Mar. 6, 2012

Int. Cl.: 36

SERVICE MARK

PRINCIPAL REGISTER

SINAI TEMPLE (CALIFORNIA CORPORATION), DBA MOUNT SINAI MEMORIAL PARK CORPORATION,
5950 FOREST LAWN DRIVE
LOS ANGELES, CA 90068

FOR: PRE-PAID FUNERAL EXPENSE SERVICES, IN CLASS 36 (U.S. CLS. 100, 101 AND 102).

FIRST USE 2-11-2011; IN COMMERCE 2-11-2011.

THE MARK CONSISTS OF STANDARD CHARACTERS WITHOUT CLAIM TO ANY PARTICULAR FONT, STYLE, SIZE, OR COLOR.

SN 85-184,188, FILED 11-23-2010.

KIM MONINGHOFF, EXAMINING ATTORNEY



David J. Kyros

Director of the United States Patent and Trademark Office

United States of America

United States Patent and Trademark Office

HITECH RADCLOUD DOWNPOUR

Reg. No. 4,109,871

SMITH, DOUGLAS (UNITED STATES INDIVIDUAL)
101 BRETTFORD COURT
SAN ANTONIO, TX 78230

Registered Mar. 6, 2012

Int. Cl.: 38

FOR: ELECTRONIC DATA TRANSMISSION SERVICES FROM A CLOUD COMPUTING BASED NETWORK USING HIGHLY ENCRYPTED AND DATA COMPRESSED METHODOLOGY, IN CLASS 38 (U.S. CLS. 100, 101 AND 104).

SERVICE MARK

FIRST USE 6-1-2010; IN COMMERCE 6-1-2010.

PRINCIPAL REGISTER

THE MARK CONSISTS OF STANDARD CHARACTERS WITHOUT CLAIM TO ANY PARTICULAR FONT, STYLE, SIZE, OR COLOR.

SN 85-184,282, FILED 11-24-2010.

JAMES LOVELACE, EXAMINING ATTORNEY



David J. Kybas

Director of the United States Patent and Trademark Office

United States of America

United States Patent and Trademark Office

RADCLOUD INFORMATION

Reg. No. 4,109,872

Registered Mar. 6, 2012

Int. Cl.: 42

SERVICE MARK

PRINCIPAL REGISTER

SMITH, DOUGLAS (UNITED STATES INDIVIDUAL)
101 BRETTFORD COURT
SAN ANTONIO, TX 78230

FOR: PROVIDING TEMPORARY USE OF PROPRIETARY CLOUD-COMPUTING BASED ON-LINE NON-DOWNLOADABLE SOFTWARE THAT GATHERS DIAGNOSTIC IMAGING STUDIES FROM MULTIPLE MEDICAL IMAGING CENTERS AND COLLECTS ELECTRONIC MEDICAL RECORDS FROM MULTIPLE DOCTORS' OFFICES AND MEDICAL PROVIDERS AND COLLATES THIS INFORMATION INTO A SINGLE INTERACTIVE LISTING THAT CAN BE VIEWED IN COMPLIANCE WITH REGULATORY REQUIREMENTS, IN CLASS 42 (U.S. CLS. 100 AND 101).

FIRST USE 6-1-2010; IN COMMERCE 6-1-2010.

THE MARK CONSISTS OF STANDARD CHARACTERS WITHOUT CLAIM TO ANY PARTICULAR FONT, STYLE, SIZE, OR COLOR.

NO CLAIM IS MADE TO THE EXCLUSIVE RIGHT TO USE "INFORMATION", APART FROM THE MARK AS SHOWN.

SN 85-184,316, FILED 11-24-2010.

JAMES LOVELACE, EXAMINING ATTORNEY



David J. Kybas

Director of the United States Patent and Trademark Office

United States of America

United States Patent and Trademark Office

bake!-cation

Reg. No. 4,109,873

DANCING SANDWICH ENTERPRISES, INC. (MICHIGAN CORPORATION)
422 DETROIT ST.
ANN ARBOR, MI 48104

Registered Mar. 6, 2012

Int. Cl.: 41

FOR: EDUCATIONAL SERVICES, NAMELY, CONDUCTING CLASSES IN THE FIELD OF BAKING AND DISTRIBUTION OF COURSE MATERIAL IN CONNECTION THEREWITH, IN CLASS 41 (U.S. CLS. 100, 101 AND 107).

SERVICE MARK

FIRST USE 9-0-2006; IN COMMERCE 9-0-2006.

PRINCIPAL REGISTER

THE MARK CONSISTS OF THE WORD "BAKE!-CATION" WRITTEN IN A STYLIZED FONT.

SN 85-184,371, FILED 11-24-2010.

GENE MACIOL, EXAMINING ATTORNEY



David J. Kyffers

Director of the United States Patent and Trademark Office

United States of America

United States Patent and Trademark Office

AMERICAN BASICS

Reg. No. 4,109,874

Registered Mar. 6, 2012

Int. Cl.: 29

TRADEMARK

PRINCIPAL REGISTER

SCHREIBER FOODS, INC. (WISCONSIN CORPORATION)
425 PINE STREET
GREEN BAY, WI 54301

FOR: CHEESE, NATURAL CHEESE, PROCESSED CHEESE, CHEESE SPREADS, CREAM CHEESE, CHEESE FOOD, DAIRY BASED DIPS AND YOGURT, YOGURT DRINKS, YOGURT BASED BEVERAGES, IMITATION CHEESE, IMITATION CHEESE FOOD PRODUCTS, IN CLASS 29 (U.S. CL. 46).

FIRST USE 1-13-2011; IN COMMERCE 1-13-2011.

THE MARK CONSISTS OF STANDARD CHARACTERS WITHOUT CLAIM TO ANY PARTICULAR FONT, STYLE, SIZE, OR COLOR.

OWNER OF U.S. REG. NO. 3,070,751.

NO CLAIM IS MADE TO THE EXCLUSIVE RIGHT TO USE "AMERICAN", APART FROM THE MARK AS SHOWN.

SN 85-185,961, FILED 11-29-2010.

LIEF MARTIN, EXAMINING ATTORNEY



David J. Kyffers

Director of the United States Patent and Trademark Office

United States of America

United States Patent and Trademark Office

Katie's Colors

Reg. No. 4,109,875

Registered Mar. 6, 2012

Int. Cls.: 16 and 40

TRADEMARK

SERVICE MARK

PRINCIPAL REGISTER

COURTNEY ZAHNER (UNITED STATES INDIVIDUAL), DBA KATIE'S COLORS,
33 RANCH STREET
NORTH ATTLEBORO, MA 02760

FOR: CUSTOM PAINTINGS; MURALS, IN CLASS 16 (U.S. CLS. 2, 5, 22, 23, 29, 37, 38 AND 50).

FIRST USE 6-19-2010; IN COMMERCE 6-19-2010.

FOR: CUSTOM FABRICATION AND PRODUCTION OF SETS FOR MUSICAL RECITALS, IN CLASS 40 (U.S. CLS. 100, 103 AND 106).

FIRST USE 6-19-2010; IN COMMERCE 6-19-2010.

THE MARK CONSISTS OF STANDARD CHARACTERS WITHOUT CLAIM TO ANY PARTICULAR FONT, STYLE, SIZE, OR COLOR.

NO CLAIM IS MADE TO THE EXCLUSIVE RIGHT TO USE "COLORS", APART FROM THE MARK AS SHOWN.

SN 85-185,992, FILED 11-29-2010.

EMILY CHUO, EXAMINING ATTORNEY



David J. Kyros

Director of the United States Patent and Trademark Office

United States of America

United States Patent and Trademark Office

NEUTRSET

Reg. No. 4,109,876

Registered Mar. 6, 2012

Int. Cl.: 3

TRADEMARK

PRINCIPAL REGISTER

SPARTAN BRANDS, INC. (NEW YORK CORPORATION)
SUITE 601
220 EAST 23RD STREET
NEW YORK, NY 10010

FOR: HAIR CARE PRODUCTS, NAMELY, HAIR CONDITIONERS AND HAIR SETTING PREPARATIONS, IN CLASS 3 (U.S. CLS. 1, 4, 6, 50, 51 AND 52).

FIRST USE 2-18-2011; IN COMMERCE 4-19-2011.

THE MARK CONSISTS OF STANDARD CHARACTERS WITHOUT CLAIM TO ANY PARTICULAR FONT, STYLE, SIZE, OR COLOR.

SN 85-186,233, FILED 11-29-2010.

HOWARD SMIGA, EXAMINING ATTORNEY



David J. Kybas

Director of the United States Patent and Trademark Office

United States of America
United States Patent and Trademark Office

DYNAFIZ

Reg. No. 4,109,877

ZYGO CORPORATION (DELAWARE CORPORATION)
LAUREL BROOK ROAD
MIDDLEFIELD, CT 064550448

Registered Mar. 6, 2012

Int. Cl.: 9

FOR: LASER INTERFEROMETER, IN CLASS 9 (U.S. CLS. 21, 23, 26, 36 AND 38).

TRADEMARK

FIRST USE 7-26-2011; IN COMMERCE 7-26-2011.

PRINCIPAL REGISTER

THE MARK CONSISTS OF STANDARD CHARACTERS WITHOUT CLAIM TO ANY PARTICULAR FONT, STYLE, SIZE, OR COLOR.

SN 85-186,264, FILED 11-29-2010.

JUSTINE D. PARKER, EXAMINING ATTORNEY



David J. Kybas

Director of the United States Patent and Trademark Office

United States of America

United States Patent and Trademark Office

CAN-BLOCK

Reg. No. 4,109,878

Registered Mar. 6, 2012

Int. Cl.: 17

TRADEMARK

PRINCIPAL REGISTER

IMAFLEX INC. (CANADA CORPORATION)
5710 NOTRE-DAME STREET WEST
MONTREAL, QUEBEC, CANADA H4C1V2

FOR: AGRICULTURAL MULCH FILM, IN CLASS 17 (U.S. CLS. 1, 5, 12, 13, 35 AND 50).

FIRST USE 1-15-2011; IN COMMERCE 1-15-2011.

THE MARK CONSISTS OF STANDARD CHARACTERS WITHOUT CLAIM TO ANY PARTICULAR FONT, STYLE, SIZE, OR COLOR.

OWNER OF U.S. REG. NO. 4,032,561.

SN 85-186,370, FILED 11-29-2010.

DAVID YONTEF, EXAMINING ATTORNEY



David J. Kyffers

Director of the United States Patent and Trademark Office

United States of America

United States Patent and Trademark Office

And Then the Stars Fell

Reg. No. 4,109,879

CHAD BLACKHAM (UNITED STATES INDIVIDUAL)
360 BROOKSIDE CIRCLE
AURORA, OH 44202

Registered Mar. 6, 2012

Int. Cls.: 9 and 41

FOR: PRE-RECORDED DVDS, CDS, AND DOWNLOADABLE AUDIO AND VIDEO FILES, ALL FEATURING PERFORMANCES OF A MUSICAL BAND, IN CLASS 9 (U.S. CLS. 21, 23, 26, 36 AND 38).

TRADEMARK

FIRST USE 10-16-2010; IN COMMERCE 10-16-2010.

SERVICE MARK

FOR: ENTERTAINMENT, NAMELY, LIVE PERFORMANCES BY A MUSICAL BAND, IN CLASS 41 (U.S. CLS. 100, 101 AND 107).

PRINCIPAL REGISTER

FIRST USE 0-0-2010; IN COMMERCE 0-0-2010.

THE MARK CONSISTS OF STANDARD CHARACTERS WITHOUT CLAIM TO ANY PARTICULAR FONT, STYLE, SIZE, OR COLOR.

SN 85-186,448, FILED 11-29-2010.

NAPOLEON SHARMA, EXAMINING ATTORNEY



David J. Kyros

Director of the United States Patent and Trademark Office

United States of America

United States Patent and Trademark Office

WAI MING

Reg. No. 4,109,880

Registered Mar. 6, 2012

Int. Cl.: 25

TRADEMARK

PRINCIPAL REGISTER

WAI MING, LLC (MISSOURI LIMITED LIABILITY COMPANY)
139 N. CENTRAL, UNIT E
ST. LOUIS, MO 63105

FOR: BLOUSES; BRIDESMAID DRESSES; BUTTON DOWN SHIRTS; CAMISOLES; CAPRI PANTS; COLLARED SHIRTS; DRESS PANTS; DRESS SHIRTS; DRESSES; EVENING DRESSES; EVENING GOWNS; HALTER TOPS; JUMPERS; KNIT BOTTOMS; KNIT DRESSES; KNIT SHIRTS; KNIT SKIRTS; KNIT TOPS; SHIRTS; SKIRTS AND DRESSES; SUNDRESSES; T-SHIRTS; TANK TOPS; WEDDING DRESSES; WOVEN BOTTOMS; WOVEN DRESSES; WOVEN SKIRTS; WOVEN TOPS, IN CLASS 25 (U.S. CLS. 22 AND 39).

FIRST USE 6-1-2010; IN COMMERCE 2-1-2011.

THE MARK CONSISTS OF STANDARD CHARACTERS WITHOUT CLAIM TO ANY PARTICULAR FONT, STYLE, SIZE, OR COLOR.

THE NAME(S), PORTRAIT(S), AND/OR SIGNATURE(S) SHOWN IN THE MARK DOES NOT IDENTIFY A PARTICULAR LIVING INDIVIDUAL.

THE ENGLISH TRANSLATION OF "WAI MING" IN THE MARK IS "GIFT OF LIGHT".

SN 85-186,644, FILED 11-29-2010.

ELLEN PERKINS, EXAMINING ATTORNEY



David J. Kyffers

Director of the United States Patent and Trademark Office

United States of America

United States Patent and Trademark Office

ACQUISIT

Reg. No. 4,109,881

Registered Mar. 6, 2012

Int. Cl.: 42

SERVICE MARK

PRINCIPAL REGISTER

ACQUISIT, LLC (DELAWARE LIMITED LIABILITY COMPANY)
510 BONSALL AVE
YEADON, PA 19050

FOR: WEBSITE HOSTING PLATFORM PROVIDING HOSTING TECHNOLOGY TO ALLOW OTHERS TO ACCEPT AND STREAM UNRELEASED FULL-LENGTH INDEPENDENT FEATURE FILMS, TV PILOTS SEEKING ACQUISITION, AND TO POST ENTERTAINMENT INDUSTRY RELATED NEWS AND EVENTS, VIA A GLOBAL COMPUTER NETWORK DATABASE USABLE BY PAID AND NON-PAID SUBSCRIBERS, IN CLASS 42 (U.S. CLS. 100 AND 101).

FIRST USE 1-20-2010; IN COMMERCE 7-31-2011.

THE MARK CONSISTS OF STANDARD CHARACTERS WITHOUT CLAIM TO ANY PARTICULAR FONT, STYLE, SIZE, OR COLOR.

SN 85-186,829, FILED 11-30-2010.

LAURIE MAYES, EXAMINING ATTORNEY



David J. Kyros

Director of the United States Patent and Trademark Office

United States of America

United States Patent and Trademark Office

KINGFIELD BOOT COMPANY

Reg. No. 4,109,882

Registered Mar. 6, 2012

Int. Cl.: 25

TRADEMARK

PRINCIPAL REGISTER

BLACK DIAMOND GROUP, INC. (MAINE CORPORATION)
400 TRADECENTER 128 SUITE 2990
WOBURN, MA 018017460

FOR: FOOTWEAR; BOOTS, IN CLASS 25 (U.S. CLS. 22 AND 39).

FIRST USE 1-3-2011; IN COMMERCE 9-27-2011.

THE MARK CONSISTS OF STANDARD CHARACTERS WITHOUT CLAIM TO ANY PARTICULAR FONT, STYLE, SIZE, OR COLOR.

NO CLAIM IS MADE TO THE EXCLUSIVE RIGHT TO USE "BOOT COMPANY", APART FROM THE MARK AS SHOWN.

SN 85-187,105, FILED 11-30-2010.

JEFFERY COWARD, EXAMINING ATTORNEY



David J. Kyffers

Director of the United States Patent and Trademark Office

United States of America

United States Patent and Trademark Office

Chi Gum

Reg. No. 4,109,883

Registered Mar. 6, 2012

Int. Cl.: 30

TRADEMARK

PRINCIPAL REGISTER

ELVEN LAND, LLC (VIRGINIA LIMITED LIABILITY COMPANY)
105 FOREST LN
FABER, VA 22938

FOR: CHEWING GUM, IN CLASS 30 (U.S. CL. 46).

FIRST USE 12-19-2011; IN COMMERCE 12-19-2011.

THE MARK CONSISTS OF STANDARD CHARACTERS WITHOUT CLAIM TO ANY PARTICULAR FONT, STYLE, SIZE, OR COLOR.

NO CLAIM IS MADE TO THE EXCLUSIVE RIGHT TO USE "GUM", APART FROM THE MARK AS SHOWN.

SN 85-187,110, FILED 11-30-2010.

PRISCILLA MILTON, EXAMINING ATTORNEY



David J. Kybas

Director of the United States Patent and Trademark Office

United States of America

United States Patent and Trademark Office

TOMAHAWK CHIEF

Reg. No. 4,109,884

Registered Mar. 6, 2012

Int. Cl.: 8

TRADEMARK

PRINCIPAL REGISTER

LOFLEY, ROBERT SR. (UNITED STATES INDIVIDUAL)
4027 WARING DRIVE
TAMPA, FL 33610 AND

LOFLEY, ROBERT JR. (UNITED STATES INDIVIDUAL)
4027 WARING DRIVE
TAMPA, FL 33610

FOR: HAND TOOL FOR ROTATING A WHEEL HAND BRAKE AND PIVOTING A KNUCKLE COUPLER ON A RAILROAD CAR, IN CLASS 8 (U.S. CLS. 23, 28 AND 44).

FIRST USE 5-18-2011; IN COMMERCE 5-18-2011.

THE MARK CONSISTS OF STANDARD CHARACTERS WITHOUT CLAIM TO ANY PARTICULAR FONT, STYLE, SIZE, OR COLOR.

OWNER OF U.S. REG. NO. 3,920,815.

SN 85-187,332, FILED 11-30-2010.

NANCY CLARKE, EXAMINING ATTORNEY



David J. Kybas

Director of the United States Patent and Trademark Office

United States of America

United States Patent and Trademark Office

Meg Runion

Reg. No. 4,109,885

Registered Mar. 6, 2012

Int. Cl.: 41

SERVICE MARK

PRINCIPAL REGISTER

MEG RUNION STUDIOS (VIRGINIA LIMITED LIABILITY COMPANY)
1761 STONEY CREEK DRIVE
CHARLOTTESVILLE, VA 22902

FOR: PHOTOGRAPHY SERVICES, IN CLASS 41 (U.S. CLS. 100, 101 AND 107).

FIRST USE 10-1-2009; IN COMMERCE 11-2-2009.

THE MARK CONSISTS OF STANDARD CHARACTERS WITHOUT CLAIM TO ANY PARTICULAR FONT, STYLE, SIZE, OR COLOR.

THE NAME "MEG RUNION" IDENTIFIES A LIVING INDIVIDUAL WHOSE CONSENT IS OF RECORD.

SN 85-187,784, FILED 11-30-2010.

REBECCA EISINGER, EXAMINING ATTORNEY



David J. Kyffers

Director of the United States Patent and Trademark Office

United States of America

United States Patent and Trademark Office

LIFE OF THE PARTY

Reg. No. 4,109,886

SCOTT ACKER (UNITED STATES INDIVIDUAL)
ROAD 1, BOX 1494
STROUDSBURG, PA 18360

Registered Mar. 6, 2012

Int. Cl.: 31

FOR: LIVE POTTED PLANTS, IN CLASS 31 (U.S. CLS. 1 AND 46).

TRADEMARK

FIRST USE 5-10-2011; IN COMMERCE 5-10-2011.

PRINCIPAL REGISTER

THE MARK CONSISTS OF STANDARD CHARACTERS WITHOUT CLAIM TO ANY PARTICULAR FONT, STYLE, SIZE, OR COLOR.

SN 85-187,962, FILED 12-1-2010.

HAI-LY LAM, EXAMINING ATTORNEY



David J. Kybas

Director of the United States Patent and Trademark Office

United States of America

United States Patent and Trademark Office

MY SIDE

Reg. No. 4,109,887

Registered Mar. 6, 2012

Int. Cls.: 9 and 20

TRADEMARK

PRINCIPAL REGISTER

KINGSDOWN, INC. (NORTH CAROLINA CORPORATION)
P.O. BOX 388
MEBANE, NC 27302

FOR: BEDDING DIAGNOSTIC SYSTEM COMPRISING A COMPUTER AND COMPUTER SOFTWARE, A MATTRESS AND BOX SPRING, AND A PRESSURE SENSITIVE PAD, SOLD AS A UNIT FOR USE IN ANALYZING AND EVALUATING INDIVIDUALS AND PRESCRIBING PREFERRED MATTRESS COMPONENTS THEREFOR, IN CLASS 9 (U.S. CLS. 21, 23, 26, 36 AND 38).

FIRST USE 9-18-2008; IN COMMERCE 10-21-2009.

FOR: MATTRESSES AND BOX SPRINGS, IN CLASS 20 (U.S. CLS. 2, 13, 22, 25, 32 AND 50).

FIRST USE 9-8-2008; IN COMMERCE 9-8-2008.

THE MARK CONSISTS OF STANDARD CHARACTERS WITHOUT CLAIM TO ANY PARTICULAR FONT, STYLE, SIZE, OR COLOR.

OWNER OF U.S. REG. NOS. 3,794,621 AND 3,794,658.

SN 85-187,968, FILED 12-1-2010.

WILLIAM BRECKENFELD, EXAMINING ATTORNEY



David J. Kypos

Director of the United States Patent and Trademark Office

United States of America

United States Patent and Trademark Office



My Side

CERTIFIED BY
Sleep to Live)

Reg. No. 4,109,888

Registered Mar. 6, 2012

Int. Cl.: 20

TRADEMARK

PRINCIPAL REGISTER

KINGSDOWN, INC. (NORTH CAROLINA CORPORATION)
P.O. BOX 388
MEBANE, NC 27302

FOR: MATTRESSES AND BOX SPRINGS, IN CLASS 20 (U.S. CLS. 2, 13, 22, 25, 32 AND 50).

FIRST USE 10-24-2011; IN COMMERCE 10-24-2011.

OWNER OF U.S. REG. NOS. 3,587,006, 3,842,778, AND OTHERS.

NO CLAIM IS MADE TO THE EXCLUSIVE RIGHT TO USE "CERTIFIED", APART FROM THE MARK AS SHOWN.

THE MARK CONSISTS OF SILHOUETTES OF TWO SLEEPING HUMAN FIGURES TO THE LEFT OF THE WORDS "MY SIDE". UNDERNEATH THE WORD "SIDE" APPEARS THE WORDS "CERTIFIED BY SLEEP TO LIVE" AND A HIGHLY STYLIZED STRETCHING HUMAN.

SN 85-187,974, FILED 12-1-2010.

WILLIAM BRECKENFELD, EXAMINING ATTORNEY



David J. Kyffers

Director of the United States Patent and Trademark Office

United States of America
United States Patent and Trademark Office

Ravvid

Reg. No. 4,109,889

Registered Mar. 6, 2012

Int. Cl.: 35

SERVICE MARK

PRINCIPAL REGISTER

MEDIACOM COMMUNICATIONS CORPORATION (DELAWARE CORPORATION)
100 CRYSTAL RUN ROAD
MIDDLETOWN, NY 10941

FOR: ONLINE BUSINESS DIRECTORY SERVICES REGARDING THE PURCHASE AND SALE OF A WIDE VARIETY OF PRODUCTS AND SERVICES OF OTHERS; ADVERTISING AND MARKETING SERVICES, IN CLASS 35 (U.S. CLS. 100, 101 AND 102).

FIRST USE 9-0-2011; IN COMMERCE 9-0-2011.

OWNER OF U.S. REG. NO. 3,796,336.

THE MARK CONSISTS OF THE WORD "RAVVID" IN STYLIZED LETTERING WITH A STAR DESIGN ABOVE THE LETTER "I".

SN 85-188,077, FILED 12-1-2010.

CORY BOONE, EXAMINING ATTORNEY



David J. Kybas

Director of the United States Patent and Trademark Office

United States of America

United States Patent and Trademark Office



The Finance INSTITUTE

Reg. No. 4,109,890

Registered Mar. 6, 2012

Int. Cl.: 41

SERVICE MARK

PRINCIPAL REGISTER

THE FINANCE INSTITUTE LLC (FLORIDA LIMITED LIABILITY COMPANY)
1775 WEHRLE DRIVE
WILLIAMSVILLE, NY 14221

FOR: EDUCATION SERVICES, NAMELY, PROVIDING WORKSHOPS IN THE FIELD OF ALTERNATIVE FINANCIAL SOLUTIONS; EDUCATIONAL SERVICES, NAMELY, PROVIDING ON-LINE SEMINARS IN THE FIELD OF ALTERNATIVE FINANCIAL SOLUTIONS, IN CLASS 41 (U.S. CLS. 100, 101 AND 107).

FIRST USE 3-3-2011; IN COMMERCE 7-8-2011.

NO CLAIM IS MADE TO THE EXCLUSIVE RIGHT TO USE "FINANCE INSTITUTE", APART FROM THE MARK AS SHOWN.

THE MARK CONSISTS OF A PIECE OF EARTH WITH THE STYLIZED TEXT "THE FINANCE INSTITUTE".

SN 85-188,086, FILED 12-1-2010.

ADA HAN, EXAMINING ATTORNEY



David J. Kyffers

Director of the United States Patent and Trademark Office

United States of America

United States Patent and Trademark Office

EXRC

Reg. No. 4,109,891

E&B GIFTWARE, LLC (DELAWARE CORPORATION)
4 EXECUTIVE PLAZA
YONKERS, NY 10701

Registered Mar. 6, 2012

Int. Cl.: 28

FOR: TOYS, NAMELY, REMOTE CONTROL CARS, TRUCKS, BOATS, PLANES AND HELICOPTERS, IN CLASS 28 (U.S. CLS. 22, 23, 38 AND 50).

TRADEMARK

FIRST USE 9-30-2011; IN COMMERCE 9-30-2011.

PRINCIPAL REGISTER

THE MARK CONSISTS OF STANDARD CHARACTERS WITHOUT CLAIM TO ANY PARTICULAR FONT, STYLE, SIZE, OR COLOR.

SN 85-188,236, FILED 12-1-2010.

MARGARET POWER, EXAMINING ATTORNEY



David J. Kybas

Director of the United States Patent and Trademark Office

United States of America

United States Patent and Trademark Office

DURO-FLEECE

Reg. No. 4,109,892

DURO-LAST, INC. (MICHIGAN CORPORATION)
525 MORLEY DR.
SAGINAW, MI 48601

Registered Mar. 6, 2012

Int. Cl.: 1

FOR: ROOFING ADHESIVE, IN CLASS 1 (U.S. CLS. 1, 5, 6, 10, 26 AND 46).

TRADEMARK

FIRST USE 12-31-2010; IN COMMERCE 12-31-2010.

PRINCIPAL REGISTER

THE MARK CONSISTS OF STANDARD CHARACTERS WITHOUT CLAIM TO ANY PARTICULAR FONT, STYLE, SIZE, OR COLOR.

OWNER OF U.S. REG. NOS. 1,798,975, 2,386,473, AND OTHERS.

SN 85-188,468, FILED 12-1-2010.

DAVID COLLIER, EXAMINING ATTORNEY



David J. Kyffers

Director of the United States Patent and Trademark Office

United States of America

United States Patent and Trademark Office

TROPICAL SMOOTHIE

Reg. No. 4,109,893

NEHEMIAH MANUFACTURING COMPANY, LLC (OHIO LIMITED LIABILITY COMPANY)
1130 FINDLAY STREET
CINCINNATI, OH 45214

Registered Mar. 6, 2012

Int. Cl.: 3

FOR: BODY WASH; HAIR SHAMPOO; LIQUID SOAP, IN CLASS 3 (U.S. CLS. 1, 4, 6, 50, 51 AND 52).

TRADEMARK

FIRST USE 3-31-2011; IN COMMERCE 3-31-2011.

PRINCIPAL REGISTER

THE MARK CONSISTS OF STANDARD CHARACTERS WITHOUT CLAIM TO ANY PARTICULAR FONT, STYLE, SIZE, OR COLOR.

SN 85-188,497, FILED 12-1-2010.

CIMMERIAN COLEMAN, EXAMINING ATTORNEY



David J. Kyffers

Director of the United States Patent and Trademark Office

United States of America

United States Patent and Trademark Office

WILDBLOOM

Reg. No. 4,109,894

BANANA REPUBLIC (APPAREL), LLC (CALIFORNIA LIMITED LIABILITY COMPANY)
2 FOLSOM STREET
SAN FRANCISCO, CA 94105

Registered Mar. 6, 2012

Int. Cl.: 3

FOR: PERFUMES, FRAGRANCES, BODY LOTIONS, SKIN MOISTURIZERS, IN CLASS 3
(U.S. CLS. 1, 4, 6, 50, 51 AND 52).

TRADEMARK

FIRST USE 2-3-2011; IN COMMERCE 2-3-2011.

PRINCIPAL REGISTER

THE MARK CONSISTS OF STANDARD CHARACTERS WITHOUT CLAIM TO ANY PARTICULAR FONT, STYLE, SIZE, OR COLOR.

SN 85-188,552, FILED 12-1-2010.

LOURDES AYALA, EXAMINING ATTORNEY



David J. Kybas

Director of the United States Patent and Trademark Office

United States of America

United States Patent and Trademark Office

3BET

Reg. No. 4,109,895

Registered Mar. 6, 2012

Int. Cl.: 25

TRADEMARK

PRINCIPAL REGISTER

DSKT, INC. (CALIFORNIA CORPORATION)
151 WEST ROSECRANS AVENUE
GARDENA, CA 90248

FOR: BOTTOMS; HEADWEAR; JACKETS; TOPS, IN CLASS 25 (U.S. CLS. 22 AND 39).

FIRST USE 12-1-2011; IN COMMERCE 12-1-2011.

THE MARK CONSISTS OF STANDARD CHARACTERS WITHOUT CLAIM TO ANY PARTICULAR FONT, STYLE, SIZE, OR COLOR.

SN 85-188,682, FILED 12-1-2010.

BENJAMIN OKEKE, EXAMINING ATTORNEY



David J. Kybas

Director of the United States Patent and Trademark Office

United States of America

United States Patent and Trademark Office

BEARING CIRCLE

Reg. No. 4,109,896

Registered Mar. 6, 2012

Int. Cl.: 36

SERVICE MARK

PRINCIPAL REGISTER

BEARING CIRCLE PARTNERS, LLC (DELAWARE LIMITED LIABILITY COMPANY)
982 NEWFIELD AVENUE
STAMFORD, CT 06905

FOR: ASSUMING FINANCIAL RISK OF OTHERS BY ENTERING INTO OPTIONS AND SWAPS; FINANCIAL ADMINISTRATION OF STOCK EXCHANGE TRADING OF SHARES AND OTHER FINANCIAL SECURITIES IN FINANCIAL MARKETS; FINANCIAL ADVICE; FINANCIAL ADVICE AND CONSULTANCY SERVICES; FINANCIAL ADVISORY AND CONSULTANCY SERVICES; FINANCIAL AFFAIRS AND MONETARY AFFAIRS, NAMELY, FINANCIAL INFORMATION, MANAGEMENT AND ANALYSIS SERVICES; FINANCIAL ANALYSES; FINANCIAL ANALYSIS AND CONSULTATION; FINANCIAL ANALYSIS AND RESEARCH SERVICES; FINANCIAL AND INVESTMENT SERVICES, NAMELY, MANAGEMENT AND BROKERAGE IN THE FIELDS OF STOCKS, BONDS, OPTIONS, COMMODITIES, FUTURES AND OTHER SECURITIES, AND THE INVESTMENT OF FUNDS OF OTHERS; FINANCIAL ASSET MANAGEMENT; FINANCIAL EVALUATION, TRACKING, ANALYSIS, FORECASTING, CONSULTANCY, ADVISORY AND RESEARCH SERVICES RELATING TO SECURITIES AND OTHER FINANCIAL INSTRUMENTS; FINANCIAL INVESTMENT ANALYSIS AND STOCK RESEARCH; FINANCIAL INVESTMENT BROKERAGE; FINANCIAL INVESTMENT BROKERAGE SERVICES; FINANCIAL SERVICES, NAMELY, A TOTAL PORTFOLIO OFFERING FOR HIGH NET WORTH CLIENTS CONSISTING OF BOTH SEPARATE ACCOUNTS AND MUTUAL FUNDS FOR EQUITY AND FIXED INCOME INVESTMENTS; FINANCIAL SERVICES, NAMELY, THE TRADING OF FINANCIAL INSTRUMENTS, SECURITIES, SHARES, OPTIONS AND OTHER DERIVATIVE PRODUCTS; PROVIDING FINANCIAL SERVICES WITH RESPECT TO SECURITIES AND OTHER FINANCIAL INSTRUMENTS AND PRODUCTS, NAMELY, TRADING OF AND INVESTMENTS IN SECURITIES AND FINANCIAL INSTRUMENTS AND PRODUCTS FOR OTHERS, IN CLASS 36 (U.S. CLS. 100, 101 AND 102).



FIRST USE 9-30-2011; IN COMMERCE 9-30-2011.

THE MARK CONSISTS OF STANDARD CHARACTERS WITHOUT CLAIM TO ANY PARTICULAR FONT, STYLE, SIZE, OR COLOR.

SN 85-188,805, FILED 12-1-2010.

JAY FLOWERS, EXAMINING ATTORNEY

David J. Kyros

Director of the United States Patent and Trademark Office

United States of America

United States Patent and Trademark Office

GOODSPRINGS

Reg. No. 4,109,897

Registered Mar. 6, 2012

Int. Cl.: 7

TRADEMARK

PRINCIPAL REGISTER

HYOSUNG GOODSPRINGS, INC. (REPUBLIC OF KOREA CORPORATION)
450, GONGDEOK-DONG, MAPO-GU
SEOUL, REPUBLIC OF KOREA

FOR: POWER OPERATED BLOWERS; AIR COMPRESSORS; PUMPS AS PARTS OF MACHINES, ENGINES AND MOTORS; AIR PUMPS; PNEUMATIC PUMPS; COMPRESSED AIR PUMPS; RECIPROCATING PUMPS; CENTRIFUGAL PUMPS; VACUUM PUMPS; DIFFUSION PUMPS; ROTARY PUMPS; MOTORS OTHER THAN FOR LAND VEHICLES; HYDRAULIC TURBINES, IN CLASS 7 (U.S. CLS. 13, 19, 21, 23, 31, 34 AND 35).

FIRST USE 2-1-2011; IN COMMERCE 2-1-2011.

THE MARK CONSISTS OF STANDARD CHARACTERS WITHOUT CLAIM TO ANY PARTICULAR FONT, STYLE, SIZE, OR COLOR.

SN 85-188,889, FILED 12-2-2010.

BENJAMIN OKEKE, EXAMINING ATTORNEY



David J. Kyffers

Director of the United States Patent and Trademark Office

United States of America

United States Patent and Trademark Office

PROFESSIONAL XP

Reg. No. 4,109,898

Registered Mar. 6, 2012

Int. Cl.: 25

TRADEMARK

PRINCIPAL REGISTER

DANSKO, LLC (DELAWARE LIMITED LIABILITY COMPANY)
33 FEDERAL ROAD
WEST GROVE, PA 19390

FOR: FOOTWEAR, IN CLASS 25 (U.S. CLS. 22 AND 39).

FIRST USE 6-23-2011; IN COMMERCE 6-23-2011.

THE MARK CONSISTS OF STANDARD CHARACTERS WITHOUT CLAIM TO ANY PARTICULAR FONT, STYLE, SIZE, OR COLOR.

SN 85-189,300, FILED 12-2-2010.

SCOTT BIBB, EXAMINING ATTORNEY



David J. Kybas

Director of the United States Patent and Trademark Office

United States of America

United States Patent and Trademark Office

Millex Samplcity

Reg. No. 4,109,899

MERCK KGAA (FED REP GERMANY A KOMMANDITGESELLSCHAFT AUF AKTIEN)
FRANKFURTER STRASSE 250
D-64293 DARMSTADT, FED REP GERMANY

Registered Mar. 6, 2012

Int. Cl.: 9

FOR: LABORATORY FILTERS, IN CLASS 9 (U.S. CLS. 21, 23, 26, 36 AND 38).

TRADEMARK

FIRST USE 7-31-2011; IN COMMERCE 7-31-2011.

PRINCIPAL REGISTER

THE MARK CONSISTS OF STANDARD CHARACTERS WITHOUT CLAIM TO ANY PARTICULAR FONT, STYLE, SIZE, OR COLOR.

OWNER OF U.S. REG. NOS. 2,467,572 AND 2,491,084.

SN 85-189,379, FILED 12-2-2010.

KIMBERLY FRYE, EXAMINING ATTORNEY



David J. Kybas

Director of the United States Patent and Trademark Office

United States of America

United States Patent and Trademark Office

BIG WILLY

Reg. No. 4,109,900

LOANSTAR JEWELRY & PAWN, LLC. (FLORIDA LIMITED LIABILITY COMPANY)
6090 SEMINOLE BLVD.
SEMINOLE, FL 33772

Registered Mar. 6, 2012

Int. Cl.: 28

FOR: FISHING RODS, IN CLASS 28 (U.S. CLS. 22, 23, 38 AND 50).

TRADEMARK

FIRST USE 12-13-2011; IN COMMERCE 12-13-2011.

PRINCIPAL REGISTER

THE MARK CONSISTS OF STANDARD CHARACTERS WITHOUT CLAIM TO ANY PARTICULAR FONT, STYLE, SIZE, OR COLOR.

SN 85-189,554, FILED 12-2-2010.

GEOFFREY FOSDICK, EXAMINING ATTORNEY



David J. Kybas

Director of the United States Patent and Trademark Office

United States of America

United States Patent and Trademark Office

The logo for BEEZAG features the word "bee" in a lowercase, rounded font where the two 'e's are stylized to resemble eyes. This is followed by the word "zag" in a bold, lowercase, sans-serif font.

Reg. No. 4,109,901

BEEZAG INC. (DELAWARE CORPORATION)
115 WEST 29TH STREET
NEW YORK, NY 10001

Registered Mar. 6, 2012

Int. Cls.: 35 and 38

FOR: ADVERTISING SERVICES, NAMELY, PROMOTING THE BRANDS, GOODS AND SERVICES OF OTHERS, IN CLASS 35 (U.S. CLS. 100, 101 AND 102).

SERVICE MARK

FIRST USE 12-17-2009; IN COMMERCE 12-17-2009.

PRINCIPAL REGISTER

FOR: COMMUNICATION SERVICES, NAMELY, TRANSMISSION OF VOICE, AUDIO, VISUAL IMAGES AND DATA BY TELECOMMUNICATIONS NETWORKS, WIRELESS COMMUNICATION NETWORKS, THE INTERNET, INFORMATION SERVICES NETWORKS AND DATA NETWORKS, IN CLASS 38 (U.S. CLS. 100, 101 AND 104).

FIRST USE 12-17-2009; IN COMMERCE 12-17-2009.

THE MARK CONSISTS OF THE WORD "BEE" IN A LOWER CASE FONT WITH THE FIRST "E" INVERTED. THE COMBINATION OF THE FIRST AND SECOND "E" IN "BEE" ARE DRAWN TO SYMBOLIZE TWO EYES. THE WORD "ZAG" FOLLOWS IN A BOLD, LOWER CASE FONT.

SN 85-189,940, FILED 12-3-2010.

SANJEEV VOHRA, EXAMINING ATTORNEY



David J. Kyros

Director of the United States Patent and Trademark Office

United States of America

United States Patent and Trademark Office

Cutzie Girl

Reg. No. 4,109,902

ENERTEC ENTERPRISES, LTD. (HONG KONG CORPORATION)
RM. 1017 CHINACHEM GOLDEN PLAZA
KOWLOON, HONG KONG

Registered Mar. 6, 2012

Int. Cl.: 28

FOR: DOLLS AND ACCESSORIES THEREFOR, IN CLASS 28 (U.S. CLS. 22, 23, 38 AND 50).

TRADEMARK

FIRST USE 1-15-2011; IN COMMERCE 4-15-2011.

PRINCIPAL REGISTER

THE MARK CONSISTS OF STANDARD CHARACTERS WITHOUT CLAIM TO ANY PARTICULAR FONT, STYLE, SIZE, OR COLOR.

NO CLAIM IS MADE TO THE EXCLUSIVE RIGHT TO USE "GIRL", APART FROM THE MARK AS SHOWN.

SN 85-190,020, FILED 12-3-2010.

SALLY SHIH, EXAMINING ATTORNEY



David J. Kyffers

Director of the United States Patent and Trademark Office

United States of America

United States Patent and Trademark Office

TRUEFRESH

Reg. No. 4,109,903

HONEYWELL INTERNATIONAL INC. (DELAWARE CORPORATION)
101 COLUMBIA ROAD
MORRISTOWN, NJ 07962

Registered Mar. 6, 2012

Int. Cl.: 11

FOR: WHOLE HOUSE HUMIDIFIERS, IN CLASS 11 (U.S. CLS. 13, 21, 23, 31 AND 34).

TRADEMARK

FIRST USE 11-4-2010; IN COMMERCE 11-30-2010.

PRINCIPAL REGISTER

THE MARK CONSISTS OF STANDARD CHARACTERS WITHOUT CLAIM TO ANY PARTICULAR FONT, STYLE, SIZE, OR COLOR.

SN 85-190,360, FILED 12-3-2010.

JACQUELINE A. LAVINE, EXAMINING ATTORNEY



David J. Kybas

Director of the United States Patent and Trademark Office

United States of America

United States Patent and Trademark Office

ARMOR

Reg. No. 4,109,904

Registered Mar. 6, 2012

Int. Cl.: 7

TRADEMARK

PRINCIPAL REGISTER

VERMEER MANUFACTURING COMPANY (IOWA CORPORATION)
1210 VERMEER ROAD EAST
PELLA, IA 50219

FOR: EARTH BORING DRILLING HEAD CONSISTING OF A SONDE HOUSING AND EXCAVATION TOOL FOR USE IN HORIZONTAL DIRECTIONAL DRILLING, IN CLASS 7 (U.S. CLS. 13, 19, 21, 23, 31, 34 AND 35).

FIRST USE 1-23-2011; IN COMMERCE 3-23-2011.

THE MARK CONSISTS OF STANDARD CHARACTERS WITHOUT CLAIM TO ANY PARTICULAR FONT, STYLE, SIZE, OR COLOR.

SN 85-190,387, FILED 12-3-2010.

THOMAS MANOR, EXAMINING ATTORNEY



David J. Kyffers

Director of the United States Patent and Trademark Office

United States of America
United States Patent and Trademark Office

X-PRE

Reg. No. 4,109,905

FLEET WHOLESALE SUPPLY CO., INC. (WISCONSIN CORPORATION)
1300 SOUTH LYNNDALE DRIVE
APPLETON, WI 54914

Registered Mar. 6, 2012

Int. Cl.: 13

FOR: GUNS, IN CLASS 13 (U.S. CLS. 2 AND 9).

TRADEMARK

FIRST USE 8-31-2011; IN COMMERCE 8-31-2011.

PRINCIPAL REGISTER

THE MARK CONSISTS OF STANDARD CHARACTERS WITHOUT CLAIM TO ANY PARTICULAR FONT, STYLE, SIZE, OR COLOR.

SN 85-190,410, FILED 12-3-2010.

DAVID C. REIHNER, EXAMINING ATTORNEY



David J. Kybas

Director of the United States Patent and Trademark Office

United States of America

United States Patent and Trademark Office

BAZILLION BUCKETS

Reg. No. 4,109,906

Registered Mar. 6, 2012

Int. Cl.: 28

TRADEMARK

PRINCIPAL REGISTER

BATTAT INCORPORATED (DELAWARE CORPORATION)
1560 MILITARY TURNPIKE
PLATTSBURGH, NY 12901

FOR: STACKING TOYS, IN CLASS 28 (U.S. CLS. 22, 23, 38 AND 50).

FIRST USE 5-31-2011; IN COMMERCE 5-31-2011.

THE MARK CONSISTS OF STANDARD CHARACTERS WITHOUT CLAIM TO ANY PARTICULAR FONT, STYLE, SIZE, OR COLOR.

NO CLAIM IS MADE TO THE EXCLUSIVE RIGHT TO USE "BUCKETS", APART FROM THE MARK AS SHOWN.

SN 85-190,547, FILED 12-3-2010.

GILBERT SWIFT, EXAMINING ATTORNEY



David J. Kyffers

Director of the United States Patent and Trademark Office

United States of America

United States Patent and Trademark Office

Rockstar Gang

Reg. No. 4,109,907

FAHIE, KARIME (US VIRGIN ISLANDS INDIVIDUAL), AKA ICON,
P.O. BOX 503166

Registered Mar. 6, 2012

ST. THOMAS, US VIRGIN ISLANDS 00805

Int. Cl.: 25

FOR: CLOTHING, NAMELY, KHAKIS; HATS; JACKETS; JEANS; JERSEYS; LONG-SLEEVED SHIRTS; PANTS; POLO SHIRTS; RUGBY SHIRTS; SHIRTS; SHORTS; SWEATPANTS; SWEATSHIRTS; T-SHIRTS, IN CLASS 25 (U.S. CLS. 22 AND 39).

TRADEMARK

FIRST USE 1-13-2011; IN COMMERCE 5-2-2011.

PRINCIPAL REGISTER

THE MARK CONSISTS OF STANDARD CHARACTERS WITHOUT CLAIM TO ANY PARTICULAR FONT, STYLE, SIZE, OR COLOR.

SN 85-190,645, FILED 12-3-2010.

LAURIE MAYES, EXAMINING ATTORNEY



David J. Kyros

Director of the United States Patent and Trademark Office

United States of America

United States Patent and Trademark Office

COCO & BREEZY

Reg. No. 4,109,908

Registered Mar. 6, 2012

Int. Cl.: 9

TRADEMARK

PRINCIPAL REGISTER

COCO&BREEZY LLC (NEW YORK LIMITED LIABILITY COMPANY), AKA COCO & BREEZY,
978 DECATUR STREET, #2
BROOKLYN, NY 11207

FOR: EYEWEAR, NAMELY, SUNGLASSES, EYEGASSES AND OPHTHALMIC FRAMES AND CASES THEREFOR, IN CLASS 9 (U.S. CLS. 21, 23, 26, 36 AND 38).

FIRST USE 11-1-2010; IN COMMERCE 6-1-2011.

THE MARK CONSISTS OF STANDARD CHARACTERS WITHOUT CLAIM TO ANY PARTICULAR FONT, STYLE, SIZE, OR COLOR.

SN 85-191,020, FILED 12-6-2010.

KIM SAITO, EXAMINING ATTORNEY



David J. Kyffers

Director of the United States Patent and Trademark Office

United States of America

United States Patent and Trademark Office

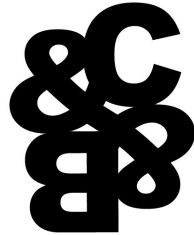

Reg. No. 4,109,909

Registered Mar. 6, 2012

Int. Cl.: 9

TRADEMARK

PRINCIPAL REGISTER

COCO&BREEZY LLC (NEW YORK LIMITED LIABILITY COMPANY), AKA COCO & BREEZY,
978 DECATUR STREET, #2
BROOKLYN, NY 11207

FOR: EYEWEAR, NAMELY, SUNGLASSES, EYEGASSES AND OPHTHALMIC FRAMES AND CASES THEREFOR, IN CLASS 9 (U.S. CLS. 21, 23, 26, 36 AND 38).

FIRST USE 11-1-2010; IN COMMERCE 6-1-2011.

THE MARK CONSISTS OF THE FOLLOWING: AN "&" AND LETTER "C" THAT ARE CONNECTED. BELOW THE "&" IS AN UPSIDE DOWN BACKWARDS LETTER "B" CONNECTED WITH AN UPSIDE DOWN BACKWARDS "&" WHERE THE SECOND "&" IS BELOW THE LETTER "C".

SN 85-191,032, FILED 12-6-2010.

KIM SAITO, EXAMINING ATTORNEY



David J. Kybas

Director of the United States Patent and Trademark Office

United States of America

United States Patent and Trademark Office

SIMPLOT TRADITIONS

Reg. No. 4,109,910

Registered Mar. 6, 2012

Int. Cl.: 29

TRADEMARK

PRINCIPAL REGISTER

J.R. SIMPLOT COMPANY (NEVADA CORPORATION)
P.O. BOX 27
BOISE, ID 83707

FOR: DEHYDRATED POTATOES; INSTANT POTATOES, IN CLASS 29 (U.S. CL. 46).

FIRST USE 9-1-2011, THE MARK WAS FIRST USED ANYWHERE IN A DIFFERENT FORM OTHER THAN THAT SOUGHT TO BE REGISTERED AT LEAST AS EARLY AS 00/00/1941.; IN COMMERCE 9-1-2011, THE MARK WAS FIRST USED IN COMMERCE IN A DIFFERENT FORM OTHER THAN THAT SOUGHT TO BE REGISTERED AT LEAST AS EARLY AS 00/00/1941..

THE MARK CONSISTS OF STANDARD CHARACTERS WITHOUT CLAIM TO ANY PARTICULAR FONT, STYLE, SIZE, OR COLOR.

OWNER OF U.S. REG. NOS. 846,389, 1,165,712, AND 1,270,115.

SN 85-191,103, FILED 12-6-2010.

FLORENTINA BLANDU, EXAMINING ATTORNEY



David J. Kyros

Director of the United States Patent and Trademark Office

United States of America

United States Patent and Trademark Office

The Bidspot

Reg. No. 4,109,911

MULTI-MEDIA INTERNATIONAL LLC (NEVADA LIMITED LIABILITY COMPANY)
13915 WEST 107TH STREET
LENEXA, KS 66215

Registered Mar. 6, 2012

Int. Cl.: 35

FOR: ON-LINE AUCTIONEERING SERVICES VIA THE INTERNET, IN CLASS 35 (U.S. CLS. 100, 101 AND 102).

SERVICE MARK

FIRST USE 11-2-2010; IN COMMERCE 5-4-2011.

PRINCIPAL REGISTER

THE MARK CONSISTS OF STANDARD CHARACTERS WITHOUT CLAIM TO ANY PARTICULAR FONT, STYLE, SIZE, OR COLOR.

SN 85-191,177, FILED 12-6-2010.

STEPHANIE ALI, EXAMINING ATTORNEY



David J. Kyffers

Director of the United States Patent and Trademark Office

United States of America

United States Patent and Trademark Office



The hungry wait. Hunger doesn't.

Reg. No. 4,109,912

HUNGRY NOW (TEXAS NON-PROFIT CORPORATION)
1565 W. MAIN STREET #208-105
LEWISVILLE, TX 75067

Registered Mar. 6, 2012

Int. Cl.: 35

FOR: CHARITABLE SERVICES, NAMELY, COORDINATION OF THE PROCUREMENT AND DISTRIBUTION OF FOOD DONATIONS FROM THE GENERAL PUBLIC TO PEOPLE SUFFERING FROM FAMINE, STARVATION AND POVERTY, IN CLASS 35 (U.S. CLS. 100, 101 AND 102).

SERVICE MARK

PRINCIPAL REGISTER

FIRST USE 10-1-2011; IN COMMERCE 10-1-2011.

THE MARK CONSISTS OF THE WORD "HUNGRY" WITH SCRATCHES IN IT OVER THE WORD "NOW" ALSO WITH SCRATCHES WITH A GLOBE IN THE "O" OVER THE WORDS "THE "HUNGRY" WAIT. "HUNGER DOESN'T."

SN 85-191,199, FILED 12-6-2010.

ANTHONY RINKER, EXAMINING ATTORNEY



David J. Kyffers

Director of the United States Patent and Trademark Office

United States of America

United States Patent and Trademark Office



Reg. No. 4,109,913

Registered Mar. 6, 2012

Int. Cl.: 35

SERVICE MARK

PRINCIPAL REGISTER

TOWN OF ADDISON, TEXAS (TEXAS MUNICIPAL CORPORATION)
ATTN: CITY MANAGER
P.O. BOX 9010
ADDISON, TX 75001

FOR: CONVENTION AND VISITOR ASSISTANCE SERVICES, NAMELY, PROMOTION OF TOURISM AND THE HOTEL AND CONVENTION INDUSTRIES IN THE ADDISON, TEXAS AREA, IN CLASS 35 (U.S. CLS. 100, 101 AND 102).

FIRST USE 12-0-2010; IN COMMERCE 12-0-2010.

OWNER OF U.S. REG. NOS. 1,859,942, 3,753,951, AND OTHERS.

THE COLOR(S) GREY, RED, LIGHT GREEN, TEAL, PURPLE, ORANGE, BLUE IS/ARE CLAIMED AS A FEATURE OF THE MARK.

NO CLAIM IS MADE TO THE EXCLUSIVE RIGHT TO USE "VISIT ADDISON VISITOR SERVICES ARTISAN CENTER", APART FROM THE MARK AS SHOWN.

THE MARK CONSISTS OF THE WORD "VISIT" WRITTEN IN GREY STYLIZED FONT ABOVE THE WORD "ADDISON" WRITTEN IN STYLIZED FONT CONSISTING OF THE FOLLOWING: A RED "A", A LIGHT GREEN "D", A TEAL "D", A PURPLE "I" WITH A LIGHT GREEN LEAF AS THE DOT ON THE "I", AN ORANGE "S", A BLUE "O", AND A RED "N" ALL WRITTEN ABOVE THE WORDS "VISITOR SERVICES" AND "ARTISAN CENTER" BOTH WRITTEN IN GREY STYLIZED FONT, WITH A GREY DOT BETWEEN THE PHRASES.

SN 85-191,501, FILED 12-6-2010.

ALEXANDER L. POWERS, EXAMINING ATTORNEY



David J. Kyffers

Director of the United States Patent and Trademark Office

United States of America

United States Patent and Trademark Office

RITEONE

Reg. No. 4,109,914

NIGHTINGALE CORP. (CANADA CORPORATION)
2301 DIXIE ROAD
MISSISSAUGA, ONTARIO, CANADA L4Y1Z9

Registered Mar. 6, 2012

Int. Cl.: 20

FOR: CHAIRS, IN CLASS 20 (U.S. CLS. 2, 13, 22, 25, 32 AND 50).

TRADEMARK

FIRST USE 7-1-2011; IN COMMERCE 7-1-2011.

PRINCIPAL REGISTER

THE MARK CONSISTS OF STANDARD CHARACTERS WITHOUT CLAIM TO ANY PARTICULAR FONT, STYLE, SIZE, OR COLOR.

SN 85-191,566, FILED 12-6-2010.

JENNY PARK, EXAMINING ATTORNEY



David J. Kybas

Director of the United States Patent and Trademark Office

United States of America

United States Patent and Trademark Office

OEM TO OH MY GOD!

Reg. No. 4,109,915

EDWARD M. FILES (UNITED STATES INDIVIDUAL)
275 NW VICTORIA DRIVE
LEE'S SUMMIT, MO 64086

Registered Mar. 6, 2012

Int. Cl.: 9

FOR: AUDIO PRODUCTS, NAMELY, SPEAKERS, AMPLIFIERS AND AUDIO PROCESSORS FOR VEHICLES, IN CLASS 9 (U.S. CLS. 21, 23, 26, 36 AND 38).

TRADEMARK

FIRST USE 12-13-2011; IN COMMERCE 12-13-2011.

PRINCIPAL REGISTER

THE MARK CONSISTS OF STANDARD CHARACTERS WITHOUT CLAIM TO ANY PARTICULAR FONT, STYLE, SIZE, OR COLOR.

SN 85-191,937, FILED 12-7-2010.

DOMINIC J. FERRAIUOLO, EXAMINING ATTORNEY



David J. Kybas

Director of the United States Patent and Trademark Office

United States of America

United States Patent and Trademark Office

BibleCandies

Reg. No. 4,109,916

PARDHE DANIEL F (UNITED STATES INDIVIDUAL)
2116 W. WILLOW AVE
PHOENIX, AZ 85029

Registered Mar. 6, 2012

Int. Cl.: 9

FOR: COMPUTER APPLICATION SOFTWARE FOR MOBILE PHONES, PORTABLE MEDIA PLAYERS, HANDHELD AND DESKTOP COMPUTERS, NAMELY, SOFTWARE FOR USE IN BIBLE LEARNING, IN CLASS 9 (U.S. CLS. 21, 23, 26, 36 AND 38).

TRADEMARK

FIRST USE 10-10-2010; IN COMMERCE 10-10-2010.

PRINCIPAL REGISTER

THE MARK CONSISTS OF STANDARD CHARACTERS WITHOUT CLAIM TO ANY PARTICULAR FONT, STYLE, SIZE, OR COLOR.

SN 85-192,065, FILED 12-7-2010.

MATTHEW EINSTEIN, EXAMINING ATTORNEY



David J. Kyros

Director of the United States Patent and Trademark Office

United States of America
United States Patent and Trademark Office

ROCKER

Reg. No. 4,109,917

WEDLAKE, KIM (UNITED STATES INDIVIDUAL)
1617 CEDAR STREET
CALISTOGA, CA 94515 AND

Registered Mar. 6, 2012

Int. Cl.: 33

OSBORNE, TED (UNITED STATES INDIVIDUAL)
1617 CEDAR STREET
CALISTOGA, CA 94515

TRADEMARK

FOR: WINE, IN CLASS 33 (U.S. CLS. 47 AND 49).

PRINCIPAL REGISTER

FIRST USE 12-9-2011; IN COMMERCE 12-9-2011.

THE MARK CONSISTS OF STANDARD CHARACTERS WITHOUT CLAIM TO ANY PARTICULAR FONT, STYLE, SIZE, OR COLOR.

SN 85-192,252, FILED 12-7-2010.

ROBERT C. CLARK JR., EXAMINING ATTORNEY



David J. Kybas

Director of the United States Patent and Trademark Office

United States of America

United States Patent and Trademark Office



SINGLE-USE BUSINESS SOCKS

Reg. No. 4,109,918

Registered Mar. 6, 2012

Int. Cl.: 25

TRADEMARK

PRINCIPAL REGISTER

AUDIBLE LLC (NORTH CAROLINA LIMITED LIABILITY COMPANY)
16847-C BIRDALE COMMONS PARKWAY
HUNTERSVILLE, NC 28078

FOR: SOCKS, IN CLASS 25 (U.S. CLS. 22 AND 39).

FIRST USE 12-1-2011; IN COMMERCE 12-1-2011.

NO CLAIM IS MADE TO THE EXCLUSIVE RIGHT TO USE "BLUE HEEL" OR "SINGLE-USE BUSINESS SOCKS", APART FROM THE MARK AS SHOWN.

THE MARK CONSISTS OF THE STYLIZED TEXT "BLUE HEEL SINGLE-USE BUSINESS SOCKS" WITH TWO FEET.

SN 85-192,709, FILED 12-7-2010.

KELLY BOULTON, EXAMINING ATTORNEY



David J. Kyffers

Director of the United States Patent and Trademark Office

United States of America

United States Patent and Trademark Office

Concept space

Reg. No. 4,109,919

Registered Mar. 6, 2012

Int. Cls.: 20 and 24

TRADEMARK

PRINCIPAL REGISTER

NINGBO HUAYI ANTIQUE FURNITURE CO., LTD. (CHINA LIMITED LIABILITY COMPANY)
NO.6 XINHENG NO.1 ROAD
CICHENG, NINGBO, CHINA

FOR: BEDS; CHAIRS; DOORS FOR FURNITURE; DRINKING STRAWS; FURNITURE; MIRRORS; NON-METAL CLOTHES HOOKS; NON-METAL HINGES; OFFICE FURNITURE; PET CASKETS; PICTURE FRAMES; PILLOWS; ROCKING CHAIRS; SOFAS; WORKS OF ART OF WOOD, WAX, PLASTER OR PLASTIC, IN CLASS 20 (U.S. CLS. 2, 13, 22, 25, 32 AND 50).

FIRST USE 3-6-2011; IN COMMERCE 3-6-2011.

FOR: BED BLANKETS; BED COVERS; BED LINEN; BED SHEETS; CURTAINS OF TEXTILE OR PLASTIC; FELTS; QUILTS; SILK FABRIC FOR PRINTING PATTERNS; TABLE CLOTH OF TEXTILE; TOWELS; WALL HANGINGS OF TEXTILE; WOOLLEN CLOTH, IN CLASS 24 (U.S. CLS. 42 AND 50).

FIRST USE 3-6-2011; IN COMMERCE 3-6-2011.

SN 85-192,738, FILED 12-7-2010.

REBECCA POVARCHUK, EXAMINING ATTORNEY



David J. Kybas

Director of the United States Patent and Trademark Office

United States of America

United States Patent and Trademark Office

H.BROTHERS
華誼兄弟

Reg. No. 4,109,920

Registered Mar. 6, 2012

Int. Cl.: 41

SERVICE MARK

PRINCIPAL REGISTER

HUAYI BROTHERS MEDIA CORPORATION (CHINA CORPORATION)
RM 908, TOWER A FULLLINK PLAZA, NO 18
CHAOYANG MEN WAI AVENUE, CHAOYANG DIST
BEIJING, CHINA

FOR: DISTRIBUTION OF MOTION PICTURE FILMS; ENTERTAINMENT SERVICES IN THE NATURE OF DEVELOPMENT, CREATION, PRODUCTION AND POST-PRODUCTION SERVICES OF MULTIMEDIA ENTERTAINMENT CONTENT; FILM PRODUCTION; INSTRUCTION IN THE FIELD OF MUSIC, ART; MOTION PICTURE RENTAL; MOVIE THEATERS; ORGANIZATION OF SHOWS FOR CULTURAL PURPOSES; RENTAL OF PHONOGRAPHIC AND MUSIC RECORDINGS; RENTAL OF SHOW SCENERY; RENTAL OF SOUND RECORDINGS, IN CLASS 41 (U.S. CLS. 100, 101 AND 107).

FIRST USE 2-7-2009; IN COMMERCE 12-26-2010.

THE MARK CONSISTS OF THE WORD "H.BROTHERS" WITH STYLIZED DESIGN AND FOUR CHINESE CHARACTERS BELOW.

THE NON-LATIN CHARACTERS IN THE MARK TRANSLITERATE TO "HUA, YI, XIONG, DI" AND THIS MEANS "FLOWERY, FRIENDSHIP, ELDER BROTHER, YOUNGER BROTHER" IN ENGLISH.

SN 85-192,805, FILED 12-8-2010.

ARETHA SOMERVILLE, EXAMINING ATTORNEY



David J. Kybas

Director of the United States Patent and Trademark Office

United States of America

United States Patent and Trademark Office

H.BROTHERS

Reg. No. 4,109,921

Registered Mar. 6, 2012

Int. Cl.: 41

SERVICE MARK

PRINCIPAL REGISTER

HUAYI BROTHERS MEDIA CORPORATION (CHINA CORPORATION)
RM 908, TOWER A FULLLINK PLAZA, NO 18
CHAOYANG MEN WAI AVENUE, CHAOYANG DIST
BEIJING, CHINA

FOR: DISTRIBUTION OF MOTION PICTURE FILMS; ENTERTAINMENT SERVICES IN THE NATURE OF DEVELOPMENT, CREATION, PRODUCTION AND POST-PRODUCTION SERVICES OF MULTIMEDIA ENTERTAINMENT CONTENT; FILM PRODUCTION; INSTRUCTION IN THE FIELD OF MUSIC, ART; MOTION PICTURE RENTAL; MOVIE THEATERS; ORGANIZATION OF SHOWS FOR CULTURAL PURPOSES; RENTAL OF PHONOGRAPHIC AND MUSIC RECORDINGS; RENTAL OF SHOW SCENERY; RENTAL OF SOUND RECORDINGS, IN CLASS 41 (U.S. CLS. 100, 101 AND 107).

FIRST USE 2-7-2009; IN COMMERCE 12-26-2010.

THE MARK CONSISTS OF THE WORD "H.BROTHERS" WITH STYLIZED DESIGN.

SN 85-192,813, FILED 12-8-2010.

ARETHA SOMERVILLE, EXAMINING ATTORNEY



David J. Kybas

Director of the United States Patent and Trademark Office

United States of America

United States Patent and Trademark Office

NIA-114 + Protein Tighteners

Reg. No. 4,109,922

Registered Mar. 6, 2012

Int. Cl.: 5

TRADEMARK

PRINCIPAL REGISTER

NIADYNE, INC. (DELAWARE CORPORATION)
2530 MERIDIAN PARKWAY
RESEARCH TRIANGLE PARK, NC 27713

FOR: MEDICATED SKIN CARE PREPARATIONS CONTAINING PROTEIN, IN CLASS 5
(U.S. CLS. 6, 18, 44, 46, 51 AND 52).

FIRST USE 8-1-2011; IN COMMERCE 8-1-2011.

THE MARK CONSISTS OF STANDARD CHARACTERS WITHOUT CLAIM TO ANY PARTICULAR FONT, STYLE, SIZE, OR COLOR.

OWNER OF U.S. REG. NOS. 3,471,879, 3,471,881, AND OTHERS.

NO CLAIM IS MADE TO THE EXCLUSIVE RIGHT TO USE "+ PROTEIN TIGHTENERS", APART FROM THE MARK AS SHOWN.

SN 85-192,850, FILED 12-8-2010.

KEVIN DINALLO, EXAMINING ATTORNEY



David J. Kybas

Director of the United States Patent and Trademark Office

United States of America

United States Patent and Trademark Office

WINDHORSE CAPITAL MANAGEMENT

Reg. No. 4,109,923

Registered Mar. 6, 2012

Int. Cl.: 36

SERVICE MARK

PRINCIPAL REGISTER

WINDHORSE CAPITAL MANAGEMENT, LLC (DELAWARE LIMITED LIABILITY COMPANY)
125 HIGH STREET, SUITE 2203
BOSTON, MA 02110

FOR: INVESTMENT MANAGEMENT AND INVESTMENT ADVISORY SERVICES; INVESTMENT OF FUNDS FOR OTHERS, IN CLASS 36 (U.S. CLS. 100, 101 AND 102).

FIRST USE 10-27-2011; IN COMMERCE 10-27-2011.

THE MARK CONSISTS OF STANDARD CHARACTERS WITHOUT CLAIM TO ANY PARTICULAR FONT, STYLE, SIZE, OR COLOR.

NO CLAIM IS MADE TO THE EXCLUSIVE RIGHT TO USE "CAPITAL MANAGEMENT", APART FROM THE MARK AS SHOWN.

SN 85-192,877, FILED 12-8-2010.

GEORGE LORENZO, EXAMINING ATTORNEY



David J. Kyros

Director of the United States Patent and Trademark Office

United States of America

United States Patent and Trademark Office

SEQUENCE DRAFT CONTROL

Reg. No. 4,109,924

THE SCHEBLER CO. (ILLINOIS CORPORATION)
HIGHWAY 67 AND FENNO ROAD
BETTENDORF, IA 52722

Registered Mar. 6, 2012

Int. Cl.: 42

FOR: DESIGN SERVICES FOR CUSTOM ENGINEERED VENTING SYSTEMS, IN CLASS 42 (U.S. CLS. 100 AND 101).

SERVICE MARK

FIRST USE 1-31-2011; IN COMMERCE 1-31-2011.

PRINCIPAL REGISTER

THE MARK CONSISTS OF STANDARD CHARACTERS WITHOUT CLAIM TO ANY PARTICULAR FONT, STYLE, SIZE, OR COLOR.

NO CLAIM IS MADE TO THE EXCLUSIVE RIGHT TO USE "DRAFT CONTROL", APART FROM THE MARK AS SHOWN.

SN 85-192,893, FILED 12-8-2010.

ELLEN BURNS, EXAMINING ATTORNEY



David J. Kybas

Director of the United States Patent and Trademark Office

United States of America

United States Patent and Trademark Office



Reg. No. 4,109,925

Registered Mar. 6, 2012

Int. Cl.: 18

TRADEMARK

PRINCIPAL REGISTER

STAR SAPPHIRE SOLUTIONS, INC. (ILLINOIS CORPORATION)
P.O. BOX 1492
BOURBONNAIS, IL 60914

FOR: CARD WALLETS; CLUTCH BAGS; CLUTCH PURSES; CLUTCHES; CREDIT CARD CASES; CREDIT CARD CASES AND HOLDERS; LEATHER BAGS AND WALLETS; LEATHER CREDIT CARD CASES; LEATHER CREDIT CARD HOLDER; LEATHER CREDIT CARD WALLETS; SMALL CLUTCH PURSES; WALLETS, IN CLASS 18 (U.S. CLS. 1, 2, 3, 22 AND 41).

FIRST USE 12-22-2011; IN COMMERCE 12-22-2011.

NO CLAIM IS MADE TO THE EXCLUSIVE RIGHT TO USE "GIFT CARD CLUTCH", APART FROM THE MARK AS SHOWN.

THE MARK CONSISTS OF A SHADED SQUARE GIFT BOX TIED WITH A LIGHT-COLORED RIBBON ACROSS THE TOP AND UP THE RIGHT SIDE TO A BOW AT THE TOP RIGHT WITH A STACK OF THREE SHADED RECTANGLES TAKING UP HALF THE SPACE OF THE SQUARE, TO THE IMMEDIATE LEFT OF WHICH ARE THE WORDS "MY GIFT CARD CLUTCH" ON FOUR LINES IN LIGHT, STYLIZED UPPER-AND-LOWER-CASE LETTERING.

SN 85-192,898, FILED 12-8-2010.

JILL C. ALT, EXAMINING ATTORNEY



David J. Kyros

Director of the United States Patent and Trademark Office

United States of America

United States Patent and Trademark Office

Inventor Sherpa

Reg. No. 4,109,926

Registered Mar. 6, 2012

Int. Cl.: 45

SERVICE MARK

PRINCIPAL REGISTER

INTELLIPRENEUR CONSULTING LLC (PENNSYLVANIA LIMITED LIABILITY COMPANY)
157 HART AVENUE
DOYLESTOWN, PA 18901

FOR: INTELLECTUAL PROPERTY CONSULTING SERVICES IN THE FIELD OF INVENTION, PROVIDING GUIDANCE TO INVENTORS AND OTHER INDIVIDUALS AND GROUPS PARTICIPATING IN THE CREATION, EXPANSION, DEVELOPMENT, PROTECTION, AND EXPLOITATION OF INVENTIVE CONCEPTS AND PARTICIPATING DIRECTLY AND INDIRECTLY IN CREATING AND EXPANDING INVENTIVE CONCEPTS; PATENT CONSULTATION, NAMELY, SEARCHING AND ANALYZING PATENT AND OPEN LITERATURE RELATED TO SPECIFIC INVENTIVE CONCEPTS AND PREPARING AND PROSECUTING PATENT APPLICATIONS, IN CLASS 45 (U.S. CLS. 100 AND 101).

FIRST USE 12-13-2011; IN COMMERCE 12-13-2011.

THE MARK CONSISTS OF STANDARD CHARACTERS WITHOUT CLAIM TO ANY PARTICULAR FONT, STYLE, SIZE, OR COLOR.

NO CLAIM IS MADE TO THE EXCLUSIVE RIGHT TO USE "INVENTOR", APART FROM THE MARK AS SHOWN.

SN 85-192,946, FILED 12-8-2010.

EMILY CHUO, EXAMINING ATTORNEY



David J. Kyjars

Director of the United States Patent and Trademark Office

United States of America

United States Patent and Trademark Office

FACE PLACE

Reg. No. 4,109,927

Registered Mar. 6, 2012

Int. Cl.: 9

TRADEMARK

PRINCIPAL REGISTER

APPLE INDUSTRIES INC. (NEW YORK CORPORATION)
BUILDING 8
200 FOREST DRIVE
GREENVALE, NY 11548

FOR: STAND ALONE PAY FOR USE INTERACTIVE PHOTO KIOSKS FOR CAPTURING, PRINTING AND UPLOADING DIGITAL AND PHOTOGRAPHIC IMAGES, IN CLASS 9 (U.S. CLS. 21, 23, 26, 36 AND 38).

FIRST USE 12-1-2011; IN COMMERCE 12-1-2011.

THE MARK CONSISTS OF STANDARD CHARACTERS WITHOUT CLAIM TO ANY PARTICULAR FONT, STYLE, SIZE, OR COLOR.

SN 85-192,978, FILED 12-8-2010.

SAIMA MAKHDOOM, EXAMINING ATTORNEY



David J. Kybas

Director of the United States Patent and Trademark Office

United States of America

United States Patent and Trademark Office

WEXFORD

Reg. No. 4,109,928

WALGREEN CO. (ILLINOIS CORPORATION)
200 WILMOT ROAD
DEERFIELD, IL 60015

Registered Mar. 6, 2012

Int. Cls.: 2 and 16

FOR: FILLED INK CARTRIDGES AND INK JET INK TANKS, IN CLASS 2 (U.S. CLS. 6, 11 AND 16).

TRADEMARK

FIRST USE 12-6-2011; IN COMMERCE 12-6-2011.

PRINCIPAL REGISTER

FOR: OFFICE SUPPLIES, NAMELY, FILLER PAPER, NOTEBOOKS, MEMO PADS, LOOSE LEAF BINDERS, DOCUMENT DIVIDERS, EXPANDING PAPER FILES, WRITING TABLETS, LEGAL PADS, PAPER REPORT COVERS, BALLPOINT PENS, MANUAL HOLE PUNCHES, MECHANICAL PENCILS, AND TRANSPARENT TAPE FOR STATIONERY OR HOUSEHOLD USE, IN CLASS 16 (U.S. CLS. 2, 5, 22, 23, 29, 37, 38 AND 50).

FIRST USE 3-28-2010; IN COMMERCE 3-28-2010.

THE MARK CONSISTS OF STANDARD CHARACTERS WITHOUT CLAIM TO ANY PARTICULAR FONT, STYLE, SIZE, OR COLOR.

OWNER OF U.S. REG. NOS. 2,803,119 AND 3,814,490.

SN 85-193,062, FILED 12-8-2010.

ALICE BENMAMAN, EXAMINING ATTORNEY



David J. Kyros

Director of the United States Patent and Trademark Office

United States of America

United States Patent and Trademark Office

IT'S ABOUT GIVING BACK.

Reg. No. 4,109,929

TRUE VALUE COMPANY (DELAWARE CORPORATION)
8600 WEST BRYN MAWR AVENUE
CHICAGO, IL 606313505

Registered Mar. 6, 2012

Int. Cl.: 35

FOR: RETAIL HARDWARE STORE SERVICES FEATURING A BONUS INCENTIVE PROGRAM, IN CLASS 35 (U.S. CLS. 100, 101 AND 102).

SERVICE MARK

FIRST USE 3-15-2011; IN COMMERCE 3-15-2011.

PRINCIPAL REGISTER

THE MARK CONSISTS OF STANDARD CHARACTERS WITHOUT CLAIM TO ANY PARTICULAR FONT, STYLE, SIZE, OR COLOR.

SN 85-193,142, FILED 12-8-2010.

PATRICIA EVANKO, EXAMINING ATTORNEY



David J. Kybas

Director of the United States Patent and Trademark Office

United States of America

United States Patent and Trademark Office

FILL GOOD

Reg. No. 4,109,930

MONROE OIL COMPANY, INCORPORATED (NORTH CAROLINA CORPORATION)
519 FRANKLIN STREET
MONROE, NC 28112

Registered Mar. 6, 2012

Int. Cl.: 35

FOR: RETAIL STORE SERVICES FEATURING CONVENIENCE STORE ITEMS AND GAS-
OLINE, IN CLASS 35 (U.S. CLS. 100, 101 AND 102).

SERVICE MARK

FIRST USE 7-1-2011; IN COMMERCE 7-1-2011.

PRINCIPAL REGISTER

THE MARK CONSISTS OF STANDARD CHARACTERS WITHOUT CLAIM TO ANY PAR-
TICULAR FONT, STYLE, SIZE, OR COLOR.

SN 85-193,155, FILED 12-8-2010.

PRISCILLA MILTON, EXAMINING ATTORNEY



David J. Kybas

Director of the United States Patent and Trademark Office

United States of America

United States Patent and Trademark Office

LOST IN HOUSE

Reg. No. 4,109,931

VERNAU, JASON WILLIAM (UNITED STATES INDIVIDUAL)
50 BISCAYNE BLVD APT 3008
MIAMI, FL 33132 AND

Registered Mar. 6, 2012

Int. Cl.: 41

DELGADO, ANA NATALIE (UNITED STATES INDIVIDUAL)
50 BISCAYNE BLVD APT 3008
MIAMI, FL 33132

SERVICE MARK

PRINCIPAL REGISTER

FOR: ARRANGING AND CONDUCTING NIGHTCLUB ENTERTAINMENT EVENTS; ARRANGING AND CONDUCTING NIGHTCLUB PARTIES, IN CLASS 41 (U.S. CLS. 100, 101 AND 107).

FIRST USE 1-1-2011; IN COMMERCE 1-1-2011.

THE MARK CONSISTS OF STANDARD CHARACTERS WITHOUT CLAIM TO ANY PARTICULAR FONT, STYLE, SIZE, OR COLOR.

SN 85-193,380, FILED 12-8-2010.

TRACY CROSS, EXAMINING ATTORNEY



David J. Kyros

Director of the United States Patent and Trademark Office

United States of America

United States Patent and Trademark Office

EIGHT BALL MAFIA

Reg. No. 4,109,932

Registered Mar. 6, 2012

Int. Cl.: 28

TRADEMARK

PRINCIPAL REGISTER

CUESTIX, INC. (COLORADO CORPORATION)
SUITE 104
1380 OVERLOOK DRIVE
LAFAYETTE, CO 800269554

FOR: BILLIARD BALLS; BILLIARD CUES; BILLIARD EQUIPMENT; BILLIARD GAME PLAYING EQUIPMENT; CUE STICKS; POOL CUE CASES; POOL CUES, IN CLASS 28 (U.S. CLS. 22, 23, 38 AND 50).

FIRST USE 7-19-2010; IN COMMERCE 7-19-2010.

THE MARK CONSISTS OF STANDARD CHARACTERS WITHOUT CLAIM TO ANY PARTICULAR FONT, STYLE, SIZE, OR COLOR.

NO CLAIM IS MADE TO THE EXCLUSIVE RIGHT TO USE "EIGHT BALL", APART FROM THE MARK AS SHOWN.

SN 85-193,641, FILED 12-8-2010.

TINA MAI, EXAMINING ATTORNEY



David J. Kyros

Director of the United States Patent and Trademark Office

United States of America

United States Patent and Trademark Office



Reg. No. 4,109,933

Registered Mar. 6, 2012

Int. Cl.: 35

SERVICE MARK

PRINCIPAL REGISTER

DARKSIDE RECORDS 7 GALLERY, LLC (NEW YORK LIMITED LIABILITY COMPANY)
782 MAIN ST
POUGHKEEPSIE, NY 12603

FOR: RETAIL MUSIC AND RECORD STORES, IN CLASS 35 (U.S. CLS. 100, 101 AND 102).

FIRST USE 10-1-2010; IN COMMERCE 1-14-2011.

NO CLAIM IS MADE TO THE EXCLUSIVE RIGHT TO USE "RECORDS & GALLERY",
APART FROM THE MARK AS SHOWN.

THE MARK CONSISTS OF A STYLIZED RECORD WITH AN EGYPTIAN LOOKING EYE
IN THE CENTER. AROUND THE RECORD IS THE WORDING "DARKSIDE" ON TOP AND
"RECORDS & GALLERY" ON THE BOTTOM. ON BOTH SIDES SEPARATING THE
WORDING ARE THREE STARS.

SN 85-193,688, FILED 12-8-2010.

TARAH HARDY, EXAMINING ATTORNEY



David J. Kybas

Director of the United States Patent and Trademark Office

United States of America

United States Patent and Trademark Office

Bandi

Reg. No. 4,109,934

B&I OVERSEAS TRADING INC (CALIFORNIA CORPORATION)
15155 STAGG ST. #7
VAN NUYS, CA 91405

Registered Mar. 6, 2012

Int. Cl.: 30

FOR: ICE CREAM; ICE CREAM DESSERTS; ICE CREAM SANDWICHES; ICE-CREAM
CAKES, IN CLASS 30 (U.S. CL. 46).

TRADEMARK

FIRST USE 5-19-2010; IN COMMERCE 5-19-2010.

PRINCIPAL REGISTER

THE MARK CONSISTS OF STANDARD CHARACTERS WITHOUT CLAIM TO ANY PAR-
TICULAR FONT, STYLE, SIZE, OR COLOR.

SN 85-193,720, FILED 12-8-2010.

TARAH HARDY, EXAMINING ATTORNEY



David J. Kyros

Director of the United States Patent and Trademark Office

United States of America

United States Patent and Trademark Office

INTANGIBLE PROSPERITY

Reg. No. 4,109,935

ADVANCED LIVING INC. (KENTUCKY CORPORATION)
2121 ARGILLITE RD.
FLATWOODS, KY 41139

Registered Mar. 6, 2012

Int. Cls.: 16 and 25

FOR: A SERIES OF BOOKS REGARDING SELF-HELP IN THE BUSINESS FIELD, IN CLASS 16 (U.S. CLS. 2, 5, 22, 23, 29, 37, 38 AND 50).

TRADEMARK

FIRST USE 11-27-2011; IN COMMERCE 11-27-2011.

PRINCIPAL REGISTER

FOR: CLOTHING, NAMELY, TOPS, SHIRTS, HATS AND JACKETS, IN CLASS 25 (U.S. CLS. 22 AND 39).

FIRST USE 11-27-2011; IN COMMERCE 11-27-2011.

THE MARK CONSISTS OF STANDARD CHARACTERS WITHOUT CLAIM TO ANY PARTICULAR FONT, STYLE, SIZE, OR COLOR.

SN 85-193,781, FILED 12-9-2010.

KATHERINE CHANG, EXAMINING ATTORNEY



David J. Kyros

Director of the United States Patent and Trademark Office

United States of America

United States Patent and Trademark Office

TOTAL CONVENIENCE

Reg. No. 4,109,936

Registered Mar. 6, 2012

Int. Cl.: 36

SERVICE MARK

PRINCIPAL REGISTER

HERITAGE FEDERAL CREDIT UNION (SOUTH CAROLINA FEDERALLY CHARTERED
CREDIT UNION)
P.O. BOX 118000
CHARLESTON, SC 294238000

FOR: CREDIT UNION SERVICES, IN CLASS 36 (U.S. CLS. 100, 101 AND 102).

FIRST USE 3-1-2010; IN COMMERCE 3-1-2010.

THE MARK CONSISTS OF STANDARD CHARACTERS WITHOUT CLAIM TO ANY PARTICULAR FONT, STYLE, SIZE, OR COLOR.

SN 85-193,873, FILED 12-9-2010.

MELISSA VALLILLO, EXAMINING ATTORNEY



David J. Kybas

Director of the United States Patent and Trademark Office

United States of America

United States Patent and Trademark Office

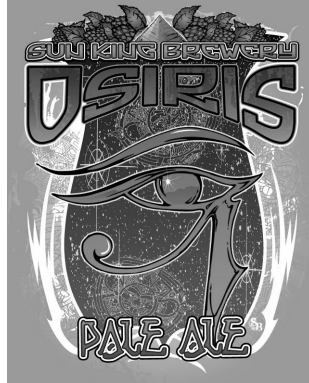

Reg. No. 4,109,937

Registered Mar. 6, 2012

Int. Cl.: 32

TRADEMARK

PRINCIPAL REGISTER

SUN KING BREWING COMPANY, LLC (INDIANA LIMITED LIABILITY COMPANY)
135 NORTH COLLEGE AVENUE
INDIANAPOLIS, IN 46202

FOR: ALES, IN CLASS 32 (U.S. CLS. 45, 46 AND 48).

FIRST USE 7-1-2009; IN COMMERCE 7-1-2009.

NO CLAIM IS MADE TO THE EXCLUSIVE RIGHT TO USE "PALE ALE" AND "BREWERY",
APART FROM THE MARK AS SHOWN.

THE MARK CONSISTS OF A LARGE TULIP-SHAPED VASE WITH A BACKGROUND OF A STARRY NIGHT AND IMAGES OF A CARVING CONTAINING A CENTRAL AMERICAN SUN KING GOD IN A CIRCLE, WITH HOT AIR BALLOON APPEARING DEPICTIONS AMID VARIOUS CIRCLES, SWIRLS AND STRIPES TO ITS LEFT AND RIGHT. A PYRAMID WITH SUNRAYS SITS ABOVE THE SUN GOD, AND FOUR SQUARES CONTAINING DECORATIVE GEOMETRIC IMAGES ARE LOCATED ON EACH OF ITS FOUR DIAGONALS. PORTIONS OF THE SUN GOD CARVINGS ARE COVERED BY OTHER FEATURES IN THE DRAWING AND ARE NOT VISIBLE. IN THE MIDDLE OF THE VASE IS A LARGE EYE OF HORUS. AT THE TOP OF THE VASE IS A PYRAMID IN THE MIDDLE OF A COLLECTION OF LEAVES AND HOPS ON TOP OF THE STYLIZED PHRASE "SUN KING BREWERY", WHICH APPEARS ABOVE THE STYLIZED WORD "OSIRIS". AT THE BASE OF THE VASE IS THE STYLIZED WORDING "PALE ALE". THE AREA IMMEDIATELY SURROUNDING EACH SIDE OF THE VASE CONTAINS MORE SMALL IMAGES OF PORTIONS THE SUN GOD CARVING, AS DESCRIBED ABOVE. THE STYLIZED LETTERS "SB" APPEAR TO THE RIGHT OF WORDING "ALE". THE ENTIRE MARK IS LOCATED ON A SHADED RECTANGULAR BACKGROUND.

SN 85-193,923, FILED 12-9-2010.

ANDREA HACK, EXAMINING ATTORNEY



David J. Kybas

Director of the United States Patent and Trademark Office

United States of America

United States Patent and Trademark Office

LIGHT WEIGHT

Reg. No. 4,109,938

Registered Mar. 6, 2012

Int. Cl.: 5

TRADEMARK

PRINCIPAL REGISTER

DISRUPTIVE BEVERAGES, INC. (CALIFORNIA CORPORATION)
901 NORTH WALTON AVENUE
YUBA CITY, CA 95993

FOR: INGREDIENTS OF BEVERAGES IN THE NATURE OF NUTRITIONAL AND DIETARY SUPPLEMENTS; DIETARY SUPPLEMENTAL DRINKS, IN CLASS 5 (U.S. CLS. 6, 18, 44, 46, 51 AND 52).

FIRST USE 5-0-2007; IN COMMERCE 5-0-2007.

THE MARK CONSISTS OF STANDARD CHARACTERS WITHOUT CLAIM TO ANY PARTICULAR FONT, STYLE, SIZE, OR COLOR.

OWNER OF U.S. REG. NO. 3,423,884.

SN 85-193,988, FILED 12-9-2010.

ERNEST SHOSHO, EXAMINING ATTORNEY



David J. Kyffers

Director of the United States Patent and Trademark Office

United States of America

United States Patent and Trademark Office

NEVER SETTLE FOR LESS

Reg. No. 4,109,939

HRB INNOVATIONS, INC. (DELAWARE CORPORATION)
2215-B RENAISSANCE DRIVE
LAS VEGAS, NV 89119

Registered Mar. 6, 2012

Int. Cl.: 35

FOR: TAX PREPARATION, TAX CONSULTATION AND TAX FILING SERVICES, IN CLASS 35 (U.S. CLS. 100, 101 AND 102).

SERVICE MARK

FIRST USE 9-0-2011; IN COMMERCE 9-0-2011.

PRINCIPAL REGISTER

THE MARK CONSISTS OF STANDARD CHARACTERS WITHOUT CLAIM TO ANY PARTICULAR FONT, STYLE, SIZE, OR COLOR.

SN 85-194,164, FILED 12-9-2010.

SALLY SHIH, EXAMINING ATTORNEY



David J. Kybas

Director of the United States Patent and Trademark Office

United States of America

United States Patent and Trademark Office

REDILAYER

Reg. No. 4,109,940

Registered Mar. 6, 2012

Int. Cl.: 25

TRADEMARK

PRINCIPAL REGISTER

SAGE MANUFACTURING CORPORATION (WASHINGTON CORPORATION)
8500 NORTHEAST DAY ROAD
BAINBRIDGE ISLAND, WA 98110

FOR: CLOTHING, NAMELY, A BASE LAYER FOR WEAR UNDER A GARMENT TO PROVIDE INSULATION, MOVE MOISTURE AWAY FROM THE SKIN AND CONTROL THE RATE OF COOLING EVAPORATION, IN CLASS 25 (U.S. CLS. 22 AND 39).

FIRST USE 9-30-2011; IN COMMERCE 9-30-2011.

THE MARK CONSISTS OF STANDARD CHARACTERS WITHOUT CLAIM TO ANY PARTICULAR FONT, STYLE, SIZE, OR COLOR.

SN 85-194,236, FILED 12-9-2010.

DEIRDRE ROBERTSON, EXAMINING ATTORNEY



David J. Kyffers

Director of the United States Patent and Trademark Office

United States of America

United States Patent and Trademark Office

Everfan

Reg. No. 4,109,941

SUPER FAN, LLC (GEORGIA LIMITED LIABILITY COMPANY)
126 S. BROAD STREET
THOMASVILLE, GA 31792

Registered Mar. 6, 2012

Int. Cl.: 25

FOR: CAPES; HEAD WEAR; T-SHIRTS; WEARABLE GARMENTS AND CLOTHING,
NAMELY, SHIRTS; WRIST BANDS, IN CLASS 25 (U.S. CLS. 22 AND 39).

TRADEMARK

FIRST USE 3-1-2011; IN COMMERCE 3-1-2011.

PRINCIPAL REGISTER

THE MARK CONSISTS OF STANDARD CHARACTERS WITHOUT CLAIM TO ANY PAR-
TICULAR FONT, STYLE, SIZE, OR COLOR.

SN 85-194,510, FILED 12-9-2010.

KELLY TRUSILO, EXAMINING ATTORNEY



David J. Kybas

Director of the United States Patent and Trademark Office

United States of America

United States Patent and Trademark Office

FINANCIAL VIEW

Reg. No. 4,109,942

BANK OF THE WEST (CALIFORNIA CORPORATION)
180 MONTGOMERY STREET
SAN FRANCISCO, CA 94104

Registered Mar. 6, 2012

Int. Cl.: 16

FOR: NEWSLETTERS IN THE FIELD OF BANKING AND FINANCIAL SERVICES, IN CLASS 16 (U.S. CLS. 2, 5, 22, 23, 29, 37, 38 AND 50).

TRADEMARK

FIRST USE 12-7-2010; IN COMMERCE 12-7-2010.

PRINCIPAL REGISTER

THE MARK CONSISTS OF STANDARD CHARACTERS WITHOUT CLAIM TO ANY PARTICULAR FONT, STYLE, SIZE, OR COLOR.

NO CLAIM IS MADE TO THE EXCLUSIVE RIGHT TO USE "FINANCIAL", APART FROM THE MARK AS SHOWN.

SN 85-194,549, FILED 12-9-2010.

LINDA POWELL, EXAMINING ATTORNEY



David J. Kybas

Director of the United States Patent and Trademark Office

United States of America
United States Patent and Trademark Office

AQUAVIEW

Reg. No. 4,109,943

SUNBELT U.S.A., INC. (CALIFORNIA CORPORATION)
1941 YEAGER AVENUE
LAVERNE, CA 91750

Registered Mar. 6, 2012

Int. Cl.: 9

FOR: OPTICAL LENSES, NAMELY, LENSES FOR PRESCRIPTION GLASSES, SUNGLASSES AND GOGGLES, IN CLASS 9 (U.S. CLS. 21, 23, 26, 36 AND 38).

TRADEMARK

FIRST USE 4-12-2011; IN COMMERCE 4-12-2011.

PRINCIPAL REGISTER

THE MARK CONSISTS OF STANDARD CHARACTERS WITHOUT CLAIM TO ANY PARTICULAR FONT, STYLE, SIZE, OR COLOR.

SN 85-194,635, FILED 12-9-2010.

JULIE VEPPUMTHARA, EXAMINING ATTORNEY



David J. Kybas

Director of the United States Patent and Trademark Office

United States of America

United States Patent and Trademark Office



Reg. No. 4,109,944

Registered Mar. 6, 2012

Int. Cls.: 9, 16, and 25

TRADEMARK

PRINCIPAL REGISTER

HIDDEN MANNA CORPORATION (CALIFORNIA CORPORATION), DBA THE WHOSOEVERS,
22324 GOLDEN SPRINGS DRIVE
DIAMOND BAR, CA 917652449

FOR: PRERECORDED DVDS AND CDS FEATURING CHRISTIAN RELIGIOUS INSTRUCTION AND SPOKEN WORD IN THE FIELD OF CHRISTIANITY, IN CLASS 9 (U.S. CLS. 21, 23, 26, 36 AND 38).

FIRST USE 8-29-2009; IN COMMERCE 8-29-2009.

FOR: CALENDARS; POSTERS; PHOTOGRAPHS; STICKERS; BOOKS AND MAGAZINES ABOUT THE CHRISTIAN RELIGION; STATIONERY; GREETING AND MOTIVATIONAL CARDS, IN CLASS 16 (U.S. CLS. 2, 5, 22, 23, 29, 37, 38 AND 50).

FIRST USE 8-29-2009; IN COMMERCE 8-29-2009.

FOR: CLOTHING, NAMELY, TOPS AND BOTTOMS; HEADWEAR; FOOTWEAR, IN CLASS 25 (U.S. CLS. 22 AND 39).

FIRST USE 8-29-2009; IN COMMERCE 8-29-2009.

THE MARK CONSISTS OF THE LETTER "W" OVERLAID ON A CIRCLE.

SN 85-194,677, FILED 12-9-2010.

DAVID YONTEF, EXAMINING ATTORNEY



David J. Kyffers

Director of the United States Patent and Trademark Office

United States of America

United States Patent and Trademark Office

MOISTURECORT

Reg. No. 4,109,945

Registered Mar. 6, 2012

Int. Cl.: 5

TRADEMARK

PRINCIPAL REGISTER

BRIGHTMOOR MEDICAL, LLC (SOUTH CAROLINA LIMITED LIABILITY COMPANY)
STE C14-321
2153 E. MAIN STREET
DUNCAN, SC 29334

FOR: DERMATOLOGICAL PHARMACEUTICAL PRODUCTS, IN CLASS 5 (U.S. CLS. 6, 18, 44, 46, 51 AND 52).

FIRST USE 12-2-2011; IN COMMERCE 12-2-2011.

THE MARK CONSISTS OF STANDARD CHARACTERS WITHOUT CLAIM TO ANY PARTICULAR FONT, STYLE, SIZE, OR COLOR.

SN 85-195,016, FILED 12-10-2010.

TINA BROWN, EXAMINING ATTORNEY



David J. Kyffers

Director of the United States Patent and Trademark Office

United States of America

United States Patent and Trademark Office

COCOANOVA

Reg. No. 4,109,946

HONEST TEA, INC. (DELAWARE CORPORATION)
4827 BETHESDA AVENUE
BETHESDA, MD 20814

Registered Mar. 6, 2012

Int. Cl.: 30

FOR: READY-TO-DRINK COCOA-BASED BEVERAGES, IN CLASS 30 (U.S. CL. 46).

TRADEMARK

FIRST USE 12-16-2010; IN COMMERCE 12-16-2010.

PRINCIPAL REGISTER

THE MARK CONSISTS OF STANDARD CHARACTERS WITHOUT CLAIM TO ANY PARTICULAR FONT, STYLE, SIZE, OR COLOR.

SN 85-195,102, FILED 12-10-2010.

ELIZABETH KAJUBI, EXAMINING ATTORNEY



David J. Kybas

Director of the United States Patent and Trademark Office

United States of America

United States Patent and Trademark Office

APPFLOW

Reg. No. 4,109,947

Registered Mar. 6, 2012

Int. Cl.: 9

TRADEMARK

PRINCIPAL REGISTER

CITRIX SYSTEMS, INC. (DELAWARE CORPORATION)
851 WEST CYPRESS CREEK ROAD
FORT LAUDERDALE, FL 33309

FOR: COMPUTER SOFTWARE FOR USE IN MANAGING AND MONITORING DELIVERY OF OTHER COMPUTER APPLICATIONS ACROSS NETWORKS, INTRANETS, EXTRANETS, AND THE INTERNET; COMPUTER SOFTWARE FOR THE ELECTRONIC TRANSMISSION OF DATA, IMAGES AND MULTIMEDIA ACROSS NETWORKS, THE INTERNET, INTRANETS AND EXTRANETS, AND FOR ANALYZING AND TRANSMITTING INTERNET TRAFFIC ACROSS LOCAL AND GLOBAL NETWORKS, PROVIDING TRAFFIC MANAGEMENT, APPLICATION ACCELERATION, APPLICATION AND NETWORK PERFORMANCE MONITORING AND SECURITY ANALYSIS, AND SYSTEM POLICY CONTROL, IN CLASS 9 (U.S. CLS. 21, 23, 26, 36 AND 38).

FIRST USE 5-10-2011; IN COMMERCE 5-10-2011.

THE MARK CONSISTS OF STANDARD CHARACTERS WITHOUT CLAIM TO ANY PARTICULAR FONT, STYLE, SIZE, OR COLOR.

SN 85-195,451, FILED 12-10-2010.

KRISTIN DAHLING, EXAMINING ATTORNEY



David J. Kybas

Director of the United States Patent and Trademark Office

United States of America

United States Patent and Trademark Office

BROUN OF COLSTOUN

Reg. No. 4,109,948

BROUN, WAYNE H. (AUSTRALIA INDIVIDUAL)
MPUMALANGA, 112 NARRABEEN PARK PARADE
WARRIEWOOD BEACH NSW, AUSTRALIA 2102

Registered Mar. 6, 2012

Int. Cl.: 35

FOR: ONLINE RETAIL STORE SERVICES ALL FEATURING CLOTHING, BELT BUCKLES,
JEWELRY, AND STATIONERY, IN CLASS 35 (U.S. CLS. 100, 101 AND 102).

SERVICE MARK

FIRST USE 12-15-2011; IN COMMERCE 12-15-2011.

PRINCIPAL REGISTER

THE MARK CONSISTS OF STANDARD CHARACTERS WITHOUT CLAIM TO ANY PAR-
TICULAR FONT, STYLE, SIZE, OR COLOR.

THE NAME(S), PORTRAIT(S), AND/OR SIGNATURE(S) SHOWN IN THE MARK DOES NOT
IDENTIFY A PARTICULAR LIVING INDIVIDUAL.

SN 85-195,573, FILED 12-10-2010.

LINDA LAVACHE, EXAMINING ATTORNEY



David J. Kybas

Director of the United States Patent and Trademark Office

United States of America

United States Patent and Trademark Office

ARTE NUEVO

Reg. No. 4,109,949

Registered Mar. 6, 2012

Int. Cl.: 33

TRADEMARK

PRINCIPAL REGISTER

MIGUEL ANGEL PALAFOX (UNITED STATES INDIVIDUAL), DBA MIGUEL ANGEL PALAFOX,
13290 PARKLAND CIRCLE
SYLMAR, CA 91342

FOR: TEQUILA, IN CLASS 33 (U.S. CLS. 47 AND 49).

FIRST USE 11-15-2011; IN COMMERCE 11-30-2011.

THE MARK CONSISTS OF STANDARD CHARACTERS WITHOUT CLAIM TO ANY PARTICULAR FONT, STYLE, SIZE, OR COLOR.

THE ENGLISH TRANSLATION OF "ARTE NUEVO" IN THE MARK IS NEW ART.

SN 85-195,890, FILED 12-11-2010.

DAWN HAN, EXAMINING ATTORNEY



David J. Kybas

Director of the United States Patent and Trademark Office

United States of America

United States Patent and Trademark Office

NOOR

Reg. No. 4,109,950

Registered Mar. 6, 2012

Int. Cl.: 16

TRADEMARK

PRINCIPAL REGISTER

NAJMA USMAN (UNITED STATES INDIVIDUAL)
837 AVENUE Z
BROOKLYN, NY 11235

FOR: A SERIES OF BOOKS AND WRITTEN ARTICLES IN THE FIELD OF RELIGION, RELIGIOUS EDUCATION, RELIGION ISLAM (BILINGUAL); A SERIES OF BOOKS, WRITTEN ARTICLES, HANDOUTS AND WORKSHEETS IN THE FIELD OF RELIGION, RELIGIOUS EDUCATION, RELIGION ISLAM (BILINGUAL); BINDING MATERIALS FOR BOOKS AND PAPERS; BOOKS IN THE FIELD OF RELIGION, RELIGIOUS EDUCATION, RELIGION ISLAM (BILINGUAL); DAILY NEWSPAPER; EDUCATIONAL AND LEARNING PUBLICATIONS, NAMELY, BOOKLETS AND FLASH CARDS ON A VARIETY OF EDUCATIONAL DISCIPLINES IN PRE-SCHOOL THROUGH EIGHTH GRADE; EDUCATIONAL BOOKS FEATURING RELIGION, RELIGIOUS EDUCATION, RELIGION ISLAM (BILINGUAL); EDUCATIONAL KITS SOLD AS A UNIT IN THE FIELD OF RELIGION, RELIGIOUS EDUCATION, RELIGION ISLAM (BILINGUAL) CONSISTING PRIMARILY OF PRINTED INSTRUCTIONAL MATERIALS AND ALSO INCLUDING AUDIO CDS; EDUCATIONAL KITS SOLD AS A UNIT IN THE FIELD OF RELIGION, RELIGIOUS EDUCATION, RELIGION ISLAM (BILINGUAL) CONSISTING PRIMARILY OF EDUCATIONAL BOOKS AND ALSO INCLUDING DVDS AND T-SHIRTS; EDUCATIONAL KITS SOLD AS A UNIT IN THE FIELD OF RELIGION, RELIGIOUS EDUCATION, RELIGION ISLAM (BILINGUAL) CONSISTING PRIMARILY OF EDUCATIONAL BOOKS, FLASH CARDS AND WORKSHEETS, AND ALSO INCLUDING AN EDUCATIONAL DVD; EDUCATIONAL PUBLICATIONS, NAMELY, BOOKS, HANDOUTS, WORKBOOKS, JOURNALS, PLAYBOOKS, WORKSHEETS AND CARDS IN THE FIELD OF RIGHT-BRAIN FITNESS; EDUCATIONAL PUBLICATIONS, NAMELY, EDUCATIONAL LEARNING CARDS, FLASH CARDS, ACTIVITY CARDS, WORKBOOKS, TEXTBOOKS, ACTIVITY BOOKS, STORY BOOKS, PUZZLE BOOKS, PRINTED PUZZLES, TEACHER GUIDES, MANUALS, POSTERS AND EDUCATIONAL BOOKLETS IN THE FIELD OF RELIGION, RELIGIOUS EDUCATION, RELIGION ISLAM (BILINGUAL); EDUCATIONAL PUBLICATIONS, NAMELY, TRAINING MANUALS IN THE FIELD OF RELIGION, RELIGIOUS EDUCATION, RELIGION ISLAM (BILINGUAL); EDUCATIONAL PUBLICATIONS, NAMELY, RELIGIOUS EDUCATION, RELIGION ISLAM (BILINGUAL) IN THE FIELDS OF RELIGION; MAGAZINE SUPPLEMENTS TO NEWSPAPERS IN THE FIELD OF RELIGION, RELIGIOUS EDUCATION, RELIGION ISLAM (BILINGUAL); NEWSPAPERS; NEWSPAPERS FOR GENERAL CIRCULATION; NEWSPAPERS IN THE FIELD OF RELIGION, RELIGIOUS EDUCATION, RELIGION ISLAM (BILINGUAL); PRINTED MATTER, NAMELY, NEWSPAPERS, PHOTOGRAPHS, MAGAZINES, BOOKS, PRINTED PERIODICALS, NEWSLETTERS, AND BROCHURES ALL IN THE FIELDS OF SECURITIES, OPTIONS AND OTHER FINAN-



David J. Kybas

Director of the United States Patent and Trademark Office

Reg. No. 4,109,950 CIAL INSTRUMENTS; PUBLICATION PAPER; PUBLICATIONS, NAMELY, BROCHURES, BOOKLETS, AND TEACHING MATERIALS IN THE FIELD OF RELIGION, RELIGIOUS EDUCATION, RELIGION ISLAM (BILINGUAL); PUBLICATIONS, NAMELY, RELIGION, RELIGIOUS EDUCATION, RELIGION ISLAM (BILINGUAL) IN THE FIELDS OF RELIGION, RELIGIOUS EDUCATION, RELIGION ISLAM (BILINGUAL) , IN CLASS 16 (U.S. CLS. 2, 5, 22, 23, 29, 37, 38 AND 50).

FIRST USE 7-4-2010; IN COMMERCE 7-4-2010.

THE MARK CONSISTS OF STANDARD CHARACTERS WITHOUT CLAIM TO ANY PARTICULAR FONT, STYLE, SIZE, OR COLOR.

THE ENGLISH TRANSLATION OF "NOOR" IS "LIGHT".

SN 85-195,999, FILED 12-12-2010.

SUSAN RICHARDS, EXAMINING ATTORNEY

United States of America

United States Patent and Trademark Office

Timeless Frames, Décor & Expressions

Reg. No. 4,109,951

Registered Mar. 6, 2012

Int. Cl.: 35

SERVICE MARK

PRINCIPAL REGISTER

LCO DESTINY, LLC (NEW YORK LIMITED LIABILITY COMPANY)
1 FISHER CIRCLE PO BOX 28
WATERTOWN, NY 13601

FOR: ORDER FULFILLMENT SERVICES, IN CLASS 35 (U.S. CLS. 100, 101 AND 102).

FIRST USE 1-31-2011; IN COMMERCE 1-31-2011.

THE MARK CONSISTS OF STANDARD CHARACTERS WITHOUT CLAIM TO ANY PARTICULAR FONT, STYLE, SIZE, OR COLOR.

SN 85-196,107, FILED 12-13-2010.

ROBIN CHOSID, EXAMINING ATTORNEY



David J. Kyffers

Director of the United States Patent and Trademark Office

United States of America

United States Patent and Trademark Office

GREENING YOUR WORKFORCE

Reg. No. 4,109,952

Registered Mar. 6, 2012

Int. Cl.: 35

SERVICE MARK

PRINCIPAL REGISTER

MARK GROUP LTD. (UNITED KINGDOM CORPORATION)
BEAUMONT LEYS
70 BOSTON ROAD
LEISCESTER, UNITED KINGDOM LE41AW

FOR: CONDUCTING EMPLOYEE INCENTIVE PROGRAMS TO PROMOTE RESIDENTIAL ENERGY EFFICIENCY BY EMPLOYEES, IN CLASS 35 (U.S. CLS. 100, 101 AND 102).

FIRST USE 10-1-2010; IN COMMERCE 10-1-2010.

THE MARK CONSISTS OF STANDARD CHARACTERS WITHOUT CLAIM TO ANY PARTICULAR FONT, STYLE, SIZE, OR COLOR.

SN 85-196,386, FILED 12-13-2010.

DEZMONA MIZELLE, EXAMINING ATTORNEY



David J. Kyffers

Director of the United States Patent and Trademark Office

United States of America

United States Patent and Trademark Office

GREENING YOUR WORKFORCE

Reg. No. 4,109,953

Registered Mar. 6, 2012

Int. Cl.: 37

SERVICE MARK

PRINCIPAL REGISTER

MARK GROUP LTD. (UNITED KINGDOM CORPORATION)
BEAUMONT LEYS
70 BOSTON ROAD
LEISCESTER, UNITED KINGDOM LE41AW

FOR: HOME ENERGY ASSESSMENT SERVICES FOR THE PURPOSE OF DETERMINING HOME IMPROVEMENTS NEEDED TO IMPROVE ENERGY USE AND EFFICIENCY; INSTALLATION OF BUILDING INSULATION; INSTALLATION OF SOLAR ENERGY SYSTEMS AND ALTERNATIVE ENERGY PRODUCTS FOR RESIDENTIAL AND COMMERCIAL USE, IN CLASS 37 (U.S. CLS. 100, 103 AND 106).

FIRST USE 10-1-2010; IN COMMERCE 10-1-2010.

THE MARK CONSISTS OF STANDARD CHARACTERS WITHOUT CLAIM TO ANY PARTICULAR FONT, STYLE, SIZE, OR COLOR.

SN 85-196,391, FILED 12-13-2010.

DEZMONA MIZELLE, EXAMINING ATTORNEY



David J. Kyffers

Director of the United States Patent and Trademark Office

United States of America

United States Patent and Trademark Office

Heritage Real Estate Associates

Reg. No. 4,109,954

BLOUNT, MONA L. (UNITED STATES INDIVIDUAL)
12786 SHORE ST
LEAVENWORTH, WA 98826

Registered Mar. 6, 2012

Int. Cl.: 35

FOR: ADVERTISING OF COMMERCIAL OR RESIDENTIAL REAL ESTATE, IN CLASS 35
(U.S. CLS. 100, 101 AND 102).

SERVICE MARK

FIRST USE 1-18-2011; IN COMMERCE 1-18-2011.

PRINCIPAL REGISTER

THE MARK CONSISTS OF STANDARD CHARACTERS WITHOUT CLAIM TO ANY PARTICULAR FONT, STYLE, SIZE, OR COLOR.

NO CLAIM IS MADE TO THE EXCLUSIVE RIGHT TO USE "REAL ESTATE ASSOCIATES",
APART FROM THE MARK AS SHOWN.

SN 85-196,716, FILED 12-13-2010.

KIM MONINGHOFF, EXAMINING ATTORNEY



David J. Kybas

Director of the United States Patent and Trademark Office

United States of America

United States Patent and Trademark Office

Redefining Independence

Reg. No. 4,109,955

Registered Mar. 6, 2012

Int. Cl.: 44

SERVICE MARK

PRINCIPAL REGISTER

INDEPENDA, INC. (DELAWARE CORPORATION)
3525 DEL MAR HEIGHTS ROAD, SUITE 800
SAN DIEGO, CA 92130

FOR: PRESCRIPTION REFILL REMINDER SERVICES VIA THE INTERNET; INTERACTIVE MEDICAL MONITORING AND ALERT SERVICE VIA THE INTERNET FOR REMINDING CLIENTS OF MEDICAL INFORMATION, NAMELY, MEDICINAL DOSAGE, ALLERGIC SENSITIVITY, AND PRESCRIPTION REFILLS; PROVIDING MEDICAL AND HEALTH INFORMATION ONLINE; REMOTE MONITORING OF DATA INDICATIVE OF THE HEALTH OR CONDITION OF AN INDIVIDUAL OR GROUP OF INDIVIDUALS; MEDICAL MONITORING AND REPORTING SERVICES; PROVIDING A WEBSITE FOR MEDICAL AND HEALTH MONITORING OF A REMOTE INDIVIDUAL, NAMELY, REMOTE MONITORING OF DATA INDICATIVE OF THE HEALTH OR CONDITION OF AN INDIVIDUAL OR GROUP OF INDIVIDUALS; PROVIDING A WEBSITE AND ONLINE SERVICE FOR PRESCRIPTION MANAGEMENT SERVICES, NAMELY, INTERACTIVE MEDICAL MONITORING AND ALERT SERVICES FOR REMINDING CLIENTS OF MEDICAL INFORMATION IN THE NATURE OF MEDICINAL DOSAGE, ALLERGIC SENSITIVITY AND PRESCRIPTION REFILLS; PROVIDING A WEBSITE FEATURING MEDICAL AND HEALTH INFORMATION ONLINE; PROVIDING A WEBSITE VIA WHICH A CAREGIVER CAN MONITOR THE HEALTH AND/OR WELLNESS OF A REMOTE INDIVIDUAL IN THEIR RESIDENCE, NAMELY, REMOTE MONITORING OF DATA INDICATIVE OF THE HEALTH OR CONDITION OF AN INDIVIDUAL OR GROUP OF INDIVIDUALS, IN CLASS 44 (U.S. CLS. 100 AND 101).



FIRST USE 1-31-2011; IN COMMERCE 1-31-2011.

THE MARK CONSISTS OF STANDARD CHARACTERS WITHOUT CLAIM TO ANY PARTICULAR FONT, STYLE, SIZE, OR COLOR.

SN 85-197,035, FILED 12-14-2010.

BRENDAN MCCAULEY, EXAMINING ATTORNEY

David J. Kyros

Director of the United States Patent and Trademark Office

United States of America

United States Patent and Trademark Office

PRESCRIPTION PUTTING

Reg. No. 4,109,956

LANNY JOHNSON (UNITED STATES INDIVIDUAL)
PO BOX 2220
FRANKFORT, MI 49635

Registered Mar. 6, 2012

Int. Cl.: 28

FOR: GOLF CLUB GRIPS; GOLF PUTTERS, IN CLASS 28 (U.S. CLS. 22, 23, 38 AND 50).

TRADEMARK

FIRST USE 12-31-2008; IN COMMERCE 12-31-2008.

PRINCIPAL REGISTER

THE MARK CONSISTS OF STANDARD CHARACTERS WITHOUT CLAIM TO ANY PARTICULAR FONT, STYLE, SIZE, OR COLOR.

NO CLAIM IS MADE TO THE EXCLUSIVE RIGHT TO USE "PUTTING", APART FROM THE MARK AS SHOWN.

SN 85-197,213, FILED 12-14-2010.

APRIL HESIK, EXAMINING ATTORNEY



David J. Kyffers

Director of the United States Patent and Trademark Office

United States of America

United States Patent and Trademark Office

PRESCRIPTION GOLF

Reg. No. 4,109,957

LANNY JOHNSON (UNITED STATES INDIVIDUAL)
PO BOX 2220
FRANKFORT, MI 49635

Registered Mar. 6, 2012

Int. Cl.: 28

FOR: GOLF CLUB GRIPS, IN CLASS 28 (U.S. CLS. 22, 23, 38 AND 50).

TRADEMARK

FIRST USE 12-31-2010; IN COMMERCE 12-31-2010.

PRINCIPAL REGISTER

THE MARK CONSISTS OF STANDARD CHARACTERS WITHOUT CLAIM TO ANY PARTICULAR FONT, STYLE, SIZE, OR COLOR.

NO CLAIM IS MADE TO THE EXCLUSIVE RIGHT TO USE "GOLF", APART FROM THE MARK AS SHOWN.

SN 85-197,223, FILED 12-14-2010.

APRIL HESIK, EXAMINING ATTORNEY



David J. Kyffers

Director of the United States Patent and Trademark Office

United States of America

United States Patent and Trademark Office

THERMO GOLD

Reg. No. 4,109,958

CHAMPION PERFORMANCE PRODUCTS, INC. (FLORIDA CORPORATION)
1301 SAWGRASS PARKWAY
SUNRISE, FL 33323

Registered Mar. 6, 2012

Int. Cl.: 5

FOR: DIETARY AND NUTRITIONAL SUPPLEMENTS, IN CLASS 5 (U.S. CLS. 6, 18, 44, 46, 51 AND 52).

TRADEMARK

FIRST USE 5-31-2011; IN COMMERCE 5-31-2011.

PRINCIPAL REGISTER

THE MARK CONSISTS OF STANDARD CHARACTERS WITHOUT CLAIM TO ANY PARTICULAR FONT, STYLE, SIZE, OR COLOR.

SN 85-197,356, FILED 12-14-2010.

MICHAEL GAAFAR, EXAMINING ATTORNEY



David J. Kybas

Director of the United States Patent and Trademark Office

United States of America

United States Patent and Trademark Office

WONDER TAN

Reg. No. 4,109,959

Registered Mar. 6, 2012

Int. Cl.: 3

TRADEMARK

PRINCIPAL REGISTER

PERFORMANCE BRANDS, INC. (FLORIDA CORPORATION)
P.O. BOX 267217
WESTON, FL 33326

FOR: SELF-TANNING PREPARATIONS, IN CLASS 3 (U.S. CLS. 1, 4, 6, 50, 51 AND 52).

FIRST USE 10-31-2011; IN COMMERCE 10-31-2011.

THE MARK CONSISTS OF STANDARD CHARACTERS WITHOUT CLAIM TO ANY PARTICULAR FONT, STYLE, SIZE, OR COLOR.

NO CLAIM IS MADE TO THE EXCLUSIVE RIGHT TO USE "TAN", APART FROM THE MARK AS SHOWN.

SN 85-197,508, FILED 12-14-2010.

KATHERINE CHANG, EXAMINING ATTORNEY



David J. Kyffers

Director of the United States Patent and Trademark Office

United States of America

United States Patent and Trademark Office

HUIJA

Reg. No. 4,109,960

Registered Mar. 6, 2012

Int. Cl.: 25

TRADEMARK

PRINCIPAL REGISTER

MANFRE, GUSTAVO GABRIEL (ARGENTINA INDIVIDUAL)
INGENIERO AMORETTI 3816, CIUDADELA
BUENOS AIRES, ARGENTINA

FOR: BLAZERS; BLOUSES; COATS; DRESSES; FOOTWEAR; JACKETS; JERSEYS; NIGHT SHIRTS; PAJAMAS; PANTS; SHIRTS; SHOES; SKIRTS; SLEEP SHIRTS; SLEEVED OR SLEEVELESS JACKETS; SPORT COATS; SUIT COATS; SWEATERS; T-SHIRTS; TUNICS; VESTS, IN CLASS 25 (U.S. CLS. 22 AND 39).

FIRST USE 3-30-2005; IN COMMERCE 2-28-2011.

THE MARK CONSISTS OF STANDARD CHARACTERS WITHOUT CLAIM TO ANY PARTICULAR FONT, STYLE, SIZE, OR COLOR.

THE WORDING "HUIJA" HAS NO MEANING IN A FOREIGN LANGUAGE.

SN 85-197,581, FILED 12-14-2010.

NANCY CLARKE, EXAMINING ATTORNEY



David J. Kybas

Director of the United States Patent and Trademark Office

United States of America

United States Patent and Trademark Office

SKINPOSSIBLE

Reg. No. 4,109,961

Registered Mar. 6, 2012

Int. Cl.: 3

TRADEMARK

PRINCIPAL REGISTER

SKINPOSSIBLE LASER & LIGHT SOLUTIONS LTD. (CANADA CORPORATION)
BOX 33
SITE 7, RR1
DEWINTON - ALBERTA, CANADA T0L0X0

FOR: COSMETICS PREPARATIONS FOR SKIN CARE, NAMELY, FOR SKIN TIGHTENING, WRINKLE REDUCTION, FACIALS, SPIDER VEINS, SKIN TAGS, BODY CONTOURING AND HAIR REMOVAL PREPARATIONS, IN CLASS 3 (U.S. CLS. 1, 4, 6, 50, 51 AND 52).

FIRST USE 12-6-2009; IN COMMERCE 10-14-2010.

THE MARK CONSISTS OF STANDARD CHARACTERS WITHOUT CLAIM TO ANY PARTICULAR FONT, STYLE, SIZE, OR COLOR.

SN 85-197,638, FILED 12-14-2010.

KELLY BOULTON, EXAMINING ATTORNEY



David J. Kyffers

Director of the United States Patent and Trademark Office

United States of America

United States Patent and Trademark Office

COUPONFACTORY

Reg. No. 4,109,962

ROCKFISH INTERACTIVE CORPORATION (DELAWARE CORPORATION)
C/O WPP GROUP USA, INC., 100 PARK AVENUE
NEW YORK, NY 10017

Registered Mar. 6, 2012

Int. Cl.: 42

FOR: PROVIDING AN ONLINE DIGITAL PORTAL FEATURING TECHNOLOGY THAT
ALLOWS USERS TO CREATE, MANAGE, ANALYZE AND DISTRIBUTE PROMOTIONAL
OFFERS, COUPONS AND DISCOUNTS THROUGH ELECTRONIC AND WIRELESS
CHANNELS, IN CLASS 42 (U.S. CLS. 100 AND 101).

SERVICE MARK

PRINCIPAL REGISTER

FIRST USE 12-14-2011; IN COMMERCE 12-14-2011.

THE MARK CONSISTS OF STANDARD CHARACTERS WITHOUT CLAIM TO ANY PAR-
TICULAR FONT, STYLE, SIZE, OR COLOR.

SN 85-197,645, FILED 12-14-2010.

JENNIFER DIXON, EXAMINING ATTORNEY



David J. Kybas

Director of the United States Patent and Trademark Office

United States of America

United States Patent and Trademark Office

FIT2GO

Reg. No. 4,109,963

Registered Mar. 6, 2012

Int. Cl.: 5

TRADEMARK

PRINCIPAL REGISTER

NEW WHEY NUTRITION, LLC (DELAWARE LIMITED LIABILITY COMPANY)
5707 DOT COM COURT
SUITE 1079
OVIEDO, FL 32765

FOR: LIQUID NUTRITIONAL SUPPLEMENT, IN CLASS 5 (U.S. CLS. 6, 18, 44, 46, 51 AND 52).

FIRST USE 2-28-2011; IN COMMERCE 2-28-2011.

THE MARK CONSISTS OF STANDARD CHARACTERS WITHOUT CLAIM TO ANY PARTICULAR FONT, STYLE, SIZE, OR COLOR.

SN 85-198,224, FILED 12-15-2010.

PAUL E. FAHRENKOPF, EXAMINING ATTORNEY



David J. Kybas

Director of the United States Patent and Trademark Office

United States of America

United States Patent and Trademark Office

Men's Pinnacle Club

Reg. No. 4,109,964

Registered Mar. 6, 2012

Int. Cl.: 45

SERVICE MARK

PRINCIPAL REGISTER

THE MEN'S PINNACLE CLUB, L.L.C. (ILLINOIS LIMITED LIABILITY COMPANY), DBA
MEN'S PINNACLE CLUB,
P.O. BOX 1231
NORTHBROOK, IL 600651231

FOR: SOCIAL NETWORKING SERVICES, NAMELY, FACILITATING SOCIAL INTERACTION
AMONG MEN FOR THE PURPOSE OF DEVELOPING FRIENDSHIPS, IN CLASS 45 (U.S.
CLS. 100 AND 101).

FIRST USE 4-11-2010; IN COMMERCE 6-1-2011.

THE MARK CONSISTS OF STANDARD CHARACTERS WITHOUT CLAIM TO ANY PAR-
TICULAR FONT, STYLE, SIZE, OR COLOR.

NO CLAIM IS MADE TO THE EXCLUSIVE RIGHT TO USE "MEN'S" AND "CLUB", APART
FROM THE MARK AS SHOWN.

SN 85-198,317, FILED 12-15-2010.

WENDY JUN, EXAMINING ATTORNEY



David J. Kyros

Director of the United States Patent and Trademark Office

United States of America

United States Patent and Trademark Office

MEVION MEDICAL SYSTEMS

Reg. No. 4,109,965

MEVION MEDICAL SYSTEMS, INC. (DELAWARE CORPORATION)
300 FOSTER STREET
LITTLETON, MA 01460

Registered Mar. 6, 2012

Int. Cl.: 10

FOR: MEDICAL APPARATUS, NAMELY, PROTON BEAM THERAPY EQUIPMENT FOR USE IN TREATING CANCER, IN CLASS 10 (U.S. CLS. 26, 39 AND 44).

TRADEMARK

FIRST USE 10-31-2011; IN COMMERCE 10-31-2011.

PRINCIPAL REGISTER

THE MARK CONSISTS OF STANDARD CHARACTERS WITHOUT CLAIM TO ANY PARTICULAR FONT, STYLE, SIZE, OR COLOR.

NO CLAIM IS MADE TO THE EXCLUSIVE RIGHT TO USE "MEDICAL SYSTEMS", APART FROM THE MARK AS SHOWN.

SN 85-198,686, FILED 12-15-2010.

TINA MAI, EXAMINING ATTORNEY



David J. Kybas

Director of the United States Patent and Trademark Office

United States of America

United States Patent and Trademark Office

FOR KIDS, FOR PARENTS, FOR FUN

Reg. No. 4,109,966

CHAD B. HOECKER (UNITED STATES INDIVIDUAL)
PO BOX 98
STILLWATER, OK 74076

Registered Mar. 6, 2012

Int. Cl.: 44

FOR: DENTIST SERVICES; MEDICAL SERVICES, IN CLASS 44 (U.S. CLS. 100 AND 101).

SERVICE MARK

FIRST USE 1-31-2011; IN COMMERCE 1-31-2011.

PRINCIPAL REGISTER

THE MARK CONSISTS OF STANDARD CHARACTERS WITHOUT CLAIM TO ANY PARTICULAR FONT, STYLE, SIZE, OR COLOR.

SN 85-198,748, FILED 12-15-2010.

NELSON SNYDER, EXAMINING ATTORNEY



David J. Kyfos

Director of the United States Patent and Trademark Office

United States of America

United States Patent and Trademark Office

WONDERALLS

Reg. No. 4,109,967

Registered Mar. 6, 2012

Int. Cl.: 25

TRADEMARK

PRINCIPAL REGISTER

SITKOFF ASSOCIATES INC. (MINNESOTA CORPORATION)
4944 NEWTON AVE SOUTH
MINNEAPOLIS, MN 55419

FOR: CLOTHING, NAMELY, TOPS, BOTTOMS, JACKETS, PANTS, SHORTS, SHIRTS, OVERALLS, SWEATERS, CLOTH DIAPERS, SHOES, FOOTWEAR, HATS, AND HEADWEAR, IN CLASS 25 (U.S. CLS. 22 AND 39).

FIRST USE 1-3-2012; IN COMMERCE 1-3-2012.

THE MARK CONSISTS OF STANDARD CHARACTERS WITHOUT CLAIM TO ANY PARTICULAR FONT, STYLE, SIZE, OR COLOR.

SN 85-199,139, FILED 12-16-2010.

JAMES GRIFFIN, EXAMINING ATTORNEY



David J. Kyffers

Director of the United States Patent and Trademark Office

United States of America

United States Patent and Trademark Office

SAVERS CHOICE

Reg. No. 4,109,968

NASH-FINCH COMPANY (DELAWARE CORPORATION)
7600 FRANCE AVENUE SOUTH
MINNEAPOLIS, MN 55435

Registered Mar. 6, 2012

Int. Cl.: 35

FOR: RETAIL GROCERY STORE SERVICES, IN CLASS 35 (U.S. CLS. 100, 101 AND 102).

SERVICE MARK

FIRST USE 6-23-2011; IN COMMERCE 6-23-2011.

PRINCIPAL REGISTER

THE MARK CONSISTS OF STANDARD CHARACTERS WITHOUT CLAIM TO ANY PARTICULAR FONT, STYLE, SIZE, OR COLOR.

SN 85-199,603, FILED 12-16-2010.

RUDY R. SINGLETON, EXAMINING ATTORNEY



David J. Kybas

Director of the United States Patent and Trademark Office

United States of America

United States Patent and Trademark Office

QwikSolver

Reg. No. 4,109,969

Registered Mar. 6, 2012

Int. Cl.: 41

SERVICE MARK

PRINCIPAL REGISTER

XEROX CORPORATION (NEW YORK CORPORATION)
45 GLOVER AVENUE
P.O. BOX 4505
NORWALK, CT 068564505

FOR: EDUCATIONAL SERVICES, NAMELY, PROVIDING COURSES OF INSTRUCTION IN THE FIELD OF PRODUCT DEVELOPMENT OF DOCUMENT SYSTEMS AND INTEGRATED SOLUTIONS SOFTWARE, BUSINESS PROCESSES, DOCUMENT OUTSOURCING AND INFORMATION TECHNOLOGY SERVICES, IN CLASS 41 (U.S. CLS. 100, 101 AND 107).

FIRST USE 1-11-2011; IN COMMERCE 1-11-2011.

THE MARK CONSISTS OF STANDARD CHARACTERS WITHOUT CLAIM TO ANY PARTICULAR FONT, STYLE, SIZE, OR COLOR.

SN 85-199,646, FILED 12-16-2010.

JEFFREY LOOK, EXAMINING ATTORNEY



David J. Kyros

Director of the United States Patent and Trademark Office

United States of America

United States Patent and Trademark Office



Reg. No. 4,109,970

Registered Mar. 6, 2012

Int. Cl.: 3

TRADEMARK

PRINCIPAL REGISTER

JOHNSON & JOHNSON (NEW JERSEY CORPORATION)
ONE JOHNSON & JOHNSON PLAZA
NEW BRUNSWICK, NJ 089337001

FOR: PRE-MOISTENED COSMETIC WIPES, IN CLASS 3 (U.S. CLS. 1, 4, 6, 50, 51 AND 52).

FIRST USE 7-8-2011; IN COMMERCE 7-8-2011.

THE MARK CONSISTS OF A PICTURE OF FINGERS HOLDING A PAD OVER A CLOSED EYE AND DIFFERENT SIZE WATER DROPLETS ON A RECTANGULAR BACKGROUND.

SN 85-199,693, FILED 12-16-2010.

KAREN K. BUSH, EXAMINING ATTORNEY



David J. Kyffers

Director of the United States Patent and Trademark Office

United States of America

United States Patent and Trademark Office

KNOWING IS GROWING

Reg. No. 4,109,971

Registered Mar. 6, 2012

Int. Cl.: 41

SERVICE MARK

PRINCIPAL REGISTER

PIZZA HUT, INC. (CALIFORNIA CORPORATION)
LEGAL / TRADEMARKS
7100 CORPORATE DRIVE
PLANO, TX 75024

FOR: EDUCATIONAL SERVICES, NAMELY, CONDUCTING PROGRAMS OF INSTRUCTION IN THE FIELD OF READING AND DISTRIBUTION OF EDUCATIONAL MATERIALS PROVIDED IN CONNECTION THEREWITH, IN CLASS 41 (U.S. CLS. 100, 101 AND 107).

FIRST USE 8-1-2011; IN COMMERCE 8-1-2011.

THE MARK CONSISTS OF STANDARD CHARACTERS WITHOUT CLAIM TO ANY PARTICULAR FONT, STYLE, SIZE, OR COLOR.

SN 85-199,837, FILED 12-16-2010.

COURTNEY ALVAREZ, EXAMINING ATTORNEY



David J. Kybas

Director of the United States Patent and Trademark Office

United States of America

United States Patent and Trademark Office

SCRUNCH PILLOW

Reg. No. 4,109,972

SERTA INC. (DELAWARE CORPORATION)
2600 FORBS AVENUE
HOFFMAN ESTATES, IL 60192

Registered Mar. 6, 2012

Int. Cl.: 20

FOR: PILLOWS, IN CLASS 20 (U.S. CLS. 2, 13, 22, 25, 32 AND 50).

TRADEMARK

FIRST USE 3-15-2011; IN COMMERCE 3-15-2011.

PRINCIPAL REGISTER

THE MARK CONSISTS OF STANDARD CHARACTERS WITHOUT CLAIM TO ANY PARTICULAR FONT, STYLE, SIZE, OR COLOR.

NO CLAIM IS MADE TO THE EXCLUSIVE RIGHT TO USE "PILLOW", APART FROM THE MARK AS SHOWN.

SN 85-199,874, FILED 12-16-2010.

BARBARA RUTLAND, EXAMINING ATTORNEY



David J. Kyffers

Director of the United States Patent and Trademark Office

United States of America

United States Patent and Trademark Office

IOZ

Reg. No. 4,109,973

ANGESTI, ANDY (INDONESIA INDIVIDUAL)
DANAU BATUR 15

Registered Mar. 6, 2012

LIPPO KARAWACI, TANGER, INDONESIA

Int. Cl.: 9

FOR: MOTORCYCLE HELMETS; PROTECTIVE HELMETS; PROTECTIVE HELMETS FOR SPORTS; RIDING HELMETS, IN CLASS 9 (U.S. CLS. 21, 23, 26, 36 AND 38).

TRADEMARK

FIRST USE 1-1-2011; IN COMMERCE 1-1-2011.

PRINCIPAL REGISTER

THE MARK CONSISTS OF STANDARD CHARACTERS WITHOUT CLAIM TO ANY PARTICULAR FONT, STYLE, SIZE, OR COLOR.

THE WORDING "IOZ" HAS NO MEANING IN A FOREIGN LANGUAGE.

SN 85-200,193, FILED 12-17-2010.

MARGERY A. TIERNEY, EXAMINING ATTORNEY



David J. Kybas

Director of the United States Patent and Trademark Office

United States of America

United States Patent and Trademark Office

THE IVY LEGACY FOUNDATION

Reg. No. 4,109,974

Registered Mar. 6, 2012

Int. Cl.: 36

SERVICE MARK

PRINCIPAL REGISTER

THE IVY LEGACY FOUNDATION (PENNSYLVANIA NON-PROFIT ORGANIZATION)
6703 GERMANTOWN AVENUE
PHILADELPHIA, PA 19119

FOR: CHARITABLE FOUNDATION SERVICES, NAMELY, PROVIDING FUNDRAISING ACTIVITIES, SUPPLEMENTAL FUNDING, AND SCHOLARSHIPS AND FINANCIAL ASSISTANCE FOR PROGRAMS AND SERVICES, TO BENEFIT THE UNDERSERVED POPULATION OF THE GREATER PHILADELPHIA COMMUNITY, IN CLASS 36 (U.S. CLS. 100, 101 AND 102).

FIRST USE 2-9-1995; IN COMMERCE 2-9-1995.

THE MARK CONSISTS OF STANDARD CHARACTERS WITHOUT CLAIM TO ANY PARTICULAR FONT, STYLE, SIZE, OR COLOR.

NO CLAIM IS MADE TO THE EXCLUSIVE RIGHT TO USE "FOUNDATION", APART FROM THE MARK AS SHOWN.

SN 85-200,231, FILED 12-17-2010.

JUDITH HELFMAN, EXAMINING ATTORNEY



David J. Kyros

Director of the United States Patent and Trademark Office

United States of America

United States Patent and Trademark Office

MODUS-PAK

Reg. No. 4,109,975

CONTAINER MFG. INC. (NEW JERSEY CORPORATION)
50 BAEKELAND AVENUE
MIDDLESEX, NJ 08846

Registered Mar. 6, 2012

Int. Cls.: 9, 20, and 21

FOR: POLYETHYLENE MEASURING CUPS; MEASURING BUCKETS, IN CLASS 9 (U.S. CLS. 21, 23, 26, 36 AND 38).

TRADEMARK

FIRST USE 0-0-2009; IN COMMERCE 0-0-2009.

PRINCIPAL REGISTER

FOR: PACKAGING CONTAINERS OF PLASTIC; PLASTIC STORAGE CONTAINERS FOR COMMERCIAL OR INDUSTRIAL USE, IN CLASS 20 (U.S. CLS. 2, 13, 22, 25, 32 AND 50).

FIRST USE 0-0-2009; IN COMMERCE 0-0-2009.

FOR: PLASTIC STORAGE CONTAINERS FOR HOUSEHOLD OR DOMESTIC USE; PLASTIC SQUEEZE TUBES SOLD EMPTY, IN CLASS 21 (U.S. CLS. 2, 13, 23, 29, 30, 33, 40 AND 50).

FIRST USE 0-0-2009; IN COMMERCE 0-0-2009.

THE MARK CONSISTS OF STANDARD CHARACTERS WITHOUT CLAIM TO ANY PARTICULAR FONT, STYLE, SIZE, OR COLOR.

SN 85-200,305, FILED 12-17-2010.

DEZMONA MIZELLE, EXAMINING ATTORNEY



David J. Kybas

Director of the United States Patent and Trademark Office

United States of America

United States Patent and Trademark Office

WIDE-FLAG

Reg. No. 4,109,976

PROCESS LEVEL TECHNOLOGY, LTD. (TEXAS CORPORATION)
888 CLEAR LAKE AVE.
LEAGUE CITY, TX 77573

Registered Mar. 6, 2012

Int. Cl.: 9

FOR: LEVEL GAUGES, IN CLASS 9 (U.S. CLS. 21, 23, 26, 36 AND 38).

TRADEMARK

FIRST USE 10-31-2011; IN COMMERCE 10-31-2011.

PRINCIPAL REGISTER

THE MARK CONSISTS OF STANDARD CHARACTERS WITHOUT CLAIM TO ANY PARTICULAR FONT, STYLE, SIZE, OR COLOR.

SN 85-200,340, FILED 12-17-2010.

ARETHA SOMERVILLE, EXAMINING ATTORNEY



David J. Kybas

Director of the United States Patent and Trademark Office

United States of America

United States Patent and Trademark Office

RACE TO THE CONCERT

Reg. No. 4,109,977

Registered Mar. 6, 2012

Int. Cl.: 28

TRADEMARK

PRINCIPAL REGISTER

MATTEL, INC. (DELAWARE CORPORATION)
M1-1518
333 CONTINENTAL BOULEVARD
EL SEGUNDO, CA 90245

FOR: DOLLS, DOLL CLOTHING AND DOLL ACCESSORIES; DOLL PLAYSETS AND ACCESSORIES THEREFOR, IN CLASS 28 (U.S. CLS. 22, 23, 38 AND 50).

FIRST USE 7-20-2011; IN COMMERCE 7-20-2011.

THE MARK CONSISTS OF STANDARD CHARACTERS WITHOUT CLAIM TO ANY PARTICULAR FONT, STYLE, SIZE, OR COLOR.

SN 85-200,555, FILED 12-17-2010.

TAMARA FRAZIER, EXAMINING ATTORNEY



David J. Kybas

Director of the United States Patent and Trademark Office

United States of America

United States Patent and Trademark Office

SWIMPROVISE

Reg. No. 4,109,978

Registered Mar. 6, 2012

Int. Cl.: 25

TRADEMARK

PRINCIPAL REGISTER

GLOBAL TRADEMARKS INC. (NEVADA CORPORATION)
110 COMMERCE WAY
STOCKERTOWN, PA 18083

FOR: SWIMWEAR, IN CLASS 25 (U.S. CLS. 22 AND 39).

FIRST USE 12-20-2010; IN COMMERCE 12-20-2010.

THE MARK CONSISTS OF STANDARD CHARACTERS WITHOUT CLAIM TO ANY PARTICULAR FONT, STYLE, SIZE, OR COLOR.

SN 85-200,572, FILED 12-17-2010.

PAUL E. FAHRENKOPF, EXAMINING ATTORNEY



David J. Kybas

Director of the United States Patent and Trademark Office

United States of America

United States Patent and Trademark Office

SLUMBER PARTY SAFARI

Reg. No. 4,109,979

Registered Mar. 6, 2012

Int. Cl.: 28

TRADEMARK

PRINCIPAL REGISTER

MATTEL, INC. (DELAWARE CORPORATION)
M1-1518
333 CONTINENTAL BOULEVARD
EL SEGUNDO, CA 90245

FOR: TOY VEHICLES AND ACCESSORIES THEREFOR, IN CLASS 28 (U.S. CLS. 22, 23, 38 AND 50).

FIRST USE 11-21-2011; IN COMMERCE 11-21-2011.

THE MARK CONSISTS OF STANDARD CHARACTERS WITHOUT CLAIM TO ANY PARTICULAR FONT, STYLE, SIZE, OR COLOR.

SN 85-200,645, FILED 12-17-2010.

TAMARA FRAZIER, EXAMINING ATTORNEY



David J. Kyffers

Director of the United States Patent and Trademark Office

United States of America

United States Patent and Trademark Office

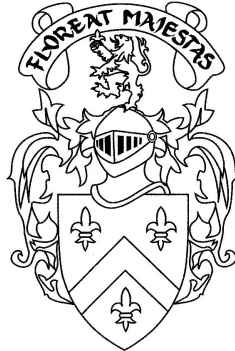

Reg. No. 4,109,980

Registered Mar. 6, 2012

Int. Cl.: 14

TRADEMARK

PRINCIPAL REGISTER

BROUN, WAYNE H. (AUSTRALIA INDIVIDUAL)
MPUMALANGA, 112 NARRABEEN PARK PARADE
WARRIEWOOD BEACH NSW, AUSTRALIA 2102

FOR: JEWELRY; IMITATION JEWELRY; COSTUME JEWELRY; JEWELRY OF NON-PRECIOUS STONES, METALS AND PEWTER; BROOCHES; MEDALLIONS; PINS BEING JEWELRY; NECKLACES; PENDANTS; LAPEL PINS; TIE FASTENERS AND PINS, IN CLASS 14 (U.S. CLS. 2, 27, 28 AND 50).

FIRST USE 12-1-2011; IN COMMERCE 12-1-2011.

THE MARK CONSISTS OF A COAT OF ARMS FEATURING A LION HOLDING A FLEUR-DE-LIS AND STANDING ATOP AN ARMOUR HELMET THAT IS ABOVE A SHIELD FEATURING A CHEVRON AND THREE FLEUR-DE-LIS, ALL SURROUNDED BY LEAVES. ABOVE THE LION IS A BANNER FEATURING THE WORDING "FLOREAT MAJESTAS".

THE ENGLISH TRANSLATION OF "FLOREAT MAJESTAS" IN THE MARK IS LET MAJESTY FLOURISH.

SN 85-200,784, FILED 12-17-2010.

LINDA LAVACHE, EXAMINING ATTORNEY



David J. Kyros

Director of the United States Patent and Trademark Office

United States of America

United States Patent and Trademark Office

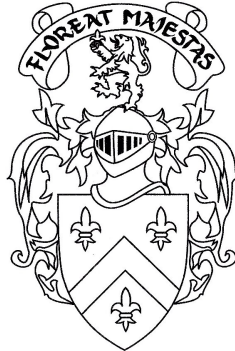

Reg. No. 4,109,981

Registered Mar. 6, 2012

Int. Cl.: 16

TRADEMARK

PRINCIPAL REGISTER

BROUN, WAYNE H. (AUSTRALIA INDIVIDUAL)
MPUMALANGA, 112 NARRABEEN PARK PARADE
WARRIEWOOD BEACH NSW, AUSTRALIA 2102

FOR: NOTE CARDS; POST CARDS; AND STATIONERY, INCLUDING WRITING PAPER
AND ENVELOPES, IN CLASS 16 (U.S. CLS. 2, 5, 22, 23, 29, 37, 38 AND 50).

FIRST USE 12-1-2011; IN COMMERCE 12-1-2011.

THE MARK CONSISTS OF A COAT OF ARMS FEATURING A LION HOLDING A FLEUR-
DE-LIS AND STANDING ATOP AN ARMOUR HELMET THAT IS ABOVE A SHIELD FEAT-
URING A CHEVRON AND THREE FLEUR-DE-LIS, ALL SURROUNDED BY LEAVES.
ABOVE THE LION IS A BANNER FEATURING THE WORDING "FLOREAT MAJESTAS".

THE ENGLISH TRANSLATION OF "FLOREAT MAJESTAS" IN THE MARK IS LET MAJESTY
FLOURISH.

SN 85-200,820, FILED 12-17-2010.

LINDA LAVACHE, EXAMINING ATTORNEY



David J. Kybas

Director of the United States Patent and Trademark Office

United States of America

United States Patent and Trademark Office

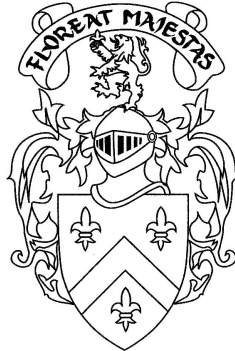

Reg. No. 4,109,982

Registered Mar. 6, 2012

Int. Cl.: 25

TRADEMARK

PRINCIPAL REGISTER

BROUN, WAYNE H. (AUSTRALIA INDIVIDUAL)
MPUMALANGA, 112 NARRABEEN PARK PARADE
WARRIEWOOD BEACH NSW, AUSTRALIA 2102

FOR: MEN'S AND WOMEN'S CLOTHING, NAMELY, T-SHIRTS, SWEATSHIRTS, HOODED SWEATSHIRTS, TOPS, SHIRTS, HATS, BELTS; GOLF WEAR, NAMELY, GOLF CAPS, CLEATS, PANTS, SHIRTS, SKIRTS, SHORTS, JACKETS AND TROUSERS; TENNIS WEAR, IN CLASS 25 (U.S. CLS. 22 AND 39).

FIRST USE 12-1-2011; IN COMMERCE 12-1-2011.

THE MARK CONSISTS OF A COAT OF ARMS FEATURING A LION HOLDING A FLEUR-DE-LIS AND STANDING ATOP AN ARMOUR HELMET THAT IS ABOVE A SHIELD FEATURING A CHEVRON AND THREE FLEUR-DE-LIS, ALL SURROUNDED BY LEAVES. ABOVE THE LION IS A BANNER FEATURING THE WORDING "FLOREAT MAJESTAS".

THE ENGLISH TRANSLATION OF "FLOREAT MAJESTAS" IN THE MARK IS "LET MAJESTY FLOURISH".

SN 85-200,846, FILED 12-17-2010.

LINDA LAVACHE, EXAMINING ATTORNEY



David J. Kybas

Director of the United States Patent and Trademark Office

United States of America

United States Patent and Trademark Office

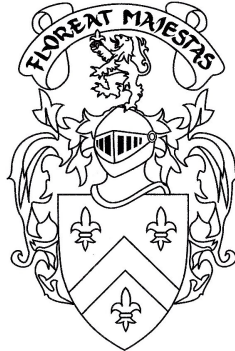

Reg. No. 4,109,983

Registered Mar. 6, 2012

Int. Cl.: 26

TRADEMARK

PRINCIPAL REGISTER

BROUN, WAYNE H. (AUSTRALIA INDIVIDUAL)
MPUMALANGA, 112 NARRABEEN PARK PARADE
WARRIEWOOD BEACH NSW, AUSTRALIA 2102

FOR: BELT BUCKLES NOT OF PRECIOUS METAL; BELT CLASPS; BROOCHES; EMBROIDERED EMBLEMS; AND ORNAMENTAL NOVELTY PINS, IN CLASS 26 (U.S. CLS. 37, 39, 40, 42 AND 50).

FIRST USE 12-1-2011; IN COMMERCE 12-1-2011.

THE MARK CONSISTS OF A COAT OF ARMS FEATURING A LION HOLDING A FLEUR-DE-LIS AND STANDING ATOP AN ARMOUR HELMET THAT IS ABOVE A SHIELD FEATURING A CHEVRON AND THREE FLEUR-DE-LIS, ALL SURROUNDED BY LEAVES. ABOVE THE LION IS A BANNER FEATURING THE WORDING "FLOREAT MAJESTAS".

THE ENGLISH TRANSLATION OF "FLOREAT MAJESTAS" IN THE MARK IS "LET MAJESTY FLOURISH".

SN 85-200,872, FILED 12-17-2010.

LINDA LAVACHE, EXAMINING ATTORNEY



David J. Kybas

Director of the United States Patent and Trademark Office

United States of America

United States Patent and Trademark Office



Reg. No. 4,109,984

Registered Mar. 6, 2012

Int. Cl.: 35

SERVICE MARK

PRINCIPAL REGISTER

BROUN, WAYNE H. (AUSTRALIA INDIVIDUAL)
MPUMALANGA, 112 NARRABEEN PARK PARADE
WARRIEWOOD BEACH NSW, AUSTRALIA 2102

FOR: ONLINE RETAIL STORE SERVICES ALL FEATURING CLOTHING, BELT BUCKLES, JEWELRY, AND STATIONERY, IN CLASS 35 (U.S. CLS. 100, 101 AND 102).

FIRST USE 12-15-2011; IN COMMERCE 12-15-2011.

THE MARK CONSISTS OF A COAT OF ARMS FEATURING A LION HOLDING A FLEUR-DE-LIS AND STANDING ATOP AN ARMOUR HELMET THAT IS ABOVE A SHIELD FEATURING A CHEVRON AND THREE FLEUR-DE-LIS, ALL SURROUNDED BY LEAVES. ABOVE THE LION IS A BANNER FEATURING THE WORDING "FLOREAT MAJESTAS".

THE ENGLISH TRANSLATION OF "FLOREAT MAJESTAS" IN THE MARK IS "LET MAJESTY FLOURISH".

SN 85-200,894, FILED 12-17-2010.

LINDA LAVACHE, EXAMINING ATTORNEY



David J. Kybas

Director of the United States Patent and Trademark Office

United States of America

United States Patent and Trademark Office

SWEATPANTS SUNDAY

Reg. No. 4,109,985

SMITH, TODD WESLEY (UNITED STATES INDIVIDUAL)
13345 90TH AVE N
MAPLE GROVE, MN 55369

Registered Mar. 6, 2012

Int. Cl.: 25

FOR: SWEAT PANTS, IN CLASS 25 (U.S. CLS. 22 AND 39).

TRADEMARK

FIRST USE 10-1-2010; IN COMMERCE 1-15-2011.

PRINCIPAL REGISTER

THE MARK CONSISTS OF STANDARD CHARACTERS WITHOUT CLAIM TO ANY PARTICULAR FONT, STYLE, SIZE, OR COLOR.

NO CLAIM IS MADE TO THE EXCLUSIVE RIGHT TO USE "SWEATPANTS", APART FROM THE MARK AS SHOWN.

SN 85-201,006, FILED 12-17-2010.

JOHN DALIER, EXAMINING ATTORNEY



David J. Kybas

Director of the United States Patent and Trademark Office

United States of America
United States Patent and Trademark Office

loanlook

Reg. No. 4,109,986

THE I3 GROUP, LLC (ILLINOIS LIMITED LIABILITY COMPANY)
1000 E WOODFIELD ROAD
SCHAUMBURG, IL 60173

Registered Mar. 6, 2012

Int. Cl.: 36

FOR: PROVIDING STUDENT LOAN INFORMATION, LOAN REPAYMENT OPTIONS, AND LOAN BUDGETING TOOLS FOR SAID LOANS BY MEANS OF THE INTERNET, IN CLASS 36 (U.S. CLS. 100, 101 AND 102).

SERVICE MARK

FIRST USE 5-30-2011; IN COMMERCE 5-30-2011.

PRINCIPAL REGISTER

THE MARK CONSISTS OF THE TEXT "LOANLOOK" IN VERDANA TYPEFACE.

SN 85-201,672, FILED 12-20-2010.

MARC LEIPZIG, EXAMINING ATTORNEY



David J. Kyros

Director of the United States Patent and Trademark Office

United States of America

United States Patent and Trademark Office

KNOCKERS

Reg. No. 4,109,987

Registered Mar. 6, 2012

Int. Cl.: 6

TRADEMARK

PRINCIPAL REGISTER

MILLER HORTICULTURAL CONSULTANTS, INC. (MISSOURI CORPORATION)
P.O. BOX 15158
ST. LOUIS, MO 63110

FOR: SCULPTURES MADE OF METAL FOR LAWN, GARDEN AND HOUSEHOLD USE;
SCULPTURES MADE OF NON-PRECIOUS METAL FOR LAWN, GARDEN AND HOUSEHOLD
USE; METAL GARDEN STAKES, IN CLASS 6 (U.S. CLS. 2, 12, 13, 14, 23, 25 AND 50).

FIRST USE 8-0-2011; IN COMMERCE 8-0-2011.

THE MARK CONSISTS OF STANDARD CHARACTERS WITHOUT CLAIM TO ANY PAR-
TICULAR FONT, STYLE, SIZE, OR COLOR.

SN 85-202,032, FILED 12-20-2010.

TINA MAI, EXAMINING ATTORNEY



David J. Kybas

Director of the United States Patent and Trademark Office

United States of America

United States Patent and Trademark Office

SWOOPERS

Reg. No. 4,109,988

MILLER HORTICULTURAL CONSULTANTS, INC. (MISSOURI CORPORATION)
P.O. BOX 15158
ST. LOUIS, MO 63110

Registered Mar. 6, 2012

Int. Cl.: 6

FOR: SCULPTURES MADE OF METAL FOR LAWN, GARDEN AND HOUSEHOLD USE;
SCULPTURES MADE OF NON-PRECIOUS METAL FOR LAWN, GARDEN AND HOUSEHOLD
USE; METAL GARDEN STAKES, IN CLASS 6 (U.S. CLS. 2, 12, 13, 14, 23, 25 AND 50).

TRADEMARK

FIRST USE 1-0-2011; IN COMMERCE 1-0-2011.

PRINCIPAL REGISTER

THE MARK CONSISTS OF STANDARD CHARACTERS WITHOUT CLAIM TO ANY PAR-
TICULAR FONT, STYLE, SIZE, OR COLOR.

SN 85-202,040, FILED 12-20-2010.

TINA MAI, EXAMINING ATTORNEY



David J. Kyffers

Director of the United States Patent and Trademark Office

United States of America

United States Patent and Trademark Office

HOMBRE CALIENTE

Reg. No. 4,109,989

Registered Mar. 6, 2012

Int. Cl.: 3

TRADEMARK

PRINCIPAL REGISTER

E.C. PERFUMES, LLC (CALIFORNIA LIMITED LIABILITY COMPANY)
303 N. SWALL DRIVE, #105
BEVERLY HILLS, CA 90211

FOR: EAU DE PERFUME, IN CLASS 3 (U.S. CLS. 1, 4, 6, 50, 51 AND 52).

FIRST USE 8-1-2011; IN COMMERCE 8-1-2011.

THE MARK CONSISTS OF STANDARD CHARACTERS WITHOUT CLAIM TO ANY PARTICULAR FONT, STYLE, SIZE, OR COLOR.

THE ENGLISH TRANSLATION OF "HOMBRE CALIENTE" IN THE MARK IS "HOT MAN".

SN 85-202,140, FILED 12-20-2010.

DAVID TAYLOR, EXAMINING ATTORNEY



David J. Kyffers

Director of the United States Patent and Trademark Office

United States of America
United States Patent and Trademark Office

ENCENDER

Reg. No. 4,109,990

Registered Mar. 6, 2012

Int. Cl.: 33

TRADEMARK

PRINCIPAL REGISTER

SPANISH VINES, INC. (SOUTH CAROLINA CORPORATION)
808 B LADY STREET
COLUMBIA, SC 29201

FOR: WINE, IN CLASS 33 (U.S. CLS. 47 AND 49).

FIRST USE 5-0-2011; IN COMMERCE 5-0-2011.

THE MARK CONSISTS OF STANDARD CHARACTERS WITHOUT CLAIM TO ANY PARTICULAR FONT, STYLE, SIZE, OR COLOR.

THE ENGLISH TRANSLATION OF "ENCENDER" IN THE MARK IS "TO LIGHT".

SN 85-202,324, FILED 12-20-2010.

SHANNON TWOHIG, EXAMINING ATTORNEY



David J. Kyffers

Director of the United States Patent and Trademark Office

United States of America

United States Patent and Trademark Office

CAPTURE THE ENERGY

Reg. No. 4,109,991

Registered Mar. 6, 2012

Int. Cl.: 39

SERVICE MARK

PRINCIPAL REGISTER

MOORHEAD PUBLIC SERVICE (MINNESOTA POLITICAL SUBDIVISION OR INSTRUMENTALITY)
500 CENTER AVENUE BOX 779
MOORHEAD, MN 56561

FOR: PUBLIC UTILITY SERVICES IN THE NATURE OF ELECTRICITY DISTRIBUTION AND TRANSMISSION, IN CLASS 39 (U.S. CLS. 100 AND 105).

FIRST USE 2-24-2011; IN COMMERCE 2-24-2011.

THE MARK CONSISTS OF STANDARD CHARACTERS WITHOUT CLAIM TO ANY PARTICULAR FONT, STYLE, SIZE, OR COLOR.

OWNER OF U.S. REG. NO. 2,427,258.

SN 85-202,540, FILED 12-21-2010.

JERI J. FICKES, EXAMINING ATTORNEY



David J. Kyffers

Director of the United States Patent and Trademark Office

United States of America

United States Patent and Trademark Office

FLYBARRE

Reg. No. 4,109,992

FLYWHEEL SPORTS, INC. (DELAWARE CORPORATION)
PO BOX 1816
NEW YORK, NY 10113

Registered Mar. 6, 2012

Int. Cl.: 41

FOR: PROVIDING FITNESS AND EXERCISE STUDIO SERVICES, NAMELY, INDOOR CYCLING INSTRUCTION, PERSONAL TRAINING AND PHYSICAL FITNESS CLASSES; COUNSELING SERVICES IN THE FIELD OF EXERCISE, IN CLASS 41 (U.S. CLS. 100, 101 AND 107).

SERVICE MARK

PRINCIPAL REGISTER

FIRST USE 12-0-2010; IN COMMERCE 12-0-2010.

THE MARK CONSISTS OF STANDARD CHARACTERS WITHOUT CLAIM TO ANY PARTICULAR FONT, STYLE, SIZE, OR COLOR.

SN 85-203,481, FILED 12-21-2010.

LINDA M. KING, EXAMINING ATTORNEY



David J. Kybas

Director of the United States Patent and Trademark Office

United States of America
United States Patent and Trademark Office

JETSTREAM

Reg. No. 4,109,993

PROMEGA CORPORATION (WISCONSIN CORPORATION)
2800 WOODS HOLLOW ROAD
MADISON, WI 53711

Registered Mar. 6, 2012

Int. Cl.: 9

FOR: SOFTWARE FOR RECEIVING, MANAGING AND CONTROLLING RADIO FREQUENCY IDENTIFICATION DEVICES AND SENSORS, IN CLASS 9 (U.S. CLS. 21, 23, 26, 36 AND 38).

TRADEMARK

FIRST USE 5-12-2010; IN COMMERCE 5-12-2010.

PRINCIPAL REGISTER

THE MARK CONSISTS OF STANDARD CHARACTERS WITHOUT CLAIM TO ANY PARTICULAR FONT, STYLE, SIZE, OR COLOR.

SN 85-203,586, FILED 12-22-2010.

MATTHEW PAPPAS, EXAMINING ATTORNEY



David J. Kappas

Director of the United States Patent and Trademark Office

United States of America

United States Patent and Trademark Office

SOUNDPROTECT

Reg. No. 4,109,994

Registered Mar. 6, 2012

Int. Cl.: 19

TRADEMARK

PRINCIPAL REGISTER

UNILIN FLOORING NC, LLC (NORTH CAROLINA LIMITED LIABILITY COMPANY)
P.O. BOX 800
MISTY YOUNG - LEGAL DEPT
CHATSWORTH, GA 30705

FOR: FLOORING UNDERLAYMENTS, IN CLASS 19 (U.S. CLS. 1, 12, 33 AND 50).

FIRST USE 2-2-2011; IN COMMERCE 2-2-2011.

THE MARK CONSISTS OF STANDARD CHARACTERS WITHOUT CLAIM TO ANY PARTICULAR FONT, STYLE, SIZE, OR COLOR.

SN 85-203,699, FILED 12-22-2010.

STEVEN PEREZ, EXAMINING ATTORNEY



David J. Kybas

Director of the United States Patent and Trademark Office

United States of America

United States Patent and Trademark Office

CLIC & PRESS

Reg. No. 4,109,995

Registered Mar. 6, 2012

Int. Cl.: 19

TRADEMARK

PRINCIPAL REGISTER

UNILIN FLOORING NC, LLC (NORTH CAROLINA LIMITED LIABILITY COMPANY)
P.O. BOX 800
MISTY YOUNG - LEGAL DEPT
CHATSWORTH, GA 30705

FOR: LAMINATE FLOORING, IN CLASS 19 (U.S. CLS. 1, 12, 33 AND 50).

FIRST USE 3-1-2011; IN COMMERCE 3-1-2011.

THE MARK CONSISTS OF STANDARD CHARACTERS WITHOUT CLAIM TO ANY PARTICULAR FONT, STYLE, SIZE, OR COLOR.

SN 85-203,778, FILED 12-22-2010.

STEVEN PEREZ, EXAMINING ATTORNEY



David J. Kybas

Director of the United States Patent and Trademark Office

United States of America

United States Patent and Trademark Office

TU NUEVA IMAGEN TU NUEVA VIDA

Reg. No. 4,109,996

Registered Mar. 6, 2012

Int. Cl.: 44

SERVICE MARK

PRINCIPAL REGISTER

ALTICOR INC. (MICHIGAN CORPORATION)
78-2M
7575 FULTON STREET EAST
ADA, MI 49355

FOR: WEIGHT MANAGEMENT SERVICES, NAMELY, PROVIDING WEIGHT LOSS AND/OR WEIGHT MAINTENANCE PROGRAMS INCLUDING SUPPORT MATERIALS, COUNSELING, PROVIDING ADVICE AND INFORMATION IN THE FIELD OF WEIGHT CONTROL AND NUTRITION, IN CLASS 44 (U.S. CLS. 100 AND 101).

FIRST USE 4-11-2011; IN COMMERCE 4-11-2011.

THE MARK CONSISTS OF STANDARD CHARACTERS WITHOUT CLAIM TO ANY PARTICULAR FONT, STYLE, SIZE, OR COLOR.

THE ENGLISH TRANSLATION OF THE WORDS "TU NUEVA IMAGEN TU NUEVA VIDA" IN THE MARK IS YOUR NEW IMAGE YOUR NEW LIFE.

SN 85-203,946, FILED 12-22-2010.

RAUL CORDOVA, EXAMINING ATTORNEY



David J. Kyros

Director of the United States Patent and Trademark Office

United States of America

United States Patent and Trademark Office

SOLUBALL

Reg. No. 4,109,997

ASSOCIATED RESEARCH DEVELOPMENTS LTD. (CANADA CORPORATION)
1235 H - 40TH AVE. N.E.
CALGARY, AB, CANADA T2E6M9

Registered Mar. 6, 2012

Int. Cl.: 7

FOR: SEALER BALLS FOR THE PURPOSE OF SEALING HOLES OR PERFORATIONS IN OIL AND GAS WELL EQUIPMENT, IN CLASS 7 (U.S. CLS. 13, 19, 21, 23, 31, 34 AND 35).

TRADEMARK

FIRST USE 11-9-2011; IN COMMERCE 12-5-2011.

PRINCIPAL REGISTER

THE MARK CONSISTS OF STANDARD CHARACTERS WITHOUT CLAIM TO ANY PARTICULAR FONT, STYLE, SIZE, OR COLOR.

SN 85-204,129, FILED 12-22-2010.

JENNIFER DIXON, EXAMINING ATTORNEY



David J. Kybas

Director of the United States Patent and Trademark Office

United States of America

United States Patent and Trademark Office

pinergy

Reg. No. 4,109,998

Registered Mar. 6, 2012

Int. Cl.: 36

SERVICE MARK

PRINCIPAL REGISTER

MLS PROPERTY INFORMATION NETWORK, INC. (MASSACHUSETTS CORPORATION)
904 HARTFORD TURNPIKE
SHREWSBURY, MA 015454169

FOR: REAL ESTATE MULTIPLE LISTING SERVICES, IN CLASS 36 (U.S. CLS. 100, 101 AND 102).

FIRST USE 11-7-2011; IN COMMERCE 11-7-2011.

THE MARK CONSISTS OF STANDARD CHARACTERS WITHOUT CLAIM TO ANY PARTICULAR FONT, STYLE, SIZE, OR COLOR.

SN 85-204,177, FILED 12-22-2010.

STEVEN PEREZ, EXAMINING ATTORNEY



David J. Kybas

Director of the United States Patent and Trademark Office

United States of America

United States Patent and Trademark Office



Reg. No. 4,109,999

MLS PROPERTY INFORMATION NETWORK, INC. (MASSACHUSETTS CORPORATION)
904 HARTFORD TURNPIKE
SHREWSBURY, MA 015454169

Registered Mar. 6, 2012

Int. Cl.: 36

FOR: REAL ESTATE MULTIPLE LISTING SERVICES, IN CLASS 36 (U.S. CLS. 100, 101 AND 102).

SERVICE MARK

FIRST USE 11-7-2011; IN COMMERCE 11-7-2011.

PRINCIPAL REGISTER

THE MARK CONSISTS OF THE WORD "PINERGY" BRACKETED BY INWARD-FACING SEMI-CIRCULAR ARCS BOTH TO THE LOWER LEFT AND THE UPPER RIGHT.

SN 85-204,191, FILED 12-22-2010.

STEVEN PEREZ, EXAMINING ATTORNEY



David J. Kybas

Director of the United States Patent and Trademark Office

United States of America

United States Patent and Trademark Office

INTELLIMATCH

Reg. No. 4,110,000

Registered Mar. 6, 2012

Int. Cl.: 35

SERVICE MARK

PRINCIPAL REGISTER

QUINSTREET, INC. (DELAWARE CORPORATION)
950 TOWER LANE, 6TH FLOOR
FOSTER CITY, CA 94404

FOR: PROMOTING, ADVERTISING AND MARKETING THE ON-LINE WEB SITES OF OTHERS; PROMOTING THE GOODS AND SERVICES OF OTHERS VIA THE INTERNET; ADVERTISING AND MARKETING FOR OTHERS VIA THE INTERNET; PROMOTING THE GOODS AND SERVICES OF OTHERS BY PROVIDING HYPERTEXT LINKS TO THE WEB SITES OF OTHERS, IN CLASS 35 (U.S. CLS. 100, 101 AND 102).

FIRST USE 3-9-2010; IN COMMERCE 12-6-2011.

THE MARK CONSISTS OF STANDARD CHARACTERS WITHOUT CLAIM TO ANY PARTICULAR FONT, STYLE, SIZE, OR COLOR.

SN 85-204,363, FILED 12-22-2010.

KAREN K. BUSH, EXAMINING ATTORNEY



David J. Kybas

Director of the United States Patent and Trademark Office

United States of America

United States Patent and Trademark Office

SEA GODDESS

Reg. No. 4,110,001

Registered Mar. 6, 2012

Int. Cl.: 9

TRADEMARK

PRINCIPAL REGISTER

BALLY GAMING, INC. (NEVADA CORPORATION), DBA BALLY TECHNOLOGIES,
ATTN: PAMELA BOWSHER, LAW DEPT.
6601 SOUTH BERMUDA ROAD
LAS VEGAS, NV 89119

FOR: COMPUTER GAMING SOFTWARE, GAMING SOFTWARE THAT GENERATES OR
DISPLAYS WAGER OUTCOMES OF GAMING MACHINES, DOWNLOADABLE COMPUTER
GAME SOFTWARE FOR GAMING, GAMING MACHINES, NAMELY, DEVICES THAT AC-
CEPT A WAGER; SLOT MACHINES, IN CLASS 9 (U.S. CLS. 21, 23, 26, 36 AND 38).

FIRST USE 11-22-2011; IN COMMERCE 11-22-2011.

THE MARK CONSISTS OF STANDARD CHARACTERS WITHOUT CLAIM TO ANY PAR-
TICULAR FONT, STYLE, SIZE, OR COLOR.

SN 85-204,435, FILED 12-22-2010.

THEODORE MCBRIDE, EXAMINING ATTORNEY



David J. Kybas

Director of the United States Patent and Trademark Office

United States of America

United States Patent and Trademark Office

ALOHA DELIGHT

Reg. No. 4,110,002

Registered Mar. 6, 2012

Int. Cl.: 9

TRADEMARK

PRINCIPAL REGISTER

BALLY GAMING, INC. (NEVADA CORPORATION), DBA BALLY TECHNOLOGIES,
ATTN: PAMELA BOWSHER, LAW DEPT.
6601 SOUTH BERMUDA ROAD
LAS VEGAS, NV 89119

FOR: COMPUTER GAMING SOFTWARE, GAMING SOFTWARE THAT GENERATES OR
DISPLAYS WAGER OUTCOMES OF GAMING MACHINES, DOWNLOADABLE COMPUTER
GAME SOFTWARE FOR GAMING, GAMING MACHINES, NAMELY, DEVICES THAT AC-
CEPT A WAGER; SLOT MACHINES, IN CLASS 9 (U.S. CLS. 21, 23, 26, 36 AND 38).

FIRST USE 12-5-2011; IN COMMERCE 12-5-2011.

THE MARK CONSISTS OF STANDARD CHARACTERS WITHOUT CLAIM TO ANY PAR-
TICULAR FONT, STYLE, SIZE, OR COLOR.

SN 85-204,441, FILED 12-22-2010.

THEODORE MCBRIDE, EXAMINING ATTORNEY



David J. Kybas

Director of the United States Patent and Trademark Office

United States of America

United States Patent and Trademark Office

ALOHA ISLAND

Reg. No. 4,110,003

Registered Mar. 6, 2012

Int. Cl.: 9

TRADEMARK

PRINCIPAL REGISTER

BALLY GAMING, INC. (NEVADA CORPORATION), DBA BALLY TECHNOLOGIES,
ATTN: PAMELA BOWSHER, LAW DEPT.
6601 SOUTH BERMUDA ROAD
LAS VEGAS, NV 89119

FOR: COMPUTER GAMING SOFTWARE, GAMING SOFTWARE THAT GENERATES OR
DISPLAYS WAGER OUTCOMES OF GAMING MACHINES, DOWNLOADABLE COMPUTER
GAME SOFTWARE FOR GAMING, GAMING MACHINES, NAMELY, DEVICES THAT AC-
CEPT A WAGER; SLOT MACHINES, IN CLASS 9 (U.S. CLS. 21, 23, 26, 36 AND 38).

FIRST USE 12-5-2011; IN COMMERCE 12-5-2011.

THE MARK CONSISTS OF STANDARD CHARACTERS WITHOUT CLAIM TO ANY PAR-
TICULAR FONT, STYLE, SIZE, OR COLOR.

SN 85-204,442, FILED 12-22-2010.

THEODORE MCBRIDE, EXAMINING ATTORNEY



David J. Kybas

Director of the United States Patent and Trademark Office

United States of America

United States Patent and Trademark Office



Reg. No. 4,110,004

Registered Mar. 6, 2012

Int. Cl.: 7

TRADEMARK

PRINCIPAL REGISTER

RIDGID INTERNATIONAL INC. (CALIFORNIA CORPORATION)
7056 ARCHIBALD AVE, STE 102-273
CORONA, CA 92880

FOR: AGRICULTURAL MACHINES, NAMELY, CULTIVATORS, HARVESTORS, DISK HARROWS, SEEDERS; AUTOMOTIVE EXHAUST PIPE; COMPRESSED AIR MACHINES; EGG INCUBATORS; ELECTRIC WELDING MACHINES; MACHINE PARTS, NAMELY, JOINTS AND JOINT PARTS FOR CONNECTING SLIDING STRIPS, PLATES AND GUIDES; MACHINES AND MACHINE TOOLS FOR THE CUTTING AND FORMING OF MATERIALS; METAL WORKING MACHINES; METALWORKING MACHINE TOOLS; MOTOR AND ENGINES EXCEPT FOR LAND VEHICLES, IN CLASS 7 (U.S. CLS. 13, 19, 21, 23, 31, 34 AND 35).

FIRST USE 2-1-2005; IN COMMERCE 12-1-2008.

THE MARK CONSISTS OF THE WORDS "HAO BAO" BELOW A DESIGN COMPOSED OF THREE CURVED BANDS.

THE WORDING "HAO" AND "BAO" HAS NO MEANING IN A FOREIGN LANGUAGE.

SN 85-204,602, FILED 12-23-2010.

DEZMONA MIZELLE, EXAMINING ATTORNEY



David J. Kybas

Director of the United States Patent and Trademark Office

United States of America

United States Patent and Trademark Office

PAC-MAN BATTLE ROYALE

Reg. No. 4,110,005

NAMCO BANDAI GAMES INC. (JAPAN CORPORATION)
4-5-15 HIGASHI SHINAGAWA
SHINAGAWA-KU TOKYO, JAPAN 140-8590

Registered Mar. 6, 2012

Int. Cl.: 28

FOR: COIN-OPERATED AMUSEMENT MACHINES; COIN-OPERATED VIDEO GAMES, IN CLASS 28 (U.S. CLS. 22, 23, 38 AND 50).

TRADEMARK

FIRST USE 1-28-2011; IN COMMERCE 1-28-2011.

PRINCIPAL REGISTER

THE MARK CONSISTS OF STANDARD CHARACTERS WITHOUT CLAIM TO ANY PARTICULAR FONT, STYLE, SIZE, OR COLOR.

OWNER OF U.S. REG. NOS. 1,260,102, 3,174,638, AND OTHERS.

SN 85-204,904, FILED 12-23-2010.

PRISCILLA MILTON, EXAMINING ATTORNEY



David J. Kybas

Director of the United States Patent and Trademark Office

United States of America

United States Patent and Trademark Office

PAC-MAN BATTLE ROYALE

Reg. No. 4,110,006

NAMCO BANDAI GAMES INC. (JAPAN CORPORATION)

Registered Mar. 6, 2012

4-5-15 HIGASHI SHINAGAWA
SHINAGAWA-KU TOKYO, JAPAN 140-8590

Int. Cl.: 9

FOR: COMPUTER GAME PROGRAMS; COMPUTER GAME SOFTWARE; DOWNLOADABLE
COMPUTER GAME PROGRAMS; DOWNLOADABLE COMPUTER GAME SOFTWARE VIA
A GLOBAL COMPUTER NETWORK AND WIRELESS DEVICES; VIDEO GAME SOFTWARE,
IN CLASS 9 (U.S. CLS. 21, 23, 26, 36 AND 38).

TRADEMARK

PRINCIPAL REGISTER

FIRST USE 1-28-2011; IN COMMERCE 1-28-2011.

THE MARK CONSISTS OF STANDARD CHARACTERS WITHOUT CLAIM TO ANY PAR-
TICULAR FONT, STYLE, SIZE, OR COLOR.

OWNER OF U.S. REG. NOS. 1,260,102, 3,174,638, AND OTHERS.

SN 85-204,907, FILED 12-23-2010.

PRISCILLA MILTON, EXAMINING ATTORNEY



David J. Kybas

Director of the United States Patent and Trademark Office

United States of America

United States Patent and Trademark Office



Reg. No. 4,110,007

Registered Mar. 6, 2012

Int. Cl.: 36

SERVICE MARK

PRINCIPAL REGISTER

THE IVY LEGACY FOUNDATION (PENNSYLVANIA NON-PROFIT ORGANIZATION)
6703 GERMANTOWN AVENUE
PHILADELPHIA, PA 19119

FOR: CHARITABLE FUNDRAISING SERVICES, NAMELY, ORGANIZING AND CONDUCTING FUNDRAISING FOOD TASTING AND COOKING EVENTS, IN CLASS 36 (U.S. CLS. 100, 101 AND 102).

FIRST USE 11-30-1993; IN COMMERCE 11-30-1993.

THE MARK CONSISTS OF A CHEF, DRESSED IN CHEF ATTIRE, CARRYING A STEAMING ENTRÉE, OVER THE OUTLINE OF A CIRCLE.

SN 85-205,087, FILED 12-23-2010.

JUDITH HELFMAN, EXAMINING ATTORNEY



David J. Kyffers

Director of the United States Patent and Trademark Office

United States of America

United States Patent and Trademark Office

OPTIMA

Reg. No. 4,110,008

Registered Mar. 6, 2012

Int. Cl.: 35

SERVICE MARK

PRINCIPAL REGISTER

ALCO INDUSTRIES, INC. (DELAWARE CORPORATION)
820 ADAMS AVENUE
SUITE 130
NORRISTOWN, PA 19403

FOR: BUSINESS SERVICES, NAMELY, SALES PROMOTION AND INVENTORY MANAGEMENT SERVICES IN THE FIELD OF BEARINGS, SEALS, BEARING HOUSINGS AND BEARING ACCESSORIES BY PLANNING, IMPLEMENTING AND COORDINATING THE BUSINESS PROCESS FROM MANUFACTURING THROUGH SHIPPING, THEREBY REDUCING LEAD TIMES IN SHIPPING PRODUCTS TO OTHERS, IN CLASS 35 (U.S. CLS. 100, 101 AND 102).

FIRST USE 6-0-2011; IN COMMERCE 6-0-2011.

THE MARK CONSISTS OF STANDARD CHARACTERS WITHOUT CLAIM TO ANY PARTICULAR FONT, STYLE, SIZE, OR COLOR.

SN 85-205,114, FILED 12-23-2010.

KIM SAITO, EXAMINING ATTORNEY



David J. Kyffers

Director of the United States Patent and Trademark Office

United States of America

United States Patent and Trademark Office

AUSSIE ICE

Reg. No. 4,110,009

BLIZZIE FREEZER PRODUCTS, LLC (CALIFORNIA LIMITED LIABILITY COMPANY)
PO BOX 55623
VALENCIA, CA 91385

Registered Mar. 6, 2012

Int. Cl.: 21

FOR: KIT FOR MAKING FROZEN CONFECTIONS, SAID KITS CONSISTING PRIMARILY OF REUSABLE CUPS WITH LIDS, PLASTIC ICE POP FORMS AND ICE CUBE MOLDS, IN CLASS 21 (U.S. CLS. 2, 13, 23, 29, 30, 33, 40 AND 50).

TRADEMARK

FIRST USE 11-28-2011; IN COMMERCE 11-28-2011.

PRINCIPAL REGISTER

THE MARK CONSISTS OF STANDARD CHARACTERS WITHOUT CLAIM TO ANY PARTICULAR FONT, STYLE, SIZE, OR COLOR.

NO CLAIM IS MADE TO THE EXCLUSIVE RIGHT TO USE "ICE", APART FROM THE MARK AS SHOWN.

SN 85-205,158, FILED 12-23-2010.

MARC LEIPZIG, EXAMINING ATTORNEY



David J. Kypos

Director of the United States Patent and Trademark Office

United States of America

United States Patent and Trademark Office



Reg. No. 4,110,010

Registered Mar. 6, 2012

Int. Cls.: 5, 40, and 44

TRADEMARK

SERVICE MARK

PRINCIPAL REGISTER

ALLOSOURCE (ILLINOIS NON-PROFIT CORPORATION)
6278 SOUTH TROY CIRCLE
CENTENNIAL, CO 80111

FOR: HUMAN ALLOGRAFT BONE, SKIN, AND TISSUE, IN CLASS 5 (U.S. CLS. 6, 18, 44, 46, 51 AND 52).

FIRST USE 12-0-2010; IN COMMERCE 12-0-2010.

FOR: CUSTOM FABRICATION OF HUMAN ALLOGRAFT BONE, SKIN, AND TISSUE TO THE ORDER AND SPECIFICATION OF OTHERS, IN CLASS 40 (U.S. CLS. 100, 103 AND 106).

FIRST USE 12-0-2010; IN COMMERCE 12-0-2010.

FOR: BONE AND TISSUE BANK SERVICES; PROCESSING OF HUMAN ALLOGRAFT BONE, SKIN, AND TISSUE, IN CLASS 44 (U.S. CLS. 100 AND 101).

FIRST USE 12-0-2010; IN COMMERCE 12-0-2010.

OWNER OF U.S. REG. NOS. 2,082,989, 3,540,316, AND OTHERS.

THE MARK CONSISTS OF THE DESIGN OF A HUMAN FIGURE AND THE WORDING "ALLOSOURCE" WRITTEN ABOVE THE WORDING "DOING MORE WITH LIFE".

SN 85-205,552, FILED 12-24-2010.

KYLE PEETE, EXAMINING ATTORNEY



David J. Kybas

Director of the United States Patent and Trademark Office

United States of America

United States Patent and Trademark Office

MODERN BOMBSHELL

Reg. No. 4,110,011

DESIGNER SKIN, LLC (ARIZONA LIMITED LIABILITY COMPANY)
6270 CORPORATE DR.
INDIANAPOLIS, IN 46278

Registered Mar. 6, 2012

Int. Cl.: 3

FOR: INDOOR AND OUTDOOR NON-MEDICATED SKIN TANNING PREPARATION, IN CLASS 3 (U.S. CLS. 1, 4, 6, 50, 51 AND 52).

TRADEMARK

FIRST USE 11-1-2011; IN COMMERCE 11-1-2011.

PRINCIPAL REGISTER

THE MARK CONSISTS OF STANDARD CHARACTERS WITHOUT CLAIM TO ANY PARTICULAR FONT, STYLE, SIZE, OR COLOR.

SN 85-206,322, FILED 12-28-2010.

BENJAMIN OKEKE, EXAMINING ATTORNEY



David J. Kybas

Director of the United States Patent and Trademark Office

United States of America

United States Patent and Trademark Office

PACS-LITE

Reg. No. 4,110,012

Registered Mar. 6, 2012

Int. Cl.: 42

SERVICE MARK

PRINCIPAL REGISTER

SMITH, DOUGLAS (UNITED STATES INDIVIDUAL)
101 BRETTFORD COURT
SAN ANTONIO, TX 78230

FOR: PROVIDING ON-LINE NON-DOWNLOADABLE SOFTWARE FOR VIEWING RADIOLOGY IMAGING STUDIES OVER SECURE INTERNET CONNECTION USING MINIMIZED BANDWIDTH REQUIREMENTS WITH CAPABILITIES FOR INITIATING ONLINE WEB CONFERENCING AND SECURE EMAIL COMMUNICATION WITH OTHER MEDICAL PERSONNEL, IN CLASS 42 (U.S. CLS. 100 AND 101).

FIRST USE 6-1-2010; IN COMMERCE 6-1-2010.

THE MARK CONSISTS OF STANDARD CHARACTERS WITHOUT CLAIM TO ANY PARTICULAR FONT, STYLE, SIZE, OR COLOR.

SN 85-206,965, FILED 12-29-2010.

JAMES LOVELACE, EXAMINING ATTORNEY



David J. Kyffers

Director of the United States Patent and Trademark Office

United States of America

United States Patent and Trademark Office

PARASIFIN

Reg. No. 4,110,013

PROMESA DISTRIBUTORS (NORTH CAROLINA CORPORATION)
5160 INDIANA AVE. STE A
WINSTON SALEM, NC 27106

Registered Mar. 6, 2012

Int. Cl.: 5

FOR: PREPARATIONS FOR DESTROYING PARASITES, IN CLASS 5 (U.S. CLS. 6, 18, 44, 46, 51 AND 52).

TRADEMARK

FIRST USE 11-30-2011; IN COMMERCE 11-30-2011.

PRINCIPAL REGISTER

THE MARK CONSISTS OF STANDARD CHARACTERS WITHOUT CLAIM TO ANY PARTICULAR FONT, STYLE, SIZE, OR COLOR.

SN 85-207,374, FILED 12-29-2010.

MICHAEL WEBSTER, EXAMINING ATTORNEY



David J. Kybas

Director of the United States Patent and Trademark Office

United States of America

United States Patent and Trademark Office

FIRE AWAY!

Reg. No. 4,110,014

Registered Mar. 6, 2012

Int. Cl.: 9

TRADEMARK

PRINCIPAL REGISTER

FIFIELD, INC. (MASSACHUSETTS CORPORATION)
72 SHARP STREET
HINGHAM, MA 020434330

FOR: FIRE BLANKETS, IN CLASS 9 (U.S. CLS. 21, 23, 26, 36 AND 38).

FIRST USE 1-31-2011; IN COMMERCE 3-11-2011.

THE MARK CONSISTS OF STANDARD CHARACTERS WITHOUT CLAIM TO ANY PARTICULAR FONT, STYLE, SIZE, OR COLOR.

SN 85-207,889, FILED 12-30-2010.

NANCY CLARKE, EXAMINING ATTORNEY



David J. Kybas

Director of the United States Patent and Trademark Office

United States of America

United States Patent and Trademark Office

TUNATHEWONDERFISH!

Reg. No. 4,110,015

NATIONAL FISHERIES INSTITUTE (DELAWARE CORPORATION)
7918 JONES BRANCH ROAD, # 700
MCLEAN, VA 22102

Registered Mar. 6, 2012

Int. Cl.: 35

FOR: ASSOCIATION SERVICES FOR PROMOTING THE INTERESTS OF THE SHELF STABLE TUNA INDUSTRY; PROMOTIONAL AND ADVERTISING SERVICE FOR THE SHELF STABLE TUNA INDUSTRY, NAMELY, PROMOTING PUBLIC AWARENESS OF THE BENEFITS OF SHELF STABLE TUNA, IN CLASS 35 (U.S. CLS. 100, 101 AND 102).

SERVICE MARK

PRINCIPAL REGISTER

FIRST USE 1-17-2011; IN COMMERCE 1-17-2011.

THE MARK CONSISTS OF THE WORDS "TUNATHEWONDERFISH" WITH AN EXCLAMATION POINT IN THE SHAPE OF A FISH.

SN 85-208,307, FILED 12-30-2010.

GENE MACIOL, EXAMINING ATTORNEY



David J. Kybas

Director of the United States Patent and Trademark Office

United States of America

United States Patent and Trademark Office



Reg. No. 4,110,016

SPECTRE GROUP INTERNATIONAL, LLC (DELAWARE LIMITED LIABILITY COMPANY)
211 NORTH UNION STREET, STE. 100
ALEXANDRIA, VA 22314

Registered Mar. 6, 2012

Int. Cls.: 41 and 45

FOR: TRAINING SERVICES IN THE FIELD OF LAW ENFORCEMENT, NATIONAL SECURITY, AND COUNTERNARCOTICS, IN CLASS 41 (U.S. CLS. 100, 101 AND 107).

SERVICE MARK

FIRST USE 12-10-2010; IN COMMERCE 11-1-2011.

PRINCIPAL REGISTER

FOR: SECURITY CONSULTANCY; SECURITY INSPECTION SERVICES FOR OTHERS; SECURITY SERVICES, NAMELY, PROVIDING SECURITY ASSESSMENTS FOR BUSINESSES AND GOVERNMENTAL AGENCIES, IN CLASS 45 (U.S. CLS. 100 AND 101).

FIRST USE 12-10-2010; IN COMMERCE 11-1-2011.

THE MARK CONSISTS OF THE WORD "SPECTRE" WITH A TRIANGULAR-SHAPED FLAG TO ITS LEFT CONSISTING OF SEVERAL HORIZONTAL STRIPES.

SN 85-208,814, FILED 1-1-2011.

HEATHER BIDDULPH, EXAMINING ATTORNEY



David J. Kybas

Director of the United States Patent and Trademark Office

United States of America

United States Patent and Trademark Office

JOM

Reg. No. 4,110,017

Registered Mar. 6, 2012

Int. Cl.: 10

TRADEMARK

PRINCIPAL REGISTER

JOM PERSONAL PRODUCTS CORP. (DELAWARE CORPORATION)
2711 CENTERVILLE ROAD, SUITE 400
WILLIMINGTON, DE 19808

FOR: ADULT SEXUAL STIMULATION KIT COMPRISED PRIMARILY OF ADULT SEXUAL STIMULATION AIDS AND A WORKBOOK, IN CLASS 10 (U.S. CLS. 26, 39 AND 44).

FIRST USE 9-15-2011; IN COMMERCE 9-15-2011.

THE MARK CONSISTS OF STANDARD CHARACTERS WITHOUT CLAIM TO ANY PARTICULAR FONT, STYLE, SIZE, OR COLOR.

SN 85-209,045, FILED 1-3-2011.

ALICIA COLLINS, EXAMINING ATTORNEY



David J. Kybas

Director of the United States Patent and Trademark Office

United States of America

United States Patent and Trademark Office

Merry & Bright

Reg. No. 4,110,018

Registered Mar. 6, 2012

Int. Cl.: 25

TRADEMARK

PRINCIPAL REGISTER

DILLARD'S, INC. (DELAWARE CORPORATION)
1600 CANTRELL ROAD
LITTLE ROCK, AR 72201

FOR: SWEATERS AND VESTS, IN CLASS 25 (U.S. CLS. 22 AND 39).

FIRST USE 11-1-2011; IN COMMERCE 11-1-2011.

THE MARK CONSISTS OF STANDARD CHARACTERS WITHOUT CLAIM TO ANY PARTICULAR FONT, STYLE, SIZE, OR COLOR.

SN 85-209,069, FILED 1-3-2011.

DEIRDRE ROBERTSON, EXAMINING ATTORNEY



David J. Kyffers

Director of the United States Patent and Trademark Office

United States of America

United States Patent and Trademark Office

RONDACK

Reg. No. 4,110,019

THE ROCKY RIVER RONDACK COMPANY, LLC (OHIO LIMITED LIABILITY COMPANY)
P.O. BOX 161001

Registered Mar. 6, 2012

ROCKY RIVER, OH 441161001

Int. Cl.: 20

FOR: CHAIRS, TABLES, OTTOMANS, IN CLASS 20 (U.S. CLS. 2, 13, 22, 25, 32 AND 50).

TRADEMARK

FIRST USE 6-1-2010; IN COMMERCE 10-1-2010.

PRINCIPAL REGISTER

THE MARK CONSISTS OF STANDARD CHARACTERS WITHOUT CLAIM TO ANY PARTICULAR FONT, STYLE, SIZE, OR COLOR.

SN 85-209,471, FILED 1-3-2011.

CHRISTINE COOPER, EXAMINING ATTORNEY



David J. Kyffers

Director of the United States Patent and Trademark Office

United States of America

United States Patent and Trademark Office

Avengees

Reg. No. 4,110,020

VELVET ARCHITECTS, LLC (CALIFORNIA LIMITED LIABILITY COMPANY)
3533 PLEASANT ECHO DR.
SAN JOSE, CA 95148

Registered Mar. 6, 2012

Int. Cl.: 9

FOR: COMPUTER APPLICATION SOFTWARE FOR MOBILE PHONES, NAMELY, SOFTWARE FOR PLAYING GAMES, IN CLASS 9 (U.S. CLS. 21, 23, 26, 36 AND 38).

TRADEMARK

FIRST USE 7-12-2011; IN COMMERCE 12-12-2011.

PRINCIPAL REGISTER

THE MARK CONSISTS OF STANDARD CHARACTERS WITHOUT CLAIM TO ANY PARTICULAR FONT, STYLE, SIZE, OR COLOR.

SN 85-209,562, FILED 1-3-2011.

JAMES GRIFFIN, EXAMINING ATTORNEY



David J. Kyffers

Director of the United States Patent and Trademark Office

United States of America

United States Patent and Trademark Office



Reg. No. 4,110,021

Registered Mar. 6, 2012

Int. Cls.: 35 and 41

SERVICE MARK

PRINCIPAL REGISTER

WILLIAMS, GRAHAM JOHN (UNITED KINGDOM INDIVIDUAL)
BEULT COTTAGE, BULL HILL, BETHERSDEN
ASHFORD, KENT, UNITED KINGDOM TN263LB

FOR: MANAGEMENT CONSULTING AND ADVISORY SERVICES IN THE AREAS OF CORPORATE GROWTH STRATEGY, INNOVATION AND GROWTH PROCESSES, ORGANIZATIONAL TRANSFORMATION, AND TALENT MANAGEMENT AND DEVELOPMENT STRATEGIES, IN CLASS 35 (U.S. CLS. 100, 101 AND 102).

FIRST USE 10-1-2011; IN COMMERCE 10-1-2011.

FOR: PERSONAL COACHING SERVICES IN THE FIELD OF PERSONAL DEVELOPMENT, IN CLASS 41 (U.S. CLS. 100, 101 AND 107).

FIRST USE 10-1-2011; IN COMMERCE 10-1-2011.

THE MARK CONSISTS OF AN ELONGATED, CURVED TRIANGULAR SHAPE WITH AN ARROW AT THE PEAK.

THE COLOR(S) BLUE IS/ARE CLAIMED AS A FEATURE OF THE MARK.

SN 85-210,046, FILED 1-4-2011.

LANA PHAM, EXAMINING ATTORNEY



David J. Kybas

Director of the United States Patent and Trademark Office

United States of America

United States Patent and Trademark Office

BURST

Reg. No. 4,110,022

Registered Mar. 6, 2012

Int. Cl.: 8

TRADEMARK

PRINCIPAL REGISTER

KAI U.S.A., LTD. (OREGON CORPORATION), DBA KERSHAW KNIVES,
18600 SOUTHWEST TETON AVENUE
TUALATIN, OR 97062

FOR: FOLDING KNIVES, IN CLASS 8 (U.S. CLS. 23, 28 AND 44).

FIRST USE 9-21-2011; IN COMMERCE 9-21-2011.

THE MARK CONSISTS OF STANDARD CHARACTERS WITHOUT CLAIM TO ANY PARTICULAR FONT, STYLE, SIZE, OR COLOR.

SN 85-210,404, FILED 1-4-2011.

GILBERT SWIFT, EXAMINING ATTORNEY



David J. Kybas

Director of the United States Patent and Trademark Office

United States of America

United States Patent and Trademark Office



Reg. No. 4,110,023

Registered Mar. 6, 2012

Int. Cls.: 9 and 42

WESTINGHOUSE ELECTRIC COMPANY LLC (DELAWARE LIMITED LIABILITY COMPANY)
1000 WESTINGHOUSE DRIVE
SUITE 141
CRANBERRY TOWNSHIP, PA 16066

TRADEMARK

FOR: NONDESTRUCTIVE TESTERS, NAMELY, ULTRASONIC TESTERS AND COMPUTER HARDWARE AND PROGRAMS IN SUPPORT THEREOF, ALL FOR USE IN TESTING COMPUTER SOFTWARE DESIGN FOR OTHERS, IN CLASS 9 (U.S. CLS. 21, 23, 26, 36 AND 38).

SERVICE MARK

PRINCIPAL REGISTER

FIRST USE 12-31-2009; IN COMMERCE 12-31-2009.

FOR: COMPUTER SOFTWARE DEVELOPMENT IN THE FIELD OF NONDESTRUCTIVE TESTING, AND COMPUTER SOFTWARE DESIGN FOR OTHERS, IN CLASS 42 (U.S. CLS. 100 AND 101).

FIRST USE 12-31-2006; IN COMMERCE 12-31-2006.

OWNER OF U.S. REG. NOS. 1,875,855 AND 1,878,285.

THE COLOR(S) BLACK, BLUE AND WHITE IS/ARE CLAIMED AS A FEATURE OF THE MARK.

NO CLAIM IS MADE TO THE EXCLUSIVE RIGHT TO USE "INTERNATIONAL", APART FROM THE MARK AS SHOWN.

THE MARK CONSISTS OF A PARTIALLY SHADED BLUE AND WHITE SQUARE FOLLOWED BY THE WORD "WESDYNE" WITH THE PARTIAL WORD "WES" IN BLACK LETTERING AND THE PARTIAL WORD "DYNE" IN BLUE LETTERING, WITH THE WORD "INTERNATIONAL" IN BLACK LETTERING BENEATH THE WORD "WESDYNE".

SN 85-210,568, FILED 1-5-2011.

KATHY DE JONGE, EXAMINING ATTORNEY

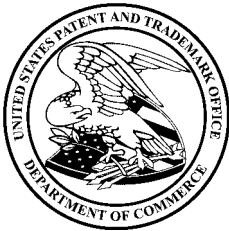

David J. Kyjars

Director of the United States Patent and Trademark Office

United States of America

United States Patent and Trademark Office

SHAKE YOURSELF SLIM

Reg. No. 4,110,024

QIVANA, LLC (DELAWARE LIMITED LIABILITY COMPANY)
5255 NORTH EDGEWOOD DRIVE
PROVO, UT 84604

Registered Mar. 6, 2012

Int. Cl.: 41

FOR: ENTERTAINMENT SERVICES, NAMELY, CONDUCTING CONTESTS, IN CLASS 41
(U.S. CLS. 100, 101 AND 107).

SERVICE MARK

FIRST USE 1-5-2011; IN COMMERCE 1-5-2011.

PRINCIPAL REGISTER

THE MARK CONSISTS OF STANDARD CHARACTERS WITHOUT CLAIM TO ANY PARTICULAR FONT, STYLE, SIZE, OR COLOR.

SN 85-210,658, FILED 1-5-2011.

DORITT L. CARROLL, EXAMINING ATTORNEY



David J. Kybas

Director of the United States Patent and Trademark Office

United States of America

United States Patent and Trademark Office

LOOP'D

Reg. No. 4,110,025

Registered Mar. 6, 2012

Int. Cl.: 41

SERVICE MARK

PRINCIPAL REGISTER

THE CARTOON NETWORK, INC. (DELAWARE CORPORATION)
ONE CNN CENTER, 10N
C/O TURNER BROADCASTING SYSTEM, INC.
ATLANTA, GA 30303

FOR: ENTERTAINMENT SERVICES, NAMELY, PROVIDING A WEBSITE FEATURING AN ON-LINE ACTIVITY WHERE USERS CREATE THEIR OWN VIDEO CLIPS FROM EXISTING FOOTAGE, IN CLASS 41 (U.S. CLS. 100, 101 AND 107).

FIRST USE 11-14-2011; IN COMMERCE 11-14-2011.

THE MARK CONSISTS OF STANDARD CHARACTERS WITHOUT CLAIM TO ANY PARTICULAR FONT, STYLE, SIZE, OR COLOR.

SN 85-210,981, FILED 1-5-2011.

FRED CARL, EXAMINING ATTORNEY



David J. Kyffers

Director of the United States Patent and Trademark Office

United States of America

United States Patent and Trademark Office

KITTY KATRA

Reg. No. 4,110,026

Registered Mar. 6, 2012

Int. Cl.: 9

TRADEMARK

PRINCIPAL REGISTER

WMS GAMING INC. (DELAWARE CORPORATION)
800 SOUTH NORTHPOINT BOULEVARD
WAUKEGAN, IL 60085

FOR: COMPONENTS FOR GAMING MACHINES THAT GENERATE OR DISPLAY WAGER OUTCOMES, NAMELY, CONTROLLERS, DISPLAYS, BUTTON PANELS, BOLSTERS, ELECTRICAL WIRING, AND COMPUTER HARDWARE AND SOFTWARE ASSOCIATED THEREWITH; GAMING MACHINES, NAMELY, DEVICES WHICH ACCEPT A WAGER; GAMING SOFTWARE THAT GENERATES OR DISPLAYS WAGER OUTCOMES OF GAMING MACHINES, IN CLASS 9 (U.S. CLS. 21, 23, 26, 36 AND 38).

FIRST USE 12-6-2011; IN COMMERCE 12-6-2011.

THE MARK CONSISTS OF STANDARD CHARACTERS WITHOUT CLAIM TO ANY PARTICULAR FONT, STYLE, SIZE, OR COLOR.

SN 85-210,982, FILED 1-5-2011.

JOHN GARTNER, EXAMINING ATTORNEY



David J. Kyros

Director of the United States Patent and Trademark Office

United States of America

United States Patent and Trademark Office

PARASOL INVESTMENT MANAGEMENT

Reg. No. 4,110,027

Registered Mar. 6, 2012

Int. Cl.: 36

SERVICE MARK

PRINCIPAL REGISTER

PARASOL INVESTMENT MANAGEMENT, LLC (DELAWARE LIMITED LIABILITY COMPANY)
520 N. CASS AVENUE, SUITE 200
WESTMONT, IL 60559

FOR: INVESTMENT MANAGEMENT SERVICES, IN CLASS 36 (U.S. CLS. 100, 101 AND 102).

FIRST USE 7-0-2011; IN COMMERCE 7-0-2011.

THE MARK CONSISTS OF STANDARD CHARACTERS WITHOUT CLAIM TO ANY PARTICULAR FONT, STYLE, SIZE, OR COLOR.

NO CLAIM IS MADE TO THE EXCLUSIVE RIGHT TO USE "INVESTMENT MANAGEMENT", APART FROM THE MARK AS SHOWN.

SN 85-211,286, FILED 1-5-2011.

KATHERINE CONNOLLY, EXAMINING ATTORNEY



David J. Kybas

Director of the United States Patent and Trademark Office

United States of America

United States Patent and Trademark Office

DRIVEN A TRIBUTE TO AFRICAN-AMERICAN ACHIEVEMENT IN THE AUTOMOTIVE INDUSTRY

Reg. No. 4,110,028

REAL TIMES, INC. OF ILLINOIS (ILLINOIS CORPORATION)
545 GRISWOLD STREET, SUITE 1300
DETROIT, MI 48226

Registered Mar. 6, 2012

Int. Cl.: 16

FOR: PRINTED PUBLICATIONS, NAMELY, PRINTED DIRECTORIES AND COMPILATIONS
FEATURING INFORMATION ABOUT AFRICAN-AMERICANS IN THE AUTOMOTIVE IN-
DUSTRY, IN CLASS 16 (U.S. CLS. 2, 5, 22, 23, 29, 37, 38 AND 50).

TRADEMARK

FIRST USE 1-12-2011; IN COMMERCE 1-12-2011.

PRINCIPAL REGISTER

THE MARK CONSISTS OF STANDARD CHARACTERS WITHOUT CLAIM TO ANY PAR-
TICULAR FONT, STYLE, SIZE, OR COLOR.

SN 85-211,700, FILED 1-6-2011.

ELLEN BURNS, EXAMINING ATTORNEY



David J. Kyros

Director of the United States Patent and Trademark Office

United States of America

United States Patent and Trademark Office

soundsleeves

Reg. No. 4,110,029

Registered Mar. 6, 2012

Int. Cl.: 9

TRADEMARK

PRINCIPAL REGISTER

SOUNDSLEEVES LLC (DELAWARE LIMITED LIABILITY COMPANY)
275 KENNETH DRIVE
SUITE 100
ROCHESTER, NY 14623

FOR: EARBUDS WITH CUSTOM COVERS INCLUDED, IN CLASS 9 (U.S. CLS. 21, 23, 26, 36 AND 38).

FIRST USE 7-15-2011; IN COMMERCE 7-15-2011.

THE MARK CONSISTS OF STANDARD CHARACTERS WITHOUT CLAIM TO ANY PARTICULAR FONT, STYLE, SIZE, OR COLOR.

SN 85-211,713, FILED S.R. 1-6-2011; AM. P.R. 4-21-2011.

ELLEN BURNS, EXAMINING ATTORNEY



David J. Kyffers

Director of the United States Patent and Trademark Office

United States of America

United States Patent and Trademark Office



Reg. No. 4,110,030

Registered Mar. 6, 2012

Int. Cl.: 42

SERVICE MARK

PRINCIPAL REGISTER

BORTA QOE CONSULTING, PLC, DBA QOE CONSULTING PLC (MICHIGAN
PROFESSIONAL DOMESTIC LIMITED LIABILITY COMPANY)
4100 CAPITAL CITY BLVD., FLR 2
LANSING, MI 48906

FOR: TRANSPORTATION AND TRAFFIC PLANNING SERVICES, NAMELY, PLANNING
AND ENGINEERING IN THE FIELD OF TRANSPORTATION, INFRASTRUCTURE AND
AIRPORT DEVELOPMENT, IN CLASS 42 (U.S. CLS. 100 AND 101).

FIRST USE 1-0-2011; IN COMMERCE 1-0-2011.

NO CLAIM IS MADE TO THE EXCLUSIVE RIGHT TO USE "CONSULTING", APART FROM
THE MARK AS SHOWN.

THE MARK CONSISTS OF STYLIZED LETTERS "QOE" OVER THE WORD "CONSULTING".

SN 85-211,893, FILED 1-6-2011.

KRISTIN DAHLING, EXAMINING ATTORNEY



David J. Kybas

Director of the United States Patent and Trademark Office

United States of America

United States Patent and Trademark Office

VALOROSO TOSCANO

Reg. No. 4,110,031

BANFI PRODUCTS CORPORATION (NEW YORK CORPORATION)
1111 CEDAR SWAMP ROAD
OLD BROOKVILLE, NY 11545

Registered Mar. 6, 2012

Int. Cl.: 33

FOR: WINES, IN CLASS 33 (U.S. CLS. 47 AND 49).

TRADEMARK

FIRST USE 8-0-2011; IN COMMERCE 8-0-2011.

PRINCIPAL REGISTER

THE MARK CONSISTS OF STANDARD CHARACTERS WITHOUT CLAIM TO ANY PARTICULAR FONT, STYLE, SIZE, OR COLOR.

NO CLAIM IS MADE TO THE EXCLUSIVE RIGHT TO USE "TOSCANO", APART FROM THE MARK AS SHOWN.

THE ENGLISH TRANSLATION OF "VALOROSO" IN THE MARK IS "VALOROUS" OR "VALIANT", AND THE ENGLISH TRANSLATION OF "TOSCANO" IN THE MARK IS "TUSCAN".

SN 85-211,957, FILED 1-6-2011.

KATHERINE CHANG, EXAMINING ATTORNEY



David J. Kyffers

Director of the United States Patent and Trademark Office

United States of America

United States Patent and Trademark Office



Reg. No. 4,110,032

Registered Mar. 6, 2012

Int. Cls.: 4 and 40

TRADEMARK

SERVICE MARK

PRINCIPAL REGISTER

HM3 ENERGY, INC. (OREGON CORPORATION)
500 SE BUTLER ROAD
GRESHAM, OR 97080

FOR: TORREFIED BIOMASS PRODUCTS, NAMELY, CELLULOSIC MATERIAL FOR USE AS FUEL PRODUCTS, IN CLASS 4 (U.S. CLS. 1, 6 AND 15).

FIRST USE 8-25-2011; IN COMMERCE 8-25-2011.

FOR: CUSTOM MANUFACTURE OF TORREFIED BIOMASS PRODUCTS, NAMELY, CELLULOSIC MATERIAL FOR USE AS FUEL PRODUCTS, IN CLASS 40 (U.S. CLS. 100, 103 AND 106).

FIRST USE 8-25-2011; IN COMMERCE 8-25-2011.

THE MARK CONSISTS OF A LEAF DESIGN WITH SERRATED EDGES, ONE SIDE OF THE LEAF BEING LIGHTER IN COLOR THAN THE OTHER SIDE.

SN 85-211,961, FILED 1-6-2011.

SUSAN RICHARDS, EXAMINING ATTORNEY



David J. Kybas

Director of the United States Patent and Trademark Office

United States of America

United States Patent and Trademark Office

ALOR

Reg. No. 4,110,033

Registered Mar. 6, 2012

Int. Cls.: 18 and 24

TRADEMARK

PRINCIPAL REGISTER

FIFIELD, INC. (MASSACHUSETTS CORPORATION)
72 SHARP STREET
HINGHAM, MA 02043

FOR: IMITATION LEATHER, NAMELY, IMITATION SUEDE, IN CLASS 18 (U.S. CLS. 1, 2, 3, 22 AND 41).

FIRST USE 10-17-2011; IN COMMERCE 10-17-2011.

FOR: FABRIC OF IMITATION SUEDE, IN CLASS 24 (U.S. CLS. 42 AND 50).

FIRST USE 10-17-2011; IN COMMERCE 10-17-2011.

THE MARK CONSISTS OF STANDARD CHARACTERS WITHOUT CLAIM TO ANY PARTICULAR FONT, STYLE, SIZE, OR COLOR.

THE WORDING "ALOR" HAS NO MEANING IN A FOREIGN LANGUAGE.

SN 85-211,996, FILED 1-6-2011.

NANCY CLARKE, EXAMINING ATTORNEY



David J. Kybas

Director of the United States Patent and Trademark Office

United States of America

United States Patent and Trademark Office

tenthavenue

Reg. No. 4,110,034

Registered Mar. 6, 2012

Int. Cl.: 35

SERVICE MARK

PRINCIPAL REGISTER

WPP PROPERTIES (DELAWARE PARTNERSHIP)
4TH FLOOR
100 PARK AVENUE
NEW YORK, NY 10017

FOR: MEDIA BUYING, RESEARCH AND CONSULTATION, NAMELY, PLANNING, BUYING AND NEGOTIATING ADVERTISING AND MEDIA SPACE AND TIME FOR OTHERS; ADVERTISING AND PROMOTIONAL AND MARKETING SERVICES; PREPARING AND PLACING ADVERTISING FOR OTHERS; BUSINESS MARKETING CONSULTING SERVICES; BUSINESS MANAGEMENT SERVICES; ADVISORY AND CONSULTATION SERVICES IN THE FIELD OF ADVERTISING AND BUSINESS; PROVIDING ADVERTISING FOR OTHERS ONLINE OVER A GLOBAL COMPUTER INFORMATION NETWORK; PUBLICITY BUREAU SERVICES; PRODUCTION OF ADVERTISING MATERIAL AND COMMERCIALS FOR OTHERS; PUBLIC RELATIONS AND PUBLICITY SERVICES; MARKET RESEARCH AND MARKET ANALYSIS; SPORTS AND ENTERTAINMENT SPONSORSHIP MARKETING SERVICES, NAMELY, PROMOTIONAL SPONSORSHIP OF A VARIETY OF SPORTING AND ENTERTAINMENT EVENTS, IN CLASS 35 (U.S. CLS. 100, 101 AND 102).

FIRST USE 3-15-2011; IN COMMERCE 3-15-2011.

THE MARK CONSISTS OF STANDARD CHARACTERS WITHOUT CLAIM TO ANY PARTICULAR FONT, STYLE, SIZE, OR COLOR.

SN 85-212,019, FILED 1-6-2011.

LINDA ORNDORFF, EXAMINING ATTORNEY



David J. Kyffers

Director of the United States Patent and Trademark Office

United States of America

United States Patent and Trademark Office

POTATO DELIGHTS

Reg. No. 4,110,035

Registered Mar. 6, 2012

Int. Cl.: 29

TRADEMARK

PRINCIPAL REGISTER

WILD PITCH IMPORTS, LLC (NEW YORK LIMITED LIABILITY COMPANY)
156 WOODMERE BLVD. SOUTH
WOODMERE, NY 11598

FOR: PROCESSED POTATOES, IN CLASS 29 (U.S. CL. 46).

FIRST USE 3-1-2011; IN COMMERCE 4-7-2011.

THE MARK CONSISTS OF STANDARD CHARACTERS WITHOUT CLAIM TO ANY PARTICULAR FONT, STYLE, SIZE, OR COLOR.

NO CLAIM IS MADE TO THE EXCLUSIVE RIGHT TO USE "POTATO", APART FROM THE MARK AS SHOWN.

SN 85-212,145, FILED 1-6-2011.

ADA HAN, EXAMINING ATTORNEY



David J. Kyffers

Director of the United States Patent and Trademark Office

United States of America

United States Patent and Trademark Office

Happy Birthday Gift Card

Reg. No. 4,110,036

Registered Mar. 6, 2012

Int. Cl.: 36

SERVICE MARK

PRINCIPAL REGISTER

HUDSON, BRETT (UNITED STATES INDIVIDUAL)
2105 VERDI DRIVE
BOYNTON BEACH, FL 33426

FOR: DEBIT ACCOUNT SERVICES FEATURING ELECTRONIC DISSEMINATION OF ACCOUNT INFORMATION THROUGH SMARTPHONES; DEBIT CARD SERVICES; ELECTRONIC DEBIT TRANSACTIONS, IN CLASS 36 (U.S. CLS. 100, 101 AND 102).

FIRST USE 2-1-2011; IN COMMERCE 2-1-2011.

THE MARK CONSISTS OF STANDARD CHARACTERS WITHOUT CLAIM TO ANY PARTICULAR FONT, STYLE, SIZE, OR COLOR.

NO CLAIM IS MADE TO THE EXCLUSIVE RIGHT TO USE "GIFT CARD", APART FROM THE MARK AS SHOWN.

SN 85-212,556, FILED 1-7-2011.

STEVEN R. FINE, EXAMINING ATTORNEY



David J. Kyros

Director of the United States Patent and Trademark Office

United States of America

United States Patent and Trademark Office

SKY LOPEZ

Reg. No. 4,110,037

Registered Mar. 6, 2012

Int. Cl.: 16

TRADEMARK

PRINCIPAL REGISTER

FLORIS-ABERCROMBIE, CORRIE R. (UNITED STATES INDIVIDUAL)
#1008
700 E. BOYNTON BEACH BLVD
BOYNTON BEACH, FL 33435

FOR: CALENDARS; POSTERS, IN CLASS 16 (U.S. CLS. 2, 5, 22, 23, 29, 37, 38 AND 50).

FIRST USE 10-14-2011; IN COMMERCE 10-14-2011.

THE MARK CONSISTS OF STANDARD CHARACTERS WITHOUT CLAIM TO ANY PARTICULAR FONT, STYLE, SIZE, OR COLOR.

THE NAME(S), PORTRAIT(S), AND/OR SIGNATURE(S) SHOWN IN THE MARK IDENTIFIES CORRIE R. FLORIS-ABERCROMBIE, WHOSE CONSENT(S) TO REGISTER IS MADE OF RECORD.

SN 85-213,432, FILED 1-8-2011.

SETH A. RAPPAPORT, EXAMINING ATTORNEY



David J. Kyffers

Director of the United States Patent and Trademark Office

United States of America

United States Patent and Trademark Office

RewardThePublic

Reg. No. 4,110,038

Registered Mar. 6, 2012

Int. Cl.: 35

SERVICE MARK

PRINCIPAL REGISTER

REWARDTHEPUBLIC INC. (WISCONSIN CORPORATION)
808 HEGGEN ST
PO BOX 70
HUDSON, WI 54016

FOR: PROVIDING A WEBSITE FEATURING INFORMATION FOR CONSUMERS IN THE FIELD REWARD PROGRAMS, COUPONS, REBATES, PRODUCT-COMPARISON, IN CLASS 35 (U.S. CLS. 100, 101 AND 102).

FIRST USE 1-7-2011; IN COMMERCE 1-2-2012.

THE MARK CONSISTS OF STANDARD CHARACTERS WITHOUT CLAIM TO ANY PARTICULAR FONT, STYLE, SIZE, OR COLOR.

SN 85-213,943, FILED 1-10-2011.

KELLEY WELLS, EXAMINING ATTORNEY



David J. Kyffers

Director of the United States Patent and Trademark Office

United States of America

United States Patent and Trademark Office

Kanisa's Call

Reg. No. 4,110,039

Registered Mar. 6, 2012

Int. Cl.: 45

SERVICE MARK

PRINCIPAL REGISTER

COVENANT WORLD MISSION, INC. (KENTUCKY CORPORATION)
10419 GISELA COURT
FAIRDALE, KY 40118

FOR: CHARITABLE OUTREACH SERVICES, NAMELY, PROVIDING COUNSELING SERVICES IN THE FIELD OF RELIGION; EVANGELISTIC AND MINISTERIAL SERVICES, IN CLASS 45 (U.S. CLS. 100 AND 101).

FIRST USE 12-6-2011; IN COMMERCE 12-6-2011.

THE MARK CONSISTS OF STANDARD CHARACTERS WITHOUT CLAIM TO ANY PARTICULAR FONT, STYLE, SIZE, OR COLOR.

SN 85-214,027, FILED 1-10-2011.

PAM WILLIS, EXAMINING ATTORNEY



David J. Kyffers

Director of the United States Patent and Trademark Office

United States of America

United States Patent and Trademark Office

BLACK OPS

Reg. No. 4,110,040

ARCHER MANUFACTURING, INC. (CALIFORNIA CORPORATION)
9000 CROW CANYON ROAD, SUITE S#329
DANVILLE, CA 94506

Registered Mar. 6, 2012

Int. Cl.: 5

FOR: ALL PURPOSE DISINFECTING AND DEODORIZING PREPARATIONS, IN CLASS 5
(U.S. CLS. 6, 18, 44, 46, 51 AND 52).

TRADEMARK

FIRST USE 6-29-2011; IN COMMERCE 6-29-2011.

PRINCIPAL REGISTER

THE MARK CONSISTS OF STANDARD CHARACTERS WITHOUT CLAIM TO ANY PARTICULAR FONT, STYLE, SIZE, OR COLOR.

OWNER OF U.S. REG. NO. 2,495,513.

SN 85-214,416, FILED 1-10-2011.

JASON TURNER, EXAMINING ATTORNEY



David J. Kybas

Director of the United States Patent and Trademark Office

United States of America

United States Patent and Trademark Office

SPECIAL OPS

Reg. No. 4,110,041

ARCHER MANUFACTURING, INC. (CALIFORNIA CORPORATION)
9000 CROW CANYON ROAD, SUITE S#329
DANVILLE, CA 94506

Registered Mar. 6, 2012

Int. Cl.: 3

FOR: ALL PURPOSE CLEANING PREPARATIONS, IN CLASS 3 (U.S. CLS. 1, 4, 6, 50, 51 AND 52).

TRADEMARK

FIRST USE 6-29-2011; IN COMMERCE 6-29-2011.

PRINCIPAL REGISTER

THE MARK CONSISTS OF STANDARD CHARACTERS WITHOUT CLAIM TO ANY PARTICULAR FONT, STYLE, SIZE, OR COLOR.

OWNER OF U.S. REG. NO. 2,495,513.

SN 85-214,421, FILED 1-10-2011.

JASON TURNER, EXAMINING ATTORNEY



David J. Kyffers

Director of the United States Patent and Trademark Office

United States of America

United States Patent and Trademark Office

TICKET TO RIDE

Reg. No. 4,110,042

Registered Mar. 6, 2012

Int. Cl.: 41

SERVICE MARK

PRINCIPAL REGISTER

SPEED CHANNEL, INC. (DELAWARE CORPORATION)
10201 WEST PICO BOULEVARD
LOS ANGELES, CA 90035

FOR: PROVIDING ON-LINE INFORMATION IN THE FIELD OF TELEVISION AND VIDEO ENTERTAINMENT FEATURING AUTOMOBILES VIA THE INTERNET; ENTERTAINMENT SERVICES IN THE NATURE OF NON-DOWNLOADABLE VIDEOS AND IMAGES FEATURING TELEVISION SHOWS AND ENTERTAINMENT PERTAINING TO AUTOMOBILES AND MOTOR SPORTS TRANSMITTED VIA THE INTERNET AND WIRELESS COMMUNICATION NETWORKS, IN CLASS 41 (U.S. CLS. 100, 101 AND 107).

FIRST USE 12-27-2010; IN COMMERCE 12-27-2010.

THE MARK CONSISTS OF STANDARD CHARACTERS WITHOUT CLAIM TO ANY PARTICULAR FONT, STYLE, SIZE, OR COLOR.

SN 85-214,470, FILED 1-10-2011.

KATHLEEN M. VANSTON, EXAMINING ATTORNEY



David J. Kybas

Director of the United States Patent and Trademark Office

United States of America
United States Patent and Trademark Office

CERPLUS

Reg. No. 4,110,043

GREEN EXCHANGE LLC (DELAWARE LIMITED LIABILITY COMPANY)
1 NORTH END AVENUE
NEW YORK, NY 10282

Registered Mar. 6, 2012

Int. Cl.: 36

FOR: PROVIDING FINANCIAL AND INVESTMENT INFORMATION SERVICES; PROVIDING FINANCIAL SERVICES, NAMELY, TRADING OF FUTURES AND OPTIONS ON FUTURES CONTRACTS BASED ON CARBON OFFSET CREDITS, IN CLASS 36 (U.S. CLS. 100, 101 AND 102).

SERVICE MARK

PRINCIPAL REGISTER

FIRST USE 1-24-2011; IN COMMERCE 1-24-2011.

THE MARK CONSISTS OF STANDARD CHARACTERS WITHOUT CLAIM TO ANY PARTICULAR FONT, STYLE, SIZE, OR COLOR.

SN 85-215,231, FILED 1-11-2011.

REBECCA POVARCHUK, EXAMINING ATTORNEY



David J. Kybas

Director of the United States Patent and Trademark Office

United States of America

United States Patent and Trademark Office

SIFT & TOSS

Reg. No. 4,110,044

NORMAN DIRECT, LLC (WISCONSIN LIMITED LIABILITY COMPANY)
16595 W. STRATTON DRIVE
NEW BERLIN, WI 53151

Registered Mar. 6, 2012

Int. Cl.: 21

FOR: DISPOSABLE LINERS FOR LITTER BOXES, IN CLASS 21 (U.S. CLS. 2, 13, 23, 29, 30, 33, 40 AND 50).

TRADEMARK

FIRST USE 12-12-2011; IN COMMERCE 12-12-2011.

PRINCIPAL REGISTER

THE MARK CONSISTS OF STANDARD CHARACTERS WITHOUT CLAIM TO ANY PARTICULAR FONT, STYLE, SIZE, OR COLOR.

SN 85-215,269, FILED 1-11-2011.

NICHOLAS ALTREE, EXAMINING ATTORNEY



David J. Kybas

Director of the United States Patent and Trademark Office

United States of America

United States Patent and Trademark Office



Reg. No. 4,110,045

Registered Mar. 6, 2012

Int. Cl.: 29

TRADEMARK

PRINCIPAL REGISTER

THE CHILL THRILL (FLORIDA LIMITED LIABILITY COMPANY)
CALIGO CROSSING SHOPPING CENTER
6970 N STATE ROAD SUITE 104
COCONUT CREEK, FL 33073

FOR: YOGURT, IN CLASS 29 (U.S. CL. 46).

FIRST USE 4-1-2010; IN COMMERCE 4-1-2010.

NO CLAIM IS MADE TO THE EXCLUSIVE RIGHT TO USE "FROSTY YOGURT" AND "CANDY", APART FROM THE MARK AS SHOWN.

THE COLOR(S) BLACK, WHITE, ORANGE, RED, PURPLE, PINK, GREEN, BROWN, YELLOW AND BLUE IS/ARE CLAIMED AS A FEATURE OF THE MARK.

THE MARK CONSISTS OF PENGUINS ON AN ICE GLACIER THAT LOOKS LIKE YOGURT WITH CANDY PIECES, WITH SNOW FALLING. THE PENGUINS ARE BLACK, WHITE, ORANGE AND RED, OUTLINED IN PINK, AND ONE IS HOLDING A YELLOW AND WHITE ICE CREAM CONE, OUTLINED IN BLACK. THE YOGURT IS WHITE, OUTLINED IN BLACK AND PINK, WITH BLUE, GREEN, YELLOW, BROWN, RED, ORANGE AND PURPLE CANDY PIECES. BELOW THIS DESIGN THERE IS THE STYLIZED TEXT "THE CHILL THRILL" IN BLUE, OUTLINED IN PINK, BENEATH WHICH IS THE STYLIZED TEXT "FROSTY YOGURT & COOL CANDY" IN BLUE. THE SKY IS BLUE, THE SNOW IS WHITE, AND THE ENTIRE DESIGN IS OUTLINED IN PINK.

SN 85-215,332, FILED 1-11-2011.

JAMES MACFARLANE, EXAMINING ATTORNEY



David J. Kyros

Director of the United States Patent and Trademark Office

United States of America

United States Patent and Trademark Office

THE HUMAN OPERATORS

Reg. No. 4,110,046

TACKETT, WALTER (UNITED STATES INDIVIDUAL)
715 PARADISE VALLEY N.
DANVILLE, CA 94526

Registered Mar. 6, 2012

Int. Cl.: 41

FOR: ENTERTAINMENT SERVICES, NAMELY, LIVE PERFORMANCES BY A MUSICAL BAND, IN CLASS 41 (U.S. CLS. 100, 101 AND 107).

SERVICE MARK

FIRST USE 12-15-2011; IN COMMERCE 12-15-2011.

PRINCIPAL REGISTER

THE MARK CONSISTS OF STANDARD CHARACTERS WITHOUT CLAIM TO ANY PARTICULAR FONT, STYLE, SIZE, OR COLOR.

SN 85-215,552, FILED 1-12-2011.

MARC LEIPZIG, EXAMINING ATTORNEY



David J. Kybas

Director of the United States Patent and Trademark Office

United States of America

United States Patent and Trademark Office

LONGFLEX

Reg. No. 4,110,047

Registered Mar. 6, 2012

Int. Cl.: 7

TRADEMARK

PRINCIPAL REGISTER

J. H. FENNER & CO. LIMITED (UNITED KINGDOM LIMITED LIABILITY COMPANY)
HESLEWOOD COUNTRY OFFICE PARK
FERRIBY ROAD
HESLE, EAST YORKSHIRE, UNITED KINGDOM HU130PW

FOR: CONVEYOR BELTS, IN CLASS 7 (U.S. CLS. 13, 19, 21, 23, 31, 34 AND 35).

FIRST USE 4-29-2011; IN COMMERCE 4-29-2011.

THE MARK CONSISTS OF STANDARD CHARACTERS WITHOUT CLAIM TO ANY PARTICULAR FONT, STYLE, SIZE, OR COLOR.

SN 85-215,605, FILED 1-12-2011.

ESTHER A. BORSUK, EXAMINING ATTORNEY



David J. Kybas

Director of the United States Patent and Trademark Office

United States of America

United States Patent and Trademark Office

Jeff Epperson Buck Evolution

Reg. No. 4,110,048

EPPERSON, ROBERT JEFF (UNITED STATES INDIVIDUAL)
5501 108TH AVE
PINELLAS PARK, FL 33782

Registered Mar. 6, 2012

Int. Cl.: 25

FOR: ATHLETIC APPAREL, NAMELY, SHIRTS, HATS AND CAPS, IN CLASS 25 (U.S. CLS. 22 AND 39).

TRADEMARK

FIRST USE 10-25-2011; IN COMMERCE 10-25-2011.

PRINCIPAL REGISTER

THE MARK CONSISTS OF STANDARD CHARACTERS WITHOUT CLAIM TO ANY PARTICULAR FONT, STYLE, SIZE, OR COLOR.

OWNER OF U.S. REG. NO. 3,753,218.

THE NAME "JEFF EPPERSON" IS ROBERT JEFF EPPERSON, A LIVING INDIVIDUAL WHOSE CONSENT IS OF RECORD.

SN 85-216,458, FILED 1-12-2011.

JENNIFER MARTIN, EXAMINING ATTORNEY



David J. Kyros

Director of the United States Patent and Trademark Office

United States of America

United States Patent and Trademark Office

CALIFORNIA'S FIRST FAMILY OF CHARDONNAY

Reg. No. 4,110,049

Registered Mar. 6, 2012

Int. Cl.: 33

TRADEMARK

PRINCIPAL REGISTER

WENTE BROS. (CALIFORNIA CORPORATION)
5565 TESLA RD
LIVERMORE, CA 94550

FOR: WINE, IN CLASS 33 (U.S. CLS. 47 AND 49).

FIRST USE 6-1-2011; IN COMMERCE 6-1-2011.

THE MARK CONSISTS OF STANDARD CHARACTERS WITHOUT CLAIM TO ANY PARTICULAR FONT, STYLE, SIZE, OR COLOR.

NO CLAIM IS MADE TO THE EXCLUSIVE RIGHT TO USE "CALIFORNIA'S" AND "CHARDONNAY", APART FROM THE MARK AS SHOWN.

SN 85-217,155, FILED 1-13-2011.

LEIGH CAROLINE CASE, EXAMINING ATTORNEY



David J. Kyffers

Director of the United States Patent and Trademark Office

United States of America

United States Patent and Trademark Office



Reg. No. 4,110,050

Registered Mar. 6, 2012

Int. Cls.: 9, 36, and 38

TRADEMARK

SERVICE MARK

PRINCIPAL REGISTER

AMERICAN EXPRESS MARKETING & DEVELOPMENT CORP. (DELAWARE CORPORATION)
200 VESEY STREET
NEW YORK, NY 10285

FOR: APPARATUS FOR PROCESSING POINT-OF-SALE TRANSACTIONS, NAMELY, MAGNETICALLY-ENCODED STORED VALUE AND DEBIT CARDS; MAGNETICALLY-ENCODED, MACHINE-READABLE, BAR-CODED, STORED VALUE AND DEBIT CARDS; MAGNETICALLY-ENCODED IDENTIFYING CARDS, IN CLASS 9 (U.S. CLS. 21, 23, 26, 36 AND 38).

FIRST USE 3-28-2011; IN COMMERCE 3-28-2011.

FOR: FINANCIAL SERVICES, NAMELY, CREDIT AND CHARGE CARD SERVICES, CONSUMER STORED VALUE AND DEBIT CARD TRANSACTION PROCESSING SERVICES; PROVIDING ELECTRONIC PROCESSING OF STORED VALUE AND DEBIT CARD TRANSACTIONS AND PROVIDING ELECTRONIC PAYMENTS VIA A GLOBAL COMPUTER NETWORK; FINANCIAL SERVICES, NAMELY, ELECTRONIC PROCESSING, VERIFICATION, AND SETTLEMENT OF SALES TRANSACTIONS USING ONLINE ACCOUNTS; STORED VALUE AND DEBIT CARD TRANSACTION VERIFICATION AND SETTLEMENT SERVICES; ELECTRONIC PAYMENT PROCESSING SERVICES, NAMELY, ELECTRONIC PROCESSING OF STORED VALUE AND DEBIT CARD AND ONLINE ACCOUNT PAYMENT DATA; STORED VALUE AND DEBIT CARD SERVICES; PROVIDING FINANCIAL INFORMATION VIA A GLOBAL COMPUTER NETWORK; AND CONSULTATION SERVICES RELATED TO THE FOREGOING, IN CLASS 36 (U.S. CLS. 100, 101 AND 102).

FIRST USE 3-28-2011; IN COMMERCE 3-28-2011.

FOR: PROVIDING ELECTRONIC TRANSMISSION OF STORED VALUE AND DEBIT CARD AND ONLINE ACCOUNT PAYMENT DATA VIA A GLOBAL COMPUTER NETWORK, IN CLASS 38 (U.S. CLS. 100, 101 AND 104).

FIRST USE 3-28-2011; IN COMMERCE 3-28-2011.

THE MARK CONSISTS OF 4 SWIRLS IN A CIRCLE DESIGN NEXT TO THE WORD "SERVE".

SN 85-217,177, FILED 1-13-2011.



David J. Kyros

Director of the United States Patent and Trademark Office

Reg. No. 4,110,050 FRANK LATTUCA, EXAMINING ATTORNEY

United States of America

United States Patent and Trademark Office

DSCI REAL ESTATE HOLDINGS, LLC

Reg. No. 4,110,051

Registered Mar. 6, 2012

Int. Cl.: 36

SERVICE MARK

PRINCIPAL REGISTER

DSCI REAL ESTATE HOLDINGS, LLC (NEW JERSEY LIMITED LIABILITY COMPANY),
DBA DREH,
P.O. BOX 360
EATONTOWN, NJ 07724

FOR: REAL ESTATE MANAGEMENT OF COMMERCIAL PROPERTIES; REAL ESTATE SERVICES, NAMELY, RENTAL, BROKERAGE, LEASING AND MANAGEMENT OF COMMERCIAL PROPERTY, OFFICES AND OFFICE SPACE, IN CLASS 36 (U.S. CLS. 100, 101 AND 102).

FIRST USE 3-31-2011; IN COMMERCE 3-31-2011.

THE MARK CONSISTS OF STANDARD CHARACTERS WITHOUT CLAIM TO ANY PARTICULAR FONT, STYLE, SIZE, OR COLOR.

NO CLAIM IS MADE TO THE EXCLUSIVE RIGHT TO USE "REAL ESTATE HOLDINGS, LLC", APART FROM THE MARK AS SHOWN.

SN 85-217,379, FILED 1-13-2011.

JOHN WILKE, EXAMINING ATTORNEY



David J. Kybas

Director of the United States Patent and Trademark Office

United States of America

United States Patent and Trademark Office

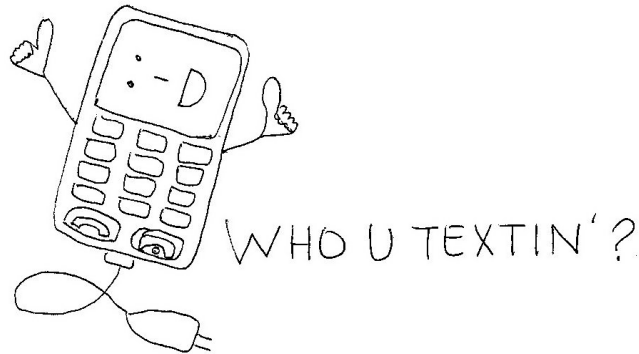

Reg. No. 4,110,052

Registered Mar. 6, 2012

Int. Cl.: 25

TRADEMARK

PRINCIPAL REGISTER

WHO YOU TEXTIN ? CLOTHING CO. (INDIANA PARTNERSHIP)
619 N. 6TH STREET
VINCENNES, IN 47591

FOR: HATS FOR INFANTS, BABIES, TODDLERS AND CHILDREN; JEANS; SWEAT PANTS;
SWEAT SHIRTS; T-SHIRTS, IN CLASS 25 (U.S. CLS. 22 AND 39).

FIRST USE 8-11-2011; IN COMMERCE 8-11-2011.

THE MARK CONSISTS OF A CELL PHONE STICK MAN WITH THE LOCATION OF THE
FACE SIDWAYS IN AN EMOTICON STYLE. THE CELL PHONE HAS TWO HANDS
STICKING OUT WITH EXTRA LARGE THUMBS AND CHARGING CHORD LEGS AT THE
BOTTOM. TO THE RIGHT THERE IS THE STYLIZED TEXT "WHO YOU TEXTIN' ?".

SN 85-217,449, FILED 1-13-2011.

JIM RINGLE, EXAMINING ATTORNEY



David J. Kybas

Director of the United States Patent and Trademark Office

United States of America

United States Patent and Trademark Office

NEMOS

Reg. No. 4,110,053

Registered Mar. 6, 2012

Int. Cl.: 10

TRADEMARK

PRINCIPAL REGISTER

CERBOMED GMBH (FED REP GERMANY CORPORATION)
HENKESTRASSE 91
ERLANGEN, FED REP GERMANY 91052

FOR: NERVE STIMULATOR APPARATUS, IN CLASS 10 (U.S. CLS. 26, 39 AND 44).

FIRST USE 5-31-2011; IN COMMERCE 9-28-2011.

THE MARK CONSISTS OF STANDARD CHARACTERS WITHOUT CLAIM TO ANY PARTICULAR FONT, STYLE, SIZE, OR COLOR.

SN 85-217,871, FILED 1-14-2011.

WILLIAM P. SHANAHAN, EXAMINING ATTORNEY



David J. Kybas

Director of the United States Patent and Trademark Office

United States of America

United States Patent and Trademark Office

Play 4 Keeps

Reg. No. 4,110,054

JOULIOS, APOLLO (UNITED STATES INDIVIDUAL)
3663 SOLANO AVE
NAPA, CA 94558

Registered Mar. 6, 2012

Int. Cl.: 25

FOR: HOODED SWEAT SHIRTS; PANTS; SHIRTS; T-SHIRTS, IN CLASS 25 (U.S. CLS. 22 AND 39).

TRADEMARK

FIRST USE 12-21-2011; IN COMMERCE 12-21-2011.

PRINCIPAL REGISTER

THE MARK CONSISTS OF STANDARD CHARACTERS WITHOUT CLAIM TO ANY PARTICULAR FONT, STYLE, SIZE, OR COLOR.

SN 85-217,968, FILED 1-14-2011.

ANDREW LEASER, EXAMINING ATTORNEY



David J. Kyffers

Director of the United States Patent and Trademark Office

United States of America

United States Patent and Trademark Office

ERDENLIED

Reg. No. 4,110,055

ASTOR HOME LTD. (NEW JERSEY CORPORATION)
186 PATERSON AVE SUITE 301
EAST RUTHERFORD, NJ 07073

Registered Mar. 6, 2012

Int. Cl.: 33

FOR: WINES, IN CLASS 33 (U.S. CLS. 47 AND 49).

TRADEMARK

FIRST USE 10-27-2011; IN COMMERCE 10-27-2011.

PRINCIPAL REGISTER

THE MARK CONSISTS OF STANDARD CHARACTERS WITHOUT CLAIM TO ANY PARTICULAR FONT, STYLE, SIZE, OR COLOR.

THE ENGLISH TRANSLATION OF "ERDENLIED" IN THE MARK IS "EARTH SONG".

SN 85-218,883, FILED 1-17-2011.

BRENDAN REGAN, EXAMINING ATTORNEY



David J. Kybas

Director of the United States Patent and Trademark Office

United States of America

United States Patent and Trademark Office

APHENA

Reg. No. 4,110,056

APHENA PHARMA SOLUTIONS - TENNESSEE, INC. (TENNESSEE CORPORATION)
1920 FISK ROAD
COOKEVILLE, TN 38506

Registered Mar. 6, 2012

Int. Cl.: 40

FOR: MANUFACTURING SERVICES FOR OTHERS IN THE FIELD OF PHARMACEUTICALS,
IN CLASS 40 (U.S. CLS. 100, 103 AND 106).

SERVICE MARK

FIRST USE 3-1-2011; IN COMMERCE 3-1-2011.

PRINCIPAL REGISTER

THE MARK CONSISTS OF STANDARD CHARACTERS WITHOUT CLAIM TO ANY PAR-
TICULAR FONT, STYLE, SIZE, OR COLOR.

SN 85-218,946, FILED 1-17-2011.

CAROLINE WOOD, EXAMINING ATTORNEY



David J. Kyros

Director of the United States Patent and Trademark Office

United States of America

United States Patent and Trademark Office



PEARL HYDROGEN

Reg. No. 4,110,057

Registered Mar. 6, 2012

Int. Cl.: 9

PEARL HYDROGEN TECHNOLOGY CO., LTD. (CHINA CORPORATION)
BUILDING 2, NO.88, NORTHERN HUANCHENG RD
COMPREHENSIVE INDUSTRIAL DEVELOPMNT ZONE
FENGXIAN, SHANGHAI, CHINA 201812

FOR: FUEL CELLS, IN CLASS 9 (U.S. CLS. 21, 23, 26, 36 AND 38).

TRADEMARK

FIRST USE 2-5-2008; IN COMMERCE 5-1-2008.

PRINCIPAL REGISTER

NO CLAIM IS MADE TO THE EXCLUSIVE RIGHT TO USE "HYDROGEN", APART FROM THE MARK AS SHOWN.

THE MARK CONSISTS OF "PEARL HYDROGEN" IN A STYLIZED FONT BENEATH AN "L" SHAPED DESIGN WITH ARTISTIC EFFECT.

SN 85-219,447, FILED 1-17-2011.

SANJEEV VOHRA, EXAMINING ATTORNEY



David J. Kyros

Director of the United States Patent and Trademark Office

United States of America

United States Patent and Trademark Office

TWGConnect

Reg. No. 4,110,058

Registered Mar. 6, 2012

Int. Cl.: 42

SERVICE MARK

PRINCIPAL REGISTER

THE WARRANTY GROUP, INC. (DELAWARE CORPORATION)
175 WEST JACKSON BLVD.
CHICAGO, IL 60604

FOR: PROVIDING A WEBSITE FEATURING NON-DOWNLOADABLE SOFTWARE IN THE FIELDS OF WARRANTY SERVICE, ASSET PROTECTION INSURANCE AND OTHER TYPES OF INSURANCE TO PROVIDE MAINTENANCE CONTRACT INFORMATION FOR USE IN CONTRACT MANAGEMENT, PROCESSING, CLAIMS ADMINISTRATION AND PROCESSING, DOCUMENTATION ISSUANCE, BILLING AND CANCELLATION, IN CLASS 42 (U.S. CLS. 100 AND 101).

FIRST USE 8-24-2010; IN COMMERCE 12-28-2011.

THE MARK CONSISTS OF STANDARD CHARACTERS WITHOUT CLAIM TO ANY PARTICULAR FONT, STYLE, SIZE, OR COLOR.

SN 85-219,784, FILED 1-18-2011.

KELLY BOULTON, EXAMINING ATTORNEY



David J. Kyros

Director of the United States Patent and Trademark Office

United States of America

United States Patent and Trademark Office

EROMA

Reg. No. 4,110,059

NATASHA HO (UNITED STATES INDIVIDUAL)
6841 AUBURN DRIVE
HUNTINGTON BEACH, CA 92647

Registered Mar. 6, 2012

Int. Cl.: 25

FOR: JACKETS; SHORT-SLEEVED OR LONG-SLEEVED T-SHIRTS; SWEATERS; T-SHIRTS,
IN CLASS 25 (U.S. CLS. 22 AND 39).

TRADEMARK

FIRST USE 10-3-2011; IN COMMERCE 10-3-2011.

PRINCIPAL REGISTER

THE MARK CONSISTS OF STANDARD CHARACTERS WITHOUT CLAIM TO ANY PAR-
TICULAR FONT, STYLE, SIZE, OR COLOR.

THE WORDING "EROMA" HAS NO MEANING IN A FOREIGN LANGUAGE.

SN 85-219,823, FILED 1-18-2011.

GINA FINK, EXAMINING ATTORNEY



David J. Kybas

Director of the United States Patent and Trademark Office

United States of America

United States Patent and Trademark Office

Take Charge of Overactive Bladder

Reg. No. 4,110,060

Registered Mar. 6, 2012

Int. Cl.: 44

SERVICE MARK

PRINCIPAL REGISTER

WATSON PHARMACEUTICALS, INC. (NEVADA CORPORATION)
311 BONNIE CIRCLE
CORONA, CA 92880

FOR: PROVIDING A WEBSITE FEATURING INFORMATION IN THE FIELD OF THE DIAGNOSIS AND PHARMACEUTICAL TREATMENT OF URINARY INCONTINENCE, IN CLASS 44 (U.S. CLS. 100 AND 101).

FIRST USE 2-28-2010; IN COMMERCE 2-28-2010.

THE MARK CONSISTS OF STANDARD CHARACTERS WITHOUT CLAIM TO ANY PARTICULAR FONT, STYLE, SIZE, OR COLOR.

SN 85-219,876, FILED 1-18-2011.

CHERYL CLAYTON, EXAMINING ATTORNEY



David J. Kyros

Director of the United States Patent and Trademark Office

United States of America

United States Patent and Trademark Office

COLOUR BUNZ

Reg. No. 4,110,061

FORGIONE, BARBARA (UNITED STATES INDIVIDUAL)
109 W FERN ST
TAMPA, FL 33604

Registered Mar. 6, 2012

Int. Cl.: 26

FOR: HAIR COLORING AND CHEMICAL TREATMENT PROTECTIVE SHIELD MADE OF ABSORBENT MATERIAL, IN CLASS 26 (U.S. CLS. 37, 39, 40, 42 AND 50).

TRADEMARK

FIRST USE 3-9-2011; IN COMMERCE 3-9-2011.

PRINCIPAL REGISTER

THE MARK CONSISTS OF STANDARD CHARACTERS WITHOUT CLAIM TO ANY PARTICULAR FONT, STYLE, SIZE, OR COLOR.

NO CLAIM IS MADE TO THE EXCLUSIVE RIGHT TO USE "COLOUR", APART FROM THE MARK AS SHOWN.

SN 85-219,883, FILED 1-18-2011.

TOBY BULLOFF, EXAMINING ATTORNEY



David J. Kyffers

Director of the United States Patent and Trademark Office

United States of America

United States Patent and Trademark Office

Wildfire

Reg. No. 4,110,062

ACME UNITED CORPORATION (CONNECTICUT CORPORATION)
60 ROUND HILL ROAD
FAIRFIELD, CT 06824

Registered Mar. 6, 2012

Int. Cl.: 8

FOR: CUTLERY; CUTLERY, NAMELY, SPORTS KNIVES, IN CLASS 8 (U.S. CLS. 23, 28 AND 44).

TRADEMARK

FIRST USE 12-5-2011; IN COMMERCE 12-5-2011.

PRINCIPAL REGISTER

THE MARK CONSISTS OF STANDARD CHARACTERS WITHOUT CLAIM TO ANY PARTICULAR FONT, STYLE, SIZE, OR COLOR.

SN 85-219,886, FILED 1-18-2011.

IRA J. GOODSaid, EXAMINING ATTORNEY



David J. Kyffers

Director of the United States Patent and Trademark Office

United States of America

United States Patent and Trademark Office

Sizzle

Reg. No. 4,110,063

ACME UNITED CORPORATION (CONNECTICUT CORPORATION)
60 ROUND HILL ROAD
FAIRFIELD, CT 06824

Registered Mar. 6, 2012

Int. Cl.: 8

FOR: CUTLERY; CUTLERY, NAMELY, SPORTS KNIVES, IN CLASS 8 (U.S. CLS. 23, 28 AND 44).

TRADEMARK

FIRST USE 12-5-2011; IN COMMERCE 12-5-2011.

PRINCIPAL REGISTER

THE MARK CONSISTS OF STANDARD CHARACTERS WITHOUT CLAIM TO ANY PARTICULAR FONT, STYLE, SIZE, OR COLOR.

SN 85-219,888, FILED 1-18-2011.

IRA J. GOODSaid, EXAMINING ATTORNEY



David J. Kyffers

Director of the United States Patent and Trademark Office

United States of America

United States Patent and Trademark Office

VueTek Scientific

Reg. No. 4,110,064

VUETEK SCIENTIFIC, LLC (MAINE LIMITED LIABILITY COMPANY)
25 NORTHBROOK DRIVE, P.O. BOX 665
GRAY, ME 040390665

Registered Mar. 6, 2012

Int. Cl.: 10

FOR: MEDICAL DEVICE, NAMELY, A NEAR-INFRARED VENOUS IDENTIFICATION DEVICE, IN CLASS 10 (U.S. CLS. 26, 39 AND 44).

TRADEMARK

FIRST USE 5-1-2009; IN COMMERCE 12-21-2011.

PRINCIPAL REGISTER

THE MARK CONSISTS OF STANDARD CHARACTERS WITHOUT CLAIM TO ANY PARTICULAR FONT, STYLE, SIZE, OR COLOR.

NO CLAIM IS MADE TO THE EXCLUSIVE RIGHT TO USE "SCIENTIFIC", APART FROM THE MARK AS SHOWN.

SN 85-220,192, FILED 1-18-2011.

JIM RINGLE, EXAMINING ATTORNEY



David J. Kybas

Director of the United States Patent and Trademark Office

United States of America

United States Patent and Trademark Office

VueTek

Reg. No. 4,110,065

VUETEK SCIENTIFIC, LLC (MAINE LIMITED LIABILITY COMPANY)
25 NORTHBROOK DRIVE, P.O. BOX 665
GRAY, ME 040390665

Registered Mar. 6, 2012

Int. Cl.: 10

FOR: MEDICAL DEVICE, NAMELY, A NEAR-INFRARED VENOUS IDENTIFICATION DEVICE, IN CLASS 10 (U.S. CLS. 26, 39 AND 44).

TRADEMARK

FIRST USE 5-1-2009; IN COMMERCE 12-21-2011.

PRINCIPAL REGISTER

THE MARK CONSISTS OF STANDARD CHARACTERS WITHOUT CLAIM TO ANY PARTICULAR FONT, STYLE, SIZE, OR COLOR.

SN 85-220,223, FILED 1-18-2011.

JIM RINGLE, EXAMINING ATTORNEY



David J. Kybas

Director of the United States Patent and Trademark Office

United States of America

United States Patent and Trademark Office

HTC ARRIVE

Reg. No. 4,110,066

Registered Mar. 6, 2012

Int. Cl.: 9

TRADEMARK

PRINCIPAL REGISTER

HTC CORPORATION (TAIWAN CORPORATION)
NO. 23, XINGHUA ROAD
TAOYUAN CITY, TAIWAN

FOR: MOBILE PHONES, SMARTPHONES, CELLULAR PHONES AND PERSONAL DIGITAL ASSISTANTS AND WIRELESS HANDHELD DIGITAL ELECTRONIC DEVICES FOR COMMUNICATING, RECORDING, ORGANIZING, TRANSMITTING, MANIPULATING, STORING, AND REVIEWING TEXT, DATA, IMAGE, AND AUDIO FILES, IN CLASS 9 (U.S. CLS. 21, 23, 26, 36 AND 38).

FIRST USE 3-20-2011; IN COMMERCE 3-20-2011.

THE MARK CONSISTS OF STANDARD CHARACTERS WITHOUT CLAIM TO ANY PARTICULAR FONT, STYLE, SIZE, OR COLOR.

OWNER OF U.S. REG. NOS. 3,584,880, 3,819,603, AND 3,890,684.

SN 85-220,242, FILED 1-18-2011.

DANNEAN HETZEL, EXAMINING ATTORNEY



David J. Kybas

Director of the United States Patent and Trademark Office

United States of America

United States Patent and Trademark Office

PEPE ZEVADA

Reg. No. 4,110,067

Registered Mar. 6, 2012

Int. Cl.: 33

TRADEMARK

PRINCIPAL REGISTER

JOSE MARÍA ZEVADA GÓMEZ (MEXICO INDIVIDUAL)
PISO 5, LETRA C
BLVD. LOPEZ PORTILLO 501
GUADALUPE, ZACATECAS, MEXICO 98618 AND

MÓNICA ALEJANDRA ZEVADA ANDERSON (MEXICO INDIVIDUAL)
PISO 5, LETRA C
BLVD. LOPEZ PORTILLO 501
GUADALUPE, ZACATECAS, MEXICO 98618

FOR: TEQUILA, IN CLASS 33 (U.S. CLS. 47 AND 49).

FIRST USE 6-0-2007; IN COMMERCE 6-0-2007.

THE MARK CONSISTS OF STANDARD CHARACTERS WITHOUT CLAIM TO ANY PARTICULAR FONT, STYLE, SIZE, OR COLOR.

THE NAME(S), PORTRAIT(S), AND/OR SIGNATURE(S) SHOWN IN THE MARK IDENTIFIES JOSE MARÍA ZEVADA GÓMEZ, WHOSE CONSENT(S) TO REGISTER IS MADE OF RECORD.

SN 85-220,384, FILED 1-18-2011.

LOURDES AYALA, EXAMINING ATTORNEY



David J. Kyros

Director of the United States Patent and Trademark Office

United States of America

United States Patent and Trademark Office

MIRACLE SLIPPERS

Reg. No. 4,110,068

Registered Mar. 6, 2012

Int. Cl.: 25

TRADEMARK

PRINCIPAL REGISTER

ONTEL PRODUCTS CORPORATION (NEW JERSEY CORPORATION)
21 LAW DRIVE
FAIRFIELD, NJ 07470

FOR: SLIPPERS, IN CLASS 25 (U.S. CLS. 22 AND 39).

FIRST USE 5-14-2011; IN COMMERCE 5-14-2011.

THE MARK CONSISTS OF STANDARD CHARACTERS WITHOUT CLAIM TO ANY PARTICULAR FONT, STYLE, SIZE, OR COLOR.

NO CLAIM IS MADE TO THE EXCLUSIVE RIGHT TO USE "SLIPPERS", APART FROM THE MARK AS SHOWN.

SN 85-222,159, FILED 1-20-2011.

ERNEST SHOSHO, EXAMINING ATTORNEY



David J. Kyffers

Director of the United States Patent and Trademark Office

United States of America

United States Patent and Trademark Office

VIEWSHARE

Reg. No. 4,110,069

Registered Mar. 6, 2012

Int. Cl.: 42

SERVICE MARK

PRINCIPAL REGISTER

LIBRARY OF CONGRESS (UNITED STATES AGENCY OF THE UNITED STATES GOVERNMENT)
101 INDEPENDENCE AVENUE, S.E.
WASHINGTON, DC 20540

FOR: SOFTWARE AS A SERVICE (SAAS) SERVICES FEATURING A FREE AND OPEN SOFTWARE PLATFORM FOR INGESTING METADATA ASSOCIATED WITH DIGITAL CULTURAL HERITAGE COLLECTIONS AND PERMITTING END USERS TO ADD ADDITIONAL METADATA, ENHANCE METADATA, AND CUSTOMIZE WEB INTERFACES TO PROVIDE VARIOUS WAYS OF VIEWING AND SEARCHING METADATA, IN CLASS 42 (U.S. CLS. 100 AND 101).

FIRST USE 10-31-2011; IN COMMERCE 10-31-2011.

THE MARK CONSISTS OF STANDARD CHARACTERS WITHOUT CLAIM TO ANY PARTICULAR FONT, STYLE, SIZE, OR COLOR.

SN 85-224,366, FILED 1-24-2011.

HANNO RITTNER, EXAMINING ATTORNEY



David J. Kybas

Director of the United States Patent and Trademark Office

United States of America
United States Patent and Trademark Office

VOLTRON

Reg. No. 4,110,070

WORLD EVENTS PRODUCTIONS, LTD. (MISSOURI CORPORATION)
50 MARYLAND PLAZA, SUITE 300
ST. LOUIS, MO 63108

Registered Mar. 6, 2012

Int. Cl.: 9

FOR: ELECTRONIC GAMES, NAMELY, INTERACTIVE VIDEO AND COMPUTER GAME SOFTWARE, PROGRAMS, CARTRIDGES AND DISCS, IN CLASS 9 (U.S. CLS. 21, 23, 26, 36 AND 38).

TRADEMARK

FIRST USE 11-29-2011; IN COMMERCE 11-29-2011.

PRINCIPAL REGISTER

THE MARK CONSISTS OF STANDARD CHARACTERS WITHOUT CLAIM TO ANY PARTICULAR FONT, STYLE, SIZE, OR COLOR.

OWNER OF U.S. REG. NOS. 1,975,721, 2,398,625, AND OTHERS.

SN 85-224,551, FILED 1-24-2011.

BENJAMIN OKEKE, EXAMINING ATTORNEY



David J. Kyffers

Director of the United States Patent and Trademark Office

United States of America

United States Patent and Trademark Office



Reg. No. 4,110,071

Registered Mar. 6, 2012

Int. Cl.: 35

SERVICE MARK

PRINCIPAL REGISTER

ANNE TAINTOR, INC. (MAINE CORPORATION)
1258 WESTBROOK STREET
PORTLAND, ME 04102

FOR: ONLINE RETAIL STORE SERVICES, WHOLESALE DISTRIBUTORSHIP SERVICES AND WHOLESALE ORDERING SERVICES FEATURING MAGNETS, CARDS, FLASKS, COASTERS, EMERY BOARDS, COIN PURSES, GIFT ITEMS AND LUGGAGE TAGS, IN CLASS 35 (U.S. CLS. 100, 101 AND 102).

FIRST USE 5-0-2011; IN COMMERCE 5-0-2011.

OWNER OF U.S. REG. NOS. 2,996,748, 3,031,214, AND OTHERS.

THE MARK CONSISTS OF THE LITERAL ELEMENTS "TAINTOR...WITH A TWIST". THE LITERAL ELEMENT "TAINTOR..." APPEARS WITHIN AN UNCLOSED OVAL. THE WORDS "WITH A" AND "TWIST" ARE CONTAINED WITHIN THREE INTERSECTING OVALS OR CIRCLES APPEARING BELOW THE LITERAL ELEMENT "TAINTOR...".

SN 85-224,681, FILED 1-24-2011.

KAREN BRACEY, EXAMINING ATTORNEY



David J. Kyros

Director of the United States Patent and Trademark Office

United States of America

United States Patent and Trademark Office

JS8

Reg. No. 4,110,072

SHAY'S GROUP, INC. (CALIFORNIA CORPORATION)
150 N. SANTA ANITA AVE., SUITE 700
ARCADIA, CA 91006

Registered Mar. 6, 2012

Int. Cl.: 25

FOR: BLOUSES; COATS; DRESSES; FOOTWEAR; HEADWEAR; JACKETS; PANTS; SHIRTS;
SHORTS; SWEATERS; T-SHIRTS; TANK TOPS; TANK-TOPS, IN CLASS 25 (U.S. CLS. 22
AND 39).

TRADEMARK

FIRST USE 1-1-2011; IN COMMERCE 1-1-2011.

PRINCIPAL REGISTER

THE MARK CONSISTS OF STANDARD CHARACTERS WITHOUT CLAIM TO ANY PAR-
TICULAR FONT, STYLE, SIZE, OR COLOR.

SN 85-225,079, FILED 1-25-2011.

LINDA POWELL, EXAMINING ATTORNEY



David J. Kybas

Director of the United States Patent and Trademark Office

United States of America

United States Patent and Trademark Office

hergonomic

Reg. No. 4,110,073

GREEN HERON TOOLS LLC (PENNSYLVANIA LIMITED LIABILITY COMPANY)
6239 SCHOCHARY RD
NEW TRIPOLI, PA 18066

Registered Mar. 6, 2012

Int. Cl.: 8

FOR: MANUALLY-OPERATED ERGONOMIC GARDENING, LAWN, AND AGRICULTURAL TOOLS THAT ARE DESIGNED FOR FEMALE USERS, NAMELY, SHOVELS, SPADES AND HYBRID SPADE/SHOVELS , IN CLASS 8 (U.S. CLS. 23, 28 AND 44).

TRADEMARK

FIRST USE 2-10-2011; IN COMMERCE 9-24-2011.

PRINCIPAL REGISTER

THE MARK CONSISTS OF STANDARD CHARACTERS WITHOUT CLAIM TO ANY PARTICULAR FONT, STYLE, SIZE, OR COLOR.

SN 85-225,276, FILED 1-25-2011.

KIMBERLY FRYE, EXAMINING ATTORNEY



David J. Kybas

Director of the United States Patent and Trademark Office

United States of America

United States Patent and Trademark Office

TRIGESTAMACE

Reg. No. 4,110,074

Registered Mar. 6, 2012

Int. Cl.: 5

TRADEMARK

PRINCIPAL REGISTER

R & D LIFESCIENCES, LLC. (WISCONSIN LIMITED LIABILITY COMPANY)
4602 DOMAIN DRIVE
SUITE B
MENOMONIE, WI 54751

FOR: NON MEDICATED ADDITIVE FOR ANIMAL FEED FOR USE AS NUTRITIONAL SUPPLEMENTS IN POWDER, LIQUID, GEL, TABLET, BOLUS OR ANY OTHER FORM , IN CLASS 5 (U.S. CLS. 6, 18, 44, 46, 51 AND 52).

FIRST USE 1-3-2011; IN COMMERCE 7-14-2011.

THE MARK CONSISTS OF STANDARD CHARACTERS WITHOUT CLAIM TO ANY PARTICULAR FONT, STYLE, SIZE, OR COLOR.

OWNER OF U.S. REG. NOS. 3,837,619, 3,918,744, AND OTHERS.

SN 85-225,315, FILED 1-25-2011.

JULIE GUTTADAURO, EXAMINING ATTORNEY



David J. Kybas

Director of the United States Patent and Trademark Office

United States of America

United States Patent and Trademark Office

FORT WILD

Reg. No. 4,110,075

Registered Mar. 6, 2012

Int. Cl.: 9

TRADEMARK

PRINCIPAL REGISTER

BALLY GAMING, INC. (NEVADA CORPORATION), DBA BALLY TECHNOLOGIES,
ATTN: PAMELA BOWSHER, LAW DEPT.
6601 SOUTH BERMUDA ROAD
LAS VEGAS, NV 89119

FOR: COMPUTER-GAMING SOFTWARE; GAMING SOFTWARE THAT GENERATES OR
DISPLAYS WAGER OUTCOMES OF GAMING MACHINES; DOWNLOADABLE COMPUTER
GAME SOFTWARE FOR GAMING; GAMING MACHINES, NAMELY, DEVICES THAT
ACCEPT A WAGER; SLOT MACHINES, IN CLASS 9 (U.S. CLS. 21, 23, 26, 36 AND 38).

FIRST USE 9-30-2010; IN COMMERCE 9-30-2010.

THE MARK CONSISTS OF STANDARD CHARACTERS WITHOUT CLAIM TO ANY PAR-
TICULAR FONT, STYLE, SIZE, OR COLOR.

SN 85-225,992, FILED 1-25-2011.

THEODORE MCBRIDE, EXAMINING ATTORNEY



David J. Kybas

Director of the United States Patent and Trademark Office

United States of America

United States Patent and Trademark Office

Remando

Reg. No. 4,110,076

Registered Mar. 6, 2012

Int. Cls.: 9 and 41

TRADEMARK

SERVICE MARK

PRINCIPAL REGISTER

ALFONSO HERNANDEZ ESTRADA (MEXICO INDIVIDUAL), AKA SAUL HERNANDEZ,
NEBRASKA 64 DESPACHO 102
MEXICO CITY, MEXICO

FOR: SERIES OF MUSICAL SOUND RECORDINGS, NAMELY, COMPACT DISCS,
PRERECORDED AUDIOCASSETTES, PRERECORDED VIDEOCASSETTES, RECORDS,
AND DOWNLOADABLE MUSICAL SOUND RECORDINGS, IN CLASS 9 (U.S. CLS. 21, 23,
26, 36 AND 38).

FIRST USE 5-3-2011; IN COMMERCE 5-3-2011.

FOR: ENTERTAINMENT SERVICES IN THE NATURE OF LIVE MUSICAL PERFORMANCES,
IN CLASS 41 (U.S. CLS. 100, 101 AND 107).

FIRST USE 5-1-2011; IN COMMERCE 5-1-2011.

THE MARK CONSISTS OF STANDARD CHARACTERS WITHOUT CLAIM TO ANY PAR-
TICULAR FONT, STYLE, SIZE, OR COLOR.

THE ENGLISH TRANSLATION OF THE WORD "REMANDO" IN THE MARK IS ROWING.

SN 85-226,172, FILED 1-26-2011.

KIM SAITO, EXAMINING ATTORNEY



David J. Kybas

Director of the United States Patent and Trademark Office

United States of America
United States Patent and Trademark Office

Hidear

Reg. No. 4,110,077

Registered Mar. 6, 2012

Int. Cl.: 9

TRADEMARK

PRINCIPAL REGISTER

RIZHAO HIDEAR ELECTRONICS CO, LTD. (CHINA LIMITED COMPANY (LTD.))
A4 BLDG, ELECTRIC INFORMATION IND PARK
HI-TECH ZONE, RIZHAO
SHANDONG, CHINA

FOR: AUDIO BOOKS IN THE NATURE OF NOVELS; COMPUTERS; DVD PLAYERS; ELECTRONIC POCKET TRANSLATORS; FACSIMILE MACHINES; FILM CAMERAS; INTEGRATED CIRCUITS; NAVIGATION APPARATUS FOR VEHICLES; NOTEBOOK COMPUTERS; PHOTOCOPIERS; PORTABLE TELEPHONES; PRINTERS FOR USE WITH COMPUTERS; RADIOS; REMOTE CONTROLS FOR RADIOS, TELEVISIONS, STEREOS; SATELLITE NAVIGATIONAL SYSTEM, NAMELY, A GLOBAL POSITIONING SYSTEM (GPS); SCANNERS; SOLAR BATTERIES; TAPE RECORDERS; TELECOMMUNICATIONS AND DATA NETWORKING HARDWARE, NAMELY, DEVICES FOR TRANSPORTING AND AGGREGATING VOICE, DATA, AND VIDEO COMMUNICATIONS ACROSS MULTIPLE NETWORK INFRASTRUCTURES AND COMMUNICATIONS PROTOCOLS; TELEPHONES; TELEVISION ANTENNAS; TELEVISION CAMERAS; TELEVISIONS; THEFT ALARMS; TIME RECORDING APPARATUS; VENDING MACHINES; VIDEO RECORDERS; VIDEO SCREENS; VIDEO TELEPHONES; WALKIE-TALKIES, IN CLASS 9 (U.S. CLS. 21, 23, 26, 36 AND 38).

FIRST USE 8-26-2010; IN COMMERCE 1-6-2011.

THE MARK CONSISTS OF THE STYLIZED WORD "HIDEAR" WHERE THE UPPER LEFT PART OF THE CHARACTER "H" IS REPLACED BY A SMALL SQUARE.

THE WORDING "HIDEAR" HAS NO MEANING IN A FOREIGN LANGUAGE.

SN 85-226,194, FILED 1-26-2011.

GINA HAYES, EXAMINING ATTORNEY



David J. Kyffers

Director of the United States Patent and Trademark Office

United States of America

United States Patent and Trademark Office

INFINITI

Reg. No. 4,110,078

AUSTRALIAN GOLD, LLC (INDIANA LIMITED LIABILITY COMPANY)
6270 CORPORATE DRIVE
INDIANAPOLIS, IN 46278

Registered Mar. 6, 2012

Int. Cl.: 3

FOR: INDOOR AND OUTDOOR NON-MEDICATED SKIN TANNING PREPARATIONS, IN CLASS 3 (U.S. CLS. 1, 4, 6, 50, 51 AND 52).

TRADEMARK

FIRST USE 11-1-2011; IN COMMERCE 11-1-2011.

PRINCIPAL REGISTER

THE MARK CONSISTS OF STANDARD CHARACTERS WITHOUT CLAIM TO ANY PARTICULAR FONT, STYLE, SIZE, OR COLOR.

SN 85-226,634, FILED 1-26-2011.

FRANK LATTUCA, EXAMINING ATTORNEY



David J. Kybas

Director of the United States Patent and Trademark Office

United States of America

United States Patent and Trademark Office

MYOP

Reg. No. 4,110,079

Registered Mar. 6, 2012

Int. Cl.: 28

TRADEMARK

PRINCIPAL REGISTER

GAMEZ, SAMUEL (MEXICO INDIVIDUAL)
PAMPLONA 1613-5, RINCO SAN JERONIMO
MONTERREY, N. L., MEXICO 64340 AND

SALAZAR, ERICK (MEXICO INDIVIDUAL)
PASEO ARROYO ZARCO 23, RES. BOSQUENCINOS
MONTERREY, N. L., MEXICO 64979 AND

CANHAM, THOMAS RICHARD (UNITED STATES INDIVIDUAL)
305 GREENLEAF STREET
EVANSON, IL 60202 AND

ESCOBEDO, WENDY (MEXICO INDIVIDUAL)
PAMPLONA 1613-5, RINCON SAN JERONIMO
MONTERREY, N. L., MEXICO 64340

FOR: PINATAS, IN CLASS 28 (U.S. CLS. 22, 23, 38 AND 50).

FIRST USE 8-1-2011; IN COMMERCE 8-1-2011.

THE MARK CONSISTS OF STANDARD CHARACTERS WITHOUT CLAIM TO ANY PARTICULAR FONT, STYLE, SIZE, OR COLOR.

SN 85-227,285, FILED 1-27-2011.

RICHARD WHITE, EXAMINING ATTORNEY



David J. Kybas

Director of the United States Patent and Trademark Office

United States of America

United States Patent and Trademark Office

RANCHO ESTANCIA

Reg. No. 4,110,080

RHE HATCO, INC. (DELAWARE CORPORATION)
601 MARION DRIVE
GARLAND, TX 75042

Registered Mar. 6, 2012

Int. Cl.: 25

FOR: CLOTHING, NAMELY, SHIRTS, SHORTS, PANTS, TOPS, T-SHIRTS AND HEADWEAR, NAMELY, HATS AND CAPS, IN CLASS 25 (U.S. CLS. 22 AND 39).

TRADEMARK

FIRST USE 6-30-2011; IN COMMERCE 6-30-2011.

PRINCIPAL REGISTER

THE MARK CONSISTS OF STANDARD CHARACTERS WITHOUT CLAIM TO ANY PARTICULAR FONT, STYLE, SIZE, OR COLOR.

THE ENGLISH TRANSLATION OF "RANCHO ESTANCIA" IN THE MARK IS "RANCH STAY".

SN 85-227,839, FILED 1-27-2011.

GENE MACIOL, EXAMINING ATTORNEY



David J. Kybas

Director of the United States Patent and Trademark Office

United States of America

United States Patent and Trademark Office

THE POLICY LAB

Reg. No. 4,110,081

THE POLICY LAB, LTD. (MASSACHUSETTS CORPORATION)
321 COLUMBUS AVENUE, 7TH FLOOR
BOSTON, MA 02116

Registered Mar. 6, 2012

Int. Cl.: 35

FOR: CONSULTING SERVICES FOR BOTH THE PUBLIC AND PRIVATE SECTORS, IN THE FIELD OF RESEARCH, DESIGN, AND IMPLEMENTATION OF HUMANITARIAN, DEVELOPMENT, AND SECURITY POLICIES AND SERVICES FOR PUBLIC BENEFICIARIES AND LOCAL COMMUNITIES, IN CLASS 35 (U.S. CLS. 100, 101 AND 102).

SERVICE MARK

PRINCIPAL REGISTER

FIRST USE 1-31-2011; IN COMMERCE 1-31-2011.

THE MARK CONSISTS OF STANDARD CHARACTERS WITHOUT CLAIM TO ANY PARTICULAR FONT, STYLE, SIZE, OR COLOR.

NO CLAIM IS MADE TO THE EXCLUSIVE RIGHT TO USE "POLICY", APART FROM THE MARK AS SHOWN.

SN 85-228,402, FILED 1-28-2011.

AMY C. KEAN, EXAMINING ATTORNEY



David J. Kappas

Director of the United States Patent and Trademark Office

United States of America

United States Patent and Trademark Office

Eyesome

Reg. No. 4,110,082

LIUZHOU WULING MOTORS CO., LTD. (CHINA CORPORATION)
NO. 18 HEXI ROAD, LIUZHOU
GUANGXI, CHINA

Registered Mar. 6, 2012

Int. Cl.: 12

FOR: AUTOMOBILES; TRACTORS; ELECTRIC CARS; REFRIGERATED TRAILERS;
COACHES; MOTOR HOMES; AUTOMOBILE CHASSIS; AUTOMOBILE BODIES; VANS;
MOTORS FOR AUTOMOBILES; MOTORCYCLES; AMBULANCES, IN CLASS 12 (U.S. CLS.
19, 21, 23, 31, 35 AND 44).

TRADEMARK

PRINCIPAL REGISTER

FIRST USE 6-25-2010; IN COMMERCE 7-8-2011.

THE MARK CONSISTS OF THE STYLIZED WORD "EYESOME".

SN 85-228,582, FILED 1-28-2011.

WARREN L. OLANDRIA, EXAMINING ATTORNEY



David J. Kyfos

Director of the United States Patent and Trademark Office

United States of America

United States Patent and Trademark Office

EXPLORER

Reg. No. 4,110,083

Registered Mar. 6, 2012

Int. Cl.: 1

TRADEMARK

PRINCIPAL REGISTER

OLYMPIC OIL, LTD. (ILLINOIS CORPORATION)
5000 W 41ST STREET
CICERO, IL 608044524

FOR: CHEMICAL ADDITIVES FOR FUELS, NAMELY, FUEL STABILIZERS, IN CLASS 1
(U.S. CLS. 1, 5, 6, 10, 26 AND 46).

FIRST USE 12-4-2011; IN COMMERCE 12-4-2011.

THE MARK CONSISTS OF STANDARD CHARACTERS WITHOUT CLAIM TO ANY PARTICULAR FONT, STYLE, SIZE, OR COLOR.

SN 85-228,699, FILED 1-28-2011.

ALICE BENMAMAN, EXAMINING ATTORNEY



David J. Kybas

Director of the United States Patent and Trademark Office

United States of America

United States Patent and Trademark Office



Reg. No. 4,110,084

Registered Mar. 6, 2012

Int. Cls.: 1 and 4

TRADEMARK

PRINCIPAL REGISTER

OLYMPIC OIL, LTD. (ILLINOIS CORPORATION)
5000 W 41ST STREET
CICERO, IL 608044524

FOR: CHEMICAL ADDITIVES FOR FUELS, NAMELY, FUEL STABILIZERS, IN CLASS 1 (U.S. CLS. 1, 5, 6, 10, 26 AND 46).

FIRST USE 12-4-2011; IN COMMERCE 12-4-2011.

FOR: ENGINE OILS; LUBRICATING OILS; NON-CHEMICAL ADDITIVES FOR FUELS, NAMELY, FUEL STABILIZERS, IN CLASS 4 (U.S. CLS. 1, 6 AND 15).

FIRST USE 12-4-2011; IN COMMERCE 12-4-2011.

THE MARK CONSISTS OF TWO WINGS IN A CIRCLE BEHIND THE WORD "EXPLORER".

SN 85-228,706, FILED 1-28-2011.

ALICE BENMAMAN, EXAMINING ATTORNEY



David J. Kybas

Director of the United States Patent and Trademark Office

United States of America

United States Patent and Trademark Office

RecipPeeps

Reg. No. 4,110,085

Registered Mar. 6, 2012

Int. Cls.: 38, 42, and 45

SERVICE MARK

PRINCIPAL REGISTER

RECIPPEEPS, INC. (FLORIDA CORPORATION)
10435 MIDTOWN PARKWAY, SUITE 419
JACKSONVILLE, FL 32246

FOR: PROVIDING ONLINE CHAT ROOMS FOR REGISTERED USERS FOR TRANSMISSION OF MESSAGES CONCERNING VIRTUAL COMMUNITIES AND SOCIAL NETWORKING , IN CLASS 38 (U.S. CLS. 100, 101 AND 104).

FIRST USE 1-19-2011; IN COMMERCE 1-19-2011.

FOR: CUSTOMIZED WEB PAGES FEATURING USER-DEFINED INFORMATION, PERSONAL PROFILES AND INFORMATION, IN CLASS 42 (U.S. CLS. 100 AND 101).

FIRST USE 1-19-2011; IN COMMERCE 1-19-2011.

FOR: ONLINE SOCIAL NETWORKING SERVICES, IN CLASS 45 (U.S. CLS. 100 AND 101).

FIRST USE 1-19-2011; IN COMMERCE 1-19-2011.

THE MARK CONSISTS OF STANDARD CHARACTERS WITHOUT CLAIM TO ANY PARTICULAR FONT, STYLE, SIZE, OR COLOR.

SN 85-228,989, FILED 1-28-2011.

GINA HAYES, EXAMINING ATTORNEY



David J. Kyros

Director of the United States Patent and Trademark Office

United States of America

United States Patent and Trademark Office

Give the Best for Less

Reg. No. 4,110,086

Registered Mar. 6, 2012

Int. Cl.: 16

TRADEMARK

PRINCIPAL REGISTER

DESIGNER GREETINGS, INC. (NEW YORK CORPORATION)
11 EXECUTIVE AVENUE
EDISON, NJ 08817

FOR: GREETING CARDS, IN CLASS 16 (U.S. CLS. 2, 5, 22, 23, 29, 37, 38 AND 50).

FIRST USE 12-12-2011; IN COMMERCE 12-12-2011.

THE MARK CONSISTS OF STANDARD CHARACTERS WITHOUT CLAIM TO ANY PARTICULAR FONT, STYLE, SIZE, OR COLOR.

SN 85-229,106, FILED 1-28-2011.

TRACY FLETCHER, EXAMINING ATTORNEY



David J. Kybas

Director of the United States Patent and Trademark Office

United States of America

United States Patent and Trademark Office

PLEX WRAP

Reg. No. 4,110,087

ESPLEX INTERNATIONAL, LLC (FLORIDA LIMITED LIABILITY COMPANY)
P.O. BOX 201817
ROYAL PALM BEACH, FL 33421

Registered Mar. 6, 2012

Int. Cl.: 24

FOR: RESIN IMPREGNATED FIBERGLASS CLOTH ADHESIVE TAPE FOR INDUSTRIAL AND COMMERCIAL USE, IN CLASS 24 (U.S. CLS. 42 AND 50).

TRADEMARK

FIRST USE 2-17-2011; IN COMMERCE 2-17-2011.

PRINCIPAL REGISTER

THE MARK CONSISTS OF STANDARD CHARACTERS WITHOUT CLAIM TO ANY PARTICULAR FONT, STYLE, SIZE, OR COLOR.

NO CLAIM IS MADE TO THE EXCLUSIVE RIGHT TO USE "WRAP", APART FROM THE MARK AS SHOWN.

SN 85-229,112, FILED 1-28-2011.

CAROLYN CATALDO, EXAMINING ATTORNEY



David J. Kybas

Director of the United States Patent and Trademark Office

United States of America

United States Patent and Trademark Office

Torpedo Fries

Reg. No. 4,110,088

Registered Mar. 6, 2012

Int. Cl.: 29

TRADEMARK

PRINCIPAL REGISTER

MEG ENTERPRISES, LLC (MARYLAND LIMITED LIABILITY COMPANY)
PO BOX 351
DAMASCUS, MD 20872

FOR: FRIED POTATOES, IN CLASS 29 (U.S. CL. 46).

FIRST USE 4-1-2011; IN COMMERCE 4-30-2011.

THE MARK CONSISTS OF STANDARD CHARACTERS WITHOUT CLAIM TO ANY PARTICULAR FONT, STYLE, SIZE, OR COLOR.

NO CLAIM IS MADE TO THE EXCLUSIVE RIGHT TO USE "FRIES", APART FROM THE MARK AS SHOWN.

SN 85-229,564, FILED 1-30-2011.

JANICE KIM, EXAMINING ATTORNEY



David J. Kyros

Director of the United States Patent and Trademark Office

United States of America

United States Patent and Trademark Office

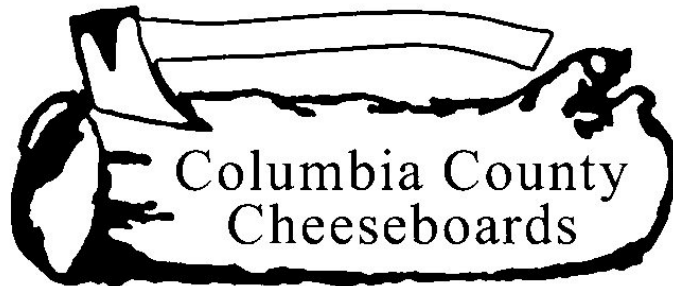

Reg. No. 4,110,089

Registered Mar. 6, 2012

Int. Cl.: 21

TRADEMARK

PRINCIPAL REGISTER

COLUMBIA COUNTY CHEESEBOARDS LLC (NEW YORK LIMITED LIABILITY COMPANY)
1837 COUNTY ROUTE 5
CANAAN, NY 12029

FOR: CHEESE BOARDS; CUTTING BOARDS, IN CLASS 21 (U.S. CLS. 2, 13, 23, 29, 30, 33, 40 AND 50).

FIRST USE 8-15-2011; IN COMMERCE 8-15-2011.

NO CLAIM IS MADE TO THE EXCLUSIVE RIGHT TO USE "COLUMBIA COUNTY CHEESEBOARDS", APART FROM THE MARK AS SHOWN.

THE MARK CONSISTS OF A LOG WITH AN AXE INSERTED WITH THE "COLUMBIA COUNTY CHEESEBOARDS" WORDS INSIDE.

SN 85-230,094, FILED 1-31-2011.

MICHAEL ENGEL, EXAMINING ATTORNEY



David J. Kybas

Director of the United States Patent and Trademark Office

United States of America
United States Patent and Trademark Office

BOVASTART

Reg. No. 4,110,090

KENT NUTRITION GROUP, INC. (IOWA CORPORATION)
1600 OREGON STREET, P.O. BOX 749
MUSCATINE, IA 52761

Registered Mar. 6, 2012

Int. Cl.: 5

FOR: MEDICATED LIVESTOCK FEEDS, IN CLASS 5 (U.S. CLS. 6, 18, 44, 46, 51 AND 52).

TRADEMARK

FIRST USE 12-21-2010; IN COMMERCE 1-1-2011.

PRINCIPAL REGISTER

THE MARK CONSISTS OF STANDARD CHARACTERS WITHOUT CLAIM TO ANY PARTICULAR FONT, STYLE, SIZE, OR COLOR.

OWNER OF U.S. REG. NO. 3,651,947.

SN 85-230,948, FILED 2-1-2011.

DOMINIC J. FERRAIUOLO, EXAMINING ATTORNEY



David J. Kyffers

Director of the United States Patent and Trademark Office

United States of America

United States Patent and Trademark Office

JENNI BY JENNI RIVERA

Reg. No. 4,110,091

JENNI RIVERA ENTERPRISES INC. (CALIFORNIA CORPORATION)
3830 ENCINO VERDE PL.
ENCINO, CA 91436

Registered Mar. 6, 2012

Int. Cl.: 3

FOR: PERFUME, IN CLASS 3 (U.S. CLS. 1, 4, 6, 50, 51 AND 52).

TRADEMARK

FIRST USE 8-1-2011; IN COMMERCE 8-1-2011.

PRINCIPAL REGISTER

THE MARK CONSISTS OF STANDARD CHARACTERS WITHOUT CLAIM TO ANY PARTICULAR FONT, STYLE, SIZE, OR COLOR.

THE NAME(S), PORTRAIT(S), AND/OR SIGNATURE(S) SHOWN IN THE MARK IDENTIFIES "JENNI RIVERA", WHOSE CONSENT(S) TO REGISTER IS MADE OF RECORD.

SN 85-231,392, FILED 2-1-2011.

SHAUNIA CARLYLE, EXAMINING ATTORNEY



David J. Kyffers

Director of the United States Patent and Trademark Office

United States of America

United States Patent and Trademark Office

BOUDIKA

Reg. No. 4,110,092

BOUDIKA, LLC (MINNESOTA LIMITED LIABILITY COMPANY)
324 PEBBLE RD N
CHAMPLIN, MN 55316

Registered Mar. 6, 2012

Int. Cl.: 25

FOR: CLOTHING, NAMELY, JACKETS, SHIRTS, T-SHIRTS, SWEATSHIRTS, PANTS, SHORTS, CAPS, HATS, IN CLASS 25 (U.S. CLS. 22 AND 39).

TRADEMARK

FIRST USE 12-1-2011; IN COMMERCE 12-1-2011.

PRINCIPAL REGISTER

SN 85-231,845, FILED 2-1-2011.

ALICIA COLLINS, EXAMINING ATTORNEY



David J. Kybas

Director of the United States Patent and Trademark Office

United States of America

United States Patent and Trademark Office

Solomon and Samson

Reg. No. 4,110,093

Registered Mar. 6, 2012

Int. Cl.: 5

TRADEMARK

PRINCIPAL REGISTER

SOLOMON AND SAMSON, INC. (NEW YORK CORPORATION)
SUITE 2
390 KINGSTON AVENUE
BROOKLYN, NY 11225

FOR: DIETARY AND NUTRITIONAL SUPPLEMENTS, IN CLASS 5 (U.S. CLS. 6, 18, 44, 46, 51 AND 52).

FIRST USE 11-3-2011; IN COMMERCE 11-8-2011.

THE MARK CONSISTS OF STANDARD CHARACTERS WITHOUT CLAIM TO ANY PARTICULAR FONT, STYLE, SIZE, OR COLOR.

SN 85-232,141, FILED 2-2-2011.

ANDREA K. NADELMAN, EXAMINING ATTORNEY



David J. Kyffers

Director of the United States Patent and Trademark Office

United States of America

United States Patent and Trademark Office

SEALFAST

Reg. No. 4,110,094

TEKNOR APEX COMPANY (DELAWARE CORPORATION)
505 CENTRAL AVE.
PAWTUCKET, RI 02861

Registered Mar. 6, 2012

Int. Cl.: 6

FOR: METAL COUPLINGS FOR USE WITH GARDEN HOSES OR WATERING HOSES, IN CLASS 6 (U.S. CLS. 2, 12, 13, 14, 23, 25 AND 50).

TRADEMARK

FIRST USE 9-30-2011; IN COMMERCE 9-30-2011.

PRINCIPAL REGISTER

THE MARK CONSISTS OF STANDARD CHARACTERS WITHOUT CLAIM TO ANY PARTICULAR FONT, STYLE, SIZE, OR COLOR.

SN 85-232,914, FILED 2-3-2011.

PAM WILLIS, EXAMINING ATTORNEY



David J. Kybas

Director of the United States Patent and Trademark Office

United States of America

United States Patent and Trademark Office

THEORY

Reg. No. 4,110,095

Registered Mar. 6, 2012

Int. Cl.: 9

TRADEMARK

PRINCIPAL REGISTER

MOTOROLA TRADEMARK HOLDINGS, LLC (DELAWARE LIMITED LIABILITY COMPANY)
600 N. US HIGHWAY 45
LIBERTYVILLE, IL 60048

FOR: CELLULAR PHONES AND SMARTPHONES, IN CLASS 9 (U.S. CLS. 21, 23, 26, 36 AND 38).

FIRST USE 5-22-2011; IN COMMERCE 5-22-2011.

THE MARK CONSISTS OF STANDARD CHARACTERS WITHOUT CLAIM TO ANY PARTICULAR FONT, STYLE, SIZE, OR COLOR.

SN 85-232,975, FILED 2-3-2011.

KEVIN DINALLO, EXAMINING ATTORNEY



David J. Kyffers

Director of the United States Patent and Trademark Office

United States of America

United States Patent and Trademark Office

FASHION WAND

Reg. No. 4,110,096

Registered Mar. 6, 2012

Int. Cl.: 20

TRADEMARK

PRINCIPAL REGISTER

SAFE-T-SHADE, INC. (NORTH CAROLINA CORPORATION)
2347 WEST HANFORD ROAD
BURLINGTON, NC 27215

FOR: WINDOW SHADES, IN CLASS 20 (U.S. CLS. 2, 13, 22, 25, 32 AND 50).

FIRST USE 12-1-2011; IN COMMERCE 12-1-2011.

THE MARK CONSISTS OF STANDARD CHARACTERS WITHOUT CLAIM TO ANY PARTICULAR FONT, STYLE, SIZE, OR COLOR.

NO CLAIM IS MADE TO THE EXCLUSIVE RIGHT TO USE "WAND", APART FROM THE MARK AS SHOWN.

SN 85-236,307, FILED 2-8-2011.

HANNO RITTNER, EXAMINING ATTORNEY



David J. Kyffers

Director of the United States Patent and Trademark Office

United States of America

United States Patent and Trademark Office

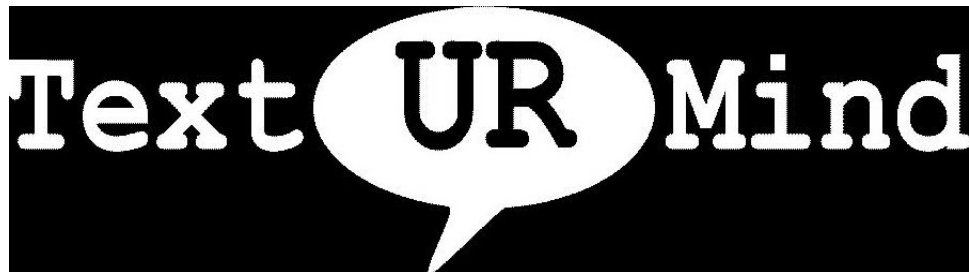

Reg. No. 4,110,097

BOGDAN RENTEA (UNITED STATES INDIVIDUAL)
1002 RIO GRANDE
AUSTIN, TX 78701

Registered Mar. 6, 2012

Int. Cl.: 38

FOR: PROVIDING ONLINE FORUMS FOR THE TRANSMISSION OF MESSAGES BY USERS OF MOBILE DEVICES CONCERNING REVIEWS, RECOMMENDATIONS, OPINIONS AND INFORMATION RELATING TO PRODUCTS, SERVICES, EXPERIENCES, EVENTS AND ACTIVITIES, IN CLASS 38 (U.S. CLS. 100, 101 AND 104).

SERVICE MARK

PRINCIPAL REGISTER

FIRST USE 3-31-2011; IN COMMERCE 3-31-2011.

THE MARK CONSISTS OF THE WORDS "TEXT UR MIND" WITH "UR" APPEARING IN AN OVAL CONVERSATION BUBBLE.

SN 85-237,878, FILED 2-9-2011.

ANGELA M. MICHELLI, EXAMINING ATTORNEY



David J. Kybas

Director of the United States Patent and Trademark Office

United States of America

United States Patent and Trademark Office

TEXT ABOUT IT (BEFORE THAT
FEELING IS GONE!)

Reg. No. 4,110,098

BOGDAN RENTEА (UNITED STATES INDIVIDUAL)
1002 RIO GRANDE
AUSTIN, TX 78701

Registered Mar. 6, 2012

Int. Cl.: 38

FOR: PROVIDING ONLINE FORUMS FOR THE TRANSMISSION OF MESSAGES BY USERS OF MOBILE DEVICES CONCERNING REVIEWS, RECOMMENDATIONS, OPINIONS AND INFORMATION RELATING TO PRODUCTS, SERVICES, EXPERIENCES, EVENTS AND ACTIVITIES, IN CLASS 38 (U.S. CLS. 100, 101 AND 104).

SERVICE MARK

PRINCIPAL REGISTER

FIRST USE 3-31-2011; IN COMMERCE 3-31-2011.

THE MARK CONSISTS OF STANDARD CHARACTERS WITHOUT CLAIM TO ANY PARTICULAR FONT, STYLE, SIZE, OR COLOR.

SN 85-237,883, FILED 2-9-2011.

ANGELA M. MICHELLI, EXAMINING ATTORNEY



David J. Kybas

Director of the United States Patent and Trademark Office

United States of America

United States Patent and Trademark Office

SOUR BRITE EGGS

Reg. No. 4,110,099

Registered Mar. 6, 2012

Int. Cl.: 30

TRADEMARK

PRINCIPAL REGISTER

FARLEY'S & SATHERS CANDY COMPANY, INC. (DELAWARE CORPORATION)
P.O. BOX 28, ONE SATHER PLAZA
ROUND LAKE, MN 56167

FOR: CANDY, IN CLASS 30 (U.S. CL. 46).

FIRST USE 11-7-2011; IN COMMERCE 11-7-2011.

THE MARK CONSISTS OF STANDARD CHARACTERS WITHOUT CLAIM TO ANY PARTICULAR FONT, STYLE, SIZE, OR COLOR.

NO CLAIM IS MADE TO THE EXCLUSIVE RIGHT TO USE "SOUR" AND "EGGS", APART FROM THE MARK AS SHOWN.

SN 85-238,729, FILED 2-10-2011.

TEJBIR SINGH, EXAMINING ATTORNEY



David J. Kyffers

Director of the United States Patent and Trademark Office

United States of America

United States Patent and Trademark Office

NLS

Reg. No. 4,110,100

NEXT LEVEL SPORTS INC. (PENNSYLVANIA CORPORATION)
P.O. BOX 334
ARDMORE, PA 19003

Registered Mar. 6, 2012

Int. Cl.: 41

FOR: ORGANIZING AND PROVIDING YOUTH SPORT ACTIVITIES, IN CLASS 41 (U.S. CLS. 100, 101 AND 107).

SERVICE MARK

FIRST USE 12-31-2008; IN COMMERCE 12-31-2008.

PRINCIPAL REGISTER

THE MARK CONSISTS OF STANDARD CHARACTERS WITHOUT CLAIM TO ANY PARTICULAR FONT, STYLE, SIZE, OR COLOR.

SN 85-239,383, FILED 2-10-2011.

APRIL HESIK, EXAMINING ATTORNEY



David J. Kybas

Director of the United States Patent and Trademark Office

United States of America

United States Patent and Trademark Office

AMERICA'S GOT FASHION

Reg. No. 4,110,101

Registered Mar. 6, 2012

Int. Cls.: 14 and 25

ASSAWAKULPAIBOOL, AUNCHALEE (THAILAND INDIVIDUAL), DBA AMERICAS GOT FASHION,
8 E. STEMMER LANE
8 E. STEMMER LANE
SUFFERN, NY 10901

TRADEMARK

PRINCIPAL REGISTER

FOR: BODY JEWELRY; BRACELETS; CHARMS; HAIR JEWELRY IN THE NATURE OF JEWELRY FOR USE IN THE HAIR; IDENTIFICATION BRACELETS; JEWELRY; JEWELRY FOR ATTACHMENT TO CLOTHING; JEWELRY FOR THE HEAD; RINGS; WOMEN'S JEWELRY, IN CLASS 14 (U.S. CLS. 2, 27, 28 AND 50).

FIRST USE 5-1-2011; IN COMMERCE 5-1-2011.

FOR: BELTS; BOTTOMS; CLOTHING FOR BABIES, TODDLERS AND CHILDREN, TREATED WITH FIRE AND HEAT RETARDANTS, NAMELY, PAJAMAS, JACKETS, SHIRTS, PANTS, JUMPERS; CLOTHING, NAMELY, ATHLETIC SLEEVES; CLOTHING, NAMELY, KHAKIS; CLOTHING, NAMELY, NECK TUBES; GLOVES AS CLOTHING; HEADBANDS FOR CLOTHING; HOODS; INFANT AND TODDLER ONE PIECE CLOTHING; JACKETS; JERSEYS; LEATHER BELTS; MANTLES; MUFFLERS; PARTS OF CLOTHING, NAMELY, GUSSETS FOR TIGHTS, GUSSETS FOR STOCKINGS, GUSSETS FOR BATHING SUITS, GUSSETS FOR UNDERWEAR, GUSSETS FOR LEOTARDS AND GUSSETS FOR FOOTLETS; PARTS OF CLOTHING, NAMELY, UNDERARM GUSSETS; SHORT SETS; SHOULDER WRAPS; SHOULDER WRAPS FOR CLOTHING; SWADDLING CLOTHES; TIES; TOPS; TRAVEL CLOTHING CONTAINED IN A PACKAGE COMPRISING REVERSIBLE JACKETS, PANTS, SKIRTS, TOPS AND A BELT OR SCARF; TRIATHLON CLOTHING, NAMELY, TRIATHLON TIGHTS, TRIATHLON SHORTS, TRIATHLON SINGLET, TRIATHLON SHIRTS, TRIATHLON SUITS; UNDERARM CLOTHING SHIELDS; WEARABLE GARMENTS AND CLOTHING, NAMELY, SHIRTS; WOMEN'S CLOTHING, NAMELY, SHIRTS, DRESSES, SKIRTS, BLOUSES; WRAPS, IN CLASS 25 (U.S. CLS. 22 AND 39).

FIRST USE 5-1-2011; IN COMMERCE 5-1-2011.

THE MARK CONSISTS OF STANDARD CHARACTERS WITHOUT CLAIM TO ANY PARTICULAR FONT, STYLE, SIZE, OR COLOR.

SN 85-239,396, FILED 2-10-2011.



David J. Kyros

Director of the United States Patent and Trademark Office

Reg. No. 4,110,101 SAIMA MAKHDOOM, EXAMINING ATTORNEY

United States of America

United States Patent and Trademark Office

Geneva's Organic Farms

Reg. No. 4,110,102

Registered Mar. 6, 2012

Int. Cl.: 31

TRADEMARK

PRINCIPAL REGISTER

BRENTWOOD DISTRIBUTIONS, LLC (NEW HAMPSHIRE LIMITED LIABILITY COMPANY)
C/O ROBERT EDMOND MITTEL
PO 427
PORTLAND, ME 04112

FOR: ORGANIC MULCH, IN CLASS 31 (U.S. CLS. 1 AND 46).

FIRST USE 12-1-2011; IN COMMERCE 12-1-2011.

THE MARK CONSISTS OF STANDARD CHARACTERS WITHOUT CLAIM TO ANY PARTICULAR FONT, STYLE, SIZE, OR COLOR.

NO CLAIM IS MADE TO THE EXCLUSIVE RIGHT TO USE "ORGANIC FARMS", APART FROM THE MARK AS SHOWN.

SN 85-240,452, FILED 2-11-2011.

CHRISTINA SOBRAL, EXAMINING ATTORNEY



David J. Kybas

Director of the United States Patent and Trademark Office

United States of America

United States Patent and Trademark Office

Evil Twin

Reg. No. 4,110,103

Registered Mar. 6, 2012

Int. Cl.: 32

TRADEMARK

PRINCIPAL REGISTER

ZAINASHEFF, JAMIL (UNITED STATES INDIVIDUAL)
STE. 106 #301
9630 BRUCEVILLE RD.
ELK GROVE, CA 95757

FOR: BEER, IN CLASS 32 (U.S. CLS. 45, 46 AND 48).

FIRST USE 9-29-2011; IN COMMERCE 12-1-2011.

THE MARK CONSISTS OF STANDARD CHARACTERS WITHOUT CLAIM TO ANY PARTICULAR FONT, STYLE, SIZE, OR COLOR.

SN 85-240,507, FILED 2-11-2011.

TOBY BULLOFF, EXAMINING ATTORNEY



David J. Kybas

Director of the United States Patent and Trademark Office

United States of America

United States Patent and Trademark Office

RECIPE PORTION

Reg. No. 4,110,104

Registered Mar. 6, 2012

Int. Cl.: 31

TRADEMARK

PRINCIPAL REGISTER

WORLD VARIETY PRODUCE, INC. (CALIFORNIA CORPORATION)
5325 SOUTH SOTO STREET
VERNON, CA 90058

FOR: FRESH HERBS, IN CLASS 31 (U.S. CLS. 1 AND 46).

FIRST USE 9-9-2010; IN COMMERCE 9-9-2010.

THE MARK CONSISTS OF STANDARD CHARACTERS WITHOUT CLAIM TO ANY PARTICULAR FONT, STYLE, SIZE, OR COLOR.

SN 85-240,932, FILED 2-12-2011.

MAYUR VAGHANI, EXAMINING ATTORNEY



David J. Kybas

Director of the United States Patent and Trademark Office

United States of America

United States Patent and Trademark Office

Piece Pouch

Reg. No. 4,110,105

MIKCO, LLC (NEVADA LIMITED LIABILITY COMPANY)
816 JACOBS LADDER PLACE
LAS VEGAS, NV 89138

Registered Mar. 6, 2012

Int. Cl.: 18

FOR: POUCHES MADE OUT OF CLOTH, IN CLASS 18 (U.S. CLS. 1, 2, 3, 22 AND 41).

TRADEMARK

FIRST USE 3-1-2011; IN COMMERCE 10-1-2011.

PRINCIPAL REGISTER

THE MARK CONSISTS OF STANDARD CHARACTERS WITHOUT CLAIM TO ANY PARTICULAR FONT, STYLE, SIZE, OR COLOR.

NO CLAIM IS MADE TO THE EXCLUSIVE RIGHT TO USE "POUCH", APART FROM THE MARK AS SHOWN.

SN 85-241,082, FILED 2-13-2011.

KATHERINE CHANG, EXAMINING ATTORNEY



David J. Kybas

Director of the United States Patent and Trademark Office

United States of America

United States Patent and Trademark Office

SIXGUN PICTURES

Reg. No. 4,110,106

BAKER, RYAN (UNITED STATES INDIVIDUAL)
740 WALKER AVE
RENO, NV 89509

Registered Mar. 6, 2012

Int. Cl.: 41

FOR: PHOTOGRAPHY, IN CLASS 41 (U.S. CLS. 100, 101 AND 107).

SERVICE MARK

FIRST USE 10-31-2006; IN COMMERCE 12-15-2011.

PRINCIPAL REGISTER

THE MARK CONSISTS OF STANDARD CHARACTERS WITHOUT CLAIM TO ANY PARTICULAR FONT, STYLE, SIZE, OR COLOR.

NO CLAIM IS MADE TO THE EXCLUSIVE RIGHT TO USE "PICTURES", APART FROM THE MARK AS SHOWN.

SN 85-241,152, FILED 2-14-2011.

JACQUELINE A. LAVINE, EXAMINING ATTORNEY



David J. Kybas

Director of the United States Patent and Trademark Office

United States of America

United States Patent and Trademark Office

DZE

Reg. No. 4,110,107

Registered Mar. 6, 2012

Int. Cl.: 9

TRADEMARK

PRINCIPAL REGISTER

NUVISIONS INTERNATIONAL, INC. (PENNSYLVANIA CORPORATION)
10 BUIST ROAD, SUITE 403
MILFORD, PA 18337

FOR: LIGHT PULSE SUPPRESSORS FOR USE IN TESTING FOR FIBER OPTIC LINES WHEN USING OPTICAL TIME DOMAIN REFLECTOMETERS, IN CLASS 9 (U.S. CLS. 21, 23, 26, 36 AND 38).

FIRST USE 3-8-2011; IN COMMERCE 3-8-2011.

THE MARK CONSISTS OF STANDARD CHARACTERS WITHOUT CLAIM TO ANY PARTICULAR FONT, STYLE, SIZE, OR COLOR.

SN 85-241,213, FILED 2-14-2011.

LESLIE RICHARDS, EXAMINING ATTORNEY



David J. Kybas

Director of the United States Patent and Trademark Office

United States of America

United States Patent and Trademark Office

Dynamic Message Optimization

Reg. No. 4,110,108

Registered Mar. 6, 2012

Int. Cl.: 35

SERVICE MARK

PRINCIPAL REGISTER

NAOMI KLAYMAN RESEARCH & CONSULTING, LLC (PENNSYLVANIA LIMITED LIABILITY COMPANY)
7340 RURAL LANE
PHILADELPHIA, PA 19119

FOR: MARKET RESEARCH SERVICES, IN CLASS 35 (U.S. CLS. 100, 101 AND 102).

FIRST USE 1-1-2011; IN COMMERCE 1-1-2011.

THE MARK CONSISTS OF STANDARD CHARACTERS WITHOUT CLAIM TO ANY PARTICULAR FONT, STYLE, SIZE, OR COLOR.

NO CLAIM IS MADE TO THE EXCLUSIVE RIGHT TO USE "MESSAGE OPTIMIZATION", APART FROM THE MARK AS SHOWN.

SN 85-241,513, FILED 2-14-2011.

SANI KHOURI, EXAMINING ATTORNEY



David J. Kyffers

Director of the United States Patent and Trademark Office

United States of America

United States Patent and Trademark Office

ARKIEVA

Reg. No. 4,110,109

Registered Mar. 6, 2012

Int. Cl.: 9

TRADEMARK

PRINCIPAL REGISTER

SUPPLY CHAIN CONSULTANTS, INC (DELAWARE CORPORATION)
5460 FAIRMONT DRIVE
WILMINGTON, DE 19808

FOR: COMPUTER SOFTWARE PROGRAMS FOR PROVIDING BUSINESS DECISION SUPPORT FOR FORECASTING, BUSINESS PLANNING, MANUFACTURING PLANNING, INVENTORY MANAGEMENT, DISTRIBUTION OF GOODS, FINANCIAL REPORTING, SALES AND OPERATIONS PLANNING, AND SCHEDULING OPERATIONS, IN CLASS 9 (U.S. CLS. 21, 23, 26, 36 AND 38).

FIRST USE 10-31-2011; IN COMMERCE 10-31-2011.

THE MARK CONSISTS OF STANDARD CHARACTERS WITHOUT CLAIM TO ANY PARTICULAR FONT, STYLE, SIZE, OR COLOR.

THE WORDING "ARKIEVA" HAS NO MEANING IN A FOREIGN LANGUAGE.

SN 85-241,655, FILED 2-14-2011.

DOUGLAS LEE, EXAMINING ATTORNEY



David J. Kypos

Director of the United States Patent and Trademark Office

United States of America

United States Patent and Trademark Office

REACH

Reg. No. 4,110,110

SPARTAN MOTORS, INC. (MICHIGAN CORPORATION)
1000 REYNOLDS ROAD
CHARLOTTE, MI 48813

Registered Mar. 6, 2012

Int. Cl.: 12

FOR: MOTOR VEHICLES, NAMELY, AUTOMOBILES, TRUCKS, VANS, SPORT UTILITY VEHICLES AND STRUCTURAL PARTS THEREFOR; TRUCKS AND STRUCTURAL PARTS THEREFOR; VANS AND STRUCTURAL PARTS THEREFOR, IN CLASS 12 (U.S. CLS. 19, 21, 23, 31, 35 AND 44).

TRADEMARK

PRINCIPAL REGISTER

FIRST USE 3-8-2011; IN COMMERCE 8-23-2011.

THE MARK CONSISTS OF STANDARD CHARACTERS WITHOUT CLAIM TO ANY PARTICULAR FONT, STYLE, SIZE, OR COLOR.

SN 85-241,701, FILED 2-14-2011.

SALLY SHIH, EXAMINING ATTORNEY



David J. Kybas

Director of the United States Patent and Trademark Office

United States of America

United States Patent and Trademark Office

TRIPLE ACTION BRIGHT-WHITE-CLEAN

Reg. No. 4,110,111

PURE & NATURAL COMPANY (ARIZONA CORPORATION)

Registered Mar. 6, 2012

M.S. 01.45
19001 NORTH SCOTTSDALE ROAD
SCOTTSDALE, AZ 85255

Int. Cl.: 3

FOR: LAUNDRY DETERGENTS, IN CLASS 3 (U.S. CLS. 1, 4, 6, 50, 51 AND 52).

TRADEMARK

FIRST USE 10-8-2011; IN COMMERCE 10-8-2011.

PRINCIPAL REGISTER

THE MARK CONSISTS OF STANDARD CHARACTERS WITHOUT CLAIM TO ANY PARTICULAR FONT, STYLE, SIZE, OR COLOR.

NO CLAIM IS MADE TO THE EXCLUSIVE RIGHT TO USE "TRIPLE-ACTION", APART FROM THE MARK AS SHOWN.

SN 85-241,810, FILED 2-14-2011.

LAURIE MAYES, EXAMINING ATTORNEY



David J. Kyros

Director of the United States Patent and Trademark Office

United States of America

United States Patent and Trademark Office

Everyday Yogini

Reg. No. 4,110,112

Registered Mar. 6, 2012

Int. Cl.: 41

SERVICE MARK

PRINCIPAL REGISTER

MAGNETTA, DURGA (UNITED STATES INDIVIDUAL), TA EVERYDAY YOGINI,
P.O. BOX 2424 EL SEGUNDO, CA 90245
1105 GOODMAN AVENUE
REDONDO BEACH, CA 90278

FOR: MEDITATION TRAINING, IN CLASS 41 (U.S. CLS. 100, 101 AND 107).

FIRST USE 3-6-2011; IN COMMERCE 3-6-2011.

THE MARK CONSISTS OF STANDARD CHARACTERS WITHOUT CLAIM TO ANY PARTICULAR FONT, STYLE, SIZE, OR COLOR.

NO CLAIM IS MADE TO THE EXCLUSIVE RIGHT TO USE "YOGINI", APART FROM THE MARK AS SHOWN.

SN 85-242,240, FILED 2-15-2011.

MARK SHINER, EXAMINING ATTORNEY



David J. Kyffers

Director of the United States Patent and Trademark Office

United States of America
United States Patent and Trademark Office

just
wink

Reg. No. 4,110,113

AGC, LLC (DELAWARE LIMITED LIABILITY COMPANY)
ONE AMERICAN ROAD
CLEVELAND, OH 44144

Registered Mar. 6, 2012

Int. Cl.: 45

FOR: PROVIDING A SELECTION OF ON-LINE ELECTRONIC GREETING CARDS, IN CLASS 45 (U.S. CLS. 100 AND 101).

SERVICE MARK

FIRST USE 6-30-2011; IN COMMERCE 6-30-2011.

PRINCIPAL REGISTER

THE MARK CONSISTS OF THE WORDS "JUST WINK". THE TITLE OVER THE LETTER "I" HAS A FANCIFUL DESIGN OF A FLOWER IN IT.

SN 85-242,936, FILED 2-15-2011.

KRISTIN CARLSON, EXAMINING ATTORNEY



David J. Kybas

Director of the United States Patent and Trademark Office

United States of America

United States Patent and Trademark Office

Auggusie

Reg. No. 4,110,114

TAN, SHUAI (UNITED STATES INDIVIDUAL)
18755 RUNNYMEDE ST.
RESEDA, CA 91335

Registered Mar. 6, 2012

Int. Cl.: 25

FOR: CHILDREN AND WOMEN'S APPAREL, NAMELY, JACKETS, COATS, BLOUSES, SHIRTS, PAJAMAS, SCARVES, UNDERWEAR, SKIRTS, DRESSES, TOPS, PANTS, CAPS, AND SWEATERS, IN CLASS 25 (U.S. CLS. 22 AND 39).

TRADEMARK

FIRST USE 1-1-2011; IN COMMERCE 1-1-2011.

PRINCIPAL REGISTER

THE MARK CONSISTS OF STANDARD CHARACTERS WITHOUT CLAIM TO ANY PARTICULAR FONT, STYLE, SIZE, OR COLOR.

THE WORDING "AUGGUSIE" HAS NO MEANING IN A FOREIGN LANGUAGE.

SN 85-243,093, FILED 2-15-2011.

ELLEN B. AWRICH, EXAMINING ATTORNEY



David J. Kyros

Director of the United States Patent and Trademark Office

United States of America
United States Patent and Trademark Office

NANOFLO

Reg. No. 4,110,115

Registered Mar. 6, 2012

Int. Cls.: 11 and 12

TRADEMARK

PRINCIPAL REGISTER

MOMENTUM DISTRIBUTION CORP (TEXAS CORPORATION), DBA AIR STRATEGIES,
11100 VALLEY BLVD.
STE. 203
EL MONTE, CA 91731

FOR: AIR FILTERS FOR AIR CONDITIONING UNITS, IN CLASS 11 (U.S. CLS. 13, 21, 23,
31 AND 34).

FIRST USE 2-16-2011; IN COMMERCE 3-0-2011.

FOR: AUTOMOBILES AND STRUCTURAL PARTS THEREFOR; STRUCTURAL PARTS
FOR AUTOMOBILES, IN CLASS 12 (U.S. CLS. 19, 21, 23, 31, 35 AND 44).

FIRST USE 2-16-2011; IN COMMERCE 3-0-2011.

THE MARK CONSISTS OF STANDARD CHARACTERS WITHOUT CLAIM TO ANY PAR-
TICULAR FONT, STYLE, SIZE, OR COLOR.

SN 85-243,318, FILED 2-16-2011.

SANJEEV VOHRA, EXAMINING ATTORNEY



David J. Kyros

Director of the United States Patent and Trademark Office

United States of America

United States Patent and Trademark Office

NANÖFLO

Reg. No. 4,110,116

Registered Mar. 6, 2012

Int. Cls.: 11 and 12

TRADEMARK

PRINCIPAL REGISTER

MOMENTUM DISTRIBUTION CORP (TEXAS CORPORATION), DBA AIR STRATEGIES,
11100 VALLEY BLVD.
STE. 203
EL MONTE, CA 91731

FOR: AIR FILTERS FOR AIR CONDITIONING UNITS, IN CLASS 11 (U.S. CLS. 13, 21, 23,
31 AND 34).

FIRST USE 2-16-2011; IN COMMERCE 3-0-2011.

FOR: AUTOMOBILES AND STRUCTURAL PARTS THEREFOR; STRUCTURAL PARTS
FOR AUTOMOBILES, IN CLASS 12 (U.S. CLS. 19, 21, 23, 31, 35 AND 44).

FIRST USE 2-16-2011; IN COMMERCE 3-0-2011.

THE MARK CONSISTS OF THE WORD "NANOFLO" WITH A LINE ABOVE EACH LETTER
"O".

SN 85-243,329, FILED 2-16-2011.

SANJEEV VOHRA, EXAMINING ATTORNEY



David J. Kyros

Director of the United States Patent and Trademark Office

United States of America

United States Patent and Trademark Office

COTTON FAIR

Reg. No. 4,110,117

Registered Mar. 6, 2012

Int. Cl.: 23

TRADEMARK

PRINCIPAL REGISTER

UNIVERSAL YARN, INC. (NORTH CAROLINA CORPORATION)
284 ANN STREET NW
CONCORD, NC 28025

FOR: YARNS CONTAINING COTTON, IN CLASS 23 (U.S. CL. 43).

FIRST USE 9-1-2011; IN COMMERCE 9-1-2011.

THE MARK CONSISTS OF STANDARD CHARACTERS WITHOUT CLAIM TO ANY PARTICULAR FONT, STYLE, SIZE, OR COLOR.

NO CLAIM IS MADE TO THE EXCLUSIVE RIGHT TO USE "COTTON", APART FROM THE MARK AS SHOWN.

SN 85-243,379, FILED 2-16-2011.

BRIAN NEVILLE, EXAMINING ATTORNEY



David J. Kyffers

Director of the United States Patent and Trademark Office

United States of America

United States Patent and Trademark Office

TRUST IN PARTNERSHIP

Reg. No. 4,110,118

BROWN BROTHERS HARRIMAN & CO. (NEW YORK PARTNERSHIP)
140 BROADWAY
NEW YORK, NY 10005

Registered Mar. 6, 2012

Int. Cl.: 36

FOR: BANKING AND FINANCIAL SERVICES, NAMELY, WEALTH PLANNING AND FIDUCIARY SERVICES, TRUST AND ESTATE GUIDANCE, INVESTMENT AND PORTFOLIO MANAGEMENT, CORPORATE BANKING; SECURITIES SERVICES, NAMELY, GLOBAL CUSTODY, ADMINISTRATION, RESEARCH AND EXECUTION SERVICES, ALL RELATING TO FINANCIAL SECURITIES, IN CLASS 36 (U.S. CLS. 100, 101 AND 102).

SERVICE MARK

PRINCIPAL REGISTER

FIRST USE 12-19-2011; IN COMMERCE 12-19-2011.

THE MARK CONSISTS OF STANDARD CHARACTERS WITHOUT CLAIM TO ANY PARTICULAR FONT, STYLE, SIZE, OR COLOR.

SN 85-244,308, FILED 2-16-2011.

JOHN WILKE, EXAMINING ATTORNEY



David J. Kybas

Director of the United States Patent and Trademark Office

United States of America

United States Patent and Trademark Office

THIS IS OUR STORY

Reg. No. 4,110,119

BATTAT INCORPORATED (DELAWARE CORPORATION)
1560 MILITARY TURNPIKE
PLATTSBURGH, NY 12901

Registered Mar. 6, 2012

Int. Cl.: 28

FOR: DOLL ACCESSORIES; DOLL CLOTHING; DOLL FURNITURE; DOLL HOUSE FURNISHINGS; DOLLS, IN CLASS 28 (U.S. CLS. 22, 23, 38 AND 50).

TRADEMARK

FIRST USE 7-31-2011; IN COMMERCE 7-31-2011.

PRINCIPAL REGISTER

THE MARK CONSISTS OF STANDARD CHARACTERS WITHOUT CLAIM TO ANY PARTICULAR FONT, STYLE, SIZE, OR COLOR.

SN 85-245,033, FILED 2-17-2011.

GILBERT SWIFT, EXAMINING ATTORNEY



David J. Kybas

Director of the United States Patent and Trademark Office

United States of America

United States Patent and Trademark Office

Luckie Losers

Reg. No. 4,110,120

Registered Mar. 6, 2012

Int. Cl.: 25

TRADEMARK

PRINCIPAL REGISTER

BAKER, RASHAD (UNITED STATES INDIVIDUAL), DBA LUCKIE LOSERS,
1791 BEYERS LANDING DRIVE
BUFORD, GA 30519 AND

PINSON JR., WILLIAM (UNITED STATES INDIVIDUAL), DBA LUCKIE LOSERS,
36872 COOLIDGE COURT, APT 737
FARMINGTON HILLS, MI 48335

FOR: CLOTHING FOR MEN, WOMEN, BOYS, AND GIRLS, NAMELY, SHIRTS, BLOUSES, TOPS, T-SHIRTS, SWEATERS, VESTS, SKIRTS, DRESSES, JEANS, PANTS, SUITS, JACKETS, BLAZERS, RAINCOATS, OVERCOATS, SHORTS, SWIMSUITS, SWEATSHIRTS, SWEAT PANTS, SWEATSUITS, SCARVES, SHAWLS, CAPES, NECKTIES, BELTS, GLOVES, LINGERIE, UNDERWEAR, PAJAMAS, ROBES, SLEEPWEAR, HOSIERY, SOCKS, LEG WARMERS AND TIGHTS; FOOTWEAR, NAMELY, SHOES, BOOTS, SANDALS, ATHLETIC SHOES, SNEAKERS AND SLIPPERS; HEADGEAR, NAMELY, HATS, CAPS, AND HEAD BANDS, IN CLASS 25 (U.S. CLS. 22 AND 39).

FIRST USE 6-1-2011; IN COMMERCE 7-23-2011.

THE MARK CONSISTS OF STANDARD CHARACTERS WITHOUT CLAIM TO ANY PARTICULAR FONT, STYLE, SIZE, OR COLOR.

SN 85-245,091, FILED 2-17-2011.

CHRISTOPHER LAW, EXAMINING ATTORNEY



David J. Kyros

Director of the United States Patent and Trademark Office

United States of America

United States Patent and Trademark Office

INLINE

Reg. No. 4,110,121

STAMINA PRODUCTS, INC. (MISSOURI CORPORATION)
2040 NORTH ALLIANCE
SPRINGFIELD, MO 65803

Registered Mar. 6, 2012

Int. Cl.: 28

FOR: MANUALLY OPERATED EXERCISE EQUIPMENT, IN CLASS 28 (U.S. CLS. 22, 23, 38 AND 50).

TRADEMARK

FIRST USE 0-0-1996; IN COMMERCE 0-0-1996.

PRINCIPAL REGISTER

THE MARK CONSISTS OF STANDARD CHARACTERS WITHOUT CLAIM TO ANY PARTICULAR FONT, STYLE, SIZE, OR COLOR.

SN 85-245,128, FILED 2-17-2011.

WILLIAM P. SHANAHAN, EXAMINING ATTORNEY



David J. Kybas

Director of the United States Patent and Trademark Office

United States of America

United States Patent and Trademark Office

ANIMAL MATTERS

Reg. No. 4,110,122

Registered Mar. 6, 2012

Int. Cl.: 28

TRADEMARK

PRINCIPAL REGISTER

DURRANT, CHRISTINE A (UNITED STATES INDIVIDUAL)
P.O. BOX 6052
CONCORD, CA 94524

FOR: BOARD GAMES, IN CLASS 28 (U.S. CLS. 22, 23, 38 AND 50).

FIRST USE 2-4-2011; IN COMMERCE 9-9-2011.

THE MARK CONSISTS OF STANDARD CHARACTERS WITHOUT CLAIM TO ANY PARTICULAR FONT, STYLE, SIZE, OR COLOR.

SN 85-245,279, FILED 2-17-2011.

PAULA MAHONEY, EXAMINING ATTORNEY



David J. Kybas

Director of the United States Patent and Trademark Office

United States of America

United States Patent and Trademark Office



Reg. No. 4,110,123

Registered Mar. 6, 2012

Int. Cl.: 11

TRADEMARK

PRINCIPAL REGISTER

NEOPAC LIGHTING, LIMITED (TAIWAN CORPORATION)
RM. 804, SINO CENTRE, 582-592 NATHAN RD.
KLN., HONG KONG

FOR: BULBS, NAMELY, LIGHT BULBS, ELECTRIC LIGHT BULBS, AND HALOGEN LIGHT BULBS; LIGHTING, NAMELY, LIGHT BULBS, INFRARED LIGHTING FIXTURES, AND ELECTRIC NIGHT LIGHTS; FLUORESCENT LAMPS; FLASHLIGHTS; LAMPS FOR INTERNAL ILLUMINATION; LIGHTS FOR VEHICLES, NAMELY, AUTOMOTIVE LIGHT BULBS, MOTORCYCLE LIGHT BULBS, BRAKE LAMPS, VEHICLE HEADLIGHTS, VEHICLE TAILLIGHTS, VEHICLE SIDELIGHTS, DIRECTION INDICATOR LIGHTS; BICYCLE LIGHTS, NAMELY, DYNAMO-POWERED LAMPS FOR BIKE, AND STOP INDICATOR LIGHTS; REFLECTORS FOR VEHICLES; ELECTRICAL LIGHT BULBS; LAMPS; FOG LAMPS, IN CLASS 11 (U.S. CLS. 13, 21, 23, 31 AND 34).

FIRST USE 8-17-2011; IN COMMERCE 8-22-2011.

OWNER OF U.S. REG. NO. 3,419,128.

THE MARK CONSISTS OF A DIAMOND LIKE CONTOUR WITHIN A BROKEN LINE DIAMOND CONTOUR NEXT TO THE STYLIZED LETTERS "NEOPAC" WITH A HORIZONTAL LINE BAR PASSING THROUGH THE STYLIZED LETTERS "NEOPAC".

SN 85-245,289, FILED 2-17-2011.

PAULA MAHONEY, EXAMINING ATTORNEY



David J. Kyffers

Director of the United States Patent and Trademark Office

United States of America
United States Patent and Trademark Office

RISQAMC

Reg. No. 4,110,124

Registered Mar. 6, 2012

Int. Cl.: 9

TRADEMARK

PRINCIPAL REGISTER

SYNDETTIC GLOBAL SOLUTIONS LLC (CALIFORNIA LIMITED LIABILITY COMPANY)
#311
4079 GOVERNOR DR.
SAN DIEGO, CA 92122

FOR: COMPUTER SOFTWARE FOR USE BY BUSINESSES IN RISK ASSESSMENT, RISK MANAGEMENT AND COMMUNICATION, NAMELY, CONNECTING COMPUTER NETWORK USERS, IN CLASS 9 (U.S. CLS. 21, 23, 26, 36 AND 38).

FIRST USE 9-1-2010; IN COMMERCE 1-17-2011.

THE MARK CONSISTS OF STANDARD CHARACTERS WITHOUT CLAIM TO ANY PARTICULAR FONT, STYLE, SIZE, OR COLOR.

SN 85-245,594, FILED 2-18-2011.

MARLENE BELL, EXAMINING ATTORNEY



David J. Kyffers

Director of the United States Patent and Trademark Office

United States of America

United States Patent and Trademark Office

FMHPI

Reg. No. 4,110,125

Registered Mar. 6, 2012

Int. Cl.: 35

SERVICE MARK

PRINCIPAL REGISTER

FEDERAL HOME LOAN MORTGAGE CORPORATION (UNITED STATES FEDERALLY
CHARTERED CORPORATION)
8200 JONES BRANCH DRIVE, MS #204
MCLEAN, VA 22102

FOR: DEVELOPMENT OF FINANCIAL INDICES TO TRACK RESIDENTIAL REAL ESTATE
PRICES, IN CLASS 35 (U.S. CLS. 100, 101 AND 102).

FIRST USE 2-0-2011; IN COMMERCE 2-0-2011.

THE MARK CONSISTS OF STANDARD CHARACTERS WITHOUT CLAIM TO ANY PAR-
TICULAR FONT, STYLE, SIZE, OR COLOR.

SN 85-245,733, FILED 2-18-2011.

LINDA POWELL, EXAMINING ATTORNEY



David J. Kybas

Director of the United States Patent and Trademark Office

United States of America

United States Patent and Trademark Office

SAVE THE DIFFERENCE

Reg. No. 4,110,126

WHATCOM EDUCATIONAL CREDIT UNION (WASHINGTON CREDIT UNION)
600 E. HOLLY STREET
BELLINGHAM, WA 98225

Registered Mar. 6, 2012

Int. Cl.: 36

FOR: CREDIT UNION SERVICES; PROVISION AND FINANCIAL ADMINISTRATION OF
A DEBIT CARD SAVINGS PROGRAM, IN CLASS 36 (U.S. CLS. 100, 101 AND 102).

SERVICE MARK

FIRST USE 12-1-2011; IN COMMERCE 12-1-2011.

PRINCIPAL REGISTER

THE MARK CONSISTS OF STANDARD CHARACTERS WITHOUT CLAIM TO ANY PAR-
TICULAR FONT, STYLE, SIZE, OR COLOR.

SN 85-246,692, FILED 2-18-2011.

RICHARD WHITE, EXAMINING ATTORNEY



David J. Kybas

Director of the United States Patent and Trademark Office

United States of America

United States Patent and Trademark Office

PAMED Better Health Network

Reg. No. 4,110,127

Registered Mar. 6, 2012

Int. Cl.: 35

SERVICE MARK

PRINCIPAL REGISTER

PENNSYLVANIA MEDICAL SOCIETY (PENNSYLVANIA CORPORATION)
777 EAST PARK DRIVE
HARRISBURG, PA 17105

FOR: ASSOCIATION SERVICES, NAMELY, PROMOTING THE INTERESTS OF PHYSICIANS BY FACILITATING DISCUSSIONS AMONG PHYSICIANS, AND PROVIDING PHYSICIANS WITH INFORMATION AND EDUCATION, IN CLASS 35 (U.S. CLS. 100, 101 AND 102).

FIRST USE 3-11-2011; IN COMMERCE 3-11-2011.

THE MARK CONSISTS OF STANDARD CHARACTERS WITHOUT CLAIM TO ANY PARTICULAR FONT, STYLE, SIZE, OR COLOR.

OWNER OF U.S. REG. NO. 3,718,410.

NO CLAIM IS MADE TO THE EXCLUSIVE RIGHT TO USE "BETTER HEALTH NETWORK", APART FROM THE MARK AS SHOWN.

SN 85-247,546, FILED 2-21-2011.

JESSICA A. POWERS, EXAMINING ATTORNEY



David J. Kybas

Director of the United States Patent and Trademark Office

United States of America

United States Patent and Trademark Office



Reg. No. 4,110,128

Registered Mar. 6, 2012

Int. Cls.: 9 and 28

TRADEMARK

PRINCIPAL REGISTER

FLANAGAN, MARY D. (UNITED STATES INDIVIDUAL)
24 SCHOOL STREET #4
HANOVER, NH 03755

FOR: COMPUTER GAME PROGRAMMES; COMPUTER GAME PROGRAMMES DOWNLOADABLE VIA THE INTERNET; COMPUTER GAME PROGRAMS; COMPUTER GAME SOFTWARE; COMPUTER PROGRAMS FOR PRE-RECORDED GAMES; COMPUTER PROGRAMS FOR VIDEO AND COMPUTER GAMES; DOWNLOADABLE COMPUTER GAME PROGRAMS; DOWNLOADABLE COMPUTER GAME SOFTWARE VIA A GLOBAL COMPUTER NETWORK AND WIRELESS DEVICES; DOWNLOADABLE ELECTRONIC GAME PROGRAMS; ELECTRONIC GAME PROGRAMS; ELECTRONIC GAME SOFTWARE; ELECTRONIC GAME SOFTWARE FOR CELLULAR TELEPHONES; ELECTRONIC GAME SOFTWARE FOR HANDHELD ELECTRONIC DEVICES; INTERACTIVE GAME PROGRAMS; INTERACTIVE GAME SOFTWARE; INTERACTIVE MULTIMEDIA COMPUTER GAME PROGRAM; VIDEO AND COMPUTER GAME PROGRAMS, IN CLASS 9 (U.S. CLS. 21, 23, 26, 36 AND 38).

FIRST USE 6-5-2011; IN COMMERCE 10-31-2011.

FOR: BOARD GAMES; EDUCATIONAL CARD GAMES; GAME CARDS, IN CLASS 28 (U.S. CLS. 22, 23, 38 AND 50).

FIRST USE 1-2-2011; IN COMMERCE 3-20-2011.

THE MARK CONSISTS OF THE FOLLOWING: THE WORDS "POX SAVE THE PEOPLE" IN BLACK STYLIZED FONT ON A WHITE BACKGROUND WHERE THE CENTER OF THE LETTER "O" IN "POX" IS IN RED.

THE COLOR(S) BLACK, WHITE AND RED IS/ARE CLAIMED AS A FEATURE OF THE MARK.

SN 85-247,633, FILED 2-21-2011.

ERNEST SHOSHO, EXAMINING ATTORNEY



David J. Kyffers

Director of the United States Patent and Trademark Office

United States of America

United States Patent and Trademark Office

SPRING NATURALS

Reg. No. 4,110,129

Registered Mar. 6, 2012

Int. Cl.: 31

TRADEMARK

PRINCIPAL REGISTER

PERFORMANCE PET PRODUCTS, LLC (MINNESOTA LIMITED LIABILITY COMPANY)
1120 LAKE AVE
FAIRMONT, MN 56031

FOR: PET FOOD; PET TREATS, IN CLASS 31 (U.S. CLS. 1 AND 46).

FIRST USE 12-30-2011; IN COMMERCE 12-30-2011.

THE MARK CONSISTS OF STANDARD CHARACTERS WITHOUT CLAIM TO ANY PARTICULAR FONT, STYLE, SIZE, OR COLOR.

NO CLAIM IS MADE TO THE EXCLUSIVE RIGHT TO USE "NATURALS", APART FROM THE MARK AS SHOWN.

SN 85-249,133, FILED 2-23-2011.

MICHAEL SOUDERS, EXAMINING ATTORNEY



David J. Kyffers

Director of the United States Patent and Trademark Office

United States of America

United States Patent and Trademark Office



Reg. No. 4,110,130

Registered Mar. 6, 2012

Int. Cl.: 36

SERVICE MARK

PRINCIPAL REGISTER

YOUR COMMUNITY CREDIT UNION (TEXAS STATE CHARTERED CREDIT UNION)
8384 N. BELT LINE ROAD
IRVING, TX 75063

FOR: CREDIT UNION SERVICES, IN CLASS 36 (U.S. CLS. 100, 101 AND 102).

FIRST USE 2-11-2011; IN COMMERCE 2-11-2011.

NO CLAIM IS MADE TO THE EXCLUSIVE RIGHT TO USE "YOUR COMMUNITY CREDIT UNION", APART FROM THE MARK AS SHOWN.

THE COLOR(S) BLUE AND RED IS/ARE CLAIMED AS A FEATURE OF THE MARK.

THE MARK CONSISTS OF A STAR SHAPE IN BLUE, THE TERMS "YOUR", "CREDIT UNION", "....A", AND "TO BANK." IN BLUE, AND THE WORDS "COMMUNITY" AND "BETTER" IN RED.

SN 85-249,482, FILED 2-23-2011.

RAUL CORDOVA, EXAMINING ATTORNEY



David J. Kybas

Director of the United States Patent and Trademark Office

United States of America

United States Patent and Trademark Office

DEPOT INTERNATIONAL

Reg. No. 4,110,131

CLOVER TECHNOLOGIES GROUP, LLC (DELAWARE LIMITED LIABILITY COMPANY)
4200 COLUMBUS ST.
OTTAWA, IL 61350

Registered Mar. 6, 2012

Int. Cl.: 41

FOR: TRAINING SERVICES IN THE FIELD OF PRINTER REPAIR, IN CLASS 41 (U.S. CLS. 100, 101 AND 107).

SERVICE MARK

FIRST USE 2-15-2011; IN COMMERCE 2-15-2011.

PRINCIPAL REGISTER

THE MARK CONSISTS OF STANDARD CHARACTERS WITHOUT CLAIM TO ANY PARTICULAR FONT, STYLE, SIZE, OR COLOR.

SN 85-251,644, FILED 2-25-2011.

CHRIS WELLS, EXAMINING ATTORNEY



David J. Kybas

Director of the United States Patent and Trademark Office

United States of America

United States Patent and Trademark Office

KITCHIT

Reg. No. 4,110,132

Registered Mar. 6, 2012

Int. Cl.: 35

SERVICE MARK

PRINCIPAL REGISTER

KITCHIT, INC. (DELAWARE CORPORATION)
848 FOLSOM STREET
SAN FRANCISCO, CA 94107

FOR: PROVIDING A WEBSITE FEATURING AN ONLINE MARKETPLACE THAT FACILITATES TRANSACTIONS BETWEEN PROFESSIONAL CHEFS AND THEIR CLIENTELE FOR PRIVATE DINING EVENTS, IN CLASS 35 (U.S. CLS. 100, 101 AND 102).

FIRST USE 9-30-2011; IN COMMERCE 9-30-2011.

THE MARK CONSISTS OF STANDARD CHARACTERS WITHOUT CLAIM TO ANY PARTICULAR FONT, STYLE, SIZE, OR COLOR.

SN 85-252,194, FILED 2-25-2011.

NICHOLAS ALTREE, EXAMINING ATTORNEY



David J. Kybas

Director of the United States Patent and Trademark Office

United States of America
United States Patent and Trademark Office

FIELDSTONE

Reg. No. 4,110,133

Registered Mar. 6, 2012

Int. Cl.: 36

SERVICE MARK

PRINCIPAL REGISTER

FIELDSTONE CREDIT UNION (ILLINOIS CREDIT UNION)
395 N. KINZIE
BRADLEY, IL 60915

FOR: CREDIT UNION SERVICES, IN CLASS 36 (U.S. CLS. 100, 101 AND 102).

FIRST USE 9-19-2011; IN COMMERCE 9-19-2011.

THE MARK CONSISTS OF STANDARD CHARACTERS WITHOUT CLAIM TO ANY PARTICULAR FONT, STYLE, SIZE, OR COLOR.

SN 85-252,433, FILED 2-25-2011.

KATHERINE CHANG, EXAMINING ATTORNEY



David J. Kybas

Director of the United States Patent and Trademark Office

United States of America

United States Patent and Trademark Office

OMNIDEGRADABLE

Reg. No. 4,110,134

7191731 CANADA INC. (CANADA CORPORATION)
43 GRAYROCKS AVENUE
HAMILTON, CANADA L8W3R9

Registered Mar. 6, 2012

Int. Cl.: 16

FOR: FOOD WRAPPING PLASTIC FILM FOR HOUSEHOLD USE; GARBAGE BAGS OF PLASTIC; GENERAL PURPOSE PLASTIC BAGS; MERCHANDISE BAGS; PLASTIC BAGS FOR PACKAGING; PLASTIC BAGS FOR PACKING; PLASTIC FILM NOT FOR COMMERCIAL OR INDUSTRIAL PURPOSES; PLASTIC FOOD STORAGE BAGS FOR HOUSEHOLD USE; PLASTIC GARBAGE BAGS; PLASTIC OR PAPER BAGS FOR HOUSEHOLD USE; PLASTIC OR PAPER BAGS FOR MERCHANDISE PACKAGING; RUBBISH BAGS MADE OF PAPER OR PLASTIC MATERIALS, IN CLASS 16 (U.S. CLS. 2, 5, 22, 23, 29, 37, 38 AND 50).

TRADEMARK

PRINCIPAL REGISTER

FIRST USE 10-18-2009; IN COMMERCE 10-18-2009.

THE MARK CONSISTS OF STANDARD CHARACTERS WITHOUT CLAIM TO ANY PARTICULAR FONT, STYLE, SIZE, OR COLOR.

SN 85-253,275, FILED 2-28-2011.

CARYN GLASSER, EXAMINING ATTORNEY



David J. Kybas

Director of the United States Patent and Trademark Office

United States of America

United States Patent and Trademark Office

Rebel Wealth Management

Reg. No. 4,110,135

Registered Mar. 6, 2012

Int. Cl.: 36

SERVICE MARK

PRINCIPAL REGISTER

THON, MARK A (UNITED STATES INDIVIDUAL), DBA REBEL WEALTH MANAGEMENT,
19552 SUMMER BREEZE LN
HUNTINGTON BEACH, CA 92648

FOR: FINANCIAL SERVICES, NAMELY, ASSISTING OTHERS WITH THE COMPLETION OF FINANCIAL TRANSACTIONS FOR STOCKS, BONDS, SECURITIES AND EQUITIES; FINANCIAL SERVICES, NAMELY, WEALTH MANAGEMENT SERVICES; PROVIDING FINANCIAL SERVICES WITH RESPECT TO SECURITIES AND OTHER FINANCIAL INSTRUMENTS AND PRODUCTS, NAMELY, PROVIDING FINANCIAL MARKET NEWS AND COMMENTARY, IN CLASS 36 (U.S. CLS. 100, 101 AND 102).

FIRST USE 9-1-2011; IN COMMERCE 9-1-2011.

THE MARK CONSISTS OF STANDARD CHARACTERS WITHOUT CLAIM TO ANY PARTICULAR FONT, STYLE, SIZE, OR COLOR.

NO CLAIM IS MADE TO THE EXCLUSIVE RIGHT TO USE "WEALTH MANAGEMENT", APART FROM THE MARK AS SHOWN.

SN 85-256,193, FILED 3-2-2011.

LINDA E. BLOHM, EXAMINING ATTORNEY



David J. Kyros

Director of the United States Patent and Trademark Office

United States of America

United States Patent and Trademark Office



Reg. No. 4,110,136

Registered Mar. 6, 2012

Int. Cl.: 3

TRADEMARK

PRINCIPAL REGISTER

LEAP ORGANICS LLC (MASSACHUSETTS LIMITED LIABILITY COMPANY)
ONE BROADWAY, 14TH FLOOR
CAMBRIDGE, MA 02142

FOR: ORGANIC SKINCARE PRODUCTS, NAMELY, FACIAL AND BODY SOAP, LIP BALM, SHAMPOO, CONDITIONER, BODY LOTION, AND FACIAL AND BODY CLEANSER, IN CLASS 3 (U.S. CLS. 1, 4, 6, 50, 51 AND 52).

FIRST USE 7-1-2010; IN COMMERCE 7-1-2010.

NO CLAIM IS MADE TO THE EXCLUSIVE RIGHT TO USE "ORGANICS", APART FROM THE MARK AS SHOWN.

THE MARK CONSISTS OF A SHIELD WITH THE WORD "LEAP" IN LARGE FONT AND THE WORD "ORGANICS" IN SMALLER FONT UNDERNEATH IT, WITH A ROW OF DOTS DOWN EITHER SIDE OF THE WORDS.

SN 85-256,913, FILED 3-3-2011.

TINA MAI, EXAMINING ATTORNEY



David J. Kybas

Director of the United States Patent and Trademark Office

United States of America

United States Patent and Trademark Office



Reg. No. 4,110,137

LEAF BRANDS, LLC (CALIFORNIA LIMITED LIABILITY COMPANY)
25 RIDGEVIEW
IRVINE, CA 92603

Registered Mar. 6, 2012

Int. Cl.: 30

FOR: STAPLE FOODS, NAMELY, CANDY, POPCORN AND CHEWING GUM, IN CLASS 30
(U.S. CL. 46).

TRADEMARK

FIRST USE 2-1-2011; IN COMMERCE 2-1-2011.

PRINCIPAL REGISTER

THE MARK CONSISTS OF CONCENTRIC RECTANGLE IN GREEN COLOR WITH WHITE
COLOR OUTLINE AND THE WORDS "LEAF" IS WRITTEN IN THE CENTER IN WHITE
COLOR. THERE IS AN IMAGE OF LEAF IN THE SPACE PROVIDED BETWEEN THE LETTER
"L" AND "E" AS SHOWN IN THE MARK.

THE COLOR(S) GREEN AND WHITE IS/ARE CLAIMED AS A FEATURE OF THE MARK.

SN 85-257,714, FILED 3-4-2011.

JOHN WILKE, EXAMINING ATTORNEY



David J. Kybas

Director of the United States Patent and Trademark Office

United States of America

United States Patent and Trademark Office

OPENROAD

Reg. No. 4,110,138

Registered Mar. 6, 2012

Int. Cl.: 41

SERVICE MARK

PRINCIPAL REGISTER

OPEN ROAD RELEASING, LLC (DELAWARE LIMITED LIABILITY COMPANY)
920 MAIN STREET
KANSAS CITY, MO 64105

FOR: DISTRIBUTION OF MOTION PICTURE FILMS; FILM DISTRIBUTION; PRODUCTION AND DISTRIBUTION OF INDEPENDENT MOTION PICTURES; PRODUCTION AND DISTRIBUTION OF MOTION PICTURES, IN CLASS 41 (U.S. CLS. 100, 101 AND 107).

FIRST USE 6-30-2011; IN COMMERCE 6-30-2011.

THE MARK CONSISTS OF THE BLOCK LETTER WORD "OPENROAD" WITH A HIGHWAY SCENE DISPLAYED WITHIN THE LETTERS "ROAD".

SN 85-258,072, FILED 3-4-2011.

CHRISTOPHER LAW, EXAMINING ATTORNEY



David J. Kyros

Director of the United States Patent and Trademark Office

United States of America

United States Patent and Trademark Office



Reg. No. 4,110,139

Registered Mar. 6, 2012

Int. Cl.: 43

SERVICE MARK

PRINCIPAL REGISTER

MCQ, LLC (IDAHO LIMITED LIABILITY COMPANY), DBA IDAHO PIZZA COMPANY,
988 W. KING RD.
KUNA, ID 83634

FOR: CAFE AND RESTAURANT SERVICES, IN CLASS 43 (U.S. CLS. 100 AND 101).

FIRST USE 8-24-2011; IN COMMERCE 8-24-2011.

OWNER OF U.S. REG. NOS. 3,899,660 AND 3,899,662.

THE COLOR(S) BROWN, BLACK, LIGHT BROWN, KHAKI, PINK, YELLOW AND WHITE
IS/ARE CLAIMED AS A FEATURE OF THE MARK.

NO CLAIM IS MADE TO THE EXCLUSIVE RIGHT TO USE "IDAHO PIZZA COMPANY",
APART FROM THE MARK AS SHOWN.

THE MARK CONSISTS OF A BROWN ELK WITH LIGHT BROWN HOOVES, ANTLERS,
AND INNER EAR FUR, BLACK AND WHITE EYES AND NOSE, PINK TONGUE, WEARING
A BLACK T-SHIRT WITH THE WORDS "SUMMIT" IN YELLOW ON THE RIGHT SIDE AND
"IDAHO PIZZA COMPANY" AS PART OF A YELLOW LOGO ON THE LEFT SIDE, WITH
KHAKI SHORTS, STANDING OVER A BLACK SHADOW.

SN 85-259,063, FILED 3-5-2011.

HANNO RITTNER, EXAMINING ATTORNEY



David J. Kybas

Director of the United States Patent and Trademark Office

United States of America

United States Patent and Trademark Office

JOCKEY JERKY

Reg. No. 4,110,140

Registered Mar. 6, 2012

Int. Cl.: 29

MEOW, LLC (KENTUCKY LIMITED LIABILITY COMPANY)
SUITE 600
271 WEST SHORT STREET
LEXINGTON, KY 40507

FOR: JERKY, IN CLASS 29 (U.S. CL. 46).

TRADEMARK

FIRST USE 5-1-2011; IN COMMERCE 5-1-2011.

PRINCIPAL REGISTER

THE MARK CONSISTS OF STANDARD CHARACTERS WITHOUT CLAIM TO ANY PARTICULAR FONT, STYLE, SIZE, OR COLOR.

NO CLAIM IS MADE TO THE EXCLUSIVE RIGHT TO USE "JERKY", APART FROM THE MARK AS SHOWN.

SN 85-259,339, FILED 3-7-2011.

KATHRYN COWARD, EXAMINING ATTORNEY



David J. Kyffers

Director of the United States Patent and Trademark Office

United States of America

United States Patent and Trademark Office

It's all about you

Reg. No. 4,110,141

JOM PERSONAL PRODUCTS CORP. (DELAWARE CORPORATION)
2711 CENTERVILLE ROAD
WILLIMINGTON, DE 19808

Registered Mar. 6, 2012

Int. Cl.: 10

FOR: ADULT SEXUAL STIMULATION KIT COMPRISED PRIMARILY OF ADULT SEXUAL STIMULATION AIDS AND A WORKBOOK, IN CLASS 10 (U.S. CLS. 26, 39 AND 44).

TRADEMARK

FIRST USE 9-15-2011; IN COMMERCE 9-15-2011.

PRINCIPAL REGISTER

THE MARK CONSISTS OF STANDARD CHARACTERS WITHOUT CLAIM TO ANY PARTICULAR FONT, STYLE, SIZE, OR COLOR.

SN 85-259,717, FILED 3-7-2011.

ALICIA COLLINS, EXAMINING ATTORNEY



David J. Kybas

Director of the United States Patent and Trademark Office

United States of America
United States Patent and Trademark Office

FABUSTEP

Reg. No. 4,110,142

Registered Mar. 6, 2012

Int. Cl.: 25

TRADEMARK

PRINCIPAL REGISTER

MSD CONSUMER CARE, INC. (DELAWARE CORPORATION)
3030 JACKSON AVENUE
MEMPHIS, TN 38151

FOR: INSOLES, IN CLASS 25 (U.S. CLS. 22 AND 39).

FIRST USE 10-1-2011; IN COMMERCE 10-1-2011.

THE MARK CONSISTS OF STANDARD CHARACTERS WITHOUT CLAIM TO ANY PARTICULAR FONT, STYLE, SIZE, OR COLOR.

SN 85-260,507, FILED 3-8-2011.

AISHA CLARKE, EXAMINING ATTORNEY



David J. Kybas

Director of the United States Patent and Trademark Office

United States of America

United States Patent and Trademark Office

ROAD RESCUE

Reg. No. 4,110,143

JOHN S. BLADES (UNITED STATES INDIVIDUAL)
2858 FM 117
UVALDE, TX 78801

Registered Mar. 6, 2012

Int. Cl.: 19

FOR: BITUMINOUS ASPHALTIC ROAD PATCH MATERIAL, IN CLASS 19 (U.S. CLS. 1, 12, 33 AND 50).

TRADEMARK

FIRST USE 12-6-2011; IN COMMERCE 12-6-2011.

PRINCIPAL REGISTER

THE MARK CONSISTS OF STANDARD CHARACTERS WITHOUT CLAIM TO ANY PARTICULAR FONT, STYLE, SIZE, OR COLOR.

NO CLAIM IS MADE TO THE EXCLUSIVE RIGHT TO USE "ROAD", APART FROM THE MARK AS SHOWN.

SN 85-260,957, FILED 3-8-2011.

KHANH LE, EXAMINING ATTORNEY



David J. Kybas

Director of the United States Patent and Trademark Office

United States of America

United States Patent and Trademark Office

BIOBLU

Reg. No. 4,110,144

Registered Mar. 6, 2012

Int. Cl.: 14

TRADEMARK

PRINCIPAL REGISTER

SCOTT KAY, INC. (NEW JERSEY CORPORATION)
780 PALISADE AVENUE
TEANECK, NJ 07666

FOR: JEWELRY, IN CLASS 14 (U.S. CLS. 2, 27, 28 AND 50).

FIRST USE 12-0-2009; IN COMMERCE 12-0-2009.

THE MARK CONSISTS OF STANDARD CHARACTERS WITHOUT CLAIM TO ANY PARTICULAR FONT, STYLE, SIZE, OR COLOR.

SN 85-261,579, FILED 3-8-2011.

JEFFREY LOOK, EXAMINING ATTORNEY



David J. Kybas

Director of the United States Patent and Trademark Office

United States of America

United States Patent and Trademark Office

SEISHO

Reg. No. 4,110,145

Registered Mar. 6, 2012

Int. Cl.: 30

TRADEMARK

PRINCIPAL REGISTER

KIKKOMAN SALES USA, INC. (CALIFORNIA CORPORATION)
SUITE 3600
50 CALIFORNIA STREET
SAN FRANCISCO, CA 94111

FOR: RICE FLAVORED GRAIN VINEGAR, IN CLASS 30 (U.S. CL. 46).

FIRST USE 6-1-2011; IN COMMERCE 6-1-2011.

THE MARK CONSISTS OF STANDARD CHARACTERS WITHOUT CLAIM TO ANY PARTICULAR FONT, STYLE, SIZE, OR COLOR.

THE ENGLISH TRANSLATION OF THE WORD "SEISHO" IN THE MARK IS "GREEN PINE".

SN 85-261,761, FILED 3-9-2011.

GISELLE AGOSTO, EXAMINING ATTORNEY



David J. Kybas

Director of the United States Patent and Trademark Office

United States of America

United States Patent and Trademark Office

UCCTW

Reg. No. 4,110,146

Registered Mar. 6, 2012

Int. Cl.: 19

TRADEMARK

PRINCIPAL REGISTER

UNIVERSAL CEMENT CORPORATION (TAIWAN CORPORATION)
10 F. NO. 125 SEC. 2
NANJING E. RD. ZHONGSHAN DIST.
TAIPEI CITY, TAIWAN 104

FOR: ALMINA CEMENT; BUILDING MATERIALS, NAMELY, WALL, HARDWOOD, DECKING, WOOD AND PARTICLE BOARDS; BUILDING STONE; BUILDING TIMBER; CONCRETE BUILDING MATERIALS, NAMELY, BLOCKS, BRICKS, POSTS, SLABS AND PANELS; DRYWALL CORNER BEAD NOT OF METAL; GYPSUM; MARBLE; MULTILAYER PANELS OF PLASTIC FOR USE IN BUILDING; NON-METALLIC REINFORCEMENTS FOR CONCRETE AND WOOD BUILDING CONSTRUCTION, NAMELY, PLATES, RODS AND BARS, IN CLASS 19 (U.S. CLS. 1, 12, 33 AND 50).

FIRST USE 3-9-2011; IN COMMERCE 3-9-2011.

THE MARK CONSISTS OF STANDARD CHARACTERS WITHOUT CLAIM TO ANY PARTICULAR FONT, STYLE, SIZE, OR COLOR.

SN 85-262,004, FILED 3-9-2011.

MICHAEL GAFFAR, EXAMINING ATTORNEY



David J. Kyffers

Director of the United States Patent and Trademark Office

United States of America

United States Patent and Trademark Office

UCCTW

Reg. No. 4,110,147

Registered Mar. 6, 2012

Int. Cl.: 9

TRADEMARK

PRINCIPAL REGISTER

UNIVERSAL CEMENT CORPORATION (TAIWAN CORPORATION)
10F. NO. 125 SEC. 2
NANJING E. RD. ZHONGSHAN DIST
TAIPEI CITY, TAIWAN 104

FOR: CALCULATING SCALES; CIRCUIT BOARDS; COMPONENTS FOR GAMING MACHINES, NAMELY, CONTROLLERS, DISPLAYS, BUTTON PANELS, BOLSTERS, ELECTRICAL WIRING, AND COMPUTER HARDWARE AND SOFTWARE ASSOCIATED THEREWITH; COMPUTER CURSOR CONTROL DEVICES, NAMELY, TOUCH PADS; DIGITAL CAMERAS; ELECTRIC SENSORS; GAMING DEVICES, NAMELY, GAMING MACHINES, SLOT MACHINES, BINGO MACHINES, WITH OR WITHOUT VIDEO OUTPUT; JOYSTICKS FOR VIDEO GAMES; LITHIUM ION BATTERIES; MOBILE PHONES; PRESSURE SENSORS, IN CLASS 9 (U.S. CLS. 21, 23, 26, 36 AND 38).

FIRST USE 3-9-2011; IN COMMERCE 3-9-2011.

THE MARK CONSISTS OF STANDARD CHARACTERS WITHOUT CLAIM TO ANY PARTICULAR FONT, STYLE, SIZE, OR COLOR.

SN 85-262,047, FILED 3-9-2011.

MICHAEL GAAFAR, EXAMINING ATTORNEY



David J. Kyffers

Director of the United States Patent and Trademark Office

United States of America

United States Patent and Trademark Office



Reg. No. 4,110,148

Registered Mar. 6, 2012

Int. Cl.: 35

SERVICE MARK

PRINCIPAL REGISTER

THE BONNIE J. ADDARIO A BREATH AWAY FROM THE CURE FOUNDATION
(CALIFORNIA NON-PROFIT CORPORATION)
1100 INDUSTRIAL RD. , SUITE 1
SAN CARLOS, CA 940704131

FOR: ASSOCIATION SERVICES, NAMELY, PROMOTING THE DETECTION AND PREVENTION OF LUNG AND RESPIRATORY DISEASES; PROMOTING PUBLIC INTEREST AND AWARENESS IN LUNG CANCER RESEARCH AND EDUCATION; CHARITABLE SERVICES, NAMELY, ORGANIZING AND CONDUCTING VOLUNTEER PROGRAMS AND COMMUNITY SERVICE PROJECTS, IN CLASS 35 (U.S. CLS. 100, 101 AND 102).

FIRST USE 2-9-2011; IN COMMERCE 2-9-2011.

THE MARK CONSISTS OF A FOOTPRINT WITH THE WORDS "YOUR NEXT STEP IS THE CURE" INSIDE THE FOOTPRINT.

SN 85-262,686, FILED 3-9-2011.

WILLIAM VERHOSEK, EXAMINING ATTORNEY



David J. Kyffers

Director of the United States Patent and Trademark Office

United States of America

United States Patent and Trademark Office

SMUSH

Reg. No. 4,110,149

Registered Mar. 6, 2012

Int. Cl.: 3

TRADEMARK

PRINCIPAL REGISTER

ALLEN, STEPHEN A. (UNITED STATES INDIVIDUAL)
13018 SUNSET LAKE DRIVE
JACKSONVILLE, FL 32258

FOR: ANTIPERSPIRANTS AND DEODORANTS FOR PERSONAL USE; BODY LOTIONS;
BODY SPRAYS; BODY WASH; COSMETICS; HAIR CARE PREPARATIONS; NON-MEDIC-
ATED SKIN CARE PREPARATIONS, IN CLASS 3 (U.S. CLS. 1, 4, 6, 50, 51 AND 52).

FIRST USE 12-6-2011; IN COMMERCE 12-6-2011.

THE MARK CONSISTS OF STANDARD CHARACTERS WITHOUT CLAIM TO ANY PAR-
TICULAR FONT, STYLE, SIZE, OR COLOR.

SN 85-262,811, FILED 3-9-2011.

FONG HSU, EXAMINING ATTORNEY



David J. Kybas

Director of the United States Patent and Trademark Office

United States of America

United States Patent and Trademark Office

CARVE

Reg. No. 4,110,150

Registered Mar. 6, 2012

Int. Cl.: 12

TRADEMARK

PRINCIPAL REGISTER

SPECIALIZED BICYCLE COMPONENTS, INC. (CALIFORNIA CORPORATION)
15130 CONCORD CIRCLE
MORGAN HILL, CA 95037

FOR: BICYCLES AND BICYCLE FRAMES, IN CLASS 12 (U.S. CLS. 19, 21, 23, 31, 35 AND 44).

FIRST USE 7-9-2011; IN COMMERCE 7-0-2011.

THE MARK CONSISTS OF STANDARD CHARACTERS WITHOUT CLAIM TO ANY PARTICULAR FONT, STYLE, SIZE, OR COLOR.

SN 85-263,226, FILED 3-10-2011.

HANNO RITTNER, EXAMINING ATTORNEY



David J. Kybas

Director of the United States Patent and Trademark Office

United States of America

United States Patent and Trademark Office

STATUS

Reg. No. 4,110,151

SPECIALIZED BICYCLE COMPONENTS, INC. (CALIFORNIA CORPORATION)
15130 CONCORD CIRCLE
MORGAN HILL, CA 95037

Registered Mar. 6, 2012

Int. Cl.: 12

FOR: BICYCLES AND BICYCLE FRAMES, IN CLASS 12 (U.S. CLS. 19, 21, 23, 31, 35 AND 44).

TRADEMARK

FIRST USE 7-9-2011; IN COMMERCE 10-0-2011.

PRINCIPAL REGISTER

THE MARK CONSISTS OF STANDARD CHARACTERS WITHOUT CLAIM TO ANY PARTICULAR FONT, STYLE, SIZE, OR COLOR.

SN 85-263,237, FILED 3-10-2011.

HANNO RITTNER, EXAMINING ATTORNEY



David J. Kybas

Director of the United States Patent and Trademark Office

United States of America

United States Patent and Trademark Office

MyPlay Chef

Reg. No. 4,110,152

Registered Mar. 6, 2012

Int. Cl.: 9

TRADEMARK

PRINCIPAL REGISTER

COLLEGE FITNESS, LLC (DELAWARE LIMITED LIABILITY COMPANY)
6685 BETA DRIVE
MAYFIELD VILLAGE, OH 44143

FOR: DOWNLOADABLE SOFTWARE IN THE NATURE OF A MOBILE APPLICATION FOR VIRTUALLY COOKING RECIPES, SIMULATING REAL LIFE COOKING PROCESSES AND TECHNIQUES, INSTRUCTING ADULTS AND CHILDREN IN THE BASICS OF COOKING AND HEALTHY COOKING PRACTICES THROUGH A REALISTIC INTERACTIVE EXPERIENCE, IN CLASS 9 (U.S. CLS. 21, 23, 26, 36 AND 38).

FIRST USE 3-29-2011; IN COMMERCE 3-29-2011.

THE MARK CONSISTS OF STANDARD CHARACTERS WITHOUT CLAIM TO ANY PARTICULAR FONT, STYLE, SIZE, OR COLOR.

NO CLAIM IS MADE TO THE EXCLUSIVE RIGHT TO USE "CHEF", APART FROM THE MARK AS SHOWN.

SN 85-264,116, FILED 3-11-2011.

ANDREA HACK, EXAMINING ATTORNEY



David J. Kyffers

Director of the United States Patent and Trademark Office

United States of America

United States Patent and Trademark Office

INSPYRIS

Reg. No. 4,110,153

Registered Mar. 6, 2012

Int. Cls.: 9, 42, and 45

TRADEMARK

SERVICE MARK

PRINCIPAL REGISTER

INSPYRIS, LLC (DELAWARE CORPORATION)
10404 43RD AVENUE
BELTSVILLE, MD 20705

FOR: COMPUTER APPLICATION SOFTWARE FOR COMPUTING DEVICES, NAMELY, SOFTWARE FOR MANAGING INTELLECTUAL PROPERTY; COMPUTER SOFTWARE FOR MANAGING INTELLECTUAL PROPERTY; COMPUTER SOFTWARE PLATFORMS FOR MANAGING INTELLECTUAL PROPERTY, IN CLASS 9 (U.S. CLS. 21, 23, 26, 36 AND 38).

FIRST USE 9-13-2011; IN COMMERCE 9-13-2011.

FOR: SOFTWARE DEVELOPMENT AND PRODUCT DEVELOPMENT IN THE FIELD OF MANAGING INTELLECTUAL PROPERTY, IN CLASS 42 (U.S. CLS. 100 AND 101).

FIRST USE 9-13-2011; IN COMMERCE 9-13-2011.

FOR: LEGAL SERVICES, NAMELY, INTELLECTUAL PROPERTY CONSULTING SERVICES IN THE FIELD OF IDENTIFICATION, STRATEGY, ANALYTICS, AND INVENTION; LICENSING OF COMPUTER SOFTWARE; LICENSING OF SOFTWARE FOR MANAGEMENT OF INTELLECTUAL PROPERTY; PROVIDING INFORMATION IN THE FIELD OF INTELLECTUAL PROPERTY LEGAL SERVICES PROVIDING ON-LINE INFORMATION IN THE FIELD OF INTELLECTUAL PROPERTY LEGAL SERVICES, IN CLASS 45 (U.S. CLS. 100 AND 101).

FIRST USE 1-1-2011; IN COMMERCE 1-1-2011.

THE MARK CONSISTS OF STANDARD CHARACTERS WITHOUT CLAIM TO ANY PARTICULAR FONT, STYLE, SIZE, OR COLOR.

SN 85-264,161, FILED 3-11-2011.

CHERYL CLAYTON, EXAMINING ATTORNEY



David J. Kyjars

Director of the United States Patent and Trademark Office

United States of America

United States Patent and Trademark Office

EMPANITAS

Reg. No. 4,110,154

TYSON FOODS, INC. (DELAWARE CORPORATION)
2200 DON TYSON PARKWAY
SPRINGDALE, AR 72762

Registered Mar. 6, 2012

Int. Cl.: 30

FOR: MEXICAN STYLE BREAD FILLED WITH MEAT, POULTRY AND CHEESE, IN CLASS 30 (U.S. CL. 46).

TRADEMARK

FIRST USE 6-13-2011; IN COMMERCE 6-13-2011.

PRINCIPAL REGISTER

THE MARK CONSISTS OF STANDARD CHARACTERS WITHOUT CLAIM TO ANY PARTICULAR FONT, STYLE, SIZE, OR COLOR.

SN 85-264,415, FILED 3-11-2011.

CHARLOTTE CORWIN, EXAMINING ATTORNEY



David J. Kybas

Director of the United States Patent and Trademark Office

United States of America
United States Patent and Trademark Office

TORRID

Reg. No. 4,110,155

UNIVERSAL COOPERATIVES, INC. (MINNESOTA CORPORATION)
1300 CORPORATE CENTER CURVE
EAGAN, MN 55121

Registered Mar. 6, 2012

Int. Cl.: 1

FOR: AGRICULTURAL ADJUVANTS FOR USE WITH HERBICIDES, INSECTICIDES, AND PESTICIDES, IN CLASS 1 (U.S. CLS. 1, 5, 6, 10, 26 AND 46).

TRADEMARK

FIRST USE 4-29-2011; IN COMMERCE 4-29-2011.

PRINCIPAL REGISTER

THE MARK CONSISTS OF STANDARD CHARACTERS WITHOUT CLAIM TO ANY PARTICULAR FONT, STYLE, SIZE, OR COLOR.

SN 85-264,438, FILED 3-11-2011.

EUGENIA MARTIN, EXAMINING ATTORNEY



David J. Kybas

Director of the United States Patent and Trademark Office

United States of America

United States Patent and Trademark Office

Duh! You're Dark

Reg. No. 4,110,156

Registered Mar. 6, 2012

Int. Cl.: 3

TRADEMARK

PRINCIPAL REGISTER

PRODUCT INNOVATIONS RESEARCH LLC (TEXAS LIMITED LIABILITY COMPANY)
SUITE 700
15770 NORTH DALLAS PARKWAY
DALLAS, TX 75248

FOR: INDOOR TANNING PRODUCTS, NAMELY, NON-MEDICATED SKIN TAN DARKENING LOTIONS AND MOISTURIZERS, IN CLASS 3 (U.S. CLS. 1, 4, 6, 50, 51 AND 52).

FIRST USE 10-1-2011; IN COMMERCE 11-1-2011.

THE MARK CONSISTS OF STANDARD CHARACTERS WITHOUT CLAIM TO ANY PARTICULAR FONT, STYLE, SIZE, OR COLOR.

SN 85-264,647, FILED 3-11-2011.

THEODORE MCBRIDE, EXAMINING ATTORNEY



David J. Kyffers

Director of the United States Patent and Trademark Office

United States of America

United States Patent and Trademark Office

SURF SHACK

Reg. No. 4,110,157

JR MEX VENTURES LLC (FLORIDA LIMITED LIABILITY COMPANY)
14537 COTSWOLDS DR
TAMPA, FL 33626

Registered Mar. 6, 2012

Int. Cl.: 43

FOR: RESTAURANT, BAR AND CATERING SERVICES, IN CLASS 43 (U.S. CLS. 100 AND 101).

SERVICE MARK

FIRST USE 12-2-2011; IN COMMERCE 12-2-2011.

PRINCIPAL REGISTER

THE MARK CONSISTS OF STANDARD CHARACTERS WITHOUT CLAIM TO ANY PARTICULAR FONT, STYLE, SIZE, OR COLOR.

SN 85-264,860, FILED 3-11-2011.

LAURIE MAYES, EXAMINING ATTORNEY



David J. Kybas

Director of the United States Patent and Trademark Office

United States of America

United States Patent and Trademark Office

Confidence: The Game

Reg. No. 4,110,158

Registered Mar. 6, 2012

Int. Cl.: 9

TRADEMARK

PRINCIPAL REGISTER

HART, TIMOTHY STERLING (ILLINOIS LIMITED LIABILITY COMPANY), AKA HART HOLDINGS LLC,
2196 BEAVER CREEK DR.
VERNON HILLS, IL 60061

FOR: COMPUTER APPLICATION SOFTWARE FOR COMPUTERS, MOBILE PHONES AND OTHER PORTABLE COMPUTER DEVICES, NAMELY, SOFTWARE FOR A TRIVIA QUIZ GAME SHOW FOR ENTERTAINMENT, GAMING, AND SOCIAL NETWORKING PURPOSES, IN CLASS 9 (U.S. CLS. 21, 23, 26, 36 AND 38).

FIRST USE 11-9-2009; IN COMMERCE 4-16-2011.

THE MARK CONSISTS OF STANDARD CHARACTERS WITHOUT CLAIM TO ANY PARTICULAR FONT, STYLE, SIZE, OR COLOR.

NO CLAIM IS MADE TO THE EXCLUSIVE RIGHT TO USE "THE GAME", APART FROM THE MARK AS SHOWN.

SN 85-265,712, FILED 3-14-2011.

JESSICA A. POWERS, EXAMINING ATTORNEY



David J. Kyros

Director of the United States Patent and Trademark Office

United States of America

United States Patent and Trademark Office

ELOQUII

Reg. No. 4,110,159

Registered Mar. 6, 2012

Int. Cl.: 35

SERVICE MARK

PRINCIPAL REGISTER

LIMITED STORES, LLC (DELAWARE LIMITED LIABILITY COMPANY)
7775 WALTON PARKWAY
NEW ALBANY, OH 43054

FOR: RETAIL STORE SERVICES, MAIL ORDER CATALOG SERVICES, AND ON-LINE
RETAIL STORE SERVICES FEATURING CLOTHING, IN CLASS 35 (U.S. CLS. 100, 101 AND
102).

FIRST USE 11-1-2011; IN COMMERCE 11-1-2011.

THE MARK CONSISTS OF STANDARD CHARACTERS WITHOUT CLAIM TO ANY PAR-
TICULAR FONT, STYLE, SIZE, OR COLOR.

SN 85-266,110, FILED 3-14-2011.

KATHRYN COWARD, EXAMINING ATTORNEY



David J. Kyros

Director of the United States Patent and Trademark Office

United States of America

United States Patent and Trademark Office

GifterClub

Reg. No. 4,110,160

ABBOTT, ELIZABETH AYN (UNITED STATES INDIVIDUAL)
12856 BANYAN CREEK DR.
FORT MYERS, FL 33908

Registered Mar. 6, 2012

Int. Cl.: 36

FOR: CREDIT CARD AND DEBIT CARD SERVICES; PROVIDING ELECTRONIC PROCESSING OF ELECTRONIC FUNDS TRANSFER, ACH, CREDIT CARD, DEBIT CARD, ELECTRONIC CHECK AND ELECTRONIC PAYMENTS, IN CLASS 36 (U.S. CLS. 100, 101 AND 102).

SERVICE MARK

PRINCIPAL REGISTER

FIRST USE 7-1-2011; IN COMMERCE 7-1-2011.

THE MARK CONSISTS OF STANDARD CHARACTERS WITHOUT CLAIM TO ANY PARTICULAR FONT, STYLE, SIZE, OR COLOR.

SN 85-266,452, FILED 3-14-2011.

KYLE PEETE, EXAMINING ATTORNEY



David J. Kyros

Director of the United States Patent and Trademark Office

United States of America

United States Patent and Trademark Office



Reg. No. 4,110,161

Registered Mar. 6, 2012

Int. Cl.: 43

SERVICE MARK

PRINCIPAL REGISTER

BERKSHIRE INN, L.P. (PENNSYLVANIA LIMITED PARTNERSHIP)
1741 PAPER MILL ROAD
C/O CROWNE PLAZA HOTEL
READING, PA 19610

FOR: RESTAURANT AND BAR SERVICES, IN CLASS 43 (U.S. CLS. 100 AND 101).

FIRST USE 3-15-2011; IN COMMERCE 3-15-2011.

NO CLAIM IS MADE TO THE EXCLUSIVE RIGHT TO USE "PRIME STEAK & WINE",
APART FROM THE MARK AS SHOWN.

THE COLOR(S) BLACK, BURGUNDY AND GRAY IS/ARE CLAIMED AS A FEATURE OF
THE MARK.

THE MARK CONSISTS OF THE BLACK UNDERLINED LOWERCASE WORD "PRIME",
WHERE THE "I" IS DEPICTED WITH A BURGUNDY COLORED WINE GLASS, WHICH
APPEARS ABOVE THE GRAY UPPERCASE WORDS "STEAK & WINE", AND ALL APPEAR
INSIDE A RECTANGLE OUTLINED IN BLACK.

SN 85-267,038, FILED 3-15-2011.

CARYN GLASSER, EXAMINING ATTORNEY



David J. Kyros

Director of the United States Patent and Trademark Office

United States of America

United States Patent and Trademark Office

SDN Communications

Reg. No. 4,110,162

Registered Mar. 6, 2012

Int. Cl.: 9

TRADEMARK

PRINCIPAL REGISTER

SOUTH DAKOTA NETWORK, LLC (SOUTH DAKOTA LIMITED LIABILITY COMPANY)
2900 W. 10TH ST.
SIOUX FALLS, SD 57104

FOR: COMPUTER SOFTWARE FOR SIMULTANEOUS, MULTIPLE MODES OF COMMUNICATION OVER LOCAL AREA NETWORKS AND THE INTERNET VIA INSTANT MESSAGING, VOICE OVER INTERNET PROTOCOL (VOIP), VIDEO CONFERENCING, AUDIO CONFERENCING, APPLICATION SHARING, COMPUTER DESKTOP SHARING, FILE TRANSFER, SENSING AND PROVIDING USER PRESENCE INFORMATION, AND TELEPHONY, IN CLASS 9 (U.S. CLS. 21, 23, 26, 36 AND 38).

FIRST USE 3-0-2011; IN COMMERCE 3-0-2011.

THE MARK CONSISTS OF STANDARD CHARACTERS WITHOUT CLAIM TO ANY PARTICULAR FONT, STYLE, SIZE, OR COLOR.

OWNER OF U.S. REG. NOS. 3,289,788, 3,475,724, AND OTHERS.

NO CLAIM IS MADE TO THE EXCLUSIVE RIGHT TO USE "COMMUNICATIONS", APART FROM THE MARK AS SHOWN.

SN 85-267,123, FILED 3-15-2011.

CARYN GLASSER, EXAMINING ATTORNEY



David J. Kyjars

Director of the United States Patent and Trademark Office

United States of America

United States Patent and Trademark Office



Reg. No. 4,110,163

Registered Mar. 6, 2012

Int. Cl.: 16

TRADEMARK

PRINCIPAL REGISTER

TWO HEARTS GREETINGS, LLC (FLORIDA LIMITED LIABILITY COMPANY)
8917 SILK BAY PL.
ORLANDO, FL 32827

FOR: GREETING CARDS, IN CLASS 16 (U.S. CLS. 2, 5, 22, 23, 29, 37, 38 AND 50).

FIRST USE 12-1-2011; IN COMMERCE 12-1-2011.

NO CLAIM IS MADE TO THE EXCLUSIVE RIGHT TO USE "GREETINGS", APART FROM THE MARK AS SHOWN.

THE COLOR(S) GREEN AND PINK IS/ARE CLAIMED AS A FEATURE OF THE MARK.

THE MARK CONSISTS OF TWO INCOMPLETE HEARTS; THE LARGE INCOMPLETE HEART IS IN GREEN, THE SMALLER INCOMPLETE HEART IS IN PINK; TWO CURVED LINES IN PINK; AND THE WORDING "TWO HEARTS GREETINGS" AND "IT ONLY TAKES TWO HEARTS...". THE WORDS "TWO", "GREETINGS" AND "IT ONLY TAKES TWO HEARTS..." ARE IN PINK; THE WORD "HEARTS" IS IN GREEN.

SN 85-267,330, FILED 3-15-2011.

DAVID C. REIHNER, EXAMINING ATTORNEY



David J. Kyffers

Director of the United States Patent and Trademark Office

United States of America

United States Patent and Trademark Office

BEAUTY SQUAD

Reg. No. 4,110,164

BOMOVA, ADRIANA (UNITED STATES INDIVIDUAL)
79 MAPLE AVE EXT
MERIDEN, CT 06450

Registered Mar. 6, 2012

Int. Cl.: 44

FOR: BEAUTY SALON SERVICES, IN CLASS 44 (U.S. CLS. 100 AND 101).

SERVICE MARK

FIRST USE 1-19-2011; IN COMMERCE 10-1-2011.

PRINCIPAL REGISTER

THE MARK CONSISTS OF STANDARD CHARACTERS WITHOUT CLAIM TO ANY PARTICULAR FONT, STYLE, SIZE, OR COLOR.

NO CLAIM IS MADE TO THE EXCLUSIVE RIGHT TO USE "BEAUTY", APART FROM THE MARK AS SHOWN.

SN 85-267,688, FILED 3-15-2011.

MIDGE BUTLER, EXAMINING ATTORNEY



David J. Kyffers

Director of the United States Patent and Trademark Office

United States of America

United States Patent and Trademark Office



Posing Pawz

Prefurred Pet Photography

Reg. No. 4,110,165

Registered Mar. 6, 2012

Int. Cl.: 41

SERVICE MARK

PRINCIPAL REGISTER

3RD DIMENSION MEDIA (CALIFORNIA LIMITED LIABILITY COMPANY)
1719 DON CARLOS AVE
GLENDALE, CA 91208

FOR: PHOTOGRAPHY SERVICES, IN CLASS 41 (U.S. CLS. 100, 101 AND 107).

FIRST USE 9-27-2011; IN COMMERCE 9-27-2011.

NO CLAIM IS MADE TO THE EXCLUSIVE RIGHT TO USE "PREFERRED PET PHOTOGRAPHY", APART FROM THE MARK AS SHOWN.

THE MARK CONSISTS OF A CAMERA ON A STAND AND A DOG TAKING A PICTURE. BELOW THERE IS THE STYLIZED TEXT "POSING PAWZ PREFERRED PET PHOTOGRAPHY".

SN 85-267,777, FILED 3-15-2011.

CAROLINE WOOD, EXAMINING ATTORNEY



David J. Kybas

Director of the United States Patent and Trademark Office

United States of America

United States Patent and Trademark Office

OCDC

Reg. No. 4,110,166

Registered Mar. 6, 2012

Int. Cl.: 42

SERVICE MARK

PRINCIPAL REGISTER

ANDY TING-CHIA KU (UNITED STATES INDIVIDUAL)
UNIT 3F
257 SOUTH SPRING STREET
LOS ANGELES, CA 90012

FOR: ARCHITECTURAL DESIGN; COMPUTER AIDED GRAPHIC DESIGN, IN CLASS 42
(U.S. CLS. 100 AND 101).

FIRST USE 12-1-2011; IN COMMERCE 12-1-2011.

THE MARK CONSISTS OF STANDARD CHARACTERS WITHOUT CLAIM TO ANY PARTICULAR FONT, STYLE, SIZE, OR COLOR.

OWNER OF U.S. REG. NO. 8,510,414.

SN 85-268,017, FILED 3-16-2011.

CURTIS FRENCH, EXAMINING ATTORNEY



David J. Kybas

Director of the United States Patent and Trademark Office

United States of America

United States Patent and Trademark Office

Ortho-shield

Reg. No. 4,110,167

ORTHO MATTRESS, INC. (CALIFORNIA CORPORATION)
15300 VALLEY VIEW AVENUE
LA MIRADA, CA 90638

Registered Mar. 6, 2012

Int. Cl.: 24

FOR: CONTOURED MATTRESS COVERS; MATTRESS COVERS, IN CLASS 24 (U.S. CLS. 42 AND 50).

TRADEMARK

FIRST USE 5-1-2011; IN COMMERCE 5-1-2011.

PRINCIPAL REGISTER

THE MARK CONSISTS OF STANDARD CHARACTERS WITHOUT CLAIM TO ANY PARTICULAR FONT, STYLE, SIZE, OR COLOR.

OWNER OF U.S. REG. NOS. 940,485, 2,997,470, AND OTHERS.

SN 85-268,927, FILED 3-16-2011.

AMY HELLA, EXAMINING ATTORNEY



David J. Kybas

Director of the United States Patent and Trademark Office

United States of America

United States Patent and Trademark Office

Keep it Kingdom

Reg. No. 4,110,168

Registered Mar. 6, 2012

Int. Cls.: 25 and 41

TRADEMARK

SERVICE MARK

PRINCIPAL REGISTER

KINGDOM COVENANT CHRISTIAN CENTER (NEW JERSEY CORPORATION)
781 FOX LANE
VINELAND, NJ 08360

FOR: BEANIES; HATS; JEANS; SCARVES; SHOES; SWEATPANTS; SWEATSHIRTS; T-SHIRTS, IN CLASS 25 (U.S. CLS. 22 AND 39).

FIRST USE 7-1-2009; IN COMMERCE 7-1-2009.

FOR: EDUCATIONAL AND ENTERTAINMENT SERVICES, NAMELY, PROVIDING MOTIVATIONAL SPEAKING SERVICES IN THE FIELD OF RENEWING LIVES WITH BIBLICAL ANSWERS TO REAL LIFE SITUATIONS; ENTERTAINMENT SERVICES, NAMELY, THE PROVISION OF CONTINUING SHOWS FEATURING EVANGELISTIC AND MINISTERIAL SERVICES DELIVERED BY TELEVISION AND RADIO, IN CLASS 41 (U.S. CLS. 100, 101 AND 107).

FIRST USE 5-1-2005; IN COMMERCE 8-1-2005.

THE MARK CONSISTS OF STANDARD CHARACTERS WITHOUT CLAIM TO ANY PARTICULAR FONT, STYLE, SIZE, OR COLOR.

SN 85-269,718, FILED 3-17-2011.

ROSELLE HERRERA, EXAMINING ATTORNEY



David J. Kybas

Director of the United States Patent and Trademark Office

United States of America

United States Patent and Trademark Office

GOOD GIRL

Reg. No. 4,110,169

Registered Mar. 6, 2012

Int. Cl.: 33

TRADEMARK

PRINCIPAL REGISTER

VAL DU CHARRON WINES (PTY) LTD. C/O MAZARS, MAZARS HOUSE (SOUTH AFRICA COMPANY)
RIALTO ROAD, GRAND MOORINGS PRECINCT
CENTURY CITY, SOUTH AFRICA 7441

FOR: ALCOHOLIC BEVERAGES EXCEPT BEERS, IN CLASS 33 (U.S. CLS. 47 AND 49).

FIRST USE 7-11-2011; IN COMMERCE 9-0-2011.

THE MARK CONSISTS OF STANDARD CHARACTERS WITHOUT CLAIM TO ANY PARTICULAR FONT, STYLE, SIZE, OR COLOR.

SN 85-269,735, FILED 3-17-2011.

HEATHER THOMPSON, EXAMINING ATTORNEY



David J. Kyros

Director of the United States Patent and Trademark Office

United States of America

United States Patent and Trademark Office

WILD GIRL

Reg. No. 4,110,170

Registered Mar. 6, 2012

Int. Cl.: 33

TRADEMARK

PRINCIPAL REGISTER

VAL DU CHARRON WINES (PTY) LTD. C/O MAZARS, MAZARS HOUSE (SOUTH AFRICA COMPANY)
RIALTO ROAD, GRAND MOORINGS PRECINCT
CENTURY CITY, SOUTH AFRICA 7441

FOR: ALCOHOLIC BEVERAGES EXCEPT BEERS, IN CLASS 33 (U.S. CLS. 47 AND 49).

FIRST USE 7-11-2011; IN COMMERCE 9-0-2011.

THE MARK CONSISTS OF STANDARD CHARACTERS WITHOUT CLAIM TO ANY PARTICULAR FONT, STYLE, SIZE, OR COLOR.

SN 85-269,767, FILED 3-17-2011.

HEATHER THOMPSON, EXAMINING ATTORNEY



David J. Kybas

Director of the United States Patent and Trademark Office

United States of America

United States Patent and Trademark Office

ELITE EXPRESS

Reg. No. 4,110,171

Registered Mar. 6, 2012

Int. Cl.: 36

SERVICE MARK

PRINCIPAL REGISTER

WELLS FARGO & COMPANY (DELAWARE CORPORATION)
1700 WELLS FARGO CENTER, MAC N9305-176
SIXTH AND MARQUETTE
MINNEAPOLIS, MN 55479

FOR: INSURANCE SERVICES, NAMELY, UNDERWRITING EXTENDED WARRANTY CONTRACTS IN THE FIELD OF AUTOMOBILES, IN CLASS 36 (U.S. CLS. 100, 101 AND 102).

FIRST USE 5-1-2011; IN COMMERCE 5-1-2011.

THE MARK CONSISTS OF STANDARD CHARACTERS WITHOUT CLAIM TO ANY PARTICULAR FONT, STYLE, SIZE, OR COLOR.

SN 85-269,974, FILED 3-17-2011.

HEATHER BIDDULPH, EXAMINING ATTORNEY



David J. Kybas

Director of the United States Patent and Trademark Office

United States of America

United States Patent and Trademark Office

THE SPICE MERCHANT'S DAUGHTER

Reg. No. 4,110,172

Registered Mar. 6, 2012

Int. Cl.: 41

SERVICE MARK

PRINCIPAL REGISTER

CHRISTINA AROKIASAMY (UNITED STATES INDIVIDUAL)
12919 SE 257TH STREET
KENT, WA 98030

FOR: EDUCATIONAL SERVICES, NAMELY, INSTRUCTION IN THE NATURE OF CLASSES, COURSES, AND DEMONSTRATIONS IN THE FIELD OF CULINARY ARTS, IN CLASS 41 (U.S. CLS. 100, 101 AND 107).

FIRST USE 1-30-2010; IN COMMERCE 1-30-2010.

THE MARK CONSISTS OF STANDARD CHARACTERS WITHOUT CLAIM TO ANY PARTICULAR FONT, STYLE, SIZE, OR COLOR.

SN 85-270,159, FILED 3-17-2011.

LINDA POWELL, EXAMINING ATTORNEY



David J. Kybas

Director of the United States Patent and Trademark Office

United States of America

United States Patent and Trademark Office

Frans Fudge
www.fransfudge.com

Reg. No. 4,110,173

FRANSFUDGE (VIRGINIA LIMITED LIABILITY COMPANY)
1104 WARE STREET
VIENNA, VA 22180

Registered Mar. 6, 2012

Int. Cl.: 16

FOR: PRINTED RECIPE CARDS, IN CLASS 16 (U.S. CLS. 2, 5, 22, 23, 29, 37, 38 AND 50).

TRADEMARK

FIRST USE 1-1-2011; IN COMMERCE 1-1-2011.

PRINCIPAL REGISTER

THE MARK CONSISTS OF THE STYLIZED TEXT "FRANSFUDGE WWW.FRANSFUDGE.COM" WITH AN ABSTRACT DESIGN.

SN 85-270,592, FILED 3-18-2011.

JACLYN KIDWELL WALKER, EXAMINING ATTORNEY



David J. Kybas

Director of the United States Patent and Trademark Office

United States of America

United States Patent and Trademark Office

WORDZUP!

Reg. No. 4,110,174

ANTHROLOGICAL, INC. (COLORADO CORPORATION)
477 ANTELOPE CROSSING
LAFAYETTE, CO 80026

Registered Mar. 6, 2012

Int. Cl.: 9

FOR: COMPUTER GAME SOFTWARE FOR USE ON MOBILE AND CELLULAR PHONES,
IN CLASS 9 (U.S. CLS. 21, 23, 26, 36 AND 38).

TRADEMARK

FIRST USE 3-18-2011; IN COMMERCE 3-18-2011.

PRINCIPAL REGISTER

THE MARK CONSISTS OF STANDARD CHARACTERS WITHOUT CLAIM TO ANY PAR-
TICULAR FONT, STYLE, SIZE, OR COLOR.

SN 85-271,388, FILED 3-18-2011.

NANCY CLARKE, EXAMINING ATTORNEY



David J. Kybas

Director of the United States Patent and Trademark Office

United States of America

United States Patent and Trademark Office

SPR
SPREADING

Reg. No. 4,110,175

LEDEBOER SEED LLC (OREGON LIMITED LIABILITY COMPANY)
22068 CASE RD. NE
AURORA, OR 97002

Registered Mar. 6, 2012

Int. Cl.: 31

FOR: GRASS SEEDS, TURF GROWN FROM SEEDS, IN CLASS 31 (U.S. CLS. 1 AND 46).

TRADEMARK

FIRST USE 9-1-2011; IN COMMERCE 9-1-2011.

PRINCIPAL REGISTER

THE MARK CONSISTS OF THE LITERAL ELEMENTS "SPR SPREADING", WHEREIN THE LETTERS "SPR" ARE WRITTEN ABOVE THE WORD "SPREADING" WHICH IS IN SMALLER FONT AS SHOWN IN THE MARK.

SN 85-271,395, FILED 3-18-2011.

RONALD AIKENS, EXAMINING ATTORNEY



David J. Kybas

Director of the United States Patent and Trademark Office

United States of America

United States Patent and Trademark Office

EVE Media Player

Reg. No. 4,110,176

NETWORK OPTIX, INC. (CALIFORNIA CORPORATION)
1146 NORTH CENTRAL AVENUE, #624
GLENDALE, CA 91202

Registered Mar. 6, 2012

Int. Cl.: 9

FOR: SOFTWARE APPLICATION FOR PLAYING VIDEO/MULTI-MEDIA FILES, IN CLASS 9 (U.S. CLS. 21, 23, 26, 36 AND 38).

TRADEMARK

FIRST USE 9-12-2011; IN COMMERCE 9-12-2011.

PRINCIPAL REGISTER

THE MARK CONSISTS OF STANDARD CHARACTERS WITHOUT CLAIM TO ANY PARTICULAR FONT, STYLE, SIZE, OR COLOR.

NO CLAIM IS MADE TO THE EXCLUSIVE RIGHT TO USE "MEDIA PLAYER", APART FROM THE MARK AS SHOWN.

SN 85-271,593, FILED 3-19-2011.

BARBARA BROWN, EXAMINING ATTORNEY



David J. Kyros

Director of the United States Patent and Trademark Office

United States of America

United States Patent and Trademark Office



Reg. No. 4,110,177

ALLTRA CORPORATION (KANSAS CORPORATION)
1600 PARTRIDGE ROAD
DEWEY, OK 74029

Registered Mar. 6, 2012

Int. Cl.: 7

FOR: SHAPE CUTTING MACHINES, IN CLASS 7 (U.S. CLS. 13, 19, 21, 23, 31, 34 AND 35).

FIRST USE 12-12-2011; IN COMMERCE 12-12-2011.

TRADEMARK

THE MARK CONSISTS OF THE LITERAL ELEMENT "ALLTRA" IN A STYLIZED FONT WITH A SUN WITH RAYS DESIGN IN BETWEEN THE TWO LETTERS "L".

PRINCIPAL REGISTER

SN 85-272,419, FILED 3-21-2011.

RON FAIRBANKS, EXAMINING ATTORNEY



David J. Kyfos

Director of the United States Patent and Trademark Office

United States of America

United States Patent and Trademark Office

YOUR BODY. OUR WORLD.

Reg. No. 4,110,178

Registered Mar. 6, 2012

Int. Cls.: 3 and 5

HIMALAYA GLOBAL HOLDINGS LTD. (UNITED ARAB EMIR. LIMITED LIABILITY COMPANY)
DIFC, THE GATE LEVEL 12
STE. 27, PO BOX 506807
DUBAI, UNITED ARAB EMIR.

TRADEMARK

PRINCIPAL REGISTER

FOR: COSMETIC PREPARATIONS FOR SLIMMING PURPOSES AND NOT FOR MEDICAL PURPOSES; SUN-TANNING LOTIONS FOR COSMETIC PURPOSES; CREAMS FOR COSMETICS PURPOSES FOR THE SKIN; CREAMS FOR COSMETICS PURPOSES FOR THE HAIR; CREAMS FOR COSMETIC PURPOSES FOR THE FACE; NON-MEDICATED FOOT CREAM, FACIAL WASHES, HAND AND BODY LOTIONS, ESSENTIAL OILS, SOAPS, SHAMPOOS, HAIR CONDITIONERS, HAIR LOTIONS, FACIAL SCRUBS, DENTIFRICES, TOOTHPASTE, NON-MEDICATED LIP CARE PREPARATIONS, MASSAGE OILS, IN CLASS 3 (U.S. CLS. 1, 4, 6, 50, 51 AND 52).

FIRST USE 12-7-2011; IN COMMERCE 12-7-2011.

FOR: NUTRITIONAL SUPPLEMENTS; DIETARY SUPPLEMENTS, IN CLASS 5 (U.S. CLS. 6, 18, 44, 46, 51 AND 52).

FIRST USE 12-7-2011; IN COMMERCE 12-7-2011.

THE MARK CONSISTS OF STANDARD CHARACTERS WITHOUT CLAIM TO ANY PARTICULAR FONT, STYLE, SIZE, OR COLOR.

SN 85-272,664, FILED 3-21-2011.

LEIGH CAROLINE CASE, EXAMINING ATTORNEY



David J. Kyros

Director of the United States Patent and Trademark Office

United States of America

United States Patent and Trademark Office

Eshticken

Reg. No. 4,110,179

Registered Mar. 6, 2012

Int. Cl.: 43

SERVICE MARK

PRINCIPAL REGISTER

ESHTICKEN PIZZA LLC (ILLINOIS LIMITED LIABILITY COMPANY)
352 LITTLETON TRAIL
ELGIN, IL 60120

FOR: BAR AND RESTAURANT SERVICES; CAFE AND RESTAURANT SERVICES; CAFE-RESTAURANTS; CAFETERIA AND RESTAURANT SERVICES; CARRY-OUT RESTAURANTS; FAST FOOD AND NON-STOP RESTAURANT SERVICES; FAST-FOOD RESTAURANT SERVICES; FAST-FOOD RESTAURANTS; FAST-FOOD RESTAURANTS AND SNACKBARS; RESTAURANT; RESTAURANT AND BAR SERVICES; RESTAURANT AND BAR SERVICES, INCLUDING RESTAURANT CARRYOUT SERVICES; RESTAURANT AND CAFE SERVICES; RESTAURANTS; RESTAURANTS FEATURING HOME DELIVERY; SELF SERVICE RESTAURANTS; SELF-SERVICE RESTAURANTS; TAKE-OUT RESTAURANT SERVICES, IN CLASS 43 (U.S. CLS. 100 AND 101).

FIRST USE 10-1-2011; IN COMMERCE 10-1-2011.

THE MARK CONSISTS OF STANDARD CHARACTERS WITHOUT CLAIM TO ANY PARTICULAR FONT, STYLE, SIZE, OR COLOR.

SN 85-273,409, FILED 3-22-2011.

CHARLOTTE CORWIN, EXAMINING ATTORNEY



David J. Kybas

Director of the United States Patent and Trademark Office

United States of America

United States Patent and Trademark Office



Reg. No. 4,110,180

Registered Mar. 6, 2012

Int. Cl.: 41

SERVICE MARK

PRINCIPAL REGISTER

GLE MUSIC INC (MINNESOTA CORPORATION)
19180 730TH AVENUE
DASSEL, MN 55325

FOR: ENTERTAINMENT IN THE NATURE OF LIVE PERFORMANCES BY MUSICAL GROUP, IN CLASS 41 (U.S. CLS. 100, 101 AND 107).

FIRST USE 1-1-1985; IN COMMERCE 1-1-1985.

THE MARK CONSISTS OF A SPACESHIP WITH AN ALIEN PILOT AND THE LETTERS "GLE" ACROSS THE FRONT.

SN 85-273,537, FILED 3-22-2011.

MARK T. MULLEN, EXAMINING ATTORNEY



David J. Kybas

Director of the United States Patent and Trademark Office

United States of America

United States Patent and Trademark Office



Reg. No. 4,110,181

Registered Mar. 6, 2012

Int. Cl.: 7

TRADEMARK

PRINCIPAL REGISTER

LINEAR MARKET TECHNICAL SERVICES CORPORATION (PENNSYLVANIA CORPORATION)
131 BEECHWOOD TERRACE
POTTSTOWN, PA 19465

FOR: LUBRICATION AND GREASING MACHINE FOR USE ON CHAINS MOUNTED ON A MOTORCYCLE, BICYCLE OR OTHER VEHICLE HAVING AN EXPOSED CHAIN , IN CLASS 7 (U.S. CLS. 13, 19, 21, 23, 31, 34 AND 35).

FIRST USE 7-12-2011; IN COMMERCE 7-20-2011.

NO CLAIM IS MADE TO THE EXCLUSIVE RIGHT TO USE "GREASE", APART FROM THE MARK AS SHOWN.

THE MARK CONSISTS OF A DROP OF OIL DRESSED AS A NINJA FIGHTER POSITIONED TO THE LEFT OF THE PHRASE "GREASENINJA".

SN 85-273,580, FILED 3-22-2011.

RON FAIRBANKS, EXAMINING ATTORNEY



David J. Kybas

Director of the United States Patent and Trademark Office

United States of America

United States Patent and Trademark Office

eshticken

Reg. No. 4,110,182

Registered Mar. 6, 2012

Int. Cl.: 43

SERVICE MARK

PRINCIPAL REGISTER

ESHTICKEN PIZZA LLC (ILLINOIS LIMITED LIABILITY COMPANY)
352 LITTLETON TRAIL
ELGIN, IL 60120

FOR: BAR AND RESTAURANT SERVICES; CAFE AND RESTAURANT SERVICES; CAFE-RESTAURANTS; CAFETERIA AND RESTAURANT SERVICES; CARRY-OUT RESTAURANTS; FAST FOOD AND NON-STOP RESTAURANT SERVICES; FAST-FOOD RESTAURANT SERVICES; FAST-FOOD RESTAURANTS; FAST-FOOD RESTAURANTS AND SNACKBARS; RESTAURANT; RESTAURANT AND BAR SERVICES; RESTAURANT AND BAR SERVICES, INCLUDING RESTAURANT CARRYOUT SERVICES; RESTAURANT AND CAFE SERVICES; RESTAURANT AND CATERING SERVICES; RESTAURANT SERVICES; RESTAURANT SERVICES FEATURING SANDWICHES; RESTAURANT SERVICES FEATURING PIZZA; RESTAURANT SERVICES, INCLUDING SIT-DOWN SERVICE OF FOOD AND TAKE-OUT RESTAURANT SERVICES; RESTAURANT SERVICES, NAMELY, PROVIDING OF FOOD AND BEVERAGES FOR CONSUMPTION ON AND OFF THE PREMISES; RESTAURANT, BAR AND CATERING SERVICES; RESTAURANTS; RESTAURANTS FEATURING HOME DELIVERY; SELF SERVICE RESTAURANTS; SELF-SERVICE RESTAURANTS; TAKE-OUT RESTAURANT SERVICES, IN CLASS 43 (U.S. CLS. 100 AND 101).

FIRST USE 10-1-2011; IN COMMERCE 10-1-2011.

THE MARK CONSISTS OF THE WORD "ESHTICKEN" IN THE COLOR BROWN AND IN ALL LOWERCASE LETTERS. THE DOT FOR THE LETTER "I" IN "ESHTICKEN" CONSISTS OF GEOMETRIC TRIANGULAR FIGURES COMPRISING A CIRCLE - WHICH REPRESENTS A PIZZA. THERE ARE FIVE SUCH TRIANGLES WITH ONE TRIANGLE MISSING. THE TRIANGLES ARE COMPLETELY SHADED IN RED. A CIRCLE BORDER IN BROWN ENCOMPASSES THE GEOMETRIC SHAPES. A RED HORIZONTAL LINE RUNS THROUGH THE BOTTOM OF THE WORD "ESHTICKEN" AND CUTS OFF THE BOTTOM OF THE LETTERS IN "ESHTICKEN".

THE COLOR(S) RED, WHITE AND BROWN IS/ARE CLAIMED AS A FEATURE OF THE MARK.

SN 85-273,807, FILED 3-22-2011.

CHARLOTTE CORWIN, EXAMINING ATTORNEY



David J. Kybas

Director of the United States Patent and Trademark Office

United States of America

United States Patent and Trademark Office

NORTH ADAPTEC

Reg. No. 4,110,183

Registered Mar. 6, 2012

Int. Cl.: 9

TRADEMARK

PRINCIPAL REGISTER

NORTH SAFETY PRODUCTS L.L.C. (DELAWARE LIMITED LIABILITY COMPANY)
2000 PLAINFIELD PIKE
CRANSTON, RI 02921

FOR: PROTECTIVE EYEWEAR, IN CLASS 9 (U.S. CLS. 21, 23, 26, 36 AND 38).

FIRST USE 6-12-2011; IN COMMERCE 6-12-2011.

THE MARK CONSISTS OF STANDARD CHARACTERS WITHOUT CLAIM TO ANY PARTICULAR FONT, STYLE, SIZE, OR COLOR.

SN 85-274,185, FILED 3-23-2011.

WILLIAM P. SHANAHAN, EXAMINING ATTORNEY



David J. Kybas

Director of the United States Patent and Trademark Office

United States of America

United States Patent and Trademark Office



Reg. No. 4,110,184

Registered Mar. 6, 2012

Int. Cls.: 18 and 25

TRADEMARK

PRINCIPAL REGISTER

TEE SHIRT SAURUS, INC. (NEW YORK CORPORATION)
7913 18TH AVE.
BROOKLYN, NY 112141703

FOR: ANIMAL CARRIERS; BABY BACKPACKS; BACKPACK STRAPS; BACKPACKS; BACKPACKS WITH ROLLING WHEELS; BOOK BAGS; BUM BAGS; BUSINESS CARD CASES; CARD WALLETS; COIN HOLDERS IN THE NATURE OF WALLETS; COIN PURSES; CREDIT CARD CASES AND HOLDERS; DOG APPAREL; DOG CLOTHING; DOG COATS; DOG COLLARS; DOG COLLARS AND LEADS; DUFFLE BAGS; FANNY PACKS; FASHION HANDBAGS; GARMENT BAGS FOR TRAVEL; HANDBAGS; KEY WALLETS; LEATHER BAGS AND WALLETS; LEATHER BAGS, SUITCASES AND WALLETS; LEATHER CREDIT CARD CASES; LEATHER CREDIT CARD HOLDER; LEATHER CREDIT CARD WALLETS; MOUNTAINEERING STICKS; NECKWEAR FOR DOGS; POCKET WALLETS; POUCHES AND BAGS SOLD EMPTY FOR ATTACHMENT TO BACKPACKS; PROTECTIVE FITTED LINERS FOR BACKPACKS AND LUGGAGE; PURSES; PURSES AND WALLETS; PURSES AND WALLETS OF PRECIOUS METAL; SACK PACKS, NAMELY, DRAWSTRING BAGS USED AS BACKPACKS; SCHOOLBAGS; SCHOOLCHILDREN'S BACKPACKS; SHOULDER BAGS; SMALL BACKPACKS; SPORT BAGS; SPORTS BAGS; SUITCASES; TOTE BAGS; WALLET CHAINS; WALLETS, AND WALLET INSERTS; WALLETS INCLUDING CARD HOLDERS; WALLETS MADE OF LEATHER OR OTHER MATERIALS; WALLETS WITH CARD COMPARTMENTS; WALLETS, NOT OF PRECIOUS METAL, IN CLASS 18 (U.S. CLS. 1, 2, 3, 22 AND 41).

FIRST USE 11-1-2010; IN COMMERCE 3-1-2011.

FOR: BALLET SHOES; BASEBALL CAPS; BASEBALL CAPS AND HATS; BASEBALL SHOES; BATHING CAPS; BEACH SHOES; BOAT SHOES; BOWLING SHOES; BOXING SHOES; BUCKET CAPS; CANVAS SHOES; CAP PEAKS; CAP VISORS; CAPS; CAPS WITH VISORS; CLEATS FOR ATTACHMENT TO SPORTS SHOES; CLIMBING SHOES; CYCLING SHOES; DANCE SHOES; DECK-SHOES; FOOTBALL SHOES; GOLF CAPS; GOLF SHOES; GYMNAS TIC SHOES; HANDBALL SHOES; HATS; HOCKEY SHOES; INFANTS' SHOES AND BOOTS; INSOLES; INSOLES FOR FOOTWEAR; JACKETS; KNITTED CAPS; KNOT CAPS; KNOTTED CAPS; LEATHER SHOES; LEGGINGS; LEISURE SHOES; MOUNTAINEERING SHOES; PANTS; RUBBER SHOES; RUGBY SHOES; RUNNING PADS THAT STRAP ON TO SHOES; RUNNING SHOES; SANDALS; SHOE SOLES; SHOE STRAPS; SHOES; SHORTS; SHOWER CAPS; SKI AND SNOWBOARD SHOES AND PARTS THEREOF; SKI BOOT BAGS; SKI BOOT CASES; SKI BOOTS; SKI GLOVES; SKIING SHOES; SLIPPER



David J. Kybas

Director of the United States Patent and Trademark Office

Reg. No. 4,110,184 SOCKS; SLIPPERS; SNOWBOARD BOOTS; SNOWBOARD GLOVES; SNOWBOARD MITTENS; SOCCER SHOES; SOCKS; SPORTS CAPS AND HATS; SWEATSHIRTS; SWIMMING CAPS; TAP SHOES; TEE SHIRTS; TENNIS SHOES; TOBOGGAN HATS, PANTS AND CAPS; TONGUE OR PULLSTRAP FOR SHOES AND BOOTS; TRACK AND FIELD SHOES; TRAINING SHOES; UNIFORMS; VOLLEYBALL SHOES; WATER REPELLING BOOTS; WATER REPELLING FOOTWEAR; WATER REPELLING LEATHER BOOTS; WATER REPELLING LEATHER SHOES AND BOOTS; WELTS FOR BOOTS AND SHOES; WOMEN'S SHOES; YOGA PANTS; YOGA SHIRTS, IN CLASS 25 (U.S. CLS. 22 AND 39).

FIRST USE 11-1-2010; IN COMMERCE 3-1-2011.

THE MARK CONSISTS OF A DESIGN THAT DEPICTS TWO DINOSAUR FOOTPRINTS, THE FOOTPRINT IN THE BOTTOM PORTION OF THE MARK APPEARS LARGER AND IS SURROUNDED BY A ROUGH EDGED CIRCULAR DESIGN, THE FOOTPRINT IN THE TOP PORTION OF THE MARK IS SMALLER IN SIZE THAN THE BOTTOM FOOTPRINT.

SN 85-274,415, FILED 3-23-2011.

GEOFFREY FOSDICK, EXAMINING ATTORNEY

United States of America

United States Patent and Trademark Office

TeeshirtSaurus

Reg. No. 4,110,185

Registered Mar. 6, 2012

Int. Cls.: 18 and 25

TRADEMARK

PRINCIPAL REGISTER

TEE SHIRT SAURUS, INC. (NEW YORK CORPORATION)
7913 18TH AVE.
BROOKLYN, NY 112141703

FOR: ANIMAL CARRIERS; BABY BACKPACKS; BACKPACK STRAPS; BACKPACKS; BACKPACKS WITH ROLLING WHEELS; BOOK BAGS; BUM BAGS; BUSINESS CARD CASES; CARD WALLETS; COIN HOLDERS IN THE NATURE OF WALLETS; COIN PURSES; CREDIT CARD CASES AND HOLDERS; DOG APPAREL; DOG CLOTHING; DOG COATS; DOG COLLARS; DOG COLLARS AND LEADS; DUFFLE BAGS; FANNY PACKS; FASHION HANDBAGS; GARMENT BAGS FOR TRAVEL; HANDBAGS; KEY WALLETS; LEATHER BAGS AND WALLETS; LEATHER BAGS, SUITCASES AND WALLETS; LEATHER CREDIT CARD CASES; LEATHER CREDIT CARD HOLDER; LEATHER CREDIT CARD WALLETS; MOUNTAINEERING STICKS; NECKWEAR FOR DOGS; POCKET WALLETS; POUCHES AND BAGS SOLD EMPTY FOR ATTACHMENT TO BACKPACKS; PROTECTIVE FITTED LINERS FOR BACKPACKS AND LUGGAGE; PURSES; PURSES AND WALLETS; PURSES AND WALLETS OF PRECIOUS METAL; SACK PACKS, NAMELY, DRAWSTRING BAGS USED AS BACKPACKS; SCHOOLBAGS; SCHOOLCHILDREN'S BACKPACKS; SHOULDER BAGS; SMALL BACKPACKS; SPORT BAGS; SPORTS BAGS; SUITCASES; TOTE BAGS; WALLET CHAINS; WALLETS, AND WALLET INSERTS; WALLETS INCLUDING CARD HOLDERS; WALLETS MADE OF LEATHER OR OTHER MATERIALS; WALLETS WITH CARD COMPARTMENTS; WALLETS, NOT OF PRECIOUS METAL, IN CLASS 18 (U.S. CLS. 1, 2, 3, 22 AND 41).

FIRST USE 11-1-2010; IN COMMERCE 3-1-2011.



David J. Kybas

Director of the United States Patent and Trademark Office

FOR: BALLET SHOES; BASEBALL CAPS; BASEBALL CAPS AND HATS; BASEBALL SHOES; BATHING CAPS; BEACH SHOES; BOAT SHOES; BOWLING SHOES; BOXING SHOES; BUCKET CAPS; CANVAS SHOES; CAP PEAKS; CAP VISORS; CAPS; CAPS WITH VISORS; CLEATS FOR ATTACHMENT TO SPORTS SHOES; CLIMBING SHOES; CYCLING SHOES; DANCE SHOES; DECK-SHOES; FOOTBALL SHOES; GOLF CAPS; GOLF SHOES; GYMNAS TIC SHOES; HANDBALL SHOES; HATS; HOCKEY SHOES; INFANTS' SHOES AND BOOTS; INSOLES; INSOLES FOR FOOTWEAR; JACKETS; KNITTED CAPS; KNOT CAPS; KNOTTED CAPS; LEATHER SHOES; LEGGINGS; LEISURE SHOES; MOUNTAIN-EERING SHOES; PANTS; RUBBER SHOES; RUGBY SHOES; RUNNING PADS THAT STRAP ONTO SHOES; RUNNING SHOES; SANDALS; SHOE SOLES; SHOE STRAPS; SHOES; SHORTS; SHOWER CAPS; SKI AND SNOWBOARD SHOES AND PARTS THEREOF; SKI BOOT BAGS; SKI BOOT CASES; SKI BOOTS; SKI GLOVES; SKIING SHOES; SLIPPER

Reg. No. 4,110,185 SOCKS; SLIPPERS; SNOWBOARD BOOTS; SNOWBOARD GLOVES; SNOWBOARD MITTENS; SOCCER SHOES; SOCKS; SPORTS CAPS AND HATS; SWEATSHIRTS; SWIMMING CAPS; TAP SHOES; TEE SHIRTS; TENNIS SHOES; TOBOGGAN HATS, PANTS AND CAPS; TONGUE OR PULLSTRAP FOR SHOES AND BOOTS; TRACK AND FIELD SHOES; TRAINING SHOES; UNIFORMS; VOLLEYBALL SHOES; WATER REPELLING BOOTS; WATER REPELLING FOOTWEAR; WATER REPELLING LEATHER BOOTS; WATER REPELLING LEATHER SHOES AND BOOTS; WELTS FOR BOOTS AND SHOES; WOMEN'S SHOES; YOGA PANTS; YOGA SHIRTS, IN CLASS 25 (U.S. CLS. 22 AND 39).

FIRST USE 11-1-2010; IN COMMERCE 3-1-2011.

THE MARK CONSISTS OF STANDARD CHARACTERS WITHOUT CLAIM TO ANY PARTICULAR FONT, STYLE, SIZE, OR COLOR.

SN 85-274,427, FILED 3-23-2011.

GEOFFREY FOSDICK, EXAMINING ATTORNEY

United States of America

United States Patent and Trademark Office



Reg. No. 4,110,186

Registered Mar. 6, 2012

Int. Cl.: 36

SERVICE MARK

PRINCIPAL REGISTER

ZIONS BANCORPORATION (UTAH CORPORATION)
SUITE 700
10 EAST SOUTH TEMPLE
SALT LAKE CITY, UT 84133

FOR: BANKING AND FINANCIAL SERVICES, NAMELY, PROVIDING ELECTRONIC ALERTS TO CUSTOMERS OF PURCHASES MADE USING CREDIT CARDS OR DEBIT CARDS THROUGH SMS TEXT MESSAGES OR EMAIL, IN CLASS 36 (U.S. CLS. 100, 101 AND 102).

FIRST USE 2-15-2011; IN COMMERCE 5-6-2011.

NO CLAIM IS MADE TO THE EXCLUSIVE RIGHT TO USE "PURCHASE ALERTS", APART FROM THE MARK AS SHOWN.

THE COLOR(S) BLACK, YELLOW, GREY, RED, ORANGE AND WHITE IS/ARE CLAIMED AS A FEATURE OF THE MARK.

THE MARK CONSISTS OF A SHIELD OUTLINED IN BLACK AND GREY WITH GREY DOTS ON THE OUTER EDGE. THE INTERIOR FACE OF THE SHIELD APPEARS IN SHADES OF ORANGE AND YELLOW WITH THE WORDS "PURCHASE ALERTS" IN BLACK OUTLINED IN WHITE OVER THE SHIELD AND WITH A RED CHECK MARK OUTLINED IN WHITE BELOW THE WORDS. UNDERNEATH THE SHIELD IS AN OVAL SHADE IN GREY.

SN 85-276,638, FILED 3-25-2011.

DANIEL CAPSHAW, EXAMINING ATTORNEY



David J. Kyffers

Director of the United States Patent and Trademark Office

United States of America

United States Patent and Trademark Office

A-KEY

Reg. No. 4,110,187

Registered Mar. 6, 2012

Int. Cl.: 9

TRADEMARK

PRINCIPAL REGISTER

HY-KO PRODUCTS COMPANY (OHIO CORPORATION)
60 MEADOW LANE
NORTHFIELD, OH 44067

FOR: TRANSPONDER KEYS, IN CLASS 9 (U.S. CLS. 21, 23, 26, 36 AND 38).

FIRST USE 6-15-2011; IN COMMERCE 6-15-2011.

THE MARK CONSISTS OF STANDARD CHARACTERS WITHOUT CLAIM TO ANY PARTICULAR FONT, STYLE, SIZE, OR COLOR.

OWNER OF U.S. REG. NOS. 3,463,272, 3,741,345, AND OTHERS.

SN 85-277,148, FILED 3-25-2011.

BRIAN CALLAGHAN, EXAMINING ATTORNEY



David J. Kyffers

Director of the United States Patent and Trademark Office

United States of America

United States Patent and Trademark Office

CPWN

Reg. No. 4,110,188

Registered Mar. 6, 2012

Int. Cl.: 4

TRADEMARK

PRINCIPAL REGISTER

JEEN INTERNATIONAL, CORP. (NEW JERSEY CORPORATION)
24 MADISON ROAD
FAIRFIELD, NJ 07004

FOR: WAXES AS RAW MATERIALS FOR USE IN THE MANUFACTURE OF COSMETIC, PERSONAL CARE AND HOUSEHOLD PRODUCTS; WAX EMULSIONS AND WAX POWDERS FOR INDUSTRIAL, HOUSEHOLD, COSMETIC AND PERSONAL CARE APPLICATIONS, IN CLASS 4 (U.S. CLS. 1, 6 AND 15).

FIRST USE 2-9-2011; IN COMMERCE 2-9-2011.

THE MARK CONSISTS OF STANDARD CHARACTERS WITHOUT CLAIM TO ANY PARTICULAR FONT, STYLE, SIZE, OR COLOR.

SN 85-277,506, FILED 3-25-2011.

GEORGE LORENZO, EXAMINING ATTORNEY



David J. Kybas

Director of the United States Patent and Trademark Office

United States of America

United States Patent and Trademark Office

ETERNITYMARK

Reg. No. 4,110,189

Registered Mar. 6, 2012

Int. Cl.: 14

TRADEMARK

PRINCIPAL REGISTER

CRANE, STEPHEN (UNITED STATES INDIVIDUAL)
767, SOUTH STATE RD. 7
MARGATE, FL 33068

FOR: DIAMONDS, IN CLASS 14 (U.S. CLS. 2, 27, 28 AND 50).

FIRST USE 3-23-2011; IN COMMERCE 3-23-2011.

THE MARK CONSISTS OF STANDARD CHARACTERS WITHOUT CLAIM TO ANY PARTICULAR FONT, STYLE, SIZE, OR COLOR.

SN 85-277,565, FILED 3-25-2011.

SUNG IN, EXAMINING ATTORNEY



David J. Kyfos

Director of the United States Patent and Trademark Office

United States of America

United States Patent and Trademark Office

Natural Instincts Photography

Reg. No. 4,110,190

Registered Mar. 6, 2012

Int. Cl.: 41

SERVICE MARK

PRINCIPAL REGISTER

NATURAL INSTINCTS PHOTOGRAPHY (CALIFORNIA PARTNERSHIP)
7706 ALCOVE AVE.
NORTH HOLLYWOOD, CA 916052016

FOR: PHOTOGRAPHY, IN CLASS 41 (U.S. CLS. 100, 101 AND 107).

FIRST USE 8-12-2011; IN COMMERCE 8-12-2011.

THE MARK CONSISTS OF STANDARD CHARACTERS WITHOUT CLAIM TO ANY PARTICULAR FONT, STYLE, SIZE, OR COLOR.

NO CLAIM IS MADE TO THE EXCLUSIVE RIGHT TO USE "PHOTOGRAPHY", APART FROM THE MARK AS SHOWN.

SN 85-277,649, FILED 3-25-2011.

ELIZABETH HUGHITT, EXAMINING ATTORNEY



David J. Kybas

Director of the United States Patent and Trademark Office

United States of America

United States Patent and Trademark Office

Get it Listed. Get it Sold.

Reg. No. 4,110,191

Registered Mar. 6, 2012

Int. Cl.: 36

SERVICE MARK

PRINCIPAL REGISTER

BABAKHANYAN, MASIS (UNITED STATES INDIVIDUAL)
14
616 N. KENWOOD ST
GLENDALE, CA 91206

FOR: REAL ESTATE AGENCIES, IN CLASS 36 (U.S. CLS. 100, 101 AND 102).

FIRST USE 9-29-2010; IN COMMERCE 9-29-2010.

THE MARK CONSISTS OF STANDARD CHARACTERS WITHOUT CLAIM TO ANY PARTICULAR FONT, STYLE, SIZE, OR COLOR.

SN 85-277,860, FILED 3-26-2011.

B. PARADEWELAI, EXAMINING ATTORNEY



David J. Kyffers

Director of the United States Patent and Trademark Office

United States of America

United States Patent and Trademark Office

XVSDOY

Reg. No. 4,110,192

Registered Mar. 6, 2012

Int. Cl.: 25

TRADEMARK

PRINCIPAL REGISTER

WANG, WENRONG (CHINA INDIVIDUAL)
NO. 101, UNIT 1, TOWER 24, WEST 88
HUIAN, QIAOXI DISTRICT, SHIJIAZHUANG
HEBEI PROVINCE, CHINA

FOR: BABY LAYETTES FOR CLOTHING; BATHING TRUNKS; BELTS FOR CLOTHING; BELTS MADE FROM IMITATION LEATHER; BELTS MADE OF LEATHER; BRAS; CLOTHING EXTENSION USED TO EXTEND THE NORMAL SIZE RANGE OF CLOTHING ITEMS TO ACCOMMODATE PREGNANCY SIZE CHANGES; COATS; DRESSING GOWNS AND BATH ROBES; FOOTWEAR; GLOVES; HEADGEAR, NAMELY, HATS, CAPS; HOSIERY; JACKETS AND SOCKS; LEATHER COATS; MASQUERADE COSTUMES; NECKTIES; OVER COATS; PAJAMAS; ROBES; SANDALS; SARIS; SCARVES; SHAWLS; SHIRTS; SHOES; SINGLETS; SKIRTS; SUITS; SWEATERS; SWIMSUITS; T-SHIRTS; TIES; TROUSERS; UNDERWEAR; UNIFORMS; VEILS; VESTS; WATERPROOF JACKETS AND PANTS, IN CLASS 25 (U.S. CLS. 22 AND 39).

FIRST USE 3-25-2001; IN COMMERCE 4-15-2011.

THE WORDING "XVSDOY" HAS NO MEANING IN A FOREIGN LANGUAGE.

SN 85-278,057, FILED 3-27-2011.

SETH A. RAPPAPORT, EXAMINING ATTORNEY



David J. Kyros

Director of the United States Patent and Trademark Office

United States of America

United States Patent and Trademark Office

Battery Beast

Reg. No. 4,110,193

Registered Mar. 6, 2012

Int. Cl.: 9

TRADEMARK

PRINCIPAL REGISTER

BATTERY BEAST, LLC (IDAHO LIMITED LIABILITY COMPANY), DBA BATTERY BEAST, LLC,
21 BANK STREET
WALLACE, ID 83873

FOR: BATTERIES AND BATTERY CHARGERS, IN CLASS 9 (U.S. CLS. 21, 23, 26, 36 AND 38).

FIRST USE 1-5-2011; IN COMMERCE 8-16-2011.

THE MARK CONSISTS OF STANDARD CHARACTERS WITHOUT CLAIM TO ANY PARTICULAR FONT, STYLE, SIZE, OR COLOR.

NO CLAIM IS MADE TO THE EXCLUSIVE RIGHT TO USE "BATTERY", APART FROM THE MARK AS SHOWN.

SN 85-278,114, FILED 3-27-2011.

ANGELA M. MICHELI, EXAMINING ATTORNEY



David J. Kyffers

Director of the United States Patent and Trademark Office

United States of America

United States Patent and Trademark Office



Reg. No. 4,110,194

Registered Mar. 6, 2012

Int. Cl.: 37

SERVICE MARK

PRINCIPAL REGISTER

GUARDIAN COMMUNITY RESOURCE MANAGEMENT, INC. (FLORIDA CORPORATION)
15380 COUNTY ROAD 565A, SUITE B
GROVELAND, FL 34736

FOR: CONSTRUCTION CONSULTANCY; CONSTRUCTION PROJECT MANAGEMENT SERVICES, IN CLASS 37 (U.S. CLS. 100, 103 AND 106).

FIRST USE 4-30-2011; IN COMMERCE 4-30-2011.

NO CLAIM IS MADE TO THE EXCLUSIVE RIGHT TO USE "COMMUNITY RESOURCE MANAGEMENT INC.", APART FROM THE MARK AS SHOWN.

THE MARK CONSISTS OF A SHIELD OVER A BACKGROUND OF SWIRL SHAPES AND LEAVES WITH A KNIGHT'S HELMET INSIDE THE SHIELD WITH THE WORD "GUARDIAN" IN A RIBBON-LIKE SHAPE ACROSS THE SHIELD WITH THE WORDS "COMMUNITY RESOURCE MANAGEMENT INC." UNDER THE SHIELD.

SN 85-278,280, FILED 3-28-2011.

KATHY DE JONGE, EXAMINING ATTORNEY



David J. Kybas

Director of the United States Patent and Trademark Office

United States of America

United States Patent and Trademark Office



Reg. No. 4,110,195

Registered Mar. 6, 2012

Int. Cl.: 31

TRADEMARK

PRINCIPAL REGISTER

SAMFORD SOUTHWEST ENTERPRISES, LLC (ARIZONA LIMITED LIABILITY COMPANY),
DBA GO DOG WILD,
2156 S. HERITAGE DRIVE
GILBERT, AZ 85295

FOR: DOG TREATS, IN CLASS 31 (U.S. CLS. 1 AND 46).

FIRST USE 5-7-2011; IN COMMERCE 5-7-2011.

THE MARK CONSISTS OF THREE PINE TREES, TWO DARK GREEN AND ONE LIGHT GREEN, AND A LIGHT TAN GOLDEN RETRIEVER ON A CHOCOLATE BROWN HIKING TRAIL. THE DOG IS SHOWN WITH A CHOCOLATE BROWN COLLAR AND THE FACE IS LOOKING UP TO THE WORDING "GO DOG WILD", WHICH IS UNDERLINED IN CHOCOLATE BROWN. A LIGHT GREEN TREE LEAF WITH DARK GREEN HIGHLIGHTS AND A CHOCOLATE BROWN PAW PRINT BOOKEND THE TEXT "NATURE PROVIDED & PUP APPROVED" IN CHOCOLATE BROWN.

THE COLOR(S) TAN, DARK GREEN, LIGHT GREEN, CHOCOLATE BROWN, AND LIGHT TAN IS/ARE CLAIMED AS A FEATURE OF THE MARK.

SN 85-279,126, FILED 3-28-2011.

GINA FINK, EXAMINING ATTORNEY



David J. Kybas

Director of the United States Patent and Trademark Office

United States of America

United States Patent and Trademark Office

IMPRACTICAL JOKERS

Reg. No. 4,110,196

Registered Mar. 6, 2012

Int. Cl.: 41

SERVICE MARK

PRINCIPAL REGISTER

COURTROOM TELEVISION NETWORK LLC (NEW YORK LIMITED LIABILITY COMPANY)
600 THIRD AVENUE
NEW YORK, NY 10016

FOR: ENTERTAINMENT SERVICES, NAMELY, CONTINUING SCRIPTED AND UNSCRIPTED TELEVISION PROGRAM SERIES IN THE FIELD OF COMEDY, DRAMA, ACTION, ADVENTURE AND/OR REALITY PROVIDED THROUGH CABLE TELEVISION, BROADCAST TELEVISION, INTERNET, VIDEO-ON-DEMAND, AND THROUGH OTHER DISTRIBUTION PLATFORMS; PROVIDING INFORMATION, NAMELY, ENTERTAINMENT INFORMATION OVER THE INTERNET, IN CLASS 41 (U.S. CLS. 100, 101 AND 107).

FIRST USE 12-15-2011; IN COMMERCE 12-15-2011.

THE MARK CONSISTS OF STANDARD CHARACTERS WITHOUT CLAIM TO ANY PARTICULAR FONT, STYLE, SIZE, OR COLOR.

SN 85-280,033, FILED 3-29-2011.

JAMES MACFARLANE, EXAMINING ATTORNEY



David J. Kybas

Director of the United States Patent and Trademark Office

United States of America

United States Patent and Trademark Office



Reg. No. 4,110,197

Registered Mar. 6, 2012

Int. Cl.: 30

TRADEMARK

PRINCIPAL REGISTER

HAMMONS, MARK ISAAC (UNITED STATES INDIVIDUAL)
7F.-10, NO. 68, SEC. 4
ROOSEVELT RD., DA-AN DIST.
TAIPEI CITY, TAIWAN

FOR: TEA; TEA BAGS; ICED TEA; TEA-BASED BEVERAGES; CHINESE TEA, NAMELY, OOLONG TEA, PU-ERH TEA; BLACK TEA; GREEN TEA; HERB TEA FOR FOOD PURPOSES; TEA POWDER, IN CLASS 30 (U.S. CL. 46).

FIRST USE 8-26-2010; IN COMMERCE 10-4-2011.

THE MARK CONSISTS OF A DESIGN OF A LEAF INSIDE TWO PAIRS OF CONCENTRIC CIRCLES, AND WORDING "WILD AND BARE" IS WRITTEN AT THE BOTTOM BETWEEN THE OUTER AND INNER PAIR OF CIRCLES.

SN 85-280,081, FILED 3-29-2011.

CHERYL CLAYTON, EXAMINING ATTORNEY



David J. Kyjars

Director of the United States Patent and Trademark Office

United States of America

United States Patent and Trademark Office

Wild & Bare

Reg. No. 4,110,198

Registered Mar. 6, 2012

Int. Cl.: 30

TRADEMARK

PRINCIPAL REGISTER

HAMMONS, MARK ISAAC (TAIWAN INDIVIDUAL)
7F.-10, NO. 68, SEC. 4
ROOSEVELT RD., DA-AN DIST.
TAIPEI CITY, TAIWAN

FOR: TEA; TEA BAGS; ICED TEA; TEA-BASED BEVERAGES; CHINESE TEA, NAMELY, OOLONG TEA, PU-ERH TEA; BLACK TEA; GREEN TEA; HERB TEA FOR FOOD PURPOSES; TEA POWDER, IN CLASS 30 (U.S. CL. 46).

FIRST USE 8-26-2010; IN COMMERCE 10-4-2011.

THE MARK CONSISTS OF STANDARD CHARACTERS WITHOUT CLAIM TO ANY PARTICULAR FONT, STYLE, SIZE, OR COLOR.

SN 85-280,091, FILED 3-29-2011.

CHERYL CLAYTON, EXAMINING ATTORNEY



David J. Kybas

Director of the United States Patent and Trademark Office

United States of America

United States Patent and Trademark Office

TAVOLO MIO

✧ SALUMERIA E BOTTEGA ITALIANA ✧

Reg. No. 4,110,199

PATELLA, BRIAN (UNITED STATES INDIVIDUAL)
12634 SARAH STREET
STUDIO CITY, CA 91604

Registered Mar. 6, 2012

Int. Cl.: 35

FOR: RETAIL DELICATESSEN SERVICES, IN CLASS 35 (U.S. CLS. 100, 101 AND 102).

SERVICE MARK

FIRST USE 9-5-2009; IN COMMERCE 12-3-2011.

PRINCIPAL REGISTER

NO CLAIM IS MADE TO THE EXCLUSIVE RIGHT TO USE "SALUMERIA E BOTTEGA ITALIANA", APART FROM THE MARK AS SHOWN.

THE MARK CONSISTS OF A FRAMED RECTANGLE WITH "TAVOLO MIO" CENTERED ALL CAPS (CASTELLAR 48), AND "SALUMERIA E BOTTEGA ITALIANA" CENTERED UNDERNEATH ALL CAPS (CASTELLAR 12).

THE ENGLISH TRANSLATION OF "TAVOLO MIO SALUMERIA E BOTTEGA ITALIANA" IN THE MARK IS MY TABLE DELICATESSEN AND "ITALIAN SHOP".

SN 85-280,227, FILED 3-29-2011.

TRACY CROSS, EXAMINING ATTORNEY



David J. Kyros

Director of the United States Patent and Trademark Office

United States of America

United States Patent and Trademark Office

RAM 1500 EXPRESS

Reg. No. 4,110,200

Registered Mar. 6, 2012

Int. Cl.: 12

TRADEMARK

PRINCIPAL REGISTER

CHRYSLER GROUP LLC (DELAWARE LIMITED LIABILITY COMPANY)
CIMS 485-13-32
1000 CHRYSLER DRIVE
AUBURN HILLS, MI 48326

FOR: MOTOR VEHICLES, NAMELY, PASSENGER AUTOMOBILES, THEIR STRUCTURAL PARTS, TRIM AND BADGES, IN CLASS 12 (U.S. CLS. 19, 21, 23, 31, 35 AND 44).

FIRST USE 4-0-2011; IN COMMERCE 4-0-2011.

THE MARK CONSISTS OF STANDARD CHARACTERS WITHOUT CLAIM TO ANY PARTICULAR FONT, STYLE, SIZE, OR COLOR.

OWNER OF U.S. REG. NOS. 2,993,078, 3,806,969, AND OTHERS.

SN 85-281,109, FILED 3-30-2011.

TINA BROWN, EXAMINING ATTORNEY



David J. Kyjars

Director of the United States Patent and Trademark Office

United States of America

United States Patent and Trademark Office



Reg. No. 4,110,201

Registered Mar. 6, 2012

Int. Cl.: 5

TRADEMARK

PRINCIPAL REGISTER

JULIE T. CHEN (UNITED STATES INDIVIDUAL)
367 SANTANA HEIGHTS, UNIT 7030
SAN JOSE, CA 95128

FOR: VITAMINS; NUTRITIONAL SUPPLEMENTS; DIETARY SUPPLEMENTS; NUTRITIONAL FOOD BARS FOR USE AS A MEAL REPLACEMENT; MEAL REPLACEMENT BARS; DIETARY SUPPLEMENTS IN THE NATURE OF NUTRITIONAL BARS, IN CLASS 5 (U.S. CLS. 6, 18, 44, 46, 51 AND 52).

FIRST USE 11-30-2011; IN COMMERCE 12-2-2011.

THE NAME IN THE MARK IDENTIFIES THE APPLICANT, JULIE T. CHEN, WHOSE CONSENT IS OF RECORD.

THE COLOR(S) BLUE, TURQUOISE, GREEN, ORANGE, AND YELLOW IS/ARE CLAIMED AS A FEATURE OF THE MARK.

THE MARK CONSISTS OF A LEAF PETAL DESIGN CONSISTING OF ONE ORANGE LEAF, ONE YELLOW LEAF, ONE GREEN LEAF, AND ONE TURQUOISE LEAF, PLUS THE WORDS "MAKING HEALTHY EZ" WITH THE FIRST LETTER IN EACH TERM IN BLUE AND THE REMAINING LETTERS IN TURQUOISE.

SN 85-281,140, FILED 3-30-2011.

DAVID ELTON, EXAMINING ATTORNEY



David J. Kybas

Director of the United States Patent and Trademark Office

United States of America

United States Patent and Trademark Office

RANCHO  ESTANCIA

Reg. No. 4,110,202

RHE HATCO, INC. (DELAWARE CORPORATION)
601 MARION DRIVE
GARLAND, TX 75042

Registered Mar. 6, 2012

Int. Cl.: 25

FOR: CLOTHING, NAMELY, SHIRTS, TOPS, T-SHIRTS, IN CLASS 25 (U.S. CLS. 22 AND 39).

TRADEMARK

FIRST USE 6-30-2011; IN COMMERCE 6-30-2011.

PRINCIPAL REGISTER

THE MARK CONSISTS OF THE WORDS "RANCHO ESTANCIA" WITH A CROSS WITHIN A CIRCLE DESIGN BETWEEN "RANCHO" AND "ESTANCIA".

THE ENGLISH TRANSLATION OF "RANCHO ESTANCIA" IN THE MARK IS "RANCH STAY".

SN 85-281,689, FILED 3-30-2011.

GENE MACIOL, EXAMINING ATTORNEY



David J. Kybas

Director of the United States Patent and Trademark Office

United States of America

United States Patent and Trademark Office

AUTUMN GOLD

Reg. No. 4,110,203

SEALD SWEET LLC (DELAWARE LIMITED LIABILITY COMPANY)
1991 74TH AVENUE
VERO BEACH, FL 32966

Registered Mar. 6, 2012

Int. Cl.: 31

FOR: FRESH CITRUS FRUITS, IN CLASS 31 (U.S. CLS. 1 AND 46).

TRADEMARK

FIRST USE 8-21-2005; IN COMMERCE 8-21-2005.

PRINCIPAL REGISTER

THE MARK CONSISTS OF STANDARD CHARACTERS WITHOUT CLAIM TO ANY PARTICULAR FONT, STYLE, SIZE, OR COLOR.

SN 85-282,512, FILED 3-31-2011.

AISHA CLARKE, EXAMINING ATTORNEY



David J. Kybas

Director of the United States Patent and Trademark Office

United States of America

United States Patent and Trademark Office

BOOZKIE

Reg. No. 4,110,204

Registered Mar. 6, 2012

Int. Cl.: 42

SERVICE MARK

PRINCIPAL REGISTER

BELL, DR. PRESTON (UNITED STATES INDIVIDUAL)
5184 NORTH 42ND STREET
MILWAUKEE, WI 53209

FOR: COMPUTER SERVICES, NAMELY, CREATING AN ON-LINE COMMUNITY FOR REGISTERED USERS TO PARTICIPATE IN DISCUSSIONS, GET FEEDBACK FROM THEIR PEERS, FORM VIRTUAL COMMUNITIES, AND ENGAGE IN SOCIAL NETWORKING FEATURING SOCIAL INTRODUCTION AND DATING; PROVIDING A WEBSITE THAT GIVES USERS THE ABILITY TO UPLOAD, POST, SHOW, DISPLAY, TAG, BLOG, SHARE OR OTHERWISE PROVIDE ELECTRONIC MEDIA OR INFORMATION OVER THE INTERNET OR OTHER COMMUNICATIONS NETWORK AND UTILIZE A CUSTOM TEMPLATE TO PROVIDE INPUT, LIKES, DISLIKES, EDITS, CHANGES, MODIFICATIONS, OPINIONS, SUGGESTIONS, AND COMMENTS AND ENGAGE IN SOCIAL AND COMMUNITY NETWORKING, IN CLASS 42 (U.S. CLS. 100 AND 101).

FIRST USE 2-9-2010; IN COMMERCE 2-9-2010.

THE MARK CONSISTS OF STANDARD CHARACTERS WITHOUT CLAIM TO ANY PARTICULAR FONT, STYLE, SIZE, OR COLOR.

SN 85-282,694, FILED 3-31-2011.

HEATHER THOMPSON, EXAMINING ATTORNEY



David J. Kyros

Director of the United States Patent and Trademark Office

United States of America

United States Patent and Trademark Office

Petite Lap Giraffe

Reg. No. 4,110,205

Registered Mar. 6, 2012

Int. Cl.: 14

TRADEMARK

PRINCIPAL REGISTER

BALLETTA, LISA M (UNITED STATES INDIVIDUAL), TA BALLETTA, LISA M,
3248 MIRELLA DRIVE
WEST PALM BEACH, FL 33404

FOR: BEADS FOR USE IN THE MANUFACTURE OF JEWELRY; BODY JEWELRY; BRACELETS; BRACELETS AND JEWELRY FEATURING ELECTRONIC CHIPS FOR ATTRACTING ENERGY TO THE BODY WHEREIN THE ELECTRONIC CHIPS INCREASE IN POWER IN THE PRESENCE OF ELECTROMAGNETIC FIELDS, FOR THE PURPOSE OF RE-BALANCING THE HUMAN ENERGY FIELD; BROACHES; BRONZE JEWELRY; BROOCHES; CAMEOS; CHARMS; CHARMS FOR COLLAR JEWELRY AND BRACELET; COSTUME JEWELRY; DIAMOND JEWELRY; GEMSTONE JEWELRY; GOLD THREAD JEWELRY; HAIR JEWELRY IN THE NATURE OF JEWELRY FOR USE IN THE HAIR; IDENTIFICATION BRACELETS; INEXPENSIVE NON-JEWELRY WATCHES; JEWELRY; JEWELRY AND IMITATION JEWELRY; JEWELRY ARMOIRES; JEWELRY BOXES; JEWELRY BOXES NOT OF METAL; JEWELRY BOXES OF METAL; JEWELRY BOXES OF PRECIOUS METAL; JEWELRY BROOCHES; JEWELRY CASES; JEWELRY CASES NOT OF PRECIOUS METAL; JEWELRY CASES OF PRECIOUS METAL; JEWELRY CASKETS; JEWELRY CASKETS OF PRECIOUS METAL; JEWELRY CHAINS; JEWELRY DISHES; JEWELRY FINDINGS; JEWELRY FOR ATTACHMENT TO CLOTHING; JEWELRY FOR THE HEAD; JEWELRY IN THE NATURE OF ARMBANDS, IN CLASS 14 (U.S. CLS. 2, 27, 28 AND 50).

FIRST USE 7-1-2011; IN COMMERCE 7-1-2011.

THE MARK CONSISTS OF STANDARD CHARACTERS WITHOUT CLAIM TO ANY PARTICULAR FONT, STYLE, SIZE, OR COLOR.

NO CLAIM IS MADE TO THE EXCLUSIVE RIGHT TO USE "PETITE" AND "GIRAFFE", APART FROM THE MARK AS SHOWN.

SN 85-283,790, FILED 4-1-2011.

SCOTT BIBB, EXAMINING ATTORNEY



David J. Kybas

Director of the United States Patent and Trademark Office

United States of America

United States Patent and Trademark Office

PICC AUTO

Reg. No. 4,110,206

FCS AUTOMOTIVE INTERNATIONAL INC. (MICHIGAN CORPORATION)
1821 NORTHWOOD DR.
TROY, MI 48084

Registered Mar. 6, 2012

Int. Cl.: 12

FOR: VEHICLE PARTS, NAMELY, SHOCK ABSORBERS, IN CLASS 12 (U.S. CLS. 19, 21, 23, 31, 35 AND 44).

TRADEMARK

FIRST USE 12-16-2011; IN COMMERCE 12-16-2011.

PRINCIPAL REGISTER

THE MARK CONSISTS OF STANDARD CHARACTERS WITHOUT CLAIM TO ANY PARTICULAR FONT, STYLE, SIZE, OR COLOR.

NO CLAIM IS MADE TO THE EXCLUSIVE RIGHT TO USE "AUTO", APART FROM THE MARK AS SHOWN.

SN 85-285,068, FILED 4-4-2011.

TRACY CROSS, EXAMINING ATTORNEY



David J. Kyffers

Director of the United States Patent and Trademark Office

United States of America

United States Patent and Trademark Office

PARALLAX SEMICONDUCTOR

Reg. No. 4,110,207

Registered Mar. 6, 2012

Int. Cl.: 9

TRADEMARK

PRINCIPAL REGISTER

PARALLAX INC. (CALIFORNIA CORPORATION)
599 MENLO DRIVE
ROCKLIN, CA 95765

FOR: MICROCONTROLLERS; EMBEDDED MICROPROCESSORS; INTEGRATED CIRCUITS; COMPUTER SOFTWARE DEVELOPMENT TOOLS, NAMELY, COMPILERS, ASSEMBLERS, AND DEBUGGERS; EMBEDDED SOFTWARE AND FIRMWARE FOR USE IN OPERATING CONTROL SYSTEMS; EMBEDDED COMPUTER OPERATING SYSTEMS; AUTOMATED PROCESS CONTROL SYSTEMS, NAMELY, MICROPROCESSOR-BASED HARDWARE AND SOFTWARE FOR USE IN MONITORING THE STATUS OF INDUSTRIAL EQUIPMENT, IN CLASS 9 (U.S. CLS. 21, 23, 26, 36 AND 38).

FIRST USE 5-2-2011; IN COMMERCE 5-2-2011.

THE MARK CONSISTS OF STANDARD CHARACTERS WITHOUT CLAIM TO ANY PARTICULAR FONT, STYLE, SIZE, OR COLOR.

NO CLAIM IS MADE TO THE EXCLUSIVE RIGHT TO USE "SEMICONDUCTOR" , APART FROM THE MARK AS SHOWN.

SN 85-286,035, FILED 4-5-2011.

NICHOLAS ALTREE, EXAMINING ATTORNEY



David J. Kyros

Director of the United States Patent and Trademark Office

United States of America

United States Patent and Trademark Office

LONG WEEKEND

Reg. No. 4,110,208

Registered Mar. 6, 2012

Int. Cl.: 32

TRADEMARK

PRINCIPAL REGISTER

BIG BAY BREWING, LLC (WISCONSIN LIMITED LIABILITY COMPANY), DBA BIG BAY BREWING COMPANY,
4517 N. OAKLAND AVE
SHOREWOOD, WI 53211

FOR: BEER, ALE AND LAGER, IN CLASS 32 (U.S. CLS. 45, 46 AND 48).

FIRST USE 8-24-2011; IN COMMERCE 9-1-2011.

THE MARK CONSISTS OF STANDARD CHARACTERS WITHOUT CLAIM TO ANY PARTICULAR FONT, STYLE, SIZE, OR COLOR.

SN 85-286,542, FILED 4-5-2011.

PAUL MORENO, EXAMINING ATTORNEY



David J. Kybas

Director of the United States Patent and Trademark Office

United States of America

United States Patent and Trademark Office

I'm Thirsty

Reg. No. 4,110,209

Registered Mar. 6, 2012

Int. Cl.: 9

TRADEMARK

PRINCIPAL REGISTER

RUTHLESS ENTERTAINMENT PTE LTD (SINGAPORE PRIVATE LIMITED COMPANY)
137 CECIL STREET, #06-01
SINGAPORE, SINGAPORE 069537

FOR: COMPUTER APPLICATION SOFTWARE FOR MOBILE PHONES, NAMELY, SOFTWARE FOR DISPLAYING AND SHARING A USER'S LOCATION, FINDING, LOCATING, AND INTERACTING WITH OTHER USERS AND PLACES, AND FINDING NEARBY BARS, CLUBS AND RESTAURANTS TO BUY A DRINK OR OFFER TO BUY OTHER USERS A DRINK, IN RELATION TO LOCATION-BASED CHECK-IN PROCESS; DOWNLOADABLE SOFTWARE IN THE NATURE OF A MOBILE APPLICATION FOR DISPLAYING AND SHARING A USER'S LOCATION, FINDING, LOCATING, AND INTERACTING WITH OTHER USERS AND PLACES, AND FINDING NEARBY BARS, CLUBS AND RESTAURANTS TO BUY A DRINK OR OFFER TO BUY OTHER USERS A DRINK, IN RELATION TO LOCATION-BASED CHECK-IN PROCESS, IN CLASS 9 (U.S. CLS. 21, 23, 26, 36 AND 38).

FIRST USE 7-1-2011; IN COMMERCE 7-1-2011.

THE MARK CONSISTS OF STANDARD CHARACTERS WITHOUT CLAIM TO ANY PARTICULAR FONT, STYLE, SIZE, OR COLOR.

SN 85-286,761, FILED 4-5-2011.

CHERYL CLAYTON, EXAMINING ATTORNEY



David J. Kyros

Director of the United States Patent and Trademark Office

United States of America

United States Patent and Trademark Office

Bucks & BBQ

Reg. No. 4,110,210

Registered Mar. 6, 2012

Int. Cl.: 41

SERVICE MARK

PRINCIPAL REGISTER

TEXAS TROPHY HUNTERS ASSOCIATION, LTD. (TEXAS LIMITED PARTNERSHIP)
8122 DATAPOINT DRIVE, SUITE 1000
SAN ANTONIO, TX 78229

FOR: ARRANGING, PLANNING, AND CONDUCTING EVENTS IN THE FIELD OF HUNTING AND OUTDOOR RECREATIONAL ACTIVITIES FOR EDUCATIONAL, SPORTING, CULTURAL AND ENTERTAINMENT PURPOSES, IN CLASS 41 (U.S. CLS. 100, 101 AND 107).

FIRST USE 4-4-2011; IN COMMERCE 4-4-2011.

THE MARK CONSISTS OF STANDARD CHARACTERS WITHOUT CLAIM TO ANY PARTICULAR FONT, STYLE, SIZE, OR COLOR.

SN 85-287,717, FILED 4-6-2011.

TINA MAI, EXAMINING ATTORNEY



David J. Kybas

Director of the United States Patent and Trademark Office

United States of America

United States Patent and Trademark Office

DIERECT

Reg. No. 4,110,211

WESTERN PRINTING MACHINERY CO. (ILLINOIS CORPORATION)
9229 IVANHOE STREET
SCHILLER PARK, IL 60176

Registered Mar. 6, 2012

Int. Cl.: 7

FOR: ROTARY DIE CUTTING MACHINERY, IN CLASS 7 (U.S. CLS. 13, 19, 21, 23, 31, 34 AND 35).

TRADEMARK

FIRST USE 5-2-2011; IN COMMERCE 8-14-2011.

PRINCIPAL REGISTER

THE MARK CONSISTS OF STANDARD CHARACTERS WITHOUT CLAIM TO ANY PARTICULAR FONT, STYLE, SIZE, OR COLOR.

SN 85-288,060, FILED 4-6-2011.

TRACY FLETCHER, EXAMINING ATTORNEY



David J. Kybas

Director of the United States Patent and Trademark Office

United States of America

United States Patent and Trademark Office

ISEENYA.COM

Reg. No. 4,110,212

Registered Mar. 6, 2012

Int. Cl.: 45

SERVICE MARK

PRINCIPAL REGISTER

ISEENYA, LLC (MASSACHUSETTS LIMITED LIABILITY COMPANY)
PO BOX 66298
AUBURNDALE, MA 02466

FOR: ON-LINE SOCIAL NETWORKING SERVICES, IN CLASS 45 (U.S. CLS. 100 AND 101).

FIRST USE 2-1-2011; IN COMMERCE 9-1-2011.

THE MARK CONSISTS OF STANDARD CHARACTERS WITHOUT CLAIM TO ANY PARTICULAR FONT, STYLE, SIZE, OR COLOR.

SN 85-288,116, FILED 4-6-2011.

TEJBIR SINGH, EXAMINING ATTORNEY



David J. Kybas

Director of the United States Patent and Trademark Office

United States of America

United States Patent and Trademark Office



Reg. No. 4,110,213

CHIPOTLE MEXICAN GRILL, INC. (DELAWARE CORPORATION)
1401 WYNKOOP STREET, SUITE 500
DENVER, CO 80202

Registered Mar. 6, 2012

Int. Cl.: 43

FOR: RESTAURANT SERVICES; TAKE-OUT RESTAURANT SERVICES, IN CLASS 43 (U.S. CLS. 100 AND 101).

SERVICE MARK

FIRST USE 9-14-2011; IN COMMERCE 9-14-2011.

PRINCIPAL REGISTER

NO CLAIM IS MADE TO THE EXCLUSIVE RIGHT TO USE "SOUTHEAST ASIAN KITCHEN", APART FROM THE MARK AS SHOWN.

THE COLOR(S) ORANGE IS/ARE CLAIMED AS A FEATURE OF THE MARK.

THE MARK CONSISTS OF A STYLIZED DESIGN OF A FLOWER WITH THREE PETALS ABOVE A BOWL TO THE LEFT OF THE WORDING "SHOPHOUSE" AND "SOUTHEAST ASIAN KITCHEN", ALL IN THE COLOR ORANGE.

SN 85-288,258, FILED 4-6-2011.

VERNA BETH RIRIE, EXAMINING ATTORNEY



David J. Kyffers

Director of the United States Patent and Trademark Office

United States of America

United States Patent and Trademark Office

Robert's Remedies

Reg. No. 4,110,214

PEP PHARMACEUTICALS (OHIO LIMITED LIABILITY COMPANY)
2549 BRYDEN RD
BEXLEY, OH 43209

Registered Mar. 6, 2012

Int. Cl.: 5

FOR: NUTRACEUTICALS FOR THE TREATMENT OF MINOR BURNS, NAMELY, SPRAY FOR ORAL BURNS, AND A GEL FOR SKIN BURNS, IN CLASS 5 (U.S. CLS. 6, 18, 44, 46, 51 AND 52).

TRADEMARK

FIRST USE 7-19-2011; IN COMMERCE 7-19-2011.

PRINCIPAL REGISTER

THE MARK CONSISTS OF STANDARD CHARACTERS WITHOUT CLAIM TO ANY PARTICULAR FONT, STYLE, SIZE, OR COLOR.

NO CLAIM IS MADE TO THE EXCLUSIVE RIGHT TO USE "REMEDIES", APART FROM THE MARK AS SHOWN.

SN 85-288,378, FILED 4-6-2011.

GINA HAYES, EXAMINING ATTORNEY



David J. Kyros

Director of the United States Patent and Trademark Office

United States of America

United States Patent and Trademark Office

mfg4

Reg. No. 4,110,215

Registered Mar. 6, 2012

Int. Cl.: 35

SERVICE MARK

PRINCIPAL REGISTER

SOCIETY OF MANUFACTURING ENGINEERS (MICHIGAN CORPORATION)
ONE SME DRIVE, PO BOX 930
DEARBORN, MI 48121

FOR: ARRANGING AND CONDUCTING BUSINESS CONFERENCES AND EXPOSITIONS
IN THE FIELDS OF AEROSPACE AND DEFENSE MANUFACTURING, MEDICAL MANU-
FACTURING, AND ENERGY MANUFACTURING, IN CLASS 35 (U.S. CLS. 100, 101 AND
102).

FIRST USE 5-17-2011; IN COMMERCE 5-17-2011.

THE MARK CONSISTS OF STANDARD CHARACTERS WITHOUT CLAIM TO ANY PAR-
TICULAR FONT, STYLE, SIZE, OR COLOR.

SN 85-288,540, FILED 4-7-2011.

ZACHARY BELLO, EXAMINING ATTORNEY



David J. Kyffers

Director of the United States Patent and Trademark Office

United States of America

United States Patent and Trademark Office

Diamonore

Reg. No. 4,110,216

Registered Mar. 6, 2012

Int. Cl.: 14

TRADEMARK

PRINCIPAL REGISTER

STAR RING, INC. (CALIFORNIA CORPORATION)
9256 OWENSMOUTH AVENUE
CHATSWORTH, CA 91311

FOR: MAN MADE ZIRCONIUM CRYSTALS FOR USE AS JEWELRY, IN CLASS 14 (U.S. CLS. 2, 27, 28 AND 50).

FIRST USE 2-15-2011; IN COMMERCE 7-12-2011.

THE MARK CONSISTS OF STANDARD CHARACTERS WITHOUT CLAIM TO ANY PARTICULAR FONT, STYLE, SIZE, OR COLOR.

SN 85-289,026, FILED 4-7-2011.

JOHN HWANG, EXAMINING ATTORNEY



David J. Kybas

Director of the United States Patent and Trademark Office

United States of America

United States Patent and Trademark Office

MOTOROLA XPRT

Reg. No. 4,110,217

Registered Mar. 6, 2012

Int. Cl.: 9

TRADEMARK

PRINCIPAL REGISTER

MOTOROLA TRADEMARK HOLDINGS, LLC (DELAWARE LIMITED LIABILITY COMPANY)
600 N. U.S. HIGHWAY 45
LIBERTYVILLE, IL 60048

FOR: MOBILE PHONES, IN CLASS 9 (U.S. CLS. 21, 23, 26, 36 AND 38).

FIRST USE 5-31-2011; IN COMMERCE 5-31-2011.

THE MARK CONSISTS OF STANDARD CHARACTERS WITHOUT CLAIM TO ANY PARTICULAR FONT, STYLE, SIZE, OR COLOR.

SN 85-289,196, FILED 4-7-2011.

BARBARA RUTLAND, EXAMINING ATTORNEY



David J. Kyffers

Director of the United States Patent and Trademark Office

United States of America

United States Patent and Trademark Office

BAR SCREEN MONSTER

Reg. No. 4,110,218

Registered Mar. 6, 2012

Int. Cl.: 7

TRADEMARK

PRINCIPAL REGISTER

JWC ENVIRONMENTAL, LLC (DELAWARE LIMITED LIABILITY COMPANY)
290 PAULARINO AVENUE
COSTA MESA, CA 92626

FOR: SCREENING MACHINE USED TO REMOVE SOLIDS FROM WASTEWATER FLOWS,
IN CLASS 7 (U.S. CLS. 13, 19, 21, 23, 31, 34 AND 35).

FIRST USE 10-8-2011; IN COMMERCE 10-8-2011.

THE MARK CONSISTS OF STANDARD CHARACTERS WITHOUT CLAIM TO ANY PAR-
TICULAR FONT, STYLE, SIZE, OR COLOR.

OWNER OF U.S. REG. NOS. 1,926,852, 3,012,022, AND OTHERS.

NO CLAIM IS MADE TO THE EXCLUSIVE RIGHT TO USE "BAR SCREEN", APART FROM
THE MARK AS SHOWN.

SN 85-289,399, FILED 4-7-2011.

GIANCARLO CASTRO, EXAMINING ATTORNEY



David J. Kyros

Director of the United States Patent and Trademark Office

United States of America

United States Patent and Trademark Office

Eat NuDe!

Reg. No. 4,110,219

Registered Mar. 6, 2012

Int. Cl.: 30

TRADEMARK

PRINCIPAL REGISTER

CRYSTAL RIVER ORGANICS LLC (COLORADO LIMITED LIABILITY COMPANY)
P.O. BOX 2076
CARBONDALE, CO 81623

FOR: CEREAL BASED SNACK BARS; CEREAL BASED HIGH PROTEIN SNACK BARS AND POWDERS; CEREAL BASED HIGH ENERGY BARS NOT FOR USE AS A MEAL REPLACEMENT; CEREALS AND PREPARATIONS MADE FROM CEREALS, NAMELY, BREAKFAST CEREALS, PROCESSED CEREALS AND CEREAL BASED SNACK FOODS; SALAD DRESSINGS, CONDIMENTS, NAMELY, SALSAS, MARINADES; PREPARED AND PACKAGED READY TO EAT MEALS CONSISTING PRIMARILY OF PASTA OR RICE, IN CLASS 30 (U.S. CL. 46).

FIRST USE 11-1-2011; IN COMMERCE 11-1-2011.

THE MARK CONSISTS OF STANDARD CHARACTERS WITHOUT CLAIM TO ANY PARTICULAR FONT, STYLE, SIZE, OR COLOR.

SN 85-290,766, FILED 4-8-2011.

GRETTA YAO, EXAMINING ATTORNEY



David J. Kyros

Director of the United States Patent and Trademark Office

United States of America

United States Patent and Trademark Office

STUCK IN THE MIDDLE

Reg. No. 4,110,220

Registered Mar. 6, 2012

Int. Cls.: 9, 16, 41, and 43

BARBARA MCVICKER, LLC (OHIO LIMITED LIABILITY COMPANY)
6722 ELMERS COURT
WORTHINGTON, OH 43085

FOR: DVDS, CDS, DOWNLOADABLE MP3 FILES, DOWNLOADABLE MP3 RECORDINGS, DOWNLOADABLE WEBINARS, AND DOWNLOADABLE PODCASTS, ALL IN THE FIELD OF ELDER CARE, IN CLASS 9 (U.S. CLS. 21, 23, 26, 36 AND 38).

TRADEMARK

FIRST USE 2-10-2009; IN COMMERCE 2-10-2009.

SERVICE MARK

FOR: PRINTED MATERIALS, NAMELY, BOOKS, WORKBOOKS, NOTEPADS, JOURNALS, AND CALENDARS, ALL FEATURING ELDER CARE TOPICS, IN CLASS 16 (U.S. CLS. 2, 5, 22, 23, 29, 37, 38 AND 50).

PRINCIPAL REGISTER

FIRST USE 9-12-2005; IN COMMERCE 2-0-2008.

FOR: CONDUCTING WORKSHOPS, SEMINARS, CLASSES, AND PRESENTATIONS IN THE FIELDS OF ELDER CARE; NON-FICTION TELEVISION PROGRAMMING IN THE FIELD OF ELDER CARE; THE PROVISION OF ON-LINE PUBLICATIONS IN THE NATURE OF E-BOOKS IN THE FIELD OF ELDER CARE, IN CLASS 41 (U.S. CLS. 100, 101 AND 107).

FIRST USE 2-22-2008; IN COMMERCE 2-22-2008.

FOR: PROVISION OF INTERNET WEBSITES FEATURING INFORMATION ABOUT ELDER CARE, IN CLASS 43 (U.S. CLS. 100 AND 101).

FIRST USE 2-0-2007; IN COMMERCE 2-0-2007.

THE MARK CONSISTS OF STANDARD CHARACTERS WITHOUT CLAIM TO ANY PARTICULAR FONT, STYLE, SIZE, OR COLOR.

SN 85-290,772, FILED 4-8-2011.

JANICE L. MCMORROW, EXAMINING ATTORNEY



David J. Kyros

Director of the United States Patent and Trademark Office

United States of America

United States Patent and Trademark Office

Get NuDe!

Reg. No. 4,110,221

Registered Mar. 6, 2012

Int. Cl.: 30

TRADEMARK

PRINCIPAL REGISTER

CRYSTAL RIVER ORGANICS LLC (COLORADO LIMITED LIABILITY COMPANY)
P.O. BOX 2076
CARBONDALE, CO 81623

FOR: CEREAL BASED SNACK BARS; CEREAL BASED HIGH PROTEIN SNACK BARS AND POWDERS; CEREAL BASED HIGH ENERGY BARS NOT FOR USE AS A MEAL REPLACEMENT; CEREALS AND PREPARATIONS MADE FROM CEREALS, NAMELY, BREAKFAST CEREALS, PROCESSED CEREALS AND CEREAL BASED SNACK FOODS; SALAD DRESSINGS, CONDIMENTS, NAMELY, SALSAS, MARINADES; PREPARED AND PACKAGED READY TO EAT MEALS CONSISTING PRIMARILY OF PASTA OR RICE, IN CLASS 30 (U.S. CL. 46).

FIRST USE 11-1-2011; IN COMMERCE 11-1-2011.

THE MARK CONSISTS OF STANDARD CHARACTERS WITHOUT CLAIM TO ANY PARTICULAR FONT, STYLE, SIZE, OR COLOR.

SN 85-290,773, FILED 4-8-2011.

GRETTA YAO, EXAMINING ATTORNEY



David J. Kyros

Director of the United States Patent and Trademark Office

United States of America
United States Patent and Trademark Office

OLYMPUS

Reg. No. 4,110,222

Registered Mar. 6, 2012

Int. Cl.: 4

TRADEMARK

PRINCIPAL REGISTER

PACIFIC COAST FIBER FUELS, LLC (WASHINGTON LIMITED LIABILITY COMPANY)
621 WEST MALLON, SUITE 507
PACIFIC COAST FIBER FUELS, LLC
SPOKANE, WA 99201

FOR: WOOD PELLETS FOR USE AS FUEL IN WOOD STOVES, IN CLASS 4 (U.S. CLS. 1, 6 AND 15).

FIRST USE 8-0-2011; IN COMMERCE 8-0-2011.

THE MARK CONSISTS OF STANDARD CHARACTERS WITHOUT CLAIM TO ANY PARTICULAR FONT, STYLE, SIZE, OR COLOR.

SN 85-291,472, FILED 4-11-2011.

JUDITH HELFMAN, EXAMINING ATTORNEY



David J. Kybas

Director of the United States Patent and Trademark Office

United States of America

United States Patent and Trademark Office



Reg. No. 4,110,223

Registered Mar. 6, 2012

Int. Cl.: 9

TRADEMARK

PRINCIPAL REGISTER

BVW HOLDINGS, LLC (NEVADA LIMITED LIABILITY COMPANY)
1688 ORD WAY
OCEANSIDE, CA 92056

FOR: AMPLIFIER FOR WIRELESS COMMUNICATIONS; AMPLIFIERS; AUDIO AMPLIFIERS; AUDIO CABLES; AUDIO CIRCUIT BOARDS; AUDIO ELECTRONIC COMPONENTS, NAMELY, SURROUND SOUND SYSTEMS; AUDIO RECORDERS; AUDIO SPEAKERS; MICROPHONE CABLES; MICROPHONE MODULES; MICROPHONES; MICROPHONES FOR COMMUNICATION DEVICES, IN CLASS 9 (U.S. CLS. 21, 23, 26, 36 AND 38).

FIRST USE 4-13-2001; IN COMMERCE 4-13-2001.

THE MARK CONSISTS OF THE LETTERS "TL" IN UPPER-CASE AND CENTERED WITHIN A CIRCLE SURROUNDING THE LETTERS. THE "T" IS LOCATED JUST LEFT OF CENTER WITHIN THE CIRCLE. THE TOP OF THE "L" IS POSITIONED JUST SLIGHTLY BELOW THE TOP CROSS OF THE "T" AND SLIGHTLY TO THE RIGHT. THE RIGHT EDGE OF THE BOTTOM LINE OF THE "L" ABUTS THE RIGHT ARC OF THE CIRCLE. THE LINES THAT MAKE UP THE "T" ARE SLIGHTLY WIDER AND LONGER THAN THOSE OF THE "L".

SN 85-293,179, FILED 4-12-2011.

LIEF MARTIN, EXAMINING ATTORNEY



David J. Kyros

Director of the United States Patent and Trademark Office

United States of America

United States Patent and Trademark Office

RONIN

Reg. No. 4,110,224

Registered Mar. 6, 2012

Int. Cl.: 8

TRADEMARK

PRINCIPAL REGISTER

LEE, PETER (UNITED STATES INDIVIDUAL)
120 E. BELMONT ST.
ONTARIO, CA 91761

FOR: JAPANESE SWORDS, IN CLASS 8 (U.S. CLS. 23, 28 AND 44).

FIRST USE 11-1-2011; IN COMMERCE 11-1-2011.

THE MARK CONSISTS OF STANDARD CHARACTERS WITHOUT CLAIM TO ANY PARTICULAR FONT, STYLE, SIZE, OR COLOR.

SN 85-293,590, FILED 4-13-2011.

RONALD AIKENS, EXAMINING ATTORNEY



David J. Kyfos

Director of the United States Patent and Trademark Office

United States of America

United States Patent and Trademark Office

FOOTSTEPS

Reg. No. 4,110,225

Registered Mar. 6, 2012

Int. Cl.: 25

TRADEMARK

PRINCIPAL REGISTER

FRISKY-NINETEEN LLC (FLORIDA LIMITED LIABILITY COMPANY)
383 NE 2ND AVENUE
HALLANDALE, FL 33009

FOR: FOOTWEAR, IN CLASS 25 (U.S. CLS. 22 AND 39).

FIRST USE 3-31-2011; IN COMMERCE 3-31-2011.

THE MARK CONSISTS OF STANDARD CHARACTERS WITHOUT CLAIM TO ANY PARTICULAR FONT, STYLE, SIZE, OR COLOR.

SN 85-295,558, FILED 4-14-2011.

BRENDAN REGAN, EXAMINING ATTORNEY



David J. Kybas

Director of the United States Patent and Trademark Office

United States of America

United States Patent and Trademark Office

Sync or Sink

Reg. No. 4,110,226

ARIAS, MATTHEW (UNITED STATES INDIVIDUAL)
4008 BRUMBY WAY
SNELLVILLE, GA 30039

Registered Mar. 6, 2012

Int. Cl.: 35

FOR: BUSINESS MANAGEMENT CONSULTING, IN CLASS 35 (U.S. CLS. 100, 101 AND 102).

SERVICE MARK

FIRST USE 6-1-2007; IN COMMERCE 3-1-2011.

PRINCIPAL REGISTER

THE MARK CONSISTS OF STANDARD CHARACTERS WITHOUT CLAIM TO ANY PARTICULAR FONT, STYLE, SIZE, OR COLOR.

SN 85-296,041, FILED 4-15-2011.

YAT SYE, LEE, EXAMINING ATTORNEY



David J. Kybas

Director of the United States Patent and Trademark Office

United States of America

United States Patent and Trademark Office

BACKBONE CAPITAL

Reg. No. 4,110,227

Registered Mar. 6, 2012

Int. Cl.: 36

SERVICE MARK

PRINCIPAL REGISTER

BACKBONE CAPITAL ADVISORS LLC (CALIFORNIA LIMITED LIABILITY COMPANY)
4084 CAMELLIA
STUDIO CITY, CA 91604

FOR: DEBT PLACEMENT ADVISORY SERVICES, NAMELY, ARRANGEMENT, NEGOTIATION AND CLOSING SERVICES FOR ALL TYPES OF CORPORATE CREDIT FACILITIES; WORKING CAPITAL FINANCING; ACQUISITION FINANCING; REAL ESTATE FINANCING; INVESTMENT BANKING ADVISORY SERVICES, NAMELY, REFERRAL OF EQUITY OPPORTUNITIES TO PRIVATE EQUITY FIRMS, IN CLASS 36 (U.S. CLS. 100, 101 AND 102).

FIRST USE 4-15-2011; IN COMMERCE 5-1-2011.

THE MARK CONSISTS OF STANDARD CHARACTERS WITHOUT CLAIM TO ANY PARTICULAR FONT, STYLE, SIZE, OR COLOR.

NO CLAIM IS MADE TO THE EXCLUSIVE RIGHT TO USE "CAPITAL", APART FROM THE MARK AS SHOWN.

SN 85-296,880, FILED 4-15-2011.

NATALIE POLZER, EXAMINING ATTORNEY



David J. Kyffers

Director of the United States Patent and Trademark Office

United States of America

United States Patent and Trademark Office

TESORO DEL AGAVE

Reg. No. 4,110,228

Registered Mar. 6, 2012

Int. Cl.: 33

TRADEMARK

PRINCIPAL REGISTER

HACIENDA SAN JOSE DE MIRAVALLE S. DE R.L. DE C.V. (MEXICO CORPORATION)
ALVARO OBREGON NO. 13, COL. CENTRO
SAN MARTIN HIDALGO, JA, MEXICO C.P.45110

FOR: TEQUILA, IN CLASS 33 (U.S. CLS. 47 AND 49).

FIRST USE 1-1-2011; IN COMMERCE 1-1-2011.

THE MARK CONSISTS OF STANDARD CHARACTERS WITHOUT CLAIM TO ANY PARTICULAR FONT, STYLE, SIZE, OR COLOR.

THE ENGLISH TRANSLATION OF "TESORO DEL AGAVE" IN THE MARK IS TREASURE OF "AGAVE".

SN 85-297,047, FILED 4-16-2011.

JACQUELINE A. LAVINE, EXAMINING ATTORNEY



David J. Kyffers

Director of the United States Patent and Trademark Office

United States of America

United States Patent and Trademark Office

B-51

Reg. No. 4,110,229

Registered Mar. 6, 2012

Int. Cl.: 33

TRADEMARK

PRINCIPAL REGISTER

HACIENDA SAN JOSE DE MIRAVALLE S. DE R.L. DE C.V. (MEXICO CORPORATION)
ALVARO OBREGON NO. 13, COL. CENTRO
SAN MARTIN HIDALGO, JA, MEXICO C.P.45110

FOR: TEQUILA, IN CLASS 33 (U.S. CLS. 47 AND 49).

FIRST USE 1-1-2011; IN COMMERCE 1-1-2011.

THE MARK CONSISTS OF STANDARD CHARACTERS WITHOUT CLAIM TO ANY PARTICULAR FONT, STYLE, SIZE, OR COLOR.

SN 85-297,048, FILED 4-16-2011.

JACQUELINE A. LAVINE, EXAMINING ATTORNEY



David J. Kybas

Director of the United States Patent and Trademark Office

United States of America

United States Patent and Trademark Office

encore

baby registry

Reg. No. 4,110,230

HERNANDEZ, FELICITY (UNITED STATES INDIVIDUAL)
2204 ASHBY AVE.
BERKELEY, CA 94795

Registered Mar. 6, 2012

Int. Cl.: 35

FOR: GIFT REGISTRY SERVICES, IN CLASS 35 (U.S. CLS. 100, 101 AND 102).

SERVICE MARK

FIRST USE 4-14-2011; IN COMMERCE 11-14-2011.

PRINCIPAL REGISTER

NO CLAIM IS MADE TO THE EXCLUSIVE RIGHT TO USE "BABY REGISTRY", APART FROM THE MARK AS SHOWN.

THE COLOR(S) PINK, BLUE, ORANGE, GREEN, PURPLE, YELLOW AND BLACK IS/ARE CLAIMED AS A FEATURE OF THE MARK.

THE MARK CONSISTS OF SIX COLORED CIRCLES, EACH CIRCLE SURROUNDING A LETTER OF THE WORD "ENCORE", WHERE THE FIRST CIRCLE IS PINK, THE SECOND IS BLUE, THE THIRD IS ORANGE, THE FOURTH IS GREEN, THE FIFTH IS PURPLE, AND THE LAST IS YELLOW. THE LETTERS ARE IN BLACK. BELOW THIS IS "BABY REGISTRY" IN BLACK.

SN 85-297,627, FILED 4-18-2011.

REBECCA POVARCHUK, EXAMINING ATTORNEY



David J. Kybas

Director of the United States Patent and Trademark Office

United States of America

United States Patent and Trademark Office

Magic Instanails

Reg. No. 4,110,231

ALIPA LLC (FLORIDA LIMITED LIABILITY COMPANY)
29 E SAN MARINO DRIVE
MIAMI BEACH, FL 33139

Registered Mar. 6, 2012

Int. Cl.: 3

FOR: NAIL CARE PREPARATIONS, IN CLASS 3 (U.S. CLS. 1, 4, 6, 50, 51 AND 52).

TRADEMARK

FIRST USE 5-1-2011; IN COMMERCE 5-1-2011.

PRINCIPAL REGISTER

THE MARK CONSISTS OF STANDARD CHARACTERS WITHOUT CLAIM TO ANY PARTICULAR FONT, STYLE, SIZE, OR COLOR.

SN 85-298,346, FILED 4-19-2011.

JULIE VEPPUMTHARA, EXAMINING ATTORNEY



David J. Kyffers

Director of the United States Patent and Trademark Office

United States of America

United States Patent and Trademark Office

FESTIVAL

Reg. No. 4,110,232

Registered Mar. 6, 2012

Int. Cl.: 23

TRADEMARK

PRINCIPAL REGISTER

UNIVERSAL YARN, INC. (NORTH CAROLINA CORPORATION)
284 ANN STREET NW
CONCORD, NC 28025

FOR: YARNS AND THREADS, IN CLASS 23 (U.S. CL. 43).

FIRST USE 2-1-2010; IN COMMERCE 2-1-2010.

THE MARK CONSISTS OF STANDARD CHARACTERS WITHOUT CLAIM TO ANY PARTICULAR FONT, STYLE, SIZE, OR COLOR.

SN 85-298,466, FILED 4-19-2011.

RONALD MCMORROW, EXAMINING ATTORNEY



David J. Kyros

Director of the United States Patent and Trademark Office

United States of America

United States Patent and Trademark Office

phonebillit

Reg. No. 4,110,233

Registered Mar. 6, 2012

Int. Cl.: 36

SERVICE MARK

PRINCIPAL REGISTER

SCHULMAN, LEE (UNITED STATES INDIVIDUAL)
211
800 COMMUNITY DR
MANHASSET, NY 11030

FOR: ELECTRONIC PAYMENT, NAMELY, ELECTRONIC PROCESSING AND TRANSMISSION OF BILL PAYMENT DATA, IN CLASS 36 (U.S. CLS. 100, 101 AND 102).

FIRST USE 11-25-2011; IN COMMERCE 11-25-2011.

THE MARK CONSISTS OF STANDARD CHARACTERS WITHOUT CLAIM TO ANY PARTICULAR FONT, STYLE, SIZE, OR COLOR.

SN 85-299,306, FILED 4-19-2011.

WENDY JUN, EXAMINING ATTORNEY



David J. Kybas

Director of the United States Patent and Trademark Office

United States of America

United States Patent and Trademark Office

BADGER MAX

Reg. No. 4,110,234

MIND MASTERS, LLC (WISCONSIN LIMITED LIABILITY COMPANY)
PO BOX 324
MADISON, WI 53703

Registered Mar. 6, 2012

Int. Cl.: 32

FOR: ENERGY DRINK MIX, IN CLASS 32 (U.S. CLS. 45, 46 AND 48).

TRADEMARK

FIRST USE 11-0-2011; IN COMMERCE 11-0-2011.

PRINCIPAL REGISTER

THE MARK CONSISTS OF STANDARD CHARACTERS WITHOUT CLAIM TO ANY PARTICULAR FONT, STYLE, SIZE, OR COLOR.

SN 85-299,423, FILED 4-19-2011.

TAMARA FRAZIER, EXAMINING ATTORNEY



David J. Kyros

Director of the United States Patent and Trademark Office

United States of America

United States Patent and Trademark Office

HOLLANDSE HONEY BZZZ CHEVRE

Reg. No. 4,110,235

Registered Mar. 6, 2012

Int. Cl.: 29

TRADEMARK

PRINCIPAL REGISTER

BEST CHEESE CORP. (NEW YORK CORPORATION)
40 RADIO CIRCLE DRIVE
MOUNT KISCO, NY 10549

FOR: CHEESE FROM THE NETHERLANDS FEATURING HONEY AND GOAT'S MILK, IN CLASS 29 (U.S. CL. 46).

FIRST USE 3-0-2011; IN COMMERCE 3-0-2011.

THE MARK CONSISTS OF STANDARD CHARACTERS WITHOUT CLAIM TO ANY PARTICULAR FONT, STYLE, SIZE, OR COLOR.

NO CLAIM IS MADE TO THE EXCLUSIVE RIGHT TO USE "HOLLANDSE HONEY" AND "CHEVRE", APART FROM THE MARK AS SHOWN.

THE ENGLISH TRANSLATION OF "HOLLANDSE" IN THE MARK IS "DUTCH".

SN 85-299,623, FILED 4-20-2011.

MARTHA FROMM, EXAMINING ATTORNEY



David J. Kybas

Director of the United States Patent and Trademark Office

United States of America
United States Patent and Trademark Office

just
wink

Reg. No. 4,110,236

AGC, LLC (DELAWARE LIMITED LIABILITY COMPANY)
ONE AMERICAN ROAD
CLEVELAND, OH 44144

Registered Mar. 6, 2012

Int. Cl.: 38

FOR: TRANSMISSION OF GREETING CARDS ONLINE, IN CLASS 38 (U.S. CLS. 100, 101 AND 104).

SERVICE MARK

FIRST USE 6-30-2011; IN COMMERCE 6-30-2011.

PRINCIPAL REGISTER

THE MARK CONSISTS OF THE WORDS "JUST WINK". THE TITLE OVER THE LETTER "I" HAS A FANCIFUL DESIGN OF A FLOWER IN IT.

SN 85-300,270, FILED 4-20-2011.

KRISTIN CARLSON, EXAMINING ATTORNEY



David J. Kybas

Director of the United States Patent and Trademark Office

United States of America

United States Patent and Trademark Office

JUSTWINK

Reg. No. 4,110,237

AGC, LLC (DELAWARE LIMITED LIABILITY COMPANY)
ONE AMERICAN ROAD
CLEVELAND, OH 44144

Registered Mar. 6, 2012

Int. Cl.: 38

FOR: TRANSMISSION OF GREETING CARDS ONLINE, IN CLASS 38 (U.S. CLS. 100, 101 AND 104).

SERVICE MARK

FIRST USE 6-30-2011; IN COMMERCE 6-30-2011.

PRINCIPAL REGISTER

THE MARK CONSISTS OF STANDARD CHARACTERS WITHOUT CLAIM TO ANY PARTICULAR FONT, STYLE, SIZE, OR COLOR.

SN 85-300,298, FILED 4-20-2011.

KRISTIN CARLSON, EXAMINING ATTORNEY



David J. Kybas

Director of the United States Patent and Trademark Office

United States of America

United States Patent and Trademark Office

JUSTWINK

Reg. No. 4,110,238

Registered Mar. 6, 2012

Int. Cl.: 9

TRADEMARK

PRINCIPAL REGISTER

AGC, LLC (DELAWARE LIMITED LIABILITY COMPANY)
ONE AMERICAN ROAD
CLEVELAND, OH 44144

FOR: COMPUTER APPLICATION SOFTWARE FOR MOBILE PHONES, NAMELY, SOFTWARE FOR ELECTRONIC GREETING CARDS ACCESSED THROUGH WIRELESS DEVICES OR ON A GLOBAL COMPUTER NETWORK, IN CLASS 9 (U.S. CLS. 21, 23, 26, 36 AND 38).

FIRST USE 6-30-2011; IN COMMERCE 6-30-2011.

THE MARK CONSISTS OF STANDARD CHARACTERS WITHOUT CLAIM TO ANY PARTICULAR FONT, STYLE, SIZE, OR COLOR.

SN 85-300,314, FILED 4-20-2011.

KRISTIN CARLSON, EXAMINING ATTORNEY



David J. Kybas

Director of the United States Patent and Trademark Office

United States of America

United States Patent and Trademark Office

WAY TO GO

Reg. No. 4,110,239

Registered Mar. 6, 2012

Int. Cls.: 12, 20, and 25

TRADEMARK

PRINCIPAL REGISTER

THE BOPPY COMPANY, LLC (COLORADO LIMITED LIABILITY COMPANY)
560 GOLDEN RIDGE ROAD, SUITE 150
GOLDEN, CO 80401

FOR: PADDED COVER FOR THE HANDLE OF AN INFANT CAR SEAT; FABRIC COVERING DESIGNED TO COVER THE ENTIRE SEATING AREA, INCLUDING HANDLEBARS, BACK, SIDES AND SEAT OF GROCERY/SHOPPING CARTS FOR THE PURPOSE OF SHIELDING BABIES AND TODDLERS FROM THE METAL, GERMS AND BACTERIA THEREON, IN CLASS 12 (U.S. CLS. 19, 21, 23, 31, 35 AND 44).

FIRST USE 12-9-2011; IN COMMERCE 12-9-2011.

FOR: HEAD AND NECK SUPPORT PILLOW FOR INFANTS AND TODDLERS; PILLOWS USED FOR CRADLING, SUPPORTING AND PROPPING BABIES, IN CLASS 20 (U.S. CLS. 2, 13, 22, 25, 32 AND 50).

FIRST USE 12-9-2011; IN COMMERCE 12-9-2011.

FOR: NURSING APPAREL, NAMELY, NURSING COVERS, IN CLASS 25 (U.S. CLS. 22 AND 39).

FIRST USE 12-9-2011; IN COMMERCE 12-9-2011.

THE MARK CONSISTS OF STANDARD CHARACTERS WITHOUT CLAIM TO ANY PARTICULAR FONT, STYLE, SIZE, OR COLOR.

SN 85-300,939, FILED 4-21-2011.

ERNEST SHOSHO, EXAMINING ATTORNEY



David J. Kybas

Director of the United States Patent and Trademark Office

United States of America

United States Patent and Trademark Office

CRUISER BOWL

Reg. No. 4,110,240

Registered Mar. 6, 2012

Int. Cl.: 20

TRADEMARK

PRINCIPAL REGISTER

D&W FINE PACK LLC (DELAWARE LIMITED LIABILITY COMPANY)
1372 N. OLD LAURENS ROAD
FOUNTAIN INN, SC 29644

FOR: MICROWAVABLE POLYPROPYLENE BOWLS FOR FOODSERVICE PACKAGING;
MICROWAVABLE POLYPROPYLENE BOWLS FOR USE AS PACKAGING SOLD TO FAST
FOOD INDUSTRY FOR TAKE-OUT AND MADE TO ORDER FOODS; MICROWAVABLE
POLYPROPYLENE BOWLS FOR COMMERCIAL USE AS PACKAGING, IN CLASS 20 (U.S.
CLS. 2, 13, 22, 25, 32 AND 50).

FIRST USE 11-15-2011; IN COMMERCE 11-15-2011.

THE MARK CONSISTS OF STANDARD CHARACTERS WITHOUT CLAIM TO ANY PAR-
TICULAR FONT, STYLE, SIZE, OR COLOR.

NO CLAIM IS MADE TO THE EXCLUSIVE RIGHT TO USE "BOWL", APART FROM THE
MARK AS SHOWN.

SN 85-302,008, FILED 4-22-2011.

HANNO RITTNER, EXAMINING ATTORNEY



David J. Kypos

Director of the United States Patent and Trademark Office

United States of America

United States Patent and Trademark Office

CC EXPERTMATCH

Reg. No. 4,110,241

Registered Mar. 6, 2012

Int. Cl.: 35

SERVICE MARK

PRINCIPAL REGISTER

MANPOWER INC. (WISCONSIN CORPORATION)
100 MANPOWER PLACE
MILWAUKEE, WI 53217

FOR: BUSINESS MANAGEMENT; BUSINESS ADMINISTRATION; EMPLOYMENT AGENCY SERVICES; TEMPORARY AND PERMANENT EMPLOYMENT AGENCY SERVICES; EMPLOYMENT RELATED SERVICES, NAMELY, SCREENING OF CANDIDATES FOR TELEPHONE CALL CENTER POSITIONS; EMPLOYMENT RELATED SERVICES, NAMELY, PROVIDING JOB PLACEMENT, CAREER DEVELOPMENT, EMPLOYMENT RECRUITMENT, AND GENERAL EMPLOYMENT INFORMATION TO OTHERS; PERSONNEL MANAGEMENT SERVICES; HUMAN RESOURCES MANAGEMENT SERVICES; PROVIDING AND MANAGING CONTRACT PERSONNEL PROGRAMS; PERSONNEL MANAGEMENT AND CONSULTANCY SERVICES; EMPLOYMENT SERVICES, NAMELY, PROVIDING EMPLOYEE SKILLS SCREENING AND ASSESSMENT TOOLS VIA A WEBSITE ON A GLOBAL INFORMATION NETWORK; EMPLOYMENT COUNSELING SERVICES; CAREER MANAGEMENT CONSULTATION SERVICES; EMPLOYMENT OUTPLACEMENT SERVICES; PROFESSIONAL BUSINESS CONSULTANCY SERVICES; BUSINESS ORGANIZATION CONSULTANCY SERVICES, IN CLASS 35 (U.S. CLS. 100, 101 AND 102).

FIRST USE 11-17-2011; IN COMMERCE 11-17-2011.

THE MARK CONSISTS OF STANDARD CHARACTERS WITHOUT CLAIM TO ANY PARTICULAR FONT, STYLE, SIZE, OR COLOR.

NO CLAIM IS MADE TO THE EXCLUSIVE RIGHT TO USE "CC", APART FROM THE MARK AS SHOWN.

SN 85-303,480, FILED 4-25-2011.

GRETTA YAO, EXAMINING ATTORNEY



David J. Kybas

Director of the United States Patent and Trademark Office

United States of America

United States Patent and Trademark Office

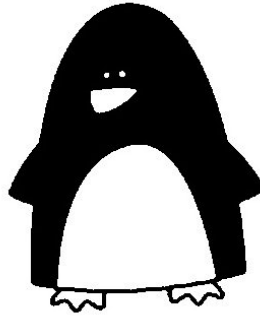

Reg. No. 4,110,242

Registered Mar. 6, 2012

Int. Cl.: 35

SERVICE MARK

PRINCIPAL REGISTER

SERVESURFER, INC. (CALIFORNIA CORPORATION)
703 SAINT JAMES PLACE
NEWPORT BEACH, CA 92663

FOR: PROVIDING DEMAND CREATION AND LEAD GENERATION ACTIVITIES AND SERVICES, IN CLASS 35 (U.S. CLS. 100, 101 AND 102).

FIRST USE 5-23-2011; IN COMMERCE 9-15-2011.

SN 85-305,447, FILED 4-26-2011.

TRACY WHITTAKER-BROWN, EXAMINING ATTORNEY



David J. Kybas

Director of the United States Patent and Trademark Office

United States of America

United States Patent and Trademark Office

SHAI

Reg. No. 4,110,243

Registered Mar. 6, 2012

Int. Cl.: 3

TRADEMARK

PRINCIPAL REGISTER

GADDE AND CHIRRA INC (DELAWARE CORPORATION)
4524 KIRKWOOD HIGHWAY
WILMINGTON, DE 19808

FOR: SOAP FOR FACE, BODY AND REMOVING MAKEUP; COSMETICS; COSMETIC PREPARATIONS FOR SKIN CARE, IN CLASS 3 (U.S. CLS. 1, 4, 6, 50, 51 AND 52).

FIRST USE 7-15-2011; IN COMMERCE 8-16-2011.

THE MARK CONSISTS OF STANDARD CHARACTERS WITHOUT CLAIM TO ANY PARTICULAR FONT, STYLE, SIZE, OR COLOR.

SN 85-305,525, FILED 4-27-2011.

JAMES GRIFFIN, EXAMINING ATTORNEY



David J. Kybas

Director of the United States Patent and Trademark Office

United States of America

United States Patent and Trademark Office

URVANA

Reg. No. 4,110,244

HONG, JI S (UNITED STATES INDIVIDUAL)
2551 S. ALAMEDA ST.
LOS ANGELES, CA 90058

Registered Mar. 6, 2012

Int. Cl.: 25

FOR: T-SHIRTS, IN CLASS 25 (U.S. CLS. 22 AND 39).

TRADEMARK

FIRST USE 8-1-2011; IN COMMERCE 8-1-2011.

PRINCIPAL REGISTER

THE MARK CONSISTS OF STANDARD CHARACTERS WITHOUT CLAIM TO ANY PARTICULAR FONT, STYLE, SIZE, OR COLOR.

SN 85-305,538, FILED 4-27-2011.

PAM WILLIS, EXAMINING ATTORNEY



David J. Kyffers

Director of the United States Patent and Trademark Office

United States of America

United States Patent and Trademark Office

Evergreen Suede Reflections

Reg. No. 4,110,245

EVERGREEN ENTERPRISES, INC. (VIRGINIA CORPORATION)
5915 MIDLOTHIAN TURNPIKE
RICHMOND, VA 23225

Registered Mar. 6, 2012

Int. Cl.: 24

FOR: CLOTH BANNERS; CLOTH FLAGS; CLOTH PENNANTS; NYLON FLAGS, IN CLASS 24 (U.S. CLS. 42 AND 50).

TRADEMARK

FIRST USE 6-1-2011; IN COMMERCE 6-1-2011.

PRINCIPAL REGISTER

THE MARK CONSISTS OF STANDARD CHARACTERS WITHOUT CLAIM TO ANY PARTICULAR FONT, STYLE, SIZE, OR COLOR.

NO CLAIM IS MADE TO THE EXCLUSIVE RIGHT TO USE "SUEDE", APART FROM THE MARK AS SHOWN.

SN 85-305,732, FILED 4-27-2011.

MIDGE BUTLER, EXAMINING ATTORNEY



David J. Kybas

Director of the United States Patent and Trademark Office

United States of America

United States Patent and Trademark Office

BLACK BEAR

Reg. No. 4,110,246

Registered Mar. 6, 2012

Int. Cl.: 13

TRADEMARK

PRINCIPAL REGISTER

SAKO OY (FINLAND CORPORATION)
SAKONKATU 2
RIIHIMAKI, FINLAND 11100

FOR: RIFLES, IN CLASS 13 (U.S. CLS. 2 AND 9).

FIRST USE 12-5-2011; IN COMMERCE 12-5-2011.

THE MARK CONSISTS OF STANDARD CHARACTERS WITHOUT CLAIM TO ANY PARTICULAR FONT, STYLE, SIZE, OR COLOR.

SN 85-305,995, FILED 4-27-2011.

MELISSA VALLILLO, EXAMINING ATTORNEY



David J. Kyffers

Director of the United States Patent and Trademark Office

United States of America

United States Patent and Trademark Office

CATAMOUNT

Reg. No. 4,110,247

Registered Mar. 6, 2012

Int. Cl.: 13

TRADEMARK

PRINCIPAL REGISTER

CENTURY INTERNATIONAL ARMS, INC. (VERMONT CORPORATION)
430 S. CONGRESS AVENUE, SUITE ONE
DELRAY BEACH, FL 33445

FOR: FIREARMS, IN CLASS 13 (U.S. CLS. 2 AND 9).

FIRST USE 6-0-2011; IN COMMERCE 6-0-2011.

THE MARK CONSISTS OF STANDARD CHARACTERS WITHOUT CLAIM TO ANY PARTICULAR FONT, STYLE, SIZE, OR COLOR.

SN 85-306,828, FILED 4-28-2011.

DAVID YONTEF, EXAMINING ATTORNEY



David J. Kyffers

Director of the United States Patent and Trademark Office

United States of America

United States Patent and Trademark Office



Reg. No. 4,110,248

Registered Mar. 6, 2012

Int. Cl.: 9

TRADEMARK

PRINCIPAL REGISTER

PRECISION LABORATORIES, INC (ARIZONA CORPORATION)
415 AIRPARK ROAD
COTTONWOOD, AZ 86326

FOR: FLEXIBLE AGAR-BEARING PADDLES FOR SELECTING AND PROPAGATING MICROORGANISM SAMPLES, IN CLASS 9 (U.S. CLS. 21, 23, 26, 36 AND 38).

FIRST USE 11-10-2011; IN COMMERCE 11-10-2011.

NO CLAIM IS MADE TO THE EXCLUSIVE RIGHT TO USE "MICROSLIDES" AND "MICROBIOLOGY", APART FROM THE MARK AS SHOWN.

THE COLOR(S) GOLD, BLACK, BLUE AND RED IS/ARE CLAIMED AS A FEATURE OF THE MARK.

THE MARK CONSISTS OF THE LITERALS "PRECISION MICROSLIDES" AND "MICROBIOLOGY SIMPLIFIED" IN THE SHADED COLOR GOLD. THE "PRECISION MICROSLIDES" LITERAL IS STACKED, WITH A SHADED HORIZONTAL GOLD LINE BETWEEN THE WORDS, D SURROUNDED BY AN ELONGATED OVAL OUTLINED IN GOLD AND BLACK WITH A CENTRALLY LOCATED OPEN AREA ABOVE THE LITERAL. THE RIGHT HAND SIDE OF THE OVAL HAS A PAIR OF STACKED DIAGONAL NARROW RECTANGLES IN SHADED GOLD COLOR JOINED TOGETHER BY A BAR AND LINE IN GOLD AND BLACK ABOUT THE INNER RIGHT PERIPHERY OF THE OVAL. THE "MICROBIOLOGY SIMPLIFIED" LITERAL IS LOCATED BELOW THE OVAL. A REPRESENTATION OF A PAIR OF ROD-SHAPED MICROORGANISMS IN BLUE AND BLACK, A HELICAL MICROORGANISM IN RED, AND A GLOBULAR MICROORGANISM IN BLUE APPEAR WITHIN THE OVAL AND BELOW THE "MICROSLIDES" LITERAL.

SN 85-306,926, FILED 4-28-2011.

ANGELA DUONG, EXAMINING ATTORNEY



David J. Kybas

Director of the United States Patent and Trademark Office

United States of America

United States Patent and Trademark Office

CELEBRATE THE GOOD LIFE

Reg. No. 4,110,249

AMERICAN LAND LEASE, INC. (DELAWARE CORPORATION)
380 PARK PLACE, SUITE 200
CLEARWATER, FL 33759

Registered Mar. 6, 2012

Int. Cl.: 36

FOR: LAND LEASING; REAL ESTATE MANAGEMENT OF RETIREMENT COMMUNITIES,
IN CLASS 36 (U.S. CLS. 100, 101 AND 102).

SERVICE MARK

FIRST USE 12-5-2010; IN COMMERCE 12-5-2010.

PRINCIPAL REGISTER

THE MARK CONSISTS OF STANDARD CHARACTERS WITHOUT CLAIM TO ANY PARTICULAR FONT, STYLE, SIZE, OR COLOR.

SN 85-307,027, FILED 4-28-2011.

ELIZABETH HUGHITT, EXAMINING ATTORNEY



David J. Kybas

Director of the United States Patent and Trademark Office

United States of America

United States Patent and Trademark Office



Reg. No. 4,110,250

Registered Mar. 6, 2012

Int. Cl.: 35

SERVICE MARK

PRINCIPAL REGISTER

MARICICH & ASSOCIATES, INC (CALIFORNIA CORPORATION), DBA MARICICH BRAND COMMUNICATIONS,
18201 MCDURMOTT WEST SUITE A
IRVINE, CA 92614

FOR: ADVERTISING AND DIRECTORY SERVICES, NAMELY, PROMOTING THE SERVICES OF OTHERS BY PROVIDING A WEB PAGE FEATURING LINKS TO THE WEBSITES OF OTHERS, IN CLASS 35 (U.S. CLS. 100, 101 AND 102).

FIRST USE 11-1-2011; IN COMMERCE 11-1-2011.

THE MARK CONSISTS OF THE WORD "HEALTHY" IS IN THE COLOR OF BLUE WITH THE "Y" TRANSFORMED INTO THE IMAGE OF A STETHOSCOPE. THE WORD "CLASS" IS IN THE COLOR OF GREEN.

THE COLOR(S) BLUE AND GREEN IS/ARE CLAIMED AS A FEATURE OF THE MARK.

SN 85-307,094, FILED 4-28-2011.

PAUL E. FAHRENKOPF, EXAMINING ATTORNEY



David J. Kyros

Director of the United States Patent and Trademark Office

United States of America

United States Patent and Trademark Office

SWEET CHEEKS

Reg. No. 4,110,251

Registered Mar. 6, 2012

Int. Cl.: 33

TRADEMARK

PRINCIPAL REGISTER

MAJOR BRANDS (MISSOURI CORPORATION)
6701 SOUTHWEST AVE
ST. LOUIS, MO 63143

FOR: WINE, IN CLASS 33 (U.S. CLS. 47 AND 49).

FIRST USE 7-28-2011; IN COMMERCE 7-28-2011.

THE MARK CONSISTS OF STANDARD CHARACTERS WITHOUT CLAIM TO ANY PARTICULAR FONT, STYLE, SIZE, OR COLOR.

SN 85-307,505, FILED 4-28-2011.

BARBARA GAYNOR, EXAMINING ATTORNEY



David J. Kybas

Director of the United States Patent and Trademark Office

United States of America

United States Patent and Trademark Office



A Helping Hand

Professional Organizing Service

Reg. No. 4,110,252

Registered Mar. 6, 2012

Int. Cl.: 35

SERVICE MARK

PRINCIPAL REGISTER

LYMAN, RANDI B. (TEXAS SOLE PROPRIETORSHIP), DBA A HELPING HAND,
15201 KILLDEER STREET
AUSTIN, TX 78734

FOR: PROVIDING ORGANIZING SERVICES FOR BELONGINGS AND SPACES IN A RES-
IDENCE OR OFFICE SUCH AS PAPERS AND TIME; PROVIDING ORGANIZING SERVICES
FOR INDIVIDUALS AT HOME, IN HOME OFFICES AND IN BUSINESS OFFICES, THAT
PROVIDES HELP WITH TIME AND PAPER MANAGEMENT, IN CLASS 35 (U.S. CLS. 100,
101 AND 102).

FIRST USE 12-12-2011; IN COMMERCE 12-12-2011.

NO CLAIM IS MADE TO THE EXCLUSIVE RIGHT TO USE "PROFESSIONAL ORGANIZING
SERVICE", APART FROM THE MARK AS SHOWN.

THE MARK CONSISTS OF THE DESIGN ELEMENT IS ONE VERTICAL LINE & TWO
SQUARES STACKED ON TOP OF EACH OTHER TO FORM AN "H". THEN TO THE RIGHT,
TWO LINES OF TEXT TO IDENTIFY COMPANY NAME & SERVICE PROVIDED: LINE 1:
"A HELPING HAND", LINE 2: "PROFESSIONAL ORGANIZING SERVICE".

SN 85-307,690, FILED 4-28-2011.

KATHRYN COWARD, EXAMINING ATTORNEY



David J. Kyros

Director of the United States Patent and Trademark Office

United States of America

United States Patent and Trademark Office

SLEEP TIGHT PRODUCTS

Reg. No. 4,110,253

Registered Mar. 6, 2012

Int. Cl.: 36

SERVICE MARK

PRINCIPAL REGISTER

MARY PAT THURSTON (UNITED STATES INDIVIDUAL)
555 FIFTH AVENUE, 10TH FLOOR
NEW YORK, NY 10017

FOR: CLAIMS ADJUSTMENT IN THE FIELD OF INSURANCE; INSURANCE CARRIER SERVICES; INSURANCE CLAIMS ADMINISTRATION; INSURANCE CLAIMS PROCESSING; INSURANCE SERVICES, NAMELY, UNDERWRITING PROPERTY INSURANCE; INSURANCE SERVICES, NAMELY, UNDERWRITING, ISSUANCE AND ADMINISTRATION OF PROPERTY INSURANCE; INSURANCE SERVICES, NAMELY, WRITING PROPERTY AND CASUALTY INSURANCE, IN CLASS 36 (U.S. CLS. 100, 101 AND 102).

FIRST USE 6-13-2011; IN COMMERCE 6-13-2011.

THE MARK CONSISTS OF STANDARD CHARACTERS WITHOUT CLAIM TO ANY PARTICULAR FONT, STYLE, SIZE, OR COLOR.

NO CLAIM IS MADE TO THE EXCLUSIVE RIGHT TO USE "PRODUCTS", APART FROM THE MARK AS SHOWN.

SN 85-308,681, FILED 4-29-2011.

RONALD DELGIZZI, EXAMINING ATTORNEY



David J. Kyros

Director of the United States Patent and Trademark Office

United States of America

United States Patent and Trademark Office

SLEEPTIGHT PRODUCTS

Reg. No. 4,110,254

Registered Mar. 6, 2012

Int. Cl.: 36

SERVICE MARK

PRINCIPAL REGISTER

MARY PAT THURSTON (UNITED STATES INDIVIDUAL)
555 FIFTH AVENUE, 10TH FLOOR
NEW YORK, NY 10017

FOR: CLAIMS ADJUSTMENT IN THE FIELD OF INSURANCE; INSURANCE CARRIER SERVICES; INSURANCE CLAIMS ADMINISTRATION; INSURANCE CLAIMS PROCESSING; INSURANCE SERVICES, NAMELY, UNDERWRITING PROPERTY INSURANCE; INSURANCE SERVICES, NAMELY, UNDERWRITING, ISSUANCE AND ADMINISTRATION OF PROPERTY INSURANCE; INSURANCE SERVICES, NAMELY, WRITING PROPERTY AND CASUALTY INSURANCE, IN CLASS 36 (U.S. CLS. 100, 101 AND 102).

FIRST USE 6-13-2011; IN COMMERCE 6-13-2011.

THE MARK CONSISTS OF STANDARD CHARACTERS WITHOUT CLAIM TO ANY PARTICULAR FONT, STYLE, SIZE, OR COLOR.

NO CLAIM IS MADE TO THE EXCLUSIVE RIGHT TO USE "PRODUCTS", APART FROM THE MARK AS SHOWN.

SN 85-308,711, FILED 4-29-2011.

RONALD DELGIZZI, EXAMINING ATTORNEY



David J. Kyros

Director of the United States Patent and Trademark Office

United States of America

United States Patent and Trademark Office

GINA RISPOLI

Reg. No. 4,110,255

VICTORIA FINE FOODS, LLC (DELAWARE LIMITED LIABILITY COMPANY)
443 EAST 100TH STREET
BROOKLYN, NY 11236

Registered Mar. 6, 2012

Int. Cl.: 30

FOR: SAUCES, NAMELY, PASTA SAUCES AND SPAGHETTI SAUCES, IN CLASS 30 (U.S. CL. 46).

TRADEMARK

FIRST USE 11-4-2011; IN COMMERCE 11-4-2011.

PRINCIPAL REGISTER

THE MARK CONSISTS OF STANDARD CHARACTERS WITHOUT CLAIM TO ANY PARTICULAR FONT, STYLE, SIZE, OR COLOR.

THE NAME(S), PORTRAIT(S), AND/OR SIGNATURE(S) SHOWN IN THE MARK DOES NOT IDENTIFY A PARTICULAR LIVING INDIVIDUAL.

SN 85-309,692, FILED 5-2-2011.

NELSON SNYDER, EXAMINING ATTORNEY



David J. Kybas

Director of the United States Patent and Trademark Office

United States of America

United States Patent and Trademark Office



Reg. No. 4,110,256

Registered Mar. 6, 2012

Int. Cl.: 9

TRADEMARK

PRINCIPAL REGISTER

BURSCH, STEPHEN L (UNITED STATES INDIVIDUAL)
234 N HIGH ST
SEBASTOPOL, CA 95472 AND

INNES, ROBERT (UNITED STATES INDIVIDUAL)
941 BLOOMFIELD RD
SEBASTOPOL, CA 95472

FOR: SOFTWARE FOR MONITORING AND CONTROLLING COMMUNICATION BETWEEN COMPUTERS AND AUTOMATED MACHINE SYSTEMS, IN CLASS 9 (U.S. CLS. 21, 23, 26, 36 AND 38).

FIRST USE 7-1-2009; IN COMMERCE 10-28-2011.

THE MARK CONSISTS OF THE WORD, "DIGISKY", IN RED UPPER CASE LETTERS, ALL LOCATED AT THE TOP OF THE MARK. BLUE NUMBERS CONSISTING OF ZEROS "0" AND ONES "1" IMMEDIATELY BELOW THE WORD, "DIGISKY", CONTINUING TO THE BOTTOM OF THE MARK. WHITE DOTS SCATTERED THROUGHOUT THE MARK. BLACK BACKGROUND.

THE COLOR(S) RED, WHITE, BLUE AND BLACK IS/ARE CLAIMED AS A FEATURE OF THE MARK.

SN 85-310,414, FILED 5-2-2011.

TRACY CROSS, EXAMINING ATTORNEY



David J. Kyffers

Director of the United States Patent and Trademark Office

United States of America

United States Patent and Trademark Office

OPEN SESAME

Reg. No. 4,110,257

Registered Mar. 6, 2012

Int. Cl.: 25

TRADEMARK

PRINCIPAL REGISTER

PORTOLANO PRODUCTS, INC. (NEW YORK CORPORATION)
15 WEST 37TH STREET
NEW YORK, NY 10018

FOR: GLOVES, IN CLASS 25 (U.S. CLS. 22 AND 39).

FIRST USE 10-5-2011; IN COMMERCE 10-5-2011.

THE MARK CONSISTS OF STANDARD CHARACTERS WITHOUT CLAIM TO ANY PARTICULAR FONT, STYLE, SIZE, OR COLOR.

SN 85-310,762, FILED 5-3-2011.

APRIL ROACH, EXAMINING ATTORNEY



David J. Kyros

Director of the United States Patent and Trademark Office

United States of America

United States Patent and Trademark Office

OPEN 
SESAME

Reg. No. 4,110,258

Registered Mar. 6, 2012

Int. Cl.: 25

TRADEMARK

PRINCIPAL REGISTER

PORTOLANO PRODUCTS, INC. (NEW YORK CORPORATION)
15 WEST 37TH STREET
NEW YORK, NY 10018

FOR: GLOVES, IN CLASS 25 (U.S. CLS. 22 AND 39).

FIRST USE 10-5-2011; IN COMMERCE 10-5-2011.

THE MARK CONSISTS OF THE WORDS "OPEN SESAME" WITH THE STYLIZED WORD "OPEN" FOLLOWED BY PARALLEL VERTICAL LINES OF IDENTICAL HEIGHT. THE STYLIZED WORD "SESAME" IS PLACED BENEATH THE WORD "OPEN" AND IS FOLLOWED BY A HAND WITH THE INDEX FINGER EXTENDED UPWARDS OVER THE PARALLEL LINES.

SN 85-311,060, FILED 5-3-2011.

APRIL ROACH, EXAMINING ATTORNEY



David J. Kyffers

Director of the United States Patent and Trademark Office

United States of America

United States Patent and Trademark Office



Reg. No. 4,110,259

PARAGON FILMS, INC. (OKLAHOMA CORPORATION)
3500 W. TACOMA
BROKEN ARROW, OK 74012

Registered Mar. 6, 2012

Int. Cl.: 17

FOR: PLASTIC FILM FOR INDUSTRIAL AND COMMERCIAL PACKING USE, IN CLASS 17 (U.S. CLS. 1, 5, 12, 13, 35 AND 50).

TRADEMARK

FIRST USE 7-6-2011; IN COMMERCE 7-6-2011.

PRINCIPAL REGISTER

OWNER OF U.S. REG. NOS. 3,624,147, 3,840,100, AND OTHERS.

NO CLAIM IS MADE TO THE EXCLUSIVE RIGHT TO USE "HIGH PERFORMANCE SOURCE REDUCTION", APART FROM THE MARK AS SHOWN.

THE MARK CONSISTS OF A STYLIZED BIRD DESIGN WITH OUTSTRETCHED WINGS ON A CIRCULAR BACKGROUND WITH THE WORDS "HIGH PERFORMANCE" APPEARING ABOVE AND THE WORDS "SOURCE REDUCTION" APPEARING BELOW THE WORD "SPARTAN" IN LARGE FONT SUPERIMPOSED OVER THE CENTER OF THE DESIGN.

SN 85-311,071, FILED 5-3-2011.

ALICE BENMAMAN, EXAMINING ATTORNEY



David J. Kyffers

Director of the United States Patent and Trademark Office

United States of America

United States Patent and Trademark Office

DELICIOUS DAILY DENTAL CARE THAT YOU DRINK

Reg. No. 4,110,260

HEALTHYMOUTH, LLC (DELAWARE LIMITED LIABILITY COMPANY)
20006 PACIFIC COAST HIGHWAY, UNIT B
MALIBU, CA 90265

Registered Mar. 6, 2012

Int. Cl.: 32

FOR: WATER BEVERAGES AND CONCENTRATE USED IN THE PREPARATION OF WATER BEVERAGES, IN CLASS 32 (U.S. CLS. 45, 46 AND 48).

TRADEMARK

FIRST USE 8-8-2011; IN COMMERCE 8-8-2011.

PRINCIPAL REGISTER

THE MARK CONSISTS OF STANDARD CHARACTERS WITHOUT CLAIM TO ANY PARTICULAR FONT, STYLE, SIZE, OR COLOR.

SN 85-311,098, FILED 5-3-2011.

ELIZABETH HUGHITT, EXAMINING ATTORNEY



David J. Kybas

Director of the United States Patent and Trademark Office

United States of America

United States Patent and Trademark Office



Reg. No. 4,110,261

Registered Mar. 6, 2012

Int. Cl.: 6

TRADEMARK

PRINCIPAL REGISTER

TRACTOR SUPPLY CO. OF TEXAS, LP (TEXAS LIMITED PARTNERSHIP)
200 POWELL PLACE
BRENTWOOD, TN 37027

FOR: FIREPLACE GRATES, IN CLASS 6 (U.S. CLS. 2, 12, 13, 14, 23, 25 AND 50).

FIRST USE 8-1-2011; IN COMMERCE 8-1-2011.

THE MARK CONSISTS OF THE WORD "RED" WITH A SMALL CIRCLE ABOVE AND TO THE RIGHT OF THE LETTER "D" IN "RED" AND THE WORD "STONE" APPEARING DIRECTLY UNDER THE WORD "RED".

SN 85-311,432, FILED 5-3-2011.

ROBERT C. CLARK JR., EXAMINING ATTORNEY



David J. Kybas

Director of the United States Patent and Trademark Office

United States of America

United States Patent and Trademark Office

CITY UNLISTED

Reg. No. 4,110,262

Registered Mar. 6, 2012

Int. Cl.: 41

SERVICE MARK

PRINCIPAL REGISTER

GILT CITY, INC. (DELAWARE CORPORATION)
2 PARK AVENUE
4TH FLOOR
NEW YORK, NY 10016

FOR: PROVIDING A WEBSITE FEATURING INFORMATION AND CONTENT IN THE FIELD OF POPULAR CULTURE, RECREATION, AND ENTERTAINMENT, IN CLASS 41 (U.S. CLS. 100, 101 AND 107).

FIRST USE 4-30-2011; IN COMMERCE 4-30-2011.

THE MARK CONSISTS OF STANDARD CHARACTERS WITHOUT CLAIM TO ANY PARTICULAR FONT, STYLE, SIZE, OR COLOR.

SN 85-311,675, FILED 5-4-2011.

GRETТА YAO, EXAMINING ATTORNEY



David J. Kybas

Director of the United States Patent and Trademark Office

United States of America

United States Patent and Trademark Office

STATE STREET SPRINGBOARD

Reg. No. 4,110,263

Registered Mar. 6, 2012

Int. Cl.: 36

SERVICE MARK

PRINCIPAL REGISTER

STATE STREET CORPORATION (MASSACHUSETTS CORPORATION)
ONE LINCOLN STREET
BOSTON, MA 02111

FOR: PROVIDING A SECURE INTRANET WEBSITE PORTAL IN THE FIELD OF SECURITIES, CASH AND FOREIGN EXCHANGE, FOR USE BY CLIENTS OF A PARTICULAR FINANCIAL INSTITUTION TO PROVIDE AND OBTAIN INFORMATION ABOUT THEIR ACCOUNTS AND TO MONITOR THE STATUS OF FINANCIAL TRANSACTIONS, ALL FOR USE IN THE FIELD OF INSTITUTIONAL INVESTING, IN CLASS 36 (U.S. CLS. 100, 101 AND 102).

FIRST USE 12-9-2011; IN COMMERCE 12-20-2011.

THE MARK CONSISTS OF STANDARD CHARACTERS WITHOUT CLAIM TO ANY PARTICULAR FONT, STYLE, SIZE, OR COLOR.

OWNER OF U.S. REG. NOS. 1,337,093, 3,699,987, AND OTHERS.

SN 85-311,824, FILED 5-4-2011.

MARC LEIPZIG, EXAMINING ATTORNEY



David J. Kyffers

Director of the United States Patent and Trademark Office

United States of America

United States Patent and Trademark Office



Reg. No. 4,110,264

Registered Mar. 6, 2012

Int. Cl.: 41

SERVICE MARK

PRINCIPAL REGISTER

ECKARD, HEIDI (UNITED STATES INDIVIDUAL)
2203 3RD ST, UNIT 4
SANTA MONICA, CA 90405

FOR: EDUCATIONAL AND ENTERTAINMENT SERVICES, NAMELY, A CONTINUING PROGRAM FEATURING EDUCATIONAL TOPICS IN A GENERAL PRE-KINDERGARTEN THROUGH 12TH GRADE CURRICULUM FOR CHILDREN ACCESSIBLE BY RADIO, TELEVISION, SATELLITE, AUDIO, VIDEO AND COMPUTER NETWORKS, IN CLASS 41 (U.S. CLS. 100, 101 AND 107).

FIRST USE 12-5-2011; IN COMMERCE 12-5-2011.

THE MARK CONSISTS OF THE STYLIZED TEXT "KUMIKO'S KALEIDOSCOPE" IN A WAVE FORM AND ALL LETTERS IN A SEPARATE BOX.

SN 85-311,877, FILED 5-4-2011.

ELLEN PERKINS, EXAMINING ATTORNEY



David J. Kybas

Director of the United States Patent and Trademark Office

United States of America

United States Patent and Trademark Office



Reg. No. 4,110,265

Registered Mar. 6, 2012

Int. Cl.: 5

TRADEMARK

PRINCIPAL REGISTER

PEP PHARMACEUTICALS (OHIO LIMITED LIABILITY COMPANY)
2549 BRYDEN RD
BEXLEY, OH 43209

FOR: NUTRACEUTICALS FOR THE TREATMENT OF MINOR BURNS, NAMELY, A SPRAY FOR ORAL BURNS AND A GEL FOR SKIN BURNS, IN CLASS 5 (U.S. CLS. 6, 18, 44, 46, 51 AND 52).

FIRST USE 7-19-2011; IN COMMERCE 7-19-2011.

THE MARK CONSISTS OF SIX BLADES OF GREEN GRASS OUTLINED IN BLUE, ENCLOSED IN A BLUE CIRCLE WITH A YELLOW FILL.

THE COLOR(S) BLUE, GREEN AND YELLOW IS/ARE CLAIMED AS A FEATURE OF THE MARK.

SN 85-311,950, FILED 5-4-2011.

GINA HAYES, EXAMINING ATTORNEY



David J. Kybas

Director of the United States Patent and Trademark Office

United States of America

United States Patent and Trademark Office

A WINTER'S TALE

Reg. No. 4,110,266

Registered Mar. 6, 2012

Int. Cl.: 33

TRADEMARK

PRINCIPAL REGISTER

WINERY EXCHANGE, INC. (CALIFORNIA CORPORATION)
GENEVIEVE BURCH
500 REDWOOD BLVD., SUITE 200
NOVATO, CA 94947

FOR: ALCOHOLIC BEVERAGES EXCEPT BEERS, IN CLASS 33 (U.S. CLS. 47 AND 49).

FIRST USE 9-0-2011; IN COMMERCE 9-0-2011.

THE MARK CONSISTS OF STANDARD CHARACTERS WITHOUT CLAIM TO ANY PARTICULAR FONT, STYLE, SIZE, OR COLOR.

SN 85-312,705, FILED 5-4-2011.

CARRIE GENOVESE, EXAMINING ATTORNEY



David J. Kybas

Director of the United States Patent and Trademark Office

United States of America

United States Patent and Trademark Office

PROPULSION PLUS

Reg. No. 4,110,267

Registered Mar. 6, 2012

Int. Cl.: 36

SERVICE MARK

PRINCIPAL REGISTER

PROGRESSIVE CASUALTY INSURANCE COMPANY (OHIO CORPORATION)
6300 WILSON MILLS ROAD
MAYFIELD VILLAGE, OH 44143

FOR: WATERCRAFT INSURANCE ADMINISTRATION SERVICES AND UNDERWRITING SERVICES FOR MECHANICAL BREAKDOWN OF WATERCRAFT DRIVE SYSTEM , IN CLASS 36 (U.S. CLS. 100, 101 AND 102).

FIRST USE 10-14-2011; IN COMMERCE 10-14-2011.

THE MARK CONSISTS OF STANDARD CHARACTERS WITHOUT CLAIM TO ANY PARTICULAR FONT, STYLE, SIZE, OR COLOR.

SN 85-312,999, FILED 5-5-2011.

SOPHIA S. KIM, EXAMINING ATTORNEY



David J. Kybas

Director of the United States Patent and Trademark Office

United States of America

United States Patent and Trademark Office



Reg. No. 4,110,268

Registered Mar. 6, 2012

Int. Cl.: 9

TRADEMARK

PRINCIPAL REGISTER

GAMESTOP, INC. (MINNESOTA CORPORATION)
625 WESTPORT PARKWAY
GRAPEVINE, TX 76051

FOR: COMPUTER, VIDEO AND ELECTRONIC GAME HARDWARE AND ACCESSORIES THEREFOR, NAMELY, COMPUTER PROGRAMS FOR VIDEO AND COMPUTER GAMES, HANDHELD JOY STICK UNITS FOR PLAYING VIDEO GAMES HEADSETS, MICROPHONES, CABLES, CONTROLLERS, REMOTE CONTROLS FOR USE WITH VIDEO AND COMPUTER GAMES, KEYBOARDS, PROTECTIVE CARRYING CASES SPECIALLY ADAPTED FOR VIDEO GAME CONSOLES FOR USE WITH AN EXTERNAL DISPLAY SCREEN OR MONITOR; COMPUTER GAME DISC CARRYING CASES, CONTROLLER CHARGING BASES, GAMEPADS; COMPUTER AND VIDEO GAME STARTER KITS COMPRISED OF EARPHONES, SCREEN PROTECTOR, STYLUS, CARRYING BAG, CLEANING CLOTH AND SOFT CARD FOR APPLYING SCREEN A PROTECTOR, POWER SUPPLIES, STEERING WHEELS, MOTION CONTROLLER ATTACHMENTS, IN CLASS 9 (U.S. CLS. 21, 23, 26, 36 AND 38).

FIRST USE 8-11-2011; IN COMMERCE 8-11-2011.

THE MARK CONSISTS OF THE TERMS "RED" AND "SAMURAI" WITH A SAMURAI SWORD SLASH MARK ACROSS THE TERM "RED".

SN 85-313,108, FILED 5-5-2011.

KELLEY WELLS, EXAMINING ATTORNEY



David J. Kybas

Director of the United States Patent and Trademark Office

United States of America

United States Patent and Trademark Office

plusfill

Reg. No. 4,110,269

Registered Mar. 6, 2012

Int. Cl.: 1

TRADEMARK

PRINCIPAL REGISTER

SOLIDSCAPE, INC. (DELAWARE CORPORATION)
316 DANIEL WEBSTER HIGHWAY
MERRIMACK, NH 03054

FOR: CHEMICAL USED IN 3-D MODEL MAKING, IN CLASS 1 (U.S. CLS. 1, 5, 6, 10, 26 AND 46).

FIRST USE 6-8-2011; IN COMMERCE 6-14-2011.

THE MARK CONSISTS OF STANDARD CHARACTERS WITHOUT CLAIM TO ANY PARTICULAR FONT, STYLE, SIZE, OR COLOR.

SN 85-313,167, FILED 5-5-2011.

JEFF DEFORD, EXAMINING ATTORNEY



David J. Kybas

Director of the United States Patent and Trademark Office

United States of America

United States Patent and Trademark Office

DOUBLE BULLS-EYE

Reg. No. 4,110,270

MISSOURI LOTTERY COMMISSION (MISSOURI STATE AGENCY)
P.O. BOX 1603
JEFFERSON CITY, MO 65102

Registered Mar. 6, 2012

Int. Cl.: 41

FOR: LOTTERY SERVICES, IN CLASS 41 (U.S. CLS. 100, 101 AND 107).

SERVICE MARK

FIRST USE 8-28-2011; IN COMMERCE 8-28-2011.

PRINCIPAL REGISTER

THE MARK CONSISTS OF STANDARD CHARACTERS WITHOUT CLAIM TO ANY PARTICULAR FONT, STYLE, SIZE, OR COLOR.

SN 85-313,176, FILED 5-5-2011.

PAM WILLIS, EXAMINING ATTORNEY



David J. Kybas

Director of the United States Patent and Trademark Office

United States of America

United States Patent and Trademark Office

DOON BUGGY

Reg. No. 4,110,271

Registered Mar. 6, 2012

Int. Cl.: 33

TRADEMARK

PRINCIPAL REGISTER

WINERY EXCHANGE, INC. (CALIFORNIA CORPORATION)
GENEVIEVE BURCH
500 REDWOOD BLVD., SUITE 200
NOVATO, CA 94947

FOR: ALCOHOLIC BEVERAGES EXCEPT BEERS, IN CLASS 33 (U.S. CLS. 47 AND 49).

FIRST USE 7-0-2011; IN COMMERCE 7-0-2011.

THE MARK CONSISTS OF STANDARD CHARACTERS WITHOUT CLAIM TO ANY PARTICULAR FONT, STYLE, SIZE, OR COLOR.

SN 85-313,719, FILED 5-5-2011.

CARRIE GENOVESE, EXAMINING ATTORNEY



David J. Kyffers

Director of the United States Patent and Trademark Office

United States of America

United States Patent and Trademark Office

SOFIA

Reg. No. 4,110,272

Registered Mar. 6, 2012

Int. Cls.: 9 and 10

TRADEMARK

PRINCIPAL REGISTER

QUIDEL CORPORATION (DELAWARE CORPORATION)
10165 MCKELLAR COURT
SAN DIEGO, CA 92121

FOR: CLINICAL LABORATORY ANALYZERS FOR MEASURING, TESTING AND ANALYZING BLOOD AND OTHER BODILY FLUIDS, IN CLASS 9 (U.S. CLS. 21, 23, 26, 36 AND 38).

FIRST USE 10-17-2011; IN COMMERCE 10-17-2011.

FOR: MEDICAL DIAGNOSTIC ANALYZERS FOR MEASURING, TESTING AND ANALYZING BLOOD AND OTHER BODILY FLUIDS, IN CLASS 10 (U.S. CLS. 26, 39 AND 44).

FIRST USE 10-17-2011; IN COMMERCE 10-17-2011.

THE MARK CONSISTS OF STANDARD CHARACTERS WITHOUT CLAIM TO ANY PARTICULAR FONT, STYLE, SIZE, OR COLOR.

SN 85-314,356, FILED 5-6-2011.

TRACY CROSS, EXAMINING ATTORNEY



David J. Kyros

Director of the United States Patent and Trademark Office

United States of America

United States Patent and Trademark Office

mParty

Reg. No. 4,110,273

Registered Mar. 6, 2012

Int. Cl.: 9

TRADEMARK

PRINCIPAL REGISTER

PROPAY, INC (UTAH CORPORATION)
3400 ASHTON BLVD. SUITE 200
LEHI, UT 84043

FOR: A MOBILE APPLICATION SOFTWARE FOR A SMART PHONE OR MOBILE DEVICE THAT ALLOWS A RECIPIENT TO ORGANIZE AND MANAGE A SOCIAL EVENT FOR A MERCHANT, WITH THE FUNCTIONS OF THE MOBILE APPLICATION INCLUDING BUT NOT LIMITED TO: AN INVITATION TO THE EVENT; PROVIDING A CUSTOMER WITH PRODUCT INFORMATION; ESTABLISHING BI-DIRECTIONAL COMMUNICATION BETWEEN SELLER AND CUSTOMER; AND FACILITATING THE TRACKING OF CUSTOMER SELECTION AND PAYMENT OF GOODS, INCLUDING MOBILE PAYMENTS FROM CUSTOMER TO SELLER, IN CLASS 9 (U.S. CLS. 21, 23, 26, 36 AND 38).

FIRST USE 6-5-2011; IN COMMERCE 6-5-2011.

THE MARK CONSISTS OF STANDARD CHARACTERS WITHOUT CLAIM TO ANY PARTICULAR FONT, STYLE, SIZE, OR COLOR.

SN 85-314,451, FILED 5-6-2011.

JOHN HWANG, EXAMINING ATTORNEY



David J. Kyros

Director of the United States Patent and Trademark Office

United States of America

United States Patent and Trademark Office

MASTERCARVED

Reg. No. 4,110,274

ROSY BLUE JEWELRY INC. (NEW YORK CORPORATION)
529 FIFTH AVENUE, 12TH FLOOR
NEW YORK, NY 10017

Registered Mar. 6, 2012

Int. Cl.: 14

FOR: JEWELRY; DIAMONDS; PRECIOUS AND SEMI PRECIOUS STONES, IN CLASS 14
(U.S. CLS. 2, 27, 28 AND 50).

TRADEMARK

FIRST USE 9-0-2011; IN COMMERCE 10-5-2011.

PRINCIPAL REGISTER

THE MARK CONSISTS OF STANDARD CHARACTERS WITHOUT CLAIM TO ANY PARTICULAR FONT, STYLE, SIZE, OR COLOR.

SN 85-314,459, FILED 5-6-2011.

HEATHER THOMPSON, EXAMINING ATTORNEY



David J. Kybas

Director of the United States Patent and Trademark Office

United States of America

United States Patent and Trademark Office

THE DAILY BURGER

Reg. No. 4,110,275

Registered Mar. 6, 2012

Int. Cl.: 43

SERVICE MARK

PRINCIPAL REGISTER

NIEPORENT, DREW (UNITED STATES INDIVIDUAL)
SUITE 2E
249 WEST BROADWAY
NEW YORK, NY 10013

FOR: RESTAURANT SERVICES, NAMELY, PROVIDING OF FOOD AND BEVERAGES FOR CONSUMPTION ON AND OFF THE PREMISES, IN CLASS 43 (U.S. CLS. 100 AND 101).

FIRST USE 12-14-2011; IN COMMERCE 12-14-2011.

THE MARK CONSISTS OF STANDARD CHARACTERS WITHOUT CLAIM TO ANY PARTICULAR FONT, STYLE, SIZE, OR COLOR.

NO CLAIM IS MADE TO THE EXCLUSIVE RIGHT TO USE "BURGER", APART FROM THE MARK AS SHOWN.

SN 85-314,510, FILED 5-6-2011.

MICHAEL KEATING, EXAMINING ATTORNEY



David J. Kybas

Director of the United States Patent and Trademark Office

United States of America

United States Patent and Trademark Office

DEALERPAD

Reg. No. 4,110,276

REYNOLDS AND REYNOLDS HOLDINGS, INC. (DELAWARE CORPORATION)
ONE REYNOLDS WAY
KETTERING, OH 45430

Registered Mar. 6, 2012

Int. Cl.: 9

FOR: COMPUTER SOFTWARE FOR USE IN CUSTOMER RELATIONSHIP MANAGEMENT (CRM), IN CLASS 9 (U.S. CLS. 21, 23, 26, 36 AND 38).

TRADEMARK

FIRST USE 5-2-2011; IN COMMERCE 5-12-2011.

PRINCIPAL REGISTER

THE MARK CONSISTS OF STANDARD CHARACTERS WITHOUT CLAIM TO ANY PARTICULAR FONT, STYLE, SIZE, OR COLOR.

SN 85-314,724, FILED 5-6-2011.

DEIRDRE ROBERTSON, EXAMINING ATTORNEY



David J. Kybas

Director of the United States Patent and Trademark Office

United States of America

United States Patent and Trademark Office

NAUTICAL FOODS

Reg. No. 4,110,277

SCANDIA SEAFOOD INC. (NEW YORK CORPORATION)
260A SECAUCUS ROAD
SECAUCUS, NJ 07094

Registered Mar. 6, 2012

Int. Cl.: 29

FOR: SEAFOOD; PREPARED ENTREES CONSISTING PRIMARILY OF SEAFOOD; PROCESSED SEAFOOD, NAMELY, FISH; FROZEN PRE-PACKAGED ENTREES CONSISTING PRIMARILY OF SEAFOOD; SEAFOOD, NAMELY, FROZEN SALMON BURGERS, FROZEN CRAB CAKES, FROZEN CRUSTED TILAPIA, FROZEN SEAFOOD SAUSAGE; FRESH SEAFOOD; FRESH SEAFOOD, NAMELY, FRESH SMOKED SALMON AND FRESH CRAB CAKE MIX, IN CLASS 29 (U.S. CL. 46).

TRADEMARK

PRINCIPAL REGISTER

FIRST USE 5-1-2011; IN COMMERCE 5-5-2011.

THE MARK CONSISTS OF STANDARD CHARACTERS WITHOUT CLAIM TO ANY PARTICULAR FONT, STYLE, SIZE, OR COLOR.

NO CLAIM IS MADE TO THE EXCLUSIVE RIGHT TO USE "FOODS", APART FROM THE MARK AS SHOWN.

SN 85-315,063, FILED 5-7-2011.

ADA HAN, EXAMINING ATTORNEY



David J. Kyros

Director of the United States Patent and Trademark Office

United States of America

United States Patent and Trademark Office



Reg. No. 4,110,278

Registered Mar. 6, 2012

Int. Cl.: 28

TRADEMARK

PRINCIPAL REGISTER

DEMME, THOMAS S. (UNITED STATES INDIVIDUAL)
5N593 QUAIL CT.
ST. CHARLES, IL 60175

FOR: CONVERSION KIT FOR A BICYCLE TO MAKE IT POSSIBLE FOR A PERSON TO SIT ON THE BICYCLE AND MOVE THE BICYCLE, BY FOOT CONTACT WITH THE GROUND INSTEAD OF THE BIKE PEDALS, IN CLASS 28 (U.S. CLS. 22, 23, 38 AND 50).

FIRST USE 5-9-2011; IN COMMERCE 8-31-2011.

NO CLAIM IS MADE TO THE EXCLUSIVE RIGHT TO USE "BIKE FITNESS", APART FROM THE MARK AS SHOWN.

THE MARK CONSISTS OF THE WORDS "STRIDE BIKE FITNESS" IN STYLIZED FONT BELOW A DESIGN OF A PERSON ON A BICYCLE.

SN 85-315,581, FILED 5-9-2011.

FRANK LATTUCA, EXAMINING ATTORNEY



David J. Kyjars

Director of the United States Patent and Trademark Office

United States of America

United States Patent and Trademark Office



Reg. No. 4,110,279

SCHWACHENWALD, ROBERT (UNITED STATES INDIVIDUAL)
659 CARY TOWNE BLVD #222
CARY, NC 27519

Registered Mar. 6, 2012

Int. Cl.: 37

FOR: PLUMBING; PLUMBING CONTRACTOR SERVICES, IN CLASS 37 (U.S. CLS. 100, 103 AND 106).

SERVICE MARK

FIRST USE 6-1-2011; IN COMMERCE 7-1-2011.

PRINCIPAL REGISTER

NO CLAIM IS MADE TO THE EXCLUSIVE RIGHT TO USE "PLUMBING, INC ", APART FROM THE MARK AS SHOWN.

THE MARK CONSISTS OF A DESIGN OF A BEE WEARING A HAT, TANK TOP SHIRT AND TOOLBELT, HOLDING A PLUMBING WRENCH IN THE LEFT AND A DRAIN CABLE WITH A CUTTER IN THE RIGHT HAND. ON THE TAIL HE HAS A PLUNGER. THE BEE IS SITTING ON TOP OF A SQUARE DESIGN MADE OF PIPES WITH THE STYLIZED WORDS "BIZZY BEE PLUMBING, INC WE MAKE YOUR HONEY HAPPY!".

SN 85-315,844, FILED 5-9-2011.

CURTIS FRENCH, EXAMINING ATTORNEY



David J. Kypos

Director of the United States Patent and Trademark Office

United States of America

United States Patent and Trademark Office

AETYPIC

Reg. No. 4,110,280

AETYPIC, INC. (CALIFORNIA CORPORATION)
7 FREELON STREET
SAN FRANCISCO, CA 94107

Registered Mar. 6, 2012

Int. Cl.: 42

FOR: CONSULTING IN THE FIELDS OF ENGINEERING AND ARCHITECTURE, IN CLASS 42 (U.S. CLS. 100 AND 101).

SERVICE MARK

FIRST USE 7-1-2011; IN COMMERCE 7-1-2011.

PRINCIPAL REGISTER

THE MARK CONSISTS OF STANDARD CHARACTERS WITHOUT CLAIM TO ANY PARTICULAR FONT, STYLE, SIZE, OR COLOR.

SN 85-316,353, FILED 5-9-2011.

JAMES LOVELACE, EXAMINING ATTORNEY



David J. Kybas

Director of the United States Patent and Trademark Office

United States of America

United States Patent and Trademark Office

GLIDE & GO BALANCE BIKE

Reg. No. 4,110,281

Registered Mar. 6, 2012

Int. Cl.: 12

TRADEMARK

PRINCIPAL REGISTER

RADIO FLYER, INC. (ILLINOIS CORPORATION)
6515 WEST GRAND AVENUE
CHICAGO, IL 60707

FOR: BICYCLES, IN CLASS 12 (U.S. CLS. 19, 21, 23, 31, 35 AND 44).

FIRST USE 10-1-2011; IN COMMERCE 10-1-2011.

THE MARK CONSISTS OF STANDARD CHARACTERS WITHOUT CLAIM TO ANY PARTICULAR FONT, STYLE, SIZE, OR COLOR.

OWNER OF U.S. REG. NO. 3,328,142.

NO CLAIM IS MADE TO THE EXCLUSIVE RIGHT TO USE "BALANCE BIKE", APART FROM THE MARK AS SHOWN.

SN 85-316,541, FILED 5-10-2011.

KEVIN CORWIN, EXAMINING ATTORNEY



David J. Kybas

Director of the United States Patent and Trademark Office

United States of America

United States Patent and Trademark Office

RespiSim

Reg. No. 4,110,282

Registered Mar. 6, 2012

Int. Cl.: 9

TRADEMARK

PRINCIPAL REGISTER

INGMAR MEDICAL, LTD. (PENNSYLVANIA CORPORATION)
5940 BAUM BOULEVARD
PITTSBURGH, PA 15206

FOR: COMPUTER SOFTWARE PROVIDING MEDICAL INSTRUCTORS AND STUDENTS WITH COMPREHENSIVE REAL-TIME INFORMATION ON PATIENT-VENTILATOR INTERACTION BY INTERFACING MECHANICAL VENTILATORS WITH BREATHING SIMULATORS; AND HARDWARE, NAMELY, ELECTRONIC CONTROLLERS AND DISPLAYS FOR USE THEREWITH, IN CLASS 9 (U.S. CLS. 21, 23, 26, 36 AND 38).

FIRST USE 8-31-2011; IN COMMERCE 8-31-2011.

THE MARK CONSISTS OF STANDARD CHARACTERS WITHOUT CLAIM TO ANY PARTICULAR FONT, STYLE, SIZE, OR COLOR.

SN 85-316,605, FILED 5-10-2011.

FRANK LATTUCA, EXAMINING ATTORNEY



David J. Kybas

Director of the United States Patent and Trademark Office

United States of America

United States Patent and Trademark Office

FREEBASE

Reg. No. 4,110,283

Registered Mar. 6, 2012

Int. Cl.: 28

TRADEMARK

PRINCIPAL REGISTER

BON HIVER, INC. (NEW YORK CORPORATION)
131 LAROE ROAD
CHESTER, NY 10918

FOR: BINDINGS FOR SNOWBOARDS, IN CLASS 28 (U.S. CLS. 22, 23, 38 AND 50).

FIRST USE 8-21-2011; IN COMMERCE 8-21-2011.

THE MARK CONSISTS OF STANDARD CHARACTERS WITHOUT CLAIM TO ANY PARTICULAR FONT, STYLE, SIZE, OR COLOR.

SN 85-317,059, FILED 5-10-2011.

REBECCA GILBERT, EXAMINING ATTORNEY



David J. Kybas

Director of the United States Patent and Trademark Office

United States of America

United States Patent and Trademark Office

HOPPER WHITMAN

Reg. No. 4,110,284

Registered Mar. 6, 2012

Int. Cl.: 32

TRADEMARK

PRINCIPAL REGISTER

WINERY EXCHANGE, INC. (CALIFORNIA CORPORATION)
500 REDWOOD BLVD., SUITE 200
GENEVIEVE BURCH
NOVATO, CA 94947

FOR: BEER, IN CLASS 32 (U.S. CLS. 45, 46 AND 48).

FIRST USE 8-0-2011; IN COMMERCE 8-0-2011.

THE MARK CONSISTS OF STANDARD CHARACTERS WITHOUT CLAIM TO ANY PARTICULAR FONT, STYLE, SIZE, OR COLOR.

THE NAME "HOPPER WHITMAN" DOES NOT IDENTIFY A PARTICULAR LIVING INDIVIDUAL.

SN 85-318,004, FILED 5-11-2011.

CARRIE GENOVESE, EXAMINING ATTORNEY



David J. Kybas

Director of the United States Patent and Trademark Office

United States of America

United States Patent and Trademark Office



Reg. No. 4,110,285

Registered Mar. 6, 2012

Int. Cl.: 14

TRADEMARK

PRINCIPAL REGISTER

SAKS, ABRAHAM (ARGENTINA INDIVIDUAL)
#136
36 N.E. 1ST STREET
MIAMI, FL 33132

FOR: WRISTWATCHES, IN CLASS 14 (U.S. CLS. 2, 27, 28 AND 50).

FIRST USE 9-1-2011; IN COMMERCE 9-1-2011.

THE MARK CONSISTS OF A STYLIZED "WM" MADE OF UP ON ONE CONTINUOUS LINE OVER THE STYLIZED TEXT "WATCHMANIA".

SN 85-318,241, FILED 5-11-2011.

THOMAS MANOR, EXAMINING ATTORNEY



David J. Kyfos

Director of the United States Patent and Trademark Office

United States of America

United States Patent and Trademark Office

NEW GIRL

Reg. No. 4,110,286

Registered Mar. 6, 2012

Int. Cl.: 41

SERVICE MARK

PRINCIPAL REGISTER

TWENTIETH CENTURY FOX FILM CORPORATION (DELAWARE CORPORATION)
10201 WEST PICO BOULEVARD
LOS ANGELES, CA 90035

FOR: ENTERTAINMENT SERVICES IN THE NATURE OF A TELEVISION SERIES FEATURING COMEDY; PROVIDING ON-LINE INFORMATION IN THE FIELD OF TELEVISION AND VIDEO ENTERTAINMENT FEATURING COMEDY VIA THE INTERNET; ENTERTAINMENT SERVICES IN THE NATURE OF NON-DOWNLOADABLE VIDEOS AND IMAGES FEATURING TELEVISION SHOWS AND ENTERTAINMENT TRANSMITTED VIA THE INTERNET AND WIRELESS COMMUNICATION NETWORKS, IN CLASS 41 (U.S. CLS. 100, 101 AND 107).

FIRST USE 8-0-2011; IN COMMERCE 8-0-2011.

THE MARK CONSISTS OF STANDARD CHARACTERS WITHOUT CLAIM TO ANY PARTICULAR FONT, STYLE, SIZE, OR COLOR.

SN 85-318,685, FILED 5-11-2011.

PAUL MORENO, EXAMINING ATTORNEY



David J. Kyros

Director of the United States Patent and Trademark Office

United States of America

United States Patent and Trademark Office

ki'netik fitness

Reg. No. 4,110,287

Registered Mar. 6, 2012

Int. Cl.: 41

SERVICE MARK

PRINCIPAL REGISTER

KI'NETIK FITNESS, LLC (PENNSYLVANIA LIMITED LIABILITY COMPANY)
2301 COMMERCIAL BLVD. SUITE A
STATE COLLEGE, PA 16801

FOR: CONDUCTING FITNESS CLASSES; PERSONAL FITNESS TRAINING SERVICES FEATURING AEROBIC AND ANAEROBIC ACTIVITIES COMBINED WITH RESISTANCE AND FLEXIBILITY TRAINING; PHYSICAL FITNESS INSTRUCTION; PHYSICAL FITNESS STUDIO SERVICES, NAMELY, PROVIDING EXERCISE CLASSES, BODY SCULPTING CLASSES, AND GROUP FITNESS CLASSES; PHYSICAL FITNESS TRAINING OF INDIVIDUALS AND GROUPS; PHYSICAL FITNESS TRAINING SERVICES, IN CLASS 41 (U.S. CLS. 100, 101 AND 107).

FIRST USE 2-1-2011; IN COMMERCE 7-1-2011.

THE MARK CONSISTS OF STANDARD CHARACTERS WITHOUT CLAIM TO ANY PARTICULAR FONT, STYLE, SIZE, OR COLOR.

NO CLAIM IS MADE TO THE EXCLUSIVE RIGHT TO USE "FITNESS", APART FROM THE MARK AS SHOWN.

SN 85-318,880, FILED 5-12-2011.

CHRISTINA SOBRAL, EXAMINING ATTORNEY



David J. Kyros

Director of the United States Patent and Trademark Office

United States of America

United States Patent and Trademark Office

G-VIEW

Reg. No. 4,110,288

Registered Mar. 6, 2012

Int. Cl.: 9

TRADEMARK

PRINCIPAL REGISTER

SHOCKWATCH, INC. (NEVADA CORPORATION)
SUITE 350
5501 LBJ FREEWAY
DALLAS, TX 75240

FOR: ELECTRONIC IMPACT RECORDERS, IN CLASS 9 (U.S. CLS. 21, 23, 26, 36 AND 38).

FIRST USE 11-30-2011; IN COMMERCE 12-9-2011.

THE MARK CONSISTS OF STANDARD CHARACTERS WITHOUT CLAIM TO ANY PARTICULAR FONT, STYLE, SIZE, OR COLOR.

SN 85-319,027, FILED 5-12-2011.

JULIE WATSON, EXAMINING ATTORNEY



David J. Kybas

Director of the United States Patent and Trademark Office

United States of America

United States Patent and Trademark Office

dre  connect

Reg. No. 4,110,289

Registered Mar. 6, 2012

Int. Cl.: 42

SERVICE MARK

PRINCIPAL REGISTER

CHICAGO PROVINCE OF THE SOCIETY OF JESUS (ILLINOIS NON-PROFIT CORPORATION)
3441 NORTH ASHLAND AVENUE
CHICAGO, IL 60657

FOR: COMPUTER SERVICES, NAMELY, CREATING AN ON-LINE COMMUNITY FOR REGISTERED USERS COMPRISING RELIGIOUS EDUCATORS TO PARTICIPATE IN DISCUSSIONS, GET FEEDBACK FROM OTHER USERS, FORM VIRTUAL COMMUNITIES, AND ENGAGE IN SOCIAL NETWORKING FEATURING TOPICS RELATING TO RELIGION AND RELIGIOUS INSTRUCTION ON CATHOLIC AND CHRISTIAN TOPICS, IN CLASS 42 (U.S. CLS. 100 AND 101).

FIRST USE 4-22-2011; IN COMMERCE 4-22-2011.

THE MARK CONSISTS OF THE LETTERS "DRE" AND THE WORD "CONNECT". A DESIGN ELEMENT OF FOUR CIRCLES AND FOUR SPHERICAL SHAPES APPEAR BETWEEN THE LETTERS "DRE" AND THE WORD "CONNECT".

SN 85-320,051, FILED 5-13-2011.

NAAKWAMA ANKRAH, EXAMINING ATTORNEY



David J. Kyffers

Director of the United States Patent and Trademark Office

United States of America

United States Patent and Trademark Office

7th Taste

Reg. No. 4,110,290

Registered Mar. 6, 2012

Int. Cl.: 29

TRADEMARK

PRINCIPAL REGISTER

SA ARTISAN FOODS COMPANY, INC (CALIFORNIA CORPORATION), DBA SA ARTISAN
FOODS COMPANY, INC,
2018 9TH STREET #F
BERKELEY, CA 94710

FOR: OLIVE OILS, IN CLASS 29 (U.S. CL. 46).

FIRST USE 12-17-2011; IN COMMERCE 12-17-2011.

THE MARK CONSISTS OF STANDARD CHARACTERS WITHOUT CLAIM TO ANY PAR-
TICULAR FONT, STYLE, SIZE, OR COLOR.

SN 85-320,781, FILED 5-13-2011.

WANDA KAY PRICE, EXAMINING ATTORNEY



David J. Kybas

Director of the United States Patent and Trademark Office

United States of America

United States Patent and Trademark Office

DELIGHTFUL COLLECTIONS Naturally Thankful

Reg. No. 4,110,291

DELIGHTFUL COLLECTIONS, LLC (NEW JERSEY LIMITED LIABILITY COMPANY)
P.O. BOX 364
PLAINSBORO, NJ 08536

Registered Mar. 6, 2012

Int. Cl.: 35

FOR: ADVERTISING AND MARKETING SERVICES, NAMELY, PROMOTING THE GOODS AND SERVICES OF OTHERS; RETAIL STORE SERVICES FEATURING HANDMADE GIFTS, NAMELY, CERAMICS, PORCELAIN, AND WOOD GIFTS ITEMS; AND ON-LINE RETAIL GIFT SHOP, IN CLASS 35 (U.S. CLS. 100, 101 AND 102).

SERVICE MARK

PRINCIPAL REGISTER

FIRST USE 10-31-2006; IN COMMERCE 10-31-2006.

THE MARK CONSISTS OF STANDARD CHARACTERS WITHOUT CLAIM TO ANY PARTICULAR FONT, STYLE, SIZE, OR COLOR.

NO CLAIM IS MADE TO THE EXCLUSIVE RIGHT TO USE "COLLECTIONS", APART FROM THE MARK AS SHOWN.

SN 85-321,019, FILED 5-13-2011.

JOHN DWYER, EXAMINING ATTORNEY



David J. Kypos

Director of the United States Patent and Trademark Office

United States of America

United States Patent and Trademark Office

Better Idea Foods

Reg. No. 4,110,292

Registered Mar. 6, 2012

Int. Cl.: 29

TRADEMARK

PRINCIPAL REGISTER

NC:TS, INC. (CALIFORNIA CORPORATION), DBA NEW CONCEPT TOTAL SALES,
321 CORPORATE TERRACE CIRCLE
CORONA, CA 92879

FOR: PREPARED ENTREES CONSISTING PRIMARILY OF VEGETABLES, SOUPS, FRUIT
SALADS AND VEGETABLE SALADS, IN CLASS 29 (U.S. CL. 46).

FIRST USE 6-16-2011; IN COMMERCE 9-7-2011.

THE MARK CONSISTS OF STANDARD CHARACTERS WITHOUT CLAIM TO ANY PAR-
TICULAR FONT, STYLE, SIZE, OR COLOR.

NO CLAIM IS MADE TO THE EXCLUSIVE RIGHT TO USE "FOODS", APART FROM THE
MARK AS SHOWN.

SN 85-321,300, FILED 5-15-2011.

PRISCILLA MILTON, EXAMINING ATTORNEY



David J. Kyffers

Director of the United States Patent and Trademark Office

United States of America

United States Patent and Trademark Office

OH MY GARLIC

Reg. No. 4,110,293

J-PACK LLC (CONNECTICUT LIMITED LIABILITY COMPANY), DBA GLOBAL SPICE,
135 SOUTH MAIN STREET
THOMASTON, CT 06787

Registered Mar. 6, 2012

Int. Cl.: 30

FOR: EDIBLE SPICES; FLAVOURINGS AND SEASONINGS; FOOD SEASONINGS, IN CLASS
30 (U.S. CL. 46).

TRADEMARK

FIRST USE 12-7-2011; IN COMMERCE 12-7-2011.

PRINCIPAL REGISTER

THE MARK CONSISTS OF STANDARD CHARACTERS WITHOUT CLAIM TO ANY PAR-
TICULAR FONT, STYLE, SIZE, OR COLOR.

NO CLAIM IS MADE TO THE EXCLUSIVE RIGHT TO USE "GARLIC", APART FROM THE
MARK AS SHOWN.

SN 85-321,633, FILED 5-16-2011.

CARYN GLASSER, EXAMINING ATTORNEY



David J. Kybas

Director of the United States Patent and Trademark Office

United States of America

United States Patent and Trademark Office

LAST MAN STANDING

Reg. No. 4,110,294

Registered Mar. 6, 2012

Int. Cl.: 41

SERVICE MARK

PRINCIPAL REGISTER

TWENTIETH CENTURY FOX FILM CORPORATION (DELAWARE CORPORATION)
10201 WEST PICO BOULEVARD
LOS ANGELES, CA 90035

FOR: ENTERTAINMENT SERVICES IN THE NATURE OF A TELEVISION SERIES FEATURING COMEDY; PROVIDING ON-LINE INFORMATION IN THE FIELD OF TELEVISION AND VIDEO ENTERTAINMENT FEATURING COMEDY VIA THE INTERNET; ENTERTAINMENT SERVICES IN THE NATURE OF NON-DOWNLOADABLE VIDEOS AND IMAGES FEATURING TELEVISION SHOWS AND ENTERTAINMENT TRANSMITTED VIA THE INTERNET AND WIRELESS COMMUNICATION NETWORKS; ON-LINE JOURNALS, NAMELY, BLOGS FEATURING PERSONAL OPINIONS IN THE FIELD OF GENERAL INTEREST AND COMEDY, IN CLASS 41 (U.S. CLS. 100, 101 AND 107).

FIRST USE 10-11-2011; IN COMMERCE 10-11-2011.

THE MARK CONSISTS OF STANDARD CHARACTERS WITHOUT CLAIM TO ANY PARTICULAR FONT, STYLE, SIZE, OR COLOR.

SN 85-323,027, FILED 5-17-2011.

PAUL MORENO, EXAMINING ATTORNEY



David J. Kyros

Director of the United States Patent and Trademark Office

United States of America

United States Patent and Trademark Office

XERCISE LAB

Reg. No. 4,110,295

Registered Mar. 6, 2012

Int. Cl.: 41

SERVICE MARK

PRINCIPAL REGISTER

ROWE, JENNY (UNITED STATES INDIVIDUAL)
4248 NOBLE STREET
PALO ALTO, CA 94306

FOR: EDUCATION AND ENTERTAINMENT SERVICES, NAMELY, A CHOREOGRAPHED GROUP FITNESS PROGRAM FOR CHILDREN AND ADULTS, IN CLASS 41 (U.S. CLS. 100, 101 AND 107).

FIRST USE 10-15-2011; IN COMMERCE 10-15-2011.

THE MARK CONSISTS OF STANDARD CHARACTERS WITHOUT CLAIM TO ANY PARTICULAR FONT, STYLE, SIZE, OR COLOR.

NO CLAIM IS MADE TO THE EXCLUSIVE RIGHT TO USE "EXERCISE", APART FROM THE MARK AS SHOWN.

SN 85-323,483, FILED 5-18-2011.

KAREN SEVERSON, EXAMINING ATTORNEY



David J. Kyros

Director of the United States Patent and Trademark Office

United States of America

United States Patent and Trademark Office

Nuits

Reg. No. 4,110,296

Registered Mar. 6, 2012

Int. Cl.: 29

TRADEMARK

PRINCIPAL REGISTER

TUTUNDJIAN, HAGOP (UNITED STATES INDIVIDUAL)
11462 GIBERTI WAY
PORTER RANCH, CA 91326

FOR: FRUITS AND NUT BASED SNACK FOODS, IN CLASS 29 (U.S. CL. 46).

FIRST USE 4-15-2010; IN COMMERCE 4-15-2010.

THE MARK CONSISTS OF STANDARD CHARACTERS WITHOUT CLAIM TO ANY PARTICULAR FONT, STYLE, SIZE, OR COLOR.

THE ENGLISH TRANSLATION OF THE WORD "NUITS" IN THE MARK IS "NIGHTS".

SN 85-323,683, FILED 5-18-2011.

APRIL HESIK, EXAMINING ATTORNEY



David J. Kybas

Director of the United States Patent and Trademark Office

United States of America

United States Patent and Trademark Office

TRUTHEART

Reg. No. 4,110,297

Registered Mar. 6, 2012

Int. Cl.: 16

TRADEMARK

PRINCIPAL REGISTER

JAFFEE & ASSOCIATES, LLC (CALIFORNIA LIMITED LIABILITY COMPANY)
14022 RUNNYMEDE STREET
VAN NUYS, CA 91405

FOR: GIFT BOXES, IN CLASS 16 (U.S. CLS. 2, 5, 22, 23, 29, 37, 38 AND 50).

FIRST USE 8-1-2011; IN COMMERCE 9-25-2011.

THE MARK CONSISTS OF STANDARD CHARACTERS WITHOUT CLAIM TO ANY PARTICULAR FONT, STYLE, SIZE, OR COLOR.

SN 85-323,934, FILED 5-18-2011.

MATTHEW KLINE, EXAMINING ATTORNEY



David J. Kyffers

Director of the United States Patent and Trademark Office

United States of America

United States Patent and Trademark Office

BlackPaw



Reg. No. 4,110,298

Registered Mar. 6, 2012

Int. Cl.: 41

SERVICE MARK

PRINCIPAL REGISTER

BLACKPAW CORPORATION (COLORADO CORPORATION)
459 S MCCASLIN BLVD
LOUISVILLE, CO 80027

FOR: EDUCATIONAL SERVICES, NAMELY, CONDUCTING CLASSES IN THE FIELD OF DOG TRAINING AND DISTRIBUTION OF TRAINING MATERIAL IN CONNECTION THEREWITH, IN CLASS 41 (U.S. CLS. 100, 101 AND 107).

FIRST USE 6-1-2011; IN COMMERCE 6-1-2011.

THE MARK CONSISTS OF THE WORD "BLACKPAW" IN BLACK LETTERS CENTERED ABOVE 3 RECTANGLES OUTLINED IN BLACK; THE RECTANGLE ON THE LEFT CONTAINS A STYLIZED FACE OF A DOG IN WHITE AND BLACK ON A YELLOW BACKGROUND; THE MIDDLE RECTANGLE CONTAINS A STYLIZED FOUR-TOE PAW DESIGN IN BLACK ON A WHITE BACKGROUND; THE RECTANGLE ON THE RIGHT CONTAINS A STYLIZED FACE OF A CAT IN WHITE AND BLACK ON A BLUE BACKGROUND.

THE COLOR(S) BLACK, WHITE, BLUE AND YELLOW IS/ARE CLAIMED AS A FEATURE OF THE MARK.

SN 85-324,225, FILED 5-18-2011.

ALEXANDER L. POWERS, EXAMINING ATTORNEY



David J. Kyros

Director of the United States Patent and Trademark Office

United States of America
United States Patent and Trademark Office

BlackPaw



Reg. No. 4,110,299

Registered Mar. 6, 2012

Int. Cl.: 44

SERVICE MARK

PRINCIPAL REGISTER

BLACKPAW CORPORATION (COLORADO CORPORATION)
459 S MCCASLIN BLVD
LOUISVILLE, CO 80027

FOR: PET CARE SERVICES, NAMELY, DOG BATHING AND NON-MEDICATED GROOMING SERVICES; PROVIDING SELF-SERVICE DOG BATHING FACILITIES, IN CLASS 44 (U.S. CLS. 100 AND 101).

FIRST USE 6-1-2011; IN COMMERCE 6-1-2011.

THE MARK CONSISTS OF THE WORD "BLACKPAW" IN BLACK LETTERS CENTERED ABOVE 3 RECTANGLES OUTLINED IN BLACK; THE RECTANGLE ON THE LEFT CONTAINS A STYLIZED FACE OF A DOG IN WHITE AND BLACK ON A YELLOW BACKGROUND; THE MIDDLE RECTANGLE CONTAINS A STYLIZED FOUR-TOE PAW DESIGN IN BLACK ON A WHITE BACKGROUND; THE RECTANGLE ON THE RIGHT CONTAINS A STYLIZED FACE OF A CAT IN WHITE AND BLACK ON A BLUE BACKGROUND.

THE COLOR(S) BLACK, WHITE, BLUE AND YELLOW IS/ARE CLAIMED AS A FEATURE OF THE MARK.

SN 85-324,246, FILED 5-18-2011.

ALEXANDER L. POWERS, EXAMINING ATTORNEY



David J. Kyros

Director of the United States Patent and Trademark Office

United States of America

United States Patent and Trademark Office

Sit Stay Play

Reg. No. 4,110,300

PETS A GO GO LLC (NEW YORK LIMITED LIABILITY COMPANY)
72 NORTH STATE ROAD, #162
BRIARCLIFF MANOR, NY 10510

Registered Mar. 6, 2012

Int. Cl.: 43

FOR: DOG DAY CARE SERVICES; DOG HOTEL SERVICES, IN CLASS 43 (U.S. CLS. 100 AND 101).

SERVICE MARK

FIRST USE 2-22-2011; IN COMMERCE 2-22-2011.

PRINCIPAL REGISTER

THE MARK CONSISTS OF STANDARD CHARACTERS WITHOUT CLAIM TO ANY PARTICULAR FONT, STYLE, SIZE, OR COLOR.

SN 85-324,247, FILED 5-18-2011.

FONG HSU, EXAMINING ATTORNEY



David J. Kybas

Director of the United States Patent and Trademark Office

United States of America

United States Patent and Trademark Office

H ZONE

Reg. No. 4,110,301

Registered Mar. 6, 2012

Int. Cl.: 36

SERVICE MARK

PRINCIPAL REGISTER

CLARK & LAVEY BENEFITS SOLUTIONS, INC. (NEW HAMPSHIRE CORPORATION)
32 DANIEL WEBSTER HIGHWAY
MERRIMACK, NH 03054

FOR: ADVISORY SERVICES IN THE FIELD OF EMPLOYEE BENEFITS FOR GROUP HEALTHCARE AND BUSINESS INSURANCE OFFERED TO EMPLOYEES IN ADDITION TO STANDARD BENEFITS SUCH AS MEDICAL, DENTAL, LIFE INSURANCE INCLUDING SHORT TERM DISABILITY, LONG TERM DISABILITY, CANCER INSURANCE, ACCIDENTAL DEATH AND DISMEMBERMENT, IN CLASS 36 (U.S. CLS. 100, 101 AND 102).

FIRST USE 3-13-2011; IN COMMERCE 4-5-2011.

THE MARK CONSISTS OF STANDARD CHARACTERS WITHOUT CLAIM TO ANY PARTICULAR FONT, STYLE, SIZE, OR COLOR.

SN 85-324,940, FILED 5-19-2011.

JEFF DEFORD, EXAMINING ATTORNEY



David J. Kybas

Director of the United States Patent and Trademark Office

United States of America

United States Patent and Trademark Office

GEOVINI

Reg. No. 4,110,302

Registered Mar. 6, 2012

Int. Cl.: 33

TRADEMARK

PRINCIPAL REGISTER

WINERY EXCHANGE, INC. (CALIFORNIA CORPORATION)
GENEVIEVE BURCH
500 REDWOOD BLVD., SUITE 200
NOVATO, CA 94947

FOR: ALCOHOLIC BEVERAGES EXCEPT BEERS, IN CLASS 33 (U.S. CLS. 47 AND 49).

FIRST USE 8-0-2011; IN COMMERCE 8-0-2011.

THE MARK CONSISTS OF STANDARD CHARACTERS WITHOUT CLAIM TO ANY PARTICULAR FONT, STYLE, SIZE, OR COLOR.

SN 85-326,647, FILED 5-20-2011.

CARRIE GENOVESE, EXAMINING ATTORNEY



David J. Kybas

Director of the United States Patent and Trademark Office

United States of America

United States Patent and Trademark Office

varsity

Reg. No. 4,110,303

VULCAN ATHLETICS, LLC (ALABAMA LIMITED LIABILITY COMPANY)
4371 CRESCENT ROAD
BIRMINGHAM, AL 35210

Registered Mar. 6, 2012

Int. Cl.: 5

FOR: ADHESIVE BANDAGES; ADHESIVE FOR BANDAGES FOR SKIN WOUNDS;
BANDAGES FOR SKIN WOUNDS, IN CLASS 5 (U.S. CLS. 6, 18, 44, 46, 51 AND 52).

TRADEMARK

FIRST USE 11-14-2011; IN COMMERCE 11-14-2011.

PRINCIPAL REGISTER

THE MARK CONSISTS OF STANDARD CHARACTERS WITHOUT CLAIM TO ANY PARTICULAR FONT, STYLE, SIZE, OR COLOR.

SN 85-327,784, FILED 5-23-2011.

WENDY JUN, EXAMINING ATTORNEY



David J. Kybas

Director of the United States Patent and Trademark Office

United States of America

United States Patent and Trademark Office

JIBJAB JR.

Reg. No. 4,110,304

Registered Mar. 6, 2012

Int. Cl.: 9

TRADEMARK

PRINCIPAL REGISTER

JIBJAB MEDIA INC. (DELAWARE CORPORATION)
228 MAIN STREET, SUITE 4
VENICE, CA 90291

FOR: DIGITAL MATERIALS, NAMELY, DOWNLOADABLE MULTIMEDIA FILES FEATURING PHOTO-PERSONALIZED CHILDREN'S STORIES; PRE-RECORDED ELECTRONIC AND DIGITAL MEDIA FEATURING CHILDREN'S ENTERTAINMENT, IN CLASS 9 (U.S. CLS. 21, 23, 26, 36 AND 38).

FIRST USE 8-31-2011; IN COMMERCE 8-31-2011.

THE MARK CONSISTS OF STANDARD CHARACTERS WITHOUT CLAIM TO ANY PARTICULAR FONT, STYLE, SIZE, OR COLOR.

OWNER OF U.S. REG. NOS. 2,587,463, 3,155,670, AND OTHERS.

SN 85-328,056, FILED 5-23-2011.

JAY FLOWERS, EXAMINING ATTORNEY



David J. Kyros

Director of the United States Patent and Trademark Office

United States of America
United States Patent and Trademark Office

HURMOSO

Reg. No. 4,110,305

HALL, TYRONE (UNITED STATES INDIVIDUAL)
PO BOX 959
NEW YORK, NY 10116

Registered Mar. 6, 2012

Int. Cl.: 25

FOR: CLOTHING, NAMELY, TOPS, BOTTOMS, UNDERWEAR, IN CLASS 25 (U.S. CLS. 22 AND 39).

TRADEMARK

FIRST USE 8-15-2011; IN COMMERCE 10-15-2011.

PRINCIPAL REGISTER

THE MARK CONSISTS OF STANDARD CHARACTERS WITHOUT CLAIM TO ANY PARTICULAR FONT, STYLE, SIZE, OR COLOR.

SN 85-328,180, FILED 5-24-2011.

JOHN SCHUYLER YARD, EXAMINING ATTORNEY



David J. Kyffers

Director of the United States Patent and Trademark Office

United States of America

United States Patent and Trademark Office

Pumpkinwear

Reg. No. 4,110,306

EVERGREEN ENTERPRISES, INC. (VIRGINIA CORPORATION)
5915 MIDLOTHIAN TURNPIKE
RICHMOND, VA 23225

Registered Mar. 6, 2012

Int. Cl.: 20

FOR: POLYRESIN HALLOWEEN PUMPKIN ORNAMENTS AND DECORATIONS, IN CLASS 20 (U.S. CLS. 2, 13, 22, 25, 32 AND 50).

TRADEMARK

FIRST USE 6-1-2011; IN COMMERCE 6-1-2011.

PRINCIPAL REGISTER

THE MARK CONSISTS OF STANDARD CHARACTERS WITHOUT CLAIM TO ANY PARTICULAR FONT, STYLE, SIZE, OR COLOR.

SN 85-329,500, FILED 5-25-2011.

MIDGE BUTLER, EXAMINING ATTORNEY



David J. Kyffers

Director of the United States Patent and Trademark Office

United States of America

United States Patent and Trademark Office

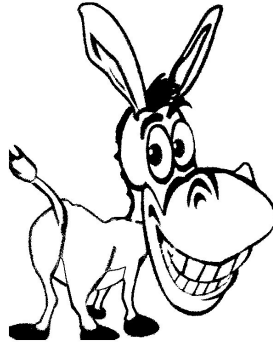

Reg. No. 4,110,307

Registered Mar. 6, 2012

Int. Cls.: 25 and 41

TRADEMARK

SERVICE MARK

PRINCIPAL REGISTER

STANOJEVIC, DEJAN (UNITED STATES INDIVIDUAL)
7822 LUXOR STREET
DOWNEY, CA 90241

FOR: HATS; JEANS; T-SHIRTS; UNDER GARMENTS, IN CLASS 25 (U.S. CLS. 22 AND 39).

FIRST USE 10-1-2011; IN COMMERCE 10-1-2011.

FOR: ENTERTAINMENT IN THE NATURE OF A SCRIPTED SITUATIONAL COMEDY SERIES FOR TELEVISION INTERNET SATELLITE AND RADIO, IN CLASS 41 (U.S. CLS. 100, 101 AND 107).

FIRST USE 10-1-2011; IN COMMERCE 10-1-2011.

THE MARK CONSISTS OF AN IMAGE OF A DONKEY SMILING WITH ITS ASS FACING THE VIEWER.

SN 85-331,005, FILED 5-26-2011.

VIVIAN MICZNIK FIRST, EXAMINING ATTORNEY



David J. Kybas

Director of the United States Patent and Trademark Office

United States of America

United States Patent and Trademark Office

RIES

Reg. No. 4,110,308

Registered Mar. 6, 2012

Int. Cl.: 9

TRADEMARK

PRINCIPAL REGISTER

ROCO RESCUE, INC. (LOUISIANA CORPORATION)
7077 EXCHEQUER DRIVE
BATON ROUGE, LA 70809

FOR: BAGS SPECIALLY ADAPTED FOR HOLDING RESCUE EQUIPMENT, IN CLASS 9
(U.S. CLS. 21, 23, 26, 36 AND 38).

FIRST USE 8-30-2011; IN COMMERCE 8-30-2011.

THE MARK CONSISTS OF STANDARD CHARACTERS WITHOUT CLAIM TO ANY PARTICULAR FONT, STYLE, SIZE, OR COLOR.

SN 85-331,261, FILED 5-26-2011.

CHRISTINE COOPER, EXAMINING ATTORNEY



David J. Kybas

Director of the United States Patent and Trademark Office

United States of America

United States Patent and Trademark Office

EZ SLEEPER

Reg. No. 4,110,309

HOLLYWOOD BED & SPRING MFG. CO., INC. (CALIFORNIA CORPORATION)
5959 CORVETTE STREET
COMMERCE, CA 90040

Registered Mar. 6, 2012

Int. Cl.: 20

FOR: BEDS, NAMELY, PORTABLE, MOBILE BEDS, IN CLASS 20 (U.S. CLS. 2, 13, 22, 25, 32 AND 50).

TRADEMARK

FIRST USE 4-21-2011; IN COMMERCE 8-8-2011.

PRINCIPAL REGISTER

THE MARK CONSISTS OF STANDARD CHARACTERS WITHOUT CLAIM TO ANY PARTICULAR FONT, STYLE, SIZE, OR COLOR.

NO CLAIM IS MADE TO THE EXCLUSIVE RIGHT TO USE "SLEEPER", APART FROM THE MARK AS SHOWN.

SN 85-331,436, FILED 5-26-2011.

KIMBERLY FRYE, EXAMINING ATTORNEY



David J. Kybas

Director of the United States Patent and Trademark Office

United States of America
United States Patent and Trademark Office

MEDLEY

Reg. No. 4,110,310

INSIGHT LIGHTING, INC. (NEW MEXICO CORPORATION)
4341 FULCRUM WAY
RIO RANCHO, NM 87124

Registered Mar. 6, 2012

Int. Cl.: 9

FOR: ARCHITECTURAL LIGHT-EMITTING DIODE (LED) LIGHTING DISPLAY, IN CLASS
9 (U.S. CLS. 21, 23, 26, 36 AND 38).

TRADEMARK

FIRST USE 6-10-2011; IN COMMERCE 6-10-2011.

PRINCIPAL REGISTER

THE MARK CONSISTS OF STANDARD CHARACTERS WITHOUT CLAIM TO ANY PAR-
TICULAR FONT, STYLE, SIZE, OR COLOR.

SN 85-333,654, FILED 5-31-2011.

KAREN K. BUSH, EXAMINING ATTORNEY



David J. Kybas

Director of the United States Patent and Trademark Office

United States of America

United States Patent and Trademark Office

METAL MACHINE

Reg. No. 4,110,311

Registered Mar. 6, 2012

Int. Cl.: 9

TRADEMARK

PRINCIPAL REGISTER

TOONTRACK MUSIC AB (SWEDEN CORPORATION)
VERKSTADSGATAN 13
UMEA, SWEDEN 90432

FOR: AUDIO RECORDINGS FEATURING DRUM SOUND LIBRARIES; MUSICAL SOUND RECORDINGS; SOUND RECORDINGS FEATURING PERCUSSION SOUND LIBRARIES, IN CLASS 9 (U.S. CLS. 21, 23, 26, 36 AND 38).

FIRST USE 11-1-2011; IN COMMERCE 11-1-2011.

THE MARK CONSISTS OF STANDARD CHARACTERS WITHOUT CLAIM TO ANY PARTICULAR FONT, STYLE, SIZE, OR COLOR.

SN 85-336,052, FILED 6-2-2011.

JANET LEE, EXAMINING ATTORNEY



David J. Kyffers

Director of the United States Patent and Trademark Office

United States of America
United States Patent and Trademark Office

CASCADE

Reg. No. 4,110,312

PACIFIC COAST FIBER FUELS, LLC (WASHINGTON LIMITED LIABILITY COMPANY)
621 WEST MALLON, SUITE 507
SPOKANE, WA 99201

Registered Mar. 6, 2012

Int. Cl.: 4

FOR: WOOD PELLETS FOR USE AS FUEL IN WOOD STOVES, IN CLASS 4 (U.S. CLS. 1, 6 AND 15).

TRADEMARK

FIRST USE 9-0-2011; IN COMMERCE 9-0-2011.

PRINCIPAL REGISTER

THE MARK CONSISTS OF STANDARD CHARACTERS WITHOUT CLAIM TO ANY PARTICULAR FONT, STYLE, SIZE, OR COLOR.

SN 85-341,041, FILED 6-8-2011.

JUDITH HELFMAN, EXAMINING ATTORNEY



David J. Kybas

Director of the United States Patent and Trademark Office

United States of America

United States Patent and Trademark Office

ORIGINAL MRS. BEACHLEY'S

Reg. No. 4,110,313

WINERY EXCHANGE, INC. (CALIFORNIA CORPORATION)
500 REDWOOD BLVD., SUITE 200
NOVATO, CA 94947

Registered Mar. 6, 2012

Int. Cl.: 33

FOR: ALCOHOLIC BEVERAGES EXCEPT BEERS, IN CLASS 33 (U.S. CLS. 47 AND 49).

TRADEMARK

FIRST USE 9-0-2011; IN COMMERCE 9-0-2011.

PRINCIPAL REGISTER

THE MARK CONSISTS OF STANDARD CHARACTERS WITHOUT CLAIM TO ANY PARTICULAR FONT, STYLE, SIZE, OR COLOR.

NO CLAIM IS MADE TO THE EXCLUSIVE RIGHT TO USE "ORIGINAL", APART FROM THE MARK AS SHOWN.

THE NAME "MRS. BEACHLEY" DOES NOT IDENTIFY A PARTICULAR LIVING INDIVIDUAL.

SN 85-341,539, FILED 6-8-2011.

CARRIE GENOVESE, EXAMINING ATTORNEY



David J. Kyros

Director of the United States Patent and Trademark Office

United States of America

United States Patent and Trademark Office

LASER NAIL REJUVENATION

Reg. No. 4,110,314

COOLTOUCH INCORPORATED (CALIFORNIA CORPORATION)
9085 FOOTHILLS BLVD.
ROSEVILLE, CA 95747

Registered Mar. 6, 2012

Int. Cl.: 44

FOR: PODIATRY SERVICES; PROVIDING LASER THERAPY FOR TREATING MEDICAL CONDITIONS, IN CLASS 44 (U.S. CLS. 100 AND 101).

SERVICE MARK

FIRST USE 7-28-2011; IN COMMERCE 7-28-2011.

PRINCIPAL REGISTER

THE MARK CONSISTS OF STANDARD CHARACTERS WITHOUT CLAIM TO ANY PARTICULAR FONT, STYLE, SIZE, OR COLOR.

NO CLAIM IS MADE TO THE EXCLUSIVE RIGHT TO USE "LASER NAIL", APART FROM THE MARK AS SHOWN.

SN 85-342,462, FILED 6-9-2011.

REBECCA EISINGER, EXAMINING ATTORNEY



David J. Kybas

Director of the United States Patent and Trademark Office

United States of America

United States Patent and Trademark Office

A NEW BIT OF HAPPINESS

Reg. No. 4,110,315

Registered Mar. 6, 2012

Int. Cl.: 30

TRADEMARK

PRINCIPAL REGISTER

HERSHEY CHOCOLATE & CONFECTIONERY CORPORATION (DELAWARE CORPORATION)
SUITE 204
4860 ROBB STREET
WHEAT RIDGE, CO 80033

FOR: CANDY; CHOCOLATE, IN CLASS 30 (U.S. CL. 46).

FIRST USE 7-31-2011; IN COMMERCE 7-31-2011.

THE MARK CONSISTS OF STANDARD CHARACTERS WITHOUT CLAIM TO ANY PARTICULAR FONT, STYLE, SIZE, OR COLOR.

SN 85-345,581, FILED 6-14-2011.

KATINA MISTER, EXAMINING ATTORNEY



David J. Kybas

Director of the United States Patent and Trademark Office

United States of America

United States Patent and Trademark Office

LIQUAMELT

Reg. No. 4,110,316

Registered Mar. 6, 2012

Int. Cl.: 7

TRADEMARK

PRINCIPAL REGISTER

H.B. FULLER COMPANY (MINNESOTA CORPORATION)
WLB-LAW-TRADEMARKS
1200 WILLOW LAKE BOULEVARD
SAINT PAUL, MN 551105101

FOR: INDUSTRIAL MACHINES FOR ADHESIVE APPLICATION TO VARIOUS SUBSTRATES, INCLUDING BUT NOT LIMITED TO CORRUGATED AND/OR PAPERBOARD SUBSTRATES AND REPLACEMENT PARTS THEREOF, IN CLASS 7 (U.S. CLS. 13, 19, 21, 23, 31, 34 AND 35).

FIRST USE 4-15-2011; IN COMMERCE 4-15-2011.

THE MARK CONSISTS OF STANDARD CHARACTERS WITHOUT CLAIM TO ANY PARTICULAR FONT, STYLE, SIZE, OR COLOR.

OWNER OF U.S. REG. NO. 3,549,742.

SN 85-359,002, FILED 6-29-2011.

SHARON MEIER, EXAMINING ATTORNEY



David J. Kybas

Director of the United States Patent and Trademark Office

United States of America

United States Patent and Trademark Office

Peachtree Meadow

Reg. No. 4,110,317

SWISS-AMERICAN, INC. (MISSOURI CORPORATION)
4200 PAPIN STREET
SAINT LOUIS, MO 63110

Registered Mar. 6, 2012

Int. Cl.: 29

FOR: CHEESE, IN CLASS 29 (U.S. CL. 46).

TRADEMARK

FIRST USE 9-12-2011; IN COMMERCE 9-12-2011.

PRINCIPAL REGISTER

THE MARK CONSISTS OF STANDARD CHARACTERS WITHOUT CLAIM TO ANY PARTICULAR FONT, STYLE, SIZE, OR COLOR.

SN 85-362,761, FILED 7-5-2011.

SAIMA MAKHDOOM, EXAMINING ATTORNEY



David J. Kybas

Director of the United States Patent and Trademark Office

United States of America

United States Patent and Trademark Office

Avanti

Reg. No. 4,110,318

Registered Mar. 6, 2012

Int. Cl.: 26

TRADEMARK

PRINCIPAL REGISTER

KANG, CURTIS (UNITED STATES INDIVIDUAL), DBA HAIR COUTURE,
14545 VALLEY VIEW AVE., SUITE N
SANTA FE SPRINGS, CA 906705230

FOR: HAIR EXTENSIONS, IN CLASS 26 (U.S. CLS. 37, 39, 40, 42 AND 50).

FIRST USE 10-13-2011; IN COMMERCE 10-13-2011.

THE MARK CONSISTS OF STANDARD CHARACTERS WITHOUT CLAIM TO ANY PARTICULAR FONT, STYLE, SIZE, OR COLOR.

THE ENGLISH TRANSLATION OF "AVANTI" IN THE MARK IS "FORWARD".

SN 85-365,993, FILED 7-7-2011.

MARGERY A. TIERNEY, EXAMINING ATTORNEY



David J. Kybas

Director of the United States Patent and Trademark Office

United States of America

United States Patent and Trademark Office



Reg. No. 4,110,319

Registered Mar. 6, 2012

Int. Cl.: 5

TRADEMARK

PRINCIPAL REGISTER

VULCAN ATHLETICS, LLC (ALABAMA LIMITED LIABILITY COMPANY)
4371 CRESCENT ROAD
IRONDALE, AL 35210

FOR: ADHESIVE BANDAGES, IN CLASS 5 (U.S. CLS. 6, 18, 44, 46, 51 AND 52).

FIRST USE 10-14-2011; IN COMMERCE 10-14-2011.

THE MARK CONSISTS OF BANNER OR PENNANT WITH TERM "VARSITY" READING LEFT TO RIGHT.

SN 85-401,665, FILED 8-18-2011.

WENDY JUN, EXAMINING ATTORNEY



David J. Kyffers

Director of the United States Patent and Trademark Office

United States of America

United States Patent and Trademark Office

DR. JULIE

Reg. No. 4,110,320

Registered Mar. 6, 2012

Int. Cl.: 44

SERVICE MARK

PRINCIPAL REGISTER

CHEN, JULIE T. (UNITED STATES INDIVIDUAL)
367 SANTANA HEIGHTS, UNIT 7030
SAN JOSE, CA 95128

FOR: PROVIDING A WEBSITE FEATURING INFORMATION IN THE FIELD OF HEALTH, NUTRITION, DIET, WEIGHT MANAGEMENT, MIND AND BODY CONNECTION, MENTAL HEALTH, AND WELLNESS; PROVIDING INFORMATION IN THE FIELD OF HEALTH, NUTRITION, DIET, WEIGHT MANAGEMENT, MIND AND BODY CONNECTION, MENTAL HEALTH, AND WELLNESS, IN CLASS 44 (U.S. CLS. 100 AND 101).

FIRST USE 11-15-2011; IN COMMERCE 11-15-2011.

THE MARK CONSISTS OF STANDARD CHARACTERS WITHOUT CLAIM TO ANY PARTICULAR FONT, STYLE, SIZE, OR COLOR.

THE NAME IN THE MARK IDENTIFIES THE APPLICANT, JULIE T. CHEN, WHOSE CONSENT IS OF RECORD.

SN 85-975,962, FILED 4-26-2011.

DAVID ELTON, EXAMINING ATTORNEY



David J. Kyffers

Director of the United States Patent and Trademark Office

United States of America

United States Patent and Trademark Office

THEODORA & CALLUM

Reg. No. 4,110,321

Registered Mar. 6, 2012

Int. Cls.: 18, 25, and 35

THEODORA & CALLUM, LLC (UNITED STATES LIMITED LIABILITY COMPANY)
915 BROADWAY
20TH FLOOR
NEW YORK, NY 10010

FOR: HANDBAGS; PURSES, IN CLASS 18 (U.S. CLS. 1, 2, 3, 22 AND 41).

TRADEMARK

FIRST USE 3-7-2011; IN COMMERCE 3-7-2011.

SERVICE MARK

FOR: DRESSES; SKIRTS, IN CLASS 25 (U.S. CLS. 22 AND 39).

PRINCIPAL REGISTER

FIRST USE 2-9-2011; IN COMMERCE 2-9-2011.

FOR: ON-LINE RETAIL STORE SERVICES FEATURING CLOTHING ACCESSORIES; RETAIL STORE SERVICES FEATURING CLOTHING ACCESSORIES, IN CLASS 35 (U.S. CLS. 100, 101 AND 102).

FIRST USE 2-9-2011; IN COMMERCE 2-9-2011.

THE MARK CONSISTS OF STANDARD CHARACTERS WITHOUT CLAIM TO ANY PARTICULAR FONT, STYLE, SIZE, OR COLOR.

SN 85-975,994, FILED 11-23-2010.

FLORENTINA BLANDU, EXAMINING ATTORNEY



David J. Kybas

Director of the United States Patent and Trademark Office

United States of America

United States Patent and Trademark Office

*Theodora
& Callum*

Reg. No. 4,110,322

Registered Mar. 6, 2012

Int. Cls.: 18, 25, and 35

THEODORA & CALLUM, LLC (UNITED STATES LIMITED LIABILITY COMPANY)
915 BROADWAY
20TH FLOOR
NEW YORK, NY 10010

FOR: HANDBAGS; PURSES, IN CLASS 18 (U.S. CLS. 1, 2, 3, 22 AND 41).

TRADEMARK

FIRST USE 3-7-2011; IN COMMERCE 3-7-2011.

SERVICE MARK

FOR: DRESSES; SKIRTS, IN CLASS 25 (U.S. CLS. 22 AND 39).

PRINCIPAL REGISTER

FIRST USE 2-9-2011; IN COMMERCE 2-9-2011.

FOR: ON-LINE RETAIL STORE SERVICES FEATURING CLOTHING ACCESSORIES; RETAIL STORE SERVICES FEATURING CLOTHING ACCESSORIES, IN CLASS 35 (U.S. CLS. 100, 101 AND 102).

FIRST USE 2-9-2011; IN COMMERCE 2-9-2011.

THE MARK CONSISTS OF THE WORD "THEODORA" ABOVE THE WORDS "& CALLUM".

SN 85-975,995, FILED 11-23-2010.

FLORENTINA BLANDU, EXAMINING ATTORNEY



David J. Kybas

Director of the United States Patent and Trademark Office

United States of America

United States Patent and Trademark Office

HYDRO-PROOF

Reg. No. 4,110,323

Registered Mar. 6, 2012

Int. Cl.: 19

TRADEMARK

PRINCIPAL REGISTER

GARDNER ASPHALT CORPORATION (DELAWARE CORPORATION)
P.O. BOX 5449
TAMPA, FL 33675

FOR: ADHESIVES AND COATINGS FOR COMMERCIAL AND INDUSTRIAL USE, NAMELY, BUILDING SEAM TAPE AND ROOFING CEMENT, IN CLASS 19 (U.S. CLS. 1, 12, 33 AND 50).

FIRST USE 11-1-2011; IN COMMERCE 11-1-2011.

THE MARK CONSISTS OF STANDARD CHARACTERS WITHOUT CLAIM TO ANY PARTICULAR FONT, STYLE, SIZE, OR COLOR.

OWNER OF U.S. REG. NO. 2,245,416.

SN 85-976,031, FILED 3-27-2010.

NICHOLAS COLEMAN, EXAMINING ATTORNEY



David J. Kyffers

Director of the United States Patent and Trademark Office

United States of America

United States Patent and Trademark Office

C. WONDER

Reg. No. 4,110,324

Registered Mar. 6, 2012

Int. Cl.: 35

SERVICE MARK

PRINCIPAL REGISTER

C. WONDER LLC (DELAWARE LIMITED LIABILITY COMPANY)
11TH FLOOR
598 MADISON AVENUE
NEW YORK, NY 10022

FOR: RETAIL STORE SERVICES FEATURING CLOTHING, JEWELRY, HOUSEWARES, STATIONERY, LEATHER GOODS AND BAGS, EYEWEAR, AND ELECTRONICS; ONLINE RETAIL STORE SERVICES FEATURING CLOTHING, FURNITURE, JEWELRY, HOUSEWARES, STATIONERY, LEATHER GOODS AND BAGS, EYEWEAR, AND ELECTRONICS, IN CLASS 35 (U.S. CLS. 100, 101 AND 102).

FIRST USE 10-22-2011; IN COMMERCE 10-22-2011.

THE MARK CONSISTS OF STANDARD CHARACTERS WITHOUT CLAIM TO ANY PARTICULAR FONT, STYLE, SIZE, OR COLOR.

SN 85-976,069, FILED 8-11-2010.

FLORENTINA BLANDU, EXAMINING ATTORNEY



David J. Kybas

Director of the United States Patent and Trademark Office

United States of America

United States Patent and Trademark Office

TWIHARD

Reg. No. 4,110,325

SUMMIT ENTERTAINMENT, LLC (DELAWARE LIMITED LIABILITY COMPANY)
1630 STEWART STREET, SUITE 120
SANTA MONICA, CA 90404

Registered Mar. 6, 2012

Int. Cl.: 25

FOR: CLOTHING, NAMELY, APRONS, HOODED SHIRTS, JACKETS, JERSEYS, LOUNGEWEAR, MATERNITY WEAR, NAMELY, MATERNITY SHIRTS, SHIRTS, SWEATSHIRTS, TANK TOPS; WIND RESISTANT JACKETS; FOOTWEAR; HEADWEAR, IN CLASS 25 (U.S. CLS. 22 AND 39).

TRADEMARK

PRINCIPAL REGISTER

FIRST USE 9-22-2008; IN COMMERCE 9-22-2008.

THE MARK CONSISTS OF STANDARD CHARACTERS WITHOUT CLAIM TO ANY PARTICULAR FONT, STYLE, SIZE, OR COLOR.

SN 85-976,081, FILED 9-14-2010.

JUSTINE D. PARKER, EXAMINING ATTORNEY



David J. Kyffers

Director of the United States Patent and Trademark Office

United States of America

United States Patent and Trademark Office

TIP IT!

Reg. No. 4,110,326

Registered Mar. 6, 2012

Int. Cl.: 25

TRADEMARK

PRINCIPAL REGISTER

INAPPROPRIATE LAUGHTER, INC. (CALIFORNIA CORPORATION)
9255 SUNSET BOULEVARD, SUITE 800
C/O EDELSTEIN LAIRD & SOBEL
LOS ANGELES, CA 90069

FOR: MEN'S, WOMEN'S AND CHILDREN'S APPAREL, NAMELY, T-SHIRTS, AND ROBES,
IN CLASS 25 (U.S. CLS. 22 AND 39).

FIRST USE 8-0-2010; IN COMMERCE 8-0-2010.

THE MARK CONSISTS OF STANDARD CHARACTERS WITHOUT CLAIM TO ANY PAR-
TICULAR FONT, STYLE, SIZE, OR COLOR.

SN 85-976,082, FILED 6-8-2010.

JAY FLOWERS, EXAMINING ATTORNEY



David J. Kyffers

Director of the United States Patent and Trademark Office

United States of America

United States Patent and Trademark Office

Disability **POWER & PRIDE**

Reg. No. 4,110,327

Registered Mar. 6, 2012

Int. Cls.: 12, 14, and 36

TRADEMARK

SERVICE MARK

PRINCIPAL REGISTER

COMMITTEE ON DISABILITY POWER & PRIDE, INC. (D.C. NON-PROFIT CORPORATION)
750-17TH STREET, NW, SUITE 1100
WASHINGTON, DC 20006

FOR: WHEELCHAIR BAGS, NAMELY, BAGS SPECIFICALLY ADAPTED FOR WHEEL-
CHAIRS, IN CLASS 12 (U.S. CLS. 19, 21, 23, 31, 35 AND 44).

FIRST USE 7-29-2010; IN COMMERCE 7-29-2010.

FOR: LAPEL PINS, IN CLASS 14 (U.S. CLS. 2, 27, 28 AND 50).

FIRST USE 7-1-2010; IN COMMERCE 7-1-2010.

FOR: CHARITABLE FUNDRAISING SERVICES BY MEANS OF ORGANIZING AND CON-
DUCTING SPECIAL EVENTS AND THE PROCEEDS ARE USED TO FINANCIALLY ASSIST
PEOPLE WITH DISABILITIES, IN CLASS 36 (U.S. CLS. 100, 101 AND 102).

FIRST USE 1-11-2009; IN COMMERCE 1-11-2009.

NO CLAIM IS MADE TO THE EXCLUSIVE RIGHT TO USE "DISABILITY", APART FROM
THE MARK AS SHOWN.

THE MARK CONSISTS OF THE STACKED WORDS "DISABILITY", "POWER" & "PRIDE"
WITH THE AMPERSAND AS PART OF THE LETTER "O" IN THE WORD "POWER".

SN 85-976,098, FILED 5-20-2010.

MARLENE BELL, EXAMINING ATTORNEY



David J. Kybas

Director of the United States Patent and Trademark Office

United States of America

United States Patent and Trademark Office

TiGr

Reg. No. 4,110,328

Registered Mar. 6, 2012

Int. Cl.: 6

TRADEMARK

PRINCIPAL REGISTER

STANTON CONCEPTS, L.L.C. (NEW JERSEY LIMITED LIABILITY COMPANY)
P.O. BOX 139
172 STANTON RD.
STANTON, NJ 08885

FOR: BICYCLE LOCKS; METAL BICYCLE LOCKS; METAL LOCKING MECHANISMS;
METAL LOCKS, IN CLASS 6 (U.S. CLS. 2, 12, 13, 14, 23, 25 AND 50).

FIRST USE 4-20-2011; IN COMMERCE 10-28-2011.

THE MARK CONSISTS OF STANDARD CHARACTERS WITHOUT CLAIM TO ANY PARTICULAR FONT, STYLE, SIZE, OR COLOR.

SN 85-976,109, FILED 4-26-2011.

PAUL E. FAHRENKOPF, EXAMINING ATTORNEY



David J. Kybas

Director of the United States Patent and Trademark Office

United States of America

United States Patent and Trademark Office



Reg. No. 4,110,329

Registered Mar. 6, 2012

Int. Cls.: 28 and 41

TRADEMARK

SERVICE MARK

PRINCIPAL REGISTER

KERZNER INTERNATIONAL RESORTS, INC. (FLORIDA CORPORATION)
1000 SOUTH PINE ISLAND ROAD, SUITE 800
PLANTATION, FL 33324

FOR: TOY FOAM NOVELTY ITEMS, NAMELY, FOAM FINGERS AND HANDS; BASKETBALLS, IN CLASS 28 (U.S. CLS. 22, 23, 38 AND 50).

FIRST USE 11-24-2011; IN COMMERCE 11-24-2011.

FOR: ENTERTAINMENT IN THE NATURE OF BASKETBALL GAMES AND TOURNAMENTS, IN CLASS 41 (U.S. CLS. 100, 101 AND 107).

FIRST USE 11-24-2011; IN COMMERCE 11-24-2011.

THE MARK CONSISTS OF THE WORD "BATTLE" AND THE NUMBER "4" WITH THE WORD "ATLANTIS" BELOW. ABOVE THE WORDING IS THE DESIGN OF A BASKETBALL FALLING INTO A STYLIZED NET.

SN 85-976,118, FILED 1-27-2011.

ELIZABETH KAJUBI, EXAMINING ATTORNEY



David J. Kyros

Director of the United States Patent and Trademark Office

United States of America

United States Patent and Trademark Office



Reg. No. 4,110,330

KRETEK INTERNATIONAL, INC. (CALIFORNIA CORPORATION)
5449 ENDEAVOUR COURT
MOORPARK, CA 93021

Registered Mar. 6, 2012

Int. Cl.: 34

FOR: CIGARETTE TUBES; HAND-HELD MACHINES FOR INJECTING TOBACCO INTO CIGARETTE TUBES, IN CLASS 34 (U.S. CLS. 2, 8, 9 AND 17).

TRADEMARK

FIRST USE 7-14-2008; IN COMMERCE 7-15-2008.

PRINCIPAL REGISTER

THE MARK CONSISTS OF THE WORD "FASFIL" APPEARING INSIDE OF A RECTANGLE, WITH A FLAME EMANATING FROM THE LETTER "I".

SN 85-976,119, FILED 12-17-2010.

HEATHER BIDDULPH, EXAMINING ATTORNEY



David J. Kybas

Director of the United States Patent and Trademark Office

United States of America

United States Patent and Trademark Office

TR

Reg. No. 4,110,331

Registered Mar. 6, 2012

Int. Cl.: 25

TRADEMARK

PRINCIPAL REGISTER

DUALSTAR ENTERTAINMENT GROUP, LLC (CALIFORNIA LIMITED LIABILITY COMPANY)
3525 HAYDEN AVENUE
CULVER CITY, CA 90232

FOR: CLOTHING, NAMELY, DRESSES, COATS, GLOVES, SHIRTS, JEANS, CARDIGANS, SHORTS, ROBES, PAJAMAS, SLEEP PANTS, CAMISOLES, BRAS, PANTIES, SLIPS, HATS, AND FOOTWEAR, IN CLASS 25 (U.S. CLS. 22 AND 39).

FIRST USE 3-31-2007; IN COMMERCE 3-31-2007.

THE MARK CONSISTS OF THE LETTERS "T" AND "R" STYLIZED.

SN 85-976,125, FILED 7-27-2010.

KAREN SEVERSON, EXAMINING ATTORNEY



David J. Kyffers

Director of the United States Patent and Trademark Office

United States of America

United States Patent and Trademark Office

NAT GEO WILD

Reg. No. 4,110,332

Registered Mar. 6, 2012

Int. Cl.: 41

SERVICE MARK

PRINCIPAL REGISTER

NATIONAL GEOGRAPHIC SOCIETY (D.C. CORPORATION)
1145 17TH STREET, N.W.
WASHINGTON, DC 20036

FOR: EDUCATIONAL AND ENTERTAINMENT SERVICES, NAMELY, PROVIDING EDUCATIONAL AND ENTERTAINMENT INFORMATION FEATURING A WIDE RANGE OF ADVENTURE, CULTURAL, EXPLORATION, GENERAL INTEREST, GEOGRAPHY, NATURAL HISTORY, WILDLIFE, NATURE, AND ENVIRONMENTAL TOPICS; PRODUCTION OF TELEVISION PROGRAMS; PROVIDING ONLINE NON-DOWNLOADABLE AUDIO FEATURING NON-MUSIC CONTENT, NAMELY, EDUCATIONAL AND ENTERTAINMENT INFORMATION FEATURING A WIDE RANGE OF ADVENTURE, CULTURAL, EXPLORATION, GENERAL INTEREST, GEOGRAPHY, NATURAL HISTORY, WILDLIFE, NATURE, AND ENVIRONMENTAL TOPICS; PROVIDING ONLINE NON-DOWNLOADABLE LESSON PLANS, PHOTOGRAPHS, VIDEOS AND WEBCASTS FEATURING A WIDE RANGE OF ADVENTURE, CULTURAL, EDUCATIONAL, ENTERTAINMENT, EXPLORATION, GENERAL INTEREST, GEOGRAPHY, NATURAL HISTORY, WILDLIFE, NATURE, AND ENVIRONMENTAL TOPICS; PROVIDING ONLINE COMPUTER GAMES FOR CHILDREN; AND PROVIDING ONLINE NON-DOWNLOADABLE TELEVISION SCHEDULES, ALL OF THE ABOVE ARE FOR EDUCATIONAL AND ENTERTAINMENT PURPOSES, IN CLASS 41 (U.S. CLS. 100, 101 AND 107).

FIRST USE 3-29-2010; IN COMMERCE 3-29-2010.

THE MARK CONSISTS OF STANDARD CHARACTERS WITHOUT CLAIM TO ANY PARTICULAR FONT, STYLE, SIZE, OR COLOR.

OWNER OF U.S. REG. NOS. 524,810, 3,781,222, AND OTHERS.

SN 85-976,127, FILED 12-14-2010.

JANICE L. MCMORROW, EXAMINING ATTORNEY



David J. Kyros

Director of the United States Patent and Trademark Office

United States of America

United States Patent and Trademark Office



Reg. No. 4,110,333

Registered Mar. 6, 2012

Int. Cl.: 43

SERVICE MARK

PRINCIPAL REGISTER

RIBWORKS, LLC (NEW YORK LIMITED LIABILITY COMPANY)
26 FRONT STREET
NEWBURGH, NY 12550

FOR: RESTAURANT SERVICES, IN CLASS 43 (U.S. CLS. 100 AND 101).

FIRST USE 1-10-2011; IN COMMERCE 1-10-2011.

THE MARK CONSISTS OF A STYLIZED GOAT'S HEAD WEARING SUNGLASSES.

SN 85-976,133, FILED 1-25-2011.

TINA MAI, EXAMINING ATTORNEY



David J. Kybas

Director of the United States Patent and Trademark Office

United States of America
United States Patent and Trademark Office

MADREPS

Reg. No. 4,110,334

RYAN, FRANCES (UNITED STATES INDIVIDUAL)
33 ARROW LANE
HICKSVILLE, NY 11801

Registered Mar. 6, 2012

Int. Cl.: 29

FOR: PROTEIN-BASED, NUTRIENT-DENSE SNACKS, IN CLASS 29 (U.S. CL. 46).

TRADEMARK

FIRST USE 8-10-2011; IN COMMERCE 11-29-2011.

PRINCIPAL REGISTER

THE MARK CONSISTS OF STANDARD CHARACTERS WITHOUT CLAIM TO ANY PARTICULAR FONT, STYLE, SIZE, OR COLOR.

SN 85-976,137, FILED 11-15-2010.

JOHN WILKE, EXAMINING ATTORNEY



David J. Kybas

Director of the United States Patent and Trademark Office

United States of America

United States Patent and Trademark Office

HURT TO WALK? LET'S TALK!

Reg. No. 4,110,335

DEKALB MEDICAL CENTER, INC. (GEORGIA CORPORATION)
2701 NORTH DECATUR ROAD
DECATUR, GA 30033

Registered Mar. 6, 2012

Int. Cls.: 9, 41, and 44

FOR: EDUCATIONAL DVDS IN THE FIELDS OF ORTHOPEDICS, ORTHOPEDIC AND JOINT REPLACEMENT, ORTHOPEDIC MEDICINE, SPORTS MEDICINE, PHYSICAL REHABILITATION, PHYSICAL THERAPY AND THE TREATMENT OF JOINT-DISLOCATIONS, SPRAINS AND BONE-FRACTURES, IN CLASS 9 (U.S. CLS. 21, 23, 26, 36 AND 38).

TRADEMARK

SERVICE MARK

FIRST USE 4-12-2010; IN COMMERCE 4-12-2010.

PRINCIPAL REGISTER

FOR: EDUCATION SERVICES, NAMELY, PROVIDING LIVE AND ON-LINE CLASSES, SEMINARS AND WORKSHOPS IN THE FIELDS OF ORTHOPEDICS, ORTHOPEDIC AND JOINT REPLACEMENT, ORTHOPEDIC MEDICINE, SPORTS MEDICINE, PHYSICAL REHABILITATION, PHYSICAL THERAPY AND THE TREATMENT OF JOINT-DISLOCATIONS, SPRAINS AND BONE-FRACTURES AND DISTRIBUTION OF PRINTED MATERIALS IN CONNECTION THEREWITH IN HARD COPY OR ELECTRONIC FORMAT ON THE SAME TOPICS; EDUCATIONAL SERVICES, NAMELY, CONDUCTING PROGRAMS IN THE FIELDS OF ORTHOPEDICS, ORTHOPEDIC AND JOINT REPLACEMENT, ORTHOPEDIC MEDICINE, SPORTS MEDICINE, PHYSICAL REHABILITATION, PHYSICAL THERAPY AND THE TREATMENT OF JOINT-DISLOCATIONS, SPRAINS AND BONE-FRACTURES AND DISTRIBUTION OF PRINTED MATERIALS IN CONNECTION THEREWITH IN HARD COPY OR ELECTRONIC FORMAT ON THE SAME TOPICS; EDUCATIONAL SERVICES, NAMELY, CONDUCTING INFORMAL PROGRAMS IN THE FIELDS OF ORTHOPEDICS, ORTHOPEDIC AND JOINT REPLACEMENT, ORTHOPEDIC MEDICINE, SPORTS MEDICINE, PHYSICAL REHABILITATION, PHYSICAL THERAPY AND THE TREATMENT OF JOINT-DISLOCATIONS, SPRAINS AND BONE-FRACTURES USING ON-LINE ACTIVITIES AND INTERACTIVE EXHIBITS, AND PRINTABLE MATERIALS DISTRIBUTED THEREWITH, IN CLASS 41 (U.S. CLS. 100, 101 AND 107).



FIRST USE 2-18-2010; IN COMMERCE 2-18-2010.

David J. Kyjars

Director of the United States Patent and Trademark Office

FOR: MEDICAL INFORMATION; PROVIDING HEALTH AND MEDICAL INFORMATION, CONSULTANCY AND ADVISORY SERVICES; PROVIDING INFORMATION IN THE FIELD OF MEDICINE; PROVIDING A WEB SITE FEATURING MEDICAL INFORMATION; PROVIDING A WEBSITE FEATURING MEDICAL INFORMATION IN THE FIELDS OF ORTHOPEDICS, ORTHOPEDIC AND JOINT REPLACEMENT, ORTHOPEDIC MEDICINE,

Reg. No. 4,110,335 SPORTS MEDICINE, PHYSICAL REHABILITATION, PHYSICAL THERAPY AND THE TREATMENT OF JOINT-DISLOCATIONS, SPRAINS AND BONE-FRACTURES, IN CLASS 44 (U.S. CLS. 100 AND 101).

FIRST USE 4-30-2009; IN COMMERCE 4-30-2009.

THE MARK CONSISTS OF STANDARD CHARACTERS WITHOUT CLAIM TO ANY PARTICULAR FONT, STYLE, SIZE, OR COLOR.

SN 85-976,160, FILED 12-7-2010.

BARBARA A. GOLD, EXAMINING ATTORNEY

United States of America

United States Patent and Trademark Office

C. WONDER

Reg. No. 4,110,336

Registered Mar. 6, 2012

Int. Cl.: 18

TRADEMARK

PRINCIPAL REGISTER

C. WONDER LLC (DELAWARE LIMITED LIABILITY COMPANY)
598 MADISON AVENUE
11TH FLOOR
NEW YORK, NY 10022

FOR: LEATHER GOODS, NAMELY, BRIEFCASES; CASUAL SPORT BAGS; ALL-PURPOSE ATHLETIC BAGS; SPORTS BAGS; LUGGAGE; DUFFLE BAGS; BOOK BAGS; MESSENGER BAGS; PURSES; WALLETS; KEY CASES; LEATHER KEY CHAINS; COSMETIC CASES SOLD EMPTY; UMBRELLAS; HAND BAGS; TOTE BAGS, IN CLASS 18 (U.S. CLS. 1, 2, 3, 22 AND 41).

FIRST USE 10-22-2011; IN COMMERCE 10-22-2011.

THE MARK CONSISTS OF STANDARD CHARACTERS WITHOUT CLAIM TO ANY PARTICULAR FONT, STYLE, SIZE, OR COLOR.

SN 85-976,162, FILED 8-11-2010.

FLORENTINA BLANDU, EXAMINING ATTORNEY



David J. Kybas

Director of the United States Patent and Trademark Office

United States of America

United States Patent and Trademark Office



Reg. No. 4,110,337

Registered Mar. 6, 2012

Int. Cl.: 3

TRADEMARK

PRINCIPAL REGISTER

PRO-ATHLETICS, LLC (DELAWARE LIMITED LIABILITY COMPANY)
9002 CEDAR GROVE RD.
FAIRBURN, GA 30213

FOR: DEODORANTS FOR PERSONAL USE; AROMATHERAPY BODY CARE PRODUCTS, NAMELY, SHAMPOO AND SOAP; SOAPS FOR BODY CARE, IN CLASS 3 (U.S. CLS. 1, 4, 6, 50, 51 AND 52).

FIRST USE 7-30-2011; IN COMMERCE 7-30-2011.

NO CLAIM IS MADE TO THE EXCLUSIVE RIGHT TO USE "BOYS", APART FROM THE MARK AS SHOWN.

THE COLOR(S) YELLOW, REDDISH-ORANGE, BLACK AND WHITE IS/ARE CLAIMED AS A FEATURE OF THE MARK.

THE MARK CONSISTS OF THE WORDING "STINKY" IN STYLIZED FONT IN YELLOW FADING DOWN TO REDDISH-ORANGE AND APPEARING ON A BLACK QUADRILATERAL WITH WHITE SHADING ON THE RIGHT SIDE OF THE QUADRILATERAL. THE TERM "BOYZ" APPEARS IN WHITE STYLIZED FONT, OUTLINED IN BLACK, TO THE RIGHT OF THE BLACK QUADRILATERAL.

SN 85-976,165, FILED 12-10-2010.

KAREN SEVERSON, EXAMINING ATTORNEY



David J. Kypos

Director of the United States Patent and Trademark Office

United States of America

United States Patent and Trademark Office

OUR FOCUS IS PATIENTS, OUR
PASSION IS INNOVATION

Reg. No. 4,110,338

Registered Mar. 6, 2012

Int. Cls.: 42 and 45

SERVICE MARK

PRINCIPAL REGISTER

MANKIND CORPORATION (DELAWARE CORPORATION)
28903 NORTH AVENUE PAINE
VALENCIA, CA 91355

FOR: SCIENTIFIC AND MEDICAL RESEARCH AND DEVELOPMENT IN THE FIELDS OF MEDICAL DEVICES AND PHARMACEUTICALS, NAMELY, INHALERS AND DRUG DELIVERY SYSTEMS, DRUG FORMULATIONS AND PHARMACEUTICAL PREPARATIONS; PRODUCT DESIGN AND DEVELOPMENT FOR OTHERS FOR MEDICAL DEVICES, MEDICAL TECHNOLOGY, AND DRUG DELIVERY SYSTEMS, IN CLASS 42 (U.S. CLS. 100 AND 101).

FIRST USE 9-21-2011; IN COMMERCE 9-21-2011.

FOR: LICENSING TO OTHERS OF TECHNOLOGY AND INTELLECTUAL PROPERTY IN CONNECTION WITH PHARMACEUTICALS AND MEDICAL DEVICES, IN CLASS 45 (U.S. CLS. 100 AND 101).

FIRST USE 9-21-2011; IN COMMERCE 9-21-2011.

THE MARK CONSISTS OF STANDARD CHARACTERS WITHOUT CLAIM TO ANY PARTICULAR FONT, STYLE, SIZE, OR COLOR.

SN 85-976,170, FILED 10-27-2010.

JASON TURNER, EXAMINING ATTORNEY



David J. Kyffers

Director of the United States Patent and Trademark Office

United States of America

United States Patent and Trademark Office

DORVAL PREMIUM COLLECTION

Reg. No. 4,110,339

DORVAL TRADING CO., LTD. (NEW YORK CORPORATION)
PO BOX 620
NANUET, NY 10954

Registered Mar. 6, 2012

Int. Cl.: 30

FOR: CHOCOLATE AND CONFECTIONERY MADE OF CHOCOLATE, IN CLASS 30 (U.S. CL. 46).

TRADEMARK

FIRST USE 9-0-2011; IN COMMERCE 9-0-2011.

PRINCIPAL REGISTER

THE MARK CONSISTS OF STANDARD CHARACTERS WITHOUT CLAIM TO ANY PARTICULAR FONT, STYLE, SIZE, OR COLOR.

NO CLAIM IS MADE TO THE EXCLUSIVE RIGHT TO USE "PREMIUM COLLECTION", APART FROM THE MARK AS SHOWN.

SN 85-976,185, FILED 2-6-2011.

TRACY FLETCHER, EXAMINING ATTORNEY



David J. Kybas

Director of the United States Patent and Trademark Office

United States of America

United States Patent and Trademark Office

JUIL

Reg. No. 4,110,340

Registered Mar. 6, 2012

Int. Cl.: 25

TRADEMARK

PRINCIPAL REGISTER

GYRO HOLDINGS, LLC (WISCONSIN LIMITED LIABILITY COMPANY)
10300 NORTH ENTERPRISE DRIVE
MEQUON, WI 53092

FOR: SOCKS, SHOES, IN CLASS 25 (U.S. CLS. 22 AND 39).

FIRST USE 11-14-2011; IN COMMERCE 11-14-2011.

THE MARK CONSISTS OF STANDARD CHARACTERS WITHOUT CLAIM TO ANY PARTICULAR FONT, STYLE, SIZE, OR COLOR.

SN 85-976,189, FILED 7-26-2010.

ALICE BENMAMAN, EXAMINING ATTORNEY



David J. Kybas

Director of the United States Patent and Trademark Office

United States of America

United States Patent and Trademark Office



Reg. No. 4,110,341

Registered Mar. 6, 2012

Int. Cl.: 35

SERVICE MARK

PRINCIPAL REGISTER

VARSITY SPIRIT CORPORATION (TENNESSEE CORPORATION)
6745 LENOX CENTER COURT, SUITE 300
MEMPHIS, TN 38115

FOR: ON-LINE RETAIL STORE SERVICES FEATURING DVDS, COMPACT DISCS, JEWELRY, ATHLETIC SHIRTS, ATHLETIC SHORTS, ATHLETIC TOPS, BODYSUITS, DRESSES, HATS, JACKETS, JERSEYS, LEOTARDS, PANTS, SHIRTS, SHORTS, SKIRTS, SWEATERS, SWEATPANTS, SWEATSHIRTS, T-SHIRTS, UNITARDS AND WARM-UP SUITS, SPORTS BAGS, CARRY-ALL BAGS, SHOULDER BAGS, BACKPACKS, KNAPSACKS, DUFFLE BAGS, ALL-PURPOSE SPORTING BAGS, ALL-PURPOSE CARRYING BAGS, TOTE BAGS, UMBRELLAS, SHOE BAGS, MESSENGER BAGS, TRAVEL CASES, KEY HOLDERS, OVERNIGHT BAGS, POM POMS, UNIFORMS FOR CHEERLEADERS, DRILL TEAMS, POM POM SQUADS, PEP SQUADS, FOOTWEAR, NAMELY, ATHLETIC SHOES, CHEERLEADER SHOES, DANCE SHOES, GLOVES, VESTS, CAPS, SPORTS BRAS, SOCKS, LOUNGEWEAR, IN CLASS 35 (U.S. CLS. 100, 101 AND 102).

FIRST USE 7-20-2011; IN COMMERCE 7-20-2011.

OWNER OF U.S. REG. NOS. 2,526,564, 3,782,740, AND OTHERS.

NO CLAIM IS MADE TO THE EXCLUSIVE RIGHT TO USE "SHOP", APART FROM THE MARK AS SHOWN.

THE MARK CONSISTS OF STYLIZED CAPITAL LETTER "V" NEXT TO THE PHRASE "SHOP" IN LOWER CASE LETTERS WHICH HAS THE PHRASE "VARSITY" IN CAPITAL LETTER, WHICH HAS A STYLIZED CAPITAL LETTER "A", ABOVE IT.

SN 85-976,194, FILED 4-16-2010.

MARLENE BELL, EXAMINING ATTORNEY



David J. Kyros

Director of the United States Patent and Trademark Office

United States of America

United States Patent and Trademark Office

CAT CORA'S KITCHEN

Reg. No. 4,110,342

Registered Mar. 6, 2012

Int. Cls.: 29 and 30

TRADEMARK

PRINCIPAL REGISTER

CORA, CAT (UNITED STATES INDIVIDUAL)
SUITE A436
315 MEIGS RD.
SANTA BARBARA, CA 93109

FOR: EXTRA VIRGIN OLIVE OIL; ORGANIC EXTRA VIRGIN OLIVE OIL; KALAMATA OLIVE OIL; PROCESSED GREEN OLIVES; BLACK GREEK PROCESSED OLIVES; PITTED KALAMATA OLIVES; PROCESSED STUFFED OLIVES; DOLMAS; TAPENADES; OLIVE PASTES, IN CLASS 29 (U.S. CL. 46).

FIRST USE 1-17-2011; IN COMMERCE 1-17-2011.

FOR: BALSAMIC VINEGAR, SAFFRON FOR USE AS A FOOD SEASONING, CORFU SAUCE; CRETAN SAUCE; SANTORINI SAUCE; CYPRUS SAUCE, IN CLASS 30 (U.S. CL. 46).

FIRST USE 1-17-2011; IN COMMERCE 1-17-2011.

THE MARK CONSISTS OF STANDARD CHARACTERS WITHOUT CLAIM TO ANY PARTICULAR FONT, STYLE, SIZE, OR COLOR.

THE NAME "CAT CORA" IDENTIFIES A LIVING INDIVIDUAL WHOSE CONSENT IS OF RECORD.

SN 85-976,198, FILED 10-20-2010.

RENEE MCCRAY, EXAMINING ATTORNEY



David J. Kybas

Director of the United States Patent and Trademark Office

United States of America

United States Patent and Trademark Office

ASCEND

Reg. No. 4,110,343

Registered Mar. 6, 2012

Int. Cl.: 9

TRADEMARK

PRINCIPAL REGISTER

HUAWEI TECHNOLOGIES CO., LTD. (CHINA CORPORATION)
ADMIN. BLDG. HUAWEI TECH. CO., LTD.
BANTIAN, LONGGANG DISTRICT
SHENZHEN, CHINA

FOR: MOBILE TELEPHONES, IN CLASS 9 (U.S. CLS. 21, 23, 26, 36 AND 38).

FIRST USE 10-27-2010; IN COMMERCE 10-27-2010.

THE MARK CONSISTS OF STANDARD CHARACTERS WITHOUT CLAIM TO ANY PARTICULAR FONT, STYLE, SIZE, OR COLOR.

SN 85-976,234, FILED 3-29-2011.

MARK SHINER, EXAMINING ATTORNEY



David J. Kybas

Director of the United States Patent and Trademark Office

United States of America

United States Patent and Trademark Office

HUAWEI ASCEND

Reg. No. 4,110,344

Registered Mar. 6, 2012

Int. Cl.: 9

TRADEMARK

PRINCIPAL REGISTER

HUAWEI TECHNOLOGIES CO., LTD. (CHINA CORPORATION)
ADMIN. BLDG. HUAWEI TECH. CO., LTD.
BANTIAN, LONGGANG DISTRICT
SHENZHEN, CHINA

FOR: MOBILE TELEPHONES, IN CLASS 9 (U.S. CLS. 21, 23, 26, 36 AND 38).

FIRST USE 10-27-2010; IN COMMERCE 10-27-2010.

THE MARK CONSISTS OF STANDARD CHARACTERS WITHOUT CLAIM TO ANY PARTICULAR FONT, STYLE, SIZE, OR COLOR.

OWNER OF U.S. REG. NOS. 2,750,650, 3,313,908, AND 3,854,515.

SN 85-976,235, FILED 3-29-2011.

MARK SHINER, EXAMINING ATTORNEY



David J. Kybas

Director of the United States Patent and Trademark Office

United States of America

United States Patent and Trademark Office

TALENT ANALYTICS

Reg. No. 4,110,345

Registered Mar. 6, 2012

Int. Cl.: 42

SERVICE MARK

SUPPLEMENTAL REGISTER

TALENT ANALYTICS CORP. (MASSACHUSETTS CORPORATION)
146 MOUNT AUBURN STREET
CAMBRIDGE, MA 02138

FOR: SOFTWARE AS A SERVICE (SAAS) SERVICES FEATURING SOFTWARE IN THE FIELD OF HUMAN RESOURCES FOR GATHERING INFORMATION ABOUT CURRENT AND FUTURE EMPLOYEES USING EMPLOYEE SURVEYS FOR A TEAM, A GROUP, AND/OR A COMPANY AND GATHERING INFORMATION USING A CUSTOMER'S OWN TALENT DATA, ALLOWING USERS TO FREELY EXPLORE AND VISUALIZE THE TEAM, GROUP AND/OR COMPANY WITH CROSS FUNCTIONALITY AND ACROSS AN ENTIRE ORGANIZATION; PROVIDES VISUALIZATIONS, NAMELY, LINE CHARTS, SCATTER PLOTS, COMBINATION SCATTER AND LINE PLOT, TABLE CHARTS AND DIALS, PROVIDES ROLL-UP AND AGGREGATION OF VALUES AND INTERACTIVELY PROVIDES FOR DRILLING DOWN TO SMALLER LEVEL OF DETAILS OF INTEREST, ALLOWS USER TO COMPARE INDIVIDUAL, TEAM AND/OR COMPANY RESULTS TO AN IDEAL SCORE OR BENCHMARK AND PROVIDES REPORTS ONLINE WITH VISUALIZATION THAT RATE EMPLOYMENT CANDIDATES USING SCORES FROM QUESTIONNAIRES COMPLETED BY CANDIDATES AND CUSTOMER SPECIFIED CRITERIA, IN CLASS 42 (U.S. CLS. 100 AND 101).

FIRST USE 10-4-2010; IN COMMERCE 10-4-2010.

THE MARK CONSISTS OF STANDARD CHARACTERS WITHOUT CLAIM TO ANY PARTICULAR FONT, STYLE, SIZE, OR COLOR.

SER. NO. 76-705,343, FILED P.R. 11-16-2010; AM. S.R. 12-28-2011.

ROSELLE HERRERA, EXAMINING ATTORNEY



David J. Kyros

Director of the United States Patent and Trademark Office

United States of America

United States Patent and Trademark Office

KEEP CHOPPING

Reg. No. 4,110,346

RUTGERS, THE STATE UNIVERSITY OF NEW JERSEY (NEW JERSEY INSTRUMENTALITY)
7 COLLEGE AVENUE, WINANTS HALL, ROOM 401
NEW BRUNSWICK, NJ 08903

Registered Mar. 6, 2012

Int. Cl.: 25

FOR: SPORTSWEAR, NAMELY, SHIRTS, HATS, JACKETS, SWEATERS, SHORTS, SWEATSHIRTS AND SWEATPANTS; CLOTHING, NAMELY, SHIRTS, HATS, JACKETS, SWEATERS, SHORTS, SCARVES, SWEATSHIRTS AND SWEATPANTS, IN CLASS 25 (U.S. CLS. 22 AND 39).

TRADEMARK

SUPPLEMENTAL REGISTER FIRST USE 10-0-2008; IN COMMERCE 10-0-2008.

THE MARK CONSISTS OF STANDARD CHARACTERS WITHOUT CLAIM TO ANY PARTICULAR FONT, STYLE, SIZE, OR COLOR.

SER. NO. 77-041,686, FILED P.R. 11-10-2006; AM. S.R. 7-13-2011.

MARC LEIPZIG, EXAMINING ATTORNEY



David J. Kyffers

Director of the United States Patent and Trademark Office

United States of America

United States Patent and Trademark Office

Duchess of Dunwoody

Reg. No. 4,110,347

SIMS, LINDA THERESA (UNITED STATES INDIVIDUAL)
144 LAKESIDE DR. NW
KENNESAW, GA 30144

Registered Mar. 6, 2012

Int. Cl.: 16

FOR: WRITTEN WORKS, NAMELY, A SERIES OF FICTION BOOKS AND WRITTEN ARTICLES FEATURING STORIES REGARDING LIFE IN DUNWOODY, GEORGIA; WRITTEN WORKS, NAMELY, A SERIES OF BOOKS FEATURING POEMS REGARDING LIFE IN DUNWOODY, GEORGIA, IN CLASS 16 (U.S. CLS. 2, 5, 22, 23, 29, 37, 38 AND 50).

TRADEMARK

SUPPLEMENTAL REGISTER FIRST USE 11-1-2011; IN COMMERCE 11-1-2011.

THE MARK CONSISTS OF STANDARD CHARACTERS WITHOUT CLAIM TO ANY PARTICULAR FONT, STYLE, SIZE, OR COLOR.

NO CLAIM IS MADE TO THE EXCLUSIVE RIGHT TO USE "DUNWOODY", APART FROM THE MARK AS SHOWN.

THE NAME "DUCHESS OF DUNWOODY" DOES NOT IDENTIFY A LIVING INDIVIDUAL.

SER. NO. 77-134,130, FILED P.R. 3-19-2007; AM. S.R. 1-13-2012.

MAUREEN DALL, EXAMINING ATTORNEY



David J. Kybas

Director of the United States Patent and Trademark Office

United States of America
United States Patent and Trademark Office

MUSUNAH

Reg. No. 4,110,348

ERNEST INDUSTRIES (NEW YORK CORPORATION)
25 SOUTH CRESCENT
MAPLEWOOD, NJ 07040

Registered Mar. 6, 2012

Int. Cl.: 25

FOR: APPAREL, NAMELY, T-SHIRTS, JERSEYS, PULLOVERS, TANK TOPS, GLOVES, SWEATBANDS, JACKETS, TIGHTS, SHORTS, PANTS, TRACK SUITS, WARM UP SUITS, SWEAT SHIRTS, SWEAT PANTS, LEGGINGS, SOCKS, FOOTWEAR AND HEADWEAR, IN CLASS 25 (U.S. CLS. 22 AND 39).

TRADEMARK

SUPPLEMENTAL REGISTER FIRST USE 2-16-2009; IN COMMERCE 2-16-2009.

THE MARK CONSISTS OF STANDARD CHARACTERS WITHOUT CLAIM TO ANY PARTICULAR FONT, STYLE, SIZE, OR COLOR.

THE WORDING "MUSUNAH" HAS NO MEANING IN A FOREIGN LANGUAGE.

SER. NO. 77-201,036, FILED P.R. 6-8-2007; AM. S.R. 1-11-2012.

DAVID MILLER, EXAMINING ATTORNEY



David J. Kypos

Director of the United States Patent and Trademark Office

United States of America

United States Patent and Trademark Office

FIGHTER

Reg. No. 4,110,349

SCOTT, LONNIE (UNITED STATES INDIVIDUAL)
2734 BRISTOL HILL CT
CINCINNATI, OH 45239

Registered Mar. 6, 2012

Int. Cl.: 25

FOR: CLOTHING, NAMELY, LONG SLEEVE T-SHIRTS, SHORT SLEEVE T-SHIRTS, SWEATSHIRTS, JACKETS, SHORTS, SKULLCAPS, AND HATS, IN CLASS 25 (U.S. CLS. 22 AND 39).

TRADEMARK

FIRST USE 4-20-2009; IN COMMERCE 4-20-2009.

SUPPLEMENTAL REGISTER

THE MARK CONSISTS OF STANDARD CHARACTERS WITHOUT CLAIM TO ANY PARTICULAR FONT, STYLE, SIZE, OR COLOR.

SER. NO. 77-727,877, FILED P.R. 5-3-2009; AM. S.R. 1-7-2012.

DANNEAN HETZEL, EXAMINING ATTORNEY



David J. Kybas

Director of the United States Patent and Trademark Office

United States of America

United States Patent and Trademark Office

24 HOUR BODY

Reg. No. 4,110,350

ALBERTO-CULVER INTERNATIONAL, INC. (DELAWARE CORPORATION)
2525 ARMITAGE AVENUE
MELROSE PARK, IL 60160

Registered Mar. 6, 2012

Int. Cl.: 3

FOR: HAIR CARE PREPARATIONS, IN CLASS 3 (U.S. CLS. 1, 4, 6, 50, 51 AND 52).

TRADEMARK

FIRST USE 12-15-2008; IN COMMERCE 12-15-2008.

SUPPLEMENTAL REGISTER

THE MARK CONSISTS OF STANDARD CHARACTERS WITHOUT CLAIM TO ANY PARTICULAR FONT, STYLE, SIZE, OR COLOR.

SER. NO. 77-799,451, FILED P.R. 8-7-2009; AM. S.R. 1-19-2012.

ROBERT C. CLARK JR., EXAMINING ATTORNEY



David J. Kyffers

Director of the United States Patent and Trademark Office

United States of America

United States Patent and Trademark Office

DSP

GROUP

Reg. No. 4,110,351

Registered Mar. 6, 2012

Int. Cl.: 9

TRADEMARK

SUPPLEMENTAL REGISTER

DSP GROUP, INC. (DELAWARE CORPORATION)
SUITE 260
2580 NORTH FIRST STREET
SAN JOSE, CA 95131

FOR: SEMICONDUCTOR CHIPS, CHIPSETS FOR CONNECTING MULTIMEDIA HOME DEVICES, HOME AND VOIP PHONES AND DIGITAL CORDLESS PHONE DEVICES SUPPORTING BOTH WI-FI AND DECT FOR CONNECTED MULTIMEDIA HOME DEVICES; INTEGRATED CIRCUITS AND INTEGRATED CIRCUIT CORES FOR USE IN WIRELESS AND WIRE-LINE COMMUNICATIONS AND WIRELESS AND WIRE-LINE COMMUNICATION EQUIPMENT AND APPARATUS; INTEGRATED CIRCUITS AND INTEGRATED CIRCUIT CORES FOR USE IN WIRELESS AND WIRE-LINE COMMUNICATIONS, WIRELESS AND WIRE-LINE MULTIMEDIA APPLICATIONS, CORDLESS TELEPHONES, VOIP (VOICE OVER INTERNET PROTOCOL) AND COIP (CORDLESS OVER INTERNET PROTOCOL); HOME MULTIMEDIA DEVICES, NAMELY, CONSUMER ELECTRONIC DEVICES WITH WIRELESS CONNECTIVITY, NAMELY, TABLET COMPUTERS, VIDEO PMP, NAMELY, A PORTABLE MEDIA PLAYER THAT IS A CONSUMER ELECTRONICS DEVICE CAPABLE OF STORING AND PLAYING DIGITAL MEDIA, NAMELY, AUDIO, IMAGES, VIDEO AND DOCUMENTS, REMOTE CONTROLS FOR RADIOS, TELEVISIONS, STEREOS, MONITORS AND COMPUTERS, INTERNET RADIO, HOME AND VOIP PHONES, DIGITAL CORDLESS PHONES AND VIDEO PHONES; DIGITAL BASEBAND PROCESSORS, COMPUTER PROCESSORS FOR MULTIMEDIA APPLICATIONS, CORDLESS TELEPHONES, AND FOR VOICE OVER IP; INTEGRATED CIRCUITS AND INTEGRATED CIRCUIT CORES FOR USE IN WIRELESS AND WIRE-LINE COMMUNICATIONS, WIRELESS AND WIRE-LINE MULTIMEDIA APPLICATIONS, CORDLESS TELEPHONES, VOIP (VOICE OVER INTERNET PROTOCOL) AND COIP (CORDLESS OVER INTERNET PROTOCOL); ALL THE AFORESAID GOODS FOR HOME COMMUNICATION DEVICES, NAMELY, HOME MULTIMEDIA DEVICES, HOME AND VOIP PHONES AND DIGITAL CORDLESS PHONE DEVICES, IN CLASS 9 (U.S. CLS. 21, 23, 26, 36 AND 38).



FIRST USE 11-30-2008; IN COMMERCE 1-31-2009.

NO CLAIM IS MADE TO THE EXCLUSIVE RIGHT TO USE "GROUP", APART FROM THE MARK AS SHOWN.

THE COLOR(S) BLUE IS/ARE CLAIMED AS A FEATURE OF THE MARK.

David J. Kyffers

Director of the United States Patent and Trademark Office

Reg. No. 4,110,351 THE MARK CONSISTS OF THE WORD "DSP" IN BLUE IN A LARGE FONT AND OF THE WORD "GROUP" IN BLUE IN A SMALLER FONT.

SER. NO. 77-807,648, FILED P.R. 8-19-2009; AM. S.R. 1-12-2011.

DAVID I, EXAMINING ATTORNEY

United States of America

United States Patent and Trademark Office

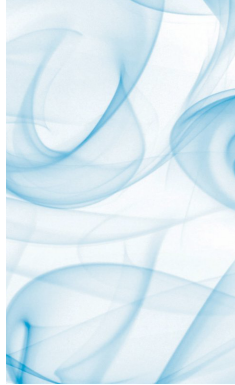

Reg. No. 4,110,352

Registered Mar. 6, 2012

Int. Cl.: 5

TRADEMARK

SUPPLEMENTAL REGISTER

JOHNSON & JOHNSON (NEW JERSEY CORPORATION)
ONE JOHNSON & JOHNSON PLAZA
NEW BRUNSWICK, NJ 089337001

FOR: VAGINAL MOISTURIZERS, IN CLASS 5 (U.S. CLS. 6, 18, 44, 46, 51 AND 52).

FIRST USE 4-27-2011; IN COMMERCE 4-27-2011.

THE MARK CONSISTS OF A CLOUD OF BLUE AND WHITE SWIRLS.

THE COLOR(S) BLUE AND WHITE IS/ARE CLAIMED AS A FEATURE OF THE MARK.

SER. NO. 77-848,464, FILED P.R. 10-14-2009; AM. S.R. 1-19-2012.

MARGARET POWER, EXAMINING ATTORNEY



David J. Kyffers

Director of the United States Patent and Trademark Office

United States of America

United States Patent and Trademark Office

we repair your home.com

Reg. No. 4,110,353

JAMES DUNLEAVY (UNITED STATES INDIVIDUAL)

Registered Mar. 6, 2012

P.O. BOX 241
WINCHESTER, MA 01890

Int. Cl.: 37

FOR: BUILDING CONSTRUCTION AND REPAIR; INSTALLATION OF HOME APPLIANCES,
IN CLASS 37 (U.S. CLS. 100, 103 AND 106).

SERVICE MARK

FIRST USE 10-20-2009; IN COMMERCE 10-20-2009.

SUPPLEMENTAL REGISTER

THE MARK CONSISTS OF STANDARD CHARACTERS WITHOUT CLAIM TO ANY PARTICULAR FONT, STYLE, SIZE, OR COLOR.

SER. NO. 77-860,256, FILED P.R. 10-29-2009; AM. S.R. 6-17-2010.

GINA HAYES, EXAMINING ATTORNEY



David J. Kybas

Director of the United States Patent and Trademark Office

United States of America

United States Patent and Trademark Office

PATIENT EDUCATION SYSTEMS

Reg. No. 4,110,354

PATIENT EDUCATION SYSTEMS, CORP. (ARIZONA CORPORATION)
3501 N SCOTTSDALE RD #230
SCOTTSDALE, AZ 85251

Registered Mar. 6, 2012

Int. Cl.: 44

FOR: PROVIDING ONLINE INTERACTIVE MEDICAL INFORMATION TO PHYSICIANS FOR USE IN EDUCATING THE PHYSICIANS' PATIENTS, IN CLASS 44 (U.S. CLS. 100 AND 101).

SERVICE MARK

FIRST USE 2-5-2009; IN COMMERCE 2-5-2009.

SUPPLEMENTAL REGISTER

THE MARK CONSISTS OF STANDARD CHARACTERS WITHOUT CLAIM TO ANY PARTICULAR FONT, STYLE, SIZE, OR COLOR.

SER. NO. 77-888,109, FILED P.R. 12-7-2009; AM. S.R. 3-18-2011.

KELLY TRUSILO, EXAMINING ATTORNEY



David J. Kybas

Director of the United States Patent and Trademark Office

United States of America

United States Patent and Trademark Office

FOOD TECH

Reg. No. 4,110,355

A&E TELEVISION NETWORKS, LLC (DELAWARE LIMITED LIABILITY COMPANY)
235 EAST 45TH STREET
NEW YORK, NY 10017

Registered Mar. 6, 2012

Int. Cl.: 41

FOR: ENTERTAINMENT SERVICES IN THE NATURE OF A MULTIMEDIA SERIES OF ON-GOING REALITY-BASED PROGRAMS ABOUT AGRIBUSINESS ACROSS MULTIPLE FORMS OF TRANSMISSION MEDIA, IN CLASS 41 (U.S. CLS. 100, 101 AND 107).

SERVICE MARK

FIRST USE 1-22-2010; IN COMMERCE 1-22-2010.

SUPPLEMENTAL REGISTER

THE MARK CONSISTS OF STANDARD CHARACTERS WITHOUT CLAIM TO ANY PARTICULAR FONT, STYLE, SIZE, OR COLOR.

NO CLAIM IS MADE TO THE EXCLUSIVE RIGHT TO USE "TECH", APART FROM THE MARK AS SHOWN.

SER. NO. 77-922,719, FILED P.R. 1-28-2010; AM. S.R. 12-22-2011.

GRETCHEN ULRICH, EXAMINING ATTORNEY



David J. Kybas

Director of the United States Patent and Trademark Office

United States of America

United States Patent and Trademark Office

SOLID SAWN

Reg. No. 4,110,356

8008655 CANADA INC. (CANADA CORPORATION)

Registered Mar. 6, 2012

1255, 98TH STREET

SAINT-GEORGES, PROVINCE OF QUEBEC, CANADA G5Y 8J5

Int. Cls.: 19 and 35

FOR: MULTI-PLY CONSTRUCTION HARDWOOD FLOORING, IN CLASS 19 (U.S. CLS. 1, 12, 33 AND 50).

TRADEMARK

FOR: RETAIL DISTRIBUTORSHIPS AND WHOLESALE DISTRIBUTORSHIPS IN THE FIELD OF HARDWOOD FLOORING; PROMOTING PUBLIC AWARENESS OF THE NEED FOR ENVIRONMENTAL MANAGEMENT THROUGH THE METHODS OF CONSERVATION, ACCOUNTABILITY, RECYCLING AND MINIMIZING THE IMPACT OF MANUFACTURING ACTIVITIES THROUGH PRINT, TELEVISION AND INTERNET MEDIA, IN CLASS 35 (U.S. CLS. 100, 101 AND 102).

SERVICE MARK

SUPPLEMENTAL REGISTER

THE MARK CONSISTS OF STANDARD CHARACTERS WITHOUT CLAIM TO ANY PARTICULAR FONT, STYLE, SIZE, OR COLOR.

PRIORITY CLAIMED UNDER SEC. 44(D) ON CANADA APPLICATION NO. 1466498, FILED 1-20-2010, REG. NO. TMA799216, DATED 6-3-2011, EXPIRES 6-3-2026.

SER. NO. 77-923,172, FILED P.R. 1-29-2010; AM. S.R. 1-26-2012.

CHRISTINE MARTIN, EXAMINING ATTORNEY



David J. Kyros

Director of the United States Patent and Trademark Office

United States of America

United States Patent and Trademark Office

MOVIE CLIPS

Reg. No. 4,110,357

QUAD/GRAPHICS, INC. (WISCONSIN CORPORATION)
N63 W23075 STATE HWY. 74
SUSSEX, WI 530892827

Registered Mar. 6, 2012

Int. Cl.: 35

FOR: DIRECT MAIL ADVERTISING; DIRECT MARKETING ADVERTISING FOR OTHERS,
IN CLASS 35 (U.S. CLS. 100, 101 AND 102).

SERVICE MARK

FIRST USE 1-1-2009; IN COMMERCE 1-1-2009.

SUPPLEMENTAL REGISTER

THE MARK CONSISTS OF STANDARD CHARACTERS WITHOUT CLAIM TO ANY PARTICULAR FONT, STYLE, SIZE, OR COLOR.

SER. NO. 77-926,277, FILED P.R. 2-2-2010; AM. S.R. 12-29-2011.

BARNEY CHARLON, EXAMINING ATTORNEY



David J. Kybas

Director of the United States Patent and Trademark Office

United States of America

United States Patent and Trademark Office



Reg. No. 4,110,358

Registered Mar. 6, 2012

Int. Cl.: 9

TRADEMARK

SUPPLEMENTAL REGISTER

CRICKET COMMUNICATIONS, INC. (DELAWARE CORPORATION)
5887 COPLEY DRIVE
SAN DIEGO, CA 92111

FOR: WIRELESS COMMUNICATION APPARATUS, NAMELY, CELLULAR TELEPHONES; PORTABLE TELEPHONE ACCESSORIES, NAMELY, FITTED TELEPHONE CARRYING CASES, BELT CLIP TELEPHONE CARRYING CASES, BATTERY CHARGERS; INTEGRATED WIRELESS COMMUNICATION AND COMPUTING APPARATUS, NAMELY, CELLULAR TELEPHONES, WIRELESS LOCAL LOOP TELEPHONES AND PERSONAL COMMUNICATION TELEPHONES INCORPORATING A COMPUTER OR PERSONAL DIGITAL ASSISTANT (PDA) DEVICE; AND TELEPHONE ACCESSORIES, NAMELY, FITTED TELEPHONE CARRYING CASES, BELT CLIP TELEPHONE CARRYING CASES, AND BATTERY CHARGERS, IN CLASS 9 (U.S. CLS. 21, 23, 26, 36 AND 38).

FIRST USE 3-17-1999; IN COMMERCE 3-17-1999.

THE MARK CONSISTS OF THE COLOR GREEN AS APPLIED TO A PORTION OF THE INNER PACKAGING OF THE GOODS. THE REPRESENTATION OF THE PACKAGING SHOWN IN BROKEN LINES SERVES TO SHOW POSITIONING OF THE MARK AND IS NOT CLAIMED AS PART OF THE MARK.

THE COLOR(S) GREEN IS/ARE CLAIMED AS A FEATURE OF THE MARK.

SER. NO. 77-932,966, FILED P.R. 2-10-2010; AM. S.R. 5-18-2011.

VERNA BETH RIRIE, EXAMINING ATTORNEY



David J. Kybas

Director of the United States Patent and Trademark Office

United States of America

United States Patent and Trademark Office

MC OUTERWRAP

Reg. No. 4,110,359

TRENTON CORPORATION (MICHIGAN CORPORATION)
7700 JACKSON ROAD
ANN ARBOR, MI 48103

Registered Mar. 6, 2012

Int. Cl.: 2

FOR: COATINGS AND CHEMICAL COMPOUNDS, NAMELY, ANTI-CORROSION AND PROTECTIVE COATINGS FOR METAL STRUCTURES, PIPES, PIPING, BRIDGES, AND ABOVEGROUND AND UNDERGROUND UTILITY STRUCTURES, IN CLASS 2 (U.S. CLS. 6, 11 AND 16).

TRADEMARK

SUPPLEMENTAL REGISTER FIRST USE 9-15-2004; IN COMMERCE 9-15-2004.

THE MARK CONSISTS OF STANDARD CHARACTERS WITHOUT CLAIM TO ANY PARTICULAR FONT, STYLE, SIZE, OR COLOR.

NO CLAIM IS MADE TO THE EXCLUSIVE RIGHT TO USE "OUTERWRAP", APART FROM THE MARK AS SHOWN.

SER. NO. 85-008,000, FILED P.R. 4-7-2010; AM. S.R. 12-30-2011.

ROBERT C. CLARK JR., EXAMINING ATTORNEY



David J. Kyffers

Director of the United States Patent and Trademark Office

United States of America

United States Patent and Trademark Office

Life has been Real GOD 2
me!

Reg. No. 4,110,360

MCMULLAN, KEVIN (UNITED STATES INDIVIDUAL)

Registered Mar. 6, 2012

2
2801 Q ST SE
WASHINGTON, DC 20020

Int. Cl.: 25

FOR: SHIRTS, IN CLASS 25 (U.S. CLS. 22 AND 39).

TRADEMARK

FIRST USE 4-7-2011; IN COMMERCE 4-7-2011.

SUPPLEMENTAL REGISTER

THE MARK CONSISTS OF STANDARD CHARACTERS WITHOUT CLAIM TO ANY PARTICULAR FONT, STYLE, SIZE, OR COLOR.

SER. NO. 85-015,288, FILED P.R. 4-15-2010; AM. S.R. 1-30-2012.

KIMBERLY PERRY, EXAMINING ATTORNEY



David J. Kybas

Director of the United States Patent and Trademark Office

United States of America

United States Patent and Trademark Office

AMERICA'S BEST HOTEL MANAGEMENT

Reg. No. 4,110,361

ROSEN HOTELS & RESORTS, INC. (FLORIDA CORPORATION)
9840 INTERNATIONAL DRIVE
ORLANDO, FL 32819

Registered Mar. 6, 2012

Int. Cls.: 35 and 43

FOR: PROVIDING HOTEL MANAGEMENT SERVICES FOR OTHERS, IN CLASS 35 (U.S. CLS. 100, 101 AND 102).

SERVICE MARK

FIRST USE 4-7-2011; IN COMMERCE 4-7-2011.

SUPPLEMENTAL REGISTER

FOR: PROVIDING HOTEL AND MOTEL SERVICES; PROVIDING FACILITIES FOR BANQUETS, SPECIAL OCCASIONS AND CONVENTIONS, IN CLASS 43 (U.S. CLS. 100 AND 101).

FIRST USE 4-7-2011; IN COMMERCE 4-7-2011.

THE MARK CONSISTS OF STANDARD CHARACTERS WITHOUT CLAIM TO ANY PARTICULAR FONT, STYLE, SIZE, OR COLOR.

OWNER OF U.S. REG. NOS. 1,779,858, 3,089,977, AND OTHERS.

NO CLAIM IS MADE TO THE EXCLUSIVE RIGHT TO USE "HOTEL MANAGEMENT", APART FROM THE MARK AS SHOWN.

SER. NO. 85-031,974, FILED P.R. 5-6-2010; AM. S.R. 1-6-2012.

KHANH LE, EXAMINING ATTORNEY



David J. Kyros

Director of the United States Patent and Trademark Office

United States of America

United States Patent and Trademark Office

PREMIERNET

Reg. No. 4,110,362

ADCAP NETWORK SYSTEMS INC. (ALABAMA CORPORATION)
6525 SHILOH RD STE. D-700
ALPHARETTA, GA 30005

Registered Mar. 6, 2012

Int. Cl.: 42

FOR: COMPUTER NETWORK DESIGN FOR OTHERS, IN CLASS 42 (U.S. CLS. 100 AND 101).

SERVICE MARK

FIRST USE 5-1-2010; IN COMMERCE 10-1-2010.

SUPPLEMENTAL REGISTER

THE MARK CONSISTS OF STANDARD CHARACTERS WITHOUT CLAIM TO ANY PARTICULAR FONT, STYLE, SIZE, OR COLOR.

SER. NO. 85-042,158, FILED P.R. 5-19-2010; AM. S.R. 1-11-2012.

ROBERT C. CLARK JR., EXAMINING ATTORNEY



David J. Kybas

Director of the United States Patent and Trademark Office

United States of America

United States Patent and Trademark Office

LUNCH EXPRESS

Reg. No. 4,110,363

O'CHARLEY'S MANAGEMENT COMPANY, INC. (TENNESSEE CORPORATION)
3038 SIDCO DRIVE
NASHVILLE, TN 37204

Registered Mar. 6, 2012

Int. Cls.: 29, 30, and 43

FOR: MENU ITEMS, NAMELY, PREPARED ENTREES CONSISTING PRIMARILY OF SOUPS, VEGETABLE AND FRUIT SALADS, IN CLASS 29 (U.S. CL. 46).

TRADEMARK

FIRST USE 4-10-2010; IN COMMERCE 4-10-2010.

SERVICE MARK

FOR: MENU ITEMS, NAMELY, PREPARED ENTREES CONSISTING PRIMARILY OF SANDWICHES, IN CLASS 30 (U.S. CL. 46).

SUPPLEMENTAL REGISTER

FIRST USE 4-10-2010; IN COMMERCE 4-10-2010.

FOR: RESTAURANT AND BAR SERVICES, IN CLASS 43 (U.S. CLS. 100 AND 101).

FIRST USE 4-10-2010; IN COMMERCE 4-10-2010.

THE MARK CONSISTS OF STANDARD CHARACTERS WITHOUT CLAIM TO ANY PARTICULAR FONT, STYLE, SIZE, OR COLOR.

NO CLAIM IS MADE TO THE EXCLUSIVE RIGHT TO USE "LUNCH" , APART FROM THE MARK AS SHOWN.

SER. NO. 85-078,585, FILED P.R. 7-6-2010; AM. S.R. 1-6-2012.

EMILY CHUO, EXAMINING ATTORNEY



David J. Kypos

Director of the United States Patent and Trademark Office

United States of America

United States Patent and Trademark Office

RESTROOM MAGNETS

Reg. No. 4,110,364

CARROLL, DUANE M (UNITED STATES INDIVIDUAL)
P.O. BOX 13213
SACRAMENTO, CA 95813

Registered Mar. 6, 2012

Int. Cl.: 9

FOR: DECORATIVE MAGNETS, IN CLASS 9 (U.S. CLS. 21, 23, 26, 36 AND 38).

TRADEMARK

FIRST USE 7-1-2010; IN COMMERCE 7-1-2010.

SUPPLEMENTAL REGISTER

THE MARK CONSISTS OF STANDARD CHARACTERS WITHOUT CLAIM TO ANY PARTICULAR FONT, STYLE, SIZE, OR COLOR.

NO CLAIM IS MADE TO THE EXCLUSIVE RIGHT TO USE "MAGNET", APART FROM THE MARK AS SHOWN.

SER. NO. 85-088,090, FILED P.R. 7-19-2010; AM. S.R. 1-27-2012.

ANTHONY RINKER, EXAMINING ATTORNEY



David J. Kybas

Director of the United States Patent and Trademark Office

United States of America

United States Patent and Trademark Office

Screen Stamp

Reg. No. 4,110,365

Registered Mar. 6, 2012

Int. Cl.: 42

SERVICE MARK

SUPPLEMENTAL REGISTER

COKA ENTERPRISES LLC (PENNSYLVANIA LIMITED LIABILITY COMPANY)
24 W HIGH ST
HELLERTOWN, PA 18055

FOR: THIRD PARTY AUTHENTICATION IN THE FIELD OF ELECTRONIC DOCUMENT AUTHENTICATION, NAMELY, AUTHENTICATION OF A WEBSITE'S CONTENTS AT A SPECIFIC TIME AND DATE VIA CAPTURED IMAGE; ELECTRONIC DOCUMENT AUTHENTICATION, NAMELY, AUTHENTICATION OF DIGITAL SIGNATURE AND PHYSICAL PRINTOUT DOCUMENTATION OF WEBSITE CONTENT, IN CLASS 42 (U.S. CLS. 100 AND 101).

FIRST USE 12-12-2011; IN COMMERCE 12-12-2011.

THE MARK CONSISTS OF STANDARD CHARACTERS WITHOUT CLAIM TO ANY PARTICULAR FONT, STYLE, SIZE, OR COLOR.

SER. NO. 85-097,039, FILED P.R. 7-30-2010; AM. S.R. 12-12-2011.

AMY C. KEAN, EXAMINING ATTORNEY



David J. Kyros

Director of the United States Patent and Trademark Office

United States of America

United States Patent and Trademark Office

VIRTUAL RESUMES

Reg. No. 4,110,366

ROO SOLUTIONS, INC. (DELAWARE CORPORATION)
10 CLIPPING TREE LANE
HUNT VALLEY, MD 21030

Registered Mar. 6, 2012

Int. Cl.: 35

FOR: PROVIDING AN INTERACTIVE WEB SITE THAT FACILITATES THE PREPARATION OF RESUMES, IN CLASS 35 (U.S. CLS. 100, 101 AND 102).

SERVICE MARK

FIRST USE 7-1-2011; IN COMMERCE 7-15-2011.

SUPPLEMENTAL REGISTER

THE MARK CONSISTS OF STANDARD CHARACTERS WITHOUT CLAIM TO ANY PARTICULAR FONT, STYLE, SIZE, OR COLOR.

NO CLAIM IS MADE TO THE EXCLUSIVE RIGHT TO USE "RESUMES", APART FROM THE MARK AS SHOWN.

SER. NO. 85-097,648, FILED P.R. 8-1-2010; AM. S.R. 2-1-2012.

ALYSSA STEEL, EXAMINING ATTORNEY



David J. Kybas

Director of the United States Patent and Trademark Office

United States of America

United States Patent and Trademark Office

POPSTER FM

Reg. No. 4,110,367

FOLGER MEDIA, INC. (TEXAS CORPORATION)
4104 GRACE LANE
GRAPEVINE, TX 76051 AND

Registered Mar. 6, 2012

Int. Cl.: 38

HUBBARD, JULIE (UNITED STATES INDIVIDUAL), DBA JULES RILEY MEDIA,
122 JACOBS RD.
ST. SIMONS ISLAND, GA 31522

SERVICE MARK

SUPPLEMENTAL REGISTER

FOR: AUDIO AND VIDEO BROADCASTING SERVICES OVER THE INTERNET; BROADCASTING OF VIDEO AND AUDIO PROGRAMMING OVER THE INTERNET; INTERNET RADIO BROADCASTING SERVICES; INTERNET RADIO SERVICES, NAMELY, TRANSMISSION OF AUDIO MATERIAL VIA THE INTERNET; RADIO BROADCASTING; RADIO BROADCASTING CONSULTATION, IN CLASS 38 (U.S. CLS. 100, 101 AND 104).

FIRST USE 1-17-2012; IN COMMERCE 1-17-2012.

THE MARK CONSISTS OF STANDARD CHARACTERS WITHOUT CLAIM TO ANY PARTICULAR FONT, STYLE, SIZE, OR COLOR.

NO CLAIM IS MADE TO THE EXCLUSIVE RIGHT TO USE "FM" , APART FROM THE MARK AS SHOWN.

SER. NO. 85-097,776, FILED P.R. 8-2-2010; AM. S.R. 1-18-2012.

JESSICA A. POWERS, EXAMINING ATTORNEY



David J. Kybas

Director of the United States Patent and Trademark Office

United States of America

United States Patent and Trademark Office

RUN

Reg. No. 4,110,368

Registered Mar. 6, 2012

Int. Cl.: 16

TRADEMARK

SUPPLEMENTAL REGISTER

THROWER VENTURES, INC. (CALIFORNIA CORPORATION)
1295 PROSPECT STREET
LA JOLLA, CA 92037

FOR: GENERAL FEATURE MAGAZINE IN THE FIELD OF HEALTH, FITNESS, EXERCISE, SPORTS, NUTRITION, TRAVEL, AND LIFESTYLE, IN CLASS 16 (U.S. CLS. 2, 5, 22, 23, 29, 37, 38 AND 50).

FIRST USE 6-1-2010; IN COMMERCE 7-3-2010.

THE MARK CONSISTS OF STANDARD CHARACTERS WITHOUT CLAIM TO ANY PARTICULAR FONT, STYLE, SIZE, OR COLOR.

SER. NO. 85-099,941, FILED P.R. 8-4-2010; AM. S.R. 12-27-2011.

LESLEY LAMOTHE, EXAMINING ATTORNEY



David J. Kybas

Director of the United States Patent and Trademark Office

United States of America

United States Patent and Trademark Office



Reg. No. 4,110,369

HOWARD, DAVID (UNITED STATES INDIVIDUAL)
8228 MENAUL BLVD NE
ALBUQUERQUE, NM 87110

Registered Mar. 6, 2012

Int. Cl.: 6

FOR: METAL KEY CHAINS, IN CLASS 6 (U.S. CLS. 2, 12, 13, 14, 23, 25 AND 50).

TRADEMARK

FIRST USE 3-11-2010; IN COMMERCE 3-11-2010.

SUPPLEMENTAL REGISTER

NO CLAIM IS MADE TO THE EXCLUSIVE RIGHT TO USE "SERVICE TABS", APART FROM THE MARK AS SHOWN.

THE MARK CONSISTS OF THE STYLIZED TEXT "SERVICE TABS" WITH A CURVED RECTANGULAR BORDER OVER THE WORD "SERVICE".

SER. NO. 85-100,767, FILED P.R. 8-5-2010; AM. S.R. 1-21-2012.

CAROLYN CATALDO, EXAMINING ATTORNEY



David J. Kybas

Director of the United States Patent and Trademark Office

United States of America

United States Patent and Trademark Office

Whistle Wand

Reg. No. 4,110,370

Registered Mar. 6, 2012

Int. Cl.: 9

TRADEMARK

SUPPLEMENTAL REGISTER

GRACE INDUSTRIES INC (DELAWARE CORPORATION)
305 BEND HILL ROAD
FREDONIA, PA 16124

FOR: BATON SHAPED, BATTERY OPERATED ELECTRONIC SAFETY DEVICE WITH WHISTLE, NAMELY, A SERIES OF SOLID-STATE GLOWING AND/OR FLASHING LIGHTS COMPRISING LIGHT EMITTING DIODES ENCLOSED IN A TRANSLUCENT PLASTIC CYLINDRICAL TUBE WITH AN ELECTRONIC WHISTLE IN TIP OF WAND. WHISTLE PRODUCES A LOUD AUDIBLE SOUND WHEN CONTROL BUTTON IS DEPRESSED, IN CLASS 9 (U.S. CLS. 21, 23, 26, 36 AND 38).

FIRST USE 12-1-2011; IN COMMERCE 12-1-2011.

THE MARK CONSISTS OF STANDARD CHARACTERS WITHOUT CLAIM TO ANY PARTICULAR FONT, STYLE, SIZE, OR COLOR.

SER. NO. 85-104,282, FILED P.R. 8-10-2010; AM. S.R. 12-22-2011.

SAIMA MAKHDOOM, EXAMINING ATTORNEY



David J. Kyros

Director of the United States Patent and Trademark Office

United States of America

United States Patent and Trademark Office



Reg. No. 4,110,371

LIDDLE MARKETING COMPANY (MINNESOTA CORPORATION)
P.O. BOX 114
VICTORIA, MN 55386

Registered Mar. 6, 2012

Int. Cl.: 35

FOR: PRODUCT DEMONSTRATION, IN CLASS 35 (U.S. CLS. 100, 101 AND 102).

SERVICE MARK

FIRST USE 0-0-2007; IN COMMERCE 0-0-2007.

SUPPLEMENTAL REGISTER

THE MARK CONSISTS OF THE STYLIZED WORDING "TESTRIDE" IN YELLOW AND OUTLINED IN RED. THE COLOR WHITE REPRESENTS BACKGROUND AND/OR TRANSPARENT AREAS AND IS NOT PART OF THE MARK.

THE COLOR(S) YELLOW AND RED IS/ARE CLAIMED AS A FEATURE OF THE MARK.

SER. NO. 85-107,241, FILED P.R. 8-13-2010; AM. S.R. 1-12-2012.

WENDY GOODMAN, EXAMINING ATTORNEY



David J. Kybas

Director of the United States Patent and Trademark Office

United States of America

United States Patent and Trademark Office

Liveset

Reg. No. 4,110,372

Registered Mar. 6, 2012

Int. Cl.: 38

SERVICE MARK

SUPPLEMENTAL REGISTER

INMUSIC LLC (DELAWARE LIMITED LIABILITY COMPANY), DBA LIVESET.COM,
643 MAGAZINE ST., SUITE 304
NEW ORLEANS, LA 70130

FOR: COMMUNICATIONS SERVICES, NAMELY, TRANSMITTING STREAMED SOUND AND AUDIOVISUAL RECORDINGS VIA THE INTERNET; ELECTRONIC TRANSMISSION AND STREAMING OF DIGITAL MEDIA CONTENT FOR OTHERS VIA GLOBAL AND LOCAL COMPUTER NETWORKS; STREAMING OF AUDIO, VISUAL AND AUDIOVISUAL MATERIAL VIA A GLOBAL COMPUTER NETWORK; STREAMING OF VIDEO MATERIAL ON THE INTERNET, IN CLASS 38 (U.S. CLS. 100, 101 AND 104).

FIRST USE 7-1-2010; IN COMMERCE 7-1-2010.

THE MARK CONSISTS OF STANDARD CHARACTERS WITHOUT CLAIM TO ANY PARTICULAR FONT, STYLE, SIZE, OR COLOR.

SER. NO. 85-108,486, FILED P.R. 8-16-2010; AM. S.R. 12-29-2011.

BRIAN PINO, EXAMINING ATTORNEY



David J. Kybas

Director of the United States Patent and Trademark Office

United States of America
United States Patent and Trademark Office

OCULOCAM

Reg. No. 4,110,373

OCULOCAM, LLC (IOWA CORPORATION)
309 E. CHURCH STREET
MARSHALLTOWN, IA 50158

Registered Mar. 6, 2012

Int. Cl.: 10

FOR: MEDICAL IMAGING APPARATUS IN THE FIELD OF EYE CARE, IN CLASS 10 (U.S. CLS. 26, 39 AND 44).

TRADEMARK

FIRST USE 3-26-2010; IN COMMERCE 3-26-2010.

SUPPLEMENTAL REGISTER

THE MARK CONSISTS OF STANDARD CHARACTERS WITHOUT CLAIM TO ANY PARTICULAR FONT, STYLE, SIZE, OR COLOR.

SER. NO. 85-111,090, FILED P.R. 8-19-2010; AM. S.R. 1-11-2012.

JESSICA FATHY, EXAMINING ATTORNEY



David J. Kybas

Director of the United States Patent and Trademark Office

United States of America

United States Patent and Trademark Office

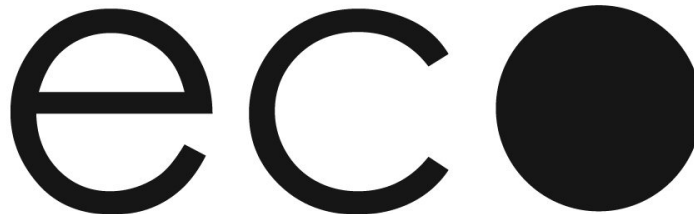

DENTISTRY ASSOCIATION

Reg. No. 4,110,374

ECO-DENTISTRY ASSOCIATION, LLC (CALIFORNIA LIMITED LIABILITY COMPANY)
2930 DOMINGO AVENUE, SUITE 113
BERKELEY, CA 94705

Registered Mar. 6, 2012

Int. Cl.: 45

FOR: GREEN DENTAL OFFICE STANDARDS, NAMELY, STANDARDS FOR ENVIRONMENTALLY SUSTAINABLE OPERATION, IN CLASS B (U.S. CL. B).

CERTIFICATION MARK

FIRST USE 1-1-2010; IN COMMERCE 1-1-2010.

SERVICES

NO CLAIM IS MADE TO THE EXCLUSIVE RIGHT TO USE "DENTISTRY ASSOCIATION", APART FROM THE MARK AS SHOWN.

SUPPLEMENTAL REGISTER

THE MARK CONSISTS OF THE WORD "ECO" ABOVE THE WORDS "DENTISTRY ASSOCIATION". THE LAST LETTER IN "ECO" IS A STYLIZED ORB.

THE CERTIFICATION MARK, AS USED BY AUTHORIZED PERSONS, CERTIFIES THE DENTAL OFFICE MEETS GREEN DENTAL OFFICE STANDARDS, NAMELY, STANDARDS FOR ENVIRONMENTALLY SUSTAINABLE OPERATION.

SER. NO. 85-114,064, FILED P.R. 8-23-2010; AM. S.R. 1-3-2012.

MICHELE SWAIN, EXAMINING ATTORNEY



David J. Kybas

Director of the United States Patent and Trademark Office

United States of America

United States Patent and Trademark Office

AQUA ALERT

Reg. No. 4,110,375

Registered Mar. 6, 2012

Int. Cl.: 9

TRADEMARK

SUPPLEMENTAL REGISTER

MICRON OPHTHALMIC, INC. (FLORIDA CORPORATION)
SUITE 300
5800 COLONIAL DRIVE
MARGATE, FL 33063

FOR: DEVICES FOR WIRELESS RADIO TRANSMISSION; SAFETY BRACELETS WITH AN ATTACHED AUDIBLE WARNING ALARM IN THE NATURE OF WATER ACTIVATED AUTOMATED ELECTRONIC WARNING LOUD PIERCING SOUND; SAFETY BRACELETS HAVING A WARNING ALARM SECURED THERETO IN THE NATURE OF WATER ACTIVATED AUTOMATED ELECTRONIC WARNING LOUD PIERCING SOUND; SAFETY WRISTBANDS HAVING A WARNING ALARM SECURED THERETO IN THE NATURE OF WATER ACTIVATED AUTOMATED ELECTRONIC WARNING LOUD PIERCING SOUND; SAFETY ARMBANDS HAVING A WARNING ALARM SECURED THERETO IN THE NATURE OF WATER ACTIVATED AUTOMATED ELECTRONIC WARNING LOUD PIERCING SOUND; SAFETY ARM BAND OR BRACELET THAT INCORPORATES AN AUDIBLE SAFETY WARNING IN THE NATURE OF WATER ACTIVATED AUTOMATED ELECTRONIC WARNING LOUD PIERCING SOUND FOR SECURING TO A BODY PART; SAFETY ARM BAND OR BRACELET THAT INCORPORATES A SAFETY WARNING ALARM IN THE NATURE OF WATER ACTIVATED AUTOMATED ELECTRONIC WARNING LOUD PIERCING SOUND FOR SECURING TO A BODY PART; SAFETY BRACELETS AND ARMBANDS THAT INCORPORATE A WATER ACTIVATED AUTOMATED ELECTRONIC WARNING LOUD PIERCING SOUND THAT ARE PRIMARILY WORN BY INFANTS AND SMALL CHILDREN; SAFETY BRACELETS AND ARMBANDS THAT INCORPORATE WATER ACTIVATED SAFETY ALARMS IN THE NATURE OF AUTOMATED ELECTRONIC WARNING LOUD PIERCING SOUND THAT ARE PRIMARILY WORN BY INFANTS AND SMALL CHILDREN, IN CLASS 9 (U.S. CLS. 21, 23, 26, 36 AND 38).



FIRST USE 9-10-2010; IN COMMERCE 9-10-2010.

THE MARK CONSISTS OF STANDARD CHARACTERS WITHOUT CLAIM TO ANY PARTICULAR FONT, STYLE, SIZE, OR COLOR.

SER. NO. 85-119,771, FILED P.R. 8-31-2010; AM. S.R. 12-14-2011.

ANTHONY RINKER, EXAMINING ATTORNEY

David J. Kyros

Director of the United States Patent and Trademark Office

United States of America
United States Patent and Trademark Office

AIRTYME

Reg. No. 4,110,376

AIRTYME COMMUNICATIONS, LLC (NEW YORK LIMITED LIABILITY COMPANY)
380 RABRO DRIVE
HAUPPAUGE, NY 11788

Registered Mar. 6, 2012

Int. Cl.: 9

FOR: WIRELESS TELEPHONES AND WIRELESS TELEPHONE ACCESSORIES, NAMELY, CELL PHONE BATTERY CHARGERS, SPECIALTY HOLSTERS, HEADSETS, CASES AND BATTERIES, IN CLASS 9 (U.S. CLS. 21, 23, 26, 36 AND 38).

TRADEMARK

FIRST USE 10-13-2010; IN COMMERCE 6-7-2011.

SUPPLEMENTAL REGISTER

THE MARK CONSISTS OF STANDARD CHARACTERS WITHOUT CLAIM TO ANY PARTICULAR FONT, STYLE, SIZE, OR COLOR.

SER. NO. 85-121,107, FILED P.R. 9-1-2010; AM. S.R. 1-9-2012.

MARLENE BELL, EXAMINING ATTORNEY



David J. Kybas

Director of the United States Patent and Trademark Office

United States of America

United States Patent and Trademark Office

SURGE WORKOUT

Reg. No. 4,110,377

Registered Mar. 6, 2012

Int. Cl.: 41

SERVICE MARK

SUPPLEMENTAL REGISTER

AFFINITY HEALTHCARE CENTER AT WATERFORD LAKES, P.L. (FLORIDA LIMITED LIABILITY COMPANY)
875 NORTH ALAFAYA TRAIL
ORLANDO, FL 32828

FOR: CONSULTING SERVICES IN THE FIELDS OF FITNESS AND EXERCISE; PERSONAL COACHING SERVICES IN THE FIELD OF FITNESS TRAINING, WEIGHT LOSS AND EXERCISE; PERSONAL FITNESS TRAINING SERVICES AND CONSULTANCY; PERSONAL TRAINING PROVIDED IN CONNECTION WITH WEIGHT LOSS AND EXERCISE PROGRAMS; PHYSICAL FITNESS CONSULTATION; PHYSICAL FITNESS INSTRUCTION; PHYSICAL FITNESS TRAINING SERVICES; PROVIDING A WEBSITE FEATURING INFORMATION ON EXERCISE AND FITNESS; PROVIDING ASSISTANCE, PERSONAL TRAINING AND PHYSICAL FITNESS CONSULTATION TO INDIVIDUALS TO HELP THEM MAKE PHYSICAL FITNESS, STRENGTH, CONDITIONING, AND EXERCISE IMPROVEMENT IN THEIR DAILY LIVING, IN CLASS 41 (U.S. CLS. 100, 101 AND 107).

FIRST USE 7-1-2010; IN COMMERCE 7-1-2010.

THE MARK CONSISTS OF STANDARD CHARACTERS WITHOUT CLAIM TO ANY PARTICULAR FONT, STYLE, SIZE, OR COLOR.

NO CLAIM IS MADE TO THE EXCLUSIVE RIGHT TO USE "WORKOUT", APART FROM THE MARK AS SHOWN.

SER. NO. 85-121,397, FILED P.R. 9-2-2010; AM. S.R. 1-23-2012.

JAY FLOWERS, EXAMINING ATTORNEY



David J. Kypos

Director of the United States Patent and Trademark Office

United States of America
United States Patent and Trademark Office

SUITE

Reg. No. 4,110,378

TMTD, LLC (DELAWARE LIMITED LIABILITY COMPANY)
6300 CARMEL RD, SUITE 110
CHARLOTTE, NC 28226

Registered Mar. 6, 2012

Int. Cl.: 43

FOR: BAR AND RESTAURANT SERVICES, IN CLASS 43 (U.S. CLS. 100 AND 101).

SERVICE MARK

FIRST USE 5-1-2008; IN COMMERCE 5-1-2008.

SUPPLEMENTAL REGISTER

THE MARK CONSISTS OF THE WORD "SUITE" IN STYLIZED FONT.

SER. NO. 85-124,393, FILED P.R. 9-7-2010; AM. S.R. 1-5-2012.

KELLEY WELLS, EXAMINING ATTORNEY



David J. Kyffers

Director of the United States Patent and Trademark Office

United States of America

United States Patent and Trademark Office

CONFIDENCE BASED LEARNING

Reg. No. 4,110,379

Registered Mar. 6, 2012

Int. Cls.: 41 and 42

SERVICE MARK

SUPPLEMENTAL REGISTER

KNOWLEDGE FACTOR, INC. (COLORADO CORPORATION)
SUITE 210
4775 WALNUT STREET
BOULDER, CO 80301

FOR: EDUCATIONAL CONSULTING SERVICES, NAMELY, PROVIDING, CONSULTATION SERVICES REGARDING THE DEVELOPMENT AND RESTRUCTURING OF LEARNING ASSESSMENTS, LEARNING AND TEACHING PROGRAMS, TRAINING PROGRAMS, ON-LINE AND IN-PERSON CLASSES, KNOWLEDGE ASSESSMENTS, AND TRAINING, ALL FOR THE PURPOSE OF CERTIFYING A LEVEL OF KNOWLEDGE OR COMPETENCY IN THE FIELDS OF HIGHER EDUCATION, CONTINUING EDUCATION, VOCATIONAL TRAINING, TECHNICAL TRAINING, EMPLOYEE TRAINING, KNOWLEDGE ASSESSMENT, AND LEARNING, AND DISTRIBUTING PRINTED COURSE MATERIALS IN CONNECTION THEREWITH IN HARD COPY OR ELECTRONIC FORMAT ON THE SAME TOPICS, IN CLASS 41 (U.S. CLS. 100, 101 AND 107).

FIRST USE 9-10-2008; IN COMMERCE 9-10-2008.

FOR: SOFTWARE AS A SERVICE (SAAS) SERVICES FEATURING SOFTWARE FOR PROVIDING LEARNING ASSESSMENTS, CERTIFICATIONS, LEARNING AND TEACHING PROGRAMS, TRAINING PROGRAMS, STUDY GUIDES, EDUCATIONAL SUPPLEMENTS, AND ELEARNING, AND ALL PROVIDED IN THE FIELDS OF HIGHER EDUCATION, CONTINUING EDUCATION, VOCATIONAL TRAINING, TECHNICAL TRAINING, EMPLOYEE TRAINING, KNOWLEDGE ASSESSMENT AND LEARNING, IN CLASS 42 (U.S. CLS. 100 AND 101).

FIRST USE 9-10-2008; IN COMMERCE 9-10-2008.

THE MARK CONSISTS OF STANDARD CHARACTERS WITHOUT CLAIM TO ANY PARTICULAR FONT, STYLE, SIZE, OR COLOR.

OWNER OF U.S. REG. NO. 3,542,336.

SER. NO. 85-126,787, FILED P.R. 9-10-2010; AM. S.R. 12-14-2011.

DARRYL SPRUILL, EXAMINING ATTORNEY



David J. Kyffers

Director of the United States Patent and Trademark Office

United States of America

United States Patent and Trademark Office

cupcake filled cookies

Reg. No. 4,110,380

Registered Mar. 6, 2012

Int. Cl.: 30

TRADEMARK

SUPPLEMENTAL REGISTER

DOROTHY TONG (UNITED STATES INDIVIDUAL), AKA CUPCAKE AND COOKIE,
1205 WILDER ST.
THOUSAND OAKS, CA 91362

FOR: CAKES; COOKIES, IN CLASS 30 (U.S. CL. 46).

FIRST USE 7-8-2010; IN COMMERCE 7-8-2010.

THE MARK CONSISTS OF STANDARD CHARACTERS WITHOUT CLAIM TO ANY PARTICULAR FONT, STYLE, SIZE, OR COLOR.

NO CLAIM IS MADE TO THE EXCLUSIVE RIGHT TO USE "COOKIES", APART FROM THE MARK AS SHOWN.

SER. NO. 85-127,641, FILED P.R. 9-12-2010; AM. S.R. 12-22-2011.

INGA ERVIN, EXAMINING ATTORNEY



David J. Kybas

Director of the United States Patent and Trademark Office

United States of America

United States Patent and Trademark Office

PHARMACYLIBRARY

Reg. No. 4,110,381

Registered Mar. 6, 2012

Int. Cl.: 41

SERVICE MARK

SUPPLEMENTAL REGISTER

AMERICAN PHARMACISTS ASSOCIATION (APHA) (D.C. NON-PROFIT CORPORATION),
FORMERLY AMERICAN PHARMACEUTICAL ASSOCIATION,
2215 CONSTITUTION AVENUE, N.W.
WASHINGTON, DC 200372935

FOR: PROVIDING ON-LINE PUBLICATIONS IN THE NATURE OF HANDBOOKS,
JOURNALS, TEXT BOOKS, CASE STUDIES, AND REVIEWS IN THE FIELD OF PHARMACY;
PROVIDING A WEBSITE FEATURING RESOURCES, NAMELY, NON-DOWNLOADABLE
PUBLICATIONS IN THE NATURE OF HANDBOOKS, JOURNALS, TEXT BOOKS, CASE
STUDIES, AND REVIEWS IN THE FIELD OF PHARMACY, IN CLASS 41 (U.S. CLS. 100,
101 AND 107).

FIRST USE 6-30-2010; IN COMMERCE 6-30-2010.

THE MARK CONSISTS OF STANDARD CHARACTERS WITHOUT CLAIM TO ANY PAR-
TICULAR FONT, STYLE, SIZE, OR COLOR.

SER. NO. 85-128,174, FILED P.R. 9-13-2010; AM. S.R. 6-17-2011.

CYNTHIA TRIPI, EXAMINING ATTORNEY



David J. Kyffers

Director of the United States Patent and Trademark Office

United States of America

United States Patent and Trademark Office

STRONGEYES

Reg. No. 4,110,382

STACOR BIOSCIENCES, LLC (MARYLAND LIMITED LIABILITY COMPANY)
133 ROLLINS AVE., SUITE 3A
ROCKVILLE, MD 20852

Registered Mar. 6, 2012

Int. Cl.: 5

FOR: DIETARY SUPPLEMENTS, IN CLASS 5 (U.S. CLS. 6, 18, 44, 46, 51 AND 52).

TRADEMARK

FIRST USE 12-31-2007; IN COMMERCE 12-31-2007.

SUPPLEMENTAL REGISTER

THE MARK CONSISTS OF STANDARD CHARACTERS WITHOUT CLAIM TO ANY PARTICULAR FONT, STYLE, SIZE, OR COLOR.

SER. NO. 85-130,127, FILED P.R. 9-15-2010; AM. S.R. 1-17-2012.

COLLEEN KEARNEY, EXAMINING ATTORNEY



David J. Kybas

Director of the United States Patent and Trademark Office

United States of America

United States Patent and Trademark Office

Clinical Solutions Newsletter

Reg. No. 4,110,383

SAVAGE DDS, RHONDA (UNITED STATES INDIVIDUAL)
374 NORTH SHORE BLVD.
FOX ISLAND, WA 98333

Registered Mar. 6, 2012

Int. Cl.: 16

FOR: NEWSLETTERS IN THE FIELD OF DENTISTRY, IN CLASS 16 (U.S. CLS. 2, 5, 22, 23, 29, 37, 38 AND 50).

TRADEMARK

FIRST USE 12-19-2011; IN COMMERCE 12-19-2011.

SUPPLEMENTAL REGISTER

THE MARK CONSISTS OF STANDARD CHARACTERS WITHOUT CLAIM TO ANY PARTICULAR FONT, STYLE, SIZE, OR COLOR.

NO CLAIM IS MADE TO THE EXCLUSIVE RIGHT TO USE "NEWSLETTER", APART FROM THE MARK AS SHOWN.

SER. NO. 85-130,666, FILED P.R. 9-15-2010; AM. S.R. 12-19-2011.

Laurie Kaufman, Examining Attorney



David J. Kybas

Director of the United States Patent and Trademark Office

United States of America

United States Patent and Trademark Office

swivel-blocks

Reg. No. 4,110,384

CREATIVE TOYS LLC (NEW HAMPSHIRE LIMITED LIABILITY COMPANY)
5 FORSYTHIA DRIVE
NASHUA, NH 03062

Registered Mar. 6, 2012

Int. Cl.: 28

FOR: CONSTRUCTION TOYS, IN CLASS 28 (U.S. CLS. 22, 23, 38 AND 50).

TRADEMARK

FIRST USE 10-0-2009; IN COMMERCE 6-0-2011.

SUPPLEMENTAL REGISTER

THE MARK CONSISTS OF STANDARD CHARACTERS WITHOUT CLAIM TO ANY PARTICULAR FONT, STYLE, SIZE, OR COLOR.

SER. NO. 85-134,083, FILED P.R. 9-20-2010; AM. S.R. 12-1-2011.

CHRISTOPHER BUONGIORNO, EXAMINING ATTORNEY



David J. Kybas

Director of the United States Patent and Trademark Office

United States of America

United States Patent and Trademark Office

COMMISSION FOR CASE MANAGER CERTIFICATION

Reg. No. 4,110,385

Registered Mar. 6, 2012

Int. Cl.: 35

SERVICE MARK

SUPPLEMENTAL REGISTER

COMMISSION FOR CASE MANAGER CERTIFICATION (ILLINOIS CORPORATION)
SUITE E
1835 ROHLWING ROAD
ROLLING MEADOWS, IL 60008

FOR: ASSOCIATION SERVICES, NAMELY, PROMOTING THE INTERESTS OF CASE
MANAGEMENT IN THE FIELD OF HEALTH SERVICES, IN CLASS 35 (U.S. CLS. 100, 101
AND 102).

FIRST USE 6-1-2011; IN COMMERCE 6-1-2011.

THE MARK CONSISTS OF STANDARD CHARACTERS WITHOUT CLAIM TO ANY PAR-
TICULAR FONT, STYLE, SIZE, OR COLOR.

NO CLAIM IS MADE TO THE EXCLUSIVE RIGHT TO USE "COMMISSION", APART FROM
THE MARK AS SHOWN.

SER. NO. 85-136,472, FILED P.R. 9-23-2010; AM. S.R. 1-6-2012.

SAIMA MAKHDOOM, EXAMINING ATTORNEY



David J. Kybas

Director of the United States Patent and Trademark Office

United States of America

United States Patent and Trademark Office

GRIDDLE READY PARTIALLY COOKED BACON

Reg. No. 4,110,386

Registered Mar. 6, 2012

Int. Cl.: 29

PATCUD INVESTMENTS, INC. (DELAWARE CORPORATION)
BAYNARD BUILDING, SUITE 103
3411 SILVERSIDE ROAD
WILMINGTON, DE 19810

FOR: BACON, IN CLASS 29 (U.S. CL. 46).

TRADEMARK

FIRST USE 11-30-2010; IN COMMERCE 11-30-2010.

SUPPLEMENTAL REGISTER

THE MARK CONSISTS OF STANDARD CHARACTERS WITHOUT CLAIM TO ANY PARTICULAR FONT, STYLE, SIZE, OR COLOR.

NO CLAIM IS MADE TO THE EXCLUSIVE RIGHT TO USE "PARTIALLY COOKED BACON", APART FROM THE MARK AS SHOWN.

SER. NO. 85-138,528, FILED P.R. 9-27-2010; AM. S.R. 1-12-2012.

ELISSA GARBER KON, EXAMINING ATTORNEY



David J. Kybas

Director of the United States Patent and Trademark Office

United States of America
United States Patent and Trademark Office

NAILPAC

Reg. No. 4,110,387

NATIONAL NAIL CORP. (MICHIGAN CORPORATION)
2964 CLYDON SW
GRAND RAPIDS, MI 49519

Registered Mar. 6, 2012

Int. Cl.: 6

FOR: METAL FASTENERS, NAMELY, NAILS, IN CLASS 6 (U.S. CLS. 2, 12, 13, 14, 23, 25 AND 50).

TRADEMARK

FIRST USE 1-19-2012; IN COMMERCE 1-19-2012.

SUPPLEMENTAL REGISTER

THE MARK CONSISTS OF STANDARD CHARACTERS WITHOUT CLAIM TO ANY PARTICULAR FONT, STYLE, SIZE, OR COLOR.

SER. NO. 85-140,591, FILED P.R. 9-29-2010; AM. S.R. 1-21-2012.

ELLEN BURNS, EXAMINING ATTORNEY



David J. Kybas

Director of the United States Patent and Trademark Office

United States of America

United States Patent and Trademark Office

EMPLOYEE EMPLOYER SWAP

Reg. No. 4,110,388

Registered Mar. 6, 2012

Int. Cl.: 35

SERVICE MARK

SUPPLEMENTAL REGISTER

ALL STAR HR, INC. (FLORIDA CORPORATION)
17600 NW 5TH AVENUE, #1218
MIAMI, FL 33169

FOR: EMPLOYMENT HIRING, RECRUITING, PLACEMENT, STAFFING AND CAREER NETWORKING SERVICES; JOB PLACEMENT; PROVIDING AN EMPLOYER WITH CANDIDATES OR POTENTIAL EMPLOYEES TO FILL TEMPORARY, CONTRACT AND PERMANENT POSITIONS; PROVIDING AN ON-LINE SEARCHABLE DATABASE FEATURING EMPLOYMENT OPPORTUNITIES; PROVIDING AN ON-LINE SEARCHABLE DATABASE FEATURING EMPLOYMENT OPPORTUNITIES AND CONTENT ABOUT EMPLOYMENT; PROVIDING EMPLOYMENT INFORMATION; PROVIDING ON-LINE EMPLOYMENT INFORMATION IN THE FIELD OF RECRUITMENT, CAREERS, JOB RESOURCES AND LISTINGS, RESUMES; PROVIDING ON-LINE EMPLOYMENT PLACEMENT SERVICES, NAMELY, MATCHING RESUMES AND POTENTIAL EMPLOYERS VIA A GLOBAL COMPUTER NETWORK; PROVIDING ON-LINE INTERACTIVE EMPLOYMENT COUNSELING AND RECRUITMENT SERVICES, IN CLASS 35 (U.S. CLS. 100, 101 AND 102).

FIRST USE 2-0-2011; IN COMMERCE 2-0-2011.

THE MARK CONSISTS OF STANDARD CHARACTERS WITHOUT CLAIM TO ANY PARTICULAR FONT, STYLE, SIZE, OR COLOR.

SER. NO. 85-142,501, FILED P.R. 9-30-2010; AM. S.R. 1-7-2012.

ELLEN B. AWRICH, EXAMINING ATTORNEY



David J. Kyffers

Director of the United States Patent and Trademark Office

United States of America

United States Patent and Trademark Office

PILLA

Reg. No. 4,110,389

PILLA, INC. (DELAWARE CORPORATION)
35 DANBURY RD.
RIDGEFIELD, CT 06877

Registered Mar. 6, 2012

Int. Cl.: 9

FOR: EYEGLOSS FRAMES; EYEGLOSS LENSES; EYEWEAR, IN CLASS 9 (U.S. CLS. 21, 23, 26, 36 AND 38).

TRADEMARK

FIRST USE 3-0-2010; IN COMMERCE 3-0-2010.

SUPPLEMENTAL REGISTER

THE MARK CONSISTS OF STANDARD CHARACTERS WITHOUT CLAIM TO ANY PARTICULAR FONT, STYLE, SIZE, OR COLOR.

SER. NO. 85-146,188, FILED P.R. 10-6-2010; AM. S.R. 1-9-2012.

TINA L. SNAPP, EXAMINING ATTORNEY



David J. Kybas

Director of the United States Patent and Trademark Office

United States of America

United States Patent and Trademark Office

LEMONAID FOR HAITI

Reg. No. 4,110,390

STRACKMAN, PAIGE (UNITED STATES INDIVIDUAL)
8 WEBERS COURT
BROOKLYN, NY 11235

Registered Mar. 6, 2012

Int. Cl.: 36

FOR: CHARITABLE FUND RAISING SERVICES, IN CLASS 36 (U.S. CLS. 100, 101 AND 102).

SERVICE MARK

FIRST USE 6-15-2008; IN COMMERCE 9-27-2009.

SUPPLEMENTAL REGISTER

THE MARK CONSISTS OF STANDARD CHARACTERS WITHOUT CLAIM TO ANY PARTICULAR FONT, STYLE, SIZE, OR COLOR.

SER. NO. 85-148,068, FILED P.R. 10-8-2010; AM. S.R. 7-14-2011.

KATHERINE CONNOLLY, EXAMINING ATTORNEY



David J. Kyros

Director of the United States Patent and Trademark Office

United States of America

United States Patent and Trademark Office

MANAGED HEAT RATE

Reg. No. 4,110,391

GFI GROUP, INC. (DELAWARE CORPORATION)
55 WATER STREET
NEW YORK, NY 10041

Registered Mar. 6, 2012

Int. Cl.: 36

FOR: PROVIDING FINANCIAL INFORMATION AND EVALUATIONS AND FINANCIAL RISK MANAGEMENT CONSULTATION SERVICES REGARDING THE PRICING AND VALUATION ASSOCIATED WITH THE COMMODITY COMPONENT OF THE CUSTOMER COST FOR ELECTRIC POWER, IN CLASS 36 (U.S. CLS. 100, 101 AND 102).

SERVICE MARK

SUPPLEMENTAL REGISTER FIRST USE 1-3-2009; IN COMMERCE 1-3-2009.

THE MARK CONSISTS OF STANDARD CHARACTERS WITHOUT CLAIM TO ANY PARTICULAR FONT, STYLE, SIZE, OR COLOR.

SER. NO. 85-153,597, FILED P.R. 10-15-2010; AM. S.R. 1-17-2012.

MARC LEIPZIG, EXAMINING ATTORNEY



David J. Kyffers

Director of the United States Patent and Trademark Office

United States of America

United States Patent and Trademark Office

CU SOLUTIONS GROUP

Reg. No. 4,110,392

Registered Mar. 6, 2012

Int. Cls.: 35, 41, 42, and 45

SERVICE MARK

SUPPLEMENTAL REGISTER

CUCORP, INC. (MICHIGAN CORPORATION)
SUITE 200
38695 WEST SEVEN MILE RD.
LIVONIA, MI 481527097

FOR: MARKETING AND ADVERTISING SERVICES, NAMELY, MARKETING CONSULTING FOR CREDIT UNIONS; MEDIA BUYING ADVICE, NAMELY, ADVISING THE CLIENT HOW MUCH MEDIA TIME, AND AT WHAT TIMES THE CLIENT SHOULD BE PURCHASING ADVERTISING; MARKET RESEARCH SERVICES FOR OTHERS; TURNKEY PROMOTIONAL TOOLS, NAMELY, PREPARING PROMOTIONAL MATERIAL FOR OTHERS; ON-LINE RETAIL STORES FEATURING OPERATIONAL BUSINESS FORMS AND OFFICE SUPPLIES; HUMAN RESOURCE SERVICES, NAMELY, EMPLOYMENT RECRUITING AND PAYROLL PREPARATION SERVICES; BUSINESS CONSULTING; MANUAL DESIGN SERVICES IN THE NATURE OF DEVELOPMENT OF CUSTOMIZED PERSONNEL MANAGEMENT MATERIALS FOR OTHERS, NAMELY, DEVELOPMENT OF CUSTOMIZED EMPLOYEE MANUALS; SHARED STAFFING SERVICES, NAMELY, EMPLOYMENT STAFFING IN THE FIELD OF CREDIT UNIONS, IN CLASS 35 (U.S. CLS. 100, 101 AND 102).

FIRST USE 1-1-2010; IN COMMERCE 1-1-2010.

FOR: TRAINING SERVICES IN THE FIELD OF CREDIT UNION OPERATIONS, IN CLASS 41 (U.S. CLS. 100, 101 AND 107).

FIRST USE 1-1-2010; IN COMMERCE 1-1-2010.

FOR: WEB SITE DESIGN SERVICES FOR OTHERS; GRAPHIC DESIGN SERVICES; COMPUTER SECURITY CONSULTING SERVICES FOR OTHERS; ENGINEERING SERVICES IN THE FIELD OF ENVIRONMENTAL COMPLIANCE; AND CONSULTING IN THE FIELD OF INFORMATION TECHNOLOGY, IN CLASS 42 (U.S. CLS. 100 AND 101).

FIRST USE 1-1-2010; IN COMMERCE 1-1-2010.

FOR: COPYRIGHT MANAGEMENT CONSULTATION; REGULATORY COMPLIANCE CONSULTING IN THE FIELD OF CREDIT UNIONS; SECURITY CONSULTING SERVICES FOR OTHERS, IN CLASS 45 (U.S. CLS. 100 AND 101).

FIRST USE 1-1-2010; IN COMMERCE 1-1-2010.



David J. Kybas

Director of the United States Patent and Trademark Office

Reg. No. 4,110,392 THE MARK CONSISTS OF STANDARD CHARACTERS WITHOUT CLAIM TO ANY PARTICULAR FONT, STYLE, SIZE, OR COLOR.

NO CLAIM IS MADE TO THE EXCLUSIVE RIGHT TO USE "GROUP", APART FROM THE MARK AS SHOWN.

SER. NO. 85-156,929, FILED P.R. 10-20-2010; AM. S.R. 1-3-2012.

NELSON SNYDER, EXAMINING ATTORNEY

United States of America

United States Patent and Trademark Office

SCALPROLLER

Reg. No. 4,110,393

Registered Mar. 6, 2012

Int. Cls.: 5 and 10

TRADEMARK

SUPPLEMENTAL REGISTER

PANGAEA LABORATORIES LTD. (UNITED KINGDOM CORPORATION)
58 CREWYS ROAD
LONDON, UNITED KINGDOM NW22AD

FOR: MEDICAL PREPARATIONS FOR STERILIZING THE SKIN AND HAIR; MEDICAL PREPARATIONS FOR STERILIZING MEDICAL DEVICES, IN CLASS 5 (U.S. CLS. 6, 18, 44, 46, 51 AND 52).

FIRST USE 4-0-2009; IN COMMERCE 8-0-2009.

FOR: STERILE SURGICAL NEEDLES SOLD AS A COMPONENT PART OF A ROLLER FOR MEDICAL USE; CONTAINERS FOR STERILIZING MEDICAL INSTRUMENTS; MEDICAL DEVICES FOR STERILIZING MEDICAL INSTRUMENTS; CONTAINERS FOR STERILIZING THE SKIN AND HAIR; MEDICAL DEVICES FOR STERILIZING A PATIENT'S SKIN AND HAIR; TRANSDERMAL TREATMENT DRUG DELIVERY SYSTEMS FOR COSMETIC USE IN THE FORM OF A ROLLER, IN CLASS 10 (U.S. CLS. 26, 39 AND 44).

FIRST USE 4-0-2009; IN COMMERCE 8-0-2009.

THE MARK CONSISTS OF STANDARD CHARACTERS WITHOUT CLAIM TO ANY PARTICULAR FONT, STYLE, SIZE, OR COLOR.

SER. NO. 85-160,592, FILED P.R. 10-25-2010; AM. S.R. 1-13-2012.

ALYSSA STEEL, EXAMINING ATTORNEY



David J. Kyffers

Director of the United States Patent and Trademark Office

United States of America

United States Patent and Trademark Office

PHRESH PROTEIN

Reg. No. 4,110,394

DOCTOR PHRESH NUTRITIONALS, L.L.C. (ARIZONA LIMITED LIABILITY COMPANY)
8618 N. TATUM BLVD.
PHOENIX, AR 85028

Registered Mar. 6, 2012

Int. Cl.: 5

FOR: NUTRITIONAL SUPPLEMENT IN THE NATURE OF A NUTRIENT-DENSE, PROTEIN-BASED DRINK MIX, IN CLASS 5 (U.S. CLS. 6, 18, 44, 46, 51 AND 52).

TRADEMARK

FIRST USE 2-17-2011; IN COMMERCE 2-17-2011.

SUPPLEMENTAL REGISTER

THE MARK CONSISTS OF STANDARD CHARACTERS WITHOUT CLAIM TO ANY PARTICULAR FONT, STYLE, SIZE, OR COLOR.

NO CLAIM IS MADE TO THE EXCLUSIVE RIGHT TO USE "PROTEIN", APART FROM THE MARK AS SHOWN.

SER. NO. 85-175,402, FILED P.R. 11-12-2010; AM. S.R. 12-22-2011.

SIMON TENG, EXAMINING ATTORNEY



David J. Kybas

Director of the United States Patent and Trademark Office

United States of America

United States Patent and Trademark Office



Reg. No. 4,110,395

Registered Mar. 6, 2012

Int. Cl.: 10

TRADEMARK

SUPPLEMENTAL REGISTER

MAST BIOSURGERY AG (SWITZERLAND CORPORATION)
CLARIDENSTRASSE 25
ZURICH, SWITZERLAND CH-8002

FOR: MEDICAL DEVICES, NAMELY, IMPLANTS OF NON-LIVING, TISSUE-COMPATIBLE SHEETS OF ARTIFICIAL MATERIALS AND NON-LIVING TISSUES, MEMBRANES OF ARTIFICIAL MATERIALS AND NON-LIVING TISSUES FOR USE IN SURGICAL CESAREAN SECTIONS, AND IMPLANTS COMPOSED OF ARTIFICIAL MATERIALS AND NON-LIVING TISSUES, AND PARTS AND COMPONENTS THEREFOR; MEDICAL DEVICES AND APPARATUS, NAMELY, SURGICAL IMPLANTS COMPRISED OF ARTIFICIAL MATERIAL AND PROCESSED ANIMAL TISSUE FOR USE IN RECONSTRUCTIVE SURGICAL APPLICATIONS, AND REPAIR, REINFORCEMENT OR BUTTRESSING OF SOFT TISSUE, AND PARTS AND FITTINGS THEREFOR; SURGICAL IMPLANTS COMPRISING ARTIFICIAL MATERIAL; MEDICAL IMPLANTS, NAMELY, POLYMER IMPLANTS; SURGICAL IMPLANTS MADE OF SYNTHETIC MATERIALS FOR USE IN SOFT TISSUE REPAIR OR THE RECONSTRUCTION OF SOFT TISSUE DEFICIENCIES, IN CLASS 10 (U.S. CLS. 26, 39 AND 44).

FIRST USE 3-31-2011; IN COMMERCE 3-31-2011.

THE MARK CONSISTS OF THE CAPITAL LETTERS "L" AND "D", SEPARATED BY AN AMPERSAND SYMBOL, ALL IN WHITE, WITH A BLUE/TURQUOISE BACKGROUND.

THE COLOR(S) WHITE AND BLUE/TURQUOISE IS/ARE CLAIMED AS A FEATURE OF THE MARK.

SER. NO. 85-185,169, FILED P.R. 11-24-2010; AM. S.R. 1-3-2012.

LAURIE KAUFMAN, EXAMINING ATTORNEY



David J. Kybas

Director of the United States Patent and Trademark Office

United States of America

United States Patent and Trademark Office

PRACTICAL GREEN

Reg. No. 4,110,396

Registered Mar. 6, 2012

Int. Cl.: 42

SERVICE MARK

SUPPLEMENTAL REGISTER

THE DUNCAN GROUP, LLC (FLORIDA LIMITED LIABILITY COMPANY)
8206 SE PALM STREET
HOBE SOUND, FL 33455

FOR: ARCHITECTURAL DESIGN SERVICES, ARCHITECTURAL SERVICES, NAMELY, ARCHITECTURAL SPECIFICATION WRITING, ARCHITECTURAL ENGINEERING SERVICES, ARCHITECTURAL CONSULTING, DRAFTING SERVICES, GRAPHIC DESIGN SERVICES, ARCHITECTURAL SITE PLANNING SERVICES, ARCHITECTURAL MASTER PLANNING SERVICES, ALL OF THE FOREGOING CARRIED OUT WITH A FOCUS ON PRESERVING THE ENVIRONMENT, IN CLASS 42 (U.S. CLS. 100 AND 101).

FIRST USE 5-15-2009; IN COMMERCE 5-15-2009.

THE MARK CONSISTS OF STANDARD CHARACTERS WITHOUT CLAIM TO ANY PARTICULAR FONT, STYLE, SIZE, OR COLOR.

SER. NO. 85-190,053, FILED P.R. 12-3-2010; AM. S.R. 1-25-2012.

KATHERINE CHANG, EXAMINING ATTORNEY



David J. Kyros

Director of the United States Patent and Trademark Office

United States of America

United States Patent and Trademark Office

RADIO MUSIK

Reg. No. 4,110,397

HALL JR, JERRY (UNITED STATES INDIVIDUAL)
100 PAM CIRCLE
MADISON, AL 35758

Registered Mar. 6, 2012

Int. Cl.: 41

FOR: ENTERTAINMENT, NAMELY, LIVE PERFORMANCES BY A MUSICAL BAND, IN CLASS 41 (U.S. CLS. 100, 101 AND 107).

SERVICE MARK

FIRST USE 6-1-2010; IN COMMERCE 6-1-2010.

SUPPLEMENTAL REGISTER

THE MARK CONSISTS OF STANDARD CHARACTERS WITHOUT CLAIM TO ANY PARTICULAR FONT, STYLE, SIZE, OR COLOR.

NO CLAIM IS MADE TO THE EXCLUSIVE RIGHT TO USE "MUSIC", APART FROM THE MARK AS SHOWN.

SER. NO. 85-209,662, FILED P.R. 1-4-2011; AM. S.R. 5-2-2011.

JULIE WATSON, EXAMINING ATTORNEY



David J. Kybas

Director of the United States Patent and Trademark Office

United States of America

United States Patent and Trademark Office

REMOVE PHONE FROM EAR STICK IT UP YOUR APPS & DRIVE

Reg. No. 4,110,398

ZAPPONE, MARLENE (UNITED STATES INDIVIDUAL)
739 PELLIS ROAD
GREENSBURG, PA 15601

Registered Mar. 6, 2012

Int. Cls.: 16 and 25

FOR: BUMPER STICKERS, IN CLASS 16 (U.S. CLS. 2, 5, 22, 23, 29, 37, 38 AND 50).

TRADEMARK

FIRST USE 7-18-2011; IN COMMERCE 7-18-2011.

SUPPLEMENTAL REGISTER

FOR: T-SHIRTS , IN CLASS 25 (U.S. CLS. 22 AND 39).

FIRST USE 7-18-2011; IN COMMERCE 7-18-2011.

THE MARK CONSISTS OF STANDARD CHARACTERS WITHOUT CLAIM TO ANY PARTICULAR FONT, STYLE, SIZE, OR COLOR.

SER. NO. 85-210,716, FILED P.R. 1-5-2011; AM. S.R. 1-13-2012.

SIMON TENG, EXAMINING ATTORNEY



David J. Kybas

Director of the United States Patent and Trademark Office

United States of America

United States Patent and Trademark Office

ADVANCED GROW GEAR

Reg. No. 4,110,399

Registered Mar. 6, 2012

Int. Cls.: 9 and 11

TRADEMARK

SUPPLEMENTAL REGISTER

ADVANCED NUTRIENTS LTD. (CANADA CORPORATION)
#102 - 32526 GEORGE FERGUSON WAY
ABBOTSFORD, BC, CANADA V2T4Y1

FOR: CO2 MONITORS FOR NON-MEDICAL USE, USED FOR GROWING PLANTS; MAGNETIC LIGHTING BALLASTS, ELECTRONIC LIGHTING BALLASTS, ALL OF THE FOREGOING USED FOR GROWING PLANTS, IN CLASS 9 (U.S. CLS. 21, 23, 26, 36 AND 38).

FOR: LIGHTING EQUIPMENT, POWER EQUIPMENT, COOLING EQUIPMENT, ODOR EQUIPMENT, VENTILATION EQUIPMENT AND AIR MOVEMENT EQUIPMENT ALL USED FOR GROWING PLANTS, NAMELY, HIGH INTENSITY DISCHARGE LIGHT BULBS, LIGHT REFLECTORS, LAMP SHADES, FLUORESCENT ELECTRIC LIGHT BULBS; FLUORESCENT LIGHT SYSTEMS COMPRISING FLUORESCENT ELECTRIC LIGHT BULBS; AIR COOLED LIGHT SYSTEMS COMPRISING ELECTRIC LIGHT BULBS; CO2 GENERATORS, HEAT EXCHANGERS, OSCILLATING ELECTRIC WALL FANS, IN-LINE DUCT ELECTRIC FAN AND CHARCOAL AIR FILTERS FOR AIR CONDITIONING, ALL OF THE FOREGOING FOR GROWING PLANTS, IN CLASS 11 (U.S. CLS. 13, 21, 23, 31 AND 34).

THE MARK CONSISTS OF STANDARD CHARACTERS WITHOUT CLAIM TO ANY PARTICULAR FONT, STYLE, SIZE, OR COLOR.

OWNER OF CANADA REG. NO. TMA813073, DATED 11-30-2011, EXPIRES 11-30-2026.

NO CLAIM IS MADE TO THE EXCLUSIVE RIGHT TO USE "GROW GEAR", APART FROM THE MARK AS SHOWN.

SER. NO. 85-217,489, FILED P.R. 1-13-2011; AM. S.R. 5-16-2011.

ANDREW RHIM, EXAMINING ATTORNEY



David J. Kyffers

Director of the United States Patent and Trademark Office

United States of America

United States Patent and Trademark Office

your local yarn store...
online

Reg. No. 4,110,400

Registered Mar. 6, 2012

Int. Cl.: 35

SERVICE MARK

SUPPLEMENTAL REGISTER

JIMMYS WOOL LLC (NEVADA LIMITED LIABILITY COMPANY), DBA JIMMY BEANS
WOOL,
5000 SMITHRIDGE DR. #A11
RENO, NV 89502

FOR: RETAIL STORE AND ON-LINE RETAIL STORE SERVICES FEATURING KNITTING
AND CROCHETING SUPPLIES, YARNS, PATTERNS, NEEDLES, KNITTING ACCESSORIES,
KNITTING KITS, BOOKS, AND MAGAZINES, IN CLASS 35 (U.S. CLS. 100, 101 AND 102).

FIRST USE 10-27-2008; IN COMMERCE 10-27-2008.

THE MARK CONSISTS OF STANDARD CHARACTERS WITHOUT CLAIM TO ANY PAR-
TICULAR FONT, STYLE, SIZE, OR COLOR.

NO CLAIM IS MADE TO THE EXCLUSIVE RIGHT TO USE "YARN STORE" OR "ONLINE",
APART FROM THE MARK AS SHOWN.

SER. NO. 85-223,318, FILED P.R. 1-21-2011; AM. S.R. 6-10-2011.

MAUREEN DALL, EXAMINING ATTORNEY



David J. Kyffers

Director of the United States Patent and Trademark Office

United States of America

United States Patent and Trademark Office

WHISKY STONES

Reg. No. 4,110,401

TERO DESIGN HOLDINGS, LLC (DELAWARE LIMITED LIABILITY COMPANY)
100 WASHINGTON STREET, 3RD FLOOR
NORWALK, CT 06854

Registered Mar. 6, 2012

Int. Cl.: 21

FOR: PIECES OF MILLED ROCK USED TO ALTER THE TEMPERATURE OF BEVERAGES,
IN CLASS 21 (U.S. CLS. 2, 13, 23, 29, 30, 33, 40 AND 50).

TRADEMARK

FIRST USE 12-7-2007; IN COMMERCE 12-7-2007.

SUPPLEMENTAL REGISTER

THE MARK CONSISTS OF STANDARD CHARACTERS WITHOUT CLAIM TO ANY PARTICULAR FONT, STYLE, SIZE, OR COLOR.

SER. NO. 85-223,454, FILED P.R. 1-21-2011; AM. S.R. 12-16-2011.

HEATHER BIDDULPH, EXAMINING ATTORNEY



David J. Kybas

Director of the United States Patent and Trademark Office

United States of America

United States Patent and Trademark Office

The Alehouse & Gourmet Burger Bar

Reg. No. 4,110,402

Registered Mar. 6, 2012

Int. Cls.: 35 and 43

SERVICE MARK

SUPPLEMENTAL REGISTER

FIRKIN CAPITAL CORPORATION (CANADA CORPORATION)
20 STEELCASE ROAD WEST
UNIT 1C
MARKHAM, CANADA L3R1B2

FOR: RESTAURANT FRANCHISING, NAMELY, OFFERING BUSINESS MANAGEMENT ASSISTANCE IN THE ESTABLISHMENT AND/OR OPERATION OF RESTAURANTS, IN CLASS 35 (U.S. CLS. 100, 101 AND 102).

FIRST USE 7-16-2011; IN COMMERCE 7-16-2011.

FOR: RESTAURANT AND BAR SERVICES, IN CLASS 43 (U.S. CLS. 100 AND 101).

FIRST USE 7-16-2011; IN COMMERCE 7-16-2011.

THE MARK CONSISTS OF STANDARD CHARACTERS WITHOUT CLAIM TO ANY PARTICULAR FONT, STYLE, SIZE, OR COLOR.

NO CLAIM IS MADE TO THE EXCLUSIVE RIGHT TO USE "ALEHOUSE & BURGER BAR", APART FROM THE MARK AS SHOWN.

SER. NO. 85-228,583, FILED P.R. 1-28-2011; AM. S.R. 1-4-2012.

CARYN GLASSER, EXAMINING ATTORNEY



David J. Kyros

Director of the United States Patent and Trademark Office

United States of America

United States Patent and Trademark Office

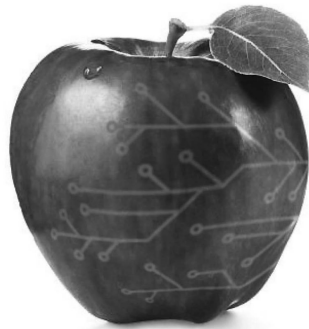

Reg. No. 4,110,403

WATERFORD INSTITUTE, INC. (DELAWARE CORPORATION)
55 WEST 900 SOUTH
SALT LAKE CITY, UT 84101

Registered Mar. 6, 2012

Int. Cl.: 16

FOR: EDUCATIONAL BOOKS FEATURING EARLY CHILDHOOD EDUCATION AND EDUCATIONAL SOFTWARE; EDUCATIONAL PUBLICATIONS, NAMELY, TRAINING MANUALS IN THE FIELD OF EARLY CHILDHOOD EDUCATION AND EDUCATIONAL SOFTWARE USE; PRINTED EDUCATIONAL MATERIALS IN THE FIELD OF EARLY CHILDHOOD EDUCATION AND EDUCATIONAL SOFTWARE USE, IN CLASS 16 (U.S. CLS. 2, 5, 22, 23, 29, 37, 38 AND 50).

TRADEMARK

SUPPLEMENTAL REGISTER

FIRST USE 1-14-2011; IN COMMERCE 8-15-2011.

THE MARK CONSISTS OF THE DESIGN OF AN APPLE PARTIALLY WRAPPED IN A PRINTED CIRCUIT LAYOUT.

SER. NO. 85-230,209, FILED P.R. 1-31-2011; AM. S.R. 12-31-2011.

PATRICIA EVANKO, EXAMINING ATTORNEY



David J. Kybas

Director of the United States Patent and Trademark Office

United States of America

United States Patent and Trademark Office

GREEN CITY CHALLENGE

Reg. No. 4,110,404

Registered Mar. 6, 2012

Int. Cl.: 35

SERVICE MARK

SUPPLEMENTAL REGISTER

GREEN CITY CHALLENGE (NEW YORK CORPORATION)
#SIX-I
474 WEST 238 STREET
BRONX, NY 10463

FOR: PROMOTING COMPETITIONS BOTH DEMONSTRATING AND IMPROVING ENVIRONMENTAL AWARENESS AND KNOWLEDGE; PROMOTING PUBLIC AWARENESS OF ENVIRONMENTAL MATTERS; PUBLIC ADVOCACY SERVICES TO EDUCATE THE PUBLIC ABOUT ENVIRONMENTAL MATTERS AND AWARENESS; PROVIDING A WEBSITE FEATURING CONSUMER PRODUCT INFORMATION RELATING TO IMPACT OF CONSUMER PRODUCTS ON ENVIRONMENTAL PRESERVATION; PROMOTING AWARENESS OF THE ENVIRONMENT AND CONSERVATION BY ORGANIZING AND DEVELOPING PROJECTS; BUSINESS CONSULTING SERVICES RELATED TO THE FIELDS OF ENVIRONMENTAL IMPACT, ENERGY CONSUMPTION AND IMPROVING ENERGY EFFICIENCY, IN CLASS 35 (U.S. CLS. 100, 101 AND 102).

FIRST USE 5-1-2010; IN COMMERCE 5-1-2010.

THE MARK CONSISTS OF STANDARD CHARACTERS WITHOUT CLAIM TO ANY PARTICULAR FONT, STYLE, SIZE, OR COLOR.

SER. NO. 85-231,640, FILED P.R. 2-1-2011; AM. S.R. 1-9-2012.

LAURIE KAUFMAN, EXAMINING ATTORNEY



David J. Kyffers

Director of the United States Patent and Trademark Office

United States of America
United States Patent and Trademark Office

muslimah

Reg. No. 4,110,405

DAVIS, ONEIL (CANADA INDIVIDUAL)
25 GOOD RD

Registered Mar. 6, 2012

SCARBROUGH, CANADA M1C3W8

Int. Cl.: 25

FOR: WOMEN'S CLOTHING, NAMELY, SHIRTS, DRESSES, SKIRTS, BLOUSES, IN CLASS 25 (U.S. CLS. 22 AND 39).

TRADEMARK

FIRST USE 3-14-2011; IN COMMERCE 4-20-2011.

SUPPLEMENTAL REGISTER

THE MARK CONSISTS OF STANDARD CHARACTERS WITHOUT CLAIM TO ANY PARTICULAR FONT, STYLE, SIZE, OR COLOR.

THE ENGLISH TRANSLATION OF THE WORD "MUSLIMAH" IN THE MARK IS A MUSLIM WOMAN.

SER. NO. 85-236,225, FILED P.R. 2-7-2011; AM. S.R. 11-18-2011.

WARREN L. OLANDRIA, EXAMINING ATTORNEY



David J. Kybas

Director of the United States Patent and Trademark Office

United States of America

United States Patent and Trademark Office

GLOBAL WATER CENTER

Reg. No. 4,110,406

WATER MISSIONS INTERNATIONAL (SOUTH CAROLINA NON-PROFIT CORPORATION)
PO BOX 31258
CHARLESTON, SC 29417

Registered Mar. 6, 2012

Int. Cl.: 41

FOR: CHARITABLE SERVICES, NAMELY, PROVIDING TRAINING IN THE FIELD OF WATER TREATMENT; CHARITABLE SERVICES, NAMELY, PROVIDING EDUCATIONAL SERVICES, NAMELY CLASSES AND WORKSHOPS IN THE FIELD OF WATER TREATMENT, IN CLASS 41 (U.S. CLS. 100, 101 AND 107).

SERVICE MARK

SUPPLEMENTAL REGISTER FIRST USE 7-24-2010; IN COMMERCE 7-24-2010.

THE MARK CONSISTS OF STANDARD CHARACTERS WITHOUT CLAIM TO ANY PARTICULAR FONT, STYLE, SIZE, OR COLOR.

NO CLAIM IS MADE TO THE EXCLUSIVE RIGHT TO USE "WATER" AND "CENTER", APART FROM THE MARK AS SHOWN.

SER. NO. 85-239,110, FILED P.R. 2-10-2011; AM. S.R. 7-6-2011.

ERIN FALK, EXAMINING ATTORNEY



David J. Kyffers

Director of the United States Patent and Trademark Office

United States of America

United States Patent and Trademark Office

A BETTER TIP

Reg. No. 4,110,407

BIOTIX INC. (DELAWARE CORPORATION)

Registered Mar. 6, 2012

9880 MESA RIM ROAD
SAN DIEGO, CA 92131

Int. Cl.: 9

FOR: LABORATORY EQUIPMENT, NAMELY, PIPETTE TIPS, IN CLASS 9 (U.S. CLS. 21, 23, 26, 36 AND 38).

TRADEMARK

FIRST USE 12-0-2010; IN COMMERCE 12-0-2010.

SUPPLEMENTAL REGISTER

THE MARK CONSISTS OF STANDARD CHARACTERS WITHOUT CLAIM TO ANY PARTICULAR FONT, STYLE, SIZE, OR COLOR.

NO CLAIM IS MADE TO THE EXCLUSIVE RIGHT TO USE "TIP", APART FROM THE MARK AS SHOWN.

SER. NO. 85-240,438, FILED P.R. 2-11-2011; AM. S.R. 1-13-2012.

ALEX KEAM, EXAMINING ATTORNEY



David J. Kybas

Director of the United States Patent and Trademark Office

United States of America

United States Patent and Trademark Office

SEO CLOUD

Reg. No. 4,110,408

CONDUCTOR, INC. (DELAWARE CORPORATION)
230 PARK AVE. S, 12TH FLOOR
NEW YORK, NY 10003

Registered Mar. 6, 2012

Int. Cls.: 35 and 42

FOR: BUSINESS MARKETING SERVICES, NAMELY, RESEARCHING, TRACKING, ANALYZING, AND MONITORING SEARCH ENGINE RESULTS AND WEBSITE TRAFFIC TO IMPROVE INCLUSION AND PROMINENCE IN INTERNET SEARCH ENGINE RESULTS, IN CLASS 35 (U.S. CLS. 100, 101 AND 102).

SERVICE MARK

SUPPLEMENTAL REGISTER FIRST USE 2-25-2011; IN COMMERCE 2-25-2011.

FOR: PROVIDING ON-LINE NON-DOWNLOADABLE SOFTWARE USED FOR TRACKING, ANALYZING, MONITORING, AND OPTIMIZING SEARCH ENGINE RESULTS AND WEBSITE TRAFFIC TO IMPROVE INCLUSION AND PROMINENCE IN INTERNET SEARCH ENGINE RESULTS; COMPUTER SERVICES, NAMELY, SEARCH ENGINE OPTIMIZATION TO IMPROVE INCLUSION AND PROMINENCE IN INTERNET SEARCH ENGINE RESULTS, IN CLASS 42 (U.S. CLS. 100 AND 101).

FIRST USE 2-25-2011; IN COMMERCE 2-25-2011.

THE MARK CONSISTS OF STANDARD CHARACTERS WITHOUT CLAIM TO ANY PARTICULAR FONT, STYLE, SIZE, OR COLOR.

NO CLAIM IS MADE TO THE EXCLUSIVE RIGHT TO USE "CLOUD", APART FROM THE MARK AS SHOWN.

SER. NO. 85-244,209, FILED P.R. 2-16-2011; AM. S.R. 1-26-2012.

MAYUR VAGHANI, EXAMINING ATTORNEY



David J. Kybas

Director of the United States Patent and Trademark Office

United States of America

United States Patent and Trademark Office

Alumni Football USA

Reg. No. 4,110,409

Registered Mar. 6, 2012

Int. Cl.: 41

SERVICE MARK

SUPPLEMENTAL REGISTER FIRST USE 10-1-2009; IN COMMERCE 10-1-2009.

ALUMNI ATHLETICS USA, INC. (CALIFORNIA CORPORATION)
SUITE 203
750 MENDOCINO AVENUE
SANTA ROSA, CA 95401

FOR: ENTERTAINMENT SERVICES, NAMELY, ORGANIZING AND STAGING FOOTBALL GAMES BETWEEN TEAMS REPRESENTING RIVAL EDUCATIONAL INSTITUTIONS , IN CLASS 41 (U.S. CLS. 100, 101 AND 107).

THE MARK CONSISTS OF STANDARD CHARACTERS WITHOUT CLAIM TO ANY PARTICULAR FONT, STYLE, SIZE, OR COLOR.

NO CLAIM IS MADE TO THE EXCLUSIVE RIGHT TO USE "FOOTBALL", APART FROM THE MARK AS SHOWN.

SER. NO. 85-246,899, FILED P.R. 2-19-2011; AM. S.R. 11-17-2011.

RONALD AIKENS, EXAMINING ATTORNEY



David J. Kyffers

Director of the United States Patent and Trademark Office

United States of America

United States Patent and Trademark Office

ROAST'N BAG

Reg. No. 4,110,410

ACH FOOD COMPANIES, INC. (DELAWARE CORPORATION)
7171 GOODLETT FARMS PARKWAY
CORDOVA, TN 38016

Registered Mar. 6, 2012

Int. Cl.: 30

FOR: SPICES AND SEASONING MIXES, GRAVIES, MARINADES AND SAUCES, TOGETHER WITH COOKING BAGS, SOLD AS A UNIT, IN CLASS 30 (U.S. CL. 46).

TRADEMARK

FIRST USE 1-1-1998; IN COMMERCE 1-1-1998.

SUPPLEMENTAL REGISTER

THE MARK CONSISTS OF STANDARD CHARACTERS WITHOUT CLAIM TO ANY PARTICULAR FONT, STYLE, SIZE, OR COLOR.

SER. NO. 85-250,910, FILED P.R. 2-24-2011; AM. S.R. 1-12-2012.

ELLEN B. AWRICH, EXAMINING ATTORNEY



David J. Kyros

Director of the United States Patent and Trademark Office

United States of America

United States Patent and Trademark Office

ELASTIC MONITORING

Reg. No. 4,110,411

ACCELOPS, INC. (DELAWARE CORPORATION)
2905 STENDER WAY, SUITE 48
SANTA CLARA, CA 95054

Registered Mar. 6, 2012

Int. Cl.: 9

FOR: COMPUTER SOFTWARE FOR DATA CENTER MONITORING AND MANAGEMENT,
IN CLASS 9 (U.S. CLS. 21, 23, 26, 36 AND 38).

TRADEMARK

FIRST USE 11-0-2010; IN COMMERCE 11-0-2010.

SUPPLEMENTAL REGISTER

THE MARK CONSISTS OF STANDARD CHARACTERS WITHOUT CLAIM TO ANY PARTICULAR FONT, STYLE, SIZE, OR COLOR.

OWNER OF U.S. REG. NO. 3,904,348.

NO CLAIM IS MADE TO THE EXCLUSIVE RIGHT TO USE "MONITORING", APART FROM THE MARK AS SHOWN.

SER. NO. 85-251,313, FILED P.R. 2-24-2011; AM. S.R. 1-10-2012.

CARYN GLASSER, EXAMINING ATTORNEY



David J. Kybas

Director of the United States Patent and Trademark Office

United States of America

United States Patent and Trademark Office

ELASTIC EPS

Reg. No. 4,110,412

ACCELOPS, INC. (DELAWARE CORPORATION)
2905 STENDER WAY, SUITE 48
SANTA CLARA, CA 95054

Registered Mar. 6, 2012

Int. Cl.: 9

FOR: COMPUTER SOFTWARE FOR DATA CENTER MONITORING AND MANAGEMENT,
IN CLASS 9 (U.S. CLS. 21, 23, 26, 36 AND 38).

TRADEMARK

FIRST USE 11-0-2010; IN COMMERCE 11-0-2010.

SUPPLEMENTAL REGISTER

THE MARK CONSISTS OF STANDARD CHARACTERS WITHOUT CLAIM TO ANY PARTICULAR FONT, STYLE, SIZE, OR COLOR.

NO CLAIM IS MADE TO THE EXCLUSIVE RIGHT TO USE "EPS", APART FROM THE MARK AS SHOWN.

SER. NO. 85-251,317, FILED P.R. 2-24-2011; AM. S.R. 1-10-2012.

CARYN GLASSER, EXAMINING ATTORNEY



David J. Kyjars

Director of the United States Patent and Trademark Office

United States of America

United States Patent and Trademark Office

America's Advocate for Women in Business

Reg. No. 4,110,413

Registered Mar. 6, 2012

Int. Cls.: 35 and 41

SERVICE MARK

SUPPLEMENTAL REGISTER

JESSICA EAVES MATHEWS (UNITED STATES INDIVIDUAL)
6565 AMERICAS PARKEWAY NE, SUITE 200
ALBUQUERQUE, NM 87110

FOR: ADVICE AND INFORMATION CONCERNING COMMERCIAL BUSINESS MANAGEMENT; ADVICE IN THE FIELD OF BUSINESS MANAGEMENT AND MARKETING; ADVICE RELATING TO THE ORGANISATION AND MANAGEMENT OF BUSINESS; ADVISORY SERVICES RELATING TO BUSINESS MANAGEMENT AND BUSINESS OPERATIONS; ARRANGING AND CONDUCTING BUSINESS CONFERENCES; ARRANGING AND CONDUCTING SPECIAL EVENTS FOR BUSINESS PURPOSES; ASSISTANCE AND ADVICE REGARDING BUSINESS ORGANIZATION AND MANAGEMENT; ASSISTANCE WITH BUSINESS MANAGEMENT AND PLANNING; ASSISTANCE, ADVISORY SERVICES AND CONSULTANCY WITH REGARD TO BUSINESS PLANNING, BUSINESS ANALYSIS, BUSINESS MANAGEMENT, AND BUSINESS ORGANIZATION; ASSISTANCE, ADVISORY SERVICES AND CONSULTANCY WITH REGARD TO BUSINESS PLANNING, BUSINESS ANALYSIS, BUSINESS MANAGEMENT, BUSINESS ORGANIZATION, MARKETING AND CUSTOMER ANALYSIS; BUSINESS ADMINISTRATION CONSULTANCY; BUSINESS ADVICE AND COMMERCIAL INFORMATION; BUSINESS ADVICE AND INFORMATION; BUSINESS ADVICE, INQUIRIES OR INFORMATION; BUSINESS ADVISORY SERVICES, CONSULTANCY AND INFORMATION; BUSINESS CONSULTATION; BUSINESS CONSULTATION AND MANAGEMENT REGARDING MARKETING ACTIVITIES AND LAUNCHING OF NEW PRODUCTS; BUSINESS CONSULTATION SERVICES; BUSINESS CONSULTING SERVICES, NAMELY, PROVIDING ASSISTANCE IN DEVELOPMENT OF BUSINESS STRATEGIES AND CREATIVE IDEATION; BUSINESS CONSULTING, INQUIRIES OR INFORMATION; BUSINESS CONSULTING, MANAGEMENT, PLANNING AND SUPERVISION; BUSINESS DEVELOPMENT CONSULTING SERVICES; BUSINESS EFFICIENCY ADVICE; BUSINESS MANAGEMENT ADVICE; BUSINESS MANAGEMENT CONSULTANCY AND ADVISORY SERVICES; BUSINESS MANAGEMENT CONSULTANCY SERVICES; BUSINESS MANAGEMENT CONSULTANCY, ALSO VIA THE INTERNET; BUSINESS MANAGEMENT CONSULTATION; BUSINESS MANAGEMENT CONSULTATION IN THE FIELD OF EXECUTIVE AND LEADERSHIP DEVELOPMENT; BUSINESS MANAGEMENT CONSULTING; BUSINESS MANAGEMENT CONSULTING AND ADVISORY SERVICES; BUSINESS MANAGEMENT CONSULTING WITH RELATION TO STRATEGY, MARKETING, PRODUCTION, PERSONNEL AND RETAIL SALE MATTERS; BUSINESS MARKETING CONSULTING SERVICES; BUSINESS NETWORKING; BUSINESS ORGANISATION AND MANAGEMENT CONSULTING SERVICES; BUSINESS ORGANISATION CONSULTING; BUSINESS ORGANIZATION ADVICE; BUSINESS ORGANIZATION AND MANAGEMENT



David J. Kyros

Director of the United States Patent and Trademark Office

Reg. No. 4,110,413 CONSULTANCY INCLUDING PERSONNEL MANAGEMENT; BUSINESS ORGANIZATION AND MANAGEMENT CONSULTING; BUSINESS ORGANIZATION AND OPERATION CONSULTANCY; BUSINESS ORGANIZATION CONSULTING; BUSINESS PLANNING; BUSINESS STRATEGIC PLANNING SERVICES; BUSINESS SUPPORT SERVICES, NAMELY, BUSINESS CONSULTING TO FREELANCERS, START-UPS, EXISTING BUSINESSES AND NON-PROFIT ORGANIZATIONS; CONSULTANCY AND ADVISORY SERVICES IN THE FIELD OF BUSINESS STRATEGY; CONSULTANCY SERVICES REGARDING BUSINESS STRATEGIES; CONSULTING IN THE FIELD OF SALES METHODS, SALES MANAGEMENT, AND SALES IMPROVEMENT; CONSULTING REGARDING INTELLECTUAL PROPERTY BUSINESS RISK MITIGATION PROCESSES; CONSULTING SERVICES IN BUSINESS LEADERSHIP DEVELOPMENT AND BUSINESS MANAGEMENT; CONSULTING SERVICES IN BUSINESS ORGANIZATION AND MANAGEMENT; CONSULTING SERVICES IN THE FIELD OF INTERNET MARKETING; CONSULTING SERVICES IN THE FIELDS OF BUSINESS MANAGEMENT, HUMAN RESOURCES, AND BUSINESS ORGANIZATIONAL DESIGN; GENERAL BUSINESS NETWORKING REFERRAL SERVICES, NAMELY, PROMOTING THE GOODS AND SERVICES OF OTHERS BY PASSING BUSINESS LEADS AND REFERRALS AMONG GROUP MEMBERS; INFORMATION AND EXPERT OPINIONS RELATING TO COMPANIES AND BUSINESS; INFORMATION IN BUSINESS MATTERS; INFORMATION OR ENQUIRIES ON BUSINESS AND MARKETING; INFORMATION, ADVISORY AND CONSULTANCY SERVICES RELATING TO BUSINESS AND MANAGEMENT OR BUSINESS ADMINISTRATION, INCLUDING SUCH SERVICES PROVIDED ON LINE OR VIA THE INTERNET; INFORMATION, ADVISORY, CONSULTING, BUSINESS RESEARCH AND PLANNING SERVICES RELATING TO PUBLICITY, MARKETING COMMUNICATIONS, REPUTATION MANAGEMENT OR BUSINESS ADMINISTRATION, INCLUDING SUCH SERVICES PROVIDED ONLINE OR VIA THE INTERNET; MARKETING CONSULTING; MEMBERSHIP CLUB SERVICES, NAMELY, PROVIDING ON-LINE INFORMATION TO MEMBERS IN THE FIELDS OF BRANDING, BUSINESS DEVELOPMENT, BUSINESS MARKETING, AND MARKETING; NEW BUSINESS VENTURE DEVELOPMENT AND FORMATION CONSULTING SERVICES; PROFESSIONAL BUSINESS CONSULTATION; PROFESSIONAL BUSINESS CONSULTING; PROVIDING AN ON-LINE COMPUTER DATABASE IN THE FIELD OF BUSINESS INFORMATION AND BUSINESS CONTACTS; PROVIDING BUSINESS INFORMATION, ALSO VIA INTERNET, THE CABLE NETWORK OR OTHER FORMS OF DATA TRANSFER; PROVIDING INFORMATION AND NEWS IN THE FIELD OF BUSINESS; PROVIDING ON-LINE BUSINESS INFORMATION OF OTHERS, NAMELY, ADVERTISEMENTS OR SOLICITATIONS; PROVIDING ORGANIZATIONAL DEVELOPMENT CONSULTING SERVICES; SOCIAL MEDIA STRATEGY AND MARKETING CONSULTANCY FOCUSING ON HELPING CLIENTS CREATE AND EXTEND THEIR PRODUCT AND BRAND STRATEGIES BY BUILDING VIRALLY ENGAGING MARKETING SOLUTIONS, IN CLASS 35 (U.S. CLS. 100, 101 AND 102).

FIRST USE 2-1-2010; IN COMMERCE 2-10-2010.

FOR: BUSINESS EDUCATION AND TRAINING SERVICES, NAMELY, DEVELOPING AND FACILITATING CUSTOMIZED LEADERSHIP AND EXECUTIVE DEVELOPMENT PROGRAMS, PROVIDING EXECUTIVE COACHING SERVICES, AND PROVIDING BUSINESS EDUCATION PROGRAMS TO EMPLOYEES AND EXECUTIVES; BUSINESS EDUCATION AND TRAINING SERVICES, NAMELY, DEVELOPING, AND FACILITATING CUSTOMIZED IN-COMPANY LEADERSHIP AND EXECUTIVE DEVELOPMENT PROGRAMS, PROVIDING EXECUTIVE COACHING SERVICES, AND PROVIDING PUBLIC AND IN-COMPANY KEYNOTE PRESENTATIONS TO BUSINESS LEADERS; BUSINESS TRAINING; BUSINESS TRAINING CONSULTANCY SERVICES; MEMBERSHIP CLUB SERVICES, NAMELY, PROVIDING TRAINING TO MEMBERS IN THE FIELD OF BUSINESS AND ENTREPRENEURSHIP; PROVIDING CONTINUING BUSINESS EDUCATION COURSES; TEACHING AND TRAINING IN BUSINESS, INDUSTRY AND INFORMATION TECHNOLOGY; TRAINING COURSES IN STRATEGIC PLANNING RELATING TO ADVERTISING, PROMOTION, MARKETING AND BUSINESS, IN CLASS 41 (U.S. CLS. 100, 101 AND 107).

FIRST USE 2-1-2010; IN COMMERCE 2-10-2010.

Reg. No. 4,110,413 THE MARK CONSISTS OF STANDARD CHARACTERS WITHOUT CLAIM TO ANY PARTICULAR FONT, STYLE, SIZE, OR COLOR.

SER. NO. 85-257,995, FILED P.R. 3-4-2011; AM. S.R. 12-6-2011.

ASMAT KHAN, EXAMINING ATTORNEY

United States of America

United States Patent and Trademark Office

Behavior Based Risk Analysis of Vicious Executables

Reg. No. 4,110,414

Registered Mar. 6, 2012

Int. Cl.: 9

TRADEMARK

SUPPLEMENTAL REGISTER

CAANES, LLC (NEW MEXICO LIMITED LIABILITY COMPANY)
7801 ACADEMY RD NE
BUILDING 1 SUITE 202
ALBUQUERQUE, NM 87109

FOR: COMPUTER SOFTWARE USED TO DETECT MALICIOUS CONTENT OVER GLOBAL
COMPUTER NETWORKS, IN CLASS 9 (U.S. CLS. 21, 23, 26, 36 AND 38).

FIRST USE 12-1-2011; IN COMMERCE 12-1-2011.

THE MARK CONSISTS OF STANDARD CHARACTERS WITHOUT CLAIM TO ANY PAR-
TICULAR FONT, STYLE, SIZE, OR COLOR.

SER. NO. 85-259,101, FILED P.R. 3-6-2011; AM. S.R. 1-10-2012.

TOBY BULLOFF, EXAMINING ATTORNEY



David J. Kyffers

Director of the United States Patent and Trademark Office

United States of America

United States Patent and Trademark Office

ChildAlert

Reg. No. 4,110,415

SCHUK CONCEPTS, INC (FLORIDA CORPORATION)
1330 SPRUCE AVE
ORLANDO, FL 32824

Registered Mar. 6, 2012

Int. Cl.: 9

FOR: ELECTRONIC DEVICES FOR MONITORING THE LOCATION OF CHILDREN, IN CLASS 9 (U.S. CLS. 21, 23, 26, 36 AND 38).

TRADEMARK

FIRST USE 11-1-2011; IN COMMERCE 11-15-2011.

SUPPLEMENTAL REGISTER

THE MARK CONSISTS OF STANDARD CHARACTERS WITHOUT CLAIM TO ANY PARTICULAR FONT, STYLE, SIZE, OR COLOR.

SER. NO. 85-259,677, FILED P.R. 3-7-2011; AM. S.R. 1-5-2012.

SUSAN RICHARDS, EXAMINING ATTORNEY



David J. Kybas

Director of the United States Patent and Trademark Office

United States of America

United States Patent and Trademark Office

Military Bible Association

Reg. No. 4,110,416

LINZEY, JAMES F. (UNITED STATES INDIVIDUAL)

Registered Mar. 6, 2012

#A
354 E. WASHINGTON AVE.
ESCONDIDO, CA 92025

Int. Cl.: 41

FOR: BOOK PUBLISHING, IN CLASS 41 (U.S. CLS. 100, 101 AND 107).

SERVICE MARK

FIRST USE 9-1-2007; IN COMMERCE 7-19-2009.

SUPPLEMENTAL REGISTER

THE MARK CONSISTS OF STANDARD CHARACTERS WITHOUT CLAIM TO ANY PARTICULAR FONT, STYLE, SIZE, OR COLOR.

SER. NO. 85-263,626, FILED P.R. 3-10-2011; AM. S.R. 1-4-2012.

STEVEN PEREZ, EXAMINING ATTORNEY



David J. Kybas

Director of the United States Patent and Trademark Office

United States of America
United States Patent and Trademark Office

TRAINER

Reg. No. 4,110,417

PFIP, LLC (NEW HAMPSHIRE LIMITED LIABILITY COMPANY)
26 FOX RUN ROAD
NEWINGTON, NH 03801

Registered Mar. 6, 2012

Int. Cl.: 25

FOR: CLOTHING, NAMELY, T-SHIRTS, IN CLASS 25 (U.S. CLS. 22 AND 39).

TRADEMARK

FIRST USE 3-2-2011; IN COMMERCE 3-2-2011.

SUPPLEMENTAL REGISTER

THE MARK CONSISTS OF STANDARD CHARACTERS WITHOUT CLAIM TO ANY PARTICULAR FONT, STYLE, SIZE, OR COLOR.

SER. NO. 85-263,682, FILED P.R. 3-10-2011; AM. S.R. 1-11-2012.

DANNEAN HETZEL, EXAMINING ATTORNEY



David J. Kybas

Director of the United States Patent and Trademark Office

United States of America

United States Patent and Trademark Office

CORPORATE RISK MITIGATOR

Reg. No. 4,110,418

Registered Mar. 6, 2012

Int. Cl.: 35

SERVICE MARK

SUPPLEMENTAL REGISTER

ROSEMARY MCDOWELL INTERNATIONAL, LLC (VIRGINIA LIMITED LIABILITY COMPANY)
10445 COURTNEY DRIVE
FAIRFAX, VA 22030

FOR: BUSINESS RISK MANAGEMENT CONSULTATION, IN CLASS 35 (U.S. CLS. 100, 101 AND 102).

FIRST USE 8-1-2010; IN COMMERCE 8-1-2010.

THE MARK CONSISTS OF STANDARD CHARACTERS WITHOUT CLAIM TO ANY PARTICULAR FONT, STYLE, SIZE, OR COLOR.

SER. NO. 85-265,953, FILED P.R. 3-14-2011; AM. S.R. 12-20-2011.

ANGELA M. MICHELI, EXAMINING ATTORNEY



David J. Kyffers

Director of the United States Patent and Trademark Office

United States of America

United States Patent and Trademark Office

BLENDING BOARD

Reg. No. 4,110,419

PAGE, PETER (UNITED STATES INDIVIDUAL)
2011 TESLA DRIVE
COLORADO SPRINGS, CO 809091450

Registered Mar. 6, 2012

Int. Cl.: 20

FOR: DISPLAY STANDS FEATURING CARDS FOR USE BY EDUCATORS, IN CLASS 20
(U.S. CLS. 2, 13, 22, 25, 32 AND 50).

TRADEMARK

FIRST USE 9-1-2007; IN COMMERCE 9-1-2007.

SUPPLEMENTAL REGISTER

THE MARK CONSISTS OF STANDARD CHARACTERS WITHOUT CLAIM TO ANY PARTICULAR FONT, STYLE, SIZE, OR COLOR.

SER. NO. 85-270,315, FILED P.R. 3-18-2011; AM. S.R. 12-16-2011.

GILBERT SWIFT, EXAMINING ATTORNEY



David J. Kybas

Director of the United States Patent and Trademark Office

United States of America

United States Patent and Trademark Office

MEDICAL MONOFILAMENT

Reg. No. 4,110,420

Registered Mar. 6, 2012

Int. Cl.: 10

TRADEMARK

SUPPLEMENTAL REGISTER

MEDICAL MONOFILAMENT MANUFACTURING, LLC (MASSACHUSETTS LIMITED LIABILITY COMPANY)
116 LONG POND ROAD
PLYMOUTH, MA 02360

FOR: MEDICAL DEVICE, NAMELY, PAPERBOARD HANDLE MONOFILAMENT INSTRUMENTS USED FOR SENSORY TESTING, IN CLASS 10 (U.S. CLS. 26, 39 AND 44).

FIRST USE 9-30-1999; IN COMMERCE 9-30-1999.

THE MARK CONSISTS OF STANDARD CHARACTERS WITHOUT CLAIM TO ANY PARTICULAR FONT, STYLE, SIZE, OR COLOR.

NO CLAIM IS MADE TO THE EXCLUSIVE RIGHT TO USE "MONOFILAMENT", APART FROM THE MARK AS SHOWN.

SER. NO. 85-270,444, FILED P.R. 3-18-2011; AM. S.R. 1-9-2012.

ALYSSA STEEL, EXAMINING ATTORNEY



David J. Kybas

Director of the United States Patent and Trademark Office

United States of America

United States Patent and Trademark Office

TIREPIX

Reg. No. 4,110,421

THE GOODYEAR TIRE & RUBBER COMPANY (OHIO CORPORATION)
1144 EAST MARKET STREET
AKRON, OH 443160001

Registered Mar. 6, 2012

Int. Cl.: 41

FOR: COMMERCIAL TRUCK TIRE DIGITAL IMAGING SERVICES, IN CLASS 41 (U.S. CLS. 100, 101 AND 107).

SERVICE MARK

FIRST USE 6-30-2011; IN COMMERCE 6-30-2011.

SUPPLEMENTAL REGISTER

THE MARK CONSISTS OF STANDARD CHARACTERS WITHOUT CLAIM TO ANY PARTICULAR FONT, STYLE, SIZE, OR COLOR.

SER. NO. 85-271,860, FILED P.R. 3-21-2011; AM. S.R. 12-14-2011.

TRACY CROSS, EXAMINING ATTORNEY



David J. Kyffers

Director of the United States Patent and Trademark Office

United States of America

United States Patent and Trademark Office

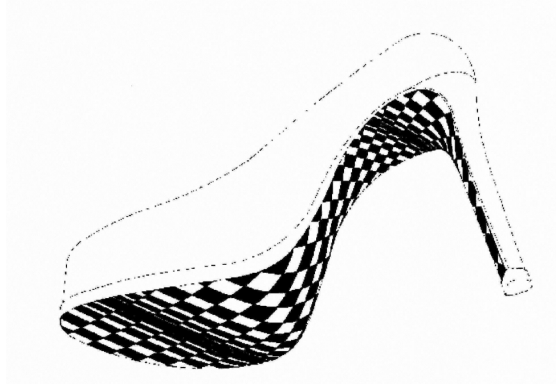

Reg. No. 4,110,422

Registered Mar. 6, 2012

Int. Cl.: 25

TRADEMARK

SUPPLEMENTAL REGISTER

PLV STUDIO, INC. (NEW YORK CORPORATION)
10 WEST 33RD STREET PH
NEW YORK, NY 10001

FOR: WOMEN'S FOOTWEAR, IN CLASS 25 (U.S. CLS. 22 AND 39).

FIRST USE 6-14-2011; IN COMMERCE 6-14-2011.

THE MARK CONSISTS OF A DISTORTED DIAGONAL CHECKER DESIGN ILLUSTRATING AN OPTICAL ILLUSION APPLIED TO THE SOLE, SHANK AND HEEL BREAST OF A WOMAN'S SHOE. THE DOTTED LINES ARE NOT PART OF THE MARK, BUT ARE INTENDED ONLY TO SHOW PLACEMENT OF THE MARK.

SER. NO. 85-272,603, FILED P.R. 3-21-2011; AM. S.R. 12-24-2011.

JENNIFER MARTIN, EXAMINING ATTORNEY



David J. Kybas

Director of the United States Patent and Trademark Office

United States of America

United States Patent and Trademark Office

PREACHING JESUS AS THE MANIFESTED WORD OF GOD!

Reg. No. 4,110,423

Registered Mar. 6, 2012

**Int. Cls.: 9, 16, 18, 38,
and 41**

TRADEMARK

SERVICE MARK

SUPPLEMENTAL REGISTER

WORD OF GOD MINISTRIES (LOUISIANA CORPORATION)
P.O. BOX 17794
6645 INDUSTRIAL LOOP
SHREVEPORT, LA 71129 AND

MCMENIS JAMES A (UNITED STATES INDIVIDUAL)
7851 OAK CREEK TRAIL
SHREVEPORT, LA 71129

FOR: DIGITAL MEDIA, NAMELY, PRE-RECORDED VIDEO CASSETTES, DIGITAL VIDEO DISCS, DIGITAL VERSATILE DISCS, DOWNLOADABLE AUDIO AND VIDEO RECORDINGS, DVDS, AND HIGH DEFINITION DIGITAL DISCS FEATURING BIBLICAL/CHRISTIAN TRUTHS; DVD CASES; DVD SLEEVES; DVDS FEATURING BIBLICAL/CHRISTIAN TRUTHS, IN CLASS 9 (U.S. CLS. 21, 23, 26, 36 AND 38).

FIRST USE 9-1-1994; IN COMMERCE 9-1-1994.

FOR: BALLPOINT PENS; BUMPER STICKERS; CARDS, NAMELY, BUSINESS CARDS, NOTE CARDS, GREETING CARDS; EDUCATIONAL KITS SOLD AS A UNIT IN THE FIELD OF BIBLICAL/CHRISTIAN TRUTHS CONSISTING PRIMARILY OF BOOKS AND ALSO INCLUDING DVDS; MAGAZINES FEATURING BIBLE BASED INSTRUCTION FOR EVERY AREA OF LIFE; STICKERS, IN CLASS 16 (U.S. CLS. 2, 5, 22, 23, 29, 37, 38 AND 50).

FIRST USE 9-1-1994; IN COMMERCE 9-1-1994.

FOR: MILITARY DUFFLE BAGS, GARMENT BAGS FOR TRAVEL, TOTE BAGS, SHOULDER BAGS AND BACKPACKS, IN CLASS 18 (U.S. CLS. 1, 2, 3, 22 AND 41).

FIRST USE 9-1-1994; IN COMMERCE 9-1-1994.

FOR: STREAMING OF AUDIO MATERIAL ON THE INTERNET; STREAMING OF VIDEO MATERIAL ON THE INTERNET, IN CLASS 38 (U.S. CLS. 100, 101 AND 104).

FIRST USE 9-1-1994; IN COMMERCE 9-1-1994.



David J. Kyffers

Director of the United States Patent and Trademark Office

Reg. No. 4,110,423 FOR: ENTERTAINMENT SERVICES, NAMELY, PROVIDING A WEB SITE FEATURING PHOTOGRAPHIC, AUDIO, VIDEO AND PROSE PRESENTATIONS FEATURING BIBLICAL/CHRISTIAN TRUTHS, IN CLASS 41 (U.S. CLS. 100, 101 AND 107).

FIRST USE 9-1-1994; IN COMMERCE 9-1-1994.

THE MARK CONSISTS OF STANDARD CHARACTERS WITHOUT CLAIM TO ANY PARTICULAR FONT, STYLE, SIZE, OR COLOR.

SER. NO. 85-273,228, FILED P.R. 3-22-2011; AM. S.R. 12-27-2011.

JASON TURNER, EXAMINING ATTORNEY

United States of America

United States Patent and Trademark Office

TAXI YOGA

Reg. No. 4,110,424

VOLLO, ANDREW (UNITED STATES INDIVIDUAL)
199-28 19TH AVENUE
WHITESTONE, NY 11357

Registered Mar. 6, 2012

Int. Cl.: 41

FOR: EDUCATION SERVICES, NAMELY, PROVIDING YOGA INSTRUCTIONAL SERVICES IN THE FIELD OF HEALTH ISSUES OF PROFESSIONAL DRIVERS, FOCUSING ON SUBTLE EXERCISES, PROPER BREATHING, RELAXATION, DIET AND POSITIVE THINKING, IN CLASS 41 (U.S. CLS. 100, 101 AND 107).

SERVICE MARK

SUPPLEMENTAL REGISTER FIRST USE 0-0-2004; IN COMMERCE 0-0-2004.

THE MARK CONSISTS OF STANDARD CHARACTERS WITHOUT CLAIM TO ANY PARTICULAR FONT, STYLE, SIZE, OR COLOR.

NO CLAIM IS MADE TO THE EXCLUSIVE RIGHT TO USE "YOGA", APART FROM THE MARK AS SHOWN.

SER. NO. 85-277,311, FILED P.R. 3-25-2011; AM. S.R. 12-26-2011.

TAMARA FRAZIER, EXAMINING ATTORNEY



David J. Kybas

Director of the United States Patent and Trademark Office

United States of America

United States Patent and Trademark Office

Pretty Practical Spaces

Reg. No. 4,110,425

Registered Mar. 6, 2012

Int. Cl.: 45

SERVICE MARK

SUPPLEMENTAL REGISTER

SMITHPETER, MICHELLE M (UNITED STATES INDIVIDUAL), DBA PRETTY PRACTICAL SPACES,
4255 LEHIGH AVE
HOUSTON, TX 77005

FOR: ORGANIZATIONAL SERVICES FOR HOME OR PERSONAL PURPOSES, NAMELY, ORGANIZING SPACES, ORGANIZING ITEMS, AND ORGANIZING OFFICES , IN CLASS 45 (U.S. CLS. 100 AND 101).

FIRST USE 2-23-2011; IN COMMERCE 3-5-2011.

THE MARK CONSISTS OF STANDARD CHARACTERS WITHOUT CLAIM TO ANY PARTICULAR FONT, STYLE, SIZE, OR COLOR.

NO CLAIM IS MADE TO THE EXCLUSIVE RIGHT TO USE "SPACES", APART FROM THE MARK AS SHOWN.

SER. NO. 85-277,998, FILED P.R. 3-27-2011; AM. S.R. 12-20-2011.

INGA ERVIN, EXAMINING ATTORNEY



David J. Kybas

Director of the United States Patent and Trademark Office

United States of America

United States Patent and Trademark Office

LOST & FOUND PETS AMERICA

Reg. No. 4,110,426

Registered Mar. 6, 2012

Int. Cl.: 35

SERVICE MARK

SUPPLEMENTAL REGISTER

LOST AND FOUND PETS AMERICA, L.L.C. (MARYLAND LIMITED LIABILITY COMPANY)
SUITE 600, PM 614
5425 WISCONSIN AVENUE
CHEVY CHASE, MD 20815

FOR: PROVIDING AN ONLINE SEARCHABLE DATABASE FEATURING CLASSIFIED AD LISTINGS ABOUT PETS, LOST PETS, FOUND PETS, SERVICES RELATED TO LOST PETS, AND PET CARE SERVICES; ONLINE ADVERTISING SERVICES FOR OTHERS, IN CLASS 35 (U.S. CLS. 100, 101 AND 102).

FIRST USE 4-1-2011; IN COMMERCE 4-1-2011.

THE MARK CONSISTS OF STANDARD CHARACTERS WITHOUT CLAIM TO ANY PARTICULAR FONT, STYLE, SIZE, OR COLOR.

NO CLAIM IS MADE TO THE EXCLUSIVE RIGHT TO USE "LOST & FOUND PETS", APART FROM THE MARK AS SHOWN.

SER. NO. 85-278,304, FILED P.R. 3-28-2011; AM. S.R. 12-22-2011.

KATHERINE STOIDES, EXAMINING ATTORNEY



David J. Kyros

Director of the United States Patent and Trademark Office

United States of America
United States Patent and Trademark Office

LashPrep

Reg. No. 4,110,427

LASHDIP, LLC (ILLINOIS LIMITED LIABILITY COMPANY)
110 EAST DELAWARE PLACE, SUITE 1101
CHICAGO, IL 60611487

Registered Mar. 6, 2012

Int. Cl.: 3

FOR: SEMI-PERMANENT COSMETIC PREPARATIONS FOR EYELASHES, IN CLASS 3
(U.S. CLS. 1, 4, 6, 50, 51 AND 52).

TRADEMARK

FIRST USE 10-31-2010; IN COMMERCE 10-31-2010.

SUPPLEMENTAL REGISTER

THE MARK CONSISTS OF STANDARD CHARACTERS WITHOUT CLAIM TO ANY PARTICULAR FONT, STYLE, SIZE, OR COLOR.

SER. NO. 85-278,830, FILED P.R. 3-28-2011; AM. S.R. 1-9-2012.

ANNE MADDEN, EXAMINING ATTORNEY



David J. Kybas

Director of the United States Patent and Trademark Office

United States of America

United States Patent and Trademark Office



Reg. No. 4,110,428

Registered Mar. 6, 2012

Int. Cl.: 25

TRADEMARK

SUPPLEMENTAL REGISTER

BARI BOOT COMPANY, INC. (NEW YORK CORPORATION)
1146 FRONT STREET
BINGHAMTON, NY 13905

FOR: BOOTS, IN CLASS 25 (U.S. CLS. 22 AND 39).

FIRST USE 9-15-2010; IN COMMERCE 9-15-2010.

THE MARK CONSISTS OF A THREE-DIMENSIONAL PRODUCT CONFIGURATION OF A BOOT RESEMBLING A BOOT USED FOR A HOCKEY SKATE, WHEREIN THE BOOT HAS A TOP TONGUE PORTION EXTENDING HIGHER THAN THE TOP ANKLE PORTION, A TOP REAR PORTION EXTENDING HIGHER THAN THE TOP ANKLE PORTION, AND AN EYELET PANEL EXTENDING FROM A TOE PORTION, ALONG AND BELOW THE TOP ANKLE PORTION, AND AROUND TO THE REAR OF THE BOOT, LEAVING A SPACE BETWEEN THE TOP REAR PORTION AND THE EYELET PANEL WHEREIN A DESIGN RESEMBLING A TENDON GUARD IS LOCATED AT THE REAR OF THE BOOT. THE DOTTED LINES SHOW THE POSITION OF THE MARK AND FORM NO PART OF THE MARK.

SER. NO. 85-278,844, FILED P.R. 3-28-2011; AM. S.R. 12-29-2011.

HEATHER THOMPSON, EXAMINING ATTORNEY



David J. Kybas

Director of the United States Patent and Trademark Office

United States of America
United States Patent and Trademark Office

LashSeal

Reg. No. 4,110,429

LASHDIP, LLC (ILLINOIS LIMITED LIABILITY COMPANY)
110 EAST DELAWARE PLACE, SUITE 1101
CHICAGO, IL 60611487

Registered Mar. 6, 2012

Int. Cl.: 3

FOR: SEMI-PERMANENT COSMETIC PREPARATIONS FOR EYELASHES, IN CLASS 3
(U.S. CLS. 1, 4, 6, 50, 51 AND 52).

TRADEMARK

FIRST USE 10-31-2010; IN COMMERCE 10-31-2010.

SUPPLEMENTAL REGISTER

THE MARK CONSISTS OF STANDARD CHARACTERS WITHOUT CLAIM TO ANY PARTICULAR FONT, STYLE, SIZE, OR COLOR.

SER. NO. 85-278,858, FILED P.R. 3-28-2011; AM. S.R. 1-9-2012.

ANNE MADDEN, EXAMINING ATTORNEY



David J. Kybas

Director of the United States Patent and Trademark Office

United States of America
United States Patent and Trademark Office

Sexstrology

Reg. No. 4,110,430

TERRY NAZON (UNITED STATES INDIVIDUAL), DBA TERRY NAZON INC,
107 SW 128TH AVE
PLANTATION, FL 33325

Registered Mar. 6, 2012

Int. Cl.: 45

FOR: ASTROLOGY HOROSCOPES, IN CLASS 45 (U.S. CLS. 100 AND 101).

SERVICE MARK

FIRST USE 1-21-2003; IN COMMERCE 1-21-2003.

SUPPLEMENTAL REGISTER

THE MARK CONSISTS OF STANDARD CHARACTERS WITHOUT CLAIM TO ANY PARTICULAR FONT, STYLE, SIZE, OR COLOR.

SER. NO. 85-278,919, FILED P.R. 3-30-2011; AM. S.R. 12-22-2011.

LIEF MARTIN, EXAMINING ATTORNEY



David J. Kyffers

Director of the United States Patent and Trademark Office

United States of America

United States Patent and Trademark Office

THE ORIGINAL CANDLE PAD FURNITURE PROTECTOR

Reg. No. 4,110,431

GIERE, CRAIG S (UNITED STATES INDIVIDUAL)
PO BOX 2429
RED OAK, TX 75154 AND

Registered Mar. 6, 2012

Int. Cl.: 20

GIERE, DANA L (UNITED STATES INDIVIDUAL)
PO BOX 2429
RED OAK, TX 75154

TRADEMARK

SUPPLEMENTAL REGISTER

FOR: PROTECTIVE COVERINGS FOR FURNITURE, NAMELY, PADS FOR SETTING
CANDLES ON FURNITURE, IN CLASS 20 (U.S. CLS. 2, 13, 22, 25, 32 AND 50).

FIRST USE 6-1-2005; IN COMMERCE 6-1-2005.

THE MARK CONSISTS OF STANDARD CHARACTERS WITHOUT CLAIM TO ANY PARTICULAR FONT, STYLE, SIZE, OR COLOR.

OWNER OF U.S. REG. NO. 3,323,918.

NO CLAIM IS MADE TO THE EXCLUSIVE RIGHT TO USE "PAD", APART FROM THE MARK AS SHOWN.

SER. NO. 85-279,295, FILED P.R. 3-29-2011; AM. S.R. 11-15-2011.

ANTHONY RINKER, EXAMINING ATTORNEY



David J. Kyffers

Director of the United States Patent and Trademark Office

United States of America

United States Patent and Trademark Office

THE ROID STORE

Reg. No. 4,110,432

DYNAMIC SPORTS NUTRITION, LLC (TEXAS LIMITED LIABILITY COMPANY)
1330 POST OAK BLVD., STE. 2900
HOUSTON, TX 77056

Registered Mar. 6, 2012

Int. Cl.: 35

FOR: ON-LINE RETAIL STORE SERVICES FEATURING DIETARY AND NUTRITIONAL SUPPLEMENTS; DISTRIBUTORSHIP SERVICES IN THE FIELD OF DIETARY AND NUTRITIONAL SUPPLEMENTS, IN CLASS 35 (U.S. CLS. 100, 101 AND 102).

SERVICE MARK

FIRST USE 10-1-2005; IN COMMERCE 10-1-2005.

SUPPLEMENTAL REGISTER

THE MARK CONSISTS OF STANDARD CHARACTERS WITHOUT CLAIM TO ANY PARTICULAR FONT, STYLE, SIZE, OR COLOR.

NO CLAIM IS MADE TO THE EXCLUSIVE RIGHT TO USE "STORE", APART FROM THE MARK AS SHOWN.

SER. NO. 85-281,366, FILED P.R. 3-30-2011; AM. S.R. 12-23-2011.

JOHN DWYER, EXAMINING ATTORNEY



David J. Kybas

Director of the United States Patent and Trademark Office

United States of America

United States Patent and Trademark Office

COON JOINT REPLACEMENT INSTITUTE

Reg. No. 4,110,433

ST. HELENA HOSPITAL (CALIFORNIA CORPORATION)
10 WOODLAND ROAD
ST. HELENA, CA 94574

Registered Mar. 6, 2012

Int. Cl.: 44

FOR: HEALTH CARE SERVICES, NAMELY, ORTHOPEDIC JOINT CARE, IN CLASS 44
(U.S. CLS. 100 AND 101).

SERVICE MARK

FIRST USE 10-0-2008; IN COMMERCE 1-0-2010.

SUPPLEMENTAL REGISTER

THE MARK CONSISTS OF STANDARD CHARACTERS WITHOUT CLAIM TO ANY PARTICULAR FONT, STYLE, SIZE, OR COLOR.

NO CLAIM IS MADE TO THE EXCLUSIVE RIGHT TO USE "JOINT REPLACEMENT INSTITUTE", APART FROM THE MARK AS SHOWN.

SER. NO. 85-282,966, FILED P.R. 3-31-2011; AM. S.R. 12-21-2011.

SUSAN LESLIE DUBOIS, EXAMINING ATTORNEY



David J. Kybas

Director of the United States Patent and Trademark Office

United States of America

United States Patent and Trademark Office

NO WAIT. ER

Reg. No. 4,110,434

ST. HELENA HOSPITAL (CALIFORNIA CORPORATION)
10 WOODLAND ROAD
ST. HELENA, CA 94574

Registered Mar. 6, 2012

Int. Cl.: 44

FOR: HEALTH CARE SERVICES, NAMELY, EMERGENCY MEDICAL CARE, IN CLASS 44
(U.S. CLS. 100 AND 101).

SERVICE MARK

FIRST USE 7-0-2009; IN COMMERCE 7-0-2009.

SUPPLEMENTAL REGISTER

THE MARK CONSISTS OF STANDARD CHARACTERS WITHOUT CLAIM TO ANY PARTICULAR FONT, STYLE, SIZE, OR COLOR.

NO CLAIM IS MADE TO THE EXCLUSIVE RIGHT TO USE "ER", APART FROM THE MARK AS SHOWN.

SER. NO. 85-282,979, FILED P.R. 3-31-2011; AM. S.R. 12-21-2011.

SUSAN LESLIE DUBOIS, EXAMINING ATTORNEY



David J. Kybas

Director of the United States Patent and Trademark Office

United States of America

United States Patent and Trademark Office

Soda Pop Shake

Reg. No. 4,110,435

FROST BITE, INCORPORATED (INDIANA CORPORATION)
7025 WEST GALEN DRIVE
AVON, IN 46123

Registered Mar. 6, 2012

Int. Cl.: 30

FOR: SHAKES, IN CLASS 30 (U.S. CL. 46).

TRADEMARK

FIRST USE 3-6-2011; IN COMMERCE 3-30-2011.

SUPPLEMENTAL REGISTER

THE MARK CONSISTS OF STANDARD CHARACTERS WITHOUT CLAIM TO ANY PARTICULAR FONT, STYLE, SIZE, OR COLOR.

NO CLAIM IS MADE TO THE EXCLUSIVE RIGHT TO USE "SHAKE", APART FROM THE MARK AS SHOWN.

SER. NO. 85-286,280, FILED P.R. 4-5-2011; AM. S.R. 1-6-2012.

AMY HELLA, EXAMINING ATTORNEY



David J. Kybas

Director of the United States Patent and Trademark Office

United States of America

United States Patent and Trademark Office

MISSION READY EQUIPMENT

Reg. No. 4,110,436

BLUE RIDGE MOUNTAIN SPORTS, LTD. (VIRGINIA CORPORATION)
24 CONESTOGA WAY
TROY, VA 23219

Registered Mar. 6, 2012

Int. Cl.: 25

FOR: CLOTHING, NAMELY, SHIRTS, IN CLASS 25 (U.S. CLS. 22 AND 39).

TRADEMARK

FIRST USE 10-31-2011; IN COMMERCE 10-31-2011.

SUPPLEMENTAL REGISTER

THE MARK CONSISTS OF STANDARD CHARACTERS WITHOUT CLAIM TO ANY PARTICULAR FONT, STYLE, SIZE, OR COLOR.

SER. NO. 85-286,725, FILED P.R. 4-5-2011; AM. S.R. 12-30-2011.

MAYUR VAGHANI, EXAMINING ATTORNEY



David J. Kybas

Director of the United States Patent and Trademark Office

United States of America

United States Patent and Trademark Office

COLLEGIATE BEADS

Reg. No. 4,110,437

COLLEGIATE BEAD CO. (MICHIGAN CORPORATION)
3417 ROCHESTER
ROYAL OAK, MI 48073

Registered Mar. 6, 2012

Int. Cl.: 14

FOR: JEWELRY, IN CLASS 14 (U.S. CLS. 2, 27, 28 AND 50).

TRADEMARK

FIRST USE 12-22-2010; IN COMMERCE 12-22-2010.

SUPPLEMENTAL REGISTER

THE MARK CONSISTS OF STANDARD CHARACTERS WITHOUT CLAIM TO ANY PARTICULAR FONT, STYLE, SIZE, OR COLOR.

NO CLAIM IS MADE TO THE EXCLUSIVE RIGHT TO USE "BEADS", APART FROM THE MARK AS SHOWN.

SER. NO. 85-287,189, FILED P.R. 4-5-2011; AM. S.R. 1-5-2012.

KAREN K. BUSH, EXAMINING ATTORNEY



David J. Kyffers

Director of the United States Patent and Trademark Office

United States of America

United States Patent and Trademark Office

FANCY SHAKES

Reg. No. 4,110,438

Registered Mar. 6, 2012

Int. Cl.: 30

TRADEMARK

SUPPLEMENTAL REGISTER

DAVID CHANG, LLC (NEW YORK LIMITED LIABILITY COMPANY)
SUITE 1211
853 BROADWAY
NEW YORK, NY 10003

FOR: FROZEN CONFECTIONS, MILK SHAKES AND FROZEN CUSTARD ALL CONTAINING ALCOHOL, IN CLASS 30 (U.S. CL. 46).

FIRST USE 8-15-2010; IN COMMERCE 8-15-2010.

THE MARK CONSISTS OF STANDARD CHARACTERS WITHOUT CLAIM TO ANY PARTICULAR FONT, STYLE, SIZE, OR COLOR.

NO CLAIM IS MADE TO THE EXCLUSIVE RIGHT TO USE "SHAKES", APART FROM THE MARK AS SHOWN.

SER. NO. 85-287,490, FILED P.R. 4-6-2011; AM. S.R. 1-13-2012.

B. PARADEWELAI, EXAMINING ATTORNEY



David J. Kyffers

Director of the United States Patent and Trademark Office

United States of America

United States Patent and Trademark Office

ORANGE COUNTY HAULING

Reg. No. 4,110,439

CHAPIN, KAREN (UNITED STATES INDIVIDUAL)

Registered Mar. 6, 2012

11H
30100 CROWN VALLEY PKWY
LAGUNA NIGUEL, CA 92677

Int. Cl.: 39

FOR: JUNK REMOVAL, IN CLASS 39 (U.S. CLS. 100 AND 105).

SERVICE MARK

FIRST USE 1-6-2006; IN COMMERCE 1-6-2006.

SUPPLEMENTAL REGISTER

THE MARK CONSISTS OF STANDARD CHARACTERS WITHOUT CLAIM TO ANY PARTICULAR FONT, STYLE, SIZE, OR COLOR.

NO CLAIM IS MADE TO THE EXCLUSIVE RIGHT TO USE "HAULING", APART FROM THE MARK AS SHOWN.

SER. NO. 85-289,576, FILED P.R. 4-7-2011; AM. S.R. 1-7-2012.

JOHN DWYER, EXAMINING ATTORNEY



David J. Kybas

Director of the United States Patent and Trademark Office

United States of America

United States Patent and Trademark Office

TRANSDERMAL CONTINUOUS O2 THERAPY

Reg. No. 4,110,440

Registered Mar. 6, 2012

Int. Cl.: 10

TRADEMARK

SUPPLEMENTAL REGISTER

NEOGENIX LLC (FLORIDA LIMITED LIABILITY COMPANY)
SUITE 102
2001 S.W. 20TH STREET
FORT LAUDERDALE, FL 33315

FOR: MEDICAL INSTRUMENT, NAMELY, AN ELECTRONIC MEDICAL APPLIANCE FOR
WOUND HEALING, IN CLASS 10 (U.S. CLS. 26, 39 AND 44).

FIRST USE 1-0-2009; IN COMMERCE 1-0-2009.

THE MARK CONSISTS OF STANDARD CHARACTERS WITHOUT CLAIM TO ANY PAR-
TICULAR FONT, STYLE, SIZE, OR COLOR.

SER. NO. 85-290,022, FILED P.R. 4-8-2011; AM. S.R. 1-12-2012.

JAY FLOWERS, EXAMINING ATTORNEY



David J. Kyffers

Director of the United States Patent and Trademark Office

United States of America

United States Patent and Trademark Office

ULTIMATE CULINARY CENTER

Reg. No. 4,110,441

Registered Mar. 6, 2012

Int. Cl.: 11

TRADEMARK

SUPPLEMENTAL REGISTER

BSH HOME APPLIANCES CORPORATION (DELAWARE CORPORATION)
5551 MCFADDEN AVENUE
HUNTINGTON BEACH, CA 92649

FOR: HOUSEHOLD AND KITCHEN MACHINES AND EQUIPMENT FOR HEATING, STEAM PRODUCING, AND COOKING IN THE NATURE OF COOKING, BAKING, FRYING, GRILLING, TOASTING, THAWING, AND HOT-KEEPING APPARATUS, NAMELY, ELECTRIC AND GAS RANGES; STRUCTURAL PARTS FOR ALL AFOREMENTIONED GOODS, IN CLASS 11 (U.S. CLS. 13, 21, 23, 31 AND 34).

FIRST USE 11-22-2011; IN COMMERCE 11-22-2011.

THE MARK CONSISTS OF STANDARD CHARACTERS WITHOUT CLAIM TO ANY PARTICULAR FONT, STYLE, SIZE, OR COLOR.

SER. NO. 85-292,828, FILED P.R. 4-12-2011; AM. S.R. 12-16-2011.

ALYSSA STEEL, EXAMINING ATTORNEY



David J. Kyffers

Director of the United States Patent and Trademark Office

United States of America

United States Patent and Trademark Office

YOURJEWISHNEWS.COM

Reg. No. 4,110,442

GROSS, YAKOV (UNITED STATES INDIVIDUAL)

Registered Mar. 6, 2012

1274 49 STREET #405
BROOKLYN, NY 11219

Int. Cl.: 41

FOR: PROVIDING A WEBSITE FEATURING ENTERTAINMENT IN THE NATURE OF INTERNET NEWS SHOWS; PROVIDING A WEBSITE FEATURING NEWS IN THE FIELD OF SPORTS AND ENTERTAINMENT; PROVIDING A WEBSITE FEATURING NEWS IN THE NATURE OF CURRENT EVENT REPORTING, IN CLASS 41 (U.S. CLS. 100, 101 AND 107).

SERVICE MARK

SUPPLEMENTAL REGISTER FIRST USE 1-1-2009; IN COMMERCE 1-1-2009.

THE MARK CONSISTS OF STANDARD CHARACTERS WITHOUT CLAIM TO ANY PARTICULAR FONT, STYLE, SIZE, OR COLOR.

SER. NO. 85-292,930, FILED P.R. 4-12-2011; AM. S.R. 1-17-2012.

CORY BOONE, EXAMINING ATTORNEY



David J. Kybas

Director of the United States Patent and Trademark Office

United States of America

United States Patent and Trademark Office

ULTRATHIN

Reg. No. 4,110,443

CREE, INC. (NORTH CAROLINA CORPORATION)
4600 SILICON DRIVE
DURHAM, NC 27703

Registered Mar. 6, 2012

Int. Cl.: 9

FOR: LIGHT EMITTING DIODES (LEDS), IN CLASS 9 (U.S. CLS. 21, 23, 26, 36 AND 38).

TRADEMARK

FIRST USE 7-12-2011; IN COMMERCE 7-12-2011.

SUPPLEMENTAL REGISTER

THE MARK CONSISTS OF STANDARD CHARACTERS WITHOUT CLAIM TO ANY PARTICULAR FONT, STYLE, SIZE, OR COLOR.

SER. NO. 85-293,231, FILED P.R. 4-12-2011; AM. S.R. 1-13-2012.

LIEF MARTIN, EXAMINING ATTORNEY



David J. Kybas

Director of the United States Patent and Trademark Office

United States of America

United States Patent and Trademark Office

FRESHSTOR

Reg. No. 4,110,444

SWANSON, GARY (UNITED STATES INDIVIDUAL)
2693 WHISPERING PINES DRIVE
GRAYSON, GA 30017

Registered Mar. 6, 2012

Int. Cl.: 34

FOR: HUMIDITY CONTROLLED STORAGE SYSTEMS, ALSO KNOWN AS HUMIDORS,
FOR SPECIALTY TOBACCO PRODUCTS, IN CLASS 34 (U.S. CLS. 2, 8, 9 AND 17).

TRADEMARK

FIRST USE 11-1-2011; IN COMMERCE 11-1-2011.

SUPPLEMENTAL REGISTER

THE MARK CONSISTS OF STANDARD CHARACTERS WITHOUT CLAIM TO ANY PARTICULAR FONT, STYLE, SIZE, OR COLOR.

SER. NO. 85-293,579, FILED P.R. 4-13-2011; AM. S.R. 12-14-2011.

RONALD AIKENS, EXAMINING ATTORNEY



David J. Kyros

Director of the United States Patent and Trademark Office

United States of America

United States Patent and Trademark Office

PAISLEY

Reg. No. 4,110,445

LE VIAN CORP. (NEW YORK CORPORATION)
235 GREAT NECK ROAD
GREAT NECK, NY 11021

Registered Mar. 6, 2012

Int. Cl.: 14

FOR: BRACELETS; EARRINGS; GEMS; JEWELRY; NECKLACES; PENDANTS; RINGS, IN CLASS 14 (U.S. CLS. 2, 27, 28 AND 50).

TRADEMARK

FIRST USE 1-1-2008; IN COMMERCE 5-1-2008.

SUPPLEMENTAL REGISTER

THE MARK CONSISTS OF STANDARD CHARACTERS WITHOUT CLAIM TO ANY PARTICULAR FONT, STYLE, SIZE, OR COLOR.

SER. NO. 85-294,360, FILED P.R. 4-13-2011; AM. S.R. 1-11-2012.

INGRID C. EULIN, EXAMINING ATTORNEY



David J. Kyffers

Director of the United States Patent and Trademark Office

United States of America

United States Patent and Trademark Office

COLOR ROOM

Reg. No. 4,110,446

Registered Mar. 6, 2012

Int. Cl.: 9

TRADEMARK

SUPPLEMENTAL REGISTER

SURETINT SYSTEMS, LLC (ILLINOIS LIMITED LIABILITY COMPANY)
500 SKOKIE BLVD., SUITE 280
NORTHBROOK, IL 60062

FOR: SOFTWARE IN THE FIELD OF BEAUTY SALON MANAGEMENT FOR MANAGING INVENTORY, CUSTOMERS, EMPLOYEES, TRACKING SALES, AND BEAUTY SALON SERVICES, IN CLASS 9 (U.S. CLS. 21, 23, 26, 36 AND 38).

FIRST USE 9-27-2011; IN COMMERCE 9-27-2011.

THE MARK CONSISTS OF STANDARD CHARACTERS WITHOUT CLAIM TO ANY PARTICULAR FONT, STYLE, SIZE, OR COLOR.

SER. NO. 85-297,628, FILED P.R. 4-18-2011; AM. S.R. 1-17-2012.

REBECCA POVARCHUK, EXAMINING ATTORNEY



David J. Kyffers

Director of the United States Patent and Trademark Office

United States of America
United States Patent and Trademark Office

SOLBERG

Reg. No. 4,110,447

MCWANE LUXEMBOURG IP S.A.R.L. (LUXEMBOURG CORPORATION)
412F, ROUTE D'ESCH
LUXEMBOURG, LUXEMBOURG L-2086

Registered Mar. 6, 2012

Int. Cls.: 1 and 9

FOR: FIRE EXTINGUISHING COMPOSITIONS, IN CLASS 1 (U.S. CLS. 1, 5, 6, 10, 26 AND 46).

TRADEMARK

FIRST USE 3-0-2011; IN COMMERCE 3-0-2011.

SUPPLEMENTAL REGISTER

FOR: FIRE-EXTINGUISHING SYSTEMS, IN CLASS 9 (U.S. CLS. 21, 23, 26, 36 AND 38).

FIRST USE 3-0-2011; IN COMMERCE 3-0-2011.

THE MARK CONSISTS OF STANDARD CHARACTERS WITHOUT CLAIM TO ANY PARTICULAR FONT, STYLE, SIZE, OR COLOR.

SER. NO. 85-298,681, FILED P.R. 4-19-2011; AM. S.R. 12-9-2011.

HELENE LIWINSKI, EXAMINING ATTORNEY



David J. Kybas

Director of the United States Patent and Trademark Office

United States of America

United States Patent and Trademark Office

CALI GAMES

Reg. No. 4,110,448

Registered Mar. 6, 2012

Int. Cl.: 35

SERVICE MARK

SUPPLEMENTAL REGISTER

CALI GAMES, INC. (CALIFORNIA CORPORATION)
14401 HAWTHORNE BOULEVARD
LAWNDALE, CA 90260

FOR: RETAIL, ONLINE AND MAIL ORDER STORE SERVICES FEATURING TOYS, ACTION FIGURES, COLLECTIBLE CARDS, COLLECTIBLE ACCESSORIES, BOOKS, CDS, AUDIO TAPES, INTERACTIVE TOYS, PUZZLES AND BOARD GAMES, PLUSH TOYS, CAMERAS, MP3 PLAYERS, CONSUMER ELECTRONICS AND ACCESSORIES, CELL PHONES AND ACCESSORIES, VIDEOS, VIDEO DISCS, DVDS, VHS TAPES, MOVIES, BOOKS, MAGAZINES, ELECTRONIC BOARD GAMES AND HAND-HELD ENTERTAINMENT DEVICES, IN CLASS 35 (U.S. CLS. 100, 101 AND 102).

FIRST USE 6-1-1991; IN COMMERCE 9-4-1993.

THE MARK CONSISTS OF STANDARD CHARACTERS WITHOUT CLAIM TO ANY PARTICULAR FONT, STYLE, SIZE, OR COLOR.

NO CLAIM IS MADE TO THE EXCLUSIVE RIGHT TO USE "GAMES" , APART FROM THE MARK AS SHOWN.

SER. NO. 85-298,714, FILED P.R. 4-19-2011; AM. S.R. 11-7-2011.

JEFF DEFORD, EXAMINING ATTORNEY



David J. Kyffers

Director of the United States Patent and Trademark Office

United States of America

United States Patent and Trademark Office

EXERCISE YOUR EYES

Reg. No. 4,110,449

EXERCISE YOUR EYES, INC. (CALIFORNIA CORPORATION)
35845 BEACH ROAD
CAPISTRANO BEACH, CA 92624

Registered Mar. 6, 2012

Int. Cl.: 10

FOR: VISION IMPROVEMENT APPARATUS CONSISTING OF SERIES OF LIGHTS ILLUMINATED IN PREDETERMINED PATTERNS, IN CLASS 10 (U.S. CLS. 26, 39 AND 44).

TRADEMARK

FIRST USE 3-26-2004; IN COMMERCE 3-26-2004.

SUPPLEMENTAL REGISTER

THE MARK CONSISTS OF STANDARD CHARACTERS WITHOUT CLAIM TO ANY PARTICULAR FONT, STYLE, SIZE, OR COLOR.

OWNER OF U.S. REG. NO. 2,946,952.

SER. NO. 85-298,718, FILED P.R. 4-19-2011; AM. S.R. 12-22-2011.

JEFF DEFORD, EXAMINING ATTORNEY



David J. Kyffers

Director of the United States Patent and Trademark Office

United States of America

United States Patent and Trademark Office

COSMETIC RADIO

Reg. No. 4,110,450

Registered Mar. 6, 2012

Int. Cl.: 41

SERVICE MARK

SUPPLEMENTAL REGISTER

FORRESTER CLINIC, S.C. (ILLINOIS CORPORATION), DBA FORRESTER CLINIC;
LIPOSUCTION AND COSMETIC SURGERY INSTITUTE,
1700 WEST CENTRAL ROAD
ARLINGTON HEIGHTS, IL 60005

FOR: EDUCATIONAL AND ENTERTAINMENT SERVICES, NAMELY, PROGRAMS CONCERNING PLASTIC SURGERY SERVICES AND BEAUTY CONSULTATION ACCESSIBLE BY RADIO, TELEVISION, SATELLITE, AUDIO, VIDEO AND COMPUTER NETWORKS, IN CLASS 41 (U.S. CLS. 100, 101 AND 107).

FIRST USE 12-1-2010; IN COMMERCE 1-1-2011.

THE MARK CONSISTS OF STANDARD CHARACTERS WITHOUT CLAIM TO ANY PARTICULAR FONT, STYLE, SIZE, OR COLOR.

NO CLAIM IS MADE TO THE EXCLUSIVE RIGHT TO USE "RADIO", APART FROM THE MARK AS SHOWN.

SER. NO. 85-299,064, FILED P.R. 4-19-2011; AM. S.R. 1-16-2012.

MARY CRAWFORD, EXAMINING ATTORNEY



David J. Kybas

Director of the United States Patent and Trademark Office

United States of America

United States Patent and Trademark Office

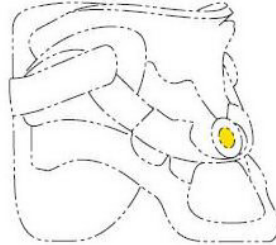

Reg. No. 4,110,451

ASPEN MEDICAL PRODUCTS, INC. (CALIFORNIA CORPORATION)
6481 OAK CANYON
IRVINE, CA 92618

Registered Mar. 6, 2012

Int. Cl.: 10

FOR: ORTHOTICS, NAMELY, SPINAL AND NECK IMMOBILIZATION DEVICES, IN CLASS 10 (U.S. CLS. 26, 39 AND 44).

TRADEMARK

FIRST USE 3-31-2007; IN COMMERCE 3-31-2007.

SUPPLEMENTAL REGISTER

THE MARK CONSISTS OF THE COLOR YELLOW AS APPLIED TO A PORTION OF AN ADJUSTMENT MECHANISM ON AN ORTHOTIC DEVICE. THE BROKEN LINES IN THE DRAWING ARE INTENDED TO SHOW THE POSITION OF THE MARK AND FORM NO FEATURE OF THE MARK.

THE COLOR(S) YELLOW IS/ARE CLAIMED AS A FEATURE OF THE MARK.

SER. NO. 85-299,288, FILED 4-19-2011.

HANNO RITTNER, EXAMINING ATTORNEY



David J. Kybas

Director of the United States Patent and Trademark Office

United States of America

United States Patent and Trademark Office

TCM FRAMEWORK

Reg. No. 4,110,452

AACE INTERNATIONAL, INC. (WEST VIRGINIA CORPORATION)
209 PRAIRIE AVENUE, SUITE 100
MORGANTOWN, WV 26501

Registered Mar. 6, 2012

Int. Cls.: 16 and 35

FOR: PUBLICATIONS, NAMELY, REFERENCE BOOKS, MANUALS AND TEXTBOOKS IN THE FIELDS OF COST MANAGEMENT AND COST ENGINEERING, IN CLASS 16 (U.S. CLS. 2, 5, 22, 23, 29, 37, 38 AND 50).

TRADEMARK

FIRST USE 6-1-2006; IN COMMERCE 6-1-2006.

SERVICE MARK

FOR: BUSINESS INFORMATION IN THE FIELD OF COST MANAGEMENT AND COST ENGINEERING, IN CLASS 35 (U.S. CLS. 100, 101 AND 102).

SUPPLEMENTAL REGISTER

FIRST USE 6-1-2006; IN COMMERCE 6-1-2006.

THE MARK CONSISTS OF STANDARD CHARACTERS WITHOUT CLAIM TO ANY PARTICULAR FONT, STYLE, SIZE, OR COLOR.

SER. NO. 85-299,546, FILED P.R. 4-20-2011; AM. S.R. 12-22-2011.

HEATHER THOMPSON, EXAMINING ATTORNEY



David J. Kybas

Director of the United States Patent and Trademark Office

United States of America

United States Patent and Trademark Office

APPROVED POSTAL PROVIDER

Reg. No. 4,110,453

Registered Mar. 6, 2012

Int. Cl.: 35

UNITED STATES POSTAL SERVICE (UNITED STATES INDEPENDENT ESTABLISHMENT OF THE EXECUTIVE BRANCH OF THE GOVERNMENT OF THE UNITED STATES OF AMERICA)

475 L'ENFANT PLAZA, SW
WASHINGTON, DC 202601136

SERVICE MARK

SUPPLEMENTAL REGISTER

FOR: RETAIL STORE SERVICES, FEATURING MAILING AND SHIPPING SUPPLIES, STAMPS AND PHILATELIC PRODUCTS; MAIL SERVICES FEATURING THE RECEIPT, SORTING AND HANDLING OF LETTERS AND PACKAGES FOR SUBSEQUENT PICKUP AND DELIVERY BY THE UNITED STATES POSTAL SERVICE, IN CLASS 35 (U.S. CLS. 100, 101 AND 102).

FIRST USE 1-13-2011; IN COMMERCE 1-13-2011.

THE MARK CONSISTS OF STANDARD CHARACTERS WITHOUT CLAIM TO ANY PARTICULAR FONT, STYLE, SIZE, OR COLOR.

SER. NO. 85-304,523, FILED P.R. 4-26-2011; AM. S.R. 11-23-2011.

JEFFERY COWARD, EXAMINING ATTORNEY



David J. Kybas

Director of the United States Patent and Trademark Office

United States of America

United States Patent and Trademark Office

UndiePads

Reg. No. 4,110,454

ILANIC SANITARY PRODUCTS, INC. (CALIFORNIA CORPORATION)
5966 TOPEKA DRIVE
TARZANA, CA 91356

Registered Mar. 6, 2012

Int. Cl.: 25

FOR: DISPOSABLE UNDERWEAR, IN CLASS 25 (U.S. CLS. 22 AND 39).

TRADEMARK

FIRST USE 8-1-2010; IN COMMERCE 8-1-2010.

SUPPLEMENTAL REGISTER

THE MARK CONSISTS OF STANDARD CHARACTERS WITHOUT CLAIM TO ANY PARTICULAR FONT, STYLE, SIZE, OR COLOR.

SER. NO. 85-311,558, FILED P.R. 5-3-2011; AM. S.R. 1-30-2012.

KAELIE KUNG, EXAMINING ATTORNEY



David J. Kyros

Director of the United States Patent and Trademark Office

United States of America

United States Patent and Trademark Office

ARUMATHERAPY

Reg. No. 4,110,455

Registered Mar. 6, 2012

Int. Cl.: 25

TRADEMARK

SUPPLEMENTAL REGISTER

RUM RUNNER PRESS, INC. (TEXAS CORPORATION)
107 ROCK CHALK COURT
ROUND ROCK, TX 78664

FOR: CLOTHING, NAMELY, JEANS, PANTS, SHORTS, OVERALLS, SHORTALLS, LEGGINGS, ROMPERS, JACKETS, COATS, SWEATSHIRTS, SWEATERS, T-SHIRTS, SHIRTS, VESTS, SKIRTS, DRESSES, SCARVES, CAPS, HATS, GLOVES, SOCKS, SHOES, TIGHTS, HOSIERY, SLEEPWEAR, APRONS, BATHING SUITS AND UNDERWEAR, IN CLASS 25 (U.S. CLS. 22 AND 39).

FIRST USE 4-1-2011; IN COMMERCE 5-1-2011.

THE MARK CONSISTS OF STANDARD CHARACTERS WITHOUT CLAIM TO ANY PARTICULAR FONT, STYLE, SIZE, OR COLOR.

SER. NO. 85-313,967, FILED P.R. 5-6-2011; AM. S.R. 1-14-2012.

TOBY BULLOFF, EXAMINING ATTORNEY



David J. Kybas

Director of the United States Patent and Trademark Office

United States of America

United States Patent and Trademark Office

Bay Area Toffee Company

Reg. No. 4,110,456

BAY AREA TOFFEE COMPANY LLC (CALIFORNIA LIMITED LIABILITY COMPANY)
7172 REGIONAL STREET, #327
DUBLIN, CA 94568

Registered Mar. 6, 2012

Int. Cl.: 30

FOR: TOFFEE, IN CLASS 30 (U.S. CL. 46).

TRADEMARK

FIRST USE 11-5-2011; IN COMMERCE 11-5-2011.

SUPPLEMENTAL REGISTER

THE MARK CONSISTS OF STANDARD CHARACTERS WITHOUT CLAIM TO ANY PARTICULAR FONT, STYLE, SIZE, OR COLOR.

NO CLAIM IS MADE TO THE EXCLUSIVE RIGHT TO USE "TOFFEE COMPANY", APART FROM THE MARK AS SHOWN.

SER. NO. 85-315,842, FILED P.R. 5-9-2011; AM. S.R. 12-29-2011.

CURTIS FRENCH, EXAMINING ATTORNEY



David J. Kybas

Director of the United States Patent and Trademark Office

United States of America

United States Patent and Trademark Office

CELLS ON DEMAND

Reg. No. 4,110,457

LONZA WALKERSVILLE, INC. (DELAWARE CORPORATION)
8830 BIGGS FORD ROAD
WALKERSVILLE, MD 217930127

Registered Mar. 6, 2012

Int. Cl.: 42

FOR: SCIENTIFIC LABORATORY SERVICES, IN CLASS 42 (U.S. CLS. 100 AND 101).

SERVICE MARK

FIRST USE 10-2-2009; IN COMMERCE 10-2-2009.

SUPPLEMENTAL REGISTER

THE MARK CONSISTS OF STANDARD CHARACTERS WITHOUT CLAIM TO ANY PARTICULAR FONT, STYLE, SIZE, OR COLOR.

SER. NO. 85-315,914, FILED P.R. 5-9-2011; AM. S.R. 1-10-2012.

MICHELLE DUBOIS, EXAMINING ATTORNEY



David J. Kybas

Director of the United States Patent and Trademark Office

United States of America

United States Patent and Trademark Office

CAMPUS COUNSEL

Reg. No. 4,110,458

Registered Mar. 6, 2012

Int. Cl.: 9

TRADEMARK

SUPPLEMENTAL REGISTER

SMITH MOORE LEATHERWOOD LLP (NORTH CAROLINA LIMITED LIABILITY PARTNERSHIP)
P.O. BOX 21927
GREENSBORO, NC 27420

FOR: DOWNLOADABLE ELECTRONIC NEWSLETTERS IN THE FIELD OF LEGAL MATTERS, IN CLASS 9 (U.S. CLS. 21, 23, 26, 36 AND 38).

FIRST USE 12-1-2011; IN COMMERCE 12-1-2011.

THE MARK CONSISTS OF STANDARD CHARACTERS WITHOUT CLAIM TO ANY PARTICULAR FONT, STYLE, SIZE, OR COLOR.

OWNER OF U.S. REG. NO. 2,953,983.

SER. NO. 85-319,510, FILED P.R. 5-12-2011; AM. S.R. 12-15-2011.

KAELIE KUNG, EXAMINING ATTORNEY



David J. Kyffers

Director of the United States Patent and Trademark Office

United States of America

United States Patent and Trademark Office

Improving quality through membrane technology

Reg. No. 4,110,459

ALLAN, JOEL (UNITED STATES INDIVIDUAL)
2336 SAN MIGUEL PLACE
SANTA ROSA, CA 95403

Registered Mar. 6, 2012

Int. Cl.: 40

FOR: PROVIDING ULTRAFILTRATION SERVICES, NAMELY, REMOVING UNDESIRABLE COLOR, FLAVOR, AND ASTRINGENCY IN WINES, FRUIT JUICES, AND NATURAL PHARMACEUTICAL, IN CLASS 40 (U.S. CLS. 100, 103 AND 106).

SERVICE MARK

FIRST USE 1-1-2011; IN COMMERCE 2-1-2011.

SUPPLEMENTAL REGISTER

THE MARK CONSISTS OF STANDARD CHARACTERS WITHOUT CLAIM TO ANY PARTICULAR FONT, STYLE, SIZE, OR COLOR.

SER. NO. 85-319,795, FILED P.R. 5-12-2011; AM. S.R. 1-12-2012.

H. M. FISHER, EXAMINING ATTORNEY



David J. Kybas

Director of the United States Patent and Trademark Office

United States of America

United States Patent and Trademark Office

WINE IN A GLASS OF ITS OWN

Reg. No. 4,110,460

Registered Mar. 6, 2012

Int. Cl.: 33

TRADEMARK

SUPPLEMENTAL REGISTER

STACKED WINES LLC (CALIFORNIA LIMITED LIABILITY COMPANY)
#105
300 CAGNEY LN.
NEWPORT BEACH, CA 92663

FOR: WINES AND SPARKLING WINES, IN CLASS 33 (U.S. CLS. 47 AND 49).

FIRST USE 12-1-2011; IN COMMERCE 12-1-2011.

THE MARK CONSISTS OF STANDARD CHARACTERS WITHOUT CLAIM TO ANY PARTICULAR FONT, STYLE, SIZE, OR COLOR.

SER. NO. 85-322,666, FILED P.R. 5-17-2011; AM. S.R. 1-4-2012.

JULIE WATSON, EXAMINING ATTORNEY



David J. Kybas

Director of the United States Patent and Trademark Office

United States of America

United States Patent and Trademark Office

Create A Cloud

Reg. No. 4,110,461

STRATEGIC SYSTEMS CONSULTING, INC. (GEORGIA CORPORATION)
7742 SPALDING DR. #363
NORCROSS, GA 30092

Registered Mar. 6, 2012

Int. Cl.: 9

FOR: COMPUTER APPLICATION SOFTWARE TO DEVELOP, MANAGE, SECURE AND OPERATE INFORMATION TECHNOLOGY INFRASTRUCTURE AND TO INTEGRATE ACCESS TO WEB SERVERS, WEB APPLICATIONS AND WEB SERVICES, IN CLASS 9 (U.S. CLS. 21, 23, 26, 36 AND 38).

TRADEMARK

SUPPLEMENTAL REGISTER FIRST USE 12-1-2010; IN COMMERCE 12-1-2010.

THE MARK CONSISTS OF STANDARD CHARACTERS WITHOUT CLAIM TO ANY PARTICULAR FONT, STYLE, SIZE, OR COLOR.

SER. NO. 85-332,775, FILED P.R. 5-27-2011; AM. S.R. 1-10-2012.

DEZMONA MIZELLE, EXAMINING ATTORNEY



David J. Kyffers

Director of the United States Patent and Trademark Office

United States of America

United States Patent and Trademark Office

The Roommate Broker

Reg. No. 4,110,462

Registered Mar. 6, 2012

Int. Cl.: 45

SERVICE MARK

SUPPLEMENTAL REGISTER

ROOMMATE HAPPY HOUR, LLC (NEW YORK LIMITED LIABILITY COMPANY)
SUITE 5D
327 E 101ST ST
NEW YORK, NY 10029

FOR: MATCHMAKING SERVICES, NAMELY, SEARCHING FOR COMPATIBLE ROOMMATES, IN CLASS 45 (U.S. CLS. 100 AND 101).

FIRST USE 9-24-2010; IN COMMERCE 12-1-2010.

THE MARK CONSISTS OF STANDARD CHARACTERS WITHOUT CLAIM TO ANY PARTICULAR FONT, STYLE, SIZE, OR COLOR.

NO CLAIM IS MADE TO THE EXCLUSIVE RIGHT TO USE "ROOMMATE", APART FROM THE MARK AS SHOWN.

SER. NO. 85-343,602, FILED P.R. 6-10-2011; AM. S.R. 1-18-2012.

STEPHANIE ALI, EXAMINING ATTORNEY



David J. Kybas

Director of the United States Patent and Trademark Office

United States of America

United States Patent and Trademark Office

Aromatherapy Brush Cleaner

Reg. No. 4,110,463

COZZETTE INC (NEW YORK CORPORATION), DBA COZZETTE INC,
311 WASHINGTON AVE, APT E1
BROOKLYN, NY 11205

Registered Mar. 6, 2012

Int. Cl.: 3

FOR: CLEANER FOR COSMETIC BRUSHES, IN CLASS 3 (U.S. CLS. 1, 4, 6, 50, 51 AND 52).

TRADEMARK

FIRST USE 1-1-2011; IN COMMERCE 6-3-2011.

SUPPLEMENTAL REGISTER

THE MARK CONSISTS OF STANDARD CHARACTERS WITHOUT CLAIM TO ANY PARTICULAR FONT, STYLE, SIZE, OR COLOR.

NO CLAIM IS MADE TO THE EXCLUSIVE RIGHT TO USE "BRUSH CLEANER", APART FROM THE MARK AS SHOWN.

SER. NO. 85-344,015, FILED P.R. 6-12-2011; AM. S.R. 1-11-2012.

ELLEN PERKINS, EXAMINING ATTORNEY



David J. Kyffers

Director of the United States Patent and Trademark Office

United States of America

United States Patent and Trademark Office

Fight Online Theft

Reg. No. 4,110,464

Registered Mar. 6, 2012

Int. Cl.: 35

SERVICE MARK

SUPPLEMENTAL REGISTER

THE CHAMBER OF COMMERCE OF THE UNITED STATES OF AMERICA (D.C. CORPORATION), AKA U. S. CHAMBER,
1615 H STREET, NW
WASHINGTON, DC 20062

FOR: ASSOCIATION SERVICES, NAMELY, PROMOTING THE INTERESTS OF BUSINESSMEN, BUSINESSWOMEN, AND INTELLECTUAL PROPERTY OWNERS AND RIGHTS HOLDERS; LOBBYING SERVICES, NAMELY, PROMOTING THE INTERESTS OF BUSINESSMEN, BUSINESSWOMEN, AND INTELLECTUAL PROPERTY OWNERS AND RIGHTS HOLDERS IN THE FIELDS OF LEGISLATION AND REGULATION; PUBLIC ADVOCACY TO PROMOTE AWARENESS OF THE IMPORTANCE OF INTELLECTUAL PROPERTY PROTECTION, INNOVATION, ANTI-COUNTERFEITING AND ANTI-PIRACY PROGRAMS, LEGISLATION AND INITIATIVES, IN CLASS 35 (U.S. CLS. 100, 101 AND 102).

FIRST USE 1-14-2011; IN COMMERCE 1-14-2011.

THE MARK CONSISTS OF STANDARD CHARACTERS WITHOUT CLAIM TO ANY PARTICULAR FONT, STYLE, SIZE, OR COLOR.

SER. NO. 85-352,785, FILED P.R. 6-22-2011; AM. S.R. 1-17-2012.

MICHELLE DUBOIS, EXAMINING ATTORNEY



David J. Kyffers

Director of the United States Patent and Trademark Office

United States of America

United States Patent and Trademark Office

PENHALL CO.
≡ CONCRETE SAWING ≡
≡ AND BREAKING ... ≡
EST. 1957

Reg. No. 4,110,465

PENHALL COMPANY (CALIFORNIA CORPORATION)
1801 PENHALL WAY
ANAHEIM, CA 92803

Registered Mar. 6, 2012

Int. Cl.: 25

FOR: CLOTHING, NAMELY, SHIRTS, T-SHIRTS AND SWEATSHIRTS, IN CLASS 25 (U.S. CLS. 22 AND 39).

TRADEMARK

FIRST USE 7-0-2011; IN COMMERCE 7-0-2011.

SUPPLEMENTAL REGISTER

OWNER OF U.S. REG. NOS. 1,942,840, 3,148,104, AND 3,929,995.

NO CLAIM IS MADE TO THE EXCLUSIVE RIGHT TO USE "CO." AND "EST. 1957", APART FROM THE MARK AS SHOWN.

THE MARK CONSISTS OF THE WORDS "PENHALL CO." SUPERIMPOSED OVER THE WORDS "CONCRETE SAWING AND BREAKING ..." PLACED IN STACKED FORMATION IN-BETWEEN FIVE HORIZONTAL LINES ON EITHER SIDE, WITH "EST. 1957" STACKED UNDERNEATH AND IN THE CENTER.

SER. NO. 85-357,589, FILED P.R. 6-27-2011; AM. S.R. 1-23-2012.

ZHALEH DELANEY, EXAMINING ATTORNEY



David J. Kyros

Director of the United States Patent and Trademark Office

United States of America

United States Patent and Trademark Office

SUPER SITE

Reg. No. 4,110,466

Registered Mar. 6, 2012

Int. Cl.: 45

JSMG WORLDWIDE, INC. (DELAWARE CORPORATION)
3401 SW 160TH AVENUE
SUITE 430
MIRAMAR, FL 33027

FOR: ON-LINE SOCIAL NETWORKING SERVICES, IN CLASS 45 (U.S. CLS. 100 AND 101).

SERVICE MARK

FIRST USE 6-22-2011; IN COMMERCE 6-22-2011.

SUPPLEMENTAL REGISTER

THE MARK CONSISTS OF STANDARD CHARACTERS WITHOUT CLAIM TO ANY PARTICULAR FONT, STYLE, SIZE, OR COLOR.

SER. NO. 85-362,104, FILED P.R. 7-1-2011; AM. S.R. 1-12-2012.

HEATHER BIDDULPH, EXAMINING ATTORNEY



David J. Kybas

Director of the United States Patent and Trademark Office

United States of America

United States Patent and Trademark Office

BRASSERIE DE MONACO

Reg. No. 4,110,467

Registered Mar. 6, 2012

**Int. Cls.: 29, 30, 32, 33,
and 43**

TRADEMARK

SERVICE MARK

SUPPLEMENTAL REGISTER

PALLANCA PASTOR, GILDO (MONACO INDIVIDUAL)
3 AVENUE PRINCESSE GRACE
MONACO, MONACO 98000

FOR: MEAT, FISH, POULTRY AND GAME; MEAT EXTRACTS; PRESERVED, DRIED AND COOKED FRUITS AND VEGETABLES; JELLIES, JAMS, STEWED FRUITS; EGGS, MILK AND MILK PRODUCTS EXCLUDING ICE CREAM, ICE MILK AND FROZEN YOGURT; EDIBLE OILS AND FATS, IN CLASS 29 (U.S. CL. 46).

FOR: COFFEE, TEA, COCOA, SUGAR, RICE, TAPIOCA, SAGO, ARTIFICIAL COFFEE; FLOUR AND PREPARATIONS MADE FROM CEREALS, NAMELY, BREAD, PASTRY AND CONFECTIONERY; EDIBLE ICES; HONEY, TREACLE; YEAST, BAKING-POWDER; SALT, MUSTARD; VINEGAR, SAUCES; EDIBLE SPICES; ICE, IN CLASS 30 (U.S. CL. 46).

FOR: BEERS; MINERAL AND AERATED WATERS AND OTHER NON-ALCOHOLIC DRINKS, NAMELY, CARBONATED BEVERAGES, BEVERAGES CONTAINING FRUIT JUICES; FRUIT DRINKS AND FRUIT JUICES; SYRUPS, CONCENTRATES, AND POWDERS FOR MAKING NON-ALCOHOLIC BEVERAGES; LEMONADES; FRUIT NECTARS; SOFT DRINKS, NAMELY, SODAS; APERITIFS WITHOUT ALCOHOL, IN CLASS 32 (U.S. CLS. 45, 46 AND 48).

FOR: ALCOHOLIC BEVERAGES EXCEPT BEERS; HARD CIDER; ALCOHOLIC BEVERAGES, NAMELY, DIGESTIFS; WINES; SPIRITS; ALCOHOLIC ESSENCES, ALCOHOLIC EXTRACTS, IN CLASS 33 (U.S. CLS. 47 AND 49).

FOR: RESTAURANT SERVICES; PROVIDING TEMPORARY ACCOMMODATION; BAR SERVICES; CATERING SERVICES; HOTEL SERVICES; MAKING RESERVATIONS AND BOOKINGS FOR OTHERS FOR ACCOMMODATIONS, IN CLASS 43 (U.S. CLS. 100 AND 101).

THE MARK CONSISTS OF STANDARD CHARACTERS WITHOUT CLAIM TO ANY PARTICULAR FONT, STYLE, SIZE, OR COLOR.

OWNER OF ERPN CMNTY TM OFC REG. NO. 007588908, DATED 8-7-2009, EXPIRES 8-7-2019.



David J. Kyros

Director of the United States Patent and Trademark Office

Reg. No. 4,110,467 NO CLAIM IS MADE TO THE EXCLUSIVE RIGHT TO USE "BRASSERIE" IN CONNECTION WITH "RESTAURANT SERVICES", "BAR SERVICES" AND "CATERING SERVICES", APART FROM THE MARK AS SHOWN.

THE ENGLISH TRANSLATION OF "BRASSERIE DE MONACO" IN THE MARK IS "BREWERY OF MONACO".

SER. NO. 85-363,179, FILED P.R. 7-5-2011; AM. S.R. 1-12-2012.

KEVIN DINALLO, EXAMINING ATTORNEY

United States of America

United States Patent and Trademark Office

BIERE DE MONACO

Reg. No. 4,110,468

PALLANCA PASTOR, GILDO (MONACO INDIVIDUAL)
3 AVENUE PRINCESSE GRACE
MONACO, MONACO 98000

Registered Mar. 6, 2012

Int. Cls.: 32 and 43

FOR: BEERS, IN CLASS 32 (U.S. CLS. 45, 46 AND 48).

TRADEMARK

FOR: RESTAURANT SERVICES; PROVIDING TEMPORARY ACCOMMODATION; BAR SERVICES; CATERING SERVICES; HOTEL SERVICES; MAKING RESERVATIONS AND BOOKINGS FOR OTHERS FOR ACCOMMODATIONS, IN CLASS 43 (U.S. CLS. 100 AND 101).

SERVICE MARK

SUPPLEMENTAL REGISTER

THE MARK CONSISTS OF STANDARD CHARACTERS WITHOUT CLAIM TO ANY PARTICULAR FONT, STYLE, SIZE, OR COLOR.

OWNER OF ERPN CMNTY TM OFC REG. NO. 007588957, DATED 9-20-2010, EXPIRES 9-20-2020.

NO CLAIM IS MADE TO THE EXCLUSIVE RIGHT TO USE "BIERE" IN INTERNATIONAL CLASS 32, APART FROM THE MARK AS SHOWN.

THE ENGLISH TRANSLATION OF "BIERE DE MONACO" IN THE MARK IS "BEER OF MONACO".

SER. NO. 85-363,196, FILED P.R. 7-5-2011; AM. S.R. 1-12-2012.

KEVIN DINALLO, EXAMINING ATTORNEY



David J. Kybas

Director of the United States Patent and Trademark Office

United States of America

United States Patent and Trademark Office

FATKID

Reg. No. 4,110,469

CHRISTOPHER SERPAS (CALIFORNIA LIMITED LIABILITY COMPANY)
16302 PARTHENIA
NORTH HILLS, CA 91343

Registered Mar. 6, 2012

Int. Cl.: 25

FOR: T-SHIRTS, IN CLASS 25 (U.S. CLS. 22 AND 39).

TRADEMARK

FIRST USE 8-1-2010; IN COMMERCE 8-15-2010.

SUPPLEMENTAL REGISTER

THE MARK CONSISTS OF STANDARD CHARACTERS WITHOUT CLAIM TO ANY PARTICULAR FONT, STYLE, SIZE, OR COLOR.

SER. NO. 85-363,265, FILED P.R. 7-5-2011; AM. S.R. 1-2-2012.

INGA ERVIN, EXAMINING ATTORNEY



David J. Kybas

Director of the United States Patent and Trademark Office

United States of America

United States Patent and Trademark Office

CONVERT

Reg. No. 4,110,470

SEIDIO, INC. (TEXAS CORPORATION)
875 PROSPECT, SUITE 305
LA JOLLA, CA 92037

Registered Mar. 6, 2012

Int. Cl.: 9

FOR: HOLDERS FOR CELLULAR PHONES, NAMELY, PROTECTIVE CASES AND HOLDERS, IN CLASS 9 (U.S. CLS. 21, 23, 26, 36 AND 38).

TRADEMARK

FIRST USE 4-20-2011; IN COMMERCE 4-20-2011.

SUPPLEMENTAL REGISTER

THE MARK CONSISTS OF STANDARD CHARACTERS WITHOUT CLAIM TO ANY PARTICULAR FONT, STYLE, SIZE, OR COLOR.

SER. NO. 85-364,580, FILED P.R. 7-6-2011; AM. S.R. 1-25-2012.

TASNEEM HUSSAIN, EXAMINING ATTORNEY



David J. Kybas

Director of the United States Patent and Trademark Office

United States of America

United States Patent and Trademark Office

Thin Technologies

Reg. No. 4,110,471

Registered Mar. 6, 2012

Int. Cl.: 42

SERVICE MARK

SUPPLEMENTAL REGISTER

NACK, INC. (WASHINGTON CORPORATION), DBA THIN TECHNOLOGIES, INC.,
BLUE FLAG BUILDING; SUITE 305
104 SOUTH FREYA STREET
SPOKANE, WA 99202

FOR: SOFTWARE AND COMPUTING SERVICES, NAMELY, SOFTWARE DEVELOPMENT, CUSTOMIZATION, IMPLEMENTATION AND MAINTENANCE; COMPUTER SOFTWARE TECHNICAL SUPPORT SERVICES, NAMELY, TROUBLESHOOTING OF COMPUTER SOFTWARE PROBLEMS; INFORMATION TECHNOLOGY CONSULTING SERVICES IN THE FIELD OF SYSTEM DESIGN, ASSESSMENT, SELECTION, IMPLEMENTATION, INTEGRATION, ADMINISTRATION, MANAGEMENT, AND THE USE OF COMPUTERS AND SOFTWARE SYSTEMS FOR OTHERS; INFORMATION TECHNOLOGY CONSULTATION IN THE FIELD OF DATA MANAGEMENT, STORAGE, SHARING, TRANSMISSION, REPLICATION, CACHING, SECURING, DUPLICATION, ENTERPRISE STORAGE IMPLEMENTATION AND MIGRATION, SERVER CONSOLIDATION AND VIRTUALIZATION, DATA CENTER RELOCATION, BACKUP STRATEGIES, DISASTER RECOVERY PLANNING, CLOUD COMPUTING, ENTERPRISE STORAGE, IP NETWORKING, AND SYSTEM HOSTING OF DIGITAL CONTENT AND COMPUTER SOFTWARE APPLICATIONS ON A GLOBAL COMPUTER NETWORK OR A LOCAL AREA NETWORK, IN CLASS 42 (U.S. CLS. 100 AND 101).

FIRST USE 1-10-2010; IN COMMERCE 3-16-2010.

THE MARK CONSISTS OF STANDARD CHARACTERS WITHOUT CLAIM TO ANY PARTICULAR FONT, STYLE, SIZE, OR COLOR.

NO CLAIM IS MADE TO THE EXCLUSIVE RIGHT TO USE "TECHNOLOGIES", APART FROM THE MARK AS SHOWN.

SER. NO. 85-369,621, FILED P.R. 7-12-2011; AM. S.R. 1-31-2012.

TRACY WHITTAKER-BROWN, EXAMINING ATTORNEY



David J. Kyffers

Director of the United States Patent and Trademark Office

United States of America

United States Patent and Trademark Office

The Original No-Clip, Non-Slip Concealment Product

Reg. No. 4,110,472

REMORA CONCEALMENT AND SECURITY PRODUCTS LLC (FLORIDA LIMITED
LIABILITY COMPANY)

Registered Mar. 6, 2012

408 PANAY AVE
NAPLES, FL 22314

Int. Cl.: 13

FOR: HOLSTERS FOR FIREARMS, IN CLASS 13 (U.S. CLS. 2 AND 9).

TRADEMARK

FIRST USE 10-15-2009; IN COMMERCE 10-15-2009.

SUPPLEMENTAL REGISTER

THE MARK CONSISTS OF STANDARD CHARACTERS WITHOUT CLAIM TO ANY PARTICULAR FONT, STYLE, SIZE, OR COLOR.

SER. NO. 85-370,632, FILED P.R. 7-13-2011; AM. S.R. 11-2-2011.

KAREN K. BUSH, EXAMINING ATTORNEY



David J. Kyffers

Director of the United States Patent and Trademark Office

United States of America
United States Patent and Trademark Office

Megashield

Reg. No. 4,110,473

Registered Mar. 6, 2012

Int. Cl.: 17

BADDAH NASSER AI ZAGHRODT EST (SAUDI ARABIA CORPORATION)
C.R1010224652 P.O BOX 21432 CODE NO11942
RYADAH-AL-GHORABE BIN SALMAH ST.
RYADAH-CITY, SAUDI ARABIA

FOR: POLYESTER WINDOW FILM, IN CLASS 17 (U.S. CLS. 1, 5, 12, 13, 35 AND 50).

TRADEMARK

FIRST USE 11-1-2010; IN COMMERCE 11-1-2010.

SUPPLEMENTAL REGISTER

THE MARK CONSISTS OF STANDARD CHARACTERS WITHOUT CLAIM TO ANY PARTICULAR FONT, STYLE, SIZE, OR COLOR.

SER. NO. 85-370,838, FILED P.R. 7-13-2011; AM. S.R. 1-12-2012.

MAYUR VAGHANI, EXAMINING ATTORNEY



David J. Kyffers

Director of the United States Patent and Trademark Office

United States of America

United States Patent and Trademark Office

RADIATOR CENTER

Reg. No. 4,110,474

RADIATOR ZONE CORPORATION (CALIFORNIA CORPORATION)
5146 CEDROS AVENUE
SHERMAN OAKS, CA 91403

Registered Mar. 6, 2012

Int. Cl.: 35

FOR: WHOLESALE AND RETAIL STORE SERVICES FEATURING AUTOMOTIVE HEATING AND COOLING SYSTEM PARTS, NAMELY, RADIATORS AND AIR CONDITIONING CONDENSERS, IN CLASS 35 (U.S. CLS. 100, 101 AND 102).

SERVICE MARK

FIRST USE 6-15-2011; IN COMMERCE 6-15-2011.

SUPPLEMENTAL REGISTER

THE MARK CONSISTS OF STANDARD CHARACTERS WITHOUT CLAIM TO ANY PARTICULAR FONT, STYLE, SIZE, OR COLOR.

NO CLAIM IS MADE TO THE EXCLUSIVE RIGHT TO USE "RADIATOR", APART FROM THE MARK AS SHOWN.

SER. NO. 85-374,099, FILED P.R. 7-18-2011; AM. S.R. 1-11-2012.

JEFF DEFORD, EXAMINING ATTORNEY



David J. Kypos

Director of the United States Patent and Trademark Office

United States of America

United States Patent and Trademark Office

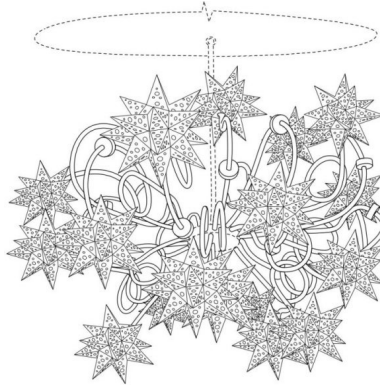

Reg. No. 4,110,475

TACO TAVERN, LLC (FLORIDA LIMITED LIABILITY COMPANY)
400 CLEMATIS STREET, SUITE 209
WEST PALM BEACH, FL 33401

Registered Mar. 6, 2012

Int. Cl.: 43

FOR: RESTAURANT AND BAR SERVICES, IN CLASS 43 (U.S. CLS. 100 AND 101).

SERVICE MARK

FIRST USE 12-10-2007; IN COMMERCE 12-10-2007.

SUPPLEMENTAL REGISTER

THE MARK CONSISTS OF A THREE-DIMENSIONAL CONFIGURATION OF A LIGHT FIXTURE DISPLAYED IN THE RESTAURANT DINING ROOM AND BAR. THE LIGHT FIXTURE IS A METAL CHANDELIER THAT CONSISTS OF A SERIES OF MULTI-POINTED STAR-SHAPED ORNAMENTS WITH SMALL PUNCHED-OUT DESIGNS THROUGH WHICH LIGHT EMANATES. THE STAR-SHAPED ORNAMENTS ARE LOCATED AT THE TIPS OF THE CURVED RODS OR LOOPS THAT EXTEND FROM THE MIDDLE OF THE FIXTURE AT ITS BASE. THE FIXTURE HANGS FROM THE CEILING. THE DOTTED LINES ARE NOT PART OF THE MARK AND SERVE TO SHOW THE POSITION OR PLACEMENT OF THE MARK.

SER. NO. 85-376,109, FILED P.R. 7-20-2011; AM. S.R. 12-28-2011.

GISELLE AGOSTO, EXAMINING ATTORNEY



David J. Kybas

Director of the United States Patent and Trademark Office

United States of America

United States Patent and Trademark Office

EXAGGERATORS Big Wave Surf Crew

Reg. No. 4,110,476

DAVID PINES (UNITED STATES INDIVIDUAL)
11841 EDGEWOOD LN
GARDEN GROVE, CA 92840

Registered Mar. 6, 2012

Int. Cl.: 25

FOR: ATHLETIC APPAREL, NAMELY, SHIRTS, PANTS, JACKETS, FOOTWEAR, HATS AND CAPS, ATHLETIC UNIFORMS, IN CLASS 25 (U.S. CLS. 22 AND 39).

TRADEMARK

FIRST USE 12-12-2004; IN COMMERCE 2-12-2005.

SUPPLEMENTAL REGISTER

THE MARK CONSISTS OF STANDARD CHARACTERS WITHOUT CLAIM TO ANY PARTICULAR FONT, STYLE, SIZE, OR COLOR.

NO CLAIM IS MADE TO THE EXCLUSIVE RIGHT TO USE "SURF", APART FROM THE MARK AS SHOWN.

SER. NO. 85-386,349, FILED P.R. 8-1-2011; AM. S.R. 1-4-2012.

LAURA KOVALSKY, EXAMINING ATTORNEY



David J. Kybas

Director of the United States Patent and Trademark Office

United States of America

United States Patent and Trademark Office

mat7 Don't Judge!

Reg. No. 4,110,477

BARKHORDAR, VALERIE (UNITED STATES INDIVIDUAL)
#112

Registered Mar. 6, 2012

1275 N. SWEETZER AVE
WEST HOLLYWOOD, CA 90069

Int. Cl.: 25

FOR: HATS; SHIRTS; SHOES; T-SHIRTS, IN CLASS 25 (U.S. CLS. 22 AND 39).

TRADEMARK

FIRST USE 6-20-2011; IN COMMERCE 7-6-2011.

SUPPLEMENTAL REGISTER

THE MARK CONSISTS OF STANDARD CHARACTERS WITHOUT CLAIM TO ANY PARTICULAR FONT, STYLE, SIZE, OR COLOR.

SER. NO. 85-390,063, FILED P.R. 8-4-2011; AM. S.R. 1-18-2012.

ELIZABETH KAJUBI, EXAMINING ATTORNEY



David J. Kybas

Director of the United States Patent and Trademark Office

United States of America

United States Patent and Trademark Office

HOLLOW ROLLER

Reg. No. 4,110,478

CARTER PRODUCTS CO., INC. (MICHIGAN CORPORATION)
2871 NORTHRIDGE DRIVE NW
GRAND RAPIDS, MI 49544

Registered Mar. 6, 2012

Int. Cl.: 7

FOR: LATHE TOOLS, NAMELY, VESSEL TURNING CUTTING TOOL, IN CLASS 7 (U.S. CLS. 13, 19, 21, 23, 31, 34 AND 35).

TRADEMARK

FIRST USE 5-30-2011; IN COMMERCE 5-30-2011.

SUPPLEMENTAL REGISTER

THE MARK CONSISTS OF STANDARD CHARACTERS WITHOUT CLAIM TO ANY PARTICULAR FONT, STYLE, SIZE, OR COLOR.

SER. NO. 85-390,624, FILED P.R. 8-5-2011; AM. S.R. 1-16-2012.

APRIL ROACH, EXAMINING ATTORNEY



David J. Kyfos

Director of the United States Patent and Trademark Office

United States of America

United States Patent and Trademark Office

Conscious Acts Of Kindness

Reg. No. 4,110,479

ORTIZ, JOAQUIN (UNITED STATES INDIVIDUAL)
9199 SW 97TH AVE.
MIAMI, FL 33176

Registered Mar. 6, 2012

Int. Cl.: 35

FOR: PROMOTING THE CONSCIOUS ACTS OF KINDNESS OF OTHERS, IN CLASS 35 (U.S. CLS. 100, 101 AND 102).

SERVICE MARK

FIRST USE 2-10-2011; IN COMMERCE 2-10-2011.

SUPPLEMENTAL REGISTER

THE MARK CONSISTS OF STANDARD CHARACTERS WITHOUT CLAIM TO ANY PARTICULAR FONT, STYLE, SIZE, OR COLOR.

SER. NO. 85-391,884, FILED P.R. 8-8-2011; AM. S.R. 12-14-2011.

MICHELE SWAIN, EXAMINING ATTORNEY



David J. Kybas

Director of the United States Patent and Trademark Office

United States of America

United States Patent and Trademark Office

Dynamic Log Analysis

Reg. No. 4,110,480

CLEAR TECHNOLOGIES, INC, (TEXAS CORPORATION)
1199 S. BELT LINE RD, SUITE 120
COPPELL, TX 75019

Registered Mar. 6, 2012

Int. Cl.: 9

FOR: COMPUTER PROGRAMS FOR MONITORING INTRUSION TO COMPUTER NETWORKS AND DEVICES, IN CLASS 9 (U.S. CLS. 21, 23, 26, 36 AND 38).

TRADEMARK

FIRST USE 3-1-2010; IN COMMERCE 3-1-2010.

SUPPLEMENTAL REGISTER

THE MARK CONSISTS OF STANDARD CHARACTERS WITHOUT CLAIM TO ANY PARTICULAR FONT, STYLE, SIZE, OR COLOR.

SER. NO. 85-392,634, FILED P.R. 8-8-2011; AM. S.R. 1-25-2012.

MICHAEL SOUDERS, EXAMINING ATTORNEY



David J. Kybas

Director of the United States Patent and Trademark Office

United States of America

United States Patent and Trademark Office

THE SAN DIEGO SOUL FOOD FESTIVAL

Reg. No. 4,110,481

EDWARDS, ERIC (UNITED STATES INDIVIDUAL)
3030 SUNCREST DRIVE #706
SAN DIEGO, CA 92116

Registered Mar. 6, 2012

Int. Cl.: 41

FOR: CONDUCTING ENTERTAINMENT EXHIBITIONS IN THE NATURE OF SOUL FOOD FESTIVALS, IN CLASS 41 (U.S. CLS. 100, 101 AND 107).

SERVICE MARK

FIRST USE 8-8-2011; IN COMMERCE 8-8-2011.

SUPPLEMENTAL REGISTER

THE MARK CONSISTS OF STANDARD CHARACTERS WITHOUT CLAIM TO ANY PARTICULAR FONT, STYLE, SIZE, OR COLOR.

NO CLAIM IS MADE TO THE EXCLUSIVE RIGHT TO USE "FESTIVAL", APART FROM THE MARK AS SHOWN.

SER. NO. 85-394,037, FILED P.R. 8-10-2011; AM. S.R. 1-6-2012.

JULIE WATSON, EXAMINING ATTORNEY



David J. Kybas

Director of the United States Patent and Trademark Office

United States of America

United States Patent and Trademark Office



Reg. No. 4,110,482

Registered Mar. 6, 2012

Int. Cls.: 16, 35, and 41

THIS LAND PRESS, LLC (OKLAHOMA LIMITED LIABILITY COMPANY)
1208 SOUTH PEORIA AVENUE
TULSA, OK 74120

FOR: PRINTED MATTER IN THE NATURE OF BROADSHEETS IN THE FIELD OF CURRENT EVENTS, IN CLASS 16 (U.S. CLS. 2, 5, 22, 23, 29, 37, 38 AND 50).

TRADEMARK

FIRST USE 5-1-2010; IN COMMERCE 5-1-2010.

SERVICE MARK

FOR: ADVERTISING SERVICES; AND PROMOTING THE SERVICES OF OTHERS BY PREPARING AND PLACING ADVERTISEMENTS IN ON-LINE PUBLICATIONS, IN CLASS 35 (U.S. CLS. 100, 101 AND 102).

SUPPLEMENTAL REGISTER

FIRST USE 5-1-2010; IN COMMERCE 5-1-2010.

FOR: PROVIDING ON-LINE PUBLICATIONS IN THE NATURE OF BROADSHEETS IN THE FIELD OF CURRENT EVENTS; DIGITAL VIDEO, AUDIO, AND MULTIMEDIA PUBLISHING SERVICES; MULTIMEDIA PUBLISHING OF DIGITAL VIDEO AND AUDIO, PRINTED MATTER IN THE NATURE OF BROADSHEETS, AND ELECTRONIC PUBLICATIONS, IN CLASS 41 (U.S. CLS. 100, 101 AND 107).

FIRST USE 6-28-2009; IN COMMERCE 6-28-2009.

THE MARK CONSISTS OF AN IMAGE OF THE STATE OF OKLAHOMA INSIDE A CIRCLE WITHIN ANOTHER CIRCLE USED AS A THIN BORDER.

SER. NO. 85-395,573, FILED P.R. 8-11-2011; AM. S.R. 1-9-2012.

JENNIFER VASQUEZ, EXAMINING ATTORNEY



David J. Kyros

Director of the United States Patent and Trademark Office

United States of America

United States Patent and Trademark Office

LOCAL ARTISAN

Reg. No. 4,110,483

SODEXO OPERATIONS, LLC (DELAWARE LIMITED LIABILITY COMPANY)
9801 WASHINGTONIAN BOULEVARD
GAITHERSBURG, MD 20878

Registered Mar. 6, 2012

Int. Cl.: 43

FOR: CONTRACT FOOD SERVICES; RESTAURANT SERVICES; SERVING FOOD AND DRINKS, IN CLASS 43 (U.S. CLS. 100 AND 101).

SERVICE MARK

FIRST USE 9-0-2011; IN COMMERCE 9-0-2011.

SUPPLEMENTAL REGISTER

THE MARK CONSISTS OF STANDARD CHARACTERS WITHOUT CLAIM TO ANY PARTICULAR FONT, STYLE, SIZE, OR COLOR.

SER. NO. 85-397,640, FILED P.R. 8-15-2011; AM. S.R. 1-4-2012.

MELISSA VALLILLO, EXAMINING ATTORNEY



David J. Kybas

Director of the United States Patent and Trademark Office

United States of America

United States Patent and Trademark Office

AGRICULTURE'S PROFESSIONAL FUNNY MAN

Reg. No. 4,110,484

MASON, DAMIAN (UNITED STATES INDIVIDUAL)
5638 WEST 600 NORTH
HUNTINGTON, IN 46750

Registered Mar. 6, 2012

Int. Cl.: 41

FOR: EDUCATIONAL AND ENTERTAINMENT SERVICES, NAMELY, PROVIDING MOTIVATIONAL SPEAKING SERVICES IN THE FIELD OF AGRICULTURE; ENTERTAINMENT SERVICES IN THE NATURE OF COMEDY SHOWS, IN CLASS 41 (U.S. CLS. 100, 101 AND 107).

SERVICE MARK

SUPPLEMENTAL REGISTER FIRST USE 4-30-2011; IN COMMERCE 4-30-2011.

THE MARK CONSISTS OF STANDARD CHARACTERS WITHOUT CLAIM TO ANY PARTICULAR FONT, STYLE, SIZE, OR COLOR.

SER. NO. 85-399,795, FILED P.R. 8-17-2011; AM. S.R. 1-17-2012.

SAIMA MAKHDOOM, EXAMINING ATTORNEY



David J. Kybas

Director of the United States Patent and Trademark Office

United States of America

United States Patent and Trademark Office

BIRD-DETER

Reg. No. 4,110,485

GLOTZBACH, GREGG (UNITED STATES INDIVIDUAL)
432 JUSTINE AVENUE
BOLINGBROOK, IL 604402221

Registered Mar. 6, 2012

Int. Cl.: 20

FOR: AN APPARATUS CONSISTING OF BIRD REPELLANT SPIKES OF POLYCARBONATE RESIN, IN CLASS 20 (U.S. CLS. 2, 13, 22, 25, 32 AND 50).

TRADEMARK

FIRST USE 5-1-2010; IN COMMERCE 10-22-2010.

SUPPLEMENTAL REGISTER

THE MARK CONSISTS OF STANDARD CHARACTERS WITHOUT CLAIM TO ANY PARTICULAR FONT, STYLE, SIZE, OR COLOR.

SER. NO. 85-401,663, FILED P.R. 8-18-2011; AM. S.R. 1-10-2012.

DANNEAN HETZEL, EXAMINING ATTORNEY



David J. Kybas

Director of the United States Patent and Trademark Office

United States of America

United States Patent and Trademark Office

BeautyAdvisor

Reg. No. 4,110,486

LEARNSOMETHING, INC. (FLORIDA CORPORATION)
2457 CARE DRIVE

Registered Mar. 6, 2012

TALLAHASSEE, FL 32308

Int. Cl.: 41

FOR: DISSEMINATION OF EDUCATIONAL MATERIALS OF MANUFACTURERS VIA A GLOBAL COMPUTER NETWORK TO MAKE ONLINE VIDEO COURSES AVAILABLE TO RETAILERS REGARDING NEW BEAUTY AND PERSONAL CARE PRODUCTS AND FEATURES, IN CLASS 41 (U.S. CLS. 100, 101 AND 107).

SERVICE MARK

SUPPLEMENTAL REGISTER FIRST USE 2-17-2011; IN COMMERCE 2-17-2011.

THE MARK CONSISTS OF STANDARD CHARACTERS WITHOUT CLAIM TO ANY PARTICULAR FONT, STYLE, SIZE, OR COLOR.

SER. NO. 85-403,222, FILED P.R. 8-21-2011; AM. S.R. 1-6-2012.

NICHOLAS ALTREE, EXAMINING ATTORNEY



David J. Kyffers

Director of the United States Patent and Trademark Office

United States of America

United States Patent and Trademark Office

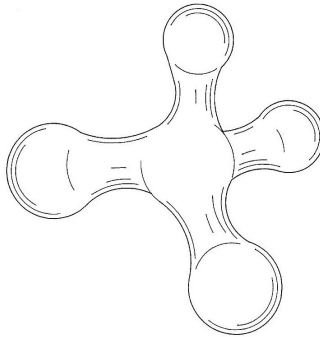

Reg. No. 4,110,487

Registered Mar. 6, 2012

Int. Cl.: 28

TRADEMARK

SUPPLEMENTAL REGISTER

THE PRESSURE POSITIVE CO. (PENNSYLVANIA CORPORATION)
128 OBERHOLTZER RD.
GILBERTSVILLE, PA 19525

FOR: PET TOYS, IN CLASS 28 (U.S. CLS. 22, 23, 38 AND 50).

FIRST USE 8-1-2010; IN COMMERCE 8-1-2010.

THE MARK CONSISTS OF THE OF FOUR ROUNDED EXTENSIONS EACH WITH A CIRCULAR END PROTRUDING FROM A CENTRAL POINT.

SER. NO. 85-404,955, FILED P.R. 8-23-2011; AM. S.R. 1-4-2012.

MARGERY A. TIERNEY, EXAMINING ATTORNEY



David J. Kybas

Director of the United States Patent and Trademark Office

United States of America

United States Patent and Trademark Office

INCONTINENCE DIRECT

Reg. No. 4,110,488

Registered Mar. 6, 2012

Int. Cl.: 35

SERVICE MARK

SUPPLEMENTAL REGISTER

INCONTINENCE DIRECT LLC (OHIO LIMITED LIABILITY COMPANY)
SUITE C
884 STRATFORD RD
DELAWARE, OH 43015

FOR: PROVIDING A WEBSITE FEATURING ONLINE RETAIL STORE SERVICES FEATURING INCONTINENCE SUPPLIES AND MOBILITY MEDICAL EQUIPMENT; PROVIDING A WEBSITE FEATURING ONLINE ADVERTISEMENTS OF INCONTINENCE SUPPLIES AND MOBILITY MEDICAL EQUIPMENT, IN CLASS 35 (U.S. CLS. 100, 101 AND 102).

FIRST USE 8-0-2010; IN COMMERCE 8-0-2010.

THE MARK CONSISTS OF STANDARD CHARACTERS WITHOUT CLAIM TO ANY PARTICULAR FONT, STYLE, SIZE, OR COLOR.

NO CLAIM IS MADE TO THE EXCLUSIVE RIGHT TO USE "INCONTINENCE", APART FROM THE MARK AS SHOWN.

SER. NO. 85-405,456, FILED P.R. 8-24-2011; AM. S.R. 1-10-2012.

STEVEN JACKSON, EXAMINING ATTORNEY



David J. Kyfos

Director of the United States Patent and Trademark Office

United States of America

United States Patent and Trademark Office

Premiere Hot Tubs

Reg. No. 4,110,489

Registered Mar. 6, 2012

Int. Cl.: 11

TRADEMARK

SUPPLEMENTAL REGISTER

PREMIERE HOT TUBS, INC. (TEXAS CORPORATION)
7601 RIALTO BLVD., APT. 2628
AUSTIN, TX 787357401

FOR: HOT TUBS, IN CLASS 11 (U.S. CLS. 13, 21, 23, 31 AND 34).

FIRST USE 2-11-2009; IN COMMERCE 2-11-2009.

THE MARK CONSISTS OF STANDARD CHARACTERS WITHOUT CLAIM TO ANY PARTICULAR FONT, STYLE, SIZE, OR COLOR.

NO CLAIM IS MADE TO THE EXCLUSIVE RIGHT TO USE "HOT TUBS", APART FROM THE MARK AS SHOWN.

SER. NO. 85-405,933, FILED P.R. 8-24-2011; AM. S.R. 12-31-2011.

GISELLE AGOSTO, EXAMINING ATTORNEY



David J. Kyffers

Director of the United States Patent and Trademark Office

United States of America

United States Patent and Trademark Office

METAL ROOF SAME PRICE AS SHINGLES

Reg. No. 4,110,490

HIPPO ROOFING, INC. (NEVADA CORPORATION)
1555 N. HARBOR CITY BLVD.
MELBOURNE, FL 32935

Registered Mar. 6, 2012

Int. Cl.: 37

FOR: ROOFING CONTRACTING; ROOFING INSTALLATION; ROOFING REPAIR; INSTALLATION OF BUILDING INSULATION, SOFFITS, SIDING, FASCIA, SKY LIGHTS AND SOLAR LIGHTING, IN CLASS 37 (U.S. CLS. 100, 103 AND 106).

SERVICE MARK

FIRST USE 3-0-2011; IN COMMERCE 3-0-2011.

SUPPLEMENTAL REGISTER

THE MARK CONSISTS OF STANDARD CHARACTERS WITHOUT CLAIM TO ANY PARTICULAR FONT, STYLE, SIZE, OR COLOR.

SER. NO. 85-406,909, FILED P.R. 8-25-2011; AM. S.R. 12-22-2011.

NATALIE POLZER, EXAMINING ATTORNEY



David J. Kybas

Director of the United States Patent and Trademark Office

United States of America

United States Patent and Trademark Office

DFWINSURANCE.COM

Reg. No. 4,110,491

WMS INSURANCE GROUP, INC. (TEXAS CORPORATION), DBA DFWINSURANCE.COM,
1701 NORTH GREENVILLE AVE., SUITE 201
RICHARDSON, TX 75081

Registered Mar. 6, 2012

Int. Cl.: 36

FOR: INSURANCE AGENCY AND BROKERAGE, IN CLASS 36 (U.S. CLS. 100, 101 AND 102).

SERVICE MARK

FIRST USE 8-1-2011; IN COMMERCE 8-1-2011.

SUPPLEMENTAL REGISTER

THE MARK CONSISTS OF STANDARD CHARACTERS WITHOUT CLAIM TO ANY PARTICULAR FONT, STYLE, SIZE, OR COLOR.

SER. NO. 85-407,379, FILED P.R. 8-25-2011; AM. S.R. 1-13-2012.

JENNIFER VASQUEZ, EXAMINING ATTORNEY



David J. Kybas

Director of the United States Patent and Trademark Office

United States of America

United States Patent and Trademark Office

Dilf Squad

Reg. No. 4,110,492

NICKELE, JAMES (UNITED STATES INDIVIDUAL)
415 COUNTRY LANE
GLENVIEW, IL 60025

Registered Mar. 6, 2012

Int. Cl.: 25

FOR: HEADBANDS; JERSEYS; SOCKS; TANK-TOPS, IN CLASS 25 (U.S. CLS. 22 AND 39).

TRADEMARK

FIRST USE 4-1-2010; IN COMMERCE 4-1-2010.

SUPPLEMENTAL REGISTER

THE MARK CONSISTS OF STANDARD CHARACTERS WITHOUT CLAIM TO ANY PARTICULAR FONT, STYLE, SIZE, OR COLOR.

SER. NO. 85-412,205, FILED P.R. 8-31-2011; AM. S.R. 1-10-2012.

JULIE GUTTADAURO, EXAMINING ATTORNEY



David J. Kybas

Director of the United States Patent and Trademark Office

United States of America

United States Patent and Trademark Office

THE GRIDIRON POOL

Reg. No. 4,110,493

Registered Mar. 6, 2012

Int. Cl.: 41

SERVICE MARK

SUPPLEMENTAL REGISTER

STORDAHL, JEFFREY (UNITED STATES INDIVIDUAL)
22531 MARLIN PLACE
WEST HILLS, CA 91307

FOR: ENTERTAINMENT SERVICES, NAMELY, PROVIDING AN INTERNET WEB SITE FEATURING FANTASY SPORTS AND FOOTBALL BASED GAMES, IN CLASS 41 (U.S. CLS. 100, 101 AND 107).

FIRST USE 7-11-2001; IN COMMERCE 9-9-2001.

THE MARK CONSISTS OF STANDARD CHARACTERS WITHOUT CLAIM TO ANY PARTICULAR FONT, STYLE, SIZE, OR COLOR.

NO CLAIM IS MADE TO THE EXCLUSIVE RIGHT TO USE "POOL", APART FROM THE MARK AS SHOWN.

SER. NO. 85-413,468, FILED P.R. 9-1-2011; AM. S.R. 1-10-2012.

JOHN KELLY, EXAMINING ATTORNEY



David J. Kybas

Director of the United States Patent and Trademark Office

United States of America

United States Patent and Trademark Office



Reg. No. 4,110,494

Registered Mar. 6, 2012

Int. Cl.: 20

TRADEMARK

SUPPLEMENTAL REGISTER

REZQPETS (TEXAS LIMITED LIABILITY COMPANY)
8131 BENT MEADOW DRIVE
CONVERSE, TX 78109

FOR: PLACARDS OF WOOD OR PLASTIC WHERE USERS CAN INDICATE PET INFORMATION TO HELP AID FIRE RESCUE PERSONNEL IN KNOWING AND SEARCHING FOR THE PETS INHABITING THE HOME, IN CLASS 20 (U.S. CLS. 2, 13, 22, 25, 32 AND 50).

FIRST USE 2-19-2009; IN COMMERCE 3-3-2009.

NO CLAIM IS MADE TO THE EXCLUSIVE RIGHT TO USE "RESCUE PETS", APART FROM THE MARK AS SHOWN.

THE MARK CONSISTS OF SILHOUETTES OF A CAT AND DOG ABOVE THE TEXT "REZ Q PETS", AND THE TEXT "THEY'RE PEOPLE TOO" BELOW AND RIGHT JUSTIFIED.

SER. NO. 85-415,330, FILED P.R. 9-6-2011; AM. S.R. 1-12-2012.

AMY ALFIERI, EXAMINING ATTORNEY



David J. Kybas

Director of the United States Patent and Trademark Office

United States of America

United States Patent and Trademark Office

AUTO ILEAD

Reg. No. 4,110,495

Registered Mar. 6, 2012

Int. Cl.: 35

SERVICE MARK

SUPPLEMENTAL REGISTER

AUTO ILEAD, INC. (IOWA CORPORATION)
SUITE 110-350
809 WHEELER ST.
AMES, IA 50010

FOR: CONSULTING IN THE FIELD OF SALES METHODS, SALES MANAGEMENT, AND SALES IMPROVEMENT; CUSTOMER SERVICES, NAMELY, RESPONDING TO CUSTOMERS INQUIRIES FOR OTHERS IN THE FIELD OF INTERNET SALES OF AUTOMOBILES VIA TELEPHONE OR OTHER ELECTRONIC MEANS, IN CLASS 35 (U.S. CLS. 100, 101 AND 102).

FIRST USE 8-23-2011; IN COMMERCE 8-23-2011.

THE MARK CONSISTS OF STANDARD CHARACTERS WITHOUT CLAIM TO ANY PARTICULAR FONT, STYLE, SIZE, OR COLOR.

SER. NO. 85-417,382, FILED P.R. 9-8-2011; AM. S.R. 1-10-2012.

ELLEN BURNS, EXAMINING ATTORNEY



David J. Kyffers

Director of the United States Patent and Trademark Office

United States of America

United States Patent and Trademark Office

MISSOURI MUSIC HALL OF FAME

Reg. No. 4,110,496

ST. JOSEPH MUSIC FOUNDATION (MISSOURI NON-PROFIT CORPORATION)
2603 FREDERICK

Registered Mar. 6, 2012

ST. JOSEPH, MO 64506

Int. Cl.: 41

FOR: MUSEUM SERVICES, IN CLASS 41 (U.S. CLS. 100, 101 AND 107).

SERVICE MARK

FIRST USE 8-24-2010; IN COMMERCE 8-24-2010.

SUPPLEMENTAL REGISTER

THE MARK CONSISTS OF STANDARD CHARACTERS WITHOUT CLAIM TO ANY PARTICULAR FONT, STYLE, SIZE, OR COLOR.

NO CLAIM IS MADE TO THE EXCLUSIVE RIGHT TO USE "MUSIC HALL OF FAME", APART FROM THE MARK AS SHOWN.

SER. NO. 85-417,510, FILED P.R. 9-8-2011; AM. S.R. 1-12-2012.

JOHN KELLY, EXAMINING ATTORNEY



David J. Kybas

Director of the United States Patent and Trademark Office

United States of America

United States Patent and Trademark Office

WEATHER^EZATION

Reg. No. 4,110,497

EXTERIOR ELEVATIONS, LLC (DELAWARE LIMITED LIABILITY COMPANY)
6825 N. LINCOLN AVE
LINCOLNWOOD, IL 60712

Registered Mar. 6, 2012

Int. Cl.: 37

FOR: CUSTOM CONSTRUCTION AND BUILDING RENOVATION; RENOVATION IN THE FIELD OF SPECIALIZED EXTERIOR RENOVATIONS OF HOMES, IN CLASS 37 (U.S. CLS. 100, 103 AND 106).

SERVICE MARK

FIRST USE 2-1-2010; IN COMMERCE 2-1-2010.

SUPPLEMENTAL REGISTER

THE MARK CONSISTS OF A RAISED LETTER "E" IN A CONTRASTING COLOR BETWEEN THE LETTERS "WEATHER" AND "ZATION".

SER. NO. 85-417,515, FILED P.R. 9-8-2011; AM. S.R. 1-11-2012.

DAWN FELDMAN, EXAMINING ATTORNEY



David J. Kyros

Director of the United States Patent and Trademark Office

United States of America

United States Patent and Trademark Office

Cloud Fest

Reg. No. 4,110,498

Registered Mar. 6, 2012

Int. Cl.: 35

SERVICE MARK

SUPPLEMENTAL REGISTER

TECH CONFERENCES LLC (COLORADO LIMITED LIABILITY COMPANY)
#243
5994 S. HOLLY STREET
GREENWOOD VILLAGE, CO 80111

FOR: ARRANGING AND CONDUCTING BUSINESS CONFERENCES, IN CLASS 35 (U.S. CLS. 100, 101 AND 102).

FIRST USE 8-14-2011; IN COMMERCE 8-14-2011.

THE MARK CONSISTS OF STANDARD CHARACTERS WITHOUT CLAIM TO ANY PARTICULAR FONT, STYLE, SIZE, OR COLOR.

NO CLAIM IS MADE TO THE EXCLUSIVE RIGHT TO USE "FEST", APART FROM THE MARK AS SHOWN.

SER. NO. 85-418,448, FILED P.R. 9-9-2011; AM. S.R. 1-3-2012.

KELLY CHOE, EXAMINING ATTORNEY



David J. Kyros

Director of the United States Patent and Trademark Office

United States of America

United States Patent and Trademark Office

PRIME FOR MBA

Reg. No. 4,110,499

Registered Mar. 6, 2012

Int. Cl.: 41

SERVICE MARK

SUPPLEMENTAL REGISTER

THE PRIMARY SUCCESS CORPORATION (DELAWARE CORPORATION)
2225 E BAYSHORE RD STE 200
PALO ALTO, CA 94303

FOR: ADMISSIONS CONSULTING, NAMELY, CONSULTING IN THE FIELD OF ADMISSION INTO COLLEGE MBA PROGRAMS AND OTHER COLLEGE GRADUATE PROGRAMS, SPECIFICALLY, COLLEGE PROGRAM SELECTION, COMPLETING ADMISSIONS APPLICATIONS FOR SAID PROGRAMS, AND PREPARATION FOR COLLEGE ADMISSION INTERVIEWS IN THIS REGARD, IN CLASS 41 (U.S. CLS. 100, 101 AND 107).

FIRST USE 11-1-2010; IN COMMERCE 11-19-2010.

THE MARK CONSISTS OF STANDARD CHARACTERS WITHOUT CLAIM TO ANY PARTICULAR FONT, STYLE, SIZE, OR COLOR.

SER. NO. 85-419,643, FILED P.R. 9-10-2011; AM. S.R. 12-28-2011.

ZHALEH DELANEY, EXAMINING ATTORNEY



David J. Kyros

Director of the United States Patent and Trademark Office

United States of America

United States Patent and Trademark Office

The Bimmer Pub

Reg. No. 4,110,500

AUTOMOTIVE DATA MEDIA, LLC (OHIO LIMITED LIABILITY COMPANY)
134B RIVER ROAD
MONTAGUE, NJ 07827

Registered Mar. 6, 2012

Int. Cls.: 16 and 41

FOR: GENERAL FEATURE MAGAZINE IN THE FIELD OF AUTOMOTIVE REPAIR AND MAINTENANCE; GENERAL FEATURE MAGAZINES; MAGAZINES IN THE FIELD OF AUTOMOTIVE REPAIR AND MAINTENANCE; PRINTED PERIODICALS IN THE FIELD OF AUTOMOTIVE REPAIR AND MAINTENANCE, IN CLASS 16 (U.S. CLS. 2, 5, 22, 23, 29, 37, 38 AND 50).

TRADEMARK

SERVICE MARK

FIRST USE 8-12-2011; IN COMMERCE 8-12-2011.

SUPPLEMENTAL REGISTER

FOR: ON-LINE ELECTRONIC NEWSLETTERS DELIVERED BY E-MAIL IN THE FIELD OF AUTOMOTIVE REPAIR AND MAINTENANCE; PROVIDING NEWSLETTERS IN THE FIELD OF AUTOMOTIVE REPAIR AND MAINTENANCE VIA E-MAIL; PROVIDING ON-LINE NEWSLETTERS IN THE FIELD OF AUTOMOTIVE REPAIR AND MAINTENANCE, IN CLASS 41 (U.S. CLS. 100, 101 AND 107).

FIRST USE 8-12-2011; IN COMMERCE 8-12-2011.

THE MARK CONSISTS OF STANDARD CHARACTERS WITHOUT CLAIM TO ANY PARTICULAR FONT, STYLE, SIZE, OR COLOR.

SER. NO. 85-420,224, FILED P.R. 9-12-2011; AM. S.R. 1-11-2012.

NICHOLAS ALTREE, EXAMINING ATTORNEY



David J. Kyffers

Director of the United States Patent and Trademark Office

United States of America
United States Patent and Trademark Office

the
bimmer
pub

Reg. No. 4,110,501

AUTOMOTIVE DATA MEDIA, LLC (OHIO LIMITED LIABILITY COMPANY)
134B RIVER ROAD
MONTAGUE, NJ 07827

Registered Mar. 6, 2012

Int. Cls.: 16 and 41

FOR: GENERAL FEATURE MAGAZINE IN THE FIELD OF AUTOMOTIVE REPAIR AND MAINTENANCE; GENERAL FEATURE MAGAZINES; MAGAZINES IN THE FIELD OF AUTOMOTIVE REPAIR AND MAINTENANCE; PRINTED PERIODICALS IN THE FIELD OF AUTOMOTIVE REPAIR AND MAINTENANCE, IN CLASS 16 (U.S. CLS. 2, 5, 22, 23, 29, 37, 38 AND 50).

TRADEMARK

SERVICE MARK

FIRST USE 8-12-2011; IN COMMERCE 8-12-2011.

SUPPLEMENTAL REGISTER

FOR: ON-LINE ELECTRONIC NEWSLETTERS DELIVERED BY E-MAIL IN THE FIELD OF AUTOMOTIVE REPAIR AND MAINTENANCE; PROVIDING NEWSLETTERS IN THE FIELD OF AUTOMOTIVE REPAIR AND MAINTENANCE VIA E-MAIL; PROVIDING ON-LINE NEWSLETTERS IN THE FIELD OF AUTOMOTIVE REPAIR AND MAINTENANCE, IN CLASS 41 (U.S. CLS. 100, 101 AND 107).

FIRST USE 8-12-2011; IN COMMERCE 8-12-2011.

THE MARK CONSISTS OF THE WORDS "THE BIMMER PUB", WITH THE WORD "THE" DIRECTLY ABOVE THE LETTER "B" IN "BIMMER" AND THE WORD "PUB" BELOW THE LETTER "R" IN "BIMMER".

SER. NO. 85-420,294, FILED P.R. 9-12-2011; AM. S.R. 1-11-2012.

NICHOLAS ALTREE, EXAMINING ATTORNEY



David J. Kyffers

Director of the United States Patent and Trademark Office

United States of America
United States Patent and Trademark Office



Reg. No. 4,110,502

LILA M. BUEN (UNITED STATES INDIVIDUAL)
2905 LYNWOOD CIRCLE
BILLINGS, MT 59102

Registered Mar. 6, 2012

Int. Cl.: 43

FOR: CAFE AND RESTAURANT SERVICES; FROZEN YOGURT SHOP SERVICES IN THE NATURE OF A RESTAURANT, IN CLASS 43 (U.S. CLS. 100 AND 101).

SERVICE MARK

FIRST USE 7-16-2010; IN COMMERCE 7-16-2010.

SUPPLEMENTAL REGISTER

NO CLAIM IS MADE TO THE EXCLUSIVE RIGHT TO USE "YOGURT", APART FROM THE MARK AS SHOWN.

THE COLOR(S) PURPLE, RED, BLACK AND WHITE IS/ARE CLAIMED AS A FEATURE OF THE MARK.

THE MARK CONSISTS OF THE WORDS "BILLINGS", "BEST" AND "YOGURT" STACKED ABOVE ONE ANOTHER USING STYLIZED LETTERS. A STYLIZED DESIGN OF FROZEN YOGURT IN A CUP APPEARS TO THE RIGHT OF THE WORDS "BILLINGS" AND "BEST". THE LETTERS IN "BILLINGS" AND "BEST" ARE RED, THE LETTERS IN YOGURT ARE BLACK, THE OUTLINE OF THE STYLIZED DESIGN OF THE FROZEN YOGURT IN A CUP IS PURPLE, AND THE FROZEN YOGURT IS WHITE.

SER. NO. 85-423,297, FILED P.R. 9-15-2011; AM. S.R. 1-5-2012.

KAREN K. BUSH, EXAMINING ATTORNEY



David J. Kybas

Director of the United States Patent and Trademark Office

United States of America

United States Patent and Trademark Office

FINGER PETS

Reg. No. 4,110,503

FLASH SALES, INC. (FLORIDA CORPORATION)
4401 NW 167TH STREET
MIAMI, FL 33055

Registered Mar. 6, 2012

Int. Cl.: 28

FOR: TOYS, NAMELY, ANIMAL FIGURES, IN CLASS 28 (U.S. CLS. 22, 23, 38 AND 50).

TRADEMARK

FIRST USE 8-1-2011; IN COMMERCE 9-17-2011.

SUPPLEMENTAL REGISTER

THE MARK CONSISTS OF STANDARD CHARACTERS WITHOUT CLAIM TO ANY PARTICULAR FONT, STYLE, SIZE, OR COLOR.

SER. NO. 85-426,554, FILED P.R. 9-19-2011; AM. S.R. 1-11-2012.

BRIDGETT SMITH, EXAMINING ATTORNEY



David J. Kybas

Director of the United States Patent and Trademark Office

United States of America
United States Patent and Trademark Office

pain vein
FREE

Reg. No. 4,110,504

ROTH, DR. STEVEN (UNITED STATES INDIVIDUAL)
605 MEDINAH DRIVE
MARTINEZ, GA 30907

Registered Mar. 6, 2012

Int. Cl.: 44

FOR: MEDICAL SERVICES, IN CLASS 44 (U.S. CLS. 100 AND 101).

SERVICE MARK

FIRST USE 12-31-2010; IN COMMERCE 12-31-2010.

SUPPLEMENTAL REGISTER

THE MARK CONSISTS OF THE WORDS "PAIN" AND "VEIN" WRITTEN IN LOWER CASE LETTERING AND APPEARING ABOVE THE WORD "FREE" WRITTEN IN ALL CAPITAL LETTERING.

SER. NO. 85-426,700, FILED P.R. 9-20-2011; AM. S.R. 1-13-2012.

LINDSEY RUBIN, EXAMINING ATTORNEY



David J. Kybas

Director of the United States Patent and Trademark Office

United States of America

United States Patent and Trademark Office

Business and the Brain

Reg. No. 4,110,505

MARSHA SHENK (UNITED STATES INDIVIDUAL), DBA THE BESTWORK PEOPLE,
4617 NE KILLINGSWORTH, #9
PORTLAND, OR 97218

Registered Mar. 6, 2012

Int. Cl.: 41

FOR: BUSINESS TRAINING, IN CLASS 41 (U.S. CLS. 100, 101 AND 107).

SERVICE MARK

FIRST USE 2-1-2010; IN COMMERCE 2-1-2010.

SUPPLEMENTAL REGISTER

THE MARK CONSISTS OF STANDARD CHARACTERS WITHOUT CLAIM TO ANY PARTICULAR FONT, STYLE, SIZE, OR COLOR.

NO CLAIM IS MADE TO THE EXCLUSIVE RIGHT TO USE "BUSINESS", APART FROM THE MARK AS SHOWN.

SER. NO. 85-426,740, FILED P.R. 9-20-2011; AM. S.R. 1-17-2012.

MEGHAN REINHART, EXAMINING ATTORNEY



David J. Kybas

Director of the United States Patent and Trademark Office

United States of America

United States Patent and Trademark Office

LEMONBERRY FROZEN YOGURT

Reg. No. 4,110,506

LEMONBERRY FROZEN YOGURT LICENSING, INC. (OHIO CORPORATION)
12927 PEARL ROAD
STRONGSVILLE, OH 44136

Registered Mar. 6, 2012

Int. Cl.: 35

FOR: SELF-SERVE FROZEN YOGURT SHOP SERVICES, IN CLASS 35 (U.S. CLS. 100, 101 AND 102).

SERVICE MARK

FIRST USE 8-24-2010; IN COMMERCE 8-24-2010.

SUPPLEMENTAL REGISTER

THE MARK CONSISTS OF STANDARD CHARACTERS WITHOUT CLAIM TO ANY PARTICULAR FONT, STYLE, SIZE, OR COLOR.

NO CLAIM IS MADE TO THE EXCLUSIVE RIGHT TO USE "FROZEN YOGURT", APART FROM THE MARK AS SHOWN.

SER. NO. 85-427,539, FILED 9-20-2011.

ALEX KEAM, EXAMINING ATTORNEY



David J. Kybas

Director of the United States Patent and Trademark Office

United States of America

United States Patent and Trademark Office

RubberDeck

Reg. No. 4,110,507

Registered Mar. 6, 2012

Int. Cl.: 19

TRADEMARK

SUPPLEMENTAL REGISTER

SIGNATURE SYSTEMS GROUP, LLC (DELAWARE LIMITED LIABILITY COMPANY)
50 EAST 42ND STREET
14TH FLOOR
NEW YORK, NY 10017

FOR: RUBBER FLOOR TILES; RUBBER FLOORING, IN CLASS 19 (U.S. CLS. 1, 12, 33 AND 50).

FIRST USE 11-20-2006; IN COMMERCE 11-20-2006.

THE MARK CONSISTS OF STANDARD CHARACTERS WITHOUT CLAIM TO ANY PARTICULAR FONT, STYLE, SIZE, OR COLOR.

SER. NO. 85-427,927, FILED P.R. 9-21-2011; AM. S.R. 1-11-2012.

LINDA POWELL, EXAMINING ATTORNEY



David J. Kybas

Director of the United States Patent and Trademark Office

United States of America

United States Patent and Trademark Office

Painted Portraits of Pets and Their People

Reg. No. 4,110,508

CONANT, NANCY (UNITED STATES INDIVIDUAL)
2484 LAKEWOOD DRIVE
GRAND PRAIRIE, TX 75054

Registered Mar. 6, 2012

Int. Cl.: 41

FOR: PORTRAIT PAINTING SERVICES, IN CLASS 41 (U.S. CLS. 100, 101 AND 107).

SERVICE MARK

FIRST USE 8-1-2009; IN COMMERCE 1-7-2010.

SUPPLEMENTAL REGISTER

NO CLAIM IS MADE TO THE EXCLUSIVE RIGHT TO USE "PAINTED PORTRAITS", APART FROM THE MARK AS SHOWN.

THE MARK CONSISTS OF THE STYLIZED TEXT "PAINTED PORTRAITS OF PETS AND THEIR PEOPLE".

SER. NO. 85-427,936, FILED P.R. 9-21-2011; AM. S.R. 1-11-2012.

MAYUR VAGHANI, EXAMINING ATTORNEY



David J. Kyffers

Director of the United States Patent and Trademark Office

United States of America

United States Patent and Trademark Office

FuelFromH₂O

Reg. No. 4,110,509

CORNELL, JAMES (UNITED STATES INDIVIDUAL)
4934 PICKYS HOLLOW SE
ACWORTH, GA 30102

Registered Mar. 6, 2012

Int. Cl.: 12

FOR: AUTOMOBILE ENGINES; ENGINES FOR LAND VEHICLES, IN CLASS 12 (U.S. CLS. 19, 21, 23, 31, 35 AND 44).

TRADEMARK

FIRST USE 4-26-2006; IN COMMERCE 6-1-2006.

SUPPLEMENTAL REGISTER

SER. NO. 85-429,171, FILED P.R. 9-22-2011; AM. S.R. 1-17-2012.

JENNY PARK, EXAMINING ATTORNEY



David J. Kybas

Director of the United States Patent and Trademark Office

United States of America

United States Patent and Trademark Office

THE BELIZE FOUNDATION

Reg. No. 4,110,510

Registered Mar. 6, 2012

Int. Cl.: 36

SERVICE MARK

SUPPLEMENTAL REGISTER

BELIZE FOUNDATION (TEXAS CHARITABLE, NON-PROFIT CORPORATION)
909 REDBUD TRL
AUSTIN, TX 78746

FOR: PHILANTHROPIC SERVICES CONCERNING MONETARY DONATIONS; PROVIDING GRANTS AND MONETARY DONATIONS FOR EDUCATION, RESEARCH, HEALTH AND WELLNESS, AND THE CONSERVATION OF NATURAL RESOURCES AND RELATED SERVICES AND ACTIVITIES, NAMELY, THE SOLICITATION, COLLECTION, AND DISBURSEMENT OF MONETARY GRANTS AND GIFTS, IN CLASS 36 (U.S. CLS. 100, 101 AND 102).

FIRST USE 5-27-2008; IN COMMERCE 5-27-2008.

THE MARK CONSISTS OF STANDARD CHARACTERS WITHOUT CLAIM TO ANY PARTICULAR FONT, STYLE, SIZE, OR COLOR.

NO CLAIM IS MADE TO THE EXCLUSIVE RIGHT TO USE "FOUNDATION", APART FROM THE MARK AS SHOWN.

SER. NO. 85-429,173, FILED P.R. 9-22-2011; AM. S.R. 1-17-2012.

JENNY PARK, EXAMINING ATTORNEY



David J. Kyffers

Director of the United States Patent and Trademark Office

United States of America

United States Patent and Trademark Office

CareOnSite Medical Services

Reg. No. 4,110,511

Registered Mar. 6, 2012

Int. Cl.: 44

SERVICE MARK

SUPPLEMENTAL REGISTER

C.B. TANG, M.D., INCORPORATED (CALIFORNIA CORPORATION), DBA CAREONSITE,
1250 PACIFIC AVENUE
LONG BEACH, CA 90813

FOR: CONDUCTING MEDICAL PHYSICAL EVALUATIONS; CONSULTING SERVICES IN THE FIELDS OF DIAGNOSTIC MEDICAL TESTING AND NUTRITION; DRUG, ALCOHOL AND DNA SCREENING FOR MEDICAL PURPOSES; EMERGENCY MEDICAL ASSISTANCE; MAINTAINING FILES AND RECORDS CONCERNING THE MEDICAL CONDITION OF INDIVIDUALS; MAINTAINING PATIENT MEDICAL RECORDS AND FILES; MEDICAL AND PHARMACEUTICAL CONSULTATION; MEDICAL ASSISTANCE SERVICES; MEDICAL ASSISTANCE SERVICES PROVIDED VIA TELECOMMUNICATION AND GLOBAL COMPUTER NETWORKS FOR INDIVIDUALS WITH HEALTH PROBLEMS THROUGH THE USE OF WEARABLE MEDICAL DEVICES WITH AUTOMATED ALERT AND MONITORING CAPACITY; MEDICAL COUNSELING; MEDICAL DIAGNOSTIC TESTING, MONITORING AND REPORTING SERVICES; MEDICAL SERVICES; MEDICAL SERVICES, NAMELY, PROVIDING INJURY CARE, DRUG AND ALCOHOL TESTING, PHYSICAL EXAMINATIONS, WELLNESS PROGRAMS AND THE ADMINISTRATION OF FLU SHOTS, IN CLASS 44 (U.S. CLS. 100 AND 101).

FIRST USE 12-1-2008; IN COMMERCE 12-1-2008.

THE MARK CONSISTS OF STANDARD CHARACTERS WITHOUT CLAIM TO ANY PARTICULAR FONT, STYLE, SIZE, OR COLOR.

OWNER OF U.S. REG. NO. 3,797,877.

NO CLAIM IS MADE TO THE EXCLUSIVE RIGHT TO USE "MEDICAL SERVICES", APART FROM THE MARK AS SHOWN.

SER. NO. 85-429,203, FILED P.R. 9-22-2011; AM. S.R. 1-10-2012.

IRA J. GOODSAY, EXAMINING ATTORNEY



David J. Kyffers

Director of the United States Patent and Trademark Office

United States of America

United States Patent and Trademark Office

how's the '08 change and
greed working for you?

Reg. No. 4,110,512

ABBOTT, MACK (UNITED STATES INDIVIDUAL)
1611 NORTH HICKORY AVE.
BROKEN ARROW, OK 74012

Registered Mar. 6, 2012

Int. Cl.: 25

FOR: SHIRTS, IN CLASS 25 (U.S. CLS. 22 AND 39).

TRADEMARK

FIRST USE 8-15-2011; IN COMMERCE 8-15-2011.

SUPPLEMENTAL REGISTER

THE MARK CONSISTS OF STANDARD CHARACTERS WITHOUT CLAIM TO ANY PARTICULAR FONT, STYLE, SIZE, OR COLOR.

SER. NO. 85-429,493, FILED P.R. 9-22-2011; AM. S.R. 1-11-2012.

SHANNON TWOHIG, EXAMINING ATTORNEY



David J. Kybas

Director of the United States Patent and Trademark Office

United States of America

United States Patent and Trademark Office

Chlorphen-12

Reg. No. 4,110,513

KVK-TECH, INC. (PENNSYLVANIA CORPORATION)
110 TERRY DRIVE, SUITE 200
NEWTOWN, PA 18940

Registered Mar. 6, 2012

Int. Cl.: 5

FOR: PHARMACEUTICAL PREPARATIONS FOR TREATMENT OF ALLERGIES, NAMELY, CHLORPHENIRAMINE MALEATE EXTENDED-RELEASE ANTIHISTAMINE TABLETS, IN CLASS 5 (U.S. CLS. 6, 18, 44, 46, 51 AND 52).

TRADEMARK

FIRST USE 2-15-2011; IN COMMERCE 2-15-2011.

SUPPLEMENTAL REGISTER

THE MARK CONSISTS OF STANDARD CHARACTERS WITHOUT CLAIM TO ANY PARTICULAR FONT, STYLE, SIZE, OR COLOR.

SER. NO. 85-431,300, FILED 9-24-2011.

MICHAEL LITZAU, EXAMINING ATTORNEY



David J. Kybas

Director of the United States Patent and Trademark Office

United States of America

United States Patent and Trademark Office

Ultra Tough

Reg. No. 4,110,514

Registered Mar. 6, 2012

Int. Cl.: 9

TRADEMARK

SUPPLEMENTAL REGISTER

NLU PRODUCTS LLC (UTAH LIMITED LIABILITY COMPANY), DBA BODYGUARDZ,
1103 LONE PEAK LANE
DRAPER, UT 84020

FOR: ACCESSORIES FOR ELECTRONIC DEVICES, NAMELY, STYLUSES, CASES, BATTERIES, SCREEN PROTECTORS, BODY WRAPS, COVERS, OVERLAYS AND BATTERY CHARGES, ALL OF THE FOREGOING FOR USE IN CONNECTION WITH PERSONAL DIGITAL ASSISTANT, CELL PHONES, PORTABLE MEDIA PLAYERS, CAMERAS, GAMING CONSOLES, LAPTOP COMPUTERS AND NOTEBOOK COMPUTERS, IN CLASS 9 (U.S. CLS. 21, 23, 26, 36 AND 38).

FIRST USE 10-1-2010; IN COMMERCE 10-1-2010.

THE MARK CONSISTS OF STANDARD CHARACTERS WITHOUT CLAIM TO ANY PARTICULAR FONT, STYLE, SIZE, OR COLOR.

SER. NO. 85-432,969, FILED 9-27-2011.

B. PARADEWELAI, EXAMINING ATTORNEY



David J. Kyffers

Director of the United States Patent and Trademark Office

United States of America

United States Patent and Trademark Office

CONSTRUCTION LABOR MARKET ANALYZER

Reg. No. 4,110,515

Registered Mar. 6, 2012

Int. Cl.: 42

SERVICE MARK

SUPPLEMENTAL REGISTER

CONSTRUCTION WORKFORCE DEVELOPMENT CENTER SERVICES, LLC (DELAWARE LIMITED LIABILITY COMPANY)
1880 HART ROAD
LEXINGTON, KY 40502

FOR: SOFTWARE AS A SERVICE (SAAS) SERVICES FEATURING SOFTWARE FOR AGGREGATING AND ANALYZING LABOR-MARKET SUPPLY-AND-DEMAND DATA AND PROVIDING FUTURE LABOR SCENARIOS IN THE CONSTRUCTION INDUSTRY, IN CLASS 42 (U.S. CLS. 100 AND 101).

FIRST USE 7-25-2011; IN COMMERCE 7-25-2011.

THE MARK CONSISTS OF STANDARD CHARACTERS WITHOUT CLAIM TO ANY PARTICULAR FONT, STYLE, SIZE, OR COLOR.

NO CLAIM IS MADE TO THE EXCLUSIVE RIGHT TO USE "ANALYZER", APART FROM THE MARK AS SHOWN.

SER. NO. 85-433,126, FILED P.R. 9-27-2011; AM. S.R. 1-24-2012.

NAPOLEON SHARMA, EXAMINING ATTORNEY



David J. Kyffers

Director of the United States Patent and Trademark Office

United States of America

United States Patent and Trademark Office

PROJECT LABOR FORECASTER

Reg. No. 4,110,516

Registered Mar. 6, 2012

Int. Cl.: 42

SERVICE MARK

SUPPLEMENTAL REGISTER

CONSTRUCTION WORKFORCE DEVELOPMENT CENTER SERVICES, LLC (DELAWARE LIMITED LIABILITY COMPANY)
1880 HART ROAD
LEXINGTON, KY 40502

FOR: SOFTWARE AS A SERVICE (SAAS) SERVICES FEATURING SOFTWARE FOR AGGREGATING AND ANALYZING LABOR-MARKET SUPPLY-AND-DEMAND DATA AND PROVIDING FUTURE LABOR SCENARIOS IN THE CONSTRUCTION INDUSTRY, IN CLASS 42 (U.S. CLS. 100 AND 101).

FIRST USE 7-25-2011; IN COMMERCE 7-25-2011.

THE MARK CONSISTS OF STANDARD CHARACTERS WITHOUT CLAIM TO ANY PARTICULAR FONT, STYLE, SIZE, OR COLOR.

NO CLAIM IS MADE TO THE EXCLUSIVE RIGHT TO USE "FORECASTER", APART FROM THE MARK AS SHOWN.

SER. NO. 85-433,128, FILED P.R. 9-27-2011; AM. S.R. 1-24-2012.

NAPOLEON SHARMA, EXAMINING ATTORNEY



David J. Kyros

Director of the United States Patent and Trademark Office

United States of America

United States Patent and Trademark Office

PROGRAM ACCELERATOR

Reg. No. 4,110,517

IOLO TECHNOLOGIES, LLC (CALIFORNIA LIMITED LIABILITY COMPANY)
7470 NORTH FIGUEROA STEET
LOS ANGELES, CA 90041

Registered Mar. 6, 2012

Int. Cl.: 9

FOR: SOFTWARE, NAMELY, SOFTWARE PROGRAM TO IMPROVE THE PERFORMANCE AND SPEED OF APPLICATIONS ON A PERSONAL COMPUTER BY EFFICIENTLY ORGANIZING RELATED FILES AND DATA ON A STORAGE MEDIUM, IN CLASS 9 (U.S. CLS. 21, 23, 26, 36 AND 38).

TRADEMARK

SUPPLEMENTAL REGISTER FIRST USE 10-12-2010; IN COMMERCE 10-12-2010.

THE MARK CONSISTS OF STANDARD CHARACTERS WITHOUT CLAIM TO ANY PARTICULAR FONT, STYLE, SIZE, OR COLOR.

SER. NO. 85-433,985, FILED 9-28-2011.

NAAKWAMA ANKRAH, EXAMINING ATTORNEY



David J. Kyros

Director of the United States Patent and Trademark Office

United States of America

United States Patent and Trademark Office

Social Media Marketing University

Reg. No. 4,110,518

SOUZA, JOHN (UNITED STATES INDIVIDUAL)
4575 WEBB BRIDGE ROAD, BOX 5394
ALPHARETTA, GA 30005

Registered Mar. 6, 2012

Int. Cl.: 41

FOR: EDUCATION SERVICES, NAMELY, PROVIDING WEB BASED TRAINING IN THE FIELD OF SOCIAL MEDIA MANAGEMENT, IN CLASS 41 (U.S. CLS. 100, 101 AND 107).

SERVICE MARK

FIRST USE 10-15-2009; IN COMMERCE 10-15-2009.

SUPPLEMENTAL REGISTER

THE MARK CONSISTS OF STANDARD CHARACTERS WITHOUT CLAIM TO ANY PARTICULAR FONT, STYLE, SIZE, OR COLOR.

OWNER OF U.S. REG. NOS. 3,899,812, 3,900,172, AND OTHERS.

NO CLAIM IS MADE TO THE EXCLUSIVE RIGHT TO USE "UNIVERSITY", APART FROM THE MARK AS SHOWN.

SER. NO. 85-439,575, FILED P.R. 10-5-2011; AM. S.R. 1-18-2012.

JULIE WATSON, EXAMINING ATTORNEY



David J. Kyffers

Director of the United States Patent and Trademark Office

United States of America

United States Patent and Trademark Office

Plantation Blend

Reg. No. 4,110,519

FAIRMONT HOLDINGS, INC. (FLORIDA CORPORATION)
3400 S.W. 26TH TERRACE, #A-1
DANIA, FL 33312

Registered Mar. 6, 2012

Int. Cl.: 34

FOR: CIGAR BOXES; CIGAR CUTTERS; CIGAR TUBES; CIGARS; TOBACCO, IN CLASS 34 (U.S. CLS. 2, 8, 9 AND 17).

TRADEMARK

FIRST USE 6-25-2010; IN COMMERCE 6-25-2010.

SUPPLEMENTAL REGISTER

THE MARK CONSISTS OF STANDARD CHARACTERS WITHOUT CLAIM TO ANY PARTICULAR FONT, STYLE, SIZE, OR COLOR.

NO CLAIM IS MADE TO THE EXCLUSIVE RIGHT TO USE "BLEND", APART FROM THE MARK AS SHOWN.

SER. NO. 85-451,388, FILED P.R. 10-19-2011; AM. S.R. 1-12-2012.

NAPOLEON SHARMA, EXAMINING ATTORNEY



David J. Kybas

Director of the United States Patent and Trademark Office

United States of America

United States Patent and Trademark Office

Rock Readings

Reg. No. 4,110,520

WEISS, DANNA (UNITED STATES INDIVIDUAL)
561 10TH AVE. #31E
NEW YORK, NY 10036

Registered Mar. 6, 2012

Int. Cl.: 45

FOR: PSYCHIC READING SERVICES, IN CLASS 45 (U.S. CLS. 100 AND 101).

SERVICE MARK

FIRST USE 1-1-2007; IN COMMERCE 1-1-2007.

SUPPLEMENTAL REGISTER

THE MARK CONSISTS OF STANDARD CHARACTERS WITHOUT CLAIM TO ANY PARTICULAR FONT, STYLE, SIZE, OR COLOR.

NO CLAIM IS MADE TO THE EXCLUSIVE RIGHT TO USE "READINGS", APART FROM THE MARK AS SHOWN.

SER. NO. 85-464,623, FILED P.R. 11-4-2011; AM. S.R. 1-10-2012.

EMILY CHUO, EXAMINING ATTORNEY



David J. Kybas

Director of the United States Patent and Trademark Office

United States of America

United States Patent and Trademark Office

TWEED STRIPES

Reg. No. 4,110,521

Registered Mar. 6, 2012

Int. Cl.: 23

TRADEMARK

SUPPLEMENTAL REGISTER

ORCHARD YARN AND THREAD COMPANY, INC. (NEW YORK CORPORATION), DBA
LION BRAND YARN COMPANY,
34 WEST 15TH STREET
NEW YORK, NY 10011

FOR: YARN, IN CLASS 23 (U.S. CL. 43).

FIRST USE 6-25-2010; IN COMMERCE 6-25-2010.

THE MARK CONSISTS OF STANDARD CHARACTERS WITHOUT CLAIM TO ANY PARTICULAR FONT, STYLE, SIZE, OR COLOR.

SER. NO. 85-466,023, FILED P.R. 11-7-2011; AM. S.R. 1-12-2012.

RONALD DELGIZZI, EXAMINING ATTORNEY



David J. Kyffers

Director of the United States Patent and Trademark Office

United States of America

United States Patent and Trademark Office

THE CODING ACADEMY

Reg. No. 4,110,522

FAZZI ASSOCIATES, INC. (MASSACHUSETTS CORPORATION)
243 KING STREET
NORTHAMPTON, MA 01060

Registered Mar. 6, 2012

Int. Cl.: 41

FOR: EDUCATION SERVICES, NAMELY, PROVIDING PROGRAMS OF INSTRUCTION AND TRAINING IN THE FORM OF CLASSES, SEMINARS, WORKSHOPS IN THE FIELD OF HOME HEALTH CARE AND SPECIFICALLY RELATIVE TO MEDICAL CLASSIFICATION FOR THE CODING OF DISEASES, SIGNS AND SYMPTOMS IN THE TRACKING OF DIAGNOSES, IN CLASS 41 (U.S. CLS. 100, 101 AND 107).

SERVICE MARK

SUPPLEMENTAL REGISTER

FIRST USE 11-15-2011; IN COMMERCE 11-15-2011.

THE MARK CONSISTS OF STANDARD CHARACTERS WITHOUT CLAIM TO ANY PARTICULAR FONT, STYLE, SIZE, OR COLOR.

NO CLAIM IS MADE TO THE EXCLUSIVE RIGHT TO USE "ACADEMY", APART FROM THE MARK AS SHOWN.

SER. NO. 85-483,588, FILED 11-30-2011.

FONG HSU, EXAMINING ATTORNEY



David J. Kybas

Director of the United States Patent and Trademark Office

United States of America

United States Patent and Trademark Office

Digital Marketing Strategies Conference

Reg. No. 4,110,523

Registered Mar. 6, 2012

Int. Cl.: 41

SERVICE MARK

SUPPLEMENTAL REGISTER

PASCH CONSULTING GROUP LLC (NEW JERSEY LIMITED LIABILITY COMPANY), DBA
PCG DIGITAL MARKETING,
446 RT 35 SOUTH BLDG C
EATONTOWN, NJ 07724

FOR: EDUCATION SERVICES, NAMELY, PROVIDING LIVE AND ON-LINE WORKSHOPS,
WEBINARS, SEMINARS, TRAINING PROGRAMS, COURSES OF INSTRUCTION, AND
CLASSES IN THE FIELD OF DIGITAL MARKETING, IN CLASS 41 (U.S. CLS. 100, 101 AND
107).

FIRST USE 2-1-2011; IN COMMERCE 2-1-2011.

THE MARK CONSISTS OF STANDARD CHARACTERS WITHOUT CLAIM TO ANY PAR-
TICULAR FONT, STYLE, SIZE, OR COLOR.

NO CLAIM IS MADE TO THE EXCLUSIVE RIGHT TO USE "CONFERENCE", APART FROM
THE MARK AS SHOWN.

SER. NO. 85-500,008, FILED P.R. 12-20-2011; AM. S.R. 1-20-2012.

SUSAN RICHARDS, EXAMINING ATTORNEY



David J. Kyffers

Director of the United States Patent and Trademark Office

United States of America

United States Patent and Trademark Office

Marijuana International

Reg. No. 4,110,524

Registered Mar. 6, 2012

Int. Cl.: 35

SERVICE MARK

SUPPLEMENTAL REGISTER

FIGUEROA, ERIC J. (UNITED STATES INDIVIDUAL)
18220 NE 25 PLACE
AVENTURA, FL 33160

FOR: CANNABIS ADVERTISING AND MARKETING; ADVERTISING AND MARKETING; ADVERTISING AND PUBLICITY SERVICES, NAMELY, PROMOTING THE GOODS, SERVICES, BRAND IDENTITY AND COMMERCIAL INFORMATION AND NEWS OF THIRD PARTIES THROUGH PRINT, AUDIO, VIDEO, DIGITAL AND ON-LINE MEDIUM, IN CLASS 35 (U.S. CLS. 100, 101 AND 102).

FIRST USE 4-21-2011; IN COMMERCE 4-21-2011.

THE MARK CONSISTS OF STANDARD CHARACTERS WITHOUT CLAIM TO ANY PARTICULAR FONT, STYLE, SIZE, OR COLOR.

SER. NO. 85-506,774, FILED 12-31-2011.

ROBERT STRUCK, EXAMINING ATTORNEY



David J. Kybas

Director of the United States Patent and Trademark Office

United States of America

United States Patent and Trademark Office

PLANADVISER

Reg. No. 4,110,525

ASSET INTERNATIONAL, INC. (DELAWARE CORPORATION)
805 THIRD AVENUE, 21ST FLOOR
NEW YORK, NY 10022

Registered Mar. 6, 2012

Int. Cl.: 9

FOR: DOWNLOADABLE ELECTRONIC PUBLICATIONS IN THE NATURE OF MAGAZINES AND NEWSLETTERS FOR RETIREMENT PROFESSIONALS ABOUT RETIREMENT PLANS, RETIREMENT BENEFITS, AND INVESTMENT ASSET MANAGEMENT, IN CLASS 9 (U.S. CLS. 21, 23, 26, 36 AND 38).

TRADEMARK

SUPPLEMENTAL REGISTER FIRST USE 1-0-2010; IN COMMERCE 1-0-2010.

THE MARK CONSISTS OF STANDARD CHARACTERS WITHOUT CLAIM TO ANY PARTICULAR FONT, STYLE, SIZE, OR COLOR.

OWNER OF U.S. REG. NO. 3,374,591.

SER. NO. 85-976,237, FILED P.R. 4-4-2011; AM. S.R. 12-5-2011.

JILL PRATER, EXAMINING ATTORNEY



David J. Kybas

Director of the United States Patent and Trademark Office